

Done's

# BLACK & WHITE

# MAD SCIENTIST'S LABORATORY

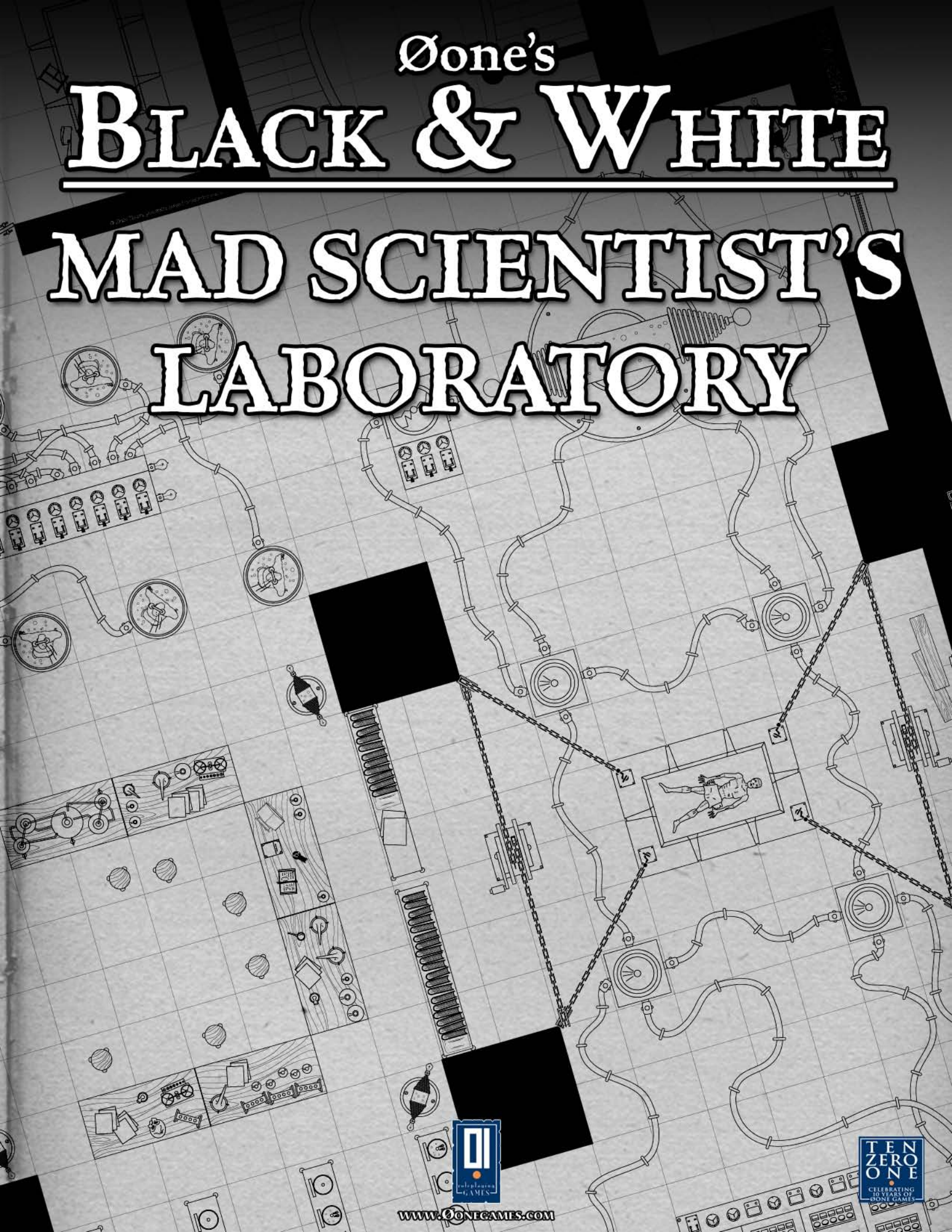

WWW.DONEGAMES.COM





# Øone's BLACK & WHITE

## Welcome

This product line will bring you simple tiles for your favorite RPGs. In each product you will find a whole fantasy location fully fleshed out in miniature-scale tiles with the usual Øone's top-notch customization capabilities. The B&W maps are simple, line art battlemaps you can customize to suit your needs and then print. These tiles are accurate, detailed, inexpensive and no ink-eaters.

## In each B&W product you'll find:

- A Referee map detailing a fantasy location
- The whole location broken in US Letter sheets in miniature scale (each sheet contains a 8x10 inches tile)
- A short description of each area of the location with suggested plots

## The Rule the Dungeon® Feature

This Øone's exclusive feature allows you to customize the look of your map by adding the furniture, toggle the grid, hide the room numbers and much more.

On the Referee Map, you will find a big "Rule the Dungeon" button. This button will not be printed, so, don't mind if it overlaps something on the map. By clicking on this button some options will be shown, as detailed below. A checkmark will appear beside the options active. The options available could vary with products, below is a list of the most common options included in B&W products:

- **Text:** toggle room numbers and tile numbers.
- **Tiling:** toggle the page tiling (Referee Map only)
- **Furniture:** toggle furniture
- **Doors:** toggle doors
- **Square Grid:** toggle square grid
- **Hex Grid:** toggle standard hexagonal grid
- **Hex Grid 1 inch:** toggle 1 inch hexagonal grid
- **Black Fill:** toggle the black in the walls
- **Grey Fill:** toggle the grey fill in the walls
- **No Fill:** toggle the white fill in the walls
- **All:** toggle default state/empty state (with just the walls).

Note that the Rule the Dungeon button on the Referee Map controls all the battlemaps at once.

## How to Use This Product

Click on the big button of the Referee Map to customize your maps. Once you have obtained the desired appearance (note that room numbers and tiling do not appear on the tiles) simply choose "Print" from the Acrobat menu.

If you need to print only some tiles, simply click on the desired tile on the Referee Map and choose "Print this Tile".

## Tips for Printing

The tiles should have enough margins to print without checking the option "fit to page". If your printer has a margin larger than ¼ inch you should check it in order to print the whole tile. This could reduce slightly your tile but it should be easily usable.



## Øone's Black & White: Mad Scientist's Lab

Product Code: bew022. First edition 09/2010  
Design: Mario Barbati  
2D drawings: Mario Barbati  
Graphics: Ø'Bully  
Software Engineer: Anna Fava

Øone Roleplaying Games  
www.Øonegames.com  
master@Øonegames.com

All of the content of this book is © by Øone Roleplaying Games. The reproduction or retransmission of any part of this book, without written permission of the copyright holder is expressly forbidden, except for the purpose of reviews. Permission is granted to print this book for personal use only.

# TIME TO GO VIRTUAL



## VIRTUAL BOXED SET®

- 225 TILES (8x10")
- 164 ROOMS
- 8 AREAS
- 164 ROOM TEMPLATES
- 16 ENCOUNTER TABLES
- REFEREE POSTER MAP



www.Øonegames.com

# MAD SCIENTIST'S LABORATORY

---

It seems a normal house on top of the hill, but peasants swear they see strange lights on second floor, during the dark and stormy nights...

Mad Scientist's Lab is the classic monster-maker laboratory where the mad scientist and his servants use corpses stolen from the nearby cemetery to build a patchwork monster.

The ground floor seems to belong to a normal house (except for a mysterious locked storage in the garden). The upper floor is entirely dedicated to the laboratory. It features one big room hosting a number of strange devices including power generators, alchemist tables, shelves full of organs and body parts. Chains and wheels are linked to the main table, allowing the scientist to lift it over the rooftop where strange devices catch lightning bolts and channel the energy to the table.

## 1. Entrance (Tile #13)

This is the foyer, two old armors stand here along with an intricate floor mosaic.

## 2. Guardpost (Tile #12)

A small guardpost with one bed and few furnishings.

## 3. Closet (Tile #14)

Various home gear are kept here.

## 4. Dining and living room (Tiles #17, 18)

A wealthy big room with a warm fireplace, a long dining table, a pipe organ.

## 5. Staircase to the Lab (Tile #16)

A grimly-looking armor guards this staircase.

## 6. Library (Tile #19)

This room is crammed with all sort of medical tomes. This is also the study of the mad scientist.

## 7. Lift (Tile #20)

This is the landing zone of the lift the servants use to lift up coffins. Some empty coffins are piled on the far wall. The lift can be activated only from the chamber above.

## 8. Kitchen (Tile #22)

A large kitchen stuffed with pots, towels and food.

## 9. Larder (Tile #21)

## 10. Servant bedroom (Tile #23)

## 11. Master bedroom (Tile #24)

A wealthy bedroom suited for two persons, even the mad scientist lives alone.

## 12. Bathroom (Tile #25)

A very large bathroom suited for two persons.

## 13. Stables (Tile #11)

A small wooden structure for guests' mounts.

## 14. Private stable (Tile #15)

The door to this wooden structure is always locked. Inside there are some coffins and a cart the servants use for carrying them.

## 15. Staircase to ground floor (Tile #1)

## 16. Power device area (Tile #2)

A strange, liquid-filled power device is bolted to the floor, it is cable-connected to various other strange devices.

## 17. Creature-making area (Tile #3)

A massive table, chained to big winches lies in the middle of this area. Mysterious power-charging devices surround it. The ceiling of this area can be opened and the table raised out.

## 18. Power device area (Tile #4)

A big power device, crammed with buttons and switches is bolted to the floor, it is cable-connected to various other strange devices.

## 19. Dissection chamber (Tile #6)

This gruesome chamber features a big marble table suited for dissecting bodies.

## 20. Body storage area (Tile #7)

Eight bodies float in big glass tubes. These are past experiments kept here for analysis. The tubes are cable-connected to a control device in the middle.

## 21. Alchemical area (Tile #8)

Large workbenches are arranged in this area. The tables are filled with kind of alchemical liquids and glassware, as well as some strange-titled books.

## 22. Organ storage area (Tile #9)

Shelves with glass bells contain organs, mainly brains and eyes.

## 23. Lift (Tile #5)

This is the lift the servants use for lifting up coffins. It can be activated only in this room.

## 24. Coffin storage (Tile #10)



BEW022#1

© One Games, permission granted to print for personal use only

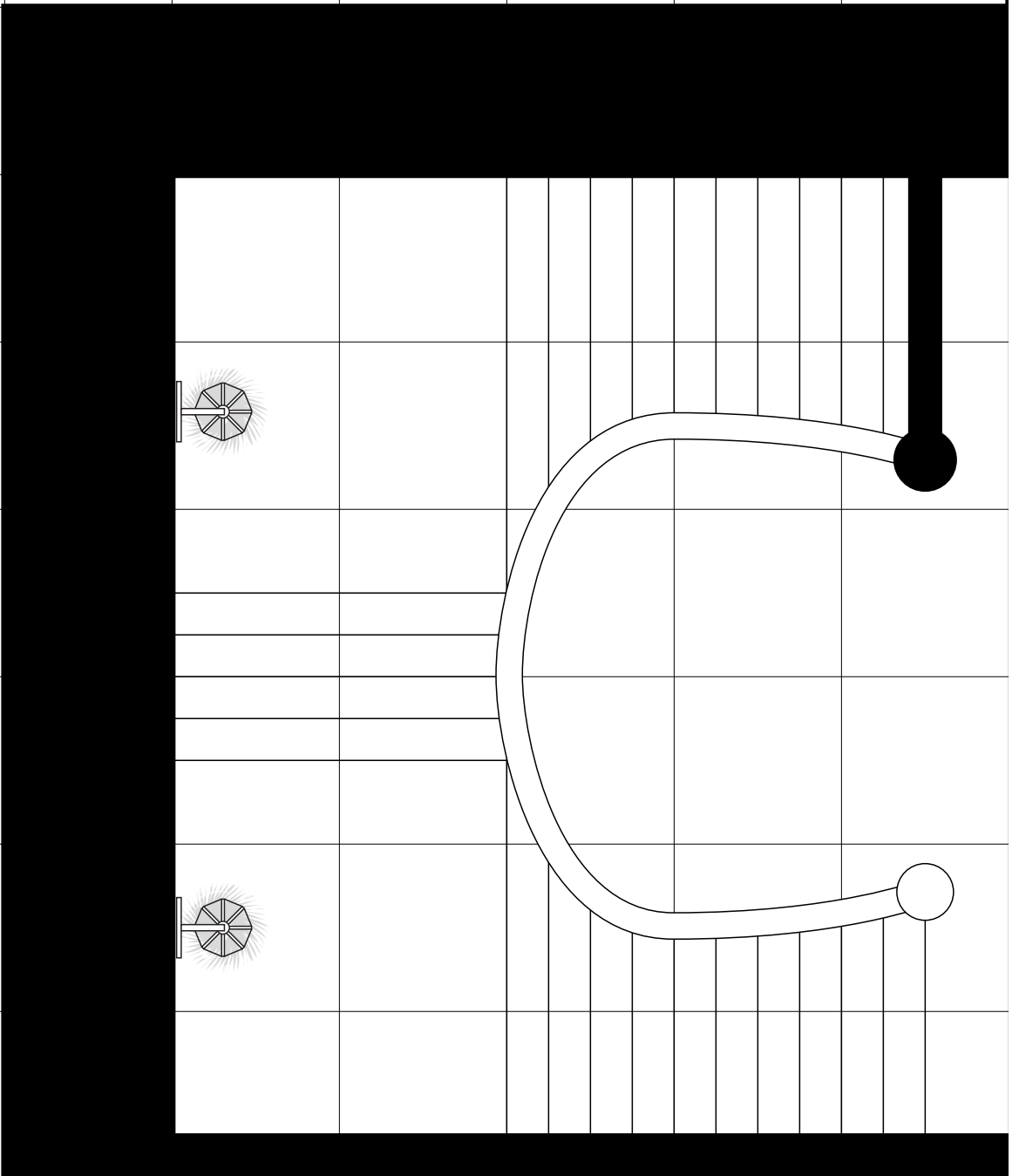



BEW022#2

© Gene Games, permission granted to print for personal use only

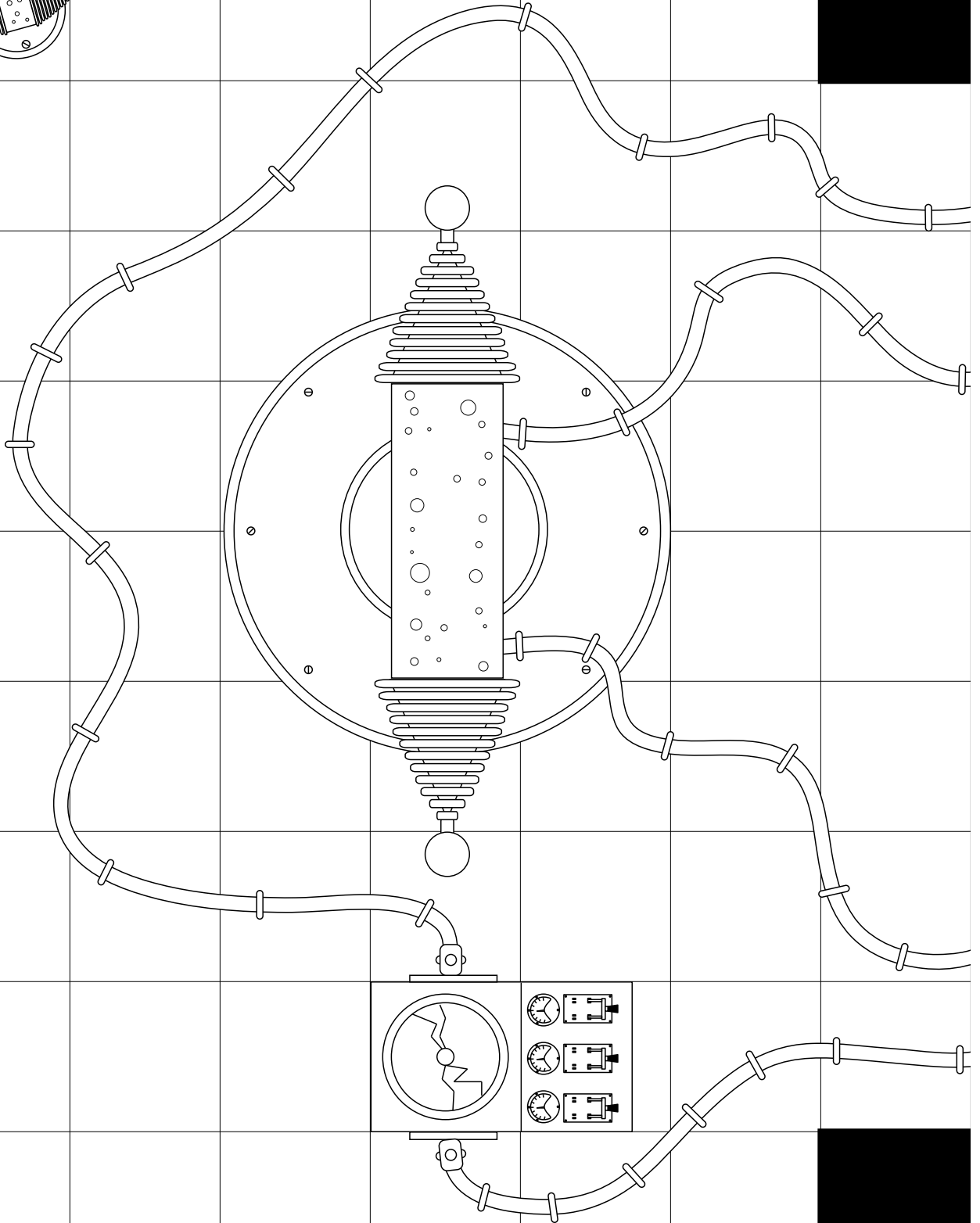
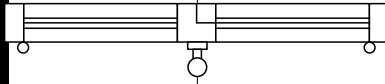
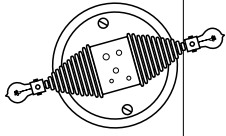

BEW022:#3

© One Games, permission granted to print for personal use only

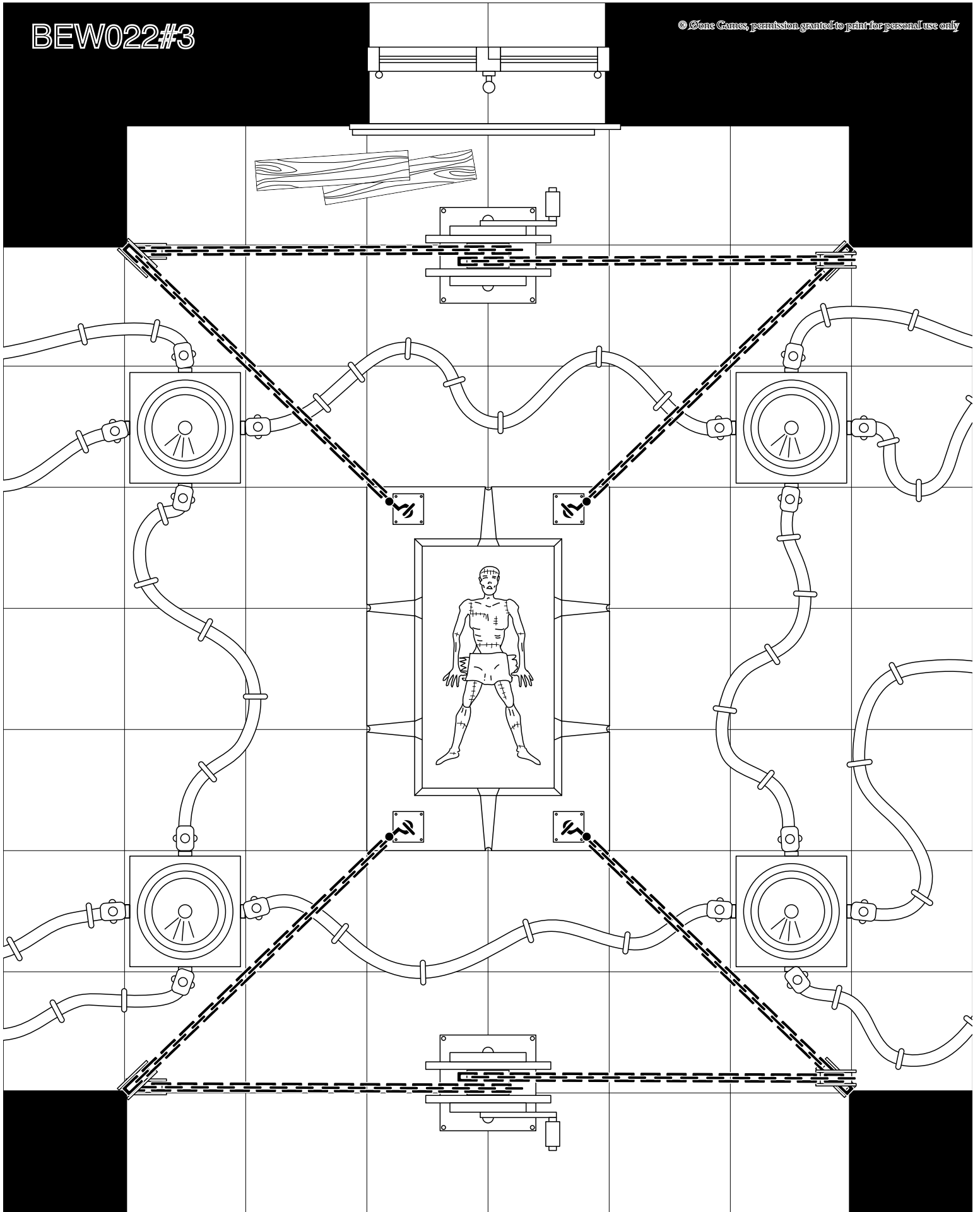

BEW022#4

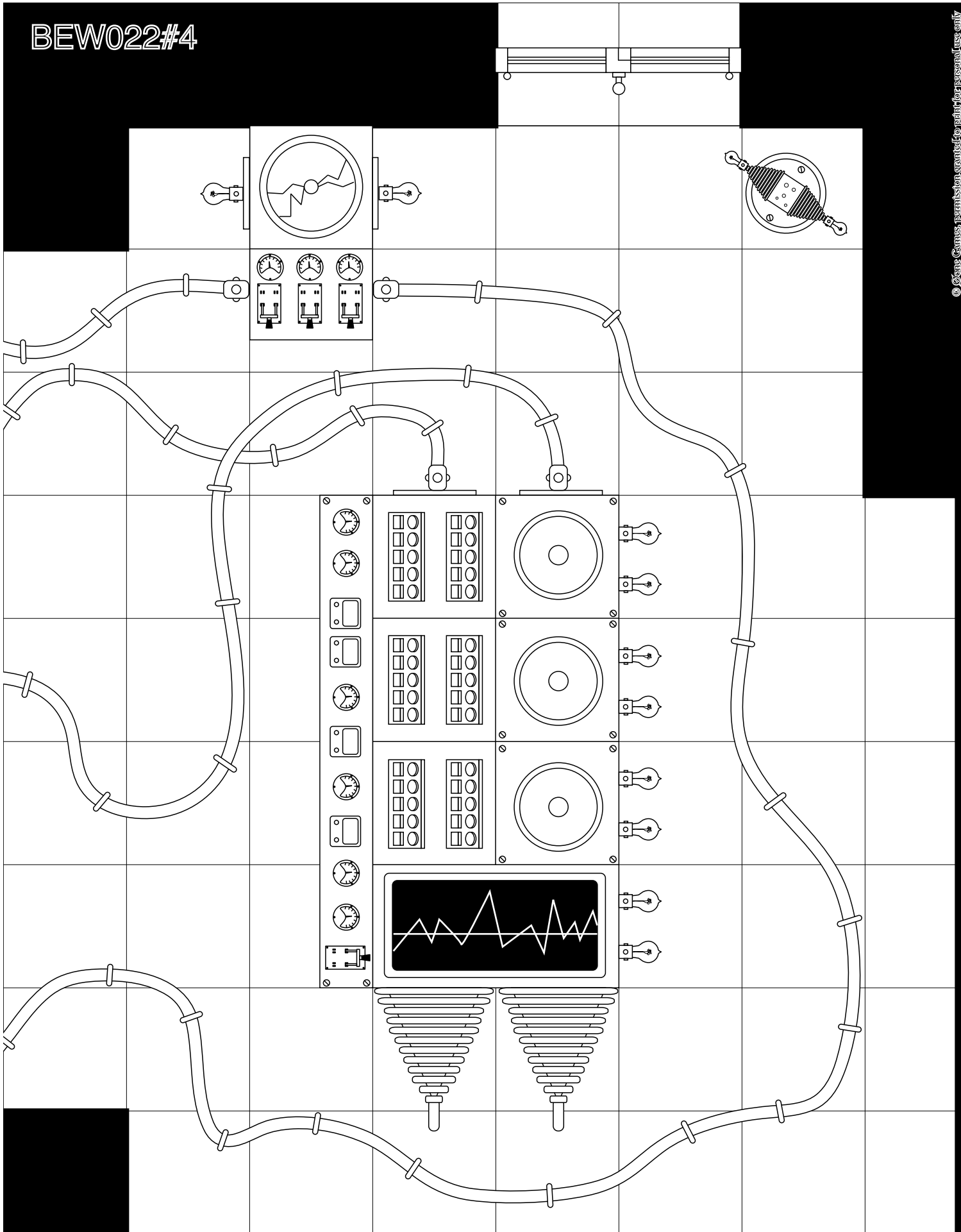



BEW022#5

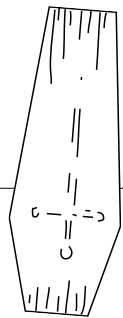
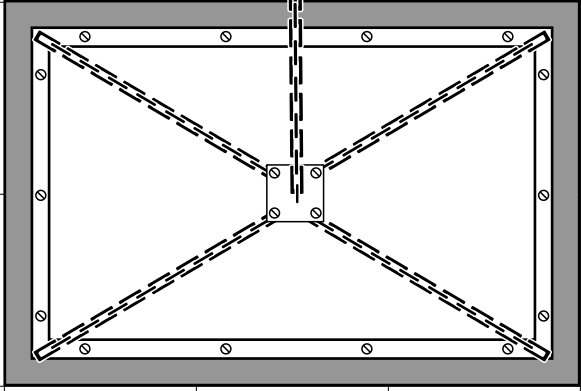
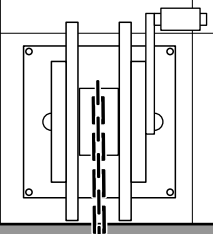
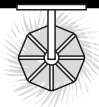

BEW022#6

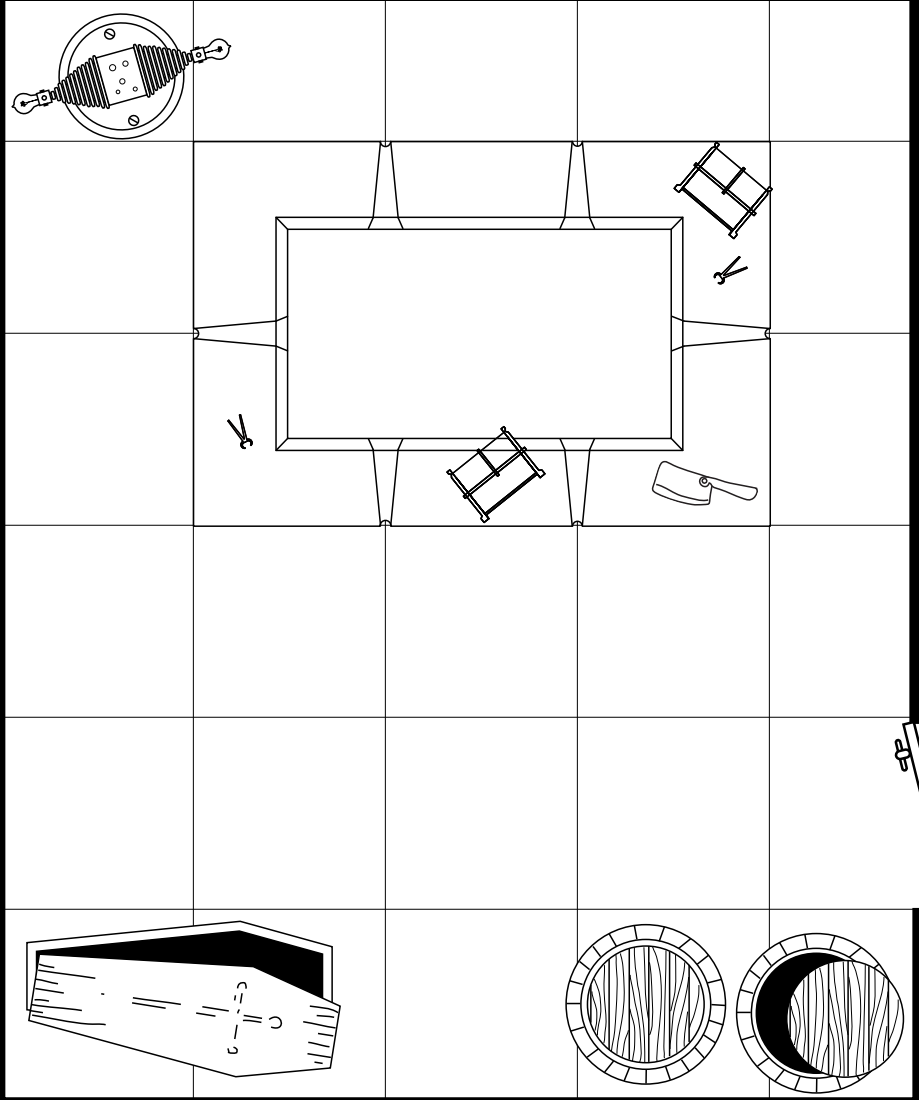

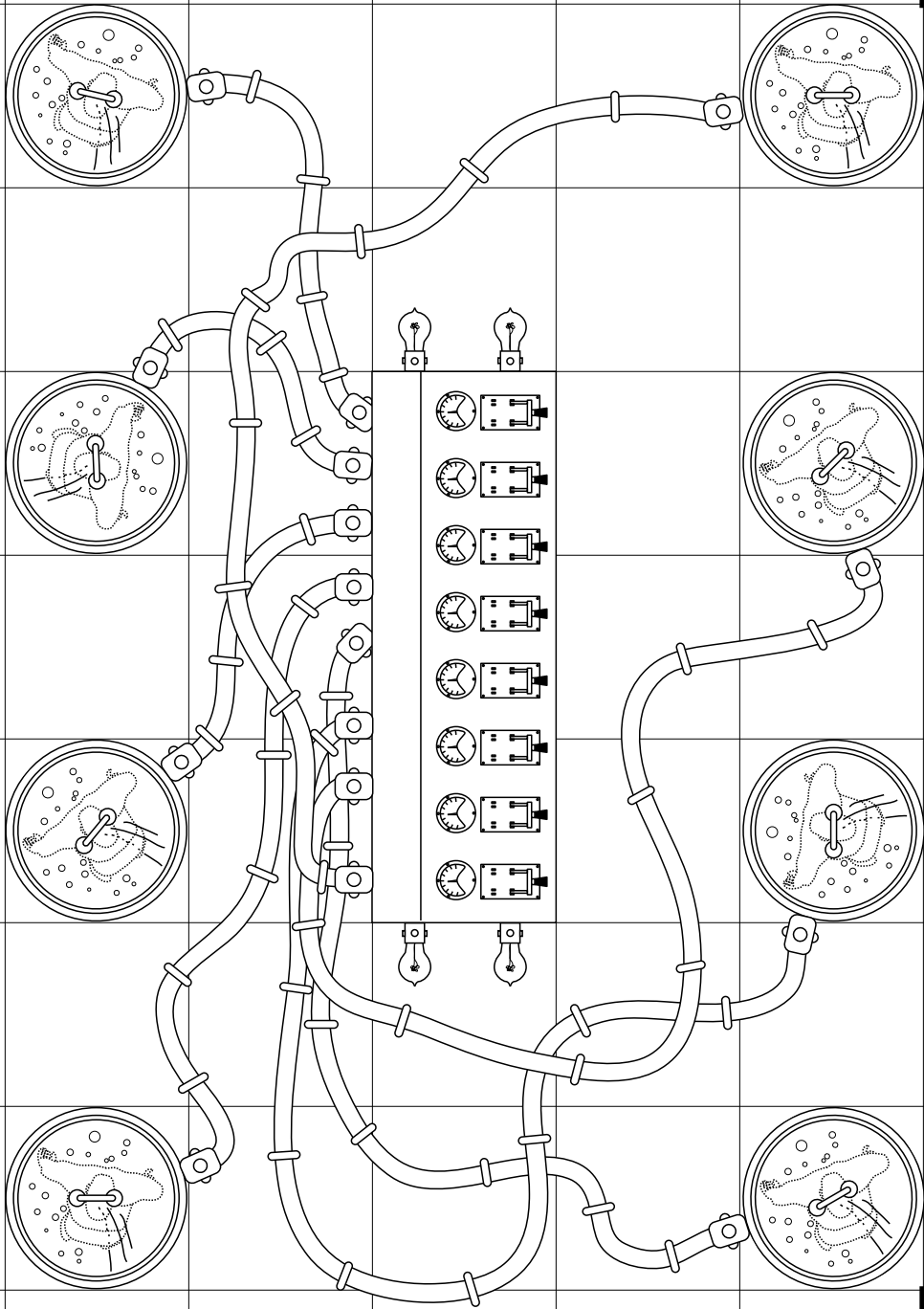

BEW022#7

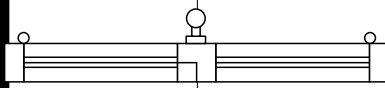

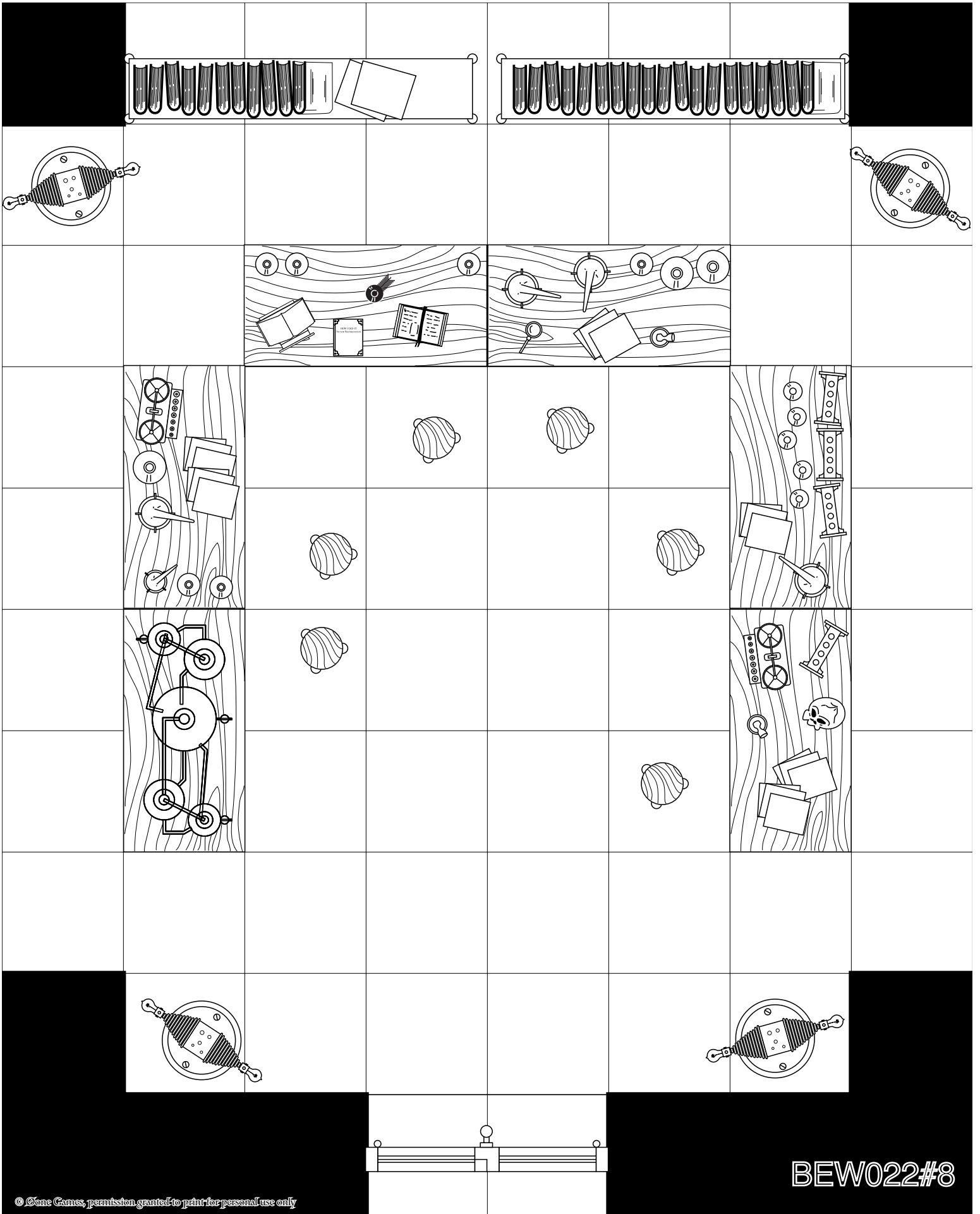

BEW022#8



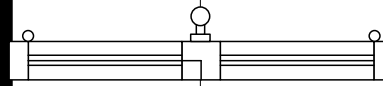
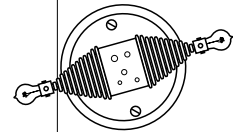
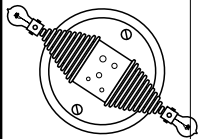
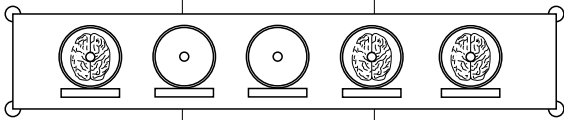
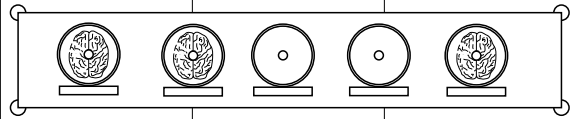
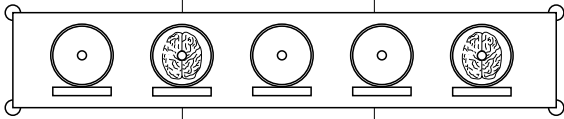
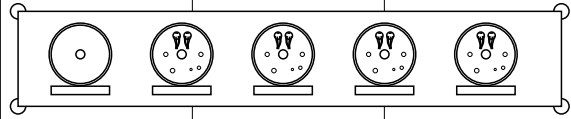
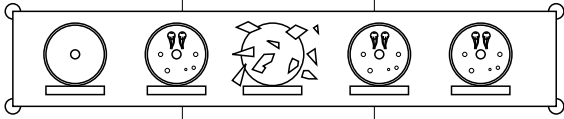
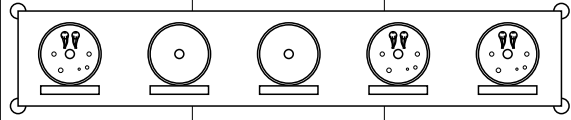
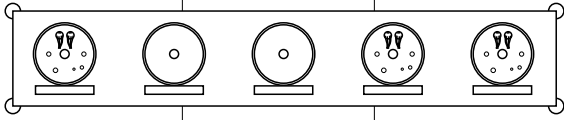

BEW022#9

BEW022#10

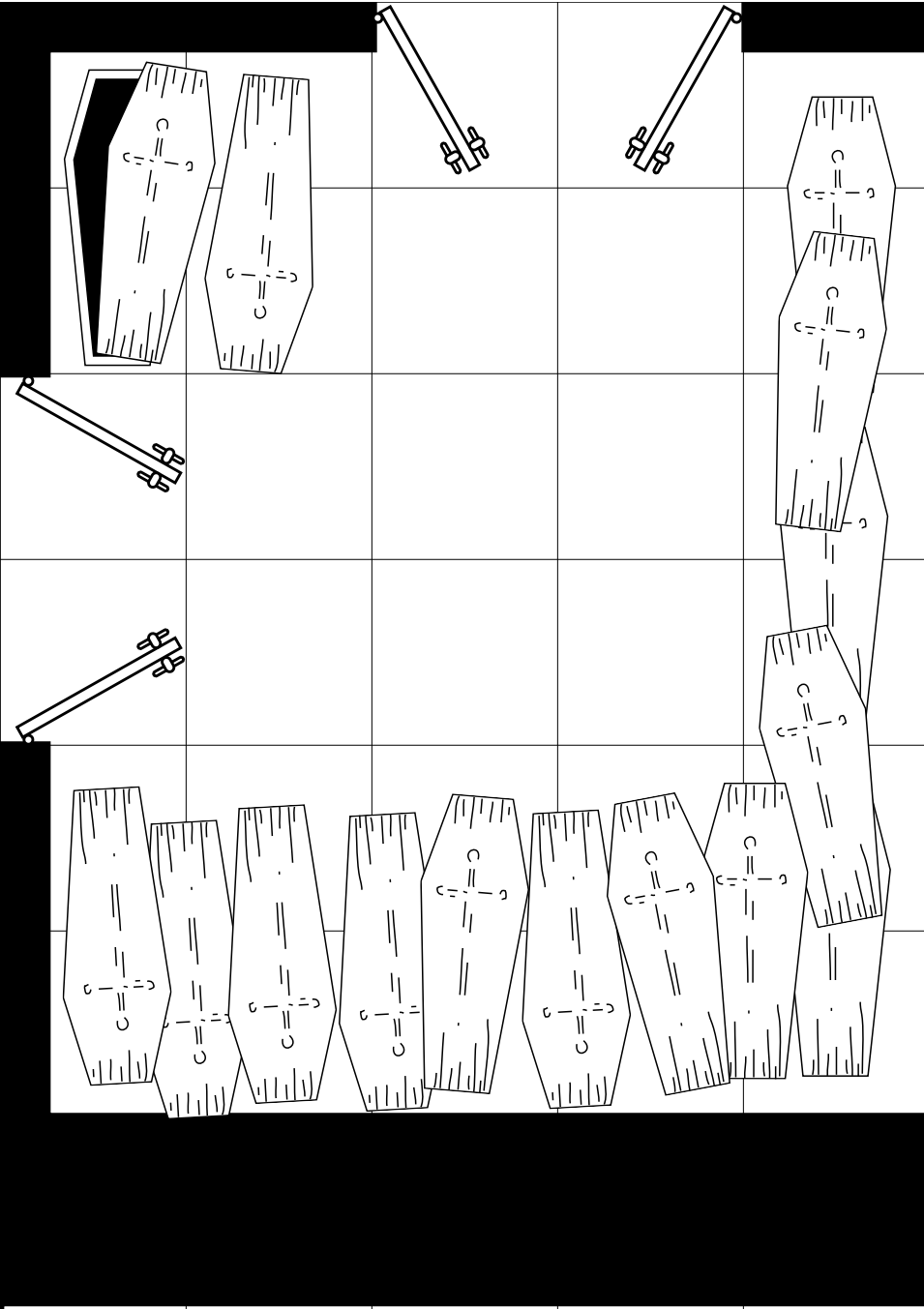

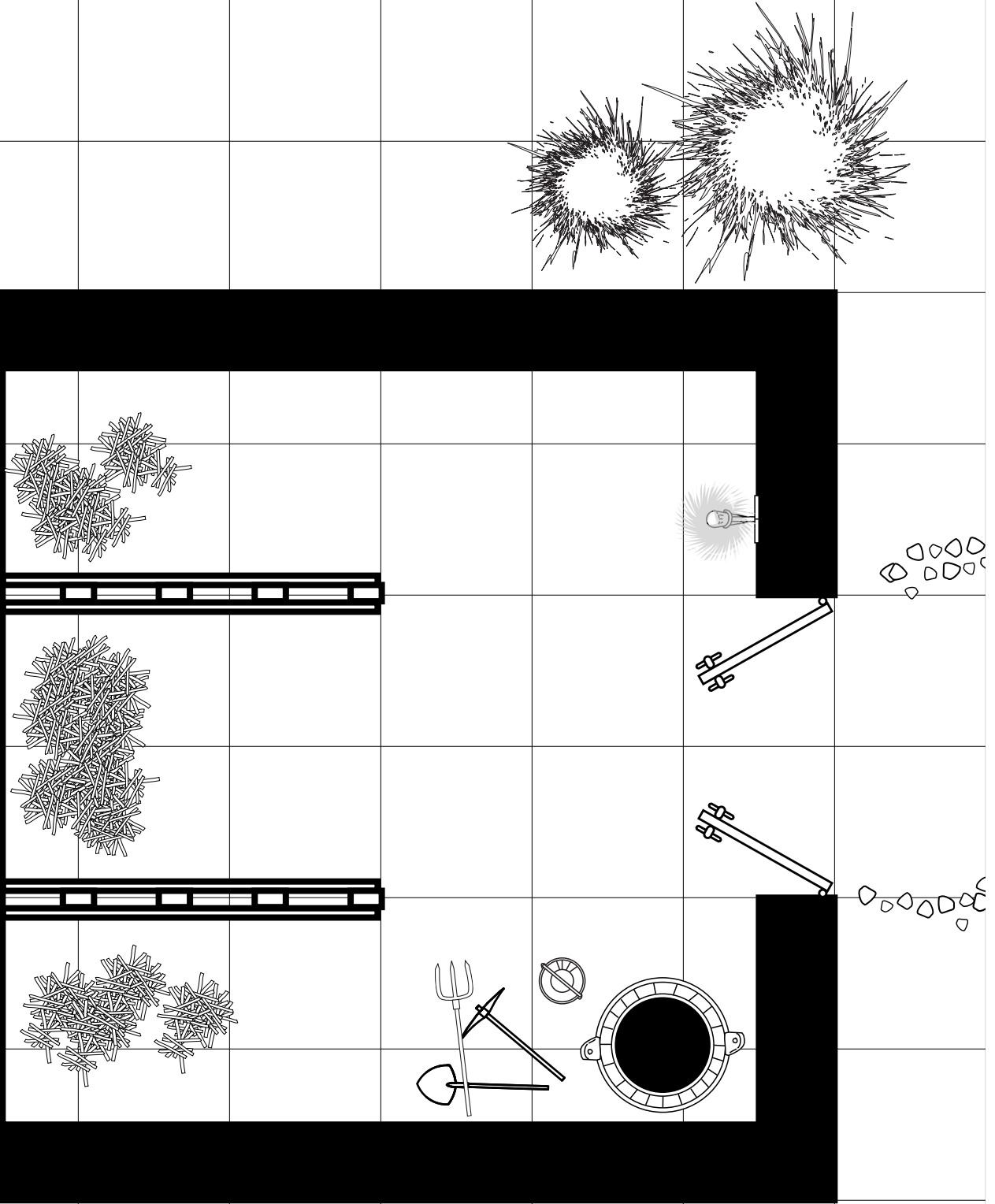

BEW022#12

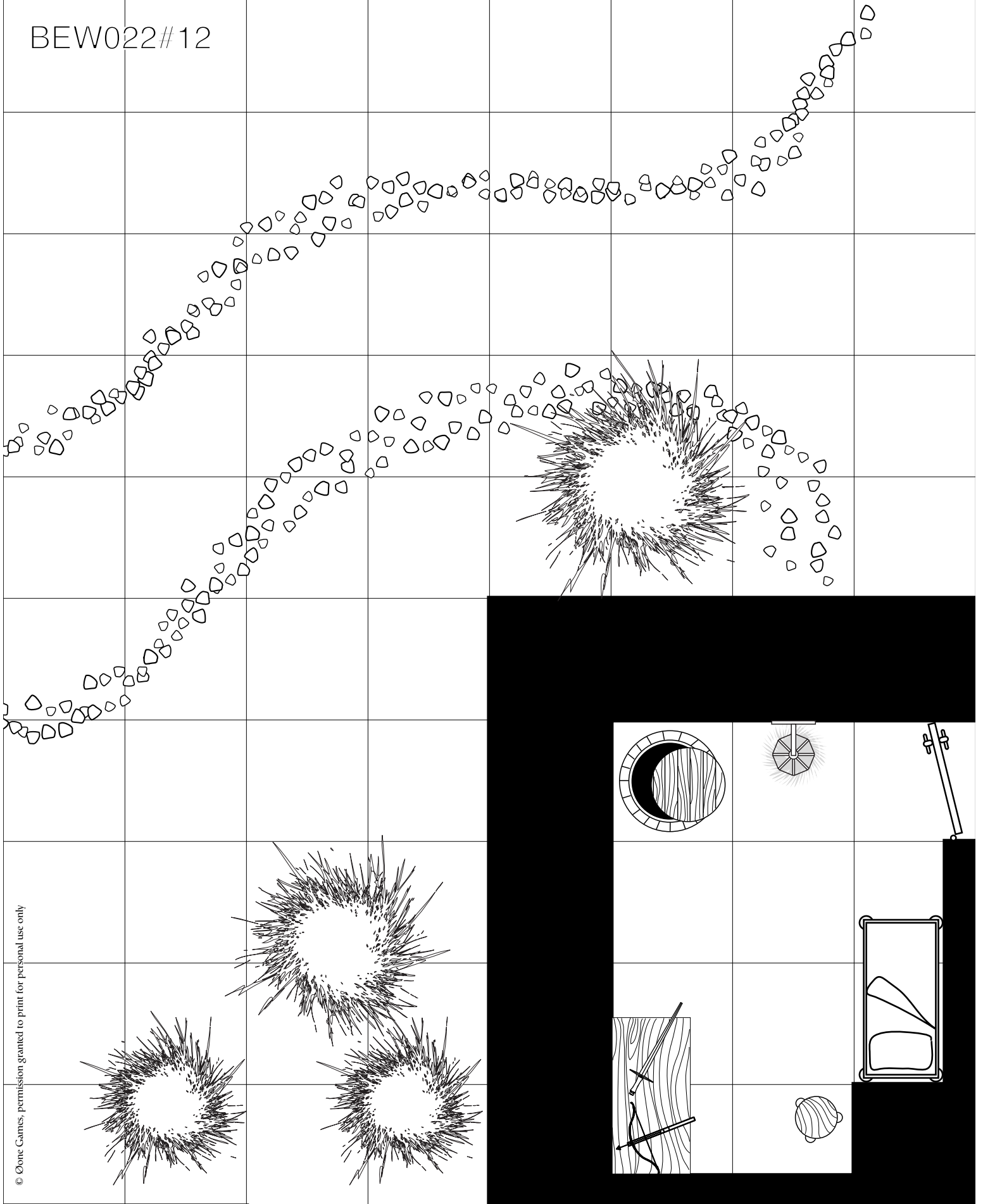



BEW022#13

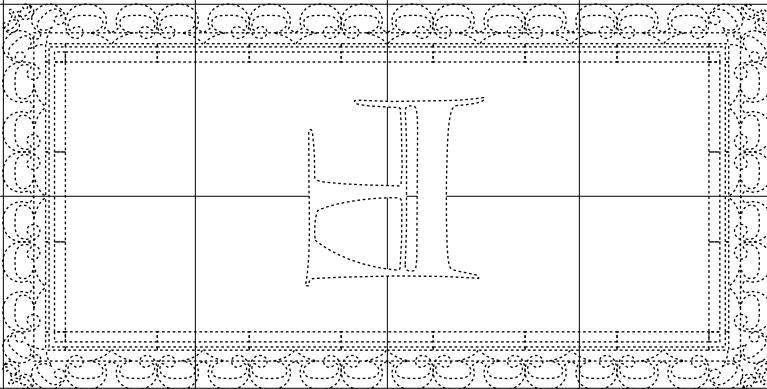
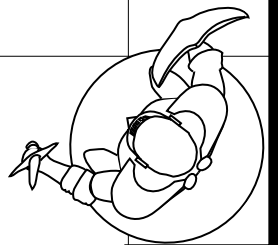
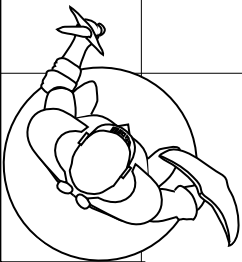
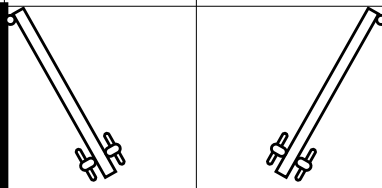
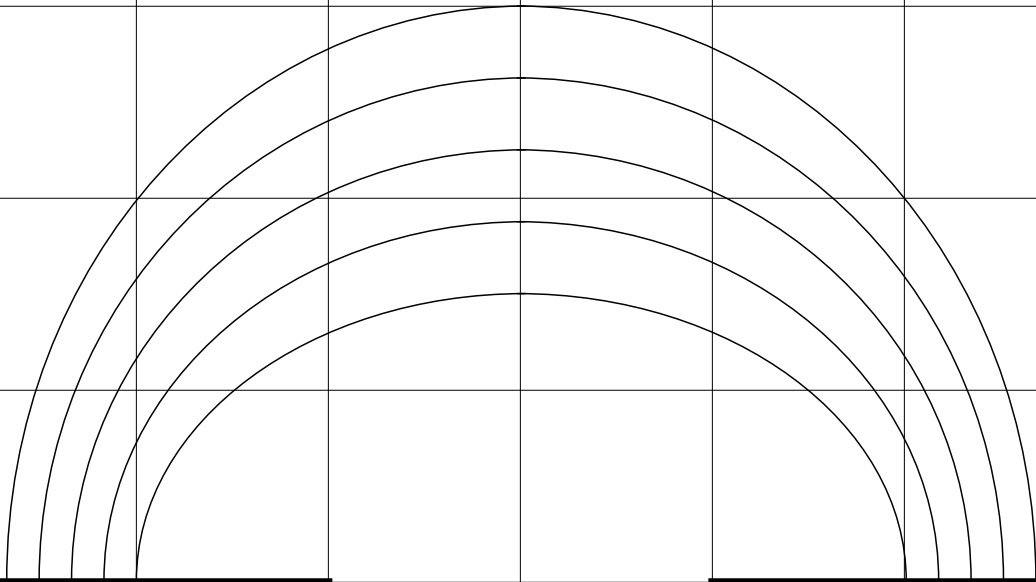

BEW022#14

© Qone Games, permission granted to print for personal use only

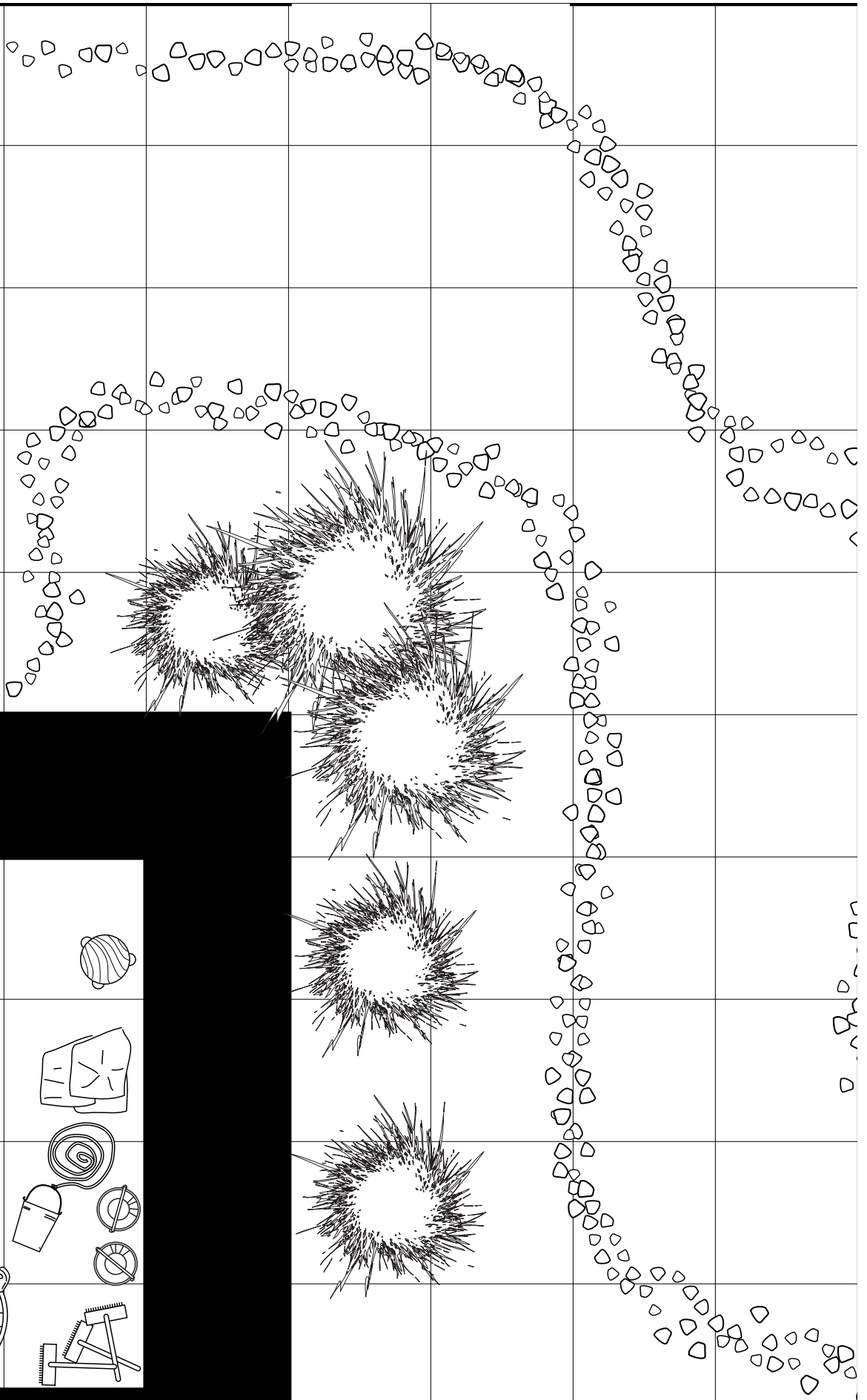

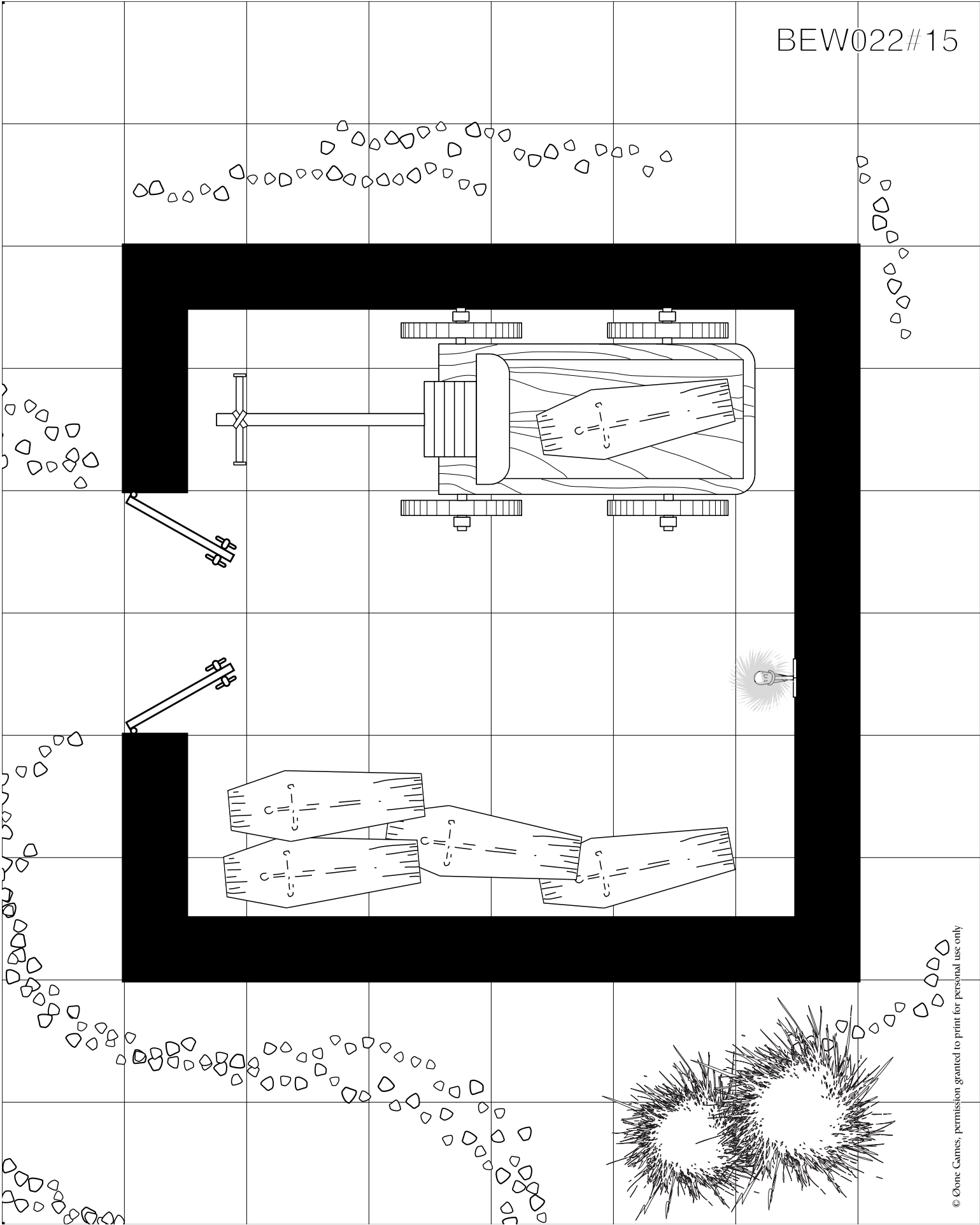

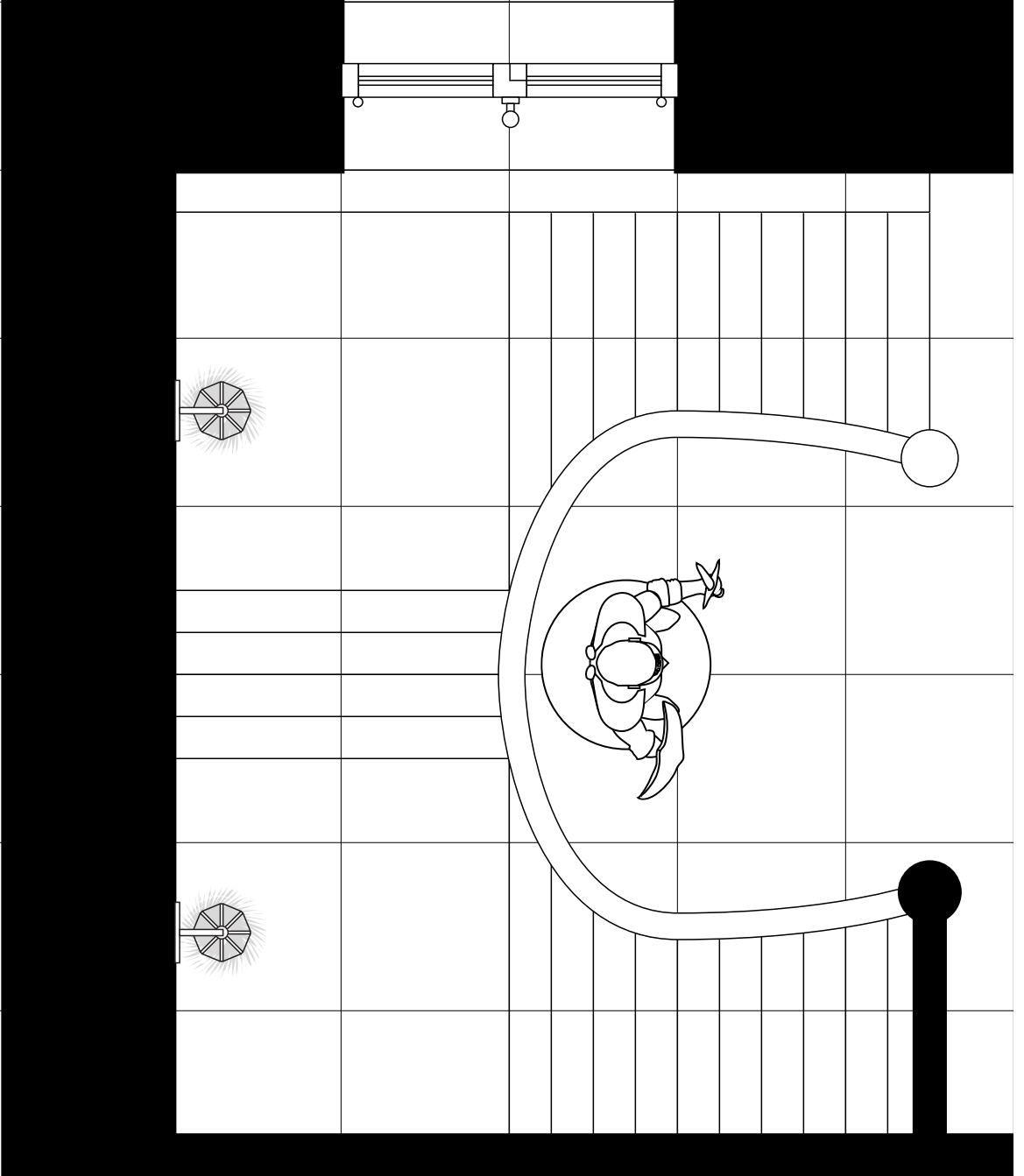
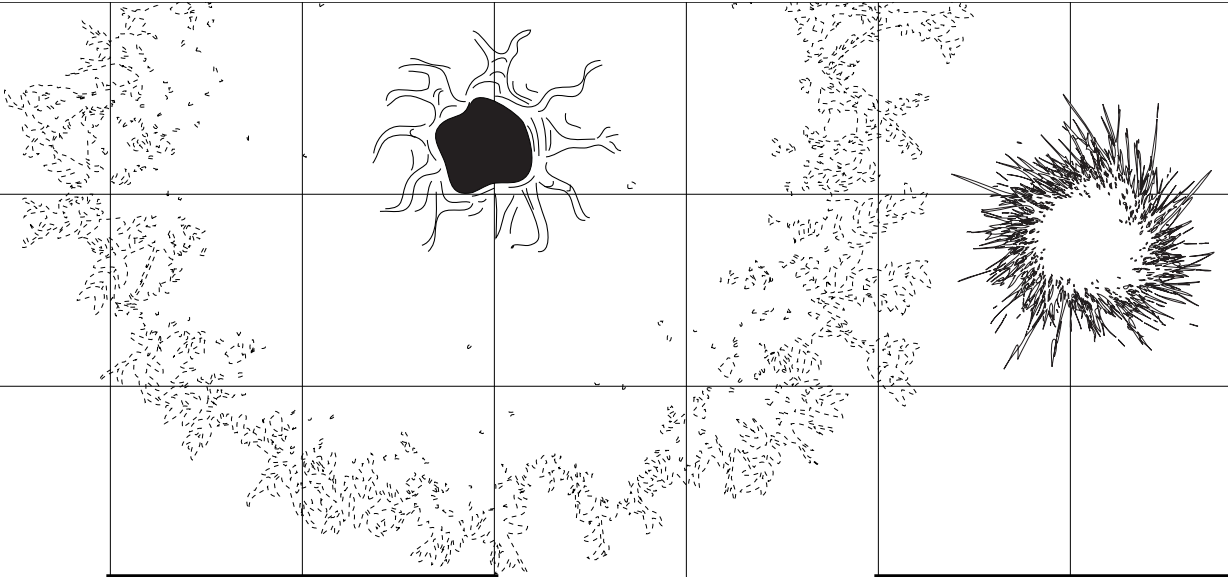



BEW022#17

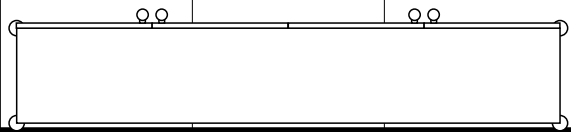
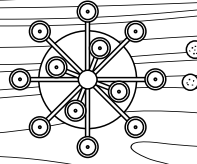
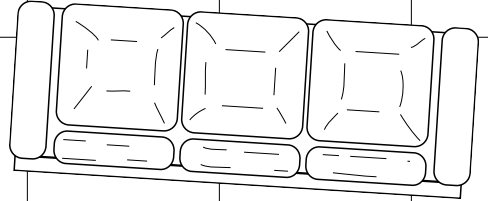
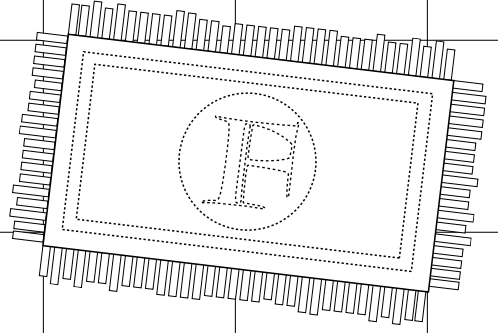
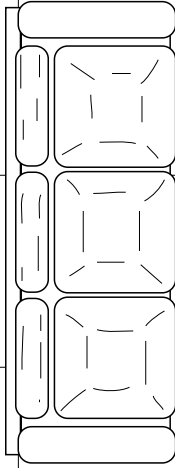
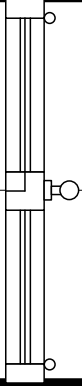
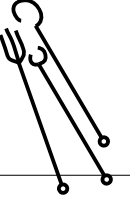
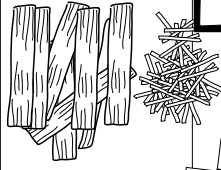
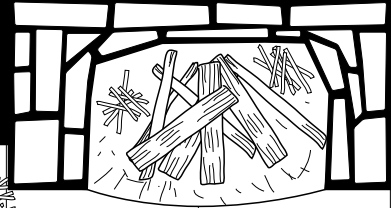
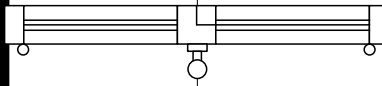

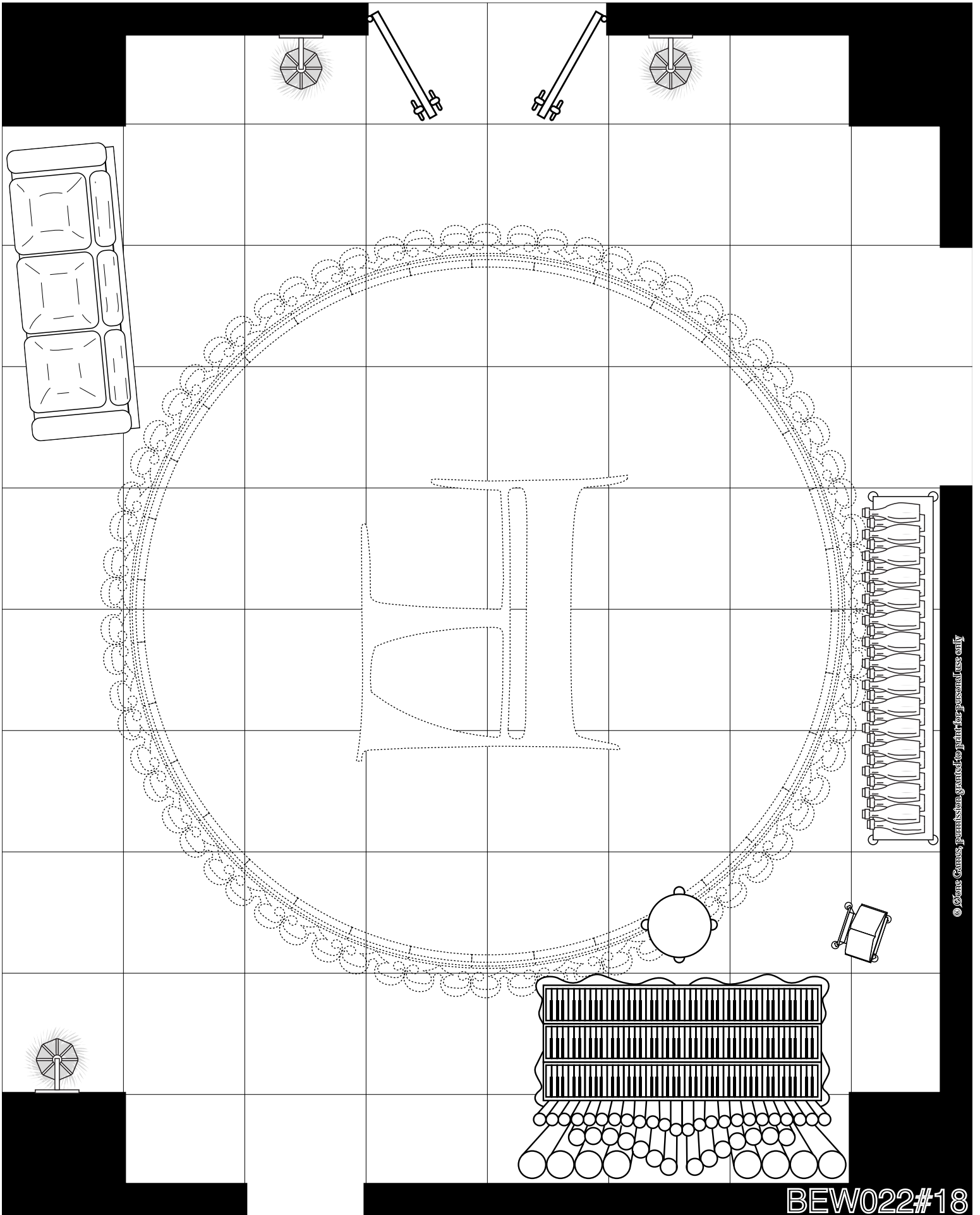

BEW022#19

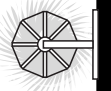
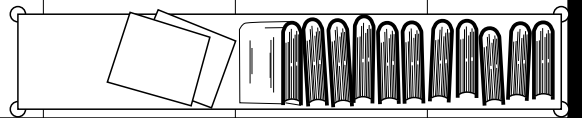
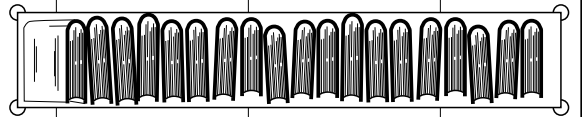
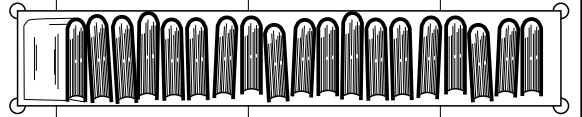
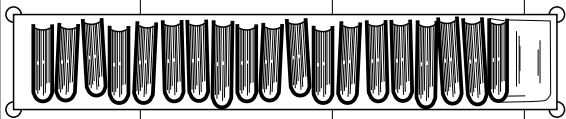
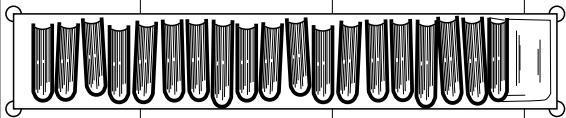
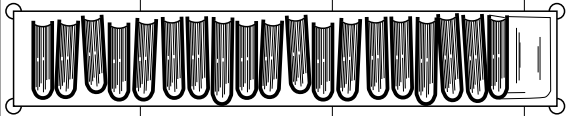
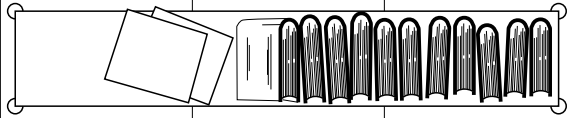
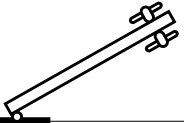
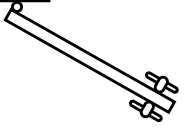
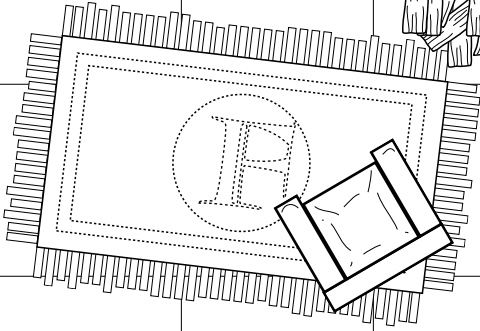
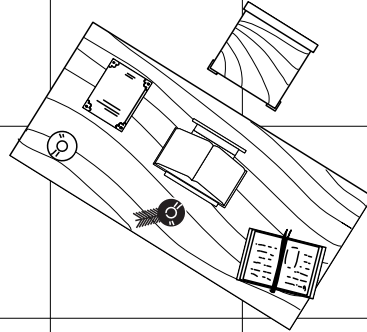
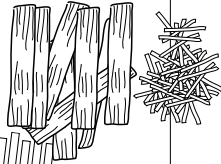
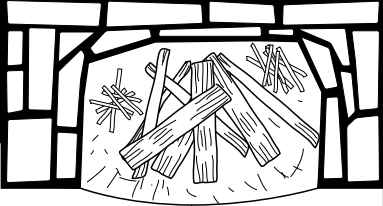

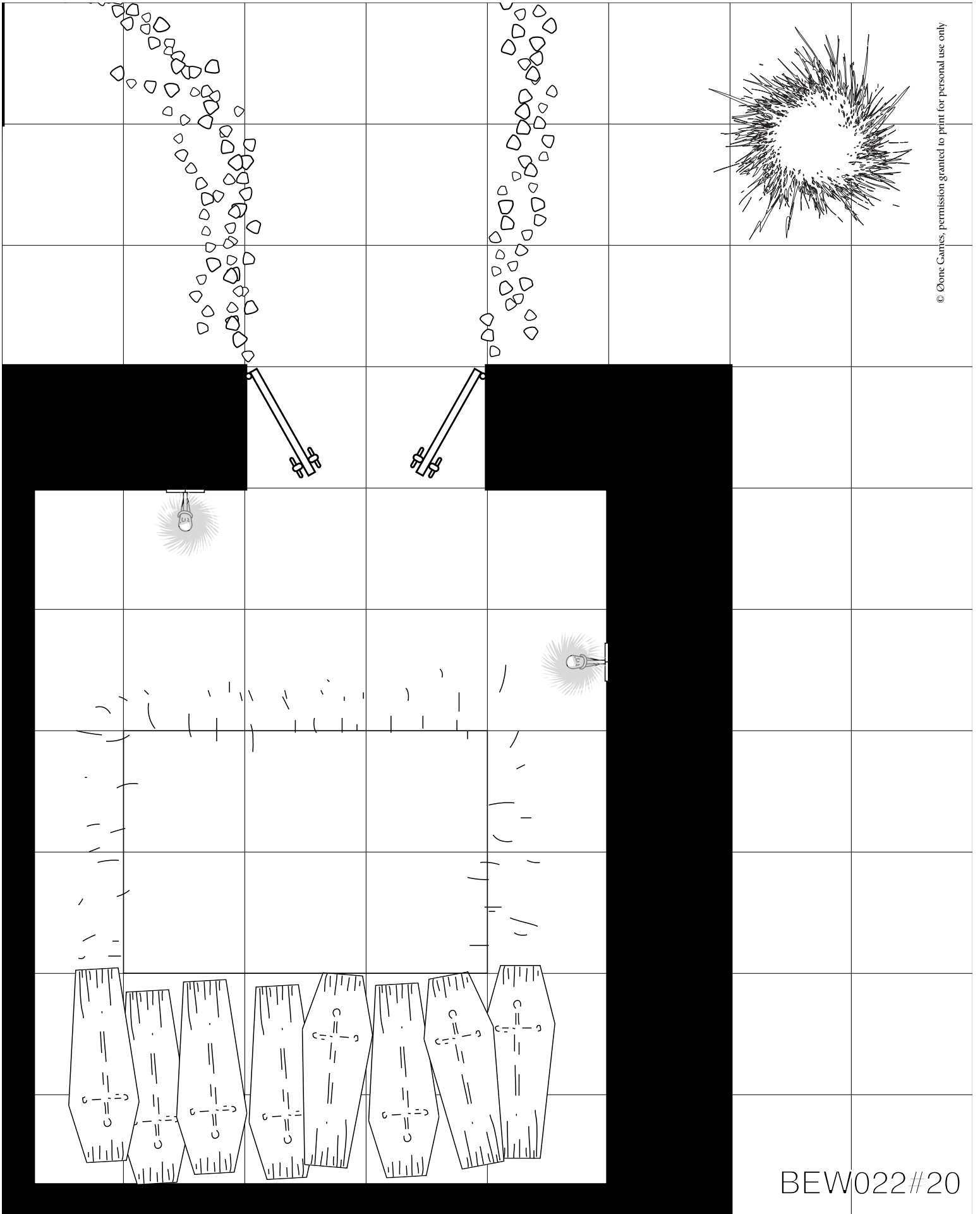

BEW022#21

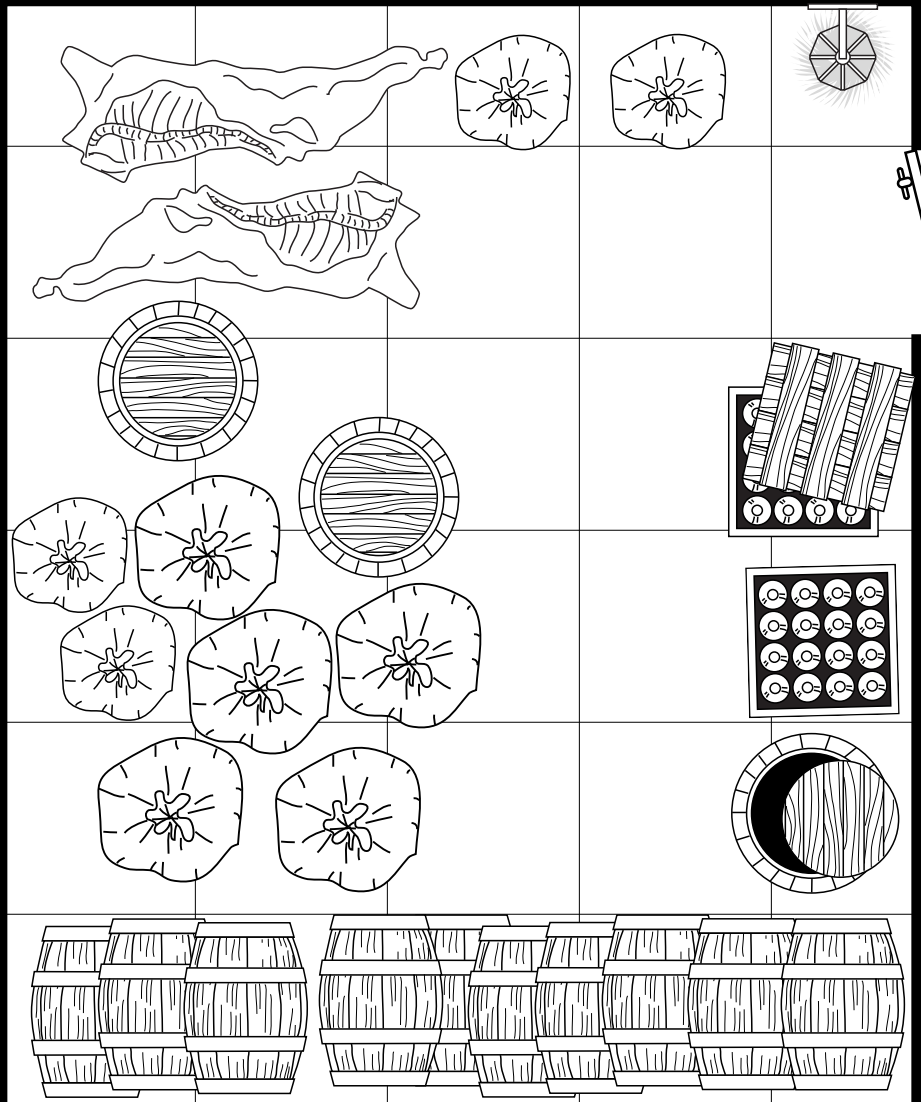





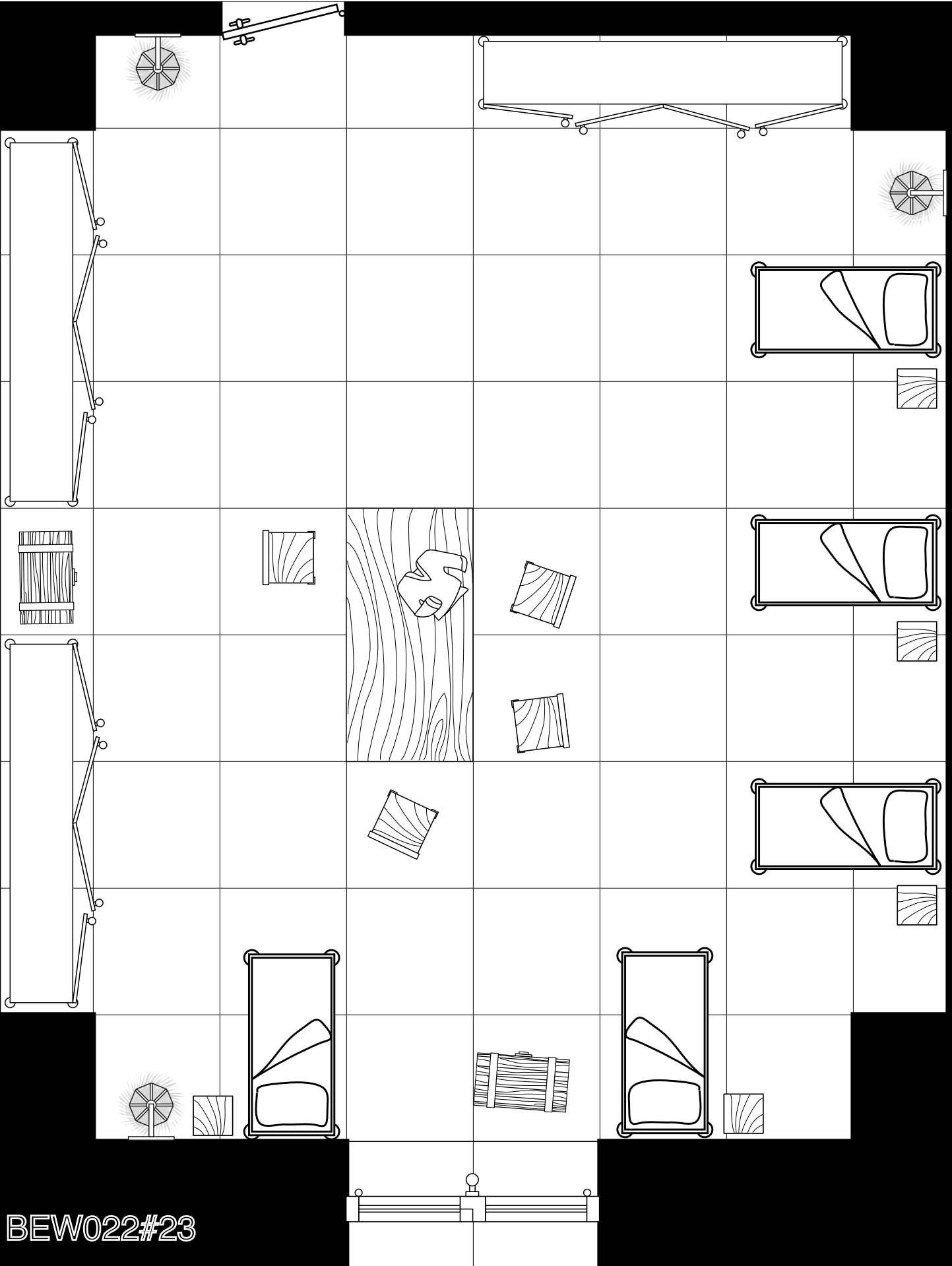

BEW022#23

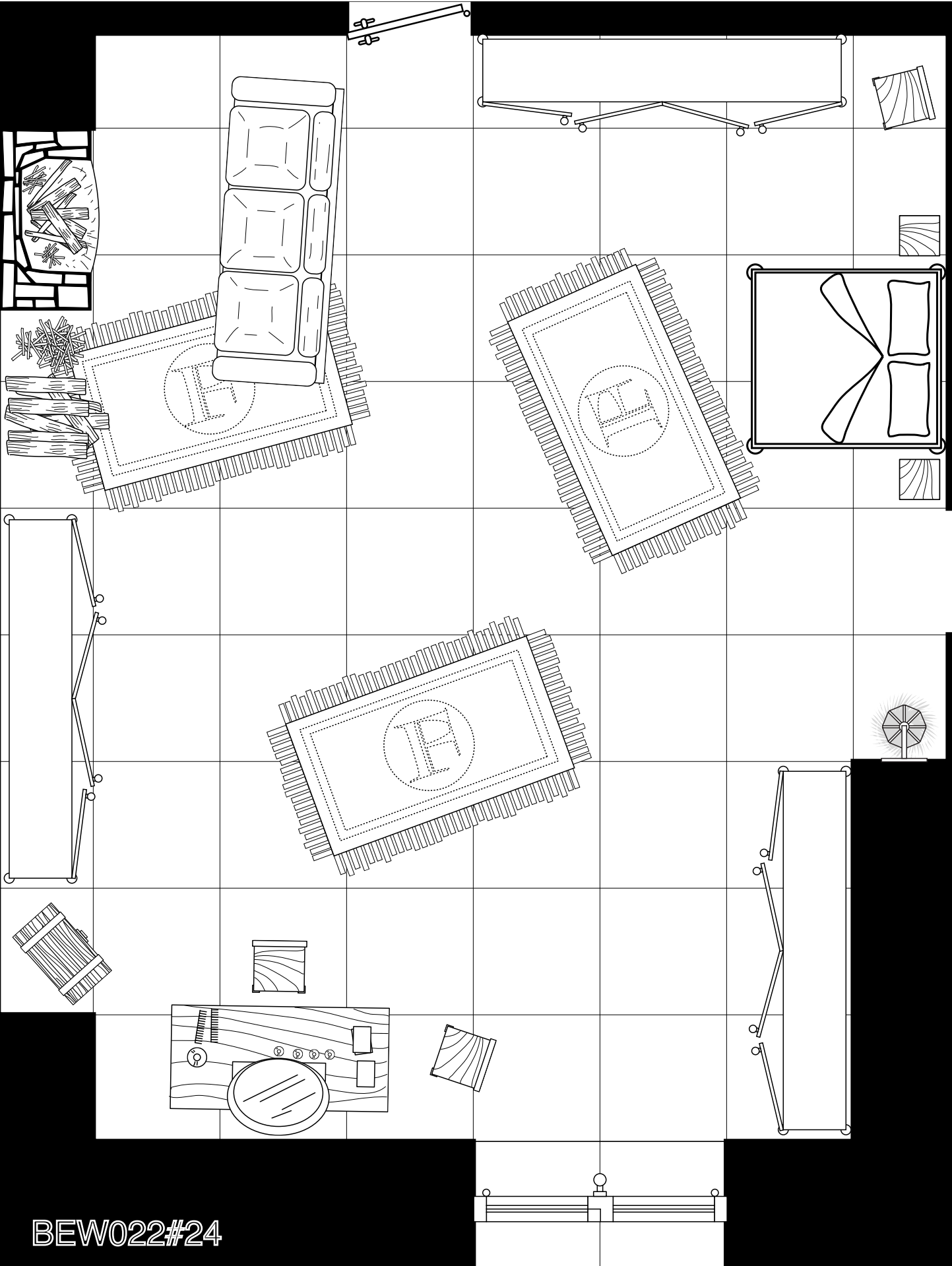

BEW022#24

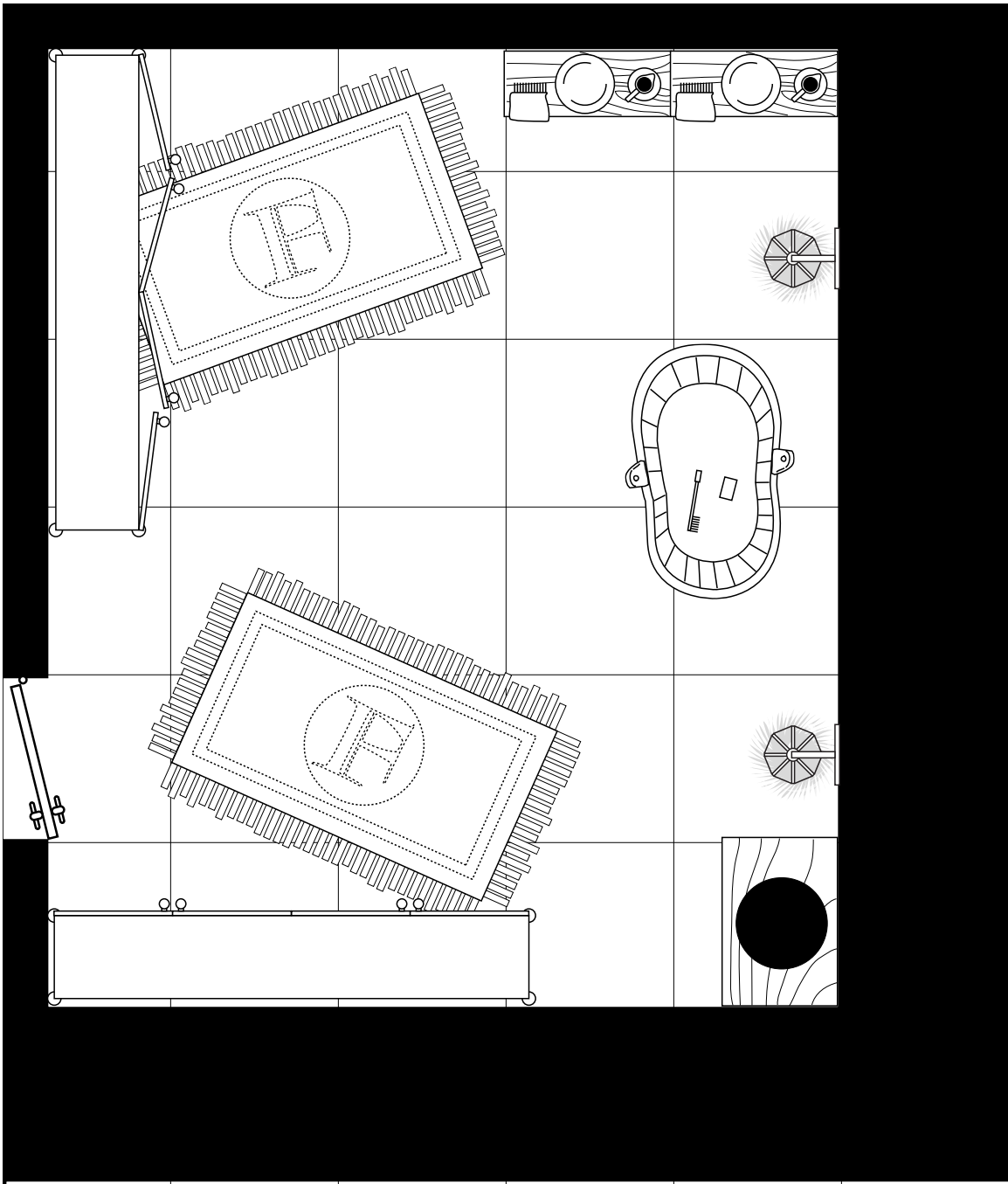

BEW022#25



# EASY TO LEARN FUN TO PLAY



OONE'S  
**VENTURE**  
OFFICIAL WEBSITE

[VENTURE.OONEGAMES.COM](http://VENTURE.OONEGAMES.COM)

free quests, resources, discussion boards and more!