

Done's

BLACK & WHITE

HEAVENRING

VILLAGE

TOWN HALL

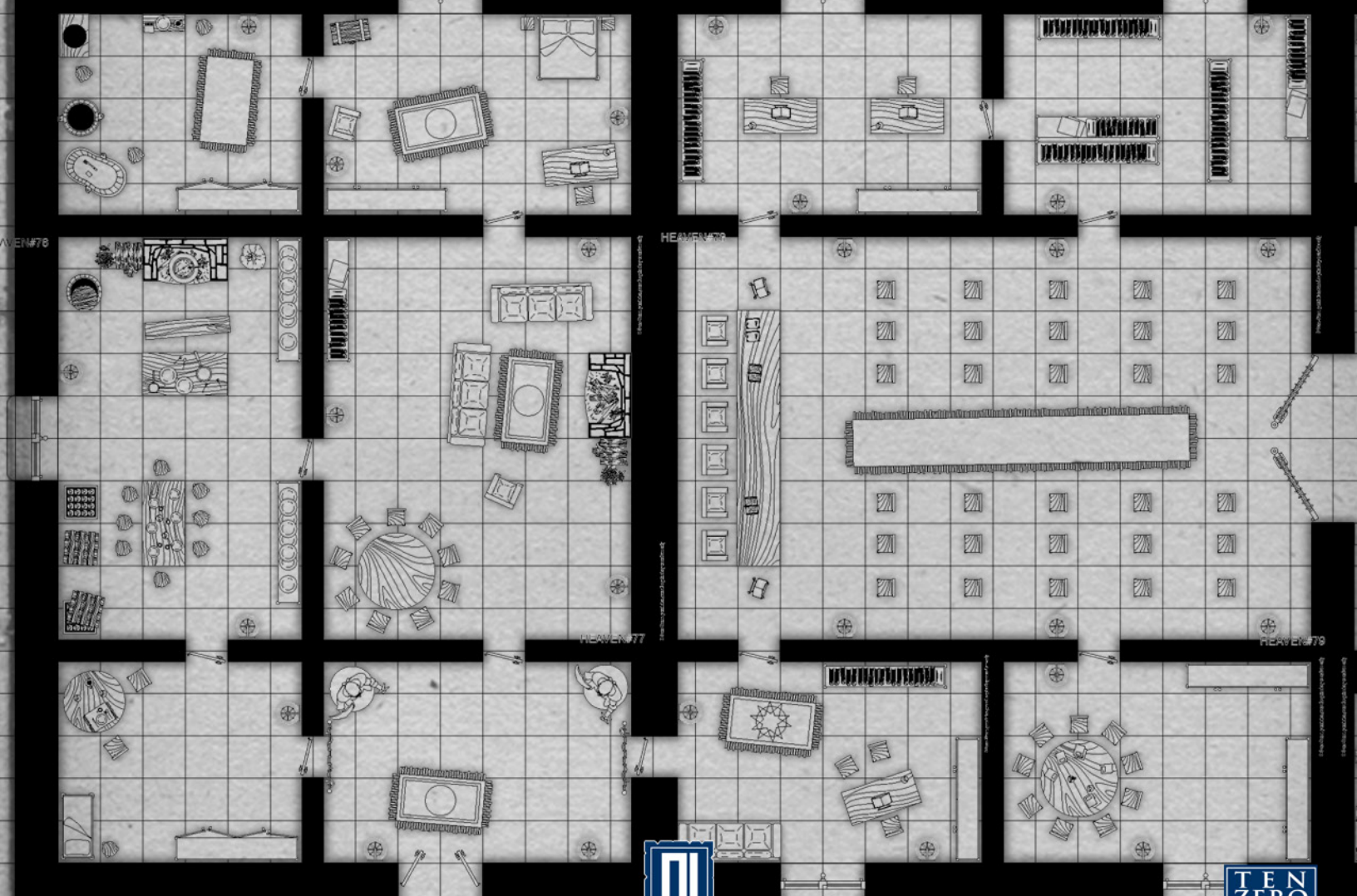

www.donesgames.com



Øone's BLACK & WHITE

Welcome

This product line will bring you simple tiles for your favorite RPGs. In each product you will find a whole fantasy location fully fleshed out in miniature-scale tiles with the usual Øone's top-notch customization capabilities. The B&W maps are simple, line art battlemaps you can customize to suit your needs and then print.

These tiles are accurate, detailed, inexpensive and no ink-eaters.

In each B&W product you'll find:

- A Referee map detailing a fantasy location
- The whole location broken in US Letter sheets in miniature scale (each sheet contains a 8x10 inches tile)
- A short description of each area of the location with suggested plots

The Rule the Dungeon® Feature

This Øone's exclusive feature allows you to customize the look of your map by adding the furniture, toggle the grid, hide the room numbers and much more.

On the Referee Map, you will find a big "Rule the Dungeon" button. This button will not be printed, so, don't mind if it overlaps something on the map. By clicking on this button some options will be shown, as detailed below. A checkmark will appear beside the options active. The options available could vary with products, below is a list of the most common options included in B&W products:

- **Text:** toggle room numbers and tile numbers.
- **Tiling:** toggle the page tiling (Referee Map only)
- **Furniture:** toggle furniture
- **Doors:** toggle doors
- **Square Grid:** toggle square grid
- **Hex Grid:** toggle standard hexagonal grid
- **Hex Grid 1 inch:** toggle 1 inch hexagonal grid
- **Black Fill:** toggle the black in the walls
- **Grey Fill:** toggle the grey fill in the walls
- **No Fill:** toggle the white fill in the walls
- **All:** toggle default state/empty state (with just the walls).

Note that the Rule the Dungeon button on the Referee Map controls all the battlemaps at once.

How to Use This Product

Click on the big button of the Referee Map to customize your maps. Once you have obtained the desired appearance (note that room numbers and tiling do not appear on the tiles) simply choose "Print" from the Acrobat menu.

If you need to print only some tiles, simply click on the desired tile on the Referee Map and choose "Print this Tile".

Tips for Printing

The tiles should have enough margins to print without checking the option "fit to page". If your printer has a margin larger than ¼ inch you should check it in order to print the whole tile. This could reduce slightly your tile but it should be easily usable.



Øone Roleplaying Games
www.Øonegames.com
master@Øonegames.com

Øone's Black & White: Heavenring Village
Town Hall
Product Code: bew015. First edition 05/2010
Design: Mario Barbati
2D drawings: Mario Barbati
Graphics: Ø'Bully
Software Engineer: Anna Fava

All of the content of this book is © by Øone Roleplaying Games. The reproduction or retransmission of any part of this book, without written permission of the copyright holder is expressly forbidden, except for the purpose of reviews. Permission is granted to print this book for personal use only.

BE PREPARED!



THE GREAT CITY PLAYER'S GUIDE

PATHFINDER®
ROLEPLAYING GAME COMPATIBLE

ØONE  GAMES

the first d20 pdf publisher of the world

www.Øonegames.com

HEAVENRING VILLAGE

TOWN HALL

Welcome to **Heavenring Village**, the largest village ever tiled!

Heavenring Village contains **11** buildings, **101** rooms, **8** different zones (each one featured in a single product) and it's broken in **225** customizable tiles.

The Heavenring Village Virtual Boxed Set© contains **8** original products plus a giant referee map, cutouts for rooftops and **101** room templates.

The 8 products are the following:

- **Black Gryphon Inn**
- **Town Hall**
- **Temple and School**
- **Cemetery**
- **Lord's Manor**
- **The Smith**
- **Emporium**
- **The Jail**

You can play **Heavenring Village** as a whole or extract your favorite building (or even a single room or encounter area) to suit your campaign. If you're bold, you can lay down a **massive 120x150 inches** village to play the most extended miniature-scaled adventure of the history!

The Story

The village of Heavenring is a small, quiet place standing in a heavily wooded valley. The place is called Heavenring because the river Heaven encircles completely the village, which is, actually, a small island. The river Heaven is not very wide but its waters run very fast making swimming nearly impossible. The river surrounds and protects the village, making him an "heaven" into an otherwise wild and dangerous area. The Valley of Dark Woods is indeed ancient and filled with old tombs, dungeons and monsters. The people of the village live inside their ring of protection and venture outside only during the day, being the monsters and the dangers a nightly thing. Only one bridge links the valley to the village and it is actually a drawbridge which is lifted at dusk each day, until the reappearing of the light on the following morning. The people of the village live by fishing and woodcutting and are a small, peaceful community. They also produces caviar, from the salmons provided by the river, using a special and unique recipe. The caviar of Heavenring is the best caviar you can find in the known world.

Note that this set details central Heavenring (the river does not appear on the map)

Town Hall

The Town Hall is divided in two zones: the actual town hall and the house of Musdus, the major. The town hall features a large council hall and some side rooms, including archives, meeting room, records and more.

A side entrance provides access to the house of the Major (and another entrance is almost hidden behind a velvet curtain in the major's office in the Town Hall).

The major, Musdus Marub, is a stout old dwarf which hair are turning to silver. He is the major of the small community and protector as well. His typical phrase is "Where the law doesn't come, there comes my axe!". He is wise and resolute.

Town Hall Rooms

Town Hall

- B1. Council Hall (Tiles #78, 79)
- B2. Meeting Room (Tile #94)
- B3. Major's Office (Tile #93)
- B4. Records (Tile #63)
- B5. Archives (Tile #64)
- B7. Guardpost (Tile #65)
- B8. Guardpost (Tile #95)

Major's House

- B9. Foyer (Tile #92)
- B10. Dining Room (Tile #77)
- B11. Bedroom (Tile #62)
- B12. Bathroom (Tile #61)
- B13. Kitchen (Tile #76)
- B14. Servant's Room (Tile #91)

- B6. Town's Well (Tile #83)

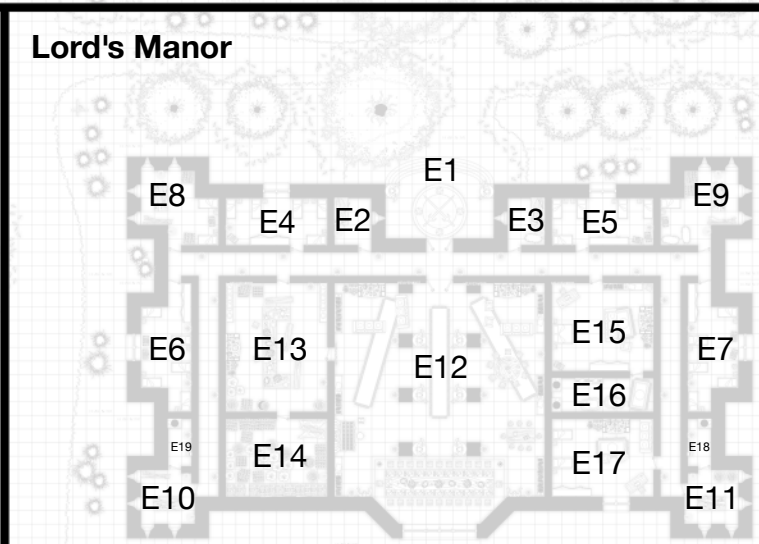
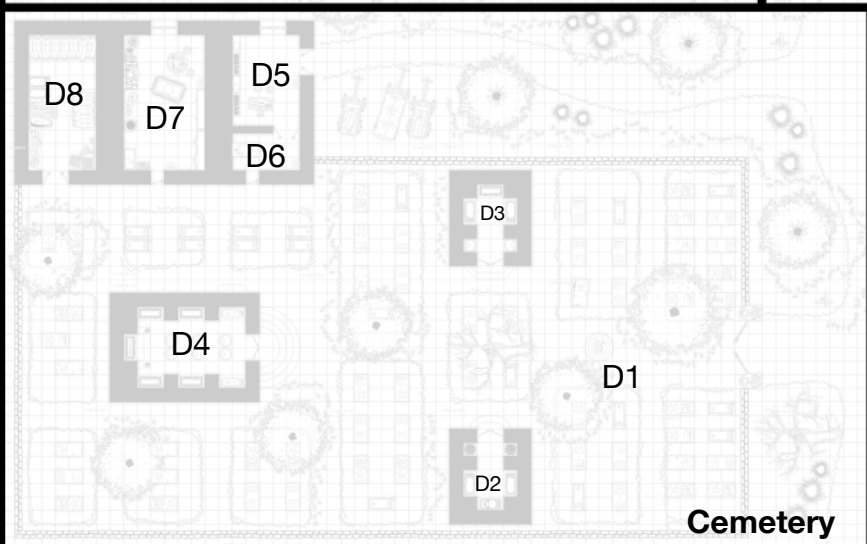
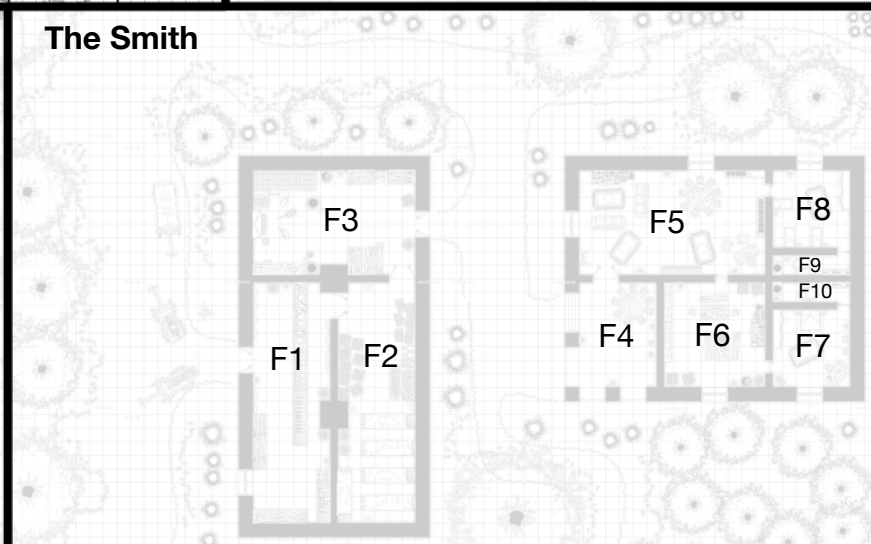
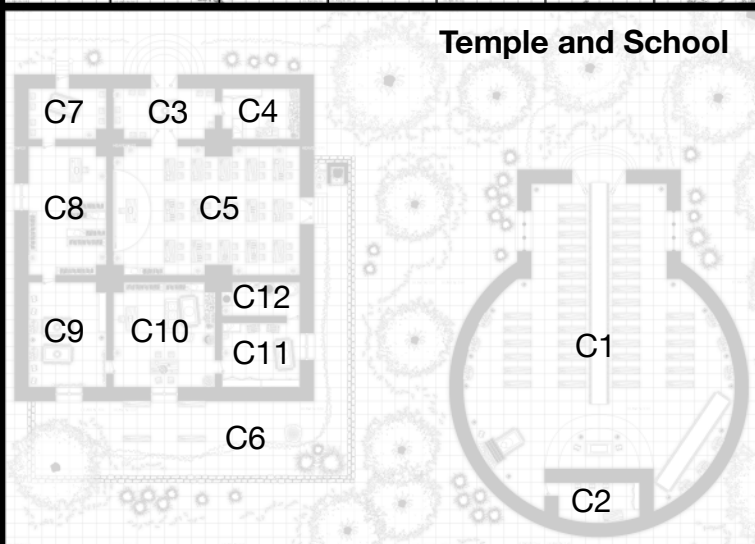
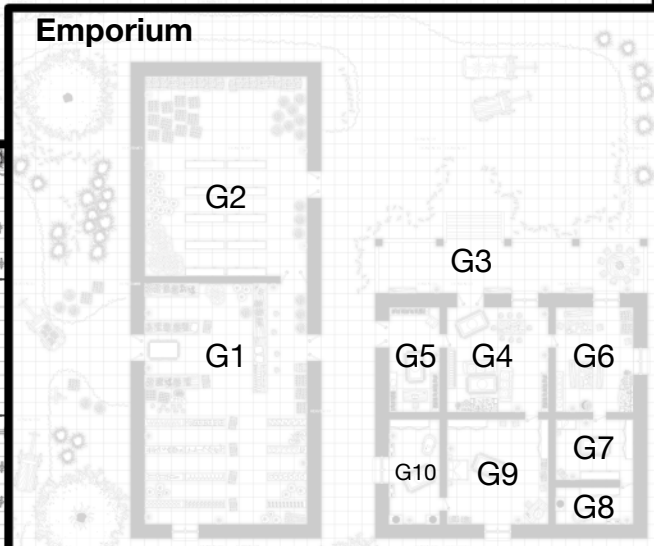
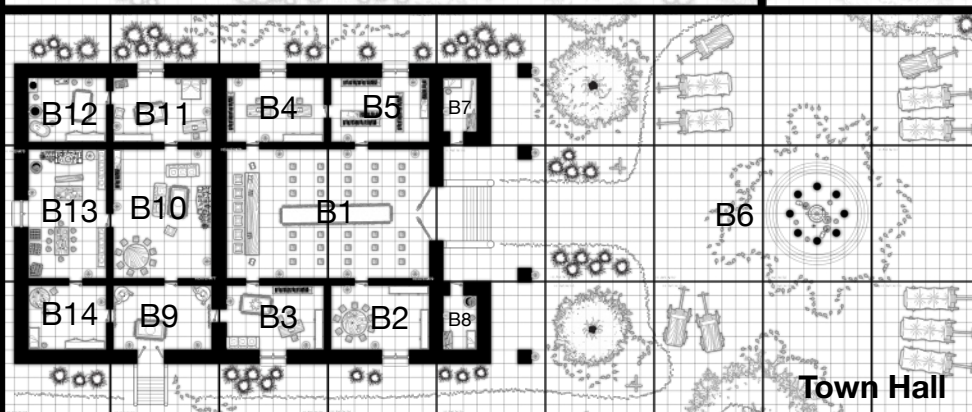
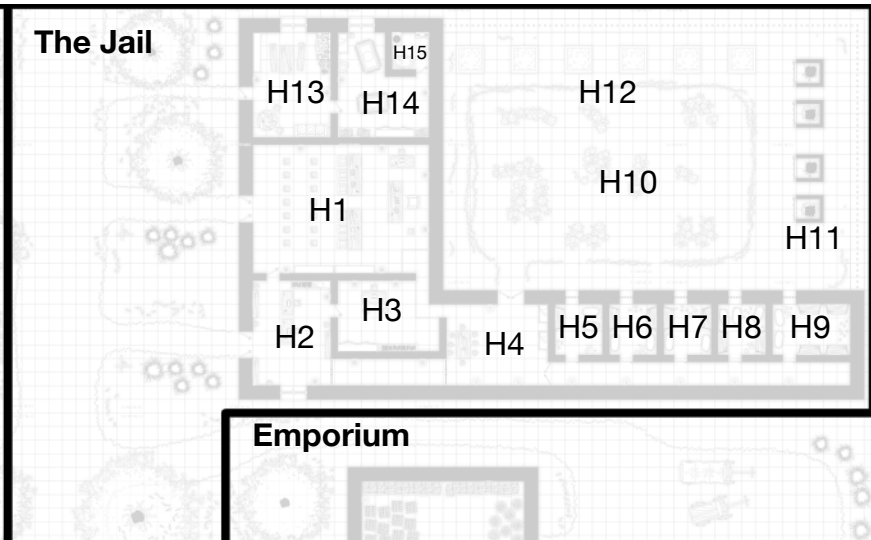
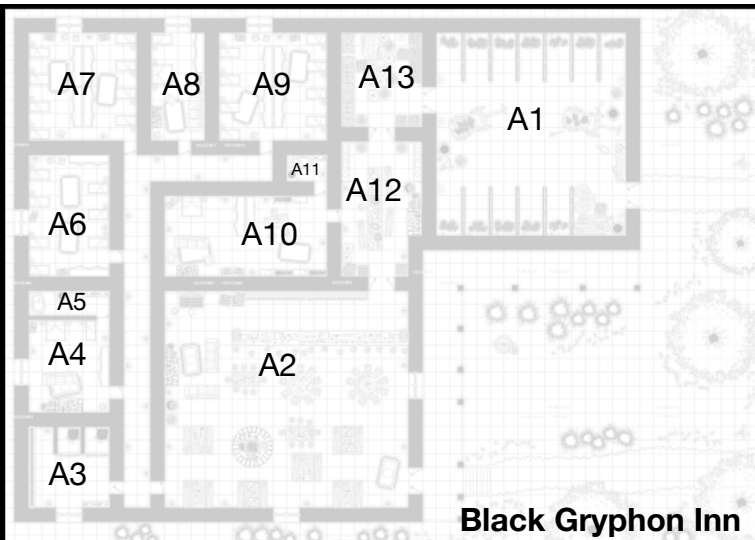

HEAVEN#61

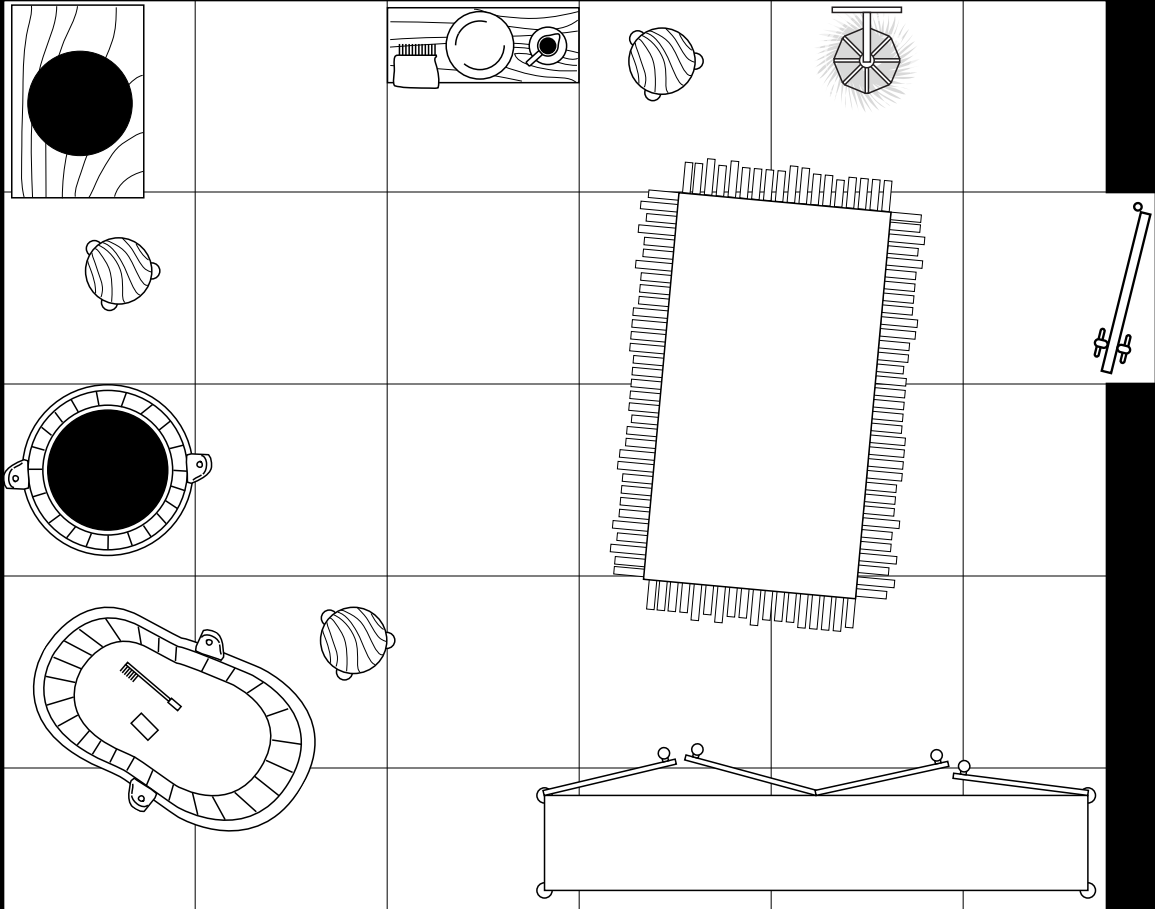
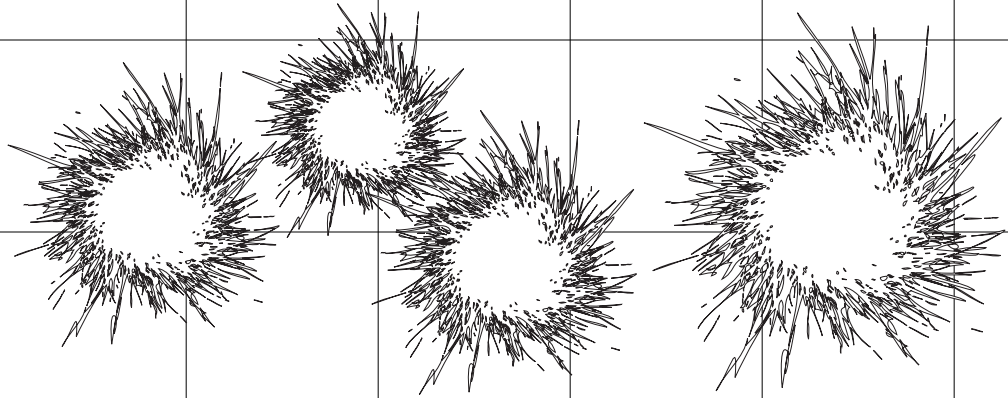

HEAVEN#62

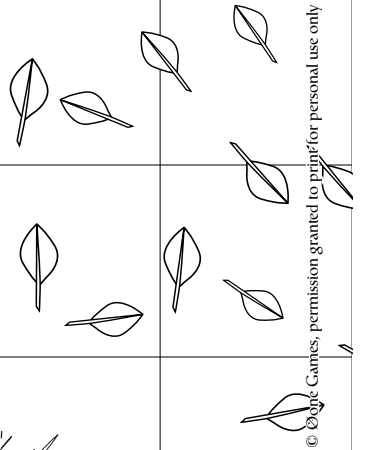
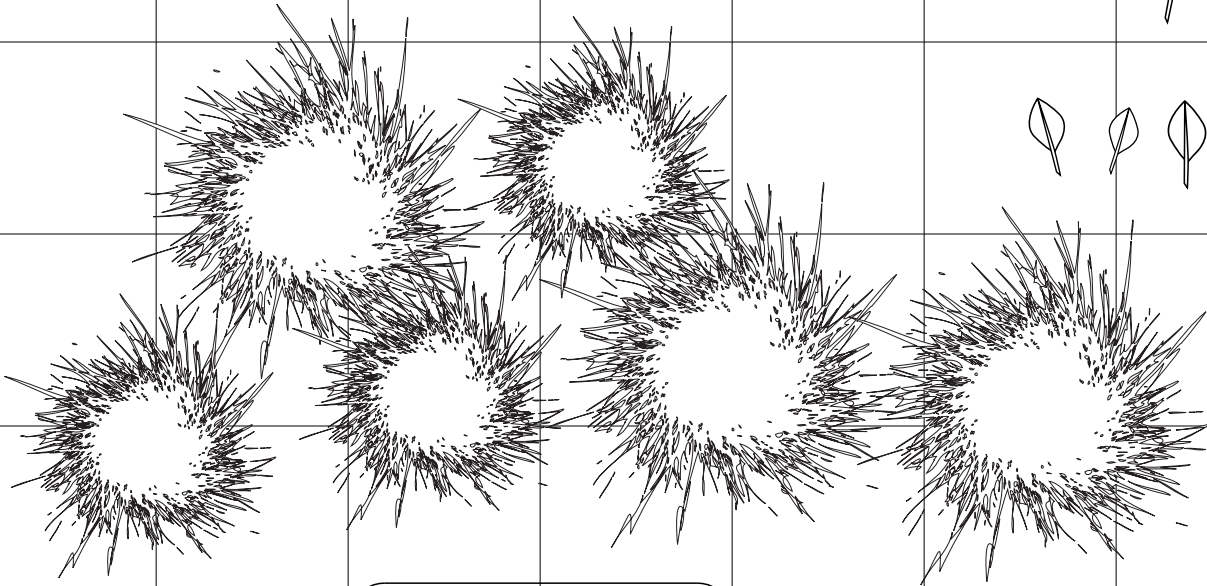

© 2016 Games, permission granted to print for personal use only

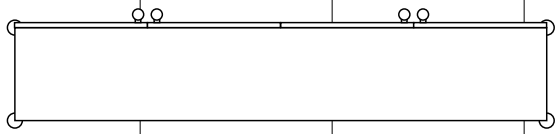
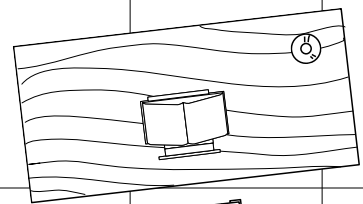
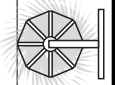
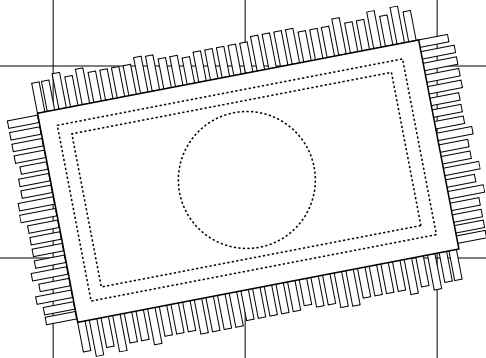
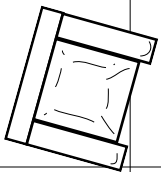
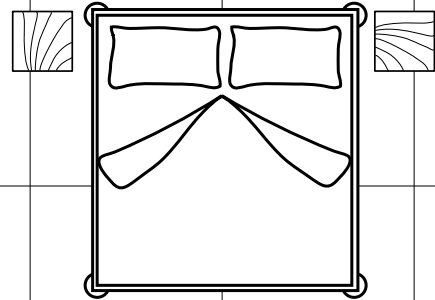
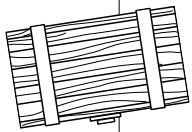
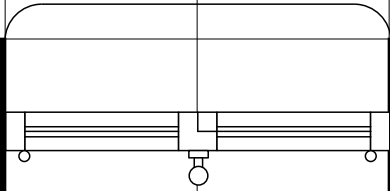

HEAVEN#63

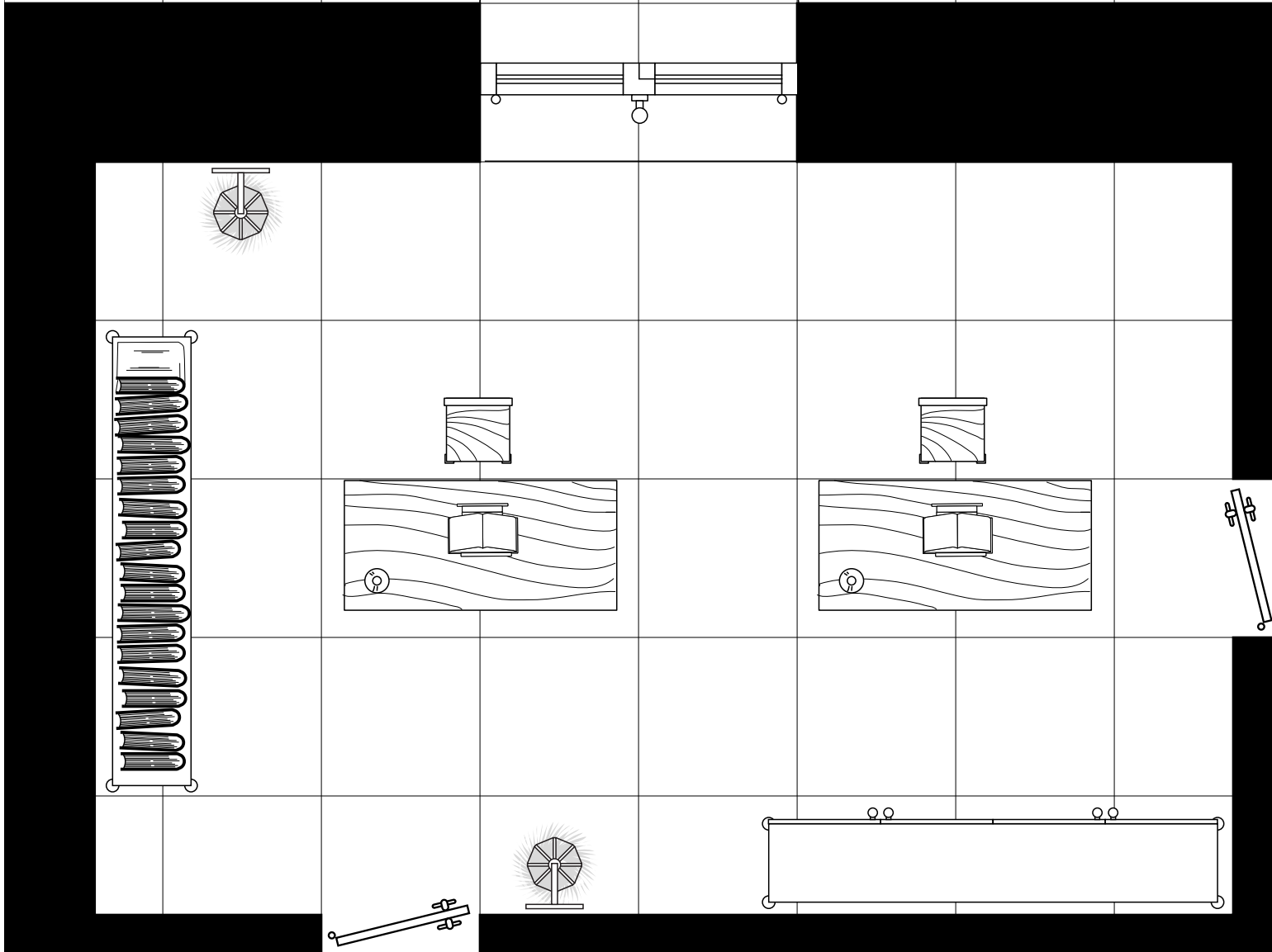
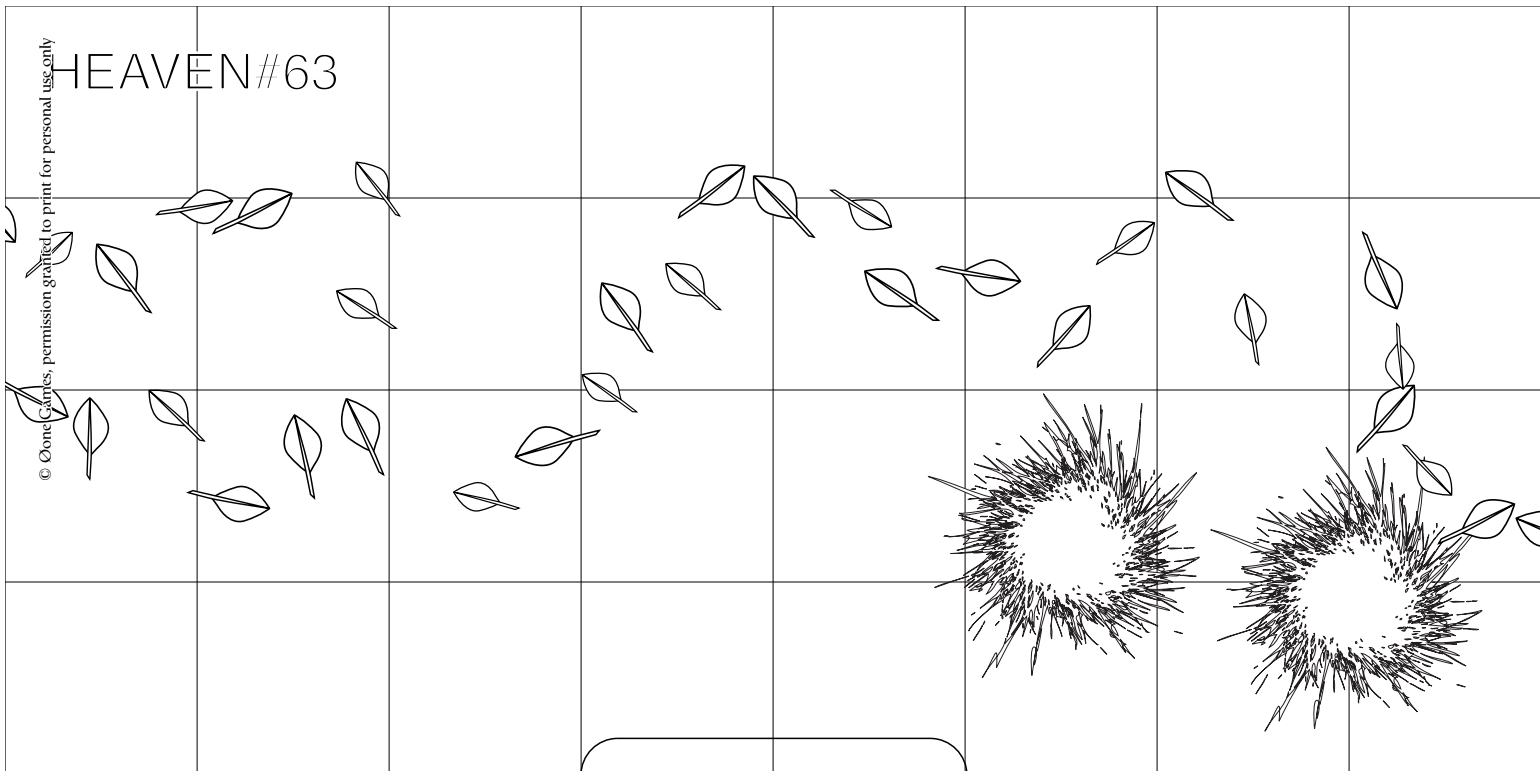

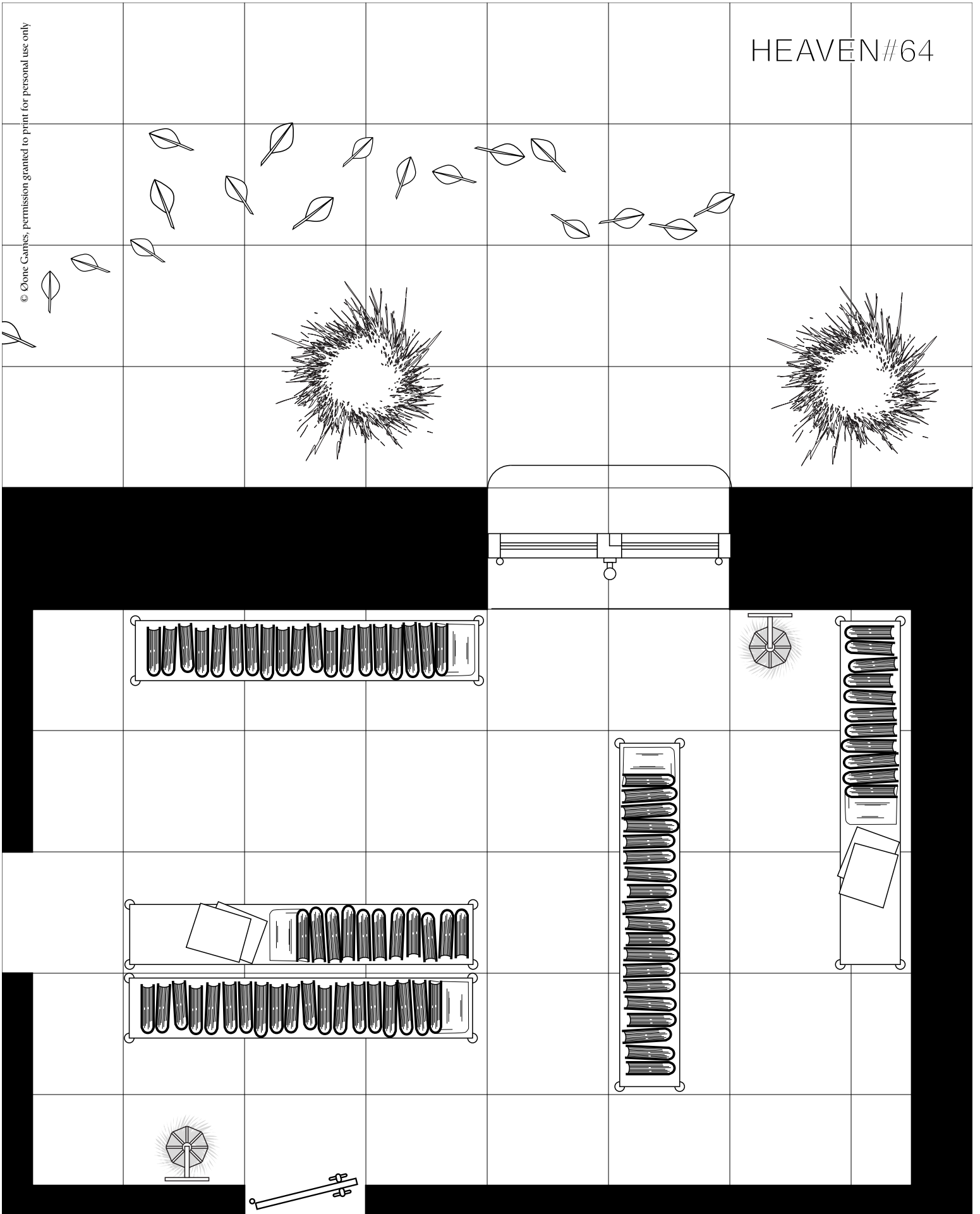

HEAVEN#65

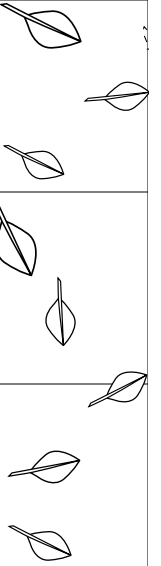
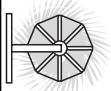
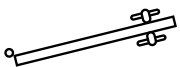
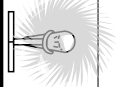
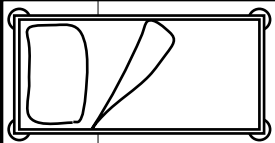
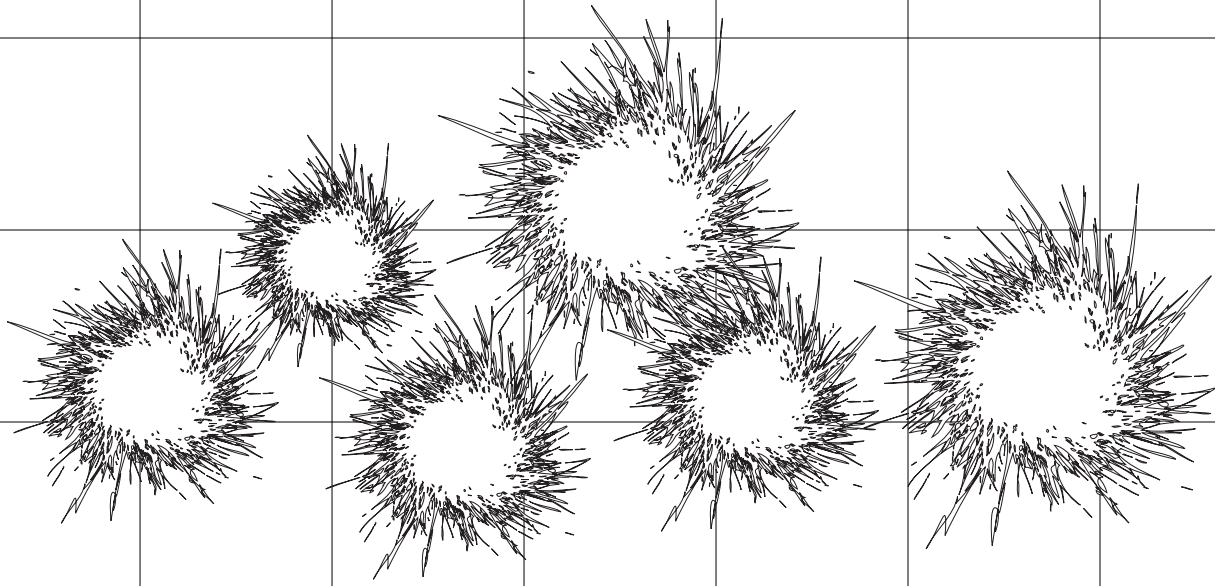

HEAVEN#66

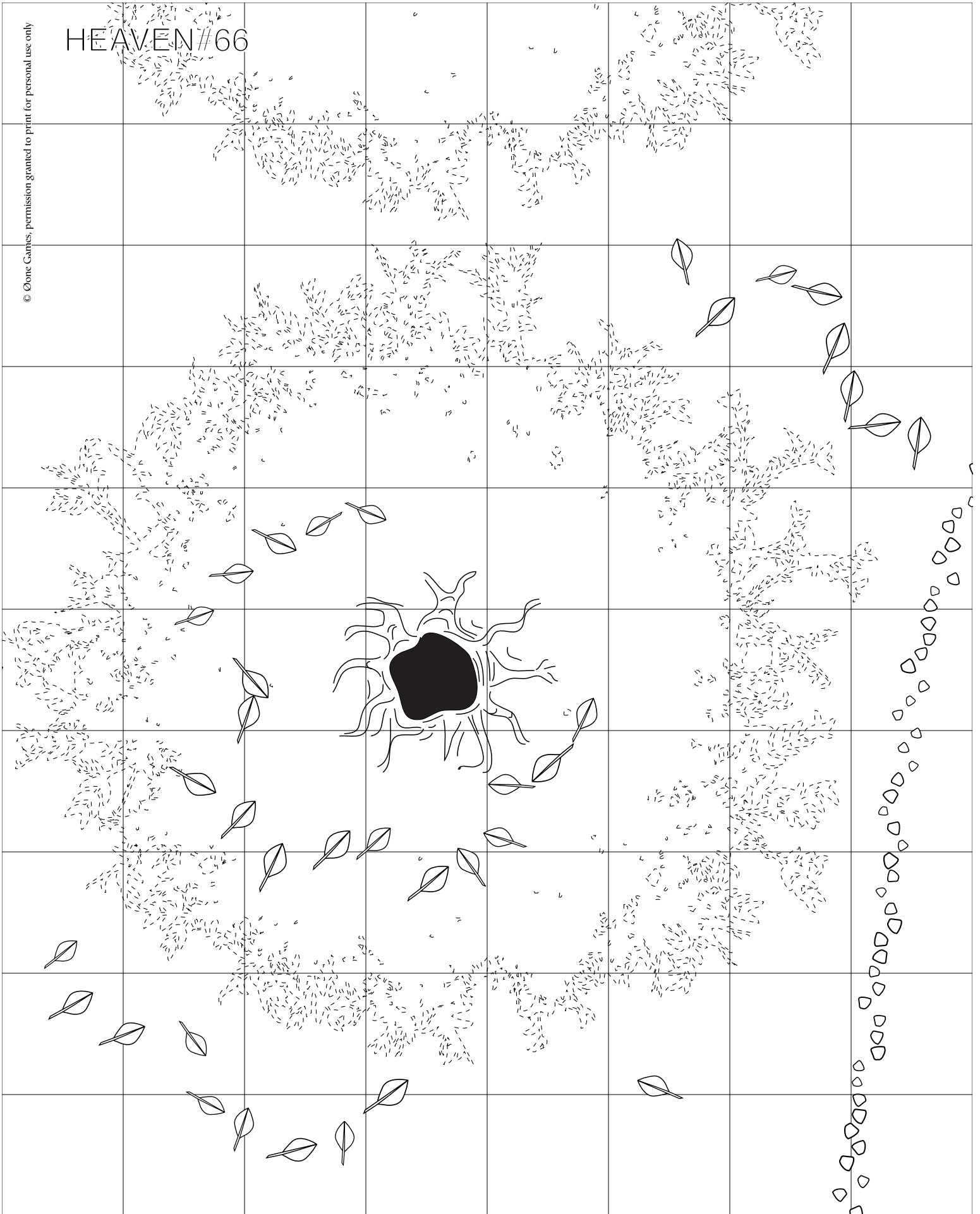

HEAVEN#67

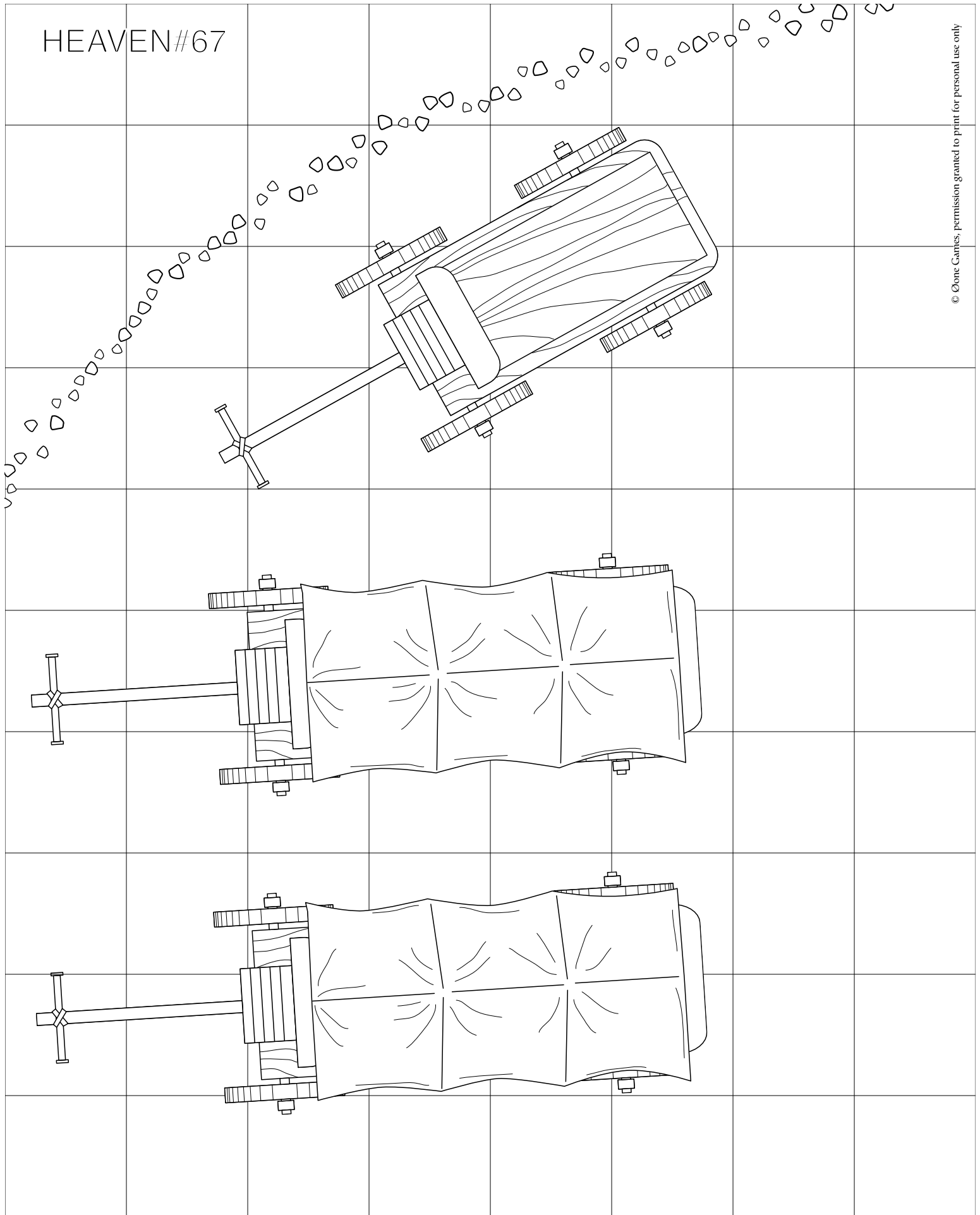

HEAVEN#68

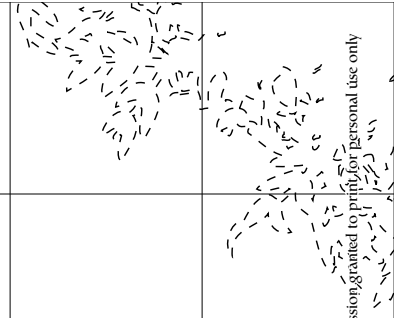

© Oone Games, permission granted to print for personal use only

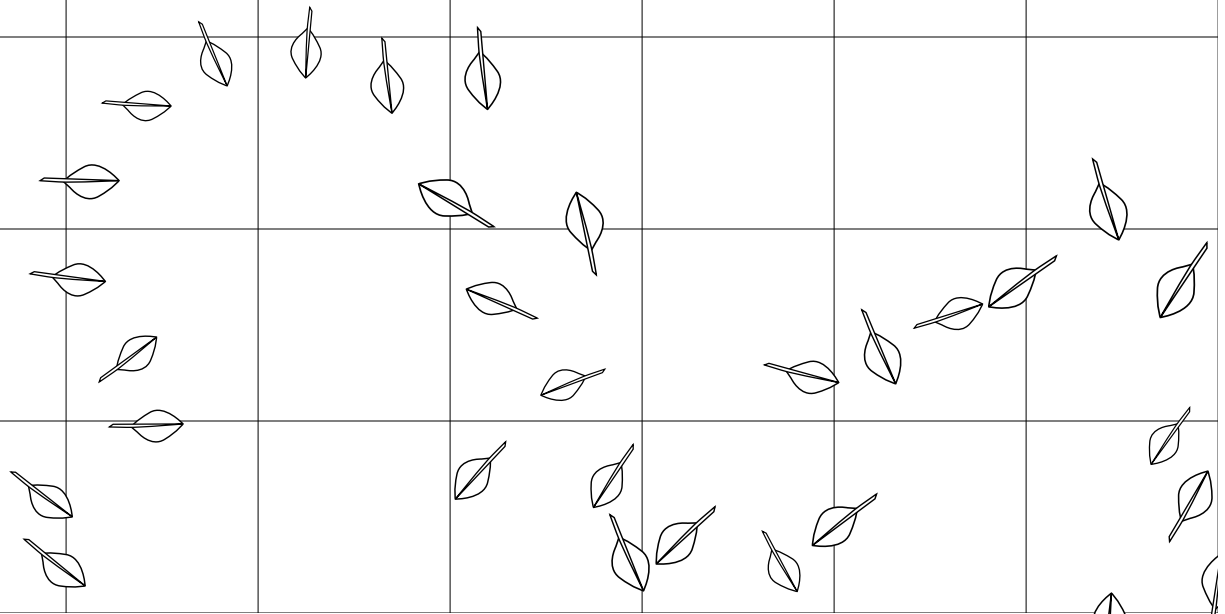

HEAVEN#69

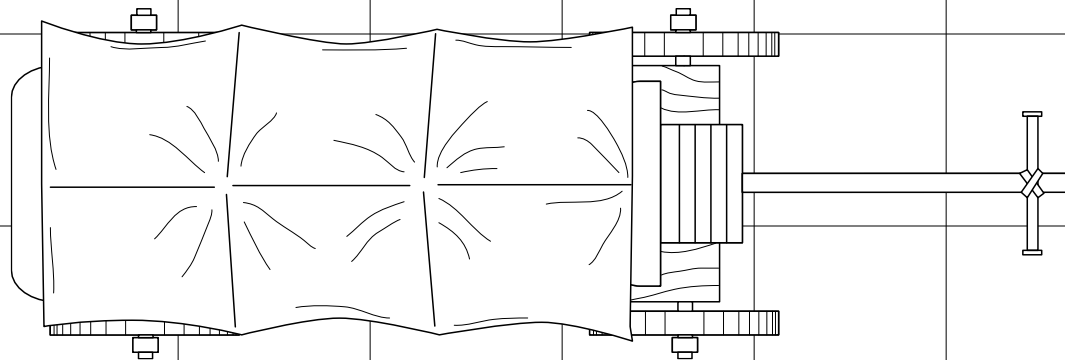
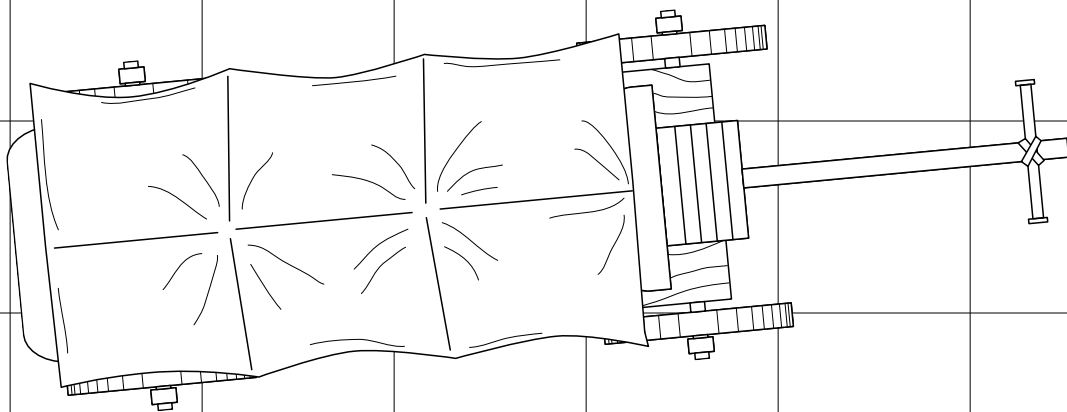
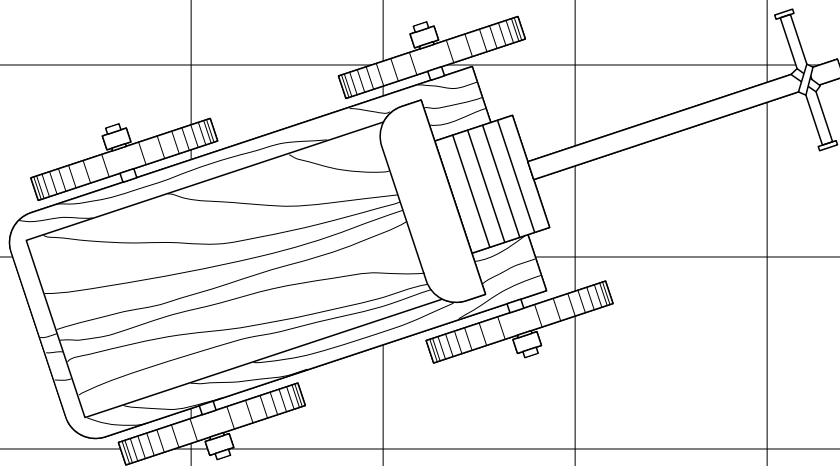
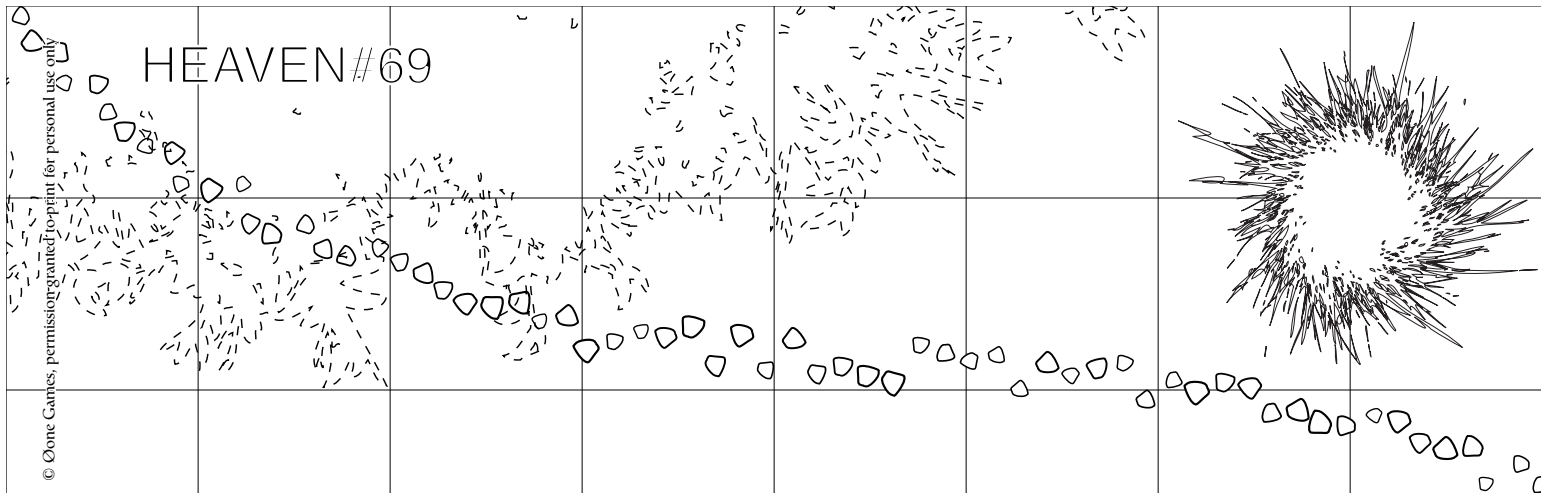

HEAVEN#76

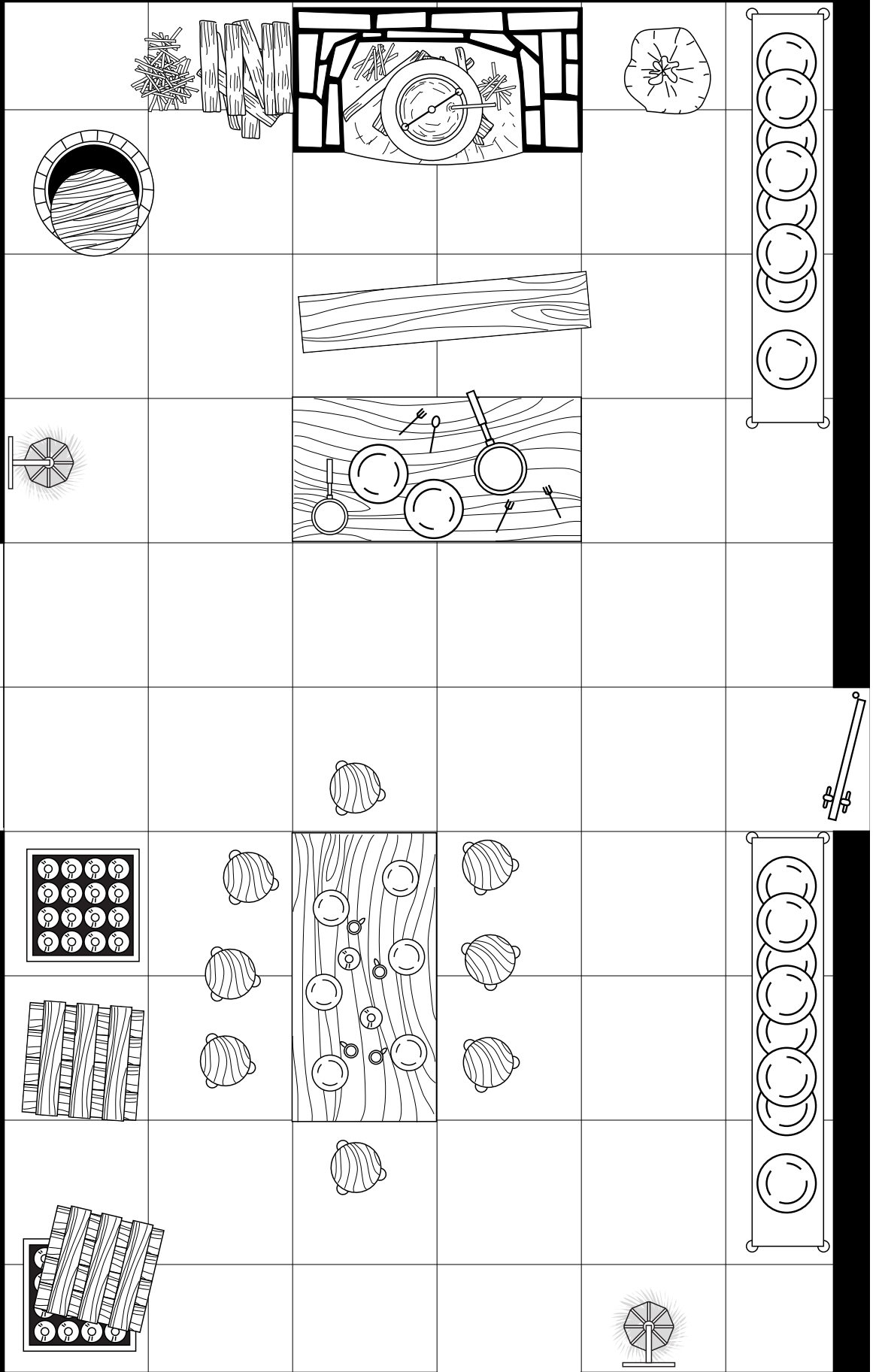

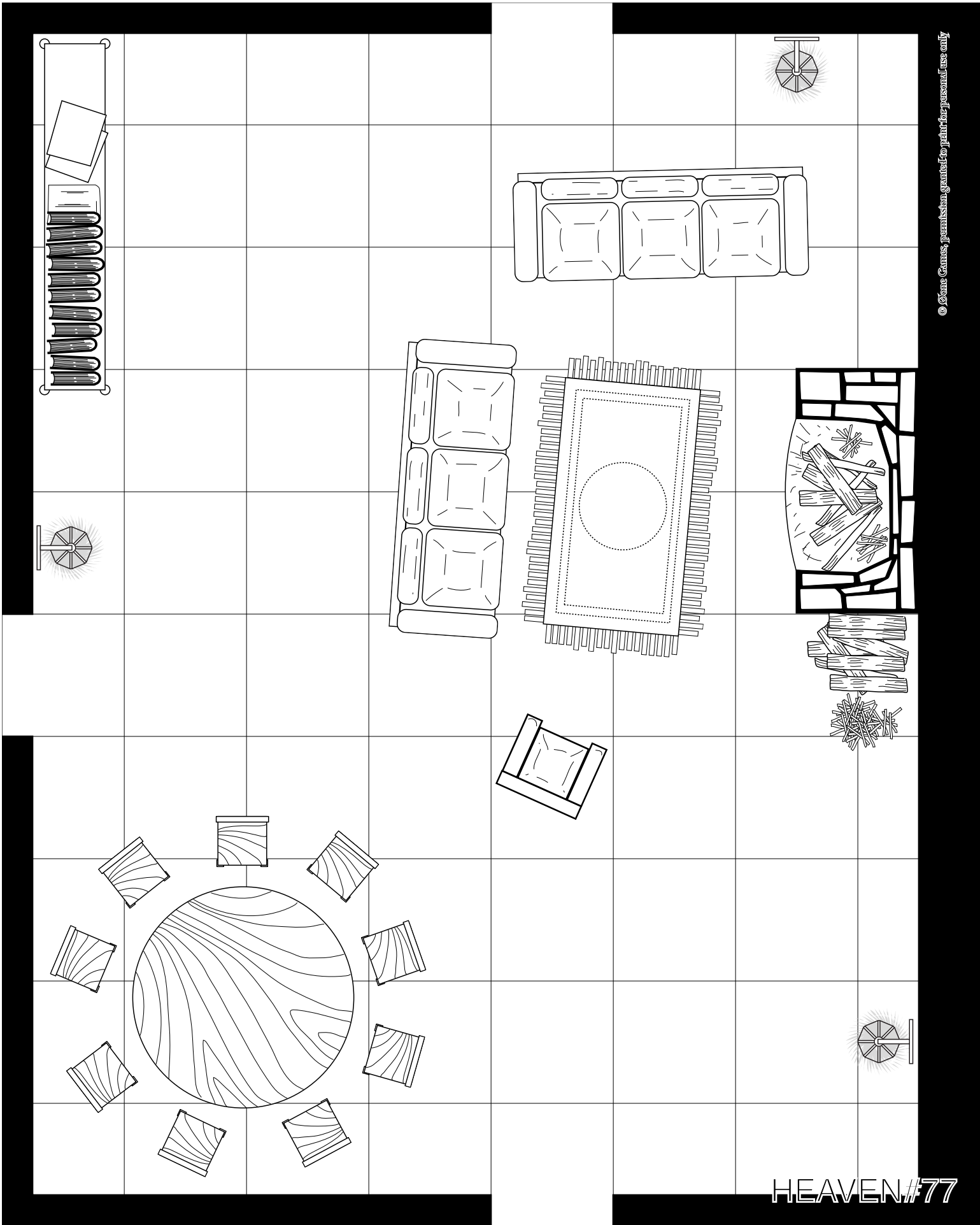

HEAVEN#78

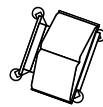
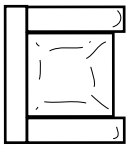
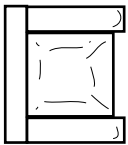
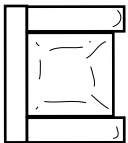
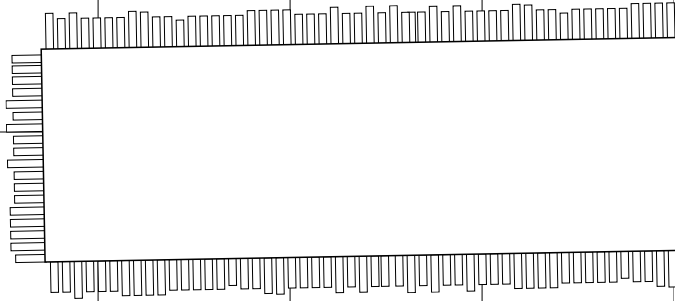
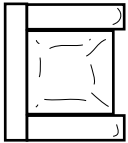
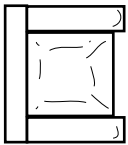
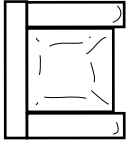
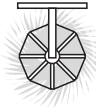
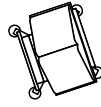

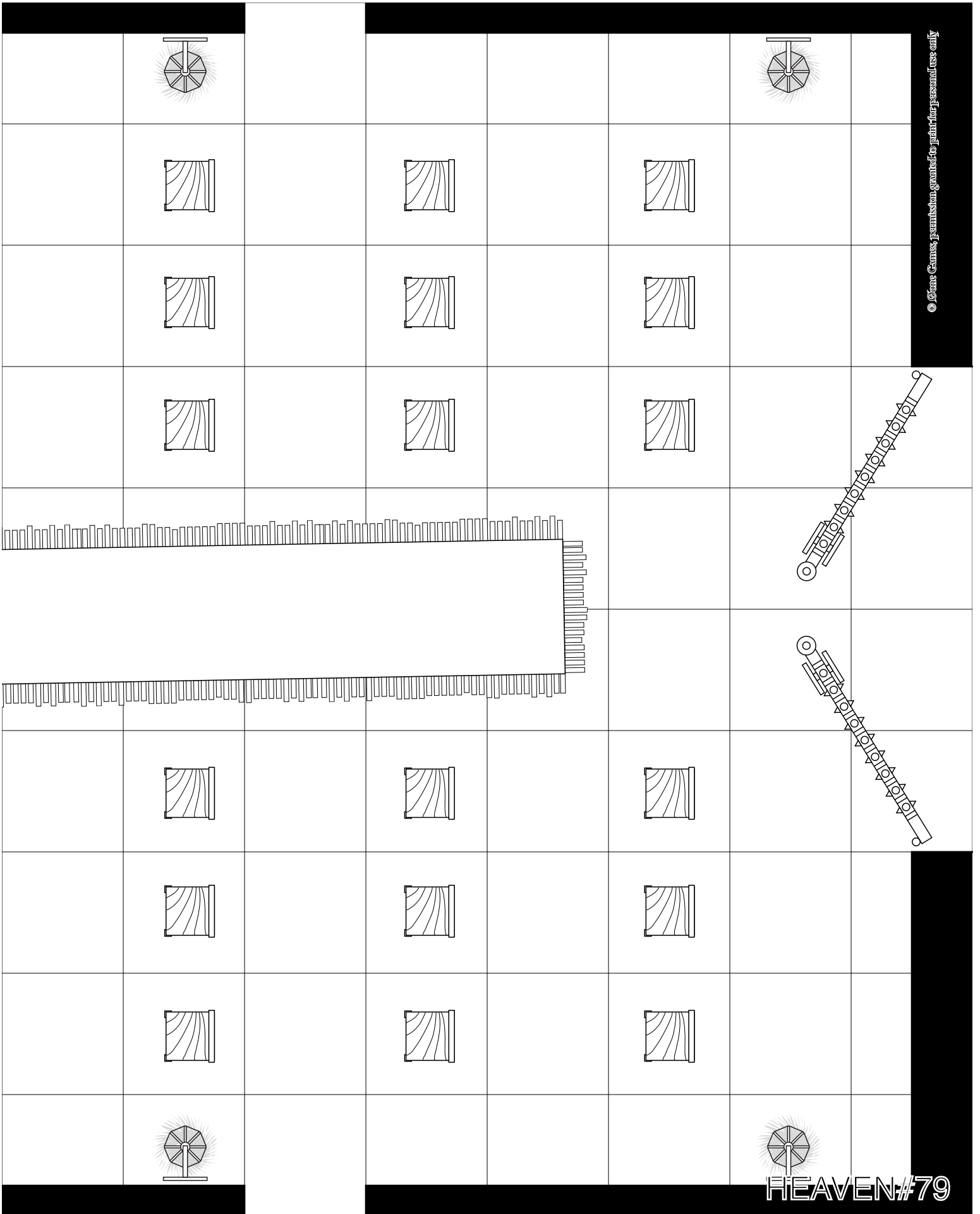

HEAVEN#80

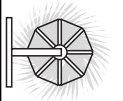

© One Games, permission granted to print for personal use only

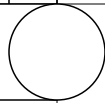
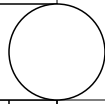

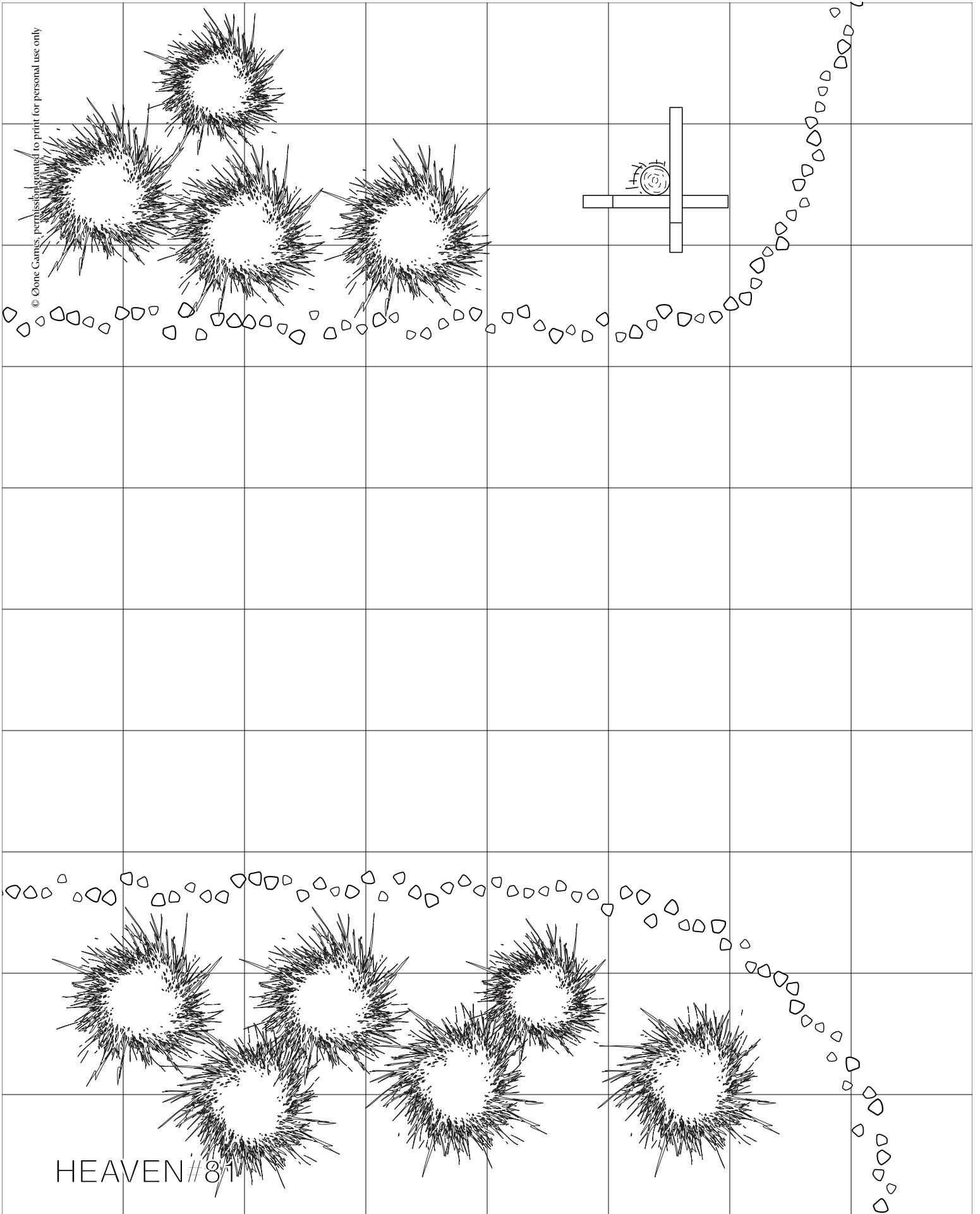

HEAVEN #81

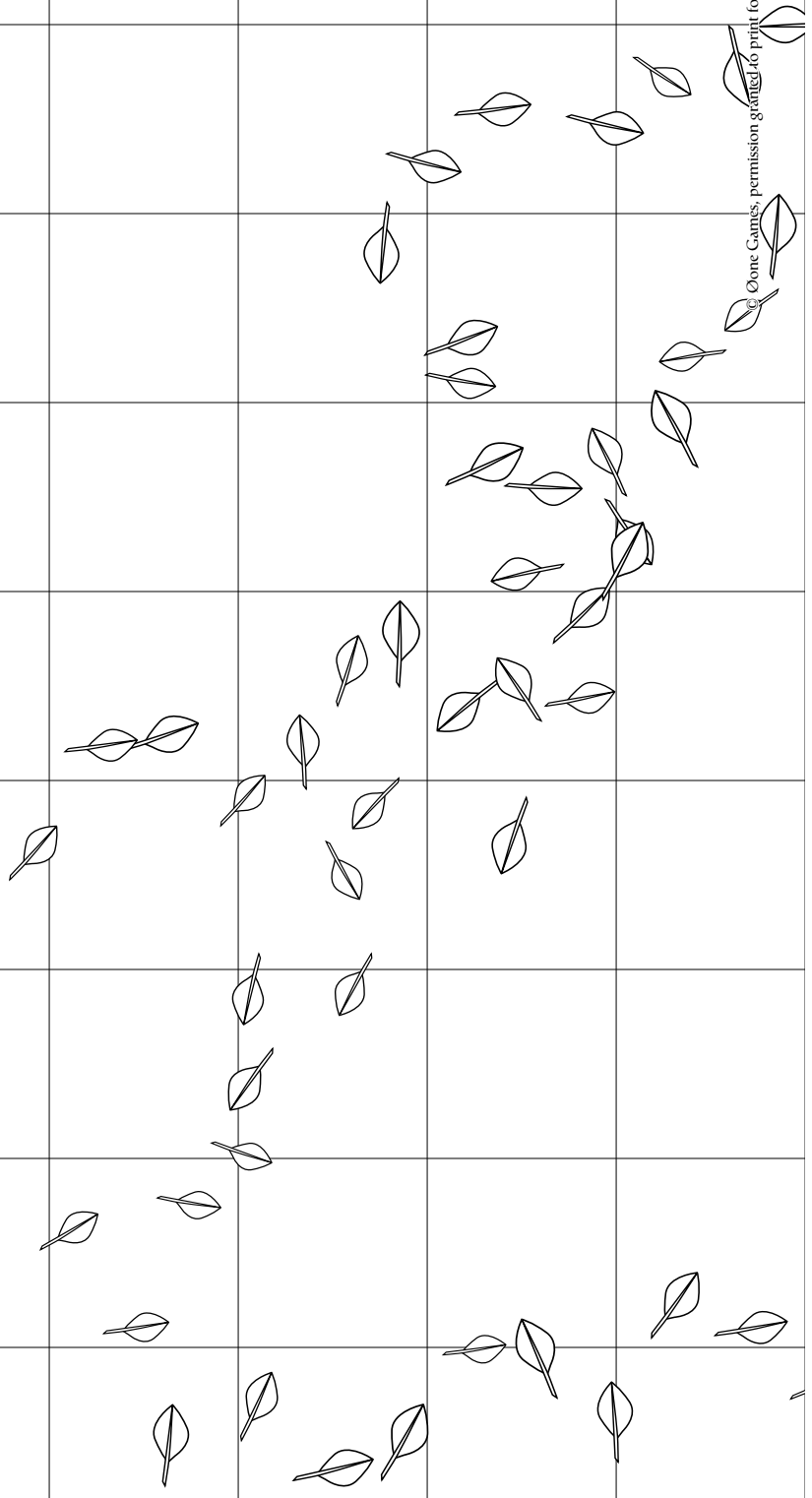

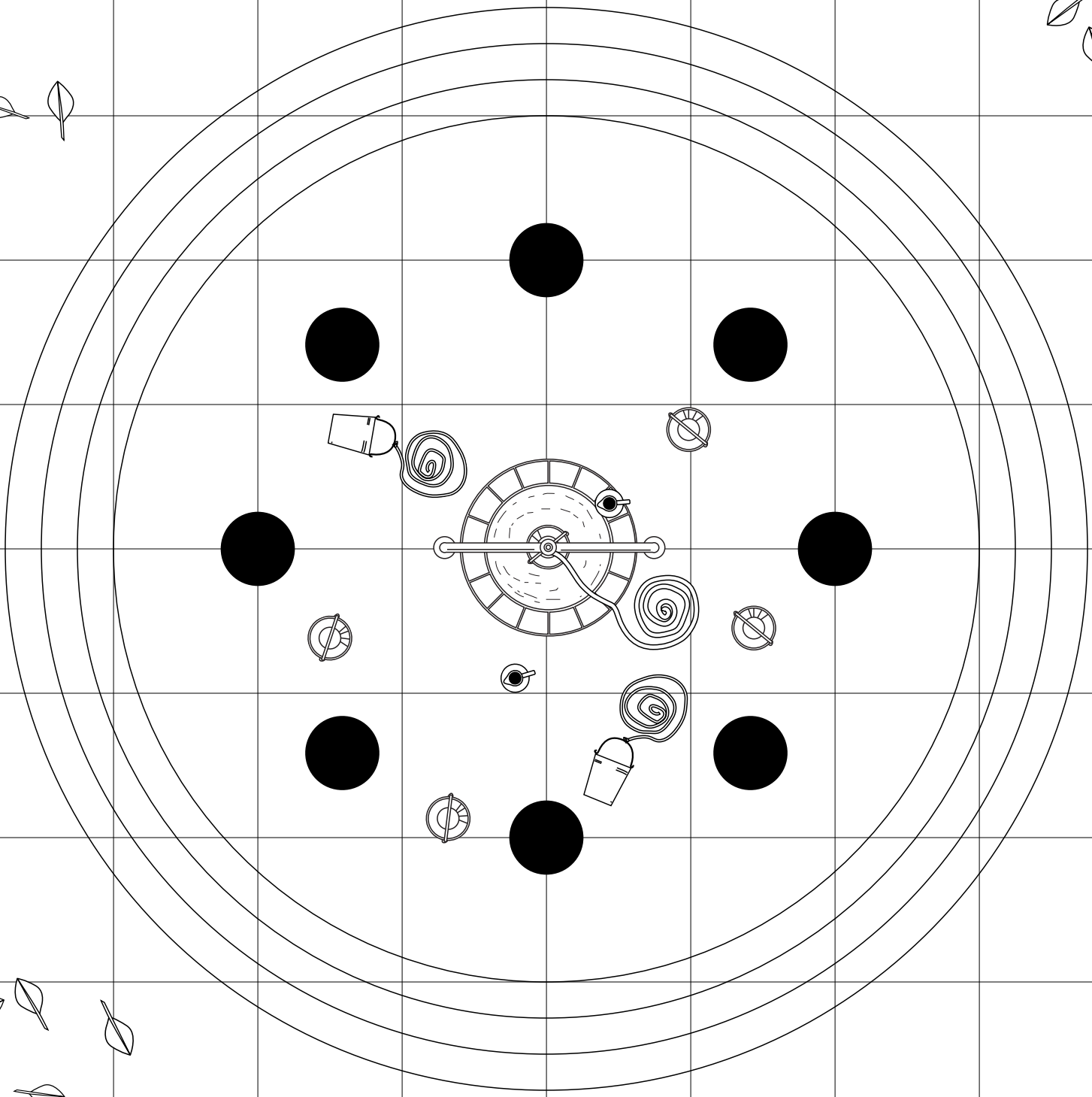

HEAVEN#83

HEAVEN#84

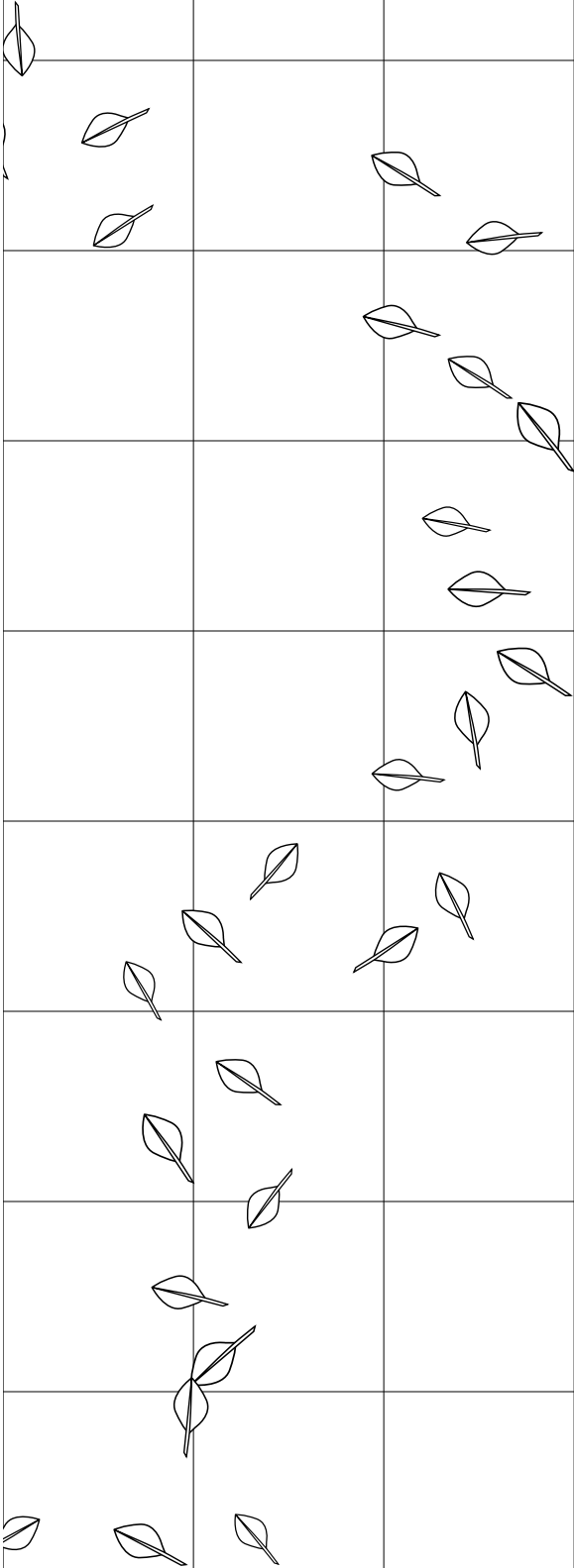

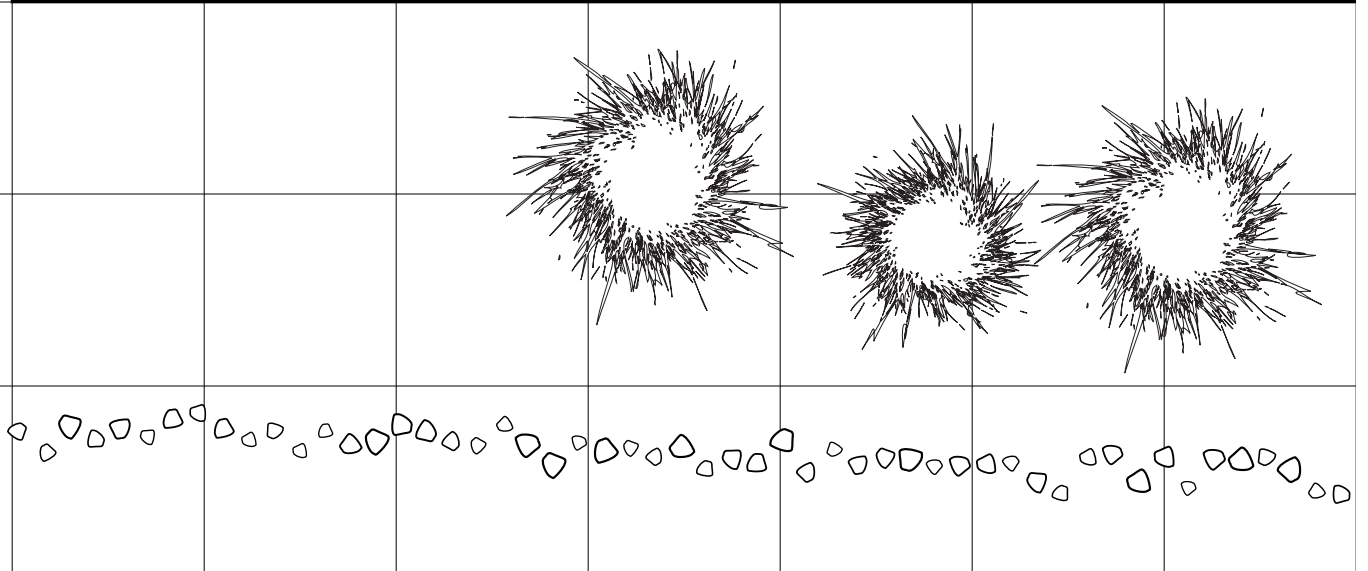
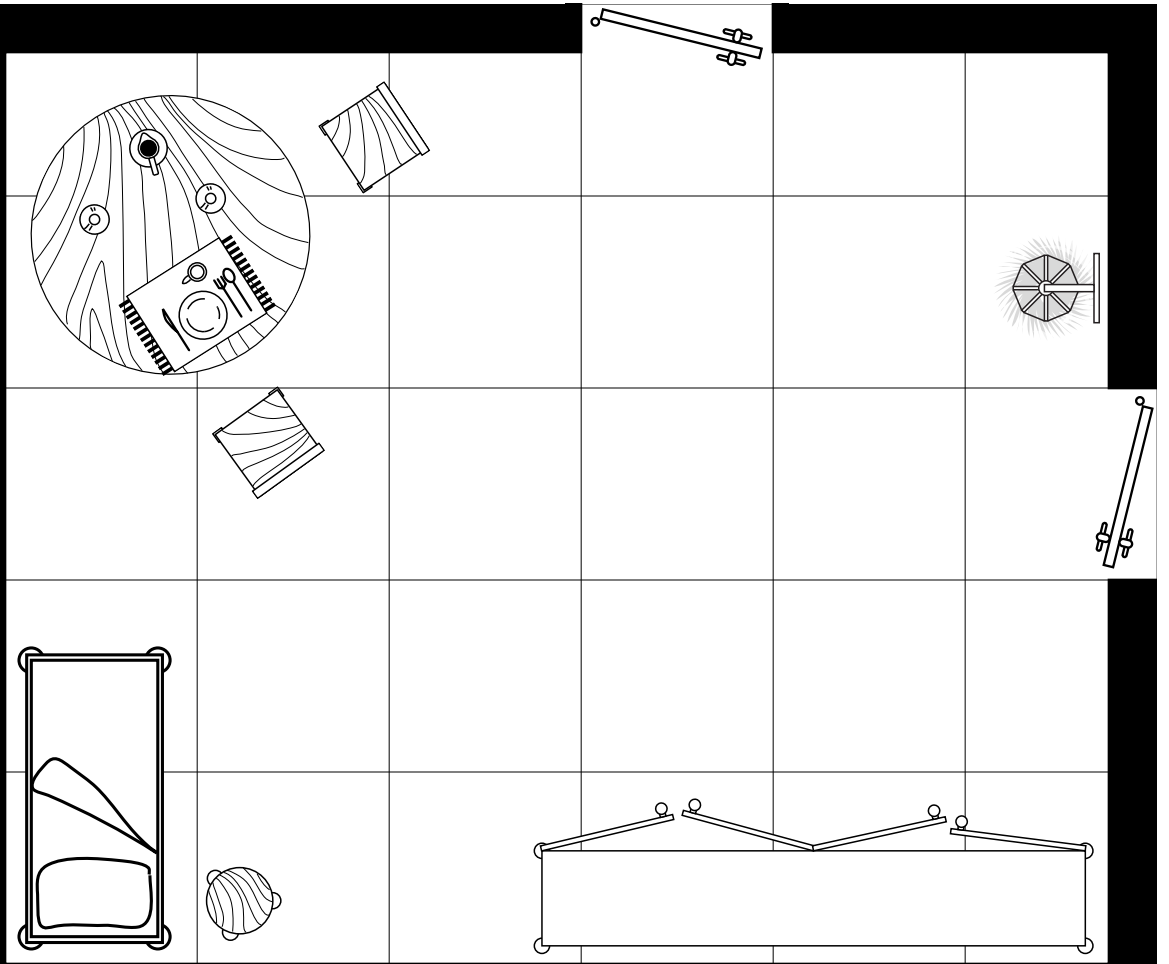

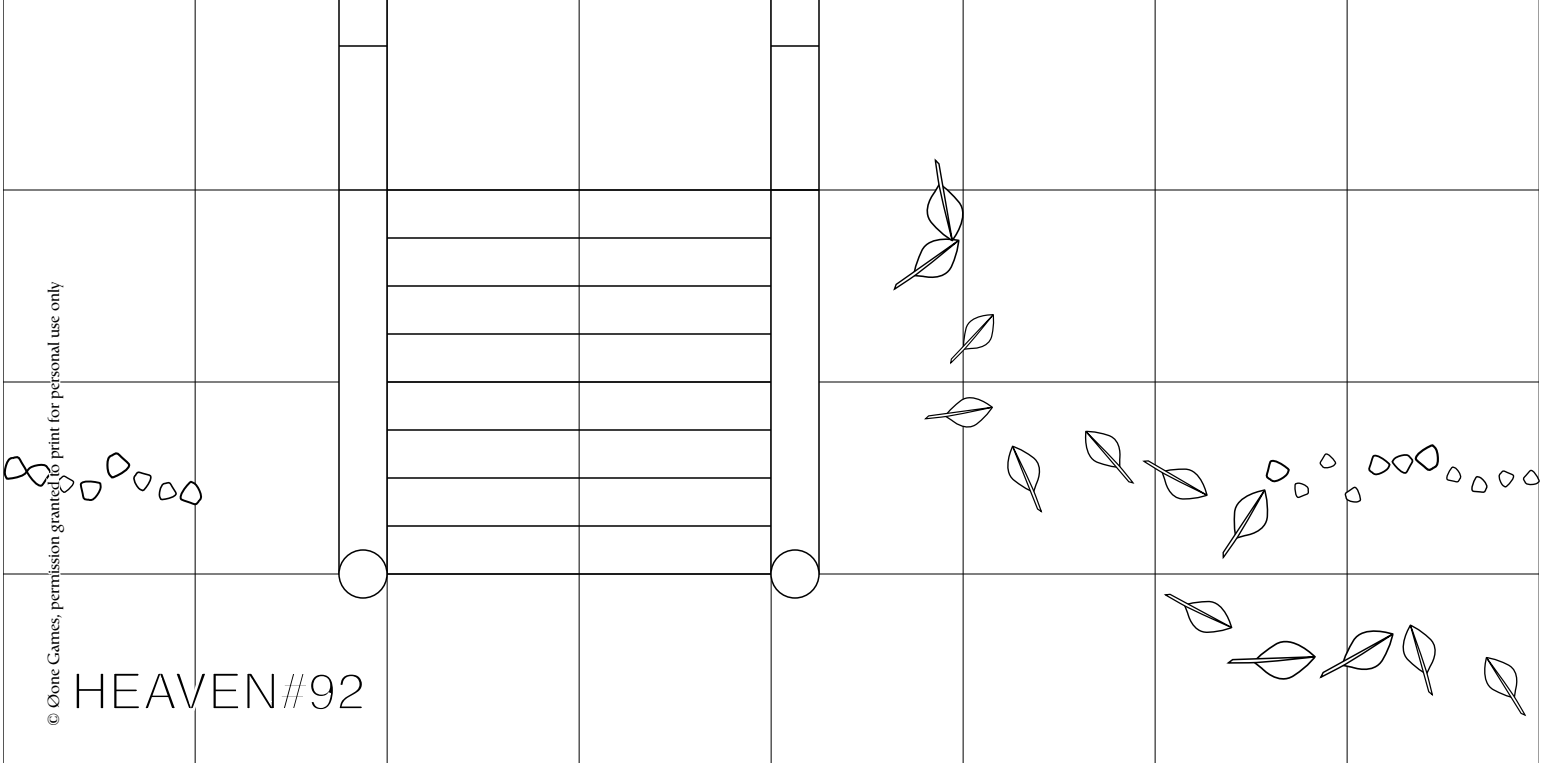
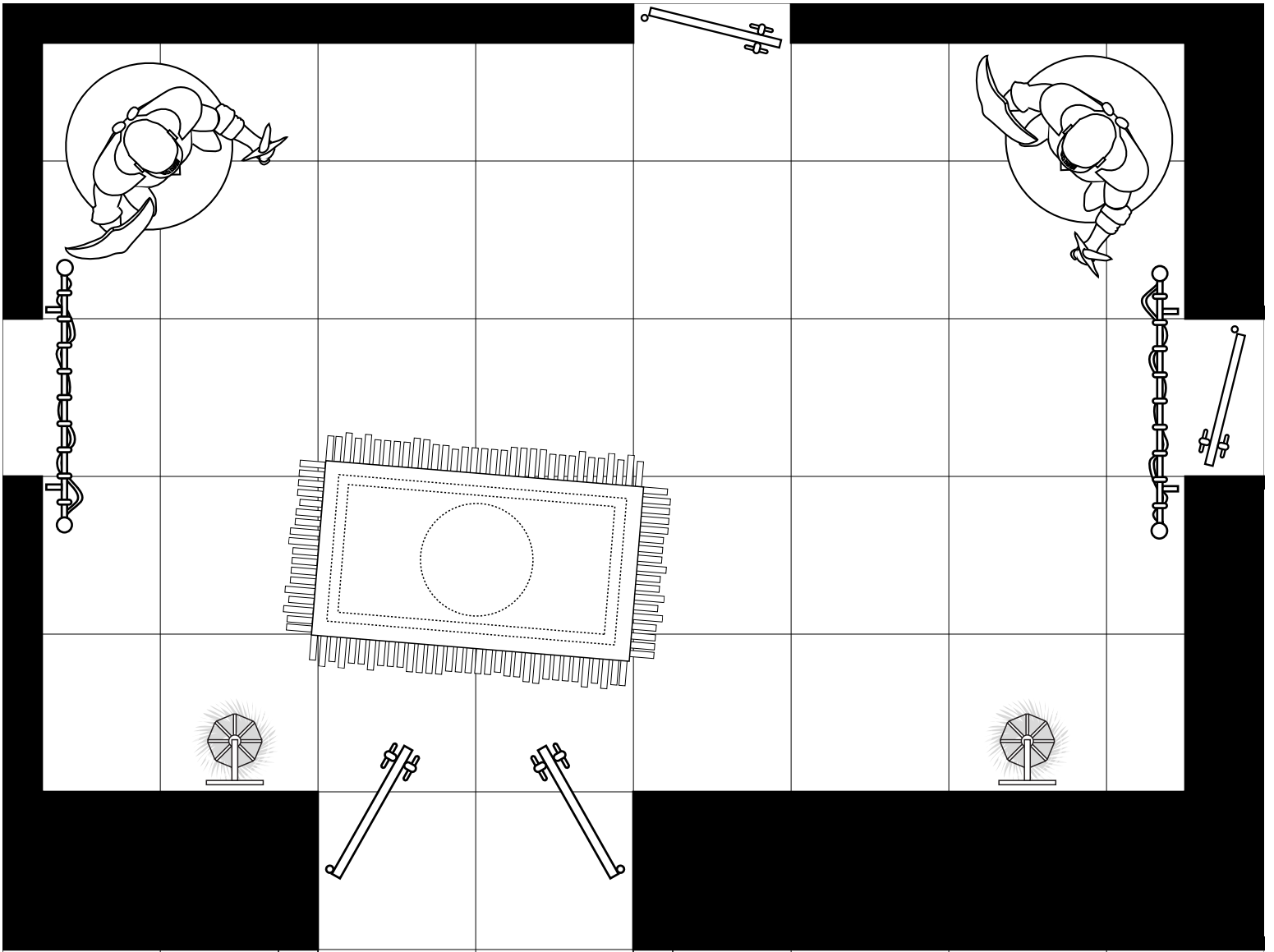

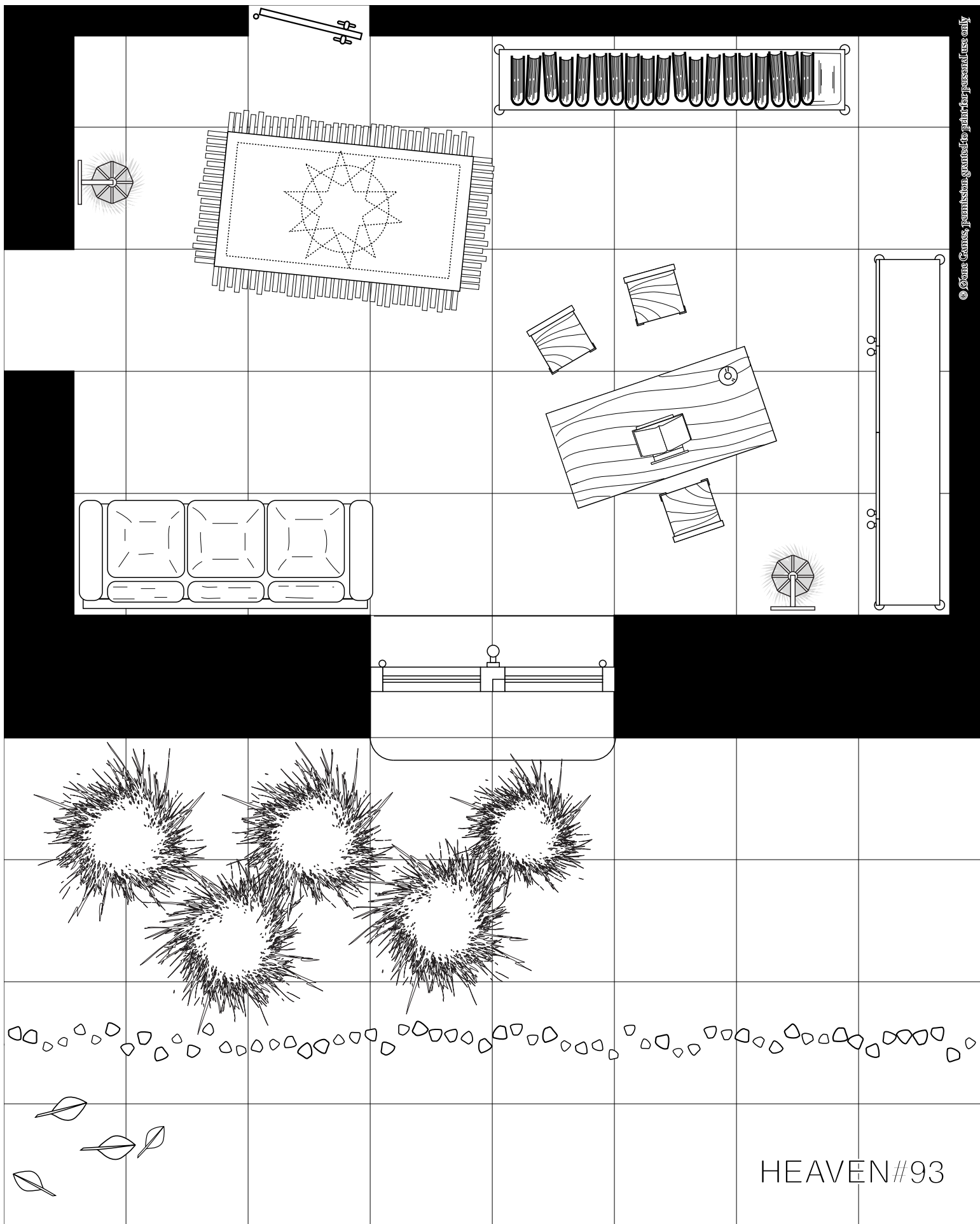

HEAVEN#93

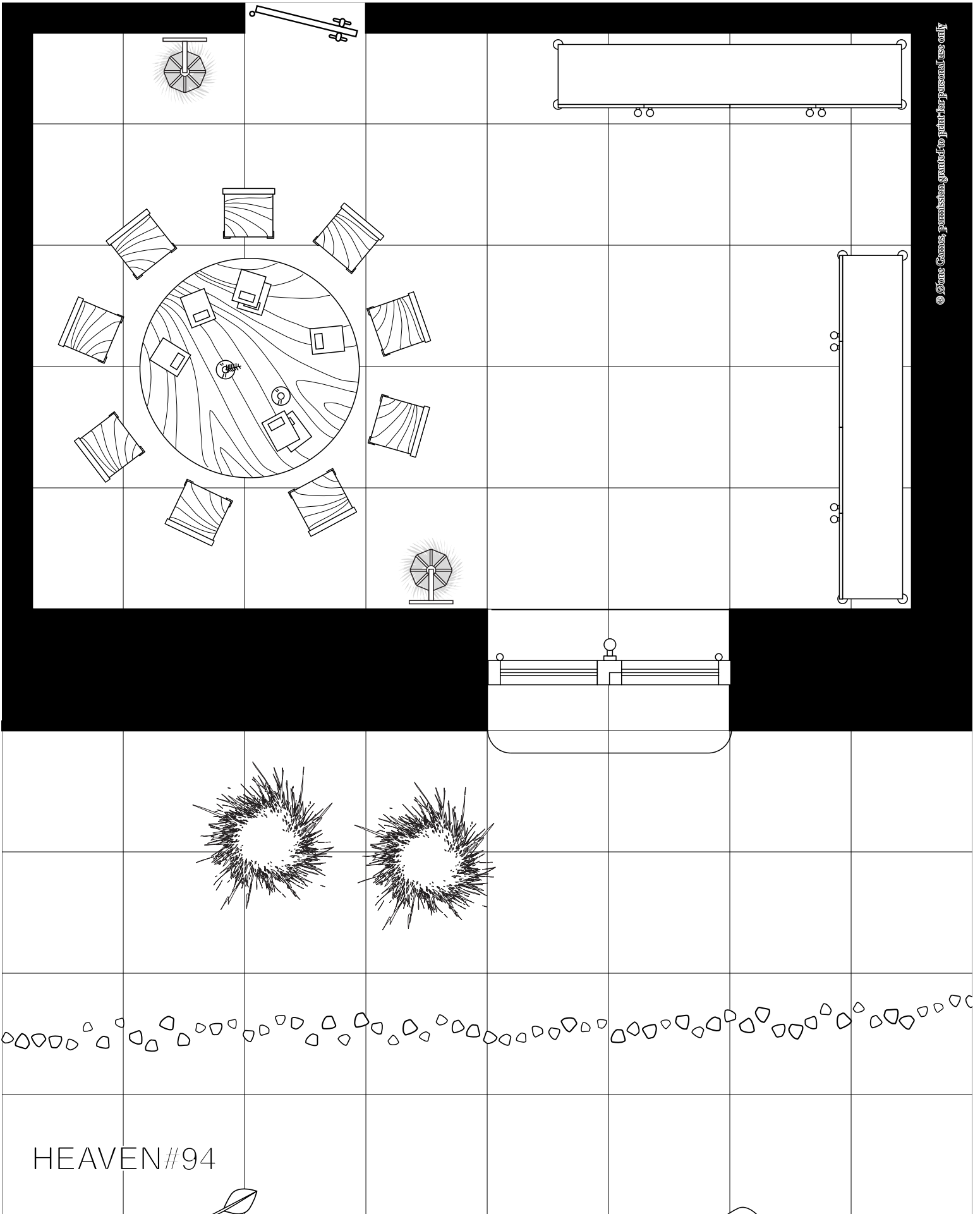

HEAVEN#94



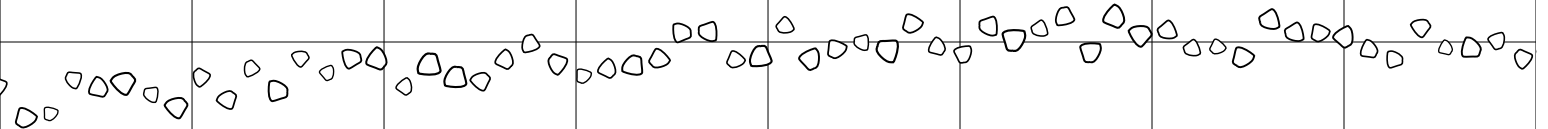
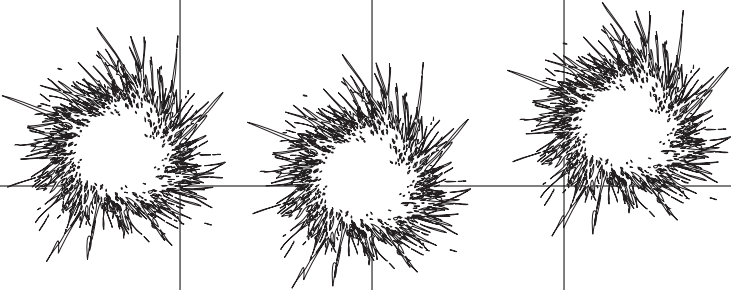
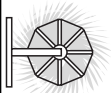
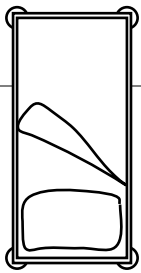
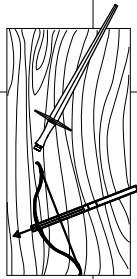
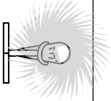
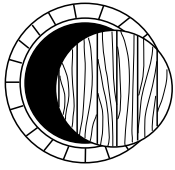
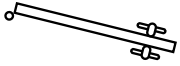

HEAVEN#95

HEAVEN#96

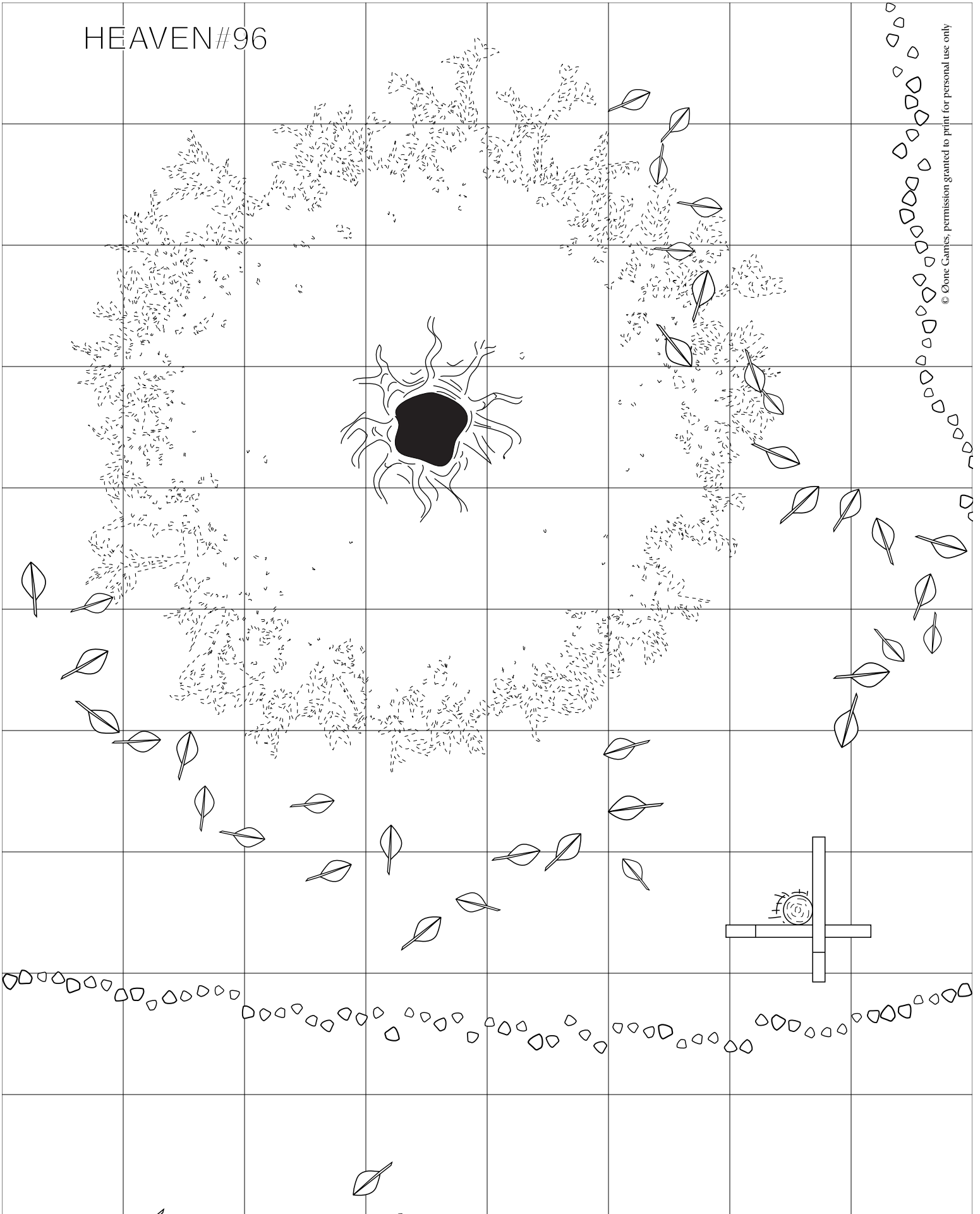

HEAVEN#97

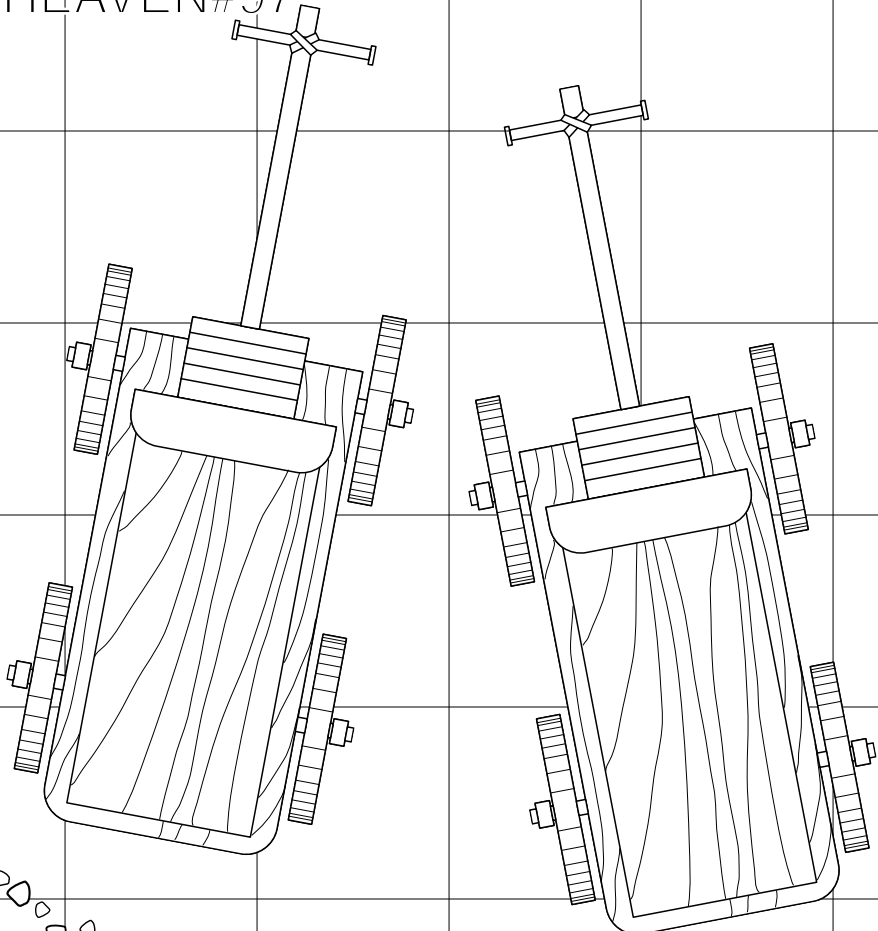

HEAVEN#98

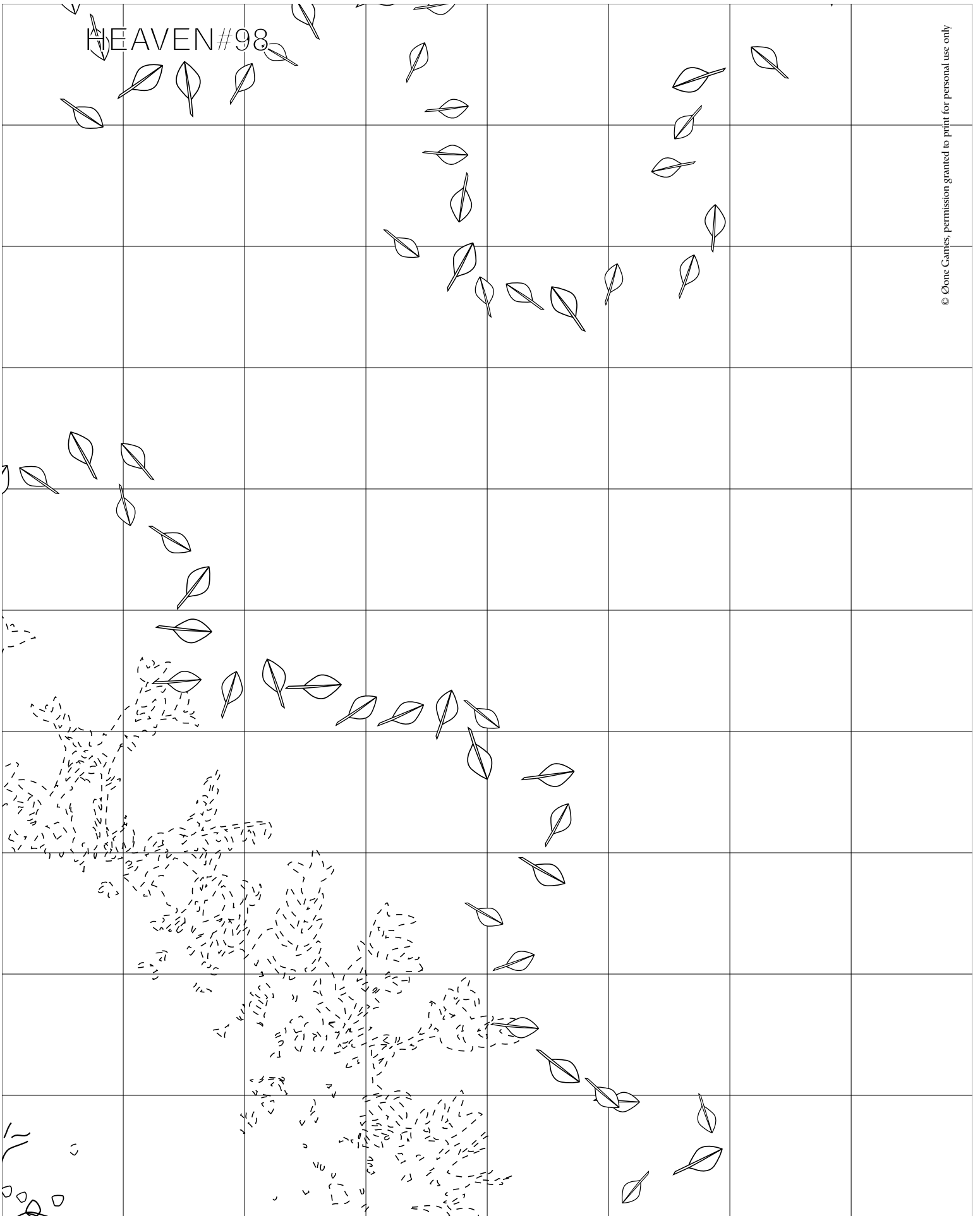

HEAVEN#99

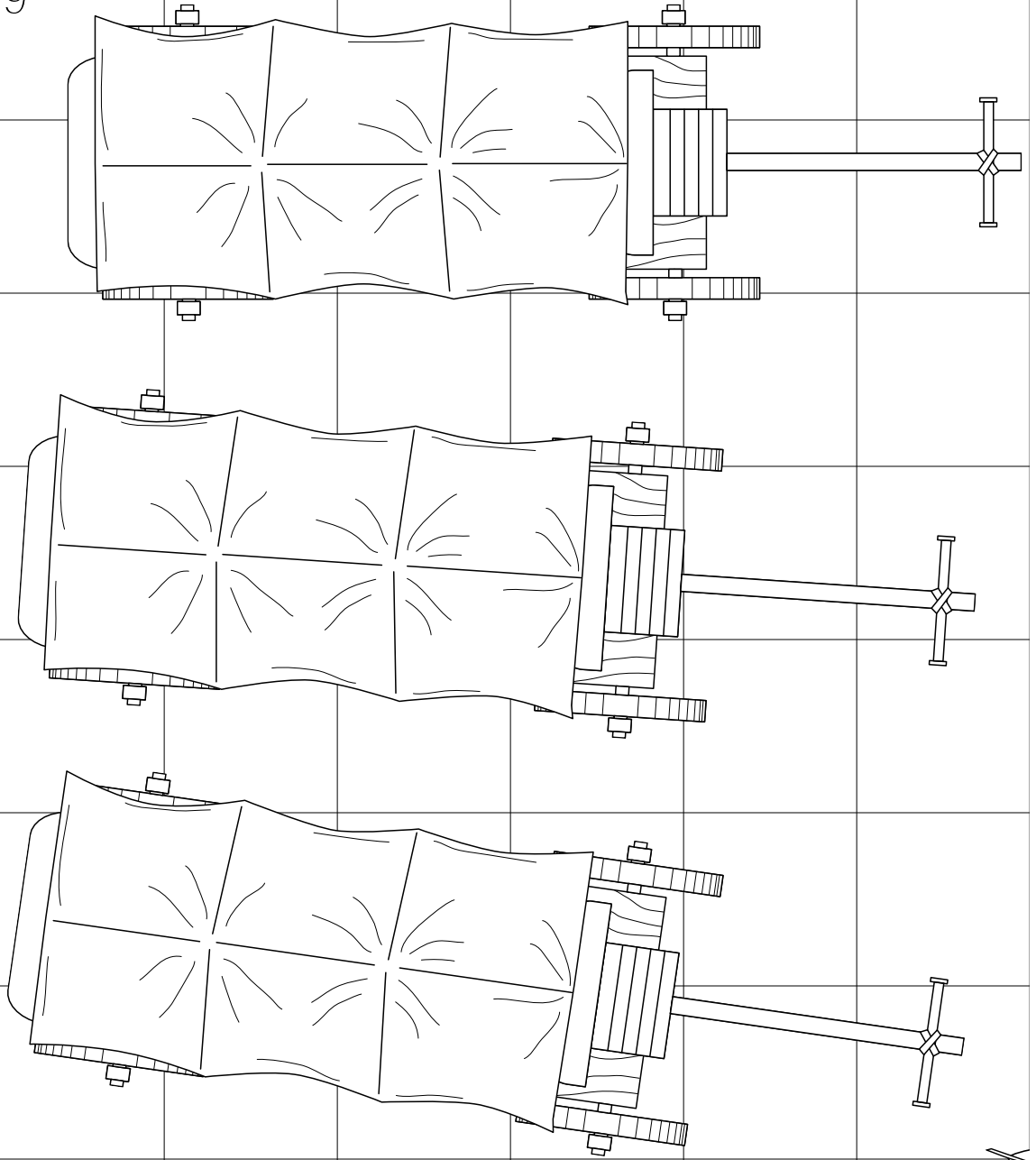



DUNGEON OF TERROR VIRTUAL BOXED SET[®]

THE LARGEST DUNGEON EVER TILED NOW BOXED!

- EIGHT ORIGINAL PRODUCTS FORMING THE DUNGEON OF TERROR
- A REFEREE MAP FEATURING THE WHOLE DUNGEON
- RANDOM ENCOUNTER TABLES
- A SET OF 164 ROOM TEMPLATES



 the first d20 pdf publisher of the world
www.Oonegames.com