

Done's

BLACK & WHITE

WHITE

WYVERN INN

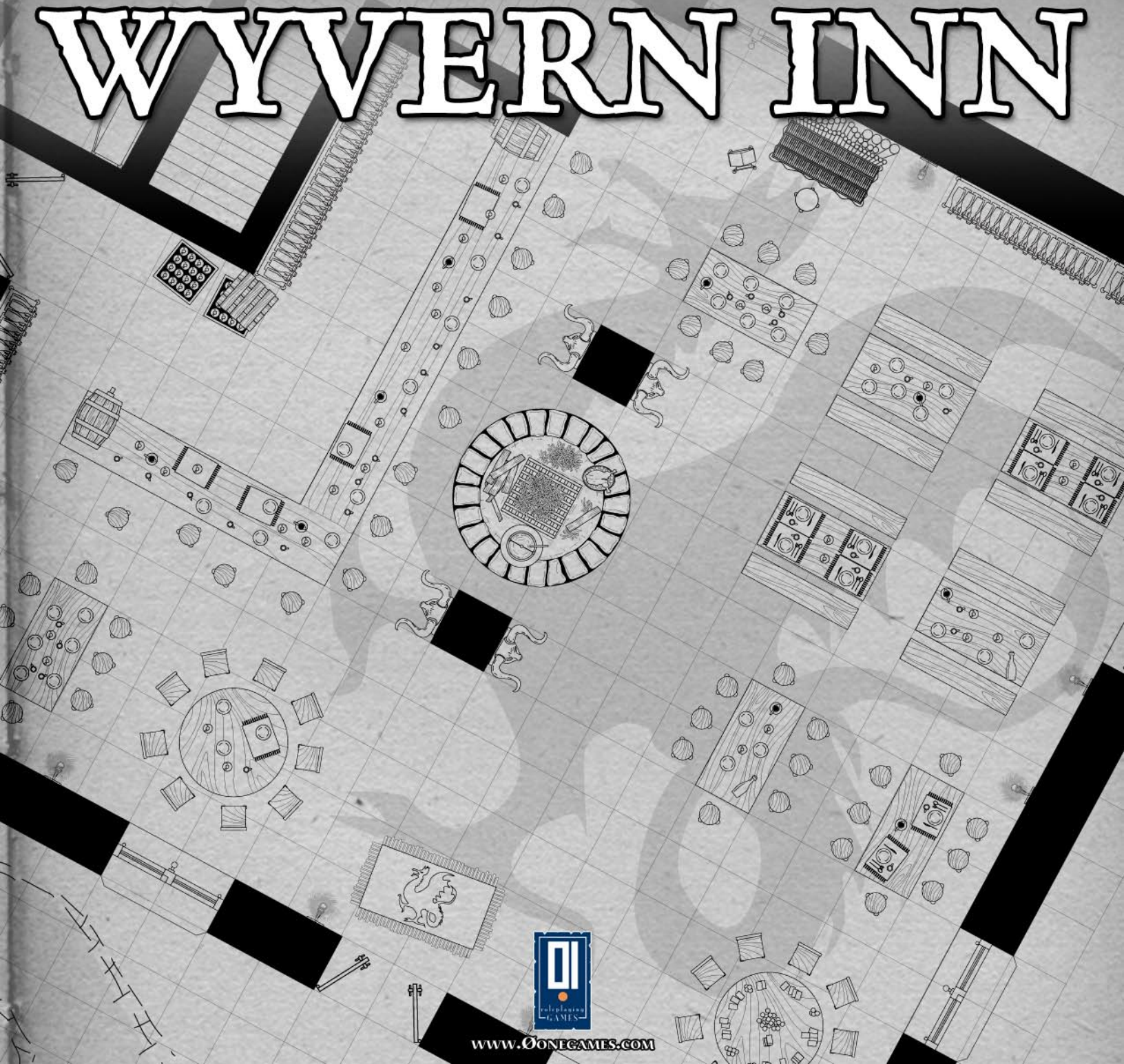

Øone's BLACK & WHITE

Welcome

This product line will bring you simple tiles for your favorite RPGs. In each product you will find a whole fantasy location fully fleshed out in miniature-scale tiles with the usual Øone's top-notch customization capabilities. The B&W maps are simple, line art battlemaps you can customize to suit your needs and then print. These tiles are accurate, detailed, inexpensive and no ink-eaters.

In each B&W product you'll find:

- A Referee map detailing a fantasy location
- The whole location broken in US Letter sheets in miniature scale (each sheet contains a 8x10 inches tile)
- A short description of each area of the location with suggested plots

The Rule the Dungeon® Feature

This Øone's exclusive feature allows you to customize the look of your map by adding the furniture, toggle the grid, hide the room numbers and much more.

On the Referee Map, you will find a big "Rule the Dungeon" button. This button will not be printed, so, don't mind if it overlaps something on the map. By clicking on this button some options will be shown, as detailed below. A checkmark will appear beside the options active.

The options available could vary with products, below is a list of the most common options included in B&W products:

- **Text:** toggle room numbers and tile numbers.
- **Tiling:** toggle the page tiling (Referee Map only)
- **Furniture:** toggle furniture
- **Doors:** toggle doors
- **Square/Hex Grid:** toggle square grid and hexagonal grid
- **No Grid:** turn off the grid
- **Black Fill:** toggle the black in the walls
- **Grey Fill:** toggle the grey fill in the walls
- **No Fill:** toggle the white fill in the walls
- **All:** toggle default state/empty state (with just the walls).

Note that the Rule the Dungeon button on the Referee Map controls all the battlemaps at once.

How to Use This Product

Click on the big button of the Referee Map to customize your maps. Once you have obtained the desired appearance (note that room numbers and tiling do not appear on the tiles) simply choose "Print" from the Acrobat menu.

If you need to print only some tiles, simply click on the desired tile on the Referee Map and choose "Print this Tile".

Tips for Printing

The tiles should have enough margins to print without checking the option "fit to page". If your printer has a margin larger than ¼ inch you should check it in order to print the whole tile. This could reduce slightly your tile but it should be easily usable.



Øone Roleplaying Games
www.Øonegames.com
master@Øonegames.com

Øone's Black & White: White Wyvern Inn

Product Code: bew003. First edition 03/2009
Design: Mario Barbati
2D drawings: Mario Barbati
Graphics: Ø'Bully
Software Engineer: Anna Fava

All of the content of this book is © by Øone Roleplaying Games. The reproduction or retransmission of any part of this book, without written permission of the copyright holder is expressly forbidden, except for the purpose of reviews. Permission is granted to print this book for personal use only.

Øone's
BLACK & WHITE
LAIR OF THE
BLACK CULT

**DETAILED
INEXPENSIVE
CUSTOMIZABLE
NO INK-EATING**

www.Øonegames.com

WHITE WYVERN INN

Stop at the White Wyvern Inn, a way inn just next to the nearest city. Taste the famous Wyvern Ale and get in the more recent gossip, but beware, the inn has more secrets than you imagine...

Brad Barrox, an old, retired hunter and his wife, the lovely Erma, runs the White Wyvern Inn. It is said Brad built the inn over the ruins of an ancient building he discovered during his old adventuring days. All that remains of the ancient palace is the white wyvern mosaic featured now on the taproom floor. The White Wyvern inn is a mandatory stop for each traveler going in the nearby great city, since the ruby-red wine produced by Brad and the Frosted Wyvern Ale are superb and unique drinks.

Brad is actually a member of a secret society called the Shadow Hunters. The aim and goals of this society remains unknown. The members have their headquarter situated in a secret room of the wine cellar of the inn. Unknown to most of the people, the cellar features another remaining of the ancient palace: a much smaller mosaic featuring the same wyvern of the taproom. Both the mosaics are magical. The smaller mosaic allows anyone standing over it to clearly hear people standing over the greater one. Using this magical device secrets are discovered, plots are uncovered and treasures can be hunt. Still no one knows the goals of the secret society.

1. The Well (Tile #15)

An old well marks the entrance to the White Wyvern Inn. The well provides fresh water for both the traveler and the inn.

2. Taproom (Tiles #4, 5, 8, 9, 10)

This is the renowned taproom of the inn. The large mosaic is clearly visible under on the floor. Ale, wine and food are served all day by Cox Hensor and his cousin Geddy, two light-hearted dwarves working as servants in the inn. A large round fireplace burns in the middle of the taproom. Behind the very long counter Heysal and Imotesch, two pretty girls, serve wines and spirits. On the northernmost side of the taproom Radosfax, a cheerful old man who has an innate talent for the music, plays a shiny pipe organ. Stairs lead up to the bedrooms.

3. Customers Toilets (Tile #8)

The public toilets are provided with a draining grate and a privy with a small curtain.

4. Kitchen (Tile #7)

Erma, the Brad's wife, mans this well furnished kitchen. A trapdoor leads to the wine cellar. Erma know of the activity of her husband, so she is accustomed to the various shadowy guys entering in the kitchen and silently descending into the cellar.

5. Larder (Tile #6)

The larder features two doors and it is easily accessible both from the inside of the tavern and from the outside, for unloading goods.

6. Servants' Bedroom (Tile #1)

Here the four inn servants sleep. This room is always well tended and clean.

7. Bran's Bedroom (Tile #2)

This large bedroom features a small fireplace and soft couches and chairs. Brad and his wife usually relax before the burning wood of the fireplace while drinking strong liquors.

8. Bran's Bathroom (Tile #3)

This very large bathroom features all comforts: from scented bath salts to hot water and flavored soaps.

9. Stables Workshop (Tile #11)

The stables are there for the inn's customers. Everyone can use the stables and their workshop, which is kept well furnished with coal, iron and wood by Brad.

10. Stables (Tiles #12, 13)

The stables are always clean and tended by Cox and Geddy. The two dwarves bring food and water for the horses and for some gold they tend the animals if asked to.

11. Bedroom (Tile #18)

A bedroom featuring its own small bathroom and a four-poster bed.

12. Bedroom (Tile #23)

A bedroom featuring its own bathroom, a four-poster bed and a single bed.

13. Common Room (Tile #17)

These large common rooms are the most popular rooms of the inn, since they are cheap, clean and comfortable.

14. Common Room (Tile #22)

These large common rooms are the most popular rooms of the inn, since they are cheap, clean and comfortable.

15. Bedroom (Tile #16)

A large, luxurious bedroom featuring its own bathroom, a four-poster bed and two single beds. Also there is a small fireplace and a soft couch.

16. Bedroom (Tile #21)

A large, luxurious bedroom featuring its own bathroom, a four-poster bed and two single beds. Also there is a small fireplace and a couple of soft chairs.

17. Toilet (Tiles #16, 21)

This toilet is for the common rooms customers.

18. Wine Cellar (Tiles #24, 25)

This wine cellar is the Brad's pride. He provides personally to the labeling, stocking and cleaning of his wine collection. An illusory wall on the north wall (to show the passage hide the door before printing this tile) leads to the Shadow Hunters hideout.

19. Shadow Hunters' Hideout (Tiles #19, 20)

This large room has been built to be a self-sufficient hideout. Wax-sealed barrels contain salted meat and a well provides fresh water. A small armory has been placed near one of the great pillars and a library sits to the southern walls. The main feature is, of course, the wyvern mosaic, which allow hearing people talking in the above taproom.

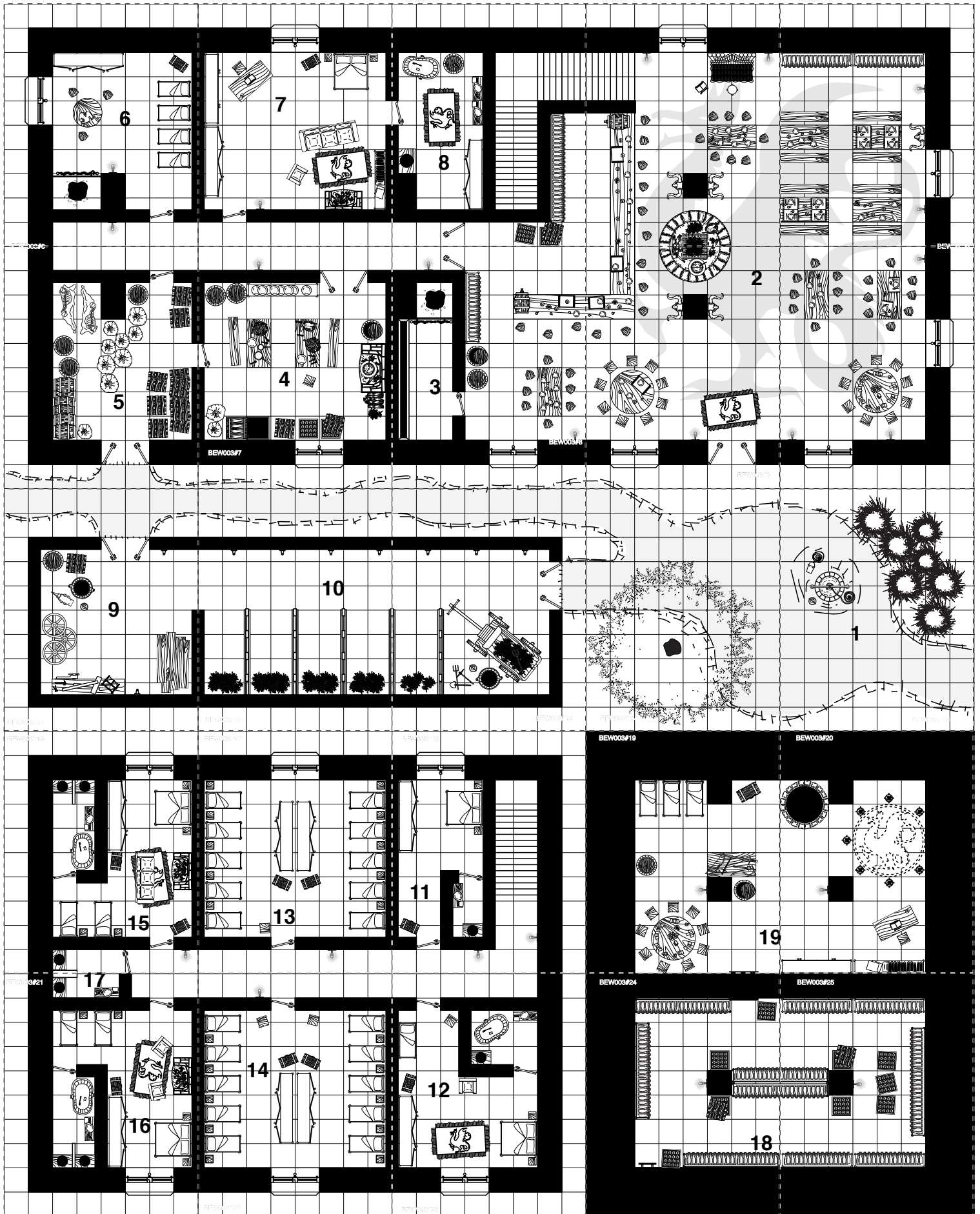

White Wyvern Inn
1 square = 5ft

BEW003#1

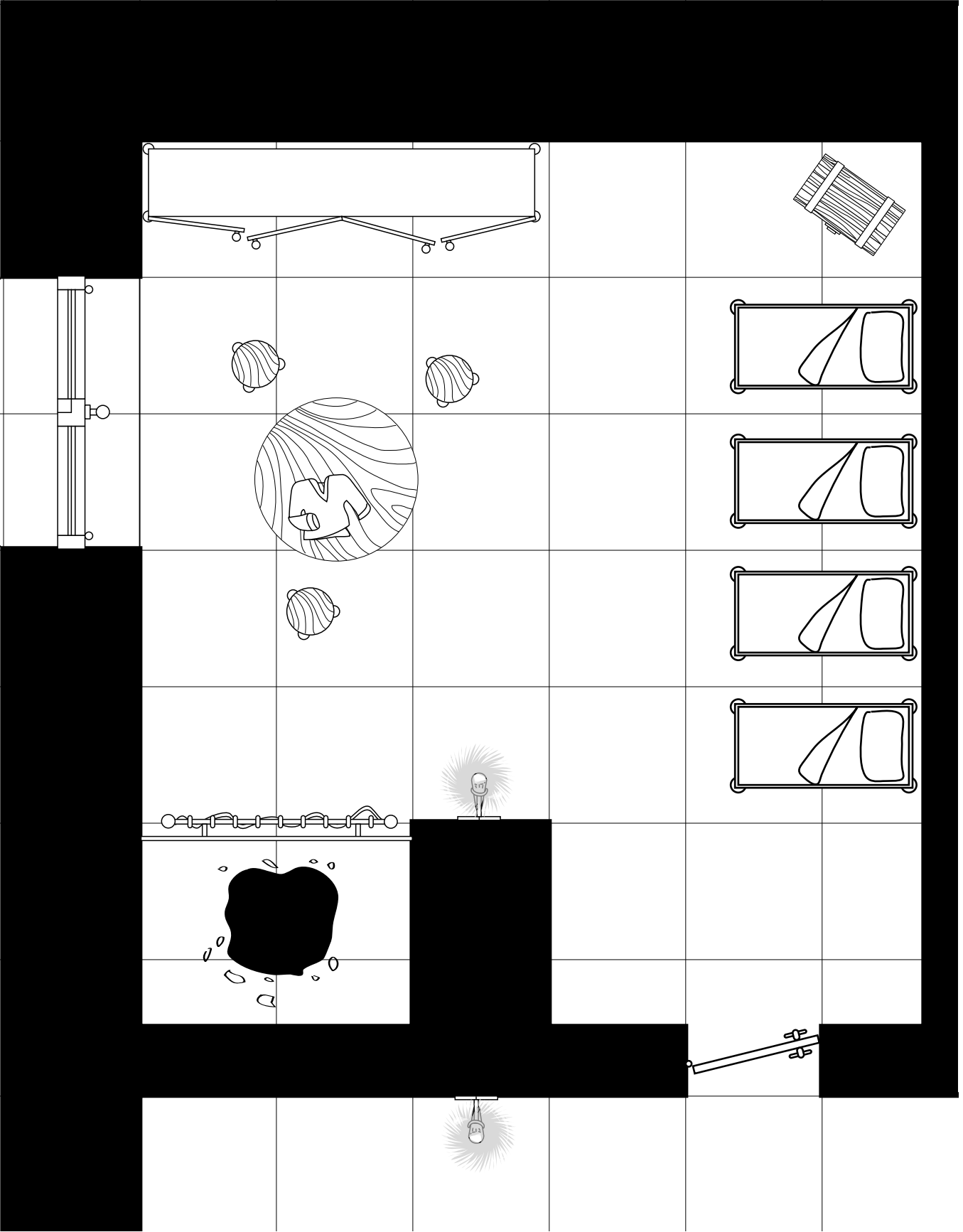

BEW003#2

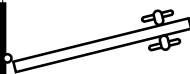
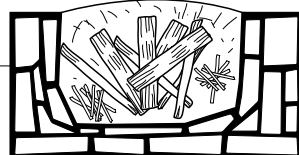
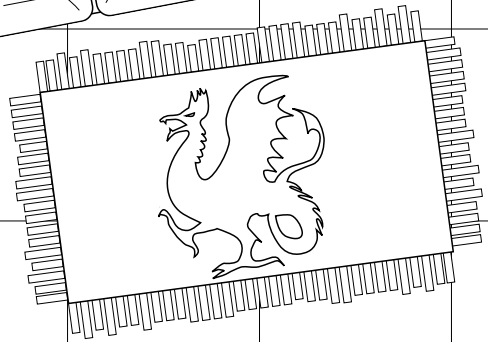
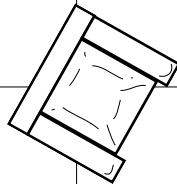
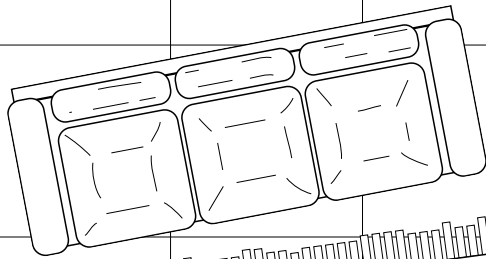
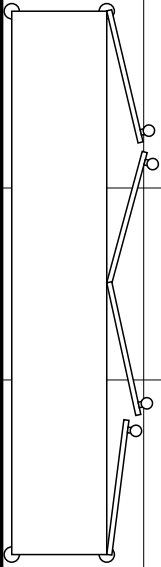
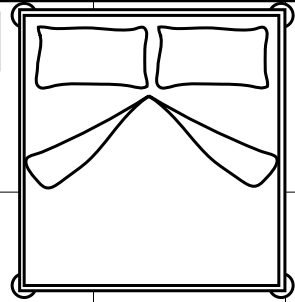
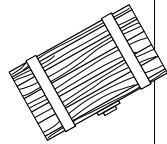
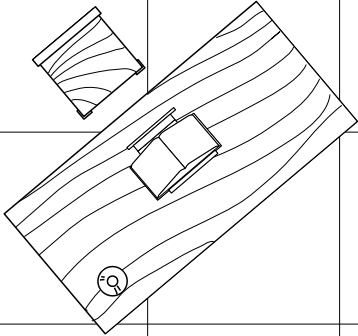
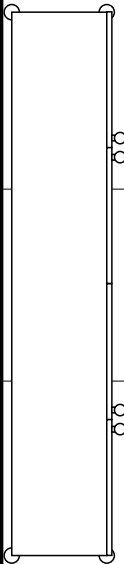
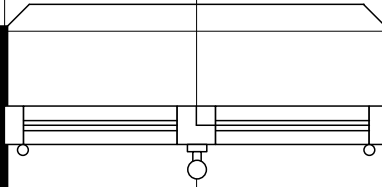

BEW003#3

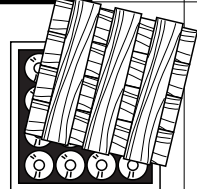
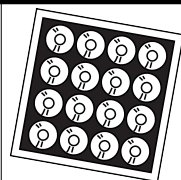
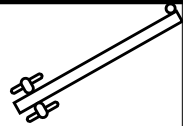
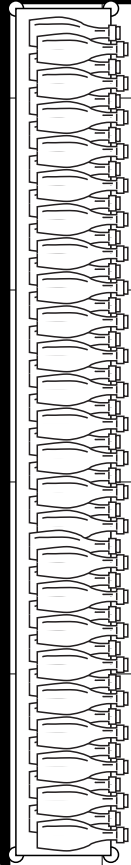
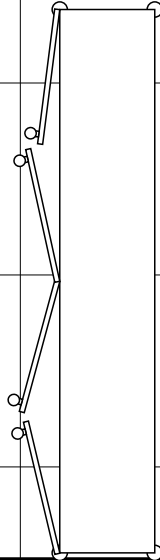
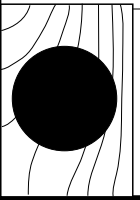
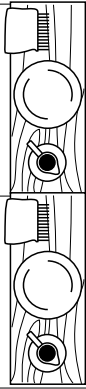
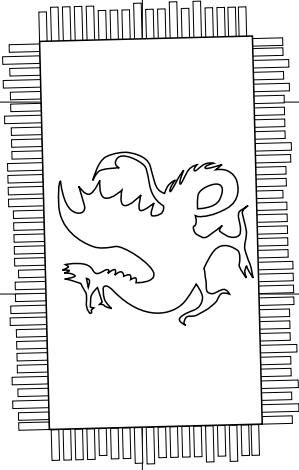
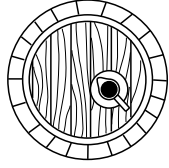
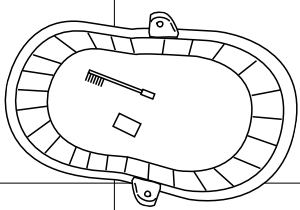

BEW003#4

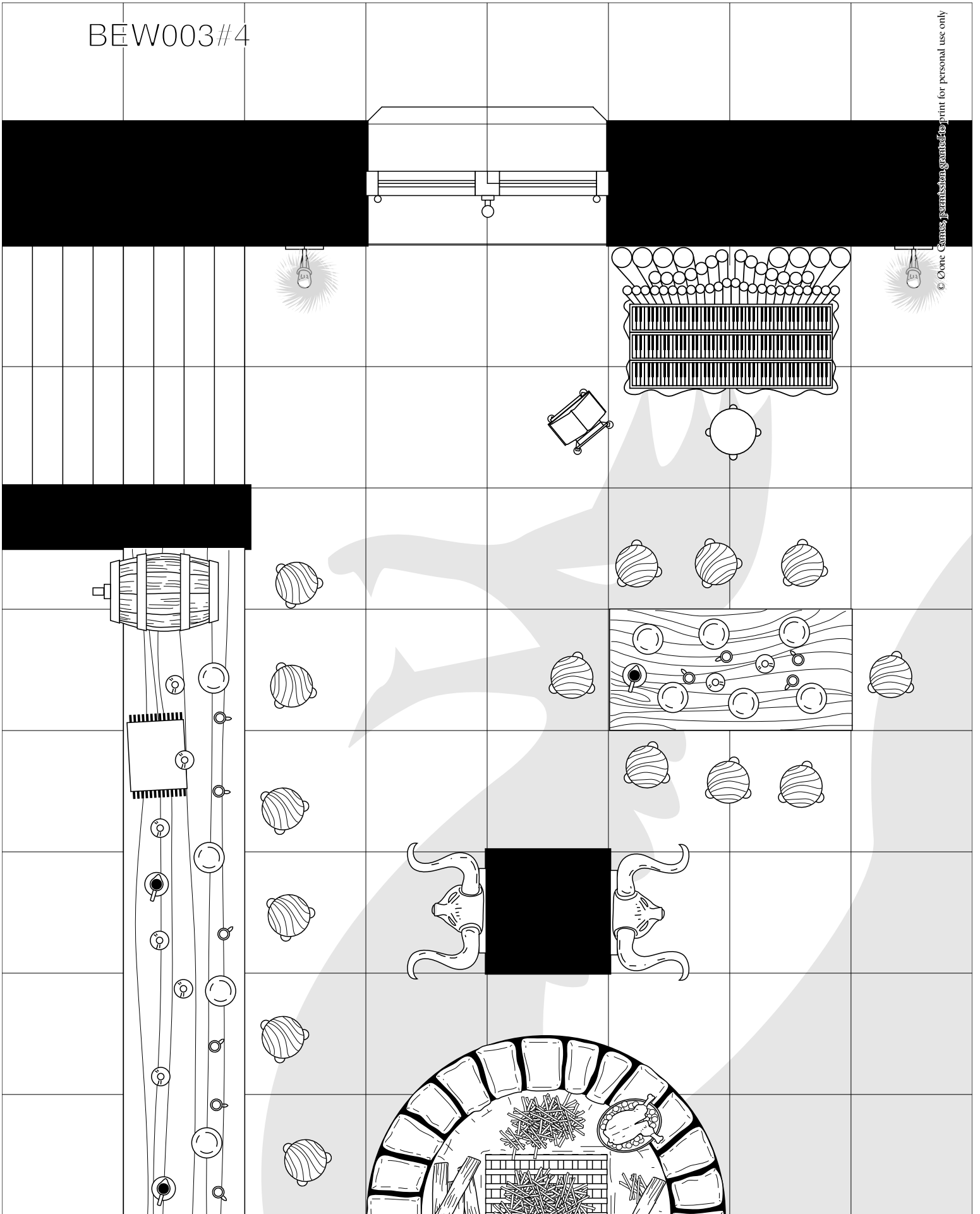

BEW003#5

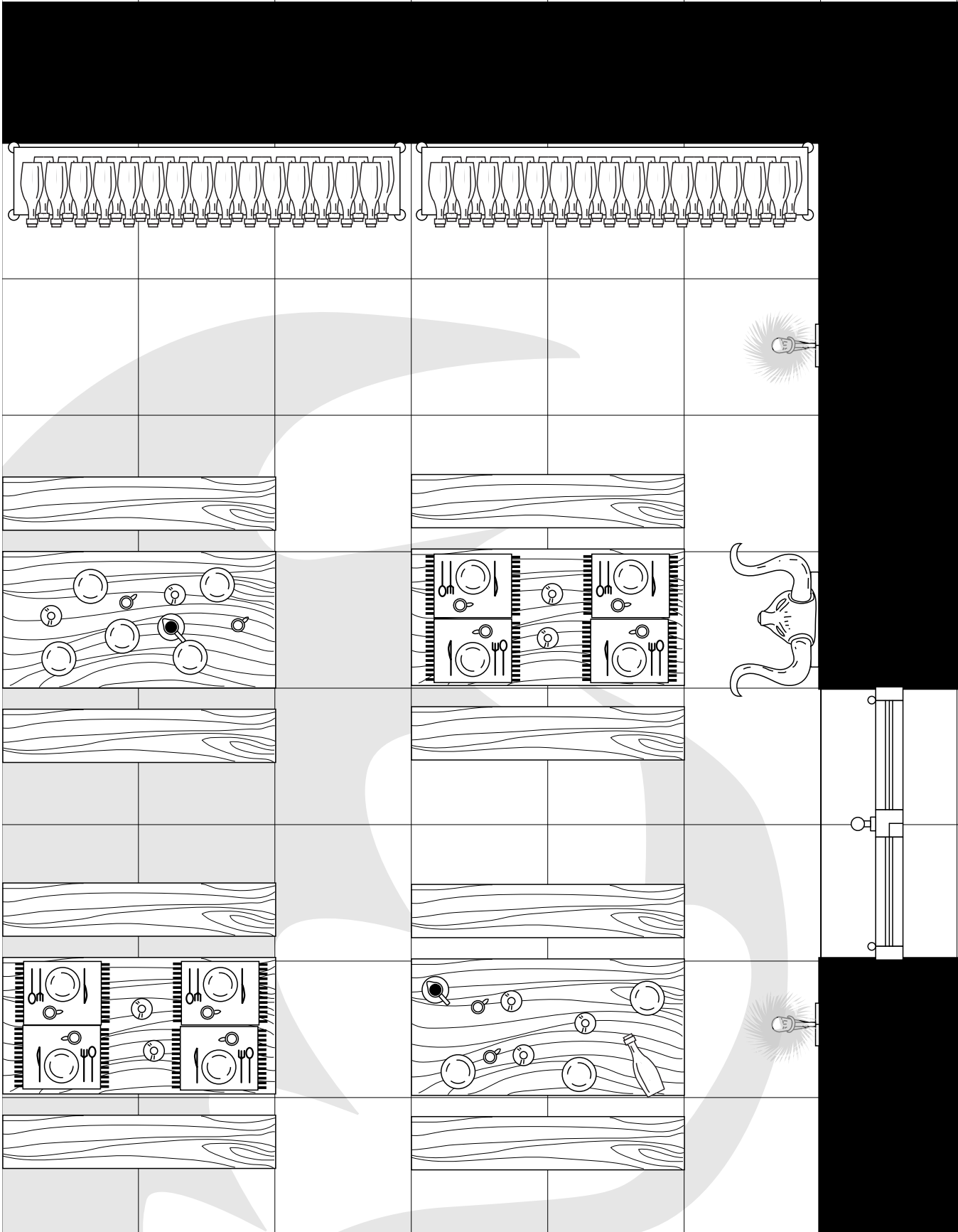

BEW003#6

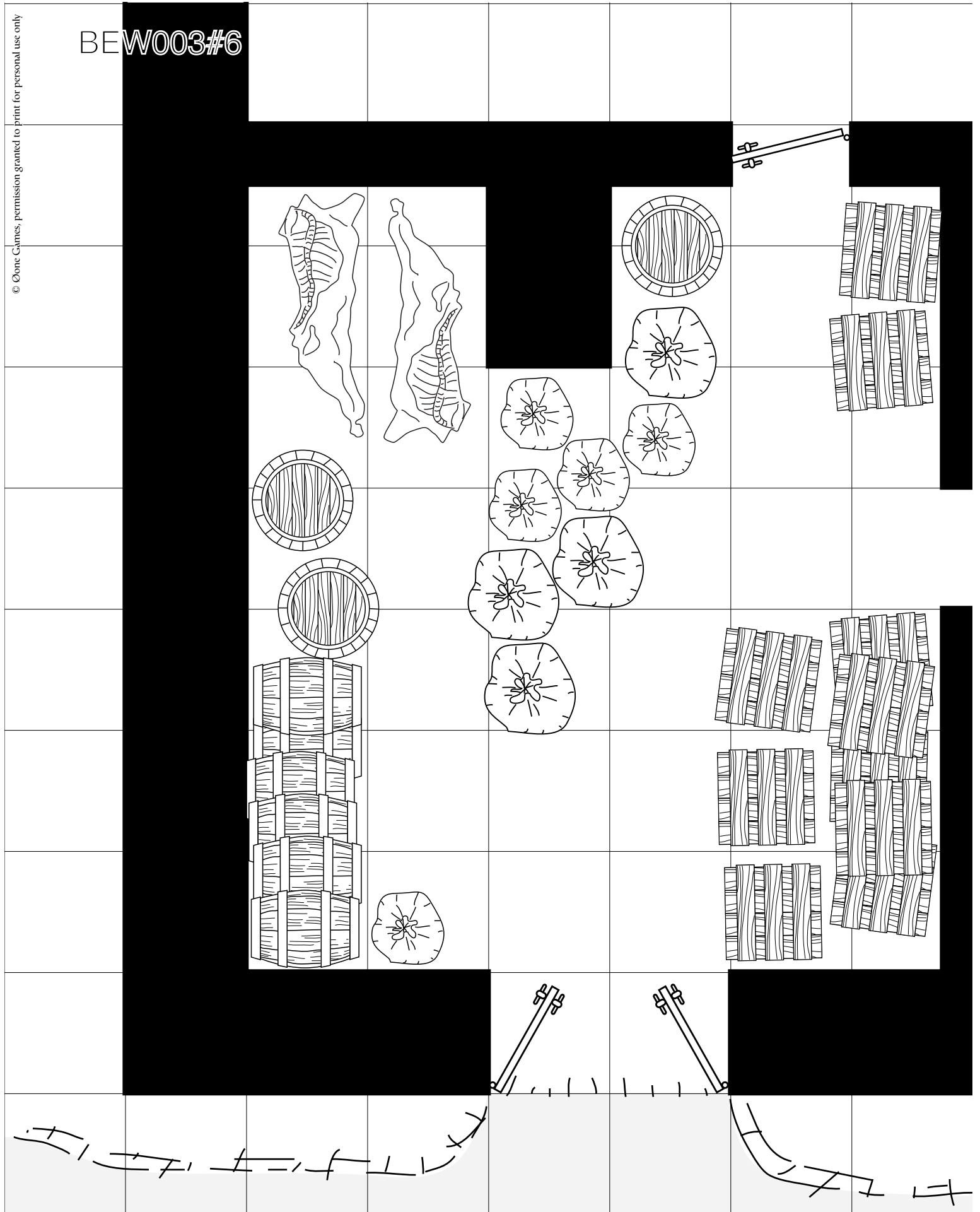

© 2006 Canvas, permission granted to print for personal use only

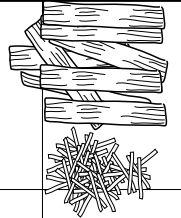
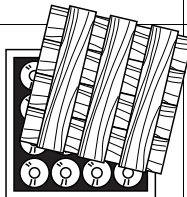
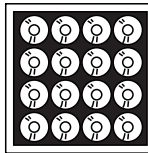
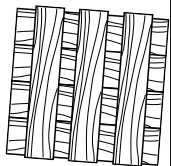
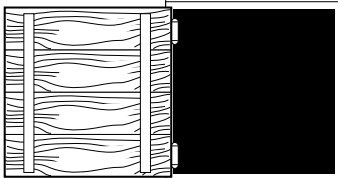
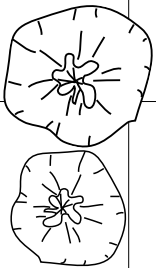
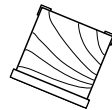
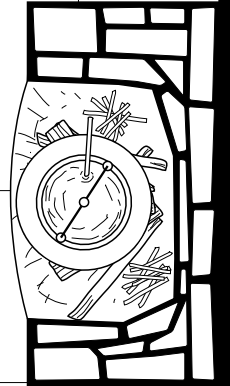
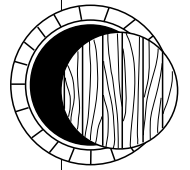
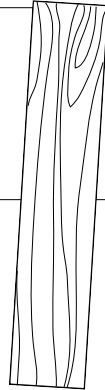
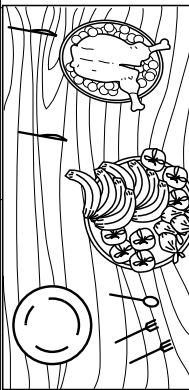
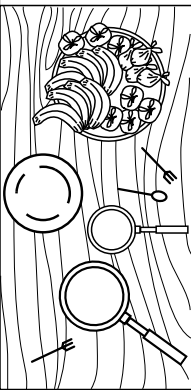
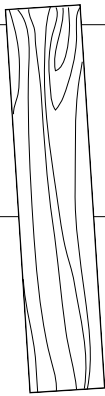
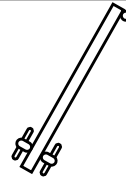
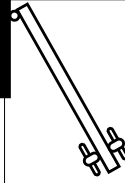
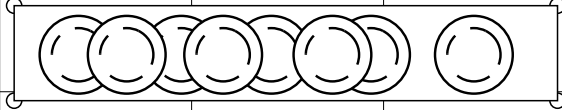
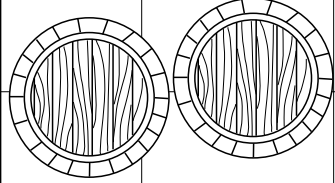
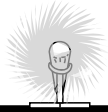

BEW003#7

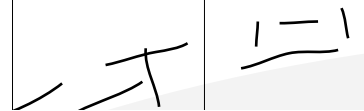
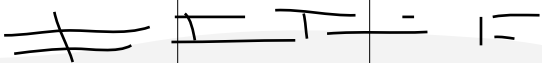
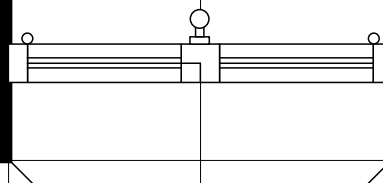

© 2016 Canvas, permission granted to print for personal use only

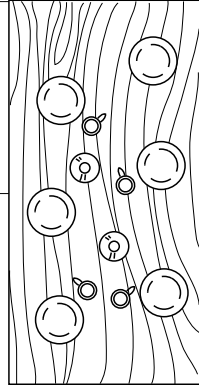
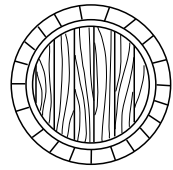
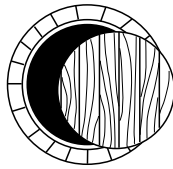
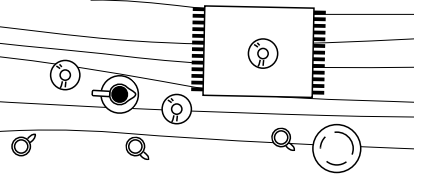
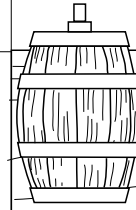
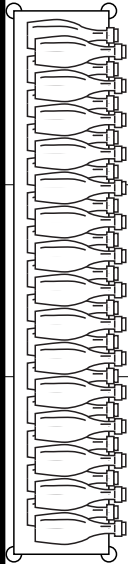
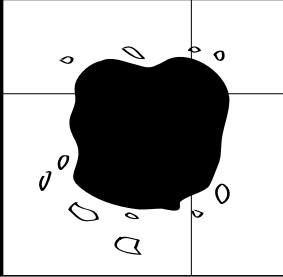
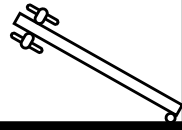
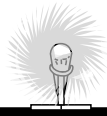

BEW003#8

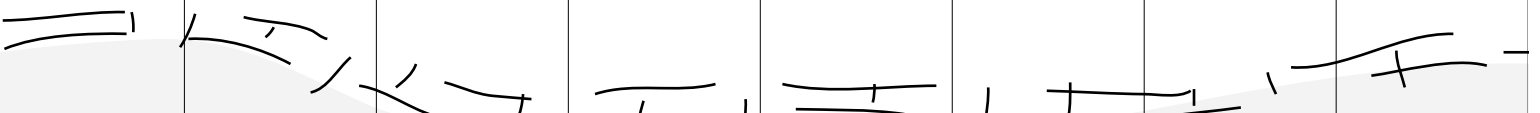
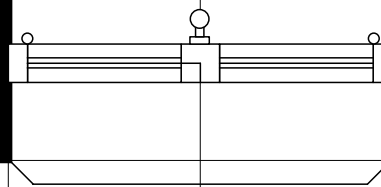

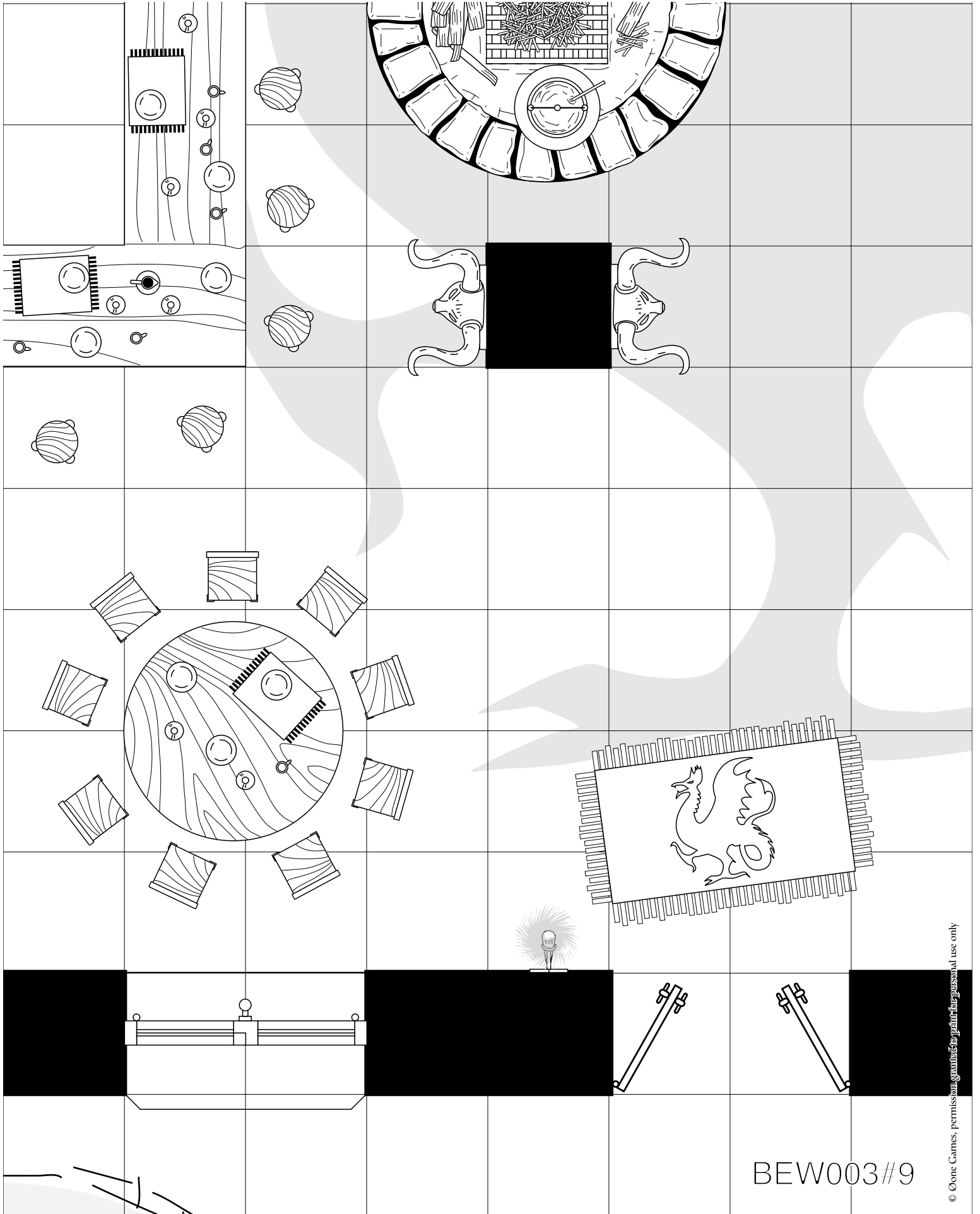

BEW003#9

BEW003#10

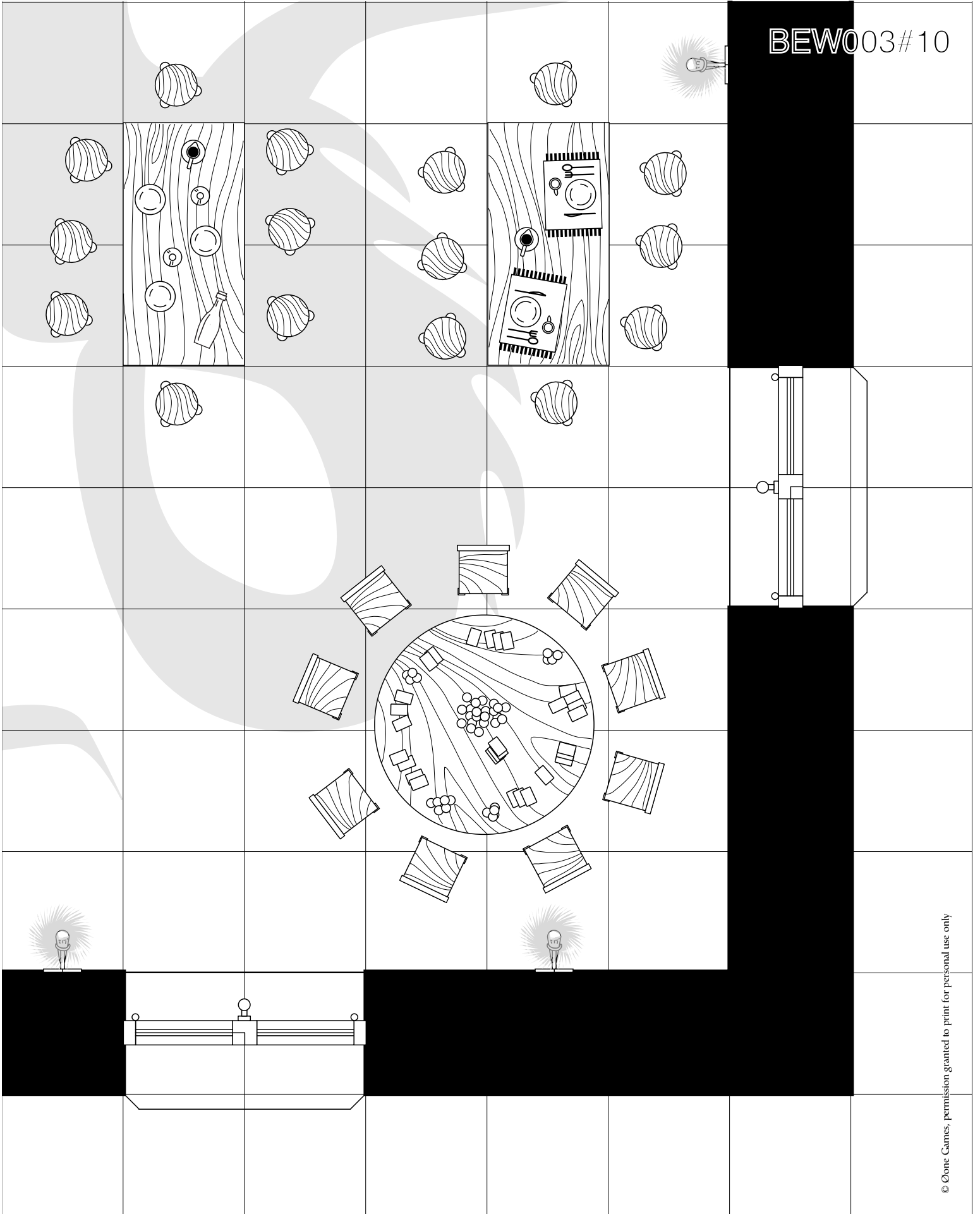

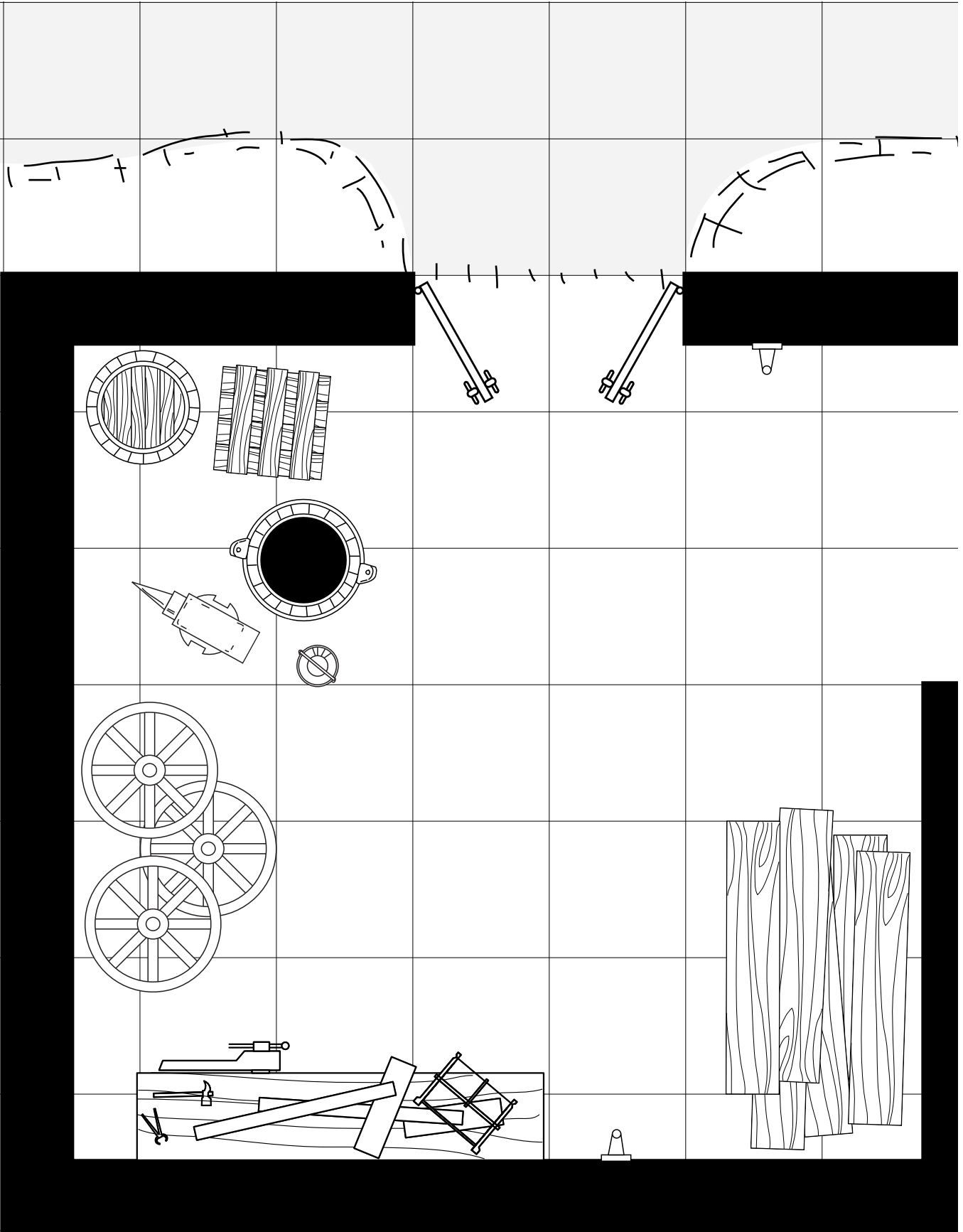

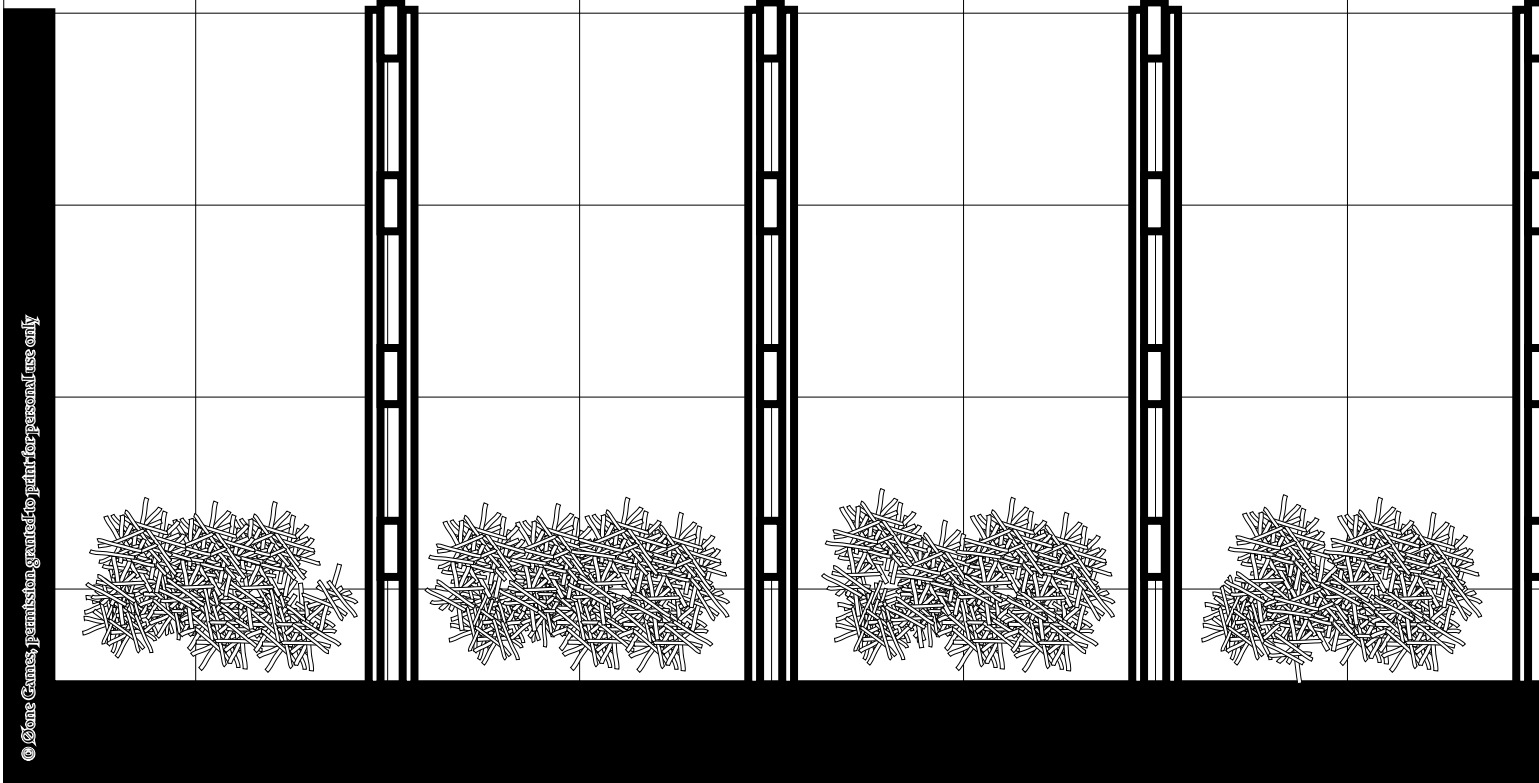
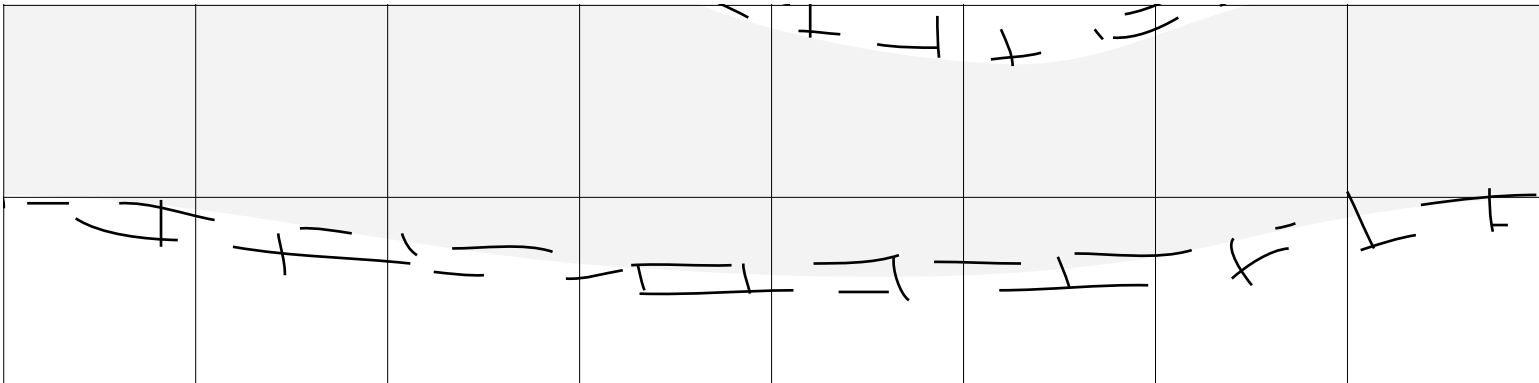

© 2016 Canvas, permission granted to print for personal use only

BEW003#12

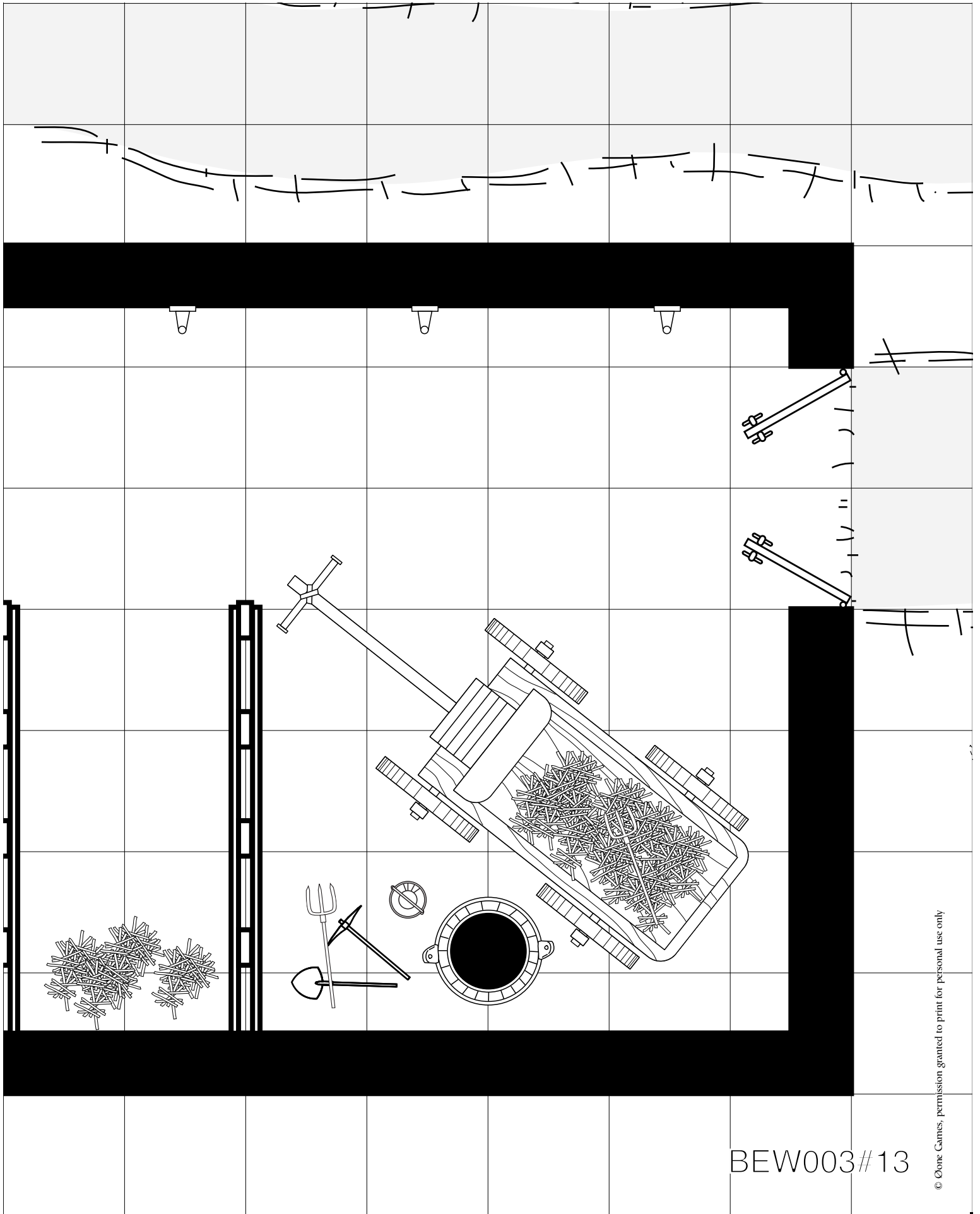

BEW003#13

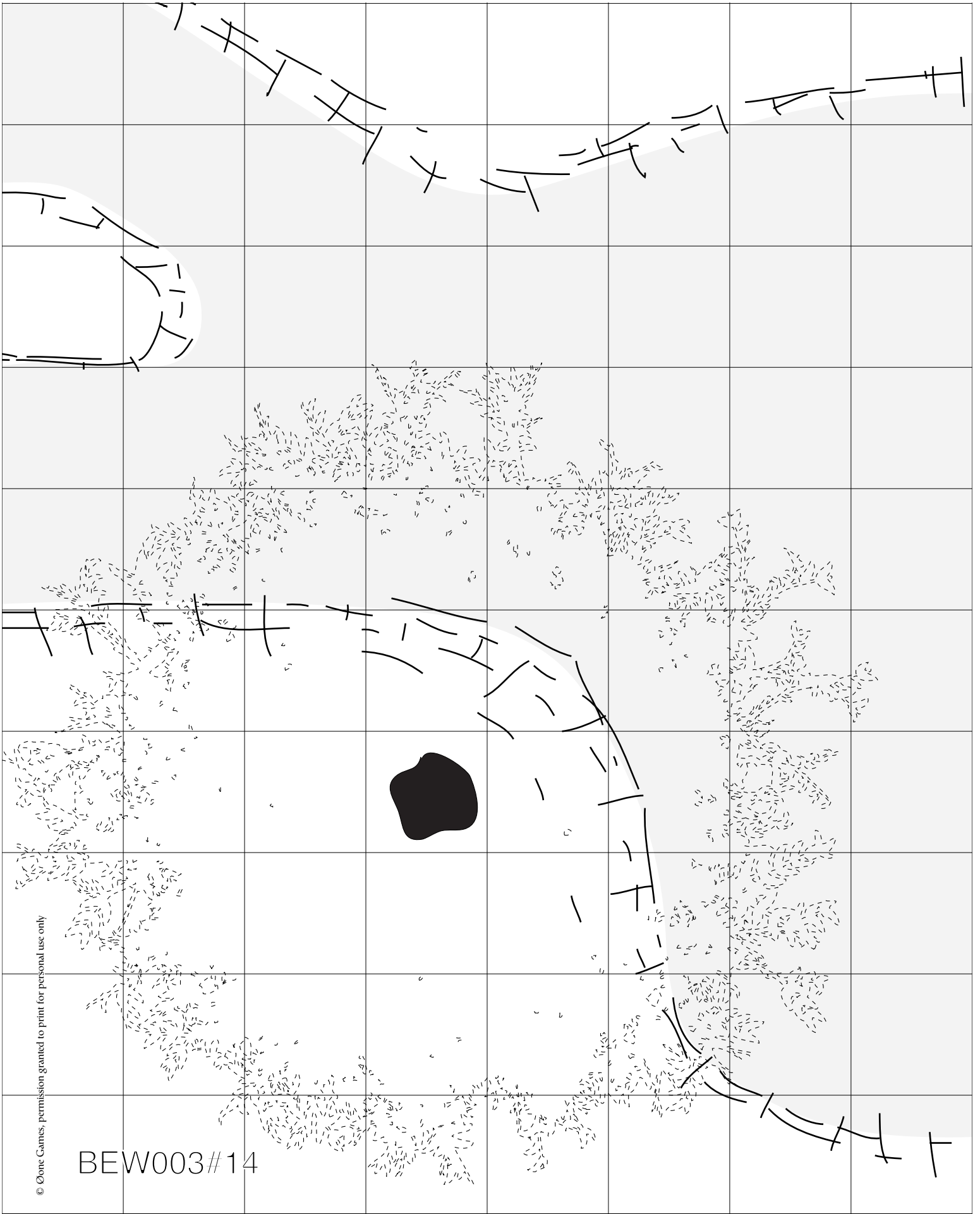

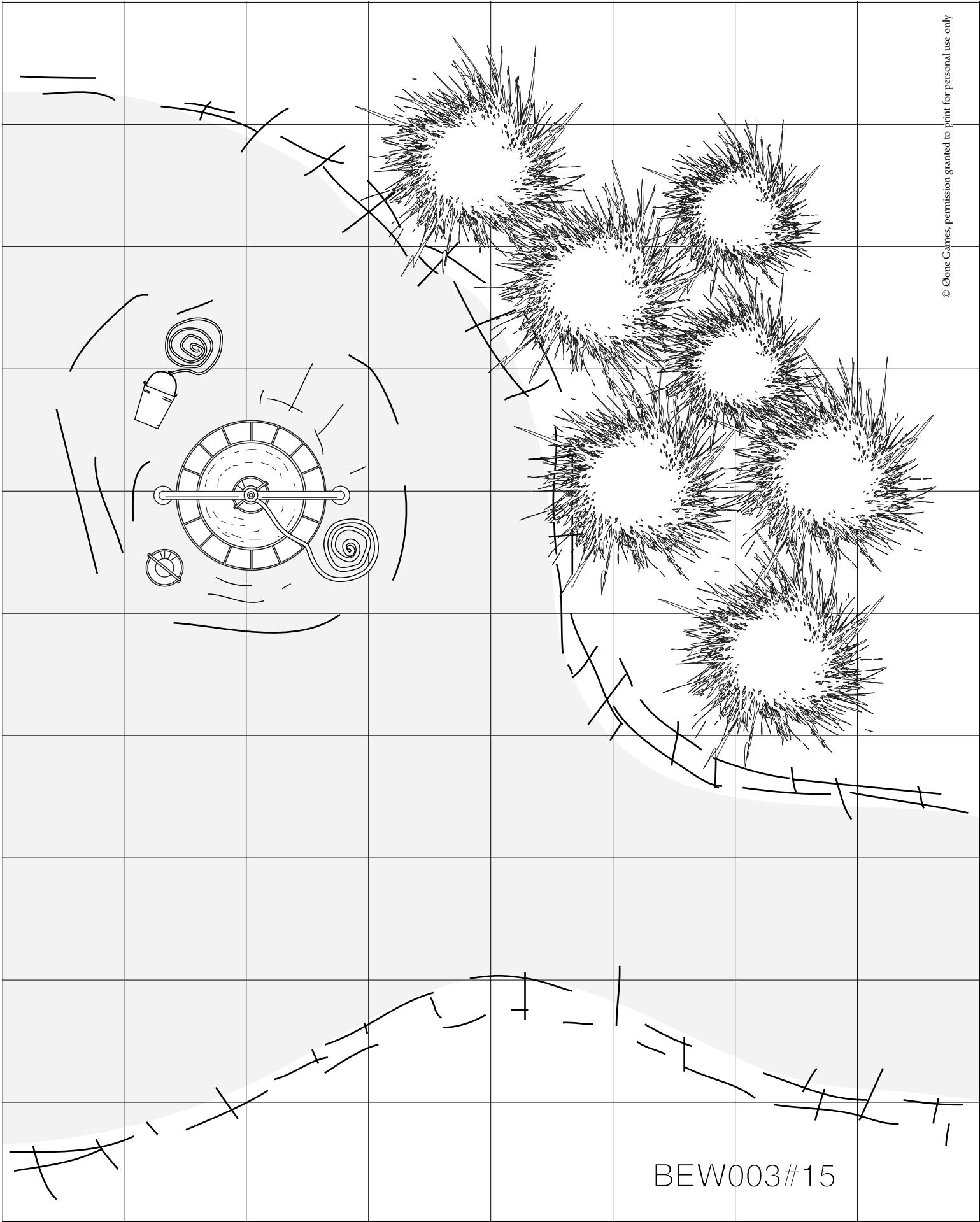

BEW003#17

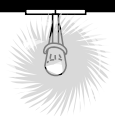
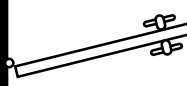
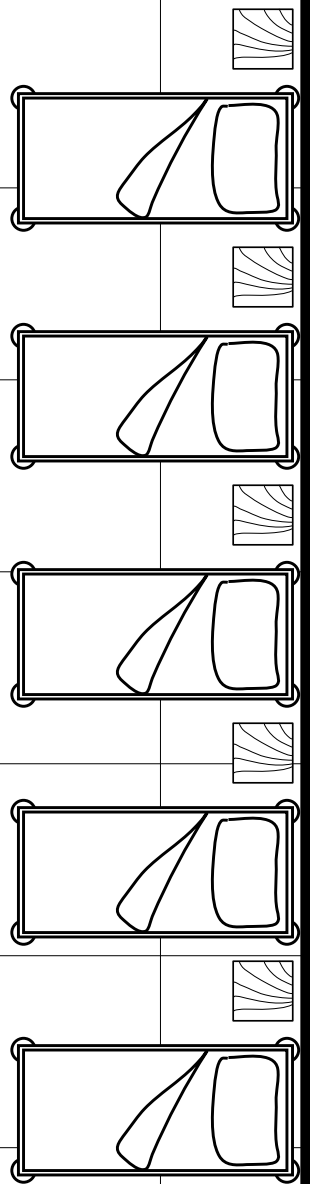
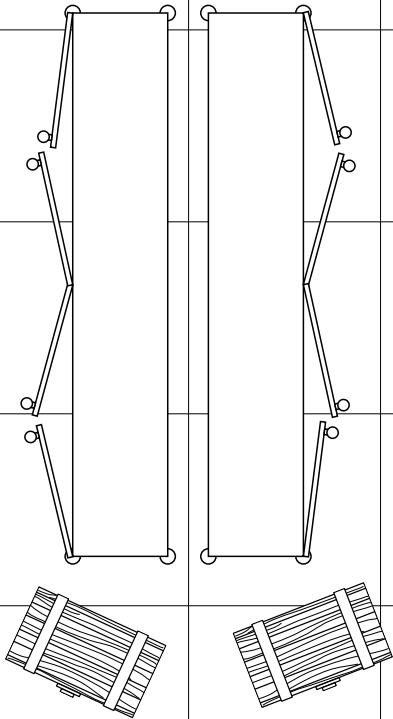
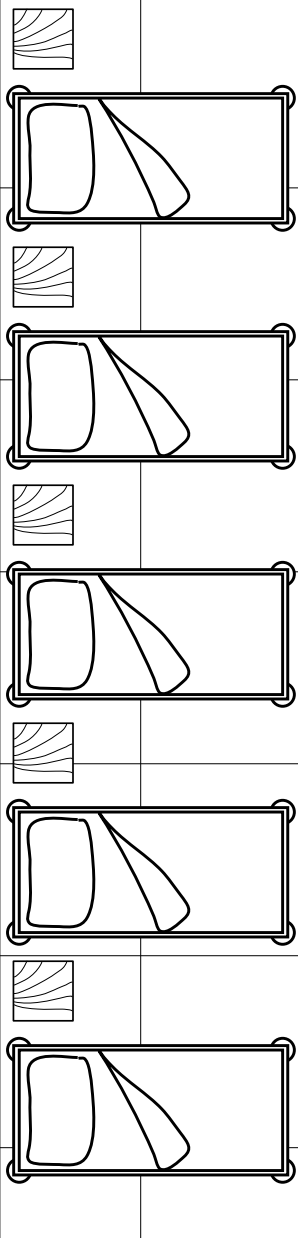
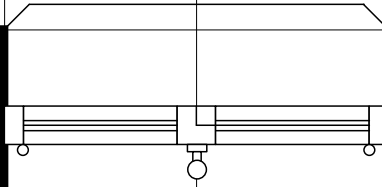

BEW003#18

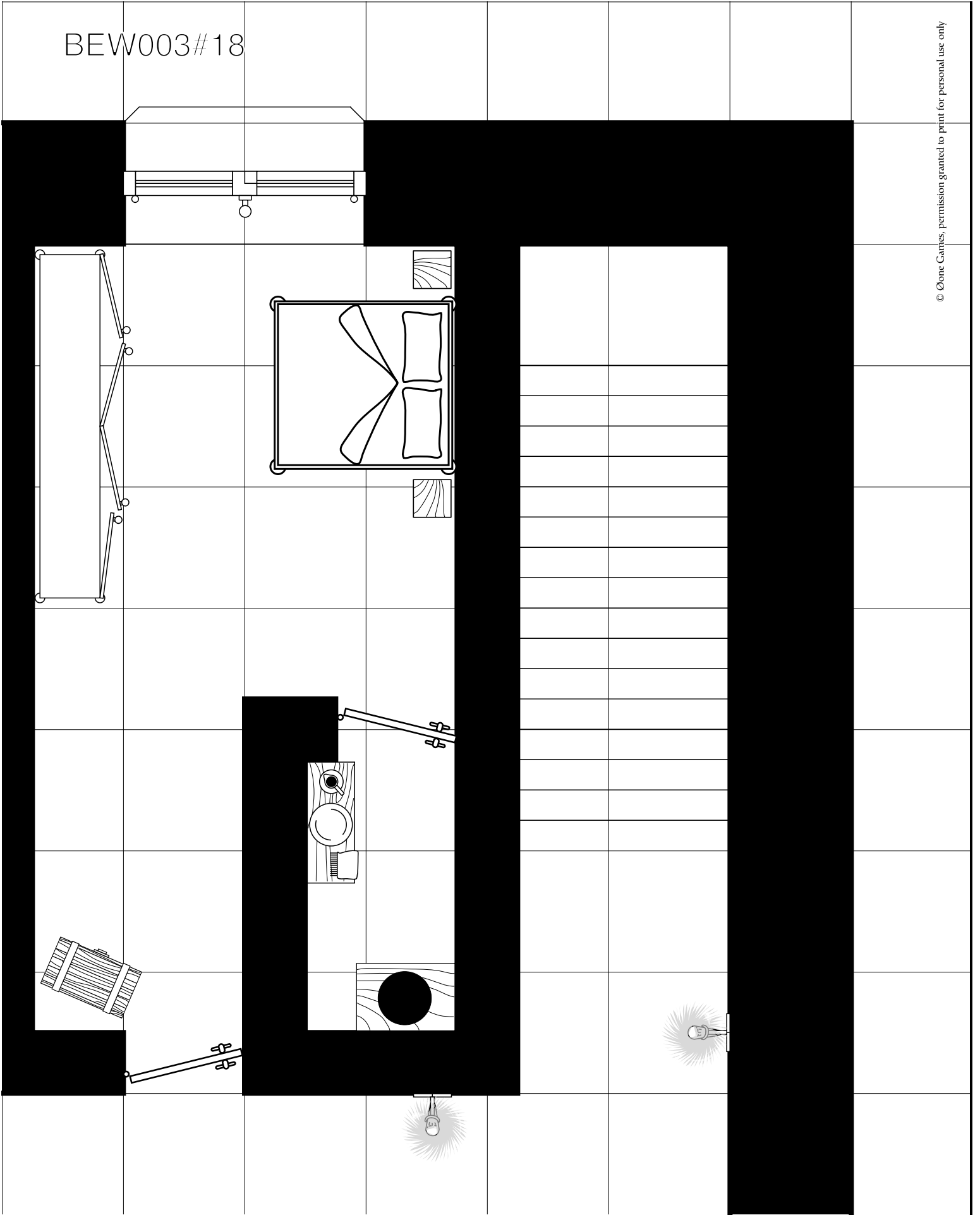

BEW003#19

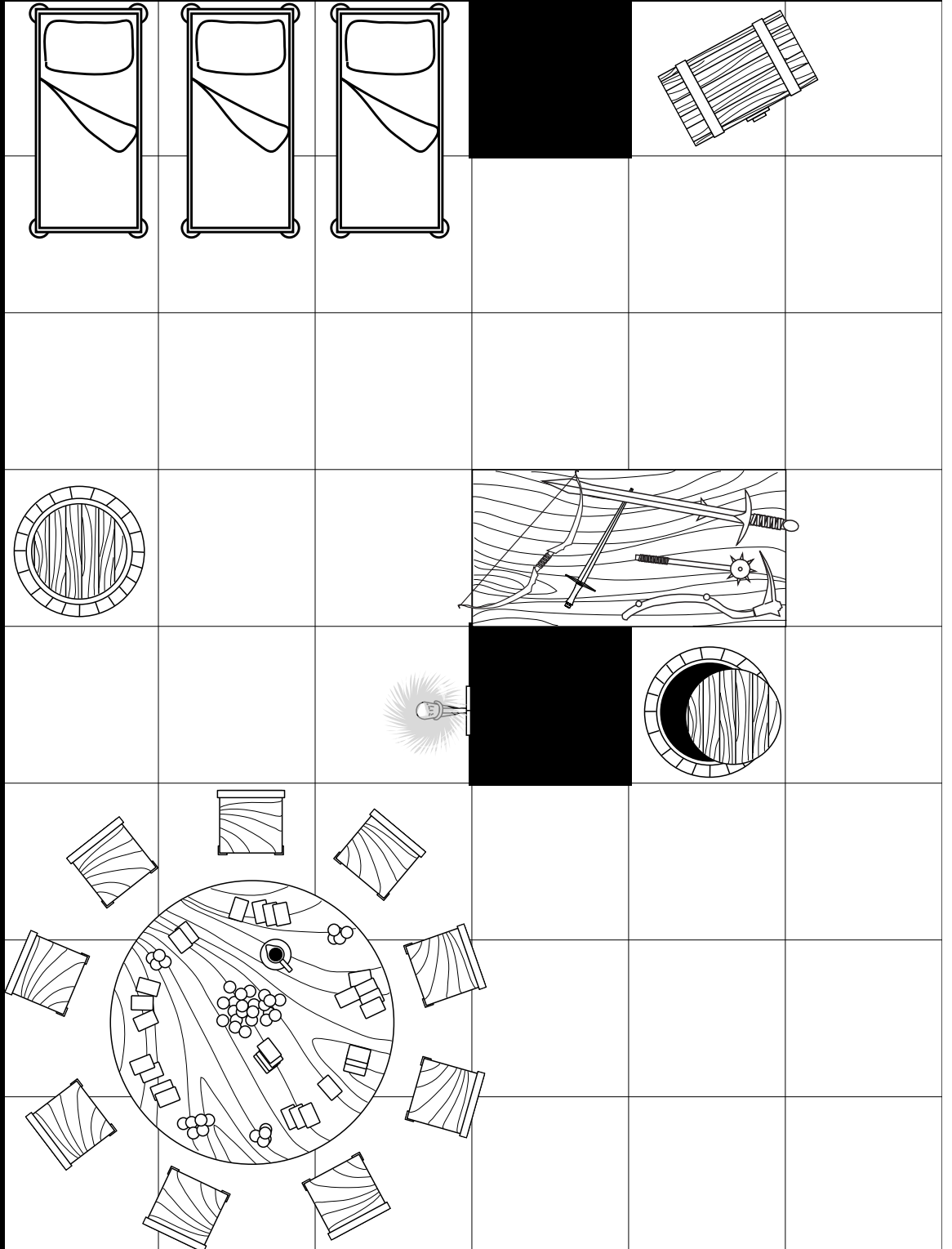

BEW003#20

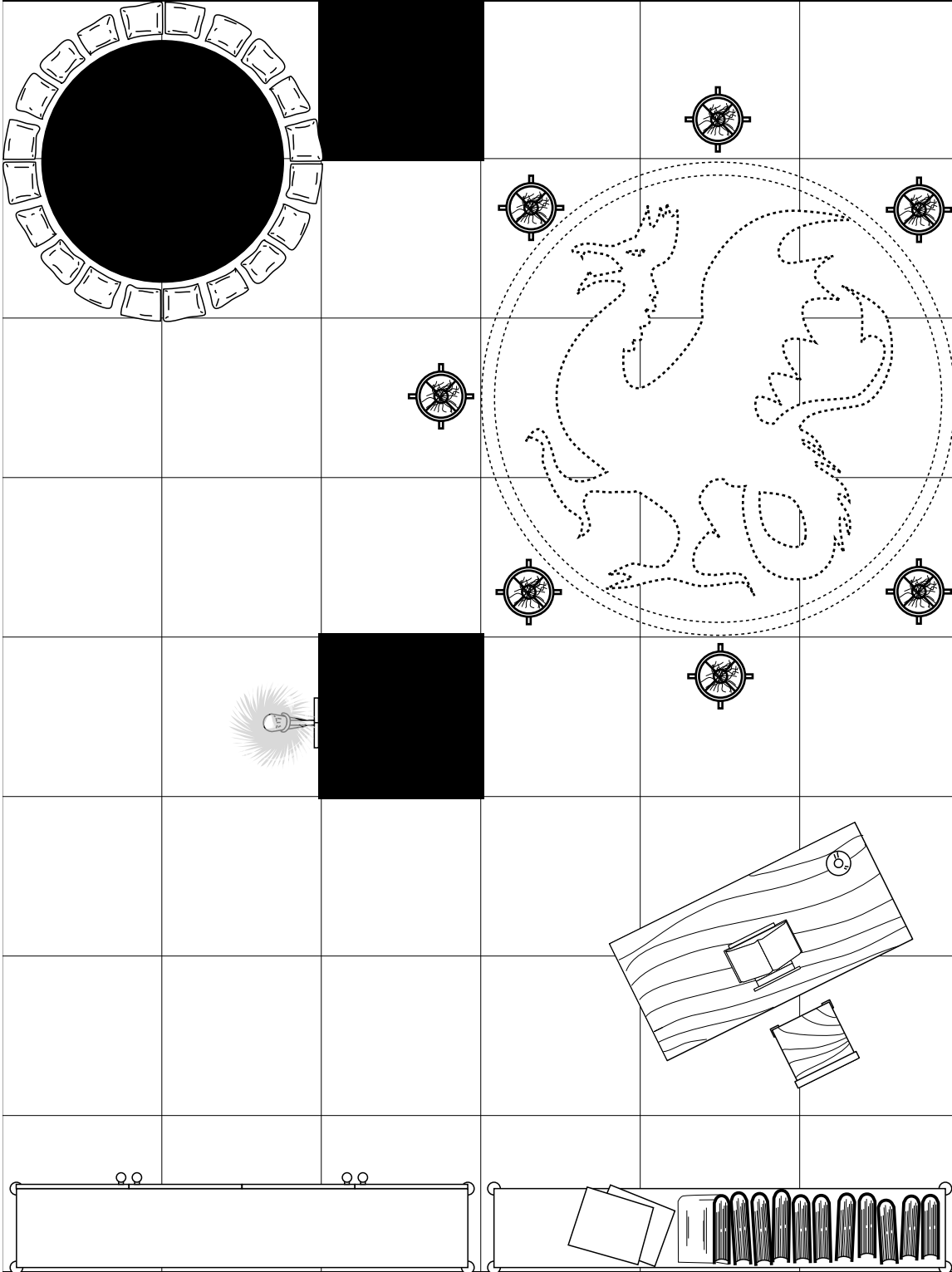

BEW003#21

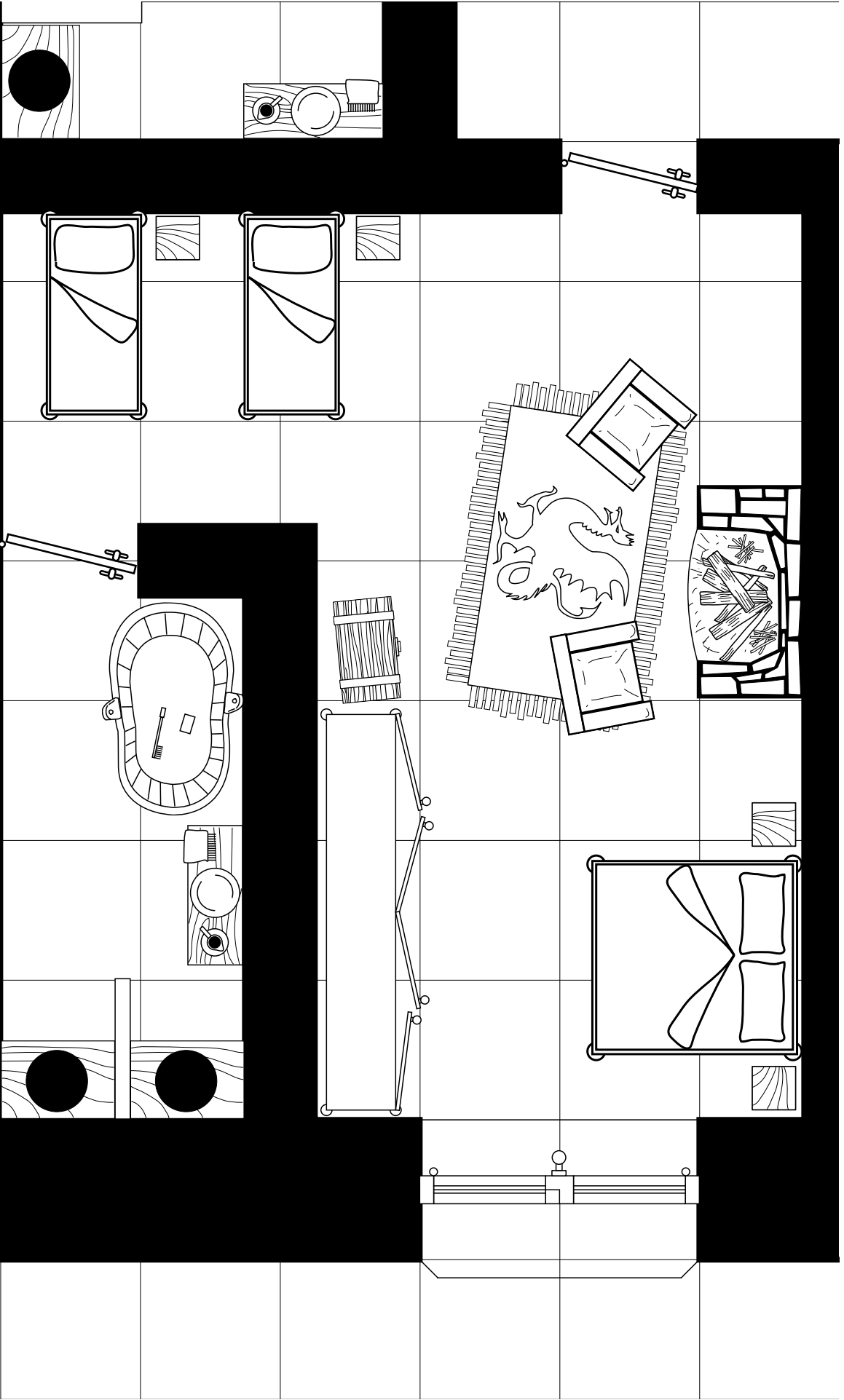

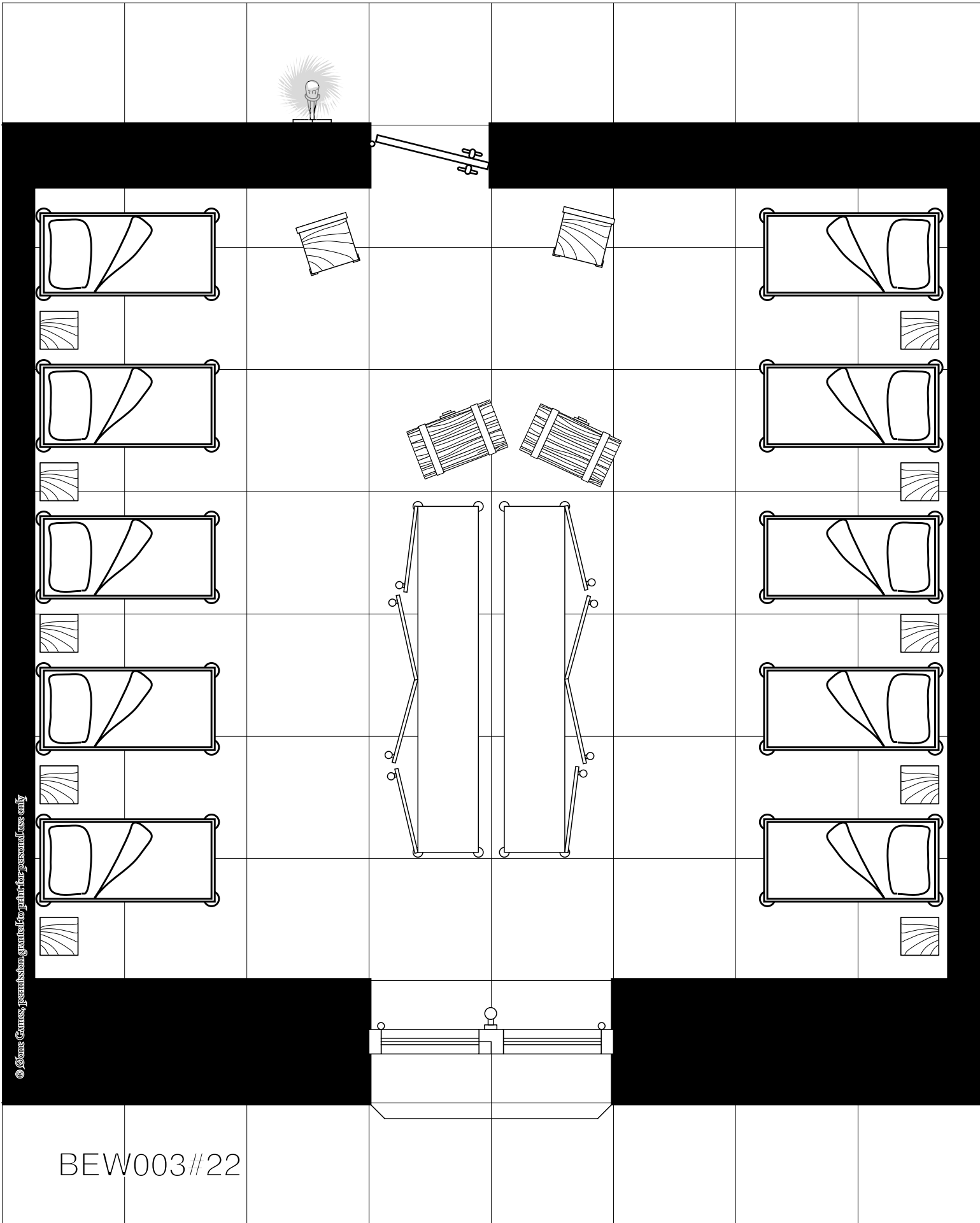

BEW003#22

BEW003#24

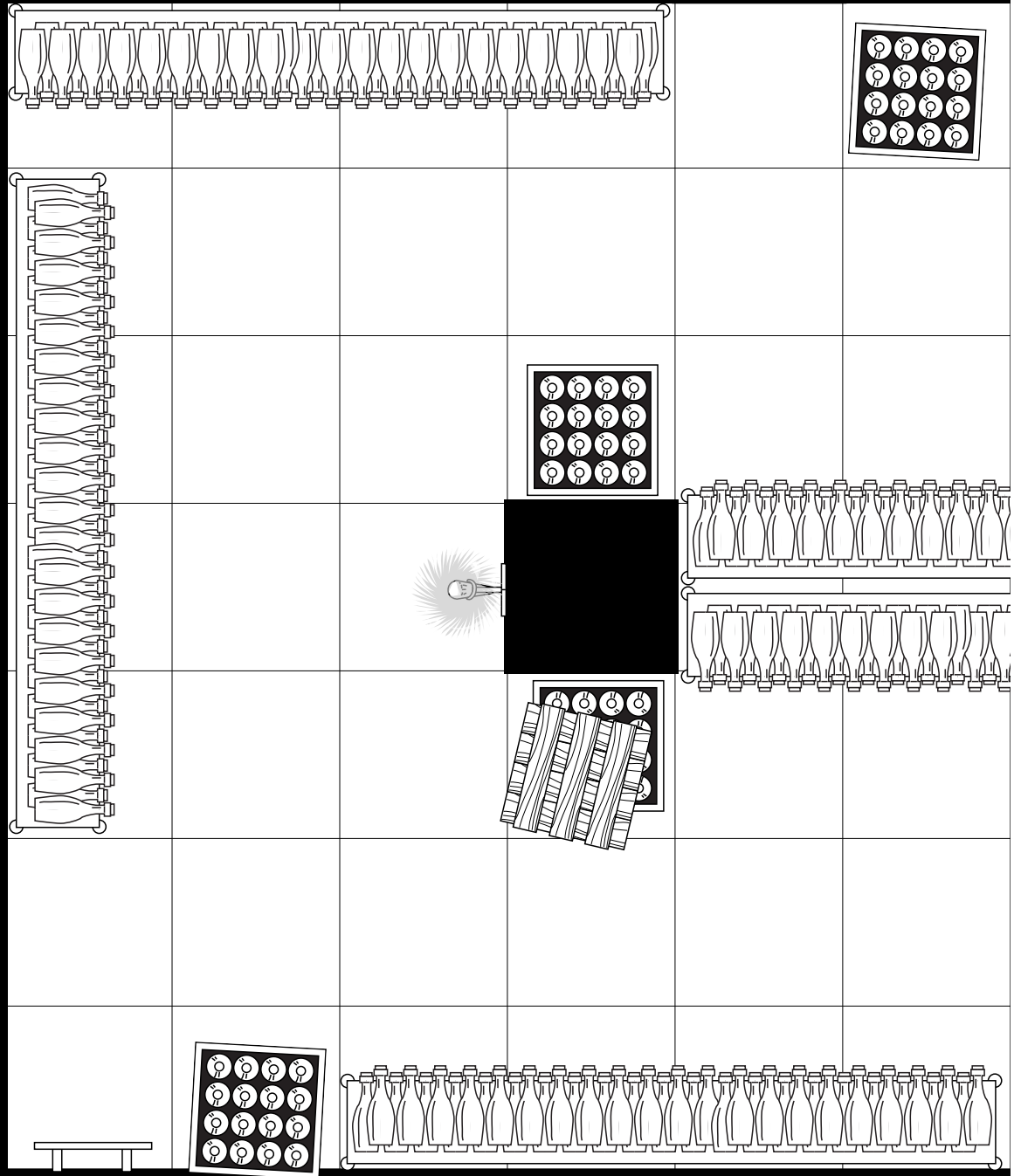

BEW003#25

