



THE ARCHAEOLOGY OF
CELTIC ART

D. W. Harding

THE ARCHAEOLOGY OF CELTIC ART

Tempering the much adopted art-historical approach, Harding argues for a broader definition of Celtic art. Contrary to recent attempts to deconstruct the Celts as an ethnic entity altogether, he argues that there were communities in Iron Age Europe that were identified historically as Celts, regarded themselves as Celtic, or who spoke Celtic languages, and that the art of these communities may reasonably be regarded as Celtic art. Though the La Tène styles represent the summation of achievement of Celtic art, the origin and geographical distribution of Celtic art extend well beyond the La Tène culture zone.

Though art-historical considerations remain essential, Harding shows that Celtic art should also be viewed within its broader archaeological context. From Central Europe to the Atlantic west, Celtic art was essentially a social and political art, as well as a religious art, and a medium through which identity could be asserted. It was fundamentally embedded in Celtic society, custom and belief. This new study will be indispensable for anyone wanting to take a fresh and innovative perspective on Celtic art.

Dennis W. Harding is Abercromby Professor of Archaeology at the University of Edinburgh. His most recent book *The Iron Age in Northern Britain* was published in 2004.

THE ARCHAEOLOGY OF CELTIC ART

D. W. Harding

First published 2007
by Routledge
2 Park Square, Milton Park, Abingdon, Oxon OX14 4RN

Simultaneously published in the USA and Canada
by Routledge
270 Madison Avenue, New York, NY 10016

Routledge is an imprint of the Taylor & Francis Group, an informa business

This edition published in the Taylor & Francis e-Library, 2007.

“To purchase your own copy of this or any of Taylor & Francis or Routledge’s collection of thousands of eBooks please go to www.eBookstore.tandf.co.uk.”

© 2007 D. W. Harding

All rights reserved. No part of this book may be reprinted or reproduced or utilised in any form or by any electronic, mechanical, or other means, now known or hereafter invented, including photocopying and recording, or in any information storage or retrieval system, without permission in writing from the publishers.

British Library Cataloguing in Publication Data

A catalogue record for this book is available
from the British Library

Library of Congress Cataloging in Publication Data

A catalogue record for this book has been requested

ISBN 0-203-69853-3 Master e-book ISBN

ISBN10: 0-415-35177-4 (hbk)

ISBN10: 0-415-42866-1 (pbk)

ISBN13: 978-0-415-35177-5 (hbk)

ISBN13: 978-0-415-42866-8 (pbk)

ISBN13: 978-0-203-69853-2 (ebk)

CONTENTS

<i>List of colour plates</i>	vii
<i>List of figures</i>	ix
<i>Preface</i>	xiii
1 Definitions, material and context	1
2 ‘An art with no genesis’: later Bronze Age and Hallstatt origins	17
3 The La Tène Early Styles: origins and influences	38
4 The La Tène developed styles	65
5 The art of the swordsmith	93
6 The La Tène later relief styles	118
7 Insular British art to the Roman Conquest	140
8 La Tène and non-La Tène in Ireland	164
9 South-West Europe and the Celtiberians	189
10 Later styles and Romanizing influences	211
11 Later insular art in Britain and Ireland	238
12 Conclusions: archaeology and Celtic art	262
<i>Bibliography</i>	275
<i>Index</i>	291

LIST OF COLOUR PLATES

(The colour plates are located between pages 144 and 145)

- 1 Later Bronze Age ceremonial 'hats'
- 2a The Dresden–Dobritz hoard
- 2b Open-work gold of Schwarzenbach bowl
- 3 The Klein Aspergle grave-group
- 4a The Glauberg gold torc
- 4b The Glauberg flagon: detail of lid
- 5a The Rodenbach arm-ring
- 5b The Waldalgesheim torc and arm-rings
- 6a The Erstfeld torcs and arm-rings
- 6b The Erstfeld torc: detail
- 7a The Amfreville helmet
- 7b The Agris helmet
- 8a The Broighter torc
- 8b The Aurillac arm-ring
- 9 The Battersea shield
- 10a The electrum torc from Snettisham Hoard E
- 10b Snettisham Hoard L *in situ*
- 11 The Book of Durrow, *f. 3 v*
- 12 The Book of Durrow, *f. 192 v*
- 13 The Book of Kells, *f. 7 v*
- 14 The Book of Kells, *f. 291 v*
- 15a The Hunterston brooch: front view
- 15b The 'Tara' brooch: back view
- 16a The Ardagh chalice: detail
- 16b The Monymusk reliquary

LIST OF FIGURES

2.1	Late Bronze Age vessels with bird and sun-disc ornament	21
2.2	Late Bronze Age cult vehicles	22
2.3	Strettweg, Austria, cult vehicle	24
2.4	Hallstatt period animal imagery in bronze and pottery	25
2.5	The Urnfield warrior with equipment	28
2.6	A: late Bronze Age cuirass from Marmesses	31
	B: Class B Atlantic cauldron from Shipton-on-Cherwell, Oxfordshire	31
2.7	Images from decorated pottery from Sopron district, Hungary	35
3.1	Details from the Klein Aspergle grave-group	39
3.2	Italic imports north of the Alps	
	A: Distribution of beaked flagons	41
	B: Distribution of cordoned buckets	41
3.3	Palmette and lotus in early La Tène art	43
3.4	Engraved ornament on the Reinheim and Waldalgesheim flagons	46
3.5	The Somme-Bionne, Marne, open-work disc	50
3.6	Dürrnberg bei Hallein, Grave 44/2: principal grave-goods	
	A: weaponry	52
	B: drinking vessels and related items	53
3.7	Face masks in early La Tène art	55
3.8	Sculpture in early La Tène art	56
3.9	Exotic influences in late Hallstatt grave-goods	59
3.10	Belt attachments from north and south of the Alps	60
3.11	The Glauberg bronze torc	64
4.1	Transition towards the Developed La Tène Styles	66
4.2	<i>Phalerae</i> with open-work borders from St Jean-sur-Tourbe	67
4.3	Open-work mount from La Bouvandeau	68
4.4	Engraved decoration of the Besançon bronze flagon	69
4.5	Developed Style in the Champagne	71
4.6	Ornament from Waldalgesheim, Mainz-Bingen, grave-group	73
4.7	Torcs and arm-ring from the Marne region	78
4.8	La Tène decorated pottery from Champagne	80
4.9	Münsingen, Berne	
	A: cemetery plan	82
	B: some characteristic brooch types	83
4.10	Scabbards with 'Vegetal Style' ornament	85

LIST OF FIGURES

4.11	Insular early La Tène metal-work	86
4.12	The Prunay 'Les Commelles' vase and the Canosa helmet	89
5.1	Hungarian and related scabbard ornament – 1	97
5.2	Eastern and western scabbards	98
5.3	'Halimba' scabbard from Co Veszprem, Hungary	100
5.4	Hungarian and related scabbard ornament – 2	101
5.5	Dragon-pairs and their distribution	103
5.6	Findings from the site of La Tène	105
5.7	Scabbards from eastern England	108
5.8	'Chagrinage'	109
5.9	Irish engraved scabbards	114
6.1	La Tène 'Plastic Style' ornament in Bohemia and Moravia	120
6.2	Relief style arm- and ankle-rings	123
6.3	Open-work mounts from Brno-Maloměřice	125
6.4	The stone sculpted head from Mšecké Žehrovice	127
6.5	Helmet with bird-crest, Çiumeşti, Romania	129
6.6	Silver ring with bull's head terminals from Trichtingen	131
6.7	Rein-rings and lynch-pins with face-images in relief	134
6.8	Bull's (A) and owl's (B) heads from the Brâ cauldron	135
6.9	The Wandsworth 'face-mask' shield	137
6.10	British Iron Age brooches	138
7.1	Engraved and relief ornament of Torrs horns and pony-cap	144
7.2	The Witham sword and scabbard mount	147
7.3	The Witham shield	148
7.4	The Wandsworth circular shield	151
7.5	Iron Age decorated pottery from Southern Britain	156
7.6	Aylesford, Kent, and Marlborough, Wiltshire, bucket ornament, with head from Rynkeby cauldron, Denmark	158
7.7	Mirrors from Holcombe, Devon and Nijmegen, Holland	160
7.8	Mirror from Desborough, Northants, and collar from Balmaclellan, Kirkcudbrightshire	162
8.1	Beehive querns and the Irish La Tène	
	A: 'La Tène' finds in Ireland	165
	B: distribution of beehive querns in Ireland	165
8.2	Regional distributions of late Bronze Age metal-work in Ireland	167
8.3	Irish 'La Tène' – 1: horse-bits, Y-pendants, spear-butts and querns	170
8.4	Knock ('Clonmacnoise') torc and Loughnashade horn	174
8.5	Irish 'La Tène' – 2: pins and brooches	176
8.6	The Turoe stone, Co Galway	180
8.7	Ireland and Northern Britain: comparative metal-work	182
8.8	Ceremonial head-gear	184
8.9	Ornamented discs	186
9.1	'Plastic Style' torcs and arm-rings from south-western France	192
9.2	Anthropomorphic and zoomorphic 'matchstick' images on pottery	194
9.3	Celto-Ligurian sanctuaries	
	A: Glanum, St Remy-en-Provence	197
	B: Entremont, Aix-en-Provence	197

LIST OF FIGURES

9.4	Celto-Ligurian statuary	198
9.5	The Celtiberian boar-hunt	201
9.6	Celtiberian swords and scabbards	202
9.7	Celtiberian brooches	205
9.8	Celtiberian symbols of status	206
9.9	The Celtiberian warrior	207
10.1	Designs on Gaulish coins	214
10.2	Trans-alpine trade in the late La Tène period	217
10.3	Late La Tène cult figures in Gaul – 1: Euffigneix and Bouray	223
10.4	Late La Tène cult figures in Gaul – 2: Neuvy-en-Sullias dancer and boar	225
10.5	‘Celtic’ iconography on the Gundestrup cauldron	226
10.6	Orientalizing <i>phalerae</i> in Western Europe	228
10.7	Native art in Northern Britain – 1: Mortonhall and Deskford	231
10.8	Native art in Northern Britain – 2: the Stichill collar, Roxburghshire	233
10.9	Native art in Roman Britain: Elmswell casket-mount, dragonesque, trumpet and Aesica brooches	235
10.10	Scottish cast bronze armlets	236
11.1	Irish zoomorphic penannular brooches	240
11.2	Hanging-bowl escutcheons	241
11.3	Irish hand-pins	243
11.4	The Norrie’s Law, Fife, silver hoard	244
11.5	Symbol stone art	247
11.6	Animal imagery in later Iron Age insular art	251
11.7	Initial letters from the <i>Catbach</i> of St Columba	253
11.8	‘Ultimate La Tène’ in Ireland	
	A: Rinnagan crucifixion plaque	255
	B: Lagore belt-buckle	255
11.9	The Book of Durrow, <i>f. 21v</i>	257
11.10	Technical details of the Ardagh chalice	
	A: trichinopoly	260
	B: <i>Pressblech</i>	260

PREFACE

My interest in Celtic art arose initially during my postgraduate years under the supervision of Professor Christopher Hawkes at the Institute of Archaeology in Oxford. In 1966, as a temporary Assistant Keeper in the Ashmolean Museum, I benefited from sessions in discussion with Professor Martyn Jope, whose book on *Early Celtic Art in the British Isles* (2000) had just that year been advertised as forthcoming. Jope had a remarkable capacity for seeing perspectives that others missed. After studying an object for some minutes, he would ask a question that suddenly focused attention on a quite novel aspect of its ornament, always crediting the student with a perception equal to his own. In 1972, a symposium on Celtic art at the Maison Française in Oxford, at which I participated, brought together a number of senior scholars and those who were emerging as the authorities of the next generation, notably Hawkes, Piggott and Jope, Klindt-Jensen, Paul-Marie Duval, Frey and Kruta among others, the outcome of which was a stimulating if idiosyncratic volume, *Celtic Art in Ancient Europe* (1976), edited by Duval and Hawkes. For the next thirty years, I taught Celtic art as integral to the European and Insular Iron Age in the University of Edinburgh, and the present volume is therefore very much the product of my study of the subject over the past forty years.

Reflecting upon my teaching of Celtic art over that period, I now regret its limitations in two principal respects. First, in common with long-standing convention in Continental Europe, I too readily equated Celtic art with La Tène art. I now believe that exclusive equation to be too restricting, and it is perhaps on account of the otherwise distracting debate about Celts and Celticity in later prehistoric Europe that I felt obliged to address the question of defining Celtic art. Second, my lectures, in common again with many archaeological, as opposed to art-historical treatments of the topic, came to a conclusion with Romanization, and scarcely looked further into the early historic period. Without suggesting that Later Celtic art, or Early Christian art, is in any meaningful sense a resurgence of earlier traditions, I believe its study can usefully inform our understanding of the processes that combined to create the more outstanding manifestations of Early Celtic art. It is with these processes, social, economic and technological, and the archaeological context and environment of Celtic art, that this book is concerned, as much as with the art-historical aspects of the subject.

Any book on Celtic art plainly requires adequate illustration, and it has to be admitted that this has presented a considerable challenge. Some objects are self-evidently treasures of great technical and artistic accomplishment, and deserve colour

PREFACE

illustration, as the publisher has generously provided. Other artefacts are less photogenic; in some cases ornament is extremely fine or barely visible through corrosion, or is such that it is hard to illuminate for photography from a single angle. In such cases it was considered better to illustrate with line-drawings rather than unsatisfactory photographs. Except where specifically acknowledged, all the line-drawings were redrawn by the author, sometimes from more than one source, for two reasons. First, it was considered preferable to have a uniform style in the drawings. Second, many published drawings, for example, of scabbard ornament, were evidently not drawn for the scale of reduction intended, with the result that detail has either bleached out or blackened in. In the present volume, all the drawings have been tested for reduction by reduced photocopies, so that the published versions should be at least as good as these, in all of which the detail survived, despite the scale of reduction. Regrettably, only a limited number are drawings from the original artefacts, so that those based upon previously published drawings or images should be regarded as interpretative rather than authoritative.

Obtaining photographic images proved more problematic than was anticipated, in some cases taking nearly a year to obtain, and in other cases never arriving at all before the book went to press. Recognizing that digital imagery has taken over from traditional photography, it is a matter of concern that so few museums seem to retain the facility or inclination to make new images on request, and even more so the implication that older photographic archives have not been maintained. I wish nevertheless to record my gratitude especially to the following individuals and institutions for their courtesy and service in providing photographic and illustrative material:

The Historisches Museum der Pfalz, Speyer, and especially Peter Haag-Kirchner, the Landesmuseum für Vorgeschichte, Dresden, the Württembergisches Landesmuseum Stuttgart, the Landesdenkmalamt Stuttgart, the Hessische Landesmuseum, Darmstadt, the Swiss National Museum, Zurich, the Musée des Antiquités Nationales and the RMN Paris, the Bibliothèque Nationale de France, Paris, the Musée des beaux-arts Angoulême, the Department of Prehistory and Europe and the Photography and Imaging Department of the British Museum, the Library Manuscripts Department of Trinity College Dublin, the National Museum of Ireland and especially Mr Finbarr Connolly, the Germanisches Nationalmuseum, Nürnberg, the Badisches Landesmuseum, Karlsruhe, the Rheinisches Landesmuseum, Bonn, the Museum für Vor- und Frühgeschichte, Munich, the National Museum of Prague, the National Historical Museum of Romania, Bucharest, the Stiftung Preussischer Kulturbesitz, Berlin, the Museum of Antiquities of Newcastle upon Tyne, the National Museums of Scotland, the Moesgård Museum and the National Museum of Denmark, Copenhagen, who were among the first to respond, the Musée historique and archéologique de l'Orléanais, the Musée Saint-Raymond, Toulouse, the Rijksmuseum van Oudheden, Leiden, the Landesmuseum Joanneum, Graz, the Historisches Museum, Berne, and the Musée du Chatillais, Chatillon-sur-Seine. I owe a particular debt to Prof. Dr Irwin Scollar for help in expediting the project, to Suzie and Gery Hermanau, and Dr Eberhard Sauer for help in German correspondence (not invariably comprehensible even to native speakers), to Ian Morrison for solving innumerable computer crises and to the many colleagues and friends who have encouraged me to completion. Most of all my thanks are due to my wife, Carole, who has lived with it and tolerated it for so long.

All sources are otherwise acknowledged individually with the photographs.

PREFACE

Finally, I should record my thanks to the University of Edinburgh for allowing me sabbatical leave in the session 2005–6 to complete the book, and to the Research Committee of the School of Arts, Culture and Environment for a subvention towards the cost of photographic material and reproduction fees.

D. W. Harding
Gullane,
June 2006

DEFINITIONS, MATERIAL AND CONTEXT

Few topics in archaeology have spawned as many perceptions and misconceptions as Celtic art. An Internet search for 'Celtic art' immediately offers patterns of 'Celtic' interlace and knot-work, elements of later Celtic art in fact derived from Mediterranean or Germanic origins, or images of high crosses of ninth-century date or later and related icons of the early 'Celtic' church. For coffee-table books a dust-jacket depicting the Gundestrup cauldron is considered representative, notwithstanding the fact that it was almost certainly of Thracian manufacture, and discovered in northern Jutland, well beyond the limits of Celtic Europe. In academic publications, Celtic art is generally synonymous with the La Tène ornamental style of the pre-Roman Iron Age, but even this equation should not pass unqualified. Since in recent years the concept of Celts and Celtic as an ethnic descriptor has itself been questioned, it seems appropriate now to re-define and re-assess what we mean by Celtic art.

History of research

The identification of distinctive styles of ornament on Iron Age metal-work as 'Celtic' has its origins in the mid-nineteenth century, and is particularly associated with John Kemble, whose work was published posthumously in 1863, together with contributions from R. G. Latham and A. W. Franks, under the title *Horae Ferales*. Franks used the term 'Late Keltic' to describe objects such as the Battersea shield and horse-gear from the Polden Hills hoard, in contrast to earlier material of the Bronze Age that was also regarded as Celtic on the basis of contemporary studies of human craniology. 'Late Keltic' was still being used at the end of the century, notably by Arthur Evans (1890) in his report on excavations at Aylesford in Kent, but fell out of use thereafter with the decline in fashion of craniological and ethnic correlations. Notwithstanding his later Aegean interests, Arthur Evans was a pioneer in the study of Celtic art, his Rhind Lectures in Edinburgh of 1895 anticipating Paul Jacobsthal by nearly half a century in recognizing the classical influences on the early La Tène style. On the Continent, cultural and even chronological identifications of some of the classic assemblages were still more tentative, with early discoveries of chieftains' burials in the Rhineland being assigned to the Roman period, while related finds were alternatively attributed to Teutonic times. One of the pioneers in the field of La Tène studies, Ludwig Lindenschmit, had classified finds from the site of La Tène on Lake Neuchâtel, but had not identified them as native Celtic, and likewise believed that objects like the Durkheim torc were Etruscan imports. In 1871, de Mortillet recognized metal-work

at Marzabotto near Bologna as similar to material from the Marne, and inferred that here was the archaeological evidence for trans-alpine Gauls of the documentary sources. As late as 1889, Adolf Furtwängler published the Schwarzenbach bowl as the product of a workshop in the vicinity of Massilia on the analogy of east Greeks on the Black Sea producing high-status metal-work for Scythians. In effect, the equation between La Tène metal-work and Iron Age Celts was not fully established until Joseph Déchelette's *Manuel d'Archéologie préhistorique, celtique et gallo-romaine* was published immediately prior to the First World War.

After the publication in 1944 of Paul Jacobsthal's *Early Celtic Art*, the equation between La Tène art and Celtic art was effectively taken as read, and it is only in the past decade that this has been seriously challenged. Unfortunately that challenge has been in the context of a wider 'deconstruction' of the 'myth' of the Celts, promoted more vigorously among English archaeologists than among their 'Celtic' neighbours in Britain and Ireland, and equally not so widely canvassed in Continental Europe. Judicious re-appraisal is unlikely to proceed while the polarized rhetoric of the Celticity debate still rages. It is self-evident that Celtic art studies in modern times owe a fundamental debt to the magisterial work of Paul Jacobsthal. In acknowledging this debt, however, we should recognize that *Early Celtic Art* adopted the perspective of a classical archaeologist, whose interest in the art of the European Iron Age had been triggered by the Celtic embellishment of the Klein Aspergle kylix (Pl. 3), noted while the author was studying Greek vases in Stuttgart in 1921 (1944, vi). Accordingly, the strength of Jacobsthal's perception was his appreciation of the various stylistic influences from classical art that impacted especially upon the earlier phases of north-alpine La Tène art. Because of the vicissitudes of late 1930s Europe and the war years, *Early Celtic Art* was produced under extremely difficult circumstances. But it has to be acknowledged that it often reads more like a scholar's notebook than a research synthesis, and its catalogue could hardly be described in contemporary terms as user-friendly.

Like many scholarly landmarks, however, *Early Celtic Art* has both stimulated further study and impeded it by imposing a framework and terms of reference that now need to be challenged. Jacobsthal concluded that 'Celtic art is an art of ornament, masks and beasts, without the image of Man' (ibid., 161). In effect, his Early Style, Waldalgesheim Style, Sword Style and Plastic Style are not *art* styles, but *ornamental* styles, as Jope evidently recognized when he referred to the *La Tène ornamental style* in Britain (1961a). Social anthropologists would not define art so narrowly, and would certainly include a range of artefacts whose role was not solely utilitarian, whether explicitly ornamented or not (Layton, 1991). It was the restricted interpretation of Celtic art as synonymous with La Tène ornamental styles that presumably caused Jacobsthal to dismiss Celtic art in Spain (1944, v). The impact of the La Tène ornamental styles in the Hispanic peninsula was, as we shall see, minimal. But if Celtic art is alternatively defined in terms of the range of weaponry and defensive armour, personal ornaments and accessories to ceremonial or ritual activities, for example, all of which from documentary sources appear to be fundamental to Celtic society, then the evidence from South-Western Europe seems as mainstream to the study of Celtic art as is the La Tène art of Central and West-Central Europe. We should surely pay homage to Jacobsthal's achievement; but after more than sixty years it is time that the theoretical framework of Celtic art studies was reviewed, and that some of the fundamental assumptions of study were challenged.

Most studies of Celtic art since Jacobsthal have been concerned primarily with discerning a sequence of 'styles' and their inter-relationships. In effect, though the principal contributors – Jacobsthal, Martyn Jope, Paul-Marie Duval, Otto-Herman Frey, Miklós Szabó and others – were archaeologists, their approach to Celtic art has been substantially from an art-historical viewpoint. This approach is important, and should not be deprecated simply because it is now less fashionable than socio-economic or cognitive reconstruction. Vincent Megaw recognized the need to set the study of Celtic art in the context of Celtic society, and has contributed significant papers to which the present study is indebted. Accordingly, this treatment of the subject will attempt to evaluate Celtic art not just in terms of stylistic developments over time and space, but in the context of Iron Age society, as far as it can be reconstructed from the evidence of archaeology. What was the role, symbolic, ritual or social, of ornamented metal-work and sculpture? What does it tell us of the technological skills and status of jewellers or armourers in Celtic society? Were there 'workshops' and 'schools' headed by master craftsmen, and, if so, did they operate under princely patronage or in a commercial market environment? What was the nature of the long-distance connections that are manifest in stylistic influences? Do these reflect population movements, movement of craftsmen, trade or diplomatic exchange? And how does this high-status expression of Celtic art compare with decorative arts in more mundane media, like pottery, wood or textiles? How might the role of art objects that survive archaeologically have functioned in the context of non-tangible art forms such as oral poetry, song and dance? And, finally, are there significant discernible changes over time or between different regions of Europe in the role of art in society?

Celtic ethnicity, Celtic languages and 'Celtic' art

The first questions that should be addressed in a book that incorporates the phrase 'Celtic art' in its title are whether the term 'Celtic' is justified, and in what sense it is being applied? Chapman (1992) cast doubt on the belief that Celts in Iron Age Europe existed as an ethnic group at all. Collis (2003) was more qualified in his critique, noting that Caesar's identification of the inhabitants of his third part of Gaul, who were known as 'Celtae in their own language, but "Galli" in ours' (*de Bello Gallico*, 1, 1), might endorse the concept of a Celtic ethnic identity. He also cited among others the case of the Romanized poet Martial, who in the first century AD claimed to be half-Celtic and half-Iberian. However inadequate or confusing the sources may be, the ancient writers evidently thought of Celts as an ethnic identification. The real problem therefore is the correlation of ancient ethnic Celts with Celtic languages, on the one hand, and with any coherent set of archaeological material, on the other.

The earliest usage of the term 'Keltoi' by ancient writers is by Hecateus and Herodotus in the late sixth and fifth centuries BC, in reference to one of the recognized groups of barbarian neighbours of the Greeks. Herodotus' grasp of European geography and his understanding of ethnography may have been tenuous, but it is important that the recognition of Celts as an ethnic identity, however ill-defined or imprecisely located in Central and Western Europe, pre-dates the appearance of the La Tène culture in the mid-fifth century BC. Since it is likely that the emergence of the Celts considerably pre-dated their first impact upon Greek historians or geographers, there is a

case for believing that Celts in Continental Europe existed from at least the later Bronze Age.

Later classical sources are by no means consistent in their references to Celts for various reasons. The problem is compounded by the various usages in Greek and Roman sources of the terms *Keltoi*, *Galatai*, *Celti* and *Galli*. The fact that tribal groups are identified by Caesar among the *Celtae* or *Galli*, the *Belgae* and *Aquitani*, for example, suggests that there may have been a hierarchy of levels within which the native communities identified themselves, and that 'Celt' was therefore almost certainly a supra-tribal and perhaps supra-regional descriptor. In this case it seems possible that Caesar's fundamental division of Gaul into three parts mistakenly equates entities at different levels. 'Belgium' plainly included a dozen or more tribal groupings, as did 'Aquitania', so these would appear to be 'middle-order' entities. Their contrasting by implication with 'Celtic' Gaul might suggest that neither Aquitania nor Belgium were Celtic, but if Caesar was unaware of a 'middle-order' designation for the rest of Gaul, he might have resorted to the 'supra-regional' name as shorthand for 'the rest'.

The absence of references to Celts in the very partial documentary record, either for Britain or for other regions of Continental Europe, particularly east of the Rhine, is no guarantee that the inhabitants of those regions were not part of the wider Celtic community. Collis' (2003) preference for regarding France west of the Rhine as the probable Celtic heartland in part derives from the fact that, through Caesar, this is where Celts are most clearly located, and in part from the fact that the documentary sources point most clearly to these regions as the homeland of Celtic migrants of the early fourth century into Italy. Yet this is not to say that regions east of the Rhine were not also Celtic from an early date, even though the surviving documentary sources are more equivocal. Caesar's distinction between Gauls and Germans along the Rhine (as opposed to Teutonic Germans of Northern Europe), quite evidently was a red herring introduced by him for political reasons. Strabo (*Geography*, IV, 4, 2; VII, 1, 2) was in no doubt that Gauls and Germans were related by kinship, and explained that the Romans called the Germans 'Germani' (L. *germanus* = true, genuine, as a natural brother) to emphasize that they were blood brothers of the Gauls. Accepting the historical migrations of Gauls into South-Eastern Europe as originating west of the Rhine, then plainly the situation in north-alpine Central Europe may have been affected by this phase of expansion, but there must be a strong possibility that people of Celtic ethnicity and speech occupied Europe east of the Rhine from a much earlier date. For Strabo, at any rate, *Celtica* at the supra-level extended north of the Alps to the mouth of the Rhine and to the Pyrenees and the Ocean in the west.

The equation of ethnic Celts of antiquity with Celtic languages has aroused equal controversy. It is true that the group of Indo-European languages now known as 'Celtic' have only been so designated since George Buchanan's pioneer work of the sixteenth century, being more widely adopted from the early eighteenth century. It is equally self-evident that much of Victorian and modern 'Celtomania' has no sound scholarly foundations in ancient history or archaeology. Yet however the language group is designated, it is clear from linguistic, epigraphic, numismatic and place-name evidence that by the early Roman Empire it covered a wide region of Central and Western Europe, including the Hispanian peninsula, northern Italy, Britain and Ireland. In the absence of evidence for wholesale population incursions of the late pre-Roman period to account for such linguistic super-strata, it seems reasonable to regard this as

the language group of the various communities whose archaeological material culture has been systematically identified by archaeologists as early Iron Age or even later Bronze Age (Harding and Gillies, 2005). Across the territory covered by the proxy-map of Celtic languages, there is plainly no uniformity of material culture, though there may be common elements. It is certainly not co-terminous with the La Tène distribution, nor with that of Hallstatt or the Urnfield series before that, though these Central European cultures certainly fall within the putative Celtic zone, and the Urnfield distribution is perhaps closest of any to a pan-European phenomenon. But in Atlantic Europe in particular there are sizeable regions, such as northern and western Britain, southern Ireland, western France and the Hispanic peninsula, where Urnfield, Hallstatt and La Tène material culture made minimal impact. While we might share Collis' view (2003, 195) therefore that 'there is likely to have been some feeling of common identity across Europe, at the level of a shared language', there can be little doubt that regional patterns of material culture must indicate some quite striking differences, notably between Central Europe, on the one hand, and the Atlantic seaboard, on the other.

How far Celtic languages can be projected backwards in time is much more contentious. Renfrew (1987) saw the emergence of Celtic languages in Europe as an indigenous development from a much earlier introduction of Indo-European with the first farmers, but this view scarcely takes account of the complexity of the evidence, and has not gained widespread support among linguists. In any event, we should not expect patterns, linguistic, archaeological or ethnic, to have remained immutable over centuries. Nor should we necessarily therefore expect close correlations between archaeological and linguistic distributions, or linguistic and ethnic distributions, any more than we would now expect the level of correlation between archaeological cultures and ethnic groups that was firmly envisaged by Gustaf Kossina or Gordon Childe in the earlier twentieth century.

If we are prepared to accept 'Celtic' as a language group, variants of which were widely spoken by Iron Age communities in Central and Western Europe, and even that the concept of Celtic ethnicity, however ill-defined in the classical sources, implies a measure of commonality of identity between neighbouring groups, what should the term 'Celtic' mean in the context of Celtic art? Most studies of Celtic art since Jacobsthal have been principally focused on La Tène art, a term that conventionally includes insular British and Irish metal-work, even though diagnostic or typical types of Continental La Tène are really relatively poorly represented here. Yet in contrast to the general pattern of Iron Age material culture, in which Britain is decidedly peripheral to Central Europe in the number and range of definitive types, in the field of ornamented metal-work from the third century BC onwards at least the British inventory is as spectacular as anywhere in Celtic Europe. In Ireland not only are key La Tène types such as safety-pin brooches represented by barely three dozen known examples, compared to a thousand or more in the Duchcov hoard from the Czech Republic alone, but even those few are of distinctive insular types, quite without parallel in Continental Europe. Other so-called La Tène types, such as Y-pendants and spear-butts, are likewise not at all characteristic of Continental La Tène, to the extent that one might question how La Tène the Irish assemblage actually is. Yet the La Tène in Ireland would normally be regarded as an important sub-group within the overall family of Celtic art.

Apart from distinctly regional sub-groups like the Irish La Tène, there are other areas of Atlantic Europe that might well qualify as 'Celtic' on the basis of linguistic or allied evidence, but where the impact of La Tène material culture is minimal or non-existent. Ireland south of a line from Dublin to the Galway Bay presents a particular problem that will be discussed in due course. But south-western France and the Hispanic peninsula beyond the Iberian zone are regions where La Tène or La Tène-related types are relatively few, and where ornament of material artefacts is not nearly as prolific or distinctive as in the La Tène tradition. In Spain, apart from the area of documented Celtiberians, there are regions to the south-west and north-west where place-names and allied evidence suggest the presence of Celtic speakers. These regions too, therefore, will need to be considered if we are to justify the title of 'Celtic' art beyond simple convenience and convention. If, then, there are regional populations that were Celtic-speaking but not characterized archaeologically by a La Tène culture, we should question reciprocally whether all bearers of La Tène culture were necessarily Celtic-speaking. Self-evidently the *exclusive* equation of Celtic identity with La Tène material culture is mistaken, but could the exclusive equation of La Tène with Celtic also be erroneous?

Finally, in this section, we should consider the chronological limits of Celtic art. Most Continental studies conclude with the Roman Empire, which effectively brought an end to the La Tène art style. In Britain, on the fringes and beyond the Roman frontiers, and in Ireland, by contrast, the 'long Iron Age' extends well into the first millennium AD. Though any elements of continuity from earlier Celtic art into the 'Pictish' period in Northern Britain, or into Early Christian art in Ireland, need to be carefully scrutinized, nevertheless these communities were Celtic-speaking, and may legitimately be included in the broader discussion of Celtic art here proposed. Indeed, consideration of the composition, context and potential meaning of these later styles may prompt questions relevant to the study of earlier Celtic art.

Materials and techniques

Attempting to define an art object in the context of later prehistoric societies is likely to be contentious. A flint axe, a bronze pin or a pottery vessel may be technically accomplished and aesthetically pleasing to handle, but we would not necessarily regard them as art objects. Yet many bronze pins or brooches that presumably served a utilitarian function as dress accessories may conform to a form and style not dictated by function alone that consciously or unconsciously identified the individual or community that made them, or satisfied the social or ritual conventions that governed their use. More elaborate objects may be ornamented in a manner that permits the identification of recurrent motifs and images, the arrangement of which according to conventions that might be compared to the rules of grammar constitutes a particular 'style' in the sense used by Jacobsthal. 'Art' is plainly not synonymous with 'ornamentation', but may be implicit in the object itself. It is probably an anachronistic coincidence that the Neuvy figurines (Figure 10.4A) should appeal to modern aesthetic taste, but they and other artefacts, like the boar images from across Iron Age Europe, must surely have had significance as art or cult objects to contemporary communities, or sects within those communities. Associations, as in graves or hoards, should be informative, and while we may legitimately be concerned with detailed analyses of individual items, it is

important not to overlook their associations in order to evaluate significance or 'meaning' in context.

The media of Celtic art were various, though metal-work predominates in the literature because it was the medium of high-status artefacts of the greatest technical competence. Bronze and iron are frequently found in combination on objects such as scabbards or parade armour that are sometimes further embellished with glass ('enamel') or coral inlay. Bronze-working skills had reached an advanced level by the later Bronze Age, with the development of complex casting techniques like the *cire perdue* or lost-wax method, the use of beaten sheet-bronze for body armour as well as buckets and cauldrons, the invention of drawn wire and rivets to assemble and reinforce such vessels, and the capacity to combine different alloys for strength or flexibility. With the notable exception of the Hungarian series of La Tène scabbards, bronze is the dominant medium of decoration, which may be achieved in two basic ways, by engraving or in relief. Engraving is achieved in a variety of techniques, using tracer, graver, scriber or scorper. Among these, the rocked graver, used to create a tremolo line, is one of the more common devices witnessed on beaten bronze. Relief ornament can be achieved by casting the design as an integral part of the artefact itself, either using a two-piece mould or by the lost-wax technique. An alternative with beaten bronze artefacts is fashioning the design in *repoussé* by hammering with punches from the reverse side. The use of compasses to outline the design may be implicit in the design itself, or sometimes betrayed by surviving compass dots in pivotal positions. More elaborate examples of metal-working may incorporate a variety of different materials and techniques, arguing for highly skilled craftsmen, perhaps operating in dedicated workshops or even 'schools'.

Iron working was also attested in Europe by the Urnfield late Bronze Age, and by the La Tène Iron Age had superseded bronze for swords and edge-tools. Whether bronze-smiths had adopted iron technology, or whether iron workers represented a separate group skill remains uncertain, but the two are certainly found in combination in many of the prestige items of early Celtic art. The technical complexity of an object like the scabbard from grave K3 at Kirkburn in Yorkshire (Figure 5.7, 4; Stead, 1991a, Figure 53), with its copper-alloy front-plate, iron back-plate, suspension-loop, chape-binding, chape and hilt with red 'enamel' studs, together with rivets and washers for assembling, betrays an expert armourer. But was he also the same craftsman who ornamented the front-plate with its engraved tendril design, or were there teams of individual specialists collaborating within the workshop?

Of the precious metals, gold is predominant in Celtic art: silver is not unknown, but is very much in the minority within the La Tène tradition. The technical proficiency of gold-working is equally of the highest quality, as may be seen, for example, in the multiple-strand construction of the electrum torc from Snettisham, Norfolk, hoard E (Pl. 10a), bedded into hollow-cast terminals with relief ornament. Relief ornament here was generally effected in *repoussé*, though in two of the Ipswich torcs it was achieved by *cire perdue* casting. Particular technical traits, like the soldered ballusters of the Rodenbach series, may be indicative of a local tradition or even a related group of workshops.

Glass (as opposed to faience) is a material that first appears in quantity in the later Bronze Age, principally in the form of glass beads, and this remains its most popular use in the Iron Age. The central grave at the Hohmichele was notable for the

discovery of hundreds of beads, the remnants of grave-goods that tomb-robbers did not stop to gather up. Some glass beads in the Iron Age are of such a simple form that their dating cannot be closely defined and their distribution is wide and hardly diagnostic. Others display recurrent traits, like bosses or spiral inlay, some with marked regional concentrations, and some of which from chemical analysis may be attributed to local workshops. By the middle and late La Tène period, bracelets in translucent blue, green, yellow and clear glass are known, some with elaborate mouldings, fluting or inlaid ornament around their edges. Glass is not simply used for objects themselves, but as an inlay to embellish larger objects, like the shields of later pre-Roman Iron Age Britain, sometimes clustered in a raised bed or metal framework (*champlevé*). In the later Iron Age, the use of *millefiore* glass embellishment is characteristic of the metal-work of Early Christian Ireland. It is therefore intriguing that Jacobsthal was so dismissive of the relevance of glass to his analysis of early Celtic art (1944, v).

Stone as a medium has a limited but not insignificant role in the archaeology of Celtic art. The subtleties developed in metal-smiths' workshops are not always amenable to rendering in stone, though the designs on the Pfalzfeld pillar (Figure 3.8A) and Turoe stone (Figure 8.6), for example, bear an obvious relationship to the metal-working styles. Relief elements might be transposed into stone sculpture more readily than incised designs, and embellishment achieved in metal-work with coral or glass inlay might have been simulated on stone with paint. Life-sized stone figures and fragmentary heads, sometimes from contexts or with attributes that have been interpreted as indicating divinities, are found in Iron Age Europe in funerary or related contexts from the late Hallstatt and early La Tène periods, and may have once had their counterparts in wood. Stone *stelae*, like those of the Breton early Iron Age, are in general not extensively carved, though they could easily have been painted with natural pigments that have not survived. Equally in the Irish Iron Age, Turoe and Castlestrange may have been the exceptions among a greater number of natural boulders in prominent locations that could have been painted to similar effect.

Among domestic artefacts, pottery is the most obviously available medium for ornamentation. Despite the selective introduction of the potter's wheel from the fifth century BC, much of the pottery of Iron Age Europe remains plain and undistinguished, and was presumably manufactured domestically or locally until the later La Tène period. Where finer wares occur, including decorated vessels or those with surface slip, they are frequently from funerary contexts, perhaps suggesting special production for the occasion. A question that needs to be addressed is whether we should necessarily expect a correlation between the ornamental styles of fine metal-work and the motifs and designs displayed on pottery, with the implication that pottery might prove to be the poor relation in that comparison, or whether the role and meaning of ceramic ornamentation were quite different from that of fine metal-work. In plotting distributions of art style-zones, therefore, we should be cautious about apparent contrasts that might reflect the medium in use rather than real differences in style if like were compared with like. Any system of classification based upon the stylistic developments in pottery is unlikely for technical reasons to accord with the system devised by Jacobsthal for the sequence of La Tène art styles on the basis principally of fine metal-work.

Among the least well preserved of the media upon which Celtic art might have been displayed are perishable, organic materials such as wood, bone and textiles. Some

examples survive, such as the textiles from late Hallstatt graves that show patterns comparable to the geometric designs of sheet bronze metal-work, or such as the lathe-turned wooden vessels from the Somerset 'lake-villages', the ornament of which reflects that of pottery vessels of similar type. We might imagine that the plaster walls of buildings could have been painted with designs proclaiming identity or invoking supernatural protection. Above all, perhaps at times of conflict or for seasonal festivals, the human body itself would almost certainly have been a medium for ornamentation. Body painting if not tattooing was doubtless a widespread practice, though it is unlikely to survive archaeologically other than in exceptional circumstances as in the burials in permafrost from Pazyryk in the Altai. Nevertheless Caesar's reference to natives dying themselves with woad, or Roman descriptions of Britons beyond the northern frontier as 'Picti' almost certainly indicates similar practices.

Artefacts, associations and context

A trawl through *Early Celtic Art* would readily reveal that the categories of metal-work that constitute the core of La Tène art are weapons and defensive armour (including equestrian gear), drinking vessels and services, and personal ornaments. There is of course much else besides, but it is from these three categories that the image, or perhaps the caricature, of the Celt derives, the aggressive, swaggering warrior, drunken and intemperate, and given to extravagant personal display. Encouraged by the classical sources, this image is easily exaggerated, even in scholarly texts, but we should also beware the fashion for 'pacification' and 'sanitization' of prehistory. From the Urnfield late Bronze Age there was an increase in the number and technical complexities of long swords and daggers, and in the Hallstatt and La Tène Iron Ages in elaborate scabbards, compatible with a society that placed great prestige on martial accomplishments. Defensive equipment, notably the insular series of shields, included prestigious display items which, unless backed by leather or wood would have been ineffective in actual combat. A problem arises therefore in evaluating the relative requirements of ceremonial prestige and military utility, allowing for the fact that in Celtic warfare the ritual component may well have been fundamental. Though specific types may differ regionally and through time, the basic warrior's equipment of the European Iron Age, sword, spear and shield, and less commonly helmets or body armour, has its antecedents in the late Bronze Age.

Personal ornaments show less obvious continuity. Pins occur in a profusion of types in the Urnfield period, and are the predominant dress-fastening in much of north-alpine Europe. Various ornamental brooch types are known, however, from the later Bronze Age north and south of the Alps. Some of the later Italic types were adopted in the late Hallstatt Iron Age north of the Alps, and the safety-pin type of brooch became the standard dress-fastening of the La Tène Iron Age. Other fashionable ornaments are neck-rings or torcs, arm-rings or bracelets (located variously between shoulder and wrist), finger-rings and leg-rings. Whether these were simply dress-accessories or had additional social significance, as indicators of age or marital status, for example, is arguable on the basis of studies of Iron Age inhumation cemeteries in Central Europe. Gold ornaments are relatively rare in the European late Bronze Age. Regional groups like the Irish 'dress-fasteners' and 'sleeve-fasteners' reflect a flourishing industry based

on local resources, while Carpathian sources doubtless continued to supply eastern Central European goldsmiths throughout the later prehistoric period.

The aristocratic drinking service of the late Hallstatt and early La Tène Iron Age displays a degree of novelty in the appearance of Greek or Etruscan types such as two-handled *stamnoi* or the beaked flagon, the latter adopted and adapted by Celtic craftsmen to reflect the decorative tastes of their patrons. In fact, the distribution of some Italic types, such as the cordoned bucket, extends well beyond any definition of Celtic Europe into the Germanic north European plain and southern Scandinavia, suggesting rather different distributional mechanisms from the more concentrated distribution of beaked flagons, for example, in the middle Rhine, Moselle and Saar. Perhaps Celtic chieftains not only exploited the southern sources for their own use, but acted as entrepreneurs for wider distribution, themselves re-distributing goods in exchange for northern raw materials. At the same time there are also 'native' Hallstatt types in the drinking service, and it may be a matter of debate how far the import was simply of a few exotic types and how far the social role of drinking, and what was drunk, were significantly changed. Late Bronze Age communal drinking vessels of beaten bronze were of native design and manufacture, whether of the central European Kurd bucket type, or regional Atlantic variants from Britain and Ireland. Cauldrons too in sheet bronze represent an Atlantic tradition, no longer regarded as derivative from the eastern Mediterranean. The Mediterranean connection remained important through to the late La Tène, however, when Italic bronze wine-flagons and ancillary equipment appears as far north-west as England, and when wine-amphorae have a widespread distribution through Gaul and into southern and south-eastern England.

Wine was evidently introduced to Celtic Europe through the Greek colony of Massilia by the sixth century and from Etruscan Italy in the following centuries. Grapes were certainly cultivated in Italy by the time of the Second Punic War; in southern Gaul, wine was first produced around the first century AD, and by the third century AD viticulture had been established in Bordeaux and Burgundy, and in the Moselle and Rhine shortly thereafter. There is some evidence of fruit wines in the Bronze Age, but otherwise the principal alcoholic drinks would have been beer and mead, the production of which undoubtedly continued despite the alternative attractions of Mediterranean wine for those who could get it. In fact, there may be some evidence, archaeological as well as documentary, to suggest that beer and wine may have been favoured differentially among different communities in Iron Age Europe.

Much of this high-status material has been well preserved because it derives from graves. Not only has it survived through burial within a pit or under a barrow, but it was generally deposited intact and whole in the first place, by contrast to domestic refuse that would only be abandoned when broken beyond repair or recycling. The instance nevertheless of grave-goods in burials is not universal, and many later prehistoric cemeteries, even those from the Hallstatt and La Tène culture zone, may yield relatively modest assemblages. The presumption therefore has been that lavishly equipped tombs, like the late Hallstatt Hochdorf and Vix burials, or those of the early La Tène period from the Rhineland, were chieftains' graves or *Fiirstengraber*, the relative status of their occupants being inferred from the range and quality of associated grave-goods. The dangers inherent in this simplistic assumption, and in its converse, that less well-equipped graves were of individuals of lesser social status, are manifest. Identification of sex too has been made too glibly on the assumption that weapons

indicate a male and personal ornaments a female burial. This too supposes that the grave-goods are the property of the deceased, rather than being part of the funerary rite itself. Grave-goods may tell us far more about the community or kin group responsible for the burial, or about the rites and requirements of the funerary process, or about the political and social circumstances in which the tomb was built, than they do about the individual or individuals whose remains were deposited in it. The unfinished board game in the late La Tène doctor's grave at Stanway or the nine drinking horns and nine bronze plates from the Hochdorf burial hint at other players in the rites of passage and other guests at the funerary feast, while the not infrequent pairing of vessels like the Basse-Yutz, Lorraine, flagons and *stamnoi* again may reflect rules of deposition rather than being just the property of the deceased.

Inference of the social status of the dead from associated grave-goods is perhaps best exemplified by 'warrior' burials, in which the absence of a wider range of grave-goods might well indicate the role of the deceased. But this inference too has been challenged as imposing one particular set of presuppositions on the archaeological data. Not surprisingly the occurrence of 'warrior' burials across Central Europe in the middle La Tène, with the 'triple panoply' of sword, spear and shield, was inevitably linked a generation ago with Gaulish migrations of documented history. The recurrence of this martial assemblage nevertheless should be indicative in some regard of the special status of the dead. Yet can we really suppose that the dead of the early La Tène vehicle burials in the Champagne were in life all charioteers, or was the vehicle a ceremonial attribute like a gun-carriage in more recent state funerals that happened to be interred in some instances with the dead?

In any event these distinctive burials are concentrated within particular regions of Iron Age Europe at certain periods, but are by no means representative of any pan-European pattern. There are extensive areas of Europe, including Britain and Ireland over protracted periods of time, that have minimal evidence of any form of burial that might be recognized as regular or recurrent; indeed, the assumption that there should be such a norm has rightly been challenged. There could have been a variety of different practices for disposal of the dead, not all of which entail interring the remains in an archaeologically conspicuous deposit. Excarnation or cremation and scattering, for example, might leave very ephemeral traces archaeologically. Perhaps instead we should ask why some communities *did* choose to make a spectacular display in burial. In the case of the late pre-Roman Iron Age burials of the Welwyn group, for example, some of which date into the early years of the Roman occupation, we might regard the lavish funerary deposits as a chauvinistic display of identity in the face of an alien and intrusive culture. Whatever the circumstances, it seems unlikely that conspicuous burials were simply intended for the disposal of the dead, but that they were part of the political and social fabric of the hierarchies that built them. As such, the accompanying grave goods are hardly a representative selection of what the deceased possessed or enjoyed in life; they are instead a statement by the community or its leaders affirming their own status and authority in the temporal and cosmic order.

A second major source of objects that display Celtic art among other utilitarian artefacts is hoards. Iron Age hoards may not be as common as are hoards of the Bronze Age, but there are notable examples like Duchcov in the Czech Republic or Hjortspring in Denmark, or even the multiple pit hoards from Snettisham in Norfolk (Pl. 10b). The purpose of these hoards is now widely regarded as votive (Bradley, 1998),

though the probability that hoards were buried for safekeeping in times of insecurity should not be discounted, particularly in areas of political instability like the frontiers of the Roman Empire. The very variable incidence of Bronze Age hoards in Europe, regionally and through time, might support the idea that they were in some instances at least prompted by political instability (Harding, A., 2000, 355–6). Bradley and others have studied the relative composition of hoards and graves, in an attempt to assess whether these two forms of ritualized deposit were similar or complementary in their composition, in which we might well expect to find regional variations in practice. A particular variant on the theme of votive deposit is the deposit of hoards, collectively or cumulative, in water, whether river, lake or marsh, a practice too which has an older ancestry than the Iron Age. The site of La Tène itself is often highlighted as an example of a water deposit, the nature of which remains contentious, not least because of the adjacent structural remains of bridges and wharf-side buildings. Special deposits like the broken weaponry from Gournay-sur-Aronde and Ribemont-sur-Ancre readily prompt a ritual interpretation, but many hoards are less spectacular and may yet have had a more mundane explanation.

Coin hoards are a special case. The interpretation of coin hoards may depend upon our understanding of the purpose of coinage in the first place. It seems probable that the initial use of coinage in Celtic Europe, from around the third century BC, was for fulfilling social obligations such as the provision of dowry or payment of fines, rather than for exchange within a market economy, which is only practical with the development of lesser denominations or ‘small change’. Payment for the services of mercenaries has been suggested as one possible catalyst for the adoption of coinage, and the fact that some of the Continental hoards number tens of thousands of coins might argue for community control rather than individual wealth. Nevertheless, Louernius, king of the Arverni, was able to distribute largesse by scattering gold and silver coins in quantity among his followers, if the Poseidonian tradition is to be believed. Numismatists have generally assumed that coin hoards might coincide with periods of political unrest such as the Gallic Wars, but smaller coin hoards are also found in ritual contexts.

The fact that artefacts of the ‘Celtic art’ class less frequently come from settlement sites or fortifications, unless buried as a hoard within their environs, need occasion no surprise, since these are not contexts like graves or votive hoards from which the objects were not expected to be retrieved. What survives archaeologically, therefore, is by definition domestic debris, generally fragmentary and not considered worthy of salvage. Smaller items like brooches may have been lost, and therefore have been found in some numbers from hill-forts like the Mont Lassois in Burgundy or from later La Tène *oppida* like the Mont Beuvray, Manching or Stradonice, where they may have been manufactured. These sites may also yield informative if fragmentary remains of glass and pottery, which may be compared to the assemblages from contemporary burials.

Craftsmen and production

Despite the fact that archaeological classification for more than a century and a half has been based upon the Three Age technological model, actual metal-working sites or evidence for the role of craftsmen is remarkably sparse in the archaeological record. Settlement sites may yield what is uncritically described as ‘slag’ (begging the question

which stage in the metal-working process it represents), but in minimal quantities compared to the actual by-product of bronze or iron-working on even a limited scale. Crucibles and fragments of moulds are found, but again it is not always taphonomically clear that they represent *in situ* activity. Excavated evidence of metal-working was recovered from the late Hallstatt occupation at the Heuneburg in south-west Germany, where a 'workshop quarter' was identified on the basis of smelting furnaces and related structures. Graphic testimony of metal-working on site was provided by the casting mould for a 'Silenus mask' for the handle attachment of an Etruscan bronze flagon. In Britain and Ireland several hill-forts of later Bronze Age and Iron Age date have yielded evidence of bronze-working, notably Rathgall in Co. Wicklow (Raftery, 1976; 1994a), the Breiddin in North Wales (Musson, 1991) and South Cadbury in Somerset (Barrett *et al.*, 2000), though the structures associated with this activity are rather ephemeral in each case. By the late La Tène period, iron production in quantity is attested by the profusion of iron implements from the *oppidum* at Manching in Bavaria, though the structural evidence here, and at Kelheim, where the volume of slag indicates very large-scale production of iron, amounts to broken debris from furnaces and hearths for smelting and smithing. The problem archaeologically in locating the actual production sites is hardly surprising. Because of noxious fumes and risks of fire, industrial processing was likely to be located away from the focus of settlement, and ethnographic evidence suggests that the mystique attached to the smiths' craft may equally have set them aside from the domestic community.

Professional metal-working, however, was not restricted to hill-forts or *oppida*. The scale of production at Gussage All Saints, Dorset, was sufficient to convince Spratling (1979, 141) that it was not simply a seasonal activity. Furthermore, it is clear that output was concentrated on the production of harness equipment and chariot fittings rather than everyday domestic goods. A similar pattern of specialization is reflected in the later Iron Age in Atlantic Scotland, as at Beirgh in west Lewis and Eilean Olabhat in North Uist. It is evident, therefore, that metal-working was conducted at a variety of levels, from the professional and specialist to the seasonal and domestic, and that the archaeological evidence for these activities, other than through the products themselves, might prove hard to recover.

Iron ore is widely available across Europe, and it is probable that local supplies were exploited without necessitating extensive mining operations. Copper and tin, on the other hand, did require deeper mining. Information regarding mining techniques, and more especially about the communities involved in mining, is less easily inferred. Modern research at the salt-mine settlement at Dürrnberg-bei-Hallein (Stöllner, 2003) paints a bleak picture of conditions underground, with miners suffering from parasite infestation and child labour making up a significant part of the workforce. It is hard to reconcile this with the relative wealth of graves from the early La Tène cemetery, probably not of the miners themselves, but of the wealthy elite that controlled the highly productive output of salt and salt-cured beef. Stylistic similarities between the flagon from grave 112 at the Dürrnberg and that from the Glauberg in Hessen argue for long-distance networks among the master craftsmen and their patrons, but there is no reason to assume that the manual labourers of the mining community enjoyed the benefits of their wealth creation.

Indicative of the status of craftsmen in Celtic society are occasional examples of burials, such as graves 469 and 697 at Hallstatt, or in some of the Celtiberian warrior-graves,

in which tools are included among grave-goods. On the basis of Urnfield and Hallstatt graves in Central Europe with metal-working accessories, Anthony Harding (2000, 239–40) has suggested that bronze-smiths may have been accorded special treatment in death as in life. Pauli raised the possibility that the early La Tène chariot-burial at the La Gorge-Meillet burial might have been that of a master craftsman on the basis of its possible association with hammer, punches and related tools (Pauli, 1978, 459). Whether we recognize the role of warrior-craftsman depends again upon whether we regard grave-goods as ‘possessions’ or symbols of office of the deceased, whether we view them as votive offerings, or whether they are indicative of those groups in society who contributed to the funerary rites. At any rate, it underscores the dangers of simplistic interpretation.

The relative absence of evidence for metal-working, more especially for permanent metal-working sites or workshops, encouraged Childe’s (1930, 44ff) belief that bronze-workers were full-time craftsmen, but operating on a peripatetic basis from village to village, a model that has proved remarkably enduring. The Megaws endorsed this model for the early La Tène period (1995, 357), though recognizing the probability of some static workshops in princely patronage. Certainly the wide-ranging sources of supply and specialist skills implicit in prestige objects like the Basse-Yutz flagons implies mobility of materials, skills and ideas, but this need not mean an independent class of itinerant craftsmen. Craftsmen may indeed have been mobile, but more probably within the constraints of a hierarchically-controlled society. Recognizing the products of individual workshops or ‘schools’ on the basis of stylistic similarities, therefore, is a tenuous principle. Technical traits, like those displayed by the Rodenbach series of balluster rings or Haffner’s (1979) Weiskirchen type of gold-leaf plaques, on the other hand, may be a more reliable indicator of the distribution area of a workshop or related ‘guild’ of craftsmen. In particular, the use of a specific formula in the compass-drawn designs of the latter might be evidence of the exclusive or ‘secretive’ nature of some groups of artists.

Ethnographic analogies (Rowlands, 1971) suggest a variety of models for the role of metal-workers in non-state societies, and it seems probable that in Iron Age Europe, given the range of craft skills involved and the great diversity of production, several different systems were in operation. Some undoubtedly involved long-distance sources of supply, of amber or coral, for instance; other more basic needs, such as supplies of iron ore, could have been met from local resources. It is inherently unlikely that the warrior elite would have relied upon itinerant tinkers for their weapons and defensive armour, and the employment of master-craftsmen under princely patronage seems probable too for the finer pieces of personal ornament, even if the individual specialists in sheet bronze-work, lost-wax casting, ornamental engraving, gem-setting, gold-working and the like were drawn from a wider pool through diplomatic liaisons.

An important and under-used source of potential light on the role of craftsmen in Celtic society is early Irish or Welsh literary sources (Gillies, 1979). Recognizing the pitfalls of treating these as a ‘window on the Iron Age’ (Jackson, 1964), they nevertheless articulate traditions that could well have had a greater antiquity. Gillies identified several recurrent themes that he believed might have a ‘respectable antiquity’ in Ireland and Wales. One of these was the belief in a triad of craft gods, Goibniu the smith, cognate to the Roman Vulcan, Luchta the wright and Creidne the bronze-smith, all linked by their role in providing spears used in battle by the ruling

Tuatha Dé Danann. Though there is no basis for assuming a pan-Celtic pantheon on the basis of insular evidence, it seems likely that smiths with particular attributions featured in the supernatural cosmology of the European Iron Age. A second recurrent theme from early Celtic literature, not just in reference to the supernatural or mythological world, but apparently in everyday life as well, is the high regard accorded to craftsmen. The smith 'from his role as armourer in a warlike society, and from his part in the creation of ornament and decoration for an intensely vain honour-culture' (Gillies, 1979, 75) was rewarded for providing through his craft endorsement of the social hierarchy that the poet provided in words. Master-craftsmen were thus ranked among freemen together with the physician, whose graves equally have been identified archaeologically by their associated assemblages. It seems possible that some of these specialized craft skills were hereditary, but the early Irish historical and genealogical texts also offer clues to the possible existence of 'occupational castes' or perhaps communities whose tribal deity was associated with particular occupational skills.

Motif, style and meaning

The conventional approach to archaeological classification, the recognition of types and type-sequences, study of their recurrent associations, and the plotting of spatial distributions of key types, has been criticized over the past generation as descriptive rather than explanatory or interpretative. Accepting that analysis is not an end in itself but a means of distilling order from the mass of data available as an essential preliminary to interpretation, this study of Celtic art will retain a framework that attempts to identify styles, broadly in chronological sequence, and that sees the recognition of recurrent themes and individual motifs as a basis for meaningful comparisons. A study of individual or recurrent motifs, like the pelta or triskele of La Tène art, is not simply an exercise in academic pedantry, but is essential to an understanding of Celtic art, just as the understanding of words is an essential prerequisite to a critical appreciation of poetry. To attempt a critical appreciation without this fundamental understanding is simply dilettantism. Jacobsthal, Fox and others have written about the 'grammar' of Celtic art, by which they meant the repertory of motifs, and their adaptation or integration into the overall composition. Some of these motifs are derived from external sources, such as the palmette and lotus of the early La Tène styles, though they are rapidly transformed, not through technical ineptitude but through positive re-interpretation, into a novel, Celtic form. Much the same processes are evident in the transformation of Greek models and classical imagery on Celtic coinage, not disintegration in the hands of inept or uncomprehending barbarians but a re-invention of the originals.

Style has been defined as the 'totality of conventions which make up the art of a particular area at a particular period of time' (Shapiro, 1953) and in the context of Celtic art by Ruth and Vincent Megaw as the 'combination of technical and iconographic elements to produce a particular form or effect' (Megaw and Megaw, 2001, 20). Jacobsthal used the term to define his principal landmarks in the development of La Tène art, Early Style, Waldalgesheim, Sword and Plastic, with regional variants like the Hungarian and Swiss Sword Styles. A review of this sequence might suggest a greater diversity still of local styles at different periods, particularly if we take a broader sweep of the media represented rather than allowing fine metal-work and a classical perspective, as was Jacobsthal's, to predominate.

DEFINITIONS, MATERIAL AND CONTEXT

The recurrence of some key motifs, and even combinations of motifs, encourages the belief that these had a 'meaning', and that it was part of the purpose of communication rather than simply the decorative embellishment of a functional artefact. In as much as art is created in a social environment, and in the context of its beliefs and values (Layton, 1991, 43) then Celtic art doubtless conveyed a meaning, overtly or sub-consciously, to those who were aware of its significance. The role of art in ethnographic contexts, however, would suggest that this meaning might be known to the community as a whole or only to a select group within it. Once again, this might argue for a plural understanding of Celtic arts, the art of fine metal-work perhaps communicating with a different social group from the art of domestic pottery or textiles, for example. Only very occasionally can we expect archaeological evidence to provide 'answers' to these issues; but the limitations of the evidence should never deter us from asking the questions.

‘AN ART WITH NO GENESIS’

Later Bronze Age and Hallstatt origins

Jacobsthal’s dictum, that early Celtic art was ‘an art with no genesis’ (1944, 157) is one of the more famous quotations in the archaeological canon. He was, of course, referring to the genesis of the La Tène style, but even if we argue for a broader definition of Celtic art, the apparently sudden appearance of the La Tène Early Style still warrants explanation. There is no contradiction in Jacobsthal’s generalization and his identifying the triple sources of influence on the Early Style as ‘the East, Italy and Hallstatt’ (ibid., 155), since in this analysis he was dissecting the grammar of early Celtic art rather than its genesis as a technical, social or cognitive phenomenon. It remains true that early La Tène art appears in north-alpine Europe in the second half of the fifth century BC without clear archaeological evidence of cataclysmic change on the scale of population displacement or colonization, and without a revolution in industrial technology that might have generated a productive capacity hitherto lacking. Attempts have been made to depict the decline of the late Hallstatt strongholds (*Fürstensitze*) in south-west Germany as the outcome of radical social change (Pauli, 1985), but even if the evidence is interpreted in this way it is tangential to the regional foci in which early La Tène art first appears. Two approaches to the clarification of the genesis of Celtic art might be proposed. The first would be to examine older north-alpine traditions to see what antecedents there might have been for the recurrent themes of early La Tène art. The second approach would be to examine the cultural, technical and social milieu of the preceding periods in order to evaluate the environment out of which early La Tène art so suddenly and apparently without antecedents emerged. Both might help to redefine Celtic art in the broader sense of the art of later prehistoric communities that might reasonably be regarded as Celtic.

The late Bronze Age industrial revolution

The introduction of iron technology might be regarded as evidence enough for an industrial revolution, though in fact its introduction and progressive adoption in Europe were protracted over more than a millennium. Iron tools were in circulation in South-Eastern Europe in the mid-second millennium BC, and by the later Urnfield (Hallstatt B) phase, some swords were being made and embellished in iron in eastern Central Europe, and occasionally much further west (Gomez and Mohen, 1981; Pleiner, 1981b; Shramko, 1981). Bronze technology itself at the outset of the Urnfield period underwent a step-change of no less significance. Casting techniques developed the use of multiple-piece moulds, and in due course the *cire perdue* or lost-wax technique,

which permitted hollow casting by the use of plugs within the mould. Alloys too were increasingly deployed in a more sophisticated fashion depending upon the method of construction or the requirements of different parts of the artefact in question; so, for example, the body, base and handles of a bronze bucket might require the use of alloys of different composition. The use of sheet bronze was an important innovation. Used variously for the different components of the feasting or drinking service, buckets for mixing drink, strainers and cups for serving and consuming it, beaten bronze was also used for high-status parade armour, including breast armour and greaves by the later Bronze Age. Embossing techniques not only added ornament and doubtless symbolism to these prestigious possessions, but lent strength to the sheet bronze construction. Specialist techniques, like the use of rivets to link panels of sheet bronze or wire-drawing to reinforce the rims of beaten bronze vessels, were the natural concomitant of these developments. But the crucial point about these innovations for the understanding of the cultural milieu that saw the genesis of early Celtic art is that these technical skills were deployed for the aristocratic pursuits of feasting and drinking and the conflict of arms, or the ceremonial and symbolic associated with these activities.

It is not simply the extension of technical capacity and therefore of the range of types that makes the late Bronze Age a period of dynamic change, it is also the scale of production. Hoards of the period are not infrequently substantial in quantity, prompting questions regarding the reasons for their burial and non-recovery. Ritual deposition and the conspicuous destruction of wealth as a demonstration of social status have both been invoked as possible motives for hoards, but the probability must also be considered that there was some serious disruption of the political and social order in Central and South-Eastern Europe, perhaps not unrelated to the apparent collapse of Mycenaean civilization at the end of Late Helladic IIIB in the thirteenth century. Climatic deterioration is sometimes suggested as a cause for economic and political turmoil, bringing pressures upon land marginal for settlement and agriculture, and prompting strife between advantaged and displaced communities. At the same time industrial production on this scale itself requires a degree of political stability, not least because the sources of supply, the twin mineral deposits of copper and tin, are widely dispersed, and stable political relationships would be required to ensure a continuing supply of raw material across the trade routes of north-alpine Europe.

Sources of raw materials for metal-workers in the Bronze Age were doubtless already those that were later to be exploited by Iron Age bronze-workers and their patrons. Copper was available in plentiful supply in the eastern Alps, in the Balkans, the Carpathians and in Ireland; tin was not so widely available, but Cornish and Breton tin was doubtless in demand, together with supplies from Spain, Italy and the Ore Mountains of Eastern Europe. Gold had been exploited from the early Bronze Age, with Irish and Carpathian sources being worked from an early period. The industrial infrastructure plainly involved long-distance connections, and affords one obvious mechanism for the transmission of foreign fashions in artefact types and ornamental styles.

Funerary practice and ritual

The most fundamental change in burial practice represented in the late Bronze Age in Europe is the widespread adoption of cremation as the funerary rite. The north-alpine

practice of burial in Urnfields, first appearing in the Bronze D phase of the thirteenth century, spread over the next half millennium northwards into the Lausitz culture zone of the north European plain, and westwards towards the Atlantic coasts as well as into southern France and across the Pyrenees. The Urnfield culture, as its name implies, is distinguished by its cremation cemeteries, in which the ashes of the dead are buried in a pottery vessel or sometimes simply in a pit. Though the burial may be covered by a low mound, there is commonly no trace of any marker that survives. Burials may be enclosed by a shallow ditch defining a circular or rectilinear enclosure, sometimes an elongated rectangle, with distinctive regional variants across Northern Europe. Even beyond the Urnfield zone proper, including Britain, cremation becomes the dominant rite of the late Bronze Age, with the ashes commonly deposited in a pottery urn.

For the most part, burials in the Urnfield tradition show little evidence of hierarchical differentiation. Only in the earliest phase in eastern Central Europe are there burials distinguished by the wealth of their accompanying grave-goods, even though these may have been largely destroyed by the funerary pyre. At Čaka (Točík and Paulík, 1960) in south-western Slovakia, a rich burial of Bronze D, including fragments of bronze armour, was inserted into a large barrow mound of the Tumulus Bronze Age, and other rich pyre-graves in the same region date from the thirteenth century. In the Hallstatt A1 phase, rich burials are found in tumuli throughout Moravia, Slovakia, Hungary and Bohemia, while burials with vehicle fittings and drinking vessels occur in several burials from Switzerland and south Germany. The grave at Hart-an-der-Alz in Bavaria (Müller-Karpe, 1956) is notable for its inclusion of the fragmentary fittings from a full-sized vehicle, including axle-caps with lynch-pins, fragments of nave-hoops and spoke-covers and other ornamental attachments. While vehicle parts are included in burials of the Bronze D to Hallstatt A1 transition, however, the practice of burying the whole vehicle intact does not become the norm until the Hallstatt Iron Age. Beyond these early Urnfield exceptions, the great majority of Urnfield cemeteries thereafter include no elite burials distinguished by the structure of the tomb, though increasingly in later Urnfields grave-goods may indicate special status.

Associations may include accessory vessels and accompanying grave-goods to a greater or lesser degree. Some have few, if any, diagnostic metal types, but cumulatively it has been possible to build up a reasonably reliable sequence, based upon the changing technical details of bronze typology. The classic demonstration of this approach was Müller-Karpe's (1959), based upon some eight hundred closed groups, even if the detail of the sequence with its sub-divisions was subsequently subject to modification. Among pottery types, the cylinder-neck urn, sometimes embellished with bosses or fluting, is widespread. The predominant bronze types, apart from weapons and edge-tools – swords, spear-heads, axes and knives – are personal ornaments, including bracelets and a great diversity of pins.

Though inhumation had been virtually non-existent from Bronze D through Hallstatt A, it reappeared as a rite in Hallstatt B, and with the transition to Hallstatt C, inhumation once again becomes fashionable, though certainly not exclusively or even predominantly. Even in contexts like the well-known princely tomb at the Hohmichele (Riek, 1962) cremation is equally represented, and evidently was not displaced by inhumation, since some cremations are stratigraphically later than inhumations. In fact, burial sites like the Hohmichele are readily attributed princely status on grounds of their size and the wealth of some burials, even though other

burials in the same tomb are virtually devoid of grave-goods to proclaim their elite status. A striking element is the inclusion in elite burials of a four-wheeled wagon, providing a link with vehicle burials of the early Urnfield phase, and equestrian equipment, again with Urnfield precedents. The practice of vehicle burial in Hallstatt C and D (van Endert, 1987; Pare, 1992) was focussed upon the four-wheeled funerary carriage, but anticipates the more obviously martial tradition of chariot-burial that developed from the early La Tène.

South of the Alps by the twelfth century BC, the rite of cremation and the practice of urn burial had spread through much of the Italian peninsula, and several of the key bronze types from the Italic urnfields, including violin-bow brooches, razors and median-winged axes are types shared in common with their north-alpine counterparts. This tradition of trans-alpine connections continues into the first Iron Age, with the regular occurrence, for example, of brooch types in common. It is unnecessary to engage in a debate regarding the significance of this commonality of culture in terms of diffusionism or whether specific types were developed in any one region first, thereafter spreading to another. The simple reality of such demonstrable relationships underscores the fact that the trans-alpine transmission of artefacts, styles and perhaps the craftsmen themselves in the early La Tène period was hardly a novelty, but based upon long-standing cultural reciprocity, however generated.

An outstanding element of the later Bronze Age of Europe is what has been called the 'spiritual revolution' (Harding, A., 1994), of which the adoption of cremation is one principal manifestation. One striking feature is the repeated use of symbolism, frequently of sun discs or water-birds, commonly the two together (Figure 2.1). The beaten bronze buckets from Unterglauheim in Bavaria and Hajdú-Böszörmény in northern Hungary both have *repoussé* ornament in which these bird motifs are balanced about a sun-disc, while radiating sun-symbols recur on several examples of body armour, and both birds and sun-discs are found on greaves. The same combination of water-birds and sun-disc or wheel-motif occurs on the beaten bronze amphora from Mariesminde, Fyn, Denmark, one of several exotic items of beaten bronze-work that have been interpreted as the products of long-distance trade or gift-exchange from eastern Central Europe. Bird imagery is widespread throughout the Urnfield and Hallstatt Iron Age, with small cast representations being used as ornamental finials or pendants. In the world of the La Tène Celts there is ample documentary evidence to endorse the special ritual associations of birds, and doubtless some representations, like the bird of prey hovering over the Çiumeşti helmet and the malevolent owls on the Bră cauldron, had a profound supernatural significance. But others, like the duck swimming down the spout of the Basse-Yutz flagons or the bird's head terminal of the Torrs horns, are more in the tradition of bird images of the Urnfield period or Hallstatt Iron Age, and if they did embody any significance more than ornamental they may have been simply tokens of good luck.

A particularly striking component of the later Bronze Age ritual assemblage is *Kesselwagen*, wheeled cauldrons, which might have been thought to have been part of the festive drinking service, but which in several instances are actually the containers of cremations (Figure 2.2A, 1–3; Piggott, 1983, 120–2). Among the earliest is an example from Milavec in Bohemia which was found with a Riegsee sword of Bronze D. Some, like the example from Orastie, Romania, or that from Acholshausen in Bavaria (Pescheck, 1972), are notionally drawn by teams of water-birds. The cult of the

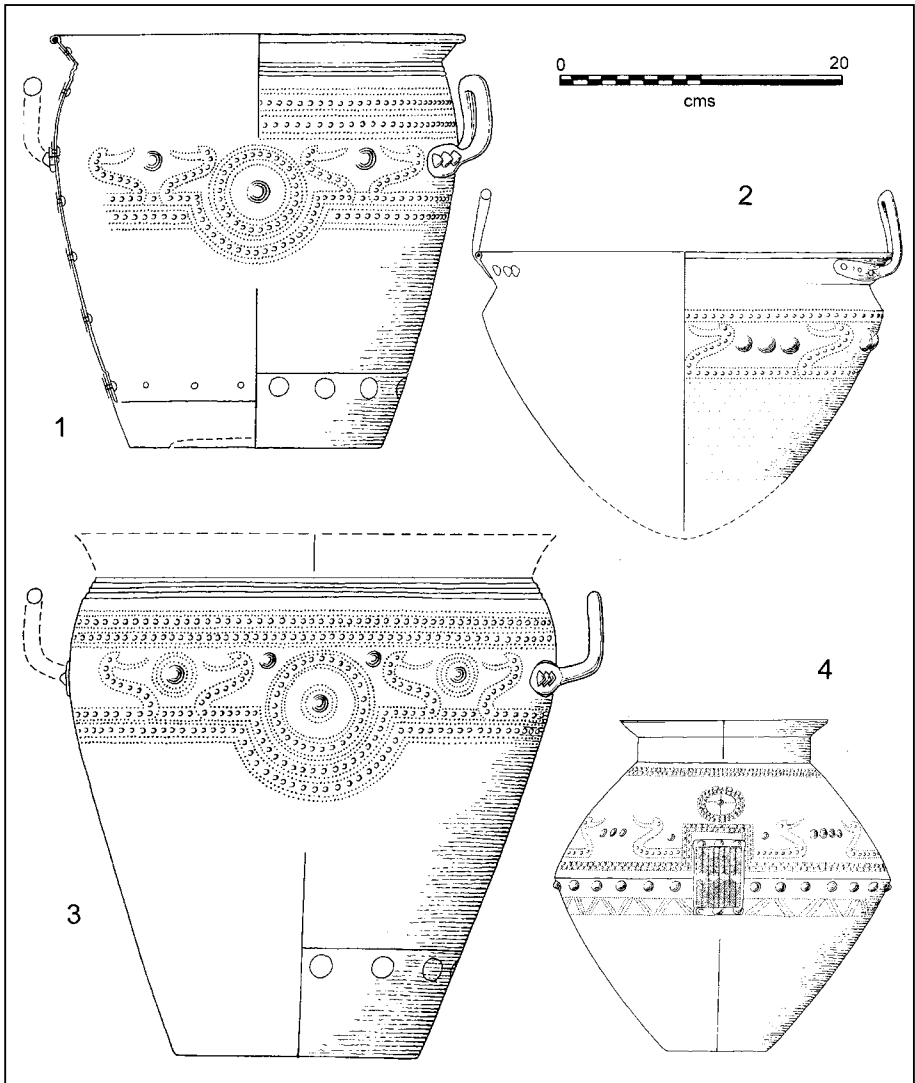

Figure 2.1 Late Bronze Age vessels with bird and sun-disc ornament. 1, Hajdúböszörmény, Hungary; 2, Tiszavasváry, Hungary; 3, Unterglauheim, Bavaria; 4, Mariesminde, Fyn, Denmark. Adapted from Kossack (1959), Patay (1990) and Thrane (1965).

wheeled cauldron was evidently not restricted to the Urnfield culture zone, however; from Denmark comes the wheeled cauldron from Skallerup, and there is evidence both from artefacts and from rock-carvings of ritual symbolism. Sun symbolism plainly is of great antiquity in both Central and Northern Europe, and for the period immediately

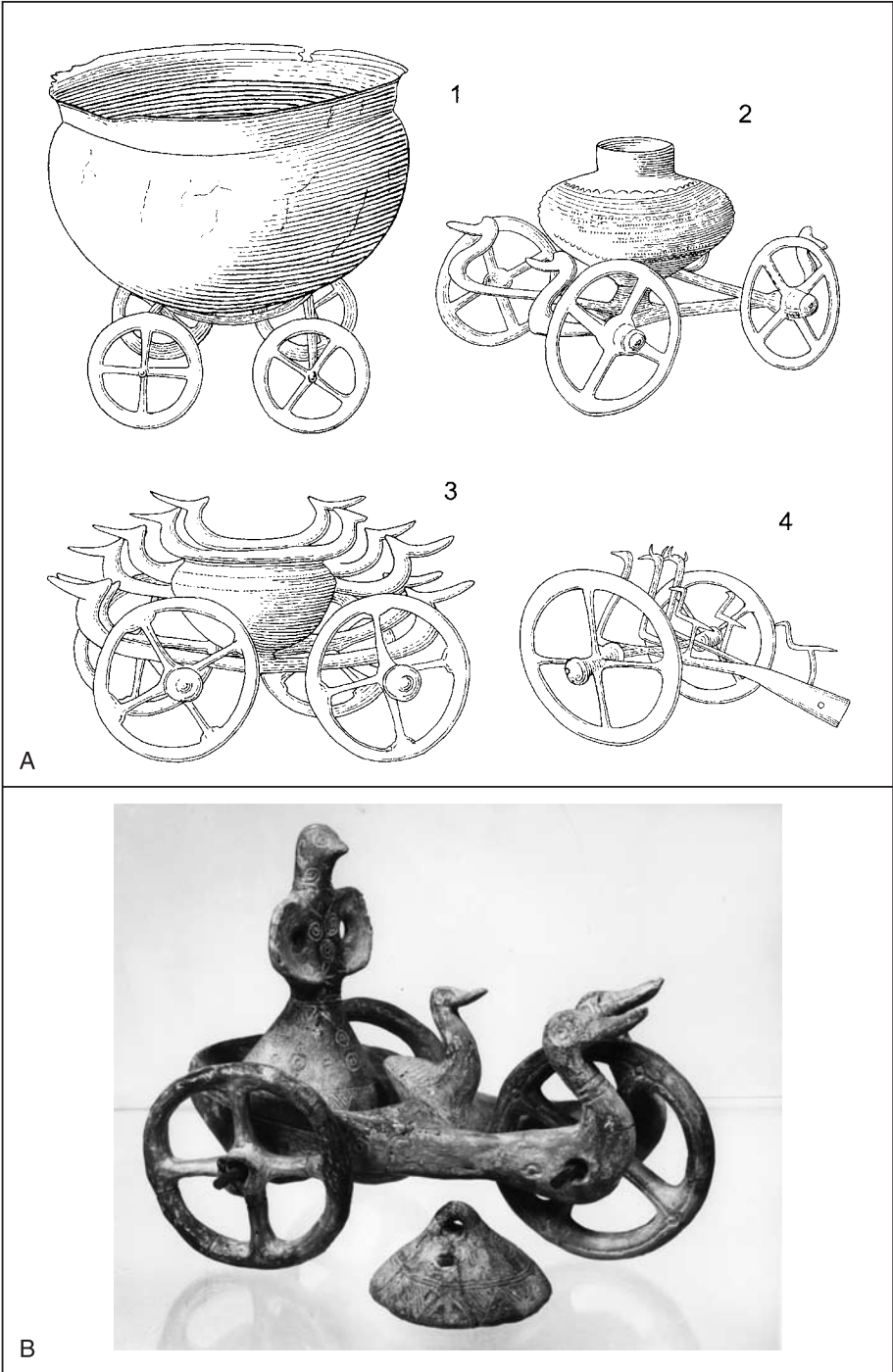

Figure 2.2 Late Bronze Age cult vehicles. A: 1, Milavec, Bohemia; 2, Acholshausen, Bavaria; 3, Orastie, Romania; 4, Burg-im-Spreewald, Brandenburg. Adapted from Piggott (1983) and Müller-Karpe (1980). Not to scale. B: Dupljaja, Serbia. Inv. No. 4533. Photo: the National Museum in Belgrade.

preceding the late Bronze Age is eloquently evidenced by the gilded sun disc on a wheeled carriage from Trundholm in Denmark and by the disc inside the pair of pottery miniature tricycles, bearing a bird-headed priest or priestess accompanied by birds, from Dupljaja in Serbia (Figure 2.2B). A variation on the theme are the *Deichselwagen*, wheeled trailers, also in miniature, with socketed shaft bearing bird-headed protomes (Figure 2.2A, 4). The occasional occurrence in Urnfield graves of the parts of such vehicles, like the bronze wheels, suggests a widespread practice that has frequently failed to survive the funerary pyre. Yet whether these vehicles in miniature, and the technical construction, for example, of their four-spoked wheels, reflected full-sized equivalents in regular use in everyday life remains a vexed issue. Evidently by the later Bronze Age, horse-drawn vehicles, notionally depicted at Trundholm, were replacing the older practice of ox-draught, and by the Hallstatt Iron Age four-wheeled carts or funerary hearses had reached a considerable level of technological sophistication. One of the most elaborate of the cult-wagons of later prehistoric Europe, dating from the Hallstatt C–D transition around 600 BC, is from Strettweg in Austria (Figure 2.3; Egg, 1996). The four-wheeled wagon bears an entourage of female and ithyphallic male figures, together with horse-warriors and stags, with a central oversized goddess bearing a shallow dish, which in the latest reconstruction served as the base for a hemispherical bowl. Here is the culmination of ritual drinking, animal and fertility symbolism combined in a single funerary emblem.

Animal symbolism in fact is not as prominent in the Urnfield late Bronze Age as it becomes in the Hallstatt Iron Age. The archaeological evidence certainly underscores the importance of pastoral agriculture in the late Bronze Age economy, but this is not evidently reflected in ritual symbolism. Where animals, and particularly horses, are depicted, on occasional pendants or in North European rock art, they are stiff-legged creatures. In the Hallstatt Iron Age, cattle are sometimes more realistically rendered, but in bovine protomes, and even in the rendering of the whole animal, there is still a cartoon-like simplicity (Figure 2.4).

One aspect of prehistoric social practice for which a ritual motive is commonly invoked is the practice of deposition, frequently in water or wetlands, of prestige goods or hoards of artefacts (Bradley, 1998). Hoards are widespread in the late Bronze Age, and votive deposition is by no means the sole explanation. Founders hoards and scrap hoards had a more practical explanation, and the conspicuous destruction of wealth has frequently been argued as an important factor in sustaining the social hierarchy. Burial with lavish grave-goods is one obvious way of disposing publicly of wealth; destruction on the funeral pyre is an even more effective way of ensuring its disposal. Wealthy graves seemingly were vulnerable to robbing in antiquity, as is witnessed by the central burial of the Hohmichele barrow. The tomb builders evidently anticipated this problem, in the case of the late Hallstatt (Hallstatt D) grave at Hochdorf in Baden-Württemberg (Biel, 1985) going to considerable lengths to create an inner and outer wall to the timber chamber with substantial stonework between. The techniques used evidently drew upon the skills of contemporary engineers of hill-fort defences. The intriguing question arises, who were the potential robbers? In the absence of evidence for external raiders, one must assume the threat was internal, and with tombs of this status and magnitude it can hardly have been any odd group of moonlighting grave-robbers. Rather than supposing social upheaval in the form of a popular uprising against the aristocracy (Pauli, 1985), Arnold (1995) proposed that the highly targeted

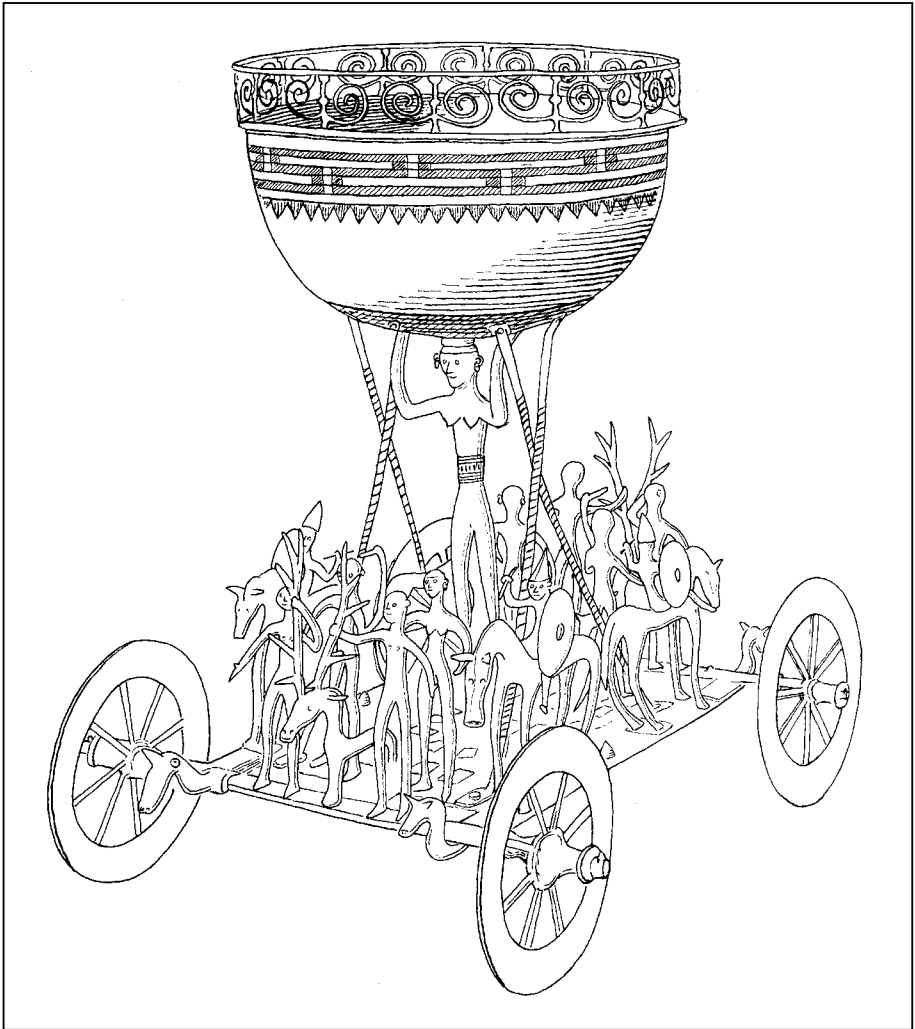

Figure 2.3 Strettweg, Austria, cult vehicle. Adapted from Egg (1996) based on original in *Ur- und Frühgeschichtliche Sammlung am Landesmuseum Joanneum, Graz.*

tomb-robbery of the late Hallstatt period reflects a change in ruling dynasties, the seizure of power by a secondary elite and the wilful destruction of the symbol of legitimacy of the overthrown regime. Tomb-robbing, therefore, may not have been intent upon the acquisition of illicit wealth so much as its public destruction, together with all it stood for.

The wealth of material for which a ritual interpretation seems probable raises the question whether by the later Bronze Age there was already a distinctive sect within society whose responsibility was the conduct of ritual activities and custody of spiritual

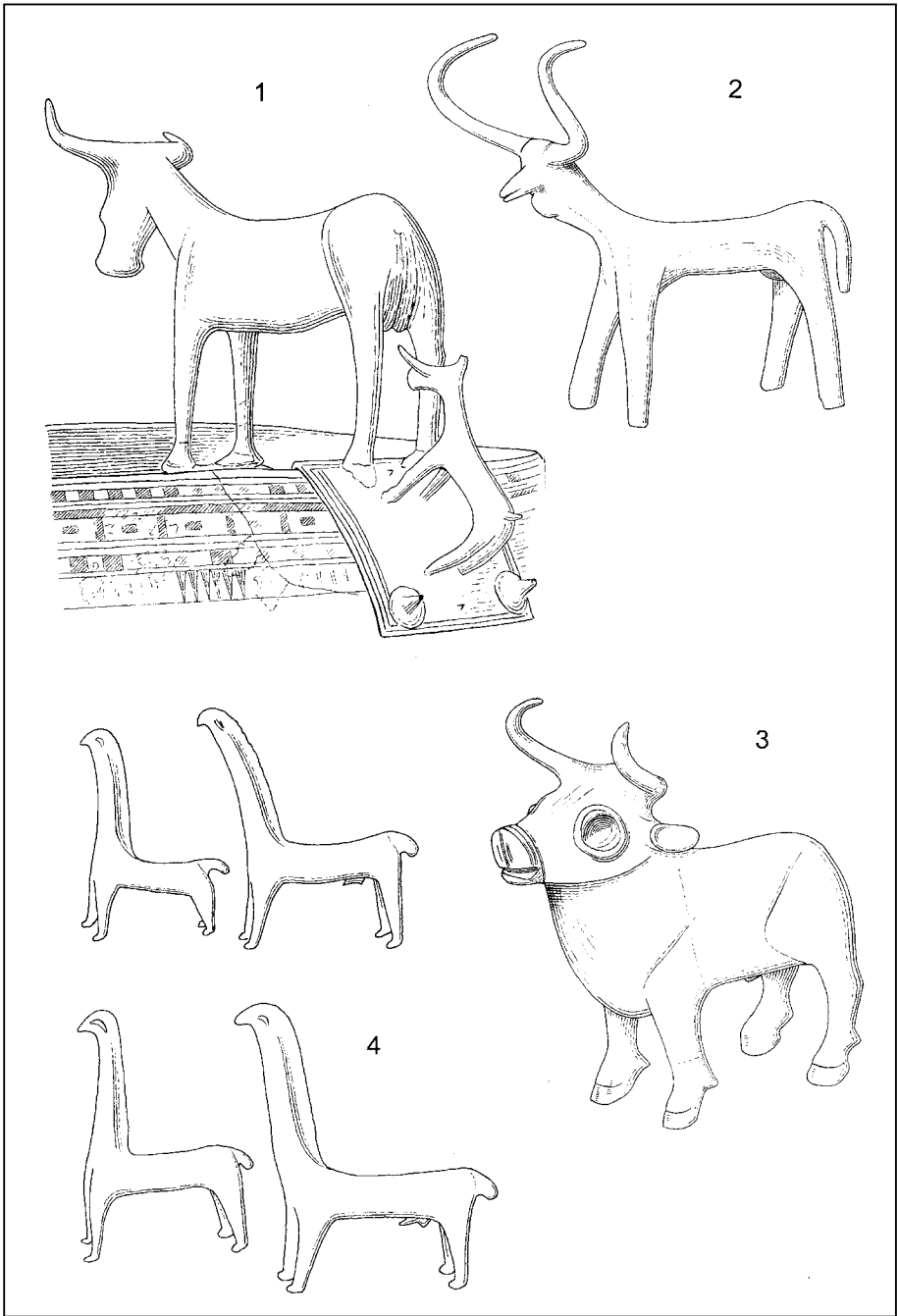

Figure 2.4 Hallstatt period animal imagery in bronze and pottery. 1, cow and calf as cauldron handle, Hallstatt, grave 671; 2, cast bronze bull, Hallstatt, grave 507; sketch drawings from various published photographs of originals in the Naturhistorisches Museum, Vienna; 3, cast bronze bull, Býčí Skála, Moravia; 4, two pairs of pottery horses and mares, Römerstein-Zainingen, Baden-Württemberg. Adapted from Torbrügge (1968). Not to scale.

knowledge, in a role comparable to that attributed to the druids of the later Iron Age. Archaeologically such a specialist group is unlikely to be readily recognizable, though it is tempting to see the decorated gold cones as 'hats' (Pl. 1), which, if they were indeed intended for use as headgear, must have been worn by a prince or priest of the Urnfield aristocracy.

Fortifications, settlements and society

From the sheer numbers of burials represented in the archaeological record for the late Bronze Age, and from the quantities of artefacts recovered from burials and from hoards, it is generally inferred that this was a period of demographic expansion and social change. Compared to some earlier periods of European prehistory, the settlement evidence too is relatively abundant. Settlements display considerable diversity, both topographical and morphological. Fortified sites become more prominent than in earlier periods, while non-fortified settlements include single nucleated farmsteads and agglomerated villages (Audouze and Büchschütz, 1992). Environmentally distinctive settlements include the lakeside villages of Switzerland, for the most part abandoned by the turn of the first millennium BC or shortly thereafter, and the lake or marsh fortifications like the Wasserburg, Buchau, Baden-Württemberg (Kimmig, 1992) or Biskupin in Poland. In parts of southern France caves continued to be used, if only for periodic activities, a practice that evidently continued into the Iron Age.

Though fortified enclosures had been known from earlier prehistory, hill-forts assume a more dominant role in the landscape from the late Bronze Age. Defensive architecture, essentially comprising wall-ramparts, stockades and gated entrance-passages, assume a variety of forms, using a combination of timber and stone. In Switzerland, the Wittnauer Horn (Bersu, 1945), occupied from Hallstatt B to Hallstatt D, but apparently with no material evidence of Hallstatt C, employed a massive timber-laced rampart across its promontory. Elsewhere its perimeter was too precipitous to warrant defensive ramparts, but the buildings themselves seem to have been backed against the perimeter instead to afford a sheltered internal compound. A similar disposition of houses against the perimeter is characteristic of the Urnfield period hill-settlements of the Ebro valley such as Cabezo de Monleon, and at Cortes de Navarra this layout developed into something approaching a pattern of streets and houses (Maluquer de Motes, 1954; 1958).

The number of fortified sites or open settlements that can be assigned confidently to the Hallstatt C phase is limited, and it is in Hallstatt D that most commentators detect an unequivocal hierarchy of settlement for the first time. The hierarchical scheme for hill-forts, developed by Kimmig (1969) and reviewed on a number of occasions since (Härke, 1979; Eggert, M., 1989; Pauli, 1994), is well known and need not be rehearsed at length. The role of the *Fürstensitze* of south-western Germany within their territories, particularly as centres for the receipt and perhaps redistribution of Mediterranean imported goods, has been extensively studied (Frankenstein and Rowlands, 1978; Fischer, F., 1995), though the evidence for redistribution has rightly been challenged (Dietler, 1990). Furthermore, the discovery of Attic pottery at lesser sites like Bragny-sur-Saône suggests a greater degree of complexity in the social and economic structure than was at first anticipated. To link any of these late Hallstatt sites to the emergence of commercial forces of the kind that some have attributed to late La Tène *oppida* (Wells, 1984), however, seems premature, explaining neither the

sudden demise of the one, the relatively rapid development of the other, nor the apparent hiatus between the two.

In domestic architecture, rectangular plans are the norm in the Urnfield and Hallstatt zones of Central Europe. Buildings range in size from substantial aisled longhouses to smaller oblong structures that may have served as ancillary units within a nucleated group. Both are present in the Urnfield settlement at Lovčičky, Bohemia, though which buildings in the maze of structures formed part of a contemporary nuclear group is less clear. For the Perleberg in eastern Germany, also dating to Hallstatt B, attempts have been made to identify contemporary clusters on the basis of entrance orientation (Audouze and Büchschütz, 1992, 195–6). At the Goldberg in Hallstatt D, there certainly appears to be a pattern of grouping of units, comprising a larger building and smaller ancillary structures in close proximity (Parzinger, 1998). Bersu believed that the stockaded compound in one corner of the site was for a chieftain's residence, segregated from the rest of the community, though other interpretations of the structural sequence have been advanced. The shift in building type at the Wasserburg from the simple *Blockbau* cabins of Hallstatt A to the winged houses with ancillary buildings of Hallstatt B, neither phase displaying any internal hierarchical differentiation, led Härke to infer a shift in social organization from nuclear to extended family groups. In general, there is little evidence for overall planning of settlements, except where the constraints of enclosure demanded it, as at Biskupin or the Senftenberg, or in the special environment of the Swiss lakeside settlements, like Cortaillod-Est or Auvèrner-Nord, where practical constraints of access over flood waters may have dictated a more orderly layout.

Though rectangularity of plan is frequently regarded as the norm in Central European later prehistory, in marked contrast to the preponderance of circular plans in Britain or the north-west of the Hispanic peninsula in the Iron Age, there is a greater diversity of size, plan and building technique than this generalization might imply. West of the Rhine especially the oblong buildings of the Urnfield period frequently include apsidal ends (Lafage *et al.*, 2006), implying hipped roof construction, as at Dampierre-sur-le-Doubs (Pétrequin *et al.*, 1969), and may even include some circular plans. The smaller, sometimes irregular circular plans of the middle Bronze Age in south-eastern Britain, represented by sites like Plumpton Plain, Itford Hill and New Barn Down in Sussex, are matched in the Netherlands at Nijnsel and Dodewaard, and for the Iron Age circular plans from Normandy now indicate that the classic Wessex roundhouses were not without their counterparts on the other side of the Channel (Dechezleprêtre *et al.*, 2000; Jahier *et al.*, 2000). Rectangularity of plan, and especially the aisled longhouse, is therefore really a characteristic type of Central Europe, more particularly in the later La Tène, and Northern Europe, where it is represented at Elp in the later middle Bronze Age and continuing through into the typical 'Germanic' aisled *Wohnstallhaus* and the classic terp settlements of the Roman Iron Age. West of the Rhine the picture is more complex, involving, as might be anticipated, a combination of Central European and Atlantic traditions.

Weapons and armour

The burgeoning technical capacity of late Bronze Age metal-working was in significant measure dedicated to the equipping of the Urnfield warrior (Figure 2.5). No better

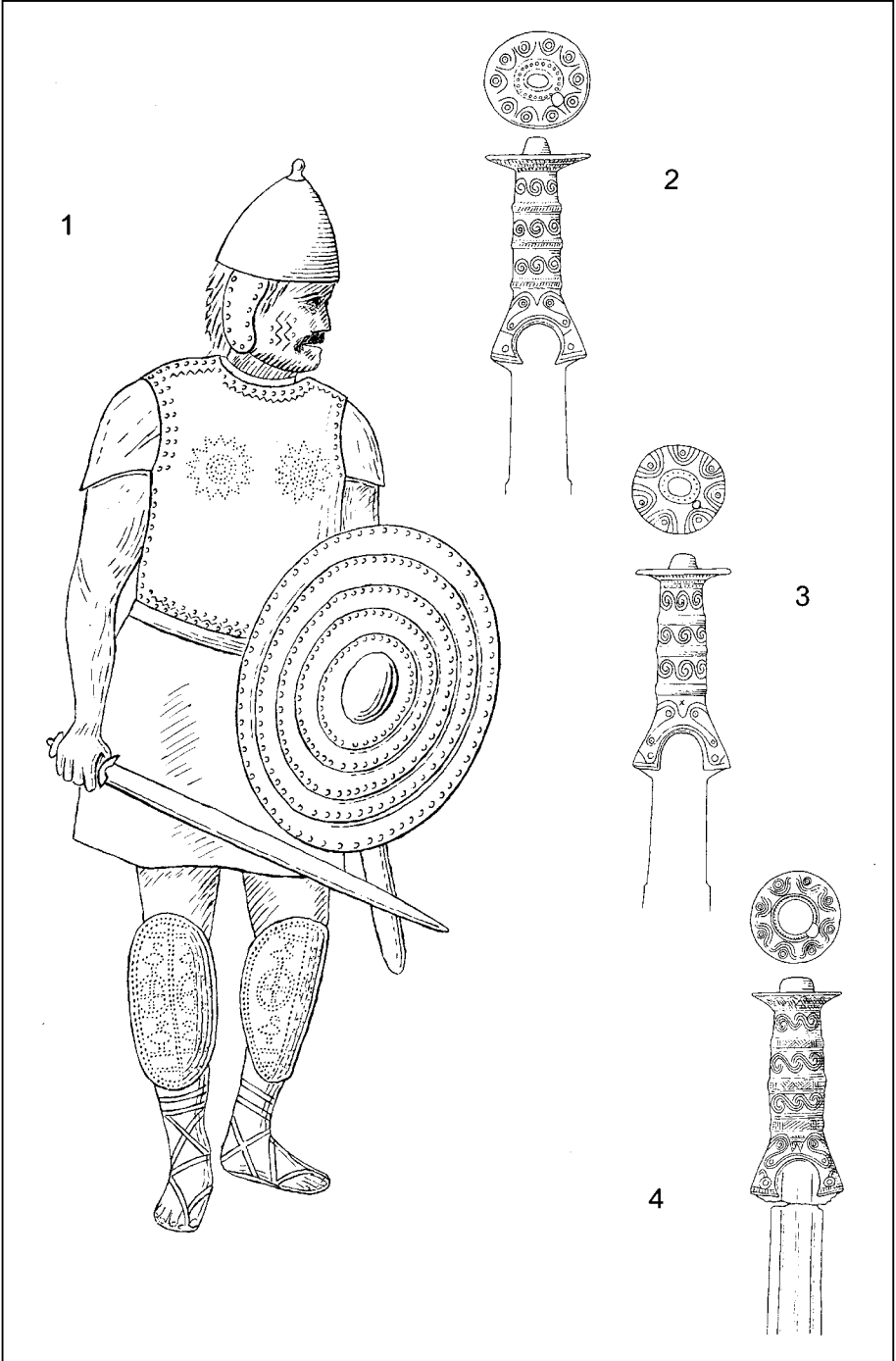

Figure 2.5 The Urnfield warrior, equipped with sword, shield, helmet, cuirass and greaves (1); early Urnfield solid-hilted swords from Erding (2), Erlach (3) and Geiging (4). Swords adapted from Müller-Karpe (1980).

demonstration of this fact could there be than the proliferation of sword types that characterize the period. Starting in Reinecke's Bronze C2 and D phases around the thirteenth century BC are the earliest of the flange-hilted swords (*Griffszungenschwerter* or 'tongue-grip' swords) of Sprockhoff's (1931) Type I, from which in the earliest Urnfield phase proper, named Hallstatt A1, developed the Nenzingen sword, with straight-sided blade and more rivets to attach its hilt to the grip. This was then the prototype, Sprockhoff's Type II, for the classic Urnfield swords, conventionally named after examples from Hemigkofen and Erbenheim, the former characterized by its short, leaf-shaped blade and fish-tailed projections at the end of the hilt, the latter also having a leaf-shaped blade but with short tang for the attachment of a pommel. A third variant, the Letten sword, was essentially an Erbenheim sword with shorter blade. Parallel to this series are the solid-hilted swords (or *Vollgriffschwerter*, 'full-grip' swords: Sprockhoff, 1934), which begin with the Riegsee type in Bronze D and which by the end of the Urnfield period are represented by a series of swords with elaborately-cast 'antenna' hilts. A third variant of sword, the rod-tanged or tapered-hilt swords are represented in Bronze D by the Rixheim and Monza types, and are essentially rapier-derivatives from the preceding middle Bronze Age. This almost bewildering variety of sword types spawns an even greater number of regional derivatives and variants in the latest Bronze Age, including those of Atlantic Europe and the British Isles.

The second principal weapon of the late Bronze Age, which remained a key element in the Celtic warrior's armoury in the La Tène Iron Age, was the spear. Spear-heads are certainly present in north-alpine Urnfield contexts, though they are hardly dominant. Arrowheads likewise, tanged and socketed, including a variant with vicious projecting barb, indicate the use of the bow. Though it is generally assumed that the bow was an aristocratic sporting weapon in Urnfield and Hallstatt Iron Age society, there is clear enough documentary evidence for the use of archers in warfare by the Iron Age, and it seems unnecessary to assume a strict distinction between sport and combat. In Eastern and South-Eastern Europe in the later Bronze Age, spear-heads are more common, the flame-shaped variant appearing together with other Urnfield types in late Mycenaean Greece. In Eastern Europe, the battle-axe is a distinctive weapon from hoards and burials, perhaps again fulfilling an aristocratic or ceremonial role as much as a practical function in warfare. Spears, bows and battle-axes all have an older ancestry, and may reflect a degree of specialization in the martial arts before the technological developments of the later Bronze Age led to the predominance of the sword as the principal aristocratic weapon of the Celts.

A question that arises therefore from a review of weaponry is whether already by the later Bronze Age there was developing a differentiation in the warrior class between swordsmen, spearmen and archers. Burgess noted some years ago (1974, 211) that votive hoards of the Broadward complex in Britain included a preponderance of spear-heads, suggesting a special role within late Bronze Age society of spearmen, or, at any rate, their particular association with ceremonial deposits and water rituals. The occurrence of both as part of the warrior's panoply need not preclude this possibility, particularly in the light of classical records of specialist archers and spearmen. Polybius's well-known account of the *Gaesatae* at the battle of Telamon in 225 BC has prompted the suggestion that mercenary warriors akin to the Fenian bands of early Medieval Ireland might have existed outside the normal tribal structure from a rather earlier period.

Body-armour too was developed with the new skill of sheet bronze-working from the Bronze D phase. Though the fragments from the wealthy tumulus burial from Čaka, Levice, in western Slovakia may at first sight seem almost risibly small to sustain the full-scale reconstruction of the bronze corselet, later examples like that from Marmesses in the Haute-Marne (Figure 2.6a) leave no doubt as to its identification and purpose. Body armour, including greaves, was evidently being made from the early Urnfield period in sheet bronze, but there is every probability that such items were made much earlier from perishable, organic materials. Helmets (Hencken, 1971) have a still wider distribution. In Northern Europe, beyond the Urnfield zone, horned helmets of the later Bronze Age are matched in miniature on small bronze figurines. Central European types include those with a simple knobbed apex and a more conical form with lateral flanges and projecting studs, and have a significant distribution south as well as north of the Alps. That these helmets with appropriate lining could have served in battle need not be challenged by the probability that they also served as prestigious head-gear for ceremonial occasions. Some of their Iron Age counterparts were probably too richly embellished to hazard in battle, raising the probability that head-gear was as much an indication of status or office as a means of protection.

Bronze shields (Sprockhoff, 1930; Coles, 1962) also were an innovation of the late Bronze Age, possibly from the Bronze D phase of the thirteenth century in Central Europe, though wooden or leather prototypes may have preceded the metal versions from an earlier date. Circular or sub-circular in shape and ranging in diameter from less than 40 centimetres to more than 70, one widespread form is distinguished by having a V-shaped or U-shaped 'notch' in its concentric raised ribs. The U-notched variant is concentrated particularly in Northern Europe and the Danish peninsula; the V-notched form is represented on rock carving in south-western Spain and is found as far east in the Mediterranean as Cyprus. The distributions are virtually exclusive; only in Ireland do they coincide. Principal among Central European shields is the Nipperwiese type, named after a type-site in Pomerania. The distribution is fairly sparse, with some regional variations, including examples from Britain (Needham, 1979). Native British shields, like the Yetholm type and other regional variants, are represented in greater numbers, frequently from wetland contexts that may suggest a ritual role in their deposition (Coles *et al.*, 1999). Though there is evidence that some were damaged by blows from weapons, the bronze shields would hardly have afforded practical protection without wooden or leather backing. The survival of leather and wooden examples from Ireland, and the fact that Hispanic rock-carvings must be representations of an organic type that has not survived, confirm the probability that these represented the utilitarian norm, and that bronze shields were largely for ceremonial purposes.

Feasting and drinking

The earliest beaten bronze vessels associated with ceremonial and perhaps ritual feasting and drinking occur in the Bronze D phase of the thirteenth century BC in Central Europe. By Hallstatt A1 in the twelfth century a typical set of vessels associated with festive or ritual drinking was buried in the chieftain's grave at Hart-an-der-Alz in Bavaria. Apart from weaponry and some personal ornaments, the grave contained a beaten bronze bucket, and as accessories a handled sieve or straining cup and a handled



A



B

Figure 2.6 A: late Bronze Age cuirass from Marmesses. Musée des Antiquités Nationales. Photo: RMN, Paris © Loïc Hamon. B: Class A Atlantic bronze cauldron from Shipton-on-Cherwell, Oxfordshire. Maximum diameter of cauldron 60cms. Photo by D. W. Harding

drinking cup. Beaten bronze cups in a succession of variant forms are characteristic of the Urnfield late Bronze Age and adjacent regions of Northern Europe, and have been classified into a typological sequence named after the hoards or rich burials in which they are found. Friedrichsruhe and Fuchsstadt cups, with decorated variants such as those from the Dresden-Dobritz hoard (Pl. 2a), date from the end of Bronze D through Hallstatt A1 and A2 respectively, and for Hallstatt B, successively Jenosovice cups, Haslau-Regelsbrunn cups and Stillfried-Hostomice cups are typical. The bucket itself, also found in a variety of different forms, was for mixing and serving the alcoholic beverage. Its ceremonial or ritual associations are suggested by the inclusion of sun-disc and bird symbolism in *repoussé*, as we have seen, on buckets like the virtually identical pair from Hajdúböszörmény and Unterglauheim. Both these hoards also included examples of another class of beaten bronze vessel, a hemispherical bowl with twin, looped handles attached by means of doubled T-shaped plates riveted to the body of the bowl. This distinctive type continues in modified form into the Hallstatt Iron Age, its distribution extending well beyond the primary Urnfield zone. A simpler variant with single handle and A-shaped attachments has a more limited distribution in Urnfield Central Europe.

In Atlantic Europe too, buckets and cauldrons were used for communal feasting and drinking in the late Bronze Age, though without the range of accessory vessels that typifies the hoards of Central and Northern Europe. Beaten bronze buckets occur widely from at least the Hallstatt A2 phase from Transylvania through the Danube, in Italy and extending as far as Northern Europe, in a range of variant types. The Irish and British buckets were related to the later Urnfield *Kurd Eimer* (von Merhart, 1952, 29–33), but with the significant addition of the loose ring-handles which Hawkes and Smith (1957) believed were assimilated from the Atlantic cauldrons. The cauldrons themselves were not characteristic of Central Europe, though they had their counterparts in the Mediterranean and Middle East. Formerly supposed to derive from these Mediterranean antecedents, the Atlantic cauldrons are now dated from the early first millennium BC, and regarded as an independent western development. In Central Europe, the smaller hemispherical bowls with cross-handle attachments and related types persisted into the Iron Hallstatt C phase, before being superseded in Hallstatt D by a larger form of hemispherical cauldron with inturned rim.

The significance of these typological variations in terms of prestigious aristocratic feasting rituals or communal celebrations is unclear. To argue that the immense volume of the Atlantic cauldrons (Figure 2.6b), compared to the smaller vessels of the Central European Urnfield or Hallstatt C assemblages, reflects communal festivities as opposed to rituals of a more selective aristocratic elite, might be unduly simplistic. But the fact remains that bronze vessels associated with feasting and drinking are a notable component of the archaeological assemblage from the beginning of the late Bronze Age through to the end of the pre-Roman Iron Age and beyond, and not exclusively in regions that by any definition might be described as ‘Celtic’ or ‘proto-Celtic’.

Personal ornament and dress

Throughout the Urnfield zone, and indeed in the cognate late Bronze Age cultures of Northern and Atlantic Europe, personal ornaments are an important component of

hoards and funerary assemblages. Some of the key types change with the transition to the first, Hallstatt Iron Age, which may reflect changes in dress and costume rather than simply decorative fashion, since the latter is commonly a factor of the former. Common to both periods in Central Europe are bracelets, generally of penannular form. Heavily-ribbed bracelets are especially characteristic of Bronze D and Hallstatt A1, but from the early Urnfield period bracelets are also decorated with fine, engraved linear ornament. Ribbed bracelets of a different variety, with more rounded, nut-like ribs, come into fashion in the final Urnfield phase, and continue in various changing forms through the Hallstatt Iron Age into La Tène.

Particularly prolific in both quantities produced and range of types in the Urnfield late Bronze Age are pins, with spherical, disc, conical, vase-shaped and poppy-shaped heads, among other variants, and a variety of ribbed embellishment of the stem. This proliferation of pin types had begun already in the late Tumulus phase, notably in the Lausitz province, some examples having their heads decorated with arcs, circles and running spirals, all rendered in a rather rigid geometric style. The position of the pins in graves suggests their use as dress fasteners, to fasten a cloak, for example, at the shoulder. But the great diversity of form and decoration suggests that they could also have conveyed, consciously or otherwise, the local or regional identity, or perhaps the status within the communal or familial group, of the wearer. The expanded head and ribbing were doubtless both decorative and functional, serving to retain the cloth at one end, while a cord loop would surely have been necessary to prevent the pin from slipping out of the fabric at the other.

In the Hallstatt Iron Age, grave-groups show that a variety of pins was still fashionable. From their position within inhumation graves it is possible to infer their use as hair-pins, or as part of some otherwise perishable head-gear, so that this possibility should not be discounted in the preceding Urnfield period. By the second Iron Age in Central and Western Europe, however, the pin has been largely superseded as a dress-fastener by the safety-pin brooch, one of the most prolific and diagnostic types of the La Tène assemblage. But the safety-pin brooch was already in use in the early Urnfield period, in the violin-bow form of the Bronze D phase. Thereafter, a variety of brooch types develop, notably those with leaf-shaped, arc or serpentiform bows, in the classic Urnfield assemblages north and south of the Alps. Likewise in the Hallstatt C and D phases, a number of spiral, boat, leech and serpentiform brooches have trans-alpine distributions. Though the La Tène brooch sequence is diagnostic, the development of a dress-fastener involving a pin, a catch-plate and foot, a spring and a bow, was not in itself a novelty.

One key ornamental type of the La Tène Iron Age that acquired a special status and symbolism was the neck-torc. Neck-ornaments certainly feature in earlier periods, though not with any direct connection with the later La Tène fashion. From the middle Bronze Age, twisted gold ribbon-torcs are known in Atlantic Europe, followed in the late Bronze Age by various forms of torcs in bar-gold, the distribution of which concentrates in Ireland and Britain, extending into north-western France and with a scatter beyond. Analogous forms of neck-ornament are known in the Mediterranean, but it is hardly a recurrent type in Urnfield Europe. In the Hallstatt Iron Age, plain gold torcs of various types are present in rich graves, including the exotic example from the princess's grave at Vix.

Late Bronze Age and Hallstatt ornamental styles

Late Bronze Age ornamental styles, as exemplified on bronzes, could be regarded as essentially geometric. Two techniques are particularly in evidence on metal-work, engraved and *repoussé*. From Northern Europe, through Central Europe and including parts of the Mediterranean, geometric curvilinear and linear motifs are widespread and recurrent, so that it would be difficult to assign these styles expressly or diagnostically to any one regional or chronological grouping. Within the Urnfield culture, sword-hilts and pommels exemplify the range of combinations of lozenges, zig-zags, triangles, stars, circles, arcs, running spirals or linked S-motifs (Figure 2.5). The style is also characteristic of bracelets and related ornaments, and is particularly well exemplified on the annular arm or leg-rings of the Hallstatt B1 phase in a hoard from the Wasserburg, Buchau, settlement, which included a complex if repetitive composition comprising concentric engraved circles, semi-circles and linear panels. To see any of these, or the designs on other items of Urnfield metal-work, as antecedents of later La Tène styles (Sprockhoff, 1955) is unnecessary, but that is not to say that Urnfield art did not fulfil a role analogous to that of later Celtic art styles. The use of curvilinear designs is in fact not nearly so prominent an element in Urnfield metal-work as it is on the swords and shaft-hole axes of the Tumulus culture in eastern Central Europe, or in the middle Bronze Age of Northern Europe and southern Scandinavia. Geometric compositions can also be rendered in *repoussé*, on beaten bronze armour such as greaves, on beaten bronze vessels, or on belt-plates. By the Hallstatt Iron Age, cummerbund-like belt-plates are elaborately ornamented with geometric designs in this fashion. To describe these ornamental designs as an early 'geometric' Celtic style might be unwarranted, but they are part of a widespread tradition of fairly simple and repetitive geometric art, involving the use of rectilinear and curvilinear motifs, which characterizes especially the Urnfield late Bronze Age and the Hallstatt Iron Age. In fact, it continues into the La Tène period, even though eclipsed by the more dominant curvilinear styles.

Pottery, too, can bear simple geometric ornament, though as with metal-work not nearly as elaborate as some eastern Central European Tumulus culture ceramics, on which curvilinear motifs can be highly developed. Horizontal rilling and vertical or diagonal fluting are characteristic of Urnfield pottery, as is the geometric style of *Kerbschnitt* ornament, excised from the clay like chip-carving in woodwork, a technique that again distinguishes the open dishes and globular jars of the Hallstatt C Iron Age in southern and south-western Germany.

In addition to this geometric style, however, there is the stylized representational art that includes the bird and sun symbolism, most frequently rendered, as we have seen, in *repoussé* on sheet bronze, or in the form of cast pendants, protomes or finials. These too continue in fashion in the Hallstatt Iron Age, with the cast versions surviving into La Tène Celtic art. Figural art, on the other hand, is not a characteristic of the Urnfield zone, unless it was deployed on perishable organic materials, though it is an element in the rock art of Northern Europe and the Italian Alps. From the Hallstatt Iron Age, however, a striking example of figural art in highly stylized form can be seen on funerary pottery from Sopron in western Hungary (Figure 2.7). Here a variety of activities is depicted, both domestic, such as spinning and weaving, and recreational or ceremonial, such as playing the harp and boxing, dancing or praying.

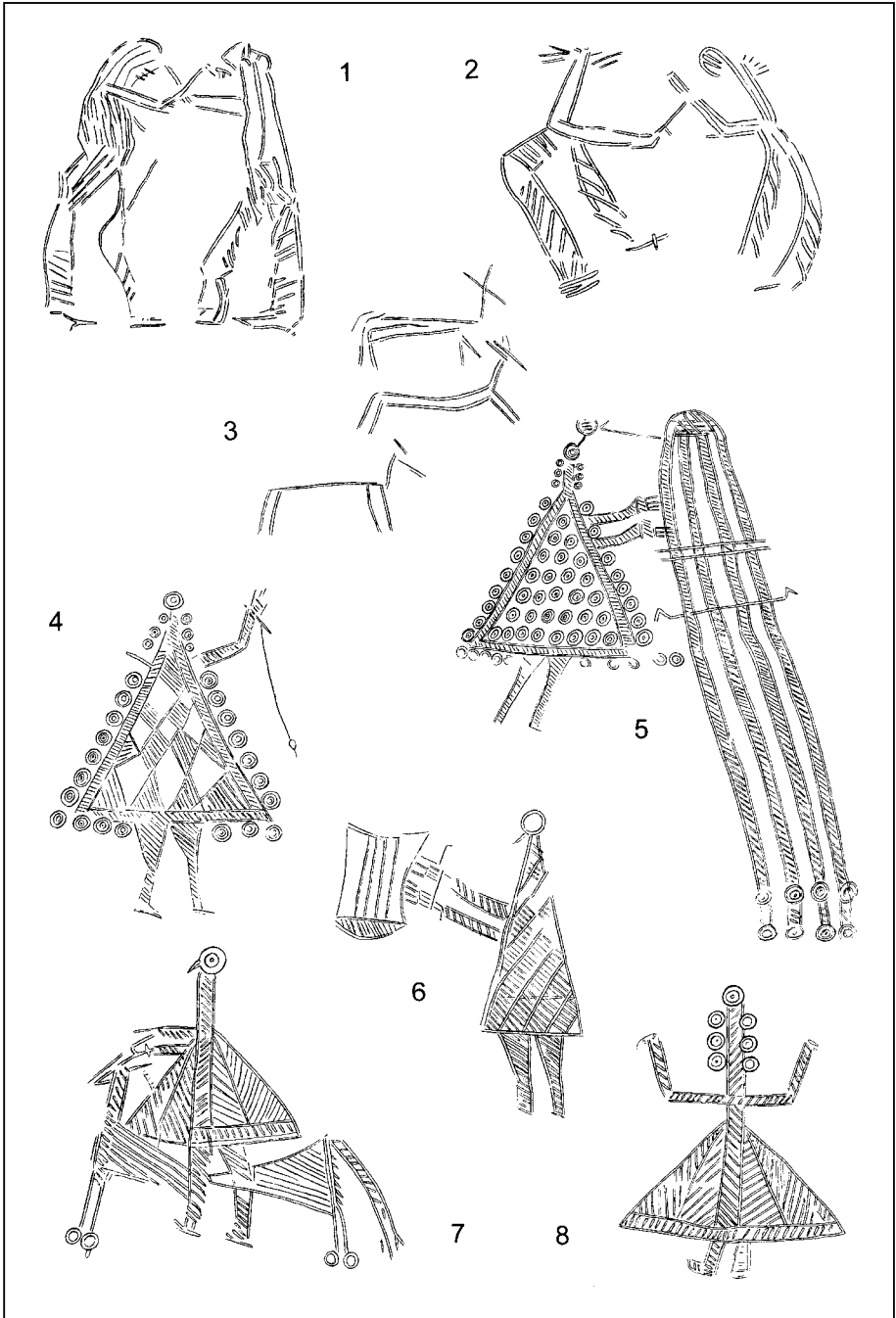

Figure 2.7 Images from decorated pottery from Sopron district, Hungary. 1, 2, figures dancing or 'boxing'; 3, 'matchstick' quadrupeds; 4, spinning; 5, weaving at a loom; 6, playing the harp; 7, horse riding; 8, dancing or praying. Adapted from Gallus (1934).

Conclusion

The purpose of this review has been not just to seek stylistic antecedents for any specific motifs or stylistic traits within early La Tène art, but to consider technological, economic, ritual and social contexts within which such a development in art might have come about. While it true that individual motifs within the widespread and long-standing tradition of geometric ornament on both metal-work and pottery might be regarded as an antecedent of simple geometric designs on pottery and metal-work in the La Tène phase, that alone does not embody the totality or even the principal essence of the early La Tène style, and cannot be regarded as a catalyst for its striking fifth-century developments.

If art is an expression of society, then it is the antecedent societies and their attributes that we must examine for the genesis of La Tène art. There can be little doubt from archaeological and historical evidence that Celtic society was hierarchically stratified, yet most commentators are more circumspect when considering Urnfield society or late Bronze Age society as a whole. It is widely accepted, if only by default (Harding, A., 1994, 304), that the Urnfield culture was probably already 'Celtic', yet an examination of the burial evidence shows little evidence, apart from the tumulus and pyre burials of Bronze D and some burials of the late Urnfield phase (Hallstatt B2 and B3), of social differentiation in the great majority of Urnfield cemeteries. We have already noted, however, that even in the *Fürstengräber* of the Hallstatt D Iron Age, generally regarded as the epitome of an hierarchical social order, there are individual graves that, outside the context of the tumulus group, would occasion no great interest on account of their associated grave assemblage. So seemingly the tumulus is an expression of monumentality in the landscape on behalf of the community or its ruling elite, rather than a mark of rank of any one individual buried within it. Once we abandon any simplistic equation that requires social rank to be expressed in archaeologically distinctive burial structures, and examine instead the full spectrum of the material assemblage, it is hard to resist the conclusion that Urnfield society was a stratified order in which political and social control was exercised by powerful aristocratic and martial elites.

What is quite clear is that most of the advanced technological skills in bronze-working that would have been a prerequisite to the La Tène artist were already available from the early Urnfield period. Long-distance contacts, essential for obtaining the raw materials of production, would hardly have presented any obstacle to a society that not only had trans-alpine connections but also far-flung contacts with Northern and Western Europe on a scale unprecedented in pre-Roman Europe since the Beaker period. The objective of this technological endeavour was evidently focused especially upon three objectives: (1) feasting and drinking, witnessed by the sheet-bronze containers and serving vessels; (2) warfare and the martial arts, witnessed by the range of weapons and defensive armour; and (3) personal aggrandizement and display, witnessed by an extravagant range of personal ornaments. These are precisely the focus of artistic endeavour and accomplishment in the Celtic society of early La Tène art. An underlying but potent spiritual or ritual element is a further bonding link between the Urnfield, Hallstatt and La Tène worlds.

It is important to recognize nevertheless that these attributes are not exclusive to the Urnfield culture of the late Bronze Age, nor to the Hallstatt Iron Age areas of

north-alpine Europe or the south-eastern Alps. They are attributes that in differing ways and in differing degrees are common across Mediterranean, Central, Northern and Atlantic Europe. That fact does not detract from the importance of their presence in the regions which, in the mid-fifth century BC, saw the genesis of early La Tène art. The fact that art styles as distinctive as La Tène did not develop in other regions simultaneously or independently was presumably because those other regions lacked the particular catalyst that triggered its inception in Central Europe, which must have been trans-alpine contacts between specialist craftsmen and intermediaries with the expanding Greek world. But our real quarrel with Jacobsthal's dictum must be with his exclusive equation of Celtic art and the La Tène styles. If Urnfield Europe was already Celtic ethnically or linguistically, then Celtic art is already abundantly represented in the profusion of Urnfield metal-work. As for the La Tène styles, all the technological, political and social requirements for their emergence were in place; only the catalyst was required. In effect, La Tène art, as the supreme manifestation of Celtic art, was not so much an art with no genesis, as an art just waiting to happen.

THE LA TÈNE EARLY STYLES

Origins and influences

Rhineland and Champagne

The early La Tène (La Tène A) assemblage found in 1879 in the aristocratic grave at the Klein Aspergle, near Ludwigsburg in Baden-Württemberg (Pl. 3; Kimmig, 1988), which first attracted Paul Jacobsthal's attention to the study of early Celtic art in the winter of 1921, provides us with an ideal introduction to the beginnings of fifth-century La Tène art, and the problems associated with its origins. The central burial of the tumulus, one of the most impressive of a group in the near neighbourhood of the Hohenasperg fortification, had been robbed in antiquity, and the finds in question came from a subsidiary chamber that had survived the depredations of the robbers. What struck Jacobsthal so forcefully was, first, the fact that a Greek cup, itself of no intrinsic quality, should be found at all in a north-alpine burial, and second, that the Greek imports were accompanied by bronze vessels of Italic form or manufacture and goldwork that displayed stylistic elements reflecting Greek forms.

The two-handled cup or *kylix* (Figure 3.1, 1) was subsequently attributed to the Amphitrite painter (formerly known as the Amymone painter), and dated to around 450 BC. It thus provides a *terminus post quem* for the grave deposit, which probably belongs to the later fifth century. Other works by the same painter are known from northern Italy, and there is thus no reason to assume that north-alpine Celts were in direct contact with Greece rather than through Greek traders in Italy or Italic intermediaries. The cup was evidently a treasured piece: not only was it embellished with gold (Figure 3.1, 2), but that embellishment concealed the repair of earlier breaks in the vessel. This red-figure cup was matched by a second, plain black cup. But these were not the only imports in the funerary assemblage. Chief among the other southern imports were a two-handled bronze jar, or *stannos*, and a sheet-bronze, cordoned bucket, or *cista a cordoni*, both part of a high-quality wine service. Two other items from the wine service, however, are not straightforward imports, incorporating stylistic elements that are alien to the Greek or Italic traditions. One is a beaked-flagon (Greek *Oenochöe*, French *Oenochöe à bec treflé*, German *Schnabelkanne*), in origin, an Etruscan type that was produced from the mid-sixth to the later fifth century BC, of which more than sixty are known north of the Alps from eastern France to Bohemia. In this case, however, the satyr-like faces with protruding eyes, puffy cheeks and bulbous noses that adorn the rim and the escutcheon at the base of the handle (Figure 3.1, 3) proclaim the vessel to be of Celtic workmanship, adapting an Etruscan design to suit the more flamboyant taste of a Celtic patron. Less than complete at the time of discovery, it was



Figure 3.1 Details from the Klein Aspergle grave-group. 1, two-handled Attic *kylix* from above; 2, two-handled Attic *kylix* under-side; 3, satyr face on handle-escutcheon of beaked flagon; 4, terminals from drinking-horn mounts. Photos: Württembergisches Landesmuseum Stuttgart; P. Frankenstein, H. Zwietasch.

for many years reconstructed as a typically dumpy beaked flagon on the Etruscan model. A newer restoration, however, with taller, slightly concave body profile, enhances its similarity to other well-known examples of Celtic renderings of the type, like those from Dürrnberg-bei-Hallein in the Austrian Alps and from Basse-Yutz in the Moselle. The other exceptional discovery from the Klein Aspergle grave-group is a pair of gold drinking-horns, not a north-alpine or Celtic type in origin, though

examples are known from late Hallstatt contexts, most strikingly the set from the richly furnished princely tomb at Hochdorf. The principal ornamental design of the Klein Aspergle horns is a simple rope-pattern or *guilloche*, and their terminals are in the form of rams' heads (Fig 3.1, 4), for which Graeco-Etruscan models and even orientalizing influences have been invoked. Other grave-goods include a beaten bronze bowl of native manufacture and a plaque of gold on an iron base with settings for coral inlay, another indicator of the Mediterranean connection.

Whoever the anonymous dignitary buried in the Klein Aspergle tomb was, whether native or incomer, male or female (the lack of weaponry might conventionally have suggested the latter), we may at least infer that his or her authority, or that of the society he or she represented, commanded trans-alpine communications at a significant level, and that feasting and drinking on a sumptuous scale for at least ceremonial occasions are indicated by the accompanying grave-goods. To illuminate the nature of that trans-alpine activity, we can examine the distributions of some of the key imports in question.

Taking first the three key types from the Klein Aspergle tomb, it is clear that their distributions are not co-terminous north of the Alps. Stamnoi are fairly limited in number, and are restricted to the regions immediately north and west of the Alps. Cordoned buckets have a wider, though not especially dense distribution (Figure 3.2B) with the majority of examples east of the Rhine, and significantly extending into the north European plain, well beyond regions that could be claimed as Celtic. Finally, beaked flagons (Figure 3.2A) were especially popular in the middle Rhine region, with a scatter of examples in Champagne and Bohemia. This type not only prompted native copies, they also inspired imitations in pottery that are occasionally found north of the Alps. For the middle Rhine region, Frey argued that the concentrations of individual types suggest that trans-alpine imports were negotiated on a highly localized basis, with the majority of beaked flagons represented in his Rhinehessen-Palatinate and Hochwald-Nahe groups, which also include another bronze type, the two-handled basin, while the adjacent Rhein-Moselle group is characterized by yet another type, the so-called Rhein-Tessin buckets (Megaw and Megaw, 1990, Figure 25). Almost all these finds come from high-status burials, and are indicative of the importance of feasting and drinking or of the symbols of feasting and drinking in the funerary ritual, and by implication in the lives of the Celtic princes and princesses whose tombs we assume these were.

Southern imports into Celtic Europe were not, however, restricted to Mediterranean wine and prestige goods associated with the serving and drinking of wine. From late Hallstatt times, a variety of Mediterranean imports had appeared in north-alpine Europe, notably but probably not exclusively through the Greek colony of Massilia at Marseilles. In the fifth century, trans-alpine trade intensified, doubtless encouraging the movement of people too, culminating in the historically recorded migrations of Celts into northern Italy by the early fourth century BC. Among the products of this activity was the appearance of coral, ivory and silk, and the introduction of a new technology based upon rotary motion, represented by the potter's wheel and the lathe. The frequent use of coral as an adjunct to ornament on early examples of Celtic art is particularly interesting (Champion, 1976; 1985), since it was already fashionable from the late Hallstatt (Hallstatt D) phase of the sixth century, before the appearance of the early La Tène art style. It therefore represents one technical component of Celtic art

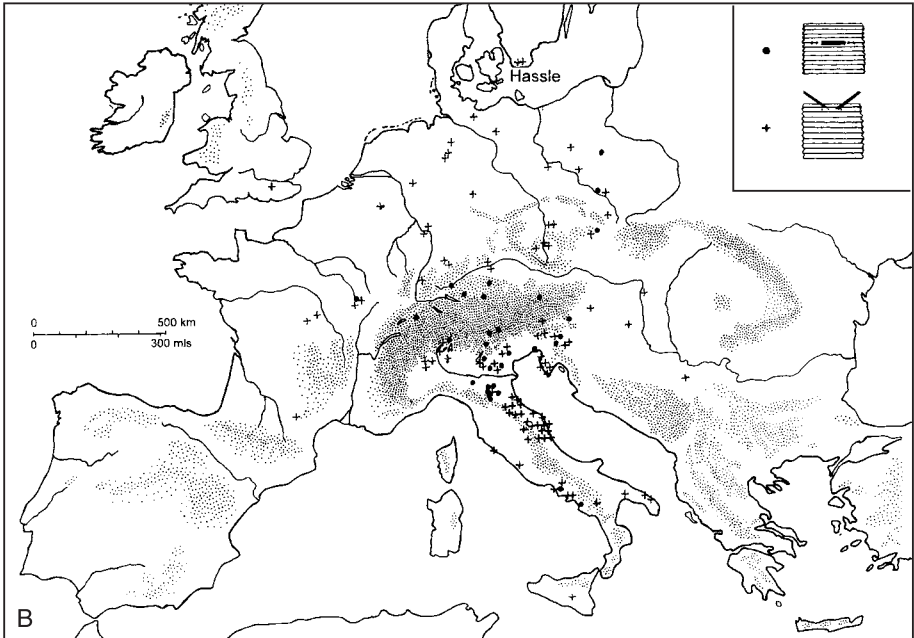
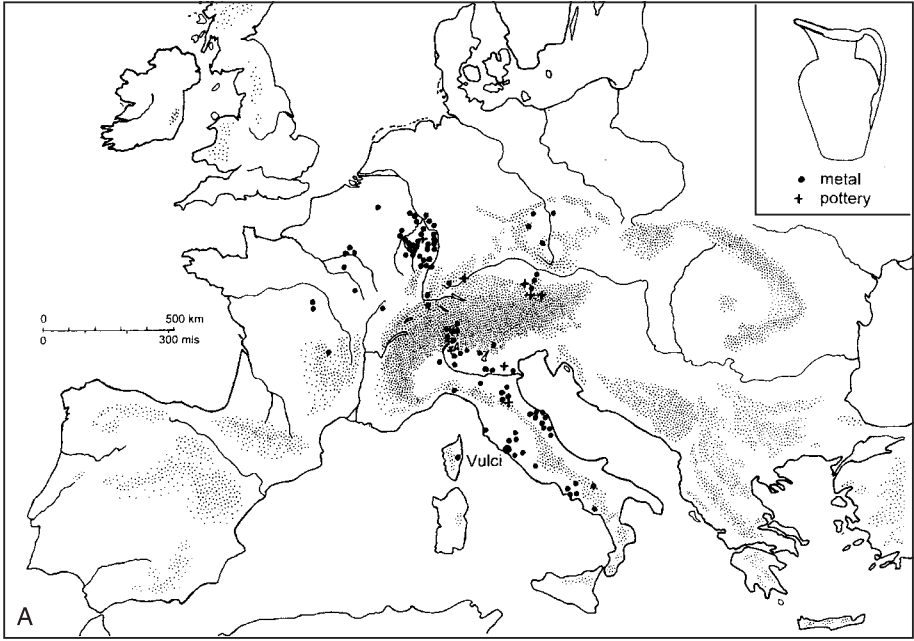

Figure 3.2 Italic imports north of the Alps. A: distribution of beaked flacons. Adapted from Kimmig (1988) and Vorlauf (1997). B: distribution of cordoned buckets. Adapted from Stjernquist (1988).

that has a history antecedent to the La Tène phase. It is, furthermore, instructive regarding the source of southern imports. The late Hallstatt distribution of coral north of the Alps covers Switzerland, the Danube, the Rhine and the Marne, but shows a marked paucity of finds in the Rhône valley or southern France. The clear implication is that coral was introduced in the sixth century via alpine routes that were evidently operational before the supposed shift away from Massilia and the Rhône-Saône route into barbarian Europe.

While the appearance of high-status goods might best be explained as diplomatic gifts, these more mundane products are surely evidence of trade or exchange on a regular basis. The question therefore naturally arises, what were the southern traders receiving in exchange? What could north-alpine Europe offer to attract the interest of Greek or Etruscan dealers? One possibility could be metal ores, another forest products, a third slaves, in effect, those exports that Strabo listed as the products that attracted the interest of the classical world several centuries later, whose reality is not susceptible to archaeological demonstration.

One outcome of the trans-alpine contacts with the Mediterranean world was to introduce the Celtic craftsman to a range of classical plant motifs that provided one of the principal stylistic influences in the development of the Early Style of early La Tène art, sometimes called the Strict Style. Two motifs derived from the classical repertory are recurrent, the *palmette* and the *lotus*. The essence of the La Tène style, however, is not the slavish imitation of classical designs, but their adaptation into a new and vibrant treatment that progressively becomes more assured and independent of any debt to the original source. This is achieved initially by breaking up the classical motifs into their component elements, and re-assembling them in a different composition. Hence the classical palmette, which is commonly rendered by the Celtic artist as a simplified three-leaved motif, may be split in half, or further reduced to individual comma-leaves, the relationship of which to the classical palmette must be regarded as secondary at best.

To understand this process of adopting and adapting the classical plant repertory, it is best to begin by examining an example in which the classical model is followed quite closely. Frey's (1976) comparison of a frieze of alternating lotuses and palmettes from Cerveteri (Caere) and the open-work gold strip from a La Tène A burial at Eigenbilzen in Belgian Limburg (Figure 3.3, 1 and 2) leaves little doubt about the Celtic artist's model, even if the palmettes have been reduced to the simple three-leaved version and the lotuses have lost some of their botanical detail. The slightly curved outline of the strip suggests that it may have been an ornamental mount from a drinking-horn. A more complex treatment is illustrated by the small open-work gold-on-bronze mounting for a wooden bowl from a La Tène A princely burial of the Hunsrück-Eifel culture at Schwarzenbach in the Saarland (Frey, 1971), dating to the later fifth century (Pl. 2b). Between the base and the frieze below the rim are two principal panels, an upper and a lower (Figure 3.3, 3). Beginning with the lower panel we may identify along its bottom half, and notwithstanding several breaks in the open-work, a series of lotuses and pendant palmettes. The lotus plants show distinct sepals, though the stamens of the Cerveteri model are missing. The pendant palmettes are again reduced to the simple, three-leaved device, but the spirals from which they spring in the model are rendered as a pair of *repoussé* circlets. Thus far the influence of the classical model is reasonably clear. The upper half of the lower panel is occupied by fragmented elements

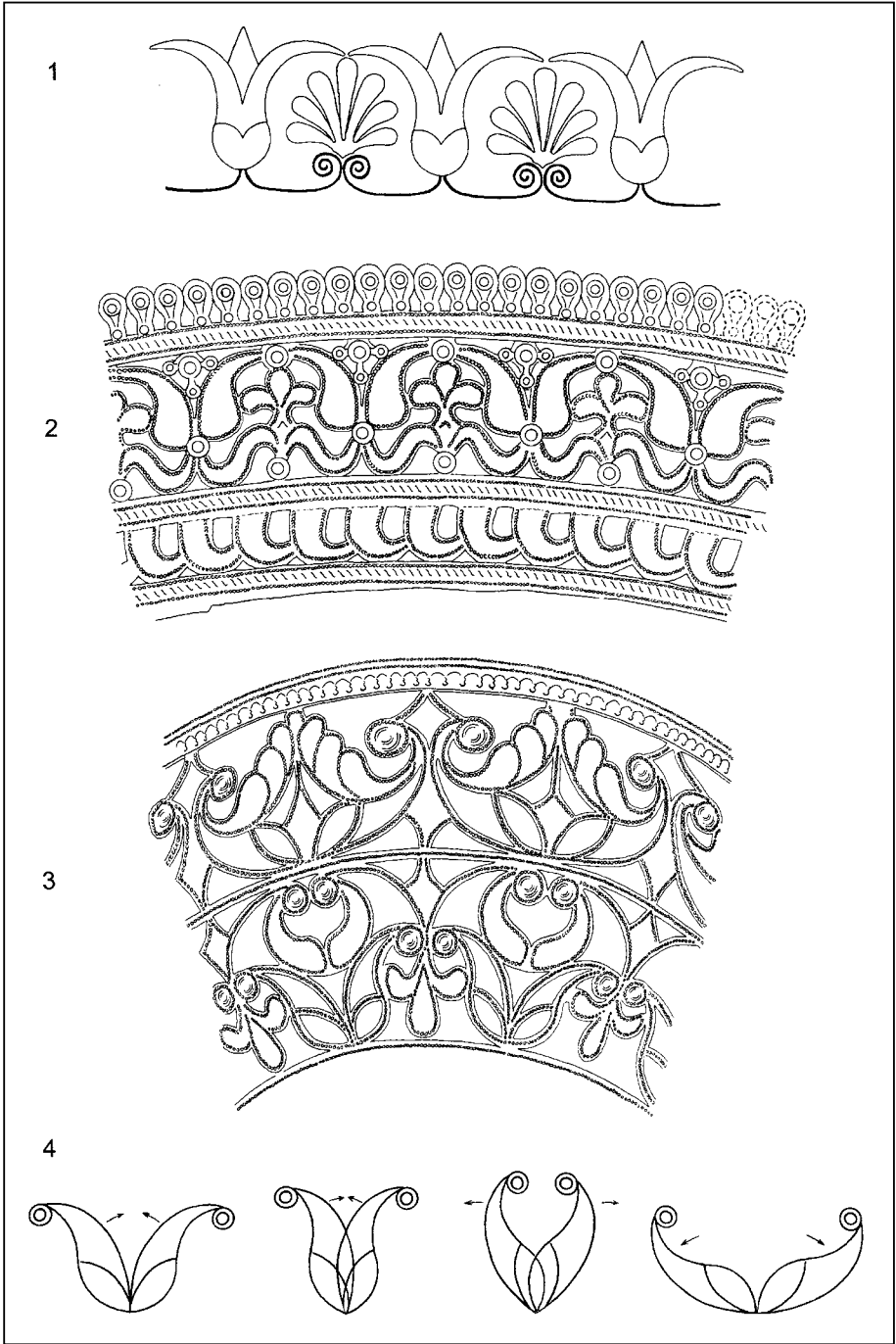

Figure 3.3 Palmette and lotus in early La Tène art. 1, the classical model: frieze on hydria from Cerveteri (Caere), adapted from Walters (1893); 2, section reconstructed of mount from Eigenbilzen, Belgium; 3, section reconstructed of Schwarzenbach bowl; 4, 'deconstruction' of lotus motif on Schwarzenbach bowl.

from the plant designs, pairs of comma-leaves alternating with truncated lotuses in which the stamens are retained. The upper panel at first sight would appear again to be an assemblage of split-palmettes and lotus-derived comma-leaves, still strictly repetitive in spite of the disjunction of the component parts. In fact, the comma-leaves that clasp the back-to-back split palmettes are lotuses in which the left petal has moved to the right, and the right has moved to the left (Figure 3.3, 4), as the position of the sepals makes clear, the stamen remaining between them. They are, of course, no longer lotuses, any more than the split palmettes are palmettes, since they are subsumed within a new and unitary composition. The base of the Schwarzenbach bowl displays another recurrent motif of early Celtic art, the triskele, here arranged as a static series of adjacent elements. The significance of this component in the development of the ensuing 'Vegetal' style will be discussed in a later chapter.

A distinctive technique that is well illustrated by the Schwarzenbach bowl is the accentuation of the decorative elements by means of *repoussé* dotting. This same technique can be seen on a series of ornamental plaques, some of which display similarities sufficient to prompt speculation that they could have been the product of a single workshop or school of craftsmen. An example from a warrior-grave at Weiskirchen on the Saar employs basically the same motifs that are characteristic of the Early or Strict Style (Megaw, 1970a, Pl. 2a). Within its central roundel, and at its four projecting terminals, were originally settings for coral inlay. Grouped around the central roundel are pairs of comma-leaves, each enclosing a small humanoid face, depicted with straight, fringe hair-style and with exaggerated eyes and twirly eyebrows. The distinctive hairstyle can be paralleled in the seventh century in northern Italy, and the same features recur in a number of similar faces disguised among the foliage of early La Tène art. Between the pairs of comma-leaves, and between them and the terminal-settings, are small, three-leaved palmettes. All the principal elements are outlined in *repoussé* dotting, and the entire composition is essentially symmetrical. With the notable exception of the miniature faces, the grouping of paired commas-leaves around a central, coral-inlaid roundel is replicated on the plaque from Schwabsburg, while essentially the same elements in a different composition can be seen on plaques from Chlum in the Czech Republic and from the Klein Aspergle tomb.

Much of the high-status metal-work that we have considered so far derives from the princely burials of the Rhineland, and in particular the Hunsrück-Eifel culture of the middle Rhine region, which for the early La Tène period achieves the same position of pre-eminence in archaeological studies as Baden-Württemberg and south-west Germany had enjoyed for the preceding late Hallstatt phase. The hallmark of these early La Tène princely burials (*Fürstengräber*) is the inclusion of a two-wheeled cart or chariot, the early La Tène counterpart of the rich four-wheeled wagon-burials of the preceding late Hallstatt era, generally contained in a sizeable wooden chamber under a barrow mound. The funerary rite is inhumation, and the grave-goods can include a wide range of weaponry, drinking service and personal ornaments. At Kärlich, near Koblenz, eight chariot burials yielded a rich assemblage of weapons, drinking vessels and ornaments (Joachim, 1968). Unfortunately, many of the classic sites were nineteenth-century discoveries, though several important sites were excavated in more recent times. Among the first sites excavated to modern standards, albeit under circumstances of rescue excavation, was the Reinheim cemetery, on the southern edge of the distribution (Keller, 1965; Echt, 1999). Subsequently, important cemeteries were excavated at

Hochscheid, between 1975 and 1977, and at Bescheid between 1977 and 1979 (Haffner, 1991). Barrow 9 at Bescheid was of particular interest, being that of a child with an unusually rich assemblage of grave-goods, including Etruscan imports. Barrow 1 at Hoppstädten, just to the south, was also a child's burial, with Etruscan flagon and a range of weaponry. Evidently children, including girls, were not excluded from these privileged burials. Bescheid is also important for its demonstration of the fact that chariot burial continued as a local tradition in the region even after the adoption of cremation, through the fourth century and down to the mid-third. A wealth of grave-goods continued to be included, piled on to the funerary pyre. In the totality of known cemeteries and burials, of course, the wealthy graves are very much a conspicuous minority. Settlement evidence, though not lacking, at least in terms of contemporary fortifications, like the Aleburg bei Befort, attracted less attention than the cemeteries with their wealth of material remains, which are more amenable to the construction of typological sequences and systems of classification than the debris of domestic occupation.

The Reinheim burial (tumulus A) is worth specific consideration here, not least because it is one of several in the Hunsrück-Eifel series that are regarded as tombs of a princess rather than a prince. We have noted earlier that attributions to gender have conventionally been made on the basis of associated grave-goods rather than anatomical analysis, the assumption being that warrior equipment implies a male burial and a preponderance of jewellery a female burial. Any study of anthropological analogues would probably advise caution before adopting such a simplistic formula, which in any case seems to presuppose that grave-goods in some sense belonged to or proclaim the identity of the deceased rather than the social office, or the requirements of the community that deposited them. The burial was inhumed within a wooden chamber under a tumulus, which was defined by a circular enclosing trench. The principal ornaments were a neck-torc of twisted, beaten gold and two arm-rings of sheet-gold, two gold finger-rings and two gold-on-iron disc brooches. A bronze brooch in the shape of a hen and another incorporating a human face in its foot were also included in the assemblage, together with more than a hundred glass and amber beads. An unusual item for a Continental La Tène grave-inventory, and one that might be taken to endorse the female stereotype, was a bronze mirror. The feasting and drinking service was represented by a pair of gold mounts for drinking-horns, a pair of bronze basins, and a gilt-bronze spouted flagon. The latter is most closely paralleled in form and decoration in the chariot-burial at Waldalgesheim, also commonly taken as a female grave on much the same evidence as Reinheim, which Jacobsthal identified as the type-site for his ensuing phase of fully developed early La Tène art. The Waldalgesheim assemblage for the most part belongs to La Tène B, but its spouted flagon was evidently old by the time it was buried.

The spouted flagon is of a distinctive type, with its flattened pedestal base, pot-belly and tubular spout, but it is not unique, individual examples having been found as widely distributed as Eigenbilzen in Belgium and the Dürrenberg in Austria, while pottery versions somewhat improbably imitate the same form. The Reinheim and Waldalgesheim flagons display several features in common (Figure 3.4). Both are ornamented at the foot of the handle with a human face, the one menacing with its lentoid eyes, the other benign and statesmanlike. Both handles are further embellished at their upper ends, at Waldalgesheim with a stylized ram's head, on the Reinheim

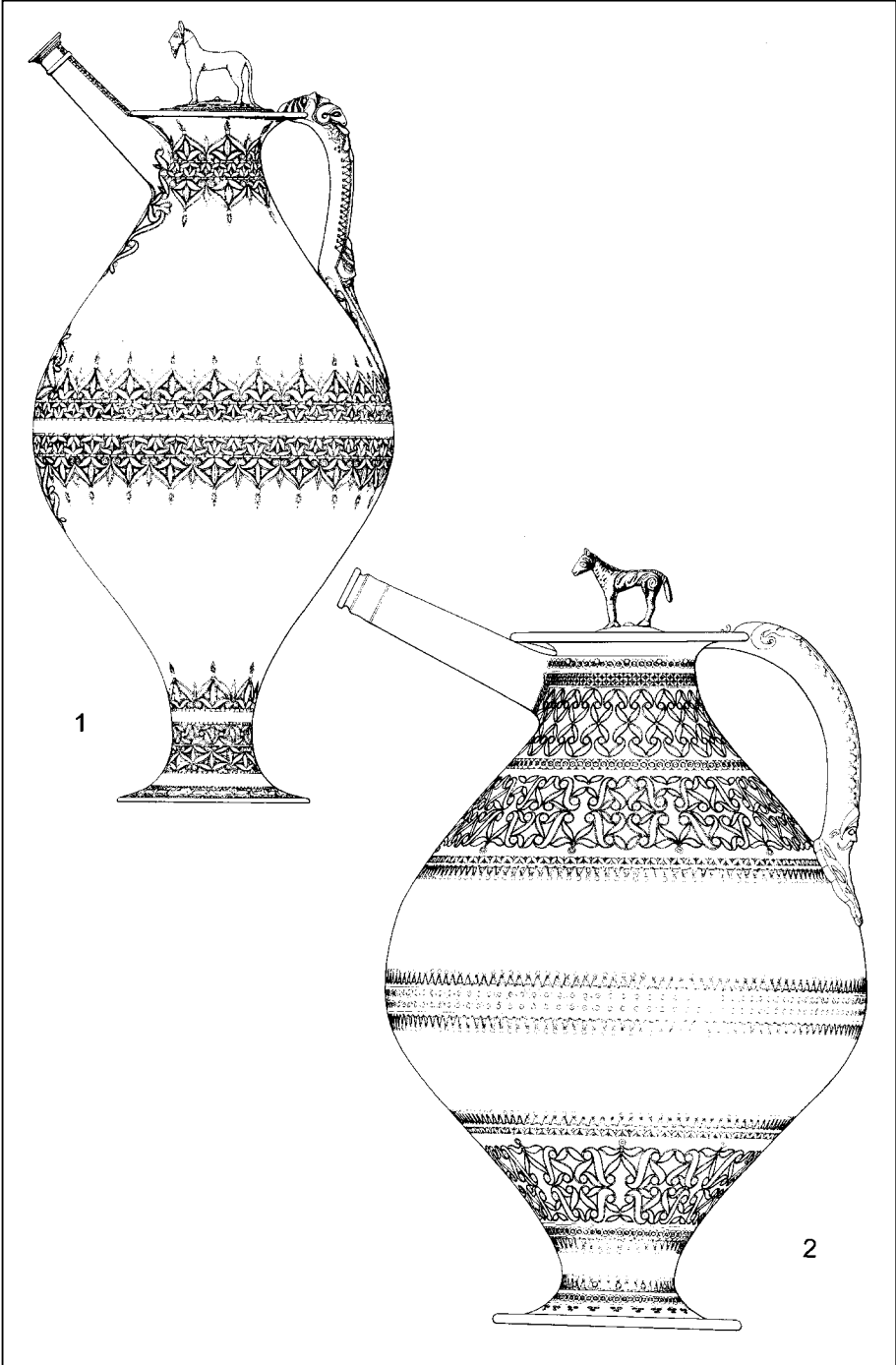

Figure 3.4 Engraved ornament on the Reinheim (1) and Waldalgesheim (2) flacons. Reproduced from Kimmig (1988) by kind permission of the Landesdenkmalamt, Stuttgart.

handle with a descending sequence of human face, with neat moustache and beard, over a ram's head resting on a three-leaved palmette. Animals feature again on the lids of both vessels, at Reinheim a centaur, at Waldalgesheim a sad-looking horse whose emaciated appearance, as we shall see later, shows eastern influences. The most significant element in common, which may even indicate they are the work of the same craftsman, or the product of the same workshop or school, is the engraved decoration of the two vessels. On the Reinheim flagon, this is restricted to three panels, around neck, girth and base, whereas at Waldalgesheim the ornament is more extensive over the body of the vessel. The technique whereby the outline of the design is executed is also different, in the former by use of a tremolo line, in the latter by fine dotting. Yet the standard repertory of motifs is common to both, including simplified lotuses, S-curving leaves, circlets, in an immensely detailed and rigorously symmetrical composition. Notwithstanding the fact that the Waldalgesheim flagon was quite old when buried, the implication of its close stylistic similarities with Reinheim should be that the latter is late within the La Tène A series, around the middle of the fourth century BC. The debate is compounded by the unsatisfactory standard of investigation of the Waldalgesheim tomb in 1869–70; indeed, the fact that the flagon and Campanian bronze bucket from Waldalgesheim were found apparently at a deeper level than the ornamented gold torc and bracelets at one stage led to the suggestion that the tomb contained two successive burials. The case nevertheless underlines the important principle that the date of manufacture is not the same as the date of deposit, and while the distinction between the two will not normally be significant or detectable in the context of domestic debris, it most certainly can be in burial contexts, especially in the accumulated wealth of high-status graves.

One of the key issues raised by the late Hallstatt to early La Tène transition is whether cultural change was coeval in different regions of Central Europe, or whether late Hallstatt and early La Tène groups overlapped in time, whether in fact they represent different regional manifestations of contemporary fashions (Frey, 1972; Pauli, 1978). Much of the debate focused upon the details of brooch typology of the Hallstatt D3 and La Tène A phases, in which there appear to be different regional sequences in the fifth century between south-west Germany, the middle Rhine and the eastern Alps, as represented by the cemetery at Dürrenberg-bei-Hallein. Similar considerations may affect the transition from La Tène A to La Tène B, the former phase apparently being absent altogether in south-west Germany. The implication for a study of the development of early La Tène art is that we should not expect a regionally uniform progression of stylistic stages as Jacobsthal's sequence might have implied. In effect, it might be argued that there is no such thing as a unitary 'Early Style', but a series of Early Styles with certain common elements or influences, a concept that is not incompatible with the idea of long-distance contacts between specialist craftsmen or their patrons, or even of mobility over long distances of craftsmen or warrior-patrons.

A second outstanding concentration of early La Tène cemeteries is located in Champagne, in the river valleys of the Aisne, Oise and Marne, where southern imports in princely tombs equally bear witness to contacts with the Mediterranean world. As in the Hunsrück-Eifel region, the great majority of known cemeteries was excavated in the nineteenth century by very mediocre standards, so that of the 10,000 or 15,000 graves uncovered, only around 2,000 are amenable to useful classification. As always, grave associations offer potential for typological seriation of artefacts, and the sequence

devised on this basis by Hatt and Roualet (1977) allows quite close chronological sub-division, at any rate for the early La Tène phase. Equally, however, the cemeteries have been studied from a social perspective by Sankot (1977) and others, basing their analyses not simply on ritual considerations, whether inhumation or cremation, the disposition and orientation of the body within the grave, or the combination and disposition of various groups within the cemetery, but upon the artefactual associations and their disposition within the burial. Several classes of burial are distinctive. Chariot-burials again have attracted attention disproportionate to their numbers, around 150 out of the many thousands of graves that have been investigated. Apart from chariot-burials, there are 'cavalier' burials, those with horse-gear though lacking a vehicle. There are 'warrior' burials, containing either sword, spear or shield fittings, on average perhaps between 10 and 25 per cent of a cemetery. And there is a rather greater number of burials containing jewellery, most commonly bracelets and brooches, but occasionally also torcs, that are generally assumed to be female burials, notwithstanding the iconographic evidence for the wearing of the torc by men, and the purely functional requirement of brooches as a fastening for clothes. The disposition of brooches and bracelets, especially where more than one is involved, could well be indicative of social or marital status. Some graves are accompanied by pottery vessels, of a variety of types. Among the earlier, angular vessels with pedestal bases (*vases carénéés*) include tall jars and bowls with lower profiles, while another variant is the straight-sided vessel resembling a saucepan (without handles!) or a lathe-turned tub. All these types may bear simple geometric, linear ornament, mainly confined to the upper half of the vessel. Overlapping the chronological currency of these, though outlasting them into the ensuing phase, are pedestal pots of more curving, pear-shaped profile (*vases piriformes*), on which the decoration occasionally aspires to more graceful curvilinear designs.

With improving standards of field recovery, there is evidence for the use of coffins, and perhaps for the existence of some superstructure over the graves. Some burials were enclosed by ditches, circular in form from the earliest phase and thereafter commonly square or rectilinear. The latter tend to enclose groups of burials rather than individual graves, and this, together with the occurrence of linear or semi-circular groups, suggests the possibility of family or kin arrangements. Grave markers do not survive, but the disposition of burials that rarely intrude one upon another suggests that such may have existed in a form that has not survived archaeologically. An intriguing feature of a number of cemeteries, notably Villeneuve-Renneville and Fère-Champenoise, is the filling of the grave with '*terre noire*', a dark deposit frequently containing fragmentary domestic debris, which could be the product of some aspect of the funerary ritual in the process of interment. On the other hand, its occurrence in cemeteries is variable, and it has been suggested that it is no more than the residue from a now-eroded former topsoil. Only in chariot-burials is its occurrence universal.

Among the most celebrated of these chariot-burials is the late fifth-century La Tène A tomb excavated in 1877 at La Gorge Meillet, Somme-Tourbe. The burial chamber was sub-rectangular or slightly trapezoidal on outline, with slots to accommodate the chariot wheels, and a raised platform at one end to support the draught pole and yoke. The interment comprised two superimposed inhumations, both regarded as male, the upper with the warrior's long sword across his left side. Grave-goods included in addition three spear-heads and a larger lance-head, and a tall, conical helmet with short

neck-guard, in effect, the classic Celtic warrior's panoply. The helmet, of a type also known in chariot-burials at Berru, Cuperly and Châlons-sur-Marne, was decorated with rectilinear zig-zag designs executed in tremolo lines. The rest of the grave assemblage included an imported Italic beaked flagon, horse-gear, coral-mounted ornaments and characteristic pedestalled pottery.

Equally prominent among the older burials is the Somme-Bionne chariot-burial, discovered in 1873. The grave pit itself was stepped, the deepest excavation being to retain the pair of wheels, while an extension of the main chamber held the draught-pole and the yoke. Nothing survived of the chassis or timber components of the chariot, but the iron tyres of the wheels indicated where they had been lowered into position. In accordance with custom in the region, no horses were buried with the dead, but bridle bits and harness equipment, including two open-work bronze plaques, were deposited in the trench that held the yoke. The burial was of an extended inhumation, again assumed to be male on account of the accompanying long iron sword in bronze and iron scabbard, suspended by its belt on the warrior's right-hand side, together with shorter iron knife at his left. At the front of the chamber were an Etruscan bronze flagon and an imported, stemless Attic red-figure cup, dating to around 420 BC, that was almost certainly quite old by the time it was incorporated into the grave. The associated grave-goods also included a fine, open-work bronze phalera and a belt-clasp depicting a pair of griffons in open-work, for which Frey, as we shall see, has cited close Italic parallels.

Open-work discs or plaques from the Champagne may also serve as an introduction to an important technical innovation in early Celtic art, the use of compasses to outline quasi-floral motifs (Frey and Schwappach, 1973). The Somme-Bionne *phalera* is a prime example (Figure 3.5). The open-work disc displays a complex geometric template based upon nine concentric circles from central disc to circumference, with innumerable intersecting arcs creating the rather rigid, quasi-floral design. A similar construction technique is deployed in an open-work disc from another Marnian chariot-burial at Cuperly. Of equal interest, however, is the second open-work mount from Cuperly, in which a nine-leaved palmette is embraced by an open-work lyre terminating in a pair of griffons-heads (Megaw and Megaw, 2001, Fig. 58).

The eastern Alps

Notwithstanding these regional concentrations in the Hunsrück-Eifel and Champagne, longer-distance contacts are attested within north-alpine Europe, as well as with the Mediterranean world. A prime example is afforded by the cemetery of Dürrenberg-bei-Hallein in the Austrian Alps (Penninger, 1972; Moosleitner *et al.*, 1974; Pauli, 1978). The Dürrenberg was evidently an important centre for the production of salt from the late Hallstatt to at least the middle La Tène period, and salt mining in fact continued in the vicinity from the Medieval period until recent times, making more difficult the task of identifying early workings. Like Hallstatt itself, a few kilometres to the south-east, the principal archaeological finds are from the cemeteries which adjoined the salt workings, overlooked from the north-east by the hillfort on the Ramsaukopf. Earlier work from the inter-war years has been supplemented by excavations from 1979–82 (Megaw, 1990; Stöllner, 2003), as a result of which more than 350 graves have now been excavated, with many more quite certainly as yet undiscovered. More recent work



Figure 3.5 The Somme-Bionne, Marne, open-work disc. © Copyright the Trustees of The British Museum.

concentrated on the mines themselves. Spoil heaps indicated where adits had been tunnelled into the mountain, from which prehistoric textiles, leather, tapers for lamps and a wealth of other material remains have been uncovered. Several Iron Age burials indicate how potentially hazardous the process of mining must have been. But it is by no means clear that the miners themselves were drawn from the local community, or that they were beneficiaries of their labours, rather than being serfs, slaves or social outcasts. The princes who controlled the production and distribution of salt evidently enjoyed considerable wealth, which enabled them to support specialist craftsmen in glass and metal-work.

Among the products interred in the Dürrnberg cemetery was the magnificent Celtic rendering of a beaked flagon from Grave 16, with its tall, slightly concave body-profile accentuated by the slender, vertical *repoussé* panels, and separately-cast handle and rim with parade of exotic beasts. The shape and execution of this vessel are now strikingly

matched by the beaked flagon from the Glauberg overlooking the Wetterau valley in Hesse, a tantalizing hint of possible long-distance links between princes or their craftsmen. Another richly furnished burial was Grave 44, a double inhumation in which the lower, earlier burial included a two-wheeled chariot and accompanying warrior's equipment (Figure 3.6). In addition to the long, iron sword, a pair of spearheads, arrowheads and knife, the assemblage was completed by a conical helmet, not quite so tall, but otherwise of the classic Marnian type. The drinking service was equally distinguished. It comprised a high-shouldered, sheet bronze bucket, or *situla*, standing 88 centimetres in height and with a capacity around two hundred litres. Together with this was a small, bronze basin, and a Celtic copy of an Italic bronze 'pilgrim flask', a type comprising a cylindrical container with tubular spout, not unlike the shape of a western cowboy's water-bottle, but with four supporting feet in the form of human legs. Inside the *situla* was a plain, two-handed, stemless Attic cup of the late fifth century. Among other items in the grave was an open-work belt-plaque that itself bears similarities to the open-work mounts of the Marne, both groups having antecedents in northern Italy, and a series of sheet-bronze mounts, including a human face with 'leaf-crown' head-gear, that have been interpreted as attachments for a wooden, spouted flagon.

The decoration on the Dürrenberg pilgrim flask warrants consideration, since it is typical of the predominance of compass-drawn designs in this eastern zone of Early Style art. The repetitive designs on the neck and body of the flask comprise essentially arcs or intersecting circles, highlighted by dotted infilling. The style is more commonly represented on pottery, the so-called 'arc and circle style' of the region east of the Rhine that Schwappach (1973; 1976) contrasted with the 'floral or plant style' of the middle Rhine and Marne. That there is a regional contrast seems clear, but it is a contrast that may have been accentuated by the dependence of the eastern distribution on examples from pottery, whereas the western distribution is predominantly of metal-work. The eastern arc and circle style itself is a complex phenomenon, including stamped ornament of arcs and circlets arranged in clusters rather than simply in linear friezes. This is especially notable in the interior-stamped 'Braubach' bowls of the ensuing La Tène B phase. Regarding the origins of the eastern style, in the east it may derive in part from the geometric decorative tradition of the preceding Hallstatt phase (Schwappach, 1976, 94), but some of the repetitive friezes suggest southern influences. The total effect is an independent Celtic abstract style (Frey and Schwappach, 1973, 343) to which Jacobsthal gave insufficient weight.

The human image

Among Jacobsthal's initial precepts regarding early Celtic art was that it was not representational, and did not in general represent human or animal forms realistically or naturalistically. Humanoid faces, sometimes described as 'satyr-faces', with exaggerated or demoniac features, however, occur within a larger design in a variety of contexts, such as within the palmette and lotus ornament of the Weiskirchen plaque, or in specific and recurrent locations such as the top and base of flagon handles, as at Basse-Yutz or on the Dürrenberg flagon. These faces have typically large rounded eyes, which on the Basse-Yutz flagons once held coral inlay. Or the eyes may be depicted as lentoid, like the face at the base of the Reinheim flagon or that on the Rodenbach gold

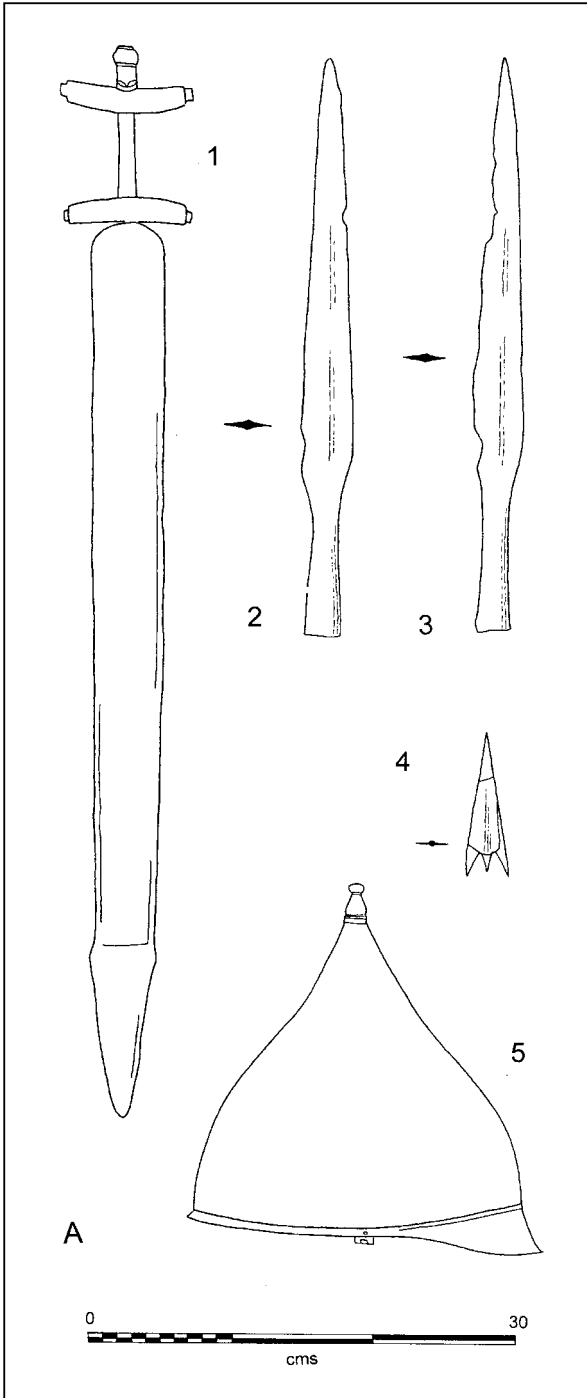

Figure 3.6 Dürrenberg bei Hallein, Grave 44/2: principal grave-goods. A: weaponry. B: drinking vessels and related items. Adapted from Penninger (1972).

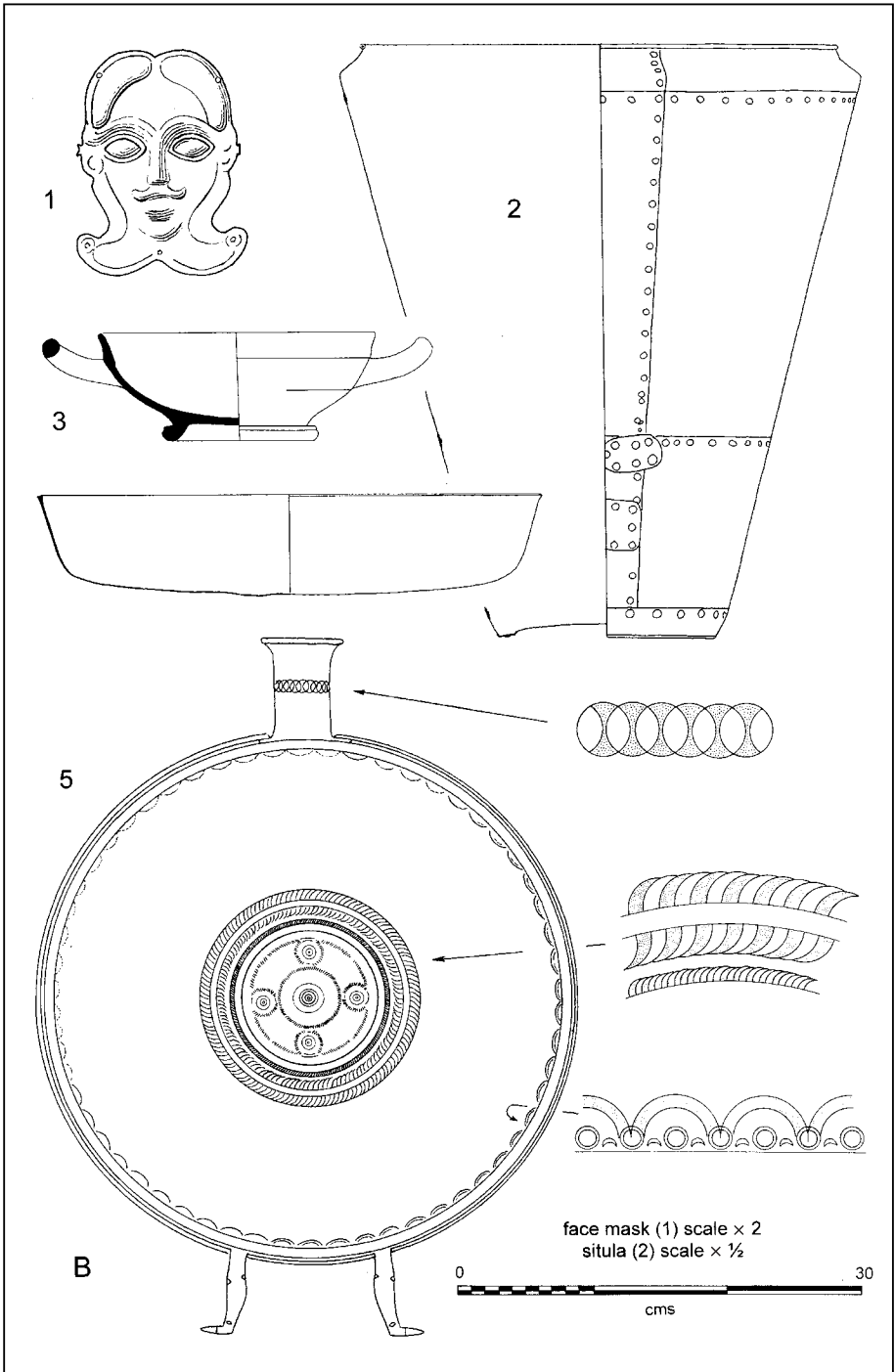

Figure 3.6 Continued.

finger-ring (Figure 3.7, 1), lending them a decidedly sinister aspect. Bulbous noses and puffy cheeks give these face-masks the appearance of an impish or devilish gargoyle, like the face on the base of the Klein Aspergle flagon, an image that is echoed in the goggly-eyed faces around its rim. It is hard to resist the suspicion in such cartoon-like faces that the craftsman was offering a wry comment on the likely effects of over-indulgence on the complexion of his princely patron! Large eyebrows frequently twirl into exaggerated spiral ends. Sometimes a moustache is depicted, as on the Basse-Yutz flagons, or a moustache and beard, like the topmost head on the Reinheim flagon-handle. Frequently the hair-style is depicted as a fringe with vertical combing, well illustrated on the phalera from Hořovičky, Czech Republic, or on the Weiskirchen plaque, which Frey compared with faces from Chiusi. In fact, the models for these Celtic face-masks are both Etruscan, the clean-shaven face with fringe hair-style and the bearded 'Silenus' mask. Trans-alpine connections from at least the beginning of the fifth century BC doubtless account for the concentration of these faces in the Rhineland and southern Germany, while some of the Eastern European examples may have been influenced from these more westerly workshops.

The contexts occupied by these stylized faces tend to be recurrent. Apart from flagon-handles, they regularly are paired back-to-back on bracelets, like those from Schwarzenbach or from Bad Durkheim (Megaw, 1970a, Plates 53, 54); they are matched on the terminals of the Reinheim torc and bracelets; they appear as a central focus flanked by paired beasts on the Rodenbach arm-ring (Pl. 5a) and on the Weiskirchen belt-clasp (Figure 3.10A). On the Glauberg torc (Pl. 4a) no less than ten human face-masks dominate the ring itself, while two grotesque figures with enlarged heads flank the pendant composition. On the slightly later Waldalgesheim bracelet they are more integral and less obtrusive, their twirling eyebrows becoming S-curves within the overall flow of the composition. Face-masks continue to feature in the repertory of the Celtic artist down to the late La Tène phase, in a variety of forms and contexts, sometimes overtly and sometimes more subtly concealed among foliage in a manner which prompted Jacobsthal to refer to the 'Cheshire' style, an allusion to the elusive quality of Lewis Carroll's cat.

The meaning of these faces is not easy to read, though in some instances they could have served as apotropaic symbols. The twin faces of the Rodenbach finger-ring have sometimes been interpreted as a Janus representation, with implications of cultic significance. From the head may protrude horns or large lobes, the so-called leaf-crown, itself possibly a symbol of divinity or regal status, witnessed not only on bronzes like the mount from the Dürrenberg or on the dignified face at the base of the Waldalgesheim flagon-handle, but also rendered in sculpture on the Pfalzfeld pillar and the stone head from Heidelberg. The Pfalzfeld pillar (Figure 3.8A) is not strictly janiform, though a Janus head could have originally capped its now broken shaft, but with lobed heads on each of its four sides it suggests omniscience. Its overtly phallic form implies fertility consistent with a ritual significance. A particularly fine stone-sculpted rendering of a full-length armoured figure sporting a leaf-crown was recovered in recent years from the ditch of the early La Tène princely tomb at the Glauberg, Wetterau (Herrmann and Frey, 1996; Frey and Herrmann, 1997; Bartel *et al.*, 1998; Frey, 1998; Weber, 2002). The warrior is depicted in armour (Figure 3.8B), with a recognizably early La Tène sword (Herrmann, 1998, Abb 19; Frey, 2004), together with miniature shield, and wearing finger, arm and neck ornaments that were presumably symbolic as much as



Figure 3.7 Face masks in early La Tène art. 1, Rodenbach finger-ring. Copyright Historisches Museum der Pfalz, Speyer (Jahr), Photo: Kurt Diehl; 2, Oberwittighausen brooch. Photo: Badisches Landesmuseum, Karlsruhe; 3, Parsberg brooch. Photo: Germanisches Nationalmuseum Nürnberg.



Figure 3.8 Sculpture in early La Tène art. **A:** the Pfalzfeld pillar. Photo: copyright Landschaftsverband Rheinland/Rheinisches Landesmuseum Bonn. **B:** the Glauberg stone warrior. Photo: Hessische Landesmuseum, Darmstadt.

ornamental. The neck torc in particular has pendants mirrored in the gold torc from one of the accompanying graves. The warrior's muscular thighs, like those of the Hirschlanden statue, are doubtless intended to represent strength; by comparison, the arms of both figures are relatively puny. The Glauberg warrior has a pronounced jaw, perhaps together with the thickened upper lip originally painted, as Frey (2004)

suggested, to represent beard and moustache. Finally, the figure has a cap and 'leaf-crown' lobes, a symbol of status, whether as ancestral hero or divinity is unclear. Similar figures carved in wood could well have been relatively common, but if so have simply not survived. A timber model seems to be implied in the rendering of the Holzgerlingen stone pillar figure, which is surmounted by a Janus-head, and the Heidelberg head may have been comparable. Janus heads, or more strictly double-heads, are known from the third and second centuries BC in southern Gaul, from the so-called Celto-Ligurian sanctuaries of Entremont and Roquepertuse. In fact, the basic concept, however inexpertly sculpted, has a very long currency. Insular examples include a three-faced head from Sutherland, and another from Corleck in County Cavan, while a later example still is known from Glejbjerg, Denmark, beyond the limits of the Celtic world.

One particular medium in which these stylized faces are found is on brooches, the so-called *Maskfibeln*, either embellishing the foot or the head of the bow above the spring (Megaw, 1982). Few faces could be more glum than that on the foot of the Parsberg brooch (Figure 3.7, 2), or more sombre than the bearded twins on the brooch from Oberwittighausen (Figure 3.7, 3). Others may simply convey an expression of bemusement. It is a natural inclination of the archaeologist to invoke ritual symbolism for anything that appears to deviate from his own concept of the functional or rational, but it is hard to understand why so seldom are Celtic craftsmen credited with a simple sense of fun or pleasure in evoking caricature, in much the same way that artists throughout the ages have used their art for satire or to lampoon the established order. Some of the faces on linch-pins of the late La Tène are caricatures that might well prompt such an explanation. At the same time we should beware anachronistic readings of early Celtic art: the somewhat later (third- or second-century) stone head from Mšecké Žehrovice in Bohemia (Figure 6.4; Venclová, 1998), with its bulging eyes, twirled moustache and dyspeptic expression, may remind us of the archetypal Colonel Blimp, but it is unlikely that the artist would have had quite that stereotype in mind! Some images may well have had a mythical, supernatural or apotropaic quality, and the concept of a 'cult of the head', though perhaps overstated in the literature, nevertheless has some basis in the archaeological and documentary record. We should therefore beware of simplistic explanations of human imagery in La Tène art: human representation in different styles may well have had different purposes in different regions at different periods.

It is not just human or humanoid heads that adorn the brooches, bracelets and other artefacts of the early La Tène phase. Animals and birds too are found in profusion, some realistic, like the amusing little ducks that float down the spout of the Basse-Yutz flagons, some more stylized and enigmatic as regards their species, sometimes even, as we shall see, with hints of an oriental origin. A group of torcs from the Marne region (Bretz-Mahler, 1971, Plates 60, 61, *torques à décor ornithomorphe*) in which pairs of stylized ducks flank or back the central ornamental focus, must be indicative of a local workshop or local tradition of symbolism. Equally stylized birds characterize a series of bird-headed or double-bird-headed brooches (*Vogel* and *Doppelvogelkopffibeln*), in which the eyes are sometimes enlarged and highlighted with coral inlay. For the origins of the pairing of birds and animals, Jacobsthal looked to the south and the east. But the use of bird symbolism itself has a long ancestry in north-alpine Europe, as we have seen, going back through the late Hallstatt to Urnfield traditions.

Orientalizing influences in the Early Styles

For Jacobsthal, Oriental influences were one of the three roots of early Celtic Art. Yet he was acutely aware that it was 'as easy to see the East behind the Celtic designs . . . as it was difficult to define precisely country and date of the prototypes' (1944, 156). The literature is strewn with parallels for individual traits, sometimes from Scythian art (itself largely the product of Greek craftsmen working for native patrons), sometimes from Luristan art of Persia, sometimes from the earlier Urartian style of Anatolia. Almost invariably it amounts to a single element within an artefact or assemblage that is otherwise wholly alien to anything that can be found in Celtic art, and in no instance does it point unequivocally to a single region or period from which a consistent pattern of influences might be derived. As to dating, exotic influences are not an innovation of early La Tène, but are already in evidence in the late Hallstatt period if not earlier.

The case for direct contacts with eastern artistic traditions was based largely upon the historical record of Persians in the sixth and early fifth centuries in Thrace, Macedonia and the Black Sea regions, notably under Darius and Xerxes (Sandars, 1971). Contemporary opinion tends to favour the view that orientalizing elements in early La Tène art derive instead through Graeco-Etruscan intermediaries, perhaps not least because simplistic diffusionism is very much out of favour as an agency of innovation. The first question to consider is whether there are any actual imports of oriental artefacts themselves, as opposed to nebulous 'influences', in Central or Western Europe at this period. The consensus is that there are not. Though outlying Scythian burials are known, like Vetttersfelde in Berlin, even Sandars (1971, 103) conceded that 'there is no single undoubted oriental object in a celtic grave of the early period'. Imports from sources beyond Graeco-Etruscan centres are virtually non-existent – the leaf-gold drinking-horn mount dating from around 500 BC, from barrow 2 at Weiskirchen with its row of sphinxes has been cited as a possible product of an east Greek workshop (Frey in Sandars, 1976, 59–60; Frey, 1980, 78).

Much the same is true of the preceding late Hallstatt phase. From the Grafenbühl burial, for example, the two carved sphinxes (Figure 3.9, 2), one of ivory and the other of bone and amber with gilt-bronze rivets, are the work of Greek craftsmen in southern Italy; two bronze clawed feet, from a tripod for holding a cauldron, were of actual Greek manufacture, and an ivory plaque, possibly a mirror handle, could have been an import from the eastern Mediterranean. The same route is clearly a strong contender for the means of transmission of eastern images into the repertory of the early La Tène artist (Megaw, 1975). The gold torc from the princess's tomb at Vix presents a more complex case. The depiction of the winged horse (Figure 3.9, 1) is plainly exotic in late Hallstatt art, as are the quasi-filigree plinths on which the horses stand. Various sources have been suggested over the years, from Scythian to Iberian. It is now generally agreed that the torc itself is of native Hallstatt manufacture, which is not, of course, to minimize the exotic influences in its ornament, doubtless transmitted via the Mediterranean.

If individual imports are lacking, could the occurrence in early La Tène graves of a novel *class* of artefact, like the drinking horn, be regarded as a direct introduction from the east? This question has never satisfactorily been resolved. It is recognized that the drinking horn is not a Greek or Etruscan type, and that it cannot therefore readily be explained as an oriental idea brought in through Italic intermediaries

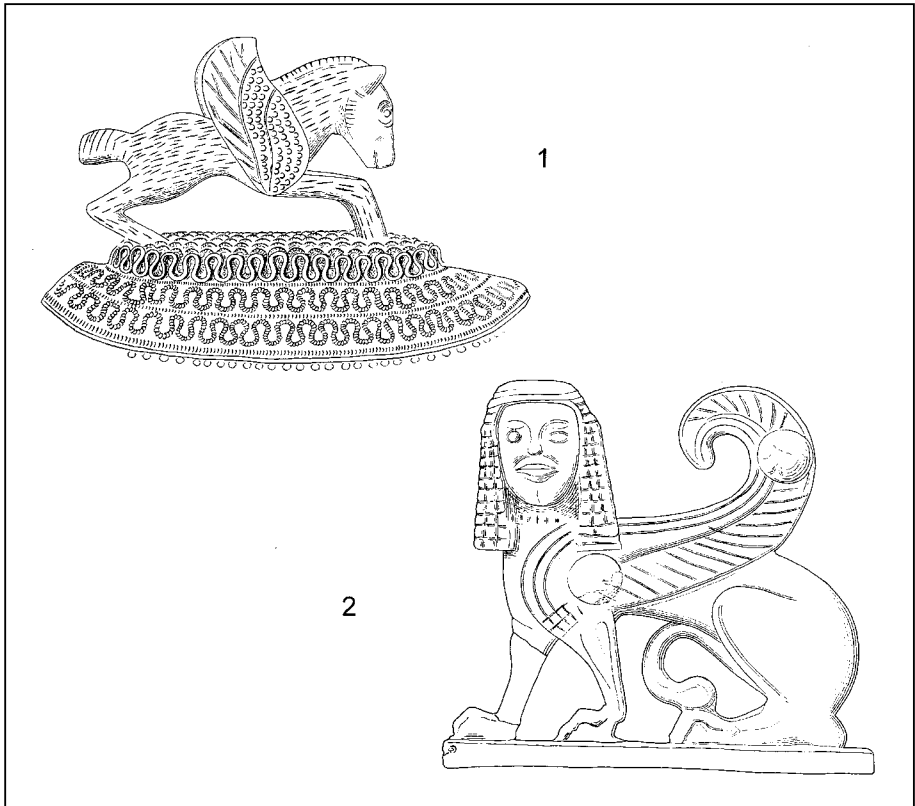

Figure 3.9 Exotic influences in late Hallstatt grave-goods. 1, Vix gold diadem, Burgundy; 2, Grafenbühl, Asperg, sphinx, Baden-Württemberg. Adapted from Rolley (2003) and various sources.

(Sandars, 1976, 42, 60). Again there is evidence from the late Hallstatt princely tomb at Hochdorf, which contained no less than nine drinking-horns, that the practice was already well established in north-alpine Europe before the early La Tène period. It is increasingly clear that a number of elements that come to prominence with the burgeoning of early La Tène art were already rooted in the antecedent Hallstatt culture, and borrowings from the east were not least among them. The mechanism for such introductions remains elusive, but the paucity of actual imports certainly suggests an indirect, rather than direct agency.

It is very largely upon the rendering of exotic beasts that claims of orientalizing influences have been based, one instance of which is the pairing of backward-looking beasts. A fine example is the belt-clasp (Figure 3.10A) from Weiskirchen barrow 1, where two pairs of backward-looking griffon-sphinx hybrids flank a humanoid head in a balanced, but not identical composition. Each pair of beasts meets at the breast, but they are not true Siamese twins in the sense of sharing common limbs, as in the Erstfeld hoard. The central head displays the usual features of bulbous eyes, twirly

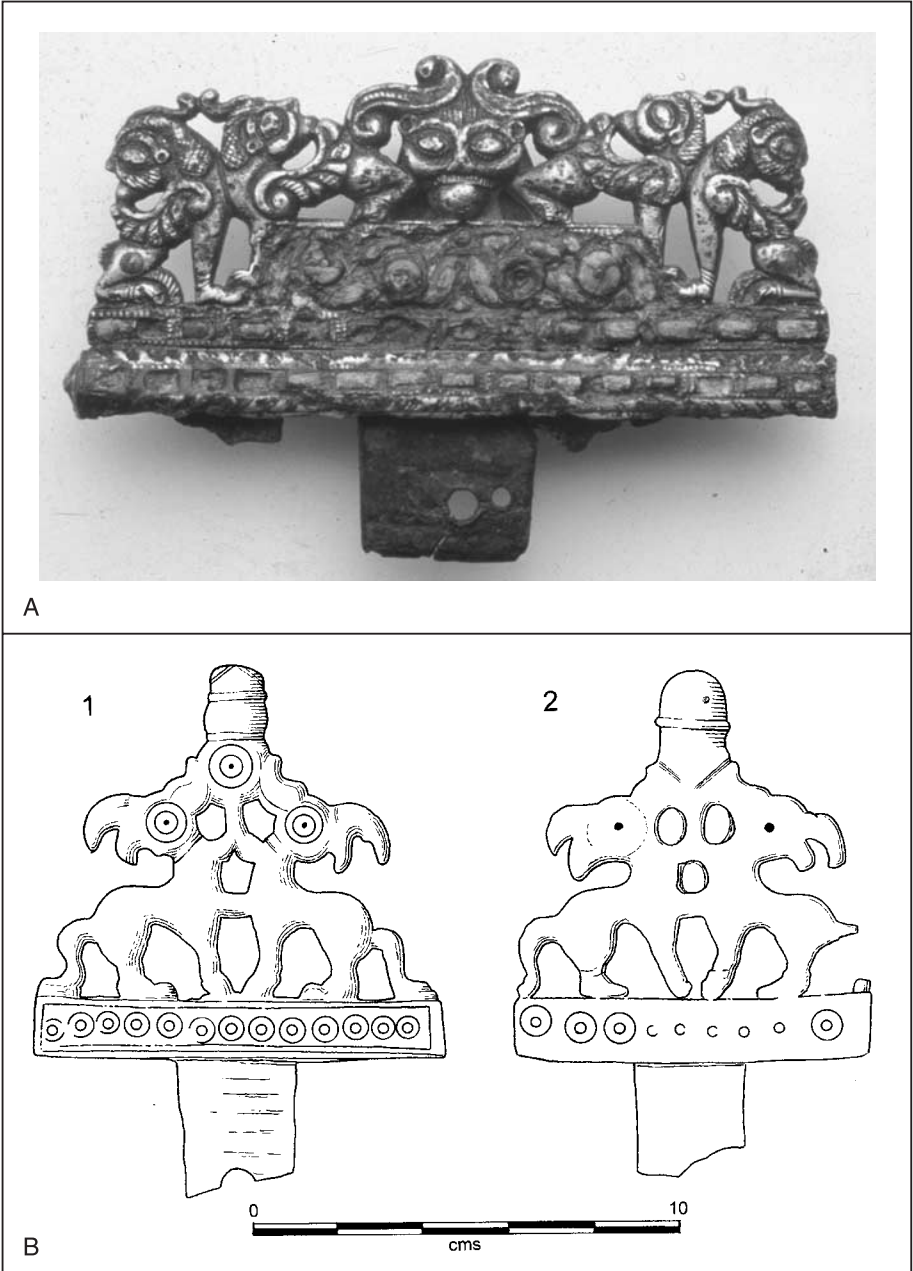

Figure 3.10 Belt attachments from north and south of the Alps. A: Weiskirchen, photo: Rheinisches Landesmuseum, Trier. B: 1, Somme-Bionne 'L'Homme Mort', Marne; 2, Este, Fondo Rebato gr. 152. Adapted from Megaw (1975) and Stead and Rigby (1999).

eyebrows, straight hair and neat moustache, with a leaf-crown comprising a splayed S-scroll lyre that rests on the rumps of the inner pair of beasts. The significance of this imagery is unclear, but a comparison with the trio of figures on the rim of the Glauberg beaked flagon perhaps affords a clue. Here a human figure is depicted with Mediterranean body-armour in cross-legged seated posture, flanked by two sphinxes on their haunches, with heads turned back in a bemused rather than menacing pose. Frey (1998) suggested that the scene might embody a Celtic version of the 'master of the beasts' theme, and that by extension a similar theme might be implicit in the Weiskirchen belt-clasp, the central figure being characteristically encapsulated in the Celtic head rather than the depiction of the body in full. The crossbar of the Weiskirchen belt-clasp is inlaid with coral, emphasizing the Mediterranean associations of the piece.

From the second (cremation) grave at the Glauberg the lid of a spouted flagon bears a backward-looking winged exotic beast (Pl. 4b). But even this was hardly as bizarre as a bronze brooch from the first (inhumation) grave depicting a backward-looking winged beast carrying a human head on its rump, the symbolism of which is quite opaque. Winged griffons are also depicted in engravings on the bronze plaque from Stupava, Slovakia, in a free-hand technique also exemplified on the fragmentary rim of a wire sieve from Hoppstädten in the Hunsrück-Eifel. The technique of engraving, particularly the use of stabbing and of hatched shading, suggests that these pieces could be from the same or a related group of workshops in the middle Rhine. Even if the theme of the fantastic beast is eastern, both interpretation and associations of the Stupava plaque are plainly Celtic. As Megaw has convincingly argued (1975, 22), the 'sickle' wings of all these beasts are much closer to Graeco-Etruscan models or even those on *situla* art than they are to the fully-stretched wings of Scythian or Persian art.

One example for which Jacobsthal saw both Persian and Scythian models was the gold arm-ring from Rodenbach (Pl. 5a), part of the rich furnishings of a warrior-grave from the Rhineland, dating to the later fifth century, which included Greek and Etruscan imports among its drinking service. The ornament comprises two pairs of backward-looking crouched animals on either side of a central face-mask, and with further faces between each pair. The central pair are rams or ibexes, the outer pair are hybrid beasts with rams' horns and predatory birds' or griffons' beaks. Along the backs of the beasts are soldered balusters, with four larger balusters over the central head. Balusters also play a prominent role in the gold torc from Besseringen in which five slender balusters are flanked by backward-looking birds. The two are not necessarily from the same workshop, but with others they suggest the existence of regional traditions manifesting themselves in specialist techniques and themes (Megaw, 1972).

Perhaps the clearest indication of the likely source of the backward-looking exotic beast theme is provided by Frey's (1995b) studies of trans-alpine connections in the early La Tène period. The belt-hook with open-work backward-looking griffons from the late fifth century Somme-Bionne chariot-burial in the Marne is almost exactly matched by one from Este (Figure 3.10B). Indeed, the distribution of belt-hooks has been taken as one possible indicator of an early phase of settlement of northern Italy that would have brought Celtic craftsmen into contact with *situla* art and orientalizing themes through Graeco-Etruscan intermediaries.

Most exotic of all the orientalizing personal ornaments of the early La Tène phase is the gold hoard from Erstfeld in Switzerland (Pl. 6a; Wyss, 1975), containing four torcs

and three bracelets. Three of the torcs are ornamented in an elaborate scheme of open-work, two forming an almost identical pair. On these, the central device is a small, abstract bird flanked by a pair of balusters. On either side of these, symmetrically disposed, are pairs of Siamese twins, the inner facing twin wholly human, the outer-facing having human arms and hands but with animal's ears or horns (Pl. 6b). The pair stands upon backward-looking creatures, half human, half griffon, which in turn lead to the end of the open-work and the decorative panel. The human figures wear shoes with upturned toe-caps in the style depicted in situla art, but also seen on bronze brooches from the Dürrnberg and from Manětín-Hřádek in Bohemia. If the interpretation of the pieces of gold-leaf from the Hochdorf burial as embellishment for shoes is correct, then this fashion was possibly in vogue north of the Alps already in late Hallstatt times. More puzzling is the use of cross-hatching on the trunk of the Siamese twins, in a chequer-pattern that Sandars (1971, 109) paralleled in the Ziwiyeh ivories. As with most of such attempts to establish direct oriental links, no single eastern source can be determined that consistently manifests a number of common motifs or techniques. One smaller bracelet from the Erstfeld group, which is generally assumed to have been the product of a single workshop, shows a series of distinctive ornamental devices that convinced Megaw (1972) that they were the work of the same Rhenish school of craftsmen that was responsible for the Bad Durkheim gold bracelet, and perhaps those from Rodenbach and Reinheim too. Why the hoard was buried at Erstfeld is unclear. Switzerland is marginal to the main distribution of Early Style artefacts. Furthermore, though trans-alpine links between the goldsmiths of the middle Rhine and their north Italian neighbours are well attested, the find-spot, just north of the St Gothard Pass, is on a route that was not extensively exploited until the Middle Ages (Pauli, 1991).

Another class of artefact upon which orientaling themes are displayed are flagons from the aristocratic wine service. One of the more tantalizing examples of the oriental connection is the animal on the lid of the Waldalgesheim flagon (Figure 3.4, 2), which Fischer (1988), following Jacobsthal, compared to the golden deer from the Oxus treasure. The rendering of ribs and spiral accentuation of the rear pelvic joint of the Waldalgesheim beast unmistakably mirrors the features of the model, even if the latter's noble posture is translated into a dejected and wooden imitation. Among earlier flagons, the Basse-Yutz pair might be regarded *prima facie* as displaying oriental features in the pack of pointed-eared dogs that guard their lids, and warrant closer examination (Megaw and Megaw, 1990). The first thing to be remarked is that the Basse-Yutz flagons depart from the standard, rounded body-profile of their Etruscan models in favour of a much more slender, almost concave form, matched most closely among Celtic flagons by the example from the Dürrnberg, or by the more recent example from the Glauberg. It need not follow that these were the products of the same craftsman or a single workshop, but they are at any rate among the more innovative pieces of early Celtic metal-work. Particularly innovative on the Basse-Yutz flagons is the extensive use of coral inlay, on the ornamental plates around the base, at the throat and around the rim and spout of the flagons. Mediterranean coral was extensively in use in north-alpine Europe from Hallstatt C until middle La Tène, and from its distribution (Champion, 1976) appears to have been imported via trans-alpine routes from the late Hallstatt period, pre-empting the intensification of reciprocal connections of the early La Tène phase. Its use on the Basse-Yutz flagons transcends the

simple application of studs for eyes to include the more unusual use of oblong settings, the comparanda for which has led to suggestions that a middle Rhenish workshop could have been responsible for the flagons. The Basse-Yutz flagons also testify to the early use of red glass inlay, commonly but erroneously referred to as red 'enamel', here used in the stopper and as filling in grooves of rim and the handle animal's mane. It is, in fact, the animals that have prompted debate regarding orientalizing influences. In particular, a succession of scholars since Jacobsthal have detected oriental influence in the stabbed rendering of the animals' pelts and in the spiral device depicting the shoulder joint of the fore-limbs, which has its closest parallel on the pair of backward-facing beasts on the Parsberg brooch. In fact, close parallels from Scythian art are hardly abundant, and even if they were, it remains in dispute whether such influences were transmitted directly via the Danube route or indirectly through Graeco-Etruscan intermediaries. The closest parallel for the shoulder-spiral as well as the stabbed pelts on early La Tène metal-work is in fact the winged beast on the terminals of the Vix torc, so that these techniques were already present in Western Europe in late Hallstatt times.

One further element of the Basse-Yutz handles should be considered. Fischer (1988) pointed out that the animal-handles of the Basse-Yutz, Borsch and Dürrnberg flagons all rose above the rim of the vessel, rather than resting directly upon it in the Etruscan manner. For this variation he cited Achaemenid sources, a comparison that might carry greater conviction if any other element from these exotic vessels had been imitated by the Celtic flagons. In the case of the Dürrnberg flagon, the swollen-cheeked and goggle-eyed handle-beast rests its chin directly upon a human head. Jacobsthal took this, and the representations on the rim of the vessel, to be instances of the 'voracious beast' theme. Whether or not these examples are persuasive, the voracious beast was evidently part of the Celtic artistic nightmare, as other examples in metal-working and sculpture indicate. Foremost among these is the fragmentary torc from the Glauberg (Figure 3.11). It features three Janus heads, two standing above the third, which is clasped by the wide-open jaws of two flanking lions, stretched at full length with their hind quarters extending along the torc. The faces themselves are readily paralleled among Celtic faces, though their flat caps are certainly unusual, and have been taken as an indication that they were intended to retain balusters (Rolley, C. (ed.), 2003, Fig. 139b). Jacobsthal was tempted by the possibility that this was the work of an eastern artist employed by the Celts. He also cited, however, the parallel of an Etruscan flagon from Perugia (1944, Pl. 223) in which the handle-beast is plainly grasping a severed human head, so that voracious beast imagery was certainly part of the repertory of the Etruscan artist. Equally at the head of the Adriatic, situla art by the fifth century could have provided a rich source of fantastic beasts, like that on the lowest panel of the Vače situla, or the winged lion on the lowest panel of the Certosa situla from Bologna, both of which are depicted devouring a well-shaped human leg.

In sum, the imagery of early La Tène art certainly includes exotic elements for which the term 'orientalizing' is not inappropriate. The balance of evidence, however, argues that this derived from the pool of Graeco-Etruscan imagery that was available to north-alpine Celtic artists at least from the late Hallstatt phase, even if their aristocratic or warrior patrons were familiar with its significance from longer-distance political or diplomatic contacts. That these Mediterranean and further contacts continued to influence La Tène art in north-alpine Europe will become apparent in the next phase of development.

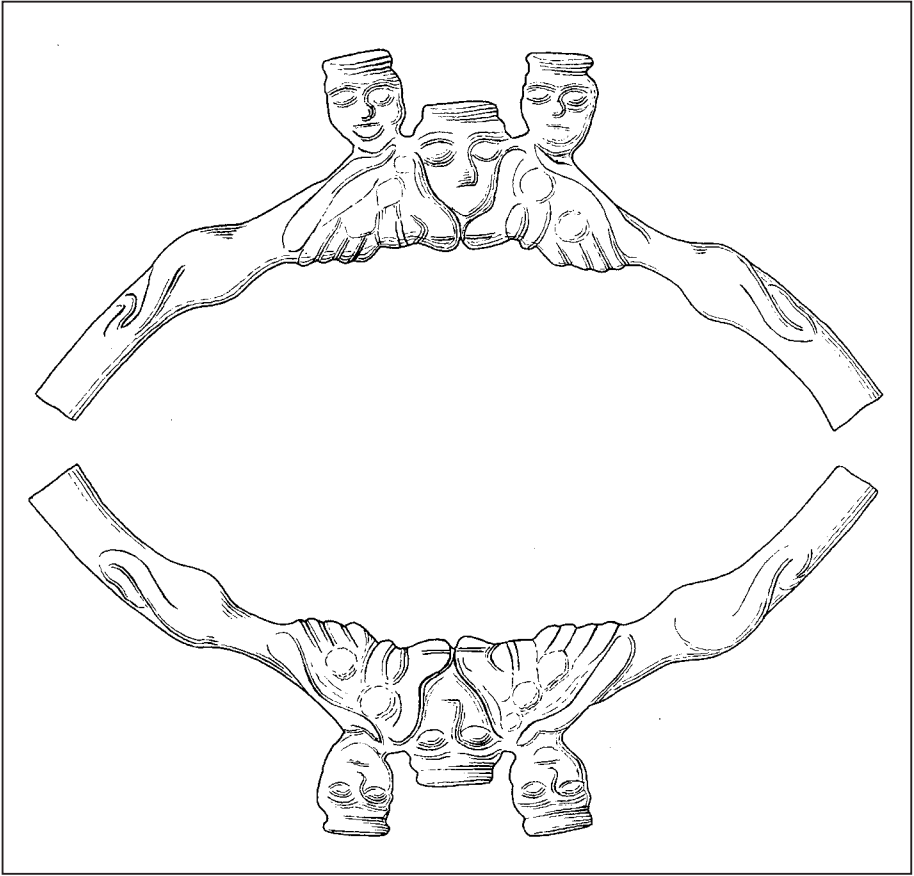

Figure 3.11 The Glaubeberg bronze torc. Interpretative drawing adapted from various photographic sources.

THE LA TÈNE DEVELOPED STYLES

In later examples of La Tène Early Style ornament around the end of the fifth century, Celtic artists reveal a restless aspiration to imbue their work with a sense of movement, manifesting itself in what the Megaws have called a 'transformation of static into continuous design' (Megaw and Megaw, 2001, 103). This trend can be seen even within a classic Early Style assemblage like the Schwarzenbach grave-group, the open-work gold bowl from which was examined in detail earlier. A novel element of the base design (Figure 4.1A, 1) is the triskele, or three-cornered whorl, each corner ending in a circlet and the whole defining a curving-sided triangle. These are ordered nevertheless as independent elements, sharing no common sides or corners with the next triskele. Integration of the design is achieved by additional curves between the circlets of adjacent triskeles to create a simple lotus plant that does then share part of its outline with its neighbours. As if to stress the pedigree of the lotus, a stamen is inserted between its base and the border of the design. In the alternate spaces, the sides of the triskeles face each other almost as an opposed pair of S-spirals. As Jacobsthal (1944, 78) observed, therefore, the base design can be alternatively read as a chain of triskeles, or as a series of lotuses and lyres, depending on whether foreground or background is dominant. But in essence, the bowl base remains firmly a product of the Early Style.

Also part of the Schwarzenbach assemblage, however, and doubtless the product of the same workshop, are two other gold discs, possibly from drinking-horn caps, one of which in particular (Figure 4.1A, 2) displays similar motifs to the bowl base, but executed in a fashion which anticipates the free-flowing effect of the subsequent Waldalgesheim Style. Here pairs of triskeles are joined by a common S-curve and terminal circlets, and to the next pair by sharing the third circlet. The continuous effect is enhanced by the alternate use of a connecting outer loop. Even in a classic Early Style workshop in the Rhineland, therefore, a restless process of experimentation was taking place at the end of the fifth century, which would shortly lead to the creation of new fashions.

Champagne and the *premier style continuu*

Nowhere is this process of experimentation better illustrated than in the Champagne, where in addition to palmette and lotus, the lyre or lyre-palmette were among those motifs adapted from classical sources through Italic intermediaries into the Celtic artist's repertory, most frequently appearing either as opposed pairs of S-scrolls

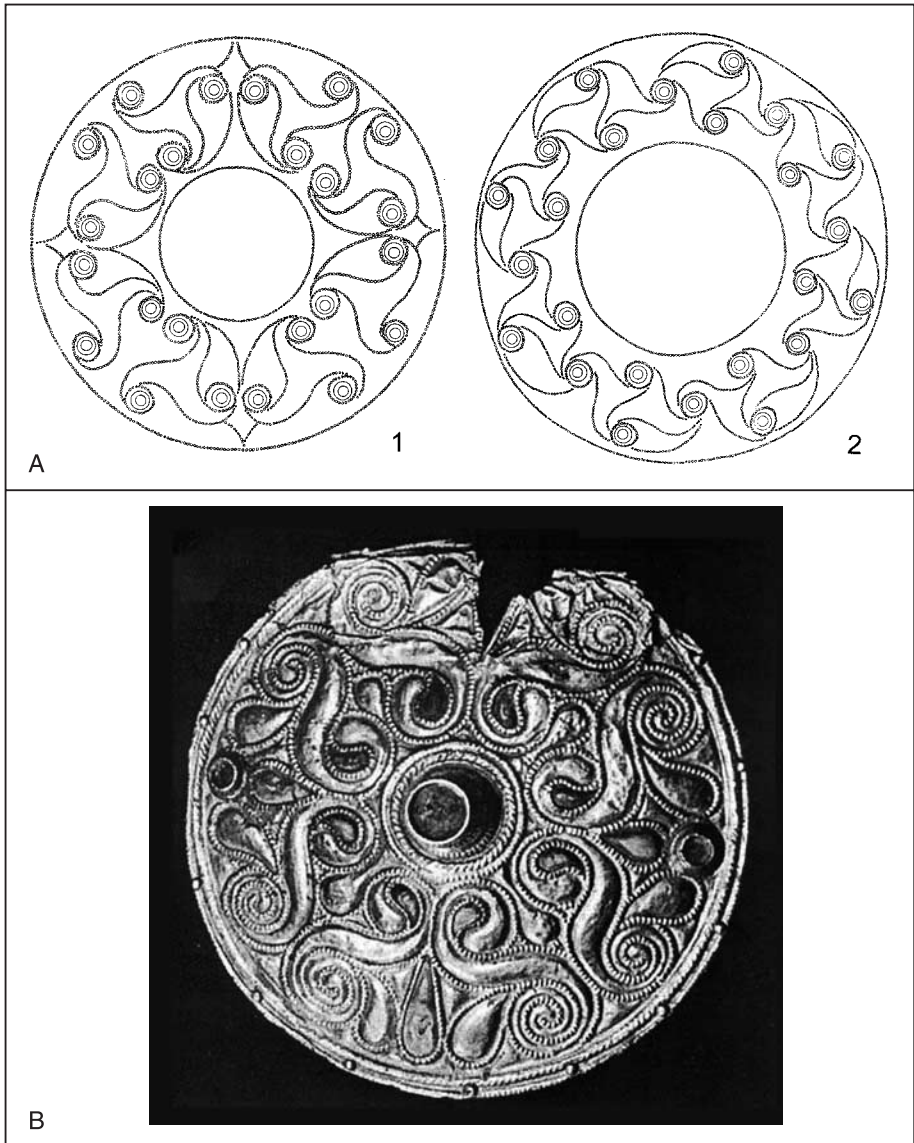

Figure 4.1 Transition towards the Developed La Tène Styles. **A:** 1, base design of the Schwarzenbach bowl; 2, design of drinking horn cap from Schwarzenbach. Adapted from Jacobsthal (1944): not to scale. **B:** the Auvers disc. Photo: Bibliothèque nationale de France, Paris.

enclosing a palmette, or in a continuous vertical sequence. An especially fine example is the gold-covered bronze disc, possibly also a drinking-horn lid, from Auvers-sur-Oise (Figure 4.1B), in which the lyre-scrolls, highlighted by *repoussé* dotting in the manner



Figure 4.2 *Phalerae* with open-work borders from St Jean-sur-Tourbe. Musée des Antiquités Nationales. Photo: RMN, Paris © Loïc Hamon.

of fifth-century Early Style pieces, flow into three-leaved palmettes, while fragmented palmette or lotus leaves fill the outer spaces between the lyres. In fact, the component motifs are still essentially independent, though sharing in places a common dotted outline. What lends the composition its sense of incipient movement is the fact that it can be viewed either from the centre outwards or from the outer edge inwards, the former reading giving a fleshy but unmistakable series of lyre-palmettes, the latter offering a more enigmatic image in which eyes, nose and 'judicial wig' anticipate the 'Cheshire Style' figures of the ensuing Waldalgesheim or Vegetal Style of La Tène art.

The sequence of stacked lyres or lyre-chains is well represented in the Marne region, notably in the border open-work of the coral-inlaid bronze disc from the chariot burial at Saint-Jean-sur-Tourbe (Figure 4.2). The open-work lyres run into each other to form a continuous movement in the design by means of interlocking waves, and are accentuated by simple incised lining in a manner that also characterizes the insular example from Wisbech in Cambridgeshire. The open-work chariot-mounts from La Bouvandeau at Somme-Tourbe illustrate the experimental nature of this process. Not an identical pair, they both use S-motifs, single, paired or opposed as lyres, upright or inverted. In the example with terminal palmette, the design at the broader end is effectively continuous, with subsidiary tendrils enhancing the sinuous quality of the design. For the most part, however, the lyre elements are stacked rather than truly interlocking (Figure 4.3). The idea of conjoined lyres was not unique to the Champagne, though the impression of restless movement is distinctive of this western group. On the gold strip from Klein Aspergle or on the handle of the Dürrenberg flagon, for example, where a

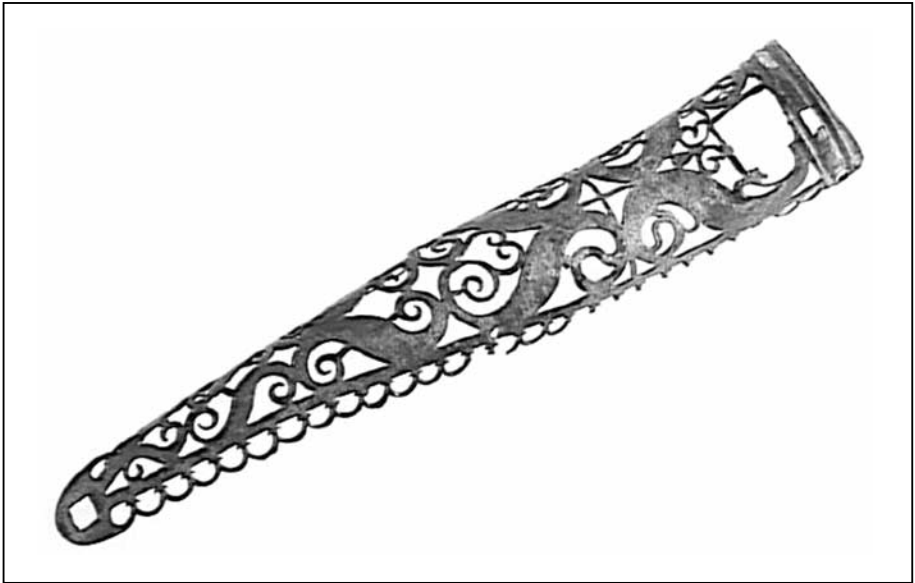

Figure 4.3 Open-work mount from La Bouvandeau. Musée des Antiquités Nationales. Photo: RMN, Paris © Gérard Blot.

similar design is in both instances combined with palmettes, the lyres are linked by a series of circlets rather than in a continuous movement.

These tentative steps towards a more fluid rendering of classical models reach a culmination in a series of objects, the distribution of which is centred in the Champagne region, and which Verger (1987), developing earlier work by Paul-Marie Duval and V. Kruta, categorized as a *Premier Style Continu*, that is, a slightly later development of the strict Early Style or *Premier Style Classique*, embodying the new trends described above. Most lavishly ornamented of these pieces is the unprovenanced beaked flagon in the museum at Besançon (Figure 4.4; Frey, 1955). It was undoubtedly of Italic manufacture, but was subsequently embellished by a Celtic artist from neck to base with a series of panels that transform classical imagery into sinuous, fleshy designs in which the sense of restless movement is pervasive. The ornament on the neck of the flagon has regularly been compared to an Etruscan flagon in the British Museum (Figure 4.4, 1; Jacobsthal and Langsdorff, 1929), on which the classical design of central palmette with flanking scrolls could almost have served as the model for the Besançon artist. Here the scrolls comprise lush, interlocking leaves, the spines of which are highlighted by wavy lines with alternating dotting. Leaves, similarly depicted, link a series of alternately upright and pendant palmettes on the shoulder of the vessel; the palmettes are reduced to three disconnected leaves within a semi-circular panel, and have been seen by Frey as antecedents of the fan-motif that is archetypal in the ensuing Waldalgesheim Style. The main panel, which occupies most of the vessel's body, elaborates on these themes, but with the leaf-scrolls flowing not into simple palmettes, but into interlocking yin-yangs supported by a peltate frame in which palmette-leaves have

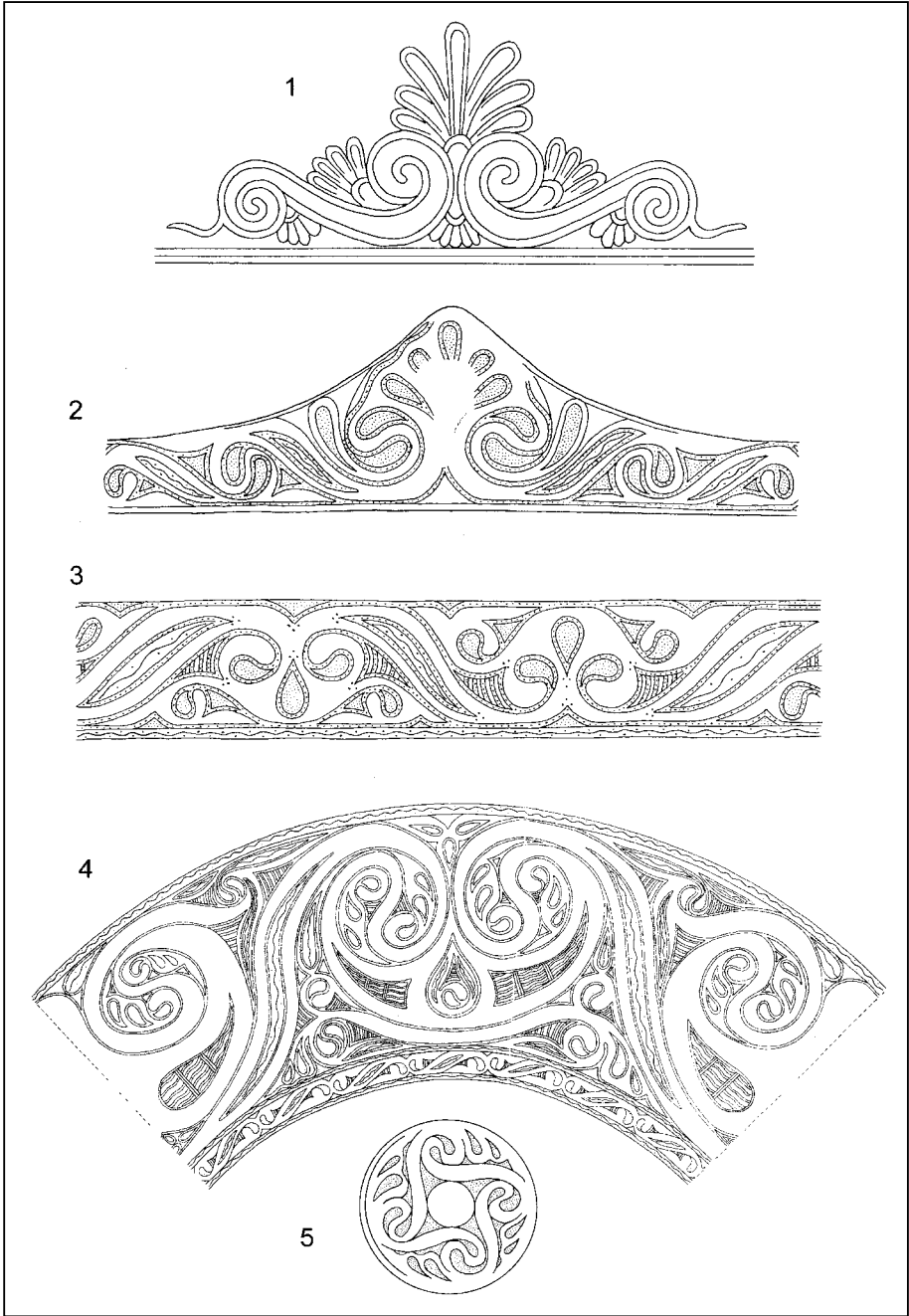

Figure 4.4 Engraved decoration of the Besançon bronze flagon. 1, design on unprovenanced bronze flagon in British Museum; 2–5, Besançon: 2, neck; 3, shoulder; 4, girth; 5, base. Panels not to same scale. 1 adapted from Jacobsthal and Langsdorff (1929), 2–5 adapted from Frey (1955).

disintegrated to form fillers together with curved-sided triangles. Below, a narrow band of slender leaves is again highlighted and enclosed with wavy line and dotting. Finally, the base is decorated with a four-cornered whorl, a variant on the commoner three-cornered whorl, made up of leaf-scrolls linking in a yin-yang, from which spring fragmented half-palmettes. This combination of leaf-scrolls, yin-yang and fragmented half-palmettes is closely replicated in a three-cornered whorl on the innermost panel of decoration on the interior of the bronze basin from Les Saulces-Champenoises, a chariot-burial in the Ardennes (Figure 4.5, 2).

In fact, notwithstanding its uncertain provenance, the Besançon flagon belongs stylistically with a group of metal-work from north-eastern France, which includes the Berru helmet (Figure 4.5, 1) and the bronze discs or phalerae from Écurey-sur-Coole (Figure 4.5, 3 and 4), both in the Marne. Closest in design to the shoulder panel of Besançon are two sections of the Berru helmet, both displaying what Jacobsthal called 'intermittent wave tendrils' linking fans containing simplified palmettes, one having supplementary leaves to fill the spaces between tendril and fan. The composition on the larger Écurey-sur-Coole disc is broadly symmetrical, and composed of four fan-like devices linked by slender leaf-tendrils. The fans in outline resemble an opposed pair of comma-leaves, but with the disarticulated leaves of palmettes unifying their component parts and the leaf-tendrils. The whole design is again contained within a border of wavy line with dotting. Some of the technical devices of the Champagne group, including the use of wavy line with dotting, are also found on key examples of insular La Tène art, like the Witham and Wandsworth shields, though rendered rather differently. In terms of stylistic similarities, however, the Cerrig-y-Drudion fragments and the Wisbech scabbard show closest affinity with the Continental series.

The combination of motifs into recurrent themes and similarities in technical detail argue positively for the emergence early in the fourth century in the Champagne region of an innovative group of Celtic artists whose luxury products combined elements from the preceding phase of the Early Style with new and imaginative rendering of classical vegetal models. Some of the key motifs that distinguish these innovative works are those that Jacobsthal used to define his Waldalgesheim Style, but the examples from the western group are not stylistically the same as those from the Rhenish type-site or elsewhere. In fact, our examination of the La Tène Early Style or series of Early Styles would not lead us to expect a unitary expression of this developed phase either, still less to assume the need for a single point of origin.

The Waldalgesheim Style

The Waldalgesheim Style, named by Jacobsthal after a princely burial in the middle Rhine (Aus'm Werth, 1870; Joachim, 1995), notwithstanding its continuing debt to classical plant prototypes, displays an independence of interpretation and confidence in execution that marks the culmination of achievement of the early La Tène period. Modern commentators are divided regarding the regional origins of this developed style, and the Rhineland is not obviously a focal point in its north-alpine distribution. In consequence, the descriptive term 'Vegetal' has been proposed in place of Jacobsthal's type-site to denote the new style, reflecting in particular its use of plant-derived tendril motifs. It should be noted, however, that this label too has its limitations; the new style is not characterized exclusively by vegetal motifs, nor are vegetal motifs exclusive to it,

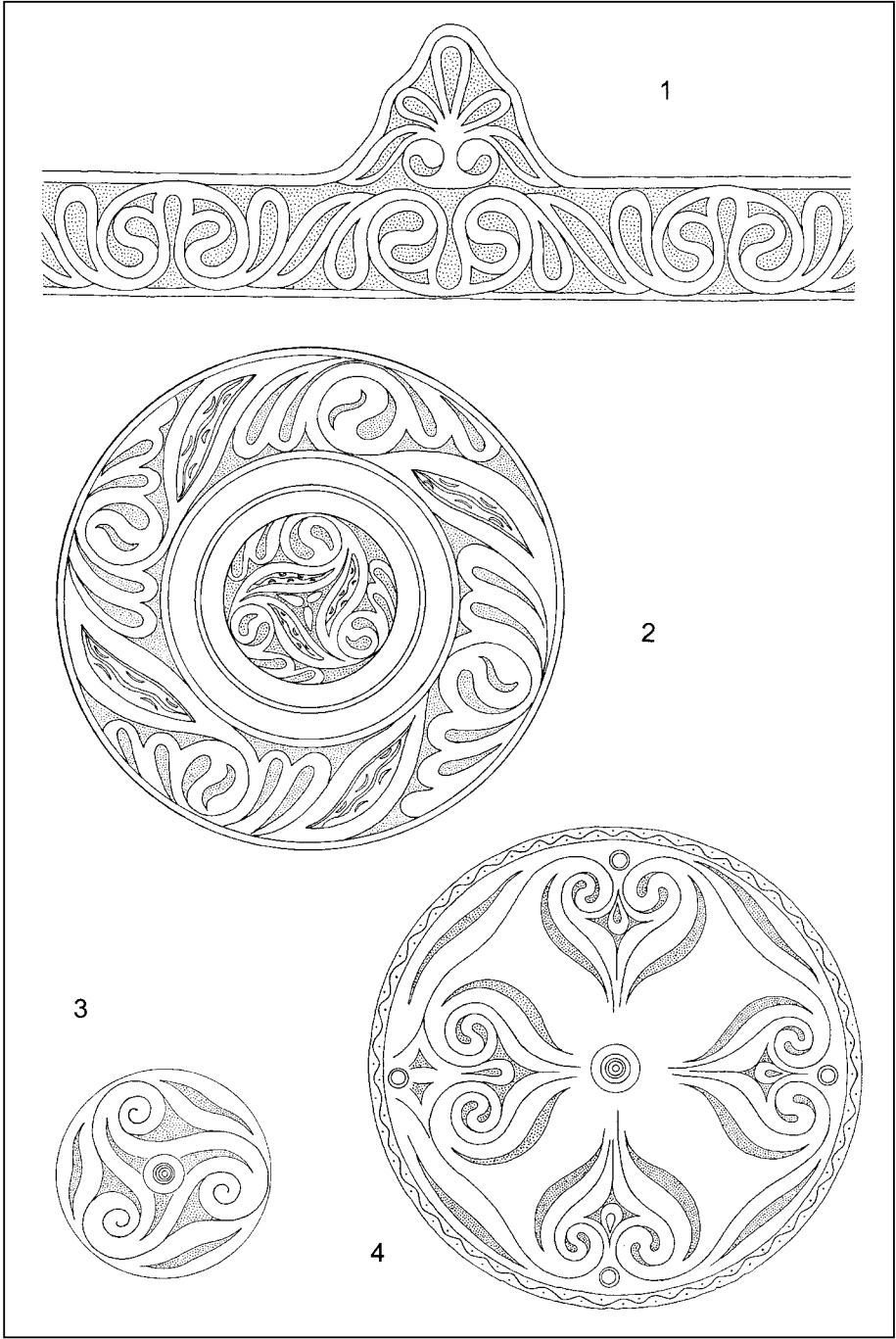

Figure 4.5 Developed Style in the Champagne. 1, Berru helmet; 2, Les Saulces Champénoise dish; 3 and 4, Écury-sur-Marne *phaleræe*. Not to scale. Adapted from Déchelette (1914) and Jacobsthal (1944).

since vegetal models of classical derivation were plainly an important component of the preceding phase. Accordingly, some scholars have preferred to retain the now-conventional name, while recognizing its limitations. Confusing as this may appear, it signals the significant fact that the new Waldalgesheim or Vegetal Style is in part the product of both continuing and renewed contact with classical artistic impulses from south of the Alps, and should not be regarded as an independent development divorced from the progressive sequence of regional styles that contributed to its genesis, and which it in turn subsequently influenced. Waldalgesheim and Besançon both reveal particular traits or 'facets' (Jope, 1971a, 178 and footnote 51) among various manifestations of the developed phase of early Celtic art, rather than representing a consistent new 'style'. In terms of absolute chronology, these developed styles were the product of the fourth century BC, but their appearance may well have been synchronous with the local or regional continuation of earlier styles. Indeed, Frey (1976) stressed the apparent disparity of distribution between artefacts with Waldalgesheim Style ornament and those of the Early Style, the only significant area of overlap between the two being in the Marne region of north-eastern France, so that the later style should not in general be regarded simply as a development of the earlier.

Waldalgesheim lies in the middle Rhine, west of its confluence with the Nahe river. Here a grave, assumed from the rich inventory of grave-goods to have been that of a Celtic princess, was excavated in 1869–70. It comprised a wooden chamber beneath a barrow mound, to one side of which were the fragmentary remains of a two-wheeled chariot. Among the rich and varied artefacts from the tomb were the vehicle fittings, a drinking service and personal ornaments, but no weapons. Finest among the personal ornaments were a gold torc, an arm-ring and two bracelets (Pl. 5b), the torc and bracelets all ornamented with low relief designs in the style that Jacobsthal identified with the site. Harness and belt attachments (Figure 4.6) display a similar style of ornament in open-work, and are a too-often neglected component of the grave-group, indicating that the gold ornaments, however distinctive, cannot be explained in isolation. The drinking service includes two contrasting pieces, the older being a locally-made spouted flagon (Figure 3.4, 2), which has been discussed earlier in the context of the engraved ornament on its body and the emaciated animal on its lid, and a younger import, a Campanian bronze bucket, probably made in or shortly after the second quarter of the fourth century BC, but deposited in the grave a couple of generations later. Both these items were found at a greater depth in the tomb than the torc and bracelets, leading at one point to the suggestion that there may have been two separate and successive burials in the tomb. The grave-goods evidently included items that were made at different times and treasured until buried together in the later fourth century. The spouted flagon is thus an heirloom, the Campanian bucket a more recent acquisition.

An initial problem in discussing the Waldalgesheim Style lies in its definition. We may speak generally of its sinuous, fleshy curvilinear tendrils and scrolls or its asymmetrical plant spirals, or in a more flippant vein we may use evocative terms like 'spaghetti-ornament' or 'sweet-pea ornament' to describe its over-and-under low-relief compositions. In more abstract mode, its vigorous, confident and yet subtly experimental quality is perhaps best summarized by Megaw's allusion (1970a, 89) in the context of another piece to the 'assured irrationality' of its ornamental style. At one level, all these descriptions serve their purpose, but to recognize the style we must

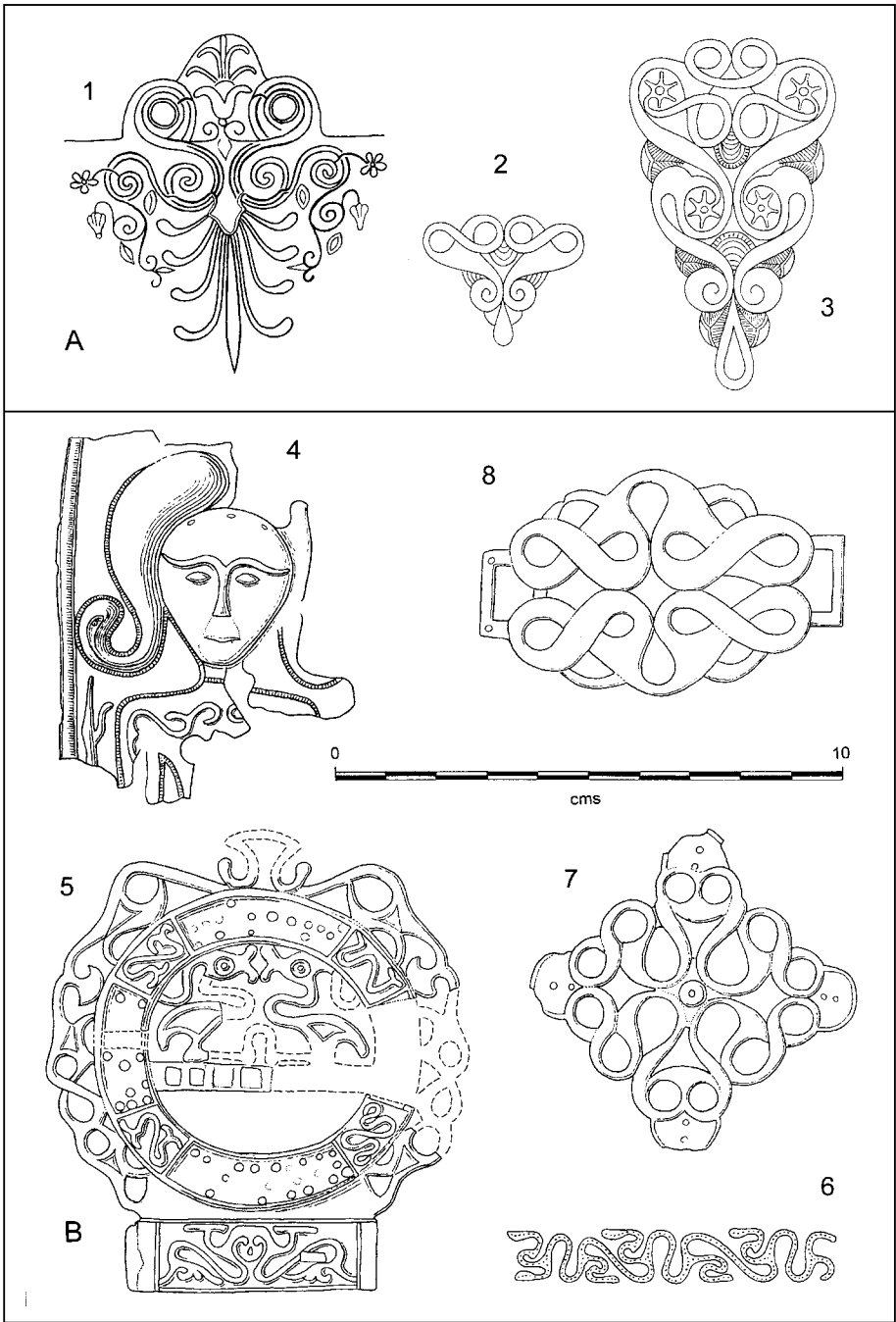

Figure 4.6 Ornament from Waldalgesheim, Mainz-Bingen, grave-group. A: 1, design on Campanian bucket handle-attachment; 2, design from arm-ring terminals; 3, design from torc terminals. Not to scale. Adapted from Jope (1971a). B: 4, face-mask 2 from yoke assembly; 5, ornamental yoke mount; 6, design on yoke terminals; 7, ornamental plaque; 8, ornamental belt plate. Adapted from Joachim (1995).

identify the component motifs and the way they interact within the overall composition, not simply to reduce the style to a series of nuts and bolts, but to understand its dynamics. To begin with, unlike the Early Style, it is a low-relief style, which means that the interplay between foreground and background, latent in the Early Style, no longer pertains, at any rate not in the same way. By contrast, the Waldalgesheim Style comprises a continuous composition of conjoined elements, rather than rows of independent but potentially inter-acting motifs.

For Jacobsthal, a key component of the Waldalgesheim Style was the tendril, which could coalesce with other motifs such as whirligigs or fans. The tendril is essentially a classical motif, and it is not difficult to cite classical prototypes for Celtic tendril designs. Jacobsthal described the classical tendril as having fluid movement, by contrast to the static Celtic version. Frey convincingly showed that by infilling the tendril to create a curved triangle or vortex, the Celtic artist was able to allow the movement of the Celtic tendril to flow both ways, rather than being uni-directional. Martyn Jope (1971a) developed Jacobsthal's analysis of Waldalgesheim motifs in a study that also attempted to establish the existence of a Waldalgesheim 'master' as the principal progenitor of the style. The term was in fact Jacobsthal's (1944, 93), but there is no evidence that in using it he was implying anything more than the existence of one among a number of specialist craftsmen or workshops. Jope's thesis has not been generally adopted, not least because it is by no means certain that any of the grave-goods from the type-site, other than the spouted flagon, were local products. But his analysis of the constituent motifs of the style as exemplified on the torc and bracelets from the type-site, notwithstanding its rather florid articulation, was still among the most perceptive analyses available until Frey's in the definitive republication of the assemblage (Frey, 1995a).

A recurrent theme of the Waldalgesheim Style is a serpentine scroll, which may swell out like a slender leaf in some versions, but which forms the main agent of articulation of the design. This element commonly flows into curved triangles or vortexes from which at least one other corner will continue the flow of the composition. A particular feature of the Waldalgesheim group, noted by Jacobsthal and Jope, is the over-and-under figure-of-eight device forming a kind of interlace pattern that is particularly suitable for use in confined spaces. Further embellishment can be provided by finials, either fan-like peltae or concave-tailed fins. These designs are particularly well illustrated on the wagon accessories from Waldalgesheim, which included a series of yoke-fittings and ornamental embellishments. Two other ornamental plaques employ over-and-under figure-of-eight motifs to conceal elusive 'Cheshire Style' face masks, while figural representations in the yoke fittings include humanoid busts with 'leaf-crown' and a pair of opposed swan-like birds but with large, coral-inlaid eyes in open-work.

A second fundamental theme, illustrated on the Waldalgesheim torc and bracelets by the triangular elements that form the ends of both central and buffer-terminal designs, is a Celtic rendering of the lyre-motif, commonly combined with palmette, but characteristically transformed by the Celtic artist through the extravagant use of over-and-under figures-of-eight or similar devices of non-classical inspiration. The bracelets nevertheless include some repetitive, frieze-like panels of stylized waves or hooks resembling those on the Amfreville helmet. And from between the foliage peer out small stylized faces with bulging eyes and twirly eyebrows, reminiscent of the face-masks of the Early Style. For two other motifs, exemplified on the torc and

bracelets, Jope argued a direct derivation from the classical design below the handle-mounts of the Campanian bronze bucket (Figure 4.6, 1). The star-rosette terminals of the torc design certainly mirror the classical model, while the axillar fillings on torc and bracelets (Figure 4.6, 2 and 3) occupy the same relative position in the tendril-design as the convolvulus trumpet-flowers of the bucket cartouches. Whether or not the bucket was the exact model for a Celtic craftsman or school of craftsmen working in the patronage of the Waldalgesheim princess, there is little doubt regarding the authenticity of the derivation of these component elements in the Celtic design from a model that would have looked very much like the bucket cartouches. In the context of trans-alpine activity in the fourth century, there seems no reason to doubt that the model of a lyre-palmette with tendrils could have been available as the inspiration for a Celtic craftsman through a variety of agencies, more especially so if that craftsman had himself operated in Italy. The Waldalgesheim bucket, therefore, is less significant for its impact upon the imagination of a middle Rhenish 'master' (appealing though such a cameo insight might be) than for the fact that it must have been one of the last of the trans-alpine imports to reach that region before links between the Mediterranean world and north-alpine Europe went into decline for a couple of centuries.

One reason for questioning the notion of a single Waldalgesheim 'master' is that close analysis has shown that the ornamented metal-work in the grave was the product of several different hands. This in itself should hardly occasion surprise, however, since the goldsmith responsible for torc and bracelets would surely not have been the same craftsman who ornamented the chariot and its draught-attachments. Jeweller, swordsmith and armourer, brooch-maker and coachbuilder would each have commanded specialist skills, and while all may have been influenced in their luxury products by new ornamental fashions, it is unlikely that individuals would have turned their hands to more than one craft in the Iron Age any more than they would today. The Waldalgesheim princess may indeed have been unusual in the middle Rhine in the fourth century by retaining in her patronage a group of skilled craftsmen whose work so magnificently reflected the new developed art style, but it seems unnecessary to deny that these products could have been made locally, even if as a result of external impulse.

Waldalgesheim Style ornament has a wide distribution, from eastern Central Europe to the Seine, and with a significant trans-alpine component that will be discussed in due course. Among the more westerly group is the helmet from Amfreville-sous-les-Monts (Pl. 7a), an example of the so-called 'jockey-cap' helmets, which, though influenced by Italic models, were undoubtedly produced by Celtic armourers. There are two principal variants of helmet found in north-alpine contexts, a taller conical form best represented at La Gorge Meillet, Berru and the Dürrnberg-bei-Hallein, and a lower version like Amfreville or the richly ornamented example from Agris in the Charente region of western France, for which the term 'jockey-cap' has been prompted by its shape, notwithstanding that the 'peak' is in fact a neck-guard. Amfreville is plainly a high-status piece of parade armour. Made of bronze, it is ornamented with iron open-work on its crown and lower panel, with gold leaf over bronze forming the ornament of the central panel between. Top knob and ear-guards are missing. The design of the central panel immediately recalls the experimental attempts to create a flowing, continuous design discussed earlier. Alternate upright and pendant triskeles are simply joined up to create a continuous chain, bordered above and below with a frieze of wave-hooks like those already remarked on the

Waldalgesheim bracelets. The lower panel, however, originally embellished with enamel infilling, is of a new order altogether, its low-relief, sinuous wave-tendrils owing much more to the assured, mature Waldalgesheim tradition. Not all such helmets translate classical themes into Celtic with this degree of confidence. Indeed, for all its splendour, the Agris helmet still retains a formal series of palmettes as its principal ornamental theme.

The Agris helmet (Pl. 7b), discovered in 1981 in a cave near Angoulême (Gomez de Soto, 1996) is a truly remarkable piece, not simply because it is one of the most westerly outliers among high-status La Tène metal-work. Its context appears not to have been funerary, and the excavators have suggested instead that the helmet was a ritual deposit to the spirits of the underworld. Despite its superficial formality of its palmette-dominated design, which might be thought to proclaim its indebtedness to the Early Style, its association with a Dux brooch of La Tène B seems to confirm the conclusion from closer analysis that the helmet belongs to the later fourth century. Its construction is based upon an iron crown, with bronze appliqué strips and gold-leaf plating. Coral is used extensively as infilling of palmettes and studs. Subsequent to the initial discovery, the top-knob and one cheek-guard of the helmet were recovered from the disturbed deposit.

Like Amfreville, the Agris helmet is divided for purposes of decoration into several panels. Lower and upper panels are dominated by a series of palmettes, arranged in a formal, unconnected frieze. The central panel likewise includes a formal arrangement of S-curves, with swelling-leaf terminals, but otherwise not linked into a continuous sequence. In fact, it is the infilling between these elements that affords the closest links with Waldalgesheim. Though the palmette is still prominent, the filler motifs combine palmettes with over-and-under tendrils that are not so far removed from those of the Waldalgesheim bracelets. On the central panel the infilling devices of palmette and comma-leaf also include hatching not unlike that used in the Waldalgesheim repertory. This is even more apparent on the upper panel, where the detail of hatched elements is very close to the style of axillar filling on the Waldalgesheim torc itself. The ornament of the neck-guard comes closest to experimentation towards a freer and more sinuous composition, with swelling leaves interlocking with a typical yin-yang. One final detail has attracted comment, the delicate curled serpent, apparently horned, lurking within the palmette design of the cheek-guard. Horned serpents have a well-documented significance in the Romano-Celtic iconography of Gaul and Britain, and of course are depicted no less than three times on the Gundestrup cauldron. Snakes also figure in various guises on the coinage of the later Iron Age in North-Western Europe. But there are hardly any representations in early La Tène art, even though snake-imagery was part of the Greek and Etruscan repertory. Its presence on the Agris helmet may be assumed to have had some special significance, if not as a signature of the artist, then perhaps as a symbol of its owner. In sum, the Agris helmet, like Amfreville, is a remarkable demonstration of the independence and creativity of the Celtic artists of this vibrant, transitional phase.

The Developed Style in Champagne

Within the Champagne region, several examples of bronze torcs are decorated in a style that echoes some of the themes of the Waldalgesheim or Vegetal Style. Despite

some uncertainties regarding provenance of certain finds, Kruta and Roualet (1982) were able to demonstrate that at least three graves from Beine-l'Argenteulle and Beine-Montequieux have reliable associations with brooches derived from the so-called Duchcov (German Dux) and Münsingen types. The Vegetal Style, in Reinecke's terminology belonging to the first half of La Tène B, would equate with La Tène ancienne II (or more specifically IIb) in the Hatt and Roualet scheme of 1977, in absolute terms spanning much of the fourth century BC. The principal types of torc are already current in phase IIb, including conical and cylindrical buffer varieties, and a more elaborate form with open-work appendages. The classic form of brooch of this phase is the Dux type. Bracelets include a serpentiform type that continues into the ensuing phase. Some simple curvilinear motifs in relief appear at this period, but it is not until the La Tène Ancienne IIIa phase, dated by Kruta and Roualet to the end of the fourth century or the early third century BC, that the Marnian torcs display more complex curvilinear designs. Two distinct types of torc can be distinguished, one a buffer-ended variety in which the buffers were commonly decorated with simple tendril or S-chains, the other having conical terminals ornamented with axially-symmetrical tendril designs. There is no indication that these are archaeologically distinct in dating or distribution, and we may therefore infer that they reflect some other difference in social fashion or symbolic significance; their similarities in ornament certainly suggest that they were the product of a local school or even of a single workshop. The example from Jonchery-sur-Suippes (Figure 4.7, 2) and the unprovenanced pair in the museum at Nancy show the classic motifs of the developed style, tendrils flowing into curved triangles, sometimes opposed in a balanced fan-like device, peltae, fan-like finials, and palmette-derivatives, used particularly to terminate the elongated triangular field of ornament. The compressed nature of the composition lends to it an appearance of asymmetry. In fact, in extended form the design would be very similar to that on the bracelet from Caurel in the Marne (Figure 4.7, 4) in which swelling leaf-tendrils lead into peltate fans with side tendrils in a wholly symmetrical composition. One further detail should be noted on the torc from Beine-l'Argenteulle (Fig. 25, 1). Within the end leaf of the terminal palmette are depicted eyes nose and mouth of a small face-mask. Pin-prick faces like this are known elsewhere in the region, at Rouillerot in the Aube, for example. But human features are even more clearly depicted on the bronze torcs from Courtisols (Figure 4.7, 3) and Witry-les-Reims in the Marne; the former is particularly remarkable since the design comprises a series of intertwined faces, some mask-like in the earlier La Tène tradition, others with features, including nose, mouth and chin more fully developed.

With the skilful use of the *cire perdue* technique to render ornament on torcs and bracelets, it is apparent that it is hard to draw a clear distinction between the relief styles of the Waldalgesheim or Vegetal tradition and the more pronounced relief ornaments, developing some of the same basic motifs, of Jacobsthal's later Plastic Style, which will be the subject of a later chapter.

The dominance of torcs and bracelets, together with brooches, in any discussion of the developed phase of early La Tène Celtic art in the Champagne should not detract from the importance of the ceramic art of this period (Corradini, 1991). Painted pottery was characteristic of funerary ceramics in the Marne from La Tène ancienne I (Roualet, 1991; Charpy, 1991; Desenne, 2003), but by the fourth and early third centuries exotic painted curvilinear designs are found on vessels from the Champagne

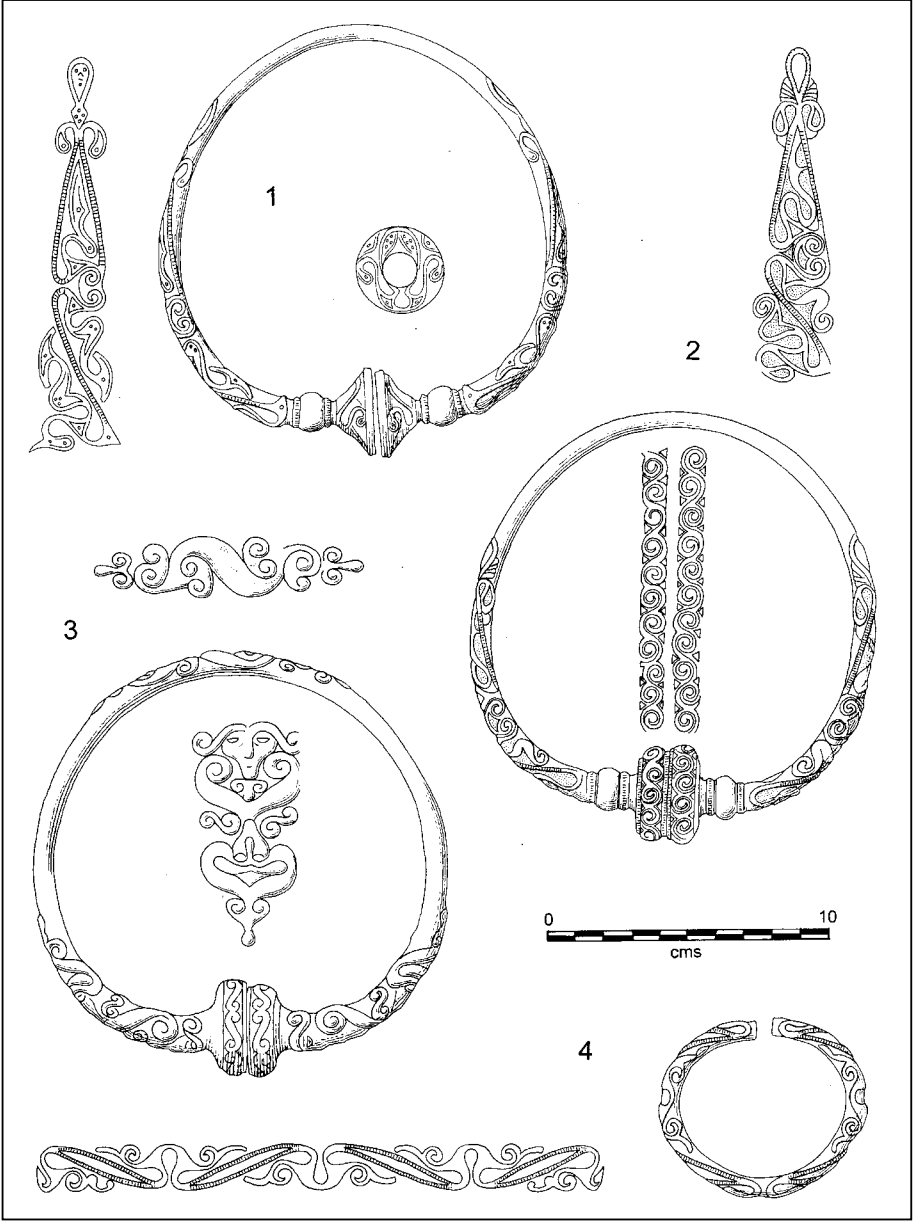

Figure 4.7 Torcs and arm-ring from the Marne region. 1, Beine 'l'Argentelle', gr. 6; 2, Jonchery-sur-Suippes; 3, Courtisols; 4, Caurel 'Mont de la Fourche' gr. 380. Adapted from Kruta and Roualet (1982) and Stead and Rigby (1999).

and Ardennes that translate into ceramics some of the principal themes of metal-work ornament (Figure 4.8). Unlike the angular-profiled pottery from the Champagne, the finer pedestal vases are wheel-thrown. Their designs are painted in red and black (or dark red), and include scrolls, tendrils, yin-yangs and even triskeles that would be familiar to the metal-worker, though not of course in low relief. The Prunay ('Le Champ la Guerre') vase is instructive, since it shows a greater degree of symmetry than is normal in this series of vases. Its uppermost panel comprises a geometric key design in black on red, matched by the lowest panel, a wavy line similarly in black on a red ground. In the main central panel the principal motif is in red on a black ground. It comprises a repeating double scroll, linked by yin-yang whorls, in which the lower element is an inverted and reversed image of the upper. Some of these ornamental motifs are shared with the pedestal vase from Caurel, but more significantly it is the detailed proportions of the two vessels that confirm that they must have been products of the same workshop (Stead and Rigby, 1999, 49).

Münsingen and Dux

From the end of the fourth century, funerary practice across north-alpine Europe became remarkably homogeneous, with extended inhumation in flat cemeteries becoming the norm. One of the best-known examples of the period is the cemetery at Münsingen-Rain near Bern (Hodson, 1968), the archaeological importance of which derives in part from the fact that its location, on an elongated terrace that permitted only linear expansion over time, allowed archaeologists to order its grave-groups on the principles of horizontal stratigraphy (Figure 4.9). The flat graves were relatively simple in construction, the pit containing the extended inhumation sometimes being lined with stones, and occasionally with traces of a wooden coffin. Though Münsingen is not large in numbers of graves by comparison with earlier La Tène cemeteries, its graves were relatively well furnished with diagnostic types, brooches especially, but also torcs, bracelets and anklets, and some examples of the so-called warrior's 'triple panoply' of sword, spear and shield. Pottery significantly seems to play no part in the grave inventory. Typical of the La Tène B phase is the Münsingen type brooch, characterized by having its foot turned back at a diagonal angle towards the low-arched bow, and sporting a large disc on the foot which, like the bow itself, is frequently the subject of ornament. Champion's (1985) analysis of two particular groups has suggested the existence of local workshops producing brooches with distinctive and recurrent styles of ornament. One, her Münsingen-Andelfingen type, has a slightly asymmetric bow, against which the foot with elongated pointed finial rests, and an enamel disc attached to the foot by a star-shaped rivet. The second, the Münsingen-Deisswil group, has red enamel inlay around an S-scroll on the bow, and around the disc-pin, which is shaped like a four-leafed flower. The ornamental repertory is obviously constrained by the size and limitations of the available surfaces, but more elaborate renderings of classical models can be seen in two brooches with complex interlocking lyre designs from Münsingen, graves 49 and 50 (Figure 4.9B). Waldalgesheim themes, including leaf-tendrill and over-and-under figure-of-eight, are exemplified on brooches from Münsingen (Gr. 107) and Rickenbach, in Switzerland and on two finger-rings, one of silver from Stettlin-Deisswil near Bern, the other in gold from grave 28/2 from the Dürrenberg-bei-Hallein. Indeed, low-relief ornament of this kind is known on brooches

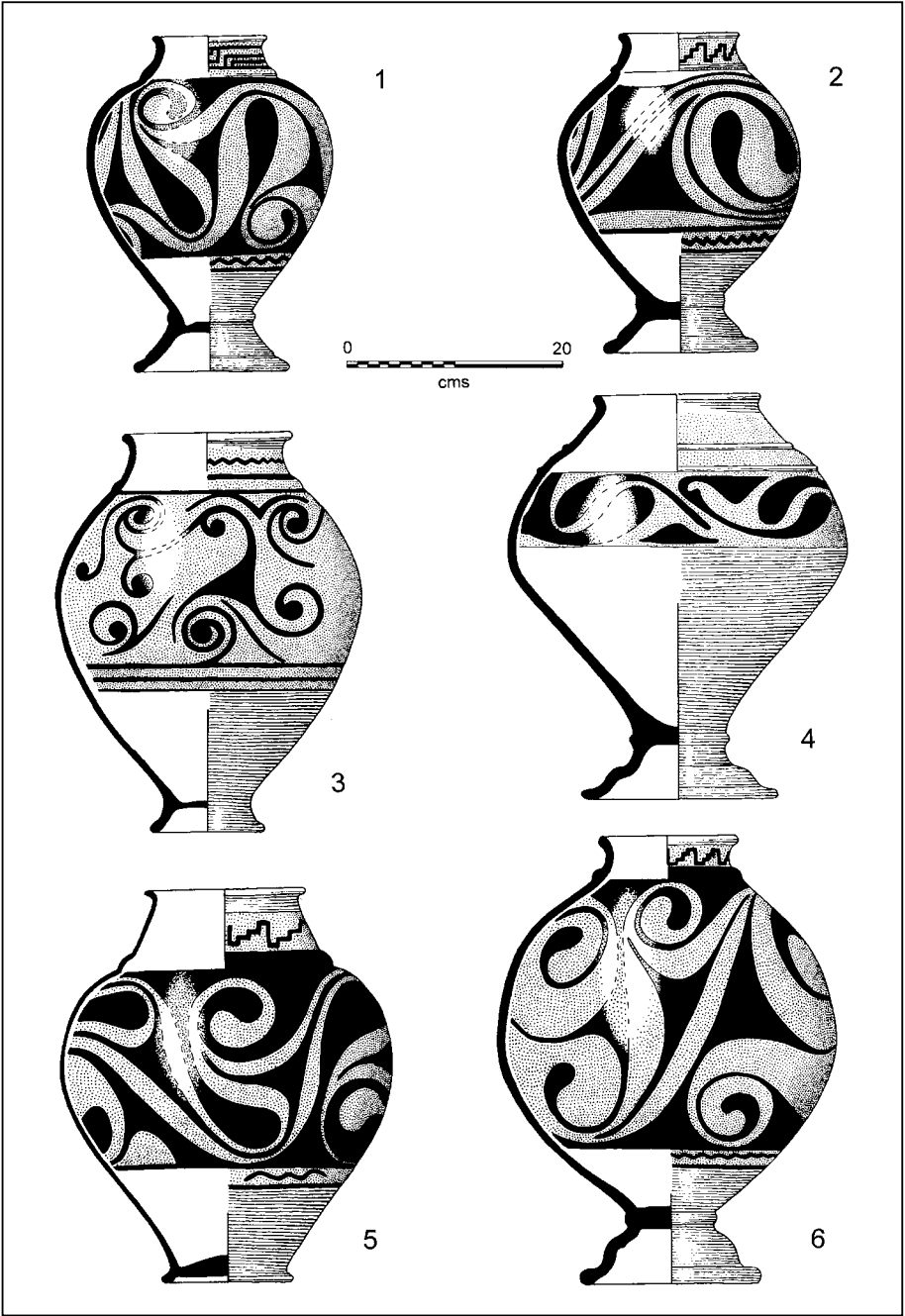

Figure 4.8 La Tène decorated pottery from Champagne. 1, Prunay, 'Le Champ la Guerre'; 2, Caurel, 'Le Fosse Minore'; 3, Beine, 'L'Argentelle'; 4, Sogny-aux-Moulins, 'Sur les Côtes'; 5, Bussy-le-Château, 'Culvidames'; 6, Lavannes, 'Le Mont de la Fourche'. Adapted from Corradini (1991).

from sites as far afield as the Marne in the west and Duchcov in the Czech Republic in the east.

The Duchcov hoard (Kruta, 1971) was found in 1882 in a cauldron at the site of thermal springs in north-western Bohemia, at the foot of the Erzgebirge mountains. It consisted principally of brooches and bracelets, and although the material was widely dispersed after discovery, the hoard probably contained a total of around 2,500 items. It was a remarkably consistent assemblage, and was perhaps deposited as a dedicatory offering to the deity that presided over the sacred springs. Among the brooches are examples of the Münsingen type, but also a broadly contemporary variant, named the 'Dux' type after the type-site, which is distinguished generally by its six-coiled spring with internal cross-over, and the knobbed moulding of its foot. Together, these two brooch types provide an invaluable fourth-century 'horizon' across much of north-alpine Europe.

The Developed Styles in Eastern Europe

As a result of the work of Kruta, Szabó and others, much more is now known than at the time of Jacobsthal's pioneering research about the impact of the Waldalgesheim style in eastern Central Europe, and its formative role in creating there the three-dimensional Plastic Style and the distinctive Hungarian Sword Style of the ensuing period. Some examples of the Developed Style from Bohemia bear striking similarities to the Waldalgesheim group, and could even have been the product of a Celtic workshop in northern Italy (Kruta, 1975). The ornamental fitting from Čížkovice shows under-and-over figure-of-eight tendrils in a triangular field, terminating in a palmette-derivative with axillar infillings, in a manner that could have been the product of the same workshop as some of the Waldalgesheim pieces. The bronze bracelet from Klobuky is ornamented with leaf-tendrils leading into peltate 'fans' in a manner seen on several western pieces, and the designs on bracelets from Jenišův Újezd and Lahošt are sufficiently close to suggest that they could be the product of the same workshop. Tendrils with curving triangles also appear in relief on the bows of two brooches from Lahošt (Kruta, 1975, Figures 7, 4 and 6) in a style quite closely paralleled on the bronze torc from Fiad in Hungary and again on a bronze torc of similar type from Muttenz in Switzerland (Szabó, 1992). Nevertheless, the absolute numbers of such pieces in Bohemia are not great, and some, like the gold torc from Oploty, are almost certainly imports from an Italo-Celtic workshop, so that current opinion favours a relatively brief period of contact with northern Italy as the most likely catalyst for their appearance.

In Hungary too, the question of origins has dominated much of recent research, with direct influence from northern Italy, though not through direct imports, currently vying with the alternative introduction of the new style from Western Europe. An unprovenanced iron spear-head from Hungary is regularly cited as having elements in common with the Waldalgesheim torc ornament, notably the lyre-palmettes and star-rosettes (Szabó, 1992, 120–1; Szabó and Petres, 1992, 19–20). These are balanced by two opposed pairs of conjoined triskeles to form a symmetrically balanced composition. The border of the blade is outlined by a wavy line in a manner also familiar in the west. The main ornamental panel of the Hungarian spear-head lacks the over-and-under figure-of-eight, characteristic of Waldalgesheim, but this does appear in cruder execution

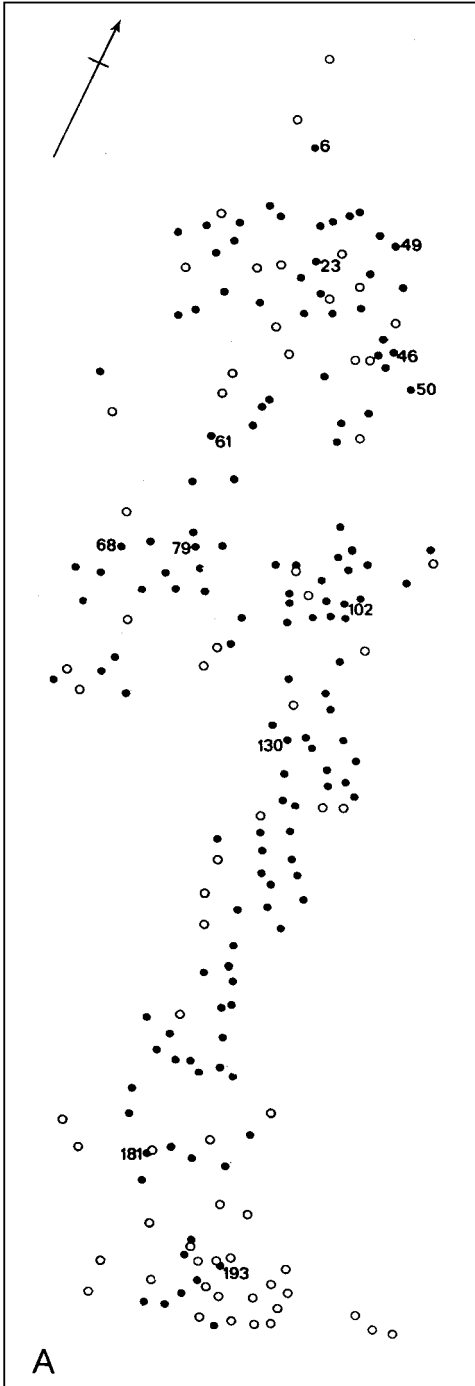

Figure 4.9 Münsingen, Berne. A: cemetery plan. B: some characteristic brooch types.
Adapted from Hodson (1968).

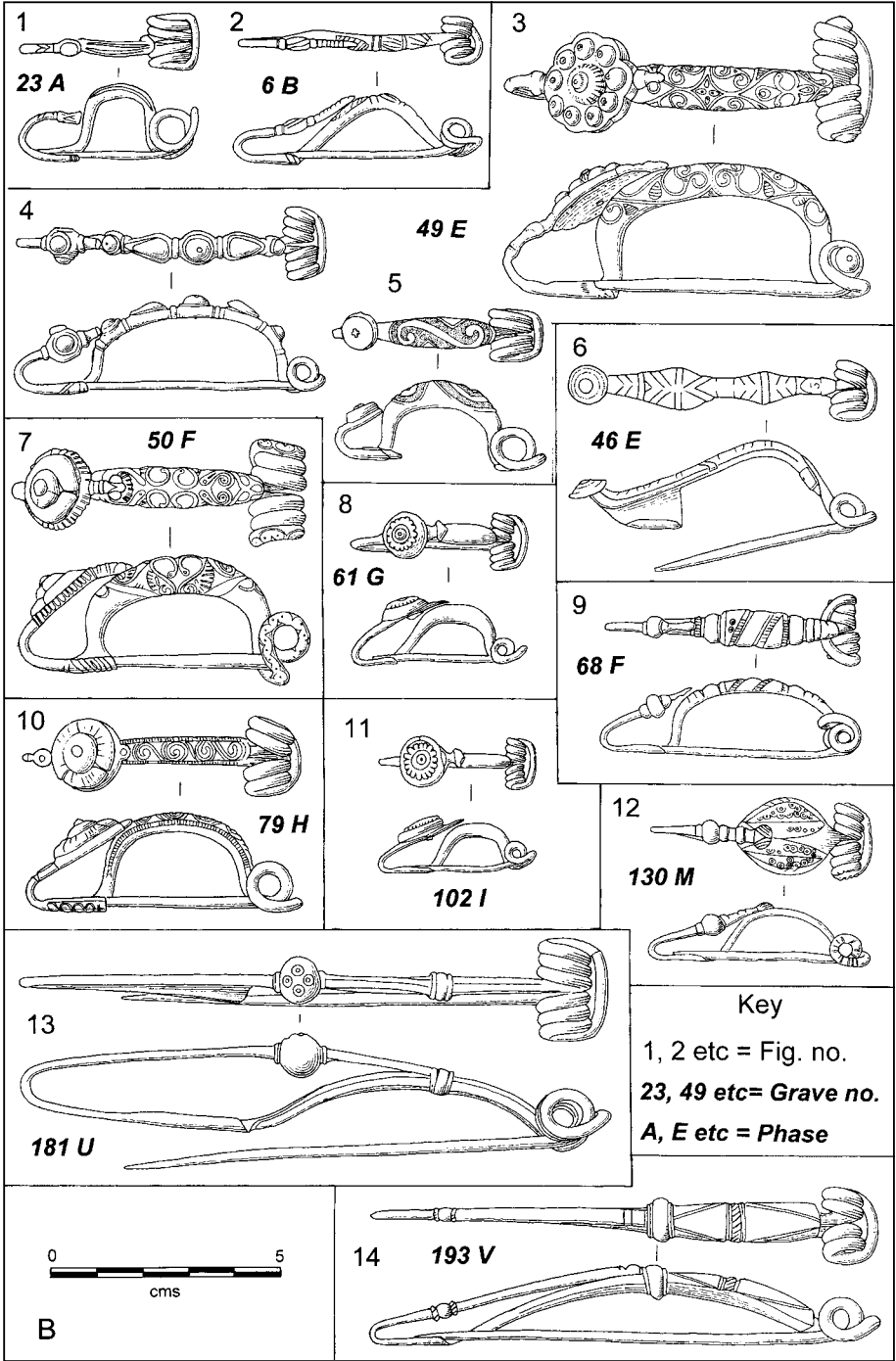

Figure 4.9 Continued.

on the socket. The best example of the sinuous tendril of the Waldalgesheim Style is the Litér scabbard (Figure 4.10, 4), the back plate of which is ornamented in pure Waldalgesheim Style in three panels, the upper and lower triangular, the middle one a diagonal band. The design is a wave-tendril leading through a series of curved triangles or vortexes, the third arm of the tendril ending in a rounded, spatulate terminal. The Italian scabbards are plainly related, though they differ in detail; Moscano di Fabriano (Figure 4.10, 3) does not have the curved triangles and on the Filottrano scabbard (Figure 4.10, 2) the triangles are linked by fleshy leaf-tendrils. The closest analogy for the Litér design, as Szabó and Petres (1992, 20) pointed out, is the ornamental fragment on the Larchant scabbard from the Champagne, but the choice of a diagonal field remains a distinctively eastern trait.

Influence of the Developed Styles on insular art

For most commentators of insular Celtic art, a retarded chronology has been axiomatic, with an inviolable threshold around 300 BC. In consequence, there are no unequivocal examples of the Continental La Tène Early Style, and any reflecting the developed Waldalgesheim tradition are generally nevertheless seen as displaying an insular character (Frey and Megaw, 1976). Megaw and Megaw (2001, 192) nevertheless cite the Cerrig-y-Drudion fragments (Figure 4.11, 1) as an example of the 'classic Waldalgesheim or Vegetal Style'. Jope, who once thought that it 'must have been made by a Gaulish craftsman' (1961a, 74) eventually believed it to have been a 'provincial' product, which, 'though structurally unique, is stylistically not entirely isolated in its insular setting' (2000, 25). An essential similarity has frequently been remarked between the fleshy lyre-palmettes of the rim ornament of Cerrig-y-Drudion with Breton pottery ornament, notably that from St Pol de Leon. In metal-work, there are certainly similarities in the rendering of palmette and leaf motifs with the bronze disc from Écury-sur-Coole, though the proportions of each are different, while the theme of alternating palmette and leaves of the Cerrig-y-Drudion rim plate and the 'yin-yang' of the body fragment can be matched in more than one panel on the bronze flagon from Besançon. The background to the Cerrig-y-Drudion design is hatching or basketry, but not of the regular, square-based variety that characterizes later insular mirror-ornament, and therefore not in any way indicative of a date later than the fourth century. In fact, this form of basketry hatching is not exclusively British, unless we are to see an insular artist as responsible in the early La Tène period for just such embellishment of a bronze chariot-nave from La Gorge Meillet (Jacobsthal, 1944, No. 157), the Erstfeld torcs (Wyss, 1975) or the Borsch flagon-handle (Jacobsthal, 1944, No. 353).

The Standlake scabbard (Figure 4.10, 5) is in many respects the prime example of Waldalgesheim-influenced ornament in Britain. As a composite piece, the dating of the scabbard is a contentious issue that will be addressed later. For the present, its importance lies in the two ornamental plates, one at the front of the chape, the other at the mouth of the leather scabbard. The basal bronze plate adopts the low-relief Waldalgesheim effect, in a meandering tendril that would not be out of place in the company of classic Continental examples. The upper plate is dominated by a bold relief design of pelta suspended from a loop, for which third-century parallels such as the Torrs pony-cap might be invoked. At the same time, from this main motif extend low-relief spatulate arms in clear Waldalgesheim fashion, with the ends of the pelta

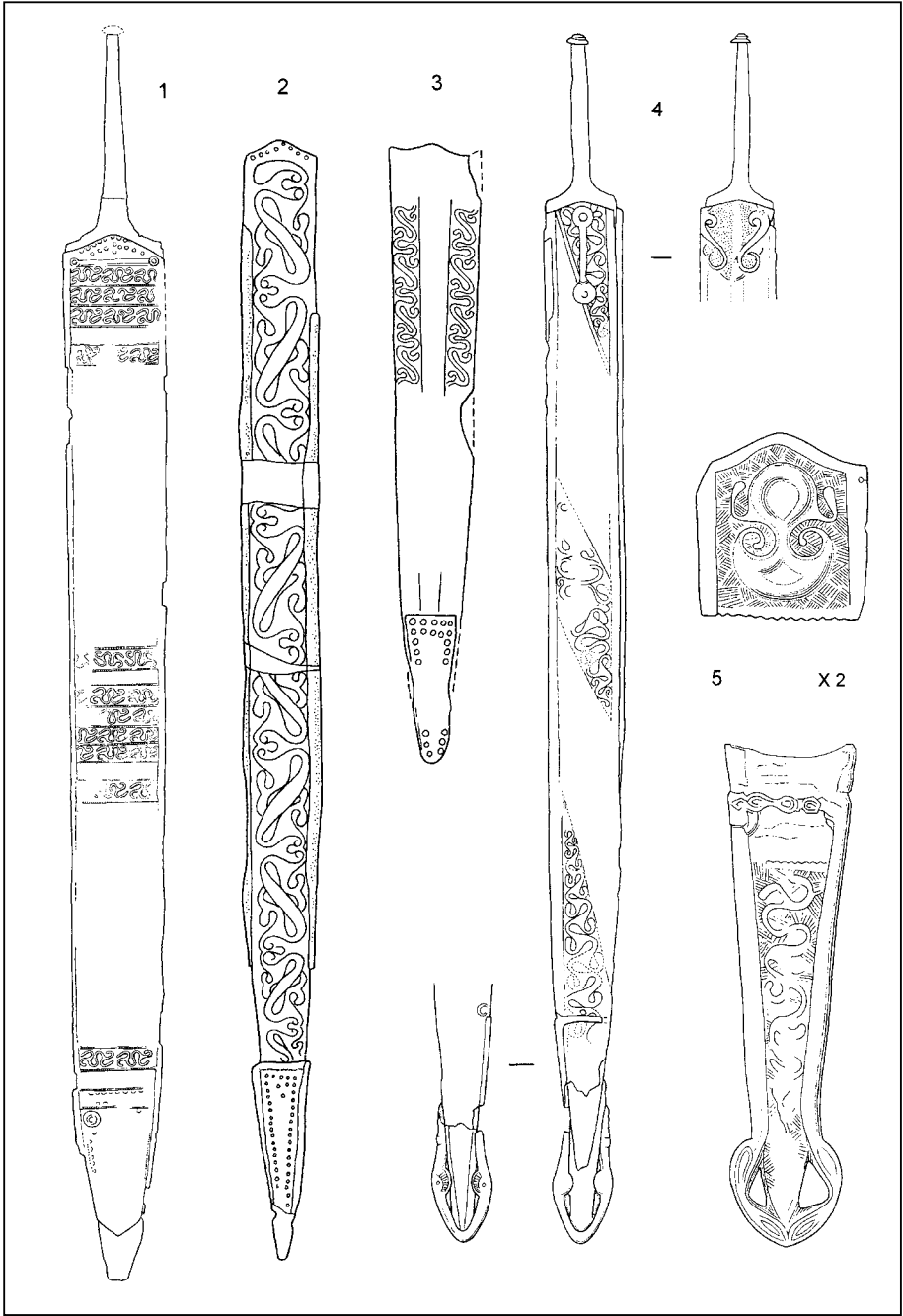

Figure 4.10 Scabbards with 'Vegetal Style' ornament. 1, Epias-Rhus, Val d'Oise; 2, Filottrano, Ancona, Italy; 3, Moscano di Fabriano, Italy; 4, Litér 1, Hungary; 5, Standlake, Oxfordshire, England. Adapted from Kruta *et al.* (1984), Megaw (1982), Szabó and Petres (1992). Standlake drawn from original in Ashmolean Museum, Oxford.

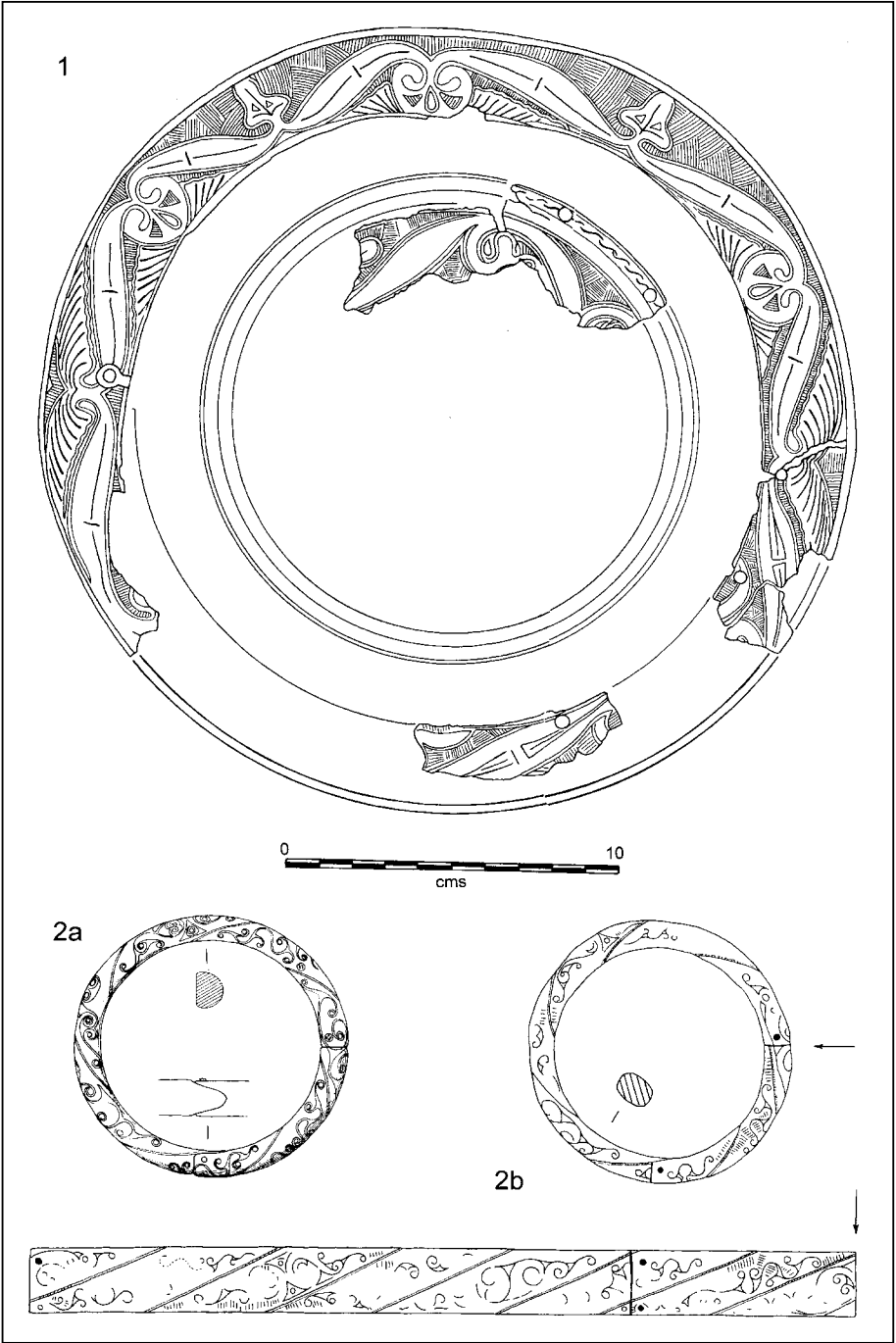

Figure 4.11 Insular early La Tène metal-work. 1, Cerrig-y-Drudion, Denbighshire, adapted from Smith (1926); 2, Newnham Croft, Cambridgeshire, 2a adapted from Fox (1958), 2b drawn by D. W. Harding by kind permission of the University Museum of Archaeology and Anthropology, Cambridge.

finished in similar technique. The background is basketry hatching of the asymmetric (non-square-based) kind. Other insular examples have been claimed of Waldalgesheim or less specifically Waldalgesheim-derived ornament, but few are convincing, and in any event are better treated within the broader compass of developing insular styles. The tendril design of the Newnham Croft bracelet (Figure 4.11, 2) certainly owes its theme if not its execution to Continental inspiration, though the reality is not quite as impressive as Fox's drawing implied. The Brentford 'horn-cap', a heavy casting that could have served as a yoke-fitting, on the other hand, has a near-symmetry that is alien to Continental Waldalgesheim, and shares several elements, peltae, curved triangles and bossed finials, with later pieces like the pair of 'spoons' from Weston, Somerset. The penannular brooches from Woodeaton and Beckley (Figure 6.10, 8 and 9) are more remarkable for their innovative insular form, unlike anything from Continental Europe, than for any influence upon their ornamentation, which is on such a limited surface that it can hardly be characterized with confidence.

One striking example of Waldalgesheim influence that passed unremarked until its rediscovery in recent years is the shield from the Trent near Ratcliffe-on-Soar, Nottinghamshire (Watkin *et al.*, 1996). Recovered from the river at the end of the nineteenth century, it was not initially recognized as the boss, spine and terminal roundels of an Iron Age shield. Like other insular parade shields, the length of the spine around the central umbo is not equally divided, though the construction and ornament are otherwise symmetrical. Most closely related to the Waldalgesheim style are two panels of meandering tendril design, not identical but in diagonally alternate relationship on the flanges of the spine, that have their closest parallels on the fourth-century scabbards from Moscano di Fabriano or Filottrano. The matching pair of alternate panels, likewise not identical, departs from the normal Waldalgesheim repertory, having sharply angular elements that hint at the presence of exotic beasts. The design on the central boss, essentially a composition in rotational symmetry around its diagonal, also includes angular elements, which, together with a profusion of pseudo-under-and-over intersections, heighten a sense that the affinities of this piece are with the Hungarian Scabbard Style, itself, as we shall see, a development out of Waldalgesheim antecedents, and that the elusive beasts concealed in the foliage are related to the dragon-pair menagerie. The piece is truly unique, and may well have been the product of a craftsman familiar with Continental fashions in the later fourth or early third centuries BC.

A more recent find that again reflects the Continental Waldalgesheim Style is the ornament of the sword-hilt from Fiskerton, Lincolnshire (Field and Parker Pearson, 2003), a waterlogged site by the River Witham that may have been the focus of ritual deposits. The ornament (Stead, 2003) includes simple lyre-palmette motifs extended into triskele-vortices, and meandering tendrils with fan-finials of the kind that Jope regarded as diagnostic of the Waldalgesheim Style. The wooden causeway with which the votive deposits were associated was apparently in use from the mid-fifth to later fourth centuries BC, which certainly does not require any time-lag in the adoption of Continental fashions in Britain.

North-alpine Europe and Italy

Finally, and perhaps crucially, we should examine the trans-alpine examples of the Developed Style of La Tène art, trans-alpine, of course, from the Celtic perspective but

vexingly cisalpine for two centuries or more from the Roman viewpoint. Discounting for the moment pieces that can be regarded as Italo-Celtic, the number of major artefacts that are of La Tène type is strictly limited, and almost invariably from funerary contexts rather than from settlements. In recent years excavations at Monte Bibele have begun to redress that imbalance, but even so perhaps the clearest evidence for a Celtic presence there comes in the form of warrior burials with sword, spear and helmet among the grave-goods.

Two of the weapons from Italic cemeteries closest in style to north-alpine Celtic models are the swords and scabbards already alluded to from Filottrano on the mid-Adriatic (dismissed by Jacobsthal as an inferior product, perhaps even a local imitation) and from Moscano di Fabriano, somewhat to the west in a mountainous pass through the Apennines, both of which were accompanied by rich assemblages of Italic and Greek grave-goods. The Filottrano cemetery, explored erratically in the early years of the twentieth century, contained around sixty graves, of which nearly half contained artefacts of 'Celtic' type, notably grave 22, which contained the sword with scabbard ornamented in Waldalgesheim Style, and grave 2, which included a gold torc with buffer terminals, again ornamented with low-relief designs allied to those of the Waldalgesheim torc and bracelets. The latter also contained a series of Attic pottery vessels, an Etruscan mirror and other ornaments that conclusively point to a dating in the mid- to late-fourth century BC. Moscano di Fabriano, by contrast, appears to have been an isolated burial. Apart from the sword with decorated scabbard, it contained an Italo-Celtic bronze helmet, bronze horse-trappings and a La Tène brooch, together with Etruscan and Campanian bronzes, Greek pottery vessels and comprehensive drinking-service, all of which date to around the second quarter of the fourth century. Without at present pre-judging the significance of historical evidence, on the archaeological evidence alone, this would appear to be a convincing case of cultural assimilation, but this still leaves open the question of who was adopting what from whom. An illustration of this dilemma is the type of helmet, found in a number of graves in northern Italy and around the head of the Adriatic, distinguished by its hemispherical shape with top-knob or plume-holder, hinged cheek-guards and flanged neck-guard. While these helmets undoubtedly influenced the style of helmet produced north of the Alps, like that from Amfreville, scholars since Jacobsthal have regarded them as the products of Etruscan or at least Italic workshops, and have not even been persuaded that they were ever worn by Celts. On the face of it, therefore, the graves with mixed inventories could be evidence of Celtic warriors assimilating the luxuries of the Italic lifestyle, or local dignitaries buried with trophies or diplomatic gifts received from northern neighbours.

One example highlights the dilemma particularly graphically. The helmet from Canosa di Puglia is one of the southernmost examples of a helmet, the Celtic character of which is seemingly proclaimed by its lavish use of the developed Vegetal Style of ornament (Figure 4.12, 2 and 3). Made of iron with bronze overlay, its lower panel depicts a series of alternately upright and pendant lyres, linked by swelling, fleshy leaves. The upper panel is filled with complex pelta-palmette motifs, again alternately upright and inverted, and again linked by fleshy leaves, the latter in both fields being accentuated by wavy lines in a manner noted earlier on the Besançon flagon, with which the design of the Canosa panels bears comparison. Kruta (1991a, 201; 1991b, 147) cited a striking and unusual comparison between this design and that of the

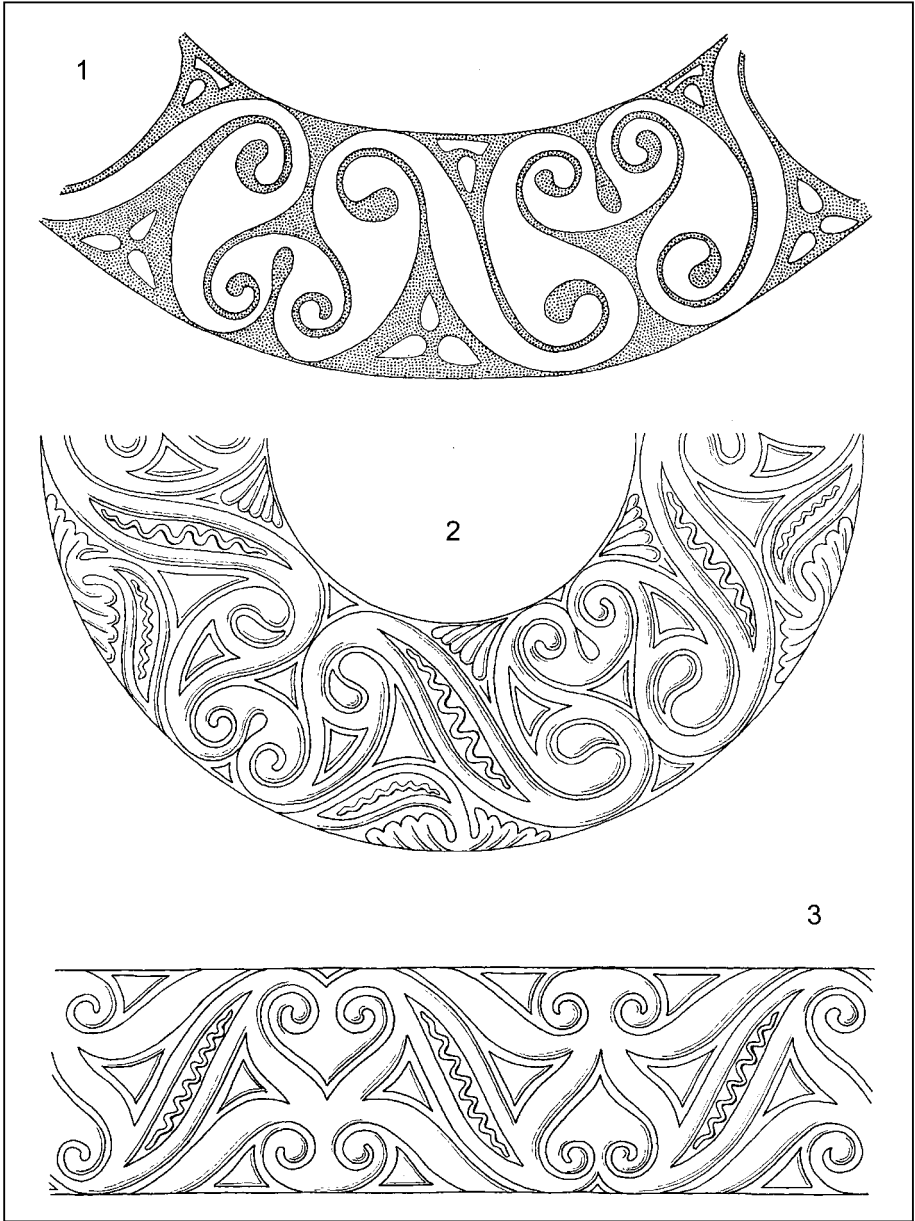

Figure 4.12 The Prunay 'Les Commelles' vase (1) and the Canosa helmet, upper (2) and lower (3) panels. Not to scale. Adapted from Jacobsthal (1944) and Kruta (1991b).

Prunay, Marne, ('Les Commelles') pottery vase (Figure 4.12, 1), that surely argues for a common stylistic source. The Canosa tomb, excavated in 1895 and not easily reconstructed from inadequate records, contained a rich panoply of armour, weapons, horse-gear, ornaments and numerous pottery vases. With its six separate chambers, it certainly contained more than one burial, but only the helmet could be claimed as evidence of Celtic workmanship. There is no case for regarding this as a Celtic or Gaulish burial, and the most probable explanation is that the helmet was a trophy from regions further north.

Finally, among the outstanding examples of the Waldagesheim or Vegetal Style in Italy are more than thirty bronze mounts (Jacobsthal, 1944, 401) of uncertain purpose from an equally insecure provenance, believed to have been Comacchio, south of the mouth of the Po. The motifs displayed by the mounts are mainstream Waldalgesheim, including leaf-tendrils, curved triangles, and peltate finials. But the execution is distinctive, the design being defined by stippled dotting of the background, almost as if it were imitating leatherwork.

Together with a number of lesser items from various cemeteries in northern Italy, these major works of Celtic art doubtless attest the Celtic presence in Italy in the fourth century recorded in historical sources, but it is a relatively modest inventory to promote as the genesis of the developed Waldalgesheim or Vegetal Styles. Jacobsthal's verdict is not easily dismissed: 'Celtic Italy is an unproductive province' (1944, 154). Even Kruta, one of the foremost proponents of an Italian origin for the new Vegetal style was obliged to concede (1991a, 198) that 'very few decorated La Tène objects datable to the fourth century BC have so far been found in Italy, and their contexts are not very representative, uncertain, or unrecorded'. We should recall Jacobsthal's dictum that the area of production of a given class of artefacts should be the area of the most frequent occurrence (1944, 155). On this principle it might be quite hard to identify any particular locality as having an indisputable claim to be the source of the Waldalgesheim or Vegetal Style, but the appearance in the Champagne of the essential elements of the style in a medium other than metal-work, namely, funerary ceramics, may suggest priority in that region. The mechanisms for these stylistic developments are in any event likely to have been complex, involving a variety of different trans-alpine and north-alpine interconnections. Notwithstanding the limited distribution of artefacts with Waldalgesheim Style ornament in Italy, there can be no doubting the significance of the classical contribution to that new style, nor the role of Italic sources in its genesis. Frey (1995b) argued convincingly for direct connections between the Champagne region of north-eastern Gaul and Italy in the distribution of fifth-century types such as belt-hooks and iron meat skewers, suggesting a 'reflux' process whereby new fashions could have been brought into North-Western Europe. If these introductions were triggered by movements among a warrior elite or their swordsmiths and armourers, it would require only a small but influential group to make a disproportionate impact upon the archaeological record.

The historical dimension

There remains the important consideration of historical records of the political expansion of Celts into Italy and the events that this precipitated. This important source of information has been deliberately left till last, since too often the archaeological

evidence is seen only as a material manifestation of the truths that are enshrined in the historical texts. Properly, both sets of data should be examined rigorously by the criteria of their respective disciplines before cross-reference is made from one to the other. The archaeological evidence, as we have seen, certainly argues for a close dependence of the Developed Styles of early La Tène art upon classical inspiration, doubtless drawn from Italic sources. But it would in itself hardly sustain widespread invasions or population movements of Gauls across the Alps to settle in the Po valley and mid-Adriatic if the historical texts were lacking. The corollary of this line of argument must be to question whether the historical texts actually tell us the whole story anyway, since it is probable that in their way they are as defective as is the testimony of archaeology.

The main thrust of the historical record is well known. Polybius, writing in the second century BC, records the defeat of the Romans by the Gauls in 387 BC at Allia, and the ensuing sack of Rome, a traumatic event that evidently left an indelible mark on the Roman psyche for more than three centuries, until it was expiated by Caesar's conquest of Gaul. Both Polybius and Livy, the latter writing around the time of Augustus, broadly agree on the names of the principal tribes involved in the invasion and settlement of northern Italy (probably because they were using a common source), in geographical sequence from the Alps to the mid-Adriatic the Insubres, Cenomani, Boii, Lingones and Senones. The history of the following two centuries involved recurrent conflicts and periodic tactical alliances between the Romans and their Celtic neighbours. In 295 and again in 285, the Romans inflicted heavy defeats upon the Senones; in 225, it was the turn of the Insubres and Boii to suffer defeat at Telamon. That these setbacks were not immediately definitive was largely because of the intervention of the Second Punic War from 218 to 202, during which the Celtic tribes evidently joined forces with Hannibal against their common enemy. Following the Carthaginian defeat at Zama in North Africa, the Insubres were finally defeated in 194, and the Boii in 191, leading to the expulsion of those Celtic groups whose territory had not already been annexed.

There is no reason to doubt the authenticity of these basic historical events, though the historical record doubtless over-simplifies a much more complex set of circumstances. Most clearly it is oblique regarding the beginnings of the Gaulish colonization of northern Italy, reducing this process to the level of the anecdotal with stories of Arrunte, the Etruscan who enticed the Celts to attack Chiusi (Livy, 33, 2–4) or of Helicus, the Helvetian blacksmith who played a similar catalytic role in Rome (Pliny, *Nat. Hist.*, XII, 5). These stories are at best metaphors for a process that doubtless has its origins several centuries earlier than the normally accepted date of the Gaulish invasions, and that was almost certainly rooted in trans-alpine trading and cultural links going back at least to the later Urnfield period. In fact, Livy refers to the migration of a cadet group of the Bituriges in the age of Tarquinius Priscus, which would place that episode in the sixth century BC. Equally, current linguistic scholarship regards as Celtic a series of Lepontic inscriptions dating from around 500, which may suggest that the Golasecca culture of north-west Italy already contained within it Celtic elements. In fact, there is very little evidence archaeologically for cataclysmic change in the cultural sequences of northern Italy, and therefore every reason to presume that the process was a progressive one over a long period of time, involving cultural assimilation rather than radical displacement. The existence of different tribal

groupings in northern Italy may well account for differences in distribution north of the Alps of Italic types or influences, but it is unlikely that those tribal groupings will manifest themselves very clearly at a local scale in specific archaeological distributions, any more than they do for the most part north of the Alps.

The lesson then is not just that, without the historical sources, any archaeologist proposing a Celtic invasion of Italy in the fourth century BC would be ridiculed as an unreformed and irredeemable diffusionist, and that in consequence we should perhaps review the extent to which archaeological interpretation is severely constrained by the limitations of the data. It is also that the archaeological evidence, for all those limitations, strongly suggests that the historical record is an over-simplification of a much more complex and protracted process of interaction to the point of distorting the likely reality. Above all, we should avoid the assumption that either source of evidence, historical or archaeological, necessarily should be accorded priority over the other as the basis of received wisdom.

THE ART OF THE SWORDSMITH

Jacobsthal coined the term 'Sword Style' with particular reference to a series of ornamented scabbards of middle La Tène type from Hungary. In doing so he recognized that this distinctive group was not generated in isolation, either geographically or chronologically; indeed, he memorably declared that 'the style is a development of the Waldalgesheim style and presupposes its existence' (1944, 95). In fact, the Hungarian Sword Style, or more strictly Scabbard Style, has a Waldalgesheim phase, best represented in the Litér scabbard, as well as subsequent Waldalgesheim-derived and later variants. Equally the construction of some of the Hungarian scabbard chapes betrays the influence of earlier La Tène 1 forms of western open-ring chapes. Broadly contemporary with the Hungarian series, Jacobsthal also recognized a Swiss grouping of decorated scabbards, more limited in its ornamental repertory, though displaying distinctive technical traits, so that it would not be unreasonable to speak of 'Scabbard Styles' in the plural as characteristic of the middle La Tène phase of early Celtic art.

Britain and Ireland too have a role in this middle La Tène story, parallel to rather than derivative from the Central European sequence. As in Hungary, the insular sequence of decorated scabbards begins with echoes of the Waldalgesheim Style, notably on the Standlake scabbard, as well as technical features such as open-ring chape-ends which signal their ultimate La Tène 1 origins from the later fourth and early third centuries. The Irish group of scabbards, geographically concentrated around the Bann river in the north and conventionally assigned to a fairly tight if late chronological span, has always been recognized as a distinctive localized tradition, notwithstanding the fact that Piggott (1950) saw them as the product of immigrants from northern England. The decorated British scabbards, on the other hand, seemed too few in number, and too widely separated both geographically and chronologically, to form a coherent group, until more recent discoveries in Yorkshire lent weight to the idea of an insular tradition of decorating scabbards, and raised once again the issue of their relationship with the Irish. One immediate distinction between the British and Irish scabbards and their Continental counterparts is the fact that the insular scabbards bear ornament over their entire surface, in contrast to the restricted panels of ornament that characterize in different ways the Hungarian and Swiss examples. They raise, nevertheless, similar questions regarding their manufacture and decoration, whether by craftsmen working under aristocratic patronage or in local workshops and 'schools'. Regionally distinctive as the ornament may be, there are some pan-European traits, most notably the 'dragon-pair' theme, a motif embellishing the hilt-plate of many swords, widely distributed from Eastern to Western Europe (including Britain, though not Ireland), to

which special significance as a cult symbol or warrior emblem has sometimes been attributed.

The archaeological and historical context

In the middle La Tène period in north-alpine Europe, the principal source of ornamented metal-work continues to be burials, but in place of the high-status *Fiirstengräber* of the early La Tène phase are cemeteries, comprising both flat-graves and tumuli according to regional preference, but seldom displaying the extravagance in grave-goods of the princely burials of the middle Rhine or Champagne. In place of the wine-service and precious personal ornaments, the best-equipped burials are those of a martial elite, whose 'triple panoply' of sword, spear and shield becomes the hallmark of the Celtic warrior. The distribution and range of ancillary types, such as brooches and bracelets, suggest a developed network of local craftsmen and markets rather than long-distance connections, which are attested only by a limited number of luxury goods.

The appearance of these cemeteries in eastern Central Europe from the end of the fourth century, like the appearance of La Tène types south of the Alps a century earlier, was inextricably associated by an older generation of archaeologists with the historical accounts of Celtic expansion eastward and south-eastward that culminated in the sack of Delphi in 279 BC. According to Livy, Gauls under Segovesus had migrated eastwards into the uplands of Bohemia at the same time as Bellovesus had led his Gallic tribes into Italy. Equally from the documentary sources, we learn that Celts had served as mercenaries in the Peloponnese as early as 369, and were also among envoys received by Alexander the Great on the lower Danube in 335. As with the trans-alpine migrations, we might suspect that these inroads had already begun well before they were recorded historically. In 280 BC, the Gauls are recorded as invading Macedonia in three divisions, led by Cerethrius, Bolgius and Brennus respectively, the latter being briefly frustrated in his advance at the Pass of Thermopylae before proceeding to sack Delphi. Named contingents, including the Tectosages, a tribe familiar from southern Gaul, the Tolistobogii and the Trocmi crossed the Hellespont, eventually being subdued by Antiochus in 276 and settling in the vicinity of Ankara, where their Gallic origins were to be enshrined in the name of the New Testament Galatians to whom St Paul wrote his epistle. The Gauls were eventually defeated by the Hellenistic ruler of Pergamon, Attalos I, who at the end of the third century was responsible for erecting the original victory monument which included the memorable images of the Dying Gaul and the suicide of a Gaul and his lady. That these accounts were doubtless based on a characteristic mix of fact, propaganda and legend need not detract from the authenticity of the fundamental fact of an aggressive Gaulish presence in South-Eastern Europe in the third century BC. Correlating that basic truth with the archaeological evidence is, as ever, much more problematic.

Middle La Tène cemeteries in eastern Central Europe divide into two distinctive distributions. Northern Bohemia, the upper Elbe, Austria and Hungary as far as the Tisza are characterized by flat-grave cemeteries; by contrast, north-eastern Bavaria and southern Bohemia are notable for their tradition of burial in barrow cemeteries. This contrast was once seen, by Filip (1956) and others, as corresponding to the graves of migrating Celts and the native population respectively, though this must always have

seemed an improbably simplistic equation. Current opinion, in any event, now favours an earlier date for the Gaulish expansion in Eastern Europe, with evidence for fifth-century La Tène A movements into the Carpathian basin (Szabó, 1992, 17). From the occurrence of square-ditched barrow cemeteries in immediate proximity to older Hallstatt burials, it might be inferred that the process of expansion and acculturation in eastern Central Europe was a relatively peaceful one rather than the culture conflict attested in the South-East by the Greek historians. Szabó (*ibid.*, 27ff) cited cemetery evidence from Transdanubia and northern Serbia that he believed indicated the co-existence of incomers with indigenous communities. New cemeteries appear in Bohemia from the early fourth century at least, pre-dating the La Tène B1 horizon, which is associated archaeologically with the type-sites at Münsingen in Switzerland and Duchcov (Dux) in the Czech Republic and their diagnostic brooch types. By the late fourth century, such cemeteries appear in Hungary and Transdanubia, but by contrast there is very little surviving evidence for a Celtic presence in Macedonia, where we must therefore conclude either that the impact of incursions was relatively brief or that any continuing presence was subject to acculturation in which the La Tène component was effectively subsumed.

Scabbards and their construction

The advantages of iron over bronze for swords at the developed level of La Tène technology is self-evident. More surprising, however, is the near-total predominance in the Hungarian and Swiss series of iron for the construction of scabbards. Commentators regularly point to the poor state of preservation as a hindrance to interpreting scabbard ornament, without remarking that iron scabbards must also have been prone to corrosion from the outset. The British scabbards alone are almost invariably of bronze, and even iron components, like chapes, commonly have cast or flashed bronze coating. The blade itself could be ground and polished, but such treatment of the scabbard would soon rub away the decoration. Whether some surface treatment was practised to protect the scabbard can only be guessed. Armourers in La Tène Europe may well have been a distinct caste among metal-smiths, following their own skills and conventions in isolation from other craftsmen.

Scabbards display a high degree of technical accomplishment, and the detail of their construction has long been the basis of archaeological classification. The scabbard case itself is made up of a front plate and a back plate, which can be of beaten bronze or iron, or of leather with bronze and iron attachments to bind the parts together. At its mouth the case may be straight or extended into a campanulate curve to match the shape of the hilt-end of the blade itself, a feature that de Navarro (1972) regarded as indicative of the scabbard's place within a typological development, but which seems in practice rather less definitive than the form of the chape. Generally, though, the campanulate variants may be assigned to the early and middle La Tène phases. A suspension-loop provides the means for attaching a belt, and ornamental chains sometimes embellish the attachments. At the bottom of the scabbard are further reinforcements to prevent the tip of the blade piercing the case. A chape binds the front and back plates of the case together, which itself requires a 'bridge' across the front of the scabbard with flanges or clamps around the back to prevent the chape from prizing apart. All of these elements can be subject to simple ornamentation, like the

stylized birds' heads of the Swiss middle La Tène chape-bridges. The chape terminals are one clear indicator of where a sword lies within the sequence. La Tène 1 chapes tend to be of open construction, either annular or cordate, whereas the middle La Tène forms are closed and either V-shaped or U-shaped in outline, but within this simplified rule of thumb there are, not surprisingly, a wide range of variants.

The Hungarian Scabbard Style

Hungarian scabbards have been divided by Szabó and Petres (1992) into those with ornament belonging within the Waldalgesheim continuum, and those that stylistically may be regarded as later. In fact, the conventional chronology for the Hungarian Scabbard Style is quite compressed, its start being dated hardly before the early third century, with its decline apparently by the second quarter of the second. While there may well have been direct influence from western Waldalgesheim centres, we should not discount the possibility of further impulses from the Mediterranean (Frey, 1974, 150).

The Litér 1 scabbard (Figure 4.10, 4), as we have seen, is the closest in the series to displaying 'pure Waldalgesheim' ornament. The upper panel of scabbard 1 from Tapolca-Szentkút (formerly Haláphegy) (Figure 5.1, 1) consists of a similar simple tendril in sub-Waldalgesheim style, so that there can be no doubt that the Hungarian workshops were conversant with that style; but here it is combined with the distinctive diagonal layout of the Hungarian Scabbard Style in which the engraved ornament and its infilling are much more stylized.

A recurrent element in the Hungarian Scabbard Style that might also be seen as analogous to the progressive aspiration of craftsmen in the west to imbue classical motifs with a sense of restless movement, is the use of devolved lyre-palmettes and lotus motifs. As in the west, the process was essentially one of deconstruction, with the residual elements being re-assembled in a form that barely acknowledges its origin. The outline of the design on the Jutas 2 scabbard (Figure 5.1, 2) might thus owe its inspiration ultimately to the lyre-palmette, while the filler elements, including over-and-under figures-of-eight and sinuous triskeles, are certainly common in the Waldalgesheim repertory. But the lack of integration of the frame of the design and the filler-motifs, together with the symmetry of composition, are distinctive of the Hungarian Scabbard Style. The same lack of integration is displayed by the scabbard from the region of Voivodina, Serbia (Figure 5.1, 3), in which a simplified lyre-palmette outline has axillar fillings of stylized lotuses, again arranged in symmetrical composition. Their origin is undoubtedly classical, but their treatment bears no relationship to any previous use of the lotus and must be indicative of the manifold and recurrent influences that combined to generate this distinctive eastern style. These simplified and stylized motifs continue in use either as infilling or as terminal finials, as on the scabbard from Batina (Kisköszeg), Croatia (Figure 5.1, 4), anticipating the later variant of the Hungarian Scabbard Style.

Connections between the Hungarian Scabbard Style and Western Europe are most clearly attested by the middle of the third century by comparison between the iron scabbard from Cernon-sur-Cooles in the Marne and the scabbard from Drňa in Slovakia (Figure 5.2, 1 and 3; Megaw, 1973). One striking motif, the bird's head with long, curving bill and plumage rendered as curving hatched triangles, could have been the

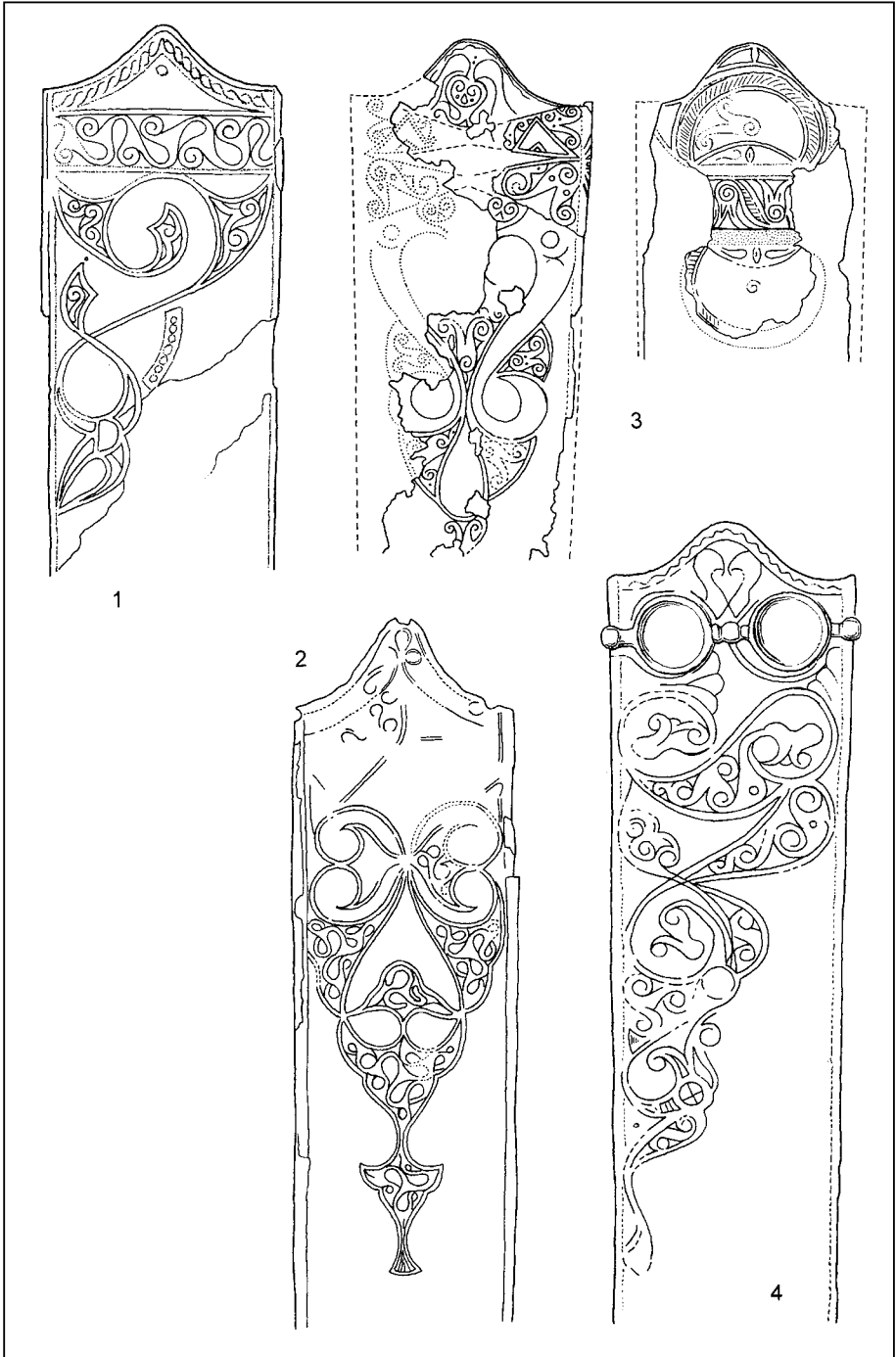

Figure 5.1 Hungarian and related scabbard ornament – 1. 1, Tápolca-Szentkút 1; 2, Jutas 2; 3, Voivodina region, Serbia; 4, Batina/Kiskőszeg, Croatia. Adapted from Szabó and Petres (1992).

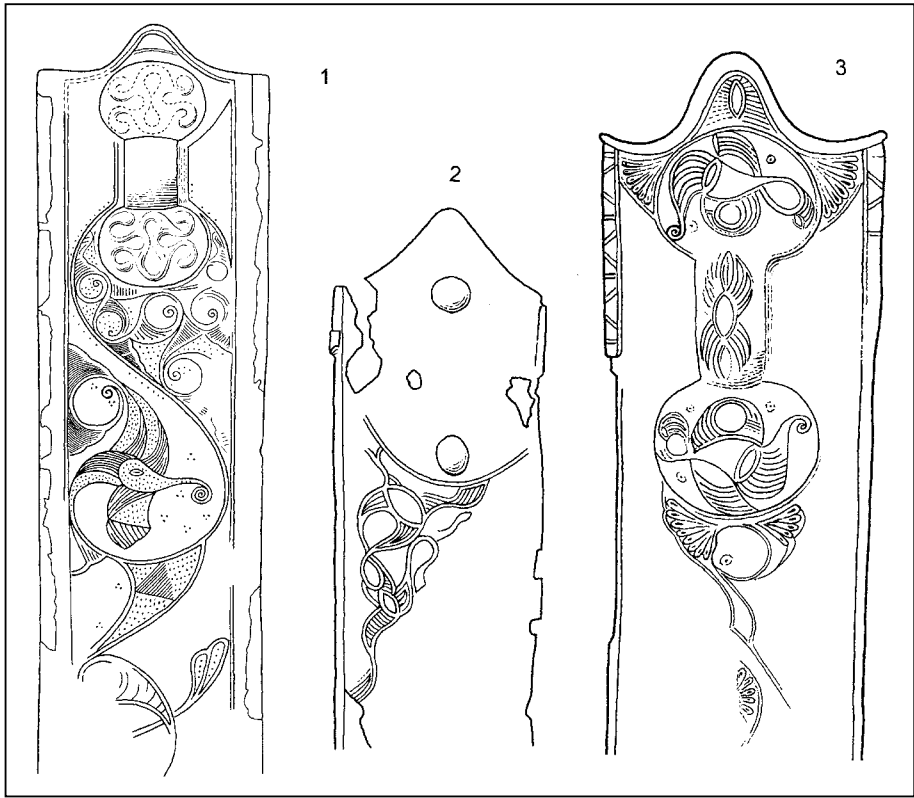

Figure 5.2 Eastern and western scabbards. 1, Cernon-sur-Coole, Marne; 2, Montbellel, Saône-et-Loire; 3, Drňa, Slovakia. Adapted from Szabó and Petres (1992) and Duval and Kruta (1986).

signature of a specific middle Danubian workshop. On the Cernon scabbard it forms a terminal motif within a tendril design; on the Drňa scabbard it occupies one end of the suspension-plate as part of a larger design in which hatched, curving triangles are also dominant. Significantly, the suspension-plate of the Cernon scabbard has a low-relief design in the Waldalgesheim tradition, matched exactly, but in different orientation, by one of the Szob series of scabbards (Szabó and Petres, 1992, Pl. 63), suggesting the continuing currency of the earlier style. The sophistication of technique of the Cernon scabbard is indicated not simply by the use of both low relief and incised ornament, but also by the subtle surface treatment of individual panels, designed to reflect light differentially (Duval and Kruta, 1986). Both bird's head motif and curved hatching occur again on a scabbard fragment from Montbellel, Seine-et-Loire (Figure 5.2, 2; Bonnamour and Bulard, 1976), in which the ornamental panel is on the inner face of the surviving back-plate, indicating secondary re-use. The design, which follows the Hungarian fashion for a diagonal layout, includes hatched, curving triangles as infilling and a variant of an over-and-under figure-of-eight design that leads in one axis to a

simplified bird's head terminal. Other examples of the hatched, curving triangle motif include one of the Kosd scabbards (Szabó and Petres, 1992, Pl. 41), one from Lovasberény (ibid., Pl. 46), and one from Ižkovce, Slovakia, suggesting that this was indeed a local stylistic tradition in the middle Danube.

One of the most distinctive scabbards of the Hungarian series is that from an uncertain provenance in the Veszprém district, frequently known as the Halimba scabbard (Figure 5.3). The ornament is essentially divided into three separate panels, the upper emanating from a Type I (or possibly Type III – it is badly abraded) dragon-pair immediately below the scabbard-mouth, the lower leading into the decorated chape. The whole composition has a tendency towards the diagonal, induced by the central swelling-leaf motif of the complex tendril design. This is especially apparent in the central element in which the tendrils are balanced in rotational symmetry around the swelling leaf. The upper and lower panels are basically made up of half each of this composite element. Raftery (1994b, 490) has pointed to the tantalizing similarity between this design and the very worn traces on the back of the Bann 1 scabbard plate from Co. Antrim; indeed, some aspects of the Halimba ornament echo the ornament of the Irish scabbard series. The symmetry of the Halimba design is not absolutely exact because of the freehand technique and differences of scale. Furthermore, wear has eroded the ornament of several tendril-ends, so that it is uncertain whether exact symmetry was maintained. In terms of infilling, swelling S-motifs, peltate finials and simple spiral comma-leaves seem to be represented. Dating remains problematical. Notwithstanding the inclination of Eastern European prehistorians to date much of the Hungarian Scabbard Style to middle La Tène, and not necessarily an early phase within it, de Navarro (1972, 84–6) was inclined to assign this piece to an earlier horizon, on grounds of ornamental style and scabbard typology.

Because of the lack of adequate contexts and associations, it is not clear whether symmetrical layout of scabbard ornament and the distinctive diagonal arrangement were sequential or concurrent, though the means of progression in principle has been demonstrated by Frey in his analysis of the Bölcske-Madocsahegy 1 scabbard. The diagonal effect is simply achieved by splitting a symmetrically balanced acanthus composition and reversing the lower component (Frey, 1974, Fig. 2.1–2), exactly the experimental approach to formal symmetry that Celtic artists in the west had adopted at an earlier stage of development. By contrast, the upper ornament on the Bölcske-Madocsahegy scabbard (Figure 5.4, 1) is still a symmetrical composition with echoes of the lyre-palmette, and with infilling of figure-of-eight and droplets reminiscent of a disintegrated palmette. The scabbard is also of interest because of its use of triple dots in the voids, a curious signature that it shares with the scabbard from Cernon-sur-Coole and some of the Irish scabbards.

The two Bölcske scabbards (Figure 5.4, 1 and 2), sometimes attributed to the same craftsman, are commonly regarded as prime examples of the later Hungarian Scabbard Style. Szabó and Petres (1992) argued that the later Hungarian Scabbard Style was characterized by a process of geometricization and increasing abstraction in design, with simplified triskeles or S-shapes, or sometimes just simple wedges or droplets being deployed as filler-motifs. One of the scabbards from Szob (Figure 5.4, 4) and one from Dobova (Figure 5.4, 3), the latter with associations from the La Tène C1–C2 phase, indicating a date spanning 200 BC, well illustrate this trend. What brought about this formalizing trend is unclear; Szabó and Petres (1992, 48) alluded to the

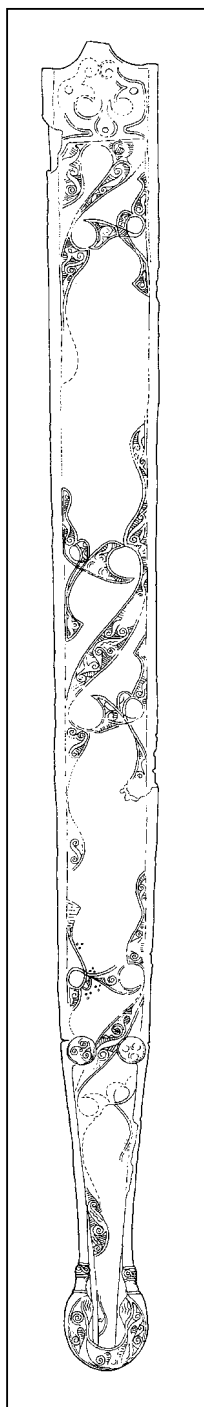

Figure 5.3 'Halimba' scabbard from Co Veszprem, Hungary. L. 64 cms. Adapted from Szabó and Petres (1992).

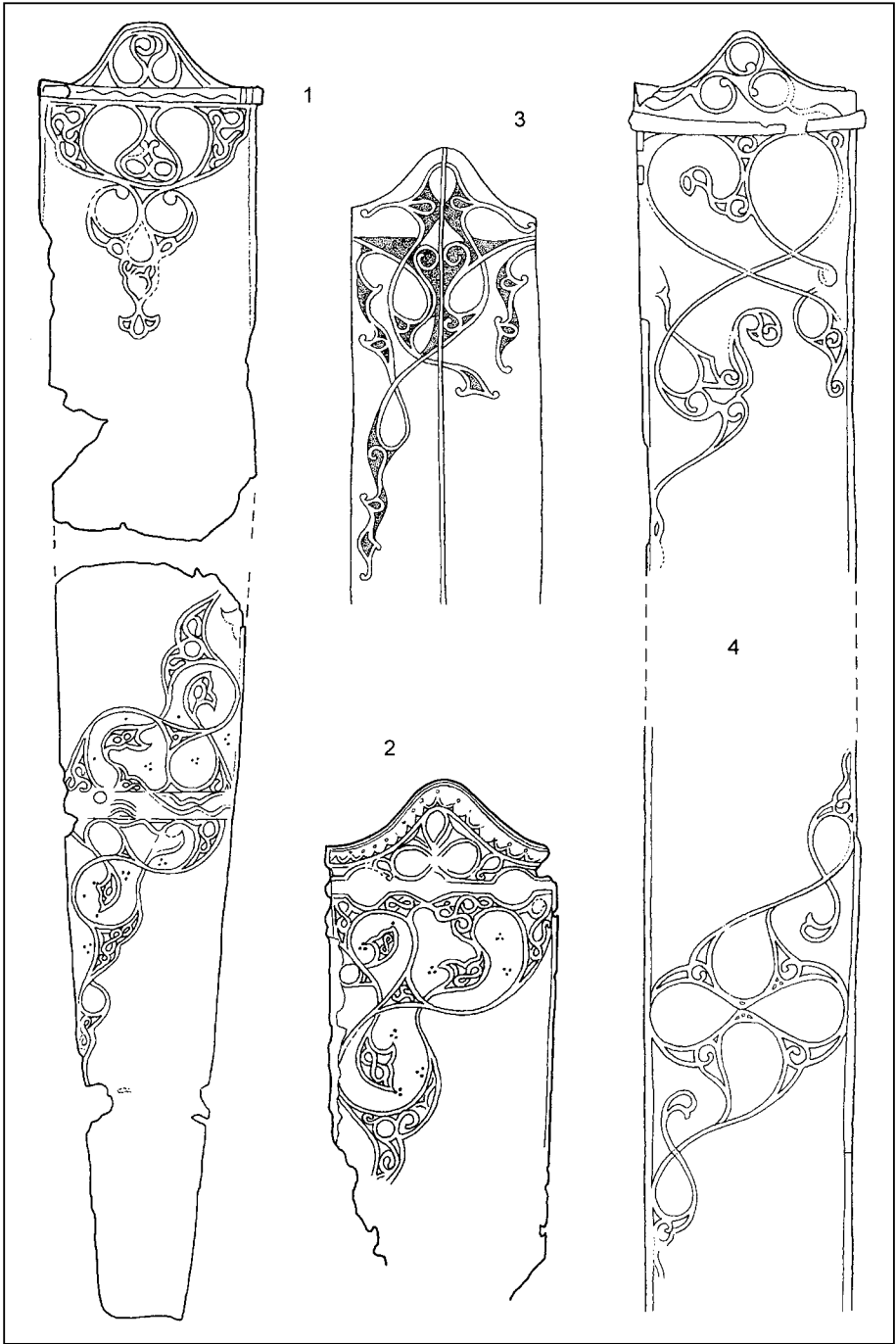

Figure 5.4 Hungarian and related scabbard ornament – 2. 1, Bölske-Madocsahegy 1; 2, Bölske-Madocsahegy 2; 3, Dobova, Slovenia; 4, Szob. Adapted from Szabó and Petres (1992).

conservative tendency of scabbard artists, and even likened it to a reversion towards the formulaic aspects of the Early Style. The continuing fashion for geometric stamped decoration on pottery into the La Tène C phase has sometimes been suggested as an influence on sword ornament. The grave associations, where they exist, clearly indicate a later third- or early second-century date for their deposit, though this of course could be considerably later than the construction and ornamentation of the scabbards themselves, so that the clarity of the sequence is far from assured. In any event, by the mid-second century, the Hungarian Scabbard Style was in decline.

If the decline of the Hungarian Scabbard Style is dated with reasonable certainty, there remains the question of its inception. Eastern European scholars have been cautious in advancing too early a date, though Waldalgesheim influence could argue in principle for the beginnings of the style as early as the fourth century. Associations include brooches of essentially early La Tène type, as at Kosd grave 16, where they are accompanied by later brooches of middle La Tène type with Plastic Style ornament, perhaps indicating the inclusion of older grave-goods in a later deposit. The Kosd scabbards also display a very distinctive form of chape-end that proclaims a connection with regions further west. Instead of a simple oval or cordate form, the Kosd chapes have a segmented construction, created by the insertion of circular studs. This variant is also displayed by the Irish scabbards, and others in Western Europe. But rather than invoking direct connections between these polar extremes, Jope (2000, 353) rightly insisted that all were regional derivatives from an ancestral early La Tène form that developed in north-eastern France out of earlier late Hallstatt anchor-chapes. They are therefore evidence not so much of direct contacts but of a broader European *koine* in the armourer's repertory, which might include technical tricks of scabbard construction as well as stylistic traits in ornamentation.

Dragon-pairs

One of the few genuinely pan-European elements in early La Tène art is the dragon-pair motif (Figure 5.5), embellishing the upper end of the front-plate of scabbards from south-eastern Britain (Stead, 1984) to Transylvania (Petres, 1982), with examples south of the Alps (Megaw and Megaw, 1989) and one outlier across the Pyrenees (Ginoux, 1995). Both Jacobsthal (1944, 46) and de Navarro (1972, 229) saw these devices as evidence of orientalizing influences in early Celtic art, or even as a direct Scythian introduction into eastern Central Europe, a view that would not have seemed implausible, given the predominantly eastern distribution at the time and the prevailing climate of diffusionism as an explanation of cultural innovation. Subsequent discoveries in the west, and critical analysis of the dating of the constituent types, have now rendered this view obsolete, though the basic classification of dragon-pairs remains that of de Navarro. Essentially he distinguished three types, of which the earliest confusingly was Type II. This comprises what has sometimes been regarded as simply a zoomorphic lyre, a pair of opposed S-shapes with zoomorphic heads facing inwards. The beasts represented are highly schematic, but have sometimes been thought of as griffons rather than dragons. The earliest incidence of a Type II dragon-pair has conventionally been the example from an old and never fully published burial from Saint Jean-sur-Tourbe in the Marne, which should belong to an early La Tène phase. More recent discoveries from northern Italy, notably at Monte Bibele and

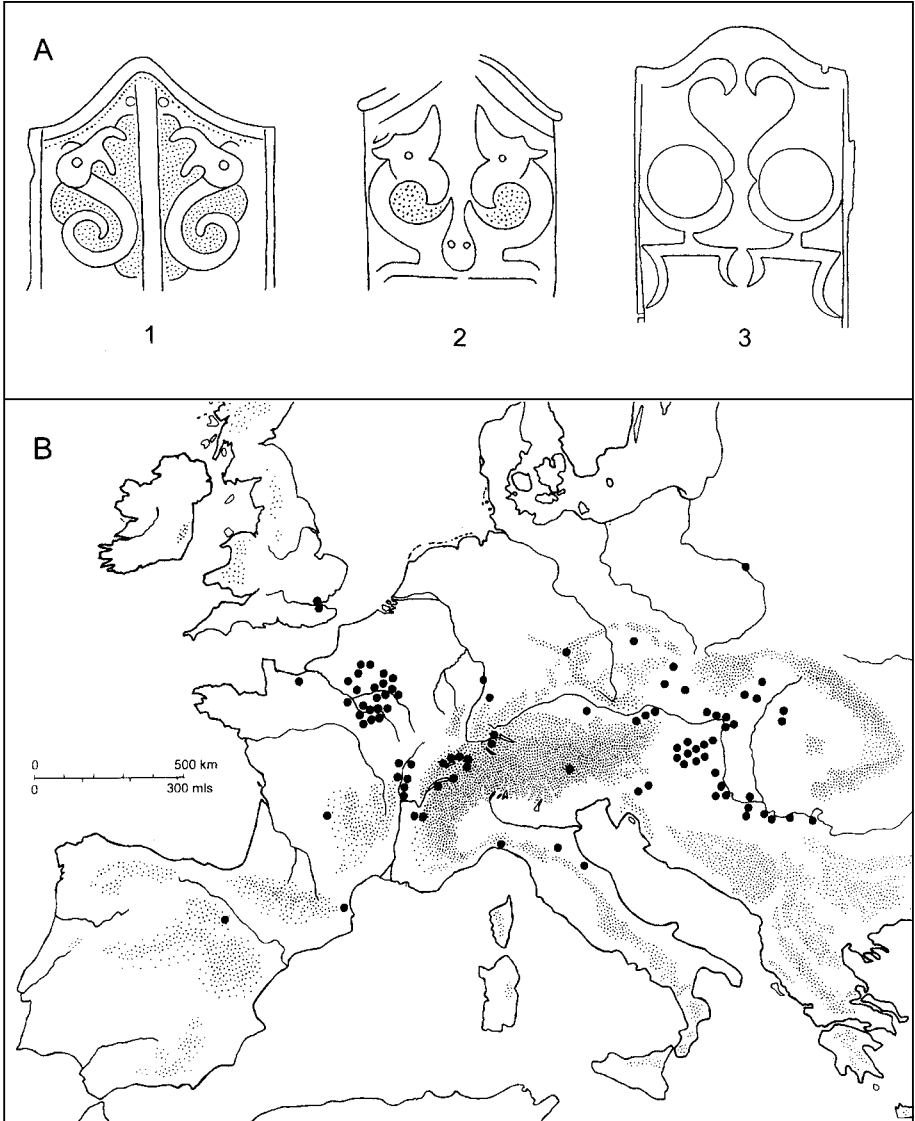

Figure 5.5 Dragon-pairs and their distribution. A: 1, Type I, Taliándörög, Hungary; 2, Type II, Münsingen, Switzerland; 3, Type III, La Tène, Switzerland. Adapted from de Navarro (1972) and Stead (1984). B: distribution of all types. Adapted from Stead (1984) and Ginoux (1995).

Ameglia, confirm the priority of Type II over Type I, but hardly afford a dating of the Italian series before the later fourth century. One suggested origin for the zoomorphic lyre type is the form of open-work belt-clasp with reversed stylized griffons' or birds' heads, the distribution of which extends north and south of the Alps. This, as the Megaws have plausibly argued, could have been the origin by analogy, or indeed could have prompted the elaboration of the widely current S-lyre motif itself into a zoomorphic version. Whatever the explanation, a western or trans-alpine introduction now seems more likely than an eastern. The wide distribution and similarity of form are remarkable nevertheless, as a comparison of examples from Italy (Ameglia), France (Montigny-Lencoup) and the Carpathian basin (Taliándörögöd) demonstrates. Doubtless other examples remain to be identified, like those from London on which the faint traces of ornament had eluded detection until relatively recently; but as the distribution stands, the marginally greater number of known examples still lies between the middle Danube and the Tizsa. Most of these examples date from the third century, rather than much earlier.

Type I has a more complex form, resembling a pair of inward-facing C-shapes, each mounted on a plinth, which is sometimes interpreted as a rear limb or tail, while the end of the C curls up towards the beast's chin. Finally, in Type III, this circle is closed completely, and the design can acquire further embellishment with tails and infilling. Dating and origin still require closer definition. Broadly third century in date, they are well represented on scabbards in Eastern Europe, in association with the Hungarian scabbard style, as at Halimba, Jutas 3, Kosd and Szob; indeed, in some cases, the dragon-pair is actually absorbed with the main scabbard design, or embellished with scabbard-style infilling.

Dragon-pairs are known from Britain, notably on a pair of iron scabbards discovered in the nineteenth century from the Thames at Battersea and Hammersmith (Stead, 1984), the former certainly of Type II and the latter possibly of Type I. An intriguing derivative of the dragon-pair motif from Fovant, Wiltshire, occurs on an iron scabbard that even Jope (2000, 278) was not disposed to date later than the third century.

The Swiss Scabbard Style

By far the greatest proportion of Swiss La Tène swords and scabbards come from, or are attributed to, the type-site itself, and for that reason lack the benefit of closed associations afforded by cemetery contexts. The purpose and function of the site at La Tène (Figure 5.6) have been a source of debate since its discovery in 1857 in an old branch of the river Thielle, between Lake Neuchâtel and Lake Biel, immediately beneath the Jura mountains in north-west Switzerland. It was the controlling of the Jura water-system in the later nineteenth century that prompted a series of investigations at La Tène and at neighbouring sites, where quantities of artefacts and structural remains in the form of preserved timbers were exposed. The most systematic excavations at La Tène took place between 1907 and 1917 under the direction principally of Paul Vouga, whose father had uncovered evidence of timber buildings on the site in the 1880s. Apart from these buildings, the main structures on the site were two timber bridges, subsequently called the Pont Vouga and the Pont Desor, the latter named after another pioneer investigator in the region. The timbers had been severely displaced by the stream, but

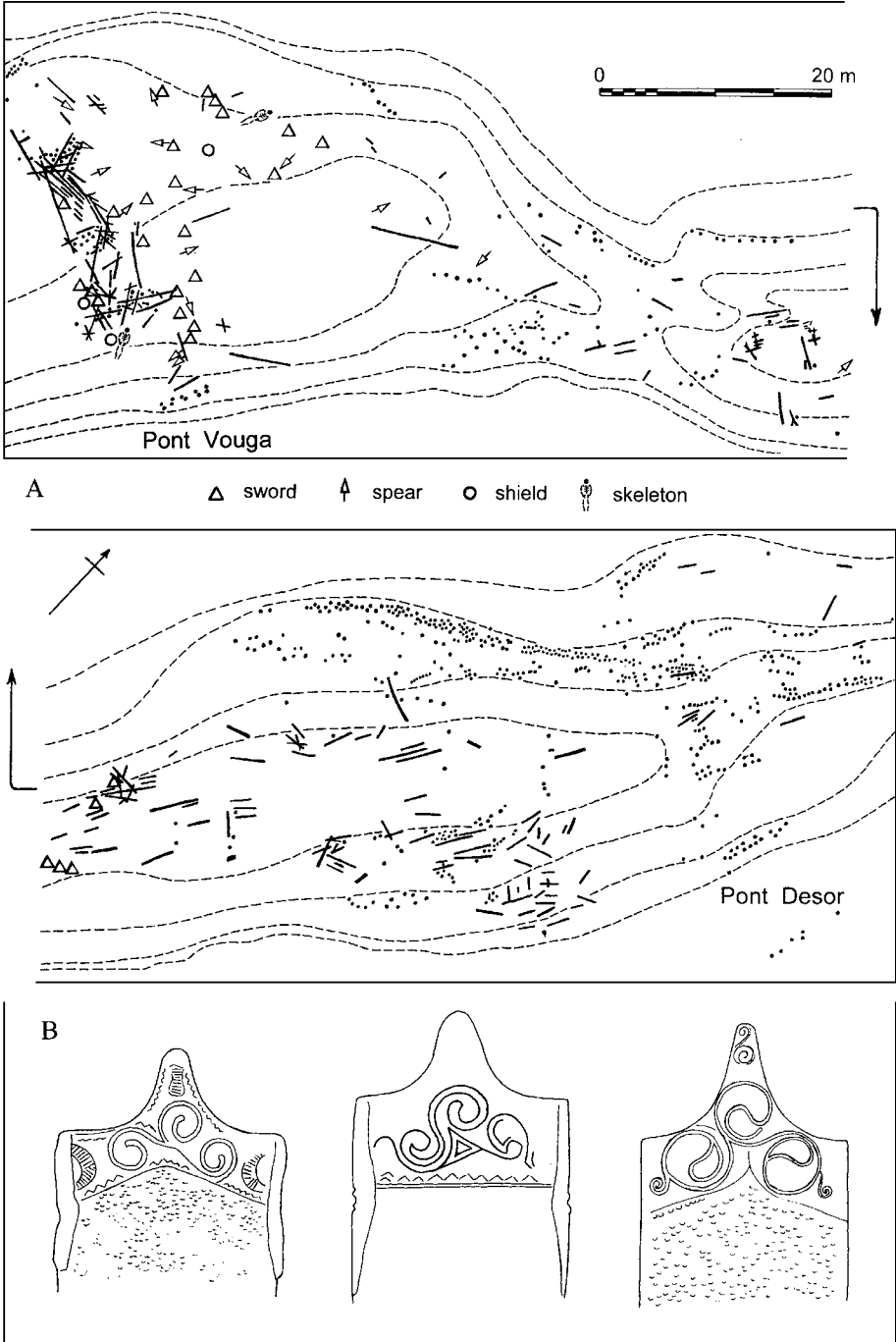

Figure 5.6 Finds from the site of La Tène. A: plan of site. Adapted from Vouga (1923). B: scabbard ornament from La Tène. Adapted from de Navarro (1972).

apart from the bridges, there were indications that the north bank had been reinforced, perhaps to create a wharf against which boats or barges could be moored. The inventory of finds from the site includes more than 150 swords, together with spears and the remains of shields. Personal ornaments that elsewhere are typical of La Tène assemblages, such as brooches and bracelets are present, but not in abundance, but the presence of tools and implements such as sickles indicates that the site's associations were not exclusively martial or aristocratic. The material dates from the early La Tène through middle La Tène, with hardly any finds thereafter, by contrast with the sites near Port, at the north-eastern end of Lake Biel, which mainly belong to the late La Tène phase. As to function, the site is plainly unlike normal domestic or fortified settlements, not simply in terms of its structural evidence but more especially for its concentration of preserved artefacts. Its location, at the intersection of natural routes and between the territories of the Helvetii and Sequani, at least as historically documented several centuries later, has led to suggestions that the site was an observation post, controlling crossing of the border, or where exchange of goods between neighbouring communities took place. The quantities of finds have prompted the idea that it was a prehistoric emporium, or alternatively a ceremonial focus, where artefacts were ritually deposited in the waters. The presence of human skeletons among the jumbled timbers lent added weight to the presumption of a ritual explanation. Furthermore, the concentration of weaponry in Vouga's plan around the Pont Vouga, contrasting with its apparent absence around the Pont Desor, might indicate that the 'bridges' served different functions, the one as a platform for ritual activities, the other perhaps more utilitarian in purpose. The discovery in the mid-1960s of another site, two miles downstream at Cornaux (Schwab, 1974), where skeletons too were found among the debris, prompted its excavators to suppose that a natural flooding disaster had overwhelmed the local community. None of these explanations satisfies the evidence entirely, though the idea of a ritual dimension would be consistent with the widespread recognition archaeologically of watery deposits in later prehistoric times throughout north-alpine Europe.

By comparison with the Hungarian Scabbard Style, the Swiss is generally described as more formal or severe, lacking the 'arabesque' fluency of the Eastern European style. It is simply much more limited in its repertory and application, being generally restricted to the panel directly below the scabbard-mouth, and very seldom extending down the length of the scabbard-plate itself. The range of designs, listed by de Navarro (1972), includes triskeles, true or false (that is, with terminals rotating in the same direction or not), zoomorphic designs other than dragon pairs or bird pairs, and what de Navarro termed 'other ternary designs', those involving triplism without being formally triskeles. Unlike the dragon pairs, in which some examples display remarkable similarities, triskeles are almost consciously not identical, as if some individual or unique group identity was implied in each. Some, like that from the famous 'doctor's grave' in Bavaria (de Navarro, 1955), are ornithomorphic.

While some early Swiss scabbards have ternary designs, the great majority of examples of the Swiss Scabbard Style belong to scabbards of the middle La Tène period. A significant proportion comes from the type-site itself, so that their classification is based upon typological considerations, which are not always above dispute, rather than upon closed associations.

Laddering and chagrinage

Two distinctive ornamental techniques characterize some of the Swiss swords and scabbards: laddering and chagrinage. Laddering is known on less than a dozen sword blades or scabbards. It comprises a series of horizontal grooves disposed invariably on either side of a central midrib, and extending for the full length of the blade or scabbard. Laddering appears on early La Tène scabbards, continuing into the earlier stages of middle La Tène. In Britain even it occurs on the early La Tène scabbard from Orton Meadows as well as on somewhat later pieces like Walthamstow and Little Wittenham, suggesting a currency marching in step with the Continental sequence. The scabbard from Sutton Reach shows a variation on the theme (Figure 5.7, 1). Its purpose remains obscure. De Navarro (1966) believed that it was to enhance 'optical contrast', which is doubtless true, though in doing so it necessarily precludes other forms of ornament, unless adopted selectively as at Sutton Reach.

Chagrinage (Figure 5.8) is broadly associated with middle La Tène scabbards in Switzerland. The term was first used by Ferdinand Keller (1858) to describe the technique of punched ornament, generally down the full length of the scabbard, and hence conventionally assumed to be in imitation of leather. The ornament itself can be stamped individually, or with compound or multiple punches, which presumably simplified a repetitive task for the artificer. Mid-ribs do not occur when chagrinage is applied. The use of chagrinage serves as a reminder that the bronze and iron sheaths that are the medium for so much scabbard ornament doubtless represented only a very small proportion of the total number of scabbards, which would have been made principally of less durable materials, though even these would have required some metal components for binding and suspension. Whether leather scabbards also bore ornament can only be surmised.

The British sword series

After an absence in the late Hallstatt (Ha D) phase, the long sword in Britain makes a delayed reappearance in La Tène 1, but throughout the fifth century and into the fourth the short dagger of late Hallstatt derivation remains a principal weapon type. Jope (1961b) effectively demonstrated that these were insular products, distinguished from their Continental counterparts by the technicalities of their twin-loop suspension and open-ring chape construction. Among early fourth-century examples, the Minster Ditch scabbard (Harding, 1972, Pl. 79A) indicates that its maker was aware of Continental fashions. Its chape proclaims insular manufacture, but the belt-attachment was plainly intended to emulate the Continental suspension-plate system. But instead of using a separate plate, the insular technician simply cut parallel openings in the back-plate, prising up the metal to take the belt, and adding skeuomorphic bosses to simulate rivets above and below. Not surprisingly, the plate snapped under pressure of use. As to ornament, the front-plate is embellished with a series of simple, geometric designs, achieved by the use of compasses; the back-plate is dominated by a compass-aided serpentine design.

For the most part, then, ornament on the insular early La Tène scabbards is simple and geometric. Minster Ditch uses conjoined, compass-drawn arcs; another scabbard from Hammersmith employs a border of intersecting arcs, with stippled infilling, in a

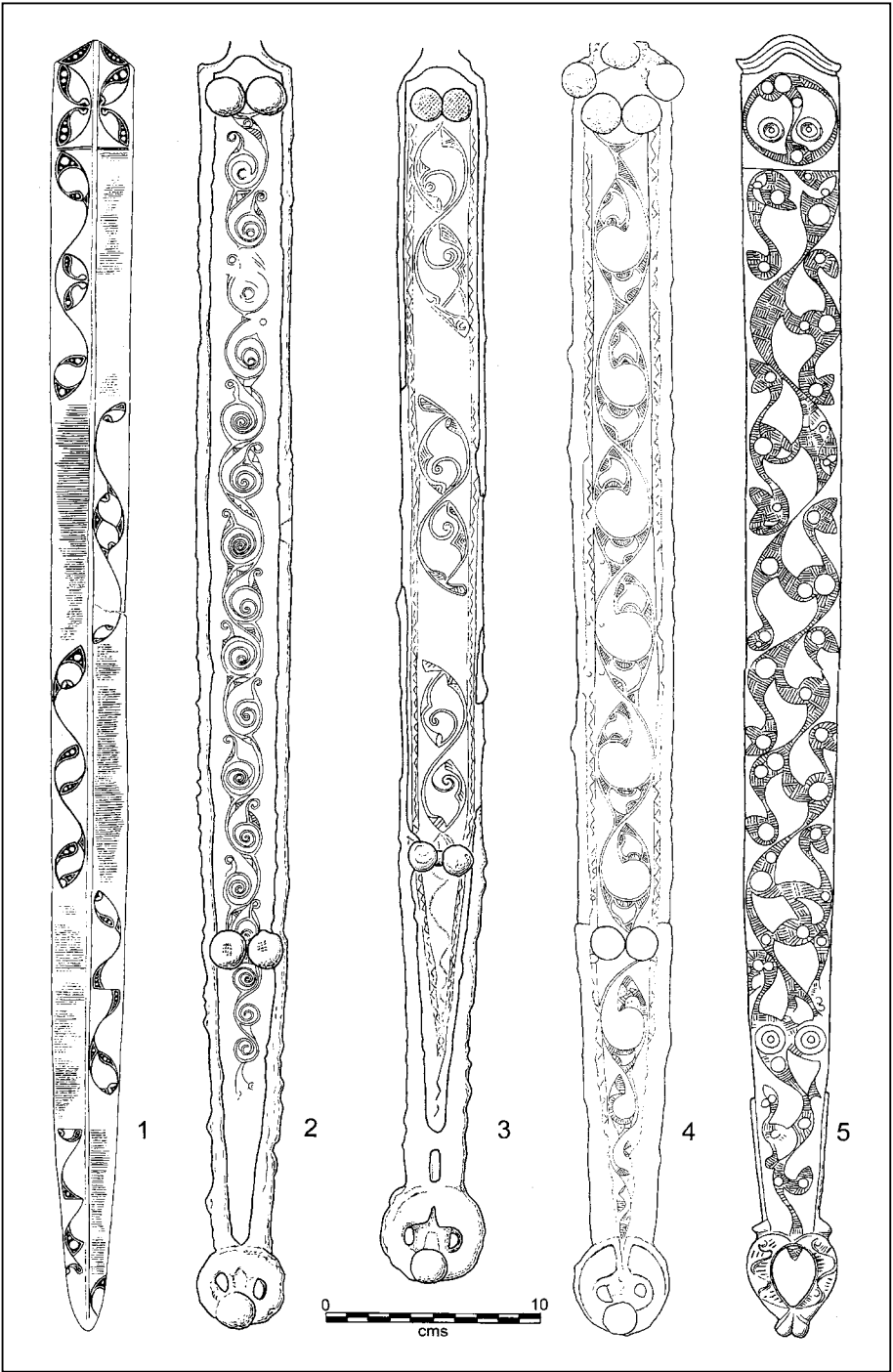

Figure 5.7 Scabbards from eastern England. 1, Sutton Reach, Lincolnshire; 2 and 3, Wetwang Slack, Yorkshire; 4, Kirkburn, Yorkshire; 5, Bugthorpe, Yorkshire. Adapted from Stead (2006).

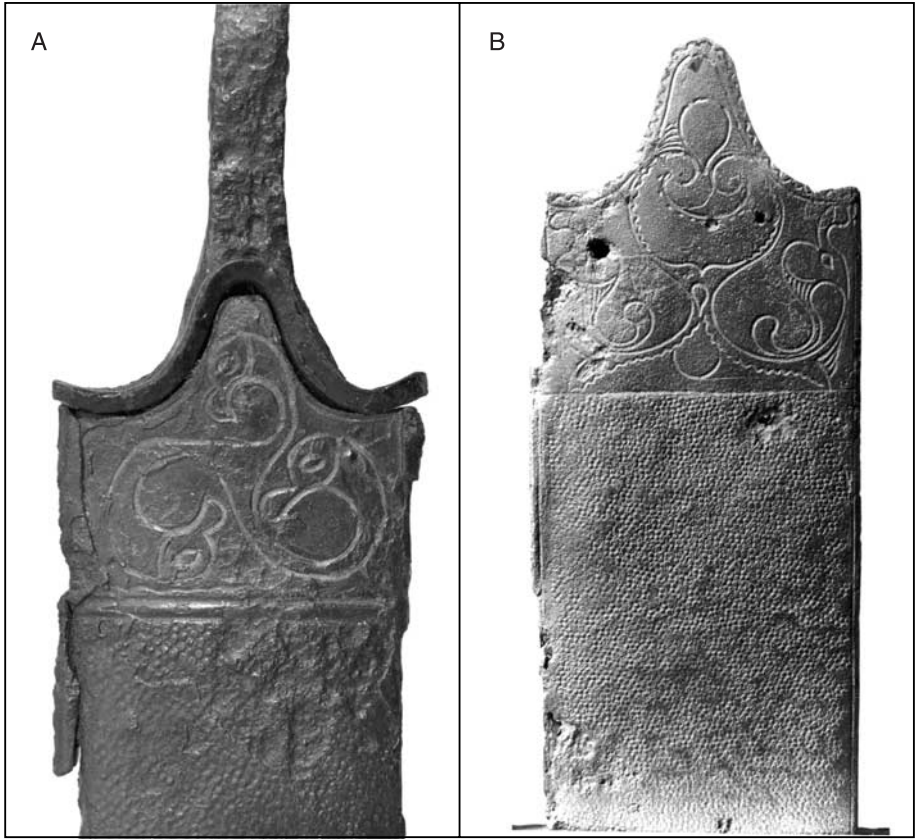

Figure 5.8 'Chagrinage'. A: Obermenzingen, Munich. Photo: Archäologische Staatssammlung, Museum für Vor- und Frühgeschichte, Munich. B: Basadingen, Thurgau. Photo: Swiss National Museum, Zurich, A-3262/10370 Neg. no. P-15226.

manner exactly matched on a scabbard from Bussy-le-Château in the Marne, or on the Zerkovice bronze disc from western Bohemia. The same motif in pottery is exemplified on the *Linsenflasche* from Dürrnberg-bei-Hallein, among many other examples of Schwappach's eastern 'arc-and-circle' style (Schwappach, 1973; 1976). The decorative motifs themselves were doubtless the product of simple experimentation with the use of compasses, so that too much significance should not be placed upon the widespread recurrence of such designs.

Among the earliest scabbards in the British series must be the Wisbech fragment (Jope, 2000, Pl. 28a, b; Pl. 29a; Stead, 2006, Fig. 48), ornamented rather crudely with stacked lyres in a manner immediately reminiscent of the transition from Early Style to *Premier Style Continu* of the Champagne region. Wisbech certainly renders the lyrepalmette motif in a more sinuous and less 'strict' treatment than classic Early Style models, with the S-scrolls becoming swelling leaves, notwithstanding the uncertain freehand execution. The curvilinear design nevertheless overlaps the border of hatched

triangles and we may therefore be dealing with a composite piece. Without the benefit of diagnostic features such as its chape, dating of the Wisbech scabbard could span from late fifth to fourth centuries rather than much later.

Rather more complex is the composite sword and scabbard fragments from the Thames at Standlake in Oxfordshire (Figure 4.10, 5). The iron sword, among the earliest long La Tène swords in Britain, survives intact, but its scabbard, presumably of leather, has been lost, with the exception of a small bronze plate that ornamented its mouth, and the iron chape with its iron and bronze attachments. The chape itself is of La Tène 1 open-ring form, its terminal made up of four leaf-shaped elements. Above it, iron side-bindings enclosing a decorated bronze plate are held together at their upper ends by an iron cross-bridge of double hour-glass form with engraved line, arguably modelled on the bird-bridges of Swiss middle La Tène scabbards. This has been taken as the decisive indicator of date, demanding a late third-century dating at earliest. On the other hand, the ornament, as we have seen, is quite close to the Continental Waldalgesheim style, and could have originated rather earlier. The ornament of the base plate is very worn, and in fact runs under, and is partly obscured by the side-binding. We are therefore dealing with a composite piece, in which the binding and cross-bridge of the scabbard could well have been repaired late in the sword's life.

Among notable finds of the past thirty years are a series of weapons from cemeteries of the Arras culture group in eastern Yorkshire, notably the decorated scabbards from Wetwang Slack (1 and 3) and Kirkburn (Figure 5.7). Hardly 'long' in Continental middle or late La Tène terms, they are nevertheless well within the range of earlier La Tène swords. Stead (1991a, 183) recognized that open-ring chapes, and the absence from the burials at Garton Station, Wetwang Slack and Kirkburn of La Tène 2 brooches, suggested a dating no later than the third century BC, and he tentatively looked to the inception of the Yorkshire Scabbard Style not too far removed from the currency of the Besançon flagon in the middle of the fourth. The evidence of insular La Tène art is inherently stacked in favour of late dating. The lack of reliable contexts for an early horizon, uncertainties of radiocarbon calibration for that period, the longevity of some stylistic techniques like background hatching, the fact that prized pieces were treasured and repaired over many generations, and deposited long after their construction and initial currency, all militate against a precocious chronology. Cumulatively, nevertheless, the evidence favours earlier beginnings than Fox, Piggott or Jope imagined, with consequences for our assessment of the relationship between insular, British and Irish, and Continental early La Tène art.

The recurrent theme of the Yorkshire scabbards, as Stead observed, is the classical wave tendril, exemplified by Wetwang 1. Here the scroll design has balanced, alternating tendril-terminals comprising a pair of spirals, one larger and with more coils, the other scarcely more than a boss. This design is sustained from below the scabbard-mouth to the chape. Kirkburn also comprises a full-length scroll with tendrils alternating to right and left, this time leading to peltate terminals that are filled with three-sided voids, one side convex, one concave and the third S-shaped. Similar voids occupy the curved triangle at the point where the terminal tendrils spring from the main scroll. Their impact is heightened by the use of hatched filling of the background, a technique that is later used widely in insular art to create an interplay between foreground and background. It is seen notably on the Bugthorpe scabbard (Figure 5.7, 5), where the hatching comprises very much denser basketry, and where a

later dating is clearly indicated by its developed, insular, 'twin-lipped' chape-end. Bugthorpe must belong to a later second- or first-century BC horizon, and its sharing with Kirkburn of the three-side curving void motif against a hatched background indicates no more in terms of chronology than the duration of this regional tradition. The earlier occurrence of this motif has been confirmed by a more recent find from Mill Hill, Deal (Stead, 1995, 95). Another signature that also appears in the repertory of the Irish scabbard-smiths and the later eastern English shield-makers is the use of wavy-line-and-dotted bordering, which first appeared on the hilt-end of the Wisbech scabbard-plate. In considering its dating, we should note that the Kirkburn scabbard-plate has been repaired in a different hand. Hidden by the chape discs is a break, below which the design is executed in much cruder fashion with a variety of different infilling.

The Wetwang 3 scabbard stands slightly apart from Wetwang 1 and Kirkburn, though it shares with those scabbards the same form of La Tène 1 chape, as well as the distinctive use of discs at the mouth of the scabbard and at the top of the chape. The striking difference is that the design is not continuous, but is divided into three discrete panels. The basic elements are described by Stead as 'well-spaced elaborate reversed-S motifs whose terminals spiral within a field defined by a triangular "cusp" on the stem' (1991a, 181). It too deploys wavy-line bordering, and this, together with the fact that the scabbard's suspension loop is located well down towards the centre of its length, quite unlike the standard British fitting, has prompted further comparison with the Irish scabbard series.

The most obvious parallel for the tripartite composition of Wetwang 3, however, is an older find from Sutton Reach in Lincolnshire (Figure 5.7, 1). The chape does not survive, but the low triangular mouth of the scabbard-plate led de Navarro to regard it as rather earlier in the middle La Tène scabbard sequence than most previous commentators had believed. Immediately below the mouth is a 'key' panel (1) occupying the full width of the plate composed of a geometrically described leaf-rossette design, within which four comma-leaves are deliberately not quite symmetrical overall, the right-hand element showing rotational symmetry, the left-hand showing mirror symmetry. The comma-leaves are filled with circular voids. Below this the ornament is separated into five further panels (2–6) of incised designs alternating across the central mid-rib with five panels of Swiss-style laddering. These panels are variants on the same simple theme, much as a musical composer compounds variations on a theme, using the variables that have been trailered in the 'key'. Panels 3 and 5 use symmetrical designs, 2, 4 and 6 are progressively more asymmetrical. The 'simple theme' is the interlocking S, which in panel 3 is achieved with rotational symmetry of cusps and finials. In panel 4 the same gives a superficial impression of symmetry from its central component, but is in fact deliberately not so in its outward elements. Panel 1 explores a further variant, overlapping the S-elements to form a sinuated wave. Here the outward elements are not symmetrical, but the medial device is borrowed from the left-hand element of panel 1. Panel 5 introduces a rarity in La Tène art, the straight line; the parallel with the Torrs horns, which had been remarked since Fox (1958, 32–3), underscores the rotational movement induced by this device, here acting as the fulcrum for exact rotational symmetry. Finally, in panel 6, the theme is completely deconstructed, with one leaf-motif even transgressing the central mid-rib. The whole composition is not just curvilinear tendrils with repetitive infilling. It is a systematic exploration of a

theme, an exercise in rational deconstruction and re-assembly in a manner that typifies the La Tène art tradition. Sutton Reach is not among the earliest British scabbards, neither on the basis of form, in so far as it can be determined, nor decoration, which belongs within the pan-European middle La Tène scabbard tradition. But it is not as late as Fox and Piggott insisted, as de Navarro rightly recognized (1966, 148–50). Stylistic similarities with the Torrs horns would not be incompatible with an early third-century date.

British scabbards of the middle Iron Age are best represented by examples from Little Wittenham, Deal and Hunsbury, though these too were subject to the late dating syndrome favoured by older commentators. The problem is simply that certain techniques, like background hatching, and certain motifs, like trumpet-voids, plainly reach their apogee on metal-work with demonstrably late associations, like some of the mirrors of first-century BC or even first-century AD date. Stead has demonstrated in the case of the trumpet-void that this should not preclude an earlier origin, and this principle almost certainly holds good for other motifs or styles of ornament. Background hatching certainly can be traced back in Britain to the early fourth century at Standlake and Cerrig-y-drudion, and even the ‘squared’ variant characteristic of mirror ornament may not have been confined exclusively to a late horizon, given that perfectly good examples occur on the handle of the early La Tène Borsch flagon and Panenský Týnec brooch. The low-relief style of the Little Wittenham or Deal scabbards is innovative, but the designs in template form would not have differed so greatly from those exemplified at Hunsbury in the incised style. The relief elements define three-sided curving voids in both, open circles become relief bosses, and comma-leaves, seen in engraved ornament on the Sutton Reach scabbard, have their counterpart in relief on both the Deal and Little Wittenham scabbards. Stead rightly emphasized the essential relationship of the main motif of the upper panel at Deal and the linked-S theme of Sutton Reach and the Yorkshire scabbards, and while the relief style, first seen in the Standlake scabbard, is doubtless thereafter a development of the third and second centuries, there can be no doubt from the Witham–Wandsworth shield series that engraved ornament continued alongside the newer relief style.

The Irish Scabbard Style

The Irish Scabbard Style is based upon just six decorated scabbard-plates, all found in relatively close proximity in County Antrim. Three of these decorated scabbards were found in the River Bann, as was a fourth undecorated example and a number of other Iron Age finds, including several horse-bits, spear-butts of both knobbed and tubular types, a sword and socketed axe, both of iron, and the well-known Bann disc. As with the British finds from the Thames and the Witham, these may well have been deposited in the river at different times as part of a ritual veneration of sacred waters or their supernatural custodians, or perhaps as a variation on the ceremonial destruction of wealth represented by the burial of prestige goods in the earth. Three more decorated scabbards, and a further undecorated example, were found in a bog at Lisnacrogher, not far from the Bann but itself a wetland location of a kind elsewhere favoured for ritual deposition.

Piggott (1950) believed that the Irish scabbards (classed as Group IIIA) were derived from his north-eastern English Group III scabbards, exemplified by the Bugthorpe

scabbard. Building upon Ward-Perkins' (1939) study of horse-bits, he concluded that the La Tène phenomenon in Ireland was introduced by 'the plantation of Ulster by Yorkshire charioteers' (1950, 16), an event that, based upon his dating of the Bugthorpe scabbard, could hardly have preceded the first century BC. The distinctive character of the Irish La Tène, and its marked differences from that of eastern and north-eastern England, made this an implausible hypothesis from the start, and though vigorously rejected by Irish scholars, the implication of a late dating for the Irish scabbard series stuck. In fact, the Bugthorpe scabbard is relatively late in the sequence, as compared with the more recent discoveries of decorated scabbards with early La Tène characteristics from the Yorkshire cemeteries. Some elements of these finds may endorse the idea of a relationship between the Irish and British series (Raftery, 1994b), but it would be a rash assumption indeed that any such relationship was of one particular kind or from one particular direction. More important, the question of chronology of the Irish scabbards is once again thrown wide open, and can be firmly detached from older models of diffusion.

The fact that the Irish swords are relatively short compared with British or Continental counterparts has been frequently remarked. Most are less than 50 cms in length, whereas British and Continental swords of the early to middle La Tène transition, like Standlake, can be as much as 75 cms in length. The more recent finds from Yorkshire, however, are not nearly so long, suggesting that here earlier swords may have been shorter, and later examples progressively longer. The difference may reflect fighting conventions. Raftery suggested that the Irish swords were for hand-to-hand combat, whereas Jope (2000) argued that the longer British swords were designed as cavalry weapons. As regards typology, most authorities, following Jope (1954a; 1974), recognize that the Irish chapes owe more to the Continental tradition than to the British, and parallels from Champagne to Hungary are really quite striking.

The initial impression created by the designs of the Irish scabbards (Figure 5.9) is one of great complexity, the full length of the scabbard being filled with intricate free-flowing curvilinear ornament. In reality, the designs are very much more regular and symmetrical than first appears, and the essential framework is based upon stacked S-motifs, lyres or spirals. The appearance of complexity is essentially achieved by the dense use of finials and appendages, themselves actually rather repetitive, and the infilling of these vegetal designs.

This principle is well exemplified in Lisnacroggher scabbard 2 (Figure 5.9, 2). Its basic structure consists of stacked lyres, or opposing stacked S-motifs on either side of the scabbard's central midrib, like the open-work mounts from La Bouvandeau each simply abutting the next, rather than being interlinked like the Wisbech scabbard ornament. Unlike La Bouvandeau's fleshy elements, however, the Lisnacroggher lyres are engraved outlines only, possibly aided by the use of compass-work, though finished in freehand with rocked graver. Each S-curve ends in a tripartite peltate finial, balanced in fold-over symmetry with its neighbour across the midrib. The infilling of the peltate finials and of the axillar fillings between stacked lyres is instructive. To the right of the midrib the dominant theme is simple hatched infilling, while to the left the pelta-within-peltae motif is preferred. In the upper third of the scabbard, however, there is greater variety, with dotted or dog-tooth infilling of peltae to the right, and spiral or leaf infilling in false relief to the left. False relief leaves infill the axillar elements throughout the scabbard's length. The reason for this contrast is not immediately

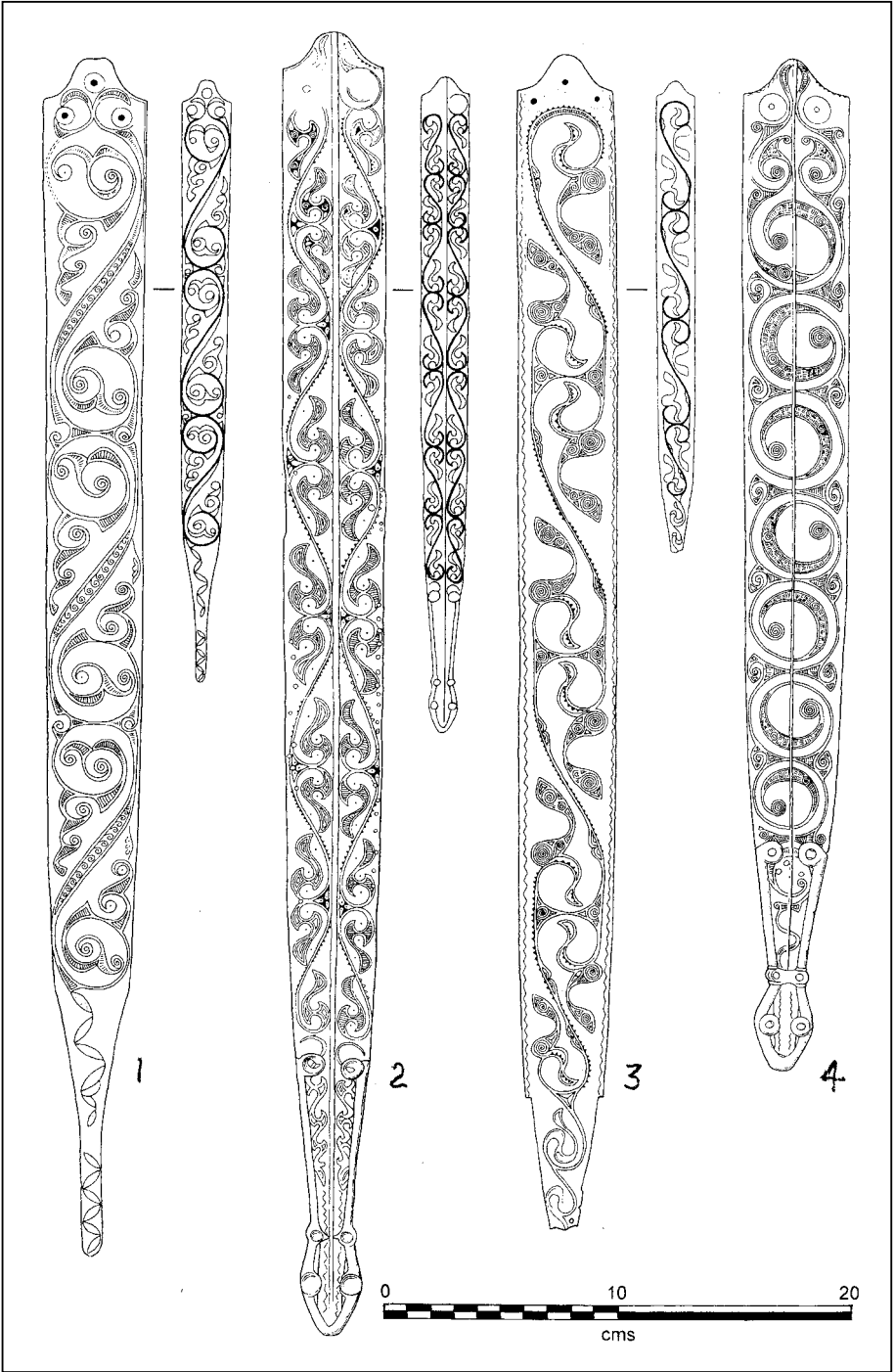

Figure 5.9 Irish engraved scabbards: 1, Toome 1; 2, Lisnacrogher 2; 3, Lisnacrogher 1; 4, Lisnacrogher 3. Adapted from Raftery (1983).

obvious, but the possibility that the design could be the work of more than one craftsman should not be overlooked. Raftery has drawn attention to the 'saw-tooth' emphasis of the lyre outlines, which he sees as a signature of this and the two other decorated scabbards of the Lisnacrogher 'school' (1994b, 476).

The design of Lisnacrogher 1 (Figure 5.9, 3, the example with broken tip in the Ulster Museum; numbering and attribution of the scabbards have not been uniformly consistent) can also be reduced in essence to a series of stacked S-scrolls with compound finials, but integrated in a fashion that enhances the overall sinuous effect. In fact, its composition is even more repetitive than Lisnacrogher 2, in that the filling of the finials and axillar triangles, and even the small, paired swellings on the stem of the S-scrolls, are exactly matched in each successive element of the series. The finials are made up of two motifs, one consisting of crescentic curves, reversed to form an S-shaped element in which the opposed inner curves are accentuated with the 'saw-tooth' technique, the second being closer to the Continental comma-leaf approximating to the shape of a sycamore seed. A dominant and repetitive motif in the filling is the tightly wound hair-spring spiral, one of the common motifs shared with Torrs and other British pieces. Perhaps because of the absence of a central mid-rib, Lisnacrogher 1 conveys a greater sense of unity in its design, and a hint of interplay created by the engraved ornament between foreground and its background.

Lisnacrogher 3 (Figure 5.9, 4) is again based upon a series of figure-of-eight S-scrolls, this time with more rounded spiral components. At the point where each figure-of-eight abuts the next, the axillar angles are filled with hatched triangles leading to alternately oriented finials. The same devices are then used at the mid-point of each figure-of-eight, creating the illusion of a continuous but alternating series of rounded spirals. Each main spiral ends in a tight hair-spring, the tendril itself swelling towards its terminal to accommodate infilling of hatched basketry. Though broadly symmetrical, the design is not consistently so in detail, the opposed finials between the second and third figure-of-eight below the mouth of the scabbard bucking the trend of orientation of the remainder. At the mouth end, the first figure-of-eight leads into a balanced design in which a pair of peltae with hairspring terminals are the dominant element, again motifs reminiscent of the repertory of the Torrs craftsmen. The use of basketry hatching, on the other hand, invites comparison with the much later South-Western Mirror Style, from which the Irish scabbard ornament cannot possibly be derived. Though the insular British character of this style of square-based basketry is often asserted, it should be regarded as one regional variant within a longer and more complex tradition, in which any particular variant might be chronologically typical but not necessarily chronologically exclusive.

A feature worth remarking on both Lisnacrogher 2 and Lisnacrogher 3 is that the chape partially obscures the scabbard ornament, raising the possibility that these may have been composite pieces. In the case of Toome 3, we might also question whether its appearance of crude execution is not in part a factor of alteration in secondary re-use. Attempting to date such composite artefacts on the combined basis of scabbard or chape typology and ornamental style is thus made still more contentious.

The basic design of Toome 1 (Figure 5.9, 1), a series of stacked S-spirals, together with its essential symmetry, allies it closely to Lisnacrogher 1 and 2. Each of the three S-spirals has a swelling leaf-shaped stem, infilled with hooks or incipient spirals, leading to terminals that are developed with fins and finials, infilled with linear hatching,

and frequently terminating in tightly coiled hair-spring spirals. Axillar fillings again create an illusion of continuity, but in fact, with very minor deviations, the three principal elements are remarkably repetitive. Towards the tapered point of the scabbard are leaf-chains created from simple intersecting semi-circular arcs, each with dotted infilling.

Of all the Irish scabbards, Toome 3 is aesthetically the least skilled piece, apparently lacking any continuity in design and displaying a very limited range of motifs and techniques. It has plainly had more than one phase of use, apparently being reversed to conceal the ornament in its adapted form, and it is possible that trimming of the metal plate may have curtailed its original design. The temptation is to see this as the work of an apprentice or an unskilled imitator, who did not understand the geometry of the design and whose line-work was crude and stilted. It would be possible to restore a continuous, sinuous design if the edges of the plate had been trimmed, but the resulting effect would still be contorted, and the use of leaf-pairs, spiral terminals and linear hatched infilling is still monotonously repetitive. Perhaps the most significant feature of the piece, however, is its almost total use of rockd tracer, which could suggest that this was an experimental piece, in which the aesthetic effect of the design was less important than the mastery of the technique.

Finally, the decorated scabbard known as Bann 1 also has ornament on both surfaces, the inner, earlier ornament being now very worn and faint. The main, outer design is based, as Raftery has observed, on a wave-tendrill, a Greek-derived theme commonly adapted into the repertory of early Celtic art. From the main tendrill spring complex peltate compositions ending in spirals, in which interlocking elements share a common spiral. These peltate elements are variations on a theme seen from Loughnashade to Torrs, and even more closely paralleled on the Newnham Croft bracelet. The whole design is enclosed within a border, on one side composed of a leaf-chain, on the other a series of simple 'steps'. Infilling includes a variety of impromptu motifs, as well as the use of the 'saw-tooth' technique seen previously on Lisnacrogher 1 and 2. In the spaces between the tendrill designs are inserted groups of fine triple dots, another curious 'signature' that Raftery has compared to examples on the Cernon-sur-Coole scabbard and on Hungarian scabbards (1994b, 490). In fact, the Continental affinities of the Bann scabbard plate are underlined by the faint surviving traces of the design on its inner face, for which Raftery has likewise argued Hungarian analogies. That both sides should display elements of Continental inspiration is surely significant, since the span of time represented by two periods of use, sufficiently long to result in the almost total obliteration of the ornament on the inner face, must be reckoned as more than a generation. In sum, Bann 1 shows a fusion of Continental and insular features; it is a consummate piece of work, in which the effect of interplay between foreground and background is stronger than in any other in the series.

Conclusion

Scabbard ornamentation was a widespread phenomenon in Celtic Europe with notable regional concentrations in Eastern Europe, Switzerland and in Britain and Ireland. Its earliest manifestations are on swords with early La Tène typological attributes, developing to a peak of production in the middle La Tène series in Continental Europe, and thus spanning chronologically the later fourth to second centuries BC. Though

reliable associations are frequently lacking, there is no *a priori* reason for believing that the British or Irish scabbards should not conform to the same chronological span. In terms of ornamental style, the different regional groups are quite distinct, the Eastern European adapting an initial Waldalgesheim impulse into its independent engraved style, the Swiss having a more limited repertory focused notably upon triskele and pseudo-triskele designs. British and Irish armourers developed parallel and perhaps related engraved styles, but not predominantly derived from any Continental antecedent. Pan-European traits are apparent, most obviously the dragon-pair motifs, while tantalizing hints of long-distance connections, like the use of the triple-dot signature on Irish and Eastern European scabbards, may be the result of mobility among specialist craftsmen in the patronage of a ruling elite. In sum, we may infer strong regional traditions with mutual inter-relationships, and with connections direct or indirect with workshops south of the Alps open to Mediterranean influences. These relationships were complex, dynamic and contemporary, rather than unilateral with implications of time-lag before their impact was felt in peripheral parts of the eastern or north-western Celtic world. What part historically recorded or even historically anonymous Celtic migrations had to play in the process can only be guessed; but swords, like pots, are not mobile of their own volition, and there can be no more personal expression of the lifestyle of the Celtic elite than the La Tène warrior's panoply.

6

THE LA TÈNE LATER RELIEF STYLES

Broadly contemporary with the Sword Styles, dating from the later fourth or third centuries BC, a range of artefacts, including personal ornaments, especially from the middle La Tène cemeteries of eastern Central Europe, developed a high-relief style of ornament which Jacobsthal defined as the 'Plastic Style'. As its name implies, the Plastic Style is characterized by its three-dimensional, relief form, in English implying a moulded quality, as in modelling in the round with clay, but in the Continental European tradition comprising all forms of relief ornament, including that of more angular profile (Duval and Hawkes, 1976, 181). The fact that the Continental usage embraces both 'soft' and 'sharp' relief modelling does not mean, of course, that the two variants are the same (Jope, in Duval and Hawkes, 1976, 183), nor indeed that the relief technique implies a uniformity or concurrency of fashion. It is true that the preceding Waldalgesheim or Vegetal Style was also a low-relief style, but the later Plastic Style is different in degree, has a marked tendency to exaggerated swelling, and can include quite baroque clusters of relief elements. The crucial difference is that even with Waldalgesheim ornament it is possible to represent the design two-dimensionally. With the Plastic Style, as Jacobsthal observed, there is 'no clear borderline between decoration and what it decorates . . . cut off the spirals and you cut into the flesh' (1944, 97).

In fact, from Jacobsthal's analysis, it is difficult to gain any sense of a coherent style, in terms either of its distribution or of the range of artefactual types represented. The distributional deficiency was in part owing to the constraints of access to museums and collections at the time. As Kruta pointed out (Duval and Hawkes, 1976, 181), a substantial concentration of Plastic Style ornaments in Bohemia and Moravia, numerically greater than those of Hungary or south Germany, had not been examined by Jacobsthal, who perhaps therefore placed undue emphasis upon particularly outstanding examples from the Marne or southern France. As regards the types that were represented, these were principally bracelets, arm- or ankle-rings in Jacobsthal's analysis, to which a wide range of brooches should certainly be added. In its wider sense, however, 'Plastic Style' might include the Torrs pony-cap and insular parade shields, as well as the Irish pin series. It is worth remarking nevertheless that, with a currency in excess of two centuries, the Plastic Style was as long-lived as any of the early La Tène styles that we have considered hitherto.

Whereas in the case of the Hungarian Sword Style the influence of the preceding Waldalgesheim Style was plain, the evolution of the Plastic Style or Styles is harder to trace. In one sense, its swelling relief form might be seen as a natural progression from

Waldalgesheim. Some motifs too might be seen as developments of those current in the Waldalgesheim Style; indeed some might be linked to antecedents in the Early Styles. These include most obviously S-motifs, commonly linking into triskele sequences, but translated into three-dimensional, high-relief form. Perhaps the difficulty in articulating the sequential relationship stems from the fact that there is no obvious debt to or stylistic input from classical prototypes, as was the case with both the principal earlier La Tène styles. To this degree it might be regarded as the culmination of La Tène achievement, but equally we might suspect that to Jacobsthal as a classical archaeologist it was becoming tangential to his primary interests. Szabó, by contrast, has described the output of eastern Central Europe from the third century BC, less in touch at least initially with Mediterranean influences, as the peak of La Tène artistic achievement, reflecting a 'democratization of ornament' in Celtic society (Szabó, 1991, 313), presumably because the media in which the Plastic Style achieves this expression are principally everyday personal ornaments or dress accessories such as bracelets, brooches and belt-hooks. Not all such ornaments, however, are of an everyday kind, and the implications of an increasingly egalitarian society should not pass unchallenged. Gold torcs of an extravagance and stylistic elaboration unsurpassed in Celtic art are also known from this period, and the highly specialized art of contemporary sword scabbards equally testifies to a highly stratified society, sustaining a military and social elite. But the Plastic Style also sees a burgeoning of what Megaw called the 'Disney Style' (1970a, 30; 1970b), the rendering of animal and bird's heads with cartoon-like techniques to emphasize mood, either benign and even comical, or malevolent and ominous. These figures especially embody what Hawkes described as the contrasting 'benign' and 'nightmare' aspects of Celtic art.

The Bohemian Plastic Style

The importance of the Plastic Style in Bohemia and Moravia has largely been established through the analytical research of Kruta (1975), whose sub-divisions have been widely adopted by other scholars. He demonstrated that the first phase of the Bohemian Plastic Style developed from types associated with the Duchcov horizon of the later fourth century. Two principal artefactual types were represented. Numerically most significant are a series of bronze penannular bracelets with buffer terminals, the decoration on which is divided into three sectors, two flanking the terminals and the third diametrically opposite the opening (Figure 6.1, 2). A few of these display vegetal-derived designs, though executed in a relief technique that is accentuated beyond the low relief of the preceding style. The majority, however, employ S-motifs in simple or compound form, for which the ultimate antecedents lie within the Early Style. The more complex examples include linked S-motifs and comma-leaves, rather than fully-integrated S-chains, together with triskeles and pseudo-triskeles, especially at the terminals. A notable aspect of the ornament, partly induced by the layout of the composition, is its symmetry, the design being balanced about the central element of the central panel. The second principal type of this early phase of the Plastic Style is a Münsingen-derivative type of brooch, with sloping foot and large foot-disc, the bow of which is also ornamented with S-motifs in heavy relief style (Figure 6.1, 1). Given the limited variation in types, and the limited range of ornamental motifs, it would be surprising if groups of artefacts could not be potentially assigned to the same

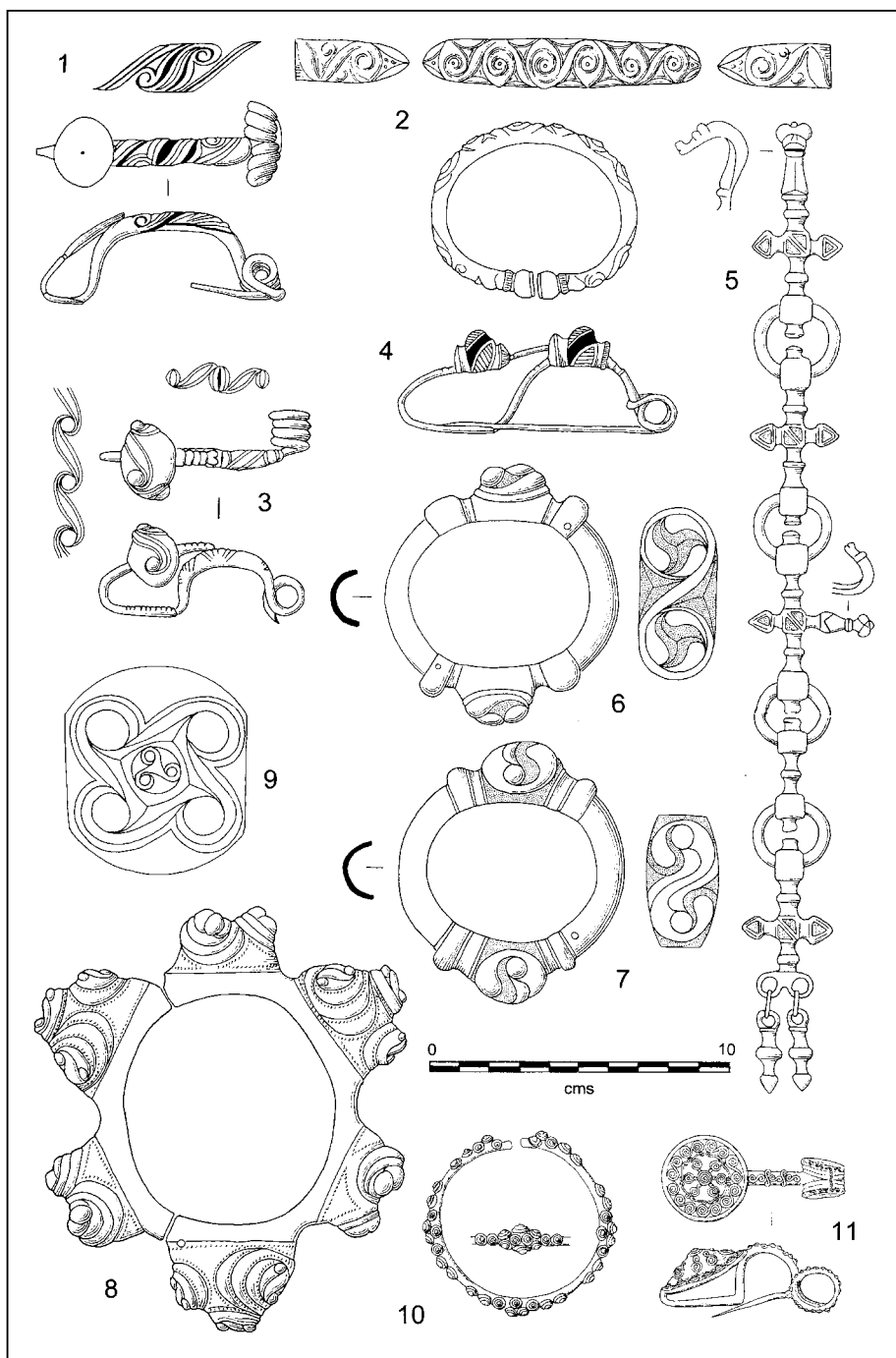

Figure 6.1 La Tène 'Plastic Style' ornament in Bohemia and Moravia. 1, Pečky 2; 2, Sulejovice 1; 3, Pečky 2; 4, Hostomice 1; 5, Telce 1; 6, Nehvizdky 1; 7, Nový Bydžov 9; 8, Staňkovic 2; 9, Hořešovice 1; 10, Podlešín 1 (all Bohemia); 11, Místřín, Moravia. 1–10 adapted from Kruta (1975), 11 adapted from Filip (1956).

workshops. Though concentrating in Bohemia, similar examples are found in a wider distribution in eastern Central Europe, in Moravia, Slovakia, Austria and Hungary. A variant of this brooch type was associated in grave 40 of the Piskolt cemetery in Romania with a warrior's equipment comprising a shield, represented by its handle and shield-boss, and a sword in an ornamented scabbard, with traces of a Type I dragon-pair (Szabó and Petres, 1992, Pl. 96).

The second phase of the Bohemian Plastic Style, starting around the second quarter of the third century BC, is represented by a wider range of types, though they are still generally regarded as essentially female costume accessories. The brooches are of two broad types. One is still within the La Tène 1 tradition, but with a large globular knob on the foot in place of the flat, circular disc of the preceding phase (Figure 6.1, 3). Ornamentation is still commonly of relief S-motifs in a chain. A variant of this type, with S-motifs winding into tight spirals, was among several globular-footed La Tène 1 brooches from grave 31 at Kosd in Hungary, in association with a scabbard with engraved ornament and chagrinage. Several other graves in the Kosd cemetery contained similar brooches, together with an example in which the foot attaches to the bow in the diagnostic manner of La Tène 2 brooches. The second brooch variant representative of the second phase of the Bohemian Plastic Style is in fact a La Tène 2 type with foot attached to the bow. It is embellished, however, with two large globular knobs, one on the foot and the other on the bow at the point of junction with the foot (Figure 6.1, 4). In one variant the moulded, relief design of the knobs is comparable; in another the bow moulding bears a transverse S-motif in contrast to the diagonal design on the foot.

Bracelets, supplemented now by ankle-rings, also develop an even more heavily three-dimensional quality, being composed of a ring of hollow-cast hemispheres or ovoids, linked together with narrower moulded bridges. Decoration of the hemispheres includes S-motifs, triskeles and the yin-yang in relief. Among the variant forms of bracelet, Kruta (1975, 80) pointed to one group from eastern Bohemia, together with an example from Brno-Maloměřice in Moravia, which, on metrical as well as stylistic grounds, he argued convincingly were the product of the same workshop. Though not identical, the similarities stylistically between the bracelets from Nehvizdky 1 and Nový Bydžov (Figure 6.1, 6 and 7), for example, certainly support this contention.

Ankle-rings of this series are particularly distinctive, commonly having a hinged opening between their six or eight hollow-cast hemispherical elements. They occur in graves in association with late La Tène 1c brooches and with La Tène 2 types, and must therefore have been in circulation from the later fourth or early third centuries BC. Once again, the similarities between individual examples from Bohemia and Moravia have led to the suggestion that they were the output of specific workshops (Kruta, 1975, 83). The dominant ornamental motifs in bold relief are again based on S-motifs, either single or paired in a chain, and sometimes linked with triskeles or an interlocking yin-yang. The spiral terminals of S-motifs and triskeles invariably are emphasized by a relief boss. Staňkovice grave 2 (Figure 6.1, 8) illustrates these motifs in alternating pairs of ovoid bosses. A relatively rare elaboration of these motifs, illustrated by an example from Hořešovice (Figure 6.1, 9), is a design with four arms, either a double-S or a curving-armed swastika. Very occasionally the designs may alternate, as on an example from Staňkovice, where two versions of a triskele, one simple and tight, the other revolving in looser motion around a fourth, central boss, occupy alternate

hemispherical elements, on which the relief designs are further reinforced with beaded dotting.

Though hollow-cast anklets of this class are especially well represented in Bohemia, there are certainly cognate groups in Moravia and Slovakia, with some outliers further west. The example from Klettham in Bavaria (Figure 6.2A) has six hemispherical elements in four plus two combination (the two forming the opening), each ornamented with a four-sided sub-swastika around a central triskele, the terminals of which are exaggerated into pronounced bosses. Another Bavarian example, from Aholming, has much more angular facetting to its relief ornament than the majority of examples, but nevertheless would qualify as Plastic Style in the Continental definition. The most westerly of the distribution, indeed the only example from west of the Rhine, and undoubtedly an export from Eastern Europe, is the example from the Tarn in south-western France (Figure 6.2B). With eight hollow-cast hemispheres, its ornament alternates between two linked S-motifs on the four smaller hemispheres, with pronounced boss at their junction, and two linked triskeles on the four larger, both with bosses accentuating their terminals. The relief designs rise from a background that has been pecked with a punch, the whole design being outlined with a ribbed border.

A distinctive aspect of the eastern Central European Plastic style ornament is the use of pseudo-filigree and *pastillage*. Pseudo-filigree is the term given to the cast relief ornament of thin wire-like scrolls or rosettes, creating an effect that is similar in superficial appearance, though quite different in technique, to the filigree work of gold and silver smiths, using droplets of precious metals to create a fine applied design. A particularly exotic example is the bracelet from a warrior's grave at Chotin in Slovakia, dating to the beginning of the third century, or on a brooch from Mistřín in Moravia (Figure 6.1, 11). In some cases the effect is not dissimilar to the relief moulding of glass bracelets, which also make their appearance at broadly this time. The technique of pseudo-filigree was used by both Greeks and Etruscans, and doubtless was introduced into Slovakia and Moravia and thence to Bohemia from the south. It is known on a range of bracelets of various types, but is almost unknown outside Bohemia.

The technique described by Kruta as *pastillage* refers to clusters of small, truncated conical discs, most commonly applied to penannular bronze bracelets (Figure 6.1, 10). Its distribution is quite wide across eastern Central Europe, extending from Bohemia and Moravia into Romania and Hungary, including an example from the cemetery at Kosd. Once again, stylistic and metrical similarities have suggested production in specialist workshops, while associations include La Tène 2 brooches, indicating that the currency of the technique continued into the developed stages of the Plastic Style. Bracelets may combine pastillage with pseudo-filigree ornament, the threads of the filigree work snaking around the body of the bracelet and its pastilles. In some cases the pastilles themselves are more like small, globular bosses, resembling droplets of metal in the style of gold or silver smiths. The summit of achievement of this series of Plastic Style ornaments in Bohemia are those that display an open-work structure, often adapted for the purposes of the opening and closing mechanism of the bracelet. Associations of this group include late La Tène 1 and La Tène 2 brooches and hollow-cast anklets, indicating a currency in the second phase of the Bohemian Plastic Style. Kruta argued from associations of an example in the rich grave at Blucina, Moravia, however, that the style may have its origins somewhat earlier.



Figure 6.2 Relief style arm- and ankle-rings. **A:** Klettham, Bavaria. Photo: Archäologische Staatssammlung, Museum für Vor- und Frühgeschichte, Munich. **B:** Tarn, southern France. Musée des Antiquités Nationales. Photo: RMN, Paris © René-Gabriel Ojéda.

A distinctive component of the female grave assemblages of this second phase of the Bohemian Plastic Style is the inclusion of bronze and iron belt-chains. Belt-hooks and attachments are known from the Hallstatt Iron Age, but the latter must have been part of a perishable belt, made, for example, of leather. The Bohemian La Tène belts are more elaborately constructed of plates and rings, linked in a symmetrical series, with the hook itself cast in the shape of an animal's head (Figure 6.1, 5). The belt was fastened by inserting the hook into whichever of the rings in the series afforded the correct tension around the wearer's waist. The penultimate ring and its terminal pendants were suspended from the third plate back from the belt-hook, so that the surplus chain hung ornamentally at the waist. The zoomorphic terminals are typically of two varieties. Both display rather stylized, rounded ears projecting upwards from the hook-end, but one variant has a roundly-modelled muzzle with straight mouth, the other has a simpler muzzle, curving and plain. On some of the more elaborate examples the more visible front plates are embellished with red enamel in *champlevé* settings. The use of enamel is evidently a fashion of the later La Tène in eastern Central Europe, since examples, together with evidence of enamel working itself, have been found from the Bohemian *oppida* horizon. A particularly fine belt-chain, with exceptionally virtually all its plates enamelled, was found at the *oppidum* of Stradonice. This and allied examples from the Carpathian Basin are unlikely to date much earlier than the beginning of the second century BC, and hence represent the later period of currency of Plastic Style ornament.

In Kruta's analysis, the Bohemian Plastic Style comes to an end in the second century BC, its decline being part of a profound social change that sees the rise of the late La Tène *oppida*. He particularly remarked the spatial displacement reflected in the distribution of early La Tène material in the southern highlands and that of the Plastic Style, which occupies the lowlands of the north and north-east, and the fact that the *oppida* are located broadly within the zone of the former rather than the latter. The immediate reason for this is that the Plastic Style artefacts come from the flat grave cemeteries of the north and north-east, whereas the southern highlands are characterized by small tumulus burials, but the distributional contrast is significant nevertheless. Trying to interpret these regional patterns is not easy, and we should certainly avoid simplistic equations based upon historical accounts of population migrations that were fashionable half a century ago. Plainly dynamic processes of interaction, including invasions and mercenary activity, could have been factors in the creation of the artistic achievements of the Bohemian and middle Danubian workshops, and the novel types and styles that characterized their output. But there remain many unresolved questions regarding the relationships between and within those various regional groups, as well as questions regarding their relationship with the Hellenistic and outside world.

The three-dimensional moulded quality of the Plastic Style lends itself particularly well to the casting of zoomorphic heads of animals or birds, a theme in Celtic art that has a long pedigree. Megaw's 'Disney Style', reducing an image to its simple essentials, and exaggerating features such as the eyes, conveys an expression of humour or gloom, benign or malevolent, in much the same way that a cartoonist creates his caricatures. There are few better examples of this than the open-work mounts from the Maloměřice cemetery at Brno in Moravia (Figure 6.3), a find which unfortunately lacks proper context, having been recovered in 1941 during construction work on the site of a flat,

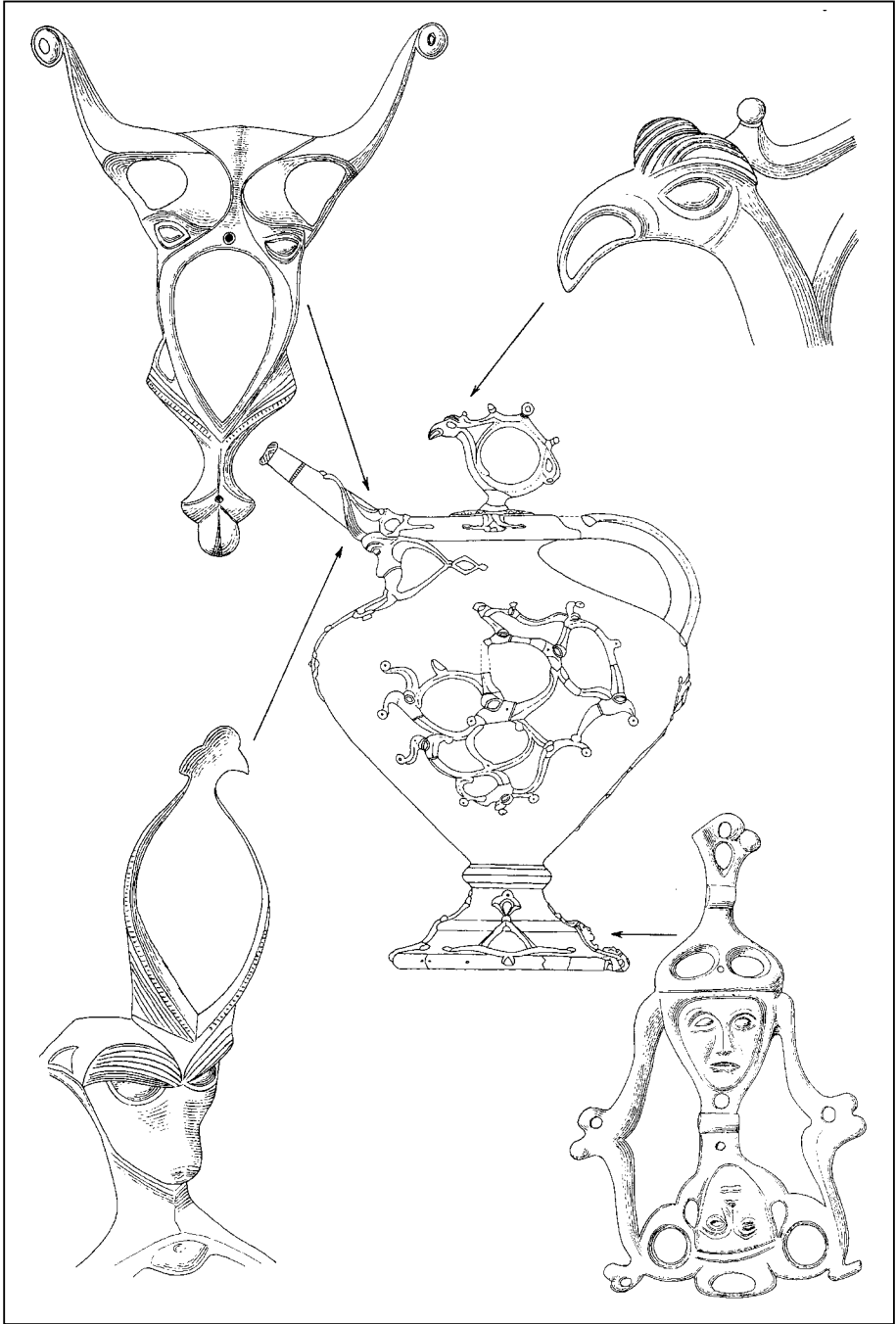

Figure 6.3 Open-work mounts from Brno-Maloměřice, with details enlarged. Adapted from Kruta (2004).

inhumation cemetery of the early to middle La Tène transition. The mounts are generally interpreted as belonging to a wooden spouted flagon, one component seemingly designed to enclose the spout itself, another most probably surmounting the lid, and others perhaps riveted to the body and the pedestal base. The spout element is distinguished by a central bull's head, its sinister expression created by lentoid eyes and heavy, grooved brows above softly-modelled muzzle and nostrils. From its head beaded branches sweep upwards as if to represent horns, more antler-like than bovine. The reverse side of the same piece, facing upwards, depicts a horned beast with gaping jaws, again with sinister lentoid eyes. Both lentoid eyes and ridged brows are reflected in the rendering of the eyes and crown of the griffon or predatory bird that dominates the lid-mount. The ring forms the creature's body and tail, linked to a backward trailing 'crest' adorned with knobbed bosses. The last of these leads into a secondary, reversed bird's head. The largest of the body panels is in many respects archetypal of the Plastic Style, asymmetric yet controlled in its balance, and composed of elements that hint at birds' heads but defy strict definition. The centre appears to embody a multiple-beaked bird, with curving arms swirling in rotation outwards. Particularly noteworthy on a cast mount on the foot of the vase is a pair of human faces in which the depiction of eyes, brows, nose, mouth and even chin is far more naturalistic than is usual in La Tène art hitherto, opposing each other in a composition that Megaw saw as a contrast of 'the sardonic and the genial' (1970a, 108).

A prime example of representation of the human head from the eastern Celtic world, conventionally dated to the third or second century BC, is the marlstone carved head found in 1943 in a pit just outside the *Viereckschanze* at Mšecke Žehrovice in Bohemia (Figure 6.4; Venclová, 1998). The features are depicted in a style reminiscent of earlier La Tène face-masks, though rendered in fuller detail. The lentoid eyes are outlined by eyelids, over which the eyebrows extend sideways to end in a pronounced twirl in the manner of earlier face-masks. Below the stubby nose, a florid moustache is similarly twirled at its ends. The hair is depicted only on the forward edge of the crown, and hence we may infer that, unlike Janus heads of the Heidelberg kind, this sculpture was intended to be viewed only from the front. The hair itself is rendered in a series of deep grooves, reflecting in sculpted form the fringes that were fashionable in earlier representations. The ears, not commonly drawn in Celtic faces, are portrayed as stylized lotuses, again a throw-back to earlier fashions. Around the neck of the head is a buffer-terminalled torc of a kind well known in the archaeological inventory, but insufficient in itself to date the sculpture closely. The appeal to modern, western audiences of the sculpture is perhaps its inadvertent parody of a dyspeptic colonel, with its bulging eyes, square-set jaw and down-turned mouth, and though plainly the analogy is anachronistic, the Celtic artist has undoubtedly once again created an image through the means of selective caricature.

The Mšecke Žehrovice head had been broken into at least five pieces when it was deposited in its pit. It was found together with burned animal bones, scraps of saponite, a piece of iron wire and several sherds of pottery, including graphite-coated wares of the late second or first centuries BC, broadly contemporary with the use of the *Viereckschanze* itself. If this provides us with a *terminus ante quem*, the assumption must be that the head itself was carved and used some time before that, possibly from two or three centuries earlier. Stylistically it is hard to pin-point its likely origin, though the Megaws are surely justified in seeing analogies for the features of the head



Figure 6.4 The stone sculpted head from Mšecké Žehrovice. National Museum, Prague, Department of Prehistory.

in the Early Style rather than later. On the other hand, they rightly observe that torcs in early La Tène seem to come almost exclusively from female burials, and only acquire their warrior associations, so graphically recorded in history and sculpture, with the Celtic migrations. Given the conservatism of some aspects of the arts of the eastern Celtic zone, a dating in the third century BC or thereabouts is not improbable.

The function of the head and the reason for its dispatch deserve consideration. While proximity need not imply association, the possible ritual function of *Viereckschanzen* might warrant speculation that the head had once surmounted a pillar-stone of ritual importance. Stone stele or statues of funerary or ritual function are familiar from the European Iron Age, and may have had more frequent counterparts in timber. At Libenice (Rybová and Soudský, 1962), the focus of ritual of an elongated, rectilinear cult enclosure was evidently a series of pits at one end, from which a pair of bronze torcs was recovered. The excavators suggested the possibility that here had stood a timber totem that may have been adorned with torcs as a symbol of deity, parallel to that depicted on the Mšecké Žehrovice sculpture. Perhaps the breaking of the latter represented a ritual act itself, a symbolic breach with the past and its spiritual order.

South-East Europe and Hellenistic influences

In various parts of South-Eastern Europe, extending into Greece and Asia Minor, finds have been made of archaeological material, including grave-goods, of La Tène type, that inevitably have been interpreted as evidence for the historically documented invasions of Celts into those regions in the third century BC. In Romania, one such burial, combining Hellenistic with 'Celtic' types, was the third-century warrior's grave at Țiumești, in the district of Maramureș near the border with Ukraine. The rite was apparently cremation, which in the adjacent cemetery outnumbered inhumations. Principal among the grave-goods was an iron helmet of eastern Celtic type with cheek-pieces, to which had been added a magnificent crest in the form of a bronze bird of prey, of which the wings are hinged to the body in order to allow them to move (Figure 6.5). The warrior's equipment also included a socketed spear, a pair of Hellenistic greaves and a suit of chain mail, to which had been attached a small bronze disc with a relief triskele as its central design and S-motifs arranged in a series of symmetrical panels around its edge.

Further south, near the Bulgarian border with Turkey, the burial at Mezek affords an even more striking confrontation of Celtic and Thracian traditions. Apparently inserted as a secondary deposit in a Thracian *tholos* tomb were the remains of a Celtic chariot burial. The primary burials were undoubtedly of the local Thracian aristocracy of the fourth century BC, but inserted into the tomb in the third century was a burial accompanied by the fittings of a chariot, including ornamented La Tène-type rein-rings and lynch-pins. One bronze-covered iron terret is embellished with a pair of goggle-eyed birds of prey overspreading a pair of faces entwined with S-motifs, all rendered in an unmistakably western 'Disney Style'. Several other attachments bear simplified versions on the same theme. A bronze and iron lynch-pin is ornamented with a series of bosses and meandering S-motifs to give the impression of a 'Disney' style face, comparable to a series known from the same period in Western Europe. A group



Figure 6.5 Helmet with bird-crest, Çiumești, Romania. Photo: National Historical Museum of Romania, Bucharest.

of gold beads had presumably once formed a necklace, the form of which Jacobsthal believed would have been the equivalent of the type of gold torc represented at Gašić in Serbia, dating from the later third or second century BC. This piece has frequently been compared to examples from south-western France from the Toulouse region and it may even have been derived from Western European workshops. But its ornamentation is simpler than some of the latter, being a series of relief elements of sub-floral design arranged repetitively around the entire circumference, very like one of the gold torcs from Fenouillet in the Haute-Garonne (Jacobsthal, 1944, no. 62). The west-east associations invite the conclusion that this was the burial of a marauding Celtic warrior, or a mercenary in a foreign land. Just conceivably it could have been the product of a diplomatic gift borne to the grave by its Thracian recipient, but the traditional explanation will probably continue to carry greater conviction.

A find that has been treated as the ultimate demonstration archaeologically of the historically documented invasions of Greece and Asia Minor is the discovery of hollow-cast anklets of La Tène type in a well at Corinth, apparently part of a votive deposit, the associated ceramics with which were dated not later than 300 BC. The anklets were of the plain variety with eight hollow hemispheres, two within the opening sector. As we have seen, they are particularly characteristic of Bohemia, Moravia and Slovakia,

with some examples in Bavaria and the west, but with few finds south of the lower Danube. Associations in Central Europe, as at Andelfingen in Switzerland, and at the Steinbichel and Hunderingen cemeteries at Manching, place them in the transition from La Tène B to La Tène C.

In view of the undoubted interaction between the La Tène Celtic world and South-Eastern Europe from the third century at least, it would hardly be surprising to find evidence of Hellenistic influence, or the influence of Thracian and Dacian styles in works of Celtic craftsmanship, or even imports from these regions. Just such may be the great silver ring from Trichtingen, near Stuttgart (Figure 6.6). Silver is not the prime medium of high-status craftsmanship in the Celtic world, though it is characteristic of Thracian and Dacian metal-working. Likewise, while the torc is certainly a Celtic icon, the use of animal heads as terminals is again alien to Celtic tradition, being more commonly featured in Achaemenid art. The bull's head terminals display more detail than is normal on the simpler moulded heads of the Plastic Style, though the melancholy expressions of the beasts would not be out of keeping with Celtic taste. Both are depicted wearing twisted buffer torcs of La Tène type, but the intricate ornamentation of the body of the torc itself is unlike Celtic ornament. The weight of the torc – more than 6kg – is often remarked, not because of the intrinsic value of the piece (much of the weight is in its iron core) but because it could hardly have been worn, even for ceremonial occasions, and has thus been supposed to have adorned a statue or wooden totem. Its combination of traits, Celtic and foreign, makes it a product of the long-distance connections exploited by the Celts from the later fourth century, and evidence for their clear attraction to the exotic themes and orientalizing styles.

In less spectacular but more regular fashion, reciprocal influence from the Hellenistic world can be seen in the pottery vessels with high, paired handles from cemeteries extending through the middle Danube from South-East Europe to the Carpathian Basin, which bear a clear resemblance to Hellenistic *kantharoi* (Kruta and Szabó, 1982). In seeking a model for the Danubian potters, however, Szabó has pointed out that the only actual Greek imports into this region are bronze *kantharoi* like that from the cemetery at Szob in Hungary, datable to the third century BC. Among exotic imports, one of the most prestigious is the drinking-horn with its terminal in the shape of a sea-serpent from a cremation burial at Jászberény-Cseröhalom in Hungary, possibly a gift or trophy in the possession of a Celtic warrior from exploits in Thrace. Quite evidently, however, this region of South-Eastern Europe in the third century was a cultural melting-pot of various influences, including some from regions further east. A striking example is afforded by Szabó's Hungarian comparison (1992, 177) of the bronze deer with turned-back head from Rákos with the incised representation of a deer in similar pose being attacked by voracious predators on the pottery vessel from Lăbatlan, the former being a modelling in the Plastic Style of an animal drawn from the artistic iconography of the Steppes.

The related styles of Western Europe

As in the eastern Celtic world, the appearance of Plastic Style ornamentation in Europe west of the Rhine was not coincident with cultural innovation on a broad range. Both in terms of relief ornament and in terms of the motifs deployed, the Plastic Style was

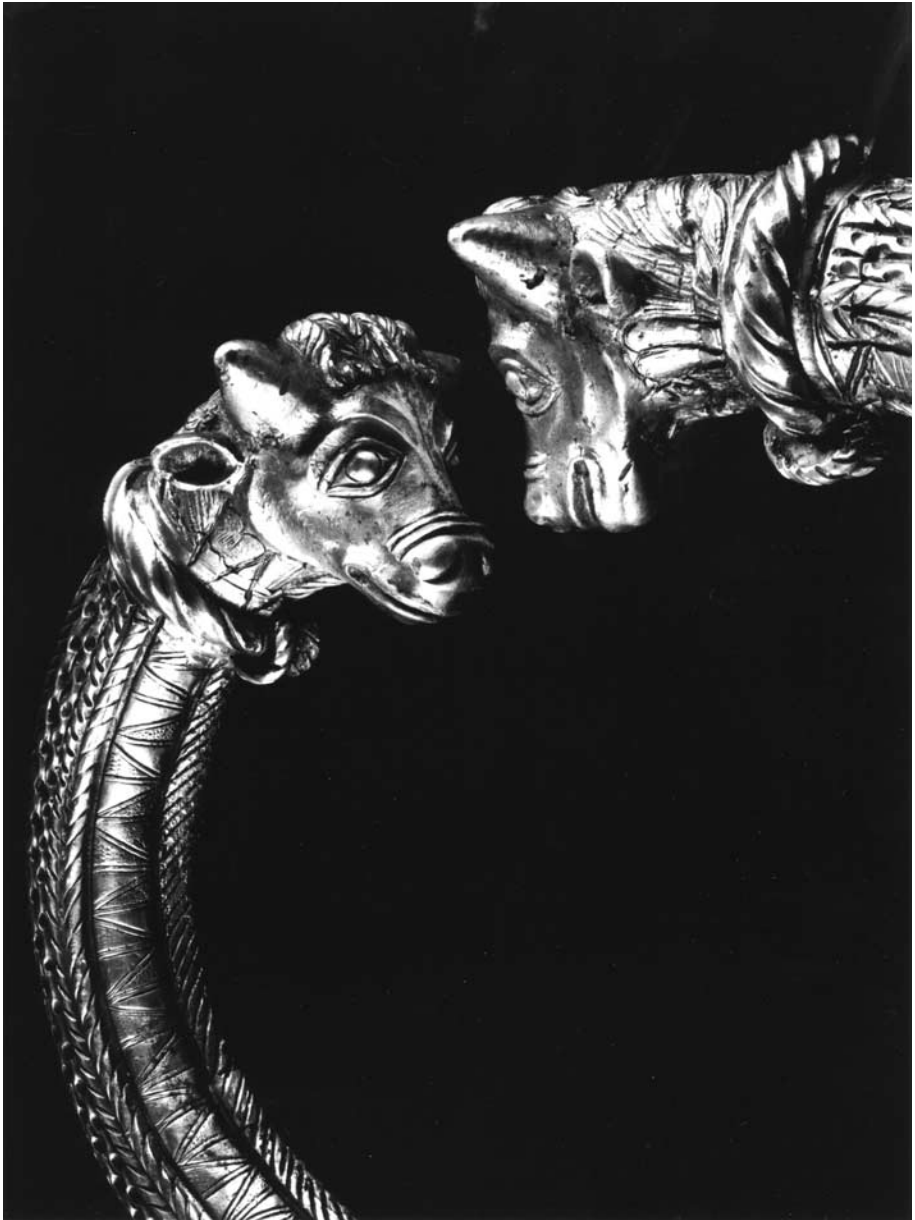

Figure 6.6 Silver ring with bull's head terminals, Trichtingen. Photo: Württembergisches Landesmuseum Stuttgart; P. Frankenstein, H. Zwietasch.

essentially a development and intensification of three-dimensional styles that had already made their appearance in the preceding Waldalgesheim or Free Vegetal Style. The types on which the ornament is displayed, notably torcs, bracelets and brooches, were also types fashionable in the preceding period, as we have seen, and the cemetery contexts from which they are derived frequently show continuity from the closing stages of the early La Tène through into the middle La Tène phase with no obvious break in funerary tradition. As regards the wealthier graves, after a relative decline in fashion for chariot burial in the fourth century, and despite a re-appearance in the third, the standard mode of burial at the end of the fourth century and into the third is in flat graves, sometimes within a square ditched enclosure. Progressively cremation is adopted as the principal funerary rite from middle La Tène, becoming dominant in the late La Tène phase.

The classification of the later Iron Age in Central and Western Europe has been a matter of debate since the pioneering schemes of Reinecke, Déchelette and Viollier in the early twentieth century. In general, the early La Tène is well documented on account of the innumerable cemeteries with grave associations that have permitted the development of detailed typological seriation. At the end of the sequence, major *oppida* have likewise provided a range of diagnostic or distinctive types that can confidently be assigned to the late La Tène or early Roman Iron Age. The middle La Tène phase, on the other hand, has suffered from a lack of definition, exacerbated by the fact that some of its ornamental types, such as bracelets and brooches, and to some degree its pottery, can be seen as developments out of earlier phases, while others are evidently antecedent to those of the era of the *oppida*. Even simple rules of thumb, like the fact that La Tène 2 brooches diagnostically have their foot attached to the bow, are sometimes less than definitive in application. Examples of the immediately preceding phase can have their unattached feet extended well up the bow, as if in anticipation of attachment, and both types otherwise can share the feature of an enlarged knob on the foot decorated in the Plastic Style. The problem is not that certain features should not be regarded as diagnostic, but that diagnostic changes need not have occurred all at the same time, and in general do not.

In the Champagne, the sequence from La Tène Ancienne III into La Tène Moyenne is well exemplified in the relatively small cemetery at La Barbière, Villeseneux, in the Marne (Favret, 1950; Roualet and Kruta, 1980; Duval and Heude, 1984, nos 67–9; Hatt and Roualet, 1977, Pl. XI, XII). Likewise in south-western Germany the cemetery at Nebringen (Megaw, 1970a, 146), assigned to Reinecke's La Tène B and dating from the fourth into the third century BC, includes torcs with coral and red glass ('enamel') inlay in association with brooches of the latest La Tène 1 types, dating to the earlier third century (La Tène B2 in Reinecke's scheme, La Tène Ancienne IIIa in that of Hatt and Roualet). This form of torc, also represented at Andelfingen (Megaw, 1970a, 148), develops Waldalgesheim themes, but does not yet wholly qualify as Plastic Style. It demonstrates nicely the limitations of rigid schemes of classification.

One class of bracelet on which the Plastic Style is manifest in a form that goes beyond any development out of earlier fashions is exemplified by an example from Semeuse in the Ardennes. This penannular bracelet has buffer terminals ornamented with S-motifs in the customary fashion, but flanking the terminals on either side are seven raised mouldings, alternating one lower and one higher, of which the latter

expand to more than twice the width of the bracelet core. A similar high baroque style characterizes a bracelet from Ménil-Annelles, ascribed to La Tène Moyenne (Hatt and Roualet, 1977, Pl. XV). These mouldings, which sometimes appear to test the limits of the craftsmen's capacity with the *cire perdue* technique, are the clearest expression of Jacobsthal's principle that the flesh and the decoration are indissoluble. Here the ornamentation actually shapes the asymmetric form of the high-relief mouldings. In the classic examples from Ripont (Duval, 1977, Fig. III) and Bussy-le-Château, Marne, the mouldings are more formally based on a series of S-motifs.

Cast chariot parts, lynch-pins, hub-attachments, terrets and other fixtures, from the Champagne and neighbouring regions are richly embellished in the 'Disney' style. Several pieces of uncertain provenance, now in the National Museum at Saint-Germain-en-Laye, Paris (Figure 6.7A), but quite possibly originally from chariot-burials in the Champagne, incorporate extravagant faces with lentoid or bulging eyes, S-curving eyebrows and bossed features in a style very similar to the pieces from Mezek discussed above. A rein-ring or similar harness fitting from Attichy, Oise (Duval and Blanchet, 1974), included the face of a beast with pronounced, moulded features with muzzle and snout not unlike some of the eastern zoomorphic belt-hooks. A more exotic face in the same style as the 'Paris' lynch-pins from a chariot burial at 'La Courte', Hainaut, Belgium, appears more sinister through the combination of lentoid eyes and the heavy, ridged eyebrows that we have already seen at Maloméřice. This exotic, even bizarre rendering of the 'Disney Style' continues into the second century in the pair of lynch-pins from Manching, Bavaria (Figure 6.7B), the curved beaks and heavy eyebrows but rounded eyes conveying a mixture of malevolence and bewilderment. It would be easy to make anachronistic inferences from such pieces, but at the same time we should not discount the Celtic artist's sense of mischief or the comical.

Northern Europe: long-distance influences

That prestige goods ornamented in the La Tène style penetrated beyond the Celtic world into the Germanic regions of Northern Europe was uniquely demonstrated by the discovery in 1952, in a pit under a stone cairn at Brå in east Jutland, of the remains of a magnificent communal cauldron (Klindt-Jensen, 1953). The fragmentary remains had been deposited under a pair of boulders with a large, iron socketed axe but otherwise with no associated artefacts, and no evidence of a burial. The cauldron had been of beaten bronze, with massive attachments for handles made of bronze-plated iron, and rim likewise of iron. A globular vessel of this form, with rim diameter in the order of one metre, has been estimated as having a capacity of 600 litres, so that its function was undoubtedly communal and probably ceremonial or ritual. The cauldron was suspended by three ring-handles, on either side of which, facing outward, were similar but not identical 'Disney Style' bull's heads (Figure 6.8A). Facing inwards from the handle-mounts were attachments in the shape of owl's heads (Figure 6.8B). The contrast in mood between the two groups could not be greater. The bulls are depicted as benign, their wide, rounded eyes firmly outlined by thin, raised mouldings. The muzzle is softly modelled, and the mouths are very slightly open beneath rounded nostrils. Between the upturned horns what Klindt-Jensen called 'cow-licks' are neatly portrayed in the same grooved technique that had characterized the eyebrows of the Maloméřice bull or the Manching lynch-pins. By contrast, the owl's heads are mean and menacing,



Figure 6.7 Rein-rings and linch-pins with face-images in relief. **A:** 1, rein-ring, 'Paris'. Musée des Antiquités Nationales. Photo: RMN, Paris © Gérard Blot; 2, linch-pin, 'Paris'. Musée des Antiquités Nationales. Photo: RMN, Paris © Georges Poncet. **B:** Manching, Bavaria. Photo: Archäologische Staatssammlung, Museum für Vor- und Frühgeschichte, Munich.

with lentoid eyes, heavily-hooded eye-lids and pronounced 'bags' beneath the eyes. The owl's heads have crests depicted in the same grooved style, again rather like the Maloměřice griffon, from the back of which extend a low-relief tendril design, sub-Waldalgesheim in origin perhaps, but itself executed in a manner closer to the curvilinear motifs of the Plastic Style. Whatever the mechanism of transmission, the bull protomes and owls from Bră would most easily have been the product of an eastern Central European workshop of the third century BC.

Actual imports of plainly Central European Iron Age types are relatively few in Northern Europe, though there is abundant evidence for cultural contacts from Hallstatt through to middle and later La Tène times. The Elbe river and the Oder to the east afforded natural arteries from Central Europe to the north German

A



B



Figure 6.8 Bull's (A) and owl's (B) heads from the Brå cauldron. Photos: Moesgård Museum.

plain, and in Holstein and Hannover there is a range of metal and ceramic forms which Klindt-Jensen and others described as Celto-Germanic. In the Danish peninsula, however, almost invariably for the La Tène period those influences are seen on types that are unquestionably of local manufacture. Shield-bosses from Hjortspring, and a handful of torcs, brooches and belt-fittings display some similarities to Central European forms or styles, but the nature of the connections they imply, and the date of transmission are notoriously hard to evaluate. Ball-torcs afford a classic illustration of the dilemma. A wholly local type in their basic design, their enlarged ball terminals bear simple designs that must be borrowed directly from the Plastic Style of Celtic Europe. An example from Tømmerup (Klindt-Jensen, 1953, Pl. XII, a) is decorated with bossed spirals, while another from Gammelborg, Møen (Klindt-Jensen, 1953, Pl. XI, bottom right, Pl. XII, c), has relief triskeles on its ball terminals. Broadly assigned to the second century BC, Danish examples are found principally in bogs, presumably as votive deposits, whereas significant numbers have been found in central Sweden in the context of graves.

In the light of the mobility and interaction between Eastern and Western European communities and their neighbours in the middle La Tène period implicit in the historical record, it would be surprising had there not been far-reaching contacts of some sort with Northern Europe at the same time, even if classical historians were not on hand to record such events. By the close of the second century they were only too well aware of the reciprocal movement of tribes from the north, Cimbri and Teutones from the Danish peninsula, whose impact on the trans-alpine and cisalpine world was abrupt and violent.

Britain and Ireland

It would be plainly misleading to argue that Britain and Ireland were exempt from the wider European trend towards the three-dimensional relief styles fashionable from the beginning of the middle La Tène, though the identification of individual pieces as Plastic Style in any formal sense might be difficult. A substantial body of the British material, including the great works of parade armour, are in a very real sense 'plastic', though their construction often entails techniques that are different from those employed in Central or Western Europe. Perhaps the most obvious example from the British series of parade armour that displays elements analogous to the European Plastic Style is the mask-shield from Wandsworth (Figure 6.9), the rendering of the glum faces of which prompted Jope (1976) to look to Western European models, like the unprovenanced rein-ring 'from Paris'. There are nevertheless occasional pieces, like the brooch from Balloch Hill, Argyll (Figure 6.10, 10), the upstanding and lateral bosses of which are plainly in the Continental Plastic Style tradition, as Hawkes recognized (Hull and Hawkes, 1987, 150). Liberating the evaluation of this and other brooches from the conventional belief that the casting of the foot in one piece with the bow was exclusively a La Tène 3 feature, he was able to assign the Balloch brooch to the third century BC. A similar case for direct influence of the Continental Plastic Style on native Irish workshops could be made on the basis of several of the unprovenanced 'pendants' cited by Raftery (1984, Fig. 32, 3, 4; Fig. 35, 13, 14), and the case could be applied with equal force to the ring-headed pins of his Type 2 (1984, Fig. 85, 1-6), with their combination of relief bosses and simple or chained S-motifs.

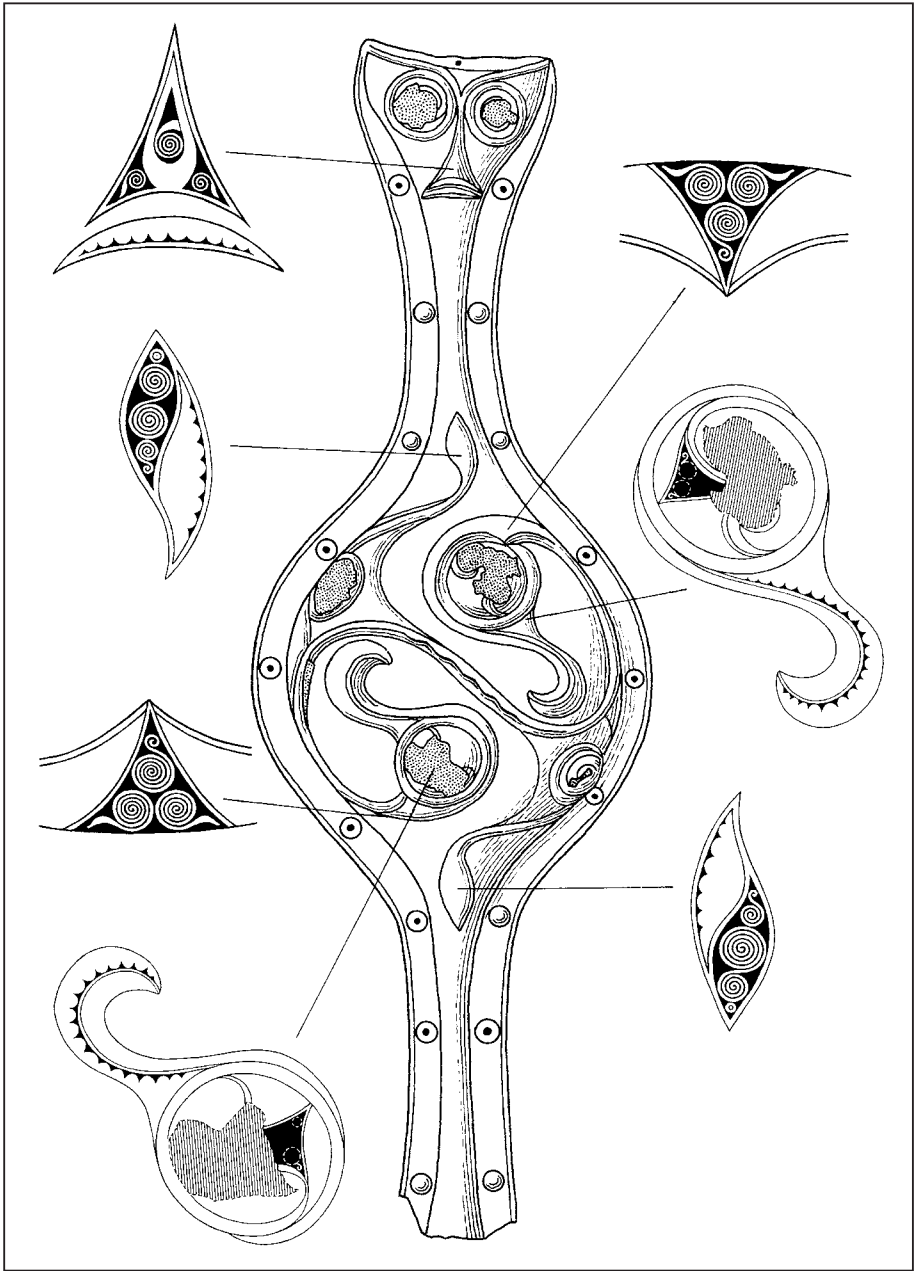

Figure 6.9 The Wandsworth 'face-mask' shield. Adapted from Brailsford (1975a).

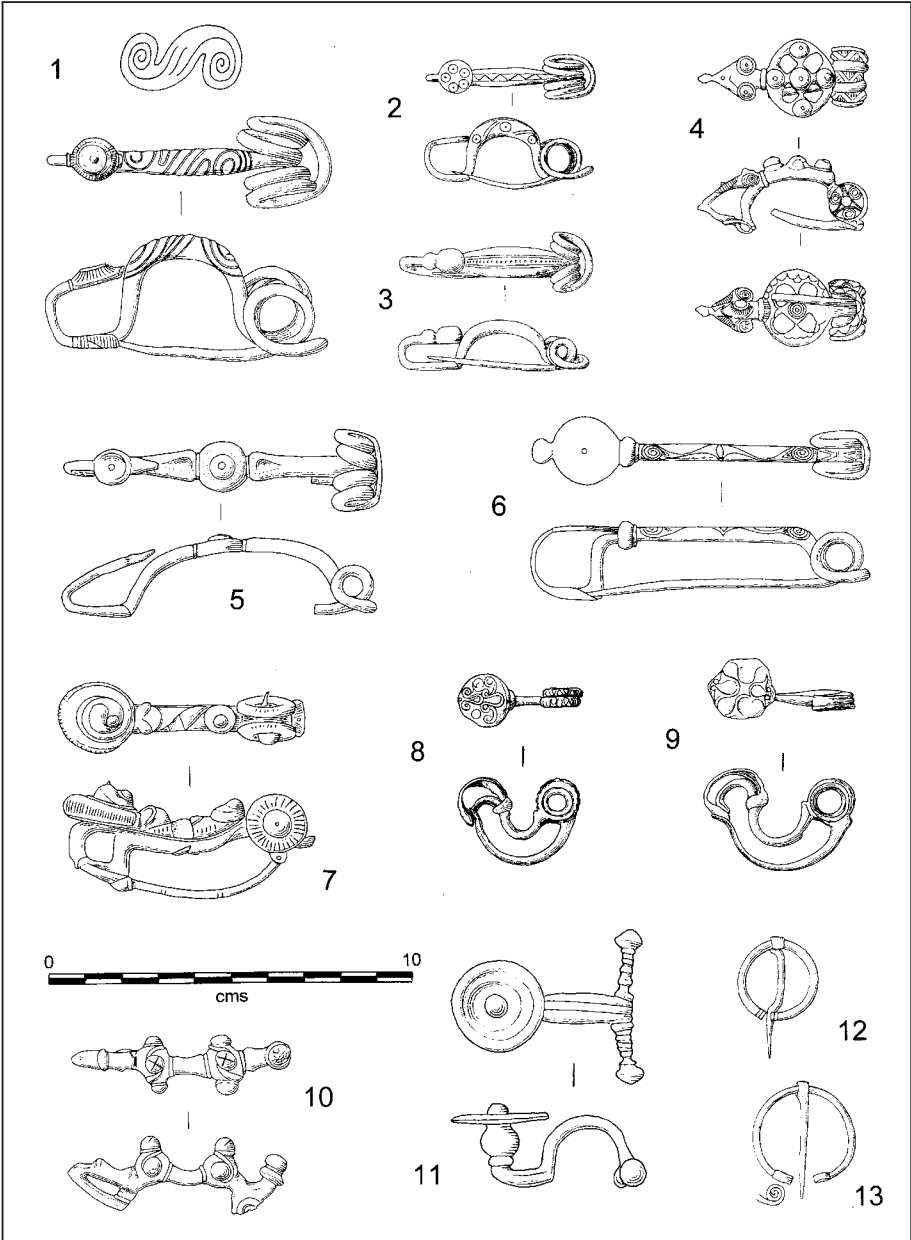

Figure 6.10 British Iron Age brooches. 1, Box, Wilts; 2, Woodeaton, Oxfordshire; 3, Blandford, Dorset; 4, Newnham Croft, Cambridgeshire; 5, Mill Hill, Deal, Kent; 6, Sawdon, Yorkshire; 7, Danes Graves, Yorkshire; 8, Woodeaton, Oxfordshire; 9, Beckley, Oxfordshire; 10, Balloch Hill, Argyll; 11, Harlyn Bay, Cornwall; 12–13, Maiden Castle, Dorset; 2, 8, 9 drawn from originals in Ashmolean Museum, Oxford; remainder adapted from Hull and Hawkes (1987), Fox (1958) and Jope (2000).

Most commentators have been reluctant to apply the term 'Plastic Style' to these or other insular pieces, recognizing that insular La Tène art, British or Irish, has its own independent expression, which will be the subject of more detailed study in later chapters.

Conclusion

From most surveys of the evidence it is apparent that the Plastic Styles are conventionally associated with the historically attested expansion of Celts, especially into South-Eastern Europe, in much the same way that the Waldalgesheim or Vegetal Style was seen as the archaeological manifestation of a Celtic presence in Italy a generation or two earlier. It is not our purpose here to deny such possible correlations, merely to suggest that there could be a number of other factors that might be involved. We must ask, as with Italy and Waldalgesheim La Tène, would anyone believe that the limited distribution of La Tène artefacts in South-Eastern Europe was the product of invasion without historical corroboration? The expansion of La Tène culture into eastern Central Europe is a rather different matter, since it is substantially documented by the evidence of settlements and cemeteries as well as material artefacts. Long-distance links are certainly evident from the archaeological distribution. But not only are there grounds for believing that transmission was east–west as well as west–east, there were also links with the north that require explanation, for which no classical historians were on hand to furnish us with a ready-made interpretation. As with the Gaulish invasion of Italy, so the Cimbric and Teutonic invasions of the late second century were in all probability only the historically recorded tip of a very much deeper iceberg.

INSULAR BRITISH ART TO THE ROMAN CONQUEST

Beginnings of the La Tène ornamental style

In the older traditional framework represented by Jacobsthal and de Navarro (1952) insular Celtic art would have been expected to reflect the Continental sequence of styles, albeit in diluted form appropriate to its peripheral position in Europe. In reality, while insular La Tène styles may indeed display characteristics analogous to Continental fashions, relatively few objects can be regarded as actual imports, and the parade armour and prestige products of the middle to late pre-Roman Iron Age in particular testify to the independence and quality of the insular artistic tradition. The absence from Britain of an Early Style manifesting itself in the translation of classical or Etruscan plant friezes or motifs in the manner of the middle Rhine or Champagne does not mean that it cannot be represented by other aspects of Early Style art, including compass-drawn geometric and open-work techniques not unlike those of Continental Europe. The 'Developed Styles', Waldalgesheim or Vegetal, are likewise sparsely represented in insular art, though we have remarked examples like the Standlake scabbard that reflect quite closely Continental fashions of the fourth century. Thereafter, there are also regional traditions in Britain and Ireland of embellishing sword scabbards with engraved ornament that should certainly be seen as cognate to those of Central and Eastern Europe, occasionally suggesting long-distance contacts among technicians and artists. Equally the concept of 'plastic' or three-dimensional relief ornament is fundamental to insular metal-working of the later pre-Roman Iron Age, though few examples accord closely to the Continental Plastic Style. In sum, insular La Tène art developed independently from, parallel to and doubtless occasionally in contact with and drawing influences from, its Continental neighbours.

In marked contrast to Continental Europe, Britain and Ireland in the Iron Age, with some notable regional exceptions, lack distinctive and recurrent burial rites to provide a context and associations for the metal-work upon which craftsmen lavished their artistic skills. In consequence, dating of insular La Tène art remains dependent almost entirely upon stylistic and typological considerations. In the late pre-Roman period between Augustus and Claudius in south-eastern England, contacts with the Roman world are archaeologically well attested by the inclusion of imports in high-status burials, here providing a datable funerary context that is lacking for earlier periods. Metal-work of the Torrs–Witham–Wandsworth series is generally agreed as preceding this late phase, but hardly earlier than the mid-third century BC, a date that derives ultimately from Hawkes' (1931) 'Marnian invasion' horizon. Long since

released from this constraint, there is no reason to assume that insular art should have been chronologically retarded, rather than broadly coincident with Continental developments.

A second factor influencing the dating of insular La Tène art was the notion of 'time lag', by which it was assumed that 'mainstream' Continental fashions took several generations to make their impact on insular cultures, and still longer to penetrate into 'peripheral' Highland Britain. As an adjunct to the diffusionist model, this precept meant that any stylistic innovation in Britain must have been later than its currency on the Continent, and in Northern Britain was secondary to Southern Britain. The principle was embodied in Sir Cyril Fox's classic dictum that in the Lowland Zone new cultures are *imposed*, in the Highland Zone new cultures are *absorbed* (1938, 34). The model, of course, took no account of local initiative as a factor in culture change, still less of reciprocal movement of ideas, and though it would now be regarded as very dated by archaeologists generally, it still seems implicit in Celtic art studies.

For most commentators, therefore, 300 BC still seems to be a watershed for the inception of insular La Tène art, and therefore of Celtic art. It is true that Continental Hallstatt culture appears to have made a relatively slight impact on Britain, and the limited number of Hallstatt types are not well authenticated in terms of archaeological provenance. Daggers of late Hallstatt type continue into early La Tène, and long swords of early La Tène type, exemplified notably at Standlake, are few in number and apparently made a relatively late appearance in Britain. Among early (Viollier 1a) type brooches, those characterized by a high-arched bow and high foot parallel to the catch-plate, sometimes designated the Marzabotto type, and assigned to the earliest La Tène phase Ia at Münsingen, few, if any, in Britain are likely to be actual imports. Hawkes (Hull and Hawkes, 1987) saw them in Britain as dating from the mid-fifth century, though possibly extending for an indeterminate period into the fourth. One example from Hunsbury, Northants, with paired S-motifs in sequence on its bow, he assigned to this early phase. Several other high-arched brooches, including one from Box, Wiltshire (Figure 6.10, 1) and one from Woodeaton, Oxfordshire (Figure 6.10, 2), in varying degree show a tendency towards the curvilinear style normally associated with the developed phases of early La Tène art, so that we should infer that this brooch type persisted in use into and probably throughout the fourth century BC. Among these, the design of the Woodeaton brooch is the crudest, being composed of a series of circlets with central dot, as if compass-drawn, linked by parallel lines, to simulate an S-scroll in extremely rigid and schematic fashion. A similar mechanical design is used on a pottery bowl from Blewburton Hill (Harding, 1972, Pl. 58, G). It could belong to an earlier, late fifth-century horizon. Taken together with the Minster Ditch scabbard, they do suggest a local dependence upon strict compass-work rather than free-hand experimentation. The S-scroll on the Box brooch, on the other hand, has a swelling leaf fleshiness that characterizes the Waldalgesheim Style, and could be later in the fourth century accordingly.

The stylistic characteristics and affinities of the Yorkshire series of engraved scabbards have been discussed in an earlier chapter. Their archaeological context and their material associations, however, remain to be considered. In contrast to the marked absence of a regular and distinctive burial rite throughout much of Britain before the first century BC, the Arras culture cemeteries of eastern Yorkshire (Stead, 1965, 1979, 1991a), named after one of the sites investigated in the nineteenth century,

are remarkable in the apparent resemblance of their mortuary ritual to practices that distinguish the early La Tène cemeteries of the Champagne region of north-eastern France. The minority of high-status burials include in the interment a two-wheeled cart or chariot, while a much greater proportion of burials was enclosed by distinctive square-ditched barrows. A small number, originally thought to be a separate subgroup, but now recognized as part of the Arras phenomenon, was accompanied by weapons.

For much of the twentieth century, understanding of the Arras culture was necessarily based upon old and not altogether reliable excavation data, until in 1971 the discovery of a cart-burial at Garton Slack triggered a renewed phase of field investigation that successively led to the recovery of a series of cart-burials at Wetwang Slack, Garton Station and Kirkburn. In the meantime, excavations at Rudston and Burton Fleming (Stead, 1976) had contributed substantially to a new appreciation of the square-ditched cemeteries and their mortuary practices. At Burton Fleming, there were two distinct groups, one comprising crouched or contracted inhumations with a predominantly north-south orientation, the other extended or flexed inhumations oriented east-west. Each group respected the graves of the other, and there was no conclusive evidence that either one was earlier than the other. Male and female burials featured in both, and children were rare in either. It would be tempting to see these two rites as indicative of separate population groups, but there is no basis from associated artefacts for making such an inference. Indeed, the chariot-burials themselves diverge in two important respects from their supposed Continental antecedents. In the Champagne, the funerary rite is extended inhumation, and the vehicle is accommodated whole into the burial chamber; in the Arras group, the rite is crouched inhumation, and the cart is almost invariably dismantled, with the wheels laid horizontally across the burial. Some divergence in practice as a result of the settlement in new lands of a cadet group might be expected, but it remains the case that no specific region can be cited in north-eastern France or Belgium as an archaeologically convincing homeland for the Arras settlers. Further uncertainty is generated by the lack of obvious imports among the associated grave-goods of the Arras burials. Brooches and bracelets in general may reflect Continental forms, but like the weapons and their ornamented scabbards, they are insular products following independent insular fashions. The pottery from the Arras culture burials is unsophisticated in the extreme, bearing little resemblance to any of the wares produced in Champagne.

Finally, there is the vexed question of dating. While chariot-burial continues in the Ardennes at least into middle La Tène, changes in Continental material associations, notably in brooch and horse-bit typology, suggest that the introduction of the new cemetery rites into eastern Yorkshire must have occurred in the early La Tène phase, by the early fourth century if not earlier, before such changes took place in the homeland. Yet most of the material assemblages of the Yorkshire cemeteries date from the third or even second centuries BC. Some early brooches, of the high-arched variety from Cowlam and Burton Fleming, for example, point tantalizingly to earlier origins, and the more recent series of decorated scabbards with their essentially La Tène 1 types of chape equally hint at earlier beginnings. But the fact remains that the Arras culture falls short of what might have been expected from wholesale settlement of an immigrant population.

From the fourth century, brooch-makers in Britain seem to have experimented with

new technical devices and ornamental embellishments. La Tène 2 brooches analogous to Continental types are known in Britain, but are actually very few in number. Native variants, however, abound, including the flat-bowed variety, as at Sawdon in Yorkshire, developed out of the flat-bowed La Tène 1c form, but with foot parallel to catch-plate and joined with a moulding to the back of the bow (Figure 6.10, 6). The Sawdon example also displays a characteristically enlarged discoidal foot-plate, though in this instance the ornamentation, a simple curvilinear design ending in tight, hair-spring spirals, is confined to the bow. The Sawdon brooch also displays another technical innovation of the British craftsman, the hinged pin replacing the coiled spring-mechanism. Yet the Sawdon brooch makes a concession to conservatism by obscuring the hinge behind a skeuomorphic spring. From this brooch form, the development of the involuted brooch (Figure 6.10, 8 and 9) was an easy step. Bending the flat bow into a deep U-shape and elongating the pin as the bow is shortened creates the involuted form, the hinge-mechanism, catch-plate and ornamental foot-disc remaining relatively as they were. A further innovation was the penannular brooch (Figure 6.10, 11 and 12), a type known in the Hispanic peninsula, but otherwise not characteristic of La Tène Europe. Both these types appear to have been introduced around the third century BC, though they remained fashionable for some time, in the case of the penannular form developing into lavish and high-status symbols of the early Christian era.

Torrs and its affinities

This period of innovation and experimentation culminated by the third century in the mature phase of insular Celtic art, and the production of a number of high-status pieces of parade armour and related ceremonial or symbolic metal-work. Foremost in this group are the Torrs pony-cap and horns, the Witham shield and the Wandsworth circular shield boss, all of which display a combination of *repoussé* relief ornament and engraved, two-dimensional designs, and which have generally been regarded since Piggott and Atkinson's study (Atkinson and Piggott, 1955) as products of an integrated eastern English tradition or 'school' of prestige metal-work. The assumption that south-west Scotland was an unlikely place of manufacture for the Torrs ensemble is certainly open to challenge, and its stylistic affinities with Northern Irish material allows the possibility of an Irish-Scottish axis instead (Harding, 2002). Given that major prestige products often enjoyed a long life, we might question whether the engraved and *repoussé* styles were necessarily both part of the original design, or whether the engraved elements were later additions (in the case of Witham and Wandsworth it cannot have been vice versa). In view of the broad co-existence of Sword Style engraving and Plastic Style in Continental Europe, however, there seems no reason to deny their contemporary use in Britain. But we may speculate whether they were the product of the same craftsmen, and whether any special significance attached to these distinctive forms of artistic symbolism.

The function of the Torrs cap and horns (Figure 7.1) has still not been resolved beyond dispute. They were apparently already associated by 1829, when they came into the possession of Sir Walter Scott, though the attachment of the horns in their present position is apparently modern. One argument for regarding horns and cap as a set is that the latter have small repairs bearing engraved ornament in the general style of the former, though detailed examination has yet to show that the engraving was by

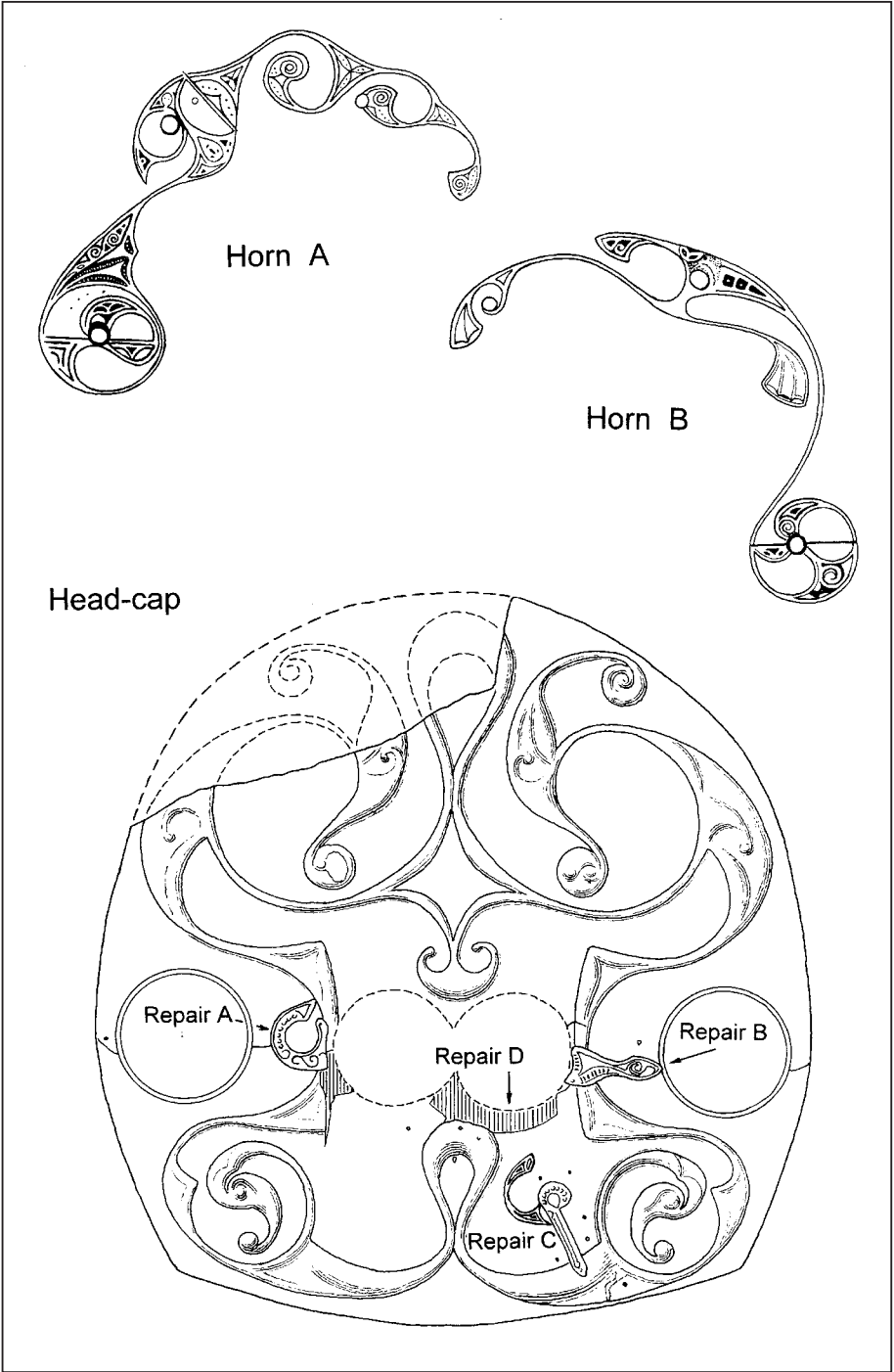

Figure 7.1 Engraved and relief ornament of Torrs horns and pony-cap. Adapted from Atkinson and Piggott (1955).



Plate 1 Later Bronze Age ceremonial 'hats'. L to R, Avanton (Musée des Antiquités Nationales, Paris); Schifferstadt (Historisches Museum der Pfalz, Speyer); Etzelsdorf-Buch (Germanisches Nationalmuseum Nürnberg); uncertain, probably S. Germany (Museum für Vor und Frühgeschichte, Staatliche Museen zu Berlin). Copyright Historisches Museum der Pfalz, Speyer (Jahr). Photo: Peter Haag-Kirchner.



Plate 2a The Dresden-Dobritz hoard (Dresden-Laubegast hoard 5). Photo: Landesmuseum für Vorgeschichte, Dresden, copyright Landesamt für Archäologie Sachsen.



Plate 2b Open-work gold of Schwarzenbach bowl. Photo copyright Stiftung Preussischer Kulturbesitz, Berlin.



Plate 3 The Klein Aspergie grave-group. Photo: Württembergisches Landesmuseum, Stuttgart; P. Frankenstein, H. Zwietsch.



Plate 4a The Glauberg gold torc. Photo: Hessische Landesmuseum, Darmstadt.



Plate 4b The Glauberg flagon: detail of lid. Photo: Hessische Landesmuseum, Darmstadt.



Plate 5a The Rodenbach arm-ring. Copyright Historisches Museum der Pfalz, Speyer (Jahr), Photo: Kurt Diehl.



Plate 5b The Waldalgesheim torc and arm-rings. Photo copyright Landschaftsverband Rheinland/Rheinisches Landesmuseum Bonn.



Plate 6a The Erstfeld torcs and arm-rings. Swiss National Museum, Zurich, A-52044-50, Neg. no. COL-3026.



Plate 6b The Erstfeld torc: detail of torc. Swiss National Museum, Zurich, Neg. no. COL-6432.



Plate 7a The Amfreville helmet. Musée des Antiquités Nationales. Photo: RMN, Paris, copyright Jean Schormans.



Plate 7b The Agris helmet. Dépôt de l'Etat. Musée des beaux-arts d'Angoulême, copyright Musée d'Angoulême. Photo: Gérard Martron.



Plate 8a The Broughter torc. Photo copyright National Museum of Ireland, Dublin, reproduced by permission.



Plate 8b The Aurillac arm-ring. Photograph: Bibliothèque nationale de France, Paris.



Plate 9 The Battersea shield, copyright the Trustees of The British Museum.



Plate 10a The electrum torc from Snettisham Hoard E, copyright the Trustees of The British Museum.



Plate 10b Snettisham Hoard L *in situ*, copyright the Trustees of The British Museum.



Plate 11 The Book of Durrow, f. 3 v Photo: The Board of Trinity College, Dublin.



Plate 12 The Book of Durrow, f. 192 v Photo: The Board of Trinity College, Dublin.



Plate 13 The Book of Kells, f. 7 v Photo: The Board of Trinity College, Dublin.



Plate 14 The Book of Kells, f. 291 v Photo: The Board of Trinity College, Dublin.



Plate 15a The Hunterston brooch: front view. Photo copyright the Trustees of the National Museums of Scotland.



Plate 15b The 'Tara' brooch: back view. Photo copyright National Museum of Ireland, Dublin, reproduced by permission.



Plate 16a The Ardagh chalice: detail. Photo copyright National Museum of Ireland, Dublin, reproduced by permission.



Plate 16b The Monymusk reliquary. Photo copyright the Trustees of the National Museums of Scotland.

the same hand. Piggott and Atkinson rightly argued that the cap was too small as a chamfrein, though the circular holes could have served for the ears rather than the eyes of a pony. Jope's (1983) suggestion that it may have been used for ceremonial charades need not be dismissed. The horns, nevertheless, may not have been part of the ensemble. The fact that their ornament is relatively on opposite sides indicates their use as a pair, but *pace* Atkinson and Piggott, drinking-horn terminals still seems the likeliest context for their use.

The detailed design of cap and horns has been reviewed elsewhere (Harding, 2002). A key element of the cap is its fold-over symmetry about an axis from front to back. The principal motifs of the *repoussé* design are gamma-loops front and back, linked by somewhat angular arches over the ear openings. From these extend peltate elements terminating in domed roundels that, in the case of the front section, simulate cartoon-like birds' heads. It is these terminals especially that invite comparison with the Loughnashade trumpet from Co. Antrim. Bird's heads also presumably formed the cast terminals of both horns, though now missing from Horn A. Horn A has also been repaired in antiquity in a style that is simpler in technique and design than the originals. Essentially the engraving of both horns comprises tendril designs emanating from a sub-circular whorl, in which, as Duval remarked (1977, 145) a central line, unusual in La Tène art, nevertheless enhances the illusion of rotary motion. Among filler elements peltae-within-peltae and hair-spring spirals evoke parallels both with the Witham-Wandsworth tradition and the Irish Scabbard Style. 'Batwing' finials also echo elements in the design of the Witham scabbard.

For Atkinson and Piggott, Torrs, together with Newnham Croft, represented their 'early' school of Waldalgesheim-derived insular art. Newnham Croft was a contracted inhumation found in 1903 that has been wrongly interpreted as a possible chariot-burial (Stead, 1965, 9; 1995, 83). Among its associated grave-goods the solid bronze arm-ring (Figure 4.11, 2) is distinguished by its ingenious lapped-over closure-mechanism, a feature that is not easily paralleled in Britain or Continental Europe. Its surface, as we have seen, shows the much-worn traces of a low-relief tendril design, twisting its course around the ring in a continuous series of diagonal panels, reminiscent of the diagonal bias of Hungarian sword-ornament. Among the elements for which an ultimate Waldalgesheim or Vegetal Style ancestry might be invoked are the curved triangles or vortex motifs that link the dividing arms of the tendril design. Similarities with Torrs include the use of peltae or flattened peltae, from which branches turn into spiral terminals, here in engraved technique in contrast to the *repoussé* version at Torrs. More controversial is the use of background hatching at Newnham Croft, not detected in Fox's earlier drawing. Neither squared hatching of the later Mirror-Style variety nor quite the alternating, diagonal kind exemplified at Cerrig-y-Drudion, it certainly does not require a late date or any particular regional context.

With the bracelet were two penannular brooches, one fragmentary, and a truly remarkable brooch (Figure 6.10, 4), which displays all the inventive ingenuity of insular brooch-makers in the middle Iron Age. Jope (2000, 45–7) listed a range of Continental parallels among disc-bow brooches of the transitional period from La Tène 1c to early La Tène 2. The bow is cast as a four-spoked, open-work wheel, at the hub of which and at the cardinal points are mounted small, white (coral?) bun-shaped studs, an unusual device that may be compared with the wheel-headed pin from Danes

Graves (Stead, 1965, Fig. 32, 3). The bun-shaped studs are repeated like a pair of eyes on a face-mask that forms the upturned foot of the brooch. Apart from the chevron with hatched background of the spring, and the simple geometric design on the spindle-caps at each end of the spring, the ornament is mainly on the underneath of the brooch, a curious foible on the part of insular brooch-makers, since it cannot possibly have been visible in use. Circlets and arcs predominate in a style reminiscent of early La Tène scabbard ornament. Distinctively insular and allied to brooches of the middle Iron Age is the use of a hinge-mechanism, even though disguised as a spring. As an indicator of dating, and noting that the foot was cast in one with the bow, Jope acknowledged that the small moulding at the point where foot and bow meet was reminiscent of the sleeve of a La Tène 2 brooch, and was compelled in consequence to offer a dating for the brooch in the early second rather than late third centuries. To some scholars, even this might seem too early to satisfy the single-piece casting of foot and bow, on which the sleeve could well be regarded as skeuomorphic rather than incipient, in effect, making it a late La Tène form. Hawkes (Hull and Hawkes, 1987, 147ff), however, attempted to dispel the belief that a foot cast in one with the bow was necessarily indicative of late La Tène, particularly in view of the inventive originality of insular brooch-makers of the middle Iron Age. A later dating might nevertheless more easily accommodate the form of the penannular brooches in the assemblage. In view of the very worn condition of its ornament, the arm-ring could easily have been a century or more old when finally deposited in the grave, and its associations therefore do not rule out a date for its manufacture in the early third century at latest.

Shields and parade armour

One of the finest examples of the *repoussé* technique combined with engraved ornament is represented by the bronze scabbard mount from the River Witham (Figure 7.2). This is a pre-eminent example of the incised ornament integrating closely with and reinforcing the *repoussé* component. The broadly diagonal layout of the ornamented panel has been frequently remarked with reference to Hungarian Sword Style analogies, but the Witham example is singular. Its design, unfolding from a sub-circular element slightly offset below the hilt-guard, and tapering progressively in a double loop, has evoked images of a stylized bird in flight, partly prompted by broad similarities to the more explicit engraved designs on the Wandsworth shield roundel, though this kind of perspective interpretation is alien to the mainstream of La Tène art. The component motifs nevertheless are familiar enough, including hair-spring spirals, peltae-within-peltae, split palmette, together with a more distinctive 'bat-wing' motif with vesica-shaped ends. Linear hatching, not remotely basketry, echoes the simple form from Newnham Croft. The form of the scabbard's fragmentary chape, which survives only in a nineteenth-century drawing, does not suggest an early type, though like Standlake it could have been a composite piece. The ornament is quite worn, suggesting that it was in circulation for several generations, so it is quite possible that the sword and scabbard's original date of manufacture was as early as the beginning of the third century BC.

Longevity of use is also attested by the Witham shield, one of the archetypes with the Wandsworth shield-boss of the developed insular style. The Witham shield (Figure 7.3) traditionally stands at the head of the insular series, modelled on Gaulish

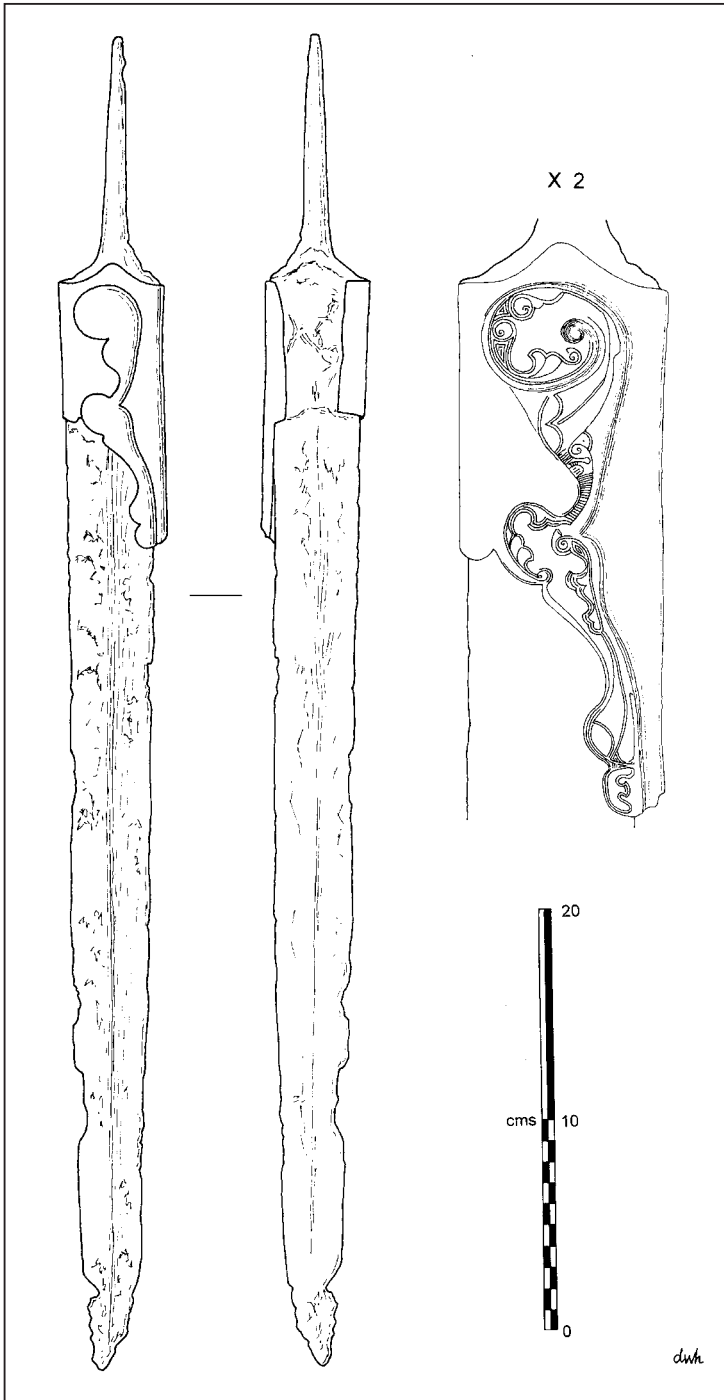

Figure 7.2 The Witham sword and scabbard mount. Drawing by D. W. Harding from original in Alnwick Castle, Northumberland, by courtesy of the Duke of Northumberland.

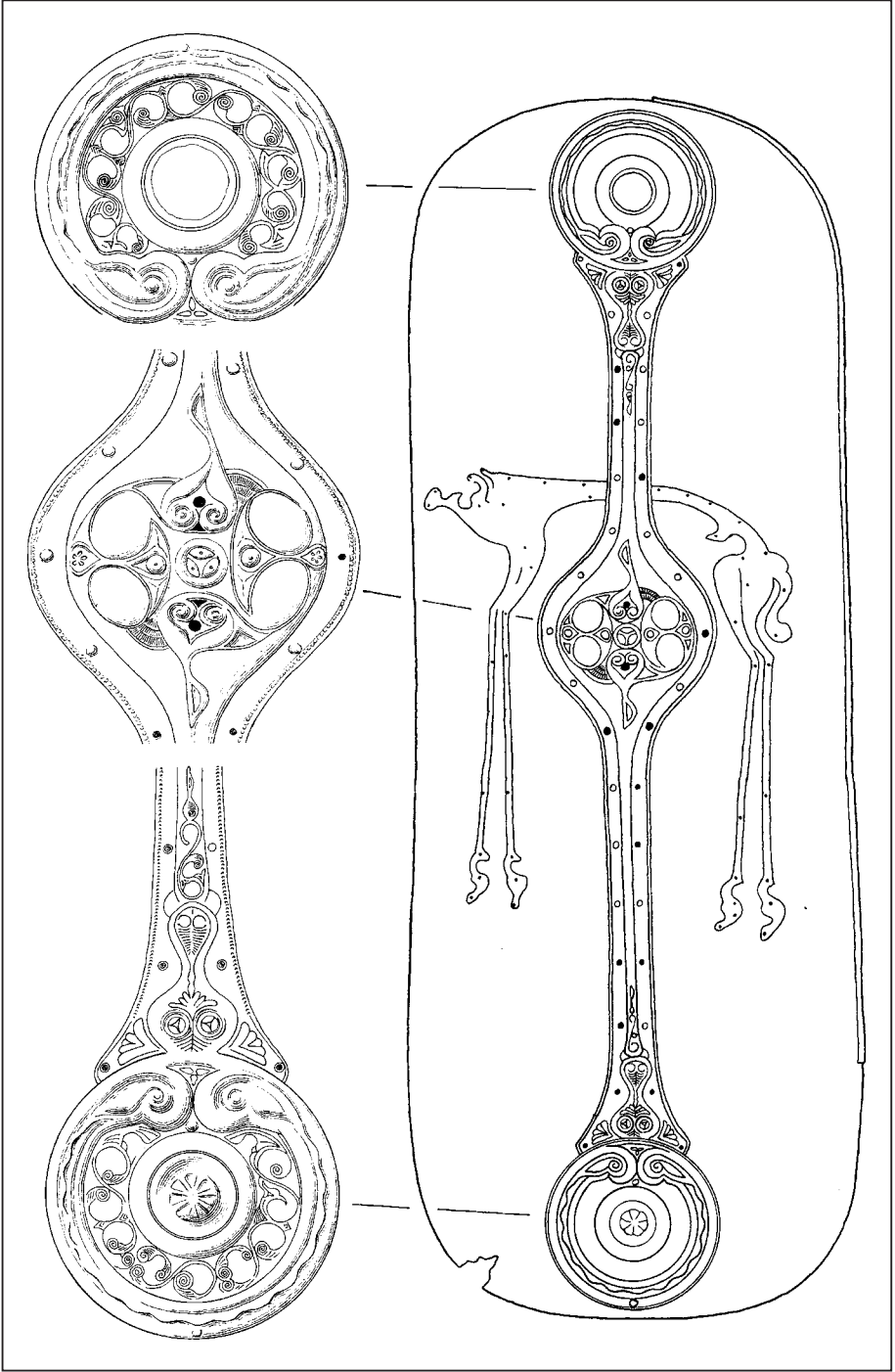

Figure 7.3 The Witham shield. Adapted from Brailsford (1975a) and Jope (2000).

and ultimately Italic types, and sometimes reflecting in consequence southern ornamental styles. Its beaten bronze facing, doubtless originally mounted on a wooden backing, covered a sub-rectangular shield with rounded corners and nearly parallel sides. It is certainly a composite piece that was substantially modified at least once in its life. Behind its surviving central boss, spine and terminal roundels can be seen the ghostly outline, preserved by differential patination, of a slender-bodied and spindly-legged boar. This might be less than convincing, were it not for many small rivet-holes that follow the outline, and must have served for holding the emblem in place.

In its modified form the dominant element is the spine, consisting of central umbo to protect the hand-grip and two terminal roundels, the umbo being located slightly above the mid-point on the long axis of the shield. Despite the complexity of infilling and spandrels, the initial impression of the design of the central umbo is its symmetry. On either side are paired, circular voids enclosed by peltate elements; along the axis of the shield are comma-leaves, pointing down the spine. The central roundel has a setting of three coral studs, suggesting a date of manufacture not later than middle La Tène, after which coral went out of fashion north of the Alps. Crucially different from Torrs, however, this design is based upon *rotational* not *fold-over* symmetry.

In terms of their *repoussé* ornament the terminal roundels are a matching pair. They are bordered by a wavy relief ribbon, leading to a pair of comma-leaves with spiral terminals that seem to simulate a pair of staring eyes. The central cupped boss, missing from the upper shield roundel, contains a domed seven-petalled flower. Both terminal roundels are supported by a pair of exaggerated sub-equine beasts that, like their counterparts on the Battersea shield, may well have had apotropaic qualities. Their features include multiple-leaved palmettes, unlike the standard La Tène attenuated form, below their eyes, over their flaring nostrils and sprouting like ears or antlers from the sides of their heads. From the snout of these beasts depends a low-relief S-scroll, leading to a tongue pointing down the spine, which Jope (2000) regarded as crucial to the dating of the shield. Dot-ended lines, not unlike Cerrig-y-Drudion, infill lobes within the design, suggesting a date perhaps earlier in the third century than Jope would admit to.

On the flat surfaces the terminal roundels are engraved with figure-of-eight scrolls that abut each other, sometimes with spandrels, rather than flowing as a continuous tendril. The use of hair-spring spirals and split-palmettes to create the illusion of bird's heads or wings resonates with both insular and Continental engraved styles. A more recent find from Chiswell Green, Hertfordshire (Jope, 2000, Pl. 89d), includes similar engraved motifs on a small bronze knife, the handle of which terminates in a cast bird's head and beak. But the sense of formality of composition of the Witham engraving, belying its lack of symmetry in detail, contrasts with the erratic freestyle of the Torrs horns or Witham scabbard, and suggested to Jope (1971b; 1978) Hellenistic or southern models.

The surviving fragment from the Thames at Wandsworth of shield boss and spine (Figure 6.9) must originally have been a sub-rectangular shield of the Witham type, but significantly smaller, though sharing the same asymmetric proportions above and below the spine, as Jope's reconstruction effectively showed (Jope, 1976, Fig. 1). In its ornamental affinities, as we have seen, it draws not on southern sources but on the Central and Eastern European Plastic Style, both in the modelling of the birds' heads of

its central roundel and in the features of the face-mask that supported the missing terminal roundels. The design of the central roundel is dominated by two *repoussé* birds' heads, again in rotational symmetry. They are linked and divided by a raised wavy line comparable to those enclosing the terminal roundels of the Witham shield, and like Witham, too, the central design of the Wandsworth piece has leaf-like fingers pointing down the spine. The appearance of sullen severity of the humanoid face is achieved by a combination of techniques. The spiral eyes, as reconstituted, simulate 'bags' under the eyes (a device that may be compared to the 'bags' under the owl's eyes of the Brå cauldron), while the straight angularity of the mouth conveys a mood of gloomy resentment. Similar spiral-boss eyes can be seen on the rein-ring 'from Paris', or on the terret from Mezek, Bulgaria, underlining the Plastic Style affinities of the insular product. Finally, we should remark the small areas of engraved infilling, notably of hair-spring spirals and dog-tooth edging, the former already seen at Torrs and Witham, but both notable features of Irish scabbard engraving (Figure 5.9). As for dating, it seems unnecessary to defer its construction much after any of those already assigned to the earlier third century.

The two other principal shields are more controversial in terms of dating. The circular shield from Wandsworth (Figure 7.4) was apparently found in 1849 during the same dredging operations in the Thames that recovered the face-mask shield, but obviously with no demonstrable association. Covering the central hand-grip is a hemispherical umbo, a feature that is normally assigned to the first century BC or later, while an outer circular flange is embellished in *repoussé* and engraved techniques. This may have formed the central component of a sub-rectangular shield comparable to those discussed earlier, or may simply have been the mount of a circular wooden or leather shield. The slightly flattened hemispherical umbo is ornamented in engraved technique, essentially with two independent tendril designs that stand in rotational relationship, though not completely symmetrical in detail. This central element is enclosed by a moulding on which wavy-line highlighting recalls earlier examples. The relief ornament of the surrounding plate also consists essentially of two independent scroll-like elements in rotational relationship, though the terminal element of each is detached from the main scroll. The focal icon of each is a bird's head, perhaps originally with coral studs for eyes. Birds also feature in the engraved ornament, more obviously as infilling of the *repoussé* plate but also in schematic form on the central dome. The engraved ornament makes particular use of triangle-within-triangle, pelta-within-pelta, linear and dotted infilling, 'bat-wing' and star-rossette, all familiar from earlier contexts. Behind one *repoussé* bird's head is an engraved design that echoes the over-and-under figure-of-eight of Hungarian scabbard ornament. The image of the bird rising from water in perspective (Jope, 2000) seems to be in the eye of the beholder, and probably should not determine the debate on dating. An important difference between the Wandsworth shield roundel and other examples of the *repoussé* technique in Britain, however, is the sharp-edged character of the *repoussé* work, in contrast to the more rounded technique and higher relief masses, for example, of Torrs or Witham. But this would not disqualify it from classification within the European Plastic Style tradition (Jope, 1976, 183).

Conventionally regarded as the latest in the shield series (though the case for an earlier date has become more compelling in recent years) is the splendid example from the Thames near Battersea (Pl. 9). Like the fragmentary face-mask shield from

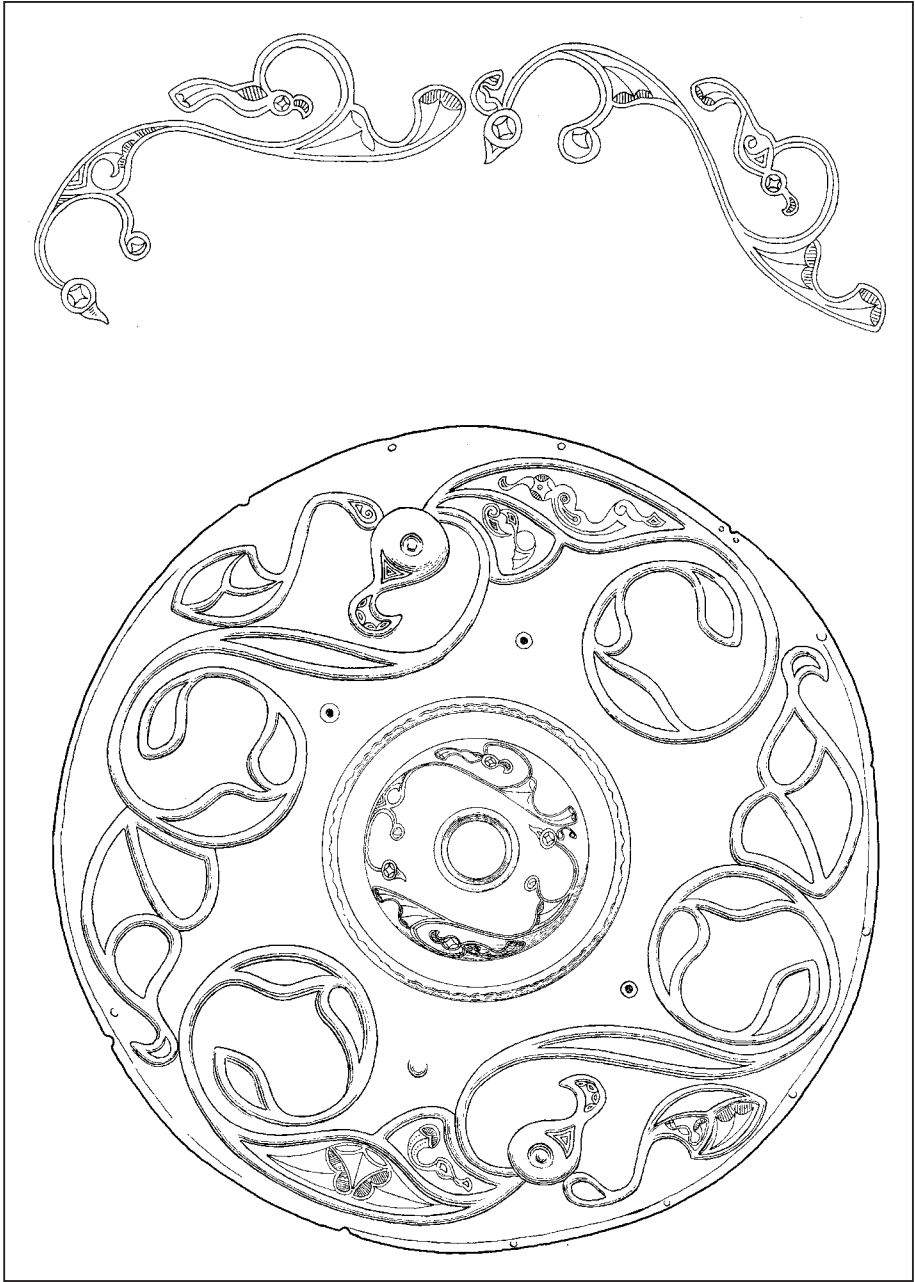

Figure 7.4 The Wandsworth circular shield, with detail of central boss ornament enlarged. Adapted from Brailsford (1975a) and Jope (2000).

Wandsworth, it is small for practical use, being just 77.5 cms in overall length. Its hand-grip cover, too, assuming its association with the shield to be genuine, is small, suggesting that it was designed for a woman or juvenile if not for a man of slight physique. At a distance an undersized shield might serve to enhance the relative stature of the holder, but in any event, the Battersea shield was more probably intended for prestigious display than for military utility. It conforms to the sub-rectangular form of the Witham class, but with a much more pronounced waisting of the sides, a feature that some commentators have attributed to Roman influence. It also follows the Witham model in having three roundels, a larger central one and two equal-sized but smaller terminal roundels, though in this instance they were made in three separate pieces. All three were then mounted on a back sheet comprising four separate pieces, and the whole, with its edge-binding, was presumably once again attached to a wooden or leather backing.

The ornament of the roundel-plates is achieved by fine *repoussé* work, supplemented by no less than nine 'enamel' inlay settings on each. Above and below the central boss of the larger roundel are designs that Stead (1985b) likened to bespectacled faces, the goggly eyes enhanced by 'enamel' settings, below which small, glum mouths recall the sullen expression of the Wandsworth face-mask. Balancing these on either side of the roundel are two matching elements that can be read as opposed comma-leaves depending from a flattened pelta, from the arms of which tendrils reach out to join the spectacle-masks in curved triangles. Stead has shown that the detailed motifs within these peltae and triangles violate the symmetry of the overall design, though the basic design is one of strict fold-over symmetry about the spinal axis of the shield. The design of the two terminal roundels is identical in conception, and only marginally different in detail of execution. It consists of linked fleshy S-scrolls with 'enamel'-inlaid settings at their intersections. Each roundel has a flanged extension, bearing a bulbous-nosed animal with spreading antlers that acts as a support for the central roundel. This device again recalls the Witham shield, though on the latter the heads support the terminal roundels, facing along the spine towards the centre.

The 'enamel' settings are plainly a dominant feature of the Battersea shield, and for Hawkes their pseudo-*cloisonné* division into key-patterned compartments was one indicator of a late Iron Age 'Belgic' date. The settings are not true *cloisonné*, which holds cut glass inclusions; nor is the opaque red glass true enamel, but glass heated to a spongy consistency and pressed into the recesses. Hawkes further argued a date in the last quarter of the first century BC for the shield on grounds of stylistic influences in its ornament from Augustan Roman silverwork, in which view he was supported by Jacobsthal and de Navarro among others (for references see Stead, 1985b, 25–6). Against the case for a late dating, Stead pointed to various aspects, technical as well as stylistic, of the Battersea shield, for which respectable antecedents as early as the fourth century could be cited. While the weight of evidence probably favours a less radical revision of its dating, chemical analysis of the 'sealing-wax red enamel' has now indicated that it cannot be later than the second century BC (Jope, 2000, 351). We should be clear that this is strictly the date of the enamel, which in principle could have been incorporated from the craftsman's recycled stock into the assembly of a later shield. This, however, would doubtless be regarded as special pleading, so the later second century may stand as the current best assessment of the date of the Battersea shield.

Crowns, torcs and personal display

Stylistic similarities can be traced with both Torrs and Newnham Croft in some of the prestige metal-work that accompanied one of the most richly-furnished burials discovered in modern times, uncovered in 1988 at Mill Hill, Deal (Parfitt, 1995). The burial, in an elongated pit, just sufficient to accommodate an extended, adult male inhumation, yielded no evidence of coffin, nor of a barrow mound or marker. Grave-goods, however, included an iron sword in its decorated bronze scabbard, a decorated suspension ring, possibly from the belt that held the scabbard, and an elaborate brooch of a kind not unlike the Newnham Croft example with coral inlay. Around the skull were the remains of a bronze crown, comprising a thin band joined in two sections that encompassed the temples, with a further band crossing the top of the head. The horizontal panel was engraved with a rather spindly tendril design with infilling of dotted circles, elements of which afford a striking parallel to the ornament of the Sutton Reach scabbard. The crown itself is not without parallel, though examples as early as this are hard to cite with confidence. On the basis of the typology of the scabbard chape, the likely date of the brooch and the stylistic affinities of the group as a whole, the Mill Hill warrior grave should be assigned to the third century BC rather than later. In fact, it stands physically apart from but chronologically at the head of a series of inhumation burials and later cremations in the adjacent cemeteries that continued in use until the Roman Conquest.

Just as parade armourers in south-eastern England were highly skilled, specialist craftsmen, in much the same way torc-makers were most probably dedicated jewellers, operating under princely patronage rather than in a market system. The quantity and sheer wealth of the products ensured their prestige and even symbolic status, as may be inferred from the quite outstanding series of finds from Snettisham in Norfolk (Clarke, 1954). First exposed by ploughing in 1948, and substantially supplemented by new finds since 1990, the number of torcs from Snettisham now totals some 75 complete examples and fragments of more than a hundred more. The special significance of torcs has long been implicit in their representation on stone sculpture, like the head from Mšecké Žehrovice, the sandstone statue from Euffigneix (associated with another potent Celtic image, the boar), or even the Dying Gaul from the Pergamon frieze. On metal-work the so-called Cernunnos figure on the Gundestrup cauldron is the most celebrated example. Literary references like Polybius' (2.29) description of Celts, naked except for their torcs, at the battle of Telamon, or Cassius Dio's record of Boudicca wearing a great twisted gold necklace (62.2.4) reinforce the belief that the torc was imbued with special status or symbolic significance. Cassius Dio's account, referring admittedly to events several generations after the presumed date of the Snettisham torcs, but nevertheless in the same geographical region, could well have described the great electrum torc from Hoard E (Pl. 10a). Twenty centimetres in diameter, the torc was made of eight twisted cables, each comprising eight wire strands, with its ends soldered into hollow cast terminals bearing chased and punched decoration. Within one terminal was a worn quarter stater of Gallo-Belgic Dc type, an issue which was probably minted before 50 BC, but in its worn condition this example could well have been in circulation for a couple of generations before being deposited with the torc. The decorative design of the terminals consists of raised, simple curves, slender trumpets and concentric circllets, enclosed within beading and raised wavy bordering.

Characteristic of the style is the use of broad matting and small bosses, each bearing three fine punched dots that serve almost as a signature of the Snettisham craftsman. Other finds from Norfolk suggest a local workshop or master craftsman responsible for these prestigious products, but one fragment from Cairnmuir in Peeblesshire, found in a hoard with Belgic 'bullet' coins, bears the stylistic hallmarks of the Snettisham school, and must surely have been a diplomatic gift or trophy, so far from its apparent source. The more recent discoveries (Stead, 1991b; Stead and Selkirk, 1991, 1993) included novel types with a variety of ornamental devices, among them stylized human faces incorporated into high-relief designs.

The most remarkable and indeed unique aspect of the Snettisham hoards is the dominance of one particular type, the torc, which is present in no less than six variant forms. Tubular torcs, together with those that have buffer-, ring- or loop-terminals are all well-known types; those with cage-terminals and reel-terminals are rarer, and perhaps suggest a regional specialist production centre. The nature of the deposits has excited no little controversy. There is little evidence in the way of industrial waste to suggest that the site itself was a production centre, though the fact that several pieces from Hoard F were in a semi-molten condition, and others bore droplets splashed from a crucible suggests the proximity of a workshop. Equally, the inclusion of ingots and broken fragments might indicate that they were being collected for re-working. The excavator of the recent finds did not regard the pit-deposits as overtly votive (Stead, 1991b), though he did not exclude altogether the possibility of ritual deposition, and quite correctly pointed out that torcs seldom feature in clearly votive deposits such as the sanctuary site of Gournay-sur-Aronde. A singular aspect of the Snettisham site is the variety in the nature of the pit deposits (Pl. 10b). Some had an upper and lower compartment within the pit, in which the upper deposit was plainly intended as a decoy to protect the wealthier, lower hoard, some were tightly packed 'nests' of torcs in very small pits, while one was buried in a bronze container. As regards the dating of the hoards, the torcs are hardly definitive, either typologically or stylistically, but on the basis of their associated coins, the recent excavators favoured a date for the deposit of Hoards B and F a generation before Caesar. Whether the entire series was buried at the same time, or over a longer period is less easily determined, and clearly is dependent upon which view is taken of the hoards' function. The principal options are that the hoards were indeed votive, that they were an adjunct to an important production centre, or that they were a treasury of accumulated wealth, personal, familial or communal. Quite extensive excavation revealed no evidence of settlement, nor even any sherds of late Iron Age pottery, but this need not militate against the production centre option, since metal-working sites, and especially those dealing in precious metals, are likely to have been located away from domestic settlements. Hoards of torcs are certainly known elsewhere; at Ipswich in Suffolk (Brailsford and Stapley, 1972), five were found in a hoard (with a sixth nearby) in 1968, among which two ornamented examples showed close affinities to the Snettisham style. But the sheer quantity of the Snettisham finds sets them apart from all other torc-hoards, testifying to the spectacular wealth and craftsmanship available to the Icenian dynasty of late pre-Roman Iron Age.

The stylistic relationship between the Snettisham torc ornament and that on the bronze helmet from the Thames at Waterloo Bridge (Jope, 2000, Pls 122–126) has been widely remarked. The helmet, distinguished by its pair of undecorated horns, is unique in bronze, though there are Roman documentary references to, and Gallo-Roman

sculptural representations of, horned Celtic helmets. The thin sheet bronze of the Waterloo helmet, like that of the parade shields, in any case suggests a ceremonial rather than a functional role for these prestigious pieces. The slender, trailing and essentially asymmetrical *repoussé* ornament of the helmet includes elements like the shallow crescents, curving leaves and trumpet-ends that also characterize Snettisham, while the use of broad, punched basketry hatching suggests that the helmet was the product of the same regional tradition, if not the same workshop. This perhaps argues for a later first-century BC date rather more convincingly than the technical rendering of the domed bosses, with their surface cross-scored to receive enamel inlay, a technique that has conventionally been regarded as diagnostic of a late (not before first century BC) date.

Ornament on pottery and other materials

Though there are distinctive pottery styles in Wessex and southern England throughout the pre-Roman Iron Age, it must be recognized that much of Britain (and Ireland) north of the Trent, with the notable exception of Atlantic Scotland, is virtually aceramic, with only minimal quantities of hand-made and poorly fired domestic ware recovered from settlement contexts. Even in Southern Britain, wheel-thrown pottery appears only in the first century BC, and though there is some evidence of regional craft specialization, perhaps as early as the fifth century, in general, pottery appears to have been of domestic or local production. The range of size and shapes of vessels is basic, not remotely as varied as those of the Mediterranean Iron Age, nor even of north-alpine Europe, and the techniques of ornamentation deployed are likewise limited. Painting is virtually unknown, though a haematite slip is common in the earliest Iron Age in Wessex, and the surface may be burnished to a smooth sheen. Among styles transitional from the latest Bronze Age, like those from All Cannings Cross or Longbridge Deverill Cow Down, white infilling of deep-scored geometric patterns provided a striking contrast to the deep red burnished haematite background. Applied and plastic ornament is generally restricted to cordons, sometimes cabled, around the girth or neck of the vessel, or rows of finger-impressions around its shoulder. Body decoration is normally incised or tooled into the surface of the green-hard clay before firing. By the middle Iron Age there are various regional styles using a combination of simple rectilinear and curvilinear motifs, but seldom reflecting the subtlety of metal-work ornament in the way that Continental ceramic art, as we have seen, aspires to do. This apparent poverty of insular pottery making may be not unrelated to the absence of a regular funerary rite, which elsewhere may have been the occasion for the production, or at least the preservation, of special funerary ceramics.

Just occasionally there are local products that suggest a higher level of artistic aspiration. In the south Midlands, at Hunsbury hillfort in Northamptonshire and at Frilford in Oxfordshire, a form of globular bowl, current perhaps from the third to first centuries BC, bears more complex curvilinear designs that echo metal-working styles (Figure 7.5, 5–8). The Hunsbury bowls in particular use a variant of the interlocking yin-yang, highlighted by rosettes, in a running S-scroll design. The Frilford ornament is more mechanical, using a series of pendant swags or interlocking swags, often apparently spaced around the girth on the basis of a geometric sub-division of cardinal points on the base of the upturned vessel. Another distinctive regional group is that

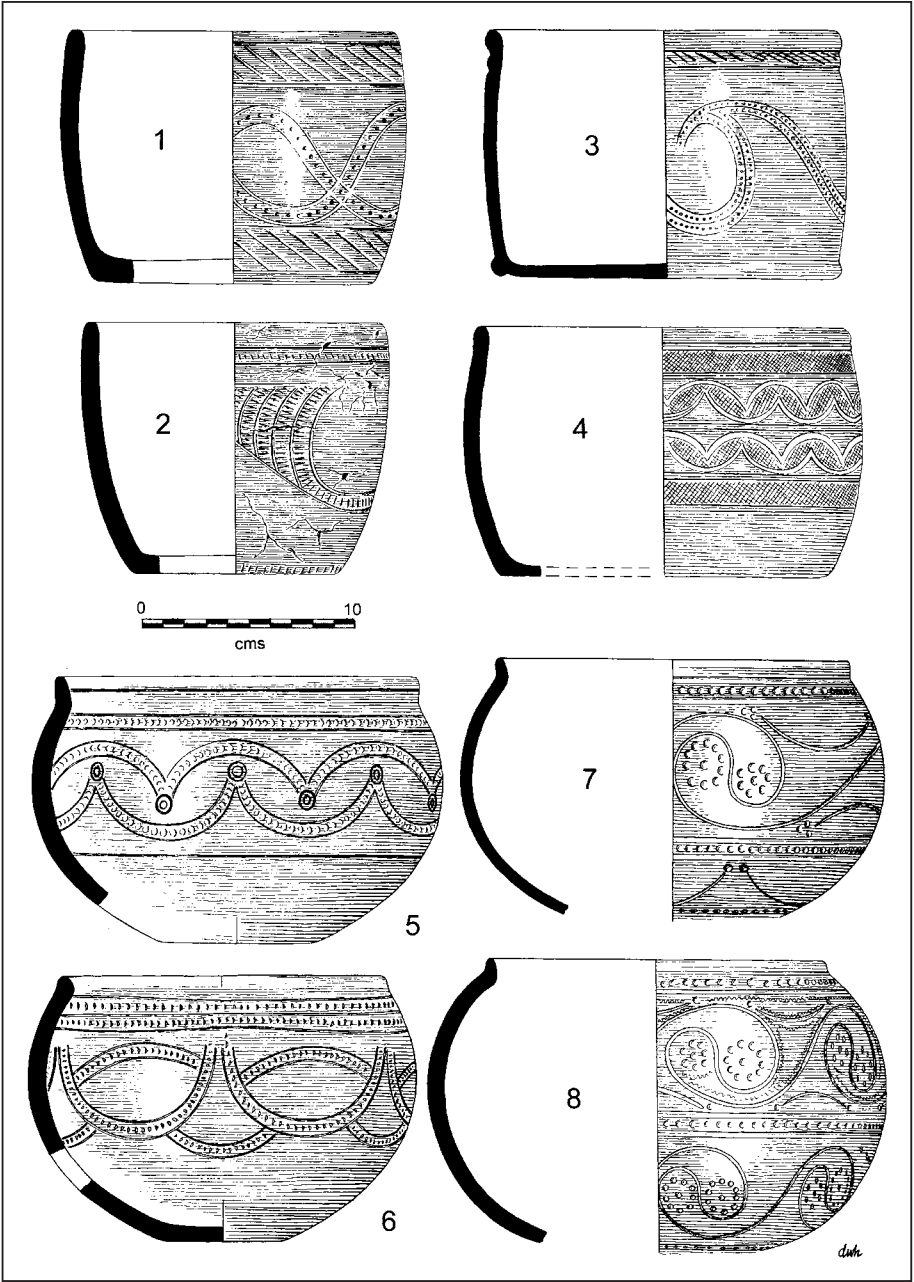

Figure 7.5 Iron Age decorated pottery from Southern Britain. 1, 2, Blewburton Hill, Oxon (Berks); 3, Caburn, Sussex; 4, Meare, Somerset; 5, 6, Frilford, Oxon (Berks); 7, 8, Hunsbury, Northants. Drawings by D. W. Harding.

centred on the 'lake-villages' of Glastonbury and Meare, with relationships on the one hand to the 'saucepan pot continuum' (Figure 7.5, 1–4) and on the other to south-western decorated wares (Cunliffe, 2005). Characteristic forms include the so-called saucepan pot, a type dated at Danebury and Hengistbury Head from the later fourth century to around 100 BC, but with antecedents in the early–middle La Tène in the Champagne, and necked bowls that may be somewhat later within that span. A distinctive feature of this series is the use of background hatching, not in itself the same as the various kinds of hatching in metal-work but serving essentially the same purpose of creating an interaction between foreground and background that was one of the characteristics of earlier La Tène metal-working styles. Similar hatching is deployed with curvilinear motifs not unrelated to those of the bronze-worker on lathe-turned wooden vessels from Glastonbury, suggesting that a more specialist set of craft skills may have been practised here than elsewhere.

Aylesford and late Iron Age cremations

From the second half of the first century BC, south-east England – north Kent, the Thames valley, Essex and thence inland to the Chilterns – sees the appearance of a new and distinctive type of burial in cremation cemeteries, a practice that is also widely represented in north-eastern France and Belgium at this period. For much of the twentieth century, following the pioneer study by Hawkes and Dunning (1930), this innovative burial rite was equated with settlement by the *Belgae*, a confederation of tribes variously defined by Caesar, for whom *Belgium* was one of the three territorial divisions of Gaul. A migration from Belgic Gaul into south-eastern Britain seemed to be confirmed by Caesar's assertion that settlers had crossed over from Belgic Gaul (*ex Belgio transierunt* in the pluperfect past), and 'after the invasion, settled and began to cultivate the fields' (*de Bello Gallico*, V, 12). Modern archaeological scholarship now recognizes that none of the cemetery evidence can be dated prior to Caesar in order to accord with the inferred date of immigration implied by his statement. If there were indeed new settlers in the later second or early first centuries BC, therefore, the archaeological evidence for their presence should be sought elsewhere, perhaps in those regions further west, in central southern England, where place- and tribal-names of the early Roman period suggest connections with Gaulish cousins.

The cemeteries remain, however, a distinctive innovation, those of the Welwyn group from north of the Thames dating to the first century AD, and some of the rich graves especially continuing into the early years of the Roman occupation. Some, nevertheless, can be dated from the third quarter of the first century BC, as at Aylesford, on the basis of associated Italic imports of the Augustan period. Aylesford was among the first such discoveries, by Arthur Evans (1890) and his father in 1886 in a gravel quarry in north Kent. One rich burial, deposited in a pit that was thought by Evans to have been one of a 'family circle', contained cremated remains in a metal-bound wooden bucket, together with a wheel-thrown, pedestalled pottery vase that also contained cremated bone. Imported grave-goods included a bronze jug of so-called Kelheim type, and bronze pan or *patella*, types that have a wide distribution across north-alpine Europe in the Augustan period. The stave-built wooden bucket is made of yew, with staves projecting downwards to create three feet, and with a single iron handle. Three thin bronze binding-plates hold the vessel together, of which the upper

was embossed with a frieze comprising two pairs of prancing horses and two further paired motifs of abstract design. The horses are of particular interest, confronting each other with backward-looking heads (Figure 7.6, 1). Apart from their exaggerated lips, head-crests and double tails, their spindly legs are jointed in a fashion that is anatomically impossible for a horse. In fact, Jope (1983) argued persuasively that the Aylesford horses were pantomime horses, that the legs were human actors concealed beneath a festive horse-costume. Finally, the Aylesford bucket has a pair of human heads on the handle-attachments, modelled in more detail than the face-masks of earlier periods, but still displaying characteristic lentoid eyes, and still not yet quite naturalistic. From their heads project peltate crowns, doubtless a skeuomorph of twin-handle attachments of southern models, but perhaps like earlier leaf-crowns bestowing status or even divinity on the figures depicted.

The Aylesford heads have more crudely depicted relatives on the buckets discovered at Baldock in Essex (Stead and Rigby, 1985). But the most remarkable of this series in Britain is another old find, made in 1807 near Marlborough in Wiltshire, well beyond the south-eastern cremation cemetery zone, though it probably contained a cremation

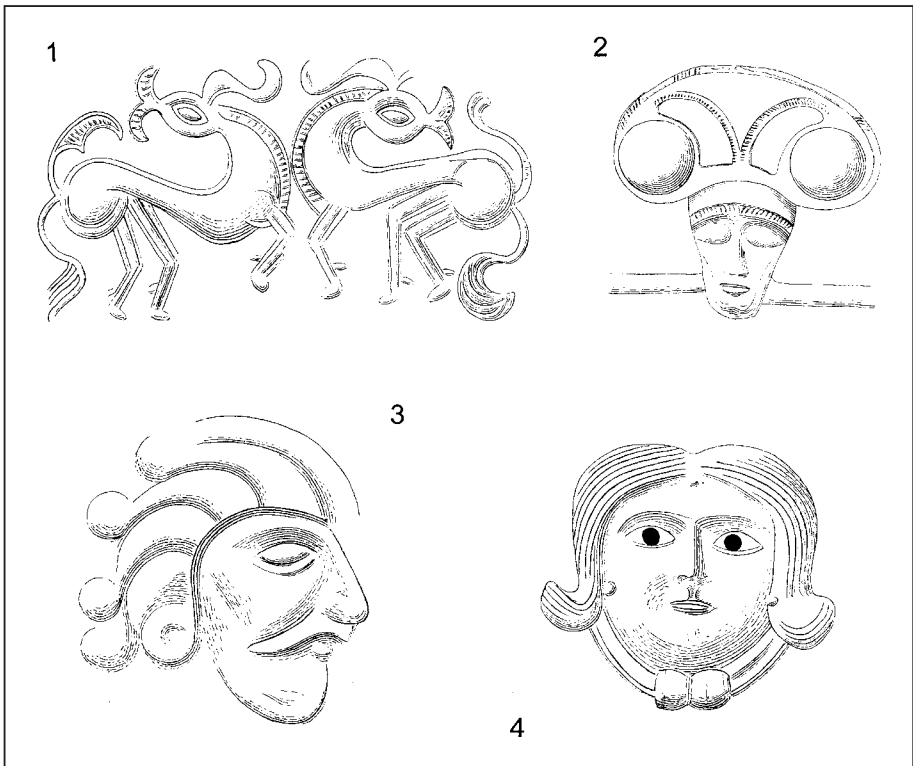

Figure 7.6 Aylesford, Kent, and Marlborough, Wiltshire, bucket ornament, with head from Rynkeby cauldron, Denmark. Aylesford: 1, *repoussé* horses; 2, head of escutcheon; Marlborough: 3, Celtic head; Rynkeby: 4, head with torc. Adapted from Jope (2000).

burial. It too was fashioned from yew staves, bound with three iron hoops and three, now highly fragmentary, bronze bands with embossed ornament. Here human heads feature prominently, both as paired profiles and as full-face, frontal representations. The latter are particularly noteworthy for their open pupils, doubtless originally filled with glass settings or the like, in a manner that is most closely paralleled in the Danish finds like the Rynkeby cauldron (Figure 7.6, 4), with which one of the Marlborough faces shares a very similar hair-style. Among the profile faces, one with moustache and long flowing locks could be the archetypal representation of a Celt (Figure 7.6, 3). The human heads are inter-spaced with animal-pairs, some probably equine, others of a more indeterminate breed. One pair appears to have limbs hanging from their mouths in a fashion reminiscent of the voracious beast theme, but a parallel representation on another pair suggests that this has become little more than a formulaic, pendant scroll. Bucket-burials like these are known on the Continent, notably at Goeblingen-Nospelt in Luxembourg, where four burials of the later first century BC were richly furnished with amphorae, drinking service and other domestic equipment, as well as metal-bound wooden buckets. Pointing to a source for the British buckets, nevertheless, is not a simple matter. Manufacture was probably local, but iconographic inspiration seems to be drawn from much wider sources: indeed, Jope's compromise (2000, 99) was to suggest 'exotic experience brought into southern British ateliers', presumably through the commissioning of works by aristocratic patrons from specialist craftsmen, who enjoyed considerable professional mobility.

The Mirror Style

Most distinctively insular of all the later examples of La Tène art are the decorated mirrors, concentrated for the most part to the south and east of a line from the Severn to the Wash. They apparently represent an innovation of the first century BC; earlier mirrors are known, in the Arras culture, and very infrequently from early La Tène contexts in Central Europe, but these are undecorated and typologically have little or no relationship to the later insular series. The later British mirrors are large, generally between 20 and 30 centimetres in diameter, of necessity, since unlike Etruscan mirrors, for example, they have planar rather than convex surfaces. It is, of course, the back-plate that bears ornament, visible to the onlooker in use or doubtless when suspended by its handle and not in use. For the most part they are preserved in burials; the fine example from Holcombe in Devon (Fox and Pollard, 1973) was one of the only examples recovered from a non-funerary, presumably domestic context.

The mirror plates can be either circular or slightly kidney-shaped, with the indentation corresponding to the point where the handle is attached. Sometimes the junction bears additional embellishment, like the feline or owl with large round eyes and pointed ears on the Holcombe mirror (Figure 7.7, 1), closely matched but with the additional use of enamelling on the Nijmegen mirror (Figure 7.7, 2). The design of mirror ornament is most frequently based upon what Fox termed a 'three-roundel' arrangement, in which the ornament might be fused into a unity to a greater or lesser degree. Jope (2000) described this as basically an omega-loop with foot-scrolls. The Colchester mirror displays a classic layout, with a pendant pelta or what Jope called a 'bag-loop' within the top circle, sometimes giving more than a hint of a ghostly zoomorphic face. The unique mirror from Great Chesterford, Essex, is modelled

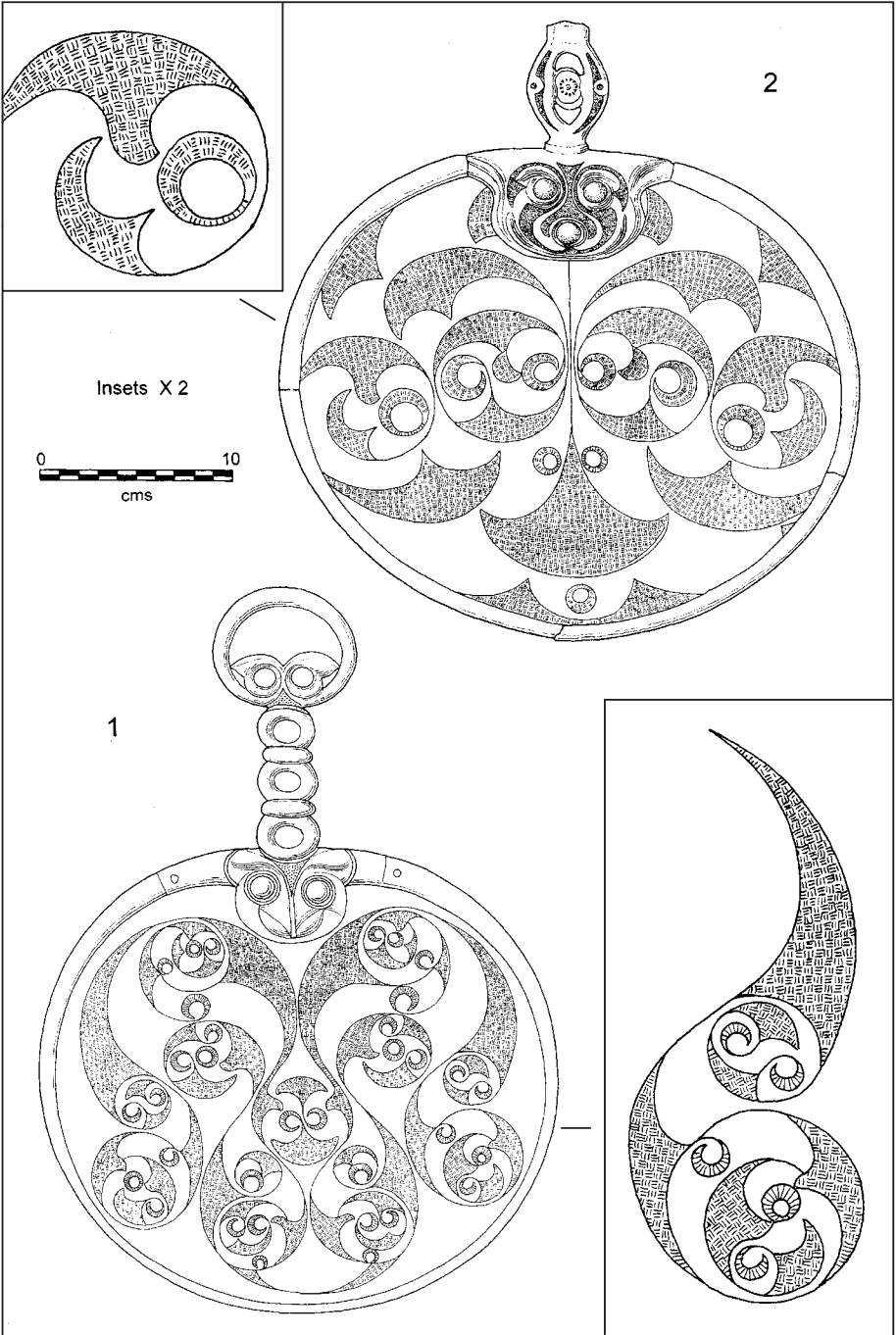

Figure 7.7 Mirrors from Holcombe, Devon (A) and Nijmegen, Holland (B). Adapted from Fox and Pollard (1973) and Jope (2000).

essentially on the same design, but displays in execution an 'unsteady lurch and leering face' (Jope, 2000, 139) that quite wilfully defies symmetry. Most mirrors do in fact display near-perfect symmetry, of the fold-over kind, in their layout. Where the layout departs from this principle, as on the Desborough and Holcombe masterpieces, it is a subtle but deliberate deviation from symmetry at the very centre of the design, easily overlooked at first sight.

Within the mirror repertory it is possible to point to stylistic elements that suggest production in the same workshop, but it is more difficult to point to regional 'schools'. The distribution shows a concentration of finds in the south-east of England, north of the Thames, in the territory that was occupied in late pre-Roman times by the Trinovantes and Catuvellauni, together with a more westerly group extending from the territory of the Dobunni and Durotriges westwards. Perhaps the strongest case can be made for a south-western group, on the basis of recurrent motifs found in association, notably crescents with radial hatching and peltae with basketry hatching. The basketry hatching itself is of a distinctive form, using invariably three strokes in each direction, alternating in blocks at right-angles. As a representative of the group the Desborough mirror (Figure 7.8, 1) is a classic example. Here the omega theme with flanking scrolls has become looser and more florid, so that the large zoomorphic aspect of the upper element has disintegrated. But there remain smaller faces peering through the foliage, a pair of Punch-like heads back to back at the top, and a succession of elusive faces, full-face or profile, created by the shaded crescents. Nowhere is the interplay of foreground and background better illustrated than in the complex designs of the decorated mirrors, as Sir Cyril Fox (1958, Pl. 56a, A1, A2) demonstrated by his two contrasting illustrations of the 'Mayer' mirror. The repetition of motifs and the way they are rendered certainly argues for local or regional traditions among craftsmen or workshops. Yet the inclusion of tiny 'signatures', like the three-pointed ('Mercedes-Benz') stars on the extreme flanks of the Desborough design (not totally unlike the small central tricorn formed by three conjoined vessicas on the main central-upper panel of the Colchester mirror), must be the hallmark of specific master-craftsmen.

Beyond the south-western and eastern English distribution, the Nijmegen mirror is an obvious candidate for an export. Despite technical features, like the use of enamelling and a preference for hatching rather than simple linear strokes as infilling for its small lunate motifs, it is hard to believe that this mirror was made anywhere other than in the south-west of England, unless by a south-western craftsman working for a Continental patron. The Balmaclellan collar from south-western Scotland (Figure 7.8, 2) is likewise so similar in its use of stroke-filled lunate finials and hatched peltate motifs that one is tempted to see it as the product of an expatriate south-western craftsman.

There remains the vexed question of dating. Most authorities are agreed on a late date, starting in the second half of the first century BC, and going out of fashion shortly after the mid-first AD. Where good associations are available, as in the burials at Colchester and Birdlip, the date of the deposit is generally first century AD. A recent find, however, from Shillington, Bedfordshire, possibly from a disturbed burial, included a bronze ornamented mirror, together with a silver brooch of Continental late La Tène type dating to the mid-first century BC. Late dating therefore may arise from the fact that most of the surviving mirrors are found in graves, the majority of which

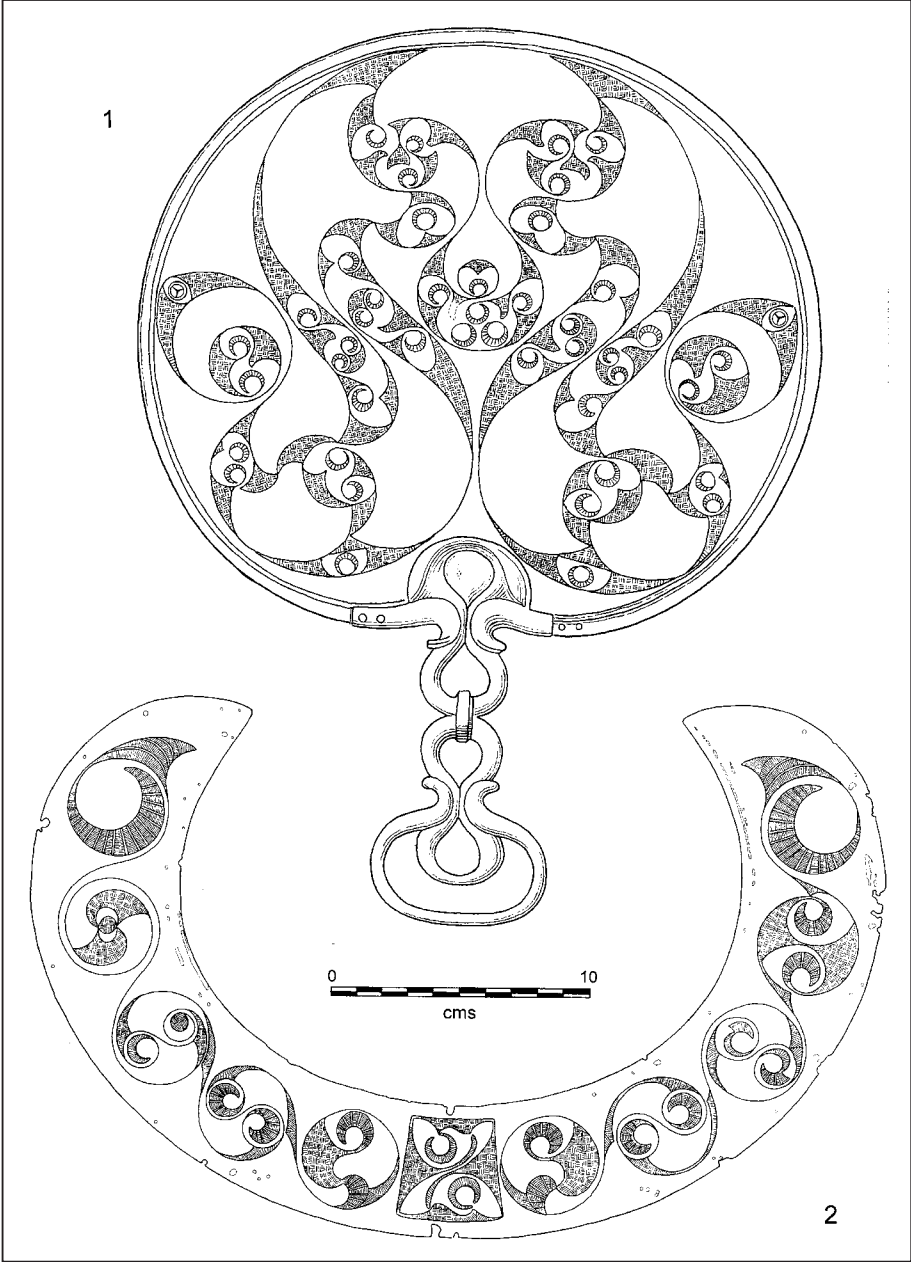

Figure 7.8 Mirror from Desborough, Northants, and collar from Balmaclellan, Kirkcudbrightshire. Adapted from Jope (2000) and MacGregor (1976).

happen to be late in the sequence. High-status metal-work is seldom abandoned on domestic sites, and many of the wealthiest graves appear to date from the latest pre-Roman Iron Age in south-eastern Britain. Why so much of the work of highest quality of insular Celtic art manifests itself on the eve of the Roman Conquest is an issue to which we shall return.

LA TÈNE AND NON-LA TÈNE IN IRELAND

Introduction: identifying the problems

The problems of identifying, dating and explaining the La Tène in Ireland are even more fundamental than for Britain. First of all, it would not be pure casuistry to ask how far the types representative of the Irish La Tène are in fact La Tène at all. Types such as Y-pendants are not part of the La Tène repertory in Continental Europe, and the one type that is ubiquitous in great numbers in Continental Europe, the safety-pin brooch, is represented in Ireland by barely thirty examples. A second consideration is the distribution of Irish La Tène types (Figure 8.1A). Their occurrence in the northern two-thirds of the country, broadly north of a line from Dublin to Galway Bay, has been long remarked and contrasted, notably by Caulfield (1977; 1981), with the 'non-La Tène' Iron Age of southern and south-western Ireland, of which the stone-built *cashels* or *catbairs* have sometimes been taken as representative. The concept of a non-La Tène Iron Age is important, not just for Ireland but for Atlantic Britain and Atlantic Western Europe as well, and challenges the exclusive equation, too often encouraged by the identification of La Tène art as Celtic, of La Tène archaeological material culture with populations that might be identified as archaeologically or ethnically Celtic. Third, there is the issue of dating. In the absence of a Roman occupation horizon, it is plainly even more difficult in Ireland than it is in most of Britain to establish an independent chronology for finds that largely lack context. Furthermore, within the older diffusionist framework, any connection that might be perceived between Irish and British La Tène metal-work necessarily saw Ireland in the secondary role of recipient. Hence the Irish decorated scabbards, instead of being recognized as a regional manifestation of the European fashion for elaborate sword ornamentation from at least the third century BC, were seen as secondary to Piggott's Group III Yorkshire swords, and interpreted as the product of a 'plantation of Ulster' by Yorkshire charioteers, with a dating in Ireland no earlier than the first century BC (Piggott, 1950, 16). Though more recent scholarship has been inclined towards an earlier dating, the weight of convention has commonly assigned the scabbards to a dating no earlier than the closing centuries of the first millennium BC. The Knock (Clonmacnoise) torc has stood alone around 300 BC on account of its recognition as an import from the La Tène B2 series of buffer torcs of Central Europe. But, as with Britain, 300 BC has remained the chronological watershed, with the bulk of 'La Tène' metal-work following that date, after due allowance for 'time lag'.

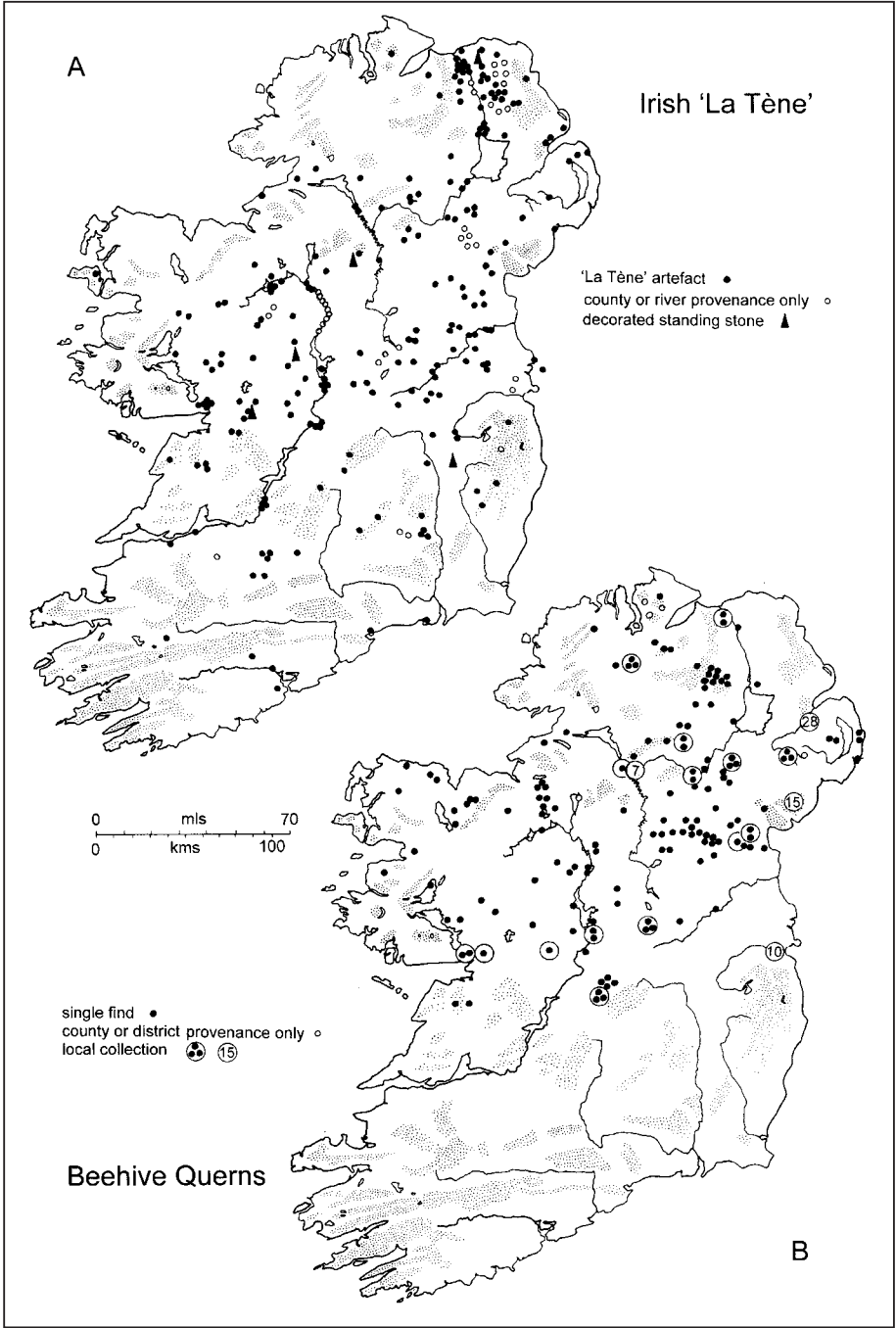

Figure 8.1 Beehive querns and the Irish La Tène. A: 'La Tène' finds in Ireland. Adapted from Raftery (1994a). B: distribution of beehive querns in Ireland. Adapted from Caulfield (1977).

The late Bronze Age and the Dowris metal-work industry

The question arises, therefore, what preceded the Irish La Tène? Metal-work in the Hallstatt Iron Age tradition is even more sparsely represented in Ireland than it is in Britain, and what there is in any significant numbers, namely, bronze swords of Gündlingen type (Cowen, 1967), is generally regarded as being of local manufacture, like their British counterparts, rather than evidence of close direct contact with Continental Europe. Hallstatt-type bracelets or Italic-type brooches, often without reliable provenance as with examples in Britain, cannot even be regarded certainly as ancient rather than more recent imports. So a substantial hiatus opens up between the retarded appearance of La Tène types and whatever latest date can be plausibly sustained for the survival of the Dowris late Bronze Age (Eogan, 1964).

Now in principle it is possible that the Dowris tradition continued in fashion for several centuries, though the notion of Ireland as a cultural backwater from the end of the late Bronze Age would not commend itself to many archaeologists in Ireland. It would, furthermore, represent a radical reversal of Ireland's role in the Atlantic late Bronze Age itself, when the Dowris tradition *par excellence* exemplified long-distance connections with the industrial sequences of Britain, north-western France and Northern Europe. Unfortunately, since Eogan's original analysis of the Irish industrial phases, the chronology for its British and European counterparts has, if anything, extended further backwards, making even longer the chronological span to be bridged. Dowris must now begin around or shortly after 1000 BC, alongside the Wilburton–Wallington tradition in England and the St Brieuc-des-Iffs in Brittany (Burgess, 1969), but how long did it survive while the latter groups progressed through their Ewart Park and Carp's Tongue phases? Only after that, around or after 700 BC, do the latter enter their 'transitional' phases, represented in Britain by sites like Llyn Fawr or in Brittany by the distribution and deposition of 'Armorican' socketed axes. Certainly, by comparison with the two preceding phases, named by Eogan after hoards from Bishopsland and Roscommon (the latter effectively represented by a single find), the Dowris phase embraces a substantial number of sites and a wide range of types, so that it could be argued that it does indeed span a protracted period of time. Indeed, some further subdivision might facilitate the identification of types that are earlier or later relatively within that protracted sequence.

Eogan himself (1974) did, of course, identify discrete groupings in the late Bronze Age metal-work assemblage, not chronological but geographical (Figure 8.2). In particular, he identified a south-western distribution, centred on north Munster, including bronze shields and Class II horns and bowls, lock-rings, and gorgets in gold. Gold is not among the known mineral resources of the region, and the earlier bronze industries had concentrated further south. Furthermore, these were novel types of the late Bronze Age, so that the possibility of an external impulse was considered, with the few available parallels being European or even Mediterranean in origin. In contrast, a north-easterly grouping was identified, comprising cauldrons of Class A, buckets, horns of Class I, striated rings and sleeve fasteners, some of which, at any rate, could be matched in Britain or Northern Europe. Other types, such as socketed sickles and gouges, tanged chisels and disc-headed pins had distributions that, while not co-terminous with this north-east/south-west divide, nevertheless were markedly sparse in the far south-west. In addition to these regional groups it should be noted that Eogan also

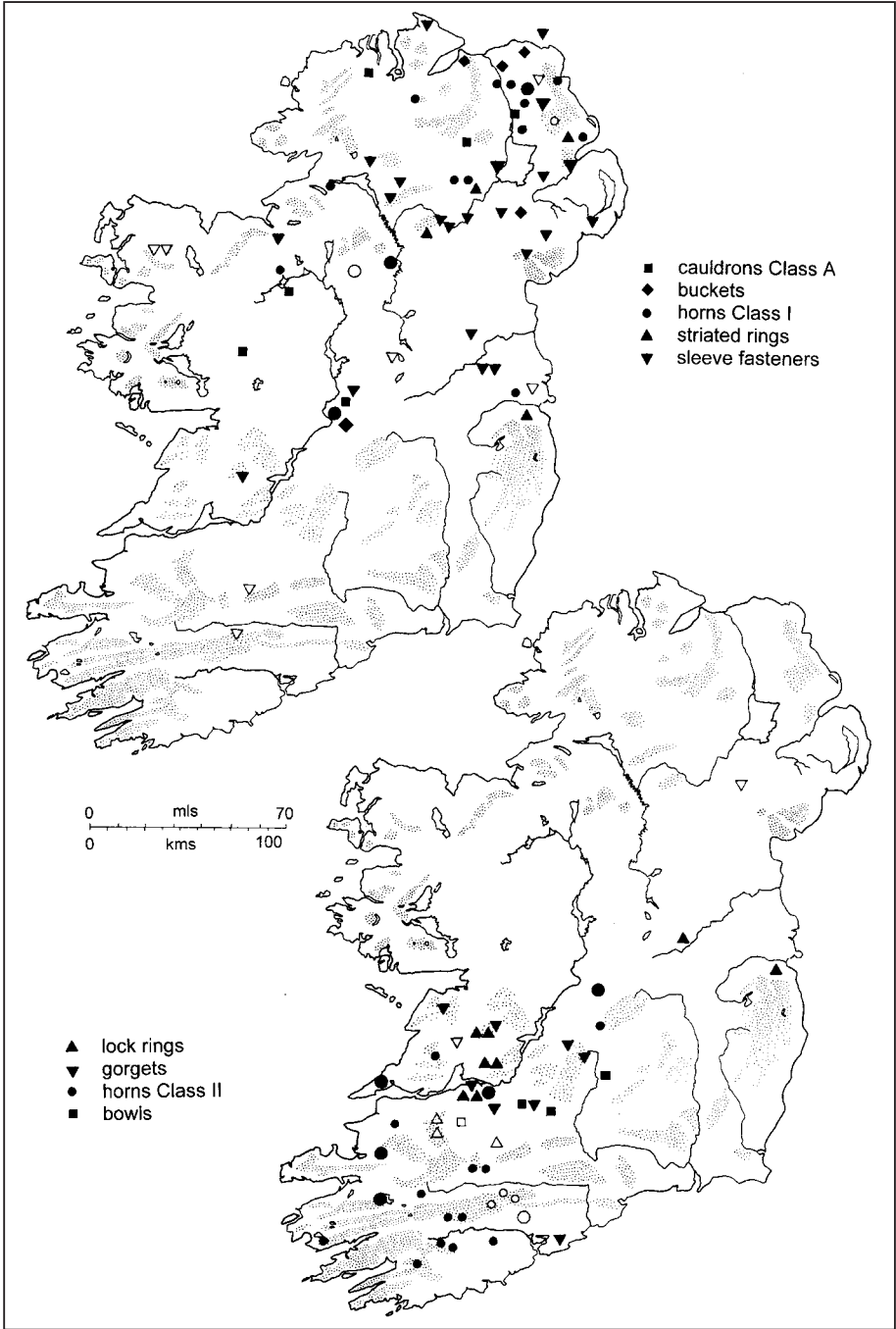

Figure 8.2 Regional distributions of late Bronze Age metal-work in Ireland. Adapted from Eogan (1974).

identified what he termed 'national' types, such as dress-fasteners, that had a much broader distribution in Ireland, as well as counterparts in Northern Britain. Linking these metal-work distributions with other archaeological or onomastic distributions is more tenuous, of course, but the concentration of *catbar* place-names, and indeed the stone forts and hill-forts themselves, seems to underline the probability that the north-east/south-west divide had its origins at an earlier stage in prehistory, at least from 1000 BC.

What evidence is there for late Bronze Age metal-working associated with field monuments that are conventionally regarded as characteristic of the Iron Age? Hill-fort sites have certainly produced late Bronze Age metal-work in Ireland, but as in Britain the difficulty lies in demonstrating that the metal-work was deposited in a phase of occupation contemporary with the fortifications themselves. At Rathgall, for instance (Raftery, 1976), Dowris metal-work included a gold ring, which was probably buried as part of a foundation deposit for a circular timber building, but while the balance of probability favours the view that these structures were contemporary with the defensive enclosure, stratigraphic demonstration of that association is plainly lacking. Equally, at Dun Aengus in the Aran Islands, the discovery of late Bronze Age metal-work with little else that is demonstrably later argues for the likelihood of the construction of the defences at this time (Cotter, 1992; 1993; 1994). On the other hand, scraps of late Bronze Age material from Mooghaun, Co. Clare (Grogan, 1994) could well be residual from a pre-fort phase of occupation, since there is evidence of such occupation sealed beneath the ramparts on the hill-top. On the other hand, a single radiocarbon date for the rampart of the outer enclosure does not preclude the possibility of later Bronze Age beginnings for the defences.

'Royal' sites, those that have historical associations as well as features like internal ditches that set them apart from regular hill-forts, also display evidence of occupation in the late Bronze Age. Emain Macha, Navan fort in Co. Armagh (Waterman and Lynn, 1997), certainly was in use in the later Bronze Age, as is attested not only by a series of radiocarbon dates but also by the presence of late Bronze Age metal-work. Neighbouring sites, such as Haughey's fort and the ritual deposits at the King's Stables site affirm the importance of this high-status or ritual complex in the later Bronze Age. Ring-forts may also have begun in the late Bronze Age, if the finds from Aughinish, Co. Limerick, are indicative, while the evidence from Rathtinaun, Co. Sligo, might argue the same for crannogs. Ironically, both these field monument types are widely regarded as typical of the early Christian period, so that it is their currency during the intervening early Iron Age that has yet to be convincingly demonstrated.

The early Iron Age (fourth to first centuries BC)

Notwithstanding the absence of Roman occupation in Ireland, its Iron Age has been divided into early, middle and late phases. As in Scotland beyond the limits of Roman occupation, the early phase is the most difficult to document in terms of material types, given the late dating conventionally assigned to the majority of La Tène types. The middle phase includes several of those distinctive types, dating to the first three centuries of the first millennium AD, and the late phase corresponds to the early historic or early Christian era from the fourth and fifth centuries AD that will be considered in a later chapter. The first task, therefore, is to examine the various categories of artefactual

evidence to determine which, if any, of these might be assigned to the early Iron Age according to the above classification.

Equestrian equipment

It is axiomatic that the Irish La Tène (Raftery, 1984) is essentially a series of artefactual types. There is no diagnostic hill-fort type of the La Tène period, insular or Continental, nor any non-fortified settlement types that are distinctive of the La Tène, as opposed to the Hallstatt Iron Age or the late Bronze Age. Burials accompanied by two-wheeled carts or chariots, or simpler burials within square-ditched barrows may be regarded as characteristically, if not exclusively, La Tène, as in Champagne or eastern Yorkshire, but there are as yet no known examples of such a distinctive burial mode in Ireland. The existence of chariots in Iron Age Ireland is assumed from historical literature, but would be hard to sustain on the evidence of archaeology alone. Wooden fragments from Corlea have been tentatively identified as part of the frame of a vehicle, and occasional metal parts have been considered as cart-fittings, but the absence of unequivocal evidence for iron tyres or linch-pins, for example, makes positive identification difficult. Pairs of horse-bits might well imply paired draught, but in the absence of cemeteries to provide the context for survival, the archaeological evidence is necessarily fragmentary. It is ironic that Piggott should have chosen the concept of a 'plantation of Ulster by Yorkshire charioteers' (1950, 16) as the agency for the introduction of the Irish La Tène, when the settlers so conspicuously failed to leave the imprint of their distinctive burial rite upon Irish soil.

This, of course, is not to say that the Irish La Tène is lacking in equestrian equipment. The example, however, of horse-bits epitomizes the problem. The Irish bits, like the British, are essentially of the three-link variety, unlike the Continental series, which after an initial phase of currency of the three-link type in early La Tène, adopts the two-link version thereafter. On this basis it was argued by Ward-Perkins (1939) that the introduction of the three-link bits into Britain and Ireland could hardly be dated later than the end of the early La Tène phase in the Marne. A current assessment would suggest that the Gaulish three-link bits did not survive much after 400 BC, and that the point of contact therefore was unlikely to be later than the early fourth century. This horizon lies well before the conventional dating of most of the British bits, and still more so of the Irish. Some elements of Raftery's Type A and Type B horse-bits (Figure 8.3, 1) bear some resemblance to the bits of the Arras group of eastern Yorkshire, including, for example, the use of studs to retain the links on the side-rings. But these similarities are eclipsed by the fundamental difference in plane of the perforations through the links, the Irish being parallel whereas the British have their perforations at right-angles on each end of the link. The Champagne horse-bits include both variants, so that an impulse into Ireland independent of Britain need not be discounted. The developed Irish bits, Raftery's Types C to E (Figure 8.3, 2), are totally unlike any British or Continental horse-bits in their elaboration, and testify emphatically to the insular character of the Irish La Tène. Their dating remains contentious, since so few have reliable provenance or helpful associations, so that much depends on a stylistic evaluation. Convention has inclined overwhelmingly towards a dating in the early centuries AD for these developed variants. By implication, however, the Type A and Type B bits should belong at least to the first and

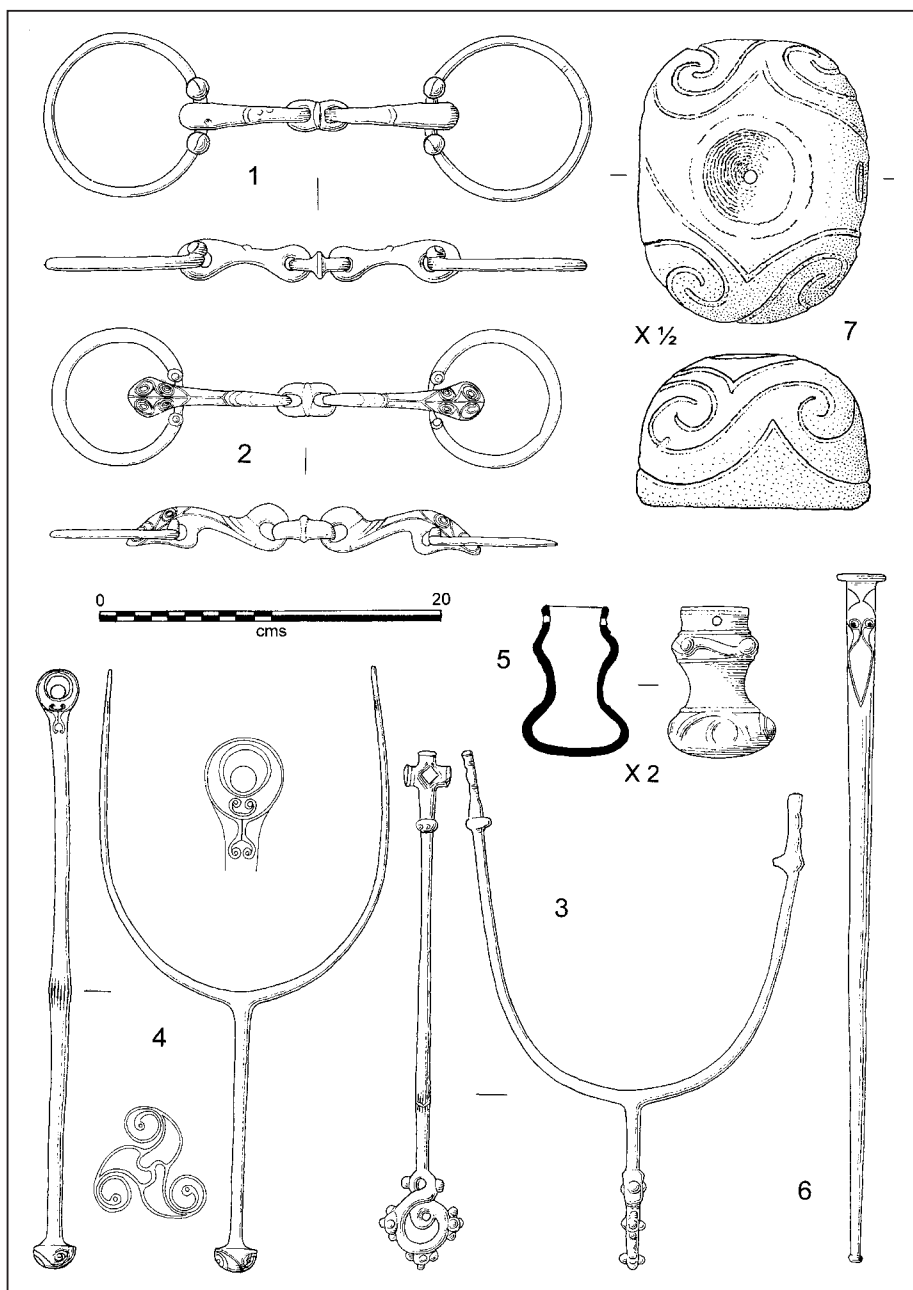

Figure 8.3 Irish 'La Tène' – 1: horse-bits, Y-pendants, spear-butts and querns. 1, Type B horse-bit, Abbeyshrule, Co. Longford; 2, Type E horse-bit, unprovenanced, but similar to examples from Attymon, Co. Galway; 3, Type 1d Y-pendant, unprovenanced; 4, Type 2a Y-pendant, Attymon, Co. Galway; 5, Lisnacrogher type spear-butt, Lisnacrogher, Co. Antrim; 6, tubular spear-butt, unprovenanced; 7, decorated beehive quern, Ticooly-O'Kelly, Co. Galway. Adapted from Raftery (1983).

second centuries BC, and possibly could have been introduced from a significantly earlier date.

Of quite uncertain function, but generally presumed to be related to equestrian gear or ceremonial activities are the so-called Y-pendants (Figure 8.3, 3 and 4), a type that has no positive parallels outside Ireland, and to that extent cannot be regarded as a regular La Tène type at all. The conventional name assumes that they were somehow attached in a pendant position from the bridle gear, perhaps even for leading a pony, but they are rather small to fit this purpose, and alternative explanations, such as plume-mounts, have also been proposed. A couple of examples of Type 1 pendants, putatively the earlier of the two principal sub-divisions, are associated with Type B horse-bits, likewise regarded as potentially among the earlier in that series; but otherwise associations, especially of Type 2 pendants, are fairly clearly of the opening centuries AD rather than earlier. In terms of ornamentation, two unprovenanced pendants of Type 1 bear relief ornament on their stem terminals of small bosses clustered on a larger boss in a fashion not unlike the Plastic Style ornament of the middle La Tène in Continental Europe. The majority of pendants with ornament, however, are of the later Type 2, and their motifs reflect the later styles of Northern Britain in the opening centuries AD. The implication nevertheless is that among the sizeable number of horse-bits and pendants are a minority whose origins could date back to the third or second centuries BC, after which there developed within Ireland a long and distinctive insular tradition of ceremonial equestrian metal-working.

The warrior's equipment

A second broad category of Irish La Tène metal-work is weapons, more specifically swords and their scabbards, and spear-heads. In general, more attention focuses upon the scabbards (Figure 5.9) than on the swords themselves, not simply on account of the elaborate ornament that they frequently display, but because scabbard typology is more amenable to classification than that of the swords. The Irish swords tend to be shorter than the norm in Continental Europe, where the shortest are among the earliest. Otherwise their blades are broadly similar, and certainly the campanulate hilt-guards of Type 1 swords match the prevailing form among Continental early and middle La Tène swords (de Navarro, 1972). Developed swords of Type 2 are demonstrably later in date, continuing into the first millennium AD. Dating has already been considered in detail in discussion of the ornament of the decorated scabbards, which, together with the form of chape-ends and other technical aspects of scabbard construction, indicates that the Irish decorated La Tène scabbards are unlikely to be earlier than early third century in date, though there may be no compelling reason for regarding them as much later. One interesting aspect of the Irish swords and scabbards, however, is their distribution. The decorated scabbards may well have been the product of a specialist workshop with limited circulation in the north-east of the country, but swords themselves, doubtless encased in plainer leather scabbards, had a much wider distribution, embracing virtually the whole of the country. Indeed, fewer swords in total come from north of the Dublin to Galway line than from south of it (Raftery, 1984, Map 7).

Spears were doubtless a key weapon in La Tène Ireland as elsewhere in Iron Age Europe, but in the absence of datable contexts, their typology is not diagnostic. Indirect evidence of spears comes in the form of so-called spear-butts, believed to have been

attached to the base of the spear to counterbalance the head. Raftery identified several distinct types. On the one hand was the Lisnacrogger type, distinguished by its hollow-cast circular socket and flattened-spherical moulding and terminal bulb (Figure 8.3, 5), and the door-knob type, with similar tube and bulb, but without mouldings. On the other hand there were tubular (Figure 8.3, 6) and conical variants that might have served a different function altogether. Iconographic evidence for the use of spear-butts is equivocal at best, and though there are indeed instances in which such 'spear-butts' have been found with the wooden shaft in place, this does not prove that the shaft was a spear, rather than a ceremonial staff, or more grandly a sceptre, to which a butt or ferrule might well be attached. The concept of a spear-butt, at any rate of the Lisnacrogger or door-knob type, is totally alien in Continental La Tène; the tubular variant, on the other hand, is not without parallel in early La Tène burials on the Continent, which could provide an analogy if not a prototype for the Irish examples. Though the tubular spear-butts of the La Tène period may owe nothing directly to those of the Dowris phase, the very fact that there was an ancestry for the practice of using tubular spear-butts lends credibility to the interpretation in this instance.

Dating of the spear-butts or ferrules of Lisnacrogger and door-knob type is, as ever, compounded by the lack of reliable, stratified associations. Debate has also been generated regarding their origins, since both types are also found in Scotland, where significantly moulds for casting such artefacts have also been found on various sites from Traprain Law in East Lothian to Dunagoil on the island of Bute in the Clyde estuary. From Beirgh in west Lewis there are radiocarbon dates in support of the stratigraphic sequence, which indicates strongly that the door-knob variety was still current in the Western Isles in the third to fifth centuries AD, rather later than conventional assessments would suggest. Raftery was inclined to date both forms around the turn of the millennia (1984, 125), though one example from Lisnacrogger has low-relief curvilinear ornament that could derive from a much earlier tradition. Notwithstanding the absence of Irish moulds, Raftery still believed that spear-butts of these types were essentially Irish in origin. More recent research has rediscovered examples from Romano-British settlements in England, suggesting that the overall distribution may be wider than formerly supposed, and further reinforcing their currency into the opening centuries of the first millennium AD (Heald, 2001). The possibility should be considered, of course, that the Lisnacrogger and door-knob types are not contemporary but sequential, albeit perhaps overlapping in time, though their contrasting distributions in Ireland (Raftery, 1994a, Fig. 88) might suggest different regional traditions.

After swords and spears, the third component of the Continental warrior's triple panoply, the oval shield, of which metal binding and spine may survive in middle La Tène burials, is completely absent from Ireland. Apart from a shield-boss from a later (i.e. early first millennium AD) burial on Lambay Island, no trace of any shield of this type, still less anything resembling the parade shields of south-eastern England, has come to light in Ireland. The sole find is that of a wooden and leather shield of comparatively small size from Clonoura, Co. Tipperary, which more probably represented the standard form of practical shield in the Iron Age. Helmets likewise are totally absent from the Irish La Tène assemblage.

Personal ornaments

Pride of place among personal ornaments as prestige products must go to the gold buffer torcs from the hoard from Knock, Co. Roscommon (Figure 8.4, 1; formerly 'Clonmacnoise') and from the Broughter hoard, Co Derry (Pl. 8a). Between them they represent the earliest and latest products of the early Iron Age phase. The splendid 'Clonmacnoise' torc falls into a well-known class, mainly in bronze, from the La Tène B2 phase on the Continent, and dated in absolute terms to the late fourth or early third centuries BC: Hawkes pronounced it 'no doubt fourth century' (1982, 52). It is almost certainly an import, though the significance of that fact need not be over-rated. The body of the torc is tubular with buffer terminals fused together, rather than being open, as they are in simpler variants. Opening was achieved by withdrawing a pin through a tenon-joint in one side of the buffers. At the back of the torc the tubular sections are jointed into a drum, ornamented with a simple, repetitive meandering scroll design executed in *repoussé*. This design almost exactly replicates the form of the serpentiform bracelets of the Münsingen–Dux horizon on the Continent, exemplified at l'Argentelle, Beine, in association with a buffer-torc which is itself ornamented in Waldalgesheim style. The ornament around the buffers consists of more complex tendrils set against background stippling, while the bosses that flank the buffer-terminal each bear a pair of relief S-motifs. Associated with the buffer-torc was a ribbon-torc of gold, a form known from the 'Ornament Horizon' phase of the middle Bronze Age. Unlike ribbon torcs of the Bishopland, or even Dowris phase, however, analysis has shown that the Knock ribbon-torc is made of platinum rich gold, and like the example from Somerset, Co. Galway, may therefore be assigned with some confidence to the Iron Age (Hartmann, 1970).

The Broughter torc was part of a hoard found in 1896 that also included fragments of bar torcs, gold wire chain, a bowl and the well-known model ship in beaten gold, fully equipped with oars, mast and fittings. The magnificent gold torc belongs to a distinctive group of late La Tène buffer torcs, characterized by their fat, tubular form with cylindrical buffers, of which there are good parallels from Snettisham and from Frasnes-lez-Buissenal in Belgium. Broadly, these torcs are classified into two groups on the basis of their opening, which is achieved either by simply inserting one tube into the other or both into a cylindrical junction-box at the back of the torc, or by means of a tenon joint at the buffers, as in the case of Broughter. The principal ornament of the torc is made up of *repoussé* motifs, including trumpet-ended curves, lentoid or almond-shaped elements and snail-shaped bosses linked into a loose S-chain, with forward and backward motion like a ballroom dancer's step-template. The design is essentially symmetrical, though the individual components are not identical in size or rendering. This is thrown into relief by the background of 'machine-turning', engraved shading of 'parallel' and intersecting arcs in a manner that is distinctively Irish. On such a curved surface the use of compasses would be difficult, except for the smaller elements, and Jope (2000) has suggested the use of a template instead. Dating is broadly established by its British and European parallels that indicate a currency of the type in the first century BC, and probably in this case in the second half of that century. But Jope (2000) argued persuasively that the torc was a composite piece, the heavier gold terminals perhaps being from an older, second-century torc that was refurbished in the rather different style of the tubular body.

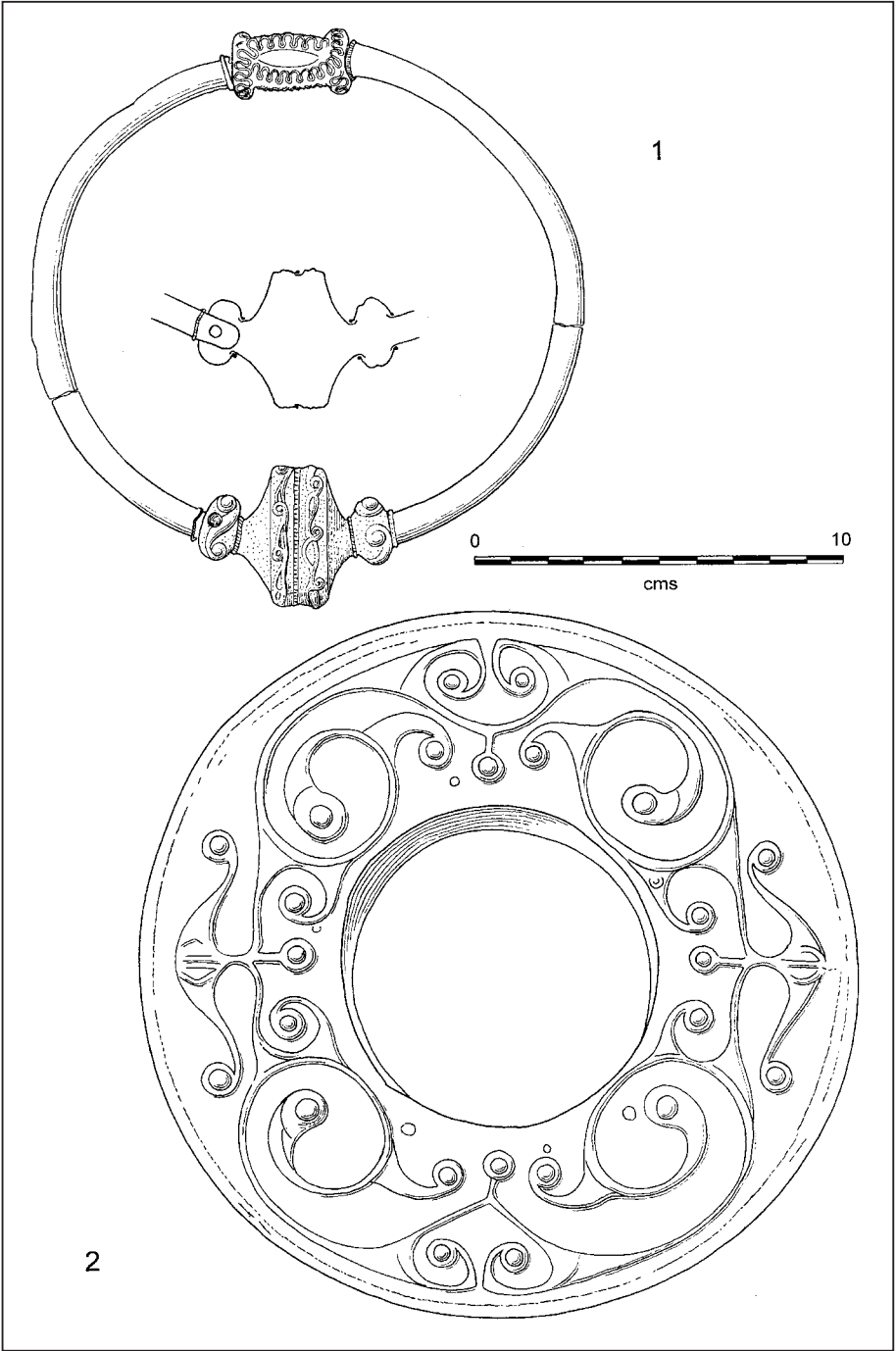

Figure 8.4 1. Knock ('Clonmacnoise') torc; 2, Loughnashade horn. Adapted from Raftery (1983) and Raftery (1984).

Among more routine personal ornaments, bracelets as a La Tène type are conspicuous by their absence in Ireland. That other most common and diagnostic La Tène type, the safety-pin brooch, is also hardly abundant, being represented in Ireland by only some thirty known examples. The main group is conventionally divided into those with leaf-bows (Figure 8.5, 7) and those with rod-bows, of which the former potentially could begin as early as the third century BC. As ever, where there are clear associations, these tend to be late, but as Hawkes (1982) convincingly showed, the leaf-shaped bow appears on the Continent and in Britain on brooches of La Tène 1 form, so that models for the Irish series would have been available from the late fourth or early third centuries BC. More importantly, Hawkes argued that, in dealing with the Irish brooches, we should not be constrained by the over-simplistic rule of thumb that casting the foot in one with the bow was exclusively a fashion of late La Tène. The 'inventive experimental character of native British brooch-making, free of dependence upon fixed Continental impositions' (Hawkes, 1982, 55) has long been recognized. Even more independent is the character and construction of the Irish brooches, making dating on the basis of typological comparisons with British or Continental brooches unconvincing. Nevertheless, there is a consensus that some of the Irish series could be relatively early. Later in the early Iron Age occasional examples of Continental types appear, such as the Nauheim brooch from Loughy, Co Down, or the Nauheim-derivative from Feerwore rath, Co. Galway. It is reasonable to infer that Irish brooch-makers from a much earlier date, though independent in their own products, need not have been totally isolated from or unaware of Continental fashions, any more than were their British counterparts.

Irish ring-headed pins endorse this impression. Ring-headed pins are not part of the Continental La Tène repertory, but the Irish series, after beginning with simple forms not unlike those of Britain, develops variants that would be described as uniquely insular, were it not for the fact that their ornamental elaboration includes elements that parallel the developed Plastic Styles of Continental Europe. There are four principal groups of ring-headed pins. Type 1 (Figure 8.5, 1) broadly mirrors the British pins, in some instances, such as in the use of cast knobs on the ring or milling around the top of the ring, being very close to English analogies. Type 2 (Figure 8.5, 2 and 3) is uniquely Irish; the example from Coll in the Inner Hebrides was plainly an export across the North Channel. What distinguishes these pins, however, is their embellishment with knobs and bosses, sometimes linked, as on the example from Grange, Co Sligo, into a simple S-chain. The use of this basic motif to link a series of bosses is one of the recurrent themes of the Continental Plastic Style, exemplified on the arm- or leg-rings from Klettham, Bavaria or from the Tarn in south-western France. Raftery was surely right to suggest that this form could date from the period of currency on the Continent of Plastic Style ornament. Type 3 (Figure 8.5, 4) is again uniquely Irish. The spoon-shaped appendage on the ring-head, to which settings of enamel or glass were formerly riveted, is without useful parallel, and stands witness simply to the ingenuity and inventiveness of the Irish pin-makers. Its distribution in north-eastern Ireland is geographically more concentrated than the other types, with the notable exception of examples from Ballacagen in the Isle of Man and from a burial at Alnham in Northumberland, both plainly exports. Type 4 (Figure 8.5, 5 and 6) is equally singular in design, but elements of ornamentation suggest broad concurrency with Types 2 and 3.

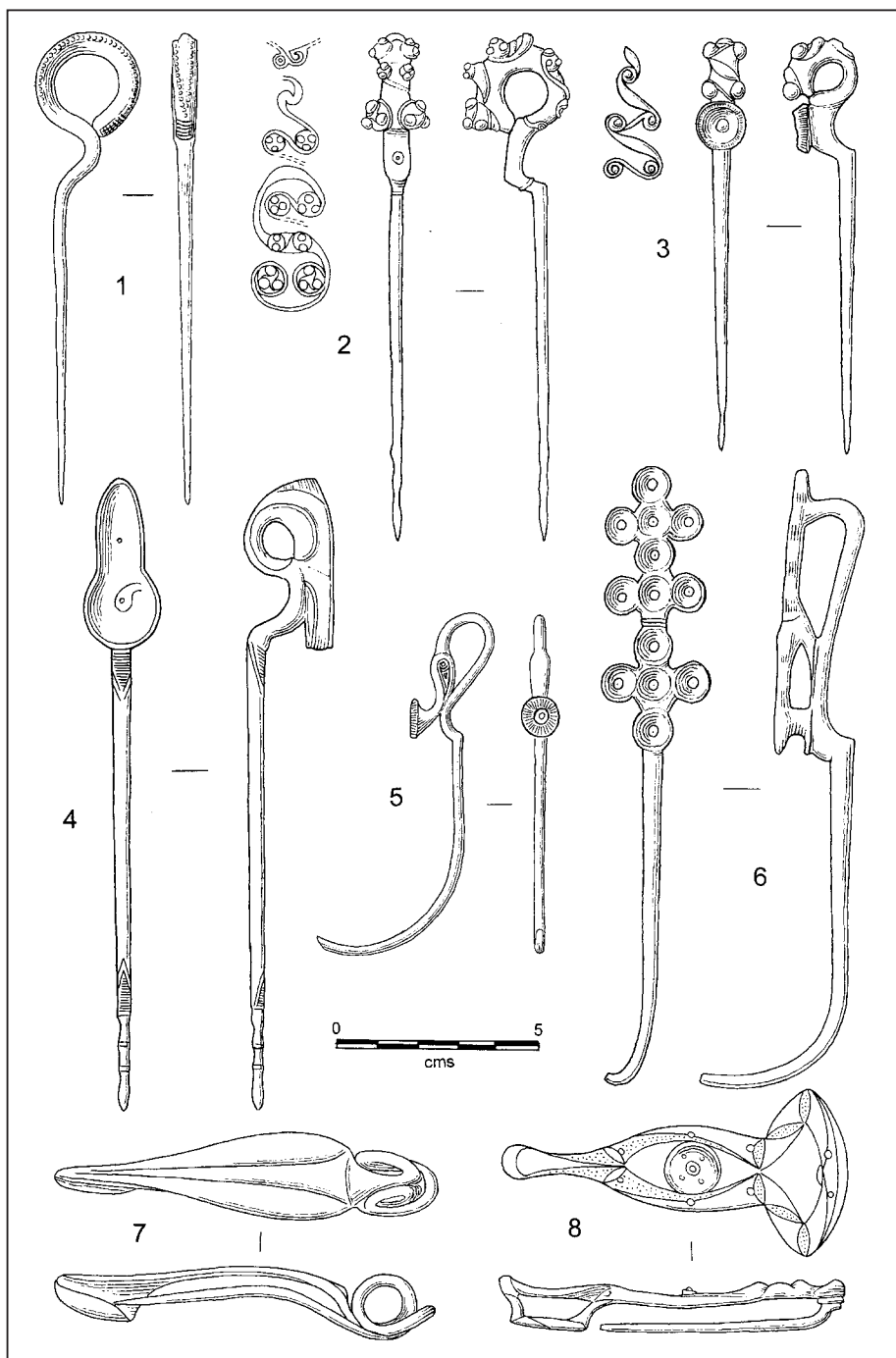

Figure 8.5 Irish 'La Tène' – 2: pins and brooches. 1, Type 1 ring-headed pin, Co. Antrim; 2, Type 2 ring-headed pin, unprovenanced; 3, Type 2 ring-headed pin, Grange, Co. Sligo; 4, Type 3 ring-headed pin, 'Roscavey', Co. Tyrone; 5, Type 4 ring-headed pin, River Shannon; 6, Type 4 ring-headed pin, Beagmore, Co. Galway; 7, leaf-bow brooch, Bondville, Middletown, Co. Armagh; 8, Navan type brooch, Navan, Co. Armagh. Adapted from Raftery (1983).

Necklaces of glass beads are among the personal ornaments that could well have been fashionable from the early Iron Age; their occurrence archaeologically in penny numbers, compared with the number required for a string to adorn neck or wrist, seems a sure indicator that they are token survivals from earlier usage. Hence the occurrence of spiral-inlaid beads at Grannagh, Co. Galway, or among the 'Loughey' group in what is probably a first-century BC deposit, need not preclude the currency of that type in Ireland equally as early – perhaps from the fourth or third centuries BC – as in south-western Britain. The same could be true of the blue glass bead with inlaid clusters of 'eyes' from Grannagh, for which Raftery (1984, 201) rightly pointed to the close parallels in the fourth-century Reinheim princess's burial from the Rhineland. From the same group came a fragmentary example inlaid with concentric rings, for which Hawkes (1982, 61, Fig. 8, 9) cited parallels from the Marne and from Southern Britain, starting in the fourth century BC. The fact that the Grannagh ring-barrow also contained narrow spiral and 'dumb-bell' beads, probably of first-century BC or even early first-century AD date, need indicate no more than the date of final deposition.

Probably dating no earlier than the second or first centuries BC is a variant form of spiral-inlaid bead, Guido's (1978) Class 6, characterized by having its spirals on low raised bosses. The British distribution is quite widespread in England and Wales, with just a few extending into Scotland. In Ireland, they are all restricted to the north-east, including an example in the Kiltierney, Co Fermanagh, ring-barrow (Raftery, 1981, Fig. 39, 2). Certainly of later Iron Age date are the larger glass beads with 'whirl' or 'ray' design of Guido's Class 7. Though more than half the Irish examples lack provenance, the type is a well documented later La Tène type on the Continent, being common on *oppida* sites of the late second and first centuries BC. They are also found around the Severn estuary as well as in south-eastern England, so that their presence in Ireland could well indicate trading connections with the Continent and along the Western Seaways in the closing centuries BC.

Beehive querns and the Irish La Tène

Following the research of Caulfield (1977), it has been suggested that the beehive quern in Ireland is broadly co-terminous in date as well as distribution with the La Tène phenomenon, and with the north–south divide that it represents. In fact, locally the querns and metal-work have been shown to be complementary rather than coincident (Warner, 2002), perhaps even reflecting distinct cultural groups. What is still not widely agreed is a more specific date for the introduction of the beehive querns and the source or means of introduction. Caulfield himself was in no doubt that on typological grounds, essentially the character of the central perforation and lateral handle-hole of the upper stone, the Irish beehive querns must have been derived from those of northern England and southern Scotland, not far removed in fact from the area from which Piggott had derived his 'plantation of Ulster by Yorkshire charioteers', and by the arrival of new community groups rather than through technical or other innovation.

It is generally agreed that the adoption of the rotary quern in place of saddle-querns represents a major technical advance, one which doubtless reflects upon the nature and scale of grain-production in the economy. In Southern Britain, the rotary quern must have superseded the saddle quern by around the fourth century, on the basis of sizeable samples of each from Danebury (Cunliffe, 1984, 418; Cunliffe and Poole, 1991, 396,

ceramic phase 7 appearing pivotal), though it undoubtedly was known here and at Gussage All Saints (Wainwright, 1979) from an earlier date. An important inference from the Danebury evidence, however, contrary to previously advanced views, is that the change was not radical with a virtually universal adoption of the new technology in place of the old, so that we might reasonably expect some beehive querns to have been in circulation in northern England, and potentially therefore in Ireland, earlier than their more general adoption.

One reason for regarding beehive querns in Ireland as part of the La Tène assemblage is that a small minority bear decoration in a very simplified La Tène style. Examples from Ticooly O'Kelly, Co. Galway (Figure 8.3, 7) and from an unprovenanced location (now in the Ulster Museum) have conjoined or running S-spiral designs that could belong virtually anywhere from the inception of the La Tène style in Ireland. In Atlantic Scotland and Ireland, there is an alternative form of quern, the disc quern, which has generally been regarded as later than the beehive series. It has been suggested, however, that this type, with its potential for adjusting the gap between upper and lower stones for coarse or fine grinding, represents a non-La Tène development that therefore need not have been sequential to the La Tène version (MacKie, 1995, 663).

The engraved style and the relief style

The engraved style of the Irish scabbards has been discussed in detail in relation to analogous fashions in Continental Europe and in Britain. The web of inter-relationships between these various groups was clearly complex, and certainly need not be presumed to have been one-way traffic; indeed, everything we know from historical sources suggests a social structure in which a variety of mechanisms could have prompted mutual exchange of artistic fashions and technical expertise. The affinities with the eastern English style of scabbard ornament are apparent, as they are with Torrs, and at further remove with parallel trends in Europe. It has been argued that there is no *a priori* case for invoking time lag in the appearance of the engraved style in Ireland, which is not to say that all the decorated scabbards need date as early as the third century BC. The Irish scabbards are seemingly later than the earliest of the Yorkshire examples in terms of their chape typology, but it need not follow that they are therefore derivative from the eastern English group.

A relief or embossed style, the insular counterpart to the Continental Plastic Style, is also represented in Ireland, as in Britain. Whereas in Britain the two appear on the same artefact, notably in the parade shields of eastern England, in Ireland, they do not coincide, which is not to say that they could not have been overlapping in chronological currency. A major example of the style is the disc embellishing the mouth of the Loughnashade horn (Figure 8.4, 2), found in 1794, apparently with three other such horns, in a marshy pool beneath the 'royal' earthwork at Emain Macha in Co. Armagh. Among British scholars, the Loughnashade piece has received a poor press. Atkinson and Piggott (1955, 231) regarded it as representing 'the Torrs style in uncomfortable decline', and more recently Jope has written of its 'mechanical uninspired *repoussé* design' and its 'rather starved effect, lacking real invention' (2000, 74). Closest stylistically is certainly the Torrs pony-cap, likewise executed in *repoussé* and likewise in fold-over symmetry. The circular field dictates its balanced design, comprising essentially four elements at the cardinal points, linked with a series

of tendril scrolls. The principal motifs like Torrs include peltate elements extending into bossed terminals, the latter curling in the same direction as on the Brentford 'horn-cap' rather than balanced reciprocally, one up, one down, as with Torrs. Some hint at exaggerated birds' heads, though not so explicitly as Torrs, and there is a strong impression of paired Cheshire-style 'eyes' in the cardinal point designs. Double finials are matched in marked imbalance on opposed sides of a small, curving triangle by a single bossed finial, a combination also seen on the Newnham Croft bracelet.

Dating the Loughnashade disc exposes all the usual limitations of the data and prejudices of archaeologists, who in general have favoured a date spanning the first century BC and first century AD, as if this was 'safer' than acknowledging that it should be contemporary with Torrs and the eastern English series. The relief style could be marginally later in its first appearance than the engraved, but still could date from the later third century BC. Raftery (1984) appears to have been influenced by the fact that the D-shape patch on the horn is paralleled on cauldrons of the first century AD. Since patches by definition imply longevity of use, the style of the patch, or its association with other repaired artefacts, can hardly be adduced as reliable evidence for the date of manufacture of the horn itself and its ornamental disc. As in Britain, however, the relief style does undergo a progressive transformation on discs and related pieces of the first and second centuries AD, which will be considered in due course.

The function of these horns or trumpets in Celtic society is a subject of much speculation, with reference inevitably to the depiction of such an instrument on the sculpture of the Dying Gaul, commemorating the Gaulish invasions of Macedonia of the third century BC, and the possible role of battle-trumpets in Celtic warfare. Relatively few curved instruments of the Loughnashade kind are known in Europe, though the existence in Ireland of wooden horns suggests the possibility of a more commonplace variant. The relationship to other classes of wind instrument is likewise unclear. The horns of the Dowris late Bronze Age are always declared to be quite different, as indeed they are to the archaeologist's typological perspective, even though their function was surely similar. The *lürer* of later Bronze Age Scandinavia, on the other hand, have ornamented discs cognate to the Loughnashade trumpet. The conclusion must be that these horns fulfilled a ceremonial function in later prehistoric society, whether festive, funerary or associated with martial display. It was plainly not an exclusively Celtic function, though it may have been an important part of Celtic practice.

The relief style in Ireland, however, is also expressed in the medium of stone, of which the finest example, Turoe (Figure 8.6), is probably not the earliest. The design of the Turoe stone is not easily described, though its recurrent component elements are clear enough. As Duignan (1976) astutely observed, the decoration of the conical stone is in fact divided into four separate panels, bound into one by the continuous stepped meander design around its base. Predominant in the curvilinear designs are peltate elements, curved triangle elements, comma-leaves and whirligig triskeles, while in the negative background are open circles, peltae and trumpet-voids. Some of these, like the comma-leaves and triskeles, have their ultimate ancestry in the Continental Early Style and its immediate successors, but here they may be no more than archaisms incorporated into a design for which later insular British parallels are more commonly cited. Certainly there are echoes of the southern British Mirror Style in the open circles, peltate or sub-crescentic elements, and the trumpet void. The isolated comma-leaf, or

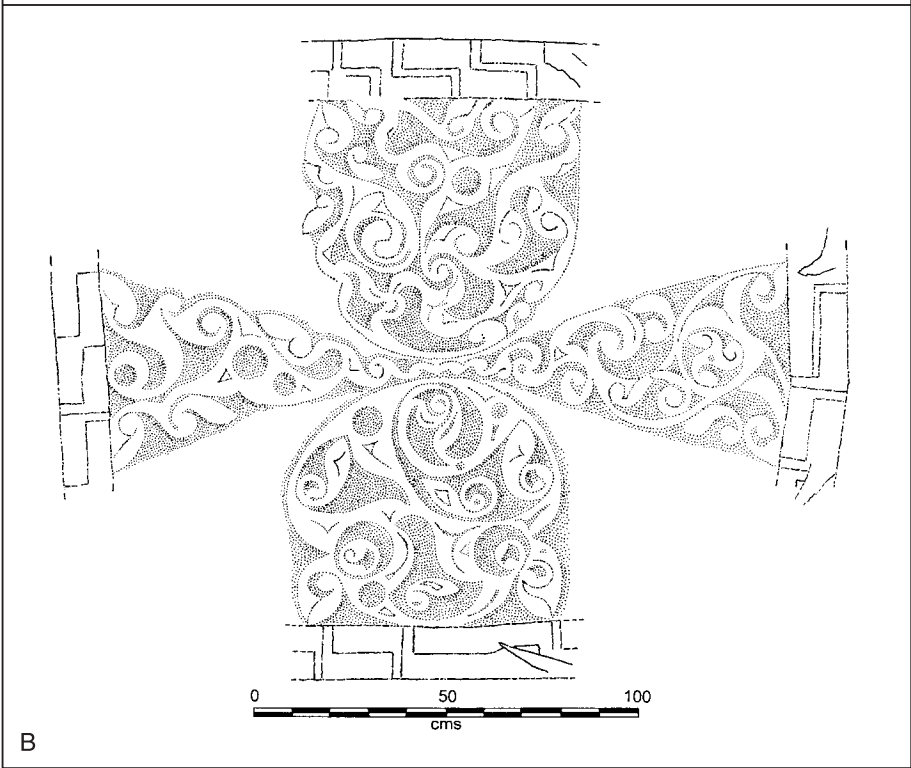

Figure 8.6 The Turoe stone, Co Galway. A: Professor Etienne Rynne examining the design. Photo by D. W. Harding. B: the quadrilateral basis of the design. Adapted from Duignan (1976).

'floating lobes' in Duignan's phrase, can be matched on the Llyn Cerrig plaque, but it is hardly a diagnostic characteristic of late La Tène British metal-work. The weight of opinion, which a generation ago saw sub-Waldalgesheim influence in the Turoe designs, now favours a late date, again spanning the first century BC or first century AD. The Breton connection, prompted by the model of the early La Tène *stèles bas* of that region, and the analogy of the Turoe stepped design and geometric patterns on the Kermaria stone in particular, has likewise been discredited in recent years, seemingly in favour of an independent Irish development prompted by various influences, filtered through unspecified intermediaries.

Among other carved stones, the designs on the Castlestrange stone is plainly in a different style, and could be somewhat earlier than Turoe. On the other hand, the incised designs on the Derrykeighan, Co. Antrim, stone are probably no earlier than the end of the first century BC on the basis of analogies with the designs on the Lough Crew flakes. The same might be argued for the incised ornament on the Killycluggin stone from Co. Cavan. What is likely is that these survivals represent only the tip of the iceberg of those ornamented stones and pillars that there once were. Various commentators have remarked that an entire body of timber carvings could have been lost, but equally many apparently plain boulders in Ireland and elsewhere could have borne similar designs in paint-work that has simply not survived.

The middle Iron Age (first to third centuries AD)

It will be apparent from the previous analysis of the La Tène material assemblage that many of the types already considered, horse-bits, Y-shaped pendants, spear-butts, brooches and pins, must have continued in modified form into the opening centuries of the Christian era. Horse-bits of Types D and E, for example, are ornamented in a more formal curvilinear style that evidently reflects Roman influence, and in some instances associations with Roman imported material confirms this assessment. Likewise, developed examples of Y-shaped pendants, several found in association with bits of Types D and E, must be assigned to a relatively late horizon. Personal ornaments too certainly included types that continued into the first century AD. One example, which may have been developed as early as the first century BC, but which belongs predominantly to the first century AD, is the Navan type brooch (Figure 8.5, 8), characterized by its expanded 'spring' head and open-work bow, in which enamel studs or settings may be included. The foot is invariably cast in one with the bow, in the late La Tène fashion, but its pin is ingeniously attached by means of a ball-socket, as on one from Navan fort itself, and on another, the only example with confirmed associations, from Somerset in Co. Galway. With the latter was a bronze bowl-handle in the form of a bird's head, similar to that from the Keshcarrigan, Co. Leitrim, bowl, normally dated to the first century BC or first century AD. Hawkes (1982) saw the Navan brooches as a development of the British late Iron Age cross-bow types, and dated them from the later first century BC onwards. Jope saw still later Roman provincial influences in their form and ornament.

Connections between Ireland and Britain also evidently continued into the first century AD, perhaps rather later in Northern Britain, where the Roman occupation did not make a significant advance until the Agricolan campaigns of the 80s. Particularly striking are the similarities in two cauldron types (Figure 8.7A). One, the

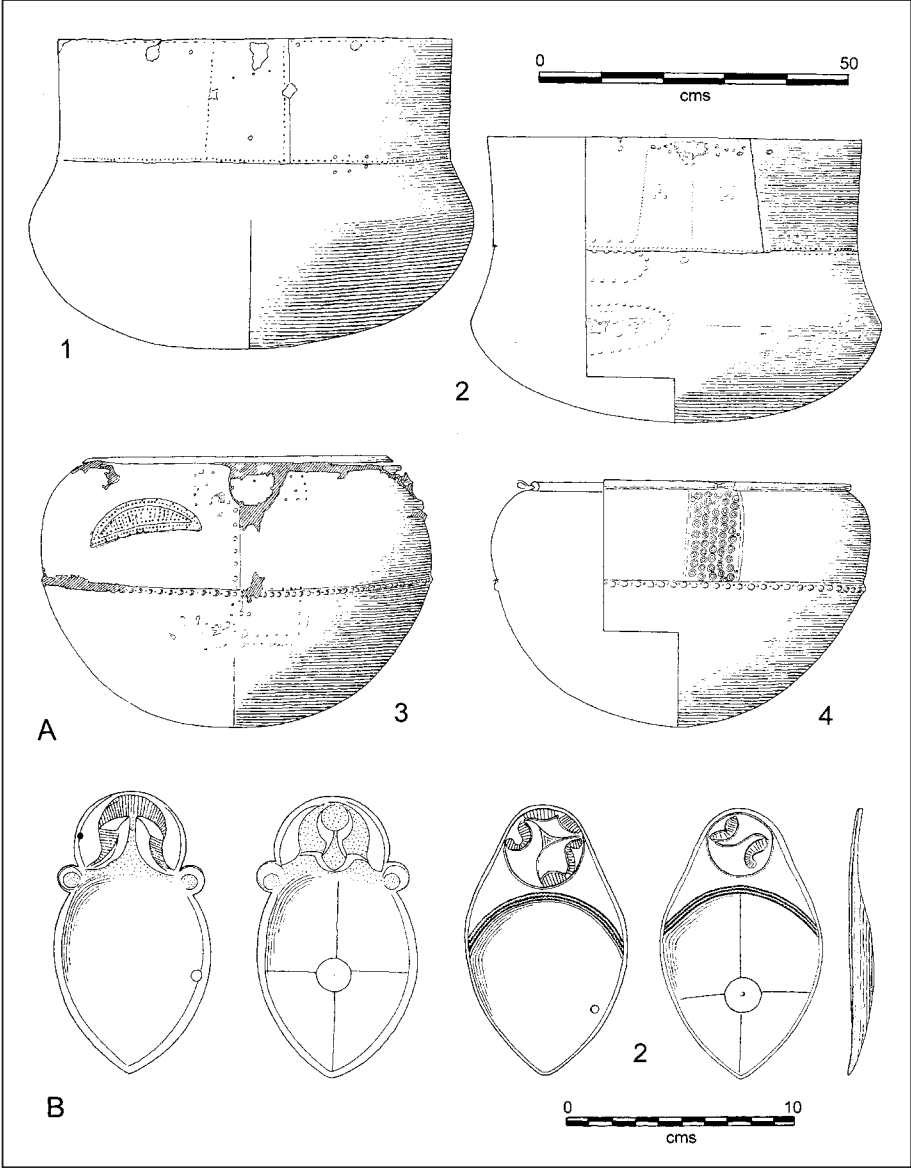

Figure 8.7 Ireland and Northern Britain: comparative metal-work. A: cauldrons. 1, Ballymoney, Co. Antrim; 2, Carlingwark Loch, Kirkcudbright; 3, Ballyedmond, Co. Galway; 4, Kincardine Moss, Stirlingshire. B: spoons. 1, Ireland, no provenance; 2, Crosby Ravensworth, Cumbria. Adapted from Raftery (1983) and MacGregor (1976).

projecting-bellied type known by the site-name of Santon in Norfolk, is represented by four examples in Ireland, including the fine cauldron from a bog at Ballymoney, Co. Antrim. Just across the North Channel, a similar cauldron from Carlingwark Loch in Kirkcudbrightshire was filled with Roman as well as native Iron Age tools and equipment that Piggott (1953) dated to the late first or early second centuries AD. The other cauldron type, the globular variant, is again found in both Ireland and Northern Britain, as well as in south-east England. The example from Ballyedmond, Co. Galway, is regularly compared to one from Kincardine Moss, Stirlingshire; neither has dated associations, but on stylistic grounds both are generally assigned to the first century AD or thereabouts. The remarkable wooden cauldron from Altartate, Co. Monaghan, however, again serves as a reminder that these vast, beaten bronze communal vessels may have had their less grand domestic counterparts in wood, so that the surviving distribution reflects only a small proportion of high-status examples. It also raises the prospect that the basic typology need not have altered much from the late Hallstatt or early La Tène models, which in general terms, if not in specifics, they emulate.

Equally prestigious, but of personal rather than communal proportions, are the bronze bowls of Britain and Ireland, likewise having humbler counterparts in wood. Perhaps the finest example of the series, the bowl with cast bronze handle in the shape of a bird's head from Keshcarrigan, Co. Leitrim (Jope, 1954b; Raftery, 1984, Fig. 107, Pl. 69), also exhibits the use of a lathe in finishing the bronze casting of the bowl. It has frequently been compared to bowls from south-western England that are certainly cognate with, without necessarily being ancestral to, the Irish examples. In fact, as Raftery pointed out, the Irish bowls, in shape and rim form, bear closer resemblance to those from Stanwick, north Yorkshire, Lambertton Moor in Berwickshire and Lochar Moss, Dumfriesshire, reinforcing the Northern British connection at this period. Again, first-century AD contexts are more easily established than earlier ones, but there is every probability that the form derives from earlier antecedents. Cast bronze spoons (Figure 8.7B), sometimes found in pairs, have a widespread distribution in Southern Britain, though in Ireland all lack provenance. The Irish examples therefore can only be dated on the basis of their compass-drawn decoration, which in comparison with the Lough Crew flakes, once again suggests a first-century AD currency for the type. Examples from Britain, however, including the pair from Mill Hill, Deal in Kent, could be earlier, and the sole find from the Continent was certainly from a cemetery with La Tène 2 associations (Stead, 1995, 107). The function of these artefacts is quite uncertain. The fact that they occur in pairs, one of which sometimes is engraved with a cross while the other has a perforation through one edge, has led a succession of scholars to suggest a ritual or magical significance. But their occurrence in graves, as Stead pointed out, might imply a personal rather than ritual purpose.

Ceremonial crowns and prestigious display

The discovery of an Iron Age crown from Mill Hill, Deal, prompted a re-appraisal (Stead, 1995) of the evidence for ritual or ceremonial head-gear in Iron Age and Roman Britain, in the light of which it seems no longer so exceptional to regard the Cork horns (Figure 8.8A) and the 'Petrie' crown (Figure 8.8B) in the same category. The Petrie crown, unprovenanced and named after its nineteenth-century antiquarian owner, comprised originally a pair of horns, each attached to a frontal disc and the

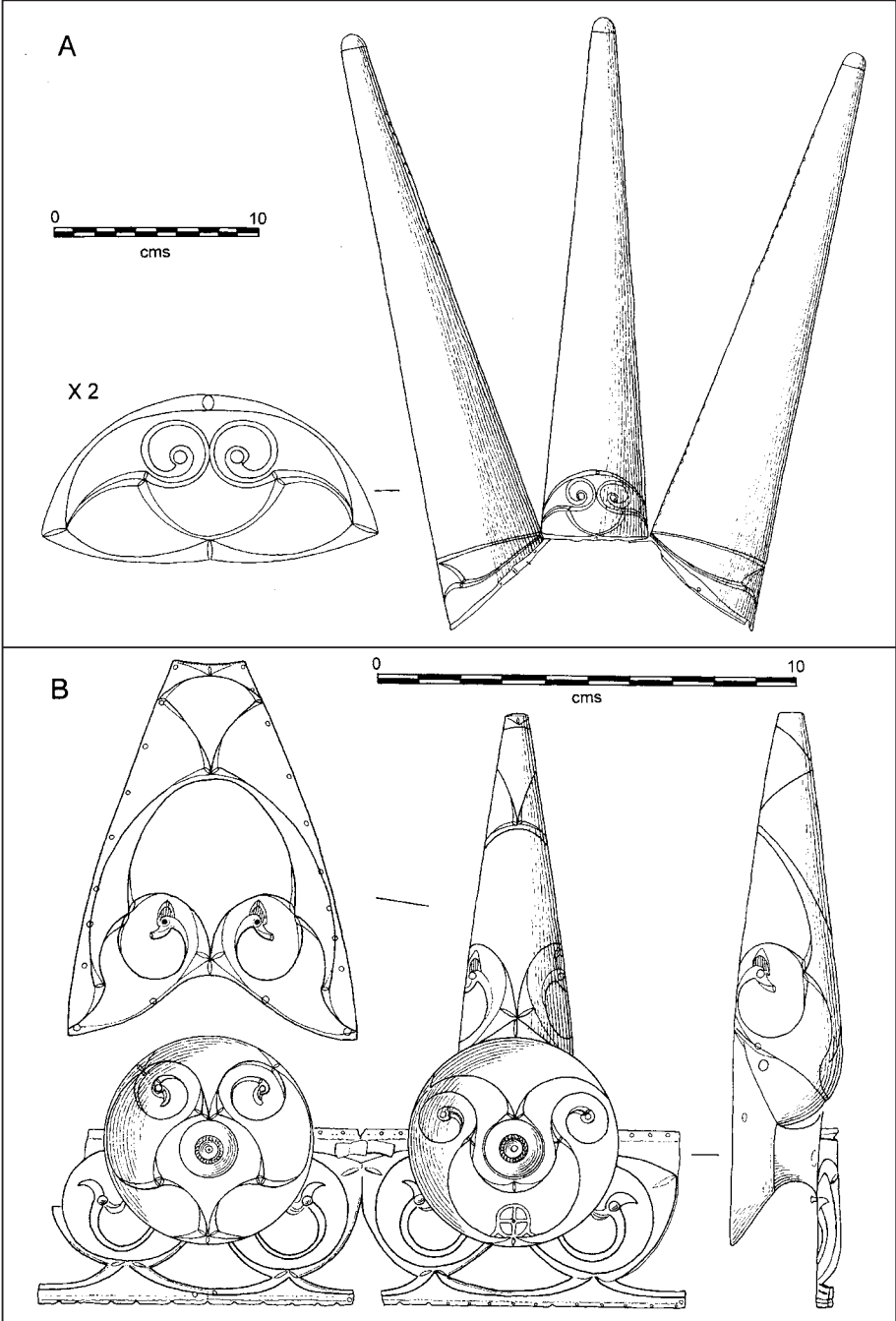

Figure 8.8 Ceremonial head-gear. A: the Cork horns; B: the Petrie 'crown'. Adapted from Raftery (1983).

whole mounted on an open-work frieze. Repairs, probably ancient, suggest that it could have undergone modifications, or could be a composite piece in its surviving form. Nevertheless the ornament of horns, discs and open-work panel is uniform in style, comprising thin trumpet curves leading to bird's head terminals, those of open-work panel and horns in particular being distinctive, though not identical, in their crested form. The discs have an elusive zoomorphic aspect, suggesting creatures with rounded muzzle and large button nose beneath spiral eyes. The Cork horns, found in 1909 on the margins of the river Lea, were reported as having leather still adhering to them, which would be consistent with their use as ceremonial head-gear. They are less lavishly decorated, but again have thin trumpet-curves and a pair of spiral 'eyes'. O'Kelly's technical examination of both these artefacts (1961), which has been endorsed by later scholars, argued that the ornament on these pieces had not been cast, but had been cut back into the thickness of the metal, to create the low relief effect. A third piece, the Bann disc (Figure 8.9A), displays the same style of ornament, with fine trumpet-curves and crested bird's heads in perfect rotational symmetry. Three perforations spaced around its perimeter, one still with a loop of bronze wire attached, suggests its use as a scales-pan. Raftery (1984) thought this function too humble for such a fine piece, but in the context of weighing precious metal, for example, it would surely have a high-status context.

The closest parallels, both for the ornament and for the 'cut-down' technique of achieving it, are once more with southern Scotland, where the Stichill collar from Roxburghshire matches both. This, too, was an old find, but its possible association with one or more 'massive armlet' supports a first- or second-century AD dating. Raftery rightly also pointed to the crested bird theme on North British dragoon-like brooches of the same period as an example analogous to the Petrie and Bann bird's heads.

Closely related in style to the discs on the Petrie crown are the much larger discs of uncertain function, of which the only provenanced examples are from Monasterevin, Co. Kildare (Figure 8.9B), from which the group therefore takes its name. Up to 30 centimetres in diameter, and slightly concave in shape, they display an eccentrically located dish roundel, around which trumpet curves with coiled terminals resemble a face with staring eyes. Almost invariably a triple-circular element corresponds to the position of the 'mouth'. Once again the stylistic analogies are with Northern Britain. Much the same trumpet curves embrace the eyes of the Deskford carnyx, and form a principal component of the Culbin Sands armlet and the massive armlets of north-east Scotland. All the comparanda suggest a dating in the first and second centuries AD, with the sole exception, which Raftery (1984) considered to be the closest parallel, of the Norrie's Law plaque from Fife. This hoard unfortunately is of questionable value for dating. Deposited doubtless at some time in or around the seventh century AD, it contains material that is certainly residual from an earlier period. How much earlier the plaque might be, or how long the Monasterevin-type ornament might have survived, is therefore a matter of unresolved debate. But the stylistic similarities with the Irish discs, and the clear evidence for contacts between Ireland and Scotland in the opening centuries AD, afford a plausible earlier context for the Norrie's Law plaque.

Hitherto we have deliberately avoided confronting the nature of these inter-relationships between Ireland and Britain, and more particularly with Northern Britain. Connections between Ireland, south-western and western Britain and the

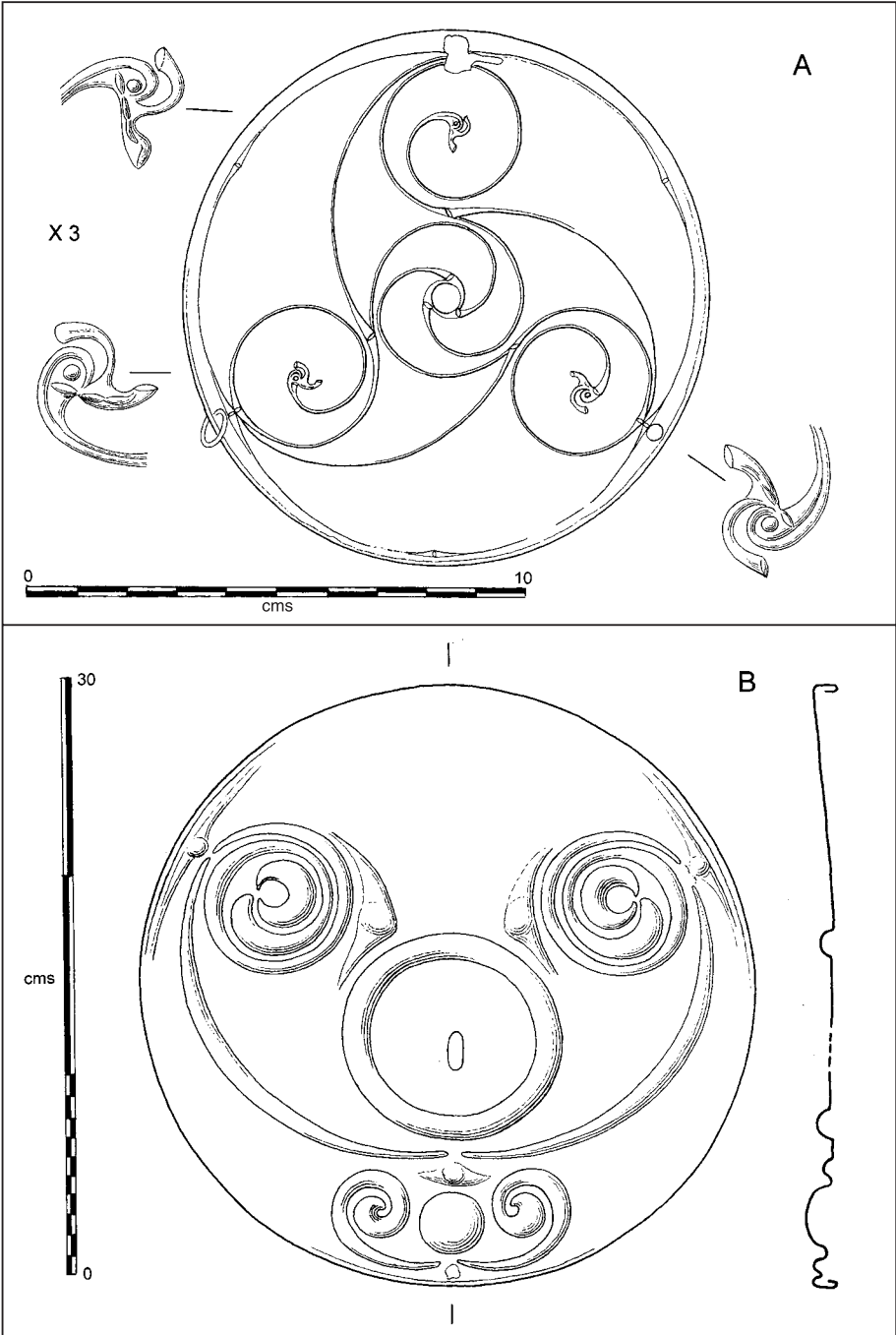

Figure 8.9 Ornamented discs. A: Bann disc; B: Monasterevin disc. Adapted from Raftery (1983).

Continent should certainly have been regular along the Western Seaways throughout prehistory, with the Iron Age as no exception. But the self-evident connections across the North Channel are more specific, and certainly indicate close links, perhaps at the level of ruling dynasties and their specialist craftsmen, over several centuries before the historically inferred settlement of Dál Riata. In recent years archaeologists have not favoured the simplistic Childean equation of artefactual distributions with discrete population groups, and hence should not expect any population movement to be manifest archaeologically by the appearance and distribution of novel artefactual, burial or settlement types. But the diplomatic and specialist links that might be inferred from the comparison of prestige goods discussed above could well have fostered an environment in which negotiated settlement of significant community groups could have become a reality.

Archaeology and language

In Ireland, it is not possible simply to equate the appearance of La Tène metal-work with the arrival of Celtic speakers, not just because so many of the diagnostic types of European La Tène culture are absent, or because the Irish pieces are often indigenous types not represented on the Continent, but because the areas of Continental (or even British) La Tène culture to which one might theoretically look as a source for their introduction to Ireland are linguistically P-Celtic, and therefore cannot account for the subsequent dominance of Q-Celtic in Ireland. Much of the Irish La Tène is high-status metal-work, which could have been introduced by specialist craftsmen or a small, but socially elite group whose externally inspired but locally produced metal-work has had a disproportionate impact on the archaeological record, by comparison to the much more numerous and no less prestigious assemblages of the preceding late Bronze Age. Indeed, the late Bronze Age is one of the periods in prehistory, perhaps rather more than the early Iron Age, when there appears to have been a widespread commonality of culture in Atlantic Europe, characterized by distinctive metal-working industries, notwithstanding regional differences within those industries. We need not demand that their distributions should be exclusively co-terminous with any subsequent cultural or linguistic group in order to infer a sequential connection, since we are dealing with a dynamic process over several centuries. In Ireland, the occurrence of Dowris-period metal-work on hill-fort sites like Rathgall, Haughey's Fort, Mooghaun and Dun Aengus serves to underline the point that field monuments that conventionally have been regarded as Iron Age may yet have had their origins in the later Bronze Age.

Without pushing the introduction of Celtic languages beyond the first millennium BC, it would be possible to propose in the Atlantic late Bronze Age an archaeological context for a population in Atlantic Europe that was Celtic-speaking in its Q-Celtic form, which thereafter, following the expansion of La Tène culture into western Continental Europe and Southern Britain, became restricted over time to those regions of Atlantic Scotland, Ireland and the Hispanic Peninsula where Q-Celtic is subsequently attested. In Ireland, the distribution of Dowris types, as we have seen, already seems to anticipate a north-south divide, mirrored by the La Tène-non-La Tène distributions of the ensuing Iron Age. If the introduction of La Tène metal-work into Ireland implies the presence of P-Celtic speakers in the northern half of this divide, then such a minority group could well have been subsumed by the dominant group, since the

distinctive archaeological distribution need not be a true measure of its numerical strength and impact on this region.

If the significance of La Tène metal-work in Ireland has been over-rated, and the introduction of Celtic speakers can be accepted as correlating archaeologically with the Atlantic late Bronze Age, then the implication of this view would be that there ought equally to have been Celtic speakers in Scotland by the end of the Bronze Age. Given the long-standing connections across the North Channel since the Neolithic, it seems improbable archaeologically that the first historically documented record of the settlement of Dalriadic Gaels was the first actual instance of Celtic speakers in the region. Accordingly, we might speculate whether there were already in later prehistory enclaves of Q-Celtic speakers in Atlantic Scotland (for which admittedly no linguistic evidence has survived), even though by the time of the Roman Conquest Scotland was evidently otherwise P-Celtic linguistically. Given the regional diversity that has already been demonstrated archaeologically within the Atlantic Iron Age, we need not demand linguistic uniformity within Scotland, or between Scotland and Ireland in later prehistory. In Scotland, as in Ireland, the later Bronze Age of the early first millennium BC looks increasingly crucial in the genesis of those forms of monumental structures that we regard as distinctive and characteristic of the early Iron Age. As an expression of identity and status, it is to this series of monuments that we naturally turn for the archaeological manifestation of Celtic-speaking communities, and archaeologically the evidence increasingly points to their inception in the earlier, rather than later first millennium BC.

SOUTH-WEST EUROPE AND THE CELTIBERIANS

With the demise of diffusionism as an explanation of culture change, older interpretations of the Celticization of South-West Europe and the Hispanic Peninsula, typified by Bosch-Gimpera's (1942) twin waves of trans-Pyrenean colonization, have been abandoned in favour of an ill-defined process of acculturation derived from Hawkes' concept of 'cumulative Celticity' (Alberro, 2003). The real issue is breaking the exclusive equation of Celts and La Tène culture, which is not simply to revert to the older view of indigenous Bronze Age Celts, though there may indeed have been Celtic-speaking communities already in Bronze Age Europe. It is instead to argue for the presence of communities, linguistically or ethnically Celtic, in Atlantic Europe that were contemporary with La Tène groups in Central Europe, but which were archaeologically non-La Tène in their material culture. Most of the problems of interpretation of the archaeological evidence in south-western France and the Hispanic peninsula have stemmed from the failure to make this distinction, and therefore from the expectation that the late and often modified manifestations of La Tène types must represent the expansion of Celts into South-West Europe.

Aquitania

The Roman province of Aquitania had very variable boundaries, extending under Augustus far beyond the area that Caesar described as one of his three parts of Gaul. For Caesar, the Garonne was a significant boundary between Aquitani and Celtae, a boundary that periodically might reflect some distinctions in the archaeological record between the regions that lie between it, the Pyrenees and the Atlantic coast, on the one hand, and the regions of the Tarn, Quercy, Périgord, Limousin and Charente that lie to the north and north-east. We have already briefly addressed the question whether Aquitania was 'Celtic' in the minds of classical writers. Though distinguished from lands occupied by Belgae and Celtae by Caesar, Strabo evidently had a broader and more inclusive definition of 'Celtica'. Nevertheless, he repeated (IV, 1, 1; IV, 2, 1) that the Aquitani differed from the Gauls physically as well as in language, being more like the Iberians. Atlantic Europe is too often regarded as peripheral to the European Iron Age, as witnessed by the Central European Urnfield–Hallstatt–La Tène sequence, and the absence of early La Tène types in any number is often taken as an indication of cultural isolation from the La Tène Celtic world until a relatively late date. In fact, what we are dealing with is a broad distinction between a Central European tradition and an Atlantic European continuum, and it would be mistaken to assume that either

one was peripheral to the other, or that either one was any more or less 'Celtic' than the other. Linguistically Aquitania is not devoid of Celtic place-names, though the limited evidence needs to be treated with caution.

The Garonne–Aude corridor affords a natural route of access between the Mediterranean and the Atlantic west, as an alternative to the longer sea passage through the Pillars of Hercules. In consequence, we may expect that south-western France might reflect archaeologically a variety of external contacts, of which those with Central Europe to the north-east were not always dominant. These multi-directional contacts of an essentially regional industry are amply demonstrated from the late Bronze Age Vénat hoard from Saint-Yrieix, Charente, on the northern fringes of the region. The hoard is unusual in the high proportion of personal ornaments, notably bracelets, and low percentage of weapons, but otherwise the bulk of the assemblage not surprisingly was characteristic of the Atlantic late Bronze Age at the point of transition to the first Iron Age. It included Carp's Tongue and Ewart Park type swords, together with various socketed axes of British type. Continental Urnfield origins can be cited for a number of the tools, notably the winged axes of various forms, and a variety of personal ornaments, some of which, such as bracelets, included local versions of Urnfield types. Finally, there are a few southern and Mediterranean-derived forms, notably 'elbowed' brooches of Cassibile type and axes of Pyrenean and Spanish type. In effect, there is evidence for a range of contacts and external influences, even though the bulk of the material assemblage retains a regional character.

The first Iron Age in Aquitania, best not described in terms of the Central European Hallstatt model, shows close contacts with the Languedoc, where Mediterranean influences undoubtedly triggered dynamic change in material culture. Most of the metal-work and pottery that forms the basis of classification is derived from funerary contexts. Mohen (1975, Carte 1) showed the contrast in distribution between the flat graves of the Garonne valley, extending north-westward from coastal Languedoc, and the uplands of the Pyrenees and the foothills of the Massif Central. The two funerary rites were mutually exclusive but broadly contemporary, with tumuli progressively becoming predominant. The idea that the two modes of burial might reflect a contrast between agricultural and pastoral economies remains undemonstrated; there was no obvious contrast between the two groups in material culture, though the importance of the Garonne–Tarn route as a cultural corridor is self-evident. In one respect, Aquitania shows its independence in the earlier Iron Age, namely, in the more widespread adoption of iron for brooches and similar artefacts than is the case in west Central Europe. Some of the key types, such as brooches with upturned feet and expanded crossbow springs, belt-clasps in a developing sequence from those with single attachment hooks to variants with multiple hooks and open-work voids are also found in the neighbouring regions of the Languedoc and across the Pyrenees, even if their local manifestations display technical differences in detail. Mohen's 'Ampurias' type brooches (1979, 30–1; 1980, 76, Phase V, Figs 31, 104), characterized by their recurving foot in the shape of a swan's neck, are found in Aquitania only south-west of the Garonne, but examples are also known from the Languedoc and in Catalonia. Belt-clasps with multiple hooks (Mohen, 1980, Fig. 130) are found in Aquitania and the Pyrenees, in the Languedoc, and in the eastern Meseta and southern Spain. Antenna-hilted swords and daggers have a wide distribution throughout South-Western Europe and are undoubtedly indicative of a widespread community of tradition in the region. Nevertheless, local conventions

differ in technical detail, and Mohen demonstrated (1975; 1980) that the distinctive Aquitanian form of the later sixth and fifth centuries BC was significantly different from its Hispanic counterparts.

Among the distinctive types that appear from the end of the first Iron Age in Aquitania are torcs, mostly of bronze, but some of iron, of which a variant with longitudinal channelling is especially characteristic of the regions between the Garonne and the Pyrenees. Possibly related to this group is the animal-headed torc from Vieille Toulouse, which on stylistic grounds might be as early as the later fifth or fourth centuries BC. Torcs were certainly being manufactured locally, as is indicated by the fragment of terminal mould from Vayres, Gironde, where contemporary occupation yielded two La Tène 1 brooches. The appearance of artefacts of La Tène type is not signalled by any widespread disruption in the settlement or cemetery sequences, however, and innovative types are best attributed to trading or related interaction, rather than to intrusive settlement of La Tène Celts. By the third century, grave-goods from tumuli at Aubagnan, Landes, included a fragment of chain mail attached to a La Tène 2 brooch, together with a button and pair of bosses ornamented in a style reminiscent of Plastic Style motifs, though individually rendered. An Iberian metal vessel with gold and silver embellishments nevertheless indicated trans-Pyrenean connections, underlining the region's focal role in South-Western Europe.

Among the regional groupings that can be loosely grouped within the Plastic Style are some of the finest products of Celtic craftsmanship in gold, to which Jacobsthal gave the term 'Aurillac' Style after the find from the Cantal in South-Western France (Pl. 8b). The body of the spiral hooped bracelet is embellished with a profusion of nodular accretions in high relief, which Jacobsthal recognized could not properly be distinguished as foliage, flowers or fruits, but which formed a 'thicket' of 'tropical exuberance'. Spiral bosses and ridged mouldings predominate, through which beaded lines meander, defining the component parts. Of similar late third or second century date are the torc and bracelet from Lasgraises in the Tarn (Figure 9.1A). The fused buffers of the torc are overwhelmed by a profusion of bosses and quasi-floral protuberances; around the rest of its circuit, similar clusters are separated by diagonal mouldings. The bracelet is based upon a hollow-bossed type, but in this case with the hollows covered in sheet gold. The bosses externally are ornamented with similar relief clusters separated into a sequence of tightly grouped bunches by plain panels, faceted like bouquet wrapping. A third group, of no less than six gold torcs, was uncovered in the nineteenth century at Fenouillet in the Haute-Garonne (Figure 9.1B). Five are of twisted gold, three with plain buffers. The two most elaborate are further embellished with high relief elements, spaced on either side of the buffers or, in the one case, around the entire circumference of the torc. An example in the same style from Montans, Tarn, is made of multiple strands of twisted gold, while another, from Civray, Indre-et-Loire, could well be from the same school or workshop. The similarity in style, and even in technique of tenon-fastener, between the Fenouillet torcs and one from Găsić, Serbia (formerly Hercegmárook, then in Hungary) has been frequently remarked, and it is hard to avoid the conclusion that they were products of the same workshop. Given that the type is essentially one developed west of the Rhine it seems probable that this third-century eastern outlier of the distribution was the outcome of mobility and long-distance contacts between eastern and western Celtic worlds.

To the north-west of the Toulouse group, the Tayac, Gironde, hoard, found in two

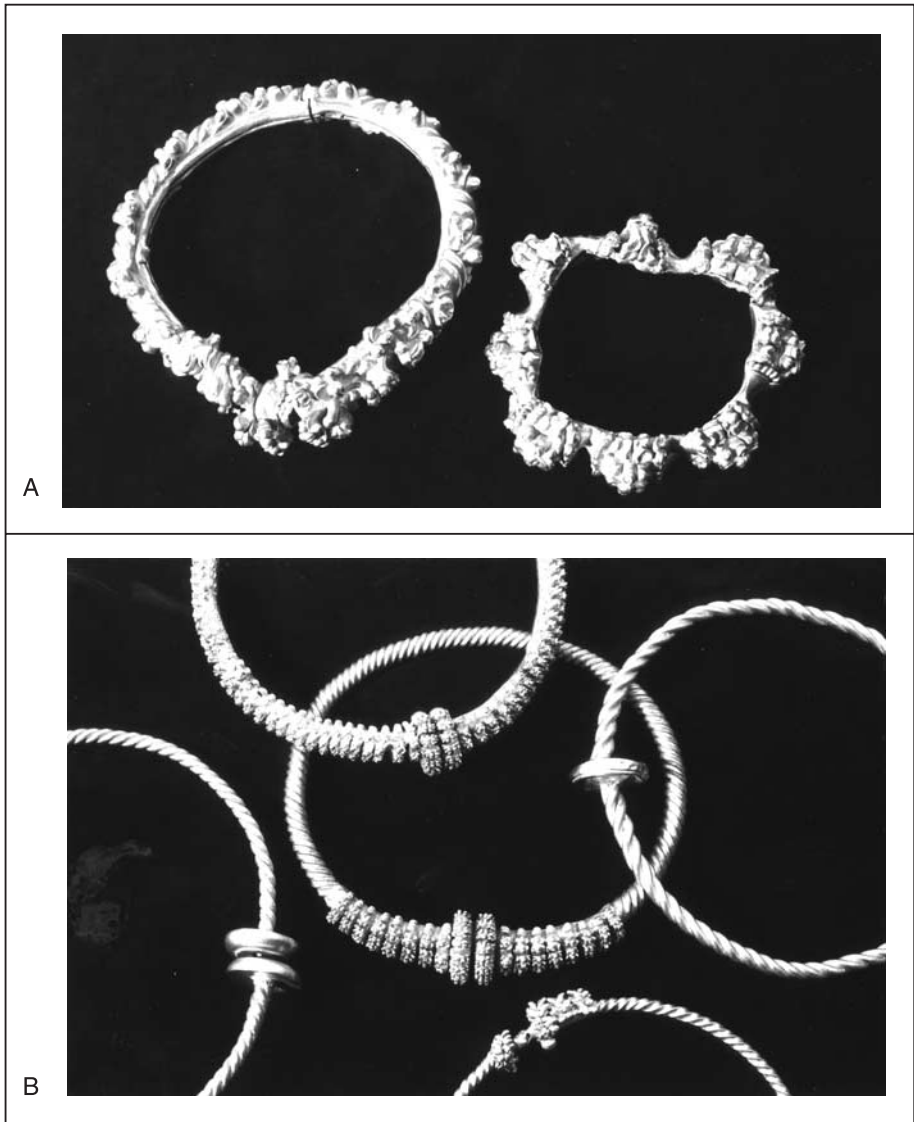

Figure 9.1 'Plastic Style' torcs and arm-rings from south-western France. A: Lasgraises, Tarn. Photo: Musée Saint-Raymond, Toulouse. B: Fenouillet, Haut-Garonne. Photo: Musée Saint-Raymond, Toulouse.

pottery vessels in 1893, contained several hundred gold coins and a torc that had been deliberately broken as if in a votive deposit. The torc was of twisted bar form, not unlike five of the Fenouillet torcs, but with channelled ends that were soldered into hollow sheet gold buffer terminals. The torc is surely considerably older than the coins

with which it was associated, and its lack of terminal fastenings suggests a closer relationship to the late La Tène 1 and La Tène 2 torcs of north-eastern France and Germany.

If Plastic Style ornament can be described as baroque, then the southern French gold-work is surely rococo. Yet in its composition, for all the impression of excess and confusion, it is much more orderly and balanced than might appear. Almost certainly there was the influence of Hellenistic gold-smiths upon the craftsmen of south-western France, though the natural resource itself would have been available in Aquitania. Inevitably some commentators have linked these finds with the historically recorded movements of the Volcae Tectosages, notwithstanding the fact that the south-western French concentration of gold-work lies somewhat on the periphery of the presumed territory of this tribal group. Strabo (IV, 1, 13) referred to the gold and silver recovered from the sanctuaries and sacred lakes of Toulouse, endorsing an implicit link between ritual and shrines with treasure and water deposits. As far as religious foci are concerned, Mediterranean Gaul is especially richly endowed.

Languedoc

The late Bronze Age and first Iron Age sequence in Languedoc is still exemplified in the classic sequence of settlements and cemeteries at Mailhac, Aude (Louis *et al.*, 1955; 1958; 1960), though more recent excavations such as those at the Peyrou cemetery at Agde have greatly amplified our understanding of the problems of the transition to the Iron Age. The assemblage from the cemetery of Le Moulin (Mailhac I), described by Guilaine (1972) as 'un authentique Age du Bronze terminal' showed a local version of Urnfield cremation in a shallow pit or scoop under a simple capping of slabs, often with several accessory vessels and offerings of meat. The pots include characteristic Urnfield types, globular jars with cylindrical neck, though sometimes with a foot-ring in place of simple, flat base, and open dishes, again in modified Urnfield tradition. Fluted decoration is characteristic, but more locally distinctive is incised geometric ornament, including triangles, chevrons and meanders, and highly stylized figural scenes, anthropomorphic and zoomorphic (Figure 9.2). The number and significance of the latter should not be over-estimated, though they are distinctive of this phase, here, and at the apparently contemporary cemeteries of Millas and Las Fados. Metal-work was evidently quite a common accompaniment of burial, but survives only in fragments. Broadly contemporary with the cemetery was the first occupation of the hilltop at Le Cayla. The 'classic' Mailhac I sequence has been subject to subdivision in recent years, and some radiocarbon dates are now available indicating that it was fully developed by the ninth century BC.

The cemetery at Grand Bassin I marks the transition to the First Iron Age, though the extent to which this represents a major break in continuity is still much debated. It was not until the later seventh and sixth centuries that the Greek colonies at Massilia and Emporion were established, with the consequential appearance in settlements and cemeteries along the Mediterranean coast of datable ceramics of Phoenician and Etruscan as well as of Greek origin. The problem of identifying a distinctive native assemblage prior to this horizon had resulted in the retarded dating of the Urnfield phenomenon in southern France. The recognition of earlier and later phases at Agde allows the possibility of a later eighth- and seventh-century transition, before the

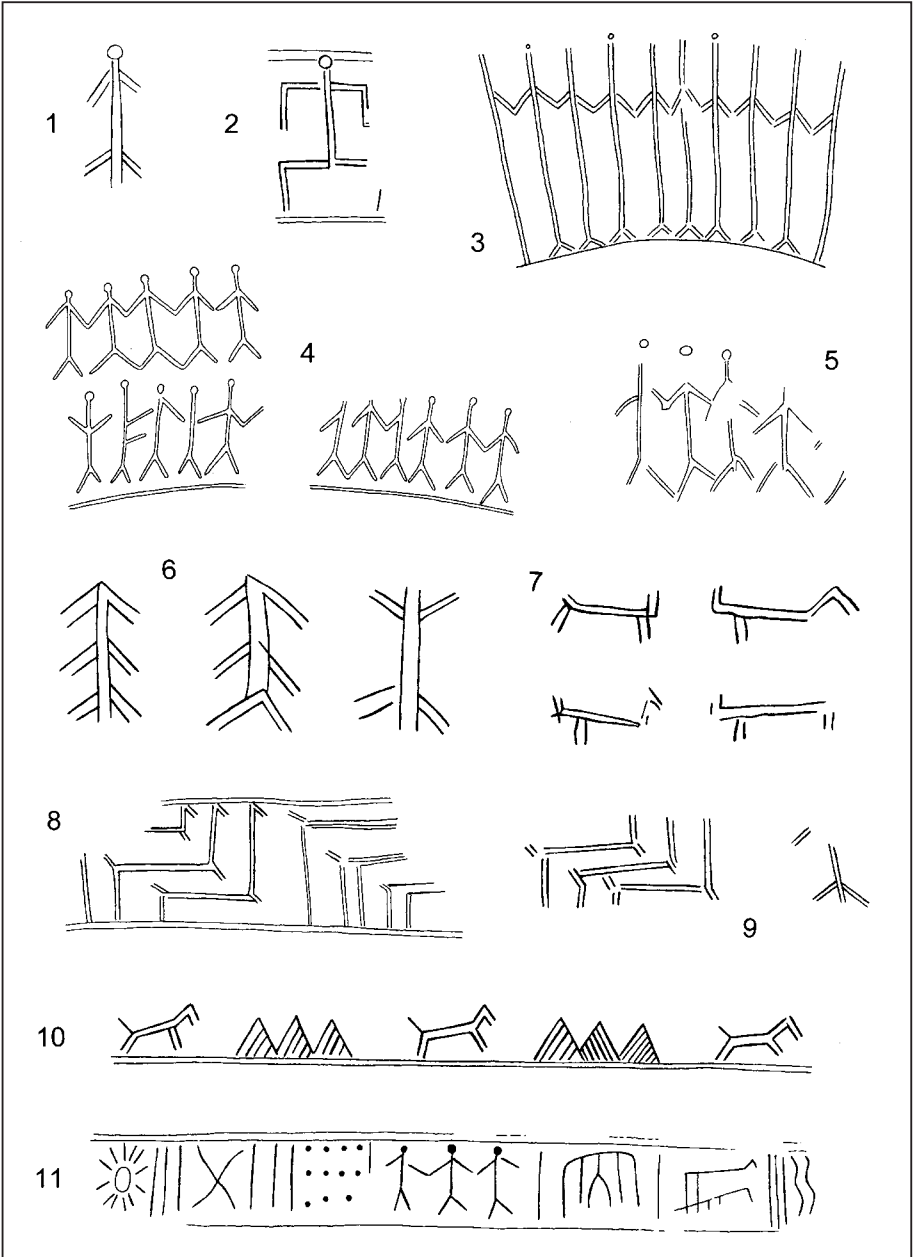

Figure 9.2 Anthropomorphic and zoomorphic 'matchstick' images on pottery. 1, 2, Cayla de Mailhac hill-fort, Aude; 3, Le Moulin cemetery, Aude; 4, Tumulus de Villement, St-Aoutrille, Indre; 5, Grotte Basse de Vidauque, Vaucluse; 6, 7, Las Fados, Pépieux, Aude, grave 22; 8, Grotte de Mont-Peyroux, Hérault; 9, d'En-Bonnes cemetery, Fanjeaux, Aude; 10, Millas cemetery, Pyrénées-Orientales; 11, Grotte de Quéroy, Chazelles, Charente. Adapted from Louis *et al.* (1955; 1958 and 1960).

advent of Mediterranean imports, to which the later phases of the Le Moulin cemetery might also be assigned (Guilaine and Py, 2000). Accordingly, Janin and others (Janin and Chardenon, 2000) have now identified a transitional phase between Bronze Age and full Iron Age, represented by a number of graves on the fringes of the Moulin cemetery, dating to the middle quarters of the eighth century. Some changes are already apparent in these grave assemblages; the range of types and number of pottery vessels increases, though incised decoration is less common, and occasional exotic types like double-springed Italic brooches are included in the inventory.

The cemetery of Grand Bassin I (Mailhac II) represents a significant development in the sequence, in which iron appears for the first time. Grave-goods are more numerous – several dozen accessory vessels may be included with a single ossuary, and metal types, brooches, bracelets and iron knives are relatively common – and the range of pottery includes taller pedestals, more angular profiles and flaring rims. Furthermore, the form of burial now includes deposition in a deeper pit, sometimes with stone capping amounting to corbelling on a small scale. One example of the better-furnished burials of this phase was tomb 68 ('La Redorte'), which included no less than fifty-eight accessory vessels together with the cremation urn, though it remains unclear how multiple accessory vessels and metal-work rank relatively as an index of social status. In the ensuing phase (Mailhac III) the Grand Bassin II cemetery expanded from its predecessor, though preserving the rite of inurned cremation. Imported Greek and Etruscan amphorae were sometimes used as the ossuary, and Attic black-figure, Etruscan *bucchero nero* and Phocaean pottery are indicative of intensified Mediterranean connections in the sixth century. Metal-work included belt-plaques with three hooks, cross-bow brooches with expanded spring and upturned feet, iron antenna daggers and iron shafted spear-heads. At the same time, the hill-fort at Le Cayla acquired defensive walls, in which mud-brick was used on stone foundations in the Mediterranean style.

From the fifth to the end of the second century, when southern Gaul came under Roman domination as the province of Gallia Narbonensis, settlements in Languedoc display obvious Hellenistic influence in the layout and construction of the major *oppida*, notable, for example, in the planned interior of the third century town of Les Castels at Nages (Gard), or in the incorporation of elliptical bastions into the walls at Ambrussum and Nages. The interior buildings nevertheless remain relatively simple, rectangular structures, aligned along the walls or metalled streets; public or religious buildings are rare, though some buildings at Ensérune doubtless served a special function. In the fifth and fourth centuries BC the cemetery of the second town at Ensérune, extending to more than five hundred graves, included among the grave-goods not only Greek, Italic and Iberian imports, but ornaments and weapons of La Tène type, indicating diplomatic or commercial contacts with Central Europe as well as with the Mediterranean.

The southern province and ceremonial statuary

From at least the beginning of the sixth century BC, following the establishment of the Greek colony of Massilia, the Mediterranean coast of Gaul had been exposed to external influences and imports, acquiring a domestic material culture in terms of settlements and architecture as well as in pottery that was distinct from that of the barbarian hinterland. After the end of the fifth century, Massilian coastal trade declined, but by

the third, Hellenistic influence is clearly visible in the appearance of urbanized settlements, the pragmatic adoption of literacy, the use of coinage and, not least, in artistic products. The specific works of relevance here are the stone heads and seated figures and related carvings that are found in the sanctuaries at Entremont, in the outskirts of Aix-en-Provence and at Roquepertuse, near Velaux, to its west. Both these sites were violently destroyed, Roquepertuse by fire in the early second century, Entremont by the forces of C. Sextius Calvinus, who defeated the local Saluvii in 124/3 BC in the process of establishing the province of Gallia Narbonnensis as the southern corridor from Italy to the Roman province in Spain. These sacred sites, at Entremont evidently destroyed in what might have amounted to a purge of paganism, therefore, plainly antedate the Roman annexation, and in all probability date from at least the third century if not earlier. The native communities of southern Gaul were on the fringes of the Celtic linguistic zone at the interface with the Mediterranean world. La Tène artefacts, as we have seen, including weaponry, are found at a number of sites, including, for example, the cemetery at Ensérune, near Béziers in the Languedoc, indicating contacts with regions further north and east. The sanctuaries of Provence are therefore commonly described as 'Celto-Ligurian', the Ligurians being a tribal group whom Strabo (IV, 6, 1–2) and Diodorus Siculus (V, 39), both drawing upon the earlier accounts of Posidonius, described as occupying the coast from the Rhône delta to the Arno.

Celto-Ligurian sanctuaries are not easily reconstructed from excavated evidence. At Roquepertuse, as at Glanum near St Rémy-de-Provence (Figure 9.3A), the focus of ritual was apparently fronted by a series of terraces, at the top of which was the shrine itself. The structure evidently consisted of a façade, incorporating pillars with niches for the display of human heads, and the statuary was doubtless part of the structural ensemble. Two pieces of sculpture are of particular importance from Roquepertuse. The first is the double-head of local limestone (Figure 9.4, 1), carved as Jacobsthal supposed by a sculptor trained in a Greek school at Massilia, but seemingly also deeply imbued with Celtic spiritual symbolism. The faces, with their squared jaws, well-defined mouths and noses drawn straight from the forehead, are more sophisticated than Celtic renderings, even though the lentoid eyes and eyelids could be matched in examples from Central Europe. More important, as Jacobsthal recognized, the damaged upstanding projection between the two back-to-back heads was evidently a leaf-crown, shared between the two faces in the manner of the Heidelberg head and Holzgerlingen pillar, both of the fifth or fourth centuries BC. This, then, is a defining feature of a Celtic deity or hero, the double or Janus portrayal also conveying omniperception. As Jacobsthal declared, the 'Celticity of the heads is proven beyond doubt', though the rendering bears signs of 'Greek humanity' (1944, 4). The second crucial fragment from Roquepertuse is the headless figure of a squatting god or hero in cross-legged posture (Figure 9.4, 2). The figure is depicted wearing an armless tunic, belted at the waist, and an overgarment on the shoulders that could be a ceremonial cape or body-armour. The arms are unfortunately broken, but the left is bent upwards, and surely held a symbolic object such as a torc, while the right was extended towards the knee, where a break could indicate the former presence of a severed head, upon which the right hand rested. The survival of faded paint-work serves as a reminder that this was surely not colourless statuary, but that features of the faces and the clothing worn by the squatting figures may well have been highlighted in some detail (Barbet, 1991). There are other carvings



A



B

Figure 9.3 Celto-Ligurian sanctuaries. **A:** Glanum, St Remy-en-Provence. **B:** Entremont, Aix-en-Provence. Photos by D. W. Harding.

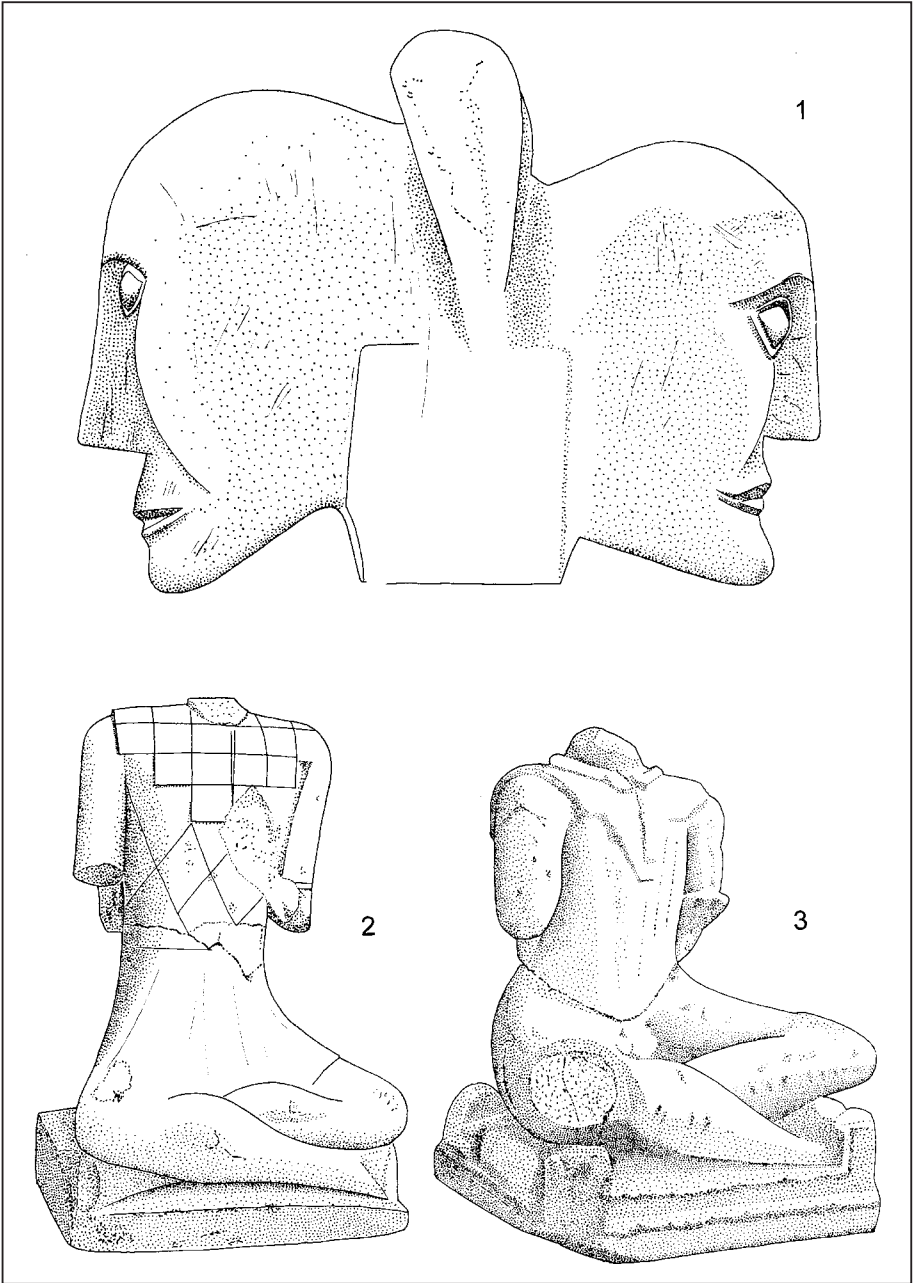

Figure 9.4 Celto-Ligurian statuary. 1, double head from Roquepertuse, Bouches-du-Rhône; 2, squatting god or hero, from Roquepertuse, Bouches-du-Rhône (sketch drawings from various published photographs of objects in the Musée d'Archéologie Méditerranéenne, Marseilles); 3, squatting god or hero from Glanum, St-Rémy-de-Provence, Bouches-du-Rhône. Adapted from Weber (2002). Not to scale.

at Roquepertuse reinforcing its spiritual ambience, including a sculpted goose, and a frieze of carved horses that Jacobsthal dismissed as 'bad and timeless' (1944, 3). Regrettably the excavations at Roquepertuse did not produce datable associations, so that it is difficult to assign the statuary a dating closer than somewhere between the fourth and second centuries. The recent restoration and reinterpretation of the Roquepertuse statuary has placed a greater emphasis on the idea that the sculpted figures were not deities but representations of the military and political elite of Celto-Ligurian society, in poses reflecting their role in life. Their association with cult symbols nevertheless underlines the continuum between the heroic and the supernatural.

At Entremont, problems of chronology are compounded by the fact that the city underwent more than one major phase of rebuilding. Within the upper precinct of Entremont III there appears to be evidence within the urban street plan for a colonnaded building, built between the bastions of the earlier city (Entremont II) beside the so-called Sacred Way (Figure 9.3B). One pillar from this building bore simple carvings of heads and a serpent, while along the street were scattered crushed skulls, some with nail perforations for ritual display. Among the fragments of statuary found along the Sacred Way was a carved head, with a human-like left hand resting upon it, most probably originally from a squatting hero or deity in the manner of the Roquepertuse sculpture. The eyes are closed and mouth down-turned, and remarkably the ear appears to be back-to-front. Elsewhere were single and grouped heads, some wearing leather helmets, and a torso, headless but apparently wearing a torc, like a cross-legged companion from the shrine at Glanum. From the presence at Entremont of both La Tène 1 and 2 brooches, and the absence of Arretine pottery, *terra sigillata* or Roman imperial coins, it is reasonable to believe that its destruction did indeed coincide with the annexation of southern Gaul at latest, and that much of the evidence for its ritual focus therefore derives from the third or fourth centuries BC.

The emphasis on the human head in the iconography of the Celto-Ligurian sanctuaries is demonstrated in no more gruesome form than in the sculpture that Megaw succinctly described as a 'great ithyphallic carnivore' (1970a, 78), the so-called Tarasque de Noves from the Bouches-du-Rhône. This fearsome creature – assuming it to be an authentic antiquity and not of much later date – belongs within the broad category of oriental-inspired 'voracious beasts', grasping in its jaws a human arm complete with bracelet on the wrist. Its triangular claws are firmly holding a pair of human heads, eyes shut like the depressed head from Entremont that was suffering the same fate and flowing, forked beards that are much more extravagant than the usual Celtic rendering. The closest parallel is the unprovenanced sculpture, formerly assigned to Linsdorf in Alsace, a scaly monster with enlarged eyes and flaring nostrils, holding a pair of clean-shaven heads, which has very similar triangular teeth and claws. The fact that the voracious lion from Cramond, Edinburgh, apparently of Roman date, displays similar features, however, shows the potential longevity of this tradition in sculpture.

The Celtiberians

Nowhere is the tacit equation of Celtic identity and La Tène material culture more apparent than in the study of Celtic communities in the Hispanic peninsula. Accepting the documentary and linguistic evidence for Celtiberians in the eastern Meseta, and

even for some late expansion of Celtic speakers into south-western and north-eastern regions, scholars have sifted through the archaeological inventory looking for the most tenuous traces of the influence of Central European La Tène types on swords or brooches, as evidence of the south-westward migration of Central European Celts. It is undeniable that Indo-European Celtic language must have been introduced by settlers from north-east of the Pyrenees, but it is highly unlikely that this episode or process of cumulative Celticization would reflect itself in the appearance of a discrete cultural assemblage or distribution of material types, and even if it had to any recognizable degree, it almost certainly would have preceded the advent of La Tène culture by many generations. In fact, examples of La Tène types in the peninsula are relatively few, and are found in the Iberian region as well as in areas putatively Celtic or Celtiberian. Furthermore, they are commonly adapted in distinctively local fashion, so that very few finds could be regarded as actual imports in their extant form. In effect, cataloguing La Tène finds in the Hispanic peninsula as an index of Celticity is a misguided and ultimately fruitless endeavour.

Not surprisingly, the greatest influence on the artefacts and art of the Celtiberians is from mainstream Iberian culture and from the Mediterranean contacts of the Iberian littoral. It was from this direction that Celtiberia adopted urbanization, monumental architecture and literacy, so it was natural that it should adapt material types such as its weaponry and wheel-thrown pottery from the same sources. Contacts with the Greek and Etruscan worlds are evident from at least the fourth century, and after the second Punic War the influence of Rome intensified, culminating in the conquest of most of the peninsula by the time of Augustus. The debate regarding the relative importance of Iberian and La Tène influences is best exemplified in the so-called 'warrior panoply', represented in both Iberian and Celtiberian regions, though varying in character and composition over time. Scholars like Stary (1982) and Lernerz-de Wilde (1991) stressed the perceived European La Tène elements, where more recent Spanish authorities such as Quesada Sanz (1997) have given greater emphasis to the Iberian component.

Though individual types may reflect trans-Pyrenean or Ibero-Mediterranean influences to varying degrees, the basic assemblage that displays evidence of Celtiberian art and high-quality technical craftsmanship indicates the same social and individual concerns that typify high-status artefacts and assemblages in the Hallstatt and La Tène world, namely, feasting and drinking, generally in the context of the funerary feast, weaponry and defensive armour, reflecting a high regard for martial prowess, doubtless with a concomitant respect for sporting achievement in the hunt (Figure 9.5), and finally dress attachments and personal ornaments. There is of course nothing uniquely Celtic about this, though it tends to reinforce the stereotype of the Celt as depicted by classical sources.

Furniture associated with the banqueting hearth, and possibly with funerary feasting rituals, is hardly represented in great numbers, but the Celtiberian cemeteries at Las Cogitas and La Osera have yielded examples of roasting spit, tripod, gridiron and tongs, mainly attributable to the middle Iron Age between the fifth and third centuries BC. Slightly earlier are the two bronze cauldrons from Carratiermes, apparently crushed deliberately as part of the ritual deposition.

The diversity of potential influences in Celtiberian metal-work is well illustrated by the fifth-century weaponry and defensive armour from Iberian and Celtiberian



Figure 9.5 The Celtiberian boar-hunt; cult-vehicle from Mérida, Badajóz. Musée des Antiquités Nationales. Photo: RMN, Paris © René-Gabriel Ojéda.

cemeteries (Figure 9.6). Several types of sword were current in the peninsula. Short antenna-hilted swords include types that indicate trans-Pyrenean connections, the Aguilar de Anguita type with links to the Languedoc through Catalonia, the Echaoui type indicating connections with Aquitania. A different type altogether is the *frontón* sword, a broader-bladed weapon that derives its name from its distinctive semi-circular hilt terminal. This is widely believed to have reached Celtiberian regions from the south. The dominant weapon in the Iberian region, however, was the *falcata*, a curving-bladed weapon of Mediterranean origin that continued in use from the fifth to first centuries BC, only appearing in limited numbers in Celtic regions from the third century. A second basic weapon was the spear, either a heavy, thrusting weapon or a lighter version for throwing, the *soliferreum*, made as its name implies entirely of iron, and possibly originating in south-western France, whence its use spread in modified form along the coast. A regular component of the basic panoply is a circular shield with central umbo of bronze or iron, sometimes decorated with geometric designs in relief. Richer graves of the Celtiberian series also include helmets and disc breast-plates, now seen in the Meseta as introductions from the Iberian south, possibly as the product of diplomatic exchange between the ruling elites of these neighbouring regions. Finally,

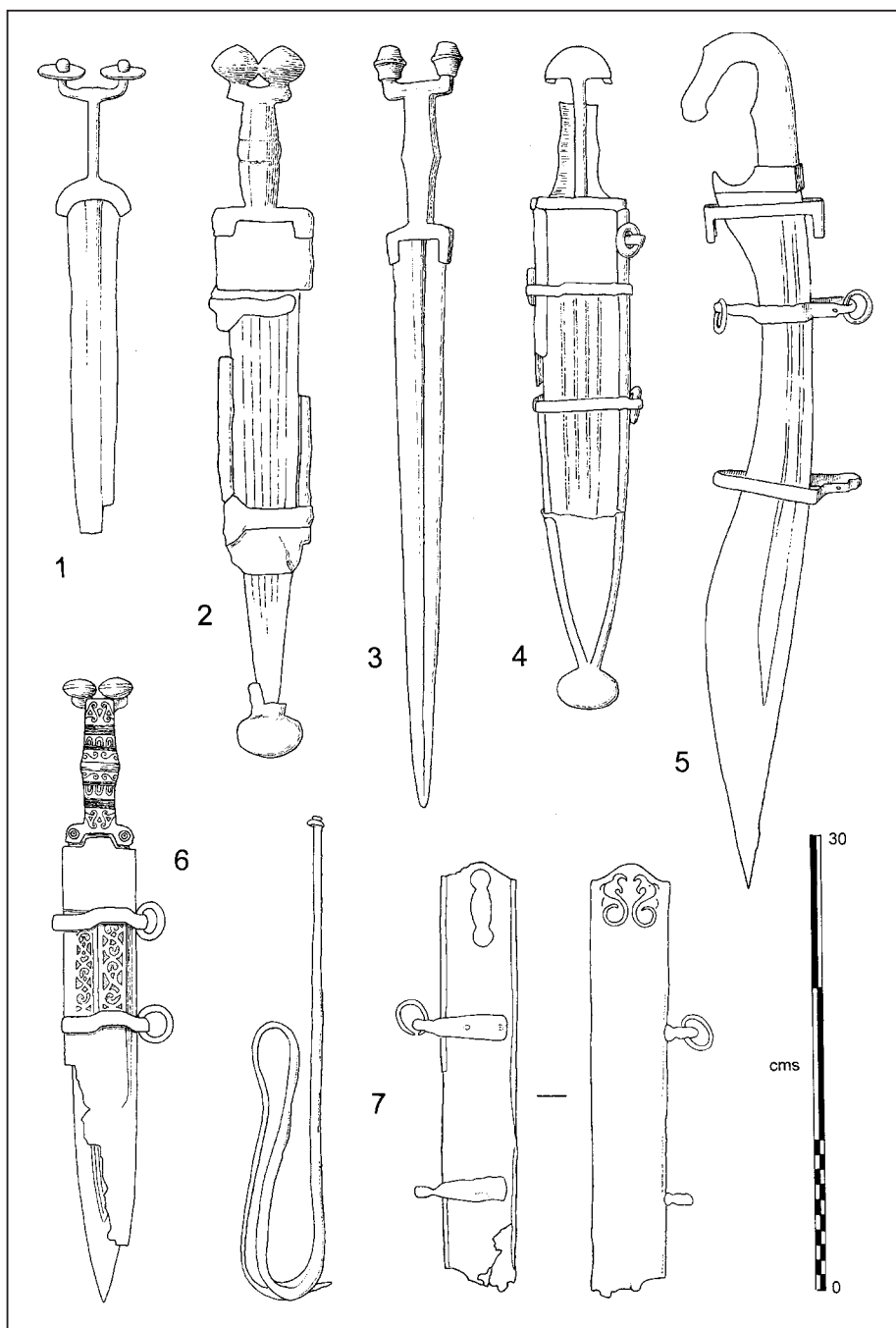

Figure 9.6 Celtiberian swords and scabbards. 1–3, Aguilar de Anguita: 1, 'Echauri' type, 2, 'Aguilar' type, 3, 'Aquitanian' type; 4, 'Frontón' type, Alpanesque; 5, 'Falcata', Almedinilla; 6, La Osera; 7, 'La Tène' sword and modified scabbard, Quintanas de Gormaz. Adapted from Schüle (1969) and Lenerz-de Wilde (1991).

the occasional presence of harness equipment indicates that these were the graves of equestrian warriors. In effect, the warrior panoply of the Celtiberians almost exactly mirrors that of middle La Tène cemeteries in north-alpine Europe, in terms of their range of types, if not in terms of the specific types themselves. From the fourth century, weaponry of the Iberian regions developed independently, and by the end of the third century novel types made their appearance as a result of the Punic wars.

Long swords of La Tène type do, in fact, appear across the Pyrenees, but mostly dating to the third and second centuries. They are found largely in Catalonia, a region that linguistically was Iberian rather than Celtic or Celtiberian, though the distinctive *falcata* is comparatively under-represented here. From the outset, however, these weapons were subject to adaptation by local armourers, as is demonstrated by the late fourth-century scabbard from Quintanas de Gormaz in the eastern Meseta (Figure 9.6, 7). Decorated with a Type II dragon-pair, a motif that might reasonably be regarded as a distinctively Celtic warrior emblem, it is the most south-easterly in Europe of the dragon-pair distribution. But the scabbard itself, designed to be attached by a suspension-loop to the belt of the wearer, has been adapted by the provision of two ring attachment-plates for carrying over the shoulder in accordance with local practice. From the Iberian cemetery at El Cigarralejo in Murcia, the suspension loop of a La Tène sword from grave 54 has actually been detached and replaced by ring-attachments. In effect, the presence of La Tène weapons in the Hispanic peninsula can hardly be regarded as direct evidence for incomers from trans-Pyrenean Europe. They could be the product of diplomatic exchange or mercenary activity, or even trophies of war. They undoubtedly had some secondary impact upon the development of Hispanic weaponry and armour, but the peninsular tradition represents essentially local development. Because it was not mainstream La Tène does not make it any less Celtic in principle, but the common elements in distribution between Iberian and Celtiberian regions preclude the identification of exclusively Celtic types.

A practice that certainly mirrors trans-Pyrenean funerary practice is the deliberate destruction of weapons in burials, including swords, daggers, spear-heads and *soliferrae* spears. Originating in the Urnfield period in the Hispanic peninsula, this is widely practised in Iberian cemeteries as well as those of the Celtic regions. Its significance could be easily over-simplified, but it certainly suggests a pan-European practice among Iron Age military elites.

One specific question needs to be addressed, namely the alleged examples of Waldalgesheim-derived ornament from the Hispanic peninsula. Lenerz-de Wilde (1991; 1995) has made the case for relationships between the ornament of silver-inlaid antenna daggers like that from La Osera, Avila, and the Central European style, and further has pointed to some Iberian *falcata*, like those from Illora, Granada, and Almedinilla, Cordoba, which likewise display cognate examples of tendril designs. The inclusion of vortex-triskeles and a hint of over-and-under figure-of-eight in the former certainly has echoes of the Waldalgesheim style, but in general the treatment of classical plant motifs and tendrils lacks the movement of Waldalgesheim ornament. The occasional examples from the Celtiberian regions of the peninsula are therefore better regarded as derived through Iberia from Mediterranean originals, parallel to the processes that inspired the Waldalgesheim style, though with lesser impact. In effect, we may prefer Quesada Sanz's (2005, 72) conclusion, that it was hardly necessary to invoke 'a "Grand Tour" of influences marching north from Italy into the Alps and France, then

south into the Meseta, and finally into Andalusia, when direct connections between Italy and Iberia have been proved beyond doubt'.

The range and variety of brooch types from the Celtiberian regions in many respects parallel the Hallstatt–La Tène sequence, though the brooches themselves are distinctively peninsular products (Figure 9.7). Some of the earliest Iron Age types, with double-spring, expanded spring or elaborated upturned foot, have counterparts in the serpentiform brooches of Italy and Sicily (Schüle, 1969, Karte 2), while various forms with elaboration of their upturned feet are analogous to late Hallstatt forms north and south of the Alps. The La Tène model is represented in all three of its sequential variants, that is with foot turned back to rest above the bow, as in La Tène 1 brooches, with foot attached to the bow, as in La Tène 2, and finally with foot and bow cast in a single piece, as in Central European La Tène 3 varieties. Some even show double feet, like the double bird-headed brooches of early La Tène in Central Europe, though the birds' heads of the Hispanic versions are fairly schematic. Few, however, have a genuine La Tène spring, rather than a pin-swivel, and few would remotely qualify as potential imports.

A distinctively peninsular variant is modelled in the shape of a horse, and a handful are depicted with rider, the so-called *jinete* type (Figure 9.7, 9), often presented as an indication of Celticity in the Hispanic peninsula, not least because of examples depicting a human head suspended from the horse's neck, in a manner reminiscent of Strabo's description of Celtic warriors. A warrior on horseback is also depicted in the low-relief funerary stele of first- or second-century BC date from Bezares, while the rider with lance is not surprisingly also included in the imagery of Celtiberian coinage. Horse symbolism is evidently of special importance in the Hispanic peninsula, and Almagro-Gorbea (1998) has argued that it was the equestrian elite that controlled civic life in the later Iron Age *oppida* in the resistance to Roman expansion and conquest, citing examples of supposed cavalry standards like one from Numantia (Figure 9.8, 1) in evidence.

Among brooches, another departure from the Central European tradition is the annular brooch, of which there are numerous variants. Some have a simple pin, akin to that of the penannular brooches of Atlantic Europe; others have a more elaborate structure comprising bow and catch-plate within the ring. Neither of these has parallels in Central Europe, and the group is illustrative of the independent development of brooch-making in the peninsula.

Belt-hooks are relatively common among the cemeteries of the eastern Meseta, and again afford a cognate inventory to those of Iron Age Europe north and south of the Alps. Of the four principal classes, two are regarded by Lorrio (1997) as Celtiberian, having their distribution concentrated in the upper Tagus and upper Jalón, though with outliers across the Pyrenees in Languedoc and Aquitaine. Two exceptional early La Tène derivatives from La Osma and La Osera date from the early fifth century, but are hardly sufficient to sustain extensive trade in prestige goods with Central Europe. On the other hand, a concentration of the Iberian type in the upper Duero as well as the upper Tagus and upper Jalón certainly indicates further contacts between the Meseta and the Mediterranean coast. These distinctive rectangular and winged belt-plates are commonly inlaid with curvilinear and geometric designs, including lyre-motifs, tendrils and stylized plant-motifs based on Hellenistic themes, but they appear to have had little impact upon the ornamentation of Celtiberian metal-work,

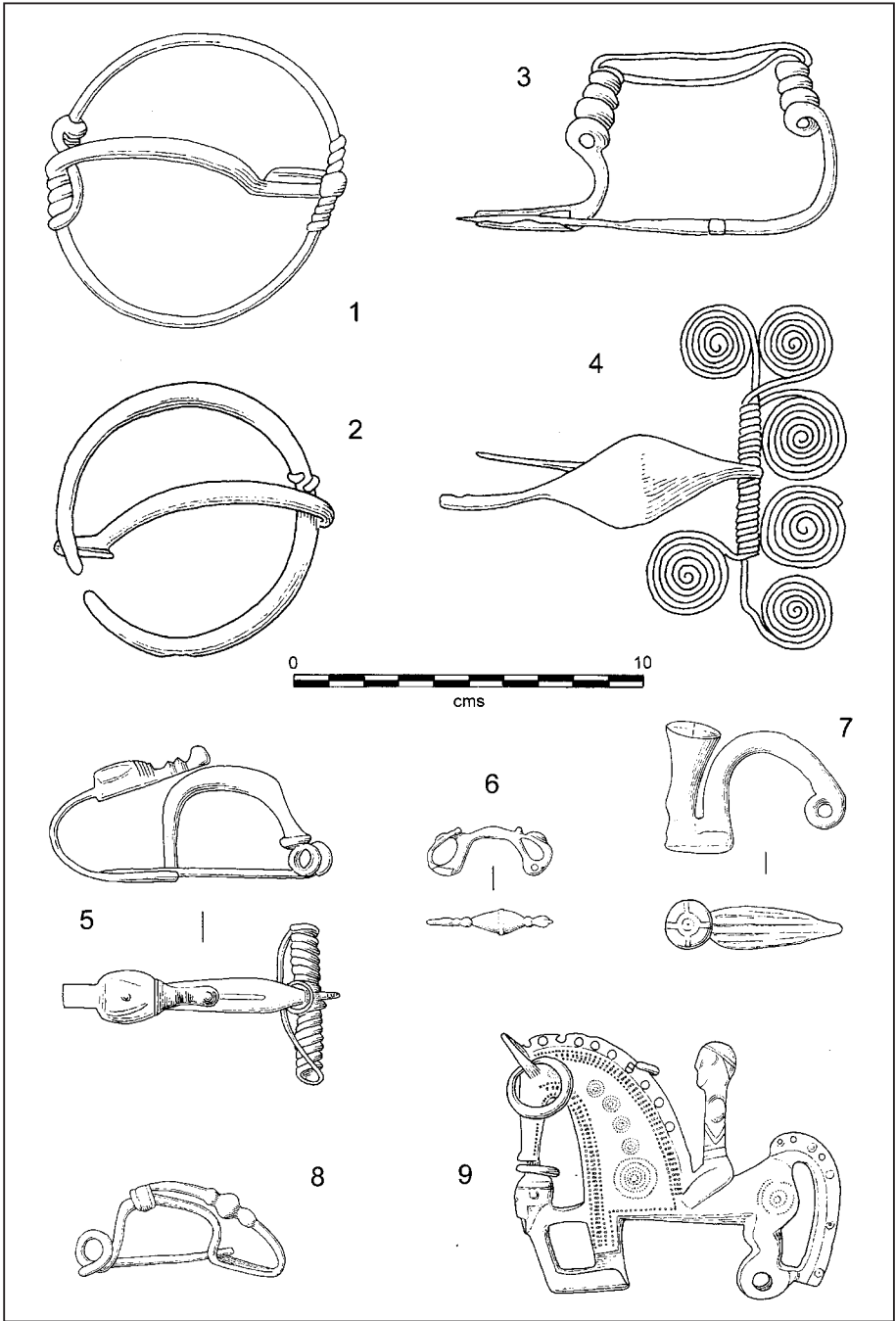

Figure 9.7 Celtiberian brooches. 1, annular brooch, Lara de los Infantes, Burgos; 2, penannular brooch, La Mercadera, Soria; 3, double-spring brooch, La Mercadera, Soria; 4, Eastern Meseta spiral brooch, Garabajosa, Guadalajara; 5-9, 'La Tène' type brooches, 5, 8, Numantia, Soria; 9, horse-rider 'jinete' brooch, unprovenanced, National Museum, Madrid. Adapted from Schüle (1969) and Lenerz-de Wilde (1991).

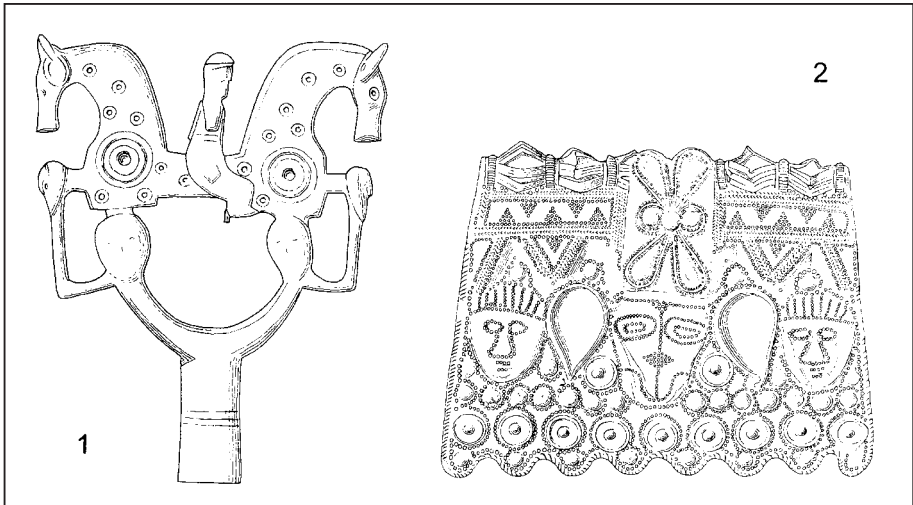

Figure 9.8 Celtiberian symbols of status. 1, 'cavalry standard' from Numantia, adapted from Lorrio (1997) and Almagro-Gorbea (1998); 2, gold plaque from La Martela, adapted from Berrocal-Rangel (1992). Not to scale: gold plaque c. 4 cms wide.

with the possible exception of some antenna swords like those from La Osera, in which others have seen the secondary influence of Waldalgesheim Style.

The standard form of decoration in the Celtiberian regions is well represented by the circular bronze disc from Aguilar de Anguita or the series of rectangular plaques from the cemetery at Arcobriga (Lorrio, 1997). Concentric circles in relief, radiating 'eyes' or 'sunbursts' and simple zoomorphic representations are recurrent themes that may have had ritual or symbolic significance. The purpose of these plaques is not clear, but they may have embellished robes or head-dress. Similar motifs feature prominently in the design of so-called 'pectorals' that may have been worn as symbols of rank or office. A similar role is commonly accorded in the La Tène Celtic world to the torc: within the Celtiberian zone, however, torcs are rare, with a few fragmentary examples lacking proper context. In the Castro culture of the north-west, however, a region that has also been claimed on documentary and linguistic evidence as Celtic, the torc is well attested from the later Bronze Age through the Iron Age, though in rather different forms than those that typify the La Tène culture zone. In the north-west anthropomorphic stone sculptures (Figure 9.9, 3) also include figures wearing torcs together with martial equipment, indicating high status if not superhuman qualities. The fact that the torc is occasionally represented on Iberian coins underlines its emblematic role.

It is often remarked that the Celtiberians seemed not to have had the same inhibitions as the Central European Celts in representing the human form. This impression stems from frequently reproduced images like the *jinete* brooches and the striking portrayal of contesting warriors on a polychrome vase from Numantia (Figure 9.9, 2), and perhaps makes too little acknowledgement of how comparatively unusual these examples are. The painted ceramics are also for the most part late in date, being assigned to the first century BC. Representations from the earlier Iron Age are few, and

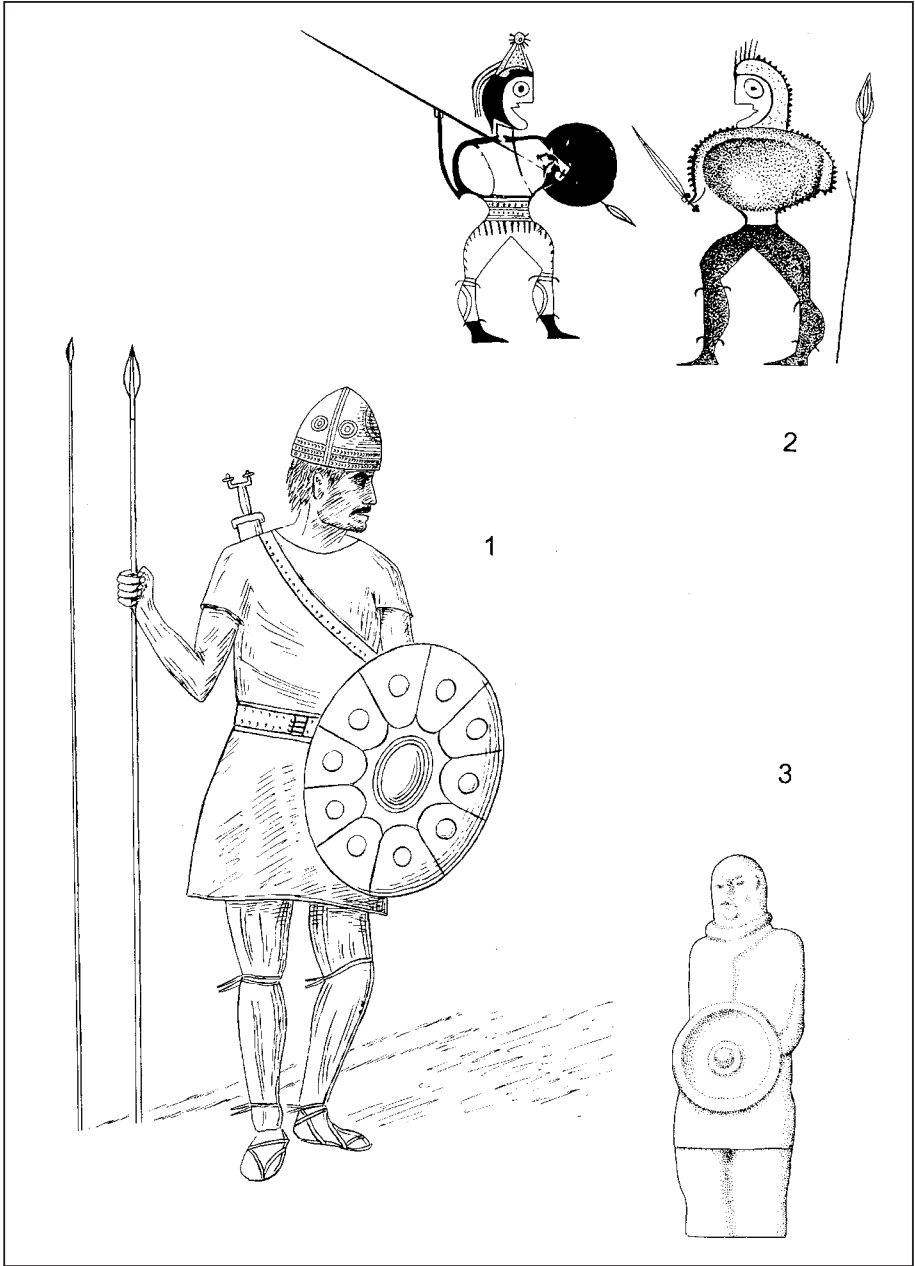

Figure 9.9 The Celtiberian warrior (1); warrior scene painted on vase from Numantia (2); stone sculpture from Castro di Lezenho, Portugal. Adapted from Lorrio (1997) and Lenerz-de Wilde (1991).

very simply sketched, like the 'matchstick' human and quadruped on the funerary stele from Aguilar de Anguita. Even on the Numantia pottery, the slim-waisted figures of warriors armed with sword or spear are highly stylized in outline. Other figures are less certainly identified. Some with human body and animal or bird-like heads are presumably representations either of mythical and supernatural beings, or of humans dressed in exotic guises depicting ritual or ceremonial events. One figure from Numantia with triple antlers radiating from its head and another antlered figure with hands raised in the *orante* gesture have inevitably and doubtless erroneously been linked to the horned god Cernunnos. Just as Jacobsthal bemoaned the fact that to some prehistorians 'everything is a palmette' (1944, 60), so we might regret that to others every totemic representation is Cernunnos. In some cases figures are shown wearing tall, pointed caps, again possibly a symbol of class or ceremonial status, in one instance, seemingly performing an act of ritual sacrifice. Female figures, on painted pottery and modelled in clay, have been interpreted as representations of divinities. Representations from the sanctuary site at Peñalba de Villastar have even been identified by some as the Celtic god Lug, while others have been variously seen as reflections of the Roman funerary pantheon. While these might well afford informative analogies, however, any approach to interpretation of archaeological data that is text-led from classical sources or based upon conventional understanding of Celtic cosmology should be eschewed, since too easily it pre-conditions our analysis of what may prove to have been a much more complex series of images.

One element in late Celtiberian art certainly prompts comparison with an older tradition in Central Europe, namely the incorporation into more complex designs of individual human heads or face-masks. As in the La Tène fashion, these may embellish the base of handles, though in this case of ceramic rather than metal vessels. But they also are included in more complex designs, not in the elusive manner of the 'Disney Style', but as an overt motif, as on pottery from the *oppidum* at Uxama. The fragments from the cemetery includes a particularly striking panel in which heads are enclosed within square frames, reminiscent of the niches of the Roquepertuse pillars, alternating in sequence with a series of birds.

Celts in south-west Spain and Portugal

Documentary sources, notably Strabo and Pliny, strongly suggest the presence of Celts in the south-west of the Hispanic peninsula, and epigraphic evidence from the Roman occupation equally endorses this conclusion. Archaeologically the inference has been that Celts expanded from the territory of the Celtiberians, both south-westward and north-westward into the region of the Castro culture, but the dating of these episodes or sequence of episodes remains uncertain.

Settlements in south-western Spain and southern Portugal are commonly enclosed by defensive walls following or reinforcing the natural contours of a hill. They range from univallate or partial enclosures to multivallate sites or citadels with outer circuits of walls. Some display monumental construction with bastions and towers, ditches and entrances. Internally the evidence for an organized plan or public buildings that might indicate a progression towards urbanization is limited to a few sites where such a layout might be reconstructed. At Pedrão, buildings back the defensive wall that cuts off the most vulnerable access to the site, leaving an open space within the interior, a simple

layout that is matched elsewhere in Spain and beyond from the later Bronze Age. At the more complex hillfort of Capote, on the other hand, from at least the fourth century BC, a network of streets creates what appear to have been public areas, adjacent to which one remarkable structure has been interpreted through excavation as a shrine (Berrocal-Rangel, 1994).

In general, the material inventory of the south-west reflects that of the Meseta, with the qualification that fewer numbers may reflect the relative paucity of excavated cemeteries rather than a significant dilution of the material assemblage. Swords of La Tène and *frontón* type are only minimally represented, with more of the Iberian *falcata* type, notably from Alcácer on the lower Sado. This site has also given its name to the local variant of antenna sword, dating from the fifth and four centuries BC. La Tène brooches are also represented, in La Tène 1, La Tène 2 and La Tène 3 (Nauheim) variants, but the distribution is again distorted by the concentration of finds from Vaiamonte in the upper Alentejo. The more representative regional type is the annular brooch, which in its variant forms spans the fifth to second centuries BC. Finally, belt-clasps include a variant with three hooks and lateral open-work, cognate to one of the principal Celtiberian forms, together with examples of Iberian derivation. Most striking among the south-western metal artefacts for their combination of stylistic influences are the small gold plaques from the castro of La Martela (Figure 9.8, 2), possibly intended as a dress embellishment or some form of pectoral. The principal elements in each, arranged in slightly different composition, are human and equine heads, and a floral rosette, enclosed by geometric circlets and zig-zags. The technical and stylistic affinities of the plaques are generally accepted as Mediterranean and orientalizing, but the representation of features of the heads show remarkably similarities to La Tène face-masks and zoomorphic representations from Celtic Central Europe. In particular, though rendered in a different technique, the hair-style of the faces recalls Central European models, and the lentoid eyes of the equine face likewise has close parallels in the La Tène inventory. Dating from the fourth century BC on the basis of ceramic associations, these pieces were evidently commissioned from craftsmen working locally but familiar with the stylistic fashions of the Celtic as well as the Mediterranean world.

The Castro Culture of the peninsular north-west

The Castro Culture of north-west Spain and northern Portugal is distinguished by its walled settlements, variously described according to size and sophistication of internal layout as *castro*, *cividade* or *citânia*. The largest and most urbanized in layout, like the Citânia de Briteiros and Citânia de Sanfins, are essentially post-Augustan in their surviving plan, but almost certainly have a longer antecedent history. They may have double or multiple enclosing walls, and their internal occupation includes a street system with enclosed compounds of domestic buildings. Recent research (Queiroga, 2003) has shown that the castros developed from the later Bronze Age and through the earlier Iron Age. Excavations at Castelo de Matos, the Citânia de S. Julião and the Castro de Torroso and elsewhere point to a less organized settlement layout in these initial stages, with circular buildings constructed of clay and perishable materials. Stone building was evidently adopted only from around the third century BC, while more complex architectural features, such as vestibules, together with rectilinear plans, were introduced in the first century AD. One distinctive form of building, the

so-called *monumentos com fornos*, is now believed to have functioned as a sauna, raising the possibility that bathing, attested by less substantial structures like the Irish *fulacht* or Scottish burnt mounds of the Bronze Age, may have been a more widespread practice in Celtic Europe than has hitherto been presumed.

Though there are rectilinear enclosures and buildings, the predominant house-plan of the Castro Culture is circular, sometimes with the distinctive vestibule, the sides of which project the radii of the circle, as in examples from the Citânia de Santa Luzia at Viana do Castelo. The circular architectural plan of domestic buildings, shared principally with Britain but also known in the Netherlands and Normandy in the later Bronze Age and Iron Age, stands in contrast to the Central European tradition of rectangular building, which also characterizes the settlements of the rest of the Hispanic peninsula. Allowing for the fact that even in Britain rectangular houses are not unknown, and that house types in general are still not well documented in parts of France, there does appear to be a real contrast in building tradition between Central Europe and Atlantic Europe. To regard either of the principal traditions as typically or diagnostically 'Celtic' would be untenable, since rectangular plans are the norm in Germanic Europe and circular plans are common in parts of the Mediterranean. House-plans may be determined by many factors, social, economic, or environmental, but are hardly a diagnostic factor of ethnicity.

Despite the paucity of cemeteries, high-status metal-work includes gold torcs, among which the contrasting distributions of those with conical terminals north of the Minho and those with tulip-shaped terminals to the south led Lernerz-de Wilde (1995) to suggest tribal sub-groups, already before the region was divided under Roman administration. Despite problems of dating, these examples of prestige gold-work were probably in circulation between the fourth and second centuries BC. Torcs, as we have seen, are depicted also on the life-sized stone sculptures of warriors, equipped with daggers and circular shields, that are almost invariably found in proximity to castros, like the example from the Castro di Lezenho (Figure 9.9, 3). Dating is problematic, and dependent upon stylistic considerations or details of weapon typology that are hardly definitive in stone. The conventional dating around 100 BC, however, is based entirely on the late dating of the castros themselves, and is almost certainly too conservative. The sculptures inevitably recall the stone figures of late Hallstatt and early La Tène in Central Europe, but their context as well as their dating set them apart from this earlier tradition.

Finally, the issue of the stamped ornament of pottery from the Castro culture, and its relationship with similar styles in the early Iron Age in Brittany, south-western Britain and elsewhere, has an important bearing on the question of Celtic ceramic art. Despite Höck's (Höck and Coelho, 1985) dating of Castro stamped wares to the Roman horizon, the similarities of both motifs and combinations of motifs between the northern Portuguese and Galician pottery and Armorican pottery of early La Tène seem sufficient to warrant a connection, even if the south-western British 'duck-stamped' ornament is rather more selective by comparison. Castro pottery ornament nevertheless displays local differences, and perhaps should be considered in the wider context of stamped decoration elsewhere in the western Peninsula. It serves to underline again the fact that Celtic is not synonymous with La Tène.

LATER STYLES AND ROMANIZING INFLUENCES

Oppida and urbanization

A major debate among archaeologists over the past twenty-five years has been the extent to which communities in Central and Western Europe in the late La Tène period had developed urban or proto-urban settlements that constituted central places within an emerging state-level social structure. Caesar described major sites in Gaul as *oppida*, though it is arguable whether this implied attributes comparable to Roman towns. He even described Avaricum, Bourges, as the fairest city (*urbs*) in all Gaul. Excavations at sites like the Mont Beuvray in Burgundy, Manching in Bavaria, or Závist in Bohemia and Staré Hradisko in Moravia have revealed intensive industrial activity, including production in pottery, metal-work and glass that has been interpreted as evidence of craft specialization within an emerging market economy. Nevertheless, though the Eastern and Central European *oppida*, including Manching, appear to have originated in the La Tène C phase in the second century BC, there remains some doubt as to the extent to which Gaulish *oppida* had developed prior to Roman annexation. Dendrochronological dates indicate the construction of ramparts from the end of the second century, but because these sites survived the Conquest to emerge as Gallo-Roman towns, it is more difficult archaeologically to establish the character of their earliest occupation. Even in the case of Manching, one of the more extensively excavated sites, though still minimally investigated relative to its total size, it is far from clear that the internal occupation was especially dense, as might be expected of an urban settlement.

Archaeologically, the term *oppidum* has been applied to a range of quite disparate late La Tène sites, though most definitions expect a substantial area to be enclosed. Some occupy low-lying locations like Manching, or Colchester (Camulodunum) in Essex, others are hill-top enclosures like the Mont Beuvray or Stradonice, or inland promontories or peninsular sites enclosed by rivers like the Enge sites at Bern or Kelheim in Bavaria. For sites like Manching, where the encircling ramparts were some 7 or 8 kilometres in length, construction of the defences must have been a massive communal effort. Simply providing the iron spikes that secured the internal timbers of ramparts of *muris Gallicis* construction for earthworks on this scale must have required an industrial level of iron-working. Regional differences in defensive construction are apparent, the *muri gallici* being mainly west of the Rhine and ramparts of Kelheim type being principally to the east. The so-called Fécamp type, with broad ditch and large dump rampart, has a more extensive distribution (Fichtl, 2000, 48) than was recognized when Wheeler (Wheeler and Richardson, 1957) dug

the type-site in Seine-Maritime, but one that is still concentrated in North-Western Europe. Entrances, notably the inturned *Zangentore* (Dehn, 1961) with their double carriageways, imply the regulation of traffic but do not absolutely confirm permanent urban occupation. Nevertheless, the scale of enclosure – up to 350 hectares in the case of Manching – outstrips the size of some Roman or mediaeval towns, and the walls and entrances of the major *oppida* would undoubtedly have been monumentally impressive. Internal occupation may have included public buildings, like the ditched structures at Villeneuve-Saint-Germain, while others like Závist and Gournay-sur-Aronde included structures that were the focus of ritual activities. Whether they existed within advanced chiefdoms or emergent state-level societies remains an issue of debate.

Coinage

The introduction of coinage to Celtic Europe was almost certainly a by-product of the expansion of Celts, raiders, traders or mercenaries, into Southern and South-Eastern Europe in the period of the historical migrations. Nash (1987) has summarized the case for regarding Celtic coinage, both in its appearance across north-alpine Europe generally, and in Britain specifically, as having relatively little to do with trade, and much more to do with payments for mercenary service. Celtic mercenaries were evidently recruited throughout the Mediterranean world, but on an especially large scale by Philip II of Macedon and Alexander the Great, whose prized coinage thus became the model for many Celtic mints. Nash cites Livy (*History*, 44, 26) and Perseus of Macedon's offer to the chief of the Danubian Bastarnae of five gold staters apiece for infantry, ten for cavalry and a thousand for himself as the 'relevant rates of pay' (Nash Briggs, 1995, 246). What we can infer of Celtic society suggests that the deal would have been with the paramount chieftain, who would subsequently have controlled the distribution of rewards. This is not to say that Fenian bands or their equivalent might not have hired out their services independently, but Livy's report related to negotiations with the tribal hierarchy. The same principle applied in intra-Celtic negotiations, as between the Insubres and Boii and the Alpine Gauls from whom they recruited *Gaesatae*, according to Polybius (*Histories*, II, 22). Even so, the paucity of evidence for imported coinage itself is surprising, and can lead only to the conclusion that bullion was promptly re-processed, and possibly alloyed, before re-distribution.

Celtic adoption of coinage from Greek or Roman models, however, displays not so much an inclination to emulate the naturalistic classical style, but wilfully to deconstruct the originals and to re-assemble the component elements into a distinctively Celtic iconography. It should certainly not be assumed that the process of 'deconstruction' was simply a consequence of the Celtic artist's ineptitude for competent imitation. Instead it may be compared to the conscious exercise in deconstruction and re-assembly that early La Tène craftsmen had engaged upon in their use of classical models in the Early Styles of the fifth century BC. Where in some later regional mintings there is a reversion to more naturalistic representation, this may equally be regarded as a conscious decision to emulate the classical style.

Minting of coins implies a political power whose authority lends it legitimacy. Gold or silver coins will, of course, have an intrinsic value, but in base metals, as with paper money, the authority of political endorsement is all important. Accordingly, studies of Celtic coinage have conventionally inferred a correlation between coin distributions

and tribal territories, and this may be reflected in the design and choice of motifs of a coin series. There are nevertheless certain motifs or symbols, such as the human-headed horse (not fully a centaur) and the boar image, that recur across a much wider distribution area, and which we may infer had pan-Celtic significance. The purpose of coinage in the Celtic world, at least initially, is unlikely to have been for day-to-day subsistence transactions. High denominations would have necessitated small change for regular use in a market economy, and though smaller coins in gold and silver together with bronze alloy coins are known from an early stage, it seems probable that coinage was used primarily for major social needs such as tribute, dowries and even votive offerings rather than as currency.

Europe can be divided broadly into two principal zones of Celtic coinage: a zone that used silver as its currency standard, extending from the Atlantic west of southern France through the Alps to the middle Danube and the Carpathians, and a zone to the north, from south-eastern Britain to Bohemia, that used gold. The earliest Celtic coinage was the middle Danubian, dating probably from the late fourth century, and using as its model the silver tetradrachms of Philip II of Macedon (ruled 359–336 BC). Celtic coinage in northern Italy using Massilian models probably dates from the third century. Of the gold belt, the western series, of which the earliest were based upon staters of Philip II (coins that continued to be struck after his death), could be earlier than the eastern, where the model was the gold stater of his successor, Alexander III (ruled 336–323 BC). The end of minting of independent coinage came abruptly with the Roman conquest of Gaul, and the subsequent expansion of the Roman Empire east of the Rhine and across the Channel into Britain.

In terms of this chronology, therefore, the earliest coinage in the east would have been co-eval with the developed Sword and Plastic Styles, and in the west might equally be expected to reflect some of the simpler, Waldalgesheim-derived motifs of the later styles in their composition. To some extent this is true, in spite of Allen's sceptical assertion (Allen, 1976, 265) that 'in the history of Celtic art as a whole, coins stand apart'. Duval's study of the coins of the Parisii especially (Duval, 1976, 253, Fig. 3, etc; 1977, Fig. 443) shows the repeated use of S-motifs, pseudo-triskeles, lyre-palmettes and even split-palmette derivatives (Figure 10.1). The manner of employment of these motifs is highly stylized, of course, in consequence of the highly specialized nature of the medium, but the motifs themselves should not be disaggregated from their wider application in Celtic art. As to manufacture, it is probable that, from an early stage, coin minting was discharged by specialists working under the patronage of their aristocratic and political masters, but it is quite unclear whether specialists would have been engaged in the production of other items of precious metals as well as coins (Duval and Hawkes, 1976, 278–9).

By contrast with earlier La Tène representations of the human head, the representations on the obverse of Celtic coins, based upon their classical models, are almost invariably in profile rather than full-face. One of the few issues with full-face representation comes from the late first century BC among the Taurisci on the middle Danube; its faces are clean-shaven, but depict oval eyes, nose and mouth, with a corrugated hair-style not unlike that of the stone sculpture from Mšecké Žehrovice or the faces on the early first century *phalerae* from Manerbio sul Mella from northern Italy (Allen and Nash, 1980, 58; Duval, 1977, 386). Perhaps significantly, the head seems complete and quite independent of the out-sized head-dress, underlining its separate pedigree.

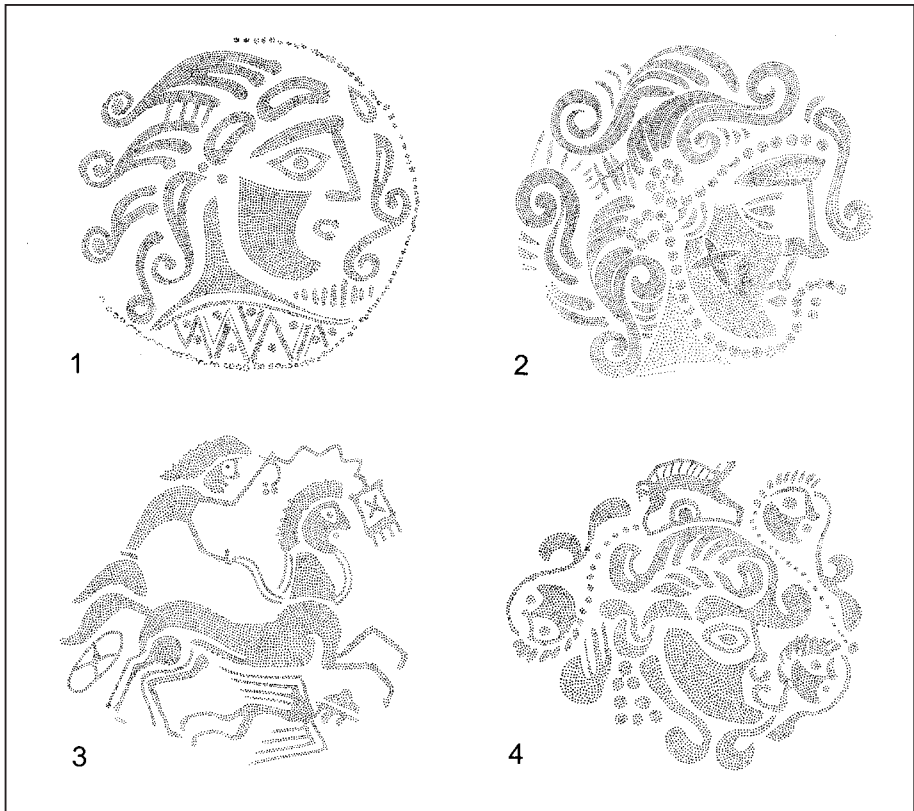

Figure 10.1 Designs on Gaulish coins. 1, stater of Parisii; 2, Parisii stater, composite of several coins from same die; 3, stater of Veneti; 4, stater of Osismii. Adapted from Duval (1976) and Allen and Nash (1980).

Profile heads on coins are mostly but not exclusively male, generally clean-shaven in the tradition of classical deities rather than following the reputed Celtic fashion of sporting moustache or beard, and occasionally bear appendages resembling horns or the symbolic leaf-crown of earlier imagery. There are also coins bearing Janus-heads, notably a second-century group among the Vindelici, but also examples from the Rhine, and one from Britain minted in the name of Cunobelin. Though Danubian and cisalpine coins may retain a semblance of portraiture, in much of the Gaulish and British coinage the head rapidly disintegrates into a series of stylized components in which only the eyes and laurel wreath, the latter reduced to a band of pellets, may be residually recognizable. Particularly bizarre is the Armorican depiction of miniature heads, seemingly dancing on the ends of tendrils attached to a still-recognizable principal head (Figure 10.1, 4). Torcs, with their connotations of high status or divinity, are commonly depicted, either around the neck or as independent accessories, though their archaeological typology is seldom assured.

On the reverse, human figures occur in several roles, as charioteer, as a rider on horseback or as a foot-soldier. In all these representations we are dealing essentially with Celticized renderings of classical models, though the accessories and associated symbols are commonly those of Celtic iconography, such as torcs, carnyxes or boar images. In more than one Gaulish example a naked female figure riding a horse is armed with the Celtic warrior's equipment of spear and shield, a graphic parallel to Polybius' account of the *Gaesatae*.

The Celtic zoo is represented on coins in a variety of ways, both naturalistic and fantastic. The horse is predominant, initially as part of the chariot team, or carrying a rider, but later as an independent representation. Its mane may be braided, and its tail tripled, like a cartoon representation of swishing movement. The horse with human head is quite common in Gaul, and is obviously related to the sphinx and centaur, which are both also represented. On one coin of Tasciovanus (Mack, 1975, no. 192; Allen and Nash, 1980, 520), a centaur is depicted playing pipes. Winged horses are not easily distinguished from griffons, and sometimes are associated with raven-like birds on their backs. Birds are relatively common, notably eagles and ravens, but also ducks among recognizable species, sometimes with snakes in their claws or beaks. But among the most potent of Celtic animal symbolism are images of bulls and boars, and these two occur in widespread regional groups on coins. Boars (Figure 10.1, 4), found especially in Gaul and parts of Germany rather than in the middle Danube, are represented either as the beasts themselves, or on boar standards, underlining their importance as a symbol in battle.

Because of the pedigree of Celtic coinage, and the obvious borrowing of myth and imagery from the classical world and beyond, it would be arguable how much one might infer of the everyday life of the Celts from images depicted on coins. The fact that a laurel wreath might be translated into an ear of corn hardly affords a profound insight into Celtic economy. Among the wardrobe of clothed figures on Celtic coinage, the use of breast armour has archaeological support, but the absence of trousers is surprising. Buildings or domestic structures one would hardly expect to find represented on coins. Allen's (1973) interpretation of a series of representations of buildings on Gaulish coins of the later first century BC as shrines or temples might be regarded as fairly speculative, but is nevertheless worth considering in the context of archaeological evidence for Romano-Celtic temples, and perhaps especially the sacred sites of Picardy. On the other hand, Allen also (1971b) drew attention to a dozen coins, principally from Normandy and probably of late second-century date, depicting a type of vessel with high prow and stern that he took to be a sea-going ship, and which would certainly be consistent with Caesar's account of the sturdy, ocean-going ships of the Veneti to the west. In general, however, we should not expect to see the iconography of the coins as a mirror of everyday life. As Allen observed, 'it was no part of the aim of the engraver to represent that which was simple and homely, but that which was bizarre and heroic' (Allen and Nash, 1980, 148). Notwithstanding his legitimate scepticism regarding some of the more extravagant claims of ritual symbolism in Celtic coins, it does appear that there were recurring images that can provide genuine insights into the Celtic mindset in terms of the heroic and supernatural pantheon.

The wine trade and southern imports

From the middle of the second century BC, southern imports, probably linked to the trade in Italian wine, once again make their appearance in north-alpine Europe (Figure 10.2). While it may be true (Fitzpatrick, 1985, 317) that North-Western Europe 'never constituted a market (in the technical sense) for Roman goods' in the period prior to the conquest of Gaul, nevertheless the archaeological distribution of *amphorae* (Figure 10.2A) affords striking testimony to the extent of the demand for Mediterranean wine and the luxury goods associated with it throughout the Celtic world. The principal types of amphorae involved are those classed as Dressel IA and Dressel IB, though other closely related types may have been on occasion confused within this classification. The Dressel IA type, characterized by its short, fairly fat, spindle-like shape with triangular rim, came into circulation around or before the mid-second century, being found crucially at Carthage in contexts earlier than 146 BC. It lasted in circulation until around 70 BC, when it was superseded by Type IB, which was taller and slimmer, with a higher, collar-like rim. By the Augustan period, this too was being replaced by Type II and later amphorae. The chronology is not absolutely secure, but it is at least clear that there is no direct correlation in north-alpine Europe with the transition to La Tène 3 or D, which is marked by the appearance of new diagnostic brooches and other material types.

The distribution of Dressel I amphorae once seemed to show a concentration around the Atlantic trade routes, but, as research fills out the distribution, much of north-alpine Europe west of the Rhine is fairly densely represented. The non-Celtic Germanic world, however, still seems largely devoid of find-spots, those from the lower Rhine being relatively late, from Roman military sites. They occur both in burials and in major excavated settlements and *oppida* in substantial numbers, over a hundred being represented at Villeneuve-Saint-Germain or at the Titelberg, for example, with significant numbers also at Manching and the Basel settlements. Their apparent scarcity further east, in the *oppida* of Bohemia and Moravia, for instance, where other items of the Campanian drinking service were present, led Wells to suggest that the trade to eastern Central Europe was dependent upon wooden barrels or leather containers, more suited to overland transport in wagons. But, as in the case of the late Hallstatt period, we may question whether individual items of imported drinking service necessarily mean that local elites were drinking imported wine rather than local brews.

Imported bronze vessels (Figure 10.2B), produced in Italic, probably Campanian workshops, do not appear north of the Alps until the end of the second century. The principal types are flagons, pans, sieves, handled tankards (*kyanthoi*), ladles and bowls. The distribution of these types is instructive, by comparison with the distribution of Italic imports of the late Hallstatt and early La Tène periods. With the exception of the handled cups and ladles, which do not extend much beyond the Danube, the late La Tène distribution is remarkably extensive, penetrating into south-eastern Britain and well beyond the territorial boundaries of Celtic communities into Germanic Northern Europe. Though there are small clusters in the distribution, there is no evidence to compare with the suggestion that early La Tène chieftains had their own favoured supplier of exotic goods, nor is there evidence that these imports were copied, adapted or imitated in pottery as they were in the earlier period.

Among these bronze imports, flagons have attracted particular attention. Werner

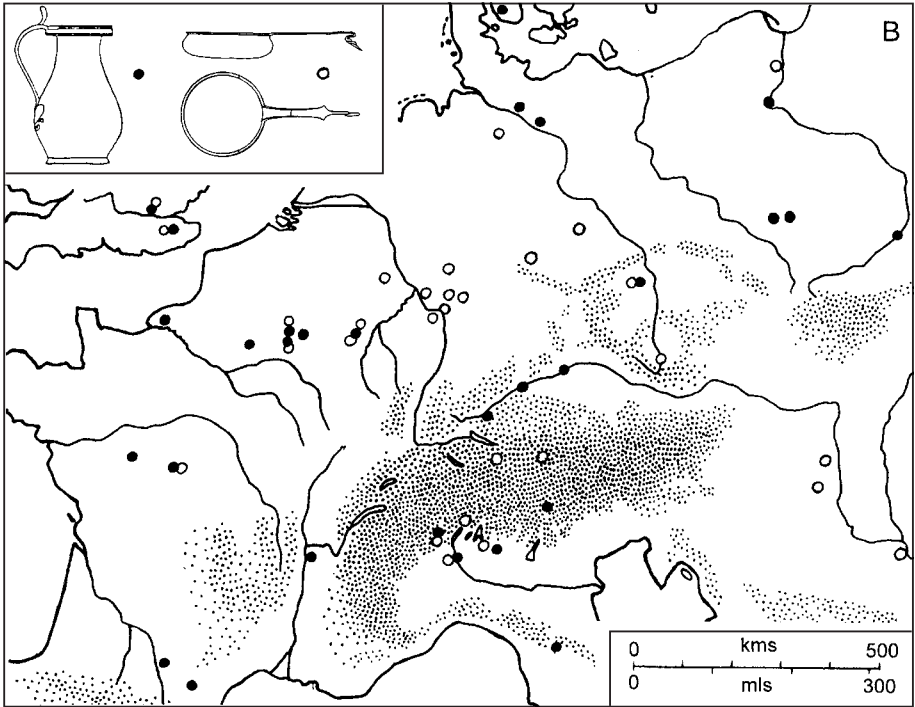
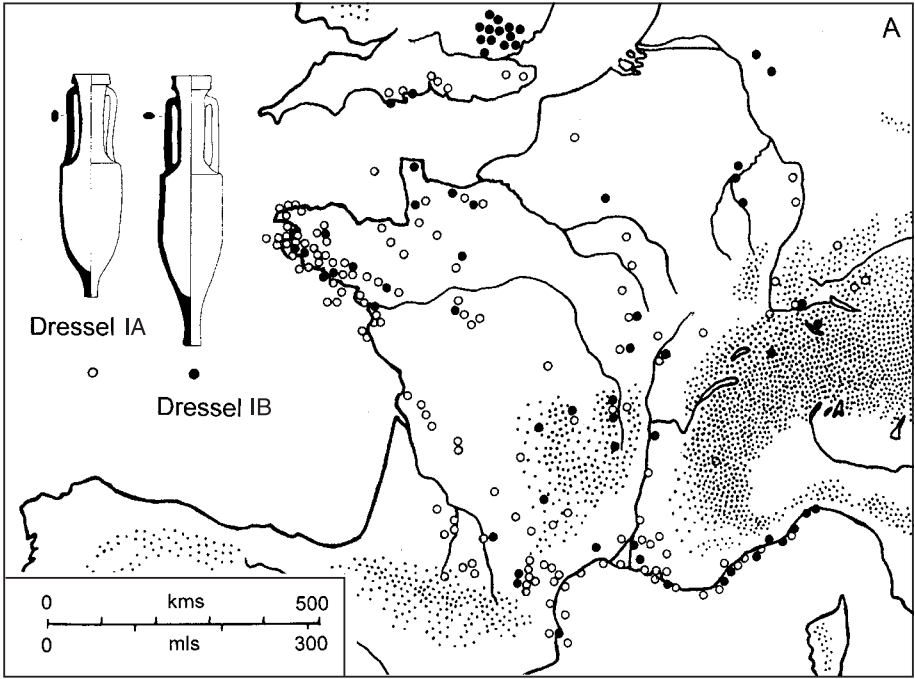

Figure 10.2 Trans-alpine trade in the late La Tène period: A: distribution of Late Republican Dressel I amphorae, adapted from Peacock (1971) and Fitzpatrick (1985). B: distribution of late La Tène jugs and pans, adapted from Werner (1978).

(1978) identified two types, his Kappel-Kelheim and Ornavasso-Kaerumba variants, which he regarded as chronologically successive, if overlapping in their currency in the mid-first century BC. The Kappel-Kelheim type probably first appeared at the end of the second century, while examples of the Ornavasso-Kaerumba type on the fringes of the distribution, including those from Britain, are likely to date from the Augustan period or later. High-status goods of this kind could easily have been handed down through several generations before finally being interred in the burials in which they were found.

The cemetery sequence at Ornavasso by Lake Maggiore is important in establishing the currency of these vessels and their associations. The two adjacent cemeteries of San Bernado and Persona, excavated in the 1890s, appear to span between them the period from the middle La Tène to the early Roman Empire. On the basis of grave associations, including some Republican coins, Graue (1974) calculated that his Group 2 at Ornavasso, in which the wine service first appeared, could be assigned broadly to the period 90–50 BC. Associated grave-goods included the so-called *vasi a trotolla*, which had appeared first in the preceding phase, and various brooches, notably of Nauheim, Stradonice and spoon-bow types. Some of the key graves containing flagons at Ornavasso, however, illustrate the problems posed by these associations, suggesting that some items must have been in circulation for a prolonged period before being deposited. Shallow, handled pans that are known after the type-site at Aylesford in Kent actually occur in significantly greater numbers than the flagons. Their distribution includes, for example, a concentration in the middle Rhine, where the flagons are notably absent, challenging the assumption that they were part of a complementary wine service.

At the end of the first century BC, the Italic imported wine-service changes significantly with the appearance of a new range of flagons, bowls, pans and ladles, still fulfilling essentially the same purpose, but by now in the distinctive style of the early Roman Empire. Late La Tène types are still present in the Goebingen-Nospelt graves in Luxembourg, dated to around 20–10 BC, and even the military establishment at Dangstetten (15–10 BC) has only late La Tène types. But the new forms appeared in the Roman military sites of Haltern, occupied from 11 BC to AD 9, and Augsburg-Oberhausen, dated to 10 BC to AD 16. The change is thus quite rapid, marking also a significant change in clientele.

Throughout the first century BC, when north-alpine Europe was enjoying once again the benefits of southern comforts, we must ask the question, what was being reciprocated? Wells has argued strongly for the production and export of iron from sites like Kelheim (1993), and certainly, before the military annexation of the sources of supply, there is every reason to believe that iron products would have been in demand. If the quantities referred to in graffiti in the cellars at the Magdalensberg in Austria, relating to trade at the end of the first century BC or early first century AD with merchants from the head of the Adriatic, are any indication of the scale of production during the previous century, then it was on a substantial industrial scale. As we have seen, any calculation of the number of iron spikes used in the construction of *muris gallicus*-type ramparts around the major *oppida* would certainly endorse that conclusion. Another probable export in return for Roman goods was slaves; while slave chains are not extensively recorded archaeologically, Roman writers certainly suggest that slaves were a regular part of the equation in barter.

Burials in the late La Tène

The evidence for these imported artefacts in north-alpine Europe is derived significantly from rich graves, which once again come into prominence in the late La Tène. In much of North-Western Europe in this period the burial rite reverts to cremation in flat cemeteries, often with minimal grave-goods to accompany the cremated remains, which are frequently deposited in a wheel-thrown pottery vessel. In Belgic Gaul and in south-eastern England, this often takes the form of a tall, pedestal vase; in the Wetterau region east of the middle Rhine, where Bad Nauheim has furnished the type-site, the cremations are contained in bowls. Elsewhere, however, a combination of rites persisted. At Basel in Switzerland, the cemetery by the gasworks site revealed that local practice in the first century BC was inhumation, while several of the smaller contemporary cemeteries on the Enge peninsula at Bern had a combination of inhumation and cremation.

Richly equipped burials, if not quite *Fürstengräber* in the late Hallstatt or early La Tène sense, make a re-appearance in the decades around 100 BC, particularly between the middle Rhine and Luxembourg. Like their predecessors, they are distinguished by the presence of southern imports, but unlike the earlier *Fürstengräber* they do not normally include gold-work among their funerary inventory. The cemetery at Hopspädten-Weiersbach near Birkenfeld (Haffner, 1969), included several cremations interpreted on the basis of associated artefacts as women's graves. One distinctive feature of the cemetery was the inclusion in a number of graves of fittings from a draught vehicle, notably iron tyres and rein-rings. The practice of chariot burial does survive intermittently through the middle La Tène phase in north-eastern France and the Ardennes, but the occurrence of vehicles or vehicle parts in graves of the early first century BC must represent the last vestiges of this funerary custom. By the time of Caesar's war in Gaul, the practice of chariot warfare was obsolete – hence the Romans' dismay at first encountering it in Britain – and it would seem that the custom in death was shortly to follow its demise in life.

One relatively early cemetery was that at Clémency in Luxembourg (Metzler *et al.*, 1991), a cemetery in proximity to the major *oppidum* of the Treveri at the Titelberg. Clémency was a cremation burial in a wood-lined pit, rather larger than most at over 4 metres square, and itself contained within a larger square enclosure. A low barrow mound may have marked the position of the burial. Grave-goods included imported amphorae, a bronze bowl and an oil-lamp, an iron roasting-grill and more than two dozen pottery vessels. What is special about the Clémency burial, however, is not just what was included in the grave, but what was found in and around the funerary enclosure. Numerous other pits containing ashes and the calcined remains of bones of pig, cattle and horses, together with other apparently ritual deposits, were evidently the product of an elaborate funerary ceremony of the early first century BC.

Rather later in the first century was the cemetery at Goebtingen-Nospelt in Luxembourg (Thill, 1966; 1967), a few kilometres from the Titelberg. Four graves were uncovered under low barrow mounds, in each case the rite being cremation with the remains scattered around and under the grave-goods in a rectilinear pit. Teeth and tusks of wild boar may have been residual from the funerary feast, and sherds within the grave filling suggested the possibility that other accessories may have been burnt on the pyre. The fact that three of the graves contained swords, spear-heads or shield

fragments lead to the conclusion that these were warrior burials. The presence of spurs prompts the suggestion that they could have been cavalymen, which would be consistent with the fact that auxiliary cavalry from the Treveri are recorded as serving in the first century AD in the Roman campaigns of Drusus and Tiberius. Spurs are now quite widely included in warrior burials in the middle Rhine and Luxembourg. In itself, the length of the swords, though appropriate for cavalry use, is no more than standard among late La Tène weapons. Grave B was the most lavishly furnished of the four burials, and is the key to dating the group. Apart from an iron sword with its scabbard, the emphasis seems to have been upon the wine-service. There were amphorae of various kinds, a bronze handled cauldron and accessory vessel, a long-handled sieve and Aylesford-type pan, and two flagons, one of late Kelheim type. There were also two stave-built wooden buckets with bronze bindings bearing simple symmetrical geometric or curvilinear designs. Among some three dozen pottery vessels were late first-century Samian and a beaker of the so-called ACO type with the stamp of the potter Hilarus, datable to the last decade BC or first decade AD.

Two of the Goeblingen-Nospelt scabbards are of particular interest because of the open-work ornament of their upper plates. The scabbard from Grave C displays an open-work tendril design for which Werner (1977) cited a close parallel from the Roman military site at Dangstetten. Not only does this provide a close dating horizon in the penultimate decade of the first century BC, it also shows that the stylistic influence was strongly Roman. The stylistic context of the design on the scabbard from Grave B, by contrast, was to be located in the eastern Alps in the kingdom of Noricum, where the arrangement of vertical columns of open-work was so closely paralleled on swords from Vrhnika, west of Ljubljana, and Smarjeta that the possibility of their being the product of the same workshop could not be discounted. In fact, this style is quite widely represented in Eastern and South-Eastern Europe, and was adapted also in the open-work ornament of the catch-plate of brooches such as those from Stradonice in Bohemia. Here then is evidence of the continuation of long-distance contacts between specialist craftsmen and their aristocratic patrons late in the first century BC.

Probably of later first-century date is the burial discovered early in the twentieth century at Châtillon-sur-Indre in the Loire basin. Grave-goods again included an imported bronze flagon of Kelheim type, an Aylesford pan and a plain bronze basin, together with early Roman amphorae. A round bronze plaque of uncertain function was ornamented with a symmetrically disposed set of four, five-armed whirligigs (Duval and Heude, 1984). Like Goeblingen-Nospelt, the grave contained boar tusks, underlining that beast's symbolic significance in the funerary feast, and like Goeblingen-Nospelt, it was apparently a warrior's grave, containing in this instance an anthropoid hilted sword of Hawkes' Class G (Clarke and Hawkes, 1955).

Ritual sites and cult practices

Ritual sites in the La Tène Iron Age take a variety of forms, and it is not until the Gallo-Roman period that a regular plan of temple buildings or sacred enclosure can be recognized. Not surprisingly the closest we have come to formalized ritual structures are the remains from the Celto-Ligurian sanctuaries of Mediterranean Gaul, with skull-niched pillars and sculpted images. Elsewhere in the absence of recognizable structural remains, altars or dedications to deities, it is not easy to infer a ritual purpose, though

the nature of deposits like those from La Tène itself or Snettisham in Norfolk may be so exceptional and so unlike normal domestic remains that a votive explanation may seem probable. Abnormal quantities of material, especially if they are prestige items or have been treated abnormally, might reasonably be explained as votive deposits, although current fashion perhaps has over-emphasized ritual as an explanation of hoards in prehistory (Bradley, 1998). It is the absence of significant material evidence of cult offerings that makes interpretation difficult of the *Viereckschanzen* (lit. 'four-cornered' or quadrangular enclosures) of Central and Western Europe, though the wooden stag carvings found in the shaft at Fellbach-Schmiden, Baden-Württemberg (Planck, 1982), might be consistent with ritual use. Classical sources might lead to an expectation that natural locations like springs or sacred groves attracted veneration, and the *ex voto* carvings from the source of the Seine or from Chamalières near Clermont-Ferrand might be cited as endorsement.

Undoubtedly the most compelling of ritual sites recognized archaeologically are the Gaulish sites such as Gournay-sur-Aronde and Ribemont-sur-Ancre (Brunaux, 1988). Gournay (Brunaux *et al.*, 1985; Brunaux and Rapin, 1994; Lejars, 1994) is particularly remarkable, since its origins clearly date from the fourth century BC, even though its early layout may have been obscured by later structural phases. The sacred enclosure was defined by a quadrangular ditch, within which were found more than two thousand weapons, apparently ritually broken, and large quantities of animal bones, deposits that evidently accumulated during the site's use. Among the seven hundred scabbards, various different styles of ornament were represented, suggesting a wide range of sources of production. A central setting of pits likewise contained cattle remains from what were interpreted as ritual sacrifices. By the first century BC this focal area had become a small wooden temple of square plan, itself succeeded towards the end of the century by a stone-founded shrine. Eventually, this exact location became the site in the fourth century AD of a Gallo-Roman temple, further endorsing, if endorsement were required, the ritual character of the site. Ribemont was a sanctuary of the Gallo-Roman period, part of an extensive complex of buildings including theatre and baths. Particularly remarkable was an ossuary of human bones, carefully constructed around three sides of a central posthole containing cremated human remains. It stood within a ditched enclosure along the sides of which had been deposited dismembered human remains, the product either of human sacrifice on a massive scale or of a hitherto undocumented funerary cult.

Gallo-Roman temple sites, like their counterparts in Britain, may well have been sited in relation to earlier pre-Roman sanctuaries, and by implication may have perpetuated some element of pre-Roman Celtic ritual practice. The recent discovery at Naves, in Corrèze, therefore, of a hoard of bronze carnixes on the site of a Gallo-Roman shrine is of particular interest, since they closely replicate the form represented both at Deskford in northern Scotland and on one of the inner panels of the Gundestrup cauldron, in which the horn mouth is in the head of an animal, here apparently including snake as well as boar imagery.

Human and animal representations

Anthropoid-hilted swords of Class G are of particular interest because of progressive Romanization in their depiction of the human head. The ancestry of this form of hilt

derives ultimately from late Hallstatt weapons, but only in the later La Tène are the hand-grips so distinctively cast with reeled mouldings, and the knobbed 'heads' given hair and facial features. The fact that examples may be Janus-faced suggests some cultic significance for the warrior's protection. The effect and extent of Romanization can be judged by comparing the Châtillon-sur-Indre head with representatives from the immediately preceding phase, probably dating to the later second century BC. A classic example is from the inhumation burial found in a dug-out boat used as a coffin from Chatenay-Macheron in the Haute-Marne, together with a spear and long sword of La Tène 2 type. Hawkes described its 'obliquely-set bulging eyes, frowning mouth, and long straight hair' as epitomizing the Celtic 'barbaric' style (Clarke and Hawkes, 1955, 211), and cited insular examples from North Grimston, Yorkshire, found with a middle La Tène long sword, and from Ballyshannon in County Donegal. Compared with the glum faces with fringe hair-styles of the latter, the Châtillon head's features are more finely depicted, and the hair-style is much more elaborately coiffured. Examples are found as far east in the Celtic world as Hungary. Two examples, broken but presumed to be from anthropoid-hilted swords, from Stradonice in Bohemia and Staré Hradisko in Moravia, have particularly elaborate hair-styles, rather small mouths and carefully highlighted eyes, which has led to the suggestion that they could even be female representations (Duval, 1977, 183).

A unique set of representations of the human head in *repoussé* distinguishes the silver discs or *phalerae* from Manerbio sul Mella in Lombardy (Megaw, 1970a, 204–5). On the three larger and fourteen smaller discs, the number of heads varies, being as many as twenty on the larger and up to ten on the smaller discs. The bulging, lentoid eyes, down-turned mouths and the furrowed hair-style are so like representations on the silver coin series, ascribed to the Taurisci, that it is probable the Manerbio pieces were imports into northern Italy from the middle Danube in the first century BC.

The late La Tène phase, and in Gaul the period known as Gallo-Roman *précoce* in particular, also see the appearance of more complete anthropomorphic representations, possibly of cultic significance, like the limestone figure from Euffigneix in the Haute-Marne (Figure 10.3A). This was doubtless a pillar-stone broken at the waist and damaged at the top of the head. The face is still uncompromisingly Celtic, with lentoid eyes, straight nose and above the ears what originally must have been a hair-style or head-dress in the familiar furrowed technique. The figure is accompanied by two of the most powerful emblems of Celtic spirituality, the torc – a buffer variant with ornamented terminals – and on its torso in vertical disposition a low-relief boar, its bristling back and limbs finely highlighted. By contrast, the bronze divinity from Bouray, Seine-et-Oise (Figure 10.3B), shows clear Roman influence in its more naturalistic features and neat hair-style. But in every other respect it violates Roman decorum. The head is too large for the body, and the shrunken legs, crossed in the pose of Celtic squatting deities, terminate in animal hooves. The arms are missing, but presumably extended from the exaggerated shoulders to the figure's knees. One eye survives, in blue and white glass, and the figure wears about its neck the ubiquitous Celtic torc.

One of the most remarkable collections of human and animal representations of this period was found on the left bank of the Loire opposite the sanctuary of Fleury at Neuvy-en-Sullias. The cast bronze figures, which range from around 13 to 20 centimetres high, have a quality of simplicity despite the rather disproportionate anatomy that lends to them an almost contemporary appeal. The nude 'dancers'



A



B

Figure 10.3 Late La Tène cult figures in Gaul – 1. A: Euffigneix. Musée des Antiquités Nationales. Photo: RMN, Paris © Jean-Gilles Berizzi. B: Bouray. Musée des Antiquités Nationales. Photo: RMN, Paris © Gérard Blot.

(Figure 10.4A), in particular, with emphasis of ribs and small breasts, seem likely to be the product of the same artist. There is really no credible antecedent for this figural work in earlier Celtic art, which must reflect the influence of Roman figurines, however un-classical the execution. The torsos of the dancers are slim, even emaciated, while their arms are too sturdy and in one case the hands are disproportionately tiny. Nevertheless the sense of movement has often been remarked, especially in respect of the female dancer poised on the tips of her toes.

By contrast with the human figurines, the boar images from Neuvy (Figure 10.4B) are strikingly life-size. The aggressive-looking creature with its tusks and whiskers rendered in *repoussé* has its spinal crest bristling in a manner seen on Gaulish coinage. Its front feet, and those of its partners, are rigid in a posture of defiance that is shared by some, but not all, of the smaller boar models from other locations. Most of these are only a few inches in height and length, and though they may have served a votive purpose, it was clearly not on the grand scale of the Neuvy boars. Some, indeed, are hardly awe-inspiring, and look more like toys than votive emblems. The Hounslow piglet (Jope, 2000, Pl. 160, a–i), with its large, saucer-like ears and delicately modelled, curving snout is quite unlike some of the stocky, heavy-shouldered Continental beasts, and would hardly have struck terror into an enemy had it adorned a helmet, as was once supposed. This suggestion arose from the fact that its feet retained pegs for attachment, possibly to a lid, as Jope suggested (2000, 264), rather than on a helmet. The idea of such images as surmounting helmets was revived by Szabó for the Báta, Hungary, boar, but in spite of the representation of boar-crested helmets on the Gundestrup cauldron, there is little positive evidence for this practice in the European Iron Age. The Hounslow boar is in fact one of three. Two have their crests rendered in open-work circles, the third having its bristles depicted in parallel lines like Neuvy and the coins. The open-work style is also known on the Continent at Tábor in Bohemia and at Lunčani in Romania. All of these are generally assigned to the last century BC. The Hungarian example from Báta is of interest, therefore, because the designs on its crest suggest possibly an earlier date. The S-motifs and spirals, as well as the modelling of the boar itself was regarded by Szabó probably with justification as reflecting the Plastic Style of the second century, and as such the Báta boar should be among the earliest in this series of representations that elsewhere continued into the opening centuries AD.

Orientalizing again: from Gundestrup to Sark

We have seen that the receipt of classical imports in the late La Tène did not prompt a revival of artistic imitation and experimentation among north-alpine workshops, other than that represented by the striking of local coinages. As a result doubtless of protracted contact with Eastern and South-Eastern Europe, however, there was evidently mutual interaction between eastern and western craftsmen, witnessed most graphically and enigmatically in the well-known silver-gilt ‘cauldron’ from Gundestrup in northern Jutland (Figure 10.5; Klindt-Jensen, 1961). Its reconstruction as a cauldron is based on the hemispherical base-plate and two lengths of tubular reinforcement for the rim, but begs the question how the side plates were to be attached and to what material. Stylistic and technical considerations have shown conclusively that five different hands are represented in the plates: the base-plate was probably originally a *phalera*,



A



B

Figure 10.4 Late La Tène cult figures in Gaul – 2. Neuvy-en-Sullias dancer (A) and boar (B). Photos: Orléans, Musée historique et archéologique de l'Orléanais.



Figure 10.5 'Celtic' iconography on the Gundestrup cauldron. Photo: Lennart Larsen, National Museum of Denmark, Copenhagen.

and it is quite possible that the side-plates too were made originally for a different purpose, such as a box or casket. As reconstructed, it is made up of five inner plates, each depicting scenes of warriors, deities and exotic beasts, and seven out of an assumed eight outer plates, each dominated by a large bust of heroes or divinities. The base-plate depicts a large bull with smaller swordsman and other animals, which led Olmsted (1979) to suggest that the 'narrative' plates depicted an Indo-European epic cognate with the *Tain Bó Cuailnge*.

Despite the iconic role that Gundestrup has acquired in popular publications on the Celts, there can be little doubt that the style of workmanship and ornament is Thracian, even if particular iconographic motifs are Celtic and western. Silver-work is not the *forte* of the Celtic artist, but is distinctive in Thracian workshops from the fifth century BC. The discovery of the plates in the Germanic north therefore introduces a third unknown into the equation that scholars have been quick to explain in the context of the historically recorded invasions of the Cimbri at the end of the second century BC. In fact, as we have seen, there is ample archaeological evidence for contacts between north-alpine Europe and the north, even into southern Scandinavia, from late Hallstatt times onwards, as well as regular east-west connections within Celtic Europe, so that it is unnecessary to assign this particular exotic import to any one historical

horizon. The 'western' elements have been frequently commented upon, and need not be rehearsed at length here. The squatting god, with twisted, buffer-torc in one hand and about his neck, and with serpent in the other hand, has inevitably been identified as Cernunnos, despite the fact that the only sculpture, from Notre Dame, Paris, that can certainly be identified as Cernunnos, has horns rather than antlers. The bird-crested helmets worn by the procession of horsemen have been compared to the Çiumeşti helmet, and the war-trumpets of the foot-soldiers have been likened to carynxes, like that from Deskford, Banff, in Scotland. The wearing of the torc by five out of seven of the deities of the outer plates, and the numerous depiction of figures in trousers, all points to a strong Celtic component in the symbolic imagery of the plates. But equally there is mythical imagery from the classical world, Heracles and the Nemean lion, the boy on a dolphin, and the deities on the outer plates whose depiction or accoutrements have prompted identifications in the Roman pantheon. Essentially, however, it is the style of the plates that is alien to the Celtic tradition, the ivy-leaves against a stippled background, and the rendering of a host of exotic beasts that have no place in the Celtic zoo, but which come from a long-established orientalizing tradition that has its parallels in Thracian art and beyond.

Dating, as ever, is a source of controversy, but manufacture in the late second or first century BC in a Thracian workshop familiar with Celtic myth and symbolism seems more probable than manufacture at a later date in a Gaulish centre where orientalizing themes had been introduced by Thracian mercenaries in Roman service. Transmission to the Germanic north could have been through one of several means, by trade, diplomatic gift or by plunder among others. Speculation of a Cimbric connection may have its appeal, but it is not the business of archaeology simply to furnish the graphics for history.

Equally exotic in the west though less cosmopolitan in its stylistic repertory is the Sark hoard, an early discovery that survives only in a set of remarkable drawings of 1725 (Allen, 1971a). The principal finds were a set of silver or silver-gilt *phalerae*, a curved silver 'dolphin' mount, an iron-bound pottery vessel of first-century BC appearance, and eighteen silver coins including Roman Republican *denarii* as well as Gaulish coins. Several of the *phalerae* were apparently from pairs, one large, one smaller, and two pairs of intermediate size, and all were probably the work of a single workshop or school of silversmiths. The two larger *phalerae* depict a central beast surrounded by a parade of confronting and cavorting beasts; on the smallest pair, two fantastic creatures confront each other in heraldic poses. The remaining *phalerae* are dominated by a single beast, some reasonably naturalist renderings like the bull, dog and elephant, others fabulous such as the winged horse, griffons, hippocamp or unicorn, if indeed the beast depicted is a unicorn rather than a horse dressed in ceremonial head-cap. The bull in its pose and rendering has undoubtedly a cousinly relationship to that on the base-plate of the Gundestrup cauldron. Confronting beasts, especially with their heads turned back, echo earlier orientalizing themes, as does the leopard attacking the cock. More unusual is the image of the elephant and castle, though it is not without parallel in the ancient world. Distinctive of the Sark engravings is the use of a 'striped' technique to render the pelt of beasts, and simple linear or curvilinear dotting of the background to the parade of beasts.

Closest in style and theme to the Sark *phalerae*, as Allen observed, is the Seven Beasts *phalera* (Figure 10.6A), one of two in the Bibliothèque Nationale in Paris. Around the

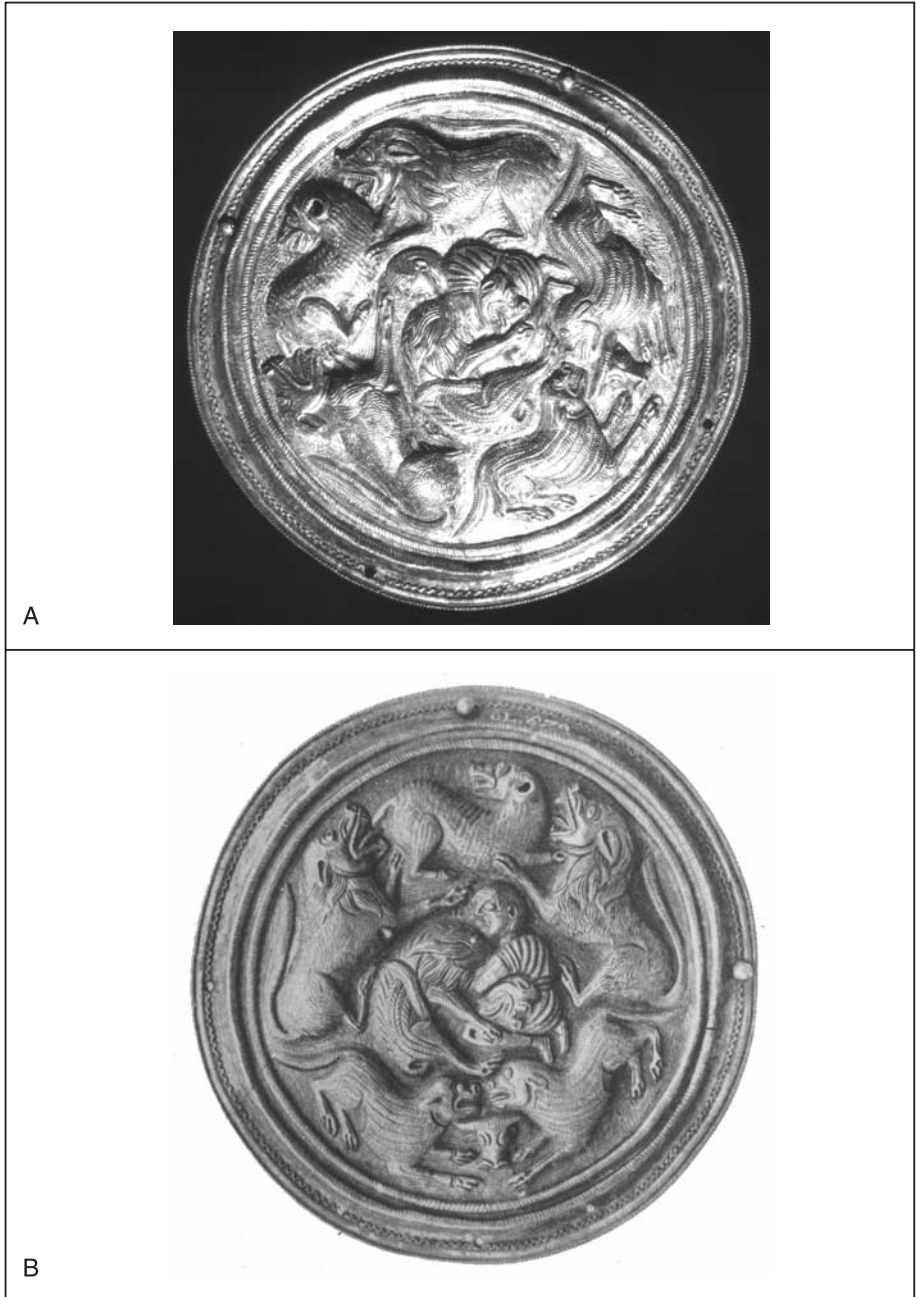

Figure 10.6 Orientalizing *phalerae* in Western Europe. A: 'Seven Beasts'. Photo: Bibliothèque nationale de France, Paris. B: Helden silver *phalera*. Photo: Rijksmuseum van Oudheden, Leiden.

central depiction of a wolf attacking a deer parade exotic winged beasts and griffons, their pelts rendered in 'striped' fashion, and against a background of trailing dotting. Located between the griffons is a bull's head, portrayed in full frontal view. The Paris *phalera* also bears an inscription in Greek referring to King Mithridates, presumed to be Mithridates the Great of Pontus (110–63 BC). The other examples of exotic *phalerae*, from Helden in Holland (Figure 10.6B) and one of three from Stara Zagora in Bulgaria, depict as their central image a man wrestling with a lion, the latter clearly recognizable from its mane, a scene paralleled also on the Gundestrup cauldron. The figure is obviously based on the same mythological tradition as the Heracles model, but doubtless from an older oriental source. In the surrounding frieze, two lions confront a ram with its head turned back, and two fierce dogs face each other across a full frontal bull's head like that of the Paris *phalera*. The Stara Zagora *phalera* was one of three found in a cauldron with various other items of a cavalry warrior's equipment, prompting the thought that all of these *phalerae* could have been the possessions of Thracian cavalymen. The inscription on the unprovenanced Paris find suggests a date in the first half of the first century BC; associations of the Stara Zagora find suggest a date at the end of the first century BC or even the beginning of the first century AD. For the deposit of the Sark hoard Allen assigned a date within a decade or two of the Roman conquest of Gaul. Finally, a *phalera* with a lion in much the same style as the series under discussion from the Roman legionary camp at Oberaden on the German *limes*, which was abandoned by the last decade BC, argues for the continuing circulation of *phalerae* in Western Europe until the close of the first century BC at least.

Britain and Rome

In parallel to the late La Tène pattern in Continental Europe, and in contrast to the widespread absence of a recurrent insular burial tradition, the south-east of England in the later Iron Age is notable for its cremation cemeteries. Among these, from the Augustan period at least, and continuing into the early years of Roman occupation, is a series of aristocratic or high-status burials, lavishly furnished with the trappings of hearth and home, and including amphorae and vessels for the drinking service imported from the Romanized Continent. Of the earliest, the imported Italic vessels from Aylesford in Kent have already been noted. Similar imports are known from north of the Thames, in the series of rich burials named after two important finds from Welwyn Garden City in Hertfordshire that belong to the decades before the Conquest. More recently richly furnished burials have been excavated at both St Albans, Hertfordshire, and at Colchester, *Camulodunum*, in Essex, which post-date the Conquest, with one at Colchester perhaps as late as the 60s or 70s of the first century AD. Probably just post-Conquest at Stanway was a warrior burial, which included imported pottery vessels, a copper jug and handled pan, and gaming pieces, as well as evidence for spear and shield, and a 'doctor's burial', so designated because of the range of surgical instruments included in the grave, though the accompanying board game and a set of copper and iron rods suggested that there may have been a measure of lottery or divination attached to medical practice. At the other end of the doctor's grave was a well-equipped dinner service with Samian cups, flagon and strainer, ensuring the availability to the dead of lavish provision of food and drink. It is an intriguing fact that communities where there had been no archaeologically visible tradition of

lavish burial prior to the period when the ruling dynasts came into contact with Roman luxury goods seemingly made their greatest display in funerary ritual at the very moment when they lost their political autonomy. If this was a demonstration of independent identity, it was tempered by a willingness to take advantage of the superficial trappings of Roman civilization.

In terms of La Tène art, the post-Caesarian period certainly saw a continuation if not an actual increase in production, stimulated by the import of wine, oil and a range of Roman provincial goods. Until the Conquest itself, craftsmen apparently maintained their independent traditions to a significant degree in a wide range of products, warrior and equestrian equipment, vessels for feasting and drinking, and items of personal ornament. But by the second half of the first century AD, the new political order had evidently disrupted the structure of production and supply, and the more striking examples of Celtic art come from the fringes of the advancing Roman frontier, from Wales, then from Scotland, where distinctive production continued into the second century beyond the Roman frontiers.

From the first century AD, the range of ornamental motifs becomes more limited and stereotyped. Scabbards for long, iron swords, like those from Battersea or from the Witham at Bardney Abbey, both Group V types in Piggott's (1950) classification, are not extensively ornamented beyond the mouldings of the sleeves that hold their suspension-plates in place. By contrast with the simple chape-bindings of Group V scabbards, northern scabbards of Piggott's Group IV Brigantian series (Group F in Stead's more detailed (2006) classification) are distinguished by the chape-terminals splitting into a pair of pronounced curving 'lips', seen in its most exaggerated form on the scabbards from Asby Scar, Cumbria and Mortonhall, Edinburgh, on which the lips are almost like walrus tusks. The Mortonhall scabbard (Figure 10.7, 1 and 2) is also one of the finest of the series in its ornament, having a panel above the chape on which a pair of trumpet-motifs lead to an elegant, interlocking S-design with high, bossed terminals, itself enclosed by symmetrical, slender trumpets. At the scabbard mouth is a four-fold pseudo-whirligig in which trumpet ends are also incipient and which also has bossed terminals. Among the most recent finds, the hoard from South Cave near Hull (Evans, D., 2006) evidently includes examples with similar chapes and ornamental motifs, but their true significance must await fuller publication. Slender trumpets are also the dominant, effectively the only motif of ornament on the Deskford, Banff, carnyx (Figure 10.7, 3), surrounding the eye cavities of the boar's head.

Apart from weaponry, high-status equestrian equipment continued to be produced in the first century AD, as exemplified at Polden Hills in Somerset (Brailsford, 1975b) and Melsonby (Stanwick) in Yorkshire (MacGregor, 1962). Among items of horse-harness are pairs of two-link bridle-bits, the side links of which are distinguished by their projecting 'lips' or 'ears', and terrets and lynch-pins, also with pronounced projecting lips or flanges. Trumpet-motifs and dragonesque S-motifs are recurrent ornamental themes. The bridle-bits from Melsonby differ in their basic typology, however, being of derivative three-link form, in which the side-ring and end-link are cast in one elaborate piece, so that it is effectively of single-link construction. A unique find from the Melsonby hoard is the small bronze mount depicting an equine face (Megaw and Megaw, 2001, Fig. 379; Jope, 2000, Pl. 175, a, b) in front view, its narrow, lentoid eyes, muzzle and nostrils depicted in sharp relief, with an expression that is aristocratic and aloof rather than sinister. The nature of the Melsonby hoard remains an enigma, not least



Figure 10.7 Native art in Northern Britain – 1. A: the Mortonhall scabbard, upper panel (1) and chape (2). B: the Deskford carnyx from above. Photos: copyright Trustees of the National Museums of Scotland.

because its discovery before 1846 left no account of its context. The nearby Stanwick complex (Wheeler, 1954), however, was evidently an important Brigantian centre in the mid-first century AD, though perhaps enjoying the benefits of commercial contacts with the Roman south, rather than being the outpost of resistance as Wheeler believed.

Among items of drinking service that continue into the first century AD, and potentially through the centuries of Roman occupation, are tankards, probably inspired by Ornavasso-type originals. The insular examples are stave-built of wood, very occasionally covered in sheet-bronze. Their substantial size – rather larger than modern counterparts – sometimes with two handles, suggests that they were used for a native brew rather than for imported wine. Ornament is restricted to the handles, in the case of the elegant, waisted tankard from Trawsfynydd in north Wales (Megaw, 1970a, 296; Jope, 2000, Pl. 228–9, a–d) including an open-work S-scroll on the hand-grip and four open-work triskeles of which the central boss conceals the rivets to attach the handle to the body of the tankard. The triskeles unwind into trumpet-motifs that lend the whole composition a stylistic similarity to the Mortonhall chape design, with which it probably shares a mid- to later first-century date. A distinctive and unusual technical feature of the Trawsfynydd tankard is the serpentine wire that holds the staves together at their base, a detail shared by another tankard of waisted or concave profile from Carrickfergus, Co. Antrim. Though the design and ornament of the handle of the latter are quite different from the Trawsfynydd tankard, its use of hatched crescentic motifs with a central design that hints of zoomorphism must imply a debt to the Mirror Style of south-western Britain. Indeed, it seems probable that the political and social disruption brought about by the Roman conquest of Southern Britain might have resulted in greater mobility and inter-dependence in the first century AD among the Celtic communities on the fringes of the advancing empire.

Among high-status symbols, bronze collars appear to replace torcs in the first century AD. A particularly fine example is the Wraxall collar from Somerset (Jope, 2000, Pls 158–9), in which an S-chain in relief, linked by loose yin-yang or by tighter circular bosses intended for glass inlay, leads at the terminals of the two halves of the collar into stylized faces, with eyebrows or ears formed with expanding trumpets. At the broader, opening front of the collar, these faces are surmounted by Siamese-twinning faces, each sharing an eye but facing the opposite direction, and from certain aspects reminiscent of the stylized faces of the earlier Plastic Style. Wraxall is undoubtedly the finest – ‘a masterpiece of simple expressiveness’ (Jope, 2000, 263) – of a series of collars that have been assigned to the Durotriges and Dobunni of south-western England. Their considerable weight, and, in the case of Wraxall, its rather constricted size, have led to the suggestion that they may have been for ritual use, perhaps adorning a wooden figure or totem, rather than being for human use, even for ceremonial occasions. Closely allied to this south-western group is the Stichill collar from Roxburghshire (Figure 10.8), which shares with a pair from Dorset a flattened profile that turns through 90 degrees at the back to provide twin decorated surfaces. The nape section is ornamented by background tooling in the technique of the Irish Bann disc, Cork horns and Petrie crown (O’Kelly, 1961); the design is simple, fine relief S-spirals, balanced like a pair of penny-farthings in the tapering triangular spaces on either side of the hinge. Similar S-spirals are engraved down the pectoral, leading into one side of a zoomorphic eared face, not unlike Wraxall, but in this instance composed of spiral eyes over a peltate muzzle. This theme is taken up in the *repoussé* ornament of the panels flanking the front

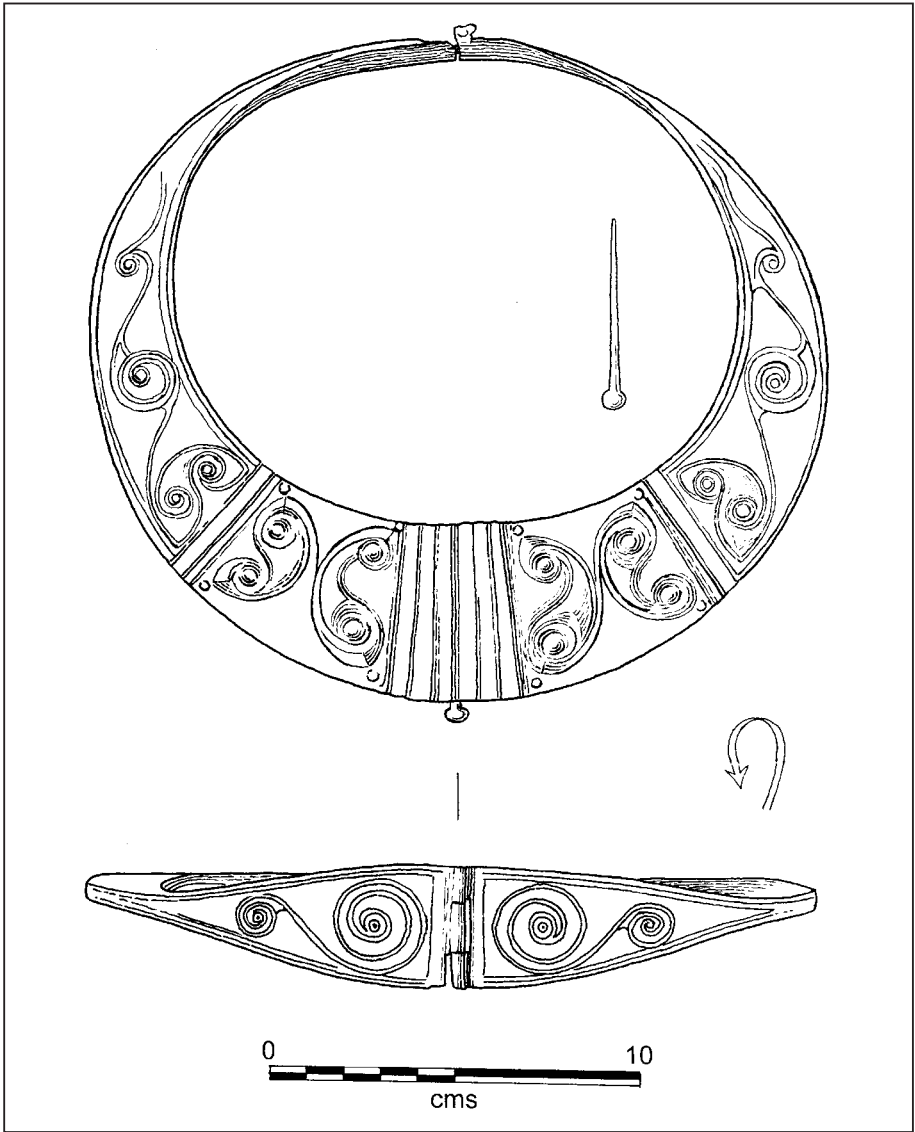

Figure 10.8 Native art in Northern Britain – 2. The Stichill collar, Roxburghshire. Adapted from MacGregor (1976) and Jope (2000).

opening of the collar. Described by Leeds as a 'swash-N', these motifs are in effect an opposed paired of lop-sided, eared, zoomorphic faces, made up of pelta and spirals, a variant on the theme that we have seen elsewhere, but here integrated particularly successfully into the *Leitmotif* of the collar. The fusion in the Stichill collar of techniques and ornamental themes familiar in other regions, and the accomplished execution of

the principal design at the front of the collar are surely indicative of a master craftsman rather than of a second-rate technician working in a provincial backwater.

Not surprisingly Roman influence is evident in ornamental metal-work of the first century AD like the bronze mounts from wooden caskets, commonly found in graves, though probably used for jewellery and personal items, rather than as funerary containers as such. The mount from Elmswell, Yorkshire (Figure 10.9, 1; Corder and Hawkes, 1940) depicts as its central motif an omega-lyre concealing a cartoon-like zoomorphic face, with 'ears' formed by trumpets and 'eyes' by berried rosettes. The cast bronze strip with *champlevé* enamel to which the sheet bronze panel was attached bears a vine-scroll design of wholly classical derivation. Rather less inspired is the repetitive design of trumpet-scrolls and berried rosettes on the bronze strip from the Santon, Norfolk, hoard.

Romano-Celtic provincial art is perhaps best illustrated by small personal items like brooches. The dragonesque brooch (Figure 10.9, 2) is based essentially on an S-motif with terminals developed to form the head of a sea-horse, the central focus of the brooch being embellished with polychrome enamel inlay. In Britain, they are distributed quite widely in northern England and Scotland south of the Forth, with few in the west of England or Wales; on the Continent they are found across Europe from France to Hungary. Their dating spans the first and second centuries. Trumpet brooches (Figure 10.9, 3) are a distinctively Romano-British provincial type, probably derived from Continental late Iron Age antecedents. In the Roman military zone they last into the second century in a variety of forms, including some with polychrome enamelling. Outstanding among earlier variants is the silver-gilt example from Carmarthen in Wales (Boon and Savory, 1975) that combines relief ornament on bow and trumpet-head with open-work on its catch-plate foot. Finest of all perhaps are fan-tail brooches, of which the prime example is unquestionably the massive silver-gilt Aesica brooch from the Roman fort at Great Chesters in Northumberland (Figure 10.9, 4), doubtless a later first-century product notwithstanding its discovery in a later hoard. Its ornamental design combines trumpets, peltae, S-scrolls and even suggestions of comma-leaf motifs, so skilfully, as to suggest zoomorphic or ornithomorphic images that defy consensual identification.

Jocelyn Toynbee (1964) saw these late masterpieces as evidence of the stimulating effect of Romanization, rather than regarding Romanization as an agency directly or indirectly for the suppression of the creative originality of insular Celtic art. It is significant, therefore, that some of the finest examples of Celtic art from the period of Roman occupation are from the northern or western fringes of the expanding military zone. Contrary to an older conventional perception, there is really no compelling reason for regarding these as the products of southern workshops, carried north and west to cultural backwaters that were incapable of independent production. Doubtless northern and western regions had been reinforced by displaced elites and their entourages from further south, whose products may have become symbols of native initiative. Though the routine products of Romano-British art are pedestrian and uninspired, the finest pieces suggest that continuing manufacture of high-quality and high-status products in the pre-Roman artistic tradition, perhaps deliberately invoking the memory of styles of a long-past era, was a potent means of re-asserting the independence and identity of the native aristocracy.

The trumpet motif is also integral to the finest of the Scottish snake armlets, that from Culbin Sands in Morayshire (Figure 10.10, 1) being the most northerly of the

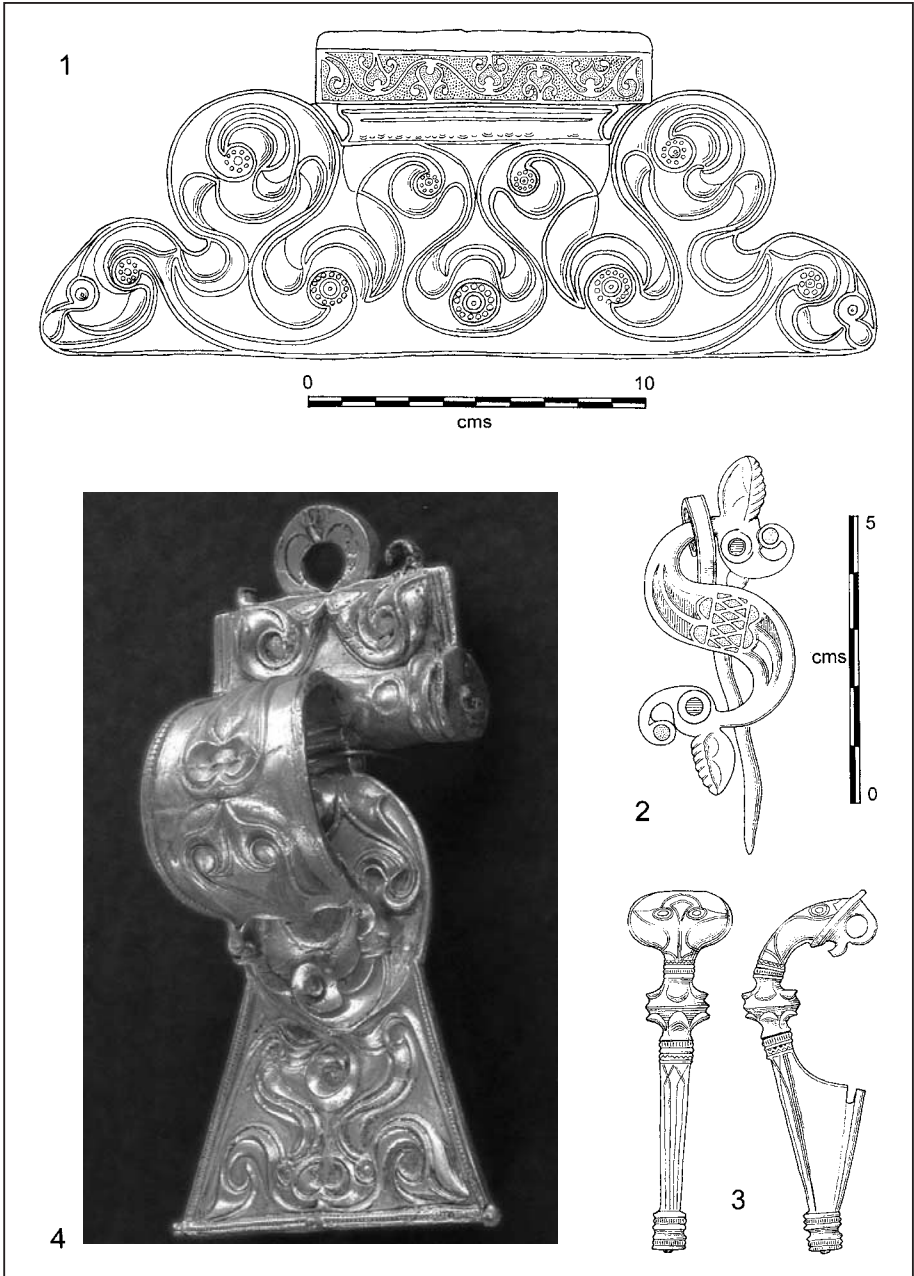

Figure 10.9 Native art in Roman Britain. 1, Elmswell casket-mount, adapted from Corder and Hawkes (1940); 2, dragonesque brooch with blue, red and yellow enamel from Norton, near Malton, Yorkshire, adapted from British Museum (1951); 3, silver trumpet brooch from Chorley, Lancashire, adapted from British Museum (1951); 4, Aesica brooch, Great Chesters, Northumberland, photo copyright Museum of Antiquities of Newcastle upon Tyne, University of Newcastle upon Tyne and Society of Antiquaries of Newcastle upon Tyne.

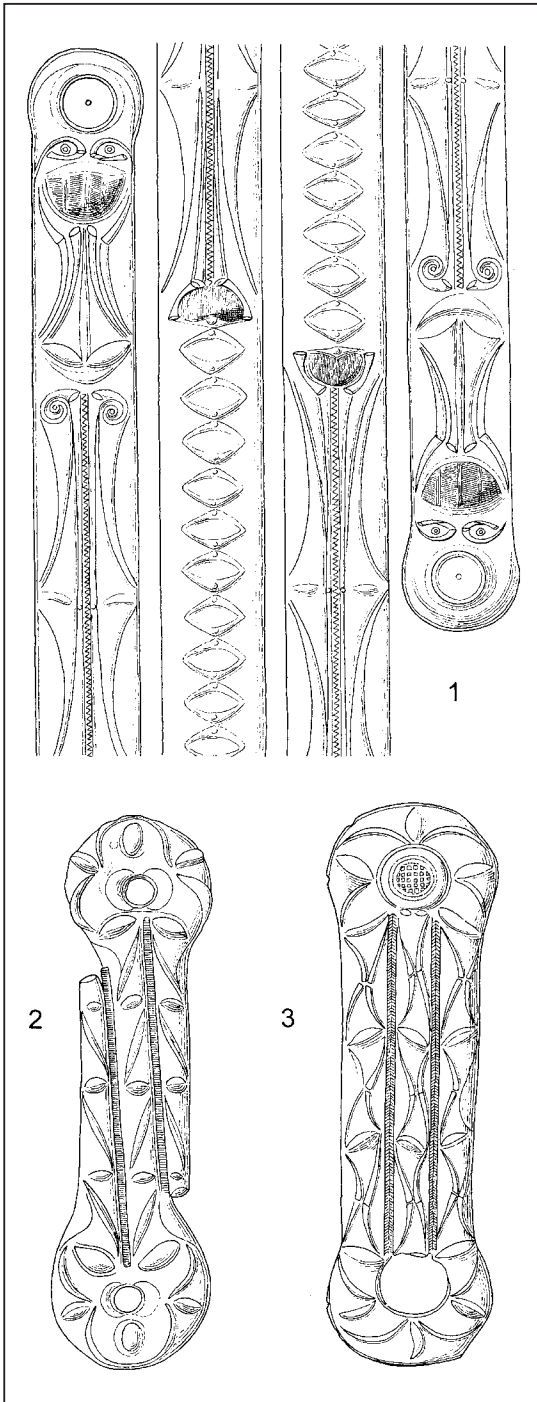

Figure 10.10 Scottish cast bronze armlets: unrolled drawings of ornamental designs. 1, spiral 'snake' armlet, Culbin Sands, Moray; 2, massive 'folded' armlet, Bunnanoch, Perthshire; 3, massive 'oval' armlet, Castle Newe, Strathdon, Aberdeenshire. Adapted from MacGregor (1976).

distribution. Others in the series are less lavishly ornamented, with simple transverse ribbing. At Bunrannoch in Perthshire, a snake armlet was found in association with a 'massive' armlet (Figure 10.10, 2), the 'folded' form of which is divided length-wise by two angled grooves, implying a skeuomorphic derivation from the snake armlet form. The second principal variant, the massive 'oval' armlet (Figure 10.10, 3) lacks this diagonal disposition. Though doubtless high-status products, and testifying to considerable technical skill on the part of their bronze-smiths, massive armlets display a limited range of relatively simple motifs repetitively deployed. The distribution of both armlet types, and that of the so-called Donside terrets, has sometimes been equated with the distribution of souterrains, though they do not extend to northern Scotland, nor to the Northern and Western Isles, where souterrains or earth-houses are common. Equally terrets and occasional massive armlets are found well south of the souterrain distribution. There is an apparent coincidence between the metal-work distribution and Class II cross-slab symbol-stones, or *Pit-* place-names, but both categories are considerably later, and we should beware of drawing superficial conclusions on the likelihood of continuity in artistic traditions into the later Iron Age.

LATER INSULAR ART IN BRITAIN AND IRELAND

It is not within the scope of the present study to trace in detail the progression of later Celtic art in Britain and Ireland through the emergence of elaborate Early Christian cross-slabs of Scotland or the metal-work, manuscripts and high crosses of Early Christian Ireland into the Medieval period. Many other studies (Henry, 1965; 1967; 1970; Henderson and Henderson, 2004; Harbison, 1999) have dealt with this rich field from an art-historical or archaeo-historical perspective much more fully than would be possible here as a postscript to earlier Celtic art. Nevertheless an examination of the origins and nascency of later Insular art, its principal influences, and political, social and economic context, is instructive in comparison especially to the origins of early La Tène art in Central Europe.

A fundamental issue is whether we should include later Insular art within the scope of Celtic art at all, whether we subscribe to the older conventional belief that Britain and Ireland were in some meaningful sense 'Celtic' in the Iron Age. Linguistically there can be no dispute that both Scotland and Ireland emerge in the historical period as Celtic-speaking, though the evidence for the earlier Iron Age is by no means so clear. 'Pictish' names and place-names were recognized as Celtic by Jackson (1955), even though he suspected non-Celtic and even non-Indo-European survivals. Furthermore, the territory that constituted 'Pictland', at least up to the seventh century, has itself recently come under review. Based on the criteria advanced at the outset for defining Celtic art, however, it is legitimate to include Northern Britain and Ireland in our discussion of later Celtic art. Having broken the exclusive equation between Celtic art and La Tène art, it also follows that for the later Insular Iron Age, any La Tène component may be minimal or at any rate significantly suffused over time to make direct correlations less meaningful.

The term 'Insular' is here adopted to cover developments of the post-Roman period in Southern Britain, Scotland and Ireland, simply because common themes and styles and evidence of mutual or reciprocal influences may be regarded as equally significant as evidence of regional differences in artistic practice. In the case of illuminated manuscripts, the artistic milieu of the *scriptoria* evidently transcended local stylistic traditions, so that attribution to place of production may still be a source of scholarly dispute. Exchange of specialist skills and techniques among high-status metal-workers (or between their patrons) may likewise make it difficult to assume place of manufacture from archaeological provenance.

One major difference between the corpus of later Celtic art and that of the earlier Iron Age is in the range of media represented in the later period – high-status metal-work,

elaborate monumental sculpture and illuminated manuscripts, often with common motifs or themes – in contrast to the largely metal-work-dominated corpus of the earlier Celtic art. Ceramic art is non-existent in early historic Scotland and Ireland, where there is, with the exception of the Northern and Western Isles, no significant tradition of pottery production in the earlier Iron Age either. In fact, in contrast to the earlier Iron Age in insular and Continental Europe, there is very little that could be described as vernacular or domestic art: for the most part, we are looking at high-status goods or artefacts of special, in this context generally of religious or related significance.

A question that conventionally has arisen in treatments of later Insular Celtic art is the extent to which, if at all, it can be regarded as derivative from earlier Celtic traditions. Françoise Henry and others used the phrase 'Ultimate La Tène' to cover the appearance of triskeles, peltae and S-spirals in Early Christian manuscript art and metal-work, and similar motifs in the later 'Pictish' cross-slabs have prompted similar attribution. It has to be admitted that if this were the basis for describing later Insular art as 'Celtic', it would amount to a very indirect and diluted inheritance, which is not to deny altogether that legacy. Taking a broader definition of Celtic art as outlined earlier, however, it is not necessary to place undue strain upon such selective links with earlier La Tène styles, though they certainly warrant examination.

'Ultimate La Tène' and the mid-first millennium background

Any attempt to trace influences in later Insular art styles from earlier La Tène traditions has invariably stumbled over the vexed problem of the hiatus between the end of Roman occupation in Britain and the appearance from the seventh century of metal-work, sculpture, and illuminated manuscripts of the Early Christian period. In Ireland, the problem is exacerbated by the fact that contact with the Roman world was limited. In Scotland, the earliest acceptable date for the appearance of Class I symbol stones has generally been the sixth century; in the absence of contextual associations to provide archaeological dates, dating has conventionally been on art-historical grounds, drawing comparisons between sculpture and manuscript art, which has tended to be a self-fulfilling circular argument in support of a late chronology.

A key artefact that spans this chronological hiatus is the zoomorphic penannular brooch, a type that is generally regarded as derivative from Romano-British penannular brooches, in which the terminals assume the form of a highly stylized, reversed animal's head (Figure 11.1). The type is distributed in Ireland in the central belt and north-east of the country, with evidence for at least one major production centre at Clogher in Co. Tyrone in the fifth and sixth centuries. According to Kilbride-Jones (1980), the successive variants of zoomorphic penannular brooches were being produced between the third and sixth centuries. Already by the fourth century, in his scheme, brooch terminals bore curvilinear designs against an enamelled background, including a kind of triskele or quadriskele, compressed to fit the sub-triangular terminal, in which the pseudo-spirals were almost interlocking yin-yangs. Furthermore, these pseudo-spirals were themselves commonly linked by a peltate loop, as on the two large brooches from Athlone (Figure 11.1, 1 and 2) creating the selfsame motif that in developed form characterizes later manuscript art and some of the later 'Pictish'

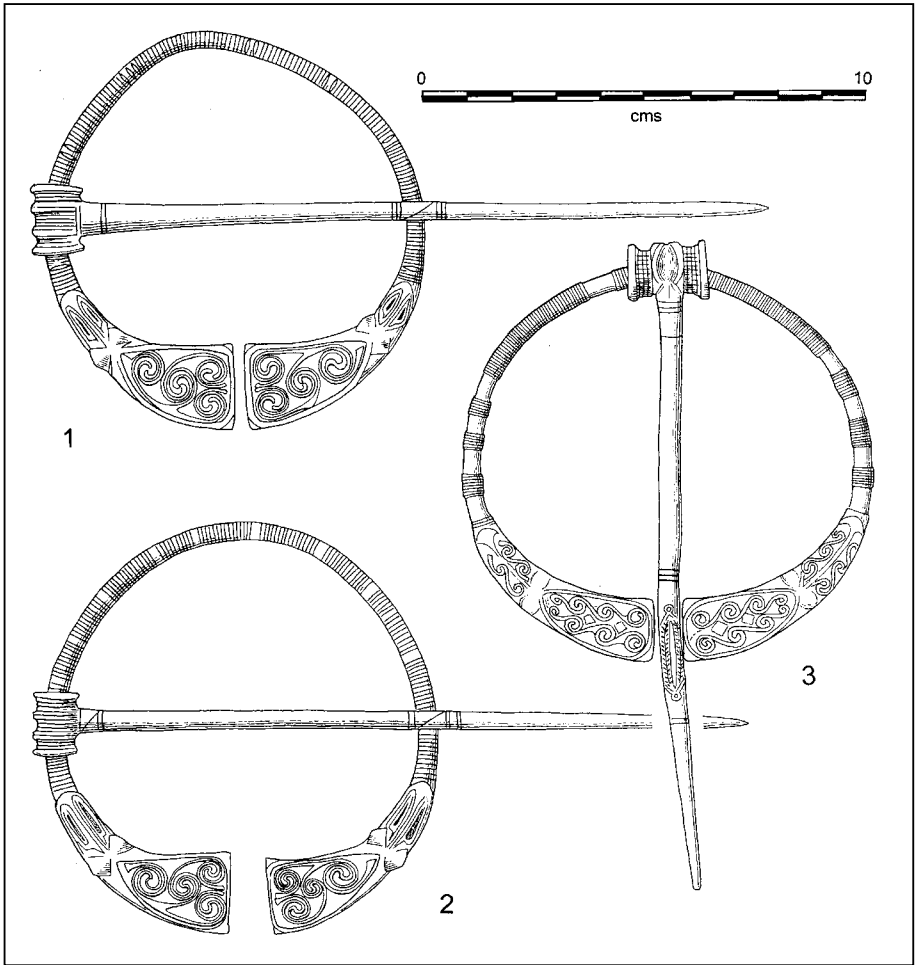

Figure 11.1 Irish zoomorphic penannular brooches. 1, 2, from River Shannon near Athlone, Co. Westmeath; 3, from Lough Neagh, Co. Antrim. Adapted from Kilbride-Jones (1980).

cross-slabs. Reminiscent of earlier La Tène styles are the S-chains or stacked lyres of the large brooch from Lough Neagh (Figure 11.1, 3). The later zoomorphic penannular brooches are technically still more advanced, employing *millefiori* as well as enamel insets, anticipating the greater technical accomplishments of the seventh century.

As evidence for the survival of Celtic motifs, archaeologists have pointed to hanging-bowl escutcheons of fifth to seventh century date (Figure 11.2), clearly reflecting Celtic craftsmanship and artistic traditions rather than Anglo-Saxon, despite their distribution, which is concentrated in eastern and south-eastern England, with relatively few outliers in the Celtic west. The paired 'spirals' linked by peltate loop, alternating

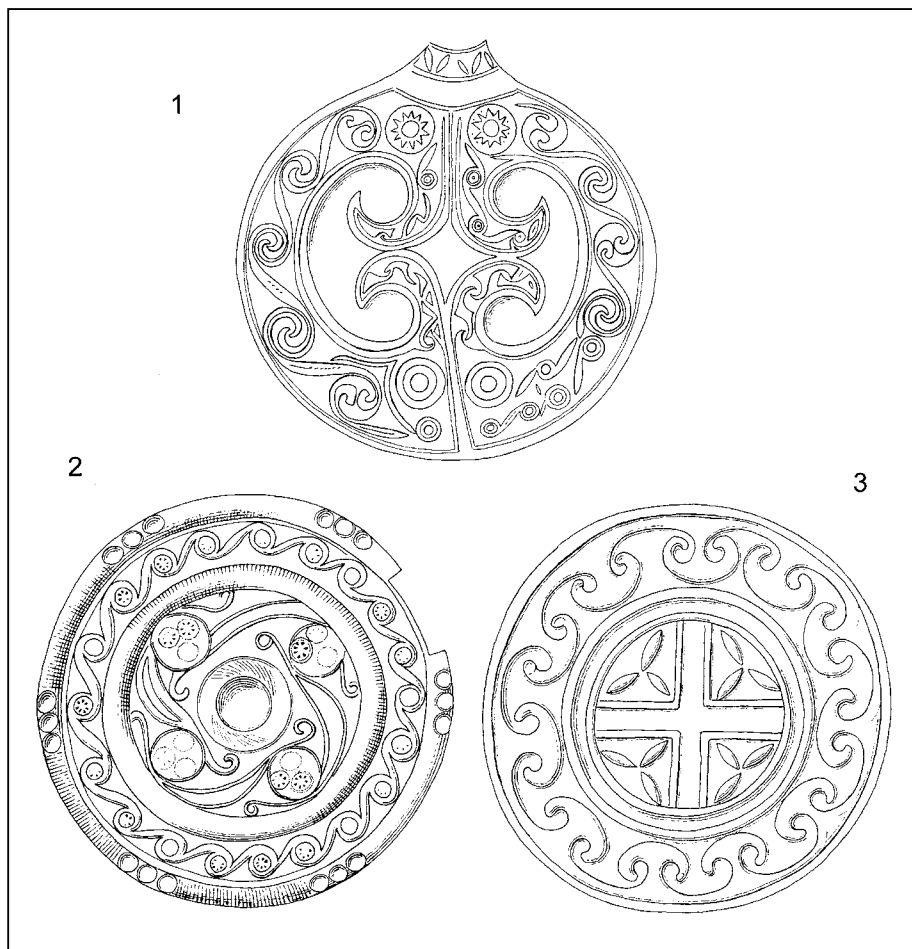

Figure 11.2 Hanging-bowl escutcheons. 1, Baginton, Warwickshire; 2, Manton Common, Scunthorpe, Lincolnshire, escutcheon inside bowl; 3, Manton Common hook-escutcheon. Adapted from Bruce-Mitford (1987).

inwards and outwards, forming a double-four composition at Chesterton-on-Fosseway had been noted by Romilly Allen (1904), and the same components are closely replicated in a double-three grouping on the Winchester hanging-bowl mount. These are essentially the same elements that are found on the developed cross-slabs at Nigg and Shandwick, or indeed on a carpet page from the Book of Durrow. What makes the comparison more telling is that the motif is not really of paired spirals, since the points of junction of the paired peltae are really yin-yang couplings. Another variant on a long-standing La Tène motif is the S-chain scrolls of Manton Common (Figure 11.2, 2) and Baginton (Figure 11.2, 1), for example, which is almost exactly replicated on the infilling of the double-disc motifs of the Class I stone from Dunnichen.

These same elements are found in simpler designs on hand-pins of the fourth to seventh centuries. Stevenson (1955) saw the hand-pin as a development out of ring-headed pins in which the ring-head was embellished with beading, or more specifically from a variant in which the beading was restricted to the upper part of the ring, which he termed a proto-hand-pin. These were assigned at Traprain Law to the late third or early fourth centuries AD, and the hand-pin was thus seen as extending from that date until the seventh or eighth centuries. A silver proto-hand-pin with pelta-based design from Oldcroft, Gloucestershire, is dated by association to the late Roman period, and a similar example from Castletown, Kilpatrick, Co. Meath, is not typologically much later. The silver-plated hand-pin from the latter site with yin-yang loops raises problems if there really was a lapse of a couple of centuries between proto-hand-pins and true hand-pins. Ó Floinn (2001), in consequence, has argued that hand-pins should probably begin rather earlier than the conventional late sixth- or seventh-century date. Moulds for hand-pins from Beirgh, Riof, in the west of Lewis (Harding and Gilmour, 2000) came from contexts radiocarbon dated to a span between the third and fifth centuries, and the moulds from Loch Olabhat, North Uist, would endorse this earlier dating. Several of the Irish hand-pins included enamelling, and one even includes elements of *millefiori* glass. These are all probably of late sixth- or seventh-century date. Possibly from the sixth century are two silver disc-headed pins (Figure 11.3), unprovenanced and not certainly of Irish rather than Northern British manufacture, which not only bear sub-peltate curvilinear designs on the disc, but have panels of ornament on the upper section of their shafts, as if they could have been products of the same workshop. That from the Londesborough collection includes on its shaft S-chain and pelta-scroll with swelling leaf designs that genuinely hark back to earlier La Tène fashions.

In Scotland too, the silver hand-pins like those from Gaulcross and Norrie's Law (Figure 11.4) are conventionally regarded as seventh-century products, though the silver pin from Oldcroft might suggest that they were earlier derivatives of southern models. The Norrie's Law pin with symbol on the reverse incised before the addition of the pin shank perhaps suggests that the pin had originally been attached slightly lower to the head, being modified over a long period of use. The silver plaque with its *repoussé* trumpet spirals really should belong to an earlier horizon. Its similarity in motif and execution to the ornament of the Deskford carnyx, and to the series of Irish *repoussé*-ornamented discs of the Monasterevin series, suggests a probable date in the second quarter of the first millennium AD rather than much later. While the Norrie's Law hoard was doubtless not deposited until the seventh century, as conventional wisdom insists, it is extraordinary that commentators who acknowledge the indisputably Roman contents of the hoard as late survivals refuse to admit the possibility of 'native' survivals from a similar period.

The dating dilemma hinges upon the conflict between art-historical and archaeological approaches. Stevenson insisted (1993) upon tying all the archaeological evidence to the horizon of the illuminated manuscripts, and in a derivative relationship to them; hence the seventh century was a *terminus post quem* for the appearance of animal or abstract designs on sculpture and metal-work alike. Archaeologically, the evidence of radiocarbon dates and associated artefacts like E-ware at Dunadd certainly argues for the production of prestige metal-work like Type G penannular brooches and Type H large annular brooches of the Hunterston class in the seventh century, and very



Figure 11.3 Irish hand-pins. **A:** unprovenanced from Londesborough collection © Copyright the Trustees of The British Museum; **B:** unprovenanced from Ireland. Photo National Museum of Ireland, Dublin.

probably nearer 600 than much later (Campbell and Lane, 1993; Lane and Campbell, 2000). In fact, it is now clear that Dunadd played a pivotal role in the integration of Celtic and Germanic styles in Dál Riata in the seventh century that resulted in the Hiberno-Saxon style of the illuminated manuscripts. The relationship between the secular capital at Dunadd and the monastic centre at Iona, and indeed the relationship between secular and religious authorities in Northern Britain and Ireland generally, is crucial to an understanding of the political, social and economic environment that generated the material expression of later Celtic art.

Radiocarbon dates and E-ware pottery were indicative of sixth- or early seventh-century activity at the now destroyed hill-fort of Clatchard Craig in Fife (Close-Brooks,

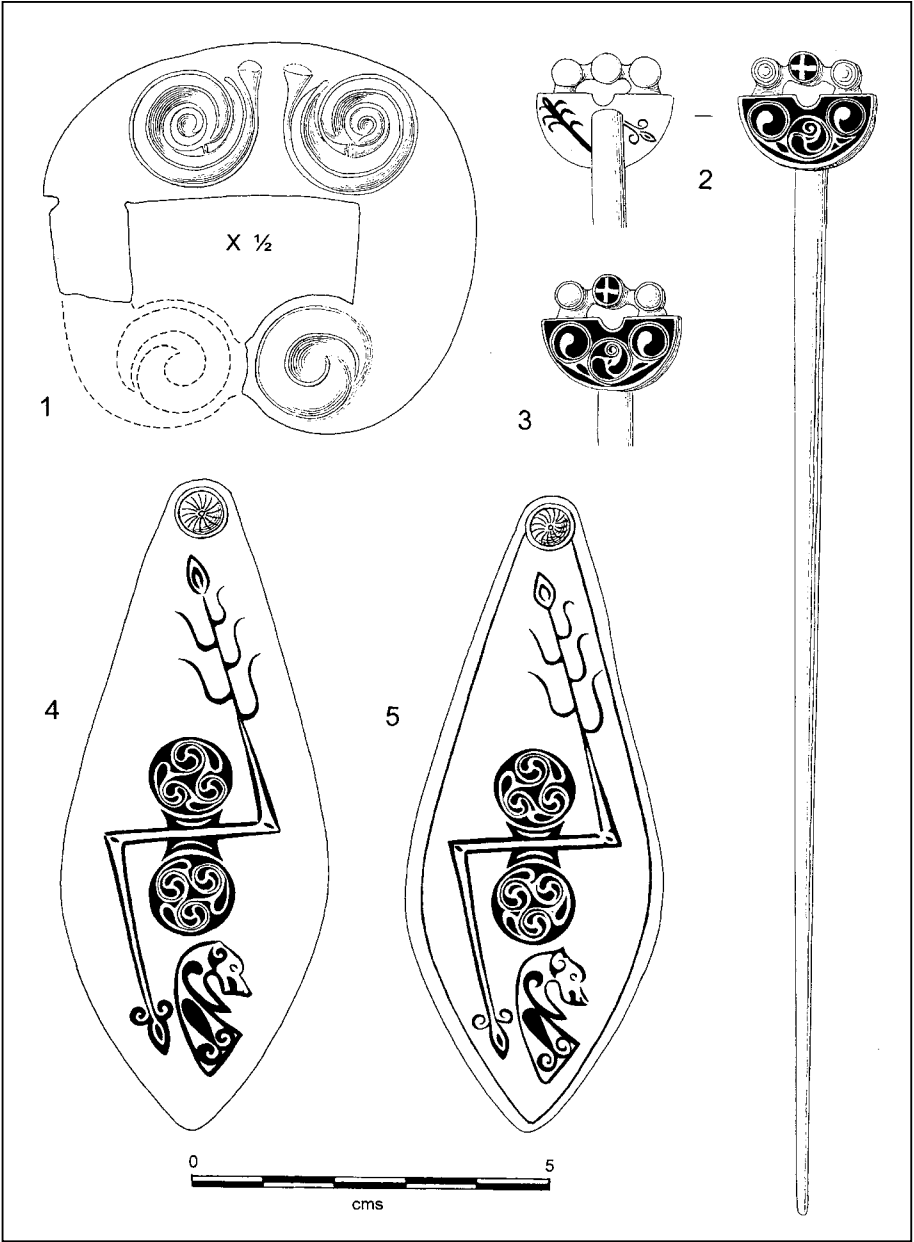

Figure 11.4 The Norrie's Law, Fife, silver hoard. 1, spiral-bossed plaque; 2 and 3, hand-pins; 4 and 5, oval plaques. Adapted from MacGregor (1976).

1986), though mould fragments for a large, Clunie type of penannular brooch may indicate a longer span of occupation on the site. Among the metal-work assemblage, a small copper alloy disc was ornamented with triple paired-spirals linked with peltate loops in the hanging-bowl style. Furthermore, a bronze open-work mount with trumpet mouldings, which in Roman military contexts would be assigned to the second or third century, together with a bead and glass fragment that should date from the fifth century, could indicate earlier beginnings. While such objects could evidently be survivals, it seems perverse to insist upon a seventh-century and later horizon, when probability suggests that some major centres in Northern Britain were active from an earlier post-Roman date.

The beginnings of Scottish symbol stone art

Sculptured stones of the early historic period were classified by Joseph Anderson for his Rhind lectures of 1892 into three principal classes, a system that was adopted in the publication with Romilly Allen of *Early Christian Monuments of Scotland* (Allen and Anderson, 1903). The three classes have since been taken as broadly successive chronologically, if overlapping in their currency, from at least the seventh to tenth centuries AD. The basis of classification involved several criteria. Class I stones were undressed boulders, often of irregular shape, and their symbols, comprising animal or abstract motifs, were incised and relatively simple. Class II stones were cross-slabs, the central cross on one side generally imposing a degree of symmetry in the shape of the stone, with the cross and its surrounding designs or motifs carved in relief. The animal and abstract symbolism was evidently assimilated into the Christian iconography, though it never actually intrudes upon the outline of the cross. In the more elaborate cross-slabs, other biblical imagery such as Daniel in the lions' den or David in various roles fill the surrounding panels, while hunting or battle scenes may have had a secular or religious significance. On the Class III stones, the original symbolism disappears, and these are assumed to be among the latest, extending into the ninth century and beyond. That a system of classification should have survived in general use for more than a century may be surprising, even allowing for modifications like Henderson's (Henderson, I. 1987) addition of a Class IV to include early incised cross-slabs.

Along with the system of classification, it is arguable whether we should link the adjective 'Pictish' to symbol stone art, as has been the convention for more than a hundred years. Daniel Wilson (1851, 499) was among the first to attribute symbol stones to the Picts, but in doing so he was essentially arguing a native origin in preference to their introduction by Dalriadic Gaels or Norse invaders. Joseph Anderson in his Rhind Lectures (1881) had not made this equation, referring instead to symbol stone art as late Celtic, and only adopting a Pictish association in his later work with Romilly Allen. In the generalized sense of the Roman sources that implies that Picti were the totality of native communities north of the frontier, then symbol stones are indeed part of the Pictish cultural world. But attempts to identify a Pictish 'heartland' on the basis of archaeological distributions, whether of symbol stones, souterrains, long-cist cemeteries, settlements and fortifications, silver chains or other distinctive material types, have invariably foundered on the diverse geographical distributions and chronology of these classes of field monument or artefact types (Harding, 2004). Even the distribution of Class I symbol stones, generally acknowledged as the earliest, is not

primarily concentrated in eastern Scotland so much as north of the Dee to Caithness and Orkney, with a few outliers to the west. So while symbol stones may be regarded as 'Pictish' in the sense of 'later Iron Age beyond the Roman frontier', any equation with an ethnic entity identified with later king-lists and their implied territories is probably best suspended as unproven.

Class I stones (Figure 11.5) do still appear to include the earliest, but the probability exists that this category includes examples from a considerable span of time. Unlike the cross-slabs, where the layout implies a degree of unitary composition, the placing of symbols on Class I stones gives no indication of necessary contemporaneity, and by analogy with earlier Iron Age metal-work we might expect that some of these carvings were composite achievements over time. The Inchyra, Perthshire, stone (Stevenson, 1959) is a clear demonstration of compound composition. There are three sets of symbols, two on one side and one on the other side of a truncated stone that in its final phase of use served as the capstone for an extended inhuman burial of uncertain date. The stone also bears *ogham* inscriptions, again evidently of more than one phase, and not necessarily in sequence with the succession of symbol carvings. Indeed, Stevenson's sequence, though plausible, is not definitive, and the span of time represented by this multiple re-use could extend backwards as well as forwards beyond the conservative time-span normally accorded to Class I stones.

The transition from Class I to Class II might also be expected to show intermediate variants. Though the cross-slab format would hardly have been adaptable to some Class I pillar stones, the two Glamis slabs could have been examples of re-used stones. In each case what becomes the back of the Class II cross-slab has irregularly disposed symbols that are simpler and less formally arranged than their successors on Class II slabs. In the case of the Glamis Manse cross-slab, Ritchie (Ritchie, A., 1989, 32) accepted that this was a case of re-use of an earlier stone, and demonstrated furthermore the experimental nature of the carvings on the cross-slab itself, a view that was echoed by the Hendersons (2004, 70–1, 83). If the cross-slab itself is early in the sequence, then its predecessor could easily have originated in the sixth rather than the seventh century. The Pabbay stone apparently represents the Christianizing of an earlier symbol stone, given the compressed field that the cross-carving occupies, and the fact that its arms are carved deeper than the adjacent symbols. In this instance it represents the combination of Class I symbols with what Thomas (1971) referred to as 'primary cross-marked stones', or Henderson's (Henderson, I., 1987) Class IV. Primary cross-marked stones in Ireland and Western Britain date from the sixth century, so that the Pabbay stone could again indicate the use of symbols by that time.

The dominant motifs of Class I stones are either abstract symbols or animal images. Human depiction or narrative scenes are a development of Class II. Classification imposes an artificial impression of standardization that is not the reality, and many of the abstract symbols defy concise description. Crescents, arcs, discs, double or multiple discs, discs with appendages, and various rectilinear shapes all feature on Class I stones. Some symbols have been viewed as representations of artefacts, either from contemporary material culture or inherited from earlier sources, whether Roman or native. The mirror has been claimed as based on actual artefacts that were current in the later pre-Roman Iron Age, while the comb, commonly linked with it, resembles later single-sided variants, both being passably realistic representations. Another symbol might represent a disc-shaped brooch, though matching its type exactly is not so easy.

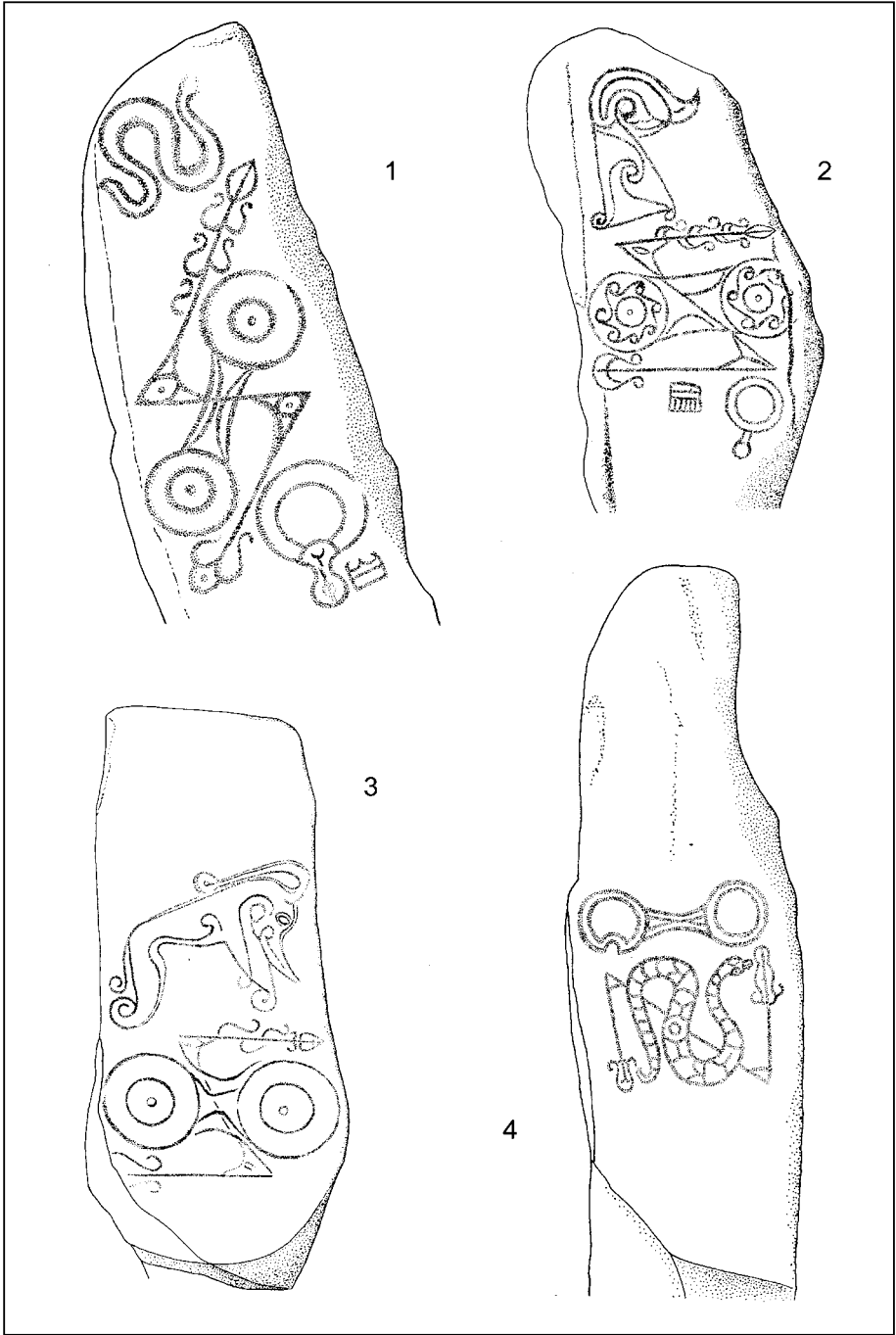

Figure 11.5 Symbol stone art. 1, Aberlemno, Angus; 2, Dunnichen, Angus; 3, Dyce, Aberdeen; 4, Newton House, Culsalmond, Aberdeenshire. Adapted from Allen and Anderson (1903).

The conjoined double disc bears some resemblance to the central spine and terminal roundels of early Iron Age shields like Witham and Battersea, an observation in which I was anticipated by some seventy years by Sir Alfred Clapham (1934). In fact, the U-notched feature on the Inchyra and Newton House, Aberdeenshire (Figure 11.5, 4) stones echoes a much older (and likewise unexplained) association with shields of the later Bronze Age. The 'tuning-fork' and its more elaborate variants are not readily explained as representations of any known artefact. In any event, this is fundamentally irrelevant, since it has never been claimed that Celtic art derived its symbolic imagery from everyday artefacts, whether contemporary or reminiscent of a bygone era.

The V-rod and Z-rod present particular problems, since neither is a motif known from earlier times. Charles Thomas (1984) suggested that the V-rod was a broken arrow, and following the same line of reasoning the Z-rod could be thought of as a broken spear. Swords ritually bent in funerary contexts are widely known in Continental Europe, and in the Celtiberian world, where spears include the all-metal *soliferreum* type, as we have seen, these are commonly bent into three in graves (Lorrio, 1997, Figs 63, 64). The same practice would be largely undetectable where the spear shaft was made of wood, but bending double or treble, or breaking the shaft altogether, is simply the further compression of the token V-rod or Z-rod. Stevenson's (1993) parallel between the terminals of the V-rods with their *fleur-de-lys* and embellished terminals and representations in the Book of Kells makes a convincing case for regarding the eighth-century depictions as sceptres, but this need not mean that this was the function or meaning of the symbol in origin. Quite evidently 'pagan' symbolism was adopted and subsumed within the Christian iconography, so there is no need to assume constancy or continuity of meaning in the transition. On the other hand, the paired V-rods could have represented divination rods of the kind found in the so-called doctor's grave at Stanway, hence symbolizing magical or super-human powers.

It would be hard to sustain any 'Ultimate La Tène' influence in the abstract symbolism itself of the Class I stones, though a tentative case might be advanced on the basis of the filler elements of some symbols. Among abstract filler motifs, peltae and trumpet-spirals and S-scrolls most obviously recall an earlier tradition. Stevenson's chart (1955) showed a range of crescents with V-rod, the one motif that is regularly infilled rather than simply being depicted in outline. Some of the more complex examples, especially those with infilling, and indeed some of the more striking parallels with earlier La Tène styles, however, are from the later Class 2 cross-slabs. Reminiscent of earlier Celtic examples like the Besançon flagon or the Cerrig-y-Drudion bronzes is the fleshy vegetal style on the back of the Skinnet, Caithness, cross-slab, which has on its front side a fine dragon-pair that has acquired interlace manes. Likewise the Ulbster, Caithness, cross-slab has the same motif executed with the yin-yang technique of earlier La Tène art. Among Class 1 stones with scrolls the S-chains on the Dunnichen stone (Figure 11.5, 2) perhaps most closely might be paralleled in the early La Tène styles.

Spirals and interlocking spirals, too, are better represented in increasingly complex form together with interlaced ornament as background filling on the later cross-slabs. These motifs have much in common with background designs on illuminated manuscripts, as has been recognized since Romilly Allen and Joseph Anderson's pioneering catalogue, and must derive either from manuscript art or from a common pool of ornamental themes that provided the source for both. This is not to deny an ultimate

debt to the pool of motifs and imagery of earlier Celtic art, but the derivation is thus at best very indirect and secondary. In its simplest form, the spiral is one of the motifs that has been regarded as one of several 'diagnostic endogenous shapes' (Dronfield, 1995), so that we would hardly claim, for example, any meaningful link between its occurrence in Celtic art and its use in megalithic art of late Neolithic Irish passage graves. But it may be worth observing that in application on the Class 2 stones, the complex spiral designs employ both of the principal forms of symmetry that can be identified in earlier Iron Age art, namely, rotational symmetry, as on one of the Nigg panels and bosses, and fold-over symmetry, as represented at Hilton of Cadboll, Shandwick and Meigle 4 and 9, for example. This may well result from the way in which the template for the design has been constructed based upon compass-work or a grid framework, as has been widely recognized in the illuminated manuscripts since Allen's pioneer study. While some survival of artistic conventions from an earlier period might be suggested, therefore, there really does seem to have been a renewed impulse into the repertory of the later seventh and eighth centuries.

Alcock (1993; 2003) stressed that, with the exception of the 'elephant' or 'beast', all the animal and bird representations from symbol stone art are remarkably naturalistic and evidently drawn from observation of the reality. It follows therefore that it is unnecessary to try to read into these symbols origins in earlier Celtic art, and equally unnecessary to imply any meaningful link between naturalistic animals in insular art and the Eurasiatic Iron Age art of the Altai (Thomas, 1961). It is worth noting, however, that the most frequently represented images, fish, snakes and eagles, are not the most characteristic of earlier La Tène art; earlier favourites, bull, boar and horse, are represented, but are in the minority in surviving examples. Dogs, sheep or goats do not register in the Class I repertory, so that animal symbolism is not simply a reflection of everyday life. The reason for the limited menagerie is not easy to explain. The combination of animals with abstract symbols certainly argues for a 'symbolic' meaning, perhaps linked to group identity or ritual associations, which is not to gainsay the view that 'a coherent symbolic language is hard to sustain' (Hicks, 1993, 199).

If animals were drawn from life, closely observed and naturalistic, then the 'beast' or 'elephant' is harder to explain as an aberrant dolphin or any other natural breed. Given the variety of fantastic beasts that occur on the developed Class II slabs, and the long antecedent history in Celtic art of fabulous animals, there seems to be no good reason why the fabulous should not appear alongside the naturalistic in symbol stone art. R. B. K. Stevenson (1955) and Charles Thomas (1961) each saw a quite different pedigree for the 'Pictish elephant', Stevenson citing Anglo-Saxon artefacts, illuminated manuscript art and Early Christian Irish artefacts, Thomas looking to early La Tène art and even its 'orientalizing' elements. Neither seem especially convincing, other than in the generalized sense of being comparative examples of fantastic beasts. More recent opinion (Hicks, 1993) has revived an older view (Clapham, 1934) that the 'elephant' derives from later Roman traditions. The 'orientalizing' theme was taken up by Thomas again in his pedigree of the Pictish S-dragon, which he relates to the dragon-pairs that characterize middle La Tène swords from Hungary westwards to the Thames. This comparison carries greater conviction, though the only Pictish opposed pairs, as opposed to solo sea-horses, are on Class II stones, and, assuming Class II stones are later than Class I, the route by which this particular theme entered symbol stone art is far from clear.

In fact, ducks, eagles, boars, deer, wolves and bulls tend to look broadly similar wherever they are depicted naturalistically, which is why dragon-pairs or fantastic beasts are perhaps more indicative of common traditions. Centaurs, hippocamps and voracious beasts are all absorbed into early Celtic art, and more particularly into the rather specialized and esoteric art of late pre-Roman Iron Age coins, but since they are obviously not exclusive to early Celtic art, we cannot assert that their appearance in the context of symbol stone art derives from continuity of that tradition. In fact, the appearance of these images on Class II symbol stones argues for the fusion of several different influences.

A major issue of contention has been the dating of symbol stones and symbol stone art. Robert Stevenson's enduring determination (1971; 1993) that symbol stone and cross-slab art was directly prompted by manuscript art has had a lasting and detrimental effect on the dating of insular sculpture. While there are some striking parallels, notably with Class II sculpture, it remains improbable that a widespread tradition of sculptural art should have been triggered by such a limited if influential set of gospel manuscripts, as the Hendersons have cogently argued. Certainly the Hilton of Cadboll stone gives the impression of a page from an illuminated manuscript (Stevenson, 1955, 116) and certainly the lion on the Class II Papil cross-slab (Figure 11.6A, 1) bears a marked resemblance to St John's lion from the Book of Durrow (Figure 11.6A, 2). Other parallels that have been asserted confidently as evidence for dating seem far less compelling. But these are both relatively late in the sculpture sequence, so the direction of influence is immaterial to the question of the origins of symbol stone art. Whether *per contra* the manuscripts were influenced by sculpture is equally arguable. Hicks (1993) re-asserted the basic principle that representation in art was more likely to progress from naturalistic to more stylized than vice versa, and that from this perspective the animals in the manuscripts were more stylized than those on symbol stones. On balance, it seems more likely that all – sculpture, manuscripts, metal-working and vernacular arts – were all drawing upon a common pool of styles and imagery that certainly must have been current before the later seventh and eighth centuries.

Plainly the problem stems from the lack of unequivocal archaeological associations for the Class I symbol stones. The earliest example from a reliable archaeological context is the much-cited slab with crude double-disc motif from Pool, Sanday, Orkney (Hunter, 1990), which was re-used as a paving slab in a structure of late fifth- or early sixth-century date. This secondary context suggests that the original use may have been from the fifth century. At Burghead, the context of the bull plaques (Figure 11.6B) is uncertain, but radiocarbon dates indicate the probable use of the fort from around the fourth to sixth centuries. In effect, it seems likely that, freed from the shackles of art-historical dating on the basis of perceived stylistic parallels, the archaeological arguments for fifth-century origins would gain credibility.

Antiquarians have for generations been absorbed by the *meaning* of symbol stone art. Various interpretations have been proposed, focusing on the stone as a statement of identity, authority, territorial rights or marriage alliances. All of these remain possibilities, though the lack of discrete distributional patterns, despite recurrences in combinations of motifs, remains an impediment to straightforward interpretation. Perhaps we would be better concerned with the *function* of symbol stones. Several, like Garbeg, Inverness and Golspie, Sutherland, were located in proximity to burials, and it

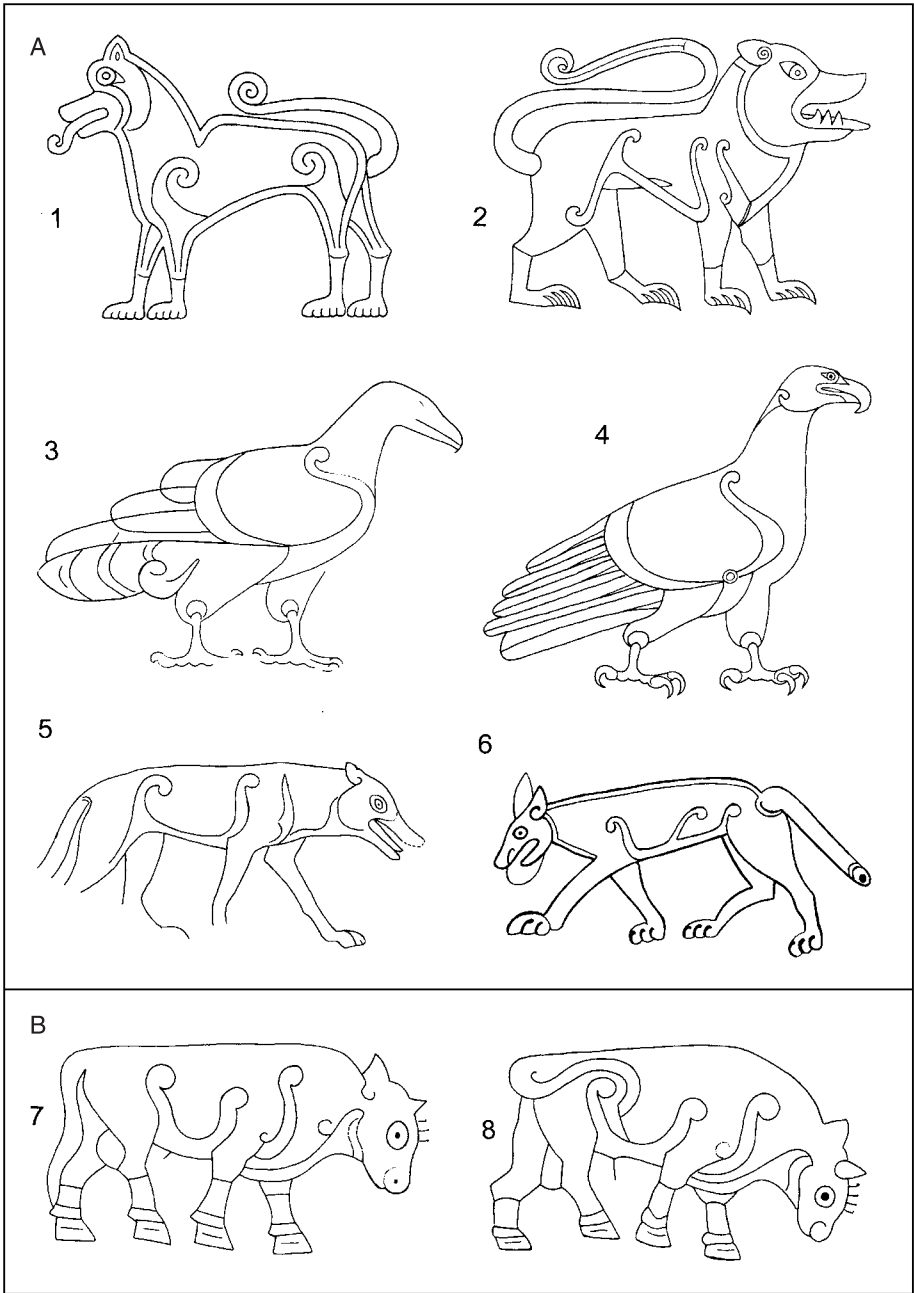

Figure 11.6 Animal imagery in later Iron Age insular art. A: animals in sculpture and manuscripts compared. 1, lion from Class 2 cross-slab, Papil, Shetland; 2, lion symbol, *Book of Durrow*, f. 191v; 3, eagle carving, Knowe of Burrian, Orkney; 4, eagle of St John, *Corpus Christi MS 197B*, f.1; 5, wolf carving, Ardross, Inverness; 6, wolf from *Book of Kells*, f. 76v. B: Burghead, Moray, bull carvings. 7, Burghead No. 3; 8, Burghead, No. 5. Adapted from various sources.

is likely that some at any rate served as memorials or funerary stele in a tradition known elsewhere in Britain from the late Roman and sub-Roman period (Thomas, 1984). Indeed, Alcock (2003) saw the pairing of symbols as a 'Pictish' version of a filiation formula cognate to the memorial formulae of Britain and Ireland. Though the symbols may be unique, there would be nothing exceptional in the practice of erecting stones as memorials.

Early Christian manuscript art

We have already considered the problems of the apparent 'hiatus' between the end of Roman occupation in Britain, and the rather less clearly defined end of the earlier Iron Age in Ireland, and the seventh/eighth-century *floruit* of Insular art. Had Jacobsthal published a study of Early Christian manuscript art, he might have observed that it was 'an art with no genesis'. He might then have proceeded to identify its three principal roots as native 'Ultimate La Tène', innovating Germanic (Hiberno-Saxon) influences and exotic Mediterranean, including Coptic, stylistic elements introduced with early monasticism. The sense of *déjà vu* is not necessarily coincidental, since the catalyst for early La Tène art and later Insular art both entailed the convergence of disparate influences under powerful patronage. The only difference is that in the early Christian period that patronage was overtly ecclesiastical as well as temporal authority, whereas in the earlier case, while the archaeological evidence may imply a stratified society headed by aristocratic patrons of craft workshops, we can only indirectly infer the religious agenda.

In Ireland, the advent of Christianity is documented linguistically and in historical sources, and archaeologically in the occurrence of early cross-slabs. Old Irish contains a substratum of pre-Patrician loanwords resulting from contacts with Christianity in Roman Britain (Mitchell, 1977), and there is evidence for Christianity in the south of Ireland in the fourth century. It was here in the south-west that the *ogham* script first makes its appearance in the fourth or even later third centuries, though not initially with Christian associations. In the fifth century, the missions of Palladius and Patrick are well documented, and, by the sixth century, monasticism is attested in the monasteries founded by St Columba in Ireland and Scotland such as Derry in 546 and Iona in 563. Archaeologically, however, few if any of these ecclesiastical foundations have yielded evidence of activity at such an early date, and the surviving remains at most of the major sites like Skellig Michael, Glendalough or Gallarus are significantly later.

The earliest Insular manuscript, the so-called *Cathach* of Columba, a psalm book dating to the late sixth or very early seventh century, certainly in its embellished lettering (Figure 11.7) reflects the limited range of motifs that had characterized Celtic metal-work of the early centuries AD. Initial letters included spirals, trumpet motifs and peltae, and though fish and animals may betray Coptic influence, there is as yet no interlace of either later variant, which does not appear until the mid-seventh century, in the Book of Durrow, the oldest illuminated Insular gospel book. Megaw and Megaw (2001, 251) summarize the enigma of the *Cathach's* incipient illumination: 'it uses Celtic designs to illustrate an artefact of a non-Celtic religion, in a non-Celtic language, and in a medium of writing with ink on vellum alien to the Celtic visual and oral tradition'. Interestingly, it is in the embellishment of initial letters that

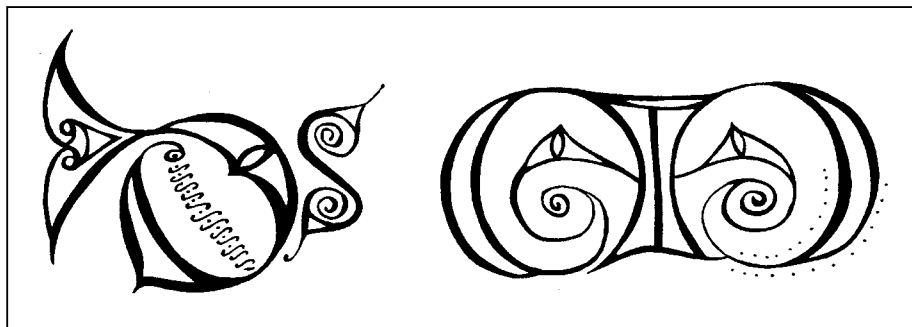

Figure 11.7 Initial letters from the *Cathach* of St Columba: left, Psalm 53 *Deus in nomine*; right, Psalm 55, *Miserere mei*.

the 'curvilinear Celtic' or 'Ultimate La Tène' elements most frequently manifest themselves in the illuminated manuscripts, invariably as embellishments to the top and bottom of letters, or as finials.

Taking the seventh- and eighth-century Insular manuscripts as a group, several distinctive artistic components can be isolated:

- The 'Ultimate La Tène' component evidently has parallels and antecedents in metal-working, notably in the 'hanging bowl' escutcheons, pins and brooches discussed earlier. It comprises a limited range of motifs, principally trumpet-linked spirals, or more accurately yin-yang whorls. Compared with earlier La Tène metal-working, however, it remains repetitive and even symmetrical, lacking the 'assured irrationality' of earlier artists in metal-work. The 'Ultimate La Tène' component seldom dominates quite as centrally as it does in *f.* 3v of the Book of Durrow (Pl. 11). Here the two larger and four smaller circular devices are rotationally symmetrical in varying degrees of complexity. The lower pair encloses linked yin-yang whorls in a triskele arrangement, with trumpet leaves around the perimeter of the circle. The upper pair is more complex, with each whorl of the triskele spawning a subordinate whorl, separated from the next primary whorl by a three-pointed ('Mercedes') star. The main central pair each encloses two larger circlelets, these in turn containing triple whorls, and two smaller spiral circlelets. Trumpet leaves linked to peltae form the outer binding of these larger circlelets. All six circlelets are linked with extended trumpet spirals, with three-pointed stars filling interstices.
- With the Book of Durrow comes broad, ribbon interlace, a style that is commonly attributed to Coptic or at least Mediterranean origins, assimilated perhaps through Italy and integral to the dissemination of monasticism itself. Interlace may be boldly rounded or more angular, but it is essentially geometric, as writers since Romilly Allen have recognized, based either upon vertical or diagonal grids, or upon compass-work. As Guilmain (1993, 92) observed,

Often the principles involved in the structuring of the ornament, though they may lead to the creation of astonishingly complex designs, are very simple,

and it is quite possible that they were known in many places within the Mediterranean world, or were discovered independently at several different times and places.

Colour changes within the same ribbon introduces variety into what otherwise may be a very repetitive formula.

- One carpet page of the Book of Durrow, *f.* 192v (Pl. 12), is ornamented with an innovative form of animal interlace derived from the so-called Germanic Style II. The overall impression of a maze of writhing creatures belies the ordered composition of the page. Around the central cirlet, in which an interlaced design rotates around a small central cross, are arranged two vertical and four horizontal panels of animal interlace. The two inside horizontal panels, in which the beasts bite their own tails, are exact replicas of each other. The two outer horizontal panels, in which they bite the next in line, also replicate each other's design, but with the colours reversed. The processions of animals in the side panels match each other in rotational, anti-clockwise sequence. This basic symmetry or order pervades the interlace of the illuminated manuscripts, even into its most intensely complex manifestation in the Book of Kells. By the end of the seventh century, animal interlace in the Lindisfarne Gospels has transcended its Germanic origins, so that the 'ribbon birds, swinging and rolling in bewildering, but controlled waves' (Guilmair, 1993, 94) have become an integral part of the new Insular Celtic style.
- Human and zoomorphic representation is plainly central to the scriptural and liturgical role of the illuminated Gospel Books, reaching its apogee in the Book of Kells. Rendering of the human form, however, is often curiously un-naturalistic or anatomically impossible, while seemingly constrained within the naturalistic genre. In the Virgin and Child of the Book of Kells, *f.* 7v (Pl. 13), the child is simply a small adult with two left feet, one with only four toes, held by a Virgin with two right feet. The left arm of the figure normally identified as St John in *f.* 291v of the Book of Kells (Pl. 14) is attached to his chest rather than his shoulder, an anatomical impossibility that can hardly be attributed to ignorance or incompetence. The presence of a figure spread-eagled behind the composition, whose head, arms and feet poke out from behind the frame, and more especially some of the human contortionists wrapped up in initials, are bizarre, and underline the deliberate intent of these so-called 'drolleries' (Rynne, 1994). Human representation, as we have seen, is not a major element in earlier Celtic art, so that the portraiture of the manuscripts bears no obvious debt to older Celtic conventions. Nevertheless, as Megaw and Megaw pointed out (2001, 252), the figures on the Rinnagan, Co. Roscommon, gilt-bronze plaque (Figure 11.8A) of the later seventh century show a remarkable similarity in their lentoid eyes and fringe hair-styles to earlier La Tène face-masks. Equally it might be said that the human heads that terminate the densely entangled interlace flanking the Virgin and Child, or human head, cats and mice, and otter with fish that lurk within the scrolls of the *Christ autem* initials on *f.* 34 were all in the spirit of the older Disney tradition.

It has been argued earlier that too much has sometimes been made of rather tenuous similarities between animals depicted in the illuminated manuscripts and the animal carvings of symbol stone art. Among examples where the similarities are detailed and convincing the eagle of St John in Corpus MS 197 B *f.* 1 is strikingly

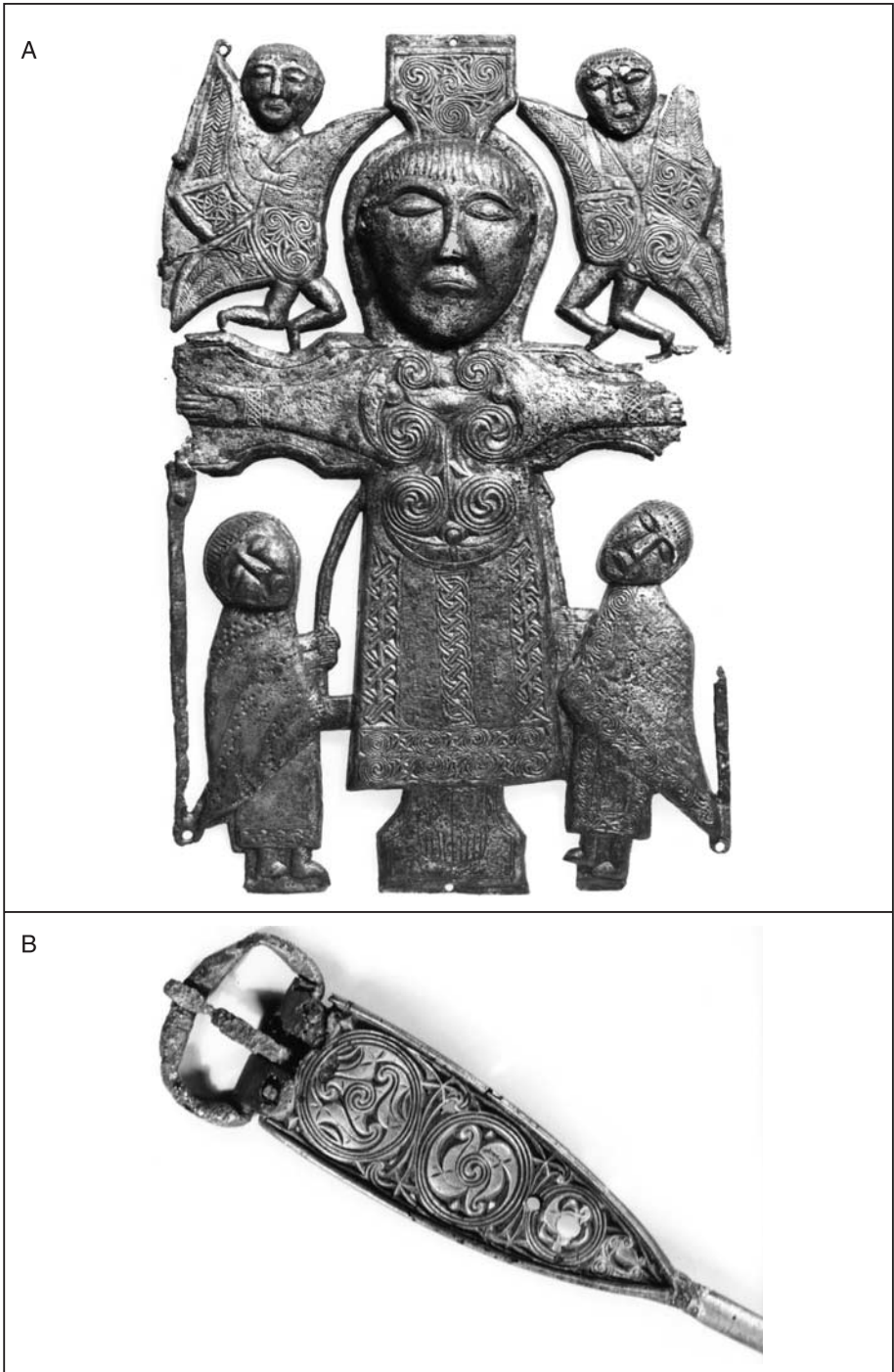

Figure 11.8 'Ultimate La Tène' in Ireland. A: Rinnagan crucifixion plaque. B: Lagore belt-buckle. Photos: Copyright National Museum of Ireland, Dublin, reproduced by permission

similar to the carving from the Knowe of Burrian, Orkney, down to the curving emphasis of breast and wing, depiction of plumage, and the rendering of legs and talons (Figure 11.6A, 3 and 4). By contrast, the eagle of the Echternach Gospels, *f.* 176v, despite its talons and beak, has the posture of a pigeon, and derives from a different aviary altogether. This must imply a connection more than indirect between *scriptorium* and sculptor's workshop, whether through the agency of Columban missionaries or even through the former existence of 'Pictish' Gospel Books (Henderson, G., 1987, 96). Unfortunately there is little archaeological evidence for the date of the Knowe of Burrian sculpture, but if the sculpture was the 'model' for the manuscript, rather than *vice versa*, as current opinion probably rightly argues, then a mid-seventh-century horizon is no more than a *terminus ante quem* for the inception of the symbol stone style. Another feature that must derive from symbol stone art is the emphasis of limb-joints and muscles by the use of scroll lines, as in the wolf from the Book of Kells, *f.* 76v, recalling similar emphasis on the Ardross wolf or the Burghead bulls (Figure 11.6A, 5 and 6; Figure 11.6B). The comparison is underlined by the fact that highlighting of the thigh and shoulder joints of the calf in the Book of Durrow, *f.* 124v, is achieved by contrast with 'Ultimate La Tène' spirals.

- Other distinctive elements of illuminated manuscript art include the geometric, rectilinear style, whether check, step or key patterns or diagonal fretwork. Like the interlace designs, these are based upon ordered geometric structures, but they may also reflect the influence of the metal-worker's craft, in examples like the chequered cape of St Mark, *f.* 21v of the Book of Durrow (Figure 11.9), widely recognized as simulating *millefiori* settings. Comparisons are likewise made between ornamented panels on the carpet pages of the Book of Durrow and *cloisonné* mounts of gold and garnet from the Sutton Hoo treasure. By the end of the eighth century, in the Book of Kells, other devices, such as rosettes and floral motifs, appear as finials and spandrel fillings.

A progression in the composition and execution of Insular manuscript art can undoubtedly be traced through the seventh and eighth centuries. Compositions become more complex and intricate in later manuscripts, but the constituent elements in terms of non-representational designs, 'Ultimate La Tène', ribbon interlace and animal interlace, never actually integrate, even though juxtaposed in subtle relationship. Only occasionally in the Book of Kells is there any sense that integration might be imminent. To this extent, Insular manuscript art differs fundamentally from early La Tène Celtic art. In the earlier style, the component influences, 'Hallstatt', classical and orientalizing, are deconstructed by the Celtic artist and re-assembled into a new, vibrant and independent style that transcends its sources. In manuscript art, 'Ultimate La Tène' is never fused into the Germanic or Mediterranean interlace. The reason is presumably that the formal geometric templates upon which these styles, including the 'Ultimate La Tène', were based, simply did not permit that integration. A question that arises is whether different artists might have been responsible for different sections of the design. For the Book of Durrow and Lindisfarne Gospels, Henderson (Henderson, G., 1987, 40) was adamant that artist and scribe were one. In the case of the Book of Kells, following Françoise Henry (1967, 73–7), it is generally agreed that several artists may have been responsible for individual pages, even though their work was

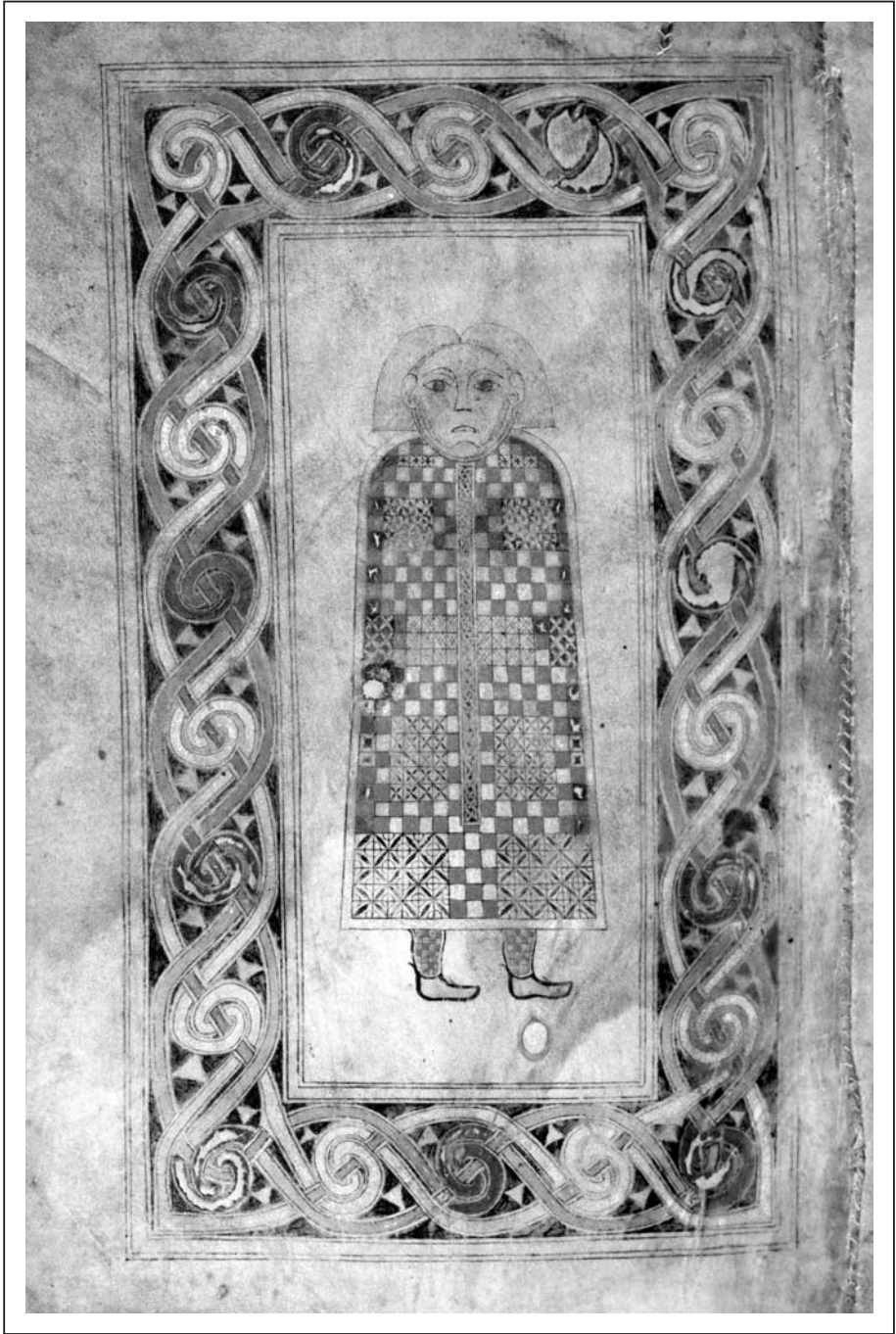

Figure 11.9 The Book of Durrow, f. 21v. Photo: The Board of Trinity College, Dublin.

skilfully combined. Equally, Henry argued for three separate scribes, so that the production of the work was collective, and one may even suggest perhaps cumulative. Indeed, taking the Book of Kells as a whole, rather than its selective highlights, one could believe that numerous different hands were involved as artists and scribes, especially if the work was disrupted by Viking raids and a retreat from Iona for completion in the comparative refuge of Kells.

Artistic and technical achievement in metal-work

In examining early Celtic art in Europe we have seen that artistic expression in metal-work concentrates within three broad fields: weaponry and equestrian gear, personal ornaments, and vessels and accessories relating to feasting and more especially drinking. Though documentary sources abundantly testify to warfare in early historic society, a reality represented especially in insular sculpture in the form of mounted warriors bearing arms, archaeologically, the evidence for weaponry and equestrian equipment is minimal. In Ireland, iron swords, possibly of later date, were recovered from Lagore crannog, while in Northern Britain Dunadd and Buiston crannog yielded a few fragmentary weapons. But the sum total is far from representative of the importance of such equipment in early historic heroic society. The reality is, of course, that from domestic settlements and even high-status centres valuable items are unlikely to be discarded unless broken beyond repair or recycling, so that, in the absence of 'warrior' burials like those of Anglo-Saxon or Viking settlers, evidence for such equipment is likely to elude the archaeological record.

From Medieval Irish documentary sources, we may infer that personal wealth and status were measured not only in holdings of cattle but also in terms of equestrian gear, traditional household accessories for feasting and drinking and in terms of personal ornaments, much as they had been in early Celtic society. In the eighth and ninth centuries, brooches ranged from simple and functional to highly elaborate, in Scotland, continuing the penannular tradition, in Ireland, developing the fashion for annular or 'pseudo-penannular' brooches. In these, an ornamented panel joins the expanded terminals, so that the ring is no longer functional but simply serves as an elaborately ornamented head to the pin. The Hunterston brooch from Ayrshire (Pl. 15a), and the so-called 'Tara' brooch from Bettystown, Co. Meath, form an instructive pair in terms of their similarities and their differences, and are conventionally regarded as successive within a generation around the turn of the eighth century. Though several ornamental panels from the 'Tara' brooch are missing, the Hunterston brooch indicates that the design was bilaterally symmetrical with the principal interlaced beasts in mirror-image relationship about the axis between the terminals. The pin heads, terminals and panels around the ring of both silver brooches are ornamented in a proliferation of filigree motifs, interlacing ribbon-bodied beasts, abstract interlace of looped and double-looped lines, minute curvilinear motifs and chevron patterns, all attached to gold foil 'back-plates' and edged with filigree borders. Forms of filigree include beading, twisted ribbon, 2-ply and 3-ply strands and combinations of these. Technical similarities indicate the influence of Germanic Anglo-Saxon sources, but at the same time differences proclaim the wider familiarity among insular craftsmen of Continental techniques and the innovative independence of metal-workers in Early Christian Ireland and western Scotland (Whitfield, 1987; 1993). The filigree artists of the early

eighth century nevertheless did not extend their repertory to include 'Ultimate La Tène' designs, and where these occur, as strikingly on the back of the terminals of the 'Tara' brooch (Pl. 15b), they are rendered in a fashion that accords most closely to the style of the manuscript artists. Cut through silvered copper to the contrasting copper background, the designs are extended yin-yang spirals in triskele layout, on one 'terminal' panel the mirror image of the other. Directly opposite on the ring of the brooch is another panel of 'Ultimate La Tène' whorls, not symmetrical in composition, but essentially two-dimensional. By contrast, the two flanking panels comprise a series of relief whorls within linked spirals, in which rotating birds' heads is the basic theme, not unrelated to the ornithomorphic-coiled designs on the lower neck mounting of the Ardagh chalice (Rynne, 1987, Pl. I, B).

Of broadly similar date to the 'Tara' brooch, and with analogous 'Ultimate La Tène' ornament, is the belt-buckle from Lagore crannog (Figure 11.8B). Whorl motifs within three linked spirals of decreasing diameter dominate the design. Only the largest is strictly a triskele, and this is extended to include three elements in rotation that are betrayed by lenticular 'eyes' to be birds' heads with hooked beaks. This is one of the few instances in which a fusion of 'Ultimate La Tène' and Germanic styles has been claimed (Rynne, 1987, 89; M. Ryan in Youngs, 1989, 64), though stylized birds' heads are of course a long-standing theme in Celtic art.

From documentary sources we may infer that a full complement of vessels for preparing, serving and consuming food and drink was an essential indicator of high social status in the early historic period. As with weaponry, however, the archaeological record is not well provided in this regard, other than in the highly specialized and numerically limited area of liturgical vessels. Apart from its primary liturgical significance, the Ardagh chalice (Pl. 16a) is perhaps the prime example of the metal-worker's technical achievement and art from the eighth century. Composed of more than two hundred separate pieces, the chalice is essentially of silver with gilded bands and ornamental panels using a range of casting, engraving, filigree, enamelling and *cloisonné* techniques. Ornament combines plain interlace, animal interlace and 'Ultimate La Tène' designs. Some technical tricks, like the trichinopoly (woven hair/wire) work on the lower foot-girdle (Figure 11.10A), have an older insular ancestry in one of the neck-rings from the Brighter hoard, but more particularly also are found on the 'Tara' brooch and Derrynaflan paten. Other techniques show the wider exchange of specialist skills between high-status workshops or their aristocratic and ecclesiastical patrons. The names of the apostles inscribed in decorative majuscule letters against a background of stippling resembles the style of Northumbrian manuscript scribes and artists, while a close connection with Northumbrian metal-workers is implied in the use of die-stamped or *Pressblech* panels of ornament (Figure 11.10B) on the foot-girdle of the chalice, a technique also displayed by the Derrynaflan paten, which may have been a product of the same Irish workshop. The use of glass studs with decorative foil backing on the same foot-binding is reminiscent of Anglo-Saxon decorative work such as the shoulder-clasps and other items from the Sutton Hoo assemblage.

Apart from altar plate, distinctive in the repertory of religious art-works are reliquaries, notably the insular house-shrines of the eighth and ninth centuries. In an age that venerated holy relics, it is assumed that these were portable containers of saint's bones, and in one example from the abbey of San Salvatore in Siena the contents have evidently been authenticated as original. Such shrines were used to solemnize special

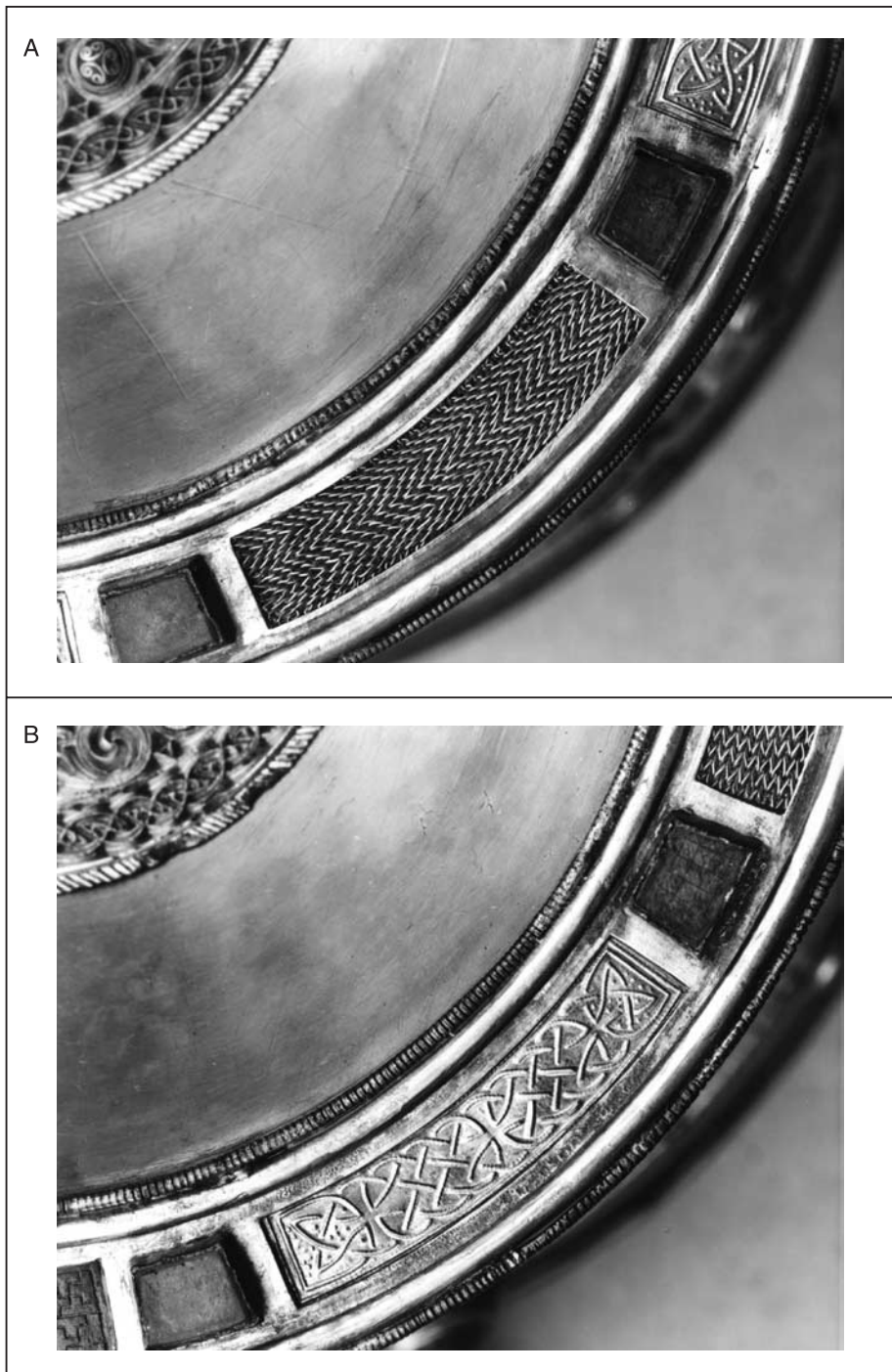

Figure 11.10 Technical details of the Ardagh chalice. A: trichinopoly. B: *Pressblech*. Photos: Copyright National Museum of Ireland, Dublin, reproduced by permission.

assemblies or even to invoke spiritual support in battle, as is claimed of the Monymusk reliquary (Pl. 16b) at Bannockburn in 1314. A wooden casket with silver, gilt and copper-alloy plating, Monymusk is attributed to 'Pictish' workmanship on account of the use of *pointillé* stippling and the style of finely incised interlaced animals on its silver front plates, techniques that are closely paralleled on the St Ninian's Isle bowls (Small *et al.*, 1973). Other examples, perhaps slightly later, show stylistic variations within the same genre. The casket in the Copenhagen National Museum has extensive engraved ribbon interlace with three circular mounts containing complex triskele motifs on its rear surfaces, but no sign of animal interlace. The Bologna house-shrine is made wholly of metal, mainly copper-alloy and originally gilded. It is ornamented with cast interlace on its front, with back and sides extensively covered with engraved ribbon interlace. Interlaced animals occupy the centre of the back panel, with animal imagery again on the roof finials. Trumpet spirals fill the disc mounts on the back of the casket.

The function of all these religious artefacts of course is documented in Christian tradition. Their counterparts in the non-literate context of later prehistoric Europe, had they existed, would be hard to interpret convincingly on the basis of archaeological evidence alone. Yet we may suspect that heroes and holy men were venerated in pre-history, and that Celtic cult traditions and practices too were highly codified, with art objects serving a similar role to that of liturgical equipment in the Christian context.

CONCLUSIONS

Archaeology and Celtic art

To the question ‘can we meaningfully talk about Celtic art?’, we have answered in the affirmative, but not simply as careless shorthand for La Tène art. It is possible to argue from the documentary record of ancient historians and geographers that there were people known to the classical world as Celts, and even people who regarded themselves as Celts. Furthermore, the evidence of personal and place-names, admittedly in many cases known from Roman period sources, allows us to infer, in the absence of any evidence for ethnic incursions to account for their recent introduction at that late date, that the Iron Age populations of Western and west Central Europe spoke related languages that are classified as Celtic. A case can therefore be made for regarding the art of any of these population groups, whether identified as Celtic on ethnic or linguistic grounds, as Celtic art. Plainly this must include La Tène art: indeed, the magnificence of the La Tène art phenomenon justifies giving it pride of place in any treatment of the subject. The fact that the archaeological distribution of La Tène culture is not coterminous with those areas recognized as Celtic ethnically or linguistically need excite no particular difficulty. Not since the generation of Gordon Childe have archaeologists expected such close correlations for many reasons, not least that the dynamic process of cultural interaction and change would have obscured geographical territories and boundaries over time. But it is also abundantly clear that Atlantic Europe had a different character archaeologically from the Urnfield–Hallstatt–La Tène sequence of Central Europe, and without presuming an Atlantic unity that may be more apparent than real, the Celtic zone evidently included a non-La Tène as well as a La Tène aspect.

Celtic art therefore is emphatically not exclusively La Tène. In fact, the persistence of that equation has greatly hindered an understanding of Celtic art in its broader geographical and chronological context. Conversely, the exclusive equation of La Tène material culture with people of Celtic speech or ethnicity is a more difficult issue. Setting aside obvious examples of prestige goods that were carried by trade, diplomatic gift, plunder or spoils of war well beyond the La Tène cultural world, there is a hinterland between the north-alpine zone and the North European Plain where, from at least the Augustan era into the first century AD, it is unclear how far Celtic and northern, Germanic-speaking groups may have integrated.

The La Tène-Celtic equation has also dominated assessments of later Insular Iron Age art. In addressing the genesis of symbol stone art in eastern Scotland (‘Pictish’ art), students are drawn to question whether it represents a late resurgence of Celtic art, by which they mean implicitly La Tène art, and if so, what had happened to the tradition

CONCLUSIONS

in the intervening centuries? The answer must be that it is not a late resurgence of La Tène art, which is not to say that it is not another manifestation of Celtic art. It might include echoes of major themes from earlier La Tène art, but it is also different in important aspects, such as the depiction of the human form in battle or hunting scenes, in which it also echoes Celtiberian art. Likewise the art of Early Christian Ireland may be regarded as Celtic art, but its debt to the La Tène tradition is perhaps less significant than that to Germanic and other traditions. Once we break the exclusive equation between Celtic art and La Tène art, it is possible to view the regional and chronological differences across the Celtic world of later prehistory and early history in a different light. Instead of trying to trace influences of one upon the other, or trying to derive one from the other, on the basis of perceived similarities in style or motifs, sometimes valid and sometimes tenuous, we can ask *why* certain periods in certain regions produced outstanding art works while others did not. What circumstances or combination of circumstances catalyzed the Golden Ages of Irish art or early La Tène art in Europe?

The traditional approach to Celtic art through a chronological sequence of 'styles' fails to address key issues of social and cognitive archaeology implicit in the evidence. The different styles in any event are not strictly comparable, being manifest in different sets of material representative of limited social groups – aristocratic drinking services, high-status warrior equipment, or high denomination coinage – and at no stage represent more than a limited spectrum of society. The art of the potter seldom reflects the art of the metal-worker, but cannot be *simply* dismissed simply as vernacular art since there are reasonable grounds for believing, for example, that some ceramics had a particular funerary role, perhaps quite different from their domestic counterparts. Celtic art has many regional sub-sets, and few pan-European traits, other than in the most general terms. Dragon-pairs represent one of the few images that have a widespread geographical distribution, but they are still only representative of a restricted if influential warrior elite. What was the status of the artists, and how did specialist armourers, jewellers, moneyers, professional brooch-makers and gold-workers operate over a millennium or more? Why did Celtic art develop so spectacularly within the La Tène world rather than in the non-La Tène Atlantic north and west? And why did it enjoy a spectacular revival in the early historic period, notably in Early Christian Ireland?

Our answer to these questions will depend in some measure upon our definition of art. The supremacy of the La Tène art style in archaeological convention derives fundamentally from the equation of art with ornamental styles embellishing high-status artifacts that display intrinsic value or high technical accomplishment. Though less prestigious, a carefully crafted brooch or spear-head, completely devoid of superficial ornament, but deposited in a grave assemblage or in a ritual hoard, might nevertheless qualify in an anthropological definition as a significant art object. The *Maskfibeln* of the early La Tène period in Central Europe or *jinete* of Celtiberian Spain certainly qualify as art objects, even though they bear no ornamental embellishment, beyond stylized human or animal imagery, that might assign them to any particular 'style'. Equally, however, wooden images that will have perished, unless preserved by unusual environmental conditions, or paintings on the daub walls of timber-and-wattle buildings, could have served the social and ritual needs that art evidently fulfilled in Celtic society.

CONCLUSIONS

First, we should try to draw together the various strands of information that have been studied in the foregoing chapters, to see whether it is possible to distil a provisional re-assessment of what constitutes Celtic art, based upon the material inventory across those regions that we have identified as probably or potentially Celtic on ethnic or linguistic grounds. Among the pre-Roman Celtic groups there are certain recurrent themes or component elements, and certainly recurrent artefact types, in the inventory. Broadly following and developing Jacobsthal's analysis, we may identify four elements: (1) anthropomorphic imagery; (2) animal imagery; (3) abstract curvilinear ornament; and (4) geometric ornament as components of early Celtic art. These elements are obviously not unique to Celtic art, and might equally be a description of other ancient or more recent ethnographic art styles. Nevertheless, they are distinctive and characteristic, and we may therefore begin with a brief review of these four aspects of early Celtic art:

- 1 *Anthropomorphic imagery.* Jacobsthal underlined the absence of a figural or narrative dimension in La Tène art, in spite of the model of figural scenes on Greek vases or the proximity of situla art around the head of the Adriatic with its ceremonial and festive scenes, so that the rejection of figural or narrative themes was clearly by deliberate choice or inclination. The scene depicting riders and foot soldiers on the La Tène A scabbard from grave 994 at Hallstatt, commonly cited as an illustration of Celtic warriors in battle, is so obviously influenced by the frieze narratives of situla art as to be scarcely representative of Celtic art. Equally the contesting warriors on later Iron Age painted vases from Numantia are part of a regional tradition that is already much influenced by southern, Iberian styles. Schematic figural scenes are represented from the eastern Hallstatt zone, on the pottery from Sopron, and simpler 'matchstick' images are occasionally found elsewhere across Celtic Europe. In the north-alpine Hallstatt world, life-sized stone sculptural figures, notably from Hirschlanden, from the early La Tène at Glauberg, or in the Castro culture of northern Portugal, may be representations of deities or ancestor-heroes. In fact, much of the human or humanoid representation in Celtic art is sufficiently stylized to be regarded as formulaic or representative of otherworld beings, rather than figural in the normally-accepted sense. Green (1989, 206ff) has argued that images of deities may be exaggerated or schematized in order to dehumanize the portrayal, in effect deliberately to distance the supernatural from the natural. This may manifest itself in an enlargement of the head, in bi-cephalic or tri-cephalic heads, or the truncation or schematic depiction of other limbs. Even in later symbol stone art or Early Christian manuscript art the human form is depicted in schematized form or in postures that are improbably contorted, so that it need not be concluded that all such images are intended to be supernatural or divine.
- 2 *Zoomorphic imagery* is certainly not unique to Celtic art, though it is a significant element from the Urnfield period through to the symbol stone art of the later Iron Age in Scotland. At one level, it constitutes a pan-European theme in Celtic art, and is one theme in which La Tène art was certainly not lacking antecedents. It could take the form of animal images modelled in the round or representations in two dimensions on pottery or metal-work, and originally doubtless was also deployed on perishable organic materials or as painted images that would not

CONCLUSIONS

survive. Animal and bird images may assume several guises. Some are of recognizable breeds, like boars or birds of prey, either complete at various scales from miniatures to life-size, like the Hounslow or Neuvy boars, or as animal-headed protomes like the Brå cauldron bovines. Alternatively, they may mutate into exotic or fantastic beasts, like those on the rim of the Dürrnberg flagon or the handle of the Borsch flagon. Fabulous creatures like centaurs and winged horses on coins are adopted into the Celtic pantheon from classical sources. Finally, zoomorphic imagery may be introduced as implicit elements in more complex designs, as in the Cheshire style or in lyre-motifs that become dragon-pairs in La Tène art.

It is worth remarking that most of the creatures represented – boar, bull, horse, stag, snake or fish – are conventionally regarded as ‘noble’ beasts, and it is hard not to believe that animal and bird imagery had a special significance for the Celts. Doubtless hunting was a highly regarded aristocratic pursuit, illustrated by the model of the Celtiberian boar hunt or by hunting scenes of ‘Pictish’ symbol stones. Animal or bird imagery was also evidently closely associated with the arts of war, as the Ciumești helmet or Witham shield testify. Even so, imagery like the serpent held by the squatting figure on the Gundestrup cauldron or the snakes of symbol stone art are suggestive of a symbolic or ritual dimension in animal imagery. In the Romano-Celtic pantheon Epona, Artio and Arduinna are identified with horse, bear and boar, and even in an Early Christian context lion and eagle are symbolic of the Evangelists.

- 3 *Abstract curvilinear ornament* is commonly regarded as the essence of Celtic art, simply because of the mistaken equation between Celtic art and La Tène art and because of its prominence in the latter style. In fact, not all La Tène styles, as we have seen, are curvilinear and among those that are, repetitive designs often underlie ornament that at first sight is characterized by freestyle complexity. The Waldalgesheim or Vegetal Style is often regarded as the high point of La Tène curvilinear ornament because it is in this style that derivative classical motifs are deconstructed and re-emerge with the ‘assured irrationality’ (Megaw, 1970a, 89) of a vibrant and independent Celtic creation. In fact, the culmination of the La Tène tradition might better be attributed to the later Plastic Style, in which the art is not simply applied as ornament but is the artefact itself fully integrated with its embellishment.
- 4 *Geometric ornament*. Geometric ornament, rectilinear, curvilinear and emblematic, occurs widely in Celtic art, separately or in combination. Emblematic here refers to the use of symbols like the ‘sun-disc’ or perhaps the swastika that may be supposed to have had a ‘meaning’ beyond simple ornament. Geometric ornament is especially characteristic of Urnfield and Hallstatt Iron Age pottery and metal-work, but continues throughout the La Tène period, as in the arc-and-circle style in the eastern La Tène zone or on the Braubach style of pottery, though it is otherwise seldom accorded a diagnostic role in schemes of classification. In the Celtiberian world, geometric, including emblematic, ornament is the norm in pottery and metal-work. Geometric ornament is widespread prior to the appearance of the La Tène curvilinear styles, but should not be regarded as necessarily earlier in any formal sequence from ‘geometric’ to ‘curvilinear’. In fact, the two should not be seen as opposites, since geometric and even compass-aided designs, as we have seen, are sometimes implicit in curvilinear composition.

CONCLUSIONS

On the principle that the object is as significant as or more significant than the ornament, we should perhaps first consider the predominant types that constitute the body of Celtic art, earlier and later, since these should be indicative of the social role and function of art objects in the Celtic world. We need not assume, of course, that priorities will remain constant over space or time. In fact, since beliefs and values may have changed with developing social and political structures, we might anticipate significant changes over the period of nearly two thousand years between the Urnfield late Bronze Age and the later Iron Age. For the present we may begin with an inventory of the principal classes or groups of artefacts that have been discussed in the context of Celtic art.

- weaponry, especially sword, spear and shield
- equestrian gear and vehicles
- personal ornaments, both everyday and high-status
- drinking and feasting equipment
- public art: sculpture, stele and related monuments
- manuscript illumination
- coinage
- pottery and domestic equipment.

Ethnographic studies suggest that works of art conferred prestige upon those who 'owned' them or had custody of them. In the case of early Celtic art, and in the context of a chiefdom-based society rather than an urbanized state society, we might infer that prestige accrued from controlling the resources for production in the case of locally produced artefacts or the negotiated means of access in the case of imported goods. It has commonly be assumed that southern imports, initially Greek and subsequently Etruscan, in the Hallstatt C-D phases and into La Tène A and B, sustained a prestige goods economy among the north-alpine aristocratic dynasties (Frankenstein and Rowlands, 1978), though the evidence for redistribution has been challenged (Dietler, 1990). Indeed, it may have been the failure to sustain the mutual obligations implied by the redistribution model that strained the social fabric of the late West Hallstatt chiefdoms to the point of collapse. The status conferred by Mediterranean contacts would equally have been visible in the mud-brick walls and bastions at the Heuneburg or in the novel treatment of Greek and orientalizing motifs in early La Tène art. In the hierarchical structure implied by the late Hallstatt *Fürstengräber* it may be supposed that prestige was acquired through the capacity to dispose of the wealth represented by 'art objects' in burials or hoards. Since disposal in hoards or high-status burials represents a primary means whereby distinctive 'art objects' enter the archaeological record, it would be easy to assume that this represented some kind of norm, whereas self-evidently the rich late Hallstatt tombs of south-west Germany or the early La Tène chariot-burials of the Champagne are very much in the minority, even in the well-documented archaeological record of these regions at those times. In all probability the majority of 'art objects' were curated and inherited over many generations, resulting in some of the composite artefacts that we have here examined.

From the eight principal categories listed above it is clear that not every category is equally represented in all periods or in all regions covered by this survey. The late west

CONCLUSIONS

Hallstatt *Fürstengräber* are especially distinguished by their wealth in terms of the drinking and dining service, but are not noted for warrior equipment. Weapons are certainly represented among the combination of grave-goods (Kossack, 1959) but not especially in the princely tombs. Ethnographic evidence (Keeley, 1996, 144) suggests that the warrior class, vital in war, was not necessarily accorded the highest rank in peace, when the skills of negotiation, wealth acquisition and knowledge of ritual may have been accorded priority. Where weapons are included in the wealthiest grave inventories, as at Hochdorf, the dagger and its sheath are particularly splendid, underlining the fact that this is as much a symbol of power as a weapon of combat. Such a scenario would not be incompatible with the evidence from the late west Hallstatt world, where the 'paramount chieftains' (Frankenstein and Rowlands, 1978) would have vied for control of the lucrative Mediterranean markets in order to sustain control over their 'vassal chiefs', and yet would doubtless have required periodically the force of arms to bolster their status and resolve disputes. Trade and exchange, as Keeley observed (1996, 125) are no more a guarantee of peace than inter-marriage, and social tensions created by contacts with the Mediterranean world are likely to have been as significant as their material benefits. That the hierarchical structure of late west Hallstatt society collapsed abruptly at the end of the sixth century is widely acknowledged by prehistorians, though whether this was occasioned by a widespread uprising against a hated feudal tyranny (Pauli, 1985) or as a result of a dynastic power-struggle between ruling kin-groups, as envisaged by Arnold (1995) for the Heuneburg, remains arguable. What is clear from the archaeological evidence is that there was major disruption of the political and social order at the end of the sixth century and the beginning of the fifth century, and that a shift in emphasis in terms of southern contacts, from the Massilian Rhône axis to the trans-alpine axis from Etruria to the middle Rhine, was either a contributory cause or a consequence of this upheaval. A further concomitant was a progressive decline in the deposition of lavish grave-goods in the La Tène A and La Tène B phases, though hardly to the point of egalitarianism (Pauli, 1985, 35), and an increase during middle La Tène in the number of graves that display the standard equipment of a 'warrior burial'. Such must surely be the simplest interpretation of tombs like Somme-Bionne and La Gorge Meillet in the Champagne, despite attempts in some quarters to 'pacify the past' (Keeley, 1996, 19; Collis, 2003, 213). In effect, there was a widespread change in the social infrastructure of north-alpine Europe that led to the kind of warrior chiefdoms and proto-states whose activities from the fourth to the first centuries BC are described extensively in classical sources.

This change in social infrastructure in west Central Europe coincides with the appearance in the mid-fifth century of early La Tène art. In the establishment of the new order in the fifth century, it doubtless provided a means for princely or warrior patrons to express their identity in contrast to the displaced order, and especially asserting their independence in the adopting and adapting of southern models into a new and vibrant art style to adorn their table services, their weapons and their personal ornaments. When Jacobsthal made his famous observation that La Tène art was an art with no genesis, therefore, he was in effect remarking the fact that the La Tène hierarchy was explicitly expressing its independence from the older Hallstatt order. La Tène art was an art with no genesis because it was intended to symbolize the new order in contrast to the old, not because its social, economic or technological roots were not embedded in the past.

CONCLUSIONS

Despite some recent reservations regarding the interpretation of 'warrior burials', warriors, or more strictly *equites* or mounted warriors constituted one of the two classes in Gaulish society that Caesar reckoned to be of any significance (*de Bello Gallico*, VI, 13; note that Caesar did not say that the *equites* and *druids* were the *only* classes apart from the *plebes*, merely that they were the two that were of any account from his perspective), and there is no archaeological basis for believing that this was not in essence true. Contemporary opinion in Spain (Lorrio, 1997; Almagro-Gorbea, 1998) certainly argues for the importance of the warrior elite in leading Celtiberian resistance to Rome. From the later Bronze Age onward the sword, predominantly long, together with the spear, were the prime weapons of Celtic society, while defensive equipment regularly included a shield, with helmet and body-armour perhaps reserved for warriors of greater status or distinction. The 'triple panoply' of sword, spear and shield, reflected widely in north-alpine Europe in the La Tène Iron Age, is the same essential combination that also characterizes Celtiberian cemeteries in Spain. These weapons doubtless were treated as highly personal items of equipment. The well-known inscription *Korisios* stamped in Greek letters on a late La Tène sword from Port, Bern (Wyss, 1955) is generally supposed to enshrine the name of the owner or the maker of the sword, but equally it could have been the name of the sword itself, personalized like the weapons of epic literature. The Port sword is also distinguished by a stamped impression adjacent to the name depicting a pair of goats flanking the tree of life, an 'orientalizing' image doubtless borrowed from Mediterranean sources. A series of swords distributed from Switzerland (Drack, 1955) through the middle Danube to Hungary (Szabó and Petres, 1992, 61–3) and dating from the middle La Tène into the first century BC displays stamped motifs, anthropomorphic or zoomorphic, that have generally been taken to be either the makers' marks or emblems of the swords' owners. Located just below the hilt they would scarcely have been visible to an adversary in combat, but nevertheless may have served a talismanic purpose. Recurrent among the zoomorphic images is that of a boar. Anthropomorphic images takes a variety of forms, but one variant, of a human head in profile, certainly resembles the style of contemporary coinage.

One other aspect of the Port sword is worth remarking; it was bent to a right-angle in a manner generally assumed to imply a ritual act (Megaw and Megaw, 2001, 158). This practice is known from both burials and hoards in Iron Age Europe, and is widely documented from the earliest Iron Age in and beyond the Hallstatt culture zone and throughout the La Tène period north and south of the Alps. From the Filottrano cemetery, the sword and scabbard with Vegetal Style ornament was similarly treated. Beyond the Pyrenees in the cemeteries of the Celtiberians a number of burials show deliberate bending of both swords and spears (Lorrio, 1997). Perhaps the most remarkable examples are those from the sanctuaries of Picardy like Gournay-sur-Aronde, where a range of armaments was systematically destroyed. Here, however, we may be seeing the destruction and dedication of the spoils of war, as opposed to the deposition of the proper and traditional perquisites of the dead. Though the practice of decommissioning weapons may be regarded at one level as indicative of a pan-European Celtic ritual, therefore, marked regional differences between funerary practice and the evidence from sanctuaries suggests a degree of complexity that militates against simplistic explanation (Rapin, 1993).

Archaeological classification may be based upon different criteria in successive periods without apparently exciting comment or explanation. Late Bronze Age and

CONCLUSIONS

Hallstatt C–D sword typology is based entirely upon sword morphology. For the La Tène period swords themselves are hardly diagnostic, and it is the scabbards that form the basis of classification. Scabbards may be assumed from an early date, since an unsheathed sword is both hazardous and threatening, but examples must have been made of organic materials. For the late Bronze Age and Hallstatt C periods chapes of bronze imply scabbards of which no other archaeological trace survives. Shorter daggers of the ensuing Hallstatt D phase are the first in north-alpine Europe to have metal sheaths. By the early La Tène Iron Age metal scabbards regularly provided a surface for ornament, as doubtless had their leather antecedents, if indeed the Swiss technique of *chagrinage* is a legacy of that medium. Embellishment of scabbards doubtless also conveyed symbolic meaning and insignia of status, with particular designs like dragon-pairs or the triskele motifs of some Swiss swords probably also indicating achievement or rank among the warrior class.

One widely distributed variant of sword from the early Iron Age is the anthropoid-hilted type, a more elaborate version of antenna-hilted forms. The ‘legs’ and ‘arms’ were functional, of course, the one as hand protection, the other to prevent the weapon slipping out of grasp. But the addition of a knobbed pommel, in later Romanizing versions depicted as a recognizable human head, makes it probable that an anthropomorphic image is implied in the design from the outset. Hawkes (Clarke and Hawkes, 1955) had drawn a clear distinction between these later (La Tène 2 and 3) variants and the ‘pseudo-anthropoid’ precursors in which no human features are represented, but in the context of Celtic iconography it seems wholly unnecessary to demand explicit representational features. Any late Bronze Age ancestry, in the spirally-coiled antenna sword series, and any relationship to the antenna swords of south-western France and the Iberian peninsula (Quesada Sanz, 1997) is perhaps more tenuous. But it is hard to resist the belief that the explicit personification of the anthropoid and pseudo-anthropoid series was not implicit in a wider range of weapons in a heroic tradition.

Closely related to warrior equipment is equestrian gear, not necessarily associated with a wheeled vehicle. Two-wheeled chariots were evidently an important accessory to the infantry warrior in the earlier La Tène Iron Age of Continental Europe, evidently surviving as an actual vehicle for engaging in battle in Britain as late as the first century BC. The mounted warrior, conventionally regarded as an introduction of the Hallstatt C Iron Age (Cowen, 1967), is a different style of combat, and again one in which the warrior doubtless took a personal pride in his horse’s prowess and ornamental trappings. The commonest indicator of horse-riding is bridle-bits, comprising snaffle-bars and cheek-pieces, sometimes accompanied in grave inventories by other items of harness attachment such as rein-rings and *phalerae*. All may be ornamented, with *phalerae* affording the best of limited surfaces for embellishment. Other metal trappings of a not specifically functional kind may have been used, as was inferred from the Hallstatt burials at Court-Saint-Etienne in Belgium (Mariën, 1958, Fig. 46). Much of the evidence for Hallstatt C and D comes from vehicle burials, where the implication is that the horse-gear was for paired draught animals, decked out for display, rather than to enhance the martial image of war horses. For ceremonial or parade purposes, we might have expected more evidence like the Torrs pony-cap, though the example of the frozen Iron Age tombs of Siberia serves as a reminder of how much of this equipment, from saddle blankets to ornamental trimmings, might have been of textiles and other perishable materials.

CONCLUSIONS

Vehicle embellishments, though not always identifiable with certainty in the absence of contextual data, occur throughout the later Bronze Age and Iron Age. In Hallstatt C, wooden yokes attracted ornament in a number of Central European graves, as in Grave 46 at Hradenin in Bohemia. In the early La Tène a notable example are the plaques emblazoned like a carriage crest at the centre of the Waldalgesheim yoke. Linch-pins attracted elaboration and ornamentation, like the Bohemian jangling pendants of Hallstatt C, or the strikingly whimsical Plastic Style images like those from Manching or Mezek.

Personal ornaments include a wide range of types, from prestigious objects like torcs and arm-rings in gold or silver, for which a high-status or even cult significance might be inferred, not least because their weight and embellishment may have made them cumbersome or downright uncomfortable to wear. The occult significance of torcs is inferred from their association with funerary stele, statuary of squatting deities or representations like the horned figure holding serpent and torc on the Gundestrup cauldron. But they are also represented on sculpture from the Dying Gaul to the life-sized warrior at the Castro di Lezenho. Even Boudicca was reported as wearing one into battle, so that a special significance in the context of warfare may reasonably be supposed. Torcs in the strict sense of twisted bars or plaited strands are seldom found in graves, though lavish neck-rings are not uncommon. The sumptuous Snettisham hoards defy adequate explanation. The relative paucity of metal-working evidence does not indicate a major production centre, yet there is no structural or other evidence for its being a ritual focus of outstanding importance.

More everyday items like pins, brooches, belt-buckles and bracelets evidently served primarily as functional dress-fasteners, but these too may have indicated identity or status of the wearer. The pin, universal dress-fastening of the Urnfield late Bronze Age, gave way in the Hallstatt Iron Age to the brooch, of which the 'safety-pin' model in successive guises become the hallmark of the La Tène Iron Age. Pins and brooches are generally regarded as fastenings for a cloak or mantle, worn around the shoulders over a tunic, knee-length for men and ankle-length for women. Trews, originating in the east, first appear in north-alpine Europe on the early La Tène scabbard from grave 994 at Hallstatt. Depicted with horizontal stripes, these are the equivalent of Gaulish *bracae*, described by Diodorus (*Bib. Hist.* V, 30) and Strabo (IV, iv, 3), based on Posidonius' observations at the beginning of the first century BC. Diodorus adds that the Gauls wore tunics dyed in various colours, and striped cloaks with chequered patterns. All would have furnished opportunity for displaying local 'tartans' to proclaim identity and social kindred, and the brooches that fastened the cloak may likewise have reflected local fashions and traditions. It is not simply the design or decoration of the artefact itself that could have conveyed the identity or status of the wearer, but the position in which it was worn, and the combination of pieces that made up the ensemble. Hodson (1990) attempted to identify status in both male and female graves at Hallstatt on the basis of grave-good combinations, and similar patterns might be detected in grave-groups from La Tène cemeteries in Bohemia (Waldhauser, 1987). The importance of dress and being correctly equipped may be inferred from the subtle complexities of the anthropomorphic belt fittings of the later Plastic Style in Bohemia (Kruta, 1975) and elsewhere in La Tène Europe in the context of both male and female attire.

If weaponry and jewellery can be regarded in any sense as 'personal' artefacts, sculpture almost by definition connotes a public statement. Sculpture is not uniformly

CONCLUSIONS

represented in the Celtic world. Where it does occur regularly, it is commonly either in a funerary context, as in the grave markers of the Hallstatt or early La Tène Iron Age, like the Hirschlanden and Glauberg figures, or in cult contexts like the human heads from the Celto-Ligurian sanctuaries of southern Gaul. Stone *stele* may have been actual grave markers, but the setting up of individual stones could simply have been commemorative without associated burial, or as indicators of territorial identity. The early Iron Age *stele* of Brittany could have been commemorative, or perhaps focal points with which local communities identified in ceremonial gatherings. The Irish decorative stones like Turoe probably belonged to this category. The *guerricos* of the Portugese castros probably served a combination of roles, not evidently funerary, but possibly commemorative and cultic in invoking the powers of ancestors, heroes or divinities to ward off threats to the citadels that they guarded. Some sculpture embodied fertility symbolism, like the explicitly phallic Pfalzfeld pillar, a meaning that may have been implicit in other standing stones. Sculpted heads are known in a variety of forms, and their wide geographical and chronological distribution invites glib equation with a pan-European Celtic 'cult of the head'. It does not seem unreasonable to regard double-heads like the Roquepertuse example or the tricephalic head from Corleck, Co. Cavan, as symbols of omniscient deities, and the recurrent 'leaf-crown' symbol certainly implies a special identity, divine, ancestral or royal, for the figures depicted. The Class 1 symbol stones of Scotland may have served a commemorative role, or may have been statements of communal or dynastic identity. Perhaps too they may have provided a focus for assembly and religious observance, a forerunner of the sculpted crosses of the early Christian period.

One medium that was expressly designed for religious purposes was the illuminated manuscripts of the early Christian period. The religious orders of the earlier Iron Age, collectively described by classical writers as *druids*, did not practise literacy, enshrining their spiritual truths in an oral tradition that was exclusive and probably elitist. In the case of the Gospel Books, the Latin text would still have been accessible only to a limited number in holy orders, and the images and symbolism of the illuminated pages likewise would have been fully comprehensible only to those who were schooled in scriptural exegesis.

'Art objects' doubtless conveyed a 'meaning', though not necessarily a universal meaning across the Celtic world, or even to all sections of society within one community. That meaning may have been symbolic without necessarily incorporating a 'code' that the modern researcher might endeavour to crack. Regional and local ceramic styles can be identified variously across Iron Age Europe, but it is unclear when recurrent formulae in ornamentation transcend local fashion or tradition to proclaim group identity or to invoke protective or other supernatural forces. It seems likely that conventions in the geometric ornament of ceramics, notably elaborate in the Hallstatt C phase in southern Germany, for instance, would have reflected local identities and traditions in much the same way that ceramic or textile decoration did in more recent ethnographic and vernacular contexts. Higher-status metal artefacts may have had more specific symbolic or ritual associations. It is not difficult to imagine that weaponry and defensive armour would have displayed images and symbolism that not only proclaimed the identity of the bearer and his kin group, but also offered him talismanic powers of protection. Bird and boar imagery on helmets doubtless were endowed with such occult powers, as well as affording a distraction to the opponent and enhancing the physical stature

CONCLUSIONS

of the wearer. In the context of pre-state societies, when conflict was arguably more 'ritualized' than 'militarized', even if no less lethal in its consequences (Keeley, 1996), even 'parade' shields of the Witham, Wandsworth and Battersea class may have been employed in the ritualized preamble to battle. Carnyxes, together with related classes of horns from the later Bronze Age onwards, doubtless fulfilled a special role in this context, as attested by both archaeological and documentary sources. Scabbard ornament especially we might expect to have had a symbolic or talismanic dimension, either personal to the user or forbidding to an adversary. The dragon-pair imagery of middle La Tène scabbards, with its very extensive distribution from Eastern Europe to the Pyrenees, comes closest to a pan-European Celtic device, perhaps heralding the rank of the bearer or the supernatural forces whose protection that he was invoking.

One medium in which motifs and designs must have been intended to convey a 'meaning' is coinage. Notwithstanding the intrinsic value of gold and silver coins, coinage within a market economy is essentially endorsed by the issuing authority. In its earliest usage in the Celtic world, coinage may not have been used as currency in this way, but for major social transactions such as diplomatic gift, dowry or payment for mercenary services. But by the late La Tène period smaller denominations, base metal coins and even forgeries would be consistent with a developing market economy. Whether distributions of coin types can be equated with tribal territories may be debated, but it is clear that some regions had distinctive design formulae that doubtless expressed the individual identity of the local political and perhaps religious authority. Particularly bizarre is the Armorican representation of miniature human heads on the ends of braids emanating from a larger human head: to offer an interpretation might be to walk the path that angels eschew, but a special significance or veneration of the head seems to be implied. Other images have a wider currency, especially animals such as boar, bulls and birds: horses are commonly represented too, but are present as a consequence of the coinage's Macedonian models. These were doubtless symbols of strength and aggressive vigour, and hardly exclusively so to Celtic society. The depiction of individuals bearing swords or spears, or wearing torcs, together with cauldrons, wheels or sun-disc, and possibly even altars, underlines the aristocratic, heroic or ritual milieu that the coins invoke. As with later Iron Age symbol stone art in Scotland, it may be that it was the combination of symbols rather than any intrinsic meaning of the images themselves that conveyed their significance.

Finally, from the highlighted categories, pottery and domestic artefacts when recovered from settlements are most likely to reflect everyday activities and social norms, which is not to suggest that a symbolic or ritual dimension need be lacking. In the Urnfield late Bronze Age, cylinder neck urns have a widespread though not uniform distribution for much of the period, extending across the Pyrenees into the Ebro valley. Widely-splayed dishes are frequently deployed as covers for the urn itself or as accessory vessels. Recurrent decorative fashions include fluting or rilling, horizontal, vertical or diagonal, as well as incised or excised (*Kerbschnitt*) styles. How far these ceramic fashions were designed for funerary as opposed to domestic use is still unclear. But such a widespread currency suggests a compelling convention in the shape of cinerary receptacles, and the possibility of special funerary production should not be excluded. In Hallstatt C funerary contexts, pottery seemingly played an important role in the funerary feast, if the numbers of vessels recorded in burials like those of Hradenin, or recent evidence from Hallstatt itself, are indicative. Hallstatt C wares in

CONCLUSIONS

the west Hallstatt zone are of high quality with elaborate geometric decoration, their recurrent style suggestive of a recognized convention if not a specific 'meaning' in the funerary ritual. Archaeological classification, too often based upon cemetery assemblages rather than settlement remains, perhaps has accorded too high a priority to grave-groups as cultural indices, and the ceramic assemblages from domestic settlements seldom reflect the range or quality of those from high-status burials. The ornamental designs of painted pottery from early La Tène cemeteries in the Champagne accords closest to that of the metal-worker, perhaps suggesting that these vessels were the product of specialist craftsmen rather than of domestic or village industries. Wheel-thrown pottery is known in north-alpine Europe from the early La Tène, and the continued production of hand-made wares in many regions doubtless reflects only the absence of an economic infrastructure within which the new technology might have been exploited. Nevertheless there is abundant evidence for regional fashions and perhaps an emerging professionalism in pottery production, in distinctive styles of ornament like the La Tène Braubach pottery of Central Europe, the stamped wares of Brittany, or even some of the regional styles of Southern Britain.

A major change in pottery production and its ornamentation takes place in the later La Tène in temperate Europe, with the rise of the *oppida* economy supporting production and distribution on a scale not hitherto witnessed in Iron Age Europe. Renewed contacts with Italy and the Mediterranean world undoubtedly had a major impact upon production in north-alpine Europe, as well as introducing Italic pottery and metal-work types. The use of the wheel resulted in a greater standardization of shapes, and encouraged production on a commercial scale. Ornamentation, including painting and graphite-coating, may be technically more proficient, but lacks the individuality of earlier ceramic styles. These changes mirror trends already noted in the production of brooches and other small ornaments such as glass beads, and are integral to the emergence of incipient state social structures and a market economy. In Gaul and in the Hispanic peninsula, Roman colonization progressively introduced new styles to regions that lay on the expanding frontiers, and made its impact on native production. Even in regions like Britain and Celtiberia, chauvinistically resistant to political domination, high-status imports were readily acquired by the local aristocracies, and new technology like the potter's wheel and lathe-turning of shale vessels was adopted by local craftsmen.

Over the two millennia that have been the subject of this study we would not expect that the role of Celtic art and art objects would remain unchanged. It seems unlikely that the one-size-fits-all principle will adequately explain the role of Celtic art in all quarters of Celtic Europe from the later Bronze Age to the early historic period. In Urnfield Central Europe and the west Hallstatt chiefdoms, it is probable that the repertory of high-status art objects was strictly controlled by an aristocratic or martial elite, while other forms of art objects were more widely understood, even though they may have been locally produced within a village or household. With the emergence of proto-state societies in parts of Europe in the immediately pre-Roman period we might anticipate from ethnographic analogy (Layton, 1991) that art objects imbued with ritual significance would have been in the custody of a restricted cabal that may also have exercised wider social authority. The Yoruba *Ogboni* evidently was a secret and highly selective organization that also mediated in disputes and imposed legal sanctions, a role that is also attributed to the Gaulish *druids* (Caesar, *de Bello Gallico* 6,

CONCLUSIONS

13). On the other hand, the beginnings of a market economy in Iron Age Europe heralded important changes in the nature of production and exchange that must have had the opposite effect of widening the currency of a number of everyday 'art' objects such as brooches or glass bracelets.

Later Celtic art need not be expected to conform consistently with the conventions of earlier Celtic art, since over a thousand years even the most conservative of traditions may be expected to change. In the case of later Insular Celtic art, there are striking innovations, like the almost total predominance of stone sculpture in 'Pictish' symbol art or the novel medium of manuscript art in the Early Christian era. But there are also significant underlying similarities in the various influences that combined to create this renaissance in Insular Celtic art, and in the social and cognitive forces that generated its finest material expressions. There are striking echoes in the genesis of later Celtic art of the factors that were undoubtedly contributory to the creation of the early La Tène phenomenon in north-alpine Europe. First, there is the catalyst of external, even long-distance contacts, resulting in the fusion of stylistic innovations with local traditions. In the early La Tène it was classical and orientaling influences, deconstructed and re-assembled, that transformed and transcended the prosaic styles of Urnfield and Hallstatt ornament. In the manuscript art of the Early Christian era, a fusion of exotic styles is equally evident, Germanic and Mediterranean as well as 'Ultimate La Tène'. In both instances, there needed also to be a compelling authority to generate and sustain these external links, and furthermore to establish an economic environment that could sustain a high level of specialist skills, one that could control the sources of supply and provide an effective milieu of production. In the earlier Iron Age, this was undoubtedly the paramount prince or princess within a hierarchical social order, an order in which the religious authority may have been as potent as the secular. In the early historic period, that authority, no less potent in its very different way, was the Christian Church, and in particular the monastic system. There is, of course, no guarantee that the concomitance of these factors will necessarily result in an efflorescence of artistic achievement, any more than one could re-create the European Enlightenment of the eighteenth and early nineteenth centuries simply by bringing together individuals of appropriate talent in circumstances that might superficially simulate the original. Not surprisingly, therefore, much of the area and period that we have designated Celtic is not characterized by these outstanding examples of artistic achievement, which does not mean that their more mundane products were any less Celtic.

Raymond Firth (1951a) argued that art was composed in a social setting, and had a context in a specific body of beliefs and values (Layton, 1991, 43). Celtic art was described by Ruth and Vincent Megaw (2001, 22) as 'shape-changing', referring to the ambiguity of interpretation that so often challenges the observer. This in itself was surely a reflection of the Celtic mindset, as revealed especially in later Irish and Welsh literature, in which there is no formal boundary between myth and reality, between this world and the Otherworld. Imbued with spiritual significance, it was to this extent a religious art. But it was also equally essentially a social and political art, and a medium through which identity could be asserted. In sum, Celtic art was fundamentally embedded in Celtic society, custom and belief.

BIBLIOGRAPHY

Abbreviations

AntJ	<i>Antiquaries Journal</i>
ArchJ	<i>Archaeological Journal</i>
BAR	<i>British Archaeological Reports</i>
BRGK	<i>Bericht der Römisch-Germanischen Kommission</i>
BSPF	<i>Bulletin de la Société Préhistorique Française</i>
CArch	<i>Current Archaeology</i>
CBA	<i>Council for British Archaeology</i>
EC	<i>Études Celtiques</i>
HBA	<i>Hamburger Beiträge zur Archäologie</i>
JRSAI	<i>Journal of the Royal Society of Antiquaries of Ireland</i>
MM	<i>Madriider Mitteilungen</i>
MSAC	<i>Mémoires de la Société Archéologique Champenoise</i>
PPS	<i>Proceedings of the Prehistoric Society</i>
PRIA	<i>Proceedings of the Royal Irish Academy</i>
PSAS	<i>Proceedings of the Society of Antiquaries of Scotland</i>
RGF	<i>Römisch-Germanische Forschungen</i>
RGZM	<i>Römisch-Germanischen Zentralmuseums in Mainz</i>
SALRR	<i>Society of Antiquaries of London Research Report</i>
UJA	<i>Ulster Journal of Archaeology</i>
WA	<i>World Archaeology</i>

- Adam, A-M. (2003) 'De l'imagerie hallstattienne aux décors laténiens: quelle filiations?', in O. Buchsenschutz *et al.* (eds) (2003): 27–36.
- Alberro, M. (2003) 'Celticisation of the Iberian Peninsula: A Process that Could Have Parallels in Other Regions', *EC*, XXXV: 7–24.
- Alcock, L. (1993) 'Image and Icon in Pictish Sculpture', in R. M. Spearman and J. Higgitt (eds) (1993): 230–6.
- Alcock, L. (2003) *Kings and Warriors, Craftsmen and Priests in Northern Britain AD 550–850*, Edinburgh, Society of Antiquaries of Scotland.
- Allen, D. (1971a) 'The Sark Hoard', *Archaeologia*, 103: 1–32.
- Allen, D. (1971b) 'The Ship on Gaulish Coins', *AntJ*, 51: 96–9.
- Allen, D. (1973) 'Temples or Shrines on Gaulish Coins', *AntJ*, 53: 71–4.
- Allen, D. (1976) 'Some Contrasts in Gaulish and British Coins', in P-M. Duval and C. F. C. Hawkes (eds) (1976) 265–80.

BIBLIOGRAPHY

- Allen, D. and Nash, D. (1980) *The Coins of the Ancient Celts*, Edinburgh, Edinburgh University Press.
- Allen, J. R. (1904) *Celtic Art in Pagan and Christian Times*, London, Methuen.
- Allen, J. R. and Anderson, J. (1903) *The Early Christian Monuments of Scotland*, Edinburgh, Society of Antiquaries of Scotland.
- Almagro-Gorbea, M. (1998) 'Signa Equitum de la Hispania Céltica', *Complutum*, 9: 101–15.
- Anderson, J. (1881) *Scotland in Early Christian Times*, Edinburgh, David Douglas.
- Arcelin, P. and Rapin, A. (2003) 'Considérations nouvelles sur l'iconographie anthropomorphe de l'âge du Fer en Gaule méditerranéenne', in O. Buchsenschutz *et al.* (eds) (2003): 183–219.
- Armit, I. (ed.) (1990) *Beyond the Brochs: Changing Perspectives on the Later Iron Age in Atlantic Scotland*, Edinburgh, Edinburgh University Press.
- Arnold, B. (1995) 'The Material Culture of Social Structure: Rank and Status in Early Iron Age Europe', in B. Arnold and B. Gibson (eds) (1995): 43–52.
- Arnold, B. and Gibson, B. (eds) (1995) *Celtic Chieftdom, Celtic State: The Evolution of Complex Social Systems in Prehistoric Europe*, Cambridge, Cambridge University Press.
- Atkinson, R. J. C. and Piggott, S. (1955) 'The Torrs Chamfrein', *Archaeologia*, 96: 197–235.
- Audouze, F. and Büchsenschütz, O. (1992) *Towns, Villages and Countryside of Celtic Europe*, London, Batsford.
- Aus'm Werth, E. (1870) 'Der Grabfund von Wald-Algesheim', *Fest-Programm zu Winckelmanns Geburtstag am 9. December 1870*, Bonn.
- Bacault, M. and Flouest, J.-L. (2003) 'Schémas de construction des décors au compas des phalères laténiennes de Champagne', in O. Buchsenschutz *et al.* (eds) (2003): 145–70.
- Barbet, A. (1991) 'Roquepertuse et la polychrome en Gaule méridionale à l'époque préromaine', *Documents d'archéologie méridionale*, 14: 53–81.
- Barrett, J. C., Freeman, P. W. M. and Woodward, A. (2000) *Cadbury Castle Somerset: The Later Prehistoric and Early Historic Archaeology*, London, English Heritage Archaeological Report, 20.
- Bartel, A., Frey, O.-H., Herrmann, F.-R., Kreuz, A. and Rösch, M. (1998) *Ein frühkeltischer Fürstengrabbügel am Glauberg im Wetteraukreis, Hessen: Bericht über die Forschungen 1994–1996*, Wiesbaden, Archäologischen Gesellschaft in Hessen, reprinted from Frey and Herrmann, 1997.
- Berrocal-Rangel, L. (1992) *Los Pueblos Celticos del Suroeste de la Peninsula Iberica*, Complutum Extra 2, Madrid, Dept. Prehistoria of Etnologia, Universidad Complutense de Madrid.
- Berrocal-Rangel, L. (1994) *El Altar Preromano del Castrejón de Capote: Ensayo Etno-Arqueológico de un Ritual Céltico en el Suroeste Peninsular*, Excavaciones Arqueológicas en Capote (Beturia Céltica) II, Universidad Autónoma de Madrid, Madrid.
- Bersu, G. (1945) *Das Wittnauer Horn im Kanton Aargau*, Monographien zur Ur- und Frühgeschichte der Schweiz, Basel, Birkhäuser.
- Biel, J. (1985) *Der Keltenfürst von Hochdorf*, Stuttgart, Theiss.
- Boardman, J., Brown, M. A., and Powell, T. G. E. (eds) (1971) *The European Community in Later Prehistory: Studies in Honour of C. F. C. Hawkes*, London, Routledge and Kegan Paul.
- Bonnamour, L. and Bulard, A. (1976) 'Une épée Celtique à fourreau décoré, découverte à Montbellel (Saône-et-Loire)', *Gallia*, 34: 279–84.
- Boon, G. C. and Savory, H. N. (1975) 'A Silver Trumpet-Brooch with Relief Decoration, Parcel-Gilt, from Carmarthen, and a Note on the Development of the Type', *AntJ*, 55: 41–61.
- Bosch-Gimpera, P. (1942) 'Two Celtic Waves in Spain', *Proceedings of the British Academy*, 26: 1–126.
- Bradley, R. (1998) *The Passage of Arms: An Archaeological Analysis of Prehistoric Hoard and Votive Deposits*, 2nd edn, Oxford, Oxbow.

BIBLIOGRAPHY

- Brailsford, J. W. (1975a) *Early Celtic Masterpieces from Britain in the British Museum*, London, British Museum.
- Brailsford, J. W. (1975b) 'The Polden Hill Hoard, Somerset', *PPS*, 41: 222–34.
- Brailsford, J. W. and Stapley, J. E. (1972) 'The Ipswich Torcs', *PPS*, 38: 219–34.
- Bretz-Mahler, D. (1971) *La Civilisation de La Tène I en Champagne: le faciès Marnien*, XXIIIe suppl. Gallia, Paris, CNRS.
- British Museum (1951) *Guide to the Antiquities of Roman Britain*, London, British Museum.
- Bruce-Mitford, R. (1987) 'Ireland and the Hanging-bowls – A Review', in M. Ryan (ed.) (1987): 30–9.
- Brun, P. and Chaume, B. (eds) (1997) *Vix et les éphémères principautés celtiques: Les VIe et Ve siècles avant J.-C. en Europe centre-occidentale*, Paris, Editions Errance.
- Brunaux, J.-L. (1988) *The Celtic Gauls: Gods, Rites and Sanctuaries*, London, Seaby.
- Brunaux, J.-L., Meniel, P. and Poplin, F. (1985) *Gournay I: Les fouilles sur le sanctuaire et l'oppidum (1975–1984)*, Revue archéologique de Picardie supplément, Amiens.
- Brunaux, J.-L. and Rapin, A. (1994) *Gournay II: Boucliers et lances, dépôts et trophées*, Paris, Éditions Errance.
- Buchsenschutz, O., Bulard, A., Chardenoux, M.-B. and Ginoux, N. (eds) (2003) *Décors, images et signes de l'âge du fer européen*, Actes du XXVIe Colloque de l'Association Française pour l'Étude de l'Âge du Fer, Paris and Saint-Denis, 9–12 mai 2002, Tours, FERACF.
- Burgess, C. (1969) 'The Later Bronze Age in the British Isles and North-western France', *ArchJ*, 125: 1–45.
- Burgess, C. (1974) 'The Bronze Age', in C. Renfrew (ed.) (1974): 165–257.
- Campbell, E. and Lane, A. (1993) 'Celtic and Germanic Interaction in Dalriada: the 7th-century Metal-working Site at Dunadd', in R. M. Spearman and J. Higgitt (eds) (1993): 52–63.
- Caulfield, S. (1977) 'The Beehive Quern in Ireland', *JRSAL*, 107: 104–38.
- Caulfield, S. (1978) 'Quern Replacement and the Origin of Brochs', *PSAS*, 109: 129–39.
- Caulfield, S. (1981) 'Some Celtic Problems in the Irish Iron Age', in Corráin D. Ó (ed.) (1981): 205–15.
- Champion, S. (1976) 'Coral in Europe: Commerce and Celtic Ornament', in P.-M. Duval and C. F. C. Hawkes (eds) (1976): 29–37.
- Champion, S. (1985) 'Production and Exchange in Early Iron Age Central Europe', in T. C. Champion and J. V. S. Megaw (eds) (1985): 133–60.
- Champion, T. C. and Megaw, J. V. S. (eds) (1985) *Settlement and Society: Aspects of West European Prehistory in the First Millennium BC*, Leicester, Leicester University Press.
- Champion, M. (1992) *The Celts: The Construction of a Myth*, New York, St Martins Press.
- Charlesworth, M. P. and Knowles, M. D. (eds) (1952) *The Heritage of Early Britain*, London, Bell.
- Charpy, J.-J. (1991) 'Les situles du Ve siècle en Champagne: formes et décors', in R. Neiss, J.-J. Charpy and A. Patroin (eds) (1991): 41–57.
- Charpy, J.-J. (ed.) (1995) *L'Europe Celtique du Ve au IIIe siècle avant J.-C.: contacts, échanges et mouvements de population; actes du deuxième Symposium d'Hautvillers 8–10 octobre 1992*, MSAC, 9, Kronos BY Editions.
- Childe, V. G. (1930) *The Bronze Age*, Cambridge, Cambridge University Press.
- Clapham, A. (1934) 'Notes on the Origins of Hiberno-Saxon Art', *Antiquity*, 8: 43–57.
- Clarke, R. R. (1954) 'The Early Iron Age Treasure from Snettisham, Norfolk', *PPS*, 20: 27–86.
- Clarke, R. R. and Hawkes, C. F. C. (1955). 'An Iron Anthropoid Sword from Shouldham, Norfolk, with Related Continental and British Weapons', *PPS*, 21: 198–227.
- Cliquet, D., Remy-Watte, M., Guichard, V. and Vaginay, M. (eds) (1993) *Les Celtes en Normandie: Les Rites Funéraires en Gaule (IIIème-Ier siècle avant J.-C.)*, Actes du 14ème colloque de l'Association Française pour l'Étude de l'Âge du Fer, Evreux, mai 1990, Revue Archéologique de l'Ouest, suppl. 6.
- Close-Brooks, J. (1986) 'Excavations at Clatchard Craig, Fife', *PSAS*, 116: 117–84.

BIBLIOGRAPHY

- Coles, J. M. (1962) 'European Bronze Age Shields', *PPS*, 28: 156–90.
- Coles, J. M., Leach, P., Minnitt, S. C., Tabor, R. and Wilson, A. S. (1999) 'A Late Bronze Age Shield from South Cadbury, Somerset, England', *Antiquity*, 73: 33–48.
- Collis, J. (2003) *The Celts, Origins, Myths, Inventions*, Stroud, Tempus.
- Cone, P. (ed.) (1977) *Treasures of Early Irish Art 1500 B.C. to 1500 A.D.*, New York, Metropolitan Museum of Art.
- Corder, P. and Hawkes, C. F. C. (1940) 'A Panel of Celtic Ornament from Elmswell, East Yorkshire', *Antf*, 20: 338–57.
- Corradini, N. (1991) 'La céramique peinte à décor curviligne rouge et noir en Champagne: approche technologique et chronologique', in R. Neiss, J.-J. Charpy and A. Patrolin (eds) (1991): 109–42.
- Cotter, C. (1992) 'Western Stone Fort Project Interim Report', *Discovery Programme Reports 1, Project Results 1992, 1993*, Dublin, Royal Irish Academy, 1–19.
- Cotter, C. (1993) 'Western Stone Fort Project Interim Report', *Discovery Programme Reports 2, Project Results 1993, 1995*, Dublin, Royal Irish Academy, 1–11.
- Cotter, C. (1994) 'Western Stone Fort Project Interim Report', *Discovery Programme Reports 4, Project Results and Reports 1994, 1996*, Dublin, Royal Irish Academy, 1–14.
- Cowen, J. D. (1967) 'The Hallstatt Sword of Bronze: on the Continent and in Britain', *PPS*, 33, 377–454.
- Cunliffe, B. W. (1984) *Danebury: An Iron Age hillfort in Hampshire*. Vol. 1, *The Excavations, 1969–1978: The Site*. London, CBA Research Report No. 52.
- Cunliffe, B. W. (1994) *The Oxford Illustrated Prehistory of Europe*, Oxford, Oxford University Press.
- Cunliffe, B. W. (2005) *Iron Age Communities in Britain*, 4th edn, London, Routledge.
- Cunliffe, B. W. and Poole, C. (1991) *Danebury: An Iron Age hillfort in Hampshire*. Vol. 5, *The Excavations, 1979–1988: The Finds*, London, CBA Research Report No. 73.
- Déchelette, J. (1914) *Manuel d'Archéologie préhistorique, celtique et gallo-romaine, II, Archéologie Celtique ou Protobistorique, 3e partie, Second âge du fer ou époque de la Tène*, Paris, Picard et fils.
- Dechezleprêtre, T., Cousyn, P., Léon, G., Paez-Rezende, L. and Rougier, R. (2000) 'Architecture des bâtiments de l'âge du fer en Haute-Normandie', in S. Marion and G. Blancquaert (eds) (2000): 321–38.
- Dedet, B., Gruat, P., Marchand, G., Py, M. and Schwaller, M. (eds) (2000) *Archéologie de la Mort: Archéologie de la Tombe au Premier Âge du Fer*, Monographies d'Archéologie Méditerranéenne 5, CNRS, Lattes.
- Degen, R., Drack, W. and Wyss, R. (eds) (1966) *Helvetia Antiqua. Festschrift für Emil Vogt*, Zürich, Schweizerisches Landesmuseum, Conzett & Huber.
- Dehn, W. (1961) 'Zangentore an spätkeltischen Oppida', *Památky Archeologické*, 52: 390–6.
- Dehn, W. (1962) 'Aperçu sur les oppida d'Allemagne à la fin de l'époque celtique', *Celticum*, 9: 77–89.
- de Navarro, J. M. (1952) 'The Celts in Britain and their Art', in M. P. Charlesworth and M. D. Knowles (eds) (1952): 56–82.
- de Navarro, J. M. (1955) 'A Doctor's Grave of the Middle La Tène Period from Bavaria', *PPS*, 21: 231–48.
- de Navarro, J. M. (1966) 'Swords and Scabbards of the La Tène Period with Incised Laddering', in R. Degen, W. Drack and R. Wyss (eds) (1966): 147–54.
- de Navarro, J. M. (1972) *The Finds from the Site of La Tène*, Vol. 1, *Scabbards and the Swords Found in Them*, London, British Academy, Oxford University Press.
- Dent, J. S. (1990) 'Changes in the Later Iron Age of East Yorkshire', in A. Duval, J.-P. Le Bihan and Y. Menez (eds) (1990): 223–31.
- Desenne, S. (2003) 'Décryptage d'un mode d'expression de la culture Aisne-Marne: élaboration d'une grille de lecture du décors céramique', in O. Buchsenschutz *et al.* (eds) (2003): 63–76.

BIBLIOGRAPHY

- Dietler, M. (1990) 'Driven by Drink: The Role of Drinking in the Political Economy and the Case of Early Iron Age France', *Journal of Anthropological Archaeology*, 9: 352–406.
- Dobiat, C. (ed.) (1994) *Festschrift für Otto-Herman Frey zum 65. Geburtstag*, Marburger Studien zur Vor- und Frühgeschichte, 16, Hitzeroth.
- Drack, W. (1955) 'Ein Mittelatèneschwert mit drei Goldmarken von Böttstein (Aargau)', *Zeitschrift für Schweizerische Archäologie und Kunstgeschichte*, 15, 1954–55: 193–235.
- Dronfield, J. (1995) 'Subjective Vision and the Source of Irish Megalithic Art', *Antiquity*, 69: 539–49.
- Duceppe-Lamarre, A. (2003) 'Les monstres caches de La Tène moyenne dans le Bassin des Carpates', in O. Buchsenschutz *et al.* (eds) (2003): 237–46.
- Duignan, M. (1976) 'The Turoe Stone: its Place in Insular La Tène Art', in P.-M. Duval and C. F. C. Hawkes (eds) (1976): 201–12.
- Duval, A. and Blanchet, J. C. (1974) 'La tombe à char d'Attichy (Oise)', *BSPF*, 71: 401–8.
- Duval, A. and Heude, D. (eds) (1984) *L'Art Celtique en Gaule*, Paris, Ministère de la Culture Direction de Musées de France.
- Duval, A., Le Bihan, J. P. and Menez, Y. (eds) (1990) *Les Gaulois d'Armorique: la fin de l'Age du Fer en Europe tempérée: Actes du XII^e Colloque de l'Association Française pour l'Etude de l'Age du Fer, Quimper, 1988, Revue Archéologique de l'Ouest, Supp. 3*, Quimper, Association pour la Diffusion des Recherches archéologiques dans l'Ouest de la France.
- Duval, P.-M. (1976) 'Matériaux pour l'étude stylistique des monnaies celtiques', in P.-M. Duval and C. F. C. Hawkes (eds) (1976): 247–63.
- Duval, P.-M. (1977) *Les Celtes*, Paris: Éditions Gallimard.
- Duval, P.-M. and Hawkes, C. F. C. (eds) (1976) *Celtic Art in Ancient Europe: Five Protobhistoric Centuries*, London, Seminar Press.
- Duval, P.-M. and Kruta, V. (eds) (1979) *Les Mouvements celtiques du Ve au Ier siècle avant notre ère*, Paris, CNRS.
- Duval, P.-M. and Kruta, V. (eds) (1982) *L'Art Celtique de la Période d'Expansion: I^{er} et III^e siècle avant notre ère*, Paris, Librairie Droz.
- Duval, P.-M. and Kruta, V. (1986) 'Le fourreau Celtique de Cernon-sur-Cooles (Marne) I. Analyse et description', *Gallia*, 44: 1–27.
- Echt, R. (1999) *Das Fürsttengrabb von Reinheim. Studien zur Kulturgeschichte der Früh-La-Tène-Zeit*, Saarbrücker Beiträge zur Altermskunde, Band 69, Bonn, Habelt.
- Egg, M. (1996) *Das Hallstattzeitliche Fürstengrabb von Strettweg bei Judenburg in der Obersteiermark*, Mainz, RGZM Monographien Band 37/ Bonn, Habelt.
- Eggert, M. (1989) 'Die "Fürstentitze" der Späthallstattzeit: Bemerkungen zu einem archäologischen Konstrukt', in H. Lüdtke, F. Lüth and F. Laux (eds) (1989): 53–66.
- Eggert, M. (1997) 'Le concept de "Fürstentitze" et autres problèmes d'interprétation: annotations sur le "phénomène princier" du Hallstatt final', in P. Brun and B. Chaume (eds) (1997): 287–94.
- Eogan, G. (1964) 'The Later Bronze Age in Ireland in the Light of Recent Research', *PPS*, 30: 268–351.
- Eogan, G. (1974) 'Regionale Gruppierungen in der spätbronzezeit Irlands', *Archäologische Korrespondenzblatt*, 4: 319–27.
- Evans, A. J. (1890) 'On a Late-Celtic Urn-field at Aylesford, Kent', *Archaeologia*, 52: 315–88.
- Evans, D. (2006) 'Celtic Art Revealed: The South Cave Weapons Hoard', *CArch*, 203: 572–7.
- Favret, C. (1950) 'La nécropole gauloise de Villeseneux', *BSPF*, 433–48.
- Fichtl, S. (2000) *La ville celtique: les oppida de 150 av. J.-C. à 15 ap. J.-C.*, Paris, Éditions Errance.
- Field, N. and Parker Pearson, M. (2003) *Fiskerton: An Iron Age Timber Causeway with Iron Age and Roman Votive Offerings: The 1981 Excavations*, Oxford, Oxbow Books.
- Filip, J. (1956) *Keltové ve Střední Evropě*, Monumenta Archaeologia V, Prague, Nakladatelství Československé Akademie Věd.

BIBLIOGRAPHY

- Firth, R. (1951a) 'The Social Framework of Primitive Art', in R. Firth (ed.) (1951b): 155–82.
- Firth, R. (ed.) (1951b) *Elements of Social Organization*, London, Watts.
- Fischer, F. (1988) 'Celtés et Achéménides', in J.-P. Mohen, A. Duval and C. Eluère (eds) (1988): 21–32.
- Fischer, F. (1995) 'The Early Celts of West Central Europe: The Semantics of Social Structure', in B. Arnold and B. Gibson (eds) (1995): 34–40.
- Fitz, J. and Farkas, Z. (eds) (1975) *The Celts in Central Europe: Papers of the II Pannonia Conference, Székesfehérvár 1974*, Székesfehérvár, István Király Múzeum.
- Fitzpatrick, A. (1985) 'The Distribution of Dressel 1 Amphorae in North-West Europe', *Oxford Journal of Archaeology*, 4(3): 305–40.
- Fox, A. and Pollard, S. (1973) 'A Decorated Bronze Mirror from an Iron Age Settlement at Holcombe, near Uplyme, Devon', *AntJ*, 53: 16–41.
- Fox, C. (1938) *The Personality of Britain*, 3rd edn, Cardiff, National Museum of Wales.
- Fox, C. (1946) *A Find of the Early Iron Age from Llyn Cerrig Bach, Anglesey*, Cardiff, National Museum of Wales.
- Fox, C. (1958) *Pattern and Purpose: A Survey of Early Celtic Art in Britain*, Cardiff, National Museum of Wales.
- Frankenstein, S. and Rowlands, M. (1978) 'The Internal Structure and Regional Context of Early Iron Age Society in Southwest Germany', *Bulletin of the London University Institute of Archaeology*, 15: 73–112.
- Frey, S. S. (ed.) (1961) *Problems of the Iron Age in Southern Britain*, London, University of London Institute of Archaeology Occasional Paper No. 11.
- Frey, O.-H. (1955) 'Au Musée de Besançon I: Eine etruskische Bronzeschnabelkanne', *Annales Littéraires de l'Université de Besançon*, 2e Série, Tome II, fasc. 1, Archéologie, 2.
- Frey, O.-H. (1971) 'Die Goldschale von Schwarzenbach', *HBA*, 1 (2): 85–100.
- Frey, O.-H. (1972) 'Einführung in die Problematik "Hallstatt D3- LaTène A"', *HBA*, 2 (2): 169–79.
- Frey, O.-H. (1974) 'Akanthusornament in der keltischen Kunst', *HBA*, 4: 141–57.
- Frey, O.-H. (1976) 'Du Premier style au Style de Waldalgesheim. Remarques sur l'évolution de l'art celtique ancien', in P.-M. Duval and C. F. C. Hawkes (eds) (1976): 141–59.
- Frey, O.-H. (1980) 'Die keltische Kunst', in *Die Kelten in Mitteleuropa. Kultur, Kunst, Wirtschaft*, Salzburg, Amt der Salzburger Landesregierung, 76–92.
- Frey, O.-H. (1995a) 'Das Grab von Waldalgesheim. Eine Stilphase des keltischen Kunsthandwerks', in H.-E. Joachim (1995): 159–206.
- Frey, O.-H. (1995b) 'The Celts in Italy', in M. J. Green (ed.) (1995): 515–32.
- Frey, O.-H. (1998) 'The Stone Knight, the Sphinx and the Hare: New Aspects of Early Figural Celtic Art', *PPS*, 64: 1–14.
- Frey, O.-H. (2004) 'A New Approach to Early Celtic Art', *PRIA*, 104C, 5: 107–29.
- Frey, O.-H. and Herrmann, F.-R. (1997) 'Ein frühkeltischer Fürstengrabhügel am Glauberg im Wetteraukreis, Hessen. Bericht über die Forschungen 1994–1996', *Germania*, 75: 459–550.
- Frey, O.-H. and Megaw, J. V. S. (1976) 'Palmette and Circle: Early Celtic Art in Britain and its Continental Background', *PPS*, 42: 47–66.
- Frey, O.-H. and Schwappach, F. (1973) 'Studies in Early Celtic Design', *WA*, 4 (3): 339–56.
- Friell, J. G. P. and Watson, W. G. (eds) (1984) *Pictish Studies: Settlement, Burial and Art in Dark Age Northern Britain*, Oxford, BAR Brit. Ser. 125.
- Gallus, S. (1934) *A Soproni Burgstall alakos urná/Die figuralverzierten Urnen vom Soproner Burgstall*, Budapest, Archaeologia Hungarica 13, Magyar Nemzeti Múzeum.
- Gillies, W. (1979) 'The Craftsman in Early Celtic Literature', *Scottish Archaeological Forum*, (1981) 11: 70–85.
- Gillies, W. and Harding, D. W. (eds) (2005) *Celtic Connections*. Vol. 2, *Archaeology, Numismatics*

BIBLIOGRAPHY

- and Historical Linguistics, Papers from the Tenth International Congress of Celtic Studies, Edinburgh, 1995*, Edinburgh, University of Edinburgh Archaeology Monograph Series No. 2.
- Ginoux, N. (1995) 'Lyres et dragons, nouvelles données pour l'analyse d'un des principaux thèmes ornementaux des fourreaux laténiens', in J. J. Charpy (ed.) (1995): 405–12.
- Gomez, J. and Mohen, J. P. (1981) 'Les plus vieux objets en fer de France', in R. Pleiner (1981a): 53–6.
- Gomez de Soto, J. (1996) *Grotte des Perrats à Agris (Charente): 1981–1994: étude préliminaire*, Chauvigny, Association des publications chauvinoises.
- Gomez de Soto, J. (2003) 'Oiseaux, chevaux, homes et autres images. Les "signes" sur céramique en Gaule, du Ha A2/B1 au Ha D. Genèse, apogée, décadence et postérité,' in O. Buchsenschutz *et al.* (eds) (2003): 11–25.
- Graue, J. (1974) *Die Gräberfelder von Ornavasso. Eine Studie zur Chronologie der späten Latène- und frühen Kaiserzeit*, HBA, Beiheft 1, Hamburg, Helmut Buske.
- Green, M. J. (1989) *Symbol and Image in Celtic Religious Art*, London, Routledge.
- Green, M. J. (ed.) (1995) *The Celtic World*, London, Routledge.
- Grogan, E. (1994) 'Excavations at Mooghaun South 1994 Interim Report', *Discovery Programme Reports 4, Project Results and Reports 1994*, 1996, Dublin, Royal Irish Academy, 47–57.
- Guichard, V. (2003) 'Un dernier moment de folie créatrice: le répertoire ornemental de la céramique dans le nord-est du Massif central au II^e siècle avant J.-C.', in O. Buchsenschutz *et al.* (eds) (2003): 91–112.
- Guido, M. (1978) *The Glass Beads of the Prehistoric and Roman Periods in Britain and Ireland*, SALRR No 35, London, Thames and Hudson.
- Guilaine, J. (1972) *L'Age du Bronze en Languedoc occidental, Roussillon, Ariège*, Paris, Klincksieck.
- Guilaine, J. and Py, M. (2000) 'Le Sud de la Gaule et les relations méditerranéennes et occidentales (1000/500)', in T. Janin (ed.) (2000): 415–32.
- Guillaumet, J-P. (2003) 'Les personnages accroupis: essai de classement', in O. Buchsenschutz *et al.* (eds) (2003): 171–82.
- Guilmann, J. (1993) 'An Analysis of Some Ornamental Patterns in Hiberno-Saxon Manuscript Illumination', in R. M. Spearman and J. Higgitt (eds) (1993): 92–103.
- Haffner, A. (1969) 'Das Trevere-Gräberfeld mit Wagenbestattungen von Hoppstädten-Weiersbach, Kreis Birkenfeld', *Trierer Zeitschrift*, 32: 71–127.
- Haffner, A. (1976) *Die Westliche Hunsrück-Eifel-Kultur*, Römisch-Germanische Forschungen, vol. 36, Berlin, de Gruyter.
- Haffner, A. (1979) 'Die frühlatènezeitlichen Goldscheiben vom Typ Weiskirchen', *Festschrift 100 Jahre Rheinisches Landesmuseum Trier, Beiträge zur Archäologie und Kunst des Triere Landes, Trierer Grabungen und Forschungen*, 14, Trier, 281–96.
- Haffner, A. (1991) 'The Princely Tombs of the Celts in the Middle Rhineland', in S. Moscati *et al.* (eds) (1991): 155–62.
- Harbison, P. (1999) *The Golden Age of Irish Art: The Medieval Achievement 600–1200*, London, Thames and Hudson.
- Harding, A. (1994) 'Reformation in Barbarian Europe, 1300–600 BC', in B. Cunliffe (ed.) (1994): 304–35.
- Harding, A. (2000) *European Societies in the Bronze Age*, Cambridge, Cambridge University Press.
- Harding, D. W. (1972) *The Iron Age in the Upper Thames Basin*, Oxford, Clarendon Press.
- Harding, D. W. (ed.) (1976) *Hillforts: Later Prehistoric Earthworks in Britain and Ireland*, London, Academic Press.
- Harding, D. W. (2002) 'Torrns and the Early La Tène Ornamental Style in Britain and Ireland', in B. B. Smith and I. Banks (eds) (2002): 191–204.
- Harding, D. W. (2004) *The Iron Age in Northern Britain: Celts and Romans, Natives and Invaders*, London, Routledge.

BIBLIOGRAPHY

- Harding, D. W. and Gillies, W. (2005) 'Introduction: Archaeology and Celticity', in W. Gillies and D. W. Harding (eds) (2005): 1–14.
- Harding, D. W. and Gilmour, S. M. D. (2000) *The Iron Age Settlement at Beirgh, Riof, Isle of Lewis: Excavations 1985–95*, Vol. 1, *The Structures and Stratigraphy*, Edinburgh, Edinburgh University Department of Archaeology, Calanais Research Series 1.
- Härke, H. (1979) *Settlement Types and Patterns in the West Hallstatt Province*, Oxford, BAR International Series, 57.
- Hartmann, A. (1970) *Prähistorische Goldfunde aus Europa: Studien zu den Anfängen der Metallurgie*, Band 3, Berlin, Mann.
- Hatt, J.-J. and Roualet, P. (1977) 'La Chronologie de La Tène en Champagne', *Revue Archéologique de l'Est et du Centre-Est*, XXVIII: 7–36.
- Hawkes, C. F. C. (1931) 'Hill Forts', *Antiquity*, 5: 60–97.
- Hawkes, C. F. C. (1982) 'The Wearing of the Brooch: Early Iron Age Dress among the Irish', in B. G. Scott (ed.) (1982): 51–73.
- Hawkes, C. F. C. and Dunning, G. C. (1930) 'The Belgae of Gaul and Britain', *ArchJ*, 87: 150–335.
- Hawkes, C. F. C., and Smith, M. A. (1957) 'On Some Buckets and Cauldrons of the Bronze and Early Iron Ages', *AntJ*, 37: 131–98.
- Heald, A. (2001) 'Knobbed Spearbutts of the British and Irish Iron Age: New Examples and New Thoughts', *Antiquity*, 75: 689–96.
- Hencken, H. (1971) *The Earliest European Helmets, Bronze Age and Early Iron Age*, Cambridge, MA, American School of Prehistoric Research, Peabody Museum.
- Henderson, G. (1987) *From Durrow to Kells: The Insular Gospel-books 650–800*, London, Thames and Hudson.
- Henderson, G. and Henderson, I. (2004) *The Art of the Picts*, London, Thames and Hudson.
- Henderson, I. (1987) 'Early Christian Monuments of Scotland Displaying Crosses But No Other Ornament', in A. Small (ed.) (1987): 45–58.
- Henry, F. (1965) *Irish Art in the Early Christian Period (to 800 AD)*, London, Methuen.
- Henry, F. (1967) *Irish Art during the Viking Invasions, 800–1020 AD*, London, Methuen.
- Henry, F. (1970) *Irish Art in the Romanesque Period (1020–1170 AD)*, London, Methuen.
- Herrmann, F.-R. (1998) 'Die steinernen Statuen', in A. Bartel *et al.* (1998): 20–31.
- Herrmann, F.-R. and Frey, O.-H. (1996) *Die Keltenfürsten vom Glauberg*, Wiesbaden, Archäologische Denkmäler in Hessen, 128/129.
- Hicks, C. (1993) 'The Pictish Class 1 Animals', in R. M. Spearman and J. Higgitt (eds) (1993): 196–202.
- Höck, M. and Coelho, L. (1985) 'Verzierte Bauteile aus Castros', *MM*, 26, 243–56.
- Hodson, F. R. (1968) *The La Tène Cemetery at Münsingen-Rain: Catalogue and Relative Chronology*, Acta Bernensia, V, Bern, Stämpfli & Cie.
- Hodson, F. R. (1990) *Hallstatt: The Ramsauer Graves, Quantification and Analysis*, Bonn, Habelt.
- Hull, M. R. and Hawkes, C. F. C. (1987) *Corpus of Ancient Brooches in Britain*, Oxford, BAR British Series 168.
- Hunter, J. R. (1990) 'Pool, Sanday: A Case Study for the Later Iron Age and Viking Periods', in I. Armit (ed.) (1990): 175–93.
- Jackson, K. H. (1955) 'The Pictish Language', in F. T. Wainwright (ed.) (1955): 129–66.
- Jackson, K. H. (1964) *The Oldest Irish Tradition: A Window on the Iron Age*, Cambridge, Cambridge University Press.
- Jacobsthal, P. (1944) *Early Celtic Art*, 2 vols, Oxford, Clarendon Press.
- Jacobsthal, P. and Langsdorff, A. (1929) *Die Bronzeschnabelkannen: ein Beitrag zur Geschichte des Vorrömischen Imports nördlich der Alpen*, Römisch-Germanische Forschungen 14, Berlin, Deutsches Archäologisches Institut, Römisch-Germanische Kommission.
- Jahier, I., Besnard-Vauterin, C., Lepaumier, H., Paris, P., Renault, V., San Juan, G., Dron,

BIBLIOGRAPHY

- J-L., Hincker, V. and Forfait, N. (2000) 'Les bâtiments des habitats de l'âge du Fer en Basse-Normandie: panorama des découvertes', in S. Marion and G. Blancquaert (eds) (2000): 339–57.
- Janin, T. (ed.) (2000) *Mailbac et le Premier Âge du Fer en Europe Occidentale, Hommages à Odette et Jean Taffanel*, Monographies d'Archéologie Méditerranéenne 7, CNRS, Lattes.
- Janin, T. and Chardenon, N. (2000) 'L'évolution des pratiques funéraires du Mailhacien et Grand Bassin I (IXe-VIIIe s. av. n. è)', in B. Dedet *et al.* (eds) (2000): 59–64.
- Jesson, M. and Hill, D. (eds) (1971) *The Iron Age and its Hill-Forts: Papers Presented to Sir Mortimer Wheeler*, Southampton, University of Southampton Monograph Series No. 1.
- Joachim, H-E. (1968) *Die Hunsrück-Eifel-Kultur am Mittelrhein*, Köln, Böhlau.
- Joachim, H-E. (1979) 'Die frühlatènezeitlichen Wagengräber von Mühlheim-Kärlich, Kr. Mayen-Koblenz', *Beiträge zur Urgeschichte des Rheinlandes III*, 507–56.
- Joachim, H-E. (1995) *Waldalgesheim. Das Grab einer keltischen Fürstin*, Katalogue des Rheinischen Landesmuseum, Bonn, vol. 3, Bonn, Habelt.
- Jope, E. M. (1954a) 'An Iron Age Decorated Sword-Scabbard from the River Bann at Toome', *UJA*, 17: 81–91.
- Jope, E. M. (1954b) 'The Keshcarrigan Bowl and a Bronze Mirror Handle from Ballymoney', *UJA*, 17: 92–6.
- Jope, E. M. (1961a) 'The Beginnings of the La Tène Ornamental Style in the British Isles', in S. S. Frere (ed.) (1961): 69–83.
- Jope, E. M. (1961b) 'Daggers of the Early Iron Age in Britain', *PPS*, 27: 307–43.
- Jope, E. M. (1971a) 'The Waldalgesheim Master', in J. Boardman, M. A. Brown and T. G. E. Powell (eds) (1971): 165–80.
- Jope, E. M. (1971b) 'The Witham Shield', in G. Sieveking de (ed.) (1971): 61–8.
- Jope, E. M. (1974) 'Iron Age Dagger- and Sword-Chape Construction: Technology, Taxonomy and Prehistory', *Irish Archaeological Research Forum*, 1: 1–8.
- Jope, E. M. (1976) 'The Wandsworth Mask Shield and its European Stylistic Sources of Inspiration', in P-M. Duval and C. F. C. Hawkes (1976): 167–84.
- Jope, E. M. (1978) 'The Southward Face of Celtic Britain, 300 B.C.–A.D. 50: Four British Parade Shields', *Accademia Nazionale dei Lincei*, 237: 27–36.
- Jope, E. M. (1983) 'Torr's, Aylesford and the Padstow Hobby-Horse', in A. O'Connor and D. V. Clarke (eds) (1983): 149–59.
- Jope, E. M. (2000) *Early Celtic Art in the British Isles*, Oxford, Clarendon Press.
- Keeley, L. H. (1996) *War before Civilization*, Oxford, Oxford University Press.
- Keller, F. (1858) 'Pfahlbauten 2. Bericht', *Mitteilungen der Antiquarischen Gesellschaft in Zürich*, 12 (116): 151ff.
- Keller, J. (1965) *Das Keltische Fürstengrab von Reinheim I, Ausgrabungsbericht und Katalog der Funde*, Bonn, RGZM/Habelt.
- Kilbride-Jones, H. (1980) *Zoomorphic Penannular Brooches*, SALRR XXXIX, London, Thames and Hudson.
- Kimmig, W. (1969) 'Zum Problem späthallstädtischer Adelsitze', in K-H. Otto and J. Hermann (eds) (1969): 95–113.
- Kimmig, W. (1988) *Das Kleinaspergle. Studien zu einem Fürstengrabhügel der frühen Latènezeit bei Stuttgart*, Forschungen und Berichte zur Vor- und Frühgeschichte in Baden-Württemberg, Band 30, Stuttgart, Theiss.
- Kimmig, W. (1992) *Die 'Wasserburg Buchau' eine spätbronzezeitliche Siedlung* Materialhefte Vor- und Frühgeschichte in Baden-Württemberg, Heft 16, Stuttgart, Theiss.
- Klindt-Jensen, O. (1953) *Bronzekedelen fra Brå*, Aarhus, Aarhus University Press.
- Klindt-Jensen, O. (1961) *Gundestrup Kedelen*, Copenhagen, National Museum.
- Kossack, G. (1959) *Südbayern während der Hallstattzeit*, RGF, Band 24, Berlin, de Gruyter.

BIBLIOGRAPHY

- Kristiansen, K. and Jensen, J. (eds) (1994) *Europe in the First Millennium B.C.*, Sheffield, Sheffield Archaeological Monographs 6, Collis.
- Kroeber, A. L. (ed.) (1953) *Anthropology Today: An Encyclopaedic Inventory*, Chicago, Chicago University Press.
- Kruta, V. (1971) *Le trésor de Duchcov dans les collections tchécoslovaques*, Ústi nad Labem, Severoceske Nakladatelství.
- Kruta, V. (1975) *L'Art celtique en Bobême: les parures métalliques du Ve au IIe siècle avant notre ère*, Paris, Librairie Honoré Champion.
- Kruta, V. (1991a) 'The First Celtic Expansion: Prehistory to History', in S. Moscati, *et al.* (eds) (1991): 195–213.
- Kruta, V. (1991b) 'La céramique peinte de la Champagne dans le contexte de l'art celtique du IVe siècle avant J.-C.', in R. Neiss, J.-J. Charpy and A. Patrocin (eds) (1991): 143–57.
- Kruta, V. (2004) *Celts*, London, Hachette.
- Kruta, V., Lambert, B., Lardy, J.-M. and Rapin, A. (1984) 'Les fourreaux d'Épiais-Rhus (Val-d'Oise) et de Saint-Germainmont (Ardennes) et l'art celtique du IVe siècle av. J.-C.', *Gallia*, 42: 1–20.
- Kruta, V. and Roualet, P. (1982) 'Une série de torques marniens à décor de style végétal continu', in P.-M. Duval and V. Kruta (eds) (1982): 115–35.
- Kruta, V. and Szabó, M. (1982) 'Canthares danubiens du IIIe siècle avant notre ère: un exemple d'influence hellénistique sur les Celtes orientaux', *EC*, 19: 51–67.
- Lafage, F., Auxiette, G., Brunet, P., Martial, E., Matteredne, V., with Praud, I. and LaPlantine, N. (2006) 'Premiers tentatives d'interprétations spatiales d'un site rural du Bronze final à Changis-sur-Marne (Seine-et-Marne)', *BSPF*, 103 (2): 323–77.
- Lane, A. and Campbell, E. (2000) *Dunadd: An Early Dalriadic Capital*, Oxford, Oxbow Books.
- Layton, R. (1991) *The Anthropology of Art*, 2nd edn. Cambridge, Cambridge University Press.
- Lejars, Th. (1994) *Gournay III: Les fourreaux d'épée: le sanctuaire de Gournay-sur-Aronde et l'armement des Celtes de la Tène*, Paris, Éditions Errance.
- Lenez-de Wilde, M. (1991) *Iberia Celtica. Archäologische Zeugnisse Keltischer Kultur auf der Pyrenäenhalbinsel*, Stuttgart, Steiner.
- Lenez-de Wilde, M. (1995) 'The Celts in Spain', in M. J. Green (ed.) (1995): 533–51.
- Lorrio, A. J. (1997) *Los Celtíberos*, Alicante, Universidad de Alicante, Universidad Complutense de Madrid.
- Louis, M., Taffanel, O. and Taffanel, J. (1955; 1958; 1960) *Le Premier Age du Fer languedocien, pt 1 Les habitats, pt 2 Les necropolis à incineration, pt 3 Les tumulus, Conclusions*, Montpellier, Bordighera.
- Lourdoux-Juriotti, S. (2003) 'L'utilisation du corail sur le casque de la grotte des Perrats à Agris' (Charente)', in O. Buchsenschutz *et al.* (eds) (2003): 113–20.
- Lüdtke, H., Lüth, F. and Laux, F. (eds) (1989) *Archäologischer Befund und historische Deutung: Festschrift für Wolfgang Hübener. Hammaburg*, n.s. 9, Neumünster, Wachholtz.
- MacGregor, M. (1962) 'The Early Iron Age Metal-work Hoard from Stanwick, N. R. Yorks, England', *PPS*, 28: 17–57.
- MacGregor, M. (1976) *Early Celtic Art in North Britain*, Leicester: Leicester University Press.
- Mack, R. P. (1975) *The Coinage of Ancient Britain*, 3rd edn, London, Spink.
- MacKie, E. W. (1995) 'The Early Celts in Scotland', in M. J. Green (ed.) (1995): 654–70.
- Maluquer de Motes, J. (1954) *El Yacimiento Hallstático de Cortes de Navarra I*, Pamplona, Institución Príncipe de Viana.
- Maluquer de Motes, J. (1958) *El Yacimiento Hallstático de Cortes de Navarra II*, Pamplona, Institución Príncipe de Viana.
- Mariën, M.-E. (1958) *Trouvailles du Champ d'Urnes et des Tombelles hallstattiennes de Court-Saint-Etienne*, Bruxelles, Musées Royaux d'Art et d'Histoire.
- Marion, S. and Blancquaert, G. (eds) (2000) *Les Installations agricoles de l'âge du fer en France*

BIBLIOGRAPHY

- Septentrionale*, Études d'histoire et d'archéologie 6, École Normale Supérieure, Colloque 1997, Paris, Éditions Rue d'Ulm.
- Megaw, J. V. S. (1970a) *Art of the European Iron Age*, Bath, Adams and Dart.
- Megaw, J. V. S. (1970b) 'Cheshire Cat and Mickey Mouse: Analysis, Interpretation and the Art of the La Tène Iron Age', *PPS*, 35: 261–79.
- Megaw, J. V. S. (1972) 'Style and Style Groupings in Continental Early La Tène Art', *WA*, 3 (3): 276–92.
- Megaw, J. V. S. (1973) 'The Decorated Sword-Scabbards of Iron from Cernon-sur-Coole (Marne) and Drňa, Rimavska Sobota (Slovakia)', *HBA*, 3: 119–37.
- Megaw, J. V. S. (1975) 'The Orientalising Theme in Early Celtic Art: East or West?', in J. Fitz and Z. Farkas (eds) (1975): 15–33.
- Megaw, J. V. S. (1982) 'An Early La Tène *Maskenfibel* from Slovenské Pravno, Okr. Martin, Slovakia', *EC*, XIX: 7–34.
- Megaw, J. V. S. (1990) 'The Anglo-Austrian Excavations on the Dürrenberg bei Hallein 1978–1981 Interim Report', *Germania*, 68 (2): 509–49.
- Megaw, J. V. S. and Megaw, M. R. (1990) *The Basse-Yutz Find: Masterpieces of Celtic Art*, SALRR XLVI, London, Thames and Hudson.
- Megaw, R. and Megaw, J. V. S. (1989) 'The Italian Job: Some Implications of Recent Finds of Celtic Scabbards Decorated with Dragon-pairs', *Mediterranean Archaeology*, 2: 85–100.
- Megaw, R. and Megaw, J. V. S. (1995) 'The Nature and Function of Celtic Art', in M. J. Green (ed.) (1995): 345–75.
- Megaw, R. and Megaw, V. (2001) *Celtic Art, from its Beginnings to the Book of Kells*, rev. edn, London, Thames and Hudson.
- Metzler, J., Waringo, R., Bis, R. and Metzler-Zens, N. (1991) *Clemency et les tombes de l'aristocratie en Gaule Belgique*, Luxembourg, Dossiers d'Archéologie du Musée National d'Histoire et d'Art.
- Milojčić, V. (ed.) (1971) *Kolloquium über Spätantike und Frühmittelalterliche Skulptur, 1970*, Mainz, von Zabern.
- Mitchell, G. F. (1977) 'Foreign Influences and the Beginnings of Christian Art', in P. Cone, (ed.) (1977): 54–60.
- Mohen, J.-P. (1975) 'Nouveaux aspects de l'étude de l'Age du Fer', *Archaeologia Atlantica*, 1: 91–106.
- Mohen, J.-P. (1979) 'La présence celtique dans le Sud-Ouest de l'Europe: indices archéologiques', in P.-M. Duval and V. Kruta (eds) (1979): 29–48.
- Mohen, J.-P. (1980) *L'Age du Fer en Aquitaine, du VIIe au IIIe siècle avant Jésus-Christ*, Mémoires de la Société Préhistorique Française 14, Paris.
- Mohen, J.-P., Duval, A. and Eluère, C. (eds) (1988) *Les Princes Celtes et la Méditerranée*, Paris, La Documentation Française.
- Moosleitner, F., Penninger, E. and Pauli, L. (1974) *Der Dürrenberg bei Hallein II. Katalog der Grabfunde aus der Hallstatt- und LaTènezeit*, Münchner Beiträge zur Vor- und Frühgeschichte Band 17, Beck, Munich.
- Moscatti, S. et al. (eds) (1991) *The Celts*, Milan, Bompiani.
- Müller-Karpe, H. (1956) 'Das urnenfelderzeitliche Wagengrab von Hart a. d. Alz', *Bayerische Vorgeschichtesblätter*, 21: 46–75.
- Müller-Karpe, H. (1959) *Beiträge zur Chronologie der Urnenfelderzeit nördlich und südlich der Alpen*, RGF Band 22, Berlin, de Gruyter.
- Müller-Karpe, H. (1980) *Handbuch der Vorgeschichte*, Band IV, *Bronzezeit*, Munich, C. H. Beck.
- Musson, C. R. (1991) *The Breiddin Hillfort: A Later Prehistoric Settlement in the Welsh Marches*, London, CBA Research Report No. 76.
- Nash, D. (1987) *Coinage in the Celtic World*, London, Seaby.
- Nash Briggs, D. (1995) 'Coinage', in M. J. Green (ed.) (1995): 244–53.

BIBLIOGRAPHY

- Needham, S. (1979) 'Two Recent British Shield Finds and their Continental Parallels', *PPS*, 45: 111–34.
- Neiss, R., Charpy, J.-J. and Patrolin, A. (eds) (1991) *La Céramique peinte Celtique dans son Contexte Européen, Actes du Symposium International d'Hautvillers, 9–11 Octobre 1987*, MSAC, 5.
- O'Connor, A. and Clarke, D. V. (eds) (1983) *From the Stone Age to the 'Forty-Five': Studies Presented to R. B. K. Stevenson*, Edinburgh, John Donald.
- Ó Corráin, D. (ed.) (1981) *Irish Antiquity: Essays and Studies Presented to Professor M. J. O'Kelly*, Cork, Tower Books.
- Ó Floinn, R. (1989) 'Secular Metal-work in the Eighth and Ninth Centuries', in S. Youngs (ed.) (1989): 72–91.
- Ó Floinn, R. (2001) 'Patrons and Politics: Art, Artefact and Methodology', in M. Redknap, *et al.* (eds) (2001): 1–14.
- O'Kelly, M. J. (1961) 'The Cork Horns, the Petrie Crown and the Bann Disk: The Technique of their Ornamentation', *Journal of the Cork Historical and Archaeological Society*, 66: 1–12.
- Olmsted, G. (1979) *The Gundestrup Cauldron*, Brussels, Collection Latomus.
- O'Mahony, F. (ed.) (1994) *The Book of Kells: Proceedings of a Conference at Trinity College, Dublin, 6–9 September, 1992*, Dublin, Scolar Press.
- Otto, K.-H. and Hermann, J. (eds) (1969) *Siedlung, Burg und Stadt: Studien zur ihren Anfängen: Festschrift für Paul Grimm*, Berlin, Deutsche Akademie der Wissenschaften.
- Pare, C. F. E. (1992) *Wagons and Wagon-Graves of the Early Iron Age in Central Europe*, Oxford, Oxford University Committee for Archaeology Monograph No. 35.
- Parfitt, K. (1995) *Iron Age Burials from Mill Hill, Deal*, London, British Museum.
- Parzinger, H. (1998) *Der Goldberg, die metalzeitliche Besiedlung*, Römisch-Germanische Forschungen, 57, Mainz, von Zabern.
- Patay, P. (1990) *Die Bronzegefäße in Ungarn*, Prähistorische Bronzefunde, Ab. 11, Bd 10, Munich, Beck.
- Pauli, L. (1978) *Der Dürrnberg bei Hallein III. Auswertung der Grabfunde*, Münchner Beiträge zur Vor- und Frühgeschichte Band 18, Munich, Beck.
- Pauli, L. (1985) 'Early Celtic Society: Two Centuries of Wealth and Turmoil in Central Europe', in T. C. Champion and J. V. S. Megaw, (eds) (1985): 23–44.
- Pauli, L. (1991) 'The Alps at the Time of the First Migrations', in S. Moscati *et al.* (eds) (1991): 215–19.
- Pauli, L. (1994) 'Case Studies in Celtic Archaeology', in K. Kristiansen and J. Jensen (eds) (1994): 67–80.
- Peacock, D. P. S. (1971) 'Roman Amphorae in Pre-Roman Britain', in M. Jesson and D. Hill (eds) (1971): 161–88.
- Penninger, E. (1972) *Der Dürrnberg bei Hallein I. Katalog der Grabfunde aus der Hallstatt- und LaTènezeit*, Münchner Beiträge zur Vor- und Frühgeschichte Band 16, Munich, Beck.
- Pescheck, C. (1972) 'Ein reicher Grabfund mit Kesselwagon aus Unterfranken', *Germania*, 50: 29–56.
- Pétrequin, P., Urlacher, J.-P. and Vuailant, D. (1969) 'Habitat et sépultures de l'Age du Bronze final à Dampierre-sur-le-Doubs', *Gallia Préhistoire*, XII, 1, 1–24.
- Petres, E. (1982) 'Notes on Scabbards Decorated with Dragons and Bird-pairs', in P.-M. Duval, and V. Kruta (eds) (1982): 161–74.
- Piggott, S. (1950) 'Swords and Scabbards of the British Early Iron Age', *PPS*, 16: 1–28.
- Piggott, S. (1953) 'Three Metal-work Hoards of the Roman Period from Southern Scotland', *PSAS*, 87, 1952–3: 175–86.
- Piggott, S. (1970) *Early Celtic Art*, Edinburgh, Edinburgh University Press.
- Piggott, S. (1983) *The Earliest Wheeled Transport from the Atlantic Coast to the Caspian Sea*, London, Thames and Hudson.

BIBLIOGRAPHY

- Planck, D. (1982) 'Eine neu entdeckte keltische Viereckschanze in Fellbach Schmid, Remsmurr-Kreis', *Germania*, 60: 105–72.
- Pleiner, R. (ed.) (1981a) *Frühes Eisen in Europa: Acta des 3. Symposiums des 'Comité pour la sidérurgie ancienne de l'UISPP'*, Schaffhausen, Meili.
- Pleiner, R. (1981b) 'Die Wege des Eisens nach Europa', in R. Pleiner (ed.) (1981a): 115–28.
- Queiroga, F. (2003) *War and Castros: New Approaches to the Northwestern Portuguese Iron Age*, Oxford, BAR International Series 1198.
- Quesada Sanz, F. (1997) *El armamento ibérico. Estudio tipológico, geográfico, funcional, social y simbólico de las armas en la Cultura ibérica (siglos VI–I a.C.)*, Monographies instrumentum 3, Montagnac, Monique Mergoïl, 2 vols.
- Quesada Sanz, F. (2005) 'Patterns of Interaction: "Celtic" and "Iberian" weapons in Iron Age Spain', in W. Gillies and D. W. Harding (eds) (2005): 56–78.
- Raftery, B. (1976) 'Rathgall and Irish Hillfort Problems', in D. W. Harding (ed.) (1976): 339–57.
- Raftery, B. (1981) 'Iron Age Burials', in D. O'Corráin (ed.) (1981): 173–204.
- Raftery, B. (1982) 'Knobbed Spearbutts of the Irish Iron Age', in B. G. Scott (ed.) (1982): 75–92.
- Raftery, B. (1983) *A Catalogue of Irish Iron Age Antiquities*, Veröffentlichung des Vorgeschichtlichen Seminars Marburg, Sonderband 1, Marburg.
- Raftery, B. (1984) *La Tène in Ireland: Problems of Origin and Chronology*, Veröffentlichung des Vorgeschichtlichen Seminars Marburg, Sonderband 2, Marburg.
- Raftery, B. (1994a) *Pagan Celtic Ireland: The Enigma of the Irish Iron Age*, London, Thames and Hudson.
- Raftery, B. (1994b) 'Reflections on the Irish Scabbard Style', in C. Dobiat (ed.) (1994): 475–92.
- Rapin, A. (1993) 'Destructions et mutilations des armes dans les necropoles et les sanctuaires au second Age du Fer: réflexions sur les rituels et leurs descriptions', in D. Cliquet, M. Remy-Watte, V. Guichard and M. Vaginay (eds) (1993): 291–8.
- Rapin, A. (2003) 'Les analyses sémiologiques de l'image: l'iconographie du deuxième âge du fer', in O. Buchsenschutz *et al.* (eds) (2003): 49–62.
- RCAHMS (1956) *An Inventory of the Ancient and Historical Monuments of Roxburghshire*, Edinburgh, HMSO.
- Redknap, M., Edwards, N., Youngs, S., Lane, A. and Knight, J. (eds) (2001) *Pattern and Purpose in Insular Art: Proceedings of the Fourth International Conference on Insular Art, Cardiff, 1998*, Oxford, Oxbow Books.
- Renfrew, C. (ed.) (1974) *British Prehistory: A New Outline*, London, Duckworth.
- Renfrew, C. (1987) *Archaeology and Language: The Puzzle of Indo-European Origins*. London, Jonathan Cape.
- Riek, G. (1962) *Der Hohmichele. Ein Fürstengrabbügel der späten Hallstattzeit bei der Heuneburg*, RGF Band 25, Berlin, de Gruyter.
- Ritchie, A. (1989) *The Picts*, Edinburgh, HMSO/Historic Scotland.
- Rolley, C. (ed.) (2003) *La Tombe Princière de Vix*, 2 vols, Paris, Picard.
- Roualet, P. (1991) 'Les vases peints marniens de La Tène ancienne I dans leur contexte funéraire', in R. Neiss, J.-J. Charpy and A. Patroin (eds) (1991): 9–39.
- Roualet, P. and Kruta, V. (1980) 'Le cimetière gaulois de "La Barbière" à Villeseneux (Marne)', *Mémoires de la Société d'Agriculture, Commerce, Sciences et Arts du département de la Marne*, XCV: 27–46.
- Rowlands, M. (1971) 'The Archaeological Interpretation of Prehistoric Metal-working', *WA*, 3/2: 210–24.
- Rozoy, J.-G. (1987) *Les Celtes en Champagne: Les Ardennes au second Age du Fer: le Mont Troté, les Rouliers*, MSAC, no. 4.
- Ryan, M. (ed.) (1987) *Ireland and Insular Art, A.D. 500–1200*, Dublin, Royal Irish Academy.

BIBLIOGRAPHY

- Ryan, M. (1989) 'Church Metal-work in the Eighth and Ninth Centuries', in S. Youngs (ed.) (1989): 125–30.
- Rybová, A. and Soudský, B. (1962) *Libenice, Keltská Svatině ve Středních Čechách*, Praha, Nakladatelství Československé Akademie Věd.
- Rynne, E. (1987) 'The Date of the Ardagh Chalice', in M. Ryan (ed.) (1987): 85–9.
- Rynne, E. (1994) 'Drolleries in the Book of Kells', in F. O'Mahony (ed.) (1994): 311–21.
- Sandars, N. K. (1971) 'Orient and Orientalizing in Early Celtic Art', *Antiquity*, 45: 103–12.
- Sandars, N. (1976) 'Orient and Orientalizing: Recent Thoughts Reviewed', in P.-M. Duval and C. F. C. Hawkes (eds) (1976): 41–60.
- Sankot, P. (1977) 'Le rite funéraire des nécropoles laténiennes en Champagne', *Etudes Celtiques*, 15, 1976–7: 49–94.
- Sankot, P. (2003) 'Nouvelles connaissances sur l'artisanat laténiens des Ve–IIIe siècle avant J.-C. en Bohême', in O. Buchsensschutz *et al.* (eds) (2003): 129–43.
- Schüle, W. (1969) *Die Meseta-Kulturen der Iberischen Halbinsel*, Madrider Forschungen Band 3, Berlin, de Gruyter.
- Schwab, H. (1974) 'Neue Ergebnisse zur Topographie von la Tène', *Germania*, 52: 348–67.
- Schwappach, F. (1973) 'Floral-decorations and Arc-designs in the "Early Style" of Celtic Art: Ornaments of the Western and the Eastern Centres of La Tène', *Actes du Quatrième Congrès International d'Études Celtiques*, II, Paris, 710–32.
- Schwappach, F. (1976) 'L'art Ornemental du "Premier Style" Celtique', in P.-M. Duval and C. F. C. Hawkes (eds) (1976): 61–110.
- Scott, B. G. (ed.) (1982) *Studies on Early Ireland: Essays in Honour of M. V. Duignan*, Belfast, Association of Young Irish Archaeologists.
- Shapiro, M. (1953) 'Style', in A. L. Kroeber (ed.) (1953): 287–312.
- Shramko, B. A. (1981) 'Die ältesten Eisenfundstücke in Osteuropa', in R. Pleiner (ed.) (1981a): 109–14.
- Sieveling de, G. (ed.) (1971) *Prehistoric and Roman Studies*, London, British Museum.
- Small, A. (ed.) (1987) *The Picts: A New Look at Old Problems*, Dundee, Dundee University/District Council.
- Small, A., Thomas, C. and Wilson, D. M. (1973) *St Ninian's Isle and its Treasure*, 2 vols, London, Oxford University Press.
- Smith, B. B. and Banks, I. (eds) (2002) *In the Shadow of the Brochs: The Iron Age in Scotland*, Stroud, Tempus.
- Smith, R. A. (1926) 'Two Early British Bronze Bowls', *AntJ*, 6: 276–83.
- Spearman, R. M. and Higgitt, J. (eds) (1993) *The Age of Migrating Ideas: Early Medieval Art in Northern Britain and Ireland*, Stroud, National Museum of Scotland/Alan Sutton.
- Spratling, M. G. (1979) 'The Debris of Metal Working', in G. J. Wainwright (1979): 125–49.
- Sprockhoff, E. (1930) *Zur Handelsgeschichte der germanischen Bronzezeit*, Vorgeschichtliches Forschungen 7, Berlin, de Gruyter.
- Sprockhoff, E. (1931) *Die germanischen Griffzungenschwerver*, Berlin, de Gruyter.
- Sprockhoff, E. (1934) *Die germanischen Vollgriffschwerver*, Berlin, de Gruyter.
- Sprockhoff, E. (1955) 'Central European Urnfield Culture and Celtic La Tène: An Outline', *PPS*, 21: 257–81.
- Stary, P. (1982) 'Keltische Waffen auf der Iberischen Halbinsel', *MM*, 23: 114–44.
- Stead, I. M. (1965) *The La Tène Cultures of Eastern Yorksbire*, York, Yorkshire Philosophical Society.
- Stead, I. M. (1976) 'La Tène Burials between Burton Fleming and Rudston, North Humberside', *AntJ*, 56: 217–26.
- Stead, I. M. (1979) *The Arras Culture*, York, Yorkshire Philosophical Society.
- Stead, I. M. (1982) 'The Cerrig-y-Drudion "Hanging Bowl"', *AntJ*, 62: 221–34.
- Stead, I. M. (1984) 'Celtic Dragons from the River Thames', *AntJ*, 64: 269–79.

BIBLIOGRAPHY

- Stead, I. M. (1985a) *Celtic Art in Britain before the Roman Conquest*, London, British Museum.
- Stead, I. M. (1985b) *The Battersea Shield*, London, British Museum.
- Stead, I. M. (1991a) *Iron Age Cemeteries in East Yorkshire*, London, English Heritage/British Museum.
- Stead, I. M. (1991b) 'The Snettisham Treasure: Excavations in 1990', *Antiquity*, 65: 447–65.
- Stead, I. M. (1995) 'The Metal-work', in K. Parfitt (1995): 58–111.
- Stead, I. M. (2003) 'The Iron Age Military Items', in N. Field and M. Parker Pearson (2003): 49–63.
- Stead, I. M. (2006) *British Iron Age Swords and Scabbards*, London, British Museum Press.
- Stead, I. M. and Rigby, V. (1985) *Baldock: The Excavation of a Roman and Pre-Roman Settlement, 1968–72*, London, Britannia Monograph Series No 7.
- Stead, I. M. and Rigby, V. (1999) *Iron Age Antiquities from Champagne in the British Museum: The Morel Collection*, London, British Museum Press.
- Stead, I. and Selkirk, A. (1991) 'Snettisham', *CArch*, 126: 260–2.
- Stead, I. and Selkirk, A. (1993) 'Snettisham', *CArch*, 135: 97–102.
- Stevenson, R. B. K. (1955) 'Pictish Art', in F. T. Wainwright (ed.) (1955): 97–128.
- Stevenson, R. B. K. (1959) 'The Inchyra Stone and Other Unpublished Early Christian Monuments', *PSAS*, 92, 1958–59: 33–55.
- Stevenson, R. B. K. (1971) 'Sculpture in Scotland in the 6th–8th Centuries', in V. Milojević (ed.) (1971): 65–75.
- Stevenson, R. B. K. (1993) 'Further Thoughts on Some Well Known Problems', in R. M. Spearman and J. Higgitt (eds) (1993): 16–26.
- Stjernquist, B. (1988) 'Die Rippenciste', in W. Kimmig (1988): 161–75.
- Stöllner, T. (2003) 'The Economy of Dürrnberg-bei-Hallein: An Iron Age Salt-mining Centre in the Austrian Alps', *AntJ*, 83: 123–94.
- Stuart, J. (1856) *The Sculptured Stones of Scotland*, Aberdeen, Spalding Club.
- Szabó, M. (1991) 'The Celts and their Movements in the Third Century B.C.', in S. Moscati *et al.* (1991): 303–19.
- Szabó, M. (1992) *Les Celtes de l'Est: Le Second Age du Fer dans la cuvette des Karpates*, Paris, Editions Errance.
- Szabó, M. and Petres, É. F. (1992) *Decorated Weapons of the La Tène Iron Age in the Carpathian Basin*, Budapest, Magyar Nemzeti Múzeum.
- Thill, G. (1966) 'Ausgrabungen bei Goeblingen-Nospelt', *Hémecht*, 18: 483–91.
- Thill, G. (1967) 'Die Metallgegenstände aus vier spätlatènezeitlichen Brandgräbern bei Goeblingen-Nospelt', *Hémecht*, 19: 87–98.
- Thomas, C. (1961) 'The Animal Art of the Scottish Iron Age and its Origins', *ArchJ*, 118: 14–63.
- Thomas, C. (1971) *The Early Christian Archaeology of North Britain*, Glasgow, University of Glasgow/Oxford University Press.
- Thomas, C. (1984) 'The Pictish Class I Symbol Stones', in J. G. P. Friell and W. G. Watson (eds) (1984): 169–87.
- Thrane, H. (1965) 'Dänische Funde fremder Bronzegefäße der jüngeren Bronzezeit (Periode IV)', *Acta Archaeologica*, 36: 157–207.
- Točík, A. and Paulík, J. (1960) 'Výskum mohyly v Čake v rokach, 1950–51', *Slovenská Archeológia*, VIII–I: 59–110.
- Torbrügge, W. (1968) *Prehistoric European Art*, London and New York, Harry Abrams.
- Toynbee, J. M. C. (1964) *Art in Britain under the Romans*, Oxford, Clarendon Press.
- van Endert, D. (1987) *Die Wagenbestattungen der spätHallstattzeit und der Latènezeit im Gebiet westlich des Rheins*, Oxford, BAR International Series, 355.
- Venclová, N. (1998) *Měcké Žebrovice in Bobemia*, Prague, Kronos Editions.
- Verger, S. (1987) 'La genèse Celtique des rinceaux à triscèles', *Jahrbuch der RGZM*, 34: 287–339.

BIBLIOGRAPHY

- Villard-Le Tiec, A., Cherel, A-F, and Le Goff, E. (2003) 'Aspects de l'art celtique en Bretagne au Ve siècle avant J.-C.', in O. Buchsenschutz *et al.* (eds) (2003): 221–36.
- von Merhart, G. (1952) 'Studien über einige Gattungen von Bronzegefäßen', *Festschrift der RGZM*, ii: 1–71.
- Vorlauf, D. (1997) *Die Etruskischen Bronzeschnabelkannen: eine Untersuchung anhand der Technologisch-Typologischen Methode*, Espelkamp, Internationale Archeologie 11.
- Wainwright, F. T. (ed.) (1955) *The Problem of the Picts*, Edinburgh, Nelson.
- Wainwright, G. J. (1979) *Gussage All Saints: An Iron Age Settlement in Dorset*, London, HMSO.
- Waldhauser, J. (1987) 'Keltische Gräberfelder in Böhmen', *BRGK*, 68: 27–179.
- Walters, H. B. (1893) *Catalogue of the Greek and Etruscan Vases in the British Museum*, Vol. 2, *Black-figure Vases*, London, British Museum.
- Ward-Perkins, J. B. (1939) 'Iron Age Metal Horses' Bits of the British Isles', *PPS*, 5: 173–92.
- Warner, R. (2002) 'Beehive Querns and Irish "La Tène" Artifacts: A Statistical Test of their Cultural Relatedness', *Journal of Irish Archaeology*, 11: 125–30.
- Waterman, D. M. and Lynn, C. (1997) *Excavations at Navan Fort 1961–71*, Belfast, The Stationery Office.
- Watkin, J., Stead, I., Hook, D. and Palmer, S. (1996) 'A Decorated Shield-Boss from the River Trent, near Ratcliffe-on-Soar', *AntJ*, 76: 17–30.
- Weber, K. (2002) *Das Rätsel der Kelten vom Glauberg*, Stuttgart, Theiss.
- Wells, P. (1984) *Farms, Villages and Cities: Commerce and Urban Origins in Late Prehistoric Europe*, New York, Cornell University Press.
- Wells, P. (1993) *Settlement, Economy, and Cultural Change at the End of the European Iron Age: Excavations at Kelheim in Bavaria, 1987–1991*, International Monographs in Prehistory, Ann Arbor, MI, University of Michigan Press.
- Werner, J. (1977) 'Spätlatène-Schwerter norischer Herkunft', *Symposium Ausklang der Latène-Zivilisation und Anfänge der germanischen Besiedlung im mittleren Donaauraum, Malé Vozokany 1972*, Bratislava, 367– (reprinted in J. Werner (1979): 165–97).
- Werner, J. (1978) 'Zur Bronzekanne von Kelheim. Rückblick und Ausblick', *Bayerische Vorgeschichtesblätter*, 43: 1–18 (reprinted in J. Werner (1979): 198–220).
- Werner, J. (1979) *Spätes Keltentum zwischen Rom und Germanien*, Munich, C. H. Beck.
- Wheeler, R. E. M. (1954) *The Stanwick Fortifications, North Riding of Yorkshire*, Oxford, SALRR XVII, Oxford University Press.
- Wheeler, R. E. M. and Richardson, K. M. (1957) *Hillforts of Northern France*, SALRR XIX, Oxford University Press.
- Whitfield, N. (1987) 'Motifs and Techniques of Celtic Filigree: Are They Original?', in M. Ryan (ed.) (1987): 75–84.
- Whitfield, N. (1993) 'The Filigree of the Hunterston and "Tara" Brooches', in R. M. Spearman and J. Higgitt (eds) (1993): 118–27.
- Wilson, D. (1851) *The Archaeology and Prehistoric Annals of Scotland*, Edinburgh, Sutherland and Knox.
- Wyss, R. (1955) 'Das Schwert des Korisios', *Arch. Helvetica*, V: 201–22.
- Wyss, R. (1975) *Der Schatzfund von Erstfeld. Frühkeltischer Goldschmuck aus den Zentralalpen*, Zürich, Gesellschaft für das Schweizerische Landesmuseum.
- Youngs, S. (ed.) (1989) *The Work of Angels: Masterpieces of Celtic Metal-work, 6th–9th Centuries AD*, London, British Museum in association with NMI and NMS.

INDEX

Italics denotes Figures; **bold** denotes Colour Plates

- Abbeysrule 170
Aberlemno 247
Acholshausen 20, 22
Aesica brooch 234, 235
Agde 193
Agris 7b, 75–6
Aguilar de Anguita 202, 206, 208
Aholming 122
Alcácer 209
Alcock, L. 249, 252
Aleburg bei Befort 45
Alexander III of Macedon 'the Great' 94, 212, 213
All Cannings Cross 155
Allen, D. 213, 215, 227, 229
Allen, J. Romilly 241, 245, 227, 229
Allia 91
Almagro Gorbea, M. 204
Almedinilla 202, 203
Alnham 175
Alpanesque 202
Altartate 183
amber 14, 45, 58
Ambrussum 195
Ameglia 104
Amphitrite painter 38
Amfreville-sous-les-Monts 7a, 74, 75–6, 88
amphorae *see* pottery
Andelfingen 130, 132
Anderson, J. 245, 248
Aquitani, Aquitania 4, 189–93
Arcobriga 206
Ardagh chalice 16a, 259, 260
Ardross 251, 256
arm-rings *see* rings
Arnold, B. 23, 267
Arras culture 141–2, 159, 169
Arrunte 91
Arverni 12
Asby Scar 230
Athlone 239, 240
Atkinson, R. J. C. 143, 145, 178
Attalos I of Pergamon 94
Attichy 133
Attymon 170
Aubagnan 191
Aughinish 168
Augsburg-Oberhausen 218
Aurillac 8b, 191
Auvernier-Nord 27
Auvers-sur-Oise 66, 67
Avaricum 211
axes: Armorican socketed 166; median-wing 20;
socketed 112, 133, 190; Spanish 190; winged
190
Aylesford 1, 157, 158, 218, 229
Bad-Durkheim 54, 62
Bad-Nauheim 219
Baginton 241, 241
Baldock 158
Ballacagen 175
Balloch Hill 136, 138
Ballyedmond 182, 183
Ballymoney 182, 183
Ballyshannon 222
Balmacellan 161, 162
Bann 99, 112, 116
Bannockburn 261
Bardney Abbey 230
Basel 216; gasworks 219
basin, bronze 45, 51; two-handled 40;
see also bowls
Basse de Vidauque 194
Basse-Yutz 11, 14, 20, 51, 54, 57, 62–3
Bastarnae 212
Báta 224
Batina (Kisköszeg) 96, 97
Battersea, dragon-pair 44; shield 1, 9, 149, 150–2,
248, 272; scabbard 230
battle-axes 29

INDEX

- beads: amber 45; 'dumb-bell' 177; Class 7, 177;
gold 129; spiral-inlaid Class 6, 177
- Beagmore 176
- Beckley 87, 138
- beer 10
- Beine-l'Argentelle 77, 78, 80, 173
- Beine-Montequaux 77
- Beirgh 13, 172, 242
- Belgae, Belgium 4, 157
- Bellovesus
- belt-chains 95, 120, 124; clasps, hooks 60, 61, 90,
104, 119, 124, 133, 190, 195, 204, 209, 270
- Berru 49, 70, 71, 75
- Bersu, G. 27
- Besançon 68–70, 69, 72, 84, 88, 110, 248
- Bezares 204
- Bescheid 45
- Besseringen 61
- Bettystown *see* 'Tara' brooch
- Bishopland 166, 173
- Biskupin 26, 27
- Birdlip 161
- Bituriges 91
- Blandford 138
- Blewburton Hill 141, 156
- Blucina 122
- boar-images 6, 153, 213, 215, 221, 222, 224,
249, 265, 268, 271
- body-armour 7, 9, 20, 28, 30, 268; chain mail
128, 191; cuirass 18, 20, 28, 30, 31, 201, 215;
greaves 18, 20, 28, 30, 34, 128; *see also* helmets
- body-painting 9
- Boii 91, 212
- Bölske-Madocsahegy 99, 101
- Bolgius 94
- Bologna house-shrine 261
- Bondville 176
- Book of Durrow 11, 12, 241, 250, 251, 252, 253,
256, 257
- Book of Kells 13, 14, 251, 254, 256, 258
- bone artefacts 9
- Borsch 63, 84, 112, 265
- Bosch-Gimpera, P. 189
- Boudicca 153, 270
- Bouray 222, 223
- bow 29; arrows 51
- bowls: bronze 166, 167, 181, 183, 219; with
T-shaped handle-attachments 32; *see also* basins
- Box 138, 141
- Brå 20, 133–4, 135, 150, 265
- bracae* 270
- bracelets 9, 33, 34, 47, 48, 54, 57, 62, 72, 74, 75,
76, 77, 79, 81, 86, 87, 94, 106, 118, 119–21,
120, 121, 122, 142, 166, 175, 190, 191, 195,
270; *see also* rings
- Bradley, R. 12
- Bragny-sur-Saône 26
- Breiddin 13
- Brennus 94
- Brentford 'horn-cap' 87, 179
- Brno-Maloměřice 121, 124–6, 125, 133, 134
- Broadward complex 29
- Broughter 8a, 173, 259
- bronze-working *see* metal-working
- brooches 9, 12, 20, 45, 47, 48, 57, 77, 88, 94,
102, 118, 119, 132, 136, 141, 142–3, 161,
164, 175, 181, 191, 195, 204, 209, 220, 253,
270, 274; Ampurias type 190; annular 204,
205, 209, 242, 258–9; Cassibile type 190;
Celtiberian 204, 205; cross-bow 195;
dragonesque 185, 234, 235; Dux type 76,
77, 81; fan-tail 234; globular-footed and
double-globular 120, 121; involuted 87, 143;
'Italic' 20, 33, 166, 195; *jinete* 204, 205, 206,
263; La Tène 2, 110, 121, 122, 132, 143, 146,
191, 199, 204, 209; *Maskfibeln* 57, 263;
Marzabotto 141; Münsingen type 79, 83,
119–21, 120; Nauheim type 175, 209, 218;
Navan type 176, 181; penannular 143, 145,
146, 204, 205, 242, 245, 258–9; spoon-bow
218; Stradonice 218, trumpet 234, 235;
Vogelkopffibeln 57; zoomorphic penannular 239,
240
- Buchanan, G. 4
- buckets 7, 20, 30, 32, 51, 166, 167; Campanian
72, 73, 75; cordoned 10, 38, 40, 41; Kurd type
10, 32; Rhein-Tessin type 40; wooden 157,
158, 220
- Bugthorpe 108, 110–11, 112–13
- Buiston 258
- bull imagery 23, 25, 126, 130, 131, 133–4, 215,
226, 227, 229, 249, 250, 251, 256
- Bunrannoch 236, 237
- Burg-im-Spreewald 22
- Burgess, C. 29
- Burghead 250, 251, 256
- burials 6, 7–8, 9, 12, 29, 32, 33, 140, 218, 250,
266; bucket- 158–9; 'cavalier' 48; chariot-
48–9, 67, 70, 72, 169, 266; chieftain's
Fürstengräber 10–11, 36, 38–40, 44–5, 54, 70,
94, 266–7; cremation 18–19, 20, 48, 132, 153,
157, 158, 219; 'doctor's' 11, 106, 229, 248;
inhumation 19, 48, 79, 153, 246; Irish 'ring-
barrows' 177; late La Tène 218, 219–20;
square-ditched 48, 95, 132, 142, 169; pyre-
graves 19; vehicle- 11, 19, 20, 44–5, 51, 128,
132, 133, 142, 219; 'warrior' 11, 48, 49, 51,
61, 88, 128, 142, 153, 203, 219–20, 258,
267–8; Welwyn type 11, 157, 229–30; *see also*
cemetaries
- Burton Fleming 142
- Bussy-le-Château 80, 109, 133

- Býččí Skála 25
- Cabezo de Monleon 26
- Caburn 156
- Čaka 19, 30
- Caesar, G. J. 3, 4, 91, 157, 189, 211, 215, 219, 268
- Cairnmuir 154
- Calvinus, C. Sextius 196
- Canosa di Puglia 88–90, 89
- Capote 209
- Carlingwark Loch 182, 183
- Carmarthen 234
- carnyxes 215, 221, 227, 230, 231, 242, 272
- Carratiermes 200
- Carrickfergus 232
- Cassius Dio 153
- Castelo de Matos 209
- Castle Newe, Strathdon 236
- Castlestrange 8
- Castletown, Kilpatrick 242
- Castro culture 206, 208, 209–10, 264
- Castro de Toroso 209
- Castro di Lezenho 207, 210, 270
- cathairs, cashels 164
- cathar place-names 168
- Catuvellauni 161
- cauldrons 7, 81, 133, 179, 200, 224, 229; Atlantic 10, 31, 32, 166, 167; globular type 181–3, 182, Hallstatt D 32; Santon type 181–3, 182; *see also* Gundestrup cauldron
- Caulfield, S. 164, 177
- Caurel 77, 78, 79, 80
- Celtrae, Celtica 4, 189
- Celto-Ligurians 196–9
- cemeteries 13, 44, 47, 49, 94, 128, 130, 132, 190, 193–5, 196, 200, 218; Arras culture 110, 141–2, 159; Aylesford series 1, 110, 157; flat-grave inhumation 79, 94, 124–6; long cist 245; *see also* burials
- Cenomani 91
- Cerethrius 94
- Cernon-sur-Coole 96, 98, 98, 99, 116
- Cernunnos 153, 208, 227
- Cerrig-y-Drudion 70, 84, 86, 112, 145, 149, 248
- Cerveteri 42, 43
- Certosa situla 63
- chagrinage* 107, 109, 121, 269
- chains, 'Pictish' silver 245
- chain mail *see* body armour
- Châlons-sur-Marne 49
- Chamalières 221
- Champion, S. 79
- Chapman, M. 3
- chariots, chariotry 13, 75, 169, 215, 219, 269
- Chatenay-Macheron 222
- Chatillon-sur-Indre 220, 222
- 'Cheshire' style 54, 67, 74, 179
- Chesteron-on-Fosseway 241
- Childe, V. G. 5, 14, 262
- chisels, tanged 166
- Chiswell Green 149
- Chiusi 54, 91
- Chotin 122
- Chlum 44
- Chorley 235
- Cimbri 136, 139, 226, 227
- Citânia de Briteiros 209
- Citânia de Sanfins 209
- Citânia de S. Julião 209
- Citânia de Santa Luzia 210
- Çiumeşti 20, 128, 129, 227, 265
- Civray 191
- Čížkovice 81
- Clapham, A. 248
- Clatchard Craig 243–5
- Clémency 219
- climatic change 18
- Clogher 239
- Clonmacnoise *see* Knock
- Clonoura 172
- Clunie 245
- coins, coinage 12, 15, 153–4, 192, 196, 204, 206, 212–15, 218, 222, 224, 227, 272; *see also* hoards
- Colchester 161, 211, 229
- Coll 175
- collars, bronze 232
- Collis, J. 3, 4, 5
- Columba 252; *Cathach* 252, 253
- Comacchio 90
- compasses, use of 7, 107, 109, 113, 140, 141, 173, 183, 249, 253, 265
- copper, sources of 18
- coral 7, 8, 14, 40–2, 44, 49, 51, 57, 61, 62–3, 67, 74, 76, 132, 145, 149, 150, 153
- Corinth 129
- Cork horns 183, 184, 185, 232
- Corlea 169
- Corleck 57, 271
- Cornaux 106
- Corpus Christi MSS 197B 251
- Cortailod-Est 27
- Cortes de Navarra 26
- Courtisols 77, 78
- Court-Saint-Etienne 269
- Cowlam 142
- craftsmen 14–15
- Cramond, Edinburgh 199
- crannogs 168
- Creidne 14
- cremation *see* burial

INDEX

- crowns 153, 183–5, 184; *see also* leaf-crown and head-gear
- Crosby Ravensworth 182
- crucibles *see* metal-working
- Culbin Sands 185, 234–7, 236
- 'cult of the head' 57, 196, 214, 214, 272
- Cunobelinus 214
- Cuperly 49
- cups: bronze 32; Friedrichsruhe type 32; Fuchsstadt type 32; Haslau-Regelsbrunn type 32; Jenosovice type 32; Stilfried-Hostomice type 32
- daggers 107, 141, 195; *see also* swords
- Dál Riata, Dalriadic settlement 187–8, 243, 245
- Dampierre-sur-le-Doubs 27
- Danebury 157, 177–8
- Danes Graves 138, 145–6
- Dangstetten 218, 220
- Darius 58
- Deal, Mill Hill 111, 112, 138, 153, 183
- Déchelette, J. 2, 132
- Deichselwagen* 22, 23
- d'En-Bonnes, Fanjeaux 194
- Derrykeighan 181
- Derrynaflan 259
- Desborough 161
- Deskford carnyx 185, 221, 227, 230, 231, 242
- Diodorus Siculus 196, 270
- 'Disney' style 119, 124, 128, 133, 208, 254
- Dobova 99, 101
- Dobunni 161, 232
- Dodewaard 27
- Dowris phase 166, 168, 172, 173, 179, 187
- dragon-pairs 87, 93–4, 99, 102–4, 103, 106, 117, 121, 202, 203, 248, 249–50, 263, 265, 269, 272
- Dresden-Dobritz 2a, 32
- 'dress-fasteners' 168
- drinking-horns 11, 39–40, 39, 42, 45, 58–9, 65, 66, 130, 145
- Drña 96, 98, 98
- druids 26, 271, 273
- Drusus 220
- Duchcov 5, 11, 77, 81, 95, 119
- Duignan, M. 179–81
- Dun Aengus 168, 187
- Dunadd 242, 243, 258
- Dunagoil 172
- Dunnichen 241, 241, 248
- Dunning, G. C. 157
- Dupljaja 22, 23
- Durkheim 1
- Durotriges 161, 232
- Dürrenberg bei Hallein 13, 45, 47, 49–51, 52–3, 54, 62, 63, 67, 75, 79, 109, 265
- Duval, P-M. 3, 68, 145, 213
- Dyce 247
- Dying Gaul 94, 153, 179, 270
- Echternach Gospels 256
- Écury-sur-Coole 70, 71, 84
- Eigenbilzen 42, 43, 45
- Eilean Olabhat 13
- El Cigarralejo 203
- Elmswell 234, 235
- Elp 27
- Emain Macha *see* Navan fort
- Emporion 193
- enamel 63, 76, 79, 124, 132, 152, 155, 159, 161, 175, 181, 234, 239, 240, 242, 259
- Enge, Bern 211, 219
- Ensérune 195, 196
- Entremont 57, 196, 197, 199
- Eogan, G. 166
- Epiais-Rhus 85
- Erding 28
- Erlach 28
- Erstfeld 6a, 6b, 59, 61–2, 84
- Este 60, 61
- Euffigneix 153, 222, 223
- Evans, A. J. 1, 157
- Ewart Park bronze industry 166; *see also* swords
- faces masks *see* 'satyr faces'
- Fécamp 211–12; -type ramparts 211
- Feerwore 175
- Fellbach-Schmidlen 221
- Fenouillet 129, 191, 192
- Fère-Champenoise 48
- Fiad 81
- Filip, J. 94
- Filottrano 84, 85, 87, 88, 268
- finger-rings *see* rings
- Firth, R. 274
- Fischer, F. 62, 63
- Fiskerton 87
- flagons 13, 62–3, 67, 216, 217, 218; beaked 10, 11, 38–9, 39, 40, 41, 49, 50, 51, 61, 62, 68–70, 84; Kappel-Kelheim 10, 157, 218, 220; Ornavasso-Kaerumgaard 218; spouted 45–7, 46, 51, 61, 62, 72, 74, 125, 126
- Fovant 104
- Fox, Sir Cyril 15, 87, 110, 111, 112, 141, 145, 159, 161
- Franks, A. W. 1
- Frasnes-lez-Buissenal 173
- Frey, O-H. 3, 40, 42, 54, 56, 61, 68, 72, 74, 90, 99
- Frilford 155, 156
- Furtwängler, A. 2

INDEX

- gaesatae* 29, 212, 215
 Gallarus 252
 Gammelborg 136
 Garabajosa 205
 Garbeg 250
 Garton Slack 142
 Garton Station 110, 142
 Gašić 129, 191
 Gaulcross 242
 Gauls, *Galli* 3–4, 189, 212, 270; historical
 migrations of 4, 90–2, 94
 Geiging 28
 Germans, *Germani* 4
 Gillies, W. 14–15
 Glamis 246
 Glanum 196, 197, 198, 199
 glass 7–8, 12, 152, 159, 211, 222, 245; bracelets
 122, 274; *see also* enamel *and* millefiore
 Glastonbury 157
 Glauberg 4a, 4b, 13, 51, 54, 56, 56–7, 61, 62, 63,
 64, 264, 270
 Glejbjerg 57
 Glendalough 252
 Goeblingen-Nospelt 159, 218, 219–20
 Goibniu 14
 Golasecca culture 91
 gold working 7, 9–10; sources of gold 18
 Goldberg 27
 Golspie 250
 gorgets 166
 gouges, socketed 166
 Gournay-sur-Aronde 12, 154, 212, 221, 268
 Grafenbühl 58, 59
 Grange 175, 176
 Grannagh 177
 Graue, J. 218
 Great Chesterford 159
 Great Chesters 234, 235
 Green, M. 264
 Guido, M. 177
 Guilmain, J. 193, 253
 Gundestrup cauldron 1, 76, 153, 221, 226, 227,
 229, 270
 Gussage All Saints 13, 178

 Haffner, A. 14
 Hajdu-Böszörmény 20, 21, 32
 Haláphegy *see* Tapolca-Szentkút
 Halimba 99, 100, 104
 Hallstatt 25, 264, 270, 272
 Haltern 218
 Hammersmith, dragon-pair 104; scabbard 107
 hanging-bowls 240–1, 253
 Hannibal 91
 Harding, A. F. 14
 Härke, H. 27

 Hart-an-der-Alz 19, 30
 Hassle 41
 hatching 110–11, 112, 145, 156, 157; basketry
 hatching 84, 87, 110, 112, 115, 155, 160, 161
 hats, gold 1, 26; *see also* head-gear
 Hatt, J.-J. 48, 77, 132
 Haughey's fort 168, 187
 Hawkes, C. F. C. 32, 119, 136, 140, 141, 146,
 152, 157, 173, 175, 177, 181, 189, 220, 222,
 269
 head-gear 30, 33, 206, 208, 213, 227;
 see also crowns, hats, helmets *and*
 leaf-crowns
 Hecataeus 3
 Heidelberg 54, 57, 126, 196
 Helden 228, 229
 Helicus 91
 helmets 9, 28, 30, 48–9, 51, 70, 74, 75–6, 88,
 128, 129, 154–5, 172, 199, 201, 224, 227,
 268, 271
 Helvetii 106
 Hengistbury Head 157
 Henderson, G. 246, 250, 256
 Henderson, I. 245, 246, 250
 Henry, F. 239, 256, 258
 Herodotus 3
 Heuneburg 13, 267
 Hicks, C. 250
 hill-forts 12, 13, 23, 26, 49, 168, 169, 187, 195,
 208–9, 243–5; *castro, citânia, cidade* 209–10;
 Fürstentzitze 17, 26
 Hilton of Cadboll 249, 250
 Hirschlanden 56, 264, 271
 Hjortspring 11, 136
 hoards 1, 6, 11–12, 18, 23, 29, 32, 33, 61, 153–4,
 166, 173, 185, 190, 221, 227, 230–1, 242,
 261, 263, 266; coin hoards 12, 192, 227; in
 water 12, 23, 29, 30, 81, 106, 112, 136, 193;
 torc hoards 153–4, 173, 191–3, 270
 Hochdorf 10, 23, 40, 62, 267
 Hochscheid 45
 Höck, M. 210
 Hodson, F. R. 270
 Hohmichele 19, 23
 Holcombe 159, 160, 161
 Holzgerlingen 57, 196
 Hoppstädten 45, 61; -Weiersbach 219
 Hořešovice 120, 121
 horns 166, 167, 178–9; *see also* carnyxes
 Hořovičky 54
 horse-harness 13, 49, 72, 88, 90, 112, 142,
 169–71, 170, 181, 203, 230, 269
 Hostomice 120
 houses: apsidal 27; *Blockbau* 27; rectangular 27,
 210; round 27, 210; *Wohnstallbaus* 27
 house-shrines 259, 261

INDEX

- Hounslow 224, 265
 Hradenin 270, 272
 Hunderingen 130
 Hunsbury 112, 141, 155, 156
 Hunsrück-Eifel culture 42, 44–7, 49, 61
 Hunterston 15a, 242, 258
- Icenii 154
 Illora 203
 Inchyra 246, 248
 inhumation *see* burial
 Insubres 96, 212
 interlace 1, 253, 254, 256, 258, 259, 261
 Iona 243
 Ipswich 7, 154
 iron working 7, 17, 95, 211, 218; sources of iron ore 13
 Itford Hill 27
 ivory 40, 58
 Ižkovce 99
- Jackson, K. H. 238
 Jacobsthal, P. 1, 2, 3, 5, 6, 8, 15, 37, 38, 47, 51, 54, 57, 58, 61, 62, 63, 65, 70, 72, 74, 77, 81, 88, 90, 93, 102, 118, 119, 129, 133, 140, 152, 191, 196, 199, 208, 252, 264, 267
 Janin, T. 195
 Jászberény-Cserőhalom 130
 Jenišűv Újjezd 81
 Jonchery-sur-Suippes 77, 78
 Jope, E. M. 2, 74, 75, 84, 87, 102, 104, 107, 110, 113, 136, 145, 146, 149, 158, 159, 173, 178, 181, 224
 Jutas 96, 97, 104
- Kärlich 44
 Keeley, L. 267
 Kelheim 13, 211, 218; -type ramparts 211; *see also* flagons
 Keller, F. 107
 Kells 258; *see also* Book of Kells
 Kemble, J. 1
 Kermaria 181
 Keshcarrigan 181, 183
Kesselwagen 20–1, 22
 Kilbride-Jones, H. 239
 Killycluggin 181
 Kimmig, W. 26
 Kiltierney 177
 Kincardine Moss 182, 183
 Kirkburn 7, 108, 110–11, 142
 Klein Aspergle 3, 2, 38–40, 39, 44, 54, 67
 Klettham 122, 123, 175
 Klindt-Jensen, O. 133, 136
 Klobuky 81
 Knock 164, 173, 174
- Knowe of Burrian 251, 256
 Kosd 99, 102, 104, 121, 122
 Kossina, G. 5
 Kruta, V. 68, 77, 81, 88, 90, 118, 119, 121, 124
- La Barbière, Villeseneux 132
 Lábatlan 130
 'La Bouvandeau', Somme-Tourbe 67, 68, 113
 'La Courte', Hainaut 133
 laddering 107, 111
 Lagore 255, 258, 259
 La Gorge Meillet 14, 48–9, 84, 267
 Lahošt 81
 La Martela 206, 209
 La Mercadora 205
 Lambay Island 172
 Lamberton Moor 183
 La Osera 200, 202, 204
 La Osma 204
 Lara de los Infantes 205
 Larchant 84
 Las Cogitas 200
 Las Fados 193, 194
 Lasgraisnes 191, 192
 La Tène 1, 12, 103, 104–6, 105, 221
 Latham, R. G. 1
 Lausitz culture 19
 Lavannes 80
 'leaf-crown' 51, 54, 57, 61, 74, 158, 196, 214, 271
 leather-work 90, 107
 leg-rings *see* rings
 Lenerz-de Wilde, M. 200, 203, 210
 Les Saulces-Champenoises 70, 71
 Libenice 128
 linch-pins 57, 128, 133, 134, 169, 230, 270
 Lindenschmit, L. 1
 Lindisfarne Gospels 254, 256
 Lingones 91
 Linsdorf 199
 Lisnacroggher 112, 113–15, 114, 116, 170, 172
 Litér 84, 85, 93, 96
 Little Wittenham 107, 112
 Livy 91, 94, 212
 Llyn Cerrig Bach 181
 Llyn Fawr 166
 Loch Moss 183
 Loch Olabhat 242
 lock-rings *see* rings
 Londesborough 242, 243
 Longbridge Deverill 155
 Lorrio, A. 204
 Lough Crew flakes 183
 Loughy 175, 177
 Loughnashade 116, 145, 174, 178–9

INDEX

- Louernius 12
 Lough Neagh 240, 241
 Lovasberény 99
 Lovčičky 27
 Luchta 14
 Lug 208
 Luncani 224
- Magdelenenberg 218
 Maiden Castle, Dorset 138
 Mailhac 193–5, 194
 Manching 12, 13, 130, 133, 134, 211, 216, 270
 Manerbio sul Mella 213, 222
 Manětiň-Hřádek 62
 Manton Common 241, 241
 Mariesminde 20, 21
 Marlborough 158–9, 158
 Marmesses 30, 31
 Martial 3
 Marzabotto, Bologna 2, 141
 ‘master of the beasts’ 61
 Massilia 10, 40, 42, 193, 196
 ‘Mayer’ mirror 161
 Meare 156, 157
 Megaw, J. V. S. 3, 14, 15, 61, 62, 65, 72, 84, 104, 119, 124, 126, 252, 254, 274
 Megaw, R. 14, 15, 65, 84, 104, 126, 252, 254, 274
 Meigle 249
 Melsonby (Stanwick) 230
 Ménil-Annelles 133
 mercenaries 212
 Mérida 201
 metal-working 7, 12–13, 14, 17–18, 27, 168, 211; alloying 7, 18; *champlevé* 8, 234; *cire perdue* 7, 14, 17, 77, 133; *cloisonné* 152, 256, 259; crucibles 13, 154; engraving 7, 34, 143, 159; filigree 258, 259; ingots 154; moulds 13, 17, 172, 242, 245; *pointillé* 261; *Pressblech* 259, 260; pseudo-filigree 120, 122; sheet-bronze 7, 14, 30; smelting 13; tools 13–14; trichinopoly 259, 260; wire 7, 18; *see also* bronze-working, gold-working *and* iron-working
- Mezek 128, 133, 150, 270
 Milavec 20, 22
 Millas 193, 194
millefiori 8, 242, 256
 mining 13
 Minster Ditch, Oxford 107, 141
 mirrors 45, 88, 112, 159–63, 160, 162, 179
 Mistřín 120, 122
 Mithridates the Great 229
 Mohen, J.-P. 190–1
 Monasterevin 185, 186, 242
 monasticism 252
- Montans 191
 Montbellel 98, 98
 Mont Beuvray 12, 211
 Mont Lassois 12
 Monte Bible 88, 102
 Montigny-Lencoup 104
monumentos com fornos 210
 Mont-Peyroux 194
 Monymusk reliquary 16b 261
 Mooghaun 168, 187
 Mortillet, G. de 1
 Mortonhall, Edinburgh 230, 231, 232
 Moscano di Fabriano 84, 85, 87, 88
 moulds *see* metal-working
 Mšecké Žhrovice 57, 126–8, 127, 153, 213
 Müller-Karpe, H. 19
 Münsingen 79, 82–3, 95, 103
murus gallicus 211, 218
 Muttenz 81
- Nages, Les Castels 195
 Nash, D. 212
 Navan, fort 168, 178, 181; *see also* brooches
 Navarro, J. M. de 95, 99, 102, 106, 107, 111, 112, 140, 152
 Naves 221
 Nebringen 132
 Nehvizdky 120, 121
 New Barn Down 27
 Newnham Croft 86, 87, 116, 138, 145–6, 153, 179
 Newton House, Culsalmond 247, 248
 Neuvy-en-Sullias 6, 222–4, 225, 265
 Nigg 241, 249
 Nijmegen 159, 160, 161
 Nijnsel 27
 Norrie’s Law, hand-pins 242, 244; oval plaques 242, 244; *repoussé* plaque 185, 242, 244
 North Grimston 220
 Norton, Malton 235
 Nový Bydžov 120, 121
 Numantia 204, 205, 206, 206, 207, 208, 264
- Oberaden 229
 Obermenzingen 109
 Oberwittighausen 55, 57
 O’Floinn, R. 242
Ogham 246, 252
 O’Kelly, M. J. 185
 Oldcroft 242
 Olmsted, G. 226
 Oploty 81
oppidum, oppida 13, 26, 124, 132, 177, 195, 204, 208, 211–12, 216, 218, 219
 Orastie 20, 22

INDEX

- 'ornament horizon' 173
 Ornavasso 218, 232
 Orton Meadows 107
 Osismii 214
 Oxus treasure 62
- Pabbay 246
 'pacification' of prehistory 9
 Palladius 253
 Panenský Týnec 112
 pans, bronze handled *see patellae*
 Pafil 250, 251
 'Paris' lynch-pins 133, 134; rein-rings 133, 134, 136, 150
 Paris, Notre Dame 227
 Parisii 213, 214
 Parsberg 55, 57, 63
pastillage 120, 122
patellae 157, 216–18, 217, 220
 Patrick 252
 Pauli, L. 14
 Pazyryk 9
 Pečky 120
 Peñalba de Villastar 208
 Pedrão 208
 Perleberg 27
 Perseus of Macedon 212
 Perugia 63
 Petres, E. 84, 96, 99
 'Petrie' crown 183–5, 184, 232
 Pfalzfeld 8, 54, 56, 271
phalerae 67, 213, 222, 224, 227–9, 228
 Philip II of Macedon 212, 213
 Picts, Picti 6, 9, 238, 245
 Piggott, S. 93, 110, 112, 143, 145, 164, 169, 177, 178, 183, 230
 'pilgrim flask' 51
 pins 9, 118, 181, 253, 270; disc-headed 166; hand- 242, 243; ring-headed 136, 175, 176, 242; Urnfield 33
 Piskolt 121
pit place-names 237
 place-names, Celtic 190
 Pliny 208
 Plumpton Plain 27
 Podlešín 120
 Polden Hills hoard 1, 230
 Polybius 29, 91, 153, 212, 215
 Pool, Sanday 250
 Port, Bern 106, 268
 Posidonius 12, 196, 270
 pottery 6, 8, 12, 34, 79, 80, 90, 155–7, 195, 211, 219, 239, 272–3; ACO beaker 220; *amphorae* 10, 195, 216, 217, 219, 220; Arrentine 199; Attic 26, 39, 49, 51, 88; black figure 195; *Braubach* 51, 265, 273; *bucchero nero* 195; cylinder neck urns 19, 193, 272; 'duck stamped' 210; E-ware 242, 243; graphite coated 126, 273; haematite coated 155; *kamtharoi* 130; *Kerbschnitt* 34, 272; *kylix* 38, 39, 51; *Linsenflasche* 109; painted 77–8, 206–8, 207, 273; Phocaeian 195; red figure 38, 49; Samian 220, 229; 'saucepan' pots 48, 157; stamped wares 210; *vases carénées* 48, 79; *vases piriformes* 48, 80, 89, 90; *vasi a trotolla* 218; wheel-thrown, potter's wheel 8, 40, 200, 219, 273
Pressblech *see* metal-working
 Prunay, 'Le Champ la Guerre' 79, 80; 'Les Commelles' 89, 90
- querns: beehive 165, 170, 177–8; disc 178; saddle 177
 Quéroy 194
 Quesada Sanz, F. 200, 203
 Quintanas de Gormaz 202, 203
- Raftery, B. 99, 113, 115, 116, 136, 169, 172, 175, 179, 183, 185
 Rákos 130
 Ratcliffe-on-Soar 87
 Rathgall 13, 168, 187
 Rathinaun 168
 razors 20
 Reinecke, P. 29, 77, 132
 Reinheim 44–7, 46, 51, 54, 62, 177
 rein-rings 128, 133, 134, 150, 230
 Renfrew, C. 5
 Rickenbach 79
 Ribemont-sur-Ancre 12, 221
 ring-forts 168
 rings: ankle- 79, 118, 121–2, 129; arm- 9, 34, 45, 54, 61, 62, 72, 73, 78, 118, 145, 270; bracelets 9, 33, 34, 47, 48, 54, 57, 62, 72, 74, 75, 76, 77, 79, 81, 86, 87, 94, 106, 118, 119–21, 120, 121, 122, 132, 142, 166, 175, 190, 191, 195, 270; finger- 9, 45, 51, 54, 55, 79; leg- 9, 34; lock-rings 166, 167; 'massive' armlets 185, 236; 237; 'snake-armlets' 234–7, 236; striated 166, 167
 Rinnagan 254, 255
 Ripont 133
 Ritchie, A. 246
 Rodenbach 7, 14; arm-ring 5a, 54, 61, 62; finger-ring 51, 54, 55
 Rome, sack of 91
 Römerstein-Zainingen 25
 Roquepertuse 57, 196–9, 198, 208, 271
 'Roscavey' 176
 Roscommon 166
 Roualet, P. 48, 77, 132
 Rouillerot 77

INDEX

- Rudston 142
 Rynkeby 158, 159
 Rynne, E. 180
- St Albans 229
 St Brieuç-des-Iffs 166
 Saint-Jean-sur-Tourbe 67, 102
 St Ninian's Isle hoard 261
 St Pol de Leon 84
 salt mining 49–50
 Saluvii 196
 Sandars, N. K. 58, 62
 Sankot, P. 48
 San Salatore, Siena 259
 Santon 183, 234
 Sark hoard 227
 'satyr-faces' 38, 39, 51–4, 55, 74, 77, 126, 208, 209, 254
 Sawdon 138, 143
 scabbards 7, 84, 87, 93–117, 119, 121, 142, 171, 178, 202, 203, 220, 221, 269; chapes 93, 95–6, 99, 102, 107, 110, 111, 113, 142, 171, 178, 230, 269; Piggott's Groups 3, 4, and 5, 230
 scales 185
 Schwabsburg 44
 Schwappach, F. 51, 109
 Schwarzenbach 2b, 42–4, 43, 54, 65, 66
 Scythians 2
 Segovesus 94
 Semeuse 132
 Senftenberg 27
 Senones 91
 Sequani 106
 settlements 12; hill 26; lake-side 26, 27; open 26; terp 27; *see also* hill-forts
 Seven beasts *phalera* 227, 228
 Shandwick 241, 249
 shields 28, 48, 166, 172, 201, 215, 268; Iron Age 8, 9, 87, 106, 111, 118, 121, 146–52, 148, 151, 172; Nipperweise type 30; U-notched 30, 248; V-notched 30; Yetholm type 30
 Shillington 161
 ships 173, 215
 Shipton-on-Cherwell 31
 sickles, iron 106; socketed 166
 'Silenus' mask 54
 silk 40
 silver working 7, 226
 situla art 61, 62, 63, 264
 Skallerup 21
 Skellig Michael 252
 Skinner 248
 slavery 42, 50, 218
 'sleeve-fasteners' 166, 167
 Smarjeta 220
 Smith, M. A. 32
 snake imagery 76, 215, 221
 Snettisham 7, 10a, 10b, 11, 153–5, 173, 221, 270
 Sogny-aux-Moulins 80
 Somerset, Co. Galway 173, 181
 Somerset 'lake-villages' 9
 Somme-Bionne 49, 50, 60, 61, 267
 Sopron 34, 35, 264
 Source-Seine 221
 Souterrains 237, 245
 South Cadbury 13
 South Cave, Hull 230
 spears 9, 29, 48, 51, 88, 106, 171, 195, 215; *soliferreum* 201, 203, 248; spear-butts 5, 112, 170, 171–2, 181
 spoons 87, 182, 183
 Spratling, M. 13
 Sprockhoff, E. 29
 spurs 220
stamnoi 10, 11, 38, 40
 Standlake 84–7, 85, 93, 110, 112, 113, 140, 141, 146
 Staňkovice 120, 121
 Stanway 11, 229, 248
 Stanwick 183, 232; *see also* Melsonby
 Stara Zagora 229
 Staré Hradisko 211, 222
 Stary, P. 200
 Stead, I. 110–11, 112, 152, 183, 230
 Steinbichel 130
 stele 181, 204, 252, 271
 Stettlin-Deisswil, Bern 79
 Stevenson, R. B. K. 242, 246, 248, 249, 250
 Strichill 185, 232–4, 233
 Strabo 4, 42, 189, 193, 196, 204, 208, 270
 Stradonice 12, 124, 211, 220, 222
 Strettweg 23, 24
 Stupava 61
 Sulejovice 120
 Sutton Hoo 256, 259
 Sutton Reach 107, 108, 111–12, 153
 swastika 121, 122, 265
 swords 9, 28, 29, 34, 48, 49, 51, 87, 88, 106, 121, 171, 203, 220, 268–9; Aguilar de Anguita 201, 202; Alcácer 201, 202; antenna-hilted 190–1, 201, 203, 209, 269; anthropoid-hilted 220, 221–2, 269; Aquitanian 202; 'carp's tongue' 166, 190; destruction of 203, 221, 248, 268; Echaury 201, 202; Erbenheim 29; Ewart Park 190; *falcate* 201, 202, 203, 209; *frontón* 201, 202, 209; *Griffszungenschwerter* 29; Gündlingen 166; Hemigkofen 29; Letten 29; Monza 29; Nenzingen 29; Riegsee 20, 29; Rixheim 29; stamped motifs on 268; *Vollgriffschwerter* 28, 29
 symbols: 'Pictish', abstract 247–50, 247; animals, birds, fish 249, 251, 256

INDEX

- symbol stones, Class I 239, 241, 245–52; Class II 237, 241
 Szabó, M. 3, 81, 84, 95, 96, 99, 119, 130, 224
 Szob 98, 99, 101, 104, 130

 Tábor 224
 Taliándörögd 103, 104
 Tankards 232
 Tapolca-Szentkút 96, 97
 ‘Tara’ brooch 15b, 258–9
 Tarasque de Noves 199
 Tarn 122, 123, 175
 Tarquinius Priscus 91
 Tasciovanus 215
 Taurisci 213, 222
 Tayac 191–2
 Tectosages 94
 Telamon 91, 153
 Telce 120
 terrets, Donside 237; *see also* rein-rings
 Teutones 4, 136, 139
 textiles 9
 Thomas, A. C. 246, 249
 Tiberius 220
 Ticooly O’Kelly 170, 178
 tin, sources of 18
 Tiszavasváry 21
 Titelberg 216, 219
 Tolistobogii 94
 Tømmerup 136
 Toome 114, 115–16
 torcs 9, 33, 45, 47, 54, 56, 57, 58, 61, 72, 74, 75, 76–7, 78, 79, 81, 84, 88, 119, 126, 128, 130, 132, 136, 153–4, 164, 173, 191, 192, 199, 206, 210, 214, 215, 222, 227, 270
 Torrs 20, 84, 111, 112, 115, 116, 118, 143–5, 144, 149, 150, 153, 178, 179, 269
 Toynbee, J. 234
 Traprain Law 172, 242
 Trawsfynydd 232
 Treveri 220
 trichinopoly *see* metal-working
 Trichtingen 130, 131
 Trinovantes 161
 Trocmi 94
 Trundholm 23
 Tuatha Dé Danaan 15
 Turoe 8, 179–81, 180, 270

 Ulbster 248
 Unterglauheim 20, 21, 32
 Uxama 208

 Vače 63
 Vaiamonte 209

 Vayres 191
 Vénat hoard 190
 Veneti 214, 215
 Verger, S. 68
 Vetttersfelde, Berlin 58
 Vidauque, grotte Basses de 194
 Vielle Toulouse 191
Viereckschanzen 126, 128, 221
 Villement, St-Aoutrille 194
 Villeneuve-Renneville 48
 Villeneuve-Saint-Germain 212, 216
 Vindelici 214
 Viollier, D. 132, 141
 Vix 10, 33, 58, 59, 63
 Voivodina 96, 97
 Volcae Tectosages 193
 ‘voracious beast’ theme 63, 64, 159, 199, 250
 Vouga, P. 104, 106
 Vrhnika 220
 Vulcan 14

 Waldalgesheim 5b, 45–7, 46, 54, 62, 72–6, 73, 76
 Walthamstow 107
 Wandsworth 112; circular shield 70, 143, 146, 150, 151, 152, 272; long face-mask shield 136, 137, 149–50, 152
 Ward-Perkins, J. B. 113, 169
 Wasserburg, Buchau 26, 27
 water deposits *see* hoards
 Waterloo Bridge 154–5
 weapons 9, 10, 27–9, 30, 44, 90, 171–2, 200
 ‘triple panoply’ 11, 29, 49, 79, 94, 172, 200, 203, 219, 268; *see also* scabbards, spears *and* swords
 Weiskirchen, belt-clasp 59, 60, 61; drinking-horn mount 58; plaque 14, 44, 51, 54
 Wells, P. 216, 218
 Welwyn 157, 229; *see also* burials
 Werner, J. 216–18, 220
 Weston 87
 Wetwang Slack 108, 110–11, 142
 Wheeler, Sir Mortimer 211, 232
 Wilburton-Wallington 166
 Wilson, D. 245
 Winchester 241
 wine 10, 38, 40, 62, 94, 216, 220, 230
 Wisbech 67, 70, 109–10, 111, 113
 Witham: shield 70, 112, 143, 146–9, 148, 152, 248, 265, 272; sword and scabbard-plate 145, 146, 147, 149
 Wittnauer Horn 26
 Witry-les-Reims 77
 Wood Eaton 87, 138, 141
 wood-working 9, 157
 Wraxall 232

INDEX

Xerxes 58

yoke fittings 73, 74, 87

Y-pendants 5, 164, 171, 181

Zangentore 212

Závist 211, 212

Zelkovice 109

Ziwiyeḥ 62