

WARHAMMER[®]

40,000

BATTLE MANUAL



CITADEL[™]
MINIATURES

GAMES[™]
WORKSHOP

A WARHAMMER 40,000 SUPPLEMENT CONTAINING RULES
FOR COMBAT AND WEAPONRY IN THE 41st MILLENNIUM

WARHAMMER[®]
40,000

BATTLE MANUAL

By Rick Priestley



PRODUCED BY GAMES WORKSHOP

White Dwarf and Warhammer are registered trademarks of Games Workshop Ltd.
Games Workshop, Citadel, the Citadel Castle and Space Marine are trademarks of Games Workshop Ltd.
"Scatter" dice are UK registered design no. 2017484.

All artwork in all Games Workshop products and the images contained therein have been produced either in-house or as work for hire. The exclusive copyright on the artwork and the images it depicts is the property of Games Workshop Ltd.

Game design consultant Bryan Ansell.

Cover by David Gallagher

© Copyright Games Workshop Ltd, 1992. All rights reserved.

GAMES WORKSHOP LTD.
CHEWTON STREET
HILLTOP
EASTWOOD
NOTTINGHAM NG16 3HY

GAMES WORKSHOP INC.
3431-C BENSON AVENUE
BALTIMORE
MARYLAND
21227-1072

A

GAMES WORKSHOP[™]

PRODUCT

REF NO: 00163,

ISBN: 1-872372-53-8

PRODUCT CODE: 0163

CONTENTS

INTRODUCTION	4	Digital Laser	32	Heavy Stub Gun	64
		Harlequins Kiss	32	Heavy Webber	65
SHOOTING	8	Lightning Claws	33	Lascannon	66
Facing the Right Direction	8	Mandiblaster	33	Multimelta Cannon	66
LINE OF SIGHT AND COVER	9	Power Axe	34	Missile Launcher	68-69
Low Obstacles	9	Power Glove	34	Multilaser	70
Shooting from Cover	9	Power Maul	34	Shuriken Shrieker Cannon	70
Woodland	9	Power Sword	35		
Obstructing Models	10	Rough Rider Hunting Lance	35	SUPPORT WEAPONS	72
Cover	10	Swords & Other Hand Arms	36	Distort Cannon on	
TO HIT	11	Thunder Hammer	36	Anti-grav Platform	72
Range	11			Rapier Laser Destroyer	73
Hitting the Target	11	PISTOLS	37	Mole Mortar	74
Basic Modifiers	11	Autopistol	37	Scatter Laser on	75
Weapon Modifiers	12	Bolt Pistol	37	Anti-grav Platform	
To Hit Scores of 7+	12	Hand Flamer	38	Tarantula	75
DAMAGE	12	Laspistol	39	Thudd Gun	76-77
Damage Chart	12	Needle Pistol	40		
SAVING THROWS	13	Plasma Pistol	40	GRENADES	80
Save Modifiers	13	Shuriken Pistol	40	Antiplant	80
Taking Shots Together	13	Stub Gun	41	Blind	80
BLAST AREA WEAPONS	14	Web Pistol	41	Choke	80
Scatter Chart	14			Frag	81
Maximum Scatter	14	BASIC WEAPONS	44	Hallucinogen	81-82
Dud Shots	15	Autogun	44	Haywire	83
THROWING GRENADES	16	Boltgun	44	Krak	83
Smoke Grenades	16	Bow	45	Photon Flash Flare	83
Shooting and		Crossbow	45	Plasma	84
Close Combat	16	Deathspitter	46	Rad Grenade	85
OVERWATCH	17	Flamer	47	Scare	85
Preparing Overwatch	17	Fleshborer	48	Smoke	86
Firing on Overwatch	17	Graviton Gun	48	Stasis	86
Losing Overwatch	17	Handbow	48	Tanglefoot	87
SUSTAINED FIRE	18	Auxiliary Grenade Launcher	49	Toxin	87
Weapon Malfunction	18	Pack Grenade Launcher	49	Virus	88
CHOOSING A TARGET	19	Lasgun	50	Vortex	89
		Melta Gun	50		
		Musket	50	FORCE WEAPONS	90
HAND-TO-HAND	22	Needle Sniper Rifle	51	Force Axe	90
COMBAT		Ogryn Ripper Gun	51	Force Rod	90
Models in combat	22	Plasma Gun	52	Force Sword	90
Close combat procedure	23	Shotgun	52	Nemesis Force Weapon	91
The Fumble rule	24	Shuriken Catapult	53	Witch Blade	91
The Parry rule	24	Storm Bolter	53		
Close Combat Modifiers	25			CATALOGUE PAGES	92-96
Vehicles	26			CARD SECTIONS	8 SHEETS
		HEAVY WEAPONS	56	Weapon Summaries (4)	
HAND-TO-HAND	30	Assault Cannon	56	Templates/Counters (4)	
WEAPONS		Auto-Cannon	56		
Banshee Mask	30	Battle Cannon	57		
Blades & Saws	30	Conversion Beam Projector	58		
Boneswords	31	Cyclone Terminator	60		
Chainfist	31	Heavy Bolter	62		
Chainsword	31	Heavy Flamer	63		
		Heavy Plasma Gun	64		

INTRODUCTION

The Warhammer 40,000 Battle Manual is our first attempt to redescribe all the weapons in the Warhammer 40,000 game since the original volume was published in 1987. Astute players will notice a few of the less useable weapons in the original book have been dropped altogether, and that other weapons have got new rules more appropriate to their appearance as depicted by the most recent models.

Our intention has been to update the rules where this was felt to benefit the game, and to compile the information in one place for the first time. Since the Warhammer 40,000 game first appeared our game universe has expanded considerably to include many new weapons and copious details about many different races and armies. Some of these new rules are readily available elsewhere, and we have chosen to avoid describing those few highly specialised or variable weapons that are already covered by published books. For example, it is hardly worth filling up lots of pages with rules for Ork kombi-weapons already covered in *Ere We Go*, as any player with an Ork army will undoubtedly already own a copy of this book.

Certainly there will be more weapons to describe as we reveal more about the Imperium, Orks, Eldar, and Tyranids. Such information will be published in *White Dwarf* magazine with army lists for new forces, painting guides, battle reports, and modelling hints.

As well as redefining some of the weapons, particularly grenades and other weapons with a burst area, improvements have been made to the game rules themselves. Many of these changes stem from the copious suggestions made by players as well as our own experiences of the game. In particular the effects of certain gas grenades have been redefined in terms more appropriate to a model's appearance and armour. We've also changed the templates used for flamers into a more appropriate shape, and the rules governing burning targets have been revised too. Distort cannons, beamers, and other more exotic weapons have been revised extensively.

A substantial change has also been made to the format in which the weapon profiles are presented. These are much more straightforward than the original style profiles, especially about special rules, area effects, and encumbrance penalties. Experienced hands will doubtless appreciate the improvement in clarity.

But perhaps the biggest change is in the rules for hand-to-hand combat. When the original rules for Warhammer 40,000 were published, the rules for combat drew heavily on Warhammer Fantasy Battle. While these rules worked well enough for large forces slugging it out with fists and teeth, we soon realised that combats of this scale were the exception on the battlefields of the Warhammer 40,000 universe.

What we needed was a new combat system, that while remaining compatible with the older rules allowed for a greater level of detail needed for smaller scale combat. The system we've come up with fulfills both criteria admirably – and uses the same statistics as the older rules.

Given that certain rules revisions were also necessary in the shooting rules, we thought it would be a good idea to print a revised section to replace the one in the Warhammer 40,000 rule book. So, for example, the section given here takes into account the new vehicle rules published in *White Dwarf*. Although the basic underlying rules remain the same, we felt it was worthwhile repeating to put the new rules into a proper context that made them easier to explain. Because the section is quite short we have been able to do this without adding to the cost of this volume.

The most significant change to the Shooting section is the way in which the deviation rules work. We've renamed the process *scatter* to bring it into line with our other games as well as to set it apart from the old system.

A few other terms have also been changed to a more convenient form, so you will not find weapons described as 'slow' when what is really meant is that they cannot move and fire in the same turn. Although such changes make no difference to the way the game plays, they make it easier to understand what is being represented by the game rules.

From the number of letters we receive requesting weapon profiles and rules we know that players will appreciate this volume as a useful reference tool. In addition, we tried to provide a genuinely useful selection of reference sheets and templates. These can be photocopied and stuck onto card or simply cut straight out of the back of the book.

Overall we're happy to be able to print this volume and hope you'll agree with us that it makes a valuable and worthwhile addition to the Warhammer 40,000 game.

WEAPONS

This section describes and provides rules for the many different kinds of weapons available to the warrior of the forty first millennium. As well as a general description, each entry includes any special rules that apply to the weapon, and summarises its effects by means of a weapon profile.

THE WEAPON PROFILE

Short Range	Long Range	To Hit Short	To Hit Long	Strength	Damage	Save Modifier	Special
0-12	12-24	+1		4	1	-1	

Short Range

The short range of the weapon, for example 0-12".

Long Range

The long range of the weapon, for example 12-24".

To Hit Short and Long

The 'to hit' modifier applied when shooting at short and long range.

Strength

The strength value of a hit caused by the weapon.

Damage

The amount of damage or amount of wounds caused by a hit.

Save Modifier

The saving throw dice modifier applied to the target's saving throw.

Special

This column lists particular rules that apply to the weapon and which are covered by the main rules. Any special rules that apply only to that weapon are explained above the profile itself. This column may contain any of the following remarks.

Close Combat: Only weapons indicated in this way may be used in hand-to-hand combat.

Heavy *n*" penalty: The word *heavy* followed by a number of inches indicates that when carried the weapon is either heavy or very bulky, and that a model carrying it suffers a movement penalty to represent this. For example "Heavy 2" penalty". Note that this penalty only applies to troops moving on foot and carrying the weapon, it does not apply to mounted troops, vehicles or dreadnoughts.

Move or Fire: Where the weapon is carried it may either move or fire during the turn, but not both. If the model moves then it cannot shoot with the weapon. This does not apply to mounted troops, vehicles, and dreadnoughts which may both move and fire with these weapons.

Sustained Fire: The weapon is capable of shooting more than once during the shooting phase as described in the sustained fire rules.

Area *n*" radius: This indicates that the weapon is an area weapon as described in the Shooting rules. The weapon uses a burst marker with a radius equal to the number shown.

See above: Many weapons have special rules which are impossible to summarise on the profile itself. These are given in the text before the weapon profile.



EXAMPLE: MELTA GUN

The melta gun is a powerful heat weapon. Its profile serves as a good example of how weapon profiles work.

The melta gun has a short range of up to 6" and a long range of up to 12", and at short range there is a +1 to hit. The weapon

has a very high strength of 8 and causes D6 damage points, which is also very high as most weapons cause only 1.

Short Range	Long Range	To Hit Short	To Hit Long	Strength	Damage	Save Modifier	Special
0-6	6-12	+1		8	D6	-4	

EXAMPLE: LASCANNON

The lascannon, or laser cannon, is a large weapon which fires a devastating blast of laser energy. The lascannon has a short range of 20" and a long range of 72" – a much longer range than the melta gun. It has a strength of 9 and causes 2D6 damage points. This combination of high strength and damage makes this weapon the ultimate tank buster! Should the

weapon be directed against armoured infantry its saving throw modifier of -6 will ensure that damage is not likely to be saved. The special section indicates that the weapon is heavy with a 2" movement penalty, and that it may not move and fire during the turn.

Short Range	Long Range	To Hit Short	To Hit Long	Strength	Damage	Save Modifier	Special
0-20	20-72			9	2D6	-6	Move or fire Heavy 2" penalty

WEAPON TYPES

The various weapons are divided into six types: hand-to-hand combat weapons, pistols, basic weapons, heavy weapons, support weapons and grenades.

Hand-to-hand combat weapons are weapons which are designed for use purely in close combat. For example swords of various types, the hunting lance and the power axe. Such weapons cannot be used in the shooting phase, only in the hand-to-hand combat phase.

Pistols can be used in close combat but also at a distance. They can be fired in the shooting phase by troops not already engaged in hand-to-hand fighting or during the hand-to-hand combat phase by troops engaged in hand-to-hand fighting.

Basic weapons are normally used only during the shooting phase, although the addition of an axe-blade or bayonet enables them to be used to stab or chop in close combat. Basic weapons are designed to be fired in both hands rather like a modern rifle.

Heavy weapons are extra-powerful or extra-ranged weapons carried by a small proportion of troops and used to support their fellows by laying down covering fire, taking out armoured vehicles, and picking off enemy from a distance. These weapons tend to be large and heavy, and are usually less mobile than ordinary weapons.

Support weapons are so large that they cannot be carried, and therefore have their own mobile transporters which carry them into the battle zone.

Grenades are small bombs or grenades that are thrown by hand. Many grenades in the arsenals of the 41st millennium are quite small, some are no larger than a coin.

The weapons described here are not all the weapons that exist in the Imperium or beyond it. To even attempt to catalogue every variation in design and capability would be futile, so we have concentrated on the main types which are used on the battlefield.

There is a further broad class of much larger and heavier weaponry, but this is hardly appropriate for battles using Citadel models - the weapons themselves might be as big as the tabletop! These are weapons designed for blasting spacecraft out of orbit, for destroying huge targets from vast distances, or for razing cities. For example, the planetary defence laser is a huge weapon designed to be fired against targets high into the atmosphere, such as enemy landing craft and orbiting spaceships. These supremely potent devices may be constructed deep underground, with only their tips protruding above the surface. Although weapons of this kind play a vitally important role in the defence and large scale destruction of planets, they have no part on the battlefield and so we have not included them in this book.

SUPPORT WEAPONS

Some support weapons incorporate their own carriage or mobile platform, such as the Thudd gun and the D-cannon. Weapons mounted in this way are so large and heavy that they cannot be carried by an ordinary trooper. The carriage permits them to be wheeled about, pushed into position, or towed by a vehicle. Specific rules relating to their use are included with the description of each weapon.

Typical examples include the Imperial tarantula and the Eldar suspensor platform. These incorporate a mount that allows the weapon to swing from side to side and pivot up and down, and a mobile base that allows it to move.

TOWING SUPPORT WEAPONS

Weapons with a mobile carriage may be towed by any suitable vehicle, while the weapon's crew ride along in the vehicle or hold onto the weapon itself. Although some model vehicles are not equipped with towing hooks, it is assumed that all vehicles except bikes and trikes are capable of towing a mobile weapon.

A mobile weapon may be coupled to a vehicle provided both models are stationary and within 1" of each other at the end of the movement phase. At least one of the weapon's crewman, or one of the vehicle crew, must be present to fasten the coupling. Once fastened the weapon is limbered.





SHOOTING

Each model may shoot one weapon or throw a single grenade during its own side's shooting phase. Generally speaking, a model may shoot only once, although in some special cases certain weapons may be fired several times as discussed later.

The rules given here are general rules which apply to most weapons in most circumstances. Some weapons are exceptions which work in their own unique way, and the rules which apply to them are discussed with their descriptions later in this book.

FACING IN THE RIGHT DIRECTION

The direction a model faces indicates the actual direction faced by the individual foot soldier it represents. The same goes for vehicles, large weapons, and every other model on the table. Obviously it is not possible for a man to shoot a weapon behind himself, or for a large artillery piece to shoot backwards. Not only would be it physically impossible to perform these contortions, but you wouldn't be able to see where you were shooting! To represent this, a weapon may be fired, or a grenade thrown, anywhere within a 90° arc to the front of the model, as shown on the diagram opposite.

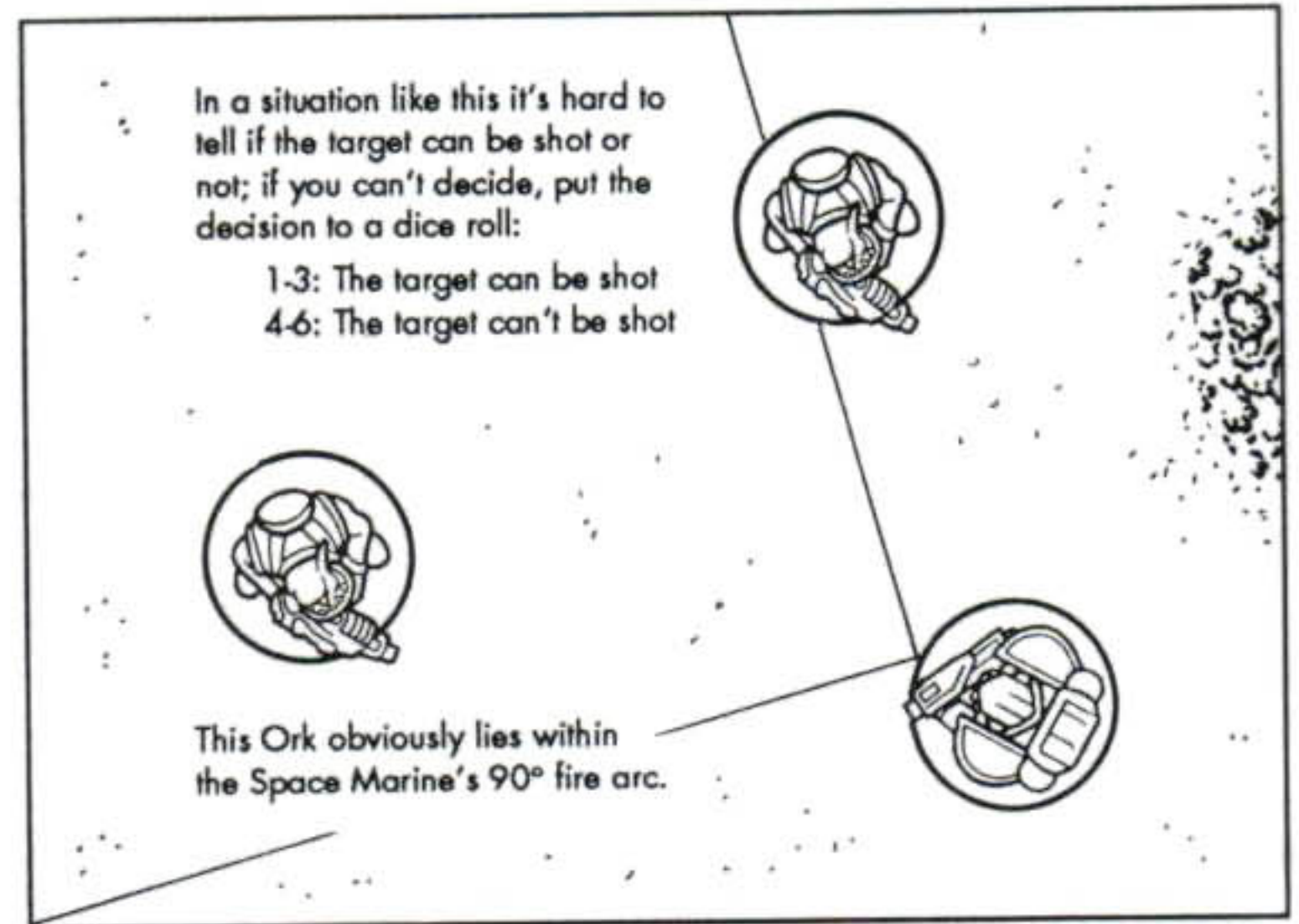

This represents the area in front of the individual that he can reasonably be expected to see. Occasionally, a target may lie very close to the edge of this arc, so that it is very difficult to tell whether it can be seen and shot at or not. In cases like this a straight 50/50 dice roll will decide the matter fairly.



LINE OF SIGHT AND COVER

A model must be able to see its target in order to shoot at it. It is not possible to shoot through terrain, buildings, vehicles or other models which conceal a target beyond. This ability to see and draw a line from the shooter to his target is called *line of sight*. It will usually be obvious that a model can't shoot at its target because there is a hill, a building, or some other large and solid object in the way. In some cases it is difficult to tell if a line of sight is blocked or not, and players must stoop over the table for a "model's eye view".

Although the general rule is that a model can shoot at anything it could theoretically see, there are a few specific exceptions as discussed below. These special rules allow us to represent the fact that real troops, unlike our models, can crouch behind cover, stoop, move through folds in the ground, and make themselves harder to see in all sorts of ways that are not necessarily apparent on the tabletop.

LOW OBSTACLES

Lines of low obstacles such as hedges or walls, and rows of bushes, scrub or rock are difficult to see through because of their broken outline and jumble of different colours and shades. Low obstacles will generally appear on the tabletop as walls or rows of scrub or rock approximately as high as a human model and up to 1" wide.

These features are important in the game because they allow foot troopers to move from one position to another, using cover to obscure them from sight or as a sheltered spot from which they can fire at the enemy. We shall therefore rule that low obstacles block the line of sight over level ground. Obviously where a model is positioned on high ground he will be able to see and fire over a low obstacle from his elevated position (eg a roof top or the slope of a hill).

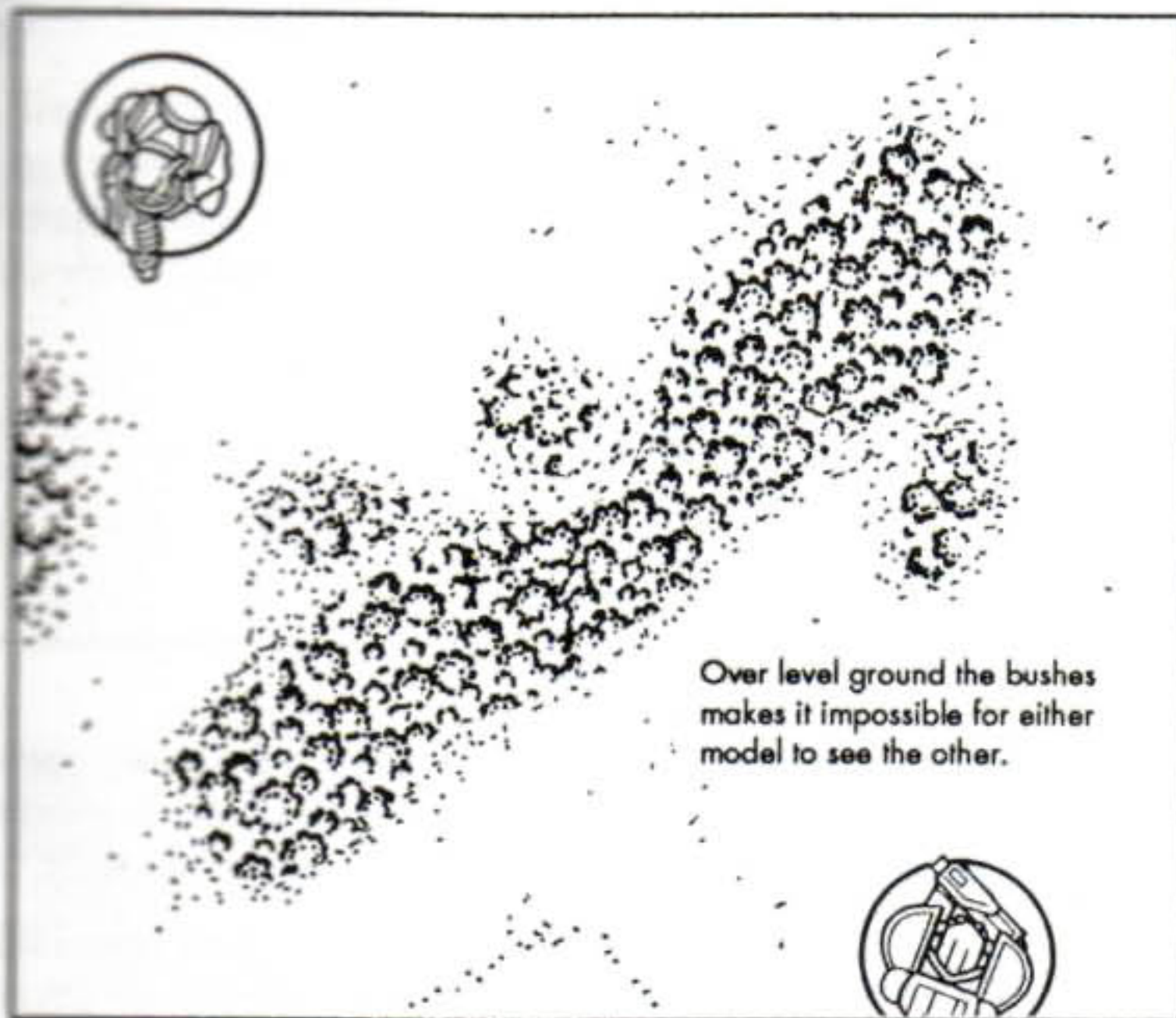

The low obstacle, together with natural falls and rises of the ground, is assumed to obscure troops on the other side even though a "model's eye view" may indicate that part of the target is visible. Remember that real people will avoid being seen by stooping low, using natural shallows of the ground, and keeping moving. Models cannot literally do this but we can imagine that they would.

SHOOTING FROM COVER

A real trooper can lean over a wall, hedge, rock, or other low obstacle with only his upper body exposed in order to shoot. Because we have already said that low obstacles block a model's line of sight we must make an exception so that troops can fire from behind cover. We shall rule that a model positioned directly behind a low obstacle is assumed to be leaning over so that he can see over it. In doing so he exposes himself to the view of troops on the other side. If a player wishes to make matters crystal clear he can simply declare to his opponent that the model is leaning over the cover. Similarly, if you want to make it especially clear that the model is not exposing himself then you can leave a easily recognisable gap between the model and the wall or hedge. If you think there's any room for confusion just tell your opponent that the model is keeping his head down.

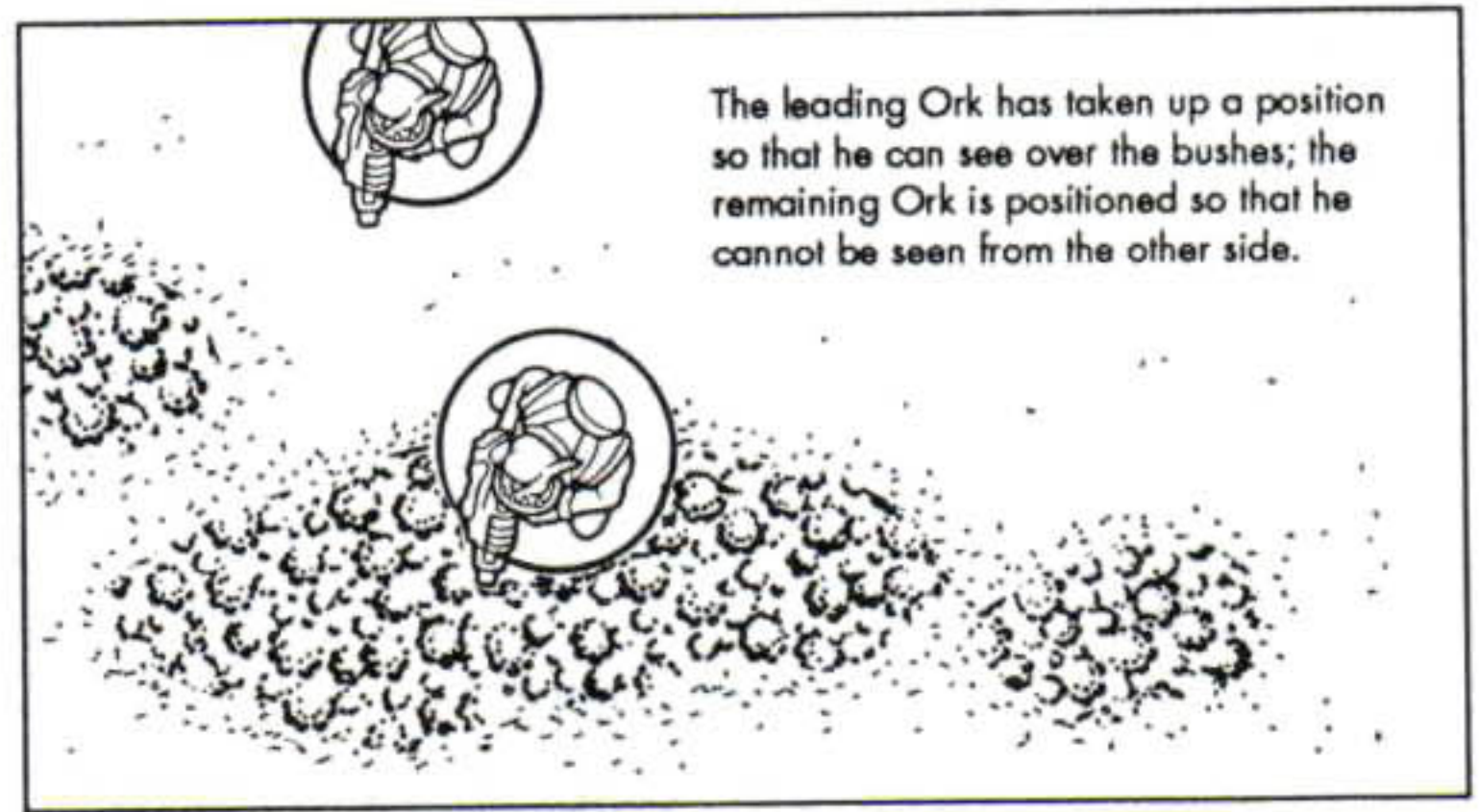

WOODLAND

It is convenient to assume that interposing woodland blocks the line of sight even though there might be little gaps between model trees. This is because there are many more trees, bushes, and other tangled undergrowth in a real wood than can be reasonably represented on the tabletop. A model on one side of a wood cannot therefore see or fire at a target on the other side.

A person inside a wood can see a little way even though he is surrounded by foliage. Models inside a wood can therefore see and fire at ranges of up to 2".

Foliage is thinner at the edge of a wood enabling troops inside to see out and troops outside to see in! Troops who are within a wood can therefore see and shoot out if they are within 2" of the edge. However, they can also be seen and shot at by other troops.

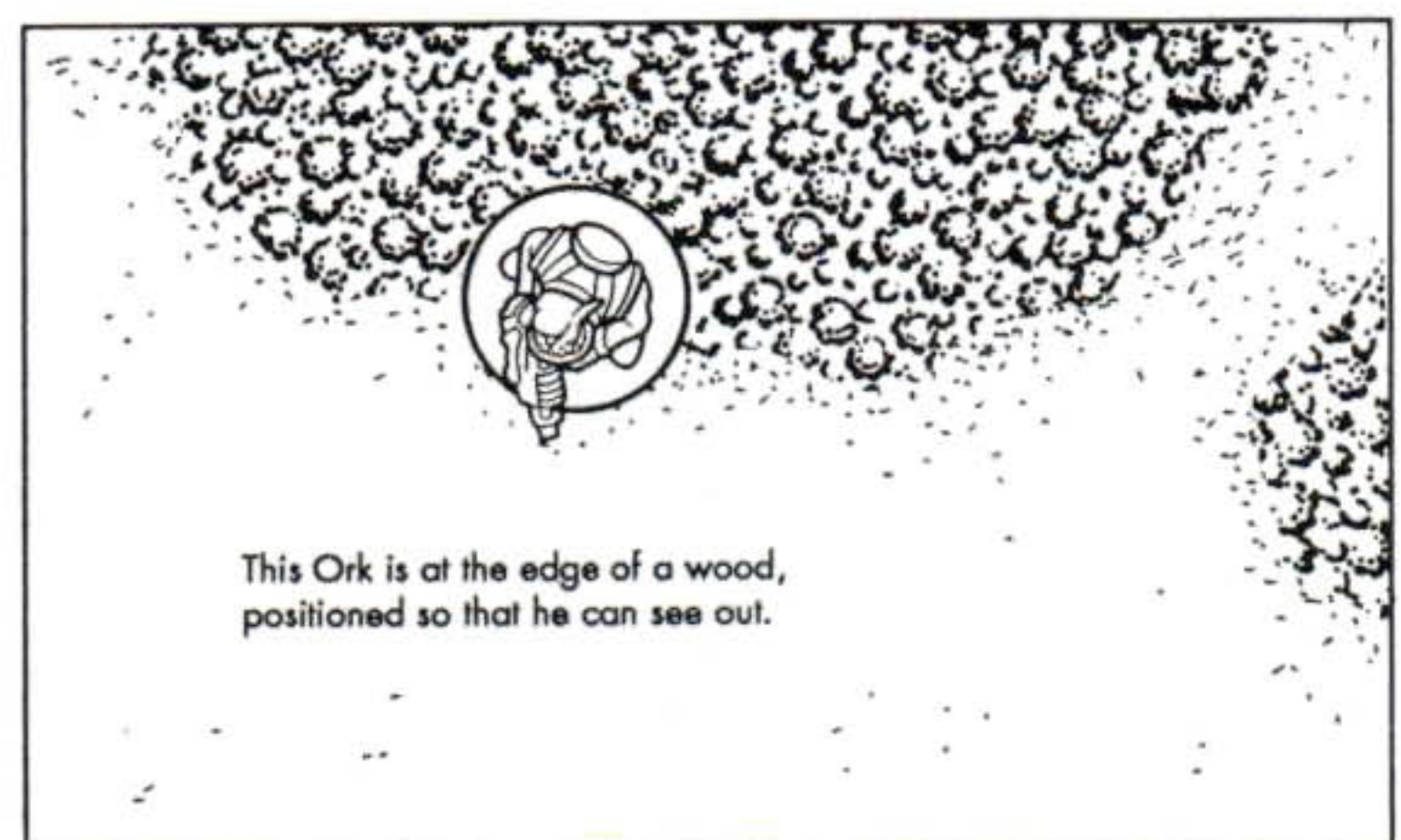

OBSTRUCTING MODELS

For reasons which are self-evident a player cannot shoot through one model at a target beyond. The only exception is where troops are positioned on a higher level, such as a roof top or a tall slope, in which case it is usually possible to shoot over the heads of troops below just as it is possible to shoot over a wall, hedge, or other obstacle. If in doubt check the "model's eye view" to see if the proposed shot is blocked by a model or obstacle. Obviously it is preferable for players to arrange their troops so that they avoid shooting through their own men!

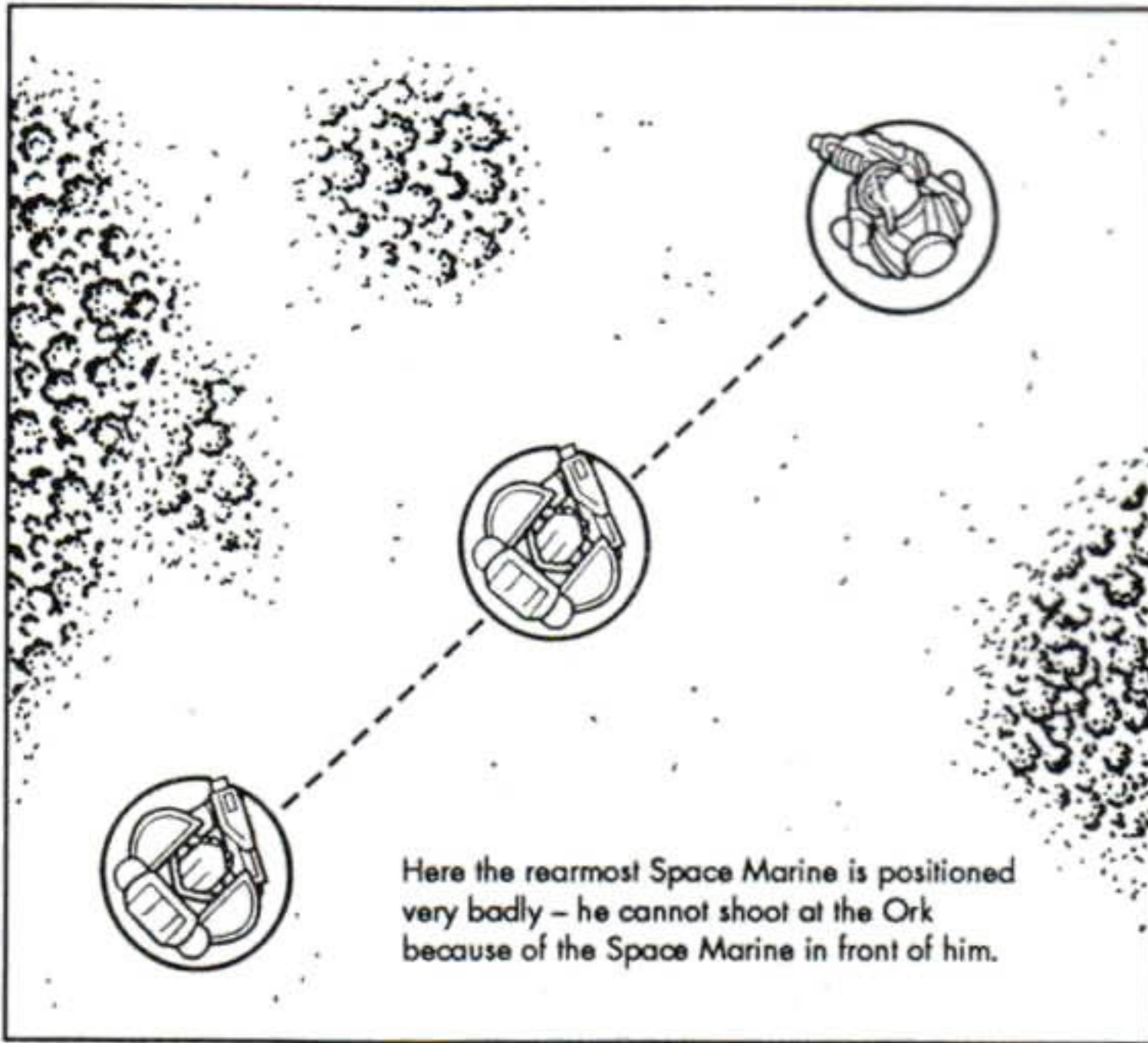

COVER

On a real battlefield, trenches, walls, scrub, woods and other features provide cover for foot troops. By moving from one patch of cover to another a trooper makes it hard for an enemy to shoot him. In the rules any shots against models in cover suffer a minus 'to hit' dice modifier as explained later.

Cover is divided into two types: *hard cover* and *soft cover*. Hard cover comprises walls, ditches, trenches, vehicles, rocks, the corners of buildings, and other features which not only partially obscure a shooter's target but which also offer a measure of solid protection. Soft cover comprises features which partially obscure the target, but which offer no substantial protection. Most vegetation is considered to be soft cover, including hedges, scrub, and woods. Obviously it is preferable from the target's point of view to be behind a wall rather than a hedge, but it is better to be behind a hedge than out in the open!

The following points should be self-evident in play. Some situations are a bit more complex and the following guidelines will help you to decide if a model is behind cover.



1. A trooper leaning over a low obstacle is in cover from shooters on the other side. It is assumed the trooper has taken up a position exposing at least some part of his body so that he can see or shoot.

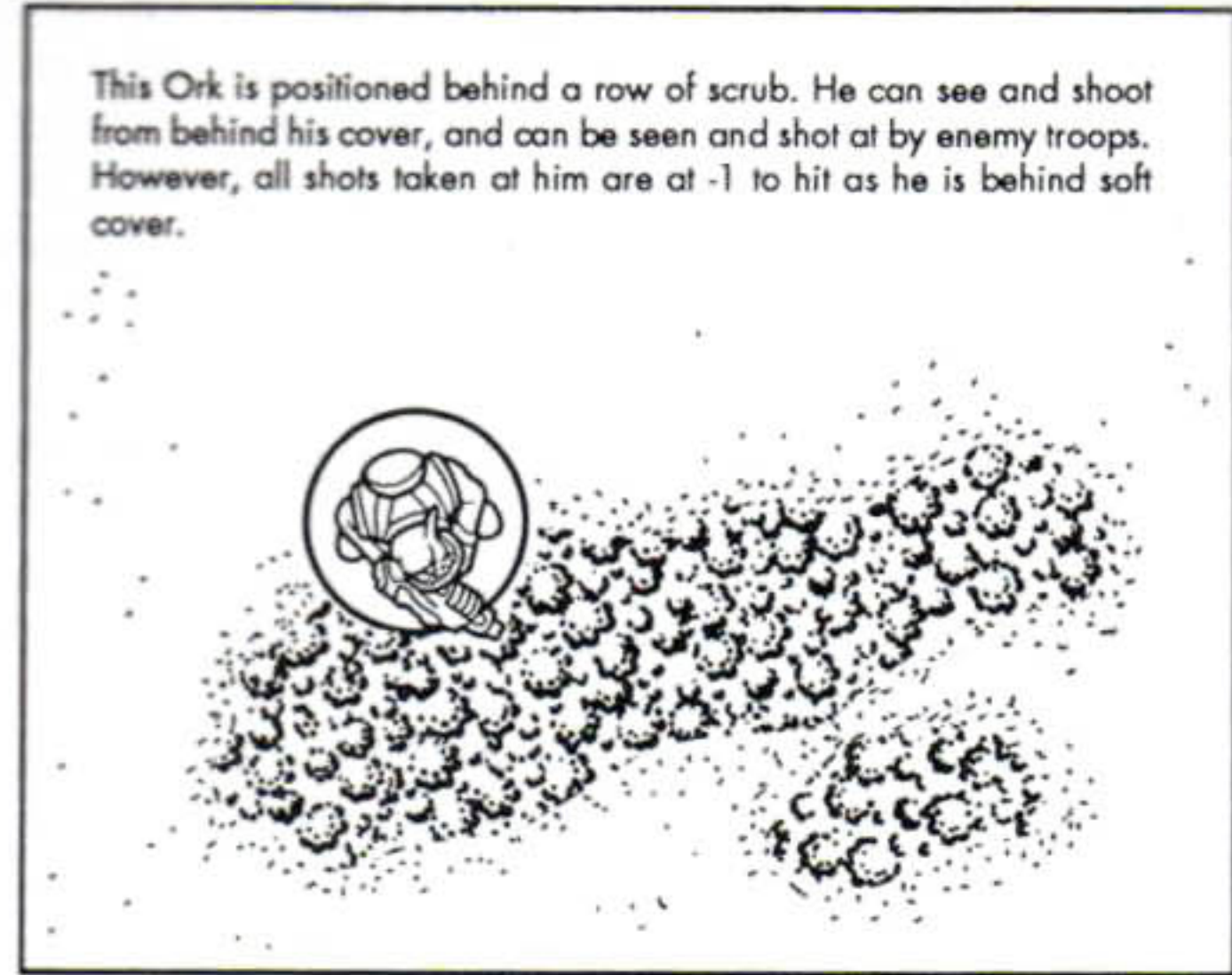

2. A trooper can lean round the corner of a building, vehicle, or large rock in order to see and shoot, in which case he leans out exposing just enough of himself to fire his weapon. The model is placed right on the corner, but if there is any room for doubt the player can declare to his opponent that the trooper is leaning out. The model counts as behind hard cover. This is very useful when you are fighting among buildings or ruins, where you want to be able to see and fire at the enemy but you don't want to present an easy target in return.

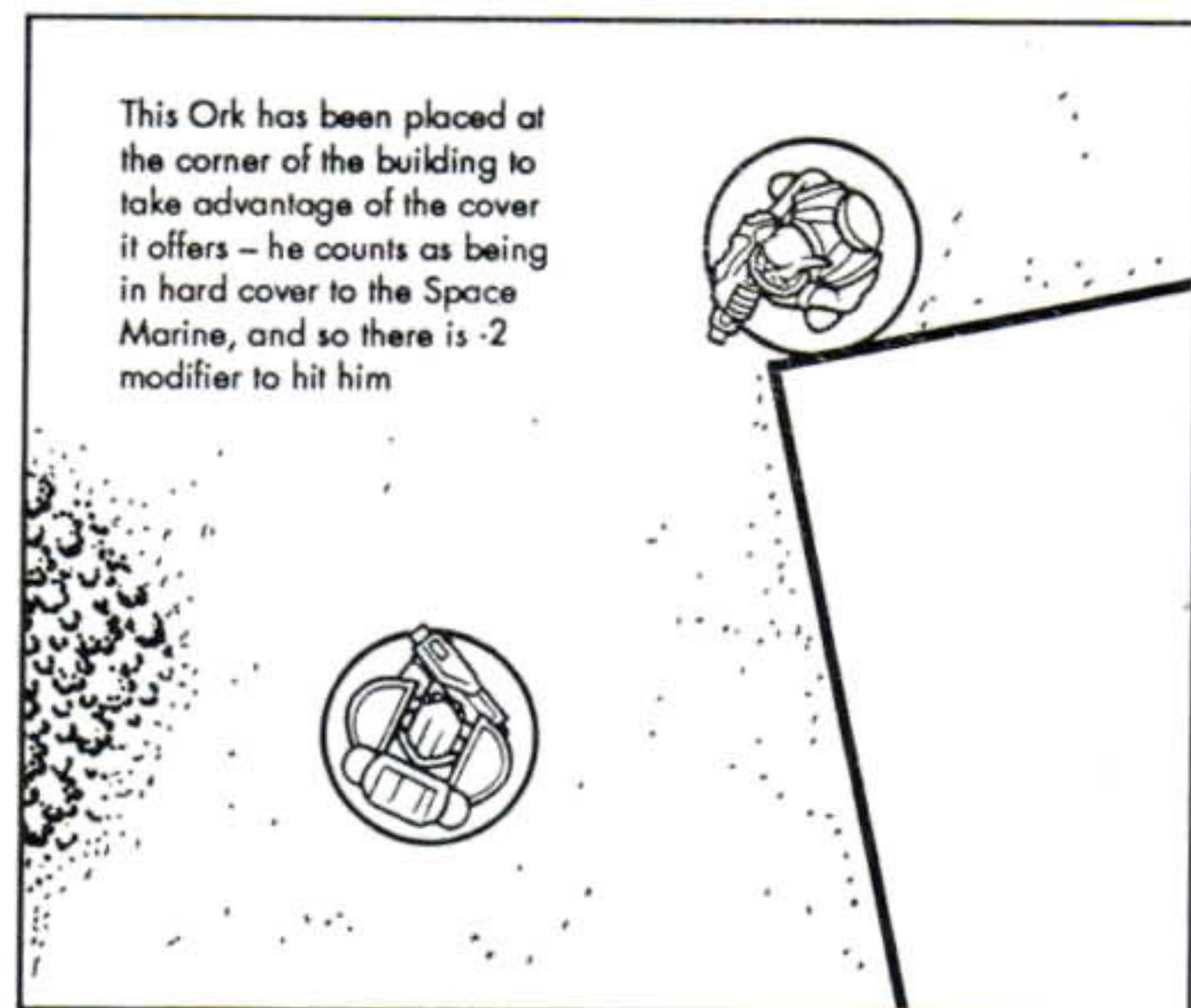

3. Inside a wood the tangle of undergrowth, small trees and branches offer a measure of protection. A model inside a wood is always considered to be in soft cover.
4. Troops inside craters, trenches or pits are well protected from enemy fire. Models within these features count as behind hard cover. Of course, if both sides are in the same trench or large crater then neither side can claim to be behind cover, although it may be possible for models to find cover behind individual small rocks or the corners of trenches.
5. Models inside buildings and positioned at windows or doors always count as behind hard cover from outside fire.

TO HIT

Before a model fires the player declares it is shooting and nominates the target. The player is not permitted to measure the range before he nominates the target - he must use his judgement to decide whether the weapon is in range or not. Once the target has been nominated the player measures the distance to see if the target is in range. If it is not in range then the shot automatically misses and has no further effect. Players are not allowed to change their mind once they have decided what to shoot at. Real life troops have to rely on their judgement and can't try again just because they made a mistake!

When you are firing with a unit of troops, such as a squad of Space Marines or a Mob of Orks, it is usual to declare targets for the whole unit before you fire. This means you have to decide how many shots to expend against each enemy target before you start to shoot - whether to concentrate on one particular enemy or spread your fire against several targets.

RANGE

In most circumstances it is easier to hit a target at short range than it is at long range. Details of each weapon's short and long ranges are given later in with the descriptions of the weapons themselves. The maximum range of a weapon is always the most extreme long range as shown by the examples below.

Weapon	Short Range	Long Range	Maximum Range
Bolt Pistol	0-8"	8-16"	16"
Plasma Pistol	0-6"	6-18"	18"
Lasgun	0-12"	12-24"	24"
Bolt Gun	0-12"	12-24"	24"
Melta Gun	0-6"	6-12"	12"

Once the shooter has nominated his target the range is measured to make sure the target is within the maximum range of the weapon, and if so check to see whether the range is short or long.



HITTING THE TARGET

To determine if a shot hits its target roll a D6. The dice score needed will depend on how good a shot the firer is (as shown by his ballistic skill characteristic or BS). The chart below shows the minimum D6 roll needed to score a hit.

BS of Shooter	Score Required
1	6
2	5
3	4
4	3
5	2
6	1
7	0
8	-1
9	-2
10	-3

For example, if the shooter has a BS of 3, a dice roll of a 4 or more is required to hit. This is easy to remember if you think of a character with a BS of 3 having a "3 in 6" chance of hitting (dice rolls of 4, 5 or 6). So a character with a BS of 1 has a "1 in 6" chance (a roll of a 6), a character with a BS of 2 has a "2 in 6" chance (rolls of 5 or 6) and so on.

Although the chart covers scores of 1 and even less, the minimum dice roll needed to hit is always at least 2. There is normally no such thing as an automatic hit, and a roll of a 1 **always** misses.

BASIC MODIFIERS

Some shots are easier than others - a target might be moving fast, or it could be behind cover. The dice roll is modified to reflect how easy or difficult the shot is.

- 1 Shooting from a vehicle which is moving at its fast rate.

Applies to all weapons fired from the vehicle including those mounted in or on the vehicle.

- 1 Shooting at a rapid moving target.
If the target moved between 10 and 20" during its previous movement phase.

- 1 If the target is behind soft cover.
As discussed in the section on cover.

- 2 If the target is behind hard cover.
As discussed in the section on cover.

- 2 Shooting at a very rapid moving target.
If the target moved more than 20" during its previous movement phase.

WEAPON MODIFIERS

Certain weapons are more accurate than others for various reasons. Some are better balanced, while others have a spread effect which makes them more likely to hit their target. Most weapons are less accurate at long range than at short, especially pistols, which are excellent short range weapons but inaccurate at long range.

Every weapon has its own "to hit" modifiers which are added to or deducted from your dice roll. These are given in full in the descriptions of the weapons. The following examples show how the system works.

Weapon	Short Range	Long Range
Bolt Pistol	+2	0
Plasma Pistol	+2	-1
Boltgun	+1	0
Lasgun	+1	0
Melta Gun	+1	0

It can be seen how the two pistol weapons confer high short range bonuses (+2). The Plasma pistol is relatively inaccurate at long range (-1). The Boltgun, Lasgun and Melta Gun are larger clumsier weapons and less likely to hit at short range than the pistols (+1).

TO HIT SCORES OF 7+

Sometimes a roll of 7 or more is needed to hit once modifiers have been taken into account. Such shots may still hit so long as the score needed is not 10 or more. The shooter must first roll a score of 6. If successful the shooter is entitled to a further roll and requires the score indicated on the chart below. If this second roll is successful the shot has hit. If the initial score required is 10 or more the shot cannot hit.

Roll Required to hit	7	8	9	10+
Second D6 score	4+	5+	6	Cannot Hit

Example. A model with a BS of 3 requires a 4 to hit with his plasma pistol. The target is at long range (-1), and behind hard cover (-2). The dice roll required to hit will be 7 as 3 will be deducted from the score and a 4 is needed to hit. The firer will therefore need to roll a 6 followed by a 4 or more if he is to hit his target.

Example. The same model is firing from a fast moving vehicle (-1) against a target behind soft cover (-1), and at long range (-1). The score required to hit is 8 as 4 will be deducted from the score and a 4 is needed to hit. The firer will therefore need to roll a 6 followed by a 5 or more if he is to hit his target.

DAMAGE

Hitting your target is not always enough to put it out of action. Some targets can take quite a bit of damage before they are destroyed while some hits cause no damage at all. A hit might result in nothing more than a superficial graze or it might rebound off a piece of equipment. To decide if a hit causes damage, compare the weapon's strength with the target's toughness. Each weapon has its own strength score as given in its description.

Consult the Damage Chart and cross reference the weapon's strength (S) with the target's toughness (T). The number indicated is the minimum score on a D6 needed to convert the hit into damage.

If this roll is successful the target has been damaged and it sustains 1 or more damage points. Most weapons cause only 1 damage point, though some large or powerful weapons cause more, usually expressed as a further dice roll number of damage points: D4, D6, D10, etc.

When a foot trooper model is hit the number of damage points caused is deducted from its wounds (W) characteristic. If the model has only 1 wound (as is usually the case) the model becomes a casualty and should be removed from play. If the model has more than 1 wound, a record is kept of damage points sustained until its wound total is reached. Once the model has zero wounds remaining it is removed from the game as a casualty. Casualties are not necessarily dead, they may be hurt, knocked unconscious or incapacitated in some way. In any event, they are no longer fit to participate in the game.

Note that N on the chart means the hit has no effect. A target with the toughness indicated cannot be harmed by a hit with that strength.

EXAMPLE: An Ork armed with a boltgun shoots at an Imperial Guardsman and hits him. The boltgun has a strength of 4 and the Guardsman has a toughness of 3. Referring to the chart a score of 3 or more is needed to convert the hit into damage. If the dice roll is 3 or more the Guardsman takes 1 point of damage - as he has only 1 wound in the first place this means that he will be 'killed' and removed from play.

		DAMAGE CHART									
		TARGET'S TOUGHNESS									
		1	2	3	4	5	6	7	8	9	10
WEAPON'S STRENGTH	1	4	5	6	6	N	N	N	N	N	N
	2	3	4	5	6	6	N	N	N	N	N
	3	2	3	4	5	6	6	N	N	N	N
	4	2	2	3	4	5	6	6	N	N	N
	5	2	2	2	3	4	5	6	6	N	N
	6	2	2	2	2	3	4	5	6	6	N
	7	2	2	2	2	2	3	4	5	6	6
	8	2	2	2	2	2	2	3	4	5	6
	9	2	2	2	2	2	2	2	3	4	5
	10	2	2	2	2	2	2	2	2	3	4

SAVING THROWS

Most troops wear some sort of protective clothing or armour. A model wearing armour is allowed a further dice roll to see if the armour stops the damage it has taken. This is called a saving throw.

The way if armour successfully stops damage roll a D6. The following table shows how the minimum D6 score required varies between three sample types of armour. Other values are indicated in the main Warhammer 40,000 rules.

Armour Type	Minimum D6 score required to save
Flak	6
Mesh armour	5
Power armour	4

If the player rolls a D6 score equal to or greater than the score required all damage points from that hit are ignored.

For example, a Space Marine wearing power armour is hit and damaged sustaining 1 wound – normally enough to remove him as a casualty. The model is entitled to a saving throw of 4 so a D6 is rolled resulting in a score of 5. The damage is therefore saved, and the Space Marine is unharmed – the shot bounces harmlessly off his armour.

SAVE MODIFIERS

Some weapons are more powerful than others and better at penetrating armour. For example, if an Imperial Guardman wearing Flak armour were hit by a relatively low-powered weapon such as a Las pistol his armour might absorb the damage and leave him unharmed. On the other hand if he were hit by the blast of the larger and more powerful Lascannon then his armour would be vapourised instantly!

Weapons which are good at penetrating armour are given a saving throw modifier. These are given later together with the descriptions of the weapons. The examples given below show how these affect the final dice roll.

Weapon	Dice Modifier	Basic Save of Mesh	Score needed to save
Bolt Pistol	-1	5	6
Plasma Pistol	-1	5	6
Boltgun	-1	5	6
Lasgun	-1	5	6
Melta Gun	-4	5	No Save
Flamer	-2	5	No Save

If the dice roll required to save is 7 or more the shot is not saved – the weapon is so powerful that the armour counts for nothing.

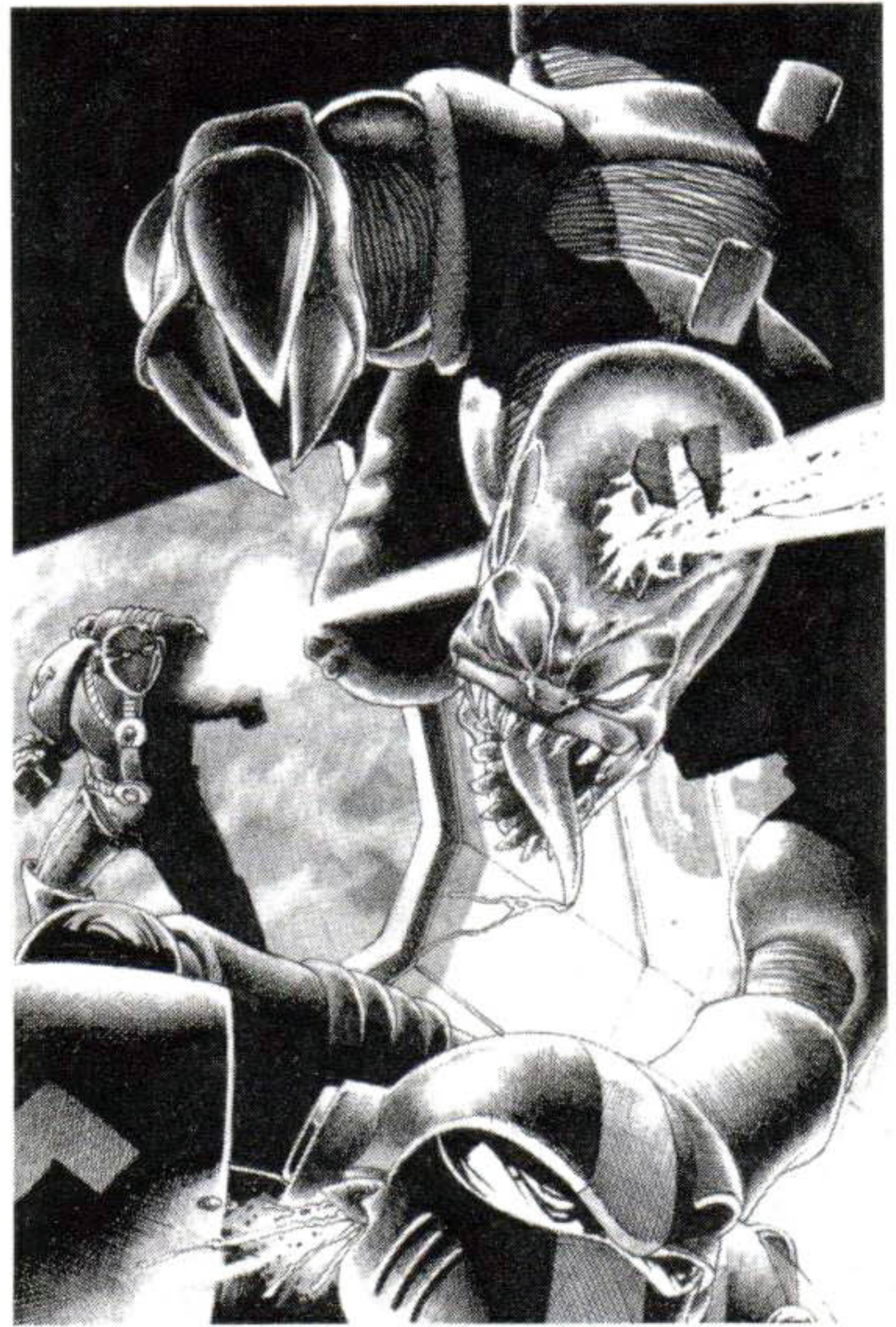

TAKING SHOTS TOGETHER

If you are fighting large battles you may find that shooting with one model at a time is a bit too time consuming. This is especially apparent when a group of identically armed troops is firing at a group of enemy with the same toughness, armour, and weapons. As each trooper will need exactly the same dice rolls it seems an unnecessary waste of time to roll for each model separately. In cases where several models are shooting at a group of enemy models and all shooters need the same 'to hit' roll, you can save time by rolling for all the shots at once.

For example, 7 Marines are firing bolters at a group of 6 Orks needing 3+ to hit. The Space Marine player rolls all 7 dice scoring 1, 1, 3, 4, 4, 5 and 6 = 5 hits.

If targets have the same toughness then damage dice may also be rolled all at once to establish how many hits cause damage.

For example, from our Space Marines' 5 hits we might be lucky and inflict, say, 3 wounds on the Orks. As Orks can only sustain 1 wound before they are 'killed' 3 Ork models are removed. Usually it doesn't matter much which actual models fall casualty in which case you can simply remove the nearest 3 without further ado. Even in cases where a target model is particularly important (because it is armed with a special weapon, for example) you can still use this faster method of casualty calculation and devise some random dice test to see which of the enemy models fall casualty.



WEAPONS WITH A BLAST AREA

Most weapons fire a single shot or blast which strikes only one target. However, a few special weapons fire a shell or project a blast which explodes and causes damage over a fairly large area. Some other weapons scatter shot with a similar effect. The spread of a shot or blast from a weapon is represented by a card circle. These circles are called blast markers or area markers and vary in size from 1" radius upwards. Depending on how large an explosion they cause, weapons use different sized blast markers as indicated in the Weapons section.

When you wish to shoot a weapon which uses a blast marker, nominate a target model and roll to determine if the target is hit just as you would with any other weapon. If the nominated target lies beyond the weapon's maximum range then the shot automatically misses and explodes or dissipates harmlessly in the air, and will not land or cause damage.

If the hit is successful, the player takes a blast marker of the appropriate size and places it with its centre exactly over the target. The target is hit, and any other model whose base is wholly inside the marker's area is also hit.

If a model's base is only partially inside the area, the model is hit on the D6 roll of a 4, 5 or 6.

SCATTER

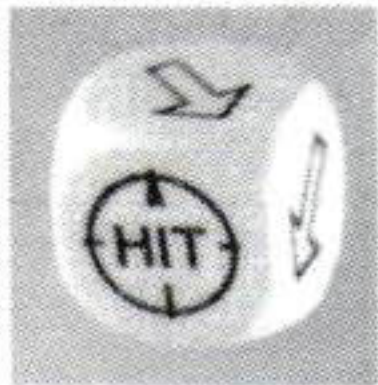

If your shot misses then you must determine where the shot lands. To do this you will need a special **scatter dice**. The scatter dice is a six sided dice with arrows on four sides and the word 'Hit' on the other two sides. The sides marked 'Hit' also have arrows marked on them just above the I of the word 'Hit'.

If you do not have a scatter dice you can continue to use the system described in the Warhammer 40,000 rulebook. Both methods work just as well but the scatter dice is much more convenient!

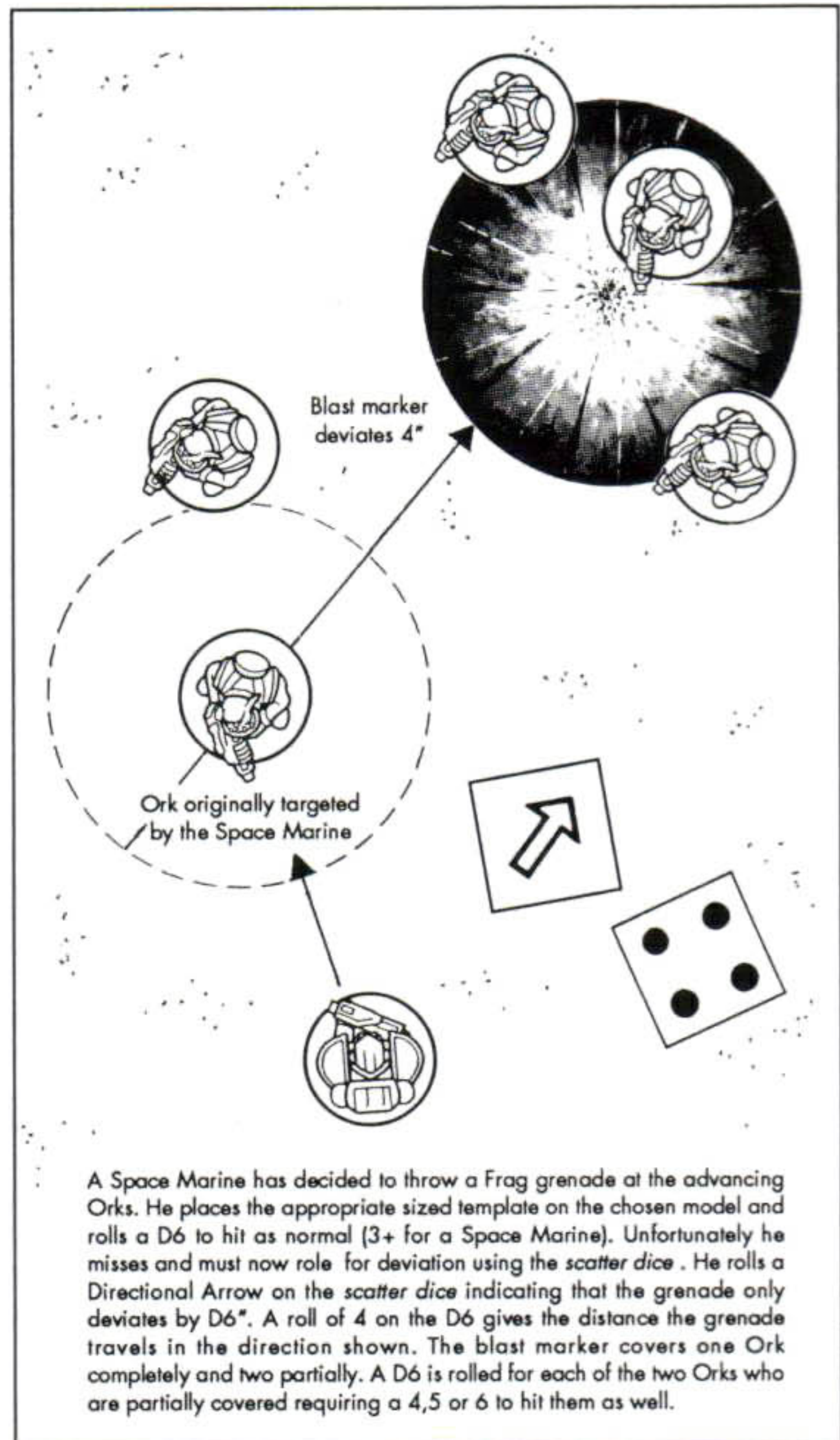

ROLL FOR SCATTER

To determine where the shot lands roll the scatter dice. The arrow indicates the direction where the shot lands - if the arrow points left the shot lands to the left and so on. The distance the shot misses by is 1D6" if the scatter dice shows an arrow, and 2D6" if it shows a 'Hit' symbol.

Remember, 'Hit' symbols actually have an arrow marked on them too. Bear in mind that the 'Hit' symbol doesn't actually indicate a direct hit - this may seem odd at first but you will quickly come to terms with it. The dice is also used in Space Marine and other Games Workshop games, and the 'Hit' symbol is used in those games to indicate a hit has been scored.

MAXIMUM SCATTER

No shot will ever scatter by more than half the range between the shooter and target. If the target is 10" away, for example, a miss may not scatter by more than 5" regardless of the dice score. Scatter may cause a shot to land outside of its normal fire-arc, in which case the missile or shell has spun wildly off-course.



DUD SHOTS

Dud shots or misfires can only occur when you roll a 'Hit' followed by a 2D6 result of a double. This means something unexpected and possibly quite spectacular has happened! Consult the chart below.

Roll Result

- 1 **Kerrrr...boom!** The shell jams in the breach or the energy charge overloads the weapon, causing it to explode. Place the blast marker directly on top of the firer and work out damage as normal. Even if the shooter survives his weapon is destroyed.
- 2 **Explodes prematurely.** The shot explodes with a few seconds of leaving the barrel. Roll D6 to establish how far the shot travels towards the target before it explodes. Place the blast marker the distance indicated down the projected flight path.
- 3 **Jams.** The weapon jams, its mechanisms freezing solid because of mechanical or electrical defects. The weapon does not fire and cannot be fired until it is fixed. A jammed gun can only be fixed if a model spends its entire movement phase stationary attempting to free the mechanism and then rolls a 4, 5 or 6 on a D6.
- 4 **Misfire.** Due to an unexpected energy drain or dud shell the shot does not fire. The shooter clears the weapon and is ready to fire again normally in his next turn.
- 5 **Explodes in mid-air.** The shot explodes high in the air and its energy is dissipated far above the target, or else a shell fails to explode when it strikes home. The shot has no effect and the weapon is ready to fire again normally in the player's following turn.
- 6 **Out of control.** The shell or energy blast spins out of control after leaving the barrel. The shell travels directly forward D6" and then changes direction! Roll the *scatter dice* to determine the new direction. **However** note that the shell cannot turn back towards the firer – it must continue to move away from him – so reroll any result that indicates otherwise. The shell continues to travel D6" in the direction shown and then strikes the ground and explodes – place the template and work out damage as normal. Of course if there is a target within the D6" this will be hit as normal.



A Space Marine with a Missile launcher has fired a Frag missile at a group of advancing Orks. He failed to hit the target and so rolled for deviation using the *scatter dice*. The roll on the *scatter dice* showed one of the HIT faces, which meant that the blast marker deviated 2D6" in the indicated direction. A roll of 6 on both dice means that something unexpected and possibly spectacular has happened! After consulting the Dud Shots table he finds that the shell is out of control. This means that he shell travels D6" forward and then changes direction. He then rolls the *scatter dice* to determine the new direction (note that the shell never turns back towards the firer – so reroll any result that indicates otherwise). The shell continues to travel a further D6" in the direction shown before striking the ground and exploding hitting any targets under the blast template as normal.

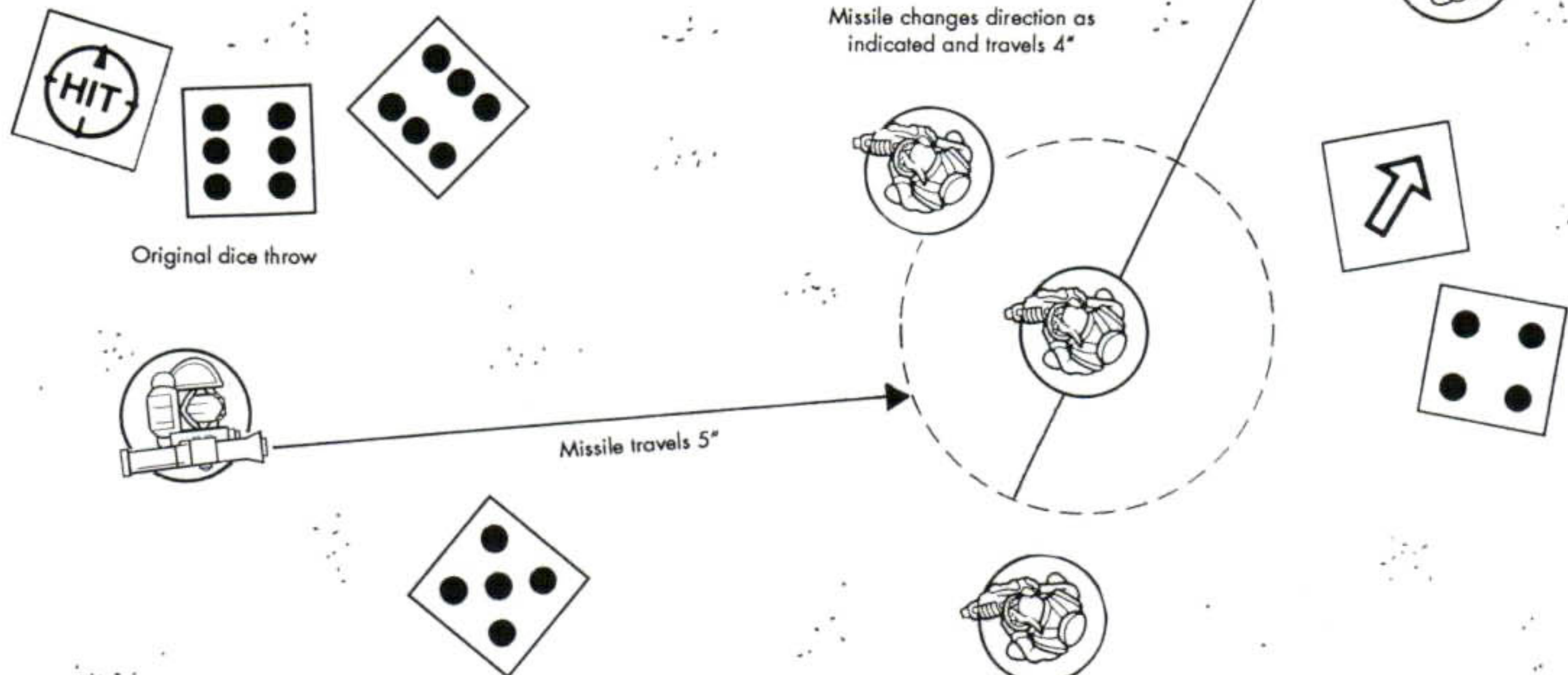

THROWING GRENADES

Many troops carry grenades of one type or another. The most common grenades are explosive, and can be used to attack vulnerable foot soldiers or even vehicles. There are also several special types of grenade which either release gas or have some other unusual effect. These different types of grenade and their effects are described in the grenade section.

A model may throw a grenade instead of shooting if the player prefers. A grenade throw is treated exactly like any other shot: a dice roll is made to score a hit, to cause damage, and saving throws are taken where models have armour. With the notable exception of Krak grenades, grenades have an area effect and will scatter if they miss.

Roll to hit as normal using the model's BS characteristic. If the shot misses, roll for scatter and establish where the shot has landed. As with other weapons which use a blast marker, scatter may never exceed half the distance between thrower and target.

Place the center of the area effect marker over the model where you wish the shot to land. All models wholly within the area are hit once. Models partially within the area are hit on the D6 roll of a 4, 5 or 6. Work out damage or special effects as appropriate for the grenade type.

The range of a thrown grenade depends on how strong the thrower is - a stronger individual can throw a grenade further than a weaker one. The strength characteristic of the thrower and the corresponding maximum range of his throw is shown on the table below.

Strength of Thrower	Maximum Throw
1	4"
2	6"
3	8"
4	10"
5+	12"

This can easily be remembered because the maximum distance a model may throw a grenade always equals 2" plus twice its strength up to a maximum of 12".

SMOKE GRENADES

Not all grenades, missile shells and mortar bombs are designed to kill - some are designed to produce clouds of smoke in order to provide cover or create barriers to movement.

When using these weapons it is not necessary to nominate a specific enemy model as the target. Instead all the player has to do is nominate a point on the tabletop which is visible to the shooting model and within the maximum range of his weapon. The following rules apply to shots or grenade throws of this kind.

1. To hit the exact spot the player requires a dice roll of 6 on a D6. This represents the fact that the shooter or grenade thrower has a broad choice of aiming points and not just the one selected by the player.

If the chance of hitting would normally be less than 1 in 6 then the chance of hitting is reduced to this level (roll a 6 followed by a further dice roll as explained above).

2. If the shot misses then a normal scatter roll is made as described above.

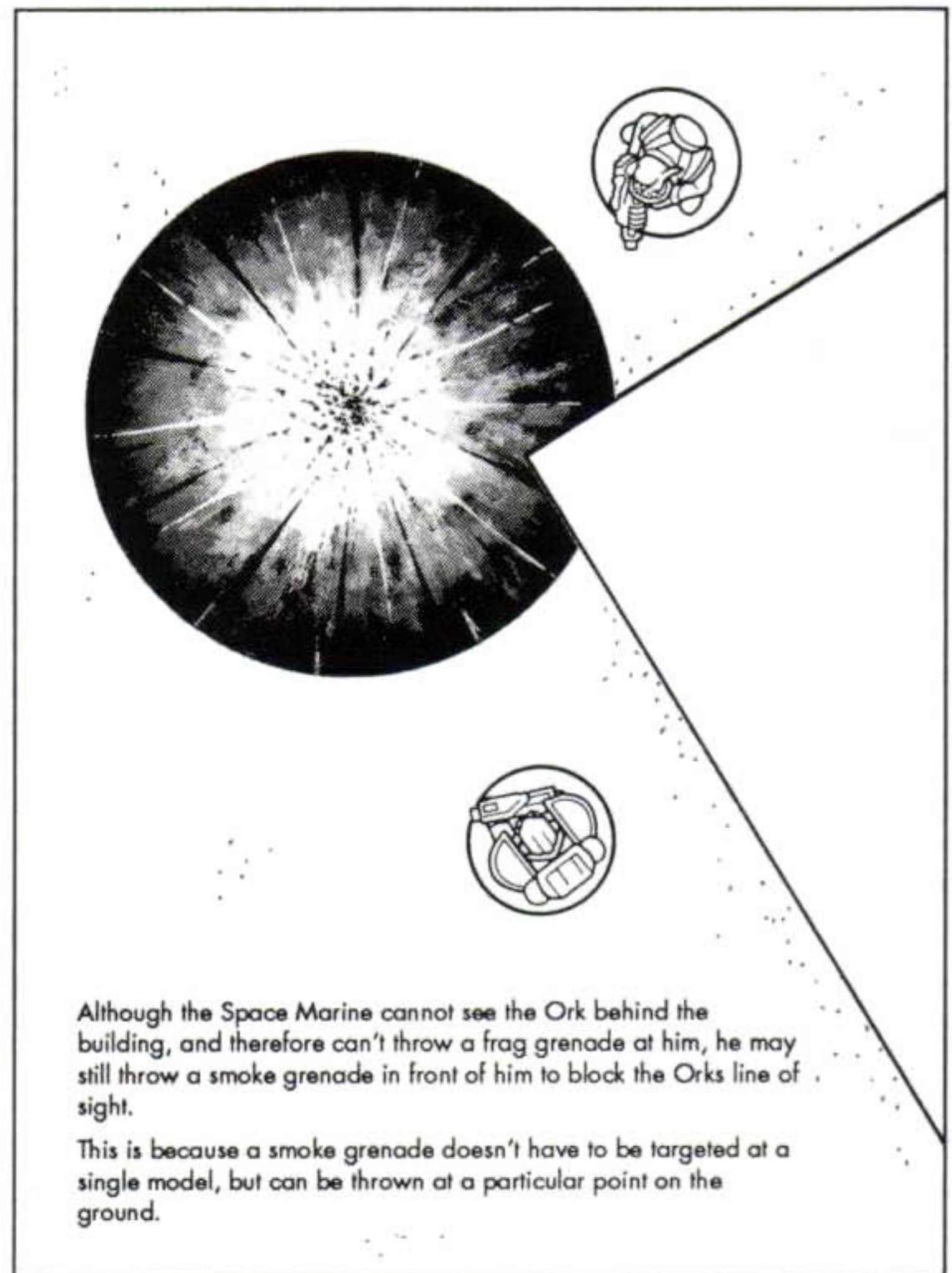

SHOOTING AND CLOSE COMBAT

Normally, troops do not shoot at models engaged in close combat because it would be very easy to hit the wrong target. However, any player wishing to take the chance may do so if he wishes.

If a model fires into a close combat, work out hits as normal and randomly allocate any successful hits between models from both sides.

For example, if firing into a combat between two models, a D6 roll of 1, 2 or 3 would indicate one model, 4, 5 or 6 the other.

A model in close combat may not shoot weapons during the shooting phase. A model equipped with a pistol may use his weapon during close combat.

OVERWATCH

As troops advance through enemy held areas they will more than likely be covered by their friends. Covering troops do not move, but watch out for enemy movement, ready to open fire should they spot any opposing troops emerging from cover or moving into view. Often two squads will take it in turns to cover each other's advance, one moving forward while the other covers, then once the advance squad is in position it halts and covers the remaining squad. This is represented in the Warhammer 40,000 game by the overwatch rule.

PREPARING OVERWATCH

The overwatch rule allows a model to shoot during the enemy's movement phase. The player declares which of his models are going on overwatch at the start of his turn, and places an overwatch counter next to them. Models on overwatch may do nothing during their turn, they may neither move nor shoot for example. The overwatch counter remains in place, so that the model is still on overwatch when it comes to the opposing player's turn.

FIRING ON OVERWATCH

A model on overwatch may shoot during the opposing player's following movement phase. Troops on overwatch may shoot at targets as they present themselves at any time during the movement phase. For example, a model can be shot at before it moves, after it completes its movement, or at any time in between. A target which doesn't move at all can still be shot at so long as it can be seen. The most common use for overwatch is to shoot at enemy as they move from cover to cover, where they would normally be hidden during the shooter's own turn. Overwatch can also be used to ambush troops as they move into range, denying them the chance to reach cover.

As soon as a model shoots its overwatch counter is removed. Work out whether the shot hits as normal and then proceed with movement. There is one extra modifier to take into account.

Some shots are easier than others - a target might be moving fast, or it could be behind cover. The dice roll is modified to reflect how easy or difficult the shot is.

- 1 Shooting at a model which is either emerging from or moving into cover, or which is charging the shooter.

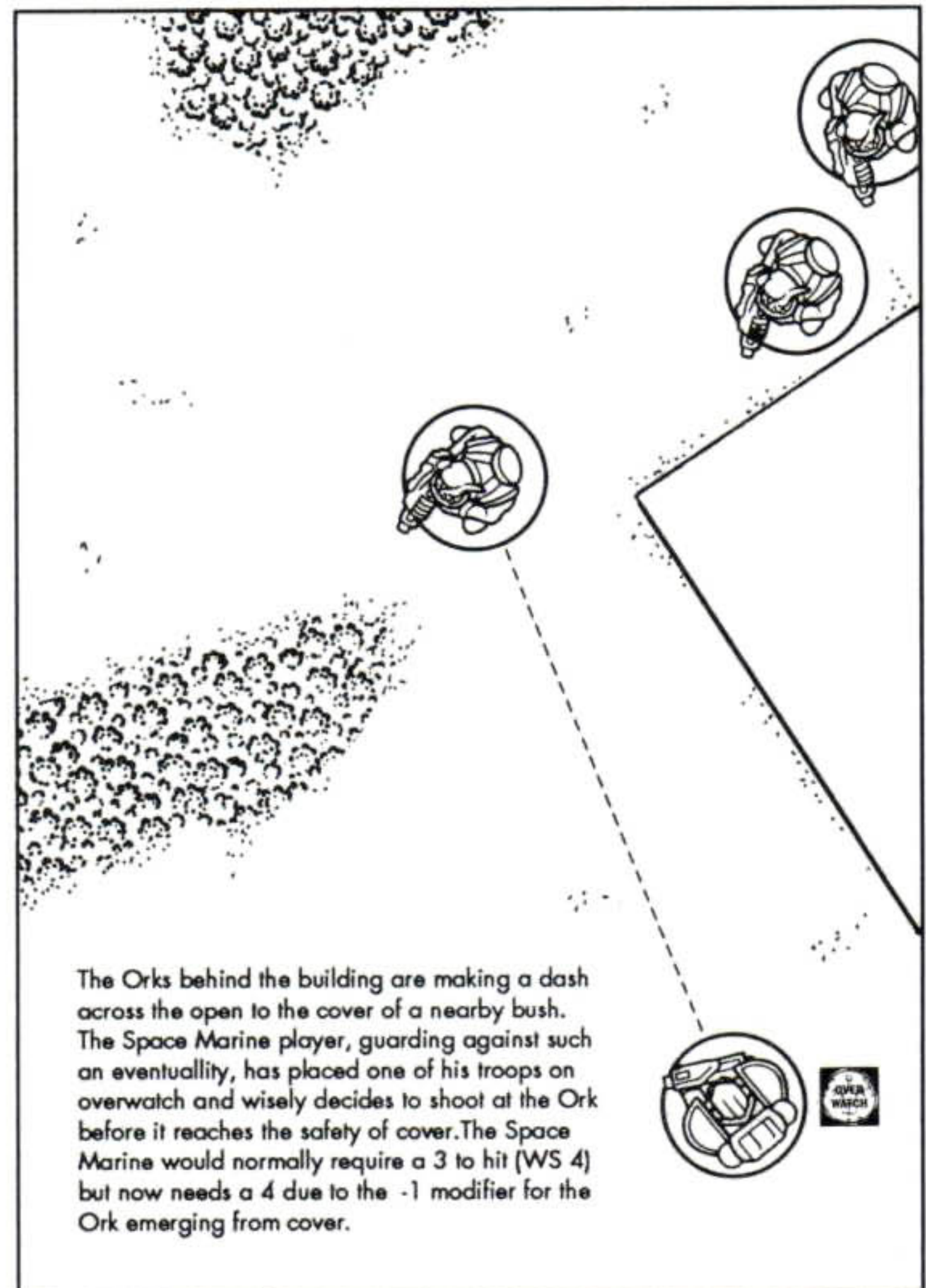

This modifier only applies to troops on overwatch. It applies if the target's intended move will take it into cover, or if it emerges from behind cover. It also applies if the target is charging the model on overwatch. This is the only time when a model which has been charged can shoot at his attacker as he closes. The factor takes into account the fact that the target will be visible only for a brief moment, or that the shooter will be flustered by the enemy's charge. Note that the -1 does not apply twice if a target jumps from behind cover and charges the shooter - it is only ever applied once.

LOSING OVERWATCH

Unused overwatch counters are removed at the start of the player's own turn. New overwatch counters may then be placed as required. A model can stay on overwatch from turn to turn so long as neither side moves or fires, but it will save confusion if old counters are removed and new ones placed.

A model which is shot at while on overwatch immediately loses its overwatch marker. Note that you don't have to hit the target to remove its overwatch marker - it only has to be shot at. This is not likely to happen often as models on overwatch will usually fire before the enemy (ie in the movement phase which comes before the shooting phase).

However, it is possible for a model to be hit by an off-target friendly weapon during his own shooting phase. It is also possible for a model on overwatch to be shot at by an enemy who is also on overwatch during his own movement phase. As soon as the overwatch counter is lost the model reverts to the normal game sequence.

SUSTAINED FIRE

Most weapons can fire only once during the shooting phase. A few special weapons are not restricted to one shot but can fire several bursts at one or more targets. This is called *sustained fire*.

Weapons which are capable of sustained fire are indicated in the descriptions of the individual weapons. These weapons fire a lengthy burst, often using a motor to force round after round into the firing chambers, spewing out a hail of bullets or devastating energy blasts.

Weapons capable of sustained fire are dealt with in the following way. The player nominates the initial target and shoots once exactly as normal.

If the shot hits the target, and the player makes a successful damage roll, the player may then choose to shoot the weapon again at either the same target, or at any other visible target within 4" of the original target.

The player may continue to shoot in this way so long as each shot hits and a successful damage roll is made, and may continue to fire until he wishes to stop, misses, fails to damage, or runs out of targets. It makes no difference if damage is saved by armour, the player may still shoot again.

If the shooter fires at the same target for a second or subsequent time, he receives a +1 to the "to hit" dice roll. If the shooter changes targets he receives a -1 penalty on the "to hit" dice roll.

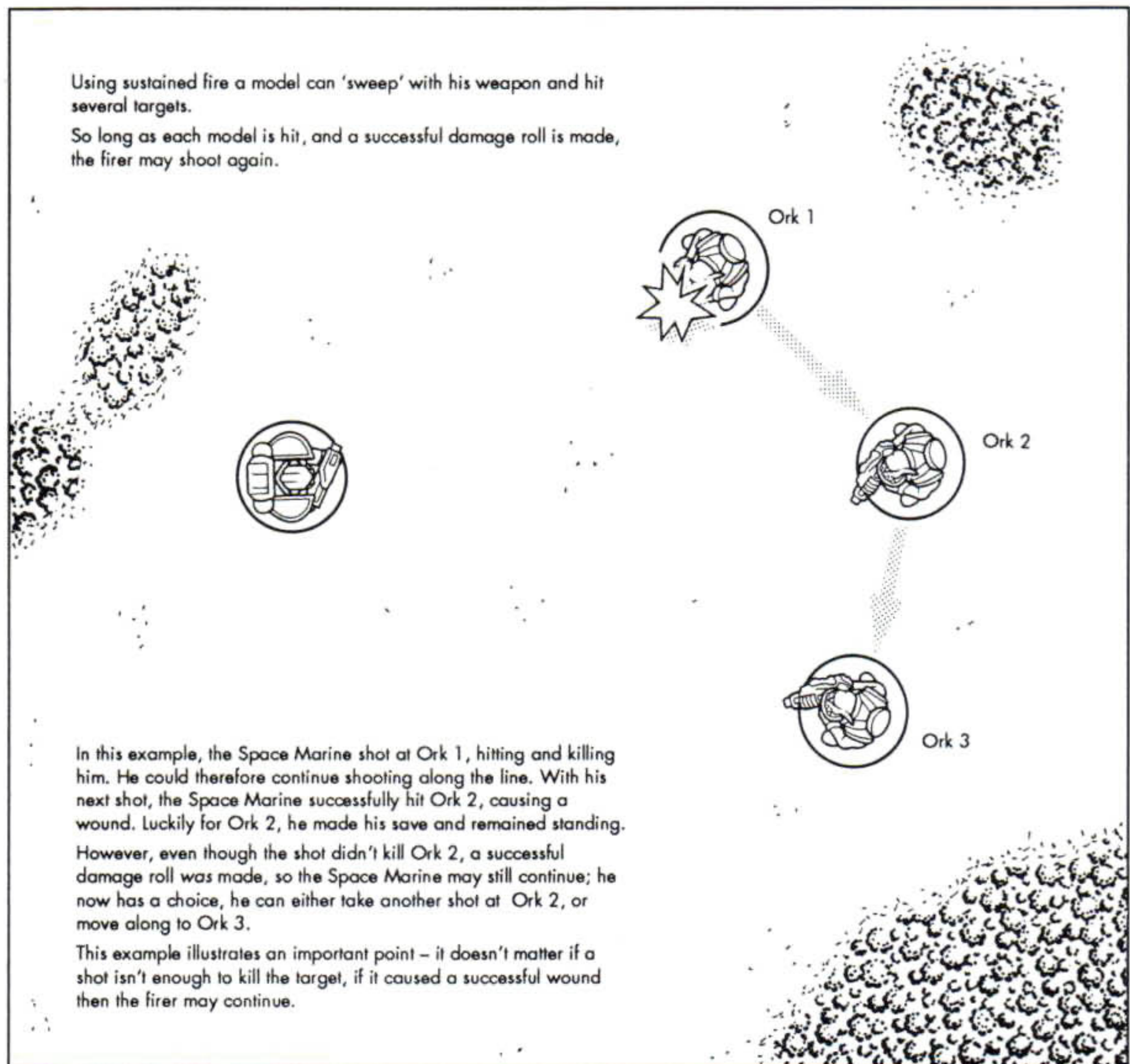

WEAPON MALFUNCTION

Sustained fire places a considerable strain on a weapon's components. Any "to hit" dice roll of a 1 during a second or subsequent shot means that the weapon has malfunctioned in some way. This does not apply to the first shot.

Once a weapon has malfunctioned it cannot be used until it has been fixed. In order to repair a weapon the model must spend an entire turn stationary doing nothing else. At the end of the turn the player rolls a D6. If the score is a 4, 5 or 6 the weapon is repaired and can be used as normal.

MOVE OR FIRE

In the case of the majority of weapons a trooper model can move in the movement phase and fire in the shooting phase. Moving the model in no way reduces its ability to shoot.

A few special weapons require reloading relatively frequently compared to others, or else they need to be set-up carefully before they fire. Rather than introduce special rules for recording how much ammunition each model carries and how much it expends (which would be very tedious indeed) we shall rule that these special weapons may not move and shoot

during the same turn. If the model moves during the movement phase the weapon may not fire during the shooting phase. Weapons restricted in this way are indicated in the Weapons section that follows.

A trooper riding a horse or on a vehicle may still fire a weapon despite a rule that forbids moving and firing. In these cases it is not the shooter who is considered to be moving but the horse or vehicle, so the trooper actually has plenty of time to reload his weapon.

CHOOSING A TARGET (Optional Rule)

Some players are quite happy to allow models to shoot at any target they like as long as it is in range. Thus a trooper might prefer not to shoot at an enemy a few inches away in favour of firing at a more distant but preferred target. There is nothing wrong with this approach, and it is suggested that all special characters should always be allowed to fire at exactly which targets they please. For example a Space Marine Captain or an Imperial Inquisitor are both steely-nerved individuals who would coolly ignore personal danger and do whatever seemed the best thing at the time. Such sure-mindedness in action is to be expected from heroes!

For players who prefer to fight larger battles, perhaps with a hundred or more models on each side, an alternative is to say that a shooter must normally fire at the closest possible target. This speeds the game up and makes it easier for troops away from the main fighting areas to move about without any great fear of being picked off in an unrealistic manner. If you decide to adopt this approach - and it is entirely up to you - the following exceptions apply.

1. A shooter may ignore vehicles in favour of other targets, or other targets in favour of vehicles. In other words you can choose to shoot at the closest vehicle or the closest target that isn't a vehicle. Obviously a trooper armed with a tank-busting Lascannon isn't going to waste his time firing at infantry if he can find a better target!
2. A shooter may also choose to shoot at a building or a specific game objective, eg storage tanks, generators, energy lines, supporting pylons, and so forth. These targets have probably been pointed out to troops before the battle so that their importance is well known.
3. Models in hand-to-hand combat and routing models may be ignored. Obviously you don't want to risk shooting your own troops and routing enemy are hardly worth shooting at.
4. Targets in cover may be ignored in favour of targets in the open, even though the targets in cover may be closer. This takes into account situations where it may be either impossible or virtually impossible to hit enemy because they are behind cover while troops in the open are an obvious alternative target.

5. When models from the same unit are shooting at a group of enemy, it is not necessary that all shooters fire at the leading enemy model even though it may be their closest target. Instead, they can shoot at the number of enemy equal to their own number. For example, 6 shooters can spread their fire amongst the closest 6 targets. There is nothing to stop 6 shooters firing at the closest 5, 4, 3, 2 or 1 targets, but they may not disregard a closer target in favour of one further away.

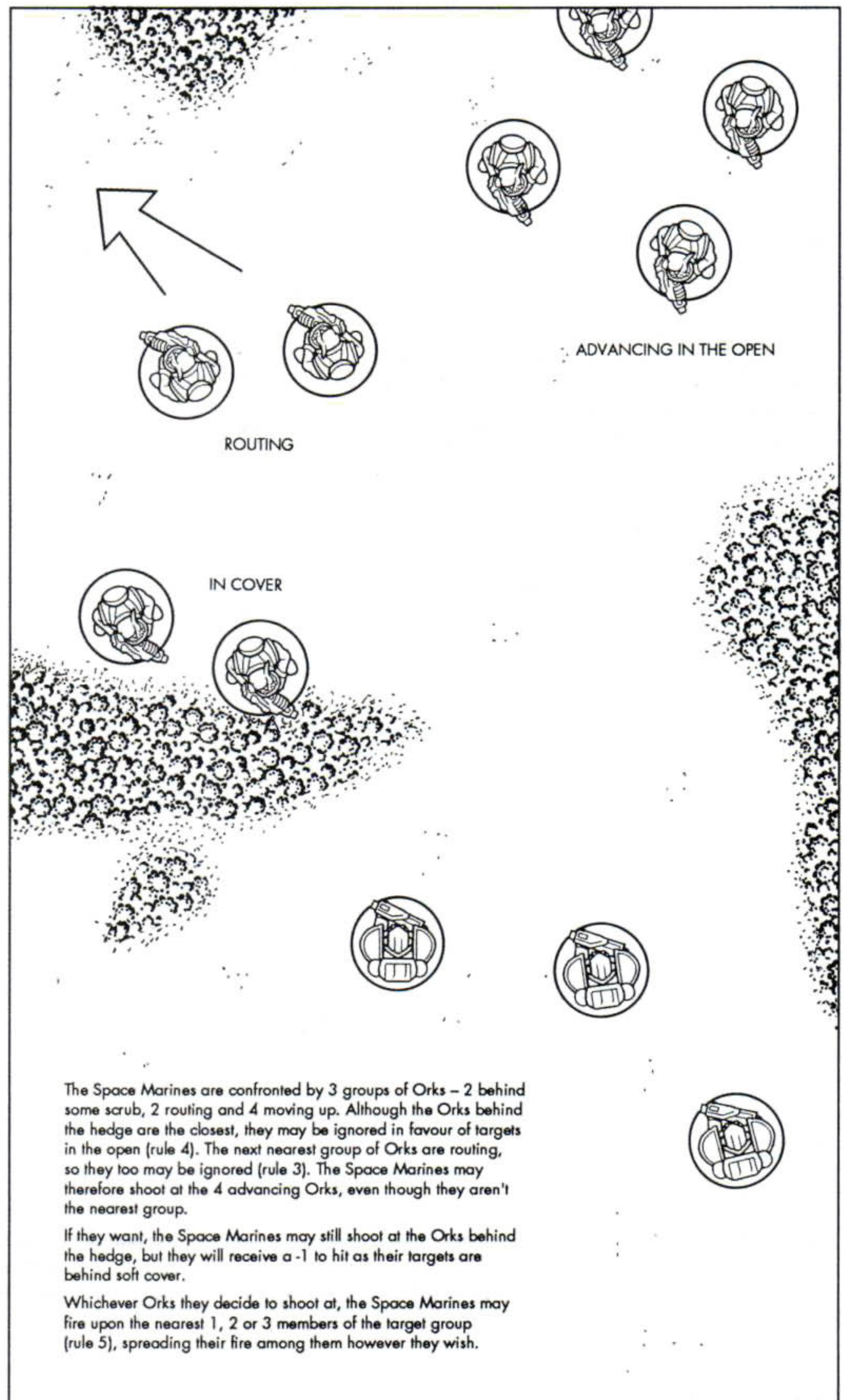



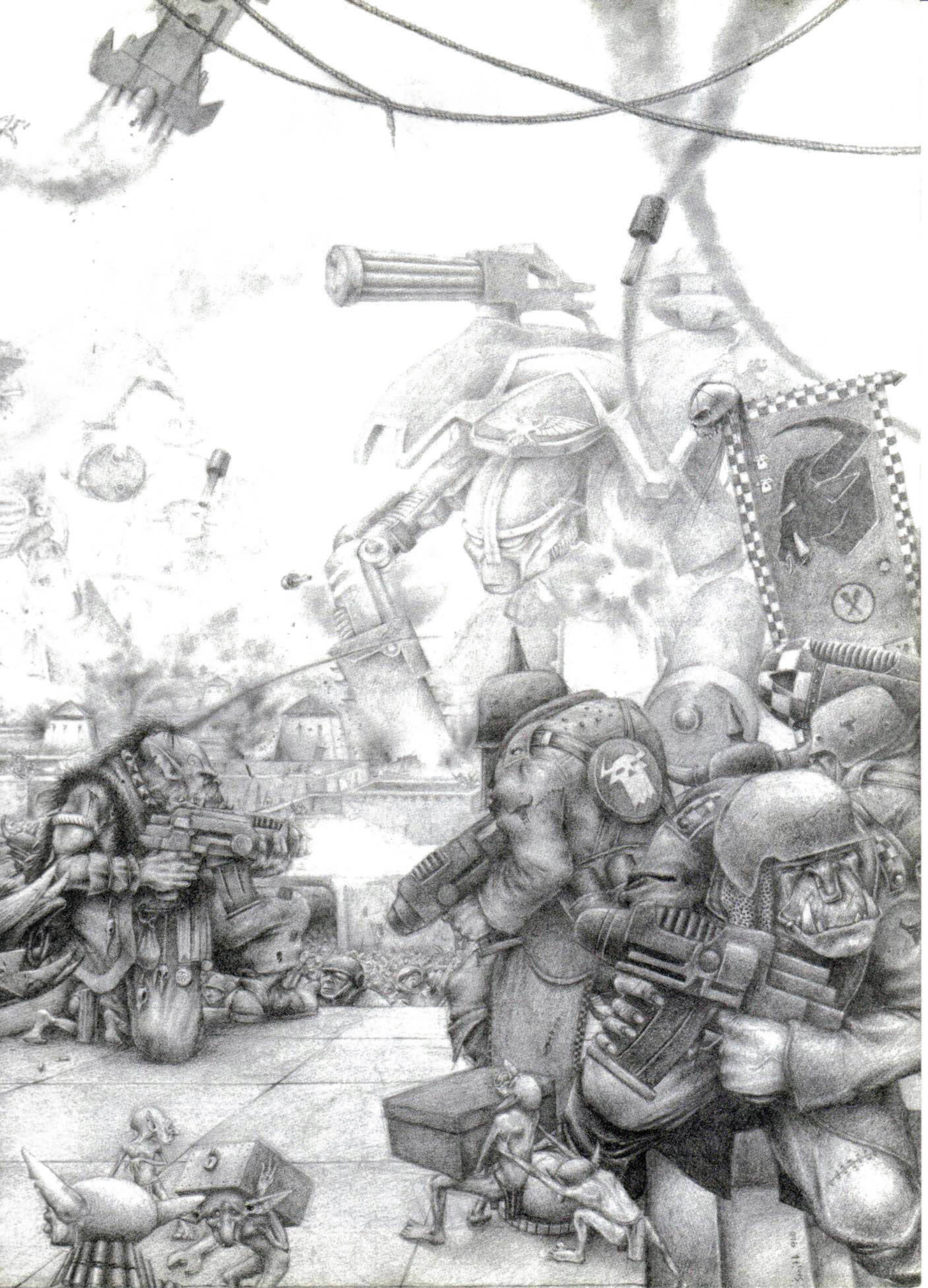

HAND-TO-HAND COMBAT

Of all forms of fighting, hand-to-hand combat is the most violent and desperate, with deadly adversaries doing their utmost to kill each other – hacking with swords, slashing with razor sharp talons, biting, kicking and punching. Hand-to-hand combat is resolved differently to shooting, as described on the following pages.

Hand-to-hand combat is more important to some troops than others. Genestealers can only fight hand-to-hand for example, and they're very good at it! Space Marines are good all-round troops, able to fight well either close to or at a distance. Gretchin, however, are too small and weak to fight very effectively at close quarters. Hand-to-hand combat is assumed to involve grappling and striking out with fists, claws, swords and rifle butts, as well as very close range weapon fire with pistols and other suitable weapons.

At such close range marksmanship counts for very little as it is almost impossible to miss if you can overpower your foe long enough to get a chance to shoot. Speed and brute strength count for a great deal, with victory often going to the combatant who manages deliver a killing blow or shot first.

MODELS IN HAND-TO-HAND COMBAT

Opposing models fight hand-to-hand combat in the hand-to-hand combat phase if their bases are touching. When a model is moved so that it touches an opposing model they are engaged in hand-to-hand combat.

Once engaged in this way neither model may shoot in the shooting phase or move at all until the combat has been resolved. There are few exceptions to this rule – it may be possible for a model to move away from his opponent in some situations – and these are described later.

It may take several turns to resolve the hand-to-hand combat if the combatants are tough and equally matched, but most combats will be completed within a single turn.

Only pistols and close combat weapons can be used in hand-to-hand combat. These are weapons specifically designed for fighting at close quarters, such as swords, chainswords, knives, axes and the like. Because they are small, pistols can also be used, one combatant trying to force his enemy's arm away while his foe uses all his energy to point and shoot his gun.

Pistols and some close combat weapons have their own strength value and saving throw modifier. Both kinds of weapon are described in the *Weapons* section of this book, along with their game details, including strength values and armour save modifiers.

All hits inflicted by hand-to-hand combat may be worked out using the strength value and saving throw modifier of either the weapon or the model, whichever is the higher. You may, for example, use the strength of the model and the save modifier of the weapon if these are the higher values. You'll usually find the weapon's value is higher.

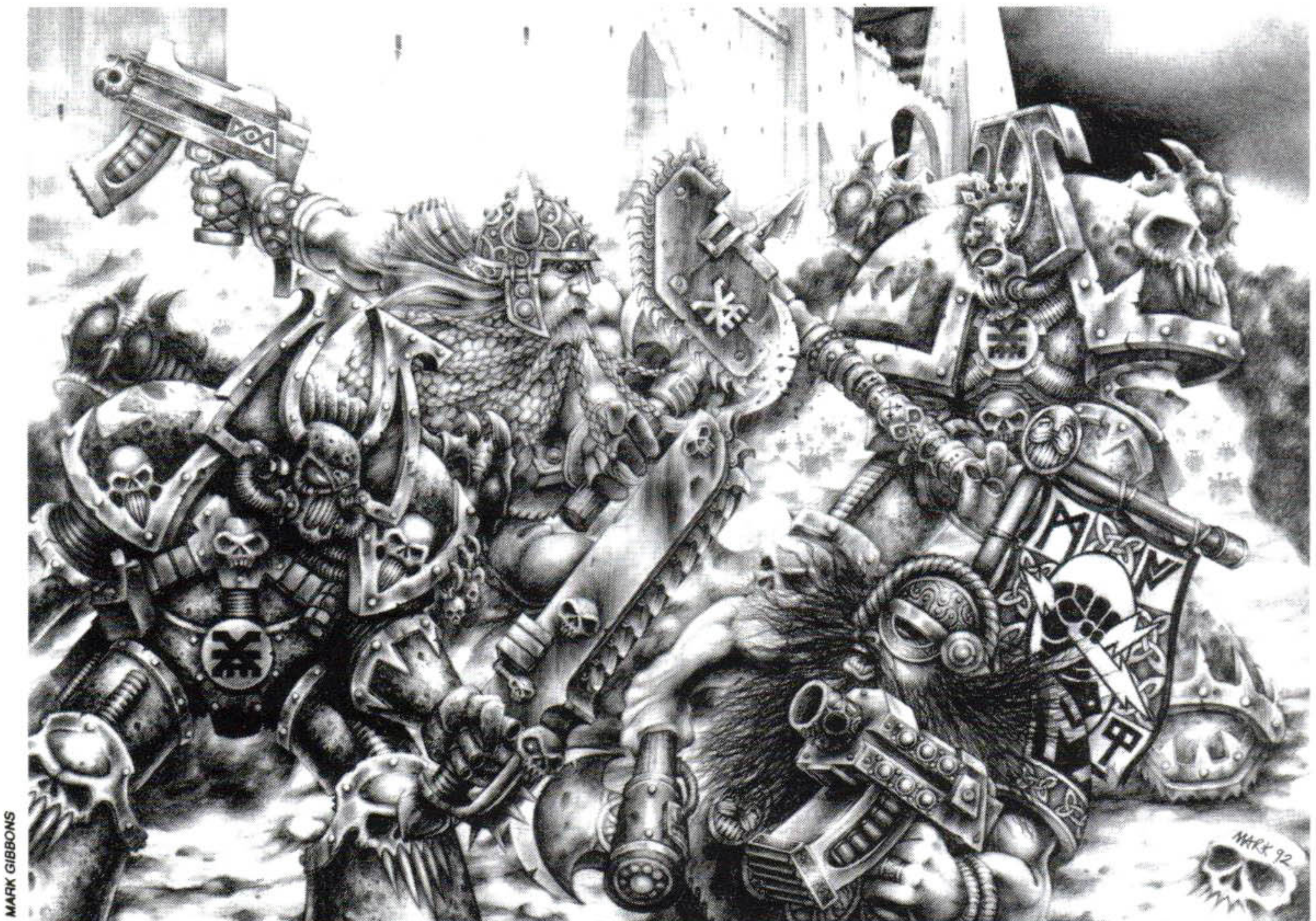

CLOSE COMBAT PROCEDURE

Most combats are 'one-on-one' which means one of your models is engaged against one of your enemy's models. These combats are worked out as shown below. Where one model is engaged against more than one enemy model, this is called a multiple combat. These have special rules and are described later.

1. Throw Attack Dice

Both players roll a number of D6's equal to their model's attack characteristic.

2. Work Out Score

Each player picks his single highest scoring dice and adds his model's Weapon Skill to the score. He then adds any other modifiers that apply from the close combat modifiers chart.

3. Determine Winner

The player who has the highest total score wins the combat. In the case of a tie the model with the highest initiative wins the combat - if there is still a tie the combat is a stand-off.

4. Number Of Hits

Compare the scores of both combatants. The difference between their scores is the number of times the winner has hit the loser. If you won the combat on a tie you still cause 1 hit.

5. Throw to Damage

For each hit scored the attacker rolls a D6 on the Damage Chart and determines if the hit causes damage exactly as with hits from shooting. You may use the strength characteristic of either the model itself or any pistol or close combat weapon it carries.

6. Saving Throw

Models that are wearing armour may attempt to avoid the effects of any damaging hits by making an armour saving throw exactly as with shooting damage.

CHARGE

A **charge** is a move intended to bring a model into hand-to-hand combat. The attacker leaps towards his enemy, yelling a blood curdling war cry or roaring a spine-chilling challenge.

A model can only engage an enemy model in hand-to-hand combat by charging. When you wish to charge an enemy model you first declare that you are charging and nominate the enemy model you wish to charge. The reason you do this is because the model you are charging may be able to shoot as the attacker bears down upon him. This can happen if the model is in *Overwatch*. The rules for *Overwatch* were printed in White Dwarf 129.

A charging model may move up to double its normal move rate. For example, if the model normally moves 4" it can charge up to 8". Players may not measure the distance before declaring the charge - they must rely on their judgement to estimate whether a model can reach its intended opponent. If a charging model fails to make contact with an enemy, it may do nothing for the remainder of the turn.

If a model charges an enemy behind a wall or other obstacle, it will be impossible to move the models so that their bases are touching because the obstacle is in the way. However, they are still considered to be touching and the hand-to-hand combat proceeds as normal. The charger suffers no move penalty on account of the obstacle.

Sometimes models move about the battlefield randomly because they are affected by gas weapons or are blinded or disoriented. Models which are moving randomly or out of control may simply blunder into hand-to-hand combat without a charge being declared. This is an exception to the normal rule that says you have to declare a charge before moving into hand-to-hand combat. Models moving unintentionally into hand-to-hand combat do not receive the usual bonus for charging, but their opponent has the same options as if he were charged.

WHICH MODELS CAN FIGHT

In the hand-to-hand combat phase all models engaged in hand-to-hand combat may fight. Note that it doesn't matter which player's turn it is. Even if it is not your turn you may fight with any models engaged in hand-to-hand combat.

Models are allowed to fight all round them, and not just against models to their front, so you can fight through a full 360° arc. This represents the fact that the warrior is whirling around, dodging and weaving, making desperate lunges, and generally doing his utmost to kill his opponent. Obviously the miniature itself is unable to move but don't let this fool you!

If a model is engaged against two or more enemy at once then all the models may fight. This is called a **multiple combat** and rules for this are covered later.



ATTACK DICE

During hand-to-hand combat a model rolls the number of attack dice indicated by the Attacks (A) characteristic on its profile. Most models roll 1 attack dice as their Attack value is 1. If a model carries a close combat weapon in each hand, such as 2 pistols or a sword and a pistol, then the model automatically rolls 1 extra attack dice to represent the extra weapon. For example, a Space Marine normally rolls 1 attack dice, but if he were carrying a chainsword and a bolt pistol this would become 2 dice.

Remember that although you may roll more than one dice, you only use one when working out who won the combat. The advantage of using more dice is that it gives you a better chance of rolling a high score.

DETERMINE WINNER

To determine the winner each player picks one of his attack dice, adds the model's Weapon Skill (WS) to the roll, and then adds any close combat modifiers to find a final score. The player with the highest score wins the combat. The winner now subtracts the loser's score from his own to determine how many hits his model causes.

In the case of a tie the model with the highest initiative wins the combat and scores one hit. If both models have the same initiative value the combat is a stand-off and no hits are scored on either model.

Example: A Space Marine is fighting an Ork. The Space Marine's WS is 4 compared to the Ork's 3 and both have 1 attack. Each player rolls a D6 and adds the score to his model's WS. The Space Marine rolls a 3 giving a score of 7 (WS4 + roll of 3) while the Ork rolls a 5, giving him a score of 8 (WS3 + roll of 5). The Ork has won by a difference of 1 so he has hit the Space Marine once. If the Ork had also been charging he would have received a close combat modifier of a further +1, giving him a score of 9 and inflicting 2 hits on the Space Marine.

THROW TO DAMAGE

Once hits have been established determine if each hit causes damage in the same way as for hits from shooting - ie compare the attacker's strength and the defender's toughness on the Damage Chart. Refer to the Shooting section for full details.

THE FUMBLE RULE

In the hurly-burly of close combat it is all too easy for a weapon to slip from your grasp, to trip over, or overbalance and expose yourself to a quick punch or stab. This is represented by the fumble rule.

When both players roll their attack dice any roll of a 1 represents a fumble. Any fumbled dice are handed over to the other player who adds +1 to his own combat score for each fumbled dice.

This rule makes it occasionally possible for an hopelessly outclassed fighter to pull off a spectacular surprise victory against all the odds!

THE PARRY RULE

A warrior armed with a sword (including Boneswords, Chainswords, Power swords and Force swords) can parry or turn aside an opponent's blow with his own blade. To represent this a model armed with a sword can force an opponent to reroll his highest attack dice before the winner of the combat is determined.

The swordsman doesn't have to parry if he doesn't want to. Though parries are useful it is possible an opponent may reroll and get a better score. An opponent who rolls several dice can always pick his next highest score and use that to determine who won the combat rather than use the score of his re-rolled dice. Re-rolled dice can still produce fumbles as described below.

Most pistols and close combat weapons have their own strength value. If a model carries a close combat weapon, a hit is worked out using either the attacker's value or the weapon's value, whichever is the higher.

SAVING THROW

Armoured models that have suffered damage can make a saving throw. This is exactly the same procedure as saving throws from shooting; refer to the Shooting section for full details.

Most pistols and close combat weapons have their own saving throw modifier. If a model carries a close combat weapon, a hit is worked out using either the attacker's value or the weapon's value, whichever is the higher.



MULTIPLE COMBATS

When two or more models are fighting a single enemy this is called a **multiple combat**. To resolve what happens the outnumbered model must fight each of his opponents one after the other. The outnumbered model may choose which opponent to fight first and the combat is resolved exactly like a one-on-one combat.

If the outnumbered model survives he must choose another opponent and fight him - but this time the enemy model rolls an extra dice and adds +1 to the score. Should the outnumbered model survive again he must fight a third, fourth and any other opponents who are attacking him.

Each further opponent adds another +1 to his score and rolls an additional dice. For example, a third opponent adds +2 and rolls 2 extra dice, a fourth opponent adds +3 and rolls 3 extra dice, and so on. This means it is possible to swamp a very strong opponent with sheer weight of numbers.

CLOSE COMBAT MODIFIERS

In some circumstances it is easier or harder to defeat your opponent than others. For example, it is easier to strike at someone from above, and harder if they are behind a wall. To represent these factors the following modifiers are applied to the model's score. All modifiers are cumulative. For example a +1, +2 and -1 gives an overall result of +2.

+2 Frenzied

A fighter who is *frenzied* automatically adds a bonus of +2 to his close combat score. *Frenzy* is a psychological effect described in the Psychology section of the Warhammer 40,000 rulebook.

+1 Fumble

If your opponent fumbles you automatically add +1 to your close combat score for each fumbled dice. Fumbles are explained above.

+1 Charging

If the model charged into combat this turn add +1 to your close combat score.

+1 Higher Up

If the model is on a higher slope, stair, rampart, etc then add +1 to your close combat score to represent the advantage gained by towering over your enemy. You don't get this advantage just because your model is taller than his opponent – that is already taken into account by their WS, A and other characteristics.

+1 Multiple Combat

If the model is the second opponent to fight in the same game turn he rolls an extra D6 and has a +1 modifier to his combat score.

-1 Obstacle

If you charge against an enemy behind a hedge, wall, barricade, or other linear obstacle then he is protected to some degree by the interposing obstacle. This is represented by a deduction of -1 from your close combat score. Note that this only applies in the turn in which you charge, afterwards your model is assumed to have climbed over the obstacle to get to grips with his opponent.



-1 Improvised attack

If the model has no close combat weapons of any sort and has no natural attacks (claws etc) then a -1 penalty is imposed on the close combat score.

It is very rare for a warrior not to have a knife or at least a blade attached to their gun, so this penalty is only applied in the unlikely event of characters fighting with their fists – civilian workers defending their work place from attack, for example.

Note that some pistol weapons have 'to hit' modifiers that are applied when shooting. These modifiers do not apply in hand-to-hand combat, only when shooting at a distance.

FOLLOW UP

If all a combatant's opponents are slain the model may make a special **follow up** move. The victor can use this special move to leap behind cover, rush forward to engage a further enemy, or to move in any way he wishes. When making a follow up move, a model may be moved up to 2" in any direction. Note that this extra move is an exception to the turn sequence in that it takes place in the hand-to-hand combat phase. If your model kills all his opponents it may make a follow up move regardless of which player's turn it is.

If you use a follow up to engage a fresh enemy then leave the models in base to base contact but do not work out the hand-to-hand combat until the next close combat phase. The victor has time to engage his new foe, but there isn't enough time left to continue fighting. Because they are engaged hand-to-hand neither model may do anything until the following hand-to-hand combat phase.

During the follow up move no movement penalty is imposed for crossing a wall or other obstacle because it is assumed troops make their way across such obstacles as they fight. Other terrain penalties apply as normal. Note that a model that makes a follow up move can still move normally in its movement phase assuming it is not engaged in hand-to-hand combat.

The follow up move does not affect the distance models are allowed to move in their next movement phase - it is a bonus due to the intense bout of activity during close quarter fighting.



DAVE GALLAGHER

UNIT COHERENCY IN HAND-TO-HAND COMBAT

Models engaged in hand-to-hand combat are not bound by the unit coherency rule. They are allowed to be more than 2" away from the rest of their unit. Models which follow up are also permitted to move out of the normal 2" coherency distance. However, once the engagement is over they will become subject to the coherency rules again, and must move back to within 2" of the rest of their unit as soon as possible. See the Movement rules for details.

BREAKING OFF FROM CLOSE COMBAT

Models engaged in hand-to-hand combat may not move during their movement phase because it is assumed the actual fighting takes place throughout the turn. Therefore the opposing models remain locked in combat and the result is worked out during the hand-to-hand combat phase.

The models cannot move away as to do so would invite their enemy to pounce and almost certainly slay them. This is the general rule - however we may allow an exception where a player feels his model is so hopelessly outclassed, or the situation is so desperate, that it is worth trying to break away from close combat.

The warrior turns his back on the enemy and tries to leap away. Perhaps the fighter is lucky enough to take advantage of a sudden lull as his enemy is thrown aside. Maybe his enemy is forced to duck to avoid a blow, giving the warrior a bare second or so to break away. It must be said that this is very risky! If the enemy recovers in time he will rush forward and attack your fighter from behind.

A model may attempt to break off from close combat in the following way. The player must declare his model is breaking away before the models fight in the hand-to-hand combat phase. Then work out the combat result as normal except that the model attempting to break away counts his Weapon Skill (WS) as 0. This is because he has his back turned and cannot fight back effectively. If the model survives it is moved out of close combat and has broken off successfully.

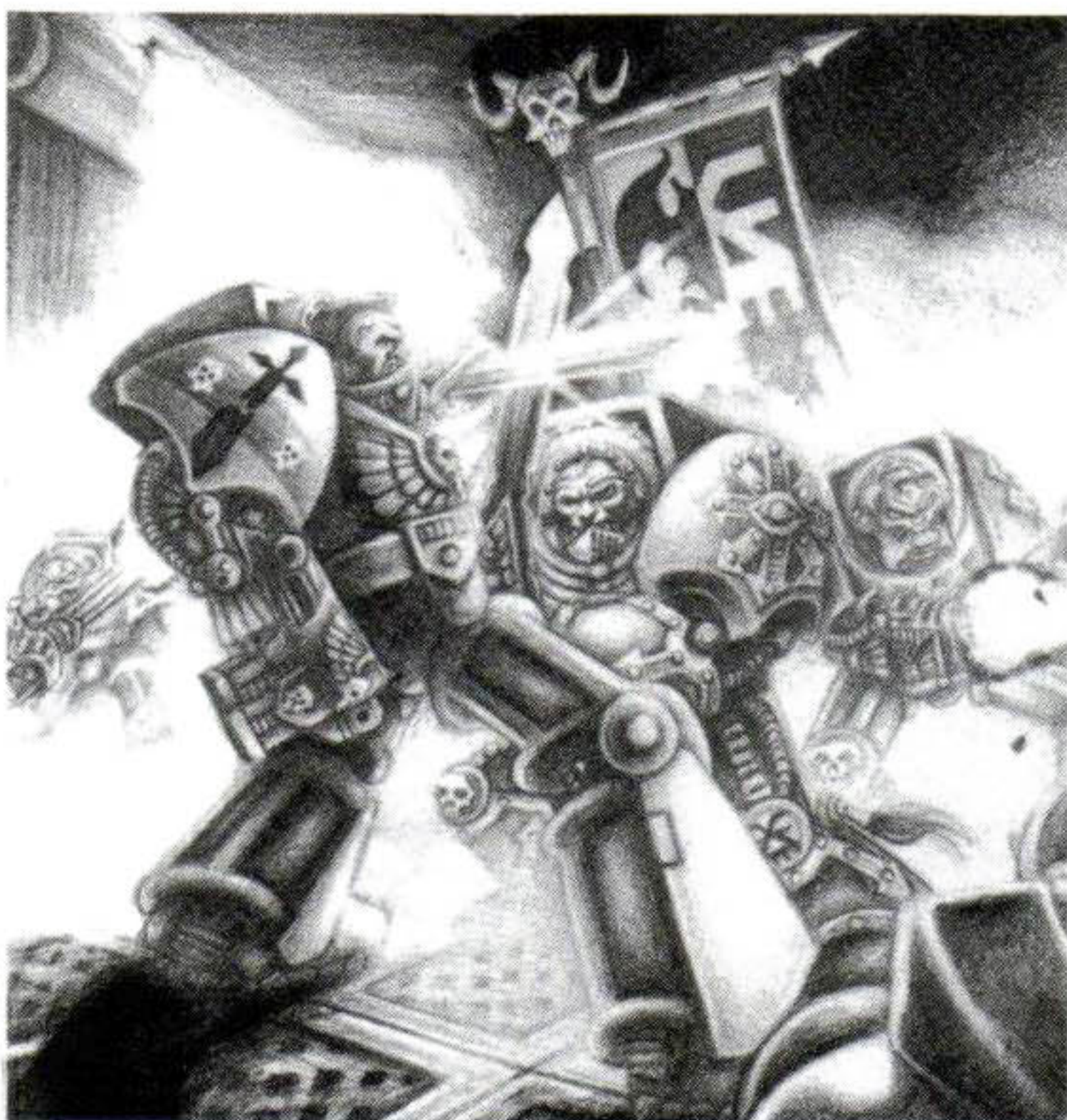

MARK GIBBONS

This is an exception to the normal game sequence as the movement takes place in the hand-to-hand combat phase. The move is at double rate and no penalty is imposed for the initial turn away from the enemy. The retreating model may not charge, shoot or do anything else for the remainder of the turn.

HAND-TO-HAND COMBAT WITH THE VEHICLE TEMPLATES

Regular White Dwarf readers will doubtless be familiar with the latest rules for vehicles that use the special targeting grid and hit location templates. The hand-to-hand combat rules described above may be used in conjunction with these rules for vehicles and Dreadnoughts. We'll be expanding on this in the forthcoming Warhammer 40,000 Vehicles Manual supplement.

ROBOTS AND DREADNOUGHTS

Robots and Dreadnoughts, or indeed any type of machine that has a Weapon Skill, may fight in hand-to-hand combat using the rules described above.

If the Robot or Dreadnought is hit then the attacker may choose which location is struck but doesn't roll for deviation.

Armour penetration and damage is assessed in the same way as shooting damage.

VEHICLES

Vehicles cannot engage in hand-to-hand combat as such, but a model may attack any vehicle it is touching during the hand-to-hand combat phase. This is not a proper hand-to-hand combat engagement and does not restrict the movement of either the vehicle or the attacker in their subsequent movement phases.

A model that is attacking a vehicle automatically hits once for each Attack on its profile. The attacker may choose the location struck and doesn't roll for deviation. Armour penetration and damage effects are worked out exactly as for hits from shooting.

If the attacker is armed with a grenade or any ranged weapon he may use this in hand-to-hand combat against a vehicle. Note that these weapons can't normally be used in close combat, so this is an exception to the normal rules. This allows for troops pushing gun barrels into hatches or through vision ports, or throwing grenades into exposed compartments. The attacker chooses his hit location exactly as if he were using a close combat weapon such as a pistol or power sword, and damage is worked out in the same way. Any area effect of the weapon is ignored - the blast being contained inside or under the vehicle. When used in hand-to-hand combat weapons only fire once, any sustained fire ability is ignored when used in close combat against vehicles.

Vehicles which are not moving are very vulnerable when attacked in close combat. The attacker can take his time to locate any weak points, climb up onto the structure, push his gun barrel through hatches, etc. To represent this hand-to-hand attacks against immobilised or stationary vehicles receive an armour penetration bonus of a further +1D6. This is very useful as it allows troops armed with relatively light weapons to swarm all over and destroy a heavily armoured vehicle that has been brought to a halt.

EXAMPLE OF HAND TO HAND COMBAT



JOHN BLANCHE

As an example of how hand-to-hand combat works we'll take a look at a combat between a Space Marine and two Ork Boyz. The Space Marine is armed with a chainsword and bolt pistol, while the Orks have their standard armament of a Bolter and a combat knife.

Space Marine												
M	WS	BS	S	T	W	I	A	Ld	Int	CI	WP	
4	4	4	4	4	1	4	1	8	8	8	8	

Ork Boyz (2)												
M	WS	BS	S	T	W	I	A	Ld	Int	CI	WP	
4	3	3	3	4	1	2	1	7	6	7	7	

The Space Marine charges the Orks in the movement phase. Neither Ork is on overwatch, so they are not allowed to take a shot at the Marine as he enters combat with them. The Space Marine is not allowed to fire at the Orks in the shooting phase because he is engaged in close combat.

We now come to the hand-to-hand combat phase. The Space Marine has to fight both Orks this phase, one after the other. The Ork player is allowed to choose which of his models will fight first, though in this case it is not important as the two models are identical.

The Space Marine has an Attack value of 1, which is increased by +1 because he is armed with two close combat weapons. His Weapon Skill is 4, and he is entitled to the +1 charging modifier from the close combat chart. This means that the Space Marine rolls two dice and adds +5 to the score of the highest roll.

The Ork also has an Attack value of 1, but this is not increased as he only has one close combat weapon. His Weapon Skill is 3, and he is not entitled to any modifiers, so the Ork player will roll one dice and add +3 to the score.

The Space Marine player rolls a 6 and a 2. He adds +5 to the highest dice roll, for an attack score of 6+5=11. The Ork player rolls a 4. He adds +3 to the score for a final total of 4+3=7. The Space Marine has won the combat by four points and so scores four hits on the unfortunate Ork.

The Space Marine player can choose which of his model's close combat weapons scored the hits, but as the chainsword and bolt pistol both have a strength of 4 and a -1 save modifier it does not matter which is used. The Marine player rolls for each hit and scores three wounds. The Ork player attempts to save against the wounds but not surprisingly fails.

The Space Marine now turns his attention to the second Ork. This combat will be resolved in exactly the same way as the first, except that the Ork rolls an extra D6 and has a +1 multiple combat modifier for being the Space Marine's second opponent in the same turn.

This time the Space Marine rolls a 1 and a 4. He takes the 4 and adds his bonus of +5 for a total of 4+5=9. The Ork rolls a 5 and a 2, which with his bonus of +4 also totals 9. In the case of a tie the model with the highest initiative (in this case the Space Marine) would score a hit.

However, the Space Marine player rolled a 1, which counts as a fumble, and which the Ork is allowed to add to his score. This takes his total to 5+4+1=10, so he wins the combat by one point and scores a hit!

The ensuing damage roll wounds the Space Marine, who fails to save and is eliminated. The Ork is now allowed to make a follow-up move of up to 2", and uses this opportunity to get under cover behind a nearby bush.

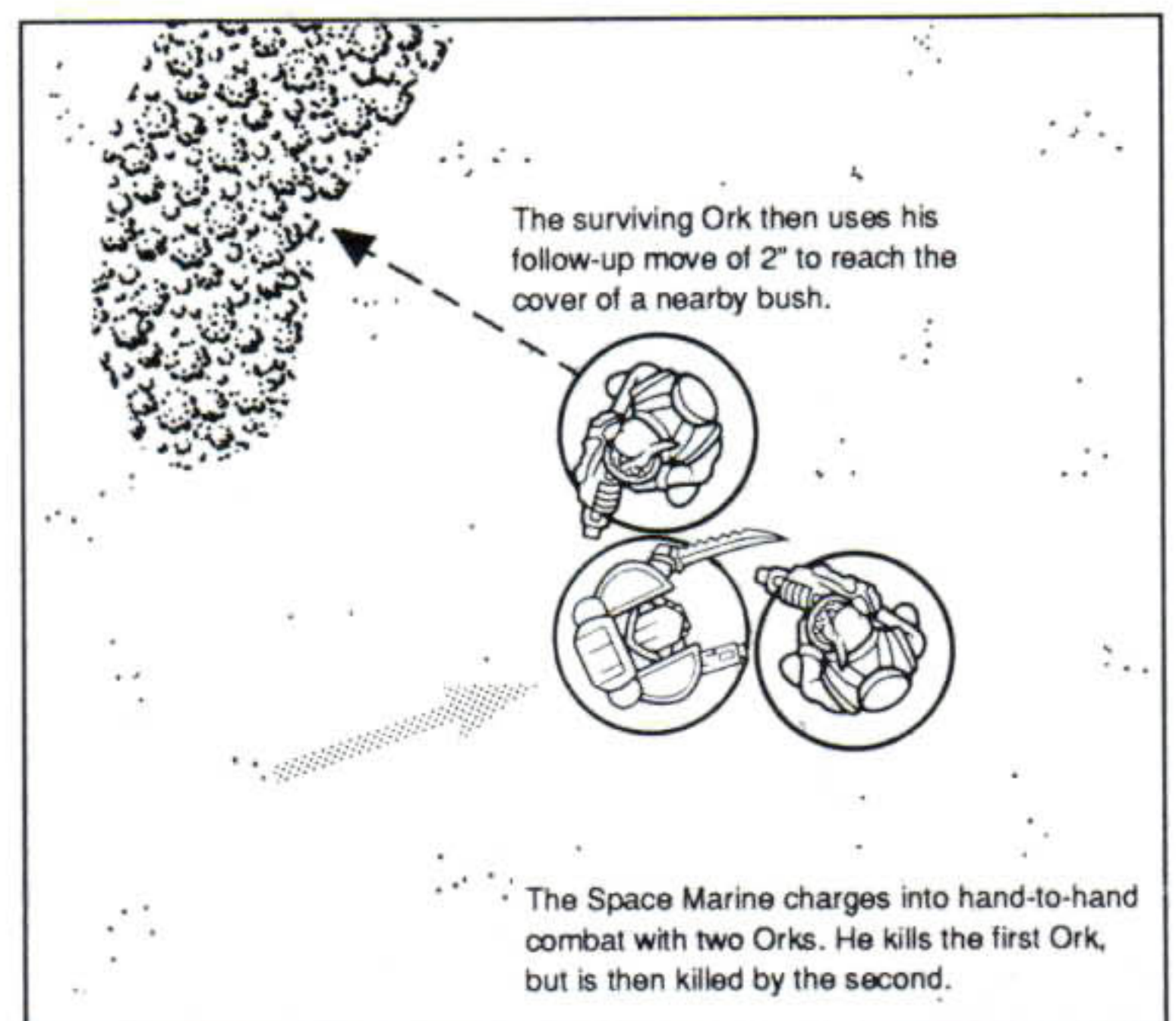

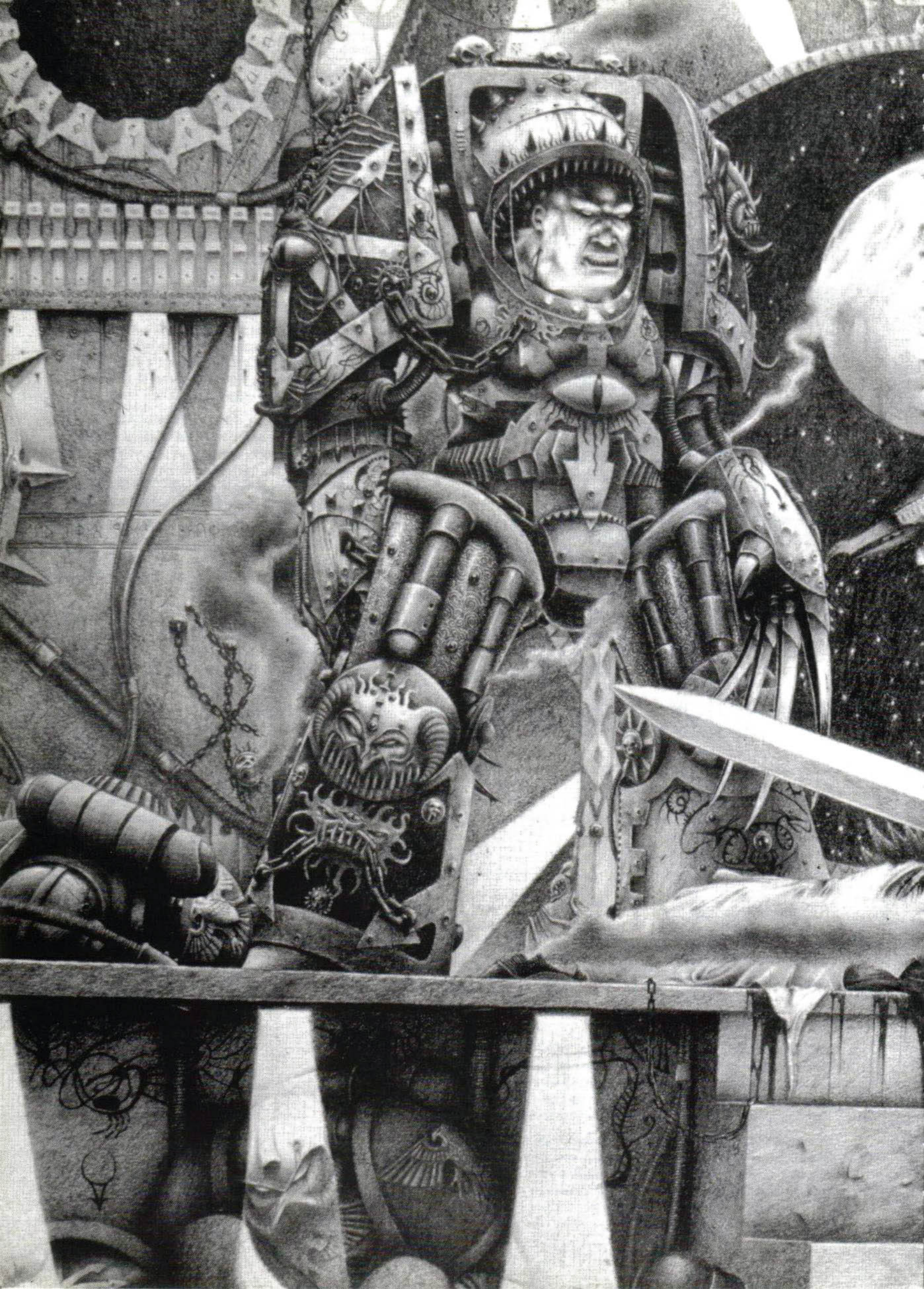

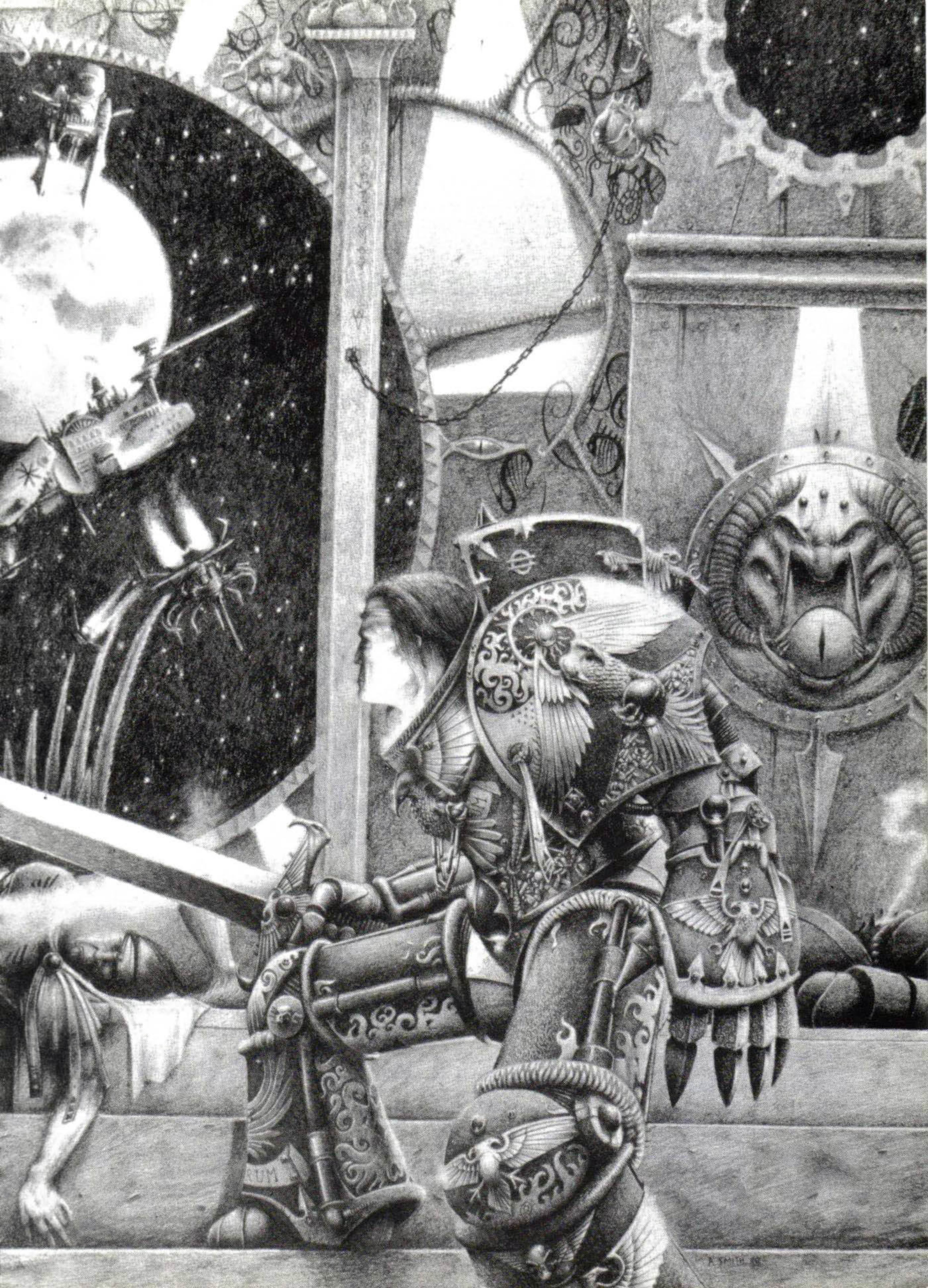

HAND-TO-HAND WEAPONS

Hand-to-hand combat weapons are designed for use purely in close combat. For example swords of various types, the hunting lance and the power axe. Such weapons cannot be used in the shooting phase, only in the hand-to-hand combat phase.

BANSHEE MASK

Banshee masks contain a special psychosonic amplifier which intensifies the Eldar's screaming battle cry to a piercing shriek. Howling Banshees are trained how to release their rage as they charge into combat, and taught how to focus and project the resultant psychic scream against their enemies. Enemies exposed to this psychic scream suffer almost total paralysis as their central nervous system is flooded with unbearable levels of psychic energy.



MARK GIBBONS

Special Rules

The target may neither run away nor fire Overwatch at the charging Banshee warrior, but is obliged to hold his ground. Furthermore, during the first round of combat the target's WS counts as 0 because of the paralyzing effect.

The Banshee Mask is only effective when the Howling Banshee charges – it has no effect if the Howling Banshee is itself charged by an enemy model. In the second and subsequent rounds of a close combat engagement the Mask also has no effect.

Short Range	Long Range	To Hit Short	To Hit Long	Strength	Damage	Save Modifier	Special
Close combat only		Enemy WS = 0 in first round of charge				Close combat	

BLADES AND SAWS

With the addition of a heavy blade, any basic weapon can be used in hand-to-hand combat. A model equipped in this fashion avoids the usual penalty for fighting with an improvised attack (-1).

Blades may be small and pointed, like bayonets, or axe-like and serrated, in which case they are used with a chopping motion like heavy axes.

These ancillary combat accessories can take many forms, and some may be concealed within the body of the weapon until needed.

Short Range	Long Range	To Hit Short	To Hit Long	Strength	Damage	Save Modifier	Special
Close combat only				As user	1	-	Close combat

BONESWORDS

Boneswords are bio-weapons used in pairs by Tyranid warriors. The blade of a Bonesword is a massively enlarged horn, sharply serrated along both edges. The blades are alive. They slowly grow in size, and are also capable of repairing themselves over time. The hilt is the hard, chitinous exoskeleton of the bio-construct. The creature's small brain is protected deep within the hilt. The creature is incapable of independent thought, but

able to generate a powerful surge of psychic energy when stimulated by the user. This psychic energy flows along the nerve tendrils embedded within the blade, causing a field effect rather like

a psyker's force weapon. This gives the Bonesword its potent 'bite' represented by its extremely high strength value and -2 save modifier.

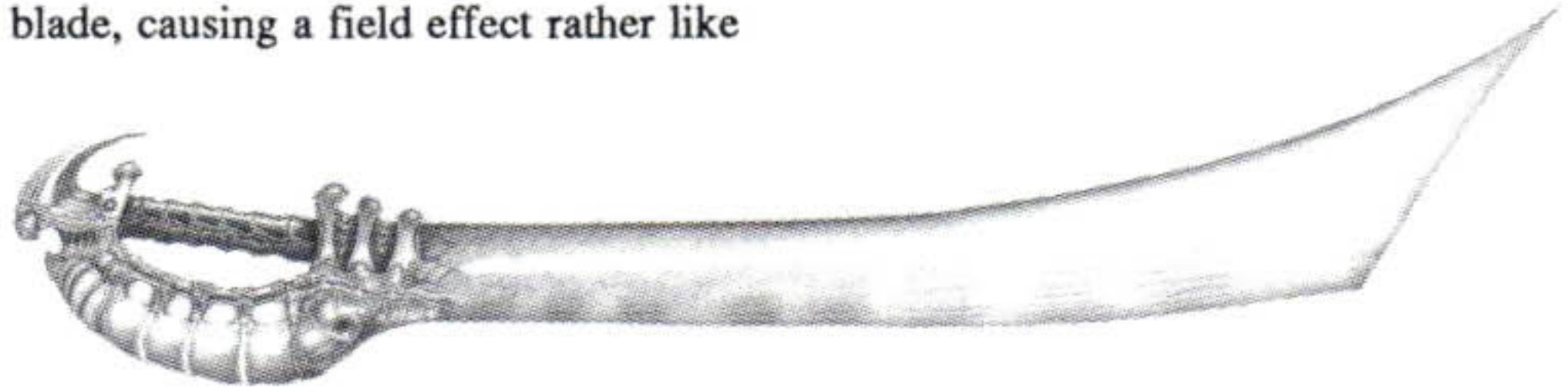

Short Range	Long Range	To Hit Short	To Hit Long	Strength	Damage	Save Modifier	Special
Close combat only				6	1	-2	Close combat

CHAINFIST

The chainfist is designed for use by Terminator Space Marines. It is primarily used for cutting holes through heavy bulkhead doors and walls, but it is also an awesome weapon in close combat.

The chainfist is essentially a power glove incorporating a chainsword. The cutting edge is encased in a power field which crackles and glows with energy. This power field discharges energy as

soon as the chainfist strikes, striking the target with flashing bursts of energy. Crackling forks of blue lightning crawl over the target's surface and shatter it, and the whirring teeth chew through armour and flesh with equal ease.

With three or four well placed cuts, a warrior can cut a hole in a bulkhead large enough for even the bulk of a Terminator to step through.

The weapon is no less deadly in hand-to-hand combat, and is powerful enough to cut through vehicles and dreadnoughts.



Its only disadvantage is its considerable bulk, but when fitted to Terminator armour this is compensated for by the power of the suit itself.

Short Range	Long Range	To Hit Short	To Hit Long	Strength	Damage	Save Modifier	Special
Close combat only				10	D4	-6	Close combat

CHAINSWORD

This is a popular weapon with officers in Imperial Guard forces, ship boarding parties and close assault troops. It is shaped like a traditional sword, but has the addition of a powered chainsaw edge that is studded with sharp monomolecular teeth capable of slicing through armour and steel bulkheads.

The chainsword makes an angry buzzing noise as its razor-edged teeth spin round, intensifying into a high pitched scream as the weapon bites.

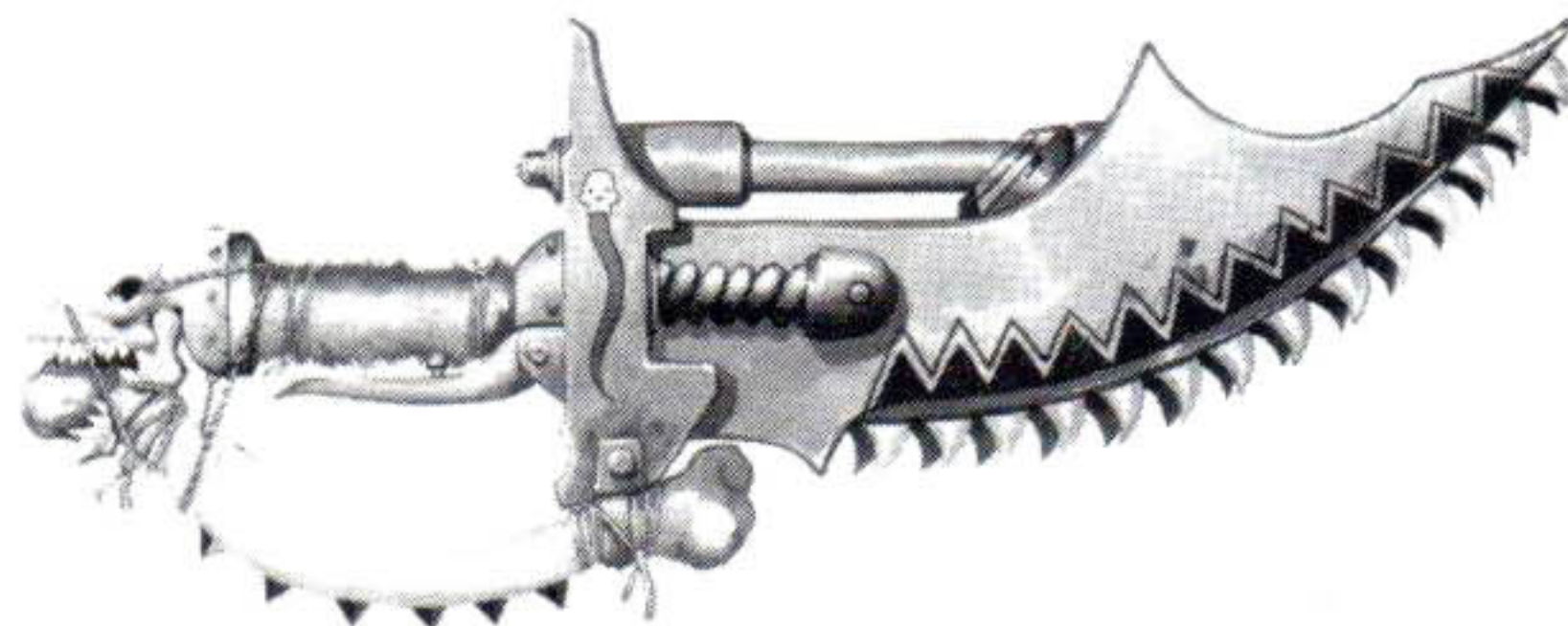

Short Range	Long Range	To Hit Short	To Hit Long	Strength	Damage	Save Modifier	Special
Close combat only				4	1	-1	Close combat

DIGITAL LASER

In a hostile and suspicious galaxy there will always be a ready market for small and easily concealed weapons. The digital laser or digilaser is a laser so tiny that it may be concealed in a finger ring, or fitted unobtrusively into a glove. Although these weapons exist, no-one knows where they come from, and it is beyond the technological capability of all known races to manufacture them.

Digilasers can be carried without affecting the wearer's ability to carry

other weapons, and greatly enhance his hand-to-hand combat potency. As they are so rare and expensive their possession is restricted to a wealthy elite, and digilasers make their appearance on the tabletop rarely and then only in the possession of the most influential and heroic characters.

Special Rules

A digilaser is worn as a finger ring, or fitted into the knuckles of a glove. They do not affect a model's ability to carry

or use other weapons. A model may wear up to 4 digilasers on each hand, or 8 in total. In hand-to-hand combat, a model may automatically shoot its digilasers before the combat proper is resolved. This is worked out in exactly the same way as shooting, representing the model blasting away at short range before its opponents close.

Once close combat has been started digilasers have no effect, so you don't roll extra dice because your model is carrying them.

Short Range	Long Range	To Hit Short	To Hit Long	Strength	Damage	Save Modifier	Special
Close combat only				3	1	-1	Close combat - See above

HARLEQUINS KISS

The Harlequins Kiss is used only by the Eldar Harlequins, and its Eldar name means 'Kiss of Evil'. It is a tubular weapon that straps to the back of the forearm. By punching forward, the Harlequin activates the weapon and releases a tightly curled 100 metre long monofilament wire (a wire only one molecule thick). If the tip of the weapon touches the enemy the wire filament pierces armour and flesh and instantly uncoils inside the victim's body. Within the space of a heartbeat the enemy's insides are reduced to the consistency of soup, and the wire whips back into the Harlequins Kiss.

Special Rules

Determine hand-to-hand combat hits as normal. If a hit is scored the target makes an immediate armour saving throw. If the save is passed the target is unharmed, and the wire fails to penetrate the armour. If the save is failed the model is automatically killed.

The Harlequins Kiss may be used against armoured targets such as Dreadnoughts and vehicles, but it cannot cause damage unless it is able to penetrate their armour. The Harlequins Kiss has its own special rule for penetrating armour.

To determine how many points of armour are penetrated roll a D6. If the score is 1 to 5 then that is the amount of armour penetrated, but if the score is 6 then roll another D6 and add this score to the first. If this second dice roll is also a 6 add the score of a further D6, and so on until a number of less than 6 is rolled.

The chances are that the Kiss won't penetrate even the most weakly protected vehicle (as most vehicles have at least 8 points of armour) but if the player is very lucky a small chink may be found which allows the wire to wreak devastation inside. If the target is penetrated roll a D6 and refer to the chart below.



VEHICLE CREW PENETRATION CHART

- 1 1 randomly determined crewman is caught and killed by the wire.
- 2-4 Roll a D6 for each crewman. On a score of 1, 2 or 3 the individual is unaffected. On the score of a 4, 5 or 6 the crewman is killed.
- 5 Roll a D6 for each crewman. On a score of a 1 the individual is unaffected, on the score of a 2 or more the crewman is killed.
- 6 All crew are killed.

Short Range	Long Range	To Hit Short	To Hit Long	Strength	Damage	Save Modifier	Special
Close combat only							Close combat - See above

LIGHTNING CLAWS

Lightning claws are a special weapon used by Space Marines in Terminator armour. They consist of a pair of heavy armoured powered gloves with long slashing talons sheathed in a rippling blue power field. They are only worn in pairs, and are a very difficult weapon to master, requiring an individual style of fighting in which the long claws are used to cover against attacks as well as to slash against the opponent.

Because the claws are sheathed with powerful energy like a power glove, when the curved blades rake across armour or flesh they discharge crackling energy like small lightning strikes over the target, tearing it apart and exposing flesh and

bone to further assault.

Special Rules

As these weapons are always worn in pairs the Terminator receives an extra attack dice in hand-to-hand combat. Lightning claws penetrate vehicle armour differently to other weapons. If one hit is scored against a vehicle or Dreadnought the amount of armour pierced is 8+D3+D6 as normal (Strength + Damage + D6). If 2 or more hits are scored the player has the option of working out each hit separately or combining hits into a single attack penetrating 8+3D6.

Short Range	Long Range	To Hit Short	To Hit Long	Strength	Damage	Save Modifier	Special
Close combat only				8	D3	-5	Close combat - See above

MANDIBLASTER

The helmets of the Striking Scorpions incorporate a pair of weapon pods positioned and shaped much like the mandibles of a scorpion. Each pod houses a mandible blaster, or Mandiblast, a unique and deadly device also known as the Sting of the Scorpion. The Mandiblast is an extremely short range weapon, useful only at a distance of a foot or so.

The weapon is activated by a psychic pick-up in the helmet, and fires a stream of tiny metallic needles straight forward into the target. These needles cannot do much damage themselves, although in the case of unarmoured targets they can tear and lacerate flesh, but they act as a conductive medium through which the Striking Scorpion delivers an intense laser energy sting.

This laser energy vaporises the tiny slivers of metal into plasma which rips straight into the target. The Mandiblast is a highly effective secondary weapon which is designed to be used in conjunction with other weapons.

It is brought into play while the Aspect Warrior's opponent is still a few feet away, enabling the Eldar to deliver a vital attack before the enemy has had a chance to strike.

Special Rules

The Mandiblast automatically shoots before the hand-to-hand combat proper is worked out. This is worked out in exactly the same way as shooting, representing the model blasting away at short range before its opponents close. Once close combat has been started Mandiblasts have no effect, so you don't roll extra dice because your model is carrying them.

If a hit is scored, searing laser arcs leap from the Striking Scorpion's helmet mandibles and send jets of laser energy into the target. Roll a D6, and if the score is equal to or more than the target's Toughness 1 wound is sustained. Saving throws from Mandiblast attacks are resolved with a -2 dice modifier.



Short Range	Long Range	To Hit Short	To Hit Long	Strength	Damage	Save Modifier	Special
Close combat only				-	1	-2	

POWER AXE

The power axe resembles a large axe or halberd. Its blade is surrounded by a hazy blue power field which crackles with discharges of energy. When the weapon strikes, this energy is discharged over the victim, rending the target apart with lightning-like power. The weapon is carried by some close

assault troops, but is commonly associated with Tech-Marines and members of the Adeptus Mechanicus. The weapon is large and requires both hands to use.



Short Range	Long Range	To Hit Short	To Hit Long	Strength	Damage	Save Modifier	Special
Close combat only				6	1	-3	Close combat

POWER GLOVE

The power glove or power fist is a heavy armoured gauntlet surrounded by an energy field which disrupts the surface of solid matter. In this form the energy field allows the glove to punch its way through walls and armour, and also to grip and tear away at solid objects. A hand wearing a power glove during hand-to-hand combat may not hold anything else, but the glove may be turned off and the hand used normally when required. Power gloves are used in conjunction with power armour by Space Marine officers and some close assault units.

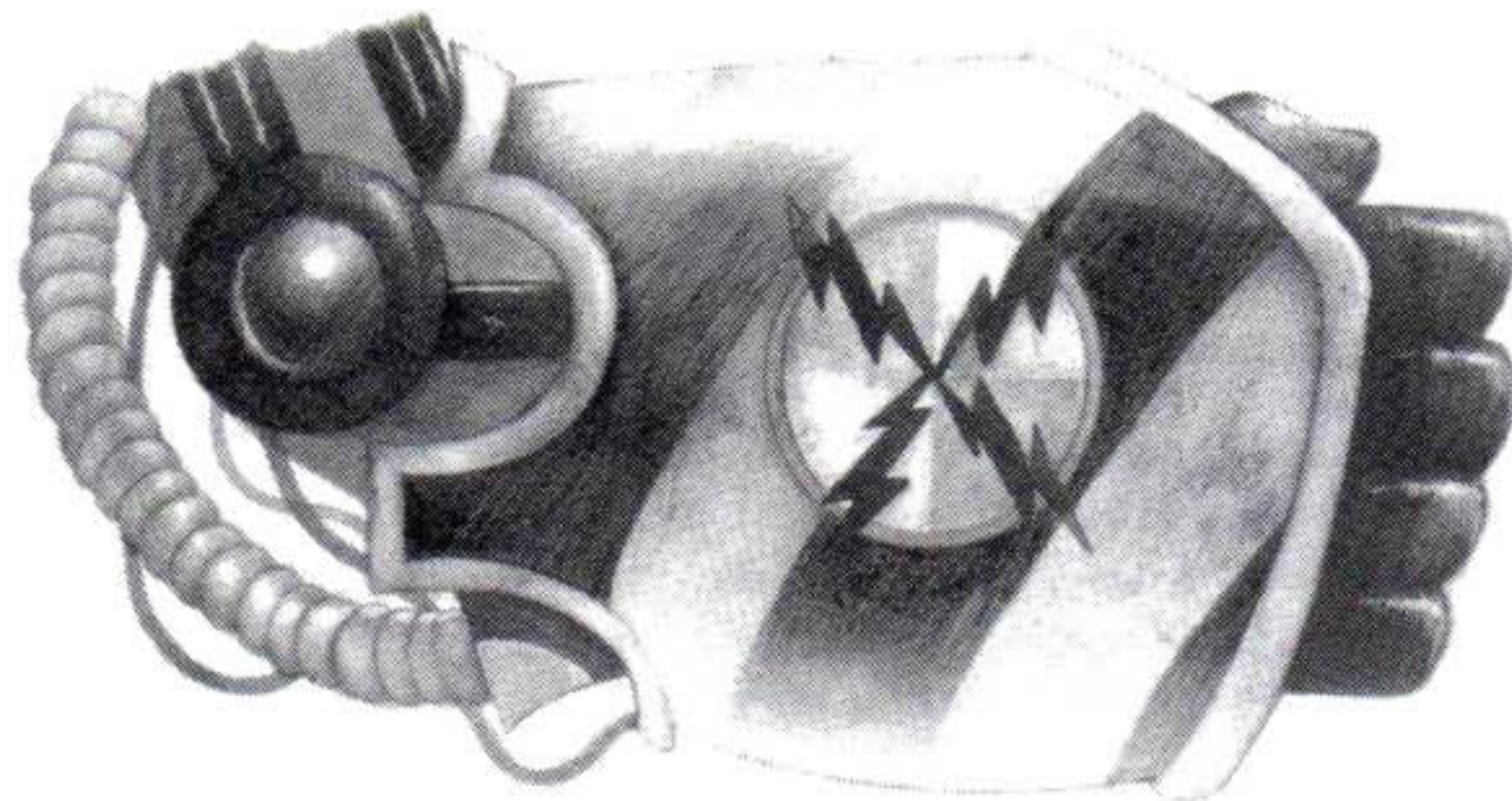

Short Range	Long Range	To Hit Short	To Hit Long	Strength	Damage	Save Modifier	Special
Close combat only				8	1	-5	Close combat

POWER MAUL

This weapon is used by the Adeptus Arbites Judges – the dreaded Arbitrators of Imperial Justice. This galactic police force hunts down criminals and enforces the Imperium's Laws.

The power maul is a club surrounded by an energy field which disrupts the surface of solid matter. The depth of the field can be adjusted to bash a hole through a wall or merely administer a knock-out blow to subdue a victim.

Unlike the power axe, the maul is held in one hand, leaving the other hand free for a pistol or shield.

Special Rules

In game terms it matters little whether a model is knocked out or slain, so the

profile reflects the weapon's maximum ability. However, any model 'killed' by a power maul may be assumed to be unconscious and automatically recovers once the game is over.



Short Range	Long Range	To Hit Short	To Hit Long	Strength	Damage	Save Modifier	Special
Close combat only				5	1	-3	Close combat

POWER SWORD

The blade of the power sword is surrounded by a hazy blue energy field which disrupts any solid matter it touches. As a blow is struck the whole length of the sword shivers with a crackling discharge of energy which then envelops the target and tears it apart. Amongst the Imperial forces the power sword is regarded very much as an officer's weapon, although it is also

carried by close assault troops where more devastating power weapons aren't available. Unlike the power axe,

the sword is held in one hand, leaving the other hand free for a pistol or other close combat weapon.

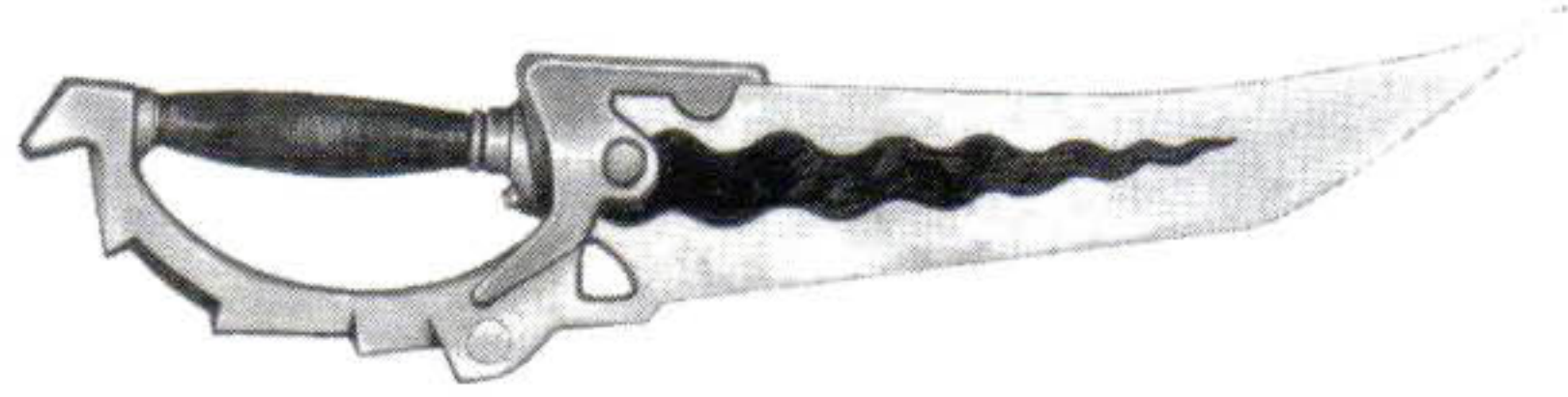

Short Range	Long Range	To Hit Short	To Hit Long	Strength	Damage	Save Modifier	Special
Close combat only				5	1	-3	Close combat

ROUGH RIDER HUNTING LANCE

The hunting lance is used by Imperial Rough Riders. These tough, frontier horse-soldiers are much valued as scouts and foragers. They also make excellent front-line troops, often using the hunting lance which they use to hunt big game on their native worlds. The lance is tipped with an explosive charge which blows apart on impact, smashing the target and shattering

armour and flesh alike. It is essentially a one-hit disposable weapon, but that hit is fully capable of taking out an armoured man.

Special Rules

The lance tip explodes on impact during the first round of hand-to-hand combat, thereafter the lance is useless and is discarded in favour of a pistol or

other suitable weapon. Each model fighting loses its lance after the combat round, even if the lancer fails to hit; in which case the lance is a 'dud' and fails to explode. If the lancers charge into combat they receive a +2 close combat modifier to the warrior's score. This bonus applies only during the first round of combat. If they are charged by enemy then this bonus does not apply.

Short Range	Long Range	To Hit Short	To Hit Long	Strength	Damage	Save Modifier	Special
Close combat only				6	1	-2	+2 Close combat modifier in first round. See above



SWORDS AND OTHER HAND ARMS

In a violent galaxy it is a mark of caution and status to carry a sword or long dagger. Many civilians go about their daily business armed, and no-one considers it in the least unusual. Swords may be made from carbon-steel, but plastic is equally flexible and sharp, and can be coloured to reflect the owner's wealth, status or allegiance.

to-hand combat using its own strength. Although a sword is hardly the most devastating of weapons in a universe in which such things are common, it is still worth having as it enables the player to avoid the -1 close combat penalty otherwise imposed for having

an improvised attack.

It is generally assumed that all troops in the game carry either a sword, dagger, or similar weapon. Only unarmed civilians or captives would be without.

Special Rules

A model armed with a sword, a long knife, or any comparable hand-to-hand weapon (such as an axe) fights in hand-



Short Range	Long Range	To Hit Short	To Hit Long	Strength	Damage	Save Modifier	Special
Close combat only				As user	1	—	Close combat - See above

THUNDER HAMMER & STORM SHIELD

This is a weapon used by Terminator Space Marines and is always used in conjunction with a storm shield. The thunder hammer is a large hammer with a power generator which energises only when the hammer strikes its target. This allows the weapon to store a tremendous amount of energy and release it only at the moment of impact, producing a terrific blast of energy and a sound like a crack of thunder. Were it not for his Terminator armour the Space Marine himself would probably be knocked over by the impact!

The storm shield is surrounded by a glowing blue field of energy which emits crackling lightning when the Space Marine parries a blow. The names of these two weapons are derived from the resulting awesome noise of thunder and lightning.

Special Rules

The thunder hammer has no strength value because this is not required. When the thunder hammer hits its target it will automatically cause damage (barring armour effects) — the normal damage roll against the target's toughness is ignored.

In the case of vehicles their armoured hull is automatically penetrated by the blow. The thunder hammer is always used in conjunction with the storm shield — a shield surrounded by a power field. A Terminator with a storm shield receives an extra armour saving throw of 5, 6 against shooting or hand-to-hand combat damage.

This saving throw ignores normal save modifiers - and therefore offers a save even against weapons with large negative modifiers such as lascannons and power weapons. As Terminators have a substantial armour save already, the storm shield save only comes into play if the Terminator armour doesn't save its wearer.



MARK GIBBONS

Short Range	Long Range	To Hit Short	To Hit Long	Strength	Damage	Save Modifier	Special
Close combat only					D6	-5	Close combat - See above

PISTOLS

Pistols are primarily designed to be used at close quarters – within hand-to-hand combat or in enclosed areas such as buildings and fortifications. In these situations, their accuracy at short range gives them a big advantage over larger weapons.

AUTOPISTOL

The auto-pistol is a rapid firing automatic pistol which shoots short bursts of caseless ammunition. It is effectively a pistol version of the larger and more powerful autogun. Like most pistol weapons it is very accurate at short range although its long range is limited. Like all pistol weapons the autopistol can be used in close combat.

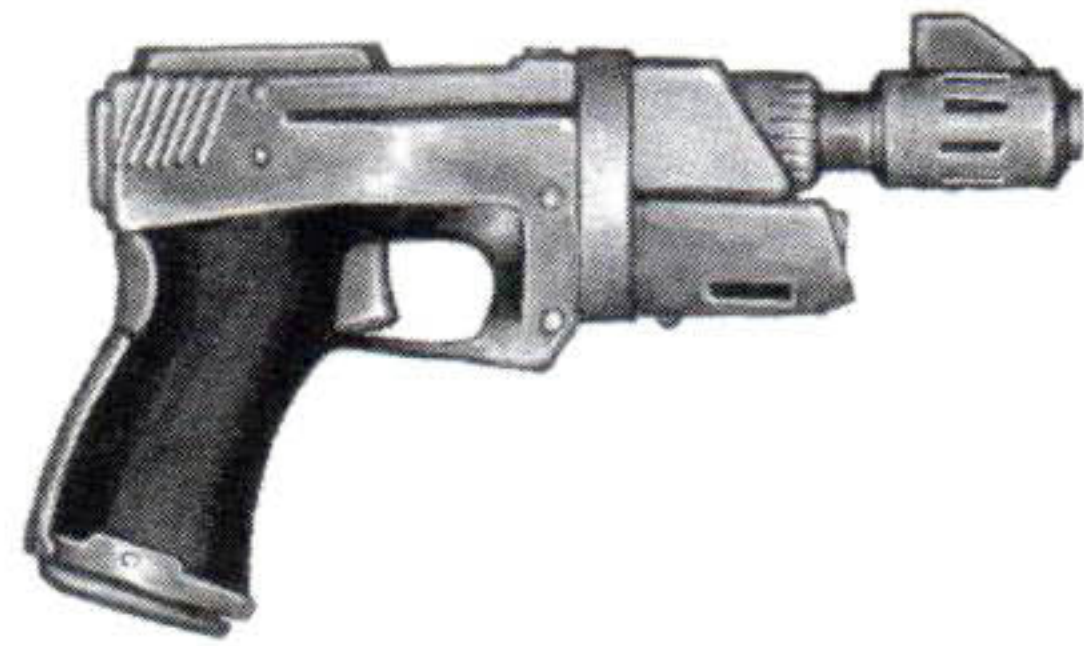

Short Range	Long Range	To Hit Short	To Hit Long	Strength	Damage	Save Modifier	Special
0-8	8-16	+2	—	3	1	-1	Close Combat

BOLT PISTOL

Bolt pistols are small versions of the boltgun and fire the same kind of explosive bolt missile. They are popular with many official and unofficial forces throughout the galaxy, especially amongst tough frontiersmen who commonly refer to the weapons as blasters or busters.

Bolt pistols are also carried by the street gangs of the hive worlds and raider pirates: individuals who prefer ugly, cumbersome weapons that make a lot of noise and cause a great deal of obvious damage.

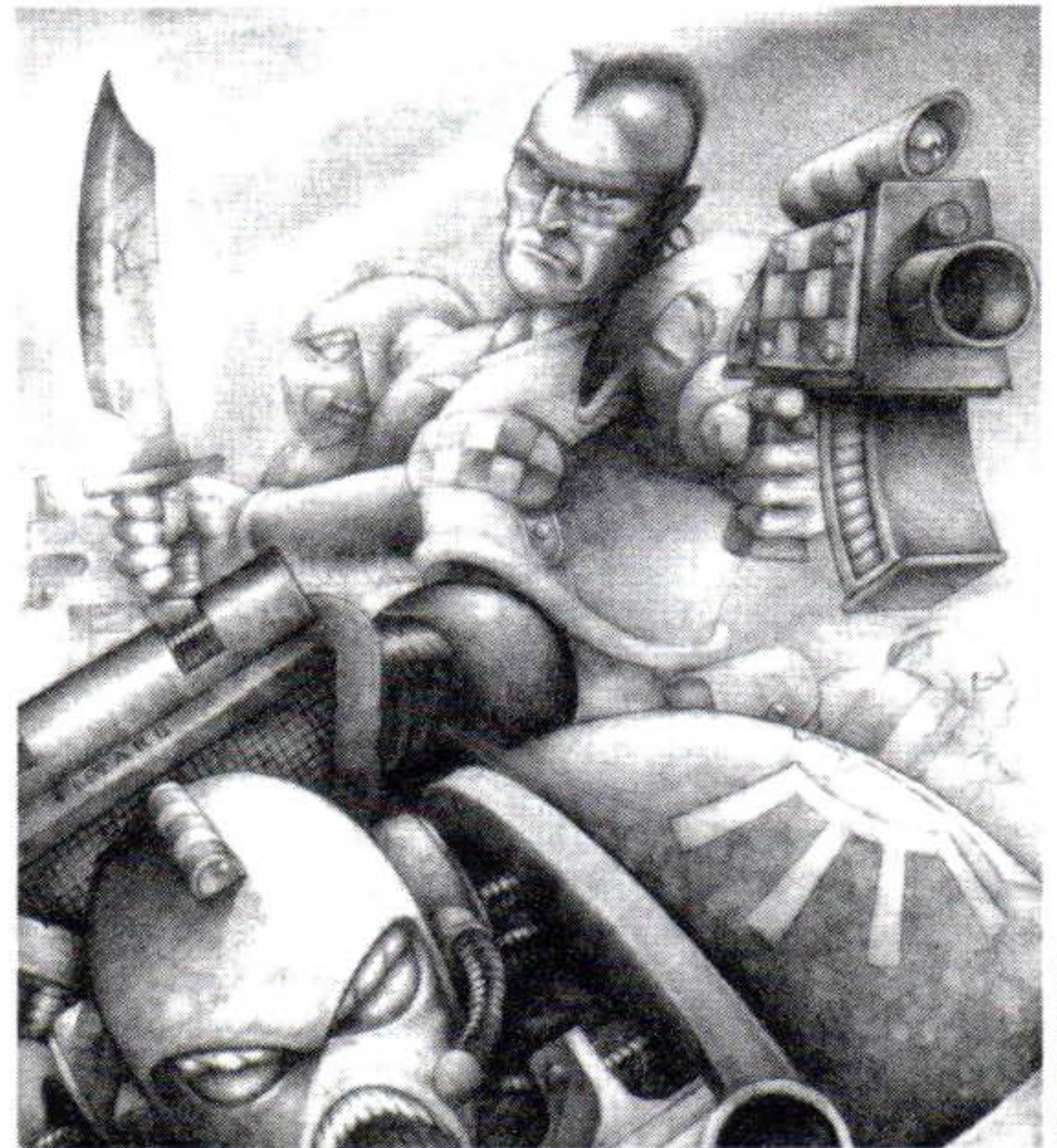
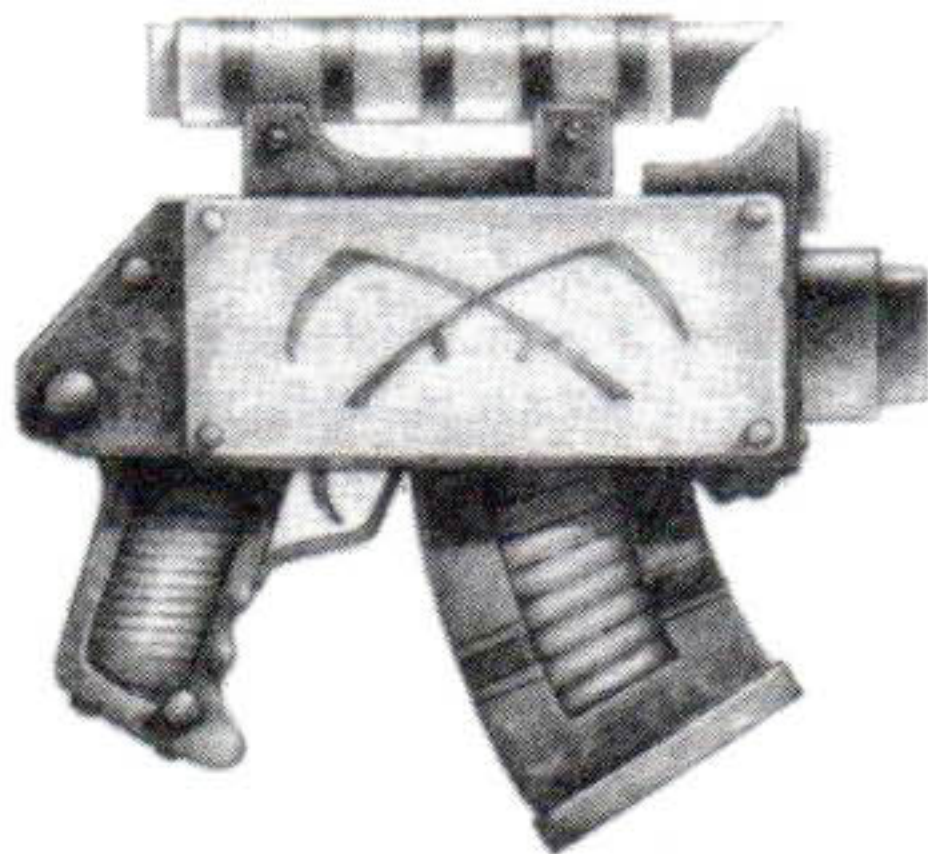

WAYNE ENGLAND

Short Range	Long Range	To Hit Short	To Hit Long	Strength	Damage	Save Modifier	Special
0-8	8-16	+2	—	4	1	-1	Close Combat

HAND FLAMER

Also known as the flame pistol, or burner, this is a smaller and more compact version of the flamer weapon. Its range is even shorter than the larger flamer, but its effects are just as deadly. Its small size means that it can also be used in hand-to-hand fighting.

To represent the blast of fire a special short triangular template with a curved tip is used when working out flamer shooting. Place the template with the pointed end against the model shooting. Any models whose base is wholly within the template area are hit automatically (there is no need to roll). Any models whose base is partially within the template area are hit on the D6 roll of a 4, 5 or 6. The template is only used for shooting in the shooting phase - not for hand-to-hand combat. In hand-to-hand combat resolve hits as normal. At such close quarters any direct hit is assumed to be wholly absorbed by the target.

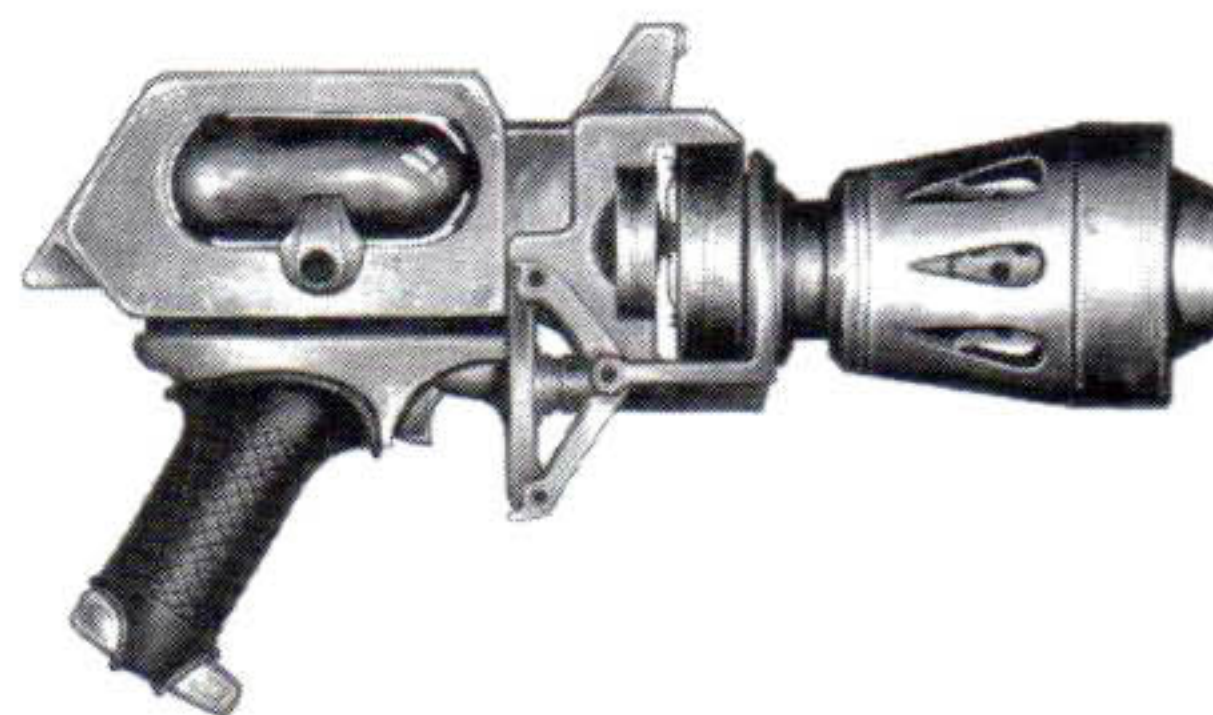

HAND FLAMER HIT CHART (D6)

- 1-3 Target does not catch fire - the small amount of burning fuel is quickly extinguished.
- 4-6 Target is smothered with fuel and ignites.

Once a target has caught fire test for the effect at the start of its own turn. Roll a D6 on the Fire Test Chart.

FIRE TEST CHART (D6)

- 1-5 Fire continues to burn causing a further automatic hit. Work out damage as normal and remove the model if slain. If the target is not slain it will move randomly and is unable to do anything else that turn. Normal coherency rules are suspended for burning models. Vehicles, dreadnoughts, and Terminator Space Marines may choose to ignore the flames and may continue to move and shoot as normal.
- 6 Fire goes out. The model may not move or fire during the current turn, but may fight normally from its following turn onwards. If coherency has been broken, the model must re-establish coherency as soon as possible. Vehicles, dreadnoughts, and Terminators are not affected by the fire and may move and shoot as normal.

Any friendly model within 1" of a burning model may attempt to beat out the flames during the movement phase. The beating model may move as normal, but may not shoot during the shooting phase. Roll a D6: if the score is 6 the flames are beaten out. If more than one model is available to help beat out the flames the chance increases by +1 per model, ie 2 models need 5+, 3 need 4+, and so on.

Any target which is already *frenzied* when hit by a flamer may continue to fight despite the fact it is burning up. The model moves, shoots and fights as normal, but will continue to roll for damage as appropriate.

A Space Marine armed with a Hand Flamer shoots at a group of advancing Orks. Taking the appropriate sized template the Marine positions it hitting two of the Orks. One is completely covered and takes an automatic hit while the other is only partially covered needing a 4, 5 or 6 on a D6 to be hit. A 5 is rolled and both models work out damage in the normal way. One Ork is slain and is removed as a casualty while the other saves.

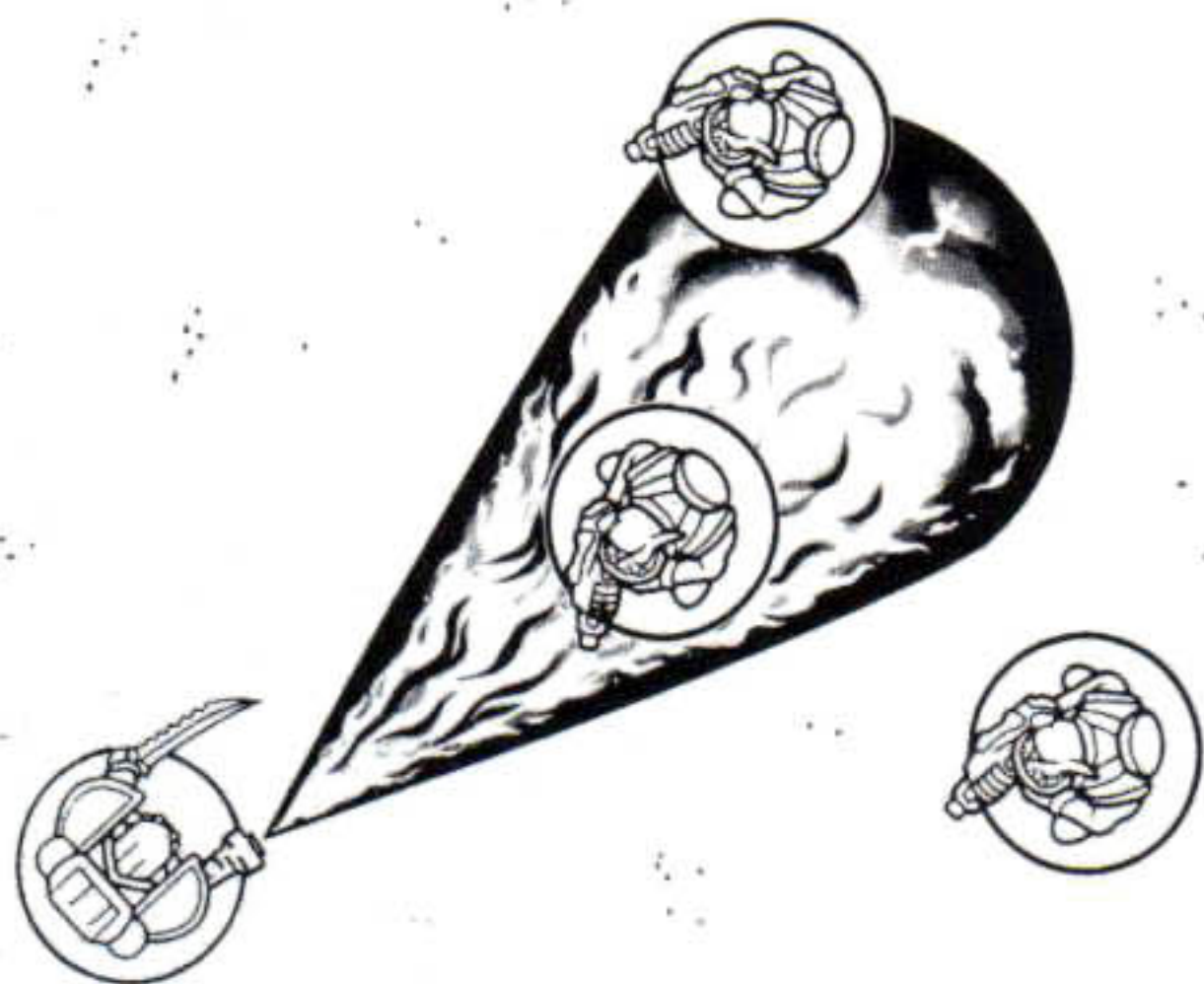

The surviving Ork rolls on the *Hand Flamer Hit Chart* to determine if he has caught fire. He rolls a 2 which means he has managed to extinguish any remaining flames and may move normally from now on.

Special Rules

If a model is hit by a flamer work out damage as normal. If the model is slain it is removed as a casualty as normal. If the model is not slain then an immediate test is made to determine if it has caught fire. Roll on the Hand Flamer Hit Chart. Because flamers use a volatile burning chemical, like oil or petrol, it is possible to set even vehicles or dreadnoughts alight.

Short Range	Long Range	To Hit Short	To Hit Long	Strength	Damage	Save Modifier	Special
Special Rules		—	—	4	1	-2	Close Combat See Above

LASPISTOL

The laspistol or laser blaster is a pistol version of the lasgun and enjoys the same reputation for ease of manufacture and convenience of use. It is a standard weapon amongst the Imperial Guard. It fires distinct bursts of laser energy, or laser shells, which explode when they hit their target. Because the laser's energy is rapidly dispersed into the atmosphere shots at long range tend to be inaccurate.

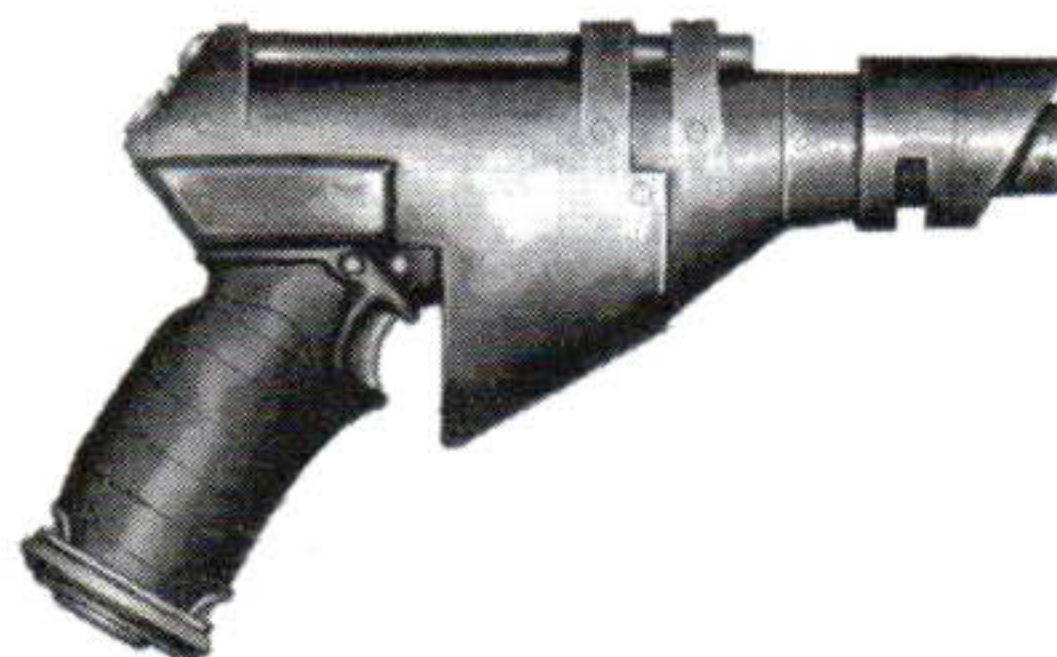

Short Range	Long Range	To Hit Short	To Hit Long	Strength	Damage	Save Modifier	Special
0-8	8-16	+2	-1	3	1	—	Close Combat

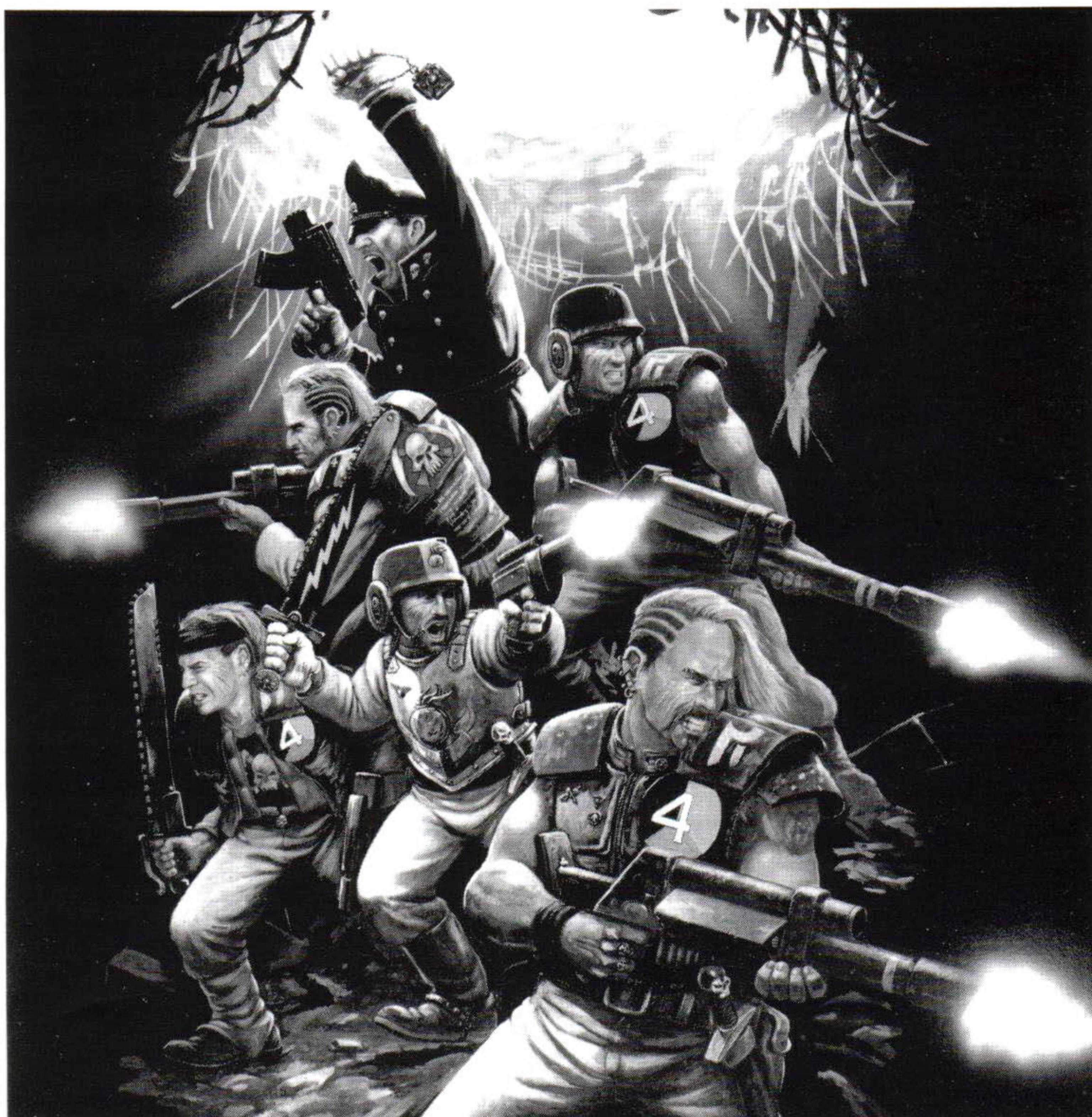

DAVE GALLAGHER

NEEDLE PISTOL

The needle pistol or needler is a smaller less powerful, but no less deadly, version of the sniper needle rifle. The weapon is based on the same design as the laspistol and fires bursts of laser energy which propels tiny toxic darts into the target. When the target is hit the laser blasts a hole and the needles slam home, delivering their toxin into the target's flesh.

Special Rules

The weapon may be used against any target, including vehicles, robots, and buildings, in which case it is the laser rather than the toxin which does the damage. Use the details

given on the weapon's profile and work out the weapon's effect as normal. When used against living targets roll to hit as normal. If the weapon hits, make any saving throw for armour as normal - no strength/toughness roll is required. The toxin automatically takes effect if the saving throw is not successful. Toxins can be tailored to affect any living creatures, but no toxin exists which will affect a daemon or Eldar Avatar. As yet no toxin has been developed that effects the extra-galactic Tyranids and Genestealers - although genestealer Hybrids are effected as normal.

Short Range	Long Range	To Hit Short	To Hit Long	Strength	Damage	Save Modifier	Special
0-8	8-16	+2	—	see above	1	-1	Close Combat See Above

PLASMA PISTOL

This is a pistol version of the plasma gun, combining the same level of devastating destruction with the same slow rate of recharging. It is sometimes known as the plasma blaster. The weapon fires energy shells of bright glowing plasma. When a plasma shell hits its target tremendous heat and energy are released, destroying the target in an almighty explosion.

Special Rules

The energy used by the plasma pistol is so vast that once it has been fired it takes time for it to recharge. If a plasma pistol is fired it cannot then be used in the player's following turn (you can use one of the recharging counters provided in the back of the book). The weapon is ready to fire again in the shooting phase of the player's turn after next. This does not affect the model's ability to move or to use another weapon if it carries one. Note that the weapon may fire

during the shooting phase using sustained fire - but sustained fire cannot be used in hand-to-hand combat.



Short Range	Long Range	To Hit Short	To Hit Long	Strength	Damage	Save Modifier	Special
0-6	6-18	+2	-1	6	1	-1	Sustained Fire – See Above Close Combat

SHURIKEN PISTOL

The shuriken pistol [Eldar: *Murehk*] is a pistol version of the shuriken catapult. The shorter barrel length and smaller capacity reduces the weapon's efficiency and so limits the range, rate of fire and power. The missiles are identical to those used in the larger weapon: a spinning disc which can slice straight through flesh and bone. Amongst humans these weapons are sometimes referred to as slingers or sling pistols.



Short Range	Long Range	To Hit Short	To Hit Long	Strength	Damage	Save Modifier	Special
0-6	6-12	+2	—	3	1	-2	Close Combat

STUB GUN

The stub or slug gun is a primitive hand gun firing solid bullets - usually one at a time. It is essentially the same as a twentieth century revolver or automatic. These pistols are common on industrial worlds where incessant gang warfare and institutional urban tribalism have created armed populations and a common acceptance of low-level weaponry. On such worlds these weapons are blessed with a variety of local names such as sluggers, smokers and shooters.



Short Range	Long Range	To Hit Short	To Hit Long	Strength	Damage	Save Modifier	Special
0-8	8-16	-	-1	3	1	—	Close Combat

WEB PISTOL

The web pistol or glue gun is an unusual weapon not seen frequently on the battlefield. It is mostly used by institutional forces for crowd control and suppression and its effects are usually debilitating rather than deadly. The pistol is bulky with a cone shaped nozzle and a distinctive underslung canister. This canister contains the weapon's ammunition: a special gluey chemical called web-chem. When the pistol is fired a dark mass of tangled threads is thrown forward over the target. As the threads are exposed to the air they expand and solidify, quickly forming a dense web of entangling sticky threads. Once a target is hit the web contracts and binds the victim tightly, preventing all movement and action. The harder a victim struggles the tighter the web becomes, and if the victim continues to struggle the web will eventually crush him.

Special Rules

Once a web pistol has hit its target the victim is enmeshed: there is no damage roll and no saving roll. The victim may do nothing until released using the special web solvent carried by all troops equipped with web guns. At the start of their turn, any models enmeshed by webs may attempt to free themselves. However, this is risky, especially for smaller weaker creatures. The player rolls a D6 and adds the trapped model's strength. If the score is 9 or more the model is freed and may move and act normally from then on. If the model fails to break free it must immediately make its normal

saving throw, and if this is failed the model sustains 1 damage point. Vehicles cannot be webbed, but crews or troops in open topped vehicles may be hit and affected. If a vehicle's driver is webbed he cannot drive, and the vehicle goes out of control.

A Space Marine armed with a Web pistol shoots at an advancing Ork. As the Ork is at short range (less than 4") the Marine receives a +1 to hit modifier. The web hits and the Ork is automatically enmeshed (although there is no damage caused there is also no saving throw) and plays no further part in the game unless he can break free.

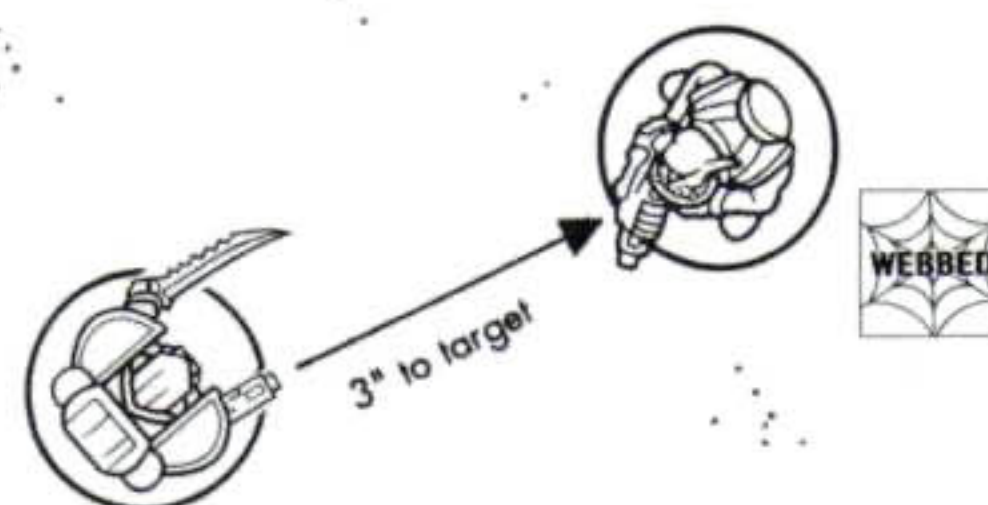

At the start of his turn the Ork player attempts to free the model. To do this the Ork must score 9 or more on a D6 adding its strength (3 for an Ork Boy). Unfortunately he rolls a 2 giving him a total of 5 and sustains 1 hit, which failing to save kills him.

Short Range	Long Range	To Hit Short	To Hit Long	Strength	Damage	Save Modifier	Special
0-4	4-8	+1	—		Special		Close Combat See Above





BASIC WEAPONS

Basic weapons are normally used only during the shooting phase, although the addition of an axe-blade or bayonet enables them to be used to stab or chop in close combat. They are designed to be fired in both hands rather like a modern rifle.

AUTO-GUN

The auto-gun is comparable to a twentieth century automatic rifle both in appearance and operation, though the introduction of caseless ammunition and high-tech components has increased the rate of fire and reliability.

The autogun fires a burst of high-velocity, caseless shot made from plastic, ceramics or metal. Its strong point is its long effective range.

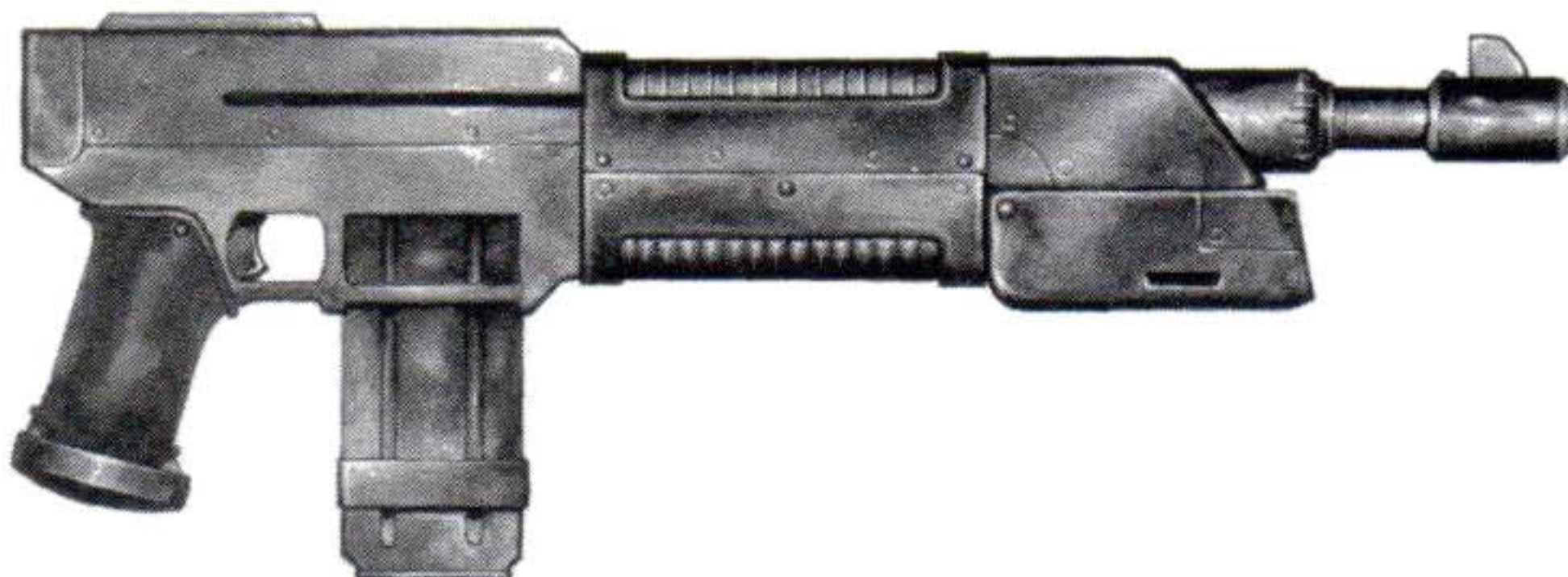

Short Range	Long Range	To Hit Short	To Hit Long	Strength	Damage	Save Modifier	Special
0-12	12-32	+1	—	3	1	-1	—

BOLTGUN

The bolt gun or bolter is the standard armament of Space Marines and the favoured weapon of Orks. It is a short compact weapon that fires a missile or bolt substantially larger than a bullet. The bolt contains an armoured piercing tip, an explosive, and a mass reactive detonator. It is shot from the barrel under low velocity, its own propellant igniting once the missile is clear of the barrel.

The explosive detonates only when it has pierced armour. Any sudden increase in local mass activates the explosive and blows the target apart from the inside.

Bolt guns are noisy and their effects are visibly devastating. Effective range is not great, and they are thus ideally suited to a shock/assault role.



Short Range	Long Range	To Hit Short	To Hit Long	Strength	Damage	Save Modifier	Special
0-12	12-24	+1	—	4	1	-1	—

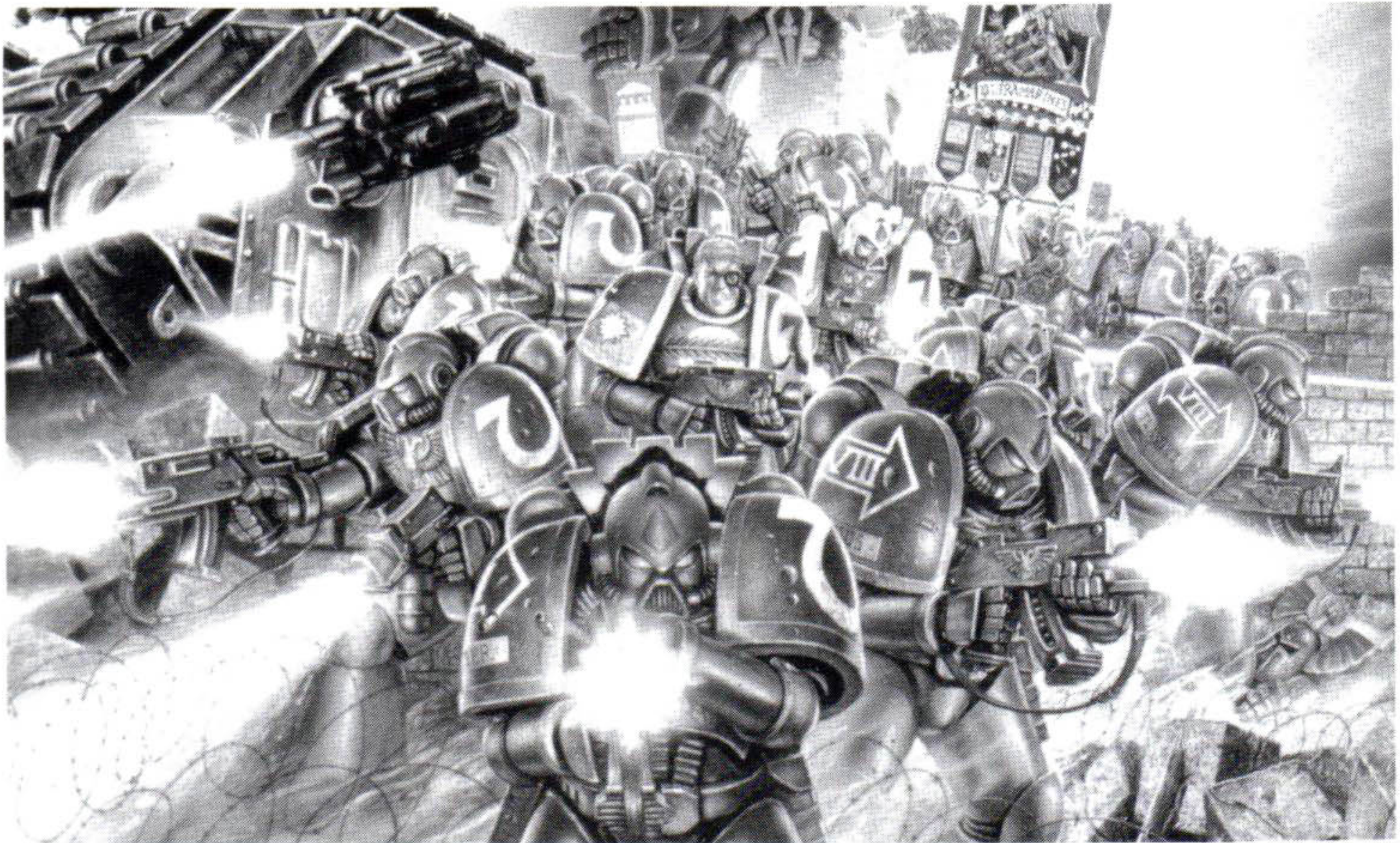

BOW

There are many primitive planets where modern weaponry is completely unknown. Bows are very common on these worlds, and are used for hunting as well as for war.

Special Rules

Although an arrow can pierce flesh or even thin armour it is relatively useless against efficient armour and vehicle hulls.

To reflect this, its armour penetration value against vehicles is only D6 rather than D6+3 as you would expect.

Although there is no armour save modifier given for hits against armoured troopers, any target with a save of 4+ or more automatically has its saving throw increased to 2+ when hit by an arrow.

Short Range	Long Range	To Hit Short	To Hit Long	Strength	Damage	Save Modifier	Special
0-12	12-24	-	-1	3	1	—	See Above

CROSSBOW

Crossbows, like bows, are used on primitive worlds where more sophisticated weapons are unknown or rare. They are not weapons commonly seen on the battlefield, although they sometimes appear in local uprisings in the hands of rebellious street gangs and other irregular troops. Constructed from modern high-tensile plastics and aided by an automatic mechanical draw, the power of such a weapon can rival that of more modern armaments. Its chief disadvantage is that it is impossible to move while reloading.

Special Rules

Although a crossbow bolt can pierce flesh or even thin armour it is relatively useless against efficient armour and thick vehicle hulls in much the same way as an arrow. To reflect this, its armour penetration value against vehicles is always D6+1. Although there is no armour save modifier given for hits against armoured troopers, any target with a save of 4+ or more automatically has its saving throw increased to 2+ when hit by a crossbow bolt.

Short Range	Long Range	To Hit Short	To Hit Long	Strength	Damage	Save Modifier	Special
0-16	16-32	-	-1	4	1	—	Move or Fire See Above

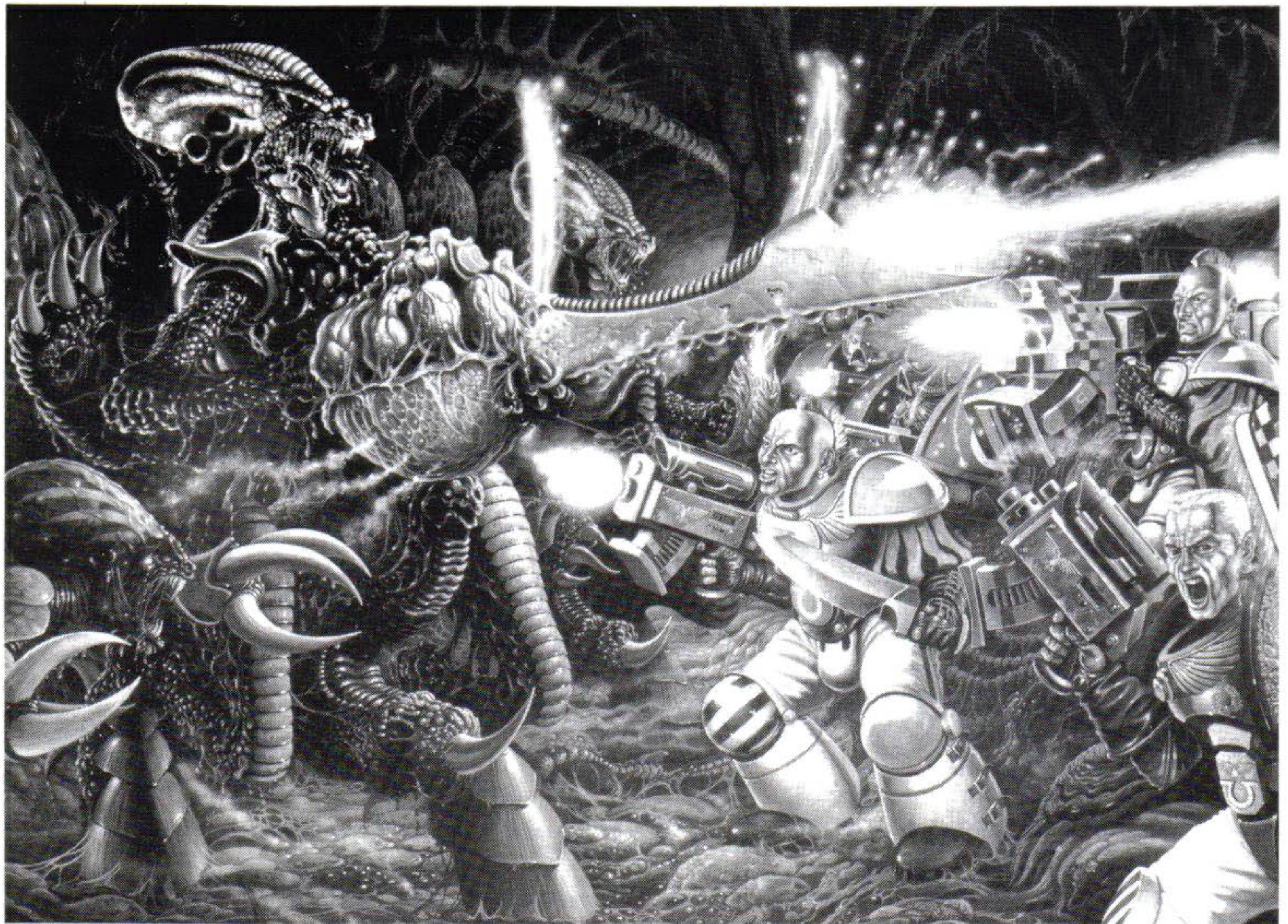

DEATHSPITTER

The Deathspitter is a bio-weapon frequently carried and used by Tyranid Warriors. It is an organic symbiote formed from three separate and quite different creatures. Deep inside the quivering innards of the Deathspitter is a warm wet brood chamber where the maggot-like creatures which form the ammunition are nurtured. These creatures have a chitinous shell and a fiery metabolism based upon their highly corrosive and volatile vital fluids. Beside the brood chamber is the arming orifice in which lurks an oozing, spider-jawed creature which strips the maggot-like creature of its carapace with a loud grinding noise before finally dropping it into the firing colon.

The firing colon reacts to the corrosive flesh of the maggot-like creature with a powerful spasm which fires the morsel of living flesh out of the Deathspitter.

The still living goblet of flesh shrieks through the air (which is poison to it) until it reaches its target. There it splatters over the target and kills its victim with a combination of velocity, poison and corrosive slime.

Nearby targets may also be unfortunate enough to be splattered by goblets of corrosive slime which eat through armour and burn flesh.

If a Tyranid armed with a Deathspitter scores a hit on an enemy model other models nearby are liable to be hit. Roll a D6 for any models within 2" of the model hit by the Deathspitter. On a roll of 4, 5 or 6 they are splattered and suffer a S3 hit with no saving throw modifier. Note that the Deathspitter doesn't have to wound the target before you check for splatter, only a hit is necessary.

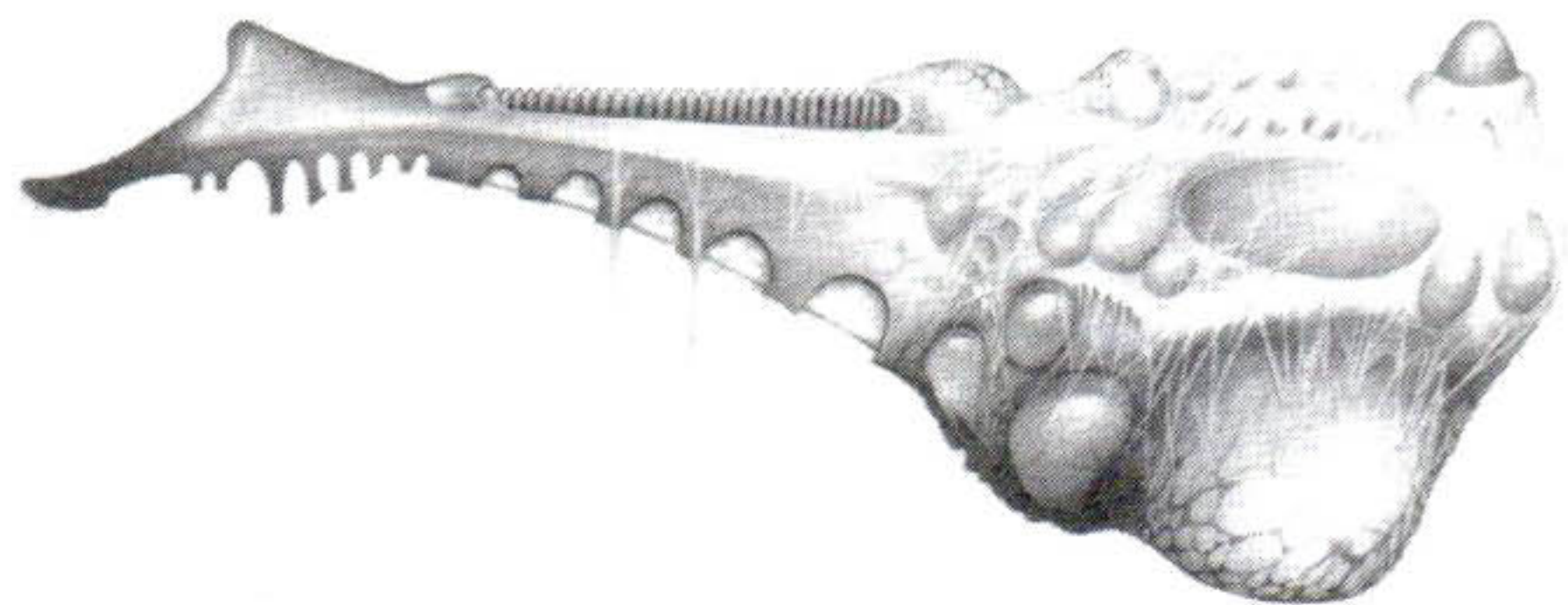

Short Range	Long Range	To Hit Short	To Hit Long	Strength	Damage	Save Modifier	Special
0-12	12-32	+1	—	6	1	-2	Special Rules See Above

FLAMER

Flamers or burners are flame throwers that fire a highly volatile liquid chemical which ignites on contact with the air throwing out a great belch of flame. The weapon has only a short range but is very effective.

To represent the blast of fire a special triangular template with a curved tip is used. Place the template with the pointed end against the shooting model. Any models whose base is wholly within the template area are hit automatically (there is no need to roll) and any models whose base is partially within the template area are hit on the D6 roll of a 4, 5 or 6.

Special Rules

If a model is hit by a flamer work out damage as normal. If the model is slain it is removed as a casualty as normal. If the model is not slain then an immediate test is made to determine if it has caught fire. As flamers use a volatile burning chemical, like oil or petrol, it is possible to set even vehicles or dreadnoughts on fire. Roll a D6 on the Flamer Hit Chart.

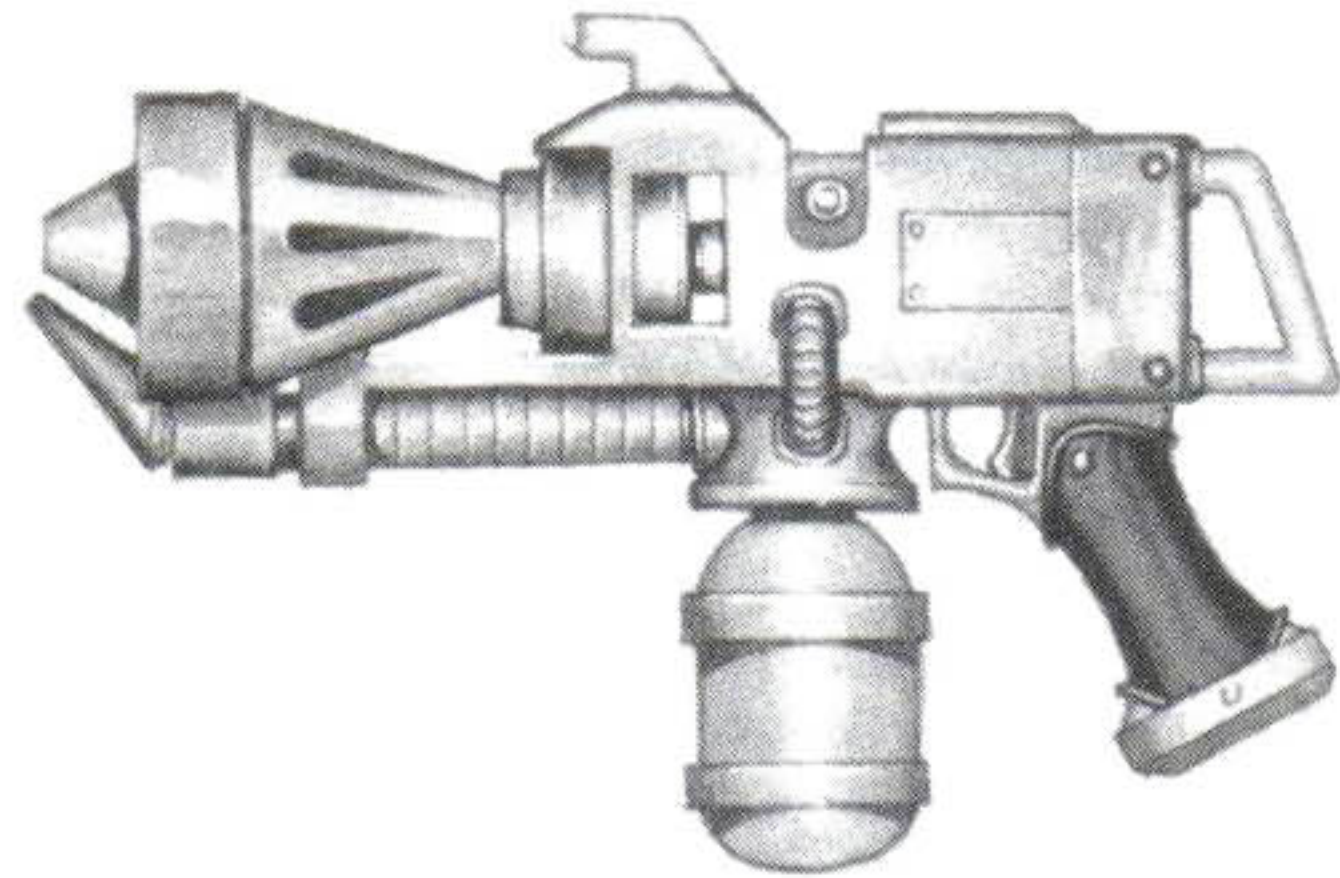

Once a target has caught fire test for the effect at the start of its own turn. Roll a D6 on the Fire Test Chart.

FLAMER HIT CHART (D6)

- 1-3 Target does not catch fire - the small amount of burning fuel is quickly extinguished.
- 4-6 Target is smothered with fuel and ignites.

FIRE TEST CHART (D6)

- 1-5 Fire continues to burn causing a further automatic hit. Work out damage as normal and remove the model if slain. If the target is not slain it will move randomly and is unable to do anything else that turn. Normal coherency rules are suspended for burning models. Vehicles, dreadnoughts, and Terminator Space Marines may choose to ignore the flames and may continue to move and shoot as normal.
- 6 Fire goes out. The model may not move or fire during the current turn, but may fight normally from its following turn onwards. If coherency has been broken, the model must re-establish coherency as soon as possible. Vehicles, dreadnoughts, and Terminators are not affected by the fire and may move and shoot as normal.

A Space Marine armed with a Flamer shoots at a group of advancing Orks. Taking the appropriate sized template the Marine positions it hitting three of the Orks. Two are completely covered and take automatic hits while the other is only partially covered needing a 4,5 or 6 on a D6 to be hit. A 5 is rolled and all the models work out damage in the normal way. Two Orks are slain and are removed as a casualties while the other saves.

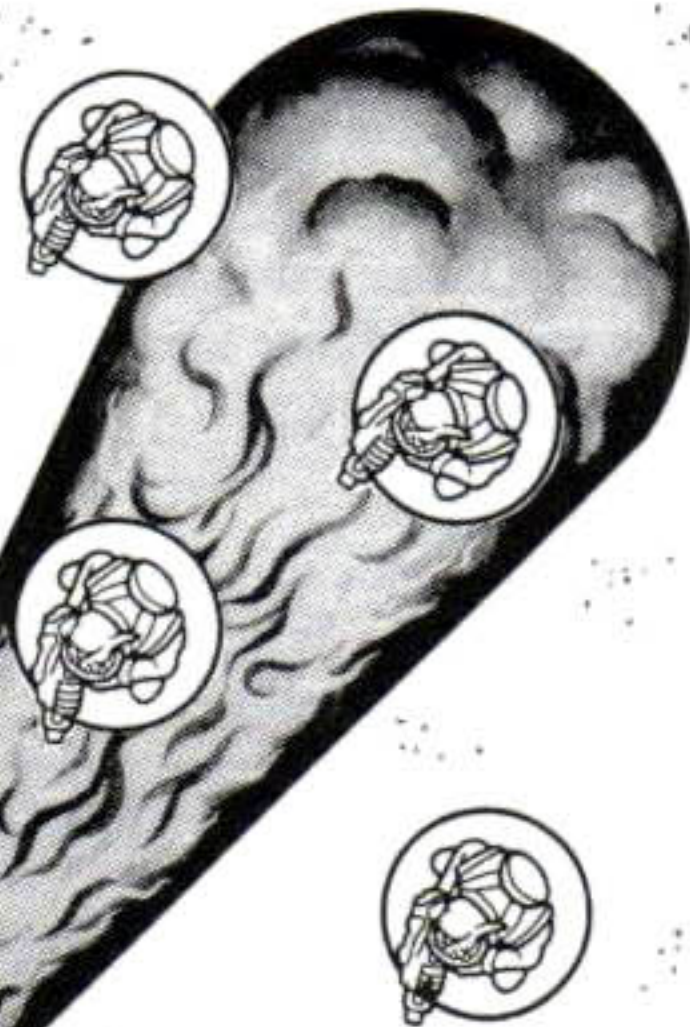

The surviving Ork rolls on the *Flamer Hit Chart* to determine if he has caught fire. He rolls a 2 which means he has managed to extinguish any remaining flames and may move normally from now on.

Any friendly model within 1" of a burning model may attempt to beat out the flames during the movement phase. The beating model may move as normal, but may not shoot during the shooting phase. Roll a D6: if the score is 6 the flames are beaten out. If more than one model is available to help beat out the flames the chance increases by +1 per model, ie 2 models need 5+, 3 need 4+, and so on.



A target which is already frenzied when hit by a flamer may continue to fight despite the fact it is burning up. The model moves, shoots and fights as normal, but will continue to roll for damage as appropriate.

Short Range	Long Range	To Hit Short	To Hit Long	Strength	Damage	Save Modifier	Special
Special Rules	—	—	—	4	1	-2	See Above

FLESHBORER

The Fleshborer weapon is normally used by Hunter- Slayers. It is in fact a compact brood nest in which Borer beetles lay their eggs, which then hatch and mature, fed by sticky sap exuded by the gun itself. Mature beetles have long flea-like legs, though they move little except to shuffle slowly into the firing cavity of the weapon. When the weapon is fired, a massive electro-chemical shock surges through the beetle, goading it into frenzied activity. Its legs push it out of the weapon at tremendous speed and it hurtles forward to strike the first thing in its path, its vicious jaws clashing furiously. Once the beetle strikes its target it expends all of its remaining life energy in a few seconds, frenziedly boring through armour, flesh and bone.

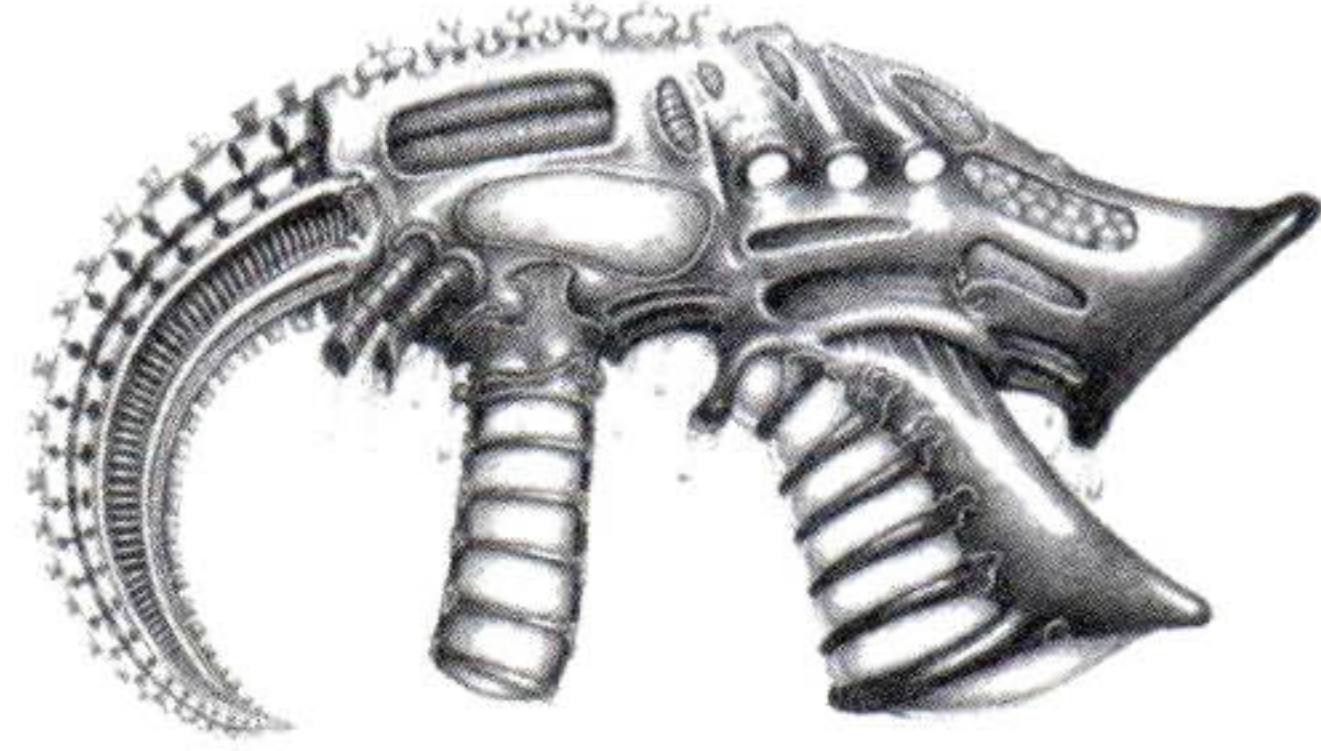

Short Range	Long Range	To Hit Short	To Hit Long	Strength	Damage	Save Modifier	Special
0-8	8-16	+1	—	4	1	—	None

GRAVITON GUN

The graviton gun is a development of the gravitic reaction principle, used in gravitic motors to propel vehicles such as the Imperial Land Speeder. It affects the local gravity field and changes the weight of objects making them far heavier or lighter than normal. The graviton gun is useful for demolition and siege work, as it is most effective when employed against massive structures such as buildings. The effect against living targets is variable: the stresses of increased weight may kill a large individual, but most targets will be merely immobilised.

When it is fired the graviton gun emits a bass rumbling noise which begins to pulse and grow louder as its weight distorting rays affect the air pressure in front of it causing the air itself to vibrate.

Special Rules

A target hit by a graviton gun is always affected, no damage roll is required. A living target is immobilised for the remainder of the game and may not move. The victim may not fight in hand-to-hand combat but may attempt to shoot. Roll a D6 – on a score of 4+ the model has overcome the gravity effect and can shoot that turn. A psyker may continue to use his powers.

If the target is a vehicle, roll for hit location as normal but ignore armour penetration. Roll once for damage on the appropriate vehicle location damage chart adding +1 to the dice score.

Short Range	Long Range	To Hit Short	To Hit Long	Strength	Damage	Save Modifier	Special
0-8	8-16	+1	—	—	—	—	1½" Radius Blast Area See Above

HANDBOW

The handbow is a modern version of a crossbow. It is made from composite plastics, drawn by automatic servos, and is every bit as powerful as a larger crossbow. It can be fired in one hand, but has the same disadvantage as its larger cousin - that it cannot be reloaded while moving.

Special Rules

Although an arrow can pierce flesh or even thin armour it is relatively useless against efficient armour and thick vehicle hulls. To reflect this, its armour penetration value against vehicles is always D6.

Although there is no armour save modifier given for hits against armoured troopers, any target with a save of 4+ or more automatically has its saving throw increased to 2+ when hit by an arrow.

Short Range	Long Range	To Hit Short	To Hit Long	Strength	Damage	Save Modifier	Special
0-8	8-16	—	-1	4	1	—	Move or Fire See Above

AUXILIARY GRENADE LAUNCHER

The auxiliary grenade launcher is a tubular device that fixes onto another weapon - many Imperial weapons are designed to take them. Pistol weapons are too small to carry grenade launchers, but bolters, lasguns, and autoguns are sometimes fitted with these devices.

Grenade launchers fire pre-primed and pre-loaded grenades. The most highly favoured type is **krak**, providing extra short range fire-power and vehicle busting capacity. When the trooper wishes to use a grenade he throws a catch on the weapon which deactivates the normal firing mechanism and activates the grenade launcher. When he pulls his trigger a grenade is blasted out of the launcher, hopefully hitting the target and exploding with a devastating boom.

Special Rules

The auxiliary grenade launcher must be pre-loaded with a single type of grenade before the game. The types of

grenade available will vary as detailed in the army lists, but **krak** and **frag** are the usual options.

Ammunition expenditure is not taken into account during the game, as the magazine is assumed to hold enough grenades to last the battle. Only preloaded grenades may be fired, grenades may not be loaded during the game.

A model carrying a weapon with a grenade launcher may choose to shoot either the weapon or the grenade launcher. A model may not fire both launcher and weapon during the same turn.



Frag Grenade. The fragmentation grenade is designed to explode and fragment causing havoc among unprotected troopers.

Str	Dam	Save Mod	Blast Area
3	1	-1	2" Radius

Krak Grenade. This grenade is designed specifically to crack open heavily armoured targets. It can also be used against foot troopers and is effective against armoured troops.

Str	Dam	Save Mod	Blast Area
6	D6	-3	None

Others. Any grenade type can theoretically be adapted to fit into an auxiliary grenade launcher. Other types available are covered by the army lists and have the same game details as their standard grenade types.

Short Range	Long Range	To Hit Short	To Hit Long	Strength	Damage	Save Modifier	Special
0-6	6-12	—	-1	—	—	—	See Above

PACK GRENADE LAUNCHER

The Pack Grenade Launcher [Eldar: *Creidann*] is used by Eldar Warlock Harlequins, consisting of a light pack harness that fits onto the shoulders. The harness is loaded with grenades which are fired over the wearer's shoulder. The grenades are fitted with whistles which make a strange shrieking noise as they climb into the air and a sombre drone as they descend on their target.

Special Rules

The *Creidann* is an exception to the normal shooting rules in that it can be fired in addition to a hand-held weapon, allowing the model to fire twice in the same turn. The grenade launcher must be pre-loaded with a single type of grenade before the

game. The types of grenade available are detailed in the appropriate army lists.

Ammunition expenditure is not considered, and the harness holds enough to last the battle.

Only preloaded grenades may be fired, and grenades may not be loaded during the game. **krak** or **frag** grenades are the most commonly carried type.

Krak Grenade. This grenade is designed specifically to crack open heavily armoured targets. It can also be used against foot troopers and is effective against armoured troops.

Str	Dam	Save Mod	Blast Area
6	D6	-3	None

Frag Grenade. The fragmentation grenade is designed to explode and fragment causing havoc among unprotected troopers.

Str	Dam	Save Mod	Blast Area
3	1	-1	2" Radius

Others. Any grenade type can theoretically be adapted to fit into a grenade launcher. Other types available are covered by the army lists and have the same game details as their standard grenade types.



Short Range	Long Range	To Hit Short	To Hit Long	Strength	Damage	Save Modifier	Special
0-8	8-16	—	-1	—	—	—	See Above

LASGUN

The lasgun or laser gun is the standard weapon of the Imperial Guard and the most popular weapon among most human forces. It fires an explosive energy blast with a similar effect to a bullet or small shell. A lasgun may not be the most effective weapon in the galaxy, but it is easy to manufacture and maintain, and very reliable even under the toughest battlefield conditions. The lasgun is powered by rechargeable batteries, but carries a residual supply and can be recharged using its own solar converters.

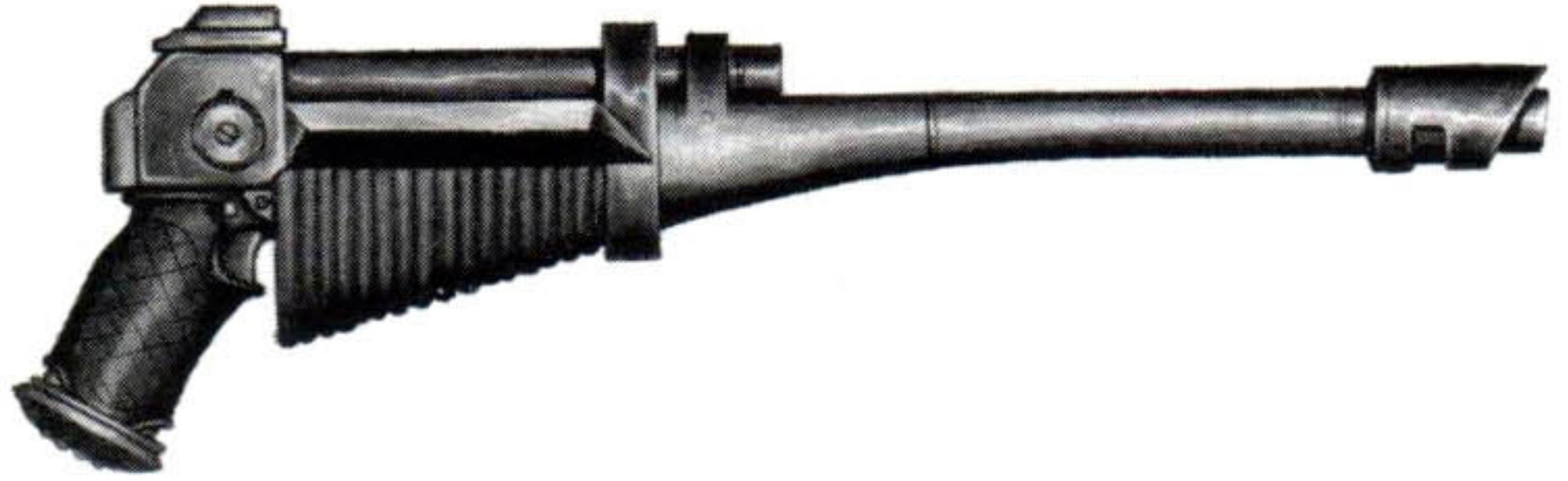

Short Range	Long Range	To Hit Short	To Hit Long	Strength	Damage	Save Modifier	Special
0-12	12-24	+1	—	3	1	-1	—

MELTA-GUN

The melta-gun is also known as the melter, cooker or vape gun. It works by sub-molecular thermal agitation in a manner comparable to microwave irradiation. The target eventually cooks, melts or evaporates. A melta gun can melt plasteel or plascrete, and its effects upon living tissue are impressive to say the least. The weapon has only a short range, so it is used for close assault and support.

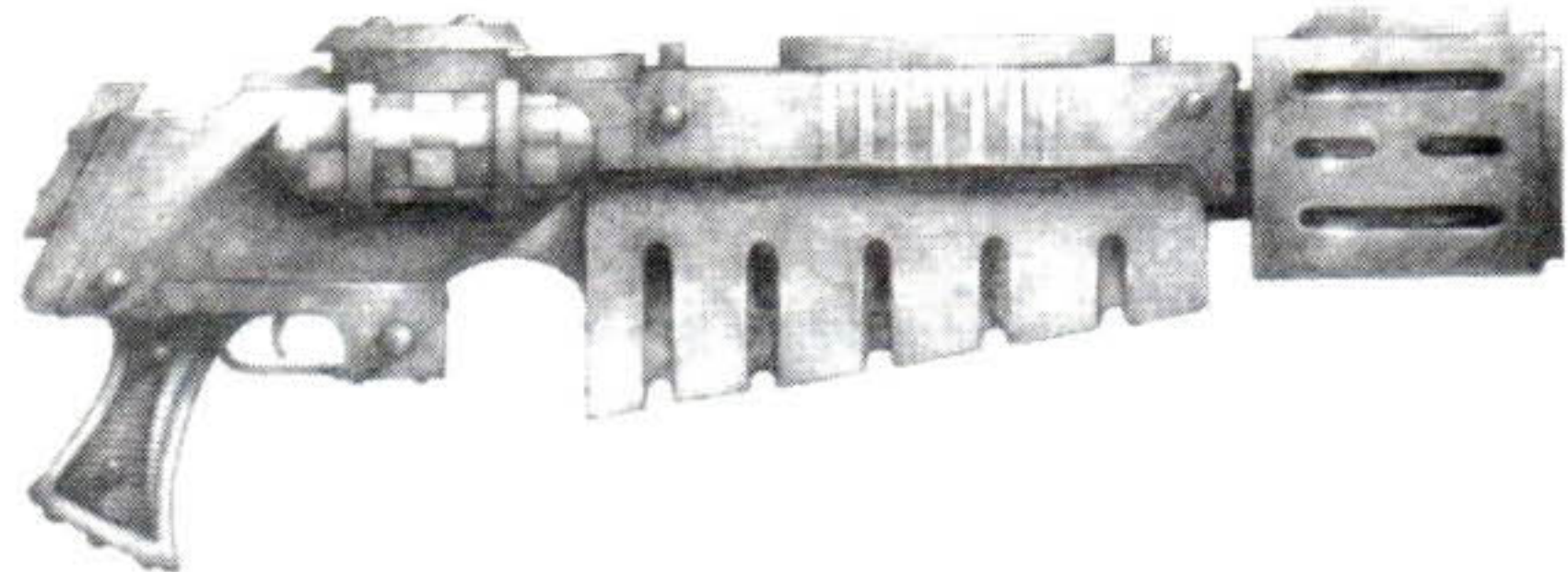

The melta-gun makes no noise when fired, but the super-heating of the air produces a distinctive hiss which becomes a roaring blast as living targets are hit and their bodies' moisture vapourises explosively.

Short Range	Long Range	To Hit Short	To Hit Long	Strength	Damage	Save Modifier	Special
0-6	6-12	+1	—	8	D6	-4	—

MUSKET

Muskets, like bows and crossbows, are primitive weapons used on feral or primitive worlds by their local inhabitants. They are slow, clumsy and inaccurate weapons which use exploding gunpowder to propel a solid leaden ball.

Short Range	Long Range	To Hit Short	To Hit Long	Strength	Damage	Save Modifier	Special
0-6	6-24	—	-1	3	1	-1	Move or Fire

NEEDLE SNIPER RIFLE

The needle rifle is a sniper's weapon used by the legendary crack-shot Ratling Snipers of the Imperial Guard. The rifle fires small darts made from a deadly neuro-toxin chemical. The liquid chemical is frozen into a dart or sliver by the gun before it is fired. Unerring accuracy is afforded by a low-power beam of invisible laser light which drives and guides the chemical dart to its target. If the target is armoured the beam automatically pulses when the rifle is fired, punching a tiny hole which allows the toxic dart to penetrate.

Special Rules

The weapon may be used against any target, including vehicles, robots, and buildings, in which case it is the laser rather than the toxin which does the damage. Use the details given on the

weapon's profile and work out the weapon's effect as normal. When used against living targets roll to hit as normal, if the weapon hits then immediately make a saving throw, no strength/toughness roll is required.

The toxin automatically takes effect if the saving throw is not successful.

Toxins can be tailored to affect any living creatures, but no toxin exists which will affect a daemon or an Eldar Avatar. As yet no toxin has been developed which affect the extragalactic Tyranid and Genestealers – although Genestealer Hybrids are affected as normal.

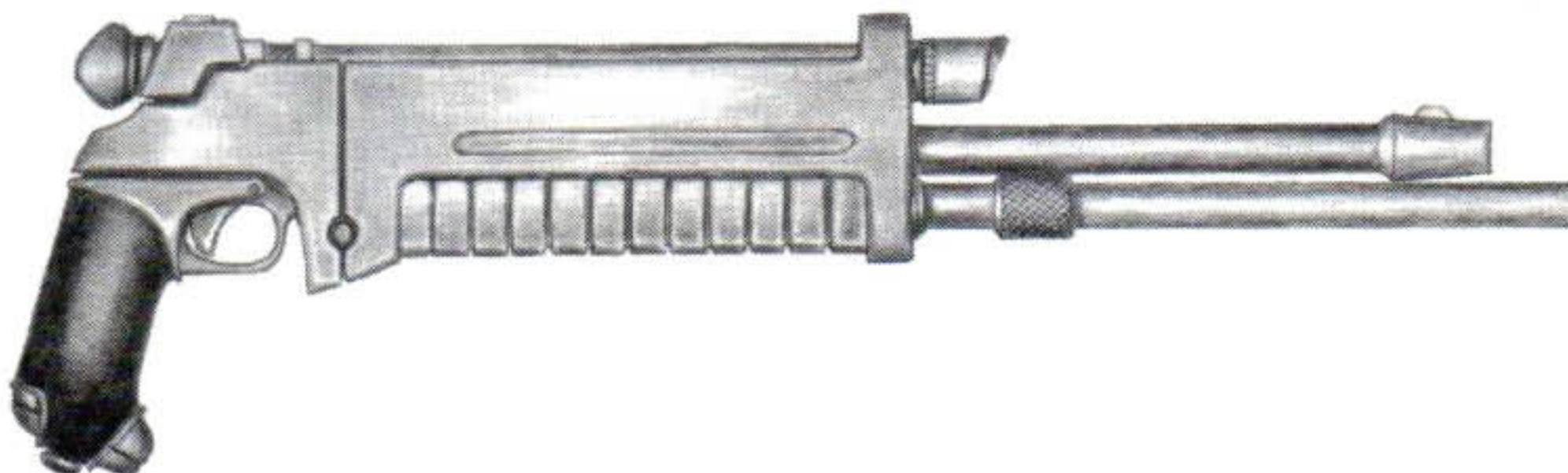

Short Range	Long Range	To Hit Short	To Hit Long	Strength	Damage	Save Modifier	Special
0-16	16-32	+1	—	See Above	1	-1	See Above

OGRYN RIPPER GUN

The Ogryn ripper gun is a drum-fed automatic combat shotgun developed by the Imperium for issue to Ogryn unit leaders. The weapon is of suitably large dimensions and is constructed as solidly as possible because Ogryns have a tendency to use their weapons as clubs. The trigger mechanism incorporates a burst limiter that prevents the firer shooting off the entire drum at once - an entertaining possibility that would appeal to Ogryns and very quickly leave them out of ammunition.

Special Rules

The ripper gun is designed within the constraints of an Ogryn's modest intelligence and limitless enthusiasm. It has a short range because an Ogryn's

instincts are for close quarter fighting - they wouldn't feel inclined to shoot at a distant target even if they carried weapons capable of doing so. At short range the hail of shot produced by their

weapon is so dense that the Ogryns literally cannot miss. No "to hit" dice roll is necessary when shooting at a target at close range.

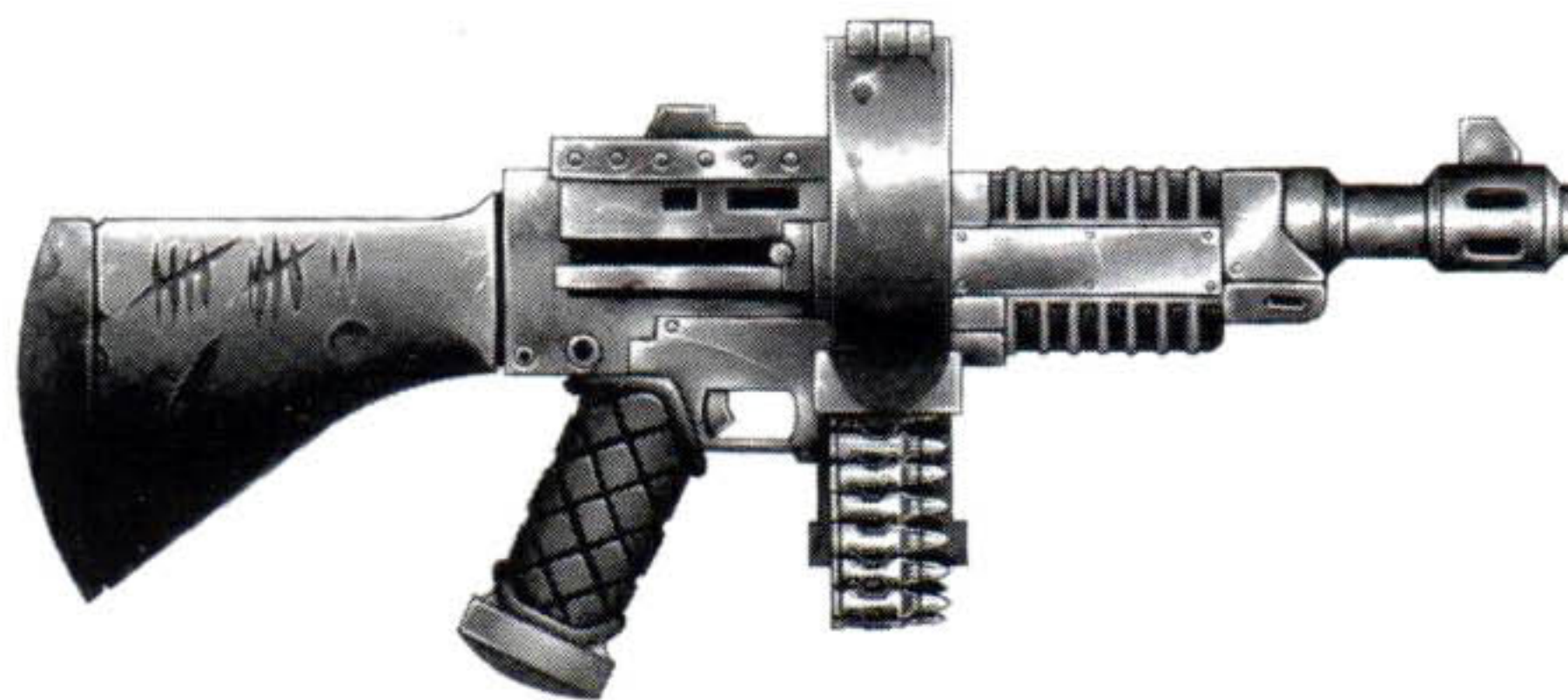

Short Range	Long Range	To Hit Short	To Hit Long	Strength	Damage	Save Modifier	Special
0-4	4-8	Always Hits	-2	4	1	—	Sustained Fire See Above

PLASMA GUN

The plasma gun fires energy shells of bright glowing plasma. When a plasma shell hits tremendous heat and energy are released, destroying the target in an almighty explosion. A target hit by a plasma shell suffers the dual effects of searing heat and explosive shock as its substance is instantly energised into boiling plasma. Though the plasma gun is highly effective, it loses accuracy over long range, and requires a massive amount of energy to power it.

Special Rules

The energy used by the plasma gun is so vast that once it has been fired it takes time for it to recharge. If a plasma gun is fired it cannot then be

used in the player's following turn, and is only ready to fire again in the player's turn after next. This does not

affect the model's ability to move or to use another weapon if it carries one.

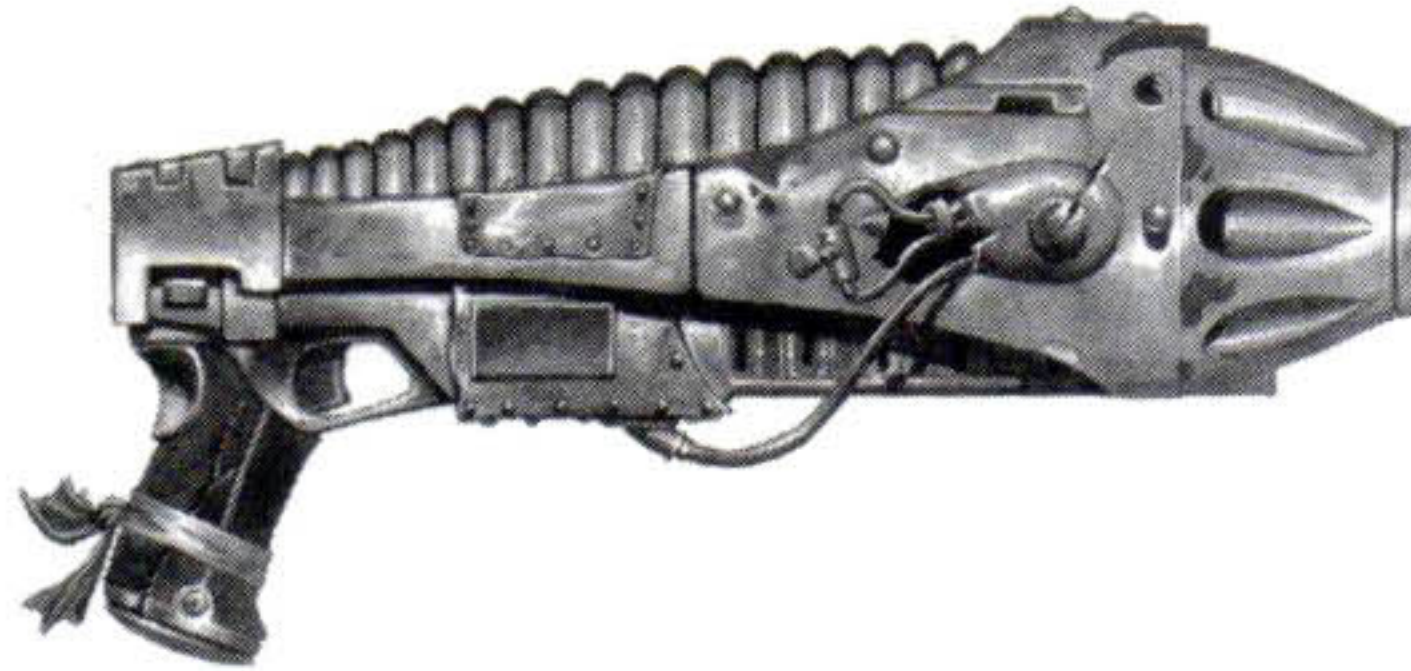

Short Range	Long Range	To Hit Short	To Hit Long	Strength	Damage	Save Modifier	Special
0-6	6-24	+1	—	7	1	-2	Sustained Fire See Above

SHOTGUN

The smooth-bore combat shotgun fires a massive low velocity shot which fragments in flight into several pieces of spinning metal or plastic. Although the weapon has only a short range it is quite dangerous against unarmoured targets.

Combat shotguns have magazines of shells and rarely need to be reloaded. They are strongly made, simple weapons which are ideally suited to brave or not very intelligent troops.

A special feature of the shotgun is its ability to fire different kinds of special shot, including solid shells and loose scatter shot.

Ordinary shells have a strength of 4. Scatter shells have a strength of only 3 but a blast area of 1".

Special Rules

If a target is hit by a shotgun but not slain, then it is automatically knocked back 2" and will fall over on a D6 score of 4+.

A knocked over model must spend its next movement phase standing up. Note that this rule only affects normal troops – not vehicles, robots or dreadnoughts.

Shot Gun Ammunition Types

Shot type	Strength	Blast Area
Solid Shell	4	None
Scatter Shot	3	1"radius



Short Range	Long Range	To Hit Short	To Hit Long	Strength	Damage	Save Modifier	Special
0-4	4-18	—	-1	Solid 4 Scatter 3	1 1	— —	See Above 1" radius Blast Area

SHURIKEN CATAPULT

The Shuriken Catapult (Eldar: *Tuelean*) and related weapons are weapons almost unique to the Eldar, their technology is extremely advanced and very difficult to replicate. The shuriken catapult is built around a gravitic accelerator similar to the gravitic motors which power vehicles like the Imperial Land Speeder. The accelerator creates a peristaltic shift from the front to the rear of the firing chamber, hurling the shuriken missiles forward at tremendous velocity. A burst of several missiles can be fired in a fraction of a second in this way. For this reason, Shuriken weapons are sometimes known as star slingers or just as slingers or sling guns.

The individual missiles are solid discs of razor sharp metal, and are usually star shaped, but may be triangular or circular.

A spinning shuriken disc can slice straight through flesh and bone and can penetrate a considerable thickness of metal or plasteel armour.



Short Range	Long Range	To Hit Short	To Hit Long	Strength	Damage	Save Modifier	Special
0-12	12-24	+1	—	4	1	-2	Sustained Fire

STORM BOLTER

The storm bolter is a specially modified pair of bolt guns which have been re-designed for use by Terminator Squads of the Space Marines. Terminators wear very bulky, powered suits, and any equipment they use has to be specially adapted to fit their armour. Their role requires that they are very well armed. They must, for example, penetrate and clear out the gigantic space hulks that occasionally drift into and threaten the Imperium, during the course of which they encounter all manner of creatures from Genestealers to Orks.

Terminator Squads may also be deployed in the depths of the Hive World tunnels or anywhere where their heavy armour and highly lethal weaponry is required.

The storm bolter consists of two ordinary bolt guns fastened together so that they fire in unison. The weapon is clumsy, but in the servo-assisted hands

of the Terminators such considerations are of no concern, the powered suits make light work of cumbersome equipment.

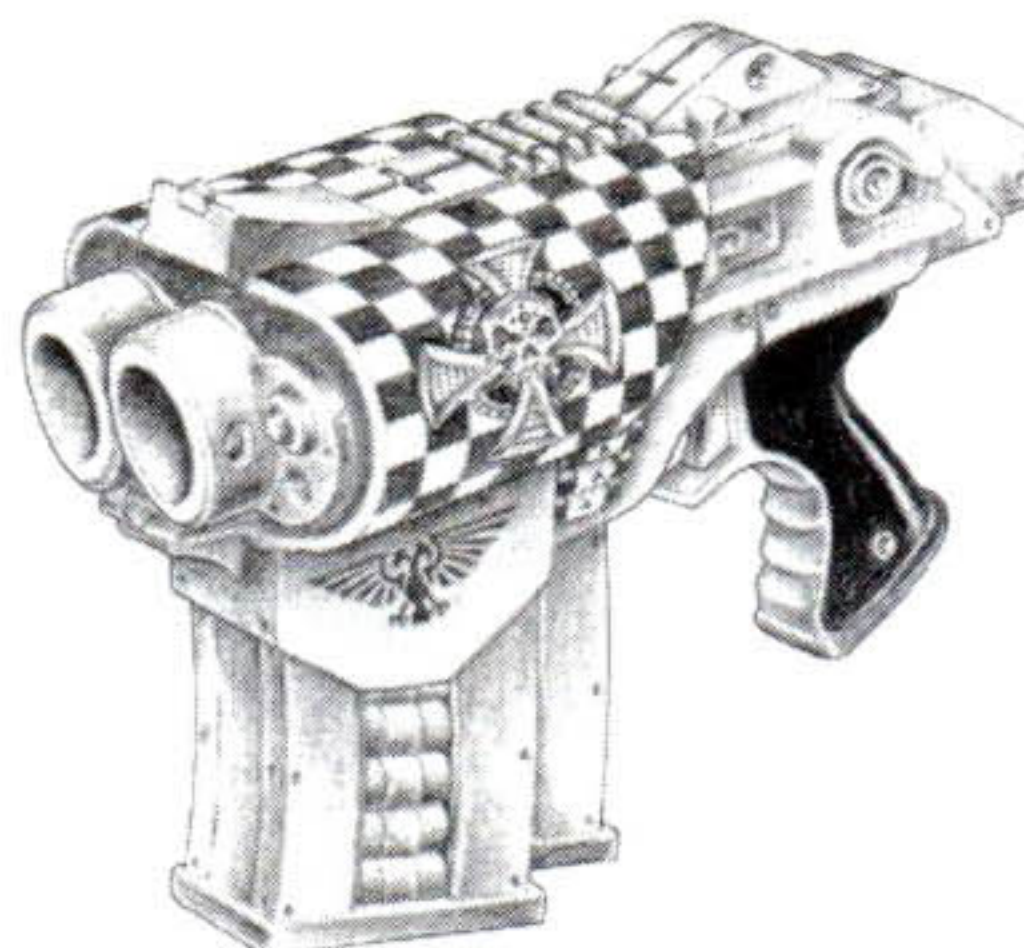

Short Range	Long Range	To Hit Short	To Hit Long	Strength	Damage	Save Modifier	Special
0-12	12-24	+1	—	4	1	-1	Sustained Fire





HEAVY WEAPONS

These are extra-powerful weapons carried by a small proportion of troops, and are generally used to lay down covering fire as their companions advance, take out armoured vehicles and pick off enemy from a distance.

ASSAULT CANNON

This weapon is a self-loading machine autocannon used by Terminator Space Marines. It has six separate barrels which are rotated by a motor, allowing the weapon to spit out a hail of shells which can easily tear a man-sized target apart and throw it several metres. The assault cannon combines high penetrating power with a fast rate of fire. The astoundingly loud noise it makes is enough to encourage any sensible troops to keep their heads down.

Although made from a special heat resistant ceramite alloy, the hundreds of shells fired every second quickly cause the weapon to overheat. This high rate of wear has little initial effect, but quickly leads to weapon jams if the weapon is kept in service.

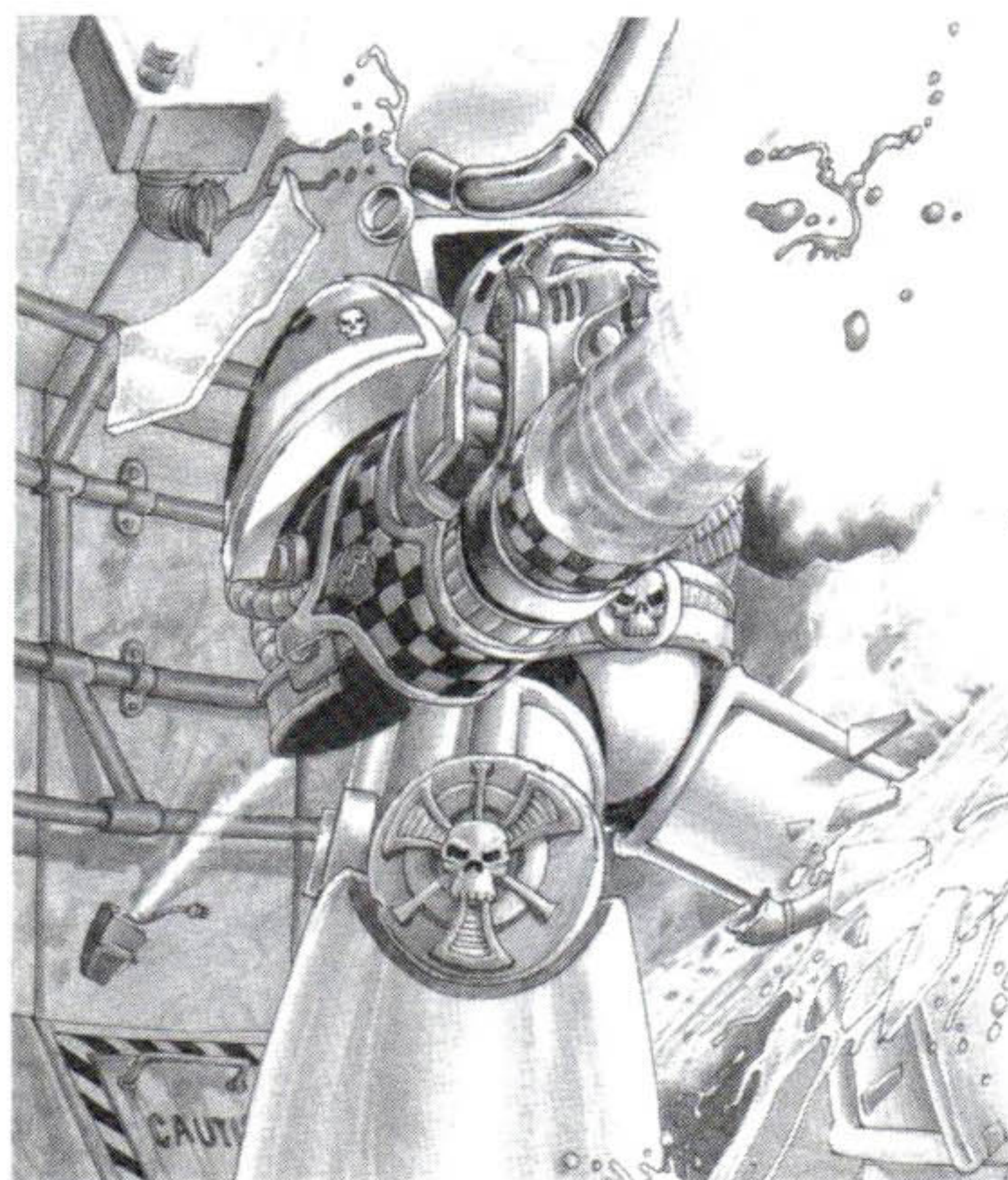

Special Rules

The assault cannon will jam on a to hit roll of a 1 on a second or subsequent shot using sustained fire. However, once the weapon has jammed it cannot be unjammed, as the heat build-up distorts the barrels and renders the weapon useless.

In addition, the sudden stopping of the motor causes the weapon to explode on the D6 roll of a 6, slaying the user instantly.

Short Range	Long Range	To Hit Short	To Hit Long	Strength	Damage	Save Modifier	Special
0-12	12-32	+1	—	8	D10	-3	Heavy – 2" penalty Sustained Fire

AUTO-CANNON

Auto-cannon are automatic, self-loading cannon firing a high-velocity hail of solid shells. They are rapid firing weapons which can lay down a burst of fire to cover advancing troops, or strafe enemy-held positions. These weapons are considered ideally suited for attacking enemy vehicles and fortifications from long ranges.

Autocannon are popular weapons in the Imperial forces but are also common amongst Orks, who especially enjoy the blaze of shells and mind-numbing recoil!

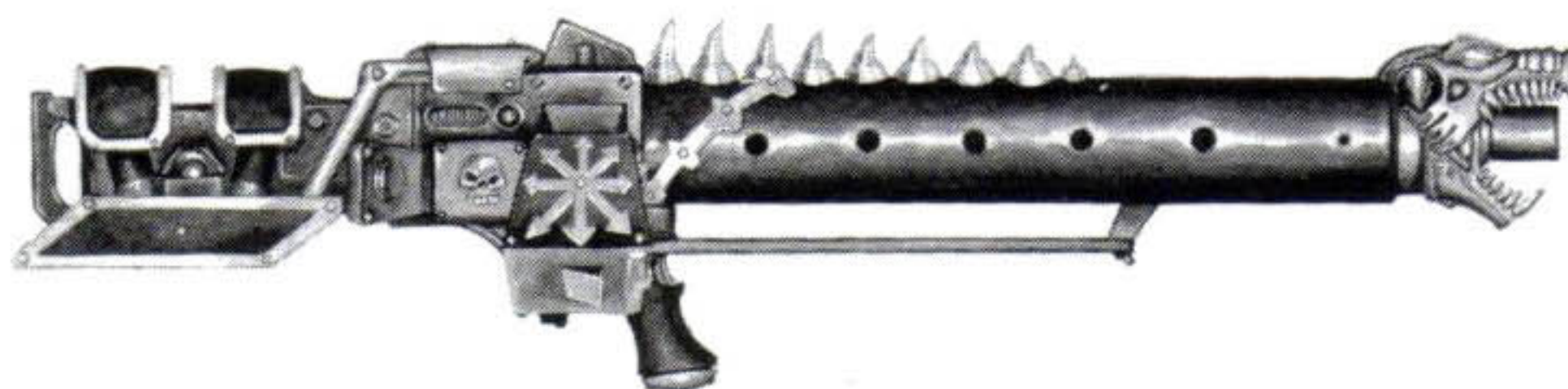

Short Range	Long Range	To Hit Short	To Hit Long	Strength	Damage	Save Modifier	Special
0-20	20-72	—	—	8	D6	-3	Heavy – 2" penalty Sustained Fire Move or Fire

BATTLE CANNON

The battle cannon is an especially large version of the auto-cannon which fires an even bigger shell and is correspondingly more powerful. Although the battle cannon is far too large to carry, and is basically a weapon which can only be mounted on a vehicle, we have included it here for the sake of completeness. Battle cannons are featured in many of the special modelling conversions described in *White Dwarf*, and form the main armament for vehicles such as the Imperial Baneblade and the Ork Gobsmasha.

Short Range	Long Range	To Hit Short	To Hit Long	Strength	Damage	Save Modifier	Special
0-20	20-72	—	—	8	2D6	-3	1½" radius Blast Area Vehicle Mounted Only



CONVERSION BEAM PROJECTOR

The conversion beam projector or 'beamer' projects a high-intensity energy beam which converts matter to energy. The denser the matter penetrated by the beam the more energy is converted, so that a particularly solid target will explode and shatter apart with a fearsome rending noise. The beamer is therefore the ideal weapon to use against vehicles, buildings or other large, solid targets. Its disadvantage is that the energy conversion takes a little time to build up, so a fast moving target may be able to escape the beam before any harm is done.

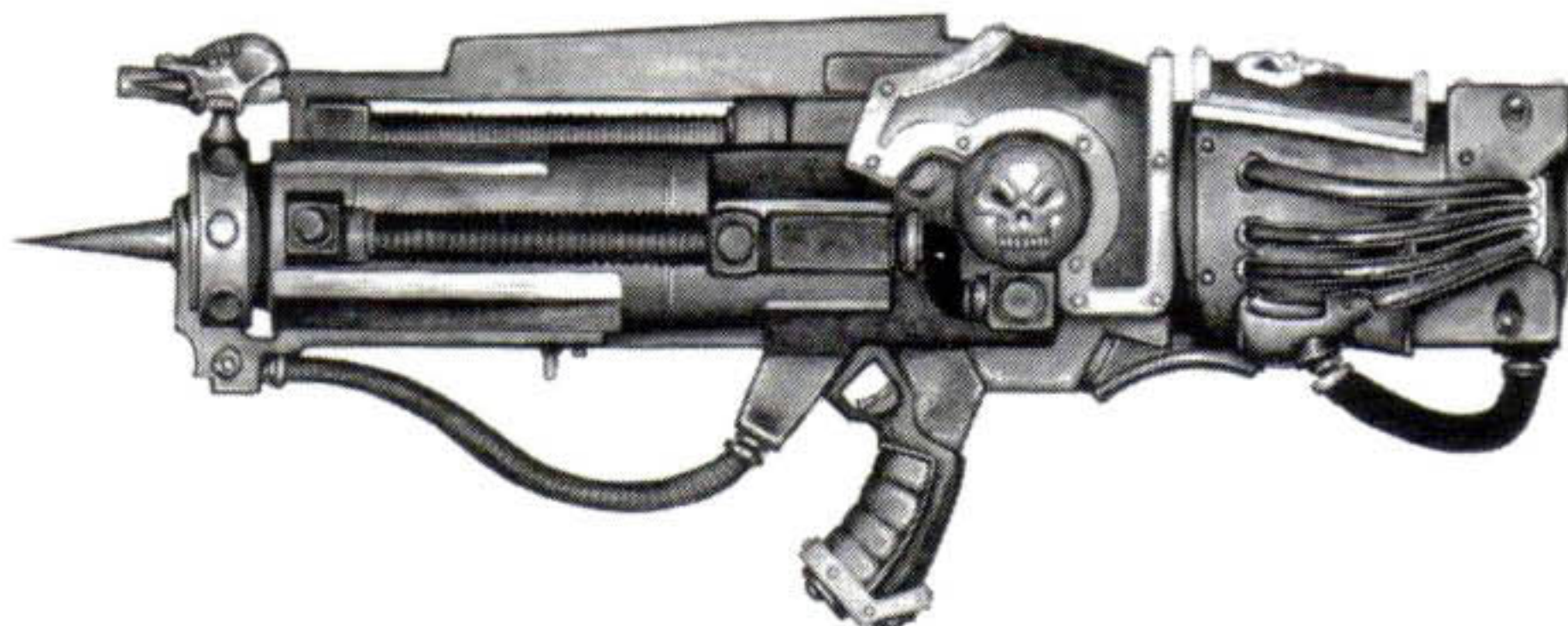

Special Rules

Roll to hit the chosen target as normal but because the beamer takes a few moments to build up its power, an agile target may be able to dive out of the way more easily than he would be able to dodge a shot from a bolter or a laser. The score to hit is therefore reduced by a variable amount which depends on the maximum move of the target (taking into account any penalty for heavy equipment where appropriate).

TO HIT PENALTY				
	Target's Maximum Movement			
	0-2"	2-3"	3-5"	5+"
To Hit Penalty	-1	-2	-3	-4

Because the beamer uses the target's own mass to create an explosion, the target's normal toughness rating offers no resistance. In fact, the denser and harder the target, the greater the molecular agitation and the more effective the weapon becomes. To represent this the beamer always causes damage on a fixed dice result.

BEAMER DAMAGE CHART (D6)		
	No Effect	Damage Caused
D6 Roll	1 or 2	3, 4, 5 or 6

The normal armour based saving throw is ignored for beamers – armour is destroyed as easily as other substances.

The size of the resulting blast varies according to range as the beam diverges. Close to the weapon the beam is tight and so the radius is smaller. Further from the weapon the diverging

beam affects a larger area, so the radius is larger. The blast area at short range is 1 1/2" increasing to 3" at long range.

BLAST RADIUS				
	Range of Shot			
	0-10"	10-20"	20-30"	20-40"
Blast Radius	1 1/2"	2"	2 1/2"	3"

When used against a vehicle or dreadnought the beamer may affect more than one location as the beam penetrates the vehicle. Roll a D3 to determine how many individual locations are hit, and re-roll any duplicate locations. The amount of armour penetrated is not worked out in the normal way, instead the thickness of armour penetrated is shown on the table below. Roll to penetrate each area. For example, against an armour thickness of 9-11 the player would roll 3D6 scoring somewhere between 3 and 18.

VEHICLE DAMAGE					
	Thickness of Target's Armour				
	1-4	5-8	9-11	12-14	15+
Penetration	D6	2D6	3D6	4D6	5D6

When used against buildings the beamer is always considered to have a strength sufficient to cause damage. The thicker and stronger the substance, the more powerful the beamer's effects become, so that even plasteel and armaplas offer no sure defence.

Short Range	Long Range	To Hit Short	To Hit Long	Strength	Damage	Save Modifier	Special
0-20	20-40	—	-1	See above	D6	See above	Heavy – 2" penalty Move or Fire See above



ORK WEAPONS



Ork weapons are often highly decorated with glyphs and clan symbols to identify ownership. Bolters in particular attract this sort of attention being a favoured weapon because they make a loud, violent and suitably satisfying noise. A few such examples are shown on this page.



BOLTER

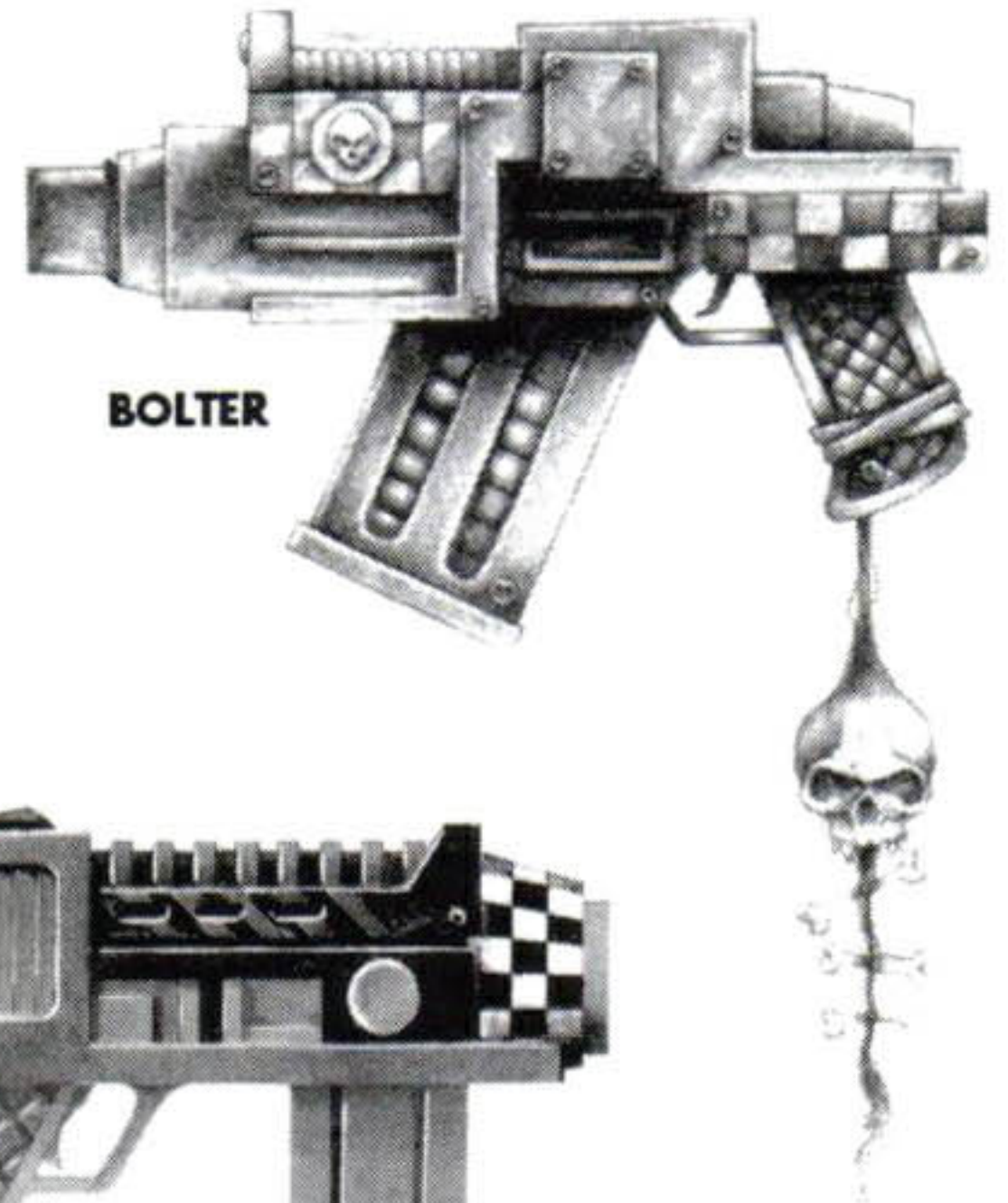

BOLTER



BOLTER

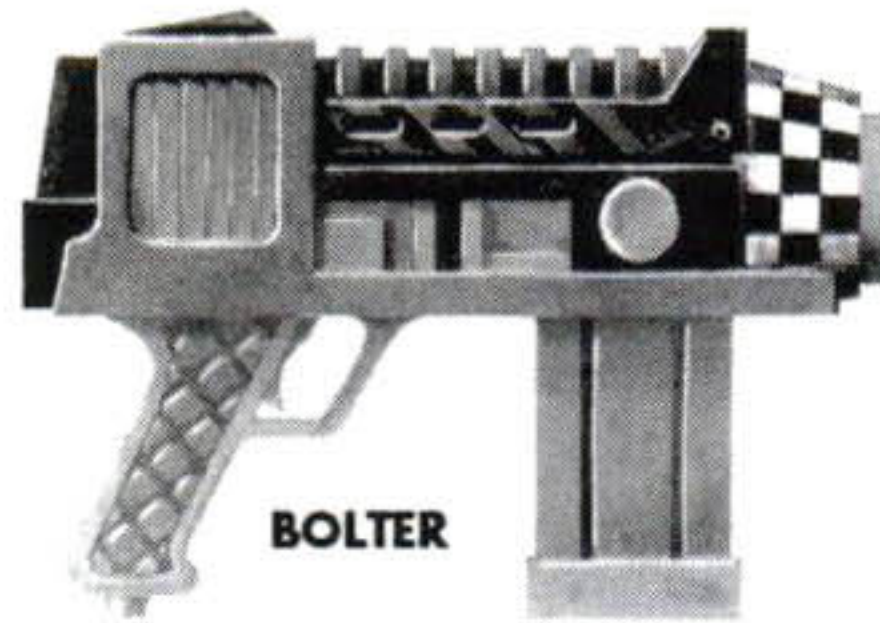

BOLTER



PLASMA PISTOL

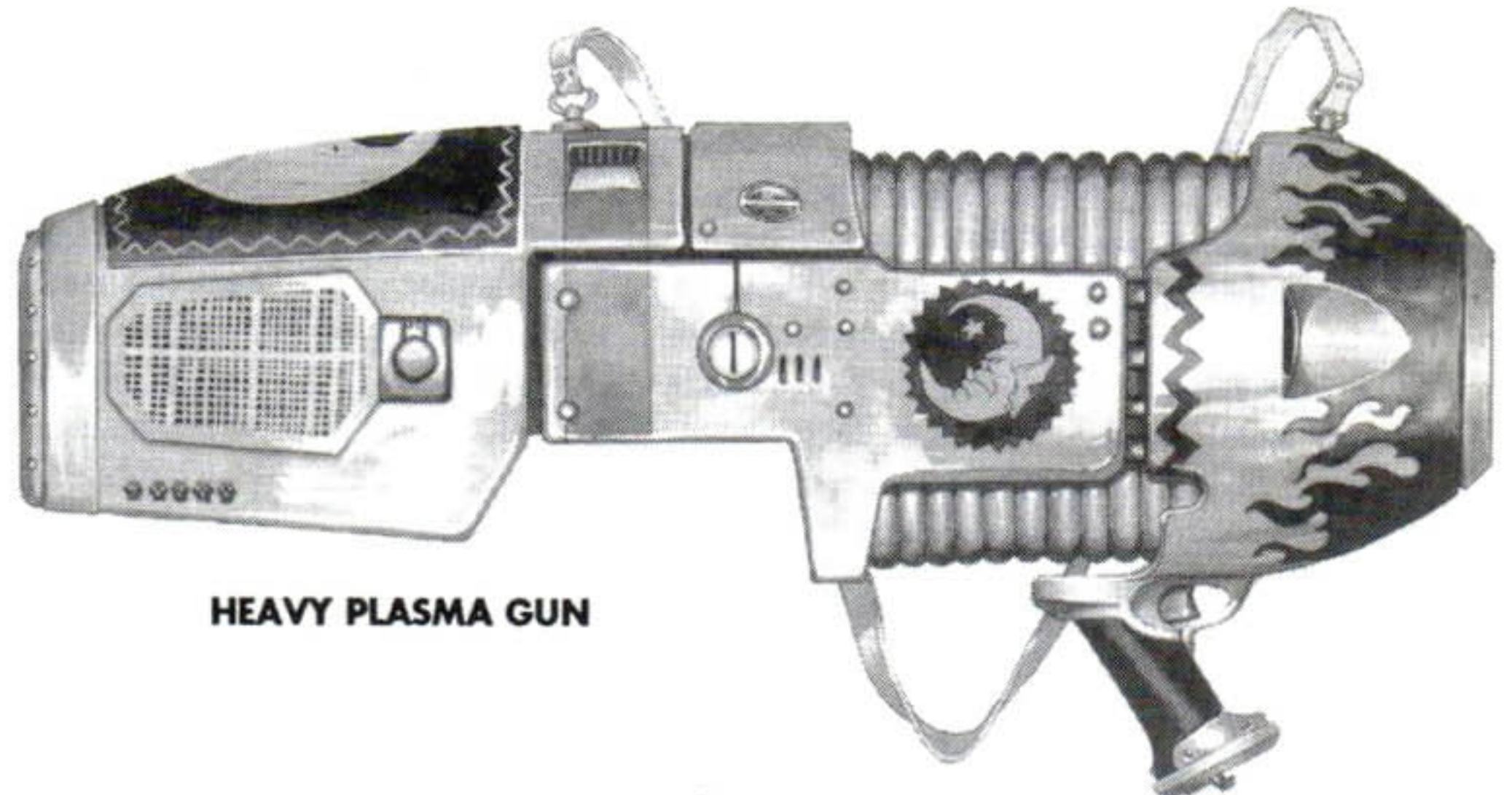

HEAVY PLASMA GUN



BOLT PISTOL



PLASMA GUN

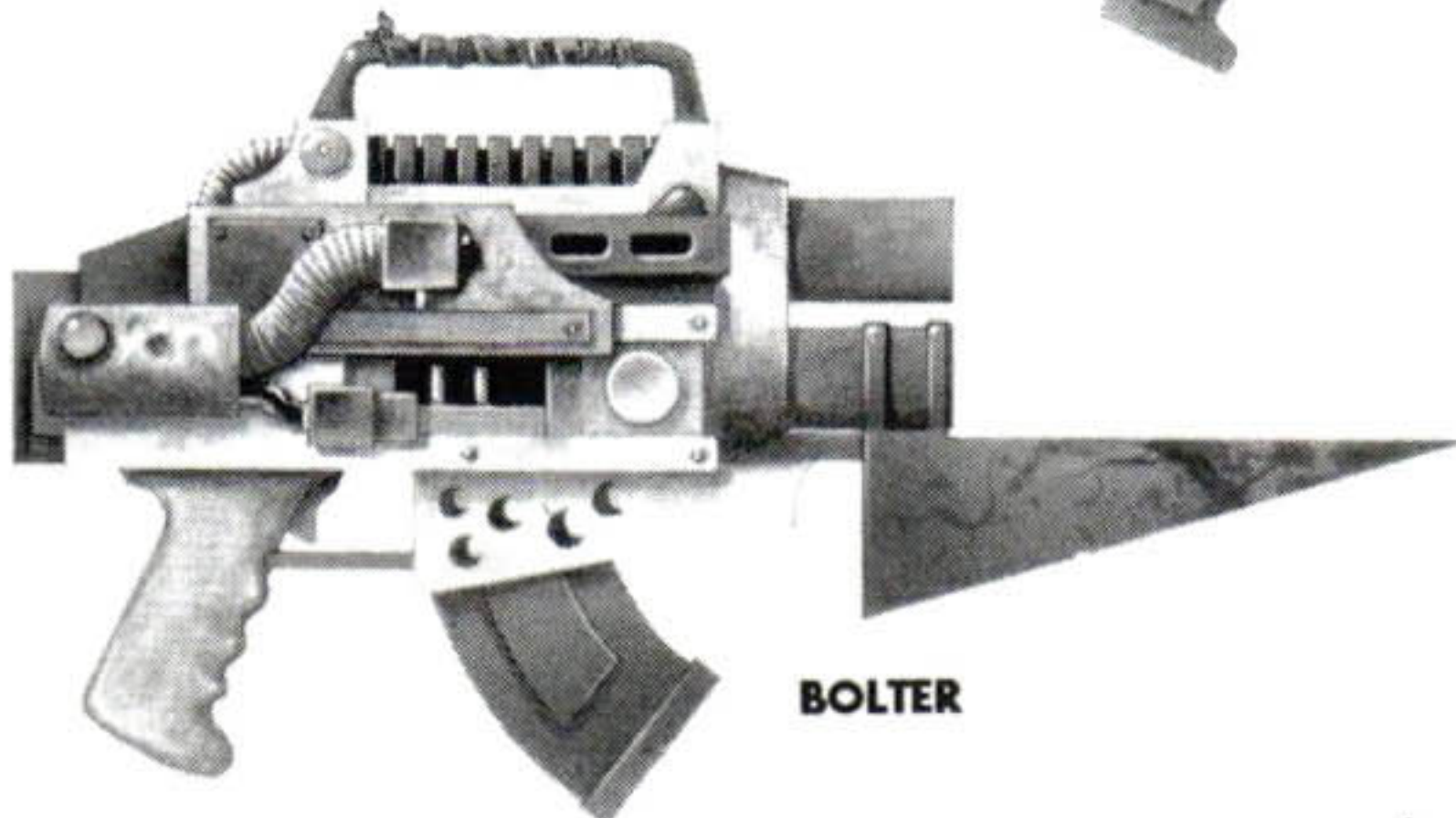

BOLTER



BOLTER



— CYCLONE TERMINATOR MISSILE LAUNCHER —

The Cyclone is designed to overcome the mechanical restrictions of the Tactical Dreadnought Suit as worn by the Terminator squads of the Space Marines.

These suits are so cumbersome that it is extremely difficult to carry heavy weapons, as normal in-line-of-sight video interface targeters cannot be used effectively. Because the Terminators are an elite force, intended to undertake the toughest and most dangerous missions either in the depths of space or on the most hazardous battlefield, various modified support weapons have been created to provide additional fire support without affecting mobility or compromising accuracy.

The Cyclone is ideally suited to this purpose. It has been developed from salvo firing ship-to-ship short range killer missiles. It is loaded with 12 krak missiles, each primed for maximum concentration of fire effect. These can be fired singly or as a massive salvo of flaming destruction.

Special Rules

The following special rules apply:

- 1 The Cyclone is built into the armoured suit of the Terminator and any weight or imbalance is compensated for by attitude sensors, gyroscopic stabilisers and suspensors. As a consequence the Cyclone does not incur weight or movement penalties. However, it may not be used by any other troops.
- 2 The Cyclone guidance system is linked into the laser guider operated by the user's left hand. The laser guider shoots a laser light line towards the target, visible via the firer's head-up video-viewer screen projected holographically in front of his visor. The same laser guider is used to trigger the weapon. The Space Marine may fire either one or a salvo of missiles and use the guider to guide the missiles to their target. The +1 on the to hit modifiers is due to the effects of the guider, which make the system equally accurate at long and short range.
- 3 The Space Marine may choose to ignore the guider system and just fire missiles over open sights. In this case the firer is free to fire any weapon in his right hand. The model may therefore shoot twice, once with the Cyclone and once with his other weapon. However, when firing in this way the guider laser cannot be used and the +1 to hit bonus does not apply.

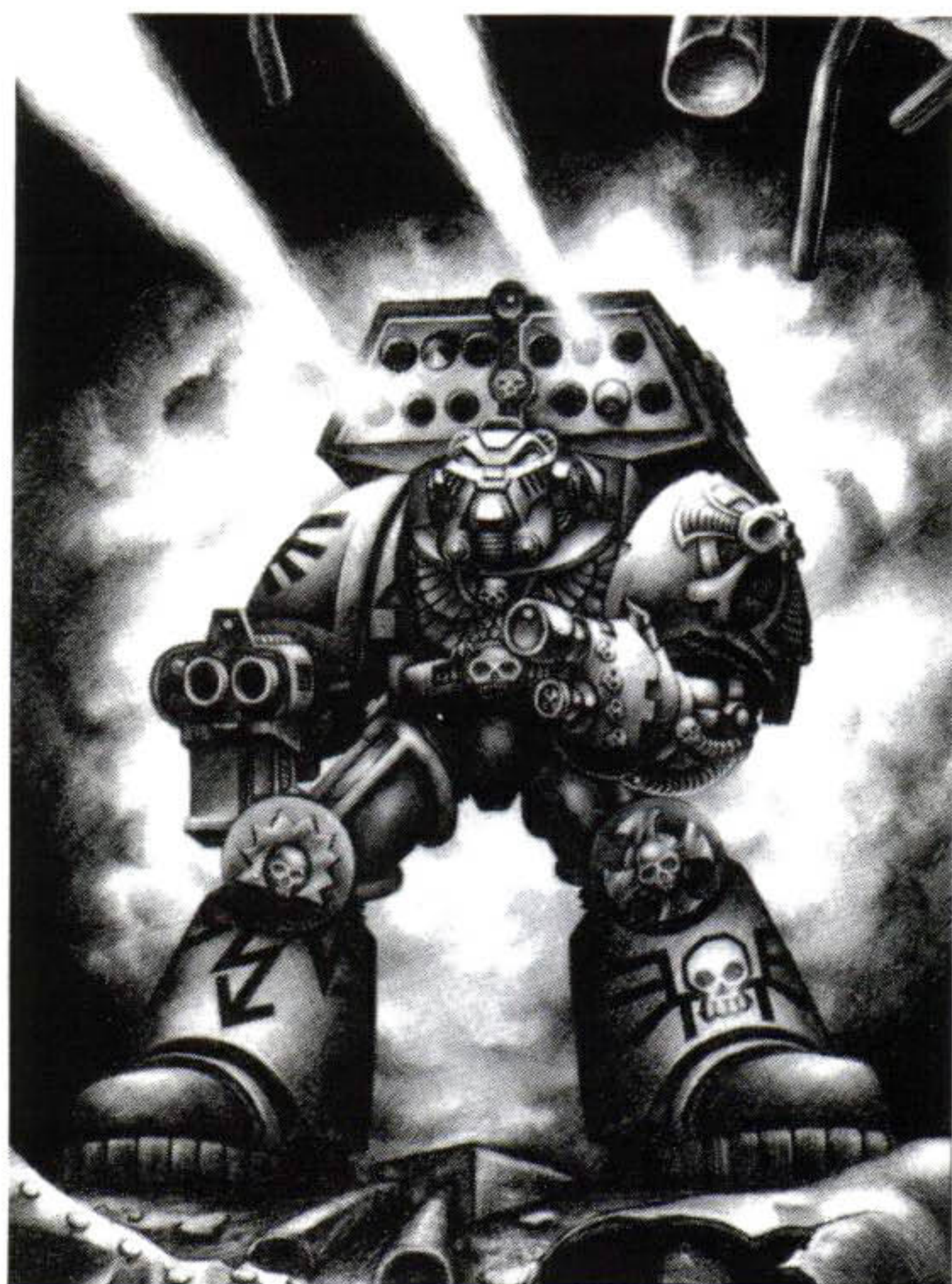

MARK GIBBONS

- 4 The Cyclone is loaded with 12 krak missiles. The player must record how many missiles have been fired. The Cyclone is loaded and armed prior to battle, and cannot be loaded by the operator during the game. This means that once the Marine has fired 12 shots from the Cyclone he cannot fire that weapon again.
- 5 The Cyclone may fire a single krak missile during the shooting phase. This has the same effect as a conventional missile launcher krak missile.

Strength	Damage	Save Modifier	Blast Area
8	D10	-6	None

- 6 Instead of firing a single missile the Cyclone may fire all of its remaining missiles to produce a saturation effect of fire and devastation called a salvo.

A Marine must have at least 2 missiles left to fire a salvo. A salvo is worked out as follows. Roll to hit as normal and position a blast template with a radius of 1/2" for every missile in the salvo. The more missiles are fired the larger the blast will be. Strength, damage and save modifiers remain the same as for a single shot.

- 7 If a Terminator equipped with a Cyclone is hit by enemy fire there is a chance that his entire stock of missiles will be accidentally fired off in a single salvo. Roll 2D6: if the score is 11 or 12 the Cyclone activates immediately. Roll on the Catastrophic Launch Chart.



Short Range	Long Range	To Hit		Strength	Damage	Save Modifier	Special
		Short	Long				
0-20	20-72	+1	+1	8	D10	-6	See above

CATASTROPHIC LAUNCH CHART(D6)

- 1 **Explode.** All missiles explode immediately! The Space Marine is torn apart in a spectacular pyrotechnic display. Assume that all missiles have exploded and place the appropriate blast marker on the model. Other models are affected as normal if they are within the blast area.
- 2 **Fire at nearest target.** All missiles launch simultaneously as a single salvo, guided to their target by the random position of the laser-guider in the Space Marine's left hand. The missiles are automatically guided to the nearest possible target within a 90 degree fire arc of the Marine's front. This may well be another Space Marine or some other friendly model.
- 3 **Fire at most distant target.** All missiles launch simultaneously as a single salvo, guided to their target by the random position of the laser-guider in the Space Marine's left hand. The missiles are automatically guided to the most distant possible target within a 90 degree fire arc of the Terminator's front and within the Cyclone's range. The missiles pass over closer targets without exploding.
- 4 **Fire straight ahead.** All remaining missiles launch simultaneously in a single unguided salvo. Without the benefit of the missile's laser-guider the salvo is fired straight ahead and lands D6 x D10" immediately in front of the Space Marine.
- 5 **Missiles move randomly.** All remaining missiles launch simultaneously in a single unguided salvo. The salvo veers around the table without the benefit of direction, its guidance system completely non-functional. Move the missiles 2D6" straight ahead of the Terminator. If a target lies in the missiles' path the salvo will hit it and explode, otherwise the missiles will change direction randomly (roll D12 for direction) and travel a further 2D6". The missiles continue to veer around in this way until they leave the table or hit something.
- 6 **Fire missiles separately.** The gyroscopic stabilisers which counterbalance the Cyclone malfunction and the Space Marine is spun round and round firing missiles in random directions. The remaining missiles fire off one at a time. For each missile in turn, determine a random direction (D12). The missile hits the first target within 1" of a direct line drawn in the direction shown. As each missile is fired the model is jarred into a new position ready to fire the next missile. Once all missiles have been fired the system shuts down and the Space Marine is unharmed.

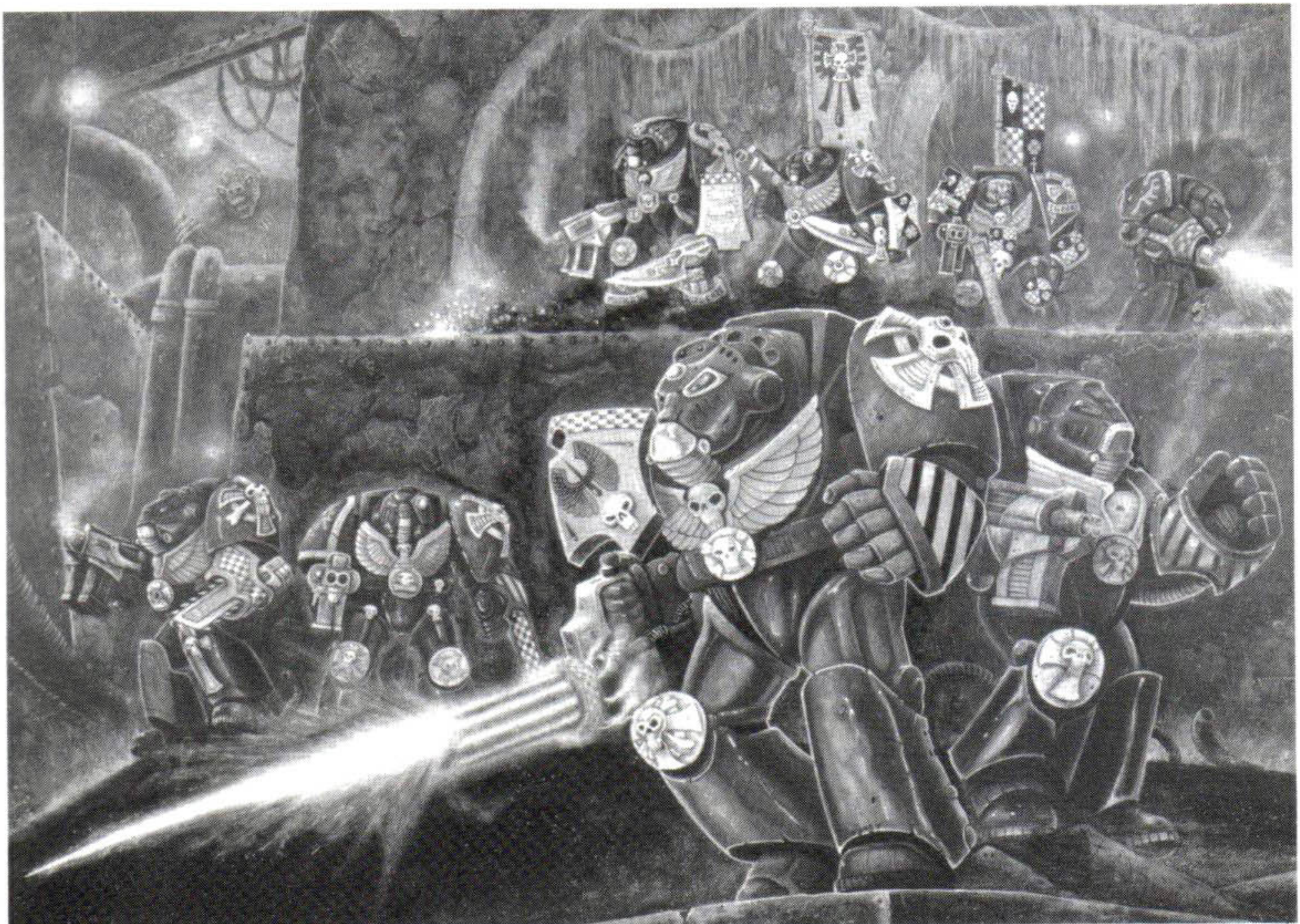

HEAVY BOLTER

The heavy bolt gun is a larger version of the standard bolter. It is sometimes known as the 'back breaker' or 'bruiser' by the crew who have to carry it because of its great weight - but also because of the heavy punishment it can deal out to the enemy. It fires a bolt which contains a more powerful propellant and explosive charge than the normal bolter. The heavy bolter is used to support more lightly equipped troops, and is designed to operate as an anti-personnel weapon although with the capacity to destroy lightly armoured vehicles. It is large and cumbersome but also very fast firing and efficient. Like all bolters it makes a loud and impressive noise as it is fired, especially when its bolt missiles hit their target and explode.

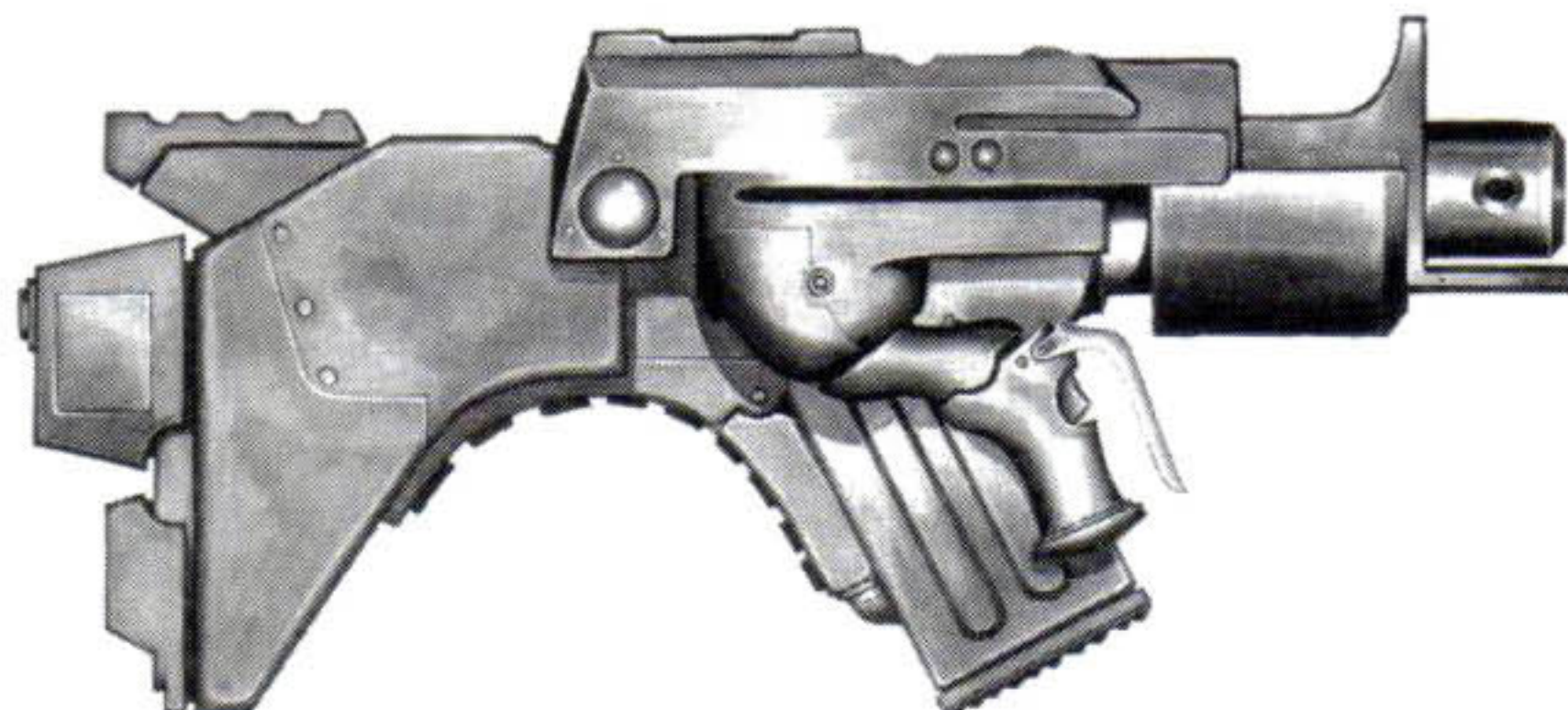

The Imperium has also developed a special shell for the heavy bolter called a Hellfire shell. This has been designed specifically to take out large alien creatures which are difficult to kill with ordinary weapons, for example Tyranid warriors. The Hellfire shell is heavier than an ordinary shell and has a more powerful propellant charge. For this reason, only one may be fired at a time, and the trooper has to load the shell into the gun manually from a separate compartment in the magazine.

What makes this shell totally different from an ordinary bolter shell is that it is made from a brittle ceramic substance much like glass. Within this ceramic case is a chamber which contains a powerful mutagenic acid developed by the Alchemists of the Adeptus Mechanicus. When the shell strikes its target at high velocity, it breaks into thousands of needle-like shards which penetrate the hide of the target and carry mutagenic acid into its blood stream. If the target is a human-sized creature it will probably be torn apart by the shards themselves - if not, the mutagenic acids will soon eat through its body, rupturing cell tissue and burning through flesh and bone. Even a large, resilient creature like a Tyranid warrior is unlikely to survive unscathed.

Special Rules

A model may fire a Hellfire shell instead of a normal heavy bolter blast. Only one shell may be fired at a time, so the weapon's ability to use sustained fire is lost when a Hellfire shell is used; the range and to hit details otherwise remain the same. However, because of the deadly nature of the Hellfire shell, any shot which hits a living target automatically causes damage on a D6 roll of 2 or more. On the roll of 1 the shell either fails to burst or the acid is splattered away from the target. There is no need to make a normal damage roll, as even the slightest skin puncture is enough to kill the target. Any target sustaining damage takes D6 wounds. If the target has an armour saving throw, then it is allowed to try and save

as normal; if the save is successful the glass splinters fail to penetrate the model's armour and no damage is inflicted on that target. Note that all the wounds inflicted are saved with the one armour roll, you do not have to make a save for each individual wound.

However, if a target is saved by its armour, splinters of glass and gobbets of mutagenic acid may rebound and hit others models within 2". Roll a dice for each model within 2" of the original target. Any models rolling a 6 are hit by acid splashes and automatically suffer 1 wound - this may be saved by armour in the normal manner.

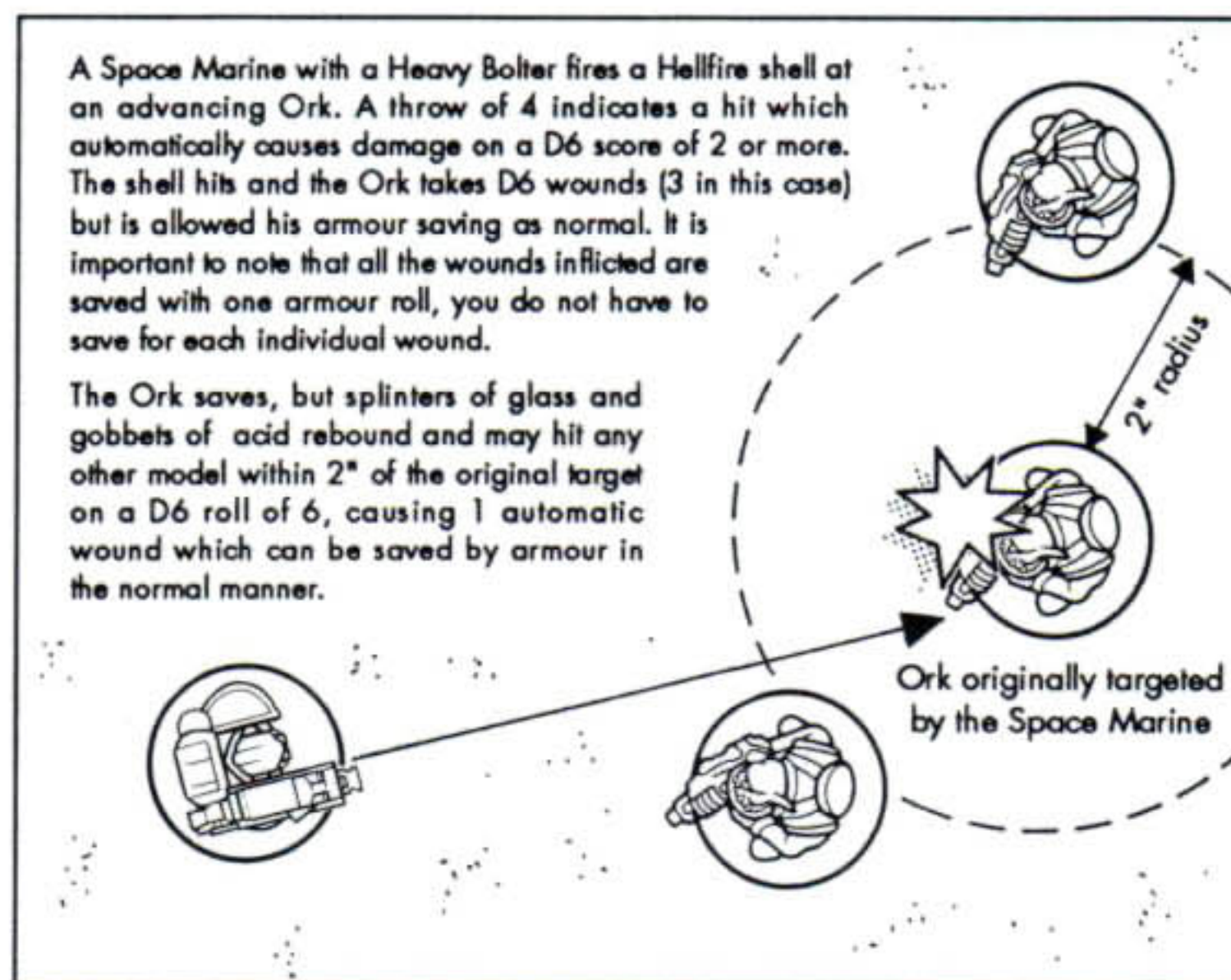

A target which is not made of living flesh, such as a robot or vehicle, cannot be harmed by a Hellfire shell - any attempt to fire a Hellfire shell against a non-living target is treated like a normal heavy bolter shot.

Short Range	Long Range	To Hit Short	To Hit Long	Strength	Damage	Save Modifier	Special
0-20	20-40	—	—	5	D4	-2	Heavy - 1" penalty Move or Fire Sustained Fire

HEAVY FLAMER

The heavy flamer operates along the same lines as the smaller flamer and hand flamer, shooting an enveloping flame at the target and setting it alight. The heavy flamer has an increased capacity and a longer range, and is known affectionately as the 'big burner' by its crew.

To represent the blast of fire a special long triangular template with a curved tip is used. Place the narrow pointed end of the template against the shooting model. Any models whose base is wholly within the template area are hit automatically (there is no need to roll) and models whose base is partially within the template area are hit on the D6 roll of a 4, 5 or 6.

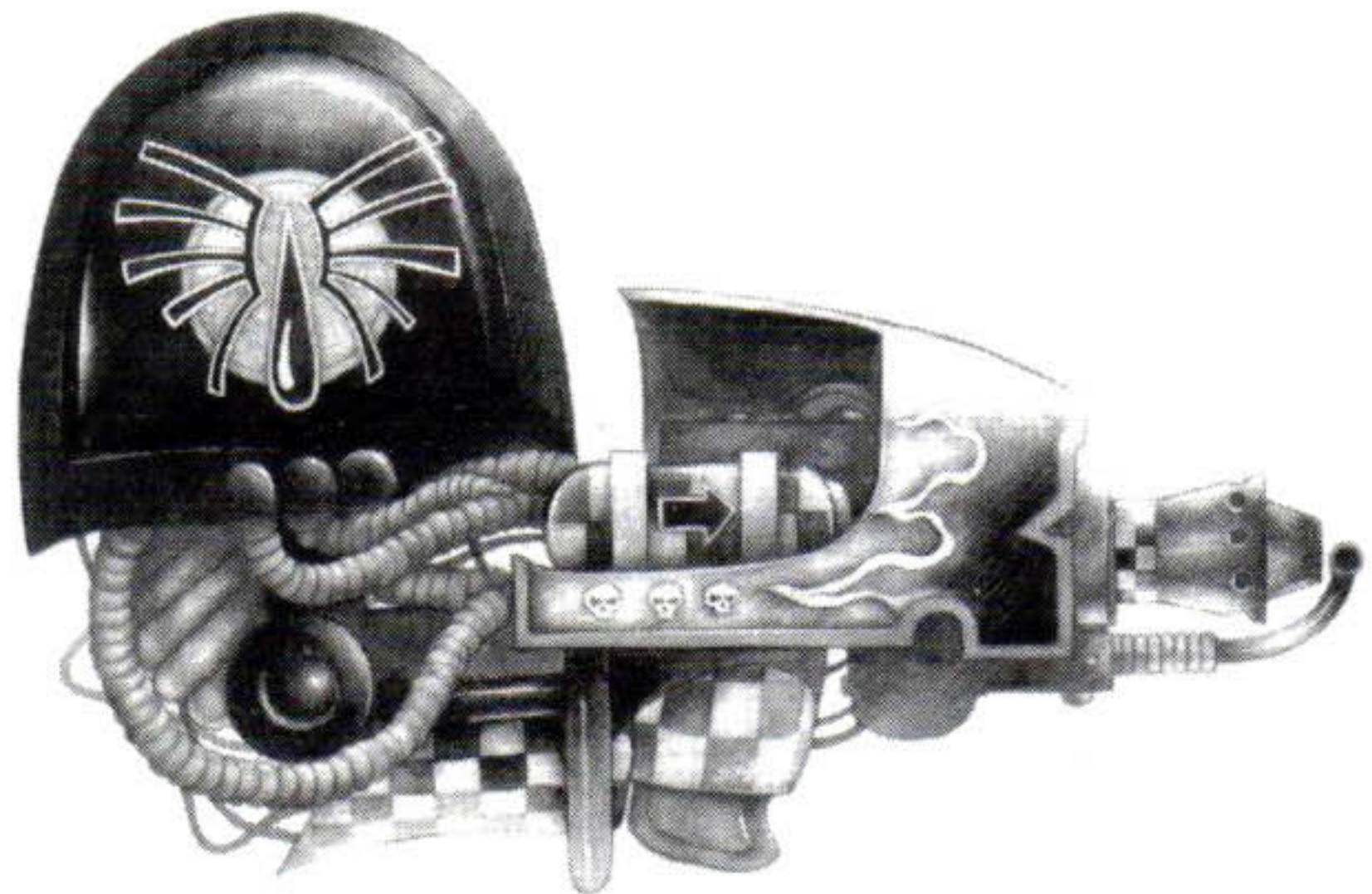

A Terminator armed with a Heavy Flamer shoots at a group of advancing Orks. Taking the appropriate sized template the Marine positions it hitting four of the Orks. Three are completely covered and take automatic hits while the other is only partially covered, needing a 4,5 or 6 on a D6 to be hit. A 4 is rolled and all the models work out damage in the normal way. Three Orks are slain and removed as casualties while the other saves.

The surviving Ork rolls on the *Flamer Hit Chart* to determine if he has caught fire. He rolls a 3 which means he has managed to extinguish any remaining flames and may move normally from now on.

Once a target has caught fire, test for the effect at the start of its own turn. Roll a D6 on the Fire Test Chart.

FIRE TEST CHART (D6)

- 1-5 Fire continues to burn causing a further automatic hit. Work out damage as normal and remove the model if slain. If the target is not slain it will move randomly and is unable to do anything else that turn. Normal coherency rules are suspended for burning models. Vehicles, dreadnoughts, and Terminator Space Marines may choose to ignore the flames and may continue to move and shoot as normal.
- 6 Fire goes out. The model may not move or fire during the current turn, but may fight normally from its following turn onwards. If coherency has been broken, the model must re-establish coherency as soon as possible. Vehicles, dreadnoughts, and Terminators are not affected by the fire and may move and shoot as normal.

Special Rules

If a model is hit by a flamer work out damage as normal. If the model is slain it is removed as a casualty; if the model is not slain then an immediate test is made to determine if it has caught fire. Because flamers use a volatile burning chemical it is even possible to set vehicles or dreadnoughts on fire.

Any friendly model within 1" of a burning model may attempt to beat out the flames during the movement phase. The beating model may move as normal, but may not shoot during the shooting phase. Roll a D6: if the score is 6 the flames are beaten out. If more than one model is available to help beat out the flames the chance increases by +1 per model, ie 2 models need 5+, 3 need 4+, and so on.

FLAMER HIT CHART (D6)

- 1-3 Target does not catch fire - the small amount of burning fuel is quickly extinguished.
- 4-6 Target is smothered with fuel and ignites.



A target which is already frenzied when hit by a flamer may continue to fight despite the fact it is burning up. The model moves, shoots and fights as normal, but will continue to roll for damage as appropriate.

Short Range	Long Range	To Hit Short	To Hit Long	Strength	Damage	Save Modifier	Special
Special Rules				5	1	-3	Heavy - 2" penalty See above

HEAVY PLASMA GUN

The heavy plasma gun generates and fires energy shells of bright glowing plasma. When the shells strike an object they react with its matter to create miniature spheres of boiling nuclear energy. For this reason heavy plasma guns are sometimes called 'sun guns'.

A target enveloped by a plasma sphere suffers the dual effects of searing heat and explosive shock. As with all plasma weapons the heavy plasma gun's chief disadvantage is the massive amount of energy required to power it. After firing it takes an appreciable time for the weapon to recharge before it is ready for a second shot. Because of this limitation, the heavy plasma gun has an alternative low energy setting which is less effective than a full plasma blast but which allows the weapon to fire more rapidly.

Special Rules

The heavy plasma gun can be fired on either Maximum Power or Low Energy. Do not be misled by the term low energy - even in this mode the plasma gun is a potent and destructive weapon.

These two alternative values are given on the weapon's profile: the Low Energy value is given first, followed by a slash, then the higher Maximum Power value. For example, range using Maximum Power is 72", while it is only 40" using Low Energy. Strength is 7 with Low Energy, 10 with Maximum Power. Damage is D4 with Low Energy, D10 with Maximum Power. The Save Modifier is -2 with Low Energy, -6 with Maximum Power.

The energy drain on the heavy plasma gun in Maximum Power mode is so vast that once it has been fired it takes two complete turns for the weapon to recharge.

While the weapon is recharging it cannot be used in either fire mode. By using the Low Energy mode the weapon does not have to recharge and can therefore be used every turn.



Short Range	Long Range	To Hit Short	To Hit Long	Strength	Damage	Save Modifier	Special
0-20	20-40/72	—	—	7/10	D4/D10	-2/-6	Heavy - 2" penalty Move or Fire 1" radius Blast Area See above

HEAVY STUB GUN

This heavy and old-fashioned weapon is affectionately known as the 'big stubber'. It rattles off a hail of heavy-weight bullets sufficient to stop a man dead in his tracks. To all intents the heavy stub gun is similar to a twentieth century heavy machine gun in appearance and effect. It is especially effective when deployed against massed formations of lightly armoured or unarmoured troops.

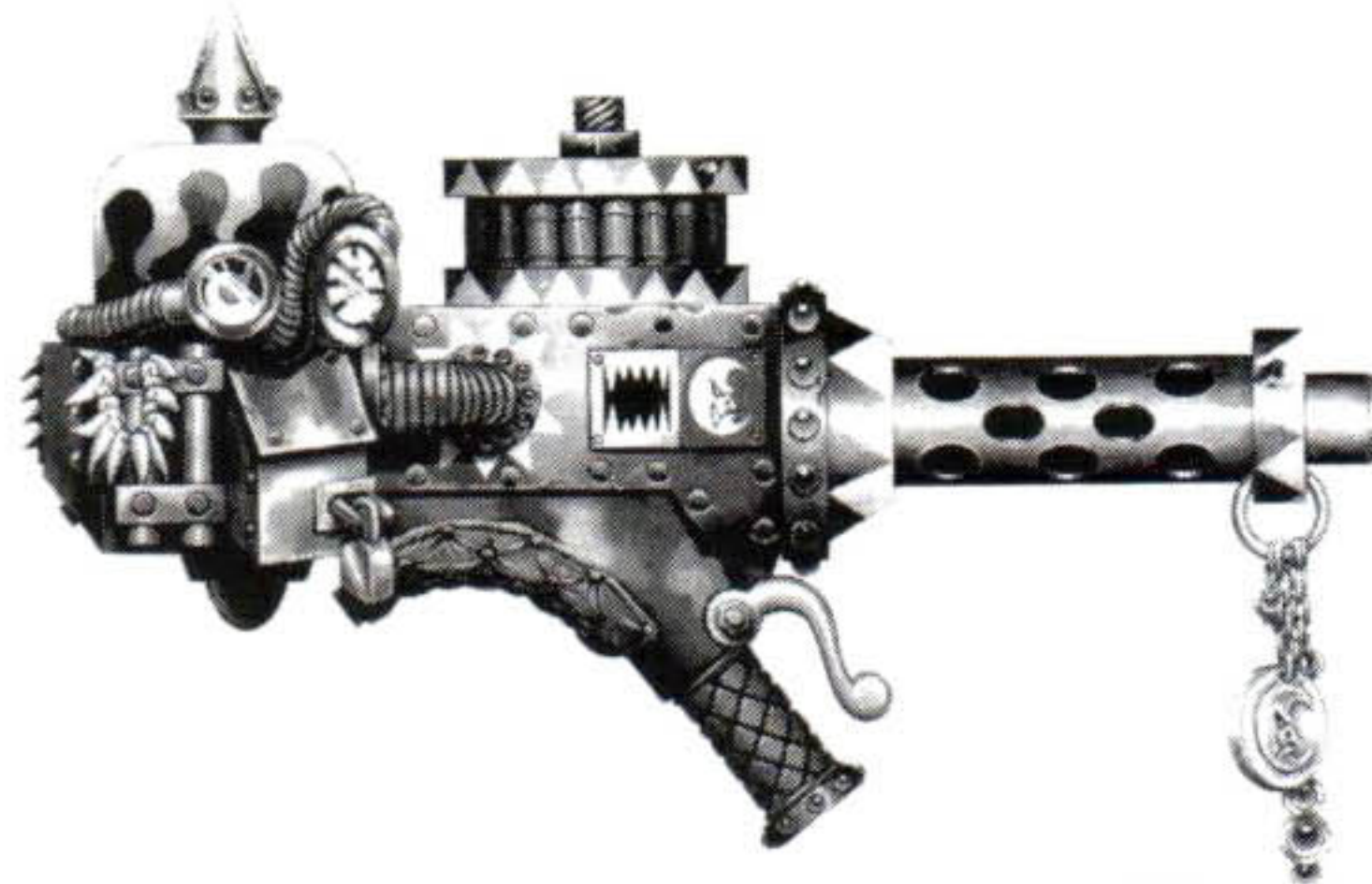

Short Range	Long Range	To Hit Short	To Hit Long	Strength	Damage	Save Modifier	Special
0-20	20-40	—	—	4	1	-1	Heavy 1" penalty Move or Fire Sustained fire

HEAVY WEBBER

This is a larger version of the web pistol or glue gun. Like the web pistol, it is an unusual battlefield weapon, being more suited to purposes of crowd control and mob suppression as its effects are debilitating rather than deadly.

Its appearance is similar to the pistol with a pronounced cone-shaped nozzle and conspicuous canister containing web-chem. The chemical web is fired from the nozzle, shooting a tangle of irregular threads which quickly solidify and form a strong, sticky mesh which covers and traps the target.

Special Rules

Once a web gun has hit its target the victim is enmeshed, there is no strength/toughness roll and no saving roll. The victim may do nothing until released using the special web solvent which is carried by all web gun crews and troops who carry web pistols. However, at the start of their turn, any models enmeshed by webs may attempt to free themselves, although this is very risky, especially for smaller and weaker creatures. The player rolls a D6 and adds the trapped model's strength. If the score is 9 or more the model is freed and may move and act normally from then on. If the model fails to break free it must immediately make its normal saving throw – if this is failed the model sustains 1 damage as the web constricts, crushing or strangling the struggling victim.

Crews or troops in open topped vehicles may be hit and affected. Vehicles can be affected if travelling slowly, otherwise the web is torn apart before it has a chance to solidify. Roll a D6 and consult the Vehicle Web Chart.

VEHICLE WEB CHART (D6)					
Vehicle Speed (last movement phase)					
	0-4"	4-8"	8-12"	12-16"	16"+
To hit	3+	4+	5+	6	Miss

A miss against a vehicle has no further effect: the web is sloughed away by the moving vehicle before its chemical base has a chance to solidify. A hit brings the vehicle to an immediate halt regardless of its speed. The vehicle may do nothing while it remains webbed. Troops inside may not operate weapons, fire from it, or leave. The vehicle may attempt to break free from the web at the start of each subsequent turn. Roll a D6 on the Vehicle Escape Chart.



VEHICLE ESCAPE CHART (D6)	
D6	Result
1	Fail - trapped for the remainder of the game, may not break free.
2-4	Fail - remain trapped. Try again next turn.
5	Fail - but 1 randomly determined weapon is freed and may be used normally.
6	Free - the web is destroyed as soon as the vehicle moves in its movement phase.

EXAMPLE

The Land Raider travelled 7" in its last movement phase.

An Ork armed with a Heavy Webber shoots at and hits a moving Land Raider. The Ork player now refers to the Vehicle Web Chart and rolls a D6. As the Land Raider on its last movement phase was travelling 7" so the Ork player needs to roll a 4+ to successfully enmesh it. He rolls a 5 and the Land Raider is now trapped, with troops inside unable to operate weapons, fire from it or leave.

On this next turn the Marine player attempts to break free of the web by rolling a D6 on the Vehicle Escape Chart. He throws a 3 which means he is unable to break free this turn but may try again at the start of each subsequent turn.

Short Range	Long Range	To Hit Short	To Hit Long	Strength	Damage	Save Modifier	Special
0-12	12-24	—	—		Special		Heavy – 2" penalty Move or Fire 2" radius Blast Area See above

LASCANNON

The lascannon, or laser cannon, operates from the same basic laser principal as the smaller lasgun. In the case of this weapon the laser chamber is larger, the power-build heavier, and the shot a single cannon blast rather than a machine-gun like hail of lower intensity laser blasts. The lascannon is designed to knock-out armoured vehicles and in this role it so effective that it is often known as the 'tank buster', or simply as the 'buster'. It can also be used against single heavily armoured foot troopers where the laser will easily penetrate armour. However, it is a poor anti-personnel weapon compared to a heavy bolter or auto-cannon.

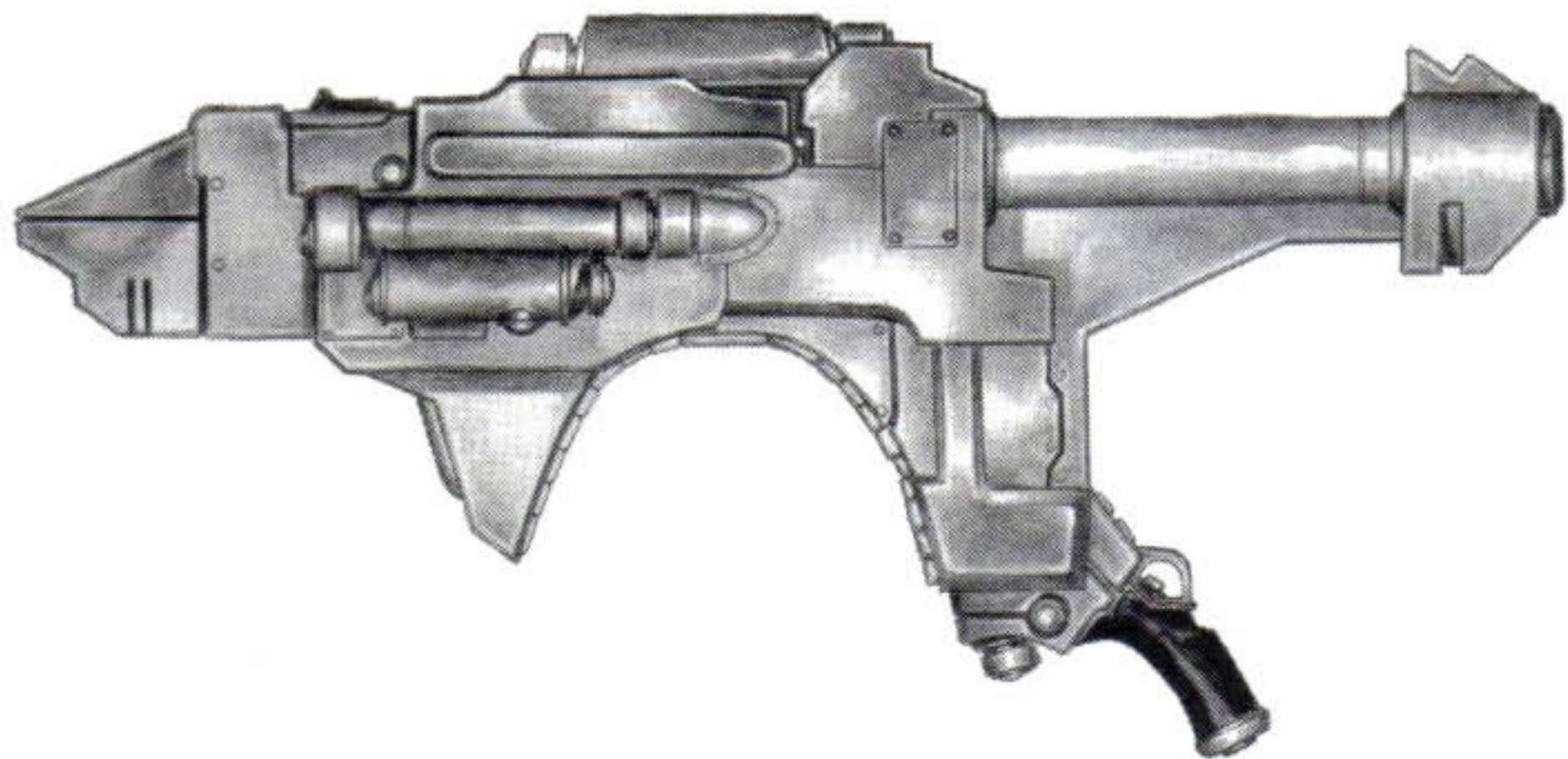

Short Range	Long Range	To Hit Short	To Hit Long	Strength	Damage	Save Modifier	Special
0-20	20-60	—	—	9	2D6	-6	Heavy - 2" penalty Move or Fire

MULTIMELTA

The multimelta or thermal cannon is named on account of the multiple barrel-elements used on some models. It is also known as 'hotstuff', 'hells breath' and 'hells halitosis' - its crewmen being noted for their sense of humour as well as the permanently singed condition of their uniforms.

The weapon is essentially a more powerful version of the standard meltagun. It works by means of sub-atomic agitation, rather like a long ranged microwave cooker, and can melt its way through even the heaviest armour. It is, however, handicapped by a relatively short range.

The multimelta makes no noise when fired, but the super-heating of the air produces a distinctive hiss which becomes a roaring blast when a living target is hit and its body moisture vapourises explosively.

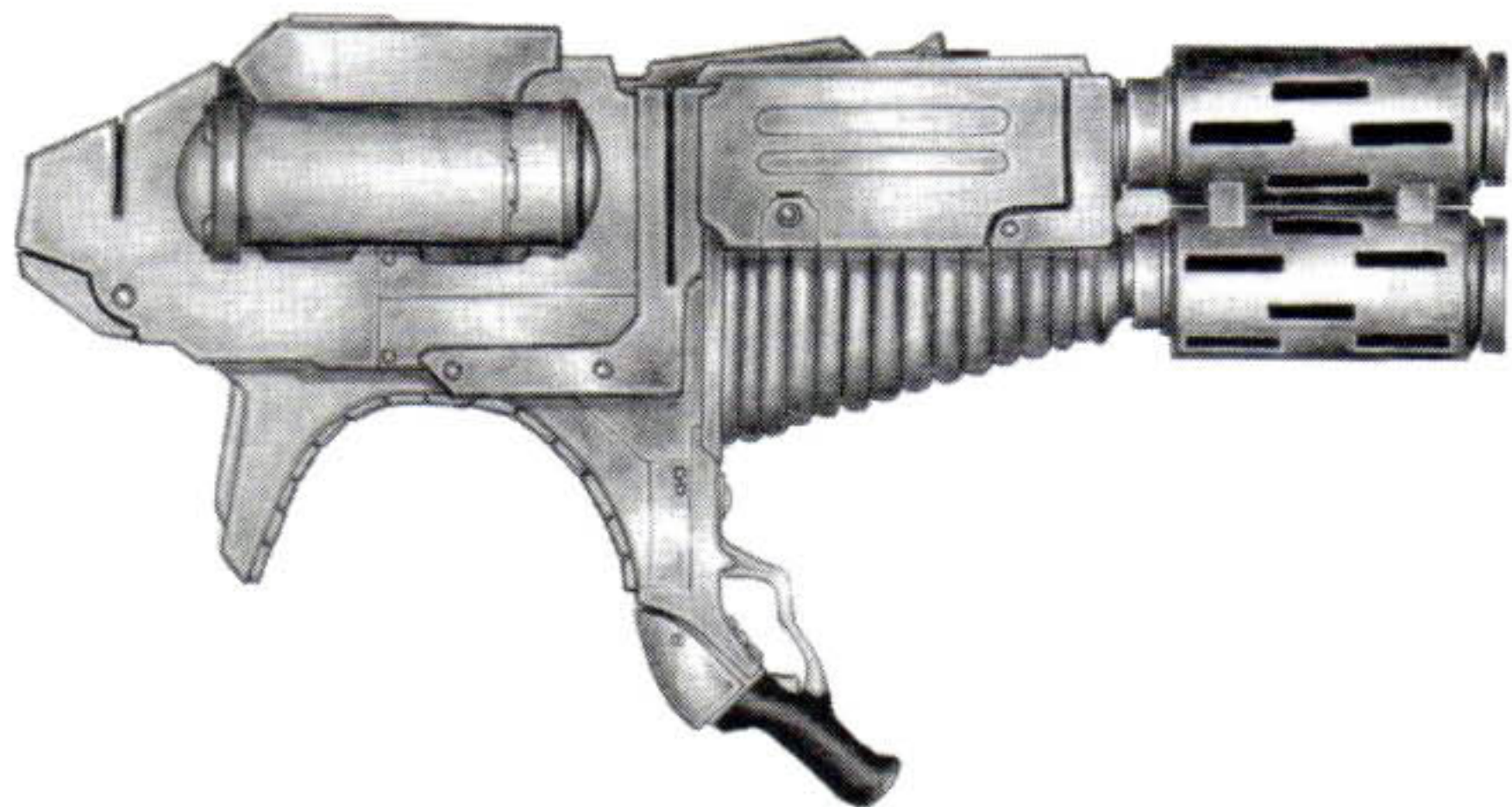

Short Range	Long Range	To Hit Short	To Hit Long	Strength	Damage	Save Modifier	Special
0-12	12-24	+1	—	8	2D12	-4	Heavy - 2" penalty Move or Fire 2" radius Blast Area

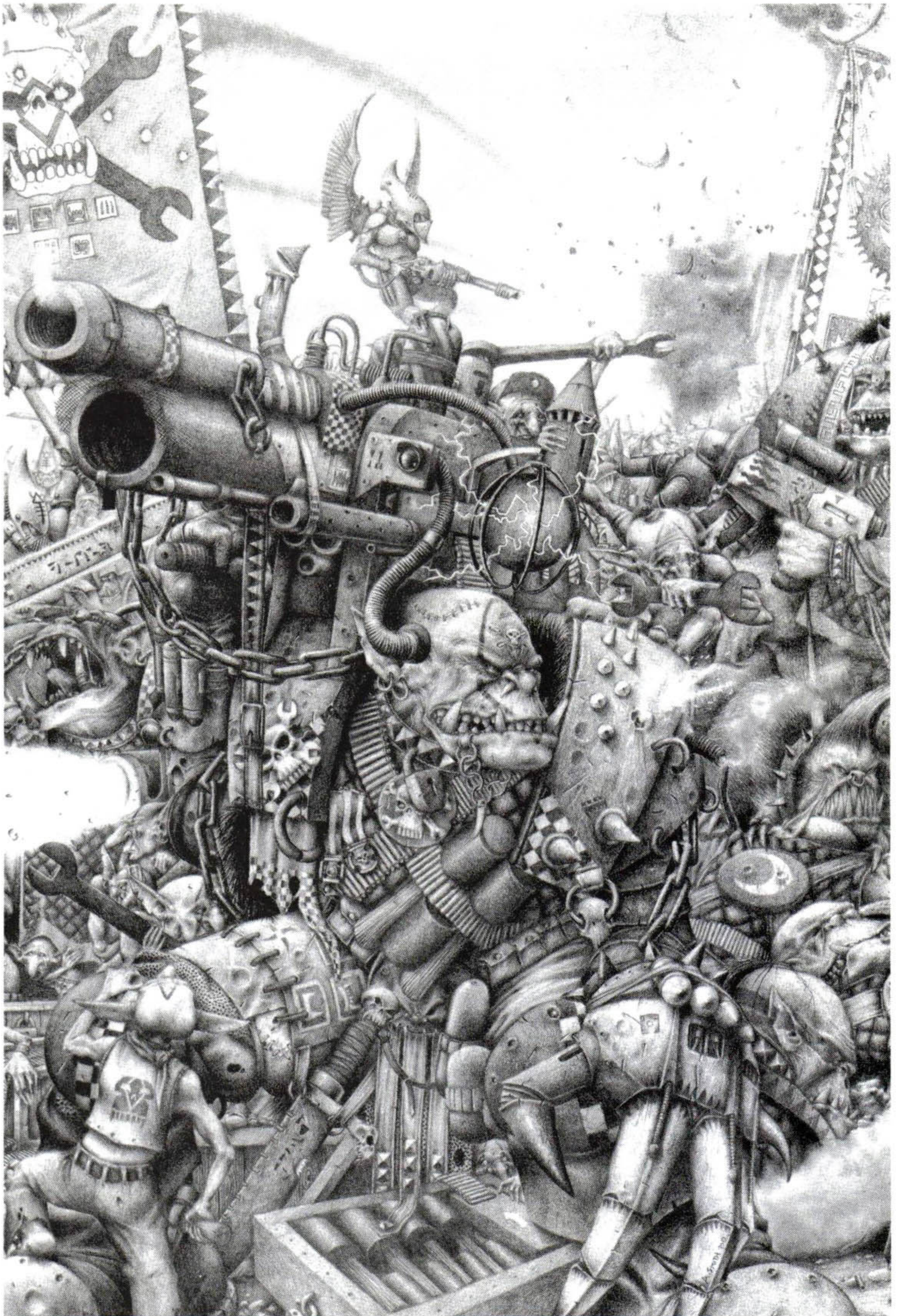

MISSILE LAUNCHER

The missile launcher is one of the most common and highly-favoured heavy weapons in the Imperial arsenal. The concept is universal, and versions are produced all over the galaxy by humans, Orks and Eldar. Missile launchers are sometimes fitted onto vehicles and Dreadnoughts too.

The Imperial version carries a missile-magazine containing individual self-propelled missiles, and can fire a variety of missile types. The most usual missile type is the krak armour penetration missile, specifically engineered to 'crack open' armour. Also popular is the frag missile, designed to cut down exposed foot troops.

Missile technology varies throughout the galaxy, and not all races or groups possess all of the types described here.

Special Rules

The effects of each missile hit depends upon the type of missile fired, as described on the opposite page.

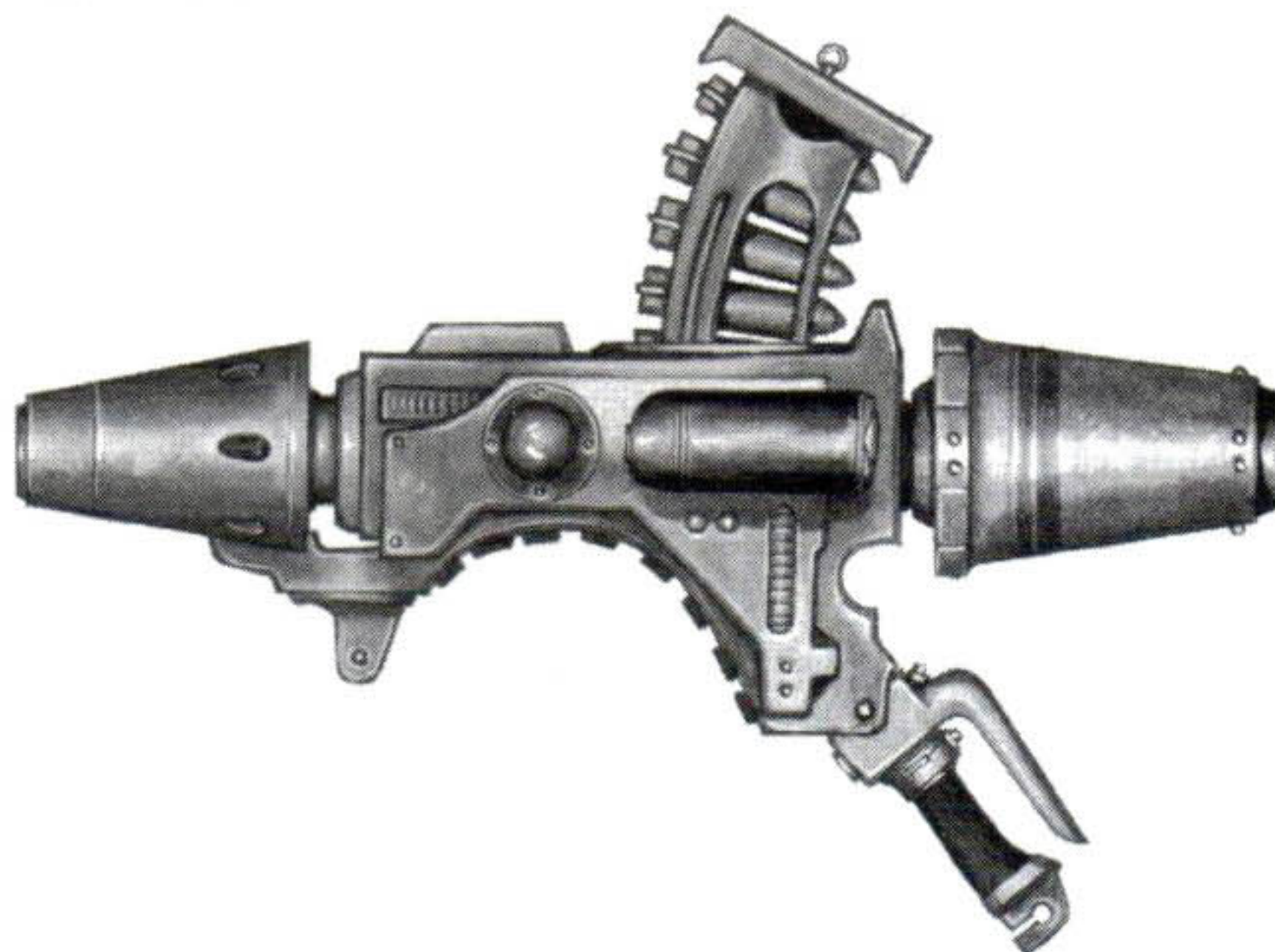

Short Range	Long Range	To Hit Short	To Hit Long	Strength	Damage	Save Modifier	Special
0-20	20-72	—	—		As Missile		Heavy - 1" penalty Move or Fire See above



KRAK MISSILE

This missile is designed specifically to crack open heavily armoured targets and is the standard anti-vehicle missile. It can also be effective against well armoured foot troopers, Dreadnoughts, etc, and is given a save modifier to reflect its armour penetrating abilities.

Strength	Damage	Save Modifier	Blast Area
8	D10	-6	None

FRAG MISSILE

This missile explodes upon impact scattering shrapnel over a wide area. Although unlikely to damage heavily armoured targets, lightly armoured troops are easily scythed down by the fragments of spinning metal.

Strength	Damage	Save Modifier	Blast Area
4	1	-1	2" radius

**BLIND MISSILE**

Blind is a sophisticated form of smoke screen which produces broad spectrum electro-magnetic interference as well as dense smoke.

The missile may be aimed against any visible piece of ground. A circular cloud of cotton wool should be placed over the area to represent the screen of blind. Models may not see through, or into, or out of, blind. Models may not use targeters or infra-vision to see through blind. Psykers may not see or use their powers through blind.

Any models within the blind cloud have the choice of remaining stationary, or moving at half rate in a random direction. Opposing models in hand-to-hand combat within a blind cloud may fight, but any advantage gained due to a higher initiative value is lost because of the reduced visibility – therefore, any tied score when in a blind cloud is a draw, and the highest initiative does not win, as would normally be the case.

Strength	Damage	Save Modifier	Cloud Area
—	—	—	2" radius

Once a blind cloud has been positioned its subsequent movement and persistence is tested at the start of each player's turn. Roll a D6 on the Blind Cloud Chart.

BLIND CLOUD CHART (D6)**D6 Cloud Movement**

- 1 Cloud remains until end of testing side's turn and then disappears with no further effect.
- 2-4 Cloud remains where it is.
- 5 Cloud shrinks to half current radius rounding down to nearest ½".
- 6 Cloud moves D6" in a random direction.

Blind clouds may be conveniently represented by a ball of cotton wool.

MELTA-MISSILE

Upon impact, the melta-missile undergoes a sub-atomic reaction releasing a blast of intense heat. This missile is capable of melting away vehicles and buildings, and is especially useful for attacking troops huddled together in defended positions.

Strength	Damage	Save Modifier	Blast Area
8	D6	-4	1" radius

ANTI-PLANT MISSILE

This missile was developed as a defoliant to clear areas of vegetation which might otherwise act as cover to enemy troops. All vegetation in the area effect of the missile is automatically destroyed. The missile cannot affect other models.

Strength	Damage	Save Modifier	Blast Area
—	—	—	2" radius

PLASMA-MISSILE

The plasma missile converts matter to plasma during flight. Determine where the missile lands as normal and place a 1 ½" radius blast marker or ball of cotton wool. Work out damage on targets within the area as normal. Any models which survive are thrown outside the area covered by the marker as a result of the blast.

Strength	Damage	Save Modifier	Area
5	1	-2	1½" radius

When the casualties have been resolved leave the blast marker in place. The area has now undergone a matter/energy transformation and has been transformed into a glowing ball of plasma. At the start of each side's following turn test to see what happens to the plasma ball by rolling on the Plasma Ball Chart.

PLASMA BALL CHART (D6)**D6 Result**

- 1 The plasma ball expands its radius by D6" and disappears at the end of the turn.
- 2-5 The plasma ball's radius shrinks by ½".
- 6 The plasma ball implodes and disappears immediately, causing no harm this turn.

The plasma ball remains on the table until it disappears. Any model within the area during a turn suffers an automatic hit. No model may draw a line of sight through the plasma ball, and all weapons discharged into it merely feed the matter-energy conversion.



MULTILASER

The multilaser is a rapid firing laser that uses a multiple barrel configuration to reduce a standard laser charge into a series of rapid pulses. The result is a weapon which retains some of the renowned penetrative power of the lascannon but

which can engage a series of targets in rapid succession. It produces a series of distinctive pulsing blasts when fired, followed by explosions as the laser energy shells strike the target and explode.

Short Range	Long Range	To Hit Short	To Hit Long	Strength	Damage	Save Modifier	Special
0-20	20-60	+1	—	6	D4	-1	Heavy – 2" penalty Move or Fire Sustained Fire

SHURIKEN SHRIEKER CANNON

The Shuriken Shrieker Cannon [Eldar: *Buanna*] is an upgraded version of the shuriken catapult with a longer barrel. It has been constructed so that it can fire either normal shuriken ammunition or the shrieker ammunition [Eldar: *Margrech*]. The special shrieker ammunition is hollow and contains a genetically tailored enzyme-based serum. As the missile hits its target the centripetal forces created by the spinning disc force the toxin through microscopic holes in the shuriken's spines and into the target. The characteristic shrieking noise is caused by the rush of air into the hollow missile as serum is forced into the victim. It is this noise which prompted the Imperial troops to give the weapon its name of Shrieker. The effect of the serum is discussed in the special rules.

Special Rules

With normal ammunition, the cannon may use sustained fire. The special shrieker ammunition must be individually loaded and so may not use sustained fire. Decide which ammunition type you want to use before firing.

Normal shuriken ammunition is fired in the usual manner. Work out hits, damage and remove casualties in the usual way. This ammunition may be used against vehicles.

Shrieker ammunition is worked out differently: it can only affect living creatures, and has no effect on vehicles. Roll to hit as normal. If the target is hit make any permitted saving throw. If this is failed the shrieker has delivered its lethal serum into the victim.

The serum works in a very complex and unpleasant manner, combining with the victim's own genetic material, twisting and distorting tissues, and causing organs to malfunction in a spectacular fashion. Eventually the victim is driven into a violent delirium as the serum reaches his brain and he loses control of his body. Afterwards the pace of the constantly replicating genetic serum reaches a fever pitch and the tissues react explosively, killing the victim in a particularly horrifying and untidy manner.

Once a target has been affected roll 2D6 during his movement phase and move the victim this number of inches in a randomly determined direction. Unit coherency is

ignored. If the 2D6 roll result is either a 7 or any double, the serum has reached its potential and the victim explodes. Place a 1" radius area effect marker over the exploding victim: any target within the area automatically takes a single automatic strength 3 hit causing 1 damage point if effective. If the victim does not explode during his first turn of random movement, he will continue to stagger around randomly during his subsequent movement phases until he either explodes or leaves the table. The victim may do nothing else.

Any unit which has one or more of its members within 2" of a shrieker victim at the *start* of their movement phase must make a rout test. As unit coherency is 2" this means a rout test will normally have to be taken by the target unit. Note that every enemy unit within 2" of a victim must test, as the risk will effect anyone too close.

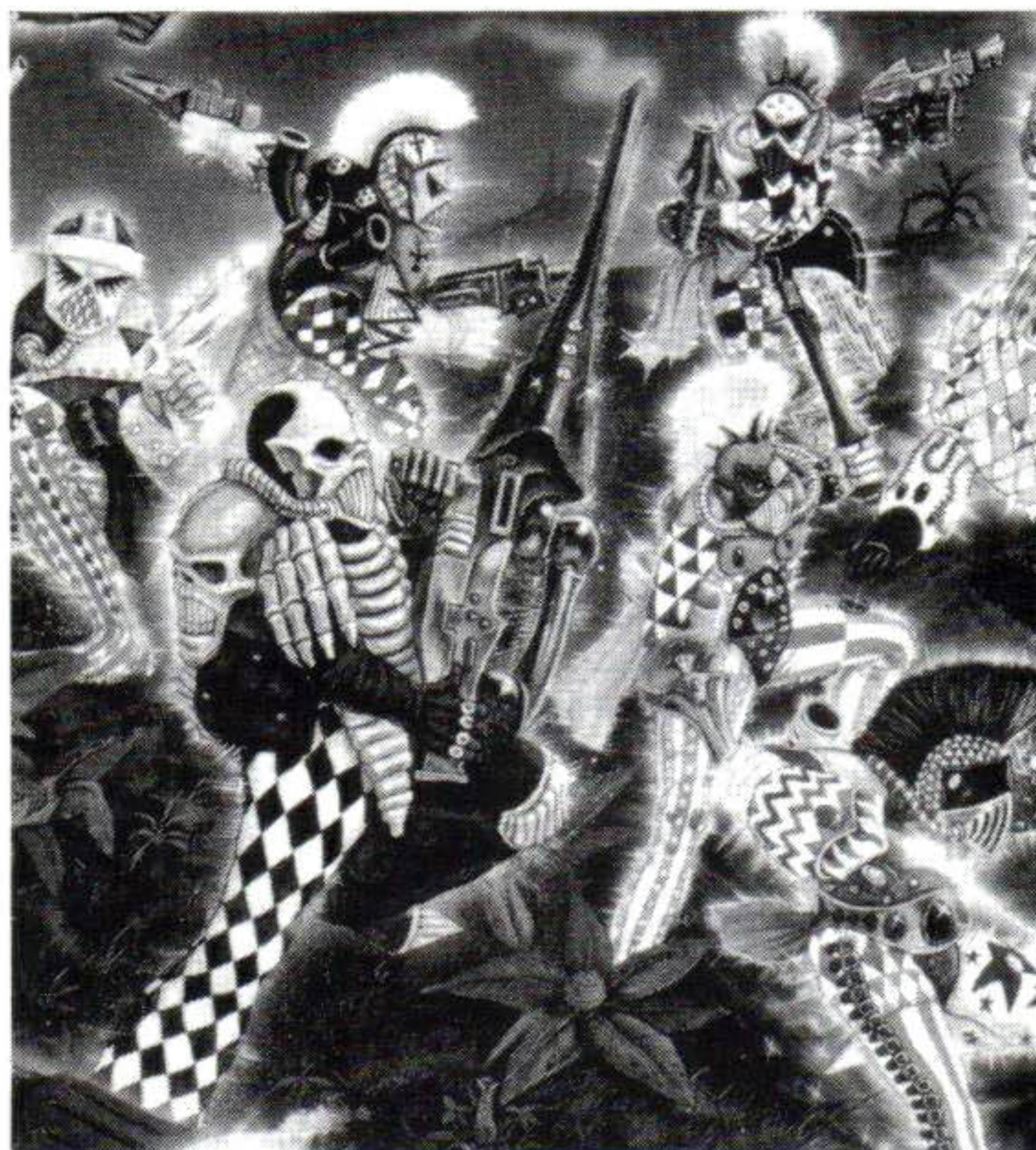

DAVE GALLAGHER

Short Range	Long Range	To Hit Short	To Hit Long	Strength	Damage	Save Modifier	Special
0-20	20-40	+1	—	5	D4	-3	Heavy – 2" penalty Sustained Fire



ELDAR WEAPONS



LASGUN

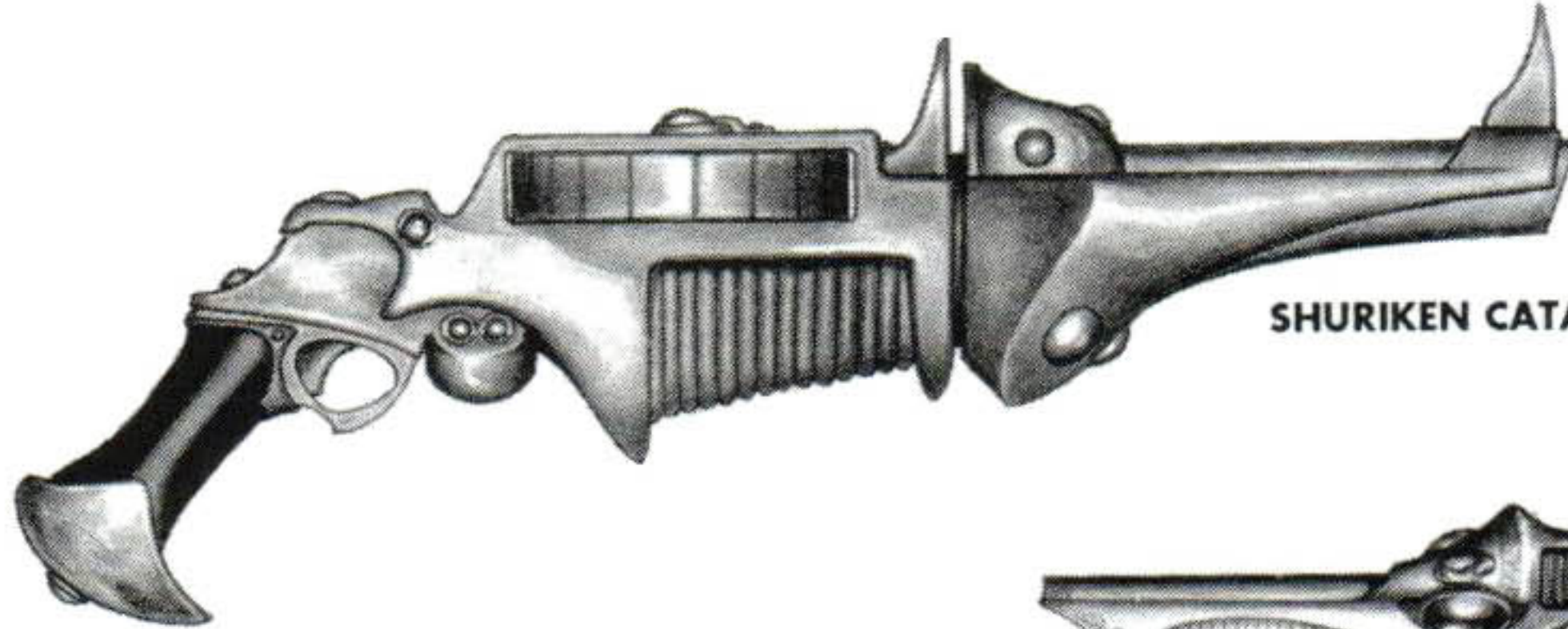

SHURIKEN CATAPULT



SHURIKEN PISTOL



MELTA GUN

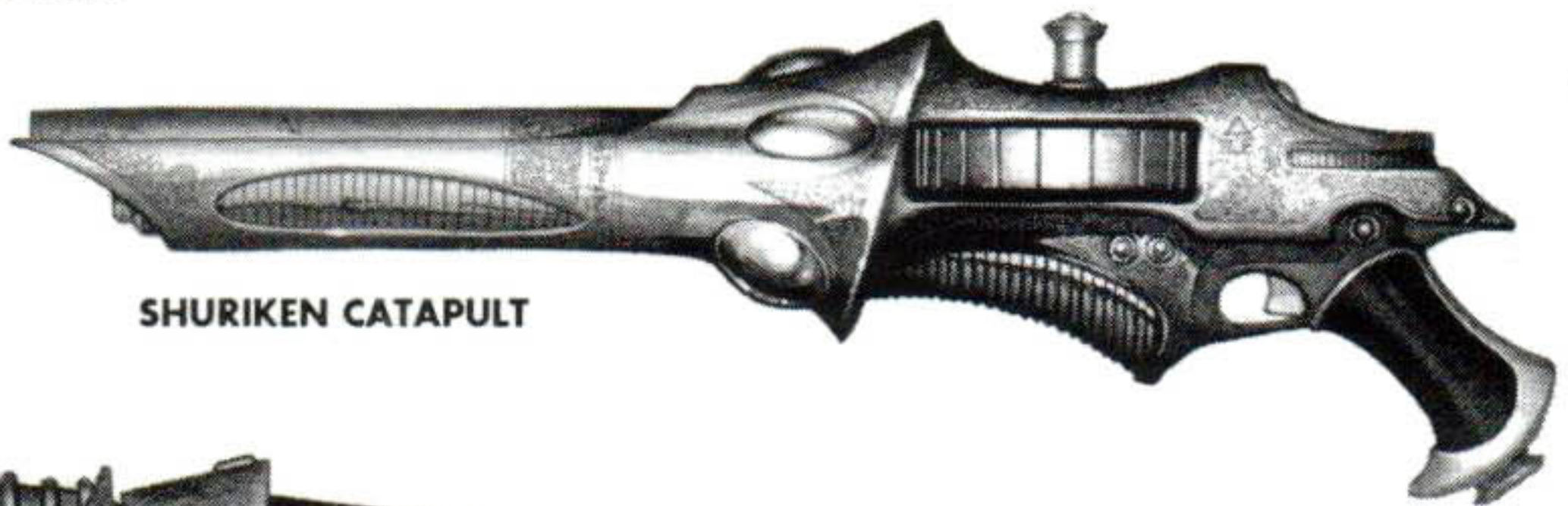

SHURIKEN CATAPULT

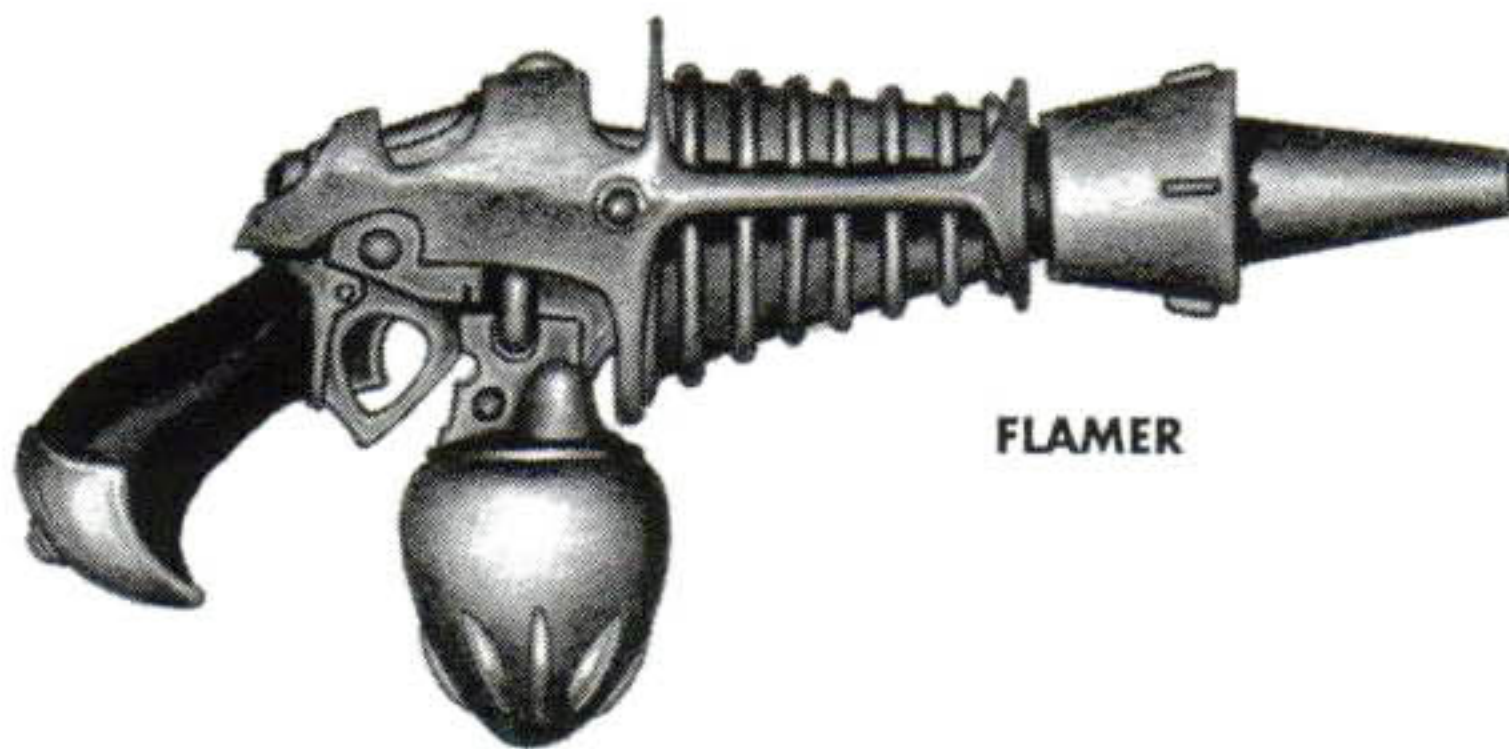

FLAMER



LASPISTOL

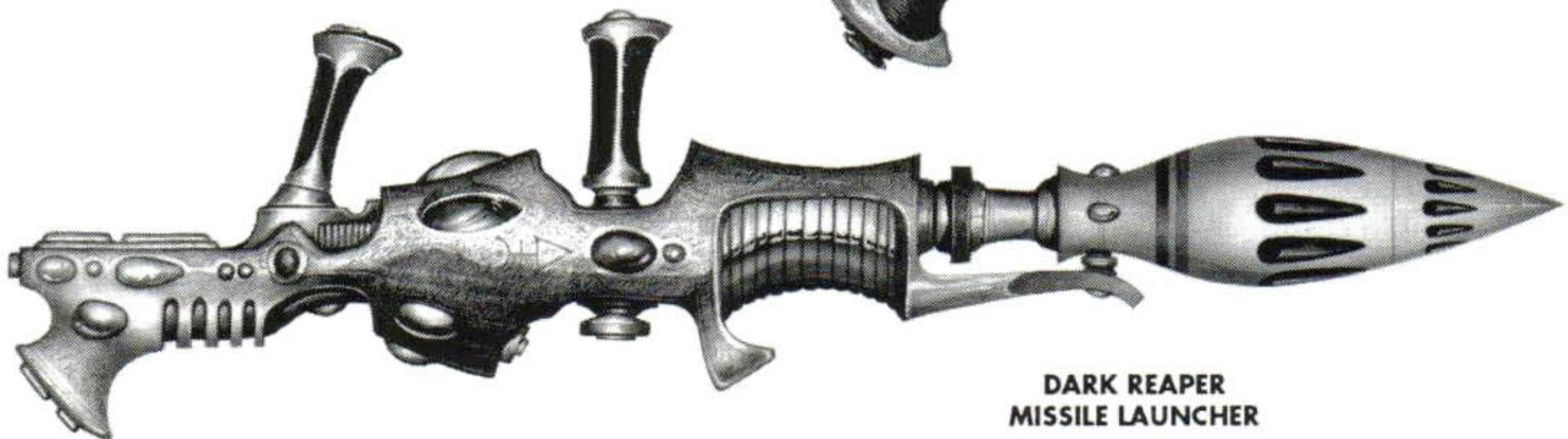

DARK REAPER
MISSILE LAUNCHER



SUPPORT WEAPONS

The weapons in this section are generally deployed to provide support for infantry and vehicles as they advance. They are not man-portable, being far too heavy to carry. Instead, they are fitted to their own mobile carriages so they can be moved around the battlefield.

— DISTORT CANNON ON ANTI-GRAV PLATFORM —

The distort or D-cannon is an Eldar weapon that makes use of the same warp-technology that enables spacecraft to move in and out of warp space. The weapon emits a low droning noise which builds in pitch until it fires with a high pitched shriek, spewing a beam of impenetrable blackness towards its target — a momentary rift between real space and the warp. The target is enmeshed in blackness and wrenched momentarily between warp space and reality. The massive internal distortion this causes tears the target apart, and usually destroys it. Living creatures are instantly burst apart, while vehicles and other constructions are ripped to pieces and wrecked. Local spatial distortion around the target may also cause some apparent movement of nearby troops as part of the fabric of reality is twisted and distorted. The only disadvantage of the weapon is its inaccuracy, inevitable with a weapon which distorts space as it is fired. The D-Cannon is mounted on a special anti-grav platform, enabling its crew of two to move it easily into position.



Special Rules

The D-cannon is so heavy that it can only move under its own gravitic power. It may be turned to face any direction and moved up to 4" in the movement phase and requires only one of its two crew members to move it. The weapon may not move through difficult terrain or over obstacles. The D-Cannon requires a reasonable time to prepare for firing, so it cannot move and fire during the same turn.

Because the weapon is a distinct piece of equipment it is considered to be a separate target from its crew. At short range an enemy may select either of the crewmen or the weapon itself as the target. At long range shots are randomised between the gun and crew. If either crewman is killed the weapon may still continue to move and fire so long as the other crewman is alive. If both crewmen are killed the weapon remains on the table but is effectively useless.

If the weapon is shot at it is considered to have an armour value of 10 as if it were a vehicle. The attacking player rolls to penetrate the weapon's armour and if the armoured casing is penetrated the weapon is automatically destroyed. Crewmen whose weapon has been destroyed may continue to fight independently, join other Eldar Guardian support weapons as spare crew or take over Eldar support weapons which have no crew.

The inherent inaccuracy of the distort cannon means that it is equally likely to hit whether used by skilled or raw troops. To an extent there is always a degree of unpredictability, as should be expected when dealing with a device which affects the spatial fabric of the universe. The special distort hit system is used to determine hits as follows:

- 1 Place the 2" radius Distort Area template over the intended target.
- 2 Roll a D12 to establish a random direction and move the template D6" in this direction.
- 3 Now roll another D12 to establish a random direction and move the template a further D6" in the direction indicated.

The final position of the template indicates where the cannon hits. Targets wholly in the area are hit automatically, those partially within it are hit on the D6 roll of a 4, 5 or 6. Most vehicles are so large that they cannot lie wholly in the area and will therefore be hit on a 4, 5 or 6. This gives vehicles a degree of protection and makes up for the loss of their armour penetration roll to some extent. All targets which are hit must make an immediate Distort Test to determine if they survive. Survivors may suffer further effects of spatial displacement as shown later.

DISTORT TEST (D6)

- 1-4 **Destroyed.** Target entirely destroyed.
- 5 **Displaced.** Target unharmed but moved physically by spatial displacement. See Displacement Test.
- 6 **Moved.** Target unharmed but moved physically 2D6" in a random direction.

On a Distort Test result of a 5 the model is unharmed but moved to a totally new position on the tabletop, possibly into the air or even under the ground surface.

Although unharmed by the distortion of space, the target may suffer damage as a result of its displacement. Roll a D6 and consult the Displacement Test Chart.

Short Range	Long Range	To Hit Short	To Hit Long	Strength	Damage	Save Modifier	Special
0-16	16-32				See special rules		2" distort area Move or fire See above

DISPLACEMENT TEST (D6)

- 1 Target moved to a random position on a randomly determined table edge.
- 2 Target moved 4D6" in a random direction.
- 3 Target moved 6D6" in a random direction.
- 4 Target moved D6" and inverted. If the target is a vehicle it is unharmed but upside down. Any weapons mounted on the top of the vehicle are unusable; side mounted weapons may be used normally. The vehicle is immobile but may continue to fight. If the target is a foot model it must spend its following movement phase standing up again.
- 5 Target moved 2D6" in a random direction and into the air approximately 10 metres. The target drops to the ground like a stone, sustaining an automatic hit with a strength of 10 causing D6 damage. If the target is a vehicle or part of a building, any models directly underneath are hit on the D6 roll of 4, 5 or 6. Any models hit automatically sustain a strength 10 hit causing D6 damage. In both the case of the target and any models caught by falling material, no armour saving throws are allowed.

Hit	Strength	Damage	Save
Automatic	10	D6	None

- 6 Target moved 2D6" in a random direction and under the ground to a depth of approximately 10 metres. As the target attempts to warp into the space occupied by solid rock, the co-existence of molecules causes a massive explosion. Place a 2" radius blast template over the spot. All models in the blast area are automatically hit and sustain a strength 6 hit causing D6 damage and with a save modifier of -2 on any saves.

Hit	Strength	Damage	Save
Automatic	6	D6	-2



RAPIER LASER DESTROYER

The rapier laser destroyer is a mobile anti-tank weapon mounted with a four-barrelled laser known as a rapier. The weapon's four separate laser chambers are designed to focus with precision accuracy at a single point. A tremendous amount of laser energy can be directed against the target, making the rapier far more powerful than the lascannon. However, the rapier is so heavy and bulky that it has to be transported on a specially-designed motorised track unit. The crewmen control the rapier's firing and movement with a special radio control box which they carry.

Special Rules

The rapier is so heavy that it can only move under its own power. It may move up to 4" in the movement phase so long as a crewman remains within 4" of it - this being the effective range of his radio control box. Thanks to its all-terrain tracks, the rapier laser destroyer can move through difficult terrain at half pace and cross obstacles up to six feet high without penalty. The rapier may not move and fire in the same turn.

The weapon has a 45° fire arc to its front. This arc is smaller than usual, but reflects the precise way in which the weapon focuses on its target. If you have to move the weapon in order to bring it within this fire arc then you cannot fire that turn.

Because the weapon is a distinct piece of equipment it is considered to be a separate target from its crew. At short range

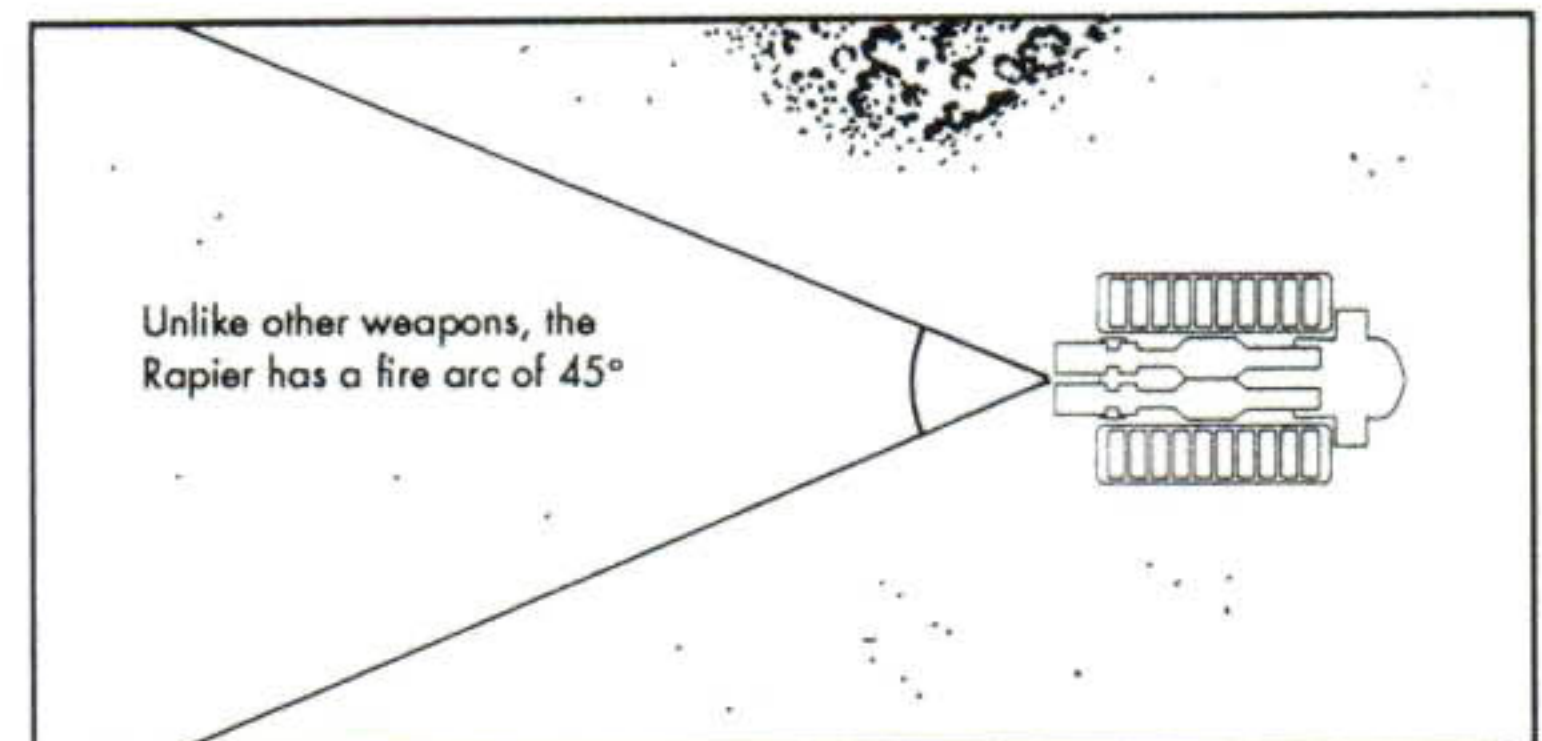

an enemy may select either crewman or the weapon itself as the target. Long range shots are randomised between the gun and crew. If either crewman is killed the weapon may still continue to move and fire so long as the other crewman is alive. If both crewmen are killed the weapon remains on the table but is effectively useless.

If the weapon is shot at it is considered to have an armour value of 10 as if it were a vehicle. The attacking player rolls to penetrate the weapon's armour and if the armoured casing is penetrated the weapon is automatically destroyed. Crewmen whose weapon has been destroyed may continue to fight independently; they may join other rapiers as spare crew or they can take over a rapier which has no crew.

Short Range	Long Range	To Hit Short	To Hit Long	Strength	Damage	Save Modifier	Special
0-18	18-72	+1	—	9	2D10	-6	Move or fire See above

MOLE MORTAR

The mole mortar or "moler" is an ingenious invention of the Squat Engineers Guild. It has been adopted by the Imperial Guard, and is copied by the Imperium for use by its forces.

The mole mortar fires a burrowing sub-surface missile, or tunnel torpedo, into the ground. The missile burrows its way towards its target, bypassing all surface hazards and defences, and then emerges from the ground underneath it. The torpedo itself is a very sophisticated self-guided device able to track its target through solid rock. This is obviously very useful to the Squats, whose worlds are usually rocky and whose sub-surface fortresses are invulnerable to ordinary artillery.

Special Rules

The tunnel torpedo cannot be aimed at a point within 12" of the weapon, but if the torpedo's guidance system goes wrong it is possible that a shot may go off target and accidentally explode within 12" of the mortar.



MOLE MORTAR ACCURACY (D6)

- 1 **Off Target.** The torpedo's guidance system draws it off-target. Randomly determine a new target point within 2D6" of the original. Re-roll on this chart - if the torpedo's guidance system malfunctions again work out yet another target point.
- 2 **Airburst.** The torpedo emerges on target, spins out of the ground and explodes in a devastating airburst. Work out damage as described below for an airburst.
- 3-4 **Surface Burst.** The torpedo emerges on target and explodes as it breaks the surface. Work out damage for a surface burst.
- 5 **Ground Burst.** The torpedo tunnels its way up to the sub-soil and explodes while still embedded in the ground partially muffling its effect. Work out damage for a ground burst.
- 6 **Subterranean Burst.** The torpedo becomes embedded in solid rock or hits some other obstruction. It explodes deep under the ground. Work out damage as described below for a subterranean burst.

The mortar has a crew of 2, although only one is necessary to operate it. The other crew member acts as a forward observer or 'spotter' and may move away from the weapon and the operator to anywhere on the battlefield. The spotter maintains a communication link with the mortar and its firer, and may instruct the mortar to fire at targets which the spotter can see but which the firer cannot. Should the weapon's crewman be killed the spotter may return to the weapon in order to operate it.

Because of its unique mode of operation the procedure for using the mole mortar is slightly different to normal weapons.

First, the player nominates a target point - this may be any point on the tabletop, it does not have to be a specific model and it can be in any direction. However, the target point must be visible to at least one of the mortar's crew - either the firer or the spotter.

Second, the player rolls a D6 to test for the mortar's accuracy on the Mole Mortar Accuracy Chart.

To work out damage consult the Mole Mortar Damage Chart, which shows the size of the blast marker, strength, damage caused, and save modifier for each burst type.

MOLE MORTAR DAMAGE

	Blast Radius	Strength of Hit	Damage Caused	Save Modifier
Airburst	3"	3	1	-2
Surface	2"	4	1	-2
Ground	1"	4	1	-2
Subterranean	D3"	3	1	-2



A ground or subterranean burst leaves a permanent crater equivalent in size to the blast area of the shot. Parts of a building lying over a crater will collapse. Any vehicle which lies 50% or more within the crater area is brought to an immediate halt, and must roll a 5 or 6 on a D6 at the start of its movement phase before it can move (vehicle with tracks may move on the roll of a 4, 5 or 6). Any other models within the crater are thrown to the ground and may not move in their following movement phase other than to get on their feet - they may shoot weapons as normal at targets they can see. The chart below summarises the rules for craters.

Building	Vehicle in crater	Vehicle on edge of crater	Trooper in crater
Collapses	Immobile	5 or 6 to escape (4,5,6 if tracked)	Miss 1 movement phase

Short Range	Long Range	To Hit Short	To Hit Long	Strength	Damage	Save Modifier	Special
12-24	24-72				See Special Rules		Heavy - 2" penalty Move or Fire See Above

— SCATTER LASER ON ANTI-GRAV PLATFORM —

The scatter laser (Eldar: *Sierbahn*) was originally devised by the Eldar for use by war walkers and dreadnoughts, though the Eldar Guardian support units use a version fitted to the Eldar anti-grav platform. The weapon comprises six separate laser chambers which can be fired simultaneously, at the same or different targets. The scatter laser is similar to the multilaser, but more refined, and is only used by the Eldar. The Eldar anti-grav platform is used to mount heavy weapons which are too heavy to be carried by foot troopers, such as the lascannon and the heavy plasma gun.

Special Rules

The scatter laser is so heavy that it can only move under the power of its anti-grav platform. It may be turned to face any direction or moved up to 4" in the movement phase and requires only one of its two-man crew to move it. The weapon may not move through difficult terrain or over obstacles.

Because the platform-mounted weapon is a distinct piece of equipment it is considered to be a separate target from its crew. At short range an enemy may select either of the two crewmen or the weapon itself as the target. Long range shots are randomised between the gun and crew. If either crewman

is killed the weapon may still continue to move and fire so long as the other crewman is alive. If both crewmen are killed the weapon remains on the table but is effectively useless. If the weapon is shot at it is considered to have an armour value of 10 as if it were a vehicle. The attacking player rolls to penetrate the weapon's armour and if the armoured casing is penetrated the weapon is automatically destroyed. Crewmen whose weapon has been destroyed may continue to fight independently, join other Eldar Guardian support units as spare crew, or take over an anti-grav platform which has no crew.

The scatter laser may fire up to 6 shots during its shooting phase. Each shot may be fired at a different target if the player wishes, but the second and any subsequent targets must lie within 6" of the first. The player fires each shot in turn, working out any damage before firing again or moving to another target.

If you want to use lascannon or heavy plasma guns on this platform then all the rules for crews and mobility apply as described above. Lascannon and heavy plasma guns mounted in this way may move and fire, but heavy plasma guns must still recharge as normal.

Short Range	Long Range	To Hit Short	To Hit Long	Strength	Damage	Save Modifier	Special
0-20	20-60	+1		6	1	-1	See above

— TARANTULA —

The Tarantula is a semi-robotic weapon system capable of moving and firing its weapons under the direction of its controller. Its base has four broad feet into which are built gravitic reaction jets. These can lift and gently hover the Tarantula into position, enabling the weapon to draw a bead on its target without exposing the firer. The Tarantula is designed to carry a pair of weapons, both coordinated to fire at the same target. Various types of weapons can be fitted to the Tarantula, but lascannon are among the most popular.

Special Rules

The Tarantula can only move under its own gravitic power. The crewman is able to control the weapon's movement and shooting with his control box up to a distance of 4" away. The Tarantula may be moved up to 4" in the movement phase, but is not able to move through difficult terrain or over obstacles. Unlike many mobile support weapons the Tarantula can move and fire in the same turn - this is one of its strengths and one which makes it especially valuable. Its weapons can also fire in any direction.

Because the weapon is a distinct piece of equipment it is treated as a separate target from its crewman. At short range an enemy may select to fire at either the crewman or the Tarantula - assuming that he is able to see both. At long range shots are randomised. If the crewman is killed the weapon remains on the table but is effectively useless. If the Tarantula is shot at it is considered to have an armour value of 10 as if it were a vehicle. The attacking player rolls to penetrate the weapon's armour and if he is successful the weapon is automatically destroyed. Crewmen whose weapon has been destroyed may continue to fight independently, join other Tarantulas as spare crew or take over a Tarantula which has no crew.

The Tarantula is an adaptable mount and can be used to mount any pair of normally shoulder carried weapons of the same type: eg two heavy bolters, two autocannon, etc. Both weapons are fired at the same target. Roll once to hit - if a hit is scored then both weapons hit, if a miss is scored both weapons miss.

The profile below shows the details for lascannons.

Short Range	Long Range	To Hit Short	To Hit Long	Strength	Damage	Save Modifier	Special
0-20	20-60			9	2D6	-6	2 Shots - Roll once to hit See above
Twin lascannon							

THUDD GUN

The quad launcher is more commonly known as the thudd gun on account of the rhythmic and distinctive thudd-thudd-thudd-thudd noise that it makes when fired. The thudd gun is an invention of the Engineers Guild of the Squat Homeworlds, although it is supplied to the Adeptus Mechanicus who have copied the design. The weapon launches a close salvo of four shots, producing a pattern of four bursts on the ground. It is unusually heavy, and for this reason is always mounted on its own special motorised tractor unit. The thudd gun's crew carry a special radio control box with which they control the weapon's movement and firing. The crew are able to lob salvos high into the air, hoping they will land on unseen enemy formations or buildings held by the foe.

Special Rules

The weapon is so heavy that it can only move under its own power. It may move up to 4" in the movement phase so long as a crewman remains within 4" - this being the effective range of his radio control box.

A thudd gun may not move through difficult terrain or over obstacles. The weapon can be turned to face any direction without recourse to the control box, but it cannot otherwise be moved unless it is towed by a vehicle. Because the thudd gun requires a reasonable time to prepare for firing, it cannot move and fire during the same turn.

As the weapon is a distinct piece of equipment it is considered to be a separate target from its crew. At short range an enemy may select either of the two crewman or the weapon itself as the target. At long range shots are randomised between the gun and crew. If either crewman is killed the weapon may still continue to move and fire so long as the other crewman is alive. If both crewmen are killed the weapon remains on the table but is effectively useless.

If the weapon is shot at it is considered to have an armour value of 10 as if it were a vehicle. The attacking player rolls to penetrate the weapon's armour and if the armoured casing is penetrated the weapon is automatically destroyed. Crewmen whose weapon has been destroyed may continue to fight independently, join other thudd guns as spare crew or take over a thudd gun which has no crew.

When firing a thudd gun at a visible target treat it exactly like any other weapon. Roll to hit as normal. If the shot misses then work out scatter to determine where to position the special thudd gun salvo template. The procedure for using the template is described later.

The thudd gun may also be used to fire at targets which its crew cannot see. Shots of this kind are called **speculative** fire because the crew are speculating that there are enemy somewhere in the unseen area. The player, of course, knows full well where the enemy are! We assume the thudd gun crews don't know for sure, although they may have some idea thanks to information passed to them via their helmet communicators. If a player wishes to fire the thudd gun speculatively the following rules apply.

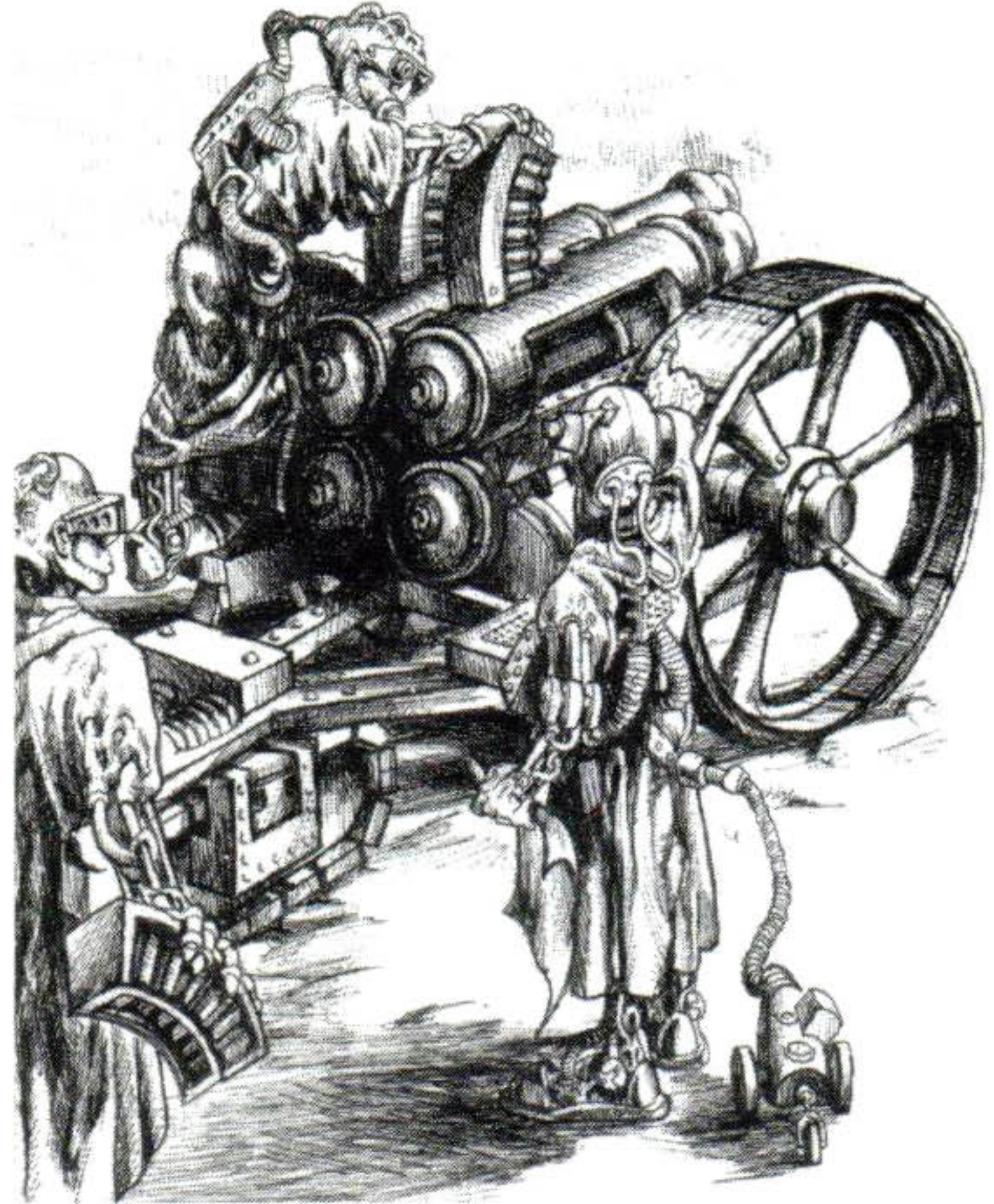

- 1 The player declares that he is firing speculatively in his shooting phase. A small marker is placed on the target point. The target point need not be a specific model, it can be any point on the table within the weapon's maximum range. This represents the trooper setting the range and place he wants to hit.
- 2 The player does not shoot the weapon that turn. Aligning the weapon to begin speculative fire takes up the whole turn.
- 3 The thudd gun must remain stationary for the remainder of the turn, throughout the enemy's turn, and until its following shooting phase. If it moves then the aim marker is moved and the player must start over again if he wants to use speculative fire.
- 4 In the following shooting phase, assuming the model has not moved, the thudd gun may fire at the target point already marked. Make a normal roll to hit, position the thudd gun salvo template as described below and work out damage as appropriate. If the shot misses work out scatter as normal.

Short Range	Long Range	To Hit Short	To Hit Long	Strength	Damage	Save Modifier	Special
0-12	12-72		-1	6	1	-2	4 x 1" blast Move or fire See above

With the new landing point established, take the thudd gun template and position the middle of burst 1 where the shell landed. The arrow on the template is positioned so that it points directly back towards the thudd gun (the 6 o'clock position). The Space Marine player now rolls a D12 for Template 1 scoring a 3. He now moves the arrow on Template 2 to the number 3 on Template 1. He continues repeating this process for the other remaining templates.

It is important to note that although a model may lie within two or more templates it can only be hit once. As normal any model partially covered by a blast template is hit on a D6 score of 4, 5 or 6. Damage and saves are worked out in the normal manner.

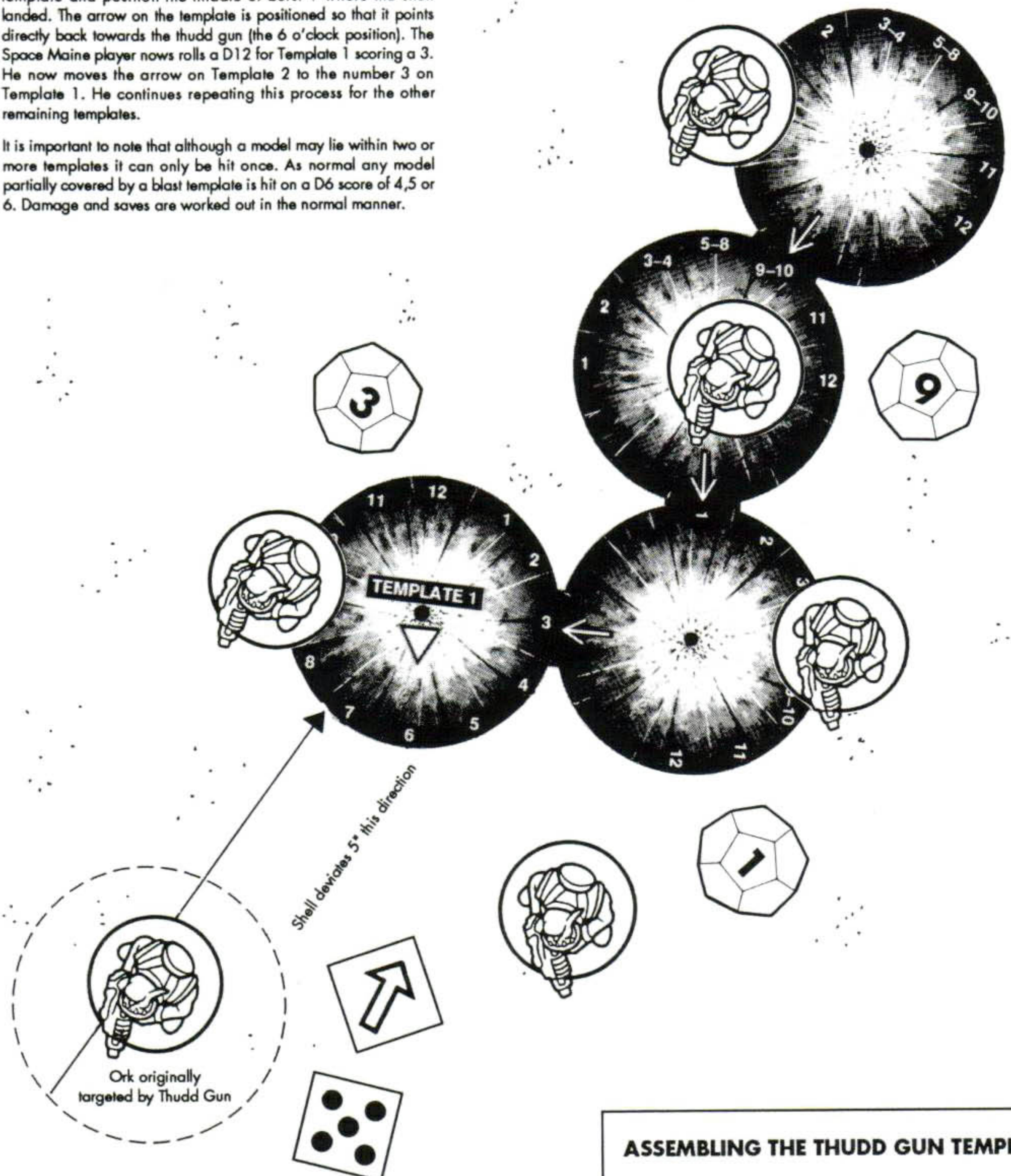

Ork originally targeted by Thudd Gun

Shell deviates 5* this direction

TEMPLATE 1

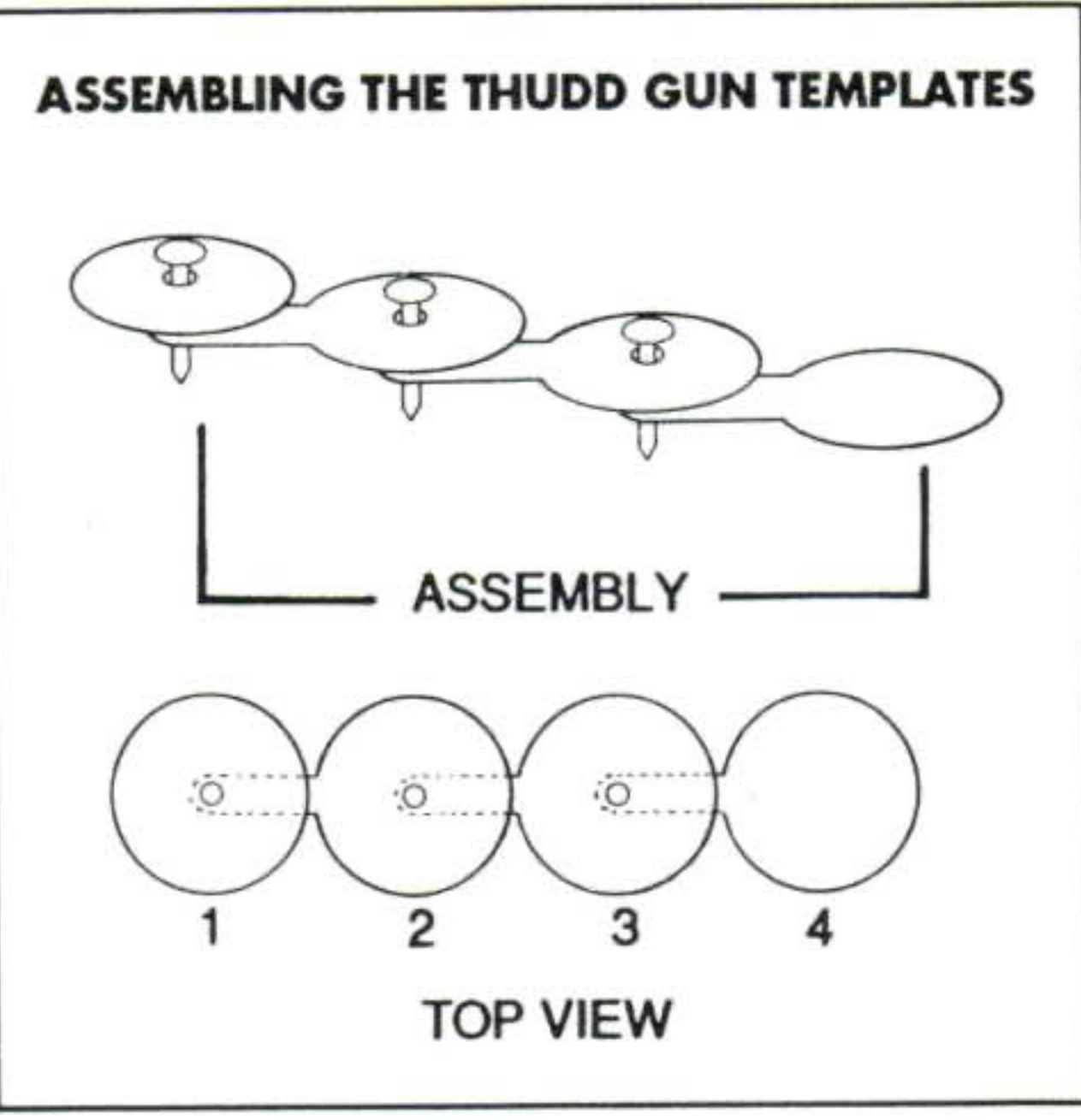

The Space Marine player fires his Thudd gun at a group of advancing Orks. He nominates the leading Ork as his target point and rolls to hit as normal. The shot misses and he must now roll for scatter. He rolls a directional arrow on the scatter dice indicating that the shot deviates by D6*. A roll of 5 on the D6 gives the distance the shell travels in the direction shown.

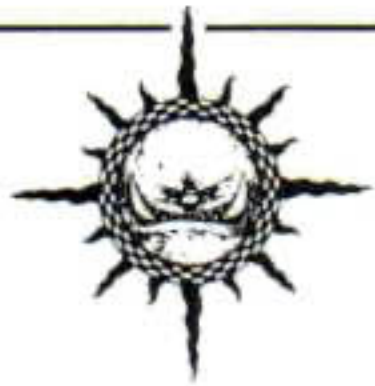

ORK KUSTOM WEAPONS

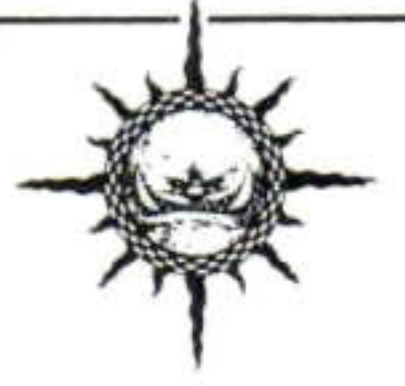

Ork Mek-Boyz build the most unusual and bewildering weapons incorporating all kinds of bizarre devices and modifications. Sometimes these work in a spectacular way, although often at the cost of startling unreliability, vastly reduced range, or some other strange side effect. As these weapons are so amazingly individual we have designed special rules for them. As these are lengthy and of interest only to Ork players we have not included these rules in the Battle Manual, but they can be found in 'Ere We Go' along with other special rules, army lists and information about Orks in Warhammer 40,000.

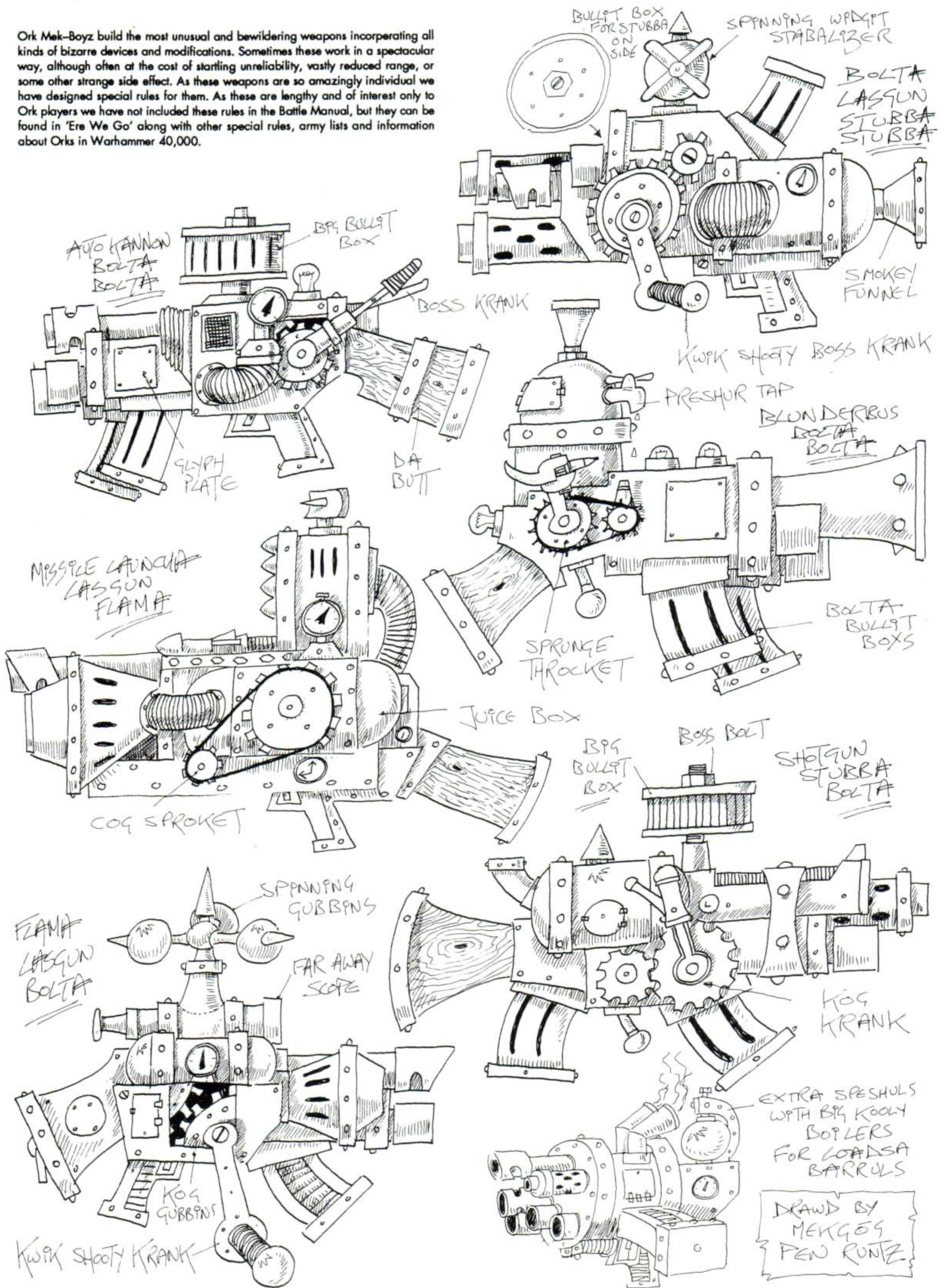

DRAWN BY
MEKGEES
PEN RUNTZ



ORK KUSTOM WEAPONS

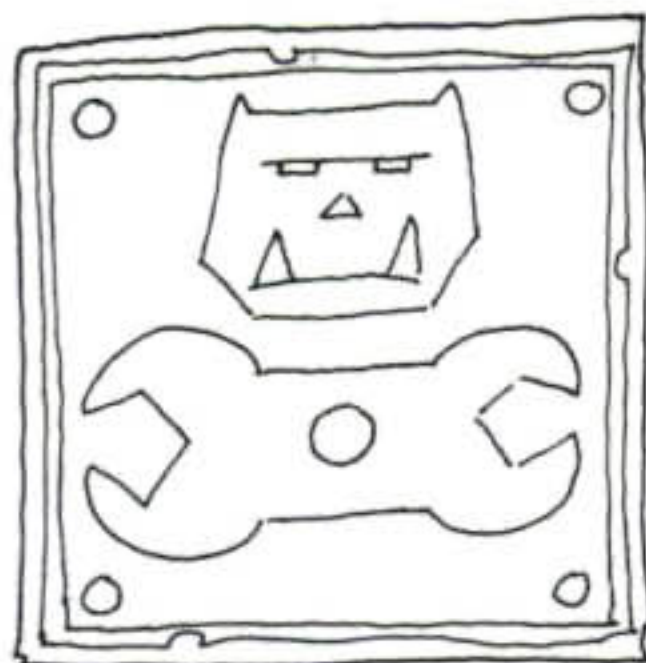

BIG BOSS MEK MEKGOG PLANS
OF TUFF SHOOTY EAVY GUNZ THATS
WOT WUN LOTSO F WARE FOR
DA BOYZ

EAVY LAS KANNON

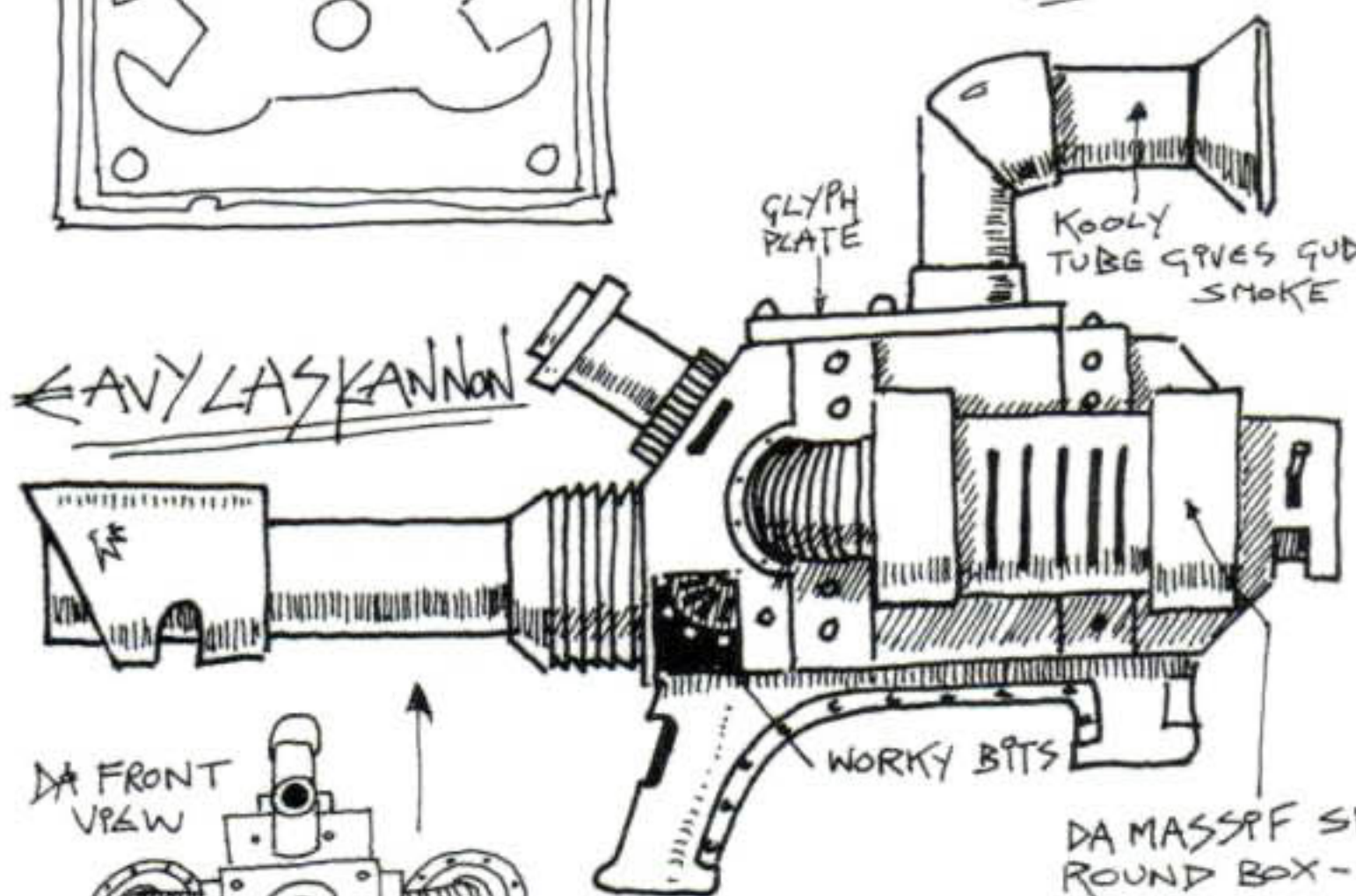

GLYPH PLATE
KOOPLY TUBE GIVES GUD SMOKE
WORKY BITS

EAVY BOLTA

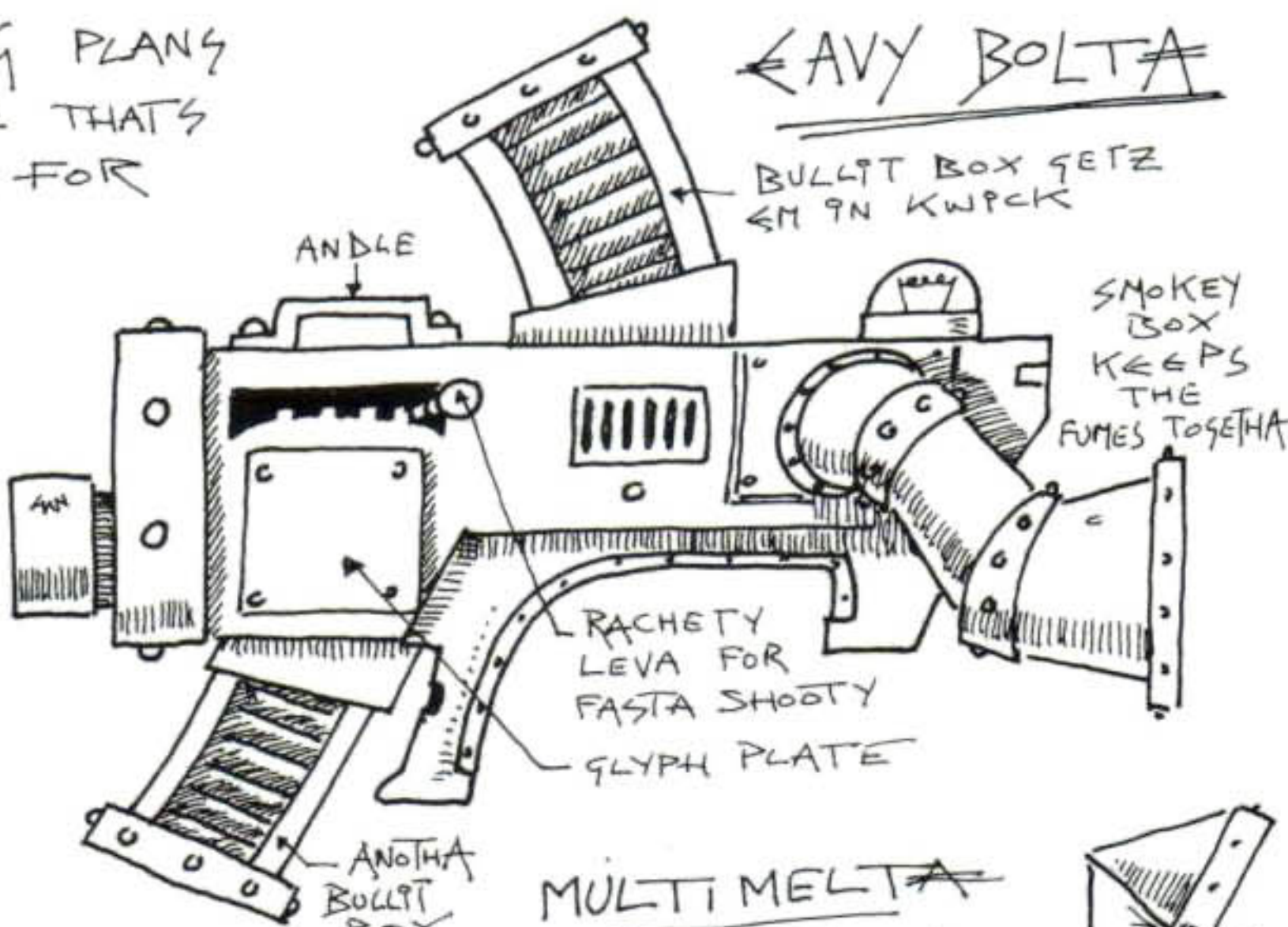

BULLIT BOX GETZ EM IN KWPKK
SMOKEY BOX KEEPS THE FUMES TOGETHA
RACHETY LEVA FOR FASTA SHOOTY
GLYPH PLATE
ANOHTA BULLIT BOX

DA FRONT VPEW

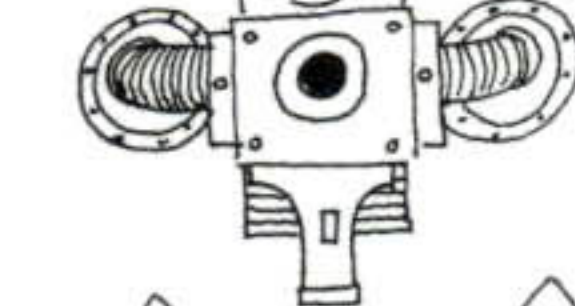

DA MASSIF SPARKY ROUND BOX - FEEDZ DA BIG BOOM TO THE SHOOTY END

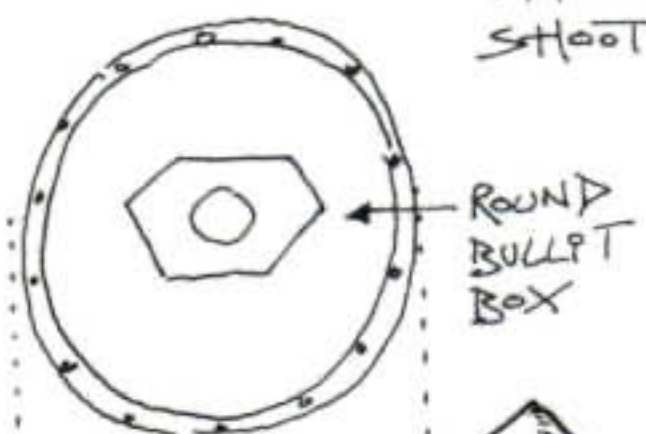

ROUND BULLIT BOX

MULTI MELTA

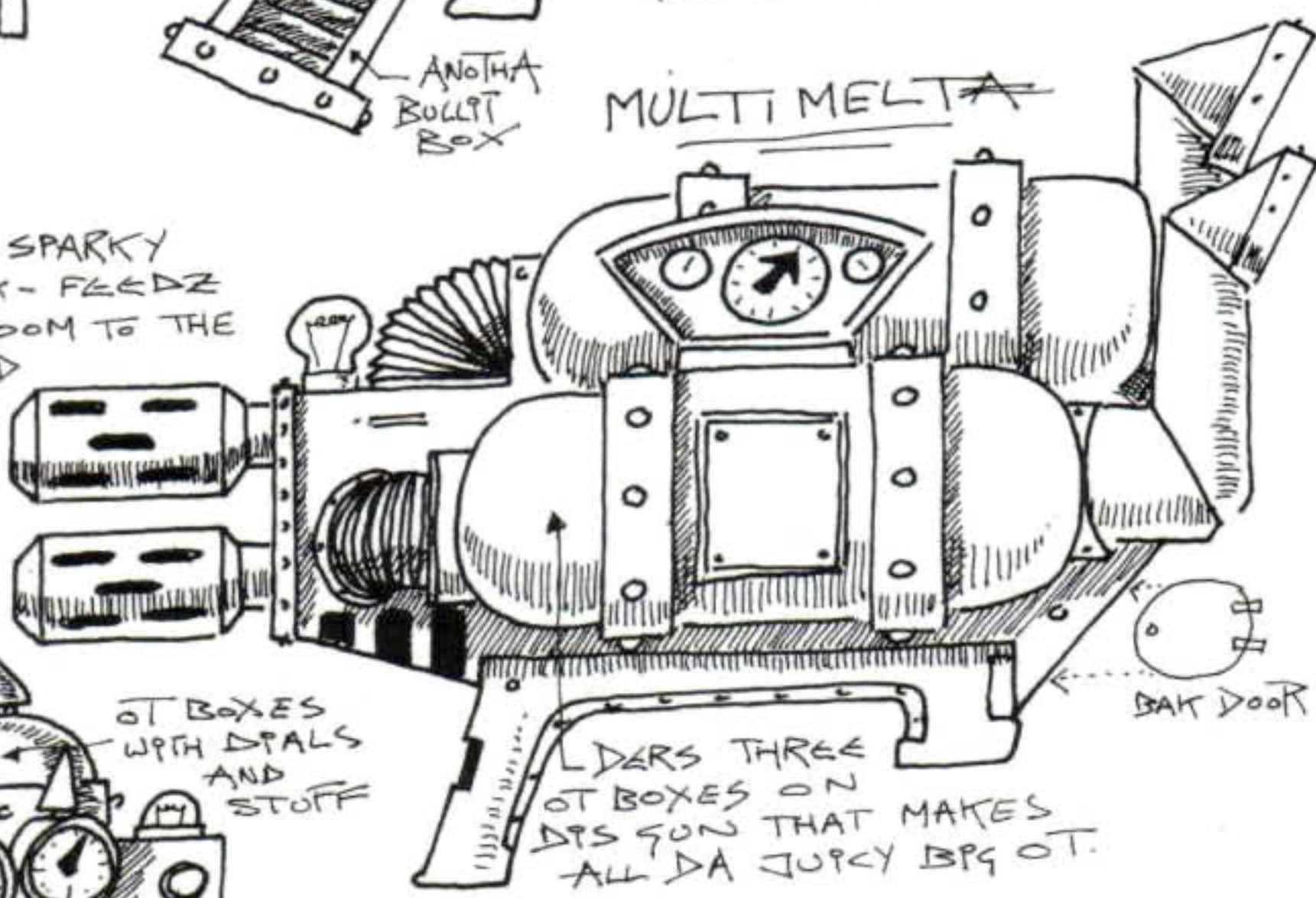

LDERS THREE OT BOXES ON DTS GUN THAT MAKES ALL DA JUICY BIG OT.

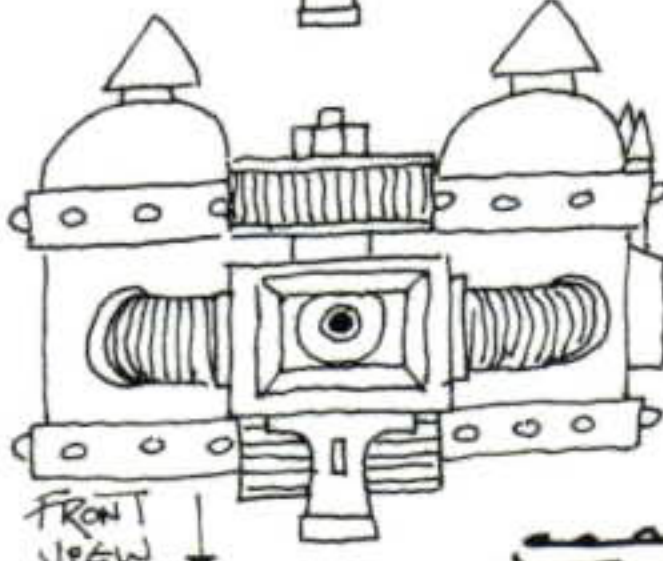

FRONT VPEW

OT BOXES WITH DIALS AND STUFF

EAVY STORBA

A KLEVA FRONT AND SIDE VPEW TOGETHA

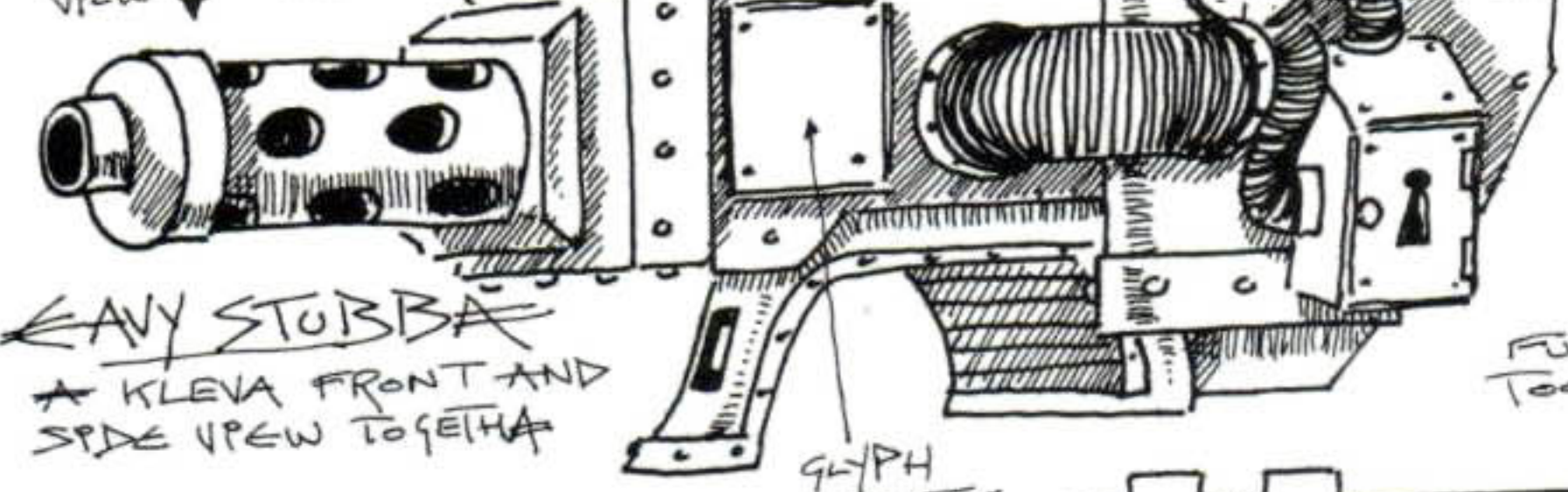

GLYPH PLATE

AUTO KANNON

BOSS BOLT MASSIF ROUND BULLIT BOX FOR DA SHELLS

FUNE TOOLZ

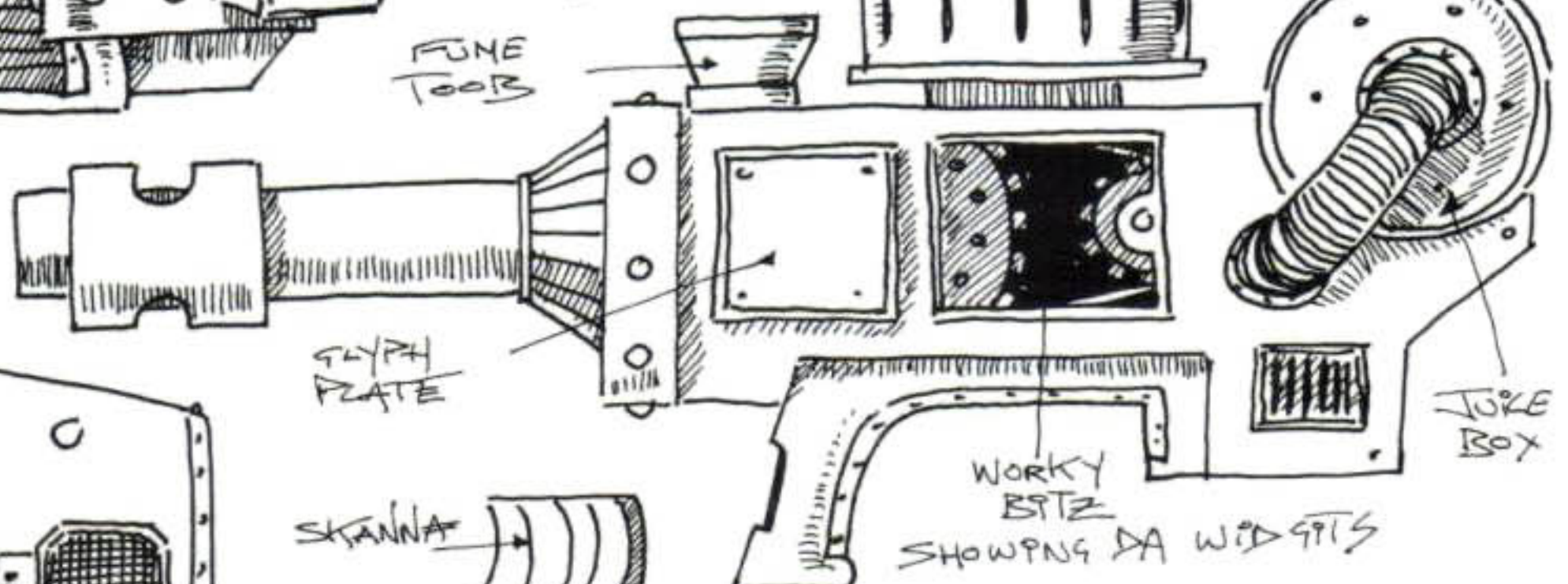

WORKY BITZ SHOWING DA WIDGITZ

JUKE BOX

EAVY PLASMA GUN

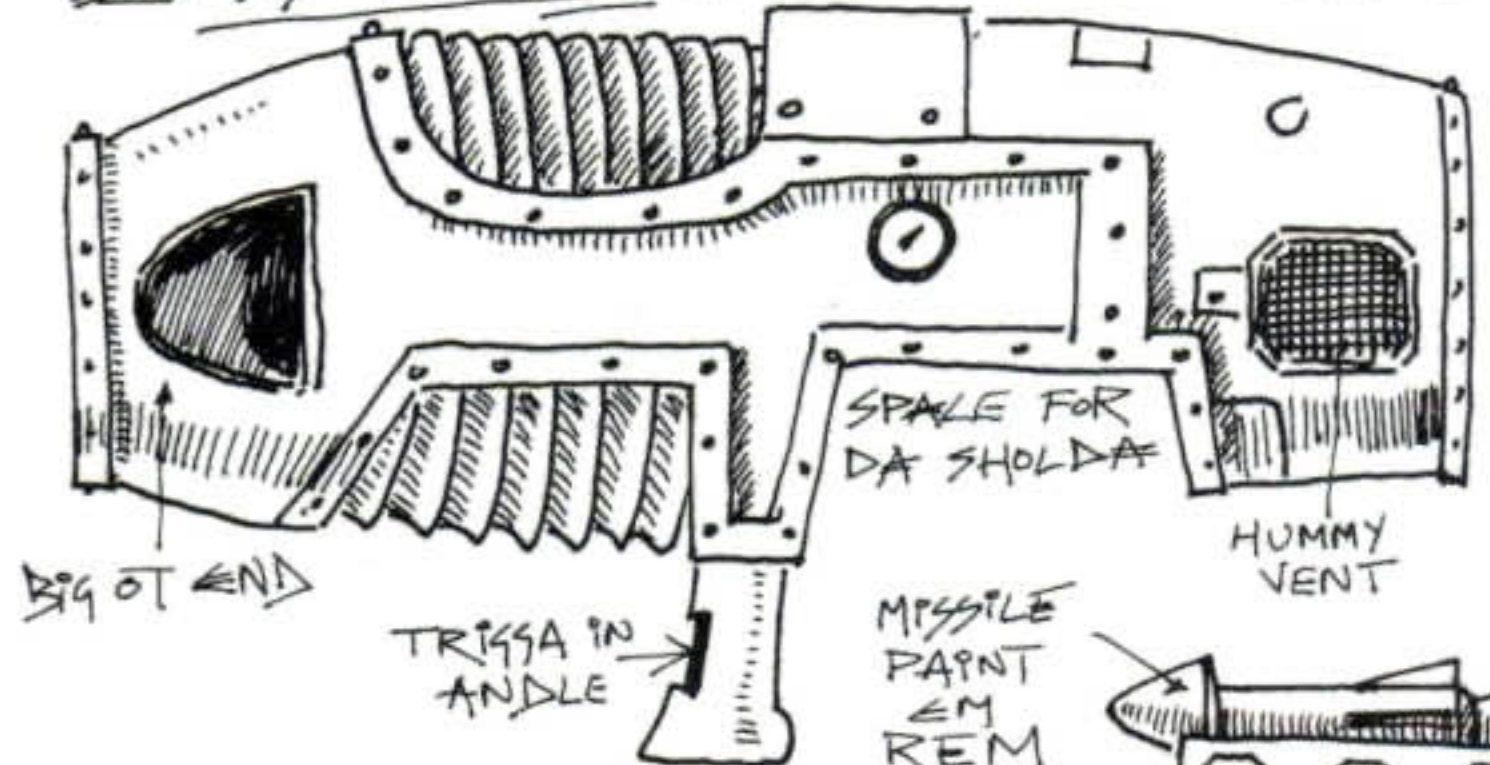

SPALE FOR DA SHOLDA

HUMMY VENT

MISSILE PAINT EM REM

TRISSA IN ANGLE

SKANNA

MISSILE BOX SHOOTY LIGHT

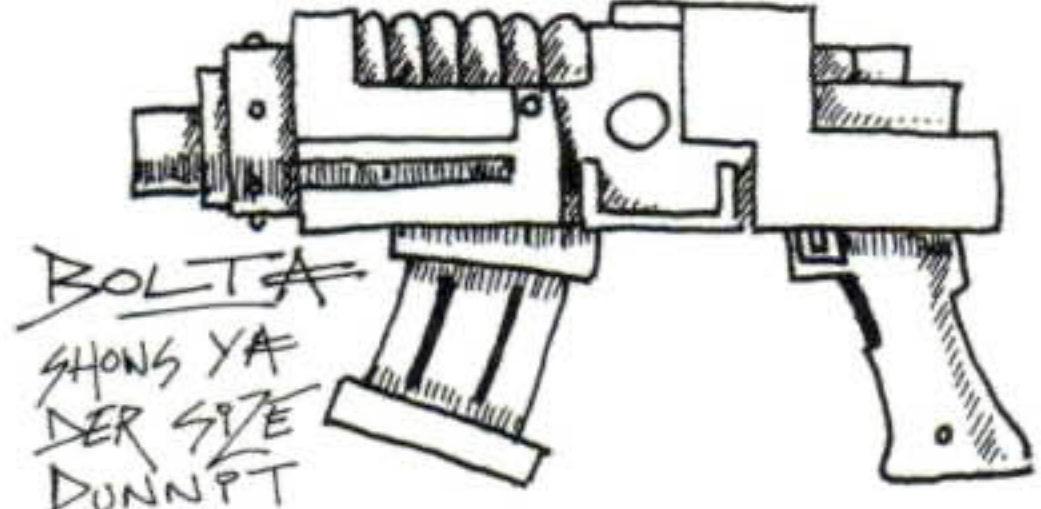

BOLTA
SHOWS YA DER SVE DUNNPT

BIG GURBPNS ON DA OUTSPDA

MISSILE LAUNCHA

DRAWN BY MEKGOG
PEN RUNT LADZ

GRENADES

Grenades are small bombs that are thrown by hand, varying in size from a sphere the size of a cricket ball, to no larger than a coin. There are many different types of grenades in the arsenal of the 41st millennium, designed to cope with a wide variety of combat situations. This section gives rules for the most common variants available.

ANTIPLANT

Strength	Damage	Save Modifier	Area
None	None	None	2"

Antiplant is the common name given to the many different types of defoliant grenade. These release a gaseous chemical which causes plant material to shrivel and die. There are thousands of different types of plant life throughout the galaxy, some of which are very different to terran plants, and many different sorts of defoliant have been developed to deal with them. Combat forces always make sure they carry the correct type for the world they are fighting on, so the different types are not distinguished in the game.

Antiplant has many uses in addition to the battlefield role of depriving enemy of cover. For example, it is used to create instant landing strips, to clear camp sites, and to prepare areas for building. The gaseous defoliant destroys the toughest foliage, but does not harm animal life and causes no damage to troops or machines.

BLIND

Strength	Damage	Save Modifier	Area
None	None	None	2"

Blind or baffler grenades are a sophisticated type of smoke grenade which release a cloud of smoke, infra-red baffler and broad spectrum electro-magnetic radiation. It is impossible to see through blind-smoke with normal eyesight, and even artificial sight aids like infra-red vision, scanners, targeters, or bionic eyes have no effect. No troops may shoot into or through a cloud of blind-smoke, and even psykers may not use their powers if a blind cloud hides their target.



Any models within the cloud have the choice of remaining stationary or moving at half rate in a random direction. Models in hand-to-hand combat within a cloud may fight, but any advantage of higher initiative value is lost due to the inhibited visibility – therefore any tied score is a draw and the highest initiative does not win as normal.

When a blind grenade is thrown work out where it lands as normal. Place a 2" radius area marker, or patch of cotton wool, on the spot to represent the cloud of baffler smoke. At the beginning of each side's turn one player rolls a D6 and consults the chart below.

CLOUD MOVEMENT (D6)

- 1 Cloud remains until end of the testing side's turn and then disappears with no further effect.
- 2-4 Cloud remains where it is.
- 5 Cloud shrinks to half current radius rounding down to nearest ½".
- 6 Cloud moves away D6" in a random direction.

CHOKER

Strength	Damage	Save Modifier	Area
None	None	None	1½"

Choke is a non-lethal gas which causes anyone who breathes it in to gasp and choke, making it impossible for them to do anything else. Most troops breathe air directly from the atmosphere, or air which is filtered but not sufficiently purified to make any difference to a choke attack. Space Marines wearing Power or Terminator armour and Eldar Aspect Warriors are not affected as their armour completely isolates them from the environment and has its own air supply. Enclosed vehicles and Dreadnoughts are also immune as they are assumed to be airtight. Other troops, including Space Marine Scouts, Imperial Guard, Eldar Guardians, and Orks, must try to avoid breathing in too much of the gas although much will depend upon the wind, how close they are, and how much warning they have. Choke gas has no effect upon daemoniac troops, robots, or other mechanical devices.

Throw the grenade, work out where it lands and place a 1½" radius blast marker, or a patch of cotton wool, on the spot to represent the gas cloud. Models whose bases are totally within the cloud are hit and cannot avoid breathing in the gas. Models whose bases are partly within the cloud are hit on the D6 roll of a 4, 5 or 6 - they stand some chance of avoiding breathing too much gas. Models hit by the gas make an immediate Choke Test.

CHOKE TEST

Troop Type	D6 Roll to Choke
Space Marines, Eldar Aspect Warriors, Dreadnoughts, Terminators, enclosed vehicles.	No effect
Other Troops including Space Marine Scouts, Eldar Guardians, Imperial Guard, Squats and Orks.	3+

Models affected by choke gas fall to the floor choking and coughing. They can do nothing else, and remain incapacitated as long as the gas cloud covers them. Once the cloud disperses or moves away they recover automatically. Models which have been immobilised by choke gas may be ignored for purposes of unit coherency, but they must try to rejoin their unit as soon as possible once they recover.

The cloud of choke gas is left on the table. At the beginning of each side's turn roll a D6 and consult the chart below.

CLOUD MOVEMENT (D6)

- 1 Cloud remains until end of the testing side's turn and then disappears with no further effect.
- 2-4 Cloud remains where it is.
- 5 Cloud shrinks to half current radius rounding down to nearest 1/2".
- 6 Cloud moves away D6" in a random direction.

FRAG

Strength	Damage	Save Modifier	Area
3	1	-1	2"

Frag is the term commonly used by troops to describe the Imperial issue fragmentation grenade. This is one of the most commonly carried grenades among Imperial and most other forces, and takes various shapes including the stick-shaped Ork Frag Stikkbomb. All these grenades are designed to explode and fragment causing havoc among unprotected troopers. Some are quite large (the Ork version is a simple can on a stick!), but there are special miniature versions no bigger than a large coin which fragment into hundreds of mono-molecular super-sharp slices and cause considerable damage despite their lack of mass. Note that frag grenades are not as effective as frag missiles fired from a missile launcher - the latter are much more substantial weapons with a more devastating effect.



HALLUCINOGEN

Strength	Damage	Save Modifier	Area
None	None	None	1 1/2"

Hallucinogen is an invisible hallucinogenic gas which affects troops who inhale it. It has strange and unpredictable effects upon the mind, turning victims into slavering idiots, homicidal maniacs, or passive zombies. Only troops isolated from their environment are safe. Space Marines wearing Power or Terminator armour are not affected, and neither are Eldar Aspect Warriors - these troops wear sealed armour which has its own air supply. Enclosed vehicles and dreadnoughts are also immune as they are assumed to be airtight. Other troops, including Space Marine Scouts, Imperial Guard, Eldar Guardians, and Orks, must try as best they can to avoid breathing in too much of the gas.



Throw the grenade, work out where it lands and place a 1 1/2" radius blast marker on the spot to represent the spread of the gas. Models whose bases are totally within the area are hit - they cannot avoid breathing in the gas. Models whose bases are partly within the area are hit on the D6 roll of a 4, 5 or 6 - they stand some chance of avoiding breathing too much gas. Models hit by the gas make an immediate test as shown below.

HALLUCINOGEN TEST

Troop Type	D6 Roll to Effect
Space Marines, Eldar Aspect Warriors, Dreadnoughts, Terminators, enclosed vehicles.	No effect
Other Troops including Space Marine Scouts, Eldar Guardians, Imperial Guard, Squats and Orks.	4+

The gas cloud is not persistent but disperses almost immediately. Determine which troops are affected and then remove the marker. The gas is now assumed to have become too dilute to have any further effect. Models affected are subject to some sort of compulsory or erratic behaviour. This may be permanent or it can last for several turns, in which case unit coherency does not have to be maintained by affected models. If models recover then they will attempt to rejoin their unit as soon as possible.

The effects of hallucinogen gas are determined for each victim separately and may last for one or several turns. Roll a D10 and consult the Hallucinogen Effects Table.

HALLUCINOGEN EFFECTS TABLE (D10)

- 1 Your hands and limbs are slimy tentacles and your fingers turn into writhing worms! You know this is an illusion and try to snap out of it.
Roll a D6. On 1-3 roll again on this chart. On 4-6 the model shrugs off the illusion and suffers no further effects.
- 2 The world is spinning and everything is all jumbled up. Your friends are all speaking too fast, you are speaking too slowly and somewhere you can hear inexplicable laughter. The faces around you change into the familiar faces of old friends, old comrades, warriors long dead and buried. You are going mad!
At the start of each of your following turns roll a D6. On the score of a 1-3 the model may do nothing that turn; on the score of a 4-6 the model shrugs off the illusion and suffers no further effects.
- 3 Thousands of spiders drop onto you, crawling into your armour and inside your clothing, swarming over your face and hands. You fall to the ground clawing and scratching your own body.
The model may do nothing while the illusion lasts. At the start of each of your following turns roll a D6 - on the score of a 6 the illusion ends with no further effect.
- 4 In the nearest patch of cover you see something move, something horrible, something dangerous...
The model may not move, but must shoot into the nearest patch of cover regardless of what, if anything, lies within it. The model remains immobile, shooting into the cover while the illusion lasts. At the start of each of your following turns rolls a D6. On the score of a 6 the illusion ends with no further effect.
- 5 Now is your chance to slip away from the others, while no-one is looking. You'll be home within a week and all this will be just a bad memory.
In its next movement phase the model heads off towards the nearest table edge, moving as fast as possible and without shooting. The model continues to move until it leaves the table.
- 6 The sky is so big and wide and inviting. Why don't you just fly into it like a bird, rolling and tumbling on the wind? The individual drops his weapon, his eyes become wide and vacant, he begins to jump up and down and flap his arms furiously.
The model continues to move around the table randomly each turn, flapping his arms and staring at the sky, and continues to do this until it leaves the table.
- 7 The enemy are all around, behind every rock, hiding in the forests, in tunnels beneath your feet, dropping down from the skies on grav-chutes. Fire fire fire! It's your only chance. Keep shooting. Keep moving!
The model goes completely out of control, shooting randomly and screaming about the enemy. During the model's own turn it is moved randomly at normal speed, and shoots its weapons in a random direction. Roll to hit the first model in the direction of fire (if any). The model continues to move and fire in this out of control state for the rest of the game.
- 8 Your fellow troopers are out to get you! They're probably traitors, they all hate you and mean to kill you if you let them. But you're too clever to fall for their tricks! You'll get them first!
In its own turn the model will attempt to shoot the nearest model, be it friend or foe, moving in such a way so that it can do so. The model continues to shoot at the nearest target for the remainder of the game, moving towards it where this does not prevent shooting.
- 9 It's all too much - the war, the killing, the endless misery. Chronically depressed, the trooper sits down upon the ground oblivious to everything around him.
The model remains in its current position for the remainder of the game, burbling quietly about 'the horror', and may do nothing else.
- 10 Suddenly its all so clear! The fighting, your fellow troopers, everything, it's all so funny! Nothing matters any more, it's a huge cosmic joke. You begin to laugh.
During its own movement phase the model moves as fast as possible in a randomly determined direction, screaming hysterically, and gesturing insanely at the nearest troops. The model continues in this fashion until it leaves the table. It can do nothing else.



HAYWIRE

Strength	Damage	Save Modifier	Area
None	None	None	1½"

Haywire or scrambler grenades emit a burst of strong electromagnetic interference which scrambles delicate circuits and overloads instruments. They are used to disrupt the robotic minds and control systems of Dreadnoughts, robots and vehicles. The effect is usually spectacular: the target jumps around jerkily, sparks fly in all directions while the operative tries feebly to control it.

A Haywire grenade can be used against a vehicle, robot, or Dreadnought, and is also effective against troops wearing Terminator Armour and Eldar Spirit Warriors - which are essentially spirit powered Dreadnoughts or robots. However, its principle use is against vehicles. The effect is as follows.

HAYWIRE EFFECT (D6)

VEHICLE OR DREADNOUGHT

Roll	Effect
1-2	No effect.
3-5	Machine goes out of control in its following turn. While out of control no weapons may be fired. The machine is only affected for 1 turn.
6	Machine goes out of control in its following turn. The machine continues to go out of control until 4, 5 or 6 is rolled on a D6 at the start of its turn. While out of control one randomly determined weapon will shoot at the nearest possible target (friend or foe). Other weapons cannot be fired while the machine is out of control.

ROBOTS, SPIRIT WARRIORS OR TERMINATORS

Roll	Effect
1-2	No effect.
3-5	The model is deactivated completely in its following turn. Circuits fizzle and pop, and the model whirs and jerks as it performs a disconnected and clumsy dance. The model is only affected for 1 turn.
6	In its following turn the model moves in a random direction at its normal move rate. Once it has moved it will attempt to shoot the closest possible target (friend or foe). The model continues to move and shoot in this way until 4, 5 or 6 is rolled on a D6 at the start of its turn, after which it is no longer affected.

Players may decide for themselves whether Haywire may affect other large pieces of machinery. There is no way we can provide an exhaustive list as new models are being made all the time!

KRAK

Strength	Damage	Save Modifier	Area
6	D6	-3	None

Krak grenades, also known as armour piercing grenades, are designed to crack open heavily armoured targets such as fighting vehicles and Dreadnoughts. They can also be used against foot troopers and are given a save modifier to reflect their armour penetrating abilities. The entire explosive effect of the krak grenade is concentrated against the target, so there is no large blast and no blast marker is used. Note that the krak grenade is smaller and less powerful than a krak missile and has a slightly less effective profile to reflect this.

Special Rules

The krak grenade is unusual in that it has no blast area. If it misses the target use the scatter rules to establish where the grenade lands. If it lands directly on another model then that target is considered to have been hit and damage is worked out as normal. This is most useful when attacking a building or vehicle, where a miss may still land where it will cause harm.

PHOTON FLASH FLARE

Strength	Damage	Save Modifier	Area
None	None	None	1½"

Photon flares explode with a tremendously powerful flash of light, enough to blind or dazzle any troops whose eyes are not protected in some way. Even troops wearing protective visors or goggles may be blinded temporarily, and light sensitive equipment such as infravision devices and targeters will be destroyed automatically.

All models completely within the blast area are hit by the light blast and must test to see if they are dazzled or blinded. Models partially within the blast area may be lucky enough to shield their eyes in time: they are hit by the light blast on a roll of a 4, 5 or 6. The following table shows the effect on troops who have been hit by the light blast.

FLASH EFFECT (D6)

	No Effect	Dazzled	Blinded
Unprotected Troops	—	1	2+
Troops wearing protective visors	1-3	4-5	6
Troops equipped with auto-senses	1-5	6	—

EXAMPLES:

Unprotected troops – Orks, Gretchin, Snotlings.

Troops with protective visors – Imperial Guards, Eldar, Squats, Space Marine Scouts.

Troops with auto-senses – Space Marines, Terminators, Dreadnoughts and enclosed vehicles.

We cannot produce an exhaustive list as new models are being made all the time. It is up to you to decide which troops are protected and which ones are not.

GRENADES

Some special Imperial agents have chemically induced or surgically implanted forms of eye protection. This can take the form of a bio-cultured artificial implant, a photochromic chemical injection, or a biosolenoid implanted into the optic nerve. Such instances are rare enough to be covered in the army lists for Imperium agents rather than here.

Auto-senses are artificial senses which relay a visual image directly into the mind, bypassing the eyes and optic nerve. Autosenses may look like goggles or the visor of a helmet, but are actually far more sophisticated, automatically shutting off if sensory stimuli reach dangerous levels. Auto-senses are fitted as standard on Space Marine helmets, Dreadnoughts and vehicle view screens but are not otherwise common.

Dazzled troops are temporarily disoriented by the light flare. Their WS and BS are reduced to 1 for the remainder of the current turn, though they are not otherwise affected. This result is only of any significance if the target is already in hand-to-hand combat.

Blinded troops cannot see where they are going. They may move, but do so in a random direction and at half their move rate. Alternatively, they may choose to remain stationary. As they can no longer see, blinded troops do not have to maintain unit coherency. Blinded troops may not shoot, but may fight in hand-to-hand combat with a WS of 1. Troops who have been blinded are automatically blind for the remainder of the current turn and their entire following turn. After that, the player rolls a D6 for each model at the start of each of his following turns.

D6	Result
1-4	Remains blind.
5-6	Recovers sight immediately.

Once a model has recovered its sight it may move and shoot normally, and must attempt to re-establish unit coherency if possible.

PLASMA

Strength	Damage	Save Modifier	Area
5	1	-2	1½"

Plasma is an unpleasant and unstable material in a highly energised state - when a plasma grenade explodes it creates a ball of shining plasma like a miniature sun.

Determine where the grenade lands as normal and place a 1½" area marker or ball of cotton wool. Work out damage on the models within the area as normal. Do not remove the area marker once casualties have been resolved. Instead leave the marker in place, the area covered by the marker has undergone a matter/energy transformation and is now glowing like a small sun. At the start of each side's following turns, a player should roll a D6.

PLASMA BALL (D6)

Result	Plasma Ball Size
1	The plasma area expands its radius by D6" and disappears at the end of the turn.
2-5	The plasma area shrinks its radius by ½".
6	The plasma area shrinks upon itself and disappears immediately causing no harm this turn.

The plasma area remains on the table until it disappears. Any model within the area during a turn suffers an automatic hit. No model may draw a line of sight through the plasma area, as all weapons discharged into it merely feed the matter-energy conversion.



RAD GRENADE

Strength	Damage	Save Modifier	Radiation effect Area
D6+D4	1	-3	D3" secretly recorded

Radiation grenades are dangerous because the deadly radiation they emit is persistent, erratic and impossible to see. It can be detected by means of a Scanner but such equipment is not normally part of an ordinary trooper's kit. To use radiation grenades you will need to cut out the markers provided in the back of the book or make your own from some thin card. These radiation counters are used to mark the spot where the rad grenades land.

The player nominates his target as normal - this does not have to be a specific model, it can be an area of ground or a piece of scenery. Before rolling to hit, the player secretly rolls a D3 (ie half the score of a D6 rounding up) and notes the result on one side of a blank counter. Determine where the grenade lands and place the counter face down on this point. This number is the range of the radiation effect and it will be 1", 2" or 3". This distance is known to the player who threw the grenade, but not necessarily to the other side. If any target moves within the distance it is automatically hit by the radiation.

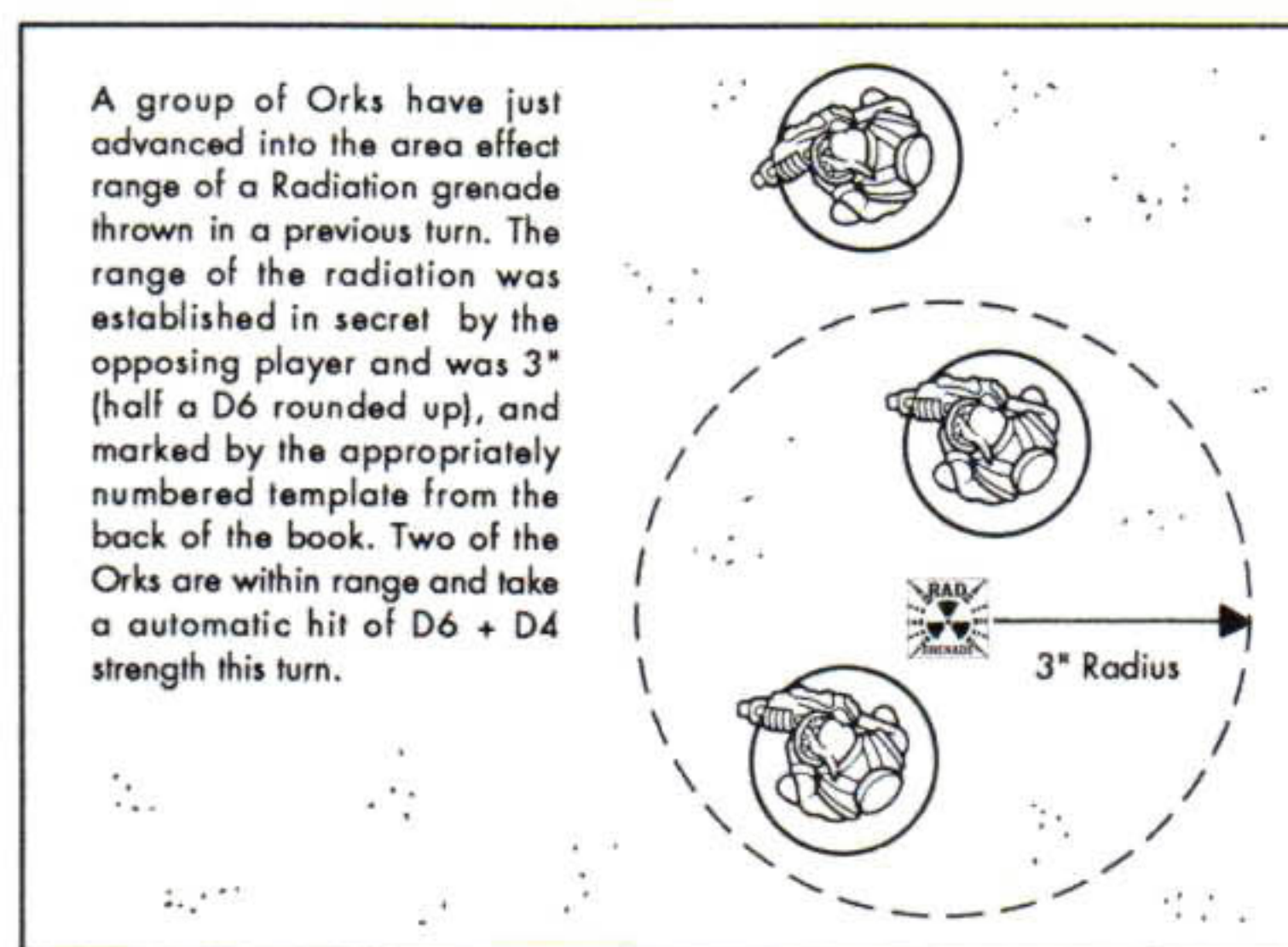

Once any damage has been worked out the counter is turned over again so that the number is hidden once more. The counter remains in place for the remainder of the game. Only the player who threw the grenade is allowed to look at the counter, the other side must try to remember its value. Any models which approach within the radiation effect distance are automatically hit, and they will be hit every turn if they remain where they are.

Radiation damage is worked out with a randomly determined strength each turn. The same strength value applies to all targets hit by that grenade during that turn. This is established by adding the score of a D6 to that of a D4 (D6+D4), so the strength of the radiation varies from 2 to 10.

If players have the benefit of a neutral third party then he can make the radiation effect distance roll and keep the result secret from both sides. No player may look at the number on the counter and the neutral party will adjudicate the effect of radiation hits. This is by far the most satisfactory way of resolving radiation, as it does not give one player the unrealistic advantage of knowing the value of the radiation counters.

SCARE

Strength	Damage	Save Modifier	Area
None	None	None	2"

Scare is a form of non-persistent gas which affects the central nervous system and produces feelings of deep anxiety and apprehension. When the grenade explodes the gas is showered over a wide area. It is absorbed quickly through the skin and so only troops who are totally isolated from the environment are safe. Space Marines wearing Power or Terminator armour are not affected, and neither are Eldar Aspect Warriors because their armour has its own air supply. Enclosed vehicles and dreadnoughts are also immune as they are assumed to be airtight. Other troops, including Space Marine Scouts, Imperial Guard, Eldar Guardians, and Orks, must try to avoid breathing in too much of the gas.

Throw the grenade, work out where it lands and place a 1½" radius blast marker on the spot to represent the spread of gas. Models whose bases are totally within the area are hit - they cannot avoid breathing in the gas. Models whose bases are partly within the area are hit on the D6 roll of a 4, 5 or 6 - they stand some chance of avoiding breathing too much gas. Models hit by the gas make an immediate Scare Test as shown below.

SCARE TEST

Troop Type	D6 Roll to Scare
Space Marines, Eldar Aspect Warriors, Dreadnoughts, Terminators, enclosed vehicles.	No effect
Other Troops including Space Marine Scouts, Eldar Guardians, Imperial Guard, Squats and Orks.	2+

The scare gas cloud disperses almost immediately. Determine which troops are scared and then remove the marker. The gas is now assumed to have become too dilute to have any further effect. Scared troops behave as described below.

If the model is in cover it will remain where it is, too scared to move or act in any way. It will not fire weapons or move. Unit coherency is suspended for this model.

If the model is not in cover it will immediately turn towards the nearest cover that lies away from the enemy or the table edge if this is closer. During its own turn the model will move as fast as it can towards this cover, and will take cover in it if possible. The model can do nothing else, and may not use its weapons or fight if attacked. Unit coherency is suspended for this model.

Once scared a model may shake off the effects of the gas if it rolls a 5 or 6 on a D6 at the start of its own side's turn. Otherwise the effects last for the rest of the game.



SMOKE

Strength	Damage	Save Modifier	Area
None	None	None	2"

Smoke grenades are a simple means of shrouding areas of the battlefield from the enemy's vision. It is impossible to see through smoke with normal vision, but troops equipped with infra-red vision, scanners, targeters, or bionic eyes can see clearly through smoke. In this respect it is not as effective as Blind which is impossible to see through even with these devices.

Troops unable to see through smoke may not shoot into or through the smoke cloud. Psykers' powers are unaffected by smoke, but they may not see through it using their normal vision. Any models within a smoke cloud have the choice of remaining stationary or moving at half rate in a random direction.

Models unable to see through smoke may still fight in hand-to-hand combat, but any advantage of higher initiative value is lost due to the inhibited visibility – therefore any tied score is a draw and the highest initiative does not win as normal.

When a smoke grenade is thrown work out where it lands as normal. Place a 2" radius area marker, or patch of cotton wool, on the spot. At the beginning of each side's turn one player rolls a D6 and consults the chart below.

CLOUD MOVEMENT (D6)

- 1 Cloud remains until end of the testing side's turn and then disappears with no further effect.
- 2-4 Cloud remains where it is.
- 5 Cloud shrinks to half current radius rounding down to nearest ½".
- 6 Cloud moves away D6" in a random direction.

The following list summarises those troops who wear some form of infra-vision goggles or visors, or whose helmets include auto-senses which can see through smoke:

Space Marine Scouts, Space Marines, Space Marine Terminators, all Imperial Guard forces, Squats, all Dreadnoughts, all enclosed vehicles, all Eldar including Aspects and Guardians.

The only major races of troops whose equipment does not enable them to see through smoke are therefore Orks and Tyranids.

STASIS

Strength	Damage	Save Modifier	Area
None	None	None	2"

The stasis grenade is a rare and unusual weapon developed by the Adeptus Mechanicus for use by the special agents of the Imperium. It is not generally issued to combat troops as it is very expensive, but they do occasionally appear on the open market where planetary rulers will pay exorbitant prices for a single grenade.

Futhermore, because the Stasis grenade is relatively bulky and cannot be used with a grenade launcher, the range, and therefore the grenade's tactical use on the battlefield by the average soldier, is more limited.

At its heart lies a small time-warp generator that creates a self-replicating time-warp or stasis-loop centred upon itself. Everything close to the grenade is condemned to relive the same instant time and time again, effectively trapping that section of space and time in a single moment, making the scene appear frozen to observers further away. The effect of the time-warp field weakens as the distance from the grenade increases. The loop becomes longer and longer, so that while time is slowed down it does not wholly stop. Troops within this outer area appear to move far slower than normal but can still move and act although in a restricted fashion. A stasis-loop lasts only for a limited time, but may persist for several game turns.

The player nominates his target model, visible area of ground, or piece of scenery. Determine where the grenade hits as normal and place a 2" blast marker. Everything within the area is trapped in a stasis-loop. Models whose bases are only partially within the area are trapped on a roll of 4, 5 or 6 - if they manage to avoid being trapped move these models out of the area. Nothing can happen inside a stasis-loop, models may neither act nor be affected by the actions of anything outside the loop, they cannot move or shoot and they cannot be shot at. It is not possible to shoot through a loop, although it is possible to see through it normally.

Objects and troops immediately outside the stasis loop are caught in a time distortion. This affects all models within 4" of the centre of the blast marker (other than models within the blast marker itself). Note that this is not an area marker and there is no need to roll to hit troops to see if time distortion takes effect. All models within 4" of the spot where the grenade lands are affected automatically regardless of whether their entire base is within the area or not. These models may move during their own turn, but may only do so at half rate. They may shoot during their own turn, but may not shoot for two turns in succession. Similarly, all of their actions take twice as long as normal, and can therefore only be attempted every alternate turn (psychic powers for example).

Hand-to-hand combat is only worked out every other turn. Models may move out of the time distortion if they have sufficient movement, and are then free of its effects. Models which move into the stasis-loop from the distortion area are trapped inside the stasis. Models within the distortion area may be shot at by troops outside. There is a -2 to hit modifier for shooting into, through or out of a time distortion.

The stasis-loop and associated time distortion area may persist for several turns. At the beginning of each side's turn one player rolls a D6 and consults the Stasis Loop Chart.

STASIS LOOP CHART (D6)

D6 Result	Stasis loop effect
1-2	The effect remains until end of the testing side's turn and then the grenade's power source is exhausted. The stasis-loop is removed with no further effect.
3-6	The loop remains in place.

TANGLEFOOT

Strength	Damage	Save Modifier	Area
None	None	None	See below

This is another grenade developed by the Adeptus Mechanicus and used in small numbers by elite Imperial forces and special agents. This grenade consists of a small but extremely powerful magno-gravitic reactor, similar in principal to the gravitic reaction motors that power many hovering vehicles. The tanglefoot creates a field at and just above ground level, imposing an opposing force to any movement. This is known as a tanglefield, or tripfield, because walking over the ground is rather like walking over a mass of trip wires.

Work out where the grenade lands as normal and place a small card chit or other suitable marker on the spot. Any models within 3" of the marker move at half rate. This does not affect any other actions, and the models may shoot and use psychic powers normally.

Vehicles moving into a tanglefield are also affected. Every inch covered counts as 2" while inside the field. As the vehicle leaves the field the vehicle must make a test to check its course. Roll a D6.

VEHICLE IN TANGLEFIELD (D6)

D6 Result	Effect
1	Complete remaining movement straight ahead.
2	Turn 45° to the left and complete remaining movement in straight line.
3	Turn 45° to the right and complete remaining movement in straight line.
4+	No effect - move as normal.



TOXIN

Strength	Damage	Save Modifier	Area
None	None	None	1½"

When a toxin grenade explodes it showers an area with a cloud of powerful chemical toxin. Toxin gas is highly poisonous and affects all living creatures which breathe it. It cannot harm troops inside sealed buildings, enclosed vehicles, or those wearing sealed types of armour. Space Marines wearing Power or Terminator armour are not affected, nor are Eldar Aspect Warriors as their armour has its own air supply. Enclosed vehicles and Dreadnoughts are also immune as they are assumed to be airtight. Tyranids and Tyranid creatures like Genestealers are immune too, as their metabolism is quite unique, being from another galaxy. Therefore toxins engineered to work on normal creatures will not work on them. Other troops, including Space Marine Scouts, Imperial Guard, Eldar Guardians, and Orks, must try to avoid breathing in the gas.

TOXIN EFFECT

Troop Type	D6 Roll to Kill
Space Marines, Eldar Aspect Warriors, Dreadnoughts, Terminators, Tyranids, enclosed vehicles.	No effect
Space Marine Scouts, Eldar Guardians, Imperial Guard, and Squats.	3+
Other troops including Orks, and Gretchin.	2+

Nominate your target points and work out where the grenade lands as normal. Place a 1½" radius blast marker, or a patch of cotton wool, on the spot. Models whose bases lie totally within the blast area cannot help but breathe in the gas and so are hit automatically. Models whose bases lie partially within the blast area may be able to avoid breathing in too much gas and so are hit on a D6 roll of a 4, 5 or 6.

Any unprotected models hit by the toxin cloud are killed on a dice roll of 2+ (this is basically Orks and Gretchin, as these do not normally have respirators). Troops with some form of protection are killed on a D6 roll of a 3 or more. Troops wearing environmentally sealed armour and Tyranid creatures including Genestealers and Screamer Killers, (but not crossbreeds such as Genestealer Hybrids) cannot be affected.

The toxin gas cloud remains on the table. At the beginning of each side's turn one player rolls a D6 and consults the chart.

CLOUD MOVEMENT (D6)

- | | |
|-----|---|
| 1 | Cloud remains until end of the testing side's turn and then disappears with no further effect. |
| 2-4 | Cloud remains where it is. |
| 5 | Cloud shrinks to half current radius rounding down to nearest ½". |
| 6 | Cloud moves away D6" in a random direction. Models in its path may be hit and killed by the gas as described above. |

VIRUS

Strength	Damage	Save Modifier	Area
None	None	None	2"

When the virus grenade explodes it releases a genetically tailored virus which mutates very rapidly. As a result its initial effect is devastating but it quickly degenerates and eventually dies out. This genetically engineered self-destruct mechanism means that viral warfare is relatively safe. Indeed, the most effective way of depopulating a planet is with giant viral missiles fired from space.

However, there is always a small element of risk. It has been known for a virus to lay dormant for centuries and reappear only when the planet has been repopulated. Most rare of all, the virus may evolve into a stable but deadly form making the whole world uninhabitable.

These drawbacks are more of a problem with large scale viral bombardment. The amount of virus in a grenade is small, so its potential for unpredictable genetic development is almost nil. Because Tyranids are from a different galaxy from other creatures they are not affected by virus' engineered to affect normal metabolisms. This means the Tyranid Screamer Killer and Purestrain Genestealer cannot be affected by virus – although this does not apply to Hybrid Genestealers as these creatures have absorbed the metabolic weaknesses from the humans, Orks or other creatures with which they interbreed.

Roll to hit the target point and place a 2" radius blast marker where the grenade hits as normal. As per usual, models whose bases lie within the area are hit, and models partially within the area are hit on a D6 roll of 4, 5 or 6. Models which

have been hit by the virus and which are not protected from the environment are killed on a D6 roll of 3 or more as shown on the Virus Effect Chart.

VIRUS EFFECT CHART

Troop Type	D6 Roll to Kill
Space Marines, Eldar Aspect Warriors, Dreadnoughts, Terminators, enclosed vehicles.	No effect
Other troops including Space Marine Scouts, Eldar Guardians, Imperial Guard, Squats, and Orks.	3+

When a model falls casualty to the virus do not remove it from the tabletop straight away. Instead lie the model down and test to see if the mutating virus spreads to nearby troops. Roll a D6 to establish the contact range in inches for the virus. Any normally vulnerable model within the contact range of a victim is killed on the D6 roll of a 4, 5 or 6.

Every time a model is killed lie it down and roll for the contact range again, and work out if models within this range are killed. It is possible that a single model may have to test several time because it lies within the contact range of more than 1 victim. If models are close together it is possible that a single virus grenade can wipe out whole squads of troops before it finishes. Once there are no more victims within the contact range the virus has mutated into a safe form and there is no further effect.



JOHN BLANCHE

VORTEX

Strength	Damage	Save Modifier	Area
None	None	None	1½"

The vortex grenade is a rare weapon which is difficult to produce. It is made by the Adeptus Mechanicus for Imperial agents, and it is possible that copies made on advanced human worlds may occasionally find their way into the hands of other troops.

The grenade takes the form of a weighty sphere rather like a cricket ball. It is far too heavy to be fired from a grenade launcher. Inside its outer shell is a delicate warp mechanism, a complicated and temperamental piece of technology.

When the grenade is activated it creates a tiny rift between the real universe and warp space, a rift which becomes a vortex in the fabric of space like a small black hole. Everything encompassed by the vortex is destroyed: all matter and all energy is drawn through the vortex and into warp space where it is turned into the very stuff of the warp.

Vortices are doubly dangerous because once created they behave in an unpredictable way. They may grow or shrink, vanish or remain for long periods, they can move, and they can divide. A vortex can be as deadly to its user as to its target.

Once the grenade has been thrown place the 1½" radius vortex marker on the spot where it hits. All matter encompassed by the vortex is destroyed. Any troops wholly or partially within the vortex are also destroyed. Trees, bits of wall, rocks, and other scenic features are destroyed where they are touched by the vortex. Any part of a building is destroyed where it is touched. Vehicles may also be destroyed as described below. It is not possible to see or shoot through a vortex or to use psychic powers through it.

VORTEX CHART (D10)

D10 Result	Effect
1-3	The vortex vanishes with no further effect. Remove the vortex marker.
4-6	The vortex remains unchanged.
7	The vortex expands by ½" radius. Replace the marker with a larger marker or add a band of cotton wool to indicate the size of the vortex. Everything within the vortex is destroyed.
8	The vortex moves D6" in a random direction, and everything in its path is destroyed.
9	The vortex pulses for a moment and then divides into two. Place another marker on top of the first and re-roll on this chart for each.
10	The vortex expands to a radius of 3" destroying everything within it. The vortex vanishes at the end of the turn with no further effect.



DAVE GALLAGHER

The vortex marker remains in place from turn to turn - an unpredictable ball of glowing blackness ready to threaten all those near it. At the beginning of each side's turn roll a D10 and consult the Vortex chart.

When a vortex comes into contact with a vehicle it may destroy or damage it depending on how much of the vehicle is covered. Work out the results as follows.

If the centre of the vortex passes over any part of the vehicle's body then the vehicle is considered to be destroyed completely. The vehicle is also considered destroyed if more than 50% of it is covered by the vortex - this means that a small vehicle may be destroyed even if the centre of the vortex doesn't touch it.

In both these cases the amount of damage caused is so great that even parts not touched by the vortex itself are turned to pulp as surrounding structures disappear and distort.

If neither of the above applies then calculate the amount of damage caused using the gun sight and target diagram for the vehicle. Roll 2D6 and read the result along the bottom of the gun sight - this shows how far the vortex has penetrated inside the vehicle.

If the vortex is approaching from the front, all areas in front of the area indicated are hit. If the vortex is approaching from behind, all areas behind the area indicated are hit. If approaching from the side then all the areas 1 either side of the number rolled are hit (eg roll 7 and all areas 6 through 8 are hit). All areas hit by a vortex are destroyed as if a 6 had been rolled on the damage chart.

FORCE WEAPONS

Force Weapons are psychically attuned to weapons, the force that gives them their name is psychicforce or energy. Only a powerful psyker can use a Force Weapon, the weapons acts as a potent psi-energy conductor which turns psychic energy into devastating psychological energy.

FORCE AXE

Terminator Space Marine Librarians wear psychically attuned armour called the Aegis suit. They also carry the Force Axe, a carbon steel smashing blade which incorporates a psi-matrix. A psi-matrix is a serpentine or interlaced pattern which concentrates psychic energy. Using a Force Axe a Terminator Librarian can magnify the power of his blows, shattering armour and pounding flesh with his supernatural strength.

A Space Marine Librarian with a Force Axe can use his psi points to increase the strength of any hits. For each psi-point

expended, increase the strength by +1. Each psi point expended also reduces the targets saving throw by -1. For example, a Librarian with a strength of 4 could add 3 psi points to his attack giving his attack a strength of 7 and a saving throw modifier of -3.

All force weapons are psychically attuned and – whether wielded by a psyker or non-psyker – will destroy a protective psychic aura on contact (by scoring a hit in hand -to-hand combat for example).

Short Range	Long Range	To Hit Short	To Hit Long	Strength	Damage	Save Modifier	Special
Close combat only	—	—	—	As user	1	—	Close combat - see above

FORCE ROD

This is an unusual weapon of alien origin. It is made from a black substance which is physically indestructible and impenetrable by X-rays or probes of any kind. Rods are nearly always about 15" long and weigh about a pound. Occasionally, rods turn up in other forms; daggers, wierd figurines and round circlets like a wrist bangle.

Force rods are useless to normal creatures; only individuals with psychic powers can utilise them. They function as storage batteries for psychic energy. A psyker may store psi-points in the rod for future use, his own points are used up as if he had employed psychic powers, but may be regained through resting as normal. The psyker may store up to 10 points in the rod for each mastery grade of psychic power he has.

The power may be used as follows:

1. A psyker can draw points back from the rod at any time He may never increase his psi-points over his normal psi level limit.
2. A psyker may instantly use points from the rod to augment/enhance psychic attacks.
3. A psyker may use the rod in combat, points used in the attack indicate the strength of successful hits. Unsuccessful hits use no points.

All force weapons including rods are psychically attuned, and – whether wielded by a psyker or non-psyker – will destroy a protective psychic aura on contact (by scoring a hit in hand -to-hand combat for example).

Short Range	Long Range	To Hit Short	To Hit Long	Strength	Damage	Save Modifier	Special
Close combat only	—	—	—	—	—	—	see above

FORCE SWORD

A Force Sword can only be used by a psyker – in the hands of a non-psyker it counts as a normal sword. A Force Sword resembles a normal carbon-steel, plastic or ceramic blade – in fact it is very different. Inside the structure is interwoven a powerful psi convector, a special material formed into a precise serpentine shape which concentrates and directs psychic energy. This sometimes appears as an interlacing or

serpentine pattern on the blade. A psyker scoring a successful hit with the weapon can expend psi points to add to the basic strength of the hit (ie that of the user). In addition each point of psi power used reduces the targets saving throw by 1 in the same way as the Force Axe.

The Force Sword is psychically attuned in the same way as a Force Axe and subject to the same psychic rules.

Short Range	Long Range	To Hit Short	To Hit Long	Strength	Damage	Save Modifier	Special
Close combat only	—	—	—	As user	1	—	Close combat - see above

NEMESIS FORCE WEAPON

The Nemesis Force Weapon is the standard armament of the Grey Knight Terminator Squads - the renowned Daemon fighters of the Imperium whose battles pitch them against the unimaginable horrors of Chaos. Each Nemesis Weapon incorporates an interlacing patterned psi-matrix uniquely matched to the psychic fields of its bearer, enhancing his hand-to-hand combat abilities far beyond those of an ordinary Marine. In addition, the Nemesis Weapons contains a compact bolter built into the haft of the weapon.

The Nemesis is a highly effective close combat weapon. It has the same abilities of a force sword - that is, the wielder can expend psi points to increase the effectiveness of a successful hit. For each psi point expended, the strength of the hit is increased by +1 point, and the targets saving throw reduced by -1 point.

The Nemesis Weapon also has the ability to store psychic power in its psi-matrix, acting as a battery from which the wielder can draw psi points to supplement his own. At the start of a battle, a Nemesis Weapon has 2D6 psi points stored (this is in addition to the Grey Knights own psi points).

The Nemesis Weapon can also project a *Psychic Blast* - a single blast of mental energy with a range of 12". The attack releases *all* of the psyker's remaining psi points and every psi point stored in the weapon's psi-matrix, reducing both scores to zero. The strength of the attack is equal to the number of psi points used up to a maximum of 10. The target is hit automatically, with no psychic saving throw, and its armour saving throw is reduced by -1 for every psi point used in the attack. A successful Psychic Blast attack causes 2D6 wounds.

Though exceedingly powerful, the Psychic blast is a weapon of last resort. The mental strain of launching the Blast is tremendous and wracks the Grey Knight with severe mental agony. After the attack, the controlling player must roll a D6: on a roll of 5 or 6, the Knight is completely disorientated by the pain - he immediately staggers D6" in a random direction. The disorientated Knight continues stagger D6" in a random direction during subsequent movement phases, until the controlling player rolls a 1 when determining the distance the Knight moves. On a roll of 1, the Knight overcomes the agony and may move normally for the rest of the game. While afflicted with pain, the Grey Knight can continue to fight but is unable to control his movement.

The Nemesis Weapon incorporates a short-range, limited-ammunition bolter in the weapons haft. As technological attacks have full effect against demonic creatures, this gives the Grey Knight Terminator ranged combat capabilities. The bolter holds 3 bolts, which can be fired individually or all at once, with a range of 4" and no modifiers to hit. When the Marine uses the bolter, the controlling player must declare how many bolts are being fired, and must keep a record of bolt expenditure.



Short Range	Long Range	To Hit Short	To Hit Long	Strength	Damage	Save Modifier	Special
0-4"	—	—	—	4	1	-1	See above

WITCH BLADE

The Witch Blade is a weapon primarily associated with the Eldar Warlocks of the Craftworlds. It is a Force Weapon which channels the user's psychic energies into the blow. Its crystalline psychic matrix is specially attuned to the Eldar psyche - other races are either unable to use a Witch Blade. The Witch Blade might appear very much like an ordinary Force Sword but in fact it is far, more powerful. The number

of psi points directed through the Witch Blade is always doubled before adding to the user's strength or deducting from the enemy's armour saving throw. So, for example, a Warlock with a strength of 3 can put 2 psi points into the weapon, increasing the strength of a hit by +4 to give a total strength of 7. the 2 psi points will also reduce the target's saving throw by -4.

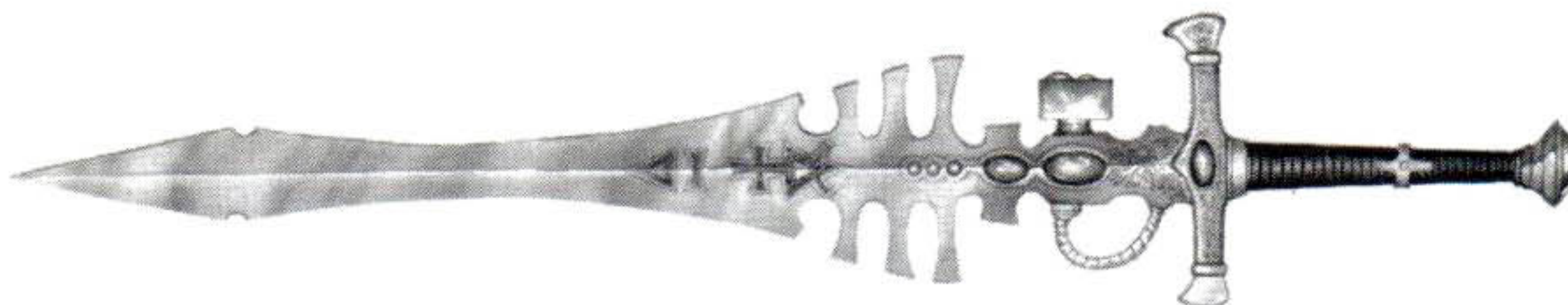

Short Range	Long Range	To Hit Short	To Hit Long	Strength	Damage	Save Modifier	Special
Close combat only	—	—	—	—	1	—	See above

ELDAR HEAVY WEAPONS



SPOTTER WITH GOGGLES
071533/12



GUNNER WITH SHURIKEN CATAPULT
071533/13



SPOTTER WITH HELMET
071533/16



GUNNER WITH SHURIKEN CATAPULT AND HELMET
071533/17



SPOTTER
071533/19



GUNNER WITH CONTROL BOX
071533/18

THESE ARE ALL EXAMPLES OF THE COMPLETE ELDAR HEAVY WEAPONS

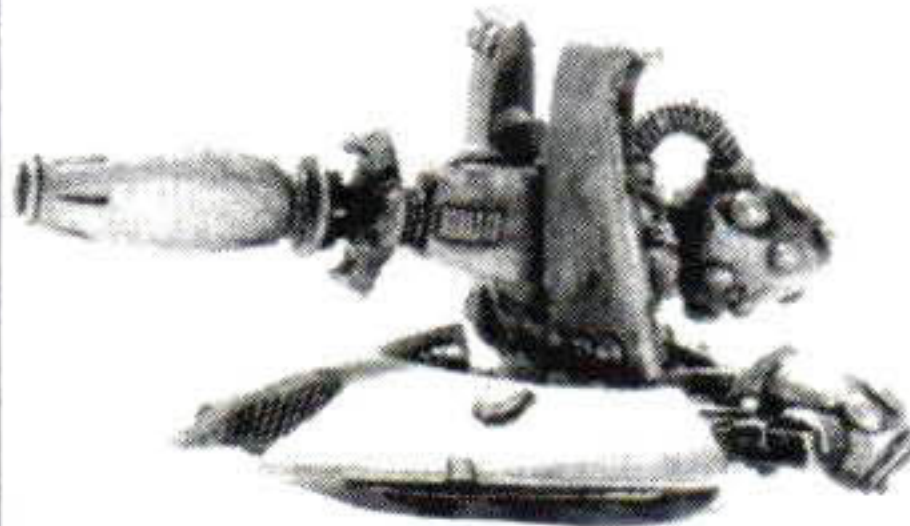

D-CANNON 1
071533/20



D-CANNON 2
071617/2

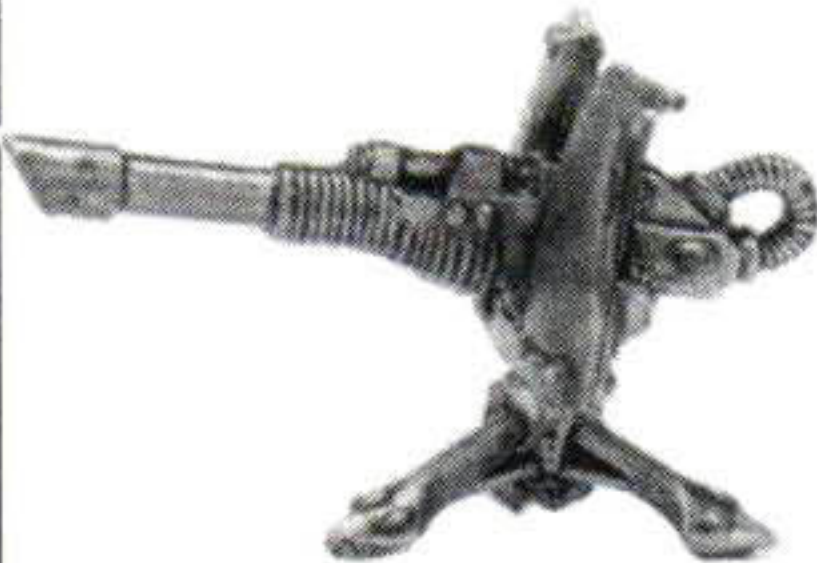

LAS CANNON
071521/5



SCATTER LASER
071521/11

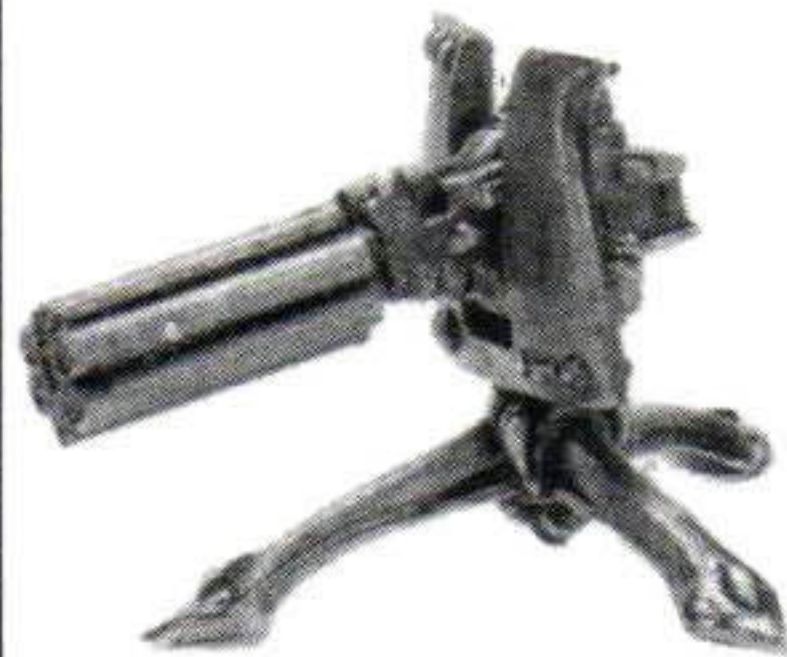

HEAVY PLASMA GUN
071521/16



MISSILE LAUNCHER
071521/19

THESE ARE ALL EXAMPLES OF THE COMPLETE ELDAR HEAVY WEAPONS

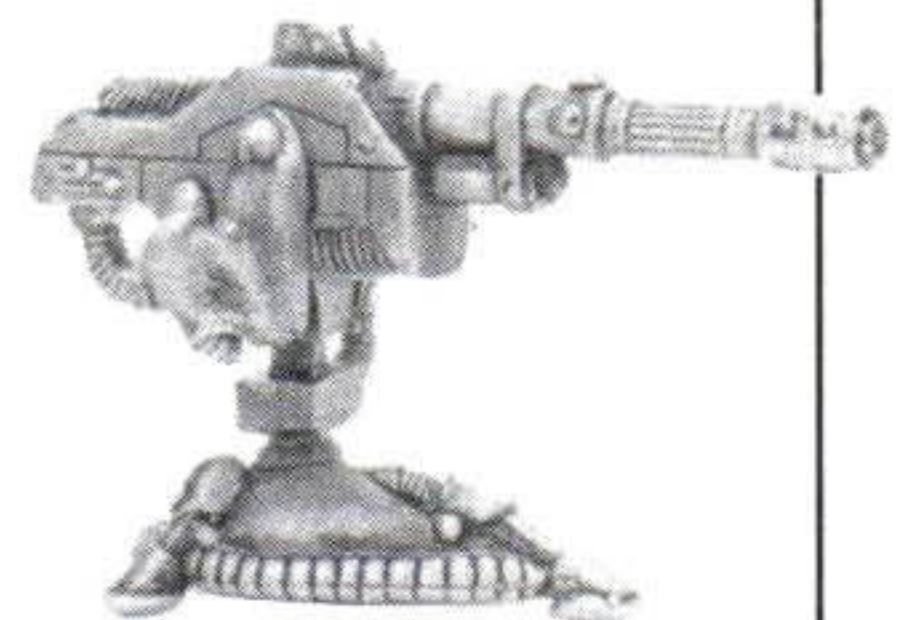
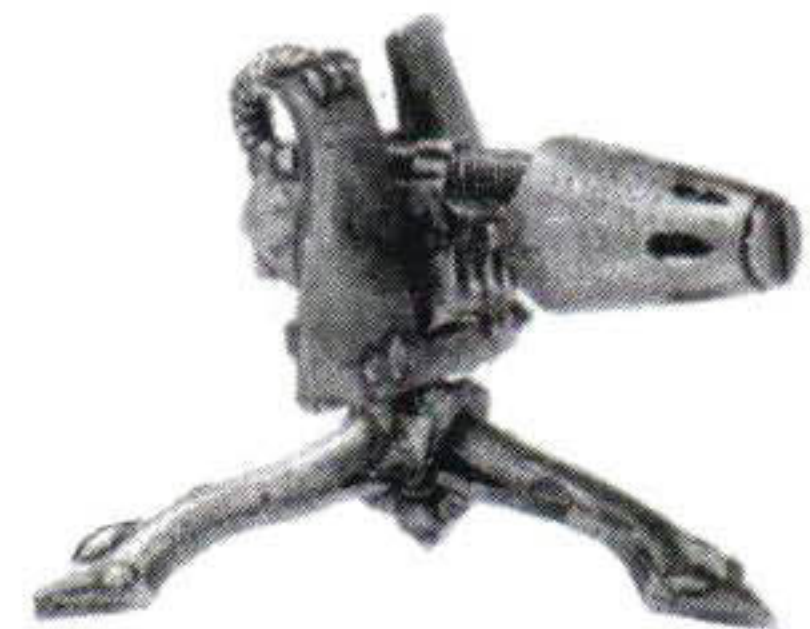

EACH COMPLETE HEAVY WEAPON CONSISTS OF:
1 x TRIPOD OR 1 x FLOATING WEAPON PLATFORM
1 x WEAPON SHIELD OR 1 x WEAPON MOUNT
1 x HEAVY WEAPON
1 x SPOTTER
1 x GUNNER

PLEASE STATE WHICH ITEMS YOU REQUIRE

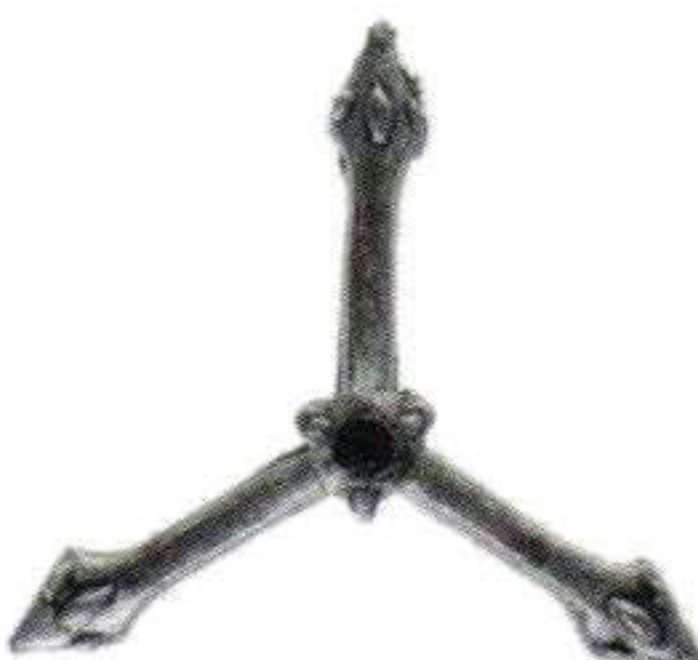

LARGE WEAPON TRIPOD
071533/14



WEAPON TRIPOD
071533/15

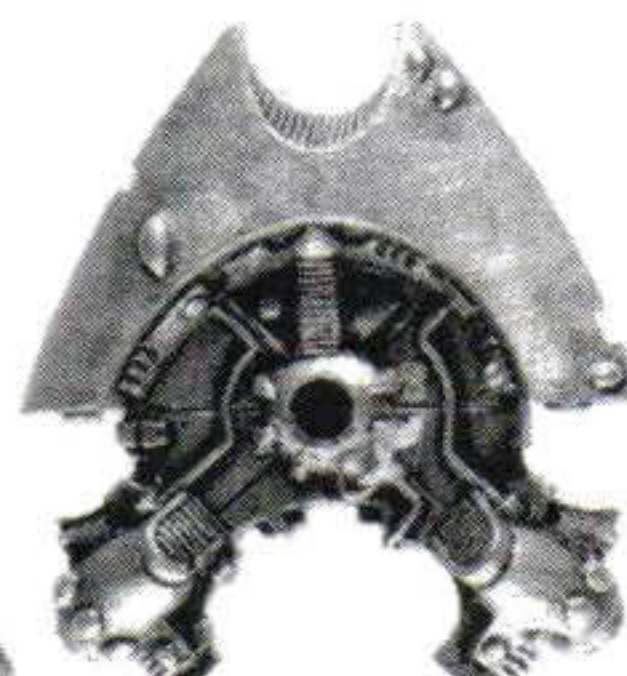

FLOATING WEAPON PLATFORM 1
071617/1



FLOATING WEAPON PLATFORM 2
071533/21

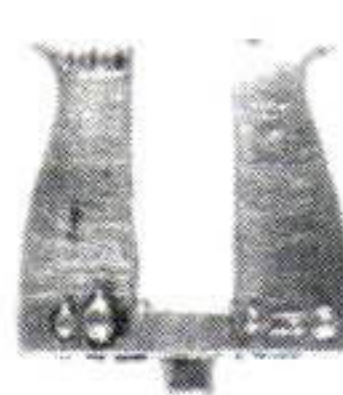

WEAPON SHIELD
071521/12



WEAPON MOUNT (D-CANNON 1)
071533/22

Minatures supplied unpainted. **WARNING.** This product contains lead which may be harmful if chewed or swallowed. Citadel Miniatures are not recommended for children under 14 years of age. © Copyright Games Workshop Ltd. All rights reserved.



CHAOS RENEGADE HEAVY WEAPONS

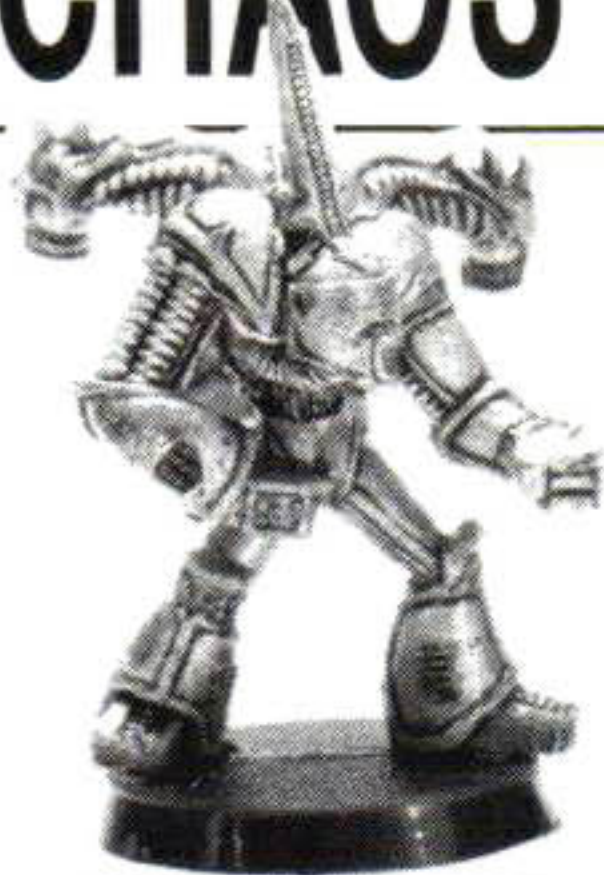

SLAANESH RENEGADE
070327/1

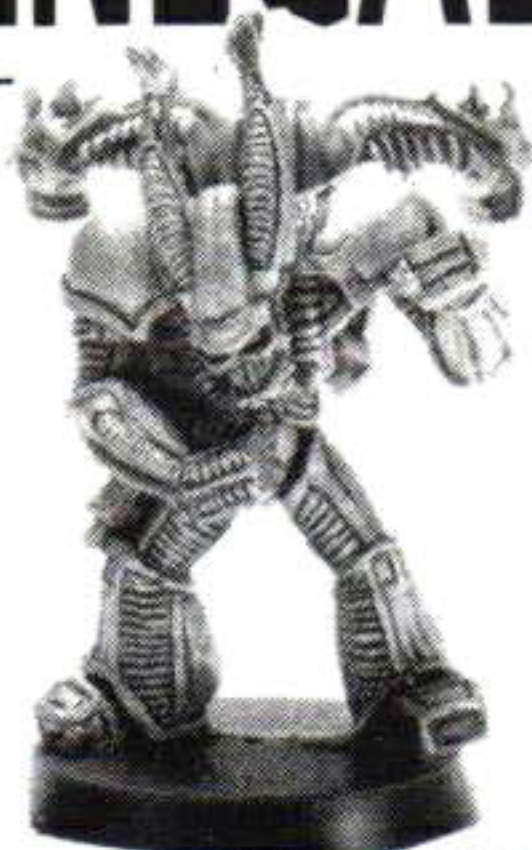

KHORNE RENEGADE WITH THE FACE OF A BLOODLETTER
070327/5



NURGLE RENEGADE WITH HORNS
070327/6



TZEENTCH RENEGADE WITH A FUNGUS BODY
070327/7



RENEGADE 1
070327/8



RENEGADE 2
070327/12



RENEGADE 3
070327/11



RENEGADE 4
070327/4

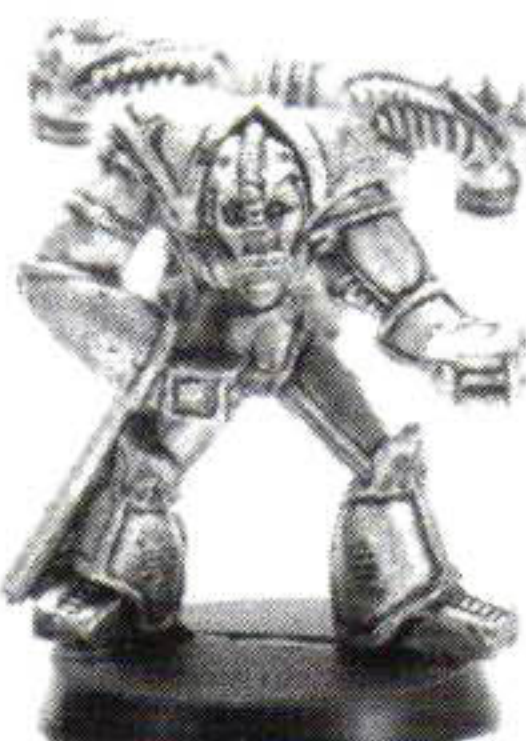

RENEGADE 5
070327/10

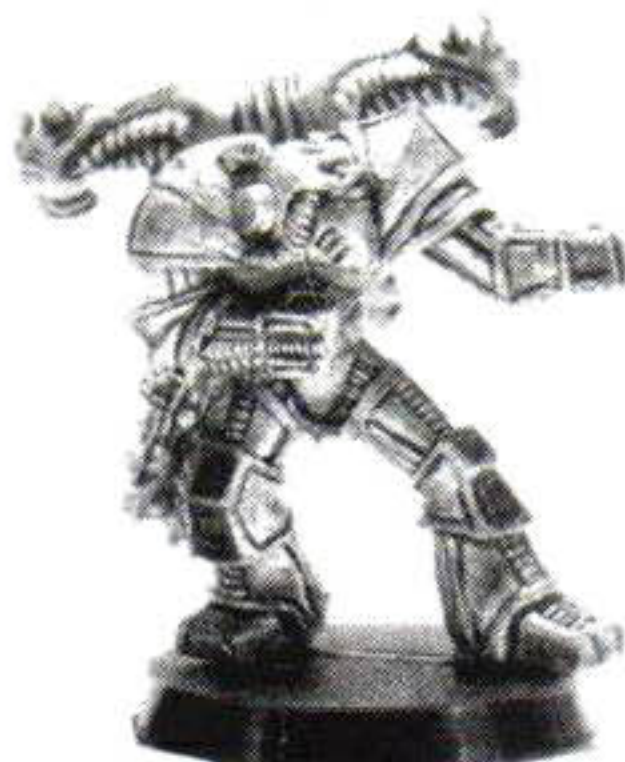

RENEGADE 6
070327/2



RENEGADE 7
070327/9



RENEGADE 8
070327/10



HEAVY BOLTER
070327/13



HEAVY PLASMA GUN
070327/17



MULTI MELTA
070327/15



CONVERSION BEAMER
070327/16



MISSILE LAUNCHER
070327/14



GRENADE LAUNCHER
070327/18



LAS CANNON
070327/19

ALL OF THESE MODELS ARE SUPPLIED WITH ONE OF THE WEAPONS SHOWN AS STANDARD, PLEASE STATE WEAPON CHOICE WHEN ORDERING.



EXAMPLES OF THE CHAOS RENEGADES WITH HEAVY WEAPONS

Designed by Michael Perry

ALL OF THE ABOVE MODELS ARE SUPPLIED WITH A CHAOS RENEGADE BACK PACK SPRUE AS STANDARD

Miniatures supplied unpainted. WARNING. This product contains lead which may be harmful if chewed or swallowed. Citadel Miniatures are not recommended for children under 14 years of age. © Copyright Games Workshop Ltd. All rights reserved.



SPACE MARINE STRIKE FORCE

EXAMPLE SPACE MARINE STRIKE FORCE.
BANNERS NOT INCLUDED



STRIKE FORCE
SPACE MARINE 1
RTB15/1



STRIKE FORCE
SPACE MARINE 2
RTB15/2



STRIKE FORCE
SPACE MARINE 3
RTB15/3

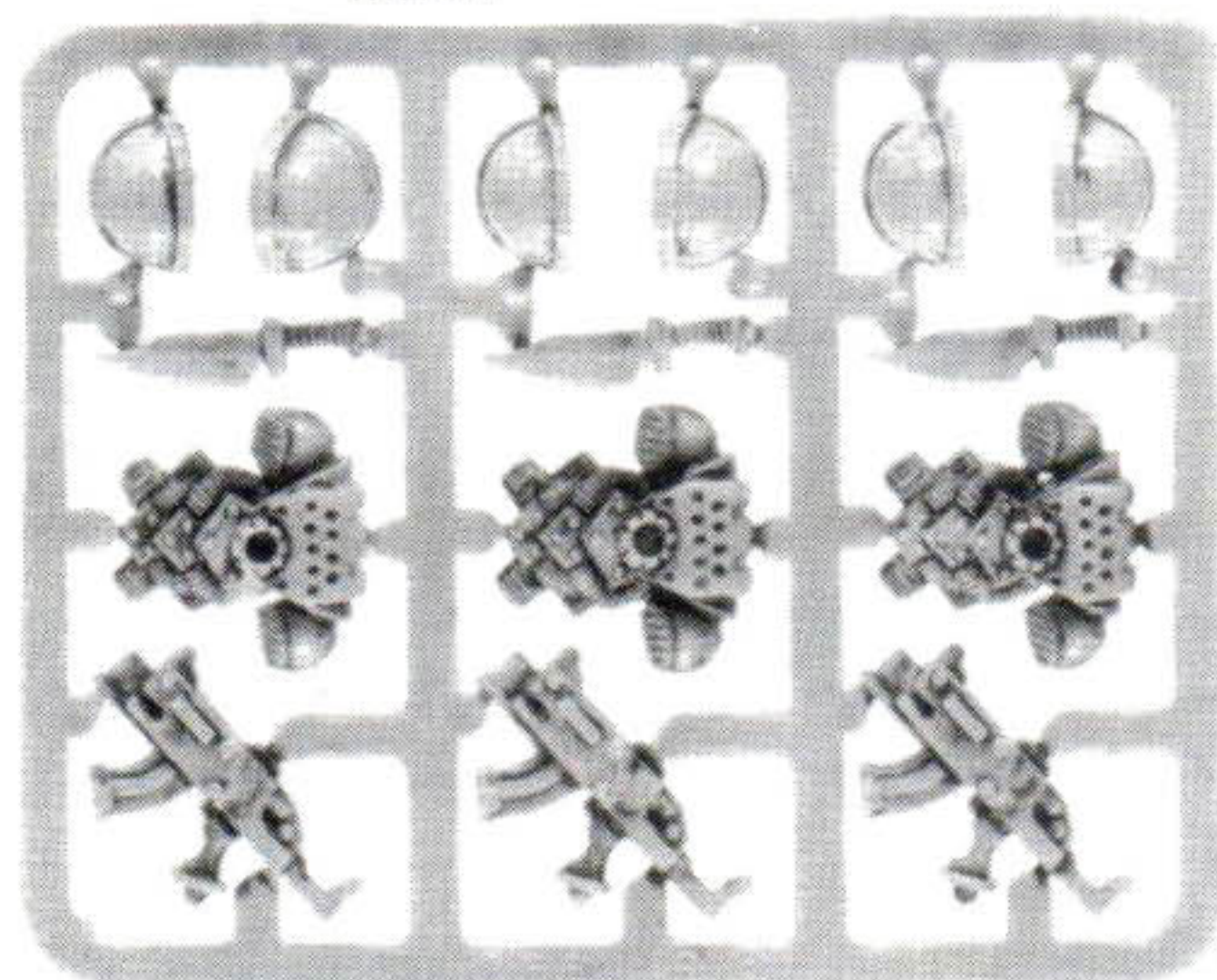

SPACE MARINE BOLTER AND BACK PACK SPRUE
101532

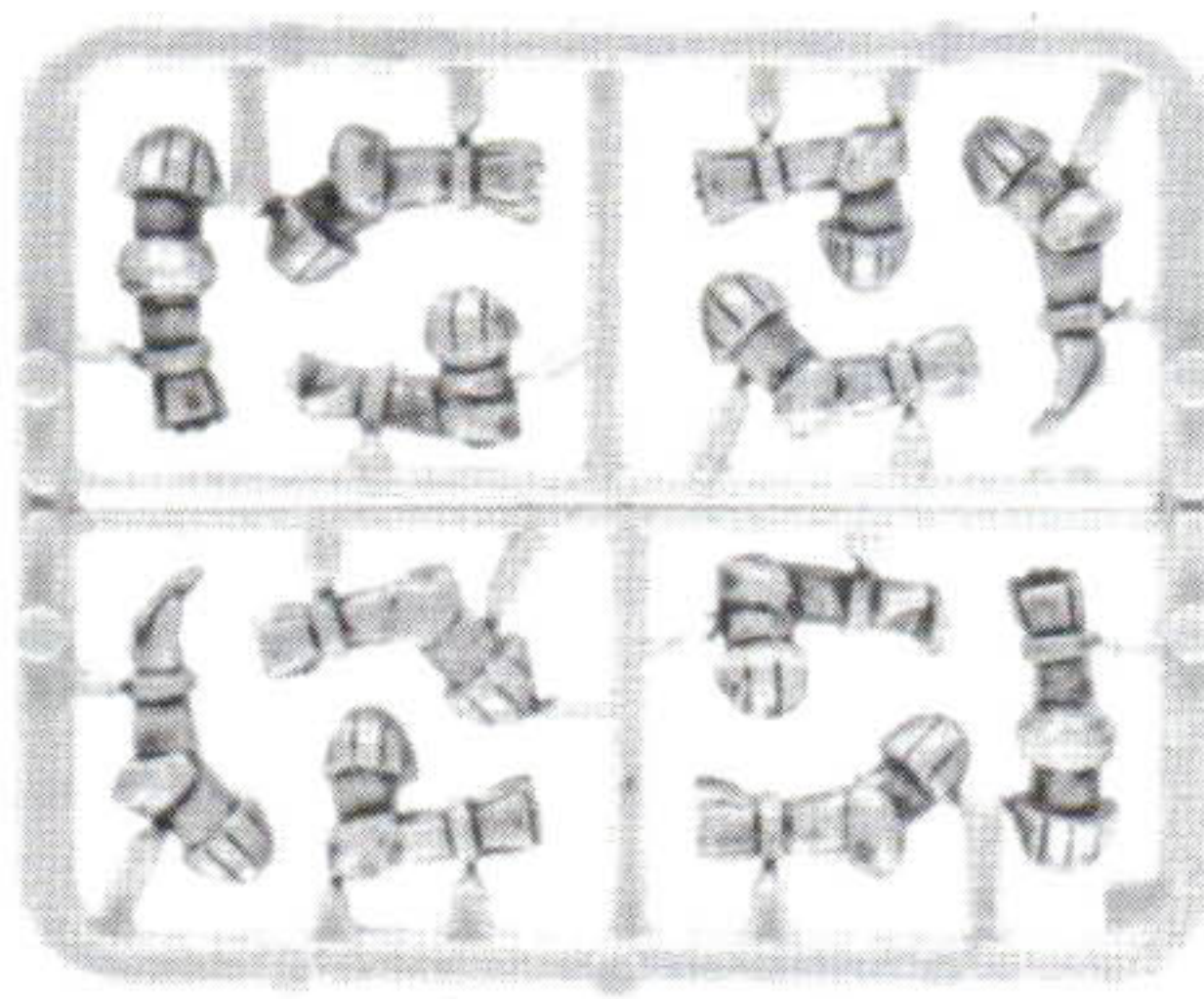

SPACE MARINE ARM SPRUE
103004

Space Marines are the ultimate warriors of the 41st Millennium and devoted servants of the Emperor. The Space Marines of the Strike Force are equipped with Mark 7 power armour - also known as *Armorum Impetor* or *Eagle armour*. The Space Marine Strike Force boxed set contains 15 superbly modelled metal miniatures (3 complete combat squads) with 5 Space Marine bolter and back pack sprues and 3 Space Marine arm sprues.



Minatures supplied unpainted. **WARNING.** This product contains lead which may be harmful if chewed or swallowed. Citadel Miniatures are not recommended for children under 14 years of age.
© Copyright Games Workshop Ltd. All rights reserved.



CITADEL
MINIATURES

TERMINATORS

BODIES



CAPTAIN
RTB9/7



LIBRARIAN
RTB/6



MARINE 1
RTB9/5



MARINE 2
RTB9/4



MARINE 3
RTB9/3

EACH COMPLETE
TERMINATOR
CONSISTS OF:
1 x BODY
1 x LEFT ARM
1 x RIGHT ARM
1 x SHIELD
PLEASE STATE WHICH
ITEMS YOU REQUIRE
WHEN ORDERING

THE COMPLETE TERMINATOR SQUAD BOXED SET CONTAINS:

- | | |
|----------------|--------------------------------|
| 1 x CAPTAIN | 1 x FORCE AXE |
| 1 x LIBRARIAN | 1 x SERGEANT'S POWER SWORD ARM |
| 2 x MARINE 1 | 1 x CAPTAIN'S POWER FIST |
| 2 x MARINE 2 | 3 x STORM BOLTER 1 |
| 2 x MARINE 3 | 3 STORM BOLTER 2 |
| 1 x SHIELD 2 | 1 x HEAVY FLAMER |
| 2 x SHIELD 3 | 1 x POWER FIST |
| 1 x CHAIN FIST | 1 x ASSAULT CANNON |



LEFT ARMS



POWER FIST
RTB9/2



FORCE AXE
(WILL TAKE SHIELD)
RTB9/13



CHAINFIST
RTB9/11



**CAPTAIN'S POWER FIST
WITH GRENADE LAUNCHER**
RTB9/12

SERGEANT'S POWER SWORD ARM
(WILL TAKE SHIELD)
RTB9/14



RIGHT ARMS



STORM BOLTER
RTB9/1



STORM BOLTER 2
RTB9/10



ASSAULT CANNON
(WILL TAKE SHIELD)
RTB9/8



HEAVY FLAMER
RTB9/9

SHIELDS



SHIELD 1
070243/13



SHIELD 2
RTB9/15



SHIELD 3
RTB9/16

NOTE THAT ALL OF THE TERMINATOR ARMS AND WEAPONS SHOWN ON PAGES 17, 18 AND 19 WILL ALSO FIT ON THESE TERMINATOR BODIES

Designed by Jes Goodwin



PLASTICS



ORK WEAPONS SPRUE
(4 BOLTERS, 4 BOLT PISTOLS,
1 PLASMA PISTOL AND CHAIN SWORD)
102749

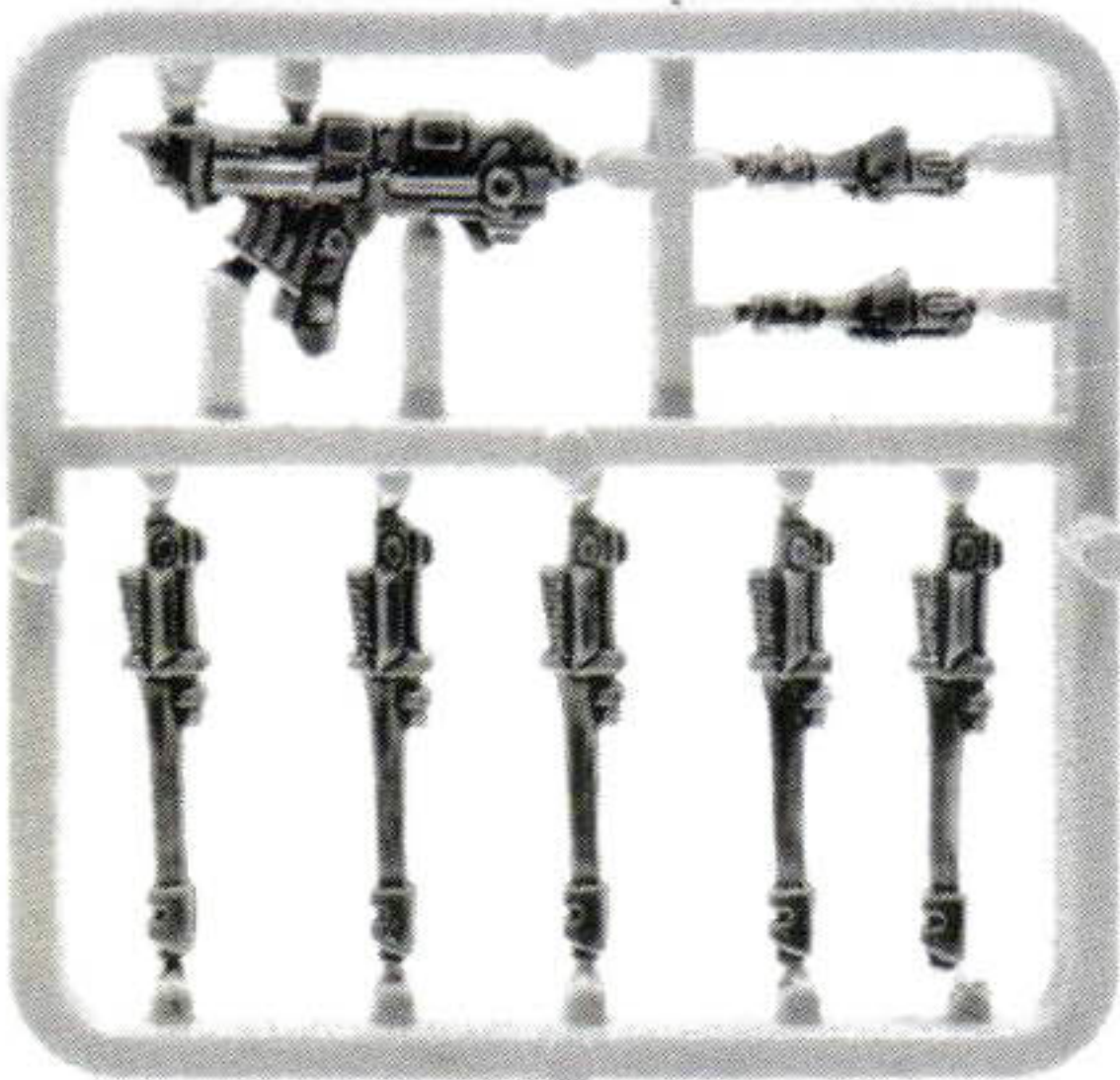

LAS GUNS AND HEAVY BOLTER SPRUE
(1 HEAVY BOLTER, 5 LAS GUNS, 2 LAS PISTOLS)
131329

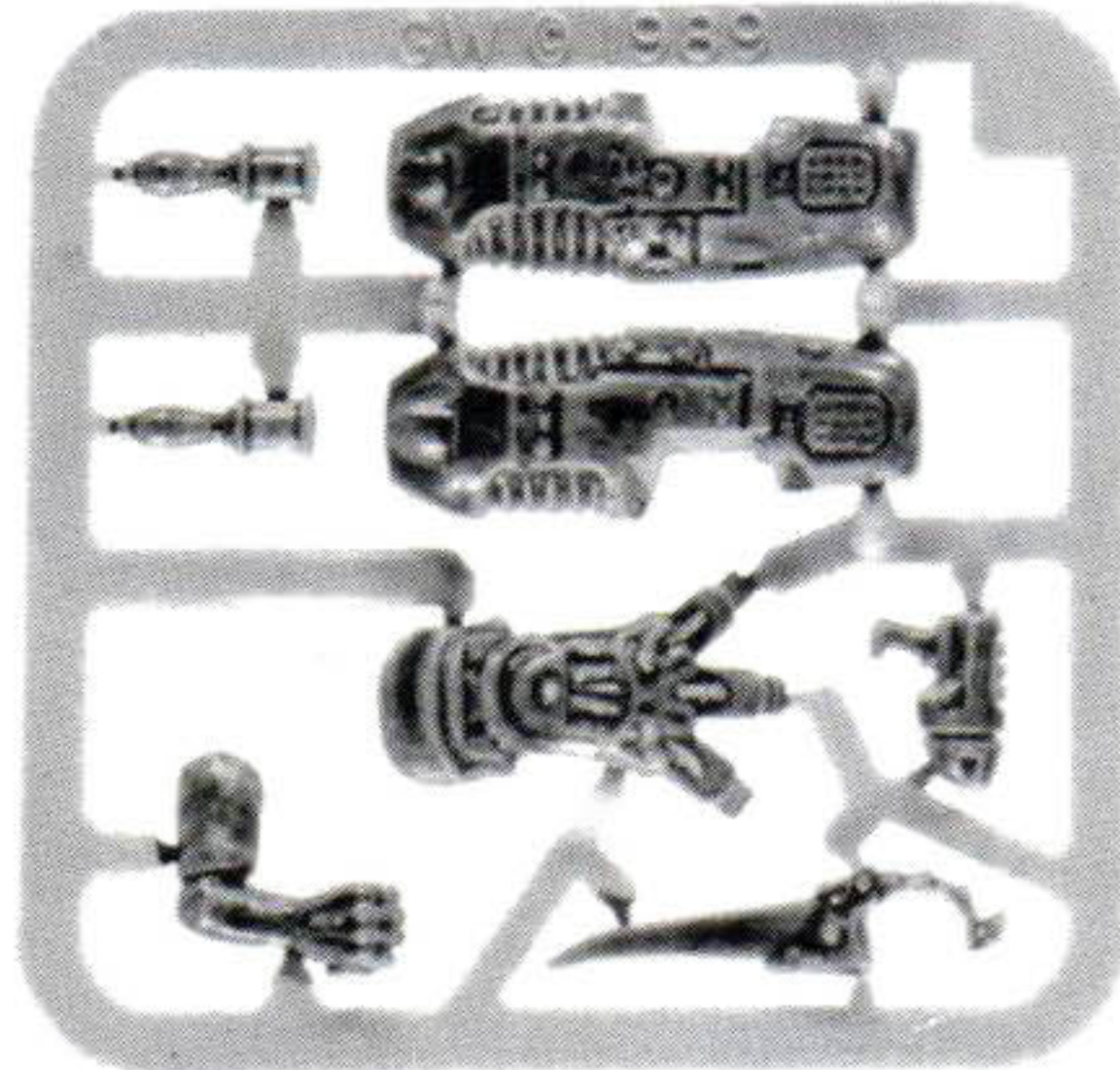

ORK HEAVY WEAPON SPRUE
(1 HEAVY PLASMA GUN, 1 POWER CLAW, 2 STIKK
BOMBZ, 1 PLASMA PISTOL AND 1 POWER SWORD)
102752

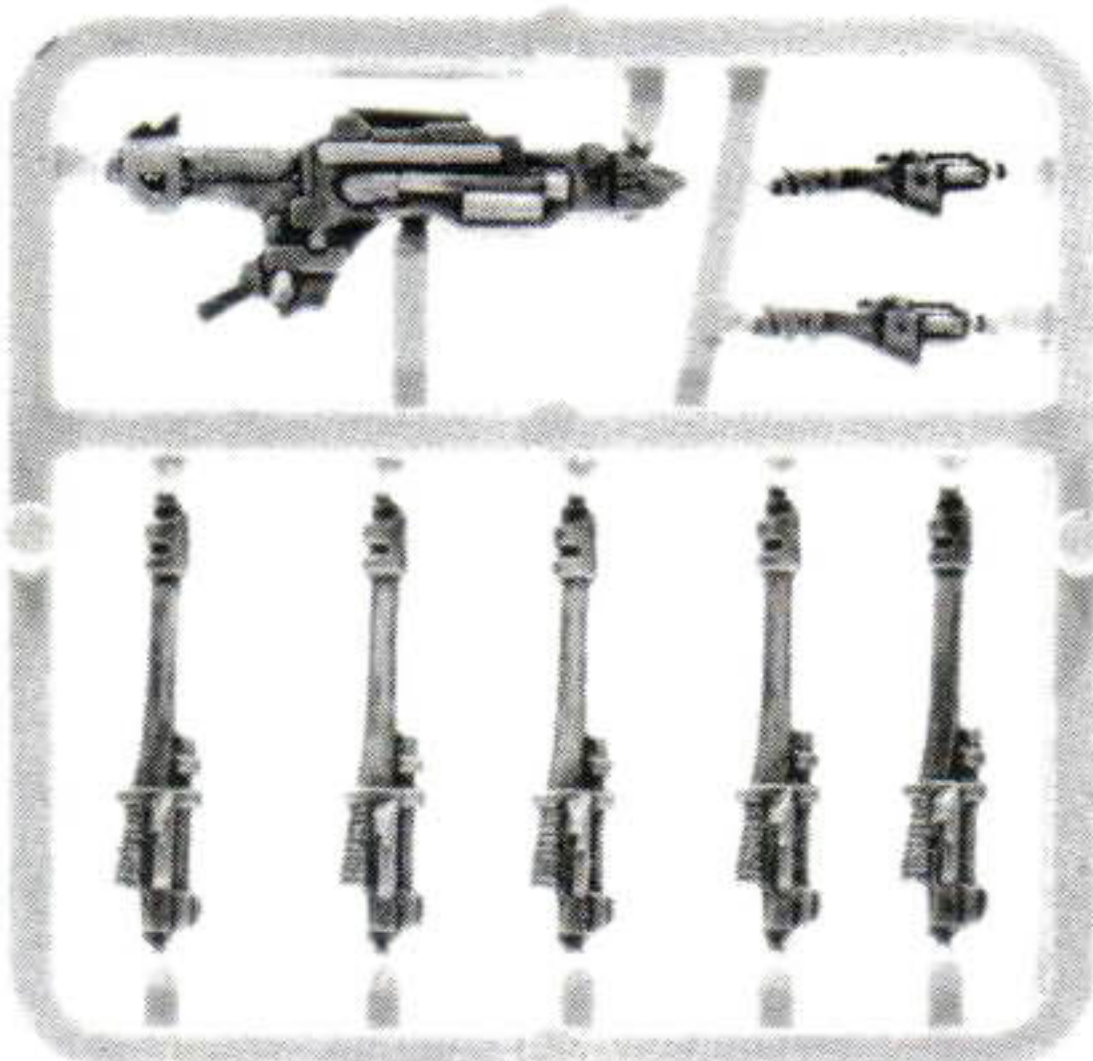

LAS GUNS AND LAS CANNON SPRUE
(1 LAS CANNON, 5 LAS GUNS, 2 LAS PISTOLS)
131260

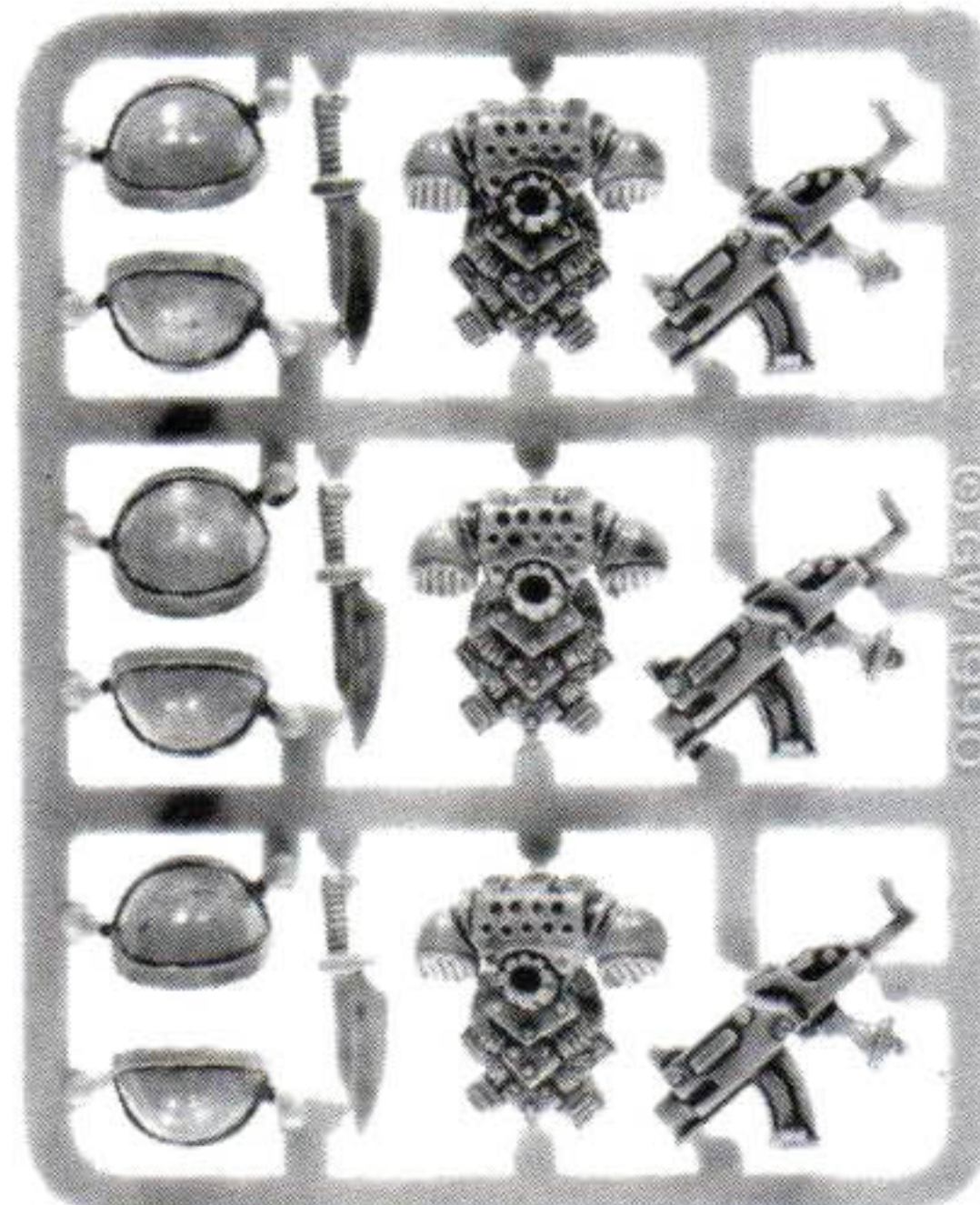

SPACE MARINE BOLTERS AND BACK PACKS SPRUE
(3 PAIRS OF SHOULDER PADS, 3 BACK PACKS,
3 BOLTERS, 3 COMBAT KNIVES)
101532

Minatures supplied unpainted. **WARNING.** This product contains lead which may be harmful if chewed or swallowed. Citadel Miniatures are not recommended for children under 14 years of age.
© Copyright Games Workshop Ltd. All rights reserved.



COMBAT REFERENCE SHEET

This sheet summarises the shooting and hand-to-hand combat rules given in this volume. Once you are familiar with the complete rules, you will find this sheet sufficient when playing Warhammer 40,000.

HITTING THE TARGET

To determine if a shot hits its target roll a D6.

BS	1	2	3	4	5	6	7	8	9	10
Score	6	5	4	3	2	1	0	-1	-2	-3

The dice roll is modified to reflect how easy or difficult the shot is.

- 1 Shooting from a vehicle which is moving at its fast rate.
- 1 Shooting at a rapid moving target 10-20".
- 1 If the target is behind soft cover.
- 2 If the target is behind hard cover.
- 2 Shooting at a very rapid moving target 20"+.
- 1 Shooting at a model emerging from or moving into cover, or charging the shooter. Applies to models on Overwatch only.

DAMAGE CHART

		TARGET'S TOUGHNESS									
		1	2	3	4	5	6	7	8	9	10
WEAPON'S STRENGTH	1	4	5	6	6	N	N	N	N	N	N
	2	3	4	5	6	6	N	N	N	N	N
	3	2	3	4	5	6	6	N	N	N	N
	4	2	2	3	4	5	6	6	N	N	N
	5	2	2	2	3	4	5	6	6	N	N
	6	2	2	2	2	3	4	5	6	6	N
	7	2	2	2	2	2	3	4	5	6	6
	8	2	2	2	2	2	2	3	4	5	6
	9	2	2	2	2	2	2	2	3	4	5
	10	2	2	2	2	2	2	2	2	3	4

SCATTER

To determine where the shot lands roll the scatter dice. The arrow indicates the direction where the shot lands. The distance the shot misses by is 1D6" if the scatter dice shows an arrow, and 2D6" if it shows a 'Hit' symbol.

Dud shots occur when you roll a 'Hit' followed by a 2D6 result of a double. Consult the chart below.

Double Score Rolled:

- 1 **Kerrrr...boom!** Place the blast marker directly on top of the firer and work out damage as normal. Even if the shooter survives his weapon is destroyed.
- 2 **Explodes prematurely.** Roll D6 to establish how far the shot travels towards the target before it explodes. Place the blast marker the distance indicated down the projected flight path.
- 3 **Jams.** The weapon does not fire and cannot be fired until it is fixed. A jammed gun can only be fixed if a model spends its entire movement phase stationary attempting to free the mechanism and then rolls a 4, 5 or 6 on a D6.
- 4 **Misfire.** The shot does not fire. The shooter clears the weapon and is ready to fire again normally in his next turn.
- 5 **Explodes in mid-air.** The shell explodes high in the air or else fails to explode when it strikes the target. the shot has no effect and the weapon may fire normally on the player's following turn.
- 6 **Out of control.** The shell travels D6" forward then changes direction (note the shell cannot turn back on the firer, so reroll any result that indicates otherwise). Roll the *scatter dice* for the new direction and a D6 for the distance travelled. Any targets within the D6" will be hit as normal.

TO HIT SCORES OF 7+

Roll Required	7	8	9	10+
Second D6 score	4+	5+	6	Cannot Hit

THROWN GRENADE CHART

Strength of Thrower	Maximum Throw
1	4"
2	6"
3	8"
4	10"
5+	12"

The following rules apply to throwing grenades or other hand-held items.

1. To hit the exact spot the player requires a dice roll of 6 on a D6. Note this only applies to smoke grenades. If the chance of hitting would normally be less than 1 in 6 then the chance of hitting is reduced to this level (roll a 6 followed by a further dice roll as explained above).
2. If the shot misses then a normal scatter roll is made as described to the left.

Cut along the dotted line to remove this page from your rulebook

CLOSE COMBAT PROCEDURE

Most combats are 'one-on-one' which means one of your models is engaged against one of your enemy's models. These combats are worked out as shown below. Where one model is engaged against more than one enemy model, this is called a multiple combat. These have special rules and are described later.

1. Throw Attack Dice

Both players roll a number of D6's equal to their model's attack characteristic.

2. Work Out Score

Each player picks his single highest scoring dice and adds his model's Weapon Skill to the score. He then adds any other modifiers that apply from the close combat modifiers chart.

3. Determine Winner

The player who has the highest total score wins the combat. In the case of a tie the model with the highest initiative wins the combat - if there is still a tie the combat is a stand-off.

4. Number Of Hits

Compare the scores of both combatants. The difference between their scores is the number of times the winner has hit the loser. If you won the combat on a tie you still cause 1 hit.

5. Throw to Damage

For each hit scored the attacker rolls a D6 on the Damage Chart and determines if the hit causes damage exactly as with hits from shooting. You may use the strength characteristic of either the model itself or any pistol or close combat weapon it carries.

6. Saving Throw

Models that are wearing armour may attempt to avoid the effects of any damaging hits by making an armour saving throw exactly as with shooting damage.

CLOSE COMBAT MODIFIERS

+2 Frenzied

A fighter who is *frenzied* automatically adds a bonus of +2 to his close combat score.

+1 Fumble

If your opponent fumbles you automatically add +1 to your close combat score for each fumbled dice.

+1 Charging

If the model charged into combat this turn add +1 to your close combat score.

+1 Higher Up

If the model is on a higher slope, stair, rampart, etc then add +1 to your close combat score to represent the advantage gained by towering over your enemy.

-1 Obstacle

If you charge against an enemy behind a linear obstacle, he is protected to some degree by it. This is represented by a deduction of -1 from your close combat score. Note that this only applies in the turn in which you charge, afterwards your model is assumed to have climbed over the obstacle to get to grips with his opponent.

-1 Improvised attack

If the model has no close combat weapons of any sort and has no natural attacks (claws etc) then a -1 penalty is imposed on the close combat score.

Note that some pistol weapons have 'to hit' modifiers that are applied when shooting. These modifiers do not apply in hand-to-hand combat, only when shooting at a distance.

FUMBLES

When both players roll their attack dice any roll of a 1 represents a fumble. Any fumbled dice are handed over to the other player who adds +1 to his own combat score for each fumbled dice.

DAMAGE CHART

		TARGET'S TOUGHNESS									
		1	2	3	4	5	6	7	8	9	10
WEAPON'S STRENGTH	1	4	5	6	6	N	N	N	N	N	N
	2	3	4	5	6	6	N	N	N	N	N
	3	2	3	4	5	6	6	N	N	N	N
	4	2	2	3	4	5	6	6	N	N	N
	5	2	2	2	3	4	5	6	6	N	N
	6	2	2	2	2	3	4	5	6	6	N
	7	2	2	2	2	2	3	4	5	6	6
	8	2	2	2	2	2	2	3	4	5	6
	9	2	2	2	2	2	2	2	3	4	5
	10	2	2	2	2	2	2	2	2	3	4

PARRIES

A warrior armed with a sword (including Chainswords, Power swords and Force swords) can parry or turn aside an opponent's blow with his own blade. To represent this a model armed with a sword can force an opponent to reroll his highest attack dice before the winner of the combat is determined.

The swordsman doesn't have to parry if he doesn't want to. Though parries are useful it is possible an opponent may reroll and get a better score. An opponent who rolls several dice can always pick his next highest score and use that to determine who won the combat rather than use the score of his re-rolled dice. Re-rolled dice can still produce fumbles as described in the fumble section.

CLOSE COMBAT SUMMARY

WEAPON	RANGE		TO HIT		STRENGTH	DAMAGE	SAVE MODIFIER	SPECIAL
	SHORT	LONG	SHORT	LONG				
Banshee Mask	Close Combat only				—	—	—	See Main Rules
Blade or Saw	Close Combat only				As user	1	—	Close Combat
Bonesword	Close Combat only				6	1	-2	Close Combat
Chainsword	Close Combat only				4	1	-1	Close Combat
Chainfist	Close Combat only				10	D4	-6	Close Combat
Digital Laser	Close Combat only				3	1	-1	Close Combat See Main Rules
Harlequin's Kiss	Close Combat only				—	—	—	Close Combat. See Main Rules
Lightning Claws	Close Combat only				8	D3	-5	Close Combat. See Main Rules
Mandiblasters	Close Combat only				—	1	-2	Close Combat. See Main Rules
Power Axe	Close Combat only				6	1	-3	Close Combat
Power Glove	Close Combat only				8	1	-5	Close Combat
Power Maul	Close Combat only				5	1	-3	Close Combat. See Main Rules
Power Sword	Close Combat only				5	1	-3	Close Combat
R. Rider Lance	Close Combat only				6	1	-2	Close Combat. See Main Rules
Sword	Close Combat only				As user	1	—	Close Combat. See Main Rules
Thunder Hammer	Close Combat only				—	D6	-5	Close Combat. See Main Rules



PISTOLS SUMMARY

WEAPON	RANGE		TO HIT		STRENGTH	DAMAGE	SAVE MODIFIER	SPECIAL
	SHORT	LONG	SHORT	LONG				
Auto-pistol	0-8	8-16	+2	—	3	1	-1	Close Combat
Bolt Pistol	0-8	8-16	+2	—	4	1	-1	Close Combat
Hand Flamer	Template		Special		4	1	-2	Close Combat Uses Hand Flamer Template Target burns on a 4+
Laspistol	0-8	8-16	+2	-1	3	1	—	Close Combat
Needle Pistol	0-8	8-16	+2	—	Special	1	-1	Close Combat, Unsaved hits always wound
Plasma Pistol	0-6	6-18	+2	-1	6	1	-1	Close Combat Sustained Fire in Shooting Phase May not fire again within 1 Turn
Shuriken Pistol	0-6	6-12	+2	—	3	1	-2	Close Combat
Stub Gun	0-8	8-16	—	-1	3	1	—	Close Combat
Web Pistol	0-4	4-8	+1	—	See Main Rules			Close Combat, Free on Strength+2D6 score of 9+

BASIC WEAPONS SUMMARY

WEAPON	RANGE		TO HIT		STRENGTH	DAMAGE	SAVE MODIFIER	SPECIAL
	SHORT	LONG	SHORT	LONG				
Autogun	0-12	12-32	+1	—	3	1	-1	—
Boltgun	0-12	12-24	+1	—	4	1	-1	—
Bow	0-12	12-24	—	-1	3	1	—	—
Crossbow	0-16	16-32	—	-1	4	1	—	Move or Fire
Death Spitter	0-12	12-32	+1	—	6	1	-2	See Main Rules
Flamer	Template		Special		4	1	-2	Target Burns on 4+
Fleshborer	0-8	8-16	+1	—	4	1	—	—
Graviton Gun	0-8	8-16	+1	—	—	—	—	See Main Rules 1½" Blast Area Target Immobilised
Aux. Grenade L.	0-6	6-12	—	-1	—	—	—	As Grenade Type
Pack Grenade L.	0-8	8-16	—	-1	—	—	—	As Grenade Type
Handbow	0-8	8-16	—	-1	4	1	—	Move or Fire
Lasgun	0-12	12-24	+1	—	3	1	-1	—
Melta Gun	0-6	6-12	+1	—	8	D6	-4	—
Musket	0-6	6-24	—	-1	3	1	-1	Move or Fire
Needle Rifle	0-16	16-32	+1	—	Special Rule	1	-1	See Main Rules
Ripper Gun	0-4	4-8	Auto	-2	4	1	—	Sustained Fire Always hits at short range
Plasma Gun	0-6	6-24	+1	—	7	1	-2	Sustained Fire May not fire for 1 turn
Shotgun	0-4	4-18	—	-1				See Shot Type Below
Solid					4	1	—	—
Scatter					3	1	—	1" Blast Area
Shuriken Catapult	0-12	12-24	+1	—	4	1	-2	Sustained Fire
Storm Bolter	0-12	12-24	+1	—	4	1	-1	Sustained Fire

SUPPORT WEAPONS SUMMARY

WEAPON	RANGE		TO HIT		STRENGTH	DAMAGE	SAVE MODIFIER	SPECIAL
	SHORT	LONG	SHORT	LONG				
D-Cannon	0-16	16-32	—	—	See Special Rules		—	Move or Fire 2" Distort Area See Main Rules
Rapier	0-18	18-72	+1	—	9	2D10	-6	Move or Fire See Main Rules
Mole Mortar	12-24	24-72	—	—	See Special Rules			Move or Fire See Main Rules
Scatter Laser	0-20	20-60	+1	—	6	1	-1	See Main Rules
Tarantula	0-20	20-60	—	—	9	2D6	-6	Roll Once for both Weapons See Main Rules
Thudd Gun	0-12	12-72	—	-1	6	1	-2	Move or Fire 4x1" Bursts See Main Rules

HEAVY WEAPONS SUMMARY

WEAPON	RANGE		TO HIT		STRENGTH	DAMAGE	SAVE MODIFIER	SPECIAL
	SHORT	LONG	SHORT	LONG				
Assault Cannon	0-12	12-32	+1	—	8	D10	-3	Heavy: 2" penalty Sustained Fire
Auto-cannon	0-20	20-72	—	—	8	D6	-3	Heavy: 2" penalty Sustained Fire Move or Fire
Battle Cannon	0-20	20-72	—	—	8	2D6	-3	1½" Blast Area Vehicle mounted only
Conversion Beamer	0-20	20-40	—	-1	Special	D6	Special	Heavy: 2" penalty Move or Fire See Main Rules
Terminator Cyclone	0-20	20-72	+1	+1	8	D10	-6	See Main Rules
Heavy Bolter	0-20	20-40	—	—	5	D4	-2	Heavy: 1" penalty Move or Fire and Sustained Fire
Hellfire Shell	0-20	20-40	Hits on 2+		Automatic	D6	-2	No Sustained Fire 2" Acid Splash
Heavy Flamer	Template		Special		5	1	-3	Heavy: 2" penalty,
Hvy Plasma Gun								Heavy 2" penalty
Low Energy	0-20	20-40	—	—	7	D4	-2	Move or Fire
Max. Power	0-20	20-72	—	—	10	D10	-6	1" Blast Area. 2 turns to recharge
Heavy Stub Gun	0-20	20-40	—	—	4	1	-1	Heavy: 1" penalty Move or Fire Sustained Fire
Heavy Webber	0-12	12-24	—	—	Special			Heavy: 2" penalty Move or Fire Web Area 2" Radius
Las-cannon	0-20	20-60	—	—	9	2D6	-6	Heavy: 2" penalty Move or Fire
Multi-melta	0-12	12-24	+1	—	8	2D12	-4	Heavy: 2" penalty Move or Fire 2" Blast Area
Missile Launcher	0-20	20-72	—	—	As Missile Type Below			Heavy: 1" penalty Move or Fire
Krak	—	—	—	—	8	D10	-6	Target Only
Frag	—	—	—	—	4	1	-1	2" Blast Area
Melta	—	—	—	—	8	D6	-4	1" Blast Area
Plasma	—	—	—	—	5	1	-2	1½ Blast Area with Chart Role
Blind	—	—	—	—		Special		2" Blast Area
Anti-Plant	—	—	—	—		Special		2" Blast Area
Multilaser	0-20	20-60	+1	—	6	D4	-1	Heavy: 2" penalty Move or Fire Sustained Fire
Shuriken Cannon	0-20	20-40	+1	—	5	D4	-3	Heavy: 2" penalty Sustained Fire
Shrieker	0-20	20-40	+1	—	5	Special	-3	No Sustained Fire 1" Blast Area See Main Rules

GRENADES SUMMARY

WEAPON	RANGE		TO HIT		STRENGTH	DAMAGE	SAVE MODIFIER	SPECIAL
	SHORT	LONG	SHORT	LONG				
Antiplant	—	—	—	—	—	—	—	2" Blast Area
Blind	—	—	—	—	—	—	—	2" Blast Area
Choke	—	—	—	—	—	—	—	1½" Blast Area
Frag	—	—	—	—	3	1	-1	2" Blast Area
Hallucinogen	—	—	—	—	—	—	—	1½" Blast Area
Haywire	—	—	—	—	—	—	—	1½" Blast Area
Krak	—	—	—	—	6	D6	-3	Target Only
Photon Flash	—	—	—	—	—	—	—	1½" Blast Area
Plasma	—	—	—	—	5	1	-2	1½" Blast Area
Radiation	—	—	—	—	D6+D4	1	-3	D3" Recorded in Secret
Scare	—	—	—	—	—	—	—	2" Blast Area
Smoke	—	—	—	—	—	—	—	2" Blast Area
Stasis	—	—	—	—	—	—	—	2" Blast Area
Tanglefoot	—	—	—	—	—	—	—	Special See Main Rules
Toxin	—	—	—	—	—	—	—	1½" Blast Area
Virus	—	—	—	—	—	—	—	2" Blast Area
Vortex	—	—	—	—	—	—	—	1½" Blast Area

PSYCHIC WEAPONS SUMMARY

WEAPON	RANGE		TO HIT		STRENGTH	DAMAGE	SAVE MODIFIER	SPECIAL
	SHORT	LONG	SHORT	LONG				
Force Axe	Close Combat only				As User	1	—	See Main Rules
Force Rod	Close Combat only				—	—	—	See Main Rules
Force Sword	Close Combat only				As User	1	—	See Main Rules
Nemesis	0-4"	—	—	—	4	1	-1	See Main Rules
Witch Blade	Close Combat only				—	1	—	See Main Rules

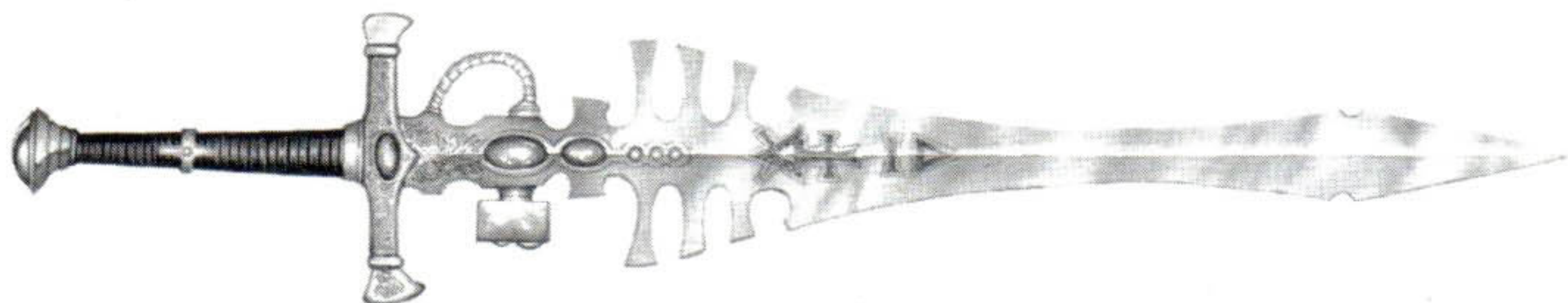

ARMOUR PENETRATION

This table summarises the armour penetration values of each weapon using the Warhammer 40,000 vehicle rules first published in White Dwarf. You can work out penetration rates for yourself using the profiles, but we thought it would be useful to have a summary.

In addition to the penetration value, we've include the minimum and maximum results and the average result which you'll get with a typical dice roll. Obviously you don't need to know these values to play the game, but smart players will quickly realise the usefulness of knowing how much armour they're likely to penetrate with a shot. Remember that the more dice you roll the greater chance you have of obtaining a result close to the average score – so a lascannon with 3D6+9 is more predictable than a plasma gun with D6+7.

PISTOLS	Armour Penetration	Min. Result	Max. Result	Average Result
Autopistol	D6+3	4	9	6.5
Bolt Pistol	D6+4	5	10	7.5
Hand Flamer	D6+4	5	10	7.5
Laspistol	D6+3	4	9	6.5
Needle Pistol	D6+3	4	9	6.5
Plasma Pistol	D6+6	7	12	9.5
Shuriken Pistol	D6+3	4	9	6.5
Stub Gun	D6+3	4	9	6.5

BASIC WEAPONS	Armour Penetration	Min. Result	Max. Result	Average Result
Autogun	D6+3	4	9	6.5
Boltgun	D6+4	5	10	7.5
Bow	D6+1	2	7	4.5
Crossbow	D6+1	2	7	4.5
Death Spitter	D6+6	7	12	9.5
Flamer	D6+4	5	10	7.5
Fleshborer	D6+4	5	10	7.5
Graviton Gun	— Automatically penetrates the target			
Hand Bow	D6+1	2	7	4.5
Lasgun	D6+3	4	9	6.5
Meltagun	2D6+8	10	20	15
Musket	D6+3	4	9	6.5
Sniper Rifle	D6+3	4	9	6.5
Ogryn Ripper	D6+4	5	10	7.5
Plasma Gun	D6+7	8	13	10.5
Shot Gun	D6+4	5	10	7.5
Shuriken Catapult	D6+4	5	10	7.5
Storm Bolter	D6+4	5	10	7.5



HEAVY WEAPONS	Armour Penetration	Min. Result	Max. Result	Average Result
Assault Cannon	D6+D10+8	10	24	17
Auto-Cannon	2D6+8	10	20	15
Battle Cannon	3D6+8	11	26	18.5
Conversion Beamer	— Varies with armour value			
1-4 armour	D6	1	6	3.5
5-8 armour	2D6	2	12	7
9-11 armour	3D6	3	18	10.5
12-14 armour	4D6	4	24	14
15+ armour	5D6	5	30	17.5
Cyclone	D10+D6+8	10	24	17
Heavy Bolter	D6+D4+5	7	15	11
Heavy Flamer	D6+5	6	11	8.5
Heavy Plasma Gun	— Varies according to power setting			
Max. Power	D6+D10+10	12	26	19
Low Energy	7+D4+D6	9	17	11
Heavy Stub Gun	D6+4	5	10	7.5
Lascannon	3D6+9	12	27	19.5
Mole Mortar	— Varies according to burst type			
Airburst	D6+3	4	9	7.5
Surface Burst	D6+4	5	10	8.5
Ground Burst	D6+4	5	10	8.5
Subterranean	D6+3	4	9	7.5
Missile Launcher	— Varies according to missile type			
Krak Missile	D6+D10+8	10	24	17
Frag Missile	D6+4	5	10	7.5
Melta Missile	2D6+8	10	20	15
Multi-laser	D6+D4+6	8	16	12
Multimelta	D6+2D12+8	11	38	24.5
Shuriken Cann.	D6+D4+5	7	15	11

SUPPORT WEAPONS	Armour Penetration	Min. Result	Max. Result	Average Result
Distort Cannon	— Automatically penetrates (see rules)			
Rapier	D6+9+2D10	12	35	23.5
Scatter Laser	D6+6	7	12	9.5
Tarantula	3D6+9	12	27	19.5
Thudd Gun	D6+6	7	12	9.5

GRENADES	Armour Penetration	Min. Result	Max. Result	Average Result
Frag Grenade	D6+3	4	9	7.5
Haywire	— Automatically penetrates (see rules)			
Krak Grenade	2D6+6	8	18	13
Plasma Grenade	D6+5	6	11	8.5
Rad Grenade	2D6+D4	3	16	9.5
Vortex Grenade	— Automatically penetrates (see rules)			



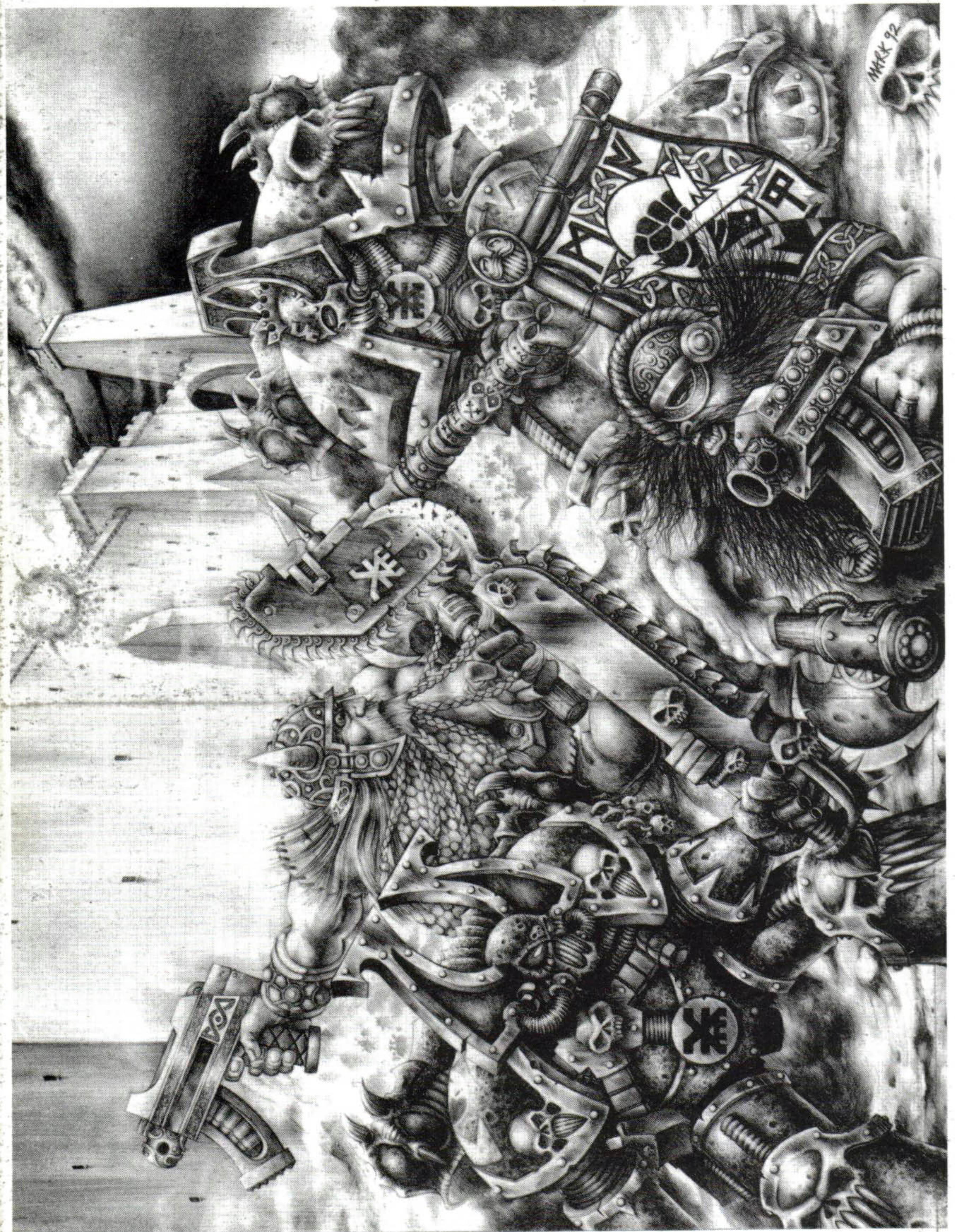

WARHAMMER 40,000 BATTLE MANUAL

This volume updates and expands the combat rules and weapon details from the Warhammer 40,000 rulebook, compiling the original and new weapons published as the game has developed into one, easy-to-use book.

The Warhammer 40,000 Battle Manual includes:

- Revised and expanded rules for shooting, including overwatch fire, an alternative scatter system and rules for choosing targets.
- New hand-to-hand combat system, with rules for parrying blows, fumbled attacks and fighting multiple opponents.
- Background and rules for the most commonly used weapons of the 41st Millennium, including basic weapons, pistols, heavy and support weapons, grenades and hand-to-hand weapons.
- Card reference sheets and templates, including each weapon's armour penetration value for use with the revised Warhammer 40,000 vehicle rules.



THE BATTLE MANUAL IS NOT A COMPLETE GAME. YOU'LL NEED A COPY OF THE WARHAMMER 40,000 RULEBOOK TO USE THE INFORMATION IN THIS BOOK



5 011921 001637

0163

Warhammer 40,000 is a registered trademark of Games Workshop Ltd.

Games Workshop, Citadel and the Citadel Castle are trademarks of Games Workshop Ltd.

© Copyright Games Workshop Ltd, 1992. All rights reserved.

PRODUCT CODE: 001633
ISBN: 1-872372-53-8

GAMES WORKSHOP™

GAMES WORKSHOP LTD.,
Chewton Street,
Hilltop, Eastwood,
Nottingham NG16 3HY

GAMES WORKSHOP INC.,
3431 - C Benson Avenue,
Baltimore
MD 21227-1072



Manufactured
in the U.K.