



THW
ROLEPLAYING

LEMURIAN TREATY PORT

Mission St. Mary



WELCOME TO NOBELONGGA

Want to buy an Artifact?

Lemuria – old when Eden was young, this primal land of adventure beckons you. Ancient kingdoms and European powers vie for control of the land and its peoples. Lemuria is a lush land, yet unforgivingly harsh at times, filled with riches beyond belief. Opportunities for Fame and Fortune present itself at every turn; but will you be brave enough to seize them?

Nobelongga is the eastern gateway to Lemuria. Located on the opposite side of the island continent, away from the civilized side, Nobelongga allows all to enter the continent through Mission St. Mary. *Mission St. Mary* is the largest Treaty Port on the east coast. It is a town where the European nations have their embassies and conduct trade; all under the watchful eyes and tacit approval of the local Nobelongga tribes.

Mission St. Mary is a stand-alone game that is compatible with *Larger Than Life – Director's Cut*, our Pulp Adventures game. It's an adventure game for use in the Victorian Era (Steam Punk and Colonials) as well as for Pulp. Players can be an explorer, soldier, native, caveman, or even a dinosaur. Inside you'll find:

- Lists for generating 15 different types of characters for you to use. From Adventurers to Steam Punks, with Cavemen, Cultists, Dinosaurs and much more in between.
- Over 18 Attributes that you can mix and match to make your characters unique.
- A system that allows your characters to increase in skills and abilities when they succeed, but force them into "retirement" when they fail.
- A complete country to adventure in that includes a civilized town, a Lost World, jungles to explore, and rivers to navigate.
- Over 20 Professions to enhance your characters and those you encounter.
- Mechanics that allow *Mission St. Mary* to be played solo or cooperatively against the game, as well as head to head versus your friends.
- Ten different scenarios that can be played over and over with no 2 ever being the same.
- All this and much more.

LEMURIAN TREATY PORT

Mission St. Mary

THW
ROLEPLAYING

2HW-1072
\$20.00

MISSION ST. MARY

LEMURIAN TREATY PORT

NOBELONGGA

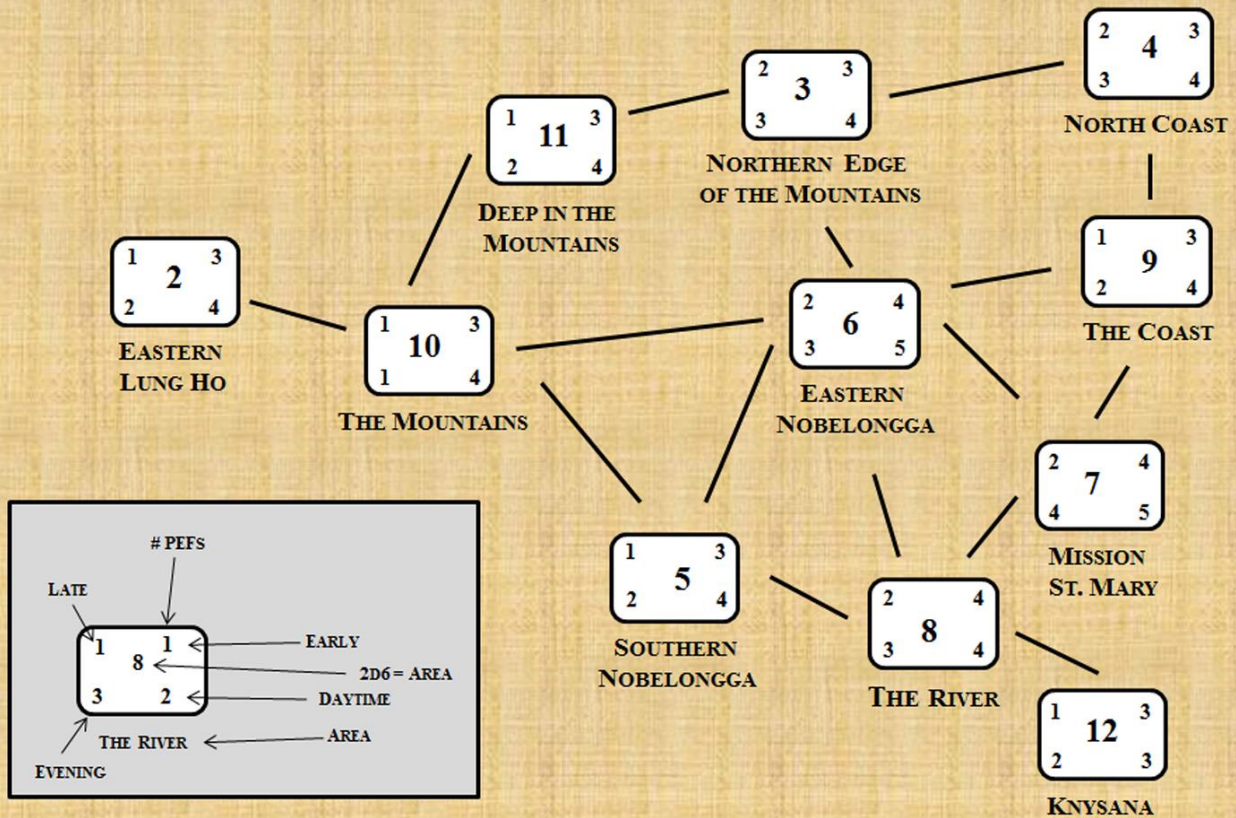

WRITTEN BY ED TELXEIRA

COVER BY PAUL KIME

DIGITALLY EDITED BY CRAIG ANDREWS

MISSION ST. MARY – LEMURIAN TREATY PORT

TABLE OF CONTENTS

	Stars	5	
	Player Grunts	5	
	Attribute Tables	6	
INTRODUCTION	1	CIRCLES	6
Word of Advice	1		
NEEDED TO PLAY	1	PROFESSIONS	6
Dice	1	Civilians	6
<i>Passing Dice</i>	1	Criminal Element	7
<i>Counting Successes</i>	1	Exotics	7
<i>Possibilities</i>	1	Movers	7
<i>Reading and Adding the Dice</i>	2	Shakers	7
<i>1/2d6</i>	2	<i>Profession Table</i>	8
<i>How Many d6?</i>	2	Stop!	8
Figures and Terrain	2	CLASS	8
<i>Basing Figures</i>	2	Adventurer	8
<i>Defining Facing</i>	2	Civilians	8
Table	2	Criminal Element	8
<i>Why So Many?</i>	2	Law & Order	8
WHO'S WHO?	3	WEAPONS	8
Adventurers	3		
Animals	3	RECRUITING NPCs	9
Askari	3	Stop!	9
Cro-Magnon	3	GROUPS	9
Cultists	3	Group Cohesion	9
Deep Ones	3	Splitting Up Groups	9
Dinosaurs	3	Activating Groups	10
Great Grey Apes	3	LEADERS	10
Jungle Lord & Lady	3	Star Leaders	10
Monkey Boys	3	Temporary Leaders	10
Natives	3	Leader Die	10
Neanderthal	3	Stop!	11
Soldiers	3	TURN SEQUENCE	11
Steam Punks	3		
DEFINING CHARACTERS	3	ACTIONS	12
STAR AND GRUNTS	4		
Star Advantages	4	MOVEMENT	12
<i>Star Power</i>	4	Normal Movement	12
<i>Free Will</i>	4	Fast Movement	12
GENDER	5	Going Prone	12
		Involuntary Movement	12
REPUTATION	5	<i>Carry On</i>	12
NPC Reputation	5	<i>Charge</i>	12
Stop!	5	<i>Duck Back</i>	12
ATTRIBUTES	5	<i>Fire</i>	12
How Many & How Determined	5	<i>Run Away</i>	12
<i>Character Attribute Table</i>	5	<i>Rush Shot</i>	13

MISSION ST. MARY – LEMURIAN TREATY PORT

<i>Stop!</i>	13	<i>Obviously Dead</i>	22
		<i>Out of the Fight</i>	22
IN SIGHT	13	<i>Run Away</i>	22
<i>In Sight or Out of Sight</i>	13	<i>Rush Shot</i>	22
<i>Triggering an In Sight Test</i>	13	<i>Stop!</i>	22
<i>Taking the In Sight Test</i>	14		
<i>Multiple In Sights</i>	14	MELEE	22
<i>In Sight Table</i>	14	<i>Melee Weapons</i>	22
<i>Optional In Sight</i>	14	<i>Melee Weapons Table</i>	22
<i>Resolving In Sight Actions</i>	14	<i>Charge into Melee Test</i>	22
<i>Completed In Sights</i>	15	<i>How to Charge into Melee</i>	22
<i>Moving, Shooting, and In Sight</i>	15	<i>Charge into Melee Table</i>	23
<i>Stop!</i>	15	<i>Duck Back & Charging</i>	23
		<i>Melee Combat</i>	23
RANGED WEAPONS	15	<i>Multiple Figure Melees</i>	23
<i>Ranged Weapons Table</i>	16	<i>Melee Combat Table</i>	23
<i>Out of Ammo</i>	16	<i>Determining Melee Damage</i>	24
		<i>Melee Damage Table</i>	24
		<i>Dinosaur Melee Damage</i>	24
		<i>Dinosaur Melee Damage Table</i>	24
SHOOTING	16		
<i>Line of Sight</i>	16	AFTER THE ENCOUNTER	24
<i>Target Selection</i>	16	<i>Recovery Table</i>	25
<i>Active Targeting</i>	16	<i>Stop!</i>	25
<i>Reactive Targeting</i>	16		
<i>Applying Target Rating</i>	16	DINOSAURS	25
<i>Firing a Weapon</i>	17	<i>Defining Dinosaurs</i>	25
<i>Shooting Table</i>	17	<i>Size</i>	25
<i>Shooting Damage</i>	18	<i>Fierce or Feeder</i>	25
<i>Stacking Damage</i>	18		
<i>Cover or Concealment</i>	18	REPUTATION	25
<i>Cover or Concealment Table</i>	18	<i>Reputation and Melee</i>	25
<i>Firing at Carrying Wounded</i>	18		
<i>Firing Two Weapons at Once</i>	18	DINOSAUR & ANIMAL LISTS	26
		<i>Dinosaur List</i>	26
DAMAGE	19	<i>Animal List</i>	26
<i>Obviously Dead</i>	19		
<i>Out of the Fight</i>	19	REACTION TESTS	26
<i>-1 to Rep</i>	19		
<i>Duck Back</i>	19	MOVEMENT	26
<i>Auto-Kill or Capture</i>	20		
<i>Stop!</i>	20	FAST MOVE	26
		<i>Chase Them Down</i>	26
REACTION TESTS	20		
<i>In Sight & Charge into Melee</i>	20	CHALLENGES	26
<i>Received Fire</i>	21	<i>Success & Failure</i>	26
<i>Man Down</i>	21	<i>Challenge Test</i>	27
<i>Multiple Tests</i>	21	<i>Stop!</i>	27
<i>Reaction Test Results</i>	21		
STATUS AND ACTIONS	21	DAY PART	27
<i>Carry On</i>	21	<i>What Day Part?</i>	27
<i>Charge</i>	21		
<i>Duck Back</i>	21		
<i>Fire</i>	21		

MISSION ST. MARY – LEMURIAN TREATY PORT

<i>Day Part Table</i>	27	HOW NPCs MOVE	36
<i>Day Parts and Visibility</i>	27	<i>NP Movement Table</i>	36
		<i>NPC Actions</i>	36
TERRAIN	28	ENCOUNTERS	36
<i>Laying Out Terrain</i>	28	<i>Presentation</i>	36
<i>Key Sections</i>	28	<i>Order of Encounters</i>	36
<i>Open Space</i>	28	CONFRONTATION	37
<i>Exotic Locales</i>	28	CONQUER	38
<i>Jungle</i>	28	CONTACT	38
<i>Lost World</i>	28	EXPLORE	39
<i>Target Building</i>	29	GATHERING	39
<i>Stop!</i>	29	HUNT	40
NOBELONGGA	29	JOB OFFER	40
<i>Map of Lemuria</i>	29	RAID	42
<i>Area Map of Nobelongga</i>	30	RESCUE	43
<i>The Rectangle Knows All</i>	30	SCAVENGER HUNT	44
<i>Area</i>	30	TRAVEL	44
<i>The Number in the Middle</i>	30	FLUCTUATING REP	45
<i>PEF</i>	30	<i>Increasing Rep</i>	45
<i>Day Parts</i>	30	<i>Decreasing Rep</i>	45
<i>Moving Between Areas</i>	31	<i>Bonus Rep d6</i>	45
PEFs	31	QUICK REFERENCE SHEETS	46
<i>Generating PEFs</i>	31	<i>Reaction Tests</i>	47
<i>PEF Rep</i>	31	<i>Dino Reaction Tests</i>	47
<i>PEF Movement</i>	31	<i>In Sight Test</i>	47
<i>PEF Movement Table</i>	31	<i>Ranged Weapons Table</i>	47
<i>Special PEF Movement</i>	31	<i>Shooting Table</i>	48
<i>Resolving PEFs</i>	31	<i>Shooting Damage Table</i>	48
<i>PEF Resolution Table</i>	32	<i>Cover or Concealment Table</i>	48
<i>Defining Moment</i>	32	<i>Charge into Melee Test</i>	49
<i>Who Are They?</i>	32	<i>Melee Combat Table</i>	49
<i>Who Are They Table</i>	32	<i>Melee Damage Table</i>	49
<i>Mission St. Mary NPCs</i>	32	<i>Dinosaur Melee Damage Table</i>	49
<i>Mission St. Mary NPCs Table</i>	33	<i>Recovery Table</i>	49
<i>NPC Lists</i>	33	<i>Challenge Table</i>	50
<i>Adventurers</i>	33	<i>PEF Movement Table</i>	50
<i>Cavemen</i>	33		
<i>Cultists</i>	33		
<i>Deep Ones</i>	34		
<i>Great Grey Ape</i>	34		
<i>Jungle Lord</i>	34		
<i>Natives</i>	34		
<i>Soldiers</i>	34		
<i>Steam Punks</i>	34		
<i>Dinosaurs</i>	34		
<i>Animals</i>	34		
<i>Are They Friends or Foes?</i>	35		
<i>Talk the Talk</i>	35		
<i>Opposites</i>	35		
<i>Opposites Table</i>	35		
<i>Stop!</i>	35		

MISSION ST. MARY – LEMURIAN TREATY PORT

<i>PEF Resolution Table</i>	50
<i>NP Movement Table</i>	50
<i>Who Are They Table</i>	51
<i>Adventurers</i>	51
<i>Cavemen</i>	51
<i>Cultists</i>	51
<i>Deep Ones</i>	51
<i>Great Grey Ape</i>	52
<i>Jungle Lord</i>	52
<i>Natives</i>	52
<i>Soldiers</i>	52
<i>Steam Punks</i>	52
<i>Dinosaurs</i>	52
<i>Animals</i>	52
<i>Mission St. Mary NPCs</i>	53

INDEX OF TABLES

Adventurers, 33, 51
Animals, 26
Animals, 34, 52
Attribute Tables, 6
Cavemen, 33, 51
Challenge, 27, 50
Character Attributes, 5
Charge into Melee, 23, 49
Cover or Concealment, 18, 48
Cultists, 33, 51
Day Part, 27
Deep Ones, 34, 51
Dinosaur Melee Damage, 24, 49
Dinosaurs, 26, 52
Dinosaurs, 34
Employer, 41
Exploration, 39
Gathering, 40
Great Grey Ape, 34, 52
In Sight, 14, 47
Jungle Lord, 34, 52
Melee Combat, 23, 49
Melee Damage, 24, 49
Melee Weapons, 22
Mission St. Mary NPCs, 33, 52
Natives, 34, 52
NP Movement, 36, 50
Opposites, 35
PEF Movement, 31, 50
PEF Resolution, 32, 50
Profession Table, 8
Ranged Weapons, 16, 47
Reaction Tests, 46
Reaction Tests, Dinosaurs, 47
Recovery, 25, 49
Shooting Damage, 18, 48
Shooting, 17, 48
Soldiers, 34, 52
Steam Punks, 34, 52
Wages, 41
Where's the Job, 41
Who Are They, 32, 51

SPECIAL THANKS TO:

Paul Kime: For another great cover.
Ken Hafer, Bob Minadeo and Ron Baddawg'Strickland: For insisting that, It's not just a gang warfare game."
The THW Guys on the Group and Forum: For the constant support.
And Lil...

MISSION ST. MARY – LEMURIAN TREATY PORT

INTRODUCTION

What is *Mission St. Mary*?

It's a stand-alone game that is compatible with *Larger Than Life – Director's Cut*, our Pulp Adventures game, as well as our other games.

It's an adventure game for use in the Victorian Era as well as for Pulp. Players can be an explorer, soldier, native, caveman, or even a dinosaur.

Mission St. Mary contains a complete area to adventure in, from a European style Treaty Port, to jungles, mountains, and even a Lost World. But enough of this; let's get started.

WORD OF ADVICE

Be sure to read the rules one section at a time and follow the *Stop Box* at the end of each section. If you have a question about the rules just keep reading as the answer will be coming along shortly.

But if you can't find the answer, just check out the Two Hour Wargames Forum link below.

<http://site.twohourwargames.com/forum/index.php>

It's a very active forum and you can expect an answer within 24 hours.

NEEDED TO PLAY

You will need a few things to play *Mission St. Mary*. They are:

- Six-sided dice, also called d6. It is best to have at least six of them and the more you have, the quicker games will play.
- One measuring device, ideally one per player.
- Any combination of metal, plastic or paper figures in a consistent scale of your choice. Note that the rules are written for 28mm and if using a different scale adjust all distances accordingly, *but only if you want to*.
- Something to represent buildings and other terrain features.
- A flat surface at least 3'x3', but you can play with a larger one if desired.

DICE

During the game you will be asked to roll dice (d6) in a variety of ways. They are:

- Passing Dice.
- Counting Successes.
- Possibilities.
- Reading and Adding the Dice.
- 1/2d6

PASSING DICE

To *pass dice*, roll 2d6 and compare each die score individually to the *Target Number*. The Target Number can be *Reputation* (page 5) or something entirely different.

- *If the score is equal or lower* than the Target Number the d6 has been passed.
- *If the score is higher* than the Target Number the d6 has not been passed.
- You can pass 2d6, 1d6, or 0d6 when the dice are rolled in this manner, regardless of the number of d6 you may actually roll.
- *Isn't passing 0d6 like failing 2d6?* No, because we are counting the number of passed dice.

Example - The Charge into Melee Table (page 49) is used by rolling 2d6 versus the Rep of the figure. That means Rep is the Target Number. The Native has a Rep of 4. I roll 2d6 and score a 5 and 2. The Native has passed 1d6 as only the 2 is equal or lower than the Rep of 4.

COUNTING SUCCESSES

Another way to use d6 is to roll them and count *successes*.

- A score of 1, 2, or 3 is a success.
- A score of 4, 5, or 6 is a failure.

Example: A Native is in melee and rolls a total of 6d6. He scores a 1, 2, 2, 3, 5, and 6. He has scored 4 successes.

POSSIBILITIES

Sometimes numbers will appear in parenthesis (1 - 2). Immediately roll 1d6. If that number is scored, that event has happened.

Example – I have met a Soldier. There is a chance (1) that we have met before. I roll 1d6 and score a 1. He is someone that I have met before.

MISSION ST. MARY – LEMURIAN TREATY PORT

READING AND ADDING THE DICE

Sometimes you simply read the result as rolled. When rolling 2d6 in this way you add the scores together to get a total.

Example – On the Who Are They Table (page 51) I roll 1d6 and score a 5.

1/2D6

Occasionally you will be asked to roll 1/2d6. Here's how we do it:

- Roll 1d6.
- (1 - 2) = 1
- (3 - 4) = 2
- (5 - 6) = 3

HOW MANY D6

How many d6 do you roll? Here's how we do it:

- Look in the upper left hand corner of each table. There will be a number that tells you how many d6 to roll.
- When a word such as *Rep* appears, that means 1d6 for each point of whatever word.
- If an "X" appears, this means no d6 are rolled.
- The number of d6 to be rolled will often be modified by applicable Circumstances.

Example – Dario Fitch declares a charge on a Gangster. Looking on the Charge into Melee Table in the upper left hand corner I see a 2. This means Dario will roll 2d6.

FIGURES AND TERRAIN

There are lots of figures that can be used with *Mission St. Mary*. There aren't any official figures so play with whatever you have.

You can choose from metal figures, plastic figures, or even paper figures. I use paper counters sometimes. The best part is that you can use any of them and still play *Mission St. Mary*. If you don't have figures, you can find them in gaming, toy and dollar stores, at conventions, or online.

Finding terrain can be handled in the same way or you can build it from scratch. Some very nice paper terrain is available online that will work just fine. I use eBay as one source for terrain; it is also a good way to find painted figures.

Perhaps the best form of guidance will come from joining the Two Hour Wargames Forum and asking your questions there.

<http://site.twohourwargames.com/forum/index.php>

BASING FIGURES

The easiest way to base figures for *Mission St. Mary* is one figure on a round or square base. Whatever size bases you decide to use, be sure to use them consistently.

DEFINING FACING

Charging onto or shooting to the rear of an enemy depends upon the actual physical location of the attacker.

To qualify as a rear attack the attacker must begin and end its movement behind the rear facing of the target.

- The front facing is defined as 180 degrees to the front of the figure. Any figure, building, or terrain feature within this facing is considered to be In Sight (page 13).
- The rear facing is defined as 180 degrees to the rear of the figure. Any figure, building, or terrain feature within this facing is considered to be Out of Sight.
- The following illustration helps to define the front and rear facings.

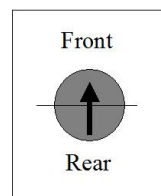

TABLES

Wherever possible, the tables that you will *usually* use during the game have been grouped together in the back of the book. You will usually use two or three tables during your games and some, like the Shooting Table (page 48) can be easily memorized.

WHY SO MANY?

Tables help to create the Story. Your *Mission St. Mary* games can be as simple or as detailed as you like. For those who want a quick pickup game, just use the basic Reaction Tables (page 46). If you want to play a full campaign, multiple adventures linked together, use the additional tables that are provided. *Mission St. Mary* is like a toolbox. You may not need all the tools, but they are there when you do!

MISSION ST. MARY – LEMURIAN TREATY PORT

WHO'S WHO?

In Mission St. Mary we use quite a few different types of characters. Players can choose to play any of the following characters:

ADVENTURERS

This list covers the European and American explorers, hunters, and soldiers of fortune that helped define the Victorian and Pulp Eras.

ANIMALS

Ever wanted to play a tiger? Yep, you can do that if you want, but you'll usually be running into them when on safari.

ASKARI

Askari are indigenous soldiers that have European weapons and training.

CRO-MAGNON

The Cro-Magnon is the closest to early modern man. When you meet them they can be a tough foe if provoked.

CULTISTS

Members of a Cult are worshippers of ancient occult figures. Usually they are trying to pave the way for the return of these Old Ones.

DEEP ONES

The Deep Ones are a race of intelligent ocean-dwelling creatures, approximately human-shaped but with a fishy, frog-like appearance. They regularly mate with humans along the coast, creating societies of hybrids.

DINOSAURS

Yes, if you want to, you can play Mission St. Mary as a Dinosaur. You'll find them Deep in the Mountains (page 30).

GREAT GREY APES

These apes are rumored to be the Guardians of the Jewels of Lemuria. Large in size, these apes exhibit intelligence not found in their African relatives.

JUNGLE LORD & LADY

The classic Jungle Lord & Lady like Tarzan and Sheena – Queen of the Jungle.

MONKEY BOYS

In *Mission St. Mary* these are the *missing link*. Not quite an ape and not quite a human these creatures are *basically* pretty docile and timid.

NATIVES

Divided into many and varied clans, the Nobelongga tribesmen are open to the European ideas, but fiercely independent. Some of the tribesmen work as bearers and diggers for the Europeans hired to carry equipment on expeditions outside of Mission St. Mary.

NEANDERTHAL

Not as advanced as the Cro-Magnon and definitely tougher than the *monkey boys*. The Neanderthal is a very dangerous adversary.

SOLDIERS

These are characters in the military arm of the various European and Western Nations.

STEAM PUNKS

Depending upon the time period you choose to play these adventurers utilize cutting edge steam and tech driven equipment (Victorian Era) or antiquated garbage.

DEFINING CHARACTERS

Mission St. Mary is played with individual figures referred to as *characters*. Characters and figures are used interchangeably in the text of the rules so don't sweat it!

Characters are defined in the following ways.

- Is it a *Star* or a *Grunt*?
- What is its *Gender*?
- What is its *Reputation*?
- What *Attributes* does it have?
- What is its *Circle*?
- What is its *Profession*?
- What is its *Class*?
- What *Weapons* does it have?

MISSION ST. MARY – LEMURIAN TREATY PORT

STARS AND GRUNTS

There are two types of characters in Two Hour Wargames. They are *Stars* and *Grunts*.

STARS – Characters that represent you, the player. We suggest your Star begin with a Rep of 5.

GRUNTS – These are the *Non-Player Characters* (NPC) that does not represent the players. *NPCs are controlled by the game mechanics whether they are fighting with or against you.* All Grunts are generated using the Mission St. Mary NPCs Table (page 53) or NPC Lists (page 51).

STAR ADVANTAGES

As a Star in *Mission St. Mary* you have two important advantages. Use both, one or none as you see fit. They are:

- Star Power.
- Free Will.

STAR POWER

Star Power is the ability of the Star to reduce damage. Here's how we do it:

- Stars begin each Encounter with Star Power equal to their Rep. So if you're a Rep 5 you get 5 Star Power dice.
- Whenever a figure with Star Power takes damage of any type he rolls his current number of Star Power dice. Read each d6 as rolled:
 - Any result of 1, 2, or 3 reduces the damage by one level.
 - Any result of 4 or 5 means the damage stays and the d6 is retained for future use later in the Encounter.
 - Any result of 6 means the damage stays and that die is removed from the figure's Star Power for the rest of the Encounter (page 36).

Damage from shooting is reduced in the following ways:

- An Obviously Dead (page 19) result becomes an Out of the Fight.
- An Out of the Fight (page 19) result becomes Duck Back.
- A Duck Back becomes Miss - Target takes a Received Fire Reaction Test.

Damage from melee is reduced in the following ways:

- An Obviously Dead (page 19) result becomes an Out of the Fight.

- An Out of the Fight (page 19) result becomes Target loses 1 point of Rep for the remainder of the Encounter and immediately fights a round of melee.
- A Target loses 1 point of Rep for the remainder of the Encounter and immediately fights a round of melee, becomes no Rep reduction and immediately fights another round of melee.

Example: A Star with a Rep of 5 is hit three times by submachine gun fire. He takes two Out of the Fight and one Duck Back result. He rolls 5d6 and scores a 1, 2, 3, 4 and 6.

The 6 is no help and is discarded for the remainder of the Encounter.

The 4 is no help but is kept.

The 1 reduces the first Out of the Fight to a Duck Back.

The 2 reduces the second Out of the Fight to a Duck Back.

The 3 reduces one of the Duck Backs to a Miss.

This leaves two Duck Backs, so the Star Ducks Back.

FREE WILL

Stars can choose to pass 2d6, 1d6 or 0d6 on the following Reaction Tests without having to roll any dice:

- Received Fire Reaction Test.
- Man Down Reaction Test.

Example – Dario Fitch is fired at by a German Askari and missed. He must take the Received Fire Test (page 46) but can use his Free Will. He chooses to pass 2d6 and returns fire.

MISSION ST. MARY – LEMURIAN TREATY PORT

GENDER

You can choose the genders of the characters as desired.

REPUTATION

Reputation or *Rep* represents a combination of training, experience, and morale. Rep is an expression of a figure's overall quality and coolness under pressure.

There are three possible *starting levels* of Reputation:

- **REP 5** - These are very confident and experienced characters. Not to be regarded lightly.
- **REP 4** - These are reliable characters of some experience. Overall pretty good characters.
- **REP 3** - These are characters of unknown quality and cannot be counted on during crunch time.

Remember, Stars always start with a Rep of 5. This doesn't mean that you're a Rep 5; your figure is! When you start playing Mission St. Mary you're really a Rep 3 but after playing a few games your real life Rep may equal the Rep of your character!

NPC REPUTATION

NPC Reps can be found on the Mission St. Mary NPCs Table (page 53) and NPC Lists (page 51).

STOP!

Mission St. Mary is played with d6.

A success is a score of 1, 2, or 3.

To pass a d6 the result must be lower than the Target Number, usually Rep.

You can play Mission St. Mary as a variety of characters.

What advantages does a Star have over a Grunt? If you roll a "6" when using Star Power what happens?

Free Will allows the Star to pass 2d6, 1d6 or 0d6 when taking a Reaction Test, without rolling dice.

Stars should begin with a Rep of 5.

ATTRIBUTES

In *Mission St. Mary* we use Attributes to further define our characters. An *Attribute* is a trait or behavior that is demonstrated over the life of the character.

HOW MANY & HOW DETERMINED

All characters have their 1st Attribute assigned to them based on who they are.

CHARACTER	ATTRIBUTE
Adventurers	<i>Initiative</i>
Askari	<i>Near Sighted</i>
Cro-Magnon	<i>Brawler</i>
Cultists	<i>Clumsy</i>
Deep Ones	<i>Slow to React</i>
Great Ape	<i>Rage</i>
Jungle Lady	<i>Quick Reflexes</i>
Jungle Lord	<i>Hard as Nails</i>
Monkey Boys	<i>Stealthy</i>
Native Bearers	<i>Poser</i>
Native Diggers	<i>Poser</i>
Native Warriors	<i>Tough</i>
Neanderthal	<i>Rage</i>
Soldiers	<i>Crack Shot</i>
Stream Punks	<i>Initiative</i>

STARS

Stars are allowed up to 3 total Attributes. The 1st is assigned by who the character is. The 2nd can be chosen by the player from the following tables. The 3rd is optional and must be rolled for. It must be kept, regardless of what it is! Here's how we do it:

- Roll 1d6 and read the result as rolled.
- Go to the corresponding Attribute Table for the result.
- Roll another 1d6, read the result as rolled, then down the left hand column to the appropriate row for the result.
- Go across to determine the Attribute the character has gained. Remember, you must keep whatever is rolled!

PLAYER GRUNTS

Player Grunts, NPCs run by the game mechanics but are part of the player's group, can have 2 total Attributes. The 1st is assigned by who the character is. The 2nd is optional and must be rolled for in the same way as you do for Stars. It must be kept, regardless of what it is!

MISSION ST. MARY – LEMURIAN TREATY PORT

ATTRIBUTE TABLE – 1, 2, OR 3

#	ATTRIBUTE
1	Ambidextrous: The character ignores the <i>shooter firing with Off Hand penalty</i> when shooting.
2	Athlete: Counts a +1 to Rep when taking a Physical Challenge.
3	Brawler: Counts a +1d6 when in melee.
4	Clumsy: Counts a -1 to Rep when taking a Physical Challenge
5	Slow: Normal movement is 6" and can only use 1d6 when attempting a Fast Move.
6	Slow to React: Counts a -1d6 when taking the In Sight Test.

ATTRIBUTE TABLE – 4 OR 5

#	ATTRIBUTE
1	Coward: Treats a result of Duck Back as Run Away.
2	Initiative: Counts one Rep higher for Activation purposes when operating alone.
3	Near Sighted: Counts Rep at one less when shooting.
4	Poser: Can never score higher than pass 1d6 when taking a Reaction Test.
5	Quick Reflexes: Counts a +1d6 bonus when taking the In Sight Test.
6	Stealthy: Opponents will always count a -1d6 penalty when taking an In Sight Test versus this character when alone.

ATTRIBUTE TABLE - 6

#	ATTRIBUTE
1	Crack Shot: Will roll 3d6 instead of 2d6 when using a Bolt-Action Rifle, counting the best 2 scores.
2	Hard as Nails: Once during each Encounter the character will treat its first Obviously Dead result as Carry On instead.
3	Nerves of Steel: Treat Duck Back as if Carry On. Counts a +1d6 when taking the Charge into Melee Test.
4	Rage: Counts a +1d6 when in melee. Roll +1d6 when taking the Charge into Melee Test.
5	Stone Cold: Will roll 3d6 when taking a Reaction Test, counting the best 2d6.
6	Tough: Once during each Encounter the character will treat the first Duck Back result as a Carry On result.

CIRCLES

In real life people tend to associate with similar people the majority of the time, and come into contact with others. An example would be the attorney that goes with his attorney friend to Starbucks. His co-worker, who he comes into contact with regularly, is in the same Circle (Shaker) while the barista (Civilian), making the latte, is an acquaintance. To reflect this moving between circles, we have grouped the people in *Mission St. Mary* into Circles. See the section on Professions for more information.

PROFESSIONS

People work. I work, you work, and in general everybody works and it doesn't change in *Mission St. Mary*. For simplicity's sake we've grouped similar professions together and placed them under five broad categories. *These categories also provide the social standing of the character.*

- **Movers** - Wealthy and powerful people. These people influence the common people either in person or behind the Encounters, usually economically.
- **Shakers** - People that have access to the Movers and often carry out their desires as well as competing with them.
- **Exotics** - People with "unique" jobs such as Adventurers, Soldier, and more.
- **Civilians** - The vast majority of people who have ordinary jobs and lead, usually, hum drum lives.
- **Criminal Element** - This covers all criminal Professions from the petty thief to the criminal mastermind and everything in between.

CIVILIANS

Citizens – A variety of non-descript NPCs used to advance the story.

Foreigner - A variety of non-descript NPCs used to advance the story, but this time they can be American (1), English (2), French (3), German (4), Italian (5) or Spanish (6).

Laborer - Someone that performs manual labor.

Service Industry – These people provide a simple service such as a store clerk or wait staff.

MISSION ST. MARY – LEMURIAN TREATY PORT

CRIMINAL ELEMENT

Thief - Thieves specialize in pick pocketing or breaking and entering with the occasional strong arm robbery.

Thug- Thugs are members of an organization that cooperate to benefit from illegal activities. Thugs are usually of a violent temperament.

Street Urchin – Street urchins are orphaned or homeless children that live on the street, sometimes (1 – 2) in the employ of criminals.

Working Girl - Those that provide companionship for a price.

EXOTICS

Adventurer – These are people that live for adventure and include Hunters, Explorers, and Intrepid Archaeologists to name a few.

Askari - Indigenous NPCs armed and trained by European military and hired to provide protection for expeditions outside of Mission St. Mary.

Bearers – Indigenous NPCs hired to carry equipment on expeditions outside of Mission St. Mary.

Police –These are local authorities and can be either an officer (1 – 4), sergeant (5), or detective (6).

Soldier – Western military men that can be an officer (1), NCO (2), or enlisted men (3 – 6).

Steam Punk – Adventurers utilizing cutting edge steam and tech driven equipment.

MOVERS

Business Magnate – These are captains of industry, successful businessmen, who wield immense power. Okay, not so much in a backwater place like Lemuria, but it's all relative.

Cultists – Members of a Cult that worships old or occult figures. Usually are trying to pave the way for the return of these Old Ones.

Foreigner - A variety of Mover NPCs used to advance the story, but this time they can be American (1), English (2), French (3), German (4), Italian (5) or Spanish (6). The Foreigner Mover is often a powerful Diplomat (1 – 2).

High Society – Members of the upper crust of Mission St. Mary society. Can be a Patron (1) with unlimited funds, a Bachelor (2), a well to do “catch” for any single lady, a Trophy Wife (3), attractive lady that has caught a Patron or Bachelor, or a non-descript NPC (4 – 6).

Politician - Those who are elected or appointed to their office in the government.

SHAKERS

Academia - Professors and those people associated with universities and other areas of education. They are usually in Lemuria, paid for by a grant.

Accountant - Accounting is the profession of managing and tracking business financial information.

Attorney - Any form of law practitioner from high-priced lawyers down to low life shysters.

Cultists – Members of a Cult are worshippers of ancient occult figures. Usually they are trying to pave the way for the return of these Old Ones.

Political Assistant - These are the people who assist the Politicians.

Safari Leader - Indigenous NPC hired to supervise the Askari, Bearers, and Diggers on expeditions outside of Mission St. Mary.

MISSION ST. MARY – LEMURIAN TREATY PORT

PROFESSION TABLE

CIRCLE	#	PROFESSION	CLASS
Civilian	1	Citizen	Civilian
Civilian	2	Citizen	Civilian
Civilian	3	Foreigner	Civilian
Civilian	4	Laborer	Civilian
Civilian	5	Laborer	Civilian
Civilian	6	Service Industry	Civilian
Criminal	1	Thief	Criminal Element
Criminal	2	Thief	Criminal Element
Criminal	3	Thief	Criminal Element
Criminal	4	Thug	Criminal Element
Criminal	5	Street Urchin	Criminal Element
Criminal	6	Working Girl	Criminal Element
Exotic	1	Adventurer	Law & Order
Exotic	2	Askari	Law & Order
Exotic	3	Bearers	Civilian
Exotic	4	Police	Law & Order
Exotic	5	Soldier	Law & Order
Exotic	6	Steam Punk	Law & Order
Mover	1	Business Magnate	Civilian
Mover	2	Cultist	Civilian
Mover	3	Foreigner	Civilian
Mover	4	High Society	Civilian
Mover	5	High Society	Civilian
Mover	6	Politician	Civilian
Shaker	1	Academia	Civilian
Shaker	2	Accountant	Civilian
Shaker	3	Attorney	Civilian
Shaker	4	Cultist	Civilian
Shaker	5	Political Assistant	Civilian
Shaker	6	Safari Leader	Civilian

STOP!

All characters are assigned 1 Attribute based on what type of character they are. Player Grunts roll for a 2nd; Stars choose a 2nd and can roll for a 3rd.

There are 5 Circles and 30 Professions. Choose your Profession based on your Attributes.

CLASS

All characters fall into one Class or another. Their Profession usually will determine the Class of the character. However there are exceptions where some Professions may appear in more than one Circle. In these cases the player must decide which Circle he is in.

Class also determines which Reaction Tests (page 46) the character will use. Here are the Classes used in Mission St. Mary.

- Adventurer.
- Civilians.
- Criminal Element.
- Law & Order.

ADVENTURER

These are hardy folk that live for adventure and are self-sufficient.

CIVILIANS

The majority of people found in *Mission St. Mary* are ordinary people doing the hum drum jobs, day after day; just content to exist. No looking for adventure.

CRIMINAL ELEMENT

Criminals are people who skirt or openly break the laws for their personal gain and profit.

LAW & ORDER

The Law & Order classification covers all police, soldier, and other martial professions.

WEAPONS

Most characters are assumed to have a weapon while some, such as Civilians, may not. Weapons are covered in more detail in the appropriate sections entitled Ranged Weapons (page 47) and Melee (page 49). For ease of play just use the weapon on the model.

In *Mission St. Mary* we have grouped weapons into broad categories. If you don't see a weapon listed use the stats for a weapon in the category that best fits it.

MISSION ST. MARY – LEMURIAN TREATY PORT

RECRUITING NPCs

Before each Encounter you may have the option to recruit Grunts. Here's how we do it:

- Go to the appropriate NPC List (page 51).
- You can choose the NPCs you want.
- You cannot recruit NPCs with an equal or greater Rep than yours.

We believe it's all about the game, so just play with what you have!

STOP!

There are four Classes of characters. Each has their own set of Reaction Tests, meaning members of one Class will behave slightly different than members of another.

Most NPCs will be armed.

Recruiting NPCs is easy, just take what you want, but you can't recruit any NPCs with a Rep equal or greater than yours; after all, you *are* the Star.

GROUPS

During the game, a *group* is any number of figures that operates together over the course of a turn.

- The smallest number of figures in a group is 1; there is no maximum number of figures in a group.

At the start of the Encounter each side deploys their figures into groups.

Figures that start the turn in the same group will activate at the same time.

GROUP COHESION

For figures to be in the same group they must:

- Start within 4" of one or more figures in the group.
- Have a LOS to one or more figures in the group and/or be in LOS of one or more figures in the group.
- Characters must be in Carry On status to continue the group.

If any of the above 3 requirements no longer apply, the figures are in separate groups.

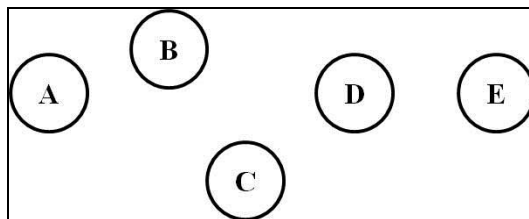

In the picture above we see a 5 figure group. All of the figures are within 4" of another figure, have LOS and are in Carry On Status.

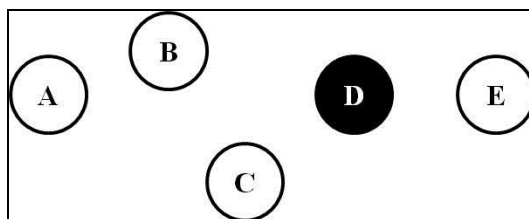

In this picture one member of the group (D) has been hit and is Out of the Fight. As he is not in Carry On status, the link between figures is broken. There are now two groups (A, B, and C are one group while E is another) and they will activate separately.

SPLITTING UP GROUPS

Groups are not permanent. You can form up or break apart your group into larger or smaller groups, at any time during the turn when you are *active*, or when forced to by a Reaction Test (page 46).

You may combine groups during the turn to form a single group. These groups can now charge, shoot, etc. as one group.

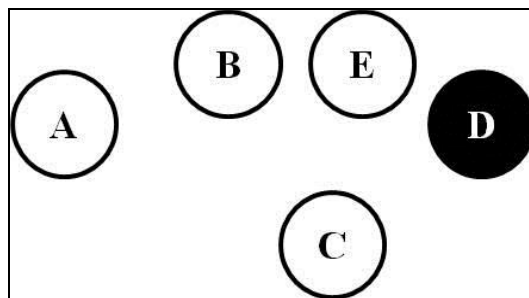

In the above picture, E has activated and moved to join the other group (A, B and C). E can now move the remainder of his movement taking A, B, and C with him. D could be carried by one of the figures, but cannot move on his own.

MISSION ST. MARY – LEMURIAN TREATY PORT

ACTIVATING GROUPS

For activation purposes groups are defined at the *start* of the turn, *before* Activation dice are rolled.

LEADERS

There are two types of Leaders in *Mission St. Mary*.

- *Star Leaders*. This is you, the player.
- *Temporary Leaders*. These are the figures with the highest Rep in a group when not led by a Leader.

Example – Dario Fitch is the Star of a small group of Adventurers. He decides to move off by himself to out flank a group of Natives, while the group moves forward. This effectively splits the group into two. The other group consists of three Grunts, one Rep 4 and two Rep 3s. The Rep 4 is the Temporary Leader of that group.

Based on the Encounter the Natives have a Rep 4 Leader, a Rep 5 Native, and Rep 3 Native. They will activate on 4, as long as the Leader is functional. Later he goes Out of the Fight and the Temporary Leader becomes the Rep 5 Native.

STAR LEADERS

Star Leaders have two functions in *Mission St. Mary*.

- They determine when the group will activate based on *their* Rep.
- They are allowed to use Leader Die.

TEMPORARY LEADERS

Temporary Leaders have one function in *Mission St. Mary*.

- They determine when the group will activate based on *their* Rep.

Example – Continuing the previous example Dario Fitch is a Star Leader (Rep 5) while Charles is the Temporary Leader (Rep 4) of the other group.

LEADER DIE

A Leader Die represents the ability of the Star Leader to lead his group, to inspire them to greater effort, and to guide them through tough situations. Here's how we do it:

- The Leader Die is an off color d6 that is rolled in addition to the 2d6 rolled by the group and doesn't apply to the Leader.
- The Leader Die is rolled, even if the Leader does not qualify for the Reaction Test.
- Roll the d6 together when taking a Received Fire or Man Down Reaction Test (page 46).
- Apply the result of the Leader Die to the Rep of the Leader. This means he will pass 1d6 or 0d6. Add this result to the number of d6 passed by the other characters in the group.
- Apply the results of the 2d6 to the Rep of the characters taking a Received Fire or Man Down Reaction Test (page 46). They will pass 2d6, 1d6, or 0d6.

Example – Dario Fitch (Rep 5) is the Leader of a group of Adventurers composed of himself and two Grunts, one Rep 4 and one Rep 3. They run into a group of Natives and two of them come under fire. After all In Sight actions are resolved, the two Grunts who came under fire must now take the Received Fire Test (page 46). Dario does not have to take the test as he was not fired on but is allowed to roll his Leader Die.

I pick up 1d6 for my Leader Die and add it to the 2d6 that I will roll for the group. I roll the d6 and compare the Leader Die to Dario's Rep. I score a 4 meaning that I have passed, based on Dario's Rep, and can now add 1d6 to however many d6 each Grunt passed.

The other 2d6 rolled for the group come up 4 and 5. The Rep 3 passes 0d6. He adds the passed 1d6 from the Leader Die, for a total of pass 1d6.

The Rep 4 Grunt passes 1d6. He adds the pass 1d6 from the Leader Die, for a total of pass 2d6.

Note that because the two Grunts passed different numbers of d6 they may behave differently.

MISSION ST. MARY – LEMURIAN TREATY PORT

STOP!

What is the maximum number of inches between figures to remain in a group? 4” is the answer.

What's a Leader Die? How is it used? Who can use it? be sure to roll it versus the Rep of the Leader, not the group.

You have a Rep 5 Leader, a Rep 4 Grunt, and a Rep 3 Grunt. The Leader score came up 4 and the 2d6 roll for the Grunts was a 1 and 4. How many d6 did each character pass? What happens if you pass 3d6? You can only count the best 2d6 results.

TURN SEQUENCE

Mission St. Mary is played in turns, with each turn divided into two phases of *activation*, one per side. When active, the side can perform actions (page 12). Although games, called Encounters, can last an unlimited number of turns, each turn follows a strict sequence.

- Before the game begins, both sides choose a d6 of different colors.

Example - I decide to play solo. I choose a blue d6 for the Star and a yellow d6 for the NPCs run by the game mechanics.

- At the start of each turn the dice are rolled. This is called rolling for Activation.
- If the die scores are the same (doubles), neither side will activate, so re-roll the activation dice.

Example – Activation dice are rolled. I score a Blue 4 and a Yellow 4. As I have doubled up, no one can activate.

- If the die scores are *not* doubles read each die individually. The higher score determines which side will activate its group or groups first.

Example - The two dice are rolled and a Blue 5 and a Yellow 4 are rolled. The Star side scored higher so I can activate those groups first.

- Only groups led by a Leader with a Rep equal to or higher than his Activation die score can be activated. Groups are activated from highest

Reps to lowest, with ties activating in the order the player desires.

Example: A Blue 5 and a Yellow 4 were rolled. The Blue d6 scored higher so the Star side activates first. I can only activate groups that are led by a Rep 5 or higher Leader.

- After the first group has completed all its actions and any reactions it may have caused have been resolved, the active side is allowed to proceed to its next group.
- After all of one side's groups have been activated the other side can activate one group at a time, based on the result of its activation die roll.

Example: A Blue 5 and a Yellow 4 were rolled. I have finished activating all the Star side groups I wanted to. It is now the Yellow sides turn. The game mechanics can only activate groups that are led by a Rep 4 or higher Leader.

- After both sides have activated all of their eligible groups and *all reactions have taken place* the turn is over and Activation dice are rolled again, signifying the start of the new turn.

This system will mean that many times lower Rep figures, will not be able to activate. This reflects their lack of confidence and hesitancy to engage the enemy. *It also stresses the importance of putting higher Rep Leaders with lower Rep groups!*

Now that you know the turn sequence, we will explain the rules in the order that they will occur during the game turn. *This may be different than what you experienced in the past.* Let's start with Actions.

MISSION ST. MARY – LEMURIAN TREATY PORT

ACTIONS

When a side is *active* its characters can voluntarily do one of the following actions:

- Charge into Melee (page 22).
- Move – Can change the direction it is facing, move up to its normal movement and shoot if desired.
- Shoot – Can shoot, change the way it is facing, and move up to its normal move.
- Search a Target Building (page 29).
- Reload a weapon. The character may move normally while doing so.
- Exchange or pick up dropped weapons, but cannot fire them at that time.

MOVEMENT

There are two types of movement, *voluntary*, when the figure is *active*, and *involuntary* when caused by a Reaction Test (page 20). Figures can be forced into involuntary actions and movement due to the results of a Reaction Test. These actions and movement are covered in more detail in the Status and Actions section (page 21).

NORMAL MOVEMENT

Normal movement for all human figures is 8”.

FAST MOVE

If desired a figure can attempt to move faster than normal speed. Here's how we do it:

- Declare the intent of the *group* to Fast Move.
- Roll 2d6 for the group and compare each die score individually to the Rep of each figure Fast Moving.
- For each d6 passed, the figure will add half their normal move for each d6 passed.
- Figures declaring a Fast Move will count as moving fast regardless of the actual distance moved.

Example – A group of four figures want to Fast Move. I roll 2d6 and score a 4 and 5. Here's how the group will move.

The Rep 5 passes 2d6 and can move 16”.

The Rep 4 passes 1d6 and can move 12”.

The Rep 3 passes 0d6 and can move 8”.

GOING PRONE

Characters may go prone at various times during the game. Here's how we do it:

- Active characters may voluntarily go prone at any time during their turn.
- If forced to Duck Back by a Reaction Test and no cover is available within 6”, the figure will drop prone in place, ending its turn.
- To regain its feet a prone figure must be active and spend 2” of their movement if in an occupied section.

INVOLUNTARY MOVEMENT

Characters may be forced into involuntary movement or actions by the results of a Reaction Test. Let's cover each one in detail.

CARRY ON

The tester carries on and can act when active and react when called upon.

CHARGE

The tester and target take the Charge into Melee Test.

DUCK BACK

Move to the nearest cover within 6”. This can be in any direction, even forward. If no cover is available within 6” the figure will drop prone in place, ending its turn. It may fire when next active or if caused by a subsequent Reaction Test. *Figures in Duck Back cannot see or be seen by the cause of the test but those that go prone can.*

FIRE

The tester must fire at the figure that caused the Reaction Test. If a figure cannot fire it will behave as directed by the Reaction Test.

RUN AWAY

The running away figure is immediately removed from the table. Characters may voluntarily Run Away.

MISSION ST. MARY – LEMURIAN TREATY PORT

RUSH SHOT

The figure must fire but counts the Rush Shot penalty.

STOP!

Grab two d6 of different colors. Grab two figures from opposing sides and place them on the table 12" from each other. One side will use one colored d6, while the other side will use the other. Both sides have a Rep of 4.

Roll for activation. Which side scored the higher number? Can that figure activate? Did you roll *doubles*? If so what happens?

Normal movement is 8" unless you have the Slow Attribute – then its 6". Roll 2d6 versus Rep when you want to Fast Move. Each passed d6 lets you increase your movement by half the norm.

The Reaction Test can cause you to make involuntary movement. Review the difference between Duck Back and Run Away.

IN SIGHT

The In Sight Test is a Reaction Test taken differently than the others. Where the others roll dice versus the Rep of the tester, the In Sight rolls dice looking for successes, a score of 1, 2, or 3.

First let's explain the difference between being In Sight and Out of Sight.

IN SIGHT OR OUT OF SIGHT

Figures are *always* in sight or out of sight. A figure is in sight when:

- An enemy figure can trace a *Line of Sight* (page 16) to that figure, from figure base to figure base. This still applies even if that figure is *in cover or concealed or both*.

A figure is out of sight when:

- It cannot be seen because of intervening terrain. Figures in Duck Back behind cover also fall into this category.
- It cannot be seen due to weather or light restrictions such as being too far away to see the enemy at night.
- It cannot be seen due to any other figure in the way.

TRIGGERING AN IN SIGHT TEST

Here's how an In Sight Test is triggered:

- Whenever a figure has an opposing figure enter into its Line of Sight or LOS, and the opposing figure was not seen previously during this activation phase, the In Sight Test has been triggered.

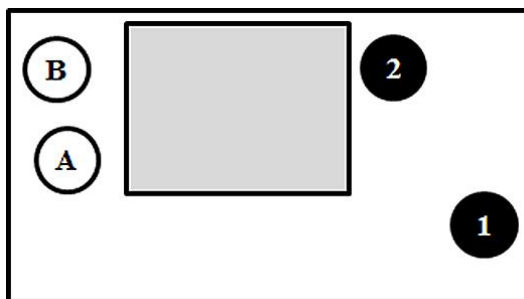

In the first picture the white side cannot be seen by "1" or "2".

- The In Sight Test is triggered as soon as *any* figure in a moving group comes into sight.

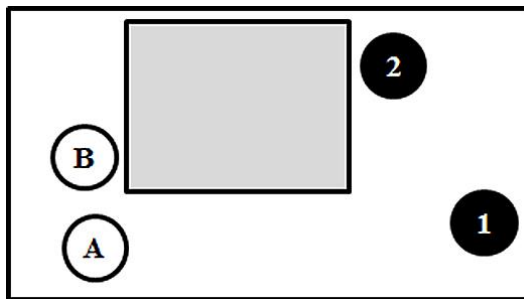

In the second picture white activates and figures "A" and "B" move forward. "A" comes into sight of "1" triggering the In Sight Test.

- Once the test is triggered the triggering group is allowed to move all of its figures (whether they triggered the In Sight or not) up to two additional inches, regardless if they have left over movement or not. This movement could result in the figure going out of sight.

MISSION ST. MARY – LEMURIAN TREATY PORT

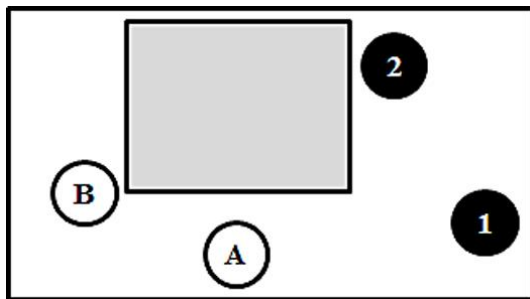

The In Sight is triggered and the figures in the triggering group are allowed to move two additional inches, before the test is resolved. Figure "A" moves closer to "1" while "B" moves to the edge of the house so "B" can see "1"; also putting "B" into sight of "1".

TAKING THE IN SIGHT TEST

After the triggering group has moved up to two additional inches all figures in sight of an enemy, or having the enemy in sight will take the test. Here's how we do it:

- The Leader of the group takes the In Sight.
- Each Leader starts with 1d6 per level of their Rep.
- Consult the In Sight Table.
- Modify the number of d6 each Leader rolls, by any applicable Circumstance or Attribute.
- There is no maximum number of d6 that can be rolled.
- There is no minimum number of d6 that can be rolled and there may be times when the Leader reaches 0d6. At this time he counts as scoring zero successes.
- All Leaders roll their modified d6 total looking for successes, score of 1, 2 or 3.
- The side with the Leader with the higher number of successes has won the In Sight and can act. The opposing side can only react.
- If the number of successes rolled is equal, immediately re-take the test.

MULTIPLE IN SIGHTS

There may be times when more than two groups are involved in the In Sight. An example would be one group moving into sight of two opposing groups. Here's how we do it:

- The Leader of each group takes the In Sight normally.
- The highest scoring Leader wins the In Sight and all figures on that side, even those in another group, are allowed to act.

REP

IN SIGHT

(Looking for successes)

ATTRIBUTE	MOD
Opponent is Stealthy and the only figure in sight.	-1d6
Quick Reflexes	+1d6
Slow to React	-1d6
CIRCUMSTANCE	MOD
Active - Character is active and moved.	-1d6
Concealed - Enemy is concealed.	-1d6
Ducking Back - Character is Ducking Back.	(1)
Evening - If the Evening Day Part.	-1d6
Late - If the Late Day Part.	-2d6
Running Away - Character is Running Away	(1)

(1) Figure cannot fire and will complete its reaction instead.

OPTIONAL IN SIGHT

If you want more detail you can have each figure roll their In Sights separately. Here's how we do it:

- Each figure rolls its own d6 for the In Sight Test.
- Place a d6 with the number of successes scored face up next to the figure.
- In Sights resolved from highest number of successes to lowest with ties being simultaneously resolved.
- If a figure is hit by fire if has its In Sight d6 removed.
- Continue the in Sight until all characters have acted or lost their chance to act from being hit by fire.
- Reaction Tests are taken after all In Sights are resolved.

RESOLVING IN SIGHT ACTIONS

The group winning the In Sight will now act, from highest Rep to lowest. Here's how we do it:

- If the figure can fire – it will.
- If the figure cannot fire – it will Charge into Melee.
- Stars can choose to move its remaining movement instead. Those characters led by the Star can choose to move as well.

MISSION ST. MARY – LEMURIAN TREATY PORT

Example – Dario, Charlene and Sooze have run into a group of six Natives. Dario wins the In Sight and chooses to run. The trio moves their remaining movement of 6" down the trail and out of sight. Heck, that's not far enough, so the trio take a Fast Move Test!

COMPLETED IN SIGHTS

Once all figures that have won the In Sight Test have completed or forfeited their actions, appropriate Reaction Tests are taken, and the active side continues its part of the turn.

MOVING, SHOOTING, AND IN SIGHT

After the In Sight Test is completed and all actions taken, figures in the moving group that triggered the test can continue their remaining movement and take active fire. This movement could trigger a new In Sight Test.

Example – Dario Fitch walks around a corner and triggers an In Sight Test. The German soldier and Dario exchange fire with Dario taking out the soldier. Dario continues his move and triggers an In Sight with another soldier. Both roll their In Sight and Dario wins again and fires but misses.

The German takes a Received Fire Test (page 46) and fires back.

STOP!

Before going any further, take two sides of two figures with different Reqs and do the following:

Place each side 6" from each other.

Roll an In Sight Test. Did you use the Leader of each side for the test?

Resolve the In Sight Test. What will each figure do when it is his turn to act?

What if a figure scores zero successes?

Remember, if you lose the In Sight, your side will react.

RANGED WEAPONS

There are two ways to inflict damage in *Mission St. Mary*. The first way is through shooting and the other is through melee (hand-to-hand combat). Each weapon is classified by type and in some cases weapons have been lumped into broader categories. If you do not see your weapon listed, simply use the one that is closest to it. Weapons are defined by two characteristics:

TYPE – The type of weapon.

TARGET RATING – The number of targets the shooter can fire at when shooting.

RANGE – The distance that the weapon can be fired where the shooter feels he can score a hit.

BA PISTOL (BAP) – The Big A\$\$ Pistol is a large caliber handgun with a Target Rating of 2.

BIG GAME RIFLE (BGR) – The Big Game Rifle is used to hunt large Creatures and Dinosaurs and has a Target Rating of 1.

BLOWGUN (BG) – The 1 Target Rating blowgun used by some natives to cause the target to go Out of the Fight without physical damage. Victims of a successful blowgun attack will automatically pass 2d6 on the Recovery Test (page 25).

BOLT ACTION RIFLE (BAR) – A single Bolt-Action Rifle has a Target Rating of 1.

BOW (BW) – The bow and arrow is usually used by “primitive people” and has a Target Rating of 1.

MACHINE PISTOL (P) – A smaller caliber handgun with a high rate of fire, the Machine Pistol has a Target Rating of 3.

PISTOL (P) – A smaller caliber handgun with a Target Rating of 1.

SEMI-AUTOMATIC RIFLE (SAR) – Semi-Automatic rifles have a higher rate of fire than the Bolt Action Rifle with a Target Rating of 2.

SHOTGUN (SG) – Big bang weapon used mainly for hunting with a Target Rating of 3.

SUB-MACHINE GUN (SMG) – A weapon with lots of firepower, used by military forces and with a Target Rating of 1.

MISSION ST. MARY – LEMURIAN TREATY PORT

RANGED WEAPONS

TYPE	TARGET RATING	RANGE
BA Pistol (BAP)	2	12
Big Game Rifle (BGR)	1	48
Blowgun (BG) – Primitive Weapon	1 ⁽¹⁾	6
Bolt Action Rifle (BAR)	1	48
Bow (BW) – Primitive Weapon	1	24
Machine Pistol (MP)	3	12
Pistol (P)	1	12
Semi-Automatic Rifle	2	48
Shotgun	3	12
SMG	3	24

(1) Used with poison. Target goes Out of the Fight if hit.

OUT OF AMMO

Ammo in *Mission St. Mary* is pretty much unlimited. However, there still is a chance that the weapon may temporarily run out of ammo and must be reloaded. Here's how we do it:

- Anytime double ones are rolled when shooting, a weapon it is out of ammo and cannot be fired again until reloaded.
- It takes one turn of activation to reload the weapon.
- Figures reloading weapons may move their normal movement.

The weapon is considered out of ammo, *after* the d6 have been applied for the purposes of hitting.

Example – Jim Bob Joe (Rep) fires at three targets. He will roll 2d6, three times. He scores 1 and 2, passes 2d6 and scores a hit on the 1st target.

He then scores a 1 and 1, passes 2d6, and scores a hit on the second, but is out of ammo.

He cannot roll for the 3rd target.

SHOOTING

Shooting a weapon and hand-to-hand combat are distinctly different ways of inflicting damage. This is reflected by the different game mechanics used in *Mission St. Mary*.

LINE OF SIGHT

To shoot something, you must first be able to see it. Here's how we do it:

- Figures can only see things through their 180 degree front facing (page 2).
- A straight line from the shooter to the target is called a Line of Sight or LOS.
- Line of Sight extends across the whole table and is only blocked by intervening figures, terrain, and buildings.

TARGET SELECTION

A figure may fire at as many targets as the weapon has Target Rating within its swath.

ACTIVE TARGETING

Active shooters can target any figure it desires.

REACTIVE TARGETING

Reacting shooters can only fire at the cause of the test.

APPLYING TARGET RATING

Each point of Target Rating can be thought of as a shot. Each shot is applied individually to the target. Here's how we do it:

- A figure may fire from 1 to 3 shots at the same target, depending upon the Target Rating of the weapon.
- A figure may fire at more than one target if each is within 1" of another target.

MISSION ST. MARY – LEMURIAN TREATY PORT

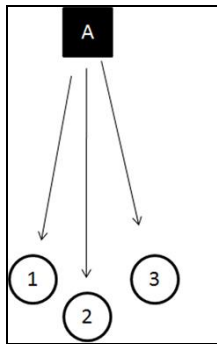

In the above picture "A" has a SMG with a Target Rating of 3. As the distance from "1" to "3" is 3", the swath of the SMG, all are eligible targets. "A" fires 1 shot at all three targets.

- Before firing the shooter must declare how many shots will go onto each target. It is possible for one target to have multiple hits.

Example – Carlos fires his SMG at Dez and Char. He declares to fire 1 shot at the first target, Dez, and the 2nd and 3rd third shots at Char.

FIRING A WEAPON

Shooting can occur when the figure is active or in reaction. Here's how we do it:

- Establish a LOS between the shooter and the targets.
- Declare how many targets you will fire at and how many shots per target.
- Roll 2d6 versus the Rep of the shooter once for *each target* regardless of the number of shots on the target. So if you fire 3, 2, or 1 shot at the same target, you only roll 2d6 once. The extra shots come into play on the Shooting Damage Table (page 48).
- Go to the Shooting Table and down the left-hand column to the appropriate row based on the number of d6 passed.
- Go across the row and carry out the result.

Example – Sooze (Rep 4) fires her Pistol at a German who is in cover. Sooze rolls 2d6, a 2 and 5, passing 1d6. Looking on the Shooting Table under Passed 1d6 we see that Sooze has missed.

2

SHOOTING

(Taken vs. Rep)

ATTRIBUTE	MODIFIER
Crack Shot using a BAR	+1d6
Near Sighted	-1 to Rep
CIRCUMSTANCE	RESULT
Any d6 score of "6"	D6 automatically fails.
Double "ones".	Weapon is now out of ammo.

#D6 PASSED	RESULT
2	Hit.
1	<p>Shooter missed if -</p> <ul style="list-style-type: none"> • Fast Moved. • Firing with the Off Hand – <i>Ambidextrous</i> ignores. • Rush Shot. • Evening or Late Day Part. <p>Target was missed if -</p> <ul style="list-style-type: none"> • Fast Moving. • Carrying wounded. • Shielded and fired on by Primitive Weapon. • In Cover. • Prone. • Second or higher target.
0	Miss.

SHOOTING DAMAGE

When the target is hit, the shooter must roll on the Shooting Damage Table. Here's how we do it:

- Start with 1d6.
- Modify this by any applicable Circumstance.
- Roll the modified number of d6 and compare each score to the Rep of the Target.
- Read the result in the left-hand column then go across to determine the result.
- Rolling multiple d6 can result in the target taking additional damage.

MISSION ST. MARY – LEMURIAN TREATY PORT

1 SHOOTING DAMAGE

(Taken versus Rep of the Target)

CIRCUMSTANCE	MODIFIER
Big Game Rifle.	+2d6
BA Pistol – Only if fired at 1 Target.	+1d6
Machine Pistol – Only if fired at 1 Target.	+2d6
Semi-Automatic Rifle – Only if fired at 1 Target.	+1d6
Shotgun – Only if fired at 1 Target.	+1d6
SMG – Only if fired at 1 Target.	+2d6

SCORE	RESULT
Equal or less than Rep of the Target.	Fierce and Feeder Class creatures take the Received Fire Test. Target Ducks Back. If target is charging, ignore and continue into contact.
Higher than Rep of the Target but not a “6”.	Fierce and Feeder Class creatures take the Received Fire Test. Target is knocked to the ground and Out of the Fight.
“6”	Fierce and Feeder Class creatures Obviously Dead. Target is knocked to the ground and Obviously Dead.

ATTRIBUTE	MOD
Hard as Nails	Treats 1 st Obviously Dead in each Encounter as Carry On instead.
Resilient	Treats 1 st Out of the Fight in each Encounter as Carry On instead.
Tough	Treats 1 st Duck Back in each Encounter as Carry On instead.

Example – Dario Fitch (Rep 5) fires with his BAP at a Native Warrior (Rep 5) and passes 2d6, scoring a hit. He now rolls for damage. He starts with 1d6 for scoring a hit and counts a +1d6 for firing his BAP at one target. I roll the 2d6 and score a 4 and 5. The 4 is a Duck Back as it is less than the Native’s Rep but the 5 is an Out of the Fight result as it exceeds the Native’s Rep.

But the Native has the Resilient Attribute so the Out of the Fight becomes a Duck Back. The Native now has 2 Duck Back results. What happens now?

STACKING DAMAGE

After any Star Power or Attributes have been applied, we stack damage in the following ways:

- Obviously Dead results will stack.
- Out of the Fight results will stack.
- Duck Back results do not.
- When taking an Out of the Fight result and a Duck Back result, the Duck Back result is ignored.

Example – Dario Fitch fires his BAP at 1 target. He rolls 2d6 and passes 2d6. He has hit his target twice.

Dario now rolls 1d6 twice, versus the Rep of the Target (4). He scores a 4 and 5. The target has suffered 2 Out of the Fight results. The target has the Resilient Attribute so 1 Out of the Fight is eliminated. The second is not so the Native goes Out of the Fight.

COVER OR CONCEALMENT

There will be times when a character will be in cover, concealment or both. Cover and concealment are different.

- *Concealment* makes you harder to see. Concealment does not stop a bullet. Concealment comes into play when taking the In Sight Test.
- *Cover* stops a bullet from hitting parts of your body, so it makes it harder to be hit. Cover comes into play on the Shooting Table.

So how do you tell which is which? We've put together a short list that answers the question. Players should match the terrain on the table with the type that best resembles it on the Cover or Concealment Table *before* the game begins.

# COVER OR CONCEALMENT	
TYPE	RESULT
Buildings, inside	Stationary figures inside of buildings are in cover and concealment. Moving figures inside buildings are concealed.
Woods or Rough	Stationary figures inside woods or rocky areas are in cover and concealment. Moving figures inside woods or rocky areas are concealed.

MISSION ST. MARY – LEMURIAN TREATY PORT

FIRING AT CARRYING WOUNDED

Characters carrying another character can be shot at. Here's how we do it:

- When firing at a character carrying a wounded character, a result of pass 1d6 is a miss.
- If firing at the wounded character, a result of pass 1d6 is a miss.

FIRING TWO WEAPONS AT ONCE

It is possible to fire two weapons at the same time. Here's how we do it:

- The shooter designates one weapon as being fired with the Off Hand and takes the penalty when rolling on the Shooting Table.
- Which two weapons can you use together? Any two that you want, it's your game.

Example – Arizona Bob has been cornered by Natives. He steps into the open and takes the In Sight. AZ wins and can act, he decides to fire. He has two BAPs, one in each hand. He declares the second one to fire as the Off Hand weapon.

AZ rolls 2d6 against his Rep of 5 and scores a 1 and 5. The Natives are in the open so he scores a hit. He then rolls for the Off Hand weapon and scores a 1 and 6 again. He has missed.

DAMAGE

Characters can suffer damage from shooting, melee or failing a Physical Challenge (page 27). There are three stages of damage in *Mission St. Mary*. They are, in order of severity from least to most:

- Obviously Dead.
- Out of the Fight.
- -1 to Rep.
- Duck Back.

OBVIOUSLY DEAD

The figure has taken such great damage that it is obvious that he is dead.

OUT OF THE FIGHT

The figure has taken serious damage and cannot continue the Encounter. He cannot move on his own and must be retrieved by others. If contacted by an enemy, he can be captured.

-1 TO REP

This is a temporary loss of Rep due to an ongoing melee. Any lost Rep is recovered after the melee is concluded.

Example – Dario (Rep 5) and an Askari (Rep 4) are in melee. Dario loses the first round of melee and uses his Star Power d6 to change the Out of the Fight result to a result of -1 to Rep. Dario is now a Rep 4 and another round of melee is immediately fought.

Dario wins the melee and the Askari goes Out of the Fight. As the melee is over, Dario wipes the blood from his mouth and recovers to Rep 5.

DUCK BACK

While technically not damage, Duck Back can be a result of being fired at. Here's how we do it:

- Move to the nearest cover within 6". This can be in any direction, even forward.
- If no cover is available within 6" the figure will drop prone in place, ending its turn.
- It may fire when next active or if caused by a subsequent Reaction Test.
- *Figures in Duck Back cannot see or be seen by the cause of the test, but those that go prone can.*

MISSION ST. MARY – LEMURIAN TREATY PORT

AUTO-KILL OR CAPTURE

If an active figure comes into contact with an Out of the Fight figure he can choose to automatically dispatch the figure or capture him. If captured the figure must be guarded by at least one armed figure. Each armed figure can guard up to six enemy figures.

STOP!

Each weapon can fire at 1 or more targets based on its Target Rating. The shooter rolls 2d6 versus his Rep for each target fired at.

Shooting is done by rolling 2d6 versus the Rep of the shooter. You roll 2d6 per target whether firing 1, 2, or 3 shots at the target. The extra shots are accounted for on the Shooting Damage Table.

Rolling 2 or more “ones” causes the weapon to become out of ammo.

Take two characters and fire at each other with a variety of weapons.

Notice the greater chance of damage when firing at one target.

Out of Fight results stack, Duck Backs do not.

REACTION TESTS

This section covers the heart of Two Hour Wargames. It is called the *Reaction Tests*. Figures will take Reaction Tests when called upon as circumstances arise. Reaction Tests reflect how a character will perform when under physical, mental, or emotional stress. Here's a list of the Reaction Tests in *Mission St. Mary*, who takes them, and how they are done:

- **In Sight** (page 14) – Taken by the Leader of the group taking the test.
- **Charge into Melee** (page 23) – Taken individually by each figure rolling their own d6.
- **Received Fire** (page 21) - Taken by each qualifying figure in the group applying the same 2d6 result.
- **Man Down** (page 21) - Taken by each qualifying figure in the group applying the same 2d6 result.

All of the tests are grouped in the rear of the book (page 46) by character Class.

IN SIGHT & CHARGE INTO MELEE

The In Sight (page 13) and Charge into Melee Tests (page 22) are taken differently than the others and covered elsewhere.

RECEIVED FIRE & MAN DOWN

These two Reaction Tests are taken versus the Rep of the character. Here's how we do it:

- Determine which characters in the group must take the test or tests. It is possible that some and not all of the characters will qualify for the test.
- Go to the appropriate table based on the test to be taken and Class (page 8) of the testers.
- Start with one set of 2d6 for the group.
- If the characters are in cover, add 1d6.
- Leader Die can be used if the Star Leader is with the group.
- Roll the modified number of d6 and read the results as rolled.
- Apply the results of each d6 to the Rep of each character individually.
- Determine how many d6 each character passed.
- Go across the row to the appropriate column passed on the number of d6 passed.

Example – Four Police Officers are in the same group. One is a Rep 5 Star Leader, one a Rep 4, and two are Rep 3. One Rep 3 Officer is shot at and hit. The Police Officers now must take the Man Down Test.

I roll a Leader Die versus the Rep of 5 and score a 4, passing 1d6.

I roll 2d6 for the group and score a 4 and a 5. The Rep 5 Star Leader passes 2d6 – the Leader Die is not applied to the Leader.

The Rep4 Officer passes 1d6 and adds 1d6 passed for the Leader Die, so passes 2d6.

The Rep 3 Officers pass 0d6 and add 1d6 passed for the Leader Die, so pass 1d6.

I now look at the Man Down Test on the Law & Order row and apply the results.

MISSION ST. MARY – LEMURIAN TREATY PORT

RECEIVED FIRE

Whenever a character is shot at and missed, he will take the Received Fire Reaction Test. More than one character firing at the *same target at the same time* will cause only one Received Fire Test to be taken.

Example –Dario is fired on by two active Askari who are already in sight. One misses, but one scores an Out of the Fight result. Dario rolls his Star Power d6 and scores two successes, reducing the damage to Carry On. As Dario has not been hit, he takes the Received Fire Test, only once, even though he was fired at twice. Being a Star he chooses his reaction, passing 2d6, and returns fire.

MAN DOWN

Each time a character sees a friendly character within 4" get one of the following results it will take the Man Down Test.

- Obviously Dead.
- Out of the Fight.
- Run Away.

If a character takes a Man Down Test and scores a result of Run Away, he will cause another Man Down Test to be taken.

Example –Dario fires his pistol at one of three Askari and scores an Out of the Fight result.

The two Askari are 3" from their friend, so take the Man Down Test. They roll 2d6 causing one Gangster to pass 1d6 and the other pass 0d6. Passing 0d6 causes the Gangster to Run Away, causing the other Gangster to take another Man Down Test.

MULTIPLE TESTS

There may be times when a figure qualifies for more than one Reaction Test at the same time. In these cases one set of d6 are rolled and the results applied to *all* the tests, with the *worst* result being counted.

Example - Three Police Officers fire at three Thugs. One hit is scored. The remaining Thugs now roll 2d6 as a group and they are applied individually, versus their Reps. The dice scores are applied to the Man Down and the Received Fire Tests. The Thugs must take the worse result.

REACTION TEST RESULTS

The result of taking a Reaction Test can cause the character's status to change for the worse, never for the better. Here are the Reaction Test results from best to worst:

- Carry On.
- Charge.
- Fire.
- Rush Shot.
- Duck Back.
- Run Away.

STATUS AND ACTIONS

The Reaction Tests can change the status of a character and force it to act in a certain way. Here we will explain the terms found on the Reaction Tests.

CARRY ON

The figure is in good order. Can act as desired and react as called on. A figure is considered to be *carrying on* if it is *not* doing any of the following.

- Duck Back.
- Out of the Fight.
- Run Away.

CHARGE

The character and target will take the Charging into Melee Test (page 22).

DUCK BACK

The character called upon to Duck Back is trying to seek cover. Here's how we do it:

- Move to the nearest cover within 6". This can be in any direction, even forward.
- If no cover is available within 6" the figure will drop prone in place, ending its turn.
- It may fire when next active or if caused by a subsequent Reaction Test.
- *Figures in Duck Back cannot see or be seen by the cause of the test, but those that go prone can.*

FIRE

The figure fires his weapon if it is loaded.

MISSION ST. MARY – LEMURIAN TREATY PORT

OBVIOUSLY DEAD

The figure has taken such great damage that it is obvious that he is dead.

OUT OF THE FIGHT

The figure has taken serious damage and cannot continue the Encounter. He cannot move on his own and must be retrieved by others. If contacted by an enemy, he can be captured.

RUN AWAY

The figure has quit the Encounter and is removed from the table. If there is an enemy figure within six inches between the character and the table closest table edge, it will surrender instead.

RUSH SHOT

The figure immediately fires counting the *Rush Shot* penalty.

STOP!

Take out two opposing figures, one Civilian and one Criminal Element, and place them 12" apart. Both are Rep 4.

Roll activation. Who goes first? Did you roll *doubles*? If you did, what happened?

Assume that the active figure has fired at the inactive figure and has missed. What Reaction Test is taken? Review the three different results for the test when passing 2d6, 1d6, and 0d6. Now review the results for the other Classes. What are the differences, if any?

How is Duck Back different than Run Away?

Remember that taking the time to review and do these little exercises will make the rules easier to understand and your games more fun.

MELEE

We use the following procedures when characters want to resort to hand to hand combat.

MELEE WEAPONS

In *Mission St. Mary* we use the following melee weapons. Whether a weapon is used with one or two hands is irrelevant as it is assumed that each character is proficient in the type of weapon it uses. The only difference in melee is if the character is using a melee weapon or not.

MELEE WEAPONS

<i>TYPE</i>	<i>TARGET</i>
Axe (AX)	1
Knife (K) ⁽¹⁾	1
Spear (SP)	1
Sword (SW)	1

(1) Includes Bayonet.

CHARGE INTO MELEE TEST

The only way to enter melee, is via the Charge into Melee Test. Here's how we do it:

- The charging figure must have a clear LOS to the target figure at the time it charges.
- Chargers can declare a charge at any time during their turn, even if the target of the charge was out of LOS at the start of the charger's turn.
- The figure can be active or inactive.
- The test is taken by the individual figure.

Example – A Thug comes is in an alley and moves 4" into sight of two Civilians. In Sight is rolled and the Civilians go first. The Civilians decide to Charge the Thug. All three roll the Charge into Melee Test and the Thug's result is applied separately to each Civilian.

HOW TO CHARGE INTO MELEE

Here's how the Charge into Melee Test is taken:

- The figure has LOS and within 8" of the target.
- Go to the Charge into Melee Table.
- Each figure starts with 2d6.
- Modify the number of d6 by any applicable Attribute or Circumstance.
- Roll the modified number of d6 versus the Rep of each involved figure.

MISSION ST. MARY – LEMURIAN TREATY PORT

- If charged by more than one figure, the target applies its results against all of the charging figures separately.
- Determine how many d6 each figure has passed.
- Go down the left-hand column to the appropriate row based on the number of d6 passed.
- Go across to the column based upon whether the Charger or Target passed more d6.
- Immediately carry out the results.

2	CHARGE INTO MELEE <i>(Taken versus Rep)</i>
----------	---

ATTRIBUTE	MODIFIER
Nerves of Steel	+1d6
Rage	+1d6
CIRCUMSTANCE	MODIFIER
Target in cover	+1d6
Target charged to flank	-1d6
Target charged to rear	-2d6

#D6 PASSED	CHARGER	TARGET
Pass more d6 than opponent	<i>Target</i> may not fire. <i>Charger</i> moves into melee. No Reaction Tests taken.	<i>Target</i> can fire. <i>Charger</i> moves into melee. No Reaction Tests taken.
Pass same number d6 as opponent	<i>Civilian Target</i> maybe not fire. <i>Other Targets</i> can fire. Count the Rush Shot penalty. <i>Charger</i> moves into melee. No Reaction Tests taken.	<i>Civilian Target</i> maybe not fire. <i>Other Targets</i> can fire. Count the Rush Shot penalty. <i>Charger</i> moves into melee. No Reaction Tests taken.

Example – Arizona Bob (Rep 5) wins the In Sight and declares a charge on an Askari (Rep 4). AZ rolls 2d6 versus his Rep and scores a 2 and 5, passing 2d6.

The Askari rolls 2d6 and scores a 1 and 4, passing 2d6.

Looking on the Charge into Melee Table I see he can fire. He rolls on the Shooting Table. The Askari rolls 2d6 on and scores a 2 and 6, passing 1d6 and scores a hit. Rolling 1d6 versus AZ's Rep of 5 and scores a 1 – Duck Back. As AZ is charging he ignores the result and charges home.

DUCK BACK & CHARGING

If a charger is shot at when charging and suffers a Duck Back result, he ignores the result and continues into contact.

MELEE COMBAT

After the Charge into Melee Test is taken and any fire is resolved, the charger is moved into contact with the target. Now it's time to melee. Here's how we do it:

- Go to the Melee Combat Table (page 49).
- Each figure starts with 1d6 for each point of Rep.
- Add or subtract d6 based on any applicable Attribute or Circumstance.
- Each figure rolls its modified total of d6, counting all successes, scores of 1, 2 or 3.
- Compare the number of successes scored by each figure.
- If both sides score the same number of successes another round of melee is immediately rolled.
- If one figure scores more successes, it has won the melee and will roll on the Melee Damage Table.

MULTIPLE FIGURE MELEES

A figure may be meleed by more than one figure. Here's how we do it:

- Up to three figures can melee one figure.
- The side with more figures decides in what order its figures will attack.
- Attacks are carried out one on one.

REP	MELEE COMBAT <i>(Looking for successes)</i>
------------	---

ATTRIBUTE	MOD
Brawler	+1d6
Rage	+1d6
CIRCUMSTANCE	MOD
<i>Dinosaur</i> – Count double Rep for melee d6.	2xRep
<i>Fierce</i> – If Fierce Class.	+2d6
<i>Weapon</i> – Using melee weapon.	+2d6

MISSION ST. MARY – LEMURIAN TREATY PORT

Example – The melee now takes place. AZ will roll 5d6 for his Rep. He scores a 1, 2, 3, 3, and 4 – 4 successes.

The Askari rolls 4 d6 for his Rep and scores a 1, 2, 4, and 5 – 2 successes.

AZ has scored more successes so has won the melee. Time to determine what damage was caused.

DETERMINING MELEE DAMAGE

When a character wins a melee, he must roll on the Melee Damage Table. Here's how we do it:

- Consult the Melee Damage Table (page 49).
- Roll 1d6 for each success scored by the winner, more than the loser.
- Compare each score to the Rep of the Target.
- Read the result in the left-hand column based on each d6 score then go across to determine the result.
- Rolling multiple d6 can result in the target taking additional damage.

Example – AZ has won the melee by scoring 2 more successes than the Askari. I roll the 2d6 and score a 2 and 5. The 2 is less than the current Rep of the Askari (4) so he reduces his Rep by 1 point for the remainder of the melee when we go to a second round.

The 5 is higher than his Rep of 4 (the reduction in Rep doesn't take effect until affect all damage is taken) so the Askari is knocked to the ground and Out of the Fight.

SUCCESS MELEE DAMAGE

(Taken versus Rep of the Target)

SCORE	RESULT
Equal or less than Rep of the Target	Target loses 1 point of Rep for the remainder of the melee and immediately fights another round of melee. Rep is recovered after the melee is over.
Higher than Rep of the Target but not a "6".	Target is knocked to the ground and Out of the Fight.
"6"	Target is knocked to the ground and Obviously Dead.

DINOSAUR MELEE DAMAGE

If a human wins a melee with a Dinosaur we use a different damage table.

1 DINOSAUR MELEE DAMAGE

(Taken versus Rep of the Target)

Used when humans win a melee with Dinosaurs.

SCORE	RESULT
Less than Rep of Target	Target loses 1 point of Rep and immediately fights a round of melee.
Equal to Rep of Target or higher	Dinosaur loses desire to fight and Runs Away.

AFTER THE ENCOUNTER

After every Encounter, each Out of the Fight and Run Away Star or Grunt must see what has become of them. Here's how we do it:

- Consult the Recovery Test.
- Roll 2d6 versus the Rep of the figure.
- Determine how many d6 are passed.
- Go down the left-hand column to the appropriate row based on the number of d6 passed.
- Go across the row and carry out the results.

Example – Char (Rep 3) went Out of the Fight and after the Encounter I roll 2d6 to see what happened to her. I roll a 4 and 2 passing 1d6. Char comes back at her normal Rep of 3 but receives 1 Decreasing Rep d6 (page 45).

Jim Bob Joe (Rep 4) ran away and after the game I roll 2d6. I roll a 5 and 3 passing 1d6. Jim Bob Joe comes back at a Rep of 4 but receives 2 Decreasing Rep d6.

Whatshisname (Rep 3) went Out of the Fight and rolls 2d6. He scores a 4 and 5, passes 0d6. Whatshisname is Obviously Dead.

MISSION ST. MARY – LEMURIAN TREATY PORT

2

RECOVERY

(Taken vs. Rep)

# D6 PASSED	RESULT
2	All return at normal Rep.
1	Out of the Fight returns at normal Rep but receives 1 Decreasing d6 (page 45). Run Aways return at normal Rep but receive 2 Decreasing d6 (page 45).
0	Out of the Fights become Obviously Dead. Run Aways never return.

STOP!

Before going any further take two figures (Rep 4) and do the following.

Place them 6" from each other.

Give them different melee weapons.

Take a Charge into Melee Test.

Resolve a melee.

Do this a second time, with two figures charging one figure. Did you roll one set of d6 for the target when taking the Charge into Melee Test and apply them individually to both chargers?

If the charger is shot at and a Duck Back result is scored, the charger ignores it and moves into contact.

Resolve a multi-figure melee. How many figures can melee one figure at the same time? Remember that melees are carried out on a one on one basis.

Humans that win a melee with Dinosaurs or Animals use a separate Dinosaur Melee Damage Table.

The Recovery Test is taken by any character that goes Out of the Fight or suffered a Run Away result. You come back at the same Rep, but could gain Decreasing Rep d6 (page 66).

DINOSAURS

You can also play *Mission St. Mary* with Dinosaurs. ⁽¹⁾ In this section we will cover all rules that apply to Dinosaurs as well as their Lists.

(1) *Dinosaurs include contemporary Animals and Prehistoric Animals and the terms are used interchangeably. References to one also apply to the other.*

DEFINING DINOSAURS

Each Dinosaur is defined in specific ways. Here's how we do it:

- What is its *Size*?
- Is it *Fierce* or a *Feeder*?
- What is its *Reputation*?

SIZE

Dinosaurs are divided into 3 sizes: large, medium, and small. The players are encouraged to define the size of a Dinosaur based on the models used. Here are some examples:

- Tyrannosaurus Rex is large.
- Woolly Mammoth is large.
- Coelodonta is medium.
- Great Grey Ape is medium.
- Protoceratops is small.
- Deinonychus is small.

FIERCE OR FEEDER

There are two Classes of Dinosaurs and each have their own specific Reaction Tests (47). They are *Fierce* and *Feeders*.

- **FIERCE** – These are terrifyingly aggressive meat eaters that often move in packs.
- **FEEDERS** – These are tranquil plant eaters that move in herds.

REPUTATION

Reputation is handled normally and range from 3 to 5.

REPUTATION AND MELEE

Dinosaurs use their Rep in melee, just like Stars and Grunts. Dinosaurs do not use weapons and their attacks are bites, slashes, and bashing. Here's how we do it:

- Dinosaurs count twice their Rep when in melee.

MISSION ST. MARY – LEMURIAN TREATY PORT

Example – A Large Ferocious Dinosaur (T-Rex) has a Reputation of 5 so starts with 5d6 in melee. This is doubled to 10d6. It also adds 2d6 for being Fierce.

DINOSAUR & ANIMAL LISTS

The Dinosaur and Animal Lists provide the information you will need. The number next to the size tells you how many figures can be fed per month killing the creature.

1 **DINOSAURS** (#)
(Read the result as rolled)

#	SIZE	CLASS	REP	MOVE
1	Large 10	Feeder	3	8"
2	Large 10	Fierce	5	12"
3	Medium 6	Feeder	3	12"
4	Medium 6	Fierce	4	16"
5	Small 3	Feeder	2	12"
6	Small 3	Fierce	4	16"

(#) The first d6 result dictates whether you have met all Feeders or Fierce. If roll the opposite on the second or subsequent roll, just use the similar size Dinosaur.

1 **ANIMALS** (#)
(Read the result as rolled)

#	SIZE	CLASS	REP	MOVE
1	Large 10	Feeder	4	8"
2	Large 10	Fierce	5	12"
3	Medium 6	Feeder	3	12"
4	Medium 6	Fierce	4	16"
5	Small 3	Feeder	3	12"
6	Small 3	Fierce	4	16"

(#) The first d6 result dictates whether you have met all Feeders or Fierce. If roll the opposite on the second or subsequent roll, just use the similar size Animal.

REACTION TESTS

Dinosaurs take Reaction Tests using the Dinosaur Reaction Tests (47).

MOVEMENT

Dinosaurs can move normal from 8 to 20 inches depending upon their Size and Class. See their NPC List for more detail (page 52).

FAST MOVE

Dinosaurs use the same Fast Move procedure as humans (page 12) and will add half their normal move for each d6 passed.

CHASE THEM DOWN

When a human scores a result of Run Away, it could be run down by a Dinosaur. Here's how we do it:

- The human scores a result of or voluntarily Runs Away.
- The Dinosaur must be Fierce.
- Roll 2d6 and add the results. If the total is "7" or greater, the Dinosaur has caught the character and made it Obviously Dead. The Dinosaur will spend the remainder of the Encounter stationary, feeding on the character, unless forced to react.

CHALLENGES

Challenges are used when you want to do something not covered in the rules. For example, if you want to leap from one building to another, over an alley.

SUCCESS & FAILURE

Challenges follow a specific formula. Here's how we do it:

- Decide what the Challenge will be.

Example - Dario wants to leap across an alley to another building.

- Decide what benefit is gained by a success and the consequences of failure.

Example – If Dario succeeds he will safely make it across the alley. If he fails he will fall into the alley and count two Out of the Fight results.

- Go to the Challenge Table.
- Start with the Rep of the character.
- Modify the Rep by any applicable Attributes or Circumstances.
- Roll 2d6 versus the modified Rep and determine how many d6 are passed.
- Go down the left-hand column to the appropriate row based on the number of d6 passed.
- Go across and immediately carry out the results.

MISSION ST. MARY – LEMURIAN TREATY PORT

REP	CHALLENGE
	<i>(Taken vs. Rep)</i>

ATTRIBUTES AND CIRCUMSTANCES	MODIFIER
<i>Athlete</i>	+1
<i>Clumsy</i>	-1
<i>Difficult</i> –If the Challenge is considered difficult by all players.	-1
<i>Easy</i> – If the Challenge is considered easy by all players.	+1
<i>Tool</i> – If have a tool that increases the chances of success.	+1

# D6 PASSED	RESULT
2	Success and reap the benefits.
1	May decide to re-take the test, counting any result of pass 1d6 as if pass 0d6 OR Decide not to take the test again, but may take the test when next Active.
0	Failed and suffer the consequences.

STOP!

Dinosaurs and Animals are divided into aggressive types (Fierce) and docile types (Feeders). Both count double their Rep for melee purposes.

Challenges are taken when you want to do something that isn't covered specifically in the rules.

That's it; you've finished the tabletop rules. If you've done the exercises, you should have a pretty good grasp of how the rules are played. Now lets' go over setting up your games.

DAY PART

Encounters can occur at any time of the day. In *Mission St. Mary*, we separate the day into four periods called Day Parts. For ease of play and storytelling we've added some arbitrary times for reference.

- **EARLY** (5AM to 11AM)
- **DAYTIME** (11AM to 5PM)
- **EVENING** (5PM to 11PM)
- **LATE** (11PM to 5AM)

WHAT DAY PART?

Sometimes you can choose the Day Part when the Encounter will occur and sometimes you can't. Here's how we do it:

- Roll 1d6, read the result as rolled, and consult the Day Part Table.
- Want more detail? Roll 1d6 after you know the Day Part and add the result to the starting time.

1	DAY PART
	<i>(Read the result as rolled)</i>

#	DAY PART
1	Early
2	Daytime
3	Evening
4	Late
5	Your choice
6	Your choice

Example – Dario has led the expedition into the Northern Edge of the Mountains and it's time for an Explore Encounter (page 39). I set up the table and roll for the Day Part. I roll 1d6 and score a 3. The Encounter will take place in the Evening. When exactly? I roll 1d6 and score a 4. The Encounter starts at 9 PM.

DAY PARTS AND VISIBILITY

Visibility may be affected by the Day Part. Here's how we do it:

- Shooting during the Evening and Late Day Parts is harder and reflected on the Shooting Table.
- Seeing someone during the Evening and Late Day Parts is harder and reflected on the In Sight Table.

MISSION ST. MARY – LEMURIAN TREATY PORT

TERRAIN

We try to make setting up terrain for your games as painless as possible. Nothing is more frustrating than deciding not to play a game because you don't have the right terrain pieces as dictated by the rules. Some gamers have wonderful resin pieces, others use paper tiles. Regardless of the type you have, we will make suggestions and where needed, provide specific instructions. The bottom line, is make whatever terrain you have, work for you. Just play the game!

LAYING OUT THE TABLE

Regardless of the size or shape of the table you play on, we divide it into sections. Here's how we do it:

- Divide the table into nine roughly equal sections. See the following illustration that shows the corresponding number for each section of terrain. In this case the table is square but you may be using a rectangle. It doesn't matter, just be sure and divide the table into nine equal sections.

1	2	3
4	5	6
7	8	9

- Refer to the appropriate Locale in the following sections for ideas on how to place terrain.
- Streets will run through sections 2, 5, and 8 or 4, 5, and 6. If you want you can have them intersect in section 5.
- Place buildings as you would see them in a city; in sections adjacent to the streets and close to each other if you like. Leave some space between buildings and you have an alley.
- When placing terrain pieces that block LOS, try and place them over 3" apart.
- Use as much or as little terrain as desired.

KEY SECTIONS

There are two key sections when laying out the table. Section 9 is always where the Star enters the table while section 1 always has the Target Building.

If you're playing a game where the Star is occupying the Target Building, just start him in section 9 and place the PEFs normally. Don't worry; we'll be explaining PEFs pretty soon.

OPEN SPACE

To better represent the Nobelongga terrain the largest area of clear terrain, does not contain any cover or concealing terrain, should not exceed 12".

EXOTIC LOCALES

Think Cairo or similar city with older buildings, smaller streets, more alleys, and a town square market place. On the edge of an Exotic Locale table you could place jungle vegetation on three sections of the table, maybe 1, 4, and 7.

JUNGLE

Jungles are pretty self-explanatory. At least 75% of the table should be jungle with trails or paths cutting through it. One fun piece of terrain is instead of a street like you would find in a city; make three sections a chasm with a rickety bridge linking the sides. When the characters cross the chasm, have them take a Challenge (page 26). Failure is off the bridge and into the chasm... Obviously Dead.

LOST WORLD

This is a great setting for letting your imagination run wild. Jungle vegetation, rock formations, waterfalls, impassable rivers; the possibilities are endless. How about a temple? Only rule is at least 75% of the table should be jungle.

As you can see we are pretty loose with terrain and that's on purpose. *Mission St. Mary* is about the Story. Many of the Encounters may not even require terrain placed on the table. In some cases, as in a Confrontation, you can make do with only one 12x12 inch section. I prefer to spend my time playing the game and try to keep the set up and take down of the table as short as possible.

MISSION ST. MARY – LEMURIAN TREATY PORT

TARGET BUILDING

As mentioned previously, the Star will enter through section 9. His object is called the Target Building and is always placed in section 1.

This can be an actual building or a terrain feature. Once there, the Star will need to accomplish an objective. This could be rescue someone, recover something or something totally different.

Once the objective is accomplished the Star must exit the table through section 9.

Example – Arizona Bob is in the Lost World Area and must reach a waterfall in section 9 – the Target Building. When he reaches there he enters the cave behind the waterfall and finds a large diamond. AZ grabs the diamond and leaves the table, back through section 1.

STOP!

Each Day is broken into four parts. Using Day Parts enriches your stories. Sometimes you can choose the Day Part of the Encounter. If you cannot, then we determine the Day Part at random.

Terrain is pretty fast and loose. Use what you have. Here are a few key points to remember.

1 – The table is always split into 9 sections.

2 – Section 9 is always where the Star enters.

3 – Section 1 is always where the Target Building or objective of the Encounter is located.

Feel free to use whatever you want for terrain as it's all about the game.

NOBELONGGA

From "My Travels on the Oldest Continent" – 1870,

Baron Sir Roger FitzLyon, 12th Baron FitzLyon.

"Tradition has it that the Nobelongga are the keepers of the most ancient knowledge in Lemuria. Legends of lost cities of the ancient peoples of Lemuria and their untold treasures are told 'round the fires and in trade villages on the coast. The Nobelongga fear of the grey apes of the island continent is very pronounced, and the apes are seen as Sacred Keepers of the land. Traditions say the elders of the tribe meet with the "Old Ones" or the "Great Ones" deep in the jungle. None can describe these creatures."

Welcome to Nobelongga, the eastern gateway to the island continent of Lemuria.

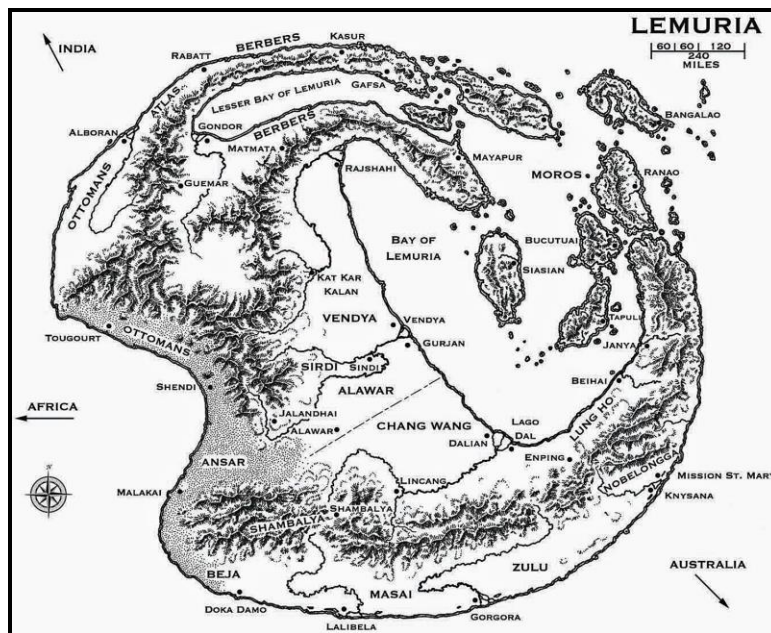

Map of Lemuria.

MISSION ST. MARY – LEMURIAN TREATY PORT

AREA MAP OF NOBELONGGA

In *Mission St. Mary* we use the Area Map movement found in many other THW games.

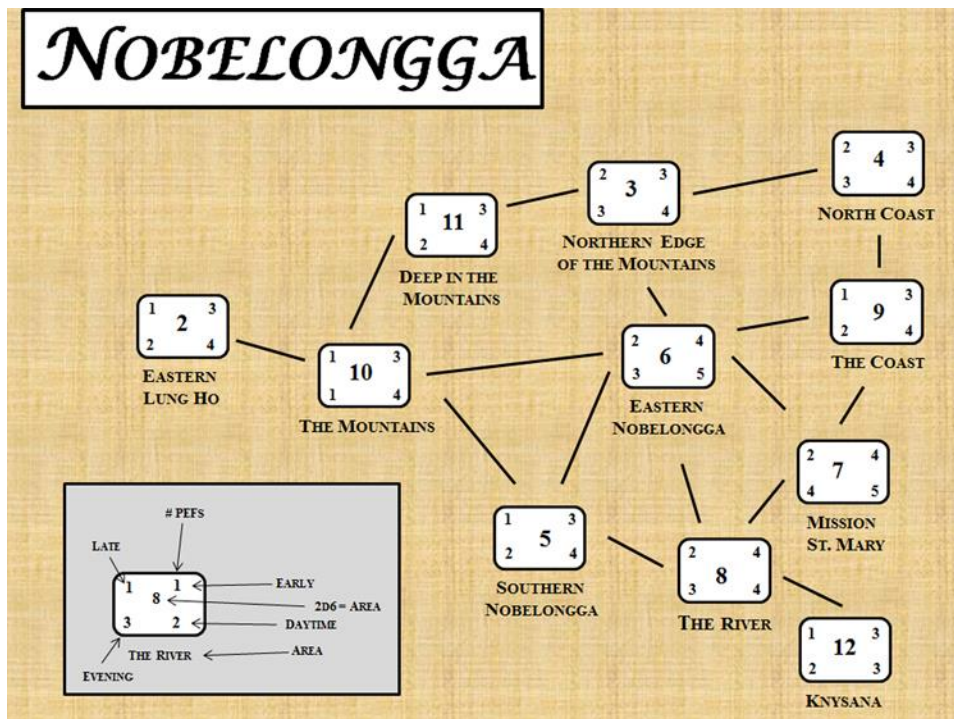

THE RECTANGLE KNOWS ALL

Now let's see how to read the map. The rectangle holds all the info you'll need.

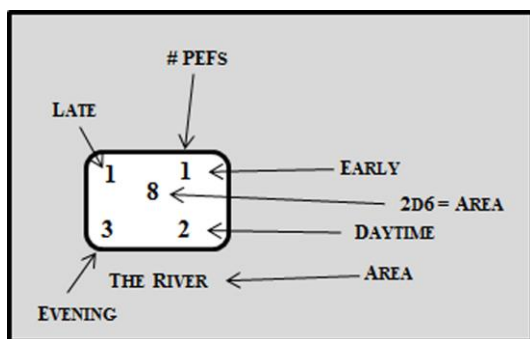

AREA

The name of the Area is listed under the rectangle.

THE NUMBER IN THE MIDDLE

This number corresponds to the Area and is used to move the characters during the Encounter. Here's how we do it:

- Roll 2d6, add the scores together, and read the result. This tells you the corresponding Area.

Example – Dario is being hired to lead an Adventurers expedition in Nobelongga. I am doing it on the fly so roll 2d6 for the location. I score a 3. Looking on the Nobelongga map I see that the Adventurers want to be led to the Northern Edge of the Mountains.

PEF

There are four numbers, one in each corner of the rectangle. Each number corresponds to the number of PEFs (page 31) for that Area during that Day Part (page 27).

DAY PARTS

The four Day Parts (page 27) are in the rectangle and appear like the face of a clock. Going clockwise they are:

- Upper right-hand corner is the Early Day Part.
- Lower right-hand corner is the Daytime Day Part.
- The lower left-hand corner is the Evening Day Part.

MISSION ST. MARY – LEMURIAN TREATY PORT

- The upper left-hand corner is the Late Day Part.

Example – I go to Mission St. Mary in the Late Day Part. Looking in the upper left corner, there will be 2 PEFs in the Encounter (page 36).

MOVING BETWEEN AREAS

When you need to move from Area to Area, here's how we do it:

- How you physically move between Areas is on foot.
- How far each Area is from the next is up to you.
- Characters move from linked Area to linked Area.

Example – Dario Fitch is in Mission St. Mary. He can move to the Coast, Eastern Nobelongga, and the River.

PEFS

PEF stands for Possible Enemy Force. We use PEFs to limit the intelligence the player has prior and during the game. By using PEFs we create a sense of uncertainty as to the size of the enemy force, if any, its composition and location. Heck a PEF could even be just a case of nerves!

GENERATING PEFs

There are two ways to generate PEFs. The first is when the Encounter begins. Here's how we do it:

- After the terrain has been set up and the player has entered or been placed on the table, it's time to generate the PEFs.
- Go to the appropriate Area Rectangle (page 30) on the map and see how many PEFs are on the table for the Area and the Day Part.
- Roll 1d6. The score indicates which numbered section of the table will contain a PEF.
- Place a marker of any type in this section of the table, to represent the possible PEF.
- If a terrain feature could block the LOS from your force to the PEF, be sure to place the PEF in a manner that does so.
- If no such feature is present then place the PEF in the center of that section.
- Repeat this process until you have placed all the PEFs for the Area and Day Part.

- It is possible to have more than one PEF in the same section.
- Do *not* place PEFs in buildings, as we will be using the Defining Moment (page 32) rules as well.

PEF REP

Just like characters have Reputation, so do PEFs. All PEF's have a Rep of 4.

PEF MOVEMENT

PEFs move just like they were groups of enemy figures. Here's how we do it:

- When the enemy is active, start with the PEF farthest from any player group.
- Roll 2d6 and compare the scores versus its Rep of 4.
- Determine how many d6 were passed.
- Consult the PEF Movement Table and carry out the results.
- Any contact that the PEF causes must be resolved prior to moving the next PEF, the next one farthest from any player group.

2

PEF MOVEMENT

(Taken versus the Rep of 4)

#D6 PASSED	RESULT
2	The PEF moves 8" directly towards the player ending in cover if possible.
1	The PEF moves 4" directly towards the player ending in cover if possible.
0	PEF does not move.

SPECIAL PEF MOVEMENT

PEFs do not suffer any terrain movement penalties.

RESOLVING PEFs

When a player group and a PEF have a LOS it's time to resolve the PEF. Here's how PEFs are resolved:

- Be sure that there is a valid LOS to the PEF. PEFs in cover can be seen while those with cover between the tester and the PEF cannot.
- Roll 2d6 versus the PEF Rep and consult the PEF Resolution Table.
- Immediately carry out the result based on the number of d6 passed.

MISSION ST. MARY – LEMURIAN TREATY PORT

2

PEF RESOLUTION

(Taken versus PEF Rep of 4)

# D6 PASSED	RESULT
2	<p><i>Contact!</i> You have run into at least 1 NPC. Roll 1d6:</p> <ul style="list-style-type: none"> • 1 = 1 less than the player group. • 2 = 1 more than the player group. • 3 = 2 less than the player group. • 4 = 2 more than the player group. • 5 = 3 more than the player group. • 6 = 3 less than the player group. <p>Go to the Who Are They Table (page 51).</p>
1	<p><i>Something's out there!</i> Resolve the next PEF with 3d6 counting the lowest two scores. If the last PEF and none have been resolved as NPCs, count as passed 2d6.</p>
0	<p><i>False alarm!</i> Nothing but a case of nerves. If the last PEF and none have been resolved as NPCs, count as passed 2d6.</p>

- Resolve each Defining Moment as if it were a PEF.
- When entering a building to meet someone in particular, the Defining Moment is resolved *before* meeting them. After it has been resolved, you will meet that person.

WHO ARE THEY?

Now it's time to determine who the NPCs are. Here's how we do it:

- Consult the appropriate Who Are They Table (page 51).
- Go down the left-hand column to the appropriate row based on the Area you are in.
- Roll 1d6, read the result as rolled, then go across the row to the appropriate column. This tells you which NPC List (page 51) you have met. If in Mission St. Mary you will be directed to the Mission St. Mary NPCs Table.

DEFINING MOMENT

The Defining Moment is the second way to generate PEFs. Here's how we do it:

- When one or more of your characters enters a building for the *first time*, this will be a Defining Moment.

2

WHO ARE THEY?

(Add the results together)

AREA	1-3	4	5	6
Eastern Lung Ho	Soldiers	Animals	Adventurers	Cultists
Northern Edge of the Mountains	Natives	Adventurers	Steam Punks	Cultists
North Coast	Natives	Cultists	Adventurers	Deep Ones
Southern Nobelongga	Natives	Jungle Lord	Steam Punks	Adventurers
Eastern Nobelongga	Animals	Natives	Adventurers	Jungle Lord
Mission St. Mary	NPC Generator	NPC Generator	NPC Generator	NPC Generator
The River	Soldiers	Steam Punks	Adventurers	Deep Ones
The Coast	Natives	Soldiers	Adventurers	Deep Ones
Mountains	Natives	Adventurers	Animals	Cavemen
Deep in the Mountains	Cavemen	Great Grey Ape	Animals	Dinosaurs
Knysana	Natives	Natives	Soldiers	Adventurers

MISSION ST. MARY NPCs

While in Mission St. Mary you've resolved a PEF as an NPC. It's time to determine who it is. Here's how we do it:

- Roll 1d6 and read the result as rolled.
- Go to the Circled own the Mission St. Mary NPC Table and down the left-hand column to the appropriate row based on the score.
- Go across to see what Circle to use, go to

MISSION ST. MARY – LEMURIAN TRADE PORT

1+1 MISSION ST. MARY NPCs

(Read the result as rolled)

#	GO TO THE FOLLOWING CIRCLE
1	Civilian
2	Civilian
3	Criminal
4	Exotic
5	Mover
6	Shaker

CIRCLE	#	PROFESSION	CLASS
Civilian	1	Citizen	Civilian
Civilian	2	Citizen	Civilian
Civilian	3	Foreigner	Civilian
Civilian	4	Laborer	Civilian
Civilian	5	Laborer	Civilian
Civilian	6	Service Industry	Civilian
Criminal	1	Thief	Criminal Element
Criminal	2	Thief	Criminal Element
Criminal	3	Thief	Criminal Element
Criminal	4	Thug	Criminal Element
Criminal	5	Street Urchin	Criminal Element
Criminal	6	Working Girl	Criminal Element
Exotic	1	Adventurer	Law & Order
Exotic	2	Askari	Law & Order
Exotic	3	Bearers	Civilian
Exotic	4	Police	Law & Order
Exotic	5	Soldier	Law & Order
Exotic	6	Steam Punk	Law & Order
Mover	1	Business Magnate	Civilian
Mover	2	Cultist	Civilian
Mover	3	Foreigner	Civilian
Mover	4	High Society	Civilian
Mover	5	High Society	Civilian
Mover	6	Politician	Civilian
Shaker	1	Academia	Civilian
Shaker	2	Accountant	Civilian
Shaker	3	Attorney	Civilian
Shaker	4	Cultist	Civilian
Shaker	5	Political Assistant	Civilian
Shaker	6	Safari Leader	Civilian

CIRCLE: The Circle that the NPC runs in.

#: This is the number needed to be rolled on 1d6 to meet that type of NPC. When numbers appear in parenthesis, roll a 2nd d6 to determine the type of NPC.

PROFESSION: The Profession of the NPC.

CLASS: The Class of the NPC.

NPC LISTS

Use these lists when you run into NPCs outside of Mission St. Mary. Here's how we do it:

- Roll 1d6 and read the result as rolled.
- Go down the left-hand column to the appropriate row based on the score.
- Go across to see who you have met.
- Roll 1d6 once for each NPC you have met.

1 ADVENTURERS

(Read the result as rolled)

#	PROFESSION	CLASS	REP
1	Leader ⁽¹⁾	Adventurer	5
2	Hunter	Adventurer	4
3	Adventurer	Adventurer	4
4	Adventurer	Adventurer	4
5	Adventurer	Adventurer	4
6	Adventurer	Adventurer	3

(1) There can be only 1. If rolled twice, count as a Rep 4 Adventurer.

1 CAVEMEN ^(#)

(Read the result as rolled)

(#) Roll 1d6. (1-3) = Cro-Magnon (4-5) = Neanderthal (6) = Monkey Boys

#	PROFESSION	CLASS	REP
1	Leader ⁽¹⁾	Law & Order	5
2	Hunter	Law & Order	4
3	Tribesmen	Law & Order	4
4	Tribesmen	Law & Order	3
5	Tribesmen	Law & Order	3
6	Tribesmen	Law & Order	3

(1) There can be only 1. If rolled twice, count as a Rep 4 Hunter.

1 CULTISTS

(Read the result as rolled)

#	PROFESSION	CLASS	REP
1	Cult Commander ⁽¹⁾	Adventurer	5
2	Cult Leader ⁽²⁾	Adventurer	5
3	Cultist	Adventurer	4
4	Cultist	Adventurer	4
5	High Society	Adventurer	3
6	Citizen	Adventurer	3

(1) This is the Supreme Leader of the Cult who will try to channel or resurrect the object of the Cult. If rolled twice, count as a Cult Leader. (2) There can be only 1. If rolled twice, count as a Rep 4 Cultist.

MISSION ST. MARY – LEMURIAN TRADE PORT

1 DEEP ONES

(Read the result as rolled)

#	PROFESSION	CLASS	REP
1	Leader ⁽¹⁾	Law & Order	5
2	Warrior	Law & Order	4
3	Warrior	Law & Order	4
4	Warrior	Law & Order	3
5	Warrior	Law & Order	3
6	Warrior	Law & Order	3

(1) There can be only 1. If rolled twice, count as a Rep 4 Warrior.

1 GREAT GREY APE

(Read the result as rolled)

#	PROFESSION	CLASS	REP
1	Alpha Male ⁽¹⁾	Fierce	5
2	Beta Male ⁽²⁾	Fierce	5
3	Ape	Fierce	4
4	Ape	Fierce	4
5	Ape	Fierce	3
6	Ape	Fierce	3

(1) If rolled twice, count as a Beta Male. (2) There can be only 1. If rolled twice, count as a Rep 4 Ape.

1 JUNGLE LORD

(Read the result as rolled)

#	PROFESSION	CLASS	REP
1	Jungle Lord ⁽¹⁾	Adventurer	5
2	Jungle Lord	Adventurer	5
3	Jungle Lord	Adventurer	5
4	Jungle Lord	Adventurer	5
5	Jungle Lady ⁽¹⁾	Adventurer	4
6	Jungle Lady	Adventurer	4

(1) There can be only 1. If rolled twice, disregard and do not – reroll.

1 NATIVES

(Read the result as rolled)

#	PROFESSION	CLASS	REP
1	Chief ⁽¹⁾	Law & Order	5
2	Leader ⁽²⁾	Law & Order	5
3	Warrior	Law & Order	4
4	Warrior	Law & Order	4
5	Warrior	Law & Order	3
6	Warrior	Law & Order	3

(1) If rolled twice, count as a Leader. (2) There can be only 1. If rolled twice, count as a Rep 4 Warrior

1 SOLDIERS

(Read the result as rolled)

#	PROFESSION	CLASS	REP
1	Military NCO ⁽¹⁾	Law & Order	5
2	Guide ⁽²⁾	Law & Order	4
3	Military Soldier	Law & Order	5
4	Military Soldier	Law & Order	4
5	Military Soldier	Law & Order	3
6	Askari	Law & Order	4

(1) There can be only 1. If rolled twice, count as a Rep 5 Soldier.
(2) There can be only 1. If rolled twice, count as a Rep 4 Askari.

1 STEAM PUNKS

(Read the result as rolled)

#	PROFESSION	CLASS	REP
1	Leader ⁽¹⁾	Adventurer	5
2	Tinkerer	Civilian	4
3	Steam Punk	Adventurer	4
4	Steam Punk	Adventurer	4
5	Steam Punk	Adventurer	3
6	Steam Punk	Adventurer	3

(1) There can be only 1. If rolled twice, count as a Rep 4 Steam Punk.

1 DINOSAURS ^(#)

(Read the result as rolled)

#	SIZE	CLASS	REP	MOVE
1	Large 10	Feeder	3	8"
2	Large 10	Fierce	5	12"
3	Medium 6	Feeder	3	12"
4	Medium 6	Fierce	4	16"
5	Small 3	Feeder	2	12"
6	Small 3	Fierce	4	16"

(#) The first d6 result dictates whether you have met all Feeders or Fierce. If roll the opposite on the second or subsequent roll, just use the similar size Dinosaur.

1 ANIMALS ^(#)

(Read the result as rolled)

#	SIZE	CLASS	REP	MOVE
1	Large 10	Feeder	4	8"
2	Large 10	Fierce	5	12"
3	Medium 6	Feeder	3	12"
4	Medium 6	Fierce	4	16"
5	Small 3	Feeder	3	12"
6	Small 3	Fierce	4	16"

MISSION ST. MARY – LEMURIAN TRADE PORT

(#) The first d6 result dictates whether you have met all Feeders or Fierce. If roll the opposite on the second or subsequent roll, just use the similar size Animal.

Example – Dario Fitch is leading an expedition to the Northern Edge of the Mountains Areas when he comes into LOS of a PEF. I roll 2d6 versus the PEF Rep of 4 and score a 2 and 3. Looking on the PEF Resolution Table (page 50) I see that the PEF is resolved as NPCs.

I now roll 1d6 to see how many of them there are and score a 5. There are 9 NPCs, 3 more than the number of figures in Dario's group.

I now go to the Who Are They Table (page 51) down to the appropriate row for the Area Dario is currently in – Eastern Nobelongga. I roll 1d6, score a 4 and go across to the appropriate column. Dario has met 9 Natives.

I now go to the Natives List (page 52) and roll 1d6, 9 times, to see who they are.

What happens now?

ARE THEY FRIENDS OR FOES?

Now that you resolved a PEF as NPCs, determined how many of them there are, and who they are, we need to see how they act. Here's how we do it:

- Consult the Opposites Table. If the 2 groups involved are not Opposites, then start with the number of figures in each group.
- Roll 1d6 for each group and add it to the number of figures in that group.
- Compare the totals scored by each group. If 1 group scores 2x that of the other, it will attack. Go to the In Sight (page 47) and resolved normally.
- If 1 group does not score 2x that of the other then it's time to Talk the Talk.

TALK THE TALK

The Leaders of each group will not talk to see how they will resolve their contact. Here's how we do it:

- Each Leader rolls 1d6 per point of Rep looking for successes.
- If the player scores equal or more successes than the NPC, they exchange pleasantries and the NPCs will move normally to exit the table.
- If the NPC scores more successes they will attack. Go to the In Sight (page 47) with both groups counting as Active.

Example – Dario (Rep 5) and the Native Leader (Rep 4) will now Talk the Talk. Dario rolls 5d6 and scores 3 successes.

The Native Leader rolls 4d6 and scores 2 successes. The two groups will part ways and the NPCs are given an Activation d6 and will move to exit the table when active.

OPPOSITES

There will be times when characters from different Lists come into contact. Some Lists are more likely to fight other Lists. We call these *opposites* of each other. Here's a list of the opposites.

OPPOSITES

LIST	OPPOSITE
Adventurers	None
Cavemen	Natives and Cavemen of other type
Cultists	None
Deep Ones	All
Feeder	Fierce
Fierce	All
Great Grey Ape	All except Cavemen
Jungle Lord	None
Natives	Soldiers, Cavemen, and rival tribes ⁽¹⁾
Soldiers	Cavemen, Natives, and rival nations ⁽¹⁾
Steam Punks	None

STOP!

Nobelongga is divided into 11 Areas on the map. The Area Rectangle (page 30) tells you all the info you need.

PEFs have a Rep of 4. They move using the PEF Movement Table (page 50), and resolved using the PEF Resolution Table (page 50). To see how many NPCs you have met, look on the pass 2d6 row. When you enter the Target Building or Objective, resolve a PEF, even if it wasn't there.

To see who the NPCs, are we use the Who Are They Table first then the Mission St. Mary NPC Table if in the Mission St. Mary Area; if not, use the appropriate NPC List.

To see if the NPCs are Friends or Foes, roll 1d6 for each group; add the score to the number of figures in the group. If one total is twice or more than the other they are enemies. Otherwise, take the Talk the Talk Test.

How NPCs Move

When PEFs are first deployed they will move according to the PEF Movement Table (page 50).

When PEFs are resolved and figures placed on the table these non-player figures use the NP Movement Table. Here's how we do it:

1 NP MOVEMENT

(Taken versus Rep)

CIRCUMSTANCE	RESULT
Mounted or in vehicles.	+1d6
Outnumber similar enemies by 2:1 or more.	+1d6

# D6 PASSED	RESULT
1	<p>Fierce Dinosaurs or Animals– Move directly to charge the closest group, player or NP.</p> <p>Feeder Dinosaurs or Animals–</p> <ul style="list-style-type: none"> • If have LOS to Fierce Dino move directly away full move. • Otherwise, move to nearest vegetation, or center of section, to feed. If already feeding, remain in place. <p>Humanoids –</p> <ul style="list-style-type: none"> • If outnumbered by 2:1 or more, or facing Fierce Dinosaur, move away from threat at Fast Movement. • Otherwise, move towards closest group.
0	<i>All</i> – Halt in place.

NPC ACTIONS

NPC humans will act in the following ways based on how they are armed.

- Those armed with ranged weapons will fire when in range. If out of range they will move into range, staying in cover if possible.
- Those armed with melee weapons only or unarmed will move to charge the closest enemy.

Example – Activation dice are rolled and the enemy activates first with a score of 4. I start from high to low and the Rep 5 group goes first. I roll a 5, passing 1d6. As it is a Fierce Dinosaur, it moves directly towards the closest group and charges when in reach.

ENCOUNTERS

We call your games in *Mission St. Mary*, Encounters. We have provided you with 10 Encounters. They are:

- Confrontation.
- Conquer.
- Contact.
- Explore.
- Gathering.
- Hunt.
- Job Offer.
- Raid.
- Rescue.
- Scavenger Hunt.
- Travel Encounter.

Some Encounters will make more sense for certain characters. An example would be the Conquer Encounter. This is slanted more towards a Soldier than a Steam Punk. Bottom line, just play whatever you like and have fun!

PRESENTATION

Although they may be different from each other, Encounters are always presented in the same way.

- **ENCOUNTER NAME** - This tells you the type of Encounter and provides a brief description.
- **OBJECTIVE** - This tells you how to be successful.
- **FORCES** - This tells you the characters involved.
- **TERRAIN** - This outlines the terrain of the table.
- **DEPLOYMENT** - This tells you where the characters and PEFs are placed.
- **SPECIAL INSTRUCTIONS** - This is information that is not covered in the other sections.

ORDER OF ENCOUNTERS

Encounters can be played in any order you desire. If you want more direction, go to the Job Offer Encounter (page 40).

CONFRONTATION

In this Encounter, two opposing groups come into open combat. It could be in an alley, jungle, or anywhere else you choose, just make terrain work for you.

OBJECTIVE:

- To defeat your enemy and escape unharmed.

FORCES:

- You can use as much or as little of your group as desired.
- Opponents will be generated as per the Special Instructions.

TERRAIN:

- The board is divided into nine sections and terrain generated normally (page 28).

DEPLOYMENT

- PEFs are placed on the table normally (page 31).

SPECIAL INSTRUCTIONS:

- Determine the Day Part randomly (page 27).
- Place the Star and his characters in section 5.
- Place the opposing group 6" away and in LOS of your group. Be sure to match up opposing characters of the same or closest Rep across from each other.
- Go to Walk the Walk.
- Play continues normally until the player has accomplished his Objective, been destroyed, or leaves the table.

WHO IS IT?

So you're having a Confrontation and must determine who it is with. Here's how we do it:

- Go to the PEF Resolution Table (page 50) and count as if passing 2d6 to determine how many enemy there are.
- Next go to the Who Are They Table (page 51).
- Go down the left-hand column to the Area you are in.
- Roll 1d6, read the result as rolled, and go across to the appropriate column to see who you have met.
- Go to the appropriate NPC List and
- If you have met Dinosaurs or Animals, they will *always* be Ferocious.

WALK THE WALK

It's come time to physically settle the issue. Here's how we do it:

- The two Leaders take an In Sight Test, with neither counting as active.
- The Leader with the higher number of successes goes first. Ties cause the test to be taken again but with both taking a -1d6 penalty.
- The side winning the In Sight will act.

Example – Dario has 6 figures in his group. Looking on the pass 2d6 row of the PEF Resolution Table (page 50) I roll 1d6. Scoring a 5 we see that he has met 9 NPCs.

I now go to the Who Are They Table (page 51) and roll 1d6, scoring a 5. Going to the Mountains, the Area where he is in, and to the 4 column I see that he has run into a rival group of Adventurers.

I now go to the Adventurers NPC List and begin rolling up the NPCs.

ENDING THE ENCOUNTER

The Encounter continues until one side has left the table or has had all of their characters go Out of the Fight or worse.

AFTER THE CONFRONTATION

Okay, so what happens after the Confrontation? Well, if you're lucky, you escaped harm. But if you lost and have gone Out of the Fight, this is what happens next:

- You have failed the Encounter, you escape but received 3 Decreasing Rep d6 (page 45).
- Complete your Travel.

CONQUER

In this scenario you are intent on staking claim to your area and driving away all other enemy. This is best played with Natives, Cavemen, or Soldiers.

OBJECTIVE

- You must drive off or kill all opponents.

FORCES:

- This is best played with a minimum of 10 figures in your group.
- Opponents will be generated as per the Special Instructions.

TERRAIN:

- The board is divided into nine sections and terrain generated normally (page 28).

DEPLOYMENT

- PEFs are placed on the table normally (page 31).
- Your group will enter through section 9.

SPECIAL INSTRUCTIONS

- The Day Part is Daytime.
- Play continues normally until the player has accomplished his Objective, been destroyed, or leaves the table.
- If you kill the opposing Leader, you gain 1 bonus Increasing Rep d6. The NPC Leader can only be encountered if rolled on the NPC List, and then only once.

WHO'S FIGHTING WHO?

This is up to you. Here are some ideas:

- Soldiers versus Soldiers.
- Soldiers versus Natives.
- Soldiers versus Cavemen.
- Natives versus Natives.
- Natives versus Cavemen.
- Cavemen versus Cavemen.

CONTACT

In this scenario you are on a quest to discover a race of primitive men rumored to live in the Deep in the Mountains Area of Nobelongga.

OBJECTIVE

- You are trying to make contact with the primitive people.

FORCES:

- You can use as much or as little of your group as desired.
- Opponents will be generated as per the Special Instructions.

TERRAIN:

- The board is divided into nine sections and terrain generated normally (page 28).

DEPLOYMENT

- PEFs are placed on the table normally (page 31).
- Your group will enter through section 9.

SPECIAL INSTRUCTIONS

- Determine the Day Part randomly (page 27).
- To succeed you must resolve a PEF as Cavemen. If and when you do, the Encounter immediately becomes an Explore Encounter. Re-stock the PEFs back to the number required in the beginning.
- Play continues normally until the player has accomplished his Objective, been destroyed, or leaves the table.

Example – Dario is in section 6 and has just resolved a PEF as Cavemen. After the NPCs have been generated and any actions resolved, it now becomes an Explore Encounter.

I need to re-stock the PEFs. There is 1 PEF left unresolved. Looking at the Deep in the Mountains Area Rectangle (page 30) for the Daytime Day Part I see that there should be 4 PEFs. I now generate 3 new ones and go to the Explore Encounter.

MISSION ST. MARY – LEMURIAN TRADE PORT

EXPLORE

In this Encounter you are entering unexplored territory with the goal of exploring the area and returning to Mission St. Mary.

OBJECTIVE

- Your objective is to explore the table.
- To be successful *you* must move to spend one turn of Activation in the center of each section. You do not need to resolve all PEFs!

FORCES:

- You can use as much or as little of your group as desired.
- Opponents will be generated as per the Special Instructions.

TERRAIN:

- The board is divided into nine sections and terrain generated normally (page 28).

DEPLOYMENT

- PEFs are placed on the table normally (page 31).
- Your group will enter through section 9.

SPECIAL INSTRUCTIONS

- Determine the Day Part randomly (page 27).
- Play continues normally until the player has accomplished his Objective, been destroyed, or leaves the table.
- If you find the Caveman camp you gain 1 bonus Increasing Rep d6.

EXPLORING THE SECTION

When you spend a full turn of Activation on the center of section 1, it's time to see what, if anything, you have found. Here's how we do it:

- Roll 2d6, add the results and consult the Exploration Table (page 39).
- Go down the left-hand column to the appropriate row and across to see what you have met.
- Set up what you have run into at the edge of the section to your front.

1

EXPLORATION

(Read the result as rolled)

#	RESULT
1	Caveman Camp (page 42).
2	Cavemen returning from a Raid with 1/2d6 Captives.
3	Cavemen Gathering Food.
4	Fierce Dinosaurs on the Hunt.
5	Rivals of the same Class.
6	Feeder Dinosaurs grazing.

GATHERING

In this Encounter you are trekking across the land gathering food from the ground to survive. This is geared towards Cavemen and Natives, but you can be any Class you desire.

OBJECTIVE

- You must gather enough food (berries, roots, etc.) to feed everyone in your group and exit the table.

FORCES:

- You can use as much or as little of your group as desired.
- Opponents will be generated as per the Special Instructions.

TERRAIN:

- The board is divided into nine sections and terrain generated normally (page 28).

DEPLOYMENT

- PEFs are placed on the table normally (page 31).
- Your group will enter through section 9.

SPECIAL INSTRUCTIONS

- Determine the Day Part randomly (page 27).
- If you find twice as much food as needed you gain 1 bonus Increasing Rep d6.
- Play continues normally until the player has accomplished his Objective, been destroyed, or leaves the table.

MISSION ST. MARY – LEMURIAN TRADE PORT

GATHERING FOOD

Each section that you enter has a possibility of containing food that you can gather. Here's how we do it:

- Roll 1 + 1/2d6 (2 – 4) when you reach the center of sections 1, 2, 3, 4, 5, or 6.
- The result is the Gathering Number representing how plentiful food will be in that section.
- When next Active, roll 2d6 versus the Gathering Number and consult the Gathering Table.
- Determine how many d6 are passed and go down the left-hand column to the appropriate row.
- Go across and carry out the result.

2	GATHERING <i>(Taken versus the Gathering Number)</i>
----------	--

#	RESULT
2	You have gathered enough food feed 2 figures.
1	You have gathered enough food feed 1 figure.
0	There is nothing to be gathered here.

HUNT

In this Encounter you are leading a group hunting food for survival or trophies, depending upon which list you choose to use. If desired, you can be a Fierce Dinosaur looking for a meal. You can use any NPC List. Only Adventurers, Cultists, and Steam Punks hunt for trophies. All Lists, including those 3, will hunt for food.

OBJECTIVE

- You must make one or more kills.
- If you are playing a campaign then you must protect your kill, (see Scavenger Hunt) before the Encounter can be completed.

FORCES:

- You can use as much or as little of your group as desired.
- Opponents will be generated as per the Special Instructions.

TERRAIN:

- The board is divided into nine sections and terrain generated normally (page 28).

DEPLOYMENT

- PEFs are placed on the table normally (page 31).

- Your group will enter through section 9.

SPECIAL INSTRUCTIONS

- The Day Part is either Early (1 – 3) or Daytime (4 – 6).
- A Hunt can only take place in Eastern Lung Ho (2), Eastern Nobelongga (6), the Mountains (10), or Deep in the Mountains (11).
- Play continues normally until the player has accomplished his Objective, been destroyed, or leaves the table.

MAKING THE KILL

When a kill is made, there is a possibility of gaining Increase Rep d6. Here's how we do it:

- Only kills made by the 1st hit on the creature can gain Increasing Rep d6.
- The kill must be stripped to gain the Increasing Rep d6 – see Stripping the Kill (page 44).
- A small Ferocious or medium Feeder kill is worth 1 Increasing Rep d6.
- A medium Ferocious or large Feeder kill is worth 2 Increasing Rep d6.
- A large Ferocious kill is worth 3 Increasing Rep d6.
- If the killer does not have a successful Encounter (goes Out of the Fight or Runs Away) he forfeits any Increasing Rep d6 rolls that he has gained.

JOB OFFER

In this Encounter the player has been approached by a NPC offering employment. You are to meet him at a Tavern in Mission St. Mary.

OBJECTIVE

- You must accept a job offer.

FORCES

- You can take up to 1 member of your group.
- NPCs will be generated normally.

TERRAIN:

- The board is divided into nine sections and terrain generated normally (page 28).
- The whole Encounter can take place inside one building – the Target Building - if desired.

MISSION ST. MARY – LEMURIAN TRADE PORT

DEPLOYMENT

- PEFs are placed on the table normally (page 31).
- Your group will enter through section 9.
- The Target Building or objective is in section 1.

SPECIAL INSTRUCTIONS

- The player decides in which Day Part the Encounter is occurring.
- Use the Mission St. Mary NPCs Table to resolve all PEFs.
- Play continues normally until the player has accomplished his Objective, been destroyed, or leaves the table.

FIND THE EMPLOYER

Before you can accept a job you need to find out who is offering employment. Here's how we do it:

- Roll 2d6 and add the results together.
- Go to the Employer Table, down the left-hand column to the appropriate row, and across to see who the Employer is.
- Now roll 1d6, read the result as rolled, and go across to the appropriate column. This tells you what job is offered.

2	THE EMPLOYER
<i>(Add the results together)</i>	

ENCOUNTER			
C = Contact	E = Explore	H = Hunt	R = Rescue

#	CIRCLE	PROFESSION	1-3	4-5	6
2	Shaker	Academia	E	C	C
3	Exotic	Adventurer	E	H	R
4	Mover	High Society	H	H	C
5	Exotic	Steam Punk	E	H	R
6	Mover	Business Magnate	H	E	C
7	Mover	High Society	H	H	H ⁽¹⁾
8	Mover	Politician	H	H	E
9	Exotic	Soldier	E	E	E
10	Shaker	Academia	C	C	C
11	Shaker	Cultist	C	C	C
12	Mover	High Society	H	H	R

Example – Dario has gone to the Rusty Pelican Tavern to meet a perspective employer. I roll 2d6 and score a 7. Looking on the Employer Table I see the employer is High Society. I next roll 1d6 and score a 3. He wants to go hunting.

WAGES

Why do you bother to accept a Job Offer instead of just playing whatever you want? Because accepting a Job Offer, let's you will earn wages. Here's how we do it:

2	WAGES
<i>(Add the results together)</i>	

CIRCUMSTANCE	MODIFIER
Each Area over the 1 st you must travel to reach the jobsite.	+1

JOB	EXOTIC	SHAKER	MOVER
Contact	x	3	5
Explore	1	2	3
Hunt	1	x	2
Rescue	2	x	5

Example – Dario has been asked to lead a hunting exhibition that of High Society Movers. The base pay is 2 Increasing Rep d6.

WHERE'S THE JOB?

Now that you know who the Employer is and what you will get paid, let's find out where it will take place. Here's how we do it:

- Consult the Where's the Job Table.
- Go down the left-hand column to the appropriate row for the type of Job.
- Roll 1d6 and go across to the appropriate row. This will tell you the Area where the Job will take you to.

1	WHERE'S THE JOB?
<i>(Add the results together)</i>	

JOB	1	2	3	4	5	6
Contact	10	10	10	10	11	11
Explore	3	3	3	10	10	11
Hunt	6	6	6	2	10	11 ⁽¹⁾
Rescue	10	2	8	4	11	12

(1) If hunting for Dinosaurs you must go to Area 11.

MISSION ST. MARY – LEMURIAN TRADE PORT

Example – Dario took the job and now must see where the High Society NPC wants to go hunting. I roll 1d6 and score a 5. Looking on the Where's the Job Table along the Hunt row I see the number 10 – Mountains. This is 2 Areas away from Mission St. Mary, so Dario will get a bonus of 1 additional Increasing Rep d6.

AFTER THE JOB

After you have completed the Job, whether successfully or not, you can choose what you want to do next.

RAID

In this Encounter you must either raid (1 – 4) a rival camp with the goal of loot and captives, or defend your camp (5 – 6) from raiders.

OBJECTIVE

- You must raid the enemy camp and exit with captives and/or captives.

FORCES:

- You can use as much or as little of your group as desired.
- Opponents will be generated as per the Special Instructions.

TERRAIN:

- The board is divided into nine sections and terrain generated normally (page 28).

DEPLOYMENT

- PEFs are placed on the table normally (page 31).
- Your group will enter through section 9.

SPECIAL INSTRUCTIONS

- The player chooses the Day Part.
- You gain 1 bonus Rep Increasing d6 for each building you loot and captive you take.
- Play continues normally until the player has accomplished his Objective, been destroyed, or leaves the table.

WHO'S FIGHTING WHO?

This is up to you. Here are some ideas:

- Soldiers versus Soldiers.
- Soldiers versus Natives.

- Soldiers versus Cavemen.
- Natives versus Natives.
- Natives versus Cavemen.
- Cavemen versus Cavemen.

FINDING THE CAMP

The enemy camp will be in section 1, 2, or 3 and must be found. Here's how we do it:

- When you enter the section roll 1d6.
 - On a score of 1 - 3 the camp is located in that section.
 - On a 4 - 6 it is not there. If you have not located the camp by the time you enter the last of the three sections it is there.

If a PEF is resolved as your opponent, he belongs to the camp you are trying to raid.

If you capture one or more of their party you have found the camp on a roll of 1 - 5 instead of 1 - 3 when searching sections 1, 2, or 3.

TAKING CAPTIVES

To capture another character you must score a result of Out of the Fight and carry them off. Use the Auto-Kill or Capture procedure (page 20).

ESCAPE

Captured characters must be guarded by a character that stays within 3" to the captive. If the captive ever gets over 1" from the guard, the captive may try to escape. Here's how we do it:

- Immediately roll 1d6 when any of the outlined circumstances occur.
- On a score of "1" it will attempt a Fast Move away from the guard. The captive can only roll 1d6 for the Fast Move instead of 2d6.
- To re-capture the captive a guard need only move into contact with the captive.

LOOT

In addition to captives you can also gain loot. Here's how we do it:

- It takes a character one turn of Activation to loot a building.

SETTING UP CAMP

You have found the camp and it's now time to set it up. Here's how we do it:

MISSION ST. MARY – LEMURIAN TRADE PORT

- The camp consist of 1+1/2d6 buildings.
- Place the first building in the center of the section.
- Place the next one 1/2d6" away from it.
- Place the next one 1/2d6" away from any other hut.
- Place the next one 1/2d6" away from any other hut.

OCCUPANTS

The camp will be occupied. Here's how we do it:

- Each building in the camp will generate one PEF that must be resolved normally.
- After you have determined the number of occupants and their type roll 1d6 for each.
 - An odd result means the figure is outside of the building. Place it in the same way as you did the building but roll 1d6 instead of 1/2d6.
 - An even result means the figure is inside the building.
- Continue in this cycle until all occupants are placed.

WHO ACTIVATES FIRST

Move the raiders to 6" from any occupant and take the In Sight.

- Cro-Magnon counts a +1d6 when rolling the In Sight versus other Cavemen.
- Monkey Boys count a -1d6 when rolling the In Sight versus all Humanoids.

RESCUE

In this Encounter you must rescue another character from a group of enemies. This rescue may be a result from a previous Encounter – a failure to defend your camp in a Raid Encounter – or an accepted Job Offer (page 40).

OBJECTIVE

- To find and rescue another character.

FORCES:

- You can use as much or as little of your group as desired.
- Opponents will be generated as per the Special Instructions.

TERRAIN:

- The board is divided into nine sections and terrain generated normally (page 28).

DEPLOYMENT

- PEFs are placed on the table normally (page 31).
- Your group will enter through section 9.
- The Target Building or objective is in section 1.

SPECIAL INSTRUCTIONS

- Determine the Day Part randomly (page 27).
- You gain 1 Increasing Rep d6 for each Hostage you rescue plus any additional Wages from accepting a Job Offer (page 40).
- Play continues normally until the player has accomplished his Objective, been destroyed, or leaves the table.

WHO HAS THE HOSTAGE?

This is up to you. Here are some ideas, same as if playing a Conquer Encounter.

- Soldiers versus Soldiers.
- Soldiers versus Natives.
- Soldiers versus Cavemen.
- Natives versus Natives.
- Natives versus Cavemen.
- Cavemen versus Cavemen.

WHERE'S THE HOSTAGE?

The hostage can be in the Target Building or resolved with a PEF. Here's how we do it:

- All PEFs that are resolved as NPCs will be the same type as the captors.
- When resolving a PEF, roll 1d6 and read the result as rolled. If the score is equal or less than the number of PEFs resolved, the hostage is with the enemy. If the result is greater than the PEF resolved, the Hostage is not with the NPCs.
- If you reach the Target Building roll 1d6. If the d6 result is equal or less than the number of PEFs resolved and buildings entered, the Hostage is there. Hostages are always with captors.
- It is possible for you to resolve all PEFs and check the Target Building and not find the Hostage!

SCAVENGER HUNT

This is the follow-up Encounter for the Hunt. In this Encounter you have just made a kill. However, the sound of the struggle and scent of blood has attracted unwanted visitors.

OBJECTIVE

- You must protect and strip down your kill (page 44) then exit the table through section 9.

FORCES

- Your group consists of the survivors from the previous Hunt Encounter.
- Opponents will be generated as per the Special Instructions.

TERRAIN

- The terrain is the table used in the previous Hunt Encounter.

DEPLOYMENT

- The kill and your force are in section 1.
- PEFs are placed on the table normally (page 31).

SPECIAL INSTRUCTIONS

- Determine the Day Part randomly (page 27).
- The Scent of a Kill rule is in play.
- Play continues normally until the player has accomplished his Objective, been destroyed, or leaves the table.

STRIPPING THE KILL

After a kill is made the hunters will spend time stripping it down for food and trophies. Here's how we do it:

- It takes 1 human 10 turns of Activation to strip a small kill.
- It takes 1 human 20 turns of Activation to strip a small kill.
- It takes 1 human 30 turns of Activation to strip a small kill.
- Using more humans will reduce the number of turns of Activation needed to strip down the kill.
- To strip a kill for trophies takes ½ the listed number of turns.
- The Size of the creature can feed that many figures per month.

SCENT OF A KILL

Whenever a creature is killed during any scenario this will trigger the Scent of a Kill rule. Here's how we do it:

- Every Activation dice total of "7" will generate a new PEF.
- Roll 1d6 to see which section the PEF is placed in.
- Any creatures generated by these PEFs will always be Fierce.

TRAVEL

Each time you move from one Area to another there is a chance that you will run into someone. This is called a Travel Encounter. Here's how we do it:

- Roll 1d6 when you leave an Area.
- If a "1" is scored you have triggered a Travel Encounter. Go to a Confrontation Encounter (page 37).
- When you are finished, continue to the next Area, if you can.

FLUCTUATING REP

After every Encounter is over you can see if you or your Grunts have increased or decreased in Rep.

INCREASING REP

Reputation can go up depending upon how well you did during the Encounter. Here's how we do it:

- The character did not Run Away.
- The character was shot at or in melee and did not go Out of the Fight or used any Star Power dice.
- The Encounter was a success, the objective was achieved. Note that an Encounter could be a success for one character but not another.

If *all 3* conditions are met the character has a chance to increase its Reputation. Here's how we do it:

- Roll 1d6 versus its Rep.
- If the score is higher than the current Rep or a "6" the character raises its Rep by one level.
- The maximum Rep a Grunt can have is 6.
- A Star has no maximum Rep.
- Any other score and the Rep remains the same.

Example – Billy Pink (Rep 5) has come back from a successful Hunt Encounter. During the encounter he was shot at by an Askari, didn't go Out of the Fight or used Star Power, did not Run Away, and killed a Dinosaur.. This qualifies as a success so he can roll 1d6. He scores a 6 so his Rep increases to 6.

DECREASING REP

What goes up must go down. Here's how Rep can decrease.

- The character suffered a result of Run Away.
- The character went Out of the Fight.
- The Encounter was a failure.

If *any* result applies the character has a chance to decrease its Reputation. Here's how we do it:

- Roll 1d6 versus its Rep.
- If the score is a "1" the Rep will go down 1 level.
- The lowest Rep a Grunt can have is 3. If it goes lower than that the Grunt "disappears".
- A Star can go as low as you want, it's up to you.
- Any other score and the Rep remains the same.

Example – The next time out Billy Pink (Rep 6) goes on another Hunt Encounter. He didn't recruit kill a prize so the Encounter is considered a failure. Billy rolls 1d6 and scores a 1. His Rep is reduced to 5.

BONUS REP D6

Some of the Encounters include chances to gain both Increasing and Decreasing Rep d6. After the Encounter you will check for fluctuations in Reputation. Here's how we do it:

- Start with all the Increasing Rep d6 you have gained during the Encounter.
- Subtract 1 Increasing Rep d6 for each Decreasing Rep d6 you have gained in the Encounter.
- This will leave you with Increasing Rep d6, Decreasing Rep d6, or neither.
- Roll any Rep d6 normally. Regardless of the number of d6 rolled, you cannot increase or decrease your Rep by more than 1 point.

Example – The Encounter is over and Dario (Rep 5) has gained 1 Increasing Rep d6 and 3 Decreasing Rep d6; it's been a bad day. This leaves him with a net of 2 Decreasing Rep d6. Dario rolls them both and scores a 1 and a 1. His Rep drops his Rep by 1 point, the most he can do.

2 **REACTION TESTS**
(Taken versus Rep)

REACTION TESTS

ATTRIBUTE
Coward: Counts Duck Back as Run Away.
Nerves of Steel: Treat Duck Back as if Carry On.
Poser: Can never score higher than pass 1d6.
Stone Cold: Rolls 3d6 counting the best 2 results.
Tough: Treat 1st Duck Back result as a Carry On result.

REASON	CLASS	PASS 2D6	PASS 1D6	PASS 0D6
RECEIVED FIRE OR MAN DOWN Star may choose to pass 2d6, 1d6, or 0d6 without rolling. Leader Die applies. +1d6 if in cover.	ADVENTURER	Fired On: <ul style="list-style-type: none"> If can – Fire. If can't - Charge into Melee. If out of reach then Carry On. Man Down: <ul style="list-style-type: none"> Carry On. 	Fired On: <ul style="list-style-type: none"> If can – Fire. If can't - Duck Back. Man Down: <ul style="list-style-type: none"> Duck Back. 	All : <ul style="list-style-type: none"> Run Away.
RECEIVED FIRE OR MAN DOWN Star may choose to pass 2d6, 1d6, or 0d6 without rolling. Leader Die applies. +1d6 if in cover.	CIVILIAN	Fired On: <ul style="list-style-type: none"> If can – Rush Shot. If can't - Charge into Melee. If out of reach then Duck Back. Man Down: <ul style="list-style-type: none"> Carry On. 	Fired On: <ul style="list-style-type: none"> Duck Back. Man Down: <ul style="list-style-type: none"> If can see more friends than enemies Duck Back, otherwise Run Away. 	All : <ul style="list-style-type: none"> Run Away.
RECEIVED FIRE OR MAN DOWN Star may choose to pass 2d6, 1d6, or 0d6 without rolling. Leader Die applies. +1d6 if in cover.	CRIMINAL	Fired On: <ul style="list-style-type: none"> If can – Fire. If can't - Charge into Melee. If out of reach then Duck Back. Man Down: <ul style="list-style-type: none"> Carry On. 	Fired On: <ul style="list-style-type: none"> If can – Rush Shot. If can't - Duck Back. Man Down: <ul style="list-style-type: none"> If can see more friends than enemies Carry On, otherwise Duck Back. 	All : <ul style="list-style-type: none"> Run Away.
RECEIVED FIRE OR MAN DOWN Star may choose to pass 2d6, 1d6, or 0d6 without rolling. Leader Die applies. +1d6 if in cover.	LAW & ORDER	Fired On: <ul style="list-style-type: none"> If can – Fire. If can't - Charge into Melee. If out of reach then Carry On. Man Down: <ul style="list-style-type: none"> Carry On. 	Fired On: <ul style="list-style-type: none"> If can – Fire. If can't - Charge into Melee. If out of reach then Carry On. Man Down: <ul style="list-style-type: none"> Carry On. 	All : <ul style="list-style-type: none"> Run Away.

MISSION ST. MARY – LEMURIAN TRADE PORT

2 DINOSAUR/ANIMAL REACTION TESTS

(Taken versus Rep)

DINO REACTION TESTS

REASON	CLASS	PASS 2D6	PASS 1D6	PASS 0D6
RECEIVED FIRE OR PACK MEMBER DOWN <i>Star may choose to pass 2d6, 1d6, or 0d6 without rolling.</i>	FERCE	Fired On: <ul style="list-style-type: none"> Charge. Pack Member Down: <ul style="list-style-type: none"> Carry on. 	Fired On: <ul style="list-style-type: none"> Charge. Pack Member Down: <ul style="list-style-type: none"> If last Pack Member – Run Away. Otherwise Carry On. 	Fired On: <ul style="list-style-type: none"> If last Pack Member – Run Away. Otherwise Carry On. Pack Member Down: <ul style="list-style-type: none"> Run Away.
RECEIVED FIRE OR PACK MEMBER DOWN <i>Star may choose to pass 2d6, 1d6, or 0d6 without rolling.</i>	FEEDER	Fired On: <ul style="list-style-type: none"> Carry On. Herd Member Down: <ul style="list-style-type: none"> If last Herd Member – Run Away. Otherwise – Carry On. 	Fired On: <ul style="list-style-type: none"> Halt in place and forfeit next Activation. Herd Member Down: <ul style="list-style-type: none"> Run Away. 	Fired On: <ul style="list-style-type: none"> Run Away. Herd Member Down: <ul style="list-style-type: none"> Run Away.

REP

IN SIGHT

(Looking for successes)

ATTRIBUTE	MOD
<i>Opponent is Stealthy and the only figure in sight.</i>	-1d6
Quick Reflexes	+1d6
Slow to React	-1d6
CIRCUMSTANCE	MOD
Active – Character is active and moved.	-1d6
Concealed – Enemy is concealed.	-1d6
Ducking Back – Character is Ducking Back.	⁽¹⁾
Evening – If the Evening Day Part.	-1d6
Late – If the Late Day Part.	-2d6
Running Away – Character is Running Away	⁽¹⁾

(1) Figure cannot fire and will complete its reaction instead.

RANGED WEAPONS

TYPE	TARGET RATING	RANGE
BA Pistol (BAP)	2	12
Big Game Rifle (BGR)	1	48
Blowgun (BG) – Primitive Weapon	1 ⁽¹⁾	6
Bolt Action Rifle (BAR)	1	48
Bow (BW) – Primitive Weapon	1	24
Machine Pistol (MP)	3	12
Pistol (P)	1	12
Semi-Automatic Rifle	2	48
Shotgun	3	12
SMG	3	24

(1) Used with poison. Target goes Out of the Fight if hit.

RESOLVING IN SIGHT ACTIONS

The group winning the In Sight will now act, from highest Rep to lowest. Here's how we do it:

- If the figure can fire – it will.
- If the figure cannot fire – it will Charge into Melee.
- Stars can choose to move its remaining movement instead. Those characters led by the Star can choose to move as well.

IN SIGHT RANGED WEAPONS

MISSION ST. MARY – LEMURIAN TRADE PORT

2	SHOOTING <i>(Taken vs. Rep)</i>
----------	---

<i>ATTRIBUTE</i>	<i>MODIFIER</i>
Crack Shot using a BAR	+1d6
Near Sighted	-1 to Rep
<i>CIRCUMSTANCE</i>	<i>RESULT</i>
Any d6 score of "6"	D6 automatically fails.
Double "ones".	Weapon is now out of ammo.

<i># D6 PASSED</i>	<i>RESULT</i>
2	Hit.
1	<p>Shooter missed if -</p> <ul style="list-style-type: none"> • Fast Moved. • Firing with the Off Hand – <i>Ambidextrous</i> ignores. • Rush Shot. • Evening or Late Day Part. <p>Target was missed if -</p> <ul style="list-style-type: none"> • Fast Moving. • Carrying wounded. • Shielded and fired on by Primitive Weapon. • In Cover. • Prone. • Second or higher target.
0	Miss.

1	SHOOTING DAMAGE <i>(Taken versus Rep of the Target)</i>
----------	---

<i>CIRCUMSTANCE</i>	<i>MODIFIER</i>
Big Game Rifle.	+2d6
BA Pistol – Only if fired at 1 Target.	+1d6
Machine Pistol – Only if fired at 1 Target.	+2d6
Semi-Automatic Rifle – Only if fired at 1 Target.	+1d6
Shotgun – Only if fired at 1 Target.	+1d6
SMG – Only if fired at 1 Target.	+2d6

<i>SCORE</i>	<i>RESULT</i>
Equal or less than Rep of the Target.	Fierce and Feeder Class creatures take the Received Fire Test. Target Ducks Back. If target is charging, ignore and continue into contact.
Higher than Rep of the Target but not a "6".	Fierce and Feeder Class creatures take the Received Fire Test. Target is knocked to the ground and Out of the Fight.
"6"	Fierce and Feeder Class creatures Obviously Dead. Target is knocked to the ground and Obviously Dead.

<i>ATTRIBUTE</i>	<i>MOD</i>
Hard as Nails	Treats 1 st Obviously Dead in each Encounter as Carry On instead.
Resilient	Treats 1 st Out of the Fight in each Encounter as Carry On instead.
Tough	Treats 1 st Duck Back in each Encounter as Carry On instead.

#	COVER OR CONCEALMENT
----------	-----------------------------

<i>TYPE</i>	<i>RESULT</i>
Buildings, inside	Stationary figures inside of buildings are in cover and concealment. Moving figures inside buildings are concealed.
Woods or Rough	Stationary figures inside woods or rocky areas are in cover and concealment. Moving figures inside woods or rocky areas are concealed.

SHOOTING

MISSION ST. MARY – LEMURIAN TRADE PORT

2	CHARGE INTO MELEE <i>(Taken versus Rep)</i>
----------	---

ATTRIBUTE	MODIFIER
Nerves of Steel	+1d6
Rage	+1d6
CIRCUMSTANCE	MODIFIER
Target in cover	+1d6
Target charged to flank	-1d6
Target charged to rear	-2d6

#D6 PASSED	CHARGER	TARGET
Pass more d6 than opponent	<i>Target</i> may not fire. <i>Charger</i> moves into melee. No Reaction Tests taken.	<i>Target</i> can fire. <i>Charger</i> moves into melee. No Reaction Tests taken.
Pass same number d6 as opponent	<i>Civilian Target</i> maybe not fire. <i>Other Targets</i> can fire. Count the Rush Shot penalty. <i>Charger</i> moves into melee. No Reaction Tests taken.	<i>Civilian Target</i> maybe not fire. <i>Other Targets</i> can fire. Count the Rush Shot penalty. <i>Charger</i> moves into melee. No Reaction Tests taken.

REP	MELEE COMBAT <i>(Looking for successes)</i>
------------	---

ATTRIBUTE	MOD
Brawler	+1d6
Rage	+1d6
CIRCUMSTANCE	MOD
<i>Dinosaur</i> – Count double Rep for melee d6.	2xRep
<i>Fierce</i> – If Fierce Class.	+2d6
<i>Weapon</i> – Using melee weapon.	+2d6

SUCCESS	MELEE DAMAGE <i>(Taken versus Rep of the Target)</i>
----------------	--

SCORE	RESULT
Equal or less than Rep of the Target	Target loses 1 point of Rep for the remainder of the melee and immediately fights another round of melee. Rep is recovered after the melee is over.
Higher than Rep of the Target but not a “6”.	Target is knocked to the ground and Out of the Fight.
“6”	Target is knocked to the ground and Obviously Dead.

1	DINOSAUR MELEE DAMAGE <i>(Taken versus Rep of the Target)</i> <i>Used when humans win a melee with Dinosaurs.</i>
----------	--

SCORE	RESULT
Less than Rep of Target	Target loses 1 point of Rep and immediately fights a round of melee.
Equal to Rep of Target or higher	Dinosaur loses desire to fight and Runs Away.

2	RECOVERY <i>(Taken vs. Rep)</i>
----------	---

# D6 PASSED	RESULT
2	All return at normal Rep.
1	Out of the Fight returns at normal Rep but receives 1 Decreasing d6 (page 45). Run Aways return at normal Rep but receive 2 Decreasing d6 (page 45).
0	Out of the Fights become Obviously Dead. Run Aways never return.

MELEE

RECOVERY

MISSION ST. MARY – LEMURIAN TRADE PORT

REP	CHALLENGE <i>(Taken vs. Rep)</i>
------------	--

ATTRIBUTES AND CIRCUMSTANCES	MODIFIER
<i>Athlete</i>	+1
<i>Clumsy</i>	-1
<i>Difficult</i> –If the Challenge is considered difficult by all players.	-1
<i>Easy</i> – If the Challenge is considered easy by all players.	+1
<i>Tool</i> – If have a tool that increases the chances of success.	+1

# D6 PASSED	RESULT
2	Success and reap the benefits.
1	May decide to re-take the test, counting any result of pass 1d6 as if pass 0d6 OR Decide not to take the test again, but may take the test when next Active.
0	Failed and suffer the consequences.

2	PEF MOVEMENT <i>(Taken versus the Rep of 4)</i>
----------	---

#D6 PASSED	RESULT
2	The PEF moves 8" directly towards the player ending in cover if possible.
1	The PEF moves 4" directly towards the player ending in cover if possible.
0	PEF does not move.

CHALLENGE PEFs NP MOVEMENT

2	PEF RESOLUTION <i>(Taken versus PEF Rep of 4)</i>
----------	---

# D6 PASSED	RESULT
2	<i>Contact!</i> You have run into at least 1 NPC. Roll 1d6: <ul style="list-style-type: none"> • 1 = 1 less than the player group. • 2 = 1 more than the player group. • 3 = 2 less than the player group. • 4 = 2 more than the player group. • 5 = 3 more than the player group. • 6 = 3 less than the player group. Go to the Who Are They Table (page 51).
1	<i>Something's out there!</i> Resolve the next PEF with 3d6 counting the lowest two scores. If the last PEF and none have been resolved as NPCs, count as passed 2d6.
0	<i>False alarm!</i> Nothing but a case of nerves. If the last PEF and none have been resolved as NPCs, count as passed 2d6.

1	NP MOVEMENT <i>(Taken versus Rep)</i>
----------	---

CIRCUMSTANCE	RESULT
Mounted or in vehicles.	+1d6
Outnumber similar enemies by 2:1 or more.	+1d6

# D6 PASSED	RESULT
1	<p><i>Fierce Dinosaurs or Animals</i>– Move directly to charge the closest group, player or NP.</p> <p><i>Feeder Dinosaurs or Animals</i>–</p> <ul style="list-style-type: none"> • If have LOS to Fierce Dino move directly away full move. • Otherwise, move to nearest vegetation, or center of section, to feed. If already feeding, remain in place. <p><i>Humanoids</i> –</p> <ul style="list-style-type: none"> • If outnumbered by 2:1 or more, or facing Fierce Dinosaur, move away from threat at Fast Movement. • Otherwise, move towards closest group.
0	<i>All</i> – Halt in place.

MISSION ST. MARY – LEMURIAN TRADE PORT

2 WHO ARE THEY? *(Add the results together)*

AREA	1-3	4	5	6
Eastern Lung Ho	Soldiers	Animals	Adventurers	Cultists
Northern Edge of the Mountains	Natives	Adventurers	Steam Punks	Cultists
North Coast	Natives	Cultists	Adventurers	Deep Ones
Southern Nobelongga	Natives	Jungle Lord	Steam Punks	Adventurers
Eastern Nobelongga	Animals	Natives	Adventurers	Jungle Lord
Mission St. Mary	NPC Generator	NPC Generator	NPC Generator	NPC Generator
The River	Soldiers	Steam Punks	Adventurers	Deep Ones
The Coast	Natives	Soldiers	Adventurers	Deep Ones
Mountains	Natives	Adventurers	Animals	Cavemen
Deep in the Mountains	Cavemen	Great Grey Ape	Animals	Dinosaurs
Knysana	Natives	Natives	Soldiers	Adventurers

WHO ARE THEY?

1 ADVENTURERS *(Read the result as rolled)*

#	PROFESSION	CLASS	REP
1	Leader ⁽¹⁾	Adventurer	5
2	Hunter	Adventurer	4
3	Adventurer	Adventurer	4
4	Adventurer	Adventurer	4
5	Adventurer	Adventurer	4
6	Adventurer	Adventurer	3

(1) There can be only 1. If rolled twice, count as a Rep 4 Adventurer.

1 CAVEMEN ^(#) *(Read the result as rolled)*

(#) Roll 1d6. (1-3) = Cro-Magnon (4-5) = Neanderthal (6) = Monkey Boys

#	PROFESSION	CLASS	REP
1	Leader ⁽¹⁾	Law & Order	5
2	Hunter	Law & Order	4
3	Tribesmen	Law & Order	4
4	Tribesmen	Law & Order	3
5	Tribesmen	Law & Order	3
6	Tribesmen	Law & Order	3

(1) There can be only 1. If rolled twice, count as a Rep 4 Hunter.

NPC LISTS

1 CULTISTS *(Read the result as rolled)*

#	PROFESSION	CLASS	REP
1	Cult Commander ⁽¹⁾	Adventurer	5
2	Cult Leader ⁽²⁾	Adventurer	5
3	Cultist	Adventurer	4
4	Cultist	Adventurer	4
5	High Society	Adventurer	3
6	Citizen	Adventurer	3

(1) This is the Supreme Leader of the Cult who will try to channel or resurrect the object of the Cult. If rolled twice, count as a Cult Leader. (2) There can be only 1. If rolled twice, count as a Rep 4 Cultist.

1 DEEP ONES *(Read the result as rolled)*

#	PROFESSION	CLASS	REP
1	Leader ⁽¹⁾	Law & Order	5
2	Warrior	Law & Order	4
3	Warrior	Law & Order	4
4	Warrior	Law & Order	3
5	Warrior	Law & Order	3
6	Warrior	Law & Order	3

(1) There can be only 1. If rolled twice, count as a Rep 4 Warrior.

MISSION ST. MARY – LEMURIAN TRADE PORT

1 GREAT GREY APE

(Read the result as rolled)

#	PROFESSION	CLASS	REP
1	Alpha Male ⁽¹⁾	Fierce	5
2	Beta Male ⁽²⁾	Fierce	5
3	Ape	Fierce	4
4	Ape	Fierce	4
5	Ape	Fierce	3
6	Ape	Fierce	3

(1) If rolled twice, count as a Beta Male. (2) There can be only 1. If rolled twice, count as a Rep 4 Ape.

1 JUNGLE LORD

(Read the result as rolled)

#	PROFESSION	CLASS	REP
1	Jungle Lord ⁽¹⁾	Adventurer	5
2	Jungle Lord	Adventurer	5
3	Jungle Lord	Adventurer	5
4	Jungle Lord	Adventurer	5
5	Jungle Lady ⁽¹⁾	Adventurer	4
6	Jungle Lady	Adventurer	4

(1) There can be only 1. If rolled twice, disregard and do not – reroll.

1 NATIVES

(Read the result as rolled)

#	PROFESSION	CLASS	REP
1	Chief ⁽¹⁾	Law & Order	5
2	Leader ⁽²⁾	Law & Order	5
3	Warrior	Law & Order	4
4	Warrior	Law & Order	4
5	Warrior	Law & Order	3
6	Warrior	Law & Order	3

(1) If rolled twice, count as a Leader. (2) There can be only 1. If rolled twice, count as a Rep 4 Warrior

1 SOLDIERS

(Read the result as rolled)

#	PROFESSION	CLASS	REP
1	Military NCO ⁽¹⁾	Law & Order	5
2	Guide ⁽²⁾	Law & Order	4
3	Military Soldier	Law & Order	5
4	Military Soldier	Law & Order	4
5	Military Soldier	Law & Order	3
6	Askari	Law & Order	4

(1) There can be only 1. If rolled twice, count as a Rep 5 Soldier. (2) There can be only 1. If rolled twice, count as a Rep 4 Askari.

1 STEAM PUNKS

(Read the result as rolled)

#	PROFESSION	CLASS	REP
1	Leader ⁽¹⁾	Adventurer	5
2	Tinkerer	Civilian	4
3	Steam Punk	Adventurer	4
4	Steam Punk	Adventurer	4
5	Steam Punk	Adventurer	3
6	Steam Punk	Adventurer	3

(1) There can be only 1. If rolled twice, count as a Rep 4 Steam Punk.

1 DINOSAURS ^(#)

(Read the result as rolled)

#	SIZE	CLASS	REP	MOVE
1	Large 10	Feeder	3	8"
2	Large 10	Fierce	5	12"
3	Medium 6	Feeder	3	12"
4	Medium 6	Fierce	4	16"
5	Small 3	Feeder	2	12"
6	Small 3	Fierce	4	16"

(#) The first d6 result dictates whether you have met all Herbivores or Carnivores. If roll the opposite on the second or subsequent roll, just use the similar size Dinosaur.

1 ANIMALS ^(#)

(Read the result as rolled)

#	SIZE	CLASS	REP	MOVE
1	Large 10	Feeder	4	8"
2	Large 10	Fierce	5	12"
3	Medium 6	Feeder	3	12"
4	Medium 6	Fierce	4	16"
5	Small 3	Feeder	3	12"
6	Small 3	Fierce	4	16"

(#) The first d6 result dictates whether you have met all Feeders or Fierce. If roll the opposite on the second or subsequent roll, just use the similar size Animal.

NPC LISTS

MISSION ST. MARY – LEMURIAN TRADE PORT

1+1 MISSION ST. MARY NPCs

(Read the result as rolled)

#	GO TO THE FOLLOWING CIRCLE
1	Civilian
2	Civilian
3	Criminal
4	Exotic
5	Mover
6	Shaker

CIRCLE	#	PROFESSION	CLASS
Civilian	1	Citizen	Civilian
Civilian	2	Citizen	Civilian
Civilian	3	Foreigner	Civilian
Civilian	4	Laborer	Civilian
Civilian	5	Laborer	Civilian
Civilian	6	Service Industry	Civilian
Criminal	1	Thief	Criminal Element
Criminal	2	Thief	Criminal Element
Criminal	3	Thief	Criminal Element
Criminal	4	Thug	Criminal Element
Criminal	5	Street Urchin	Criminal Element
Criminal	6	Working Girl	Criminal Element
Exotic	1	Adventurer	Law & Order
Exotic	2	Askari	Law & Order
Exotic	3	Bearers	Civilian
Exotic	4	Police	Law & Order
Exotic	5	Soldier	Law & Order
Exotic	6	Steam Punk	Law & Order
Mover	1	Business Magnate	Civilian
Mover	2	Cultist	Civilian
Mover	3	Foreigner	Civilian
Mover	4	High Society	Civilian
Mover	5	High Society	Civilian
Mover	6	Politician	Civilian
Shaker	1	Academia	Civilian
Shaker	2	Accountant	Civilian
Shaker	3	Attorney	Civilian
Shaker	4	Cultist	Civilian
Shaker	5	Political Assistant	Civilian
Shaker	6	Safari Leader	Civilian

MISSION ST. MARY NPCs

MISSION ST. MARY – LEMURIAN TREATY PORT

INDEX

- 1 to Rep, 19*
- 1/2d6, 2*
- Actions, 12*
- Adventurer, 3, 8, 33, 51*
- After the Encounter, 24*
- Animals, 3, 26, 34, 52*
- Area Rectangle Knows All, 30*
- Askari, 3*
- Attributes, 5, 6*
- Auto-Kill or Capture, 20*
- Bonus Rep d6, 45*
- Carry On, 12, 21*
- Cavemen, 33, 51*
- Challenge, 26, 27, 50*
- Characters, 3*
- Charge into Melee, 22, 49*
- Charge, 12, 21*
- Chase Them Down, 26*
- Circles, 6*
- Civilians, 6, 8*
- Class, 8*
- Confrontation, 37*
- Conquer, 38*
- Contact, 38*
- Cover or Concealment, 18, 48*
- Criminal Element, 7, 8*
- Cro-Magnon, 3*
- Cultists, 3*
- Deep Ones, 3*
- Cultists, 33, 51*
- Damage, 19*
- Damage, Melee, 24*
- Damage, Stacking, 18*
- Day Part, 27, 30*
- Decreasing Rep, 45*
- Deep Ones, 34, 51*
- Defining Moment, 32*
- Dice, 1*
- Dinosaur Melee Damage Table, 24, 49*
- Dinosaur Reaction Tests, 26, 27, 47*
- Dinosaurs, 3, 25, 34, 52*
- Encounters, 36*
- Exotic Locales, 28*
- Exotics, 7*
- Explore, 39*
- Facing, 2*
- Fast Move, 12, 26*
- Fierce or Feeder, 25*
- Firing a Weapon, 12, 17, 18, 21*
- Fluctuating Rep, 45*
- Free Will, 4*
- Friends or Foes?, 35*
- Gathering, 39*
- Gender, 5*
- Great Grey Ape, 3, 34, 52*
- Groups, 9, 10*
- Grunts, 5*
- How Many & How Determined, 5*
- How Many d6, 2*
- Hunt, 40*
- In Sight, 13, 14, 15, 20, 47*
- Increasing Rep, 45*
- Involuntary Movement, 12*
- Job Offer, 40*
- Jungle Lord, 3, 28, 34, 52*
- Jungle, 28*
- Key Sections, 28*
- Law & Order, 8*
- Leaders, 10*
- Line of Sight, 16*
- Lost World, 28*
- Man Down, 21*
- Map of Lemuria, 29*
- Map of Nobelongga, 30*
- Melee Combat, 23, 49*
- Melee Weapons, 22*
- Melee, 22*
- Mission St. Mary NPCs Table, 32, 33, 53*
- Monkey Boys, 3*
- Movement, 12, 26*
- Movers, 7*
- Moving Between Areas, 31*
- Multiple Figure Melees, 23*
- Multiple In Sights, 14*
- Multiple Tests, 21*
- Natives, 3, 34, 52*
- Neanderthal, 3*
- Needed to Play, 1*
- Nobelongga, 29*
- NP Movement Table, 36, 50*
- NPC Actions, 36*
- NPC Lists, 33*
- NPC Reputation, 5*
- NPCs Move, 36*
- Obviously Dead, 19, 22*
- Open Space, 28*
- Opposites, 35*
- Out of Ammo, 16*
- Out of the Fight, 19, 22*
- Passing Dice, 1*
- PEF Movement Table, 31, 50*
- PEF Rep, 31*
- PEF Resolution, 31, 32, 50*
- PEF, 30, 31*
- Possibilities, 1*
- Profession, 6, 8*
- Prone, 12*
- Quick Reference Sheets, 46*

MISSION ST. MARY – LEMURIAN TREATY PORT

Raid, 42
Ranged Weapons, 15, 16, 47
Reaction Tests, 20, 21, 26, 47
Received Fire, 21
Recovery Table, 25, 49
Recruiting NPCs, 9
Reputation, 5, 25
Rescue, 43
Run Away, 12, 22
Rush Shot, 13, 22
Scavenger Hunt, 44
Shakers, 7
Shooting Damage, 18, 48
Shooting, 16, 17, 48
Size, 25
Soldiers, 3, 34, 52
Star Advantages, 4
Star and Grunts, 4
Star Leaders, 10
Star Power, 4
Steam Punks, 3, 34, 52
Stop! 5, 8, 9, 11, 13, 15, 20, 22, 25, 27, 29, 35,
Success & Failure, 26
Successes, 1
Talk the Talk, 35
Target Building, 29
Target Rating, 16
Target Selection, 16
Targeting, 16
Temporary Leaders, 10
Terrain, 28
Travel, 44
Turn Sequence, 11
Weapons, 8
Who Are They, 32, 51
Who's Who?, 3
Word of Advice, 1