

Price: \$200,000 (S/R)

RF: +4

Armament: 105mm gun, MAG MG (coaxial)

Stabilization: Fair

Ammo: 38x105mm

Fuel Type: D, A

Load: 400 kg

Veh Wt: 15 tons

Crew: 4

Mnt: 8

Night Vision: Headlights, image intensification

AMX-10RC (Light Combat Vehicle): The AMX-10RC (*Roues Canon*) is a 6x6 light armored vehicle using the hull and many chassis components from the French AMX-10P. It is the most advanced armored car in service with the French armed forces, and its 105mm low-pressure gun system makes it one of the most heavily armed armored cars in the world. The vehicle has a driver's hatch on the upper front hull, and gunner and commander's hatches on the turret deck. The vehicle is fully amphibious at one-quarter its cross-country speed, and is NBC sealed.

Tr Mov: 170/120

Com Mov: 85/60

Fuel Cap: 720

Fuel Cons: 280

Damage Record

Crewmembers: Commander Driver Gunner
 Loader

Sight/Vision: Gun sight Range finder Night vision equipment

Radio:

105mm Gun:

MAG MG (Coaxial):

Traverse:

Engine:

Fuel (% Consumed or Destroyed):

Suspension: Minor damage Immobilized

Combat Statistics

Config: Trt TF: 6 HF: 8

Susp: W(3) TS: 4 HS: 4

TR: 3 HR: 4

AMMUNITION

Use MG ammo records provided on page 5.

105mm Gun (38 rounds)

WEAPON DATA

Type	Round	Rng	Damage	Pen
105mm	HEAT	400	C:6, B:12	80C
Rld: 1	WP	400	C:3, B:20	Nil

—Recoil—

Weapon	ROF	Dam	Pen	Blk	Mag	SS	Brst	Rng
MAG MG	10	4	2-3-Nil	6	50B	1	9	65
bipod	10	4	2-3-Nil	6	50B	1	5	90
tripod	10	4	2-3-Nil	6	50B	1	4	125

AMX 155 GCT

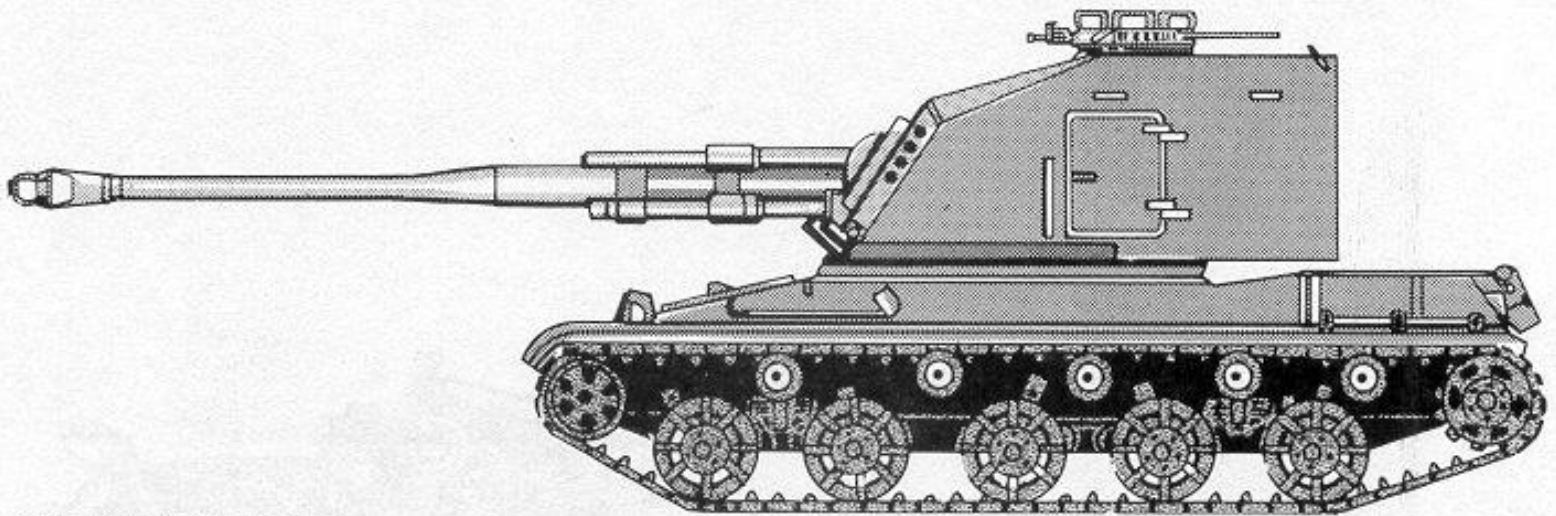

Price: \$220,000 (S/R)
Armament: 155mm howitzer, MAG MG (C)
Ammo: 32x155mm howitzer
Fuel Type: D, A
Load: 400 kg
Veh Wt: 41 tons
Crew: 4
Mnt: 6
Night Vision: Headlights

AMX 155 GCT (Self-Propelled Artillery): This is a French-built 155 howitzer mounted on an AMX-30 chassis, intended to replace the open-topped Mk F3 SP howitzer. The hull has a driver's hatch on the front deck; the turret has a door on the right side, and commander and gunner's hatches on the turret roof. A MAG MG is fitted in a cupola mount (C) at the commander's hatch.

Tr Mov: 100/75
Com Mov: 50/40
Fuel Cap: 800
Fuel Cons: 200

Combat Statistics

Config: Trt TF: 3 HF: 16
Susp: T: 6 TS: 3 HS: 12
 TR: 3 HR: 6

AMMUNITION

Use MG ammo records provided on page 5.

155mm Howitzer (32 rounds and charges)

WEAPON DATA

Type	Round	Rng	Damage	Pen
155mm	HE	350	C:30, B:36	3C
IFR: 2 km	HEAT	350	C:20, B:28	110C
Rld: 2	WP	350	C:3, B:44	Nil
	CHEM	350	C:3, B:28	Nil
	ICMDP	—	B:60	Grenade
	ILLUM	—	B:2000	Nil
	FASCAM	—	B:124	Mine

—Recoil—

Weapon	ROF	Dam	Pen	Blk	Mag	SS	Brst	Rng
MAG MG	10	4	2-3-Nil	6	100B	1	7	65
bipod	10	4	2-3-Nil	6	100B	1	4	90
tripod	10	4	2-3-Nil	6	100B	1	2	125

BV-206

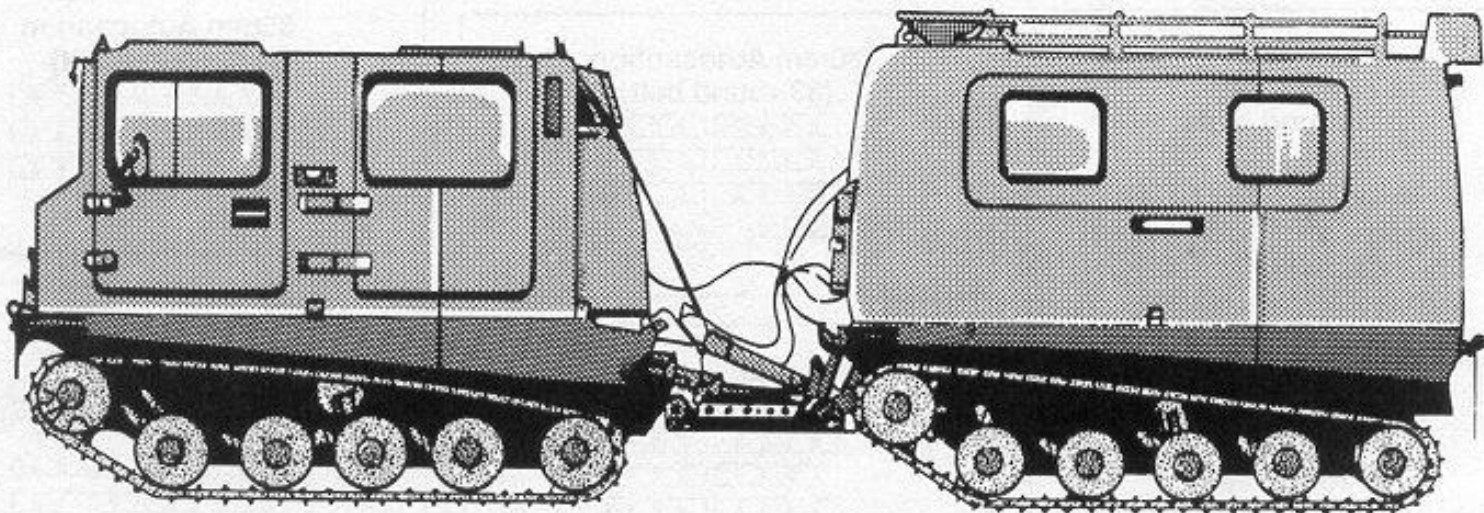

Price: \$30,000 (R/—)

Fuel Type: D, A

Load: 1 ton

Veh Wt: 4.2 tons

Crew: 2+6

Mnt: 10

Night Vision: Headlights

Damage Record

Crewmembers: Commander Driver

Passengers: 1 2 3 4 5 6

Sight/Vision: Night vision equipment

Radio:

Weapon (If Any):

Engine:

Fuel (% Consumed or Destroyed):

Suspension: Minor damage Immobilized

BV-206 (Unarmored Cargo Vehicle): Designed specifically to operate in very cold and/or snowbound conditions, the BV-206 is an odd-looking vehicle. It comes in two sections, the forward section containing the engine and crew, the rear section carrying passengers or cargo. The articulated drive train/link between the two sections allows the BV-206 greater cross-country ability than a similar-sized vehicle with a more conventional layout. The vehicle is fully amphibious, at one quarter its cross-country speed. The forward section has two doors on each side and two hatches on the right deck. The rear section has a single large door in the rear. The vehicle has a weapons mount (NHT equivalent) at the forward deck hatch, but no weapon is normally installed. In US service, the vehicle is known as the M973 carrier, cargo, tracked, 1½-ton SUSV (small unit support vehicle). It is NBC sealed.

Tr Mov: 180/80

Com Mov: 50/40

Fuel Cap: 360

Fuel Cons: 120

Combat Statistics

Config: Stnd HF: 1

Susp: T: 2 HS: 1

HR: 1

It's rare for the United States military to adopt a vehicle designed in a foreign country (the "not invented here" prejudice is very strong in the Pentagon). The BV-206 is an exception because no domestic vehicle could fulfill the requirement.

Cougar

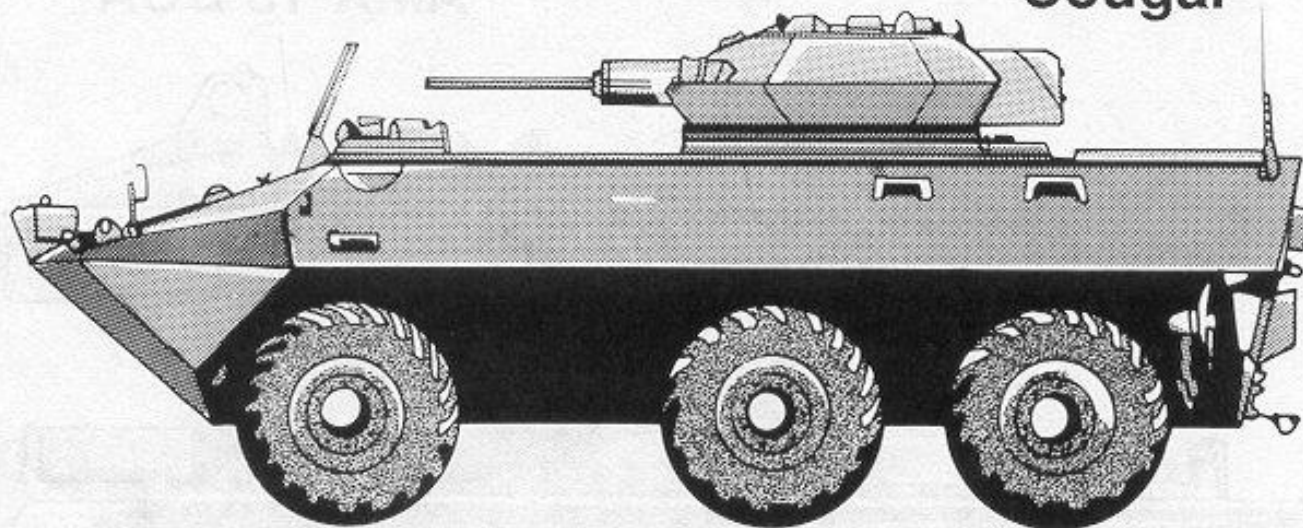

Price: \$70,000 (R/R)

RF: +2

Armament: 76mm gun, C-6 GPMG (coaxial)

Stabilization: Fair

Ammo: 40x76mm

Fuel Type: D, A

Load: 300 kg

Veh Wt: 9.6 tons

Crew: 3

Mnt: 8.

Night Vision: Headlights, passive IR

Cougar (Light Combat Vehicle): The Cougar is a Canadian armored car and, like the Canadian Grizzly, is based on the Swiss 6x6 MOWAG Piranha amphibious vehicle. The vehicle has a driver's hatch on the front hull deck, and commander and loader's hatches on the turret deck. Access to the hull is also provided by two hinged doors at the rear of the vehicle. The armored car has two firing ports on either side and two at the rear. The C-6 is the Canadian version of the Belgian MAG-58 MG.

Tr Mov: 180/70

Com Mov: 60/25

Fuel Cap: 250

Fuel Cons: 60

Combat Statistics

Config: Trt TF: 6 HF: 6

Susp: W(6) TS: 3 HS: 3

TR: 3 HR: 3

AMMUNITION

Use MG ammo records provided on page 5.

76mm Gun (40 rounds)

WEAPON DATA

Type	Round	Rng	Damage	Pen
76mm	HE	300	C:6, B:12	-3C
Rld: 1	HESH	300	C:6, B:12	20C
	CHEM*	300	C:3, B:20	Nil
	Cannister	50	C:6, B:12	4/3/2/-1

* HC smoke is the only chemical round available for this gun.

—Recoil—

Weapon	ROF	Dam	Pen	Blk	Mag	SS	Brst	Rng
C-6 GPMG	10	4	2-3-Nil	6	100B	1	7	65
bipod	10	4	2-3-Nil	6	100B	1	4	90
tripod	10	4	2-3-Nil	6	100B	1	2	125



A1: Leopard II of FRG 10th Panzer Division, specific unit unknown, vicinity of Brest-Litovsk, USSR; July 1997.



A2: C1 (Leopard I), Brigade Headquarters, Canadian 4th Mechanised Brigade, Poland; June 2000.



A3: Challenger, A Troop, 1/Queen's Dragoon Guards, 7th Armoured Brigade, 1st Armoured Division, Poland; 1998.



A4: MOWAG SW-1 Roland APC, 11th Panzer *Aufklarungs* Battalion, II West German Corps, location unknown; December 1998.



B1: Chieftain, Brigade Headquarters, 2nd Armored Brigade, IPA 3rd Armored Division, Kazerun, Iran; July 2000.



B2: Vickers Mk 7, A Company, 2/5th Armored Brigade, IPA 3rd Armored Division, Kazerun, Iran; July 2000.



B3: Scorpion, Recon Company, 11th Mechanized Infantry Brigade, IPA 12th Infantry Division, Jahrom, Iran; June 2000.



B4: TH-301, *Leicht* Company, 11th *Aufklarungs* (Reconnaissance) Battalion, 1 PzGrD, Austria; 2000.



C1: M60A3 with explosive applique armor, Turkish 3rd Armored Brigade, Bulgaria; 1997.



C2: Leopard III of the US 2nd Marine Division, Poland; 2000.

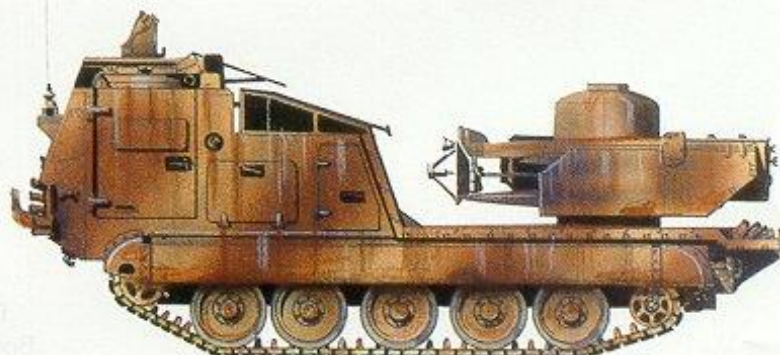

C3: Rapier SP, MEFF Brigade HQ, Bahrain; December 1999.



C4: Gepard of 1st Flak Battalion, 1st Panzer Division, Italian Front; 1998.



D1: Wildcat of 24th Fallschirmjäger Brigade, Poland; 1997.



D2: Spartan APC from an unknown troop of the British 12th Armoured Brigade, 1st Armoured Division, Poland; 1999.



D3: Wiesel TOW, Support Company, 1/15th Light Mechanized Brigade, Litsa River Line, USSR; 1997.



D4: FV-102 Striker, Royal Scots Dragoon Guards, Germany; 1999.



E1: *Marder 2* of 1/19th Panzergrenadier Brigade, 6th Panzergrenadier Division, Hamburg, Germany; 2000.



E2: FV-510 Warrior, Brigade Headquarters, 7th Armoured Brigade, 1st Armoured Division, Germany; 1997.



E3: FV-432 of B Company, 1/Royal Regiment of Fusiliers, 19th Infantry Brigade, Germany; January 2000.



E4: Grizzly, Recon Company, 1/22e Regiment, Germany; March 1999.



F1: FV-603 Saracen of the Ulster Defence Regiment, Northern Ireland; 1995.



F2: FV-721 Fox, Headquarters Troop, 2/Royal Tank Regiment, 4th Armoured Division, Germany; 1999.



F3: Luchs, American 278th ACR, Germany; January 2000.



F4: Cougar of the Canadian detachment, United Nations Peace-keeping Forces, Ceylon; 1996.



G1: Foden 10-Ton Cargo Truck, unknown Soviet unit, Poland; December 1999.



G2: Landrover, unknown Tudeh unit, Iran; 2000.



G3: M151 Jeep, Brigade Headquarters, Turkish 3rd Armored Brigade, Thrace; August 1997.



G4: BV-206 of the Norwegian 5th Mountain Brigade, Litsa River Line, USSR; June, 1997.



G5: FV-107 Scimitar, Queen's Royal Irish Hussars, German Democratic Republic; December 1997.



G6: AT-105 Saxon, operating with unknown marauder band, vicinity of Berlin; July 2000.



H1: Leopard AEV, unit and location unknown; August 1999.



H2: FV-433 Abbot, 2nd Field Regiment, 2nd Armoured Division, Germany; July 2000.



H3: M109A3G of 1st Battery, 3rd Artillery Battalion, 3rd Panzer Division, Siege of Warsaw, Poland; September 1997.



H4: AIFV, unknown Dutch unit, Defense of the Rhine, the Netherlands; 1999.

ERC-90

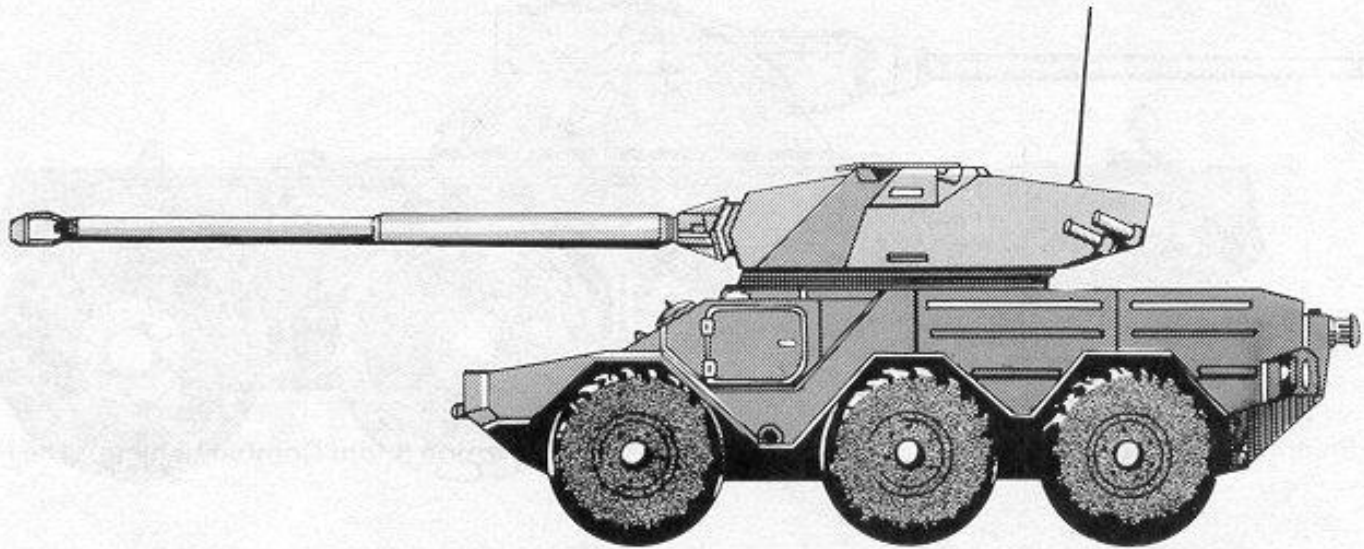

Price: \$200,000 (R/C)
RF: +3
Armament: 90mmf gun, MAG MG (coaxial), MAG MG (C)
Stabilization: Fair
Ammo: 36×90mm
Fuel Type: G, A
Load: 300 kg
Veh Wt: 7.8 tons
Crew: 3
Mnt: 6
Night Vision: Headlights, passive IR, light intensification

ERC-90 (Light Combat Vehicle): This French-built armored car entered production in 1979, intended primarily for overseas sales. The *Engin Reconnaissance de Canon 90* is used by Argentina and Mexico (where it is known as the Lynx), Chad, Iraq, and the Ivory Coast, and is also used in small numbers by the French Army. The vehicle has a driver's hatch on the right hull side, and commander and gunner's hatches on the turret deck. The vehicle is not amphibious, and export versions have no NBC protection.

Tr Mov: 200/140
Com Mov: 100/70
Fuel Cap: 480
Fuel Cons: 120

Combat Statistics

<i>Config:</i> Trt	TF: 8	HF: 8
<i>Susp:</i> W(3)	TS: 8	HS: 6
	TR: 4	HR: 4

AMMUNITION

Use MG ammo records provided on page 5.

90mmf Gun (36 rounds)

WEAPON DATA

Type	Round	Rng	Damage	Pen
90mmf	APFSDS	300	24	30/25/20/15
Rld: 1	HEAT	300	C:5, B:10	60C
	HE	300	C:5, B:10	4C

—Recoil—

Weapon	ROF	Dam	Pen	Blk	Mag	SS	Brst	Rng
MAG MG	10	4	2-3-Nil	6	50B	1	9	65
bipod	10	4	2-3-Nil	6	50B	1	5	90
tripod	10	4	2-3-Nil	6	50B	1	4	125

Flakpanzer Gepard

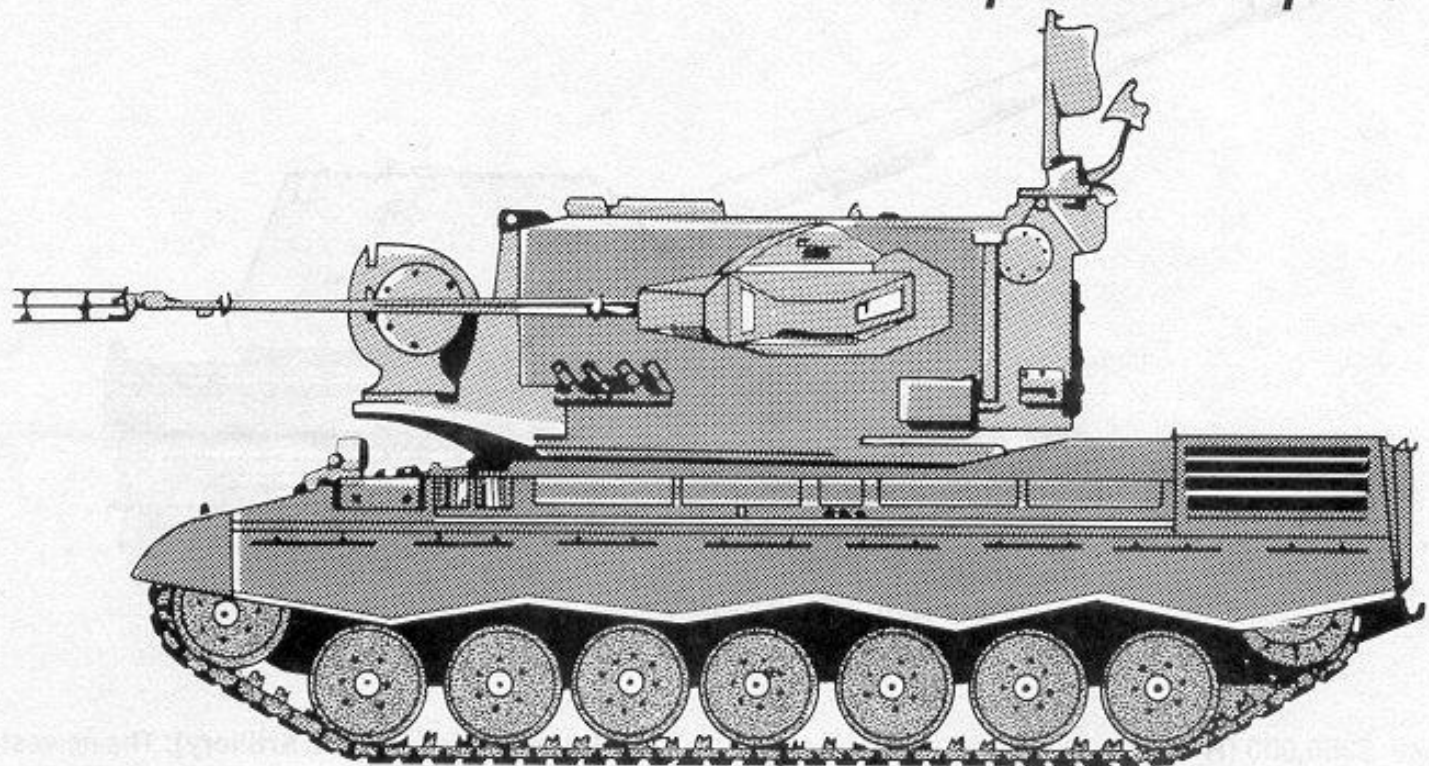

Price: \$850,000 (R/R)

RF: +4

Armament: 2x35mm AC, MG3 MG

Stabilization: Fair

Ammo: 240x35mm

Fuel Type: D, G, AvG, A

Load: 500 kg

Veh Wt: 56 tons

Crew: 4

Mnt: 8

Night Vision: Headlights

Flakpanzer Gepard (Self-Propelled Artillery): The *Flakpanzer* (self-propelled anti-aircraft gun) *Gepard* is an armored, self-propelled anti-aircraft vehicle. The layout is conventional for an AFV, except for the turret. One 35mm anti-aircraft gun is mounted on each side of the turret. The gunner's hatch is on the front turret deck, and a large, target-acquisition radar dish is mounted on the rear turret deck, giving the vehicle a superficial resemblance to the Soviet ZSU-57-2.

Tr Mov: 115/50

Com Mov: 40/30

Fuel Cap: 2000

Fuel Cons: 500

Combat Statistics

Config: Trt TF: 3 HF: 27

Susp: T: 6 TS: 3 HS: 7

TR: 3 HR: 5

AMMUNITION

Use MG ammo records provided on page 5.

WEAPON DATA

Weapon	ROF	Mag	Rng	Ammo	Damage	Pen
35mm	5	33B	400	HE-1	C:1, B:2	-2C

WEAPON DATA

—Recoil—

Weapon	ROF	Dam	Pen	Blk	Mag	SS	Brst	Rng
MG3	10	4	2-3-Nil	6	50B	1	7	65
bipod	10	4	2-3-Nil	6	50B	1	3	90
tripod	10	4	2-3-Nil	6	50B	1	1	125

Damage Record

Crewmembers: Commander Driver Gunner

Loader

Sight/Vision: TA radar Night vision equipment

Radio:

35mm AC (L):

35mm AC (R):

MG3 MG:

Traverse:

Engine:

Fuel (% Consumed or Destroyed):

Suspension: Minor damage Immobilized

Foden 10-Ton Truck

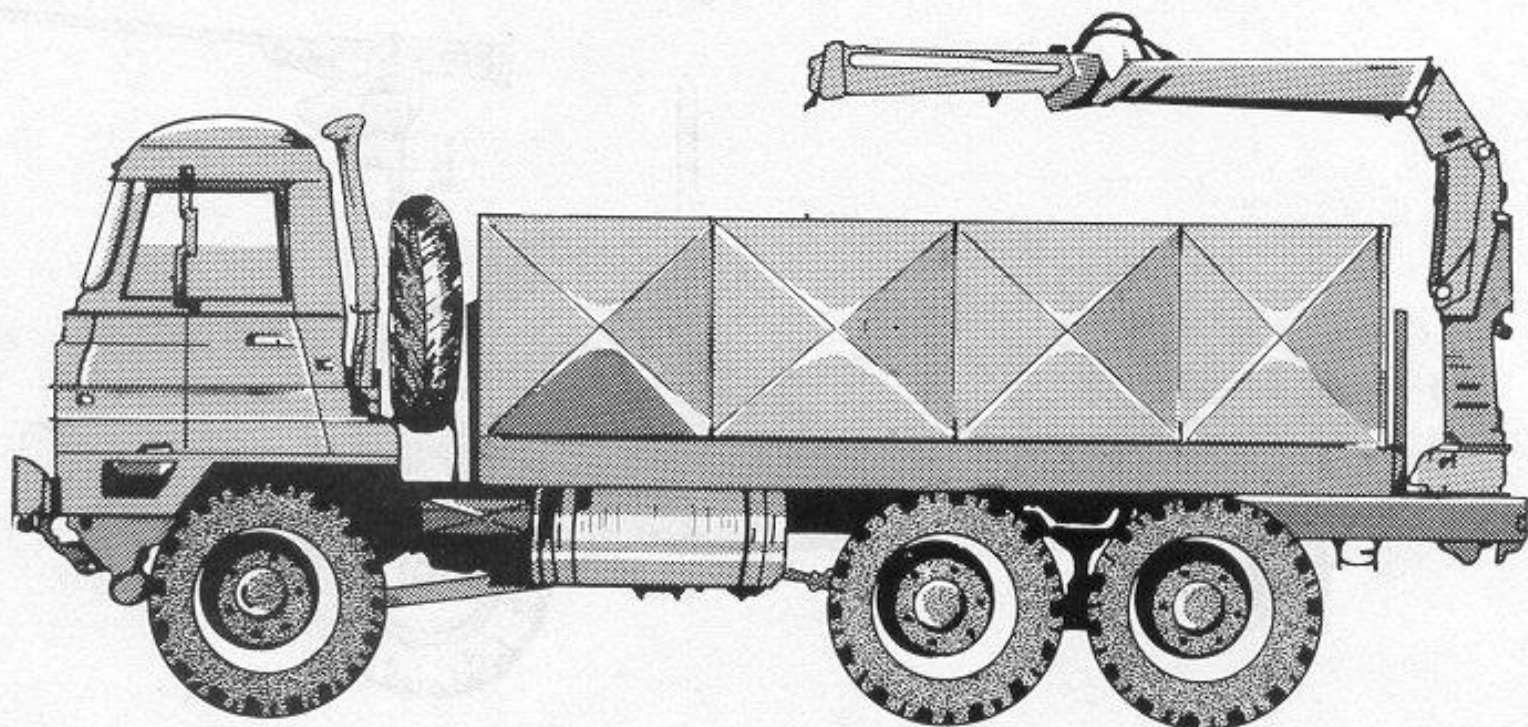

Price: \$35,000 (S/R)
Fuel Type: D, A
Load: 10 tons
Veh Wt: 14 tons
Crew: 2+12
Mnt: 8
Night Vision: Headlights

Damage Record

Crewmembers: Driver Assistant driver
Passengers: 1 2 3 4 5 6 7 8 9 10
11 12
Sight/Vision: Night vision equipment
Radio:
Weapon (If Any):
Engine:
Fuel (% Consumed or Destroyed):
Suspension: Minor damage Immobilized

Foden 10-Ton Truck (Unarmored Cargo Vehicle): The Foden 10-ton cargo truck is typical of the more modern family of transport trucks in that it comes with provisions for standardized pallets and is fitted with its own crane to speed loading/unloading. This vehicle can be fitted with a weapons mount (NHT equivalent) but is not normally armed. One disadvantage of this system is that the truck is not readily converted to carry passengers. The passenger rating listed is with jury-rigged seating arrangements, which are neither as efficient nor as comfortable as more conventional arrangements.

***Tr Mov:* 100/10**
***Com Mov:* 35/10**
***Fuel Cap:* 450**
***Fuel Cons:* 150**

Combat Statistics

Config: Std HF: 1
Susp: W(2) HS: 1
HR: 1

FV-101 Scorpion

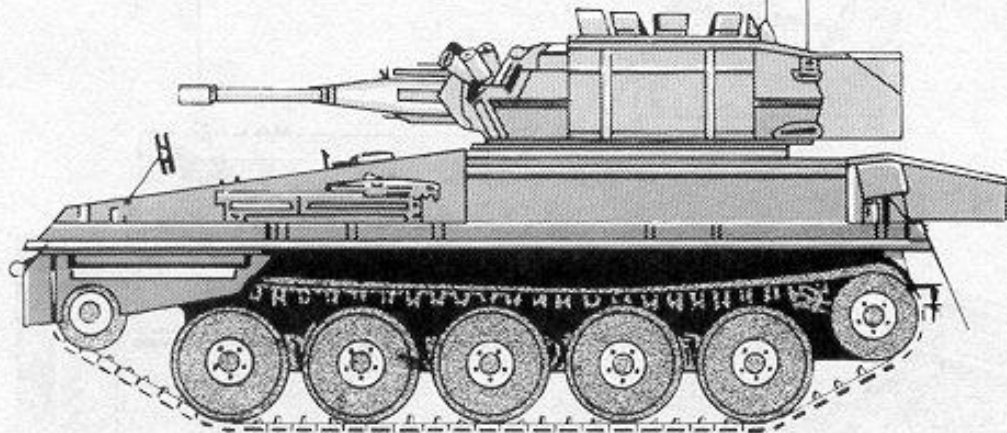

Price: \$70,000 (S/R)

RF: +2

Armament: 76mm gun (or 90mm gun), L7A2 GPMG

Stabilization: Fair

Ammo: 40x76mm or 30x90mm

Fuel Type: G, A

Load: 300 kg

Veh Wt: 8 tons

Crew: 3

Mnt: 8

Night Vision: Headlights, passive IR

FV-101 Scorpion (Light Combat Vehicle): The FV-101 Scorpion is a British-built light reconnaissance tank which comes in several variants. The vehicle has a two-man turret with hatches for the commander and gunner, and has a driver's hatch on the front deck. Some versions of the Scorpion use diesel instead of regular automotive gasoline, and a few were built using the Cockerill 90mm gun.

Tr Mov: 160/130

Com Mov: 80/65

Fuel Cap: 423

Fuel Cons: 105

Damage Record

Crewmembers: Commander Driver Gunner/loader

Sight/Vision: Gun sight Range finder Night vision equipment

Radio:

76mm Gun:

90mm Gun:

L7A2 GPMG:

Traverse:

Engine:

Fuel (% Consumed or Destroyed):

Suspension: Minor damage Immobilized

Combat Statistics

Config: Trt TF: 6 HF: 6

Susp: W(6) TS: 3 HS: 3

TR: 3 HR: 3

AMMUNITION

Use MG ammo records provided on page 5.

76mm Gun (40 rounds)

90mm Gun (30 rounds)

WEAPON DATA

Type	Round	Rng	Damage	Pen
90mm	APDS-T	350	24	30/25/20/15
Rld: 1	HEAT	350	C:5, B:10	60C
76mm	HE	300	C:6, B:12	-3C
Rld: 1	HESH	300	C:6, B:12	20C
	CHEM*	300	C:3, B:20	Nil
	Cannister	50	C:6, B:12	4/3/2/-1

*HC smoke is the only chemical round available for this gun.

—Recoil—

Weapon	ROF	Dam	Pen	Blk	Mag	SS	Brst	Rng
L7A2 GPMG	10	4	2-3-Nil	6	100B	1	7	65
bipod	10	4	2-3-Nil	6	100B	1	4	90
tripod	10	4	2-3-Nil	6	100B	1	2	125

FV-433 Abbot

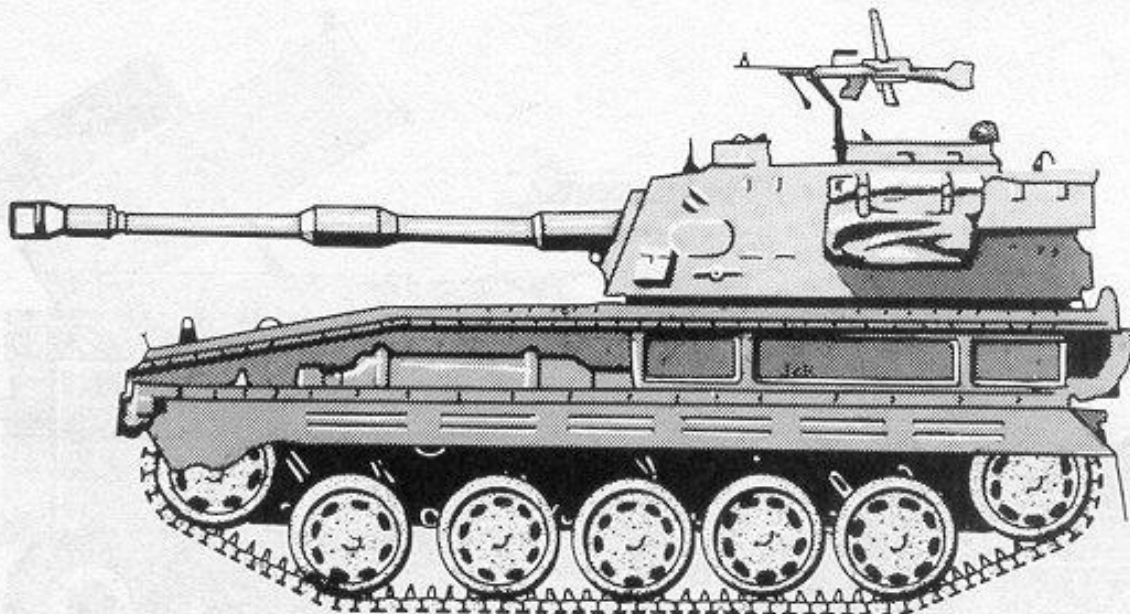

Price: \$500,000 (R/—)

Armament: 105mm howitzer, L7A2 GPMG

Ammo: 40x105mm howitzer

Fuel Type: D, G, A

Load: 400 kg

Veh Wt: 16 tons

Crew: 4

Mnt: 6

Night Vision: Headlights

Damage Record

Crewmembers: Commander Driver Gunner Loader

Sight/Vision: Night vision equipment

Radio:

105mm Howitzer:

L7A2 GPMG:

Traverse:

Engine:

Fuel (% Consumed or Destroyed):

Suspension: Minor damage Immobilized

FV-433 Abbot (Self-Propelled Artillery): The FV-433 Abbot is a British-built, self-propelled, 105mm howitzer which uses engine and drive train components from the FV-432 APC. The front deck contains a driver's hatch, and the turret contains hatches for the gunner and commander (the loader uses the gunner's hatch). The vehicle is not amphibious, but is NBC sealed.

Tr Mov: 95/20

Com Mov: 30/20

Fuel Cap: 390

Fuel Cons: 120

Combat Statistics

Config: Trt TF: 2 HF: 3

Susp: T: 3 TS: 2 HS: 3

TR: 2 HR: 2

AMMUNITION

Use MG ammo records provided on page 5.

105mm Howitzer (40 rounds)

WEAPON DATA

Type	Round	Rng	Damage	Pen
105mm how	HE	300	C:6, B:8	4C
IFR: 17 km	HESH	300	C:6, B:12	12C
Rld: 1	CHEM	300	C:3, B:20	Nil

WEAPON DATA

Weapon	ROF	Dam	Pen	Blk	Mag	—Recoil—		
						SS	Brst	Rng
L7A2 GPMG	10	4	2-3-Nil	6	100B	1	7	65
bipod	10	4	2-3-Nil	6	100B	1	4	90
tripod	10	4	2-3-Nil	6	100B	1	2	125

By a tradition dating back to WWII, British self-propelled guns tend to be given ecclesiastical names (Bishop, Priest, Sexton, etc.). The Abbot is no exception.



FV-4333 Stormer

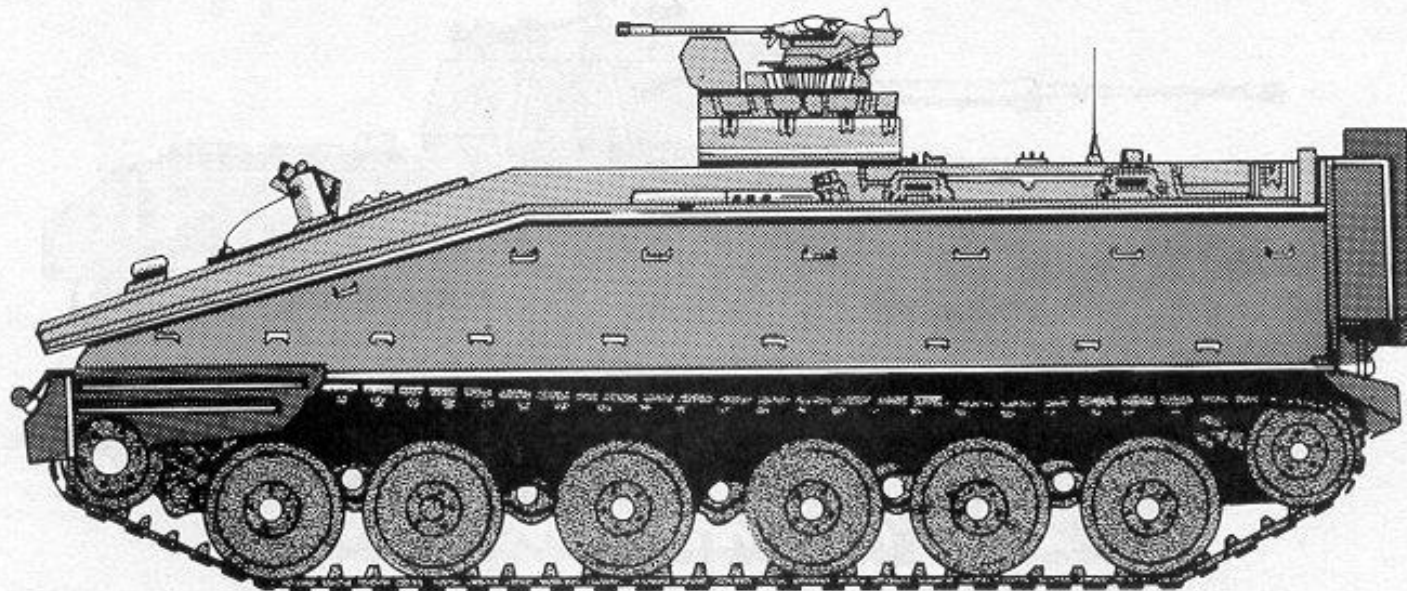

Price: \$45,000 (S/—)

Armament: L7A2 GPMG (C)

Ammo: As cargo

Fuel Type: D, A

Load: 800 kg

Veh Wt: 10.6 tons

Crew: 3+8

Mnt: 6

Night Vision: Headlights, passive IR/thermal imaging

Damage Record

Crewmembers: Commander Driver Gunner

Passengers: 1 2 3 4 5 6 7 8

Sight/Vision: Gun sight Range finder Night vision equipment

Radio:

L7A2 GPMG (C):

Engine:

Fuel (% Consumed or Destroyed):

Suspension: Minor damage Immobilized

WEAPON DATA

Weapon	ROF	Dam	Pen	Blk	Mag	—Recoil—		Rng
						SS	Brst	
L7A2 GPMG	10	4	2-3-Nil	6	100B	1	7	65
bipod	10	4	2-3-Nil	6	100B	1	4	90
tripod	10	4	2-3-Nil	6	100B	1	2	125

FV-4333 Stormer (Armored Personnel Carrier): The Stormer was developed from the Spartan APC series, incorporating the same drive components, but in a lengthened and slightly widened chassis. The vehicle entered production in 1981, is NBC sealed, and is fully amphibious at one-quarter its cross-country speed.

Normal armament for the APC version is a L7A2 GPMG in a cupola mount. Some versions are fitted with a turret containing a larger weapon: either a 20mm autocannon, 30mm Rarden autocannon, 76mm gun, 90mm gun, or twin 20mm anti-aircraft autocannon (stabilization is fair in all cases). The normal APC version is shown.

Tr Mov: 144/110

Com Mov: 70/55

Fuel Cap: 405

Fuel Cons: 110

Combat Statistics

Config: Stnd HF: 4

Susp: T: 3 HS: 3

HR: 3

AMMUNITION

Use MG ammo records provided on page 5.

FV-510 Warrior

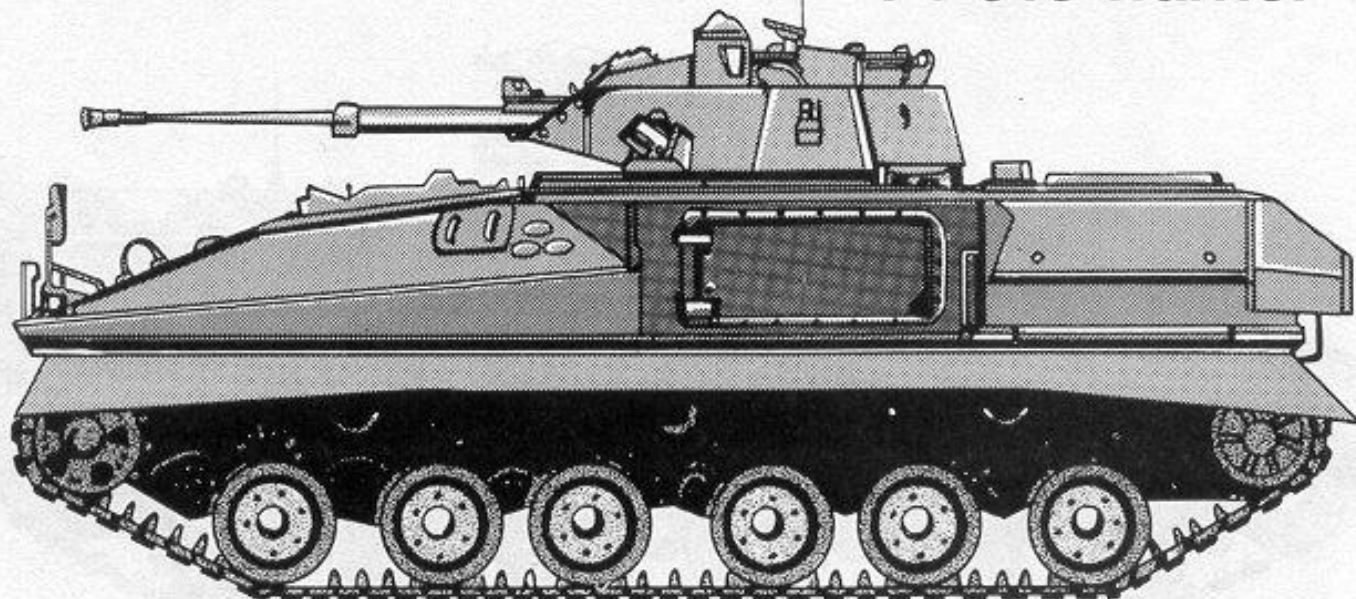

Price: \$250,000 (S/R)

RF: +2

Stabilization: Fair

Armament: 30mm Rarden AC, MAG (coaxial)

Ammo: 200x30mm

Fuel Type: D, A

Load: 600 kg

Veh Wt: 24 tons

Crew: 2+8

Mnt: 12

Night Vision: White light/IR spotlight, active/passive IR

FV-510 Warrior (Armored Personnel Carrier): Introduced in the mid-1980s, the Warrior was criticized by many for being just another "battle taxi" rather than a full-fledged infantry combat vehicle. Warriors have no firing ports and carry no ATGMs. The vehicle has a driver's hatch on the forward deck, a commander's hatch atop the turret, a hatch on the rear deck, and a drop ramp in the rear for departure of troops.

Tr Mov: 150/110

Com Mov: 35/25

Fuel Cap: 722

Fuel Cons: 280

Damage Record

Crewmembers: Commander/gunner Driver

Passengers: 1 2 3 4 5 6 7 8

Sight/Vision: Gun sight Range finder Night vision

equipment

Radio:

30mm Rarden AC:

MAG MG (Coaxial):

Traverse:

Engine:

Fuel (% Consumed or Destroyed):

Suspension: Minor damage Immobilized

Combat Statistics

Config: Tr TF: 6 HF: 6

Susp: T: 4 TS: 4 HS: 4

TR: 2 HR: 3

AMMUNITION

Use MG ammo records provided on page 5.

30mm Rarden Autocannon (200 rounds)

<input type="checkbox"/>	<input type="checkbox"/>	<input type="checkbox"/>	<input type="checkbox"/>	<input type="checkbox"/>	<input type="checkbox"/>	<input type="checkbox"/>	<input type="checkbox"/>	<input type="checkbox"/>	<input type="checkbox"/>
<input type="checkbox"/>	<input type="checkbox"/>	<input type="checkbox"/>	<input type="checkbox"/>	<input type="checkbox"/>	<input type="checkbox"/>	<input type="checkbox"/>	<input type="checkbox"/>	<input type="checkbox"/>	<input type="checkbox"/>
<input type="checkbox"/>	<input type="checkbox"/>	<input type="checkbox"/>	<input type="checkbox"/>	<input type="checkbox"/>	<input type="checkbox"/>	<input type="checkbox"/>	<input type="checkbox"/>	<input type="checkbox"/>	<input type="checkbox"/>
<input type="checkbox"/>	<input type="checkbox"/>	<input type="checkbox"/>	<input type="checkbox"/>	<input type="checkbox"/>	<input type="checkbox"/>	<input type="checkbox"/>	<input type="checkbox"/>	<input type="checkbox"/>	<input type="checkbox"/>
<input type="checkbox"/>	<input type="checkbox"/>	<input type="checkbox"/>	<input type="checkbox"/>	<input type="checkbox"/>	<input type="checkbox"/>	<input type="checkbox"/>	<input type="checkbox"/>	<input type="checkbox"/>	<input type="checkbox"/>
<input type="checkbox"/>	<input type="checkbox"/>	<input type="checkbox"/>	<input type="checkbox"/>	<input type="checkbox"/>	<input type="checkbox"/>	<input type="checkbox"/>	<input type="checkbox"/>	<input type="checkbox"/>	<input type="checkbox"/>
<input type="checkbox"/>	<input type="checkbox"/>	<input type="checkbox"/>	<input type="checkbox"/>	<input type="checkbox"/>	<input type="checkbox"/>	<input type="checkbox"/>	<input type="checkbox"/>	<input type="checkbox"/>	<input type="checkbox"/>
<input type="checkbox"/>	<input type="checkbox"/>	<input type="checkbox"/>	<input type="checkbox"/>	<input type="checkbox"/>	<input type="checkbox"/>	<input type="checkbox"/>	<input type="checkbox"/>	<input type="checkbox"/>	<input type="checkbox"/>
<input type="checkbox"/>	<input type="checkbox"/>	<input type="checkbox"/>	<input type="checkbox"/>	<input type="checkbox"/>	<input type="checkbox"/>	<input type="checkbox"/>	<input type="checkbox"/>	<input type="checkbox"/>	<input type="checkbox"/>
<input type="checkbox"/>	<input type="checkbox"/>	<input type="checkbox"/>	<input type="checkbox"/>	<input type="checkbox"/>	<input type="checkbox"/>	<input type="checkbox"/>	<input type="checkbox"/>	<input type="checkbox"/>	<input type="checkbox"/>
<input type="checkbox"/>	<input type="checkbox"/>	<input type="checkbox"/>	<input type="checkbox"/>	<input type="checkbox"/>	<input type="checkbox"/>	<input type="checkbox"/>	<input type="checkbox"/>	<input type="checkbox"/>	<input type="checkbox"/>
<input type="checkbox"/>	<input type="checkbox"/>	<input type="checkbox"/>	<input type="checkbox"/>	<input type="checkbox"/>	<input type="checkbox"/>	<input type="checkbox"/>	<input type="checkbox"/>	<input type="checkbox"/>	<input type="checkbox"/>
<input type="checkbox"/>	<input type="checkbox"/>	<input type="checkbox"/>	<input type="checkbox"/>	<input type="checkbox"/>	<input type="checkbox"/>	<input type="checkbox"/>	<input type="checkbox"/>	<input type="checkbox"/>	<input type="checkbox"/>
<input type="checkbox"/>	<input type="checkbox"/>	<input type="checkbox"/>	<input type="checkbox"/>	<input type="checkbox"/>	<input type="checkbox"/>	<input type="checkbox"/>	<input type="checkbox"/>	<input type="checkbox"/>	<input type="checkbox"/>
<input type="checkbox"/>	<input type="checkbox"/>	<input type="checkbox"/>	<input type="checkbox"/>	<input type="checkbox"/>	<input type="checkbox"/>	<input type="checkbox"/>	<input type="checkbox"/>	<input type="checkbox"/>	<input type="checkbox"/>
<input type="checkbox"/>	<input type="checkbox"/>	<input type="checkbox"/>	<input type="checkbox"/>	<input type="checkbox"/>	<input type="checkbox"/>	<input type="checkbox"/>	<input type="checkbox"/>	<input type="checkbox"/>	<input type="checkbox"/>
<input type="checkbox"/>	<input type="checkbox"/>	<input type="checkbox"/>	<input type="checkbox"/>	<input type="checkbox"/>	<input type="checkbox"/>	<input type="checkbox"/>	<input type="checkbox"/>	<input type="checkbox"/>	<input type="checkbox"/>
<input type="checkbox"/>	<input type="checkbox"/>	<input type="checkbox"/>	<input type="checkbox"/>	<input type="checkbox"/>	<input type="checkbox"/>	<input type="checkbox"/>	<input type="checkbox"/>	<input type="checkbox"/>	<input type="checkbox"/>
<input type="checkbox"/>	<input type="checkbox"/>	<input type="checkbox"/>	<input type="checkbox"/>	<input type="checkbox"/>	<input type="checkbox"/>	<input type="checkbox"/>	<input type="checkbox"/>	<input type="checkbox"/>	<input type="checkbox"/>
<input type="checkbox"/>	<input type="checkbox"/>	<input type="checkbox"/>	<input type="checkbox"/>	<input type="checkbox"/>	<input type="checkbox"/>	<input type="checkbox"/>	<input type="checkbox"/>	<input type="checkbox"/>	<input type="checkbox"/>
<input type="checkbox"/>	<input type="checkbox"/>	<input type="checkbox"/>	<input type="checkbox"/>	<input type="checkbox"/>	<input type="checkbox"/>	<input type="checkbox"/>	<input type="checkbox"/>	<input type="checkbox"/>	<input type="checkbox"/>
<input type="checkbox"/>	<input type="checkbox"/>	<input type="checkbox"/>	<input type="checkbox"/>	<input type="checkbox"/>	<input type="checkbox"/>	<input type="checkbox"/>	<input type="checkbox"/>	<input type="checkbox"/>	<input type="checkbox"/>
<input type="checkbox"/>	<input type="checkbox"/>	<input type="checkbox"/>	<input type="checkbox"/>	<input type="checkbox"/>	<input type="checkbox"/>	<input type="checkbox"/>	<input type="checkbox"/>	<input type="checkbox"/>	<input type="checkbox"/>
<input type="checkbox"/>	<input type="checkbox"/>	<input type="checkbox"/>	<input type="checkbox"/>	<input type="checkbox"/>	<input type="checkbox"/>	<input type="checkbox"/>	<input type="checkbox"/>	<input type="checkbox"/>	<input type="checkbox"/>
<input type="checkbox"/>	<input type="checkbox"/>	<input type="checkbox"/>	<input type="checkbox"/>	<input type="checkbox"/>	<input type="checkbox"/>	<input type="checkbox"/>	<input type="checkbox"/>	<input type="checkbox"/>	<input type="checkbox"/>
<input type="checkbox"/>	<input type="checkbox"/>	<input type="checkbox"/>	<input type="checkbox"/>	<input type="checkbox"/>	<input type="checkbox"/>	<input type="checkbox"/>	<input type="checkbox"/>	<input type="checkbox"/>	<input type="checkbox"/>
<input type="checkbox"/>	<input type="checkbox"/>	<input type="checkbox"/>	<input type="checkbox"/>	<input type="checkbox"/>	<input type="checkbox"/>	<input type="checkbox"/>	<input type="checkbox"/>	<input type="checkbox"/>	<input type="checkbox"/>
<input type="checkbox"/>	<input type="checkbox"/>	<input type="checkbox"/>	<input type="checkbox"/>	<input type="checkbox"/>	<input type="checkbox"/>	<input type="checkbox"/>	<input type="checkbox"/>	<input type="checkbox"/>	<input type="checkbox"/>
<input type="checkbox"/>	<input type="checkbox"/>	<input type="checkbox"/>	<input type="checkbox"/>	<input type="checkbox"/>	<input type="checkbox"/>	<input type="checkbox"/>	<input type="checkbox"/>	<input type="checkbox"/>	<input type="checkbox"/>
<input type="checkbox"/>	<input type="checkbox"/>	<input type="checkbox"/>	<input type="checkbox"/>	<input type="checkbox"/>	<input type="checkbox"/>	<input type="checkbox"/>	<input type="checkbox"/>	<input type="checkbox"/>	<input type="checkbox"/>
<input type="checkbox"/>	<input type="checkbox"/>	<input type="checkbox"/>	<input type="checkbox"/>	<input type="checkbox"/>	<input type="checkbox"/>	<input type="checkbox"/>	<input type="checkbox"/>	<input type="checkbox"/>	<input type="checkbox"/>
<input type="checkbox"/>	<input type="checkbox"/>	<input type="checkbox"/>	<input type="checkbox"/>	<input type="checkbox"/>	<input type="checkbox"/>	<input type="checkbox"/>	<input type="checkbox"/>	<input type="checkbox"/>	<input type="checkbox"/>
<input type="checkbox"/>	<input type="checkbox"/>	<input type="checkbox"/>	<input type="checkbox"/>	<input type="checkbox"/>	<input type="checkbox"/>	<input type="checkbox"/>	<input type="checkbox"/>	<input type="checkbox"/>	<input type="checkbox"/>
<input type="checkbox"/>	<input type="checkbox"/>	<input type="checkbox"/>	<input type="checkbox"/>	<input type="checkbox"/>	<input type="checkbox"/>	<input type="checkbox"/>	<input type="checkbox"/>	<input type="checkbox"/>	<input type="checkbox"/>
<input type="checkbox"/>	<input type="checkbox"/>	<input type="checkbox"/>	<input type="checkbox"/>	<input type="checkbox"/>	<input type="checkbox"/>	<input type="checkbox"/>	<input type="checkbox"/>	<input type="checkbox"/>	<input type="checkbox"/>
<input type="checkbox"/>	<input type="checkbox"/>	<input type="checkbox"/>	<input type="checkbox"/>	<input type="checkbox"/>	<input type="checkbox"/>	<input type="checkbox"/>	<input type="checkbox"/>	<input type="checkbox"/>	<input type="checkbox"/>
<input type="checkbox"/>	<input type="checkbox"/>	<input type="checkbox"/>	<input type="checkbox"/>	<input type="checkbox"/>	<input type="checkbox"/>	<input type="checkbox"/>	<input type="checkbox"/>	<input type="checkbox"/>	<input type="checkbox"/>
<input type="checkbox"/>	<input type="checkbox"/>	<input type="checkbox"/>	<input type="checkbox"/>	<input type="checkbox"/>	<input type="checkbox"/>	<input type="checkbox"/>	<input type="checkbox"/>	<input type="checkbox"/>	<input type="checkbox"/>
<input type="checkbox"/>	<input type="checkbox"/>	<input type="checkbox"/>	<input type="checkbox"/>	<input type="checkbox"/>	<input type="checkbox"/>	<input type="checkbox"/>	<input type="checkbox"/>	<input type="checkbox"/>	<input type="checkbox"/>
<input type="checkbox"/>	<input type="checkbox"/>	<input type="checkbox"/>	<input type="checkbox"/>	<input type="checkbox"/>	<input type="checkbox"/>	<input type="checkbox"/>	<input type="checkbox"/>	<input type="checkbox"/>	<input type="checkbox"/>
<input type="checkbox"/>	<input type="checkbox"/>	<input type="checkbox"/>	<input type="checkbox"/>	<input type="checkbox"/>	<input type="checkbox"/>	<input type="checkbox"/>	<input type="checkbox"/>	<input type="checkbox"/>	<input type="checkbox"/>
<input type="checkbox"/>	<input type="checkbox"/>	<input type="checkbox"/>	<input type="checkbox"/>	<input type="checkbox"/>	<input type="checkbox"/>	<input type="checkbox"/>	<input type="checkbox"/>	<input type="checkbox"/>	<input type="checkbox"/>
<input type="checkbox"/>	<input type="checkbox"/>	<input type="checkbox"/>	<input type="checkbox"/>	<input type="checkbox"/>	<input type="checkbox"/>	<input type="checkbox"/>	<input type="checkbox"/>	<input type="checkbox"/>	<input type="checkbox"/>
<input type="checkbox"/>	<input type="checkbox"/>	<input type="checkbox"/>	<input type="checkbox"/>	<input type="checkbox"/>	<input type="checkbox"/>	<input type="checkbox"/>	<input type="checkbox"/>	<input type="checkbox"/>	<input type="checkbox"/>
<input type="checkbox"/>	<input type="checkbox"/>	<input type="checkbox"/>	<input type="checkbox"/>	<input type="checkbox"/>	<input type="checkbox"/>	<input type="checkbox"/>	<input type="checkbox"/>	<input type="checkbox"/>	<input type="checkbox"/>
<input type="checkbox"/>	<input type="checkbox"/>	<input type="checkbox"/>	<input type="checkbox"/>	<input type="checkbox"/>	<input type="checkbox"/>	<input type="checkbox"/>	<input type="checkbox"/>	<input type="checkbox"/>	<input type="checkbox"/>
<input type="checkbox"/>	<input type="checkbox"/>	<input type="checkbox"/>	<input type="checkbox"/>	<input type="checkbox"/>	<input type="checkbox"/>	<input type="checkbox"/>	<input type="checkbox"/>	<input type="checkbox"/>	<input type="checkbox"/>
<input type="checkbox"/>	<input type="checkbox"/>	<input type="checkbox"/>	<input type="checkbox"/>	<input type="checkbox"/>	<input type="checkbox"/>	<input type="checkbox"/>	<input type="checkbox"/>	<input type="checkbox"/>	<input type="checkbox"/>
<input type="checkbox"/>	<input type="checkbox"/>	<input type="checkbox"/>	<input type="checkbox"/>	<input type="checkbox"/>	<input type="checkbox"/>	<input type="checkbox"/>	<input type="checkbox"/>	<input type="checkbox"/>	<input type="checkbox"/>
<input type="checkbox"/>	<input type="checkbox"/>	<input type="checkbox"/>	<input type="checkbox"/>	<input type="checkbox"/>	<input type="checkbox"/>	<input type="checkbox"/>	<input type="checkbox"/>	<input type="checkbox"/>	<input type="checkbox"/>
<input type="checkbox"/>	<input type="checkbox"/>	<input type="checkbox"/>	<input type="checkbox"/>	<input type="checkbox"/>	<input type="checkbox"/>	<input type="checkbox"/>	<input type="checkbox"/>	<input type="checkbox"/>	<input type="checkbox"/>
<input type="checkbox"/>	<input type="checkbox"/>	<input type="checkbox"/>	<input type="checkbox"/>	<input type="checkbox"/>	<input type="checkbox"/>	<input type="checkbox"/>	<input type="checkbox"/>	<input type="checkbox"/>	<input type="checkbox"/>
<input type="checkbox"/>	<input type="checkbox"/>	<input type="checkbox"/>	<input type="checkbox"/>	<input type="checkbox"/>	<input type="checkbox"/>	<input type="checkbox"/>	<input type="checkbox"/>	<input type="checkbox"/>	<input type="checkbox"/>
<input type="checkbox"/>	<input type="checkbox"/>	<input type="checkbox"/>	<input type="checkbox"/>	<input type="checkbox"/>	<input type="checkbox"/>	<input type="checkbox"/>	<input type="checkbox"/>	<input type="checkbox"/>	<input type="checkbox"/>
<input type="checkbox"/>	<input type="checkbox"/>	<input type="checkbox"/>	<input type="checkbox"/>	<input type="checkbox"/>	<input type="checkbox"/>	<input type="checkbox"/>	<input type="checkbox"/>	<input type="checkbox"/>	<input type="checkbox"/>
<input type="checkbox"/>	<input type="checkbox"/>	<input type="checkbox"/>	<input type="checkbox"/>	<input type="checkbox"/>	<input type="checkbox"/>	<input type="checkbox"/>	<input type="checkbox"/>	<input type="checkbox"/>	<input type="checkbox"/>
<input type="checkbox"/>	<input type="checkbox"/>	<input type="checkbox"/>	<input type="checkbox"/>	<input type="checkbox"/>	<input type="checkbox"/>	<input type="checkbox"/>	<input type="checkbox"/>	<input type="checkbox"/>	<input type="checkbox"/>
<input type="checkbox"/>	<input type="checkbox"/>	<input type="checkbox"/>	<input type="checkbox"/>	<input type="checkbox"/>	<input type="checkbox"/>	<input type="checkbox"/>	<input type="checkbox"/>	<input type="checkbox"/>	<input type="checkbox"/>
<input type="checkbox"/>	<input type="checkbox"/>	<input type="checkbox"/>	<input type="checkbox"/>	<input type="checkbox"/>	<input type="checkbox"/>	<input type="checkbox"/>	<input type="checkbox"/>	<input type="checkbox"/>	<input type="checkbox"/>
<input type="checkbox"/>	<input type="checkbox"/>	<input type="checkbox"/>	<input type="checkbox"/>	<input type="checkbox"/>	<input type="checkbox"/>	<input type="checkbox"/>	<input type="checkbox"/>	<input type="checkbox"/>	<input type="checkbox"/>
<input type="checkbox"/>	<input type="checkbox"/>	<input type="checkbox"/>	<input type="checkbox"/>	<input type="checkbox"/>	<input type="checkbox"/>	<input type="checkbox"/>	<input type="checkbox"/>	<input type="checkbox"/>	<input type="checkbox"/>
<input type="checkbox"/>	<input type="checkbox"/>	<input type="checkbox"/>	<input type="checkbox"/>	<input type="checkbox"/>	<input type="checkbox"/>	<input type="checkbox"/>	<input type="checkbox"/>	<input type="checkbox"/>	<input type="checkbox"/>
<input type="checkbox"/>	<input type="checkbox"/>	<input type="checkbox"/>	<input type="checkbox"/>	<input type="checkbox"/>	<input type="checkbox"/>	<input type="checkbox"/>	<input type="checkbox"/>	<input type="checkbox"/>	<input type="checkbox"/>
<input type="checkbox"/>	<input type="checkbox"/>	<input type="checkbox"/>	<input type="checkbox"/>	<input type="checkbox"/>	<input type="checkbox"/>	<input type="checkbox"/>	<input type="checkbox"/>	<input type="checkbox"/>	<input type="checkbox"/>
<input type="checkbox"/>	<input type="checkbox"/>	<input type="checkbox"/>	<input type="checkbox"/>	<input type="checkbox"/>	<input type="checkbox"/>	<input type="checkbox"/>	<input type="checkbox"/>	<input type="checkbox"/>	<input type="checkbox"/>
<input type="checkbox"/>	<input type="checkbox"/>	<input type="checkbox"/>	<input type="checkbox"/>	<input type="checkbox"/>	<input type="checkbox"/>	<input type="checkbox"/>	<input type="checkbox"/>	<input type="checkbox"/>	<input type="checkbox"/>
<input type="checkbox"/>	<input type="checkbox"/>	<input type="checkbox"/>	<input type="checkbox"/>	<input type="checkbox"/>	<input type="checkbox"/>	<input type="checkbox"/>	<input type="checkbox"/>	<input type="checkbox"/>	<input type="checkbox"/>
<input type="checkbox"/>	<input type="checkbox"/>	<input type="checkbox"/>	<input type="checkbox"/>	<input type="checkbox"/>	<input type="checkbox"/>	<input type="checkbox"/>	<input type="checkbox"/>	<input type="checkbox"/>	<input type="checkbox"/>
<input type="checkbox"/>	<input type="checkbox"/>	<input type="checkbox"/>	<input type="checkbox"/>	<input type="checkbox"/>	<input type="checkbox"/>	<input type="checkbox"/>	<input type="checkbox"/>	<input type="checkbox"/>	<input type="checkbox"/>
<input type="checkbox"/>	<input type="checkbox"/>	<input type="checkbox"/>	<input type="checkbox"/>	<input type="checkbox"/>	<input type="checkbox"/>	<input type="checkbox"/>	<input type="checkbox"/>	<input type="checkbox"/>	<input type="checkbox"/>
<input type="checkbox"/>	<input type="checkbox"/>	<input type="checkbox"/>	<input type="checkbox"/>	<input type="checkbox"/>	<input type="checkbox"/>	<input type="checkbox"/>	<input type="checkbox"/>	<input type="checkbox"/>	<input type="checkbox"/>
<input type="checkbox"/>	<input type="checkbox"/>	<input type="checkbox"/>	<input type="checkbox"/>	<input type="checkbox"/>	<input type="checkbox"/>	<input type="checkbox"/>	<input type="checkbox"/>	<input type="checkbox"/>	<input type="checkbox"/>
<input type="checkbox"/>	<input type="checkbox"/>	<input type="checkbox"/>	<input type="checkbox"/>	<input type="checkbox"/>	<input type="checkbox"/>	<input type="checkbox"/>	<input type="checkbox"/>	<input type="checkbox"/>	<input type="checkbox"/>
<input type="checkbox"/>	<input type="checkbox"/>	<input type="checkbox"/>	<input type="checkbox"/>	<input type="checkbox"/>	<input type="checkbox"/>	<input type="checkbox"/>	<input type="checkbox"/>	<input type="checkbox"/>	<input type="checkbox"/>
<input type="checkbox"/>	<input type="checkbox"/>	<input type="checkbox"/>	<input type="checkbox"/>	<input type="checkbox"/>	<input type="checkbox"/>	<input type="checkbox"/>	<input type="checkbox"/>	<input type="checkbox"/>	<input type="checkbox"/>
<input type="checkbox"/>	<input type="checkbox"/>	<input type="checkbox"/>	<input type="checkbox"/>	<input type="checkbox"/>	<input type="checkbox"/>	<input type="checkbox"/>	<input type="checkbox"/>	<input type="checkbox"/>	<input type="checkbox"/>
<input type="checkbox"/>	<input type="checkbox"/>	<input type="checkbox"/>	<input type="checkbox"/>	<input type="checkbox"/>	<input type="checkbox"/>	<input type="checkbox"/>	<input type="checkbox"/>	<input type="checkbox"/>	<input type="checkbox"/>
<input type="checkbox"/>	<input type="checkbox"/>	<input type="checkbox"/>	<input type="checkbox"/>	<input type="checkbox"/>	<input type="checkbox"/>	<input type="checkbox"/>	<input type="checkbox"/>	<input type="checkbox"/>	<input type="checkbox"/>
<input type="checkbox"/>	<input type="checkbox"/>	<input type="checkbox"/>	<input type="checkbox"/>	<input type="checkbox"/>	<input type="checkbox"/>	<input type="checkbox"/>	<input type="checkbox"/>	<input type="checkbox"/>	<input type="checkbox"/>
<input type="checkbox"/>	<input type="checkbox"/>	<input type="checkbox"/>	<input type="checkbox"/>	<input type="checkbox"/>	<input type="checkbox"/>	<input type="checkbox"/>	<input type="checkbox"/>	<input type="checkbox"/>	<input type="checkbox"/>
<input type="checkbox"/>	<input type="checkbox"/>	<input type="checkbox"/>	<input type="checkbox"/>	<input type="checkbox"/>	<input type="checkbox"/>	<input type="checkbox"/>	<input type="checkbox"/>	<input type="checkbox"/>	<input type="checkbox"/>
<input type="checkbox"/>	<input type="checkbox"/>	<input type="checkbox"/>	<input type="checkbox"/>	<input type="checkbox"/>	<input type="checkbox"/>	<input type="checkbox"/>	<input type="checkbox"/>	<input type="checkbox"/>	<input type="checkbox"/>
<input type="checkbox"/>	<input type="checkbox"/>	<input type="checkbox"/>	<input type="checkbox"/>	<input type="checkbox"/>	<input type="checkbox"/>	<input type="checkbox"/>	<input type="checkbox"/>	<input type="checkbox"/>	<input type="checkbox"/>
<input type="checkbox"/>	<input type="checkbox"/>	<input type="checkbox"/>	<input type="checkbox"/>	<input type="checkbox"/>	<input type="checkbox"/>	<input type="checkbox"/>	<input type="checkbox"/>	<input type="checkbox"/>	<input type="checkbox"/>
<input type="checkbox"/>	<input type="checkbox"/>	<input type="checkbox"/>	<input type="checkbox"/>	<input type="checkbox"/>	<input type="checkbox"/>	<input type="checkbox"/>	<input type="checkbox"/>	<input type="checkbox"/>	<input type="checkbox"/>
<input type="checkbox"/>	<input type="checkbox"/>	<input type="checkbox"/>	<input type="checkbox"/>	<input type="checkbox"/>	<input type="checkbox"/>	<input type="checkbox"/>	<input type="checkbox"/>	<input type="checkbox"/>	<input type="checkbox"/>
<input type="checkbox"/>	<input type="checkbox"/>	<input type="checkbox"/>	<input type="checkbox"/>	<input type="checkbox"/>	<input type="checkbox"/>	<input type="checkbox"/>	<input type="checkbox"/>	<input type="checkbox"/>	<input type="checkbox"/>
<input type="checkbox"/>	<input type="checkbox"/>	<input type="checkbox"/>	<input type="checkbox"/>	<input type="checkbox"/>	<input type="checkbox"/>	<input type="checkbox"/>	<input type="checkbox"/>	<input type="checkbox"/>	<input type="checkbox"/>
<input type="checkbox"/>	<input type="checkbox"/>	<input type="checkbox"/>	<input type="checkbox"/>	<input type="checkbox"/>	<input type="checkbox"/>	<input type="checkbox"/>	<input type="checkbox"/>	<input type="checkbox"/>	<input type="checkbox"/>
<input type="checkbox"/>	<input type="checkbox"/>	<input type="checkbox"/>	<input type="checkbox"/>	<input type="checkbox"/>	<input type="checkbox"/>	<input type="checkbox"/>	<input type="checkbox"/>	<input type="checkbox"/>	<input type="checkbox"/>
<input type="checkbox"/>	<input type="checkbox"/>	<input type="checkbox"/>	<input type="checkbox"/>	<input type="checkbox"/>	<input type="checkbox"/>	<input type="checkbox"/>	<input type="checkbox"/>	<input type="checkbox"/>	<input type="checkbox"/>
<input type="checkbox"/>	<input type="checkbox"/>	<input type="checkbox"/>	<input type="checkbox"/>	<input type="checkbox"/>	<input type="checkbox"/>	<input type="checkbox"/>	<input type="checkbox"/>	<input type="checkbox"/>	<input type="checkbox"/>
<input type="checkbox"/>	<input type="checkbox"/>	<input type="checkbox"/>	<input type="checkbox"/>	<input type="checkbox"/>	<input type="checkbox"/>	<input type="checkbox"/>	<input type="checkbox"/>	<input type="checkbox"/>	<input type="checkbox"/>
<input type="checkbox"/>	<input type="checkbox"/>	<input type="checkbox"/>	<input type="checkbox"/>	<input type="checkbox"/>	<input type="checkbox"/>	<input type="checkbox"/>	<input type="checkbox"/>	<input type="checkbox"/>	<input type="checkbox"/>
<input type="checkbox"/>	<input type="checkbox"/>	<input type="checkbox"/>	<input type="checkbox"/>	<input type="checkbox"/>	<input type="checkbox"/>	<input type="checkbox"/>	<input type="checkbox"/>	<input type="checkbox"/>	<input type="checkbox"/>
<input type="checkbox"/>	<input type="checkbox"/>	<input type="checkbox"/>	<input type="checkbox"/>	<input type="checkbox"/>	<input type="checkbox"/>	<input type="checkbox"/>	<input type="checkbox"/>	<input type="checkbox"/>	<input type="checkbox"/>
<input type="checkbox"/>	<input type="checkbox"/>	<input type="checkbox"/>	<input type="checkbox"/>	<input type="checkbox"/>	<input type="checkbox"/>	<input type="checkbox"/>	<input type="checkbox"/>	<input type="checkbox"/>	<input type="checkbox"/>
<input type="checkbox"/>	<input type="checkbox"/>	<input type="checkbox"/>	<input type="checkbox"/>	<input type="checkbox"/>	<input type="checkbox"/>	<input type="checkbox"/>	<input type="checkbox"/>	<input type="checkbox"/>	<input type="checkbox"/>
<input type="checkbox"/>	<input type="checkbox"/>	<input type="checkbox"/>	<input type="checkbox"/>	<input type="checkbox"/>	<input type="checkbox"/>	<input type="checkbox"/>	<input type="checkbox"/>	<input type="checkbox"/>	<input type="checkbox"/>
<input type="checkbox"/>	<input type="checkbox"/>	<input type="checkbox"/>	<input type="checkbox"/>	<input type="checkbox"/>	<input type="checkbox"/>	<input type="checkbox"/>	<input type="checkbox"/>	<input type="checkbox"/>	<input type="checkbox"/>
<input type="checkbox"/>	<input type="checkbox"/>	<input type="checkbox"/>	<input type="checkbox"/>	<input type="checkbox"/>	<input type="checkbox"/>	<input type="checkbox"/>	<input type="checkbox"/>	<input type="checkbox"/>	<input type="checkbox"/>
<input type="checkbox"/>	<input type="checkbox"/>	<input type="checkbox"/>	<input type="checkbox"/>	<input type="checkbox"/>	<input type="checkbox"/>	<input type="checkbox"/>	<input type="checkbox"/>	<input type="checkbox"/>	<input type="checkbox"/>
<input type="checkbox"/>	<input type="checkbox"/>	<input type="checkbox"/>	<input type="checkbox"/>	<input type="checkbox"/>	<input type="checkbox"/>	<input type="checkbox"/>	<input type="checkbox"/>	<input type="checkbox"/>	<input type="checkbox"/>
<input type="checkbox"/>	<input type="checkbox"/>	<input type="checkbox"/>	<input type="checkbox"/>	<input type="checkbox"/>	<input type="checkbox"/>	<input type="checkbox"/>	<input type="checkbox"/>	<input type="checkbox"/>	<input type="checkbox"/>
<input type="checkbox"/>	<input type="checkbox"/>	<input type="checkbox"/>	<input type="checkbox"/>	<input type="checkbox"/>	<input type="checkbox"/>	<input type="checkbox"/>	<input type="checkbox"/>	<input type="checkbox"/>	<input type="checkbox"/>
<input type="checkbox"/>	<input type="checkbox"/>	<input type="checkbox"/>	<input type="checkbox"/>	<input type="checkbox"/>	<input type="checkbox"/>	<input type="checkbox"/>	<input type="checkbox"/>	<input type="checkbox"/>	<input type="checkbox"/>
<input type="checkbox"/>	<input type="checkbox"/>	<input type="checkbox"/>	<input type="checkbox"/>	<input type="checkbox"/>	<input type="checkbox"/>	<input type="checkbox"/>	<input type="checkbox"/>	<input type="checkbox"/>	<input type="checkbox"/>
<input type="checkbox"/>	<input type="checkbox"/>	<input type="checkbox"/>	<input type="checkbox"/>	<input type="checkbox"/>	<input type="checkbox"/>	<input type="checkbox"/>	<input type="checkbox"/>	<input type="checkbox"/>	<input type="checkbox"/>
<input type="checkbox"/>	<input type="checkbox"/>	<input type="checkbox"/>	<input type="checkbox"/>	<input type="checkbox"/>	<input type="checkbox"/>	<input type="checkbox"/>	<input type="checkbox"/>	<input type="checkbox"/>	<input type="checkbox"/>
<input type="checkbox"/>	<input type="checkbox"/> </								

FV-603 Saracen

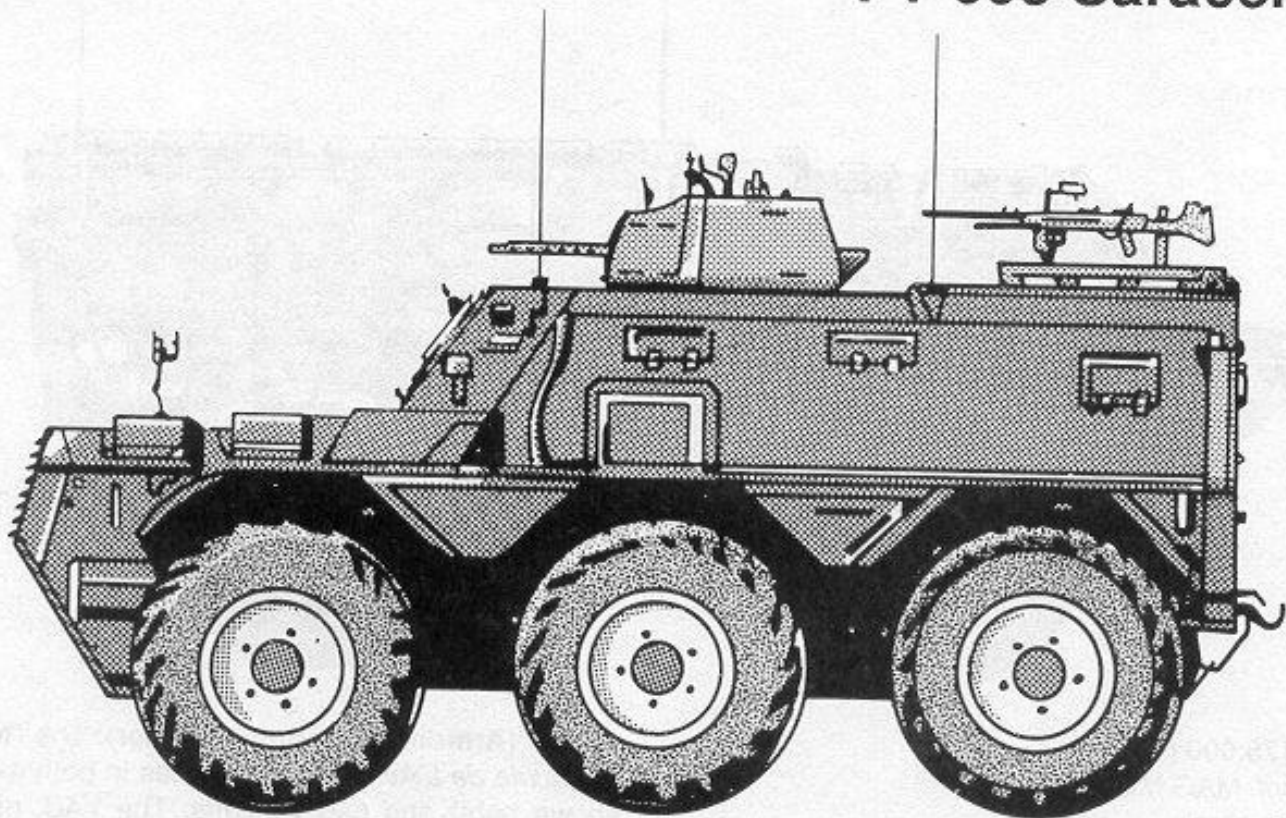

Price: \$35,000 (R/—)

Armament: L7A2 GPMG, L7A2 GPMG (C)

Ammo: As cargo

Fuel Type: G, A

Load: 1 ton

Veh Wt: 10 tons

Crew: 2+10

Mnt: 4

Night Vision: Headlights

FV-603 Saracen (Armored Personnel Carrier): The Saracen is an obsolete, 6x6 APC which left British service in 1984. It lacks NBC sealing and advanced night vision equipment, and is thus not up to front-line service in modern armies. A number were brought out of depot storage late in the war and pressed into service with rear echelons in order to free more modern vehicles for front-line service. Two doors in the rear facilitate passenger departures. The vehicle has a machinegun turret on the front deck and a ring mount for a dismountable MAG MG on the rear deck. The Saracen is not amphibious. The vehicle is equipped with three firing ports on each side and one in the rear (these accept any assault or battle rifle).

Damage Record

Crewmembers: Commander/gunner Driver

Passengers: 1 2 3 4 5 6 7 8 9 10

Sight/Vision: Night vision equipment

Radio:

L7A2 GPMG:

L7A2 GPMG (C):

Traverse:

Engine:

Fuel (% Consumed or Destroyed):

Suspension: Minor damage Immobilized

Tr Mov: 120/80

Com Mov: 60/40

Fuel Cap: 200

Fuel Cons: 55

Combat Statistics

Config: Trt TF: 1 HF: 3

Susp: W(3) TS: 1 HS: 2

TR: 1 HR: 2

WEAPON DATA

Weapon	ROF	Dam	Pen	Blk	Mag	—Recoil—		
						SS	Brst	Rng
L7A2 GPMG	10	4	2-3-Nil	6	100B	1	7	65
bipod	10	4	2-3-Nil	6	100B	1	4	90
tripod	10	4	2-3-Nil	6	100B	1	2	125

AMMUNITION

Use MG ammo records provided on page 5.

FV-721 Fox

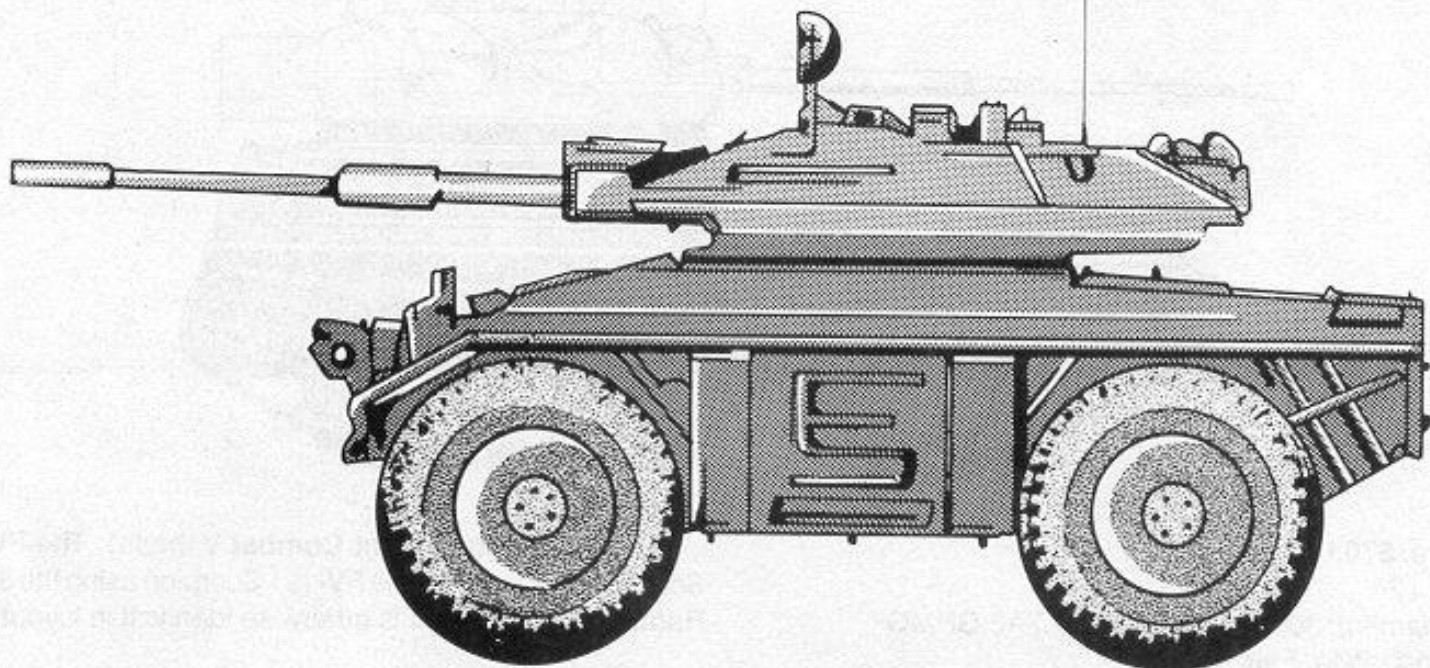

Price: \$50,000 (S/R)

RF: +3

Armament: 30mm Rarden AC, L7A2 GPMG

Ammo: 135x30mm

Fuel Type: G, A

Load: 400 kg

Veh Wt: 6 tons

Crew: 3

Mnt: 8.

Night Vision: Headlights, passive IR

FV-721 Fox (Light Combat Vehicle): The FV-721 Fox armored car is a British-built, 4x4, armored reconnaissance vehicle, which replaced the earlier (and now obsolete) Ferret armored car. Its lack of an amphibious capability is a severe drawback in a reconnaissance vehicle, however. The Fox has a driver's hatch on the front deck, hatches on the turret deck for the commander and gunner, and another hatch on the left side of the vehicle.

Tr Mov: 200/100

Com Mov: 90/50

Fuel Cap: 390

Fuel Cons: 180

Damage Record

Crewmembers: Commander Driver Gunner

Sight/Vision: Gun sight Range finder Night vision equipment

Radio:

30mm Rarden AC:

L7A2 GPMG:

Traverse:

Engine:

Fuel (% Consumed or Destroyed):

Suspension: Minor damage Immobilized

Combat Statistics

Config: Trt TF: 6 HF: 6

Susp: W(3) TS: 3 HS: 4

TR: 3 HR: 4

AMMUNITION

Use 30mm and MG ammo records provided on page 5.

WEAPON DATA

Weapon	ROF	Mag	Rng	Ammo	Damage	Pen
30mm Rar	5	100B	250	APDS	16	8/3/-2
			250	HE	C:1, B:2	-6C

WEAPON DATA

Weapon	ROF	Dam	Pen	Blk	Mag	—Recoil—		
						SS	Brst	Rng
L7A2 GPMG	10	4	2-3-Nil	6	100B	1	7	65
bipod	10	4	2-3-Nil	6	100B	1	4	90
tripod	10	4	2-3-Nil	6	100B	1	2	125

C-1 "Ariete"

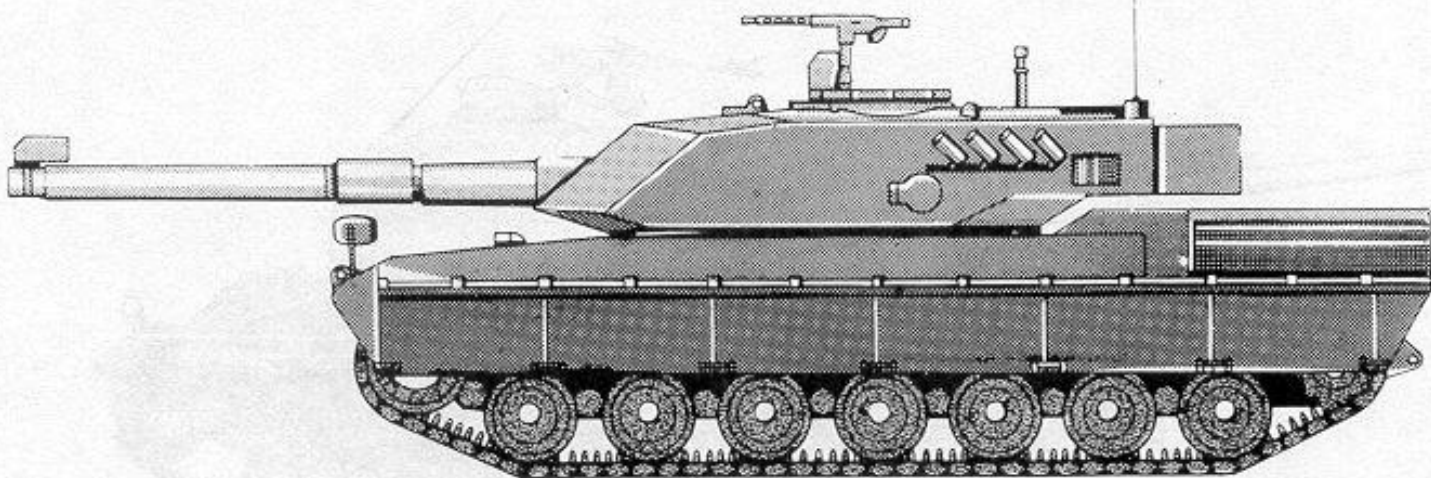

Price: \$700,000 (S/R)

RF: +4

Armament: 120mm gun, MAG MG (coaxial), MAG MG (C)

Stabilization: Good

Ammo: 40x120mm

Fuel Type: D, A

Load: 700 kg

Veh Wt: 50 tons

Crew: 4

Mnt: 12

Night Vision: White light searchlight, image intensifier

C-1 "Ariete" (Main Battle Tank): Adopted in the early 1990s, the C-1 became the principal combat tank in Italian service, replacing the M60 and older tanks of US manufacture. There is a driver's hatch on the middle front deck, and a loader's hatch and commander's hatch on the turret deck. A weapons mount is located by the commander's hatch.

Tr Mov: 120/70

Com Mov: 30/20

Fuel Cap: 2000

Fuel Cons: 500

Damage Record

Crewmembers: Commander Driver Gunner
Loader

Sight/Vision: Gun sight Range finder Night vision equipment

Radio:

120mm Gun:

MAG MG (Coaxial):

MAG MG (C):

Traverse:

Engine:

Fuel (% Consumed or Destroyed):

Suspension: Minor damage Immobilized

Combat Statistics

Config: Trt	TF: 80-Cp	HF: 100-Cp
Susp: T: 6	TS: 20	HS: 20
	TR: 10	HR: 10

AMMUNITION

Use MG ammo records provided on page 5.

120mm Gun (40 rounds)

WEAPON DATA

—Recoil—

Weapon	ROF	Dam	Pen	Blk	Mag	SS	Brst	Rng
MAG MG	10	4	2-3-Nil	6	100B	1	7	65
bipod	10	4	2-3-Nil	6	100B	1	4	90
tripod	10	4	2-3-Nil	6	100B	1	2	125

WEAPON DATA

Type	Round	Rng	Damage	Pen
120mm	APFSDS	500	28	110/100/90/70
Rld: 1	APFSDSDU	500	28	150/140/130/110
	HEAT	400	C:10, B:20	110C
	WP	400	C:3, B:36	Nil

INTRODUCTION

This book, like **American Combat Vehicle Handbook** and **Soviet Combat Vehicle Handbook**, is intended to supplement the basic vehicle listing provided with the 2nd edition **Twilight: 2000** rules. Its pages provide a new approach to information handling by making the information a referee needs readily available, in a form that is compact and easy to use.

It is intended that referees photocopy the relevant pages (one copy for each vehicle used by the players or NPCs) and lay these out in front of him. Ammunition, fuel, and damage from travel or combat are easily recorded by the system of boxes, and other information can be noted in the margins as needed. The sheets can be saved from session to session or disposed of as the situation dictates.

In any case, the referee has the information needed for a particular vehicle and will not need to constantly flip through several booklets as the adventure session proceeds.

Permission is granted for purchasers of this book to photocopy any page or pages for personal use.

Data Conversion: Data conversions from game terms to reality are straightforward except for speed. The number to the left of the slash under Travel Movement (TrMov) is the vehicle's road speed in kilometers per hour times two. So obviously, halving the TrMov will give kilometers per hour. Cross-country speeds can be determined by proportional calculations.

EQUIPMENT LIST ADDITIONS

Autocannon

20mm AC: An autocannon mounted on a variety of armored cars and APCs.

30mm AC: An autocannon mounted on a variety of armored cars and APCs.

35mm AC: An autocannon mounted on a variety of self-propelled anti-aircraft vehicles.

Large-Caliber Guns

76mm Gun: A large-caliber rifled gun mounted on the British Scorpion, the Canadian Cougar and other vehicles.

90mm Gun: A low-pressure 90mm gun used in a number of light combat vehicles.

90mmf Gun: A French-built 90mm gun, mounted in a number of French vehicles.

Howitzers

105mm Howitzer: A light howitzer mounted in the British Abbot APC.

AMMUNITION

Antitank Guided Missiles

Swingfire ATGM: A British-built, first-generation, antitank guided missile, the most sophisticated of its class.

Wt: 28 kg.

Price: \$3000 (S/R).

Antiaircraft Missiles

Rapier: A radar-guided anti-aircraft missile with an HE warhead.

Wt: 43 kg.

Price: \$4500 (R/—).

Roland II: A radar-guided anti-aircraft missile with an HE warhead.

Wt: 80 kg.

Price: \$2500 (R/R).

Autocannon Rounds

20mm HE:

Wt: 0.5 kg each, 50 kg per 100-round belt.

Price: \$450 per case (S/R).

20mm AP:

Wt: 0.5 kg each, 50 kg per 100-round belt.

Price: \$450 per belt (S/R).

25mm Oerlikon API:

Wt: 0.5 kg.

Price: \$9 each (R/—).

30mm API:

Wt: 100 kg per case of 33, belted.

Price: \$300 per case (R/—).

35mm API:

Wt: 120 kg per case of 33, belted.

Price: \$350 per case (R/—).

Large-Caliber Rounds

76mm HE:

Wt: 0.3 kg.

Price: \$35 each (S/—).

76mm HESH:

Wt: 0.3 kg.

Price: \$37 each (R/—).

76mm CHEM: HC smoke is the only type available for this round.

Wt: 0.3 kg.

Price: \$35 each (R/—).

76mm Cannister:

Wt: 0.4 kg.

Price: \$32 each (S/—).

90mm APDS-T:

Wt: 31 kg.

Price: \$500 each (S/R).

90mm HEAT:

Wt: 30 kg.

Price: \$500 each (S/R).

90mmf APFSDS:

Wt: 32 kg.

Price: \$600 each (R/—).

90mmf HEAT:

Wt: 32 kg.

Price: \$620 each (S/R).

90mmf HE:

Wt: 29 kg.

Price: \$550 each (S/R).

Howitzer Rounds

105mm How HE:

Wt: 38 kg.

Price: \$450 each (R/R).

105mm How HESH:

Wt: 37 kg.

Price: \$550 each (R/—).

105mm How CHEM:

Wt: 38 kg.

Price: \$630 each (R/—).

Ammunition Distribution 120mm Gun (42 rounds)

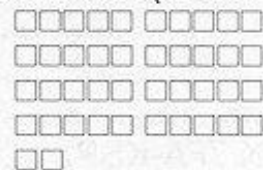

Where different types of ammunition are stored, simply draw lines sectioning off portions of the record and label them accordingly. This is especially useful for keeping track of tank gun ammunition.

For example, to record that a particular Leopard II tank starts out carrying 22 APFSDS rounds and 20 APFSDSDU rounds, and has fired one of each, mark the chart as shown above.

Ammunition Record Forms

Some ammo types are present in too large a quantity to be readily recorded in the space available on the vehicle sheets. Make as many copies of these forms as you need (clipping and pasting them as required) to assemble an ammunition record for each vehicle.

Each box represents a single round of ammunition.

**7.5mm MAS
(50-round belt)**

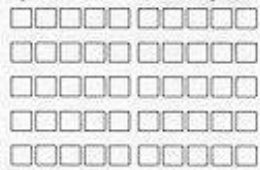

**30mm Autocannon
(33-round belt)**

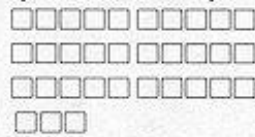

**35mm Autocannon
(33-round belt)**

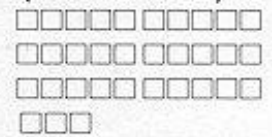

**7.5mm MAS
(50-round belt)**

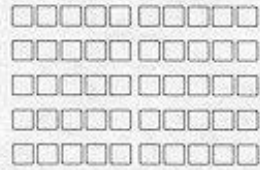

**30mm Autocannon
(33-round belt)**

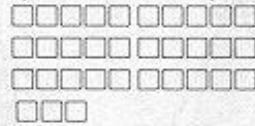

**35mm Autocannon
(33-round belt)**



**7.5mm MAS
(50-round belt)**

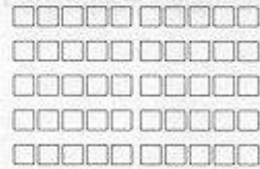

**30mm Autocannon
(33-round belt)**



**20mm Autocannon
(100-round belt)**

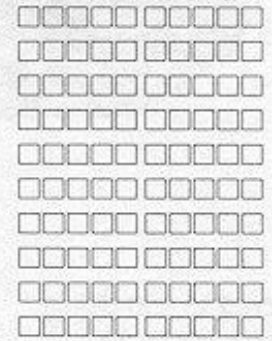

**7.62mmN
(100-round belt)**

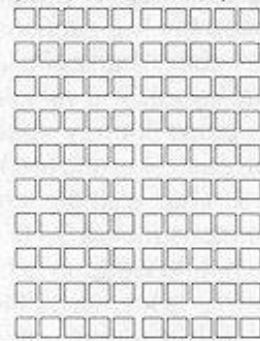

**.50 BMG/SLAP
(105-round belt)**

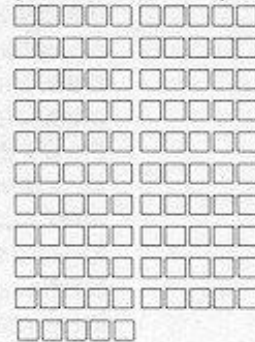

**20mm Autocannon
(100-round belt)**

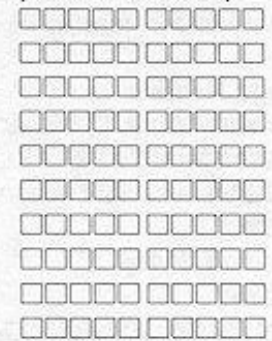

**7.62mmN
(100-round belt)**

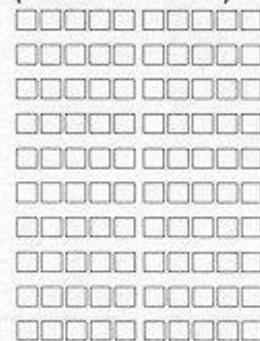

**.50 BMG/SLAP
(105-round belt)**

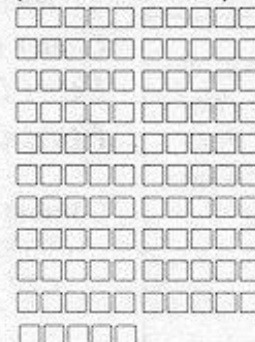

**20mm Autocannon
(100-round belt)**

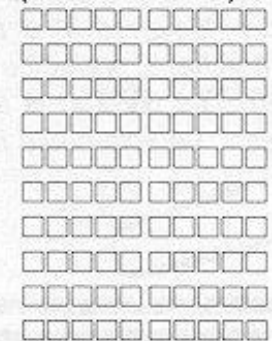

YA 4442

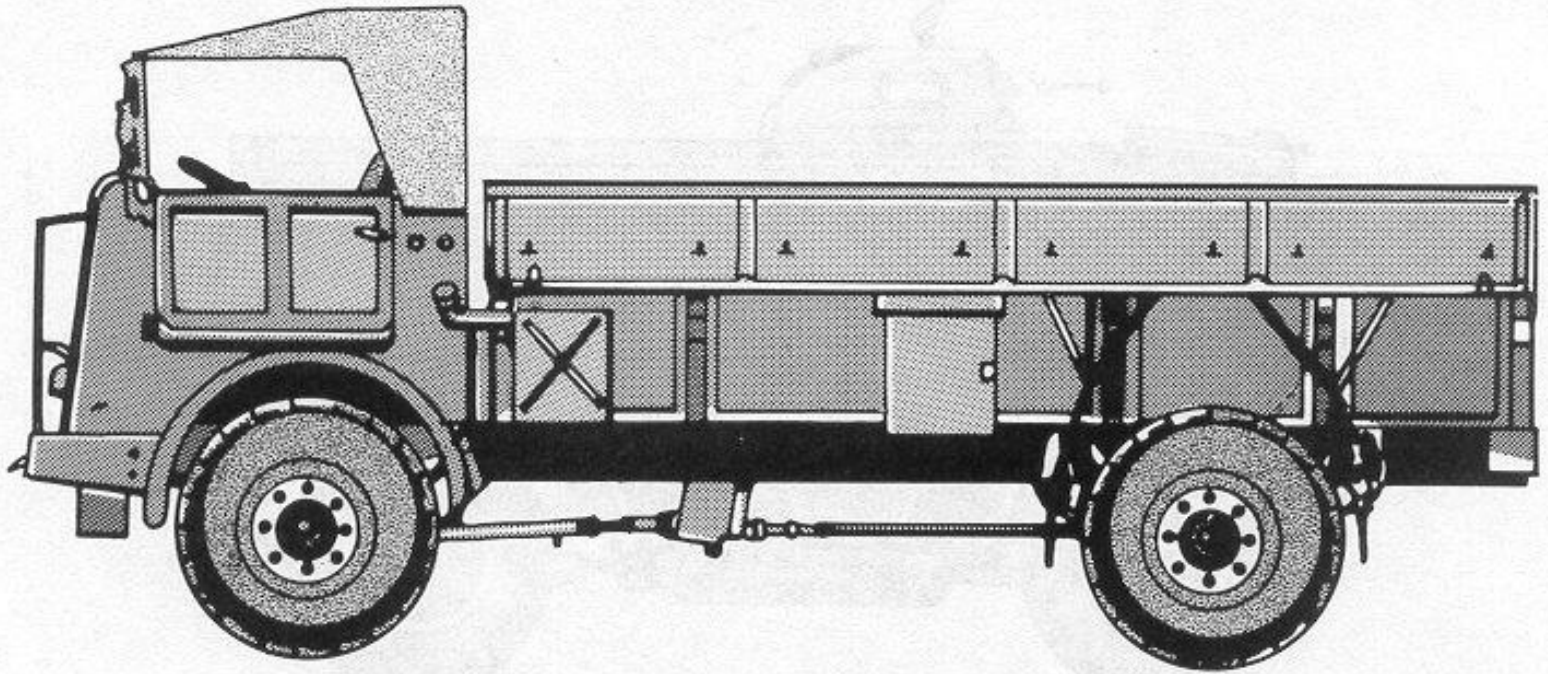

Price: \$20,000 (C/S)
Fuel Type: D, A
Load: 4 tons
Veh Wt: 8 tons
Crew: 2+10
Mnt: 8
Night Vision: Headlights

Damage Record

Crewmembers: Driver Assistant driver
Passengers: 1 2 3 4 5 6 7 8 9 10
Sight/Vision: Night vision equipment
Radio:
Weapon (If Any):
Engine:
Fuel (% Consumed or Destroyed):
Suspension: Minor damage Immobilized

YA 4442 (Unarmored Cargo Vehicle): The Dutch firm of DAF manufactures a number of tactical transport vehicles, of which the 4x4 YA 4442 is typical. It and similar vehicles by the same manufacturer have been adopted by several European armies, including the British forces in the BAOR (British Army of the Rhine). The vehicle can be fitted with a weapons mount (NHT equivalent) but is not normally armed.

Tr Mov: 160/15
Com Mov: 55/10
Fuel Cap: 280
Fuel Cons: 70

Combat Statistics

Config: Std HF: 1
Susp: W(2) HS: 1
HR: 1

Jagdpanzer Kanone

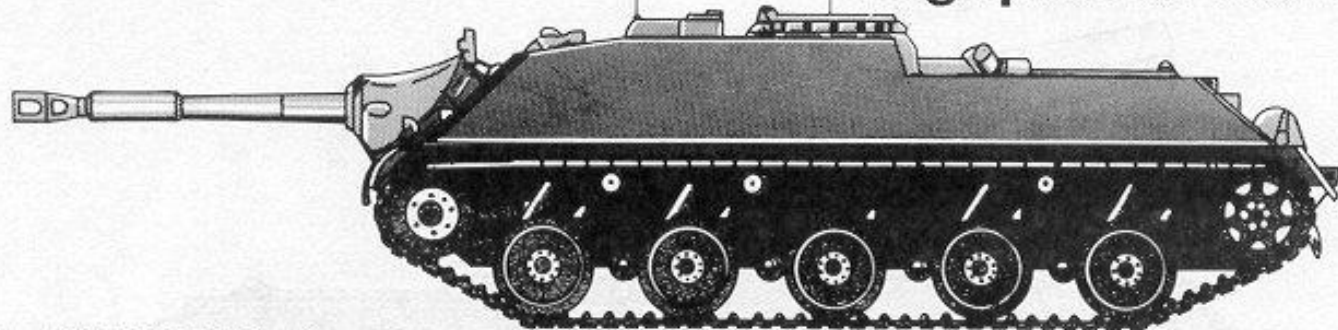

Price: \$850,000 (R/R)

RF: +4

Armament: 90mm gun, MG3 MG (C)

Stabilization: Fair

Ammo: 36x90mm

Fuel Type: D, G, AvG, A

Load: 500 kg

Veh Wt: 56 tons

Crew: 4

Mnt: 6

Night Vision: Headlights, passive IR

Jagdpanzer Kanone (Self-Propelled Artillery): The German-built *Jagdpanzer Kanone* is a turretless antitank vehicle on a Leopard chassis. The 90mm gun is located in the forward casemate; the crew enter and exit through two hatches on the forward deck. Typical of vehicles of this configuration, the *Jagdpanzer Kanone* has a low silhouette and a limited arc of fire. This is not as great a disadvantage in a tank destroyer as it would be in a main battle tank, however, since the former is usually deployed to attack from prepared positions.

Tr Mov: 130/80

Com Mov: 30/20

Fuel Cap: 800

Fuel Cons: 200

Damage Record

Crewmembers: Commander Driver Gunner Loader

Sight/Vision: Gun sight Range finder Night vision equipment

Radio:

90mm Gun:

MG3 MG (C):

Engine:

Fuel (% Consumed or Destroyed):

Suspension: Minor damage Immobilized

Combat Statistics

Config: Stnd HF: 26

Susp: T: 6 HS: 7

HR: 5

AMMUNITION

Use MG ammo records provided on page 5.

WEAPON DATA

Type	Round	Rng	Damage	Pen
90mm	APDS-T	350	24	30/25/20/15
Rld: 1	HEAT	350	C:5, B:10	60C

—Recoil—

Weapon	ROF	Dam	Pen	Blk	Mag	SS	Brst	Rng
MG3	10	4	2-3-Nil	6	50B	1	7	65
bipod	10	4	2-3-Nil	6	50B	1	3	90
tripod	10	4	2-3-Nil	6	50B	1	1	125

90mm Gun (36 rounds)

The tank destroyer as a separate vehicle class was developed during WWII. Many nations built them, including the US and the USSR. The Jagdpanzer (tank hunter) is almost the last of the antitank vehicles to use a gun—antitank guided missiles such as the TOW or Milan are now the standard.



EPC "LeClerc"

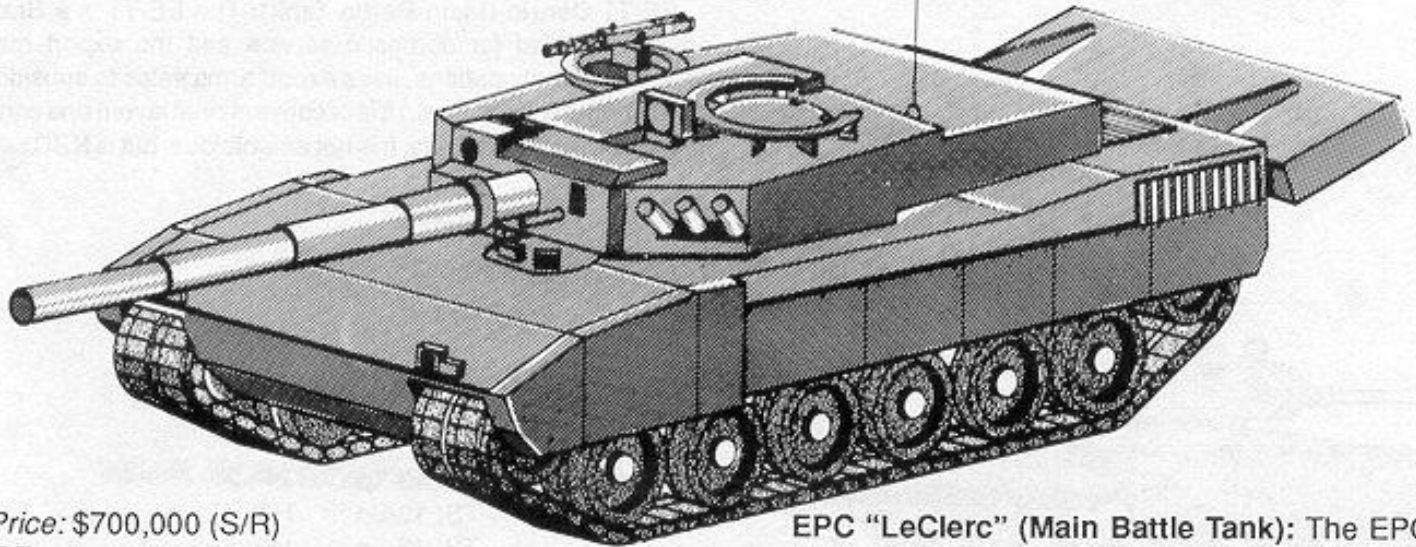

Price: \$700,000 (S/R)

RF: +4

Armament: 120mm gun, MAG MG (coaxial), MAG MG (C)

Stabilization: Good

Ammo: 40x120mm

Fuel Type: D, A

Load: 700 kg

Veh Wt: 54 tons

Crew: 3

Mnt: 14

Night Vision: White light searchlight, image intensifier

EPC "LeClerc" (Main Battle Tank): The EPC (*Engin Principal de Combat*, or main battle tank) began entering service in the early 1990s with French units deployed along the Rhine River. It replaced the earlier AMX-30B2. It is a fairly advanced design and was the first Western tank to include an autoloader for its 120mm smoothbore gun. There is a driver's hatch on the middle front deck, and gunner and commander's hatches on the turret deck. The gun is automatically reloaded. A weapons mount is located by the commander's hatch.

Tr Mov: 140/110

Com Mov: 35/25

Fuel Cap: 2000

Fuel Cons: 550

Damage Record

Crewmembers: Commander Driver Gunner

Sight/Vision: Gun sight Range finder Night vision equipment

Radio:

120mm Gun:

MAG MG (Coaxial):

MAG MG (C):

Loader:

Traverse:

Engine:

Fuel (% Consumed or Destroyed):

Suspension: Minor damage Immobilized

Combat Statistics

Config: Trt TF: 100-Cp HF: 100-Cp

Susp: T: 6 TS: 20 HS: 20

TR: 10 HR: 10

AMMUNITION

Use MG ammo records provided on page 5.

WEAPON DATA

Type	Round	Rng	Damage	Pen
120mm	APFSDS	500	28	110/100/90/70
Rld: 1	APFSDSDU	500	28	150/140/130/110
	HEAT	400	C:10, B:20	110C
	WP	400	C:3, B:36	Nil

—Recoil—

Weapon	ROF	Dam	Pen	Blk	Mag	SS	Brst	Rng
MAG MG	10	4	2-3-Nil	6	100B	1	7	65
bipod	10	4	2-3-Nil	6	100B	1	4	90
tripod	10	4	2-3-Nil	6	100B	1	2	125

120mm Gun (40 rounds)

Leopard II

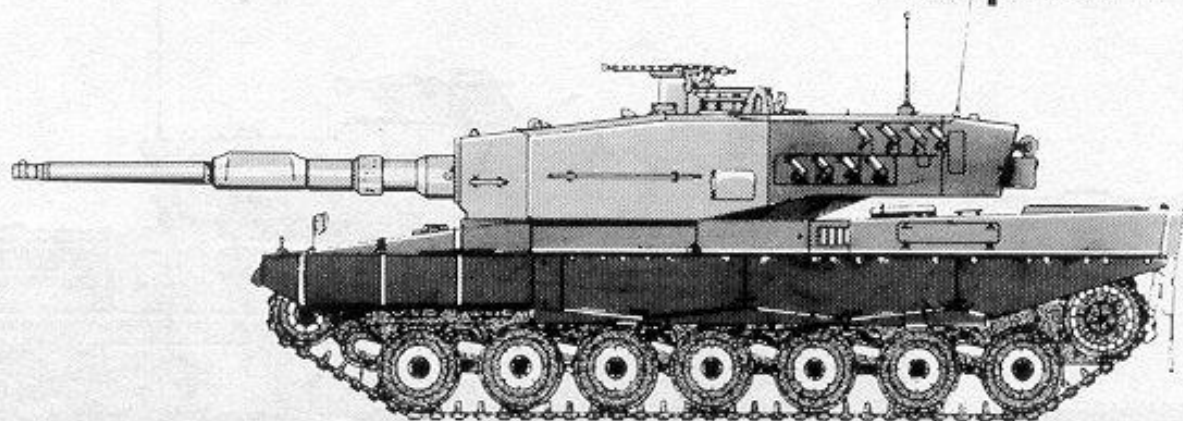

Price: \$650,000 (S/R)

RF: +4

Armament: 120mm gun, MG3 MG (coaxial), MG3 MG (C)

Stabilization: Good

Ammo: 42x120mm

Fuel Type: G, D, A

Load: 700 kg

Veh Wt: 55

Crew: 4

Mnt: 14

Night Vision: White light or IR searchlight, active/passive

Leopard II (Main Battle Tank): Despite its name, the Leopard II actually represents an entirely new design rather than an upgrade of the Leopard I. Protection has been enhanced by the use of a form of compound armor, and the Leopard II was the first Western tank to mount the 120mm smoothbore gun which has since become nearly universal. There is a driver's hatch on the middle front deck, and a loader's hatch and commander's hatch on the turret deck. A weapons mount is located by the commander's hatch.

Tr Mov: 140/110

Com Mov: 35/25

Fuel Cap: 1900

Fuel Cons: 550

Combat Statistics

Config: Trt TF: 100-Cp HF: 200-Cp
 Susp: T: 6 TS: 24 HS: 24
 TR: 20 HR: 10

AMMUNITION

Use MG ammo records provided on page 5.

120mm Gun (42 rounds)

WEAPON DATA

Weapon	ROF	Dam	Pen	Blk	Mag	—Recoil—		
						SS	Brst	Rng
MG3	10	4	2-3-Nil	6	50B	1	7	65
bipod	10	4	2-3-Nil	6	50B	1	3	90
tripod	10	4	2-3-Nil	6	50B	1	1	125

Damage Record

Crewmembers: Commander Driver Gunner Loader

Sight/Vision: Gun sight Range finder Night vision equipment

Radio:

120mm Gun:

MG3 MG (Coaxial):

MG3 MG (C):

Traverse:

Engine:

Fuel (% Consumed or Destroyed):

Suspension: Minor damage Immobilized

WEAPON DATA

Type	Round	Rng	Damage	Pen
120mm	APFSDS	500	28	110/100/90/70
Rld: 1	APFSDSDU	500	28	150/140/130/110
	HEAT	400	C:10, B:20	110C
	WP	400	C:3, B:36	Nil

The 120mm gun of the Leopard II is the same gun used on the American M1A1 and M1A2 Abrams AFVs.

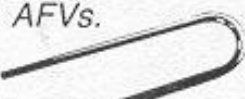

Leopard III

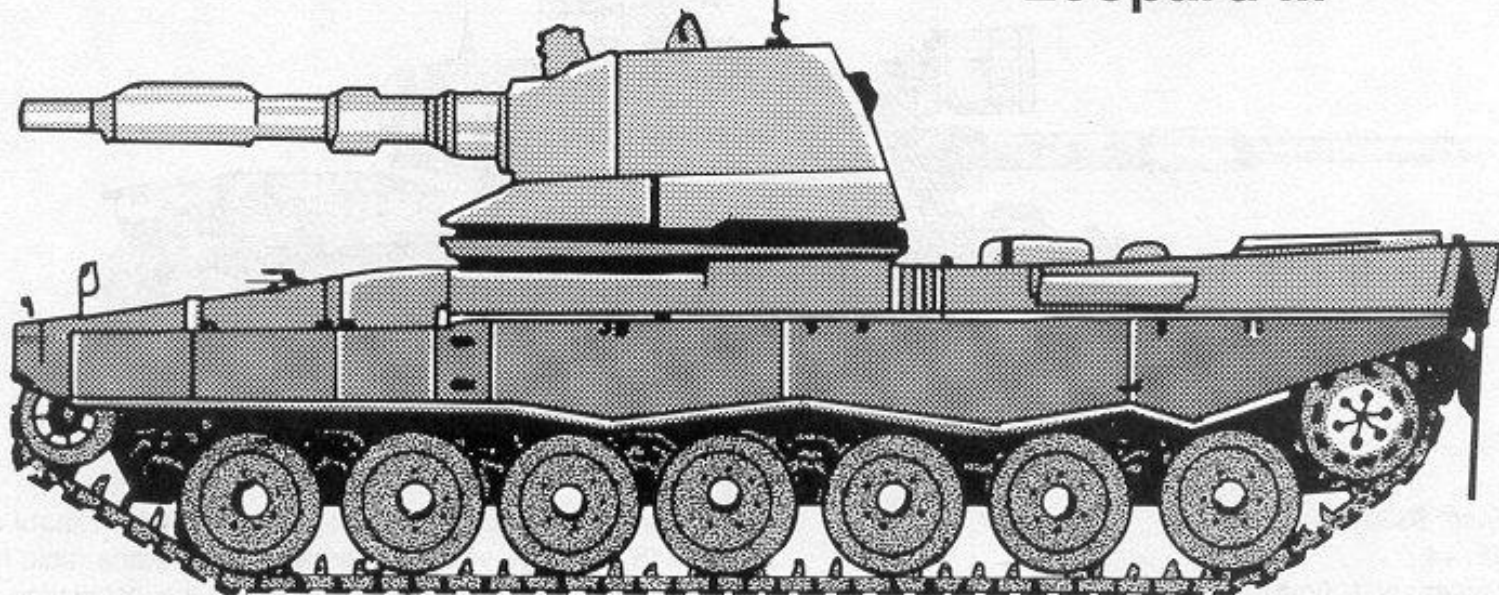

Price: \$700,000 (R/—)

RF: +4

Armament: 120mm gun, MG3 MG (coaxial), MG3 MG (C)

Ammo: 38x120mm

Fuel Type: D, G, A

Load: 500 kg

Veh Wt: 53 tons

Crew: 3

Mnt: 8

Night Vision: White light or IR searchlight, active/passive IR

Damage Record

Crewmembers: Commander Driver Gunner

Sight/Vision: Gun sight Range finder Night vision equipment

Radio:

120mm Gun:

MG3 MG (C):

MG3 MG (Coaxial):

Loader:

Traverse:

Engine:

Fuel (% Consumed or Destroyed):

Suspension: Minor damage Immobilized

WEAPON DATA

Weapon	ROF	Dam	Pen	Blk	Mag	—Recoil—		Rng
						SS	Brst	
MG3	10	4	2-3-Nil	6	50B	1	7	65
bipod	10	4	2-3-Nil	6	50B	1	3	90
tripod	10	4	2-3-Nil	6	50B	1	1	125

Leopard III (Main Battle Tank): Faced with a need for a new and better MBT, the Bundeswehr chose the less expensive of several options and refitted the Leopard II with an automated gun system similar to that mounted on the American M1A2. The Leopard III entered service in 1993, but by the outbreak of the war it had not yet completely replaced the Leopard II.

Tr Mov: 140/110

Com Mov: 35/25

Fuel Cap: 1900

Fuel Cons: 600

Combat Statistics

Config: CIH TF: 120-Cp HF: 200-Cp

Susp: T: 6 TS: 40 HS: 24

TR: 20 HR: 10

AMMUNITION

Use MG ammo records provided on page 5.

120mm Gun (38 rounds)

WEAPON DATA

Type	Round	Rng	Damage	Pen
120mm	APFSDS	500	28	110/100/90/70
Rld: 1	APFSDSDU	500	28	150/140/130/110
	HEAT	400	C:10, B:20	110C
	WP	400	C:3, B:36	Nil

Leopard ARV

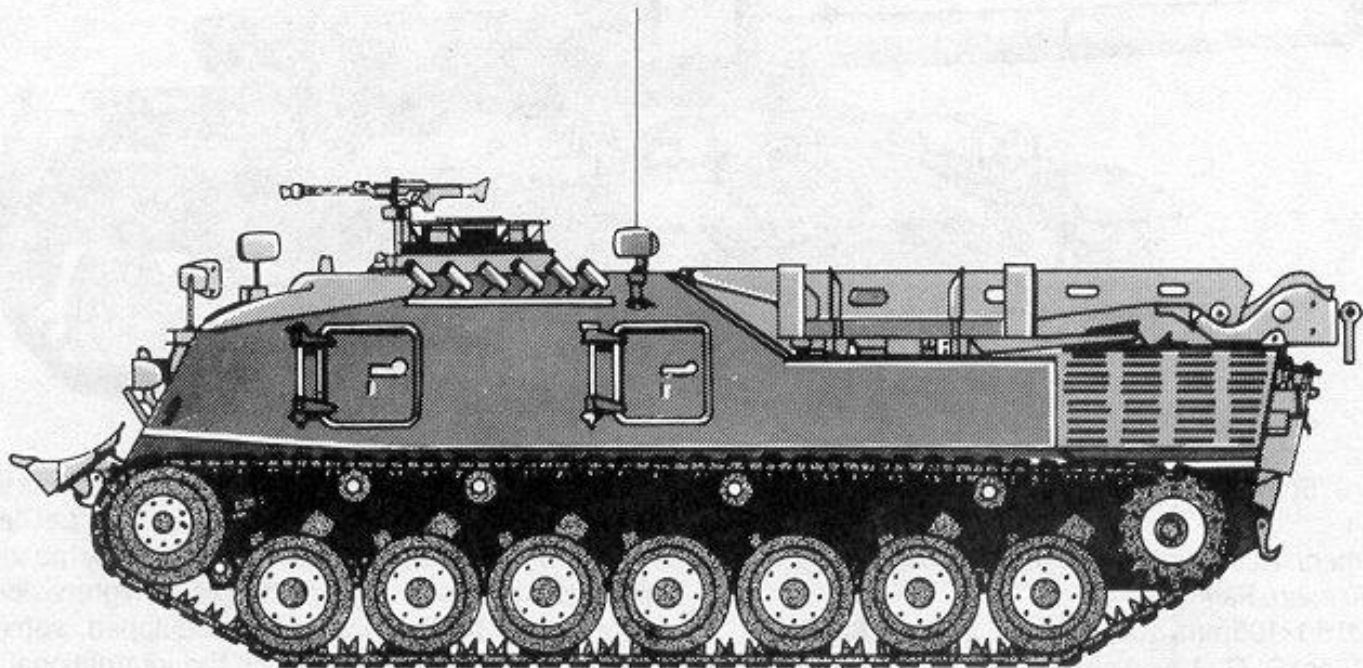

Price: \$160,000 (R/—)
 Armament: MG3 MG
 Ammo: 300x7.62mmN belted
 Fuel Type: D, A
 Load: 400 kg
 Veh Wt: 44 tons
 Crew: 4
 Night Vision: Headlights

Leopard ARV (Engineering Vehicle): The Leopard ARV (armored recovery vehicle) is intended to provide quick repairs to damaged vehicles and then bring them out of the combat zone to rear echelon repair depots. The vehicle's turret has been replaced with a larger crew compartment and a crane (with a capacity of 12 tons) for hoisting engines out of damaged vehicles.

Damage Record

Crewmembers: Commander Driver/Mechanic 1
 Mechanic 2 Mechanic 3
 Sight/Vision: Night vision equipment
 Radio:
 MG3 MG:
 Engine:
 Fuel (% Consumed or Destroyed):
 Suspension: Minor damage Immobilized

Tr Mov: 90/60
Com Mov: 30/20
Fuel Cap: 960
Fuel Cons: 320

Combat Statistics

Config: Stnd HF: 26
 Susp: T: 6 HS: 7
 HR: 5

WEAPON DATA

Weapon	ROF	Dam	Pen	Blk	Mag	—Recoil—		Rng
						SS	Brst	
MG3 MG	10	4	2-3-Nil	6	50B	1	7	65
bipod	10	4	2-3-Nil	6	50B	1	3	90
tripod	10	4	2-3-Nil	6	50B	1	1	125

AMMUNITION

Use MG ammo records provided on page 5.

LWB Land Rover

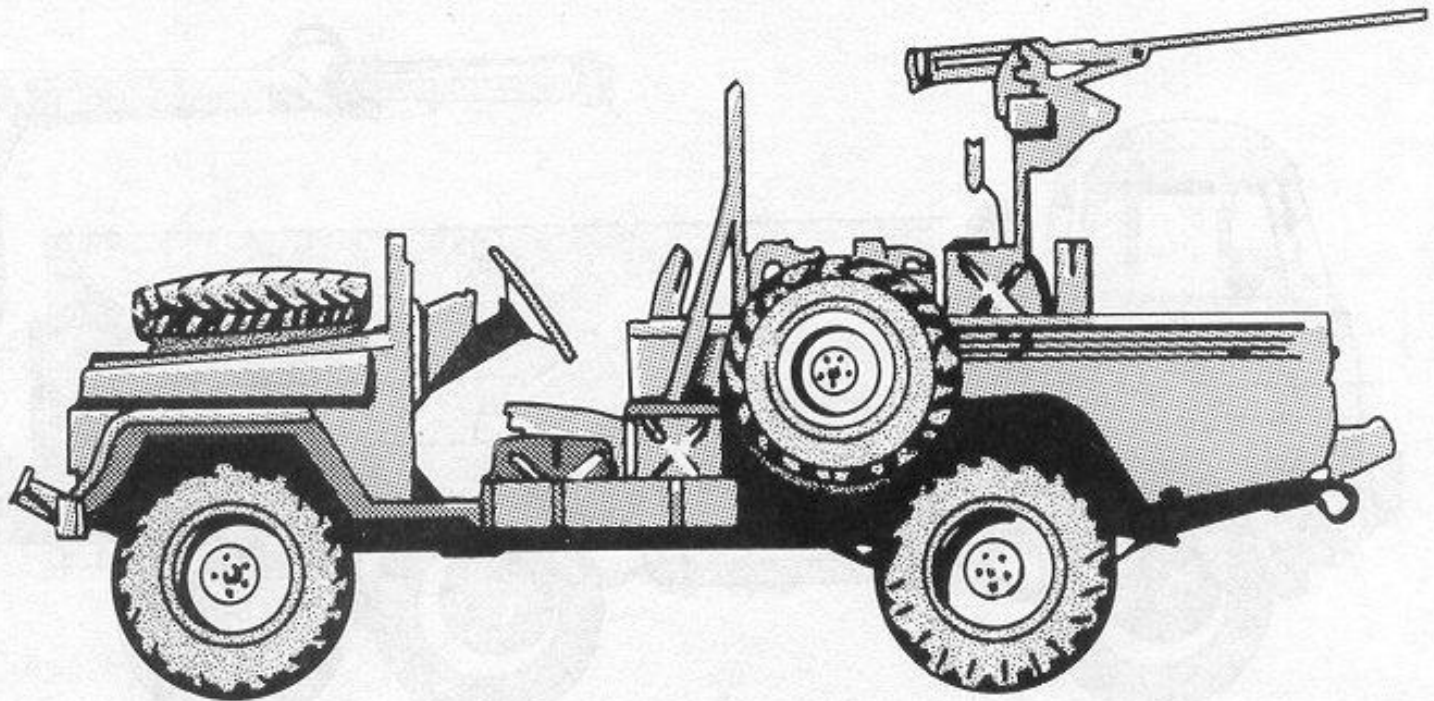

Price: \$8000 (C/S)
Fuel Type: G, AvG, A
Load: 850 kg
Veh Wt: 2.5 tons
Crew: 2+6
Mnt: 6
Night Vision: Headlights

Damage Record

Crewmembers: Driver Assistant driver
Passengers: 1 2 3 4 5 6
Sight/Vision: Night vision equipment
Radio:
Weapon (If Any):
Engine:
Fuel (% Consumed or Destroyed):
Suspension: Minor damage Immobilized

LWB Land Rover (Unarmored Cargo Vehicle): The British-made LWB (long wheelbase) Land Rover is the workhorse general-purpose transport vehicle of many armies worldwide. The vehicle may be equipped with a pintle mount (equivalent to a NATO heavy tripod).

Tr Mov: 180/45
Com Mov: 60/35
Fuel Cap: 90
Fuel Cons: 30

Combat Statistics

Config: Stnd HF: 1
Susp: W(2) HS: 1
HR: 1

M151 1/4-ton Truck "Jeep"

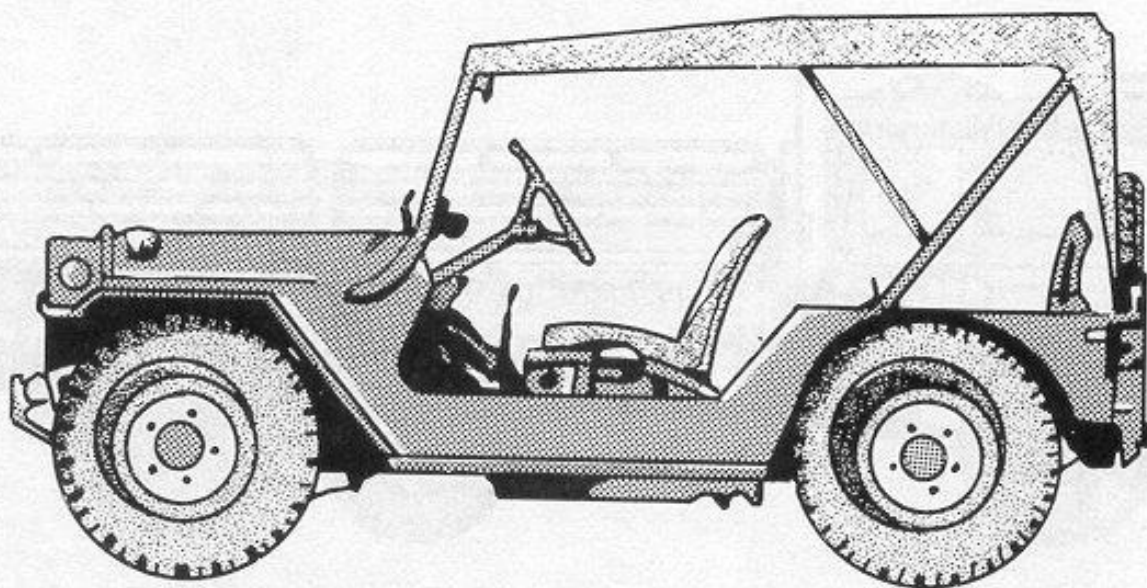

Price: \$7500 (V/C)
Fuel Type: G, A
Load: 500 kg
Veh Wt: 1.2 tons
Crew: 1+3
Mnt: 6
Night Vision: Headlights

Damage Record

Crewmembers: Driver
Passengers: 1 2 3
Sight/Vision: Night vision equipment
Radio:
Weapon (If Any):
Engine:
Fuel (% Consumed or Destroyed):
Suspension: Minor damage Immobilized

M151 1/4-Ton Truck "Jeep" (Unarmored Cargo Vehicle): The American-designed jeep is the descendant of the WWII 1/4-ton general-purpose truck and takes its name from the two-letter designation "GP." The vehicle may be equipped with a pintle mount (equivalent to a NATO heavy tripod), but no weapon is ordinarily fitted. The trucks are found in armies throughout the world. Several civilian versions exist which are identical in game terms to the military ones except for the weapons mount.

***Tr Mov:* 180/45**
***Com Mov:* 60/35**
***Fuel Cap:* 90**
***Fuel Cons:* 30**

Combat Statistics

Config: Stnd HF: 1
Susp: W(2) HS: 1
HR: 1

MAN 7t

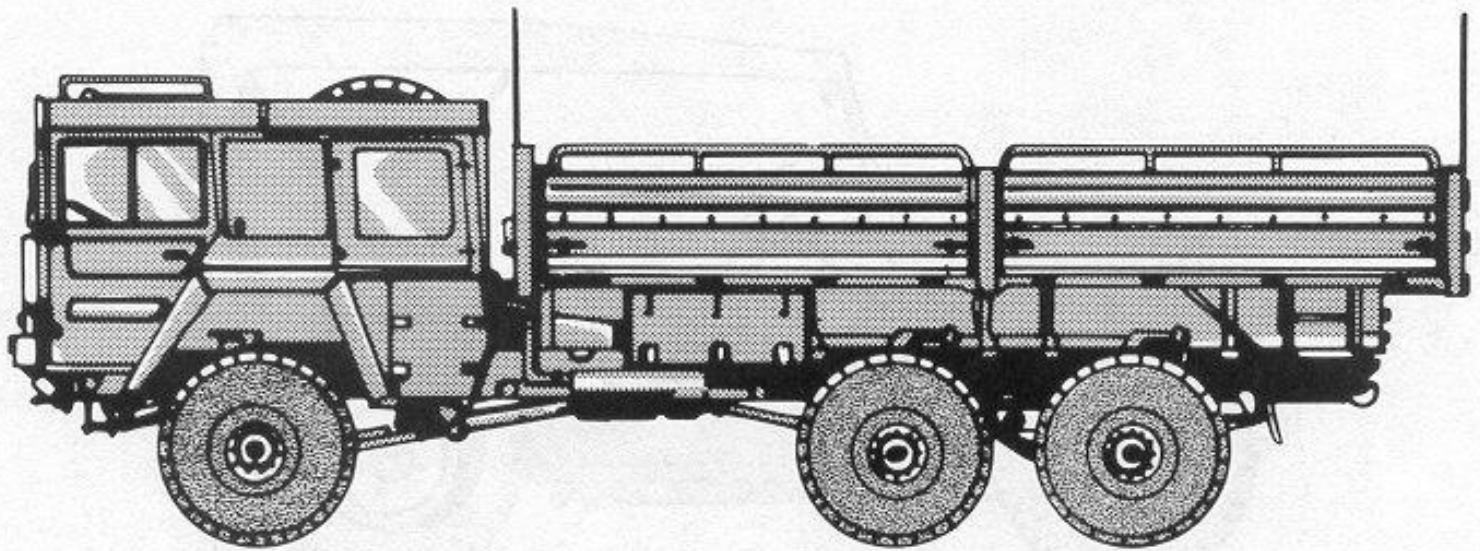

Price: \$35,000 (S/R)
Fuel Type: D, A
Load: 7 tons
Veh Wt: 10 tons
Crew: 2+12
Mnt: 8
Night Vision: Headlights

Damage Record

Crewmembers: Driver Assistant driver
Passengers: 1 2 3 4 5 6 7 8 9 10
11 12
Sight/Vision: Night vision equipment
Radio:
Weapon (If Any):
Engine:
Fuel (% Consumed or Destroyed):
Suspension: Minor damage Immobilized

MAN 7t (Unarmored Cargo Vehicle): The 6x6 MAN 7t (seven-ton) truck is typical of a number of tactical transport vehicles in use by the Bundeswehr. The vehicle can be fitted with a weapons mount (NHT equivalent) but is not normally armed.

***Tr Mov:* 100/10**
***Com Mov:* 35/10**
***Fuel Cap:* 450**
***Fuel Cons:* 150**

Combat Statistics

Config: Stnd HF: 1
Susp: W(2) HS: 1
HR: 1

Marder

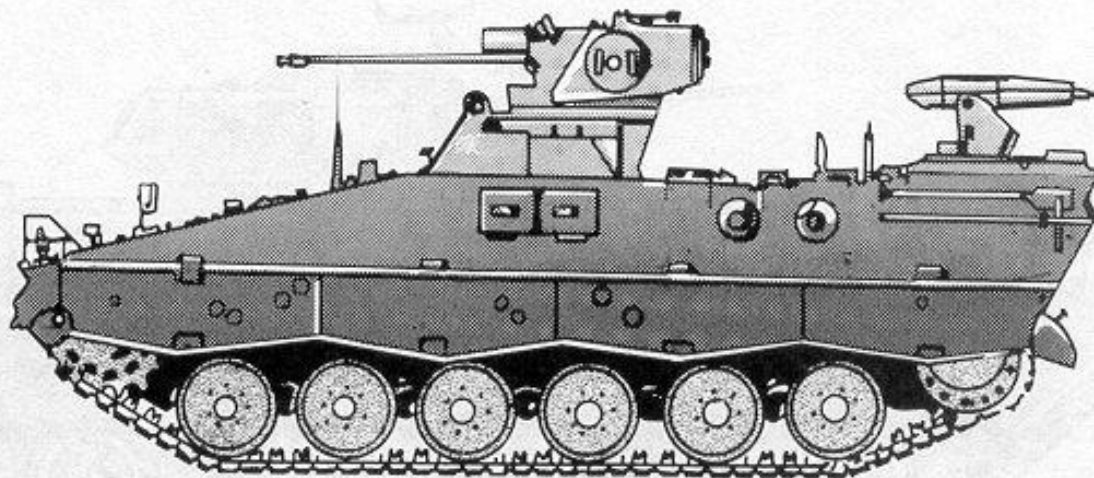

Price: \$200,000 (S/R)

RF: +2

Stabilization: Fair

Armament: 25mm AC, MG3 MG (coaxial), MG3 remote, Milan II ATGM

Ammo: 1100x25mm, 3xMilan II

Fuel Type: D, A

Load: 600 kg

Veh Wt: 29 tons

Crew: 3+7

Mnt: 10

Night Vision: Passive/active IR, IR searchlight

Marder (Infantry Fighting Vehicle): The Marder is an aging warhorse; it has been in service in one form or another since the 1960s. The most recent variant incorporates a 25mm autocannon and an external mount for the squad's Milan II ATGM. Another notable feature is the MG3 machine-gun firing in a 270° arc from a remote mount on the rear deck above the rear debarkation ramp. The Marder has two firing ports on each side.

Tr Mov: 150/90

Com Mov: 35/20

Fuel Cap: 440

Fuel Cons: 110

Damage Record

Crewmembers: Commander Driver Gunner

Passengers: 1 2 3 4 5 6 7

Sight/Vision: Gun sight Range finder Night vision equipment

Radio:

25mm AC:

MG3 MG (Coaxial):

MG3 MG (Remote):

ATGM Launcher:

Traverse:

Engine:

Fuel (% Consumed or Destroyed):

Suspension: Minor damage Immobilized

Combat Statistics

Config: Trt TF: 12 HF: 25

Susp: T: 4 TS: 8 HS: 10

TR: 8 HR: 5

AMMUNITION

Use 25mm autocannon ammo record provided on page 5.

Milan II (3 missiles)

WEAPON DATA

—Recoil—

Weapon	ROF	Mag	Rng	Ammo	Damage	Pen
25mm AC	5	100B	250	APFSDSDU	14 ³⁾	13/9/3
			250	API	14 ³⁾	4/0/-2
			250	HE	C:1, B:2	-8C

Weapon	ROF	Dam	Pen	Blk	Mag	SS	Brst	Rng
MG3 MG	10	4	2-3-Nil	6	50B	1	7	65
							3	90
							1	125

Type	Rld	Rng	Damage	Pen
Milan II	3	2000	C:12, B:12	145C
Milan IIT	3	2000	C:12, B:12	145C

Pz-68

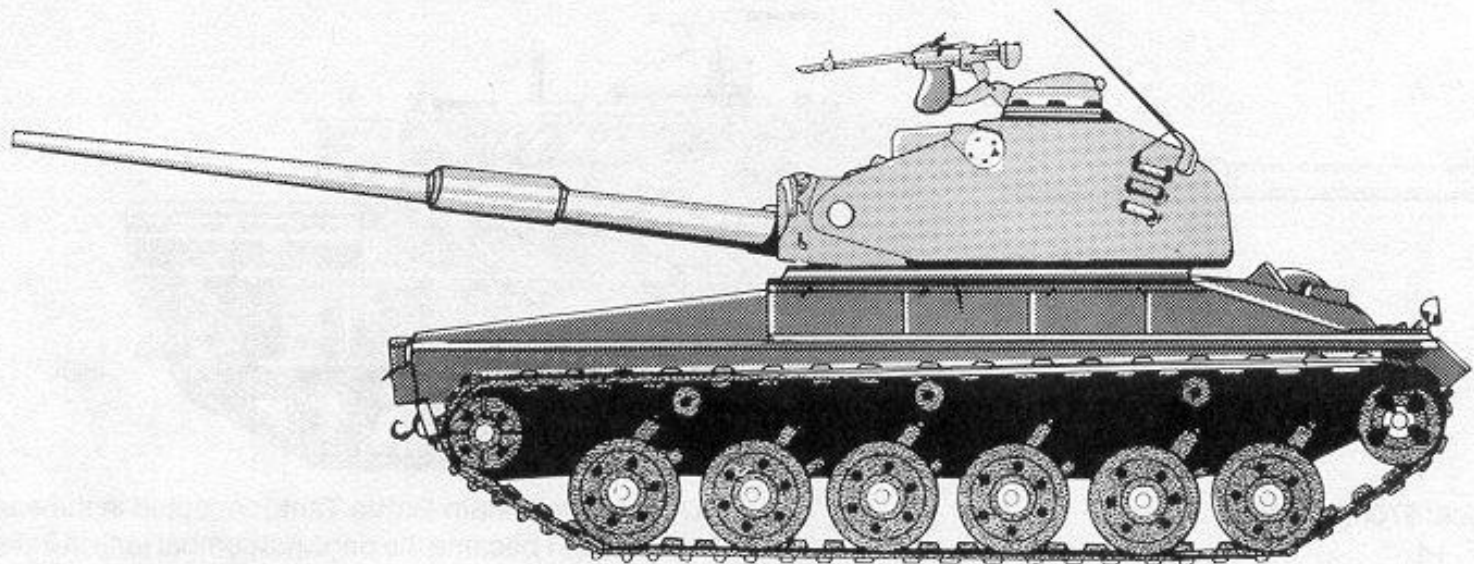

Price: \$500,000 (R/—)

RF: +4

Armament: 105mm gun, AAT-52 MG (coaxial), AAT-52 MG (C)

Stabilization: Fair

Ammo: 62x105mm

Fuel Type: D, A

Load: 400 kg

Veh Wt: 39.7 tons

Crew: 4

Mnt: 6

Night Vision: Headlights, passive IR

Pz-68 (Main Battle Tank): The Pz-68 is a Swiss MBT produced in limited numbers for export in the mid- and late-1990s. It is of conventional layout and is NBC sealed, but is not amphibious.

Tr Mov: 110/88

Com Mov: 55/40

Fuel Cap: 710

Fuel Cons: 180

Combat Statistics

Config: Tr	TF: 24	HF: 26
Susp: T: 6	TS: 5	HS: 7
	TR: 5	HR: 5

Damage Record

Crewmembers: Commander Driver Gunner
Loader

Sight/Vision: Gun sight Range finder Night vision equipment

Radio:

105mm Gun:

AAT-52 MG (Coaxial):

AAT-52 MG (C):

Traverse:

Engine:

Fuel (% Consumed or Destroyed):

Suspension: Minor damage Immobilized

AMMUNITION

Use MG ammo records provided on page 5.

105mm Gun (62 rounds)

WEAPON DATA

Weapon	ROF	Dam	Pen	Blk	Mag	—Recoil—		
						SS	Brst	Rng
AAT-52 MG	10	4	2-3-Nil	5	50B	1	7	65
bipod	10	4	2-3-Nil	5	50B	1	4	90
tripod	10	4	2-3-Nil	5	50B	1	2	125

WEAPON DATA

Type	Round	Rng	Damage	Pen
105mm	APFSDS	500	26	80/70/60/40
Rld: 1	APFSDSDU	500	26	100/90/80/60
	HEAT	400	C:6, B:12	80C
	WP	400	C:3, B:20	Nil

Roland SPAA

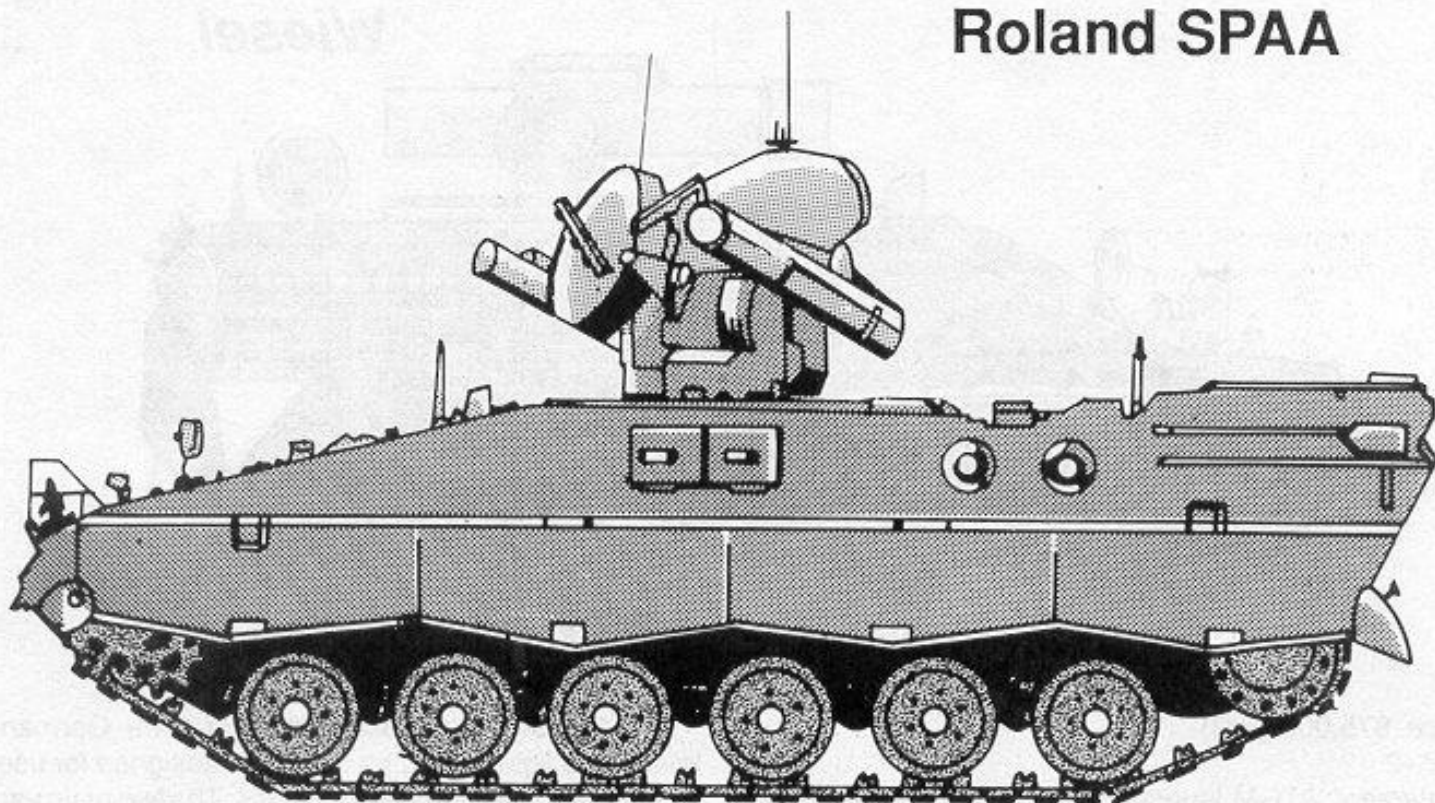

Price: \$900,000 (R/—)

Armament: Twin Roland SAM launchers, MG3 MG

Ammo: 6 Roland SAMs

Fuel Type: D, G, AvG, A

Load: 500 kg

Veh Wt: 29 tons

Crew: 4

Mnt: 6

Night Vision: Headlights, passive IR

Roland SPAA (Self-Propelled Artillery): The Roland system is the standard self-propelled anti-aircraft missile system of the Bundeswehr, and the Roland launching/target acquisition system can be mounted on a variety of chassis types, replacing the vehicle's normal turret. The illustration and statistics here are for the version mounted on a Marder hull.

Tr Mov: 150/90

Com Mov: 35/20

Fuel Cap: 440

Fuel Cons: 110

Damage Record

Crewmembers: Commander Driver Gunner Loader

Sight/Vision: Gun sight Range finder Night vision equipment

Radio:

Roland SAM Launcher (L):

Roland SAM Launcher (R):

MG3 MG:

Loader:

Traverse:

Engine:

Fuel (% Consumed or Destroyed):

Suspension: Minor damage Immobilized

Combat Statistics

Config: Trt TF: 2 HF: 6

Susp: T: 6 TS: 2 HS: 4

TR: 2 HR: 4

AMMUNITION

Use MG ammo records provided on page 5.

Roland SAMs (6 missiles)

WEAPON DATA

Weapon	ROF	Dam	Pen	Blk	Mag	—Recoil—		
						SS	Brst	Rng
MG3	10	4	2-3-Nil	6	50B	1	7	65
bipod	10	4	2-3-Nil	6	50B	1	3	90
tripod	10	4	2-3-Nil	6	50B	1	1	125

Sabre SPAA

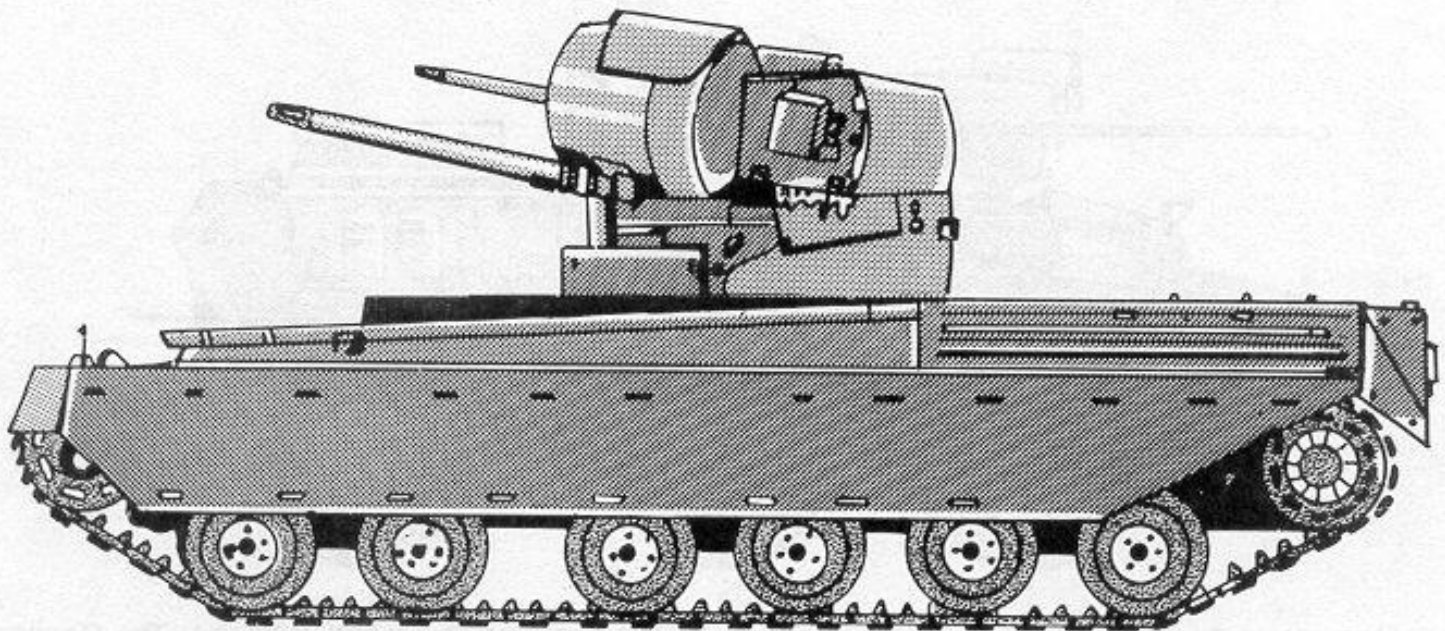

Price: \$100,000 (R/—)

RF: +4

Armament: 2x30mm AC

Stabilization: Fair

Ammo: 1200x30mm

Fuel Type: D, A

Load: 300 kg

Veh Wt: 38 tons

Crew: 3

Mnt: 8

Night Vision: Headlights, passive IR

Sabre SPAA (Self-Propelled Artillery): The Sabre 30mm anti-aircraft gun system was developed by the firm of Thompson CSF and can be found in service with armies of several nations. In the British Army, it is mounted on a Chieftain MBT chassis, and this is the version illustrated here.

***Tr Mov:* 110/80**

***Com Mov:* 55/40**

***Fuel Cap:* 950**

***Fuel Cons:* 380**

Damage Record

Crewmembers: Commander Driver Gunner

Sight/Vision: Gun sight Range finder Night vision equipment

Radio:

30mm AC (L):

30mm AC (R):

Loader:

Traverse:

Engine:

Fuel (% Consumed or Destroyed):

Suspension: Minor damage Immobilized

Combat Statistics

Config: Trt TF: 4

HF: 120-CP

Susp: T: 6 TS: 4

HS: 12-SP

TR: 4

HR: 12

AMMUNITION

Use 30mm ammo records provided on page 5.

WEAPON DATA

Weapon	ROF	Mag	Rng	Ammo	Damage	Pen
30mm AC	5	100B	250	API	16	5/1/-2
			250	HE	C:1, B:2	-6C

Spahpanzer Luchs

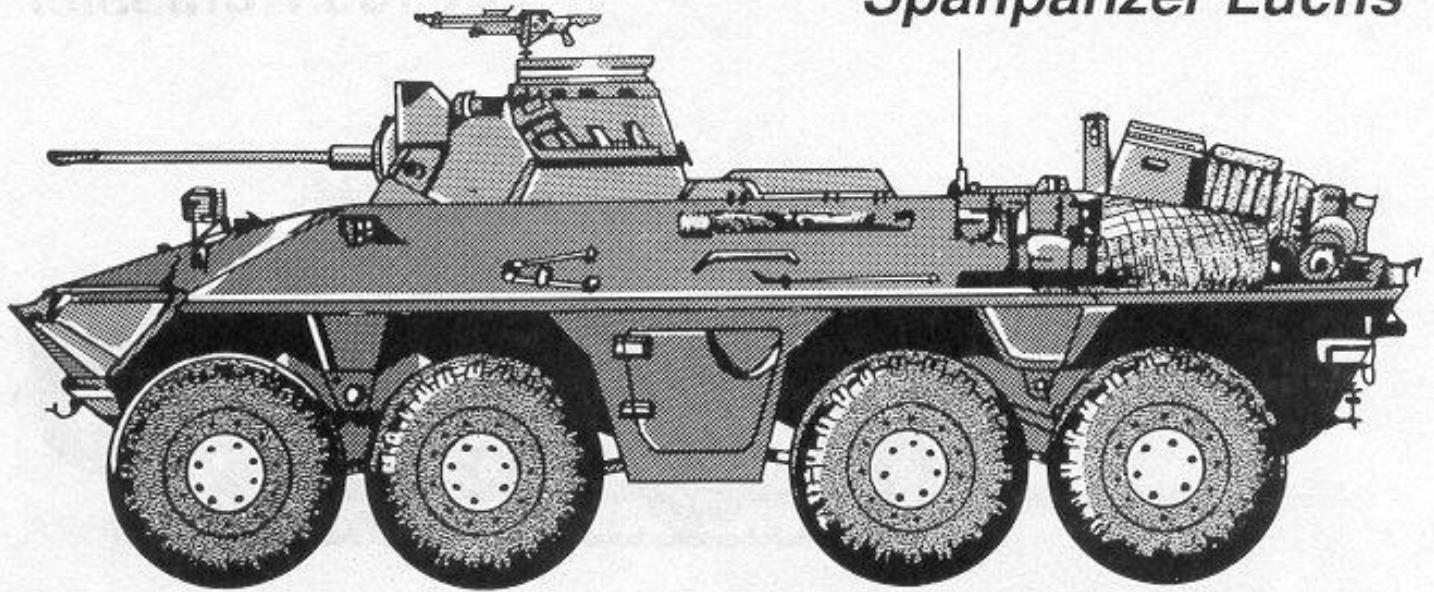

Price: \$250,000 (S/R)

RF: +2

Armament: 1x25mm AC, MG3 MG (C)

Stabilization: Fair

Ammo: 600x25mm

Fuel Type: D, A

Load: 400 kg

Veh Wt: 19.5 tons

Crew: 4

Mnt: 8

Night Vision: Headlights, passive IR

Spahpanzer Luchs (Light Combat Vehicle): The *Luchs* (Lynx) is an 8x8 wheeled, amphibious, reconnaissance vehicle in service only with the German Bundeswehr. The vehicle is unusual in that it has two drivers, one forward facing and one rearward facing, and is capable of the same speed both forward and backward. Each driver has a hatch (forward and rear deck), and the gunner and commander each have a hatch on the turret. The *Luchs* is fully amphibious at one-quarter its cross-country speed.

Tr Mov: 180/120

Com Mov: 90/60

Fuel Cap: 320

Fuel Cons: 160

Damage Record

Crewmembers: Commander Front driver Rear driver

Gunner

Sight/Vision: Gun sight Range finder Night vision equipment

Radio:

25mm AC:

MG3 MG (C):

Traverse:

Engine:

Fuel (% Consumed or Destroyed):

Suspension: Minor damage Immobilized

Combat Statistics

Config: Trt TF: 10 HF: 12

Susp: W(3) TS: 6 HS: 6

TR: 4 HR: 4

AMMUNITION

Use 25mm autocannon and MG ammo record provided on page 5.

WEAPON DATA

Weapon	ROF	Mag	Rng	Ammo	Damage	Pen
25mm AC	5	100B	250	APFSDSDU	14	13/9/3
			250	API	14	4/0/-2
			250	HE	C:1, B:2	-8C

—Recoil—

Weapon	ROF	Dam	Pen	Blk	Mag	SS	Brst	Rng
MG3	10	4	2-3-Nil	6	50B	1	7	65
bipod	10	4	2-3-Nil	6	50B	1	3	90
tripod	10	4	2-3-Nil	6	50B	1	1	125

SW-1 Roland

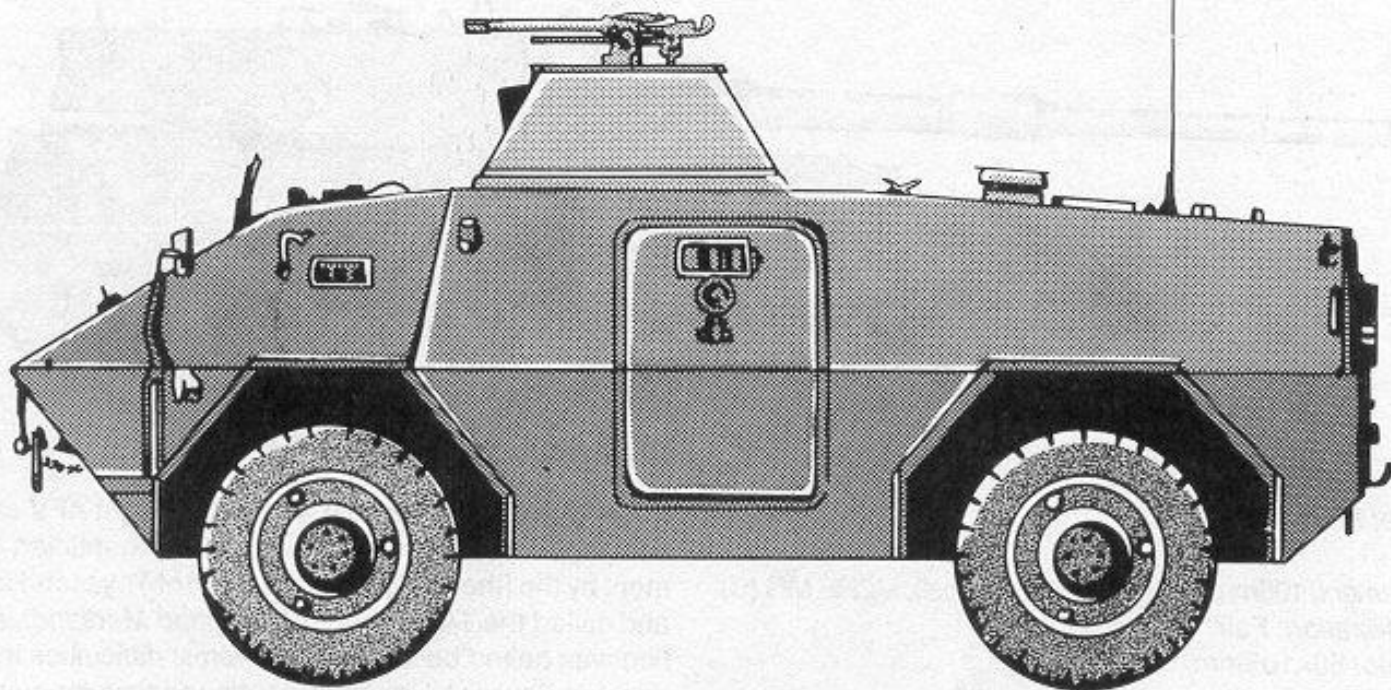

Price: \$20,000 (R/—)

Armament: MG3 MG

Ammo: 300×7.62mmN belted

Fuel Type: D, A

Load: 50 kg

Veh Wt: 6 tons

Crew: 2+6

Mnt: 8

Night Vision: Headlights, passive IR

SW-1 Roland (Light Combat Vehicle): A small number of these 4x4 light APCs, which were built by the Swiss firm of MOWAG, were acquired by the Bundeswehr for evaluation purposes in the early 1990s. The Roland was never adopted for service by the FRG. However, a number of the evaluation vehicles were pressed into service by the German II Corps to be used as replacements in 1997.

Tr Mov: 120/50

Com Mov: 60/40

Fuel Cap: 170

Fuel Cons: 80

Damage Record

Crewmembers: Commander Driver/gunner

Passengers: 1 2 3 4 5 6

Sight/Vision: Gun sight Range finder Night vision

equipment

Radio:

MG3 MG:

Traverse:

Engine:

Fuel (% Consumed or Destroyed):

Suspension: Minor damage Immobilized

Combat Statistics

Config: Trt TF: 4 HF: 6

Susp: W(2) TS: 3 HS: 3

TR: 3 HR: 3

AMMUNITION

Use MG ammo records provided on page 5.

WEAPON DATA

—Recoil—

Weapon	ROF	Dam	Pen	Blk	Mag	SS	Brst	Rng
MG3 MG	10	4	2-3-Nil	6	100B	1	7	65
bipod	10	4	2-3-Nil	6	100B	1	4	90
tripod	10	4	2-3-Nil	6	100B	1	2	125

TH-301

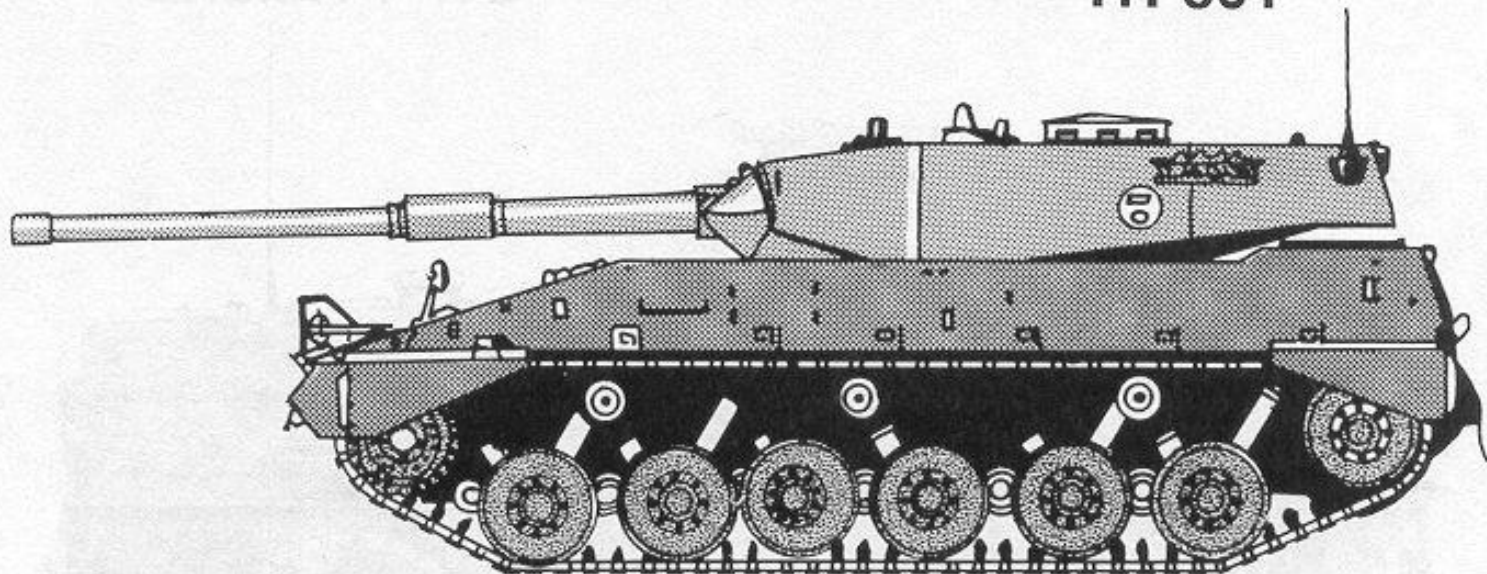

Price: \$750,000 (S/R)

RF: +3

Armament: 105mm gun, MG3 MG (coaxial), M2HB MG (C)

Stabilization: Fair

Ammo: 50x105mm

Fuel Type: D, A

Load: 400 kg

Veh Wt: 30.5 tons

Crew: 4

Mnt: 8

Night Vision: Passive IR, headlights

TH-301 (Light Combat Vehicle): A light AFV originally developed in the early 1970s for the Argentinian government by the (then) West German firm of Thyssen-Henschel and called the TAM (*Tanque Argentino Mediano*). Production was halted because of economic difficulties in Argentina, but Thyssen-Henschel continued development of the vehicle in hopes of a sale to the Bundeswehr, which eventually came through in the early 1990s. The vehicle is conventional in its layout, and is NBC sealed.

Tr Mov: 130/110

Com Mov: 60/40

Fuel Cap: 650

Fuel Cons: 150

Combat Statistics

Config: Trt	TF: 35	HF: 35
Susp: T: 3	TS: 20	HS: 25
	TR: 20	HR: 15

AMMUNITION

Use MG ammo records provided on page 5.

WEAPON DATA

Weapon	ROF	Dam	Pen	Blk	Mag	—Recoil—		
						SS	Brst	Rng
MG3 MG	10	4	2-3-Nil	6	50B	1	7	65
bipod	10	4	2-3-Nil	6	50B	1	3	90
tripod	10	4	2-3-Nil	6	50B	1	1	125
M2HB MG	5	8	2-2-3*	8	105B	3	14	65
tripod	5	8	2-2-3*	8	105B	2	7	150

*.50 SLAP ammunition has a penetration of 1-1-2.

WEAPON DATA

Type	Round	Rng	Damage	Pen
105mm	APFSDS	500	26	80/70/60/40
Rld: 1	APFSDSDU	500	26	100/90/80/60
	HEAT	400	C:6, B:12	80C
	WP	400	C:3, B:20	Nil

TPz1 Fuchs

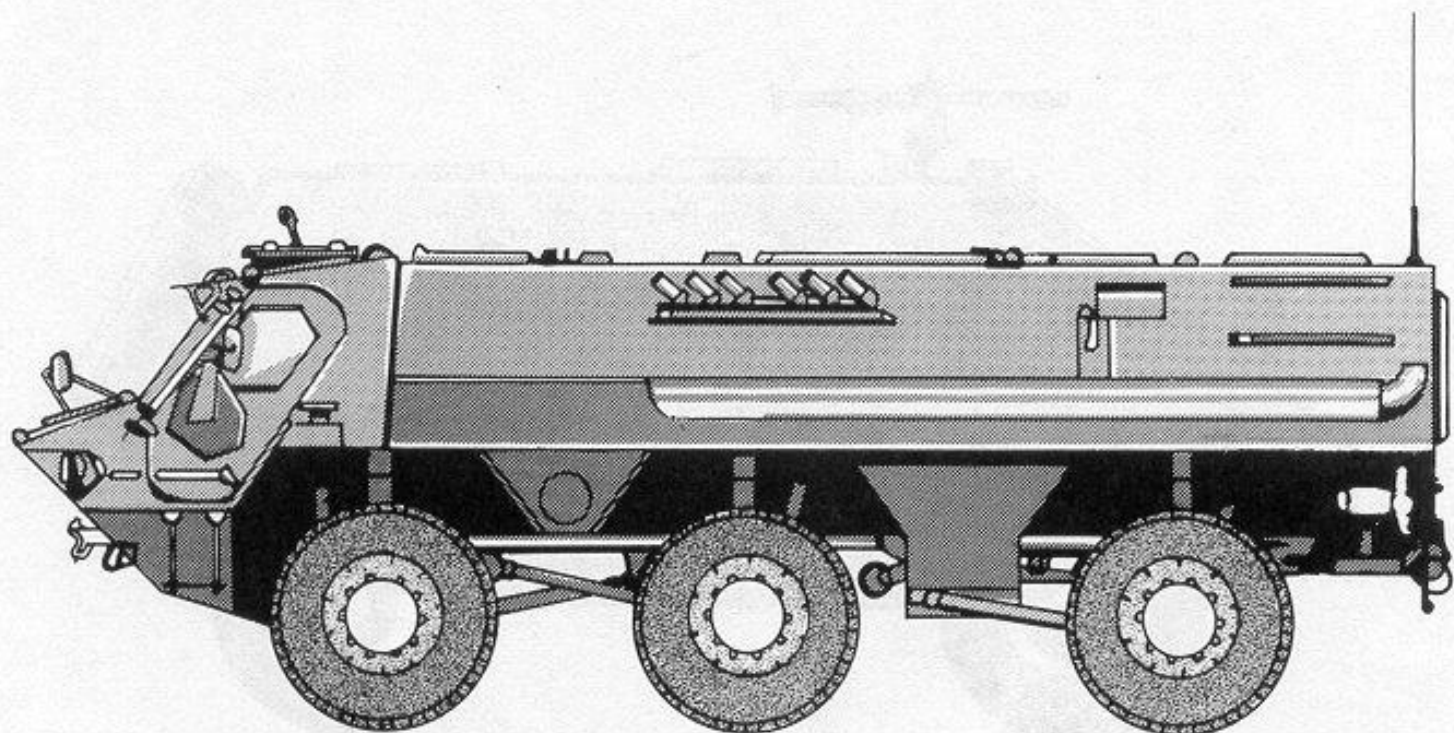

Price: \$250,000 (C/S)

Armament: MG3 MG

Ammo: 300x7.62mmN belted

Fuel Type: D, G, A

Load: 1 ton

Veh Wt: 16 tons

Crew: 2+10

Mnt: 8

Night Vision: Headlights, passive IR

TPz1 Fuchs (Light Combat Vehicle): The TPz1 *Fuchs* (Fox) is a German-built, 6x6 AFV armed with the MG3 general-purpose machinegun. The TPz1 has double cargo doors in the rear, and both driver and gunner's hatches on the front deck (the gunner's hatch, on the right, is NHT equivalent). Each side of the forward compartment has a conventional door. The *Fuchs* was designed primarily for use by headquarters and other specialty detachments (commo, NBC, EW, etc.) rather than as a combat vehicle. Firing ports are located on the left, right, and rear sides of the vehicle. The vehicle is fully amphibious at one-quarter its cross-country speed.

Tr Mov: 110/60

Com Mov: 55/40

Fuel Cap: 400

Fuel Cons: 170

Combat Statistics

Config: Std HF: 4

Susp: W(3) HS: 3

HR: 3

AMMUNITION

Use MG ammo records provided on page 5.

Damage Record

Crewmembers: Commander/gunner Driver

Passengers: 1 2 3 4 5 6 7 8 9 10

Sight/Vision: Night vision equipment

Radio:

MG3 MG:

Engine:

Fuel (% Consumed or Destroyed):

Suspension: Minor damage Immobilized

WEAPON DATA

—Recoil—

Weapon	ROF	Dam	Pen	Blk	Mag	SS	Brst	Rng
MG3 MG	10	4	2-3-Nil	6	50B	1	7	65
bipod	10	4	2-3-Nil	6	50B	1	3	90
tripod	10	4	2-3-Nil	6	50B	1	1	125

Tracked Rapier SPAA

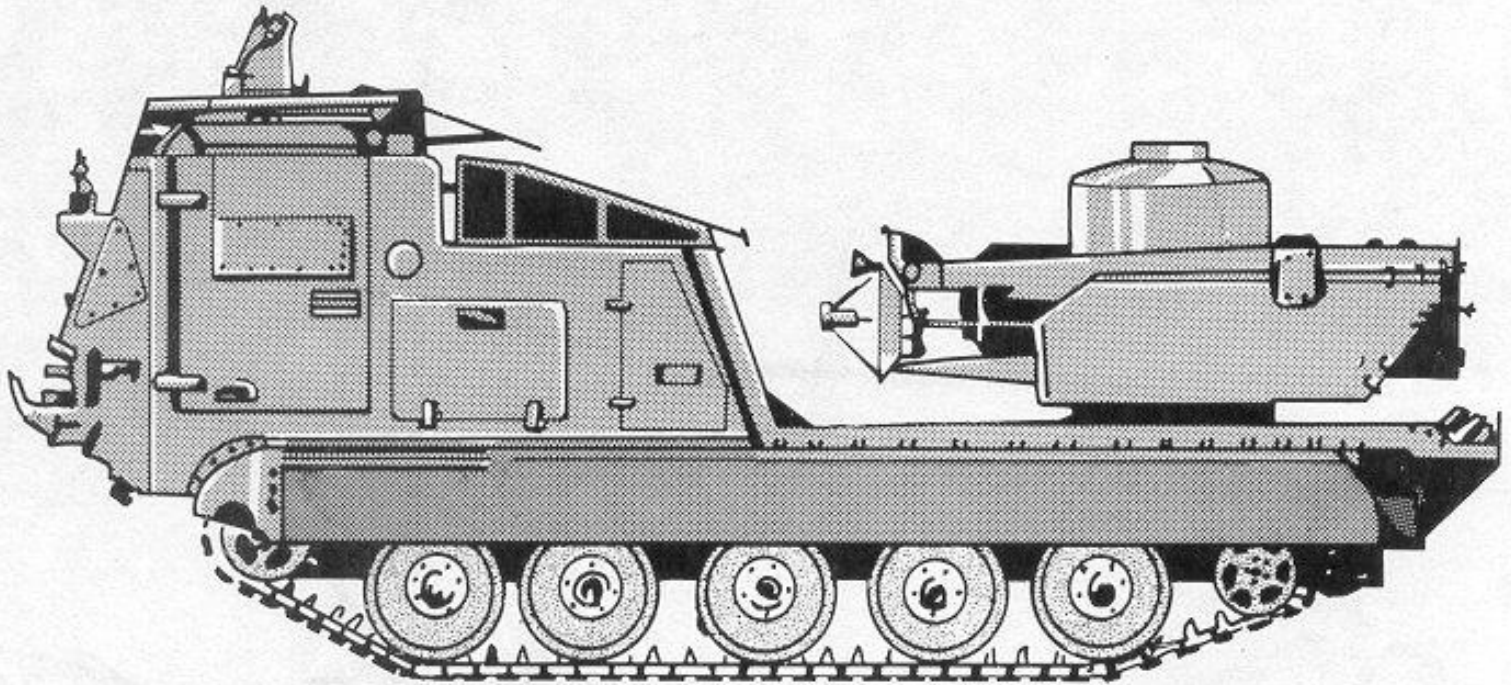

Price: \$75,000 (S/R)

RF: +4

Armament: Quad Rapier launcher, L7A2mm GPMG

Ammo: 4 missiles in launch position (plus 4 reloads)

Fuel Type: D, A

Load: 500 kg

Veh Wt: 12 tons

Crew: 4

Mnt: 8

Night Vision: Headlights, passive IR

Tracked Rapier SPAA (Self-Propelled Artillery): The tracked Rapier self-propelled anti-aircraft vehicle was developed to fill a need for a fast-moving AA missile launcher capable of keeping up with the rapidly changing conditions of the modern battlefield. The existing towed Rapier AA missile launcher was perfectly adequate for defense of static positions against air attack, but it was of little use in a fluid situation. The vehicle has a forward compartment for the crew, but the launcher is mounted on a rear platform with full 360° traverse. The vehicle is not amphibious, but is NBC sealed.

Tr Mov: 120/80

Com Mov: 60/40

Fuel Cap: 380

Fuel Cons: 140

Combat Statistics

<i>Config:</i> Trt	TF: 2	HF: 3
<i>Susp:</i> T: 3	TS: 2	HS: 3
	TR: 2	HR: 3

AMMUNITION

Use MG ammo records provided on page 5.

Rapier SAMs (8 missiles)

□□□□□□□□

Damage Record

Crewmembers: Commander Driver Gunner Loader

Sight/Vision: Gun sight Range finder Night vision equipment

Radio:

Quad Rapier Launcher:

L7A2 GPMG:

Loader:

Traverse:

Engine:

Fuel (% Consumed or Destroyed): □□□□□□□□□□

Suspension: Minor damage Immobilized

WEAPON DATA

—Recoil—

Weapon	ROF	Dam	Pen	Blk	Mag	SS	Brst	Rng
L7A2 GPMG	10	4	2-3-Nil	6	100B	1	7	65
bipod	10	4	2-3-Nil	6	100B	1	4	90
tripod	10	4	2-3-Nil	6	100B	1	2	125

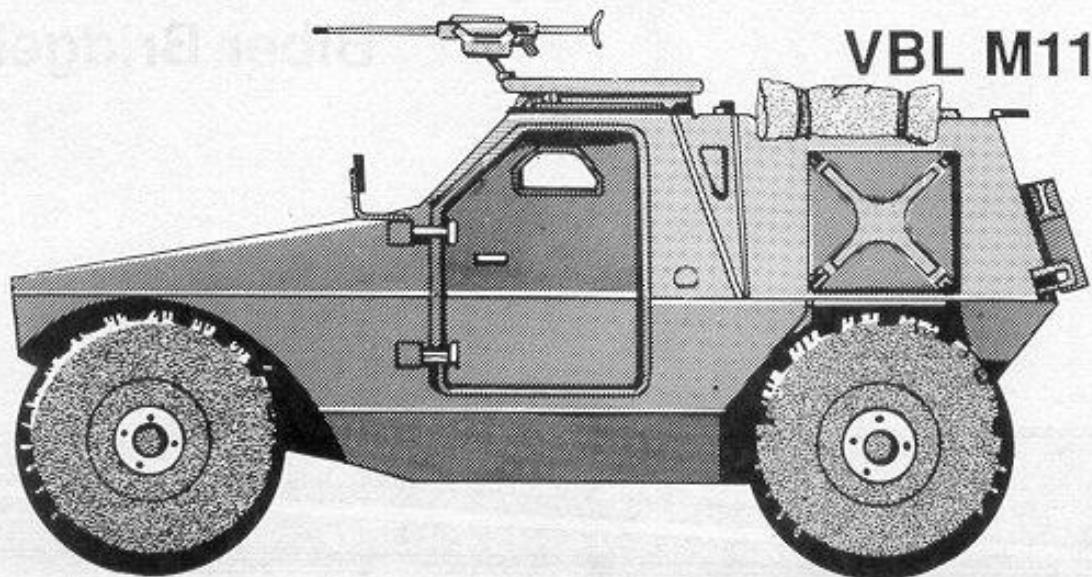

Price:

- ATGM: \$9600 (C/S)
- Scout: \$8500 (C/S)
- Commo: \$10,000 (C/S)

Armament:

- ATGM: ATGM, M2HB MG (C)
- Scout, Commo: MAG MG (C)

Ammo:

- ATGM: 6xATGM (ATGM)
- Scout, Commo: MG ammo as cargo

Fuel Type: G, Avg, A

Load:

- ATGM, Commo: 300 kg
- Scout: 400 kg

Veh Wt: 3.5 tons

Crew:

- ATGM: 3
- Scout, Commo: 2

Mnt: 4

Night Vision: Headlights

VBL M11 (Light Combat Vehicle): The VBL M11 is a 4x4 light vehicle built by the French firm of Panhard. The three most common variants are a scout vehicle (armed with a MAG MG), and an ATGM vehicle (armed with an ATGM launcher and M2HB MG), and a communications vehicle (armed with a MAG MG).

The Milan can be fired from the vehicle or dismounted (a tripod is included with the vehicle). The vehicle is fully amphibious at one-quarter its cross-country speed, but is not NBC sealed.

Tr Mov: 180/140

Com Mov: 90/70

Fuel Cap: 120

Fuel Cons: 30

Combat Statistics

- Config: Stnd HF: 2
- Susp: W(2) HS: 2
- HR: 2

Damage Record

Crewmembers (ATGM): Commander Driver Gunner

Crewmembers (Scout, Commo): Commander Driver/
radio operator

Sight/Vision: Night vision equipment

Radio:

ATGM Launcher (ATGM):

M2HB MG (C) (ATGM):

MAG MG (C) (Scout, Commo):

Engine:

Fuel (% Consumed or Destroyed):

Suspension: Minor damage Immobilized

AMMUNITION

Use MG ammo records provided on page 5.

Milan ATGM (6 missiles)

WEAPON DATA

Weapon	ROF	Dam	Pen	Blk	Mag	—Recoil—		
						SS	Brst	Rng
MAG MG	10	4	2-3-Nil	6	100B	1	7	65
bipod	10	4	2-3-Nil	6	100B	1	4	90
tripod	10	4	2-3-Nil	6	100B	1	2	125
M2HB MG	5	8	2-2-3*	8	105B	3	14	65
tripod	5	8	2-2-3*	8	105B	2	7	150

*.50 SLAP ammunition has a penetration of 1-1-2.

WEAPON DATA

Type	Rld	Rng	Damage	Pen
Milan II	3	2000	C:12, B:12	145C
Milan IIT	3	2000	C:12, B:12	145C

Wiesel

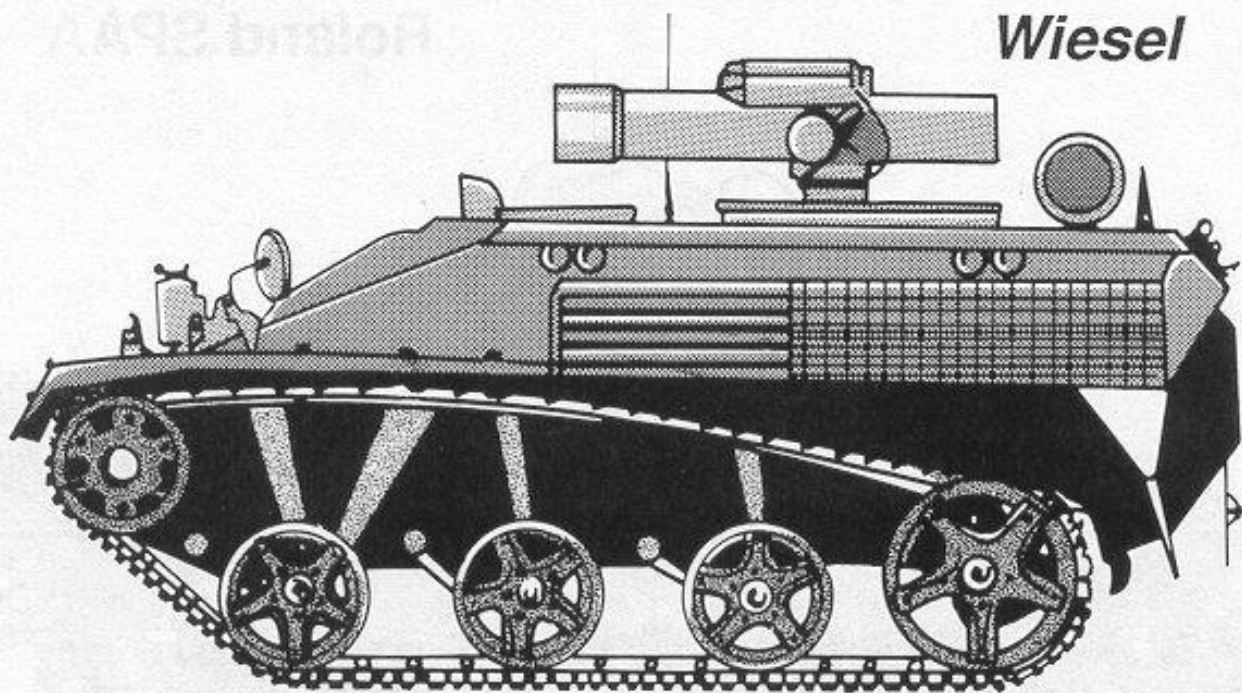

Price: \$75,000 (S/R)

RF: +2

Armament: ATGM launcher (ATGM) or 20mm AC (fire support)

Stabilization: Fair

Ammo: 1+4 reloads (TOW II) or 300x20mm

Fuel Type: G, A

Load: 300 kg

Veh Wt: 5 tons

Crew: 3 (ATGM), 2 (fire support)

Mnt: 8

Night Vision: Headlights, passive IR

Wiesel (Self-Propelled Artillery): The German-built *Wiesel* is a lightweight, tracked AFV designed for use with light infantry or airmobile formations. The two main variants are the ATGM version and the fire support version (armed with a 20mm autocannon). Produced initially for service with the Bundeswehr, the *Wiesel* was exported in small numbers in the mid-1990s. It has a pair of hatches on the front deck for crew access, is NBC sealed, and is fully amphibious at one-quarter its cross-country speed.

Tr Mov: 160/110

Com Mov: 80/55

Fuel Cap: 320

Fuel Cons: 80

Damage Record

Crewmembers (ATGM): Commander Driver Gunner

Crewmembers (Fire Support): Commander/gunner

Driver

Sight/Vision: Gun sight Range finder Night vision equipment

Radio:

20mm AC or ATGM Launcher:

Loader:

Engine:

Fuel (% Consumed or Destroyed):

Suspension: Minor damage Immobilized

Combat Statistics

Config: CIH HF: 4

Susp: T: 3 HS: 3

HR: 2

AMMUNITION

Use 20mm ammo records provided on page 5.

ATGM (5 missiles)

WEAPON DATA

Weapon	ROF	Mag	Rng	Ammo	Damage	Pen
20mm	10	100B	250	API	10	3/-2/-5
			250	HE	C:1, B:2	-8C

Type	Rld	Rng	Damage	Pen
TOW II	2	3500	C:12, B:12	160C

Wildcat

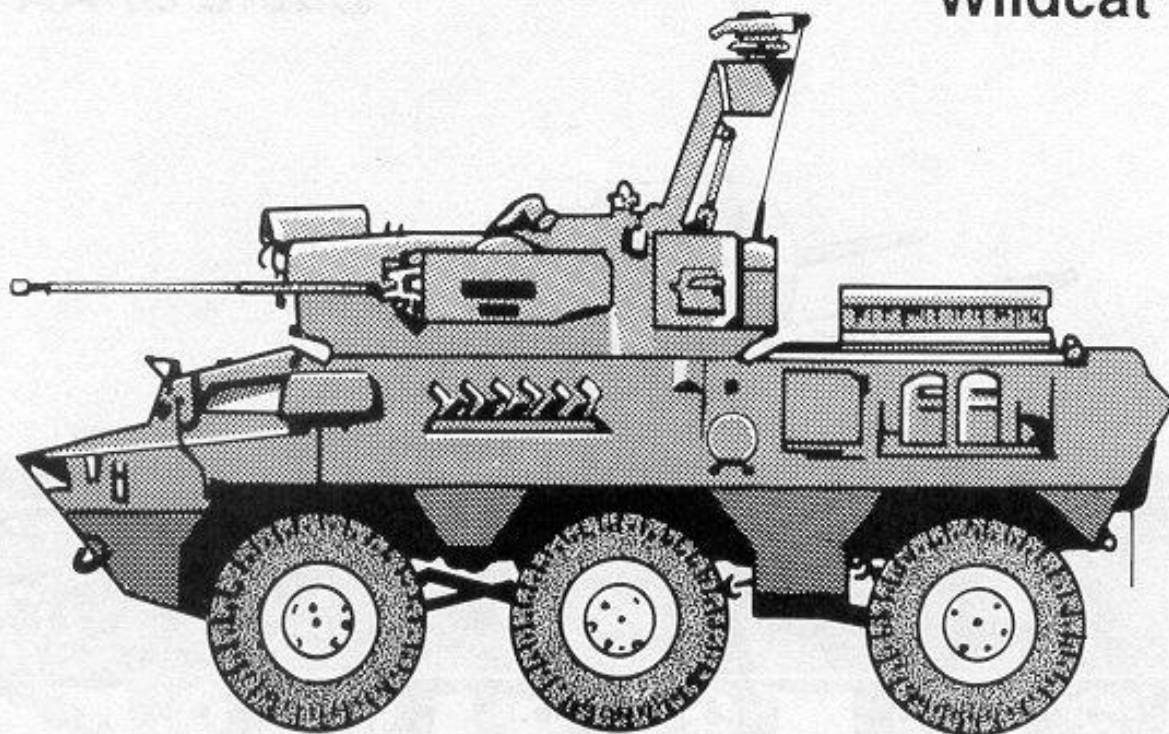

Price: \$65,000 (S/R)

RF: +4

Armament: 2x30mm autocannon, MG3 MG

Stabilization: Fair

Ammo: 1200x30mm

Fuel Type: G, A

Load: 300 kg

Veh Wt: 18 tons

Crew: 3

Mnt: 10

Night Vision: Headlights, passive IR

Wildcat (Self-Propelled Artillery): The German-built Wildcat is a 4x4 light anti-aircraft vehicle designed for use with light infantry or airmobile formations. It has a driver's hatch on the front deck and hatches for the commander and gunner on the turret deck

Tr Mov: 160/100

Com Mov: 80/50

Fuel Cap: 360

Fuel Cons: 180

Damage Record

Crewmembers: Commander Driver Gunner

Sight/Vision: TA radar Night vision equipment

Radio:

30mm AC (L):

30mm AC (R):

MG3 MG:

Loader:

Traverse:

Engine:

Fuel (% Consumed or Destroyed):

Suspension: Minor damage Immobilized

Combat Statistics

Config: Trt TF: 3 HF: 6

Susp: W(3) TS: 3 HS: 4

TR: 3 HR: 4

AMMUNITION

Use 30mm autocannon and MG ammo records provided on page 5.

WEAPON DATA

Weapon	ROF	Mag	Rng	Ammo	Damage	Pen
30mm	5	100B	250	API	16	5/1/-2
			250	HE	C:1, B:2	-6C

WEAPON DATA

—Recoil—

Weapon	ROF	Dam	Pen	Blk	Mag	SS	Brst	Rng
MG3 MG	10	4	2-3-Nil	6	50B	1	7	65
bipod	10	4	2-3-Nil	6	50B	1	3	90
tripod	10	4	2-3-Nil	6	50B	1	1	125

Scan courtesy of Deathwind