

SHIPS OF THE REACH

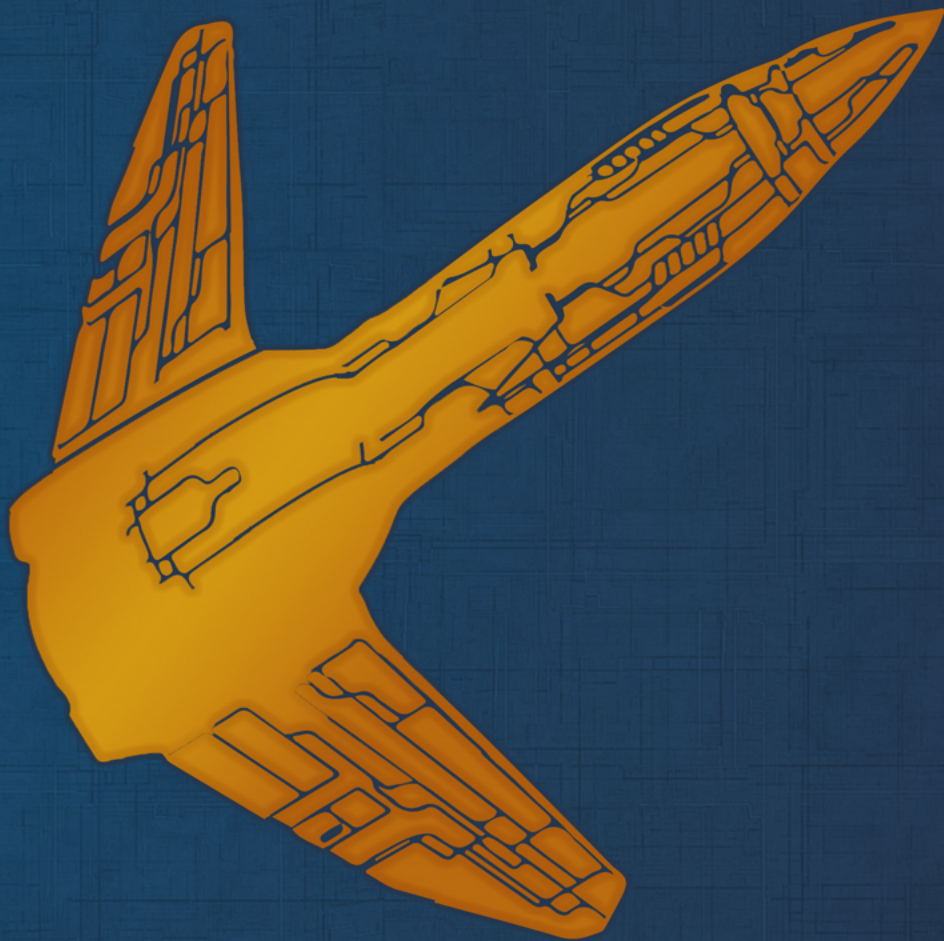

TRAVELLER

TRAVELLER

PIRATES OF DRINAX: SHIPS OF THE REACH

CREDITS

CLASSIC TRAVELLER

Marc Miller

John Harshman, Frank Chadwick, Darryl Hany,
Winston Hamilton, Tony Svajlenka, Scott Renner, Doug Poe,
David MacDonald, Wayne Roth, Paul R. Banner.

Author

Gareth Hanrahan

Developer

Matthew Sprange

Layout and Graphic Design

Amy Perrett, Sandrine Thirache

Interior Illustrations

Amy Perret, Michael Rookard, Sandrine Thirache

TRAVELLER INNER CIRCLE

Andrew James Alan Welty, Colin Dunn, M. J. Dougherty,
Rob Eaglestone, Sam Wissa, Joshua Bell, Maksim Smelchak

Special Thanks

Marc Miller, Loren Wiseman

CONTENTS

SHIPS OF THE REACH	2
HIGH GUARD ASLAN	58
SHIPS OF THE ASLAN	62
SHIPS INDEX & AND DECKPLANS KEYS	96

Traveller ©2017 Mongoose Publishing. All rights reserved. Reproduction of this work by any means without the written permission of the publisher is expressly forbidden. All significant characters, names, places, items, art and text herein are copyrighted by Mongoose Publishing.

This game product contains no Open Game Content. No portion of this work may be reproduced in any form without written permission. To learn more about the Open Game License, please go to www.mongoosepublishing.com.

This material is protected under the copyright laws of the United Kingdom and of the United States. This product is a work of fiction. Any similarity to actual people, organisations, places or events is purely coincidental.

Traveller is a trademark of Far Future Enterprises and is used under licence.



FAST TRADER

TYPE-A3

TL12		TONS	COST (MCR)
Hull	200 tons, Streamlined	-	12
Armour	Crystaliron, Armour 2	5	1.2
M-Drive	Thrust 4	8	16
J-Drive	Jump 2	15	22.5
Power Plant	Fusion, Power 135	9	9
Fuel Tanks	4 weeks operation, J-2	41	-
Bridge		10	1
Computer	Computer/5bis	-	0.45
Sensors	Civilian Grade	1	3
Weapons			
Systems	Fuel Scoop	-	
	Fuel Processors (20/ tons day)	1	0.05
	Cargo Crane	3	3
	Aerofins	10	1
Software	Jump Control/2	-	0.2
	Library	-	
	Manoeuvre/0	-	
Staterooms	Standard x 10	40	5
	Low Berths x 20	10	1
Common Areas		11	1.1
Cargo		36	-

TOTAL: MCR 76.5

CREW

PILOT, ASTROGATOR,
ENGINEER, MEDIC,
STEWARD

RUNNING COSTS

MAINTENANCE COST
Cr6375/month

PURCHASE COST
MCR76.5

POWER REQUIREMENTS

80
MANOEUVRE
DRIVE

40
BASIC SHIP
SYSTEMS

40
JUMP DRIVE

1
SENSORS

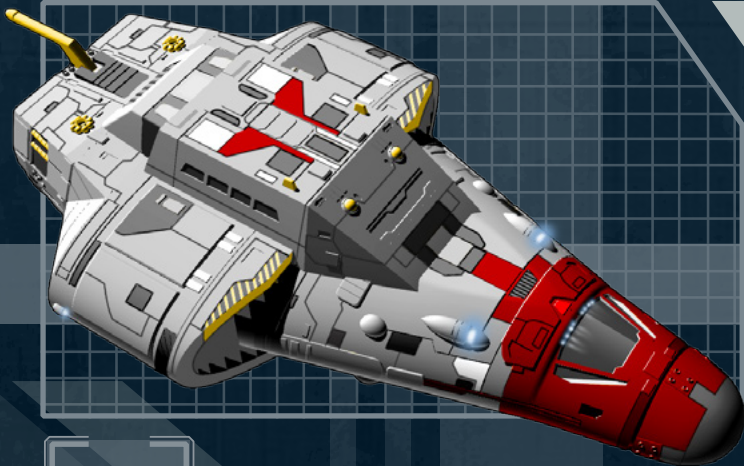

80
HULL POINTS

Effectively a stripped-down version of the ubiquitous Type-A Free Trader, the A3 Fast Trader gives up cargo space in favour of a more powerful manoeuvre drive and greater jump drive. This translates not only into greater speed but also better agility. In regions of space where pirates and raiders lurk, this extra speed can make all the difference, though the Fast Trader is also popular among pirate forces for the same reasons.

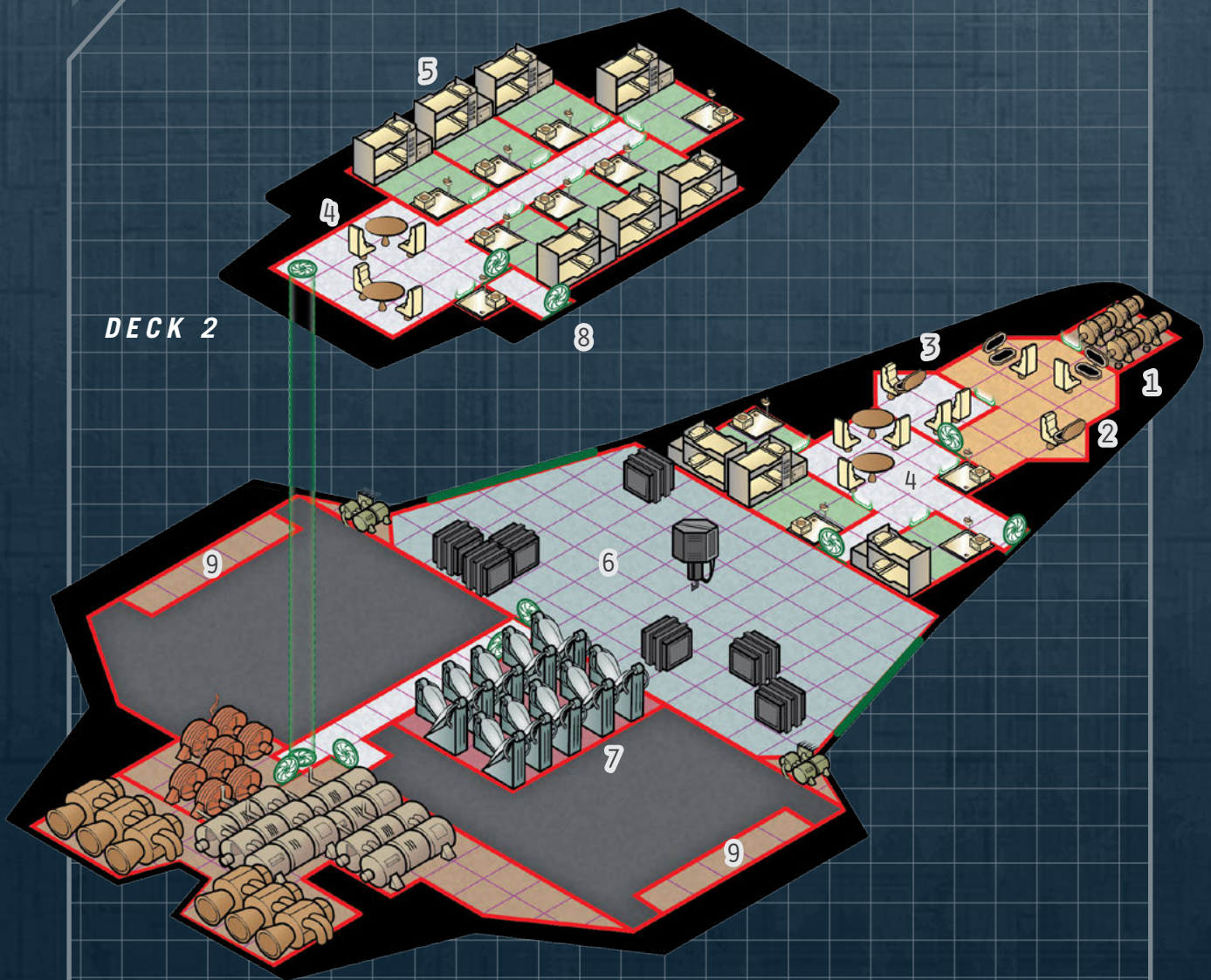

DECK 2

DECK 1

- 1. SENSORS
- 2. BRIDGE
- 3. OFFICE
- 4. COMMON AREA
- 5. STATEROOMS
- 6. CARGO HOLD
- 7. LOW BERTHS
- 8. AIR LOCK
- 9. AEROFIN

STAR RAY-CLASS INTERCEPTOR

XX

TL12		TONS	COST (MCR)
Hull	200 tons, Streamlined	-	12
Armour	Crystaliron, Armour 4	10	2.4
M-Drive	Thrust 3	6	12
J-Drive	Jump 1	10	15
Power Plant	Fusion (TL15), Power 140	7	14
Fuel Tanks	J-1 (twice), 4 weeks of operation, plus Light Fighter	42	-
Bridge		10	1
Computer	Computer/10	-	0.16
Sensors	Improved	3	4.3
Weapons	Double Turrets (beam lasers) x 2	2	3
Systems	Fuel Processor (20 tons/day)	1	0.05
	Fuel Scoops		
	Cargo Crane	3	3
	Heavy Grappling Arm	6	3
	Cargo Scoop	2	0.5
	Forced Linkage Apparatus (TL15)	2	0.5
	Docking Space (10 tons)	11	2.75
	Light Fighter	-	9.09
Software	Manoeuvre/0	-	-
	Jump Control/1	-	0.1
	Library	-	-
Staterooms	Standard x 8	32	4
	Low Berths x 6	3	0.3
Common Areas		6	0.6
Cargo		44	-
TOTAL: MCr 87.75			

CREW

CAPTAIN, PILOT, ASTROGATOR,
ENGINEER, GUNNERS X 2,
FIGHTER PILOT, MARINES X 6

RUNNING COSTS

MAINTENANCE COST
Cr7312/month

•••••
PURCHASE COST
MCr87.75

POWER REQUIREMENTS

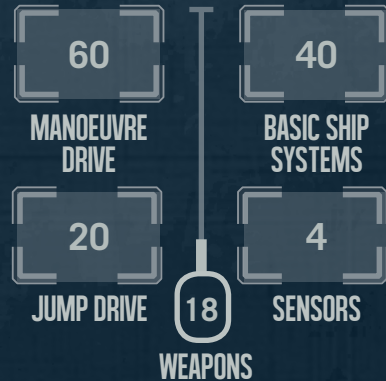

80

HULL POINTS

The *Star Ray* is a small combat-ready interceptor with an excellent array of features for any pirate, from cargo-retrieving grappling arms to its double-jump range fuel tanks. This comes at the compromise of performance, for while the *Star Ray* is well-armed, its relatively low thrust makes catching anything more sprightly than a merchant vessel difficult. However, its low cost has made it a popular choice for production within the shipyards of Theev.

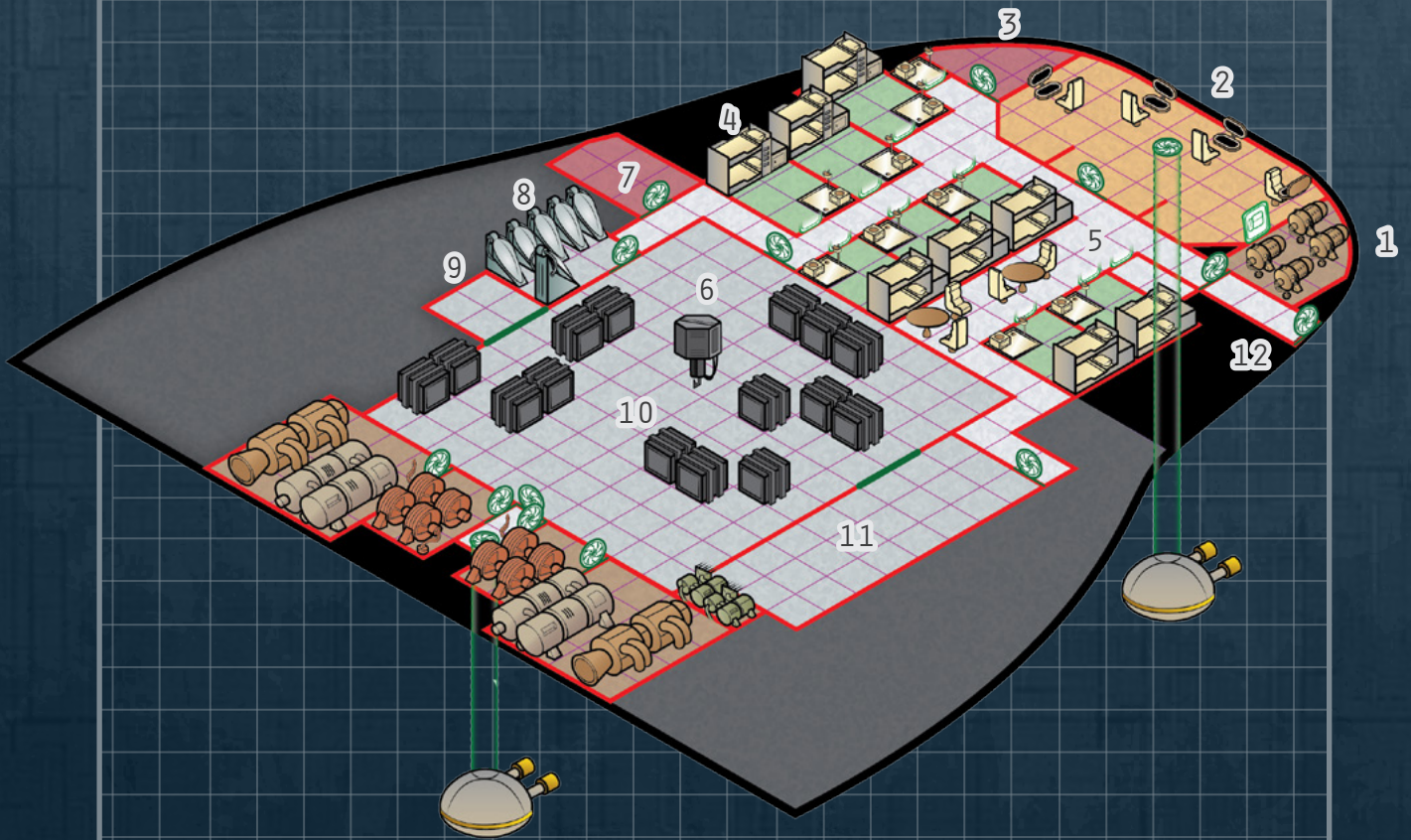

- 1. **SENSORS**
- 2. **BRIDGE**
- 3. **FORCED LINKAGE APPARATUS**
- 4. **STATEROOMS**
- 5. **COMMON AREA**
- 6. **CARGO CRANE**
- 7. **HEAVY GRAPPLING ARM**
- 8. **LOW BERTHS**
- 9. **CARGO SCOOP**
- 10. **CARGO HOLD**
- 11. **FIGHTER DOCKING SPACE**
- 12. **AIR LOCK**
- 13. **BEAM LASER TURRET**

HERALD-CLASS FAST MESSENGER

XX

TL15		TONS	COST (MCR)
Hull	300 tons, Streamlined	-	18
Armour	Bonded Superdense, Armour 4	9.6	5.76
M-Drive	Thrust 2	6	12
J-Drive	Jump 4	35	52.5
Power Plant	Fusion (TL15), Power 240	10	24
Fuel Tanks	J-4, 6 weeks of operation	123	-
Bridge		20	1.5
Computer	Computer/15bis	-	3
Sensors	Civilian Grade	1	3
Weapons	Double Turret (missile rack, sandcaster)	1	1.5
Systems	Fuel Scoops	-	-
	Docking Space (20 tons)	22	5.5
	Launch	-	2.367
Software	Manoeuvre/0	-	-
	Jump Control/4	-	0.4
	Library	-	-
	Evade/2	-	2
	Intellect	-	1
Staterooms	Standard x 4	16	2
	High x 2	12	1.6
	Luxury x 2	20	3
Common Areas		10	1
Cargo		14.4	-
TOTAL: MCR 140.127			

CREW

CAPTAIN, PILOT, ASTROGATOR,
ENGINEERS X 2, GUNNER,
STEWARD

RUNNING COSTS

MAINTENANCE COST
Cr11677/month

•••••
PURCHASE COST
MCR140.127

POWER REQUIREMENTS

60
MANOEUVRE
DRIVE

60
BASIC SHIP
SYSTEMS

120
JUMP DRIVE

1
SENSORS

1
WEAPONS

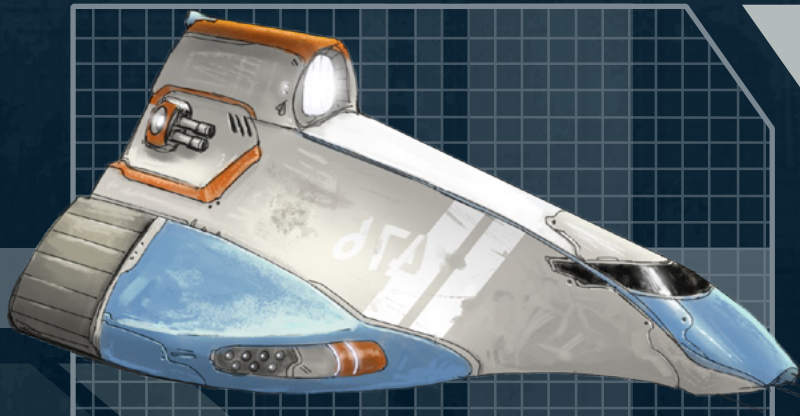

120

HULL POINTS

Elegant, agile and eye-wateringly expensive, the jump-4 *Herald* is the ship of choice for the wealthy noble or corporate executive who needs to get somewhere fast while still sipping champagne in a zero-g ultra-Jacuzzi. The rear turret is almost an afterthought and provides minimal defensive capabilities. A common refit is to replace the ship's lifeboat with escape pods and use the added tonnage for more cargo space and staterooms.

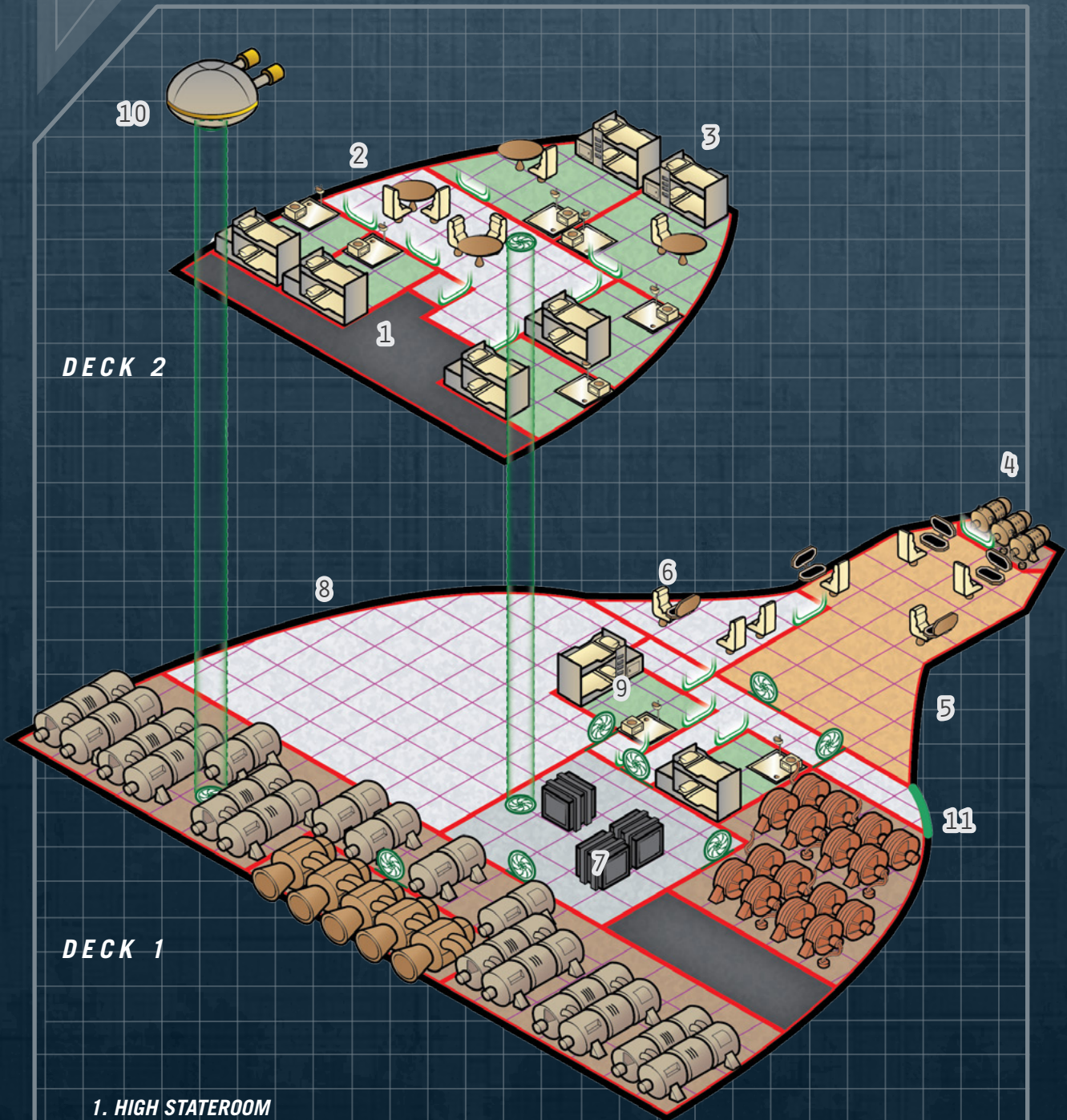

DECK 2

DECK 1

- 1. HIGH STATEROOM
- 2. COMMON AREA
- 3. LUXURY STATEROOM
- 4. SENSORS
- 5. BRIDGE
- 6. OFFICE
- 7. CARGO HOLD
- 8. DOCKING SPACE
- 9. STATEROOM
- 10. MISSILE RACK/SANDCASTER TURRET
- 11. AIR LOCK

INDIGO-CLASS PIRATE CARRIER

XX

TL15		TONS	COST (MCR)
Hull	300 tons, Dispersed	-	7.5
M-Drive	Thrust 1	4	8
J-Drive	Jump 2	25	37.5
Power Plant	Fusion (TL12), Power 135	10	10
Fuel Tanks	J-2, 4 weeks of operation, plus Light Fighters	81	-
Bridge		20	1.5
Computer	Computer/10	-	0.16
Sensors	Military Grade	2	4.1
Weapons	Triple Turrets (beam lasers x 2, missile rack) x 3	3	8.25
Systems	Fuel Processor (20 tons/day)	1	0.05
	Cargo Net	5	1
	Heavy Grappling Arm	6	3
	Type I Docking Clamps x 10	10	5
	Light Fighters x 10	-	90.9
Software	Manoeuvre/0	-	-
	Jump Control/2	-	0.2
	Library	-	-
Staterooms	Standard x 10	40	5
	Low Berths x 8	4	0.4
Common Areas		24	2.4
Cargo		65	-

TOTAL: MCR 184.96

CREW

CAPTAIN, PILOT, ASTROGATOR,
ENGINEER, GUNNERS X 3,
FIGHTER PILOTS X 10

RUNNING COSTS

MAINTENANCE COST
Cr15413/month

•••••
PURCHASE COST
MCR184.96

POWER REQUIREMENTS

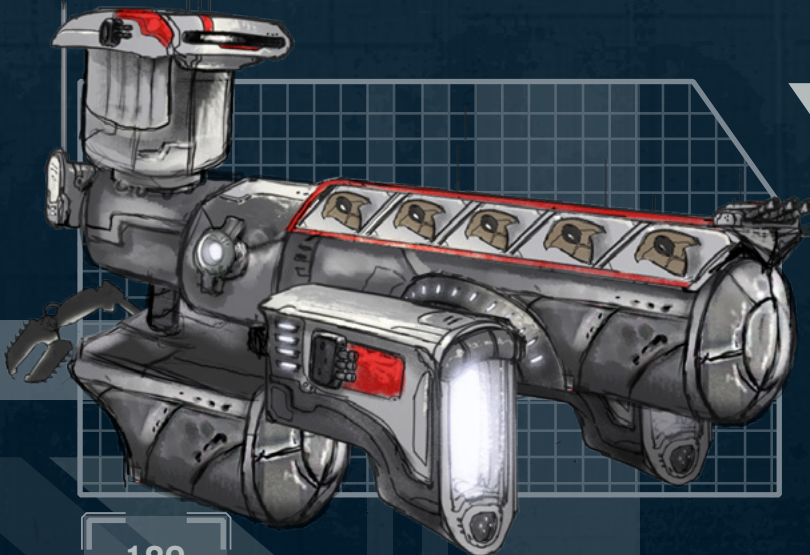
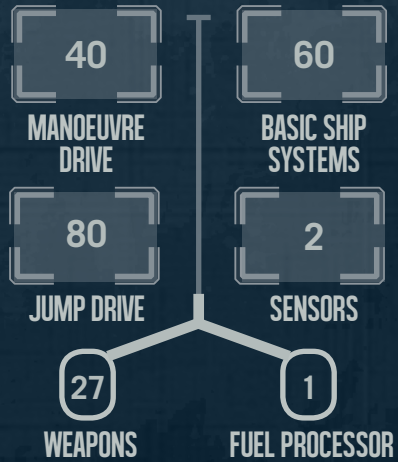

180

HULL POINTS

The *Indigo*-class was designed as a tiny light carrier, and quickly found favour among raiders and pirates. Its complement of ten light fighters are clamped to the hull, attacking targets and either forcing them to surrender or blasting them apart for the *Indigo* to follow behind and sift through the wreckage with its cargo net.

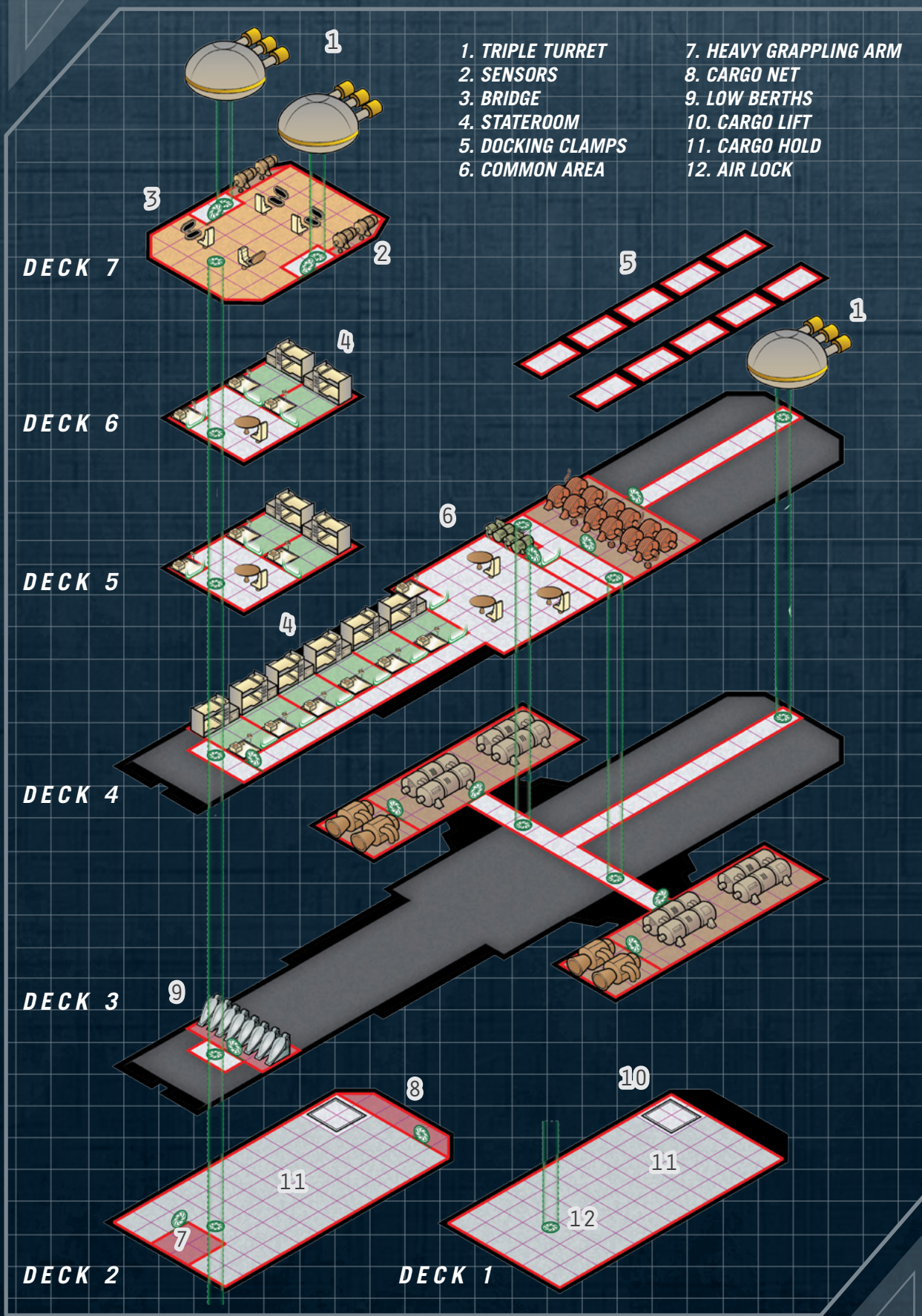

- | | |
|-------------------|------------------------|
| 1. TRIPLE TURRET | 7. HEAVY GRAPPLING ARM |
| 2. SENSORS | 8. CARGO NET |
| 3. BRIDGE | 9. LOW BERTHS |
| 4. STATEROOM | 10. CARGO LIFT |
| 5. DOCKING CLAMPS | 11. CARGO HOLD |
| 6. COMMON AREA | 12. AIR LOCK |

DECK 7

DECK 6

DECK 5

DECK 4

DECK 3

DECK 2

DECK 1

BUCCANEER-CLASS BLOCKADE RUNNER

XX

TL15		TONS	COST (MCR)
Hull	400 tons, Streamlined	-	24
Armour	Bonded Superdense, Armour 5	16	9.6
M-Drive	Thrust 3	12	24
H.B. Thruster	Thrust 3	24	4.8
J-Drive	Jump 2	25	37.5
Power Plant	Fusion (TL15), Power 300	15	30
Fuel Tanks	J-2, 4 weeks of operation, plus Launch	81	-
Thruster Fuel	2 hour burn	60	-
Bridge		20	2
Computer	Computer/5bis	-	3
Sensors	Improved	3	4.3
Weapons	Double Turrets (pulse lasers) x 2	2	5
	Double Turret (sandcaster, pulse laser) x 2	2	3.5
Ammunition	Sandcaster Barrel x 40	2	-
Systems	Fuel Processor (100 tons/day)	5	0.25
	Fuel Scoops		
	Docking Space (20 tons) Launch	22	5.5
		-	2.367
Software	Manoeuvre/0	-	-
	Jump Control/2	-	0.2
	Library	-	-
Staterooms	Standard x 8	32	4
Common Areas		17	0.17
Cargo		62	-

TOTAL: MCR 160.187

CREW

CAPTAIN, PILOT, ASTROGATOR,
MEDIC, ENGINEERS X 3,
GUNNERS X 4

RUNNING COSTS

MAINTENANCE COST

Cr13348/month

PURCHASE COST

MCR157.347

POWER REQUIREMENTS

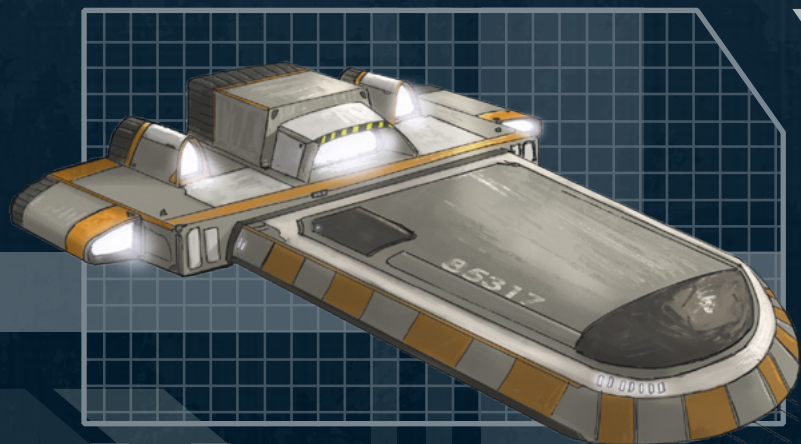
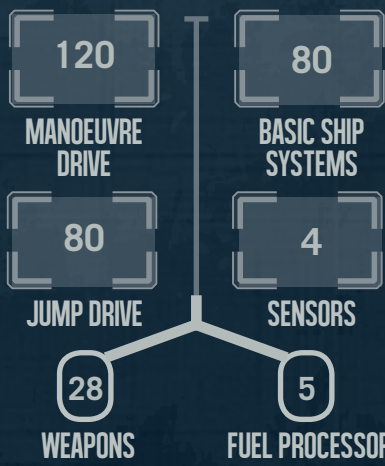

160

HULL POINTS

The *Buccaneer*-class was designed specifically to break through blockades and deliver small, high-value cargoes, such as weapons or illegal drugs. It therefore sees use among both militaries and pirate forces. While it has relatively limited cargo space, the ship is also equipped with an auxiliary high-burn thruster with enough fuel to create a combined thrust of 6G for two hours; enough to break orbit and reach the hundred diameter limit of all but the largest gravity wells.

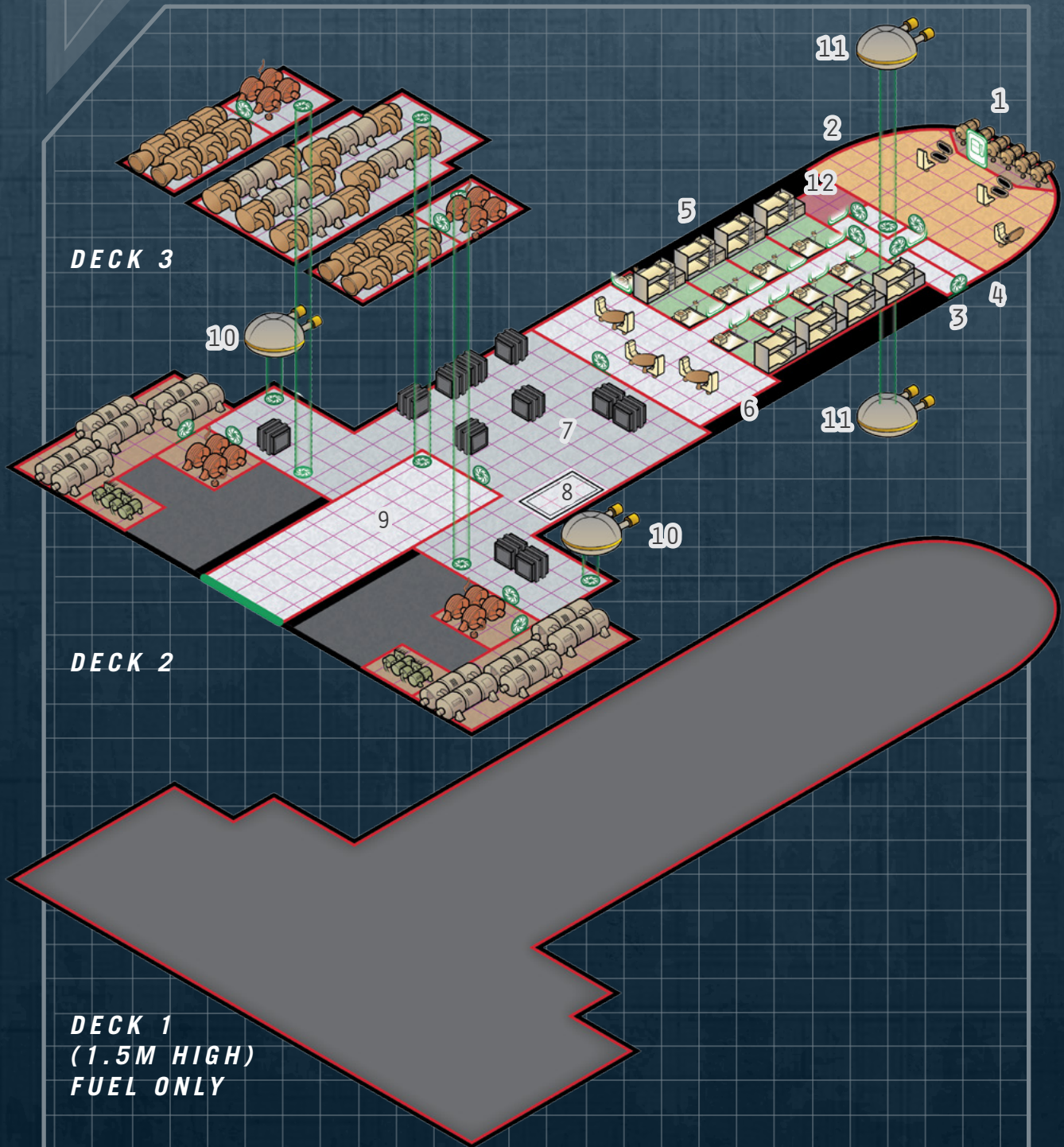

DECK 3

DECK 2

**DECK 1
(1.5M HIGH)
FUEL ONLY**

- 1. SENSORS
- 2. BRIDGE
- 3. AIR LOCK
- 4. SHIP'S LOCKER
- 5. STATEROOMS
- 6. COMMON AREA

- 7. CARGO HOLD
- 8. CARGO LIFT
- 9. DOCKING SPACE
- 10. PULSE LASER TURRET
- 11. SANDCASTER/PULSE LASER TURRET
- 12. SANDCASTER BARRELS STORAGE

FIERY-CLASS GUNSHIP

[XX]

TL12		TONS	COST (MCR)
Hull	400 tons, Streamlined	-	24
Armour	Crystaliron, Armour 6	30	7.2
M-Drive	Thrust 6	24	48
J-Drive	Jump 2	25	37.5
Power Plant	Fusion (TL12), Power 525	35	35
Fuel Tanks	J-2, 4 weeks of operation	84	-
Bridge	Holographic Controls	20	2.5
Computer	Computer/20 fib	-	7.5
Sensors	Military Grade, Improved Signal Processing	3	8.1
Weapons	Small Fusion Gun Bay	50	8
	Particle Barbette	5	8
	Double Turret (beam lasers)	1	1.5
	Triple Turret (sandcasters x 2, beam laser)	1	2
Ammunition	Sandcaster Barrel x 40	2	-
Systems	Fuel Processor (40 tons/day)	2	0.1
	Fuel Scoops	-	-
	Breaching Tube	3	3
	Armoury	6	1.5
Software	Manoeuvre/0	-	-
	Jump Control/2	-	0.2
	Library	-	-
	Evade/2	-	2
	Fire Control/3	-	6
Staterooms	Standard x 9	36	4.5
	Barracks x 30	60	1.5
	Brig	4	0.25
Common Areas		3	0.3
Cargo		6	-

TOTAL: MCR 208.65



160
HULL POINTS

CREW

CAPTAIN, OFFICER, PILOT, ASTROGATOR,
ENGINEER X 2, MAINTENANCE, GUNNERS
X 4, MARINES X 30

RUNNING COSTS

MAINTENANCE COST

Cr17387/month

• • • • •

PURCHASE COST

MCr208.65

POWER REQUIREMENTS

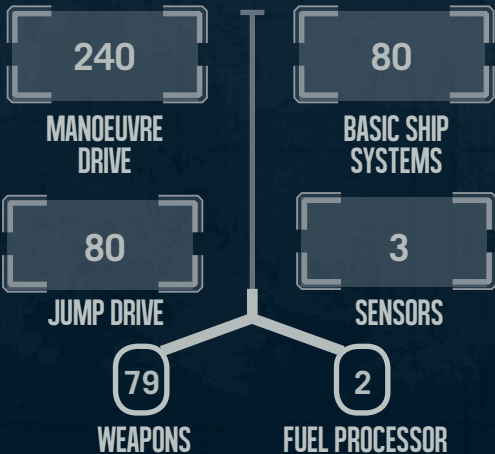

This gunship was intended to be used by small navies, moving quickly into range, blasting an invader, and then boarding it. However, these qualities also make the *Fiery*-class highly attractive to pirates and other criminals. The presence of this ship can either give merchants in the area complete confidence in reaching their destinations safely, or it can send ripples of fear throughout an entire system. It all depends whose side the crew is on.

- 1. SENSORS
- 2. BRIDGE
- 3. AIR LOCK
- 4. SHIP'S LOCKER
- 5. STATEROOMS
- 6. COMMON AREA
- 7. CARGO HOLD

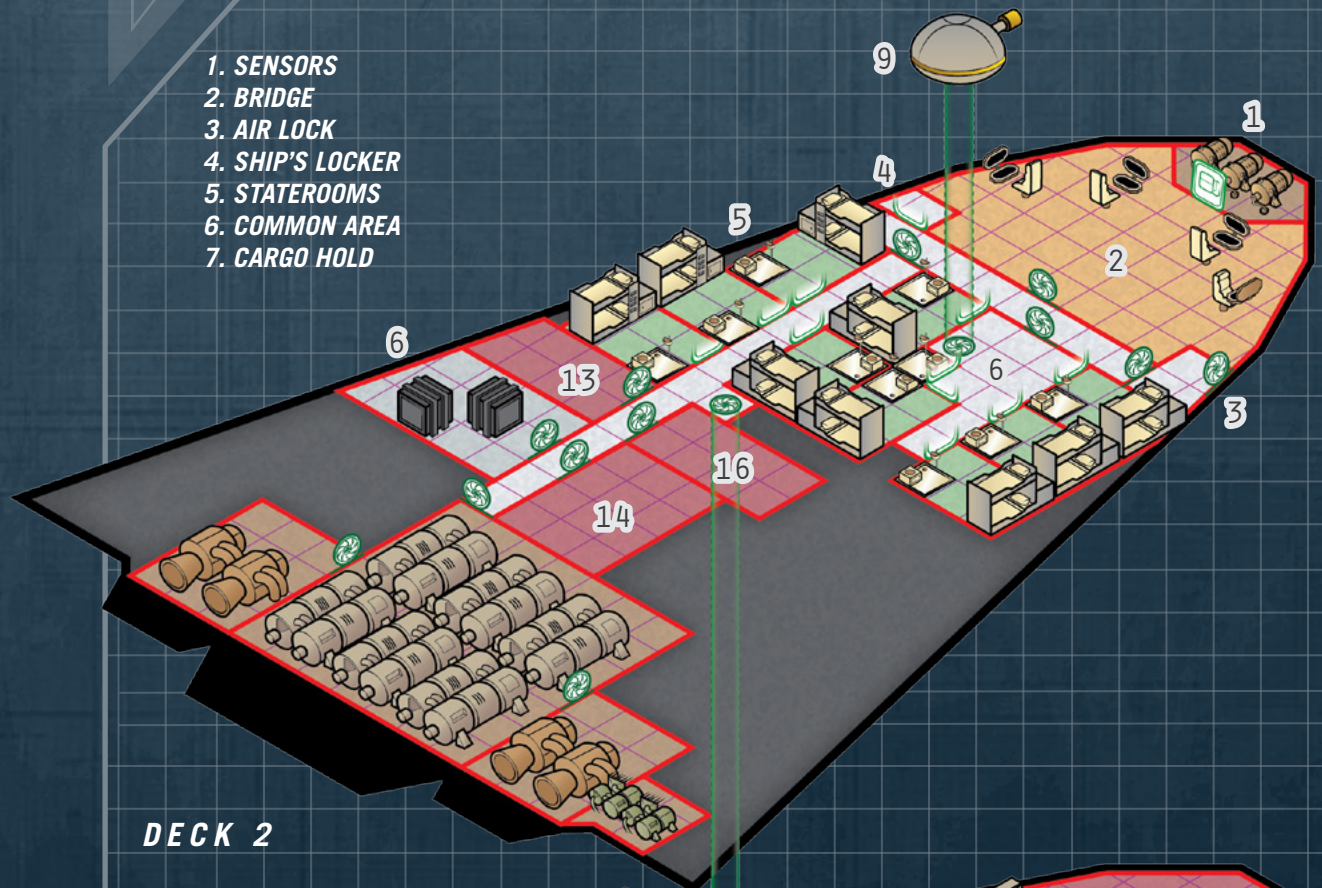

DECK 2



DECK 1

- 8. SANDCASTER BARREL STORAGE
- 9. PARTICLE BARBETTE
- 10. SMALL FUSION GUN BAY
- 11. BEAM LASER TURRET
- 12. SANDCASTER/BEAM LASER TURRET
- 13. BREACHING TUBE
- 14. ARMOURY
- 15. BARRACKS
- 16. BRIG

THE GHOST OF THE REACH

XX

TL15		TONS	COST (MCR)
Hull	400 tons, Streamlined	-	24
	Superior Stealth	-	400
	Emissions Absorption Grid	8	16
Armour	Bonded Superdense, Armour 6	19.2	11.52
M-Drive	Thrust 3	12	24
J-Drive	Jump 3	35	52.5
Power Plant	Fusion (TL15), Power 360	18	36
Fuel Tanks	J-3, 4 weeks of operation, plus Ship's Boat	123	-
Bridge	Holographic Controls	20	2.5
	Sensor Station	1	0.5
Computer	Computer/15 fib	-	3
Sensors	Advanced	5	5.3
	Enhanced Signal Processing	2	8
Weapons	Double Turrets (beam lasers) x 4	4	6
Systems	Fuel Processor (120 tons/day)	6	0.3
	Fuel Scoops	-	-
	Probe Drones	1	0.5
	Armoury	2	0.5
	Briefing Room	4	0.5
	Medical Bay	4	2
	Laboratory	4	1
	Docking Space (30 tons)	33	8.25
	Ship's Boat	-	7.272
Software	Manoeuvre/0	-	-
	Jump Control/3	-	0.3
	Library	-	-
	Evade/2	-	2
	Fire Control/3	-	6
Staterooms	Standard x 10	40	5
Common Areas		22	2.2
Cargo		36.8	-

TOTAL: MCR 625.142

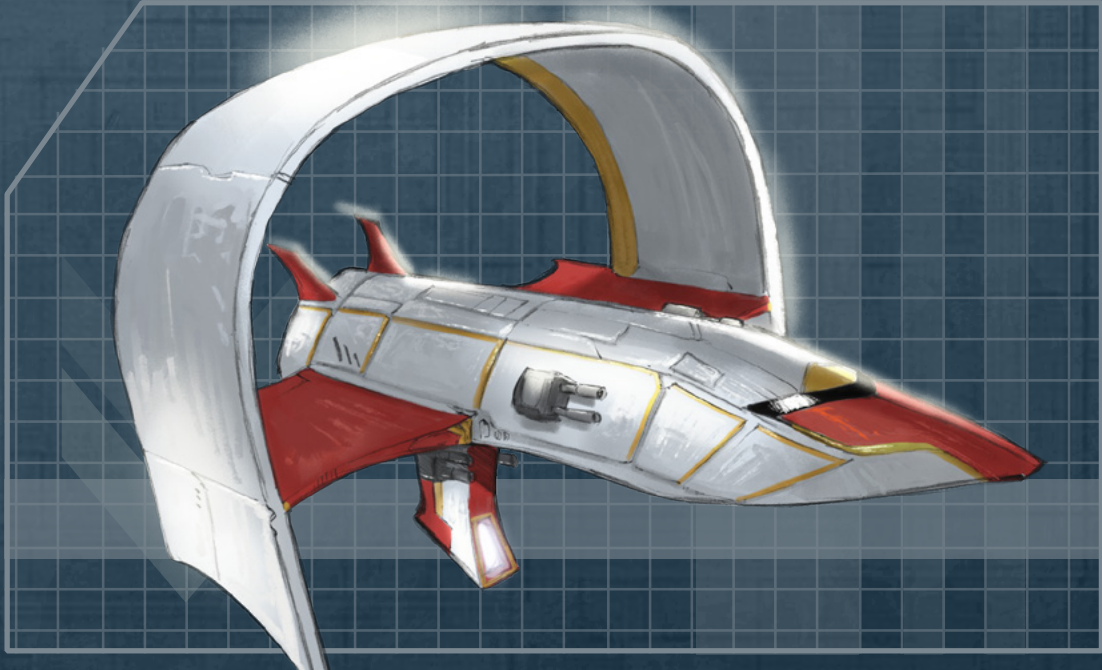

160

HULL POINTS

CREW

CAPTAIN, PILOT, ASTROGATOR, SENSOR OPERATOR, MEDIC, ENGINEERS X 2, GUNNERS X 4, MARINES X 6

RUNNING COSTS

MAINTENANCE COST

Cr52095/month

•••••

PURCHASE COST

MCr625.142

POWER REQUIREMENTS

120

MANOEUVRE DRIVE

80

BASIC SHIP SYSTEMS

120

JUMP DRIVE

8

SENSORS

36

WEAPONS

6

FUEL PROCESSOR

The Ghost of the Reach is a long-range Zhodani heavy scout. While it uses mostly standard components, its hull is coated with sensor-baffling material, and it is equipped with cutting-edge electronic countermeasures. When this vessel closes on a target, there is little chance of the target having enough time to transmit a distress call before teleporting marines arrive. Fast-moving enemies that might be able to escape *The Ghost of the Reach* can be flanked by the ship's boat.

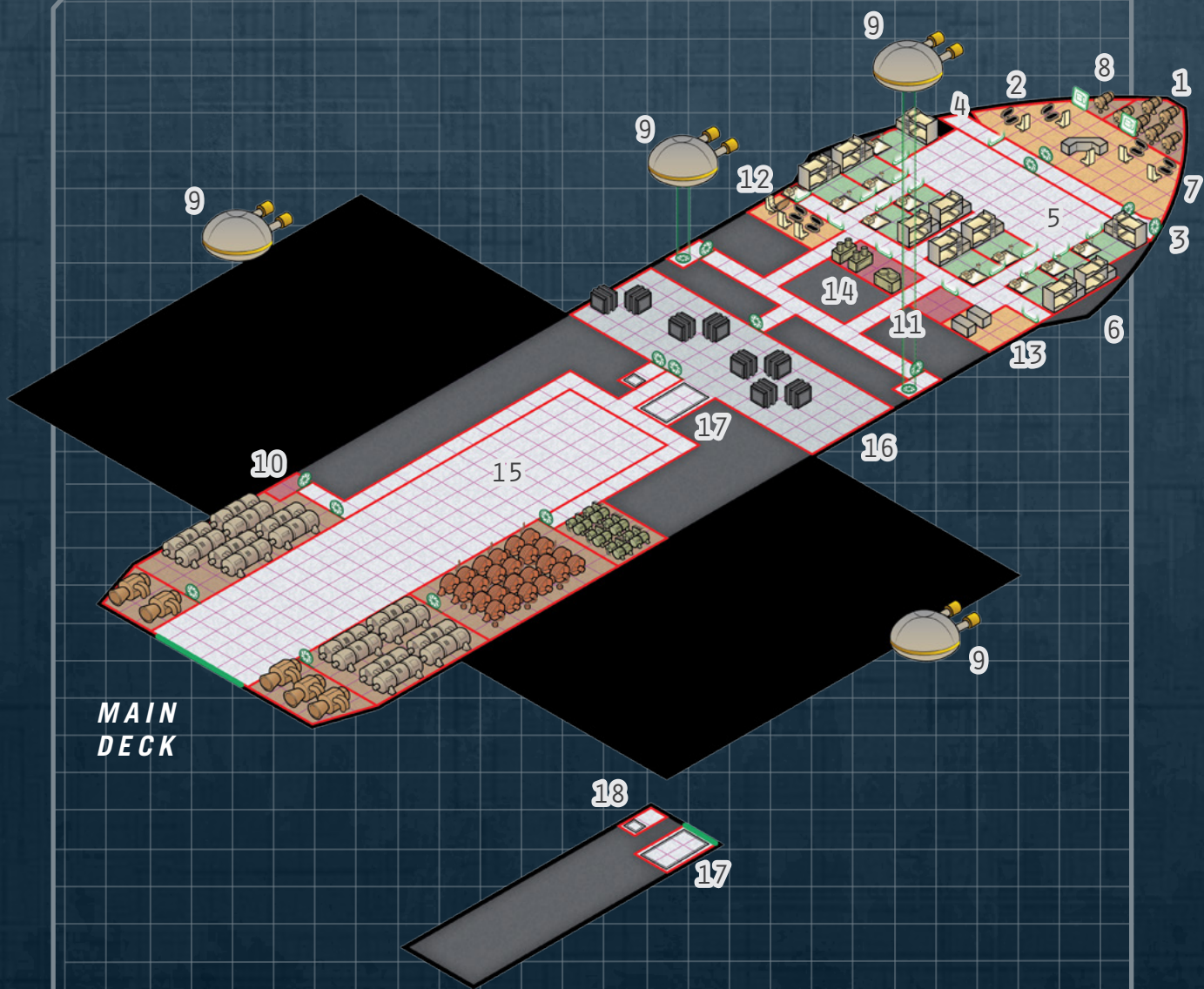

**MAIN
DECK**

- | | |
|-------------------------------|---------------------|
| 1. SENSORS | 10. PROBE DRONES |
| 2. BRIDGE | 11. ARMOURY |
| 3. AIR LOCK | 12. BRIEFING ROOM |
| 4. SHIP'S LOCKER | 13. MEDICAL BAY |
| 5. COMMON AREA | 14. LABORATORY |
| 6. STATEROOMS | 15. DOCKING SPACE |
| 7. SENSOR STATION | 16. CARGO HOLD |
| 8. ENHANCED SIGNAL PROCESSING | 17. CARGO LIFT |
| 9. BEAM LASER TURRET | 18. LIFT & AIR LOCK |

SUBSIDISED MERCHANT

TYPE RQ

TL12		TONS	COST (MCR)
Hull	400 tons, Streamlined	-	24
Armour	Crystaliron, Armour 8	40	9.6
M-Drive	Thrust 4	16	32
J-Drive	Jump 1	15	22.5
Power Plant	Fusion (TL12), Power 315	21	21
Fuel Tanks	J-1, 4 weeks of operation	43	-
Bridge		20	2
Computer	Computer/20	-	5
Sensors	Improved, Improved Signal Processing	4	8.3
Weapons	Pop-up Triple Turrets (pulse lasers) x 4	8	20
Systems	Fuel Processor (20 tons/day)	1	0.05
	Fuel Scoops	-	1
	Breaching Tube	3	3
	Armoury	4	1
	Booby-trapped Airlock (TL12)	-	1
	Grav-screen	2	2
	Docking Space (10 tons) x 4	44	11
	Light Fighter x 4	-	36
	Low Berths x 10	5	0.5
Software	Manoeuvre/0	-	-
	Jump Control/1	-	0.1
	Library	-	-
	Fire Control/4	-	8
	Evade/2	-	2
	Anti-Hijack/2	-	8
Staterooms	Standard x 14	56	7
	Barracks x 16	32	1.6
Common Areas		10	1
Cargo		76	-

TOTAL: MCR 227.65



160

HULL POINTS

CREW

**CAPTAIN, PILOTS X 5, ASTROGATOR,
ENGINEER, MEDIC, GUNNERS X 4,
MARINES X 16**

RUNNING COSTS

MAINTENANCE COST

Cr18970/month

• • • • •

PURCHASE COST

MCr227.65

POWER REQUIREMENTS

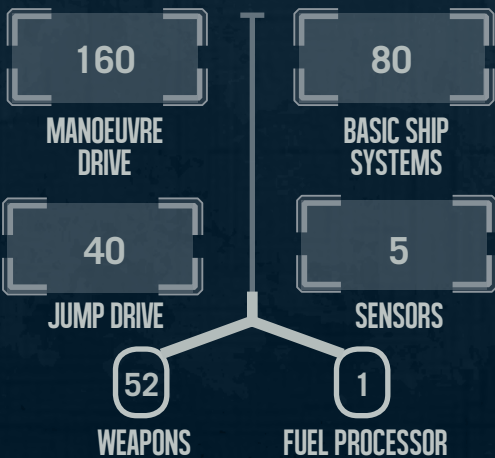

Externally indistinguishable from a standard subsidised merchant, the Type-RQ is a pirate's nightmare. Posing as a helpless trader, the crew will attempt to sucker a pirate into striking range and then reveal the full capabilities of their ship. Compared to other subsidised merchants, this ship has a much more powerful manoeuvre drive, heavy armour, concealed weaponry and internal bays capable of releasing light fighters to swarm and destroy an enemy.

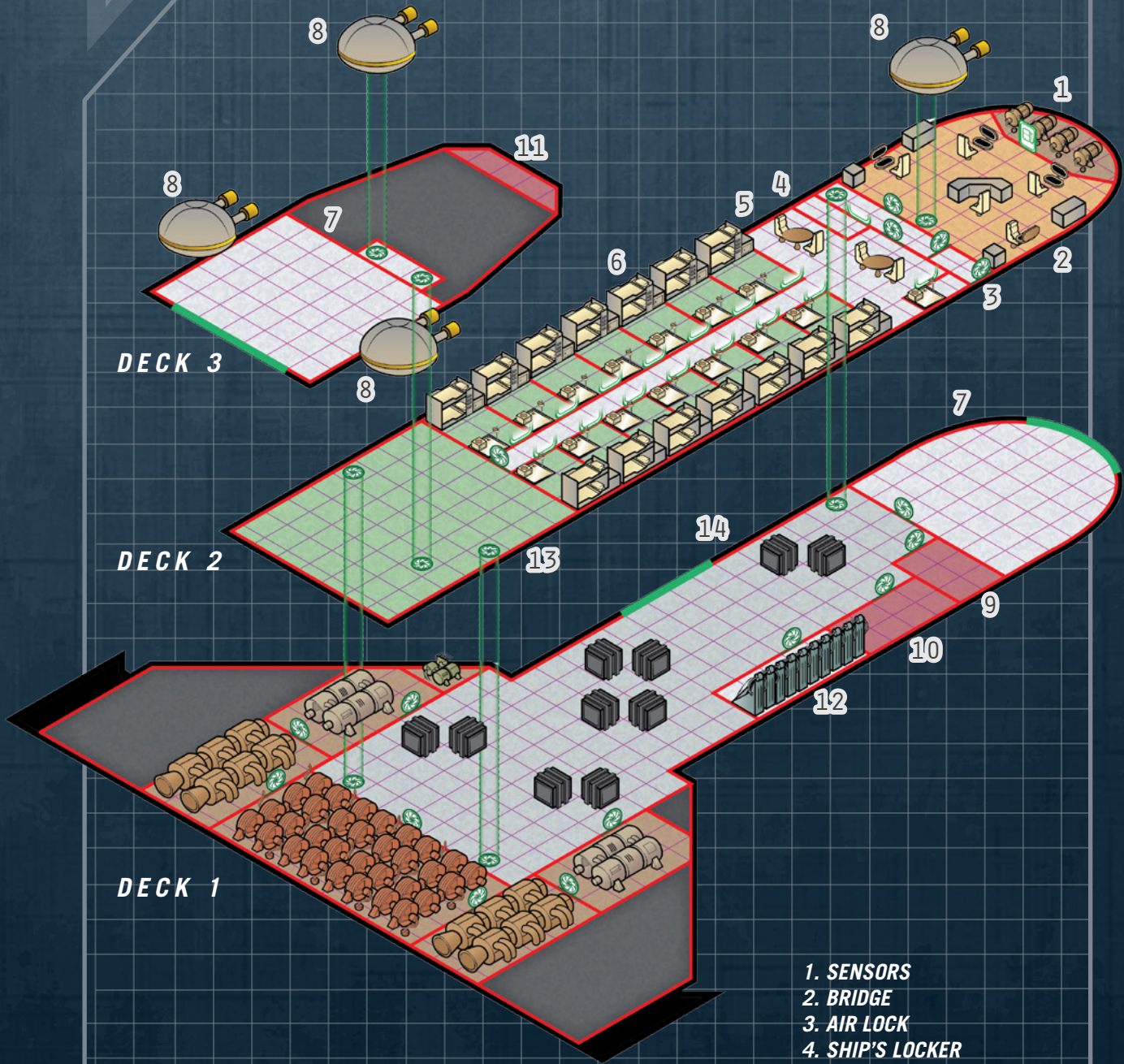

1. SENSORS
2. BRIDGE
3. AIR LOCK
4. SHIP'S LOCKER
5. COMMON AREA
6. STATEROOMS
7. DOCKING SPACE
8. PULSE LASER TURRET
9. BREACHING TUBE
10. ARMOURY
11. GRAV-SCREEN
12. LOW BERTHS
13. BARRACKS
14. CARGO HOLD

VULTURE-CLASS SALVAGE HAULER

XX

TL15		TONS	COST (MCR)
Hull	400 tons, Standard	-	20
M-Drive	Thrust 1	4	8
J-Drive	Jump 2	25	37.5
Power Plant	Fusion (TL12), Power 135	9	9
Fuel Tanks	J-2, 8 weeks of operation	82	-
Bridge		20	2
Computer	Computer/5 bis	-	0.045
Sensors	Civilian Grade	1	3
Weapons	Double Turret (pulse lasers)	1	2.5
Systems	Fuel Processor (40 tons/day)	2	0.1
	Fuel Scoops	-	1
	Cargo Scoop	2	0.5
	Loading Belt (TL12)	1	0.01
	Probe Drones x 5	1	0.5
	Forced Linkage Apparatus (TL12)	2	0.1
	Grappling Arm	2	1
	Heavy Grappling Arm	6	3
	Docking Space (20 tons)	22	5.5
	Launch	-	2.367
Software	Manoeuvre/0	-	-
	Jump Control/2	-	0.2
	Library	-	-
Staterooms	Standard x 4	16	2
Common Areas		5	0.5
Cargo		199	-
TOTAL: MCR 98.822			

CREW

CAPTAIN, PILOT,
ASTROGATOR, ENGINEER,
GUNNER

RUNNING COSTS

MAINTENANCE COST
Cr8235/month

•••••
PURCHASE COST
MCR98.822

POWER REQUIREMENTS

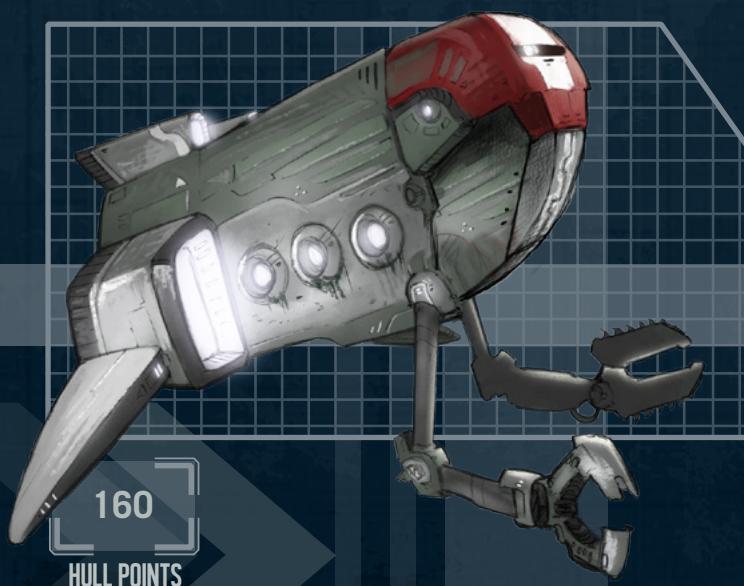
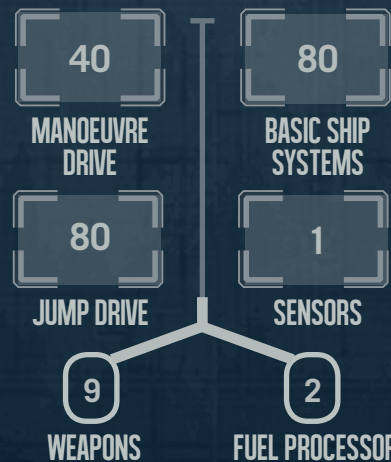

160

HULL POINTS

Easily recognised by the two grappling arms mounted upon the prow, the *Vulture*-class salvage hauler can usually be found in-system, picking apart derelicts for spare parts and materials. The cargo bay also opens within the prow, allowing the grappling arms to tear chunks off a derelict ship and feed them directly into the cargo bay. When not engaged in salvage operations, Vultures are perfectly functional as small traders, due in no small part to their large cargo space and jump range.

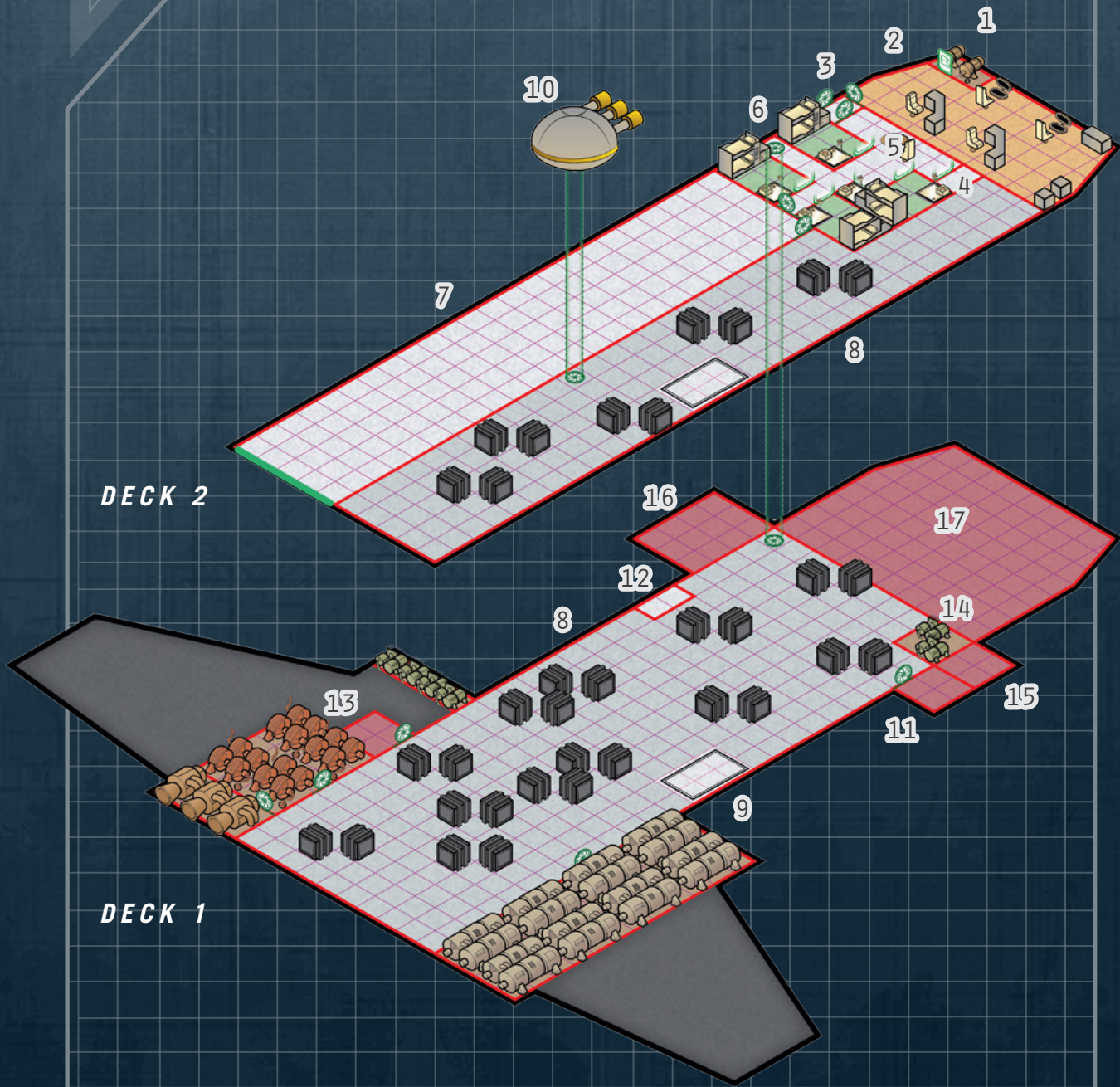

DECK 2

DECK 1

- 1. SENSORS
- 2. BRIDGE
- 3. AIR LOCK
- 4. SHIP'S LOCKER
- 5. COMMON AREA
- 6. STATEROOMS
- 7. DOCKING SPACE
- 8. CARGO HOLD
- 9. CARGO LIFT
- 10. PULSE LASER TURRET
- 11. CARGO SCOOP
- 12. LOADING BELT
- 13. PROBE DRONES
- 14. FORCED LINKAGE APPARATUS
- 15. GRAPPLING ARM
- 16. HEAVY GRAPPLING ARM
- 17. OPENING JAWS

WATCHDOG-CLASS FLEET PICKET

XX

TL13		TONS	COST (MCR)
Hull	500 tons, Standard	-	25
Armour	Crystaliron, Armour 8	50	10
M-Drive	Thrust 3	15	30
J-Drive	Jump 4	55	82.5
Power Plant	Fusion (TL12), Power 330	22	22
Fuel Tanks	J-4, 12 weeks of operation, plus Launch	210	-
Bridge		20	2.5
	Sensor Station	1	0.5
Computer	Computer/20 fib	-	7.5
Sensors	Improved	3	4.3
	Enhanced Signal Processing	2	8
	Countermeasures Suite	2	4
	Extension Net	5	5
Weapons	Triple Turrets (beam lasers) x 5	5	12.5
Systems	Fuel Processor (60 tons/day)	3	0.15
	Fuel Scoops	-	1
	Solar Panels	2.2	0.22
	Docking Space (20 tons)	22	5.5
	Launch	-	2.367
	Low Berths x 8	4	0.4
Software	Manoeuvre/0	-	-
	Jump Control/4	-	0.4
	Library	-	-
	Electronic Warfare/1	-	15
Staterooms	Standard x 8	32	4
Common Areas		30	3
Cargo		16.8	-

TOTAL: MCR 245.837

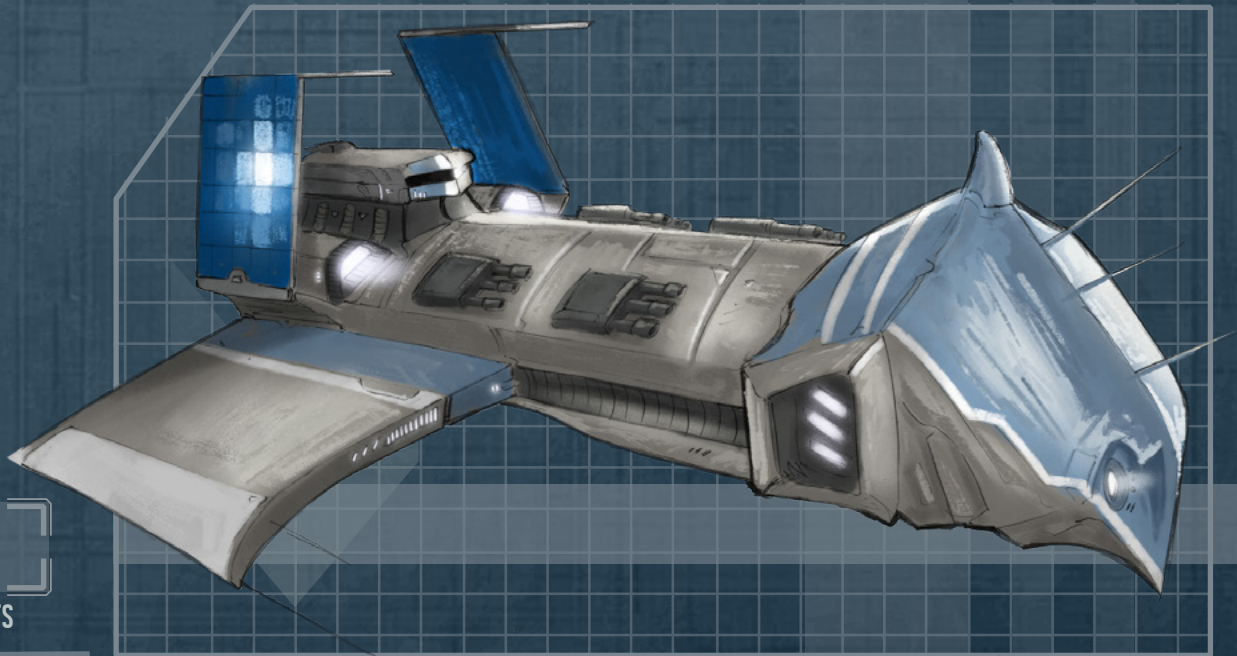

200

HULL POINTS

CREW

**CAPTAIN, PILOT, ASTROGATOR,
SENSOR OPERATOR, ENGINEERS X 3,
GUNNERS X 5**

RUNNING COSTS

MAINTENANCE COST

Cr20486/month

• • • • •

PURCHASE COST

MCr245.837

POWER REQUIREMENTS

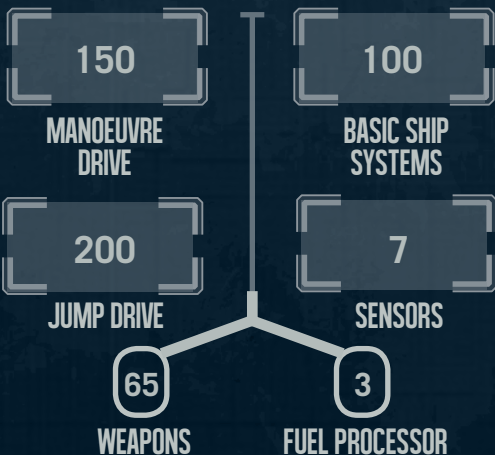

Designed to stay on station at the outer edges of a fleet's deployment, the *Watchdog* stands sentry, using its enhanced sensor array to filter incoming craft. In this way, it not only forms a barrier to enemies but acts as the eyes and ears of an entire fleet when jumping into a hostile system.

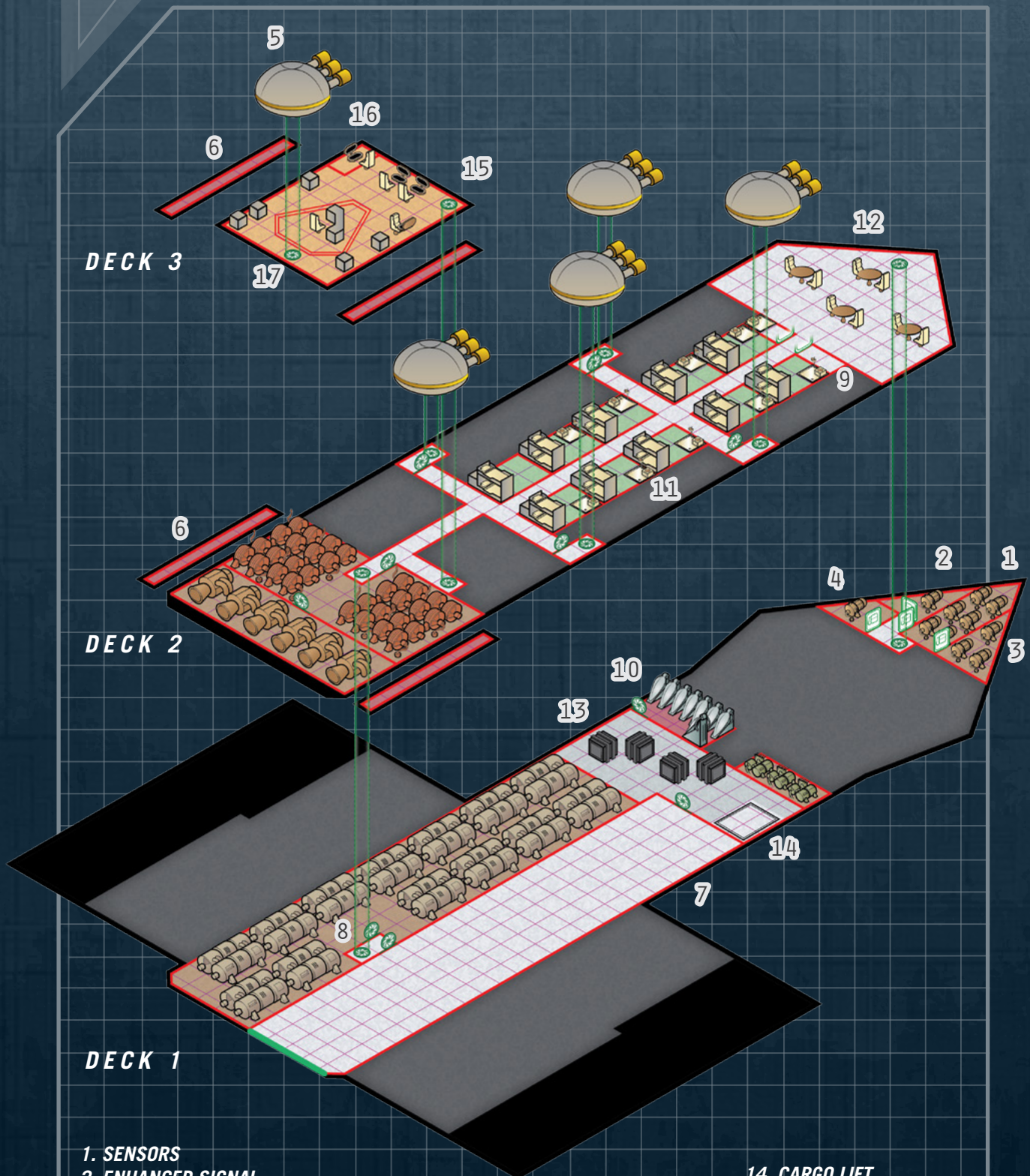

1. SENSORS

2. ENHANCED SIGNAL PROCESSING

3. COUNTERMEASURE SUITE

4. EXTENSION NET

5. BEAM LASER TURRET

6. SOLAR PANELS

7. DOCKING SPACE

8. AIR LOCK

9. SHIP'S LOCKER

10. LOW BERTHS

11. STATEROOMS

12. COMMON AREA

13. CARGO HOLD

14. CARGO LIFT

15. BRIDGE

16. RAISED PLATFORM

17. SENSOR STATION

CORSAIR

XX

TL15		TONS	COST (MCR)
Hull	600 tons, Streamlined	-	36
M-Drive	Thrust 3	18	36
J-Drive	Jump 2	35	52.5
Power Plant	Fusion (TL15), Power 660	33	66
Fuel Tanks	J-2, 8 weeks of operation	128	-
Bridge		20	3
Computer	Computer/10	-	0.16
Sensors	Military Grade	2	4.1
Weapons	Triple Turrets (beam lasers) x 3	3	7.5
Systems	Fuel Processor (140 tons/day)	7	0.35
	Fuel Scoops	-	-
	Cargo Scoop	2	0.5
	Repair Drones	6	1.2
	Breaching Tube	3	3
	Forced Linkage Apparatus (TL15)	2	0.5
	Armoury	2	0.5
Software	Fire Control/2	-	4
	Evade/1	-	1
	Jump Control/2	-	0.2
	Library	-	-
	Manoeuvre/0	-	-
	Auto-Repair/1	-	5
Staterooms	Standard x 10	40	5
	Low berth x 20	10	1
Common Areas		10	1
Cargo		279	-

TOTAL: MCR 228.51

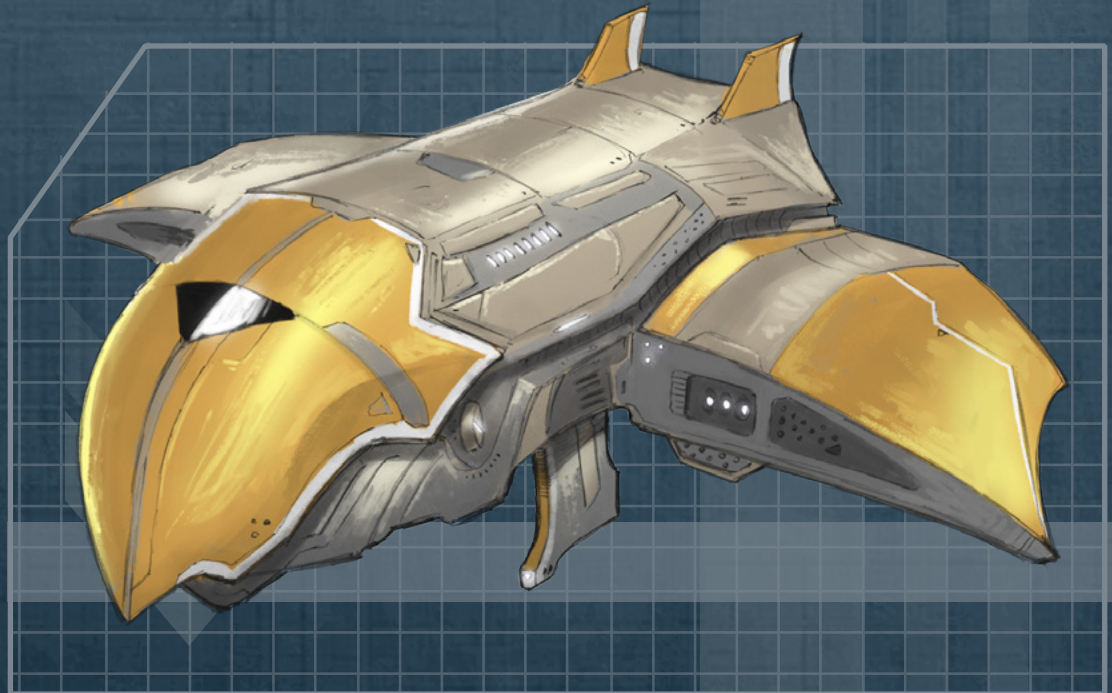

240

HULL POINTS

CREW

**CAPTAIN, PILOT, ASTROGATOR,
ENGINEER X 4, MEDIC, GUNNER X 3,
BOARDING PARTY X 5**

RUNNING COSTS

MAINTENANCE COST

Cr19042/month

•••••

PURCHASE COST

MCr228.51

POWER REQUIREMENTS

180

MANOEUVRE
DRIVE

120

BASIC SHIP
SYSTEMS

120

JUMP DRIVE

2

SENSORS

39

WEAPONS

7

FUEL PROCESSOR

Originally designed as a raider and pocket warship, the corsair has been adopted by pirates and criminal gangs across Charted Space (especially by the Pirate Lords of Theev, whose shipyards specialise in constructing this class). The large clamshell cargo doors are a distinctive feature and can open to reveal the entire cargo bay, allowing the corsair to easily carry a 100-ton ship within.

In addition, corsairs have several variable identification features, allowing them to alter their shape and configuration within minutes. These include fins that can retract or extend, modules that can be deployed or sunk into the hull, and radio emissions that alter frequency and content. Unusually, the corsair's transponders are highly adaptable, allowing them to be altered to identify the ship as having a variety of missions and identities.

Being unarmoured, the corsair relies on speed and hitting power, and is not designed to duke it out with warships in the depths of space. However, its weapon modules are highly adaptable and while most come out of the shipyards armed with three triple beam laser-filled turrets, the hull can readily accept more weaponry be it in turrets, barbettes or bays, and the power plant has enough excess energy to power them.

- 1. SENSORS
- 2. BRIDGE
- 3. STATEROOMS
- 4. COMMON AREA
- 5. AIR LOCK & LIFT
- 6. SHIP'S LOCKER
- 7. CARGO SCOOP
- 8. REPAIR DRONES

DECK 2

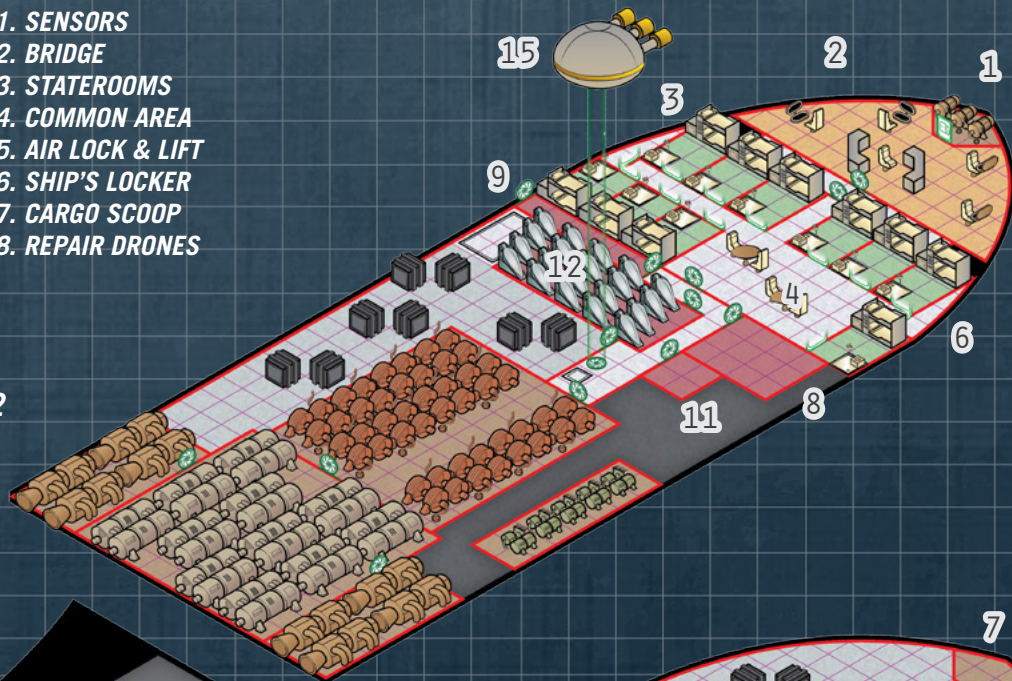

DECK 1

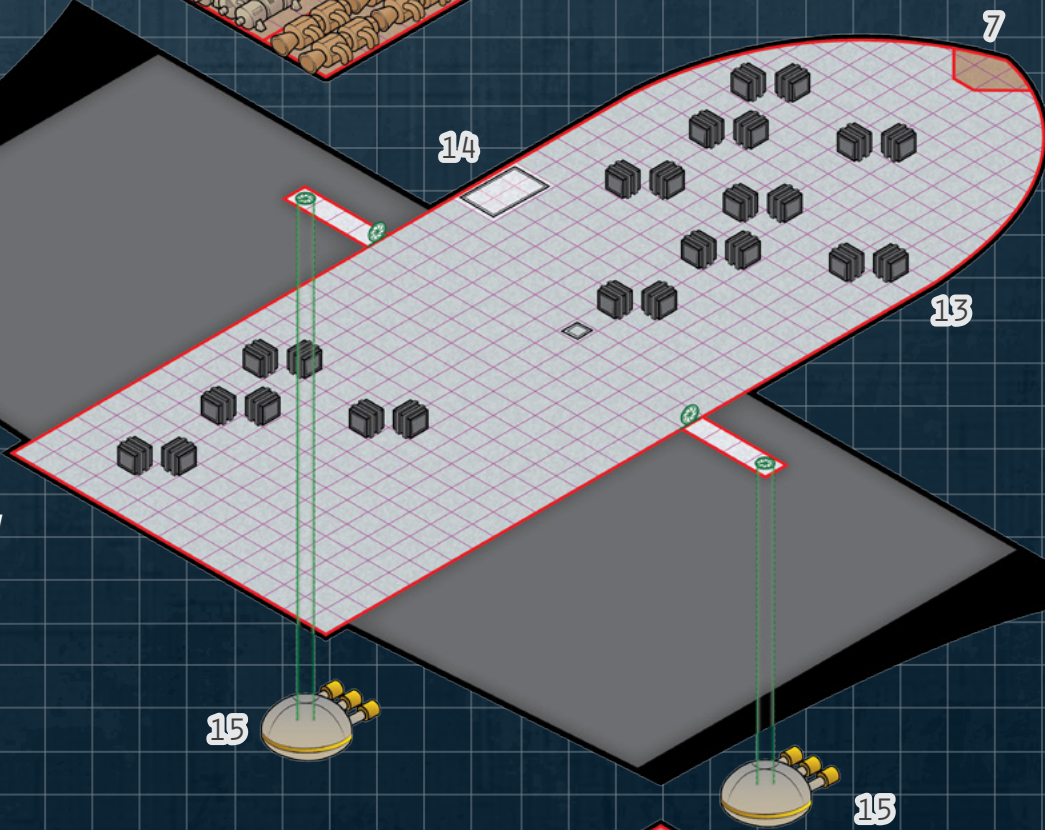

- 9. BREACHING TUBE
- 10. FORCED LINKAGE APPARATUS
- 11. ARMOURY
- 12. LOW BERTHS
- 13. CARGO HOLD
- 14. CARGO LIFT
- 15. BEAM LASER TURRET

MAGENTA-CLASS REPAIR SHIP

XX

TL12		TONS	COST (MCR)
Hull	700 tons, Streamlined, Radiation Shielding	-	59.5
Armour	Crystaliron, Armour 1	8.75	2.1
M-Drive	Thrust 1	7	14
J-Drive	Jump 3	57.5	86.25
Power Plant	Fusion (TL12), Power 240	16	16
Fuel Tanks	J-3, 12 weeks of operation	216	-
Bridge		20	2
Computer	Computer/10 bis	-	0.24
Sensors	Civilian Grade	1	3
Weapons	Double Turret (pulse lasers)	1	2.5
Systems	Fuel Processor (80 tons/day)	4	0.2
	Fuel Scoops	-	-
	Docking Clamp, Type IV	20	4
	Heavy Grappling Arm	6	3
	Repair Drones	7	1.4
	Tow Cable	7	0.035
	Grappling Arm	2	1
	Workshop	12	1.8
	Full Hangar (100 tons)	200	40
	Docking Space (20 tons)	22	5.5
	Launch	-	2.367
	Low Berths x 10	5	0.5
Software	Manoeuvre/0	-	-
	Jump Control/3	-	0.3
	Library	-	-
	Auto-Repair/1	-	5
Staterooms	Standard x 16	64	8
Common Areas		4	0.3
Cargo		19.75	-

TOTAL: MCR 258.992



280

HULL POINTS

CREW

CAPTAIN, PILOT, ASTROGATOR,
ENGINEERS X 6, MAINTENANCE X 2,
MEDIC, GUNNER

RUNNING COSTS

MAINTENANCE COST

Cr21582/month

•••••

PURCHASE COST

MCr258.992

POWER REQUIREMENTS

70

MANOEUVRE
DRIVE

140

BASIC SHIP
SYSTEMS

210

JUMP DRIVE

1

SENSORS

9

WEAPONS

4

FUEL PROCESSOR

If a crippled ship cannot make it back to the shipyards, the *Magenta*-class will be dispatched. Sufficient repairs will then be made to allow the stricken vessel to make it back to a starport under its own power. Small ships can be swallowed whole by the *Magenta*, permitting crews to make repairs within the comfort of its hangar, while larger ships can be repaired by EVA engineers, or even towed. Unusually for this type of vessel, the *Magenta*-class is capable of safely entering atmospheres, enabling it to repair ships planetside.

- 1. SENSORS
- 2. BRIDGE
- 3. AIR LOCK
- 4. SHIP'S LOCKER
- 5. STATEROOMS
- 6. COMMON AREA
- 7. PULSE LASER TURRET
- 8. DOCKING CLAMP

- 9. HEAVY GRAPPLING ARM
- 10. REPAIR DRONES
- 11. TOW CABLE
- 12. GRAPPLING ARM
- 13. WORKSHOP
- 14. FULL HANGAR
- 15. DOCKING SPACE
- 16. LOW BERTHS
- 17. CARGO HOLD

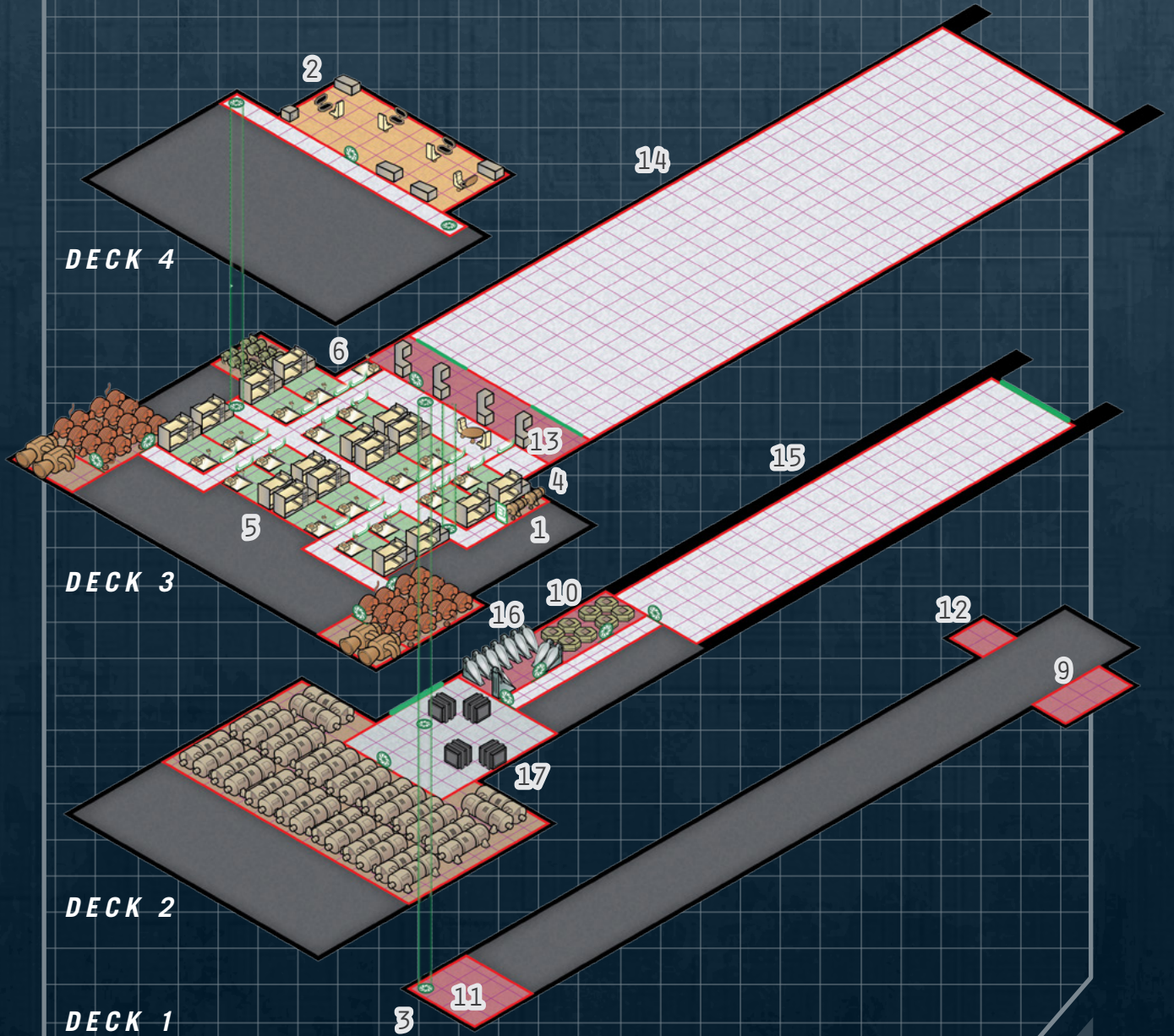

PATROL TENDER

XX

TL15		TONS	COST (MCR)
Hull	1,000 tons, Standard	-	50
Armour	Crystaliron, Armour 4	50	10
M-Drive	Thrust 2	20	40
J-Drive	Jump 4	105	157.5
Power Plant	Fusion (TL15), Power 600	30	60
Fuel Tanks	J-4, 4 weeks of operation, plus Slow Pinnacle	404	-
Bridge		20	5
Computer	Computer/15bis	-	3
Sensors	Military Grade	2	4.1
Weapons	Triple Turret (beam lasers) x 3	3	7.5
	Triple Turret (sandcasters) x 3	3	5.25
Ammunition	Sandcaster Barrel x 100	5	-
Systems	Fuel Processor (100 tons/day)	5	5
	Fuel Scoops	-	1
	Cargo Crane	3.5	3.5
	Heavy Grappling Arm	6	3
	Loading Belt (TL12)	1	0.01
	Docking Space (30 tons)	33	8.25
	Slow Pinnacle	-	5.787
Software	Manoeuvre/0	-	-
	Jump Control/4	-	0.4
	Library	-	-
Staterooms	Standard x 9	36	4.5
	Low Berths x 10	5	0.5
Common Areas		30	3
Cargo		238.5	-

TOTAL: MCR 377.297

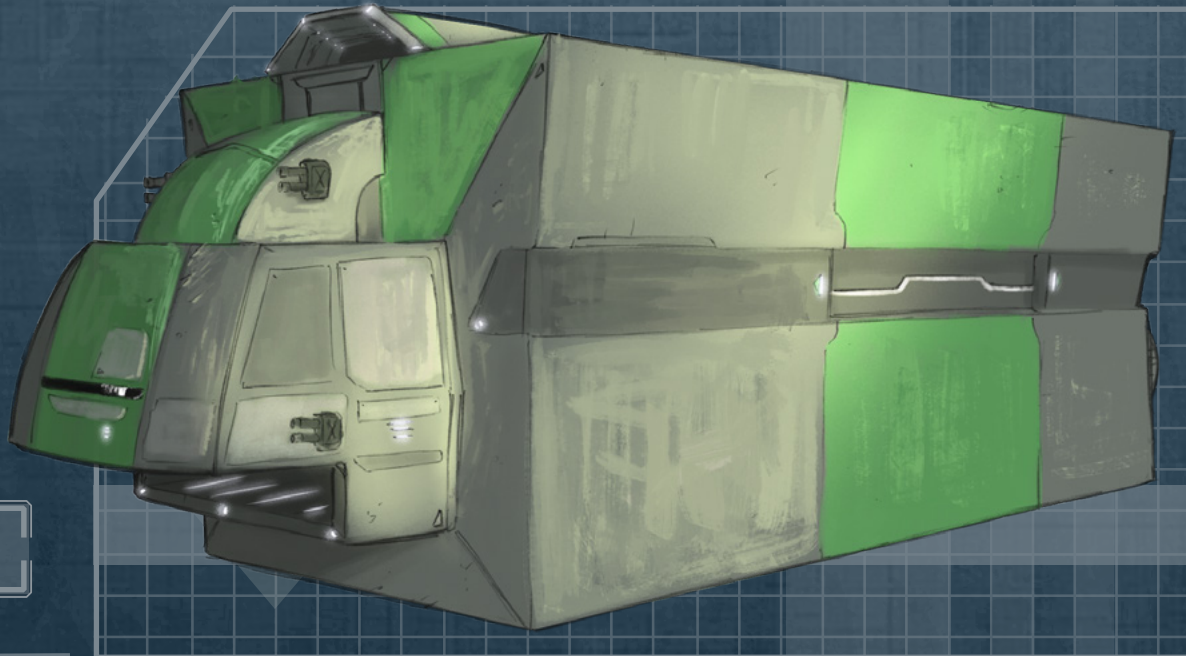

400

HULL POINTS

CREW

**CAPTAIN, PILOT, ASTROGATOR,
ENGINEERS X 5, GUNNERS X 6,
PINNACE PILOT**

RUNNING COSTS

MAINTENANCE COST

Cr31441/month

•••••

PURCHASE COST

MCr377.297

POWER REQUIREMENTS

200

MANOEVRE
DRIVE

200

BASIC SHIP
SYSTEMS

400

JUMP DRIVE

2

SENSORS

42

WEAPONS

5

FUEL PROCESSOR

These ships are used by the Imperial Navy to resupply other vessels on the front line or patrol duty. The Slow Pinnacle transports cargo containers to ships, which are unloaded while the Slow Pinnacle is fetching more. Patrol Tenders often find use in civilian service once they have been decommissioned, where they are used as long-ranged trading vessels.

- 1. SENSORS
- 2. BRIDGE
- 3. AIR LOCK
- 4. SHIP'S LOCKER
- 5. STATEROOMS
- 6. COMMON AREA
- 7. BEAM LASER TURRET
- 8. SANDCASTER TURRET

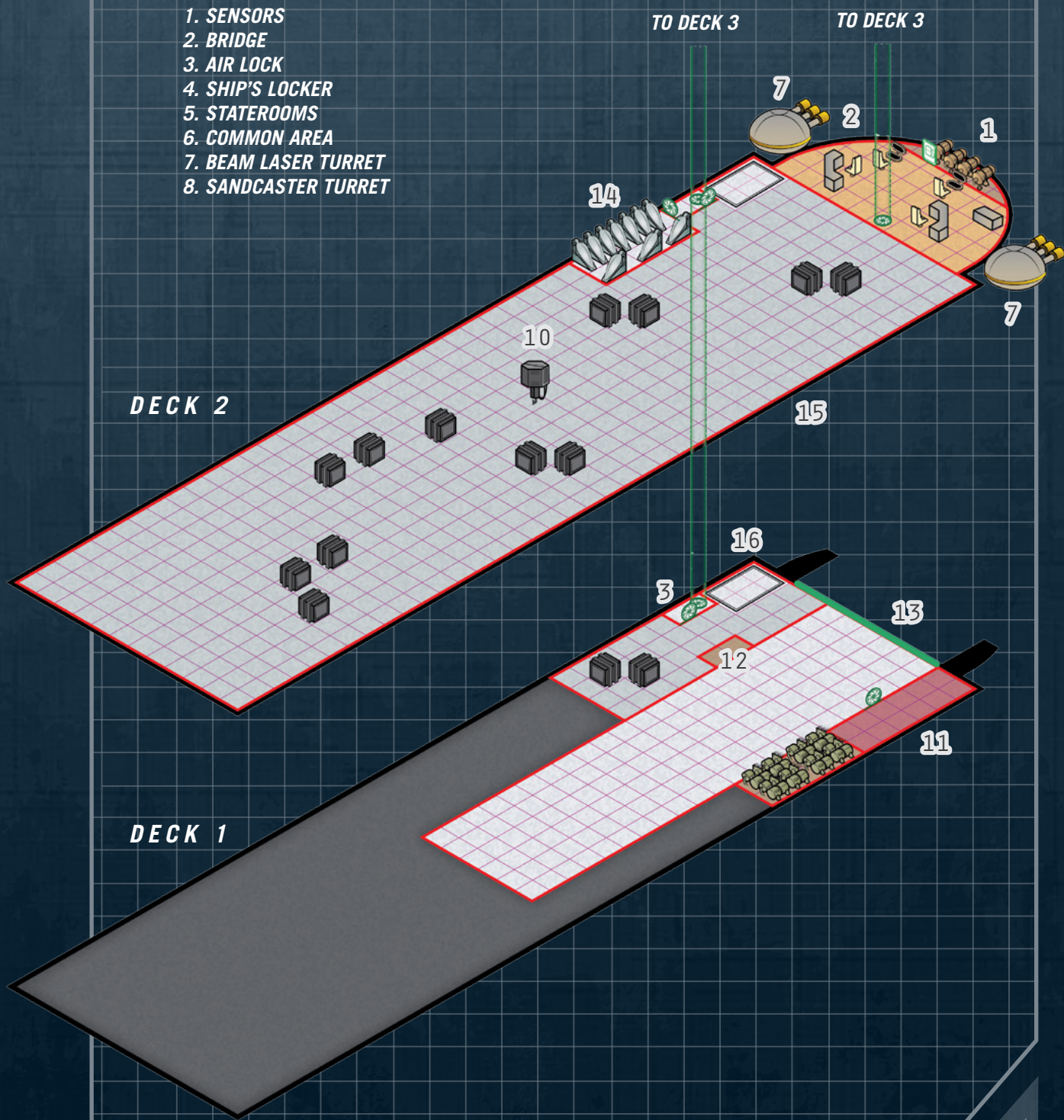

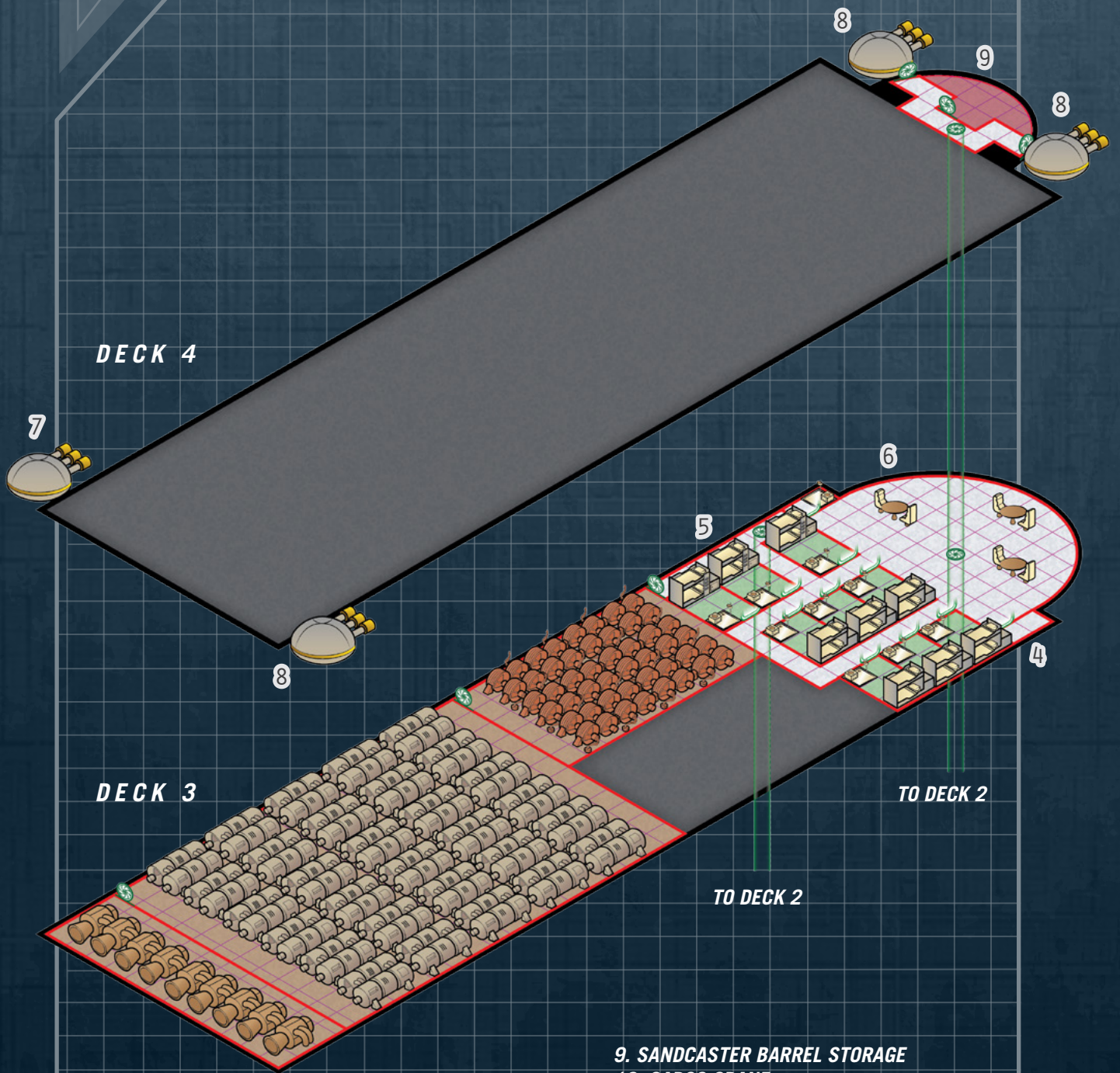

DECK 4

DECK 3

- 9. SANDCASTER BARREL STORAGE
- 10. CARGO CRANE
- 11. HEAVY GRAPPLING ARM
- 12. LOADING BELT
- 13. DOCKING SPACE
- 14. LOW BERTHS
- 15. CARGO HOLD
- 16. CARGO LIFT

QUEEN ELIZABETH-CLASS LINER

XX

TL12		TONS	COST (MCR)
Hull	1,200 tons, Streamlined	-	72
M-Drive	Thrust 1	12	24
J-Drive	Jump 3	95	142.5
Power Plant	Fusion (TL12), Power 600	40	40
Fuel Tanks	J-3, 4 weeks of operation, plus Shuttle	365	-
Bridge		40	6
Computer	Computer/10 bis	-	0.24
Sensors	Civilian Grade	1	3
Systems	Fuel Processor (100 tons/day)	5	0.25
	Fuel Scoops	-	-
	Gaming Space	15	0.09
	Library	4	4
	Medical Bay	4	2
	Docking Space (95 tons)	105	26.25
	Passenger Shuttle	-	12.807
	Low Berths x 10	5	0.5
Software	Manoeuvre/0	-	-
	Jump Control/3	-	0.3
	Library	-	-
Staterooms	Standard x 78	312	39
	High x 10	60	8
	Luxury x 4	40	6
Common Areas		92	9.2
Cargo		5	-

TOTAL: MCR 396.137

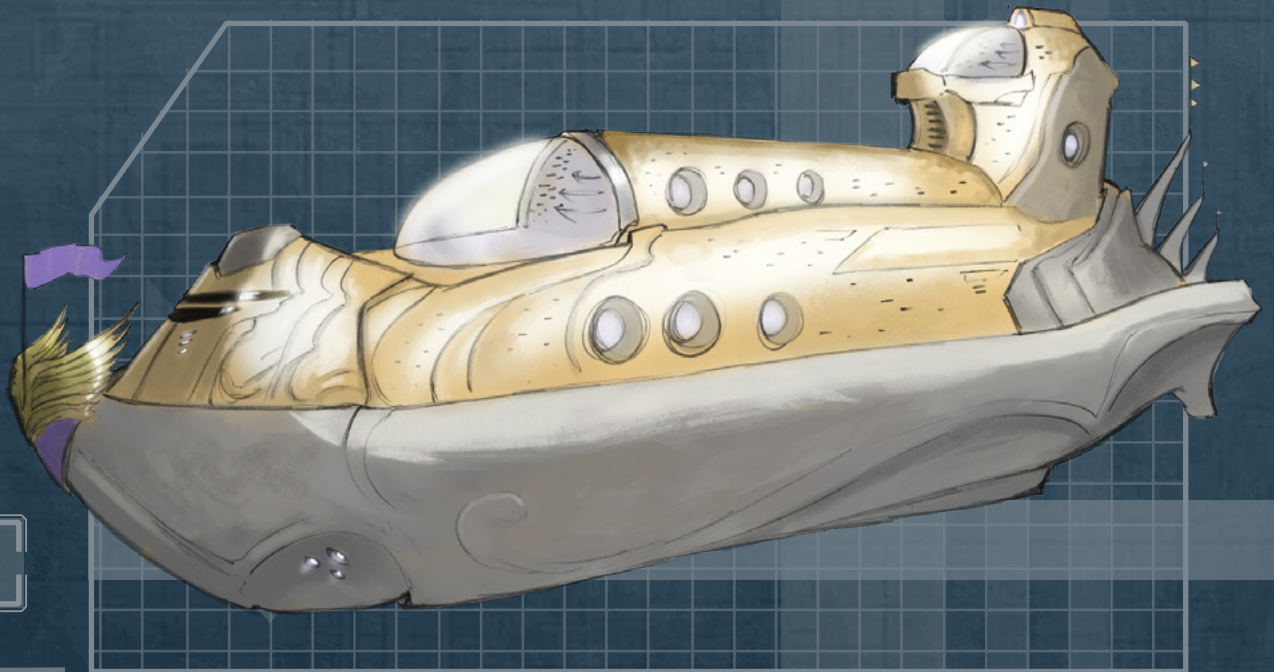

480

HULL POINTS

CREW

CAPTAIN, PILOT, ASTROGATOR,
ENGINEERS X 5, MEDIC, SHUTTLE PILOT,
STEWARDS X 3, ADMINISTRATOR

RUNNING COSTS

MAINTENANCE COST

Cr33011/month

•••••

PURCHASE COST

MCr396.137

POWER REQUIREMENTS

120

MANOEUVRE
DRIVE

240

BASIC SHIP
SYSTEMS

360

JUMP DRIVE

1

SENSORS

5

FUEL PROCESSOR

The *Queen Elizabeth*-class of liners are built as flying hotels, typically leased out to governments, corporations and excessively rich nobles. Capable of atmospheric landings, these liners can either function as conventional hotels on any flat space upon an attractive world, or float within range of spectacular stellar phenomena.

- 1. SENSORS
- 2. BRIDGE
- 3. GAMING SPACE
- 4. LIBRARY
- 5. MEDICAL BAY
- 6. DOCKING SPACE
- 7. LOW BERTHS

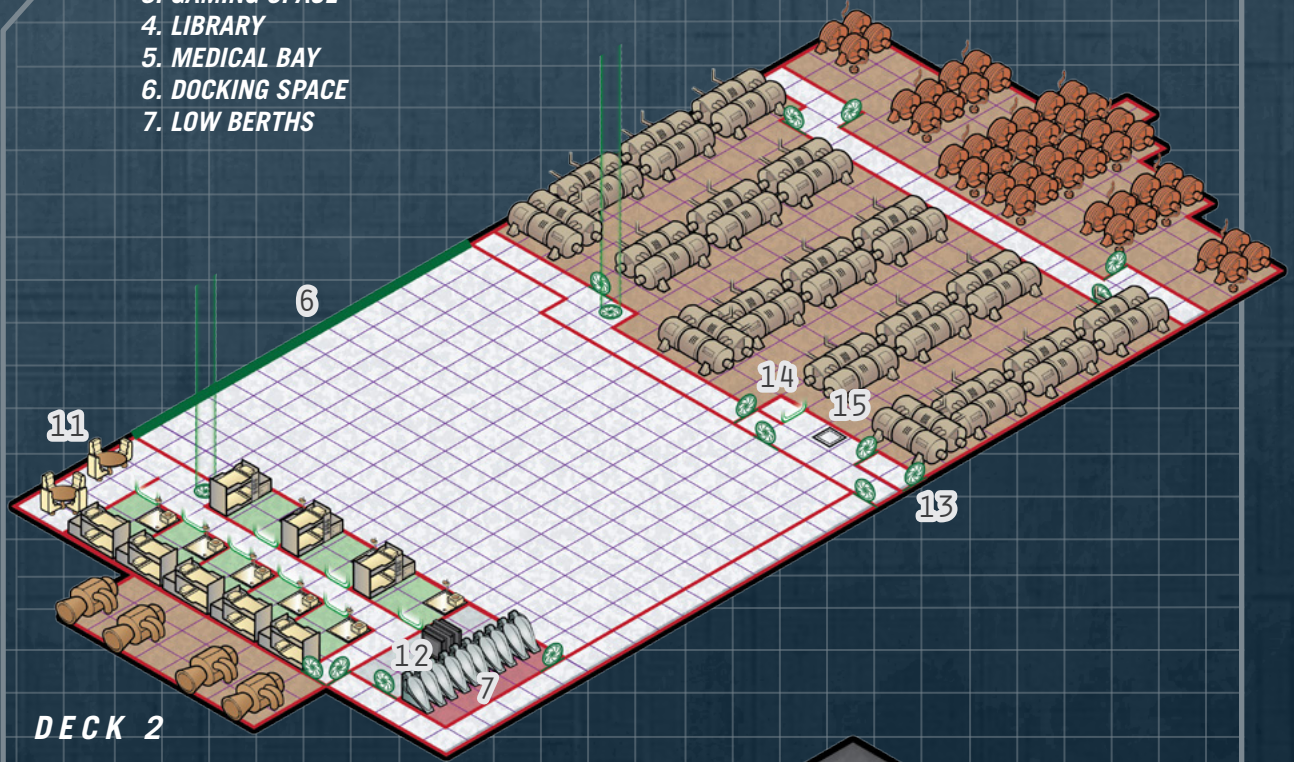

DECK 2

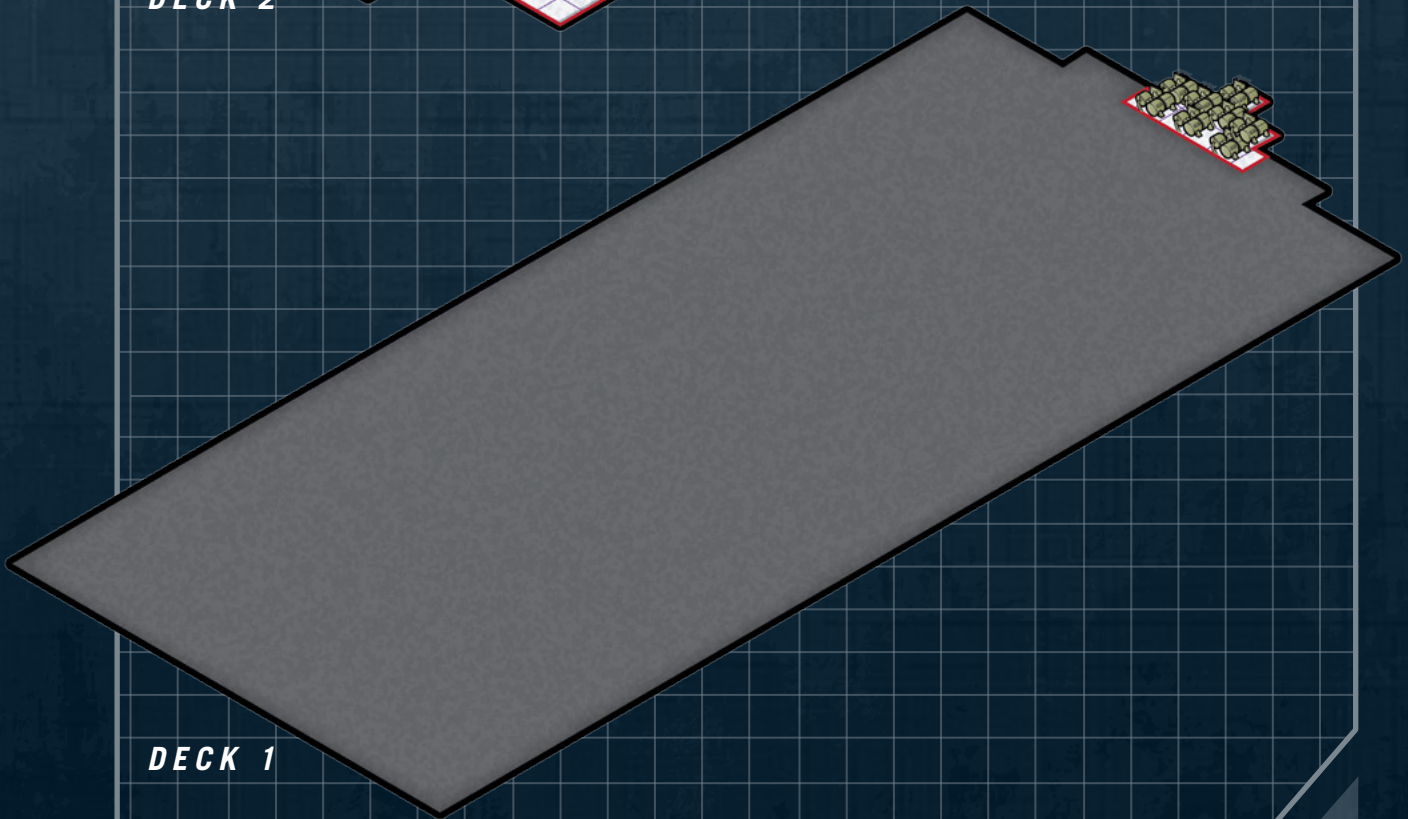

DECK 1

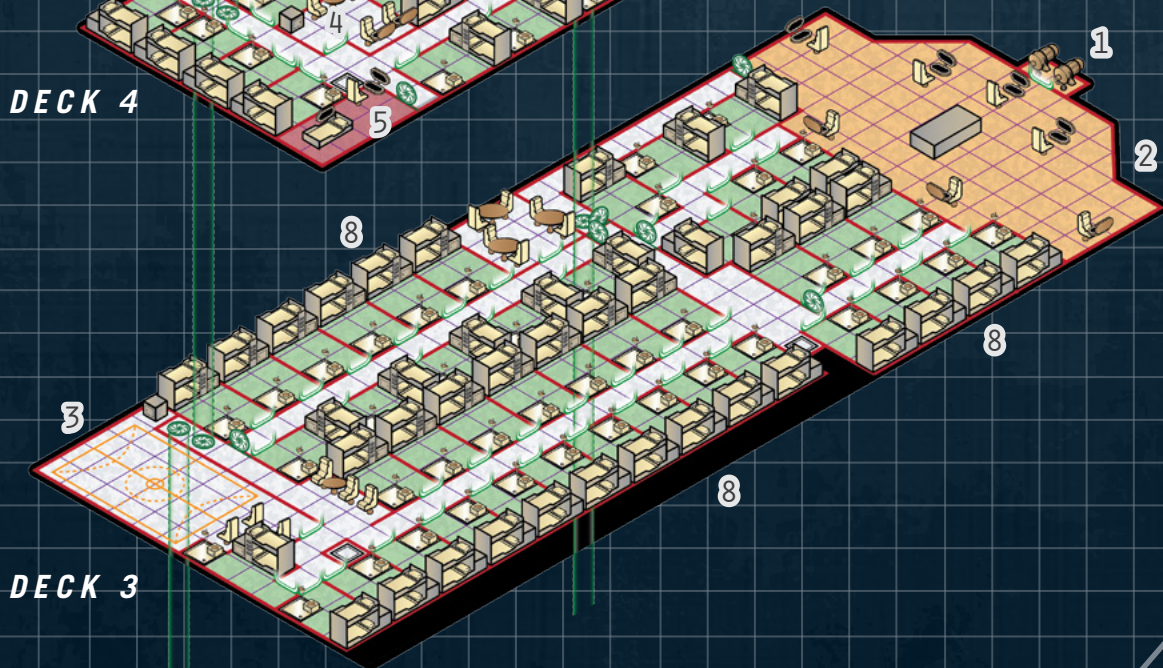
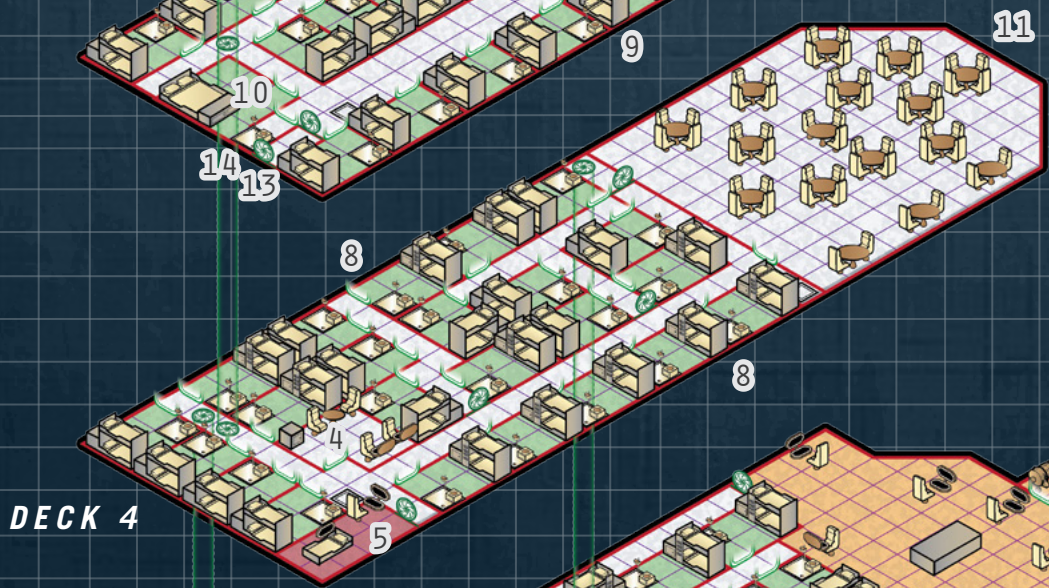
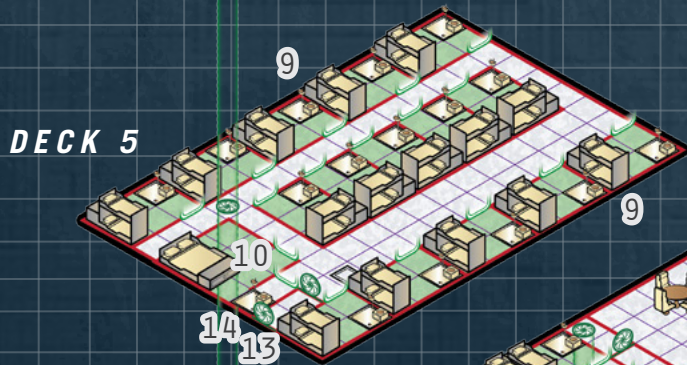
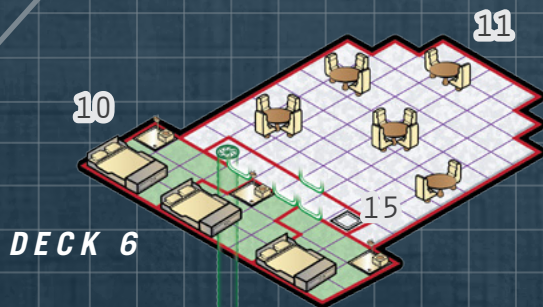

- 8. STATEROOMS
- 9. HIGH STATEROOMS
- 10. LUXURY STATEROOMS
- 11. COMMON AREA
- 12. CARGO HOLD
- 13. AIR LOCK
- 14. SHIP'S LOCKER
- 15. LIFT

ULFHEDNAR-CLASS ESCORT CARRIER

XX

TL13		TONS	COST (MCR)
Hull	2,000 tons, Standard	-	100
Armour	Crystaliron, Armour 4	100	20
Armoured Bulkheads	Bridge, Turrets	5	1
M-Drive	Thrust 4	80	160
J-Drive	Jump 4	205	307.5
Power Plant	Fusion (TL12), Power 2205	147	147
Fuel Tanks	J-4, 4 weeks of operation, plus Light Fighters	825	-
Bridge	Holographic Controls	40	12.5
	Sensor Station x 2	2	1
Computer	Computer/20 fib	-	7.5
Sensors	Improved	3	4.3
	Countermeasures Suite	2	4
	Enhanced Signal Processing	2	8
Weapons	Triple Turrets (beam lasers) x 10	10	25
Systems	Fuel Scoops	-	1
	Medical Bay	4	2
	Briefing Rooms x 2	8	2
	Recovery Deck (10 tons)	100	50
	Launch Tube (10 tons)	100	50
	Full Hangar (120 tons)	240	48
	Light Fighters x 12	-	109.08
Software	Manoeuvre/0	-	-
	Jump Control/4	-	0.4
	Library	-	-
	Battle System/1	-	18
Staterooms	Standard x 25	100	12.5
Common Areas		20	2
Cargo		7	

TOTAL: MCR 1091.70



800

HULL POINTS

CREW

CAPTAIN, PILOT, ASTROGATOR, OFFICER X 2, ENGINEERS
X 13, MAINTENANCE X 4, SENSOR OPERATORS X 2,
MEDIC, GUNNERS X 10, FIGHTER PILOTS X 12

RUNNING COSTS

MAINTENANCE COST

Cr90975/month

• • • • •

PURCHASE COST

MCr1091.7

POWER REQUIREMENTS

800

MANOEUVRE
DRIVE

400

BASIC SHIP
SYSTEMS

800

JUMP DRIVE

7

SENSORS

130

WEAPONS

10

FUEL PROCESSOR

Used for escorting other ships, typically convoys, the *Ulfhednar*-class not only carries a full squadron of fighters but can protect its charges with its own laser turrets. Within naval fleets, escort carriers such as the *Ulfhednar* are capable of carrying fewer but heavier fighters for a stronger punch.

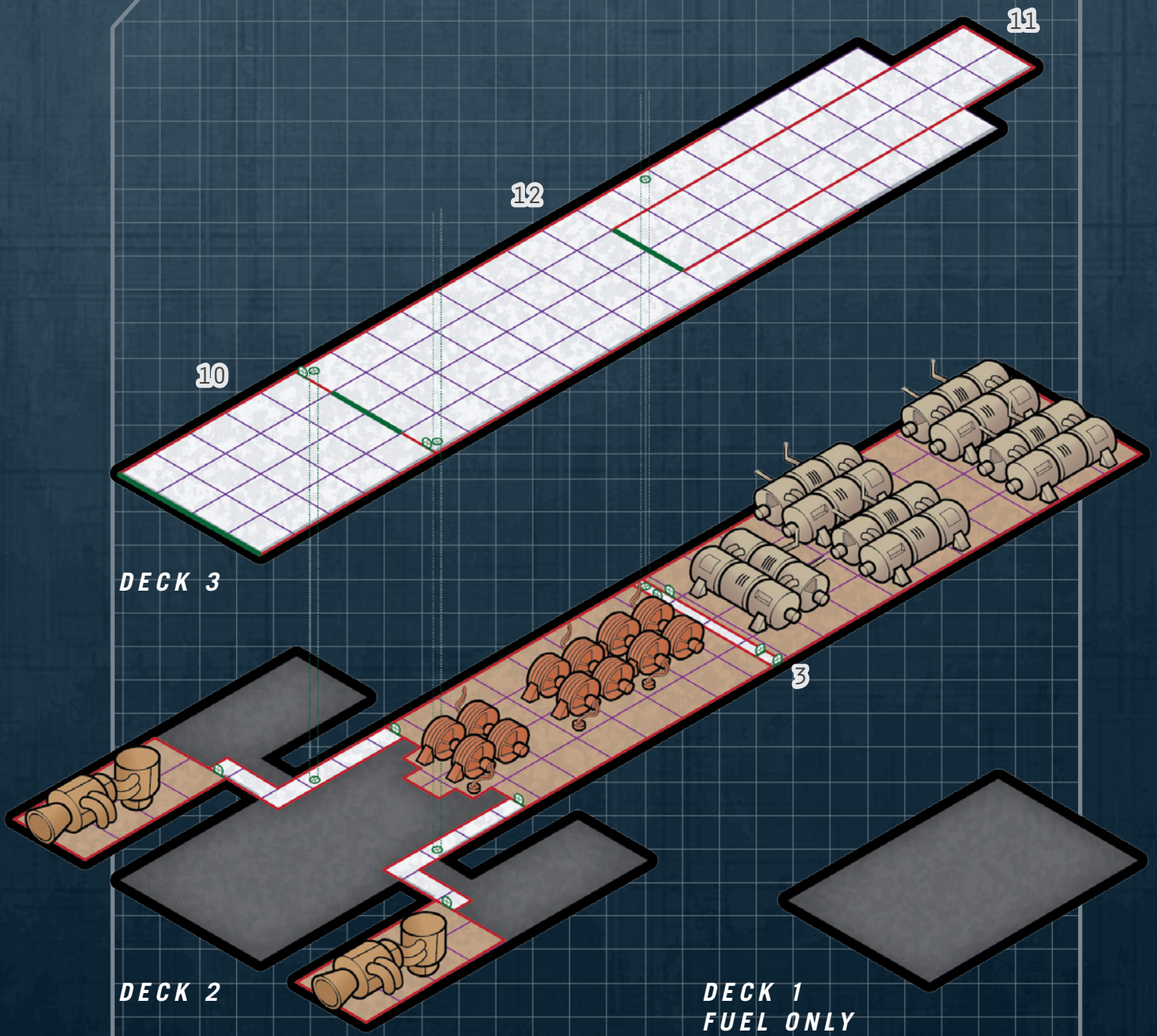

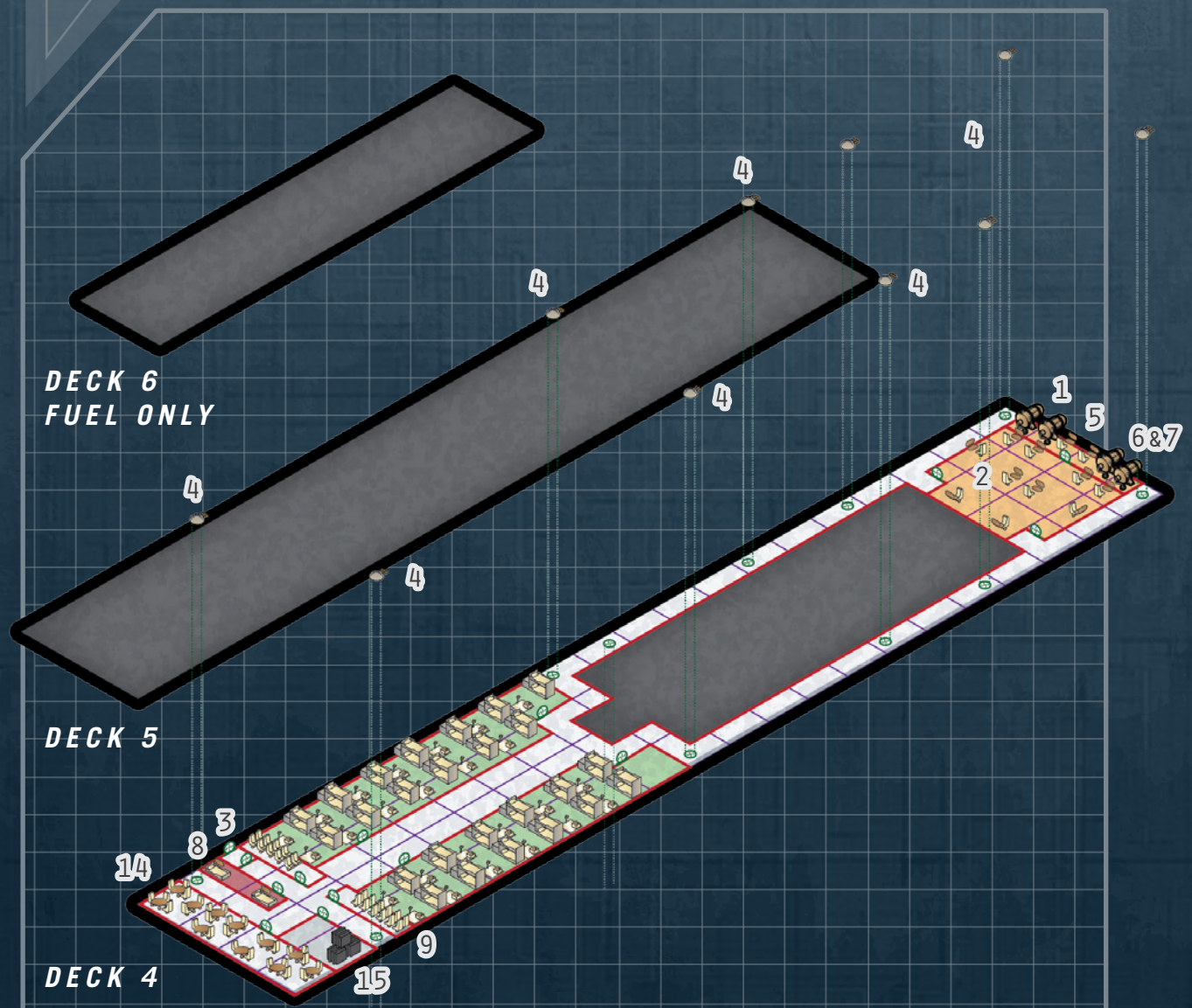

**DECK 6
FUEL ONLY**

DECK 5

DECK 4

- | | |
|-------------------------------|-------------------|
| 1. SENSORS | 9. BRIEFING ROOMS |
| 2. BRIDGE | 10. RECOVERY DECK |
| 3. AIR LOCK | 11. LAUNCH TUBE |
| 4. BEAM LASER TURRET | 12. FULL HANGAR |
| 5. SENSORS STATION | 13. STATEROOMS |
| 6. COUNTERMEASURES SUITE | 14. COMMON AREA |
| 7. ENHANCED SIGNAL PROCESSING | 15. CARGO HOLD |
| 8. MEDICAL BAY | |

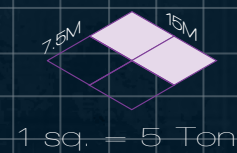

RITCHEY-CLASS ESCORT

XX

TL13		TONS	COST (MCR)
Hull	8,000 tons, Standard	-	400
Armour	Crystaliron, Armour 6	600	120
	Radiation Shielding	-	200
Armoured Bulkheads	Bridge, M-drive, J-drive, Power Plant, Screens, Turrets, Barbettes, Bays	275.3	55.06
M-Drive	Thrust 6	480	960
J-Drive	Jump 4	805	1207.5
Power Plant	Fusion (TL12), Power 10770	718	718
Fuel Tanks	J-4, 4 weeks of operation, plus Pinnaces	3274	-
Bridge	Holographic Controls	60	50
Computer	Computer Core/40 fib	-	67.5
Sensors	Improved, Distributed Array	9	12.9
	Countermeasures Suite	2	4
	Enhanced Signal Processing	2	8
Weapons	Small Missile Bays x 10	500	120
	Particle Barbettes x 10	50	80
	Triple Turrets (beam lasers) x 40	40	100
Ammunition	Standard Missiles x 2400	200	-
Screens	Meson Screens x 5	50	100
	Nuclear Dampers x 5	50	50
Systems	Repair Drones	80	16
	Armoury	3	0.75
	Medical Bay	8	4
	Full Hangar (80 tons)	160	32
	Pinnaces x 2	-	17.424
Software	Manoeuvre/0	-	-
	Jump Control/4	-	-
	Library	-	-
	Evade/1	-	1
	Auto-Repair/2	-	10
	Advanced Fire Control/1	-	12
	Electronic Warfare/2	-	18
	Point Defence/2	-	12
Staterooms	Standard x 110	440	55
Common Areas		110	11
Cargo		83.7	-

TOTAL: MCR 4442.134

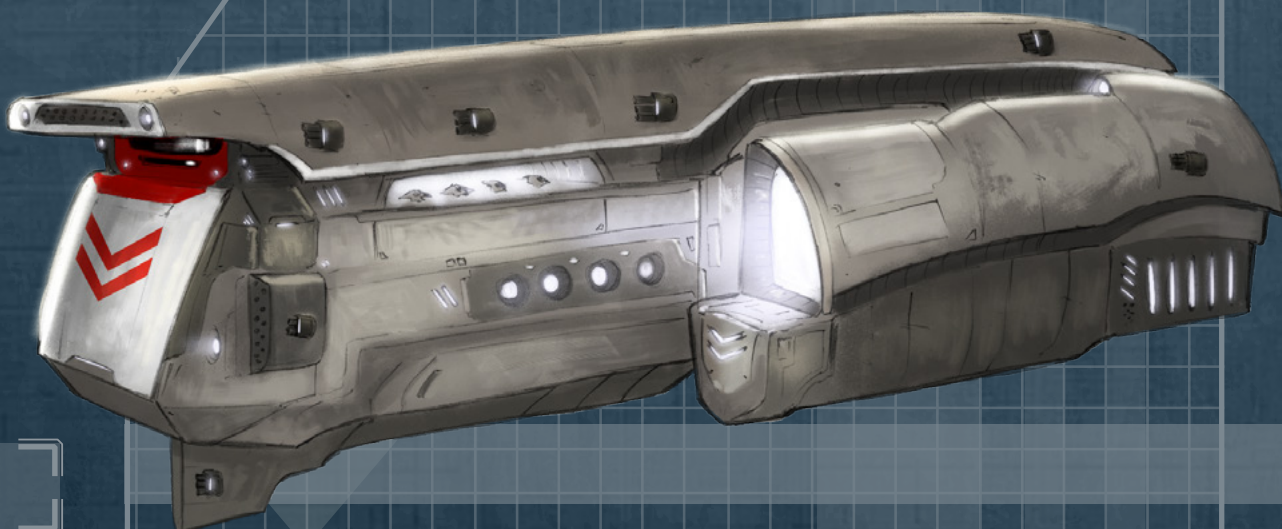

800

HULL POINTS

CREW

CAPTAIN, PILOTS X 2, ASTROGATOR, OFFICERS X 21,
ENGINEERS X 59, MAINTENANCE X 16, MEDICS X 2,
GUNNERS X 70, PINNACE PILOTS X 2,
ADMINISTRATORS X 8, MARINES X 12

RUNNING COSTS

MAINTENANCE COST
Mcr3.701778/month

• • • • •
PURCHASE COST
Mcr4442.134

POWER REQUIREMENTS



Not intended to go toe-to-toe with other warships alone, the Ritchey-class escort protects other ships in fleets or convoys. To this end, the escort is equipped with weapons and systems designed to 'screen' friendly ships from enemy fighters, missiles and lighter attackers.

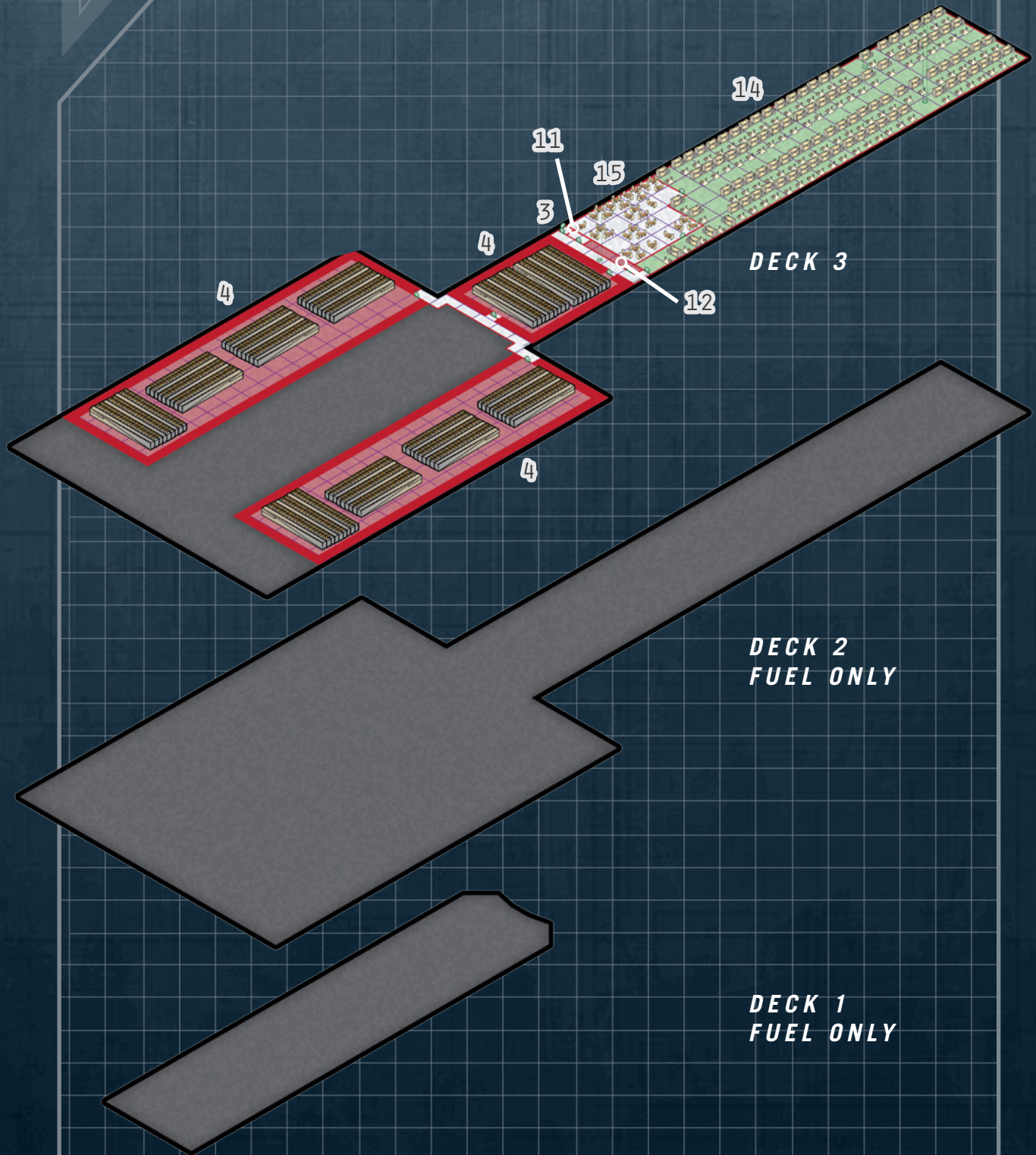

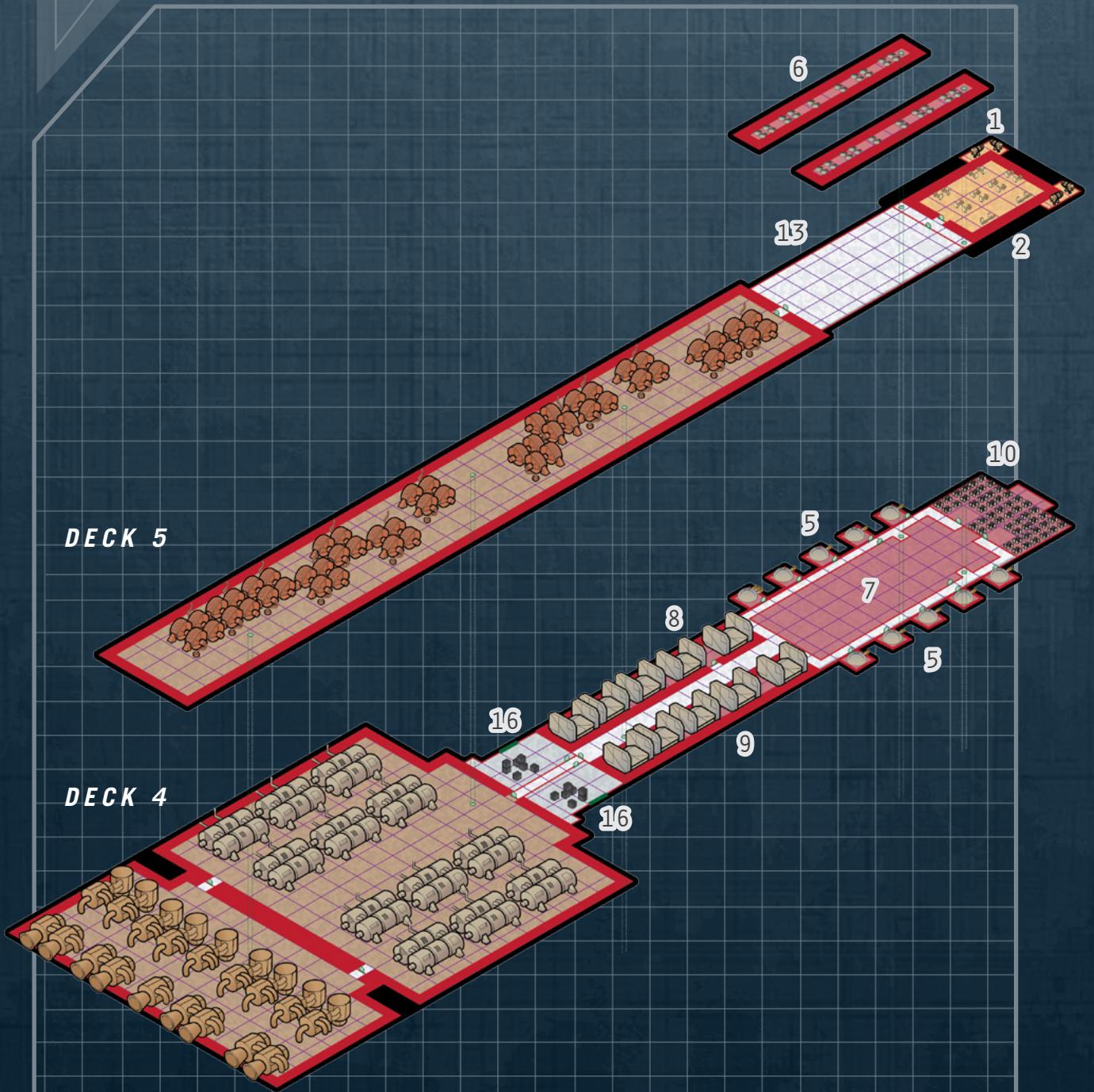

DECK 5

DECK 4

- 1. SENSORS
- 2. BRIDGE
- 3. AIR LOCK
- 4. SMALL MISSILE BAYS
- 5. PARTICLE BARBETTES
- 6. BEAM LASER TURRETS
- 7. MISSILE STORAGE
- 8. MESON SCREEN

- 9. NUCLEAR DAMPER
- 10. REPAIR DRONES
- 11. ARMOURY
- 12. MEDICAL BAY
- 13. FULL HANGAR
- 14. STATEROOMS
- 15. COMMON AREA
- 16. CARGO HOLD



1 sq. = 5 Ton

GALOOF-CLASS MEGAFREIGHTER

XX

TL12		TONS	COST (MCR)
Hull	30,000 tons, Standard	-	1500
M-Drive	Thrust 1	300	600
J-Drive	Jump 3	2255	3382.5
Power Plant	Fusion (TL12), Power 15000	1000	1000
Fuel Tanks	J-3, 4 weeks of operation, plus Shuttles	9105	-
Bridge		60	150
Computer	Computer Core/10 bis	-	0.24
Sensors	Civilian Grade	1	3
Systems	Loading Belts x 10 (TL12)	10	0.1
	Briefing Room	4	0.5
	Cargo Cranes x 6	304	304
	Medical Bay	4	2
	Re-entry Capsules x 170	85	3.4
	Full Hangar (475 tons)	950	190
Software	Shuttles x 5	-	75.735
	Manoeuvre/0	-	-
	Jump Control/3	-	-
Staterooms	Library	-	-
	Standard x 87	348	43.5
Common Areas	High	6	0.8
		320	32
Cargo		15248	-

TOTAL: MCR 7287.77



15000

HULL POINTS

CREW

CAPTAIN, PILOT, ASTROGATOR, OFFICERS X 8, ENGINEERS X 102, MAINTENANCE X 30, ADMINISTRATORS X 15, MEDICS X 2, SHUTTLE PILOTS X 5,

RUNNING COSTS

MAINTENANCE COST
MCr6.073145/month

• • • • •
PURCHASE COST
MCr7287.77

POWER REQUIREMENTS

3000

MANOEUVRE
DRIVE

6000

BASIC SHIP
SYSTEMS

9000

JUMP DRIVE

1

SENSORS

The *Galoof*-class megafreighter is a capital ship-sized trading vessel, funded by the largest corporations to transport vast quantities of cargo across the stars. It is not pretty to look at by any means, but forms a vital lifeline to systems that are too heavily populated to be served by free traders. Capturing a megafreighter like the *Galoof* is a lifelong ambition for many pirates, and so it rarely travels without an escort which grows only larger as more dangerous space is crossed. Conditions on board are Spartan, but the sheer size of the cavernous cargo bays always leave a first-timer Traveller breathless.

- 1. SENSORS
- 2. BRIDGE
- 3. AIR LOCK
- 4. LOADING BELTS
- 5. BRIEFING ROOM
- 6. CARGO CRANE

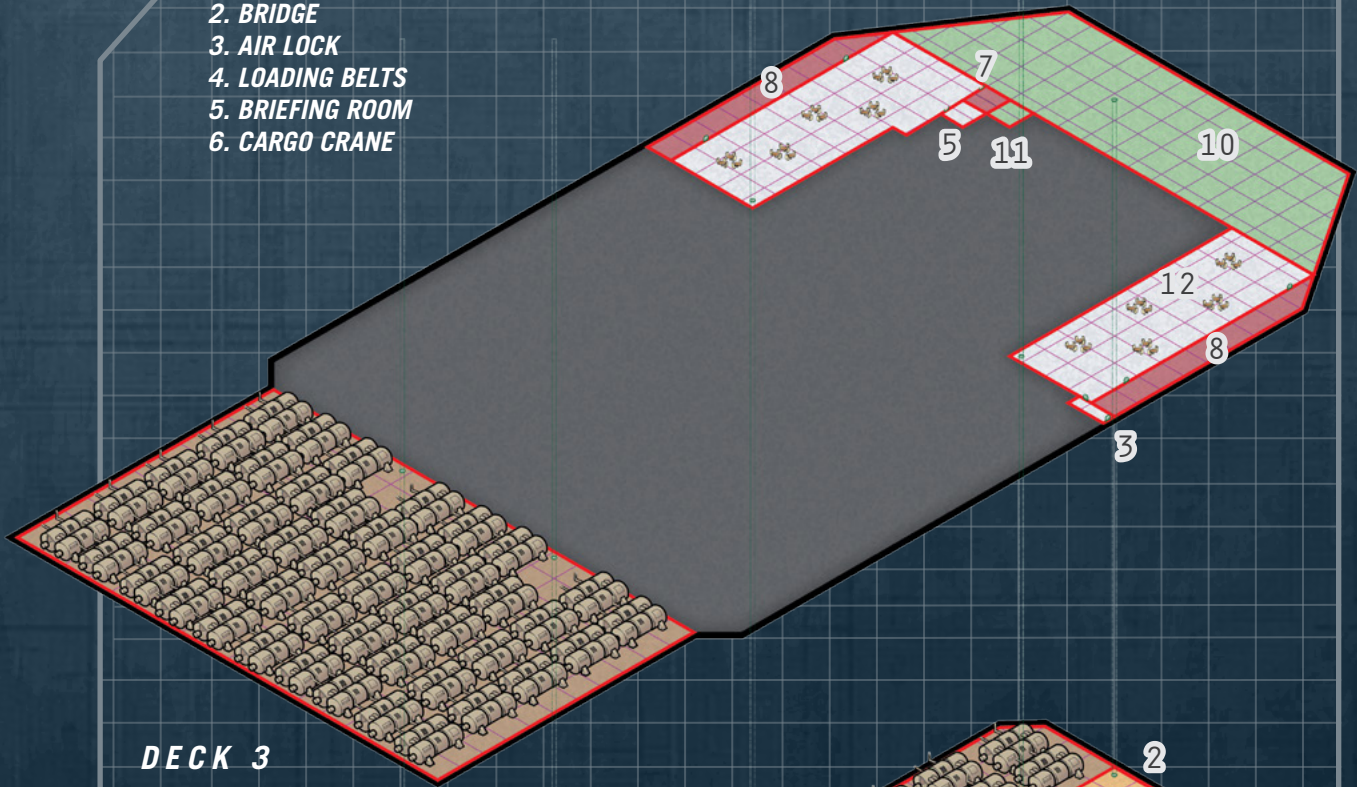

DECK 3

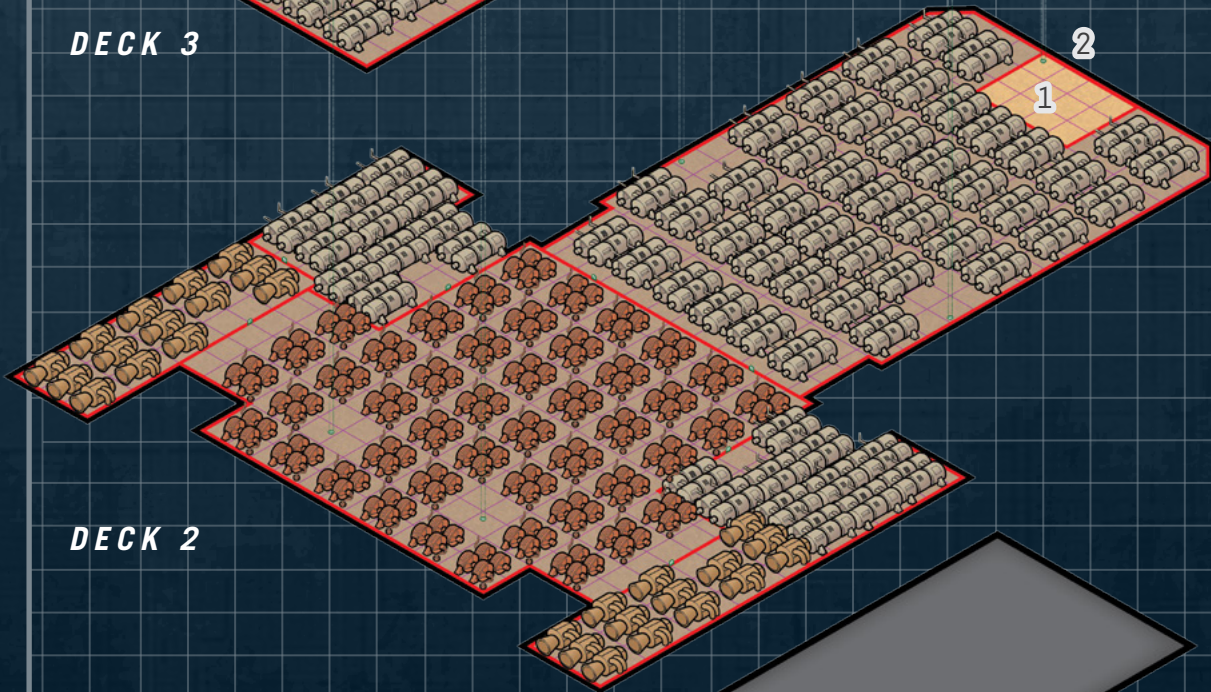

DECK 2

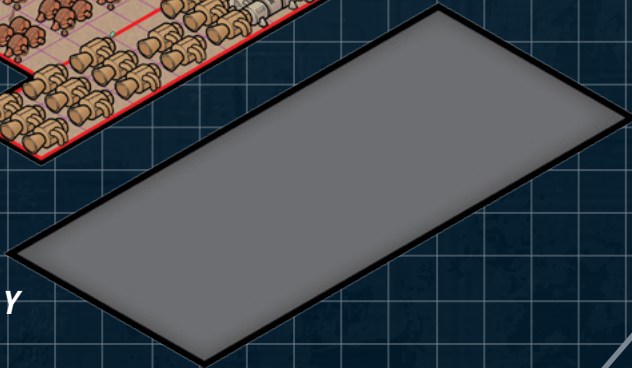

**DECK 1
FUEL ONLY**

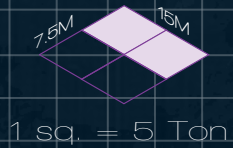

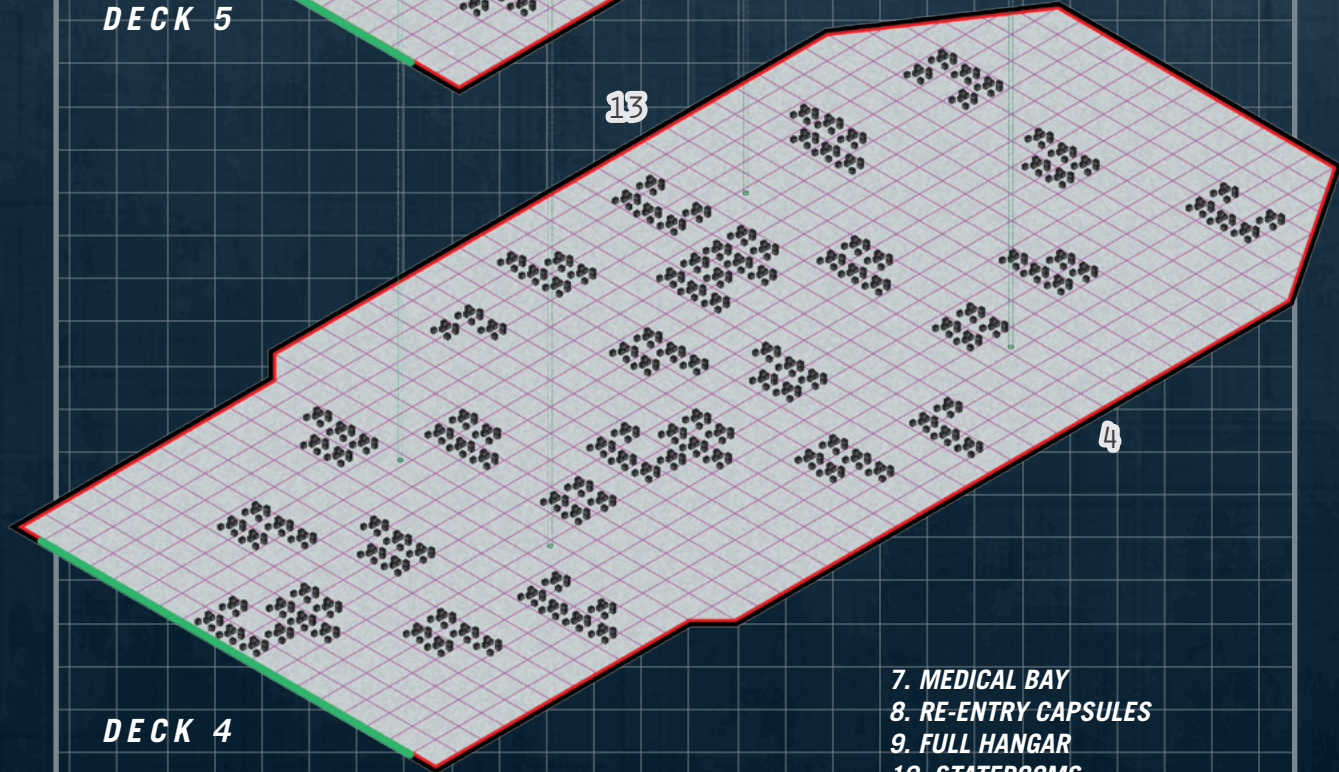
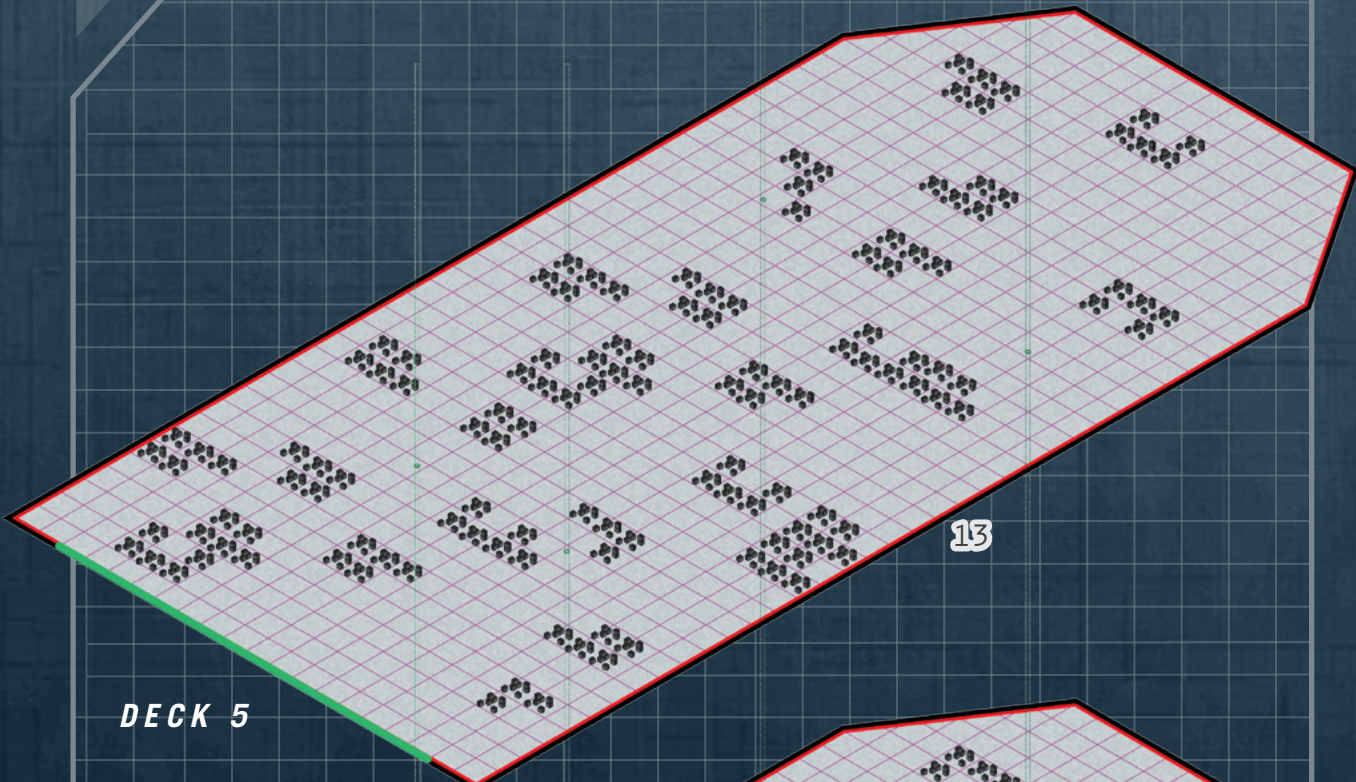

- 7. MEDICAL BAY
- 8. RE-ENTRY CAPSULES
- 9. FULL HANGAR
- 10. STATEROOMS
- 11. HIGH STATEROOMS
- 12. COMMON AREA
- 13. CARGO HOLD



1 sq. = 5 Ton

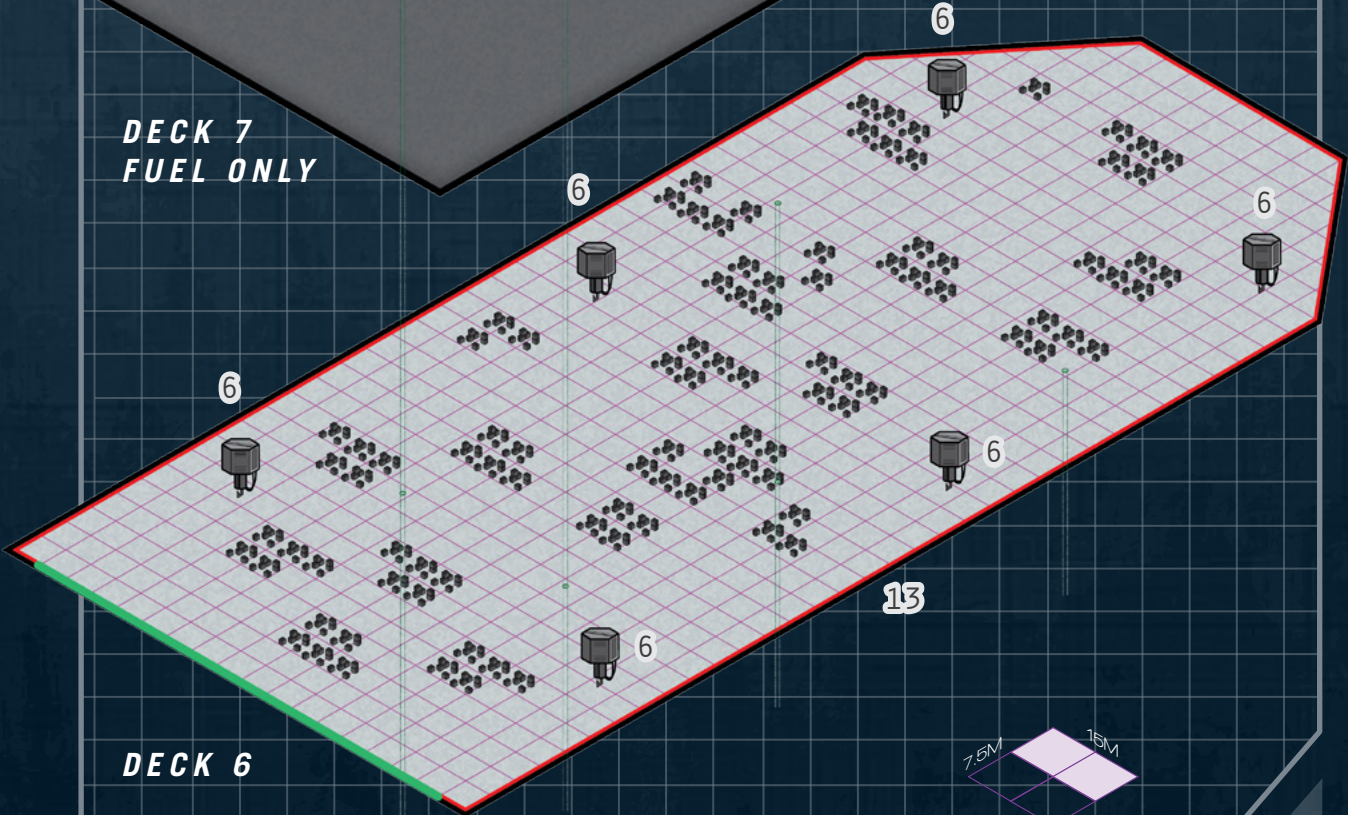
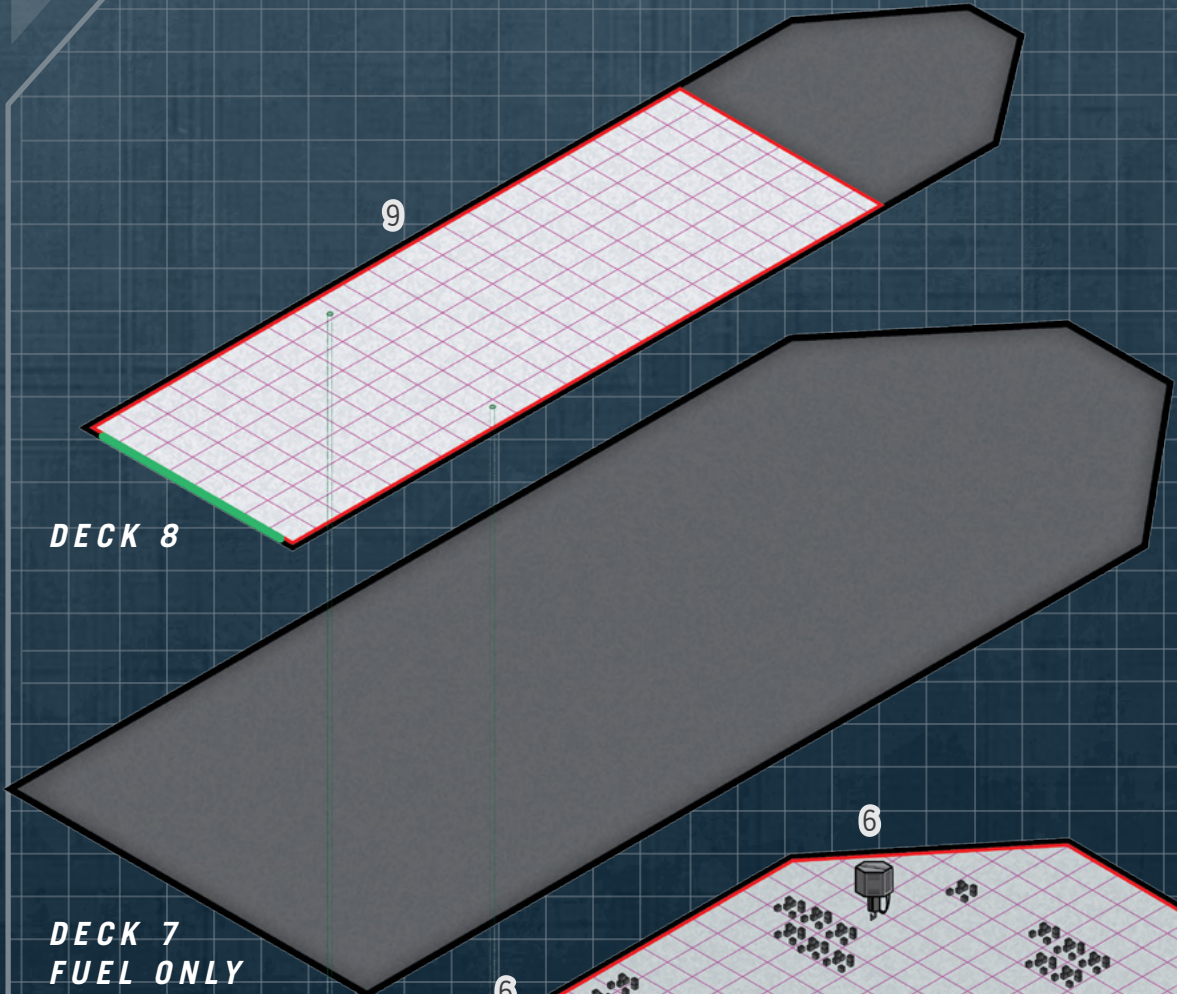

PLANET-CLASS HEAVY CRUISER

XX

TL15		TONS	COST (MCR)
Hull	75,000 tons, Standard, Reinforced	-	5,625
Armour	Bonded Superdense, Armour 15	9,000	6,750
	Radiation Shielding	-	1,875
Armoured Bulkheads	Power Plant, M-Drive, J-Drive, Spinal Mount, Small Bays, Meson Screens, Nuclear Dampers, Bridge, Command Bridgem Missile Storage, Sensors	2,647.2	529.44
M-Drive	Thrust 6	4,500	9,000
J-Drive	Jump 4	7,505	11,257.5
Power Plant	Fusion (TL15), Power 100,000	5,000	10,000
Fuel Tanks	J-4, 8 weeks of operation, plus Troop Transports	31,006	-
Bridge	Holographic Controls	60	468.75
	Command Bridge, Holographic Controls	80	703.125
Computer	Computer Core/100	-	130
Sensors	Advanced (distributed arrays) x 2	30	31.8
	Military Countermeasures Suite	15	28
	Enhanced Signal Processing	2	8
Weapons	Spinal Mount: Improved Particle (2DD)	5,600	2,600
	Small Missile Bays x 60 (720 missile salvo)	3,000	720
	Fusion Barbettes x 16	80	64
	Triple Turrets (sandcasters) x 20	20	35
	Triple Turrets (beam Lasers) x 30	30	75
	Type III Point Defence Battery x 2	40	40
Ammunition	Standard Missiles x 5,760	960	-
	Sandcaster Barrel x 800	80	-
Screens	Meson Screen x 10	100	200
	Nuclear Damper x 10	100	100
Systems	Fuel Processor (4,000 tons/day)	200	10
	Fuel Scoops	-	1
	Medical Bay x 2	8	4

PLANET-CLASS HEAVY CRUISER (CONTINUED)

TL15		TONS	COST (MCR)
Systems	Repair Drones	750	150
	Briefing Room x 8	32	4
	Armoury	40	10
	Docking Space (50 tons) x 6	330	82.5
	Troop Transport x 6	-	219.726
Software	Manoeuvre/0	-	-
	Jump Control/4	-	0.4
	Library	-	-
	Intellect	-	1
	Evade/3	-	3
	Fire Control/5	-	10
	Auto-Repair/2	-	10
Staterooms	Standard x 600	2,400	300
	High x 3	18	2.4
	Barracks x 225	450	22.5
Common Areas		540	54
Cargo		376.8	-
TOTAL: MCR 45425.141			

POWER REQUIREMENTS

200	45,000	15,000	3,230
FUEL PROCESSOR	MANOEUVRE DRIVE	BASIC SHIP SYSTEMS	WEAPONS & SCREENS
	30,000	28	
	JUMP DRIVE	SENSORS	



41,250

HULL POINTS

CREW

**CAPTAIN, OFFICERS X 110, PILOTS X 3,
ASTROGATOR, ENGINEERS X 485, MAINTENANCE
X 150, MEDICS X 9, GUNNERS X 240,
ADMINISTRATORS X 75, TROOP TRANSPORT
PILOTS X 6, MARINES X 6**

RUNNING COSTS

MAINTENANCE COST
Mcr 37.854284/month

• • • • •
PURCHASE COST
Mcr 45425.141

The Planet-class heavy cruiser is a workhorse of the Imperial navy, encountered as the centrepiece of a task force or operating as part of a major fleet. The Planet-class was originally named the Ghalalk-class (enlarged), since the design was developed from that vessel. The Ghalalk and the following Planet-class cruisers were designed from the outset for the fleet role.

Tactical and strategic mobility match the requirements for all major Imperial fleets – jump-4 and 6G acceleration. Armament is built around an advanced spinal particle accelerator capable of destroying lesser ships and inflicting serious damage on cruisers and even battleships. Secondary armament is missile-based, with an extensive fusion gun battery for close-in combat. A force of marines is routinely carried for intervention and fast-response situations.

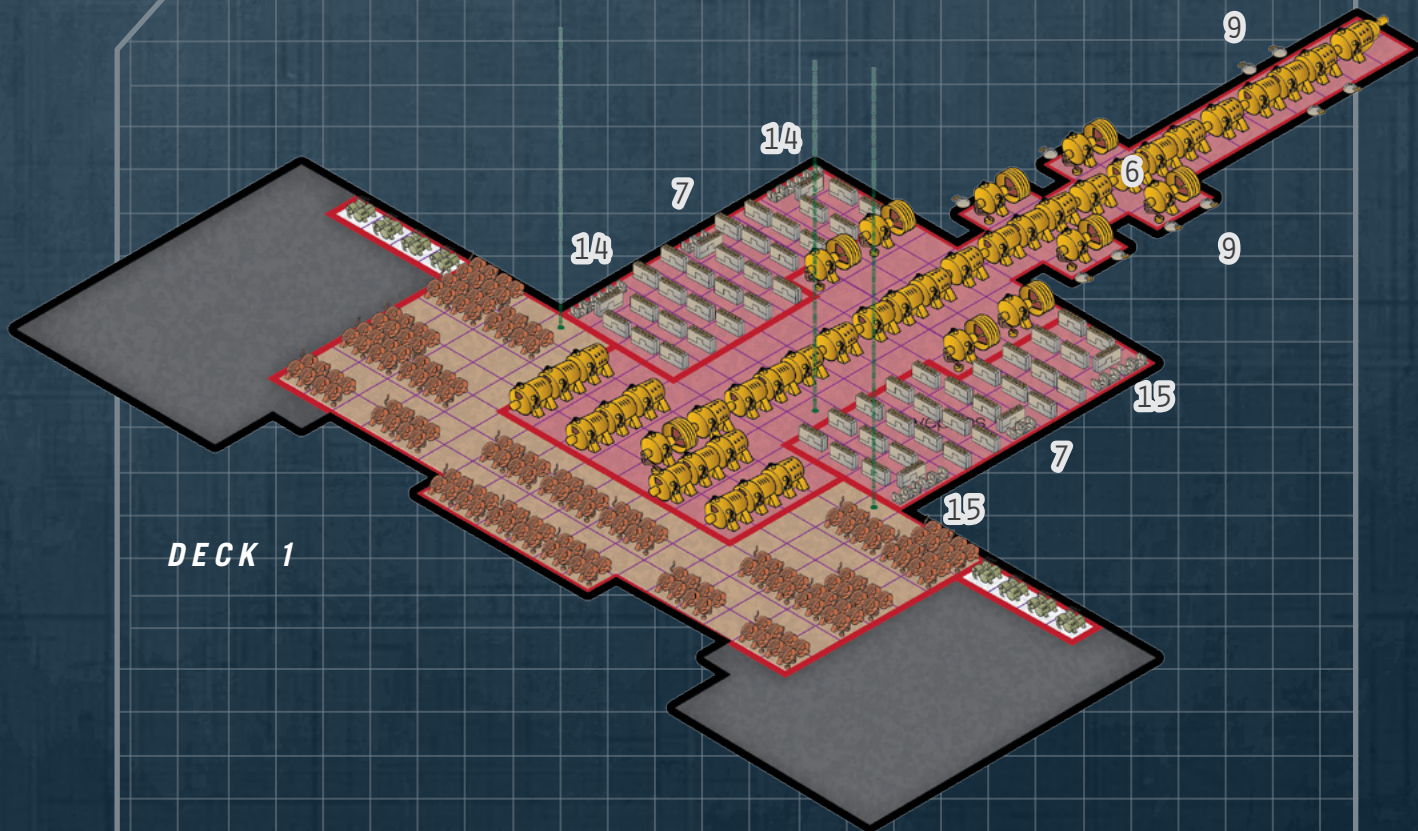

DECK 1

- | | |
|-----------------------------------|---------------------|
| 1. SENSORS | 14. MESON SCREEN |
| 2. BRIDGE | 15. NUCLEAR DAMPER |
| 3. COMMAND BRIDGE | 16. MEDICAL BAY |
| 4. MILITARY COUNTERMEASURES SUITE | 17. REPAIR DRONES |
| 5. ENHANCED SIGNAL PROCESSING | 18. BRIEFING ROOMS |
| 6. SPINAL MOUNT | 19. ARMOURY |
| 7. SMALL MISSILE BAYS | 20. DOCKING SPACE |
| 8. FUSION BARBETTES | 21. STATEROOMS |
| 9. SANDCASTER TURRET | 22. HIGH STATEROOMS |
| 10. BEAM LASER TURRET | 23. BARRACKS |
| 11. POINT DEFENSE BATTERY | 24. COMMON AREA |
| 12. MISSILE STORAGE | 25. CARGO HOLD |
| 13. SANDCASTER BARREL STORAGE | |

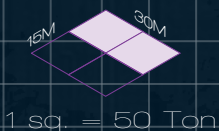

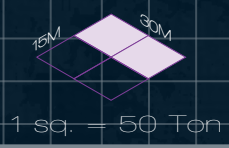
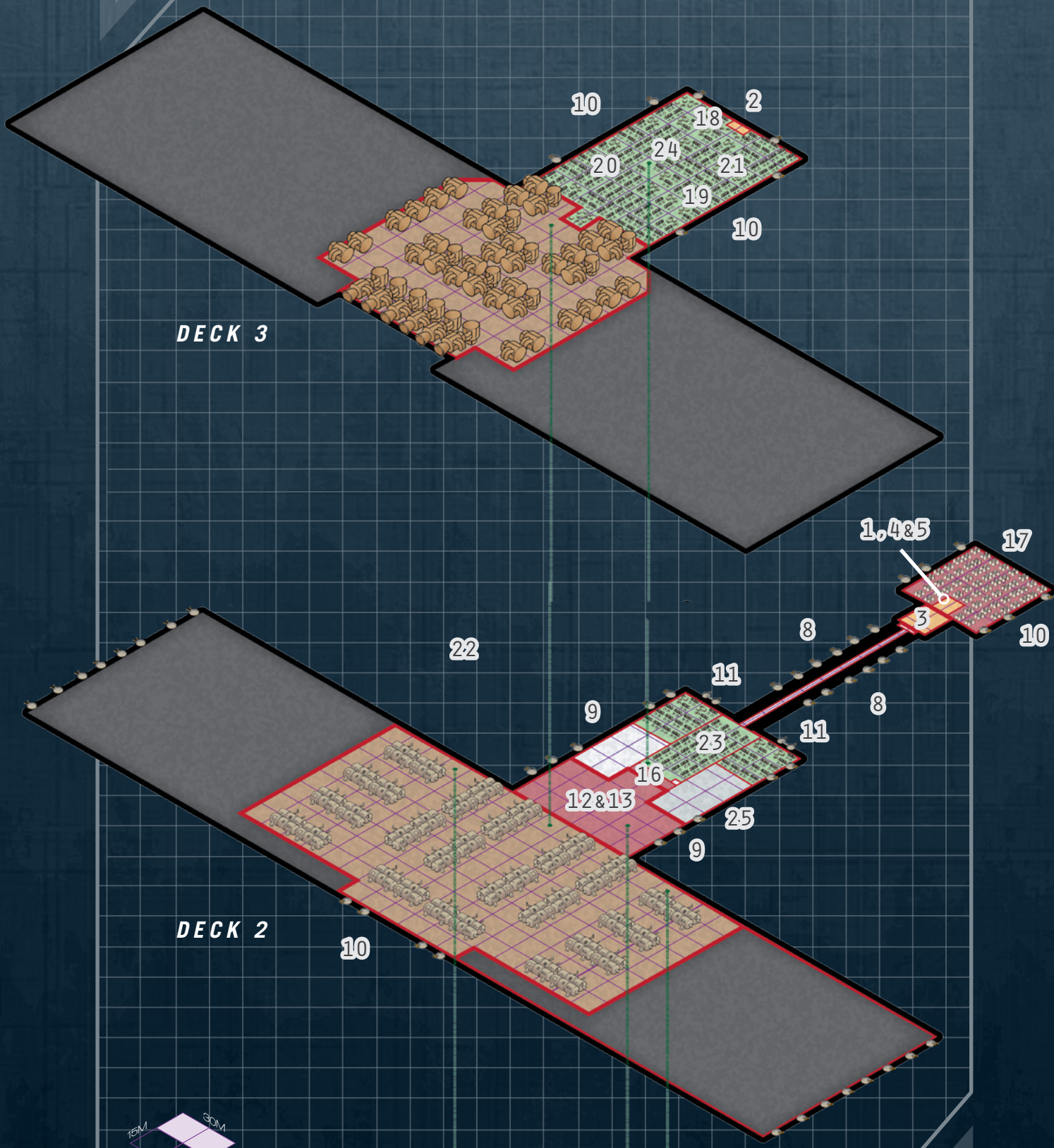

HIGH GUARD: ASLAN

Despite outward appearances, Aslan ships use much the same technology as human vessels, and either race can readily utilise ships belonging to the other with a minimum of difficulty. However, Aslan do display a slightly different approach towards ships and this is reflected in their design.

Aslan have no special regard for luxury, and the Hierate does not have separate High Passage tickets. All paid passages are Middle, Basic or Low. However, any Aslan of SOC 9+ will receive the services of the ship's steward automatically, and the Middle passage baggage allowance increases to 500 kg. Aslan nobles always have precedence, and usually bump passengers of lesser standing. Working passage is common within a clan but rarely available to non-clan members.

The following are customs within Aslan space.

Space is not Territory: No Aslan male may claim a region of space. A Traveller need not ask permission to enter any region of space – but before he puts a single

foot on the ground, he must give all traditional honours to the landowner.

Clan Hospitality: There is a strong tradition that 'the clan takes care of its own.' If members of a Traveller's clan live on a particular world, they will offer free food and lodging, and provide a Middle Passage ticket upon a Difficult (10+) Persuade check. Outcasts or Travellers who have been Outcasts are not extended this hospitality.

Referees can determine the presence of an Aslan's clan on a world through materials they have previously prepared; alternatively, roll 10+ on 2D, modified by the Clan Presence table.

Clan Presence

Condition	DM
Local Population 9+	+1
Local Government type H	+1
Aslan is member of one of the Tlaukhu clans	+2
Per sector distant from the clan homeworld	-1



Swapping Stories: Aslan with time on their dewclaws enjoy telling stories of their exploits and adventures. During the long days of a space journey, the passengers (and crew with no immediate jobs to perform) meet in the galley or central lounge and take turns telling stories of what they have seen, what they have done, and what they plan to do.

Participants in these story-swapping sessions gain acceptance into the group as well as diversion from the boredom of a long journey. In addition, the stories told are often the source of further adventures or expeditions.

Decoration: Aslan ships are invariably heavily decorated with inscriptions and clan heraldry; even control systems can be decorated with gold, jewels or other art. Even on military vessels, the Aslan like to decorate their surroundings.

CREWS

Aslan crew standards vary since there is no central authority to prescribe the number and type of crew required. The fundamentals of ship operation mean the requirements for pilot, astrogator, and engineer are the same as for human ships. Pilots are almost always male; astrogators and engineers are almost always female.

Stewards are not required. Most properly staffed ships will include at least one because noble males tak-

ing passage on any ship require the services of one steward per four nobles, and if no proper steward is provided, another crew member will be co-opted for the position. A well-prepared ship thus provides a steward in order to avoid losing an engineer or astrogator at the wrong moment.

Medics are not required either; the position of medic is filled when the ship's owner feels it necessary or when the crew demands it forcefully enough.

Because of the nature of Aslan society and upbringing, most ships have a male in formal command of the ship and a female who deals with many details (specifically finances) which are beneath the male's dignity. The male captain is almost always the pilot. On military ships, the female is the captain's executive officer, while on commercial ships, she will be the purser. In both cases, she may also be the astrogator.

Purser: A merchant ship engaged in commercial activity, trade, commerce, cargo transport, passenger transport, or charter activity must have a purser. Invariably, the purser will be female, and must have a minimum of either Admin 1 or Broker 1. The purser is paid a salary of Cr5000 per month.

The Aslan Crew Requirements table replaces that on page 21 of *High Guard*.



Aslan Crew Requirements

Position	Gender	Skills	Salary	Commercial	Military
Captain	Male	-	Cr10000	Usually the leading officer	1
Pilot	Male	Pilot	Cr6000	1	3
Purser	Female	Admin or Broker	Cr5000	1	-
Executive Officer	Male	Leadership or Tactics	Cr5000	-	1
Astrogator	Female	Astrogation	Cr5000	1 if jump drive installed	1 if jump drive installed
Engineer	Female	Engineer	Cr4000	1 per 35 tons of drives and power plant	1 per 35 tons of drives and power plant
Maintenance	Female	Mechanic	Cr1000	1 per 1000 tons of ship	1 per 500 tons of ship
Gunner	Male	Gunner	Cr2000	1 per turret, bay or screen	2 per turret, bay or screen, 1 per 100 tons of spinal mount weaponry
Steward	Female	Steward	Cr2000	1 per 4 noble males	1 per 4 noble males
Administrator	Female	Admin	Cr1500	1 per 2000 tons of ship	1 per 1000 tons of ship
Officer	Either	Leadership or Tactics	Cr5000 *	1 per full 20 crew	1 per full 10 crew

* This can be presumed to be an average taken across all officer positions on a ship. In practice, it will vary a great deal between junior and senior officers.



Note that any smaller craft carried by a ship will have their own crew in addition to those necessary for the mother vessel.

Societal Standards: Because of expectations within Aslan society, all but pirate ships will restrict crew positions to the proper gender. Only males may be gunners and pilots. Only females will be astrogators, pursers, engineers, medics, and stewards. Otherwise undefined crew positions (security personnel, mechanics, technicians, small craft pilots, and clerks) are open to any properly skilled individuals, although noble males will refuse most positions other than gunner or pilot.

ASLAN CONTROL SYSTEMS

Aslan controls fall into four categories – male, female, dual and reconfigurable. Male controls are deliberately simplified and abstracted, displaying only the most vital information. Female control displays are overly complex, giving a bewildering array of options to the user and requiring great skill to master. Dual controls include both male and female control systems in the one system; either the male controls are a clearly demarcated subset of the female controls, or the control system is compact enough to have two entirely separate interfaces. Finally, reconfigurable controls are the most advanced, and can dynamically change themselves to present the appropriate interface.

On most large spacecraft, the piloting and gunnery interfaces are male, while all other control systems are female. Dual controls are more common on smaller ships, where a smaller crew makes it more likely that an Aslan will have to perform duties commonly associated with the opposite gender. Ships built at TL13 or higher always have reconfigurable controls throughout.

A female Aslan will never suffer penalties for using male-configured controls (though she will likely become frustrated at their simplicity), but male Aslan using female-configured controls suffer DM-2 to all relevant checks.

Aslan dislike automated systems, so few Aslan ships come equipped with Evade programs, and Fire Control software only offers DMs to attack rolls – it cannot make automated attacks by itself.

SHRINES

All Aslan ships carry a Shrine to Heroes, where Aslan go to meditate on (and gain confidence from) the thoughts, deeds and philosophies of their ancestors. This is typically a small, private room, draped in tapestries and decorated with scenes of conquest.

An Aslan ship of more than 100 tons must have at least one Shrine to Heroes (smaller ships may have them at the option of their owners), and larger ships must have at least one per 10,000 tons. A Shrine is treated as if it were a normal stateroom (consumes 4 tons and costs MCr0.5), but it cannot be used for occupancy and does not incur any life support costs.



HRAYE-CLASS SCOUT



TL13		TONS	COST (MCR)
Hull	100 tons, Streamlined	-	6
Armour	Crystaliron, Armour 4	5	1.2
M-Drive	Thrust 2	2	4
J-Drive	Jump 2	10	15
Power Plant	Fusion (TL12), Power 45	3	3
Fuel Tanks	J-2, 12 weeks of operation	23	-
Bridge		10	0.5
Computer	Computer/5 bis	-	0.045
Sensors	Civilian Grade	1	3
Weapons	Double Turret (pulse laser/missile rack)	1	2.25
Systems	Fuel Processor (20 tons/day)	1	0.05
	Fuel Scoops	-	-
	Shrine	4	0.5
	Probe Drones x 5	1	0.5
Staterooms	Standard x 4	16	2
	Jump Control/2	-	0.2
Software	Library	-	-
	Manoeuvre/0	-	-
Common Areas		8	0.8
Cargo		15	-
TOTAL: MCR 39.045			

CREW
PILOT, ASTROGATOR,
ENGINEER

RUNNING COSTS
MAINTENANCE COST
Cr3253/month
.....
PURCHASE COST
MCR39.045

POWER REQUIREMENTS

20
MANOEVRE
DRIVE

20
BASIC SHIP
SYSTEMS

20
JUMP DRIVE

1
SENSORS

5
WEAPONS

1
FUEL
PROCESSOR

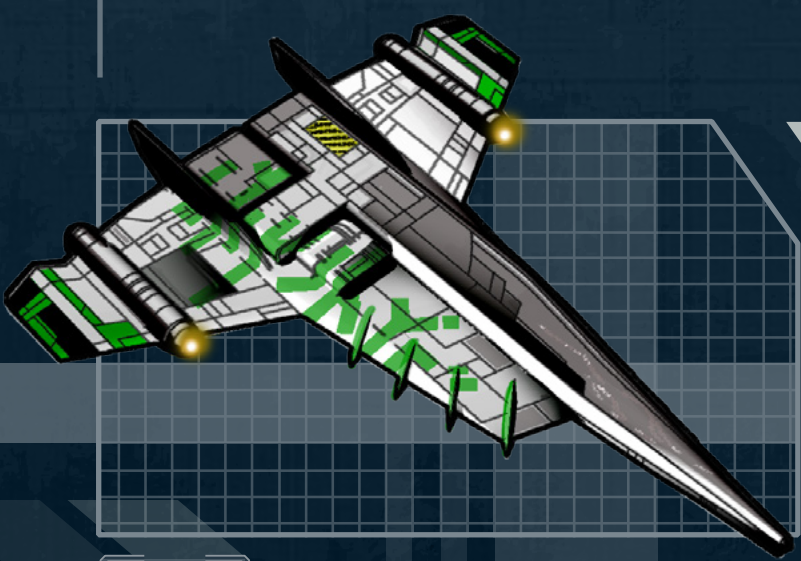

40
HULL POINTS

Using a 100-ton hull, the *Hraye* scout is intended primarily for exploration duties (the variant *Ihateisho*-class scout is a more common sight outside Hierate space). This ship requires a crew of two, pilot and engineer/astrogator (though one individual with pilot, engineer, and astrogator skills can handle the ship alone). The *Hraye's* cheap running cost means these vessels are often found serving as couriers or transports in small colonies.

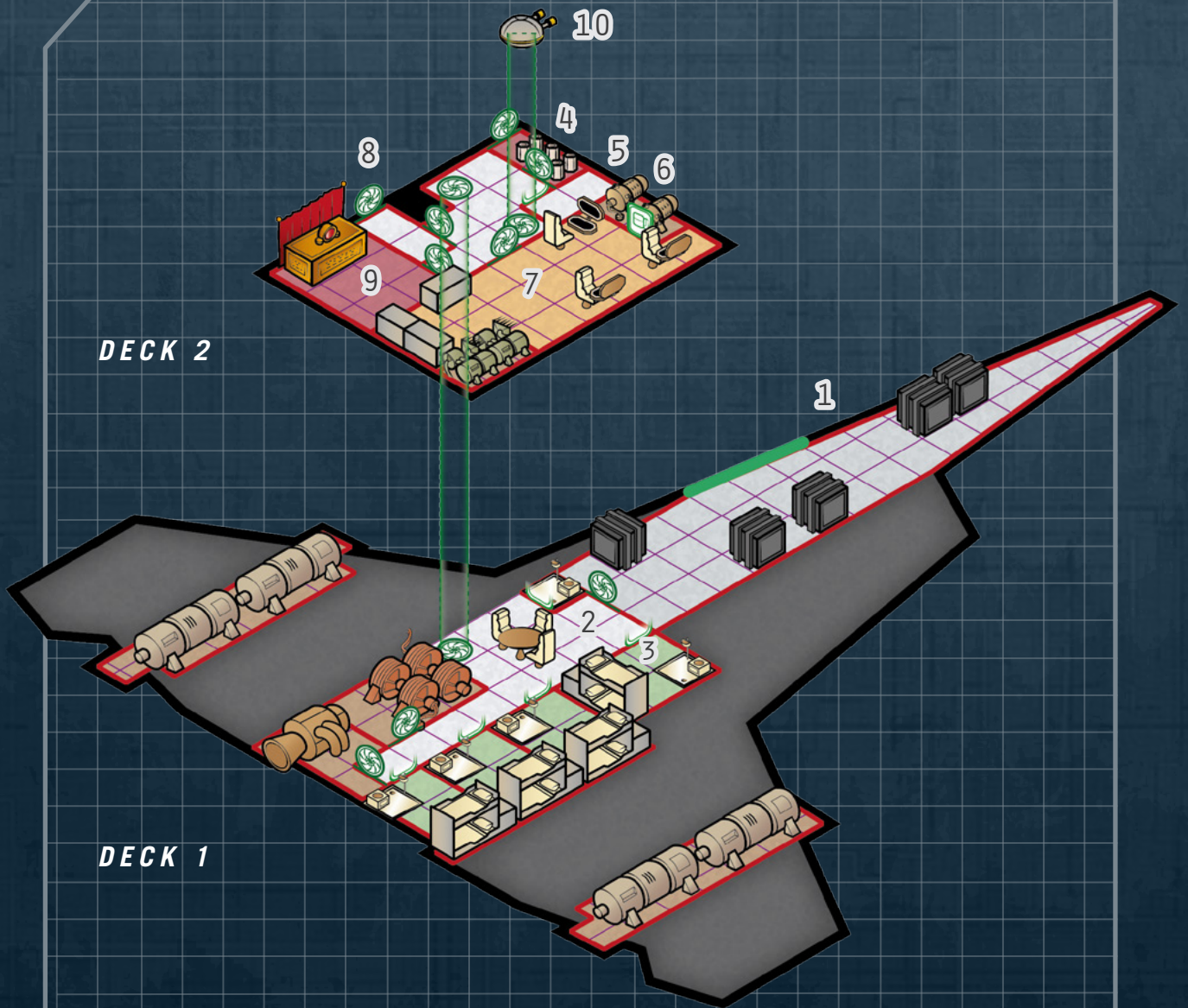

DECK 2

DECK 1

- 1. CARGO HOLD
- 2. COMMON AREA
- 3. STATEROOMS
- 4. PROBE DRONES
- 5. SHIP'S LOCKER
- 6. SENSORS
- 7. BRIDGE
- 8. AIR LOCK
- 9. SHRINE
- 10. DOUBLE TURRET

IHATEISHO-CLASS SCOUT



TL13		TONS	COST (MCR)
Hull	100 tons, Streamlined	-	6
M-Drive	Thrust 2	2	4
J-Drive	Jump 4	15	22.5
Power Plant	Fusion (TL12), Power 60	4	4
Fuel Tanks	J-4, 12 weeks of operation	43	-
Bridge		10	0.5
Computer	Computer/15 bis	-	3
Sensors	Military Grade	2	4.1
Weapons	Triple Turret (pulse lasers)	1	4
Systems	Fuel Processor (20 tons/day)	1	0.05
	Fuel Scoops	-	-
	Shrine	4	0.5
	Docking Space (4 tons)	5	1.25
	Air/raft	-	0.25
Staterooms	Standard	4	0.5
	Low Berth	0.5	0.05
Software	Jump Control/4	-	0.4
	Library	-	-
	Manoeuvre/0	-	-
	Fire Control/3	-	6
	Intellect	-	1
Common Areas		4	0.4
Cargo		4.5	-
TOTAL: MCR 58.51			

CREW

PILOT, ASTROGATOR,
ENGINEER

RUNNING COSTS

MAINTENANCE COST
Cr4876/month

PURCHASE COST
MC58.51

POWER REQUIREMENTS

20

MANOEUVRE
DRIVE

20

BASIC SHIP
SYSTEMS

40

JUMP DRIVE

2

SENSORS

13

WEAPONS

1

FUEL
PROCESSOR



40

HULL POINTS

This is one of the iconic Aslan vessels. Ships of this design are given to the *ihatei* of nobles, to roam the galaxy in search of territories to conquer. Contrary to most Aslan vessels, the controls of this ship have a high degree of automatation, to allow less than technically adept males operate it without female help.

The *ihateisho* is capable of making four-parsec jumps, allowing it to reach systems beyond the range of a standard scout. A typical *ihateisho* exploration lasts two to three years, at which point the wanderer returns to the nearest *ihatei* camp and gathers an army to conquer the most suitable territory found during his wandering. The *ihateisho* is then either returned to the clan or traded for a share in a larger vessel. An *ihateisho* is sometimes considered especially lucky if former owners have gone on to find good territories.

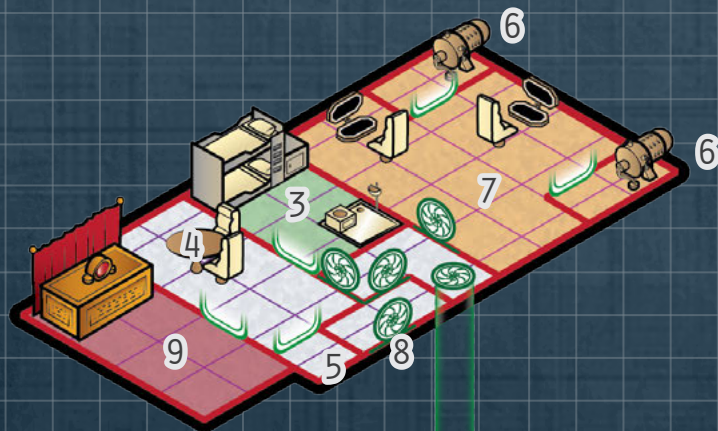

DECK 2

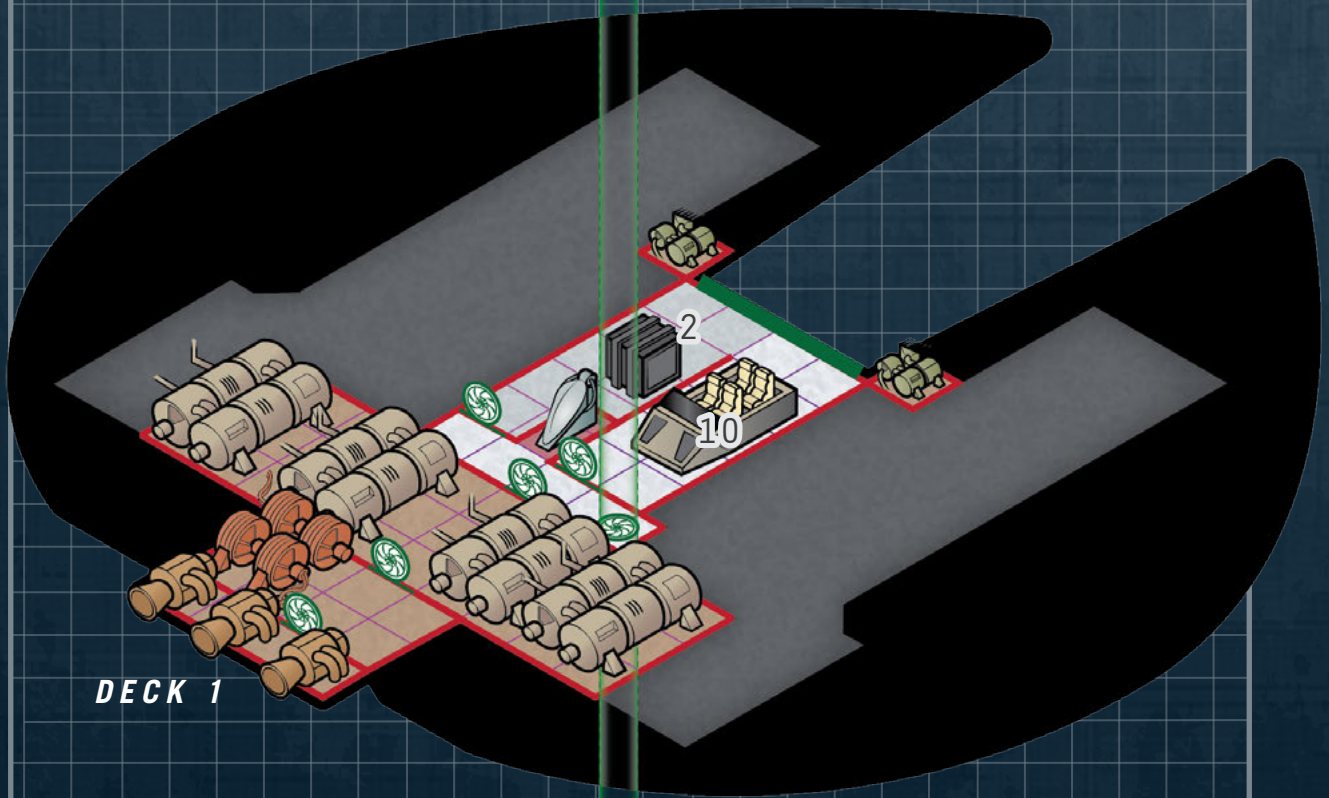

DECK 1

- 1. TRIPLE TURRET
- 2. CARGO HOLD
- 3. STATEROOM
- 4. COMMON AREA
- 5. SHIP'S LOCKER
- 6. SENSORS
- 7. BRIDGE
- 8. AIR LOCK
- 9. SHRINE
- 10. AIR/RAFT DOCKING SPACE

KTIYHUI-CLASS COURIER



TL13		TONS	COST (MCR)
Hull	200 tons, Streamlined	-	18
Armour	Crystaliron, Armour 12	30	10.8
M-Drive	Thrust 4	8	16
J-Drive	Jump 3	20	30
Power Plant	Fusion (TL12), Power 135	9	9
Fuel Tanks	J-3, 4 weeks of operation	61	-
Bridge		10	1
Computer	Computer/10 bis	-	0.18
Sensors	Improved	3	4.3
Weapons	Double Turret (pulse laser/missile rack)	1	2.25
	Double Turret (sandcaster/missile rack)	1	1.5
Ammunition	Missiles x 12	1	0.25
	Sandcaster Barrels x 20	1	0.025
Systems	Fuel Processor (40 tons/day)	2	0.1
	Fuel Scoops	-	-
	Shrine	4	0.5
Staterooms	Standard x 6	24	3
	Luxury	10	1.5
Software	Jump Control/3	-	0.3
	Library	-	-
	Manoeuvre/0	-	-
	Fire Control/2	-	4
Common Areas		12	1.2
Cargo		3	-

TOTAL: MCR 103.905

CREW

PILOT, PURSER,
ASTROGATOR, ENGINEER,
GUNNERS X 2

RUNNING COSTS

MAINTENANCE COST

Cr8659/month

•••••

PURCHASE COST

MCR103.905

POWER REQUIREMENTS

80

MANOEVRE
DRIVE

40

BASIC SHIP
SYSTEMS

60

JUMP DRIVE

4

SENSORS

6

WEAPONS

2

FUEL
PROCESSOR

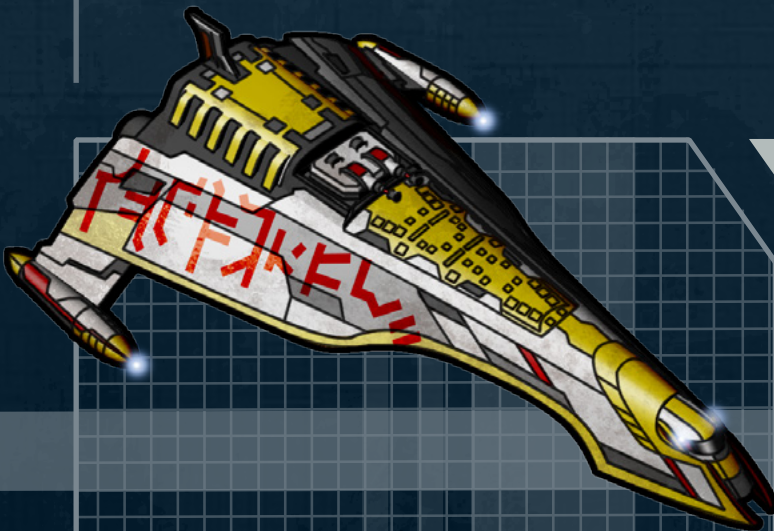

Using a heavily armoured 200-ton hull, the *Ktiyhui*-class courier is a fast, long-range ship used to conduct clan business across interstellar distances. As the courier is often used to carry important dignitaries and nobles, it dedicates space to various luxuries, usually either a harem or holographic hunting ground.

88

HULL POINTS

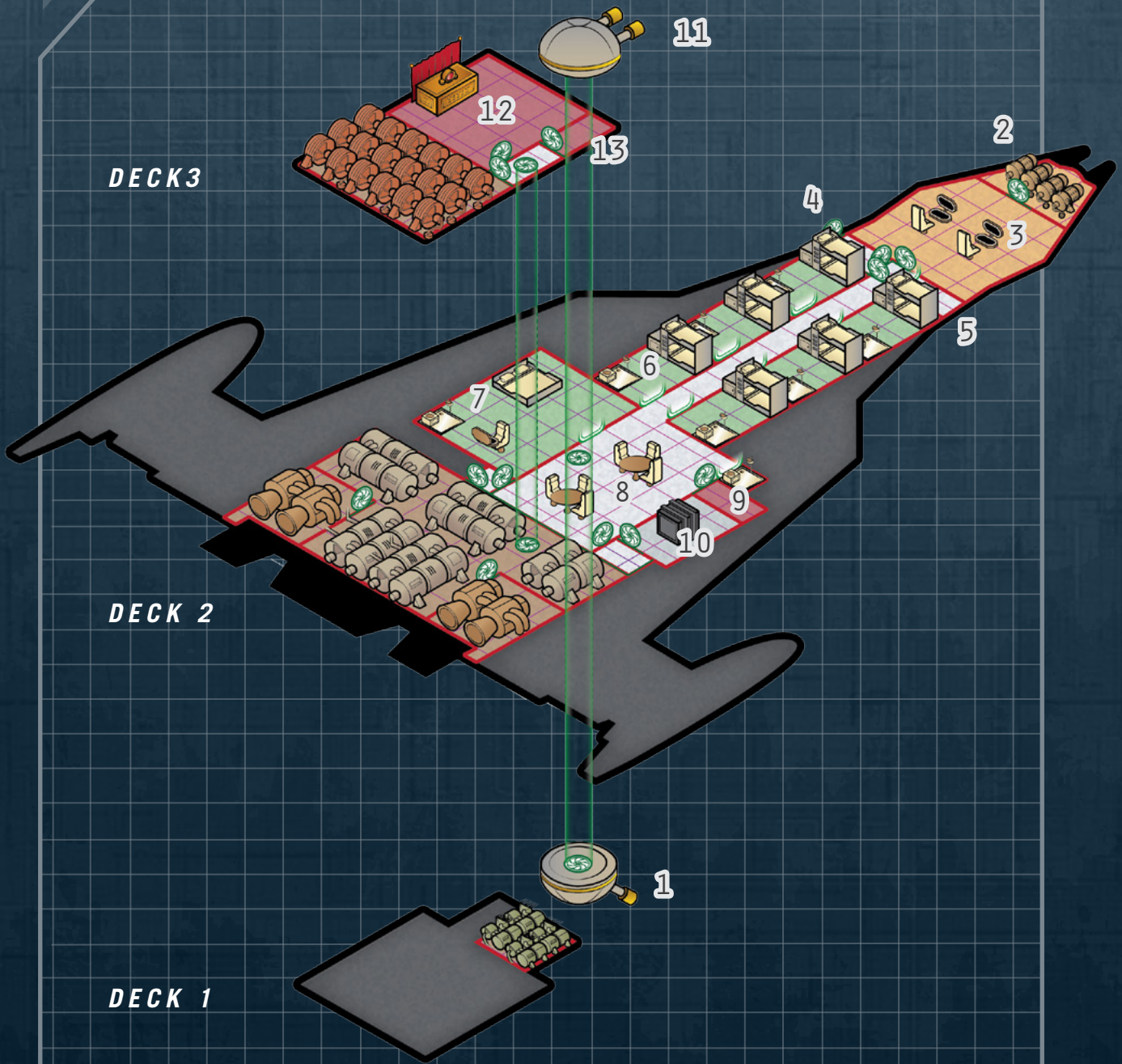

- 1. DOUBLE TURRET (SANDCASTER/MISSILE)
- 2. SENSORS
- 3. BRIDGE
- 4. AIR LOCK
- 5. SHIP'S LOCKER
- 6. STATEROOMS
- 7. LUXURY STATEROOM

- 8. COMMON AREA
- 9. SANDCASTER BARREL STORAGE
- 10. CARGO HOLD
- 11. DOUBLE TURRET (PULSE LASER/MISSILE)
- 12. SHRINE
- 13. MISSILE STORAGE

KTEIROA-CLASS SEEKER



TL11		TONS	COST (MCR)
Hull	200 tons, Streamlined	-	12
M-Drive	Thrust 2	4	8
J-Drive	Jump 2	15	22.5
Power Plant	Fusion (TL8), Power 90	9	4.5
Fuel Tanks	J-2, 4 weeks of operation	41	-
Bridge	Small bridge	6	0.5
Computer	Computer/5 bis	-	0.045
Sensors	Civilian Grade	1	3
Systems	Fuel Scoops	-	-
	Fuel Processor (20 tons/day)	1	0.05
	Mining Drones x 20	40	4
	Shrine	4	0.5
Staterooms	Standard x 4	16	2
Software	Jump Control/2	-	0.2
	Library	-	-
	Manoeuvre/0	-	-
Common Areas		2	0.2
Cargo		61	-
TOTAL: MCR 57.495			

CREW

CAPTAIN, PILOT,
ASTROGATOR, ENGINEER

RUNNING COSTS

MAINTENANCE COST
Cr4791/month

PURCHASE COST
MCR57.495

POWER REQUIREMENTS

40

MANOEVRE
DRIVE

40

BASIC SHIP
SYSTEMS

40

JUMP DRIVE

1

SENSORS

1

FUEL
PROCESSOR

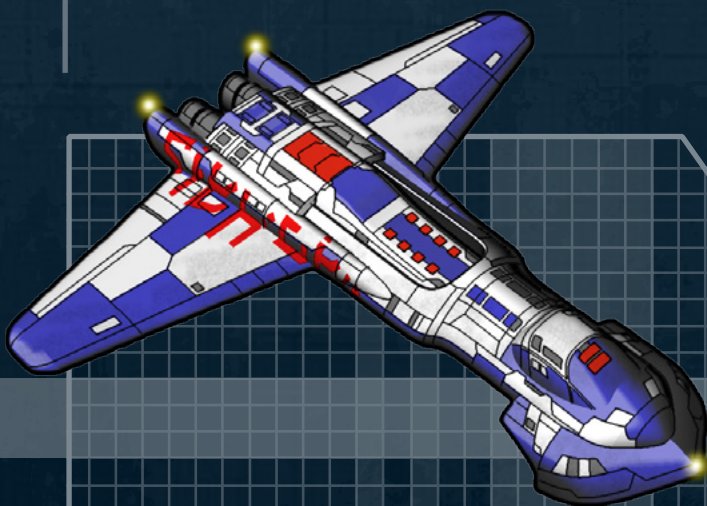

80

HULL POINTS

Using a 200-ton hull, the *Kteiroa*-class seeker is a prospecting vessel adapted to explorations in asteroid belts. Unlike many similar ships, there are four staterooms – more than the crew needs, but *Kteiroa* are commonly also used as transports in isolated systems.

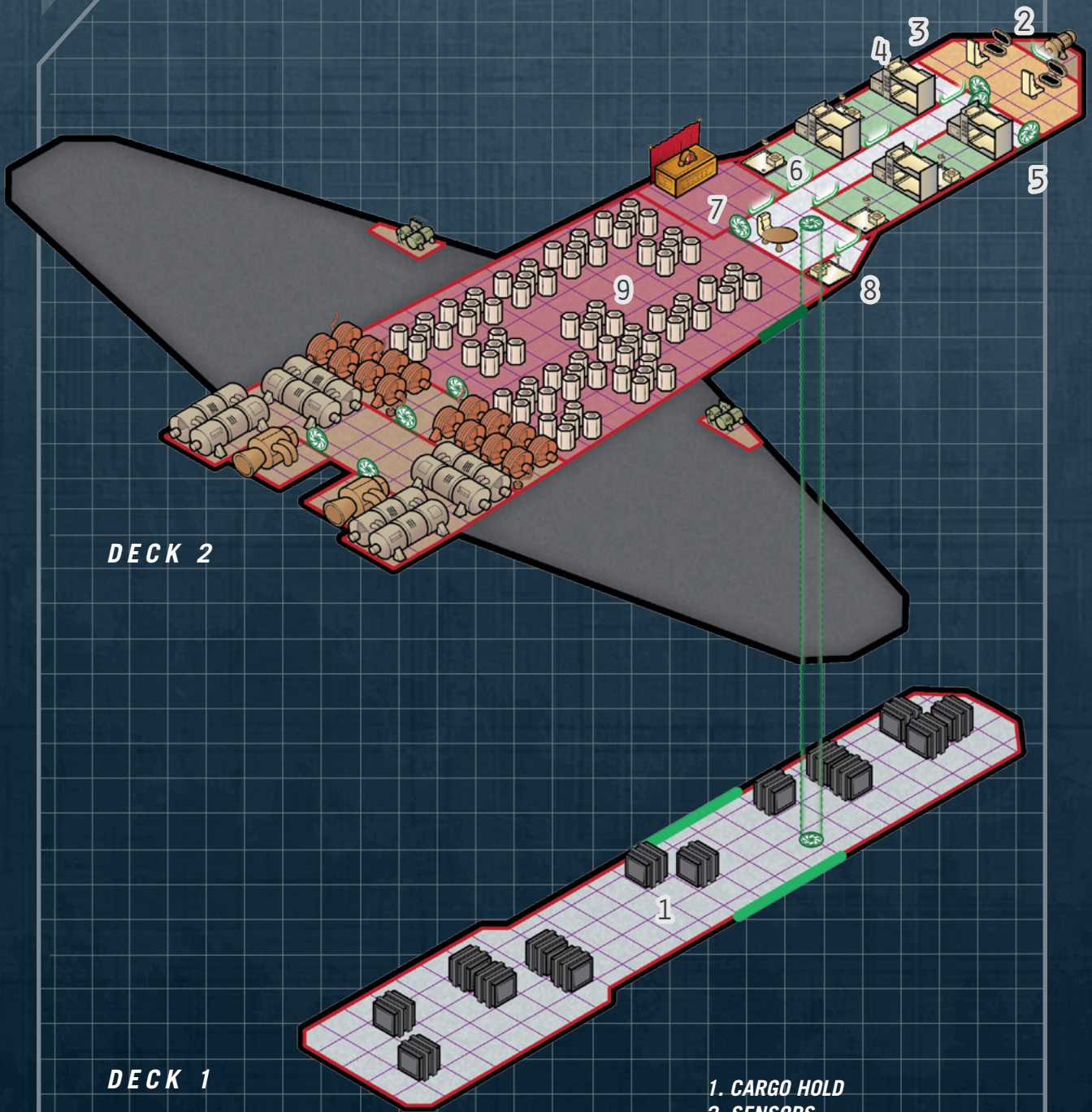

DECK 2

DECK 1

- 1. CARGO HOLD
- 2. SENSORS
- 3. BRIDGE
- 4. SHIP'S LOCKER
- 5. AIR LOCK
- 6. STATEROOMS
- 7. SHRINE
- 8. COMMON AREA
- 9. MINING DRONES

IYELIY-CLASS MESSENGER



TL14		TONS	COST (MCR)
Hull	200 tons	-	10
M-Drive	Thrust 1	2	4
J-Drive	Jump 5	30	45
Power Plant	Fusion (TL12), Power 150	10	10
Fuel Tanks	J-5, 4 weeks of operation	101	-
Bridge		10	1
Computer	Computer/20 bis	-	7.5
Sensors	Military Grade	2	4.1
Weapons	Triple Turret (pulse lasers)	1	4
Systems	Shrine	4	0.5
	Mail Distribution Array (TL13)	20	10
Staterooms	Standard x 2	8	1
	Jump Control/5	-	0.5
Software	Library	-	-
	Manoeuvre/0	-	-
	Intellect	-	1
Common Areas		4	0.4
Cargo		8	-
TOTAL: MCR 99.85			

CREW

PILOT, PURSER, ENGINEER,
GUNNER

RUNNING COSTS

MAINTENANCE COST
Cr8238/month

•••••
PURCHASE COST
MCR99.85

POWER REQUIREMENTS

20

MANOEUVRE
DRIVE

40

BASIC SHIP
SYSTEMS

100

JUMP DRIVE

2

SENSORS

13

WEAPONS

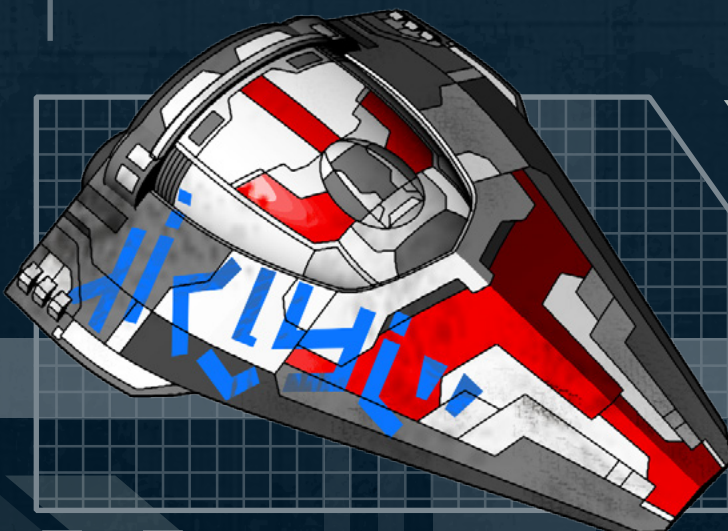

80

HULL POINTS

70

The *Iyeliy*-class is the Aslan equivalent of the Imperial X-boat. Larger clans have a network of these vessels, and some Aslan news corporations have their own fleets to relay information across the Hierate. The Aslan network is much less extensive than the Imperial X-boat system, but the *Iyeliy* are capable of five-parsec jumps and so information moves faster within the Hierate. Due to the limited crew positions on the messenger ship, astrogation is often relegated to Intellect software, unless the female purser/engineer is unusually skilled.

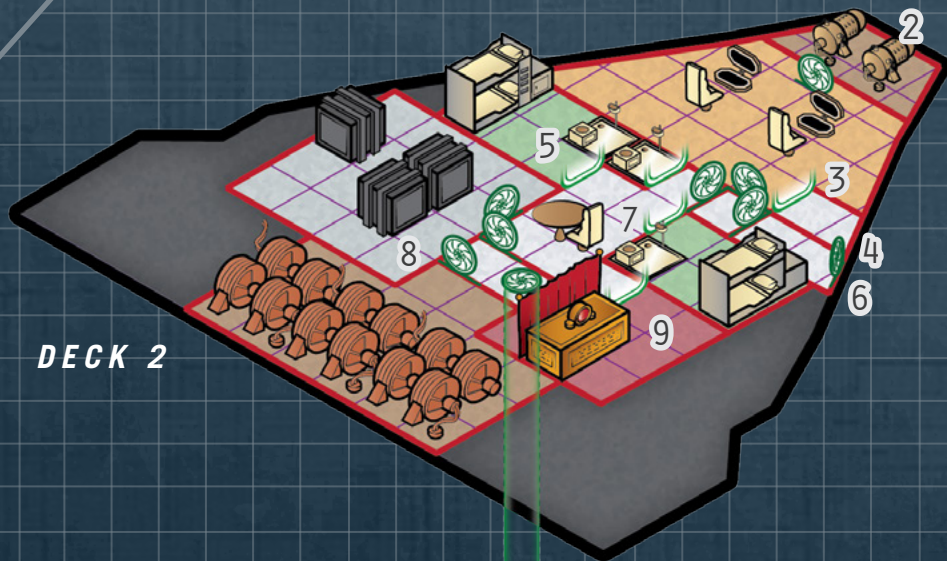

DECK 2

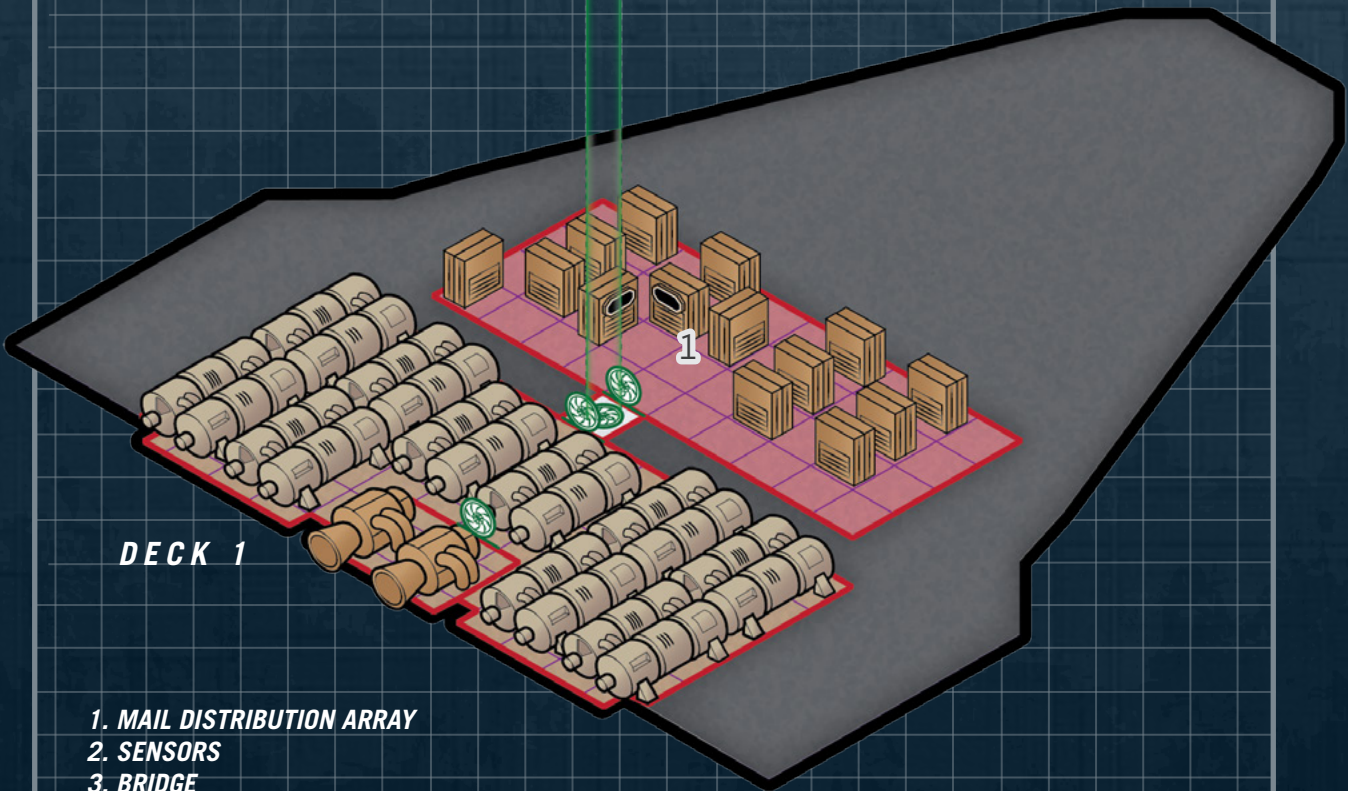

DECK 1

- 1. MAIL DISTRIBUTION ARRAY
- 2. SENSORS
- 3. BRIDGE
- 4. SHIP'S LOCKER
- 5. STATEROOMS
- 6. AIR LOCK
- 7. COMMON AREA
- 8. CARGO HOLD
- 9. SHRINE

AOA'IW-CLASS LIGHT TRADER

TL11		TONS COST (MCR)	
Hull	300 tons, Streamlined	-	18
Armour	Crystaliron, Armour 4	15	3.6
M-Drive	Thrust 1	3	6
J-Drive	Jump 2	20	30
Power Plant	Fusion (TL8), Power 130	13	6.5
Fuel Tanks	J-2, 4 weeks of operation	62	-
Bridge		20	1.5
Computer	Computer/10	-	0.16
Sensors	Civilian Grade	1	3
Weapons	Double Turrets (beam lasers) x 2	2	3
	Double Turrets (missile rack, sandcaster)	1	1.5
Ammunition	Missiles x 12	1	-
	Sandcaster Barrels x 20	1	-
Systems	Shrine	4	0.5
	Fuel Scoops	-	-
	Docking Space (4 tons)	5	1.25
	Air/Raft	-	0.26
	Docking Space (20 tons)	22	5.5
Staterooms	Launch	-	5.607
	Standard x 8	32	4
	Low Berths x 12	6	0.6
Software		-	0.2
	Jump Control/2	-	-
	Library	-	-
Common Areas	Manoeuvre/0	-	-
		6	0.6
Cargo		86	-
TOTAL: MCR 91.777			

CREW

PILOT, ASTROGATOR,
PURSER, ENGINEER,
GUNNERS X 2

RUNNING COSTS

MAINTENANCE COST

Cr7648/month

PURCHASE COST

Mcr91.777

POWER REQUIREMENTS

30

MANOEUVRE
DRIVE

60

BASIC SHIP
SYSTEMS

60

JUMP DRIVE

1

SENSORS

19

WEAPONS

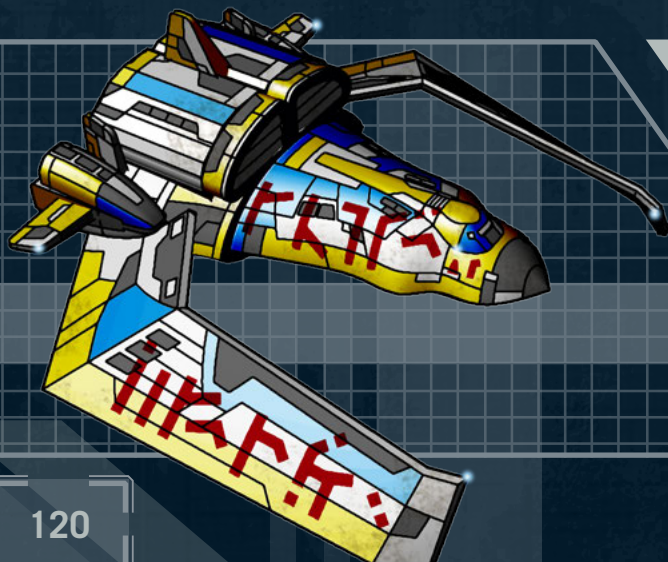

120

HULL POINTS

A popular design inside the Hierate, especially within the Trojan Reach, the little *Aoa'iw* is a 300-ton trader that combines a sizable cargo bay with space for passengers, enough firepower to serve as a raider or defend itself from piracy, and vehicles to support a flexible mission profile. *Aoa'iws* are often owned by clans, as they are capable of performing a wide variety of tasks. On the border worlds, the *Aoa'iw* is nicknamed the 'pouncer', as it does resemble a crouching animal from certain angles.



DECK 4



DECK 3

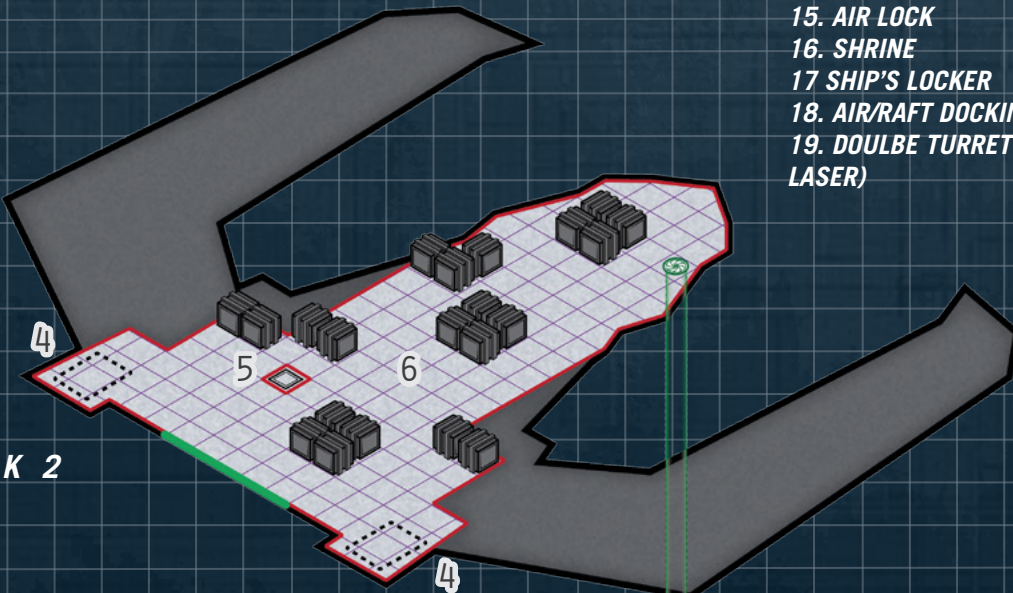

DECK 2

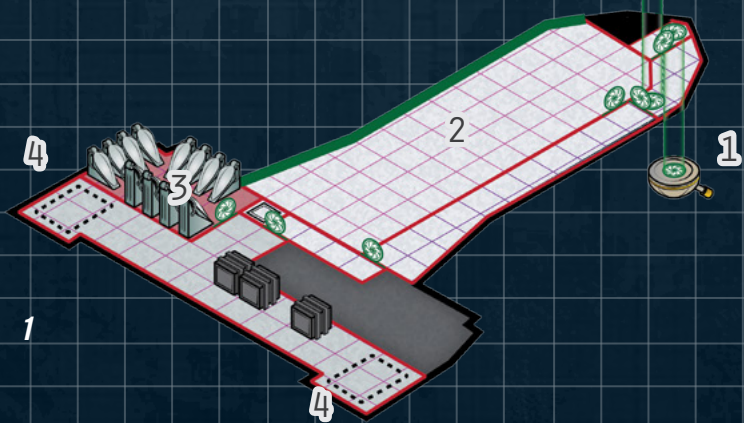

DECK 1

- 1. DOUBLE TURRET (BEAM LASER)
- 2. LAUNCH DOCKING SPACE
- 3. LOW BERTHS
- 4. CARGO LIFT
- 5. LIFT
- 6. CARGO HOLD
- 7. DOUBLE TURRET (MISSILE/SANDCASTER)
- 8. MISSILE STORAGE
- 9. SANDCASTER BARREL STORAGE
- 10. STATEROOM
- 11. COMMON AREA
- 12. SENSORS
- 13. BRIDGE
- 14. CAPTAIN'S OFFICE
- 15. AIR LOCK
- 16. SHRINE
- 17. SHIP'S LOCKER
- 18. AIR/RAFT DOCKING SPACE
- 19. DOULBE TURRET (BEAM LASER)

EAKHAU-CLASS TRADER



TL12		TONS	COST (MCR)
Hull	400 tons, Streamlined	-	24
M-Drive	Thrust 1	4	8
J-Drive	Jump 2	25	37.5
Power Plant	Fusion (TL12), Power 165	11	11
Fuel Tanks	J-2, 4 weeks of operation	82	-
Bridge		20	2
Computer	Computer/ 5 bis	-	0.045
Sensors	Civilian Grade	1	3
Systems	Fuel Processor (20 tons/day)	1	0.05
	Fuel Scoops	-	-
	Shrine	4	0.5
	Re-entry Capsules x 13	6.5	0.26
Staterooms	Standard x 13	52	6.5
	Low Berths x 16	8	0.8
Software	Jump Control/2	-	0.2
	Library	-	-
	Manoeuvre/0	-	-
Common Areas		12	1.2
Cargo		173.5	-
TOTAL: MCR 95.145			

CREW
PILOT, ASTROGATOR,
PURSER, ENGINEER

RUNNING COSTS
MAINTENANCE COST
Cr7928/month
•••••
PURCHASE COST
MCR95.145

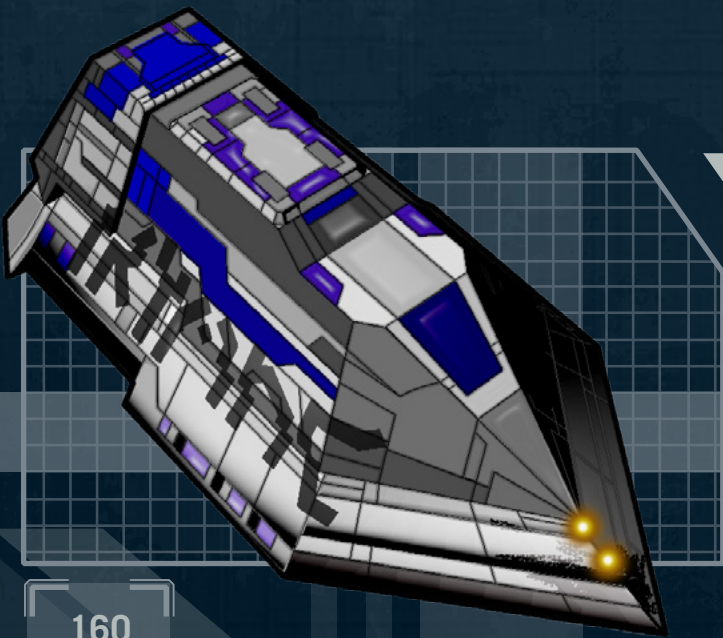
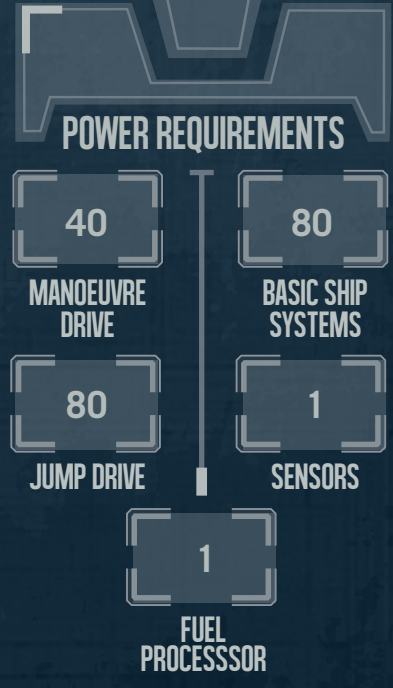

160
HULL POINTS

The *Eakhou* is an Aslan tramp trader, commonly crewed by a single family. Nomadic Aslan families travel in this fashion as part of a pride-fleet of a dozen or so ships, and whole generations can be born, live and die on these cramped vessels before the pride finds suitable territory. Out of the shipyard, eleven tons of space is unallocated but new owners quickly fill this with weapons, vehicles, and other optional extras.

The *Eakhou* is one of the few Aslan designs to carry escape pods, which are seen as inviting failure. A true warrior will never flee.

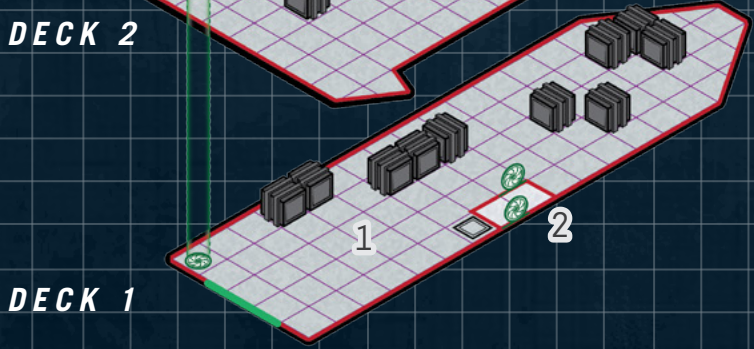
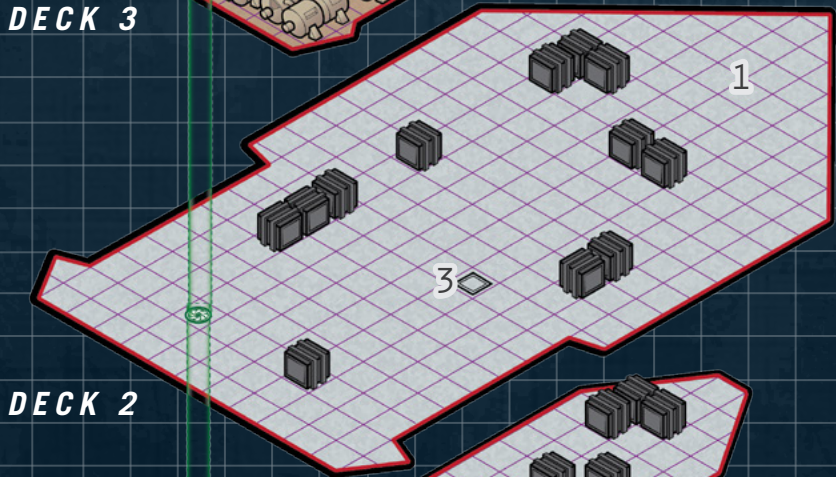

- 1. CARGO HOLD
- 2. AIR LOCK
- 3. LIFT
- 4. SENSORS
- 5. BRIDGE
- 6. OFFICE
- 7. STATEROOM
- 8. COMMON AREA
- 9. SHRINE
- 10. RE-ENTRY CAPSULES
- 11. LOW BERTHS
- 12. SHIP'S LOCKER

HKIYRERAO-CLASS RESEARCHER

TL14		TONS	COST (MCR)
Hull	400 tons, Streamlined	-	24
M-Drive	Thrust 1	4	8
J-Drive	Jump 3	35	52.5
Power Plant	Fusion (TL12), Power 240	16	16
Fuel Tanks	J-3, 16 weeks of operation	128	-
Bridge		20	2
Computer	Computer/25	-	10
Sensors	Improved	3	4.3
Systems	Fuel Scoops	-	-
	Fuel Processor (60 tons/day)	3	0.15
	Shrine	4	0.5
	Laboratories	40	10
	Docking Space (40 tons)	44	11
	Pinnacle	-	8.732
Staterooms	Standard x 15	60	7.5
	Low Berths x 10	5	0.5
	Jump Control/3	-	0.3
Software	Library	-	-
	Manoeuvre/0	-	-
	Intellect	-	1
Common Areas		10	0.4
Cargo		28	-
TOTAL: MCR 157.832			

CREW

CAPTAIN, PILOT, EXECUTIVE OFFICER/HEAD SCIENTIST, ASTROGATOR, ENGINEERS X 2

RUNNING COSTS

MAINTENANCE COST

Cr13153/month

•••••

PURCHASE COST

MCR157.832

POWER REQUIREMENTS

40

MANOEVRE DRIVE

80

BASIC SHIP SYSTEMS

120

JUMP DRIVE

4

SENSORS

3

FUEL PROCESSOR

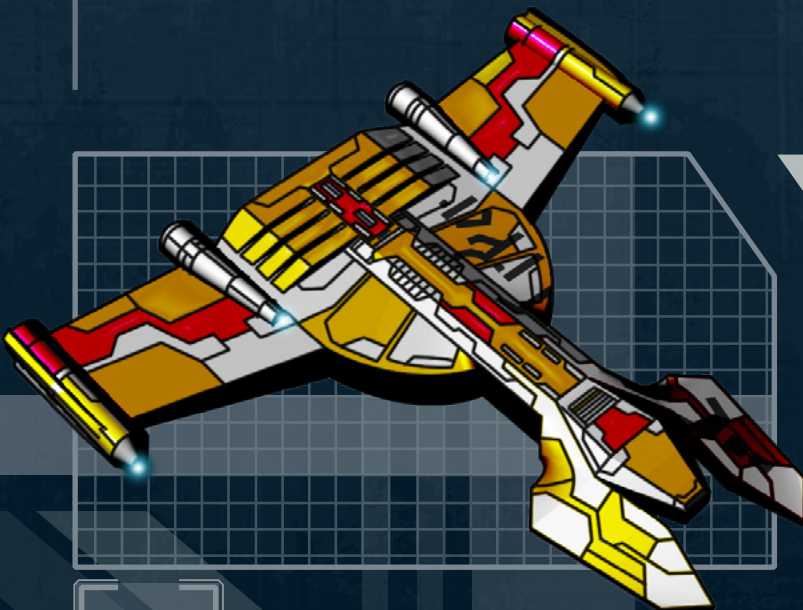

160

HULL POINTS

Using a 400-ton hull, the *Hkiyrerao*-class researcher was designed to investigate scientific phenomena and conduct tests around newly discovered worlds. The ship carries one pinnacle and one GCarrier as vehicles, along with a fully-equipped scientific laboratory that can cater to the needs of up to ten scientists.

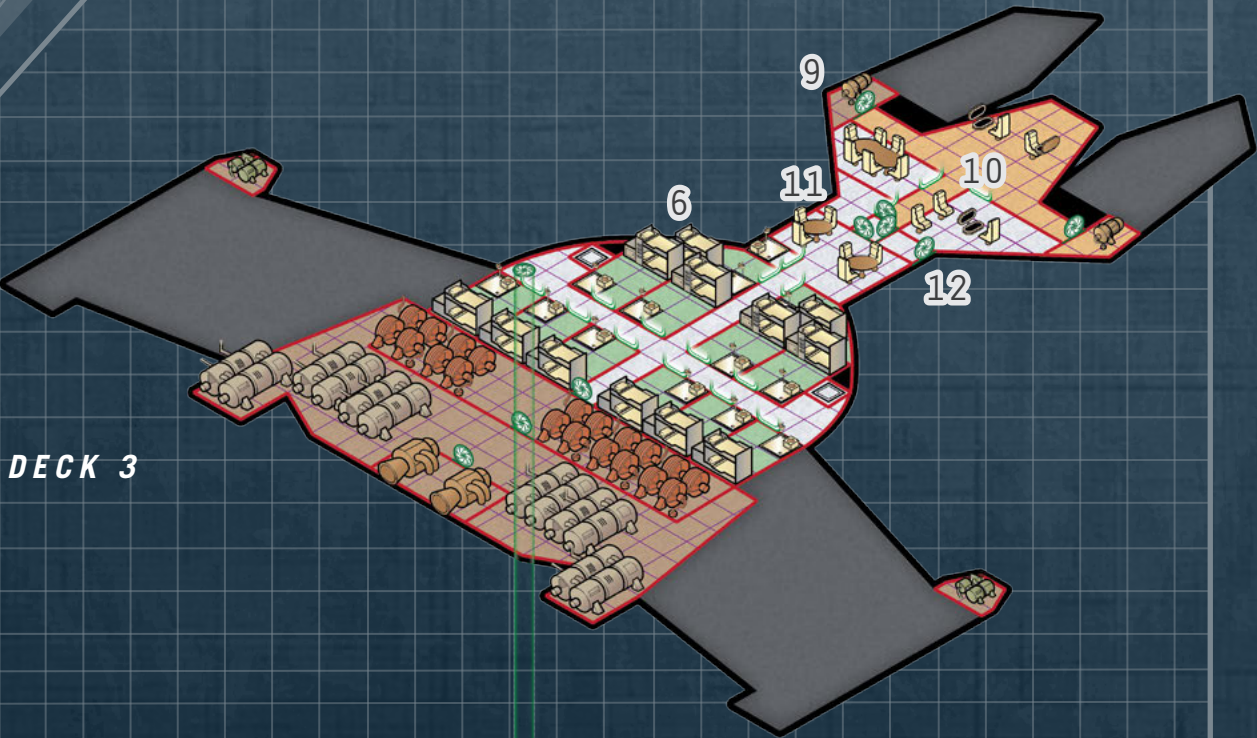

DECK 3



DECK 2

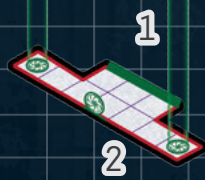

DECK 1

- 1. PINNACE DOCK
- 2. PINNACE BOARDING AREA
- 3. CARGO HOLD
- 4. LOW BERTHS
- 5. COMMON AREA
- 6. STATEROOM
- 7. LIFT
- 8. LABORATORY
- 9. SENSORS
- 10. BRIDGE
- 11. SHIP'S LOCKER
- 12. AIR LOCK
- 13. SHRINE

KHTUKHAO-CLASS CLAN TRANSPORT

TL12		TONS	COST (MCR)
Hull	600 tons, Standard	-	30
M-Drive	Thrust 2	12	24
J-Drive	Jump 2	35	52.5
Power Plant	Fusion (TL12), Power 255	17	17
Fuel Tanks	J-2, 4 weeks of operation	122	-
Bridge		20	3
Computer	Computer/5 bis	-	0.045
Sensors	Civilian Grade	1	3
Systems	Shrine	4	0.5
	Docking Space (95 tons)	105	26.25
	Shuttle	-	15.167
Staterooms	Standard x 25	100	12.5
	Low Berths x 30	15	1.5
Software	Jump Control/2	-	0.2
	Library	-	-
	Manoeuvre/0	-	-
Common Areas		20	2
Cargo		149	-
TOTAL: MCR 187.662			

CREW

PILOT, ASTROGATOR,
PURSER, ENGINEERS X 2

RUNNING COSTS

MAINTENANCE COST
Cr15639/month

PURCHASE COST
MCR187.662

POWER REQUIREMENTS

120

MANOEVRE
DRIVE

120

BASIC SHIP
SYSTEMS

120

JUMP DRIVE

1

SENSORS

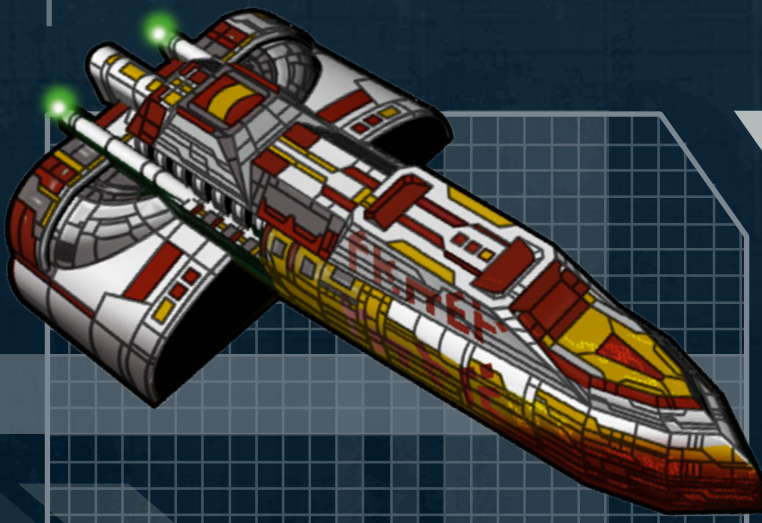

240

HULL POINTS

Using a 600-ton hull, this clan transport is a large freight and passenger vessel used by clans and companies upon major trade routes. A 95-ton shuttle is carried as ship's vehicle which, with a generous passenger or cargo capacity means the transport does not require a streamlined hull itself, and the shuttle's cargo bay is often utilised to increase the total tonnage this ship can carry.

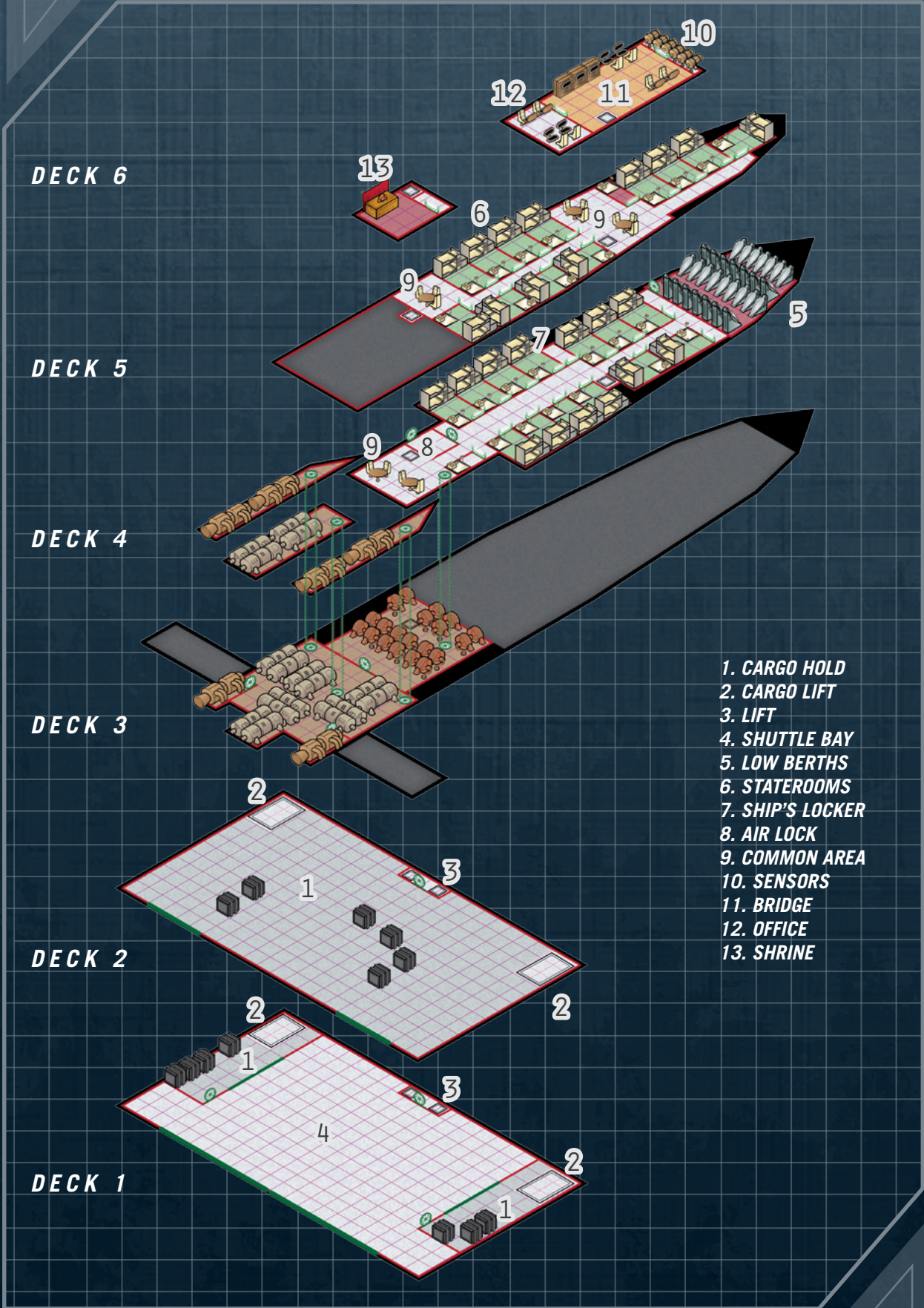

DECK 6

DECK 5

DECK 4

DECK 3

DECK 2

DECK 1

- 1. CARGO HOLD
- 2. CARGO LIFT
- 3. LIFT
- 4. SHUTTLE BAY
- 5. LOW BERTHS
- 6. STATEROOMS
- 7. SHIP'S LOCKER
- 8. AIR LOCK
- 9. COMMON AREA
- 10. SENSORS
- 11. BRIDGE
- 12. OFFICE
- 13. SHRINE

OWATARL-CLASS TENDER



TL12		TONS	COST (MCR)
Hull	600 tons, Dispersed	-	15
Armour	Crystaliron, Armour 4	30	3
M-Drive	Thrust 1	6	12
J-Drive	Jump 2	35	52.5
Power Plant	Fusion (TL12), Power 255	17	17
Fuel Tanks	J-2, 4 weeks of operation	122	-
Bridge		20	3
Computer	Computer/10	-	0.16
Sensors	Military Grade	2	4.1
Weapons	Triple Turrets (beam lasers x 2, sandcaster) x 3	3	6.75
Ammunition	Sandcaster Barrels x 20	1	0.025
Systems	Shrine	4	0.5
	Docking Space (95 tons)	105	26.25
	Shuttle	-	15.167
Staterooms	Standard x 10	40	5
	Jump Control/2	-	0.2
Software	Library	-	-
	Manoeuvre/0	-	-
	Fire Control/2	-	4
Common Areas		4	0.4
Cargo		211	-
TOTAL: MCR 165.027			

CREW

CAPTAIN, PILOT, ASTROGATOR,
PURSER/EXECUTIVE OFFICER,
PILOT, ENGINEERS X 2,
GUNNERS X 3

RUNNING COSTS

MAINTENANCE COST

Cr13752/month

•••••

PURCHASE COST

MCR165.027

POWER REQUIREMENTS

60

MANOEUVRE
DRIVE

120

BASIC SHIP
SYSTEMS

120

JUMP DRIVE

2

SENSORS

27

WEAPONS



216

HULL POINTS

The *Owatarl*-class are military tenders, but also see use as corporate freighters in regions where normal cargo ships would be vulnerable to attack. Three turrets provide basic cover, although many *Owatarls* refit some of their cargo bay to carry auxiliary fighters. The tender is unable to land, so it carries a shuttle for cargo transfer. Tenders assigned to supply other ships may replace the shuttle bay with a suite of repair drones and smaller launches.

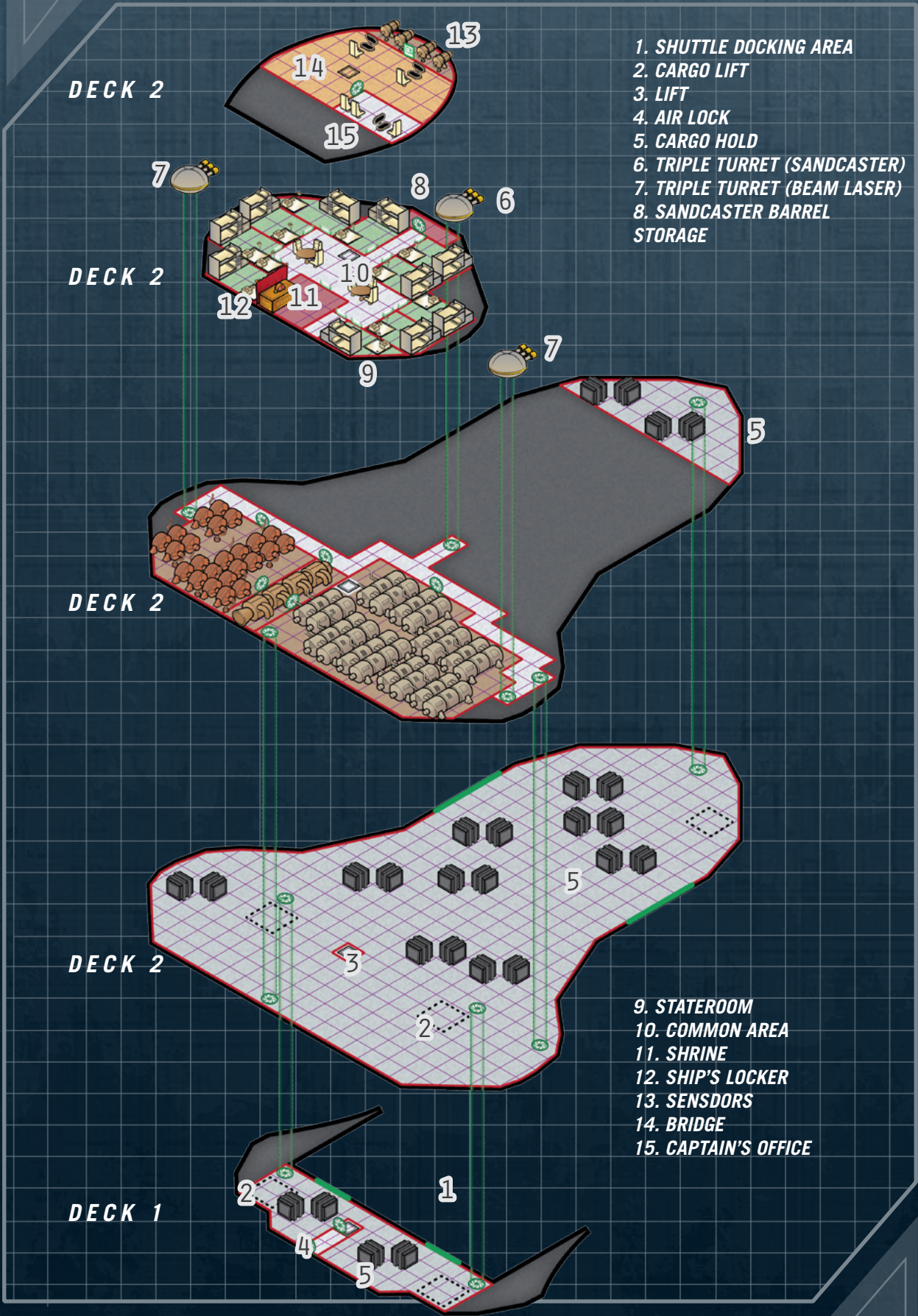

EKAWSIYKUA-CLASS ESCORT

TL13

TONS COST (MCR)

Hull	800 tons, Dispersed	-	20
M-Drive	Thrust 4	32	64
J-Drive	Jump 4	85	127.5
Power Plant	Fusion (TL12), Power 540	36	36
Fuel Tanks	J-4, 4 weeks of operation	324	-
Bridge		20	4
Computer	Computer/20	-	5
Sensors	Improved	3	4.3
Weapons	Triple Turrets (pulse lasers) x 3	3	12
	Triple Turrets (missile racks) x 3	3	9.75
	Triple Turret (sandcasters) x 2	2	3.5
Ammunition	Missiles x 240	20	-
	Sandcaster Barrels x 240	12	-
Systems	Shrine	4	0.5
	Docking Space (40 tons) x 2	88	22
	Pinnacle with pulse laser x 2	-	19.664
	Docking Space (10 tons) x 5	55	13.75
	Light Fighters x 5	-	39
Staterooms	Standard x 20	80	10
	Jump Control/4	-	0.4
Software	Library	-	-
	Manoeuvre/0	-	-
	Fire Control/4	-	8
Common Areas		14	1.4
Cargo		19	-

TOTAL: MCR 400.464

CREW

CAPTAIN, PILOT, ASTROGATOR,
PURSER/EXECUTIVE OFFICER,
OFFICERS X 3, PILOTS X 7, MEDIC,
ENGINEERS X 5, MAINTENANCE,
GUNNERS X 10, MARINES X 10

RUNNING COSTS

MAINTENANCE COST

Cr33372/month

PURCHASE COST

MCR400.464

POWER REQUIREMENTS

320

MANOEUVRE
DRIVE

160

BASIC SHIP
SYSTEMS

320

JUMP DRIVE

4

SENSORS

44

WEAPONS

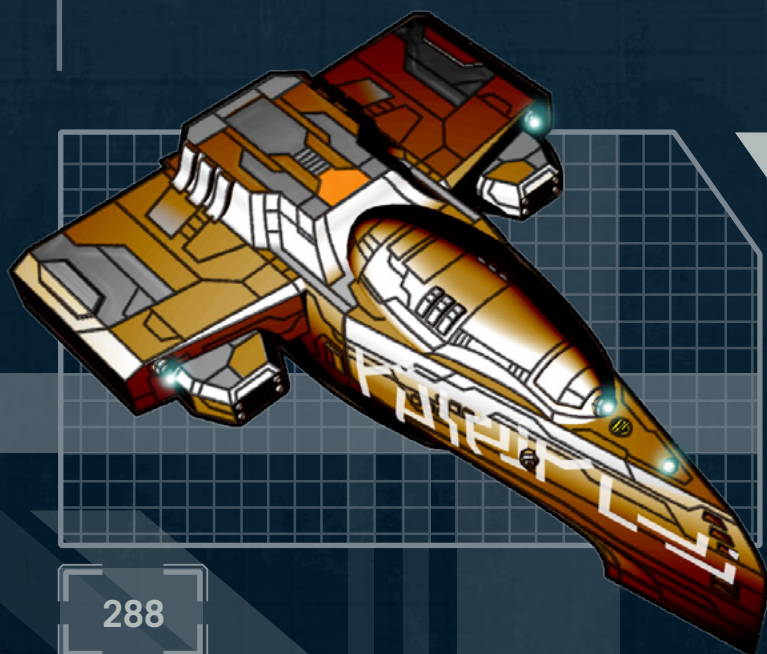

288

HULL POINTS

Using an 800-ton hull, the *Ekawisykua*-class escort is a military vessel employed by clans for space patrol and combat duties, and are often encountered alongside Aslan freighters. Eight triple turrets mount three triple lasers, three triple missile racks, and two triple sandcasters, while inside the ship carries two armed pinnaces and five fighters for scouting and patrol duties.

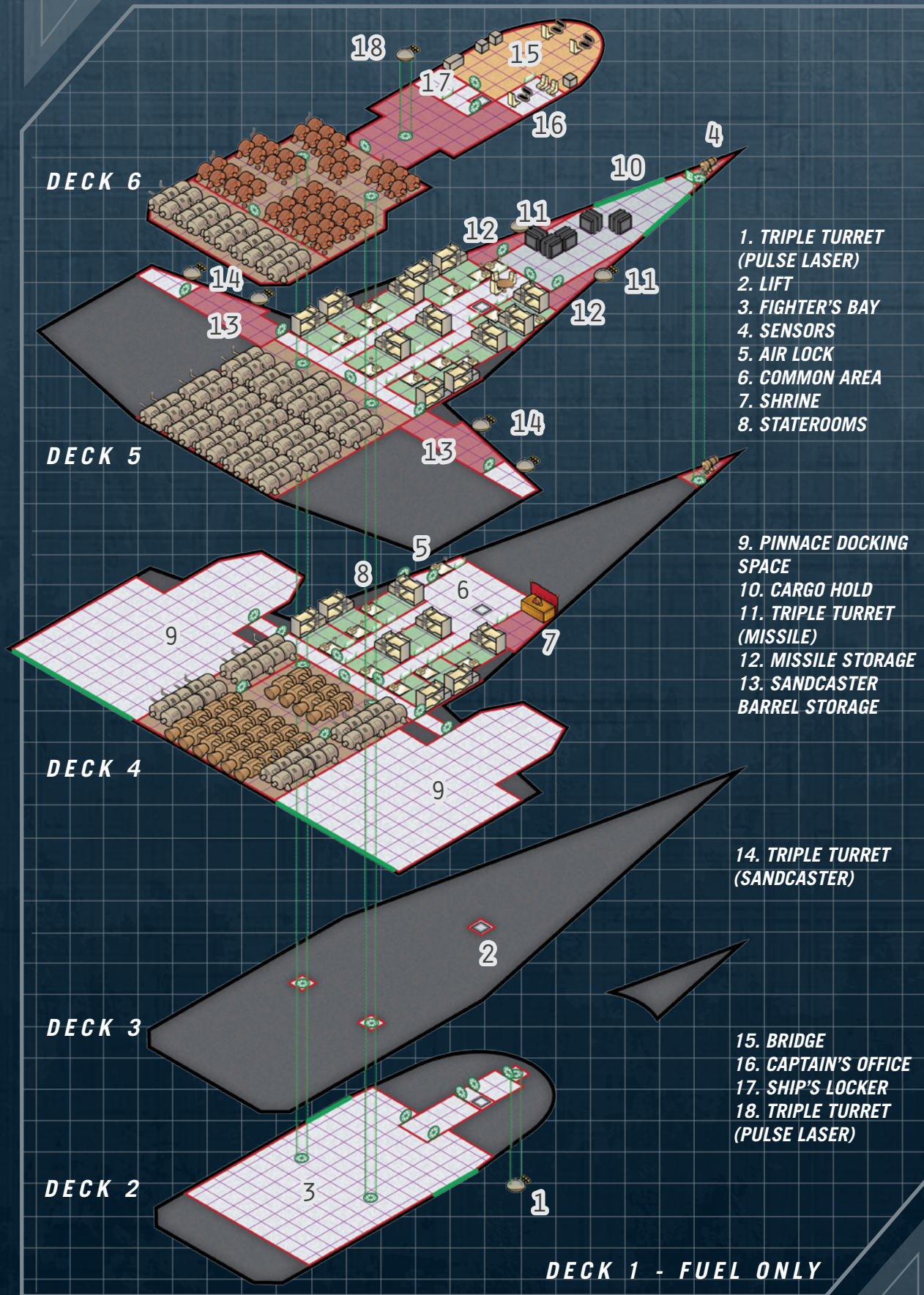

- 1. TRIPLE TURRET (PULSE LASER)
- 2. LIFT
- 3. FIGHTER'S BAY
- 4. SENSORS
- 5. AIR LOCK
- 6. COMMON AREA
- 7. SHRINE
- 8. STATEROOMS

- 9. PINNACE DOCKING SPACE
- 10. CARGO HOLD
- 11. TRIPLE TURRET (MISSILE)
- 12. MISSILE STORAGE
- 13. SANDCASTER BARREL STORAGE

- 14. TRIPLE TURRET (SANDCASTER)

- 15. BRIDGE
- 16. CAPTAIN'S OFFICE
- 17. SHIP'S LOCKER
- 18. TRIPLE TURRET (PULSE LASER)

DECK 1 - FUEL ONLY

AOSITAOH-CLASS CRUISER



TL12		TONS	COST (MCR)
Hull	1,000 tons, Streamlined	-	60
Armour	Crystaliron, Armour 6	75	18
M-Drive	Thrust 4	40	80
J-Drive	Jump 3	80	120
Power Plant	Fusion (TL12), Power 705	47	47
Fuel Tanks	J-3, 4 weeks of operation	305	-
Bridge	Holographic Controls	20	6.25
Computer	Computer/20	-	5
Sensors	Improved	3	4.3
Weapons	Triple Turrets (pulse lasers) x 6	6	24
	Triple Turrets (missile racks) x 3	3	9.75
	Triple Turret (sandcasters)	1	1.75
Ammunition	Missiles x 216	18	-
	Sandcaster Barrels x 120	6	-
Systems	Fuel Processor (60 tons/day)	3	0.15
	Fuel Scoops	-	-
	Shrine	4	0.5
	Docking Space (40 tons) x 2	88	22
	Pinnacle x 2	-	17.464
	Docking Space (4 tons) x 2	10	2.5
	Air/rafts x 2	-	0.52
	Docking Space (10 tons) x 4	44	11
Staterooms	ATVs x 4	-	0.216
	Standard x 54	216	27
Software	Jump Control/3	-	0.3
	Library	-	-
	Manoeuvre/0	-	-
	Fire Control/4	-	8
Common Areas		18	1.8
Cargo		13	-
TOTAL: MCR 467.48			

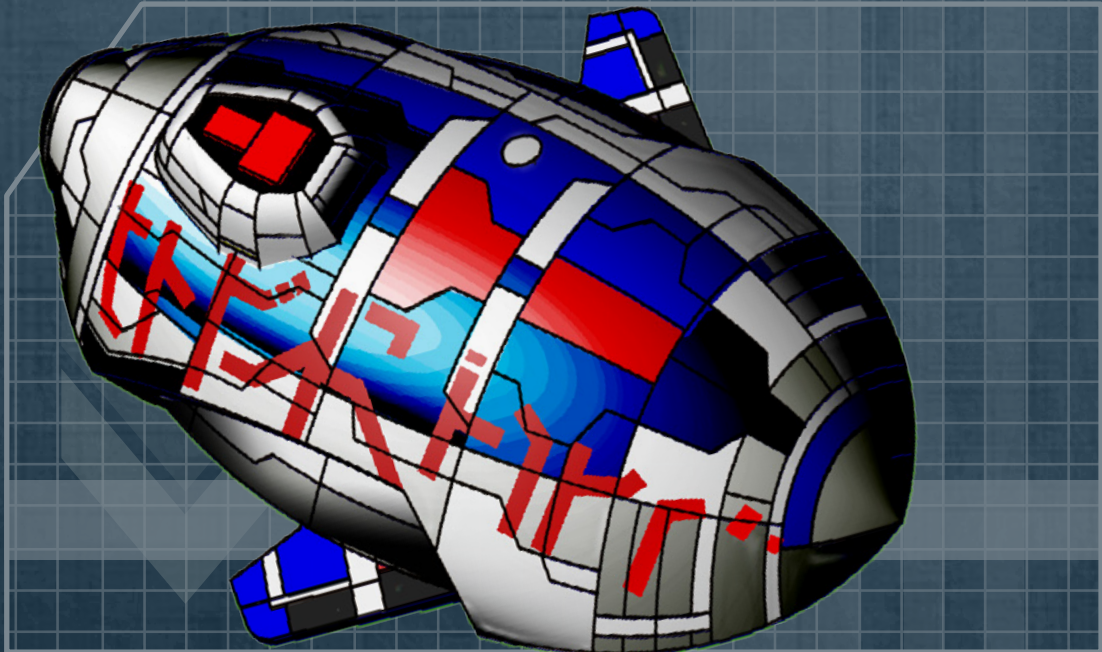

400

HULL POINTS

CREW

CAPTAIN, PILOT, ASTROGATOR, PURSER/
EXECUTIVE OFFICER, PILOTS X 2,
ENGINEERS X 5, MAINTENANCE X 2,
GUNNERS X 10, MARINES X 80

RUNNING COSTS

MAINTENANCE COST

Cr38957/month

•••••

PURCHASE COST

MCr4567.48

POWER REQUIREMENTS

400

MANOEUVRE
DRIVE

200

BASIC SHIP
SYSTEMS

300

JUMP DRIVE

4

SENSORS

82

WEAPONS

3

FUEL PROCESSOR

Using a 1000-ton hull, the *Aositaoh*-class cruiser is built for small-scale clan troop transport and combat operations. Ten triple turrets are installed, typically mounting six triple beam lasers, three triple missile racks, and one triple sandcaster. The ship also carries a launch, two pinnaces, four ATVs, and four air/rafts; the pinnaces can each carry two ATVs, allowing the cruiser to deploy a considerable fighting force comprising two full platoons from orbit.

Both this ship and the *Ekawsiykua*-class escort have low cargo capacities for their size, and are often accompanied by *Owatarl*-class tenders.

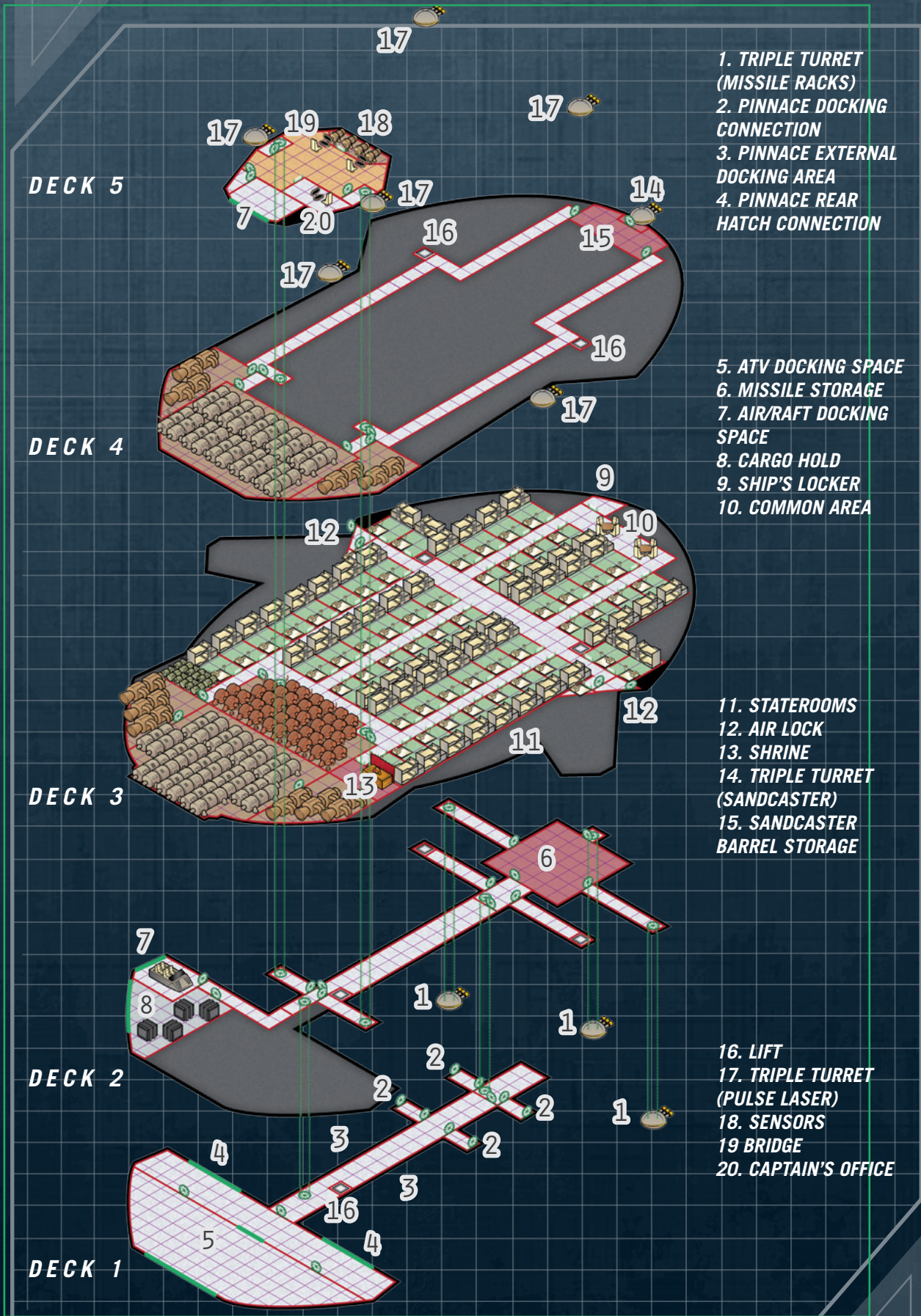

HKISYELEAA-CLASS SLAVER



TL12		TONS	COST (MCR)
Hull	1,000 tons, Streamlined	-	60
M-Drive	Thrust 2	20	40
J-Drive	Jump 2	55	82.5
Power Plant	Fusion (TL12), Power 510	34	34
Fuel Tanks	J-2, 4 weeks of operation	204	-
Bridge		20	5
Computer	Computer/5 bis	-	0.045
Sensors	Military Grade	2	4.1
Weapons	Triple Turrets (beam laser, missile rack, sandcaster) x 3	3	7.5
Ammunition	Missiles x 36	3	-
	Sandcaster Barrels x 60	3	-
Systems	Fuel Processor (60 tons/day)	3	0.15
	Fuel Scoops	-	-
	Shrine	4	0.5
	Docking Space (10 tons) x 8	88	22
	ATVs x 8	-	0.432
Staterooms	Standard x 12	48	6
	Low Berths x 750	375	37.5
Software	Jump Control/2	-	0.2
	Library	-	-
	Manoeuvre/0	-	-
Common Areas		24	2.4
Cargo		114	-

TOTAL: MCR 302.327

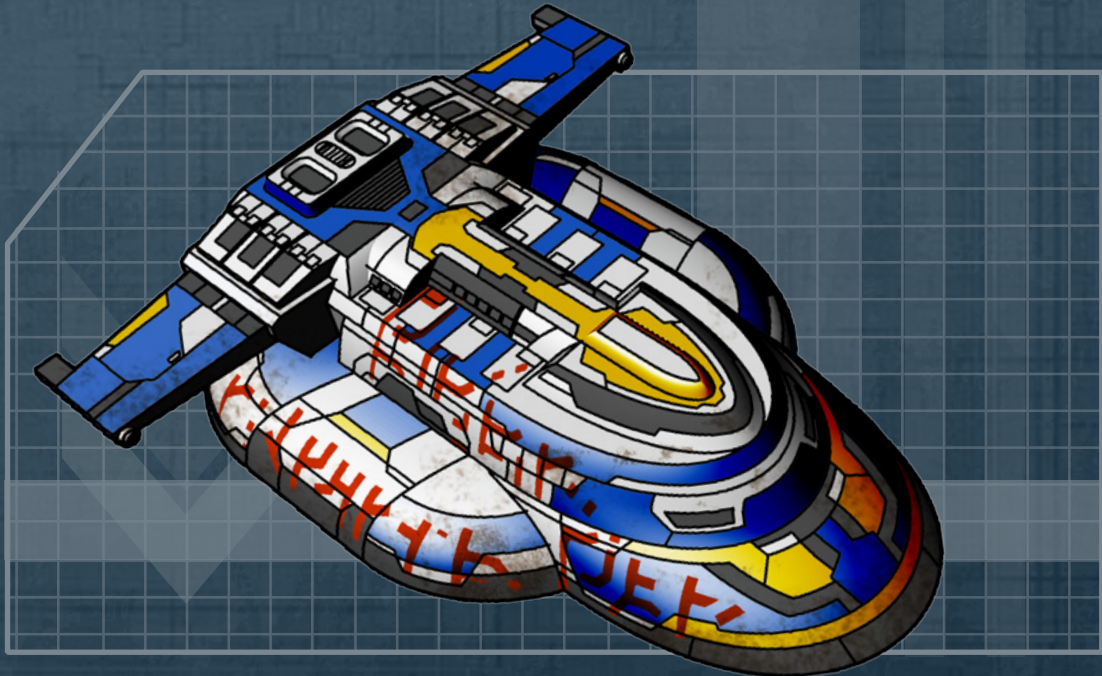

400

HULL POINTS

CREW

CAPTAIN, PILOT, ASTROGATOR,
PURSER, PILOT, ENGINEERS X 4,
MAINTENANCE, GUNNERS X 3

RUNNING COSTS

MAINTENANCE COST
Cr25194/month

• • • • •

PURCHASE COST
MCr302.327

POWER REQUIREMENTS

200

MANOEUVRE
DRIVE

200

BASIC SHIP
SYSTEMS

200

JUMP DRIVE

4

SENSORS

15

WEAPONS

3

FUEL PROCESSOR

75

LOW BERTHS

The slaver is commonly associated with the Glorious Empire, but it can be found throughout the Hierate. They are converted agricultural transports, with the low berths designed for freezing large food animals. A *Hkisyaleaa* would land on an agricultural planet and load up on hundreds of live animals, taking them to be devoured by rich nobles.

The Glorious Empire has adapted their *Hkisyaleaas* for slave raiding. Unfortunate humans are captured by Aslan raiders riding ATVs and thrown into the freezing chambers.

A fully-stocked Slaver can carry more than 1,500 slaves if the captain is willing to cram as many bodies as possible into the low berths; 750 is more of a safe number. Slavers are comparatively lightly armed and have little protection from attackers, so are normally escorted by more combat-ready ships.

OVERCROWDING LOW BERTHS

Only the most callous captain would intentionally set out to squeeze two bodies into one low berth, as this is highly dangerous and subjects are unlikely to survive without the best medical treatment available upon their awakening. A low berth subjected to double occupancy will inflict DM-4 to any Medic check used to revive its occupants

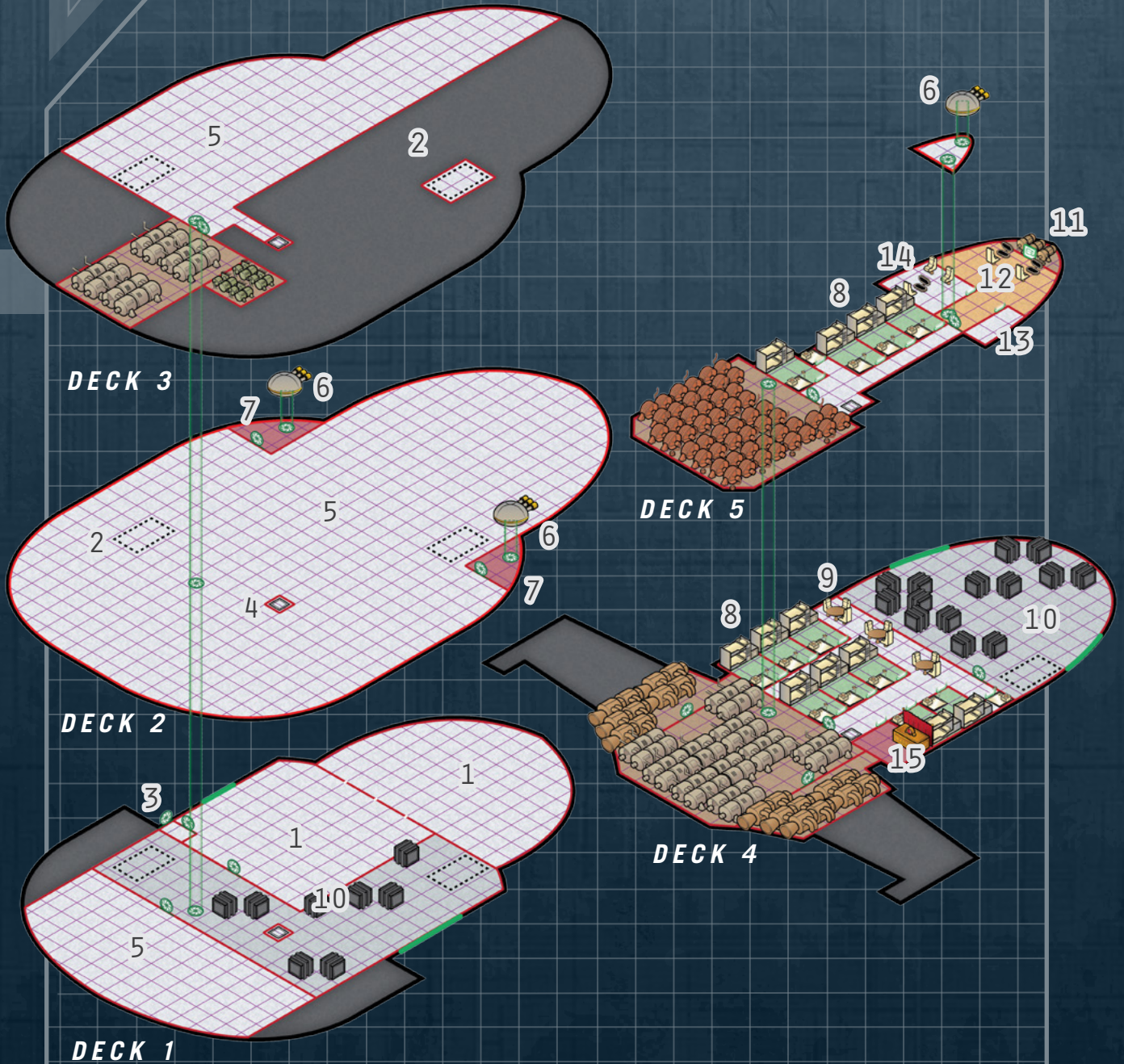

- 1. ATV BAY
- 2. CARGO LIFT
- 3. AIR LOCK
- 4. LIFT
- 5. LOW BERTHS UNITS
- 6. TRIPLE TURRET (BEAM LASER/MISSILE/SANDCASTER)
- 7. MISSILE AND SANDCASTER BARREL STORAGE
- 8. STATEROOMS
- 9. COMMON AREA
- 10. CARGO HOLD
- 11. SENSORS
- 12. BRIDGE
- 13. SHIP'S LOCKER
- 14. CAPTAIN'S OFFICE
- 15. SHRINE

HALAHEIKE-CLASS POCKET WARSHIP



TL14		TONS	COST (MCR)
Hull	1,200 tons, Streamlined, Reinforced	-	108
Armour	Bonded Superdense, Armour 10	96	86.4
M-Drive	Thrust 3	36	72
J-Drive	Jump 3	95	142.5
Power Plant	Fusion (TL12), Power 720	48	48
Fuel Tanks	J-3, 4 weeks of operation	364	-
Bridge	Holographic Controls	40	7.5
Computer	Computer/30 fib	-	30
Sensors	Improved	3	4.3
Weapons	Small Particle Beam Bay x 2	100	40
	Triple Turrets (beam lasers) x 4	4	10
	Triple Turret (missile racks x 2, sandcaster) x 6	6	16.5
Ammunition	Missiles x 360	30	-
	Sandcaster Barrels x 240	12	-
Systems	Fuel Processor (60 tons/day)	3	0.15
	Fuel Scoops	-	-
	Shrine	4	0.5
	Docking Space (10 tons) x 10	110	27.5
	Light Fighter x 10	-	78
	Docking Space (20 tons) x 2	44	11
Staterooms	Launch x 2	-	11.214
	Standard x 30	120	15
Software	Jump Control/3	-	0.3
	Library	-	-
	Manoeuvre/0	-	-
	Fire Control/5	-	10
Common Areas		20	2
Cargo		65	-

TOTAL: MCR 720.864

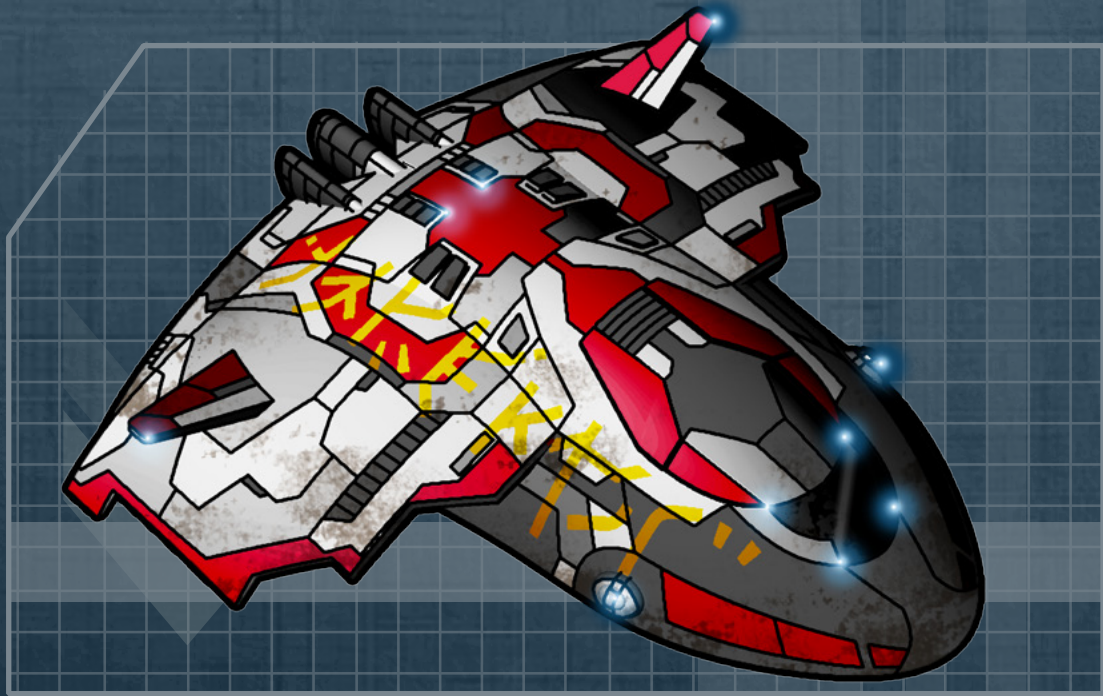

528
HULL POINTS

CREW

CAPTAIN, PILOTS X 14, ASTROGATOR,
EXECUTIVE OFFICER, OFFICERS X 3,
ENGINEERS X 5, MAINTENANCE X 3,
GUNNERS X 12

RUNNING COSTS

MAINTENANCE COST

Cr60072/month

•••••

PURCHASE COST

MCr720.864

POWER REQUIREMENTS

360

MANOEUVRE
DRIVE

240

BASIC SHIP
SYSTEMS

360

JUMP DRIVE

4

SENSORS

112

WEAPONS

3

FUEL PROCESSOR

This so-called 'pocket warship' is a 1,200-ton spacecraft used by smaller clans for military operations. The *Halaheike* is heavily armed for its size, with a range of missile racks, lasers and particle beams, and carries a fighter complement of ten fighters and two launches for boarding actions and customs inspections. Some owners convert the cargo bay to hold troops or some 200 low berths (though this will put a serious strain on the power plant), allowing the *Halaheike* to serve as a troop transport.

The design is known for maintenance issues and jump drive failures, but the vessel's main problem is that it tries to do too much in one package, requiring the most advanced Aslan technology just to function. The *Halaheike* might be a carrier, assault cruiser, system defence boat and troop carrier all in one, but is sub-par in all those roles. Larger clans that can afford specialist vessels rarely field *Halaheikes*.

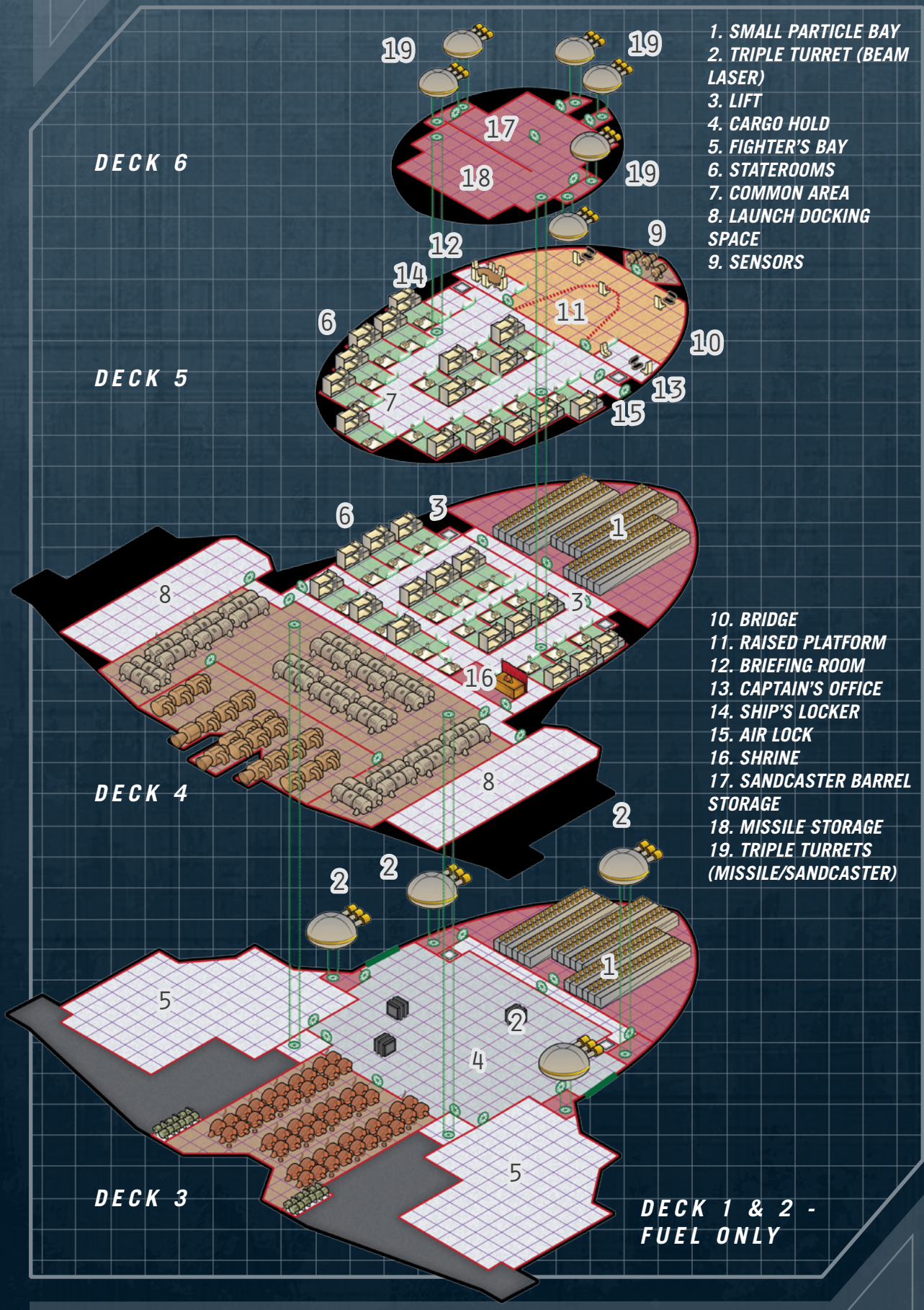

- 1. SMALL PARTICLE BAY
- 2. TRIPLE TURRET (BEAM LASER)
- 3. LIFT
- 4. CARGO HOLD
- 5. FIGHTER'S BAY
- 6. STATEROOMS
- 7. COMMON AREA
- 8. LAUNCH DOCKING SPACE
- 9. SENSORS

- 10. BRIDGE
- 11. RAISED PLATFORM
- 12. BRIEFING ROOM
- 13. CAPTAIN'S OFFICE
- 14. SHIP'S LOCKER
- 15. AIR LOCK
- 16. SHRINE
- 17. SANDCASTER BARREL STORAGE
- 18. MISSILE STORAGE
- 19. TRIPLE TURRETS (MISSILE/SANDCASTER)

DECK 6

DECK 5

DECK 4

DECK 3

DECK 1 & 2 -
FUEL ONLY

SAKHAI-CLASS ASSAULT CARRIER



TL12		TONS	COST (MCR)
Hull	2,000 tons, Streamlined, Reinforced	-	180
Armour	Crystaliron, Armour 8	200	72
M-Drive	Thrust 3	60	120
J-Drive	Jump 3	155	232.5
Power Plant	Fusion (TL12), Power 1500	100	100
Fuel Tanks	J-3, 4 weeks of operation	610	-
Bridge		40	12.5
Computer	Computer/25	-	10
Sensors	Improved	3	4.3
Weapons	Medium Fusion Gun Bay	100	16
	Small Missile Bays x 2	100	24
	Particle Barbettes x 3	15	24
	Triple Turrets (beam lasers) x 6	6	15
	Triple Turret (sandcasters) x 5	5	8.75
Ammunition	Missiles x 600	50	-
	Sandcaster Barrels x 120	6	-
Systems	Fuel Processor (120 tons/day)	6	0.03
	Fuel Scoops	-	-
	Shrine	4	0.5
	Armoury	32	8
	Briefing Room	4	0.5
Staterooms	Standard x 17	68	8.5
	Barracks x 160	320	8
	Low Berths x 200	100	10
Software	Jump Control/2	-	0.3
	Library	-	-
	Manoeuvre/0	-	-
	Fire Control/5	-	10
Common Areas		12	1.2
Cargo		6	-

TOTAL: MCR 857.15

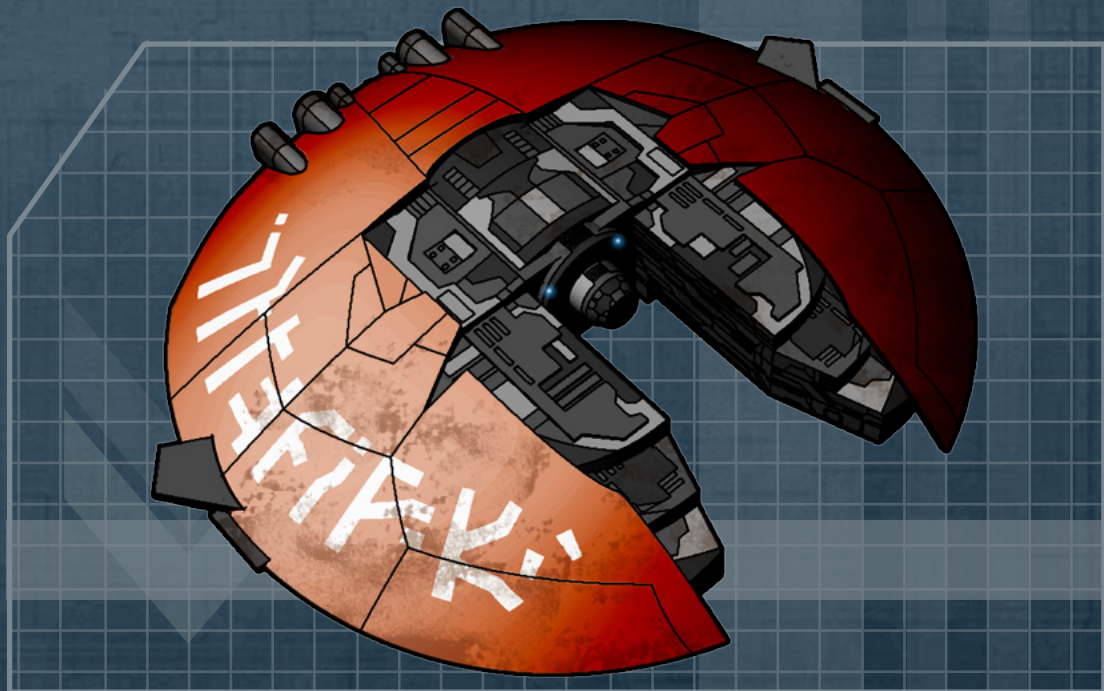

880

HULL POINTS

CREW

CAPTAIN, PILOT, ASTROGATOR,
PURSER/EXECUTIVE OFFICER, OFFICERS
X 18, PILOTS X 2, ENGINEERS X 5,
MAINTENANCE X 4, GUNNERS X 18,
MARINES X 160

RUNNING COSTS

MAINTENANCE COST

Cr71,429/month

•••••

PURCHASE COST

MCr857.15

POWER REQUIREMENTS

600

MANOEUVRE
DRIVE

400

BASIC SHIP
SYSTEMS

600

JUMP DRIVE

4

SENSORS

218

WEAPONS

6

FUEL PROCESSOR

These heavy carriers are designed for invasions and open wars. If a *Sakhai* appears in the skies over a world, then it will be under the claw in a matter of days. The *Sakhai's* distinctive 'horseshoe' profile allows its batteries of beam lasers and missile racks to rake targets on either side, while protecting the mighty fusion bay mounted in the centre. It can carry one hundred and sixty marines in addition to its normal 40-person crew; there are another two hundred low berths for frozen troops or captives.

While the *Sakhai* is capable of landing on a planet, it takes a skilled hand at the controls and a dedicated team of engineers to keep the ship spaceworthy after touching down. A bad landing can warp the ship's dorsal struts, effectively crippling it. Many far flung Aslan outposts have a downed *Sakhai* at their hearts.

DECK 5



- 1. SMALL MISSILE BAY
- 2. MISSILE STORAGE
- 3. LIFT
- 4. MEDIUM FUSION GUN BAY
- 5. PARTICLE BARBETTE
- 6. STATEROOMS
- 7. SHRINE
- 8. AIR LOCK
- 9. TRIPLE TURRET (SANDCASTER) & BARREL STORAGE
- 10. COMMON AREA

DECK 4



- 11. SENSORS
- 12. ARMOURY
- 13. BRIDGE
- 14. CAPTAIN'S OFFICE
- 15. SHIP'S LOCKER
- 16. BRIEFING ROOM
- 17. RAISED PLATFORM
- 18. TRIPLE TURRET (BEAM LASER)
- 19. LOW BERTHS
- 20. CARGO HOLD

DECK 3

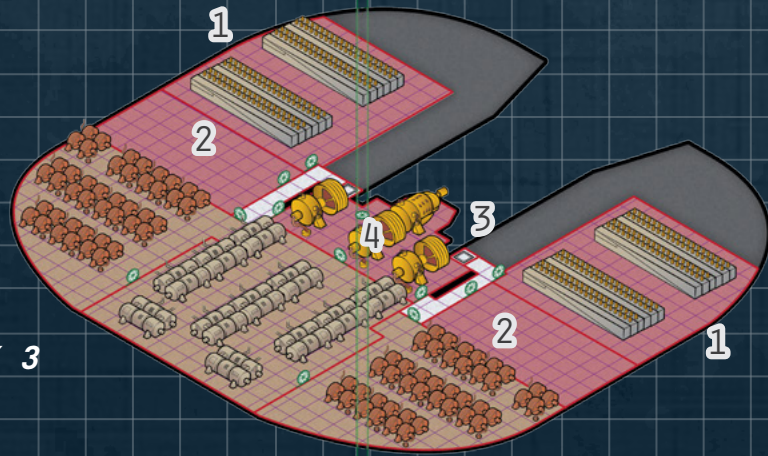

DECK 2

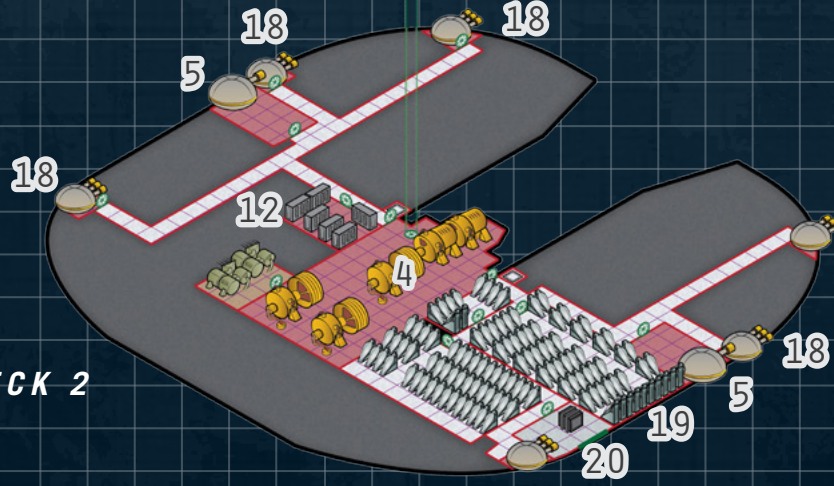

DECK 1 - FUEL ONLY

SHIPS INDEX

















SHIPS OF THE REACH







Buccaneer-class Blockade Runner	10
Corsair	26
Fast Trader	2
Fiery-class Gunship	12
Galoof-class Megafreighter	48
Herald-class Fast Messenger	6
Indigo-class Pirate Carrier	8
Magenta-class Repair Ship	29
Patrol Tender	32
Planet-class Heavy Cruiser	52
Queen Elizabeth-class Liner	36
Ritchey-class Escort	44
Star Ray-class Interceptor	4
Subsidised Merchant Type RQ	18
The Ghost of the Reach	15
Ulfhednar-class Escort Carrier	40
Vulture-class salvage hauler	21
Watchdog-class Fleet Picket	23

ASLAN SHIPS

Aoa'iw-class Light Trader	72
Aositaoh-class Cruiser	84
Eakhau-class Trader	74
Ekawsiykua-class Escort	82
Halaheike-class Pocket Warship	90
Hkisyeeleaa-class Slaver	87
Hkiyrerao-class Researcher	76
Hraye-class Scout	62
Ihateisho-class Scout	64
Iyeliy-class Messenger	70
Khtukhao-class Clan Transport	78
Kteiroa-class Seeker	68
Ktiyhui-class Courier	66
OwatarL-class Tender	80
Sakhai-class Assault Carrier	93

ISOMETRIC FLOORPLAN & DECKPLAN KEY

	BUNK		HATCH		FUEL PROCESSOR
	FRESHER		IRIS VALVE (WALL)		POWER PLANT
	WORKSTATION		IRIS VALVE (FLOOR/CEILING)		JUMP DRIVE
	G-CHAIR		INTERNAL WALL		MANOEUVRE DRIVE
	LOW BERTH		HULL		
	CRATE				

	STATEROOMS		MISCELLANEOUS		FUEL
	CARGO		ENGINEERING		BRIDGE

