

# Orbital

*A Solar System Setting for the Traveller Roleplaying Game*



**TRAVELLER**

Compatible Product

ZOZER

Requires the use of the Traveller<sup>™</sup> Main Rulebook, available from Mongoose Publishing



# Orbital

***A Solar System Setting for the Traveller Roleplaying Game***

***Requires the use of the Traveller<sup>TM</sup> Main Rulebook,  
available from Mongoose Publishing***



**Author**

*Paul Elliott*

**Developer**

*Ben Lecrone*

**Cover Art**

*Ian Stead/biomassart.wordpress.com*

**Interior Art**

*Donald Davis ('stanford torus'), Bryan Versteeg/Spacehabs.com ('asteroid station'); Steve Attwood/www.digitalwaterfalls.co.uk ('tharsis orbiter'), Someformofhuman ('martian fossil'), Joowwww ('IAU logo'), Evgeniy Bazurov ('hotel interior'), Auris ('futuristic corridor'), Luca Oleastri ('astronaut'), Jankaliciak ('mars rover'), ESO/L. Calçada ('Triton' & 'Pluto'), Paul Elliott (drawings, maps & diagrams), two of the images have been made available via the Creative Commons Attribution-Share Alike 3.0 license, other images courtesy of NASA/JPL*

**Special Thanks**

*Omar Golan, Lou Wester, Russ Venlos, Boris Cibic, John Bee, Alexander Shaw, Colin Dunn*

**Publisher in PDF format**

*Zozer Games 2013*

*Visit Zozer Games at [www.zozer.weebly.com](http://www.zozer.weebly.com)*

*Find me on Facebook as Zozer Games*

*All rights reserved. Reproduction of this work by any means is expressly forbidden.*

*"Traveller" and the Traveller logo are Trademarks owned by Far Future Enterprises, Inc. and are used according to the terms of the Traveller Logo Licence version 1.0c. A copy of this licence can be obtained from Mongoose Publishing. The mention or reference to any company or product in these pages is not a challenge to the trademark or copyright concerned.*

*"Traveller" and the Traveller logo are Trademarks owned by Far Future Enterprises, Inc. and are used with permission. The Traveller Main Rulebook is available from Mongoose Publishing.*

# CONTENTS

1	The Situation .....	5
2	The Cold war .....	7
3	Organisations .....	15
4	Character Creation .....	30
5	Spacecraft Design .....	40
6	Operating Spacecraft .....	54
7	Hardware .....	62
8	Orbital society .....	86
9	Working in Space .....	104
10	Worlds .....	119
11	Running Orbital .....	195
12	Resources .....	212
	Appendix .....	218
	Index .....	219

# 1 THE SITUATION

*"In spite of the opinions of certain narrow-minded people, who would shut up the human race upon this globe, as within some magic circle which it must never outstep, we shall one day travel to the moon, the planets, and the stars, with the same facility, rapidity, and certainty as we now make the voyage from Liverpool to New York."*

Jules Verne, From the Earth to the Moon, 1865

Jules Verne was right. The human race made it out into space, to the Moon, to Mars and beyond to the outer planets. Not just to visit and measure, but to work and live and reproduce. Mankind stepped out of the cradle and out into the interplanetary nursery that is the solar system.

But. There is always a but; the misguided, almost blind, optimism that plagued many of the philosophers, cosmologists, scientists and space advocates throughout the 20<sup>th</sup> century disguised the darker truths of human nature. Perfect beings, angels, saints and Peace Prize winners were not the new colonists. Those wonderful 1970's paintings of vast space habitats, with lakes and gardens and forests and smiling happy Americans so beloved by Gerard O'Neill and his fans, proved unattainable, and when the reality of life in space hit home, human nature kicked in.

**Orbital** is a TL 9 setting for the Traveller roleplaying game. Although set in Earth's near future, it is neither a cyberpunk dystopia nor a trans-human melting pot, it is the future of space colonisation envisaged by planners of the 1980s, albeit with a healthy dose of realism.

Quotes from historical figures litter the book, they reveal the subtext, the real story of what is going on, how things are developing and what may be the inevitable end. Many of these figures commented on the first space race and the Cold War that kicked it off. Our future history is built on the foundations of a *new* cold war, fought between the Luna colonists and the people of Earth. Fear and national competitiveness spur on the exploration and settlement of the solar system, for without this political imperative, humans would be content to sit in their own nest and wait for that life-killing asteroid to strike.

*"I'll believe in people settling Mars at about the same time I see people setting the Gobi Desert. The Gobi Desert is about a thousand times as hospitable as Mars and five hundred times cheaper and easier to reach. It's ugly, it's inhospitable and there's no way to make it pay. Mars is just the same, really. We just romanticize it because it's so hard to reach."*

Bruce Sterling, SF author

The cold war setting of **Orbital** drives everything; exploration, settlement, technological development, it is the political will and the energy behind life in the solar system. A lot is happening and there are humans scattered all across the moons and planets. For the Traveller referee, the solar system resembles a typical subsector. Many of the adventures that could take place in a subsector can happen here too, just remember that travel times are longer, ships more fragile, communications a little easier, and a polarized political world complete with mistrust, espionage and puppet governments dominates the stage.



## Other Uses for Orbital

The setting in **Orbital** is offered as a ready-made backdrop in which to set near future games. There is plenty more here than setting, though, from rules for rovers, vacc suits, rockets and activity in zero-G, to the write-ups of moons and planets and of course the spacecraft design system.

Several gaming possibilities spring immediately to mind:

***Spin Gravity in the Spinward Marches*** - Use these rules in a Third Imperium setting to represent the unique technologies of TL 7 and 8 worlds where gravity drives are a dream, or in TL 9 star systems where gravity manipulation is new, exciting and expensive. There are a staggering 153 worlds at TL 7-9 within the Spinward Marches alone, including high population worlds like Ruie, Natoko and Roup that could easily have their own solar system society.

***The Game of the Movie*** - There are plenty of movies that could make decent scenarios, in fact there are plenty that would turn out *better* in the hands of a group of Traveller players! With **Orbital** you can run that movie, or its 'sequel', as a one shot. Try *2001: A Space Odyssey*, *Mission to Mars*, *Ghosts of Mars*, *Apollo 18*, *Red Planet* or even *The Abyss*.

***Back in the Day*** - Every setting has a TL 9 past somewhere along the way. It is possible to create a series of adventures in the past, to set a campaign there, or, as happened in numerous Star Trek episodes, for spacecraft from the past to come through a temporal rift to reach the current setting date, or vice versa! There were spin gravity settings within the solar system in both Third Imperium history and in the history of *2300AD*. For *2300AD*, events set before 2137, when the first stutter warp probe reaches Alpha Centauri, could be played out. Likewise, the solar system of Earth prior to 2096 when the USS StarLeaper makes the first jump to Barnard's Star, is full of potential for adventure. Within this latter setting, the Earth Union can be simply be replaced with the United Nations. Vilani or other alien visitors, as spies or agents may appear as exotic and unexplainable UFO sightings, or perhaps there are Vilani at work on Earth already.

***Mixing Old with New*** - Of course many Traveller published scenarios, seeds, NPCs and encounters still work in **Orbital**; Mongoose Publishing's book *760 Patrons* is filled with adventure ideas and most work in the non-jump, non-grav drive world of 2100.

## Why 2100 AD?

It is natural to ask the question, if, when you can run many already existing Traveller situations and adventures within the **Orbital** universe, why anyone should bother going back to TL 9 at all? Are we not just narrowing our options? Yes we are, and that's the point. Spaceflight is very much like it is today, it is hard and dangerous and not to be taken for granted. That adds an extra dimension to any scenario, and connects the sci-fi shenanigans with real world spaceflight, something I love. I waited with baited breath in March, 2011 to watch the ISS pass through the night sky, and was stunned to see two fast moving points of light where there should have been one. I realised at once that the space shuttle Discovery had undocked from the ISS for the last time and that I was looking at them both. **Orbital** is for those Traveller players like me, who always wanted to go into space and who want to pretend for a couple of hours that they really are about to land on an asteroid, dig for iridium on Mercury or try to fix an out-of-control satellite during an EVA. Maybe I just want my space travel to be a bit more difficult...

~ Paul Elliott



# 2 THE COLD WAR

*"Mankind's journey into space, like every great voyage of discovery, will become part of our unending journey of liberation. In the limitless reaches of space, we will find liberation from tyranny, from scarcity, from ignorance and from war. We will find the means to protect this Earth and to nurture every human life, and to explore the universe. . . .This is our mission, this is our destiny."*

Ronald Reagan, speech at Houston, 1988

On July 20, 1989, the 20th anniversary of the Apollo 11 Moon landing, President George Bush announced plans for the Space Exploration Initiative (SEI). His speech detailed the construction of space station Freedom, it described returning to the Moon, this time 'to stay', and it ended with a proposed manned mission to Mars. Bush laid out, not a ten-year Apollo-style plan, but a long-range continuing commitment. Unfortunately, Congress shot the SEI down in flames due to the huge budget that it would have required. But consider an alternative where the SEI was passed, where the project thrived because of the international co-operation that the president was able to muster. With new partners on board, including Russia, Space station Freedom ends up looking much like the International Space Station we know so well. It even carries the same name. Why was the initiative passed? Mars beckoned. Besides the enigmatic Face, NASA had more concrete proof that some alien intelligence had (or still) existed on the red planet. This evidence was concealed from the public, yet the fact it existed drove the SEI forward with vigour.

What else differs in our alternate history? On August 20, 1998, a barrage of American cruise missiles struck terror camps in Afghanistan, and (unlike in our timeline, where he missed the attack by hours) Osama Bin Laden was killed. There was no 21<sup>st</sup> century War on Terror. The Space Exploration Initiative enjoyed the optimism and support of a new century unfettered by Middle East wars and on-going terror.

*"Don't tell me that man doesn't belong out there. Man belongs wherever he wants to go - and he'll do plenty well when he gets there."*

Wernher von Braun, 1958

## A CENTURY OF RIVALRY

### **To the Moon and Mars**

Americans returned to the Moon in 2001, twelve years after Bush gave his speech on the steps of the National Air and Space Museum. By 2006 there were up to eight astronauts living there semi-permanently. Within another six years they were producing their own oxygen, and crew numbers had doubled. This was a scientific base on the Sea of Tranquility.

In 2017 the first manned mission to Mars was successfully carried out. It was truly multi-national, with a great deal of technological support provided by Russia. Using similar technologies to that employed on the Moon, an international crew stayed for several weeks and left behind habitats for more permanent crews who followed on a year later. The modular design allowed nations to add



to the new colony, expanding its scope and population in fits and starts for the next four years. All of these SEI milestones were reached on time (if a little over budget).

### **China Reaches Orbit**

As the Space Exploration Initiative was embraced and executed in the West, a rising star in the East began to make its own bid for space. China launched its first astronauts in 2003, and immediately planned further launches, the construction of a small space station and even a permanent Moon base. Success, coupled with a competitive spirit, spurred the Chinese government to back its space program to the hilt.

By 2010 the Chinese had landed men on the Moon and five years later they established a semi-permanent base. By 2020 the Chinese presence on Luna (as the Moon is being referred to) was almost self-sustaining and a future bridgehead for the planned construction of solar power stations. There were now two separate Lunar colonies, one chiefly American, the other Chinese.

### **The Power From Space Design Agreement 2015**

China made its intentions clear on October 13, 2000, when its space timetable was reported by the Xinhua News Agency. It planned to mine Lunar resources and beam solar power from space to alleviate China's massive energy needs. In 2015, China and the US, as the operators of the only two Luna bases, came together to sign the Power From Space Design Agreement. Government investment would match private investment, and the aim was to start mining the Moon's surface in order to build these solar power ground-stations that would beam to Earth free, sustainable energy. The project involved setting up automated mining and processing facilities, as well as equatorial solar panel collectors microwave beaming stations. By 2028 the first beaming stations began to test their equipment, and a year later microwave beaming to the Earth's surface from the surface of the Moon was underway. From 2030 onwards, a new era in Earth's history had begun.

A decade of Earth-Lunar manufacturing followed, immigration of skilled labour from Earth began as a trickle, and ended as a steady flow. In 2032 a mass driver 'catapult' was constructed on the Moon's surface, this would launch unmanned loads of mineral ore out to various nearby orbital positions (the Lagrange points) where experimental spinning space stations were being constructed. These new stations required raw materials from the Moon, in return they would become centres of orbital manufacturing. By 2040 the L5 stations began to act as a space vehicle construction and preparation yard. It also served as the prime way station for future manned missions to Mars and a hub of the new space industries. While there were perhaps 6,000 people at the orbital stations by the year 2040, there were over 22,000 living and working on Luna.

*"Experience has shown how deeply the seeds of war are planted by economic rivalry and social injustice."*

Harry S. Truman

### **Them and Us – The Orbit War**

It wasn't really a war at all, but the orbital fracas of 2044 certainly had dramatic repercussions that are still felt sixty-years later. It had begun in 2040 when the Lunar management requested increased investment to handle the growing labour force. Plans were on the table for a new colony, greatly enlarged and upgraded. Backers on Earth, both governments and shareholders, refused to further stretch the finances of the operation. A backlash movement began on the Moon; a hostile mood was sweeping the habitats of the colony. Earth held fast, pushing for its quota of microwave transmissions, but remained reluctant to step up the investment to unrealistic levels. The Lunar crisis lasted for more than a year, with the rising political movement threatening to halt all power transmission until the Lunar requests were reviewed.





In 2044, a delegation of ministers and company chiefs from Earth landed on the Moon for an emergency summit. It looked like the Lunars had maybe gotten their way, but things were moving fast. Many of the Chinese colonials sought to deal with Earth and get back to business, while the American colonials proved more stubborn. These factions were at odds, and in the ensuing chaos, all of the delegates from Earth were kidnapped and later murdered. Small scale rioting took place, but the habitats of Luna soon came under the control of the most influential of the anti-Earth factions, mainly made up of Americans and a small number of liberal Chinese. Through coercion, and control of the main oxygen factories, this militant faction was able to drag the rest of the Chinese toward complete independence.

What became known as the Orbit War was actually no more than tit-for-tat destruction of orbital assets. The Lunar colonists sabotaged several communications satellites in Earth orbit, while Earth destroyed a Lunar space vehicle in Low Earth Orbit (LEO) that refused to respond to transmissions. Finally, an automated vehicle en route from L5 was crashed into a small modular station over Australia, killing four people. When it became obvious to the colonists that China and the US were putting military forces into orbit, ready for an assault on the Moon bases or the L5 station, the ante was suddenly - and dramatically - upped.

In a state of extreme brinkmanship, the colonists directed the Luna mass driver to launch several ore payloads at Earth itself, each one impacting with the force of an atomic bomb. The three payloads smashed into the Thar Desert of India, the an-Nafud desert of Saudi Arabia and Egypt's Western Desert. Although it was intended that no lives should be lost, 34 miners on an Egyptian drilling operation were killed by the third payload strike. The governments of Earth had no choice but to stand down their military task force. Everyone understood the harsh new message delivered by these three rocks from space: "don't mess us around again, because next time it'll be Beijing, Miami and Washington ..."

Such daring apocalyptic blackmail prevented an imminent Earth takeover, but of course there was to be no future investment in expanding the Moon colony, in fact there was to be no more investment from Earth at all. The strong ties of belonging, support, nationhood and commerce were quickly severed and although neither side was able or willing to make war on the other, a cold silence descended between Earth and Luna. The Cold War had begun...

*Peace*, noun. *In international affairs, a period of cheating between two periods of fighting.*  
Ambrose Bierce, *The Devil's Dictionary*

### **An Uneasy Peace**

How could two Lunar colonies and a space station survive a total Earth embargo? In truth, it wasn't total. Earth had become dependant on the power being beamed to it from the Moon; and the Lunar colonists needed nitrogen. It was amazing how many raw materials that the Moon *could* provide, given suitable excavation technology. Oxygen could be extracted, iron, aluminium, magnesium and silicon too. Water was being mined from craters at the Moon's south pole, and although very costly to ship to the lunar bases at the equator, or out to the L5 stations, could then be recycled almost indefinitely. Habitat construction could continue as it had for the past decade, greenhouse cultivation provided food, and bio plastics (made from corn or potatoes) was beginning to stand in for the traditional Earth-dependant petroleum versions.

But Luna needed nitrogen. It was essential for the success of any artificial crop production and it was also essential as a component in the atmospheres of the Luna habitats. Without it the colonists would be forced to breathe 100% oxygen, a very flammable and potentially disastrous atmosphere indeed. After several months of static, Luna and Earth began to conduct business with one another. It was sullen, reluctant and mistrustful commerce. The Earth governments looked to a future where they didn't need Lunar solar power, where they could gain all the free, cheap and

clean energy they needed from fusion reactors. Such reactors were still in development and were perhaps 20-30 years away. Luna looked to a future where it could scoop nitrogen for free, from the surface of a distant moon. That future would one day arrive.

### **War in South East Asia**



The Forties were a time for Luna to stand on its own two feet and for Earth to undergo a radical and momentous change, for the people of Earth through war, created what would almost amount to a world government. Although China was investing heavily in asteroid mining, many of the other nations in the western Pacific lacked the funds to look off world for resources. Instead they turned to sea-floor mining. Inevitably this led to clashes over mineral rights in the South China Sea. The Asian League, a very pro-Lunar alliance of nations, backing Malaysia's sea floor claims, watched the Orbit War with unhidden glee. They felt that by being put in their place the space faring nations would be willing to give concessions regarding sea-floor mining. Unfortunately, they had miscalculated. China, the space power least affected by the Orbit War, took the opportunity to reassert its claims to most of the islands in the South China Sea. China hoped to offset the high start up costs involved in asteroid mining by exploiting these same sea floor resources.

War in South East Asia began on August 2, 2045, shortly after Chinese and Filipino ships opened fire on one another. Chinese diplomacy scored a huge early victory by reaching an agreement with the United States concerning the settlement of Mars and the Asteroid Belt. Unfortunately, the Chinese were far less successful closer to home. The accidental shooting down of an Indian passenger liner en route to Singapore led to increased tensions along the Sino-Indian border. This blunder was followed just four weeks later by the accidental sinking of the Indian aircraft carrier, INS Vikrant, by a Chinese submarine. India declared war on China two days later and threatened to respond to any nuclear weapon use with equal force.

By the end of 2045 the East Asian War had become exceedingly destructive. Both sides launched deep penetration strikes into enemy territories targeting industrial and power generating sites. Russia's entry into the war on India's side and Indonesia's alliance with China continued the move towards global conflict. As the UN proved incapable of halting the slide towards armageddon, the nations of Europe and South America began to call for boycotts and an immediate end to the fighting. America and the UK, however, stood aloof. America's on again off again trade war with China, as well as concerns for the safety of Taiwan and Japan, had done much to harden their stance towards that nation. Both the US and the United Kingdom gravitated towards India and supplied the anti-China bloc with arms and loans.



After twenty months of war the unthinkable finally happened. A pro-Chinese coup in Pakistan panicked the Indian government. On March 5, 2047 India launched four intermediate range ballistic missiles at troop concentrations of Chinese troops moving through China. A fifth missile was launched at Pakistan's primary military command headquarters. Pakistan had not yet declared war on India or even fully mobilized its military. The Chinese and Pakistani response was immediate, but American supplied THAAD-X anti-ballistic missiles proved surprisingly effective. Only three of the eight missiles launched penetrated Indian defences, one of those missed by several miles and a Pakistani launched missile failed to go fusion and was far less effective than intended. America was appalled. It had been assured by the Indian government that they would not initiate first use.

Sanctions were immediately declared by all the nations of Europe as well as North and South America. They also demanded an immediate end to the conflict and as this occurred in the UN a second nuclear exchange ensued. Over the first week of April no less than twenty-five nuclear missiles were fired. Even though only two population centres were struck by nuclear weapons, Russian Vladivostok and Chinese Harbin, millions died in the ensuing chaos. Before long, clouds of radioactive dust circulated about the northern hemisphere causing slow deaths for thousands more. The East Asian War ended on May 15, 2047. The overall cost of the war remains unknown. It is estimated that just fewer than 50 million people died as a direct of the war. An unknown number of would die over the years due to malnutrition and radiation poisoning.

Even those nations that were not direct participants were greatly affected by the war. America, one of the nations most responsible for India's overly confident posture coming into the war, experienced a severe political crisis as confidential memos leaked showing that its government had done much to instigate the conflict. The UK too found its reputation sullied by its role in the affair. In the end the devastation caused by the war solidified international support for a replacement for the United Nations, and the ex-secretary-general Matthias Vanderveen proposed a world alliance based on the current regional organisations. Even the United States found itself unable to halt the inexorable move towards a united global government.

After eight months of detailed planning, the Lima Conference of 2048 set out the structure of an international confederation that recognised regional organisations such as ASEAN, the European Union and the Arab League as decision-making entities linked with a supra-national confederation parliament. Nations gave up some of their powers to the regional bodies, just as European nations had in the 1990s. San Francisco, Singapore and Munich became the joint capitals of the Earth Union. With the rise of Lunar ambition, signatories at the Lima Conference agreed that all military space activity was to be carried out under the umbrella of this new Earth Union. Fear and mistrust of another nuclear war, and of the Lunars, brought the Earth nations together, perhaps temporarily, perhaps forever.

### **Under the Asteroids**

Out in space, there were others who would help shape the future of humanity. The Mars colonies were expanding rapidly, scientists and engineers vied with prospectors and miners for seats on outbound rocket flights. There were tens of thousands of people from many different nations on Mars by 2040.

Further out even than Mars, are the asteroids of the Belt. Here, throughout the Forties, Chinese astronauts established tiny mining outposts, at first experimentally, and then productively, as newly installed mass drivers began launching valuable ores back toward Earth. China, using the technology developed to drop its astronauts on the Moon, had first sent out a manned prospecting mission to 4660 Nereus (a rogue asteroid orbiting close to Earth) in 2027. The mineral-hungry nation followed it up in 2035 with a long duration mining mission to the Asteroid Belt. This was



never part of the 2015 Power From Space Design Agreement. China had gone it alone in a risky venture to prospect for rare minerals. Out in the black, these souls were brave beyond measure ... or just desperate. A massive Chinese recruitment drive attracted educated young men with no prospects of marriage since the ratio of men to women was so low. They would expend their energies in the Belt instead, establishing outposts, bases, green-houses, refuelling stops, trade centres and mass drivers ... and how the Earth distrusted anyone with a mass driver!

### The Belt War (2052-2055)

When news came to Earth in 2052 that envoys from Luna had visited miners in the Belt, the government was electrified with nervous energy. Within months Earth military were in the Belt trying to 'secure the safety of the Chinese belters'. Earth did not want Luna to co-opt the belt miners, and have them stop sending raw materials back to their home planet. Instead, the world government cultivated the new concept of Cascadia, a free and independent nation of belt miners. Luna reacted predictably by sending in its own newly constructed military vehicles. Earth fought this war by supplying the Cascadian miners with craft, supplies and weaponry, but they dare not intervene directly. Lunar military troops broke up the burgeoning 'nation of Cascadia' created by the free-thinking miners, and imposed their own restrictions. There were an estimated 1,000 deaths in the Belt, and more than five hundred on Mars, which could not escape the war. Luna power supply workers had long been established with enclaves on the Martian surface, and these Luna colonists brought the war to Mars. Troops of both Luna and Earth fought each other on Martian soil. In the end, the Moon established a colony on Vesta, and broke up the dream of a free Cascadian nation. As a counter-balance, the Earth Union was able to maintain its first colonial presence in the Belt at the asteroid called Ida.

*"Here men from the planet Earth first set foot upon the Moon. July 1969, A.D.  
WE CAME IN PEACE FOR ALL MANKIND"*

Apollo 11 plaque left on Moon.

### Showdown Over Mercury

The Earth Union soon found a way to shake-off its dependence on Luna when the first fusion reactor came online in 2060. The 'miracle powerplant', fusion reactors produced very little radioactive waste but incredible amounts of power. Various fuels are needed, the most sought after being helium-3. Although small amounts can be gathered on Earth, the greatest concentrations are out there, in the solar system, waiting to be collected. This helium-3 is blasted into rocky surfaces by the solar wind and is found on Mercury, the Moon and on the gas giants in the outer solar system. Now the Earth Union had to secure a source of He-3 and it set its sights on Mercury, sending an initial colony to the Sobkou region in 2067.

Luna was determined to spoil this party and a colonial mission of its own arrived in orbit in 2068. It soon emerged that the Earth colony included military assets, and that the Lunar mission had also included weaponry. The stand-off was tense and after several weeks the Luna ships were resupplied with fuel from the Moon and then they withdrew. Crisis talks were held between Luna and the Earth Union, the outcome falling in Earth's favour, it would continue with a 3 year plan of development on Mercury. Here was cheap solar power, immense mineral wealth and a truly amazing export: helium-3. It looked like Mercury would eventually out-perform Luna; Earth had a super-colony!

Traveller	
Tech Levels	
<b>TL 7</b>	<b>1969 – 2020</b>
<b>TL 8</b>	<b>2020 – 2070</b>
<b>TL 9</b>	<b>2070 – 2100+</b>

It wasn't to be. The Earth Union sponsored expensive operations that began to mine helium-3 from the Sobkou basin, but where was it all? To the shock of all concerned, it seemed that Mercury had very little of the precious material. It was now the dash for Saturn, and the vast amounts of helium-3 there, that quickly turned the Sobkou debacle into a forgotten memory.





*"Here's my strategy on the Cold War: we win, they lose."*

Ronald Reagan, USSR-USA Summit, Moscow, May 29 June 2, 1988

### **Jupiter and Beyond**

The great expansion into the outer solar system began apace in the early 2070s. New rockets, nuclear thermal drives that were based around a fission gas-cored reactor using liquid hydrogen or water as a reaction mass, now powered these long range missions. Fusion powerplants were far too large to scale down enough for use as a space drive and so fission reactors have remained the powerplant that has allowed the exploration of the furthest parts of the solar system. Both powers established bases at Jupiter. Luna planted a small outpost on Europa that would later develop into a fully-fledged colony, while Earth set up bases to monitor Luna activity at both Callisto and Ganymede.

It was in 2082 that a Lunar expedition reached Titan, the sixth moon of Saturn. This world had everything that the Moon didn't, including nitrogen, methane and hydrocarbons! It was going to be the perfect source of raw materials, materials that would be shipped back to Luna to free the people from its reliance on nitrogen from Earth. Within two years, though, the Earth Union had arrived and brought everything it needed to begin mining helium-3 from the Saturnian atmosphere. It established bases on the twin planetoids of Janus and Epimetheus; the tension between the Earth depot and the Lunars on Titan grew year by year.

From 2090 onwards expeditions even reached Neptune and Uranus, but settlement has been light and patchy, sponsored not just by the two superpowers, but also by corporations or wealthy individuals.

It was in 2098 that a peace conference was held that would see the cold war between Luna and Earth thaw a little. Three years earlier (2095) the Earth Union had staged an invasion of Luna-aligned Titan. Titan was a Luna colony that had been granted autonomy, yet it was still a staunch Lunar supporter and crucial to Lunar affairs. Its hydrogen was easy to scoop and a ready source of affordable fuel that attracted the envious gaze of the Earth Union. Titan was also seen by Earth as a deniable tool of the Luna government, exporting revolution, opposing Union expansion, challenging Union vehicles and detaining Union citizens. Military intelligence suggested that the small moon Helene was being used by the aggressive Titan military to build up a force ready for the invasion of the Earth-aligned moon Iapetus. As a pre-emptive move, declared Earth Union ambassadors, an invasion of Titan was found necessary in order to prevent interplanetary war. Luna furiously accused the Earth Union of starting such a war itself. Occupation forces were first met with some grudging acceptance, but armed opposition and then rebellion soon followed.

For three years escalation continued until full scale war threatened to engulf the entire solar system. Such a war was unthinkable. Luna could drop rocks on Earth's cities with impunity, Earth could launch missiles at Luna space stations or habitats killing tens of thousands in a single strike. At the last hour, with ambassadors recalled, militaries on stand-by and fingers hovering over buttons, one sane human being stepped out of the political fog. The 76 year-old Evelyn Chen was a Shandong politician who had represented Earth for four decades across the solar system. With a hastily gathered group of equally Jurassic diplomats and ambassadors around her, she addressed the Council of National Leaders in 2098. Her rhetoric was good, her PR blitz was even better, resulting in an immediate pause in the escalation, then a roll back to more peaceful conditions. Chen's role in cooling the Titan conflict was key. Within a matter of months a timetable for meetings and summits that would bring the nations of Earth and Luna closer together, was put forward. Titan was still occupied by Earth troops trying to root out White Tiger terror cells, but a reduction in the occupation forces had helped to calm the international situation. Evelyn Chen



accepted nomination to secretary-general and given emergency powers to help normalize relations with Luna. She currently enjoys massive popularity on Earth.

Two years on, the rival powers are no longer at war and a measure of co-operation is possible in some spheres (notably trade and science); but sixty years of rivalry and mistrust cannot be banished with a wave of the hand.

The future may be uncertain, but one thing *is* certain, events are going to be interesting...

*"The Cold War is over, but Cold War thinking survives."*  
Joseph Rotblat

### ***Predicting the Unpredictable***

*No one predicted the collapse of Communism in 1989 or the Arab Spring of 2010. The future history depicted here is not what I think will happen, but a narrative that explains why the world is as-it-is in 2100 AD. It explains how a cold war divides the solar system, a cold war that the setting needs in order to fuel another race into space .... and it is into space we want our adventures to go. The East Asian War is not a world war but a regional nuclear confrontation which provides just enough incentive for the nations of Earth to realise how beneficial a union of world governments would be. We need there to be a single government on Earth to establish our cold war setting.*

*Many other elements in this setting are based on the predictions of agencies, developers, scientists and others, from the rate of global warming to population growth, and the rise of new economies to the cultural dominance of emerging nations. Overall, my choices have been optimistic ones, and a glance at the entry for Earth in the Worlds chapter will show that mankind has done his best to provide a viable future for his descendants.*

*Where is America in this future? Still there, still a powerful international force, but now shoulder-to-shoulder with equally powerful nations: China, Brazil, Indonesia, India. Their rise to prominence and the massive populations they bring with them has transformed the default Western culture to a more Western-Oriental culture, fusing East Asian fashions, names, cuisine and tastes into the Western culture that dominated in 2013. That shift is represented in **Orbital** on the orientation of the world map, in names and in the location of the the biggest, most influential cities on Earth.*



# 3 ORGANISATIONS

## GOVERNMENT AGENCIES

### Earth Space Development Agency



With the establishment of the Earth Union, the space agencies of individual nations became irrelevant. A global space effort was needed and nations were invited to participate in a global space programme. The Earth Space Development Agency (ESDA) co-ordinates all of Earth's national space efforts, it built the L4 Vanderveen colony and pioneered the audacious helium-3 mining programme inside the Saturn system.

The ESDA is a descendant of the European Space Agency, NASA and Roscosmos, and fulfils many of the same functions in 2100. It funds technology demonstrators, engineering projects, astrophysical and astronomical science missions, and provides space-based data for government, the military and business.

### International Astronomical Union



Perhaps the only truly international organization in existence, having no real allegiance to the Earth Union or to the Lunar Republic, the IAU has been in existence since 1919. For much of its history, the IAU was based in Paris, and its main function was to act as a clearing house for new discoveries and catalogues and assigning designations for new bodies or features found on them. New stars, comets, dwarf planets, all were officially named by the IAU. The organisation also promoted astronomy and safeguarded international links and working partnerships to make the study of astronomy a truly universal and multinational affair. After the Orbit War, the IAU virtually ignored the barriers between Luna and Earth that were raised at the start of the Cold War. With no concern for day-to-day politics, the then president Pierre Moitessier, signed the Lunar Republic into the IAU and ensured that data, communications, assistance and access to records was freely available to the Lunars. Pressure from the government of Earth failed to dissuade Moitessier who felt that the IAU transcended politics, worlds and ideologies.

Today the IAU is still based in Paris, but has a second office at the IAU orbital observatory (SGS-34 'the Bernard Lovell Observatory') in geostationary orbit around the Earth. Earth and Luna visitors, students, researchers, scientists and engineers have all been made welcome. The IAU, due to its almost 'Swiss' neutrality, soon acted as a clearing house for orbital allocations, transponder frequencies and the like. With the establishment of a new legal department, the IAU has now become the de facto space co-ordination body, creating rules and regulations, and using the laws of either Luna or Earth to bring what power it has to bear. It was the IAU which brokered the Fairline Space Convention on Compatibility & Co-ordination in 2059. Both national powers see the need for such a regulatory agency, and although both sides have at one time or another tried to influence or even co-opt the allegiance of the IAU, it has remained gloriously and stubbornly

independent. At least one commentator has remarked that once the Cold War ends, it will be the IAU which has the aloofness and assured integrity to govern the entire solar system! Some of those commentators aren't even joking... The IAU has its own army, actually a small security force called Eckard Tactical Management (ETM) on a long term contract. ETM puts its full complement of security personnel and vehicles at the IAU's disposal, and this includes a mechanized company of infantry deployed to Mars in order to guard some of the alien ruins at Cydonia. In common parlance, EMT troops are known as the 'Swiss Guard', a reference to the ceremonial mercenary troops that have provided protection for the pope inside the Vatican for the past 600 years.

The 57<sup>th</sup> IAU General Assembly took place at Reunion on Mars in 2099. The next is scheduled for the Matthias Vanderveen L4 colony in 2102.

## Lunar Outsystem Patrol & Security (LOPS)

---

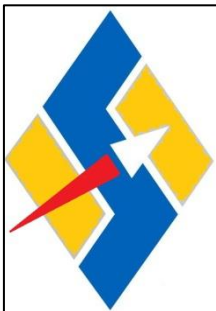

Filling a role very similar to SARA's is the Lunar Outsystem Patrol and Security (LOPS). LOPS focuses on placing agents within those stations and outposts controlled by or allied to Luna. LOPS has no jurisdiction on Luna itself but does share nearly all of its information with LunaPol, while LunaPol often sends up-and-coming officers on detached assignments with LOPS. LOPS agents can work as handlers for the notorious Lunar Security Detachment (LSD) but here too they must report back to LunaPol and follow its orders.

Due to Luna's low population LOPS makes extensive use of robots and drones which saves lives and money, but which has given the organisation a reputation for being aloof and uncaring. This is especially true in the Belt where members of the Cascadian Alliance already have a poor view of Lunar meddling. On Venus this arrangement gives LOPS a distinct edge over rival organizations as tele-operated robots are the norm away from the floating cities. Around Jupiter, LOPS has had problems. Jupiter's highly irradiated environment can adversely affect electronics and remote operations. Several embarrassing incidents in the late 80s have some observers wondering if Luna backed down during the Titan Crisis because of problems inherent with their entire military force structure.

## Martian Rangers

---



Perhaps no single law enforcement group more exemplifies the rough and tumble pioneer spirit of the 'final frontier' than the near-legendary Martian Rangers. Formed in 2042 by recently retired Colonel Creighton Deerman, the Martian Rangers were created to capture criminals and provide aid to those in need. Deerman, an outspoken supporter of the Greens and a strong advocate of opening Mars for settlement by anyone who could make the trip, hated the idea that Mars might become just another government-run bureaucracy. To this day the Rangers have a strong bias against the Reds and anyone they suspect to be of Red alignment. Sure they'll still rescue them or give them medical aid, but they'll be a bit rough and ready.

Individual Rangers are recruited from the many small settlements that dot Mars and they go through gruelling survival training that has a 65% wash out rate. Yet every year dozens of young Martians flock to Deerman Base, just south of Reunion. After six months of survival training the recruits are given two years of weapons training and extensive course work in criminal justice, research and intelligence analysis. Although some specialisation eventually occurs, each Ranger is expected to be a jack-of-all-trades and also a master of Martian survival.

## Space Activities Regulatory Agency (SARA)

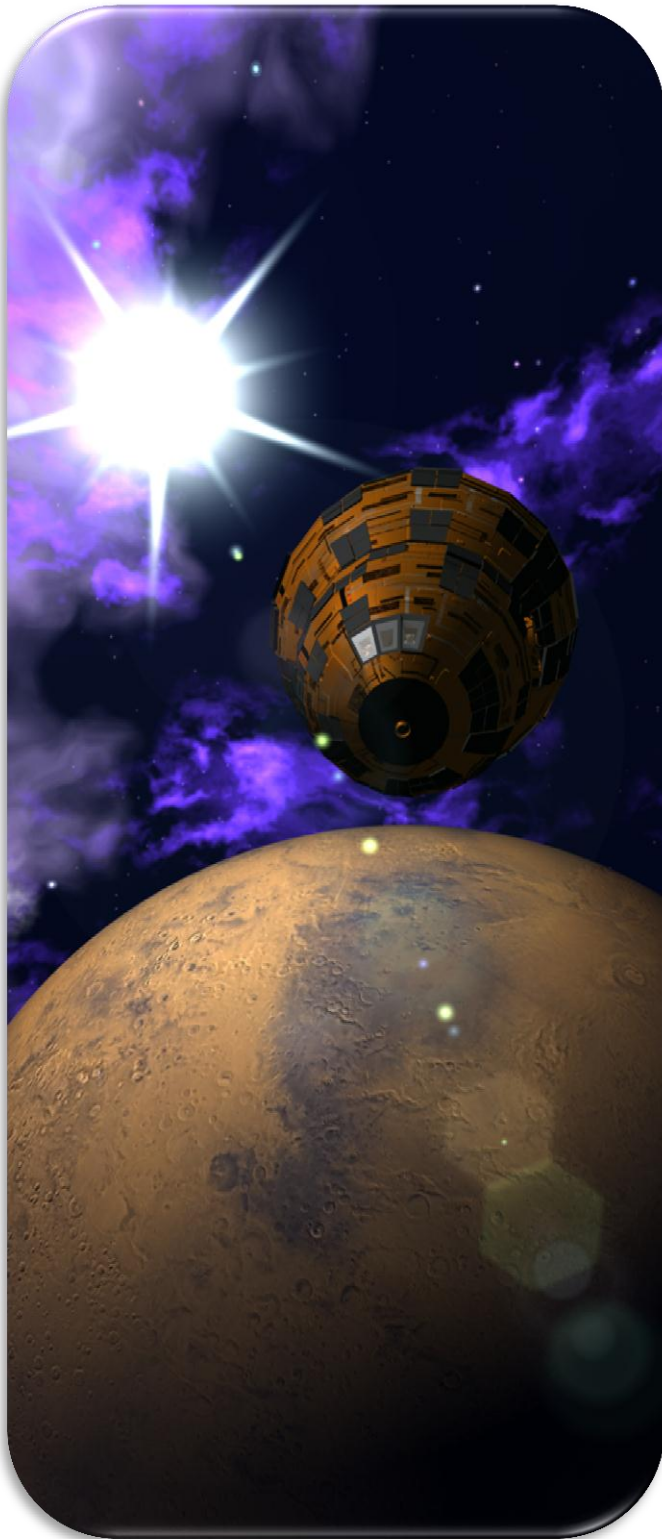

Celebrating its forty-fifth year of existence in 2100, the Space Activities Regulatory Agency is the Earth Union's primary extra-terrestrial law

enforcement agency. SARA formed in the aftermath of the SolCom Industrial Station Disaster of 2054. The loss of life and the fear of an orbital cascade event prompted the bickering members of the Earth Union to come to quick agreement. The agency draws on personnel and expertise from numerous Earth based agencies both government and private but recruits agents right out of university. SARA was given a mandate to police all Earth Union affiliated outposts and colonies, provide deep space search and rescue, enforce space safety regulations, recapture escaped convicts and provide professional assistance to Earth Union allies.

Headquartered in Phoenix, Arizona, the agency employs nearly 15,000 people though only 370 of those are in Phoenix. Most of the agency's marshals work off planet as field agents, technical experts and support personnel. Initial training begins after college and occurs at Vanderveen L4 colony station. After a year at Vanderveen the trainee is posted on board one of SARA's many deep space vehicles. These three year tours focus on search and rescue, anti-smuggling and assisting any isolated outpost in need of help. After serving as crew member of a DSV the marshals or deputies are promoted and allowed to pick a specialty. Upon making their choice they are given a further six months training and then given a posting. Currently the most prestigious postings are in the Belt at the EU facility on Ida and at the EU consulate at Reunion on Mars.

SARA currently operates twenty-two heavily modified Wu-Ketai Spartan DSVs as well as numerous smaller vessels, their white and green hulls are a welcome sight in many regions of the solar system. On large stations, planet-side or within a habitat, SARA agents work in teams of six; two of them being technical and support while the others are deputy marshals (field agents). SARA has full access to all paramilitary weaponry and many military grade weapons, but if heavy resistance is expected real military units are often brought in to assist.

# CORPORATIONS

## Aerodyne



Aerodyne is a relatively recent merger of several high profile aerospace companies on Earth. The business focuses on producing deep space vehicles and a whole range of components for space colonization, from guidance computers to airlocks and module hatches.

## Baospace



Baospace is a fiercely competitive Luna corporation based in Meridian city that specialises in consumer products, food stuffs, clothing and interior fittings. It has a sparse but chic look which is a reaction to the older 'ergo' design principles, and it is in front of the fashion trends at the moment. The better space lines often boast of having a Baospace cabin decor, and at least one passenger line has fitted out its cabin crew in designer uniforms created exclusively for that line by Marco Yen, the

most famous of Baospace's design houses. Baospace even builds chic custom-designed pressure suits! Baospace decors are minimalist, and favour white, grey or beige colour schemes with a touch of black or an occasional pop of colour. There is little clutter, strip lights are used as linear architectural features, and edges flow and merge to create an organic whole. Simple lines, decorative restraint and neat geometric shapes all encourage tranquillity, peace and serenity and typify Baospace furniture.

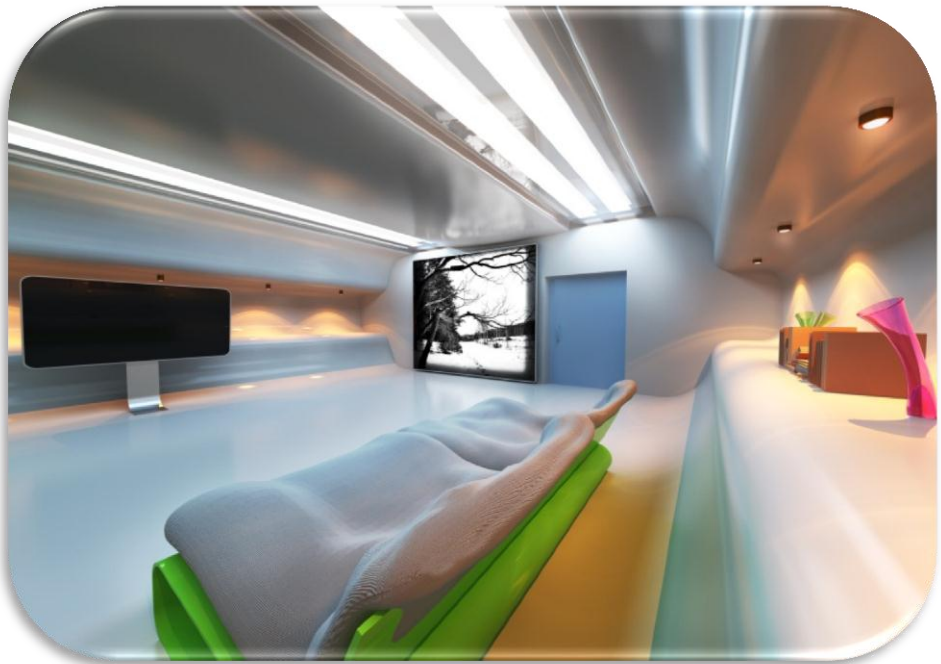

## Centennial



Probably the largest corporation of Luna origin, Centennial has expanded out into the solar system to create a dynamic business. It is an engineering firm, focusing on large scale projects for the Luna government as well as other corporations (including those from Earth). Centennial can build colonies, drilling rigs, space stations and became famous for its pioneering success with the construction of the submarine outpost under the ice crust of Europa.



---

## Colonial Endeavours

---



An Earth-based transport corporation that is not particularly large, but that is able to move its assets quickly and ingeniously to deal with unorthodox cargoes and unusual situations. CE purchased several Reiner-Gama DSVs from Luna as soon as the cold war trade embargoes were lifted 2 years ago. In return, and as a sign of trust, the Luna Republic has employed Colonial Endeavours on a number of occasions. Of course there are many other customers that also use the flexible 'can-do' services of Colonial Endeavours.

---

## Erebus Power

---

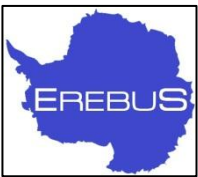

The symbol of Erebus Power is a map of Antarctica which hints at the petrochemical history of the corporation. The multinational corporation is British and was involved in oil and gas drilling a century ago. Then known as BP, it merged profitably with both a French and a Chinese petro-corp to become Erebus Power, at a boom time in Southern Ocean drilling. Hard times followed the start of the solar power project on the Moon, but Erebus R&D had seen the danger and had made plans to move into space in order to secure new sources of energy. Near Earth asteroids proved to be the lucrative new industry upon which the 21<sup>st</sup> century Erebus was to be founded. More recently, lucrative licenses to extract petrochemicals from the surface of Titan have been gained. This new extractive industry has made Erebus a new high-end player in the solar system power business. Erebus is massive in size and ever hungry for profit - the corporation is interested in keeping other companies out of Titan if at all possible.

---

## Ellis-Itami

---

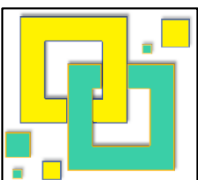

Ellis-Itami is small but powerful information corporation and is widely respected. It has an unprecedented data network, owns insurance subsidiaries, a detective agency, stock traders, several small Japanese banking companies and Kodai-Secure the globally famous courier and security firm. Information is Ellis-Itami's game, and the corporation has a reputation for hiring the brightest cyberspace cowboys and the best investigators. Trying to be impartial, they sell data to all the big corporations, all governments: to everyone who can afford the fees. Ellis-Itami operates mapping subsidiaries, phone systems and digital location services. Much feared is the E-I credit section hired by other firms to collect debts. The 'credit adjustors' are basically hired guns, often Shanghai street scum.

---

## Fly By

---



Fly By is one of several low cost carriers intent on cutting as many corners as legally possible to maximise profits and stay ahead of larger firms like Trans-Solar. Freight only companies, not likely to kill their passengers through lack of care, Fly By is not the fastest, the most flexible, or the most versatile – but it will get your cargo there, and get it there cheaply. Other cargo companies of a similar ilk include **FR8, Direct** and **2GO**. Their biggest rivals are Trans-Solar, Colonial Endeavours, Mammoth and Inter-Planetary Services (IPS).



## Hermes Systems

---



While many considered the Earth colony on Mercury an abject failure, and predicted the return of the colonists within the year, Hermes Systems proved them wrong. Established by Sajid Khan during the Sobkau debacle, Hermes rationalized the colonial project, offered the colonists jobs and published a four year plan for Mercury. Investors bought in, Khan snapped up unwanted and unused machinery from the Earth Union at a massive discount and the modern state of Mercury was born. Khan may be the richest man off-Earth, a billionaire who has made his fortune from the solar power, electronic and metallurgical industries that make up Hermes Systems. He took a gamble, and it certainly paid off.

## IPS

---



One of the top transport companies, Inter-Planetary Systems (IPS) prides itself on efficient and fast delivery of cargoes to almost anywhere in the solar system. It has an integrated system of transport networks including cargo jets, rail connections and, on Earth, parcel vans. Its famous mustard yellow livery is known as a sign of dependability and reliability. The 10 ton cargo module forms the backbone of the interplanetary transportation industry, it has become a space-borne version of the modern-day 40 foot shipping container.

## Luxor Aerospace

---



With its origins in the rush of private firms competing for space contracts in the 2020s, Luxor Aerospace has pioneered the expandable transhab. Luxor was once far more well known for its chain of hotels, spas and luxury resorts across Earth, but today Luxor is the leading owner of entertainment and vacation services in the solar system. It boasts a new resort facility on Luna, at Tranquillity, a spin gravity hotel and leisure complex at L5, six Deep Space Passenger Vehicles that tour the solar system, and many more vacation spots, habs and stations. Luxor also runs a space passenger service in Earth-Moon space.

## Matsuyama

---



Almost a dinosaur from the 20th century, Matsuyama has managed to adapt to the new solar system environment, whilst many of its turn-of-the-century rivals became extinct. The Japanese corporation builds, prolifically and on a huge scale. Governments and other businesses hire Matsuyama's expertise when a bridge, tunnel or skyscraper is needed. Where the corporation really led however, was in the way it created an affordable method to colonise other worlds. Rather than simply finance off-world projects, Matsuyama created the tools for the first time colonist to get started with only a small investment. In a method similar to modern-day franchising, training courses were established and linked to corporate-designed colony modules, rovers and other hardware. Colonists train together and ship out together, they pay for their own training and sign contracts with Matsuyama. The corporation supports the colony with maintenance runs, supply drops and medical assistance for a defined period, while the colonists are bound by their contract to work in the colony's interest for a similar period. In the longer term, Matsuyama benefits from long term maintenance and hardware replacement contracts with the colony, even if the pioneers should turn to other carriers for their supply runs.



---

## Nortinghouse

---



Nortinghouse has been building nuclear reactors since the days of the very first cold war, back in the 1950s. It worked with NASA on various nuclear thermal rocket designs in the 1970s, and helped to kick-start the revolution in space transportation almost a hundred years later with its new gas core reactor designs. Constantly in competition with smaller, newer firms, Nortinghouse is an adaptable and energetic corporation, re-inventing itself constantly. It not only produces good quality reactors and NTRs but also solar cells, life support systems, space suits and even something as humble as zero-G power tools. Nortinghouse is the epitome of reliability.

---

## Parkfield Biolabs

---



Parkfield's operations include agri-chemicals, genetics, pesticides, GM crops and livestock. Its logo is a green crystal maple leaf on a blue background. Parkfield is headquartered in Toronto, Canada, and its current president is James Parkfield Jr. The corporation is a large Canadian agri-corp specialising in genetic manipulation to produce superior crops and associated crop enhancers. Parkfield owns large areas of farmable land in Canada. Its main laboratory ('Rockwell') is situated in an underground complex which extends deep into a Canadian mountainside, but it also runs a large facility on the remote asteroid 17253 Vonsecker. Rumours rocked the company twenty years ago when stories emerged that Parkfield was responsible for many of the more accessible synthetic street drugs, but such internet buzz was never proven. Initially getting into space by sponsoring crop experiments on the ISS, Parkfield later paid for a complete module on the Russian OPSEK 1 station. Many of the techniques pioneered by the corporation are used today under license in many of the hydroponic units of deep space vehicles.

---

## Reiner-Gama

---



The Reiner-Gama anomaly is a mysterious area on the Moon of very high magnetic strength. The mining company that began operations in the area took the name and went on to become the bedrock corporation of the Luna economy, responsible for engineering, mining, construction and aerospace. With many subsidiaries, Reiner-Gama products are found on most Luna DSVs and in many Luna-sponsored outposts and colonies. The CEO of R-G is Susan Leung, a young business-woman of extraordinary determination and vision who enjoys the loyalty of those who work around her.

---

## Southern Cross Mining

---



Southern Cross is a cutting edge mining and development corporation that has seen much successful activity in the Asteroid Belt and in more recent years, the atmosphere of Saturn. In 2084 the corporation signed a contract with ESDA to begin extracting helium-3 from the upper atmosphere for use as fuel in Earth's newly designed fusion reactors. The Kronos units built in partnership with Voroncovo were the product of eleven years of research and testing. The base on Janus, a minor inner moon of Saturn, is a Southern Cross centre of operations for the outer system. Ida in the Asteroid Belt is the base centre for the inner worlds.



## Tharsis Heavy Industry

---



Although Mars has become almost the black sheep of the interplanetary community, Tharsis has thrived, not just on its home planet, but out in the wider solar system, picking up mining and engineering contracts as far afield as Mercury, Io and Iapetus. Tharsis is the product of the nationalization of the mining group AIMCON working on Mars in the 2050s. When the Green movement (the Third Way) took control of Mars after the Belt War and established its own planetary government, it nationalized AIMCON and renamed it Tharsis Heavy Industries. To everyone's surprise the Martian economy flourished and this was in no small part due to the efficient way in which the new Tharsis Heavy Industries corporation was run. Mining is the focus of the corporation, but it also builds outposts, colony buildings, rovers and large scale agricultural stations. A subsidiary, named **Tharsis Space Systems**, also constructs orbital craft and deep space vehicles for sale throughout the solar system.

*"One year, they told you. Just one year of hard work and your duty tour was over and you could go home... After a month you began wondering if it was really such a good deal. After two, you wished you hadn't signed. After nine, you found yourself counting the minutes remaining to your year instead of the days. After eleven months you spent much of your time trying not to scream."*

Alan Dean Foster, *Outland*

## Trans-Solar

---



'A to B' means Trans-Solar. This transport corporation has a fleet of DSVs and orbital craft that keep freight and passengers moving, from Titan to Mars, Mercury to Earth, Luna to Titan and every point in between. Large scale transport of colony parts, powerplants, supplies, equipment, rovers and personnel are the basis of Trans-Solar's business model. T-S is an Earth Union enterprise that initially began as a coalition of private firms that were trail-blazing access to space in the 2020s. After the 2040s this coalition incorporated as Trans-Solar, in order to supply Mars and the Asteroid Belt with supplies. Causing great controversy, and jeopardizing its excellent reputation, T-S initiated transport links with the cold war enemy Luna in 2060, although these links were highly scrutinized by security and customs officials. It was only the Teflon, 'non stick', reputation of the corporation that enabled Trans-Solar to survive such controversy. Today, anyone wanting to start up a space transportation business has to somehow deal with the market domination of T-S.

## Voroncovo

---



This Russian corporation is focussed on sophisticated engineering, rocket systems, satellite technology, surveillance and the technology of security. Voroncovo is feared in corporate circles, both for its sheer size and amount of force it can bring to bear. Developed from an amalgam of Russian state industries during the tumultuous times in the early 2030s, Ilyech Voroncovo brought together the brightest scientists and projects from the CIS before the West could buy them first. Voroncovo inherited **Korolev Rocket and Space Corporation Energia (RSC Energia)**, which is its successful rocket subsidiary, and **Obyedinyonnaya Aviaostroitel'naya Korporatsiya (OAK)** the famous Russian aircraft design corporation. Voroncovo is successful in the space industry, and well-known for its Speransky Heavy Lift Vehicles.

Voroncovo is known as an information broker that rarely uses what it knows for personal gain (the space industry excepted). Voroncovo also provides security bodyguards, escorts, armoured cars,



detective services, mercenary units, and corporate arbitration services. It is tough and uncompromising. This company has its own private launch complex at Plesetsk, Russia. The OPSEK 1 and 2 orbital module platforms were Voroncovo designs that revolutionized modular living in space. Similar modules are still used today. This corporation has its HQ in Moscow (constructed over old nuclear bunkers and tunnels). The current CEO is Vladimir Dubovka.

---

## Wu-Ketai

---



Patrick Wu is one of the solar system's few billionaires and the owner of Wu-Ketai, a huge and profitable corporation that has many subsidiary companies. Although Wu retains complete ownership and control of Wu-Ketai, the commercial set-up of companies within it is varied and complex. Each of the companies operating under the Wu-Ketai brand is a separate entity, with Patrick Wu completely owning some and holding minority or majority stakes in others. In some instances, he has simply licensed the brand to a company that has purchased a division from him.

The Wu-Ketai brand is strongest in manufacturing, with companies like **Wu-Ketai Industries**, **Wu-Ketai Components**, **Wu-Ketai Power Tech**, **Wu-Ketai Mining** and **Wu-Ketai Aerospace** creating huge profits. Patrick Wu has spread the corporation into mining, colonial sponsorship, entertainment, food production, publishing and automobiles.

---

## Zenith Electronique

---



This European corporation is a world leader in computer systems, lasers, advanced electronics, application software and cyber systems. Its development of optical computing is revolutionary, and will soon pay off. By buying out various optics manufacturers at the start of the century such as Zeiss, Canon, Siemens and Optique, Zenith became a world leader in this field. It is a dynamic corporation with an attitude and is run by a young, no bull management that likes to take risks. The company has separate subsidiary divisions in each product area: **Okuda** specializes in sensors, optics, lasers, high tech surveillance and monitoring devices; **Transdyne** specialises in robotics; **Eurodyne** specialises in electronic systems and **Helix** specialises in computer systems. **Helix** has been developing artificial intelligence for the past decade with patchy and inconclusive results, its greatest triumph is 'Sentinel' the experimental AI on Ganymede.

# NON-GOVERNMENTAL ORGANIZATIONS (NGO)

An NGO can be described as 'an independent voluntary association of people acting together on a continuous basis for some common purpose other than achieving government office, making money or illegal activities.' Charities, trusts, religions, humanitarian groups, and labour organizations all fit this definition.

---

## The Network

---

The Space Workers Network (SWN or simply 'Network') is a trade union, info-share and lobby group that serves freelance spacers. DSV crews can operate alone without a corporate or national backer, but need the Network to assist them with finding work, negotiating fees, dealing with legal issues and so on. Few crewmen will find work on a DSV without membership of the Network. 'Terminal Station' (SGS-78) located at L-4 is a Goddard-style spin gravity station and headquarters

of the Network. Terminal tried to establish itself as an unaligned station, but it required Earth Union backing, which meant that up until recently, there had only been a token Luna presence. Since 2098, however, Terminal has flourished and the numbers of disillusioned, disenfranchised and independently-minded corporations and individuals operating from there, has grown tremendously.

## Cascadian Alliance

---

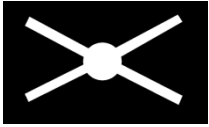

The Asteroid Belt had been targeted early on by Chinese mining corporations who had decided to by-pass Mars. When the Orbit War began, some miners reacted sympathetically to the plight of the Luna colonists and set up on their own. Independent of the corporations they used stolen equipment to hide out on remote asteroids, lending one another assistance and keeping out of the way of the Chinese ore transports and prospectors. Some of the dissidents were Christians who, back in China, had worshipped in secret 'house churches' for fear of persecution and arrest. Others were members of the Uygur minority, a Muslim people from Xinjiang province who had been offered mining contracts when many other Chinese refused to leave the comfort of Earth. For decades restricted, pressurized and persecuted, the Uygurs were enticed into space by the promise of good pay. Like some of the Christians, there were Uygurs who likewise fled out into the Main Belt with stolen equipment. These first few formed the core of what was to become the Cascadian Alliance, named after a new breakaway state in north-west America that had a lifespan of only six months (during 2045) before being forcefully dissolved by the US and Canada. The 48 Cascadian martyrs proved an inspiration to the hard-working Chinese dissidents, just as the revolutionaries of 1789 France were partly inspired by the successes of the American Founding Fathers. In more recent times, the Cascadian dream has been fuelled by new immigrants fleeing persecution or more commonly, the pressures of civilized, high-tech, corporate-dominated life. They wanted freedom from laws and regulations, and Cascadia, or the dream of Cascadia, provided that freedom.

Today, Cascadian homesteaders have cultivated a cottage industry in spacecraft design. Wanting to be independent and free from solar system-wide market forces, they extract the materials they need from asteroids for vehicle hulls, and purchase second-hand components for drives and interior fittings. Many spacecraft parts have been removed from Earth Union war craft that were broken up by the Luna authorities at the end of the Belt War, fifty years ago; they are TL 8 but still work fine! Recycling and sharing is an important part of the Cascadian culture. These homebuilt 'rock-hoppers' are used to launch homesteaders out to new asteroids, and are typically orbital vehicles of less than 100 ton mass. These are communal efforts, with several families pulling together to help one another, sharing skills, resources and goodwill. Hulls are fabricated from aluminium mined and smelted by the Cascadians, and used to sandwich a layer of sand to provide some shielding. In this way Cascadian hulls costs 1/10 of those in TMB. Power comes from fuel cell batteries and solar panels, second hand reaction drives are bought, refurbished, tested and installed. Most are connected to fuel tanks providing only 2-3 burns. Parts are often old (TL8) and acquired at 50% of prices listed in *High Guard* or TMB. Compact bridges are popular, while an airlock, a farm, a hab module and mining drones are virtual necessities. Another module of choice is the micro-smelter for total self-sufficiency.

## Church of Heavenly Stigmata

---

A popular Christian movement established on the Net during the preparations for the first manned Mars flight by the Reverend Shire Kavanagh. It is an evangelical movement tying Christianity and the fate of the cosmos up with the settlement of Mars. In Heavenly Stigmata doctrine Mars symbolizes the blood of Christ, a permanent sign to the sinful that their sins were forgiven on the cross. Reverend Kavanagh made no secret of his belief that Jesus was an 'extra-terrestrial' that came to Earth from beyond our galaxy, and in this doctrine, Mars plays a central role as a stop

over and the place that Christ returned to after his Crucifixion. Mars is the god of war, it is Rome the conqueror and the Devil tempting Christ in the wilderness. For the members of the church, Jesus is on Mars still, it is the desert testing Christ, and now testing Mankind. To survive the End of the World (tentatively dated to 2066, then 2099 and now 2121), a believer must make the pilgrimage to Mars, must go through the ordeals of life on Mars and must fight the Devil and find Christ. Mars is a stepping stone to Heaven, after all. The religion aims to try and keep Mars 'pure' and free from human interference, to oppose sinful city developments and any moral or ethical freedoms, to oppose any research into the existence of alien life (dead or otherwise). To prove that Jesus walked on Mars and fought the Devil there, to prove that Mars was created in 4004 BC.

## Cydonian Society

---



The Cydonia region of Mars is associated with that enigmatic Martian feature: the Face. Seen from orbital photos, the rock outcrop resembled a humanoid face. Other features in the Cydonia region include weirdly shaped pyramidal rock formations - indeed some proponents of intelligent alien life on Mars initially insisted that the entire area was the remnant of a ruined Martian city. In the universe of **Orbital**, these theories were actually proved correct once explorers reached the planet. We were not alone. A new age had begun, and a new

Martian religion, too. But debate began immediately. Had the Martians died off millennia ago? Or were they still out there somewhere? The scientists on Mars who have aligned themselves with the latter theory and who have steadfastly adhered to it, have been driven to set up habitats in the region in order to live amongst the structures they study. But in doing so they have become scientific pariahs - fringe researchers. Someone built these things, some intelligence once walked the Martian surface. Controversially these Cydonian scientists believe the Martians are here still - in hiding or exile - that the human race is somehow related to the Martians, that the Martian race has something to teach us. Perhaps the Martians are actually the physical embodiment of God. The Cydonians have built up quite a store of beliefs and have fashioned a new Martian religion, they are determined to unlock the secret code of these alien structures and to communicate with their builders.

## Frontier Foundation

---

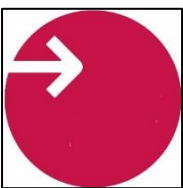

Established in 2018 by billionaire space visionary, Eddie Muzner, the Frontier Foundation provides low cost access to space for anyone willing to partake in a five month training course. Low interest loans are available through its Outbound Bank and its real estate department helps prospective space settlers sell their Earth-based housing. It even runs the popular Space Settlement Lottery which gives 500 winners every year the chance to move to Mars or the Asteroid Belt.

The Foundation still uses the Muzner-Zubrin Spaceport outside of Phoenix as its primary launch facility, but instead of direct shots to Mars all settlers stop at the SGS-45 Neil DeGrasse-Tyson Space Training Centre for a two week orientation. The Frontier Foundation also launches from Sri Lanka and Cape Verde and also has extensive facilities on Mars and in the Belt. An extremely close working relationship exists with Matsuyama, whose company's roving technician teams are a common sight at many Foundation settlements.

Providing inexpensive access to space for the largest most diverse group of people possible, the Frontier Foundation hopes that by giving nearly everyone a chance to move to outer space they will ensure the long term survival of the human race. Unknown to most, the organisation also supports the Green Mars movement and actively works to hinder the Red Legion. Ties also exist with the Cascadian Alliance and as such the Foundation often comes into conflict with Luna as well as some factions of the Earth Union. Despite this the Foundation is looked upon rather fondly by the majority of Lunar citizens as it represents the pioneering spirit they once lived by. Its biggest





secret is the on going covert war against the Snakehead criminal groups of Asia. These human traffickers see the Foundation as competition and have used violence against Foundation employees. To deal with this the organisation has hired operatives to try to eliminate the leadership of certain Snakehead gangs, thus provoking a tit-for-tat cycle of violence. Recently, the Frontier Foundation switched to the tactic of subverting Snakehead gangs in order to divert the off-world migrants toward the Foundation or at least to improve the conditions these people endure during their attempt to get off-world and reach the new frontier.

## **Planetary Reproductionists**

---

Planetary Reproduction is an idea that borrows heavily from James Lovelock's Gaia Hypothesis. Simply put, if Earth's organisms all interact to form a single complex system that works to maintain all life on the planet, than this system can be compared to the cells and organs that make up the body of living creature. Furthermore given that all living creatures have as their most important function the need to reproduce it can be deduced that Gaia itself strives to reproduce. Upon further analysis the only currently known process that can transfer Gaia's offspring to other locals, beyond a few microbes that might be dispersed by meteorite collisions, is human terraforming. The Earth needs you!

Planetary Reproductionists believe that it is the destiny of human kind to spread the seed of Gaia not just throughout the solar system but also eventually to other stars. As the Greens are the political proponents of terraforming the Reproductionists are the spiritual proponents of the process. They are strongly opposed to the Reds and the Church of the Heavenly Stigmata, though on Mars this conflict in ideology is often blurred. Many Reproductionists are scientists, academics and engineers who have no traditional religious beliefs but instead have taken up the idea of Planetary Reproduction as a spiritual replacement. There is no real dogma or scripture per say for Reproductionist philosophy, although a handful of books including *Lonely Mother* (2077) and *Children of Earth* (2082) are considered must reads.

# **CRIMINAL ORGANIZATIONS**

## **Nine-Heads of Xiangliu**

---

Labelled an Earth-sponsored terrorist organization by the Lunar Republic, members of Xiangliu are seen as heroes by the Cascadian Alliance and also many people on Mars. The 'Nine-Headed' Xiangliu originated in the Belt shortly after the Belt War and has been actively striking at Luna outposts there ever since. Xiangliu is a nine-headed snake monster from Chinese mythology and a creature who also served as the minister of Gong Gong, the water god. The Xiangliu organisation is based on a secret asteroid known only as Mount Buzhou. Mount Buzhou was a mythological Chinese mountain which lay to the northwest of the Kunlun Mountains (the modern Pamirs). Mount Buzhou is said to have supported the heavens, against which the Chinese water god Gong Gong smashed his head in a fit of anger.

Organised into nine independent teams of close companions they receive their orders by way of anonymous dead drops or coded messages posted to open chat sites. Very few members know who's pulling the strings but as Luna and the corporations are their most common targets they don't much care. Those working for the Nine-Heads are divided into three areas of expertise; the Eyes of Xiangliu are spies who specialize in infiltration and observation, the Ears of Xiangliu consist largely of computer and technical experts who use their special skills to hack their way into targeted systems, and the Fangs of Xiangliu are those members who wage a propaganda war against their enemies.





Given that terrorism is neither profitable nor a full time job many members of the Nine-Heads of Xiangliu earn a living by hiring out as private investigators or protective service providers. Within the Belt the Xiangliu have made a name for themselves as being both fair and affordable. Furthermore they have somehow been able to afford a growing fleet of modified mining vehicles that ply the Belt assisting homesteaders and delivering much needed supplies. In the recent past the Nine-Heads have worked alongside SARA and even earned the grudging respect of some LOPS agents.

## **Reds (The Red Legion)**

---

Members of the Red Legion are stalwart supporters of the 'Pristine Mars' movement. They believe mankind should have come here to study and observe. All industry, much settlement and all terraforming are abhorrent, unethical and wrong. Members of the Red Legion support the sabotage of such projects where lives are not put at risk. The Legion is connected to several eco-terrorist groups back on Earth. Crucial to the Red argument is the proposal that life that has been found on Mars, hidden away within its depths, is being influenced by human meddling, some species declining while others flourish in the artificially-induced wetter and warmer conditions. The Red Legion is a secret terrorist organization with members in many walks of life on Mars. The Reds find the Cydonians strange but useful allies.

## **Snakeheads**

---

With a long history of criminal activity, the Snakeheads crime syndicate had its origins in Fujian province, eastern China. The gang grew out of the racketeering of the Triads and made a name for itself at the end of the twentieth century as a people smuggling ring. This lucrative illegal business capitalized on the plight of the poor in developing countries (in particular China, but in more recent decades elsewhere around the globe) and their desire to move to a developed and prosperous nation.

The Snakeheads work as independent organizations that come under the umbrella of the Dragon King who is a shadowy hereditary figure whom the police struggle to identify, much less arrest. In these off-planet times, the Snakeheads have extended their criminal tentacles into orbit and beyond.

There are millions who want to leave Earth and make a fresh start on Mercury, Titan, Mars, L4 or L5, or one of the many inhabited moons of the solar system; but moving off-Earth is not as simple as the Utopian space pioneers of the 1970s envisaged. If you want a stake in the new future of mankind, you need to be assessed, tested, trained, retrained and retested. Education, talent and ability get you a long way through the training programmes - hard work and perseverance take you the rest of the way. The Snakeheads are able to bypass all of this nonsense and get someone into a job or a colony position as long as they have money. Members are able to bribe or intimidate officials, spaceport workers, dock managers and so on ... smuggling individuals, couples or families off Earth and into their dream assignment, perhaps that of a worker on an L4 colony or a spin gravity station, a miner earning big bucks on Io or Ida. Miners can sign up for lucrative contracts, earning many times what they could ever earn on Earth. The Snakeheads make it happen.

...or do they? For some, maybe, but new reports come in weekly of illegal migrants asphyxiated in a poorly maintained transport module, or indentured on some remote asteroid with no way to leave, or thrown out of an airlock as soon as money changes hands, or arrested by the colony police for carrying false papers and having no qualifications for the heavy equipment they are operating ... the horror stories are many. Yet the Snakeheads are never out of work, people pay



and the Snakeheads pull the strings that make the off-world illegal network operate. The desperate send their earnings back to family living in squalor back on Earth; in some cases a village may have clubbed together to sponsor a migrant – so great is the comparable wage they can send back.

## Tijuana Brothers

---

Why, when the North American Free Trade Agreement (NAFTA) bound Canada, Mexico and the USA into the largest trade bloc in the world, did Mexico end up as part of the Amazonian Union thirty years later? Blame the Tijuana brothers, two Mexican crime lords who run one of the biggest and most high tech crime syndicates in history. The Tijuana cartel, a Mexican gang active in the state of Baja back in the 2010s had moved into counterfeiting and by 2030 this had easily eclipsed its revenues from drugs. The gang wasn't just copying handbags, DVDs and iPods, though, but software, patents, genetic code and intellectual property. When human cloning hit the headlines in 2040, with the claims and counterclaims over the identity of the alleged human clone Lisbeth Stratton, the Tijuana brothers were involved in the cover up and the pay-offs of US officials. When the story broke, it transpired that Stratton *was* a clone (the first, and so far only, official human clone), but rumours have been rife for decades that the shadowy brothers who are rarely photographed have also been cloned. By 2042 the Tijuana syndicate had a fiefdom along the US border and paid the Mexican government for this privilege, using its proximity to the US border to smuggle in its low cost, high profit, fakes. In that year the US government, after applying intensive diplomatic pressure, decided to carry out cross-border strikes in order to neutralize the drugs and counterfeiting centres in the Tijuana 'kingdom'. This Baja Affair, which could have turned into conventional war, was averted by Matthias Vanderveen, the UN secretary-general, after he conducted a series of diplomatic shuttles between Mexico City and Washington.

Mexico was expelled from NAFTA for its intransigence, and as new regional economic organisations were established soon after during the creation of the Earth Union, the nation was allowed membership of the new Amazonian Union. The Tijuana brothers were able to survive the crisis and today continue to dominate the counterfeiting market, selling everything from GM crops to vacc suits, microchips to enhanced hormones. Baja still remains the heartland of the operation, but the syndicate can shift goods out as far as Uranus using its complex network of agents. And yes, the brothers must be pushing ninety, re-igniting the rumours of illegal cloning from sixty years ago... and creating speculation amongst some journalists that the Tijuana brothers' greatest counterfeiting scam might actually be human beings!

## 'TASTING FREEDOM'

*No-one could come into the desert and remain indifferent; its impact on the soul equalled its withering impact on the weak human body. Artists at Andamooka waxed lyrically about its primal beauty, day-trippers up from Adelaide wrote home about the infernal heat, while geologists and archaeologists admired its scientific purity.*

*Rahman certainly recognized its beauty. The sun was low in the west, the sky pale and washed out and the rolling desert glowed with tangerine hues. Acacia, salt bush and the odd eucalypt were starting to cast long shadows, though it was not yet dark enough to see stars. He could see the beauty but he felt the frustration of a prisoner. Trapped here for two days, in the same spot, he was beginning to crave colour, shade and shape - something that did not resemble dry, orange desert and yellow scrub.*



*A few metres away, on the slope of a low rise, Indah, his wife, drew shapes in the sand with a stick. He dare not ask her what she thought. This enterprise had been his idea, and she had gone along with it trusting in his good intentions and solid judgement. Yet Rahman was terrified that the plan to have them smuggled off-Earth would fail, if not here in the outback, then at the check-in, or up in orbit, or even, if they should ever reach it, the Asteroid Belt. On the huge krill ships forging through the north Pacific waters, stories were told by the workers on the 14 hour shifts of relatives who had gotten into space, out to the Belt, and fallen on their feet. Some were sending money back to Earth, some were moving on beyond the Belt.*

*Rahman and Indah had borrowed money from relatives to move to Australia, the past six months they had worked at the Olympic Dam mines. It had been hard work, with good pay, and they had been lucky to avoid the Australian labour officials, repatriating illegal workers. But now they were here, close to the biggest spaceport in south-east Asia, close to leaving behind them a life of unending poverty and desperate hard-work.*

*Behind Indah sat the six-wheeled camper they currently called home. It was an old Imperial, bloated and fat, with tall wheels that gave it the resemblance of a Martian rover. Vaas, their driver and snakehead contact, had unfurled the awning to provide shade and shelter while the camper waited.*

*Vaas was waving them now, calling them for supper. In his shirt and waistcoat, and long black hair pulled back into a pony-tail, the street poseur looked incongruous as the king of camping. Always smiling, the middleman had arranged for their transport to this forbidding rendezvous. He'd been well paid, Rahman knew that, yet the couple were utterly at his mercy, isolated and alone as they were in the middle of the Australian outback.*

*"Rahm," moaned Indah, "how long now? It's not the heat. I'm just not used to sitting around."*

*"I can't say. Vaas said he's waiting for a call from his contact inside the spaceport. Tonight or tomorrow he said, didn't he? Just a little longer baby." He stroked her hair. Big brown eyes stared up at him, that cute baby nose, framed by high cheek bones. Indah was Javanese, like Ramhan, but her mother's Chinese heritage dominated her good looks.*

*"I can't stand that camper van any more, and Vaas, well, he's just too ... cheerful..." She smiled at her husband, noted the lines of worry across his young face. Such a lot of worry, always worry. And more worry to come no doubt. The furrows melted into a smile, and the couple stood and turned toward the RV.*

*They sauntered back down the dusty slope until the sound of a low rumble stopped them. Looking west Ramhan could see the first star of the evening, blinking against the deep blue. And there, responsible for the low roar, two contrails on the horizon, rocket exhausts powering vertically up toward the heavens, golden rods of opportunity, spearheads leading to new worlds, to fortune and prosperity. At the tip of each plume, a spacecraft packed with supplies and colonists. Their gaze followed the rocket trails until their necks hurt and the plumes eventually drifted apart.*

*Indah squeezed her husband's hand, "Just a little longer".*

# 4 CHARACTER CREATION







Characters are created for the **Orbital** setting using the standard rules and careers found in the Traveller Main Book. Some of the careers exist in a slightly different form, however, or are renamed, while a number of others do not exist at all. This chapter looks at each of the relevant occupations and suggests how they might fit into the solar system setting of 2100 AD.

## SKILLS & CHARACTERISTICS

The character creation rules in the TMB provide a full explanation of how to determine a character's characteristics and how to run that character through a career in order to gain skills and earn promotions. The **Orbital** setting requires a change to Social Standing (TMB pg.5) and also the way in which background skills (TMB pg.6) are determined.

### Social Standing

In the Third Imperium, social standing of 12 or greater implies that the character is a noble with an official title, such as baron or duke. Such aristocratic titles are inappropriate for the world of 2100.

Instead it is better to see Soc ratings of 12 or more as an indicator of unusual power, fame, wealth or reputation. The player should select a family connection or avenue through which this wealth and prestige has been gained.

Family Connection	Mid-20 <sup>th</sup> Century Example
Corporate Leader	Howard Hughes
Celebrity	Marilyn Monroe
Member of Government	Robert Kennedy
Old Monied Family	Prince Rainier III of Monaco

### Background Skills

As explained in the Traveller Main Book, characters get a number of background skills equal to 3 + their education DM. These skills must be taken from one of the background categories in the accompanying table, the rest are spent on the education skills listed on TMB pg. 6.

Select a background, or roll 2d6.

2d6	Category	Skill
2-3	Earth Rural	Drive 0
4	Earth Slum	Streetwise 0
5	Orbital Colony	Trade: Hydroponics 0
6	Earth Metropolis	Computer 0
7	Earth Industrial Zone	Trade 0
8	Luna	Trade 0, Vacc 0
9	Mars	Survival 0, Vacc 0
10	Titan	Survival 0, Vacc 0
11-12	All other stations, habs, colonies and outposts	Vacc 0

## SELECT A CAMPAIGN

Referee and players should decide what type of campaign they wish to play. **Orbital** is written with the transport, rescue and salvage theme in mind, but others are possible. The transport, salvage, science and mining campaign concepts are fleshed out in greater deal in chapter 11, Running Orbital. Each type of campaign is best played with characters suited to it.

- Transport, Rescue & Salvage
- Science & Exploration
- Investigation, Espionage & Crime
- Mining and Colony Survival
- Military





### Transport, Rescue & Salvage

**Orbital** is written with the transport campaign in mind. PCs are independently-minded space crew, either from a commercial, science or military background. They fly spacecraft out into the black, ferrying unique and specialized cargoes insane distances. Out in the far reaches of the system, they are on their own when things go wrong. And things always go wrong...

Career	Traveller Equivalent
Commercial Spacer	Merchants:Merchant Marine
Free Trader	Merchants:Free Trader
Broker	Broker
Space Agency: Flight	Scout:Courier
Space Agency: Colony	Scout:Survey
Space Force:Crew	Navy: Line/Crew
Space Force:Engineering	Navy: Engineering
Space Force:Flight	Navy: Flight

### Science & Exploration

Science teams and explorers can visit remote moons, land on newly discovered comets or drill for life on moons. Characters in this setting may take passage on a chartered transport, or may have their own Deep Space Research Vehicle.

Career	Traveller Equivalent
Scientist	Explorer:Scientist *
Civil Engineer	Explorer:Civil Engineer *
Surface Operator	Explorer:Surface Ops. *
Space Agency: Flight	Scout:Courier
Space Agency: Colony Support	Scout:Survey

\* New career, see below

### Investigation, Espionage & Crime

If the players don't want to fly spaceships, then a life of intrigue, deals and espionage might suit instead. PCs might be government secret service agents, corporate spies, criminals or police investigators. They travel incognito as passengers, uncovering plots and investigating murders, spy rings and sabotage...

Career	Traveller Equivalent
Law Enforcer	Agent:Law Enforcer
Government Spy	Agent:Intelligence
Corporate Spy	Agent:Corporate
Thief	Rogue:Thief
Enforcer	Rogue:Enforcer
Journalist	Entertainer:Journalist

### Mining & Colony Survival

A campaign might focus on the plight of some remote colony. The PCs are key individuals, either colony leaders, miners or colony workers with prominent roles. What catastrophe or challenges the colony must weather is determined only by the dark imagination of the referee. Alternatively the PCs might be miners out in the Belt with their own deep space mining vehicle, trying to make that one big score.

Career	Traveller Equivalent
Colonist	Citizen:Worker
Belt Miner	Drifter:Scavenger
Colony Administrator	Citizen:Corporate
Civil Engineer	Explorer:Civil Engineer *
Law Enforcement	Agent: Law Enforcement
Surface Operator	Explorer:Surface Ops. *

\* New career, see below

### Military

Although the focus of the game is purely civilian, there is a great deal of military activity in the post-Cold War period. PCs could be special force Luna marines, the crew of an Earth Union patrol vehicle or a unit of Martian mechanised infantry tracking a sneak Lunar sabotage squad. Many of the Traveller books and supplements will be helpful here.

Career	Traveller Equivalent
Space Force:Crew	Navy: Line/Crew
Space Force:Engineering	Navy: Engineering
Space Force:Flight	Navy: Flight
Army:Support	Army:Support
Army:Infantry	Army:Infantry
Army:Cavalry	Army:Cavalry
Marines:Support	Marines:Support
Marines:Space Marine	Marines:Space Marine
Marines:Ground Assault	Marines:Ground Assault



## SELECT A CAREER

**Army:Support** – These are the army's technical experts, engineers, mechanics, signallers and medics etc. Only Earth and Mars have armies.

**Army:Infantry** – The infantry take ground and occupy targets, clearing out enemy infantry in turn. Only Earth and Mars have armies.

**Army:Cavalry** – Cavalry ride in tanks or APCs, and provide a mobile element to any force. Only Earth and Mars have armies.

**Belt Miner** – Mining in zero-G is hazardous. Belt miners live and work in space, hoping to strike it lucky on an asteroid, or just survive to the end of their contract on some big corporate drilling rig.

**Broker** - Interplanetary commerce is handled by brokers, commercial experts based at spaceports, stations and trading posts. They may work freelance or act as representatives for big corporations like Ellis-Itami or Baospace.

**Civil Engineer** – Colony projects require good engineers capable of overcoming all kinds of technical, man-made and natural obstacles.

**Colonist** – These guys live and work in space or on planets, growing crops, maintaining life support systems and fabricating new habs, rovers and spare parts in order to maintain their survival on a hostile world.

**Colony Administrator** – Colonies grow and soon require managers and supervisors capable of providing leadership able to tackle a myriad of deadly threats to the colony's existence.

**Commercial Spacer** – With the privatization of space travel in the 2010s, civilian astronauts began to be trained. In 2100 AD these 'space truckers' crew the freighters, transports, liners and mining vehicles that criss-cross the solar system.

**Corporate Spy** – Large corporations need to find out what the opposition is up to, and sometimes steal or sabotage that work. Corporate spies are the long arm of a corporation, capable of reaching any facility or world to spy for the company.

**Enforcer** – Organized crime has followed explorers and astronauts into space. An enforcer is an agent of a group like the Triads or Snakeheads, and capable of intimidation, bribery and violence.

**Free Trader** – Some commercial transports are privately owned, and the crews all hold a share in the business venture. The crews of such vehicles are called free traders.

**Government Spy** – The Cold War bred countless secret agents, spies, moles and contacts that still proliferate. Both the Lunar and the Earth Union secret services still maintain active espionage networks to counter the efforts of the other. For these guys, the Cold War never ended...

**Journalist** – Cover-ups, fraud, military incompetence, industrial accidents, embezzlement and a host of other crimes need uncovering. Journalists can make it big investigating a story that the establishment want buried. They have the skills to dig up the truth.

**Law Enforcer** – Eventually, all colonies require law officers, either recruited locally from trusted individuals, or sent from a distant authority such as a national government or corporate headquarters. Agents of SARA and LOPS, LunaPol and the Martian Rangers are all law enforcers.

**Marines:Support** – Support from engineers, technicians, com specialists and artillery experts keep the Marine infantry in the field.

**Marines:Space Marine** – These marines specialise in zero-G combat, in boarding actions and the security of deep space military vehicles. Military craft often carry a contingent of space marines.

**Marines:Ground Assault** – Luna and Earth both train and maintain units of ground assault marines who are capable of landing on foreign soil and taking defended positions. They are equipped with APCs and backed up with artillery and heavy weaponry. They are garrisoned on planet.

**Scientist** – Scientists investigate new phenomena, conduct experiments and travel to distant worlds in order to take samples and image landscapes and geology. They must be self-reliant and adaptable.

**Space Agency:Flight** – Both Luna and Earth maintain government space agencies, much like NASA or the ESA. Flight crew man the exploratory craft that conduct research, and transport science teams to distant worlds.

**Space Agency:Colony Support** - Both Luna and Earth maintain government space agencies, much like NASA or the ESA. Colony support crews ferry supplies and colonists out to new outposts or space stations. They are not just space pilots and astrologators, but also problem-solvers, fixers and diplomats.

**Space Force:Crew** - The military space forces of Earth and Luna are equipped with powerful armed and armoured deep space vehicles (DSVs). On large DSVs crewmen are needed for all kinds of positions, from sensor or coms operator to logistics officer, mechanic and weapons operator.

**Space Force:Engineering** - The military space forces of Earth and Luna are equipped with powerful armed and armoured deep space vehicles (DSVs). There are numerous technical jobs aboard, including the all-important flight engineer.

**Space Force:Flight** - The military space forces of Earth and Luna are equipped with powerful armed and armoured deep space vehicles (DSVs). Flight crew are the pilots of shuttles, interceptors and DSVs.

**Surface Operator** – Surface exploration of a world requires the skills of a surface operator, someone skilled in the use of vacc suits, rovers, field equipment and survival equipment. Every mining expedition or science team includes a few surface operators to keep everyone safe.

**Thief** – Low-lifes, con-men, hustlers, snakeheads, hackers, pimps, forgers and smugglers have made it to the colonies, often taking up some dead-end job as a cover. Pray your life doesn't one day depend on one of these scum-bags.





# EXPLORER

Individuals selected as explorers are all field researchers. Whether it's setting up weather stations, digging bore holes or laying pipelines through unstable fracture-zones, the explorer lives and works on the surface of a moon or planet. He or she is tough, single-minded and resourceful; above all he is a team player, able to work in co-ordination with members of a small team for long periods of time.

**Qualification:** Int 6+

-1 DM for every previous career.

## CAREER PROGRESS

	Survival	Advancement
<b>Science</b>	Edu 4+	Edu 8+
<b>Civil Eng.</b>	Edu 4+	Int 9+
<b>Surface Ops</b>	End 6+	Edu 7+

## MUSTERING-OUT BENEFITS

Roll	Cash \$	Other Benefits
1	5,000	+1 Edu
2	20,000	Ally
3	20,000	Contact
4	30,000	Scientific Equipment
5	30,000	+1 Int
6	50,000	+1 Soc
7	500,000	+1 Soc

**Assignments:** Choose one of the following:

**Science:** You are a scientist with extensive knowledge of a scientific discipline.

**Civil Engineer:** You are a highly trained engineer and hands-on problem solver.

**Surface Ops:** You are trained to assist Martian field research, operating equipment and spearheading expeditions into the Martian outback.

## SKILLS AND TRAINING

Roll	Personal Development	Service Skills	Advanced Education (Minimum Edu 8)
1	+1 Int	Science (any)	Admin
2	+1 Edu	Investigate	Language (any)
3	+1 Dex	Vacc Suit	Navigation
4	+1 Edu	Drive or Flyer	Computers
5	+1 End	Computers	Engineer (any)
6	Jack of All Trades	Comms	Science (any)

Roll	Specialist: Science	Specialist: Civil Engineer	Specialist: Surface Ops
1	Investigate	Mechanic	Medic
2	Science (see below)	Engineer (see below)	Survival (see below)
3	Science (see below)	Sensors	Survival (see below)
4	Science (see below)	Engineer (see below)	Drive or Flyer
5	Navigation	Trade (see below)	Recon
6	Vacc Suit	Engineer (see below)	Remote Operation

Rank	Explorer	Skill or Benefit
0	Researcher	
1	Team Leader	Investigate 1
2	Assistant PM	
3	Project Manager	Computer 1
4		
5	Assistant Director	
6	Director	



## MISHAPS

### 1d6 Mishap

- 1 Injured. Roll on the Injury table.
- 2 A disaster leaves several injured and others blame you, forcing you to leave your career. Roll on the injury table twice, taking the higher result, and gain a Rival.
- 3 The expedition is forced to use illegal methods to gain its data, and when it comes to light, you are put on trial. Your employer cannot condone your actions and its lawyers cannot save you! You are forced from the institute and spend a spell of time in prison. Reduce your Soc by 2, but gain Streetwise 1. Do not collect Benefits from this career.
- 4 An expedition is cut off due to unforeseen events, and the team must somehow make its way back to civilization. Gain one of Survival 1 (any) or Drive 1
- 5 Your research is hot! Your employer dare not reveal it to the international community suppress all of your data. You are forced out to keep you quiet, but you gain an additional Benefit roll.
- 6 Your work is sabotaged by a rival group, team members blamed and data destroyed. You may start again, losing Benefits for this term but able to continue within your employer, or you can salvage what you can (i.e. retain this term's Benefit roll but leave the career).

## EVENTS

### 2d6 Events

- 2 Your recent research has been good and your recommendations to solve a problem have been implemented. Gain a +2 DM on your next Advancement roll.
- 3 A previous institute team fouled up, and you are sent to make amends. Gain a Rival.
- 4 You are asked to write a paper on some of your research and present it to an international conference. Gain +1 Edu.
- 5 You are asked to critique the research of another member of the organisation. Roll Edu 10+ to spot the flaws, and if successful gain one level in any Science skill.
- 6 Adaptability is important in this career so you pursue some cross-training. Roll on a Specialist Skill table for an assignment other than your own.
- 7 Life Event
- 8 You discredit the work of another scientific organization that has already studied the problem. Gain an Enemy.
- 9 A media team wants to make a documentary about your exploits. Gain Art (Imaging) 1, or a Contact.
- 10 You are forced to justify your research in front of a panel of independent scientists, roll Edu 10+ or suffer -1 on your next Advancement roll.
- 11 The media paint your team as partisan supporters of an extreme group, such as the Reds, Reproductionists or Voyagers. Roll Advocate 9+ or suffer -1 on your next advancement roll.
- 12 Miners call upon the team to investigate illness amongst their number. Gain a Contact.

## SKILL SPECIALITIES

**Drive:** There are no Drive specialities. Drive includes all wheel and track based vehicles.

**Engineer:** The following engineering specialities exist -

**Electronics**

**Life Support**

**Power**

**Flyer:** There are no Flyer specialities.

**Language:** Common 2100 AD languages are English, Russian, Japanese, Chinese, Hindi, Malay and Arabic.



### Science:

**Archaeology** - The study of ancient cultures. On Mars archaeologists study the alien remains found in the Cydonian region, there may be ruins elsewhere in the solar system. With only structures and artefacts of this long dead alien civilization left to study, archaeology has become an invaluable subject.

**Astronomy** - Astronomy is the study of stars, galaxies and other observable phenomenon. It is also the study of asteroids, meteoroids, orbits, comets, the Sun and its cosmic radiation. An astronomer is skilled with optical and radio telescopes.

**Biology** - Biologists study the processes of life and on Mars they look at the development of plants and animals brought here. They also study primitive life discovered on Mars, Venus and Europa. Biologists have a great knowledge of the diversity of life forms back on Earth.

**Geomorphology** - The interpretation of land-forms such as ridges, canyons, craters, valleys and a multitude of surface features. On most airless worlds, without oceans or vegetation to cover the surface, there is plenty to study! Importantly, the geomorphologist can explain the processes that created many land forms, and often these involve wind-blown dust, meteor impacts, volcanism or (on Mars and Titan) the action of rivers and lakes.

**Geophysics** - This is the study of the global or planetological whole. The structure of planets and moons interest a geophysicist, their internal make-up, the earthquakes which shake them, ancient or recent volcanoes which rise up out of them, the effects of rotation and orbital tilt, of magnetic fields and gravity. Geophysics is the 'big picture'.

**Glaciology** - The study of ice masses and polar ice caps. Glaciologists study the frozen environment, the effects of ice, and the widespread phenomenon (on Mars) of frozen ground water (permafrost).

**Meteorology** - The study of atmospheric conditions, of winds, dust-storms, cloud formation, climate change and frost formation. Several worlds boast atmospheres worthy of study including Earth, Venus, Titan and Mars, as well as the gas giants with their 'extreme weathers...'

**Petrology** - The study of rocks in all their aspects, including rock types, mineral composition and chemistry, origins, metamorphic changes, usual occurrences and the relationships to other rock types. Petrology is the prime subject of a mining geologist.

**Stratigraphy** - The study of historical geology, of stratified rocks, their sequencing in time and the correlation of different rock beds in different locations. A stratigrapher is a detective who can interpret the rock layers to explain the exact sequence of geological events - to say what happened when and how this relates to other structures in the area.

### Survival:

**Caving** - Knowledge of cave formation and layouts, of cave hazards and how to overcome them. A caver is familiar with climbing and rappelling gear as well as safety techniques.

**Desert Survival** - Knowledge of the hazards of travel and survival in the arid deserts of Earth and Mars.

**Mountaineering** - Knowledge of mountain slopes, climbing techniques and route-finding, of mountaineering hazards and how to overcome them. A mountaineer is familiar with climbing and rappelling gear as well as various safety techniques.

**Polar Survival** - Knowledge of the hazards of travel and survival on the frozen ice caps at the north and south poles of Earth and Mars as well as the ice caps of distant moons.

### Trade:

**Construction** - The theory and practice of civil engineering. The construction engineer can envisage a construction project (a habitat, bunker, airstrip or road, for example), draw up plans and costings and then oversee the actual construction by a crew or robots.

**Biotechnology** - The relatively new technology of biologicals includes DNA work, retro viruses and other bio-modification. It is in its very early days and on a small scale, far from the lofty goals of transhumanism! This industry is mainly used to modify crops for survival in hydroponics units on large scale colonies, or on the Martian surface.

**Hydroponics** - Construction and maintenance of enclosed self-sufficient greenhouses that have become crucial to life on many worlds, and as a life support system on deep space vehicles.

**Materials Technology** - Knowledge of the chemical makeup of industrial materials including glass, acid, steel, polymer and a hundred other materials. The character is able to create a desired substance provided he has suitable equipment (typically a workshop or auto-factory) on hand. This specialism incorporates industrial chemistry as well as metallurgy.



# MILITARY & SPACER RANKS

Ranks for the military careers (Marines and Army) and those involving spaceflight organizations (the Merchants, Navy and Scouts) will use new, setting specific, rank tables as presented below.

## Space Force

Rank	NCO	Lunar Officer	Earth Union Officer
0	Crewman		
1	Senior Crewman	Lieutenant	Lieutenant
2	Corporal	Flight Lieutenant	Flight Lieutenant
3	Sergeant	Major	Squadron Leader
4	Flight Sergeant	Lieut. Colonel	Wing Commander
5	Master Sergeant	Colonel	Group Captain
6	Sergeant Major	General	General

## Army/Marines

Rank	NCO
0	Private
1	Lance Corporal
2	Corporal
3	Sergeant
4	Staff Sergeant
5	Master Sergeant
6	Sergeant Major

Officer
Lieutenant
Captain
Major
Lieut. Colonel
Colonel
General

## Commercial Spaceline

Rank	Title
0	Crewman
1	Senior Crewman
2	Fourth Officer
3	Third Officer
4	Second Officer
5	First Officer
6	Captain

## Space Agency

Rank	Title
0	Crewman
1	Senior Crewman
2	Flight Officer
3	Senior Flight Officer
4	Department Chief
5	Executive Officer
6	Captain

## Law Enforcement

Rank	SARA
0	Asst. Deputy
1	Deputy
2	
3	Marshal
4	Senior Marshal
5	Chief Marshal
6	Commissioner

LOPS
Patrol Agent
Senior Patrol Agent
Lead Patrol Agent
Watch Supervisor
Watch Commander
Deputy Div. Chief
Division Chief

# MUSTERING OUT

In a typical Traveller game characters must muster out *before* the game begins. In **Orbital**, it is more likely that characters will still be in employment within their chosen career. Player's may finish character generation at any desired point and have their characters join the game, although an aging crisis or some events may also indicate a character has left the character generation process and begun the game.

At mustering out, roll **once** on the appropriate cash table for the career, but award only 10% of the value. In addition, roll only **once** on the accompanying universal benefit table. Do not use the benefits table for the character's chosen career that appears in the Traveller Main Book.

## UNIVERSAL BENEFITS TABLE

Roll	Other Benefits
1	Weapon
2	+1 Int
3	+1 Edu or +1 End
4	+1 Soc
5	Contact
6	Ally
7	+1 Soc

## NIKOLAY KAMOV: SAMPLE CHARACTER

I roll C85B77 for Nikolay and a quick roll tells me he is from a metropolis on Earth, I choose Volgograd. Nikolay is a big guy and clever, yet didn't pursue university education. I'd like him to be a cop, maybe a SARA agent, but first he needs some life experience. Nikolay joins a commercial spaceline, Interkosmos, as soon as he can. Although he gains some training in vacc suits and in piloting spacecraft, his career is cut short when a crime syndicate forces Interkosmos out of business. The legal trouble that he is landed in, forces Nikolay to learn the ropes of space law in a hurry and his next career choice is easy: the Space Activities Regulatory Agency (SARA). He has developed an interest in space law and has a real motivation to tackle crime, it isn't revenge, Nikolay is too level-headed for that.

He serves three terms in SARA (I use the Agent career) and is promoted every term, entering the game as a marshal.

In term one Nikolay establishes a network of contacts and learns basic investigation and computer skills. In term two he toughens up (+1 End) as one of his investigations turns dangerous and ends in disaster. He trips over a conspiracy on Mars and gets off the planet to save his life. Agents within the government of Mars want Nikolay dead.

In his last term he gains some advanced training and learns how to gain entry to a spacecraft from outside (+1 Vacc Suit). Nikolay is promoted to marshal with a roll of 'double 6', perhaps indicating that he was decorated for bravery on a particularly audacious collar of a Snakehead gang-lord.

Today Nikolay is known as a reliable and tenacious agent who may turn up anywhere in the solar system in his pursuit of organised crime. Like other plain-clothes agents he travels by commercial liner and may even take passage on the PCs spacecraft with some of his incognito deputies. On Earth Union territory, including that of corporations registered with the EU, he can temporarily deputise civilians and also commandeer vehicles and other assets in the pursuit of criminals.

Nikolay Kamov is six feet tall. He has close cropped blonde hair with a long asymmetric fringe. His chiselled face and blue eyes are striking, as his physique which he must devote much gym time to retaining, since space travel encourages muscle wastage. He favours a short grey jacket worn with black combat trousers.

Nikolay enjoys conversation and seems a good judge of character. He has a lot of respect for spacers since he is a qualified pilot himself. He never discusses details of a case unless it is to a trusted ally, deputised civillian or contact.

**Marshal Nikolay Kamov** C86B78 Age 34 4 terms Cr2,500  
Computers 2, Vacc suit 2, Pilot 1, Deception 1, Investigate 1, Advocate 2, Streetwise 3  
Contacts 3, Enemies 1 (Mars government conspiracy group)

# 5 SPACECRAFT DESIGN

Spacecraft form an integral part of **Traveller**, and although the craft in **Orbital** are a little different from those in the Traveller Main Book, they are just as important to the setting and to the adventures that take place there. Before we look at the types of spacecraft that exist in 2100 and how to design them, a quick primer on those important differences is in order. **Orbital** is set in 2100 and this equates to TL 9 (with TL 11 in computing and electronics). This isn't the Official Traveller Universe, however; anti-gravity propulsion and the jump drive that was derived from it do not exist in this setting. It is TL 9 without those innovations. Where does this leave the spacecraft of our setting? For one thing, they are trapped inside our solar system. There are no trips to other stars, a journey out to Neptune or Pluto is a long, long voyage. There are still a lot of worlds to visit, probably as many as in a traditional Traveller subsector, but these are mainly moons along with a handful of planets.

The biggest difference in space technology is the absence of anti-gravity. Ships require the use of fuel-hungry reaction rockets similar to those in use today, and they follow orbital paths familiar to NASA mission planners. Not only are the drives different but the lack of on-board anti-gravity means that crews must operate in zero-G throughout the mission. The only way to mitigate this is the installation of spin habitats, or rotating sections of the spacecraft, that 'simulate' gravity. Several movies have shown us what ships or space stations employing this type of technology might look like.

Traveller split spacecraft into two easily defined types; small craft (without jump drives and under 100 tons) and starships (100 tons or larger, and incorporating a jump drive). **Orbital** does something similar. We have orbital vehicles (under 100 tons, using regular chemical rockets) and deep space vehicles, or DSVs, which are 100 tons or greater and fitted with powerful nuclear thermal rockets. These are the equivalent of **Traveller** 'starships' and form the focus of most games. Orbital vehicles are just that, ancillary craft, landers, and orbital shuttles which allow characters to leave the DSV and land on a planet, visit a station or go to the aid of a crewman on a doomed spacewalk.

## DESIGNING DSVs

Vehicles travelling the long distances to other planets are radically different to the short-range orbital craft in use in 2100. Fuel cells and solar powers are replaced with a nuclear fission reactor, and puny chemical rockets are replaced with a more powerful nuclear thermal rocket that is built around the reactor. Long journey times typically require spin capsules that create an artificial gravity for the DSV crews. Craft like this have not yet been built, but several designs for missions to Mars have appeared on drawing boards over the past few decades. The latest in-house NASA design is Nautilus-X, a manned interplanetary explorer. **Orbital** allows referees to design DSVs using the *Traveller Main Book* only (pg.105), although a number of additional options (all TL 9, with TL11 for electronics) can be found in *High Guard*, if desired. In an attempt to simplify the calculation of journey times across the solar system, this design system *does not* use the rules for reaction drives provided in *High Guard*. Several modifications are required to the established Traveller construction rules, these changes are given below.

## DESIGN CHECKLIST

1. Hull. It will be distributed, and may have armour or be self-sealing.
2. Drives. Decide on the DSV's delta-V to determine the drive number of the NTR. In addition, set the powerplant to the same number. Purchase drives accordingly.
3. Fuel. The fuel tank requires tonnage of  $0.1 \times M \times J_n$ .
4. Flare damper. Always fit this essential piece of equipment.
5. Bridge. Install a bridge.
6. Computer. Install either a Model/1, Model/2 or (rarely) a Model/3 computer.
7. Electronics. Fit the DSV with an electronics package of TL 11 or less.
8. Cargo Hold. Assign tonnage for cargo; even war craft will require several tons just for supplies, spares and carrying emergency equipment.
9. Other Components. Consider extras such as modules, hydroponics, fuel processors, luxuries, and workshops.
10. Calculate crew requirements and then allocate  $\frac{1}{2}$  stateroom to each. On large DSVs the commander, exec and perhaps the department heads may get their own stateroom. Middle passengers are expected to share, while high passengers receive a stateroom to themselves.
11. Low berths may be included for passengers travelling in cryogenic suspension. In addition, you may want to provide some low berth capacity for the crew in emergency situations.
12. Consider a medlab bay.
13. Provide spin gravity for accommodations and the medlab.
14. Install turrets or bays if required.
15. Add weaponry if turrets or bays were fitted.
16. Add tonnage of all components. Does it all fit? If not make some hard choices, if there is a surplus then this can be used to add to cargo capacity or perhaps accommodate more options.
17. Total the cost and note the time required for construction.

## The Hull

Since launch vehicles from Earth struggle to reach orbit with anything greater than 100 tons, there is little use in building a streamlined DSV; it would never reach orbit again. As a consequence, all Deep Space Vehicles utilise distributed hulls. They are all unstreamlined.

## The Engineering Section

Drives and the power plant are installed in the engineering section. The powerplant is a TL 9 fission reactor as described in the Traveller Main Book, and the manoeuvre drive is a powerful reaction rocket that uses the heat of the powerplant to accelerate hydrogen propellant as a reaction mass. It is an expensive device and uses a massive amount of fuel; **Orbital** simulates the nuclear thermal rocket (NTR) by simply using all of the details of the standard Traveller jump drive. DSVs, then, have a fission powerplant and a reaction drive that uses the statistics of the standard jump drive. The Traveller manoeuvre drive does not exist in this setting.



### Nuclear Thermal Rocket (NTR)

This rocket motor has the same costs and tonnage as a jump drive from the Traveller rules. Various real-world nuclear thermal rocket (NTR) designs have been on the drawing boards since the 20<sup>th</sup> century, including the NERVA, Project Rover, the Soviet Kosberg RD-0410 and the cleverly designed TRITON. It is assumed that in 2100 a highly efficient descendant of these prototypes is in use, perhaps a gas-core NTR (GCNTR) which has a 'clean' (non-radioactive) exhaust. It is a type of nuclear thermal rocket that separates the nuclear fuel from the propellant with a quartz wall. The core of a 'nuclear light bulb' NTR is molten, and can operate at temperatures in excess of 25,000 °C.

This design system uses the NTR's drive's Jump number (Jn) to determine the distance covered by the spaceship in one month. The Jump number equates to a drive rating called delta-V, put simply it is a measure of the DSV's acceleration. These craft will coast without thrust for most of the journey and so it is the delta-V during acceleration and deceleration which really determines how long that journey will last. Delta-v values and travel times are given in the table (below). Delta-V is given in kilometres per second.

Drive Jn	Delta-V	Distance/ Month in Mkm
1	50	120
2	65	160
3	80	200
4	95	240
5	110	290
6	125	330

### Powerplant

A nuclear fission gas core reactor is crucial for long-term power, and it forms the heart of the nuclear thermal rocket. Liquid hydrogen is sent through the reactor and, superheated, it expands out of the reaction chamber to push the spacecraft forward. Without it the drive does not function. When the NTR is shut down (for coasting in space), the powerplant switches to a power generation mode. As hinted in the *Traveller Main Book*, and clarified in *High Guard* (p.42), simply double the size and cost of the fusion powerplants listed in the core book. Powerplant number must equal or exceed the NTR's Jump number.

### Fuel

Total fuel storage must be indicated in the design plans.

- **NTR Fuel:** The NTR has the same fuel requirements as the Traveller jump drive. Liquid hydrogen fuel for the NTR takes up considerable space, equivalent to standard jump fuel requirements (0.1 x M x Jn).
- **Powerplant Fuel:** Nuclear reactor fuel is made up of enriched uranium pellets, this fuel is rarely replaced. Assume that new uranium fuel is installed during the 5-yearly maintenance (which must, due to long travel times, replace the *annual* Traveller ship maintenance). There are no other powerplant fuel requirements.

### Flare Damper

The flare damper or Generator-Magnetospheric Field (GMF), is included as part of the engineering equipment on all DSVs. Essential for travel through Jupiter or Saturn space, the flare damper creates an artificial magnetosphere around the vehicle which diverts high speed radioactive protons and protects the crew from deadly radiation. The fission reactor easily has enough excess power to run the GMF. Spinning space stations are also fitted with a flare damper, allowing them to be located in high orbits outside of the Earth's protective magnetosphere.

Note that smaller orbital vehicles also include a flare damper, though this draws so much power from fuel cells that it can only be used for 6 hours, making it useful for protection against solar



flares, but not against the continuous bombardment of radiation in the Jupiter and Saturn systems. Landers, however, are able to utilise the 6 hour GMF duration to deorbit and land within these hostile systems, but the work of other orbital vehicles is carried out by 100 ton DSV ferries dedicated to the Jupiter/Saturn environment. Fitted on a DSV, a flare damper masses 1 ton and costs MCr1. Fitted on an orbital vehicle, a flare damper masses 100kg and costs Cr60,000.

## The Control Section

A DSV's control section contains the bridge and associated components.

### Bridge

As core book.

### Computer

As core book. Model/1 or Model/2 computers are required for all spacecraft; advanced 'next generation' Model/3 computers are available for the newest military DSVs.

### Electronics

As core book, use any electronics system up to and including TL 11.

## The Equipment Section

### Cargo Hold

As core book. A DSV's cargo hold is used for supplies, equipment and items integral to the DSV's mission. Like most of the vehicle, the hold is typically a zero-G environment, and palletized cargo is strapped to all walls and other surfaces of the hold with tension rigs, or is held in place on a ratchet system, similar to that found in modern cargo jets.

Smaller cargo amounts are packed into zippered Cargo Transfer Bags (each holding up to 20kg) which prevent small items drifting away. CTBs allow rapid transfer of small items without fuss and are rectangular in shape which allow them to be slotted into any available cargo rack. These racks feature CTB-shaped spaces that are often mounted on the walls of cargo holds.

### Modules

Many DSVs are fitted with docking clamps that allow them to carry 10-ton modules of various types, depending on the DSV's mission. Some of the 'mission configurable' Deep Space Vehicles are able to easily swap out two cargo modules for two science modules, for example. At least one docking clamp is required in order to carry modules, vehicles carrying several may need a grappling arm too, which allows them to dock and undock modules without assistance from space station personnel. Modular clusters are several modules (typically 5) arrayed like the spokes of a wheel, connected together at a central hub which is then attached to a larger type of docking clamp on the spacecraft. Airlocks are fitted to the docking, science, workshop, low berth and micro smelter modules. More information on module clusters is provided later in the Hardware chapter.

### MODULE TYPES

Module Type	Price
Docking Module	MCr2.6
Rover Module	MCr1.05
Hab Module	MCr2.5
Science Module	MCr3.24
Office Module	MCr1.03
Workshop	MC2
Power/Fuel Cell Module	MCr4.09
Power/Fission Module	MCr8.57
Laser Module	MCr7.8
Missile Module	MCr3.88
Passenger Module	MCr1.46
Low Berth Module	MCr2.06
Cargo Module	MCr1
Transhab	MCr4.9
Micro Smelter	MCr 4
Hydroponics Unit	MCr3.05

### ACCESSORIES

Grappling Arm	2 tons	MCr 1
Docking Clamp (per 10 ton module)	1 ton	MCr 0.5
Docking Clamp (per 50 ton module cluster)	5 ton	MCr 1



### **Fuel Processors**

As core book. Liquid hydrogen must be tanked on-board at space stations and refuelling points. However, some DSVs that are involved in asteroid mining are able to process ice to create liquid hydrogen using fuel processors. They will also require landing legs and mining drones.

### **Luxuries**

As core book.

### **Ship's Locker**

As core book.

### **Workshop**

Many interplanetary craft are able to repair even the biggest system failures on their own, since they are out of touch of repair yards and ports for months if not years. DSVs can dedicate several tons of their internal space to a workshop, typically equal to 2% of its hull size (maximum 6 tons). Now even if the fission reactor itself is 'damaged' the crew have the ability to fabricate most of the parts they need to fix it, as described on TMB p.143. The workshop costs MCr 0.5. Note that each ton assigned to the workshop provides the DSV with a ton of spare parts.

### **Storm Shelter**

A safe-room, or storm shelter, shielded against solar flare radiation by thick cavity walls filled with water or sand, is a common feature of many DSVs. This acts as a back-up to the ubiquitous flare damper and helps to protect against the most serious of solar storms. A safe-room is built as a 4 ton stateroom, and can house 8 passengers for 12 hours. Multiple safe-rooms may be needed, or just a partial-tonnage safe-room. Each costs MCr 1.0 and acts as additional rest area or gym space when not in use.

### **Landing Gear**

Although expensive and bulky, some DSVs have a requirement to land on asteroids or small moons. To do this they need landing legs and suspension, as well as braking rockets and compressed-gas activated pitons and cables, in order to anchor the spacecraft in a low-G environment. Landing gear takes up 10% of the vehicle's mass at a cost of MCr1 per ton of equipment. See the section on

### **Hydroponics**

Many ships carry hydroponic gardens or farms to help shoulder the life-support load or as decorative or recreational hydroponic gardens.

**Garden** displaces 1 ton per person it supports, and cost MCr 0.25 per person. It includes a limited variety of plant life and serves as both decorative-recreational facilities, as a source for fresh fruit, vegetables and spices and also assists the life support system by producing some foodstuffs and helping recycle air and water. Reduce the monthly life support costs of any person supported by partial hydroponics by 50%. Partial hydroponics requires 2 kg of additional nutrients, seeds and spare parts (costing Cr 300) per month per person it supports. Does not require a dedicated crewman.

**Farm** is a full-scale, closed-circuit shipboard biosphere. It displaces 2 tons per person it supports and costs MCr 0.5 per person. It includes organisms ranging from bacteria and yeast to higher plants and animals, and is capable of providing all the life support and food requirements of any person supported by it. Life support costs are not paid for each person that the farm supports. Full hydroponics requires 1 kg of nutrient replacements and spare parts (costing Cr 200) per month per person it supports. A farm requires the services of one or more dedicated, crewman; 1 level of Trade (Hydroponics) is needed for every 20 tons of farm installed.



## Vehicles and Drones

Drones are available as per the core book, but small craft must be selected from the list of orbital vehicles given here in **Orbital**. Drones are only semi-autonomous, more akin to modern remotely operated vehicles (ROVs). Orion capsules are often used as lifeboats or as emergency orbital runabouts. So many were produced in the 2020s by the USA for itself and allies and the design was so successful that it is still in service today, in the same way that Cessna's 172 was first flown in 1955, but is still rolling off the production lines in 2013, fifty-eight years later! Escape pods are not used by any DSVs or space stations. Safety procedures recommend staying with a stricken vessel where life support and power may be found or restarted, as an alternative to 'jumping overboard' into the vast emptiness of space with only two hours of oxygen. As a consequence the rescue bubble and other types of escape pods are never installed. Instead, the rescue bubble (TMB p.97) makes a wonderful emergency spacesuit for children, the elderly or infirm, those who are injured and anyone who lacks training in the use of a pressure suit, such as passengers on a commercial liner.

Orbital Vehicle	Tons	Cost (MCr)
Spider Light Lander	5	8.16
Palomino Heavy Lander	10	7.29
Skycrane Module Lander	10	16.52
Orion Transfer Pod	5	1.98
Long Beach Transfer Shuttle	20	16.61
Taurus Light Tug	10	14.52
Argus Heavy Tug	55	43.94
Star Sabre Interceptor	5	5.36
Spaceplane	40	40.30
Venus Dart	80	38.80

## Crew Requirements

The crew requirements for deep space vehicles are broadly in line with those provided in TMB p.113, with a number of minor changes.

Traveller Position	Orbital Title	Civilian Requirement	Military Requirement
Captain	Command-Pilot	1	1
Pilot	Pilot		2
Astrogator	Astrogator	1 per craft of 200 tons+	1 per craft of 200 tons+
Engineer	Flight Engineer	1 per 50 tons of drives	1 per 35 tons of drives
Medic	Medical Technician	1 per craft of 200 tons+, +1 per 100 passengers	1 per craft of 200 tons+, +1 per 50 crew
Gunner	Weapons Operator	-	1 per turret or bay
-	Payload Specialist	1 if cargo 50 tons+	1 if cargo 50 tons+
Steward	Flight Steward	1 per 8 high passengers	1 (optional) to attend to senior officers
Executive Officer	Executive Officer	-	1
Tactical Officer	Tactical Officer	-	1
Electronics Technician	Electronics Technician	-	3 if craft 400 tons+
Logistics Specialist	Logistics Specialist	-	1 if craft 400 tons+
Data Specialist	Data Specialist	-	2 if craft 800 tons+

Traditionally, the vehicle commander (captain) is the command-pilot and on most commercial and military vehicles there will be back-up (co-) pilots, known as 'first', 'second' etc. The astrogator manages all sensor and navigation data coming into the spacecraft. Engineers are known as flight engineers, and if there are several engineers, the most senior is designated the chief flight



engineer. Similarly, when the crew maintains several medical technicians, weapons operators, payload specialists or stewards, the most senior of those is designated as 'chief'. Payload specialists move cargo and modules, pilot the grappling arms and have responsibility for loading/off-loading and cargo safety and security.

Military vehicles require additional crew positions, including a tactical and executive officer, a logistics specialist (or officer), electronic technicians who keep the military systems running, additional systems operators and one or two data specialists acting as assistants to the commander. Other positions may exist, such as interceptor pilots, vehicle technicians, on-board troops etc.

Why bother with a human crew when scientists today (at TL 7) can send automated spacecraft across the solar system on long and complex missions? The answer is fail safe. Although the computers of the day are sophisticated and able to handle many aspects of a mission, the human crew act as a back-up, a fail safe, an adaptable and ingenious problem solver that can think 'outside-of-the-box'. In addition, Traveller character generation often creates crewmen with a diverse set of skills and we can interpret this as indicating a good deal of cross-training and redundancy. Just as the Apollo astronauts could all do each other's jobs, here the pilot might operate the sensors, the second engineer might be trained as a medic, the systems operator able to act as co-pilot, and so on. Remember that the crew is a back-up to the computer and cross training reduces the likelihood of losing a critical member of the crew.

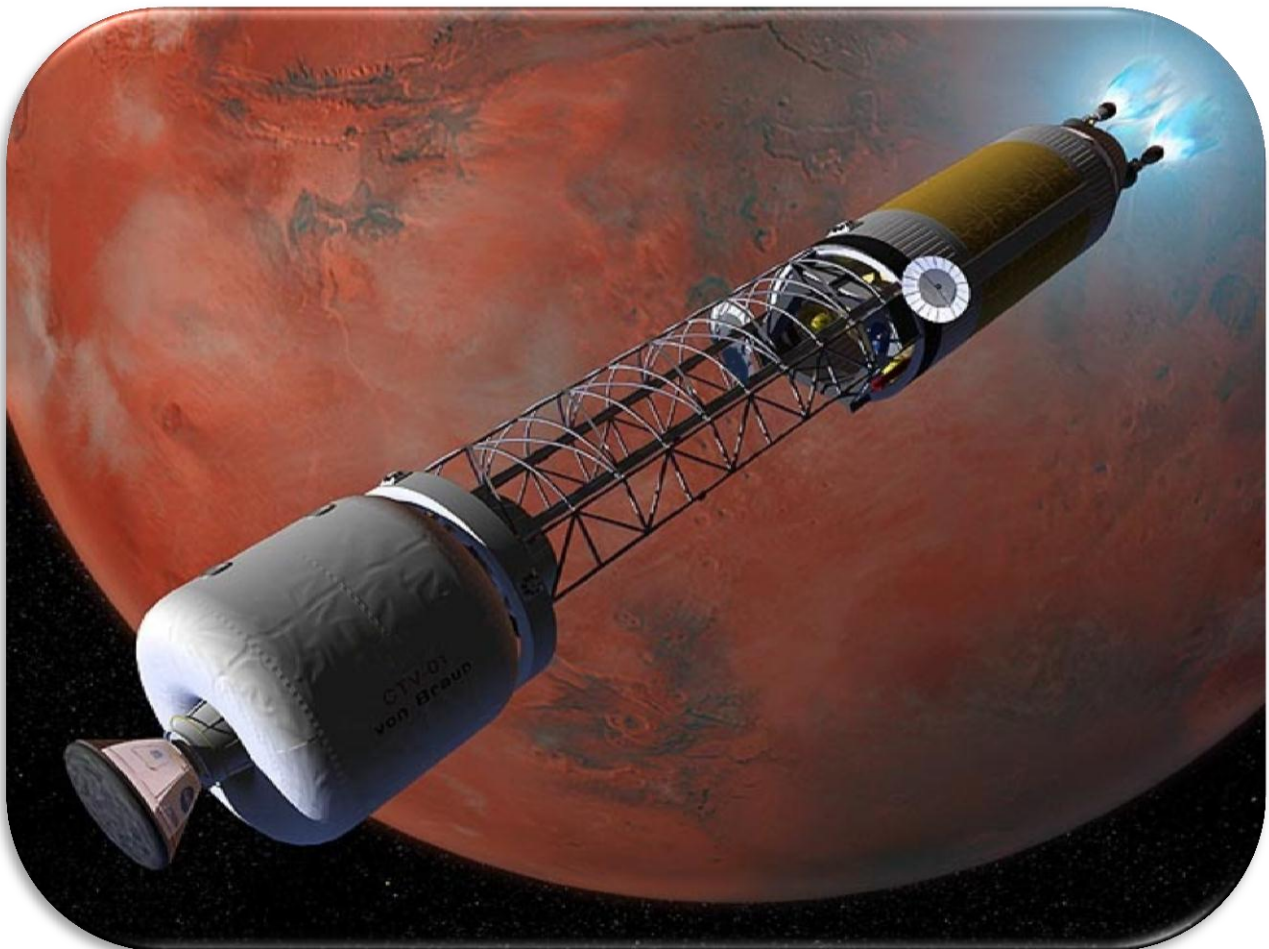



## The Living Section

### Low Passage Berths

Passengers on long haul flights out to the outer planets will probably travel in cryogenic chambers (Traveller's low berth). A cautious designer should include emergency low berths for the crew, should catastrophic accident or fuel leak leave the spacecraft stranded in deep space. Assume every emergency low berth is powered independently by a radioisotope thermoelectric generator (RTG) as used on the Voyager probes, keeping the passenger alive for decades even if the powerplant shuts down. A low berth module is shielded against radiation to protect passengers against solar flares.

Passengers are rarely killed by low berths, but injuries (including serious or permanent ones) can result from their use. Under standard procedure, preparing a passenger for low passage takes 1-6 hours and requires the presence of a medic but no task roll.

*Medic, Endurance, 1-6 hours, Easy (+4)*

One medic could simultaneously work on up to 20 low berths, but the medic has to make a separate task roll for each passenger they attempt to revive. A failed revival roll results in 3d6 damage rather than instant death. Healthy low passengers frozen and revived according to the standard regulations rarely die, but may need prompt medical attention in some cases; infirm, ill or wounded passengers are at greater risk.

In emergencies it is possible to quickly freeze a passenger, taking only 10-60 seconds and not requiring any medic to be present. This emergency procedure is automatic and may be initiated by the passenger using an override switch inside the low berth. Reviving a passenger frozen in this manner is subject to a -2 DM.

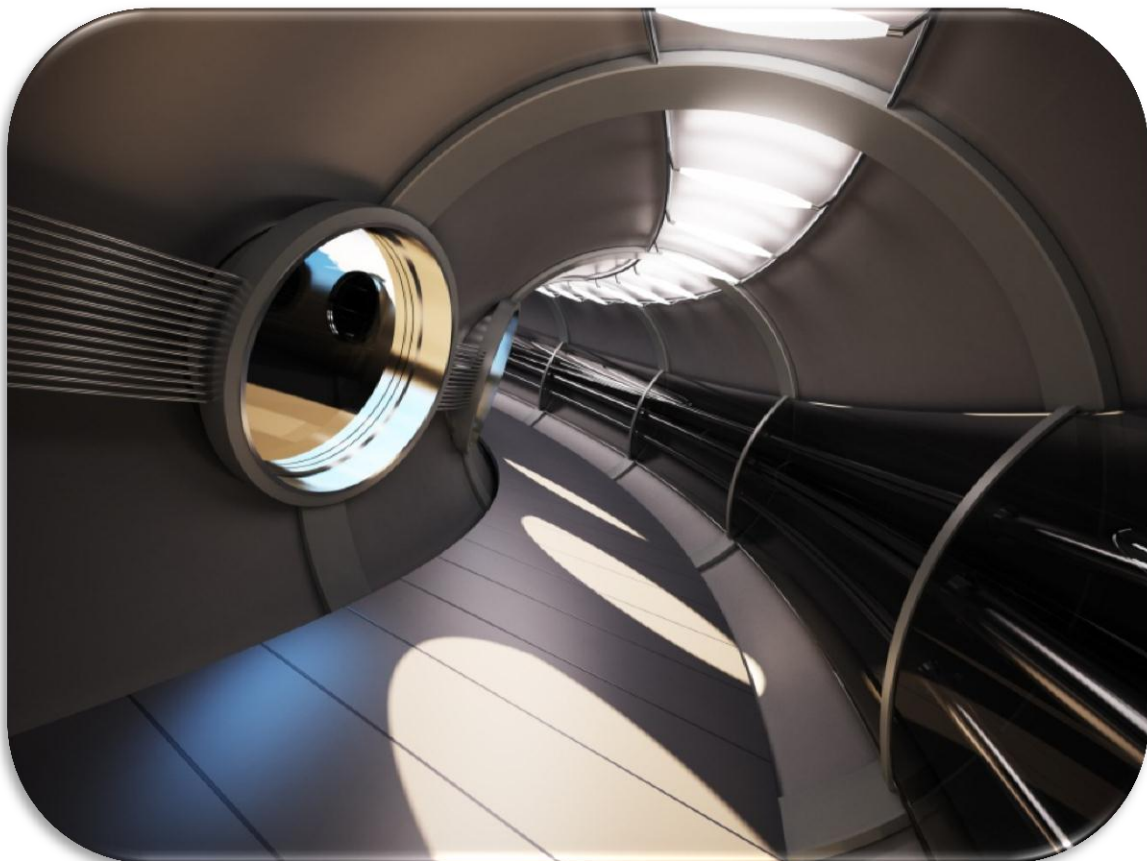



*Emergency low berth revival procedure: a Medic, Endurance, 1-6 minutes, Average (+0)*

This can either be done by a medic or by triggering an override failsafe mechanism of the low berth (which is treated as if it had Medic 0 for this purpose). A failed emergency revival task causes a roll on the Injury table; damage is permanent unless treated in a major hospital facility. If a low berth is cut off from the ship's power, it switches to the internal RTG power source in order to keep the occupant alive.

### **Staterooms**

Large, spacious staterooms are a luxury afforded only on space-stations and private or corporate transports. Typically, staterooms are doubly occupied (two people to a room), by both crew and by passengers. The commander and perhaps one or two senior officers (a least on larger vehicles) may enjoy the privacy of a stateroom to themselves. To determine the total number of crew on-board, refer to Crew Requirements on page 45.

### **Medlabs**

Fully-fledged hospitals are uncommon so many ships carry their own medical facilities.

**Standard Medlabs** are subsumed in the stateroom tonnage and cost. Assume 0.25 tons of medical equipment available per stateroom. Small ships have medical equipment lockers and a folding stretcher or two, while larger ships have infirmaries. Standard Medlabs have paramedic-level or ambulance-level equipment. Whilst they allow rudimentary surgery and long-term care to be administered, they incur a -2 DM to all medical tasks due to the limited equipment available. The referee may decide that certain medical procedures are too complex for such basic facilities. Standard Medlabs do not provide any additional life support beyond what the ship's staterooms already provide.

**Dedicated Medlab** unit displaces 8 tons, cost MCr 1.5 and provides facilities for up to two patients including dedicated life support and intensive care. Each additional patient capacity adds 2 tons and MCr 0.25. Its equipment and facilities allows most medical tasks to be carried out without additional difficulty. Each Dedicated Medlab unit requires one medic for every four patients (or a fraction thereof). A ship will carry as many Dedicated Medlabs as it has medics. A Dedicated Medlab includes one medical-purpose low-berth per patient it has capacity for.

**Shipboard Hospital** displaces 16 tons, costs MCr 5 and houses up to two patients with complete life support facilities. Each additional patient capacity adds 2 tons and MCr 0.5. It is a fully-fledged hospital, complete with laboratories and extensive imaging systems, allowing complex medical procedures such as cybernetic implantation and giving a +2 DM to all medical tasks. A Shipboard Hospital requires one doctor for every 8 patients (or a fraction thereof) and one nurse or medical technician for every 4 patients (or a fraction thereof).

### **Spin Gravity**

Without artificial gravity, everyone on board runs the risk of muscle wasting and bone degeneration. A portion of leisure time on-board will have to be spent exercising, whilst drugs to counter the effects of muscle wastage and bone degeneration must be taken daily. These include antiresorptives, bisphosphonates, angiotensin-converting enzyme inhibitors, parathyroid hormone treatments and anti-sclerostin therapies. For this reason the long duration out-planet spacecraft typically include spin habitats. These are rotating accommodation areas with an artificial gravity that is produced by the result of rotational centripetal force. Once rocket acceleration is complete within the first two or three hours of leaving orbit, the DSV will begin to rotate its spin habitats. The spin provides gravity (typically around 0.5-0.6 G) in those living compartments while the craft coasts for the rest of its journey. Spin habitats are always stopped prior to any acceleration or deceleration manoeuvres, due to the damage that would be sustained to the habitat machinery

and the people inside them. There are several types of spin habitat currently being built into deep space vehicles: the rotating ring, spin capsule, centrifuge and the twin body tether.

**Rotating Ring** - A large passenger vehicle with plenty of staterooms or science labs or whatever, will not have spin capsules on rotating arms, but instead will resemble a torus (doughnut shape) with an unbroken outer ring which spins, leaving the bridge, drives and other components in the non-spinning centre. This may also be called a 'double hull'. The outer hull must have a minimum radius of 30m. Minimum vehicle tonnage assigned to the rotating ring must be 60 tons, with an additional 10% of ring structure added (round this figure). The cost of a ring and all components on it is 125% of standard costs of anything mounted on the ring.

**Spin Capsule** – Arms or hull extensions, with capsules or accommodation units at their ends, rotate around the main hull to provide gravity in those areas. These add a little extra space and cost to the design. Minimum tonnage allocated to the spin pylons is 2 x 6 tons, while the maximum practical limit for spin capsules is 2 x 50 tons. The additional pylon and machinery tonnage equals 10% of the two spin habitats (round this figure), and this costs MCr 0.1 per ton of additional machinery. Spin capsules are the most common method of creating gravity on a spacecraft. Some military craft install retractable spin capsules that are used in order to minimise radar profile and damage inflicted by a hostile vehicle. Retractable spin capsules require machinery equal to 20% of the spin capsules (round this figure) and that machinery costs MCr 0.2 per ton.

**Centrifuge** – Shaped as a wide, flattened cylinder, the centrifuge spins on its axis, providing gravity for those inside (who are stood on the inside of the rim). Although a centrifuge may be installed within a large spacecraft (as one was on the 'Discovery', in *2001: A Space Odyssey*), it is more common to see them mounted on the side of a DSV, often as a counter-rotating pair, in order to off-set the effects of torque. Minimum tonnage allocated to a centrifuge is 10 tons, while the maximum practical limit for a single centrifuge is 50 tons. The additional machinery tonnage equals 10% of the two centrifuges (round this figure), and this costs MCr 0.1 per ton of additional machinery. May also be called a 'hamster cage'.

**Twin Body Tether** – Useful only on smaller craft (up to 300 tons), this concept simply has two halves of the vehicle separate from one another following initial acceleration. Yet they remain connected by a nanofibre cable. The two halves spin around each other thus providing gravity on the outer hull of each. Cost is minimal, Cr50,000 for the cable and another Cr50,000 for the winches and locking mechanisms. Only 2 tons is required for the cable winches. The disadvantage is that the two halves remain separated and cannot easily communicate physically. To move from one body to the other without reattaching, a crewman must perform an EVA and traverse the cable on an attached sled. Both halves of the twin body vehicle must have the same tonnage. Bridge, fuel, drives, etc. can be mounted on either half. The 'Alhambra' in Bova's *Mercury* is of this design.

#### Spin Science (Juggling Forces)

To create artificial gravity, the habitat has to spin, the faster the spin the greater the feeling of 'weight'. But the faster the spin the greater the lateral forces at play (Coriolis force) and the greater the degree of motion sickness the crew may experience. The inner ear can get used to zero-G, can it adapt to constant circular motion?

The greater radius of spin, though, the fewer spins will be needed to achieve the same degree of artificial gravity. Most DSVs have a radius for the arms or centrifuge of 24m as a minimum to achieve 0.5G. At this length the spin rate is 4 revolutions per minute and the ring/capsule has an actual speed of 11 metres per second. This is still a moderately fast spin and the only way to reduce it is to increase the radius of spin. Bigger DSVs with rotating rings are able to achieve this. A 40m radius spin will reduce the spin rate to just over 3, which easily sits within modern scientific definitions of 'comfortable'. It may be that drugs are needed by some crewmen that treat motion sickness – a small price to pay for the availability of gravity (even if reduced).



## Weapons Section

Turrets and bays may be fitted with whatever core book or *High Guard* weapons are available at TL 9. However, Lunar and Earth space forces have differing views on how to equip a DSV. Lunar DSV designers favour the use of railguns, based on a technology that the Luna engineers are extremely familiar with. Mass drivers and railguns use the same application of magnetic linear acceleration. Supplementing railguns are ASATs (the equivalent of Traveller missiles) and Counter-Measure Launchers (the equivalent of Traveller sandcasters). Beam lasers are popular only as anti-missile defence systems. Earth Union designers favour the use of beam and pulse lasers and have experimented with particle accelerators. The Union also uses ASATs and CMLs, and although some of its DSVs sport railguns, this technology has not been widely applied.

Both sides employ AKVs (Autonomous Kill Vehicles), large 2.5 ton missiles with powerful DSV or station killing capabilities. Use the rules provided in *High Guard* for torpedoes when dealing with AKVs. The warheads available for these weapons include Kinetic Kill (basic torpedo), Nuclear, X-Ray Laser and Precision Ground Strike (ortillery torpedo).

## Life Support

Life support machinery for air processing, temperature regulation and water and waste recycling is included in the drive tonnage. Air and water can be recycled, but not indefinitely. Every DSV needs water, filters, food and air to supply the crew and passengers for **6 months**. To stock up on life support supplies costs Cr 12,000 per person aboard. These supplies require 0.5 tons of cargo space per person. Expeditions may want to include *additional* reserves, including food, air, filters and water, which will take up 0.5 ton per person for an additional 6 months. A 20-man crew would therefore require an additional 10 ton supply of food, air, filters and water for a 12 month mission. Remember this all costs Cr 12,000 per person. Unused supplies can be reused on later missions.

## High Guard Options

*High Guard* offers a number of additional options for the spacecraft designer. Many of these are available for the **Orbital** setting, and the referee interested in building DSVs is urged to buy a copy of the book. Do not use the Power, Jump Drive or Manoeuvre Drive options. The Internal and External Components options are eminently suitable. The following are very useful:

<b>Laboratory</b>	4 tons, MCr 1
<b>Docking Clamp</b>	1 ton, holds <30 ton craft, MCr 0.5 5 ton, holds 40-90 ton craft, MCr 1 10 ton, holds 100-300 to craft, MCr 2
<b>Grappling Arm</b>	2 tons, MCr 1
<b>Compact Bridge</b>	-25% tonnage, -1 DMs on extended skill checks
<b>Hardened Bridge</b>	+25% cost, provides 1,000 rad protection
<b>Detachable Bridge</b>	200 ton craft                      15 ton bridge 200-1000 ton craft              30 ton bridge 1000-2000 ton craft              50 ton bridge More than 2000 ton craft       80 ton bridge
Cost is MCr 0.8 per ton of ship, it is capable of soft-landing on a planet's surface.	
<b>Railgun Barbette</b>	5 tons, MCr 4, Damage 3d6, Short Range
<b>Railgun Bay</b>	50 tons, MCr 30, Damage 3d6x4, Short Range
<b>Improved Processing</b>	1 ton, MCr 4, provides +2 to sensor tasks; chance to jam is doubled
<b>Extended Arrays</b>	triple weight & cost of sensors; increases sensor range; +2 to detect





## Putting it All Together

As you've already guessed, **Orbital** tries to cultivate a modern-day aerospace feel with its terminology and its limitations on technology. We eschew nautical terms for those used in aerospace; engineers refer to the fuselage, as well as the hull, to the cockpit or the flight deck, not the bridge, and to the vehicle or craft, not the ship or vessel. In this way we can relate to, and understand **Orbital** as a linear progression of the technology of today, rather than some far future space-faring navy.

### BUILD TIMES

Hull	Build Time (months)
100 tons	10
200 tons	12
300 tons	14
400 tons	16
500 tons	18
600 tons	20
700 tons	22
800 tons	24
900 tons	26
1,000 tons	28
1,200 tons	30
1,400 tons	32
1,600 tons	34
1,800 tons	36
2,000 tons	38

Let's look at how the Deep Space Vehicle fits together once designed, what do these things look like? The short answer is: "generally similar". They are distributed hulls without atmospheric streamlining since none have engines powerful enough to return to orbit. The reactor sits at the rear of the vehicle, along with the NTR. Fuel tanks, at low (-253°C) temperature, are cylindrical or spherical and mounted close to the rocket motors. The flight deck and accommodation will be as far forward as possible in order to provide some protection from possible reactor leaks. Carried vehicles (landing craft, etc.) can be carried inside standard-Traveller form-fitting hangers, but also simply connected via an airlock, and left hanging from the side, front, or top of a DSV. It might look ungainly but the vehicle only has to cope with moderate acceleration, and not the effects of wind shear, or re-entry.

The DSV is built in orbit. It will include at least one airlock, and more often two or three, with an adjacent Extra Vehicular Activity (EVA) locker complete with suits, umbilicals, cables and tools for the support of spacewalks. There are suits for all the crew with a couple of spares. Rescue bubbles (TMB p.97) are typically mounted on passengers' stateroom wall next to the door with an

instruction sheet. Everyone also gets their own acceleration couch for the initial acceleration burn, as well as the deceleration burn at the end of the trip. They resemble the crew seats of the US Shuttle Orbiter, with four-point harnesses.

The flight deck or cockpit is designed to allow the pilot and systems operator (navigator) to control the vehicle. Additional positions exist for a flight engineer, and on military DSVs, for weapons specialists and additional sensor operatives. The tonnage allocated to the bridge covers the two airlocks, as well as space for the computer mainframe and for the communications and sensor arrays. These will both require external dishes and other complex equipment mounted outside the fuselage. Both the flight deck and the engineering section are separated from the rest of the craft by pressurised bulkheads, and can be isolated should depressurisation or a reactor leak occur. Other pressurized bulkheads exist within the vehicle; these prevent catastrophic depressurisation of the entire vehicle in an emergency.

Deep Space Vehicles are rarely equipped with solar panels (see *High Guard* pg.42) since they often travel out beyond Mars where sunlight is weak and there is little energy to be gathered from it. However, most DSVs do sport solar-panel like 'wings' near their engineering section, these are actually radiators. Getting rid of waste heat is essential. The International Space Station, for example, uses honeycomb-structured, aluminium-panelled radiators filled with ammonia-tubing.

Finally, to understand the DSV, we have to forget what we know of traditional Traveller starships. Crew and passengers can't walk down corridors to their staterooms, most of the DSV, in particular any 'work' area, is in zero-gravity. Only those parts of the craft assigned to a spin habitat will have



simulated gravity, and for the most part this will be the accommodation and recreation areas. The idea here is that crews work in zero-G but then relax and sleep in artificial gravity to give them some resilience to the inevitable bone and muscle wastage associated with zero-gravity.

The gravity capsules or rotating rings are mounted on arms more than 20m long and these hollow arms usually have internal ladders or elevators to allow crew or passengers to descend into their respective capsule. They enter the capsule or ring through a hatch in the ceiling and can enjoy downtime in a gravity environment. These capsules and the pylons that spin them must be locked into place during manoeuvres to prevent them suffering damage, but in orbit, or during the long coasting voyages with the drives off, the pylons spin to provide gravity.

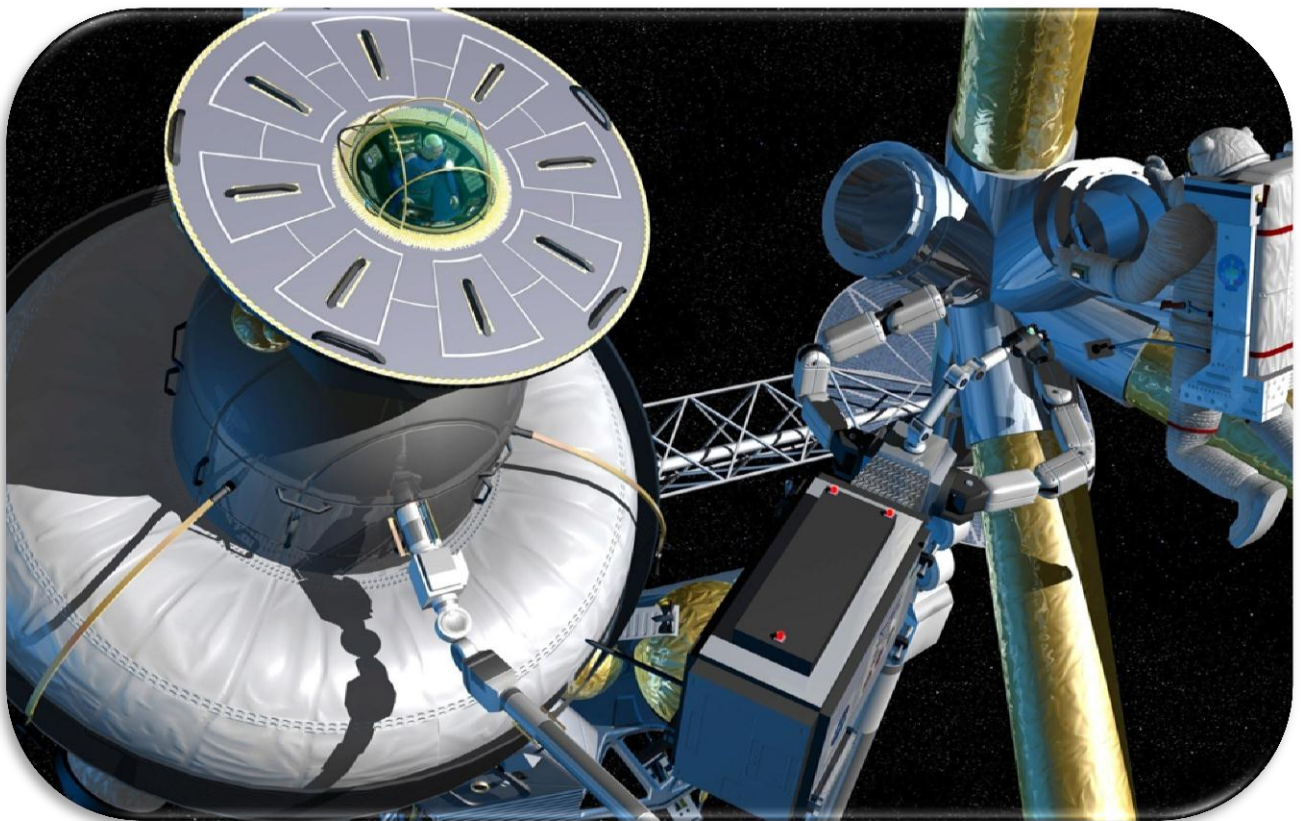

# 6 OPERATING SPACECRAFT

Many of the rules in the Traveller Main Book governing the use of starships, including of course space combat, are very relevant for slow reaction-drive DSVs in **Orbital**. There are a number of key differences, however, mainly revolving around travel times through the solar system.

## LAUNCH & RE-ENTRY

While streamlined Traveller starships find little problem in landing and taking off, the vehicles of **Orbital** find both of these manoeuvres extremely difficult. On large planets like Earth, Venus and Mars the only way to reach orbit is by spaceplane, orbital catapult, high energy laser lift or conventional rocket systems, with all the technical support and infrastructure that entails. Spaceplanes carry little in the way of cargo, which means conventional rocket systems are responsible for 70% of the materials placed in orbit. Small planets and moons, with their lower gravity gradients are easier to leave and the landers described in chapter 7 Hardware, are all capable of reaching orbit.

Returning to the surface may be equally fraught. For small airless moons (atmospheres 0 or 1) unstreamlined landers are able to touch down without difficulty just as the Apollo Lunar Modules did routinely in the 1970s. Difficulties arrive when the vehicle wants to land on a moon or planet with an atmosphere. Spaceplanes use heat-resistant tiles to protect themselves from the heat of re-entry, most other vehicles including DSVs, landers and orbital tugs are unstreamlined and will be destroyed if they attempt re-entry.

Re-entry vehicles are often small aerodynamic capsules fitted with an ablative heat-shield that is able to stand the stresses and temperatures of re-entry. These capsules are only capable of transporting a few passengers or crewmen at a time, deploying parachutes or parawings and using retros to touch down on the planet's surface. Larger cargoes can be landing using aeroshells, a collection of five cargo modules mounted behind a large heat-shield that uses parachutes and retros to land safely.

The crew and passengers of DSVs then, need some way to get down to the surface of a moon or planet. Most carry landers for airless moons and asteroids and use the services of local spaceplanes when visiting Earth, Venus, Titan or Mars.

# TRAVEL TIMES

Jump drives take one week, regardless of distance travelled but travel from Earth to Mars, or Uranus to Mercury is a bit more involved. This is a game, though, so don't expect involved calculations or a detailed description of different orbital transfer choices. We want to get on with the story and let the characters worry about such details, just as they take the pressure of us referees when it comes to calculating jump drive trajectories.

## Travelling to Planets

First, the distance from port to destination must be determined. For the Outer Planets (the Asteroid Belt, Jupiter, Saturn, Uranus, Neptune or the Kuiper Belt) this is fairly static. In a ten year time frame, those bodies are still in the same part of their orbit, enough to ignore any movement during the life of a role-playing campaign. In the interests of fast gameplay, we assume these outer planets remain at a generally static distance from the Inner Planets. Check this table to determine distances *from any Inner Planet* to individual Outer Planets (distances are in millions of kilometres):

### Catching Mercury

Mercury is travelling incredibly fast around the Sun and a spacecraft needs to match that velocity.

The 2004 probe MESSENGER needed six fly-bys for purposes of gravity assist to match the planet's velocity. For ease of gameplay, **Orbital** neither factors Mercury's speed or the use of gravity assist.

## Outer Planets: Distance from Inner Planets

Destination	Distance (Mkm)
Vesta/Asteroids	375
Jupiter	780
Saturn	1427
Uranus	2,900
Neptune	4,500
Kuiper Belt	6,000

The Inner Planets (Mercury, Venus, Earth and Mars) are moving very swiftly through their orbits around the Sun and distances change from month to month. To determine the distance from one Inner planet to another requires that the player refer to the Basic Distance Chart *as well as* the Orbit Chart (both next page). Treat the Orbit Chart like an important star-map in your Traveller game. Print it off and draw on it. Look at the chart. The orbit of each planet is marked on, and each is divided up into monthly sections. Look at Mercury, it has 3 sections to its orbit, it orbits the Sun in 3 months. Look at Earth, it has 12 sections, it orbits the Sun in 12 months. The aim of the chart is to allow the players to move the planets on one space, every month of the Traveller campaign. Simple and easy book-keeping. Suggested start positions are already placed on the chart.

## Travel Between Inner Planets

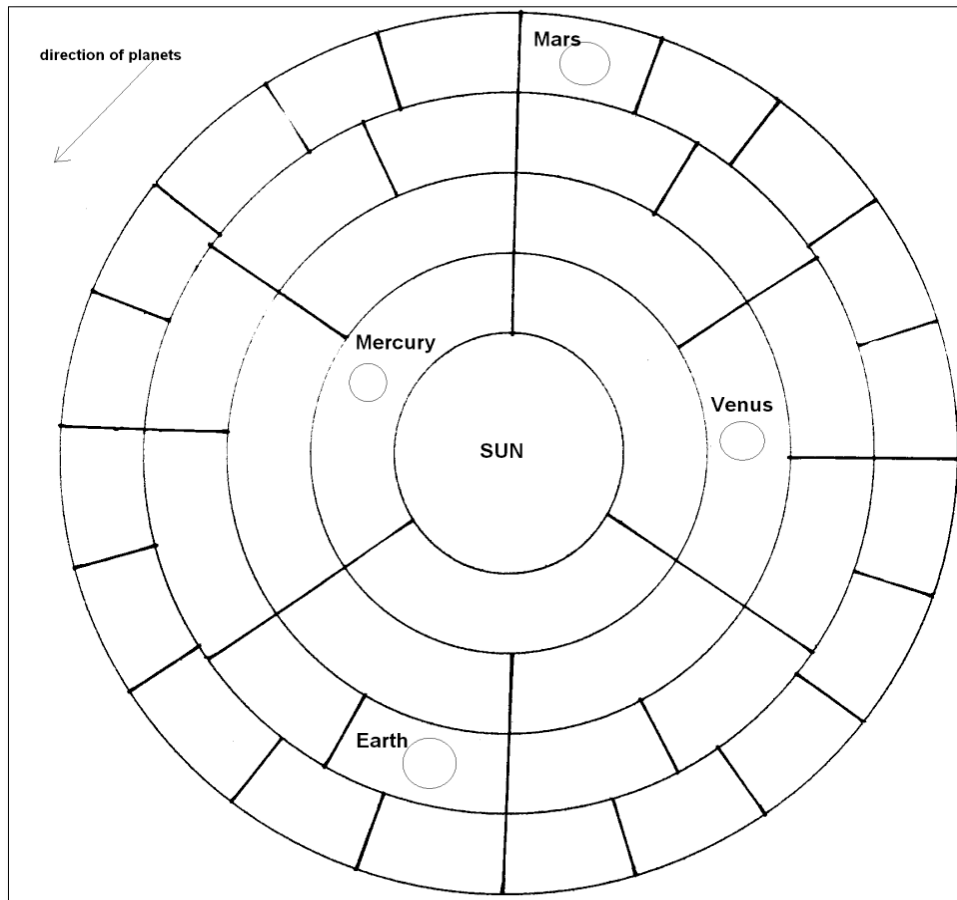

1. Place planets on chart (with markers) in initial positions.
2. Each month, move planets one space in their own orbit.
3. To determine current distance from one world to another, count squares. If moving along the orbit when counting, always move clockwise. The count can move down (toward the Sun) or up into higher orbits, as well as along, but not diagonally. The fastest distance between Venus and Mars in their starting positions is 3 squares, one along the orbit, then two squares out. Obviously as planets move, these distances will vary.
4. A square represents adding an extra 30 Mkm to the base distance that must be travelled. Base distances from one world in the Inner System to another, are listed on the following table.

### Inner Planets: Basic Distance

Home Planet	Destination Planet			
	Mercury	Venus	Earth	Mars
Mercury	-	42	92	172
Venus	42	-	50	130
Earth	92	50	-	80
Mars	172	130	80	-

Look at the basic distance on this table; add the extra distance provided by the Orbit Chart. The result is the total distance to the destination in Mkm.

Calculating travel times is easy. Divide the distance to destination (say 780 Mkm to Jupiter from an Inner Planet) by the speed of the NTR rocket (for example, a Jn 3, 160 Mkm/month, rocket). This rocket would reach Jupiter in almost five months ( $780 \div 160 = 4.9$ ). It would be coasting for much of this, after tens of hours of an accelerating and then decelerating burn from the main rockets.

## Travelling to Gas Giant Moons

NTR rockets can take humans from one moon around a gas giant to another, but travel times are shorter and the NTR will not have time to reach its maximum delta-V. Instead use this simplified formula to determine the required hours of flight time:

**DSV:** 1200 hours divided by delta-V (or 2000 hours if moving to or from one of the very small outer moons)

**Orbital Vehicle:** 140 hours (+60 if travelling to a very small outer moon)

For example, an NTR (delta-V 65) travels from Ganymede to Io (both inner moons of Jupiter) and takes 18 hours; a faster craft (delta-V 95) takes 12 hours. A conventional chemical rocket transfer vehicle takes almost 6 days, twice the time it took the Apollo astronauts to reach the Moon.

## Travelling to Luna and LaGrange

Use the following table for all chemical rocket spacecraft to move from Luna to Earth or the LaGrange points. NTR rockets can halve these times.

Flight Plan	Duration
From L1 to Luna	2.5 days
From L1 to L5 or L4	0.5 days
From Earth orbit to L1	0.5 days
From Earth orbit to L3, L4, L5	1.5 days
From Earth to L2	3 days
From Earth orbit to Lunar orbit	3 days
Orbit Earth	100 minutes
Orbit Luna	80 minutes
From Luna to L5 or L4	1.5 days
From Luna to L2	0.5 days
From Luna to L3	3 days

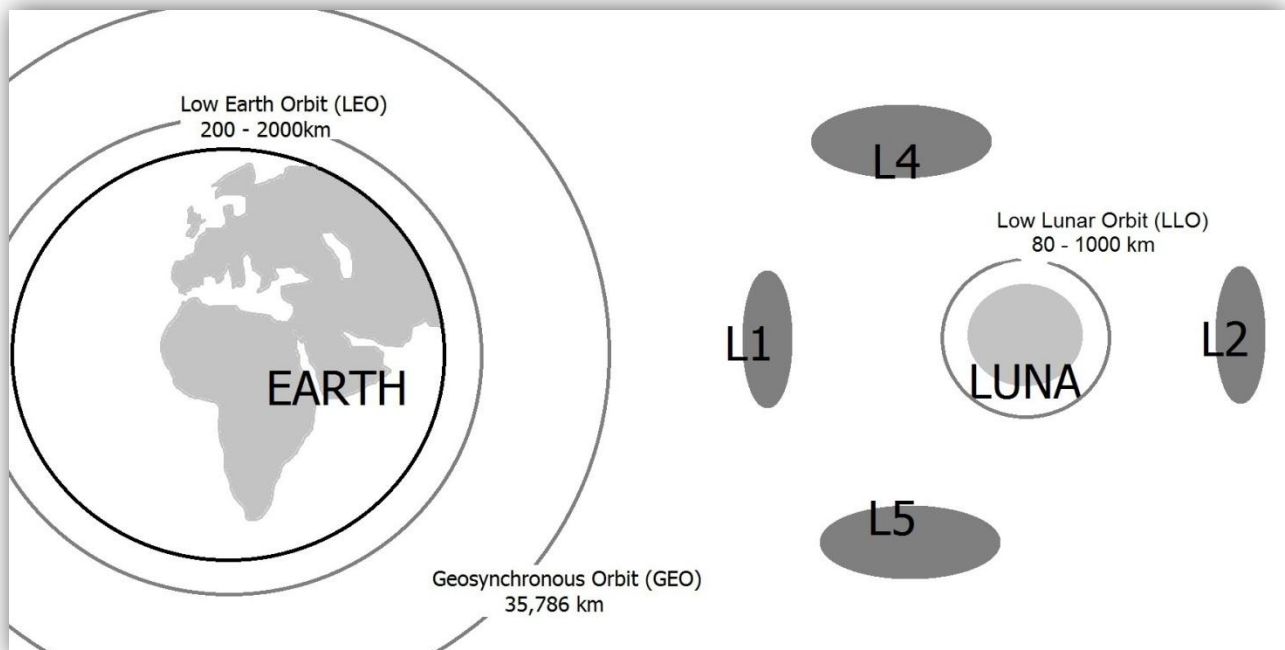



## Fuel

The nuclear thermal rockets of Deep Space Vehicles use liquid hydrogen as a propellant, super-heated by the nuclear reactor it expands at incredible speed and is thrown out as rocket exhaust to accelerate the craft forward. Hydrogen and oxygen can be split from water through a process of electrolysis, which means that any source of water-ice could theoretically be used to create rocket fuel and oxygen for life support uses. Liquid hydrogen is sold to DSV operators at a flat cost of Cr500 per ton. A crew might be able to gain access to water-ice, on a moon or asteroid, and if the DSV is equipped with a fuel processors it is able to melt this ice and conduct electrolysis in order to create hydrogen fuel. DSV operators could opt to purchase water from stations for use as fuel at Cr100 per ton. Water acts as an 'unrefined fuel' for the **Orbital** setting.

What can a DSV do with this fuel? Most of it is used for a voyage to a destination planet. It spends several hours accelerating, cuts the motors to coast most of the way, then turns around and decelerates for an equal amount of time to finally reach Venus, Saturn or where-ever. There is a reserve fuel supply which is used to allow short journey's within a planetary-moon system. But these vehicles don't have Traveller's magical gravity drives, a DSV can run out of fuel very easily and the commander won't order any wasteful manoeuvres if at all possible.



Every DSV is capable of **12 burns**, used in the same way that orbital vehicles use theirs.

BURN OPTIONS TABLE

Manoeuvre	Burns Required
<b>Interplanetary Manoeuvres</b>	
Leave orbit for trip to another planet	4
Enter orbit around another planet	4
<b>Planetary System Manoeuvres</b>	
Leave orbit for trip to a local moon	1
Enter orbit around a moon/planet	1
Lander descends to moon's surface	1
Lander ascends to orbit from moon's surface	1
Minor orbit change	1
De-orbit burn	1



## Maintenance

### Monthly Maintenance Checks

Life in the **Orbital** world is slower than the jump-capable world of Traveller; some interplanetary NTR craft may not even reach a port within a year, and are not put under the same stresses as Traveller ships. They can go five years between standard 'annual' maintenance overhauls, similar to modern Boeing 747s. These overhauls still cost 0.1% of the spacecraft's total value. Maintenance should be carried out every month, and the engineer should likewise roll 2d6 for potential equipment failures once per month. This replaces maintenance rules on TMB p.138.

Roll 6+ to avoid any breakdowns

+ engineers' highest skill of Mechanics or Engineering

+1 if the DSV is fitted with repair drones

+1 if the engineering department have put in overtime to maintain the craft

-2 if no routine maintenance had been carried out this month

-2 if the DSV has missed its 5-yearly maintenance

-1 if the DSV has suffered a solar storm this month, entered Jupiter or Mercury space or has been hit in space combat.

-1 if using unrefined fuel, which focuses a lot of maintenance time on the drive

Failure to achieve 6+ indicates some sort of system degradation (see table, below).

Note that a natural roll of '2' is an automatic, dramatic and serious failure!

Example: The Luna-owned DSV *Glorious Future* is in Jupiter space, and its engineer has been busy helping to rescue the crew of a crashed spacecraft from the surface of Europa. As the *Glorious Future* leaves orbit, the end of the month maintenance check is required. The following DM's apply: +1 Engineer's skill, +1 the DSV has repair drones, -2 no time for maintenance, -1 stuck in hostile Jupiter space. Total DM's: -1. The player rolls a '5' on the dice, reduced to '4'. Looking on the System Degradation table tells us that 2 hits have been suffered on components.

The referee takes over, decides both are interior hits and using the Location Table in TMB p.151, rolls Structure, and re-rolls to get a Hold result. For the second hit he rolls Structure again, and after rerolling gets another Hold result. Looking up the effects, the table tells us that a second hit on the hold destroys 30% of the stored cargo. The cargo is mainly supplies for the crew, so the referee decides that humidity controls in the hold have failed and that a third of the crew's dried rations have been ruined. It's going to be tough to eke out what food is remaining ... the DSV can't ask Europa for help since the captain has already initiated the burn to leave Jupiter's orbit.

### SYSTEM DEGRADATION

Monthly Roll	Number of Hits on Components
7+	none
5-6	1
3-4	2
1-2	3

### REPAIR

Use the repair rules on TMB p.143. Spare parts cost Cr10,000 per ton.

### WHICH COMPONENT?

Use the Location Table on TMB p.151 to determine what has actually failed. Decide Interior or Exterior.

- Re-roll a 'Jump Drive' result.
- 'First Bridge Hit' will be computer failure.
- Re-roll Hull Hits. Another result of Hull Hit indicates airlock, pressure hull or bulkhead failure.
- Re-roll Structure Hits. Another result of Structure Hit indicates life support damaged. Further hits then disable and finally destroy life support machinery.



## Revenues

The interstellar society of a typical Traveller subsector can be scaled down to work within the solar system. Passengers need to get out to Saturn, cargoes must be shifted out to Ida, or L5 or Mercury. DSVs are cruising between worlds packed full of passengers and/or goods. The trade and transport rules of the Traveller Main Book serve this purpose well, although the differences between jumping between stars and accelerating out to distant orbits require clarifying.

## Passengers

The exact cost of catching a ride out to a far orbiting world depends on the distance travelled. Each orbital transfer will push the price up, instead of the number of parsec jumps as used in the Traveller book. So, the more orbits a passenger crosses, the higher the cost of his ticket will be. If an orbit is that of an outer planet (Jupiter, Saturn, Uranus, Neptune) then the price increases massively due to the much greater distances involved.

<b>Ticket</b>	<b>Base Cost</b>	<b>Per Orbit Supplement (Inner Planets)</b>	<b>Per Orbit Supplement (Outer Planets)</b>
Low	Cr2,000	+ Cr2,000	+ Cr15,000
Middle	Cr10,000	+ Cr10,000	+ Cr80,000
High	Cr20,000	+ Cr20,000	+ Cr100,000

A middle passenger seeking passage on a DSV from Mercury to Mars (3 orbital transfers: Venus, Earth, then Mars) will be expecting to pay Cr40,000. Or he could go via cryogenic suspension (lowberth) and pay only Cr8,000. Fast NTR craft with delta-V of 80 km/s or more can push up their prices, charging 35% + delta-V).

## Cargo

Instead of shipping freight per parsec, as done in the Traveller Main Book, here it is done instead as per 'orbital transfer'. Fast NTR craft, those with delta-v of 80 km/s or more can again charge more for shipping freight. They charge 35%+ delta-V.

<b>Base Cargo Cost</b>	<b>Per Orbit Supplement (Inner Planets)</b>	<b>Per Orbit Supplement (Outer Planets)</b>
Cr2,000	+ Cr2,000	+ Cr15,000

## Moon Transfers

Transporting freight or passengers within a planetary system between orbits or between moons costs less, and requires less time. Simply use the base costs at half their normal value, and do not add in any bonus for fast craft. It is probably not cost effective for DSVs to transfer cargoes or passengers within a planetary system.

## Encounters

Rules for creating random encounters are explained on TMB p.139. Use these tables for the **Orbital** setting rather than those given in the Traveller Main Book. Encounters occur on a '6' on 1d6. Encounters don't and can't occur in deep space between the planets. DSV's are coasting at tens of kilometres per second and are saving most of their fuel for the big deceleration when they near their destination. Imagine two bullets whizzing past each other above a battlefield, the energy needed to slow down and rendezvous is immense.



## ENCOUNTER MODIFIERS

Zone	DM	Range	Description
Earth Orbit	+3	41-96	In low or geostationary orbit around Earth.
Earth-Moon System	+2	31-86	In Luna orbit, at the Lagrange points.
Colonized Space	+1	21-76	Mars, Ida, Ceres, Mercury.
Outer Planets	-	11-66	Jupiter and Saturn
Far Space	-1	01-56	Neptune, Uranus, other parts of the Belt
Empty Space	-4	01-26	Beyond Neptune ... the Kuiper Belt

## ENCOUNTER TABLE

d66	Encounter	d66	Encounter
01	Solar flare (2d6 hours see pg.109)	51	Hostile Vehicle (roll again for type)
02	Rich ore-bearing asteroid	52	Garbage ejected from a ship
03	Mining Vehicle with drones	53	Medical Vehicle
04	Rich ore-bearing asteroid	54	Research vehicle
05	Explorer	55	Drone
06	Asteroid hermit/miner	56	Police/Customs/Patrol Craft
11	Military Scout Vehicle	61	Executive Transport
12	Derelict vehicle (possible salvage)	62	Cargo Hauler
13	OMP (on 1-4, derelict)	63	Police or Military Vehicle
14	Comet or barren asteroid	64	Cargo Vehicle
15	Mining station on asteroid	65	Navigation satellite
16	Vehicle in distress	66	Argus Heavy Tug
21	Mining vehicle	71	Collision with space junk!
22	Small general transport	72	Taurus Light Tug
23	Micrometeorite storm! Collision	73	Small transport vehicle
24	Shanghai II Mining Rig	74	Dumped cargo module
25	Mining drone	75	Military Patrol Vehicle
26	Transfer pod used as lifeboat	76	Cargo hauler
31	Rescue vehicle	81	Passenger liner
32	Starlander Module Lander	82	Defence station
33	Space junk (possible salvage)	83	Long Beach Transfer Shuttle
34	Solar flare (1d6 hours see pg.109)	84	OMP; corporate
35	Science vehicle	85	OMP; industrial
36	Spider Light Lander	86	OMP; scientific
41	Palomino Heavy Lander	91	Communications satellite
42	Orion Transfer Pod	92	Spaceplane
43	Colony resupply or cold sleep liner	93	Cargo Hauler
44	Explorer	94	Old rocket debris from 20 <sup>th</sup> century
45	OMP (varies with location)	95	Star Sabre Interceptor
46	Cargo hauler	96	Military Vehicle

## Space Combat

Clashes between spacecraft in the **Orbital** setting do inevitably occur. The rules provided in the Traveller Main Book are perfectly able to handle the slow, cruel space warfare of 2100 AD.

All that separates the orbital craft and DSVs from the fast moving grav-drive equipped ships of the Traveller universe, however, is the way in which they can (or cannot) manoeuvre in space. Potential energy is at a premium, movement costs huge amounts of fuel, and so the Manoeuvre Phase of space combat may differ slightly.



## Thrust

While Traveller ships have a G rating which provides them with Thrust points for use at the start of a space combat turn, DSVs and orbital vehicles do not. Instead each burn allocation that an orbital vehicle possesses provides 5 points of Thrust to be used in a single space combat turn. Points not used can be saved for later turns, but the maximum thrust allowance in a turn is 5. Few orbital craft have many burns to spare for this kind of use. DSVs, having reaction drives that have a much lower thrust, but that are in the long term more efficient, only receive 3 points of Thrust per point of Burn; they are not good when it comes to manoeuvring in combat. Unused points can be saved for later turns, but the maximum thrust allowance in a turn is 3. Otherwise, Thrust points are used as in the Traveller Main Book.

## Range

Ranges in **Orbital** are shorter; reduce all ranges by a factor of 10. The revised Range Table looks like this:

Range	Distance	Thrust to Change	Example
Adjacent	<100m	1	Docked vehicles
Close	100m to 1000m	1	Nearby vehicles; close visual
Short	1km to 125km	2	Vehicles in same orbital path, visual
Medium	125km to 1000km	5	Surface to orbit
Long	1,000km to 2,500km	10	Near a planet
Very Long	2,500km to 5,000km	25	-
Distant	5,000km +	50	-

## Trajectory

Traveller players may be used to encountering other ships in space, hailing them, and then rendezvousing to dock, even in deep space. In **Orbital**, the trajectory is king. What the pilot has decided to do with the ship dominates its entire voyage and makes deviations difficult, if not impossible. Imagine a DSV as a bullet, fired from a rifle that slows itself down to come to rest as it reaches the target. If it spies an enemy bullet shooting across its path, it can do little about it! It has used a third of its fuel in the acceleration, and saves another third for the deceleration. Space combat out in the vacuum between planets is virtually impossible. Space combat occurs around, or near, worlds. Spacecraft do not move wherever they please, as if on a hex map. They are all in orbit around something, even if it is the Sun. All vehicles are moving in circles or ellipses. Few are pointing toward their destination, they are arcing their way there in long orbital curves around the Sun or a planet. Instead of thinking about starship combat as a hex map, it is more helpful to think of spacecraft travelling along a racecourse around the Sun, the Earth, the Moon, Jupiter, Titan, etc. Each world has its own racecourse of tracks, each track a higher and higher orbit. Flying from Earth to Mars, for example, could be seen as leaving one racetrack, to temporarily follow the Sun's racetrack, finally arriving at Mars and joining that planet's racetrack. Everything is circles and ellipses.

We assume that the attacker and the target are in approximately the same orbit, going the same direction. Of course vehicles can change their orbit to intercept if desired, but this takes time ... and fuel. All space combat is interception, an aggressor is closing on a stationary target (perhaps a OPM in orbit), or on a fleeing target. Sometimes the aggressor may be stationary and not manoeuvring, waiting for a target vehicle to approach. When two craft are moving towards one another, in the **Orbital** setting, this is achieved by the aggressor accelerating toward the target and the target carrying out braking manoeuvres to slow itself. None of this alters the rules given on TMB p. 147, but should always be borne in mind.

## Combat Phase

The combat phase of space combat is conducted as presented in the *Traveller Main Book*.



# 7 HARDWARE

## SPACE SUITS



Whether you live on Luna or Titan, Ida or Mercury, your space suit is more important to you than any mere piece of clothing. You spend hours in it every week and some people spend most of their working day inside a suit. Your suit is personal, customised to the way you work. Colloquially they are known as vacc suits (from their common use in the 'vacuum' of outer space), but these suits are able to operate on the dusty, rocky surface of Luna, on chilly ice sheet environments like Enceladus, in the staggeringly cold temperatures of a world like Titan, in fierce dust storms on Mars and in many other hostile places besides.

Vacc suits are complex. Each is a self contained space vehicle in its own right, with a breathable atmosphere, pressure regulation, heating and cooling controls, drinking water, 10km radio and TV camera communications, 5m range flashlight, limited micrometeoroid and radiation protection and the ability to do all that in a low pressure environment that threatens to turn your suit into a balloon.

Rather than present player characters with a single off-the shelf vacc suit, **Orbital**, like the suit manufacturers themselves, offer customizable suits for the hard-working spacer who has exacting needs. Players should design their suits as soon as they have designed characters, or else simply pick up the soft suits installed as standard on most newly built space vehicles.

### VACC SUITS & ACTION PENALTIES

Suits are bulky and constraining. All suits begin with a basic penalty to all physical actions taken while in the suit. Added extras further increase general encumbrance, and can further increase this action penalty. Training and experience counts for a lot, though. The wearer can use his Vacc Suit skill to cancel out the action penalty DMs up to his level in that skill. For example, a wearer with Vacc Suit 2 inside a soft suit (action penalty -4) only suffers a -2 when attempting physical tasks.

**Soft Suit (TL 8):** The soft suit is the standard Traveller vacc suit available at TL 8. Used at one time for spacewalks (Extra Vehicular Activities, or EVAs), the soft suit is now relegated for use as an emergency pressure suit worn by space vehicle crews. Although bulky when pressurized, there are no action penalties when reclined in an acceleration couch, operating controls or computers. Unpressurized, it is quite comfortable, utilitarian and easy to wear. Although it is possible to carry out EVAs in the pressurized soft suit, the -4 Action Penalty (AP) make it inferior to the TL 9 hard suit. The soft suit is used to provide life support and mobility within a spacecraft or on a world surface for up to 6 hours. It is a bulky soft suit with a helmet and backpack PLSS (Portable Life Support System). It provides Protection 4, masses 24kg and Costs Cr7,000. It cannot be customized. All actions carried out in a pressurized soft suit are done so with a -4 action penalty.

**Hard Suit (TL 9):** The hard suit is capable of maintaining its shape and flexibility while pressurized (unlike the soft suit). This makes it ideal for all EVAs in zero gravity and on a world's surface. With fewer APs, both movement and work are made much easier. However, hard suits are not ideal for long-term wear, being uncomfortable for any duration of 6 hours or more. Some DSV crews employ hard suits for EVAs, while using soft suits for all intra vehicle activity. Most crews have switched to hard suits and dress casually while on board, resorting to their suits during any period of danger (rendezvous, fly bys, atmospheric braking, EVAs, dockings and other situations in which there may be an unexpected decompression through hull puncture).

The hard suit is a modular design, and although once built cannot be altered, it can be tailored by the manufacturer to suit the needs of the customer. Weights, costs and life support duration are all defined by the buyer. Any hard suit is more expensive than a soft model, but the player character gets what they *want*.

### Building a Suit

To build a hard suit, select a suit design, select a PLSS and then choose up to three options that make your suit unique. Total the weight, the cost and make a note of any penalty assigned to any actions taken when in the suit. A suit is made up of several components: a torso assembly, a helmet and limbs. Select the basic suit design from the table below.

Suit Design	Description	Action Penalty	Mass (kg)	Cost (Cr)	Base Protection
Full Hard Suit	Hard shell suit with rotating joints	-1	16	9,000	4
Semi Hard Suit	Hard shell torso with flexible arms and legs	-2	14	7,000	3

Next, select the type of PLSS that will be worn with the suit. The PLSS includes oxygen, pressure regulation systems, and unlike Apollo and ISS systems which cooled their suits with a sublimator (which only works in a vacuum), these TL 9 PLSS employ a water membrane evaporation cooler that chills the wearer using the same principle as sweating. It works fine on Mars, Titan and other worlds with an atmosphere. Another TL 9 innovation is the way in which the PLSS dumps wasted carbon dioxide every few minutes, rather than collect it within lithium hydroxide/metal oxide scrubbers, a method used by the old TL 7 and 8 suits. Who wants to have to constantly replace those CO<sub>2</sub> scrubbers?



PLSS	Duration (hrs)	Mass (kg)	Cost (Cr)
A	6	7	3,000
B	9	8	5,000
C	12	12	10,000

All suits have 3 customizable slots that can be used to build in extra features. Select up to three from the table below. Once chosen add the combined weights, this total may adversely affect the suit's action penalty: if 4kg+ then apply a DM of -1 to the action penalty, if 7kg then apply a DM of -2 to the action penalty and if 10kg then apply a DM of -3 to the action penalty. Note that even the 'cosmetic' option called Baospace Fashion also takes up a full slot, that futuristic ergonomic design takes up valuable space.

Feature	Description	Cost (Cr)	Mass (kg)
Ablative Outer Layer	Protection 6, from lasers		2
Atmosphere Tester *	Provides detailed chemical analyses	500	1
Baospace Fashion	A sleek, tailored and futuristic look	2000	-
Binoculars*	Fold-down vision aids, with laser range finder	800	1
Climbing Harness	Integral harness with rings and attachment points for rope climbing and rappelling	250	-
Collapsible Helmet	Helmet folds back and slots into hard torso shell; for the hard or mixed suit only	500	-
Comms, Long Range *	Extends radio range out to 50km	250	-
Crampons*	Extending boot spikes for stability on icy terrain	200	1
Extended Life Support*	Extend PLSS duration to 18 hours	10,000	4
Flashlights*	Twin helmet-mounted flashlights, illuminating up to 20m	200	-
Flare Damper	Magnetic field generator that can protect against solar flares, but saps power from the PLSS at a rate of 5 minutes per PLSS hour	1000	3
Inertial Locator *	Indicates direction and distance travelled from a starting location	1,200	1.5
Mag Boots *	Allow walking on metal hulls and deck plates in zero-G	200	2
Power Pack	Extra power source with cables, for running equipment etc. as an emergency back-up	1000	2
Radiation Counter *	Provides warnings of radiation threats	200	-
Resistant Outer Layer	adds +2 to suit Protection	1000	3
Zero-G Tool-Belt *	With zero-G tools attached	500	2
Spotlight *	Powerful helmet-mounted spotlight, illuminating up to 50m	1000	1
Thruster Unit	PLSS-mounted thrusters providing limited movement in zero-G for a total of 10 minutes	1000	4
Wrist-Mounted Computer *	as Computer/1	1000	1

\* These components can be fitted to the Hostile Environment Suit (see below)

## Hostile Environment Suits

Most vacc suits are able to cope with vacuum and with extremes of temperature from 120°C down to -180°C. There are more hostile environments, the Jovian moons are bathed in radiation, Mercury's dayside surface is a boiling 427°C and on Venus a visitor suffers the heat of Mercury with the added peril of being crushed by 92 atmospheres! Only one suit has so far been widely marketed that can cope with all of these hazards, and that is the Aerodyne HEV-X manufactured on Earth for use on Mercury. With the failure of that colonisation effort, the Earth Union sold on suits to other worlds, and even struck up a deal to export them to the Luna Republic. This is the TL 9 Hostile Environment Suit appearing on TMB p.87.

It is a hard-suit with heat-shielding, radiation protection and flare damper (see above). To prevent flash explosions should the radiators on the PLSS accidentally touch super-cold surfaces, they are carefully shielded. The visor can screen out UV radiation and allow vision even on Mercury's dayside. Finally, the suit is resistant to flame and extremely toxic atmospheres. It is coated with a distinctive gold, mylar film for temperature reduction. The HEV-X provides Protection 7, masses 27kg and Costs Cr16,000. A difficult beast to operate, the Aerodyne HEV requires a minimum skill of Vacc Suit 2 and has an action penalty of -4. The PLSS operates for 6 hours.

## Suit Colours

Early explorers on Mars soon discovered that they needed to identify each other while out on the surface and wearing heavy pressure suits. A form of identification was created; the back of the suit's helmet became a place to put a personal logo or custom paint job, this large space could be seen from a distance and instantly identify the wearer. Since most designs wrap around the top and sides too, identification is often possible from the sides and front also. Designs might be chequered patterns, solid colours, geometric shapes, coloured letters, pictures, logos or anything else that is colourful and recognizable from a distance. It's not just scientists and explorers that practice this custom, but miners, engineers, construction workers - almost everyone! Passengers, visitors and temporary crew-members hire or borrow TL 8 soft suits that have blank helmet backs with simple stencilled numbers for ID. The players with customized suits might want to create their own custom logo (just draw round a coin and grab some colouring pens or pencils..).

Teams or personnel grades are usually identified with coloured arm-bands. For example, on a construction site, managers have red arm-bands, workers blue armbands, and scientists green armbands. Stencilled numbers on these armbands denote the wearer's actual site ID number.

### PRE-BREATHING (Hard Science Option!)

It is possible to reduce the AP on the soft suit, making it much less of a cow to work in. Pressure inside can be lowered, lessening the ballooning effect. However, with less air comes less oxygen and the wearer will need to switch the air to 100% oxygen, or risk blacking out. AP is reduced to a more manageable -2. The downside is significant; leaving the airlock under such partial pressures will usually result in decompression sickness ('the bends'). To prevent this the space-walker can either spend 8 hours slowly depressurizing in the airlock (what is known as 'camping out'), or pre-breathe pure oxygen for 4 hours before he begins the EVA in his partial-pressure suit.

**The Bends:** Symptoms of the bends (deep pain, confusion, fatigue) occur in 1d6 hours. The spacer makes a Difficult (-2) End roll, and if successful suffers 3d6 damage. If unsuccessful, the bends are almost certainly fatal (6d6 damage). Quick medical care (Medic 6+) with oxygen mask and medkit, can reduce damage by 6 points.

Treat the Bends: Medic, 1-6 hours, Routine (+0)





## Life Inside the Suit

It goes without saying that a vacc suit can be bulky and uncomfortable, but there are some comforts. A full-body garment is worn beneath the suit that includes a water-cooled layer, but warm water can instead be sent through the system as the suit detects a change in the outside temperature.

Drinking water, typically a litre or two, is included and a drinking tube is fixed close to the wearer's mouth. He or she can also mount a food stick into a nearby housing, giving the wearer a chance to eat something if in the suit for several hours. Urine is processed in thigh pockets and sent to the PLSS for recycling as drinking water. And if you need to defecate, then the suit holds it in place, that's all it can do. Even the best of the TL 9 units can't reprocess that stuff. Go before you put the suit on.

### **BREACH!**

Hard suits and HEV suits in **Orbital** are self-repairing as stated in the box-out TMB p.88. But they aren't magical. Once a suit is breached (perhaps from colliding with a piece of sharp debris while the wearer is repairing a drive) it takes 1-3 turns for the suit to repair the tear.

In the first turn the wearer suffers 1 pt of damage, in the second turn he suffers 2 pts of damage and in the third turn he suffers 4 pts.

For larger breaches, the damage is instant and often fatal, depending on the environment. A breach on Mars can be handled with the suffocation rules (TMB p.142), other worlds should factor in temperature (TMB p.74). See Ways to Die in Space (pg.106).

To repair a major breach: Vacc Suit, 10-60 seconds hours, Difficult (-2) or Very Difficult (-4) if repairing one's own suit. All suits include a suit repair kit.

A TL 8 suit will include gauges on wrists and chest that allow the wearer to check battery life, pressure, temperature, air and the PLSS system. At TL 9 these are integrated into a Heads Up Display that appears on the wearer's faceplate. Comms are all voice activated, with a wrist mounted manual control as a back-up. Controls for the PLSS are also mounted on the same wrist controller. It is standard practice to switch on the helmet camera when working, it means you aren't alone, comrades inside the base or DSV can give you guidance and advice, and everything you see is recorded for later analysis. A small light illuminates the wearer's immediate working area.

The PLSS can be recharged (air, water and electricity) at dedicated connectors within most airlocks. Other places, such as mining facilities, may have large banks of connectors in an EVA prep hall for many users to top up their PLSS at once. Every acceleration couch in a spacecraft includes an umbilical allowing the wearer to take-off the PLSS (it gets in the way when laying in the couch) and rely on air from the vehicle if needed. Most crewman take off the helmet once aboard, but keep the suit on.

## Getting it On

TL 7 and 8 soft suits are only partially pressurized so they don't balloon, and circulate 100% oxygen to compensate for the thin atmosphere. Getting into one requires the wearer pre-breathe oxygen to reduce nitrogen in the bloodstream. TL 9 hard suits are able to circulate a normal spacecraft cabin-type atmosphere at normal pressures due to innovations in suit materials, keeping them flexible while preventing them from ballooning. Player characters can take their helmets off in the cockpit without suffering the bends. It is possible to climb inside a vacc suit while wearing normal clothes, but they'd better be tight fitting, the urine connections won't work and without the water-cooled full body garment, any movement becomes hot and sweaty. Increase the action penalty by -1 every 2 hours.



Putting on a suit requires 10 minutes if help is available, 15 minutes if it isn't. Taking the suit off takes 3 minutes. It is possible to do either of these a lot faster in an emergency! To speed up the process use the tasks below (do **not** factor in the suit's action penalty).

*Putting on a vacc suit while under stress:* Vacc Suit, 1-6 mins, Difficult (-2)

*Taking off a vacc suit while under stress:* Vacc Suit, 10-60 seconds, Difficult (-2)

## ROVERS

An all terrain vehicle designed for use on moons and planets is traditionally called a rover. It is used as a general purpose truck and utility vehicle, but other more specialized variants can be purchased for certain jobs. There are five main versions of the Rover: the Utility Rover, the Survey Rover, the Rover Crane, the Rover Excavator, the Expedition Rover and the Venus Rover.

**Utility Rover** (TL 9) Cr 489,000, 10 tons. A six-wheeled off-road vehicle intended for local transport of cargoes. The utility rover is rated for use on Luna, Mars, Titan, Mercury (with appropriate modifications) and any moon of size 1 or greater. It cannot operate on Venus. The rover has a rear flat-bed for cargo transport, and a cramped control cockpit. There is an airlock. The rover can carry 0.5 tons of cargo internally and 6.5 tons externally on the exposed flatbed. Tie downs and cargo nets are included along with various tools for digging the rover out of loose ground and for making repairs in the field.



Space is provided for a driver and co-driver, but no passengers. Life support can keep the crew alive for up to 90 days, but there is no accommodation. The rover cruises at 100 kph (for a range of 825 km), and can achieve a maximum speed of 135 kph (for a range of 550 kph). The vehicle is powered by a fuel cell.



Vehicle	TL	Skill	Agility	Speed	Range	Crew/Pass	Cargo	Open?	Hull	Structure	Cost	Ship Size
Rover	9	Drive	-1	135	550	2/0	7 t	-	10	10	489,000	10t

<b>Armour</b>	4	<b>Equipment/Modifications:</b> Comms (TL 8), Long Term Life Support, Vacuum Protection, Increased Range /Fuel Efficient, Off-Road, Navigation (Std), Airlock.										
---------------	---	---	--	--	--	--	--	--	--	--	--	--

**Survey Rover (TL 9)** Cr607,000, 10 tons. A six-wheeled off-road vehicle intended as a survey vehicle. The cabin holds two crew only, with no bunks or other facilities, but oxygen for up to 90 man-days. Designed for geology surveys, this rover has automated extending scoops and rock drills, external sample trays and mineral analysis units as well as a hollow-core drill for taking rock samples down to 500m. It requires an hour to set up the flatbed mounted derrick. A survey expedition will typically take a cargo trailer for tents, supplies, etc. or even a refuelling trailer.

Vehicle	TL	Skill	Agility	Speed	Range	Crew/Pass	Cargo	Open?	Hull	Structure	Cost	Ship Size
Rover	9	Drive	-1	135	550	2/0	-	-	10	10	607,000	10 t

<b>Armour</b>	4	<b>Equipment/Modifications:</b> Comms (TL 8), Long Term Life Support, Vacuum Protection, Increased Range /Fuel Efficient, Off-Road, Navigation (Std), Airlock, Geology Samplers.										
---------------	---	---	--	--	--	--	--	--	--	--	--	--

**Rover Crane (TL 9)** Cr607,000, 10 tons. This is a six-wheeled off-road vehicle intended as a lifting crane for the construction of large projects on airless worlds. The cabin holds two crew only with no bunks or other facilities, but oxygen for up to 90 man-days. The flatbed mounts a telescoping crane that is kept locked in place across the top of the cab. When needed, the crew must spend 10 minutes extending the stability legs and unlatching the crane mechanism. A separate cab is built onto the crane's revolving turntable to allow the operator to control the crane. It can lift a 10 ton object (divide by surface gravity of the world : maximum 80 ton).

Vehicle	TL	Skill	Agility	Speed	Range	Crew/Pass	Cargo	Open?	Hull	Structure	Cost	Ship Size
Rover	9	Drive	-1	135	550	2/0	-	-	10	10	607,000	10 t

<b>Armour</b>	4	<b>Equipment/Modifications:</b> Comms (TL 8), Long Term Life Support, Vacuum Protection, Increased Range /Fuel Efficient, Off-Road, Navigation (Std), Airlock, Heavy Crane.										
---------------	---	--	--	--	--	--	--	--	--	--	--	--

**Rover Excavator (TL 9)** Cr532,000, 10 tons. This is a six-wheeled off-road vehicle intended as a digging machine and outpost support vehicle. The cabin holds two crew only with no bunks or other facilities, but oxygen for up to 90 man-days. The flatbed mounts a hydraulic boom arm mounted on a rotating platform. The boom is connected at an elbow to a secondary arm that holds the excavation bucket. This bucket can be replaced with a claw attachment which is able to lock onto modules, allowing them to be lifted and manoeuvred into position. An earth-moving blade is mounted on the back of the rover and a secondary cab is included allowing the driver to either operate the bucket or drive the rover backwards to move earth. The excavator is especially useful for creating trenches into which hab modules can fit, then covering over the modules with regolith to act as shielding.

Vehicle	TL	Skill	Agility	Speed	Range	Crew/Pass	Cargo	Open?	Hull	Structure	Cost	Ship Size
Rover	9	Drive	-1	135	550	2/0	-	-	10	10	532,000	10 t

<b>Armour</b>	4	<b>Equipment/Modifications:</b> Comms (TL 8), Long Term Life Support, Vacuum Protection, Increased Range /Fuel Efficient, Off-Road, Navigation (Std), Airlock, Digging Equipment.										
---------------	---	--	--	--	--	--	--	--	--	--	--	--



**Expedition Rover** (TL 9) Cr 533,000, 15 tons. A larger six-wheeled off-road vehicle intended for transporting small teams of engineers or scientists across a hostile environment for long periods of time. The expedition rover is rated for use on Luna, Mars, Titan, Mercury (with appropriate modifications) and any moon of size 1 or greater. It cannot operate on Venus. The rover has a rear flat-bed for cargo transport, and a two part cab, divided into control cockpit and living module. There is an airlock at the juncture of the two. The rover can carry 0.5 tons of cargo internally and 6.5 tons externally on the exposed flatbed. Tie downs and cargo nets are included along with various tools for digging the rover out of loose ground and for making repairs in the field.

Space is provided for a driver and co-driver, as well as 6 passengers. All have cramped bunks and use of both a fresher and galley. Life support can keep everyone alive for up to 90 days. The rover cruises at 100 kph (for a range of 825 km), and can achieve a maximum speed of 135 kph (for a range of 550 kph). The vehicle is powered by a fuel cell.

Vehicle	TL	Skill	Agility	Speed	Range	Crew/ Pass	Cargo	Open?	Hull	Structure	Cost	Ship Size
Rover	9	Drive	-1	135	550	1/7	7 t	-	15	15	533,000	15 t

Armour	4	Equipment/Modifications:										
Comms (TL 8), Long Term Life Support, Vacuum Protection, Increased Range /Fuel Efficient, Off-Road, Navigation (Std), Bunks for 8, Galley & Fresher, Airlock.												

**Venus Rover** (TL 9) MCr 2.45, 15 tons. A tracked all-terrain rover carrying 8 passengers and 0.27 tons of cargo through the corrosive and burning environment of Venus. It includes an airlock and can travel at 75 kph for 500km. The Venus Rover is detailed more fully as the Tracked Exploration Vehicle (TEV) on p.77 of *Supplement 5-6 The Vehicle Handbook*.

**Refuelling Trailer** (TL 9) Cr117,000, 5 tons. On worlds with access to water ice, a rover is able to pull a 5 ton Refuelling Trailer. Chunks of ice are manually fed into a hopper and heated. The water is then electrolysed to create hydrogen and oxygen for use in the rover's fuel cells. Including labour, it requires 24 hours to completely top up the fuel cells. Vehicle handling is reduced by another -1 when the trailer is hooked up. A Refuelling Trailer costs Cr 117,000 and has 1.5 ton of additional cargo space.

**Cargo Trailer** (TL 9) Cr12,000, 5 tons. A rover may need extra cargo space, and although towing a trailer reduces the agility and control of a rover (-1 to Drive roll), it provides a highly useful cargo capacity. The cargo trailer can carry 4 tons internally and an additional 1 ton strapped to the top of the trailer, held in place by cargo netting.

## COMPUTERS

Predicting the way computing will change in the future is a game no-one can win, therefore, in **Orbital**, we assume that the current set up of mobile devices linked to a wireless network continues. The advantage of this is that players begin the game with a general understanding of how computing works, and can then go on to use the technology effectively and efficiently in the game.

### Coms

What has changed is ubiquity. Everyone carries a 'com' which is a smartphone, personal data assistant, sound and image recorder and network terminal. The word 'com' has the dual meaning of computer as well as communicator, but is actually an acronym meaning 'Configurable



Operations & Messaging'. Every com has a lot more computing power than a modern smartphone and of course data storage is immensely improved on today. Your com will contain more data than the Library of Congress. The rover workstation will contain almost every article ever written and a vast wealth of cultural and scientific data. Storage capacity is vast. Your computers contain more data than anyone could ever use in a lifetime. Think of having the entirety of today's net on your palm and you're getting there. When contact is available your workstation will automatically check for updates to the network and will send these to your com where relevant. Machines communicate without the need for supervision. Your com will note your interests and fields of enquiry and will liaise with the workstation and local network whenever possible to check for any developments which should be on your personal machine. Coms and more complex computers can receive data by voice, typing, handwriting, whatever you prefer at the time.

### **On-Board Computing**

On board a spacecraft there are mounts and Velcro pads for the fixing of coms so that they do not float away. They can be tasked to operate and interface with all kinds of equipment, becoming a mobile control board for anything that operator has the access code for.

Of course spacecraft have their own Model/1 computers which is the industry standard. The Model/1 is a TL 9 integrated platform with automatic oversight and auto-pilot functions. In most cases the computers can fly DSVs and perform all required manoeuvres. More advanced Model/2 and 3 computers utilise self-learning algorithms and are able to autonomously communicate with and direct subsidiary vehicles; if there are repair drones then they may act as a set of avatars for the ship itself. A soft interface is common amongst Model/2 and 3 systems, with the central computer having a voice or some digital face with which to communicate with crew. TL 9 computers are far from truly intelligent however, and certainly not artificial intelligences. Model/3 computers are second generation TL 11 computer systems used by extremely large DSVs or military craft.

### **Networks**

Working in an orbital hab, an outpost on Mars or in the science bay of the DSV Marketeer en route to Io, a character will have access to a Local Area Network (LAN) sometimes called a LiveNet because it constantly monitors machinery, environmental readings and subsystems such as rovers, vacc suits and drones in real time. Of course the Livenet also features extensive memory files and scientific software, but it is mainly concerned with monitoring and controlling a complex piece of machinery. Some corporations and other organisations run their own LANs known as intranets, closed systems that allow access to wider nets only through established data gateways.

The internet as we know it has been replaced by the Interplanetary Network (IPN). Because communication is greatly delayed by the great interplanetary distances involved the IPN employs a new set of protocols and technologies that are tolerant to large delays and errors. Data requiring transfer is bundled, stored and then forwarded and this means that instantaneous net usage is impossible. The IPN across the solar system is broken up into separate Global Area Networks (GANs), such as Earthnet, Lunanet, Titanet and so on. The huge communication time lag between worlds effectively closes these GANs off from one another and communication between them is effectively via text, voice or video email, forwarded data transfer packets and bulletins. Very much like today, the com allows an individual to connect to his LAN or Livenet wirelessly to monitor drones or access information or operate cameras. The Livenet is a self regulating system, which keeps all coms registered with the system up to date with all current information.

### **Drones**

Limited AI is used to create expert systems capable of volitional action and learning. They are sophisticated devices which observe how they are being used and learn from it. A tele-operator is indeed, in part, a coach. A mining drone for example, when first used, is stupid and requires



considerable supervision. Over time it will learn how its operator uses it, what types of things he or she does and what places are chosen for prospection. In time the drone will be capable of doing these things independently and operator control will only be required for new or unusual situations. These types of computers do not normally have a sense of self, although they often develop rudimentary 'personalities' depending on what they have learnt. A competent operator is always checking to see exactly what the drones 'think' they have learnt and what conclusions they seem to be drawing from it.

**Repair Drones** – A common type of repair drone is short and squat; they are two legged robots, easily able to crawl through ducts and passages, but also able to clamber across the hull's exterior to make repairs. Their chest opens up to display an array of extendable tools, from power wrenches, drills, AC connectors and manipulators. Think of the three drones, Huey, Dewey and Louie that feature in Douglas Trumbull's 1972 movie *Silent Running*. Other designs also exist.

**Probe Drones** - A single probe drone is 0.2 dtons in volume and masses around one metric ton, roughly the size of a car. The probe drone is powered by a fuel cell and is equipped with a LOX rocket motor; it is equivalent to a small 2013 NASA space probe, with a bank of cameras and sensors and a comms dish.

**Mining Drones** – Mining drones mass 2 tons each. They are large machines equipped with LOX rockets, fuel cells, two side-mounted ore baskets and a forest of manipulators, drills and grinders up front. Most have landing gear fitted, allowing them to touch down before beginning mining operations. An ore conveyor unit on-board the parent vehicle will extend out to the drone's location to accept the ore. Further ore bodies require the drone to life ore in its side-cages back to the DMV.

## ORBITAL VEHICLES

Orbital vehicles are similar to small craft in the Traveller Main Book. They displace less than 100 tons; they are fitted with conventional chemical rockets and are typically used as landers or orbital shuttles. Few have any endurance and they cannot reach other planets, (although some are able to reach a moon or geostationary orbit). All small craft are fitted with cockpit control systems, standard electronic sensor fits and Model/1 computers. These small craft were designed using Traveller's *High Guard* and *Archaic Smallcraft & Space Stations*. Use of these two books will allow the referee to modify the following designs, or to come up with his own.

Most small craft are powered by chemical batteries (fuel cells); some are equipped with solar panels. On-board space is at a premium, crew and passengers are confined to acceleration couches, usually with some limited free movement during zero-G coasting. Fuel for Earth Union vehicles is liquid hydrogen and liquid oxygen, but Luna, with its difficulty in obtaining hydrogen, often builds small craft that are able to burn aluminium micro-particles in combination with oxygen. All but the spaceplane are fitted with flare dampers (see Spacecraft Design).

Each vehicle has a number of 'burns' allocated to it that are used to travel within a planetary system and its moons. Each major manoeuvre requires one burn. An orbit change or de-orbit burn requires 1 burn, leaving orbit for a moon requires 1 burn as does decelerating to enter the orbit of a moon or planet. Landers also require 1 burn for each ascent and one for each descent. Once burns are used up, the vehicle requires refuelling. Leaving planetary orbit to travel out to another planet in the solar system requires acceleration equal to 4 burns, and a following deceleration equal to 4 burns. No orbital craft has the fuel reserves or motor powerful enough to do this. See DSVs (later).



Earth Union operators use the names of the orbital vehicles; Lunar operators build almost identical orbital vehicles, but prefer to use the letter designations given in parentheses.

Orbital Vehicle	Tons	Cost (MCr)
Spider Light Lander	5	8.16
Palomino Heavy Lander	10	7.29
Skycrane Module Lander	10	16.52
Orion Transfer Pod	5	1.98
Long Beach Transfer Shuttle	20	16.61
Taurus Light Tug	10	14.52
Argus Heavy Tug	55	43.94
Star Sabre Interceptor	5	5.36
Spaceplane	40	40.30
Venus Dart	80	38.80

**Spider Light Lander (LL):** The Spider is a lander used as an excursion craft by some DSVs. A lander is unstreamlined, and designed to drop from orbit to land passengers or cargo onto a moon with atmosphere 0 or 1. It requires landing suspension and resembles the small Apollo LEM. Using a 5-ton hull, the light lander is capable of 2 burns, carries 0.5 tons of fuel and has a crew of two. It is fitted with landing suspension and chemical batteries that provide 1000 hours of power. The craft can carry 1.18 tons of cargo which can be customized instead to carry two passenger couches. It costs MCr8.16.



**Palomino Heavy Lander (HL):** The Palomino is used to ferry passengers to a world surface from a DSV, or to cross from a Lagrange station to the Moon. Using a 10-ton hull, the heavy lander is capable of 3 burns, carries 1.5 tons of fuel and has a crew of two. It is fitted with an airlock, landing suspension and chemical batteries that provide 300 hours of power. The craft has a 1.55 ton cargo bay and a cabin large enough to hold 8 passenger couches. The heavy lander costs MCr7.29.

**Skycrane Module Lander (ML):** Using a 10-ton hull, this vehicle can safely bring a standard 10 ton module out of orbit and land it on a world surface for use in habitat construction. It resembles the proposed US lander called Altair and is capable of 2 burns, carries 2 tons of fuel and has a crew of two. It is fitted with a docking ring that enables the tug to carry a standard 10 ton module, as well as landing suspension. Power for 1000 hours is provided by chemical batteries. A 1.5 ton cabin area provides accommodation for the two man crew, and 0.7 ton of cargo capacity is provided for crew equipment. The module lander costs MCr16.52.

**Long Beach Transfer Shuttle (TS):** This vehicle is unstreamlined and spends its life in low or geostationary orbit. The Long Beach is a common orbital transporter, ferrying passengers from DSV to stations or from stations to station. It could easily carry people from planetary orbit out to the low orbit of a moon. What the Long Beach lacks is any landing or re-entry capability. Using a 20-ton hull, the transfer shuttle is capable of 4 burns, carries 4 tons of fuel and has a crew of three (two pilots and a flight attendant). It is fitted with an airlock, solar panels as well as chemical



batteries that provide 1000 hours of power. The transfer shuttle has a 2.75 ton cargo bay and a cabin large enough to hold 6 passenger couches. The transfer shuttle costs MCr16.61.

**Taurus Light Tug (LT):** Cargo needs moving from one orbit to another, perhaps out to a moon. Using a 10-ton hull, the light tug is capable of 4 burns, carries 4 tons of fuel and has a crew of two. It is fitted with a docking ring that enables the tug to haul a standard 10 ton module to its destination and power for 1000 hours is provided by chemical batteries. A 1.5 ton cabin area provides cramped accommodation for the two man crew, and 0.7 ton of cargo capacity is provided for crew equipment. The light tug costs MCr14.52.

**Argus Heavy Tug (HT):** Like the Taurus, the Argus is a cargo hauler, pulling versatile modules out to higher orbits, moons or DSVs. Using a 55-ton hull, the heavy tug is capable of 4 burns, carries 19 tons of fuel and has a crew of three (two pilots and a payload specialist). It is fitted with a docking mounts that enable the tug to haul up to four standard 10 ton modules to its destination. Power for 1000 hours is provided by chemical batteries. A 3 ton cabin area provides cramped accommodation for the three man crew, but the tug also has 2.76 tons of cargo capacity, an airlock and a grappling arm for the manipulation of modules. At the front of the tug is docked a 10-ton Starlander module lander which is used to deliver modules to a world surface. The heavy tug costs MCr43.94, without any attached modules.

**Star Sabre Orbital Interceptor (OI):** Military forces use the orbital interceptor as a high velocity space fighter, burning into a high speed interception orbit to launch up to three volleys of missiles at a target, then either returning to its launch platform, or dropping into a planetary atmosphere for retrieval. Although typically launched from military space stations, interceptors from Earth can also be launched atop rockets or hypersonic spaceplanes. Using a streamlined 5-ton hull, the orbital interceptor is capable of 3 burns, carries 1.5 tons of fuel and has a crew of one. It is fitted with chemical batteries/fuel cells providing 100 hours of power as well as a heat shield and parachute system for atmospheric re-entry if required. The orbital interceptor is armed with three forward-facing missile launchers, each carrying two reloads. There is 0.4 ton of unused space. The orbital interceptor costs MCr5.36.

**Shenlong Spaceplane (SS)** – The Shenlong series of spaceplanes are streamlined cargo or passenger liners capable of taking off from a runway on Earth on the back of a reusable winged booster called the Tianlong and then returning to Earth as a glider. The manoeuvre drive of a Shenlong is a SABRE synergistic air breathing rocket engine that accelerates the airliner to hypersonic speeds. It can reach low Earth orbit, but not move beyond it. It resembles the Pan-Am shuttle in *2001: A Space Odyssey*, and Rutan's *SpaceShipOne* concept. The spaceplane has fuel enough for 2 burns, one gets it into orbit, the other it uses to deorbit and begin its descent into Earth's atmosphere. The Shenlong has a 40 ton hull and costs MCr 40.30. It has a crew of 4 and carries 30 passengers.

**Orion Transfer Pod (TP):** The Orion is a ubiquitous orbital crew vehicle, a 5-man taxi cab for transport between DSVs and stations, or between stations. It includes re-entry capability for emergencies. Using a 5-ton hull, the transfer pod is capable of 3 burns, carries 0.75 tons of fuel and has a crew of five (one pilot and four passengers). It is fitted with solar panels that provide power, and has a re-entry capsule fitted with heat shield and parachute system. The transfer pod is very cramped, but does have a 0.475 ton cargo area. It costs MCr1.98.

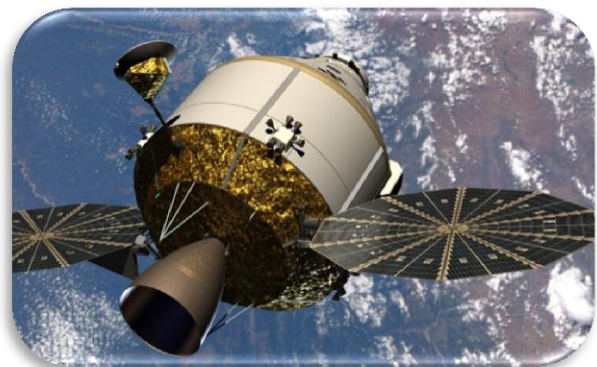



**Venus Dart (VS):** Using an 80-ton hull, the Venus dart is a sleek and aerodynamic spaceplane using rockets and ramjets to return to orbit. Unlike conventional spaceplane designs used on Earth, the Venus lander does not touch down as an aeroplane. Instead, after atmospheric entry, the lander deploys parachutes and retros to slow the descent enough that at an altitude of around 10,000m a hydrogen gas envelope is inflated and the dart becomes an airship, able to travel through the Venus atmosphere and even descend to the planet's surface for a soft touchdown.

The gas envelope is an aerodynamic wedge in shape and the sleek dart fits snugly beneath it within a form-fitting cavity. The cockpit, fitted with two acceleration couches, sits in an under slung position to allow vision even when the balloon is inflated. When time comes for return to orbit, the hydrogen pressure is lowered and the balloon and dart lifts off, climbing to an altitude of 25km. At this altitude the balloon is discarded and when the spaceplane drops rockets ignite and as velocity and altitude suddenly increases, the ramjets open up and carry the dart into orbit with a rendezvous with its parent craft.

The Venus dart cannot be reused until it is serviced and resupplied with a fresh hydrogen envelope (12 tons, Cr50,000). The vehicle includes acceleration couches for 4 passengers and double occupancy cabins for crew and passengers. A Model/1 computer is fitted along with an airlock, retractable landing suspension and standard electronic sensors. Fuel cells provide power for 1000 hours. The cargo deck has a capacity of 10 tons. Cost MCr38.8.

### **Cascadian Rock Hopper**

Using a home-made 60 ton hull, the Cascadian rock hopper is a self-sustaining colony vehicle, home to a family of up to five. The rock hopper allows colonists to live a nomadic existence, moving from asteroid to asteroid as needed. The vehicle is fitted with recycled chemical rockets and draws power from recycled chemical batteries (fuel cells). Fuel tankage provides 2 burns. The cockpit holds a pilot and co-pilot and is fitted with standard sensors and a Model/1 computer. A fuel processor can turn ice that is extracted by 5 tons of mining drones, into fuel, water or oxygen. There is a single airlock.

Modules attached to the rock hopper include a 20 ton transhab, a micro-smelter module and an agri-module (capable of sustaining five people indefinitely). Landing suspension allows touch down and tethering onto an asteroid. So much is squeezed into a rock hopper that cargo capacity is limited to just 2.17 tons, with the result that supplies and spare parts are packed into rec areas, corridors, overheads and staterooms.

Using recycled drives and second-hand TL 8 components purchased at ½ price, the rock hopper can be manufactured for around MCr 12 in about a year. Typically, several families will pool their abilities and resources to build a number of rock hoppers at the same time. Cascadians will then set off in small groups, the rock hoppers travelling together to provide assistance and back-up for one another should disaster strike one of the vehicles.

## **LAUNCH VEHICLES**

Getting cargo and passengers off the surface and into orbit takes a huge amount of energy, particularly when launching from a large world like Earth, Mars or Venus. Even moons require some launching capability beyond simple landers if they are to move a large volume of people and freight off world. Multi-stage rockets have always worked and are still very popular. On Mars and Earth the discarded stages of these rockets are typically recovered by parachute and reused (reducing the cost of the rocket for the next launch by 50%). The cost is still enormous, however.



Two other launch methods have been introduced, the mass driver orbital catapult and the high-energy laser lift vehicle (HELL-V). The mass driver is used on Earth, Mars and Luna, though prohibitive set-up costs have limited the numbers so far built. HELL-Vs have proven cost effective but again require immense set-up costs and have an upper limit on their size.

## Mass Driver Catapult

The mass driver catapult is a giant coilgun that accelerates a cargo sled to escape velocity speed via electro-magnetic induction of superconducting coils along a tunnel. The tunnel has to be very long and is depressurized to vacuum to eliminate drag. The coils are arranged along and around the tunnel and are switched on and off in sequence, causing the projectile to be accelerated along the vacuum tunnel.

There are two mass drivers on Earth. Their tunnels are both longer than 150 km in length and include a plasma window preventing vacuum loss when the large shutters open at the 'barrel-end'. Both the catapults exit on the upper slopes of a mountain peak at a minimum of 5,000 metres altitude. The aerodynamic sled leaves the tunnel at 9 km per second and

initiates a rocket motor burn that accelerates it to escape velocity. All the tunnels face east, for an extra kick of velocity. Each cargo sled is a 14-ton cargo craft, with a 4.5 metres diameter and 12.5 metres length, reaches LEO then opens its cargo doors to release a 10-ton cargo module, before initiating a deorbit burn and gliding back to the mass driver centre to land on its runway.

The two mass drivers are located at the Carl Friedrich Gauss Mass Drive Centre (Mount Kinabalu, east of Bandar Seri Begawan, capital of Brunei) and the East African Space Launch Facility (Mount Kenya, north of Nairobi in Kenya). No more will be built due to the sheer difficulty of finding a suitable site with the correct orientation, elevation and crustal stability.

## High Energy Laser Lift

A high energy laser lift vehicle (HELL-V) is a surface-to-orbit craft that carries only a fraction of the fuel needed by a multi-stage rocket of the same size. Energy is provided by a megawatt laser at the launch facility which targets a parabolic reflector on the underside of the vehicle. This concentrates the laser energy to produce a region of super-heated air that expands violently, producing thrust with each pulse of laser light. As it reaches the upper atmosphere where there is very little air, the vehicle jettisons the mirror assembly and pumps liquid hydrogen fuel into the exposed combustion chamber. The laser continues to target the base of the vehicle, turning the hydrogen into highly energetic plasma which propels the HELL-V into low Earth orbit.

There are several drawbacks. The HELL ground stations are very expensive to establish, lasers must be careful not to strike other orbital craft, and there is an upper limit to the size of the vehicle, equivalent to a medium multi-stage rocket. The vehicles are more conical in shape than conventional rockets to maximise the available base area the laser can target. There are four HELL facilities on Earth that are launching 24 hours a day: the Myrabo Launch Centre at Macapa, Brazil; the Muzner-Zubrin spaceport in Arizona; Spaceport America in New Mexico; the Woomera Laser Lift Complex in Australia and Lanyu Island Spaceport off the coast of Taiwan.

### Voroncovo Coil Sled

Using an aerodynamic and heat-shielded 14 ton hull the Coil Sled is accelerated to high altitude by magnetic induction coils. At the edge of the atmosphere the sled initiates a rocket burn to put itself in orbit before releasing its payload and gliding to Earth. It has reaction drive-sA and chemical powerplant-sA with 0.75 ton of rocket fuel and 0.020 ton of powerplant fuel, this provides two burns and 3 hours of electrical power. It is fitted with an automated cockpit and Model/1 computer. Folding aerofins are integral to the design for the glide stage and parachutes are included to slow the glider once it has touched down. The payload bay holds a single 10 ton module, but cargos loaded must be able to withstand accelerations of 20G. There is an additional 0.58 ton of payload capacity. Cost is MCr 3.55.



### Aerodyne Griffin

While many HELL-Vs mass between 10-20 tons, the largest is the 50 ton Aerodyne Griffin. This streamlined vehicle has a chemical powerplant-sC with 2.5 tons of fuel to provide up to 3 hours of electrical power. There is hydrogen fuel tankage of 26.7 tons as well as an automated cockpit, a Model/1 computer and a 2.85 ton jettisonable mirror assembly. A 2.5 ton heat-resistant combustion chamber protects the cryogenic fuel from the incoming megawatt laser energy. The Griffin can lift 10.95 tons into low orbit, typically a single module. Cost of a Griffin is MCr 4.53.

## Multi-Stage Rockets

Chemical rockets are still the primary method of reaching orbit from Mars, Titan and Earth. With small payloads, thirsty rocket motors and cavernous fuel tanks, these launch vehicles would be familiar to anyone working in the rocket industry in 2013. Complete rules for designing launch vehicles are included in Comstar/Avenger's highly recommended book *Archaic Small Craft and Space Stations*. The rockets described below were designed using that supplement.

**Light Launch Vehicle (LLV):** Using a 50 ton multi-stage hull the LLV has a 4G reaction drive (type sK) and 40.15 tons of fuel for 15 minutes of flight. A chemical powerplant (type sC) provides electrical power for up to 3 hours. A Model/1 computer and standard electronics are fitted. The LLV can lift 2.85 tons into low orbit. The LLV is suitable for launching satellites. Cost: MCr 8.43. Modern comparisons include the Vega, Rokot and the Long March 2.

**Medium Launch Vehicle (MLV):** Using a 70 ton multi-stage hull the MLV has a 4G reaction drive (type sN) and 56.2 tons of fuel for 15 minutes of flight. A chemical powerplant (type sD) provides electrical power for up to 3 hours. A Model/1 computer and standard electronics are fitted. The MLV can lift 5.55 tons into low orbit. The MLV is suitable for launching a large satellite, interceptor or Orion vehicle. Cost: MCr 10.5. Modern comparisons include the Delta II, Long March 4, the Soyuz FG and the Zenit 3.

**Heavy Launch Vehicle (HLV):** Using a 100 ton multi-stage hull the HLV has a 4G reaction drive (type sR) and 80.25 tons of fuel for 15 minutes of flight. A chemical powerplant (type sE) provides electrical power for up to 3 hours. A Model/1 computer and standard electronics are fitted. The HLV can lift 10.25 tons into low orbit. The HLV is suitable for launching both a lander and Orion together or a single 10 ton module. Cost: MCr 18.83. Modern comparisons include the Angara A5, the Ariane 5, Titan III, Atlas V, Long March 3 and Delta IV.

**Very Heavy Launch Vehicle (VHLV):** Using a 500 ton multi-stage hull the VHLV has a 4G reaction drive (5 clustered type sRs) and 401.25 tons of fuel for 15 minutes of flight. A chemical powerplant (5 clustered type sEs) provides electrical power for up to 3 hours. A Model/1 computer and standard electronics are fitted. The VHLV can lift 63.25 tons into low orbit. The VHLV is suitable for launching either large components required for space station construction or sections of DSVs. Cost: MCr 94.03. Modern comparisons include the proposed Space Launch System, the Saturn V and the Falcon Heavy.

Payload figures listed are for insertion into low Earth orbit. To launch from Mars or Titan refer to the following table.

Launch Origin	LLV Payload	MLV Payload	HLV Payload	VHLV Payload
Titan	12.9 ton	19.6	30.31	163.56
Mars	10.88 ton	16.79	23.3	143.5
Earth	2.85	5.55	10.25	63.25

These payload figures are only for launching into low orbit. To launch to a geosynchronous orbit or reach an escape velocity, then more fuel is required which will reduce the effective payload. Reduce payload to 30% of its stated size.



# DEEP SPACE VEHICLES

## Designations

As stipulated by the FSC59 regulations, manufacturers of DSVs are obliged to designate them according to an agreed system. This is counter to the method used by modern civilian airliner manufacturers, and more akin to the way in which the Canadian and US air forces refer to their aircraft.

DSVs are given a type name and a letter code that relates to their primary function (M for mining, for example). They can then be referred to not just as a DSV (Deep Space Vehicle), but also as the more mission-specific DMV (Deep Space Mining Vehicle). The big manufacturers are Aerodyne, Tharsis Heavy Industries, Matsuyama, Reiner-Gama, Voroncovo and Wu-Ketai. Each has their own preferences for naming the types of vehicles they produce. Individual DSVs are often given a unique name by the company or crew using them, and again these space lines and shipping companies may have their own naming preferences.

Code	Mission	Code	Mission	Code	Mission
A		J		S	
B		K	Construction/Repair/ Salvage	T	Module Transporter
C	Cargo Transport	L	Cold Sleep Transport	U	
D		M	Mining	V	
E	Executive	N		W	
F	Fueller	O	Colony Transport	X	
G		P	Passenger Liner	Y	
H	Rescue/Medical	Q		Z	
I		R	Research & Science		

eg. Wu-Ketai Messenger DCV, Reiner-Gama Horizon DRV, etc.

*"You will address me as Sir or Captain," the captain interrupted. "The computers do most of the brainwork aboard ship, but you will still have to learn astrogation, logistics, communications, propulsion, and life support. If you goof off or prove too stupid to master these subjects I'll sell you off to the first work gang on the first rock we rendezvous with. Is that clear?"*

Captain Farad, Ben Bova's Mercury

## Transport Craft

### Tharsis Industries DCV Electra

Using a 200-ton hull, the Electra is an elementary interplanetary cargo vehicle plying the space lanes carrying cargo and passengers. It has nuclear thermal rocket-A and power-plant-A giving a delta-V of 50 km/s. Fuel tankage of 40 tons allows for two trips at full thrust. There are no fuel processors, but the Electra includes a flare damper. Adjacent to the bridge is a Model/1 computer and a standard sensor suite. There are three double-cabins for the crew, three double-cabins for passengers and 20 cryogenic low berth units. The Electra has three spin pylons that keep all cabins and low berths in gravity. A Palomino heavy lander is used to ferry passengers to world surfaces. Cargo capacity is 84 tons.

The Electra requires a crew of six: pilot-commander, astrogator, engineer, medic, steward and payload specialist. The vehicle costs MCr 46.57 and takes 12 months to build.



### **Wu-Ketai DCV Messenger**

Using a 300 ton hull, the Messenger is a fast cargo courier making runs to all of the major planets. It has nuclear thermal rocket-F and powerplant-F, and a fuel tankage of 120 tons, which provides a delta-V of 95 km/s. Adjacent to the bridge is a Model/1 computer and a suite of standard electronics. Mounted on two spin capsules are 3 staterooms and a solar storm shelter. There are no emergency low berths. A flare damper is fitted, and the Messenger also carries a Palomino heavy lander. Cargo capacity is 58 tons.

The Messenger has a crew of six: command-pilot, astrogator, two engineers, medic and payload specialist. The vehicle costs MCr179.03 and takes 14 months to build.

### **Aerodyne DTV Trojan**

Using a self-sealing 300-ton hull the Trojan is a tug designed to ferry 10-ton modules out to the planets for use as space stations or surface habitats. It has nuclear thermal rocket-E and powerplant-E providing a performance of 80 km/s. Fuel tankage of 90 tons allows for a single trip at full thrust. Adjacent to the compact bridge is a Model/1 computer and a standard suite of avionic sensors. There is a single cabin for the commander and three double cabins for the rest of the crew, two passenger low berths are fitted, as well as two emergency low berths for emergency use. The Trojan is fitted with a grappling arm for module manipulation, eight docking clamps arrayed in a circle for the attachment of 8 modules (not included), a flare damper and a Skycrane module lander. The latter is used to transport individual modules down to a moon's surface. A spin habitat houses all cabins and some rec facilities. The Trojan has a 10 ton cargo bay for supplies.

The Trojan requires a crew of seven: command-pilot, co-pilot, astrogator, chief engineer and assistant, a medic and a payload specialist. The vehicle can carry 2 passengers in cryogenic suspension. It costs MCr 167.93 and takes 14 months to build.

### **Wu-Ketai DCV Wayfarer**

Using a 400 ton hull, the Wayfarer is a cargo carrier making runs to all of the major planets. It has nuclear thermal rocket-D and powerplant-D, and a fuel tankage of 80 tons, which provides a delta-V of 65 km/s. Adjacent to the bridge is a Model/1 computer and a suite of standard electronics. Mounted on two spin capsules are 4 staterooms, 2 emergency low berths and a solar storm shelter. Other features of the spacecraft include a flare damper and an 8 ton workshop, a hydroponic garden, four standard module clamps (with a capacity to carry four 10 ton modules), a grappling arm and a Palomino heavy lander. Dominating the Wayfarer's hull is the cavernous 156 ton cargo bay.

The Wayfarer has a crew of seven: command-pilot, two co-pilots, astrogator, engineer, medic and payload specialist. There is capacity to carry an additional crew-member. One of the pilots operates the lander. The vehicle costs MCr136.35 and takes 16 months to build.

### **Matsuyama DPV Swiftliner**

Using a 600 ton hull, the Swiftliner is a passenger and freight carrier committed to long-haul routes between high population centres. It has reaction drive-J and powerplant-J, giving a delta-V of 80 km/s. Fuel tankage of 180 tons allows for a single trip at full thrust. A flare damper is fitted. Adjacent to the bridge is a Model/2 computer and a suite of standard sensors. There are four double-cabins for the crew and a single cabin for the commander, 20 cryogenic sleep berths, 16 single occupancy cabins for first class passengers, and 11 double-cabins for economy class passengers. The Swiftliner has a large centrifuge ring housing all cabins, low berths and 10 tons of luxury lounges and facilities. The vehicle has three hardpoints and three tons set aside for fire control, no turrets or weapons are installed. A 20-ton Long Beach transfer shuttle is used as an orbital transport, able to ferry passengers and freight to stations or other vehicles. Cargo capacity is 100 tons.



The Swiftliner requires a crew of nine: command-pilot, co-pilot, astrogator, chief flight engineer, two assistant engineers, chief steward and assistant, and a medic. The vehicle can carry 16 high class, 22 middle class and 20 low berth passengers. It costs MCr 320.86 and takes 24 months to build.

### **Reiner-Gamma DCV Nova**

Using a 600 ton hull, the Nova is a multi-mission transporter, capable of carrying passengers, freight and modules. This makes the Nova a very versatile DSV. It has nuclear thermal rocket-F and powerplant-F, and a fuel tankage of 120 tons, which provides a delta-V of 65 km/s. Adjacent to the compact and crowded little bridge is a Model/2 computer and a suite of basic civilian electronics. Mounted on two spin capsules are 16 staterooms, 5 emergency low berths, 20 passenger low berths, medlab and a solar storm shelter. There are two double turrets fitted, both with twin counter-measures launchers. Other features of the spacecraft include a flare damper and a 12 ton workshop, two docking clamps, each rated for a 50 ton module cluster and a grappling arm used to manipulate the module clusters. Carried craft include a Palomino heavy lander for passenger transfer and a Skycrane module lander used to ferry individual modules down to moon surfaces if needed. An additional 9 tons of fuel is held in reserve in order to refuel these vehicles. Total cargo capacity for the Nova is a 130 ton cargo bay as well as 100 tons of modules.

The Nova requires a crew of ten: command-pilot, two co-pilots, astrogator, chief engineer, assistant engineer, medic, steward and two payload specialists. There are cabins for 10 passengers and low berths for 20 carried in cryogenic suspension. The vehicle costs MCr261.85 and takes 24 months to build.

### **Reiner-Gamma DCV Corona**

Using a 600 ton hull, the Corona is a module transporter, an inter-planetary container-ship that can ship 30 modules to multiple destinations. It has nuclear thermal rocket-F and powerplant-F, and a fuel tankage of 120 tons, which provides a delta-V of 65 km/s. Adjacent to the compact and crowded bridge is a Model/2 computer and a suite of standard electronics. Mounted on two spin capsules are 6 staterooms. Other features of the spacecraft include a flare damper, six docking clamps, each rated for a 50 ton module cluster and a grappling arm used to manipulate the module clusters. There are two Flying Cranes carried as auxiliary craft, used to carry individual modules down to a moon's surface. Total cargo capacity for the Corona is a 13 ton cargo bay as well as 300 tons of modules.

The Corona requires a crew of ten: command-pilot, co-pilot, astrogator, chief engineer, assistant engineer, medic, two lander pilots and two payload specialists. The vehicle costs MCr251.41 and takes 24 months to build.

## **Mining Craft**

### **Aerodyne DMV Viking**

Using a 200 ton, self-sealing hull the Viking is a small mining exploration vehicle, capable of long-term prospecting missions. It has nuclear thermal rocket-A and powerplant-A, and a fuel tankage of 20 tons, which provides a delta-V of 50 km/s. Adjacent to the bridge is a Model/1 computer and a suite of standard electronics. Mounted on two spin capsules are 2 staterooms and one emergency low berth. Other features of the spacecraft include a flare damper, a 1 ton fuel processor, mining drones and a single mining laser. The Viking is fitted with landing gear for touch-down on asteroids and carries a 10 ton Palomino heavy lander. A 19 ton cargo bay holds supplies, parts and equipment, while an 80 ton ore bay carries minerals excavated by the mining drones.

The Viking has a crew of 4: command-pilot, astrogator, engineer and mining specialist. The vehicle costs MCr76.18 and takes 12 months to build.



## **Wu-Ketai DMV Shanghai II**

Using a 600 ton hull the Shanghai mining derrick targets previously identified asteroids with high metal contents to set up drilling operations. It can mine iron-nickel and carbonaceous asteroids as well as comets and ice balls. These last targets are mined for water ice which can be pumped through a fuel processor to be turned into liquid hydrogen fuel. The Shanghai is built around a power drill assembly, above which are mine operations areas, the rig is topped with an accommodation and control section. Huge landing pylons with piton drills used to anchor the rig to the asteroid surround the drill assembly and give the vehicle the appearance of a small Earth-side oil platform. Flood-lights above the legs illuminate the drill site. The Shanghai has a nuclear thermal rocket-C and fission power plant-F and a fuel tankage of 60 tons of liquid hydrogen which provides a delta-V of 50 km/s. Adjacent to the bridge is a Model/1 computer and a suite of standard electronics. There are 4 single and 17 double staterooms, two low berths used for medical emergencies and no provision made for the areas of artificial spin gravity. The main feature of the derrick is its six landing legs. At the centre of these gigantic pylons is the 80 ton drill assembly, complete with its own 10 ton drill control centre. The ore bay holds 150 tons of extracted material, which typically is first refined in the Shanghai's own 25 ton smelter. A 2 ton fuel processor, a 6 ton workshop and a 4 ton geology lab are all adjacent to the drill control room. Other features of the rig include a flare damper, a Palomino heavy lander with a 3 ton liquid hydrogen/liquid oxygen reserve tank used to refill the lander. General cargo capacity is 26 tons.

The Shanghai has a crew of 36: commander-pilot, operations manager, 3 admin staff, co-pilot, astrologator, chief engineer, 2 assistant engineers, doctor, drill supervisor, 11 drill hands, 6 smelter operators, 6 mining technicians and a lander pilot. There is a spare double stateroom for extra crew/company officials. The rig costs MCr 277.72 and takes 20 months to build.

## **Military Craft**

### **Wu-Ketai Spartan**

Using a self-sealing and laser reflective 400 ton hull, the Spartan is an Earth Union military patrol and customs vehicle, responding to threats, combatting terror, piracy and smuggling. It also carries out search and rescue operations. It has reaction drive-H and powerplant-H giving a delta-V of 95 km/s. Fuel tankage of 160 tons allows for one trip at full thrust. Adjacent to the bridge is a Model/3 computer and a basic military sensor suite. There are 3 single cabins for commander, his executive officer and the troop commander, and 9 double-cabins for the rest of the crew. There is a bay for 5 military probe drones as well as a flare damper. The Spartan has a centrifuge, spinning the cabin accommodation. The vehicle has four hardpoints each fitted with triple turrets, two of these turrets are pulse lasers, and two are ASAT missile launchers. The Spartan is equipped with a 20-ton Long Beach transfer shuttle used to ferry crew to habitats, or send boarding parties over to suspect spacecraft. Cargo capacity is 6 tons. The hull is armoured (4 pts.) with titanium-steel composite.

The Spartan requires a crew of twenty: commander, executive officer, pilot and co-pilot, astrologator, chief engineer, 2 assistant engineers, chief weapons operator and 4 weapons operators and a medic. Eight boarding troops are also carried. The vehicle costs MCr 343.79 and takes 16 months to build.

### **Reiner-Gamma Constellation**

Using a laser reflective, stealth-capable 500 ton hull, the Constellation is a Luna strike vehicle designed to hit a space station or DSV hard with AKVs and railguns. It has reaction drive-H and powerplant-H giving a delta-V of 80 km/s. Fuel tankage of 150 tons allows for one trip at full thrust. Adjacent to the bridge is a Model/3 computer and a basic military sensor suite. There are 5



single cabins for commander, his executive officer, chief engineer, tactical officer and the troop commander, and twelve double-cabins for the rest of the crew. There are two spare cabins for additional personnel or passengers. A flare damper and a 6 ton workshop are fitted along with a dedicated medlab and 33 low berths. The Constellation has a centrifuge, spinning the cabin accommodation. The vehicle has five hardpoints one fitted with an AKV barrette and 4 AKVs, two fitted with railgun barbettes (each with 1 ton of railgun ammo, 20 shots per gun), one fitted with a triple turret of ASAT missile launchers and the fifth fitted with dual beam lasers and a CM launcher. The Constellation is equipped with a 20-ton Long Beach transfer shuttle used to ferry crew to habitats, or send boarding parties over to suspect spacecraft. Cargo capacity is 15 tons. The hull is armoured (4 pts.) with titanium-steel composite.

The Constellation requires a crew of twenty-nine: command-pilot, executive officer, two co-pilots, astrogator, chief engineer, 3 assistant engineers, tactical officer and four weapons operators, a medic, three electronics technicians, logistics specialist, a marine sergeant and eight marines. The vehicle costs MCr 394.96 and takes 18 months to build.

### **Tharsis Space Systems Interdictor**

Using a stealth-coated and laser reflective 200 ton hull, the Interdictor is a military patrol and rescue vehicle, responding to distress calls or intercepting suspicious vehicles in Martian space. It has reaction drive-D and powerplant-D giving a delta-V of 95 km/s. Fuel tankage of 80 tons allows for one trip at full thrust. Adjacent to the bridge is a Model/2 computer and a basic civilian sensor suite (^). The commander and his executive officer both have single staterooms; there are 3 double staterooms for the rest of the crew and a spare stateroom for two rescue victims. A flare damper is fitted. The Eris has no spin gravity, but is fitted with a storm shelter and 18 low berths, 8 for the crew and 10 for rescue victims. The Interdictor has two hardpoints, one holds a single-mount particle accelerator weapon, the other is fitted with a triple turret, mounted with a single CM launcher and two ASAT missile launchers. The Interdictor is equipped with a 5-ton Orion transfer pod used to ferry crew to habitats or investigate disabled spacecraft. Cargo capacity is 13 tons. The hull is not armoured.

The Interdictor requires a crew of eight: command-pilot, executive officer, co-pilot, astrogator, flight engineer, two weapons operators and a medic. The vehicle costs MCr 167.88 and takes 12 months to build.

## **Support Craft**

### **Voroncovo DKV Starlifter**

Using a 600 ton, self-sealing hull the Starlifter is a salvage craft, a big lifter, repair and construction tug. It has nuclear thermal rocket-K and powerplant-K and a fuel tankage of 180 tons, which provides a delta-V of 80 km/s. Adjacent to the bridge is a Model/2 computer and a suite of standard electronics. Mounted on a rotating ring, around the main body of the spacecraft, are 17 staterooms, four storm shelters, eight emergency low berths and a dedicated medlab. Other features of the spacecraft include a flare damper, a 6 ton workshop, repair drones, two grappling arms, an extendable airlock and an 80 ton internal maintenance hanger. Docking clamps are fitted that allow the Starlifter to pull any other vehicle (up to 1400 tons) through space, although this reduces the effective velocity of the two vehicles.

This powerful salvage tug carries a 20 ton Long Beach shuttle as well as two Orion transfer pods. They are routinely used by maintenance crews during a salvage job. A 20 ton cargo bay holds supplies for the crew, parts and equipment are carried within the workshop or maintenance hanger.

The Starlifter has a crew of twenty-four: command-pilot, two co-pilots, two astrogators, chief engineer, two assistant engineers, medic, logistics specialist, technical operations manager, assistant operations manager and twelve technicians. There are four spare cabins capable of





carrying eight additional crew, company representatives or non-paying passengers. The vehicle costs MCr376.91 and takes 24 months to build.

### **Reiner-Gama DKV Proton**

Using a self-sealing 100 ton hull the Proton is a small salvage and repair vehicle operated by a crew of between 2 and 4. It has nuclear thermal rocket-A and powerplant-A and a fuel tankage of 20 tons, which provides a delta-V of 65 km/s. Adjacent to the bridge is a Model/1 computer and a suite of standard electronics. A flare damper is fitted along with a fuel processor and 5 tons of mining drones (giving 50% of the standard mining capability). The drones are used to mine ice to replenish the Proton's hydrogen fuel tanks. Landing legs allow the vehicle to touch down on asteroids and moons. Also installed are repair drones and a grappling arm for retrieving objects in space without the crew resorting to an EVA. The cargo bay of 20 tons is quite large for a vehicle of this size, with doors that open up and expose the entire bay to space allowing the grappling arm to place objects inside. There are no auxiliary vehicles carried. Spin habitats house two double staterooms and six low berths.

The Proton has a crew of up to four: command-pilot, co-pilot, astrogator and engineer, though some crews function with only an engineer and pilot. The vehicle costs MCr 43.45 and takes 10 months to build.

## **Private Craft**

### **Matsuyama DEV Sunrise**

Using a 200 ton, self-sealing hull, the Sunrise is a luxury executive craft for the transport of corporate, government or independently wealthy individuals and their aides to the furthest reaches of the solar system. It has nuclear thermal rocket-C and powerplant-C, and a fuel tankage of 60 tons, which provides a delta-V of 80 km/s. The bridge is detachable and as a one-use lifeboat can make a safe re-entry and landing. It is equipped with a Model/1 computer and a basic civilian suite of electronics. Mounted on a double-wheel centrifuge are 10 standard staterooms, 4 emergency low berths and two double sized stateroom suites (both fitted out to luxury quality). Other features of the spacecraft include a flare damper and an 8 ton hydroponic garden, repair drones and a 6 ton luxury zero-G lounge. Cargo capacity is 8 tons.

The Sunrise has a crew of seven: command-pilot, two co-pilots, astrogator, engineer, medic and two stewards. Up to four passengers can occupy the two luxury suites, while an additional two passengers can occupy a standard stateroom each. The vehicle costs MCr108.78 and takes 12 months to build.

## **Exploration Craft**

### **Reiner Gama DRV Horizon**

Using a 100 ton self-sealing hull, the Horizon is a light scientific research and reconnaissance craft. It has nuclear thermal rocket-A and powerplant-A giving a delta-V of 65 km/s. Fuel tankage of 40 tons allows for two trips at full thrust, and 1 ton of fuel processors is fitted. Adjacent to the bridge is a Model/1 computer and a basic civilian sensor suite. There are two double-cabins for the crew, a laboratory, and a 4-man emergency low berth unit for emergency situations. The Horizon has no spin capability; all interior areas are in zero-G. The vehicle has a single hardpoint with a double turret fitted. No weapons are installed. There are 5 science probes on-board with a launching station, as well as 5 tons of mining drones, used to bring ice aboard for fuel reprocessing. Carried craft includes a small 5 ton Spider light lander used for surface missions. Cargo capacity is 4 tons. The craft includes a flare damper.

The Horizon requires a crew of four: pilot-commander, astrogator, engineer and science specialist. The vehicle costs MCr 42.48 and takes 10 months to build.



### **Voroncovo DRV Sirius**

Using a self-sealing 400 ton hull the Sirius is a mobile laboratory used for scientific analysis and investigation. It has nuclear thermal rocket-D and powerplant-D that produces a performance of 65 km/s. Fuel tankage of 80 tons allows for a single trip at full thrust. Adjacent to the bridge is a Model/1 computer and a suite of basic civilian sensors. The bridge is hardened and doubles as a storm shelter for all the flight crew. There are six single cabins for the crew, 20 low berths, and 14 single occupancy cabins for the science personnel. The hull of the Sirius is a single rotating ring, with only two auxiliary craft (both 10 ton Palomino landers) and their mounting in zero-G. It has 62 tons of configurable lab space, a flare damper, 15 probe drones, mining drones used to refuel from ice deposits and fuel processors. The vehicle has no hardpoints or weaponry installed. Cargo capacity is 23 tons.

The Sirius requires a crew of six: command-pilot, co-pilot, astrogator, a chief engineer and assistant, and a medic. The vehicle can carry 14 science personnel. It costs MCr 176.86 and takes 16 months to build.

### **Wu-Ketai DRV Surveyor**

Using a 400 ton self-sealing hull, the Surveyor is a deep space exploration and research craft. It has a nuclear thermal rocket-F and powerplant-F giving a delta-V of 80 km/s. Fuel tankage of 120 tons allows for a single full thrust voyage. One ton of fuel processors and a flare damper are fitted. Adjacent to the bridge is a Model/2 computer and a basic civilian sensor suite. There are twelve double cabins for the crew, a single cabin for the command-pilot as well as an 8 ton workshop and 10 tons of mining drones used to bring ice aboard for fuel reprocessing. There are repair drones, 10 probe drones and a 12 ton hydroponic garden which cuts crew life support requirements by a ¼. The Surveyor includes a medlab, four laboratories and storm shelters and six emergency low berths for emergency situations. Its carried craft are two 5 ton Spider light landers used for surface missions, an Orion transfer pod and a Palomino heavy lander. Staterooms, medlab and storm shelters are all mounted on spin capsules to provide artificial gravity. Cargo capacity is 22 tons.

The Surveyor requires a crew of thirteen: pilot-commander, two co-pilots, two astrogators, a chief engineer, two assistant engineers, two technicians, a medic, two lander pilots and up to 12 scientists. The vehicle costs MCr 243.05 and takes 10 months to build.

### **Voroncovo Kronos III Refining Drone**

Using a 100 ton streamlined hull with heat-shielding, the Kronos refining drone is intended for free-fall descent into the Saturnian atmosphere where it deploys balloons and spends fourteen and a half days processing helium-3 from the native gases. It then ignites its NTR motor for an orbital insertion. The drone has a type B NTR producing 4G thrust and tankage for 40 tons of liquid hydrogen fuel. It enters the atmosphere with fuel tanks empty, topping up its hydrogen tank on-site. A type B fission reactor provides power for control systems and the atmosphere processor. The Kronos probe is equipped with an automated control section controlled by a Model/1 computer, and uses a standard electronics sensor suite. Balloons and parachutes take up 12 tons, the atmospheric processor takes up an additional 4 tons; the rest of the payload (5 ton) is devoted to helium-3 tankage. It takes the Kronos refiner fourteen and a half days to process 5 tons of helium-3 as well as the 40 tons of liquid hydrogen it requires for orbital insertion. The drone costs MCr 58.03 and takes 10 months to build, it has no crew or life support.

## MODULES & SPACE STATIONS

Large cargo ships may carry attached cargo modules and like the maritime cargo containers of today, they can be transferred to other vehicles for transport further along the logistics chain. More than that, these 10 ton modules can be docked together to form small space stations (orbital module platforms, or OMPs), or even landed on a moon to create a base of interconnected modules. Our International Space Station is a TL 7 platform of around 100 tons in total. Each module is a cylinder, 4.5m wide and 9m long, with docking adaptors at either end. Based on the particulars of their use, some have integral solar panels, some include EVA-rated airlocks (see below). Modern equivalents are the Zvezda, Kibo and Columbus modules of the ISS.

### **Orbital Module Platforms**

OMPs are non-gravity stations, designed for research or manufacturing. The average platform is made up of five to ten modular sections, perhaps a lab section, and certainly a hab module and a power module. The modules are standardized. Most OMPs support crews of around 10 people, some more, some less. Since many platforms are located outside of the Earth's Van Allen Belts which protect the planet from solar radiation, all hab modules include a small, heavily-shielded section designed as a solar flare shelter, able to support four people for 12 hours. A specialized 10 ton docking module includes three airlocks, allowing several spacecraft to dock with the station. Most of these modular stations will have at least one docking module, although some modules come ready-made with an integral airlock.

### **Clusters**

Module clusters are made up of five modules arrayed like the spokes of a wheel and connected together at a central, 5 ton node. Nodes cost MCr1.8. Module clusters can all be undocked and transferred from one DSV to another or to a space station all at once, speeding up the process. However, the modules cannot be disengaged from the cluster without several hours of mechanical work. Cargoes destined for Mars or Titan are placed inside these module clusters, and the cluster is locked onto a disc-shaped Module Lander Aeroshell (MLA) which allows the entire cluster to make an atmospheric entry.

### **Module Aeroshell**

Dropping cargo onto Mars requires a heat-shield and braking rockets. The Module Lander Aeroshell (MLA) mounts a cluster of 5 modules, arrayed like the spokes of a wheel, on the rear-face of a large re-entry shield (the aeroshell). With its modules, the aeroshell masses 70 tons; it is fitted with a guidance unit, parachutes, braking rockets and inflatable landing bags. Five modules (of the carrier's choice) are mated to a central Node, a 5 ton, 6-way airlock connector allowing access from one module to another. The MLA comes with a 3 ton de-orbit motor carrying 1.9 tons of fuel; this is enough for a single burn, before it is jettisoned. After this the aeroshell re-orientates itself for atmospheric entry. Total cost of an MLA is MCr18.95; this does *not* include the cost of 5 modules! See the illustration on pg.152.

### **Transhabs**

The transhab is an 'expandable' module concept that allows a module of a standard 10 ton size to be doubled in internal capacity once in orbit. These transhabs are expensive and so far have been used to provide living space and accommodation on a number of orbital stations. Although they can be docked to a standard module and can be launched by a rocket, they are not able to be clustered, nor can they be mounted on aeroshells. Currently the only type in service is the transhab living module.



Module Type	Airlock?	Price	Notes
Docking Module	Three	MCr2.6	This cargo module includes three airlocks at one end and controls for an exterior grappaling arm. Webbing and frames are fitted for 5 tons of cargo storage. Includes vacc suit storage.
Rover Module	No	MCr1.05	A storage garage for a 10 ton utility rover, with wide doors and ramp to reach the ground. It includes wall-mounted tool racks.
Hab Module	No	MCr2.5	Shared living facilities for 4, with multi-gym, mess, galley, entertainment etc. Includes 2 ton storm shelter for 4 that also doubles as the mess and galley.
Science Module	Yes	MCr3.24	Two 4 ton labs, with work-stations, closed facilities and experiment space.
Office Module	No	MCr1.03	Office space for 4, with storage
Workshop	Yes	MC2	Tool shop, typically fitted with an airlock, docking extension and spare parts.
Power/Fuel Cell Module	No	MCr4.09	Every station requires a power module, fitted with a Model/1 computer, comms gear, radar and controls for life support, attitude, power, etc. This module is fitted with solar panels. It also provides batteries (fuel cells) that give a 24 power supply in case of accidents. It features a rocket motor for station-keeping. One power module is required for each 200 tons of platform.
Power/Fission Module	No	MCr8.57	Every station requires a power module, fitted with a Model/1 computer, comms gear, radar and controls for life support, attitude, power, etc. This module is fitted with solar panels. It also provides a small fission reactor with power for 12 months. The module also features a rocket motor for station-keeping and a flare damper. One fission power module will be enough for a platform of 1000 tons or less.
Laser Module	No	MCr7.8	Mounting for a single pulse laser turret and control bay, along with a chemical powerplant with fuel for 12 hours of operation. It includes a Model/1 computer.
Missile Module	No	MCr3.88	Mounting for a single missile turret and controls. Like some of the other modules it takes its power from the platform's solar power grid. It includes a 90 missile magazine and Model/1 computer.
Passenger Module	No	MCr1.85	Cabin space for 16 passenger couches, with 1.5 tons cargo space. It includes solar panels.
Low Berth Module	Yes	MCr2.06	Holds 17 low berths, and includes 0.4 tons of baggage space. With solar panels.
Cargo Module	No	MCr1	Configurable 10 ton cargo module.
Transhab	No	MCr4.9	Inflatable module with 20 ton final interior space. Quarters for 8 people, with central 8-man storm shelter. Includes solar panels.
Micro Smelter	Yes	MCr 4	An industrial unit able to process 2 tons of ore per day to produce 200kg of metal. Needs crew 2.
Hydroponics Unit	No	MCr3.05	Solar panels provide power for this unit which supports 4 people with hydroponics and traditional soil farming facilities.
ORVIN	No	MCr7.3	Oxygen mining factory, with fuel processor for creating liquid hydrogen and liquid oxygen from water ice. See pg.114.

# 8 ORBITAL SOCIETY

## LAW ENFORCEMENT

*"The Marshal turned to the pickup. 'You can't keep the door closed, Sagan. The moment the hydraulics are cut off it will open inward. You can't stay in there. You might as well come out... Sagan's voice rose in response, came harshly through the speaker and rattled around the silent corridor. The second that door opens, I'm going to kill her! I'm going to slice her!'"*

Alan Dean Foster, *Outland*

With such long travel times across the solar system, communities, whether they are on Mercury, Eros, Europa or Hyperion must rely on their own resources and police themselves. Should a criminal run riot, help might be weeks away. Every community has its own methods and levels of tolerance, this is what the Law Level measures, exactly how severe or 'on the ball' any colony treats its security measures. Above and beyond what local outposts and cities can manage, both Luna and the Earth Union have their own interplanetary police forces. Luna has the patrol agents of LOPS while the EU has the marshals and deputies of SARA. The Space Activities Regulatory Agency (SARA) polices all Earth Union affiliated outposts and colonies and provides deep space search and rescue, enforces space safety regulations, recaptures escaped convicts and provides professional assistance to Earth Union allies. LOPS (Lunar Outsystem Patrol and Security) provides a similar service for the Lunar Republic. Licensed private security firms such as Eckard Tactical Management (ETM) have carved themselves a niche within the orbital society, able to provide law and order where no government authority exists. Strict limits are, however, imposed on the weaponry such firms are able to use; they are security companies and not mercenary units, after all. Most have access only to small arms.

### Crime

Most developed countries realised by 2050 that drug prohibition was costly and futile. Being illegal did nothing to reduce either consumption or lower supply but it greatly increased the likely-hood that drugs were dangerous and the cause of urban violence. Over time governments turned their efforts towards rehabilitation and to monitoring the rise of dangerous homemade pharmaceuticals. As of 2100 the 'drug war' has all but ended although

### Money

Most financial transactions are completed electronically and the standard Traveller credit works well as an accepted e-credit, used by both Luna and Earth as well as other independent worlds such as Mercury and Iapetus. Certainly each of these worlds will have their own currency standard, based perhaps around the value of that most precious trading commodity, helium-3. In an **Orbital** Traveller we can forgo that detail and skip straight to the e-credit.

Credit and debit cards work as they do today, though they now contain a tough microprocessor which communicates with the store computer and exchanges details. Daily, store computers on worlds across the solar system upload their transaction data to the Net which is transmitted to the relevant holding bank on Earth or Luna. So when a traveller next slots his card into a machine on Titan, for example, the bank will already have details of his last purchase and his card too will retain its own record, should the data not get to the holding bank for whatever reason (comms failure, solar flare, poor electronic infrastructure, etc.).





some laws remain on the books allowing for the prosecution of those who knowingly produce and sell harmful substances. A similar line of thought has also led to the legalization of nearly all consensual prostitution and most gambling.

Conversely, the ease in which a small group of people can set up a highly advanced chemical or biological laboratory has created many new dangers. It is relatively easy to create weaponized biological agents or extremely harmful chemical agents. When introduced into the confines of an enclosed space-station or habitat these can have truly devastating effects. Thus both Earth and Luna closely monitor the sale and distribution of a wide variety of common and not so common, chemicals and equipment. Given that most lab equipment that can be used to create weapons of mass destruction also has numerous legitimate uses this can be an exceedingly difficult task.

A great area of concern is people trafficking, organizations like the Snakeheads specialize in the illegal movement of people throughout the solar system. Other concerns include immigration law violations, the transportation and harbouring of wanted fugitives and the defection of contract-bound government or corporate employees.

There are several other areas of concern for law enforcement agencies. Claim jumping is common on Mars, in the Belt and on Venus. Current international law requires a claimant to clearly mark their claim visually and electronically and they must establish a substantial presence on the property within two years time. Intellectual property rights are a concern for many corporations but since the IP Revolt of 2029 much has been done to level the playing field between the large corporations, smaller businesses and the consumer. Copyright and patent periods have been reduced to a more manageable twenty years for both individuals and corporations; the doctrine of fair use and the creation of derivative works are both now better protected.

Environmental regulations both on Earth and in space continue to keep some agencies busy. Earth is doing well as the general decline in the use of fossil fuels and CFCs has decreased global warming, allowed the ozone layer to recover and greatly decreased acid rain. Mars on the other hand is a mess. The process of terraforming has sparked countless lawsuits and counter lawsuits that may continue for decades. Finally, a major though unlikely threat that the EU monitors involves the use of weapons powerful enough to threaten global annihilation. Having been hit by rocks aimed by the Lunars, the government of Earth knows all too well what damage even a small impact can have.

### **Mass Driver N6**

In the tit-for-tat struggles for freedom and supremacy in the Belt, the Cascadians have stung the Luna authorities there just too many times. Luna military moved in and took a score of prisoners. En route to Luna they all died in a pressurisation accident, or so the Republic news channels reported. Now the Cascadian freedom fighters want revenge and are about to seize control of a Luna mass driver (nicknamed 'The Six-Gun') on asteroid 42 Isis, an S-type asteroid roughly 100km in diameter. This they will use to launch destructive rocks at the Luna far side as a show of force (before Luna marines from Vesta arrive 24 hours later to recapture the facility).

Perhaps the PCs unwittingly ferry the Cascadians (disguised as Luna technicians) to the Six-Gun facility, or maybe they have just been hired to make a routine delivery and arrive at the wrong time. Locked up along with the mass driver staff, they must affect an escape and stop the terrorists in time.

## ART

The most impressive forms of art to come out of the Belt are asteroid sculpting and light clusters.

**Rock Art** - Asteroid 'Rock Art' sculpting involves entire asteroids being carved into recognizable shapes using several types of mining robots, plasma torches and laser drills. Once the major cuts are made, and the waste material sifted for valuables, the artists themselves add the final details. Two of the most famous asteroid sculptures are the Dreamers and Athena in Repose. The 6 km long Dreamers is shaped like a pair of porpoises jumping over the Moon. The memorial doubles as a refuelling station and even houses a small museum dedicated to the history of manned space flight. The memorial has a permanent staff of four and due to their very pro-Luna stance it has been the target of numerous terrorist threats by the Cascadian Alliance. The largest asteroid sculpture yet completed is the beautiful Athena In Repose. This 9 km long sculpture depicts the goddess Athena nude and floating through space, draped across the edge of the asteroid 3277 Aaronson.

**Lights** - Light clusters on the other hand make use of advanced solar cells to capture energy and then release it again as coloured lights. The size of these lights can be up to several tens of kilometres in diameter as the cells are made of flexible mats. The three most famous light clusters are the Eros Wrap, the Dancing Fates and the Beacon. The **Eros Wrap** was meant to be a temporary art show to commemorate the 25th Anniversary of NASA's landing a probe on asteroid 433 Eros (which today orbits the planet Venus). The asteroid was wrapped with millions of high powered pink Christmas lights all powered by an old Northinghouse nuclear reactor. Like the Eiffel Tower before it; this 'temporary' display became extremely popular as it could be seen from Earth by any decent sized telescope. In 2039 the lights were upgraded and given the ability to change colour depending upon the season. Today Eros is considered neutral territory by both Earth and the Luna Republic. The **Dancing Fates** is a light display located near Ceres that consists of twelve high powered coloured lights; two of each colour of the visible spectrum. The lights flicker on and off to the beat of a musical accompaniment and thus give the illusion that they dance. While fun to watch on their own, the Fates only get their full effect if the observers tune their radios to receive the music been broadcast from the light display. Like Eros, the Dancing Fates often change their routine based upon the season.

Unlike Eros and the Fates which are seen as works of art, the **Beacon** has become something of a mystery. First noticed on July 20, 2069 the Beacon consists of just one very powerful light source that rotates like a light house. Originally located on 911 Agamemnon, a large member of Jupiter's 'Greek camp' trojan asteroids, the light takes a full sidereal day to make a rotation and thus always points at Earth while North America is experience night. In 2071 a Lunar expedition visited the beacon and found it to be powered by a cutting edge fission plant but was other wise unremarkable. A year later the Earth Union deemed the Beacon to be '...a threat to deep space navigation and a system wide eye-sore.' In late 2073 the Beacon was destroyed by an EU mission. To everyone's surprise the Beacon reappeared July 4, 2076 on Jupiter's 'Trojan camp' trojan, 617 Patroclus. Five years later this Beacon too was destroyed by the EU. The Beacon remained absent for nearly eight years but reappeared in the trailing Martian trojans on August 21, 2089 to be once more destroyed by an EU military vehicle. Surprisingly, the Beacon came back, located on a Near Earth Asteroid, on September 25, 2089. Now maddened by the reappearing nature of the Beacon, the EU offered a reward for information regarding those responsible and had the newest Beacon destroyed. The current Beacon came on December 15, 2091 and emanates from an unmanned asteroid outpost on Jupiter's 'Greek camp' trojan, 4543 Phoenix. The Titan Crisis prevented the EU government from launching an expedition to destroy the newest Beacon and as of yet the new EU government appears resigned to allow the Beacon to continue operating for the time being.

# COLONIES, STATIONS, HABITATS

There is a lot of human construction out there, but most of it can be easily categorized.

## Surface Installations

There are humans living on Luna, Mercury, Ganymede, Titan and many other planets and moons, in one of four types of installation: city, township, outpost or Venusian floating city.

### City

A large population centre (8,000+) that is purpose built, often in several stages. It boasts amenities including movie theatres, meeting halls, entertainment complexes, restaurants, bars, offices, warehouses, shops and gardens. Much of a city is underground in dispersed chambers connected by wide tunnels providing electric vehicle access, while ramps lead to surface garages, factories and solar power and communications facilities. The city will have surface landing pads (typically providing a spaceport of level C or D). Cities have an administration and a government as well as a police force. Thompson in Canada, (population 12,000) makes a good modern-day equivalent, a city that has grown up around a single industry to develop an infrastructure, housing and a service economy.

Parts of the city, mainly industrial sectors, are above ground by necessity, but all living quarters are underground, protected by at least 2m of radiation-proof soil. Public areas often have access to the surface with large windows or domes which are provided for psychological reasons. To prevent a decompression blowout affecting the entire city, sections are strung out, decentralized and capable of being isolated from one another by bulkheads and airlocks. Domes are constructed from strengthened glass, divided into many tiny panes, that way a blow-out will affect only a single pane and not 'crack' the entire window. Teams will be able to repair the pane before too much air has escaped.

Landing pads allow landers to touch down with passengers and cargo. Most pads have integral elevators lowering the vehicle into an underground pressurized hanger for easy fuel, cargo and passenger management. Otherwise there may be tracks that slide landers into surface hangers for routine servicing.

A fission plant provides power, and is often partnered with fuel cell and solar cell technology to provide power for secondary systems, or as a back-up. Close to the power-plant is the life support plant, recycling oxygen and water and dealing with waste. This depends on near-by electrolytic plants, catalytic crackers and smelters that produce the city's raw materials. Meanwhile, after an early preparation of lunar soil with nitrogen, earthworms and other techniques, the farms focus on fast-growing, protein-rich soya food. Vegetables and fruits are grown in hydroponics sections, whilst poultry, guinea pig and fish are reared as delicacies. Shellfish can be eaten and assist in the water purification process. Most habitat dwellers are vegetarians, though not by choice, it is more energy efficient in these closed environments to eat vegetables rather than have those vegetables processed by an animal that is consumed months or even years later. Living areas may be single, double or triple level cylinder-shaped habitats, with stairs leading to different levels from a single access corridor. Designs of cities do vary, but the main principles of habitat design remain the same and the most ubiquitous building material is the baked soil brick.



## Township

The township is a small settlement which usually serves a basic economic function, most often mining. Its population ranges from 200 to 8,000. The township is quite independent, providing for its own oxygen, metals and food, but will need to bring in a whole range of other goods from elsewhere. It will export its prime resource, whether that is oxygen, nitrogen, aluminium, helium-3, water, liquid hydrogen or food. Most were initially established around ORVINS, each one capable of sustaining around 250 people. As settlement on Mars began, hundreds of Mars-adapted ORVINS (named MARVINS) were autonomously landed across the surface. The township will often be in contact with a city, or a spaceport, so that it can import and export goods. Townships are purpose-built structures, smaller-scale versions of the city (see above). The oil-refining town of Nikiski (population 4,000), on the Kenai Peninsula in Alaska, provides a useful analogy.

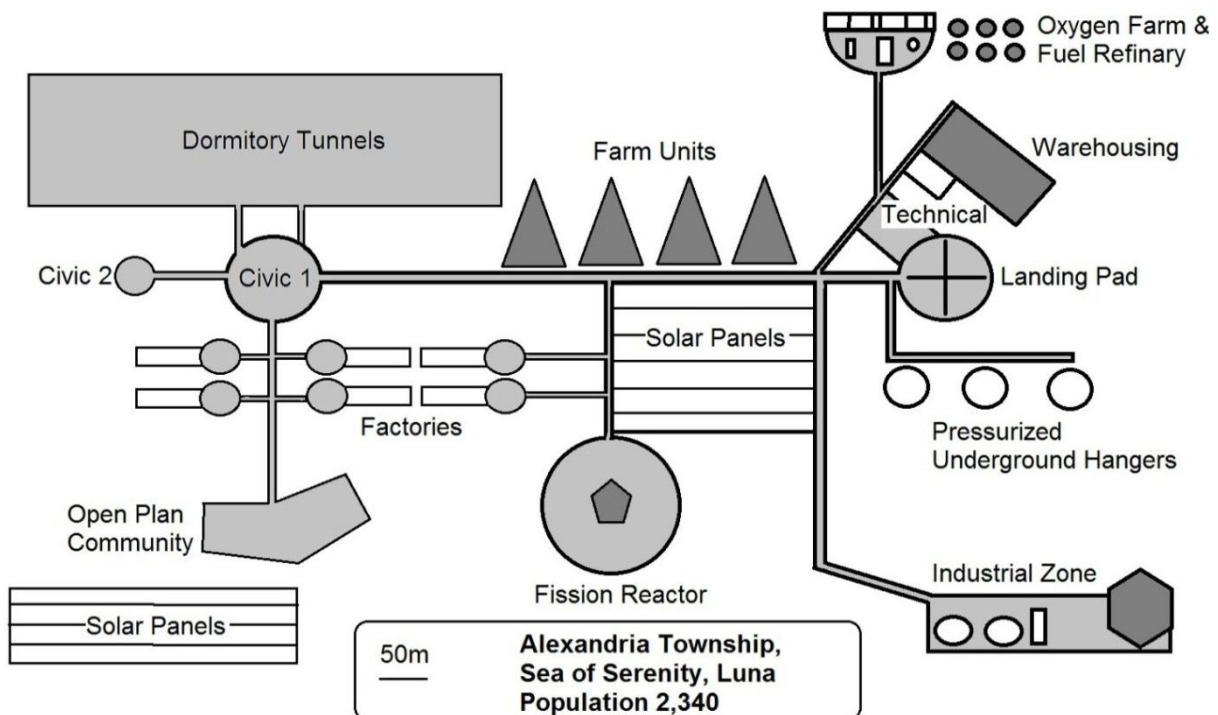



## Outpost

A small settlement with a particular mission, a population less than 200 and a dependency on another installation for regular shipment of supplies epitomizes the outpost. Individuals or teams will be regularly rotated back to the main installation on a regular basis. Outposts can be purpose-built, but are more often created from 10-ton modules. A township or city will be ringed by outposts, serving as extraction sites, industrial plants and refineries. Their organization and day-to-day life resembles that of the modern-day North Sea oil & gas platform called Elgin (population 100), or the Amundsen–Scott South Pole Station (population 50-150).

Modules are often buried in shallow trenches and soil then shovelled into long 'regolith-bags' which are pulled across modules, draping over the top to protect the occupants from solar flare radiation. Alternatively, if a digger is available, soil can be shovelled directly over the modules to cover them completely. Imagine an outpost almost as a partially buried International Space Station. Nodes connect multiple modules together, docking modules become gateways to the surface via ramps. Rovers and equipment shelter beneath simple aluminium shades. On the surface, power comes from a bank of fuel cells, most often regenerated via large solar arrays. As the outpost slowly becomes a township, these are often replaced with a buried fission reactor, large radiators taking the place of those solar panels. The outpost has covered rover areas, a beacon, floodlight towers and at least one comm tower. Tool sheds, equipment lockers and sheltered work areas are also sited on the surface, close to airlocks.

An advanced follow-up to the Martian MARVIN stations that dot the surface of Mars (see the Mars entry, chapter 9) is in use by the Lunar Colonization Office. Called ABODE (Automated Base or Outpost Deployment Equipment), these modular payloads are essentially self-deploying outposts launched towards an uninhabited moon or asteroid. Upon arrival, drones and memory metal go to work and over the course of several weeks a fully functional outpost facility is constructed. Once ready for habitation a crew can move in. With a much smaller population and fewer overall resources, the Lunar government feels the need to blindly claim as much real estate as quickly as possible in a struggle to catch up to Earth. These ABODEs can sometimes be found on asteroids of moons ready for future science teams or colonists to arrive and take control. On occasion a crew in trouble might find an ABODE a useful emergency shelter. Some ABODEs have been occupied by independent groups unafraid of Lunar retaliation.

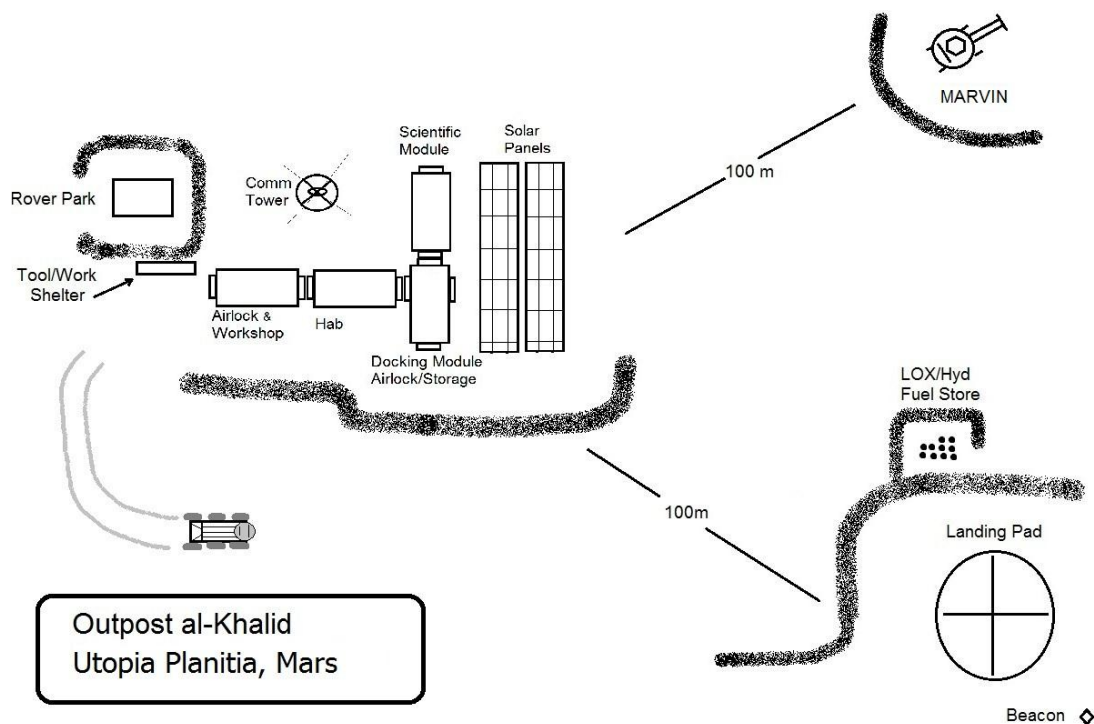





## Venusian Floating City

***Eagle City, typical aerostat type city:*** Each Venusian floating city, or aerostat holds around 10,000 individuals, not just scientists, but engineers, hydroponics technicians, mechanics, and the whole spectrum of personnel that allow a colony to function. Transport between aerostats is carried out by the special Venus flyers that make suborbital journeys across the globe to the widely dispersed cities. Like all the other aerostats, Eagle City is a modular design consisting of four wedge shaped sections arranged like a flower. The central core contains a large water tower, which in the case of Eagle City acts both as the central water reservoir and also a large aquarium filled with fresh water fish. At the tip of each wedge butted up against the aquarium are the six story tall farm towers that also assist in waste and water treatment and produce oxygen. Running along the outside of the farm towers are numerous passenger and freight elevators. Outside of the core area where each wedge widens housing is intermixed with commercial and light industrial zones. Eagle City has very little heavy industry except for fabrication plants to replace solar cells and repair interior features.

Each wedge, known as a sector, has a unique feel and design. Red Sector is nicknamed "the Maple Leaf" it is home to many people sympathetic to the Red Legion and the League of Aphrodite. While occasionally referred to as the Canadian Sector, most Canadians find the area tacky and cliché. Most income derived in Red Sector comes from crafts and tourism along with a number of comedy clubs and software micro-corporations. Blue Sector, known to locals as "the Bell" due to the lovingly made Liberty Bell replica that graces its central pavilion, makes use of artificial wood trim and moulding. In this case though the wood is finished, stained and often elegantly carved. The affect has been described as a beautiful blend of Scandinavian simplicity and Arts & Craft style designs. The Bell has the largest number of residents and much of its income is derived from service and entertainment companies.

Between the Red and Blue Sectors lies White Sector. Originally conceived as a Greek Revivalist tribute to Washington DC, the funds fell short. Very few of the planned columns and facades made their appearance despite the sterile white paint used throughout. Fortunately, the low property costs attracted the attention of several Earth based companies and White Sector now houses a first rate medical centre, several food processing industries and a micro-drone assembly plant. The final sector, lying between Blue and Red sectors, is Gold Sector. Called Futura by nearly everyone on Venus, Gold Sector has a retro 1950s sci-fi look and feel. Futura has a good mix of housing and business.

Atop the four colour coded sectors sits the aviary. This large dome-shaped habitat is possible because of the giant gas balloon that encircles all of Eagle City and provides most of the needed buoyancy. The floor of the aviary is covered in a mossy soil out of which grow various grasses and small bushes. Near the center atop the farm towers are four large trees. Numerous species of birds live within the aviary including a nesting pair of bald eagles. Small clouds occasionally form since the central aquarium is covered only by a screen thus allowing water vapour to rise up into the open space above. The aviary not only provides more oxygen but also acts as a public park. The dome roof above the aviary is partially covered in acid resistant solar cells and the smart plastic dome can become opaque to create a day-night cycle. The underside of the outer gas bag acts as a spacious hanger for the city's two Venus Darts. Two extra visiting Darts can be held without putting undo strain on the city's lifting capacity. A large number of smaller remotes and drones are also stored and launched from the underside hangers. Dangling down below the city by way of a ten kilometre long carbon fibre cable is a small science station and atmospheric scoop. This cable and facility doubles as a keel to keep the entire city stable and prevent excessive rolling.

## Orbital Installations

Four types of orbital installation have been developed for use across the solar system: orbital modular platforms (OMP), single-hull stations (SHS), spin gravity stations (SGS) and the stunning megastructures known as large scale space colonies (LSC). Some attempts have been made to tunnel into asteroids to create pressurized cavities, but these projects are still experimental.

### Orbital Module Platforms (OMP)

Cheap and simple, the OMP is an orbital station composed of 10 ton cylindrical modules (see pg.84). These have been in use for decades, are ubiquitous, cheap and versatile. Simply by adding two new modules, an OMP can change its mission from a transfer station to an orbiting laboratory. All OMPs require a minimum of 2 modules, power and hab, but many are made up of 4-9 and there are some even bigger. Some of the modules come with their own solar panels, providing power should the main powerplant be shut down for repair or maintenance.

OMP's are no-gravity stations which mean that crews either have to be rotated back to a planet like Mars, Luna or Earth regularly, or have to maintain a fierce regime of fitness while on-board to prevent bone and muscle wastage.

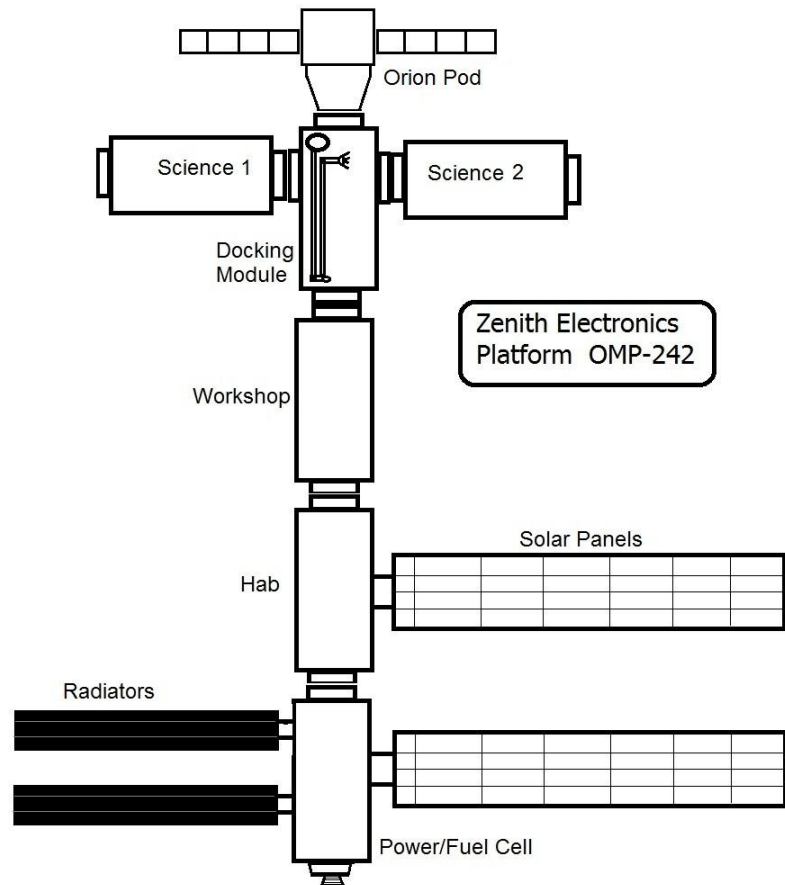

#### OMP-242 Zenith Electronics Platform

Built up from six 10 ton modules, OMP-242 is a research and testing centre for zero-G electronic production methods. It is a 65 ton station, mounting a fuel cell module, a hab module, two science modules, a workshop module and a docking module. A Model/1 computer is fitted within the power module. There is accommodation for 4 personnel and no weaponry is mounted, but a single 5 ton Orion transfer pod is docked with the platform which provides transport for 3 people. Cargo capacity is 5 tons. The Zenith platform cost MCr 15.38.

Some OMP's are extremely old, with many previous owners. Those left abandoned are quickly inhabited by squatters, eager to set up shop away from which ever government they feel was persecuting them. Modules can be bought second hand for a fraction of the original cost, but requiring renovation and work. A character might find a module for sale for 10-60% of its price when new, but it would require Cr100-600,000 spending on it, along with a complete overhaul:

*Overhaul an Old Module:* Mechanics or Engineering, Intelligence, 1-6 weeks, Average (+0)

Failure means that the module contributes a -1 to the OMP's monthly maintenance check, unless the overhaul is redone.

## Single Hull Stations (SHS)

While the gravity requirements of passengers and tourists are catered for by the torus-like spin gravity stations, there are a huge number of industries, operations and activities that cannot be conducted on such a station. For these unique activities, a station is constructed like a DSV from a zero-G hull, with components and facilities added on, modules fitted, and all of the machinery required by the sponsor. If a crew is going to live there permanently then some form of spin gravity is also required. All SHS are different, tailored to their unique needs. A great example of an SHS is the 300 ton Cryostat series, built by the Earth Space Development Agency (ESDA) to supply Earth vehicles with liquid hydrogen fuel.

### Cryostat SHS 4LH

Using a 300 ton hull the automated cryogenic fuelling station ('cryostat') has been developed by ESDA to emplace caches of liquid hydrogen where refuelling may be a problem or even impossible at key points throughout the solar system. Vehicles registered with ESDA (any Earth Union vehicle, civilian or military) may dock with any cryostat once the computer management system has identified and billed the vehicle. Lack of funds is no matter, the bill is sent electronically to Earth, refuelling can always be done once ID is verified. Solar panels provide basic electrical power for life support and to power the refrigeration equipment that super-chills the 200 tons of liquid hydrogen on-board. Large radiators keep the tank cool, preventing the hydrogen from boiling off. There are two extendable fuel arms, either can pump fuel onto a visiting craft, or alternatively, offload fuel from a tanker in order to fill the cryostat's own tanks. In addition, 12 tons of chemical fuels (such as hydrazine and kerosene) is kept on board for smaller rocket motors and retro-rockets, and the use of a 20 ton fresh water tank is available for those wanting to top up their vehicle's water tanks.

A compact, fully-automated bridge fitted with a Model/1 computer controls all station functions, although there are four double staterooms within a centrifuge for the use of visitors or maintenance crews. There are also 10 emergency low berths on-board that can hold up to 40 individuals in a crisis. Five tons of emergency supplies and medical equipment are also available for the use of a visiting crew in dire straits. Up to three vehicles can dock at any one time; access to the interior of the station is allowed only under emergencies, the ESDA authorities will be notified who will then attempt to make contact with the vehicle in distress. Cost is MCr 17.75



## Spin Gravity Stations (SGS)

The days of OPSEK, Mir, ISS and Tiangong 3 were left behind in the 2020s with the first spin habitats, large wheels in space that, when spinning, create an artificial gravity for crewmembers on the inside of the curved rim. There is nothing modular about these stations; each is a one-off build using the spacecraft rules in this book. Crews on an SGS stay fit and healthy, life has that fixed gravity normality that OPMs lack, making them easy places for travellers and transient visitors to cope with. They make ideal transfer stations for people used to gravity, or long term stations for people employed to live and work in space.



The wheel-like torus of a spin gravity station is mounted around a cylindrical axle, which acts as a non-rotating, zero-G docking area for spacecraft. This central core also includes a control centre and fission powerplant.

### **SGS-16 Goddard Low Orbit Transfer Station**

Using a 2000 ton hull, Goddard Station is a spin-gravity station with two counter-rotating wheels. It allows passengers and cargoes arriving via spaceplane from Earth to transfer to shuttles heading out for stations in geosynchronous orbit. From there they board DSVs heading out to the distant planets. It has a fission powerplant-K and a station-keeping reaction drive-K, both providing a rating of 1. Fuel tankage of 230 tons supports one burn (50 tons) and provides fuel surplus for visiting craft. Adjacent to the control centre is a Model/2 computer and a basic civilian sensor kit. There are 75 crew staterooms, 20 of which are singles and 55 of which are double occupancy, and no low berths are carried. No hardpoints or weapons are fitted.

Goddard has many amenities, a 100-room hotel, a 25 ton restaurant and bar, 100 ton of offices, 40 ton of workshops, a 19 ton customs and security section, repair drones, a dedicated medlab, 160 ton of open concourse and shopping with 20 individual stores, 380 ton of cargo warehousing and a 300 ton zero-G docking bay complete with a 10 ton docking control centre. Four vehicles are routinely carried on board, two Long Beach shuttles and two Orion transfer pods. There is approximately 55 tons of integral pylon structure that incorporates elevators to take goods and guests from the zero-G spine down to the fixed gravity rim. Goddard has a crew of 130. It cost MCr 666.06 and took 32 months to build.

### **Large Scale Space Colonies (LSC)**

So called Lagrange space colonies have been proposed by space advocates like Gerard O'Neill since the early 1970s. His vision for the 'High Frontier' postulated almost a utopian civilisation living in space with limitless power, living room and mineral resources. There are currently three O'Neill style colonies in Earth space, all are massive rotating rings, 1,800m in diameter, with enclosed environments that include huge agricultural areas, with some open water and parkland, a glass ceiling sitting 65m above. In essence, these LSC are up-scaled versions of the small spin gravity stations, the major difference here being that the interior is one vast habitat rather than corridors and compartments. Glass windows cover one third of the surface of the torus to allow sunlight directly into the habitat, providing night and day and allowing crops to grow. Spinning slowly in the space the torus enjoys a full 1G on the inside of the rim, whilst the central hub or 'axle' remains at zero-G allowing vehicles and supply craft to dock easily. Six spokes housing large elevators connect the hub with the rotating rim.

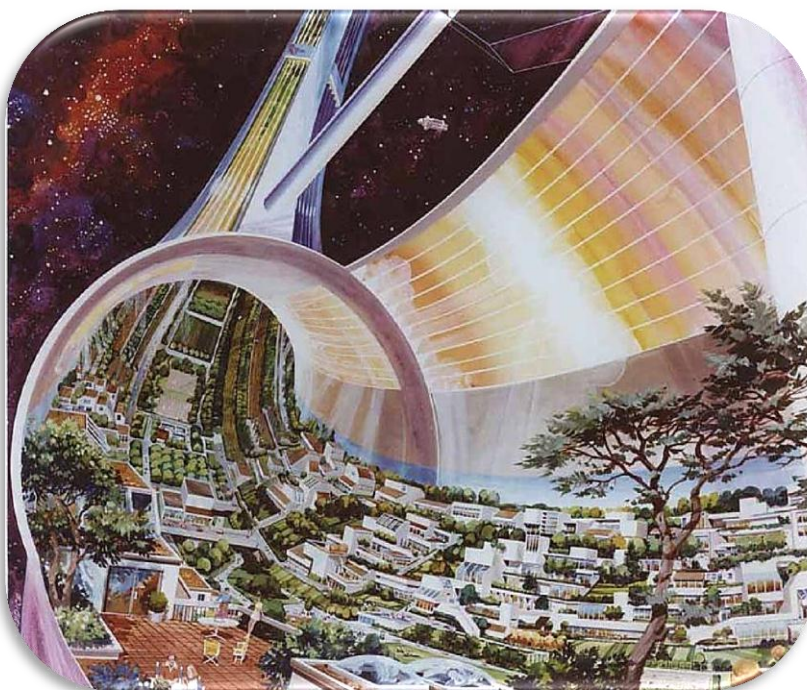

Shielding against cosmic rays is created by large 'bricks' of fused undifferentiated lunar or asteroidal soil held together by mechanical fasteners. This shielding is up to 2m thick and coats the outer rim, beneath the 'floor' of the habitat. To prevent cosmic rays cascading through the windows above, ingenious angled mirrors are mounted there which absorb radiation, but bounce light into the habitat. The glass windows are made up of small panes mounted in strong metal frames; a meteoroid punctures only one pane, providing plenty of time for repair crews to fix

the problem. Power needs are met by areas of solar cells spreading out from the hub like the petals of a flower. These colonies have been massive undertakings and all are still undergoing construction of new agricultural areas, housing and other services as the population expands. With almost a million square metres of community living space, there is plenty of potential for development.

The LSC require stable orbits, they are so massive that they cannot easily boost themselves to prevent orbital decay. Stable points around Earth and Luna are found in two locations, named Lagrange 4 (L4) and Lagrange 5 (L5) after Joseph Lagrange, the scientist who discovered them. Both are points on the Moon's orbit 60° ahead of (L4) and 60° behind (L5) the Moon as it orbits the Earth. It takes around a day and a half to reach these points from Luna or Earth by conventional rocket. L1 is another stable Lagrange position between the Earth and the Moon.

Location	Large Scale Colony	Alignment	Population	Date Completed
L4	LSC-1 Matthias Vanderveen	Earth	220,000	2064
	LSC-3 Sword of Damocles	Luna	15,000	Begun 2080
L5	LSC-2 Revolution	Luna	85,000	2078

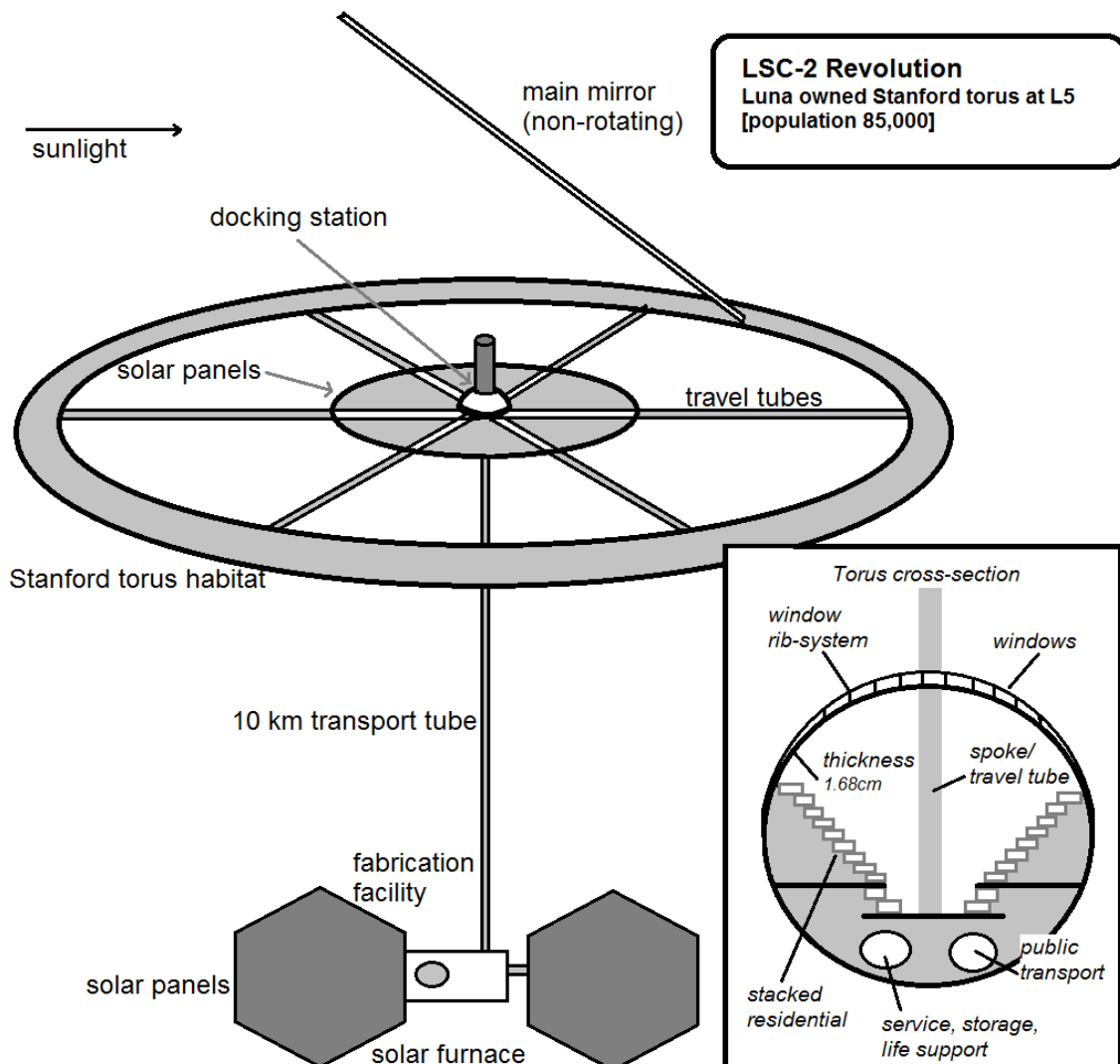



## Colony Crew Requirements

When designing spin stations, colonies and OPMs, the crew requirements are slightly different from those of standard Traveller spacecraft. A large number of personnel are required just to maintain the life support and integrity of the station. All stations and colonies have a Hab Systems Manager, and under him or her are the following departments:

Department	Responsibilities	Typical % of total population
Admin	Office staffing and managerial oversight	2
Life Support	Air, water and temperature, hydroponics	4
Integrity	Airlocks, evacuation, seals and hull integrity	2
Power	Power generation & distribution	4
Fire Safety	Fire drills, extinguishers and practice	2
Catering	Food preparation, restaurants & canteens	4
Cleansing	Laundry and cleaning	2
Security	Guards, customs and police officers	1
Technical	General maintenance	4

This forms a total of 25% of the total population of any type of artificial colony, whether an OPM, a space station, LCC or colony on Mars or Miranda. Consider for a moment how many people work day to day at an international airport, whilst thousands of passengers pass through every day. These figures are just approximations, but they give the referee some idea of the numbers of people required on a colony or space station project.

The referee might decide on a colony's overall population and then use the % values to determine the number of security personnel or admin staff, as needed for the game in hand. Such calculations become useful once the referee begins to construct spin gravity stations.

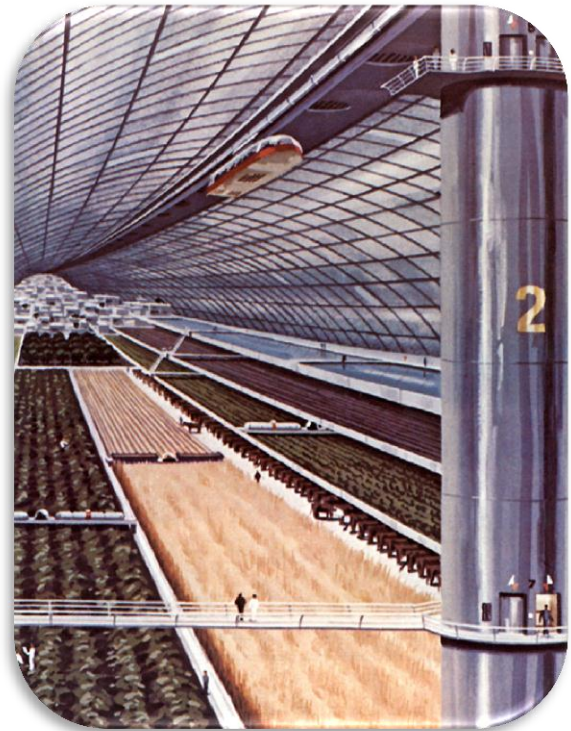

*"It's just a big tube and they pour things through it," Molly said. 'Tourists, hustlers, anything. And there's fine mesh money screens working every minute, make sure the money stays here when the people fall back down the well.'"*

William Gibson, Neuromancer

# RUNNING A DSV

*"The first officer was boss of the ship and a wise captain did not interfere with him. The captain, although by law monarch of his miniature world, turned his eyes outward; the first officer turned his eyes inward. As long as all went well the captain concerned himself only with the control room and with astrogation; the first officer bossed everything else."*

Robert Heinlein, Starman Jones

## Officers

Officers hold a commercial space license, they are known as 'licensed' personnel. In **Traveller** terms they are commissioned Merchants. Officers on-board a commercial DSV are able spacers, technically competent and cross-trained. Below the rank of captain (or vehicle commander) sits a ladder of ranks named first, second, third and fourth officer. Although the captain and first officer are both qualified DSV pilots, the other officers do not have specific roles associated with them. The second

### RANK TABLE

Rank	Epaulette Insignia	Associated Benefit
Crewman	-	
Senior Crewman	-	Mechanic 1
Fourth Officer	broken stripe	
Third Officer	1 stripe	
Second Officer	2 stripes	
First Officer	3 stripes	Pilot 1
Captain	4 stripes	

officer may be the engineer **or** the medic, for example. The second, third and fourth rank structure establishes seniority, responsibility and experience. These officers take turns in standing watch on the bridge, and sharing that responsibility with the captain.

There are a lot of jobs that need attending to on-board a DSV that fall outside the specific job that a spacer has been hired on to do. Cargo needs loading and unloading, orbital craft launched and retrieved, life support systems checked, airlocks cycled, radio messages sent and received, and a host of checks on every part of the spacecraft in a never-ending maintenance and replacement cycle. Much of the work and responsibility is shared, most DSV crews are small (less than 20 in number) and there's very little 'pulling rank' between first, second, third and fourth officers. Everyone works together, but when the captain and first officer are absent, it's the second officer who calls the shots. When he's unavailable it's the third officer who is in charge. The first officer has some extra duties; he is a qualified pilot, able to take control of the vehicle in the absence of the captain. Additional responsibilities include the welfare of the crew and their training in fire fighting, explosive decompression and other emergency situations. The first officer will decide who is on watch and assign jobs to crew members in order that the captain's orders may be carried out most effectively. On-board large DSVs with several departments and a large number of crewmen, there may well be more than one fourth officer. This often happens on passenger craft, large repair and construction DSVs and on hospital DSVs, where responsible officers are required to lead departments. Should two fourth officers have no senior officer in charge, then the one serving the most terms has seniority.

## Crewmen

Although some crewmen can be quite skilled, holding levels in engineering, sensors, astrogation or pilot, for example, they hold no licence, have no command responsibility and are not allowed to stand watches (ie. be the sole person on the bridge). They are far from being the 2100 AD version of the hull-painting, deck-scrubbing able seaman, however. They are technically proficient and able to work with the officers as part of a tight-knit team. Most will be skilled in space suit operation, zero G activities, remote ops, communications and mechanics. On small DSVs there may not be many crewman on board, most personnel will be made up of officers (purely so that

watch duties can be shared out) but when they are, they are typically assigned to the engineering section, although military vehicles may assign some to the weapons section and passenger vehicles to the customer service (stewards) section. Like officers, crewmen receive a good deal of cross-training.



## **Downtime**

Once the DSV's acceleration burn is complete the spin habitats begin revolving and the crew and passengers settle down to a routine that lasts weeks or even months. There are daily tasks to complete related to the crewman's specific job, and the officers take it in turns to monitor the bridge. There is always one officer on duty at all times. Then there are the training regimes, changing every day. They prepare the crew for all of the expected dangers of space travel; from how to deal with explosive depression, reactor leaks, fire, medical emergency, evacuation and a host of other crises. Engineers are always keen on preventative maintenance; rather than waiting for machinery or electronics to fail, parts are taken out, tested and put back or replaced according to a schedule. For larger or more complex components the entire crew may get involved with that job.

That still leaves plenty of free time; the crewmen can indulge in hobbies, they can socialise and they can even freelance. Some crewmen have other jobs, ranging from writing novels, debugging software, data entry, creating art or anything else that can be done by telecommuting and that is not adversely affected by the communication lag.

Passengers can be frozen in cryogenic low berth, but there are always associated risks (although minor) and so many passengers prefer to travel in conventional staterooms. These passengers require diversions and so every stateroom includes some type of data station within their cabin that can provide games, movies and other entertainments. Many bring work with them and can get on with that in the privacy of their stateroom (or not if they are sharing a cabin). There is always a lounge with gym facilities, game tables and VR booths. Passengers crave the company of others, they routinely occupying lounges, canteens or other areas set aside for socialising. Most of these areas are in gravity.





Time served on-board a military vehicle is a little different. Since the enemy can't conceal a nuclear thermal drive burning as hot as a small sun, the vehicle commander can use the trip to spy on anything out there that emits radiation (using everything from multi-band encrypted radio to plain old optical spying with a good sized reflector telescope). While coasting between acceleration and deceleration the crew will assist the vehicle's computer in all sorts of active and passive surveillance. Depending on the trajectory of the voyage, time can also be spent seeding different areas with passive observation drones (spy satellites).

If the DSV is large enough, then training will be conducted in boarding or assault techniques, emergency procedures, rules of engagement, combat medicine and prisoner handling. Most vehicles contain a common area large enough to accommodate the entire crew. On many military vehicles this will be everything: flare shelter, mess, exercise/training room, off-duty lounge and briefing room. Typically, the day begins with an all-crew briefing (only a select bridge crew is exempt) led by the executive officer. This will be a review of any news received from HQ, the vehicle's current situation and intent, as well as a general Q&A for crew members to air their concerns. These are people confined to a small sterile cylinder for months at a time, and most people selected to serve aboard military DSVs will be single; physical relationships will be allowed so long as they don't interfere with a person's ability to do their duties.

## TREATIES & REGULATIONS

Interplanetary space, much like the world's oceans today, may not be sovereign territory, but there are still regulations which have been agreed upon by the system's great powers (Earth, Luna, Mars and Mercury) to ensure the smooth passage of vehicles and trade between worlds.

### Outer Space Treaty (1967)

Signed by many Earth nations in 1967, the Outer Space Treaty established legal responsibilities of spaceflight and declared outer space to be a nuclear free zone, within which no weapons of mass destruction could be stored. Following the Orbit War of 2044, the Outer Space Treaty became a worthless document, of use only to the nations of Earth itself. Luna never signed the OST.

### Fairline Space Convention on Compatibility & Co-ordination (2059)

In 2059 a tragic disaster inside the Asteroid Belt led the Earth Union and the Lunar Republic to put various differences aside and create a set of compatible, space-faring standards.

- **Article 1** – Vehicles receiving an emergency SOS call must respond. All reasonable efforts must be made to rescue survivors and assist with the recovery of the stricken craft. Insurers are bound by law to recompense rescuers, and settlement sums are often inflated, acting as incentives.
- **Article 2** – Airlocks should be manufactured to FSC59 standards, compatible with both Luna and EU spacecraft designs.
- **Article 3** – Radio transponder frequencies should match those agreed with the FSC59 standards.
- **Article 4** – International English is the agreed language of solar system communication; Standard Chinese (also known as Mandarin) is the second agreed language.
- **Article 5** – All measurements are metric, using SI units. Radiation levels may use either rads or grays.
- **Article 6** – Plumbing, fuel, water and other lines on board space vehicles (and within space colonies and stations) are labelled in English as a minimum, in line with FSC59 directives.
- **Article 7** – Computer communication systems, both wired and wireless, follow FSC59 compatibilities. Software follows the GMX protocols of 2050.



The DSV 'Fairline' was a Luna cargo transport inside the Asteroid Belt that suffered a catastrophic malfunction in 2059. All 12 of its crew died, despite a rescue attempt made by the Earth Union research vehicle DRV 'Europa'. It soon became apparent that the incompatibilities between the transponder and radio practices of the two powers significantly slowed the response time of the Europa. Not only that, but use of differing airlock designs prevented the Europa from docking with the stricken craft. An attempt was made to get badly wounded crewmen, and others suffering from severe radiation sickness, across in space suits and rescue bubbles. Time wasted, however, meant that the effort was futile. The Fairline's reactor flooded the main compartment with radiation, preventing the Europa's rescue team from crossing to the Lunar vehicle.

Within a year both powers had made an agreement to ensure that airlocks, transponder codes, radio frequencies and a host of small details (such as oxygen valve sizes, emergency signage and vacc suits) were compatible, and these during the height of the Cold War! The size of the ubiquitous 10-ton module and the details of its couplings were standardized at this time, enabling the swapping out of modules and international trade using these cylindrical containers. The convention was drafted in 2061 by the International Astronomical Union, which also invited Earth, Luna, Mars and Mercury to sign it. The Fairline Space Convention on Compatibility and Co-ordination 2059 (FSC59), became a part of international law.

### **Mercury Convention (2068)**

Following the crisis in Mercury orbit, when a Luna colony expedition arrived to challenge the Earth Union's settlement of Mercury, the Mercury Convention of 2068 was signed. Luna had been forced to back down, but it grudgingly entered talks with the Earth Union. The convention essentially laid down guidelines for the exploration and settlement of the solar system. Both sides signed the treaty, which stated that all worlds (planet, moon or asteroid) with a diameter of 6 km or greater were open for settlement by any group able to make a landing. For rocks less than 6 km, international mining rights would instead come into force and could be claimed wholesale, so long as a physical or remote presence is maintained. Despite this legal victory, Luna did not pursue a colony on Mercury, instead turning to Venus.

### **Titan Agreement (2098)**

In 2095 increasing tensions in the Saturn system led to the outbreak of war on Titan. The Luna colony there held a monopoly on hydrocarbons, methane and abundant nitrogen and its government, although Luna aligned was technically fully independent. It had begun to interfere with Earth Union affairs in the Saturn system and most crucially of all had tried to foster revolutions amongst the Earth Union colonies there. What followed was a short invasion by the Union and a violent backlash fought by the Titan colonists. Luna did not intervene directly (although it was obvious that Titan had been acting as a puppet of the Luna Republic all along), but continued to provide materials and assistance and sent military vehicles into orbit. Escalation increased and historians looked back at the 2044 Orbit War with trepidation and concern. Could the Titan War escalate beyond Saturn to trigger a solar system wide war between Earth and Luna? Such a war would obviously prove catastrophic.

Peace talks were held on Mercury in 2098, and although these talks lasted for six months, they eventually proved successful. They led to the signing of the Titan Agreement by both warring factions. This agreement ostensibly established the rights of both powers to enjoy peaceful economic activities within the Saturn system, more importantly, the leaders of Titan's hardline revolutionary party were removed from office and given shelter on Luna. The new Titan government was a co-signatory of the Agreement, which now allowed Earth Union personnel to visit the moon without restrictions.

Peace descending upon the Saturn system. More than that, peace descended across the *solar* system. With the signing of the Titan Agreement everyone breathed a collective sigh of relief, the





Cold War tension of the past fifty years had suddenly dropped a notch. Co-operation between Earth and Luna in other spheres, beginning at the smallest scale, but becoming more and more frequent, began soon after. It seemed to be a thaw and one which has lasted for the past eighteen months. Is it a temporary lull in the Cold War? Is it the start of a new order in which humans across the solar system join together in peace and co-operation? However things may turn out, people from both sides are beginning to work together and plan co-operative projects. A collaborative Pluto science mission is being planned and a Titan/Janus trade agreement has been signed. Of course, blind optimism is rare, and there is still massive cynicism and mistrust on both sides. People everywhere want to believe that the Cold War is over, but everyone knows what the other side is like. You can't really trust anyone, can you? Most especially an old enemy...

## EARTH ORBIT NETWORK

Travelling from a city on Earth out to a distant planet is not as simple as getting into a spacecraft and flying there. While passengers generally reach Low Earth Orbit on a Shenlong spaceplane, cargoes get there via conventional chemical rockets, mass driver catapult or high energy laser lift (HELL) systems. For an additional cost in fuel, rockets can reach geostationary orbit or leave Earth orbit entirely to travel to another planet, although payload is greatly reduced.

For larger cargoes and most passengers the first destination is a LEO transfer station, such as Goddard or Oberth. These spin gravity stations act as interplanetary passenger and freight terminals, with hotels, shopping areas, restaurants and warehousing. From here orbital vehicles carry cargoes and passengers out to the Lagrange stations, Luna or Marco Polo High Port. Some DSVs leave the LEO stations and head out to Mercury, Venus or Mars.

Marco Polo High Port is the transit station for DSVs outbound to the outer planets, the Belt, Jupiter, Saturn, Uranus and Neptune.

### LIST OF SPACEPORTS ON EARTH

#### Large Rocket Launch Facilities

Baikonur Cosmodrome, Russia  
 Alcantara Rocketport, Brazil  
 Kennedy Space Centre, USA  
 Satish Dhawan Space Centre, Sriharikota, India  
 Hainan Spaceport, Wenchang, Hainan island, China  
 Xichang Launch Centre, Sichuan, China  
 Guiana Space Centre, Kourou, French Guiana

#### High Energy Laser Lift Facilities

Myrabo Laser Lift Centre, Macapa, Brazil  
 Muzner-Zubrin spaceport, Arizona, USA  
 Spaceport America, New Mexico, USA  
 Woomera Lift Complex, Australia  
 Lanyu Island Spaceport, Taiwan

#### Mass Driver Catapults

East African Space Facility, Mount Kenya, Kenya  
 Carl Friedrich Gauss Mass Drive Centre, Mount Kinabalu, Indonesia

#### Other Rocket Launch Facilities

Dongfeng Aerospace City, Inner Mongolia, China  
 East London Launch Centre, South Africa  
 Tanegashima, Japan  
 Plesetsk Cosmodrome, Russia  
 Simpang Tiga Spaceport, Pekanbaru, Indonesia  
 Palmachim Rocketport, Yavne, Israel  
 Central African Space Centre, São Tomé Island, Africa  
 Quito Commercial Spaceport, Ecuador  
 Trincomalee, eastern Sri Lanka  
 Alborz Space Centre, west of Tehran, Iran

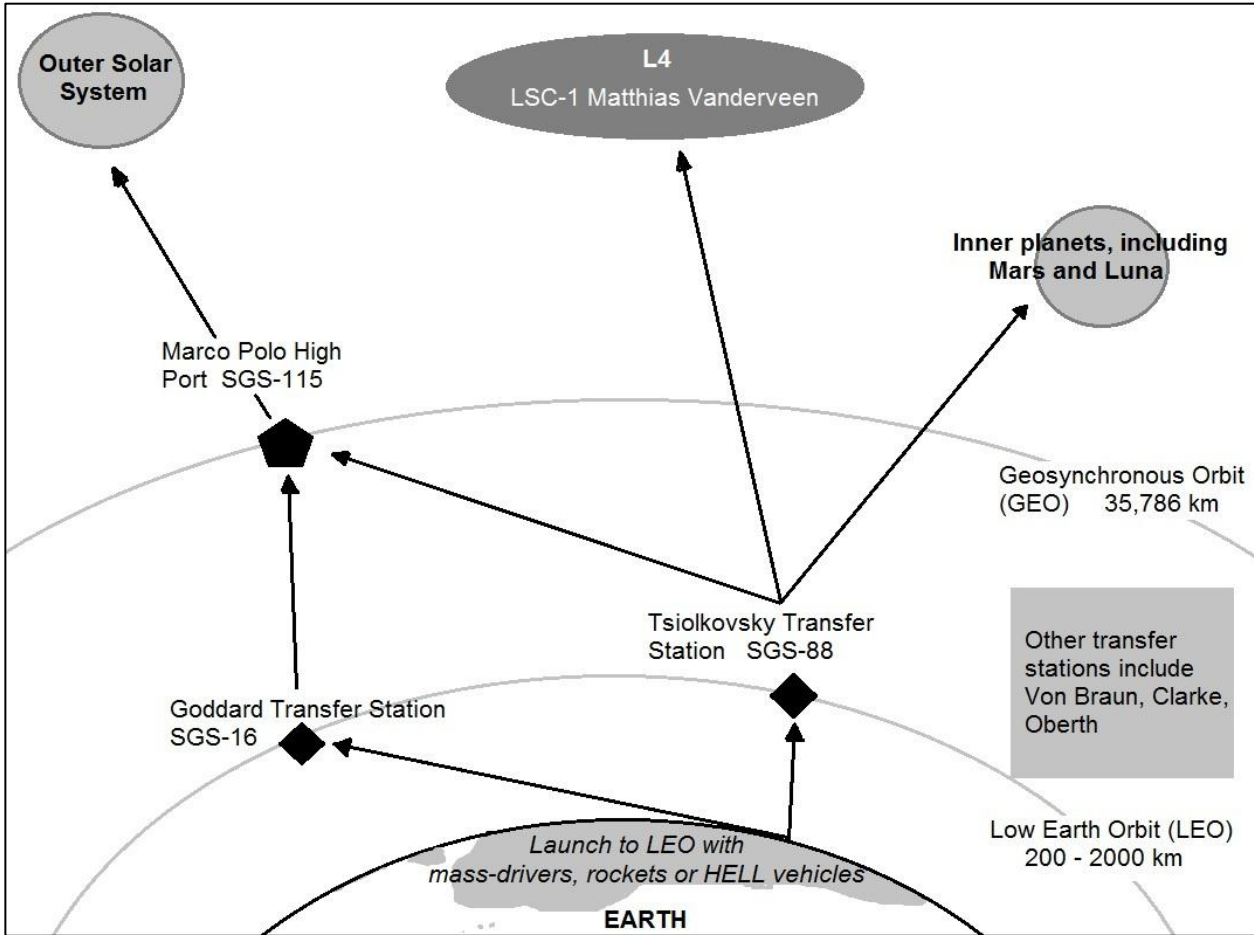

# 9 WORKING IN SPACE

## THE ZERO-G WORKPLACE

*"For every action there is always an equal and opposite reaction..."*

Isaac Newton, Third Law of Motion

It's called microgravity, because where-ever you are in the solar system, you can't really escape the gravitational pull of something, whether it's the Moon, Jupiter or the Sun. But we call it zero-G because, near as dammit, there's no up or down and physical action or motion is problematic. The weightlessness is an illusion and is due to the fact things in space are in 'free-fall' around Earth, the Moon, a planet or the Sun.

Spacecraft in **Traveller** traditionally use grav plates to create artificial gravity, allowing crew to walk around as if they were on an airliner. In **Orbital**, the only gravity is produced artificially by spinning capsules on long pylons or arms, in the same way that you can swing a bucket of water upside down on Earth and not lose a single drop. It's expensive to create these standard gravity areas, though, so only accommodation and living areas will enjoy such luxury. On-board the craft, while it coasts from departure point to destination, everywhere else is in zero gravity. Characters pull themselves along, kick off of surfaces and use hand rails to help them move around. In some areas Velcro carpeting provides a sense of normality and Velcro gym shoes provide grip, but this is ungainly and though comforting to groundsidiers, not an efficient way to work in space. Velcro mats are best used at workstations, where a crewman has to spend a good deal of time operating a grappling arm or drone, or working at a computer station. A Velcro mat prevents him floating free while he concentrates.

Every crewman on a DSV or orbital vehicle will have Zero-G skill-0 as standard. Higher levels of the skill are indicative of much greater experience of working in zero gravity. A crucial task, whether it is aligning an antenna on an EVA, shooting someone with a revolver or trying to shut an airlock door quickly to prevent an intruder forcing their way in, requires a skill check. For regular activities, skip the rolls entirely.

*Avoid Losing Control in Zero-Gravity: Zero-G, Dexterity, Instant, Average (+0)*

Apply the following DMs: Using a tool to repair/construct -2, Firing a gun -3, striking with tool, weapon, fist etc., or pushing/pulling -4, using a handheld +2

Losing control means that the task has failed until control is re-established, the character is tumbling! Roll again to regain control, but this time there are no DM's, either positive or negative, except for those derived from Zero-G skill and the Dexterity characteristic.



## Zero-G Tools

Working in zero-G requires highly specialised tools.

**Locked Umbilical:** Although many spacers carry out EVA's using thruster packs, disconnected from the spacecraft, it is often safer to use a length of umbilical. Gone are the days of a loose air pipe trailing in space. Each umbilical is flexible pipe actually made up of 10m of ball and socket links encased in an outer soft covering. A ratchet on the spacer's belt enables him to apply immediate tension to the links, locking him in place at his worksite. Up to 10 umbilicals can be connected together to create a single tether, 100m long. Cr 1000. 5kg.

**Grab-Pad:** The grab pad is analogous to a climber's piton which protects him from a fall by anchoring him to the rock face. A short metre-long tether connects the spacer's belt to the grab pad, and this electro-adhesive pad adheres strongly to any metal surface, once activated, by means of passing a small current through two metal electrodes. It resembles a simple plate with rugged hand-grip. Electro-adhesive boots (known as 'mag boots') can be fitted to hard suits. Cost Cr100, 500g.

**Hand-held Thruster:** For short duration EVAs the handheld thruster is an invaluable and powerful tool, capable of providing the spacer with a delta-V of 2 metres per second. It uses high pressure cold gas (typically oxygen) as thrust, and being hand-held it is extremely versatile. The thruster costs Cr300 and has a mass of 2kg. It is good for 15 minutes of flight.

**Thruster Pack:** Longer EVAs, or transfers between spacecraft, require the use of a thruster pack. Most DSVs have one in their locker. The pack is a 30kg fuel and motor unit worn on the back, with control arms swinging around for use at the front of a user. A joystick on the right arm and keypad on the left provide complete control. Once a desired orientation is achieved, the user can engage an automatic attitude-hold function that maintains the inertial position of the pack in flight. This frees both hands for work. The pack holds enough nitrogen gas fuel for approximately 6 hours of EVA, though this does not constitute continuous thrust. Delta-V is an impressive 25 metres per second. Cost is Cr2000, 30kg.

**Grappling Arm:** Costing MCr 1, and massing 2 tons, the grappling arm described in High Guard is a remote manipulator designed to hold or retrieve cargo, salvage or other objects in space. It also has a foot harness at the 'hand' to enable a space-walker to stand on the end of the arm and be transported out to a work-site. The TL 9 grappling arm can extend out to a maximum of 50m.

**Zero-G Tool Kit:** The zero-G tool kit is essential for any repairs or construction work undertaken in zero gravity. It must be carried to the worksite, though hard suits can have such kits fitted as an optional extra. Tools in this kit are tailored for zero-G work, drills have counter-rotating heads to prevent torque spinning the user around as a reaction. There are powered screwdrivers, wrenches, angle-grinders and saws, all battery-powered and benefitting from torque compensation. The basic portable kit costs Cr250 and masses 2kg. The full kit, based on-board the DSV, costs Cr1000 and weighs 12kg.

# WAYS TO DIE IN SPACE

*"WARNING. FAILURE TO EQUALISE PRESSURE BEFORE UNLATCHING CAN RESULT IN CREW INJURY AND EQUIPMENT DAMAGE"*

Airlock warning sign from the movie 'Sunshine'

It's a terrifyingly hostile universe out there and mankind has not evolved to survive the rigors of space. Without air the traveller will asphyxiate, in a vacuum he will suffer heart failure or brain damage, in the cold he will freeze solid, in the heat he will be vaporized. The traveller can be poisoned by toxic gases and irradiated by cosmic rays or solar flares. Few of these dangers worry a Traveller character in the Third Imperium, but in **Orbital** they should be paramount concerns. Likewise a standard Traveller starship has an incredibly resilient hull, with 50 points of weapon damage required to affect it. On **Orbital's** DSVs, habitats and stations, however, guns are anathema, and fatal blow-outs resulting in explosive decompression are an ever-present danger.

## 1. Pressure Loss (the 'Blow-Out')

On all worlds throughout the solar system (with the exceptions of Titan and Venus) humans are battling against lack of pressure, in most cases a vacuum or near vacuum. This is always the greatest danger to any space traveller.

**Puncturing the Hull:** An attack from outside the hull may puncture it if the roll to hit is successful. Inside the hull, stray bullets or other missiles may strike furniture or equipment instead of the hull. If a gun is discharged and does not hit a human target, roll its damage dice to determine its trajectory. On 1-9 the bullet lodges in something else, on 10+ the bullet strikes the hull, or just ploughs through the piece of furniture to hit the hull anyway! Lasers will destroy whatever they hit, so the chance of a hull strike for a laser is a flat 50% (roll 1-3 on a d6 for a hull strike).

If a weapon hits a hull, roll for weapon damage as normal and subtract from this the armour rating of the target. If penetration occurs, a 1 cm diameter hole is punched into the hull and decompression begins.

Hull of a ...	Armour
Rover or orbital vehicle	4
Spacecraft, habitat, DSV or space station	12
Large Scale Colony (hub/spokes)	24

Explosives of any kind automatically strike the hull if detonated internally. The fact that the atmospheric pressure of the cabin is exerting great force on the skin of the habitat or vehicle adds a considerable punch to any internal explosion, increasing the chance of a puncture. Roll explosive damage as listed in TMB p.101, and subtract the relevant armour modifier. Every point of explosive damage beyond that needed to puncture the hull widens the hole by 10cm. A frag grenade tossed into a lab module goes off and does 24 points of damage, lowered to 12 after the module's hull is considered: a breach. The 12 points cause a hull rupture 1.2m in diameter...

This combat rule can serve as a guideline for other projectiles, from micrometeoroids striking the hull, to rovers crashing into a hab, fuel pumps exploding or a grappling arm malfunction.

**The Speed of Decompression:** Designers do not build huge open-spaced colony buildings or spacecraft, they are divided up into smaller compartments separated by pressure bulkheads. Decompression of one section will not affect the rest of the vehicle or habitat. Puncturing the skin of a spacecraft or habitat is easy and great efforts must be made to avoid situations where such a catastrophe might occur. But what happens when such a situation arises?





For a 1 ton cabin, a 1 cm diameter hole will cause pressure to drop by 50% in 5 minutes and to vacuum in 10 minutes. The half-way point marks the level at which asphyxiation begins (TMB p.142) and the character suffers 1d6 damage per minute. This basic value can be extrapolated to determine pressure loss for other sized-compartments. Should a bullet punch a hole through the skin of a 20 ton cargo hold, for example, pressure loss will take 20x longer (1 hr 40 mins to reach half an atmosphere, 3 hrs 20 minutes to be reduced to vacuum). The real danger is in hatches popping open and in ruptures caused by explosions. Using the previous example of a 10 ton lab module damaged by a grenade, the breach created was 1.2m in diameter. Increasing the affected volume increases the time to asphyxia to 50 minutes, but the breach was also 120x larger:

*Time to Asphyxia:*  $(5 \text{ mins} \times 10) / 120 = 0.42 \text{ mins}$  (25 seconds or 4 Traveller combat rounds)

If a 1 ton airlock blew its hatch and exposed unprotected individuals to vacuum, the effects of asphyxia would occur much faster! Assume the hatchway is a 1.2m breach:

*Time to Asphyxia:*  $(5 \text{ mins} \times 1) / 120 = 0.042 \text{ mins}$  (3 seconds or half a combat round)

Note that since full vacuum is reached after **twice** this duration, the folks in the airlock will suffer the perils of vacuum at the end of the six-second combat round. What exactly does this do to the characters?

**Effects of Vacuum on the Human Body:** There are a lot of movie myths about exposure to a vacuum, so the best place to find the truth is to look at books like the *USAF Flight Surgeon's Guide*, Shaylor's *Disasters and Accidents in Manned Spaceflight* and NASA's *Bioastronautics Data Book SP-3006*. Human and animal testing, coupled with accident reports give us the following facts:

- Victims can stay conscious for up to 12 seconds (two Traveller rounds).
- Next, convulsions will take hold while water vapour forms in the soft tissue and veins, resulting in the body swelling up.
- Arterial blood pressure plummets as pressure in veins increases, and within a minute of exposure, blood flow has stopped and the heart goes into fibrillation.
- After an initial rush of gas from the lungs during decompression, gas and water vapour will continue to flow outward through the airways. This continual evaporation of water will cool the mouth and nose to near-freezing temperatures; the remainder of the body will also become cooled, but more slowly. Extremities suffer hypothermia; fingers, toes, etc. freeze.
- Nitrogen gas, which is dissolved under normal pressure, comes out of solution and forms gas bubbles within the body. These bubbles cause the 'bends' (decompression sickness), lodging in joints, lungs, the spinal cord and the brain and causing paralysis, pain and possible brain damage and death.
- Victims are clinically dead from 2 to 4 minutes after exposure to vacuum. In tests, some victims exposed for up to 2 minutes can be successfully resuscitated and recover, if quickly restored to pressure.
- Blood does not 'boil' and victims do not freeze solid (at least not immediately).
- Lungs do not burst; opening the airways allows gases to escape easily. However, tests have indicated that holding one's breath causes the lungs to swell, with tearing and rupture of the lung tissues and capillaries. Trapped air is forced through the lungs into the chest cavity, and air can be injected directly into the blood-stream by way of the ruptured blood vessels. Massive air bubbles move throughout the body and lodge in vital organs such as the heart and brain (a process called ebullism) causing symptoms similar to the 'bends'. This makes recovery unlikely.



In game terms, exposure to vacuum results in 3d6 damage per combat round.

To save someone suffering catastrophic haemorrhage and ebullism requires that pressure be restored to at least 50% or more of atmospheric norm. This will prevent further damage. Recovery requires a medic kit, with defibrillator to restart the heart, oxygen and specific drugs (namely pentoxifylline, prostaglandins and calcium channel blockers, all of which are found within spacecraft and hab first aid kits).

*To stabilize a patient exposed to vacuum:* Medic, Education, 1-6 mins, Difficult (-2). Failure indicates the patient continues to deteriorate at 1d6 pts per hour. The medic can try again each hour. Success indicates the patient regains 4 points of damage and can begin recovery as normal.

**An Alternative to Guns:** Obviously firearms and spacecraft don't mix very well, yet military personnel and police officers need the ability to take down and/or kill a target. Popular amongst space-borne forces are Glaser bullets which break apart, they are frangible, with a good degree of stopping power, but that shatter when striking a hard surface such as a bulkhead, window glass or piece of armour. Glaser rounds are the opposite of armour-piercing, they cannot penetrate even kevlar vests or vacc suits and so in that respects are not much use to a military force. Glaser rounds are great for police officers, bodyguards, counter-terrorist units and military groups assigned to stations or habitats. Otherwise use them as standard firearms ammunition, at the same prices.

Non-lethal weapons are very popular and found in use all across the solar system. The following pieces of equipment pass for weaponry in super-sensitive space society: dye guns, stunsticks, stun pistols and thumpers. Although it is legal for a civilian to carry a restraining device around, such behaviour is frowned upon and viewed with intense suspicion. Typically only law enforcers or military personnel carry these items.

**Dye Gun** - Crazy? If you fire a gun at a suited man you are going to kill him - horribly. A dye gun marks his suit as hit by law-enforcement, and if you can hit his visor you blind him and have practically immobilized him. Dye guns could be used inside as well as outside if they carried a pepper-like irritant to temporarily blind targets (they make an Endurance check, if successful they may continue acting, but at -1; if failed they must flee the area of the spray and are effectively incapacitated for 1-3 rounds).

**Stun Pistol** – Described in TMB p.100, this nerve-induction weapon is very popular with police forces everywhere.

**Stunstick** – Described in TMB p.98, most law enforcers carry one these nerve-induction batons; they telescope out to about 60cm ready for use and are readily available. It is believed that the stunstick has been misused by some authorities as a torture device.

**Thumper** - Thumpers are ugly and dumpy little folding-stock launchers that fire subsonic sand-bag jellies at targets with the aim of knocking them down by kinetic force and pain, rather than deadly bullet penetration. Thumpers would work equally well against a suited target as an unsuited one. They aren't a stun weapon, they deliver a good smack equivalent to being hit in the face with a well delivered police baton.

Weapon	TL	Range	Damage	Recoil	Mass (kg)	Magazine	Cost (Cr)
Dye Gun	7	Ranged (pistol)	None	-	1	6	200/10
Stun Pistol	9	Ranged (pistol)	3d6	-	3	100	500/200
Stunstick	8	Melee	1d6	-	0.5	-	300
Thumper	6	Ranged (shotgun)	2d6	2	2	3	200/10

## 2. Exposure

If a character is exposed to the elements, the referee must decide what the local temperature is. Vacuum, in the shade, has a temperature of -270°C (3° above absolute zero), but the sun at varying distances can heat up suits, equipment and hull surfaces. In space, and on worlds without an atmosphere, use the guidelines for exposure to a vacuum. See **Pressure Loss** (above). On planets and moons with atmospheres, it is easier to determine temperature when a character's suit



rips or he is thrown out of an airlock, or someone blows-out the windows on a habitat. Use the temperature damage rules in TMB p.74, a range of examples follow, and they include massive pressure differences too:

World	Day Temp	Effect	Night Temp	Effect
Mercury	400	3d6/rd	-180	2d6/rd
Venus	500	4d6/rd	500	4d6/rd
Mars	-10	2d6/hr	-50	3d6/hr
Titan	-180	1d6/rd	-180	1d6/rd

### 3. Poison Gas

**Exposure to Poison Atmospheres** - Venus, Mars and Titan all have appreciable atmospheres, and none are breathable. Walking out of a habitat or suffering a suit breach on one of these worlds has the added complication of a poisonous gas being inhaled. However, pressure and temperature differences will probably be far more dangerous to the exposed characters. The referee should apply damage for vacuum or temperature as suits the environment.

**Habitat Leaks on Venus and Titan** - Although not a problem on Mars, where air will leak *out* of a habitat, on Venus and Titan, pressure outside is so great that a small breach in the colony hull will mean poison air leaking *in!* This is very dangerous. Use the Poisons rule on TMB p.74. The main gas on Titan is nitrogen, on Venus it is carbon dioxide, but treat damage for both as 1d6 and the interval is per 1 minute of exposure.

### 4. Radiation

Radiation could be the real killer in space. In-frequent solar storms bathe interplanetary space with energized protons that can reach deadly levels very quickly and Jupiter has a particularly deadly radiation belts making prolonged travel nearby equally unhealthy. Spacecraft hulls may be double-thickness, filled with asteroid sand, but they are not proof against the higher levels of radiation. Instead small 'storm shelters' are provided on long distance craft, able to provide protection for the crew for a few hours by shielding them with a double-skinned cavity filled with sand or, more likely water, which is a good defence against hostile radiation. For longer periods the flare damper, or Generator-Magnetospheric Field (GMF), is used. This is effectively a magnetic field generator using the effects of plasma to divert radioactive particles harmlessly around the spacecraft. Only theoretical at the start of the 21<sup>st</sup> century, the device is now used on DSVs, orbital vehicles and even hard suits.

The colonies, cities and outposts on exposed moons and planets are able to protect against radiation by being half-buried, or by using a layer of water within the skin of the dome. The soil or water will absorb the deadly radiation.

#### RADIATION EXPOSURE

Radiation Source	Rads
Jupiter space	100 per hour (2400 per day)
Saturn/Uranus/Neptune space	25 per hour (600 per day)
Minor Solar Flare (duration 1-6 hours)	25 per hour *
Major Solar Flare (duration 2-12 hours)	50 per hour *

\*Apply the full rad total to the victim at the end of the flare event.

But systems fail. Or they are not there at all. For this, the Radiation rules on TMB p.141 can be used. There are ways to protect from radiation (see below).



#### RADIATION PROTECTION

Protection	Reduction in Rads
Soft Suit	10
Hard Suit or Spacecraft Hull	20
Hard Suit with Flare Damper	100
Hostile Environment Suit	100
Flare Damper on DSV/Station/Orbital Vehicle	300
Storm Shelter	500
Large Scale Colony	500

*Example: Third Officer Peterson is in orbit around Mars conducting an EVA in a soft suit. He is attempting to repair the flare damper. Unfortunately he runs out of time and continues the repair during the flare in order to try and save his crewmates. The flare lasts 2 hours and produces a total of 50 rads. His soft suit reduces this to 40 rads. He appears to suffer no ill effects, but his cumulative exposure has now shot up from 85 (before this flight) to 125. If Peterson had tried this stunt in orbit around Io (a moon of Jupiter) then he'd have suffered an additional  $2 \times 100 = 200$  rads during his EVA, making a total of 250 rads which his suit reduces to 240. That's enough to inflict 2d6 burn damage on him.*

## AIRLOCKS

Rules for airlocks are found on TMB p.137, but the referee may find additional explanation useful when it comes to entering an airlock from outside the space craft. Can it be done? How? Is it difficult? An airlock forms the main route in and out of a spacecraft. When docked at a station, or with another vehicle, the airlock is the 'front door.' An extending docking tunnel from a station can fit into the airlock's docking tunnel recess (1) allowing ease of passage, much like a modern airport 'air-bridge'. Although there are variations between airlock types, many incorporate the features described here.

### Automatic Access

The lock has two settings, automatic and manual, switching between the two is done from the flight deck, from the inner hatch or from the control panel (4) next to the outer hatch.

Automatic is the default: the lock is operated from the flight deck by radio request, or it is overridden by any crewman using the security keypad. Crewmembers wanting to board a vehicle after passing through the docking tunnel need to input their access code on the door's security keypad (8). The door slides up and admits entrance. In space, far from docking tunnels and other vehicles, access may be made in the same manner. A character conducting an EVA in a vacc suit can leave the airlock and upon his return can input his security code with his gloved fingers (one reason swipe cards and retina readers are rarely used). Often he will leave the airlock door open for easy access.

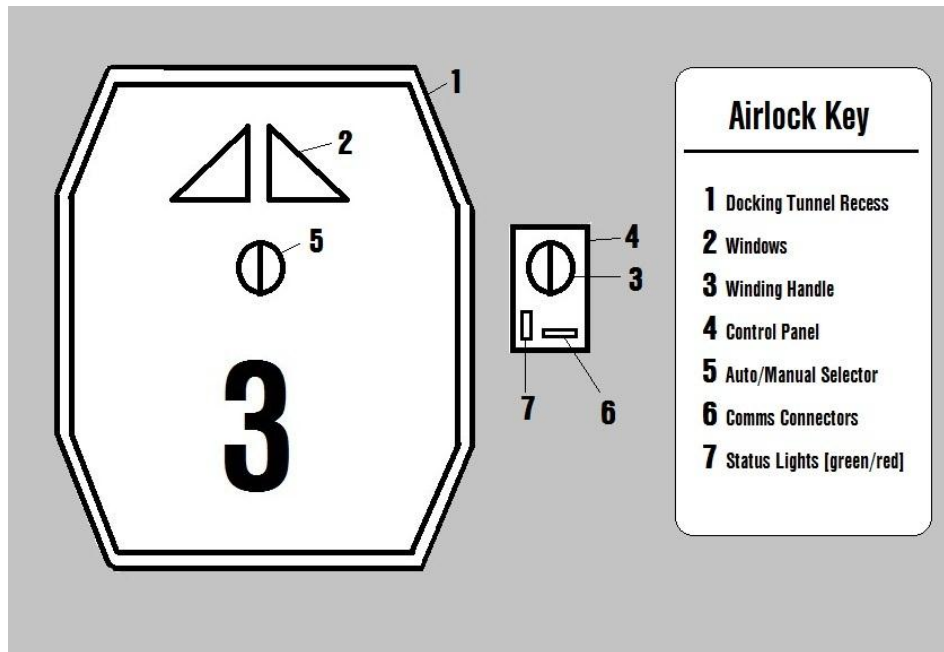

### Manual or Forced Access

Manual is an emergency measure, used by rescue workers, or crewmen during some crisis. The auto/manual selector (5) is turned to manual, and then the rescuer turns to the winding handle (3) and physically and laboriously winds up the airlock door. It takes around 10 minutes and alarms sound on the flight deck and at the inner airlock door. A grappling arm or auto-lock mechanism (used by rescue teams) can speed this up to 1 minute.

Rescue workers will look through the windows (2) to establish the lock is empty before opening it and will check the status light (7). Green indicates the lock is unpressurized and safe to open, red indicates the lock is pressurized and that it may be dangerous to open. A flashing light indicates the lock is pressurizing (red)/depressurizing (green).

The comms connectors (6) allow a rescue party to plug in directly to the flight deck to signal the crew about their intentions should there be some kind of communications blackout or failure. Individuals accessing the lock do not have the means to pressurize the airlock until they get inside. If they spot an unconscious crewman within the lock and without a vacc suit, they cannot open the airlock door without killing the crewman. Pressurization controls are located on an inner wall of most airlocks, and the flight deck can operate these controls remotely. An override command can easily be input by a character who knows the access code and inputs on the internal airlock control panel.

### Protocol

Most vehicles leave their airlocks unpressurized. Many vehicles actively want their airlocks to be accessible to rescue crews. 2100 AD is not like the Third Imperium, piracy is incredibly rare, military conflict does not end in a boarding action; DSV's are far more likely to need assistance from another craft. Sliding doors are common. Swing-out hatches are still used for secondary, emergency or maintenance locks, but main locks use sliding doors. Traveller iris valves are not yet in use. Explosive bolts: Many exterior airlock doors are primed with explosive bolts to allow for instant airlock decompression, primarily to allow for rescue or evacuation should the automatic or manual airlock mechanism fail. These bolts can only be fired by keypad code from the flight deck, from the inner door or from the internal airlock control panel.



# ASTEROID MINING

Little of the great achievements of the past 100 years could have been made without access to the incredible resources of the solar system. The most accessible of these resources are found within asteroids and comets, objects found across the solar system in great numbers. It is likely that player characters will get involved with asteroid mining, either directly or through a patron during a mission.

## Reasons for Mining

There are three reasons to go hunting asteroids.

- **Mining For Profit** – Large corporations such as Erebus or Matsuyama, or independent miners like the crew of the DMV Ten Jin Maru, search asteroids for profitable minerals which they can sell to Luna, Earth or another nation requiring raw materials. Some colonists and homesteaders mine asteroids for the raw materials to enable them to construct new habitats. The main requirement is a number of mining drones.
- **Fuelling Stop-Over** – Comets or icy asteroids provide valuable water ice that can be mined and used as life support water or processed into liquid hydrogen as rocket fuel. This enables DSVs to stop-off and use these rocks as gas stations. The main requirements are mining drones and a fuel processor.
- **Homesteading** – Cascadians making a living out amongst the asteroids are able to mine organic materials used to maintain their agricultural modules or on-board gardens. In addition they may mine minerals to create modules and other metal parts and extract water from icy rocks to provide oxygen and water. In this way the Cascadians can become almost totally self sufficient out amongst the rocks. The main requirements are mining drones, a fuel processor and a smelting unit.

## Common Target Locations

Most asteroids are rocky bodies that orbit the Sun between Mars and Jupiter in the Asteroid Belt that is centred around 400 million km from the Sun. Two 'clouds' of icy asteroids, 60° ahead of and behind Jupiter (and at the orbital distance as Jupiter) are called 'Jupiter Trojans', while two similar objects in Mars orbit are called 'Martian Trojans.' Some asteroids have been found inside Earth's orbit (including many Near Earth Objects), while others - including burnt out or dormant comets, such as perturbed Kuiper Belt objects called 'Centaur's' - are located beyond Saturn's orbit. While most asteroids may be only the size of pebbles, 16 asteroids have a diameter of 240 km and Ceres, the largest, has a diameter of about 914 km. Many of the tiny moons of Jupiter, Saturn and the other gas giants can be mined in the same way as asteroids, in fact, many may be captured asteroids.

Finally, resources may be gathered from two unusual locations. The first is the dust and ice rings around the gas giants, the second is the Kuiper Belt, a disc-shaped region of icy objects beyond the orbit of Neptune. Pluto and Eris are the best known of these icy worlds, but there are probably thousands more of these ice dwarfs out there. The Kuiper Belt and even more distant Oort Cloud are believed to be the home of comets that orbit the Sun. Mining out there is a lonely and remote business that rarely justifies the time and expense of travelling that far away from the inhabited worlds.

### Target Locations

Main Asteroid Belt

Centaur Asteroids

Near Earth Objects

Jupiter Trojans

Mars Trojans

Tiny Moon of a Gas Giant

Gas Giant Ring

Kuiper Belt



## Useful Mining Equipment

**Radioisotope Thermoelectric Generator (RTG):** This RTG generates heat from the radioactive decay of a suitable radioisotope (such as uranium or strontium titanate), using the heat to power a helium compression engine. It serves as a portable long-term power unit in places where solar panels cannot draw enough power from a very distant Sun (anywhere beyond the Asteroid Belt). The RTG provides a Traveller powerplant value of 1, is shipped in two parts (the generator and the extendable radiators) and masses a total of 0.6 tons. It costs MCr 1.5.

**Portable Solar Power Array (PSPA):** The most basic of mining outposts might simply consist of a hab and workshop module where crews rely on supplies flown in for survival. In this case power is supplied by a PSPA, a solar array that can be carried on-board a lander as cargo or within one of the modules, to be unpacked, unfolded and extended on the world's surface. It comes with folding solar panels, an inverter, battery, solar tracker and interconnection wiring. The PSPA provides an equivalent powerplant value of 1 (see *High Guard* p.42). The array masses 0.5 tons when packed, and costs Cr 50,000; use of a PSPA allows the module to start operating almost immediately.

**Fuel Processor:** A spacecraft's fuel processor is used to electrolyse melted water ice to create both oxygen and hydrogen; the first can be used for life support, the second for chilling and using as liquid hydrogen fuel for the nuclear thermal rocket. One ton of fuel processing equipment can convert 20 tons of water ice into liquid hydrogen per day. One ton of fuel processing gear costs Cr50,000.



**Atmospheric Processor:** An atmospheric processor is used to extract valuable helium-3 from the atmosphere of a gas giant. It consists of pumps and refrigeration equipment which liquefy the atmospheric gases. While the liquid methane is discarded, liquid hydrogen is used to pre-cool more incoming gases before also being discarded. The liquid helium is retained, so that the helium-3 isotope can be separated from the more abundant helium-4 isotope. This helium-4 is then discarded, and the helium-3 is retained. One ton of processor can extract 0.1 ton of helium-3 per day. The processor may instead be tasked to create liquid hydrogen fuel at a rate of 5 tons of liquid hydrogen per day per ton of equipment. A ton of processor costs MCr1.

**Mining Drones:** Massing 10 tons, a set of mining drones is the most useful piece of equipment any DSV can carry. The set includes three 2 ton mining drones, a 1 ton docking and recharging unit and a 3 ton ore handling unit. The ore unit channels and transports ore from the drones into the cargo or ore bay. Drones process 1d6 x 10 tons of asteroid material per working day and cost MCr 1.

**Mining Laser:** Some dedicated mining DSVs (such as the DMV Ten Jin Maru) are equipped with a mining laser. In all particulars this resembles the pulse laser described in TMB p.111. It is mounted in a single turret and is used to vaporise rock allowing the drones access to the ore layers within. Use of a mining laser in conjunction with a set of mining drones allows the drones to process 40-60 tons of ore in a day (1d3+3 x 10 tons), improving efficiency. The laser must be used at a range of 5km or less. The mining laser costs MCr 0.5.

**Smelting Plant:** Requiring a crew of six, this 25 ton smelting plant can process asteroid ore gathered by mining drones, separate the gangue (the useless rock) from the metal ore, then roast and melt the ore in an electric or plasma arc furnace. The plant also has a vacuum arc capability for re-melting and refining metals like titanium which require high grades of purity. In one day the smelting plant can produce 1 ton of metal for every 10 tons of ore that is fed into it. Metals treated with vacuum arc re-melting are produced in 2 days. Residual rock waste, or slag, is thrown into space or onto the asteroid's surface. The smelting plant costs MCr 9.

**Micro-Smelter:** A micro-smelter is available as a 10 ton module for use as part of a mining station, or by homesteaders in the Belt. It functions as a scaled down version of the industrial smelter, processing, in one day, 2 tons of asteroid ore to produce 0.2 tons of metal. It is not as versatile as the industrial plant and may require several hours of maintenance to switch between different types of ore. The micro smelter requires a crew of two and costs MCr 4.

**ORVIN (Oxygen RecoVery IN situ):** The ORVIN module was developed by NASA for its return to the Moon in 2001, a TL 9 derivative of those early TL 7 ORVINS are still used today across the solar system, each is a complete self-sufficient life support plant used on asteroids and small moons by miners, colonists and scientists. The plant is installed within a standard 10 ton module and built around a 2.5 ton fission powerplant which can also provide electrical power for the outpost. A 1 ton, wheeled drone shovels asteroid/Luna regolith into a 1 ton hopper system that feeds the material into the production plant (most plants use carbothermic reduction or molten regolith electrolysis). The oxygen plant itself masses 2 tons and produces oxygen from the regolith. A 1 ton fuel processor is also installed which is able to melt local ice deposits (if any) and electrolyse the water to produce oxygen as well as the much needed rocket fuels: liquid oxygen and liquid hydrogen. Fuel is stored in 2.5 tons of integral cryogenic tankage for later transfer to a vehicle. Oxygen is typically stored in empty tanks brought as cargo with the expedition and stored on external racks at ground level. An ORVIN costs MCr 7.30. Unlike most modules, the cylindrical ORVIN module is jacked up into a vertical position on fold-out legs before operations can commence. External panelling must then be manually removed to expose the equipment and allow the feed belt and hopper to be deployed. The ORVIN does not connect with other modules and cannot be entered.



## Mission Profile

**1 Prospecting** - Using telescopes and spectroscopy, asteroids can be prospected from millions of kilometres away. The player characters must identify an asteroid that fulfils their needs, and this is done with a task roll.

*Locate a suitable rock for mining:* Sensors, Intelligence, 1-6 days, Routine (+2)

*Locate a suitable ice chunk:* Sensors, Intelligence, 1-6 days, Average (+0)

*Locate a suitable source of water & nutrients:* Sensors, Intelligence, 1-6 days, Average (+0)

**2 Travel to the Rock** – Characters must travel to the rock; distance depends on its location within the solar system. Once mining is completed, a second asteroid may be located in the same general location, if desired. Travel time to this new rock takes  $1d6 \times 10$  hours, add the following:

**Travel by DSV:** 1200 hours divided by delta-V

**Travel by Orbital Vehicle:** 140 hours

**3 Touchdown & Anchor** – Touching down on an asteroid requires landing gear which most DSVs do not have. Most dedicated mining vehicles, such as drilling rigs, do however have heavy duty landing suspension. Pitons, harpoons or rock drills are needed to anchor the vehicle and prevent it from drifting away in the asteroid's pathetic gravity field. It is impossible to touch down on a planetary ring. If a craft is unable to touchdown, then reduce all drone extraction rolls (see below) by -2.

**4 Extraction** – Decide what the crew want to extract (minerals, water or agricultural materials). Roll the relevant task. Each mining roll represents a full day of maintenance, preparation, mining and clean-up.

**Extracting Minerals:** The solar system has an ample supply of asteroids which makes mining unprofitable and prices very low. Belters look for the very rare asteroids in which valuable materials exist in relatively high purity. Uncommon ores include platinum, rhodium, iridium, osmium, ruthenium, palladium, gold and the naturally occurring alloys of osmiridium and iridosmium. Common ores are aluminium, nickel, iron and copper. Raw materials are sand, gravel and silica used for shielding and as a raw material for manufacturing. Once a potentially profitable asteroid is found and on-site prospecting has begun, roll  $2d6$  on the Asteroid Yield table; then proceed to the extraction task roll.

### ASTEROID YIELD

2d6	Yield	Description
4-5	Icy	Largely made of water ice and other volatiles. Can be mined for $1d6 \times 100$ displacement tons of water ice which can be sold for Cr 100 per ton if located in the Outer Zone; otherwise treat as Low Yield.
6-8	Low	Worthless rock with a surface veneer of $1d6 \times 100$ tons of water/ice and $1d6 \times 50$ tons of volatiles (frozen methane, ammonia, nitrogen and carbon dioxide) will be present if the asteroid is located in the Outer Zone. These can be sold for Cr 500 per ton.
9-11	High	Roll on the High Yield table to determine the contents. $1d6 \times 100$ tons of water ice and $1d6 \times 50$ tons of volatiles (frozen methane, ammonia, nitrogen and carbon dioxide) will be present if the asteroid is located in the Outer Zone. These can be sold for Cr 500 per ton.
12	Special	Unusually rare or large deposits. Roll on the Special Yields table.





2d6	High Yield	Tons
2	Basic Ore	1d6 × 5
3	Basic Ore	1d6 × 25
4	Uncommon Ore	1d6 × 5
5	Basic Ore	1d6 × 50
6	Basic Ore	1d6 × 100
7	Uncommon Ore	1d6 × 20
8	Basic Ore	1d6 × 500
9	Uncommon Ore	1d6 × 50
10	Basic Raw Materials	1d6 × 50
11	Uncommon Ore	1d6 × 100
12	Special	

2d6	Special Yield	Tons
2	Alien artefact	*
3	Distress beacon	*
4	Salvage	*
5	Uncommon raw materials	1d6 × 100
6	Uncommon raw materials	1d6 × 25
7	Basic raw materials	1d6 × 100
8	Crystals & gems	1d6 × 25
9	Precious metals	1d6 × 50
10	Crystals & gems	1d6 × 100
11	Biochemicals	1d6 × 50
12	Radioactives	1d6 × 10

\* The Referee should determine the exact nature of these finds.

*Mine an asteroid & process the ore:* Remote Operations, Intelligence, 1-6 hours, Routine (+2).

Each 10 tons of mining drones installed on a ship can mine 1d6 × 10 tons + the Effect of the Remote Operations roll × 5 for each successful mining task.

**Extracting Water & Hydrogen:** A ship may use mining drones to mine ice from icy asteroids or comets and convert it into unrefined liquid hydrogen fuel and oxygen. Mining water ice from an icy asteroid or comet requires a separate task.

*Mine water ice:* Remote Operations, Intelligence, 1-6 hours, Routine (+2).

Each 10 tons of mining drones installed on a ship will mine 1d6 × 10 tons of ice + the Effect of the Remote Operations roll × 5 for each successful mining task.

**Extracting Agricultural Materials:** A ship equipped with both hydroponics and mining drones may obtain the monthly supplies for the hydroponic units by mining asteroids and comets. Extracting enough nutrients and water for a month requires a separate task. Such nutrients include (in order of usefulness) nitrogen, phosphorus, potassium, magnesium, sulphur and calcium.

*Mine water & nutrients:* Remote Operations, Intelligence, 1-6 hours, Routine (+2).

**5 Problems** – At the start of each day of mining activities, the referee should secretly roll for a Mining Problem on 2d6. Add the highest Engineer skill amongst the characters to the 2d6 roll, as well as the highest Sensor skill and the highest Remote Pilot skill. A natural roll of '2' is unmodified by skill levels and remains at '2'.





#### MINING PROBLEM

2d6	Problem Encountered
2	Roll again, this time do not add skill levels
3	Sensor failure
4	Fuel Leak
5	Machinery Failure (processor/smelter/ore handling)
6	Landslide/Cave-in, relocate activities (takes 1 day)
7	Comms Failure (with drones)
8	Drone Failure
9+	No problem

Each problem is a roleplaying opportunity, a physical and mental challenge that will require a degree of problem solving as well as a task roll. The referee should adjudicate the subsequent events to fit the situation and the characters. A simple repair may suffice, perhaps the failure is due to something unusual and not yet detected, perhaps the failure cannot easily be repaired and needs drastic action: cannibalisation of some other equipment, for example. The landslide/cave-in event may trap a drone or even a character who is trying to free an unresponsive drone, it may lead to a chain of other complications, perhaps presaging an asteroid quake, or tipping the DSV violently, putting a successful launch in jeopardy. Have fun with these problems, they are intended to be entertaining, and food for adventure, not a pain.

**6 Repeat** – Continue cycling through **4** and **5**, making new extraction rolls and new problem rolls each day of mining activity. Continue like this until the ore bay is full, a problem stops production, or something more interesting crops up! There is no need to reroll again on the Asteroid Yield Table though.

## SETTING UP AN OUTPOST

During the course of a mission the players may need to set up a fully functioning base on a small moon or asteroid, indeed this task itself may become the adventure. Although establishing outposts has become quite routine, the hard physical labour required in setting up a module outpost retains an element of danger.

How do you set up an outpost? It is the high tech equivalent of setting up a camp site while you mine the local area or conduct scientific research. Generally, the explorer needs the following pieces of equipment:

**Skycrane Lander** - Required in order to set down modules onto the surface of the moon or asteroid.

**Hab module** - A place to live.

**Rover Excavator module** - A rover excavator can clear an area ready for the creation of the outpost, and this is most important when building a landing pad. Large rocks may be thrown for kilometres by a rocket exhaust, and so high berms of regolith are often built up as protection around such pads, as well as around habs and fuel stores. Diggers can also help to cover modules with industrial-sized sacks of regolith in order to protect the inhabitants and to also manoeuvre the modules into place via the rover's hydraulic arm. Not required for set-up on an asteroid, where a Skycrane can land anywhere without damaging previously emplaced modules.

**ORVIN module** - Electrical power, plus a method of creating oxygen and, if there is ice then water and rocket fuel too.

**Science or Workshop module** - Somewhere where you can do your job, and with an integral airlock, a way of getting outside to fix things and carry out practical activities on the surface.



**Hydroponics Module** - Whether accomodating miners or scientists, a self sufficient outpost needs to be able to feed itself, this module allows for the sustainable production of foodstuffs.

The most basic of outposts might simply be a hab module and science module connected together, with an external solar array providing power. This outpost will not be self sufficient however, and requires oxygen, water and food to be brought in on a regular basis.

### Which Module First?

The order of construction should be as follows:

1. Remote survey of the area.
2. Land the hab module along with a portable solar panel array, get the hab up and running with power supplied by the array.
3. Land the ORVIN at least 100m from the hab.
4. Designate a landing site at least 100m from both hab and ORVIN modules for the next stage of module landings.
5. Land the rover excavator module and offload the rover ready for work. Use it to shovel regolith to create a blast berm around the designated landing area.
6. Land other modules and, as they arrive, use the rover excavator to connect them together.
7. Set up the ORVIN for oxygen production.
8. Set up the hydroponics module.
9. Establish a fuel dump, protected by a prefab sunshield roof and berms made of regolith for the storage of manufactured rocket fuel.
10. Establish a rover park, a place close to the airlock surrounded by a regolith berm and covered with a sun shield. The garage module that the rover was landed in should be connected to the outpost, pressurised and used as a general workshop and storage area.

The total hardware cost to reach stage 10 is approximately MCr 32, if including a single hab and workshop module as well as the associated modules noted above (plus a Skycrane lander). Without the lander the cost is around MCr 16. These costs don't include transport, fuel, wages and the cost of supplies or additional tools and equipment.

### Construction Tasks

*Unloading a module from lander:* Pilot, 10-60 mins, Average

*Connecting a module to the outpost on a major moon:* Drive and Mechanics, 10-60 mins, Difficult

*Connecting a module to the outpost on an asteroid:* Drive and Mechanics, 10-60 mins, Very Difficult

*Get an ORVIN operational:* Engineer (or Mechanics -1), 1-6 days, Average

*Setting up comms tower:* Comms, 1-6 days, Routine

*Building protective berms:* Drive, 1-6 days, Routine

*Setting up hydroponics:* Trade (Hydroponics), 1-6 days, Difficult

*Connecting a module to the outpost using the 1 ton ORVIN drone:* Remote Ops and Mechanics, 1-6 hrs, Difficult

# 10 WORLDS

## PLANETARY WORLD PROFILES

**Starports:** These are rated just as on TMB p.178, but all information found there obviously relates only to DSVs, not starships.

**Size:** A rating of 0 for World Size indicates a body less than around 1,200 km and includes tens of thousands of asteroids, comets and tiny irregular satellites of the larger planets of the solar system. Many of these moons, particularly of the large gas giants, may even have retrograde orbits, these travel the opposite way around a planet from its rotation and that of most of its larger moons (which instead go 'prograde').

**Atmosphere:** Mars has a Very Thin, Tainted atmosphere due to half a century of terraforming; this increase in pressure has allowed a small increase in average global temperature. Some worlds are listed with trace atmospheres in the scientific literature, a tenuous body of gas which has measurable chemical constituents, such as Io and Triton. They are listed here as Atmosphere 1 (Trace) although the actual pressure readings of these atmospheres are far lower than those given on TMB p.171.

**Hydrographics:** To provide more diversity in trade codes, some of the icy moons have been given Hydrographic ratings of 1 qualifying them as Ice-Capped. Since nearly every body in the solar system that has regions experiencing little sunlight has deposits of water ice, we use the term Ice-Capped in **Orbital** to mean 'has liquid water beneath an icy crust'. These liquid water oceans are postulated on Europa, Enceladus and on other moons also. Ice-capped means 'a subsurface ocean beneath an ice cap'.

**Bases:** The following codes may be used in the UWP following the Tech Level code:

- R Research station – A self-contained scientific outpost.
- M Military base – A military garrison, not part of the space force.
- N Space Force base – Military space port with associated facilities, crews and vehicles.
- S Space Agency base – Outpost supporting government exploration, crews and craft

### **Tidally Locked**

Finally, T indicates that a moon is tidally locked to the planet it rotates around.



# THE SOLAR SYSTEM

Sol	G2V			
<b>Mercury</b>	B300538	N	NI	
<b>Venus</b>	C8B0525		De NI	
Eros	C000364		As Lo	T
<b>Earth</b>	A8779A4	N,S	Hi In Ga	
Luna	A200527	N,S	NI	T
<b>Mars</b>	B420585	N,S	De Po NI	
Phobos	C000366	N	Lo	T
Deimos	X000000		Ba	T
<b>Asteroid Belt</b>	C000571		As NI	
Vesta	C000422	N,S	As NI	
Ida	C000466	N,M	As NI	
Moore	D000433		As NI	
<b>Jupiter</b>	<b>Large GG</b>			
Ring System	X000000		Ba	
Io	X210000		Ba	T
Europa	D201452		IC NI	T
Ganymede	E300168	M	Lo	T
Callisto	D311366	M	IC Lo	T
Constitution	E000154	R	As Lo	
<b>Saturn</b>	<b>Large GG</b>			
Ring System	X000000		Ba	
Janus	B000485	S	As NI	
Mimas	E0004A6	R	NI	T
Enceladus	E011302	R	IC Lo	T
Tethys	X000000		Ba	T
Dione	X000000		Ba	T
Rhea	C10039B	S	Lo	T
Titan	C3A2464	N	FI NI	T
Hyperion	E000163	S	As Lo	
Iapetus	D1003C7		NI	T
Phoebe	X000000		As Ba	
<b>Uranus</b>	<b>Small GG</b>			
Ring System	X000000		Ba	
Miranda	D000222	S	Lo	T
Ariel	X000000		Ba	T
Umbriel	E000106		Lo	T
Titania	X000000		Ba	T
Oberon	D000264	S	Lo	T
<b>Neptune</b>	<b>Small GG</b>			
Proteus	X000000		Ba	T
Triton	E210370	M	Lo	T
Nereid	E000200		Lo	T
<b>Kuiper Belt</b>				
Pluto	X110000		Ba	T
Charon	X000000		Ba	T
Haumea	X000000		Ba	
Makemake	X000000		Ba	
Eris	X200000		Ba	

# MERCURY B300538 – 9 N NI

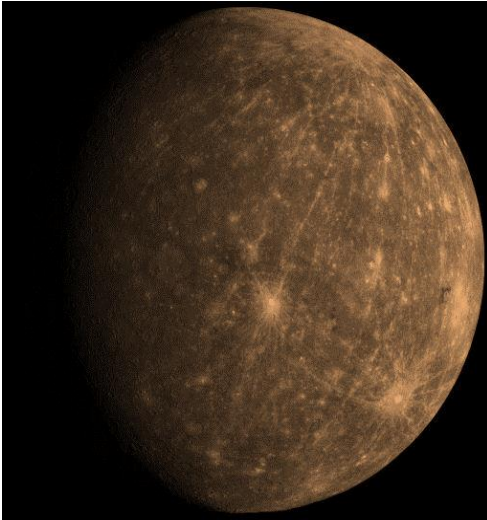

<b>Spaceport</b>	Good Quality
<b>Diameter</b>	4,880 km
<b>Gravity</b>	0.38 G
<b>Pressure</b>	vacuum
<b>Composition</b>	-
<b>Temperature</b>	-170°C night +420°C day
<b>Population</b>	112,000;
<b>Government</b>	Self-perpetuating oligarchy
<b>Law Level</b>	High
<b>Dist. from Sun</b>	58 Mkm
<b>Solar Day</b>	176 days
<b>Year</b>	88 days



## Planetology

Mercury is larger than the Moon and has a liquid iron core much larger than expected, suggesting a very early impact which stripped away much of the outer mantle and crust to leave the core intact. As a result little Mercury has a huge core for its size and a strong magnetic field, which greatly assisted the human colonisation attempt.

The planet exhibits strange orbital mechanics. It has a very elliptical orbit, swinging in close (46 million km) to the Sun, and then slowing down as it moves out to (70 million km). At that distance the intensity of sunlight on Mercury's surface is less than half the intensity at its closest approach. Mercury rotates very slowly, on average, 176 Earth days elapse between one sunrise and the next on Mercury, 88 Earth days of sunlight followed by 88 Earth days of night. The planet turns so slowly that one full Mercury day requires two orbits of the Sun, or two Mercury years! Because of Mercury's elliptical, egg-shaped, orbit and its sluggish rotation, the morning Sun appears to rise briefly, set and then rise again from some parts of the planet's surface. The same thing happens in reverse at sunset. To the Mercury colonists, the Sun looks nearly three times as large as it does from Earth. Mercury's surface experiences the steepest temperature gradient of all the planets, ranging from a very cold -170°C at night to a scorching 420°C during the day. The seasons on the planet's surface are caused by the variation of its distance from the Sun, growing hotter as mid-day approaches, rather than due to axial tilt.

The surface of Mercury, covered with ridges, highlands, mountains, plains, escarpments, and valleys, is geologically dead and has been for billions of years. The planet was heavily bombarded by asteroids and comets about 3.8 billion years ago and the planet received an overwhelming number of impacts. At that time, the planet was volcanically active and areas like the Caloris Basin were filled with magma, which are today smooth plains. Much of the surface, however, is a very jumbled, broken and distorted landscape.

Mercury's thousands of craters range in size from tiny bowl-shaped cavities, to multi-ringed basins that are hundreds of kilometres in diameter. The largest known crater is Caloris Basin, with a diameter of 1,550 km. The impact that created this was so powerful that it caused lava eruptions and left a concentric ring over 2 km tall around the impact crater. At the opposite end of the





planet (the 'antipode') to the basin is a large region of unusual highland known as the "Weird Terrain". One hypothesis for its origin is that shock waves generated during the Caloris impact travelled around the planet, converging at the basin's antipode; the resulting high stress split apart the surface. One unusual feature of the planet's surface is the numerous compression folds, or 'rupes', which criss-cross the plains. As the planet's interior cooled, it may have contracted and its surface began to deform, creating these features. The folds can be seen on top of other features, such as craters and smoother plains, indicating that the folds are more recent.

A danger to orbiting spacecraft are the magnetic flux tubes, twisted bundles of magnetic fields, up to 800 km wide, that connect Mercury's magnetic field to interplanetary space. These are tornado-like 'leaks' in the planet's magnetic field created as the solar wind whips past.

### **Human Development**

When the first fusion reactor came online in 2060, at Korea's National Fusion Research Institute in the city of Daejeon, the Earth Union looked out to the worlds of the solar system for the perfect fuel: helium-3. Mercury looked to be the prime candidate; probes suggested that great quantities of the element had been blasted onto the surface of the planet by the intense solar wind. If it could be mined and returned to Earth, then fusion power could prove the saviour of mankind, the key to unlimited power and unlimited potential.

The first human landing on Mercury took place in 2061, the Hermes 1 dropped a team of astronauts and scientists onto the surface at Sobkau Planitia. They landed during the 88 day night and spent two weeks in the darkness, building a solar shelter, conducting geological tests and setting up scientific instruments to monitor surface conditions on Mercury. Hermes 2, 3 and 4 were follow on missions. Hermes 5 and 6 landed construction equipment and robots that began work on the subsurface colony structure. In 2067, Hermes 9, composed of a small fleet of DSVs, entered orbit around Mercury with a full payload of colonists, supplies and machinery - this was the big landing, the Earth Union were moving people in to the buildings they had so laboriously constructed over a two year period.

Helium-3 was not yet on the colonists' agenda, they had to face their first 2000 hour Mercury day and it proved to be a tough one. Many more days followed and with a grim realisation they understood the difficulties ahead of them. Temperatures peaked at 420 degrees during the day and sank to -170 degrees at night. Machinery, habitats, rovers and suits struggled to cope with the temperature differences and several lives were lost.

Realising how much Mercury meant to the Earth Union, the Luna Republic launched a colonial effort of its own a year later, four DSVs fully equipped with colony construction materials, willing colonists and supplies for a year entered low Mercury orbit. They got a shock, however. The Hermes 9 colonists refused the Lunars permission to land and threatened military action should they attempt it. By dropping construction robots and hab modules from orbit, the Lunar contingent called the Hermian's bluff. It ended with all the robotic landers destroyed by Earth Union AKV's (the first historical use of these robotic missiles in combat). Shocked that the Earth colonists had brought military assets with them, the Lunars called for assistance and the stand-off intensified when supply craft and Lunar strike vehicles entered orbit several weeks later. They met an even larger force of Earth Space Force vehicles.

September 2068 looked like all out war between the Earth Union and Lunar Republic. The stand off intensified even more as bigger assets arrived in an attempt to intimidate the opposition. Diplomacy in Earth orbit cracked the ice, however, and to everyone's relief the crisis abated - the Lunar colonists returning home without setting foot on Mercury. A year later the Mercury Convention was signed by both governments allowing open access to any astronomical body in excess of 6 km diameter. Anyone could colonise Mercury or Titan or Mimas, for example. This



law, now enshrined, seemed to act in the opposite direction, however. When one government colonised a world, the other seemed to shun it and instead looked to another moon or planet to colonise. Both sides ignored the Mercury Convention in order to play interplanetary leapfrog!

Within three years the Sobkau helium-3 project had ended. Massive Earth investment had been poured into the Mercury project, colonists had arrived and facilities constructed, all to process and export the deposits of helium-3. But there was little to be found. The political storm that engulfed the project was known as the Sobkau Debacle, and it resulted in the EU pulling the plug. Investment stopped, as did the colonial transports, and although some assets were shipped back to Earth, much of the infrastructure remained in place. Where was the helium-3? Scientists speculated that the magnetosphere of the planet had diverted or swept away most of the material being blasted out by the Sun, but that the twisting flux tubes brought down concentrated deposits here and there where they touched the surface. Sobkau had been at the bottom of one of an ancient flux tube, a permanent kink in the magnetic field that had provided this erroneous reading.

Sajid Khan, a millionaire entrepreneur and supplier of mining equipment, took a big gamble at this time and bought up equipment and assets at a huge discount. He established Hermes Systems and began rationalising his new-found business. Key to his success was the use of solar power satellites in low Mercury orbit providing power at all times, even during the 88 day night. Khan moved much of his electronics manufacturing to Mercury and the colonists there snapped up the jobs. With few other competitors, and making use of abandoned facilities, Khan rapidly expanded.

Khan's four year plan came to fruition in 2074. Hermes Systems by this time was exporting solar energy technology to the rest of the solar system, and had opened up mines to secure a source of raw materials. Most of the population was an employee of his and morale on Mercury was improving. By 2080, Khan and his family sat at the head of an independent Mercury, one with bold, enterprising citizens who welcomed the corporate freedom that Khan extended to other businesses from Earth. He was keen to offer investment opportunities and mining rights to companies as well as freelancers, in the hope that a 'rush to Mercury' would energise the planet's economy even more; but convincing miners to leave the relatively easy asteroid mining industry proved almost impossible.

The mineral strike at Caloris Basin in 2084 by a co-operative of freelancers changed that. A wide ranging survey by these miners had discovered huge deposits of some of the solar system's rarest minerals, over a vast area. Scientists suggested this was due to much of the planet's lighter, more worthless outer layers being blasted away during the Mercury's early collision. A flood of miners arrived; many were new to the job, helped to Mercury by the Frontier Foundation. Illegal immigrants also made their way to the planet, brought in by Chinese Snakehead gangs. Too many of these desperate migrant workers died on the unforgiving and brutal surface of Mercury, unprepared and untrained. The Kolkata Offworld Movement (see pg.140) has pushed mining consortiums to bring in reduced training times and statutory quotas of climate refugees purely to get more people to Mercury, and the pressure has worked.

All this immigration, particularly from Kolkata, Bangladesh, the flood zones of the Pearl River Megacity and over populated Egypt has meant continual urban development. Sun City is the show-piece settlement of Sajid Khan's new Mercury and the planet's new capital city, made rich through the leasing of mining rights to off-world corporations and co-operatives. Khan's open door policy to business and relaxed approach to corporate taxation has made Mercury an enclave for banks and canny enterprises. The Khan family owns much of the infrastructure and employs 90% of the planet's permanent residents. Owner of Hermes Systems, Khan is also the permanent chairman of the company's Citizen Advisory Board, which effectively acts as a planetary parliament to oversee non-commercial affairs of the business. As 'The Chairman', Khan is defacto ruler of the planet. Many of his relatives have been given high level positions within Hermes Systems.



Although business has free rein and people in work are affluent, society is not free. The media faun over the Chairman and heavily self censor their news reports to show Hermes and Khan in a good light, police have many powers that enable them to detain suspects, deport malcontents without trial, employ 'rigorous' interrogation methods and effectively act as the Hermes Systems goon squad. Visitors to Mercury should expect to be challenged by police patrols and at checkpoints frequently. The same visitors will find they are treated affably and courteously should they display legitimate corporate IDs. Human rights issues have been raised within the Earth Union, and by Luna, but Mercury is a sovereign state ...

A number of coups and failed revolutions have been started on Mercury within the past decade, all brutally put down by the security forces on Mercury. The blame for all of these has been put on Luna, fomenting discontent in order to seize Mercury as a prize of itself. Some outsiders see this as Hermian propaganda and evidence of widespread unhappiness and discontent amongst the poorest class of Mercurians. Most of these arrived with the blessing of KOM or in a Snakehead cargo module and being unfit for mining work, fell into the service industries at Sun City and other corporate-dominated settlements. Cleaners, nannies, cooks, hydroponics operators, prostitutes, low paid construction workers, waiters, laundry staff and others, all came to Mercury with dreams of making themselves a fortune.

### **Places of Interest**

**Sun City** – Sun City is Mercury's capital city, located on the wide floor of crater Gothe, close to the north pole. The city holds 50,000 people and is built underground. A central twenty-five storey shaft houses a fusion powerplant and three large tunnels radiate away eastwards from the central core to form major route ways, the northerly tunnel connects with light industry districts, the most southerly connects with farms and low cost accommodation. The central tunnel is the major artery, shopping and entertainment zone, and heads directly for the underground public plazas and the central business district. A curving link tunnel connects these districts together and also runs through high class corporate housing areas as well as a second district of low cost housing.

The tunnels demarcate an area criss-crossed with small tunnels, networked together to form distinct districts, one of which is the Village, a place of artists and craftsman, a bohemian, relaxed place. The artwork coming out of Sun City is highly prized, and the community developed primarily to produce one-off works of art for the offices of the big corporations that do business here. Pottery, jewellery, metalwork, sculpture and glass blowing are all popular art forms there. The business district is a huge cylindrical cavern with parkland at the bottom and multiple galleries running along the sides, home to the offices of Luxor, Erebus, Ellis-Itami, Aerodyne and many more. The outward status of a corporation is typically shown through architecture, but here the companies instead display exotic artwork, such as Aerodyne's famous "Glass Waterfall", Baospace's "Automata Ferrata" and Matsuyama's bronze sculpture "My Liquid Hell". To the west a new tunnel has been cut, and splits to a new heavy industry district and to a zone of fresh tunnelling. There are passenger and freight elevators dotted all across the city, and light shafts also reach the surface, constructed to channel light down via mirrors to some of the open public spaces.

Sun City was built quite recently to service the corporate clients that the Khan family do business with. Corporate executives live here along with large numbers of their employees. On the surface there are various installations, including a spaceport (Port Bhandari Ram) with underground hangers and the Sun Lotus. This huge lotus-shaped construction sits atop the fusion shaft and closes up during the 2000 hour-long daylight hours to protect the fusion core, it then opens up during the 200 hour-long night, the individual petals acting as vast radiators that dissipate the tremendous heat built up and stored during the day.

**Sobkau** – Site of the first Mercury landings and the failed helium-3 mining attempts, Sobkau is now a thriving and energetic electronics industrial zone. Components (including solar power sats for Earth) are manufactured here that are top grade quality. If your DSV has a Hermes Systems component, it comes from Sobkau! Some of the habs and tunnels were built three decades ago and will need repairing and upgrading soon.

**Heliopolis** – Like Luna’s Shackleton Crater, Heliopolis is located within a polar crater that carefully guards its own ice reserves. Like Shackleton it has been covered with a dome and serves as an extremely exclusive resort for corporations, Hermes executives and government workers. Low cost housing for staff and technicians exists, and is shared by the ice miners who ship fresh water south to Caloris Basin and Sun City. Heliopolis is an exclusive corporate centre, a resort with fabulous hotels and spas, swimming pools and gardens. The crater was previously named Aristoxenes.

**The Mines of Mercury** - The famous Mines of Mercury actually include the Caloris Mountain Mine, the Terminal Mine and the Paradise Mine. All are there to exploit the fabulous resources discovered within the vast impact crater known as Caloris Basin. Without doubt these mines produce more wealth in a given time period than any other asteroid or planetary mining operation in the solar system. Caloris Port includes landing pads for incoming supply shuttles and series of magnetic accelerator catapults for launching 10 ton ore modules into low Mercury orbit. Here they are intercepted and shipped to elsewhere in the solar system (typically Earth).

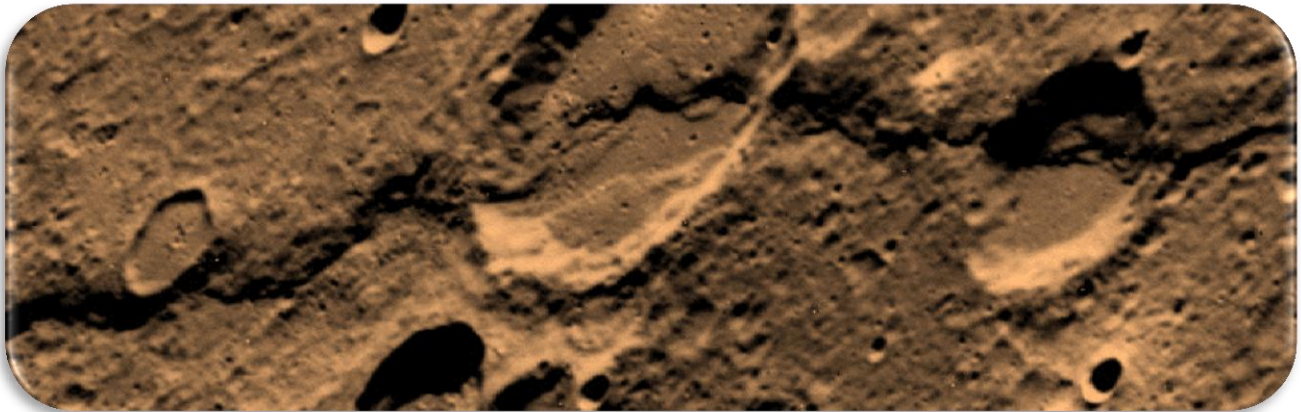

**Discovery Ridge** – Freelancers, wildcatters and co-operatives can get their own official license to mine on Mercury. Bribery will often work well, cutting through the endless red-tape that the government has created to foil ambitious freelancers. Most head away from Caloris, however, and fly down south to the Discovery Mine, located at Discovery Ridge, a 400 km long uplifted scarp in the southern hemisphere. This stunning, south-east facing, escarpment crosses the landscape and cuts across two craters, including Rameau. The ridge was formed by geological uplift that occurred as a result of compression of the crust and this uplift exposed huge metal ore deposits. Discovery Ridge is a settlement drilled into the cliff, cramped living space utilising the first mines cut here in the 2070s. It is a rough frontier settlement, with various small companies operating services such as power and life support for a modest fee, while other companies supply tools, pressure suits, rovers, food and fuel at not so modest prices. The latter are often owned by Chinese Snakehead gangs from Earth. There are fortunes to be made in small enough quantities that the big mining corporations are not interested (yet), and this opportunity draws in the ambitious, the dedicated, the fool-hardy, the reckless and the desperate.

The Frontier Foundation tries to assist miners who have run out of credit and need passage home, whilst the Snakeheads are at the same time bringing in more and more useless dreamers without the skills or experience to even begin mining, never mind strike it big. For this reason, Discovery Ridge is known to local miners as ‘Heartbreak Ridge’.



# VENUS C8B0525 – 9 De NI

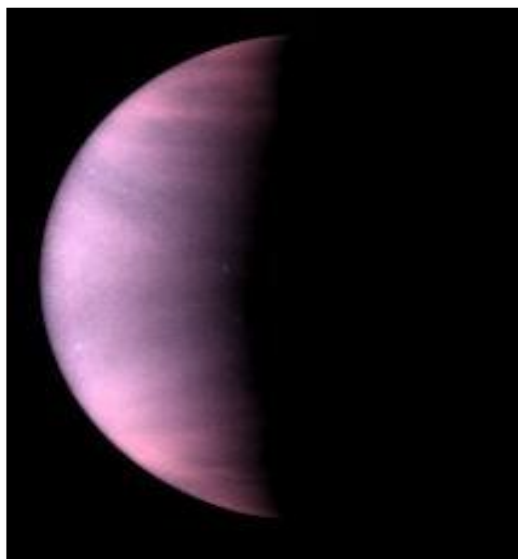

<b>Spaceport</b>	Good Quality
<b>Diameter</b>	12,092 km
<b>Gravity</b>	0.9 G
<b>Pressure</b>	90 atm (corrosive)
<b>Composition</b>	carbon dioxide
<b>Temperature</b>	460°C
<b>Population</b>	125,000; Yuru, Eagle City, Centorum, Skyland, Cupid's Regret, Cerberus
<b>Government</b>	Participating democracy plus independent cities
<b>Law Level</b>	Moderate
<b>Dist. from Sun</b>	108 Mkm
<b>Solar Day</b>	116 hours
<b>Year</b>	225 days
<b>Moon</b>	Eros C000364-9

From the amazing life that thrived in the planet's acid ridden atmosphere to diamonds the size of a motorcycle helmets, Venus soon drew the interest of Lunar colonists. A large asteroid strike nearly sixty years ago exposed extensive mineral veins and created a mother lode of exotic debris. After the impact the scientists were soon followed by miners and treasure seekers who in turn were followed by shopkeepers and settlers.

All large settlements are either floating high above the surface or buried deep within the ground. Venus and the space around the planet is now home to almost 125,000 Luna colonists and the planetary personification of love now has a permanent consort in the form of Eros, once an asteroid and now a moon. Eros is home to the B-class spaceport that gives Venus its B-class rating. Life in the clouds centres around the collection and processing of Venusian life or in catering to those who work in that industry. Overall it is a good life in a beautiful locale bedevilled only by the threat of a disastrous descent into the crushing depths below or the occasional pirate attack. For those on the surface life is harsh and the crushing pressure ever present. Even so the underground corporate cities are growing centres of trade and industry. For a person brave or foolish enough to take the risks the riches of Venus await, and so people of all walks of life make their way to a world that can truly be called...a living hell.

*"Venus favours the bold."*  
Ovid

## Planetology

Venus and Earth are similar in size, mass, density, composition, and distance from the sun. There, however, is where the similarities end. Venus is covered by a thick, rapidly spinning atmosphere, creating a scorched world with temperatures hot enough to melt lead and a surface pressure 90 times that of Earth.

Venus' atmosphere consists mainly of carbon dioxide, with clouds of sulphuric acid droplets. Only trace amounts of water have been detected in the atmosphere. This incredibly thick atmosphere has trapped the sun's heat, resulting in surface temperatures over 470°C. Probes landed on Venus in the 20<sup>th</sup> century did not survive more than a few hours before being destroyed by the incredibly high temperatures. Unusually, Venus rotates retrograde (east to west) compared with Earth's west to east rotation. Seen from Venus, the sun rises in the west and sets in the east and as Venus



moves forward in its orbit while slowly rotating 'backwards' on its axis, the cloud-level atmosphere zips around the planet in the opposite direction from the rotation every four Earth days, driven by constant hurricane-force winds. Venus does not have its own planetary magnetic field to protect it from the solar wind.

Around 90% of the surface of Venus appears to be recently solidified basalt lava; it is thought that the planet was completely resurfaced by volcanic activity 300 million to 500 million years ago. Much of the surface is covered by smooth, volcanic plains while two highland 'continents' make up the rest of its surface area; one lying in the planet's northern hemisphere and the other just south of the equator. The northern continent, about the size of Australia, is called Ishtar Terra. Maxwell Montes, the highest mountain on Venus, sits within Ishtar Terra. This peak rises 11 km above the average elevation. The southern continent, Aphrodite Terra, is the larger of the two highland regions similar in size to South America. A network of fractures and faults covers much of this area.

In addition to the impact craters, mountains, lava-carved channels, dune fields, shield volcanoes and valleys, Venus has a number of unique surface features. Among these are flat-topped volcanic features called 'farra', which look somewhat like pancakes and range in size from 20–50 km across, and rise up 100–1,000 m; radial, star-like fracture systems called 'novae'; features with both radial and concentric fracture zones resembling spider webs and known as 'arachnoids'. 'Coronae' are circular fracture rings sometimes surrounded by a depression that scientists believe formed when hot material beneath the crust rose up, warping the planet's surface. These features are all volcanic in origin.

### **Human Development**

Venus is a planet shrouded by dense clouds and covered in lava flows. At the planet's surface it's atmosphere is a crushing 90 times that of Earth's and composed almost entirely of carbon dioxide. The mean planetary temperature hovers around 460 °C; hot enough to melt lead. Sulphuric acid falls from the sky as rain, and the planet rotates so slowly upon its axis that its' day is longer than its orbital year. Finally, Venus lacks a natural geodynamo and thus does not produce a magnetosphere powerful enough to protect the planet from solar radiation. Overall, Earth's supposed twin appeared to be nothing but a lifeless scarecrow. By the start of the Second Space Race Venus was all but forgotten, but there were those who looked towards the bizarre extremophile life on Earth and drew inspiration and hope that Venus held a few secrets. Unmanned missions to Venus continued haphazardly during the early decades of the 21<sup>st</sup> century. In 2023 the Japanese probe Bifuu dove deep into Venus' atmosphere and confirmed what a few eccentric astrobiologists had been speculating for decades. Fifty kilometres above the planet's surface and deep within the layer of sulphuric acid clouds the world teemed with life. Unfortunately, this discovery was very quickly overshadowed by the startling confirmation that the Face, City and Pyramids of Mars were in fact the remains of some sort of alien outpost. Physical proof of aliens so close to home made the existence of primitive Venusian life look rather boring. Even so within the scientific community interest in Venus grew.

The first humans to orbit Venus were the eight cosmonauts of the Russian Vega-8 mission which reached Venus in 2028 and spent four months orbiting Venus. They mapped its surface, launched atmospheric probes and dropped two Venera landers. To cap the mission three of the cosmonauts attempted to take a manned flight through the sulphur layer to collect samples of the life that existed there. Sadly, there was a major failure as their ramjet aircraft attempted to gain altitude and all three perished as the vehicle plunged to the planet's surface. While the Russians orbited Venus, a joint American-Australian mission, dubbed the Anteros Program, visited the asteroid 433 Eros. The second phase of the Anteros Program involved inserting a habitable but initially unmanned space station into orbit 500 km above Venus. This station, called Adonis Station, entered orbit in 2031 but did not receive a crew until 2035.



The first manned landing on Venus occurred in 2037 when a lander crewed by three Americans, two Australians and a Briton touched down in the Niobe Planitia region. The self-contained capsule did not allow egress and all exploration was accomplished via remote rovers. A year later a second landing took place in which several of the explorers were to leave their capsule. This ended in tragedy when an airlock seal failed and all fourteen crew members died over the course of several days. No further manned landings were attempted over the next five years, but the crew of Adonis station doubled and by 2041 forty people worked at the station. Instead of risking a manned landing they controlled a swarm of unmanned aerostats, skimmers and even several surface rovers. Their investigations found that Venus was a treasure trove of precious metals, gemstones and other rare minerals shaped by volcanism, high pressure and scouring heat.

On September 4, 2041 the asteroid known as 4593 Cloacina smashed unexpectedly into the the surface of Venus between Beta Regio and Osteria Regio, creating a crater 34km wide and over 800 meters deep. The impact threw debris high into the atmosphere and triggered a massive quakes. As soon as the debris settled the scientists renewed their research, interrupted only the by the Orbit War that saw Adonis station and Eros both abandoned by the Earth Union and quickly occupied by the Lunar colonists.

Subsequent investigations found that some of the life forms had interesting chemical properties with industrial, life support and even medicinal applications. Around the newly formed crater were lodes of exposed minerals and valuable post impact debris. In 2052 Luna began the long process of slowly nudging Eros towards Venus. The initial intent was to disassemble Eros and use it to assist in a massive terraforming effort of Venus, but that idea was quickly scrapped. Instead moving Eros became a proof of concept exercise with dual purposes both protective and military. As Eros moved closer to Venus mining facilities began to dot the large asteroid. Most of the metals mined there were sent to Luna but some loads made their way to Venus where they helped to construct SGS-272 Cyprus Station, a larger replacement for the overcrowded Adonis Station, and the first two aerostat cities. It would not be until 2094 that Eros finally entered a stable orbit 2,500 km above Venus.

Venus saw very little fighting during the Belt War despite the presence of numerous Earth Union dirigible science missions and surface based survey teams. But despite avoiding conflict during that war Venus has seen its share of fighting and death. Soon after the renewal of manned missions to Venus' surface in 2057, mining facilities were established in and around Cloacina Crater. With the Earth Union having no military or police presence on Venus and Luna's effort turned towards constructing aerostat cities; Crapper Crater, as the hole became locally known as, developed into a lawless frontier. Conflicting claims and a personal rivalry soon led to armed conflict, and from 2064 to 2069 a state of warfare existed within the crater. Independent and wildcat miners fled in their 'hardbug' Venus rovers to safer regions. By 2070 the bowl of the crater was dominated by the big four mining companies; Centennial, Erebus Power, Preston Enterprises and Southern Cross Mining. Bored deep into the crater's rim reside the four sub-surface cities which together have a population just under 20,000 people.

After the Belt War the settlement of Venus more attractive to Luna. Mars was independent, many in the Belt were overtly hostile to the Luna Republic and Saturn was too far away for immediate colonization. So Luna launched an aggressive effort to secure dominance over Venus and prevent the Earth Union from doing the same. Right from the start Luna built big. It's floating science base was converted into permanent structure, built over six years and able to hold a thousand personnel. Australians volunteered for the job, creating a unique culture of can-do engineering, but one which never took itself too seriously and had a laid back attitude once things were up and running. The Earth Union struggled to get anything to match the audacious Luna colonisation project since they lacked the Moon's real trump card – the Aerodyne Venus Dart, an aerodynamic Venus ramjet spaceplane that utilizes helium bags to transform itself, mid flight, into an airship.



Once in airship mode they slowly coast into position alongside the target aerostat and then dock in the underside hangers to offload supplies and raw materials.

Each aerostat holds around 10,000 individuals, not just scientists, but engineers, hydroponics technicians, mechanics, and the whole spectrum of personnel that allow a colonial city to function. Transport between aerostats is carried out by the special Venus flyers that make suborbital journeys across the globe to the widely dispersed cities. These flyers can also take personnel to the low orbit Cyprus Station station, a manned spin gravity station in low Venus orbit used as a cargo transfer point and launching point for Venus Darts. It is equipped with 12 Venus fliers and has docking facilities for incoming Luna DSVs as well as large warehouses for the stockpile of supplies. Rapid response to an aerostat crisis is uppermost in the operations of Cyprus Station and it also acts as the control centre for the hundreds of satellites that orbit Venus providing communication, planetary positioning and weather services. While Eros has recently replaced Cyprus as the planet's primary spaceport the older station still acts as a busy stop over. By adding a reusable liquid fuel booster Venus Darts are able to easily reach Eros from Cyprus.

Today the skies of Venus are now home to thirteen aerostat cities. Ten of these were built by the Luna Republic and include the nominal capital of Yuru a tethered aerostat that acts as the planet's spaceport. An eleventh aerostat city, Aerostat 3, suffered a catastrophic accident in 2085 and plummeted 50 kilometres to the surface. Over 6,540 people perished, while 1,230 mostly children were saved by the heroic efforts of nearby Eagle City. Two other non-Luna aerostat cities also float through the clouds of Venus. The afore mentioned Eagle City was constructed during the 2070s by the Earth Union as allowed by the Mercury treaty. The last floating city on Venus is Themiscyra. Home to the infamous or heroic, depending upon one's point of view, aero-pirates. this had been called Aerostat 2, but since it was built to the same design specifications as the failed Aerostat 3, it was evacuated and allowed to drift after springing several small leaks. Expecting the city to drop to the surface of Venus the Luna government planned on salvaging as much as possible but found that the city had moved and its transmitters ceased broadcasting. Four years later it was discovered that the city had been taken over and refurbished by a group calling itself the League of Aphrodite. The city is now the home base for a band of dirigible riding raiders that often attack other cities.

### **Places of Interest**

***Yuru, primary spaceport and largest aerostat city*** - Yuru has become the largest aerostat city with population of over 12,560. It is one of only two tethered aerostats and is located along Venus' equator at the northern edge of Phoebe Regio. A fifty kilometre long cable anchors the city to the planet's surface where the small underground town of Thawun acts as its warehouse and industrial district. Yuru, because it is tethered and under more wind stress, has a more heavily reinforced structure than most aerostat cities. Even so visitors are often amazed by the open spaces and expansive room within the city. Yuru is Aerostat 6; an unusual feature of the city is the high percentage of children present, survivors and orphans from Aerostat 3. A portion of the city was set aside for these survivors which has since acquired the nick-name, Neverland. Despite its reputation for crime, Neverland is one of the more open and entertaining districts in the otherwise heavily controlled city. Most of the city's nightlife, live entertainment and art studios are located in Neverland. Murals cover the walls and despite repeated attempts at enforcing a curfew the corridors of Neverland are lively throughout the artificial twenty-four hour day/night cycle adhered to by the city. Yuru also acts as the unofficial capital of Venus and as such has a small government district and even several consulates. As the seat of government Yuru is home to Luna's elite Venus Intervention and Priority Emergency Reaction Force. VIPER acts as both a search and rescue unit and a military response force. Like most other Lunar military units VIPER makes extensive use of autonomous and remote military robots.



Finally, Yuru serves as Venus' primary surface spaceport. Launches are conducted from the upper part of the aerostat by releasing a large torus shaped balloon in the centre of which hangs a large chemical rocket. As the torus reaches the upper limits of its lifting capacity the rocket launches and exits the planet's atmosphere en route to Cyprus Station or Eros. Trips down to Yuru from orbit are made either by manned Venus Darts or unmanned drop capsules that are snagged by one of four catcher blimps.

Since it is the primary transportation hub for people to and from the planet's surface, Luna has gone to great expense to connect Yuru's downport to the mining region around Cloacina Crater. This was achieved by way of two large mass drivers. These mass drivers accelerate large 14 ton lifting body capsules to speeds of 1,200 kilometres per hour. A further boost is given by internal rockets to maintain speed and course. This means the 3,457 kilometre long trip takes just under three hours. The flight vehicle lands on a long conveyor-belt like runway consisting of special rollers after being slowed by a drag parachute. Thus far the mass driver system only provides transportation back and forth between Yuru and Centorum, but by increasing the speed at which the drivers propel their projectiles unmanned cargo pods can be sent into orbit.

***Centorum, largest surface city on Venus*** - Starting life in 2057 as a small mining outpost called Craterton, Centorum has endured two name changes and massive growth. With a population totalling 9,458 Centorum is by far the largest surface city on Venus. After changing hands during the Crater Conflict, Craterton became Caverton. The entire outpost was moved underground by the now defunct Great Crater Mining Corporation. When Centennial acquired GCM, Corp in 2077, they rapidly carved larger spaces deep into the sides of the Beta Regio highlands. Volunteers were given a large signing bonus, medical care to raise their strength enough to live on Venus and extensive training. In return they were expected to stay on Venus at least ten years and start up a new mining business. Centennial knew from history that the miners would find their own way to Venus and that to really make money on Venus more business and industry was needed than just mining.

After five years of recruitment and expansion, Centennial announced the re-opening and renaming of Caverton. Now called Centorum, the massive underground city offered a wide array of services and industries for the miners to buy from or sell to. Despite its relatively small population Centorum has hundreds of small shops, restaurants and services. As nearly all the industrial labour is provided by robots practically everyone of working age is available to start a business or provide a service. This has given the town a very free wheeling capitalistic feel. Nowhere is this more evident than the centrally located Market Dome. The Dome is the largest open space known to exist on Venus and encompasses a space four times as large as the average sports arena. In the middle of the dome is a water filled recreation of Cloacina Crater referred to as "the Fish Bowl". This pond is home to a wide variety of koi and carp. It is also the largest source of liquid water anywhere on Venus.

At the top of the dome, hanging high above the Fish Bowl, is Centennial Plaza. Originally conceived as an observation deck open to the public, the plaza now contains the offices for Centennial Corporation as well as several luxurious apartments for high level corporate and government officials. Access to the Plaza is restricted. Radiating out from the central Market are numerous passageways leading to industrial and residential districts. Since these passages were carved out of solid rock they have a claustrophobic cave like feel. This is something most Lunars feel at ease with, but newly arrived Australians or visiting aerostat dwellers find the effect to be very disconcerting. To bring some beauty to their cave homes much of the wall space both public and private has been covered in relief murals. The overall interior design theme in public areas draws heavily from the same Asian influences that are seen throughout Luna. The primary entrance into Centorum is by way of a massive set of airlocks. These airlocks are large enough to allow all sizes of Venus rovers to pass through as well as the huge Yuru Transit Planes that land

and launch nearby. Tethered to the highlands just east of the city is the aerostat city Yanggal. Yanggal was completed just four years ago and is already home to 1,840 permanent residents. Connected to Centorum by way of a subterranean mag-lev train this city has one major industry; catering to the needs and wants of the many miners that control the mining bots or drive the surface rovers. Yanggal houses three casinos and twice that many brothels. Police presence is heavy but low key. A few shops exist on Yanggal but are notoriously over priced; anyone wishing to do serious shopping must travel down the tether to the Market Dome.

***Eagle City, typical aerostat type city populated by Nationalists*** - Referred to as a 'Nest of Nationalism' by many delegates in the EU World Council, Eagle City is an anomaly floating through the clouds of a world otherwise dominated by the Lunar Republic. Constructed between 2071 and 2079, the city came to be dominated by Americans and Canadians. The first North Americans arrived as part of the initial engineering teams who worked on its construction. As these workers got along well with the pro-Luna Australians who were overseeing the effort many of them took the opportunity to pre-purchase living space on Eagle City at discount rates. By the time of its completion in 2079 nearly two thirds of the available living space was already owned by North American buyers. Attempts were made by the World Council to limit further domination by North Americans but they were opposed by delegates from the United States. Today Eagle City is the second largest aerostat city and the largest free-floating settlement with a population just over 11,750. For more information on Eagle City see chapter 8, Orbital Society.

***Eros-Neith Station, primary spaceport and industrial centre*** - Eros-Neith Station stands out as one of humanity's greatest achievements. The first outpost on 433 Eros was a small eight man modular outpost established by the Anteros 1 astronauts. This initial habitat was joined two years later in 2031 by an ORVIN outpost. Left unmanned for several years the Eros outpost finally saw occupants in 2035 when an unsanctioned mining crew attempted to mine the asteroid. They were arrested in 2037, but initial digs showed that Eros held large amounts of magnesium and calcium. As these elements could be used to sequester carbon and free up oxygen they would be highly beneficial in any effort to terraform Venus. As the terraforming of Mars saw some early successes the proponents of terraforming looked towards Venus as the next target. Studies were done that showed Venus could be terraformed over the course of several hundred years. In that amount of time native Venus life could be modified to survive the new environment created by terraforming. Opponents protested and launched a barrage of lawsuits. Plans to proceed with terraforming were halted, but Eros Station continued to grow into a major mining facility. Following the Orbit War all lawsuits against Luna and lunar corporations were dismissed. This reopened the possibility to begin the terraforming of Venus.

In 2050, Reiner-Gama was tasked to move the asteroid 433 Eros to Venus. The Earth Union protested but Luna countered by citing an IAU provision allowing the movement of any asteroid, comet or space object deemed a potential impact hazard. As Eros was considered a possible impact hazard in the very long term this gave the Luna Republic the excuse it needed to move the asteroid. The process began slowly with a mass driver firing mining waste to propel the asteroid into orbits closer and closer to Venus. In 2082 a large fission reactor was put in place on Eros and used to heat water as a reaction mass. This hastened the pace of Eros' move and twelve years later the asteroid became a moon of Venus.

Long before Eros entered Venus orbit it had already become an important industrial centre, mining facility and shipyard. The primary complex making up the Neith Spaceport and Transit Station is the 750 meter tall Monolith Tower located along the edge of Himeros Depression. Once covered in solar collectors the tower now holds numerous space vehicle construction hangers, sensors, communication arrays and vacuum fabrication facilities. Surrounding the base of the tower is an extensive network of mines and manufacturing plants that feed raw material and parts to the vehicle yards. Several kilometres away and connected by an enclosed monorail lies the landing





field. Given the extremely low gravity of Eros almost all space vehicles can land and take off from this facility. Those that cannot land are serviced by the numerous Taurus space tugs.

Neith Spaceport does not handle a large number of incoming and out going passengers compared to Earth, Luna or even Mars, but as the largest Luna Republic construction yards outside of Lunar space it sees a large number of transport vehicles. The primary residential zone consists of Psyche Dome, constructed over the 5.3 kilometre wide impact crater, Psyche, that dominates the side of Eros facing Venus. It is a double-glazed dome sandwiching several meters worth of water which acts to absorb cosmic radiation while allowing light through. Psyche Dome houses about 9,000 people and has further room for expansion, it is connected to Neith by way of an elevator system that runs directly through the centre of the asteroid. A further 2,000 people live in housing along the core hole where they experience near zero gee.

The last major structure on Eros is the uncompleted Centrifugal Gravity Simulator. This structure encircles the entire asteroid like a ring on a finger. The CGS idea came about as a way to create artificial gravity by using a tram that runs very quickly through a vacuum tube. Special elevators would match the tram's speed and allow people to embark to or disembark from the tram which had their living quarters. The Luna government scrapped this idea and the plan to convert the mostly completed tube into a large particle collider never received funding. Portions of the tube were converted to warehousing but the majority was left unattended. Over the years the Tube has filled with a wide assortment of habitats, businesses and secretive research labs. It is believed that the Tube now has a population numbering over 2,000. Very few places in the solar system can match the Tube's unsavoury reputation, and even the vaunted VIPER Force rarely enters it without a very good reason.

# EARTH A8779A4 – 9 N,S Hi In Ga

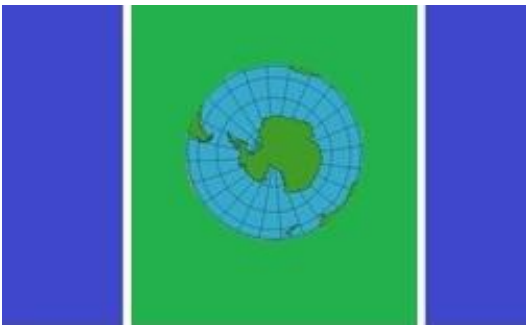

Spaceport	Excellent Quality
Diameter	12,750 km
Gravity	1.0 G
Pressure	1 atm (Std/Tainted)
Composition	nitrogen, oxygen, particulate taints
Temperature	18°C
Population	8,000,000,000 cities: Singapore, Yangtze Delta Community, Delhi Autonomous Cities, Pearl River Megacity, San Francisco, Kanto Prefectures, Munich, Klang Valley Cities, Valley of Mexico, American North East City Cluster, Jakarta Raya
Government	Charismatic dictator
Law Level	Moderate
Dist. from Earth	150,000,000 km
Solar Day	24 hours
Year	365 days
Moons	Luna A200527 - 9

Many people at the turn of the century predicted that Earth would have gone to the dogs by 2100, with a ruined climate, food shortages and terrible living conditions, as anywhere from 10 to 20 billion struggle to survive on dwindling resources. It didn't come to pass *because we did something about it*. In 2011 there were twenty one 'megacities' (a city containing more than 10 million people), and although the trend for these vast urban conurbations peaked in 2040, it was a trend which did begin to reverse. In early 2012 the global population passed 7 billion and continued to rise, but by 2025 many democratic nations were clamouring for a way to decrease their populations and stem rural emigration. With the establishment of the Earth Union, population decrease became a global matter and was enacted on a global scale.

*"The day of small nations has long passed away. The day of empires has come."*  
Joseph Chamberlain 1904

**Population Reduction:** Today the population stands at a healthy 8 billion individuals and there are only two remaining 'megacities' in existence: the Pearl River Megacity (the partly-flooded Guangzhou-Shenzen-Dongguan-Foshan-Jiangmen-Zhongshan conurbation) and Jakarta Raya (the Jakarta-Bandung supercity). Elsewhere, megacities have fragmented, a worldwide trend extending to many other conventional cities too. The domination of tele-commuting, of local power production (through renewables or beamed solar energy from orbit) and efficient transport networks, has meant that industries are dispersed and populations are dispersed too. The typical global city holds around 2 million people and is small enough to create its own sense of unity and community. Many cities have shrunk to even smaller sizes, and they are better for it. It couldn't



have happened without the drop in population or the new technologies. Green spaces, open public areas and low-rise architecture are common urban forms as are dispersed industrial developments. The skeletons of the old megacities can still be discerned, but these days where one monolithic urban monster spread out its tentacles, today half a dozen independent cities engage with one another like any other community. Small-scale local communities have become central to the modern city, arguing with one another, or working together over projects that concern them. Democracy is at work on every level. This way of life, where small communities interact with their peers, works at every scale, between cities, between regions or provinces, between nations and even between inter-regional organisations. Of course there are mayors and presidents, governors and community leaders, but these are all elected by those over whom they have power. It can be a messy system, with groups at different scales sometimes in opposition, or alliances of groups composed of cities, communities or industries all caught up in intense arguments and negotiations; but the system works because it allows those who have an interest to see their concerns through to the end. Only the ubiquitous use of the Net has allowed such a complex system of digital government to function effectively. This is not 'internet democracy', however, the single click is only a part of the machinery of society.

**Local Government:** This is not direct democracy, Luna-style, either. Representatives are still voted in and the organs of government still function, but communities are able to vote instantly and are able to take part in all manner of consultation groups and voting juries. There are no more party politics in 2100, the incredible fragmentation of society means that interest groups (communities) are the building block of political and social activity; and the definition of a community is a lot more than the population of a place, like Harlem, or Boulder Colorado or Spurn Point in England. It might be all doctors or all snowboarders, people in Massachusetts opposed to a new solar-power rectenna farm, the fishermen of Mumbai or the Canadian police officer's union, and so on. Any group that needs or wants a voice is a community and has by virtue of digital democracy, a voice. These communities may oppose one another, form alliances, or trade positions or policies with one another to gain an advantage in some other area.

Economically, Earth is the powerhouse of the solar system, an industrial hothouse with the capacity to produce fusion reactors, deep space vehicles, mega cities, skyscrapers and every conceivable mechanical and electronic device that its inhabitants could ever dream of. The ubiquity of 3D printing and the speed of modern transportation, means that local industries in cities dispersed across the globe can punch far above their weight. So where do you *want* to live? Now that the global population has stabilized, the agricultural industry has fewer demands placed upon it, food is plentiful and there is a tremendous diversity and a huge cottage industry. Niche markets, local growers and regional food varieties abound.

**Outlook:** In all, this is a good time to be alive. Men and women have good sense, they fight their particular corner, they may live within a city or out in the dispersed rural communities, they waste nothing and consume what they need. Idiots, thieves, con-men and wasters still exist, but they have little chance of long-term political office, mitigating their destructive power. What do people think? If you are British, look back at 1940 and imagine the apocalyptic scenario of Hitler succeeding in his invasion of the British Isles. That was a close run thing, but catastrophe was averted. For everyone else, think of the 1961 Cuban Missile Crisis. Here the world quaked in its boots as the USSR and the USA leaned over to press those nuclear triggers. Life on Earth was almost extinguished. In 2100 the people of Earth look back at the insane early 21<sup>st</sup> century growth of megacities and the runaway population growth in the same way; 'the idiots almost wiped us out'. Today we have restraint, common sense and more than anything else, breathing space. Hard work carried out in the 2050s and '60s ensured that there was enough and 'enough' would last indefinitely. Society is no longer focussed on 'how much can you get', but instead on 'maintaining what we have, and also on preparing for the future'. Ten thousand years ago, all humans thought this way.



## **Planetology**

In general, the Earth has changed little since the early 21<sup>st</sup> century, but still, the vicissitudes of environmental damage have made their mark. Of greatest impact are the periods of poor air quality that can drive people indoors, or force them to wear simple filter masks. Particulate matter, the detritus of hundreds of years of intensive industrialization, peaked in 2067, and today affects certain regions at certain times of the year. It is this contaminant that is responsible for Earth's atmospheric classification of 7 ('Standard, Tainted') in its UWP.

Global temperature has increased by 5°C and although it has stabilised, its effects have been dramatic. There is now little polar sea ice and sea levels around the world have risen by about 1m. Flooding has occurred on many low-lying Pacific islands, coastal plains and cities (including the Caspian Sea coastline, the Mekong Delta, large parts of coastal Bangladesh, Jersey City, Oakland, areas of the Pearl River Metroplex, the Netherlands and of course, New Orleans).

Only 90% of species have survived the depredations of mankind and the change in climate. Most prominent of Earth's most wondrous animal species: rhinos, tigers, snow leopards, gorillas, orang-utans, sperm whales and polar bears, exist today only in picture books and archived video libraries. There are far too many species of plants and animals that have been lost in the century just gone and the people of 2100 feel a bitterness toward those fools of earlier years who let these species slip through their fingers. In this age of space travel, bold explorers study microscopic life on Mars, Venus and Europa, yet their grand-parents shrugged their shoulders as the most fantastic life-forms of planet Earth were forced out of their habitats to face starvation and extinction. What irony!

Weather patterns and the seasons are distinctly different from 20<sup>th</sup> century norms: weather can be more unpredictable, with flooding, drought, hurricanes and either early or late seasons depending on location. In addition, large areas of farmland in Africa, Russia and China have been swamped by encroaching deserts, the destructive effects of desertification. Thirty years ago a tide of climate refugees began to sweep across the continents and when the sea level rise stabilized, this refugee crisis abated. Some areas of the Earth are no longer farmable, yet the local populations have adjusted to match the new conditions. There has been a great deal of pain and suffering over the last few decades, but the worst is now over and it is a 'new Earth' that enters the 22<sup>nd</sup> century.

## **Political History**

The world of 2040 was still essentially the world of 2010; the United Nations acted as an international debating chamber, the two Koreas faced off against one other, Mexican immigrants still crossed the border into the US, Brazil was struggling with the dilemma of industrialization versus deforestation, and countries like Mali and Niger struggled with desertification. Organisations like the United Nations, NATO and the OAS still existed. However, war, albeit a trifling and low intensity war with people from another world, forever changed the politics of planet Earth.

Backers of the new Moon colonies, namely China and the USA, mobilised for a military response to the Lunar aggression of the Orbit War in 2044. The BRIC nations (Brazil, Russia, India and China) had gained the most from the power beamed down from the Moon, it had increased their industrial capacity to turn them into first world nations. These countries, then, were keen to secure the solar power assets upon which their economies now depended. As generals planned their deployments into space, bureaucrats formulated the Orbital Defence Alliance, a treaty which bound these nations together for their strike against the Moon.

The ODA outlasted the invasion plan, which fell apart as soon as the colonists dropped devastating deadfall rocks onto unpopulated areas on the Earth as a show of strength. The ODA began further preparations for a more prolonged war, but 2045 became a year of international turmoil. The ODA members and their allies were pro-war, but there were many anti-war nations at varying levels of



resistance. The Outer Space Treaty of 1967 had been broken by all of the ODA nations, and their dominance seemed to flout all international law. Sympathy for the Lunar colonists from the lesser nations, unaffected by the beaming of power from the Moon, also played a part in this unease. The United Nations and its reputation fared badly in the 2045 crisis.

The year 2045 saw the start of the East Asian War, a conflict with atomic consequences and a frightful loss of life that shocked the world into ridding itself of the United Nations. China, eager for wealth with which it could finance its new off-world mining projects, had flouted mineral rights in the South China Sea. A naval war with the Philippines and Malaysia soon spread to neighbouring countries, including India and, fatefully, Pakistan. The course of the war is more fully described in chapter 1, The Cold War.

Matthias Vanderveen, the retired two-time secretary-general of the United Nations, was asked in June 2047 by several minor and some of the major nations, to return to the UN to broker an international accord that would suit all of the parties in the war's aftermath. This statesman had gained the respect of the international community following his settlement of the Baja Affair and the Central Asian refugee crisis. The nations of Earth speak with one voice, declared Vanderveen, they must put their rivalries aside to preserve the human race, and create a single nation of Earth. If Earth should fail, Luna will be the inheritors of the future and that should not happen. Mistrust of the Lunars, combined with a terror of the new war that the people of Earth had just experience, drove the nations together.

Vanderveen set up commissions to address specific problems, and the two main findings of these commissions were 1) The nations of Earth must create a unified voice and a medium of international regulation and accountability that goes beyond anything the UN can currently offer; and 2) Earth people should make every effort to colonise other worlds in the solar system, since threats from the Moon and Earth's own nuclear devices could wipe out all life here. And if Earth doesn't spread into the solar system, the Lunars, with their initial advantage, certainly will. Matthias proposed a third tier of supra-national organization to replace the United Nations that would act as a co-ordination and policy-making body, working closely with the important regional organisations that already existed. These regional bodies, like the Andean Community, European Union, Association of South-East Asian Nations (ASEAN), Gulf Co-operation Council and the Arab League had been in existence for decades and were powerful regional agencies for economic and governmental policy. Now they would bind their member nations closer together, becoming stronger and speaking in the new supra-national parliament with a stronger voice. Initially titled the Union of Inter-regional Organizations (UIO) at the Lima Conference in 2048, this new body was re-named the Earth Union in 2050 following a derogatory speech denouncing the UIO by Lunar Premier Paul Barclay Wu.

Nations are represented by their regional organisations (European Union, NAFTA, etc.) and these organisations send representatives to the World Council. National autonomy is preserved, although a number of laws, particularly those dealing with trade, electronic communication or international law, are of necessity directed by Union legislation. The first few years were chaotic, with some overlapping representation, nations trying to opt out, others trying to take a lead at the regional level, but the overwhelming desire was to step away from the brink, to refrain from war with Luna and also with each other. It was the now defunct Orbital Defence Alliance which backed down. It had wanted its space assets back, but had to let them go. One of the requirements of many nations entering into the fledgling UIO was the disbandment of the Orbital Defence Alliance, and the setting up of a multinational equivalent. This new body became the Department for Defence Co-ordination (DDC). Uppermost in the DDC's first meetings was the defence of Earth and to this end nuclear weaponry was placed in Earth orbit ready for a first or retaliatory strike on the Moon. The governing institutions of the Earth Union are not concentrated in a single capital city; they are instead spread across three cities (Singapore, San Francisco and Munich) with other Earth Union





agencies and bodies based elsewhere. However, Singapore has become the primary seat, with each major institution and now the World Council being based wholly or in part there. The seats had been a matter of political dispute since the states first failed to reach an agreement in 2052. However, a final agreement between the world's nations was reached in 2067 during the drawing up of new regional organisations. Despite this, the seat of the World Council remains controversial. The work of the Council is divided between all three major cities, which, despite virtual conferences and electronic communications, is still seen as a problem creating extra work and inefficiency. Staff travel between the cities using sub-orbital hypersonic airliners that vastly reduce flight times, compared to traditional wide-body planes. Other branches of the Earth Union include the Council of National Leaders, the World Bank, the Central Court, the World Commission, the Earth Space Development Agency (ESDA) and the Department for Defence Co-ordination (DDC). The ESDA requires access to specialist space launch and testing facilities and is headquartered at Macapa in Brazil, close to the huge Myrabo Space Launch Centre.

With the reorganisation of the regional bodies in 2067, the Earth Union began to resemble the representative democracy we see today, in 2100. In 2098, a Shandong politician named Evelyn Chen brought the Titan Crisis to an end with a peace agreement between Luna and Earth. She was then elected secretary-general of the EU and awarded emergency powers to find a way to normalise relations with Luna. Chen currently enjoys the overwhelming support of the majority of Earth's nations (giving Earth its UWP rating of A, Charismatic Dictator).

<b>Earth Regional Organisations (post 2067)</b>		
<b><i>Name</i></b>	<b><i>Territory</i></b>	
African Union	Sub-Saharan Africa	
Amazonian Union	Mexico, Central & South America	
Arab League	Middle East	
Central Asian Federation	Central Asia	
Chinese Federation	China and SE Asia	
Council of Himalayan States	Indian subcontinent (not Pakistan)	
European Union	Eastern & Western Europe	
Mekong States Co-operative	South-east Asia (not Indonesia)	
North Atlantic Organisation	USA, Canada, UK	
Organisation of Trans-Sahara	North African and Saharan states	
Pacific Economic Zone	Australia, Japan, Indonesia	
<b>Off-World Colonies</b>		
<b><i>Colony</i></b>	<b><i>Established</i></b>	<b><i>Status</i></b>
Matthias Vanderveen ( <i>L4 orbital habitat</i> )	2064	Colony
Mars	2020	Independent since 2060
Mercury	2067	Independent since 2070
Venus (Eagle City)	2071	Nationalist
Ida	2056	Corporate License
Ganymede	2070	Military
Callisto	2073	Military
The Twins (Janus & Epimetheus)	2084	Corporate License
Mimas	2084	Nationalist
Enceladus	2090	Colony
Hyperion	2091	Military
Iapetus	2085	Independent since 2096
Oberon	2093	Military

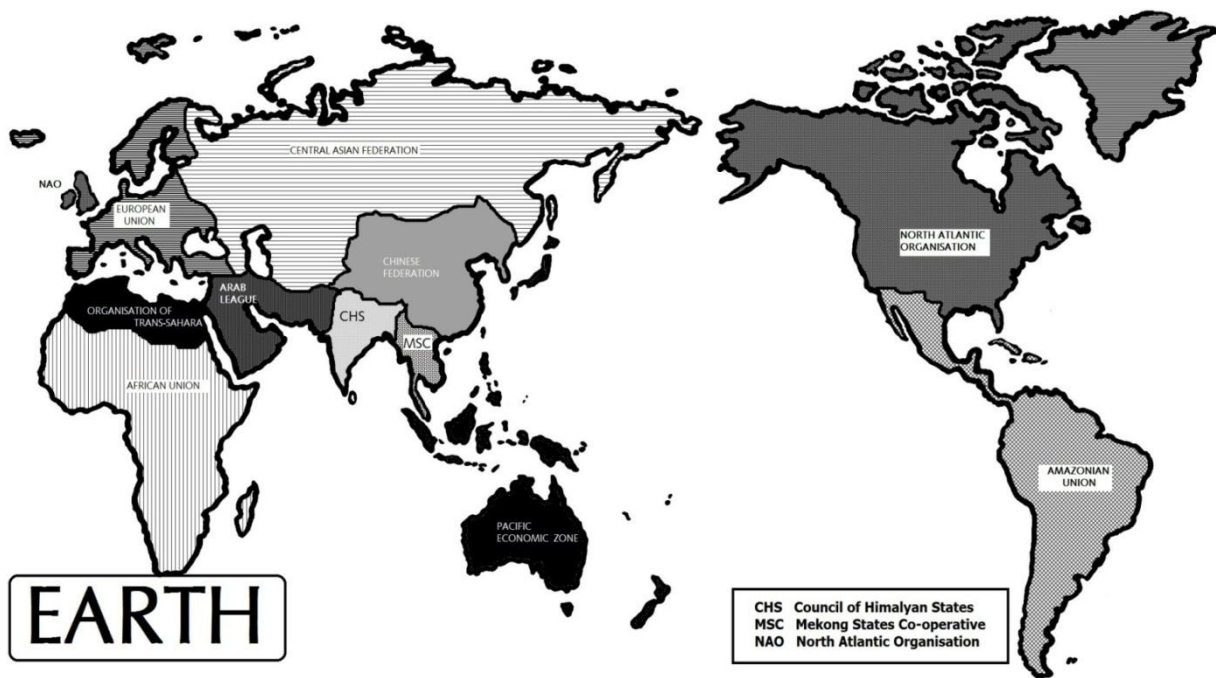

### Places of Importance

**San Francisco** – This beautiful city on the west coast of the USA is one of the Earth Union’s three capitals and home to Union Square, the Golden Gate Bridge, Coit Tower, Alcatraz and historically famous districts like Castro, Pacific Heights and Mission. A serious earthquake in 2028 resulted in a large rebuilding programme which transformed the city into one of the world’s most progressive cities, a blue-print for what was to come in later decades. In 2100 San Francisco is a model ectopia that combines innovative green technologies with the city’s unique microclimate and geology. It features algae-harvesting towers, a vast geothermal energy centre (a mushroom-shaped structure on Bernal Heights Hill), and numerous building-sized and flower-shaped fog catchers along Ocean Beach that are designed to distil fresh water from San Francisco’s infamous fog. A new aquaculture zone with elegantly designed ponds of algae and forests of sinuous accommodation towers occupies part of the Baylands inundated by rising sea levels. Hydrogen fuel is produced by the algae, and is stored and distributed within the nanotube wall structure of the city’s robotically-drilled automobile tunnels. The system is a hydro-net, a self-sustaining water, algae, fuel network that extracts every last joule of energy from its surroundings.

**Singapore** – The island based nation-city of Singapore has proved to be an economic powerhouse and a beacon of success for the emerging South East Asian nations. Flooding issues were addressed with a coastal protective ring project which was then followed by the creation of Sun City, an innovative solar and wind power district on the island’s north coast. Essentially a vast lagoon with tidal power and 50,000 houses built in surrounding terraces, Sun City is home to hundreds of solar arrays as well as the impressive 900m-tall, twin-tower energy harvester standing either side of the lagoon entrance. This acts as the country's largest residential solar and wind power plant. The city has always been cosmopolitan, with four major ethnic groups: Chinese, Malays, Indians and Eurasians; the mix of cultures has kept Singapore on the pulse of changes in global affairs. It includes the ethnic quarters of Kampong Glam, Joo Chiat, Katong and Little India, along Serangoon Road. The Downtown Core at the mouth of the Singapore River is the traditional heart of business and filled with stunning, almost gravity-defying skyscrapers. As its name implies, it forms the economic core of Singapore, including key districts such as Raffles Place and administrative buildings including World Parliament House, the World Bank and Singapore’s own City Hall. Along the south east coast, self-contained housing blocks (arcologies) have been built to resemble the forested mountains of Vietnam’s Ha Long Bay. Seafood farms and mushroom plantations go toward supporting 500,000 Singaporeans within the magnificent enclosed eco-

structures. More traditional food is sourced from the western Jurong Plantations zone, where terraced paddy fields share the wetlands with light industry. Revolutionary new dragonfly-inspired wind turbines were created for this Jurong Agri-Industrial Zone.

***Pearl River Megacity*** - The Chinese city of Guangzhou close to Hong Kong, had, by 2020, merged with its neighbours on the Pearl River delta to form the Guangzhou-Shenzen-Dongguan-Foshan-Jiangmen-Zhongshan conurbation. Despite the trend in recent decades for urban decentralisation across the globe, the trend has barely begun here and the megacity inhabitants still face decades of overcrowding, crime, environmental damage and urban stress. Elevated highways, tower-blocks, office skyscrapers and sprawling shopping centres dominate the centres of the megacity, with poorer housing, apartment blocks and gated communities of suburban workers surrounding these urban hot-spots. Tianhe is the old and run-down commercial centre, while Haizhu has become the new core, here visitors will find the Sun Yat-Sen university and the Guangzhou Tower. Shenzhen Container Port is the busiest on the planet, and Zhangmutou, once a sleepy resort town is now on the forefront of robotic assembly and auto factory manufacturing. The megacity is bursting with problems as well as solutions, indifference, greed, ingenuity and intransigence, optimism and crime - all in equal amounts. It can be a tough place for an off-worlder to negotiate. Some parts of the city have suffered permanent flooding due to rises in sea level, but with a total population approaching 70 million, those affected don't have the option to move out to somewhere new and have taken to a waterborne existence.

***New York*** – While Guangzhou just continued its relentless growth and cities like Singapore and San Francisco transformed themselves into integrated cutting edge ecotopias that proved to be models for urban development elsewhere, most cities like New York charted a more modest path. The city would still be recognisable to a visitor from 2013, although the Manhattan commercial centre has shrunk and the spread of suburbs outward into green areas stopped decades ago. Places like the East River Greenway and the Fresh Kills Dump are now open parkland. Green spaces are dotted everywhere, and new housing developments and skyscrapers have moved out to places like Prospect Heights in Brooklyn, Hudson Yards and Willets Point where individual buildings sport solar panels and wind turbines as well as reclaimed rainwater facilities, skyfarms and bio-gas powerplants using methane from plant production. Tower-blocks in New York and cities like it have been sustainable for the past four decades. This is normal. The old monoliths still stand on Manhattan, however, the Chrysler building, Empire State and the Flatiron are ancient standing stones totally unable to support themselves or pay their way within the modern eco-economy of modern New York.

## **Factions on Earth**

***Asian League*** – The Asian League is an unofficial 'clique' that supports Luna's claim to independence and has since the very early days. Australia and Malaysia were the first nations to be publicly identified as pro-Lunar, after their secret trade deals with the Luna colonists were revealed. In 2046 it was discovered that Australia, under the guise of shipping life support technology to the Moon had instead been exporting nuclear reactor components. Under further investigation it transpired that Malaysia had similarly been shipping hydrocarbons and weaponry; all this despite a UN general embargo that allowed only life support materials and nitrogen to be sold to Luna. Both nations were reluctant to join the new Earth Union in 2048, but they (and other reluctant countries) realised it was suicide to be locked out of a world-spanning economic and political union. Today there are a number of other Asian nations who have also been identified by the Earth Union as Lunar sympathizers and illegal trade partners, including Burma, Pakistan and the Confederate Republic of Koryo (a united Korea). Embargoes have been in place for decades on many different types of items, and members of the Asian League regularly flout these embargoes to the frustration of the Union security services. Since the 2098 thaw in relations, Luna has been able to normalize some of its trade with Earth and its first point of contact has been with the sympathetic nations of the Asian League. The rift between the league and the rest of the Earth



Union nations will not go away however, could such a rift be exploited by anyone wanting to try to destroy the union of Earth nations?

**Kolkata Offworld Movement** - Despite the majority of nations achieving carbon neutral status by around 2050 and some of the most highly developed even achieving carbon negative status (where carbon dioxide is permanently removed from the atmosphere), sea levels continued to rise. This rise is predicted to continue till around 2120 before halting and then reversing. There are nations suffering greatly from the incursions of sea water and the flooding of coastal farmlands and cities; hundreds of thousands of sea level refugees have been created since 2050. Inhabitants of Bermuda and the Bahamas, the Pacific islands of Palmerston, Tuvalu, Kiribati, Vanuatu, Marshall Islands, Cook Islands, Fiji, Solomon Islands, and the Maldives in the Indian Ocean have all had partial or whole evacuations. However, in terms of numbers of people affected, the oceanic islands pale in comparison with the slow-motion disaster that is affecting the densely populated, low-lying coastal locations of Bangladesh and the Indian city of Kolkata.

The Kolkata Offworld Movement (KOM) is an informal network of pressure groups, politicians and NGOs that pushes for the shortening of training programmes, the adoption of a quota of displaced peoples, and the lowering of educational requirements required for off world work. KOM pursues the mass off world emigration of displaced Bangladeshis and Kolkatans and champions the chances of these refugees to settle on new worlds.

**Nationalists** - When the Earth Union formed nearly every nation on Earth appeared to eagerly support the new organization. Despite this, not all people were entirely convinced by the idea of a global government. This was especially true in Australia, which had suffered for its support of Luna, the United Kingdom where the mood was often isolationist and most notably the United States, a nation still clinging to world power status. Even these three powerful nations could not stand alone against the entire world, and one by one throughout the autumn of 2048 each signed the Lima Accord.

For some this perceived surrender was the final straw and some Americans and Britons emigrated to Mars over the next ten years, likewise, thousands of Australians settled on Luna. It was this influx of militant Brits and Americans that strengthened Mars in time for the Belt War. These settlers were the strongest supporters of Martian independence. Earth still harbours Nationalists, both in the United Kingdom and the US, where a significant Nationalist third party controls close to ten per cent of the seats in Congress and even elected a President in 2076. Australia's Nationalist movement has all but died out, but some nations like France, Iran, Mexico and Canada (blessed with two competing Nationalist parties, one English speaking and one French speaking) all have minor Nationalist movements.

Most Nationalists seek to either disband or weaken the Earth Union by political means and do not support violence. A few have connections to Luna but usually this connection is weak and exists only to serve Luna's political agenda. Several of Earth Union intelligence and security agencies have various Nationalist groups on their terror watch lists, but violence is extremely rare. The recent thaw in the Earth-Luna Cold War has some in the Earth Union government extremely worried as it lessens the perceived need for a global organization and supports the Nationalist call for disunification. A recent bill pending in the EU World Council is a symptom of the Union's paranoia. Termed the Security Affairs Extension Act, it would enhance the EU's ability to directly intervene in security issues concerning its member nations. For many Nationalists the intrusive SAFE Act is the very thing they have long feared from a world government.

**The Stranglehold** – Also known as the G2 and 'Chimerica', the Stranglehold is a political alliance from the 2030s that has survived the creation of the Earth Union. After a long spell at economic odds throughout the 2020s, the two nations were to become key to the creation of the



economic trade alliance called the Group of Two (G2) in the 2030s. When both nations entered the Lima Conference, they argued together as the G2 for special dispensations, with the unspoken threat that without their approval, the (Earth Union) would never get past the planning stage. As it was, the G2 became a major factor in the establishment of the Earth Union but only after it had accorded for itself certain rights and privileges associated with voting rights, as well as certain special exemptions on defence and foreign policy. In this way the role of the G2 within the Earth Union somewhat resembles that of the permanent members of the United Nations Security Council.

Today the G2 is often referred to as the Stranglehold, or Chimerica (with lexical allusions to the multi-part Greek monster of myth). Both China and America wield significantly more power through the Earth Union than their populations and economic capacity would suggest, and this power is derived from those early years of political leverage. Now that the threat of a war with Luna has abated, the existence of the G2 has come under increased criticism. To say that there are many nations, regional organisations and colonies which resent this special alliance is an understatement. The G2 Stranglehold is a thorn which must be dealt with by the Earth Union at some point in the near future, otherwise the resentment and jealousy of other states will threaten a political crisis.

**Voyagers** –With the discovery of SETI signals, signs of extra-terrestrial intelligence around distant stars, a movement has begun to reach those stars. Never unified and represented by a handful of politicians, a few corporations, social groups and scientists, the Voyagers seek to pool ideas, resources and funding together for a robotic mission to the stars. Project Daedalus will use an advanced nuclear pulse motor and reach incredible speeds... if it ever gets built. Voyagers are optimistic about the nature and intentions of extra terrestrial civilisation.

### **3752 Cruithne C000365-9 N Lo**

Cruithne travels in an orbit that interacts with Earth's gravity well and the two appear to chase and retreat from each other along the same orbital path. As space industry increased numerous Earth based mining companies looked for ways to become involved in this lucrative business. One of these was Pennsylvania based ALCOA which invested heavily in lunar mining. In 2021 ALCOA sent a manned expedition to Cruithne and with the tacit support of the American claimed the entire asteroid. Three years later a small mining crew landed on the asteroid and began operations to extract ore.

ALCOA soon discovered that Cruithne was not in the ideal position to provide metals for the large construction projects now being undertaken at Earth and Luna. Plans were drawn up in 2029 for an ambitious project to alter Cruithne's orbit, but public outrage at the idea of altering the location of "Earth's second moon soon" led to numerous lawsuits. ALCOA soon found itself deep in debt and in 2032 filed for bankruptcy. By this point the outpost on Cruithne had grown to over 300 people many of whom were not even employees of ALCOA but had moved there to set up small support businesses. In a controversial move the commonwealth of Pennsylvania used the bankruptcy procedures to take control of Cruithne.

Cruithne remained unharmed during the Orbit War and fought off a half-hearted attack during the Belt War. Today Cruithne is a significant Earth-owned township with a population of 6,560. It is home to a significant Earth Union Space Force base as well as an extensive spacecraft repair yard. Cruithne is also the location of a major medical facility and research center known as the Johns Hopkins' Jane Crosson Advanced Medical Center as well as the Pennsylvania State University College of Space Sciences and Orbital Industries. Cruithne has significant defences in the form of three defence stations and numerous AKV platforms.





<b>Spaceport</b>	Excellent Quality
<b>Diameter</b>	3,500 km
<b>Gravity</b>	0.165G
<b>Pressure</b>	vacuum
<b>Composition</b>	-
<b>Temperature</b>	-150°C night +100°C day
<b>Population</b>	290,000 cities: Cold Mountain, Tranquillity, Meridian, Shackleton
<b>Government</b>	Participating democracy
<b>Law Level</b>	Moderate
<b>Dist. from Earth</b>	360,000 km
<b>Solar Day</b>	14 days
<b>Year</b>	365 days

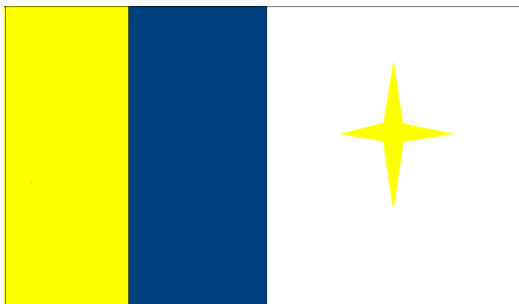

Luna is one half of the solar system's balance of power. An airless moon of Earth, Luna is today a highly industrialized self-sustaining colony. It can produce every product needed for survival, from metals and plastic-substitutes to food, textiles, complex machinery, computers and electronics. The Luna government is a representative democracy, established by the first Chinese and American astronauts. The people of Luna prize freedom, self-determination and above all, hard-

work, honestly done. They are successful and determined, driven by a sense that there is always a way to overcome a problem. Culturally, the Lunars resemble Asian-Americans of any large American city in the 21<sup>st</sup> century. Inter-marriage is common, and American names are often mixed with Chinese.

*"A man's homeland is wherever he prospers."*  
Aristophanes, Plutus

### Planetology

Luna is Earth's only moon and is in synchronous rotation with that planet, always showing the same face toward Earth. This 'near-side' face is covered with maria or seas, regions of volcanic flood basalts, split by regions of ancient highlands and mountain chains. The near-side has been cratered by asteroid impacts over a period of 4 billion years. The far-side of Luna, which is never seen from Earth, is far more intensively cratered, with no discernible regions of volcanic activity. Luna is not large enough to hold on to an atmosphere, and vacuum conditions prevail across the moon's surface. With only a tiny liquid core, Luna has only a trace magnetosphere which provides no protection to its inhabitants from cosmic radiation and solar flares.

Luna does have day and night, but they are both two weeks long, that is two weeks of harsh daylight followed by two weeks of night. This can cause problems with equipment and buildings, which must survive incredible changes in temperature, from 100°C at 'midday' at the equator, to -150°C in the depths of the long night. The Moon's daylight is brighter and harsher than the Earth's, there is no atmosphere to scatter the light, no clouds to shade it and no ozone layer to block the sun-burning ultraviolet light.



Luna was probably created from the impact of a Mars-sized planet with the early Earth, with Luna being formed from Earth-material thrown off during the cataclysm. Initially orbiting close in to Earth, Luna has over the intervening 4 billion years spiralled out further and further to reach its present position. The distance between Earth and Luna is still increasing.

The dark plains visible on Luna are the maria or seas, vast solidified oceans of basalt lava that contains a high iron content. Maria fill the large impact basins and were formed through volcanic upwelling several billion years ago. However, several extinct shield volcanoes have also been found on the moon, although only on the near side. Most of the maria are connected, forming one huge system of flat plains. A notable exception is Mare Crisium on the north east of the near side. There are no maria on the far side to speak of. Because there are few impact craters on the lava plains, scientists know that the great bombardment of Luna occurred before the cataclysmic episode of lava upwelling, around 3,500 million years ago.

Separating the maria are the highlands or terrae. Lighter in colour to look at from orbit, these highlands are ridges, mountain chains and rough terrain. Since they were not covered by the flood lavas, the highlands are the oldest rock structures on the Luna surface, they are the remnants of the lunar crust. Moonquakes do occur, but in the distant past these were far stronger and have left their mark on the surface. Faults, uplifts and depressions all exist on Luna, Rilles are long fractures or scarps that twist and turn across the surface. The far side of Luna is almost exclusively made of these terrae or highlands. There are some huge craters on the far side, but of course they are not flooded with basalt.

Dominating the surface of Luna, however, are the thousands of impact craters that litter the near side and absolutely cover the far side. There are more than 300,000 craters over 1km in diameter, on the near side alone, many have diameters measuring in the hundreds of kilometres. The South Pole-Aitken Basin is the solar system's largest impact crater, some 13km deep and 2,240km wide. Some of the craters are so large they could be described as walled plains, and some are truly immense, Bailey, for example is 300km in diameter. Impacts continue today and small meteors (often less than a metre across) strike the surface every year.

While many craters are of the standard type, with a wide flat floor and a wall of hills or scarps around the edge (Bailey's rim rises to around 3.6km), there are other types. Some have central peaks or mountains. Terraced craters have a central mountain peak and the ground rises to the rim in well-defined steps or terraces. Concentric craters have nested rings of crater rims, getting gradually higher. Ghost craters occur in maria, these are so flooded that only the very tops of the rim can be seen to show where the crater existed, sometimes barely a few metres or tens of metres above ground. Ray craters are distinguished by systems of bright rays which may extend for great distances.

A blanket of regolith, or shattered rock fragments, blankets much of the Lunar surface. This 'soil' is composed of basalt fragments and silicon dioxide glass. It has a texture like snow, and when the dust falls off in airlocks and habs, it has faint smell of spent gunpowder. Looking around in daylight everything is some shade of 'concrete' colour, and the glare from the sun is quite significant. At night the stars shine brightly in the Lunar night sky. Although the surface looks dead and fossilized, there is some activity. Lunar out-gassing of radon and other gasses occurs intermittently and is seen as a faint haze or white cloud above the surface of a floor-fractured crater or at the edge of a maria. Although rare, these outgassings prove that there is some kind of geothermal activity going on beneath the surface. The Moon is not dead!

## Human Development

Luna interplanetary policy has been extremely defensive, the new colony has a paranoid view of its place in the solar system. It over-compensates for its small size and industrial capacity with an overt and militaristic attitude to politics, economics and development. It attempts to export revolution to Earth colonies in its fight for solar system domination; a way to win without risking all-out war. With Earth and Luna a mere 300,000 km apart, both could annihilate the other, Earth using its huge stocks of nuclear weapons; Luna with the mass-driver systems used to launch ores into Luna orbit. It seems strange to many that two worlds facing each other, their inhabitants able to look up at one another in the sky, should be fighting a proxy war in the remote wild lands of the solar system, hundreds of millions of km from home.

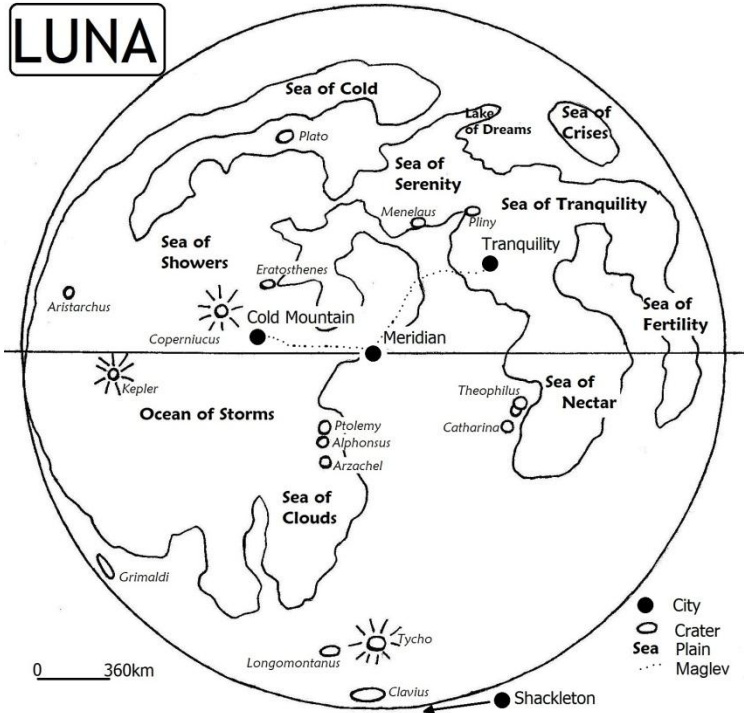

The population of Luna in 2040 was 22,000. Today it stands at 290,000 due to an aggressive child-bearing policy. In addition, two colonies have been established at the Lagrange points, and together they have a combined Lunar population of 100,000. With the colonial holdings on other worlds factored in, there are perhaps half a million Lunars throughout the solar system, yet they are pitted against 8 billion Earth people! It seems a crazy ratio, but the cost to launch an Earthman into space is so high that there are perhaps only a million of them spread throughout the solar system. And in the Earth-Moon system, the situation is so delicately balanced, that it resembles a giant with a sword facing off against a dwarf with a high-powered rifle... and the rifle rests on the giant's forehead. This isn't the Mutually Assured Destruction (MAD) of the Russo-American cold war, but a one-sided deterrence. "Leave us alone, or else!". This threat from the Lunar mass driver in some way resembles the leverage that Israel wielded in the early 21<sup>st</sup> century with its policy of 'nuclear ambiguity', threatening atomic strikes on neighbouring countries which looked to overwhelm it at the first opportunity.

Where do Lunars live? The largest Luna city is Cold Mountain which is located on the equator, south of Copernicus crater. Cold Mountain is the site of China's initial Moon colony and has a population of around 100,000 people. In the early days it acted as the centre for solar power manufacturing, but more recently is the Moon's main spaceport and industrial centre. Most of the Moon's energy needs are provided by the incredible solar power network established in the late 2020s. The second city of Luna is Tranquillity, site of the American moon base which was initialled titled 'Armstrong' by the American government. Around 80,000 people live at this second city. The third main settlement is Meridian, established on the equator to oversee the construction of solar power collectors and beaming stations; today it is a busy industrial centre, with a population of 60,000. All three cities are connected by a magnetic levitation ('maglev') railway. Shackleton crater, at the south pole, is home to the smallest of Luna's four cities. It sits in the darkness within a permanently sun-less crater, a place rich in water ice that is extracted, processed and flown to the cities of the north. Perhaps 25,000 people live in this strange polar city. There are maybe thirty thousand other Luna inhabitants, spread out at mining installations, solar power units, outposts, landing fields and crater colonies all across the Moon's surface.

## Places of Interest

**Shackleton** - Around 2005 an illustration of a domed lunar city 25 miles in diameter and 5,000 feet tall over Shackleton Crater began circulating in briefings at aerospace conferences. At first glance, this domed community seemed structurally impossible. However, materials such as basalt fibres and S-glass among others, made this type of structure possible. Today the South Pole city of Shackleton occupies an entire crater, one that is bathed in darkness and that contains abundant water ice deposits. With artificial walls and a 40km wide, clear protective dome, the Lunars have created a huge open space habitat with lakes and farmland, as well as industrial units and housing. It is the polar location which means sunlight cannot get into the crater, shading all that ice, but a mirror has been built above and behind the rim to focus sunlight down into Shackleton. Water is a big industry here, exported to other Lunar cities by Skycrane, ten ton water modules are able to carry up to 10,000 litres of fresh water. Shackleton citizens are tougher than the tough Luna norm, people with a self- sufficiency and 'apartness' that reminds us of places like Barrow in Alaska.

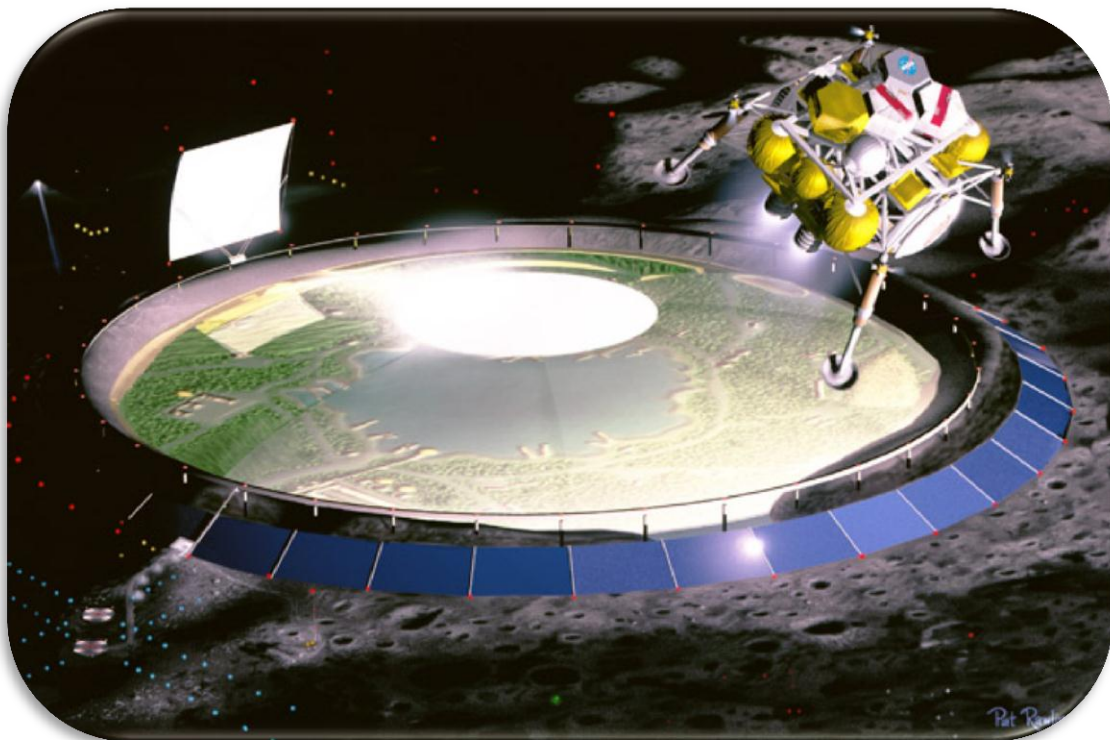

**Tranquillity** - Once called Armstrong, after the first man to set foot on Luna, the name was changed during the Orbit War when many overt Earth-based naming systems were abandoned. The titles of craters, seas and other features were all retained, but a change in the language meant that things like buildings, events and the names of space vehicles eschewed reference to Earth, where practical. The city is typically Luna, underground chambers linked by wide tunnels passable by pedestrians or electric buggies towing supply or passenger carts. The modular design of the 2020s has been left behind, today Tranquillity boasts several open spaces equal to any 21st century shopping mall, multi-level galleries used by industry with airlocks and ramps providing rover access to the surface. Large farms exist and receive light from artificial sources powered from batteries that store the intense solar energy collected over the two week Luna day. Much of the industry here is devoted to resource mining, the Sea of Tranquillity is one giant strip mine, and the city connects to dozens of ore refineries, oxygen plants, silica factories, glass blowing plants and agricultural resource depots.





Tranquillity is also Luna's most cosmopolitan city, with a huge number of American descendants. It is home to a university as well as an entertainment industry that creates that unique brand of culture typifying the Lunar psyche. Unlike the Earth entertainment they left behind, Luna media looks to the pioneer trope. While there are crime thrillers and murder mysteries, the media doesn't revel in the criminal lives of heroes or villains. Drug gangs, serial killers, kidnappings or any sort of violent crime are incredibly rare on Luna. Good stories remind us of the Hollywood movies of the 1950s, where the heroes are military folk or pioneers on the frontier opposed by corruption, outlaws or others who don't want to fit in. Of course there's comedy, love, drama and pathos too.

Unique to Tranquillity is The Drop, a sixty floor underground shaft falling into the Abyss, an old vertical mine shaft. It is surrounded by retail shopping and small craft businesses, along with a mix of cafes and restaurants. Balconies look out and down into the Drop, and on the top floor, below they sky dome, is the Hanging Gardens. This is a top-notch restaurant, lounge and meeting place with trailing ivy and tropical plants that looks down the entire Drop. A spectacular waterfall drops from the floor of the Hanging Gardens and pours down through the centre of the Drop and down into the dark Abyss. The water's caught far below where it can't be seen, heated up a little and allowed to rise as steam to repeat the process. Given the weaker gravity to someone from Earth the water falls in slow motion. The addition of a second crystal clear balcony at the lowest floor of the Drop allows people to look down into the Abyss.

**Cold Mountain** - While Tranquillity is known for its mines, Cold Mountain stands out for its industrial capacity, especially for its sophisticated electronics and mechanical engineering firms. It is a bustling city with engineers and workers engaged in all kinds of manufacturing, from computers to fuel cells, coffee machines to rovers. As the world's capital, the city is also home to the Republican Demos building as well as the government buildings and offices that allow for the smooth running of Luna society. The Demos was recently rebuilt, although the Old Demos is now used for something else! This new showcase government building, designed to impress visiting earthmen, is made almost wholly of Lunar glass, coloured, etched, pure, beaded, frosted .... from benches to tables, walls, stairs and ceilings - the effect is incredible. The visitor feels they are deep within a glacier, seeing many layers of building around them at once, but also feeling some of the space pilot's sense of free fall vertigo. The democracy is run electronically and directly with only a limited need for representatives. The Demos houses ministerial offices as well as the meeting chamber for the Select, a random jury of citizens brought together to discuss and help decide on hot topics, new legislation and controversial plans. Jury duty lasts for two months and is compensated for, with both a wage allowance and various tax perks. Citizens must be 16 or over and registered as a resident of Luna.

Cold Mountain itself is a confusing city to navigate, building and rebuilding took place at such a ferocious pace in the early years that older habs were not removed, older structures were always incorporated into the new ones. Visitors must learn to live with the chaos. The Chinese origins of Cold Mountain are still visible, particularly around Iridium Square, the civic centre of the city, an arched, semi-sunken construction that is the meeting place, market and performance area for the citizens. Chinese New Year and Thanksgiving are the biggest days of the calendar and celebrations spread out through Cold Mountain from this square. At each end stand large Chinese gateways and lighting is provided during the two weeks of night by large Chinese lantern-style lighting fixtures that slowly rotate above the heads of onlookers.

**Meridian** - The city was initially established as a base from which the work to build the massive equatorial solar power collectors could take place. Power generation is one of Meridian's main concerns and the vast engineering undertaking has left it's mark on the city. It builds nuclear fission reactors for spacecraft and pioneered Luna's only fusion reactor. Mining for helium-3 now takes place across the Sea of Vapours, to the north. Meridian is a clean, well run place, well ordered and efficient. Of course the equatorial power collectors still work, but many of the



beaming stations that sent the power to Earth were taken over by the military decades ago to become defensive installations or retaliatory weapons should Earth decide to try and invade the Moon. Luna uses the power generated for its own industries whilst Earth now uses renewables, fusion and a clouds of solar power satellites in high Earth orbit. The city is well known for its Blue Rooms, a hotel complex used by many visiting technicians or family members arriving for holidays. Each room is an explosion of art-work, the very opposite of what anyone expects to see on Luna, every surface is brightly coloured and patterned. This riot of colour at the Blue Rooms pioneered the 'ergo' art style of the 2070s. The current chic look of Baospace is a massive understated reaction to this over-the-top art, and Baospace currently dominates the fashion and consumer industry. Of course Baospace itself is a Meridian-born company. Dated though they may be, the Blue Rooms have a place in history, and should not be missed by the traveller to Meridian.

**Möbius Farside Observatory** - A collection of telescopes (optical, radio and infra-red) benefitting from the way in which the mass of the Moon blocks the interference of radio emissions from Earth. Möbius A and B are civilian, while Möbius C is a military site with a top secret array of sensors.

**Rainbow Tunnels** - A vast system of volcanic lava tunnels extend deep into the ground within the Sinus Iridium (Bay of Rainbows). Explorers, scientists and other adventurers have climbed into these tunnels to map them. There is much more to do, new expeditions are setting off each year.



**Old Town** - Prior to the establishment on Meridian, the Chinese created Central City within Sinus Medii ('Central Bay'). Unfortunately the initial surveys proved inadequate and four years after its construction a severe moonquake triggered a collapse of the regolith beneath Central City, burying many habs and buildings, crushing accommodation blocks, swallowing rovers trying to escape and killing around one thousand people. It is a little talked about catastrophe, but the ruins are still there. Old Town is a semi-sunken ghost town occasionally visited by salvage teams, historians or the inquisitive. All bodies were removed after the incident.

**Clavius Space Science Museum** - Built onto the southern wall of the crater made famous by *2001: A Space Odyssey*, the Clavius Space Science Museum is dedicated to humanity's achievements in space. It is an international museum funded by private donations. Despite the occasional accusations of favouritism, the museum's staff attempt to present balanced exhibits that highlight individuals and not nations. The museum is headed by the eccentric Dr. Wong, who many claim is the oldest living human being. Due to its neutral attitude the museum, its associated



hotel (Earth View) and restaurant (Moon Cheese), it has become a favourite meeting place for those wishing to avoid national attention. Both the Luna Republic and Earth Union make use of this neutrality and Clavius is widely considered to be the Casablanca of outer space. This idea was further enhanced by the 2092 release of *Trigger 5: Clavius*, a critically acclaimed thriller that has become one of the highest grossing movies in human history.

### **Factions on Luna**

***Infinite Circle*** – The Infinite Circle is an association of scientists, thinkers, researchers and space travellers who devote their efforts to looking for Cydonians. Cydonian ruins exist on Mars, as everyone knows, but there is also tantalizing hints of this alien civilization elsewhere. The Infinite Circle pools resources, knowledge, favours and secrets to fund projects to find this evidence. Some say the Infinite Circle has more evidence than they are willing to share ...

***White Tigers*** – Established decades ago by members of the Luna government, the White Tigers is a pro-revolutionary organization officially condemned by the Republic, but in actual fact supplied, funded and supported by it. The White Tigers take the direct, participatory democracy championed on Luna to other worlds, often by force. Its agents are active on Titan, Mars and work with the Red Legion in an attempt to bring down the Green cabal that controls that world. They have agents on Iapetus and on Mercury. Essentially, the organization acts to counter Earth Union power and huge population by subverting established governments, trying to replace them with pro-Lunar participatory democracies instead. Luna pushes its population growth to the limit, but is still dwarfed even by Earth's off-world population; the White Tigers see the subversion and control of older Earth colonies a quick way to boost the number of Luna allies across the solar system. For them, the new detente is a way to gain easier access to Earth colonies, with their covert agents visiting as workers, space crew, trade delegates or science advisors.

***Divine Unity*** – Currently very active, this association is politically minded and attempts to foster co-operation between Luna and the Earth Union. More than that though, Divine Unity seeks to unify the two powers to create a single human civilization, under a single government within the solar system. It is visionary, progressive and hated and mistrusted by most Lunars. Some believe that during this current (2098 – 2100) period of peace and co-operation between Earth and Luna, Divine Unity is at its most dangerous. Politics are in flux and these weak-kneed appeasers will be the ruin of a proud nation and world. The faction has a counterpart on Earth, and is popular amongst politicians and populations in Australia, Malaysia and other pro-Luna regions.

***Flying Dragons*** – Personal freedom is valued highly by Lunar citizens and if a family wishes to make its living out on the maria or up in the terrae, then good fortune to them. Everyone benefits by this pioneering spirit. Some of these independents have travelled out to the Asteroid Belt where Luna guarantees their right to self determination and freedom. The Cascadian Union (which they believe is oppressive) is mistrusted by these Flying Dragon independents and Luna has made a point of breaking up and harassing any self-proclaimed Cascadian colonies in the Belt. The protection and support given to the Flying Dragons fosters an acute sense of loyalty to Luna, to the home world, and these independents continue to play a small part in the Luna economy and fly the flag for Luna all across the Belt.

***Copernicus Brotherhood*** – An association of miners on Luna which is quite exclusive, with membership based on family standing and personal recommendations. Copernicus brothers get access to lucrative contracts, perks and opportunities not open to others. Because some of the brotherhood engage in extortion and bribery as well as some petty criminality, the association is now an illegal one and membership is kept secret. Yet the brotherhood continues to operate on Luna, in the Asteroid Belt and where-ever Luna miners ply their trade.

# MARS B420585 – 9 N,S De Po NI

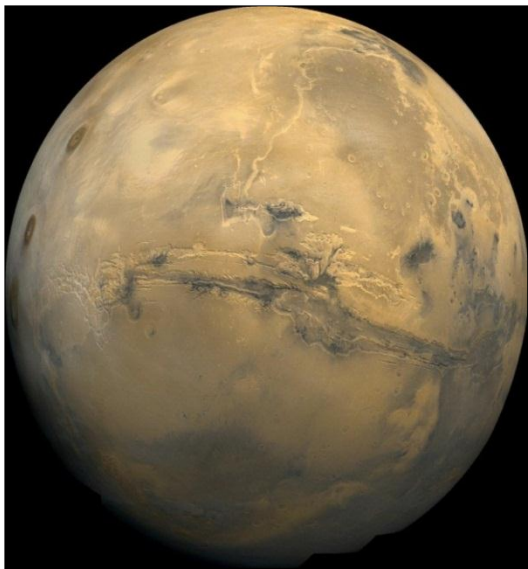

Spaceport	Good Quality
Diameter	6,800 km
Gravity	0.38 G
Pressure	0.1 atm (v/thin)
Composition	carbon dioxide
Temperature	-40°C
Population	900,000; Reunion, Adrienne, High-point, Schaeffer
Government	Representative Democracy
Law Level	Moderate
Dist. from Sun	108 Mkm
Solar Day	24.6 hours
Year	687 days
Moons	Phobos C000366-9 N Deimos X000000-0



Mars is an independent world, unaligned with Earth or Luna. Colonized before the start of the Cold War, Mars has been the subject of incredible scientific discoveries. Actual alien remains, enigmatic, mute and splendid were found at Cydonia, simple extremophile life has also been discovered, living within the soil. Yet life goes on, cities have developed, industries established and a programme of terraforming begun at a rapid pace. Already liquid water is sustained at Lake Barsoom in the

Hellas Basin and thriving (though still small scale) surface agriculture provides food for the Martian colonists. Air pressure and air temperature have been increased enough through terraforming to allow for such developments and a number of surface farms have been established in other low-lying areas. Mars is still a dry, desert world, inhospitable and alien, though stunningly beautiful. Its people are stubborn and hard-working, drawn from all nations of Earth (except China, which shunned Mars in favour of an asteroid mining programme). For an in-depth treatment of Mars, refer to the Zozer Games companion book **Outpost Mars**, available in print or PDF.

## Planetology

The Martian atmosphere is very thin, and may have once been much thicker. Pressure at the surface has been thickened by terraforming, and currently can reach as high as 0.1 atmosphere (Earth is 1 atmosphere), yet it is still as thin as the rarefied air at an altitude of 15,000m on Earth (that's twice the height of Mount Everest!). It is composed mainly of carbon dioxide, with some argon and ozone. Temperatures across Mars can rise above freezing point, and it has been known for summertime temperatures to reach 18 degrees at the equator. At night the temperature plummets to below -50°C. Typically, a daily Martian temperature resembles the Canadian winter, perhaps hovering somewhere between 0° and -20° or so. In the polar latitudes temperatures almost never rise above -100°C. Walking on the Martian surface without a vacc suit would soon result in death by asphyxiation (no oxygen), freezing of exposed flesh (frostbite), and the effects of high altitude (cerebral oedema or swelling of the brain, fluid leaking into the lungs, tunnel vision, light-headedness and loss of mental faculties).





The surface of Mars is dominated by the colour red and orange, a red-oxide covers most of the rock surfaces and this gives the planet its distinctive colouration. A world without free-flowing water, Mars is a deep-frozen desert planet, scoured by high-velocity dust-laden winds. There has also been definite water erosion in the planet's past, and this water is now locked up within frozen Mars bedrock underground, as well as at the two polar ice caps. Mars is not a perfect sphere, most planets are oblate ('flattened'), as is Mars, but this world also has a peculiar and noticeable 'bulge' in the Tharsis region, an area of tremendous volcanic uplift rising 10km above the planetary mean altitude. With a diameter of 6,800km, the planet is small and has a density even lower than its size would account for. Mars has a weak magnetic field and geological surveys have shown the planet lacks a defined core and its interior acts much like a fluid, with mantle up-wellings feeding the volcanoes on the surface at irregular intervals.

The surface of Mars can be divided into two rather unequal hemispheres categorized by terrain type. Generally, the southern hemisphere is older, a fact proven by the incredible number of meteorite craters there. The northern hemisphere, on the other hand, is lower lying and much less cratered, in fact it may have once held an ancient ocean. Surveys have shown that a high degree of volcanic action has taken place in the north, including the spectacular shield volcanoes (some of which rise from the Tharsis 'bulge'). The lava re-surfacing of the northern hemisphere took place 4,000 million years ago; the geological events giving rise to Tharsis, Marineris Valley and other volcanic features came after that re-surfacing. A lengthy volcanic episode must have wracked Mars, but whether this volcanism ceased hundreds of millions of years ago, or whether it continued until relatively recently - no-one knows. Volcanism and also rare meteor strikes, are known to be responsible for the sudden and energetic release and melting of subsurface ground ice in the past and the subsequent creation of the outflow channels observed almost everywhere on Mars.

Mars is famous for its volcanoes, and for one volcano in particular - Olympus Mons, the largest volcano known to mankind. This volcano rises 22 km above the surrounding plain, and is 550km across (compare Everest which is 8.8km above sea level). Around its edge is a near vertical escarpment which drops suddenly to the plain. The volcanic crater alone is 80km across and is surrounded by concentric fractures echoing the central crater shape. Olympus Mons sits in the Tharsis region, an area of Mars that is also dominated by the Syria Rise (also called the Tharsis 'bulge') a region of volcanic uplift 5,000km across and almost 10km high. Atop the Tharsis 'bulge' are the three enormous volcanoes called Ascraeus Mons, Pavonis Mons (with its crater dead centre on the Martian equator) and Arsia Mons.

There are extensive fields of sand dunes on Mars, but due to the peculiar but reliable wind effects around the poles these sand-seas exist close to the north and south poles. There are many channels and valleys cutting across the landscape, formed by rivers, streams and tributaries. There are even signs of large river deltas that once emptied into now long-gone seas and lakes. A single vast canyon system dominates Mars and dominates the solar system - the famous Valles Marineris. Visible from way out in space on final approach, this canyon system straddles the globe a little south of the equator. It is a 4,000km network of interconnecting canyons that begins to the east of Tharsis and ends in a region of chaotic terrain between Margaritifer Sinus and Chryse Planitia. Individual canyons can be up to 200km in width and the deepest sections drop down more than 7km! The central section is a region of connected rift valleys that is 700km in width. This is awesome terrain.





## Human Development

Mars was colonized in 2020 by the nations of Earth in a grand multinational effort. Three thriving scientific bases were established which soon developed into permanently manned colonies. Reunion is the largest settlement and is linked to the mining camp at Shaeffer at Tharsus by a monorail. The third colony is Adrienne. Highpoint is a later off shoot from Reunion. Two other settlements were later established, Cydonia and Otgwehda.

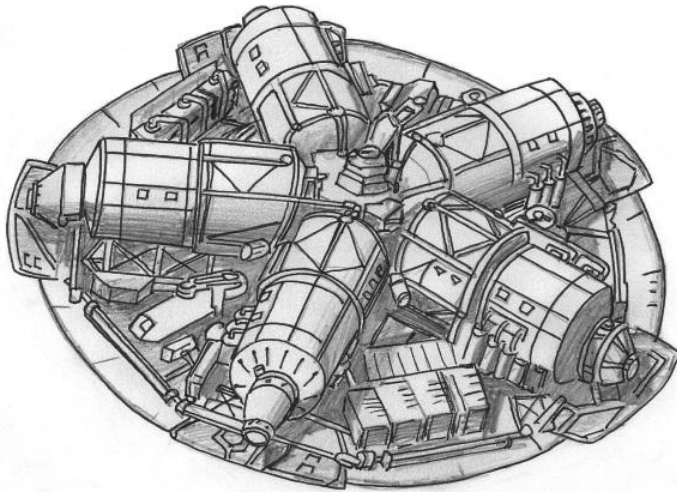

*An Aeroshell after deorbit burn, about to begin atmospheric entry.*

The Space Colonization and Investment Foundation (later renamed the Frontier Foundation) began operations in 2022 by providing the European Space Agency with rockets and expertise for their own Mars program. The Foundation came in to being in 2018 just after the first manned mission to Mars. Space travel and exploration had finally captured the public's imagination, but high costs and government control worked to severely limit the number of people able to make the trip. For a time only trained astronauts or the very wealthy had any realistic chance of getting into space. But there were visionaries who

sought change. Using money made from his OrbiTours and Super Sat corporations billionaire Edward "Eddie" Muzner developed a cheap heavy lift rocket derived from the old Space Transportation System's large liquid propellant tank. Capable of sending about 50 tons directly to Mars, Muzner's Ares Express rocket made it possible to launch twenty-four colonists on a one way trip to the red planet.

In 2025 the Frontier Foundation made headlines by launching two unmanned rockets to Mars each month for the entire year. Each rocket carried an automated factory, known as a MARVIN, that used local Martian resources to produce oxygen, nitrogen, fresh water, rocket propellant and concrete powder. Every MARVIN was built around a small fission reactor which led to numerous protests by the nascent 'pristine Mars' movement. All but three of the MARVIN outposts landed on Mars and immediately went to work. The Foundation's stock on the other hand plummeted as investors wondered if Muzner had gone crazy. Muzner used the drop in stock price to buy back much of the Foundation and then gift it to more traditional pro-space organizations such as the National Space Society, the Mars Society and the Planetary Society. In April of 2026 the organisation began to sell spots on board its manned Ares Express rockets for prices far below anything offered by government agencies. The initial wave of settlement sold out in less than three weeks. The first manned Ares Express rocket launched late that year from a newly built commercial launch centre near Phoenix, Arizona. On board were twenty-four intrepid souls hoping to find a new life on Mars. Five months later their habitat module landed very near MARVIN SIX where they discovered an ample supply of air and water.

The later history of Mars is one of growing tension. The nations of Earth established the Martian colonies but following the Orbit War Luna made economic advances, offering cheap power satellites to help the colonies grow (and undermining the influence of the newly established Earth Union). These satellites beamed solar power down to large collector stations on the surface - free power, and Luna technicians and their families maintained these installations. These bases got bigger and bigger, to the growing complaint of some Martians and many Earth Union observers. During the Belt War (2052-54) Martians, still loyal to Earth, attacked these small Luna enclaves.



Luna responded in force, dropping in troops and using the opportunity to turn them into officially sponsored Luna colonies on Mars! To hold them in this manner, Luna used the power-sats as a blackmail tool. Earth fought back with its Deployment Force, eventually taking all of the new Luna enclaves and seizing all of the collector installations. During the conflict both sides conducted jamming and electronic warfare. Luna forces blew up the monorail while Union troops established forward bases with air defences. They advanced across the desert in armoured rovers, seizing mines and farms that were key for supply and survival. In orbit the battle raged, with spysats being shot down week after week, and replacements coming in from Earth or Luna, to again be shot down. The war on the ground dominated, but there were high intensity periods of devastating strikes from orbit. Earth prevailed, but the Martian colonists with Earth assistance set up their own government at Reunion. From the start it was destined to fail, pulled in different directions by the competing politics of mining corporations, Earth scientists, the Reds, Greens and the Church of Stigmata. It proved to be hamstrung and ineffective, leading to the growth of the canyon pirates, wildcatters and city criminals.

In 2060 the Green movement (the Third Way) launched a coup that seized control of the government, it had been carefully orchestrated with union bosses, company chiefs, select science groups and various allied politicians. There were riots at Reunion, riots that led to a long-running civil conflict. This is the Martian insurgency, a low-key rebellion beginning in 2072 that continues today.

Sabotage, terrorism, sudden strikes and the fomenting of revolt and disturbance epitomize the insurgency. Miners, rovers, workers... people who want to return to a free Mars, where no one government dictates the policies, have decided to fight for that freedom. They are the Red Legion. Their attacks are aimed at the government and the military, avoiding any civilian casualties (which, on Mars, could run to the hundreds or thousands with a single well-placed bomb). The insurgents are not mass murders, they see themselves as the Red Legion, the army of Mars, fighting to protect the pristine environment from any further terraforming and industrial development. Members are typically jaded workers, disenchanted scientists and colonists who have worked hard to see their labours swallowed up by rapid urbanization.

Today, Mars is independent, but with a heavy Earth Union bias. People look back at Earth with respect and a sense of heritage, naming buildings, places and their children with terrestrial titles. While the Lunars disdain any Earthly associations, the Martians embrace them. The Martians are moderately religious, most inhabitants following the Church of the Heavenly Stigmata to a greater or lesser extent. Most fear and hate the expansionist policies of the Luna government and the population would fight it again if another invasion were to take place. The government on Mars is an effective oligarchy of Third Way leaders, with little input from the common man.

### **Places of Interest**

***Reunion, city and spaceport.*** Reunion began life as the International Mars Base, established on Chryse Planitia on 4th October 2020, forty years after the first man (Kyle Schaeffer) stepped foot on the planet. It was already partly assembled when the first twelve NASA and ESA astronauts arrived, they continued the work and made it ready for the 100 scientists and engineers that followed in 2022. From 2024 when tracking equipment was installed and shuttle links made with Phobos, the population began to soar and other space agencies sent in crews and further modules. Construction has never stopped. By 2030 the population of Reunion was 3,000 (mostly scientists and engineers and tracking and shuttle technicians). Today the population stands at 500,000, and marks Reunion as the greatest population centre on Mars. The city is known for the Spire, a 30 storey pinnacle, an office and apartment on the very site of the first landing.

Reunion has a fission power plant, a busy spaceport, offices, labs and research facilities, apartment blocks, several hotels, it has out-planet tracking facilities, two great shopping malls,

cafeterias, movie theatres as well as some other entertainment facilities, a large garden dome called the Glasshouse and the Grand Hall, built after 2054. In Reunion you can buy or rent rovers and airships and also rent garage or warehouse space. Most buildings are largely underground, and all include deep shelters for protection from solar flares. Most of the big corporations and organizations have offices here. A network of roads have been built that connect to smaller settlements and habitats. constructed by robot rovers they are really no more than wide tracks cleared of rock debris for the easy passage of rovers, and marked every 500m with a radio beacon.

**Adrienne, home of the Hellas Terraforming Project:** Second in size to Reunion, Adrienne was established in 2035 primarily as a terraforming project; the **Hellas Terraforming Project**. The Hellenes (the scientists and engineers of the Hellas Basin Terraforming Project) are proud of their lake, Lake Barsoom. It was the first body of free-standing water on Mars and a model for other projects to copy. As the lowest point on the planet, the Hellas Basin has seen the most dramatic environmental changes. The Hellenes have been able to grow a significant amount of vegetation on the lake shore, and at specially prepared oases on the basin floor. The project habitat enjoys the luxury of vast greenhouses. It has a population of 100,000 people, dominated by biologists, hydrologists and technicians who have actually been able to create a mostly-liquid (depending on the season) lake called Lake Barsoom as well as algae crops on the surface of Mars. This is the Hellas Terraforming Project, in the Hellas Basin in the southern hemisphere. Given the density of academics in Adrienne it is no surprise that the University of Mars is located at Adrienne. This school is centre of learning for all of Mars even rivalling major universities on Earth and Luna, particularly in the fields of terraforming and genetic engineering.

Adrienne boasts spacious accommodation (although again much of it is underground), and since Adrienne is built into the side of a steep hill, has some stunning views over the lake. There is a runway and associated facilities, twelve launch pads and lots of factories and workshops. Adrienne is capable of launching rockets and receiving them, too. In Reunion there are more technicians and officials than scientists, in Adrienne the place is still virtually a scientific commune (despite the large size). Visitors will find the 'Hellenes' open, enthusiastic and optimistic.



**Shaeffer, home of Tharsis Mining:** Shaeffer has always had a rough reputation, this is surprising considering the nature of people who fly into space. But the scientists and engineers who came to Mars were soon accompanied by astronaut-miners, and then just by miners. Exploratory mining had been allowed at first, but as larger scale mining was begun experienced





mining professionals were needed from Earth - and they came from the North Sea, from Alaska, the Gulf, Siberia and the South China Sea, Libya and Texas. A mining consortium established a base at Alba Patera north of Tharsus. This was named Shaeffer and became both a landing station for equipment and fresh miners beginning their two-year contracts, as well as a launch facility for mineral 'sleds' fired out toward Earth-space by a sophisticated magnetic linear accelerator (colloquially known as the 'Slingshot'). After the Belt War the consortium was nationalized by the new Martian government and reformed as Tharsis Industries. Shaeffer also has a spaceport. Crucial to the town's development has been the Shaeffer industrial zone, a sprawling district of factories, assembly plants, foundries and workshops producing a huge array of products for export across the solar system at a low cost. This growing industrial sprawl is connected to the Reunion spaceport and Adrienne via monorail link. The monorail is a maglev system, at ground level, that utilises robotic monorail trains for shifting heavy goods, 10-ton modules or passengers.

Some of Shaeffer is underground for protection reasons, some of it is not, since there is a vast amount of equipment in hangers, garages and workshops that need servicing. The sprawling habitat complexes have the best hospitals on the planet, and they see regular use due to the high number of injuries sustained by the Tharsis mining community. The international polyglot mix of miners has turned the habitat into a complicated series of ethnic quarters. What began as an optimistic and well-run operation soon turned into a cynical and lawless one; some once compared Shaeffer to a prison. Those days are long gone and today Tharsis runs the mines professionally and with an eye to competing with the 'Big Boys': Luna and Earth. Without doubt though, miners from Shaeffer are the best in the solar system. Shaeffer was established in 2030 and has a current population of 120,000 men and women.

**Otgwehda:** Meaning red in Onondaga, an Iroquois language, this city of almost 15,000 is the brainchild of Ellis Parker, who made his fortune in casinos and entertainment, He saw the settlement of Mars as a second chance for his sons to live the frontier life of which he had always dreamed. To this end he invested heavily in key space corporations and in late 2054 he, his four youngest sons, and 500 other settlers, all of whom were Iroquois, began their departure to Mars. His oldest son stayed on Earth with his family to coordinate the settlement process.

As more Iroquois joined the effort, the media reported on the programme. In India the Kolkata Off-world Movement (KOM) reported that an American man was funding a massive settlement of Mars for any Indian who wished to participate. This misunderstanding led thousands of Indian citizens to enrol in the colonization effort. Otgwehda Bound, as the migration came to be known, was overwhelmed; even more so when violence erupted in Quebec due to the Referendum of 2057 which led a large portion of the Canadian Mohawk population to join the migration. Parker, feeling sorry for those people from India, teamed with the Frontier Foundation to increase their ability to move people to the red planet.

Otgwehda is located just south of the Noctis Labyrinthus along the edge of the Syria Planum. Building upon the skills possessed by the Parker family the city has become the entertainment capital of Mars. Otgwehda is home to several casinos, movie theatres and even an orchestra hall. Luxor Aerospace have hotels there and run regular shuttles to Otgwehda from orbit. It houses the system's largest aquarium outside of Earth as well as a botanical garden. It is also possible to charter dirigible tours of the nearby labyrinth.

**Highpoint, home of the Mariner Terraformers:** As the Hellenes have already discovered, the first impact of the early terraforming techniques has been evident at the planet's lowest points. Great efforts had been made to try to grow lichens on the walls and floors of the Mariner Valley system of canyons and valleys, efforts proving fruitful. With water now becoming less rare, and seeping to the surface within the valley and with the lichen population now living side by side with simple mosses, the stage is set for an agricultural revolution within the Mariner Valley. Free



holding colonists have taken up the struggle and are having fantastic success with greenhouse crops and a good supply of water. They continue to experiment with genetically-modified vegetation in the Martian soil. The Mariner Terraformers have a central meeting place called High Point. The colony sits atop the Valles Marineris and is cut into the cliff-face, in essence it is a vertical settlement utilising the many kilometres of caverns and caves found naturally in this region - all utilised by the inventive Highpointers! The settlement sits on the south wall of Ius Chasma and holds about 29,000 people. It exists to supply the Mariner Terraformers with supplies flown in from Reunion. There is no orbital capability other than a runway and associated hanger and terminal facilities. High Point boasts several hotels, usually filled with tourists and climbers. A rover trail zigzags up the south wall to enter the habitat and the garages through a tunnel. Elevators take personnel and rovers up to desired levels through a maze of gantry-work that are the innards of High Point. On the canyon lip the elevators can bring their cargos up to the landing strip and control office. Given that the view over the Mariner canyon is one of the most spectacular in the solar system, Highpoint is a popular site for the wealthy of Mars and elsewhere who wish to build themselves a luxury home with a balcony, a glass floor and a view that can't be found anywhere else.

High Point might seem high tech, but it is essentially a huge vertical shaft bored through the rock and filled with gantries and walkways. The inside of the city resembles some bizarre factory floor with ladders, elevators, cages, chain-link fences and so on. High Point is a fairly easy-going place with little law enforcement - there is little animosity, just a lot of good will. Always wary of that perennial Marian disease, the canyon pirate, the Mariner terraformers long ago formed a close-knit brotherhood. Unlike the 'high science' of Adrienne, High Point is a place of 'hard-work and good advice'. Practical experiments and the results of tests that succeed lead to plenty of exchanges and information sharing. No-body wants anyone to fail. You get the feeling of a frontier here more than anywhere, a place where no-one is left to struggle and fail. It might be you next month...

**Cydonia:** Cydonia is a small region on the Acidalia Planitia, and it is a site which is (in)famous for the presence of giant pyramids and the vast carving of a 'face' constructed by some unknown intelligent life. The nature of the civilization that produced these staggering works can only be guessed at - archaeologists piece together what information they can, but so much is unknown. The first expedition to Cydonia took place in 2023 and the 'Ruined City' was mapped in detail. With the arrival of many more scientists two years later, the site received a lot of attention. A site habitat was established 3km from the Ruined City and was used as a stop-over for visiting teams. The UN refused to allow any permanent settlement in the area. Its reasoning was simple - it feared degradation of the site and damage to the monuments. Some sapientologists, biologists, archaeologists thought differently and considered the ban unreasonable. They suspected a cover-up and some kind of conspiracy. When the UN began restricting site licenses to just a few experts in 2028, the riled scientists occupied Camp Cydonia (the temporary habitat). Immediately they began to enlarge it and offered places to friendly groups and individuals who wanted to study the artefacts. The camp had the air of a cultists compound or hippy commune (depending on your point of view).

Today Cydonia is a town in its own right, an extremely popular location for visitors, tourists and travellers of all kinds. A population of 25,000 maintains the habitats and hotels, agricultural stations and factories. There are still scientists and researchers here, but tourism has now arrived. Some areas of the Ruined City are off limits for research, but tours can be joined. Unrestricted access is frowned upon and a guide is legally required for any visit to the Face or the Ruined City. Enforcing the restrictions is a small freelance security force paid for by the International Astronomical Union (IAU), and having a long-standing relationship with that organization. The force is Eckard Tactical Management (ETM), a company-sized force of mechanized infantry know throughout the solar system as the 'Swiss Guard'. ETM are the infamous security detail on-board SGS-90 Grimaldi, the orbital component of Monte Carlo. Despite the tourism, Cydonia has a





strange feel to it. Everyone believes they are in the presence of something mysterious, spiritual and awesome. Crime is rare there, the place attracts thinkers, believers and researchers ... all seekers after 'Truth'. There is a church of the Holy Stigmata at Camp Cydonia.

### **Factions on Mars**

**Rovers:** Every Martian expedition from Earth sent Martian ATVs (rovers), and people trained to operate them. As colonists and scientists took root on the Red Planet, they found that some of their number could not fit in and adapt to colony life. Homesickness and a difficulty living closely with other people day after day proved too much for many, and these men and women opted to drive the rovers out across the Martian wilderness on solitary and extended missions, perhaps repairing transponders and the many MARVINS that dotted the landscape, checking weather stations, carrying out geological surveys or ferrying parts to some remote base. During the Black Out of 2029 many of these rovers turned independent and stopped working for their own people. Today the rovers roam Mars carrying out jobs for bases, stations and colonies, always moving on. Often the rovers have crews of 2, 3 sometimes more, and all have shunned the static, organized, focussed societies of Mars. Rovers are rebels, 21st century cowboys, nomads with a love of travel and adventure.

**Flyers:** Early mission plans often voiced a need for flyers to be sent to Mars, either robotic airships or robotic airplanes. These could cover lots of ground very quickly. When the first bases began to be established on the planet, airships were again considered for transport purposes - and they proved highly useful. Manageable in the thin Martian atmosphere, the airships were able to cross vast distances easily with relatively little energy loss (all are solar powered). The modern airship operators ('flyers') balked at the tightly knit colonial way of life during the Black Out just like the rovers. And like the rovers the flyers roam the planet carrying out jobs and contracts for colonies, bases and stations across Mars.

**Greens (The Third Way):** Mars is being terraformed, human engineering and science is being used to alter the Martian atmosphere in order that it may become breathable, and in order that vegetation might flourish. A second unspoiled Earth is the goal. The process is slow, taking many decades, perhaps centuries. One of the most active solutions so far is the shepherding of ice chunks and comets from the Kuiper Belt, burning up in the Mars atmosphere and dumping its gasses and water there. Members of the Third Way, the current governing party, have supported an even more hard-line stance and have used maximum impact solutions to the terraforming problem. They have detonated seventeen atomic weapons at the poles to melt ice and increase atmospheric heat. They have authorized the bursting of underground aquifers in the same way meteors occasionally do, causing catastrophic water release and immense flooding. Most of these are highly unpredictable techniques - anathema to the scientific method - but now all in play, now that the Third Way has taken control of the Mars government.

**Reds (The Red Legion):** Members of the Red Legion are stalwart supporters of the 'Pristine Mars' movement. They believe man should have come here to study and observe. All industry, much settlement and all terraforming is abhorrent, unethical and wrong. Members of the Red Legion swear to sabotage such projects as they are able. They have been connected to several eco-terrorist groups back on Earth. Crucial to the Red argument is that microbial life exists on Mars today, and is being affected by the terraforming. The Red Legion is a secret terrorist organization with members in many walks of life on Mars. Some say the Reds have already lost, others, who see evidence that native microbial life seems to be flourishing under the new terraformed conditions that are warmer and wetter, say that the Greens are actually *helping* native life. The blurred issues mean that belief counts for much in the battle between the Reds and the Greens.



**Canyon Pirates:** Canyon pirates are rovers who have taken up illegal methods of supplying themselves with air, water and food. They raid lone farming stations, centred on modified MARVINS adjusted to give off gases that assist in the terraforming process such as CO<sub>2</sub>. The Green government of Mars is happy to subsidize these farms. Those in the Mariner Valley are raided by the pirates with virtual impunity and the outlaws find many places to hide up within the convoluted terrain of the canyon systems. Canyon pirates are considered by everyone on Mars to be the planet's ultimate unwanted scum. Some masquerade as legitimate rovers from time to time, giving legit rovers a bad name.

**Church of Heavenly Stigmata:** A Christian movement established on the Net during the preparations for the first manned Mars flight by the Reverend Shire Kavanagh. The church is an evangelical movement tying Christianity and the fate of the cosmos to the settlement of Mars. In Heavenly Stigmata doctrine Mars symbolizes the blood of Christ, a permanent sign to the sinful that their sins were forgiven on the cross. Reverend Kavanagh makes no secret of his belief that Jesus was an 'extra-terrestrial' that came to Earth from beyond our galaxy and in this doctrine Mars plays a central role as a stop-over while he 'wandered in the desert' and the place that Christ returned to after his Crucifixion. Mars is the god of war, it is Rome the conqueror and the Devil tempting Christ in the wilderness. For the members of the church, Jesus is on Mars still, the very planet is the desert testing Christ, and now testing mankind. To survive the End of the World (tentatively dated to 2121), a believer must make the pilgrimage to Mars, must go through the ordeals of life on Mars and must fight the Devil and find Christ. Mars is a stepping stone to Heaven, after all.

The Face is akin to the Turin Shroud, it is the face of Christ, the Ruined City is evidence that he dwelt here. This religion is very popular on Mars, though there are slightly different sects and beliefs, splitting the church into three factions. There are those who like the idea that Mars is a spiritual place, and who resent the old faiths being focussed on Earth locations, there are also extremists who believe Mars was created in 4004 BC. The religion is a fairly open and evolving one.

*"It was noon, and the chase would not end. At twenty-five milers per, two Marsbuggies a quarter of a mile apart moved serenely through an orange desert. Crescent dunes drifted by, as regular as waves on an ocean. The ghostly path of a meteorite touched the northern horizon in a momentary white flash. The hills were higher now, humps of smooth rock like animals sleeping beyond the horizon."*

Larry Niven, How the Heroes Die

# THE BELT C000571 – 9 As, NI



Spaceport	Average Quality
Diameter	Asteroid Belt
Gravity	0 G
Pressure	-
Composition	-
Temperature	-
Population	448,000; Vesta, Ida, Moore
Government	Balkanised
Law Level	Low
Dist. from Sun	2.2 – 3.3 Mkm
Solar Day	-
Solar Year	4-5 years

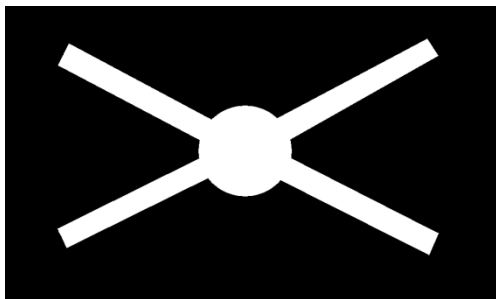

The 'high frontier', the Asteroid Belt, is made up of thousands of asteroids, each one of which can support thousands of colonists. To live out here, to mine for metals, ice and nutrients, you have to be independent, resourceful and technically proficient. The Chinese miners who first came to the Belt were joined by others from Earth, Mars and elsewhere, individuals keen to breakaway from big governments and power politics. Here you, your family, your sect or your friends could set up and do what

you wanted within reason. Once you had claimed an asteroid and filed the claim with the IAU, it was yours to exploit and other parties could not extract resources from it without your permission unless in an emergency.

Both Earth and Luna have an outpost in the Belt and the Cascadians, as the Belt inhabitants refer to themselves, want little to do with either superpower. The Belt then is a diverse place of local communities, mixed with intensive commercial mining and the meddling of the major powers that are dead set against their rival seizing political control of these contrary, unaligned Cascadian settlers.

## Planetology

There are thousands of asteroids orbiting the Sun between the orbits of Mars and Mercury (typically between 2.2 and 3.3 million km from the Sun). Asteroids are named and also given a number designation which records the order in they were discovered. The object 1 Ceres was the first asteroid to be discovered. All but 1 Ceres are smaller than 900 km. Some of the larger rocks have tiny satellites of their own and some asteroids are part of 'families' that move together along the same orbital path; some of these families are probably fragments of a larger body that suffered a collision in the distant past.

Asteroids are not identical in composition; about 75% are C-type or carbonaceous asteroids; around 15% are S-type or iron and silicate asteroids. M-types are iron-nickel in composition and make up the rest of the asteroid types. Miners are interested in the iron and nickel rich M-types, but colonists need the materials found in the C-types, the carbonaceous chondrites. These yield water (anything from 5 to 20% of the total mass) sulphur, hydrogen, oxygen, carbon and nitrogen, all useful elements. The rest of the rock is iron-nickel metal, which means a typical C-type can provide metals, rocket fuel, radiation shielding, drinking water, atmospheric gases and nutrients for the cultivation of crops!



Nearly all asteroids are irregular in shape and there are many that seem to be created from the merging of two separate rocks. Now moving as a single asteroid they appear swollen at both ends with a narrow waist between them, much of an asteroid like this is loose rubble, giving them the name 'rubble piles'. The surfaces of most asteroids are covered with blanket of pulverized rock, called regolith, sometimes many metres thick. Most asteroids have a rotation period in the range of 2 to 24 hours.

### **Human Development**

While most nations of Earth looked at Mars as the new frontier, the Chinese were looking toward the asteroids, to the flying mountains of mineral wealth that did not have the romance of Mars, but that promised greater riches. Spurred by an American landing on 3752 Cruithne in 2021, the first Chinese mission to an asteroid was launched in 2027 to 4660 Nereus, a rogue asteroid orbiting close to Earth. This early success encouraged a longer duration mining mission to the Asteroid Belt in 2035, and with that a Chinese presence in the Belt was established. A large recruiting drive targeted young men without marriage prospects due to the low male to female ratio in the country. These men would be the creators of the Belt's new infrastructure, building outposts and bases, establishing hydroponic farms, refuelling stops, trade centres and mass drivers (that catapulted the refined ores back to a metal-hungry Earth).

These hardy and independently minded colonists constructed six magnetic accelerator mass drivers to send ore back to Earth. In 2052 the Luna government made overtures to some of the Belt miners and it looked like a trade alliance was on the cards. The Earth Union, ready to ignore Luna for the rest of the century, realised how dangerous an alliance that might be and sent DSVs full of colonists, diplomats and troops into the Belt. Publicly these Earth missions were an attempt to secure the safety of the Chinese belt miners, but by 2052 they were almost totally independent, yet still loyally sending ores back to Earth. Privately Earth needed that ore and could not let Luna cut off the supply.

The world government, unable to adequately defend such a scattered population, instead fostered a sense of group identity amongst the mining settlements. The birth of the Cascadia Nation arose at this time, and some attempt was made to unify the miners through the creation of Cascadia, a free and independent nation of belt miners.

Luna reacted by sending military vehicles into the Belt to stop any attempt at nation-building and fought a prolonged low-intensity war against the Cascadians. These nationalists were supplied with craft, consumables and weapons by Earth forces who would not intervene directly for fear of triggering a full scale war. The war ended in 2055 with the loss of around 3000 lives and the establishment of a Lunar outpost on the asteroid Vesta. Cascadia was broken, its leaders imprisoned or killed and many of the attack DSVs and weaponry supplied by Earth destroyed or wrecked. Luna poured as many colonists into the Belt as it could spare in an attempt to tip the balance of loyalties and ensure that no single movement could unite the belt miners. Yet Cascadia still exists as an idea, a political movement and an ideal. The Jolly Roger emblem of the Cascadians is a joke at their own expense, they consider themselves a bunch of renegades who prize freedom and self-determination above all things. Even now, in 2100, the Cascadian movement has made little headway and the flag is used as an emblem of passive resistance or a badge of traditional values in a manner reminiscent of the way the Confederate flag continued to fly in parts of the American South throughout the 20<sup>th</sup> century.

Earth established an official colony on Ida to counter the Luna settlement of Vesta, this settlement was given all the rights of a nation of Earth, and it is still recognised as such by the EU constitution. Read about the Cascadian Alliance in chapter 3: Organisations.

## Places of Interest

There are approximately (because no-one is quite certain) 120 permanently inhabited asteroids. This section describes six, and provides the UWP for six more. Referees can create an asteroid community to suit the purpose of their scenario, providing it does not out shine Vesta or Ida, the two big centres of Belt life.

**4 Vesta (C000422-9 NS)** - Vesta is a Luna outpost with a population of 23,000. Unity is the civilian city adjacent to Dauntless Base which services armed DSV's that patrol the Belt. Spire is Vesta's spaceport, a 1000m docking boom that extends out from the surface and to which vehicles can connect. Crew and cargoes then take the elevators down to reach Unity. The port is classified as a C type. Crater Calpurnia is home to a stockpile of ancient DSVs, engines, reactors, and stripped down vehicles that have been seized from the renegade Cascadians. A lot of the older TL 8 stuff is available for sale at 50% discount, and more modern parts at 80% discount, now that the Titan Agreement has come into force.



Compared to most asteroids, Vesta is big, with a diameter of 525 kilometres and a surface area approximately the same as that of Pakistan. Billions of years ago a collision left an enormous crater known as Rheasilvia that occupies much of the Vesta's southern hemisphere. It is 505 kilometres in diameter and centred on the south pole. The floor of this crater is about 13 kilometres below the surface and a central peak rises 23 km above the crater floor. The crater has penetrated through several distinct layers of the crust, and possibly into the mantle.

**243 Ida (C000466-9 NM)** - The centre of the Earth Union's asteroid colonization effort, Ida is a busy port and commercial centre with a population of 30,000. Goods flow in and then out to individual asteroid colonies, making Ida not just a market-place but also a melting pot and meeting place. Mithril is the Idan capital, sited within the asteroid's largest, 12 km diameter, crater called Lascaux. It is also home to a large SARA police base that monitors activity throughout the Belt. The asteroid has a diameter of 31 km and is composed of two large rock piles merged together. It is an S-type and has its own moon named Dactyl, orbiting 90 km distant. Dactyl is the site of the Nigel Leakey Earth Space Force defence base, and is packed with ASAT missile silos and laser weapons. Ida's irregular shape is responsible for the asteroid's uneven gravitational field. Surface gravity is lowest at the extremities because of their fast rotational speed. It is also low near the 'waist' because the mass of the asteroid is concentrated in the two halves.







**253 Matilda (E000357-9)** - Matilda is home to the Ohm Collective, a Cascadian group whose members follow strict social rules laid down by the founder Aleksandr Varov. The collective members are scientists and engineers and all believe in the efficacy of running a society along genetic lines. Ohm use DNA therapy and resequencing, along with artificial insemination to plan and then create the 'perfect society', one new baby at a time. It's just one big lab experiment where all of the inhabitants are willing participants. Current population is 3,400. Matilda is 50 km in diameter and has slow, 17 day, rate of rotation. It is a C-type asteroid with a number of extremely large craters, the two largest called Ishikari and Karoo. Matilda's orbit is eccentric, taking it to the outer reaches of the main belt.

**17253 Vonsecker (D000312-9 R)** - The C-type asteroid Vonsecker is owned by Parkfield Biolabs and used as a mineral extraction site and remote laboratory. Commissions for the Earth government are processed here, particularly those products that would have dire consequences should the material leak out. It is thought that nerve agents and antidotes as well as bio agents and their vaccines are manufactured here. Passing DSVs are welcome to dock and buy food, fuel and other supplies, but crews are not allowed beyond the modest spacedock into the Vonsecker facility. Population is around 1,200.

**2602 Moore (D000433-9)** - Chinese miners settled on Moore (named after the British astronomer, Patrick Moore) during the Belt War and have continued to develop their settlement. Around 16,000 people now work on this C-type rock, they are an insular bunch of Christians with Uyghur ethnic roots. A visit to Moore will often involve an encounter with the 'sims', genetically uplifted chimpanzees who act as servants and labourers, living amongst the miners as second class citizens. The sims are mute, but excel at sign language, having a Traveller intelligence of, on average, 2 or 3. Sims number around 2,000.

**7758 PoulAnderson (D0003B8-9)** – PoulAnderson is another C-type asteroid that was colonised by miners fleeing Earth Union oppression in the Belt War. It is a world on the verge of collapse. In 2081 the entrepreneur Hugh Kim arrived and revolutionised the impoverished mining station he found, introducing them to a new religion and proving to be their messiah. With the resources he brought with him and the new dynamism they gained from their faith, PoulAndersons have become serious players in the Belt economy. Population is 8,000.

What is this new religion? It *is* Hugh Kim; within his philosophy, the universe was created at the moment of his birth and the stars will go out upon his death. This faith he calls I-AM, and so convincing is his revelation that the asteroid of PoulAnderson is a shrine to their messiah. His image is everywhere and a vast rock-cut statue of Kim's head dominates the landing pads at the spaceport. Terrifyingly, though, Kim is ill and this has sent the PoulAndersons into a frenzy of doom saying and despair. The bishop of I-AM, Dr. Rachel Deane, has had Hugh Kim placed into cryogenic low berth and has become the defacto ruler of PoulAnderson, claiming to speak to the frozen Kim through a cortical transmitter implanted before he entered cryosleep. Some believe Kim is dying, some think him dead and that the universe is about to unravel, others believe he will live forever and that the universe is saved. Police battle small scale riots almost every week, riots in protest against Dr. Deane's government, tunnel fights between opposing factions ... visitors beware.



*"Belters don't need houses. A Belter's home is the inside of his pressure suit."*

Larry Niven, *At the Bottom of a Hole*

### **Other Sample Asteroids**

1812 Gilgamesh	E000133-8	Asteroid, Low Pop
4889 Praetorius	D000253-9	Asteroid, Low Pop
17058 Rocknroll	E000264-8	Asteroid, Low Pop
285 Regina	E0001C8-8	Asteroid, Low Pop
62 Erato	E000198-8	Asteroid, Low Pop
2709 Sagan	D000286-8	Asteroid, Low Pop

If you would like to create an asteroid community randomly, then follow the guidelines here:

#### **Name**

A full list of asteroids so far discovered can be found here: [www.nofs.navy.mil/festsoci/list/astname.html](http://www.nofs.navy.mil/festsoci/list/astname.html)

#### **Spaceport (roll 1d6)**

1 = C type, 2-3 = D type, 4-6 = E type

#### **Population (roll 1d6)**

1,2 = Pop 3, 3-4 = Pop 2, 5-6 = Pop 1

#### **Government (roll 2d8 - 2)**

#### **Law Level (roll 2d6 - 7, add Government Level)**

#### **Cultural Differences (d66)**

Roll for one cultural difference, consider rolling for a second and combining the results, asteroids attract people who want to do things differently!

# JUPITER

## Large Gas Giant



**Distance from Sun** 780 Mkm

**Orbital Year** 11.86 yrs

**Major Moons**

Io X210000 - 0

Europa D201452 - 9

Ganymede E300168 - 9

Callisto D311366 - 9

Constitution E000154 - 9

Jupiter is a gas giant and the largest planet in the solar system at over 143,000 km in diameter. It is composed mainly of hydrogen, with a quarter of its mass made up of helium. Because of its great size, Jupiter has a large collection of moons, some rocky and terrestrial, like

Mercury and the Earth, others balls of ice or rock or captured asteroids; in 2013 there were 67 known moons. Jupiter rotates every 10 hours. From orbit one cannot but be impressed by the planet's magnificent cloud formations, separated into several coloured bands at different latitudes, resulting in incredible storms and areas of ferocious turbulence where they meet. Most famous of all storms is the ancient Red Spot, a churning blood-red storm over 40,000 km in diameter. Like most gas giants, Jupiter has a faint ring system.

Jupiter really is a giant and a dangerous one at that. Its magnetic field is fourteen times stronger than that of Earth's, and its radiation belts are hazardous to human life closer than the orbit of its fourth moon, Callisto. This makes any colonisation a fraught and dangerous business and exploration often a short term affair.

Manned exploration of Jupiter space began in the 2070s when Luna arrived on Europa in order to look for life. Success was almost immediate, a colony planned and constructed that hid from the withering radiation *under* Europa's icy crust. The only other colonies have been military outposts on Callisto and Ganymede, forward stations to counter the Luna presence within the Jupiter system.

### Trojan Asteroids

Jupiter is massive and has pulled many rogue asteroids into its orbit; here two groups have stabilised, like leaves caught in a river eddy. Just over half of these belong to the leading group (L4) located 60° in front of Jupiter along its orbit, while the rest cluster around the L5 point which trails 60° behind Jupiter. The L4 asteroids are named after Greek heroes from the Trojan War, the L5 asteroids after the Trojan heroes. There are currently over 4,800 known trojan asteroids caught at these two points along Jupiter's orbit, but estimates exceed 250,000 trojan asteroids of a diameter 2 km or greater. There could be as many asteroids in total at the trojan points as there are asteroids within the Belt. Most of the trojans are D-type asteroids, relatively poor in metals or exploitable materials. They are mostly composed of organic rich silicates, carbon and anhydrous silicates. There are a small number of C-type asteroids, and a handful of these have been settled.

One example:

**2920 Automedon** (L4 Trojan Asteroid) **D0001A9-9 Asteroid, Lo**

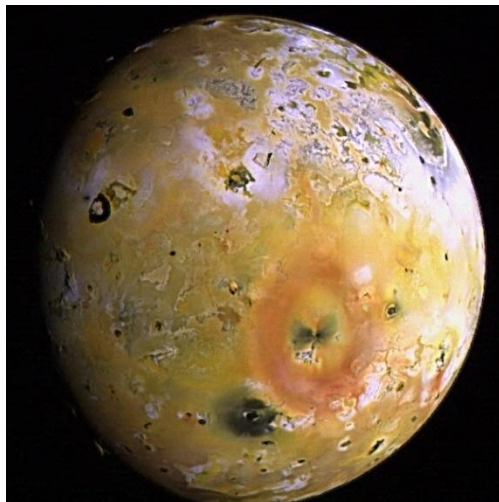

<b>Spaceport</b>	Frontier Quality
<b>Diameter</b>	3,640 km
<b>Gravity</b>	0.18 G
<b>Pressure</b>	Trace
<b>Composition</b>	Sulphur Dioxide
<b>Temperature</b>	-180°C
<b>Population</b>	-
<b>Government</b>	-
<b>Law Level</b>	-
<b>Dist. from Jupiter</b>	422,000 km
<b>Solar Day</b>	42 hours
<b>Solar Year</b>	11.86 years

A world of vivid scars and numerous active volcanoes, this Jovian moon Io is like no other in the solar system. Constantly churned by powerful gravity tides, exposed lava oozes outward in snaking lines across the sulphurous yellow surface while the ground is continually peppered with the dust of new explosions. Volcanoes, lava-flows and lakes of orange molten sulphur dominate the surface of Io. In addition, there are extensive regions frosted with sulphur dioxide snow. Io has not been colonised, the radiation levels are deadly, the surface is constantly erupting and has no regions of predictable stability. With its huge shield volcanoes and continual lava eruptions, the moon is the most active volcanic body in the solar system. There are no impact craters on the surface, the massive and continual volcanism eradicates them.

The gases spewed out by Io are ionized by radiation from the Jovian magnetic field and get swept up by it to be pushed ahead of Io by the rapid rotation of the magnetosphere. This creates a region of ionized gas. This 'plasma torus' generates an electrical current along the magnetic field lines that cross it creating a 'pipeline' of confined ions moving from Io's poles to the Jovian magnetic poles – and back again. This is the Io flux tube, a channel of high intensity magnetic power generating upward of 2,000 gigawatts. The flux tube scars the polar regions of Io, ionizing and stripping off the top surface layers of material and sending the particles out to the polar regions of Jupiter to trigger intense aurorae and lightning discharges in the Jovian atmosphere.

With no mining resources and the deadly radiation bathing the surface, Io has seen no human explorers. But Luna has had an interest in the flux tube. In 2090 military engineering and science teams from Luna arrived in the Jovian system and set up a base on the tiny irregular moon of Jupiter known as S/2000 J 11. Re-naming it Constitution, they began a one year project to change its orbit, bringing into equilibrium with Callisto.

By 2092 Constitution had become a co-orbital of Callisto. This 2 km diameter moon was to become their base of operations for experiments and engineering projects involving Io's flux tube. Callisto would have been a more practical base, but the Earth Union had established a military outpost there in 2074. The Republic was within its rights to set up a station on the moon too, but Luna seemed reluctant to do so. Callisto's orbit though, was the perfect place to establish a base, just outside of Jupiter's deadly radiation belts.

The engineers on Constitution built 'the Array' in orbit around Jupiter which remains within the flux tube at all times, it is undoubtedly drawing massive amounts of power from the tube (or has the potential to). Yet its exact purpose is unknown. Much of the construction and all of the maintenance on the Array is done via tele-presence controlled drones, few humans visit the site. Any unauthorised DSV is warned of by Luna operators on Constitution, who threaten a strike from an orbiting Autonomous Kill Vehicle. What is the Array? Earth Union surveillance is hampered by layers of micro-meteoroid shielding, redundant power and heat sources, all concealing the machine's true purpose. Is it a huge magnetic accelerator catapult – a weapon? Is it an experimental cyclotron? Is it some exotic technology perhaps inspired by a Cydonian find on Mars or in the outer system? A jump gate? Time machine? Who knows? It makes the secretary-general of Earth, Evelyn Chen, and her military advisors very nervous...

## EUROPA D201452 – 9

IC NI

T

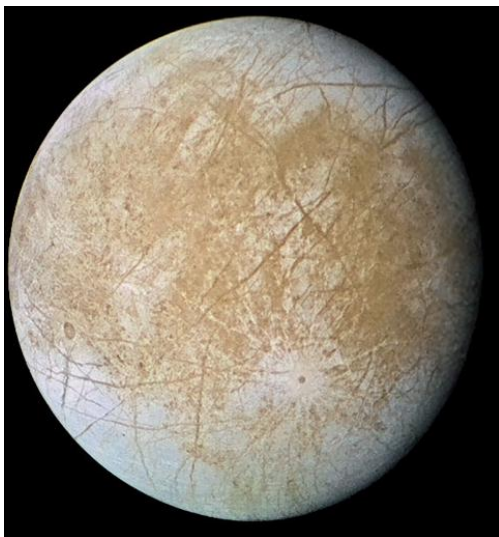

Spaceport	Poor Quality
Diameter	
Gravity	0.134 G
Pressure	-
Composition	-
Temperature	-180°C
Population	10,000; New Haven, Resolution
Government	Feudal Technocracy
Law Level	Low
Dist. from Jupiter	670,000 km
Solar Day	3.5 days
Solar Year	11.86 years



Europa is the flagship Luna colony, an outer system development that uses high tech ingenuity to enable human beings to live within the planet's subsurface ocean. The first explorers found life there, once they had drilled through the ice, life that had been evolving and thriving for perhaps a billion years. The settlements on Europa are submarine cities hanging beneath the ice crust of the planet, and the community is a purely submarine one, since Jupiter's radiation makes life on the surface untenable.

### Planetology

Europa is slightly smaller than Earth's Moon and is tidally locked to Jupiter. It is primarily made of rock and has an iron core. The surface of the moon is one of the smoothest in the solar system, being composed of a thick layer of water ice. This surface is scored and striated with cracks and streaks, impact craters are quite rare, giving some indication that the icy surface is quite recent and self-renewing.

Europa's rocky core is constantly flexing under the tidal force of Jupiter's gravity and the gravitational plucking of the other large moons as they pass by. This creates heat energy that causes a subsurface ocean to remain liquid and it drives geological activity in a way similar to plate





tectonics on Earth. The ocean is around 100 km deep. Red-brown lines on the ice (known as lineae) are actually cracks in the surface caused by tectonic stress; while circular patterns (known as lenticulae) are areas of melted and then refrozen ice. Some lineae are extremely long, running half way around the moon and can be up to 20 kilometres wide. These cracks always have ridges built up on either side of the fissure, i.e. they develop as double ridges. The circular lenticulae are around 10 kilometres wide. The colourful red-brown staining on Europa reflects mineral contamination by saltwater, sulphur compounds, and organic compounds from layers of warmer ice rising from beneath Europa's frozen surface.

Europa's ice shell is only a few kilometres thick at most and some areas are less than a 1000 metres thick. Regular contact of the subsurface ocean with the surface often occurs through open ridges, causing the formation of areas of chaotic terrain where rafts of ice have moved around and rotated. Surrounding these plates is a jumble of ice blocks which were formed where water, slush, or warm ice has risen up from below the surface. The largest area of this type is the Conamara Chaos.

Life exists within the subsurface ocean, despite the absence of sunlight. The European life-forms have an ecology that is based upon the volcanic sea floor vents, these geothermal 'black smokers' pour incredible amounts of useful minerals into the sea that living creatures can survive upon, leading to a complex food chain. The creatures here are far more than just single-celled organisms, they are 'macro-fauna', the largest of which is as big as a shark. Most are exotic light emitters, and the range of shape and morphology is bewildering, from jelly-fish 'floaters' to finned 'hunters' and legged 'scrawlers' (after the bizarre writing-like patterns they make on the seabed).

### **Human Development**

Europa was always going to be difficult to settle (the first landing took place in 2071), bathed as it was in Jupiter's radiation; but the prize for Luna was unlimited water useable as a rocket fuel source, and a viable aquaculture industry in the outer system. When Luna settled Titan in 2082, ostensibly for its hydrocarbon fuel supplies, Europa became second fiddle and measures were made to allow the Europeans to govern themselves. Today there are 10,000 Luna colonists living on Europa, all underneath the ice, around 8,000 split between the two cities New Haven and Resolution, and 2,000 others in smaller more mobile submarine habs. The two submarine settlements hang in cylindrical towers beneath the ice, a design pioneered by Centennial corporation engineers, twin elevators connect them to the surface via two kilometre-long tubes. Each includes automated surface facilities such as radio transmitters, landing pads and elevators to bring spacecraft into hangers sunken into the ice. Here there are warehouses, workshops, fuel bays etc., all beneath the ice to protect the staff at the port from Jupiter's radiation.

In addition there are 200 or so homesteads, travelling families making a profit from harvesting food from the sub-surface ocean. There is microbial life clustered around the volcanic vents at the seabed, and other life forms within the black cold depths of the sea. Trade, traffic, communications are all by submersible. One settlement conducts scientific experiments, two others mine precious materials from the 'black smokers'. The colony is loyal to Luna and enjoys good trade and military relations with the home nation. Ostensibly independent from Luna, yet remaining a staunch ally, it is dependant on trade for its survival. The government is based around the Central Administration, a body of scientists and planners who are crucial to the survival of the colony. Votes, referendums and polls are taken, but all major decisions are (and must) be taken by these highly educated technical experts.

# GANYMEDE E300168 – 9 M Lo T



Spaceport	Frontier Quality
Diameter	5,270 km
Gravity	0.15 G
Pressure	-
Composition	-
Temperature	- 170°C
Population	10-20; Osiris Base
Government	Captive Government (EU)
Law Level	Low
Dist. from Jupiter	1.07 Mkm
Solar Day	7.15 days
Solar Year	11.86 years

## Planetology

Holding the title of the largest moon in the solar system, Ganymede is the third moon of Jupiter. It is an icy moon, composed of approximately equal amounts of silicate rock and water ice. A salt water ocean is believed to exist nearly 200 km below the surface, sandwiched between two layers of ice. Hydrated salt minerals have been found on Ganymede, as the result of brine making its way to the surface by eruptions or through cracks. Natural radioactivity in the moon's interior provides the heat that maintains this underworld ocean.

The surface of Ganymede is composed of two main types of terrain. Very old, highly cratered, dark regions, saturated with impact craters and dated to four billion years ago, cover about a third of the satellite. Lighter regions, crosscut by extensive grooves and ridges and only slightly less ancient, cover the remainder. The cause of the light terrain's disrupted geology is the result of tectonic activity brought about by tidal heating. The grooves are troughs between long ridges of up-thrust ice.

Craters both overlay, and are cross-cut by, the groove systems, indicating that some of the grooves are quite ancient. Ganymedian craters are flatter than those on Luna and Mercury. This is due to the relatively weak nature of Ganymede's icy crust, which can (or could) flow and thereby lessen the relief of the crater walls. There are some ancient craters whose outline has almost disappeared leaving only the 'ghost' of a crater. One significant feature on Ganymede is the dark plain named Galileo Regio, which contains a series of concentric grooves, or furrows, probably created during a period of ancient geologic activity.

## Human Development

Ganymede is partially protected from Jupiter's deadly blast of radiation by its own magnetic field, but nevertheless, the radiation arriving on Ganymede's surface is still harmful to humans in the long term. The Earth Union initially established automated weapon systems on Ganymede in 2070, following the Mercury incident. They were controlled from Asgard Base on Callisto, further out from Jupiter and tasked to monitor the movements of Lunar spacecraft throughout Jupiter space. It was felt that the robotic systems on Ganymede could dominate the Jovian system with long range nuclear missiles fitted to AKVs. However, as Saturn began to attract the attention of colonial expeditions instead, the system was stood-down.

In the late '80s and early '90s, with the construction of 'the Array', the Earth Union decided to upgrade the Ganymede facilities with state of the art artificial intelligence (AI) defence systems able to react autonomously should war broke out. A sophisticated artificial intelligence (AI) called Sentinel was constructed by the Helix corporation (a subsidiary of Zenith) at the main bunker, buried beneath Osiris crater. Earth lags behind the Luna Republic in AI development and so Sentinel is the result of espionage, developed from stolen plans. The Sentinel defence system is a model of autonomous programming and an experiment that has not been replicated anywhere by anyone else, even the Lunars. It has full control over AKVs, drone recon satellites and laser defences. Working at an advanced proto-TL 12 stage, however, Sentinel is a functioning prototype with all of the problems that may occur when trialling such a prototype. There may be a reason the Lunar Republic hasn't yet unveiled their own fully-functioning AI...

Regular maintenance and supply flights are made into Asgard Base from Callisto, and there are always a handful of human technicians, armourers and programmers at the base, as well as three officers capable of over-riding Sentinel if need be. Due to the long term radiation risks, however, these personnel are rotated regularly. The Earth Union military facility at Ganymede does not accept un-scheduled visits from spacecraft unless under emergency conditions and even then Sentinel will put out a call for assistance to Asgard Base on Callisto and may refuse or halt any attempt at a landing.

## CALLISTO D311366 – 9 M IC Lo T

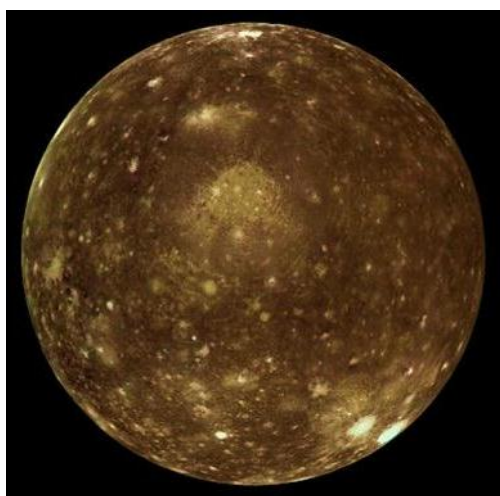

<b>Spaceport</b>	Poor Quality
<b>Diameter</b>	4,820 km
<b>Gravity</b>	0.13 G
<b>Pressure</b>	Trace
<b>Composition</b>	Carbon dioxide
<b>Temperature</b>	-170°C
<b>Population</b>	3,500; Asgard Base
<b>Government</b>	Captive Government (EU)
<b>Law Level</b>	Moderate
<b>Dist. from Jupiter</b>	1.88 Mkm
<b>Solar Day</b>	16.7 days
<b>Solar Year</b>	11.86 years
<b>Co-Orbital</b>	Constitution E000358-9 R

### Planetology

Callisto is Jupiter's fourth moon, orbiting at a distance of 1,880,000 km. At this distance the radiation levels from Jupiter are at a low level, making the colonisation of Callisto a practical matter. Like most of the gas giant moons, Callisto is a mixture of rock and ice; its surface is heavily cratered and extremely old, one of the most heavily cratered in the solar system. There are no large Callistoan mountains or volcanoes, the entire surface is a mass of craters.

The only prominent landscape structures are chains of craters (catenae) and huge multi-ring impact craters. Two of these multi-ring basins are enormous. Valhalla is the largest, with a central region 600 kilometres in diameter and rings extending as far as 1,800 kilometres from the centre. The second largest is Asgard, measuring about 1,600 kilometres in diameter. Multi-ring craters were formed when large asteroids or comets smashed into the icy crust and the slushy sub-surface ocean radiated the shockwaves throughout the crust. The existence of a subsurface ocean at a depth of 100–150 km is a fact, but the limited tests so far conducted have not discovered any evidence of life within it.

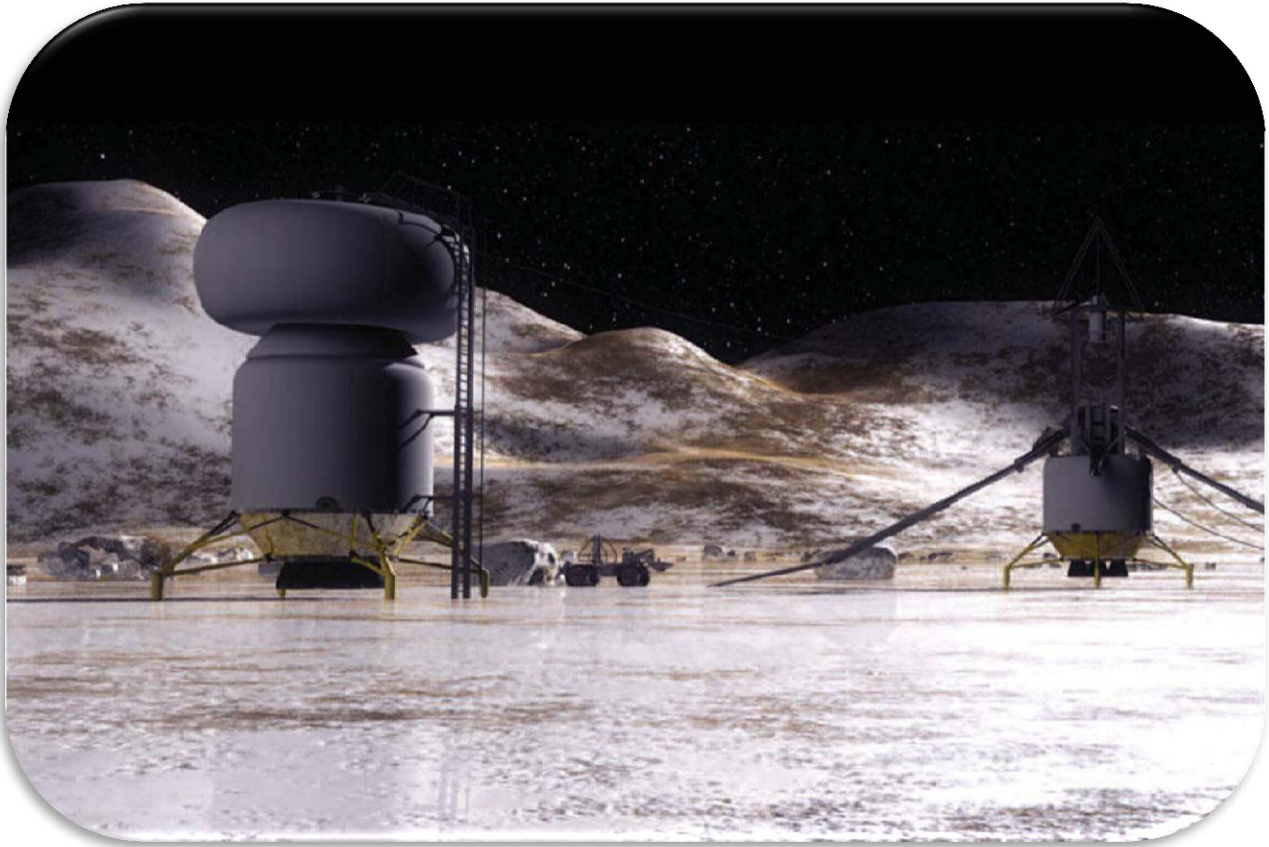

### **Human Development**

Callisto colony began life in 2073 as a small Earth Union military tracking station, established to monitor DSVs of the Lunar Republic as they entered Jupiter space and began operations on Europa. The Mercury incident of only five years earlier had both sides on high alert and mistrustful of each other's intentions. The station, constructed inside Asgard crater, also produced fuel that Earth DSVs could use to explore the outer solar system. As Saturn became the new focus of space activity in the 2080s, the military facilities on Callisto fell out of use and instead attracted entrepreneurs eager to pick up the fuel processing business opportunities that Callisto offered.

In the early '90s, the rival Lunar military changed the orbit of an irregular moon of Jupiter designated S/2000 J 11. Re-naming it Constitution, they were able to put into a co-orbital position with Callisto, trailing 250,000 km behind the larger Jovian moon. The Lunar base on Constitution is a military one, overseeing the construction and operation of the mysterious 'Array' that has been built using drone technology close to Io. Io is an inner moon bathed in Jupiter's deadly radiation, which has forced Luna to set up its control centre outside the radiation zone on Constitution. A military force soon relocated back to Asgard base alongside the fuel brokers, ice refiners and other colonists from Earth. Its job was now to determine the purpose of the Array and, without beginning a war, shut it down or hamper its operation. Of course both military bases, Earth and Luna, located so close together, are constantly spying on one another. Current population of Asgard, including the civilian settlement and the military garrison is 5,500. Population of Constitution is 1,250.

***Constitution E000358-9 R***

***Ast Lo***



# SATURN

## Large Gas Giant



<b>Distance from Sun</b>	1427 Mkm
<b>Orbital Year</b>	30 yrs
<b>Major Moons</b>	
Janus/Epimetheus	B000485-9
Mimas	E0004A6-9
Enceladus	E011302-9
Tethys	X000000-0
Dione	X000000-0
Rhea	C10039B-9
Titan	C3A2464-9
Hyperion	E000163-9
Iapetus	D1003C7-9
Phoebe	X000000-0

Saturn is the wonder of the solar system, a large gas giant that possesses an array of stunning rings. With a diameter of around 120,000 km, the planet is smaller than Jupiter but far more beautiful. It has seen more human colonisation than Jupiter due to the former's lower lethality of its radiation bands. Like Jupiter, Saturn's atmosphere is wracked by storms, but they are generally less violent; wind speeds are high though, clocking up 1,800 kph, faster than Jupiter but not as fast as Neptune. The planet exhibits a soft yellow colour due to ammonia crystals within the upper atmosphere which is composed mainly of hydrogen, with some helium. It is this helium that has drawn humans to the Saturnian system. Helium-3, a non-radioactive isotope of helium, is used to fuel fusion reactors on Earth and supports modern civilized life. Helium-3 is found within the atmosphere of all the gas giants, but the shallower gravity well of Saturn, coupled with its distance from Earth compared to Neptune and Uranus, and its more survivable radiation levels, make Saturn the perfect candidate for helium-3 extraction. Robert Zubrin once called Saturn 'the Persian Gulf of the solar system', and the rush for the oil analogue of the year is 2100 is in full flow. See Janus/Epimetheus for details of the operation.

Saturn has several peculiar phenomena including a persistent hexagonal cloud formation at its north pole and of course those rings. These extend from 6,630 km out to 120,700 above Saturn's equator. They average only 20-50m in thickness and are composed mainly of water ice with various rocky impurities. Are they the remains of a moon? Or debris left over from the creation of the solar system? Saturn is orbited by 62 moons in total, some of which lay within the ring system and act as shepherd moons, tugging at the ring material as they traverse their orbit.

Colonisation began with an Earth mission to Janus and Epimetheus in an attempt to mine helium-3 from Saturn's atmosphere, but the Cold War race to space soon brought in the Lunar Republic with their colony on Titan. Today, the Saturnian system is the hot battleground between the two powers; war, revolution and Cold War tension has turned this gold-rush frontier into a potential war zone.



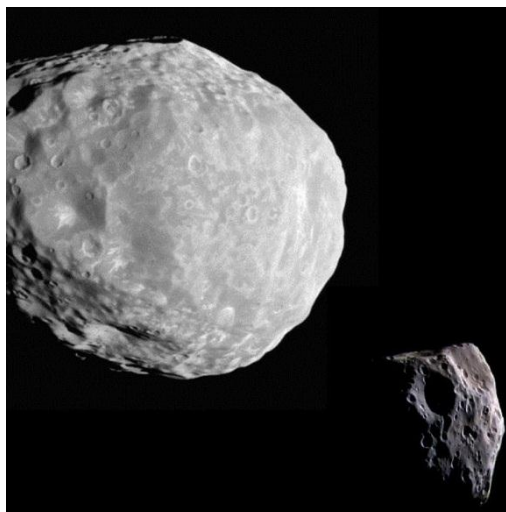

<b>Spaceport</b>	Good Quality
<b>Diameter</b>	<200km km
<b>Gravity</b>	0.002 G
<b>Pressure</b>	-
<b>Composition</b>	-
<b>Temperature</b>	-180°C
<b>Population</b>	87,000;
<b>Government</b>	Civil Service Bureaucracy
<b>Law Level</b>	Moderate
<b>Dist. from Saturn</b>	151,400 km
<b>Solar Day</b>	0.69 hours
<b>Solar Year</b>	30 years

Janus and Epimetheus are two moons of Saturn that share the same orbit; they are 'co-orbital' with the distances between them increasing and decreasing on their journey around Saturn. Both are heavily-cratered icy rubble piles and both are irregularly-shaped. The largest of the two moons is Epimetheus, four times larger than Janus. The two moons never approach closer than 10,000 km and exchange places within their orbit every 4 years. These satellites of Saturn lay between rings F and G at a distance of 151,000 km and are fragments of a single body, both under 200km in diameter. The Earth Union colonised these moons in order to skim He-3 and hydrogen from Saturn's atmosphere, they are close to Saturn, actually within the ring system and small enough to allow large transports from Earth to dock directly at the installations.

Vessels from Earth dock at Janus to unload passengers and freight. There is a hotel and a transfer station for those travelling on to other out system destinations. The boats then cross to Epimetheus to load up with He-3 or hydrogen fuel for the return trip to Earth. Epimetheus is the site of the mining and reprocessing facilities, with repair yards and control centres for the refining drones that skim Saturn's atmosphere. There are unloading bays, hangers and vast hydrogen storage and processing plants. Fuel is also stored here. Southern Cross Mining is the corporation currently holding the license from the Union to conduct the operations, it has extensive installations on Epimetheus.

How does the helium-3 extraction operation work? A 100 ton Kronos refining drone (see pg.83) is launched from Epimetheus and it enters the Saturnian atmosphere slowing with a heat-shield and parachutes. At low speeds a balloon is inflated using gases from the atmosphere and the parachutes are discarded. The probe slows as it passes through ever denser layers of the atmosphere until it reaches neutral buoyancy and floats. Now pumps and refrigeration equipment begin operating and the fission plant comes online. The atmospheric gases are liquefied by the machinery, dumping unwanted liquid methane overboard, using hydrogen gas to maintain the balloon's buoyancy and liquid hydrogen to pre-cool the incoming gas stream. The helium extracted is liquefied and cooled close to absolute zero where helium-3 isotopes and helium-4 isotopes begin to behave differently and can be separated; the helium-4 is dumped overboard. This small quantity of helium-3 (5 tons) is stored for return to orbit. As the helium-3 tank fills up buoyancy is compromised, but waste heat from the refrigeration process as well as waste hydrogen gas easily compensates. Finally, hydrogen gas is liquefied and diverted to the fuel tanks, the waste heat from the condensation process is added to the balloons to compensate yet again for the increased

weight. The drone has spent twelve and a half days filling its helium-3 tank and another two days filling its huge fuel tank ready for the burn to orbit.

Once full the rocket engine ignites, the balloon is discarded and the refining probe rockets up to low Saturnian orbit and back to Epimetheus where it docks with a Southern Cross support DSV. The drone is unloaded, re-equipped with fresh balloons and parachutes; it is serviced and refuelled by the DSV and within 3 days is ready to be plunged once more into the Saturnian atmosphere.

At any one time there are 3-4 Southern Cross drones within the planet's atmosphere. Losses due to storms or lightning strikes do occur and so new drones are often being ferried to Epimetheus ready for service.

## MIMAS E0004A6 – 9 R NI T



<b>Spaceport</b>	Frontier Quality
<b>Diameter</b>	400 km
<b>Gravity</b>	0.006G
<b>Pressure</b>	-
<b>Composition</b>	-
<b>Temperature</b>	-180°C
<b>Population</b>	17,000; Nagamachi
<b>Government</b>	Charismatic Dictator
<b>Law Level</b>	Moderate
<b>Dist. from Saturn</b>	185,000 km
<b>Solar Day</b>	0.942 days
<b>Solar Year</b>	30 years

Mimas is the first major moon of Saturn, orbiting at just over 180,000 km distance. Like many outer moons, the world is composed of ice on a rocky core. The most extraordinary feature of the moon is the huge impact crater Herschel. At 130 km in diameter it is almost a third of the moon's own diameter, with a rim 5 km in height and a central peak rising 6 km above the crater floor.

Mimas supports an Earth colony of Japanese Nationalists, a colony sponsored by Matsuyama in return for supply and mining rights. Its leader is Joseph Takamura, who convinced the colonists to embrace aspects of traditional Japanese culture. So, at work the Mimans are modern space settlers using vacc suits and wearing jump suits, but at home they wear the Japanese kimono tied with the sash-like obi, practice the tea ceremony and engage in hobbies pulled directly from the distant past: poetry, calligraphy, bonsai and Saturn viewing, for example. Living spaces reflect a simple and elegant Japanese aesthetic where possible. The Mimans enjoy a good relationship with the Earth Union, being part of an established EU colonisation effort. The moon's main settlement is called Nagamachi, located in crater Gawain, and home to 17,000 people.

Whilst the colonists go about their business, growing hydroponic crops and mining water ice for their survival, they must deal with the scientists from the research centre at Herschel. Earth Union scientists have established a camp at this massive crater to undertake highly secretive studies. Little of what they do leaks out, even though plenty of the 100-strong science team visit the Nagamachi colony on their rest-days or as they pass through to catch the next shuttle into orbit. What are they investigating? Rumour says that a local discovered alien ruins and was quickly ushered off world by a Union agent. Is the huge Herschel crater connected with the Cydonian

ruins on Mars? If so, how? Or are these investigations into exotic minerals of Mimas' bizarre geology? Everyone knows that with a diameter of 400 km it really shouldn't be spherical at all - there are plenty of asteroids out there *bigger* than Mimas that are nowhere near spherical in shape....

## ENCELADUS E011302-9 R Lo T

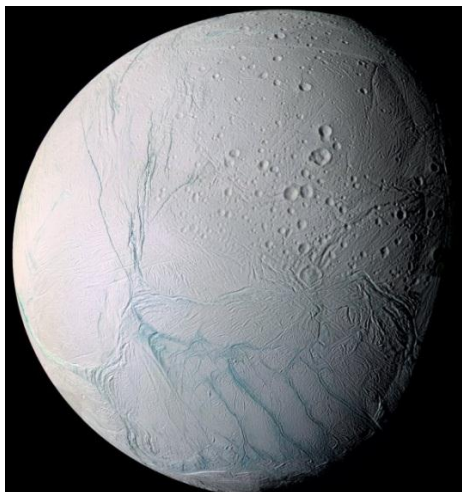

<b>Spaceport</b>	Frontier Quality
<b>Diameter</b>	500 km
<b>Gravity</b>	0.0113G
<b>Pressure</b>	Trace
<b>Composition</b>	Water Vapour, Nitrogen
<b>Temperature</b>	-198°C
<b>Population</b>	2,390; Thera
<b>Government</b>	None - Family Groups
<b>Law Level</b>	Low
<b>Dist. from Saturn</b>	238,000 km
<b>Solar Day</b>	1.37 days
<b>Solar Year</b>	30 years

Enceladus orbits Saturn at a distance of 238,000 km, between the orbits of Mimas and Tethys. and is another icy moon. This moon has a thin crust of water ice beneath which lies a subsurface ocean which is kept at liquid temperature due to a hot core at the centre of the moon. Dramatic plumes, both large and small, spray the water ice out from many cryovolcanoes along the famous 'tiger stripe' features near the south pole. Some of this water falls back onto the moon as snow. The icy crust splits and spreads apart just like the ocean floor on Earth, but is also peppered with fairly young impact craters.

Enceladus, like Europa, has a subsurface ocean, but the crustal ice is only metres thick and was easily able to be penetrated by the simple drilling equipment of South American colonists from Earth. They brought with them genetically-engineered fish stocks that they harvest. Geo-thermal energy is tapped and used to power the seabed habitats. There are 2390 inhabitants living a life remote from the concerns of the solar system and the Cold War in a single submarine habitat called Thera. These colonists are mainly of Brazilian descent and organized into loose family units, creating farming co-operatives that can act together as needed for certain projects or during trade deals of other external affairs. The Earth Union supports the colony with supplies, equipment and the best in submarine technology. There is no mining of metals, such valuable resources are brought in from elsewhere. The moon also has a research station for the purposes of studying the native life found there.

Life was discovered within the oceans, dominated by the famous 'vine-stars' that fill various ecological niches, from sea-bed walkers to free swimmers. The organisms are so prolific that they provide, in the same way as plankton in the seas of Earth, food for imported marine organisms.

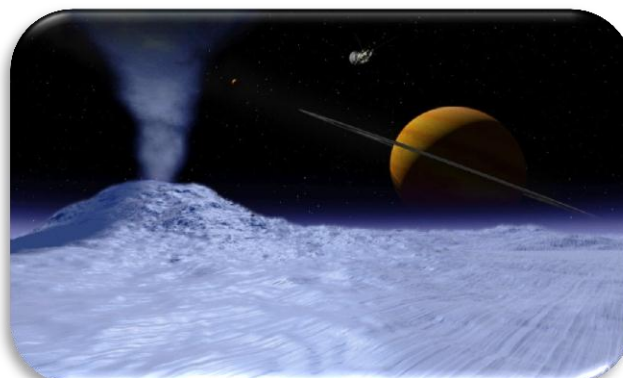

# TETHYS X000000 – 0

Ba

T



Spaceport	No spaceport
Diameter	1,060 km
Gravity	0.0116G
Pressure	-
Composition	-
Temperature	-187°C
Population	-
Government	-
Law Level	-
Dist. from Saturn	295,000 km
Solar Day	1.88 days
Solar Year	30 years

Tethys is an uninhabited world, the third of Saturn's major moons. Like many moons in the outer system, it is composed mainly of ice with some rocky material. At the incredibly low temperatures experienced this far out from the Sun (around -180° C) ice has almost the same properties as solid rock which explains how asteroid impacts can punch craters into Tethys, just as they do on Luna. There are a lot of craters on Tethys and the moon is also cut by a number of large faults. The largest of the craters, Odysseus, is around 450 km in diameter and although quite flat it still has a rim approximately 5 km above the moon's surface.

The largest fault, Ithaca Chasma, is 100 km wide, 3 km deep and more than 2,000 km long; it runs almost three-quarters of the way around Tethys's circumference. Ithaca Chasma may have formed as Tethys' internal liquid water solidified, causing the moon to expand and crack the surface to accommodate the extra volume within it. A small area, on the opposite side of the moon to Odysseus is covered by smooth plains that may be cryovolcanic in origin. Unusually, Tethys reflects a lot of sunlight, the result of the sand-blasting of the surface by particles from Saturn's E-ring. This E-ring is faint composed of small, water-ice particles that are generated by Enceladus' south polar geysers.

# DIONE X00000-0

Ba

T



Spaceport	No spaceport
Diameter	1,128 km
Gravity	0.0116G
Pressure	-
Composition	-
Temperature	-186°C
Population	-
Government	-
Law Level	-
Dist. from Saturn	377,400 km
Solar Day	2.7 days
Solar Year	30 years



Dione is composed of water ice but due to its higher density than Tethys, probably includes layers of silicate rock in its interior. The moon's leading hemisphere is heavily cratered while its trailing hemisphere contains an unusual and distinctive surface feature: a network of bright ice cliffs, some of which are several hundred metres high. Craters often don't display prominent features like those on Luna due to slumping of the weak icy crust over time. They do display bright white icy crater walls where fresh ice has been exposed and crater floors of darker material, dirt, rock and slush mixed together – a layer of much older deposits.

An interesting feature of Dione is its exosphere, too tenuous to be called an atmosphere, it is composed of a thin layer of molecular oxygen ions. It seems that highly charged particles from the Saturn's powerful radiation belts have been splitting the water within ice crystals into hydrogen and oxygen. It acts as a standard **Orbital** fuel processor, which electrolyses water ice to create oxygen and hydrogen!

**RHEA**                      **C10039B-9**   **s**                      **Lo**                      **T**



<b>Spaceport</b>	Routine Quality
<b>Diameter</b>	1,532 km
<b>Gravity</b>	0.019G
<b>Pressure</b>	-
<b>Composition</b>	-
<b>Temperature</b>	-174°C
<b>Population</b>	5,000
<b>Government</b>	Impersonal Bureaucracy
<b>Law Level</b>	Very High
<b>Dist. from Saturn</b>	527,100 km
<b>Solar Day</b>	4.5 days
<b>Solar Year</b>	30 years

The surface of Rhea resembles that of Dione, both have leading and trailing hemispheres that are very different from one another. The trailing hemisphere (the side facing away from the direction of motion along Rhea's orbit) has a lightly cratered surface criss-crossed with numerous ice cliffs (chasmata) that are the result of extensive fracturing of the moon's surface as its internal ocean froze and expanded. The leading hemisphere is heavily cratered, these craters are not of any great height since the icy crust has slumped over time. The moon has two very large impact basins which are 400 and 500 km across. The more northerly and less degraded of the two is called Tirawa. Of note is a 48 km diameter crater easily seen from orbit because of its extended system of bright rays. This crater, called Inktomi, is nicknamed 'The Splat'.

Rhea is unusual because it is the only moon within the solar system that possesses rings of its own, though these are very faint. The tenuous ring system is composed of three narrow, relatively dense bands of stony material, within a fine particulate disk.

The colony on Rhea was established by the Lunar Republic in 2086 in order to consolidate a Lunar presence within the Saturnian system and to grow crops on a large scale for Lunar out-system operations. Huge hydroponic greenhouses were erected, and although an initial population of 1,000 was landed to construct and operate the farms, much of the labour was conducted by drones. Yields looked promising and contracts have been fulfilled, with shipments of food-stuffs going out to Titan, Europa and Constitution.



In 2092 a gang of asteroid miners-turned pirate landed on Rhea and carried out a smash-and-grab raid, killing several Rheans and cowing the authorities with lethal force. Although the Luna Outsystem Patrol and Security (LOPS) force ultimately caught up with these desperadoes, Rhean society was never the same. It became introverted and security conscious and although the leaders demanded a space force garrison for future protection, they were granted only the siting of a Space Agency base which had already been planned. With upgrades to the spaceport taking effect simultaneously with the construction of the space agency base, traffic flow and off-world visitors were increasing rapidly. The new Rhean authorities have tried to insulate themselves from the interplanetary society around them, fulfilling their agricultural quotas, accepting shipments of machinery and supplies from Luna, but maintaining a disciplined distance from visitors.

A conspiracy to overthrow the new pro-security regime in 2096 has only intensified the government trend for more security, more surveillance and the constant monitoring of visitors. Whether you hail from the home world (Luna), from Earth or elsewhere, visitors will be assigned a government guide (a 'minder') who ensures that you do not stray into unauthorised areas, spread dissension or commit crimes. Their hotel room will be bugged and all of their affairs recorded and analysed. Of course, this police state with all of its repression simply fuels the desire for revolution. While many Rheans remember the events of the past decade and see the need for the totalitarian control of the government, there are some who want the clock turned back. As of yet they have no real leader or organization...

## TITAN C3A2464 – 9 N FI NI T

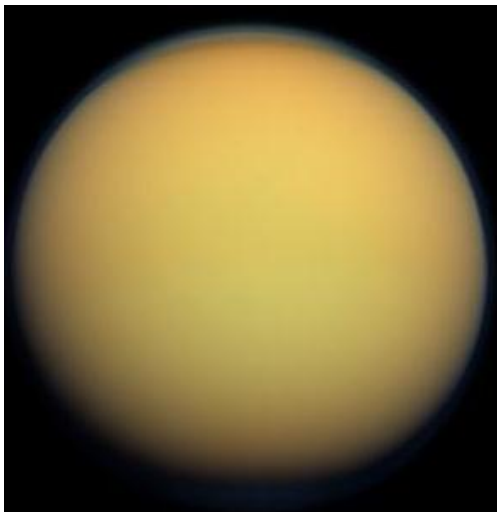

<b>Spaceport</b>	Average Quality
<b>Diameter</b>	5,150 km
<b>Gravity</b>	0.14 G
<b>Pressure</b>	1.6 atm (exotic)
<b>Composition</b>	Nitrogen, methane
<b>Temperature</b>	-180°C
<b>Population</b>	87,000; Xanadu City, Tuosheng, Mindanao, Acheron, Banquo, Jianying
<b>Government</b>	Captive Government (EU)
<b>Law Level</b>	Moderate
<b>Dist. from Saturn</b>	1.22 Mkm
<b>Solar Day</b>	16 days
<b>Solar Year</b>	30 years

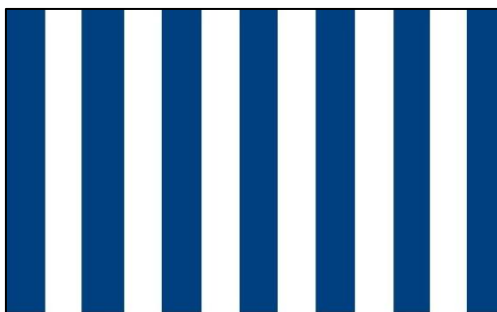

Titan is a troubled world, an ex- Luna colony in Saturnian space that just got out of control. Earth Union forces occupied Titan in an attempt to prevent the rogue government from destabilizing Earth colonies in the region, a contentious move which has resulted in a five year counter-insurgency war and has almost led Luna and Earth to the brink of all-out war. Troops still occupy Xanadu, Titan's cave-like capital, but Chinese gangs control some of the other habitats and make life hard for the Earth force. Titan is a prize worth fighting over, Luna

has been convinced that the EU wants to seize the world's huge hydrocarbon and methane resources, or at least deny them to Luna.

## Planetology

Titan is the sixth moon of Saturn and its largest and actually larger than the planet Mercury. Titan orbits Saturn once every 16 days and like many of the other satellites of the gas giants it is tidally locked, in synchronous rotation with Saturn, always showing one face to the planet. Titan has an extremely thick atmosphere with a pressure actually 1.5 times *greater* of that on Earth and, like Earth, it consists mainly of nitrogen ( 95%) with the remaining 5% formed of methane (3%) and hydrogen (2%). The average surface temperature is colder than anywhere on Earth, a flesh-freezing  $-179^{\circ}\text{C}$  . Due to the thickness of the atmosphere there is little temperature difference between night and day. The weather, including wind and liquid methane rain, creates surface features similar to those of Earth, such as dunes, rivers, deltas, lakes and seas of liquid methane and ethane. Titan's methane cycle is viewed as an analogue to Earth's water cycle, although at a much lower temperature. The wind patterns have created a permanent hurricane at the moon's south pole. Although it has no magnetic field, Titan's colonists are shielded from the solar wind by the powerful magnetosphere of Saturn.

Methane storms and rain are continually sculpting the moon's landscape with the result that the surface is geologically young. Although there are mountains and several cryovolcanoes, the terrain is smooth with relatively few impact craters. A lack of crater impacts indicates a surface continually being modified by flowing liquids, and some craters have been filled in, either by raining hydrocarbons or volcanoes. Standing lakes of liquid methane exist on the surface as well as dry river valleys. There are a number of cryovolcanoes which, instead of spewing molten rock, erupt with water and ammonia; in fact the tallest peak on Titan is Mount Shackleton, an 8 km high cryovolcano.

Titan's surface is marked by broad regions of highlands and plains, including Xanadu, a large, equatorial region about the size of Australia covered with hills and cut by convoluted valleys, ridges and chasms. The equatorial regions in particular are dominated by extensive sand seas, with dunes up to 330m high, a kilometre wide and tens to hundreds of kilometres long. These linear dunes are formed by winds that trend in one direction; the wind patterns cause the dunes to build up in long parallel lines aligned west-to-east and they break up around mountains, where the wind direction shifts.

The sand on Titan derives from organic hydrocarbons clumping together after raining onto the surface and, while devoid of open liquid, nonetheless holds more organics than all of Earth's coal reserves put together ... a massive untapped source of energy. Titan is a colourful world of oranges, reds and browns and decorated by ammonia ice in glaciers or snow drifts that are banded with stunning blues and purples.

Titan's greatest marvel is its shallow lakes of liquid methane and ethane. Although most of the lakes are concentrated near the poles (where the relative lack of sunlight prevents evaporation), a number of long-standing hydrocarbon lakes in the equatorial desert regions also exist including Lake Spirit in the Shangri-La region, which is about half the size of Utah's Great Salt Lake. The equatorial lakes are fed by underground aquifers. Most lakes are black in colour and often decorated by great whorls and loops of lighter material, looking for all the world like a cup of black coffee complete with a quick stir of cream! Some of the lakes rival seas - Ligeia Mare has a surface area of over 100,000 km<sup>2</sup> (larger than Lake Superior), and Kraken Mare is the size of the Caspian Sea.

A singularly impressive phenomenon is the Methane Monsoon, occurring throughout spring in northern latitudes. During the winter, methane condenses into shallow lakes, some with a surface slush of ammonia ice. Spring conditions, a 'warmer' wind, or a significant break in the clouds causes the lakes to suddenly flash into vapour, evaporating quickly. This amazing phenomenon is often accompanied by huge windstorms, lasting up to a quarter of an hour.



## Human Development

Titan is the jewel of the outer system, a moon with a dense atmosphere, liquid seas and cryo-volcanoes - truly a world to rival Earth for interest and complexity. It was economic forces, inevitably, that powered the first human colonization in 2082. Luna had access to oxygen, water-ice, minerals and as much helium-3 as it could scrape out of its own regolith but it desperately needed hydrogen if it was to fuel its nuclear thermal spacecraft and compete with Earth for the moons of the solar system. Titan was a perfect choice, a world able to sustain a human colony, a real prize amongst the gas giants, and a prize rich in hydrocarbons, methane and hydrogen that could be refined and sent back to Luna. Titan has proven to be the gas station of the solar system, at least for the Lunars.

The majority of settlers from Luna were Han Chinese, and here on Titan, away from the strictures of Luna, traditional gang activity has been re-established. These gangs form a network of social powerbases that get things done and protect the interests of the colonists within their settlement. They organise their own militia's, unions and social events and they only rarely cross the line into illegal criminal activity. Major settlements exist at Xanadu City (capital, with spaceport and processing plants), Tuosheng (centre of anti-Earth activity and home to the Golden Sun gang), Mindanao (a lakeshore colony and hydrocarbon processing centre) and Acheron, where miners work hard to extract ore from Titan's only bedrock outcrops. Minor settlements include Banquo, site of the first landing, and home to the Black Lotus gang; and Jianying, riverside town split between the Heavenly Fist and the Black Lotus.

The Cold War came to Titan in the '90s. A political faction gained the upper hand within the Titan government in 2094 that included members of the White Tigers. This revolutionary organisation aims to overthrow Earth governments on worlds across the solar system in an attempt to undermine the Earth Union's off world powerbase; quite rightly, Luna has always felt outnumbered. With the White Tigers in control on Titan, the world became a base of operations in the outer solar system for subversion against the Earth Union.

An attempt to use agents to overthrow the government of another Saturnian moon, Iapetus, succeeded in 2095. Yet this new government did not immediately throw in its lot with the Luna Republic and, to the dismay of Titan premier Steven Taylor Wang, simply declared its independence. Unable to secure an alliance, Titan was, however, able to secure trade agreements with the new Iapetus leaders which infuriated the Earth Union. When EU surveillance detected a build-up of Titan forces on the tiny moon of Helene, supplied and paid for by Luna, the Union decided to mobilise its military might at long last. It looked like Titan was about to ferry troops across the Saturnian system in order to seize Iapetus by force. The Earth Union carried out a two-stage military operation. First, it launched a pre-emptive strike on Helene, and on the moon of Hyperion, which was being used by the Titans as a surveillance centre and military base. Secondly, and most audaciously, the Earth Union landed ground troops on Titan and took control of the capital city, Xanadu. A shooting war ranging across the frozen surface lasted for a full month before the Luna-supplied forces surrendered. The occupation forces tried to keep a lid on the Titans, but within three months armed opposition and then outright rebellion took hold. Fighting within colony habs, corridors and public spaces amongst innocent civilians proved a serious headache for the occupation forces and progress toward crushing the rebellion was slow. Luna accused the EU of attempting to take control of the entire Saturnian system. Diplomatic meetings were held to resolve the Titan crisis that ended in mutual dissatisfaction, although Luna was able to convince the Union to resume launches of methane and hydrogen from Titan. Quickly life on Titan got back to normal, Luna received its shipments of supplies, Titans mined, grew food, processed hydrocarbons ... and plotted to kick out the Earth forces. Rocket attacks, bombs and sabotaged hab systems killed a steady stream of Earth troopers month by month.



In 2098 a company of Earth troopers turned off the life support to a colony zone, and watched as 150 Titan civilians asphyxiated. They stated their reasons, but the incident provoked a full scale mobilisation of forces by the Luna Republic. Within months a Luna space force had arrived to directly contest the occupation and it quickly matched orbit with the Earth Space Force already there. Three sporadic combat encounters occurred during this tense stand-off and although lives were lost, nervousness on both sides prevented a rapid escalation toward full scale war. Politicians were twitching, full scale war and annihilation looked likely.

A venerable politician from Shandong, the 76 year-old Evelyn Chen, won massive support from Earth's Council of National Leaders in late 2098. With an entourage of grizzled diplomats and ambassadors behind her, she was able to champion the argument for common sense and peace. Her PR campaign was superb and after the war fleets dispersed and the population of the solar system breathed a collective sigh of relief, Evelyn Chen was elected secretary-general of the EU and awarded emergency powers to find a way to normalise relations with Luna. She currently enjoys the overwhelming support of the majority of Earth's nations.

The peace talks were held on Mercury in 2098 and proved successful, leading to the signing of the Titan Agreement by both factions. War was averted and although a plan for staged withdrawal was established, the occupation forces are still in place. In 2100 the Titans are still in revolt against the Earth forces and the low intensity conflict continues. The Earth-based corporation Erebus Power has been quick to establish a mineral extraction agreement with the Luna government, giving it the right to extract and ship hydrocarbons to Earth. This power corp will use every trick in the book to try to keep other Earth-based companies from getting a toe-hold on Titan.

## Places of Interest

***Xanadu City*** – Xanadu is Titan's capital city. With a population of 21,000 and served by a C type spaceport, the city is built within a series of caverns. These caverns are cut into the rock cliffs that separate the Xanadu highlands from the Shangri La lowlands. Large scale hydrocarbon processing facilities at Xanadu prepare raw materials from Lake Telmar and transport them on to the spaceport's magnetic accelerator catapult for launching out to Luna. Xanadu is known for its civic dome, covering the entrance to the main cavern, an impressive nine storey transparent window looking out over the processors and lake, with glorious Saturn hanging permanently in the sky above.

***Tuosheng*** – This highland township is a bed of anti-Earth sentiment, many fighters and saboteurs are trained and supplied here. The Golden Sun gang runs Tuosheng.

***Mindanao*** – Lake Telmar stretches for 300 km, and Mindanao is a township built out on an island in the lake. It is a hydrocarbon processing point, pipelines connect it to Xanadu, while hovercraft ship people and products between the island and the capital city.

***Acheron*** – Acheron is a mining city that exploits one of only a handful of rock outcrops on Titan. Its inhabitants are tough, hard-working individuals.

***Jianying*** – This township is a split settlement, the two halves of the city straddle the Anduin River. Two gangs jostle for power within Jianyang, the Black Lotus and the Heavenly Fist.

# HYPERION

**E000163-9 s Lo**

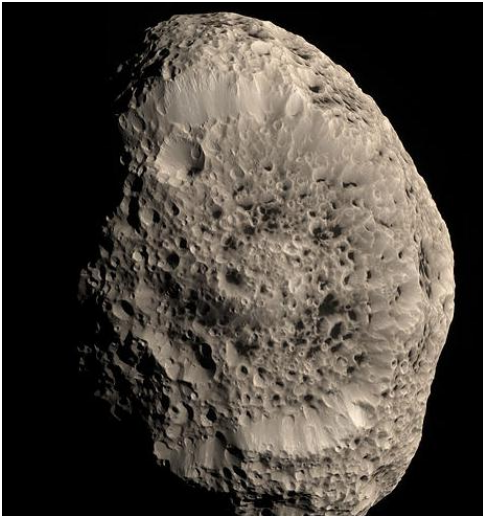

Spaceport	Frontier Spaceport
Diameter	270 km
Gravity	0.002 G
Pressure	-
Composition	-
Temperature	-180°C
Population	50
Government	Captive Government (Titan)
Law Level	Low
Dist. from Saturn	1.481 Mkm
Solar Day	'chaotic'
Solar Year	30 years

Hyperion is an usual little moon of Saturn, it is irregularly shaped, it has an eccentric orbit and is close to a much larger moon, Titan. It may be a fragment from a much larger body, broken apart by an asteroid impact because although it has average diameter of only 270 km, it possesses an impact crater 120 km in diameter! Hyperion is mostly ice and it has suffered repeated impacts of hundreds of millions of years; so many sharp-edged craters litter the surface that there are few areas of flat ground, giving it the appearance of a sponge. A reddish residue coats the moon and this has spiralled in from the outer moon of Saturn, called Proteus. Iapetus is coated in the stuff to an even greater degree.

The only permanent base on Hyperion is a Titan reconnaissance and surveillance facility. Due to its unforgiving terrain and chaotic rotation, Hyperion wobbles significantly as it orbits, and its rotation cannot be accurately predicted which makes landings tricky.

# IAPETUS D1003C7 – 9

**NI**

**T**

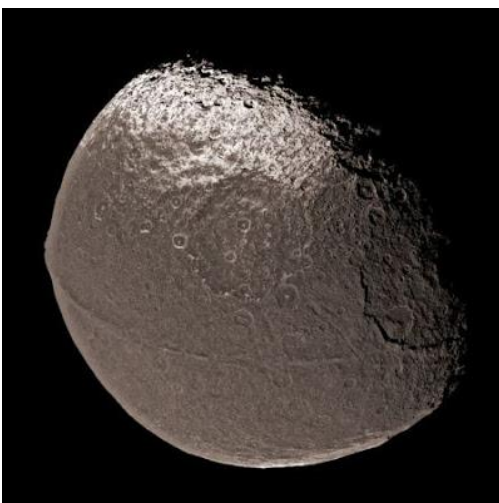

Spaceport	Poor Quality
Diameter	1,470 km
Gravity	0.023 G
Pressure	-
Composition	-
Temperature	-180°C (dark region) -140°C (bright region)
Population	7800;
Government	Charismatic oligarchy
Law Level	Moderate
Dist. from Saturn	3.56 Mkm
Solar Day	79.3 days
Solar Year	30 years

Iapetus was an Earth Union scientific colony, but in 2095, encouraged by meddling from Titan, rebellion broke out amongst the leadership and a new government took control. It is now an



independent world. Although now more focussed on developing Iapetus rather than on pure scientific research, the new government did not suddenly ally itself with Titan as that world had hoped. Titan planned to invade Iapetus with help from Luna, and the Titan War began.

### Planetology

Iapetus is the eighth moon of Saturn, mostly composed of ice with only a small amount of rocky material. It is without doubt the most unusual object in the solar system. Firstly it is neither spherical nor ellipsoid and has a bulging waistline and squashed poles. Perhaps the shape of the moon was frozen by the formation of a thick crust shortly after its formation, and its rotation continued to slow afterwards due to tidal dissipation. Later it became tidally locked.



The dramatic 'two-tone' coloration of Iapetus' surface is its most famous feature, but it also features a strange equatorial ridge that runs about halfway around the moon. The difference in colouring between the two Iapetian hemispheres is striking. The leading hemisphere and sides are dark with a slight reddish-brown colouring, while most of the trailing hemisphere and poles are bright. This dark region is named Cassini Regio, and the bright region is divided into Roncevaux Terra (north of the equator) and Saragossa Terra (south of it). During an orbital approach a traveller can easily pick out the dark Cassini Regio along with its border with the brighter Roncevaux Terra; he will also spot several large craters and of course the unmistakably weird, equatorial ridge. The dark material is a very thin layer, only a few tens of centimetres thick and comes from elsewhere in the Saturnian system. This debris has been knocked free from the surface of the outer moon Phoebe by micrometeoroid impacts and it has then spiralled in toward Saturn as its orbit decays. A portion of this material crossing Iapetus' orbit is swept up by its leading hemisphere, coating it.

Yet another Iapetus mystery is the existence of the equatorial ridge that runs along the centre of Cassini Regio. It is around 1,300 km long, 20 km wide, 13 km high. Peaks in the ridge rise to more than 20 km above the surrounding plains, making them some of the tallest mountains in the solar system. The ridge does form a complex system of highlands, with isolated peaks, ridges more than 200 km in length and some sections with three parallel ridges. Within the bright regions there is no ridge, only a series of isolated 10 km peaks along the equator. The ridge system is heavily cratered indicating that it is ancient; the bulge gives the moon a walnut-like appearance. Opinions on the origins of the ridge have been divided over the decades:

- 1- The ridge could be a remnant of the oblate shape of the young Iapetus when it rotated more rapidly than it does today.
- 2- The ridge could be icy material that welled up from beneath the surface and then solidified.
- 3- Iapetus could have had a ring system during its formation. The equatorial ridge was created as this ring collapsed and was attracted to the surface of Iapetus by gravity. Against this theory, the ridge appears too solid to be the result of a collapsed ring.
- 4- The ridge is a Cydonian engineering project on a massive scale, up close there are well defined regular features, tunnels into the ridge and what appear to be roadways leading to ice lakes. Ground penetrating radar has shown chambers along a symmetrical axis, all pointing to some sort of intelligent design.

## Human Development

The colony had first been established in 2086 to study the moon's unusual features, in particular the equatorial ridge and the strange ice lakes nearby. The initial government had been a committee of Earth Union engineers and scientists, supported by a large service, technical and ancillary staff. When evidence came to light that the ridge may be an alien artefact, perhaps of Cydonian origin, the scientists began to lose their impartiality and scientific neutrality. To many in the colony the researchers became frothing obsessives within a matter of months. Theories about the nature of the alien ridge ranged from a hypergate, a huge magnetic accelerator catapult or even a type of faster-than-light drive. With the scientists and leadership becoming ever more unstable, and even establishing what amounted to an alien contact 'cult' (Voices), the colonists (with backing from Titan) decided to act.

The new 'Enterprise Authority', a revolutionary coup of businessmen and engineers has moved away from the 'alien study project' to maximise the production and export of water to Titan. Links have been forged, and the Luna-aligned colony on Titan was eager to prise Iapetus away from its founder, the Earth. The Earth-aligned scientists who were unseated now form an intellectual movement, a radical subculture that sometimes conducts subversion and propaganda strikes against the new government of Iapetus.

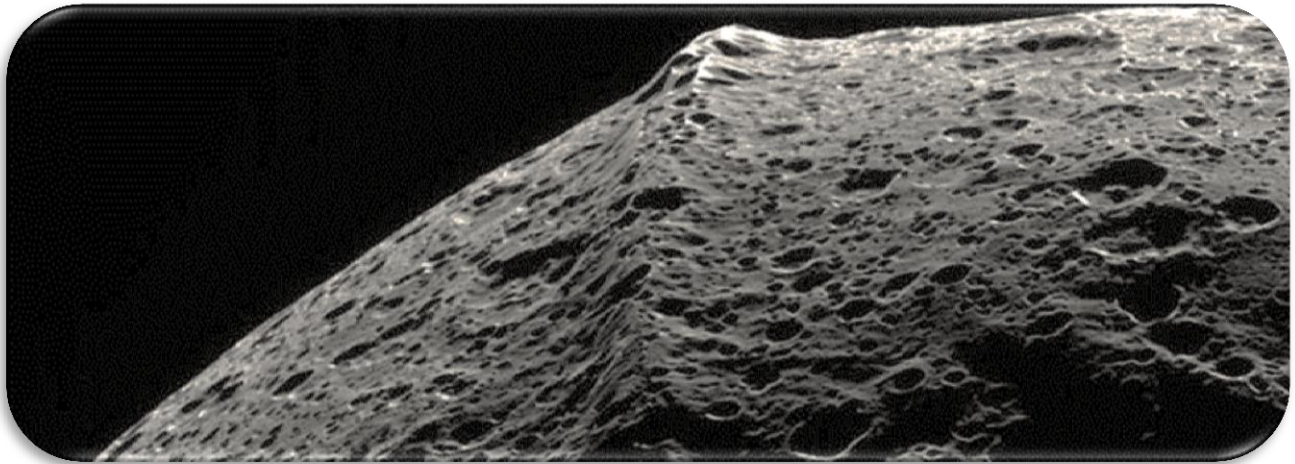

**Voices** - Alain Voss is the leader of Voices, an underground sect of scientists who used to work on the ridge project. They believe they are in contact with the long dead aliens of Iapetus and Mars. Voss channels communications with these aliens and he hears the voice of Valthor, the high priest of the long-dead Martians. There are perhaps 60 members of this sect.

# PHOEBE X000000-0 Ba

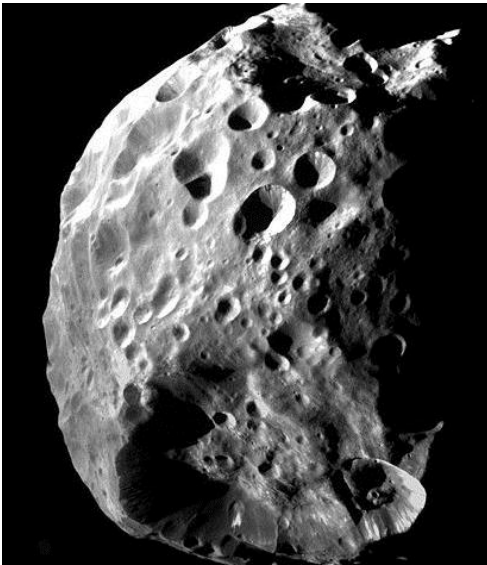

<b>Spaceport</b>	No Spaceport
<b>Diameter</b>	212 km
<b>Gravity</b>	0.01 G
<b>Pressure</b>	-
<b>Composition</b>	-
<b>Temperature</b>	-180°C
<b>Population</b>	-
<b>Government</b>	-
<b>Law Level</b>	-
<b>Dist. from Saturn</b>	12.995 Mkm
<b>Solar Day</b>	9 hrs 16 mins
<b>Solar Year</b>	30 years

Phoebe is an irregular, distant moon of Jupiter, an ice and rock body that is probably a captured asteroid, one of a number of icy planetoids from the Kuiper belt that orbit the Sun beyond the orbit of Neptune. Phoebe is almost four times more distant from Saturn than its nearest major neighbour, Iapetus. The irregular satellites orbiting much further out follow very eccentric orbits while the regular moons of Saturn (all except Iapetus) orbit very nearly in the plane of Saturn's equator.

The Phoebean surface is heavily cratered, some of these craters are up to 80 kilometres across, one of which has crater walls 16 kilometres high. Much of the surface is water ice laying beneath a relatively thin blanket of dark surface deposits, several metres deep. In addition, carbon dioxide ice has been detected on the surface, something never replicated in explorations of other asteroidal bodies. Material thrown off of Phoebe's surface by the millions of years of microscopic meteor impacts is responsible for the unusually dark surfaces of Hyperion and Iapetus, both further in toward Saturn. Much of this material continues to orbit Saturn as the 'Phoebe Ring' which extends from at least 128 to 207 times the radius of Saturn. Since the ring's particles originated on Phoebe, they share its retrograde orbit which is opposite to the orbital motion of the next inner moon, Iapetus. This inwardly spiralling ring material strikes Iapetus' leading hemisphere, and has triggered the process that led to the two-tone coloration of that mysterious moon.

# URANUS

## Small Gas Giant



<b>Distance from Sun</b>	2,900 Mkm
<b>Orbital Year</b>	84.32 yrs
<b>Major Moons</b>	
Miranda	D000222-9
Ariel	X000000-0
Umbriel	E000106-9
Titania	X000000-0
Oberon	D000264-0

A distant object in the solar system, Uranus is a small gas giant with an atmosphere composed mainly of hydrogen with some helium and methane. Unlike its larger cousins, Saturn and Jupiter, Uranus shows no defined bands of cloud, it appears to be almost a featureless disk of pale blue. Wind speeds reach up to 900 kph.

Uranus is almost 3 billion km from the Sun and takes 84 years to complete one orbit; so distant is the planet that the strength of sunlight is barely 1/400<sup>th</sup> that on Earth. The planet's strangest feature is its tilt; its axis of rotation is almost parallel to the plane of the solar system. This gives it seasonal changes completely unlike those of the other major planets. Visualise other planets rotating like spinning tops on the plane of the solar system, while Uranus rotates more like a tilted rolling ball. At the Uranian solstices, the north pole faces the Sun continuously while the south pole faces away. Only a narrow strip around the equator experiences a rapid day-night cycle, but with the Sun very low over the horizon as in the Earth's polar regions. At the other side of Uranus' orbit the orientation of the poles towards the Sun is reversed. Each pole gets around 42 years of continuous sunlight, followed by 42 years of darkness. In 2100 AD Uranus has almost reached its equinox, it is almost 'side-on' to the Sun, and rotates with a normal day/night cycle, just tipped over to the side with its north pole pointing along the direction of travel. The moons rotate around the tipped up equator of Uranus, moving into the sunlight then back around the night side. They are all tidally-locked to Uranus, with the same hemisphere always facing the gas giant.

Uranus possesses a faint ring system and 27 known moons, although few have been colonised and those at relatively low levels; most are barren ice balls with few resources. Uranus stands to be the solar system's current frontier, the location of the newest colonies and the boldest ventures. In the Chinese, Vietnamese, Korean and Japanese languages, Uranus is known as 'Sky King'.

**MIRANDA D000222-9 Lo T**



Spaceport	Poor Quality Spaceport
Diameter	470 km
Gravity	0.008 G
Pressure	-
Composition	-
Temperature	-200°C
Population	120
Government	Participatory Democracy
Law Level	Low
Dist. from Uranus	129, 390km
Solar Day	1.4 days
Solar Year	84.32 years

Like most moons in the outer system, Miranda is composed of water ice; its surface is a patchwork of chaotic and broken terrain cut by rifts and canyons and huge formations of grooves. The most spectacular of the features is Verona Cliff, a sheer scarp rising from the approximately 8-10 km in height, the highest in the solar system. Once geologically active due to tidal heating caused by the pull of Uranus, Miranda is now a cold, dead world. Settled by the Earth Space Development Agency, the moon is a research outpost, established with the aim of assessing the suitability of skimming Uranus for helium-3. The scientists and engineers there experiment and explore and have proven to be extremely self-reliant. They have a single experimental Kronos drone which they use to test the parameters of atmospheric processing within Uranus' upper atmosphere. A SGS serves as a receiving station for a research DSV that acts as the scientist's only lifeline with the rest of the solar system.

**ARIEL X000000-0 Ba T**

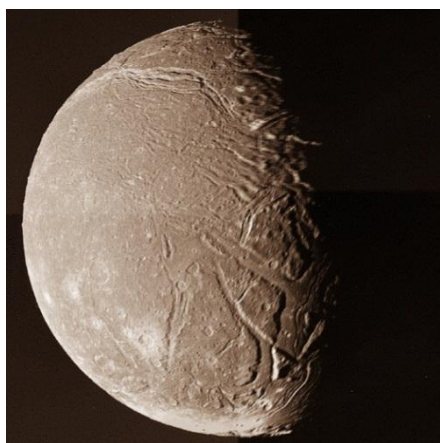

Spaceport	No Spaceport
Diameter	1160 km
Gravity	0.028 G
Pressure	-
Composition	-
Temperature	-200°C
Population	-
Government	-
Law Level	-
Dist. from Uranus	191, 020km
Solar Day	2.5 days
Solar Year	84.32 years

Another icy moon of Uranus, Ariel has a surface landscape much like Miranda's, with ridges, cratered plains, scarps and canyons. Tidal heating seems to have played a part in the subsurface movement of ice leading the formation of these features. The largest crater on Ariel is Yangoor, 78 km in diameter. Many of the craters aren't circular but polygonal, indicating that although originally circular, the ice has subsequently shifted. There have been cryo-volcanic eruptions on Ariel in the past, but none have been observed erupting as yet. The liquid erupted was a very thick, super-cooled mix of water and ammonia, it may be that volcanism has stopped completely on the moon.



# UMBRIEL E000106-9 Lo

T

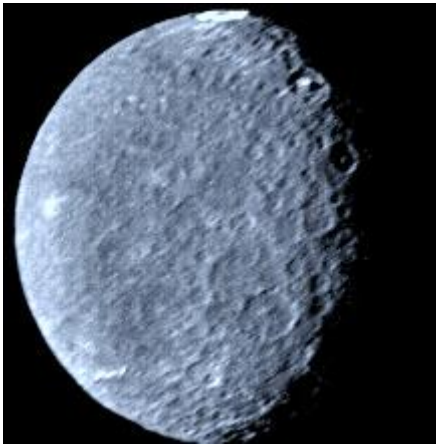

Spaceport	Frontier Spaceport
Diameter	584 km
Gravity	0.05 G
Pressure	-
Composition	-
Temperature	-200°C
Population	50
Government	0
Law Level	0
Dist. from Uranus	266, 000km
Solar Day	4.14 days
Solar Year	84.32 years

Umbriel has been settled by the billionaire family of DeGrace and forms a retreat for its members. Dug in deep into Heller crater, the DeGrace estate is a series of large interconnected habitats, yet less than a hundred people live here. Harman DeGrace, who made his fortune in the 1980s micro-computing boom, is the 150-year old recluse who lives here, guarded by security staff and ASAT launchers, pampered by stewards and robotic aides.

Umbriel is an icy moon, its surface is covered almost entirely with craters and also cut by a system of canyons trending northeast–southwest. Some of the biggest craters reach over 100 km in diameter and all have central peaks. Wunda crater (diameter 131 km), located on the moon’s equator, has a remarkable coating of bright material on the crater floor which has not yet been studied. The moon in general is covered in a layer of dark material, perhaps excavated by a huge ancient impact or expelled in an explosive volcanic eruption.

# TITANIA X000000-0 Ba

T

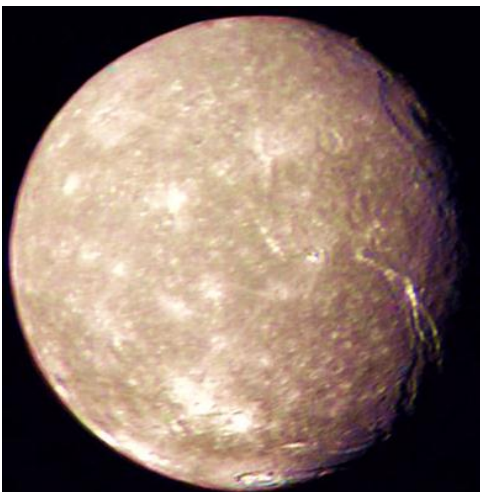

Spaceport	No Spaceport
Diameter	788 km
Gravity	0.078 G
Pressure	-
Composition	-
Temperature	-200°C
Population	-
Government	0
Law Level	0
Dist. from Uranus	435, 900km
Solar Day	8.7 days
Solar Year	84.32 years

Titania is the largest moon of Uranus, an icy moon with a surface much like Umbriel’s, covered with craters and cut by a system of enormous canyons and scarps. There isn’t just water ice on the moon but also some frozen carbon dioxide which has come from the outgassing of primordial CO<sub>2</sub> trapped by water ice in Titania’s interior. A region of smooth plains is split by the

deep canyon Belmont Chasma and includes the crater Ursula. Ursula crater, along with Jessica crater and others, are surrounded by bright impact ejecta (rays) that consist of relatively fresh ice. All of the large craters on Titania have flat floors and central peaks, although Ursula is an exception and actually has a pit in the centre. To the west of crater Gertrude there is an area with very irregular terrain, the so-called 'Unnamed Basin', which was once a huge crater, now deformed and degraded to only the vague outline of a crater. It has a diameter of about 330 kilometres. The most prominent of Titania's canyons is Messina Chasma, which runs for around 1,500 kilometres all the way from the equator to the south pole.

## OBERON D000264-0 Lo

T



<b>Spaceport</b>	Poor Quality Spaceport
<b>Diameter</b>	768 km
<b>Gravity</b>	0.078 G
<b>Pressure</b>	-
<b>Composition</b>	-
<b>Temperature</b>	-200°C
<b>Population</b>	450
<b>Government</b>	Captive Government
<b>Law Level</b>	Low
<b>Dist. from Uranus</b>	583, 500km
<b>Solar Day</b>	13.46 days
<b>Solar Year</b>	84.32 years

Oberon is the second largest of the moons of Uranus and, like the others, is an icy moon with a surface covered in impact craters. There are also faults and canyons splitting some areas of the ice caused by warm ice upwelling during a long period of tidal heating in the moon's distant past. The leading face of Oberon is a darker red than elsewhere and this is caused by the collection of a reddish dust spiralling in from outer parts of the Uranian system, probably from the many irregular satellites. Craters can reach up to 200 km in diameter (Hamlet, 206 km) and there are so many that Oberon is the most cratered moon in the Uranian system, which means its landscape is the oldest by far. The most prominent canyon on Oberon is Mommur Chasma, these canyons are giant cracks in the ice surface and some have obliterated the older cratered landscape. Oberon has one of the tallest mountains in the solar system, Mount Pelion, some 11 km from base to summit.

Oberon is a LOPS Lunar outpost. Its goal is to spy on ESDA's experimental activities around Uranus, however it does also incorporate a tracking station and a small scientific section.

# NEPTUNE

## Small Gas Giant

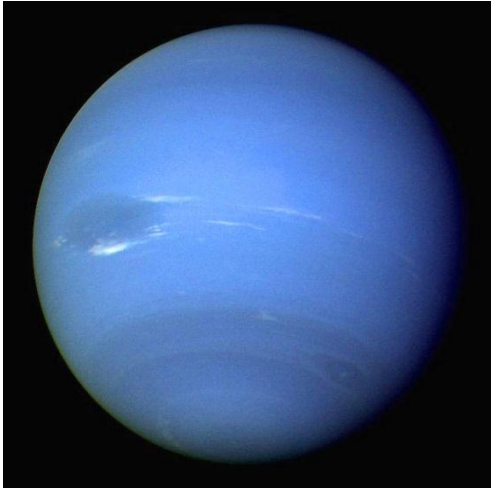

<b>Distance from Sun</b>	4,500 Mkm
<b>Orbital Year</b>	164.79 yrs
<b>Major Moons</b>	
Proteus	X000000-0
Triton	E210311-9
Nereid	E000200-5

Neptune is the most distant of the solar system's gas giants and its smallest, with a diameter of only 49,530 km. Like the other gas giants, Neptune's atmosphere is composed mainly of hydrogen with some elements of helium, but also significant levels of water, methane and ammonia.

It is the methane which gives Neptune its vivid blue colouration. There are dark clouds within the turbulent blue atmosphere, sped along by winds reaching up to 2,100 kph - the highest wind speeds in the solar system. So distant from the Sun is this gas giant that the cloud tops are a chilly -218°C. Neptune has a faint ring system like the other gas giants and a family of 13 moons, the largest of which by a large measure is Triton. Unusually, Triton orbits in the opposite direction to Neptune's spin (a phenomenon known as a retrograde orbit), suggesting that it is a captured dwarf planet. Neptune's innermost four moons, Naiad, Thalassa, Despina and Galatea orbit close enough to actually be within the rings of Neptune.

Neptune has not yet been the target of any colonisation efforts by the Luna Republic, the Earth Union or an independent body, but it stands ready as a new frontier or battleground depending on how the future of Luna-Earth relations are resolved.

# PROTEUS

**X000000-0**

**Ba**

**T**



<b>Spaceport</b>	No Spaceport
<b>Diameter</b>	420 km
<b>Gravity</b>	0.07 G
<b>Pressure</b>	-
<b>Composition</b>	-
<b>Temperature</b>	-220°C
<b>Population</b>	-
<b>Government</b>	-
<b>Law Level</b>	-
<b>Dist. from Neptune</b>	117, 600km
<b>Solar Day</b>	1.12 days
<b>Solar Year</b>	164.79 years

Proteus is Neptune's second largest moon, an irregular 420 km diameter ice chunk coated with a dark dust of complex organic compounds such as hydrocarbons and cyanides. Its surface is dark and heavily cratered, the largest of which (named Pharos) is more than 200 km in diameter. It has a depth of about 10–15 km and a central dome on its floor a few kilometres high. There are also a number of scarps, canyons on the moon.

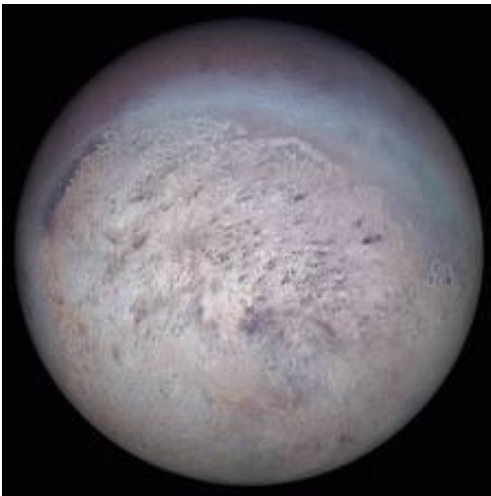

<b>Spaceport</b>	Frontier Spaceport
<b>Diameter</b>	1,350 km
<b>Gravity</b>	0.78 G
<b>Pressure</b>	Trace
<b>Composition</b>	Nitrogen
<b>Temperature</b>	-220°C
<b>Population</b>	60
<b>Government</b>	Balkanized
<b>Law Level</b>	None
<b>Dist. from Neptune</b>	354,800km
<b>Solar Day</b>	5.8 days (retrograde)
<b>Solar Year</b>	164.79 years

Triton is the largest moon of the planet Neptune and is still geologically active, with cryovolcanoes and geysers erupting nitrogen, enough to give the moon its own trace nitrogen atmosphere. It has a retrograde orbit, opposite to Neptune's rotation, which it has in common with some of Neptune's outer moons. Triton is probably a captured object from the distant Kuiper Belt (the source of most comets in the solar system), it also has a very eccentric (tilted) orbit compared to most of the other moons.

Around half of the moon's landscape is covered with frozen nitrogen, with water ice comprising one quarter and dry ice (frozen carbon dioxide) forming the remaining quarter. Triton's reddish colour is the result of the methane ices, which have been converted to a substance called tholins by the Sun's ultraviolet radiation.

Triton's icy surface is cut by valleys and ridges caused by ice tectonics and cryo-volcanism. This shows that solar heating, although weak at Triton's great distance from the Sun, plays a crucial role in the world's geology. A translucent layer of frozen nitrogen forms much of the surface, overlying a darker layer, which creates a kind of 'solid greenhouse effect'. Solar radiation passes through the surface ice and then slowly heats and vaporizes the nitrogen below until enough gas pressure accumulates for it to erupt through the crust. These geysers produce a trace atmosphere up to 8 km high; each geyser eruption lasts anything up to a year.

There are ice plains, such as Cipango Planum, on Triton's eastern hemisphere; these cover older features and are the result of icy lava washing over the existing landscape. Some of the plains are dotted with pits which are the vents from which this ice lava emerged. Leviathan Patera is one example. The lava is a mix of ammonia and water which fills in any impact craters as it spreads across the landscape. Extensive ridges and valleys form complex patterns which are the result of an age-old freeze-thaw cycle.





Centennial, the Luna corporation, recently established a scientific colony on Triton. There are 60 Luna scientists living in a purpose-built complex studying the geysers, cryovolcanoes, deep crevasses and the likely possibility of a subsurface ocean.

Rumours circulating within the International Astronomical Union suddenly sparked interest amongst Earth Union researchers. The rumours hinted that the team on Triton had discovered regularly-shaped heat sources beneath the ice. The scientific community is still buzzing with theories, some of which revolve around Cydonian aliens or other extra-terrestrials. It is highly likely, though, that the heat sources will be explained as natural phenomena, dashing the alien theories.

The stories have caused a storm and the ESDA planted its own 50-man team of scientists onto Triton earlier this year (2100). As surveying began, an incident occurred in which several Luna researchers were inadvertently killed by an ESDA team in a dispute over a 'hot-spot'. A second incident looked less like an accident and has led some to believe that military agents are part of the ESDA team and that there is more at stake than the discovery of a subsurface ocean.

To forestall a sudden military build-up of Lunar and Earth Union forces, the IAU immediately sent a small contingent of troops to police the situation. Eckard Tactical Management is a private security firm that acts as the IAU's own solar system police force. There are two 8-man squads of ETM on Triton living within their own secure habitat. Events could spiral out of control on this frozen moon, or, should the heat sources prove to be easily explainable, the scientists may be packing up for home within the year.



# NEREID E000200-5 Lo



<b>Spaceport</b>	Frontier Spaceport
<b>Diameter</b>	170 km
<b>Gravity</b>	0.016 G
<b>Pressure</b>	-
<b>Composition</b>	-
<b>Temperature</b>	-220°C
<b>Population</b>	230
<b>Government</b>	None
<b>Law Level</b>	None
<b>Dist. from Neptune</b>	5,513,800 km
<b>Solar Day</b>	11.5 hours
<b>Solar Year</b>	164.79 years

Nereid is the third-largest moon of Neptune. It has a highly eccentric orbit and may be either a captured asteroid or a Kuiper belt object (KBO, see later). This moon has a surface of water ice over a stony core.

Nereid is an agricultural testing station established by the now bankrupt corporation, Visiontech. A virus outbreak in 2099 brought the colony to a stand-still, Visiontech collapsed and Nereid was quarantined. In recent months, the colony has devolved and various bands of survivors wage war for consumables and territory within the honeycomb of tunnels and agri-farms. Rescue workers from the ESDA have been caught in these factional wars.

## KUIPER BELT

Beyond the orbit of Neptune is a vast population of small rocky and icy bodies slowly orbiting the Sun, most composed of frozen methane, ammonia and water. Estimates, and there can only be estimates, put the number at least 100,000 of these 'trans-Neptunians' objects. These are only the ones with diameters over 100 km! This band of objects begins at around 4,500 million km from the Sun and extends out to perhaps 7,500 million km, with scattered objects out as far as 22,500 million km. Trans-Neptunians are mostly confined within a thick band generally referred to as the Kuiper Belt.

It is likely that the Kuiper Belt Objects (KBOs) are extremely primitive remnants from the early creation phase of the solar system. The inner, denser parts of the 'accretion disk' of planetary material condensed into the major planets, probably within a few million to tens of millions of years. The outer parts, however, were less dense and the accretion of dust and particles into recognisable bodies progressed much more slowly and is still going on. The Kuiper belt is home to at least three dwarf planets: Pluto, Haumea, and Makemake. These are small planets that are unable to clear their orbit around the Sun of rocky debris, asteroids and other dwarf planets. Some of the solar system's moons, such as Neptune's Triton and Saturn's Phoebe, are also believed to have originated in the belt. There may be 200 or more of these dwarf planets out in the Kuiper Belt.

In 2028 it was proven that the Kuiper Belt was the source of short-period comets, which are those comets that orbit in the plane of the solar system and return every 200 years or less. A thousand times more distant than the Kuiper Belt may be the theoretical Oort Cloud which could surround the solar system completely, from which long-period comets begin their journey toward the Sun. Long-period comets may spend hundreds, thousands, even millions of years between one visit to the inner solar system and the next, and their orbits are highly irregular which points to some 'cloud' of icy debris completely surrounding the solar system. Out in the dark they are tumbling rocks coated in kilometre-thick frozen gases; as they dive toward the inner solar system the solar heat causes the gases to evaporate creating an aura and a tail of dust and gas blown away from the Sun by the solar wind. After many, many passes through the solar system, a KBO loses its layers of ice to expose its bare, rocky core.

## Comets

A comet is a small KBO, a 'dirty snowball' that orbits the Sun and that can create a coma (or atmosphere) and/or a tail. Both are generated by the effects of solar radiation heating up the comet's nucleus, which itself is a minor body composed of rock, dust, and ice. Comets' orbits are rarely fixed and unchangeable, their origins are in the Kuiper Belt or Oort Cloud and they have a propensity to be highly affected by close approaches to the larger planets. Some comets are pulled into sun grazing orbits that destroy them as they near the Sun, while others are thrown out of the solar system forever. Although asteroids within the inner solar system were created by a different process, ancient comets that have lost all their volatile materials and have their small, rocky cores exposed, will end up resembling asteroids.

Comets range from around 100 meters to more than 40 kilometres in diameter. They are composed of rock, dust and water ice as well as frozen gases such as carbon monoxide, carbon dioxide, methane and ammonia. They also contain a variety of organic compounds including methanol, hydrogen cyanide, formaldehyde, ethanol and ethane and even amino acids. Some of the building blocks of DNA, adenine, guanine and related organic molecules have also been found on a handful of comets. Landing on a comet is best done out beyond the orbit of the Asteroid Belt, any closer and sunlight will begin to evaporate the frozen gases in explosive jets, surrounding the comet with bowling-ball sized ice fragments and creating an unstable and chaotic surface with zero visibility and spontaneous gas jets that will rip a DSV from its moorings and throw it, damaged, into space.



## Objects of Interest

There are hundreds of thousands of KBOs within the Kuiper Belt, including many comets; but the objects of most interest are the dwarf planets.

**Comet Wild 2 (X000000-0)** – Wild 2 is a short-period comet with a diameter of 5 km. It originally had an orbital period of 43 years until, in 1974, it passed Jupiter which changed Wild's orbit. Now it orbits the Sun in only 6 years, diving in as far as Earth's orbit and returning out to a distance somewhere past Jupiter. Its rigid surface is covered with towering pinnacles, plunging craters, steep cliffs and, when in the inner system, dozens of jets violently spewing evaporating gases.



**134340 Pluto (X110000-0)** - Pluto is a dwarf planet 2,322 km in diameter in an eccentric and highly inclined orbit that takes it from 4.4 – 7.4 billion km from the Sun. At certain periods in its 264 Earth-year orbit, the dwarf planet comes closer to the Sun than Neptune. Pluto's surface is made up of nitrogen ice with traces of frozen methane and carbon monoxide, remarkably it has a trace atmosphere of nitrogen, methane, and carbon monoxide gases. The temperature on the frozen surface of Pluto is -230 C and at this remote distance, the Sun appears to be no more than the brightest star in the sky. There have as yet been no human landings on the surface of Pluto.

Pluto can be said to be a binary planet, since it is tidally locked to a smaller partner, Charon. Charon is a size 1 moon with a water ice landscape and some ammonia is present as well as cryogeysers. Charon has no atmosphere. Both these worlds revolve around a central point and they are tidally locked, always showing the same face to one another. Around these two worlds are four more tiny moons: Nix, Hydra, Hypnos and Hecate.

**136108 Haumea (X000000-0)** - Around 1200 km in diameter, Haumea is another distant dwarf planet that has two small moons, Hi'iaka and Namaka. The world has a surface of water ice. Like many Kuiper Belt Objects its orbit is eccentric and inclined, taking it 283 Earth-years to make one orbit around the Sun, with a closest approach of 5,500 million km.

**136472 Makemake (X000000-0)** – This dwarf planet is 1,430 km in diameter and like Haumea, has an eccentric orbit that brings it as close to the Sun as 5,700 million km. Makemake's surface is covered with methane, ethane, and nitrogen ice, but unlike Pluto it has no atmosphere.

**136199 Eris (X200000-0)** – At 2,360 km, Eris is the most massive of the solar system's dwarf planets, it is around the same size as Saturn's moon Dione, or Pluto. Its eccentric orbit takes Eris out as far as 10,200 million km from the Sun and as close in as 5,700 million km. Eris has a tiny ice moon, 600km across, called Dysnomia.

# 11 RUNNING ORBITAL

## WHAT DO WE DO?

**Orbital** is a science fiction setting for Traveller with a fairly realistic feel. In keeping with the near-future and hard-science fiction theme, role-playing campaigns focus on real people doing real jobs. While the Third Imperium setting admirably supports groups of ne’r do wells, shady free traders, mercenaries and fortune hunters, the more tightly restricted solar system of 2100 AD does not.

Any one of the following types of activities make the perfect premise for a game.

### 1 - Deep Space Haulage

The default **Orbital** campaign premise, player characters are the crew of a deep space vehicle (DSV) owned by an interplanetary transport company. They ship freight from Mercury to Pluto and all points in between. It’s a dangerous business, fraught with malfunctions, odd cargoes, political mine-fields, mysterious patrons and of course the perils of deep space.

Missions might include transporting a science expedition to a near earth asteroid, shipping a reactor core to a colony split by civil war, bringing food supplies to an asteroid that is quarantined, or lifting a new and expensive drilling rig (complete with its tetchy coterie of designers and technicians) out to Mimas for trials. Inspirations for this campaign type include the movie *Alien*, the TV show *Ice Road Truckers* and the work of outsize cargo logistics firms such as Ruslan International.

### 2 - Asteroid Mining

As any miner today will tell you, the work is not studded with drama, excitement and adventure; but the work of an asteroid miner is. It isn’t the actual mining that produces the drama since mining drones do most of the hard work, it is finding the ore, navigating deep space, surviving alone for months at a time and encountering problems, dangers and catastrophes far from help or assistance.

A group of player character miners can go anywhere they like and being in such remote locations means that they often encounter phenomenon never discovered before – and they have to deal

### Carbothermic reduction ? Do I Care?

*Star Trek* was well known for its use of technobabble, basically impressive and scientific sounding phrases that are ultimately nonsensical. **Orbital** uses a lot of technical language (‘jargon’) but it isn’t technobabble. While jargon may seem incomprehensible it does indeed make sense to anyone familiar with the terms involved and the jargon in this book is taken from design briefs and space agency papers setting out how a piece of hardware works or will work once someone gives them the funding for it!

It is included for three reasons. Firstly it adds setting flavour, secondly it illustrates that while this is science fiction, a lot of what appears is based on known technologies, and thirdly, it makes looking something up on the Net a whole lot easier should a referee want to expand on part of the setting. The techno-jargon might sound intimidating but it can easily be ignored and the Traveller rules function as normal. Does it matter that the ORVIN uses carbothermic reduction? No! The phrase indicates to the referee that the concepts behind the ORVIN are sound. In fact NASA trials of oxygen mining have already been carried out in Hawaii...



with it themselves. Of course there are profits to be made, but the real adventure is in the danger and the challenge of going it alone. Inspirations include the movie *Deep Impact*, *Armageddon* and the TV show *Black Gold*.

### 3- Salvage and Rescue

In the real world, the work of marine salvage teams can be a difficult one. Scaled up and out to the entire solar system, the difficulties are hugely magnified. These guys operate from a DKV, perhaps a Proton or a Starlifter, with specialized gear on board. It is their job to locate and rendezvous with wreckage, hulks, abandoned space vehicles, stations or satellites and retrieve them. Sometimes only a part of the target requires retrieval, perhaps a cargo or a computer processor. Remember, though, if the job were easy the owner would have salvaged the vehicle themselves.

The obstacles to salvage can be many. The target could be crashed on an icy moon in Jupiter's radiation field, it might be a DSV flooded with radiation from a reactor leak, or perhaps a research team trying to lift off from a comet that has gotten into difficulties. The salvage and rescue premise could easily be folded into that of deep space haulage, for a crew that can respond to emergencies with the right skills and the right equipment. Inspirations include a variety of TV coastguard shows (such as *SOS: Coastguard Rescue*), as well as the movie *Space Cowboys* and the premise of the movie *Event Horizon*.

### 4 – Exploration & Science

The work of science teams features in **Outpost Mars**, which forms a companion book to **Orbital**. Here a disparate band of scientists are sent on a series of expeditions across the solar system to investigate newly discovered, or long understood, phenomena. Operating far from civilization (and rescue) means that the team is truly independent and forced to overcome natural and technical obstacles alone. Of course where there are academics there are petty politics and not everyone's agenda will be exactly the same.

The nature of the mission itself may be quite innocuous ('examine streaky black ice deposits on Ganymede') and the resolution may be equally innocuous (discover that ground up carbonaceous asteroid dust sits inside the ice') but that isn't the point. The science investigation is just a setting for the story, the real adventure involves the obstacles, difficulties and technical problems the team will endure. Mix in a dash of secret agendas and the science expedition doesn't need to find dormant alien robots or diamonds the size of your head, to be exciting.

Inspiration for the dynamics and work of the science team (but definitely not the findings!) include the movies *Prometheus*, *The Sphere*, *Red Planet*, *Mission to Mars* and *2010*. More realistic inspiration is provided by a multitude of excellent National Geographic and BBC documentaries that follow a science team investigating a habitat, volcano or other feature. Examples include the BBC's *Lost Land of the Jaguar* and the TV show *Oceans*.

## RUNNING A CAMPAIGN

Should the referee and players decide to stick with the default campaign premise for **Orbital**, then the player characters will be spacers, the rough and tough crew of a deep space vehicle owned by a corporation that leases its spacecraft out to agencies, individuals and corporations. Like the crew of a salvage or heavy lift ship today, the PCs will find themselves engaged in diverse, challenging and dangerous jobs with every mission.

One month may involve dropping a cargo of habitat modules into the Martian atmosphere, a few months later it could be salvaging a robotic drilling rig in the asteroid belt that has come to the





end of its useful life. The emphasis is on 'being in space', working in space and dealing with all of the challenges that operating in the solar system throws at them. The referee can put all kinds of obstacles in the way of PCs, making the outcome of a mission always uncertain. It will be ingenuity, resourcefulness, skill and bravery that will see them right in the end – or alternatively, asphyxiated, frozen, irradiated, boiled, depressurized or out of a job! The death toll for civilian spacers, guys and girls just doing their job in the black between the planets, is alarmingly high; modern maritime work is no different. In the twelve months of 2011, for example, a mining platform as well as a dozen cargo ships had sunk and more than a hundred crewmen tragically killed.

In many, many role playing games characters are hard-headed heroes and often skilled fighters (or at least easily able to take care of themselves); they are action-driven doers, larger than life extra-ordinary heroes. However, in **Orbital** the characters are qualified space crewmen, technical experts and astronauts responsible for operating a multi-million credit interplanetary transport across the solar system. Now that doesn't sound exciting does it? For a real-life astronaut, the chance to travel through deep space would be a fantastic personal experience, but in all probability (unless something went wrong) it would make dull as dish-water gaming. Astronauts have such long and laborious technical tasks to carry out that from a gaming perspective they have little free time and no real independence.

In **Orbital**, there's a lot more latitude. Although they are assigned missions by their patron (the DSV owner), they are given plenty of freedom in carrying out that mission. The team are free to achieve their mission goals in the way they see fit, changing trajectories, stop-overs and swapping priorities. Most of the missions will be interesting, some will be challenging, and hopefully the GM can make them somewhat enigmatic as well. Occasionally they will be dangerous. Every one will involve some kind of complication. As an option, additional drama can come from the characters themselves, and their allegiances to their respective ally groups.

## Complications

A haulage or salvage job forms the backdrop for personal dramas. As such you don't really need to worry about alien warlords, lasers, bandits, mercenary wars or piracy - not every mission, anyway! Transport and salvage missions, like those in the real world, can seem quite mundane and prosaic. It is a good idea to give every mission a complication:

- A cargo that is dangerous, but the client hasn't said so.
- A piece of kit that needs to be relied upon, but that reliably fails.
- Red tape stops unloading, for a time sensitive cargo.
- On a remote world, several legitimate factors arrive to take possession of the cargo.
- The secret service want to use the DSV and crew to spy on another government.
- A rival DSV has been tasked to destroy a wreck due for salvage.
- The station taking delivery is mysteriously abandoned.
- A strange disease begins to spread through the crew.
- A delivered cargo is illegal and seized, along with the DSV.

## Secret Agendas

If the referee and players choose, the impersonal universe and its dangers and the daily missions assigned to the crew, are just a background to more personal dramas. The use of secret agendas is entirely optional. If used, each player selects an organization at the start of the game with which to ally his character.

As an example, a newly created character might select the Erebus corporation as his ally. It is assumed that characters are in touch with their ally, or usually act in the ally's best interests. On



some of the missions the character undertakes, Erebus will give him some extra task to accomplish. It may be nothing more than 'report to us - tell us what the mission achieved', it may be more, such as 'pass us blueprints of the cargo', right up to the ultimate 'your navigator works for a rival - discredit and replace her'. Tasks and objectives such as murder and assassination are not what **Orbital** is about - save it for some near-future cyberpunk game. This is a game of interpersonal politics on the fringe of human society and things are carried out much more subtly, with care and attention to detail. Just like life, everyone has their own secret agenda. We don't kill each other. Hey, even the pissed off Marines in the movie *Aliens* didn't shoot the double-crossing corporate executive Carter Burke, did they? Play it subtle.

### **The Benefit of Status**

How does allying with a group benefit the character? The player character's standing with the ally group is given a rating called Status. Player characters are forced to work secretly to achieve ally group aims and gain Status in secret. This forms a whole new fund of benefits and resources that a player can tap. Status is fluid and unofficial. Essentially, the character will receive minor (or not so minor) tasks to complete during his routine missions. By successfully carrying out a task he gets a +1 bonus to his Status. Often it is best to keep one's ally faction secret - just in case a rival group is represented by a team-mate. Status begins at 4. A failed secret mission will garner no status increase, and a botched secret ally mission will probably result in a status penalty.

Having a high status gets the character access to useful contacts quickly, to borrowed equipment, to materials, to information, to resources, to secret slush funds (perhaps up to Cr1,000 per point of current Status) and to 'clout' higher up in the group if needed. All these things make life easier and often turn a difficult secret mission into a much less difficult one! When the player decides his character needs one of the 'perks' just listed, the referee calls for a roll of 2d6. The player must roll equal to or less than his current Status score to gain the perk. However, sometimes certain perks will just not be available at all. Each time a roll is made (successful or not) the Status score is lowered by 1 pt. until the end of the mission. Further rolls continue to lower the score. The benefits of Status are very tightly constricted to that organization's aims and activities. Be warned that the acquisition of Status can foster a very competitive style of play.

### **Joining Forces With Another Character**

By now it should be pretty obvious where this kind of game is headed. The situation puts all of the player characters together and forces them to co-operate to succeed in their DSV mission as well as give them competing secret agendas to pursue in light of ally groups. Total co-operation with another player-character is not an ideal situation from the referee's perspective, if two player characters find they share the same ally group or agenda, then the referee has lost a point of friction (and therefore interest). Or has he? It might not be the end of the world if both players find out that their characters are both allied with the Cydonians. Yes, they may begin to work together, but this trust can readily be exploited by a diligent referee. Chances are they know different Cydonian contacts, and will be issued with slightly different orders. In fact, the chances are that each contact will represent a separate (and perhaps rival) faction within the Cydonian movement. Imagine the player's surprise when his character is ordered to erase all of his Cydonian comrade's files ... Remember, conflict = story...



## Example Mission: 'RIG L6650'

### The Situation

There are four crewmembers of the DSV Vanishing Point: Carina Zhao, pilot and captain; Richter, the co-pilot and navigator; Neven, the engineer; and Lin, the medic.

Although they work as a team, they are secretly divided. Carina is allied to the Earth Union military and feeds information to them, perhaps her father was an officer. Richter is a spy for the corporation that owns and operates the Vanishing Point, he earns extra privileges and a wage bonus for reporting on any infractions or embezzlement by his crewmates. Neven is receiving payments from a rival corporation that often competes with the DSV's owners for contracts. He may let the corporation in on secrets, and try to keep the crew of the Vanishing Point off his patron's back if there is ever a conflict of interest during a mission. Lin is a Luna agent (connected through an ex-partner) and she keeps this secret, but she may try to skew the mission outcomes in favour of the Lunar Republic if given half a chance. None of the respective players know each others allegiances, and the game would be ruined if this information were to be shared. These secret agendas often lay dormant until an opportunity arises, and in some games the characters will act normally, with no opportunity or reason to engage in espionage, deceit or theft.

The crew of the Vanishing Point are sent out to an asteroid deep within the Asteroid Belt. The team's mission is to decommission an old robotic mining rig that had been placed there by the Lunar Republic a decade ago. Today it is out-of-date and broken down and requires stripping down at L5 and recycling. The DSV will rendezvous with the asteroid and the team will EVA to cut the four legs that have drilled themselves into the rock. The three-part hull needs to be separated and the machinery loaded on board, along with the large solar panels. Disassembled, the entire rig should just about fit within the Vanishing Point's hold.

### Complications (or, What Can Go Wrong, Will Go Wrong)

What are the spanners we can throw into the works? Firstly, cutting the legs does not go smoothly. The fourth leg remains impervious, which means the rig cannot be hauled up (using a grappling arm) next to the DSV's hold where it can be stripped and loaded on-board. Instead a number of lengthy EVAs down to the asteroid surface are going to have to be made. Can the team provide a method of severing Leg #4 that is more effective than the plasma cutters they have up till now been using? Secondly, this old Luna rig may hold some cold war secrets. Perhaps it was used for surreptitious surveillance of Earth Union movements in the Belt (in the same way some Russian trawlers were kitted out as spy ships). Some way into the disassembly, perhaps at a moment of crisis, such as an EVA accident, the rig's hidden sensor array will activate, jamming all sensors and comms in the area. This should create fear, make life difficult and perhaps prove dangerous.

### Agendas

Each player is given the general mission briefing from their employer as well as a highly secret personal briefing from their Ally Group. These are the briefings provided to Carina, Richter, Neven and Lin:

- **Carina** – The military suspect that Rig L6650 may have been used by Luna for illegal surveillance. Find material evidence. 'Bring it back.'
- **Richter** – No special orders for this mission. 'Do your job.'
- **Neven** – As usual, watch out for anything which looks like it might not be in the company's interest. 'Report back and earn a bonus!'
- **Lin** – Lin is informed that the rig contains illegal sensor gear and exactly where it is. She is given a passcode which can be input at a maintenance hatch to create a localized self destruct sequence, this will turn the sensor equipment to scrap with a built-in thermite charge. 'Do not let anyone see you do this!'

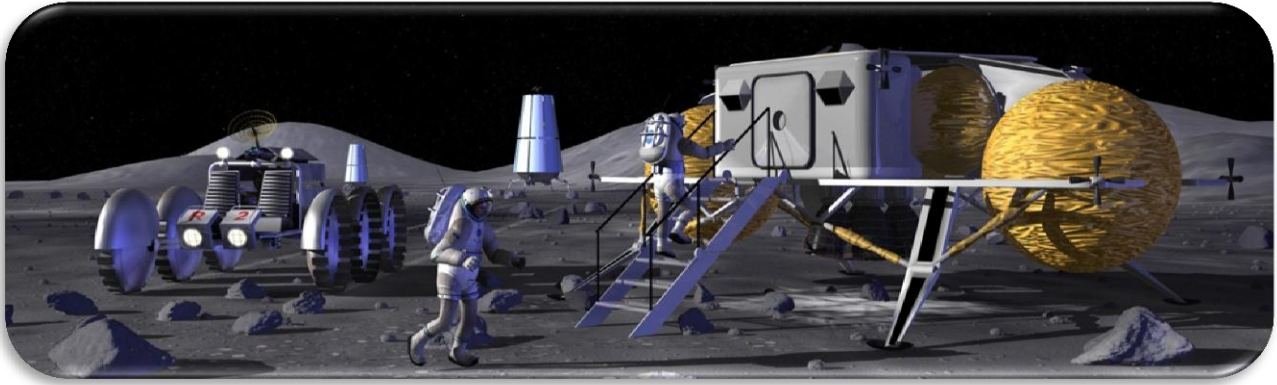

## The Resolution

We will describe the basic flow of this sample mission as an example of how a typical agenda-driven game should run. The team arrives in the Vanishing Point and descends in suits to cut the legs. Lin is left on the DSV, much to her annoyance, yet she doesn't want to seem pushy. The problem with Leg #4 is encountered and the team take a rest to discuss this. Lin offers to bring charges down and she brings an additional charge and detonator with her. Lin, Richter and Neven set the charges while Carina Zhao scouts around 'for anything that might be damaged by the explosives'. She is looking for Luna sensor technology, but does not find it. The team decide the solar panels might be damaged by zero-G shrapnel and disassemble them before blowing the leg.

As the charge goes off the Luna sensor jammer turns on with an ear-splitting howl in their suit phones. Everyone starts exploring in silence, Lin heads for the access hatch and begins the code input. Richter sees her and tries to challenge her. They touch helmets to communicate directly and she claims she is 'trying to get in'. He helps and she sets the code that blows up the sensors, quickly restoring comms. When Carina finds she may have just missed the chance to locate a trove of high-tech Lunar electronics she is furious, but can't show her frustration, because Lin 'did good'. After pulling the rig up to the DSV, they begin the disassembly. During the work Carina fails a task roll and collides with hull plating, knocking herself unconscious and floating free, to be rescued by Neven. Later, on-board, Carina sifts through the wreckage and finds surviving evidence of an illegal sensor array. Richter sees her take this and reports back to his superiors that she is a thief.

Does Lin find out about this surviving piece of the array? Of course she does! What will she do about it? Neven is told by the computer that part of the rig had been melted by a thermite charge. Will he go to investigate? Will he find his own evidence? What if an Earth Union vehicle, in orbit nearby, manoeuvres across to board the DSV and conduct a 'routine search' (in other words, try to find parts of the array...). Even more disturbing, what would happen should a Luna cargo craft nearby appeal for help before the Vanishing Point launches for the inner worlds? Is it a ruse to get some Luna secret service personnel on-board to ensure the array is destroyed? What lengths will they go to make sure nothing gets back to L5 intact? Would they sabotage the drives of the Vanishing Point? Or will Lin make contact, revealing her sympathies to the Luna cargo crewmen?

Get the idea? No fights, no shots exchanged. No physical conflict, but a definite lack of trust and no-one is ever quite sure of the others' motives. The referee can't ban any physical conflict, but it should be an unwritten rule: ***the player characters never try to harm one another***. Secret agendas are best dealt with using a few hand-written notes, quickly passed, rather than private chats. Any group using this secret agenda mechanic should understand that occasional notes will be passed between the referee and the players and that none of the character's lives are at risk from these notes.

# NON-PLAYER CHARACTERS

## Mars NPCS

**Hatta Goldbeck (Researcher):** Hatta is a renowned geologist from the University of Adrienne. His field is sedimentary structures, though his recent work has led him to look for 'quarries' that supplied stone for the great ruins at Cydonia. He is still looking. Hatta is a slight man in his 50's, with a polite yet serious demeanour. Recently two attempts on his life have him extremely scared, he has abandoned his work in the Cydonia area and returned to analysing stream bed deposits. Hatta may need help if he finds that the assassins are not going to give up. Why do they want him dead? Are they warning him off? Who do they represent, and why?

**Andrea Milanezi (Administrator):** Andrea is a cool 34 year-old junior minister of finance in the Reunion government, and she is a rising star. Pretty, confident, some would say arrogant; she will go far. However, she has experienced a number of burglaries recently. They may be the crimes of an old lover trying to retrieve an item of great sentimental value, a journalist after sensitive information, or a rival party trying to recover documents stolen by Milanezi. It is telling that the young woman has not told the security forces. Why?

**Lonzo Remick (Underworld Leader):** Mars is a world of hard-working individuals and grafters, but there is a small underworld community of smugglers, counterfeiters, extortionists and thugs. Mostly they come from the world of the disenchanting mining community. Remick is one of these. He runs a prostitution ring in Shaeffer and he supplies legal recreational drugs to workers. He has contacts at Phobos Station and at Reunion spaceport and is well connected. He is also brutal. There are four unsolved murders at Shaeffer that Remick is responsible for, although these days he hires guys to do that kind of work for him. Remick is an ugly, shaven-headed man in his forties who masquerades as a mining personnel agent. Remick is thinking big and wants to expand his operations, but he needs off-world contacts, new routes of supply and a reliable importer. Do the PCs have a role in Remick's plans?

**Robert Stone (Soldier):** Stone is a member of the Mars Regiment, a paramilitary brigade of professionals, supplemented by part-timers and national servicemen. He has seen action against members of the Red Faction in the last five years, and knows a good deal about the insurgency. Yet the conflict is rarely mentioned in the newscasts, when Stone visits the cities he feels he and his men are fighting for people who don't care about the war. Stone is a tall, dark-haired man, thoughtful and clever. Stone is at a crisis point in his life. He has met Reds, sat in on interrogations and heard their views and he was once witness to a brutal murder of two Red suspects that the army covered up. As he sees the impact of development on Mars, he has begun to question the war. Can we win? *Should* we win? Should humans even be here? Stone is ripe for Red Faction brain-washing, but perhaps the way the war is being waged has already done that job for them ...

**Alexander Kozak (Space Force Officer):** Yes, Mars has its own space force (although it concerns itself mainly with orbital security, safety checks and customs searches). Lieutenant Kozak is a confident technical expert, a computer and tactical officer on one of the space force's smaller vehicles. He could be encountered on Phobos or at Reunion, or anywhere on Mars, since he is an avid climber and caver. Recently Kozak's vehicle, the Oppenheimer, seized a cargo of stolen hormone triggers from an incoming transport, biogenic body modifiers untested and unlicensed and no doubt destined for Shaeffer. Kozak took a cut of the stuff and has them at his apartment in Reunion. His morality has crumbled ... but what now? His girlfriend Maria has found out what he's done, and left him. Does he sell them? Ditch them? Hand himself in? What a fool ....





## Luna NPCS

**Eddy Zhao** - Eddy is a senior administrator at Port Selene, Luna's main spaceport located at Cold Mountain. He is a busy man, with his finger on the pulse of the port and connections with people all across the facility. In recent years, Eddy has been working with a mysterious financier to supply arms to the Reds on Mars. He cooks the books to ensure his tracks are covered and the identity of his financial backer is kept secret. Zhao is a slim man, calm and serene, but he is greedy and will do almost anything to feather his nest.

**Li Johnson** - Li is a spy for the Earth Union, currently working as a Republic Space Force officer at Port Selene. Although of fairly low rank, Li is part of the security detail and tasked with searching vehicles just landed. She is a diligent and model employee. Her position allows her to pick up packages or communications hidden aboard a recently arrived vehicle. Likewise, she is able to smuggle things out. Li is small and wiry, her hair is cut into a bob.

**Ling Westcott** - Ling is a veteran miner who has worked on oxygen mines, helium-3 mines, iron and aluminium mines. These days he acts as a recruiting agent for the mining industry, finding suitable miners and hiring them out as a team. He is a member of the exclusive Copernicus Brotherhood, and his teams can also work on difficult jobs or mine rescue missions. Ling is a tough cookie who drives his mining teams hard, but retains a professional edge. He always meets his deadlines. He has a shaven head with elaborate tattoos all across the back of it.

**Torregrosa Jones** - Jones is a young spacer who has recently been fired from the Centennial corporation. She is an astrogator and mechanical engineer who has a long term problem with drugs that has got her into trouble. She is looking to hire onto a crew again and get away from Luna. She is streetwise and, though young, she always seems to stumble onto street deals, fixers, other hustlers and corrupt security officers. Back on Luna Jones feels like a fish out of water, security is tight and there is only a watered-down underworld. The real 'action' is elsewhere in the solar system.

**Belanyek** - Belanyek is a skilled civil engineer who has worked on several high profile building projects on Luna. He has recently been hired to plan a new settlement project based around an aluminium mine. He will need to carry out surveys, gather teams and equipment, as project manager he will be given total control ... only there are things he isn't being told. There are mine workings and shafts that must not be touched, the project seems to be a science base, but there seems to be some military advisors with oversight. What is going on?

**Dr Tsang Bo-Lin** - One of Luna's top astrophysicists, and a senior lecturer at the University of Tranquillity, Bo-Lin has a reputation amongst Earth academia too. The scientist is often rocketing around the solar system on a Luna research vehicle and a government grant. He has gathered an eclectic mix of crewmen around him, rogues, misfits and free thinkers, but experts in their field every one. There are rumours that the Luna military are pulling his strings and that he is on the trail of Cydonian remains. Some think that his media profile could really expand, dangerously so and that the government want him kept at arms length - in orbit around some distant moon!

## Earth NPCS

**Prince Nicholas II of Monaco** - Prince Nicholas is the head of state of the principality of Monaco, a rich and independent financial city and banking centre in the south of France. Monaco's vast financial service industry is, in 2100, split between the European city-state and the wholly-owned SGS-90 Grimaldi Station. Nicholas is one of the wealthiest men on Earth, although he spends much of his time at L4 Vanderveen and travelling the solar system on business in his



executive transport, the 'Salvatica del Carretto'. With little actual work to do, Nicholas ('His Serene Highness', if the situation calls for it ...) is one of the solar system's playboys, an adventurer and self-financed traveller, sponsoring exotic expeditions and investigations. As always he takes a direct role in the expeditions he is funding, and there is sometimes a camera crew around making a documentary about the mission. Nicholas is a dedicated man who has a university degree in astrophysics and qualifications in handling space suits, rovers and scientific equipment. He is bullish, stubborn and hyper-critical of those he employs.

**General Wade Cronenberg (Senior Army Officer):** Cronenberg is angry with the recent thawing of relations between Luna and the Earth Union. He led the invasion forces onto Titan in 2095 and was rewarded for his clearly defined vision and clean execution with a top job in the Department for Defence Co-ordination (DDC), Now he fears that the efforts were for nothing and that Titan, with Lunar backing, will rule the Saturnian system. Cronenberg has established his own line of communications amongst loyal officers within the Earth Space Force ready to act on his instructions. This informal secret organisation is known to its members as 'Channel X'. Cronenberg's agents are all within the military, many are stationed in Jupiter and Saturnian space, all are ready to carry out acts of espionage and perhaps even sabotage to ensure the sacrifices made by Earth soldiers on Titan were not in vain.

**Evelyn Frost (Asteroid Heiress):** Privately owned asteroids are not uncommon as it is legal to lay stake to any rock smaller than 5 km in diameter so long as a physical or remote presence is maintained. Most consist of nothing more than several habs supported by an ORVIN. This makes 'Gosciny Castle' something of an anomaly in the belt. Located on the near Earth asteroid 4179 Toutatis, the Castle is probably the most elaborate single family dwelling ever built outside of the Earth-Luna system. It is owned by actress and outspoken supporter of the Cascadian Alliance, Evelyn Frost. Frost was formerly Evelyn Gosciny, her recent messy divorce from French billionaire, Jean-Paul Gosciny, made headlines throughout the system. The trial that followed was a media circus, but Evelyn was able to keep the deed to Toutatis and thus Gosciny Castle. Though taking time off from acting and personal appearances she still does a weekly four hour live broadcast that consists mainly of celebrity interviews and ends with a half hour long investigative segment that often has a pro-Cascadian Alliance message. Recently her extremely popular weekly show went off air just a few minutes in, and the show's guests were unable to dock at the Castle.

**Carmen Xuesen (Hustler):** Lifted from the ghettos of the Pearl River megacity, Carmen lives by the rules which saw her survive and thrive in the dog-eat-dog street culture in which she grew up. With her striking good looks and body tattoos, Carmen cuts her distinctive way through interplanetary society as a courier for a criminal syndicate. On the streets she used to hustle unlicensed drugs as well as biologicals and hormonal triggers. Twists of fate brought her to the attention of the Tijuana Brothers during a job that took her to Florida. Today Carmen can be accompanying legal or illegal cargoes, verifying goods the Tijuana Brothers want to deal in, carrying money, samples or threats to friends and foes of the criminal bosses from Mercury to Pluto.

**Ramon Mantega (Belt Miner):** Once an Earth Union soldier, Staff Sergeant Mantega was given a medical discharge after losing both legs to an anti-personnel mine. His Brazilian regiment had been conducting peace-keeping operations in northern Kashmir. Later, with some buddies and his pension, Ramon set out for the asteroids, a place his lack of legs seemed irrelevant. Together, with Ramon leading, these veteran soldiers have established a reasonably profitable enterprise. Nicknamed 'Mantega's Miners' they have a good reputation and other miners like to do business with them. Recently trouble has developed; Luna loyalists have been sabotaging claims and automated equipment... it's only a matter of time before an Earth miner gets killed. The military that share the base on Ida with Southern Cross Mining don't seem interested. People want to

know of Mantega's Miners will help them, will they dust off that military training and put a stop to Luna-inspired harassment?

***Indah & Rahman (Migrants):*** This young couple from Jakarta in Indonesia have been looking for a new life for four years. Their respective families are desperately poor and have placed all of their hopes onto the shoulders of their children. At first they got jobs on the big krill ships going south into the Southern Ocean, later they worked illegally in Australia at the Olympic Dam mines. Finally, after huge payments to the Snakeheads, they seemed to have struck it lucky and gotten a ticket to the asteroids. Miners were reputed to be sending home tens of thousands of credits back every year. Sadly, the Snakeheads delivered only misery; they arrived on asteroid 1888 Zu Chong-Zhi to be met by a gang master and twenty other unfortunates. They are currently working on Zu Chong-Zhi as slaves, paying for their air, water and food by meeting their quotas. Every possible corner is cut and the asteroid is pretty rich in minerals, but the Snakeheads take all the profit. None of the migrants get to leave, and all want to. Rahman is gentle and fears more for his beautiful Indra. Three migrants died of the bends last month during an airlock malfunction – who will be next? Rahman plans to lead a mutiny when a supply vehicle arrives to take off the ore, to hijack the vehicle at return to Earth. He knows the crew will probably be oblivious to the plight of the miners on 1888, but it is a desperate measure that he has to take.

***Vernon Stanwick (Club Owner):*** Ida is the centre of the Earth-based mining community within the Asteroid Belt, the base there is dominated by the operations of Southern Cross Mining, but an important military outpost, the Nigel Leakey Earth Space Force defence base, also exists there. Vernon owns and runs a club on Ida, it is a bar and Net hangout during the day and a restaurant and nightclub in the evening. 'The Square Club' is popular with everyone on the tumbling rock, which makes Verne a man with some important friends and favours to call in. A thick-necked bruiser from London, Verne looks like the archetypal gangster, with gold chain and tattooed knuckles. Looks can deceive, though, he has a long history in the music industry and although he has acted as a fixer and middleman for several illegal deals, he is a man of integrity and a man to be trusted. Verne's a good man to have as a friend, if he can't help you then he certainly knows someone who can.

***Marshal David Reinjang (SARA detective):*** Of mixed American-Thai heritage, Reinjang is an investigator working for the Earth Union's SARA interplanetary police force. He specialises in people-smuggling, but his work on the space lanes has brought him into conflict not just with Snakeheads but also the Tijuana Brothers, Brazil's Primeiro Comando and the Triads. He is cool and tight-lipped, a middle-aged man who is careworn and cynical. Out in the depths of the solar system Reinjang and his team feel they are fighting against a growing tide of crime that reaches further out each year. Find Reinjang on Ida, at the Vanderveen colony or on Janus & Epimetheus.

## ALIENS

Where are the aliens? Ruins were found on Mars back in the 2020s that were immediately attributed to some sort of extra-terrestrial civilisation. Where are they? What were they like? Was life ever found on Europa or Mars?

This section has purposefully been left till the end of the book because it provides an opportunity for the referee to go to town with any theory he fancies or to even import aliens from other games, movies or novels. The discovery of life and what happens next is a staple of science fiction that goes way back and the 'emerging space-faring society' of 2100 is exactly the kind of civilisation that will soon be faced with such dilemmas. What will explorers find? What *have* they found within those Cydonian pyramids? Giger's Alien? A dozen of the Third Imperium's Ancients?

This section will also layout what might have been found on Mars and elsewhere and provide a set of aliens the referee can use as a setting tool.

## We Found Life!

Life has been found on Mars, on the cloud-tops of Venus and within the subsurface ocean of Europa, see the relevant listings within the Worlds chapter for more information. In all three cases the type of life took scientists by surprise; it wasn't microbial, it was big. Explorers could see the organisms with the naked eye and some of the sea creatures on Europa are as big as terrestrial fish. These discoveries altered mankind's world-view, there was no doubt of that, but as the shock wore off these new ecologies became something new to study and quickly became as familiar as any of the more exotic Earth-side micro-ecologies. What happens next varies from world to world; on Venus the organisms are simply studied, on Mars it appears some of the organisms are flourishing with the warmer, wetter conditions, while other species are declining. On Europa the colonists are able to catch and even eat the local organisms, although the first colonist to take a bite certainly took a chance!



## SETI – Intelligent Life

The Search for Extra-terrestrial Intelligence (SETI) is a co-operative group of scientists, activities and projects that has been looking for evidence of intelligent extra-terrestrial life amongst the stars. Some of the most well known projects have been run by Harvard University, the University of California, Berkeley and the SETI Institute. Methods include monitoring electromagnetic radiation for signs of transmissions from civilizations on other worlds. The first SETI conference took place at Green Bank, West Virginia in November 1961 and Carl Sagan was one of the ten attendees. While we have only just pressed our ears to the interstellar glass, within the next century surely we will have heard what there is to hear on the other side of the wall. Here then, are eight SETI intercepts, all confirmed as of January 2100, discovered either through listening for radio broadcasts or the direct observation of atmospheric pollution which indicated industrial level technology. Yet... a referee can pick and choose, perhaps deciding, for example, that only the WOW Civilisation has yet been discovered and that this discovery is going to have repercussions in a future scenario.



***Cydonians (verified 2023)*** – This civilisation left ruins on Mars and possibly elsewhere in the solar system (some scientists also suspect Mimas and Iapetus). Their place of origin is as of yet, unknown. See the section entitled The Real Cydonians (later).

***The Musicians (verified by radio telescope: 2043)*** - The Musicians are so named because of the content of their broadcast. The radio signal received from them consists solely of music in what can only be described as a concerto. Numerous separate instruments have been identified along with what appear to be three distinct organic singing voices. The 'Soul of the Stars', as the music is called, has been used and abused by media and advertising. Scientists, cryptologists and linguists are all still trying to find hidden meaning within its notes. Oddly, its star of origin is a dim red dwarf just eighteen light years from Sol past 61 Cygni, with no evidence of a habitable planet. It appears the signal did not begin broadcasting until quite recently and, unfortunately, the signal strength has been gradually decreasing over the last five years. Researchers believe that it will be lost to background radiation before the end of the next decade.

***WOW Civilization (unverified signal: 1977, verified by radio telescope: 2064)*** - Despite a brief portion of its signal having been noticed in 1977, the WOW Civilization is typically listed as the third alien society to be discovered by human kind. The second WOW signal was discovered by Luna's massive Möbius-A Farside Observatory and shortly thereafter caused major power and control failures within the observatory and associated systems. Lunar officials were able to take the Observatory offline and isolate the intrusive programming inserted by WOW. Further observation found that the WOW signal originated from a gas giant orbiting the G class star Omega Sagittarii, some 78 light years from Sol. Due to the gas giant's slow orbit around its parent star, the WOW signal is only detectable for a few days out of every eighty-six and a half years. The WOW virus downloaded by Luna, code-named Poison Arrow, is kept isolated in a secure data fortress at the observatory. Unverified rumours exist that a portion of the virus was also downloaded by the Big Ear radio-telescope in 1977 but that it was unable to harm any local networks due to the primitive state of human computer technology at the time. Further reports claim that several of the creepy super computer viruses of the early 21st century, notably Stuxnet and Agent.btz, had WOW programming as part of their coding.

***Alien Species Four (verified by optical observation: 2072, possible radio signals detected: 2081)*** - Not much is known about Alien Species Four other than their being an industrial level society. Their planet orbits a main sequence K type star and has oceans over 70% of its surface. This star, Gliese 667 is located about 22.1 light years from Earth. There is some evidence that these aliens have both radio and space launch technology.

***The Lost People (verified by radio telescope: 2065, and optical viewing: 2070)*** - This alien broadcast consists of a huge data dump of encyclopaedic knowledge about the aliens, although only fragments can be understood. It continued for several years interrupted periodically by orbital rotation of the origin. In 2069 it stopped suddenly during mid broadcast. Scientists used the newly constructed Mimir Space Observatory to get an optical view of the planet a year later. Sadly, it soon became apparent that the planet had undergone a massive nuclear war or possible asteroid strike and was now entering a severe nuclear winter. This planet orbits a K type star about 42 LY away called HD40307.

***Alien Species Six (verified by optical observation: 2079, faint radio waves detected: 2083)*** - Detected by the Comprehensive Near Systems Life Search made by SETI from 2077 to 2090; Alien Species Six seems on the way towards extinction as well. Its atmosphere is heavily polluted and there is evidence of the possible use of nuclear weapons. Furthermore there are numerous odd sources of neutrino and hawking radiation within the star system as well as several





neighbouring systems. Species Six is located about 36 light years from Sol within the system of Gamma Serpentis, a bright F-class sub-dwarf.

***The Big Pulse (verified by radio telescope: 2084)*** - The signal known as the Big Pulse is the most distant alien signal yet detected by humanity. Originating over 1,200 light years from Earth, the Big Pulse was briefly thought to be a natural pulsar but recent observations have shown this to be incorrect. Current theory holds that the Big Pulse may be something of a light house or navigation beacon for its creator species.

***Alien Species Eight (verified by optical observation: 2090)*** - Known popularly as the Cygnians, the civilisation native to 61 Cygni B-II is the most recently discovered alien species. It is also the closest alien species at only 11.4 light years from Sol. Atmospheric content suggests that there is very little industrial development on the planet but there is notable volcanic activity.

## **The Future**

The summary of the eight species listed here does not include the many other exo-planets suspected of harbouring life that have oxygen rich atmospheres. Currently that list has reached thirty-eight worlds, including one circling Alpha Centauri A, one of Sol's closest neighbours. Given the ubiquitous nature of life in the known portions of the Galaxy, and in the solar system in general, many philosophies and religions have had to adapt. While the presence of these alien races and the ruins on Mars does not much affect the daily lives of most humans, it has led to changes in how mankind perceives both itself and the universe as a whole. The idea that humans are in no way special has proven disheartening for many, especially the devout, but equally important has been the abrupt end to our eternal loneliness. The idea that one day humans will stand face to face with another intelligent creature and perhaps sit down to debate the great questions of the universe has had a very telling effect on our identity and sense of belonging.

SETI and its associates were forced to abandon their planned twenty year Comprehensive Near Systems Life Search due to the Titan Crisis and due to extensive damage done to the Mimir array caused by a terrorist attack. The current detente has proven to be a boon and the repairs and upgrades to Mimir are nearing completion. Additionally, Luna has finally reopened several of its radio telescope arrays for SETI use and will commence the Deep Space Extra-terrestrial Intelligence Search in early 2102. SETI on the other hand, will begin to refocus on those civilisations that are already known and located. A movement of scientists and thinkers on Earth known as the Voyagers are putting pressure on the government and on government agencies to consider funding an interstellar mission using nuclear pulse drives. Their concept project is called Daedalus.

## **The Real Cydonians**

The creators of the Cydonian pyramid city as well as the enigmatic Face, have been the subject of intense speculation since the first Cydonian expedition in 2023. The pyramids are heavily eroded stone structures with signs of metallic rooms and chambers, also heavily corroded and collapsed. Almost no machinery has been recovered beyond worthless unintelligible lumps of corroded alloy. There have been findings of abstract sculpture and some stone carved hieroglyphs, and at least three mangled and chemically weathered alien bodies. These are the Cydonians. That they did not originate on Mars is almost definite. Why they constructed the Face is unknown. Their level of technology was superior to Earth's and they were certainly capable of spaceflight. There are unusual structures located on Iapetus and Mimas within the Saturnian system, discovered via ground-penetrating radar, they may be natural but there is a growing body of scientific evidence which suggests otherwise. Many suspect a Cydonian connection.



### **Hard Facts for the Referee Only**

The Cydonians came to Earth from a planet circling the K-type star HD40307, about 42 LY away. They were the aliens known to the SETI programme as 'The Lost People' though no-one has, or can, make that connection. They were oxygen breathers with a much higher tolerance for CO<sub>2</sub>. Coming from a lower gravity world (size 6) they were a little weaker than humans although more dexterous.

Why are they here? The Cydonians arrived via Traveller-style jump drive around 1 million years ago to use the solar system as a large scale laboratory for the testing of mega-power devices which were parts of a planetary-scale engineering project. Our solar system was remote from their trade routes, or perhaps away from the eyes of other states or even factions within their own interstellar government. However you may judge these interstellar scientists, they must have lived by some moral code; they scouted out Earth but spotted there the beginnings of intelligent life and left our ancestors in peace. Mars was to become the home of their colony, even though it was almost as barren and inhospitable as it is in 2013.

#### **The Planetary Transporter**

If you like your tech even more radical then the Mimas array may actually have been constructed within the Saturnian system so that it could attempt to send Iapetus through space. The equatorial accelerator had to be fired up to generate a warp field around the moon itself, then the Death Star-like Mimas 'transmitted' Iapetus out to some interstellar location ... and back again, hundreds of times.

Without a biosphere to wreck, the Cydonians tested their machines in the deserts as well as out in the distant parts of the solar system. Here, under the rings of Saturn they got to work on a radical new faster-than-light drive. The unusual equatorial bulge around Iapetus is actually the surviving part of a vast particle accelerator that was able to briefly create a wormhole. Antimatter powerplants, field generators, accelerator chambers and service halls all lay beneath the pocked marked surface of the moon. Much of the cratering and weathering is artificial, clearly the Cydonians were trying to hide their creation from someone. The wormhole experiments persisted for several hundred years without conclusive results. Crater Herschel, on Mimas was similarly camouflaged, but was actually a vast experimental faster-than-light communications array that spent two centuries sending back encrypted data to HD40307.

The Ruined City and the Pyramids on Mars were the aliens' primary outpost. They avoided Earth mainly due to the fact that its gravity is about 35% higher than they were used to, but the evolution of human life also played a part. The Cydonians did not want to disrupt human evolution but they did study us. In fact there is a large unmanned Cydonian spacecraft buried under the sediment on the ocean floor a mere 165 km south east of the remains of the HMS Titanic. This long buried alien spacecraft holds several hundred reconnaissance and research drones, all still active, awaiting orders. The Face was built after the City and the Pyramids, its purpose was to eventually lure humans to Mars in order for us to find 'the Cache' (see later).

### **Cydonians in the Flesh**

The Cydonians were actually of three distinct types; the Makers, the Hands and the Servants. The Makers were extremely long lived, very intelligent and rather aloof. They certainly weren't amoral, immortal or bad, at least not in conventional human terms. Only a few in number, these aliens were very risk averse; nine Makers travelled to the solar system, three mated trios. Two died in a the distasterous accident involving the Iapetus wormhole and one killed itself as a result of those deaths. Another three attempted to return home using a starship constructed from parts stripped from the ship that propelled them to Sol in the first place. The final three are entombed deep within Mimas, whether they are merely asleep and whether or not they can be reawakened must be discovered by the players.



The most common 'aliens' are the ever-present Hands of the Makers, high-tech robots constructed by the original aliens. Standing at around TL14 (less in weapons, more in power sources but no anti-matter), they were more sophisticated than the Cydonian computers. These seem somewhat disappointing. They were no better than those humans were building around 2040 or so and were definitely not self-aware. The Makers feared the threat that superior artificial intelligence would pose (perhaps through past experience) and so intentionally 'braked' their computers. In general morphology most robots resemble eight-limbed walkers with a rough approximation to the body shape of the Makers themselves. Small anti-grav floaters were also built that could act as boat or submarine. The walkers came in two sizes, small dog or pony-sized; meanwhile the aero-floaters ranged in size from a football to a pick-up truck. The larger aero-floaters could carry 2-8 passengers and were capable of reaching orbit with integral anti-grav units.

The final group of aliens were the Servants of the Makers. It was the mummified remains of Servants that were dug out of the crumbling pyramids at Cydonia during the 2050s. Initially, around three thousand Servants travelled to the solar system with the Makers and they were, quite literally, the sentient pets of their masters. While evolving on the same planet as the Makers they were different enough (two sexes, less intelligent, six limbs, arboreal and mostly carnivorous) that the Makers viewed them solely as animals. In fact some Makers still found them to be a delicacy. Selective breeding had made certain breeds of the Servants sapient and a Servant uprising that left several hundred Makers dead led eventually to several important restrictions. Servants were tagged, they were not trained in warfare and the most intelligent Servants were coded in a way that prevented them from learning how to build or use high tech items. Over several decades the Makers were also able to insert special bundles of data into the Servants' DNA which acted as DNA 'computers' and 'firewalls' that literally codified what the Servants were able to comprehend or not. This effectively limited the Servants to TL7 for space, aerospace, energy production and material science (usefully for helping the Makers run a large spacecraft) and TL5 for weapons (some self defence is needed against wild animals and escaped Servants) and everything else.

### **What Happened?**

The Saturnian moon Iapetus is still in the irregular orbit it was placed in by the Cydonians purposefully to get it away from everything else. This was a safety measure to prevent other astronomical bodies being dragged into the jump-field. However, something *did* go wrong and one wormhole started to suck in dark matter. Much of the dark colouration on one side of the moon is not caused by the break up of Phoebe as astronomers believe, but by the dark matter attraction. Most of the Cydonian technicians died and the facility was ultimately abandoned.

Once the Makers were either dead, fled or dormant the Servants were left alone with the Hands. The Servants were intelligent, civilized slave-beings left in the palace with the keys to all the rooms. They attempted to make something of their new world but the Hands (the robots) ignored them, bent instead on finishing up the last few arcane tasks set forth by the Makers before they vanished. In the end most of the remaining robotic Hands followed protocol and sealed themselves up into a vault buried deep beneath the Martian surface. The Servants, though, struggled on. In fact they even prospered for a time; but without the luxury of nuclear power they lived a paltry existence in the glorious pyramid city bequeathed to them by the Makers. Imagine Scott and Amundsen pooling the 1912 resources of their countries to run a colony in Antarctica, this was the scale of the Servants' task. After several hundred years a Maker probe returned to Mars and the Servants rejoiced, but this joy was short lived. The probe, seeing that no Makers remained to watch over their wayward pets, released a tailored virus. In the course of a few Martian days all of the Servants within the City were dead, their bodies experienced accelerated decay and wiped them (or nearly all of them) from the surface of Mars. Its job completed the Maker probe departed for home to report on the failed Martian colony, unaware that three of the Makers still slept soundly beneath the surface of Mimas.



However, a small group of Servants lived on and this group knew of the Makers sleeping on Mimas. These secret survivors lacked, or overcame, their genetically tailored ignorance and were able to form their own society within the complex, twisting caves north of Valles Marineris. They survived there for nearly a thousand years before their limited technology began to give out. Realizing the end was near they broke into the great vault that contained the Hands of the Makers and retasked them to build the Face. Other Hands were used to create the Cache which held the history of the Makers, of the Hands and of the Servants. Waiting patiently through the ages, this Cache still holds DNA samples of many of the animals from the Maker's home world (HD40307), as well as works of art, stories, and great cultural treasures. All of these were secreted away aboard the original colony ship long ago under the very noses of the arrogant Makers. There are clues to the location of the Cache in a series of chambers within the Face. Thus far, humans only know that portions of the Face are hollow and the few rooms reached by drilling through the side of the Face have been either empty or filled with worthless trinkets. Somewhere in the Face lies the key that opens the door to the greatest mystery ever encountered by humanity.

Even if the Cache north of Valles Marineris is discovered (by the player characters, naturally!), the human race should not experience a radical increase in tech level. Sure, the cultural artefacts are priceless but there is little to gain technologically from a few select Maker tools and a breakthrough in one or two of the material sciences. The jump drive is gone and the wormhole generator is trashed.

### **Where Does This Leave Modern Explorers?**

The Makers recognized a kindred spirit in Homo Erectus, a fellow tool and (probable) fire user. Luckily for human-kind the hominids of one million years past were sufficiently advanced that the Makers did not view them as another type of Servant! Beyond their immediate trinary family groups the Makers were never very social creatures and were habitually secretive. They may have feared reprisals for their work, or the attentions of rival states and so disguised their projects. While Iapetus certainly used a high powered fusion reactor tied to some sort of capacitor for the wormhole experiments, Mimas had a smaller fusion generator with a very long decay-time radioisotope thermoelectric generator, perhaps cesium-135 with a half life of around 2.4 million years. This RTG has powered the Makers' low berth pods up until 2100 AD and beyond. Whether they are still powered and the Makers are still alive is up to the referee. The Servant-built Cache probably makes use of geothermal taps to maintain itself at minimal levels, or it may be a frozen cavern that must be excavated in order to gain access. If the Cache remains sealed then it should remain in a decent state for over a million years and the same goes for the storage areas that the Hands (the robots) retreated into after the Makers retired.

### **ADVENTURE SEED: FIRST CONTACT**

When it was first picked up by the Möbius array scientists thought it was an asteroid, slicing into the solar system before vanishing back into interstellar space. Experts at the IAU realised, however, that it was slowing down. The object, christened 196743 Carthage, was in a comet-like sun grazing orbit and telescopes showed that it was an asteroidal object, spinning regularly with the direction of spin at ninety degrees to the direction of travel. Was it of alien origin? Why was it braking? Did it intend to stay? If it was artificial, was it hollow? If it was spinning did it have artificial gravity?

The PCs and the vessel are on a course roughly parallel to that of Carthage and are ordered by the Lunar/Earth government to make a landing as soon as possible to investigate. They will discover hidden openings/airlocks leading into a spin-gravity environment 3 km in diameter. There are aliens on board, metre-high, tripods that seem to ignore the PCs but get on with their mundane lives. None seem to carry out technical tasks, there are wheeled and tripod robots that carry out these tasks.

The aliens are of animal-level intelligence (Int 1) on a sleeper ship, they keep the biosphere ticking over, shepherded by expert robots that maintain the spacecraft. The minds of the true aliens are held in hundreds of golden globe structures, much like computer arrays, ready to be downloaded into the primitives when a suitable system is found. The home world of the Carthaginians is a G type that began a long period of flare activity, the world was wet, with low gravity, with a large tidal range. The aliens are amphibian air-breathers of roughly TL 15.

Problems to be encountered: there are large high tech facilities within the artificial countryside housing life support machinery and control systems. The robots will typically kill and reprocess any life form trying to enter. The globes are found in a series of halls deep within a guarded tunnel complex. One of the aliens may be found injured or dying and others will come and begin to eat it alive. Later the aliens may suddenly 'notice' the PCs and follow them around. Killing one may be catastrophic, alerting the ship computer to their presence, waking a globe who will attempt to have them eliminated. It will wake other globes too who will download themselves into the bodies of the primitives tripods.

The asteroid vessel is about to plunge into the photosphere of the Sun in order to refuel, this will destroy the DSV that the players have docked at one of the poles unless they get off in time. In fact the aliens may actually forcefully undock the DSV (panicking the crew, whichever side of the airlock they are on) prior to their final trajectory change in order to save it. The Carthaginians consider the computer aboard the DSV their equal, an uploaded intelligence, and the PCs as dog-brained primitives not really worthy of communication or rescue! Anyone planning a scenario along these lines should first read Arthur C. Clarke's *Rendezvous With Rama*.



# 12 RESOURCES

## Movies

Short reviews of SF movies from the past four decades, not based on plot and drama, but on technology and potential usefulness to an **Orbital** scenario!

**2001: A Space Odyssey** (1968) – A stunning movie in every way, but for me the attention to detail in the spaceflight sequences makes this the bar all other 'hard' SF movies strive to reach. There are a couple of concessions Kubrick makes, but on the whole the look of this film and its level of technology inspired much of what appears in **Orbital**. The curved interior of Spacestation V, the entire design (inside and out) of the Ares moon lander, the Luna moonbus, the Orion III spaceplane, the centrifuge on the Discovery, the workpods, the way in which the airlocks work ... there's so much here to admire and use in your game. **Orbital's** standard airlock is based on that used in the "HAL, open the pod bay doors" sequence.

**2010** (1984) – The movie sequel to *2001: A Space Odyssey* does not disappoint the fan of space technology. The Soviet deep space vehicle, the Alexei Leonov, has a rotating spin habitat and an inspiring interior, it also carries robot probes and a telescoping docking tunnel. Watch for the EVA that is carried out to reach the Discovery in orbit over Io as well as the aero-braking manoeuvre. The politics of the movie, with a split US/Soviet crew being forced to react to events in the Cold War back on Earth provide a useful analogy to the tensions that will exist between crews from Luna and Earth.

**The Abyss** (1989) – Look at this outstanding movie in one of two ways, as a guide to operations within the subsurface oceans of Europa and Enceladus, or as a straight-up tale of miners on an asteroid or remote moon. If you simply pretend the subs are orbital craft and the moon pool is an airlock, you can certainly use the mining rig as inspiration for something on a similar scale in **Orbital**. Personally I don't like the big alien city/ship at the end, but do like the ominous encounters with ETs earlier on in the movie.

**Apollo 13** (1995) – A pretty accurate re-telling of the Apollo 13 mission, with its disastrous explosion and nail-biting swing around the Moon. This mission could easily have ended with the death of all three astronauts, and this movie shows how bravery, ingenuity and the technical expertise of people on the ground found a way to bring the crew back. Few films like this ever get made, so it's great that it was enjoyed by so many people.

**Apollo 18** (2011) – Filmed in the *Blair Witch* hand-held-camera-style, this can be tough viewing, but worth watching if only to see what the Apollo 18 crew found on the moon ... just follow the footsteps.. neat! It may be claustrophobic in the LEM, but I found it interesting to see how and where the astronauts slept and worked when they weren't on the Moon's surface.

**Deep Impact** (1998) – Comet Wolf-Beiderman is 11 km wide and going to strike the Earth, wiping out all life. Watch this movie to see the Messiah, a joint Russian-American spacecraft as it rockets to meet the asteroid using an Orion nuclear pulse drive (an actual theoretical drive concept). The craft has a lander which uses pitons fired into the comet for stability and the crew drill down into the comet in order to place their nuclear device that will blow the comet apart.



Great scenes for any asteroid miner! It gets even better as the comet rotates and exposes the drill site to daylight, causing explosive jets to break the surface which threaten the operation. A nice movie that illustrated just how hard it is to deal with a planet-killing asteroid (the Messiah was only partially successful, one fragment of the comet still hit Earth to cause massive devastation). Please don't watch Michael Bay's *Armageddon* that was released the same year; *Deep Impact* is the go-to impact movie!

**Escape from Mars** (1999) – A film that has so far eluded me, but it may be worth a view if you can see it. *Escape from Mars* looks at the first manned mission to Mars.

**From the Earth to the Moon** (1998) – This was a twelve-part HBO television mini-series co-produced by Ron Howard, Brian Grazer, Tom Hanks, and Michael Bostick. Howard and Hanks worked together on *Apollo 13* and this was their sequel. What a sequel! Nothing to do with Mars, but a fascinating insight into all of the tiny problems that need to be overcome to get astronauts into space and onto another world. Some of the best space-based TV ever.

**Ghosts of Mars** (2001) – It's a trashy horror film, and I love it. 'Zombies on Mars' uses a mining colony as its setting, and Martians as body-invading creatures. Scaled down a bit, the plot *may* have a place in **Orbital**, but the setting and scenery certainly does.

**The Martian Chronicles** (1980) – TV mini-series based on Ray Bradbury's novels. My memory is fuzzy (it *was* 32 years ago!), but I do remember some great scenes set within an early Martian colony.

**Mission to Mars** (2000) – A goofy plot with goopy aliens. Yet, if you can ignore the alien weirdness, look at the hardware, the tripod-based radar, the rover, habitat and suits. There are lots of great images and nice design in the movie, it's really worth watching! As in *Red Planet*, the location filming could have been done on Mars - it looks good. You will wince when the crew start up the rocket-motor after the meteoroid strike ...

**MOON** (2009) – A movie about helium-3 mining on the Moon! A lone miner is responsible for operating automatic mining machinery and for sending the ore back to Earth, but one day he stumbles upon a stranger ... Watch out for the robotic ore harvester and for GERTIE the hab's robot.

**Outland** (1981) – A tough cop thriller starring Sean Connery that is set on a realistic looking mining rig on Io. Fabulous film, with a grungy, realistic look but I've since found out that there isn't actually much of anything on Io worth mining. Set the mine on an M-type nickel/iron asteroid instead. Great scene in the 'Greenhouse' and also in the access corridor with Connery in outside a vacc suit!

**Red Faction: Origins** (2011) – Pilot movie made to coincide with the launch of the Red Faction Armageddon video game.

**Red Planet** (2000) – Of the two releases in 2000, I like *Red Planet* the most, probably because there are no aliens or Cydonian 'Face' in there! Of course Val Kilmer and Carrie Anne Moss are neat too. The plot is much more in line with something from **Orbital**, though why the agency didn't look into the problem with orbital cameras first ... is anyone's guess. Mars 1 with its counter-rotating hulls is fantastic, the suits are gorgeous, the Kosmos probe and its display is a lot of fun (though irrelevant on an automated probe) ... enjoy the design of this movie!



**Saturn 3** (1980) – A movie from my childhood. I like the idea of pair of scientists stuck on Saturn's moon Tethys to tend a remote agricultural testing station. Worth a view. Farrah Fawcett, Harvey Keitel and Kirk Douglas star.

**Space Cowboys** (2000) – Perhaps one of my favourite movies of all, Clint Eastwood leads two other retired 1960's test pilots on a shuttle mission to recover a Soviet satellite. It's an intelligent film with great regard for all the NASA culture and NASA technology that we know so well. It also brilliantly captures the tough, maverick spirit of the test pilots from that earlier, pioneering era. The Soviet satellite IKON is brilliant and terrifying. Watch for use of the Manned Maneuvering Unit thruster pack which, historically, only served for three missions in 1984 before being retired.

**Space Odyssey: Voyage To The Planets** (2004) – This was released as **Voyage To The Planets And Beyond** in the United States, and is a documentary fictionalising a manned 'Grand Tour' flight around the solar system. Great kit, great science, a brilliant programme with plenty of ideas for an **Orbital** game. The mission visits Venus, Mars, a close flyby of the Sun, Jupiter's moon Io and Europa, Saturn, Pluto (although not in the US version), and the fictional Comet Yano-Moore. Most of the destinations the spacecraft reaches are followed by a manned landing there.

**The Sphere** (1998) – In the same way that I suggested using *The Abyss* in a space context, this Michael Crichton-inspired movie could easily be set on Mars, Venus or some remote moon. A strange alien spacecraft is discovered on the seabed and contains the eponymous 'sphere' which turns out to be an extra-terrestrial artifact. Where did the ship come from? What happened to the aliens? What is the sphere? The cramped submarine outpost makes a neat asteroid base and the plot could easily be set on the surface of Venus where thick clouds and stunning pressures make exploration as difficult as walking around on the North Atlantic seabed.

**Sunshine** (2007) – Danny Boyle's SF movie about 'restarting the Sun' with a vast bomb is great. The spacecraft Icarus 2 does not have zero-G but still looks the part, the crew are scientists and astronauts making level-headed decisions and working together to solve problems. Things to look out for in this movie are the Mylar suits, the tense 'leaping out of the airlock without a suit' scene, the hydroponics bay and Kappa's ingenious method of escaping from a locked airlock. The DVD includes a commentary from the movie's scientific consultant, Professor Brian Cox, worth the price just for that!

**Total Recall** (1990) – So cyberpunk! But look at the Mars colony, the Pyramid mine and the train, look at the interiors and the vehicles, and it may conjure up something of Reunion or Schaeffer. Of course the Pyramid mine could easily be found at **Orbital's** Cydonia.

## Books

My novel reading is eclipsed by my non-fiction reading, but the seminal fiction on the colonization of Mars is Kim Stanley Robinson's Mars trilogy, from **Red Mars (1992)**, to **Green Mars (1993)** and **Blue Mars (1996)**. **The Martians (1999)** is a later, connected, collection of short stories.

Ben Bova has written extensively about this period of future human colonisation, and two books particularly will help the GM or player get into the game's mind-set: **Mars (1992)**, **Return to Mars (1999)** and **Mars Life (2008)**.

**Moving Mars (1993)** by Greg Bear and **Red Dust (1993)** by Paul J. McAuley were both published in the same year. *Red Dust* takes place against a backdrop of a failing attempt at terraforming Mars by the Chinese.

**First Landing (2002)** by Robert Zubrin. Zubrin is the president of the Mars Society and a great advocate of Martian colonization.



Brian Aldiss and Roger Penrose wrote **White Mars (1999)** which counters the terraforming agenda of Kim Stanley Robinson, and becomes the seminal Red Faction pamphlet!

**Red Genesis** (1991) by S.C. Sykes, is about a rebellion by human colonists.

The brilliant Larry Niven wrote two gripping short stories set on a newly colonised Mars: **How The Heroes Die** and **At the Bottom of a Hole** (both **1966**). They may be old, but they're very relevant....

**A Fall of Moondust** (1961) by Arthur C. Clarke, is a tense rescue mission carried out on the Moon.

**Labyrinth of Night** (1992) Allen Steele's novel, as well as others in his series, such as Lunar Descent will provide plenty of ideas, locations and characters for an **Orbital** game.

**Imperial Earth** (1975) Clarke postulated a community of colonised worlds in this seminal novel; it placed Titan at the centre, trading on its hydrocarbon and methane resources to provide rocket fuel for the other worlds of the solar system.

**Rendezvous With Rama** (1972) is another landmark Clarke novel; a spacecraft intercepts a vast alien craft travelling through the solar system. Brilliant because it keeps the aliens remote and 'off-screen'.

**Voyage** (1996), **Titan** (1997), **Moonseed** (1998) by Stephen Baxter are all based on well known NASA technology and postulate missions that 'might have been'.

**Empire Builders** (1993) by Ben Bova is the start of the author's Grand Tour series which explores many locations in the solar system as they are being colonised in the 21<sup>st</sup> century. Highlights are **Moonrise** (1996), **The Rock Rats** (2002), **Leviathans of Jupiter** (2011), **Mercury** (2005), **Venus** (2000) and **The Silent War** (2004).

**Heart of the Comet** (1986) by David Brin and Gregory Benford describes an attempt to capture comet Halley in order to mine its resources.

CJ Cherryh wrote a series of books set within the solar system; **Heavy Time** (1991) and **Hellburner** (1992) which both involve asteroid mining for minerals to support the Earth's economy and a war. Disputes over mining rights, corporate corruption and economic exploitation are key plot elements in the novels.

Joe Haldeman's **Worlds** (1981) and its sequels are all set on space stations and asteroid colonies in our solar system.

**Leviathan Wakes** by James S. A. Corey is about the struggle of people on Earth, Mars, and the Asteroid Belt (which has been colonised by 'Belters').

There is a mountain of non-fiction work available, everything from Wikipedia to technical websites, downloadable PDFs and lots of good books. I will list the handful of books I used in writing **Orbital** here, and recommend (almost) all of them:

**Space Traveller's Handbook** (1979), by Michael Freeman, the ultimate 'how-to' book written from the viewpoint of around 2080. With photos of EVA equipment and articles on transfer orbits,



stellar navigation, rovers, Lunar and Mars bases, training, food, space stations and more. Wonderfully illustrated. Very highly recommended if you can find a copy.

**NASA Mission AS-506 Apollo 11 Owners' Workshop Manual** (2009), written by Chris Riley and Phil Dolling for the Haynes car manual series of books. In depth treatment of the suits and the vehicles, from rocket fuel tanks to fuel cells, life support and plenty of other technical 'reasons why' decisions were made the way they were.

**The Encyclopedia of Soviet Spacecraft** (1987) by Douglas Hart for Bison Books.

**How to Live on Mars** (2008), Robert Zubrin. *The* advocate of a colonization effort on Mars writes a 'how-to' guide that is full of fascinating information, but has far too many bitter quips at NASA's expense, which leaves a sour taste in the reader's mouth.

**Mining the Sky** (1997) by John S. Lewis, if you buy one book this must be it, the scientific and technical low down on the exploitation of moons, planets and asteroids. Readable, technical and full of great, realistic ideas.

**The High Frontier** (1977), by Gerard K. O'Neill. This book lays out O'Neill's extraordinary and visionary plans for space colonies at the Lagrange points. It includes diagrams, illustrations and articles from like-minded contributors. It is very optimistic, but shows what *could* be achieved...

## Role-Playing Games

**Traveller** is published by Mongoose Publishing and is required for use with **Orbital**. There are numerous supplements in the Traveller line, many of them will be of use to the **Orbital** referee.

**2300AD** is a Traveller setting book published by Mongoose which explores nearby stars and their worlds with a Tech Level similar to that of Orbital, with projectile weapons, rockets and spin-gravity. The **2300AD** supplement *Tools for Frontier* is full of useful equipment.

**Outpost Mars** by Zozer Games is an in-depth setting treatment of Mars for Traveller, with lots of scenario ideas and in-depth descriptions of the Martian landscape. It is set in 2040, sixty years earlier within the **Orbital** timeline.

**High Guard** by Mongoose Publishing. This spacecraft construction expansion allows the referee to add extras to DSVs and to build orbital vehicles (although Comstar/Avenger's *Archaic Smallcraft & Space Stations* adds a great TL 7, 8 and 9 dimension to the builds).

**Near Space** and **Far Space**, both published by R.Talsorian Games, near future space flight that gels really well with the setting of **Orbital**.

**Archaic Smallcraft & Space Stations** by Comstar/Avenger is available as a PDF and provides rules for building TL 7, 8 and 9 vehicles like the Apollo CSM, the International Space Station or the Soyuz TMA. **Orbital** uses the rules in this book to create orbital vehicles and launch vehicles – a recommended buy!

**Transhuman Space** by Steve Jackson Games describes a 2100 AD universe dominated by cybershells, AIs, ghosts, slinkies and xoxworkers.

**Book 6-Scouts**, by GDW, authors Marc Miller and Frank Chadwick (1983). This book provided the first Traveller UWP ratings for planets and moons within the solar system.

**GURPS Space 4<sup>th</sup> ed.** is a mine of useful data for any SF RPG in any setting.





## Web-Based PDFs

**Report of the 90 day Study on Human Exploration of the Moon and Mars** (1989) This is NASA's Space Exploration Initiative (SEI) laid out at every stage with illustrations and diagrams. It includes concepts for Mars transfer craft, landers, surface installations and even an oxygen mining plant. [http://history.nasa.gov/90\\_day\\_study.pdf](http://history.nasa.gov/90_day_study.pdf)

**Space Settlements – A Design Study** (1977) – NASA's study into the feasibility of O'Neill's giant space colonies. This PDF includes lots of diagrams and hard facts. [http://ntrs.nasa.gov/archive/nasa/casi.ntrs.nasa.gov/19770014162\\_1977014162.pdf](http://ntrs.nasa.gov/archive/nasa/casi.ntrs.nasa.gov/19770014162_1977014162.pdf)

**Plasma Radiation Shields** – This technical PDF explores the theoretical use of what **Orbital** calls the 'Generator Magnetospheric Field' or flare damper. <http://www.minimagnetosphere.org/downloads/pdfs/9Levy%20French%20AIAA-29306-386.pdf>

**Triton: A Trimodal Thrust Optimized Nuclear Propulsion and Power System for Advanced Space Missions** – This PDF discusses the technical merits of a trimodal nuclear thermal rocket of the type used for the DSVs in Orbital. <http://www.pwrengineering.com/dataresources/AIAA-2004-3863.pdf>

**Lunar Base Concepts** – A collection of NASA documents from the 60s and 70s which plan out in great detail ideas for different types of Lunar colony. Learn about the problems, the dangers, the solutions and the hardware. [http://www.lpi.usra.edu/publications/books/lunar\\_bases/LSBchapter02.pdf](http://www.lpi.usra.edu/publications/books/lunar_bases/LSBchapter02.pdf)

**International Space Station Familiarization** (1998) – Want a user's handbook to a space station? This PDF is it. How fire suppression works, how the airlock works, connections, module protocols, electrical wiring diagrams, plumbing, life support details ... read this and when you eventually get to the ISS, you will be a lot more clued up than Howard Wolowitz! <http://www.spaceref.com/iss/ops/iss.familiarization.pdf>

**Space Suit Evolution** – A PDF that gives the reader a detailed insight into the US spacesuit designs, how they work, what they feature and the problems encountered by designers. <http://history.nasa.gov/spacesuits.pdf>

## Web-based Videos

I recommend touring the International Space station! The technology is similar to that used in orbital, and will illustrate the typical appearance of any OMP or ground-based modular outpost. Look at the sleeping compartments, where the laptops are mounted, how cargo and supplies are stowed, whether hatches are left open or closed, where space suits are stowed ... and so on. Listen to the continual sound of the air blowers. All of these videos are currently hosted on You Tube and filmed by astronauts during their tour. The links may move, if so try search for 'ISS tour' on You Tube or something similar. The following links are live as of 1/1/13:

[http://youtu.be/QF2w2Dx\\_QMs](http://youtu.be/QF2w2Dx_QMs) (55 mins)

<http://youtu.be/H8rHarp1GEE> (6:53 mins)

<http://youtu.be/JgBgmw-2U8c> Part I (9:44 mins)

<http://youtu.be/F-yIqxoMBVU> Part II (9:58 mins)

# APPENDIX

## Acronyms

Mirroring the real world of spaceflight and aviation, **Orbital** has its share of TLAs (Three Letter Acronyms), whether it's the MARVINS, the PLSS or DSV. All of the setting specific abbreviations are listed here, along with a brief explanation.

<b>ADOBE</b>	Automated Base or Outpost Deployment Equipment	<b>LAN</b>	Local Area Network
<b>AIMCON</b>	Ares International Mining Consortium (see <i>Outpost Mars</i> )	<b>LEO</b>	Low Earth Orbit
<b>AKV</b>	Automated Kill Vehicle	<b>LLO</b>	Low Lunar Orbit, also Low Planetary Orbit
<b>AP</b>	Action Penalty	<b>LLV</b>	Light Launch Vehicle
<b>ASAT</b>	Anti-Satellite Missile	<b>LOPS</b>	Lunar Outsystem Patrol and Security
<b>ASEAN</b>	Association of South-East Nations	<b>LSC</b>	Large Scale Space Colony
<b>CML</b>	Counter Measures Launcher	<b>LSD</b>	Lunar Security Detachment
<b>COM</b>	Configurable Operations & Messaging	<b>MARVIN</b>	Martian Resource Recovery In-Situ
<b>DSV</b>	Deep Space Vehicle	<b>MLA</b>	Module Lander Aeroshell
<b>D_V</b>	Deep Space Vehicle, second letter denoting mission (eg. DKV)	<b>MLV</b>	Medium Launch Vehicle
<b>ESDA</b>	Earth Space Development Agency	<b>NASA</b>	National Aeronautics and Space Administration
<b>ETM</b>	Eckard Tactical Management	<b>NTR</b>	Nuclear Thermal Rocket
<b>EU</b>	Earth Union	<b>OMP</b>	Orbital Module Platform
<b>EVA</b>	Extra Vehicular Activity	<b>OPSEK</b>	Orbital Piloted Assembly and Experiment Complex
<b>FSC59</b>	Fairline Space Convention on Compatibility & Co-ordination (2059)	<b>ORVIN</b>	Oxygen Recovery In-Situ
<b>GAN</b>	Global Area Network	<b>PLSS</b>	Personal Life Support System
<b>GEO</b>	Geosynchronous Orbit	<b>PSPA</b>	Portable Solar Panel Array
<b>GMF</b>	Generator : Magnetic Field	<b>RTG</b>	Radiothermic Isotope Generator
<b>He3</b>	Helium-3	<b>SARA</b>	Space Activities Regulatory Agency
<b>HELL-V</b>	High Energy Laser Lift Vehicle	<b>SETI</b>	Search for Extra-Terrestrial Intelligence
<b>HEV-X</b>	Aerodyne's Hostile Environment Suit	<b>SGS</b>	Spin Gravity Station
<b>HLV</b>	Heavy Launch Vehicle	<b>SHS</b>	Single Hull Station
<b>IAU</b>	International Astronomical Union	<b>SWN</b>	Space Workers Network
<b>IPN</b>	Interplanetary Network	<b>THAAD-X</b>	Terminal High Altitude Area Defence (NeXt Generation)
<b>IPS</b>	Interplanetary Services	<b>UN</b>	United Nations
<b>ISS</b>	International Space Station	<b>VHLV</b>	Very Heavy Lift Vehicle
<b>L5</b>	Lagrange Point 5, also L1, L2, L3 and L4		

# INDEX

- Acheron 180  
 ADOBE 91  
 Adrienne 154  
 Aerodyne 18  
 aeroshell (see Module Lander Aeroshell)  
 aerostat 92, 128-131  
 agendas (see Secret Agendas)  
 AIMCON 22  
 airlock 110-111, 214  
 AKV 50, 122, 141, 166, 168-169  
 aliens 204-211  
 Apollo programme 7, 12, 46, 53, 63, 72, 212, 213  
 Ariel 186  
 Armstrong 144, 145  
 The Array 166, 170  
 Asian League 10, 139-140  
 Asgard Base 168-169, 170  
 Asteroid Belt 10, 11-12, 16, 21, 22, 24, 25, 148, 159-163  
 Asteroid Mining 19, 112-117, 159-160, 195, 203, 212-213  
 Australia 75, 128, 139, 204  
  
 Baospace 18, 64, 124  
 Bangladesh 123, 135, 140  
 Belt (see Asteroid Belt)  
 The Belt War 12, 22, 128, 141, 152-153, 160, 162  
 Bin Laden, Osama 7  
 Brazil 75, 133, 174, 203, 204  
 Brunei 75  
 Burma 139  
 Bush, George 7  
  
 cache 208, 210  
 Callisto 13, 169-170, 165, 168  
 Caloris Basin 121-123  
 campaigns 31-32  
 Canada 21, 24, 28  
 canyon pirates 158  
 careers 33  
 cargo costs 59  
 Cascadia 12, 24, 74, 148, 159, 160, 203  
 Centennial 18, 128, 167, 191, 202  
 Centorum 130-131  
 character creation 30-38  
 Charon 194  
 Chen, Evelyn 13-14, 137, 166, 180  
 China 8-14, 24, 27, 135-136, 149-141, 142, 149, 159, 160, 179  
 Church of Heavenly Stigmata 24-25, 26, 153, 157  
 Clavius 147-148  
 cluster 84  
 Cold Mountain 144, 146, 202  
 cold war 9-14, 15, 16, 102, 140, 144, 171, 179, 212  
 Colonial Endeavours 19  
 colony 89-92  
  
 combat, space 60  
 comets 193, 194  
 complications 197  
 computers 69-70  
 coms 69-70  
 Constitution 165, 170, 176  
 Copernicus Brotherhood 148, 202  
 Crapper Crater 128  
 crew 45-46, 98-100  
 Cruithne 141, 160  
 cryostat 94  
 Cydonia, Cydonians 16, 25, 127, 149, 156-157, 166, 173-174, 191, 198, 201, 202, 206, 207-210, 214  
  
 Daedalus 141, 202  
 Department Defence Co-ordination (DDC) 136, 203  
 depressurization 106-108  
 Dione 175-176  
 Direct 19  
 Discovery Ridge 125  
 Divine Unity 148  
 drones 45, 70-71, 83, 114, 170, 172-173  
 DSV 40-52, 53, 57, 77, 95, 98-100, 161, 162, 166, 170, 186, 195, 196, 199  
  
 Eagle City 92, 131  
 Earth, Earth Union 11, 12, 17, 20, 86, 122, 128, 133-141, 153, 168-170, 172-174, 179, 181-183, 191, 199-200, 202-204  
 East Asian War 10-11, 14, 136  
 Eckard Tactical Management 16, 86, 156, 191  
 Egypt 9, 123  
 Ellis-Itami 19  
 Enceladus 174, 212  
 Epimetheus (see Janus & Epimetheus)  
 Erebus Power 19, 112, 128  
 Eris 194  
 Eros 126-132  
 ESDA 15, 21, 94, 137, 186, 188, 191, 192  
 Eurodyne 23  
 Europa 13, 18, 166-167, 174, 176, 205, 212, 214  
 EVA 6, 104-105  
  
 The Face 7, 25, 127, 156, 207, 208, 210, 213  
 Fairline Space Convention 15, 100-101  
 fission reactor 13, 20, 42  
 flare damper 42, 109, 217  
 Fly By 19  
 Flying Dragons 148  
 FR8 corporation 19  
 Frontier Foundation 25, 152  
 fuel processor 44, 113  
 fusion reactor 12, 13, 21  
  
 G2 (see Stranglehold)  
 Ganymede 13, 168-169

- genetic engineering 21, 28, 154, 168
- GMF (see flare damper)
- Greens 16, 22, 25, 153, 157
- Guangzhou (see Pearl River Megacity)
- guns 108
  
- hard suit 63-64
- Haumea 192, 194
- Helene 13, 179
- Heliopolis 125
- helium-3 12, 13, 15, 21, 83, 114, 122-123, 171-173, 186
- Helix 23, 169
- high energy laser lift (HELL) 75-76
- Hermes Systems 20, 123
- high passage 59
- High Point 155
- hostile environment suit 65
- hydrogen fuel 13, 57, 71, 94, 116, 172, 176
- hydroponics 44, 85, 118, 176
- Hyperion 181, 184
  
- Iapetus 13, 22, 181-183, 184, 207-210
- Ida 12, 17, 21, 160, 161, 204
- India 9, 10, 140
- Indonesia 10, 204
- Infinite Circle 148
- International Astronomical Union (IAU) 14, 156, 191
- International Space Station (ISS) 6, 7, 21, 51, 63, 91, 94, 217
- Interplanetary Services (IPS) 19, 20
- Io 22, 165-166, 213, 214
  
- Janus & Epimetheus 13, 21, 172-173, 204
- Japan 10, 19, 20, 173-174
- Jianying 180
- Jupiter 13, 16, 54, 109, 127, 164-170, 214
  
- Kenya 75
- Khan, Sajid 20, 123-124
- Kolkata Off-world Movement (KOM) 123-140
- Korea (Confederal Republic of Koryo) 122, 139
- Kuiper Belt 54, 112, 157, 192-194
  
- Lagrange stations (L1 – L5) 8-9, 15, 16, 17, 20, 23, 27, 56, 95-96, 103, 200, 202, 204
- lander 53, 72, 117
- landing 53, 44, 115
- large scale space colony (LSC) 95-96
- launching 53, 74-76
- launch vehicle 76, 130
- law enforcement 86-87
- LEO 9, 75, 102, 103
- Lima Conference 11, 136, 140
- low berths 47-48, 59
- Luna 7-14, 16, 18, 19, 20, 21, 22, 65, 86, 122, 128, 135-136, 142-148, 166-167, 176-180, 191, 199-200, 202
- Luna Outsystem Patrol and Security (LOPS) 16, 86, 177, 188
- LunaPol 16
- Luna Security Detachment 16
- Luxor Aerospace 20
- maintenance 58
  
- Makemake 192, 194
- Malaysia 136, 139
- Mammoth 19
- Mars 7, 10, 11, 12, 16, 17, 22, 24-26, 39, 53, 54, 65, 76, 91, 149-158, 201, 205, 207-210, 213, 214
- Mars Regiment 201
- Martian Rangers 16
- MARVIN 91, 152, 157
- mass driver catapult 8, 9, 75, 87, 130, 155, 180
- Matilda 162
- Matsuyama 20, 25, 112, 124
- Mercury 12, 20, 22, 54, 65, 101, 121-125, 168, 180
- Mercury Agreement 12
- Meridian 144, 146-147
- Mexico 28
- middle passage 59
- Mimas 173-174, 207-210
- Mimir Observatory 206-207
- Mindanao 180
- Mines of Mercury 125
- Mir 94
- Miranda 186
- missiles 11, 50, 161
- Möbius Observatory 147, 206, 211
- Moitessier, Pierre 15
- module 20, 23, 24, 43, 84-85, 91, 93, 117-118, 145
- Module Lander Aeroshell (MLA) 84, 152
- Monaco 202
- The Moon (see Luna)
- Moore 162
- Munich 11, 137
- mustering out 38
- Muzner, Eddie 25, 152
  
- NAFTA 28
- Neptune 13, 54, 189-192
- Nereid 192
- Nereus 160
- Netherlands 135
- The Network 23-24
- New York 139
- Northinghouse 21
- NPCs 201-204
- nuclear power (see fission or fusion reactor)
- nuclear thermal rocket (NTR) 13, 40, 41, 42, 217
  
- Oberon 188
- Ohm Collective 162
- Okuda 23
- O'Neill, Gerard 5, 95
- Oort Cloud 112, 193
- OPSEK 21, 23, 94
- Orbital Defence Alliance (ODA) 135-136
- orbital module platform (OMP) 84, 93, 217
- orbital vehicles 71-74
- Orbit War 8-9, 15, 101, 128, 135, 141
- Orion nuclear pulse rocket 212
- Orion spacecraft 73
- ORVIN 114, 117, 131, 195
- Otgwehda 155
- Outer Space Treaty 100, 136
- outpost 91
- Outpost Mars 149, 196, 216

- Pakistan 11, 136, 139, 161
- Parkfield 21, 162
- Pear River Megacity 133, 135, 139, 203
- Personal Life Support System (PLSS) 63-66
- Philippines 136
- Phobos 153, 201
- Planetary Reproductionists 26
- poison gas/atmosphere 109
- Poulanderson 162
- Power from Space Design Agreement 8, 12
  
- radiation 109-110
- radiothermic isotope generator (RTG) 47, 113, 210
- Rainbow Tunnels 147
- ranks 38
- Reds 16, 25, 153, 157-158
- Reunion 16, 17, 153-154, 201, 214
- Rhea 176-177
- rocket (see launch vehicle)
- Russia 10, 21, 22-23, 135
  
- SAFE Act 140
- salvage & rescue 196
- San Francisco 11, 137, 138
- Saturn 13, 15, 21, 54, 83, 101, 171-184, 214
- Saudi Arabia 9
- Schaeffer 154-155, 201, 214
- secret agendas 197-198
- Sentinel 169
- SETI 141, 205-207
- settlements 89-97
- Shackleton 144, 145
- Shanghai 19
- Singapore 10, 11, 137, 138-139
- single hull station (SHS) 94
- skills 36-37
- smelter 85, 114
- Snakeheads 26, 27-28, 33, 34, 39, 123, 125, 204
- Sobkai 12, 19, 122-123, 125
- soft suit 63
- solar power 8,9, 144, 146-147
- Southern Cross Mining 21, 128, 172-173, 203, 204
- south pole (Luna) 9, 144-145
- Space Activities Regulatory Agency (SARA) 17, 86, 161, 204
- spacecraft design 40-52
- Space Worker's Network 23-24
- spin gravity 48-49, 51-52, 94-96
- spin gravity station (SGS) 94
- Spinward Marches 6
- Space Exploration Initiative (SEI) 7-8, 217
- spaceplane 72
- status 198
- storm shelter 44
- Stranglehold 140-141
- Sun City 123, 124
- SGS-16 Goddard Station 95, 103
- SGS-34 Bernard Lovell Station 15
- SGS-Neil DeGrasse-Tyson Station 25
- SGS-78 Terminal Station 23-24
- SGS-88 Tsiolkovsky Station 103
- SGS-90 Grimaldi Station 156, 202
- SGS-115 Marco Polo Station 103
- SGS-272 Cyprus Station 128-129
  
- 2Go 19
- 2300AD* 6, 216
- Taiwan 75
- temperature 108-109
- Tethys 175, 214
- Tharsis corporation 22
- Third Imperium 6, 111, 204
- Tiangong 94
- Tijuana Brothers 28, 203, 204
- Titan 13, 14, 16, 19, 53, 76, 101-102, 137, 161, 177-180, 182, 203, 207
- Titan Agreement 13-14, 101-102, 161, 180
- Titan War 13, 16, 137, 179-180, 182, 203, 207
- Titania 187
- Toutatis 203
- Transdyne 23
- transhab 84
- Tranquillity 20, 144, 145-146, 202
- Trans-Solar 19, 22
- treaties 100-102
- Triton 190-191, 192
- trojan asteroids 112, 164
- The Tube 132
- tug 73
- Tuosheng 180
  
- Umbriel 187
- Union of Inter-regional Organisations (UIO) 136
- United Nations (UN) 6, 10, 11, 141, 156
- United Kingdom (UK) 10-11, 140
- United States 7, 8, 10-11, 24, 28, 45, 135, 140-141, 142
- Uranus 13, 54, 185-188
  
- Vacc Suit 62-67, 106-108, 217
- Vanderveen, Matthias 11, 36
- Venus 53, 54, 65, 126-132, 205, 214
- Venus Dart 74, 92, 128-129
- Venus Floating City 92
- Venus Rover 69
- Vesta 12, 54, 160, 161
- VIPER 129
- Voices 183
- Vonsecker 21, 162
- Voroncovo 21, 22-23
- Voyagers 141
  
- Wang, Stephen Taylor 179
- weapons 50, 108
- White Tigers 13, 148
- Wild 2 asteroid 194
- World Council 137, 140
- Wu, Paul Barclay 136
- Wu-Ketai 23
  
- Xanadu 177-180
- Xiangliu, 9 Heads of 26-27
  
- Yanggal 131
- Yuru 129-130
  
- Zenith 23, 169
- zero-G 104-105
- Zu Chong Zhi 204





## Legal Information

### OPEN GAME LICENSE Version 1.0a

The following text is the property of Wizards of the Coast, Inc. and is Copyright 2000 Wizards of the Coast, Inc ('Wizards'). All Rights Reserved.

1. Definitions: (a)'Contributors' means the copyright and/or trademark owners who have contributed Open Game Content; (b)'Derivative Material' means copyrighted material including derivative works and translations (including into other computer languages), potation, modification, correction, addition, extension, upgrade, improvement, compilation, abridgment or other form in which an existing work may be recast, transformed or adapted; (c) 'Distribute' means to reproduce, license, rent, lease, sell, broadcast, publicly display, transmit or otherwise distribute; (d)'Open Game Content' means the game mechanic and includes the methods, procedures, processes and routines to the extent such content does not embody the Product Identity and is an enhancement over the prior art and any additional content clearly identified as Open Game Content by the Contributor, and means any work covered by this License, including translations and derivative works under copyright law, but specifically excludes Product Identity. (e) 'Product Identity' means product and product line names, logos and identifying marks including trade dress; artifacts; creatures characters; stories, storylines, plots, thematic elements, dialogue, incidents, language, artwork, symbols, designs, depictions, likenesses, formats, poses, concepts, themes and graphic, photographic and other visual or audio representations; names and descriptions of characters, spells, enchantments, personalities, teams, personas, likenesses and special abilities; places, locations, environments, creatures, equipment, magical or supernatural abilities or effects, logos, symbols, or graphic designs; and any other trademark or registered trademark clearly identified as Product identity by the owner of the Product Identity, and which specifically excludes the Open Game Content; (f) 'Trademark' means the logos, names, mark, sign, motto, designs that are used by a Contributor to identify itself or its products or the associated products contributed to the Open Game License by the Contributor (g) 'Use', 'Used' or 'Using' means to use, Distribute, copy, edit, format, modify, translate and otherwise create Derivative Material of Open Game Content. (h) 'You' or 'Your' means the licensee in terms of this agreement.

2. The License: This License applies to any Open Game Content that contains a notice indicating that the Open Game Content may only be Used under and in terms of this License. You must affix such a notice to any Open Game Content that you Use. No terms may be added to or subtracted from this License except as described by the License itself. No other terms or conditions may be applied to any Open Game Content distributed using this License.

3. Offer and Acceptance: By Using the Open Game Content You indicate Your acceptance of the terms of this License.

4. Grant and Consideration: In consideration for agreeing to use this License, the Contributors grant You a perpetual, worldwide, royalty-free, non-exclusive license with the exact terms of this License to Use, the Open Game Content.

5.Representation of Authority to Contribute: If You are contributing original material as Open Game Content, You represent that Your Contributions are Your original creation and/or You have sufficient rights to grant the rights conveyed by this License.

6.Notice of License Copyright: You must update the COPYRIGHT NOTICE portion of this License to include the exact text of the COPYRIGHT NOTICE of any Open Game Content You are copying, modifying or distributing, and You must add the title, the copyright date, and the copyright holder's name to the COPYRIGHT NOTICE of any original Open Game Content you Distribute.

7. Use of Product Identity: You agree not to Use any Product Identity, including as an indication as to compatibility, except as expressly licensed in another, independent Agreement with the owner of each element of that Product Identity. You agree not to indicate compatibility or co-adaptability with any Trademark or Registered Trademark in conjunction with a work containing



Open Game Content except as expressly licensed in another, independent Agreement with the owner of such Trademark or Registered Trademark. The use of any Product Identity in Open Game Content does not constitute a challenge to the ownership of that Product Identity. The owner of any Product Identity used in Open Game Content shall retain all rights, title and interest in and to that Product Identity.

8. Identification: If you distribute Open Game Content You must clearly indicate which portions of the work that you are distributing are Open Game Content.

9. Updating the License: Wizards or its designated Agents may publish updated versions of this License. You may use any authorised version of this License to copy, modify and distribute any Open Game Content originally distributed under any version of this License.

10. Copy of this License: You MUST include a copy of this License with every copy of the Open Game Content You Distribute.

11. Use of Contributor Credits: You may not market or advertise the Open Game Content using the name of any Contributor unless You have written permission from the Contributor to do so.

12. Inability to Comply: If it is impossible for You to comply with any of the terms of this License with respect to some or all of the Open Game Content due to statute, judicial order, or governmental regulation then You may not Use any Open Game Material so affected.

13. Termination: This License will terminate automatically if You fail to comply with all terms herein and fail to cure such breach within 30 days of becoming aware of the breach. All sublicenses shall survive the termination of this License.

14. Reformation: If any provision of this License is held to be unenforceable, such provision shall be reformed only to the extent necessary to make it enforceable.

#### 15. COPYRIGHT NOTICE

Open Game License v 1.0a Copyright 2000, Wizards of the Coast, Inc.

**Traveller System Reference Document** Copyright © 2008, Mongoose Publishing.

**Traveller is © 2008 Mongoose Publishing.** Traveller and related logos, character, names, and distinctive likenesses thereof are trademarks of Far Future Enterprises unless otherwise noted. All Rights Reserved. Mongoose Publishing Ltd Authorized User.

#### **NASA/JPL Legal Agreement**

NASA still images, audio files and video generally are not copyrighted. You may use NASA imagery, video and audio material for educational or informational purposes, including photo collections, textbooks, public exhibits and Internet Web pages. This general permission extends to personal Web pages. This general permission does not extend to use of the NASA insignia logo (the blue "meatball" insignia), the retired NASA logotype (the red "worm" logo) and the NASA seal. These images may not be used by persons who are not NASA employees or on products (including Web pages) that are not NASA sponsored.

If the NASA material is to be used for commercial purposes, especially including advertisements, it must not explicitly or implicitly convey NASA's endorsement of commercial goods or services. If a NASA image includes an identifiable person, using the image for commercial purposes may infringe that person's right of privacy or publicity, and permission should be obtained from the person.