

# **Ships of Clement Sector 4**

# **Small**

# **Craft**

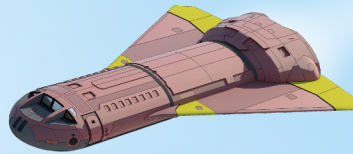

SHIPS

**TRAVELLER**

Compatible Product

*Requires the use of the Traveller (TM) Main Rulebook, available from Mongoose Publishing.*

# ***Ships of Clement Sector 4: Small Craft***

*Author  
Michael Johnson*

*Additional Material by Bradley Warnes*

*Artists  
Ian Stead (Cover, p.1,2,5,9,10,12,17,22,26,27,33,34,40,44,49,51,57,  
61,65,72,78,); Michael Johnson (p.7,11,14,16,19,25,29,30,31,36,42,  
46,52,53,59,63,67,74,75); Bradley Warnes (p.11,16,38,39,55,69,77)*

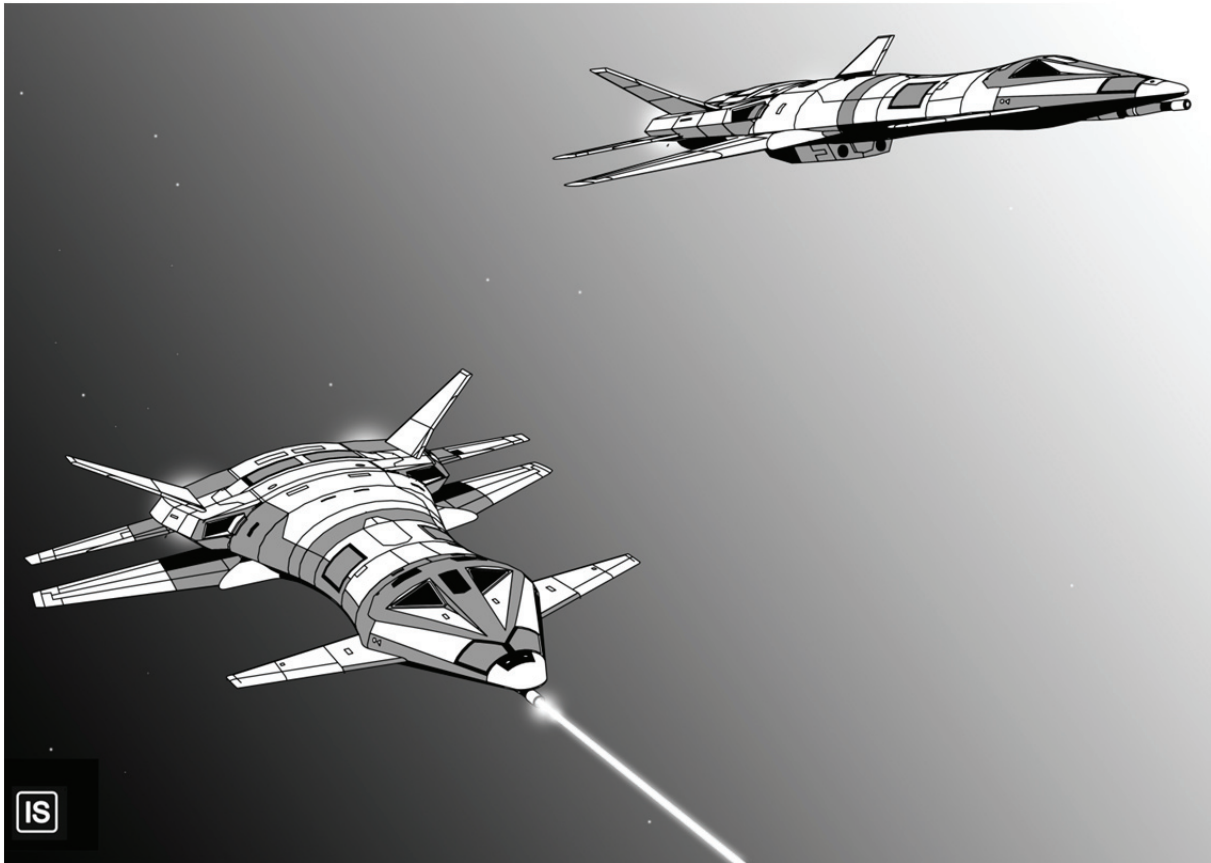

## *Ships of Clement Sector 4: Small Craft*

---

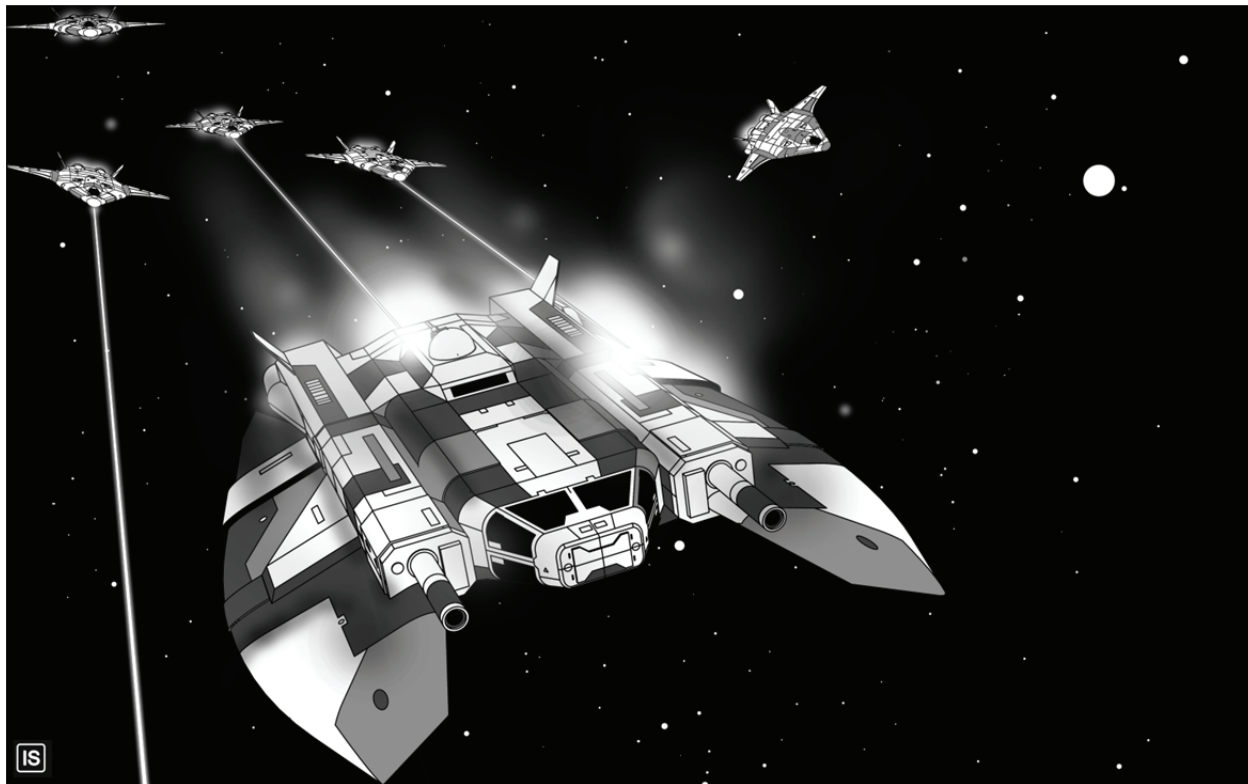

*Editor*  
*Curtis Rickman*

### *Playtesters*

*Bradley Warnes, Ian Stead, John Watts, Graham Bonny, James Willoughby, Mark Downsborough, John Ord, Nick Cook, Anthony Faulkner, Greg Seaborn, Mike Nixon and Wendy Watts*

*Find us on Facebook (GypsyKnights Games), Google + (+Gypsy Knights Games), and Twitter (@GKGames). Keep up with the latest from Gypsy Knights Games on our news blog [gypsyknightsgames.blogspot.com](http://gypsyknightsgames.blogspot.com). And you can join the Clement Sector discussion in our Clement Sector discussion group at <https://www.facebook.com/groups/clementsector/> And you can find all of our products on our website [www.gypsyknightsgames.com](http://www.gypsyknightsgames.com) or at Drive-Thru RPG, the [d20PFSRD.com](http://d20PFSRD.com) store and [Paizo.com](http://Paizo.com).*

*All rights reserved. Reproduction of this work by any means is expressly forbidden.*

*“Traveller” and the Traveller logo are Trademarks owned by Far Future Enterprises, Inc. and are used according to the terms of the Traveller Logo Licence version 1.0c. A copy of this licence can be obtained from Mongoose Publishing. The mention or reference to any company or product in these pages is not a challenge to the trademark or copyright concerned.*

*“Traveller” and the Traveller logo are Trademarks owned by Far Future Enterprises, Inc. and are used with permission. The Traveller Main Rulebook is available from Mongoose Publishing.*

# *Ships of Clement Sector 4: Small Craft*

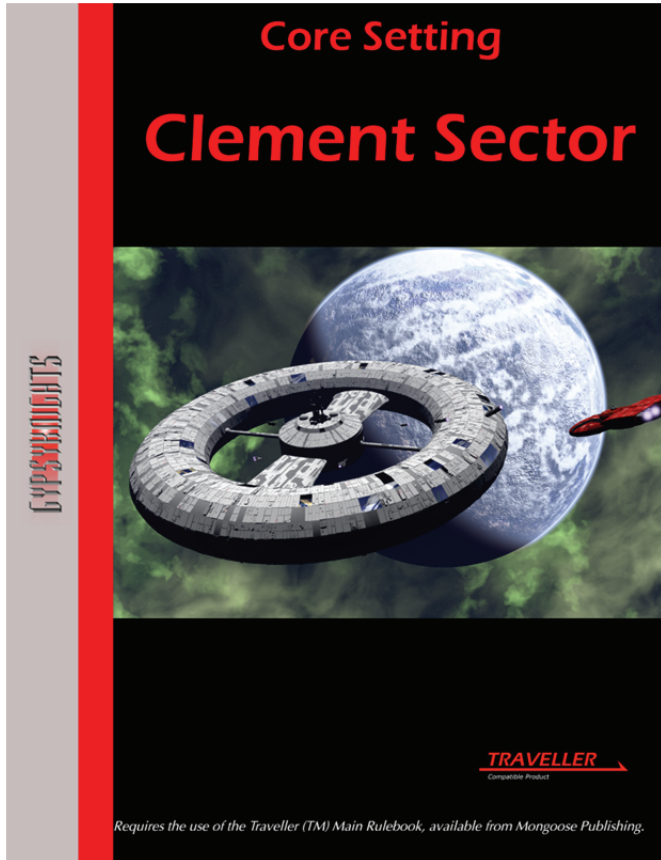

*In 2210, scientists discovered a wormhole allowing travel to the opposite side of the Milky Way galaxy. Once across, exploration teams discovered worlds far more suited to human habitation than those in star systems nearer to Earth. Were they terraformed by some unknown race? Are they just a coincidence in the vast diversity of the universe?*

*Over the ensuing years humans left Earth and began to colonize these worlds. Nation-backed colonies. Corporate colonies. People who simply no longer felt compelled to remain on Earth. The best and brightest.*

*In 2331, the unthinkable happened. The wormhole collapsed leaving those in Clement Sector cut off from Earth. Now these new worlds and new civilizations must stand on their own.*

*The year is 2342. Adventure awaits!*

*Clement Sector is the core setting book for Gypsy Knights Games' alternate Traveller universe. This book ties together all of Gypsy Knights Games' previous subsector sourcebooks and colony books into a vibrant and growing space opera setting.*

*Available now in print and PDF at [rpgnow.com](http://rpgnow.com). Available in PDF form at [d20pfsrd.com](http://d20pfsrd.com) and [Paizo.com](http://Paizo.com).*

*Find out more about our products at [gypsyknightsgames.com](http://gypsyknightsgames.com). Follow us on Twitter @GKGames and on Facebook as GypsyKnights Games.*

*"Traveller" and the Traveller logo are Trademarks owned by Far Future Enterprises, Inc. and are used with permission. The Traveller Main Rulebook is available from Mongoose Publishing.*



# *Ships of Clement Sector 4: Small Craft*

---

## *Small Craft*

*“Look here, those starship pilots are the glamour boys. Just look all around and you see small craft everywhere, the spacers flying those are the hard workers. They do all the dirty jobs...”*

*Unknown spacer c2157 CE*

Starships may have taken humanity to the stars but small craft took humanity into space. Now over three centuries later, small craft types are as wide and varied as the uses they are tasked to undertake. For some users, like the ever present beltlers that work claims and explore vast asteroid fields for precious metals, a small craft even becomes a home for themselves and their family.

Most small craft have their origins in the national navies, those nations that seeded colonies throughout the Clement Sector, private businesses and traders operating out of those colonies. Before the Collapse, local shipbuilding industries on many settled worlds made available these “standardised” designs as there was no demand for anything different. However once the Conduit collapsed in 2331 and the colonies were isolated from their home

governments and the rest of humanity, new home grown designs and other newer designs not yet readily available in Clement Sector emerged.

Design, construction and supply of small craft (new or pre-owned) are constantly in demand, with new orders often causing a waiting list for popular models. Major shipbuilding companies such as Anderson and Felix Shipbuilding Company, based in the Hub Federation, have separate design and construction divisions dedicated to small craft.

This book covers a selection of small craft of the many types seen in Clement Sector, from small work pods and fighters up to armoured assault landers with enough firepower to level a small town.

# *Ships of Clement Sector 4: Small Craft*

---

## *Orbital and Work Pods*

*“Cramped? Yeah mate, not much room for us repair blokes to move about in a vacc suit. My work mate Jonesy is a good sort even though he is as slow as a bloody wombat at times. Wouldn’t change a bloody thing though!...”*

*Josh “Donger” Smith Orbital Maintenance Technician, New Perth 2339 CE*

### **Background and Development**

Look at any orbital installation, either highport, shipyard or military installation and you will notice little points of light buzzing around like bees near a flowering plant. These are the work and orbital pods, small 10dT customisable inter-orbital spacecraft used for maintenance, repairs, construction, cargo and passenger runs and numerous other tasks.

Pods are essentially an open distributed framework consisting of a spherical style cockpit, 5dT work module and drive section. They are capable of a thrust of two gravities and generally have a crew of one or two. They are incapable of entering a planetary atmosphere.

### **Work Modules**

The work module provides the pod with task specific flexibility. Module types are as varied as the need for them and many owner operators will customise them even further.

### **Maintenance Bug**

By far the most common role for a work pod is for maintenance, construction

and repair. The maintenance bug work module carries two grappling arms, a small maintenance workshop and a cramped airlock.

### **Courier Pod**

The courier or cargo work module allows a pod to transfer 5dT of cargo to orbitals and ships in orbit. Access to the cargo pod is via a large hatch on the dorsal surface.

### **Transfer Pod**

This pod can carry eight passengers and 1dT of cargo on short duration orbital transfer or ship to ship transfers.

### **Mining Pod**

The mining pod can carry 3dT of ore with two grappling arms to assist loading. This work module makes the pod an ideal small craft for seeker starships, widening the exploration reach.

# *Ships of Clement Sector 4: Small Craft*

---

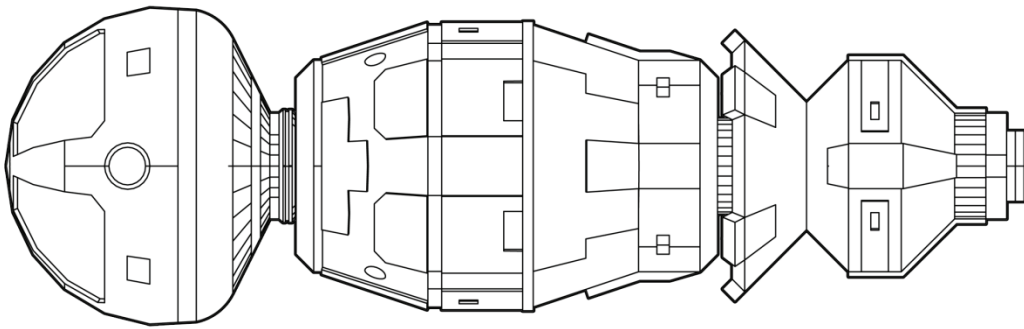
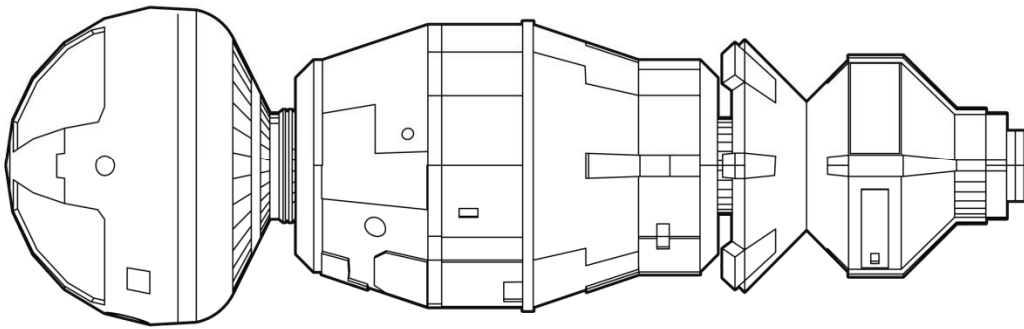
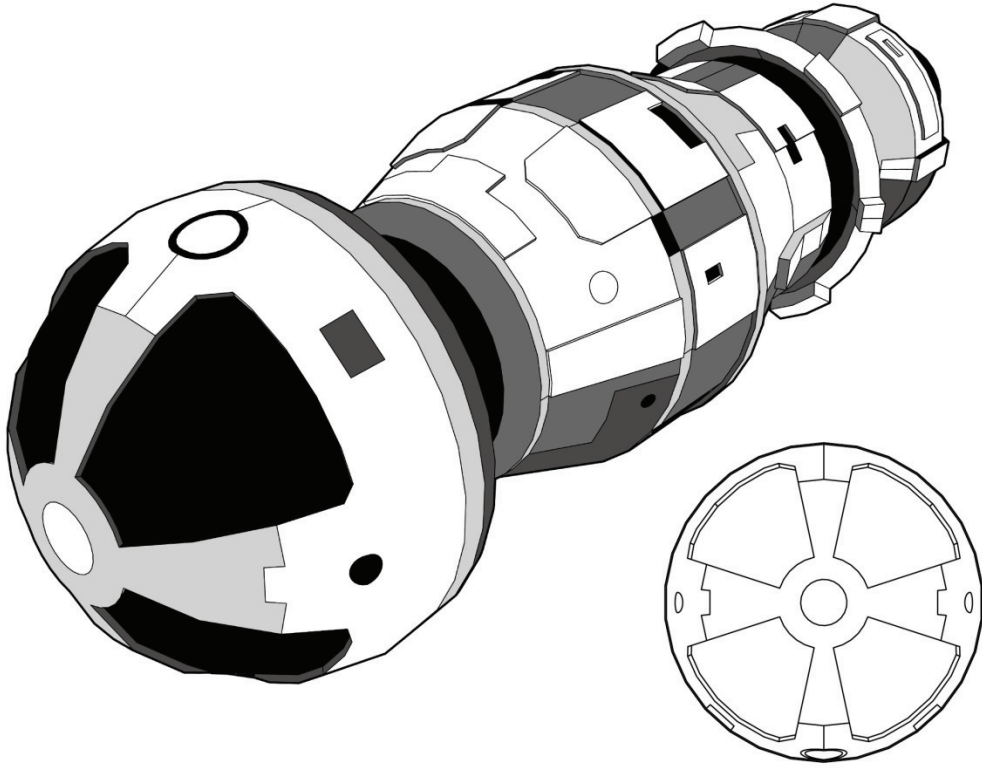

## *Ships of Clement Sector 4: Small Craft*

Type			Tonnes	Price (MCr)
<b>Hull</b>	10 dT Distributed	Hull 0 Structure 1	10.0	0.9
<b>Armor</b>	None			
<b>Zimm Drive</b>				
<b>Maneuver Drive</b>	sA	Thrust 2	0.5	1.0
<b>Power Plant</b>	sA	Rating 2	1.2	3.0
<b>Bridge</b>	Cockpit		3.0	0.1
<b>Computer</b>	Model 1	Rating 5		
<b>Electronics</b>	Standard	DM -4		
<b>Weapons</b>				
<b>Fuel</b>		One days operation	0.1	
<b>Cargo</b>				
<b>Crew</b>	up to 2			
<b>Airlock</b>				
<b>Software</b>	Maneuver/0 and Library			
<b>Basic Frame Tonnage &amp; Cost</b>			4.8	5.0

<b>Maintenance Bug</b>		Grappling Arm	2.0	1.0
		Maintenance Workshop	2.0	0.3
		Airlock	1.0	0.2
<b>Total Tonnage and Cost</b>			9.8	6.4

<b>Courier Pod</b>		cargo 5 tonnes	5.0	
<b>Total Tonnage and Cost</b>			9.8	5.0

<b>Transfer Pod</b>		8 passengers	4.0	0.2
		cargo 1 tonnes	1.0	
<b>Total Tonnage and Cost</b>			9.8	5.2

<b>Mining Pod</b>		Grappling Arm	2.0	1.0
		cargo 3 tonnes	3.0	
<b>Total Tonnage and Cost</b>			9.8	6.0















## Orbital and Work Pods

### Deck Plan Key

1. Control cabin
2. Airlock
3. Passenger section
4. Cargo section
5. Maintenance Workshop
6. Ore Hopper
7. Grappling Arm Machinery

### Deck Plan Symbols

-  Manual Hatch (overhead)
-  Manual Hatch (deck)
-  Iris Valve (overhead)
-  Iris Valve (deck)
-  Turret Access (overhead)
-  Turret Access (deck)
-  Iris Valve
-  Manual Hatch
-  Workstation
-  Sliding Door
-  Interior Wall
-  Bulkhead
-  Maintenance Hatch

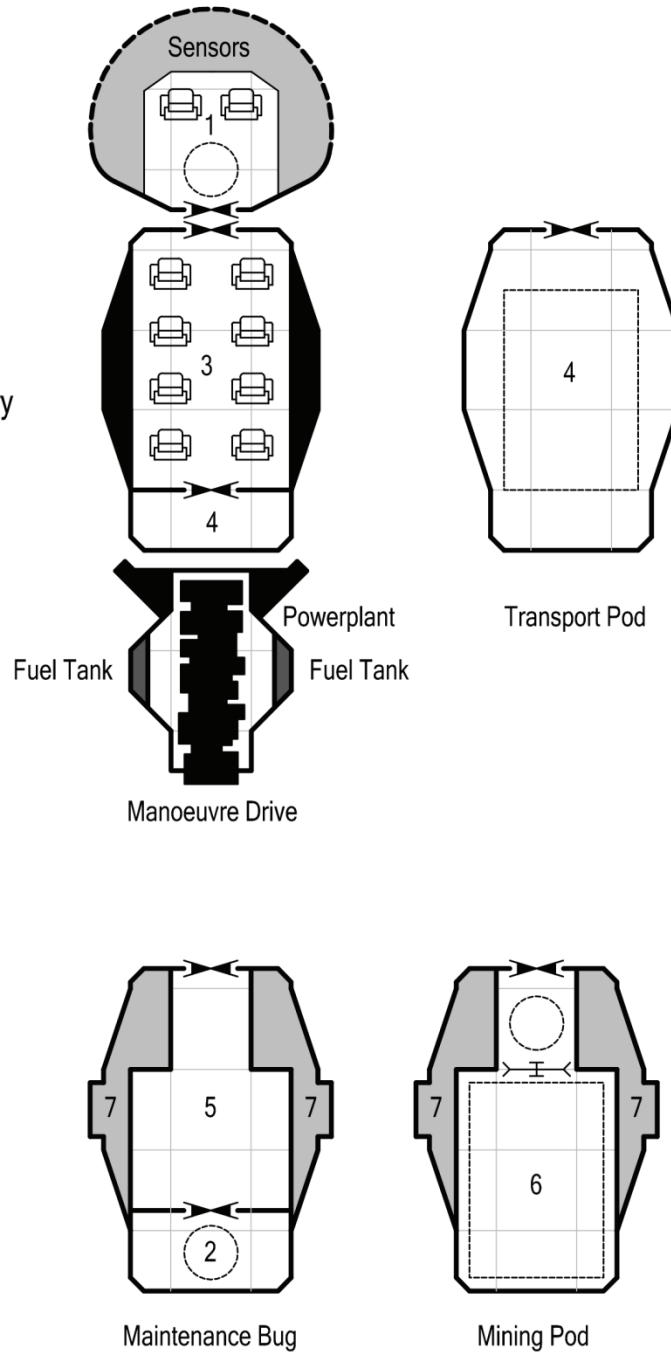

# *Ships of Clement Sector 4: Small Craft*

---

## *Fighters*

*“What do I say to capship taxi drivers? I might not be able to bother you when I am all on my lonesome, but I do have a bunch of friends who love to party with me...”*

*Lieutenant Commander Blake Sommers RN Fleet Air Arm, CO 71 Squadron c2280 CE*

### **Background and Development**

Fast and agile, fighters form part of the integrated defense of both systems and fleets. Indeed, many of the independent worlds of Clement Sector sole defense are squadrons of aerospace or space fighters reinforced by system defence boats.

Fighters are a cheap and cost effective solution to providing an independent system with a respectable and flexible defensive capability.

Within the larger system defense forces and navies, the fighter is most often deployed from orbital bases, system bases or carriers. Normally, a single fighter does not provide much of a threat to a heavily armed naval ship, but in numbers they are deadly.

Though there are many different types of fighter currently being used within Clement Sector, either “home grown” or from pre-collapse national naval forces, only four are outlined in this publication.

### **Besellschaft Be152-11 Dragonfly Space Superiority Fighter**

In service with the German Space Navy prior to the Collapse and now the standard space superiority fighter with the Hub Federation Navy, the Dragonfly is a 10dT fighter with excellent combat capability. Standard offensive armament is a starship class beam laser and a standard autocannon. Its excellent pilot visibility seems to be an anachronism for a spaceship, but in a close range furball, proved to be very popular with its pilots.

The Dragonfly has a crew of one and is capable of a thrust of eight gravities.

### **British Space Systems FA-135C Reaver Aerospace Fighter**

In service with the Royal Navy Fleet Air Arm for five years prior to the collapse, the 10dT Reaver is now used as the Hub Federation Navy and Marine Corp’s standard Aerospace Fighter. Offensive armament consists of a single starship class beam laser. For in-atmosphere and ground attack roles, a light gauss cannon and a bay containing a twelve missile rotary tactical launcher able to be armed with a variety of missiles dependent on mission role. The Reaver is the only fighter within Clement Sector to be armed with the powerful new technology gauss cannon. This weapon is equally at home in atmosphere or against targets in space.

Fuel processors allow for gas giant refuelling as required.

The only other manufacturer of the Reaver within Clement Sector is Commonwealth Aerospace (CAe) based in the New Perth system. The CA-12C Perentie (nicknamed “goanna”) is used solely by the New Perth Navy and Aerospace Force.

The Reaver has a crew of one and is capable of a thrust of eight gravities.

## ***Ships of Clement Sector 4: Small Craft***

---

### **American Aerospace F-212E Scorpion Interceptor**

A United States design, the Scorpion has a standard offensive armament of a starship class missile launcher with a twelve missile capacity and twin autocannon with 1200 rounds each.

Originally nicknamed the “bathtub” by the USSN pilots due to its large cockpit and curved canopy, the nickname has carried through to present times by all the operators of the fighter. Most production of the 10dT Scorpion is by Cascadian ship building companies. Used by the Cascadian Navy and system defense forces, it is also exported to many independent systems within the Cascadia subsector.

Kingston also builds the Scorpion, utilising their small capacity shipbuilding industry. There, the F-212E is known as the Truth’s Sword. Some modifications have been made to the original design, including the cockpit systems which have been modified to provide datalink capability for its pilots.

The Scorpion has a crew of one and is capable of a thrust of eight gravities.

### **Atlanta Consolidated F-38D Lightning System Defense Fighter**

A Southern Alliance and Republic of Texas design, the 20dT Lightning is a heavily armoured twin engined fighter that uses a starship class missile launcher as its main offensive armament. A magazine with thirty six missiles ensures that it can maintain a continuous rate of fire against a single target or at multiple targets. Secondary armament consists of two autocannon with 1200 rounds each.

Currently the only operator of this fighter in Clement Sector is Harrison, though there are unconfirmed reports of other operators using the Lightning. Whether Harrison is exporting the fighter is still purely conjecture.

The Lightning has a crew of two (pilot and weapons officer) and is capable of a thrust of seven gravities.

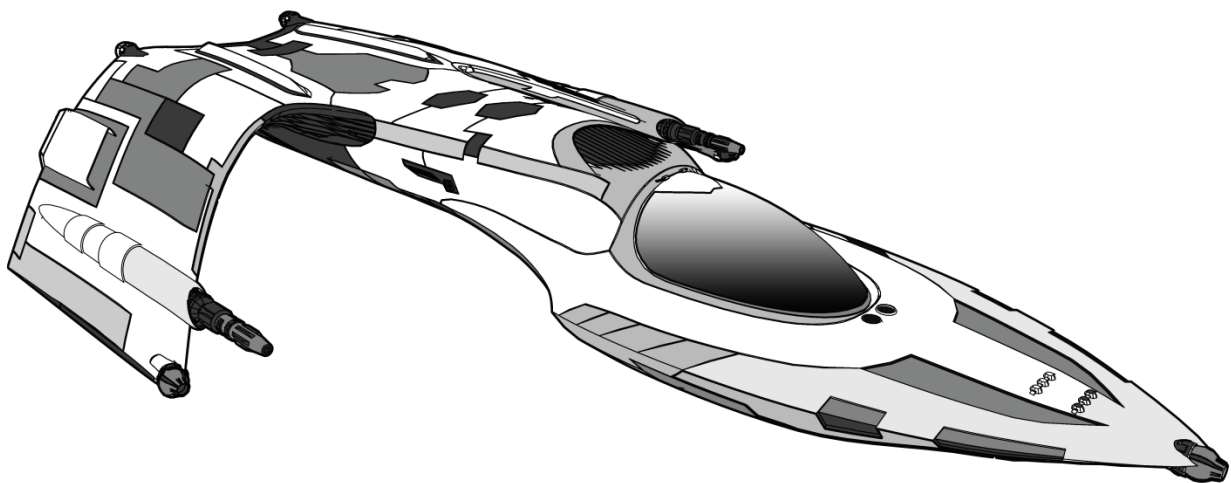

## *Ships of Clement Sector 4: Small Craft*

### *Be-152-11 Dragonfly Space Superiority Fighter*

Type			Tonnes	Price (MCr)
<b>Hull</b>	10 dT Streamlined	Hull 0 Structure 1	10.00	1.10
<b>Armor</b>	Crystaliron x0.5	2 points	0.25	0.11
<b>Zimm Drive</b>				
<b>Maneuver Drive</b>	sD	Thrust 8	2.00	3.50
<b>Power Plant</b>	sG		3.00	6.00
<b>Bridge</b>	Cockpit		1.50	0.05
<b>Computer</b>	Model 2(fib)	Rating 5		0.24
<b>Electronics</b>	Basic Military	DM 0	2.00	1.00
<b>Weapons</b>	Fixed Mount (anti ship)	Beam Laser	1.00	1.10
	Fixed Mount (anti personnel)	Autocannon (1200 rounds)		0.22
<b>Fuel</b>		12 hours of operation	0.08	
<b>Cargo</b>				
<b>Crew</b>	1			
<b>Software</b>	Maneuver/0			
	Library			
	Evade			1.00
	Fire Control/1			2.00
<b>Total Tonnage and Cost</b>			9.83	16.32

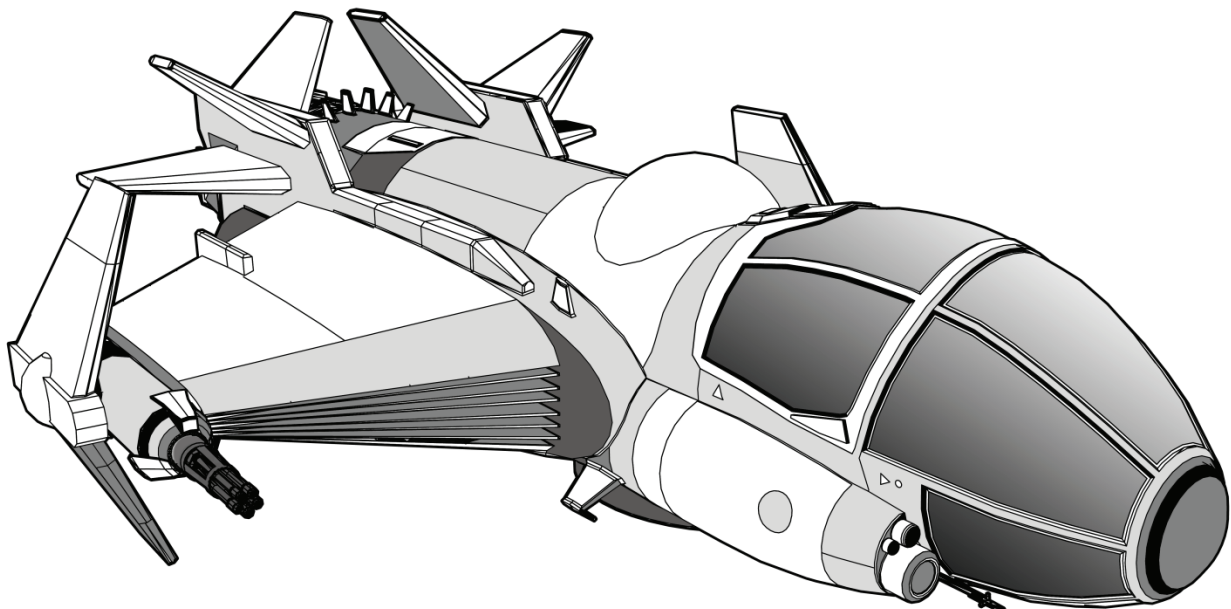

# Be-152-11 Dragonfly Space Superiority Fighter

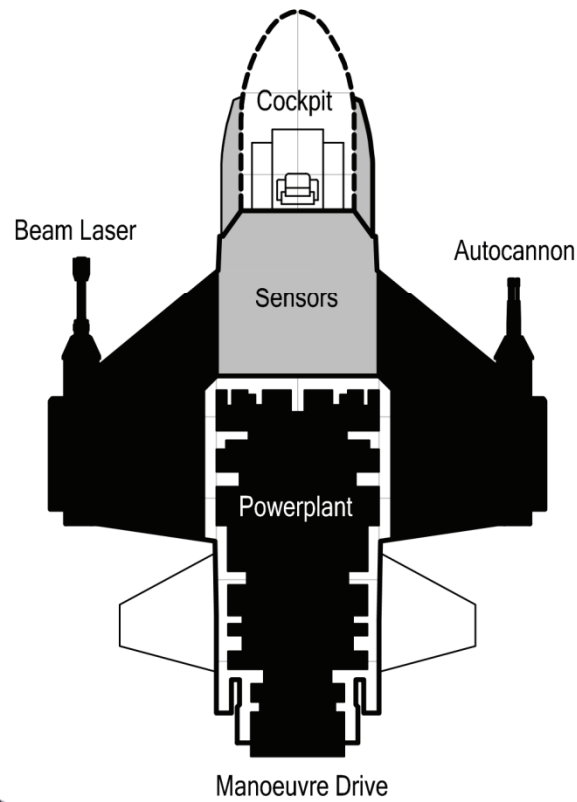

# *Ships of Clement Sector 4: Small Craft*

---

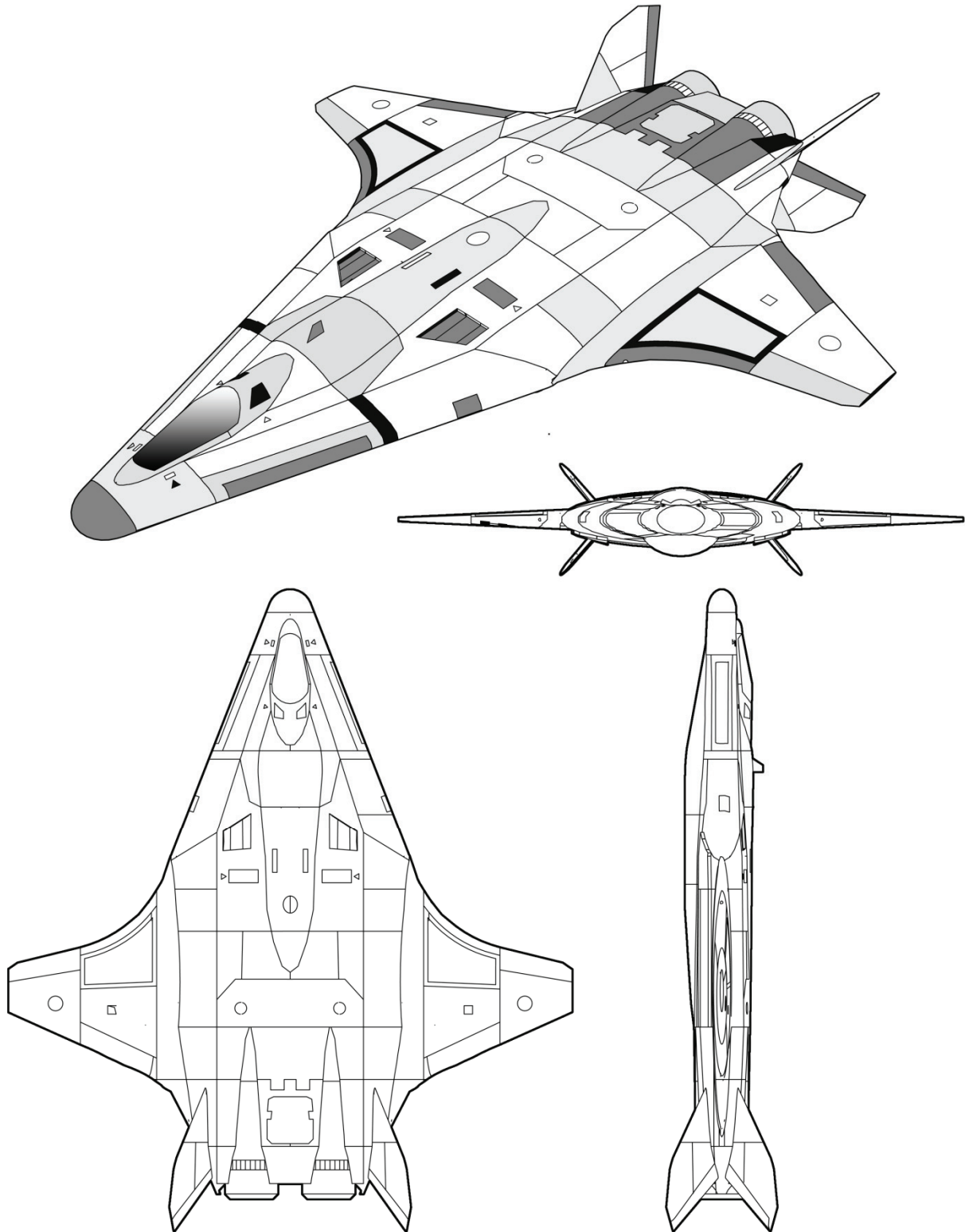













## *Ships of Clement Sector 4: Small Craft*

### *FA-135-12 Reaver Aerospace Fighter*

Type			Tonnes	Price (MCr)
<b>Hull</b>	10 dT Streamlined	Hull 0 Structure 1	10.0	1.10
<b>Armor</b>	Crystaliron x0.5	2 points	0.3	0.11
<b>Zimm Drive</b>				
<b>Maneuver Drive</b>	sD	Thrust 8	2.0	3.50
<b>Power Plant</b>	sG		3.0	6.00
<b>Bridge</b>	Cockpit		1.5	0.05
<b>Computer</b>	Model 2(fib)	Rating 5		0.24
<b>Electronics</b>	Basic Military	DM 0	2.0	1.00
<b>Weapons</b>	Fixed Mount (anti ship)	Beam Laser	1.0	1.10
	Fixed Mount (anti personnel)	Light Gauss Cannon (1200 rounds)		3.00
	Fixed Mount (anti personnel)	Missile (Tac) bay (12 capacity)		
<b>Fuel</b>		12 hours of operation	0.1	
<b>Components</b>	Fuel Processor	see modified design rules	0.3	0.01
<b>Cargo</b>				
<b>Crew</b>	1			
<b>Software</b>	Maneuver/0			
	Library			
	Evade			1.00
	Fire Control/1			2.00
<b>Total Tonnage and Cost</b>			10.1	16.11

# FA-135-12 Reaver Aerospace Fighter

## Deck Plan Symbols

-  Manual Hatch (overhead)
-  Manual Hatch (deck)
-  Iris Valve (overhead)
-  Iris Valve (deck)
-  Turret Access (overhead)
-  Turret Access (deck)
-  Iris Valve
-  Manual Hatch
-  Workstation
-  Sliding Door
-  Interior Wall
-  Bulkhead
-  Maintenance Hatch

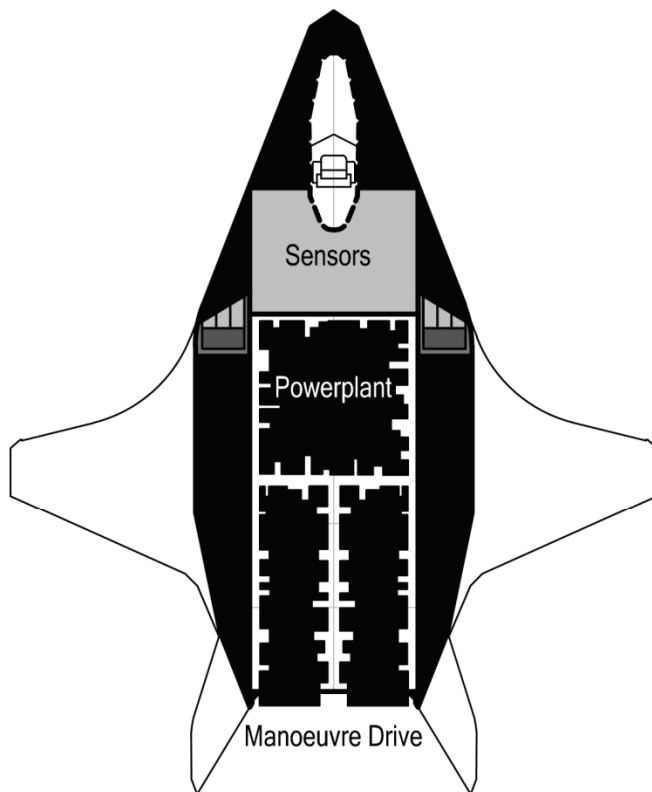



## *Ships of Clement Sector 4: Small Craft*

### *F-212E Scorpion Interceptor*

Type			Tonnes	Price (MCr)
<b>Hull</b>	10 dT Streamlined	Hull 0 Structure 1	10.00	1.10
<b>Armor</b>	Crystaliron x0.5	2 points	0.25	0.11
<b>Zimm Drive</b>				
<b>Maneuver Drive</b>	sD	Thrust 8	2.00	3.50
<b>Power Plant</b>	sD	Power 8	3.00	6.00
<b>Bridge</b>	Cockpit		1.50	0.05
<b>Computer</b>	Model 2(fib)	Rating 10		0.24
<b>Electronics</b>	Basic Military	DM 0	2.00	1.00
<b>Weapons</b>	Fixed Mount (anti ship)	Missile Rack	1.00	0.75
	Fixed Mount (anti personnel)	Autocannon x2 (1200 rounds ea)		0.44
<b>Fuel</b>		12 hours of operation	0.08	
<b>Cargo</b>				
<b>Ammunition</b>	12 Missiles		1.00	
<b>Crew</b>	1			
<b>Software</b>	Maneuver/0			
	Library			
	Evade			1.00
	Fire Control/1			2.00
<b>Total Tonnage and Cost</b>			10.83	16.19

## F-212E Scorpion Interceptor

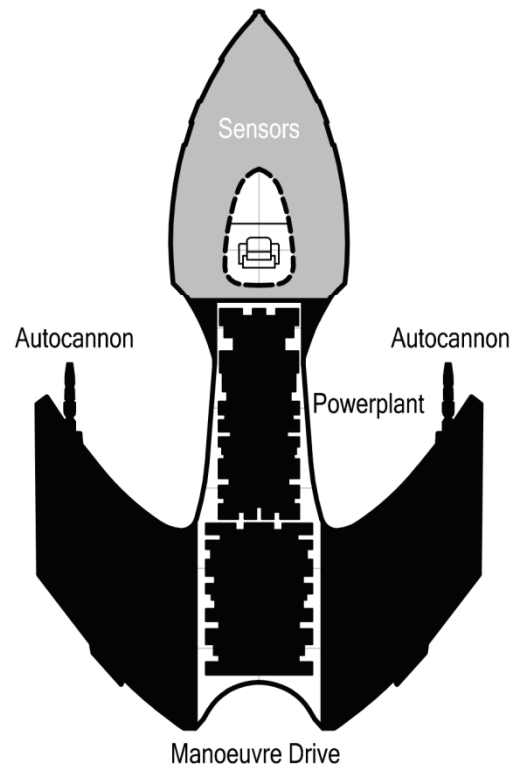

## *Ships of Clement Sector 4: Small Craft*

---

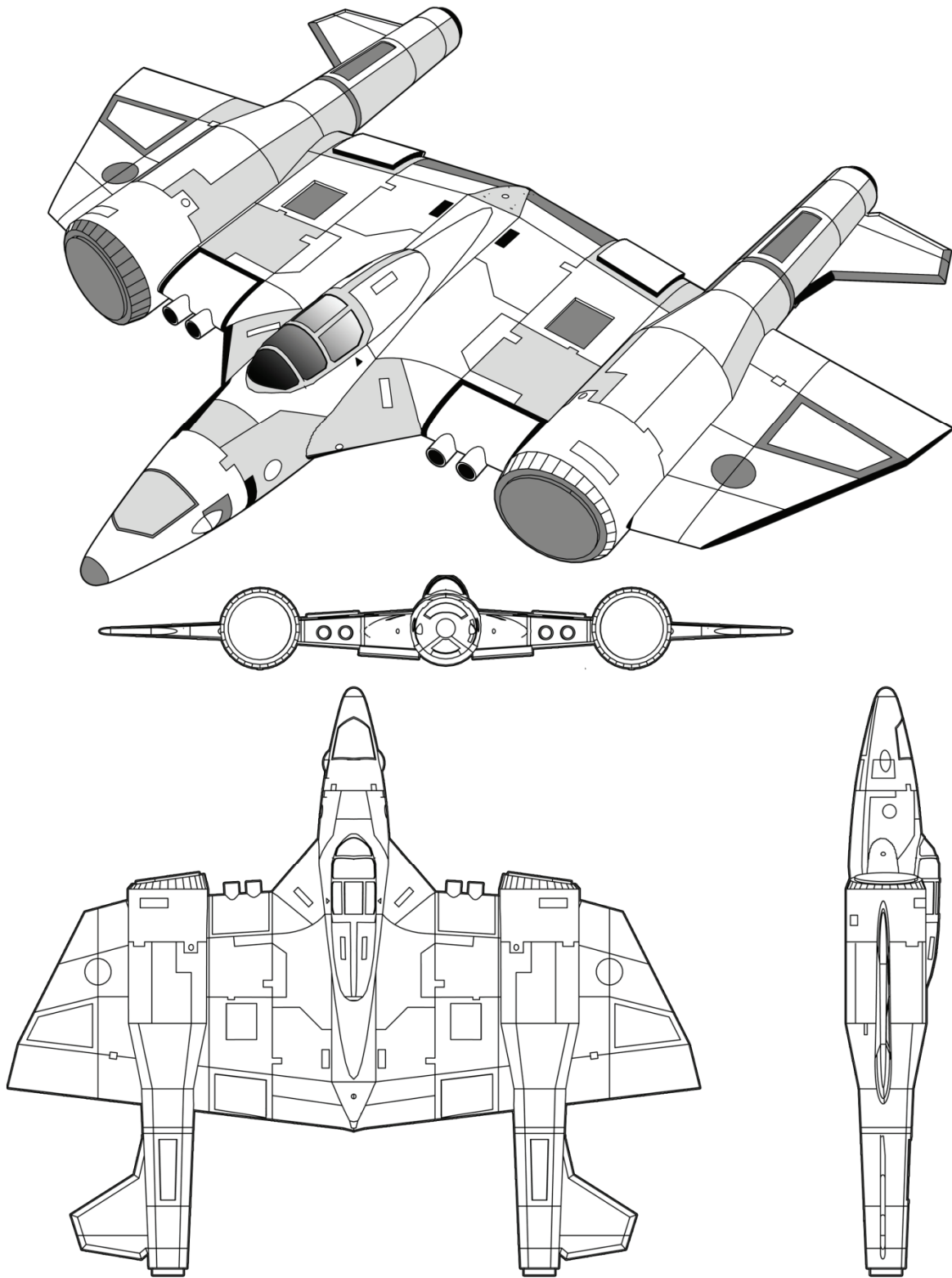

## *Ships of Clement Sector 4: Small Craft*

### *F-38D Lightning System Defence Fighter*

Type			Tonnes	Price (MCr)
<b>Hull</b>	10 dT Streamlined	Hull 0 Structure 1	20.00	1.32
<b>Armor</b>	Crystaliron x2	8 points	2.00	0.61
<b>Zimm Drive</b>				
<b>Maneuver Drive</b>	sG	Thrust 7	3.50	8.00
<b>Power Plant</b>	sG	Power 7	3.00	6.00
<b>Bridge</b>	Cockpit	2 workstations	3.00	0.10
<b>Computer</b>	Model 2(fib)	Rating 5		0.24
<b>Electronics</b>	Basic Military	DM 0	2.00	1.00
<b>Weapons</b>	Fixed Mount (anti ship)	Missile Rack	1.00	0.75
	Fixed Mount (anti personnel) x 2	Autocannon (1200 rounds)		0.44
<b>Ammunition</b>		3 x missile reloads (36)	3.00	
<b>Fuel</b>		2 weeks of operation	0.08	
<b>Cargo</b>	1 tonne			
<b>Crew</b>	2	pilot & weapons officer	1.00	
<b>Software</b>	Maneuver/0			
	Library			
	Evade			1.00
	Fire Control/1			2.00
<b>Total Tonnage and Cost</b>			18.58	18.46

## F-38D Lightning System Defence Fighter

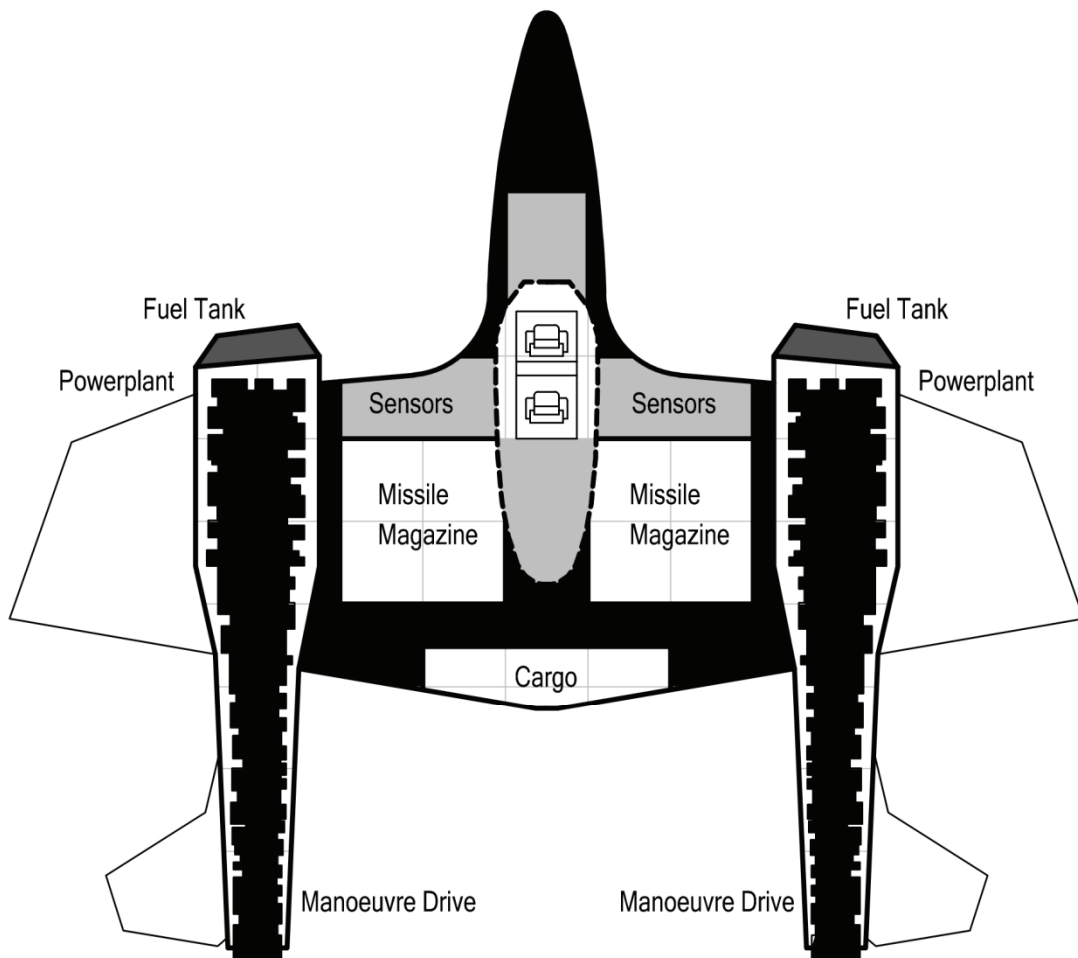

# *Ships of Clement Sector 4: Small Craft*

---

## *Fast Launch*

*"I keep asking the skipper for something faster than this slow piece of cobbled together dross, but he reckons it is fine as it is. I can EVA faster than this!"*  
*Unknown launch pilot 2340 CE*

### **Background and Development**

Responding to requests from both the Hub Federation Navy and commercial interests, Anderson and Felix Shipbuilders Company began design and development of a new, more capable ships launch to replace the current flattened cylinder shape model so widely used throughout the Clement Sector.

The Hub Federation Navy was very desirous of a new, more capable ships launch as a direct replacement for the current SL-31-9 model currently deployed throughout the fleet. The SL-31-9, though rugged and reliable, was only able to achieve a thrust of two gravities making it incapable of keeping up with other current small craft.

Anderson and Felix's design division produced a new design identical in outward appearance to the older SL-31-9 but with an uprated drive providing thrust of six gravities. The design division also unveiled a new launch design based on discussions with the Navy and commercial transport corporation representatives. One of the major points of discussion was the lack of airworthiness of not only the SL-31-9 but the broader issue of all small craft of similar hull type.

The new launch is an aerospace small craft with integral lifting surfaces and atmospheric flight controls to allow for smoother, more manoeuvrable in-atmosphere flights than the standard flattened cylinder designs introduced when gravitic drives replaced plasma reaction drives. The only drawback to this design was that the wider configuration, even with folding wings, would not fit into Navy starship hangar spaces.

Regardless, the Hub Federation Navy immediately placed an order for both designs so as to replace all their SL-31-9 launches in

service with the newer, faster SL/F-31-11 and to use the winged Meteor class for non-starship duties. Currently the only Hub Federation Navy vessel using the Meteor class is the new *Vulkan*-class Attack Boat tender currently entering service.

Delighted with the performance of the Meteor class, trans-orbital transport companies throughout the Hub Federation quickly made orders for the new design. As the design became better known, orders began to flow in over time from interested parties all over Hub and surrounding subsectors.

A&F continues limited production of the older design (now reassigned the type code of SL/S-31-11 slow launch), recognising that it would still have commercial appeal as a budget option for commercial use.

### **SL/F-31-11 Fast Launch**

A more powerful version of the older and slower flattened cylindrical design, the SL/F-31-11 fast launch is the preferred launch of the Hub Federation Navy. This is due to several factors including familiarity of use and the compact hull form allowing more efficient use of hangar space.

It is available as a standard passenger/cargo configuration but this can be customised to any arrangement according to purchaser's specific requirements. The default standard version is configured primarily for passenger duties. Interior cabin space has been configured to allow transport of ten passengers and space for 4dT of cargo, externally accessible via a large cargo door in the launches port side or via the passenger cabin.

## *Ships of Clement Sector 4: Small Craft*

---

In extreme situations, the fast launch can be used as a lifeboat. With extended operations duration of two weeks, this can be a critical consideration for surviving crew in such situations.

The SL/F-31 can be armed with a standard ships laser at the expense of 1dT of cargo space required to install fire control. It has a crew of one within a cockpit and is capable of a thrust of six gravities.

### **Meteor Class**

Available as a standard combined passenger/cargo version configuration, cabin space can be customised to any arrangement according to purchaser's specific requirements. The launch is atmospherically streamlined with the wings designed to be folded when docked in a hangar, thus reducing space requirements.

In extreme situations, the fast launch can be used as a lifeboat. With extended operations duration of two weeks, this can be a critical consideration for surviving crew in such situations. Fuel scoops and fuel processors allow the fast launch to refuel as required by either scooping fuel from gas giants or planetary oceans.

The Meteor class series cannot be armed with a starship class weapon system and has a crew of one within a cockpit. It is capable of a thrust of six gravities.

The Hub Federation Navy currently uses two other versions for non-starship duties. These designs are not restricted to

Navy use and can be ordered by any A&F customer.

### **Standard version**

This version is configured primarily for passenger transport. Interior cabin space has been configured to allow transport of twelve passengers and space for 4dT of cargo, externally accessible via a large cargo door in the launches stern or internally via the passenger cabin.

### **Beatty class Captain's Gig**

This version is configured primarily for transportation of command rank officers. Interior cabin space has been configured to allow transport of six passengers, two staterooms and space for 4dT of cargo, externally accessible via a large cargo door in the launches stern or internally via the passenger cabin.

### **Nelson class Admiral's Barge**

This version is configured primarily for transportation of flag rank officers. Interior cabin space has been configured to allow transport of four passengers, four staterooms and space for 2dT of cargo, externally accessible via a large cargo door in the launches stern or internally via the passenger cabin.

## *Ships of Clement Sector 4: Small Craft*

---

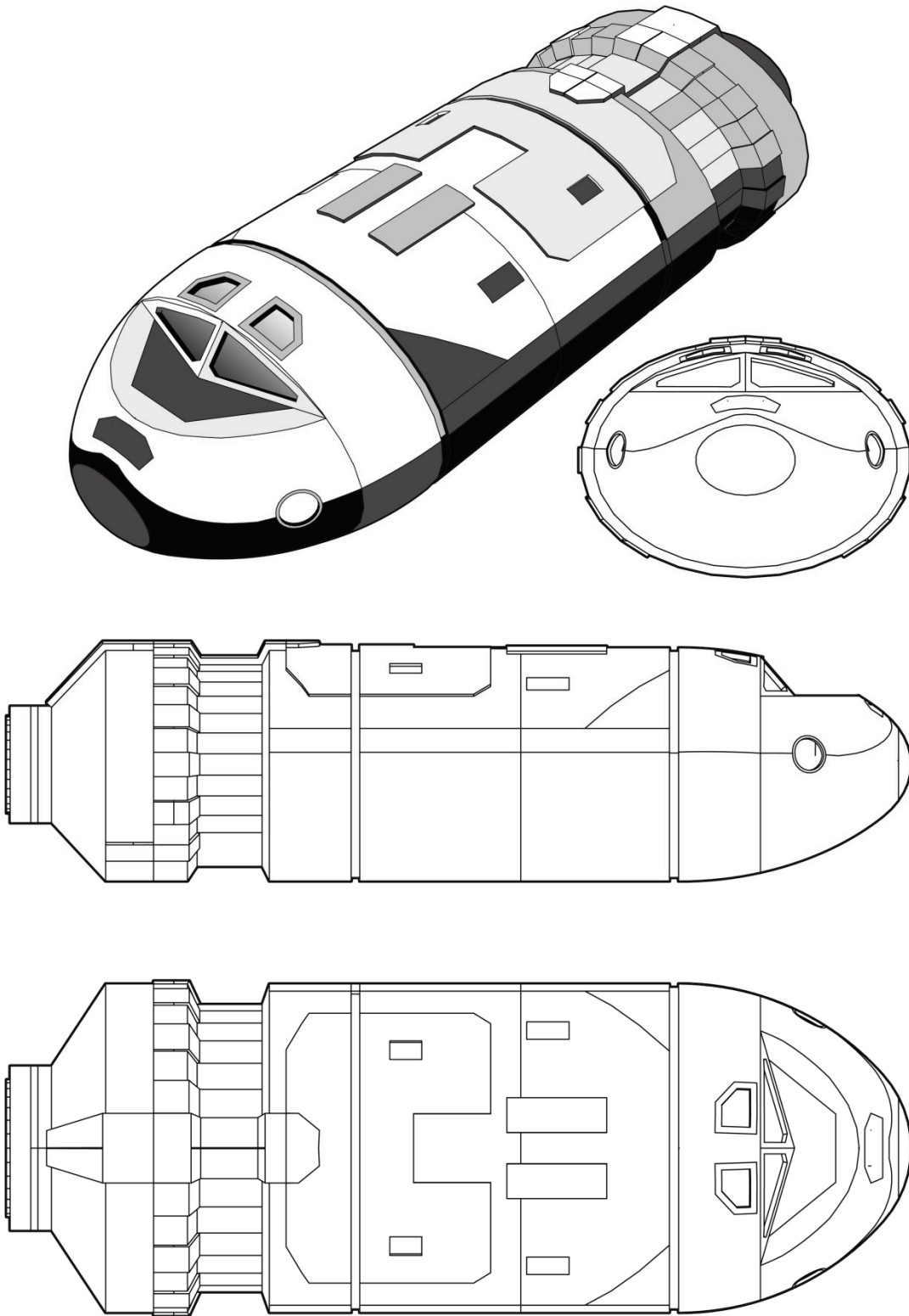



## *Ships of Clement Sector 4: Small Craft*

---

### *SL/F-31-11 Fast Launch (Armed)*

Type			Tonnes	Price (MCr)
<b>Hull</b>	20 dT Streamlined (flattened cylinder)	Hull 0 Structure 1	20.0	1.2
<b>Armor</b>	Crystaliron x1	4 points	1.0	0.3
<b>Zimm Drive</b>				
<b>Maneuver Drive</b>	sF	Thrust 6	3.0	6.0
<b>Power Plant</b>	sG	Rating 6	3.0	6.0
<b>Bridge</b>	Cockpit		1.5	0.1
<b>Computer</b>	Model 1	Rating 5		
<b>Electronics</b>	Standard	DM -4		
<b>Weapons</b>	Fixed Mount (anti ship)	Beam Laser	1.0	1.1
<b>Fuel</b>		2 weeks of operation	1.5	
<b>Cargo</b>	3 tonnes		3.0	
<b>Crew</b>	1			
<b>Airlock</b>			1.0	0.2
<b>Software</b>	Maneuver/0			
	Library			
<b>Passengers</b>		10 passengers	5.0	0.3
<b>Total Tonnage and Cost</b>			20.0	15.2

## *Ships of Clement Sector 4: Small Craft*

---

### *SL/F-31-11 Fast Launch (Unarmed)*













Type			Tonnes	Price (MCr)
<b>Hull</b>	20 dT Streamlined (flattened cylinder)	Hull 0 Structure 1	20.0	1.2
<b>Armor</b>	Crystaliron x1	4 points	1.0	0.3
<b>Zimm Drive</b>				
<b>Maneuver Drive</b>	sF	Thrust 6	3.0	6.0
<b>Power Plant</b>	sF	Rating 6	2.7	5.5
<b>Bridge</b>	Cockpit		1.5	0.1
<b>Computer</b>	Model 1	Rating 5		
<b>Electronics</b>	Standard	DM -4		
<b>Weapons</b>				
<b>Fuel</b>		2 weeks of operation	1.5	
<b>Cargo</b>	4 tonnes		4.0	
<b>Crew</b>	1			
<b>Airlock</b>			1.0	0.2
<b>Software</b>	Maneuver/0			
	Library			
<b>Passengers</b>		10 passengers	5.0	0.3
<b>Total Tonnage and Cost</b>			19.7	13.6

# Fast Launch

## Deck Plan Key

1. Control cabin
2. Airlock
3. Fresher
4. Passenger section
5. Cargo section

## Deck Plan Symbols

-  Manual Hatch (overhead)
-  Manual Hatch (deck)
-  Iris Valve (overhead)
-  Iris Valve (deck)
-  Turret Access (overhead)
-  Turret Access (deck)
-  Iris Valve
-  Manual Hatch
-  Workstation
-  Sliding Door
-  Interior Wall
-  Bulkhead
-  Maintenance Hatch

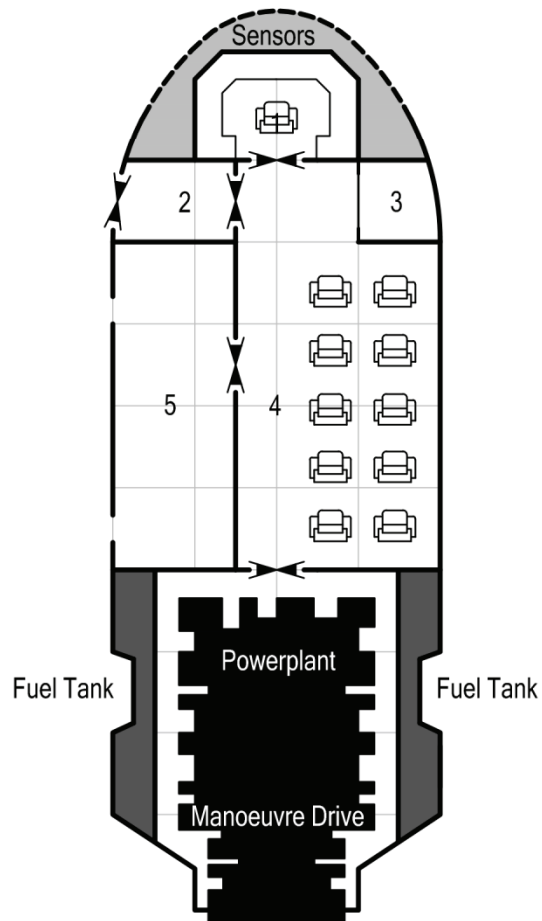

## ***Ships of Clement Sector 4: Small Craft***

---

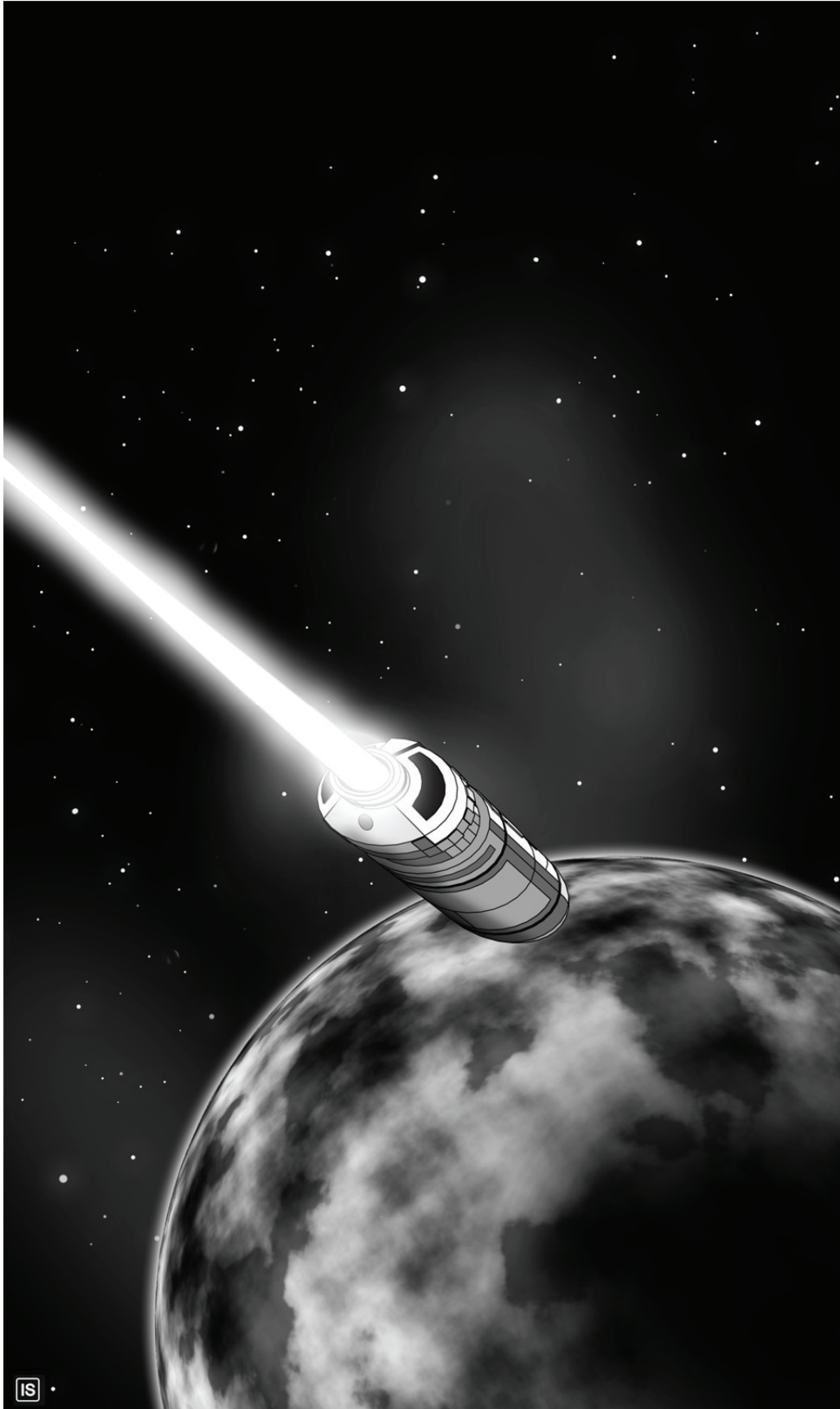

## *Ships of Clement Sector 4: Small Craft*

---

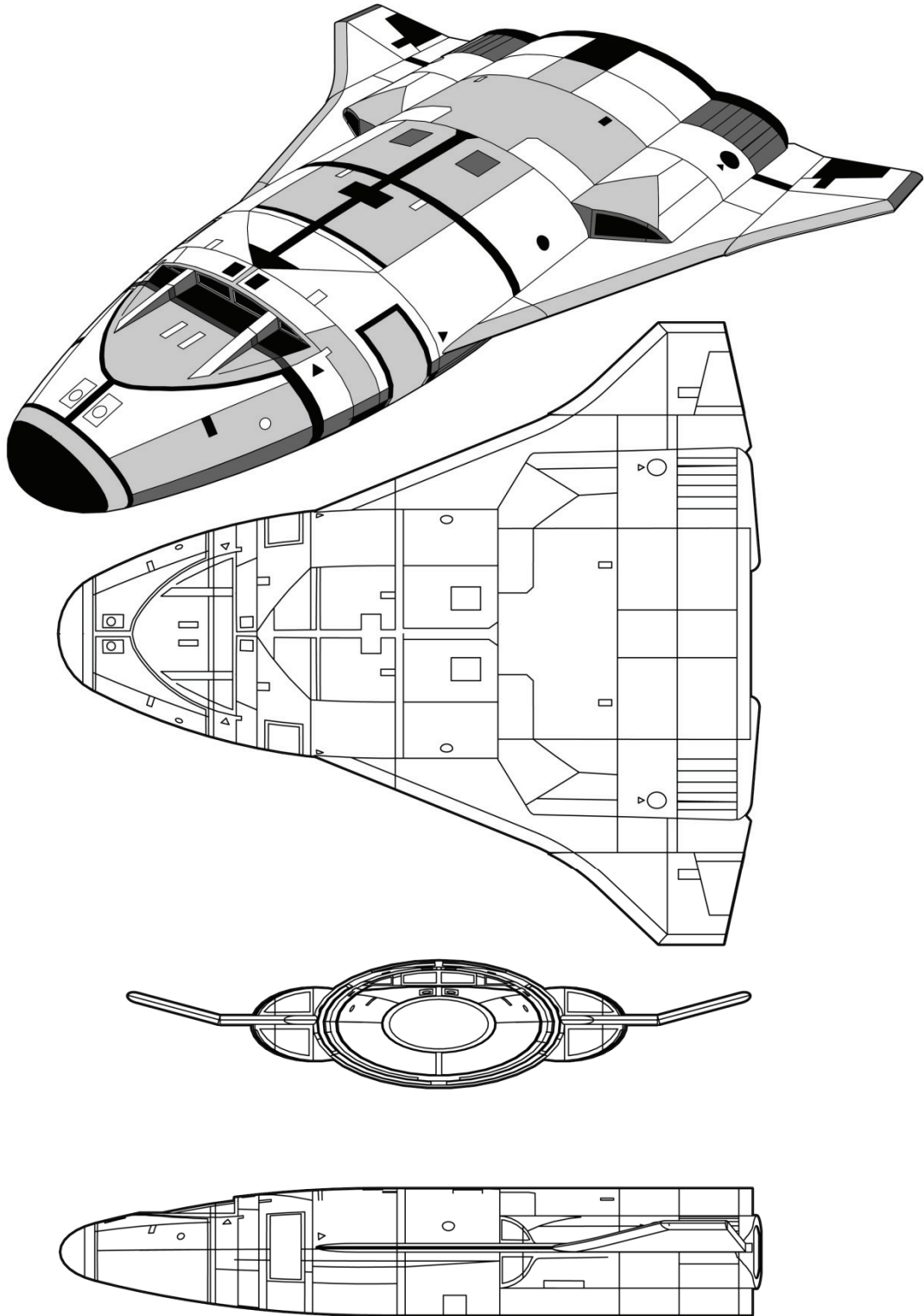

## *Ships of Clement Sector 4: Small Craft*

### *Meteor-class Fast Launch*

Type			Tonnes	Price (Mcr)
<b>Hull</b>	20 dT Streamlined	Hull 0 Structure 1	20.0	1.2
<b>Armor</b>	None			
<b>Zimm Drive</b>				
<b>Maneuver Drive</b>	sF	Thrust 6	3.0	6.0
<b>Power Plant</b>	sF	Rating 6	2.7	5.5
<b>Bridge</b>	Cockpit		1.5	0.1
<b>Computer</b>	Model 1	Rating 5		
<b>Electronics</b>	Standard	DM -4		
<b>Weapons</b>				
<b>Fuel</b>	including onboard processor	2 weeks of operation	1.8	
<b>Cargo</b>				
<b>Crew</b>	1			
<b>Airlock</b>			1.0	0.2
<b>Software</b>	Maneuver/0 Library			
<b>Basic Frame Tonnage &amp; Cost</b>			10.0	11.8

<b>Variant A</b>	Standard (Meteor Class)	12 passengers cargo 4 tonnes	6.0 4.0	0.2
<b>Total Tonnage and Cost</b>			20.0	12.0

<b>Variant B</b>	Captain's Gig (Beatty Class)	6 passengers 2 staterooms cargo 4 tonnes	3.0 3.0 4.0	0.1 0.2
<b>Total Tonnage and Cost</b>			20.0	12.1













<b>Variant C</b>	Admiral's Barge (Nelson Class)	4 passengers 4 staterooms cargo 2 tonnes	2.0 6.0 2.0	0.1 0.3
<b>Total Tonnage and Cost</b>			20.0	12.2

# Meteor Class Fast Launch

## Deck Plan Key

1. Control cabin
2. Airlock
3. Fresher
4. Passenger section
5. Cargo section

## Deck Plan Symbols

-  Manual Hatch (overhead)
-  Manual Hatch (deck)
-  Iris Valve (overhead)
-  Iris Valve (deck)
-  Turret Access (overhead)
-  Turret Access (deck)
-  Iris Valve
-  Manual Hatch
-  Workstation
-  Sliding Door
-  Interior Wall
-  Bulkhead
-  Maintenance Hatch

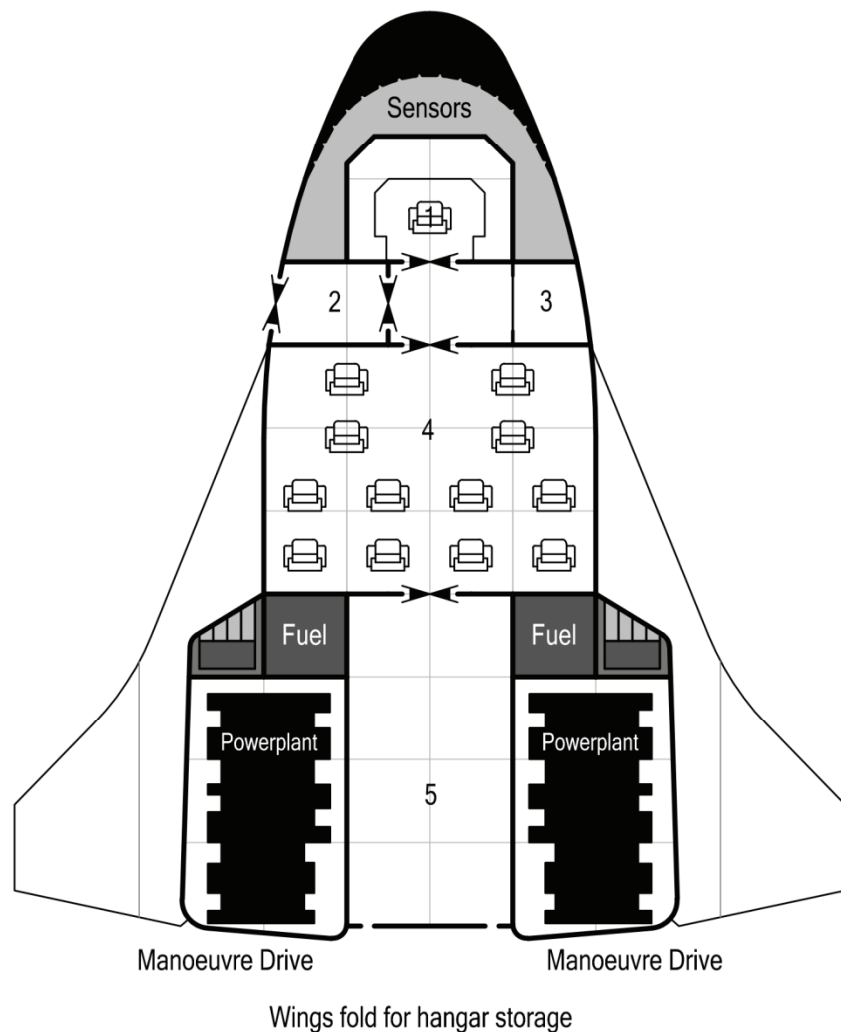













# Beatty Class Captain's Gig

## Deck Plan Key

1. Control Cabin
2. Airlock
3. Fresher
4. Passenger Section
5. Passenger Stateroom
6. Cargo Section

## Deck Plan Symbols

-  Manual Hatch (overhead)
-  Manual Hatch (deck)
-  Iris Valve (overhead)
-  Iris Valve (deck)
-  Turret Access (overhead)
-  Turret Access (deck)
-  Iris Valve
-  Manual Hatch
-  Workstation
-  Sliding Door
-  Interior Wall
-  Bulkhead
-  Maintenance Hatch

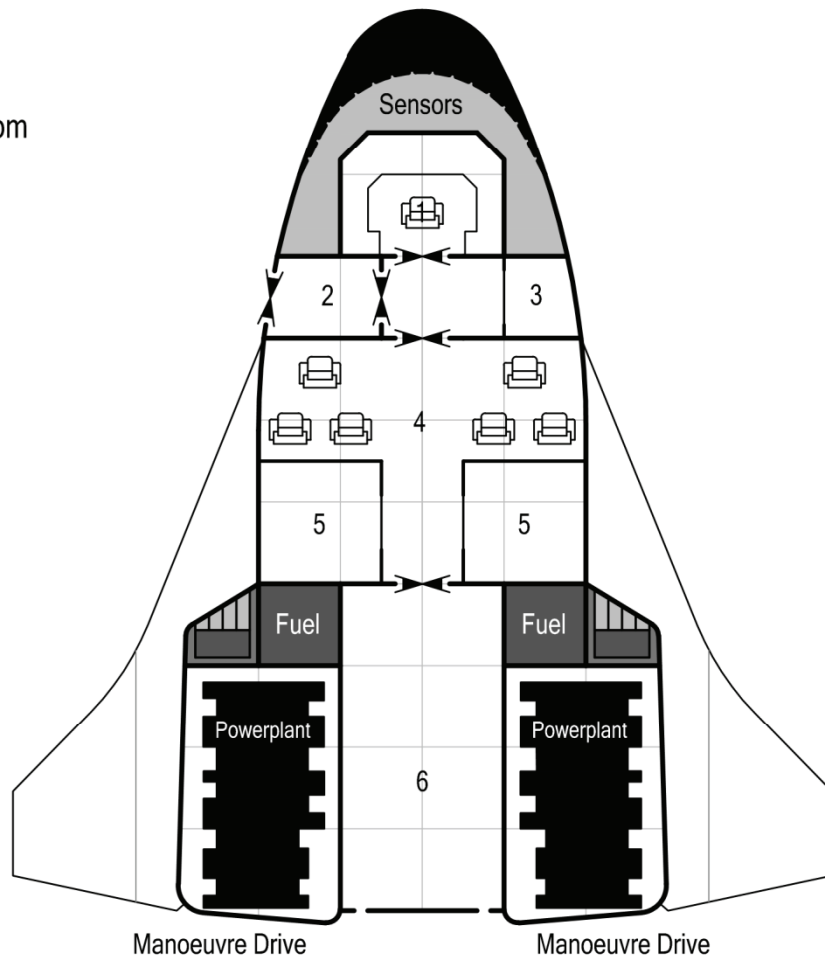

Wings fold for hangar storage















# Nelson Class Admiral's Barge

## Deck Plan Key

1. Control Cabin
2. Airlock
3. Fresher
4. Passenger Section
5. Passenger Stateroom
6. Cargo Section

## Deck Plan Symbols

-  Manual Hatch (overhead)
-  Manual Hatch (deck)
-  Iris Valve (overhead)
-  Iris Valve (deck)
-  Turret Access (overhead)
-  Turret Access (deck)
-  Iris Valve
-  Manual Hatch
-  Workstation
-  Sliding Door
-  Interior Wall
-  Bulkhead
-  Maintenance Hatch

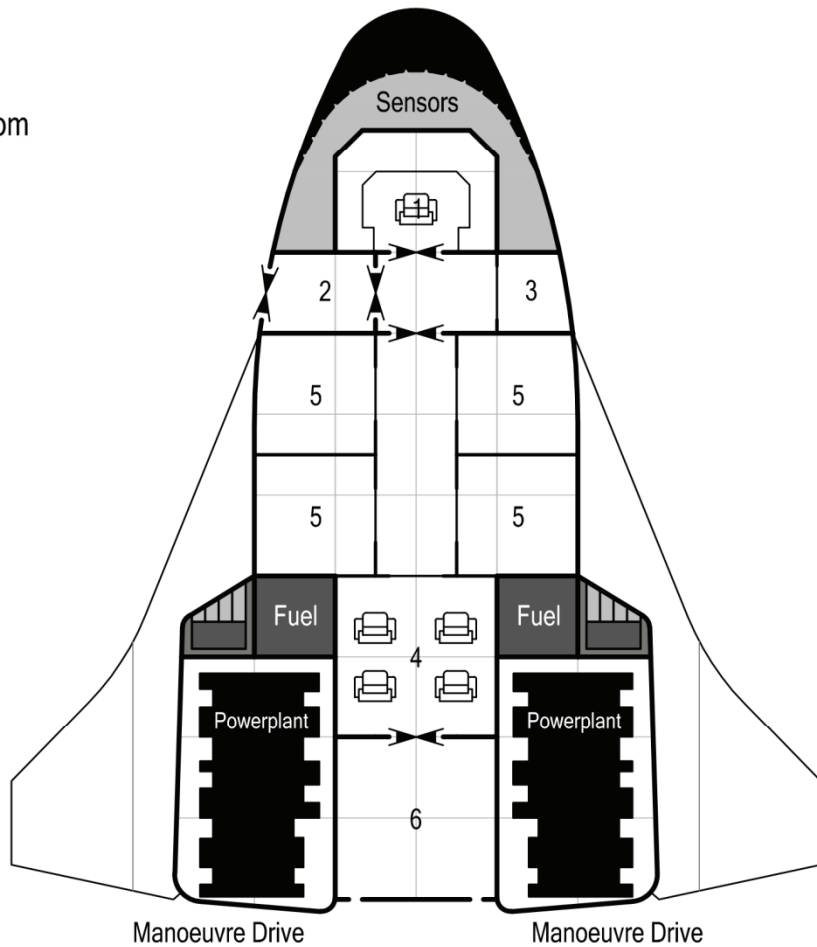

Wings fold for hangar storage

# *Ships of Clement Sector 4: Small Craft*

---

## *Ship's Boats*

*"Oh, SHINY!"*

*Attributed to Test Pilot Catriona Draper when shown the Eagle Class Ship's Boat  
2338 CE*

### **Background and Development**

Part of the design and construct contract for the *Kiviat*-class Patrol Corvette issued to Anderson and Felix Shipbuilders Company was the requirement for a ship's boat that was to be used as a boarding craft. The boat was to have an enlarged boarding airlock, beam laser armament and be armoured for protection if fired on. The boarding boat was to follow the ubiquitous flattened cylinder hull type allowing use of existing ship's boat hangar spaces.

Another ship's boat design was tabled at a meeting at BuShips during discussions regarding a new generation of small craft designs. Not only were the Navy consulted but commercial interests based within the Hub Federation and several other independent worlds were involved in later discussions. The Eagle class ship's boat is a standard 30dT aerospace small craft that has integral lifting surfaces and atmospheric flight controls. This allows for smoother, more manoeuvrable in-atmosphere flights than the standard flattened cylinder design introduced when gravitic drives replaced plasma reaction drives.

### **SB/B-22-11 Ships Boat – Boarding**

Initially designed for use in the new *Kiviat*-class patrol corvette, the boarding boat is configured primarily for boarding disabled or surrendered pirate ships, rescuing crew personnel from crippled or damaged ships or moving prize crews to captured ships.

Modifications to the standard ship's boat design include adding crystaliron hull armour and enlarging the airlock to facilitate rapid egress. Interior cabin space has been

configured to allow transport of twelve passengers and space for 3dT of cargo, externally accessible via a large cargo door. A single fixed mount beam laser provides the boat with offensive/defensive capability as required.

In extreme situations, the ship's boat can be used as a lifeboat. With extended operations duration of two weeks, this can be a critical consideration for crew in such situations.

Boarding boats are now embarked on all smaller fleet units of the Hub Federation Navy that are engaged in anti-piracy patrols, replacing the standard ship's boat version usually carried.

The boarding boat has a crew of two within a cockpit and is capable of a thrust of six gravities.

### **Eagle Class**

Available off the shelf as a standard combined passenger/cargo version configuration or a more passenger orientated version. Cabin space arrangements however can be customised to any arrangement according to purchaser's specific requirements. The launch is atmospherically streamlined with the wings designed to be folded when docked in a hangar, thus reducing space requirements.

In extreme situations, the Eagle class can be used as a lifeboat. With extended operations duration of two weeks, this can be a critical consideration for surviving crew in such situations. Fuel scoops and fuel processors allow the fast launch to refuel as required by either scooping fuel from gas giants or planetary oceans.

## ***Ships of Clement Sector 4: Small Craft***

---

The Naval version of the Eagle class series is armed with a single fixed mount beam laser providing the boat with offensive/defensive capability as required. Civilian owned and operated boats do not normally come armed with a starship class weapon system.

The Eagle class ship's boat has a crew of two within a cockpit and is capable of a thrust of six gravities.

### **Standard version**

This version seeks to provide a balance for the transport of passengers and cargo. Interior cabin space has been

configured to allow transport of fourteen passengers and space for 7dT of cargo, externally accessible via a large cargo door in the launches stern or internally via the passenger cabin.

### **Passenger Version**

This version is configured primarily for transportation of passengers. Interior cabin space has been configured to allow transport of twenty passengers and space for 4dT of cargo, externally accessible via a large cargo door in the launches stern or internally via the passenger cabin.

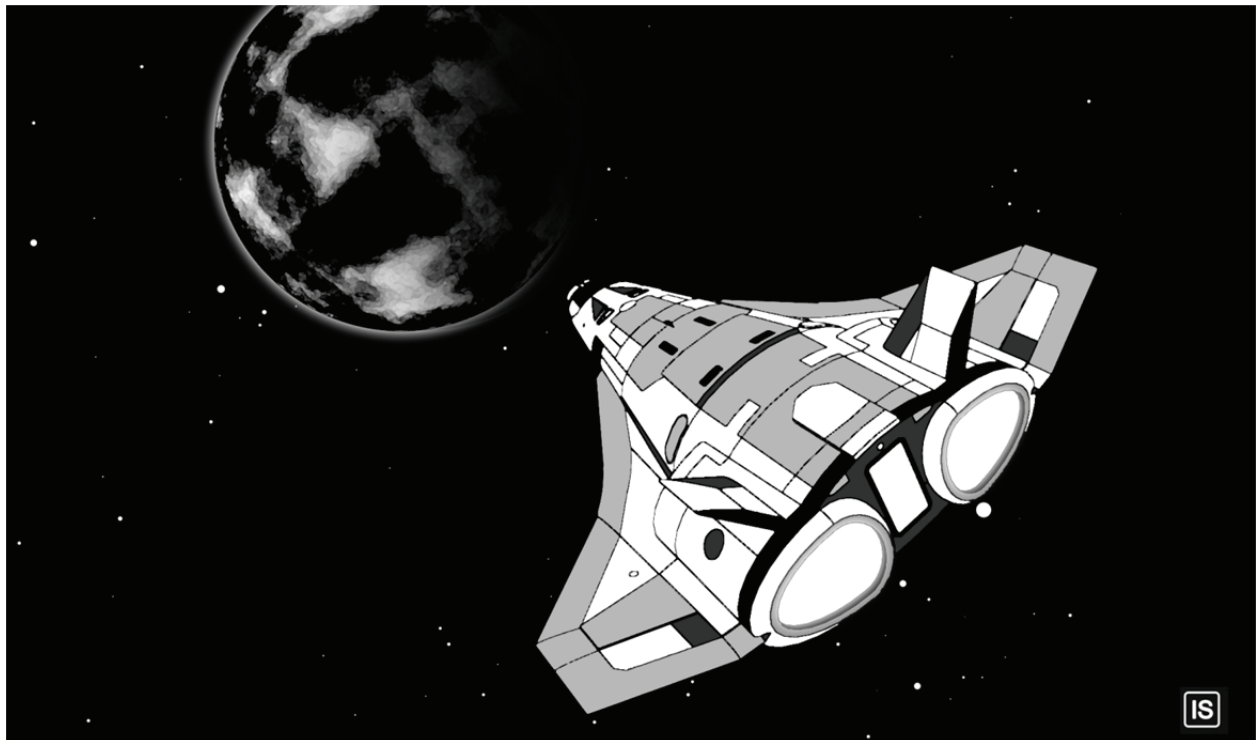

## *Ships of Clement Sector 4: Small Craft*

---

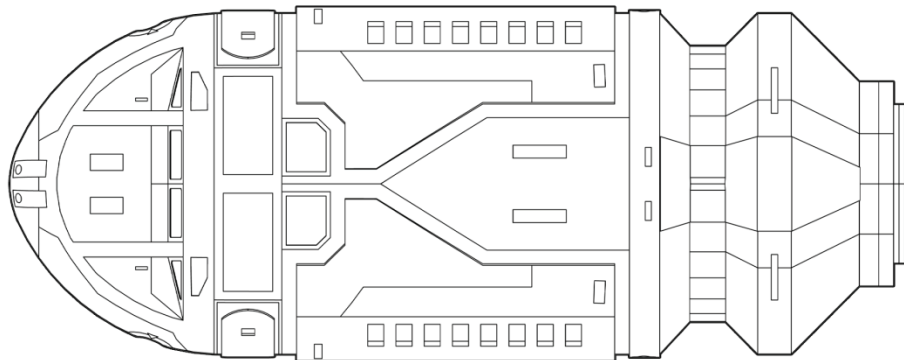
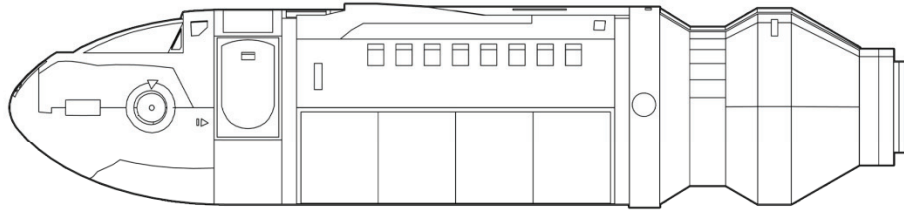
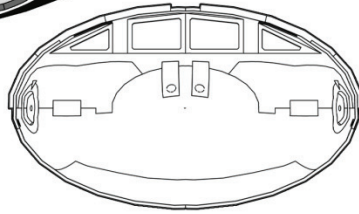
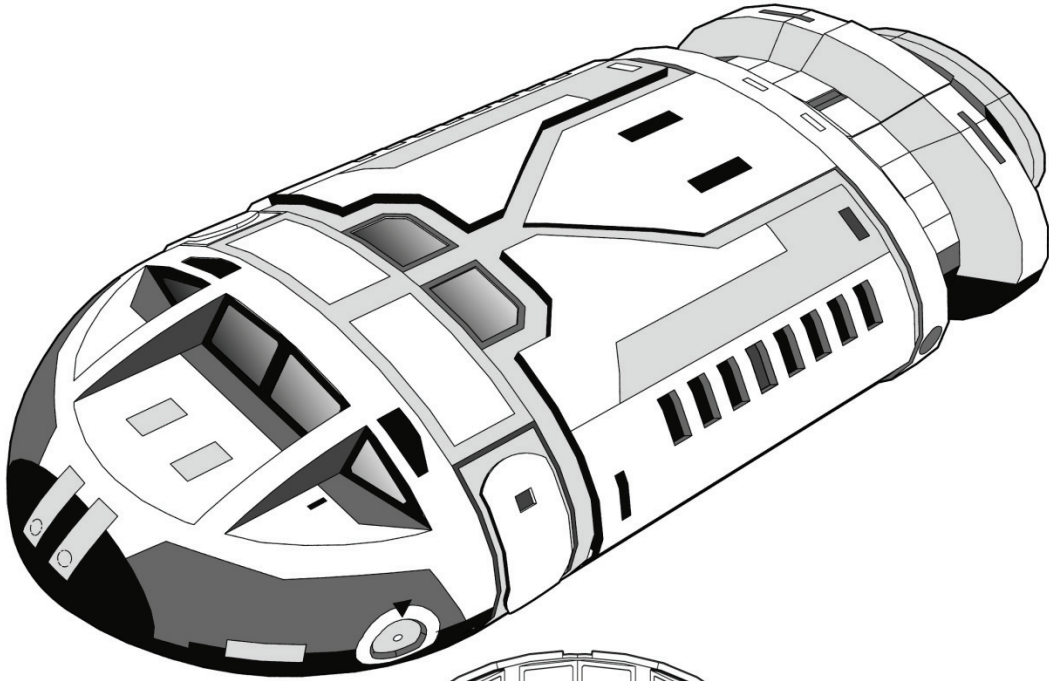

## *Ships of Clement Sector 4: Small Craft*

---

### *SB/B-22-11 Ships Boat – Boarding Craft*













Type			Tonnes	Price (MCr)
<b>Hull</b>	30 dT Streamlined (flattened cylinder)	Hull 0 Structure 1	30.0	1.3
<b>Armor</b>	Crystaliron x1	4 points	1.5	0.3
<b>Zimm Drive</b>				
<b>Maneuver Drive</b>	sJ	Thrust 6	4.5	10.0
<b>Power Plant</b>	sJ	Rating 6	3.6	7.0
<b>Bridge</b>	Control Cabin		6.0	0.2
<b>Computer</b>	Model 1	Rating 5		
<b>Electronics</b>	Standard	DM -4		
<b>Weapons</b>	Fixed Mount	Beam Laser	1.0	1.1
<b>Fuel</b>	including onboard processor	2 weeks of operation	2.3	
<b>Cargo</b>	3 tonnes		3.0	
<b>Crew</b>	2			
<b>Airlock</b>	boarding type		2.0	0.4
<b>Software</b>	Maneuver/0			
	Library			
<b>Passengers</b>		12 passengers	6.0	0.2
<b>Total Tonnage and Cost</b>			29.9	20.2

# Ship's Boat - Boarding Craft

## Deck Plan Key

1. Control cabin
2. Boarding Airlock
3. Fresher
4. Passenger section
5. Cargo section

## Deck Plan Symbols

-  Manual Hatch (overhead)
-  Manual Hatch (deck)
-  Iris Valve (overhead)
-  Iris Valve (deck)
-  Turret Access (overhead)
-  Turret Access (deck)
-  Iris Valve
-  Manual Hatch
-  Workstation
-  Sliding Door
-  Interior Wall
-  Bulkhead
-  Maintenance Hatch

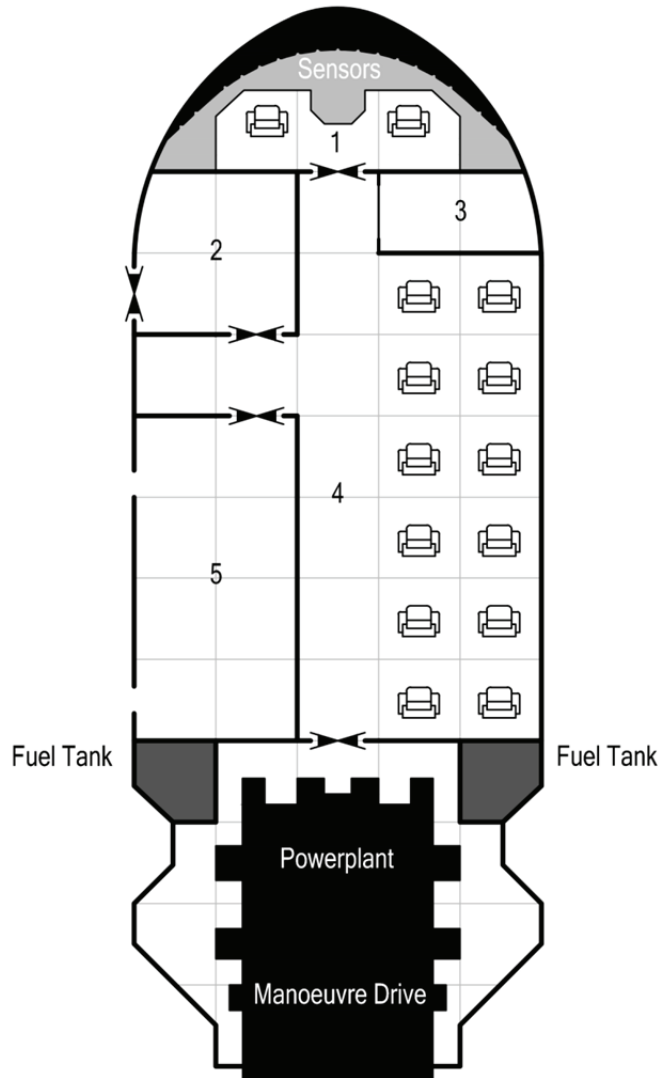

## *Ships of Clement Sector 4: Small Craft*

---

**Cascadia Orbital Space**  
**Cascadia System, Cascadia Subsector 0705**  
**March 5th, 2343 (Santos 64, 68)**  
**1450 Standard Time**

*"When are you going change that awful red hair to something approaching normal, Betty?"*

*"I thought you liked it, Mister Speaker? Do you want me to colour it in yellow and green with our flag on the side?"*

*"No... not yet, but ask me again next week after the senate subcommittee meeting about Tranquillity." Giving a grin, he waved a hand at the dynamic controls with lights flashing in a low-light setting across the canopy. "Last minute change of plan, we aren't heading back to Baker yet. Miriam is giving a presentation at Trinity College and I want to surprise her there. Think you can get me planetside by sixteen hundred?"*

*She held back the frown, because you never frowned in front of the Speaker of Congress if you wanted to remain as his chief pilot. "Well, Mister Speaker, our flight plan is already laid on for Baker and your ground party will be waiting there... and the fighter boys escorting us ain't gonna like it, nor will the Secret Service. Are you planning on staying in Roosevelt overnight or just picking up Mrs Blackledge and then coming on to Baker?"*

*"Don't worry about them, Betty, I'll have Art take care of them. It's just to save Miriam from having to catch the suborbital and gives me a chance to press a few hands ahead of the subcommittee meeting. We'll be home by supper."*

*"Aww, how can I refuse a command from the Speaker of the Congress? I can get us there in thirty minutes, but I just need to make sure the traffic from Taylor is cleared from our path, sir."*

*"Good work, I'll be aft getting Art to chase up the changes from his end. Just get me to Trinity on time and I'll see you get a few days off from ferrying me around."*

*Once he left the cockpit, she glanced at her co-pilot, instinctively blowing the loose lock of red hair from her face. "Aww, dammit! The Admiral is going to kick us clear over to Langley for this one. He said last time not to deviate; even if the Speaker demands it!"*

*"The bathtubs are going to be less thrilled, skipper." He added with a wave out the window to the ten-ton fighters out to the port side.*

*Flying a tight formation that looked like it had been forged through invisible metal beams holding them together, the CSC F-212 Scorpion Interceptors did indeed look like bathtubs with the rounded basin holding the cockpit at the front of the craft. She could clearly see the pilot through the tinted glass, close enough to reach out and touch with the way they were flying the escort mission.*

*It had only been last year that the Speaker of Congress, when he was still a congressman, had almost been assassinated. Some said it was enough to propel him into the lead for the campaign, but she knew he worked hard to get the job, not sitting on the side like some and letting their constituents do the groundwork. Speaker Blackledge was a good man, hardworking and tireless in his efforts to bring Cascadian interests to the front of the agenda.*

*Thanks to him, the CDF could count on new developments to keep its forces modernized and ready to counter anything offered by the never-ending pirate threat. She knew when this tour as his pilot finished that she could thank him for keeping the defense force at a level where she*

## *Ships of Clement Sector 4: Small Craft*

---



*could be comfortable in having a job to go to... without needing to look at the burgeoning new colonies open in Tranquillity.*

*There were rumours that the shipyards were even working on new designs... acquired from Kingston and Hub, which would lead to expanded opportunities for pilots and flight crews. She'd seen holovids of the Hub attack boats, and wanted more than anything to fly one herself one day, and if it was a locally built design, then even better. Somehow, being the bus driver on a highly modernised Eagle-Class Ship's Boat ferrying Veeps about the system didn't compare to the power those attack boats contained.*

*"Betty, I've plotted a new course in the nav, check it over when you are ready. It'll get us to Trinity and down at the university ahead of the deadline. Major Pittsborough is cussing us seven ways to Langleigh about it, but is ready to follow your lead."*

*"Thanks, Foxman, let's give the flyboys some practice in formation flying... are the compensators locked in?"*

*"Check... but what do you mean?"*

*Not answering her co-pilot, she took manual control and slid his new course into the virtual display. Humming to herself, offered a wink to the HUD and rolled the Eagle in a half-Immelman*



## *Ships of Clement Sector 4: Small Craft*

---

turn to change course. Out to the side, the Scorpion fighters kept their formation as they manoeuvred, the separation between the craft barely changing.

Frowning, she thought she saw one of the pilots give her an impolite salute with his free hand. Damn flyboys and their fighters!

“Course locked in and tracking to Trinity. As expected, Taylor orbital control is protesting at the interruption to their standard flight traffic... I think we'll leave that to the State Department to sort out later on the ground.”

“Let's make like a shooting star...” Grinning, she pushed the throttle control until the thrust from the power plant was pulsing below the redline. At six gravities thrust, the ship's boat would streak through the sky during re-entry and give anyone watching a spectacular show.

“Mister Speaker,” she announced on the intercom to the passenger compartment behind, “Lieutenant Foxman has set us a course for Trinity that will have you planetside in twenty minutes. Thanks for flying Cascadia Air and please ensure you fasten your restraints for landing.”



## ***Ships of Clement Sector 4: Small Craft***

---

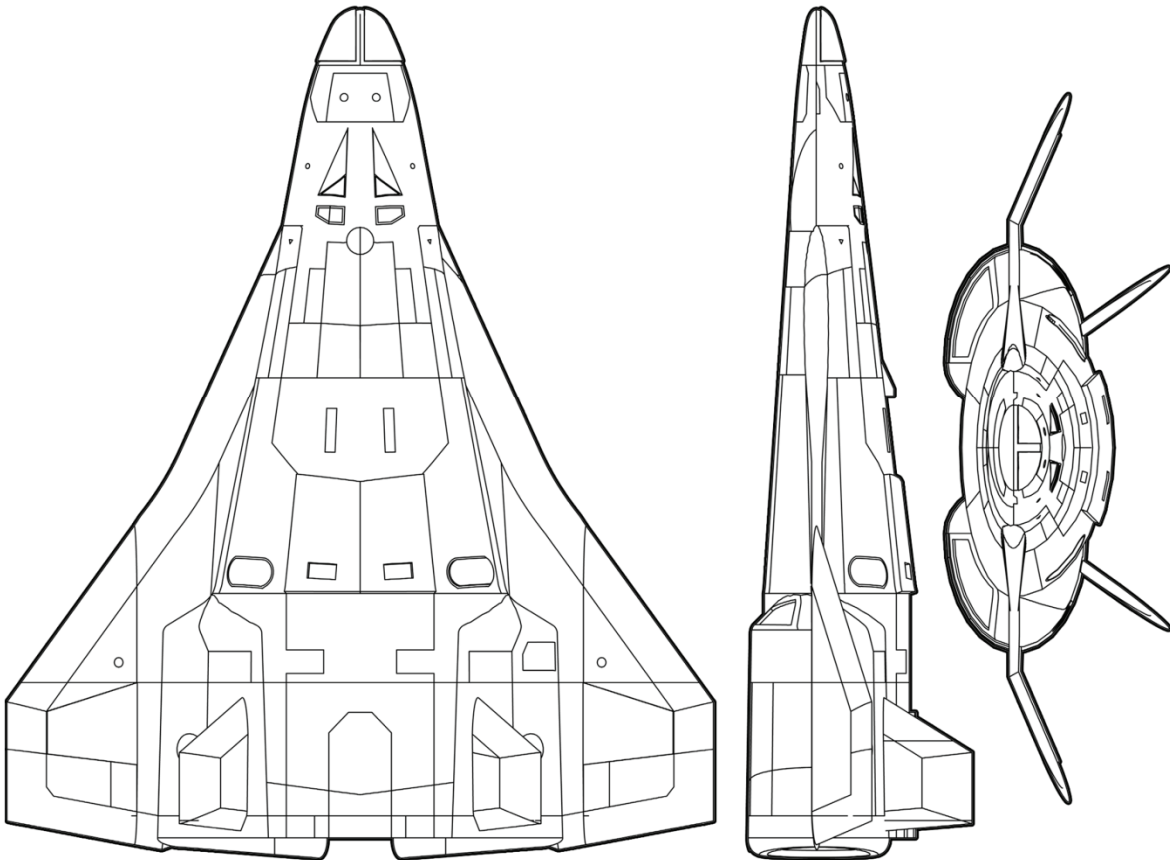
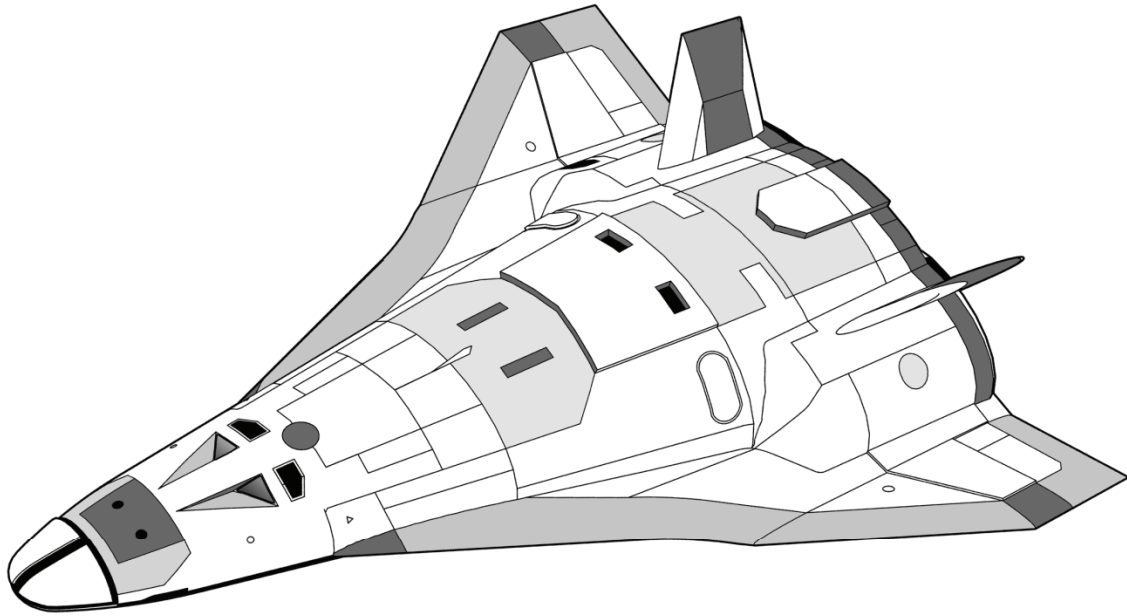

## *Ships of Clement Sector 4: Small Craft*

### *Eagle-class Ship's Boat*

Type			Tonnes	Price (MCr)
<b>Hull</b>	30 dT Streamlined	Hull 0 Structure 1	30.0	1.3
<b>Armor</b>	Crystaliron x0.5	2 points	0.8	0.1
<b>Zimm Drive</b>				
<b>Maneuver Drive</b>	sJ	Thrust 6	4.5	10.0
<b>Power Plant</b>	sJ	Rating 6	3.6	7.0
<b>Bridge</b>	Cockpit		3.0	0.2
<b>Computer</b>	Model 1	Rating 5		
<b>Electronics</b>	Standard	DM -4		
<b>Weapons</b>	Fixed Mount (Navy version only)	Beam Laser	1.0	1.1
<b>Fuel</b>	including onboard processor	2 weeks of operation	2.0	
<b>Cargo</b>				
<b>Crew</b>	2			
<b>Airlock</b>			1.0	0.2
<b>Software</b>	Maneuver/0			
	Library			
<b>Total Tonnage and Cost</b>			15.9	19.9

<b>Variant A</b>	Standard	14 passengers cargo 7 tonnes	7.0 7.0	0.2
<b>Total Tonnage and Cost</b>			29.9	20.1













<b>Variant B</b>	Passenger	20 passengers cargo 4 tonnes	10.0 4.0	0.3
<b>Total Tonnage and Cost</b>			29.9	20.3

# Eagle Class Ship's Boat

## Deck Plan Key

1. Control Cabin
2. Airlock
3. Fresher
4. Passenger Section
5. Passenger Stateroom
6. Cargo Section

## Deck Plan Symbols

-  Manual Hatch (overhead)
-  Manual Hatch (deck)
-  Iris Valve (overhead)
-  Iris Valve (deck)
-  Turret Access (overhead)
-  Turret Access (deck)
-  Iris Valve
-  Manual Hatch
-  Workstation
-  Sliding Door
-  Interior Wall
-  Bulkhead
-  Maintenance Hatch

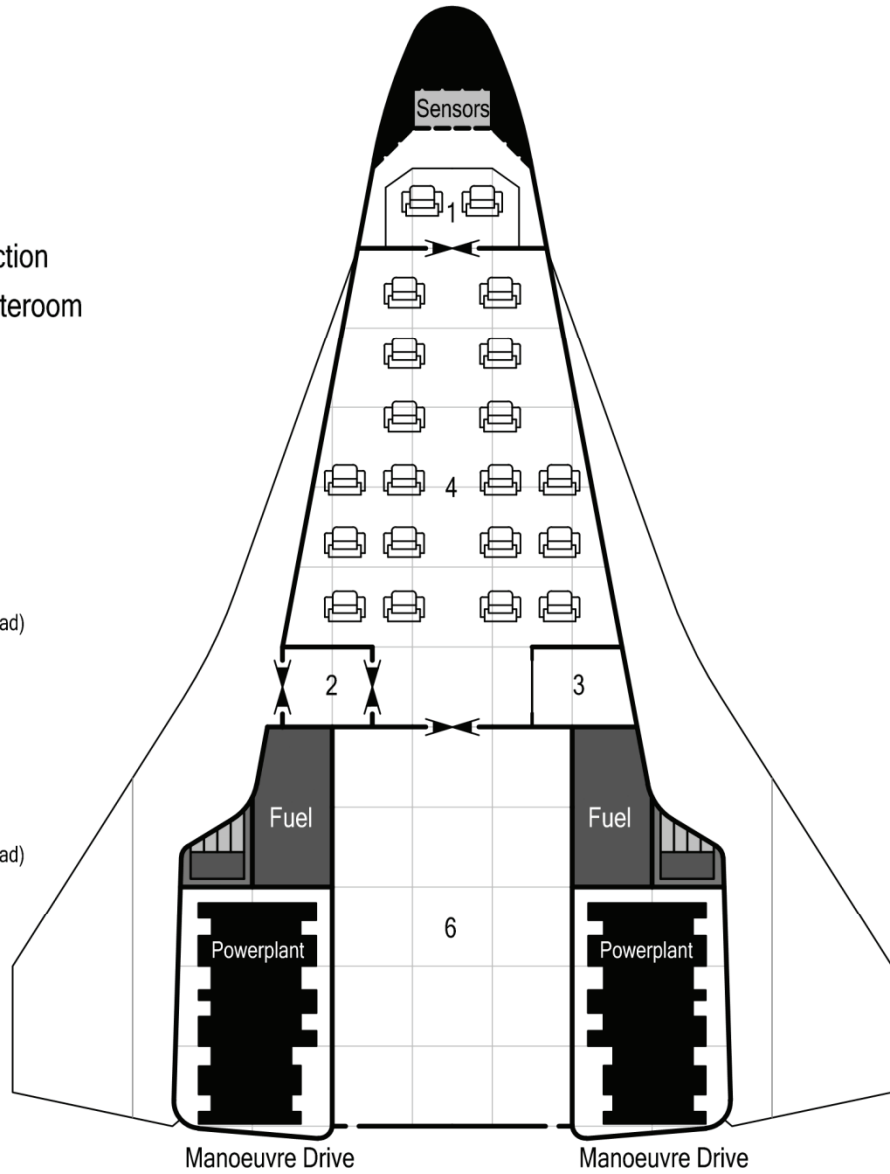

Wings fold for hangar storage

# *Ships of Clement Sector 4: Small Craft*

---

## *Mosquito-class Attack Pinnace*

*"I'll take two please. Wrap them up to go..."*  
*Leutnant Hans Kaufmann Hub Federation Navy 2341 CE*

### **Background and Development**

A private venture development by Felix and Anderson Shipbuilders, the attack pinnace concept is a smaller, more lightweight version of the Fast Attack Boat. Displacing only 40dT, the standard accepted displacement tonnage for the pinnace class of small craft, the attack pinnace is nothing like its older more sedate brother currently in service.

Currently, the Hub Federation Navy is testing one of the prototypes at an undisclosed location and is rumored to be very impressed with the performance and capabilities of the new design. Concurrently Anderson and Felix are also in pre-contract discussions with Harrison for a potential order as part of Harrison's aggressive system defense force expansion.

Capable of a sustained thrust of eight gravities, which is enough to keep pace with the current generation of light fighters throughout the Clement Sector, the attack pinnace has a main armament of a starship class beam laser and missile launcher.

Magazine capacity is limited to twelve missiles.

What sets it aside from the Fast Attack Boat however is its ability to be able to combat manoeuvre far more efficiently using variable geometry wings and canards, along with full atmospheric control surfaces which provide that manoeuvrability within a planetary atmosphere. This enables the attack pinnace to even actively engage other atmospheric aircraft as the need arises, using its secondary armament of twin nose mounted 30mm autocannon and twin missile (tac) bays, though its prime mission within atmosphere is to engage nominated ground targets and any landers in an orbit drop scenario.

Operational duration allows for a lengthy two weeks and fuel scoops with integrated fuel processor provides for gas giant refuelling if required. The attack pinnace has a four man crew, two small staterooms and a small compartmented galley.

## *Ships of Clement Sector 4: Small Craft*

---

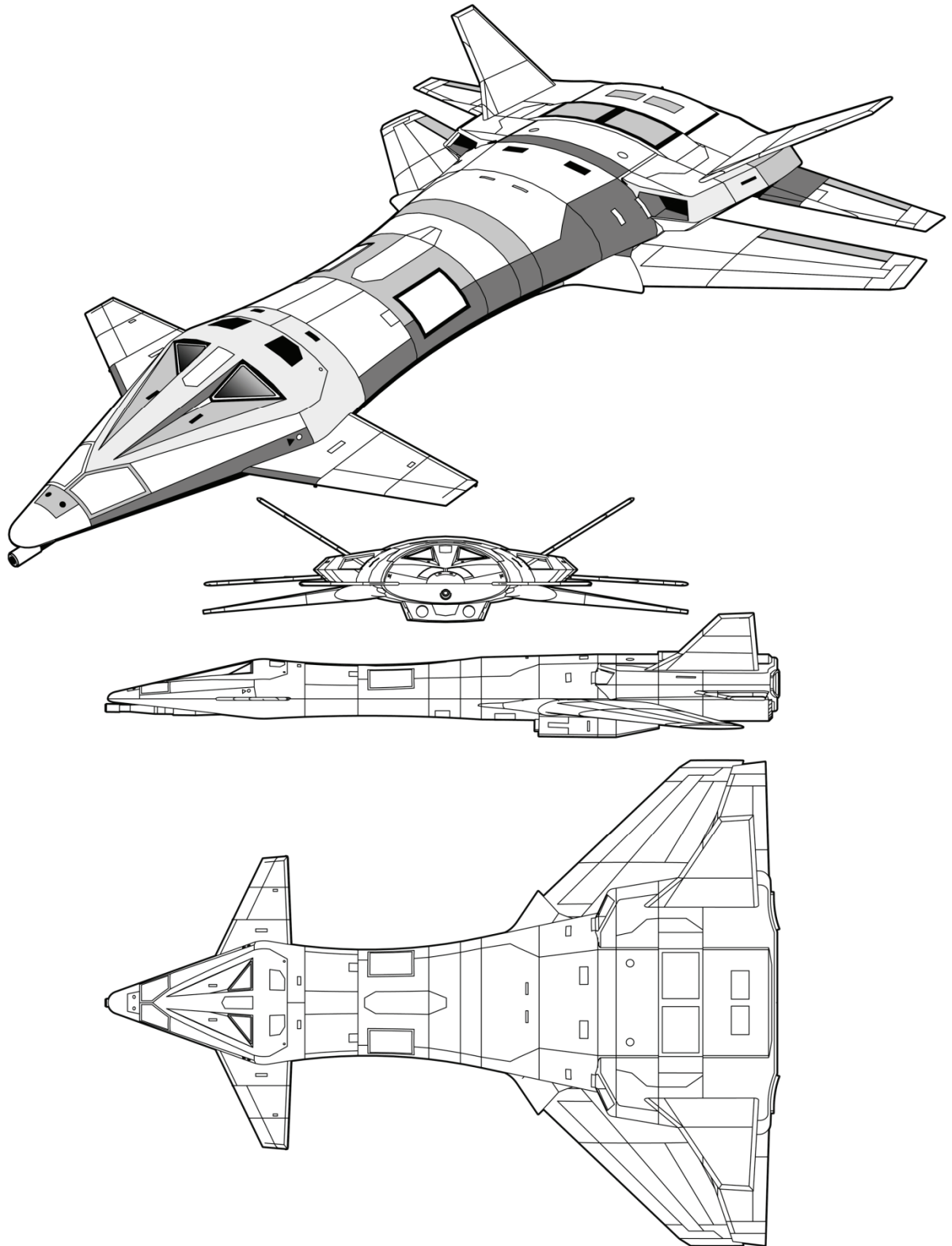

## *Ships of Clement Sector 4: Small Craft*

### *Mosquito-class Attack Pinnace*













Type			Tonnes	Price (MCr)
<b>Hull</b>	40 dT Streamlined	Hull 0 Structure 1	40.00	1.40
<b>Armor</b>	Crystaliron x1	4 points	2.00	0.28
<b>Zimm Drive</b>				
<b>Maneuver Drive</b>	sR	Thrust 8	11.00	22.00
<b>Power Plant</b>	sR	Power 8	7.50	16.00
<b>Bridge</b>	Cockpit	2 workstations	3.00	2.00
<b>Computer</b>	Model 2(fib)	Rating 10		0.24
<b>Electronics</b>	Basic Military	DM 0	2.00	1.00
<b>Fuel</b>		2 weeks of operation	2.50	
<b>Weapons</b>	Fixed Mount (anti ship)	Beam Laser	1.00	1.10
	Fixed Mount (anti ship)	Missile Launcher	1.00	0.85
	Fixed Mount (air to ground) x2	Autocannon medium (1200 rounds)		0.22
	Fixed Mount (air to ground) x2	Missile (Tac) bay (20 capacity)		
<b>Ammunition</b>	Missile magazine	12 missiles	1.00	
<b>Cargo</b>	2		2.00	
<b>Crew</b>	4	pilot, copilot, 2x weapons officers		
<b>Components</b>	Weapons Control	2 gunners	3.00	0.2
	Accommodations	2 staterooms	3.00	0.2
	Airlock		1.00	0.20
<b>Software</b>	Maneuver/0			
	Library			
	Evade			1.00
	Fire Control/2			4.00
<b>Total Tonnage and Cost</b>			40.00	50.64

# Mosquito Class Attack Pinnacle

## Deck Plan Key

1. Control cabin
2. Gunnery stations
3. Airlock
4. Fresher
5. Staterooms
6. Cargo section

## Deck Plan Symbols

-  Manual Hatch (overhead)
-  Manual Hatch (deck)
-  Iris Valve (overhead)
-  Iris Valve (deck)
-  Turret Access (overhead)
-  Turret Access (deck)
-  Iris Valve
-  Manual Hatch
-  Workstation
-  Sliding Door
-  Interior Wall
-  Bulkhead
-  Maintenance Hatch

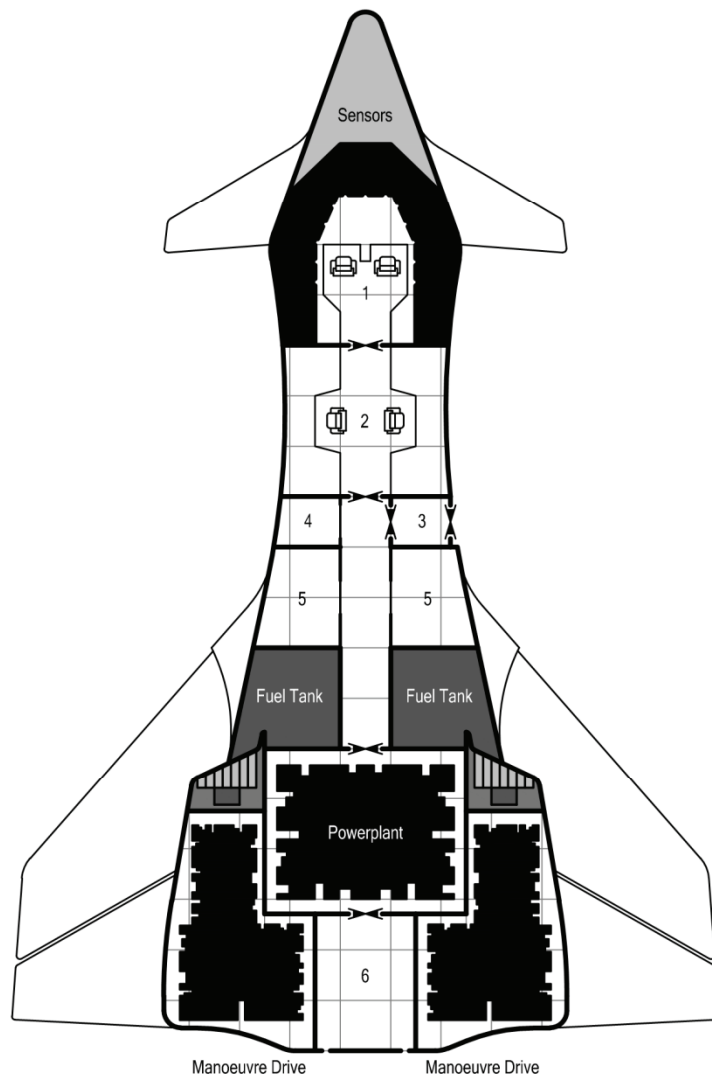



# *Ships of Clement Sector 4: Small Craft*

---

## *Modular Cutter*

*“Neutronium Nellie? Nah, I won her fair n square playin’ blackjack at the Roid Bar on New Strike. Named her after a senorita I know, dense as neutronium. Ya know I actually married her, thank the stars she has a sense of humour!”*  
*Belter Louis Haydee, Donar system 2340 CE*

### **Background and Development**

Long considered the workhorse for cargo and passenger transport even before the discovery of the gravitic drive, the 50dT modular cutter with its ability to be tailored quickly for almost any task, is commonly seen within all occupied systems in Clement Sector.

The most common version of the modular cutter is the ubiquitous MC-17-11. This design has been in service for over one hundred years though internal systems and drives have been upgraded regularly. Like other small craft of similar style, the compact flattened cylinder hull form allowing more efficient use of hangar space when carried on board starships.

The cutter with the belter workpod module is a popular choice with “belters” or asteroid miners that work claims throughout the multitude of asteroid belts and moons within all of the inhabited systems of Clement Sector. Indeed sales of used cutters are amongst the most lucrative portions of the used spacecraft market for any shipyard.

However the MC-17-11 cutter suffers with the same drawbacks maneuvering in atmospheres as other similar type small craft. Without lifting surfaces and control systems similar to pure atmospheric and aerospace craft, the flattened cylinder shaped cutter handles like a brick when in atmosphere. For users that spend a lot of time manoeuvring within planetary atmospheres the preferred choice of cutter is the Spacehound class, with its variable geometry atmospheric wings.

### **MC-17-11 Modular Cutter**

Virtually unchanged outwardly since it entered service over one hundred and fifty years ago the MC-17-11 is used by both civilian and military operators. The standard 30dT module can be swapped out to configure the cutter for any purpose, making it the most versatile small craft in use.

This version of the cutter is the preferred version of most navies of Clement Sector due to both the inherited designs of the ex-national navy ships that make up the bulk of the starships in service and the compact flattened cylinder hull form that allows for efficient use of hangar space.

The cutter typically has a crew of two within a control cabin environment and is capable of a thrust of four gravities. It cannot be armed with a starship class weapon system of any type.

### **Spacehound Class Modular Cutter**

Described by seasoned spacers as a “just a standard bloody cutter that grew wings”, the Spacehound class has been designed to be able to provide much better manoeuvrability in planetary atmospheres.

The Naval version of the Spacehound class is either armed with a single fixed mount beam laser providing the cutter with offensive/defensive capability as required or unarmed with crystaliron armour. Civilian owned and operated boats do not normally come armed with a starship class weapon system and often convert the 1dT space normally allocated to fire control systems to a small cargo bay.

## *Ships of Clement Sector 4: Small Craft*

---

The Spacehound class utilises variable geometry wings to provide improved lift and maneuverability within planetary atmospheres. This ability has made the cutter popular amongst transport and passenger companies moving cargo and passengers to and from orbital installations and ships and for smaller navies as dropships or troop transports.

Like the MC-17-11, the Spacehound class typically has a crew of two within a control cabin environment and is capable of a thrust of four gravities.

Fuel scoops and fuel processors allow the cutter to refuel as required by scooping fuel from gas giants.

### **Modules**

Modules are the key to the versatility of the modular cutter. A module is 30dT and is internally configured for a variety of specific configurations allowing the cutter to perform tasks or missions as required. Configuration possibilities are virtually endless, though there are many task specific modules available "off the shelf".

### **Standard**

This module is configured primarily for passenger and cargo transport. Interior cabin space has been configured to allow transport of twenty four passengers and space for 18dT of cargo, externally accessible via a large cargo door on the cutters port side.

### **Intra-System Passenger**

This module is configured for intra-system passenger transport. A typical journey might be between a system main world and an outer system colony, mining outpost or naval base. Cabin space allows for twenty passengers, six staterooms and 2dT of passenger cargo.

### **Intra-System Cargo**

This module is configured for intra-system cargo transport. The module can

carry up to 30dT of cargo, externally accessible via a large cargo door on the cutters port side.

### **Vehicle Transport**

Configured for deployment of vehicles from orbit, the vehicle module can carry up to 30dT of vehicles (or cargo) which can be deployed or loaded via a floor ramp to the rear of the module.

### **Belter Workpod**

Singlehandedly making the cutter the most popular choice for in-system belters, the belter workpod provides living space for four occupants. There are two double occupancy staterooms, a small common area/galley and an equipment store/machine shop. The remaining module space is divided into two 10dT ore containers each with handling machinery to assist loading and unloading. It is quite common for belter couples to raise a family within these "mobile homes" as they ply their claims, returning to major belt settlements once a month to assay and sell their finds.

### **Troop Deployment**

Configured for deployment of troops from orbit, this armoured module can carry up to forty equipped troops, 8dT of equipment and 1dT of dedicated cargo. Space is also allocated for a troop commander's office and communications/briefing room. Access and exit to the module is made via an airlock on the port side.

### **Medipod**

Designed for use as an emergency hospital by both emergency services and the military, the medipod contains a fully equipped ward with twelve beds, an operating theatre, eight emergency low berths and medical stores area.

## *Ships of Clement Sector 4: Small Craft*

---

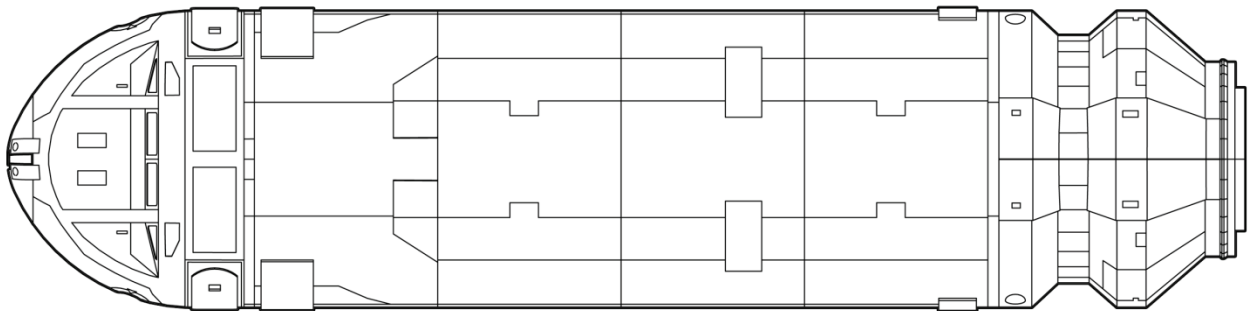
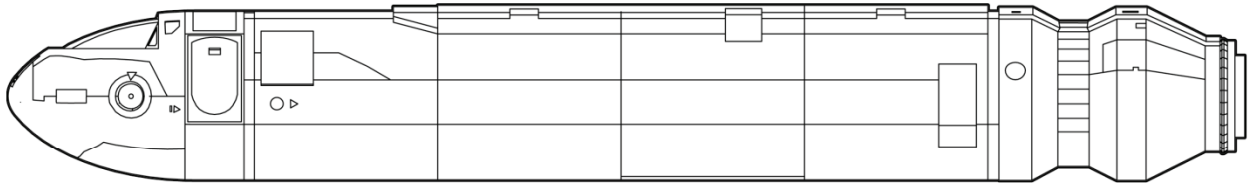
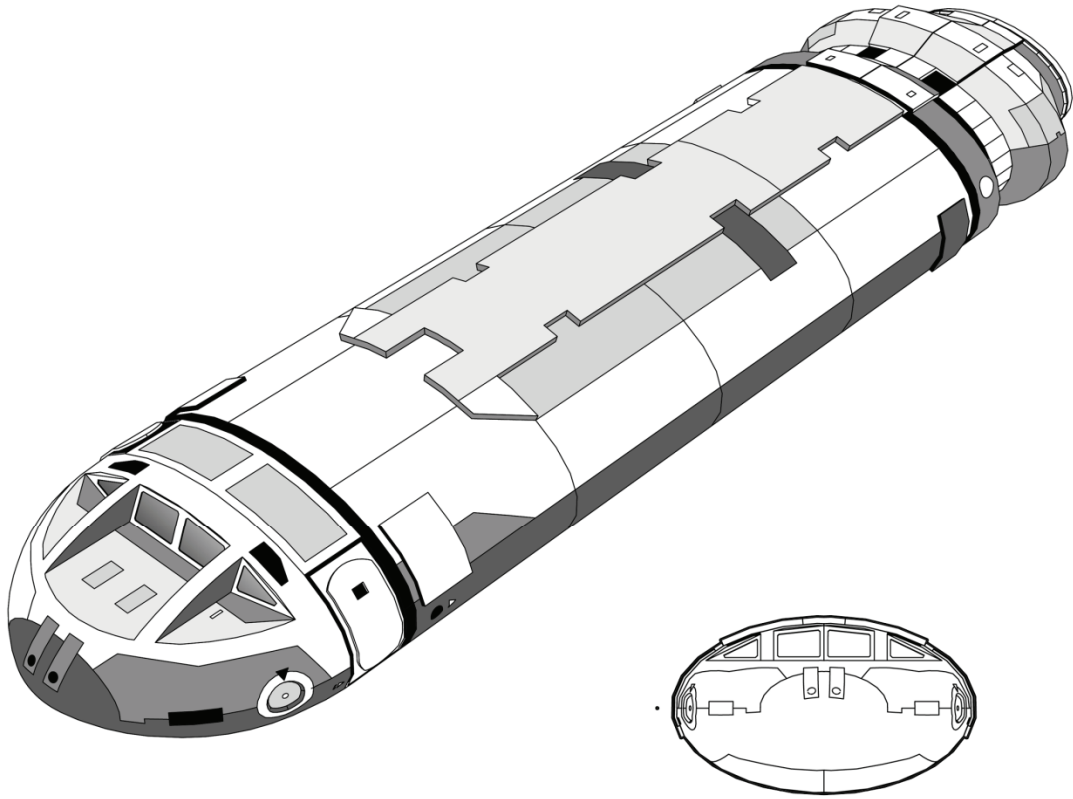

## *Ships of Clement Sector 4: Small Craft*

### *MC-17-11 Modular Cutter*

Type			Tonnes	Price (Mcr)
<b>Standard</b>			30.0	1.0
	Seating Section	Passengers x24	12.0	0.7
	Cargo Section	18 tonnes	18.0	0.9
<b>Total Tonnage and Cost</b>			30.0	1.6

<b>Intra - System Passenger</b>			30.0	1.0
	Seating Section	Passengers x20	10.0	0.6
	Cabin Section	Staterooms x6	18.0	0.9
	Cargo 2 tonnes		2.0	
<b>Total Tonnage and Cost</b>			30.0	2.5

<b>Intra - System Cargo</b>			30.0	1.0
	Cargo	30 tonnes	30.0	
<b>Total Tonnage and Cost</b>			30.0	1.0

<b>Vehicle Transport</b>			30.0	1.0
	Vehicle and Cargo Section	30 tonnes	30.0	
<b>Total Tonnage and Cost</b>			30.0	1.0

<b>Belter Workpod</b>			30.0	1.0
	Habitat Section	Staterooms x2		
		Equipment stores & Workshop	9.0	0.5
	Cargo 20 tonnes	Ore containers x2	20.0	
		Ore Handling Machinery	1.0	0.2
<b>Total Tonnage and Cost</b>			30.0	0.7

## *Ships of Clement Sector 4: Small Craft*

<b>Troop Deployment</b>			30.0	1.0
<b>Armor</b>	Crystaliron x0.5	2 points	0.8	0.1
	Seating Section	Troops x 40	20.0	0.6
	Equipment	8 tonnes	8.0	
	Cargo	1 tonne	1.0	
	Airlock		1.0	0.2
<b>Total Tonnage and Cost</b>			30.0	1.9

<b>Medipod</b>			30.0	1.0
	Ward Area		20.0	6.7
	Operating Theatre		4.0	2.0
	Low Berths		4.0	0.4
	Cargo (stores and equipment)	1 tonne	1.0	
	Airlock		1.0	0.2
<b>Total Tonnage and Cost</b>			30.0	9.3

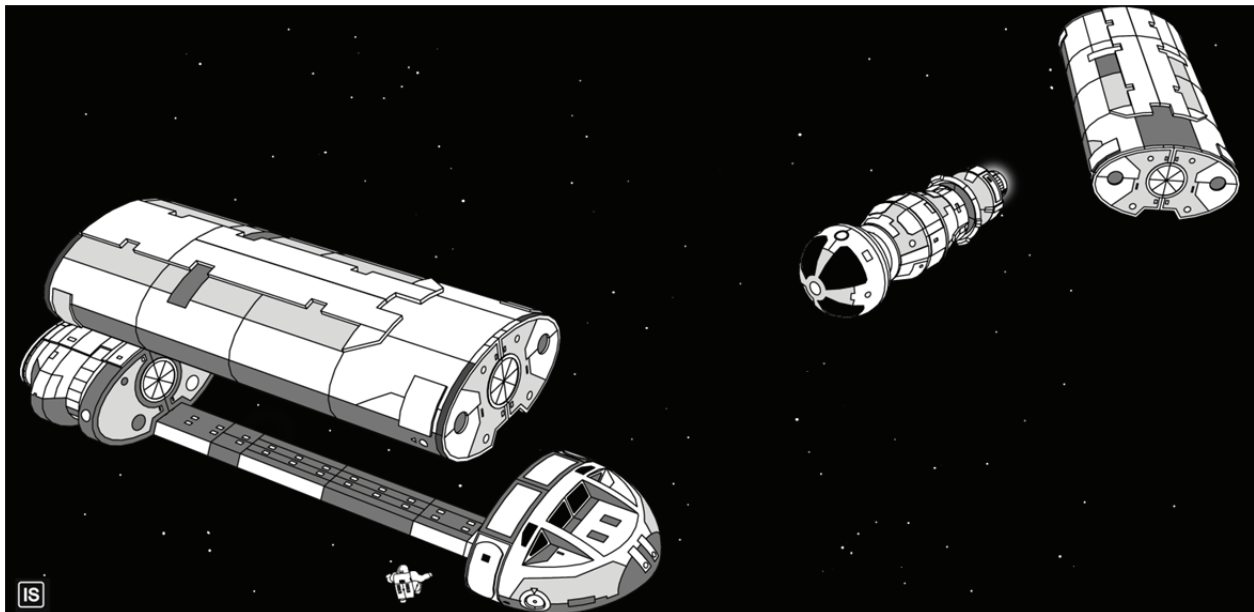

# MC-17-11 Modular Cutter

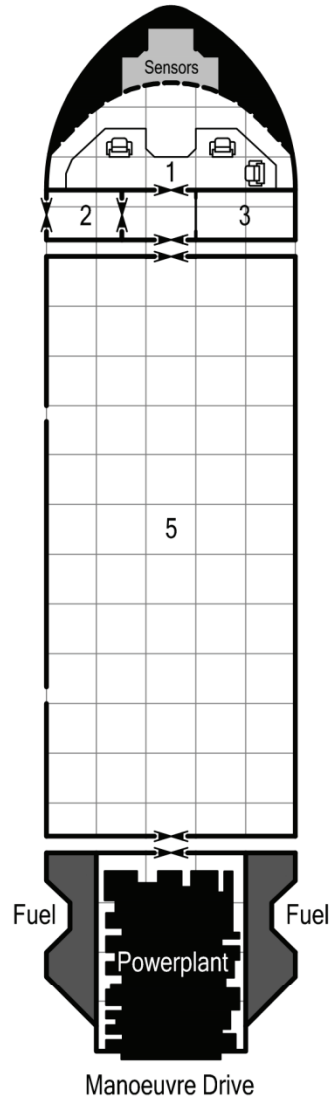

## Deck Plan Symbols

	Manual Hatch (overhead)		Manual Hatch
	Manual Hatch (deck)		Workstation
	Iris Valve (overhead)		Sliding Door
	Iris Valve (deck)		Interior Wall
	Turret Access (overhead)		Bulkhead
	Turret Access (deck)		Maintenance Hatch
	Iris Valve		

## Deck Plan Key

1. Control cabin
2. Airlock
3. Fresher
4. Troop section
5. Cargo section
6. Engineering

# Modular Cutter - 30dT Modules

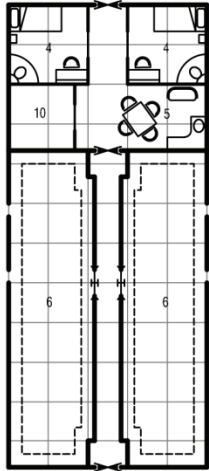

Belter Workpod

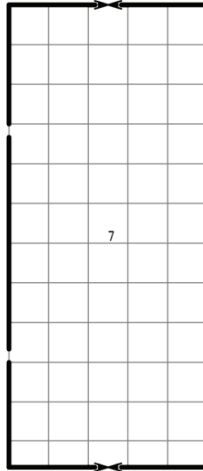

Intrasytem Cargo

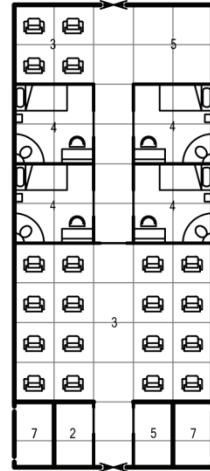

Intrasytem Transport

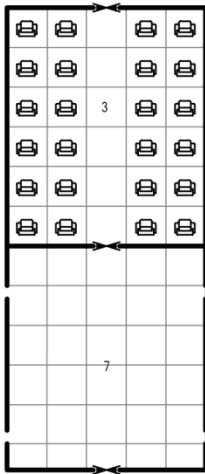

Standard Module

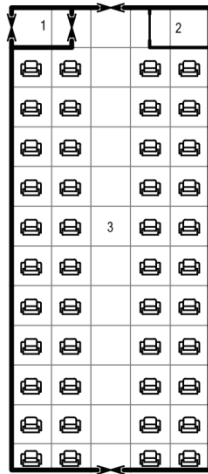

Troop Transport

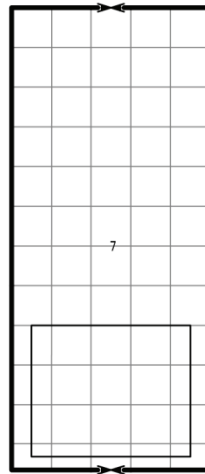

Vehicle Transport

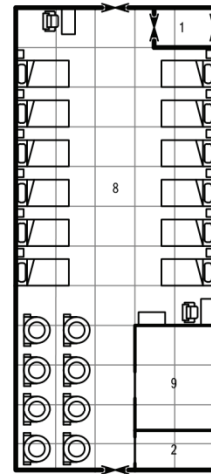

Medipod

## Deck Plan Symbols

	Manual Hatch (overhead)		Manual Hatch
	Manual Hatch (deck)		Workstation
	Iris Valve (overhead)		Sliding Door
	Iris Valve (deck)		Interior Wall
	Turret Access (overhead)		Bulkhead
	Turret Access (deck)		Maintenance Hatch
	Iris Valve		

## Deck Plan Key

1. Airlock
2. Fresher
3. Troop/passenger section
4. Stateroom
5. Common room or galley
6. Ore Silo
7. Cargo section
8. Ward and treatment area
9. Surgical theatre
10. Equipment store

## *Ships of Clement Sector 4: Small Craft*

---

**Madgar**

**Serapis System, Franklin Subsector 0108**

**August 18th, 2343 (Honor 15, 27)**

**0635 Standard Time**

*In a tunic and shorts, the heat and humidity still caught you. It was intense... unbearable... overpowering. No matter how many times you showered, in minutes you would be drenched in sweat again. Even the air scrubbers and cooling system protested, giving loud snorts of displeasure every ten minutes. But they persevered... there was nothing else to do here on Madgar, less than 60 million clicks from the G9 V star Ptolemy, and as close to physical hell as you could get in any stellar system.*

*When the chime began sounding overhead, he paused cleaning the sample canister. Wiping gathering moisture from his forehead with an equally wet hand, he gazed up to the console above his head and slid fingers over the surface to bring up a display. The reading forced him to shake his head in resignation. Time had escaped them again.*

*Pressing the commbutton on his tunic, he took a deep breath of the oppressive heat. "Twenty minutes before Ptolemy comes over the horizon... close the pod bay doors, Allesandro. Despene, we're moving back to the Blaylock shelter, I hope you have your gear inside."*

*Hearing the muffled responses in turn from his son and spouse over in the work area of the cutter, he secured the canister he had been cleaning in the cramped engineering section. The cutter had been their home now for close on ten years, ever since scraping together the money from his pension, generously given by Harlan Grant for services rendered during the revolution against the corporates almost thirty years ago. It wasn't much, but the century old small craft was his... even if the plaque above the bridge coaming did say "Made in Novy Ostrava".*

*Hearing the airlock close up near the bridge, he finished securing the other ore canisters and equipment in their holders beside the engineering hatch. It was a well-disciplined process, one he'd learned the hard way back in the Alexander Belt, or Alliance Belt as they called it now, when he was a corporate belter for the mining conglomerates. Before any move, lock down the ship and secure the equipment, because if there was a malfunction, the last thing you wanted was a twenty kilo ore canister coming at you like a missile in the close confines of a ship.*

*Catching the appearance of his wife at the end of the module, he gave a smile. Her face was glowing, and not just from the heat as she shook a ream of flexes in her hand.*

*"We've found it! Look at the concentration report... almost pure molybdenum, osmium and platinum. All of them are here in the samples from today's drilling. Ernesto, this is big and deep, based on the follow on scans!"*

*Pausing, he cocked his head to the side. They had called him lucky twice in his life, once was back when he survived a merc ambush in the belt and saved Harlan Grant's life along the way, and the other had been finding Despene and winning her heart on Serapis, but that was it. Luck rarely happened to one like him, and as the common saying went, what can you do?*

*She must have recognised the expression on his face, for the dark eyes sparkled in amusement. Pushing the flexes toward him, she skipped closer.*



## *Ships of Clement Sector 4: Small Craft*

---



*“This is important, mi amor, really important. How big is the finds area we have under license in this region?”*

*Shrugging, he avoided the sweep of flexes in his face.*

*“Most of this valley... about two hundred square clicks on this side of Madgar.”*

*Offering a chortle, she threw the flexes into the air and leapt into his arms. “All the samples you and Allesandro brought in carry high concentrations at near-pure levels. If we can keep this to ourselves long enough, you can get that starship you always wanted... dios mio, we can get a fleet of them!”*

*“Have you told Allesandro?”*

*Shaking her head, she let out a joyful sigh. “I only just finished rechecking and doing the follow-up scan. Where is he?”*

*“Closing the pod bay doors....” Lowering his wife, he offered a tentative smile.*

## *Ships of Clement Sector 4: Small Craft*

---

*It was too soon to let the joy overwhelm him, luck had a way of vanishing if you chased it. Perhaps the Caxtonists had the right of it by outlawing that Irish Murphy and avoiding bringing bad luck upon themselves?*

*Turning her around, he pointed to her workstation in the far corner of the belter pod. "Go secure your work area, I'll bring up the engines and get us out of here before Ptolemy comes over the horizon and turns us into a frittata."*

*"Aren't you excited? This is the answer to all our dreams... a chance to leave here and find a new home for us... at last a chance for Allesandro to get an education and...."*

*"Si, but not when Ptolemy is rising." Swiping her rear, he gave a growl and helped her move down the narrow corridor. "Celebrate later, Despene, for now we...."*

*The scream over the comm sent a shiver down his spine. High pitched and wailing, it was hard to place it as a sound their seventeen-year-old son would make.*

*Leaving his wife in his tracks, he darted past her toward the airlock and the pod bay controls on the port side. It was the last place he had seen his son.*

*A bright ribbon of light from Ptolemy could be seen illuminating the distant horizon, drawing closer as he cast eyes through the window for any trace of Allesandro. Time was running out and there was no sign of the boy, nor anymore sound. Not getting a response through the combutton, he pulled his suit down from the hanger as his wife came alongside.*

*"If he was closing the doors, he can't be far." She offered, her voice capturing what they both felt inside.*

*Life as a belter was hard enough, especially just living in a small container for most of your life. But when the environment and vacuum could kill you at any opportunity or from the smallest mistake, nothing could be taken for granted. Allesandro's wail had sent a shiver down his spine, matching what he'd heard in the old days mining the 'roids for Blaylock. If his son was in trouble, there was no time to loose.*

*Not meeting her gaze as he entered the airlock and closed the hatch, he kept his breathing as slow as possible. They had less than fifteen minutes to leave this location and skim the surface before the sun shone over the location. The shallow walls of the valley would offer no protection, and if there was any delay, it wouldn't matter what rich finds they had found.*

*Even as the external hatch opened, he saw his son in the dirt only metres away. Air was streaming from above the knee of his suit and the glowing plasma torch that had cut through it, still shone nearby. With no time to spare, he left the gravity of the cutter and dived to save his son.*

## *Ships of Clement Sector 4: Small Craft*

---

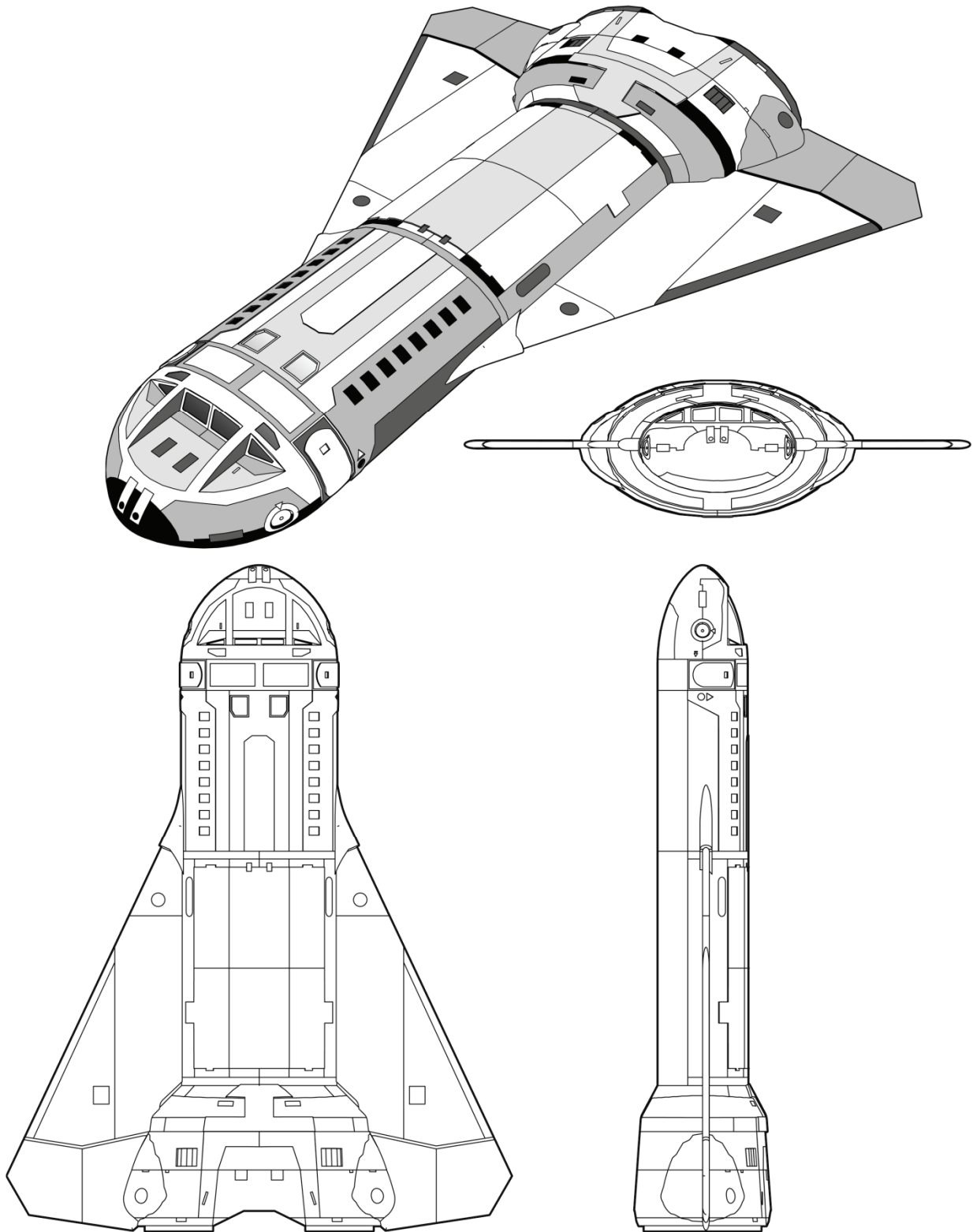

## *Ships of Clement Sector 4: Small Craft*

### *Spacehound-class Modular Cutter*

Type			Tonnes	Price (MCr)
<b>Hull</b>	50 dT Streamlined	Hull 1 Structure 1	50	1.5
<b>Armor</b>				
<b>Zimm Drive</b>	None			
<b>Maneuver Drive</b>	sK	Thrust 4	5.0	11.0
<b>Power Plant</b>	sK		3.9	7.5
<b>Bridge</b>	Control Cabin		6.0	0.3
<b>Computer</b>	Model 1	Rating 5		
<b>Electronics</b>	Standard	DM-4		
<b>Weapons</b>	Fixed Mount	Beam Laser	1.0	2.0
<b>Fuel</b>	including onboard processor	2 weeks of operation	2.3	
<b>Cargo</b>				
<b>Crew</b>	2			
<b>Airlock</b>			1.0	
<b>Modules (30dT)</b>	Standard	24x Passengers 18dT Cargo	12.0 18.0	1.5 0.7
<b>Software</b>	Maneuver/0			
	Library			
<b>Total Tonnage and Cost</b>			49.2	24.5

# Spacehound Class Modular Cutter

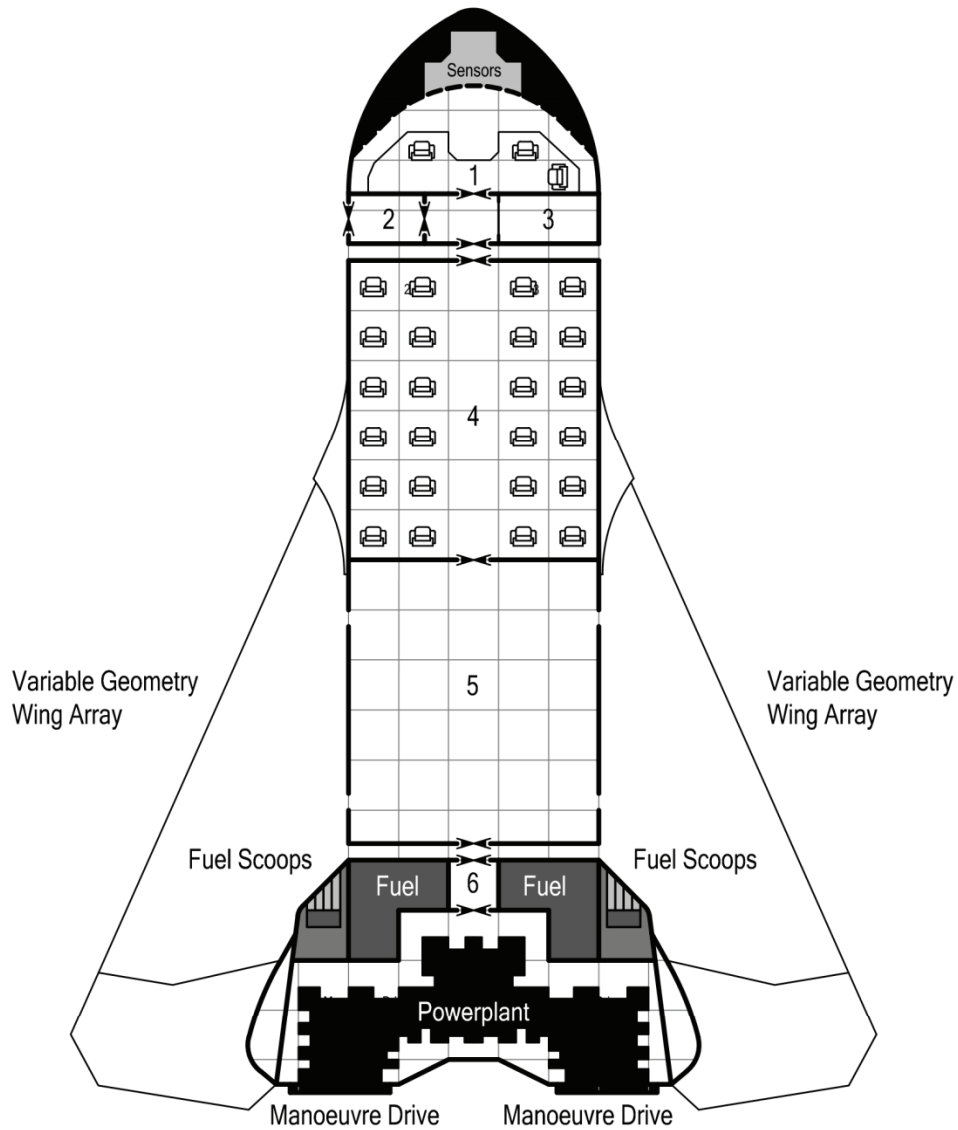

## Deck Plan Symbols

	Manual Hatch (overhead)		Manual Hatch
	Manual Hatch (deck)		Workstation
	Iris Valve (overhead)		Sliding Door
	Iris Valve (deck)		Interior Wall
	Turret Access (overhead)		Bulkhead
	Turret Access (deck)		Maintenance Hatch
	Iris Valve		

## Deck Plan Key

1. Control cabin
2. Airlock
3. Fresher
4. Troop section
5. Cargo section
6. Engineering

## *Ships of Clement Sector 4: Small Craft*

---

### *Orbit-class AL-22-11 Assault Lander*

*“You’ve felt nothing like it until you do a combat drop in one of these babies. Straight down, hot as Hades, get your troops on the ground and then go blow things up. Mind you, you can blow things up on the way down. Four 30mm autocannon make perfect air brakes...”*

*Oberleutnant Veronica Patterson, assault lander pilot, Hub Federation Marine Corps  
HFS Intrepid  
2342 CE*

#### **Background and Development**

For most national navies the 50dT modular cutter provided the means to deploy troops from orbit. Due to its modular nature, the cutter was the ideal choice for such a task.

However, it was vulnerable to incoming fire and did not carry sufficient firepower to attack targets on the ground if the landing was opposed. This was not a real issue to the various navies of the different nations of Earth as there was no need to undertake mass invasions from orbit either at the present or in the future.

Ten years before the Collapse however, the Royal Navy commissioned a new, larger assault carrier class that used a new, bigger small craft, almost double the size of the modular cutter previously used. The AL-22-11 Assault Lander is heavily armoured and able to deliver devastating firepower to any ground targets before landing and deploying armoured troops, their equipment and as needed, mechanised combat vehicles. Lifting surfaces and atmospheric manoeuvring control surfaces provide the lander with far more atmospheric manoeuvrability than the older MC-17-11 modular cutter commonly used. No other navy at the time of Collapse had designed or placed in commission anything remotely like the AL-22-11.

By the time of the Conduit Collapse in 2331, more than fifty of the AL-22-11 had been deployed for the Royal Marines operational use within the Royal Navy Clement Sector Fleet. Now, eleven years after the Collapse, the AL-22-11 Assault Lander is used by the Hub Federation Marines for rapid deployment operations.

Well-armed, the AL-22-11 is equipped with twin starship class beam lasers and twin sandcasters which can be used for defense or loaded with pebble canisters to add to the landers offensive capability. Within atmosphere, the lander can switch to quadruple nose mounted 30mm autocannon and a selection of missiles (including air to air missiles) to ensure that opposed landings are dealt with prior to placing its carried troops on the ground.

The lander can deploy fifty equipped troops to a landing zone or target area, along with two armoured vehicles (via the rear cargo ramp) for fire support or transport. Space is also allocated on-board for a troop commander’s office and communications /briefing room.

The lander typically has a crew of four within a cockpit and is capable of a thrust of four gravities.

## *Ships of Clement Sector 4: Small Craft*

---

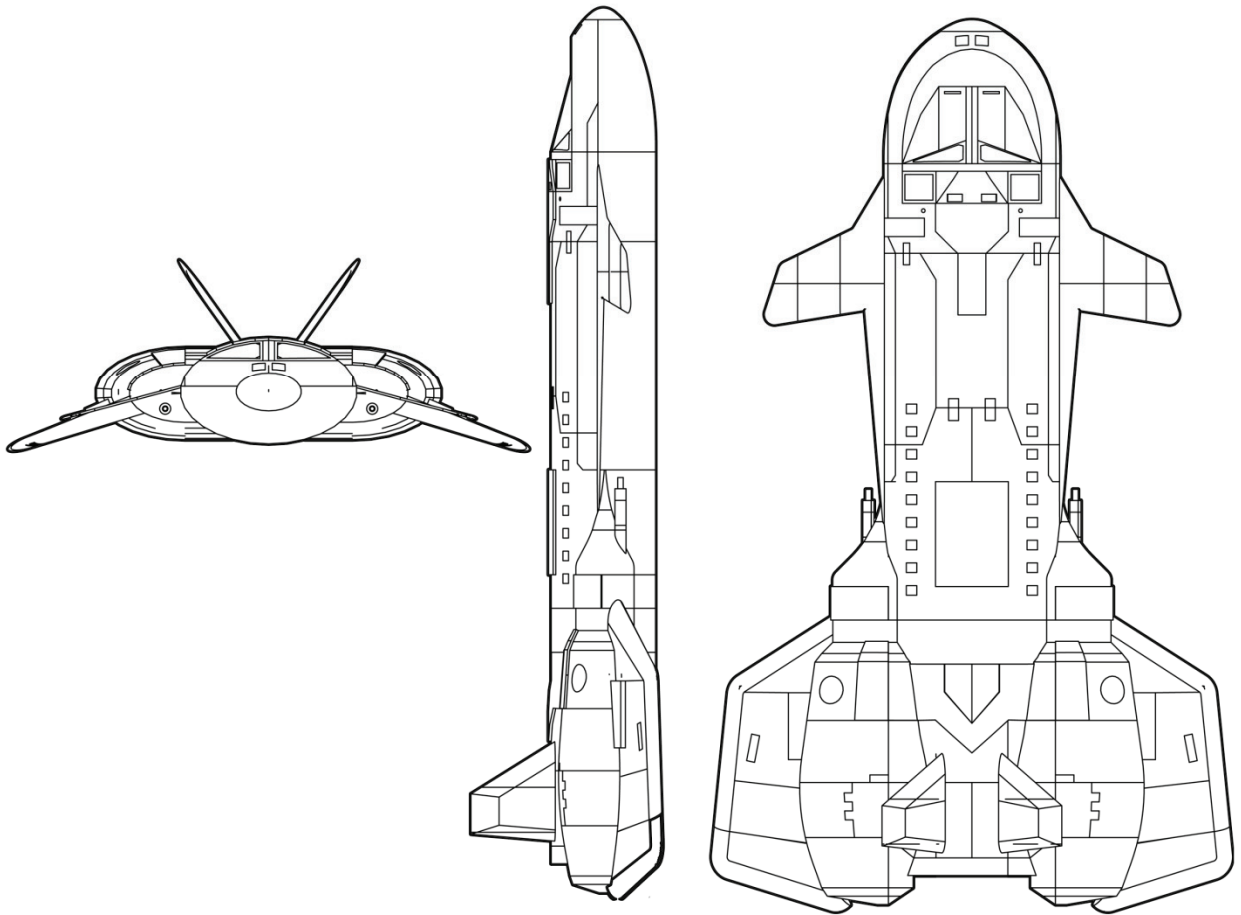
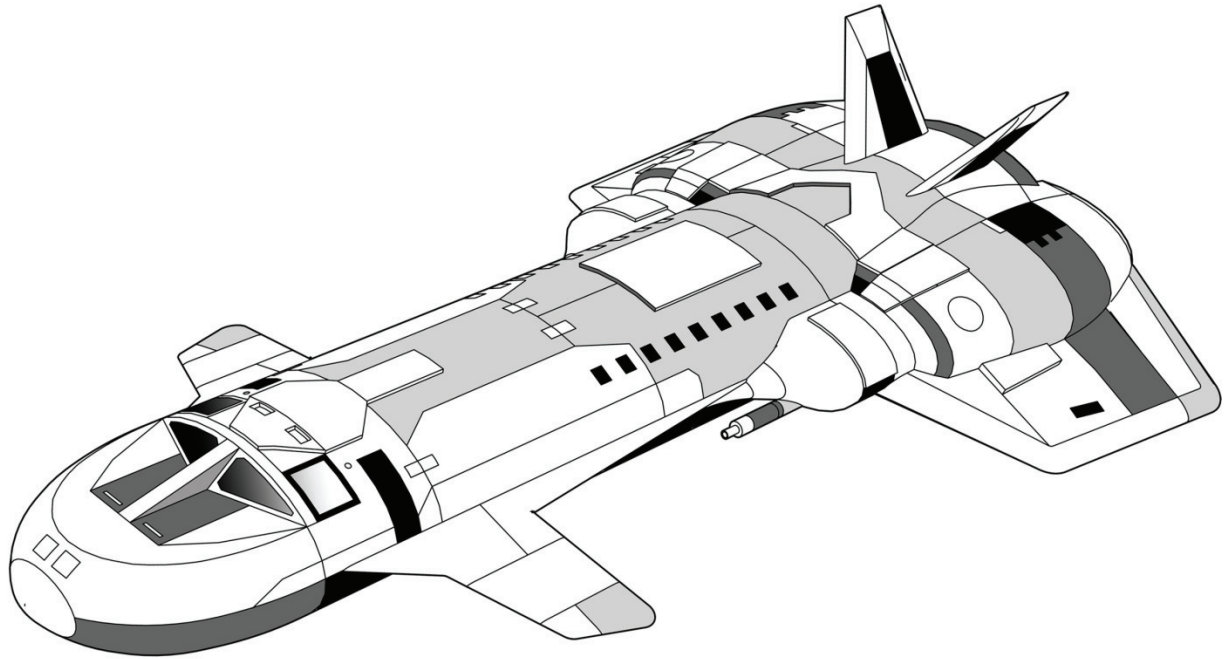

## *Ships of Clement Sector 4: Small Craft*

### *Orbit-class AL-22-11 Assault Lander*

Type			Tonnes	Price (MCr)
<b>Hull</b>	90 dT Streamlined	Hull 1 Structure 1	90.00	2.09
<b>Armor</b>	Crystaliron x2	8 points	9.00	0.84
<b>Zimm Drive</b>				
<b>Maneuver Drive</b>	sN	Thrust 4	9.00	18.00
<b>Power Plant</b>	sN	Power 4	6.30	12.00
<b>Bridge</b>	Cockpit	4 workstations	6.00	0.45
<b>Computer</b>	Model 2(fib)	Rating 10		0.24
<b>Electronics</b>	Basic Military	DM 0	2.00	1.00
<b>Fuel</b>		1 week of operations	1.25	
<b>Weapons</b>	Fixed Mount (anti ship) x2	Beam Laser	2.00	3.00
	Fixed Mount (anti ship) x2	Sandcaster Launchers	2.00	2.00
	Fixed Mount (air to ground) x4	Autocannon medium (1200 rounds)		0.44
	Fixed Mount (air to ground) x2	Missile (Tac) bay (20 capacity)		
<b>Ammunition</b>	Sandcaster Canisters	40 (20 per launcher)	2.00	
<b>Cargo</b>	18		18.00	
<b>Crew</b>	4	pilot, copilot weapons officer & systems officer		
<b>Components</b>	Accommodations	50 passengers	25.00	1.5
		2 staterooms	4.00	0.1
	Airlock x2		2.00	0.4
	Heat Shielding			9.0
<b>Software</b>	Maneuver/0			
	Library			
	Evade			1.00
	Fire Control/2			4.00
<b>Total Tonnage and Cost</b>			88.55	51.06



# Orbit Class AL-22-11 Assault Lander

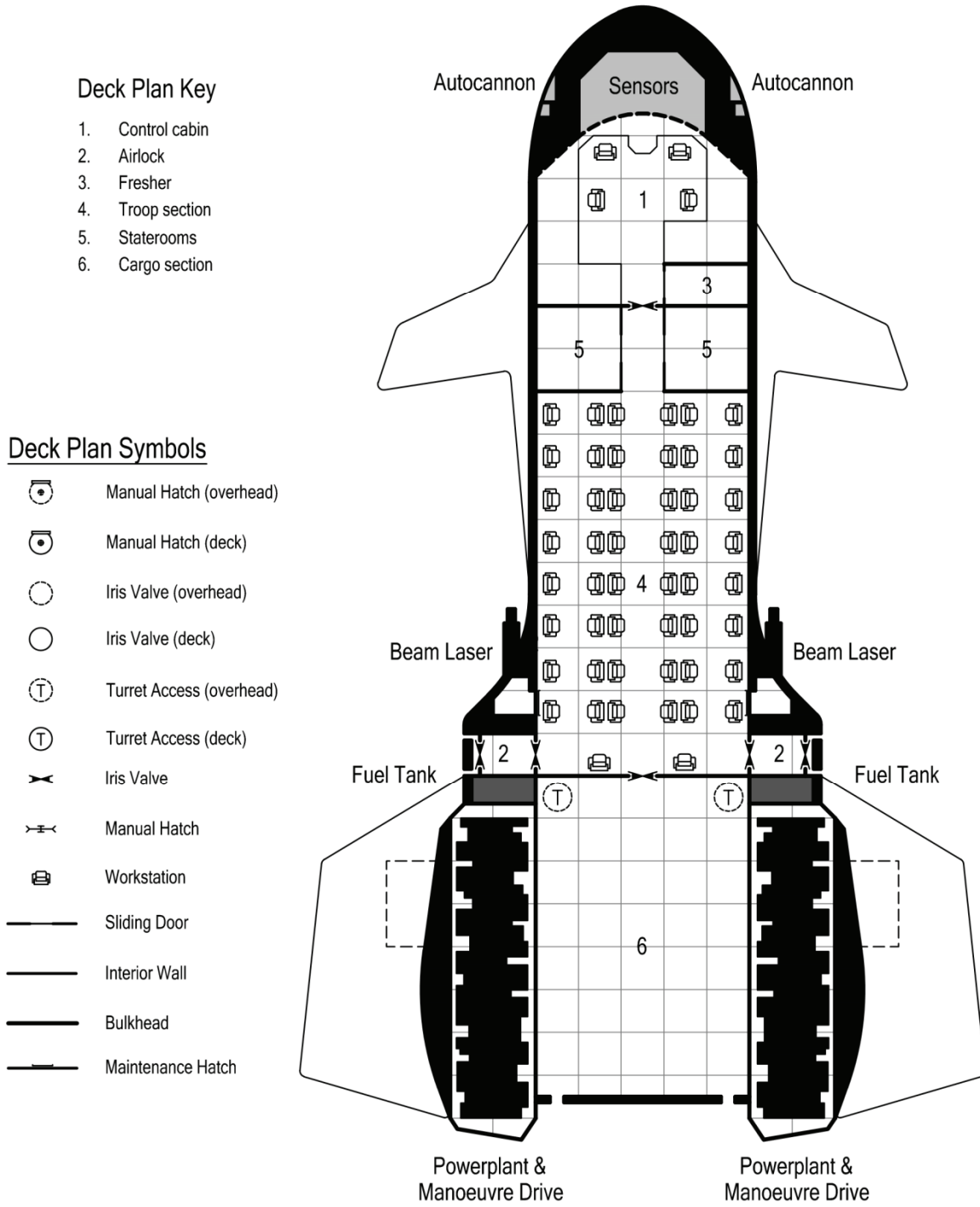

## *Ships of Clement Sector 4: Small Craft*

---

### *Talons of Belief-class Gunned Attack Boat*

*“For the Lord hath provided us, his true followers, such wonderful machines in order to defend the faith and persecute the apostate who seek to corrupt his chosen...”*  
*Patriarch Martin, Kingston 2342 CE*

#### **Background and Development**

Designed for use solely with the Kingston Defense Forces, the Gunned Attack Boat is a home grown response to the Hub Federation Navy's recently created Attack Boat force.

The Gunned Attack Boat (GAB) is an 80dT streamlined design with downward curved “wings”. These wings contain the railgun barbets and magazines and give the GAB a vague batlike shape, earning it the nickname of “slugbat” by the Fast Attack Boat and Torpedo Attack Boat pilots of the Hub Federation Navy.

It is unknown how many of the boats are currently in service with the Kingston Defense Forces, but it is believed that several wings have been formed around the new craft and that integration with the fleet has been completed. Hub Federation Naval Intelligence is also investigating the credibility of reports that a rudimentary tender/carrier is under construction at an undisclosed location under a more than tight veil of secrecy.

The GAB has an armament of twin starship class railgun barbets and a dorsal mounted beam laser turret. The short range of the railgun barbets means the GAB must close to almost knife range with a target. An engagement run exposed to point defenses and fighter/attack boat screens for a considerable amount of time. The Kingston Defense forces frequently use mindcomp datalinking to assist coordinated attacks and believe the short attack range of the GAB is not a shortcoming, rather a show of strength and an exercise in the strong belief in their God.

Normal crew total for the GAB is four crew (commander, pilot, engineer and gunner). The bridge is at the bow of the boat with three staterooms and a small common room aft of the bridge, amidships. Aft of the access corridor running athwartships to the port storeroom and starboard airlock are the drives which provide the attack boat with a total sustained thrust of five gravities.

## *Ships of Clement Sector 4: Small Craft*

---

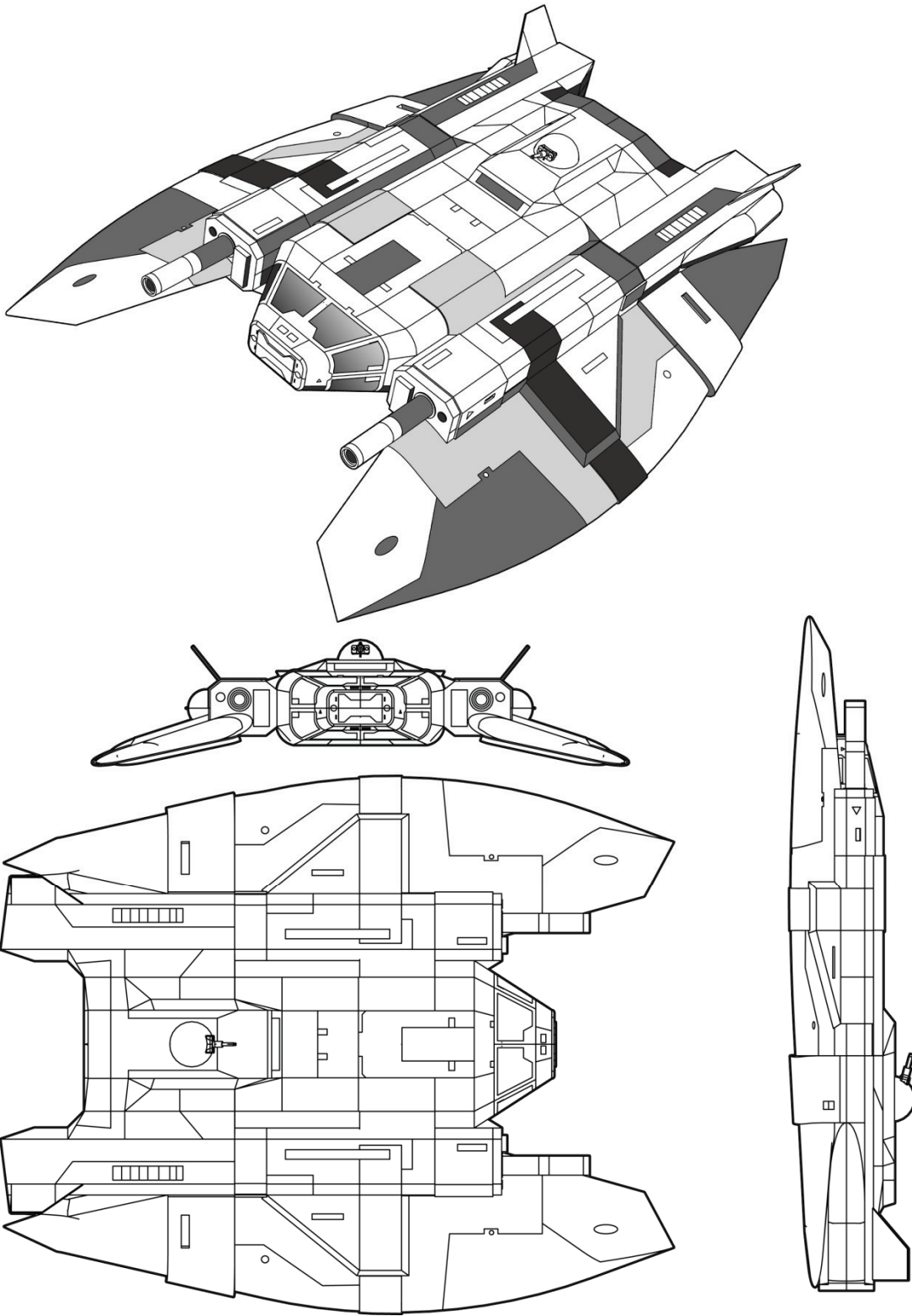

## *Ships of Clement Sector 4: Small Craft*

### *Talons of Belief-class Gunned Attack Boat*













Type			Tonnes	Price (MCr)
<b>Hull</b>	80 dT Streamlined	Hull 1 Structure 1	80.00	2.00
<b>Armor</b>	Crystaliron x1	4 points	4.00	0.10
<b>Zimm Drive</b>				
<b>Maneuver Drive</b>	sW	Thrust 5	16.00	32.00
<b>Power Plant</b>	sW	Power 6	10.50	26.00
<b>Bridge</b>	Control Cabin	4 workstations	12.00	0.40
<b>Computer</b>	Model 2(fib)	Rating 10		0.24
<b>Electronics</b>	Basic Military	DM +0	2.00	1.00
<b>Fuel</b>		2 weeks of operations	3.50	
<b>Weapons</b>		Railgun Barbette	10.00	8.00
		Single Beam Laser Turret (dorsal)	1.00	1.20
<b>Ammunition</b>	Railgun ammunition	60 rounds per railgun	4.00	
<b>Cargo</b>	1		1.00	
<b>Crew</b>	4	commander, pilot, gunner & engineer		
<b>Components</b>	Accommodations	3 staterooms	12.00	1.5
	Fuel Processor	Standard ship type	1.00	0.1
	Airlock x1		1.00	0.2
	Lifepods	One per stateroom (3)	1.50	0.3
<b>Software</b>	Maneuver/0			
	Library			
	Evade			1.00
	Fire Control/2			4.00
<b>Total Tonnage and Cost</b>			79.50	72.99

# Talons of Belief Class Gunned Attack Boat (GAB)

## Deck Plan Key

1. Control cabin
2. Common Room
3. Staterooms
4. Airlock
5. Stores
6. Railgun Magazine

## Deck Plan Symbols

-  Manual Hatch (overhead)
-  Manual Hatch (deck)
-  Iris Valve (overhead)
-  Iris Valve (deck)
-  Turret Access (overhead)
-  Turret Access (deck)
-  Iris Valve
-  Manual Hatch
-  Workstation
-  Sliding Door
-  Interior Wall
-  Bulkhead
-  Maintenance Hatch

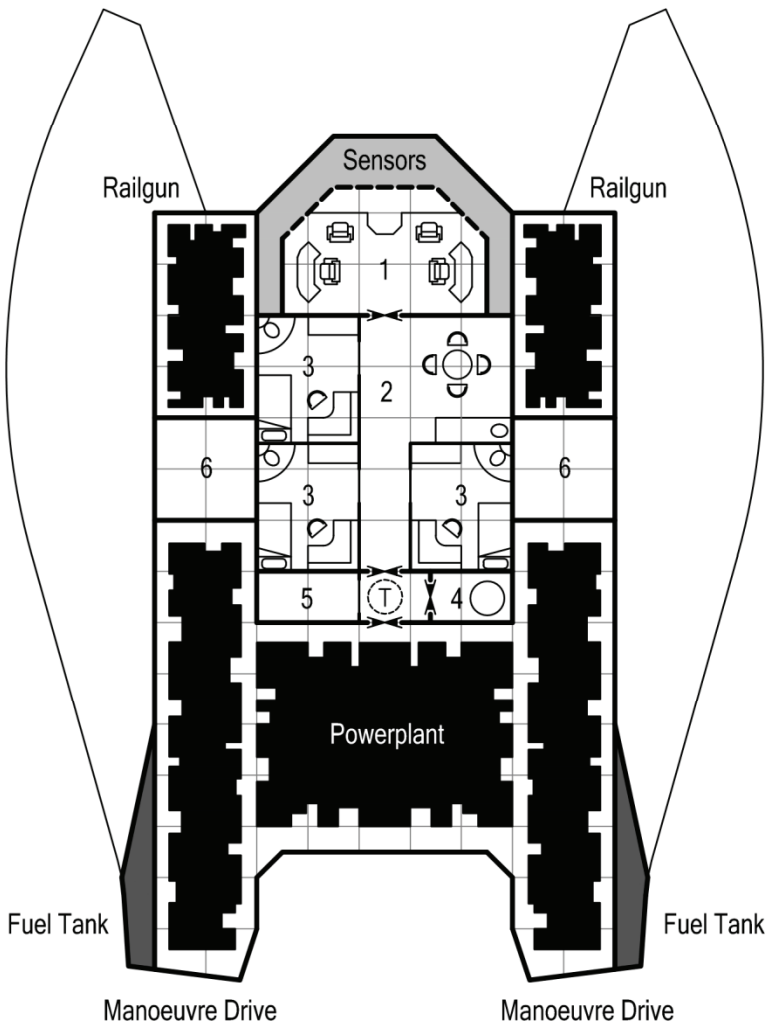

## *Ships of Clement Sector 4: Small Craft*

---

**Jericho Forward Operating Station, Morant Belt  
Kingston System, Hub Subsector 0106  
August 9th, 2343  
0920 Standard Time**

*“Through this link I receive thy blessing. With this data I shall be whole in the word. As Tralixi commands, I throw off the shackles of sin and receive the blessed light in my life. I am one of the connected, a servant of God. I am a sword for the glory of the Holy word.”*

*It was a simple catechism, accompanying the action of connecting to the datalink, but they sent a shiver through his body. There was an almost palpable burst of electricity coursing through the implant directly into his brain when the secondary localnet took over from the primary network offered by the station.*

*It was the way of things, out here in the fringe of the system and more than three AU's from the comfort of the worldnet. Blessed by the priests and configured to be one of the sub-channels in the datalink between the flight of attack boats, he felt comfort that there was no interruption in the link.*

*Last week the secondary localnet had been forced to re-initialise in the middle of a patrol, sending them all into panic for two very long minutes. Disconnected from the network, too far from the worldnet to feel it's comforting embrace, the crew had been on the verge of panic. They had been trained for it, subjected to longer periods without the bliss of holy connection, but you were prepared for that mentally. When it happened unexpectedly out in the wilds, no amount of training could account for the sense of loss and fear.*

*In the back of his skull near the implant, a throbbing pulse grew as he contemplated the disconnection. It was becoming more than an annoyance, transforming into a small ice-hammer tapping into his brain and radiating stabs of agony. The growing pain that forced him to gasp in momentary worry.*

*“Retain your holiness, Senior Pilot Benn, for the light is with us on this blessed day. The Lord has bestowed goodness upon you, for your fourth wife will birth a child soon and you shall partake in the joys of fatherhood again when we return to Kingston.”*

*The voice of the commander swept through his head, reminding him that he was straying from the path of righteousness with his recollection. Not daring to think about his fourth wife and the coming of the sixth child, he nodded to himself.*

*“Aye, all blessings are upon us, Holy Commander.”*

*Smiling, he fixed his attention to the control screens and dynamic panels. Behind him the engineer and gunner focussed on their tasks as the Gunned Attack Boat joined up with the other vessels in the patrol. To one side, the commander nodded with an encouraging smile and pointed out the canopy.*

*There was a patrol to fly, and with the three other boats forming into an Angelic Sabre formation, he needed to keep his attention where the light demanded. There would be time to contemplate the mundane later, much later. For now, the powerplants were begging the engineer to unleash the full power of five gravities and accelerate them on course toward the*

## *Ships of Clement Sector 4: Small Craft*

---

target sector; the intelligent agent program controlling them pinging the request every few seconds.

*“Remember the briefing,” the commander advised them through the network. “We have multiple reports from one of the mining camps indicating scavengers and ore poachers are in this region. The Morant Belt is restricted space, and from what the High Assessors Office determined, the poachers are not connected to the worldnet or any discernible localnet. Therefore, they are unblest heathen, trespassing in our holy lands without authority. Our mission is to smite the unholy, and all blessings from Tralixi have been giving unto us to use these new weapons to prosecute the heathen. Maintain vigilance and attend to your prayers... knowing that the blessed angel is watching over us.”*

*Mental murmurs of ‘amen’ responded from the crew, with each focussed upon the tasks. He allowed his fingers to move across the controls, dialling the first waypoint caret to sit centered in the navigation display. At five gravities, it would take them less than a day to where the heathens were last detected.*



## ***Ships of Clement Sector 4: Small Craft***

---

*If they were pirates, poachers or scavengers, he smiled at the blessings they would soon receive from the rail gun barbets mounted beneath the boat. Designed to kill starships, the long twin barrels would accelerate super-hardened 'mana' that would leave them in no doubt of the seriousness of their crimes. Kingston was a holy place, a system not deserving the corruption of sin from heathens. It was bad enough the Hubbites were trying to control the sector, sending agents of sin to mislead the Holy, and throwing their aggression around to humble anyone not sharing their viewpoint.*

*One day, he maintained in prayer, he hoped he would be worthy to fire the rail guns at one of their Kiviat ships... demonstrating how the holy faith would overwhelm their ships with a massed attack boat force they could never match.*

*"Amen," echoed the commander sitting beside him, monitoring his thoughts through the localnet. "Let us pray the heathens will regret their sin when we smite them... and until that blessing is upon us, you will focus your attention on the mission today."*

*"Blessed be the light... the miners have spotted the heathens again and are tracking them!" The gunner announced with his voice tinged in excitement. "Jericho is sharing the latest course update to the localnet now. By glory it's a big one, six hundred d-tons... suspected to be a corporate miner but no registry transponder is being detected."*

*"Six hundred...? Our swords will all get some practice today, by the light of all that is good in the universe and comes from the angel. What's the new time to target, Benn?"*

*It was times like this, when God's blessings came in blissful showers, that he knew his service in the Kingston Defense Forces was the right choice.*

*"Four hours at maximum thrust, commander... they have blundered too close to us this time."*

*"Answer the engines request, engineer, and bring us to full speed. It's time to prove why we are the sharp sword of righteousness defending our system."*



## *Ships of Clement Sector 4: Small Craft*

---

### *Fire of the Holy-class Missile Attack Boat*

*“Gentlemen an ladies, ya’ll sit down now, we have ourselves a situation”  
Vice Admiral Bob Calico Sr. Harrison Defense Forces, Harrison 2341 CE*

#### **Background and Development**

A variant of the Gunned Assault Boat, details and more information were obtained by Hub Federation Naval Intelligence about six months after rumors of the design surfaced. This boat alone is causing some concern at the Admiralty and steps are being undertaken to ensure that an adequate countermeasure to mass missile attacks on fleet units is developed at the earliest opportunity.

Normally missiles pose little threat to a modern warship, either being unable to penetrate armor or not able to slip past datalinked/single ship point defenses. However, massed fire is another matter. With the Kingston Defense Forces widespread use of mindcomp datalinking to assist coordinated attacks, the real possibility of massed missile fire saturating a fleet unit is very high, hence the Hub Federation Navy’s concern.

Tacticians from the Hub Federation Navy and Harrison’s defense forces believe that disrupting the mindcomp datalinking may

well be the Achilles heel of these highly coordinated mass attacks and are working on a countermeasure to assist in disrupting communications.

The Missile Attack Boat (MAB) replaces the Gunned Attack Boat’s railgun barbette armament with two fixed forward missile launchers each with a 6dT magazine providing 72 missiles per launcher. A rear dorsally mounted single laser turret provides for defense.

Normal crew total for the MAB is four crew (commander, pilot, engineer and gunner). The bridge is at the bow of the boat with three staterooms and a small common room aft of the bridge, amidships. Aft of the access corridor running athwartships to the port storeroom and starboard airlock are the drives which provide the attack boat with a total sustained thrust of five gravities.

## *Ships of Clement Sector 4: Small Craft*

---

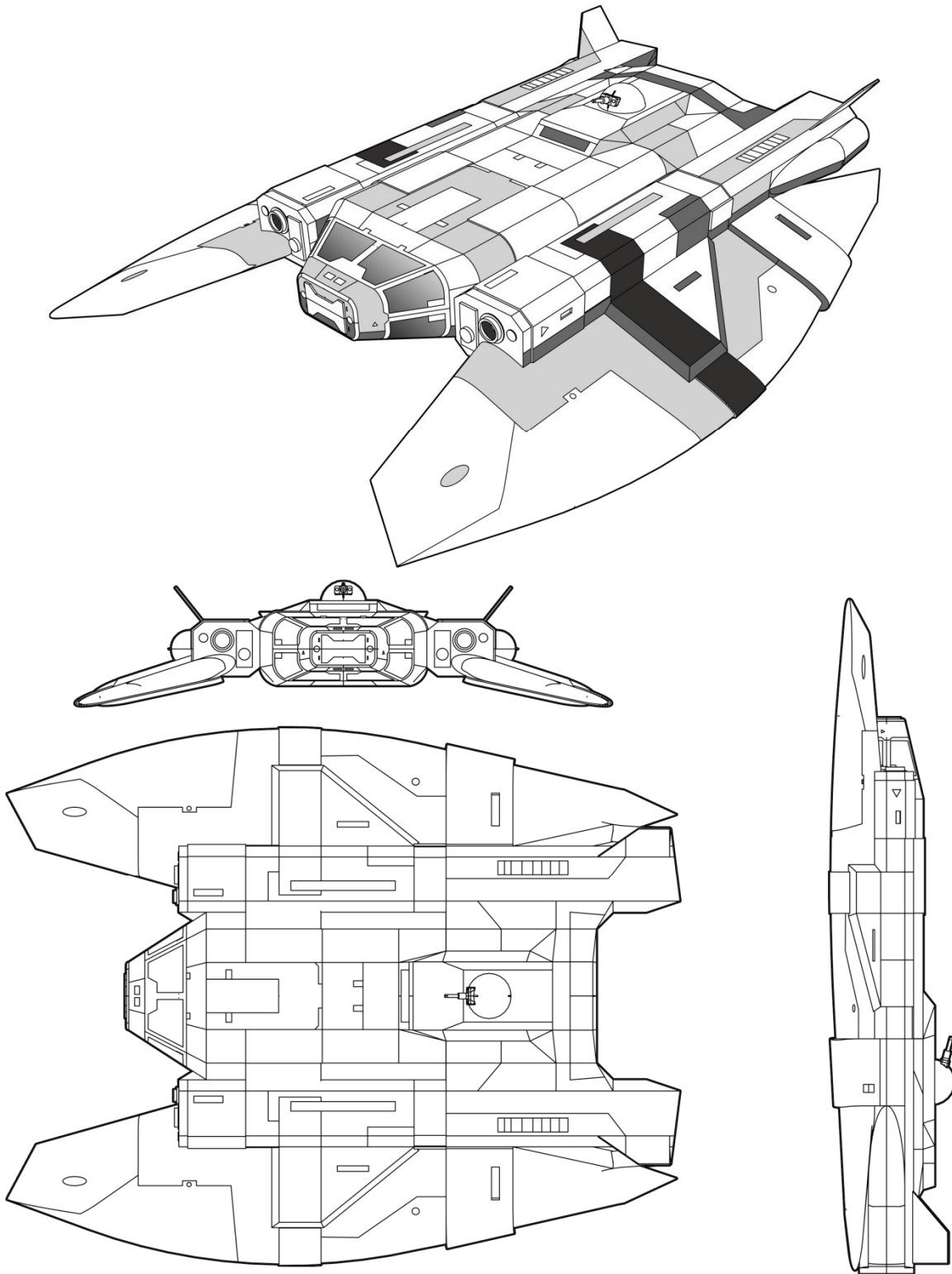

## *Ships of Clement Sector 4: Small Craft*

### *Fire of the Holy-class Missile Attack Boat*













Type			Tonnes	Price (Mcr)
<b>Hull</b>	80 dT Streamlined	Hull 1 Structure 1	80.00	2.00
<b>Armor</b>	Crystaliron x1	4 points	4.00	0.10
<b>Zimm Drive</b>				
<b>Maneuver Drive</b>	sW	Thrust 5	16.00	32.00
<b>Power Plant</b>	sW	Power 6	10.50	26.00
<b>Bridge</b>	Control Cabin	4 workstations	12.00	0.40
<b>Computer</b>	Model 2(fib)	Rating 10		0.24
<b>Electronics</b>	Basic Military	DM +0	2.00	1.00
<b>Fuel</b>		2 weeks of operations	3.50	
<b>Weapons</b>	Fixed Forward x2	Missile Launchers	2.00	0.95
		Single Beam Laser Turret (dorsal)	1.00	1.20
<b>Ammunition</b>	Missile magazines	72 missiles per launcher	12.00	
<b>Cargo</b>	1		1.00	
<b>Crew</b>	4	commander, pilot, gunner & engineer		
<b>Components</b>	Accommodations	3 staterooms	12.00	1.5
	Fuel Processor	Standard ship type	1.00	0.1
	Airlock x1		1.00	0.2
	Lifepods	One per stateroom (3)	1.50	0.3
<b>Software</b>	Maneuver/0			
	Library			
	Evade			1.00
	Fire Control/2			4.00
<b>Total Tonnage and Cost</b>			79.50	65.94

# Fire of the Holy Class Missile Attack Boat (MAB)

## Deck Plan Key

1. Control cabin
2. Common Room
3. Staterooms
4. Airlock
5. Stores
6. Missile Magazine

## Deck Plan Symbols

-  Manual Hatch (overhead)
-  Manual Hatch (deck)
-  Iris Valve (overhead)
-  Iris Valve (deck)
-  Turret Access (overhead)
-  Turret Access (deck)
-  Iris Valve
-  Manual Hatch
-  Workstation
-  Sliding Door
-  Interior Wall
-  Bulkhead
-  Maintenance Hatch

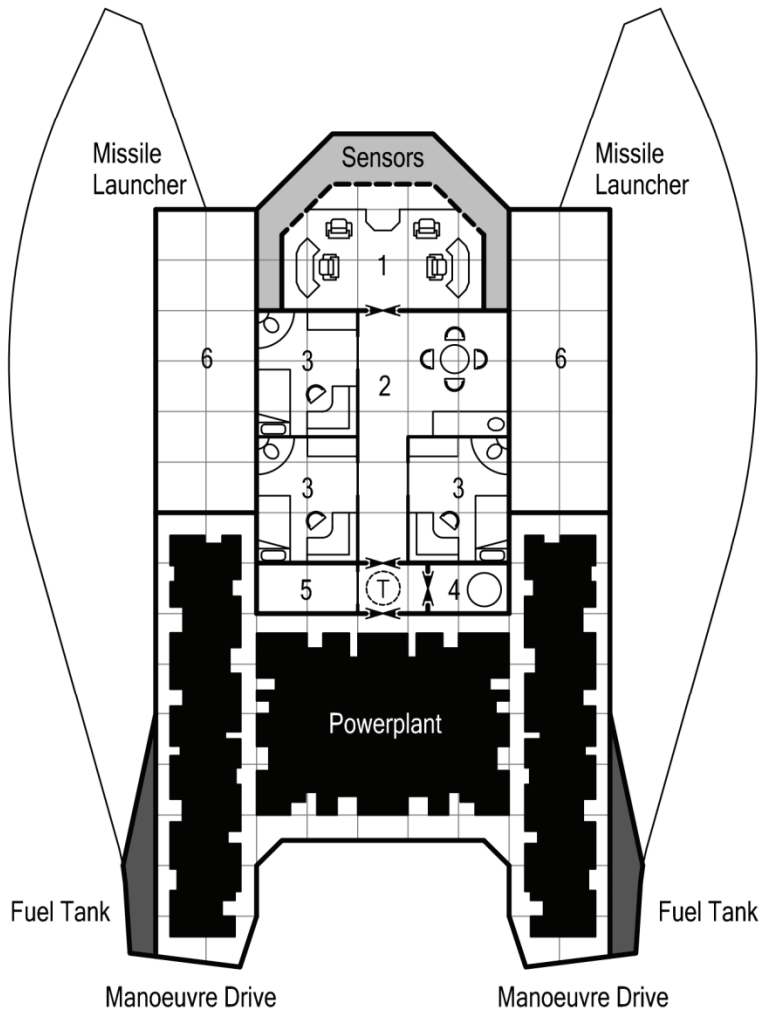

# Ships of Clement Sector 4: Small Craft

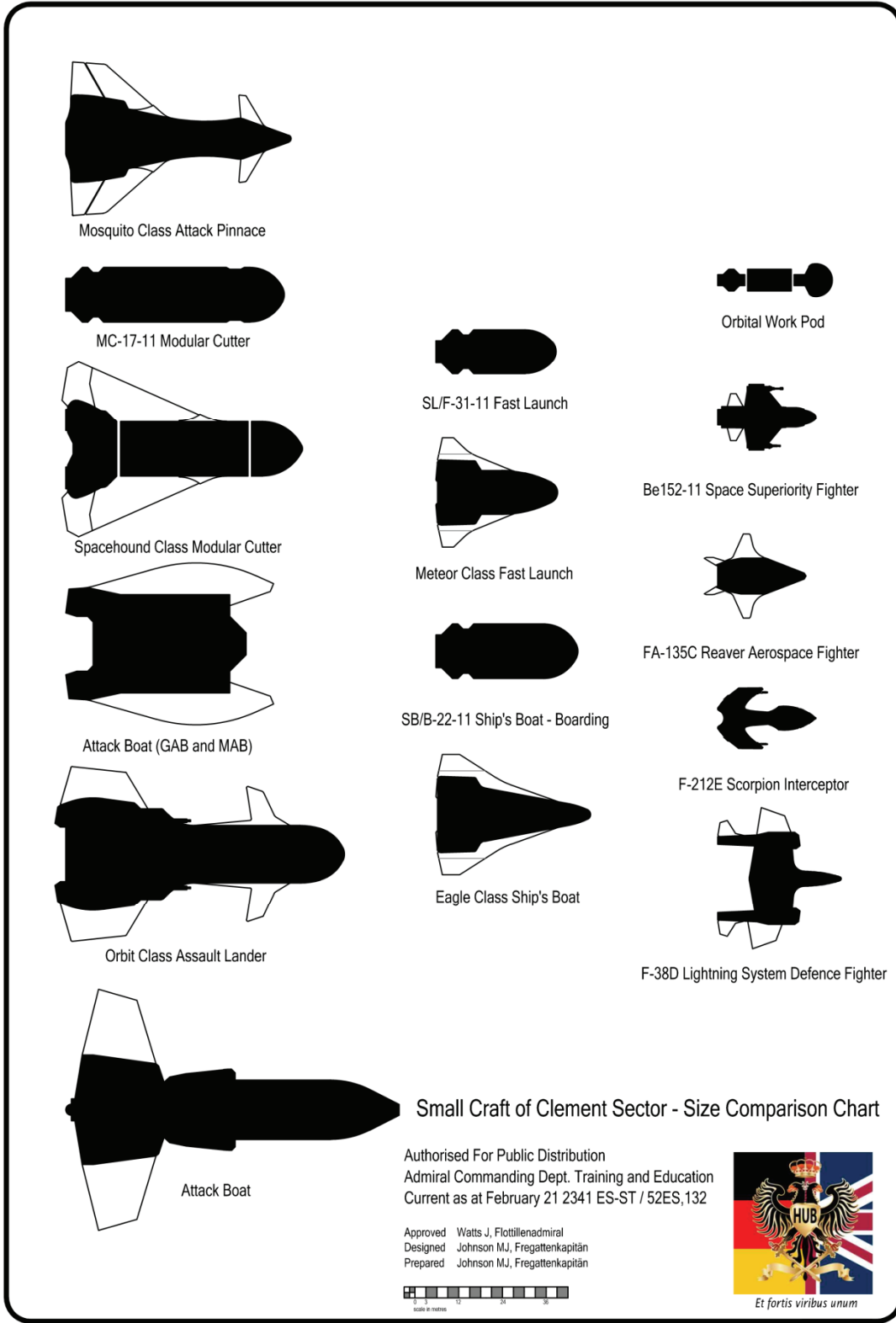

## *Ships of Clement Sector 4: Small Craft*

---

### **Ernesto Felipe Almanzar**

Independent Prospector; Owner and operator of the modular cutter (belter workpod module) "Precious Strike"

Spouse to Despene Almanzar

**STR 11 DEX 9 END 10 INT 9 EDU 8 SOC 7**

Age 47 (30)

Prospecting 3  
Sensors 2  
Vacc Suit 2  
Advocate 1  
Astrogation 1  
Engineering (Manuever Drive) 1  
Engineering (Power) 1  
Gun Combat (slug pistol) 1  
Jack of all Trades 1  
Pilot (small craft) 1  
Pilot (spacecraft) 1  
Survival (mountains) 1  
Zero-G 1

A calm man, with a methodical approach to his craft, Ernesto descends from a long line of asteroid miners that has origins stretching back to the first generations of asteroid belt miners in Sol system.

Ernesto keeps to himself what he undertook and endured during the period of unrest and open warfare that saw the overthrow of the "old regime" on Serapis. He does earn a small pension from the government of Harlan Grant and no one, except Despene, knows why. If anyone asks, he is not going to tell them, preferring to change the subject.

Considered a successful belter by his peers, Ernesto has been very successful working his claim, putting earnings away for both retirement and the purchase of a starship in order to go seek richer finds in other systems. His wife of 20 years, Despene, thinks he is slightly crazy, but knows he is usually right, trusting in his ability to make the big finds.

Ernesto on the other hand trusts Despene to being able to ascertain that those rocks he brings back to their home and mining cutter "*Precious Strike*" for analysis contain those big finds. Most times they do.

### **Despene Jenifur Almanzar (nee Thomas)**

Researcher

Spouse to Ernesto Almanzar

**STR 7 DEX 10 END 9 INT 11 EDU 10 SOC 7**

Age 43 (22)

Computers 3  
Science (Chemistry) 2  
Admin 1  
Advocate 1  
Comms 1  
Gun Combat (slug pistol) 1  
Investigate 1  
Jack of all Trades 1  
Pilot (small craft) 1  
Science (Physics) 1  
Sensors 1  
Vacc Suit 1

Despene Almanzar is a slim dark brown haired woman well used to the belter way of life. As a young assay and claims analyst/researcher working out of a large materials mining business in the City of Adapa on Serapis (Franklin 0108), meeting scruffy often unwashed beltters bringing in ore cargos was simply part of the job. When she first met Ernesto, she realised he was different; he cracked jokes, smiled a lot and never overestimated his finds. Twelve months later they were married.

Despene has a fully equipped lab on board their cutter, "*Precious Strike*" which she uses to analyse samples bought on board by either Ernesto or their sixteen year old son Allesandro. She is a skilled field researcher as well and often helps Ernesto and Allesandro out amongst "the rocks".

## *Ships of Clement Sector 4: Small Craft*

---



### **Allesandro Vicente Almanzar**

Son to Ernesto and Despene Almanzar

**STR 6 DEX 9 END 8 INT 10 EDU 7 SOC 7**

Age 17 (17)

Computers 0  
Prospecting 0  
Vacc Suit 0

According to his mother, Allesandro is a sponge, ready to soak up all that he sees and all that he experiences. With the methodical patience inherited from his father and the analytical ability of his mother, Alex assists his parents where he can, trying to balance his schooling program.

Of late though, he tends to spend (according again, to his mother) too much time chatting to Brianna Craice, a pretty sixteen year old redhead living with her family working a claim on the other side of Boon Ridge, near their claim area on Madgar. Ernesto simply pats his mother Despene's hand every time it is raised at the dinner table and simply says that "the boy has to have friends".

# *Ships of Clement Sector 4: Small Craft*

---

## **Small Craft design Sequence Modifications**

The small craft designs presented in this supplement make use of the following modifications and additions to the design sequences within Mongoose Traveller Core Rules and Book2: High Guard.

### **Fuel Processors**

Fuel scoops are provided for streamlined hulls  
Fuel processors for small craft are as below  
0.25dT refining up to 2dT per day 0.01Mcr

### **Armament**

Standard starship class weapon allocation for small craft to remain the same.  
However allocation of much smaller anti-personnel weapons is increased by one for hull sizes 50dt and under.

e.g. for a 10dT hull ship weapon 1, anti-personnel 2

Any anti-personnel missile racks are to be enclosed in bays to protect the missile warheads from the heat of re-entry.





# *Ships of Clement Sector 4: Small Craft*

---

OPEN GAME LICENSE Version 1.0a

The following text is the property of Wizards of the Coast, Inc. and is Copyright 2000 Wizards of the Coast, Inc ("Wizards"). All Rights Reserved.

1. Definitions: (a) "Contributors" means the copyright and/or trademark owners who have contributed Open Game Content; (b) "Derivative Material" means copyrighted material including derivative works and translations (including into other computer languages), potation, modification, correction, addition, extension, upgrade, improvement, compilation, abridgment or other form in which an existing work may be recast, transformed or adapted; (c) "Distribute" means to reproduce, license, rent, lease, sell, broadcast, publicly display, transmit or otherwise distribute; (d) "Open Game Content" means the game mechanic and includes the methods, procedures, processes and routines to the extent such content does not embody the Product Identity and is an enhancement over the prior art and any additional content clearly identified as Open Game Content by the Contributor, and means any work covered by this License, including translations and derivative works under copyright law, but specifically excludes Product Identity. (e) "Product Identity" means product and product line names, logos and identifying marks including trade dress; artifacts; creatures characters; stories, storylines, plots, thematic elements, dialogue, incidents, language, artwork, symbols, designs, depictions, likenesses, formats, poses, concepts, themes and graphic, photographic and other visual or audio representations; names and descriptions of characters, spells, enchantments, personalities, teams, personas, likenesses and special abilities; places, locations, environments, creatures, equipment, magical or supernatural abilities or effects, logos, symbols, or graphic designs; and any other trademark or registered trademark clearly identified as Product identity by the owner of the Product Identity, and which specifically excludes the Open Game Content; (f) "Trademark" means the logos, names, mark, sign, motto, designs that are used by a Contributor to identify itself or its products or the associated products contributed to the Open Game License by the Contributor (g) "Use", "Used" or "Using" means to use, Distribute, copy, edit, format, modify, translate and otherwise create Derivative Material of Open Game Content. (h) "You" or "Your" means the licensee in terms of this agreement.
2. The License: This License applies to any Open Game Content that contains a notice indicating that the Open Game Content may only be Used under and in terms of this License. You must affix such a notice to any Open Game Content that you Use. No terms may be added to or subtracted from this License except as described by the License itself. No other terms or conditions may be applied to any Open Game Content distributed using this License.
3. Offer and Acceptance: By Using the Open Game Content You indicate Your acceptance of the terms of this License.
4. Grant and Consideration: In consideration for agreeing to use this License, the Contributors grant You a perpetual, worldwide, royalty-free, non-exclusive license with the exact terms of this License to Use, the Open Game Content.
5. Representation of Authority to Contribute: If You are contributing original material as Open Game Content, You represent that Your Contributions are Your original creation and/or You have sufficient rights to grant the rights conveyed by this License.
6. Notice of License Copyright: You must update the COPYRIGHT NOTICE portion of this License to include the exact text of the COPYRIGHT NOTICE of any Open Game Content You are copying, modifying or distributing, and You must add the title, the copyright date, and the copyright holder's name to the COPYRIGHT NOTICE of any original Open Game Content you Distribute.
7. Use of Product Identity: You agree not to Use any Product Identity, including as an indication as to compatibility, except as expressly licensed in another, independent Agreement with the owner of each element of that Product Identity. You agree not to indicate compatibility or co-adaptability with any Trademark or Registered Trademark in conjunction with a work containing Open Game Content except as expressly licensed in

another, independent Agreement with the owner of such Trademark or Registered Trademark. The use of any Product Identity in Open Game Content does not constitute a challenge to the ownership of that Product Identity. The owner of any Product Identity used in Open Game Content shall retain all rights, title and interest in and to that Product Identity.

8. Identification: If you distribute Open Game Content You must clearly indicate which portions of the work that you are distributing are Open Game Content.
9. Updating the License: Wizards or its designated Agents may publish updated versions of this License. You may use any authorized version of this License to copy, modify and distribute any Open Game Content originally distributed under any version of this License.
- 10 Copy of this License: You MUST include a copy of this License with every copy of the Open Game Content You Distribute.
11. Use of Contributor Credits: You may not market or advertise the Open Game Content using the name of any Contributor unless You have written permission from the Contributor to do so.
- 12 Inability to Comply: If it is impossible for You to comply with any of the terms of this License with respect to some or all of the Open Game Content due to statute, judicial order, or governmental regulation then You may not Use any Open Game Material so affected.
- 13 Termination: This License will terminate automatically if You fail to comply with all terms herein and fail to cure such breach within 30 days of becoming aware of the breach. All sublicenses shall survive the termination of this License.
- 14 Reformation: If any provision of this License is held to be unenforceable, such provision shall be reformed only to the extent necessary to make it enforceable.
- 15 COPYRIGHT NOTICE  
Open Game License v 1.0 Copyright 2000, Wizards of the Coast, Inc.  
Traveller System Reference Document Copyright © 2008, Mongoose Publishing.  
Ships of Clement Sector 4: Small Craft Copyright 2014, Gypsy Knights Games LLC