

**TOP
SECRET**



Pop the Clutch!

Rules for car chases in TOP SECRET play

A Script Moocher Games Publication

Originally published in Dragon Magazine

by Ed R. Teixeira
Car Stats Compiled by Urk



Murphy was desperate. Everything he had tried so far had failed. Since he first spotted the black sedan, it had stayed 100 feet behind him. At first he tried to be subtle: a few quick lefts and then a right. After five minutes the sedan still hung behind. Whoever was behind him was a good driver. Murphy stepped on the gas pedal, and his Porsche leapt forward. Running parallel to the river, the Porsche sped down the road.



City streets aren't made for this,. Murphy thought as the car slid sideways coming out of a turn. Murphy slowed down to regain control, then looked in to his rear-view mirror. The sedan had closed to within 65 feet. Downshifting, Murphy spun the wheel to the right and accelerated. Tires squealed as the cars raced around another corner. Then Murphy remembered something that the driver of the sedan might not know. The road they had turned onto crossed a river at a drawbridge, and he had heard a ship's whistle about a minute ago.

As Murphy approached the bridge, it started to rise. The Porsche crashed through the wooden cross-guards and was airborne. The Porsche flew over the river and landed on the other side of the bridge, its stiff suspension absorbing most of the shock of the landing. The driver of the sedan thought he could make it, too . but the ball of flame in Murphy's rear-view mirror confirmed that he didn't.

Murphy let up on the accelerator, turned left, and slipped away into the night.

The chase described above happened in a recent TOP SECRET® game scenario that I had the pleasure of running. It was able to happen because of a set of special rules I drew up. The TOP SECRET rules include guidelines for vehicle movement, but not any specific rules beyond that to govern the use of a motor vehicle. Using the rules in this article, it is possible to handle chase scenes like the ones in almost every spy movie.

Scales and time vs. distance

The time scale used for-vehicle movement in the TOP SECRET rules is the same as for personal movement turns; that is, one turn equals five seconds. If an agent wants to fire a weapon during a car chase, he is allowed only one round of fire per turn of vehicle movement; not five rounds of projectile combat, as is otherwise possible in the projectile firing system. If both the target and the shooter are in moving vehicles, only one round of fire is allowed, and this occurs at the end of the movement turn. If either the shooter or the target is not in a moving vehicle, then projectile fire is handled as normal in the rules. If Murphy had been shot at by a person not in a vehicle, then the distance that Murphy's car traveled would have to be divided into second-by-second movement, and a round of projectile combat would be allowed each second. In such a case, it is important to correctly calculate the distance traveled per second by dividing the distance traveled in a turn by 5 (and round down) to arrive at the feet per second traveled by a vehicle at a certain speed.

MPH	1	2	3	4	5	10	15	20	30	40	55
Ft/Turn	7	14	21	28	35	70	105	140	210	280	385

To figure out the distance traveled for a speed that is not on the above chart, add two or more speeds together. Example: The feet per turn traveled per turn by a vehicle at 18 mph would be 105 (for 15 mph) plus 21 (for 3 mph), or 126. If it was necessary to divide this into one-second increments, then 126 divided by 5 would yield a distance of 25.2, rounded to 25 feet per second.

Combat

To clarify projectile combat involving a stationary (not in a vehicle) shooter and a target in or on a moving vehicle, consider this example: A guard sees a vehicle trying to escape at a current speed of 50 mph. The distance traveled at 50 mph is 350 feet per turn, or 70 feet per second. After he sees it, the vehicle travels for three more seconds before the guard opens fire. After the car has moved 210 feet (in those three seconds), the guard would be allowed to fire one round of projectile combat. He would be allowed additional rounds of firing if desired, and the Administrator should keep in mind that the vehicle is allowed one second of movement (another 70 feet of distance) before the each subsequent round of fire. And, it is important to take into account the penalty to hit the vehicle due to consecutive shots. Characters will realize that is often beneficial to spend a second steadying their weapon after squeezing off a few rounds of fire.

Turn sequence

1. The vehicle (or car, for simplicity's sake) that is being pursued is said to have the initiative. The positions of all other vehicles are expressed in relation to the "chase car" (the one being pursued). The player representing the driver of the chase car will first write down the speed he wishes to move, any shifting of gears, and any maneuvers he is attempting this turn.
2. After the chase car's actions are secretly recorded, the pursuit vehicles are allowed three options:
 - Tail:** allows the pursuer to copy the actions of the chase car. This will not change the distance between cars.
 - Speed up:** allows the pursuit car to copy the actions of the chase car, but also to accelerate its speed to either close the distance between cars or to overtake the chase car.
 - Slow down:** will increase the distance between the cars.Under any of the three options, the pursuit car(s) may make any maneuver that the chase car is making, subject to the physical restrictions of a certain vehicle or vehicle type.
3. If any vehicle will intersect the path of another vehicle during the turn, the Admin must determine if a collision occurs. Distance traveled during the turn should be broken down into one-second increments if needed.
4. Each pursuit driver either records his action choice or selects an action card secretly and once all drivers have made their selections all cards are revealed simultaneously. If no vehicle collisions occur, the characters involved are allowed to carry out any actions desired before another vehicle movement turn begins.
5. Damage incurred by any actions in steps 1-4 is recorded and survivors are allowed to proceed to the next movement turn, repeating steps 1-4 as many times as needed.

Note: The pursuing driver(s) must declare a speed for the pursuing vehicle(s), just as the driver of the chase car must do for his vehicle, but the pursuer(s) should always be able to figure out (roughly, at least) how fast the chase car is traveling, to help the pursuer(s) decide what speed to choose. If "speed up" or "slow down" is the selected option, assume an increase or decrease of 5 mph in speed for the pursuing car (either a gradual acceleration, or just taking one's foot off the gas), unless the driver is accelerating or decelerating abruptly. (See the Vehicle Chart later in this article for details on acceleration and braking.)

Vehicles involved in a chase should be plotted on a map that was made prior to playing the scenario. It is important to keep track of the location of the pursuing vehicle(s) each turn, both actually (on the map) and in relation to the chase car. If a pursuing car is able to catch and pass the chase car during a turn, the driver may immediately exercise the option of slowing down to remain abreast of the chase car.

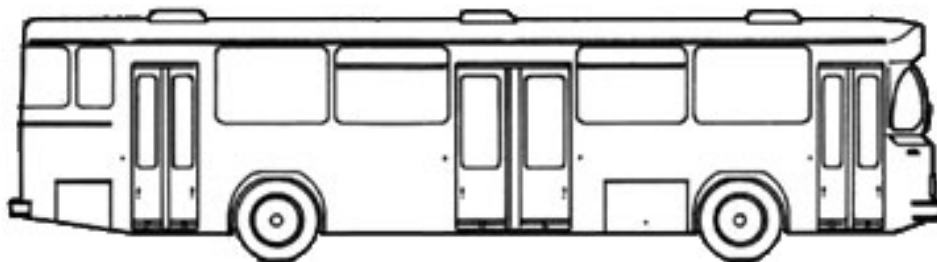

Turning

Various kinds of curves and corners are classified according to a recommended speed and the chances of a mishap if that speed is exceeded. For cars making a turn at or below the recommended speed, simply plot the vehicle's movement as if it was going straight. Whenever a driver attempts a turn at more than the recommended speed, do the following:

Calculate the driver's Coordination plus 50. From this number subtract the Cornering Rating of the turn (see the Turn Chart following). Then subtract 5 for each mph of speed more than the recommended speed. To this apply the Cornering Rating of the vehicle (see the Vehicle Chart). The net result is the percentage chance for a successful turn. Example: Murphy hits a medium turn at 45 mph. Murphy's Coordination of 75 plus 50 equals 125. The Cornering Rating of a medium turn is 30. This, and 50 more for exceeding the recommended speed by 10 mph, is subtracted from 125, leaving 45. To this is added the Cornering Rating for Murphy's Porsche, which is +20. So, a percentile dice roll of 65 or less is needed for Murphy to make the turn safely.

**Turn Description Chart
Recommended Cornering Speeds**

Type of turn	speed (mph)	rating	Stress roll*
Sharp	15	50	02%
90-degree	25	30	01%
Medium	35	30	01%
High-speed	50	50	02%
Special	75	60	04%

Sharp turns are hairpins or U-shaped curves.

90-degree turns are the type found at most street corners.

Medium turns are the gradual curves often found on highways and freeways.

High-speed turns are shaped like medium turns, but are somewhat banked.

Special turns are of the sort found on a test track or speedway, deeply banked.

* Stress roll refers to the car, not the driver. Whenever a vehicle takes a turn at more than the recommended speed, regardless of the result of the attempt, the Admin must make a stress roll for the vehicle. On a percentile dice roll equal to or less than the stress roll value for that type of turn, the vehicle has suffered a mechanical failure. Make another dice roll, as if the vehicle had missed the turn and suffered a result of .Lose Control. on the Turn Failure Chart (below). Even if the driver avoids a crash and an injury, the car counts as a disabled vehicle and will roll to a stop. The vehicle cannot be operated again before being repaired by a qualified mechanic.

If a driver makes it through a curve or corner safely, the turn sequence continues as outlined in steps 1-5 above. If the dice roll is more than the needed number, the driver has missed the turn, and the Admin rolls again, consulting the Turn Failure Chart to see what happens next.

Turn Failure Chart

Type of turn	Skid, speed reduced 50%	Lose Control	Crash	Explode
Sharp	01-60	61-87	88-99	00
90-degree	01-60	61-95	96-99	00
Medium	01-60	61-92	93-99	00
High-speed	01-50	51-90	91-98	99-00
Special	01-50	51-85	86-96	97-00

Modifiers: Add 10% to any dice roll if road is wet.

Skid, speed reduced 50%: Vehicle will reduce speed by at least, half next turn with any needed downshifting of gears.

Lose control: When this result occurs, a dice roll is necessary on the Loss of Control Table. A driver with Coordination of more than 80 adds 1% to the dice roll for every point above 80.

Crash: Vehicles in a crash must roll on the Crash Table. Use the Damage modifier for the vehicle type (found on the Vehicle Chart) as an adjustment to the dice roll, and also add +1% to the dice roll for every mph of speed the vehicle possessed at the time of the crash (assuming the crash is with a stationary object).

Explode: This result from the Turn Failure Chart is played the same way as a Crash Table result of 126 or more except there is a 25% chance of the explosion being instant and killing everyone in the car, and a 75% chance that the explosion will occur in 2-200 seconds.

Loss of Control Table Roll D%

01-60 Vehicle will crash. Refer to the Crash Table.

61-80 Driver regains control of vehicle, but must reduce speed by at least 50% (as for skid result), with appropriate downshifting

81-00 Driver remains in full control of vehicle; no reduction of speed necessary.

Crash Table

Roll D%

01-35 Vehicle skids off the road to the inside of the turn. If nothing is there that the vehicle can hit, it will roll over once and land upright. Passengers will receive 1 injury per each 10 mph of speed at the time of the crash, or only 1 injury if seat belts are worn. Injuries are determined as per projectile combat. The car may be restarted on a roll of 60 or less on the following turn. If it does not restart, then it may not be driven until repaired. If the vehicle hits a solid structure, passengers will receive double the injuries given above.

36-70 As above, but vehicle skids to outside of curve.

71-125 Vehicle rolls over three times, either to the inside or outside (50-50 chance) of the curve. If there is nothing the vehicle can hit, it will land upright 50% of the time, and passengers will receive 2 injuries per 10 mph of speed at the time of the crash, or only 2 injuries if seat belts are being worn. If the vehicle hits a solid structure, passengers will receive double the injuries given. The vehicle may not be restarted. There is a 15% chance the vehicle will explode in 4-400 seconds ($d\% \times 4$) from the time it stops rolling, and all inside the car at that time will perish. Those within 40 feet of the explosion will suffer 1-10 damage points.

126+ The vehicle rolls five times, and passengers will receive 3 injuries per each 10 mph of speed, or only 5 injuries if seat belts are being worn. There is a 50% chance the vehicle will explode in 2-200 seconds ($d\% \times 2$) from the time it stops rolling, and all inside the car at that time will perish. Those within 40 feet of the explosion will suffer 1-10 damage points.

Chevrolet S10 (Extended Bed)

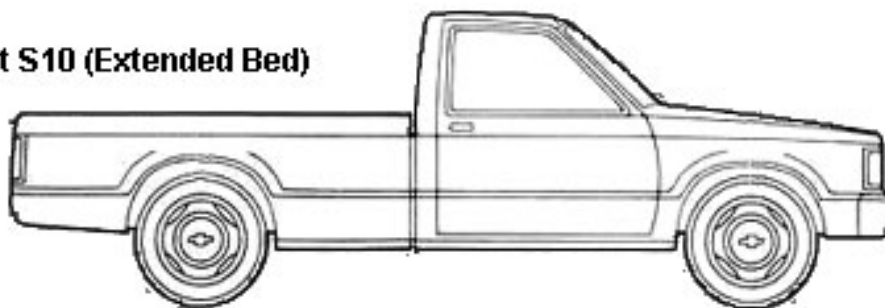

Advanced Crash Rules

Loss of consciousness: A crash victim may lose consciousness in addition to being injured. The chance of being knocked unconscious is equal to the victim's current damage points (in life levels) divided by the character's normal, healthy Life Level and expressed as a percentage. A passenger who rolls this percentage or less is unconscious. Example: A passenger has lost 5 points from his original Life Level of 20 following a crash. This is 25% of the passenger's normal Life Level, so he has a 25% chance (01-25) of being knocked unconscious by the crash.



Escaping a crash scene: Passengers can exit a crashed vehicle without help if they are conscious. Unconscious passengers must be dragged out. The time, in seconds, required for a conscious passenger to get himself out of a vehicle after a crash is equal to 200 minus his total of Coordination and Willpower. If a rescuer is attempting to free an unconscious passenger, add 100 to the weight of the victim and subtract from that the rescuer's total of Coordination and Willpower to get a time in seconds.

A passenger cannot rescue someone else until he has pulled himself free to start with, and an extra five seconds of escape time is needed for any passenger wearing a seat belt at the time of the crash.

Example: Murphy attempts to extract himself from a crashed vehicle. His Coordination (75) plus Willpower (85) equals 160. The difference between 160 and 200 is 40, the number of seconds it will take him to get out. If Murphy then decides to pull his 125-pound passenger Tanya out of the wreckage, he can do it in 65 seconds: Tanya's weight plus 100 equals 225, minus 160 (Murphy's Coordination plus Willpower) equals 65.

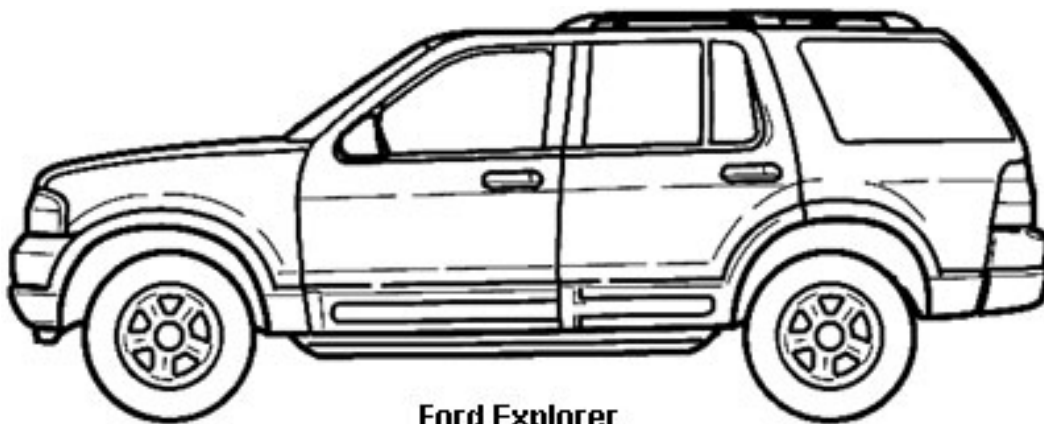

Ford Explorer

Vehicle Chart Generic Vehicles

Type	Cost	Spd	Range	Cor	Acc	Brk	Bsh	Dam	Seats
Motorcycle	\$9000	55/100	350*	+35	2	1	1	+40	2
Sports car	\$35,000	85/155	350*	+20	2	2	2	+20	2
Sedan	\$17,000	65/110	350*	0	1	2	3	0	5
Police Car	22,000	85/130	350*	0	1	2	3	0	5
Van	\$16,000	50/90	350*	-10	1	2	3	0	2+
SUV	30,000	60/105	350*	-10	1	2	4	-10	6+
Pickup	\$17,000	55/95	350*	0	1	2	4	-10	3+
Bus	\$40,000	40/85	350*	-15	1	1	8	-20	30+
Semi-rig	\$85,000	60/85	350*	-35	1	1	10	-20	3

* Generic Vehicle Fuel Capacity: Assume if a player agent has purchased a vehicle that he or she will have shopped around for a vehicle with 350 mile range. For random vehicles roll 1d10x10+250 for Range.

Cost: Cost of vehicle new in US dollars. Assume monthly maintenance costs (fuel, insurance, repairs, upkeep, etc) equal to 1.5% of the cars value.

Spd: Maximum Cruising Speed / Top Speed

Range: Approximate cruising range in miles before refueling is required. If needed, when appropriating a random car roll percentile dice to determine the amount of fuel in the tank.

Cor: The vehicle.s Cornering Rating, used as a modifier to the dice roll for an attempted turn.

Acc: Acceleration Rating: the number of Speed Levels (see below) that a vehicle can increase in one turn.

Brk: Braking Rating: the number of Speed Levels a vehicle can decrease in one turn.

Bsh: A vehicle.s .Bash Value,. used to help determine the outcome of a bashing attempt (see below).

Dam: Damage modifier, to be incorporated into a dice roll to determine the outcome of a crash.

Seats: Shows number of seats in vehicle including driver and passengers. A "+" sign indicates that the vehicle also has cargo space available large enough to allow for at least one extra passenger to function.

Speed Levels

Listed below are the categories for each miles-per-hour range of speed that a vehicle may achieve (up to its top speed). The numbers given in the "Acc" and "Brk" columns on the Vehicle Chart indicate how many speed levels a vehicle can move up or down from its present speed during a single five-second movement turn.

Slow	0-15	Excessive	56-75
Low	16-25	Extreme	76-90
Medium	26-40	Maximum	Top speed for vehicle type, if over 90; reached in 15mph increments.
High	41-55		



Example: A sports car is accelerating from a stationary position (technically, slow speed). It can reach a speed of up to 40 mph (the upper limit of medium speed, two levels higher than slow) in the next turn, since its Acc number is 2. If the car is traveling 40 mph, it can accelerate to as much as 75 mph (the upper limit of excessive speed, two levels higher than medium), or can use its Brk number (also 2) to come to a full stop (the lower limit of slow speed, two levels lower than medium) in the next turn.

Bashing

This is a combat/collision situation where two vehicles are involved, and one of them is attempting to smash into the other. A bash is accomplished by either matching or exceeding the speed of the target vehicle and/or intersecting its path, coming from the rear, the side, or head on. To determine if any driver suffers a Loss of Control from a bashing attempt, compare the Bash Values of the vehicles and refer to the following table, using "L" for the vehicle with the higher Bash Value and "S" for the vehicle with the lower Bash Value.

If L and S are equal, each driver will suffer a Loss of Control on a 20% chance (roll separately for each vehicle).

If L is greater than S by 1-3, L will lose control on a 10% chance and S on a 30% chance.

If L is greater than S by 4-8, L will lose control on a 5% chance and S on a 60% chance.

If L is greater than S by 9 or more, L will lose control on a 2% chance and S on a 95% chance.

Damage from a bash: When a bash attempt is made, the attacker rolls percentile dice. On a roll of 75 or less, both vehicles will sustain damage points equal to the Bash Value of the opposing vehicle. (If a bus bashes a pickup truck, the truck takes 8 damage points and the bus takes 4.) Whenever a vehicle accumulates damage points equal to 10 times its Bash Value, the vehicle must first roll on the Crash Table and is then considered immobile and beyond repair. If a damage roll after a bash attempt is 76 or higher, it is assumed that the bash actually took place, but it was a glancing blow (at best) and neither of the vehicles involved sustained any significant damage.

Head-On Collisions

If vehicles involved in a bashing attempt collide head-on, the speeds of both vehicles are added together and used as a modifier for each vehicle on the Crash Table (roll for each vehicle separately, even though they are traveling at the same speed.). Damage to vehicles resulting from a head-on collision is triple the normal amount (as for a bash, above), and both vehicles must automatically roll on the Loss of Control Table. Note: In order for a head-on collision to occur, the damage roll described in the procedure for a bash must be 75 or less. If this roll is 76 or more, it is assumed that one vehicle swerved at the last instant and missed the other one, or caused the head-on collision to be turned into a sideswipe that resulted in no significant damage.

Projectile combat and vehicles

As stated in the first part of this article, if either the shooter or the target in a projectile combat situation is not riding in or upon a vehicle, then the combat is carried out as per the regular TOP SECRET rules. If both the shooter and the target are riding in or on vehicles, then only one round of projectile fire is allowed for each five-second movement turn.

If the result on the General Injury Determination Table in the TOP SECRET rule book gives a body location for a passenger that is covered by the body of the vehicle (but not the glass of the windshield or windows), then the result of the projectile combat must be found on the Bullet Use Against Vehicle Table. If the injury result is to a part of the body covered only by the vehicle's window glass, then roll as normal for damage to the target and add 1-4 more damage points from glass breakage. See the section on Bulletproof Equipment in the rules if this is applicable.

Rundown Combat

A third type of combat involving vehicles is a combination of bashing and projectile combat called "rundown" combat, where the driver of a car tries to collide with a pedestrian.

To attempt to run down a pedestrian, the driver must have a clear path to the target, and the vehicle must already be moving. A successful hit is scored on a percentage chance equal to the driver's Offense value, plus 1% for each mph of speed the vehicle has at the moment of the collision, minus the Coordination value of the intended target. All modifiers for normal projectile combat apply, with a roll of 01-05 being an automatic hit and a roll of 96-00 an automatic miss.

A pedestrian who is hit will suffer one injury for each 20 mph of speed the vehicle had at the time of the collision, and additional injuries equal to the vehicle's Bash Value. Specific injuries are determined as per projectile combat, using the charts in the TOP SECRET rule book.

Obstacles and interference

Lots of terrain features can have an effect on vehicle movement, especially in an urban environment. My favorites are the railroad crossing and the drawbridge, both described below. In addition to physical features (obstacles shown on the map), the Administrator can devise obstructions such as road-construction areas, detours, and the like.

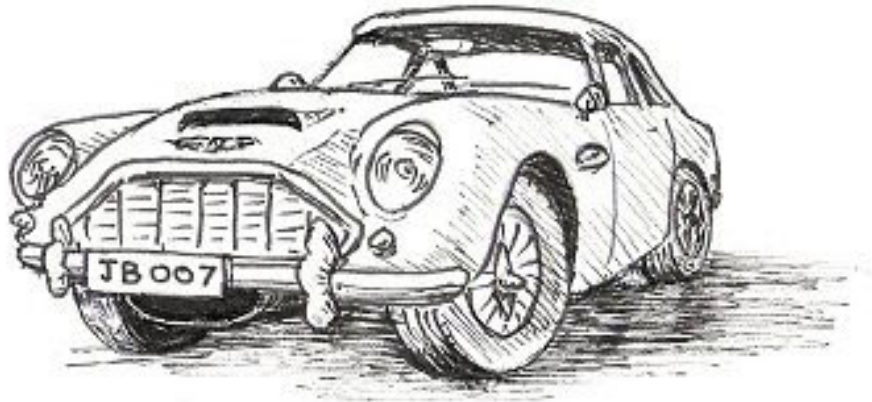

Railroad crossing: The chance of a train converging on a crossing at the same time as a vehicle is either 10% (a rural freight line), 20% (suburban commuter or freight), or 30% (urban commuter or freight). The train is first noticed by those in the vehicle when the train is at a distance of 200-2,000 feet from the crossing (roll randomly or assign a range of sight based on the surroundings). It will be traveling between 20 and 50 mph (possibly faster in open country), depending on the type of train and the surroundings. The speed and length of a train will determine how long it blocks an intersection; most of the time, vehicles will have to wait from 1-10 minutes to get across the tracks.

A vehicle approaching an “occupied” railroad crossing has three options — one, turn off the road and backtrack or find another route; two, come to a stop at the crossing and wait for the train to pass; and three, go for it. Options one and two are self-explanatory. The fun one is handled this way: Make no calculations, and don’t allow players to make any calculations, until the driver has announced a decision to try to beat the train. Then, break down the speed and distance traveled of the train and the vehicle into one-second increments, until plotting on the map determines whether the train and the vehicle will hit. If the vehicle hits the train, determine the effect on the vehicle and passengers as for a roll of 126 or more on the Crash Table.

Drawbridge: If a drawbridge (like the one Murphy jumped at the start of this article) is in use, it will be on the way up or down, and thus can be jumped, 50% of the time. The other half of the time it will be in the fully raised position, it cannot be jumped, and it will not begin going down for 1-10 minutes after the vehicle arrives at the site. The chance of a drawbridge being in use at any given time depends largely on other circumstances (time of day, shipping schedules, etc.), or can be determined to occur randomly on a roll of 40% or less.

Buses, Semi-Rigs, and similarly large vehicles cannot jump a bridge successfully, and smaller vehicles can only succeed if the vehicle is traveling faster than 55 mph when it reaches the bridge. If these two conditions are met, the jump is successful; however, the landing on the other side may be a rough one. A vehicle landing after jumping a drawbridge is treated as if it had just failed to negotiate a high-speed turn; roll for the vehicle on the Turn Failure Chart under this category.

Special situations

Driver incapacitated: If the driver is disabled and cannot control his vehicle, it is possible for a passenger to reach out and grab the wheel by making a roll of Coordination or less. The passenger will only be able to steer the car unless the driver is moved from his seat; this will take one turn, or two turns if the driver is wearing a seat belt. If the vehicle has only one passenger, the only way that person can steer the vehicle and move the driver aside at the same time is by pushing the driver out the driver's side door.

Jumping from one vehicle to another: A character can leap from one moving vehicle to another under these conditions:

- The target vehicle must offer a suitable place to land, and/or a handhold for the jumper to grab.
- Someone must control the vehicle being jumped from, unless the "vehicle" is an animal (a rider on horseback, for instance).
- The distance to be jumped must not exceed three feet.
- The vehicle being jumped from must be going at least as fast as the target vehicle.

If these conditions are met, the jumper will succeed on a roll of his Coordination or less. (Rolls of 01-05 are automatic success and rolls of 96-00 are automatic failure.) The dice roll is modified by -1% for every 1 mph difference in speed between the two vehicles — and remember that any jump will fail if the target is moving faster than the vehicle being jumped from.

Someone who has made a successful jump must roll his Strength or lower on each turn thereafter to keep from being shaken loose. The dice roll is modified by +10% if the driver of the vehicle announces that he is trying to shake off the jumper. If the jumper falls from the vehicle before it comes to a stop, he sustains one injury (as per projectile combat) for each 10 mph of speed the vehicle had at the time of the fall.

Cadillac Seville STS

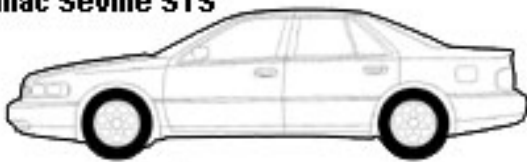

Moto Guzzi V10



Chevrolet Astro

BMW R1200



Audi A6

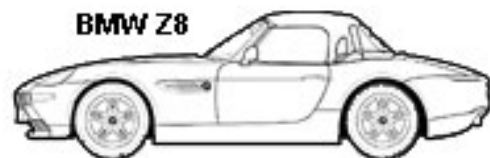

BMW Z8

Specific Vehicle Charts

Model	Cost	Spd	Rng	Cor	Acc	Brk	Bsh	Dam	Seats
Cars									
Budget Sub Compact	\$13,000	55/85	350*	+10	1-	2	2	+25	4
Budget Compact	\$14,000	50/80	350*	+5	1-	2	2	+15	4
Budget Mid Sized	\$15,000	50/80	350*	0	1-	2	2	0	5
Budget Compact Station Wagon	\$15,000	50/80	350*	-5	1-	2	2	+10	5+
Compact Station Wagon	\$16,000	65/110	350*	-5	1	2	2	+5	5+
Standard Compact	\$15,000	70/115	350*	+5	1	2	2	+10	4
Standard Mid Sized	\$16,000	65/110	350*	0	1	2	3	0	5
Standard Full Sized	\$18,000	60/105	350*	-5	1	2	3	-5	5
Station Wagon	\$17,000	60/105	350*	-10	1	2	3	-5	6+
2003 Acura CL	\$28,000	65/130	280	+5	1+	2	3	0	4
Aston-Martin DB7	\$170,000	100/170	220	+25	2	2	2	+10	2
Aston-Martin V-8 Volante	\$60,000	100/170	240	+20	2-	2	2	+15	2
Audi A-6	40,000	80/130	245	+5	1+	2	3	+15	5
Bentley Turbo R RT	\$200,000	80/155	200	+5	1+	2	3	0	5
BMW Z3	\$39,000	75/135	220	+15	1+	2	2	+20	2
BMW Z8	\$160,000	90/150	300	+20	2-	2	2	+20	2
BMW 750 iL	\$80,000	80/120	320	+5	1+	2	2	-5	5
Cadillac Seville STS	\$50,000	110/150	300	0	2-	2	3	-10	5
Chevrolet Corvette	\$51,000	100/170	300	+20	2-	2	2	+20	2
Chrysler Sebring LXI	\$22,000	70/120	400	0	1	2	3	0	5
Ferrari 456GT	\$250,000	120/185	210	+20	2	2	2	+15	4
Ferrari 550 Maranello	\$225,000	110/199	200	+25	2	2	2	+20	2
Ford Mustang GT	\$22,500	80/150	275	+15	2-	2	3	+10	5
Ford Taurus	\$20,000	90/130	350	0	1	2	3	0	5

* use Generic Vehicle Fuel Capacity rule from Generic Vehicle chart



Ferrari 550

Cars	Cost	Spd	Rng	Cor	Acc	Brk	Bsh	Dam	Seats
Honda Accord	\$23,000	60/130	350	0	1	2	2	0	5
Infinity Q45	\$48,000	70/144	280	+5	2-	2	3	0	5
Jaguar XK8	\$70,000	80/150	260	+15	2-	2	2	+10	4
Lamborghini Diablo	\$250,000	130/202	220	+25	2+	2	2	+20	2
Lexus SC400	\$58,000	80/150	250	+5	1+	2	3	-5	4
Mazda Miata/Euro MX-5	\$18,000	70/120	325	+10	1+	2	2	+25	2
Mercedes Benz E420	\$46,000	70/130	350	0	1+	2	3	0	5
Mercedes Benz SL500	\$130,000	75/150	300	0	1+	2	3	+5	2
Porsche Boxster	\$40,000	80/150	300	+10	1+	2	2	+20	2
Toyota Camry DX	\$23,000	60/102	375	0	1+	2	3	0	5

Jaguar XK8

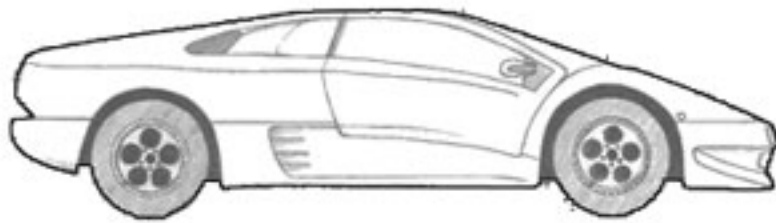
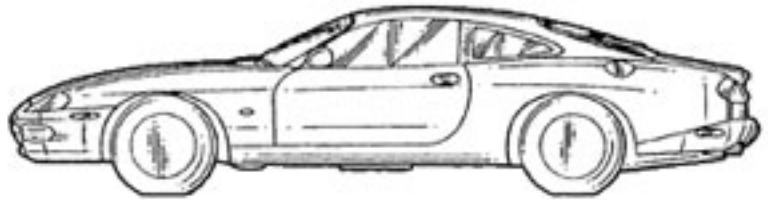

Lamborghini Diablo

Porsche Boxster

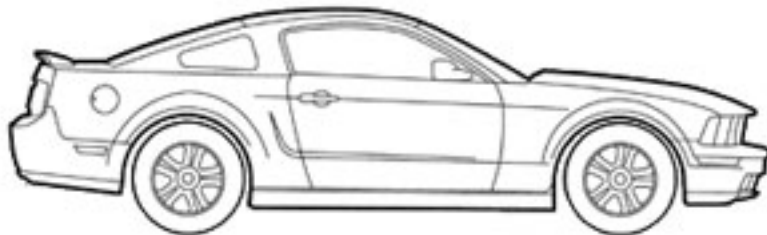
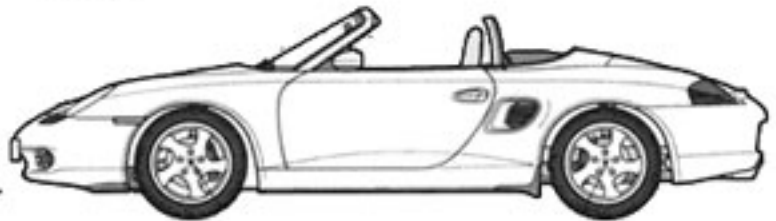

Ford Mustang GT

Trucks, Vans, & SUVs	Cost	Spd	4WD	Rng	Cor	Acc	Brk	Bsh	Dam	Seats
Chevrolet Blazer	\$28,000	70/120	X	350	-10	1	2	3	-5	5+
Chevrolet S10	\$17,000	70/110		300	0	1+	2	3	-10	4+
GMC Sonoma	\$17,000	70/110		300	0	1+	2	3	-10	4+
Isuzu Hombre	\$17,000	70/110		300	0	1+	2	3	-10	4+
Dodge Ram	\$25,000	70/120		300	0	1	2	3	-10	4+
Ford Explorer	\$26,000	70/105	X	350	-10	1	2	3	-10	5+
Range Rover	\$40,000	50/100	X	400	-10	1+	2	3	-15	5+
Volkswagon Eurovan MV	\$24,000	50/90		300	-10	1	2	3	-10	7

Motorcycles										
BMW R 1200 C	\$15,500	80/130		190	+35	2-	1	1	+40	N/A
Buell X1 Lightning	\$17,500	100/160		200	+35	2-	1	1	+40	N/A
Ducati 916	\$16,500	100/154		180	+35	2	1	1	+40	N/A
Moto Guzzi V10 Centauro Sport	\$12,500	90/150		180	+35	2	1	1	+40	N/A

4WD: Indicates vehicle is a four wheel drive. Such vehicles will have less difficulty traversing hostile terrain and will be less affected by adverse weather conditions.

Pop the Clutch!

a Script Mocher Games Publication by
Ed R. Teixeira

Edited By Urk
Vehicle Stats Compiled by Urk

Originally Published By **Dragon** Magazine: October 1983