

XANDORIA

GARDEN



**D
D
B
G**
Dilly Green
Bean Games

NAME: _____ ALIGNMENT: _____ AGE: _____

RACE: _____ GENDER: _____

PRIME
ATTRIBUTES

CLASS: _____ LEVEL: _____

ABILITY SCORES

**ATTRIBUTE
BONUSES**

STRENGTH []

TO-HIT-MOD
(STR) _____

INTELLIGENCE []

OPEN DOORS
(STR) _____

WISDOM []

DAMAGE BONUS
(STR) _____

CONSTITUTION []

CARRY MODIFIER
(STR) _____

DEXTERITY []

SHOOTING TO HIT
(DEX) _____

CHARISMA []

ARMOR BONUS
(DEX) _____

SAVING
THROW []

HIT POINT BONUS
(CON) _____

BASE HIT
POINTS []

RAISE DEAD
SURVIVAL (CON) _____

EXPERIENCE
BONUS _____

EXPERIENCE POINTS _____

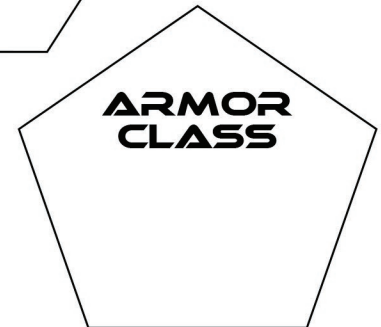
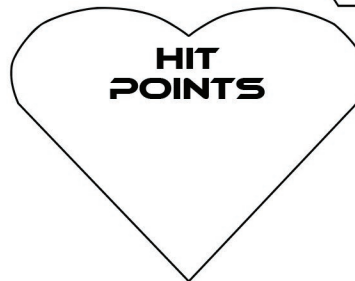
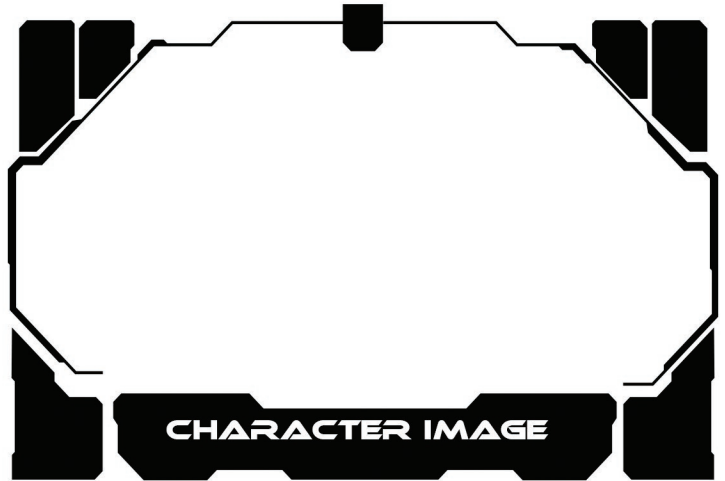

RACIAL BONUS

WEAPONS	DAMAGE	RANGE

ARMOR	AC BONUS

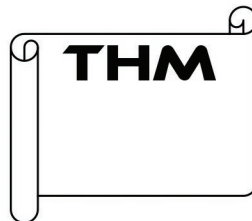

CLASS ABILITIES

DANCE MOVES []

DRAW

PANZ & TREASURE
PANZ: _____

OTHER: _____

ITEMS & EQUIPMENT



Xandoria Gaiden

Another story from Xandoria

~Setting for Matt Finch's Swords & Wizardry~

Art and Writing by
JAY LIBBY

Editing
Renee Libby

“Swords & Wizardry” used with permission of
Frog God Games and Matthew J. Finch

Dedicated to my little Bio-Beast
~For all the hours spent in the Eternal Tower

Xandoria ©2002-2019 Jay Libby

XANDORIA GAIDEN (Swords & Wizardry)

Welcome to Xandoria Gaiden, a science fiction/fantasy setting powered by the *Swords & Wizardry* rules by Frog God Games. Over the years I have done many different variations of Xandoria. One used a simple d20 powered system called The Basic System. Another used Fuzion by R. Talsorian Games. And yet another used G-Core by Dilly Green Bean Games. Hell, there was even a D6 version out there that never saw the light of day. Presented here is something different than rehashes of old materials. As I started putting Xandoria Gaiden together, I looked at the mountain of old stuff and was turned off. I didn't want to sell yet ANOTHER version of the exact same module. So I started playing around and this is what I came up with.

So what is Xandoria?

The original Xandoria product lines were tribute games to the classic Sega sci-fi/fantasy game Phantasy Star. You'll see plenty of homage in this module. In the old versions you could almost play ALL four original Phantasy Star games right out of the book. But this new Xandoria Gaiden is different. It has all the same feel as the older stuff, but it is its own beast here. Is this book connected to the history in the others? Absolutely. I just didn't want to redo massive tomes. This book is a great starting point for anyone not familiar with Xandoria. And old fans will get something new here. I am NOT a fan of changing systems and selling the same product over and over with different mechanics. Xandoria Gaiden takes us to the Eppi colony, but not like the one in the old modules. This is re-imagined in a way that makes it much more stand alone. The events are still unfolding in the Xandoria system, but now YOU the players and game master are getting to live through the impact of those events. Did Shiva infect the archives? If so, what will happen to every AI across the Terran Empire? Xandoria Gaiden is where you find out.

So why Swords & Wizardry?

For starters, Swords & Wizardry brings Xan-

doria full circle. It was designed for a d20 base in the beginning. After years of writing for myself and other companies, I found that Swords & Wizardry really fits what it was supposed to be all those years ago. Best of all, it's less mechanics just like the original.

Playing Xandoria Gaiden

This book is a starter. Think of it as the pilot episode to a series. The pages that follow will get players and game masters started. There is enough here to begin your adventures and to test out characters. There are only two classes presented here: Agent and DRAW Adept. Why? It's all in the title: Xandoria ***Gaiden***. Gaiden stands for 'side story'. That is exactly what Xandoria Gaiden is. The main story is unfolding on Xandoria. Agents (police type) and DRAW Adepts (wizard type) are the main characters of this side story. Will there be new classes later? Most likely. Let's see how well people like Xandoria Gaiden first. This book will be the first in a series of story arc modules that will lead to the final conflict. Everything included in this book covers the opening story with further modules moving the story forward. So now it's time to enter the world of Xandoria and Xandoria Gaiden for every world has darkness.



Welcome Agent, I am the Magistrate. My role is to oversee all operations at the Eppi colony. During emergencies I am authorized to take control of all mechanical functions across the colony, including dolls. Whenever you have a question, simply go to an 'Agent Station' at any of the settlements and I will be there to answer it.

I do ask that you only carry out missions that are on the Agent Missions list at the Agent Stations. I do try and keep things organized. This keeps agents from stepping on each others' toes.

On the following pages you will learn more about the colony and the Terran Empire.



RISTAAR



FERAMAAR



PLUFAAR

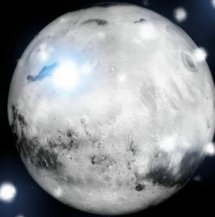

CALUMUTT



ALUS

VOSHT



EPPI SOLAR SYSTEM

The Eppi System and Some History

Far past the frontier of the Terran Empire is the Eppi system. The first solar system on the way to the Xandorian system, Eppi was originally going to be used as a dump for colony waste. That changed when the Science Guild started receiving signals from beyond Eppi, originating from Xandoria. Needing a staging ground, the Terrans sent Protectors and engineers to scout out the Eppi system in an attempt to find a world that could be terraformed. What they found was that the third planet, Alus, was stable enough to support a long term colony. The other five worlds were deemed too hostile or unstable to risk losing resources. Alus was occupied by the Protectors and the Science Guild began assessment of what way would be best to terraform the alien world. Alus was close enough to Terra that very little would need to be done other than clear out an area to set up a viable colony. With that the Terrans exterminated existing incompatible life on Alus and set up an Atmosphere Processor to begin terraforming the world into something a little less environmentally hostile. It only took five years before gene ships were allowed to land on Alus and begin 'awakening' cycles (growing Terrans). A decade later and the Eppi colony was fully up and running. The timing was perfect. The Terrans had suffered terrible losses to their population from disease and famine. The empire population was reduced to 1/3 of what it was prior to the establishment of the colony. Gene ships were stockpiled with materials and sent past the frontier in hopes that some might find a world that would support life. There was no longer any organization to salvation and the Eppi colony was left to fend for itself.

The Science Guild and Order of the Lightess have taken a great interest in the Eppi colony. For the Order it's the fact that every solar cycle (once a decade) all six Eppi system planets align. For the Science Guild it was the ruins of an alien civilization located not just on Alus, but on each of the other worlds. It is one of the reasons why the five other planets were deemed unworkable. It would allow the Science Guild a chance to study alien ruins with-

out having colonists getting in the way. The plans of the guild were spoiled, however, after a tragic shuttle crash destroyed the space port on Alus. Not only that, but the Terran Empire had already moved on, leaving the colony to fend for itself. The Science Guild would have to make do with studying Alus.

The Six Planets

Alus: Smallest planet. Home to the Eppi colony. Originally a jungle-like planet with dangerous native life, terraforming destroyed all native agriculture. Alien ruins found underneath the planet's surface and in jungle regions. Colony activity is restricted to a valley that shields the colonists from hostile weather conditions. One solar day is roughly 34 Terran hours. Without the Atmosphere Control Tower, weather and temperatures would become tropical with seasonal wet seasons.

Calumutt: Largest planet. Thought to be a desert world, but just beneath the sand is a massive crystal sphere. No life present. No precipitation. Average surface temperature 110° Fahrenheit. Severe wind storms. Alien structures believed to be present in interior of planet.

Feramaar: Medium planet. Heavy gas atmosphere. Highly toxic. Surface mix of swamp and waters. Home to alien ruins. Constant precipitation. Warm temperatures. Possible native life.

Plufaar: Medium planet: Volcanic world. Alien ruins present. Dry atmospheric conditions. Occasional rain. No native life discovered. 96% of the time planet atmosphere is filled with volcanic ash.

Ristaar: Large planet. Storm world with lightning storms raging planet-wide. Alien ruins present. No data on native life due to inconclusive readings. Planet surface believed to be a wasteland deemed too dangerous for exploration.

Vosht: Small planet. Massive rock in space with one alien structure and no atmosphere. Surrounded by dense asteroid field.

Life on Alus

The Eppi colony is one of the smaller colonies in the Terran Empire. It served its purpose to help move Terrans closer to the Xandorian system. Now it is left to grow the Terran population and try to survive on its own. Originally the colony was supposed to pack up and head to Xandoria, but after the space port was destroyed, the magistrate and the Science Guild thought it wise to focus on population growth and the study of the alien ruins. Most colonists didn't mind being stuck on Alus because they were born there onboard the gene ship. They call it home. Others, who were part of the original mission, aren't fans of being stranded. There is nothing they would like more than to get off Alus and go be with the rest of their civilization. It was only in the last year that Alus found it impossible to get communications out of the Eppi system or receive communications. The last message the Protectors on Alus received was a cryptic message from the Xandorian system originating from the primary colony on Santha Prime: Shiva. That's when things at the Eppi colony started getting strange. Be it malfunctions or strange creatures in the wilds, it all started with the message. The Science Guild and the Engineers Guild have been working overtime doing checks of all the colony systems to make sure nothing goes wrong. Little do they know...a lot has gone wrong.

Most colonists work in their towns, maintaining systems, having babies, manufacturing equipment etc.

Travel from one town to another is done via automated sky busses (runs three times a day, fits 30 passengers) and shipping of supplies is done the same way. The colony is run by a magistrate (Artificial Intelligence) that helps maintain order and productivity. It sends messages to the towns with daily work orders and random words of encouragement. It also runs all the automated systems. If the magistrate were to ever fail, the entire colony would shut down until the colonists could come up with a new way to get things operational. The magis-

trate's mainframe is located in Tesliop at the Science Guild Academy on the top floor. The magistrate can even manifest as a hologram and does so at times. Some towns elect local leaders to be their voice when dealing with colony issues. Others just communicate their issues directly to the magistrate.

The only religion at the colony is the Order of Lightness, which is mostly Clonora based. There are Terrans that have turned to the Lightness too, which is where Terran DRAW adepts come from. While the order is mostly peaceful, there are some elements that would prefer a Clonora only membership. The Order of Lightness throws seasonal festivals to honor the gift of life that the Lightness offers.

All weather is controlled by the Atmosphere Control system, located in the Atmosphere Control Tower (ACT). The magistrate tries to offer weather patterns that favor good crops and growth. Every now and then the system glitches and dumps foul weather on the colony. All power for the colony comes from the Star Power Condenser, a star that is compacted into a small stasis field that harnesses the star's power. Energy is transmitted via massive underground conduits to each township.

There are four large rivers that run from each corner of the colony to the ACT. At each corner there are water filtration systems that clean the water and make it potable. This allows Terran aquatic life to flourish and provides water for the colonists to drink and use for agriculture. Unfiltered water on Alus isn't exactly dangerous, but small organisms that live in the water can be troublesome (like the Hark Worm that swims up through the rectum and lays hundreds of little eggs, which when hatched begin to eat the patient from the inside out). Water temperature must be kept above freezing otherwise the water filtration system will freeze up and break. Engineers check the system weekly and conduct regular maintenance.

Plant-life at the colony isn't that much different for Terra. Most of the land is flowing plains (minus around Terminus) and small for-

ested areas here and there. The Bio-Plant has produced herd wildlife and other creatures (like birds and fish). There are even insects that the plant produced to help pollinate plants across the colony. The mountains that surround Eppi are impassible. The only way to get through to the other side is either to drill a hole or fly over. The colony sky busses aren't capable of flying that high and the Engineers Guild is under orders by the magistrate to not drill through. There is too great of a risk of colony contamination from the outside.

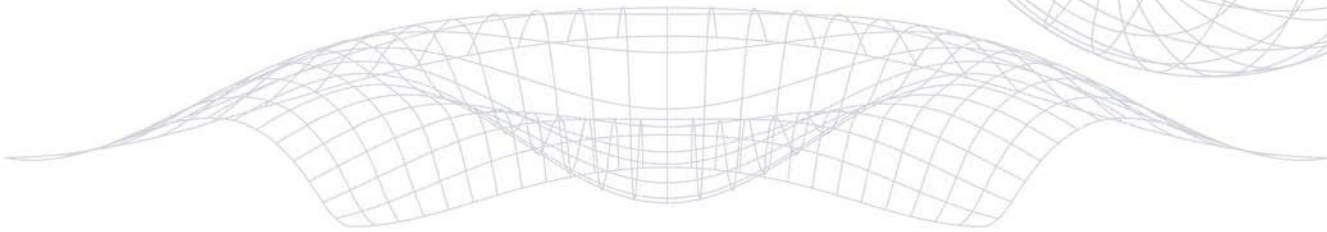
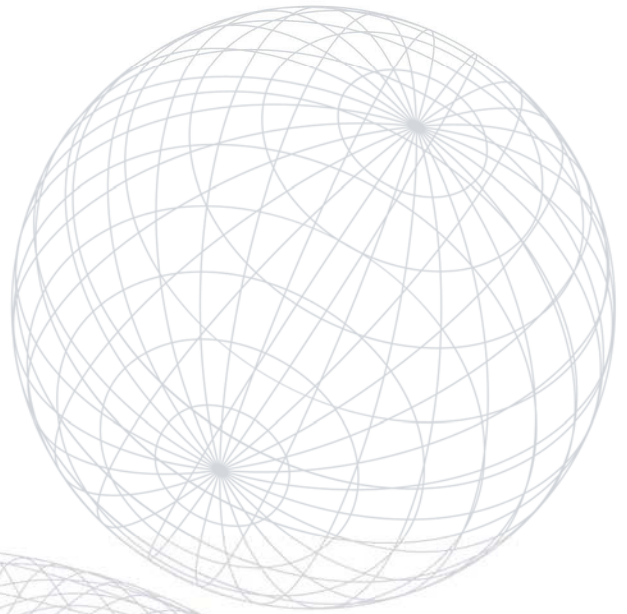

THE MAGISTRATE*

*Game Master EYES ONLY

In order to prevent corruption across the colonies and onboard ships, the Terran Empire commissioned the Engineer and Science Guilds to construct a massive master control system that could manage all walks of life within the empire. This system became an artificial intelligence and that AI gave birth to smaller AIs. Not only was this more efficient, but the smaller AIs could function independently from the master system in case something bad were to happen. On Alus, this AI is called the Magistrate. Directly linked into every system in Eppi, the Magistrate is constantly processing data and managing the daily lives of the colonists. Most of the time, the Magistrate remains silent only to speak when sending out community messages or when guild leaders meet to discuss the monthly schedules or pending issues. In times of emergency the Magistrate summons Protectors to carry out operations. While the Magistrate can't control the non-doll Protectors, it can control dolls. This has caused some friction on Alus and across the Terran Empire. The idea that an AI can control military dolls makes some feel uncomfortable. Even the Science Guild is uneasy around the Magistrate and with good reason. There have been instances where AI controllers have torched labs with guild members still inside, even though the threat wasn't that bad. Most colonists don't mind the Magistrate because it takes care of them. It means more time for pleasure and less for stress. The primary system for the Magistrate is housed on the top three floors of the Science Guild Academy. But a backup system is located in the ACT just in case the Science Guild members tried to shut it down. This system is relatively new and was constructed just after the message from Santha Prime was received. The only people that knew about the backup system have mysteriously died over the last year.

ORGANIZATIONS

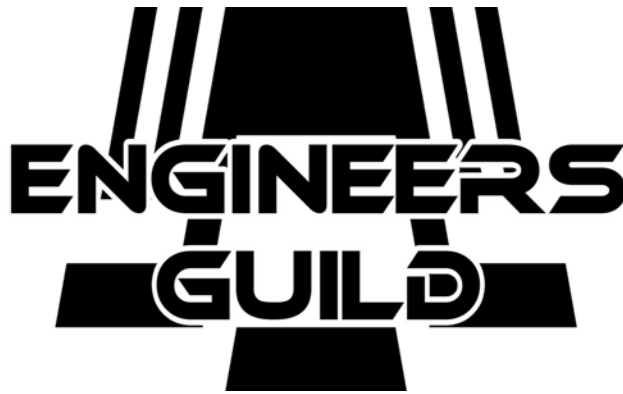

Engineers Guild: The Terran Empire would not function without the Engineers Guild. These men, women and dolls keep all the machines running. From colony ships to bio-plants, the engineers are responsible for making sure all technology is fully functional. Each engineer must pass a series of exams and tests to make sure that they are right for the job. Most engineers are intelligent in some areas and useless in others. What makes them valuable is they know machines and can tell you how it all works, right down to a small screw. Besides medics, engineers are one of the most important and vital assets to colonies, especially if the SPC (SEE: Atmosphere Control Tower) starts acting up.



Library Guild: Organization responsible for gathering data and storing it in the Great Archive. Members can be found on every colony and colony ship in the Terran Empire. Guild members all carry Librarian Rods, massive data collection devices that store all information that it experiences. Once the rod is full it is loaded into a data transmitter where infor-

mation is sent to a mega computer data archive known as the Great Archive. Librarians are authorized to have access to everything, which also makes them targets of assassinations by those who don't wish their secrets to be known. The Library Guild was considered one of the most powerful organizations in the empire, but since the colonization of the Xandorian system things have begun to fall apart. Corrupt data and more and more missing members have put doubt into the minds of those in power within the Terran Empire.



Medical Guild: The Medical Guild is responsible for the training of all medical doctors and medics within the Terran Empire, along with staffing and managing all hospital facilities. Medics have seen some of the worst horrors imaginable done to Terrans and Clonora. They rarely show fear and are meticulous in their care for patients. Every colony is required to have at least 10 Medical Guild members on site, with colony ships required to have one medic for every 10 colonists. Many hospitals utilize dolls to carry out medical procedures and care, but nothing is more comforting than having an organic taking care of an organic.



Order of the Lightness: No one knows where the Order first started or how the geneti-

cally engineered Clonora were somehow pre-programmed with the knowledge about the Lightess. What is known is that the Order of the Lightess has spread across the outer Terran Empire via Clonora, who believe the Lightess is their god. Members of the Order must follow the teachings of the Lightess, which boils down to peace, harmony, and mind. Different Clonora see those rules differently. Some believe that they are destined to outlive Terrans. Others feel that it is their role to help Terrans. And fringe elements see Terrans as blight on the universe. The fact that actual artifacts have been found on alien worlds confirming the existence of the Lightess has made even the Terran Empire respect that there might indeed be some type of 'god' out there. But until the day comes that it manifests, the Clonora have a duty to the empire. Places of worship have a mix of alien and oriental architecture and design, along with technology that not even the Science Guild fully understands.



Protectors: The military fist of the Terran Empire. Before colonists step foot on alien worlds, the Protectors are deployed to do threat assessment. Most Protectors are dolls, but there are thousands of Terrans that also serve. Combat training is intense and not for the weak. While Terran life is almost more valuable than panz, dozens of young men and women are killed each year in training exercises. It's why dolls became the primary Protectors because a doll could be manufactured. While Protectors do hold a lot of power over colony governments, the Science Guild actually outranks them. If there is a Science Guild member of medium rank or higher on site, they may pull rank and take over. Protectors are the only peo-

ple allowed to carry any form of firearm or cannon. Agents fall under the Protector umbrella and are responsible for investigating incidents and usually resolving them too.



Science Guild: At the heart of the Terran Empire is the Science Guild. Dedicated to discovery and innovation, the Science Guild is the only reason why the Terran race wasn't brought to extinction. Through scientific discovery, the Science Guild was able to construct gene ships (massive starships with genetic materials) and growth chambers (bio-plant tools used to grow those genes into viable Terrans). And it was the Science Guild that used alien genetic material and Terran DNA to create the Clonora. Only the smartest can be members of the guild and membership is roughly 62% Terran and 38% Clonora. Because the Science Guild is so important, they hold almost absolute power over the empire. No one in government is allowed to interfere with the guild unless there is a threat so great that the empire and the Terran race would be threatened. This creates problems on colonies where the Science Guild only has a minor presence, especially if people are starving. People expect the Science Guild to solve all their problems. To help soften tensions, the guild runs academies for colonists to help better educate them and make the people more useful in maintaining colonies and systems.



Greetings Agent,
While it's important to keep track of your panz, there is a way to make sure that your money isn't lost on adventures. In your home you will find a 'away' station. Simply place your panz under the station's scanner and I will document your current balance. If you spend panz while away, I will deduct it from this amount. This is efficient and in case of death, funds will be transferred to the cost of your clone or medical care to revive you.

You will also find a food processor in your home. Each week you are provided with enough rations for seven Terran days. The processor allows you to customize your meals. You cannot produce medical foods, however. Those must be purchased from the local Medical Guild clinic or hospital.

Please take good care of yourself on missions. You are property of the Terran Empire and a valued asset.

Monetary System

The Terran Empire uses a monetary system called panz. These small tokens (the size of casino chips) may hold between one and one hundred panz electronically. The face of the chip has a digital imprint of the current amount on the token, so in case of a massive electronic failure or electromagnetic pulse, the last amount is stamped on the piece and no money is lost. When used, the token is scanned or cashed in for purchases or services. Scanned tokens will reflect money remaining on the face. When agents go on missions for the Magistrate or other parties, upon completion of mission or as it progresses, panz is transmitted to specially keyed tokens. So if an agent is tasked with clearing out a location filled with horrors, for each horror they kill will instantly add panz to the token.

Food

While the Eppi colony relies heavily on agriculture and produce, most materials are processed into high vitamin and protein food forms. The basic food forms include a liquid shake and a tofu-like burger. Colonists have gotten crafty over the years, pulling off treats

like cookies and cupcakes. But all food in the colony is made from most of the same materials. During festivals, fresh foods are served. Each town is equipped with a food processing center that takes delivered food materials and converts them over to long term ration based foods that don't require refrigeration and last for weeks on end. These centers also produce ingredients for breads and butters.

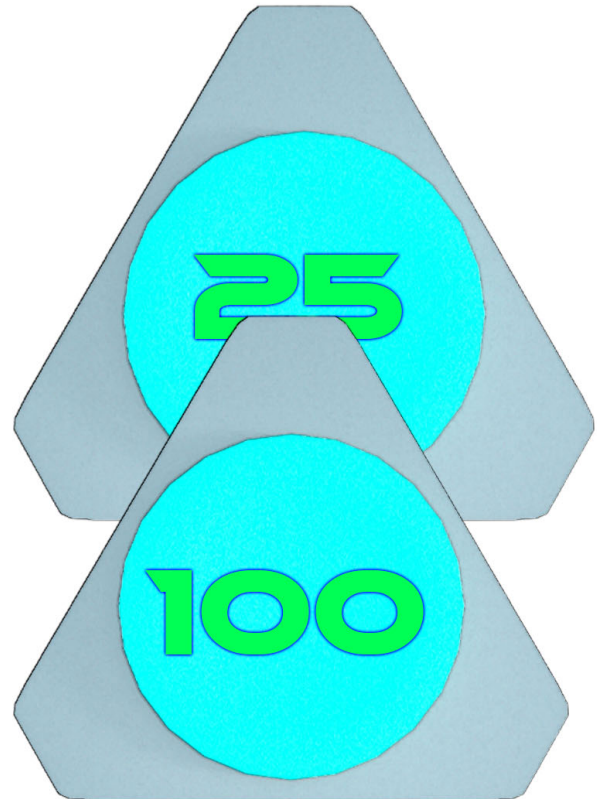

Item	Notes	Cost
Healing Fluid	This basic black liquid heals 10 HP to anyone who drinks it. Healing fluid is sold in cans, much like soda is. It is very common in almost all cities and towns.	10 panz
Healing Chow	This shrink wrapped food pack actually has several healing drugs mixed into it. Overall, no one has complained about the taste. The drugs heal up to 40 HP of damage. It can be found in most cities and towns.	40 panz
Cure Shot	This syringe is filled with an all purpose anti-toxin. It can cure the toughest poisons.	20 panz
Flashlight	These cheap flashlights can only be turned on once before they need to be recharged. They last for about one hour. Why anyone would want one is a mystery, but they light the way in the underworld.	20 panz
Dragon Ring	These rings are used to speak to dragons. They were designed by the Order of the Lightness.	30 panz
Medical Port	This small coin sized device teleports the user to the nearest Hospital. It has a one mile limit, however. It also only works in dungeons and the underworld. Once activated it transports the user and then self destructs ten seconds after arrival causing 1d4 damage.	100 panz
Distress Port	This small device the size of a silver dollar is a small port. It scans out the location and teleports the user to a safe location. This can only be used in enclosed spaces and self destructs after use causing 1d4 damage to anyone holding it.	100 panz
Travel Flute	This instrument can cause creatures to become passive. The target monster needs to make a Save roll. If they fail then the beast will become passive. If they pass then someone is going to get hurt.	N/A

Service	Cost	Description
Hospital	10/25 panz	Cure Poison/Full Heal
Inn	10 panz per night	Allows resting to restore full DRAW
Field Hospital	15/25 panz	Cure Poison/Heal ½ HP
Repair	50 panz	Repairs damaged machines
Revive	200 panz	May only be done at temples. Brings back the dead. Only works once.
Cloning	500 panz+100 per level	The dead character is cloned. It will have all the same abilities and memories as the original. This may ONLY be done to DEAD characters who cannot be revived.

***NOTE on cloning:** Terrans may be cloned but Clonora may not because of genetic imprinting that limits their growth ability. Because of this, Clonora may live to be almost 250 years old. Any Clonora that is cloned has a 5 in 6 chance of becoming a homicidal rage machine or a passive rage machine. Only the

Order of the Lightness has the ability to successfully clone a Clonora and even that is done sparingly.

ARMOR

Protector Explorer

Standard explorer combat armor of the Protectors. Usable in the vacuum of space or in environmentally hazardous locations. Laser resistant. Not a common item and not sold in any regular shop. Issued by the Magistrate as needed.

Mesh Vest

This vest was designed to have armor attached to it. While it is expensive to upgrade, the armor reduces non-energy damage in half! The only available upgrade is the Grettle Vest.

Mesh Suit

This is a full body suit that works like the Mesh Vest. It is designed to be upgraded with the Grettle Suit.

Leather Armor & Helm

This is the most basic type of armor. It is made of synthetic leather and is great for non-combat use. This armor is available at almost every armor shop on Santha Prime. The helmet is made of the same material with the same properties.

Light Armor & Helm

Made of light plastics, this armor is favored by travelers and adventurers. Colonists are most commonly found wearing this type as well. The helmet is made of the same material with the same properties.

Grettle Vest & Helm

Grettle is a strong metal that is light in weight. The Grettle vest comes in the form of thin plates that clamp onto the Mesh Vest. Grettle is very expensive and very rare. The helmet is made of the same material with the same properties.

Grettle Suit

Just like the Grettle Vest, these plates fit onto the Mesh Suit. Because Grettle is so rare, the suit itself is very expensive.

Leather Cloak

Made of synthetic leather and designed for DRAW Adepts.

Light Cloak

Unlike the armor, the cloak is made of mesh material that can withstand damage. It is commonly used by DRAW Adepts and users of magic.

Grettle Cloak

The Grettle cloak is made up of Grettle chain links. It is commonly used by DRAW Adepts. It is somewhat rare, however, and expensive.

Ceramic Shield

This shield is light and offers great protection especially against lasers. It cuts laser damage in half. A lot of warriors choose this shield over all others. Great for battles with machines.

Reflect Shield

This decorative shield was designed just for hanging on the wall. It is made of reflective mineral that shatters easily. It will reflect any energy attack. Commonly found in palaces.



Greetings Agent,

To get you started, I have provided you with the basic armor and weapon that will you need.

As you earn more panz you may upgrade your equipment. Armor is an important part of your gear. Without it you are left exposed and vulnerable to threats. While basic armor serves its purpose, there are much better options for a seasoned agent. The colony even has an armorer who is highly skilled at making improved armor and weapons. And not all armor works against certain threats. A ceramic vest, for example, cannot stop poison gas. So please be mindful of your surroundings.

Good luck!

Armor	Effect on AC from base of 9[10]	Cost	Special
Protector Explorer	-6[+6]	1500	Vacuum ready, Environmental Resistance, ½ laser damage
Ceramic Shield	-3[+3]	400 panz	Halves laser damage
Ceramic Vest	-4[+4]	500 panz	Halves laser damage
Grettle Vest	-9[+9]	800 panz	+1 to wearer's attack roll
Grettle Suit	-10[+10]	1000 panz	+5 to wearer's attack roll
Grettle Cloak	-10[+10]	1000 panz	+5 to wearer's attack roll
Grettle Helm	-5[+5]	300 panz	+1 to wearer's Saves
Leather Armor	-2[+2]	12 panz	--
Leather Cloak	-2[+2]	30 panz	--
Leather Helm	-1[+1]	10 panz	--
Light Armor	-3[+3]	30 panz	--
Light Cloak	-3[+3]	40 panz	--
Light Helm	-1[+1]	15 panz	--
Mesh Vest	-4[+4]	75 pans	Halves non-energy damage
Mesh Suit	-5[+5]	125 panz	Halves non-energy damage
Reflect Shield	-1[+1]	N/A	Reflects any incoming energy based attack back at attacker



WEAPONS

Combat Knife

This is the standard side weapon of any normal person. The blade was designed for harsh use and is very durable. Any sane person will arm themselves with a combat knife when they don't have much money.

Strike Knife

Just like the combat knife, but armor piercing. The blade is made up of unstable alloys which allow it to cut through armor like it was butter.

Short Sword

This blade is the most common 'rebel' weapon. The blade is easily concealed in jackets and armor. While it doesn't offer much for damage, it's a good start to arming your characters.

Strike Sword

The most favored weapon on Alus is the Strike Sword. It packs damage and makes short work of armor. Made up of unstable alloys that allow it to cut through the toughest armors, this three to four foot blade is the prime choice for anyone.

Walking Stick

This simple stick is about four to ten feet long and made from wood. A lot of DRAW Adepts use this as a tool and a weapon. The wood can actually soak DRAW energy, reducing incoming DRAW damage by 1.

DRAW Staff

A special staff designed to wield DRAW energies in a focused way, crafted out of special metals. Also great for martial combat. May only be wielded by DRAW Adepts.

Throwing Blade

This blade was designed by a group of Ronan as a way to hit the enemy with a ranged attack. They are about a foot long and throw like a boomerang. The user of this weapon may hit one additional target per Class level.

Strike Throwing Blade

Once the Ronan learned how valuable the throwing blades were, they had the Strike blade versions done up. They work just like the regular blades but are made up of unstable alloys that are able to cut through armor.

Weapon	Damage	Cost	Hands	Special
Combat Knife	1d6	15 panz	1	--
Strike Knife	1d6+3	40 panz	1	Ignores half of defender's AC
Short Sword	1d6	30 panz	1	--
Sword	1d8	35 panz	2	--
Strike Sword	1d8+4	75 panz	2	Ignores half of defender's AC
Walking Stick	1d4	5 panz	2	Soaks 1 point of DRAW damage
Mystic Rod	1d6	300 panz	1	+2 to user's DRAW attack rolls
DRAW Staff	1d6	400 panz	2	+4 to user's DRAW attack rolls and damage
Throwing Blade	1d6	30 panz		--
Strike Throwing Blade	1d6+3	90 panz	1	Ignores half of defender's AC
Royal Halberd	1d10+5	400 panz	2	User gains -4[+4] AC

Weapon	Damage	Range	Firing Rate	# Hands	Ammo	Cost
Needle Pistol	1d6	75 ft	3	1	20	300 panz
Laser Pistol	1d8+4	100 ft	2	1	50	1400 panz
Laser Rifle	2d8+8	500 ft	1	2	100	5000 panz
Ice Rifle	2d8	300 ft	1	2	50	4000 panz
Heat Rifle	2d8	300 ft	1	2	50	4000 panz
Beam Sprayer	1d4	40 ft	2	2	50	4000 panz

RANGED WEAPONS

Needle Pistol

This small handy weapon can only be used by those who have traveled off world. It fires small needles that can penetrate some of the toughest armors (user gains a +2 to hit). The weapon is manufactured on Colony Ships.

Laser Pistols

A weapon used by pirates. The pistol fires a concentrated beam of light that can cut through the toughest creatures. Colony agents are trained in their use.

Laser Rifles

Just like the laser pistol but a rifle version. Agents and colony guards were trained how to use these deadly weapons.

Ice Rifle

This rifle fires a beam of cold that can freeze a

target in a matter of seconds. It was designed to help cool Atmosphere processors. Any target hit by this beam must make a saving throw or be frozen for 1d6 turns.

Heat Rifle

This rifle was designed to help defrost ships before take-off. They emit a heat beam that can melt ice in a matter of seconds. Against a living creature it can be devastating. Any target hit by this beam will catch on fire and take 1 point of burning damage each turn AFTER until the fire is put out.

Beam Sprayer

This tool turned weapon is used to clean off the side of spacecraft, stripping away bacteria from other world that didn't burn up in reentry. As a weapon it can hit 1d4 targets.



Xandoria Gaiden

TYPE	CREW	Armaments	Structural Points	Speed	Cost
Land Rover, Small	2	--	10	30 Ground	10,000 panz
Land Rover, Medium	4	--	12	40 Ground	20,000 panz
Limo	8	--	15	30 Ground	30,000 panz
Transport, Small	2	--	14	50 Air	100,000 panz
Transport, Medium	2	--	15	60 Air	150,000 panz
Shuttlecraft	10	--	50	70 Air 100 Space	--
Space Transport	30	--	55	70 Air 1,000 space	--

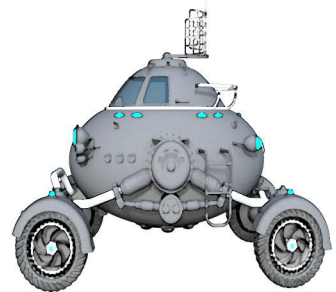
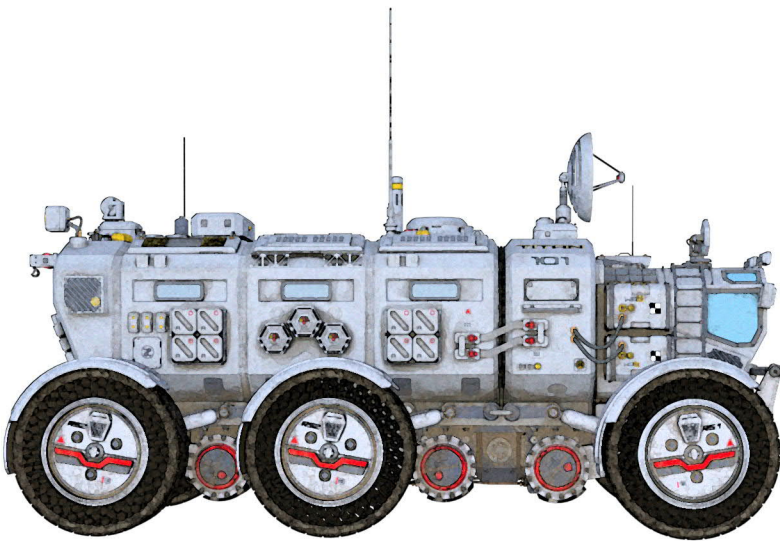

Greetings Agent, Transportation is limited to necessity in the colony. We need to maintain the ecosystem as much as possible. Please make use of provided services or use your legs. Exercise is important for the extension of your life cycle. There are currently no available shuttles on Alus due to the incident at Terminus. Avoid the city at all costs.

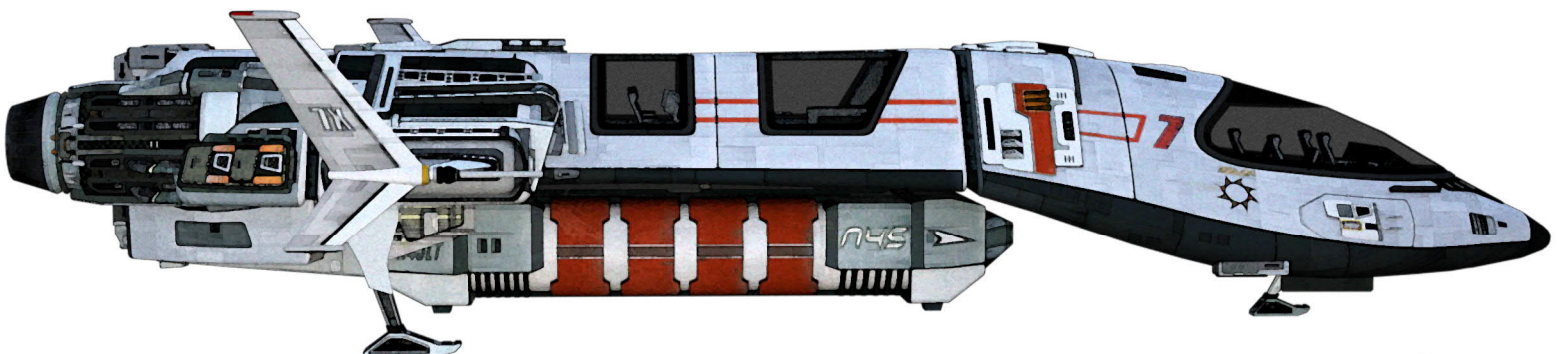

CHARACTER CREATION PROCESS

Before starting any of the steps, think about whether you want to play a wise wizard like character or a military agent. Also think about your race too. All of these play into the game's story.

1) Roll Attributes

Roll 4d6 and remove the lowest die. Do this for each Attribute.

2) Choose Race: Clonora or Terran

SEE write-ups in next section.

3) Choose Class: Agent or DRAW Adept

SEE write-ups in next section.

NOTE: With the Game Master's permission a Clonora may be an Agent.

4) Gather gear: armor, weapons etc.

Players get 100 panz to arm and equip their characters. Alignment: Law, Neutrality, Chaos

ATTRIBUTES

Strength: The physical might of the character. Helps determine how much they are able to carry and any bonus damage they might cause.

Score	To-Hit-Mod	Damage Mod	Open Doors	Carry Mod (in pounds)
3-4	-2	-1	1	-10
5-6	-1	+0	1	-5
7-9	+0	+0	1-2	+0
10-12	+0	+0	1-2	+5
13-15	+1	+0	1-2	+10
16	+1	+1	1-3	+15
17	+2	+2	1-4	+30
18	+2	+3	1-5	+50

Dexterity: How well your agility and reflexes work. Used for parrying and shooting, along with getting out of the way. It also helps you crank out dance moves for those dance-offs!

Score	Shooting To Hit Bonus/Penalty	Effect on Armor Class	# of Dance Moves
3-8	-1	Worse by 1 point	0
9-12	+0	None	2
13-18	+1	Better by 1 point	3

Constitution: How in shape the character is and how much they can endure and withstand.

Score	Hit Point Mod
3-8	-1
9-12	+0
13-18	+1

Intelligence: How smart the character is and how well they understand things they see. (Wait, no table? Nope. In the Terran Empire everyone speaks Terran. Understanding alien languages requires Intelligence checks.)

Wisdom: This is intelligence through experience. Life lessons form this Attribute. When put in a situation that has the character wondering about if it's a good idea or not, Wisdom comes into play. Characters with a Wisdom of 13 or higher gain 5% XP bonus.

Charisma: The charm and personality of the character. Helps them lead and helps them get their way with other people. Characters with a Charisma of 13 or higher gain 5% XP bonus.

NEW STAT

DRAW

DRAW Adepts, be them Clonora or Terran, have the DRAW stat. This is used a pool to use DRAW abilities and DRAW based weapons.

Once DRAW is all used up, the DRAW Adept must either meditate (+2 DRAW per 30 minutes) or recharge (at DRAW recharge stations).

Gaining DRAW Abilities

DRAW Adepts all start with one DRAW ability being either: Evac, Talk, or HaluSin (player picks). As the game progresses, the DRAW Adept will come across opportunities to learn new DRAW abilities. This is tied to encounters with creatures in most cases, but in

other cases it could be another DRAW Adept passing on their power to a fellow adept. The DRAW Adept has the ability to absorb DRAW abilities from anyone who is dying that uses DRAW. So if a creature has the DRAW ability *HEAL* and is defeated, the DRAW Adept makes an Intelligence check to see if they absorb *HEAL* or not (SEE DRAW Adept for Chance to Understand New Ability).



Greetings Agent,

Not much is known about DRAW. The Science Guild has theorized that every world has 'DRAW' pools that are thought to be left over from creation. While DRAW is usable on planets, it is not usable in space. It is for this reason that the Terran Empire has not invested resources into harnessing this vast power. For some reason, however, the Clonora seem to be directly linked to it even though there is no genetic connection or application to their growth cycle. Be warned, DRAW is dangerous.





Greetings Agent,
I have authorized recreational activities for the colonists. I would like to introduce you to Zal-Ziff, our dance instructor. He will walk you through some of the basics. Competing in dance-offs is a quick way to make panz. Good luck.



Hey there sexy,
So you want to dance like a master? First you need to learn the basics. Once you have those down you can break out into your own style and wiggle away. So let's get started...

This is the Doggy Paddle. The easiest of all moves. That is probably because all you colonists swim this way when dropped in water. No one thought to make it a dance form until me. That is why I am the best. So doggy up!

Dance Move Cost: 1
Target Roll: 10
Panz Value: 2



This is the Wave.
Nothing fancy here, just moving your arms to the rhythm. You do have rhythm, right? I know it is hard for you organics.

Dance Move Cost: 2
Target Roll: 12
Panz Value: 3



My favorite is the Egyptian. Taken from old history files, I have converted these hieroglyphics into radical moves.

Dance Move Cost: 2
Target Roll: 14
Panz Value: 4



The last I have for you in the Flip. While it might mess up your hair, this one is the crowd pleaser. But this one isn't for rookies. You could end up breaking your neck and be stuck with a lisp.

Dance Move Cost: 3
Target Roll: 16
Panz Value: 5

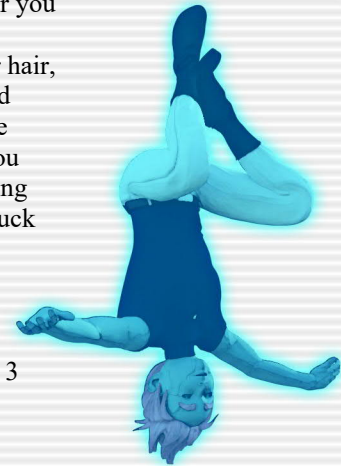



Greetings Agent,

As you know, Terrans and Clonora are primarily clones and not born from natural procreation. While there is a 'birth' movement with Terrans, most of their population is still grown. Because natural birth is risky to both child and mother, we try to keep natural births managed. The Clonora on the other hand are genetically engineered using Terran and alien DNA. This makes them highly intelligent and which is why you see so many Clonora in the Science Guild. Clonora aren't able to mate by design. We are sure there are a few anomalies, but not enough to warrant panic. Because you are an agent, you are more likely to encounter deviations from the Bio-Plant's primary growing mission. You are also more likely to be injured. Because you are property of the Terran Empire and an asset, we ask that you try not to get killed. That would require regrowing you and implanting previous memories that have been stored at the 'Agent Station' you accepted a mission from. Two things to remember:

Terrans: Physically stronger

Clonora: Superior Intelligence

So be mindful as you travel the colony. Show respect and you will get farther.

CLONORA

Genetically engineered to be a possible next step in Terran evolution; the Clonora have come into their own as a super intelligent species with a natural aptitude to DRAW energies. This could be explained by the process in which Clonora are engineered. In the cell stage, the genetic materials are bombarded with DRAW energy. This technique was discovered in ancient alien ruins on a far off world. The first Clonora was an experiment that went right. Since that day the Clonora's numbers have grown and they have established themselves in the Terran Empire. Most Clonora are members of the Science Guild, but all are part of the Order of Lightness. The Clonora worship a being they refer to as the Lightness, a cosmic force that's sole purpose is keeping the Darkness contained. The Clonora don't quite understand what the Darkness is, other than when they are near its touch they have a strange feeling. The clergy of the Order are DRAW Adepts. These Clonora travel the colonies and help maintain righteousness in the name of the Lightness and when needed, help stomp out the influences of the Darkness. While the Clonora are almost incorruptible, the Darkness has turned some, unknown to their brothers and sisters.

Clonora have the following racial abilities:
DRAW Masters: When using DRAW, Clonora gain +1 (per level) to all DRAW rolls and DRAW damage. This is in addition to any DRAW bonuses they gain from their class.

I Sense a Disturbance: Clonora have the uncanny ability to 'sense' disturbances, be it deception or traps or even the touch of the Darkness*. They have a 4 in 6 chance of seeing through such things.

***NOTE:** If another Clonora is tainted by the Darkness, their fellow Clonora only have a 1 in 6 chance of detecting it.

The Order of Lightness: Clonora follow a strict path of wellness. They gain a +2 Dexterity/Intelligence/Wisdom during character creation.

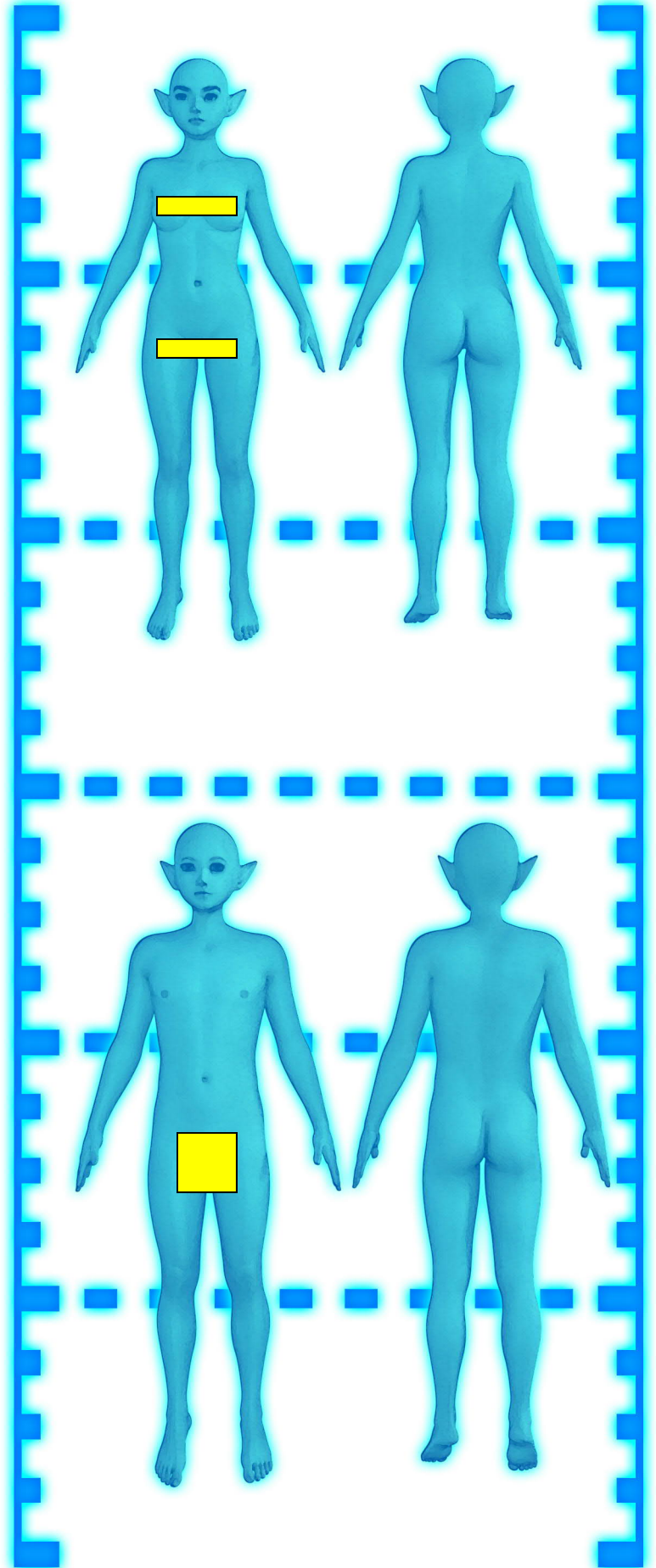

TERRANS

These are your standard Terrans, be it clones or descendents of original Terrans. They can be found throughout the colonies and are considered the dominant life forms, even though their species has been dying off for centuries. The Terran is durable, crafty and intelligent (for the most part). They are the workers of the colonies, explorers and soldiers of the Terran Empire. They adapt rather quickly to environments and situations and best of all, they are easily corruptible. On the Eppi colony, Terrans manage the daily operations of the colony and help maintain the machines and systems that run it. Every Terran dreams of striking it rich on a colony and living in comfort in their remaining years, something that rarely happens.

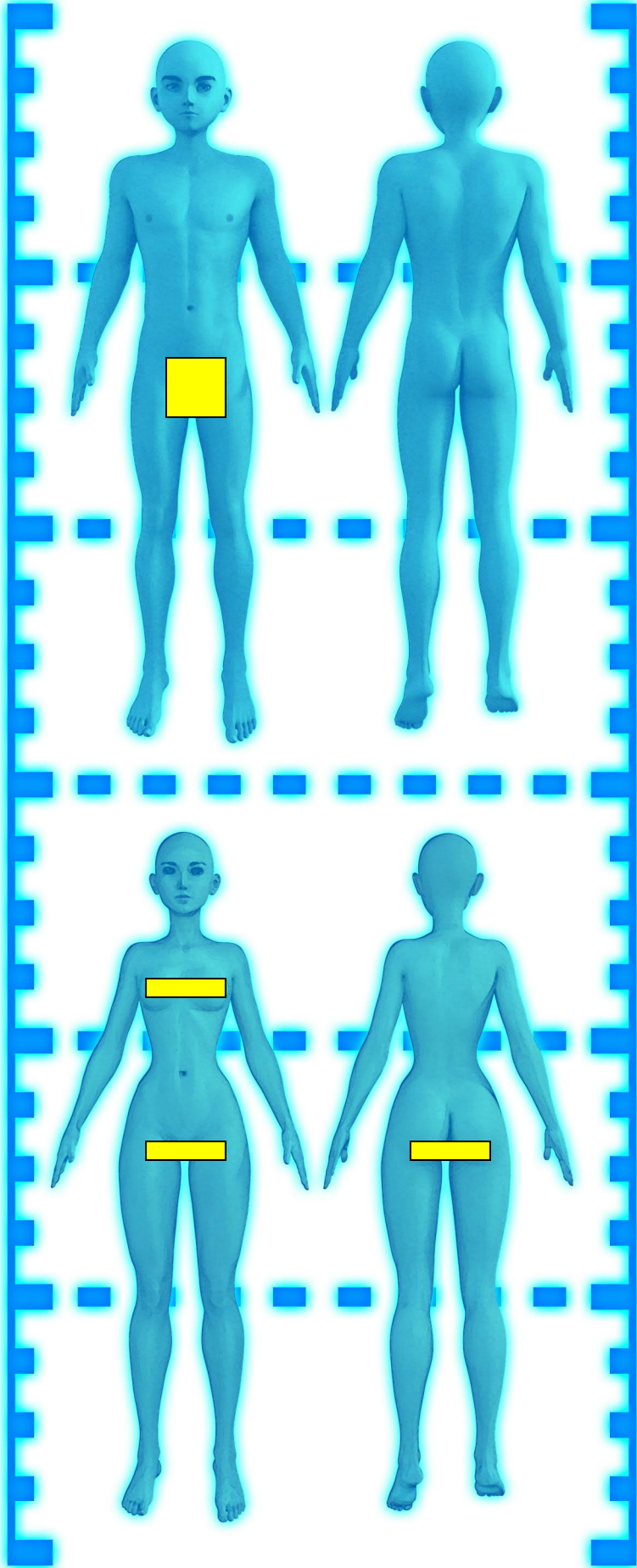

Greetings Agent,

As the Terran race faces extinction, it was important for the Science Guild to find a way to keep the species alive. Cloning has become the primary way to do so. It's hard to tell who is clone, who is half-clone and who is full blooded human. It is believed that the full blooded humans died out well over a century ago. Their genetic coding was cloned and placed on gene ships, which were sent across the Terran Empire and into unexplored space. As gene ships landed, they began mass growing Terrans. This has helped populate all of our colonies. Feel grateful that your DNA lives and that you carry with you the past and future of your species.

AGENT

Prime Attributes: Strength 13+ (5% experience bonus)

Hit Dice: 1d10/level (Gains +2 hp/level after 9th)

Armor/Shield Permitted: Any but cloaks

Weapons Permitted: Blades, Guns

Race: Terran

EXCLUSIVE GEAR: Strike Blade, Ceramic Vest

The agent is a man or woman trained in the arts of military and technology. They are well versed in how things work and help to enforce the laws of the Eppi colony. Training for agents begins at a young age. They are taught how to recognize different types of technology and its basic functions. The young agent is also trained in different forms of armed combat. By fifteen, an agent in training can hold their own

with a blade and a wrench. Agents are trained for off-world missions and it's common for agents to head off world to deal with problems that might arise. The agent is truly a jack-of-all trades. Most agents prefer light weight equipment that doesn't hinder their ability to move. It's why their standard uniform is usually a vest of some type. Agents answer to the colony Magistrate.

There are three different ranks for the Agent: Novice, Expert and Master.

Levels 1-4: Novice: The agent is still young and is just learning about the world of science and space. Most have a mentor that guides them along the way.

Levels 5-10: Expert: The agent has been in the field and knows how it all works. Most agents come from this rank.

Levels 11+: Master: These are the heroes of old who now run their own colonies. The mayor of Eppi is a Master Agent.

EXCLUSIVE ABILITY

Increased Strength, Dexterity & Intelligence

Because of the training the Agent receives, an Agent player gains a +2 to their starting Strength, Dexterity & Intelligence. These stats increase by +1 every three levels after that capping at 18.

Starting Gear: Combat Knife, Leather Armor

Level	Experience Points	Hit Dice	Saving Throw	DRAW	To Hit Bonus
1	0	1	14	10	+1
2	2,000	2	13	20	+1
3	4,000	3	12	30	+2
4	8,000	4	11	40	+2
5	16,000	5	10	50	+3
6	32,000	6	9	60	+3
7	64,000	7	8	70	+4
8	128,000	8	7	80	+4
9	256,000	9	6	90	+5
10	350,000	9+2hp	5	100	+5
11	450,000	9+4hp	4	110	+6
12	550,000	9+6hp	4	120	+6
13	650,000	9+8hp	4	130	+7
14	750,000	9+10hp	4	140	+7
15	850,000	9+12hp	4	150	+8
16	950,000	9+14hp	4	160	+8
17	1,050,000	9+16hp	4	170	+9
18	1,150,000	9+18hp	4	180	+9
19	1,250,000	9+20hp	4	190	+10
20	1,350,000	9+22hp	4	200	+10
21+	+100,000 per level	+2hp per level	4	+10 per level	+10

DRAW Adept

Prime Attributes: Wisdom 13+, Intelligence 15+ (5% experience bonus)

Hit Dice: 1d4/level (Gains +2 hp/level after 9th)

Armor/Shield Permitted: Cloaks

Weapons Permitted: Staffs

Race: Clonora, Terran

EXCLUSIVE GEAR: DRAW Crystal Armor

DRAW is a mystical energy that flows like blood through all that lives, including worlds. The DRAW Adept spends their life studying and learning to harness these powerful energies. Some use DRAW for good, while others use it for evil. DRAW Adepts have been called wizards on some worlds. Because DRAW can easily corrupt, only a select few are authorized to practice it. Clonora have a life-bond to

DRAW and are less likely to succumb to the Darkness. Terrans are able to tap into DRAW, but only a handful have ever dared become DRAW Adepts, instead sticking to very basic DRAW tricks.

There are three different ranks for the DRAW Adepts: Novice, Expert and Master.

Levels 1-4: Novice: This is the DRAW Adept who is just learning to harness DRAW energy. They are mentored by an Expert DRAW Adept, who instructs them on the benefits and dangers to DRAW energy and use. These Adepts do not have access to the DRAW inner sanctums and the books about the lore of DRAW.

Levels 5-10: Expert: These DRAW Adepts have learned to properly harness the DRAW energies and are capable of using it without risk of something bad happening (like tearing open reality and letting the Darkness in). These are the advisors to the government and spiritual clergy. If agents are sent on missions where there is even the slight question of DRAW corruption, the expert will accompany them.

Levels 11+: Master: The masters of the DRAW Adepts, these powerful DRAW users can summon energies that can tear whole starships apart. Most masters spend their days in the inner sanctums of the DRAW temples, studying the ancient texts and preparing for the day when the Dark-

Level	Experience Points	Hit Dice	Saving Throw	DRAW	To Hit Bonus	DRAW Learn %
1	0	1	15	20	+0	20
2	2,000	2	14	30	+0	20
3	4,000	3	13	40	+1	20
4	8,000	4	12	50	+1	20
5	13,000	5	11	60	+2	30
6	20,000	6	10	70	+2	30
7	40,000	7	9	80	+3	30
8	60,000	8	8	90	+3	40
9	90,000	9	7	100	+4	40
10	130,000	9+1hp	6	110	+4	50
11	200,000	9+2hp	5	120	+5	50
12	400,000	9+3hp	4	130	+5	50
13	800,000	9+4hp	4	140	+6	65
14	950,000	9+5hp	4	150	+6	65
15	1,100,000	9+6hp	4	160	+7	75
16	1,250,000	9+7hp	4	170	+7	75
17	1,400,000	9+8hp	4	180	+8	85
18	1,550,000	9+9hp	4	190	+8	95
19	1,700,000	9+10hp	4	200	+9	95
20	1,850,000	9+11hp	4	210	+9	95
21+	+100,000 per level	+1hp per level	4	+10 per level	+10	—

ness may emerge from its dimensional prison. If a master emerges from the inner sanctum, it means danger is coming (or they need a breath of fresh air).

EXCLUSIVE ABILITY

DRAW Power-Up

The DRAW Adept is constantly trying to master their DRAW powers. As the DRAW Adept increases in levels, so does the effect of their

DRAW abilities. Add the level of the DRAW Adept to any DRAW Ability effect or damage.

Starting Gear: Walking Stick, Leather Cloak

DRAW	TYPE	DRAW Cost	Description
Evac	Defensive	3	Teleports user out of danger and to a safe area.
Talk	Defensive	3	Allows user to communicate with creatures
Heal	Defensive	11	Heals 2d6 Hit Points to self/others
Heal+	Defensive	15	Heals 4d6 Hit Points to self/others
Assist	Defensive	11	Summons 1d6 friendly creatures
HaluSin	Defensive	3	Target must make a save or become confused. 1 in 6 chance the victim will accidentally attack an ally.
Shield	Defensive	11	Boosts AC -3[+3] for 10 actions
Telepathy	Defensive	5	Allows user to mentally communicate with others
Fi-Lo	Attack	5	Low level fireball 5 damage, 50 ft range
Fi-Me	Attack	15	Medium range fireball 15 damage, 100 ft. range
EE-Lo	Attack	5	Low level Lighting 5 damage, 100 ft. range
EE-Me	Attack	15	Medium level lightning 15 damage, 100 ft. range
Tor-Lo	Attack	5	Low level wind 5 damage, 25 Strength
Tor-Me	Attack	15	Medium level wind 15 damage, 35 strength
Flight	Movement	10	30 Air Speed
Escape	Movement	5	Allows user to escape from combat
Contain	--	5	Creature must make a save or be trapped for 1d6 actions
Open	--	5	Unlocks doors
Cure	Recovery	7	Cures all poison
Raise	Recovery	20	4 in 6 chance of raising dead party member
Grou	Omni	10	May be added to any DRAW ability, turning it into an area/group effect

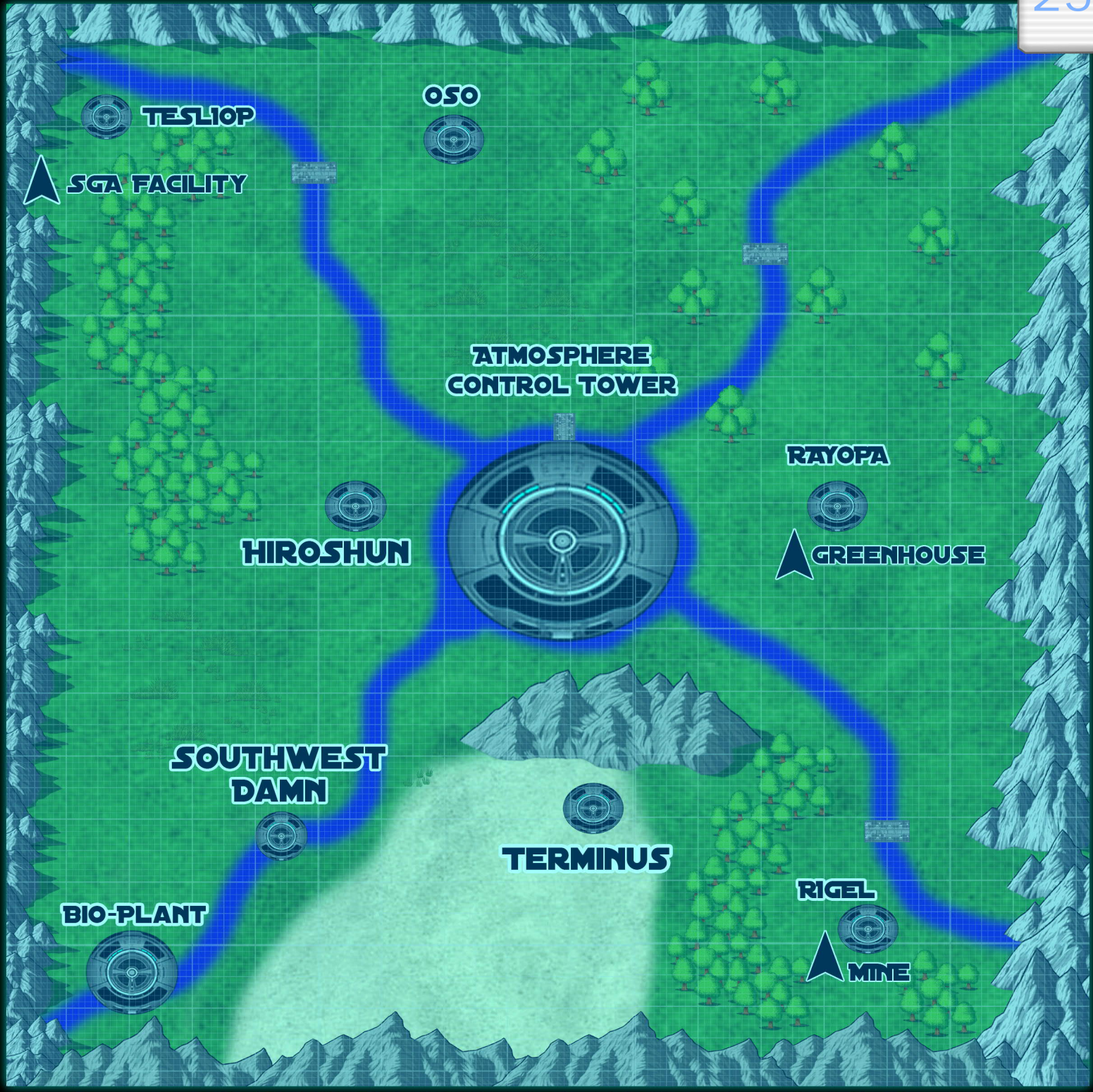

The EPPI Colony

On the edge of Xandorian space...

HIROSHUN (W)

Considered the ‘colonists’ town, HiroShun’s population is made up of regular colonists who are there with families. Their primary mission is to reproduce and grow Eppi’s numbers into a full sized colony. The people here tend to stay out of the politics surrounding the leadership and the Science Guild. These men and women are kind and compassionate. Many of the working class colonists resent the people of HiroShun because the work the townspeople do is practically mundane. To the Science Guild, HiroShun is a eugenics experiment, but to the magistrate these people are the future of the Terran race, especially on Alus. This is the only community that comes with an inn, hospital and supply shop, but offers no weapons.

~Key Personalities~

Mayor Gunru: A youthful old man who was a former Protector. Elected to office by the people of HiroShun and well loved. Has no problem taking a stand against injustice.

Lady Gunrey: Wife of Mayor Gunru. Terran spiritualist who has taken to the Order of the Lightess. Believes that all worlds have been touched by the Lightess and it is her job to promote the love and joy that comes with it. Some think Lady Gunrey is slightly spacey.

Doctor Colbrey: Terran female. Medical Guild. The town’s doctor and the colony’s foremost expert on child birth. While not that old, Dr. Colbrey comes off like a veteran war doctor at times. That’s because she was there for the first few months of chaos on Alus when the gene ship first landed.

Norkibo: Terran male. Runs local commissary. Knowledgeable about quality of items and origins. Huge history buff. Former member of the Library Guild who turned in his Librarian rod for a life as a merchant.



UN-KUN



UN-KUN



UN-KUN

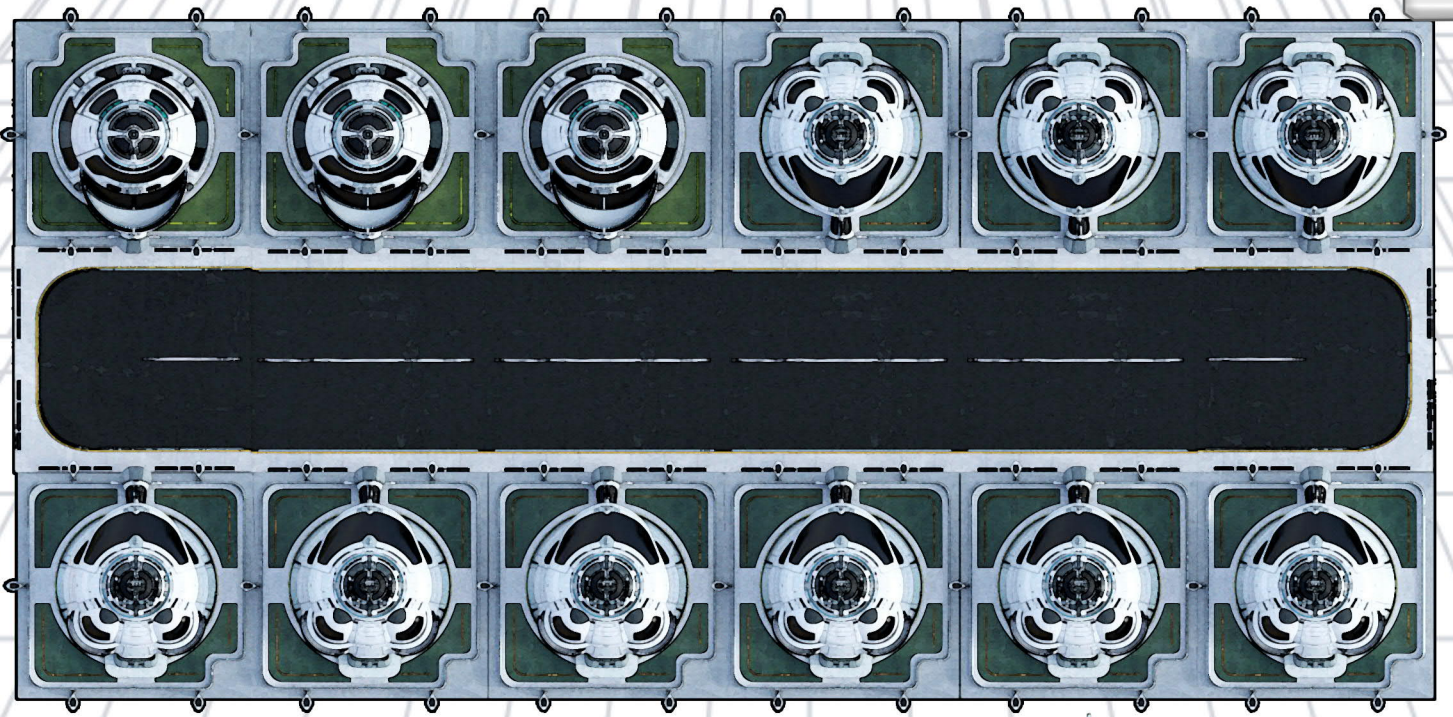

Xandoria Gaiden

OSO (N)

The town of Oso is dedicated to the Order of Lightness. The population is mostly Clonora with a few Terrans here and there. But everyone who lives in Oso is a DRAW Adept. It is here that they may hone DRAW abilities without being shunned by other colonists. The Terran Empire and the governor of Eppi allow the town to exist because it is far enough away from the other towns to be of any harm. Science Guild members frequently come to Oso looking for information and to collect data on DRAW energy. Oso was built around two large glimmering towers that were discovered during the initial colonization of Alus. Members of the Science Guild believe that the towers are transmission towers of DRAW energy. The DRAW Adepts claim that the towers are a shrine of the Lightness. No one has yet to gain access into the towers, but the Clonora of Oso worship at the base of the towers each day. During the moon alignment the people of Oso throw a huge celebration (every 3rd month).

~Key Locations~

Cathedral: Below the town of Oso is a large and complex cathedral designed by the Clonora. Rumor has it that the structure was already there and that it is part of the Towers of Light. Only Clonora are allowed entry and only the highest ranking Clonora may enter the inner sanctum. It is there that Master Ikka keeps alien artifacts that were discovered on Alus and kept from Terran eyes. The entrance to the Cathedral is in the northwest corner of Oso. There is a biometric lock on the door and it will only open for Clonora.

The Towers of Light: Impenetrable twin towers made of a silver-like material. Constantly sending DRAW energy into space, but not enough to do any harm.

~Key Personalities~

Master Ikka: Clonora male. Head of the Order of Lightness on the Eppi colony. Not a fan of Terrans because he feels they lack faith. Very uppity and highly religious. Senses some-

thing is wrong on Alus and is determined to find out what it is, without letting the Terrans know.

Niex: Clonora female. DRAW Adept. Assistant to Master Ikka, Niex believes with all her heart in the Lightness. She handles logistics of celebrations and daily prayer. Friendly and overly superstitious.

Zielx: Clonora male. Dark and brooding. Rarely leaves Cathedral. Head of the Angelites. Hates Terrans in a way that isn't sane.

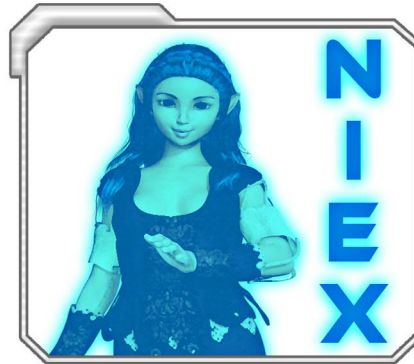

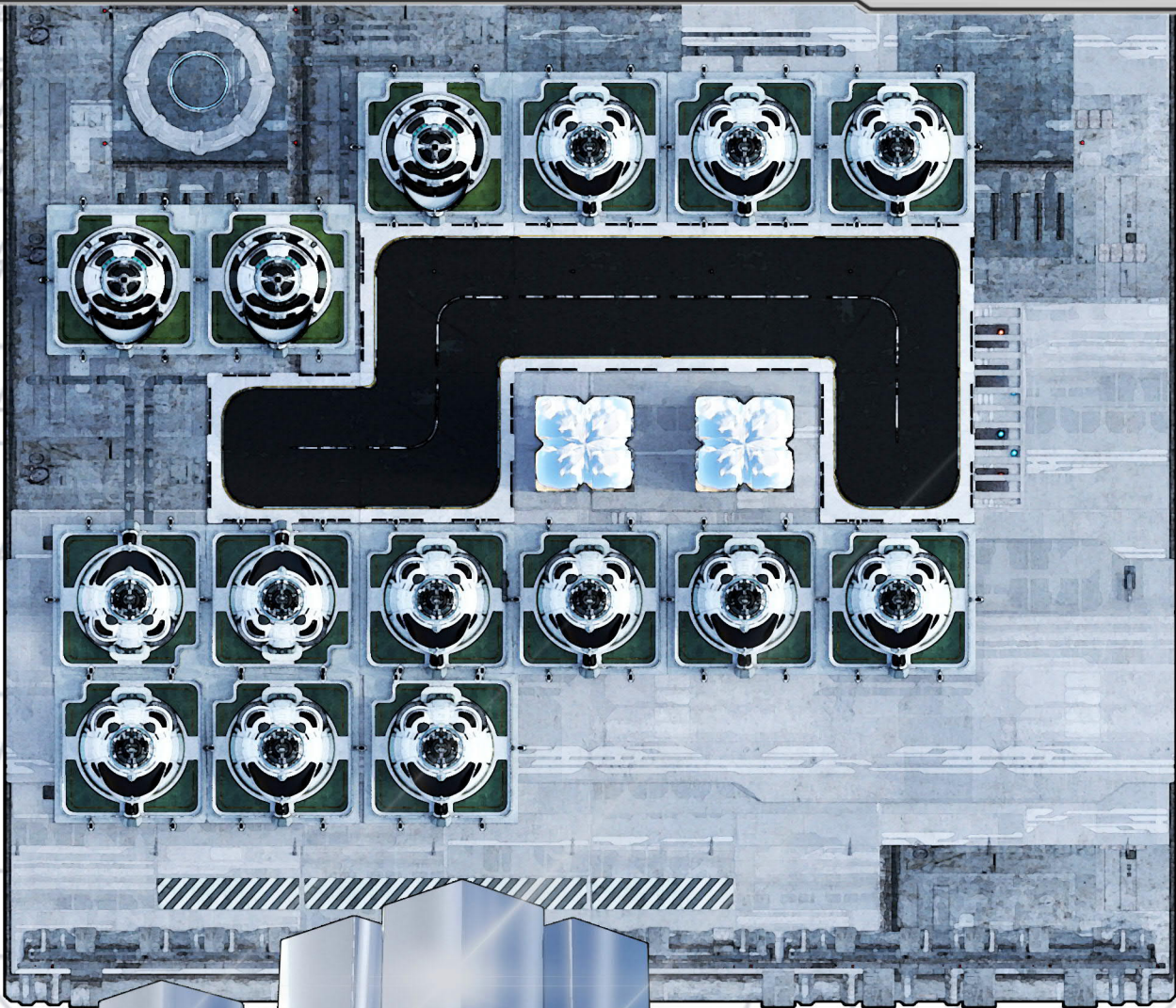

RAYOPA (W)

The western town of Rayopa is an agricultural center for Eppi. The townspeople operate and manage the massive greenhouse that the town is built upon. Because some plant-life native to Terra cannot grow on Alus, the Rayopa greenhouse must manage the growth of the entire organically grown food supply for the colony. The land around the town is also used for farming, but until a hybrid crop can be genetically engineered to grow on Alus, food plants must be grown in a controlled environment. Rayopa is so important that an entire unit of Protector dolls is stationed there as a security detail for the greenhouse. Only authorized personnel are allowed to come and go from the growing chambers. Rayopa produces around 5 tons of produce a week using hyper fertilizers engineered by the Science Guild.

~Key Locations~

Office of Agriculture: At the west end of town is the Office of Agriculture. It is here that greenhouse systems are monitored and the supply orders are received.

Rayopa Greenhouse: A massive greenhouse broken down into smaller chambers to help promote growth. For eight hours a day massive UV generators project artificial sunlight onto the crops and twice a day a misting system waters the plants. There are ten Protector dolls that patrol the greenhouse at all times. All workers must have a 'GREEN' ID badge or risk getting arrested or shot. At the end of the week harvester drones collect all ripe fruits and vegetables and load them onto carriers that distribute to other towns.

~Key Personalities~

Engineer Marlo: Terran engineer responsible for making sure the entire greenhouse system is in top shape. Takes job seriously and doesn't like outsiders messing with things. Spends most of his time walking the greenhouse making sure conditions are just right.

Gren Lox: Clonora biologist and botanist. Lead researcher for growing better crops. Famous for cataloging dozens of wildlife discoveries when Alus was first colonized. Highly intelligent, semi-social, especially when it comes to science.



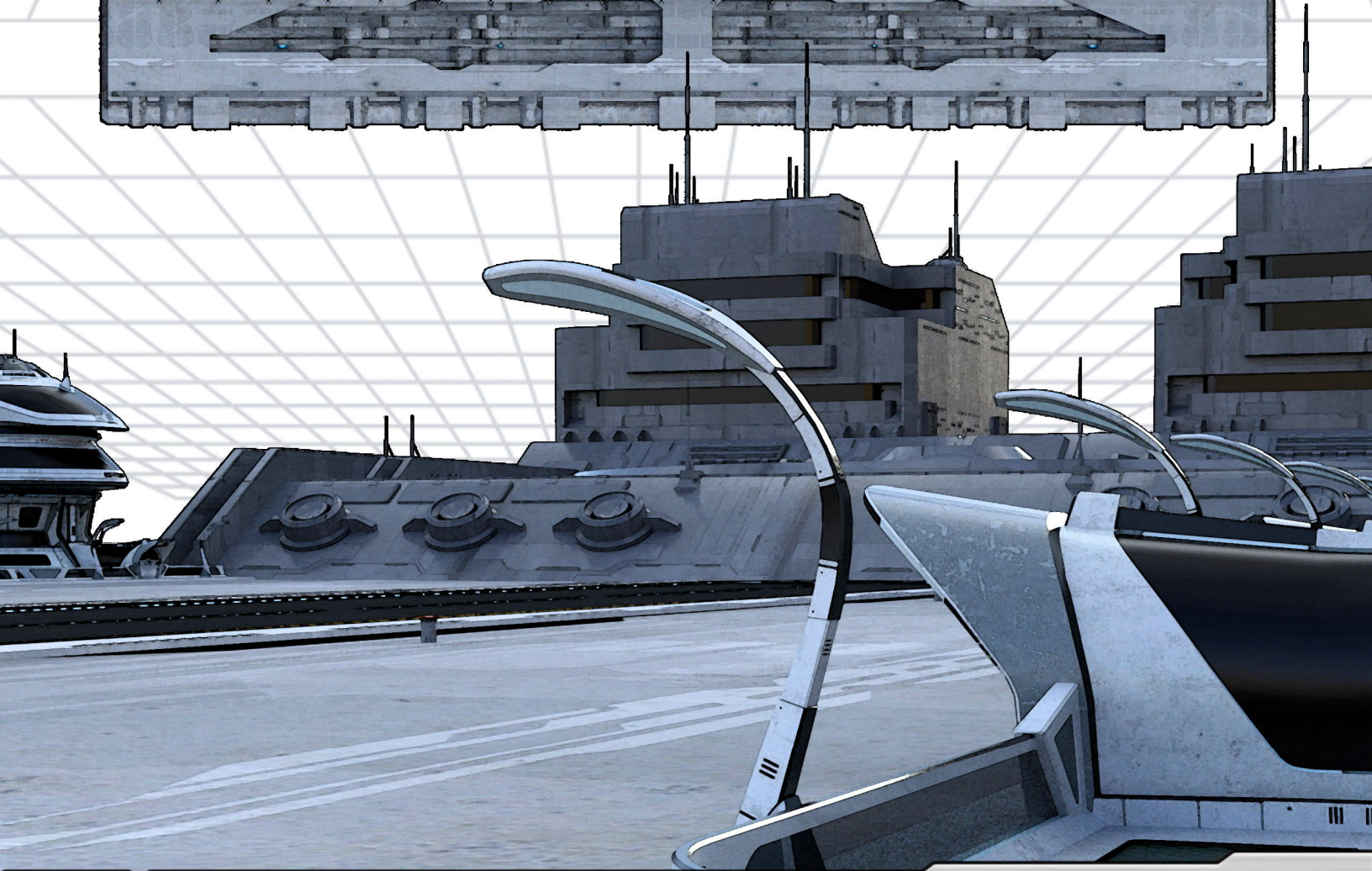
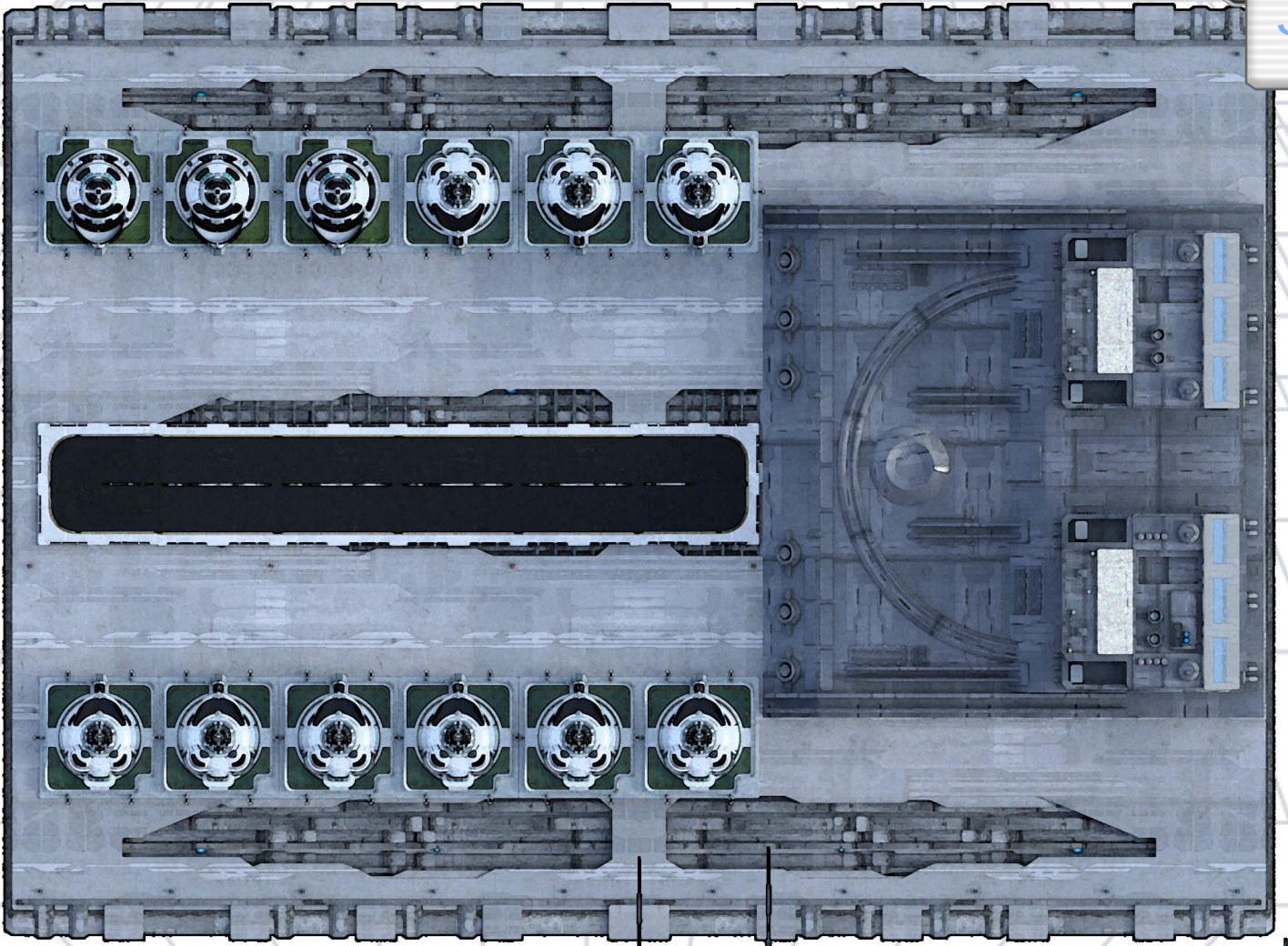

REGIL (SW)

In the southwest corner of the Eppi colony is the town of Regil. Responsible for mining operations on the colony, the town is built next to the entrance of the Eppi mine which allows workers to be closer to home and cuts back on transportation time. The people of Regil tend to be a bit rough around the edges. They work hard and don't like government bureaucrats breathing down their necks. The way they see it is that they are the ones putting themselves in harm's way and they know what is best when it comes to mining operations. Of course a large chunk of mining is done by machines, but it's still dangerous going miles below the surface of an alien world digging through minerals, some unknown. All materials mined are processed at the facility above the mine and distributed as needed. If it weren't for the town of Regil, there wouldn't be metal for construction and manufacturing. Regil tends to be a popular destination for adventurers and engineers looking for special tools and weapons. The town even has an armorer and a weaponsmith. With the right permits, an agent can get tricked out with some pretty amazing gear.

~Key Locations~

The Eppi Mining Facility: The large building to the east of Regil is the mining facility. The above ground levels are for manufacturing and processing. The top floor is where all the mine offices are. It is there that requests can be made for anything from building supplies to custom gear. Below ground is the primary shaft that goes for miles, splitting off into other shafts and so on. Most of the mining is carried out by large robots called 'Minators' that are capable of hauling tons of material at a time and smaller robots known as 'MineBots' do all the drilling and tunnel maintenance.

Solis Commissary: A one-stop shopping experience and one of the best stocked shops across the entire colony. There is a small diner connected to it along with an inn. It even offers Healing Pods.

~Key Personalities~

Director Krauff: Head of mining operations at Regil. Not a fan of government types. Prefers that he and his people be left to do their work. Known for saying "The more time we argue the less time I have to supervise." Frequently goes into the mine to see how things are going. Takes great pride in not having any accidents on his watch.

Dorfman: Mining foreman. Knows the mines well and is responsible for making sure all maps are up to date. Does safety inspections once a day on the primary shaft and rotates inspections on the others. Prefers working with machines over Terrans, mostly because it means more panz for him.

Layner: Weaponsmith. Well known for the quality of his strike blades. Can identify almost every metal known to the Terran Empire. Former Protector grunt who served in a few major campaigns before retiring to life as a colonist. Has plenty of stories to tell about the dangers of space colonization.

Sergeant Zole: Clonora medic. Runs the medical team for the mine. Based out of the Solis Commissary. Extremely blunt and logical. One of the few military Clonora in the entire Terran Empire. Medical knowledge is far above some of the brightest in the Science Guild.

Solis: Commissary owner. A rough and tough lady with a wicked mouth on her. Her commissary offers some of the best gear panz can buy. She also has her finger on the pulse of the people. She hears their stories every day. Has a soft spot for kids and keeps a stash of candy behind the counter. Solis' family is well connected with the supply officers of the Terran Empire. If there is something she doesn't carry, she'll make some calls. No promises.

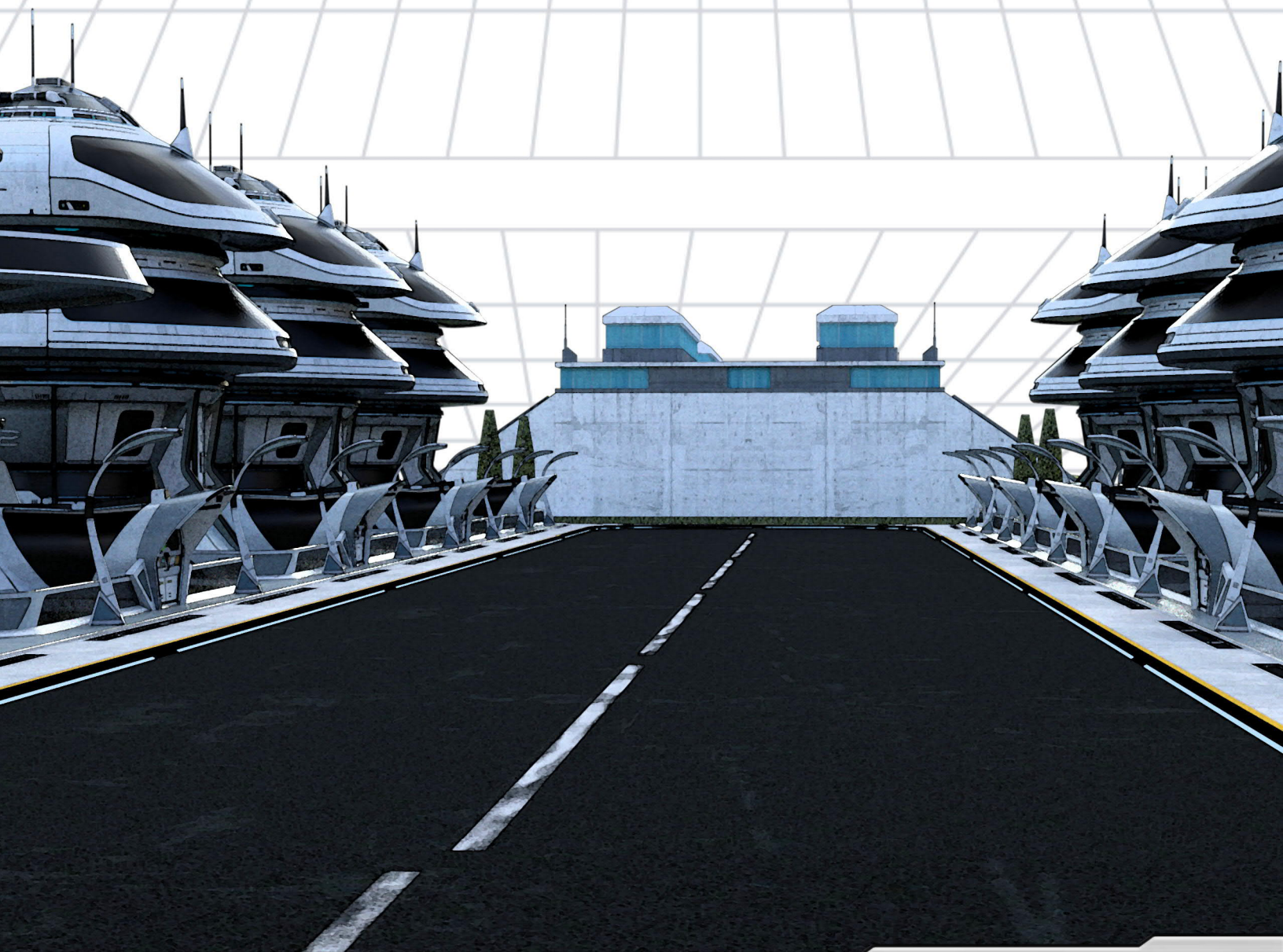
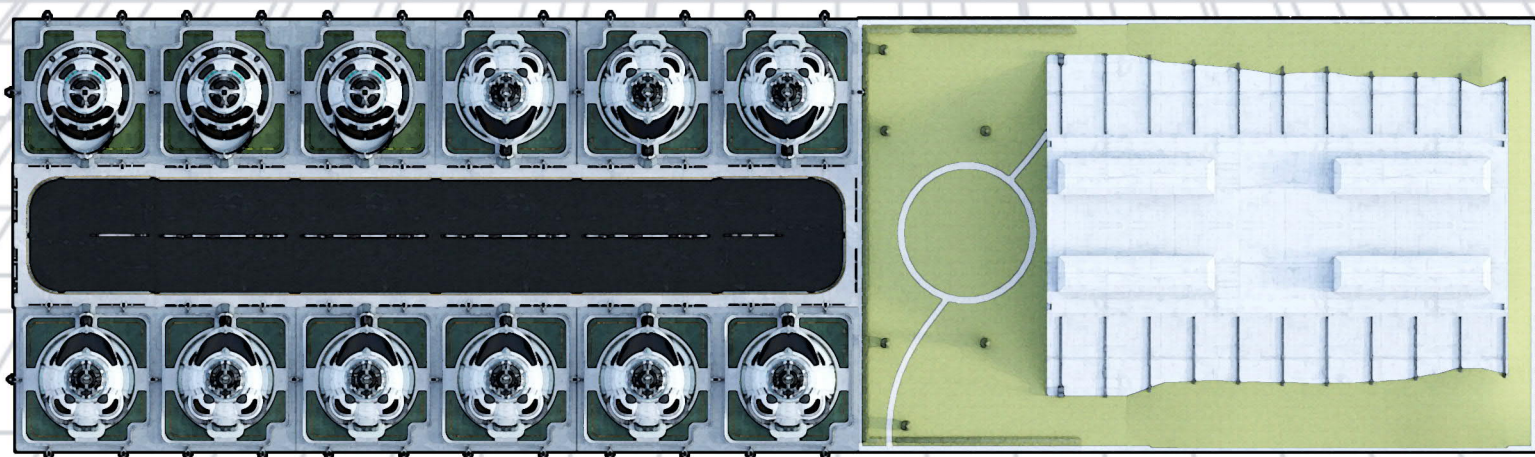

TERMINUS (S)

Terminus was once the space terminal for the Eppi colony before a crash wiped out the port and radiation killed off half of the population living in surrounding apartments. The land around the terminal was also severely damaged by radiation. In the end survivors fled and the space terminal became known as Terminus. The area is still highly radioactive and cannibalistic mutards roam the ruins living off of anyone foolish enough to wander into the area. And there lies the problem. Beneath the ruins are large hangar bays with fully functional shuttles, but because the main platform fell on the bay doors, there is no way to free the spacecraft. Because of the radiation and mutards, it's not safe enough to clear the debris field. There aren't enough Protectors to carry out the operation and dolls are too valuable to chance on a hazardous mission like that. Every few years a band of colonists and some agents try and venture into Terminus and never return.



Greetings Agent,
The information about Terminus is not authorized to your security level. All you need to

know is that the town is off limits and no colonist or agent is allowed near it. The 'mutard' creatures that occupy Terminus and the hangar bay below it are extremely dangerous. If, at any time, you learn of colonists entering Terminus it is your responsibility to notify me immediately. We must not lose any colonists to the creatures there, nor do we need anyone 'exposed' to the radiation that continues to contaminate the surrounding lands. If a 'mutard' wanders from Terminus, do NOT engage. Notify me and I will deploy Protectors to deal with it.

One last time:

**STAY OUT OF
TERMINUS**



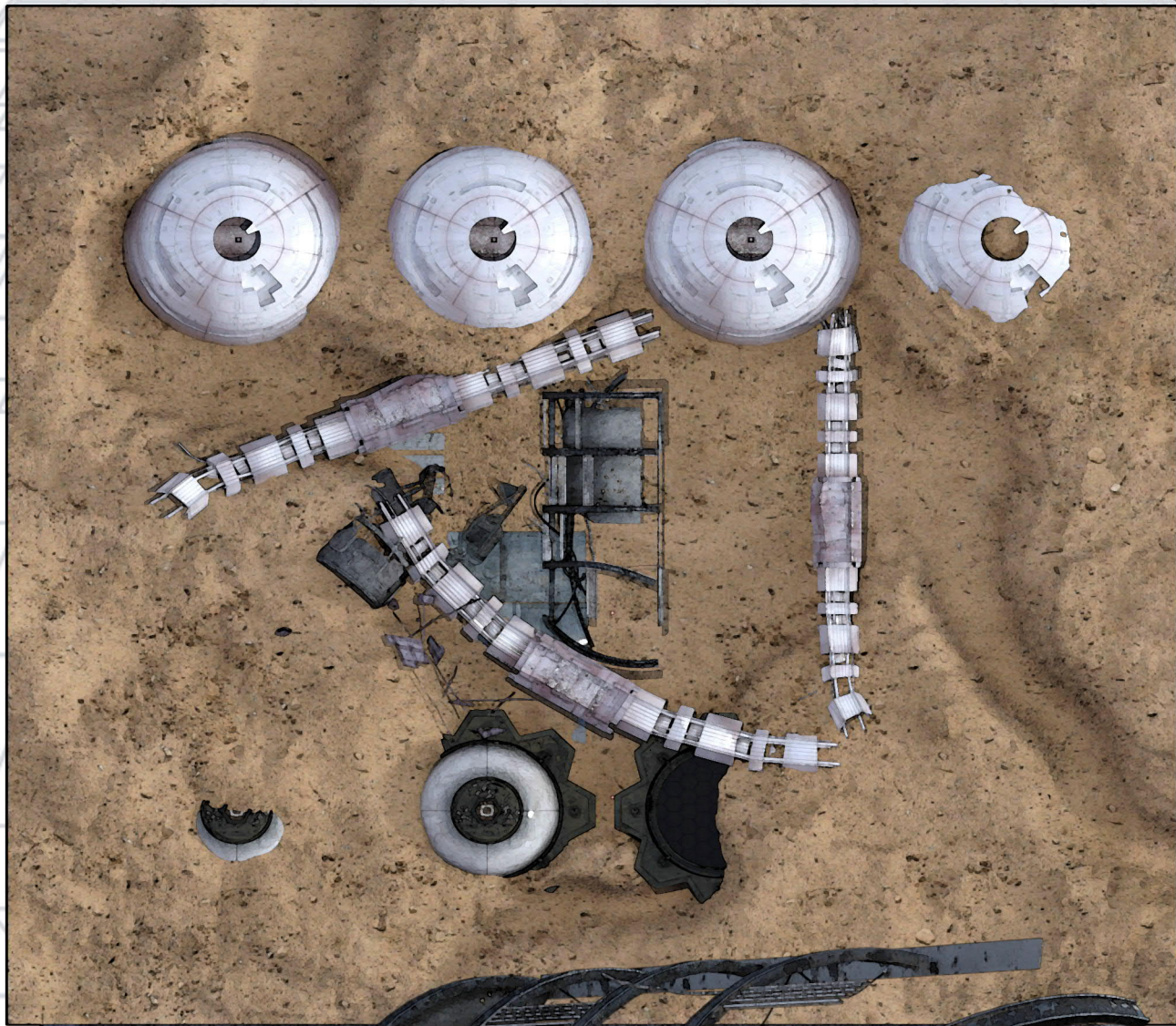

TESLIOP (NW)

The town of Tesliop is home to the Science Guild Academy (SGA) for the colony. The mission of the SGA is to make sure all gene ship materials are properly initiated in a clean and scientific manner, ensuring the survival of the Terran people. They also are in charge of data storage for the colony, acting as a library of all information on activities and occurrences. The people of Tesliop mostly consist of Terran scientists and their families. They tend to be standoffish when it comes to agents and are very cautious around DRAW Adepts. There are only two Clonora that live in Tesliop, both high ranking members of the SGA and both highly fanatical about the Lightness, something that causes friction with the more scientific minded members.

Tesliop is located in the northwest corner of the Eppi colony. Part of the reason for this is to offer some peace and quiet to the scientists, but also because some of the experiments the SGA conducts are dangerous and need to be done away from the rest of the population. While many of the more volatile research is conducted in the cave to the west of the town, some are carried out in the basement level of the SGA building.

~Key Locations~

The Science Guild Academy: Headquarters of the Eppi Science Guild and home to its academy. A place of logic and enlightenment in all areas of science. One of the few actual clean places in the entire colony. The higher levels house the elite of the Science Guild, while middle levels include classrooms and labs. The ground floor is all offices and conference rooms. The sub-levels of the academy are off limits to all non-Science Guild members. Most colonists believe that the lower levels house dark secrets about the planet, but those are just rumors...or are they?

~Key Personalities~

Professor Areal: Clonora and member of the Science Guild. Specializes in archeology and

alien languages. Also has commanding knowledge of physics. Currently working on analysis of DRAW energy use in Clonora and documentation of DRAW dating back to the dark ages of humanity. Believes the answer is somewhere out in space, which is why he came to Alus.

Professor Gould: Member of the Science Guild specializing in genetic engineering. Sees himself as the next head of the SGA and has frequently bullied other members into backing his ideas. While extremely intelligent, he takes far too many chances than other scientists would dare. Tends to be secretive.

Professor Shamus: Member of the Science Guild specializing in physics. Made studying DRAW energy his life's work. He's also been exposed to dark energies that have corrupted his mind. Possibly insane, but cunning as hell, Shamus is confined to his lab and quarters until the Science Guild can figure out what to do with him. He can be found talking to himself frequently even though he is claiming that he's actually talking with someone.

Professor Tomas: Head of the SGA. Professor of xenobiology with years of experience. Came to the Alus in search of answers after the Science Guild received an alien signal coming from the planet. Getting along in his years and relies heavily on his assistant, Vestra.

Vestra: Clonora and member of the Science Guild. Close friend of Prof. Tomas who acts as his field assistant. She is logical and dedicated to the Lightness. Her religious beliefs do cause conflict with other scientists who don't believe in the Lightness. Vestra is extremely useful as a researcher and she is a brilliant scientist. Any time there is a meeting of the Science Guild leadership, Vestra is there next to the professor.

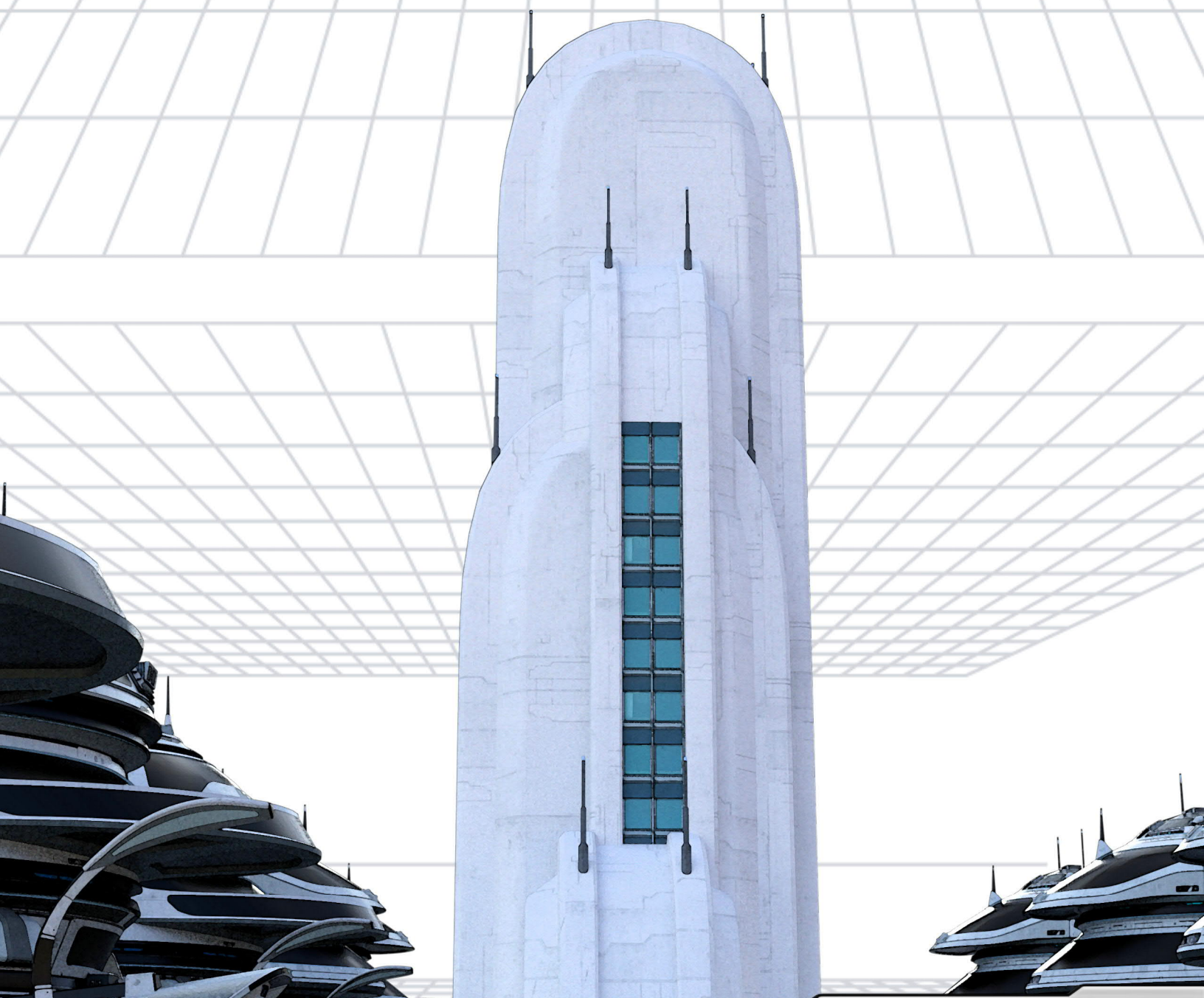
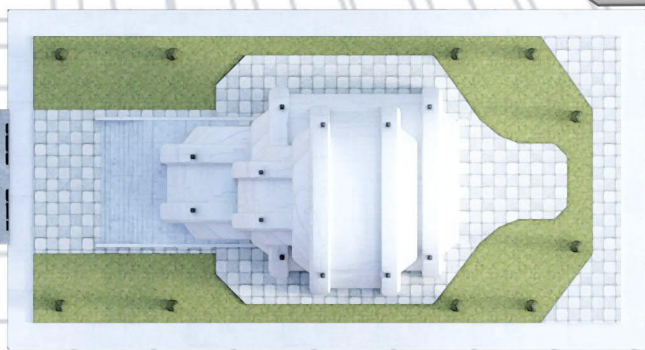
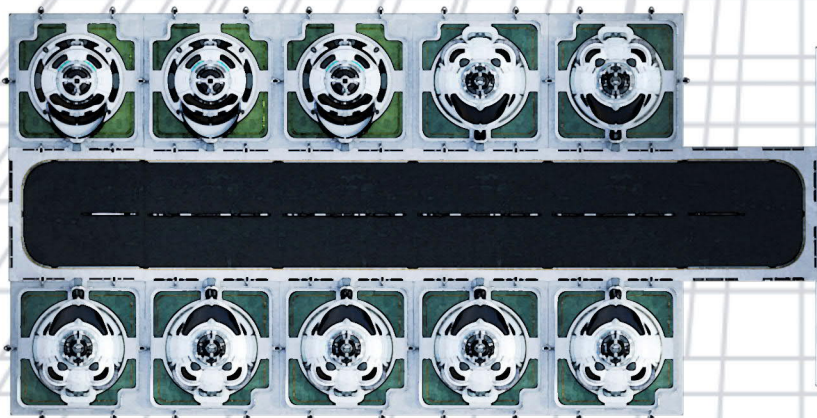

Xandoria Gaiden

ATMOSPHERE CONTROL TOWER

(Center)

At the heart of the Eppi colony is the Atmosphere Control Tower or ACT. It is here that all the life support systems for the colony are located. It controls weather, shields Eppi from meteorites, and keeps out the hostile environment. The ACT is powered by a Star Power Condenser (SPC) which is literally a compacted star that is placed in stasis and power is drawn from it in small doses. The SPC powers everything on Eppi. If the containment field were to ever rupture or fail, Alus would be consumed by the star compacted within the SPC. The ACT is manned by Terran planetary engineers and dolls. A RED card key is required to enter the ACT and only high ranking engineers carry them.

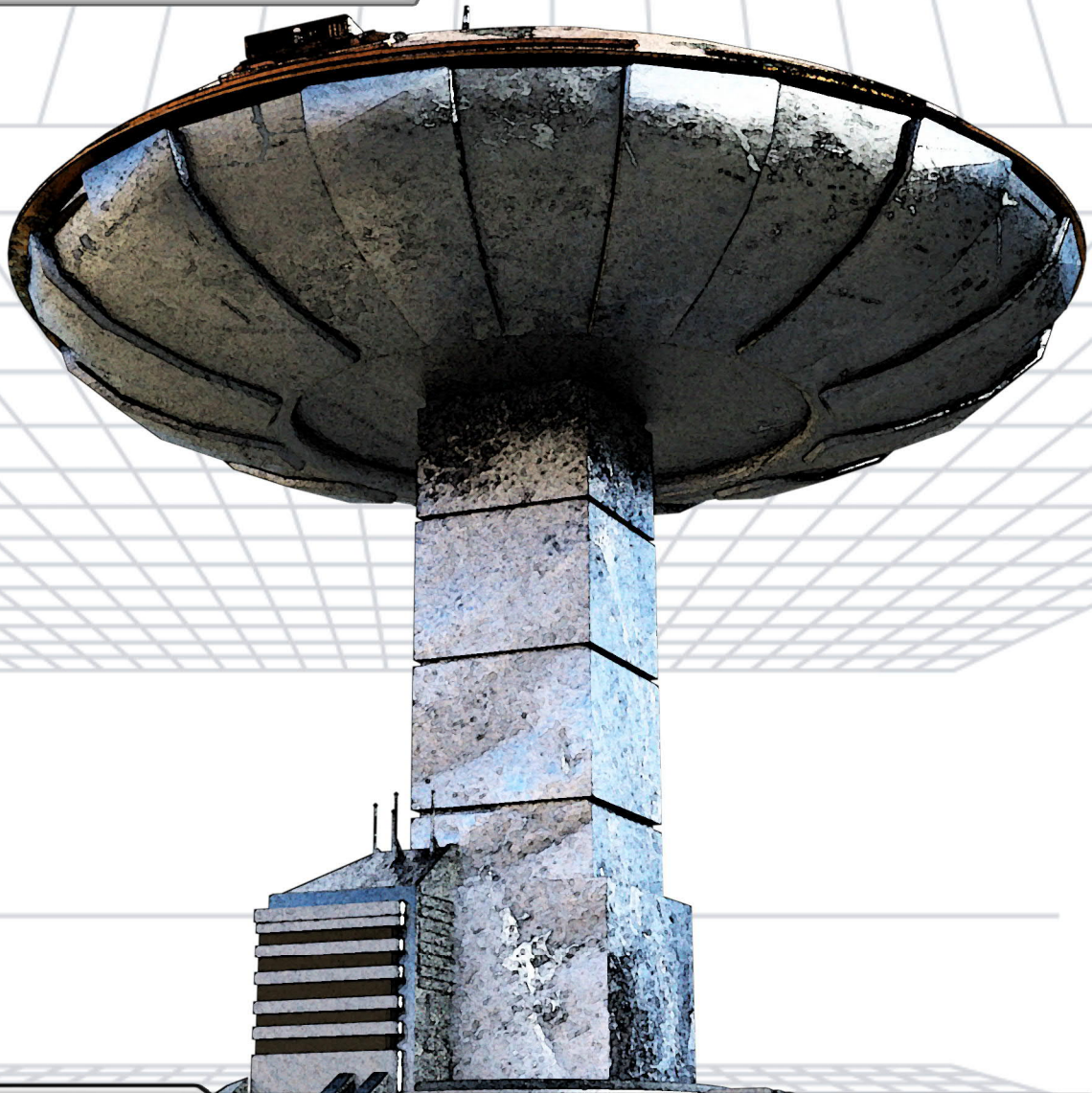
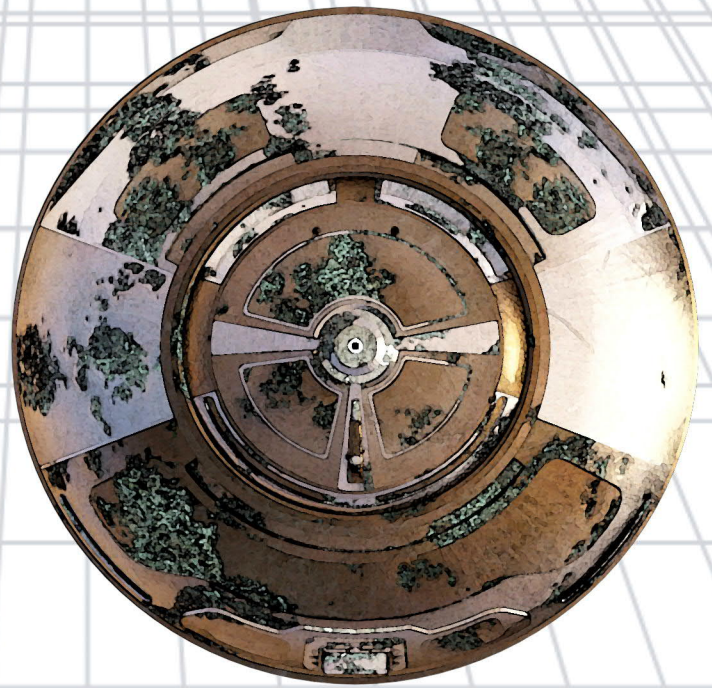

BIO-PLANT

(SW)

The Bio-Plant is a massive genetics facility that grows cattle and other helpful wildlife for the colony. It is also where some of the colonists were grown using genetic material from the colony gene ship. All life grown in the Bio-Plant is closely monitored by the Science Guild. It's vital that anything brought to full maturity not be a threat to the colonists. It is why predatory animals tend to not be produced. Access to the Bio-Plant requires a WHITE key card. Running at full capacity a bio-plant can produce almost 100 viable colonists in a month. In addition to standard genetics, the Bio-Plant also conducts genetic experimentation under close supervision. This involves gene-splicing of both Terran and alien genetic materials (which gave birth to the Clonora).

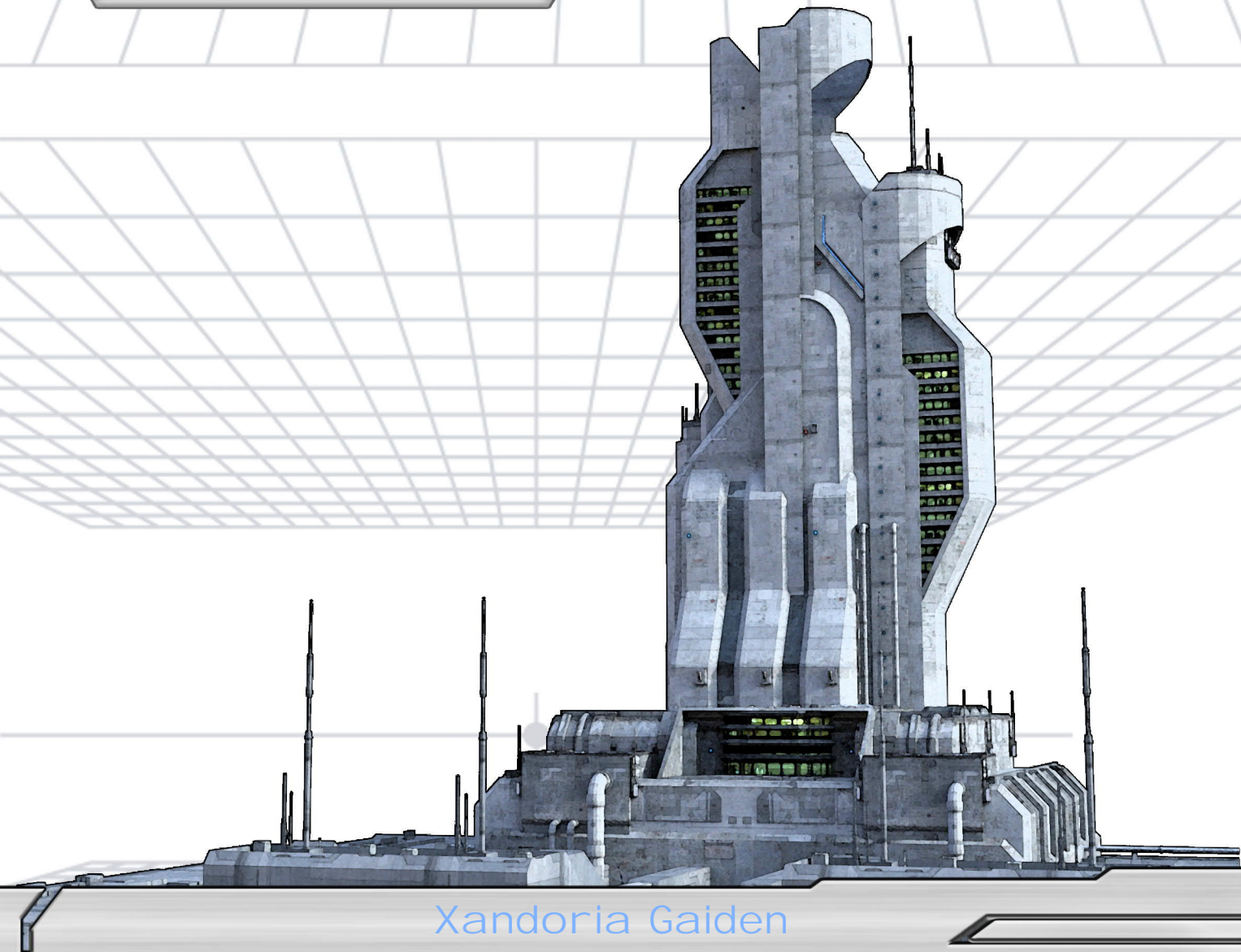
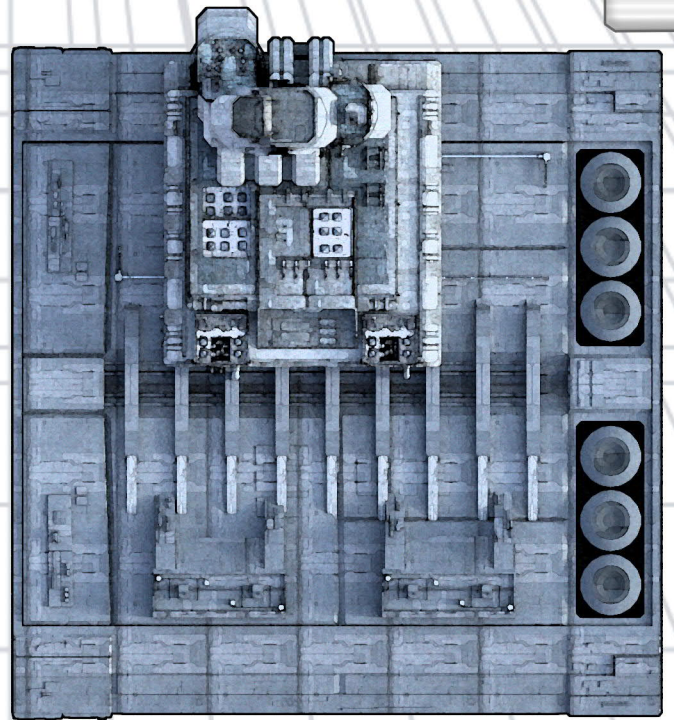

SOUTHWEST DAM

(SW)

Before water based creatures from the Bio-Plant are allowed to swim freely through the waters of the Eppi colony they must first circulate through the Southwest Dam. While the Science Guild can study the creatures they grow at the Bio-Plant, they don't know exactly how the life will respond once put into the wild. The waterways between the plant and the dam are a sort of proving grounds. If a creature is deemed dangerous, it is filtered out at the dam and destroyed. The remains are then either turned into food or fertilizer if possible. Access to the dam release requires a WHITE card key, while entering the dam requires a RED card key.

Before the Southwest Dam became the dam, it was home to hundreds of Science Guild and Engineers Guild members who were helping construct the Bio-Plant. The dam was originally the city of Feresh before being practically abandoned by order of the Science Guild, who didn't want casual civilians having access to their experiments. The apartments are still fully operational, but power and water has been turned off. There are still around fifty engineers that still live at the Southwest Dam along with twenty scientists. A small unit of Protectors is also stationed there just in case something happens.

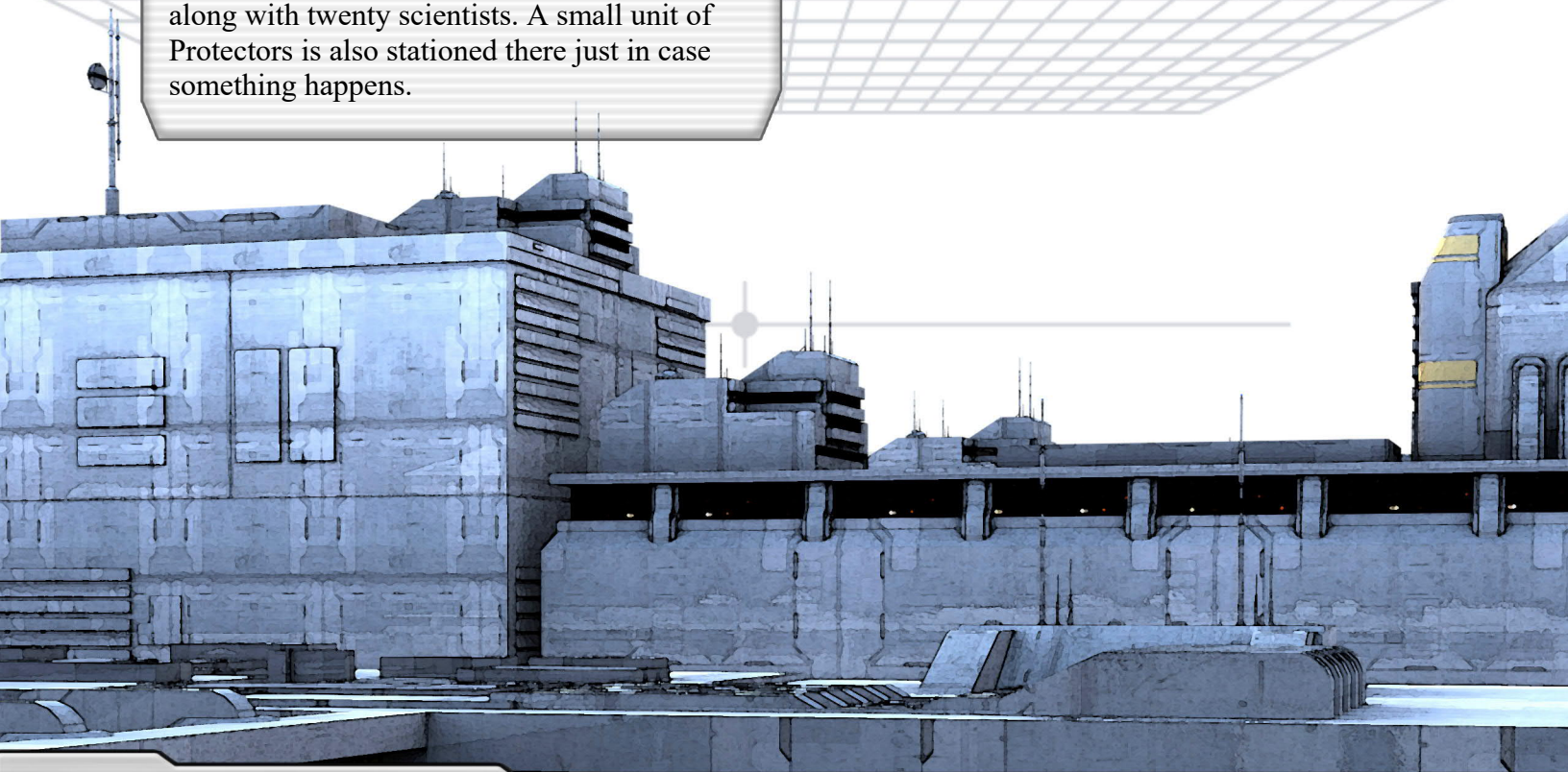
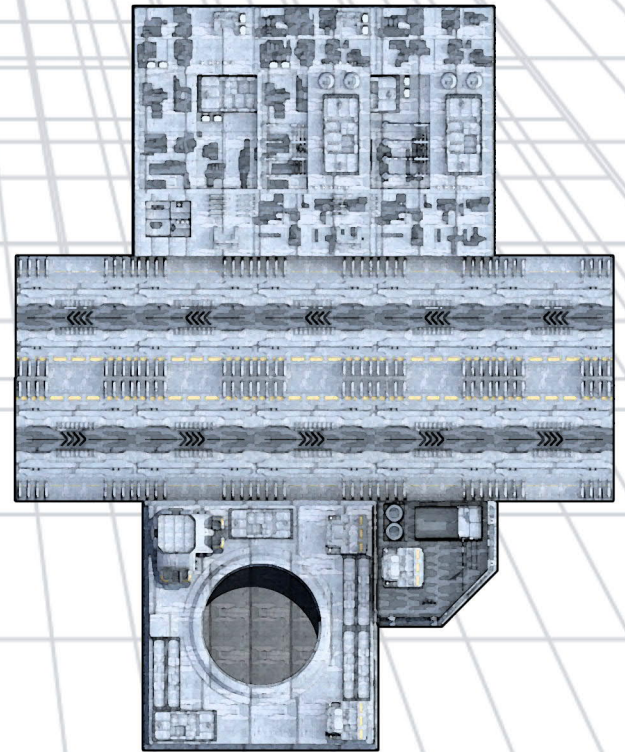

Science Guild

Academy Research Facility

(West of Tesliop)

West of Tesliop is the SGA research facility, located deep within a cave. The placement of the lab in the cave allowed the SGA to conduct risky experiments away from the general population. And if something went wrong, the cave could be sealed off and no one would know what had transpired (The main entrance is armed with two large bombs to generate a cave in). The outside of the facility looks like the opening to a Terran mining operation. The inside tunnels are better maintained than a mine, however. There is wall lighting every few yards, metal support beams make the tunnel almost look like a hallway. If not for the open on the sides, roof and floor, it would look like any other Terran ship hallway. The first set of labs are low level and deal with basic experiments and autopsies, while the deeper levels are where genetic experimentation and energy studies are carried out. Air to the facility is pumped in via several small air ducts that go to each major chamber. The air filter and pump station is located just south of the cave entrance. There are always at least 2 Android Police (Silver) guarding it at all times.





Common Wildlife (Non-lethal)

Bass
Bees, Honey
Beavers
Butterflies
Cat, House
Cockroaches
Deer
Dog, Domestic
Earth Worm
Frogs
Mice
Pigeons
Rats
Salmon
Swine



AMOBIAN ARACHNID

Frequency: Uncommon

Appearing: 1d4

Lair Occupation: 1d4

Hit Dice: 2d6

Armor Class: 6[13]

Attacks: Claws (1d8 damage), Bite (1d6 damage, poison)

Saving Throw: 16

Special: Semi-transparent (-4 to detect visually)

Move: 12

Alignment: Chaos

Challenge Level/XP: 2/50

Panz Value: 100

Special Treasure: N/A

One of the odder creatures to wander Alus is the Amobian arachnid, a transparent and rather large arachnid, which can be found hunting on the beaches outside of the colony. The amobian stands around ten feet tall and eight feet wide and has a body color like a jellyfish. It's very hard to spot when it's on the beach or in the ocean. The amobian actually lives in the water and surfaces to feed on land creatures. Only a handful were encountered during the initial survey mission to Alus, but once the colony was established the amobians started appearing more and more, first outside the colony and then inside the barrier. It's easy to tell when this arachnid has fed; because the blood of whatever they drank dry can be seen flowing through its digestive system. The only good thing about the amobian arachnid is that it doesn't have webbing, which Protectors appreciate.

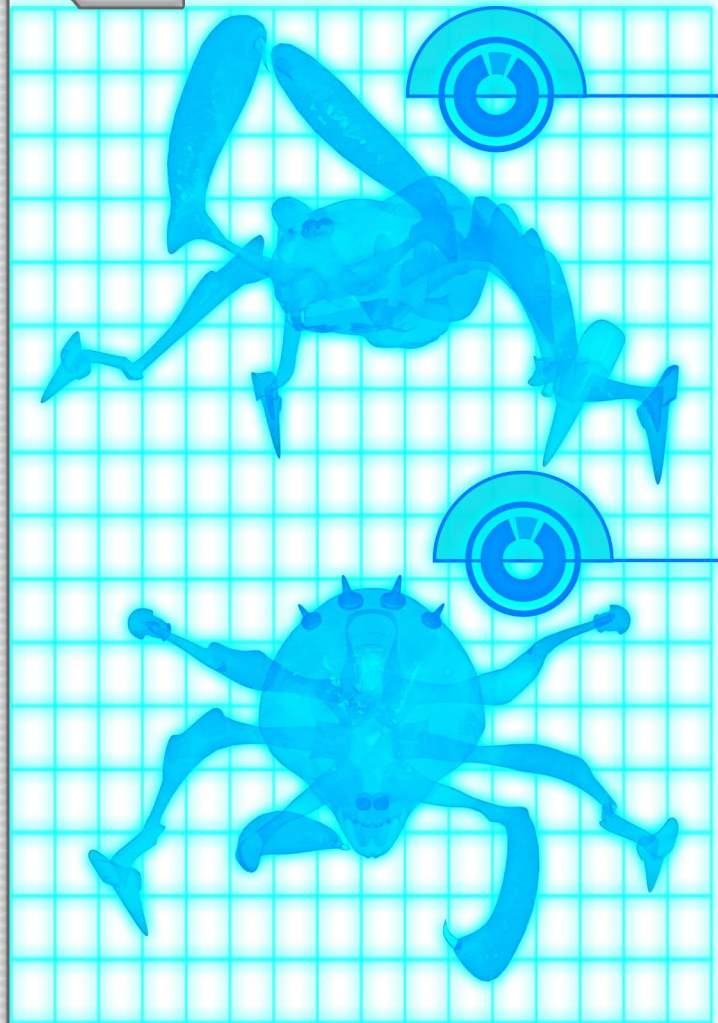

BANDIT

Frequency: Common
Appearing: 1d4
Lair Occupation: 6
Hit Dice: 1
Armor Class: 7[12]
Attacks: Blade (1d6 damage)
Saving Throw: 17
Special: N/A
Move: 12
Alignment: Usually Chaos
Challenge Level/XP: 1/15
Panz Value: 25
Special Treasure: Combat Knife

While most Terrans live peacefully on the colony, there are those that always want more. They move in the shadows and rob travelers and raid towns. The bandit's life isn't a great one. Most didn't start out that way either. Some were forced into it by the fates while others feel slighted by the Magistrate. Bandits tend to live near the mountains and in the forests, avoiding areas where machines fly overhead in order to not be spotted by the ever reaching eyes of the Magistrate.



BOAR

Frequency: Common

Appearing: 1d6

Lair Occupation: 1d6+2

Hit Dice: 1d6

Armor Class: 7[12]

Attacks: Gouge (1d6)

Saving Throw: 17

Special: Heightened Smell (+2 to detect as long as downwind)

Move: 10

Alignment: Neutrality

Challenge Level/XP: 1/15

Panz Value: 15

Special Treasure: N/A

Another herd animal on the colonies, the boar is primarily a source of meat. Grown to be rugged and adaptable, the boar is allowed to roam the lands in packs. Once a month, colonists gather up the swine and butcher them. Then another wave of pig is released from the Bio-Plant and the cycle is continued. Most boars aren't dangerous, but some can get pretty testy around Terrans. Many a colonist has needed a trip to a hospital after being gouged by these creatures.

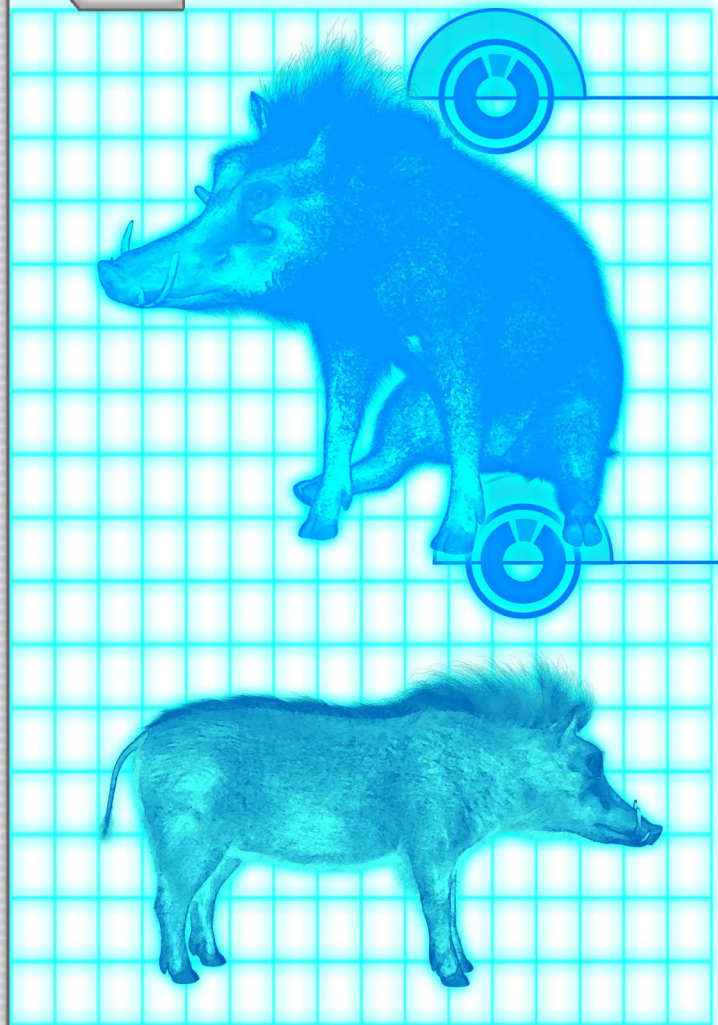

COLONY WASP

Frequency: Common

Appearing: 1d6

Lair Occupation: 25

Hit Dice: 1d6

Armor Class: 8[11]

Attacks: Sting (1d6 damage, Saving Throw vs. Poison)

Saving Throw: 18

Special: Drawn to Sugars (+5 to track sugary products)

Move: 2 (ground), 12 (flight)

Alignment: Chaos

Challenge Level/XP: 1/15

Panz Value: 20

Special Treasure: N/A

One of the biggest problems that have plagued every colony that the Terran Empire has established is Colony Wasps. These two foot long wasps are ferocious and love to cause problems. No matter how well the empire plans out their wildlife growth cycle, the Colony Wasp seems to appear one year after establishment of a colony. The Science Guild believes that their gene stock for bees and wasps must have somehow mutated and in turn offering a variable wasp that manifests after the first year life cycle of regular wasps. The Colony Wasps tend to build their hives atop massive Terran structures where they get plenty of sun and heat. The ACT always has problems with the wasps clogging up ventilation ports and frequently calls on Protectors to clean out parts of the ACT where Colony Wasps have built their hives. The wasps even have a tendency to attack festivals because of their attraction to sugary treats. Luckily only a handful attack at a time and the only time they become truly dangerous is when their hives are threatened.

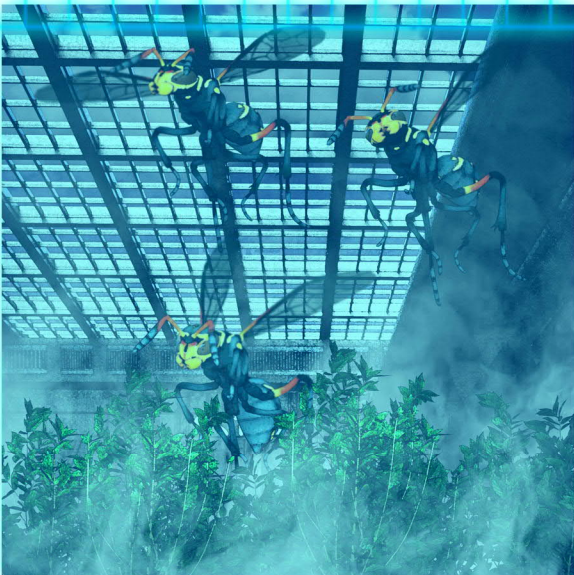
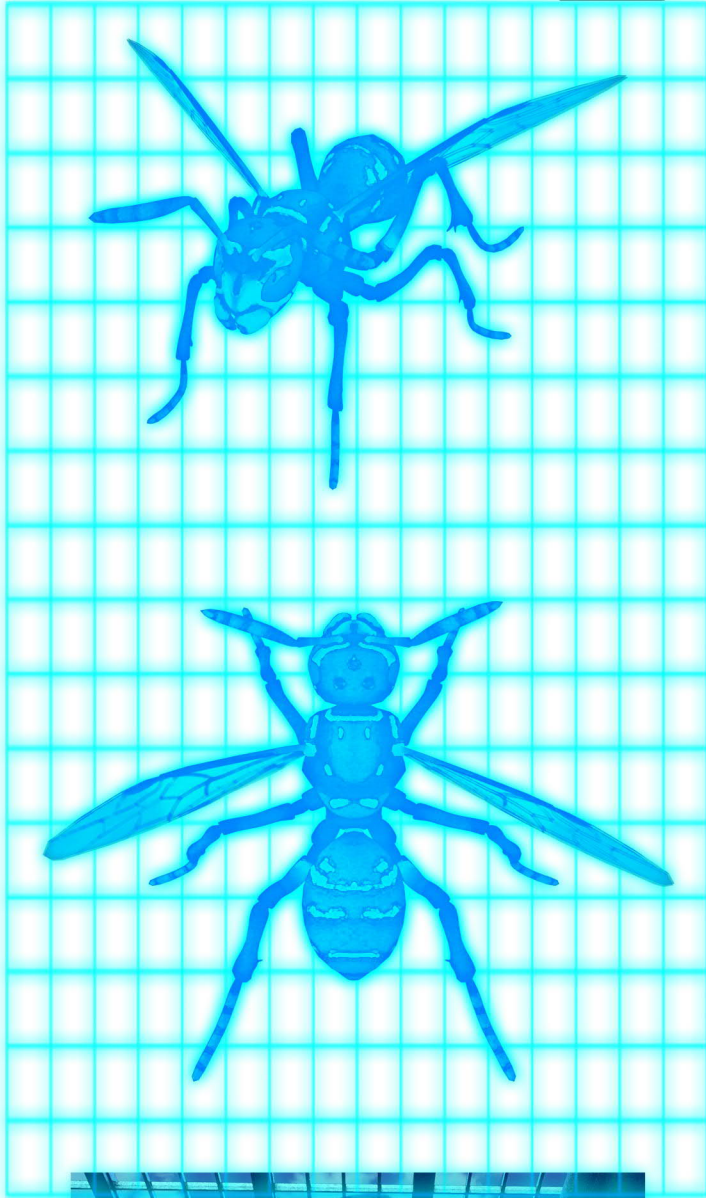

COPPER TOAD

Frequency: Uncommon

Appearing: 1d4

Lair Occupation: 1d4

Hit Dice: 2d6

Armor Class: 6[13]

Attacks: Tongue Smack (1d6 damage)

Saving Throw: 18

Special: Night Vision (75ft)

Move: 4 (ground), 14 (leaping)

Alignment: Chaos

Challenge Level/XP: 2/35

Panz Value: 50

Special Treasure: N/A

The Copper Toad is a large amphibian native to Alus. Roughly four feet long and three feet wide, this toad tends to hunt smaller prey like birds and domestic pets, but has been known to cause havoc in the fishing trade by binging on fish. When threatened, the copper toad can be quite aggressive with its tongue. The big question is: how does the toad get into the colony? No matter how hard the Protectors work to keep native life on the other side of the mountain range, they still can't manage to keep the toads out. The copper toad tends to hang out near the waterways, but has been seen in other regions from time to time.

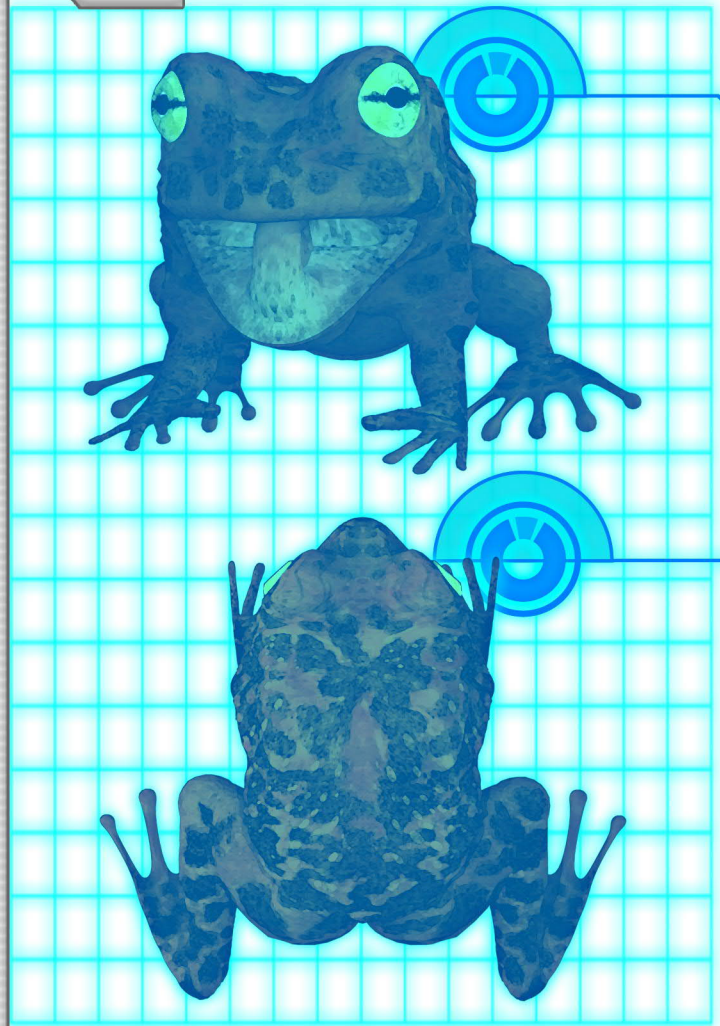

DEER, BUCK

Frequency: Common

Appearing: 1d4

Lair Occupation: 1d4

Hit Dice: 2d6

Armor Class: 8[12]

Attacks: Horns (1d6 damage), Trample (1d4 damage)

Saving Throw: 16

Special: Heightened Smell (+2 to detect as long as downwind)

Move: 14

Alignment: Neutrality

Challenge Level/XP: 2/25

Panz Value: 25

Special Treasure: N/A

On most of the Terran colonies, deer have been introduced into the wilderness in large numbers; partly because if there is something dangerous to Terrans, it will most likely attack deer first and secondly because deer are one of the primary meat sources on standard colonies. In order to protect the deer population overall, the Science Guild grew tougher males that could drive off predators. While not aggressive to Terrans, these 'bucks' have been known to get nasty around unwanted company in the wild. Bucks are highly defensive and protective of their herds. Their antlers have been known to dent transports and they have trampled dolls into pieces. Still, most are passive enough under optimal conditions, that bucks are regularly grown to protect the food chain.

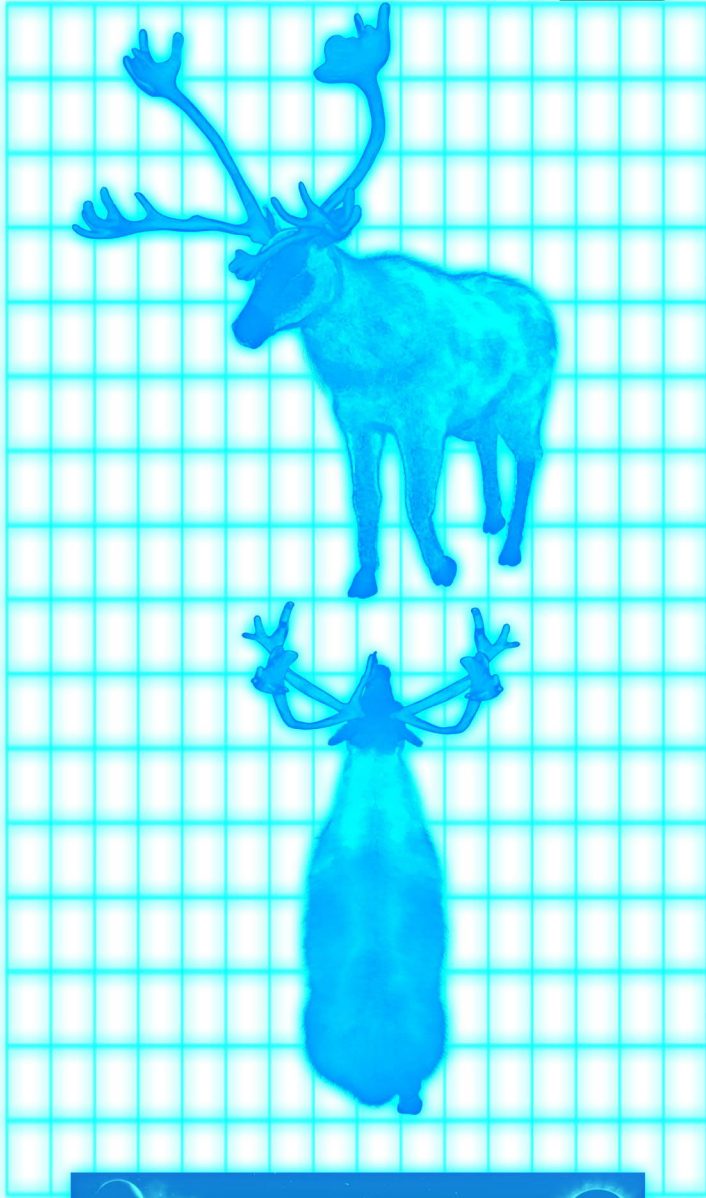

FLY, BARK

Frequency: Uncommon

Appearing: 1d4

Lair Occupation: 1d4

Hit Dice: 1d6

Armor Class: 8[11]

Attacks: Sonic Bite (1d4 damage, stun)

Saving Throw: 14

Special: Taint of the Darkness (The Darkness can see through the eyes of the Bark Fly and communicate through it. People of Chaos alignment don't hear barking, but instead hear mumblings telling the person to do evil deeds.)

Move: 2 (ground), 12 (flight)

Alignment: Chaos

Challenge Level/XP: 1/25

Panz Value: 10

Special Treasure: N/A

Considered one of the weirdest creatures on Alus, the Bark Fly spends its days flying around and appearing to bark at people. Only around six inches long, this fly has a mouth that almost appears humanoid and it constantly barks. When threatened, the bark of Bark Fly becomes high pitched enough to actually damage flesh and machine. The Science Guild has yet to determine if the fly is native to Alus or not, because similar flies have appeared on Xandorian system colonies and outer system colonies. There is no insect like the Bark Fly recorded in any of the Terran Empire databases and the only thing remotely close are drawings that were discovered in dozens of aliens ruins across the known galaxy. It is said that the Bark Fly also causes insanity and that the truly deranged hear voices and not actual barking. The Clonora hate Bark Flies with a passion because the creatures give off a 'dark' vibe.

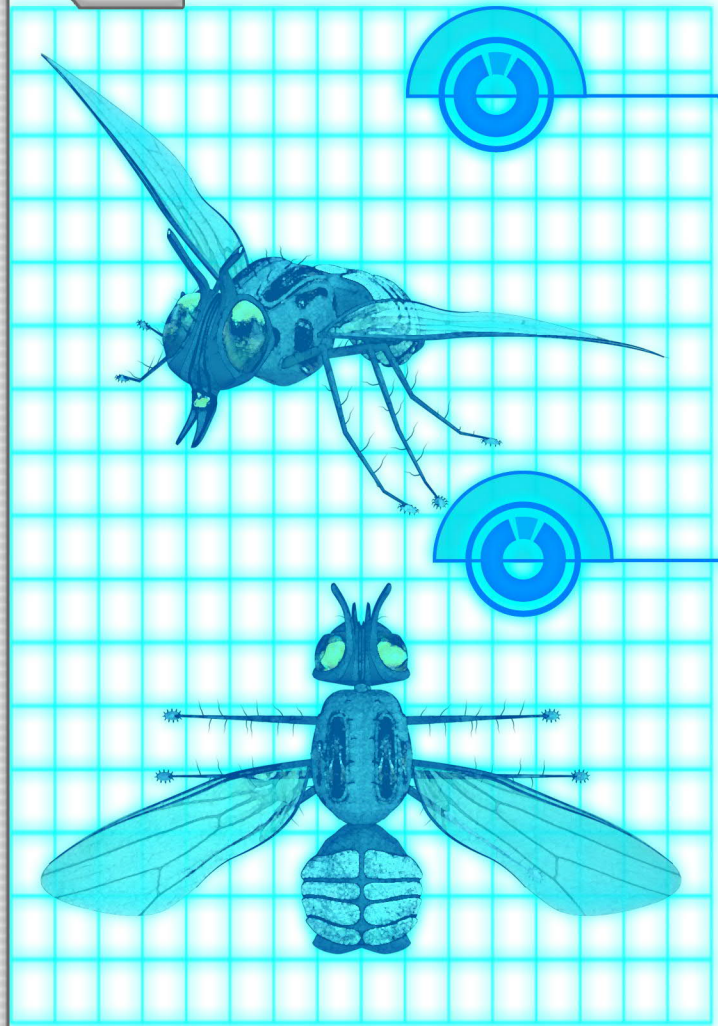

MANTIS, ALUS

Frequency: Uncommon

Appearing: 1d4

Lair Occupation: 1/2

Hit Dice: 2d6

Armor Class: 3[16]

Attacks: Crushing Claws (1d8 damage)

Saving Throw: 16

Special: N/A

Move: 5 (ground), 18 (flight)

Alignment: Chaos

Challenge Level/XP: 2/45

Panz Value: 100

Special Treasure: N/A

This mantis, native to the planet Alus, was once one of the dominant insect forms on this alien world. But after the Terran Empire terraformed the planet, the mantis found it harder to survive in such large numbers. The mantis is approximately ten feet tall with a wing span of around eight feet wide. While not exactly evil, it is a hostile predator that lays in waiting or swoops in from above, grabbing prey with their powerful claws and crushing their food. It then sucks out all the fluids from the neck. A mantis nest is easy to identify because there are usually mountains of skulls at the outer perimeter. In recent months more and more Alus mantises have appeared in the colony. Some feeding on the giant colony wasps and others eating deer and swine, with only one actual case of a Terran being killed by one.

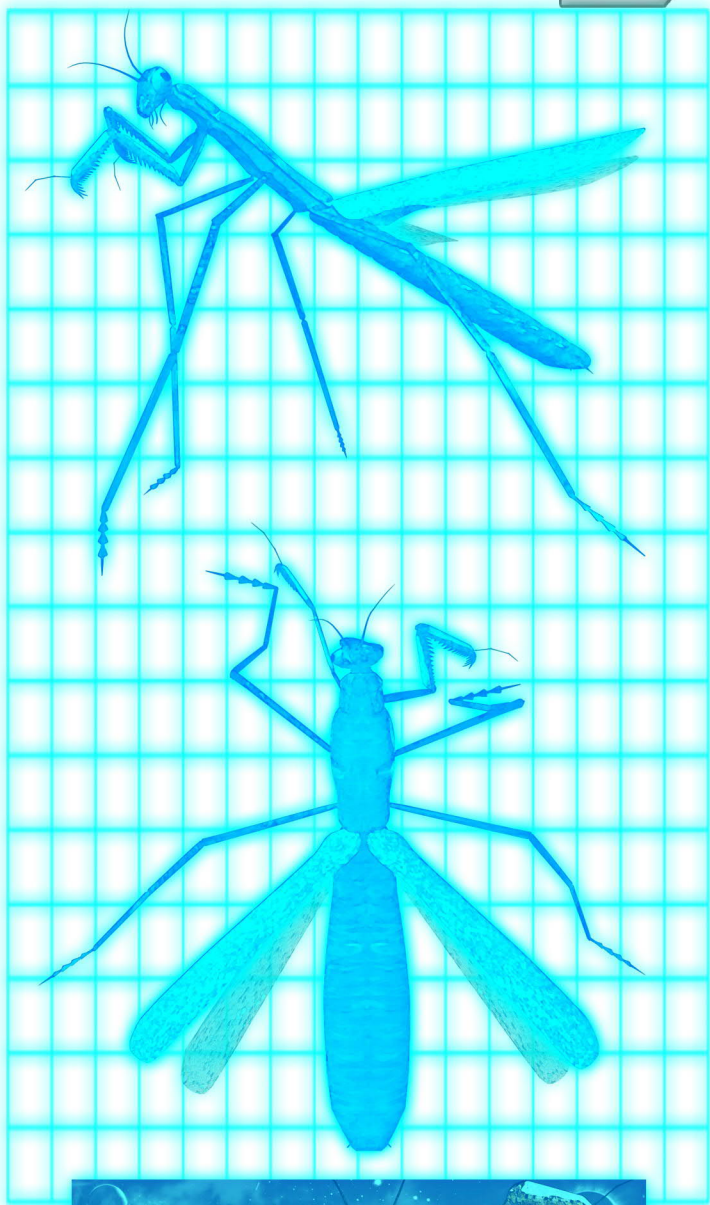

MITE WORM

Frequency: Rare

Appearing: 1

Lair Occupation: 1

Hit Dice: 4d6

Armor Class: 4[15]

Attacks: Tor-Lo-Grou (5 damage, 25 strength), Bite (1d6 damage)

Saving Throw: 14

Special: Sense vibration (+10 to detect movement through vibration), Burrow (travels through soft earth, but may not pass through rock or hard materials)

Move: 5 (above ground), 14 (below ground)

Alignment: Neutrality

Challenge Level/XP: 4/200

Panz Value: 200

Special Treasure: 1 in 6 chance of finding more panz (1d4x10)

The Mite Worm is a nasty native of Alus. These small worms (10 feet long, 1 foot in diameter) travel underground and surface when it's time to feast. They track their prey by following vibrations. The Science Guild believes that the Mite Worm is actually the young of the massive worms that roam the desert areas outside the colony. The guild is also fascinated by the fact that the Mite Worm is able to tap into a low level DRAW ability called Tor (wind based). There is no scientific explanation yet that explains this phenomenon. While not common within the Eppi colony, every now and then a Mite Worm pops up and the Protectors have to deal with it.

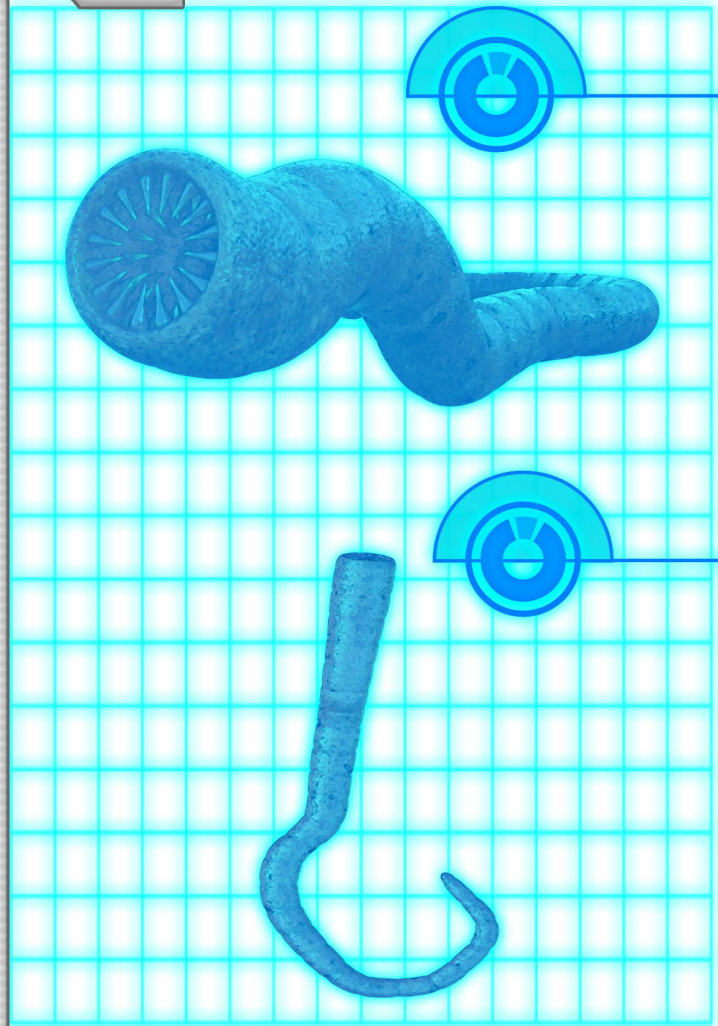

SPIDER, FOREST

Frequency: Uncommon

Appearing: 1d4

Lair Occupation: 1

Hit Dice: 2d6

Armor Class: 6[13]

Attacks: Bite (1d6 damage, poisonous)

Saving Throw: 16

Special: Webbing (10 hits, vulnerable to fire and lasers)

Move: 10

Alignment: Chaos

Challenge Level/XP: 2/30

Panz Value: 30

Special Treasure: Possible item of 50 panz value or less (Game Master's choice)

The origin of the Forest Spider is a mystery. There are no releases from the Bio-Plant that match the spider's makeup and genetics. There also isn't anything like the Forest Spider on record from the survey mission to Alus back before the days of the colony. But somehow this rather ugly spider emerged a few months after the colony was finally up and running. The Forest Spider is roughly four feet long and three feet wide and nests in forested areas where it lays its webbing and catches wildlife to eat. A nesting area covers usually around ten yards of ground space with random webbing up to twenty yards out from that. The Forest Spider doesn't seem to mate and doesn't reproduce, as far as the Science Guild can tell. It just exists and that is something that bothers many in the colony. What's worse is the Magistrate doesn't deem the Forest Spider a threat and will only order action being taken against them if it threatens basic colony life. The spider doesn't appear to be aggressive until a poor victim is caught in its webbing, and then it goes completely psychotic. A creature eaten by a Forest Spider looks as if they had been grudge brutalized a dozen times over, with parts strewn everywhere.

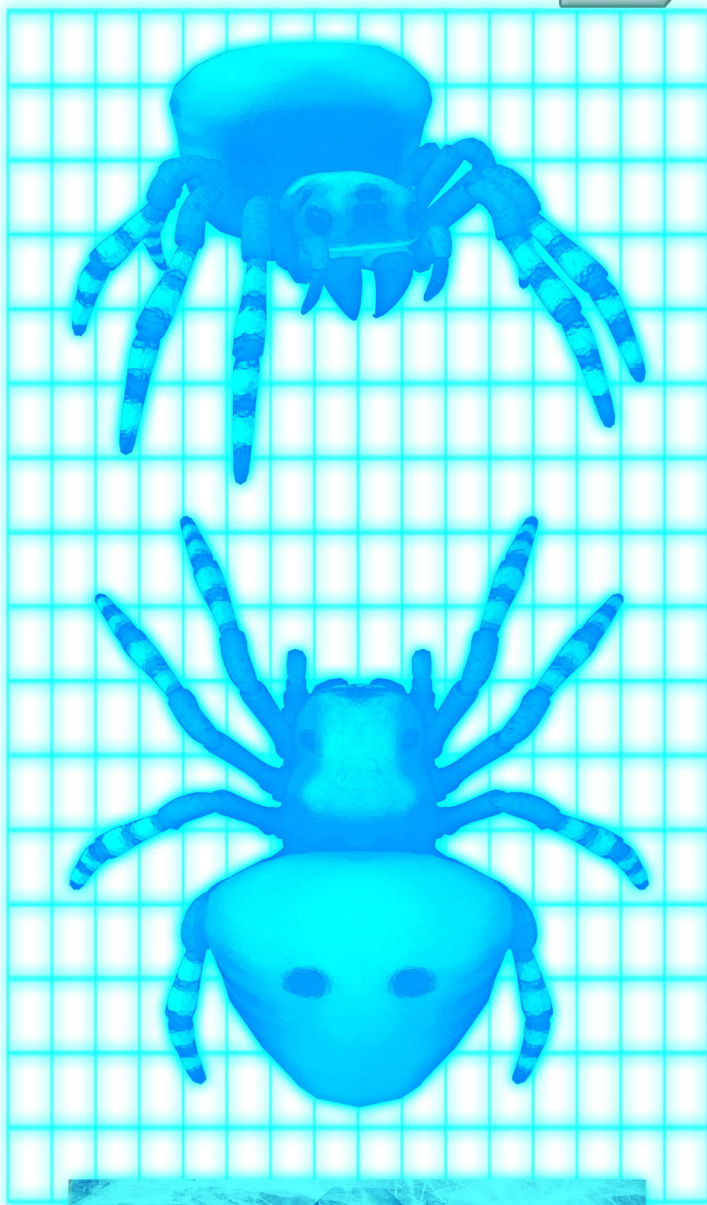

WART WORM

Frequency: Uncommon

Appearing: 1d4

Lair Occupation: 1d4x10

Hit Dice: 1d6

Armor Class: 9[10]

Attacks: Slim Slap (1d4 damage)

Saving Throw: 18

Special: Burrowing (able to move underground in soft soils)

Move: 5

Alignment: Neutrality

Challenge Level/XP: 1/15

Panz Value: 10

Special Treasure: N/A

Wart worms are native to Alus. These purple wart colored three foot long, six inches in diameter worms are notorious for eating plant life. In the early days of the colony, entire crops were wiped out by wart worm infestations. Eventually the Magistrate and the Protectors went on a massive extermination campaign and destroyed the primary colonies. So they thought. Wart worms can hibernate underground for up to a decade before giving birth to anywhere between 10 and 50 offspring. While not dangerous to wildlife, a wart worm can fling slime from its body at such a rate of speed it can break bones on impact. And if a wart worm kills an organic creature, it will make the carcass a nest. Most wart worms can consume five pounds of vegetable matter an hour. Waste materials from the worm are toxic to plant life and it's always clear when a wart worm has been in the area because anything green has turned putrid purple.

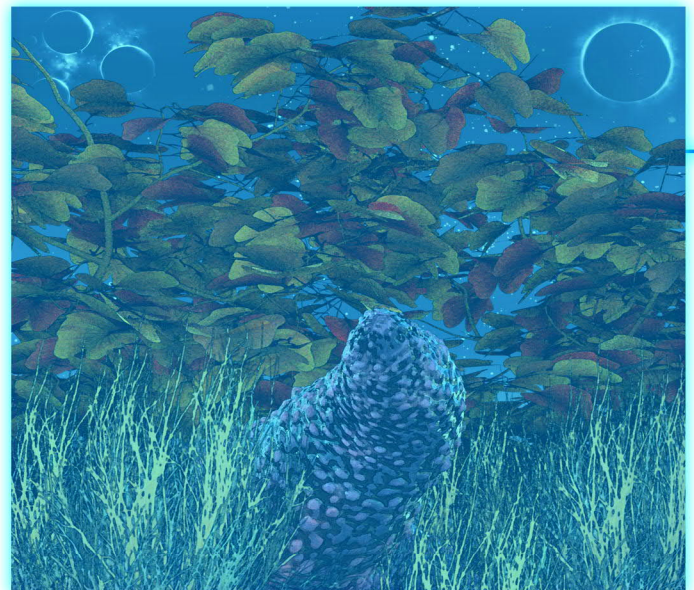
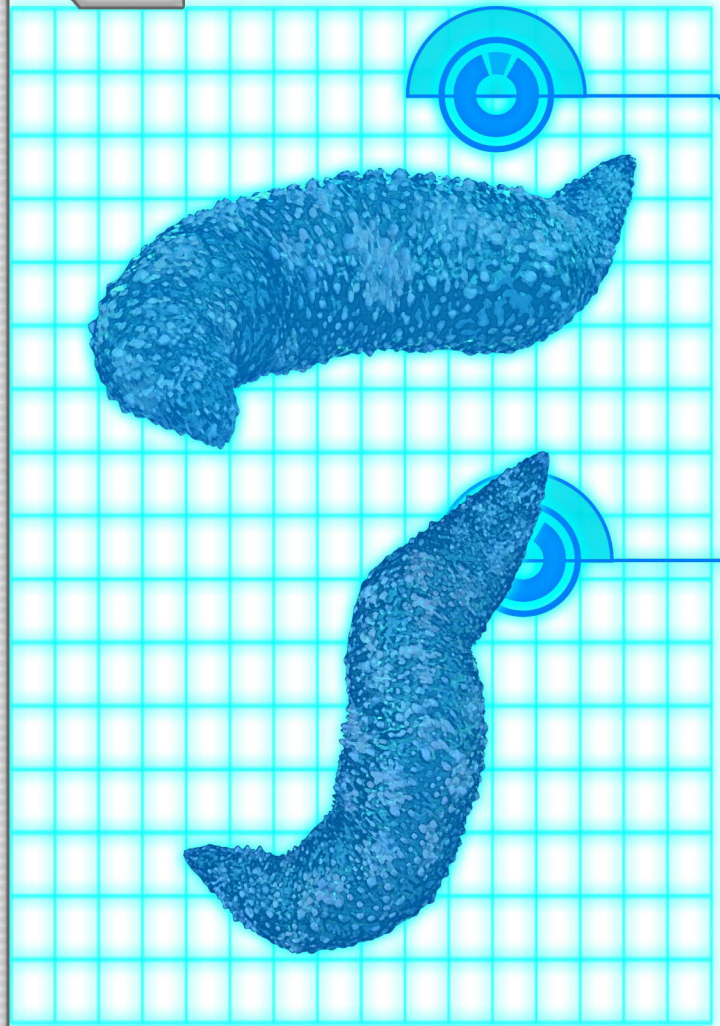



DOLL, SERVICE

Frequency: Common

Appearing: 2d12

Lair Occupation: 24

Hit Dice: 2d6

Armor Class: 6[13]

Attacks: Robot Brawl [1d4 punch, 1d4+2 kick]

Saving Throw: 12

Special: Immune to disease, gasses and toxins; Heat Vision [60ft], Enhanced Senses [+5 to all spot rolls]

Move: 12

Alignment: Law (under the control of the Magistrate, so alignment could change)

Challenge Level/XP: 2/200

Panz Value: N/A

Special Treasure: N/A

The Service Doll is a standard android type designed for service, be it in a lab or hospital. They are fully programmed with engineering skills, making them useful during emergencies when extra engineers might be needed. Service Dolls lack personality which tends to make people feel uneasy because the machine doesn't generate body language. But without Service Dolls, much of the Eppi colony would fall into disarray. Each Service Doll is powered by a micro fusion cell located in their chest (1d10x5 damage if exploded). At the end of each day the doll shuts down and hibernates, which prolongs the life of the battery. A fully charged micro fusion cell can keep a doll going for almost a year. While the Service Doll has basic programming, it may be commandeered by the Magistrate at any time. Colonists may purchase a Service Doll for a whopping 2000 panz.

***NOTE:** There are no manufacturing facilities for dolls on Alus. The current supply was left over from the initial terraforming of Alus and what was left behind by the Terran Empire. Current inventory of Service Dolls is estimated at 1000 inactive and 100 in service.

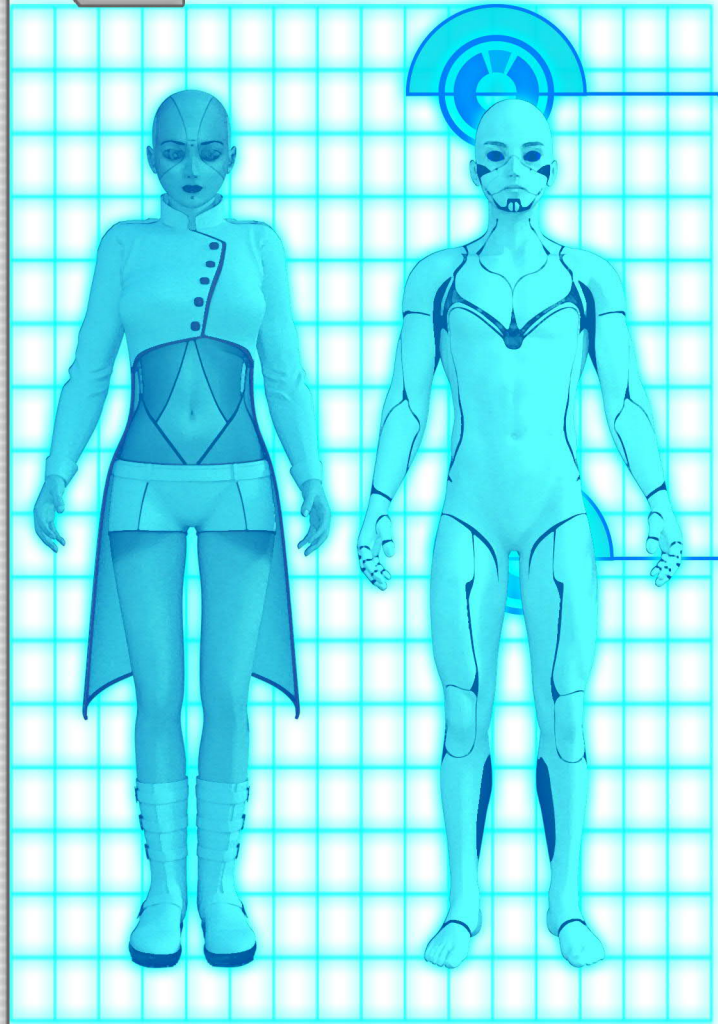

DOLL, PROTECTOR

Frequency: Common

Appearing: 1d4

Lair Occupation: 10

Hit Dice: 6d6

Armor Class: 3[16] Laser and Melee Damaged Halved (unless attacking weapon is Armor Piercing)

Attacks: Laser Rifle [2d8+8], 500ft RNG, 1 RoF, 100 Ammo; Commando Brawl [1d6 punch, 1d6+2 kick]

Saving Throw: 10

Special: Immune to disease, gasses and toxins; Heat Vision [60ft], Enhanced Senses [+5 to all spot rolls]

Move: 14

Alignment: Law (under the control of the Magistrate, so alignment could change)

Challenge Level/XP: 6/600

Panz Value: N/A

Special Treasure: White Card Key (Master key)

Protector Dolls are part of the military might of the Terran Empire. While there aren't many on Alus, there are still enough to defend the colony in case of an attack or insurrection. Most are stationed in critical areas around the colony. Protector Dolls are programmed for hand to hand combat and energy weapons. They struggle with melee weapons. The doll also has a series of military protocol skills which allows them to use heavy weapons and pilot vehicles. Each Protector Doll wears a Ceramic Combat Suit (CCS) and is armed with a standard laser rifle. Like the standard Service Doll, the Protector Doll is powered by a micro fusion reactor and may be controlled by the Magistrate at any time. The Protector Doll rarely has interaction with colonists unless on official business, even though there is at least one in every town.

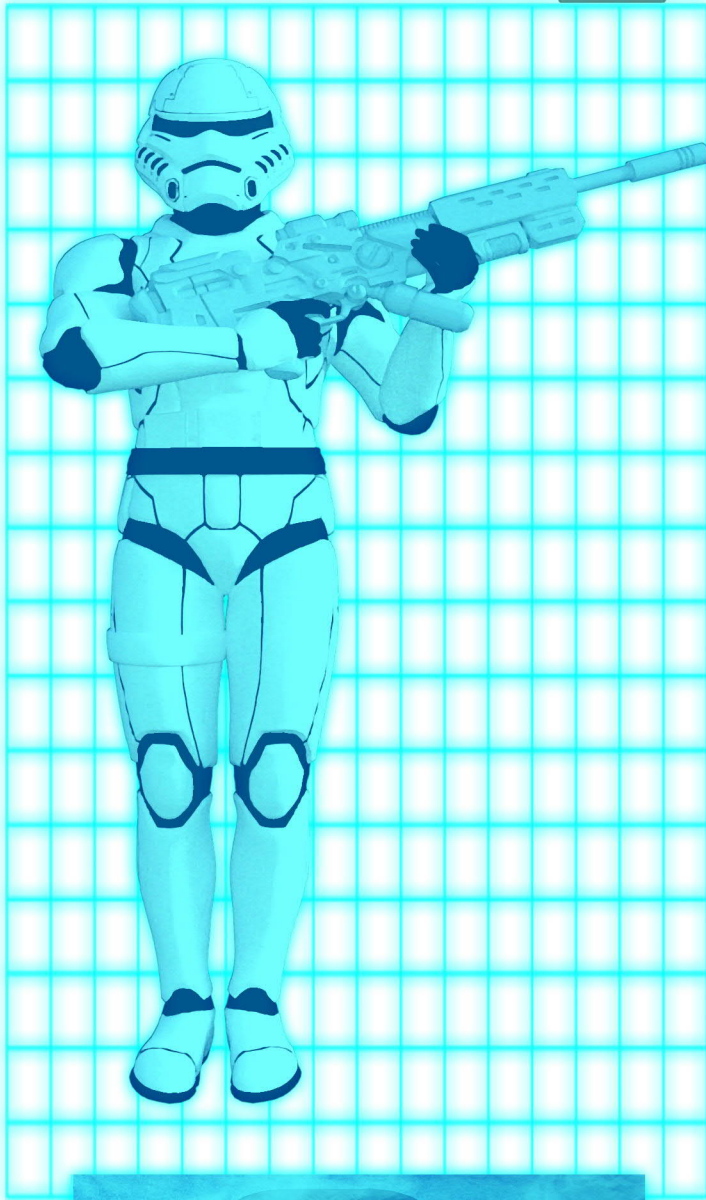

MINEBOTS

(Drilling and tunnel robots)

Frequency: Common (in the mines)

Appearing: 1d8

Lair Occupation: 10

Hit Dice: 5d6

Armor Class: 4[15]

Attacks: Claw (1d8+5), Laser Drill (2d10+5, Armor Piercing), Crush (1d12)

Saving Throw: 10

Special: Immune to disease, gasses and toxins; Heat Vision [60ft], Enhanced Senses [+5 to all spot rolls], Spotlight

Move: 6

Alignment: Law (under the control of the Magistrate, so alignment could change)

Challenge Level/XP: 4/400

Panz Value: 400

Special Treasure: 1d4 rare minerals (May be used to increase damage to a weapon or improve armor's AC. Needs a smith to do this.)

While not as sophisticated as the doll; the minebot makes up for it with its sheer strength and efficiency. Designed to work around the clock, this five foot tall robot comes equipped with everything needed to work in the mines. From its super laser drill to the rugged hydraulics that allows it to lift and carry far more than the standard machine, the minebot surpasses old school mining operators. It even has a storage compartment for materials that might need to be analyzed by the Science Guild. The minebot has a basic intelligence and programming, allowing it to operate independently from the Magistrate system while deep below the surface of Alus. There are currently 30 minebots in service at the colony, with 20 more in storage. Minebots work in shifts in order to make time for charging (takes 5 hours to charge).

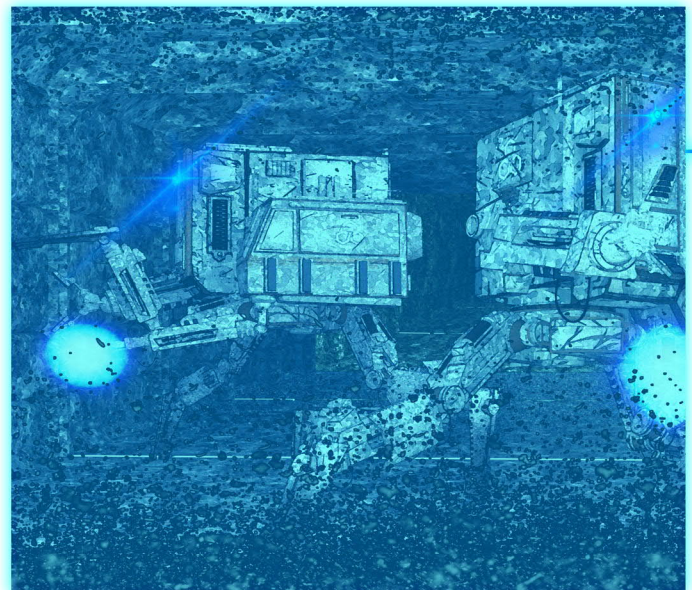
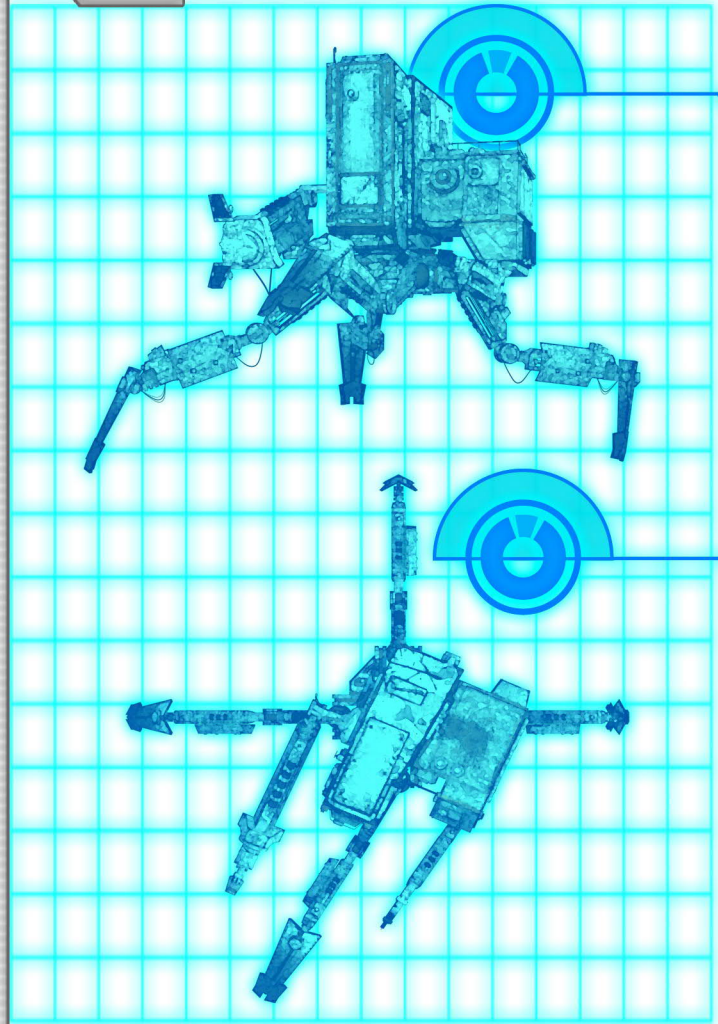

MINATORS

(Mining hauler robots)

Frequency: Common (in mines)

Appearing: 1d4

Lair Occupation: 4

Hit Dice: 8d6

Armor Class: 2[17]

Attacks: Ram (1d10+4 damage), Stomp (1d10)

Saving Throw: 14

Special: Immune to disease, gasses and toxins; Heat Vision [60ft], Enhanced Senses [+5 to all spot rolls], Spotlight

Move: 6 (walk), 20 (flight)

Alignment: Law (under the control of the Magistrate, so alignment could change)

Challenge Level/XP: 6/600

Panz Value: 600

Special Treasure: N/A

Minators are large mining haulers that bring materials out of the mines and deliver them for processing. While nothing to look at, this large robot can haul over 20 tons an hour and only needs to recharge once a day. This is why Minators work in shifts and rotate out of charging stations. In the mines the robot uses a set of legs to move around, but once clear of the mine, a large hover system engages allowing the minator to fly at a decent speed. The body of the minatory is made from super alloys making it one of the toughest transports on the colony. Like with other Terran made machines on Alus, the minator may be controlled by the Magistrate.

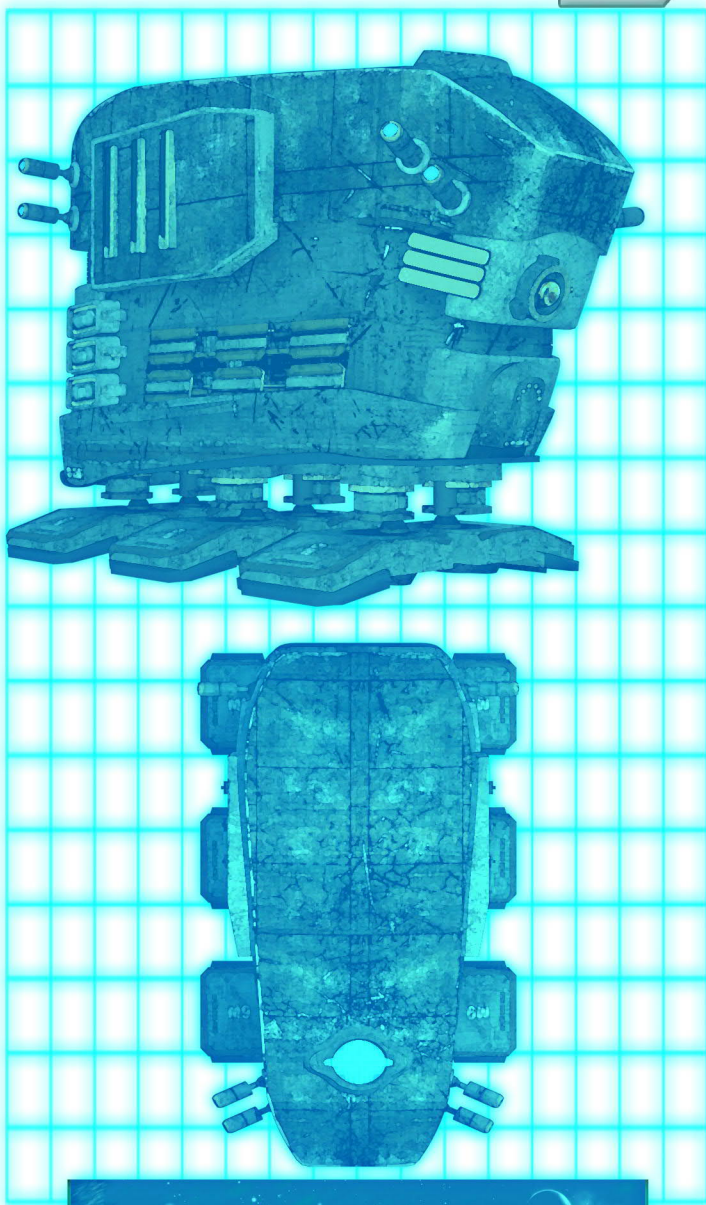

CLONORA ANGELITES

(DRAW Adept Warriors)
defenders of the cathedral

Frequency: Rare

Appearing: 1d4

Lair Occupation: 16

Hit Dice: 4d6

Armor Class: 3[16]

Attacks: Holy Blade of the Lightness (1d8+2 damage, pole-arm, Fi-Me which appears as a purple flame, +4 to attack roll when using blade)

Saving Throw: 14

Special: Clonora abilities, Martial Master (for every successful hit, the Angelite may have a free follow up attack and may do this up to 3 times).

Move: 16

Alignment: Law

Challenge Level/XP: 5/500

Panz Value: N/A

Special Treasure: Holy Blade of the Lightness (useable ONLY by Clonora, the DRAW ability of this weapon uses the DRAW of the wielder)

When the Clonora were originally grown, they were thought to be incapable of aggression and violence. And that was true for the first few generations. But when the Order of the Lightness emerged, the Clonora realized that their days could be numbered if the Terran Empire deemed the genetically engineered race obsolete. So a plan was hatched and a deviation was introduced to the Clonora growth cycle, one that would allow them to be capable of defending themselves if the time ever came. The Clonora of the Science Guild began adjusting the seed growth cycles of certain Clonora which gave birth to a small army of combat ready Clonora. These special Clonora were then shipped off to be trained by Terrans who were sympathetic to the genetically engineered race (partly due to interbreeding between the two races). Trained to be devotees of the Lightness and deadly martial combatants, the Clonora Angelites were charged with defending the leadership and secrets of the Order of the Lightness. On Alus, they made the Cathed-

ral their base of operations. It is here that they spend most of their days, rarely surfacing to do business with Terrans. The Angelites have also become cold to Terrans over all and feel that their creators are a 'lesser' species that serves no real purpose. This is why they have no problem killing any colonist who would dare enter the holy Cathedral. Each Angelite is armed with a Holy Blade of the Lightness, a master crafted pole-arm that has been imbued with Fi-Me DRAW energies. In combat the blade glows purple and the flames it casts are of the same hue. The Angelite is a master of martial arts and can hold their own against both Terrans and dolls. They are so blindly devoted to the Lightness that they can't accept anything else past their teachings. Even Clonora of the Science Guild struggle when dealing with these radicals. The Angelite will stand in waiting before striking, which can be unnerving when trying to sneak around the Cathedral, because the Angelites almost appear out of nowhere. Outside of this, they are physically no different than regular Clonora and must eat and sleep just like everyone else.

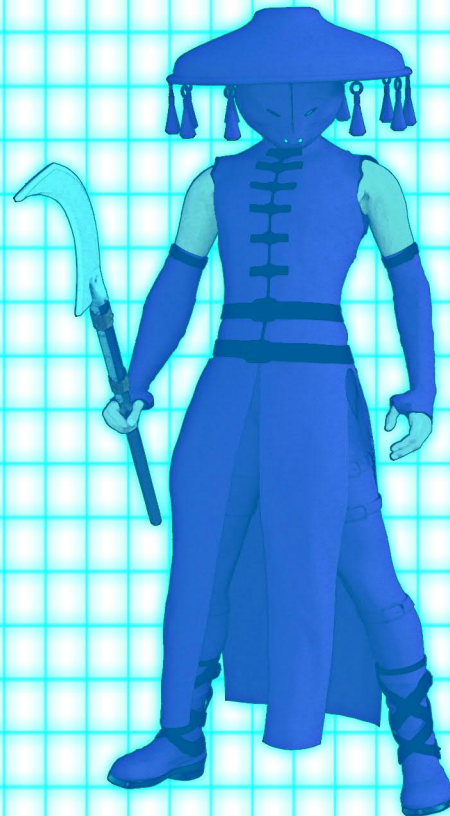

HARVESTER DRONES

Frequency: Common (in greenhouse)

Appearing: 2d10

Lair Occupation: 30

Hit Dice: 1d6

Armor Class: 8[11]

Attacks: Pinching Grip (1d4 damage)

Saving Throw: 18

Special: Immune to disease, gasses and toxins; Heat Vision [60ft], Enhanced Senses [+5 to all spot rolls], Spotlight

Move: 14 (hover ONLY)

Alignment: Law (under the control of the Magistrate, so alignment could change)

Challenge Level/XP: 1/25

Panz Value: 50

Special Treasure: N/A

Probably one of the most harmless of all the machines on Alus, the harvester drone has one purpose: harvest. Programmed to work in the Rayopa Greenhouse, these little robots are the backbone of the food supply chain on the colony. They spend their entire day flying around harvesting vegetation and bringing it to be shipped or processed. The robot also helped replant garden sections. Each harvester drone is programmed in agriculture and horticulture and comes equipped with a pack that has both pesticide and watering features. The robot can talk, but conversation is limited to plants and growth of plants. Harvester drones work in shifts in order to allow for charging. There are usually 10 drones running at all times, with up to 20 during bigger harvests. There are 80 harvester drones total on Alus. The drone never leaves the greenhouse area.

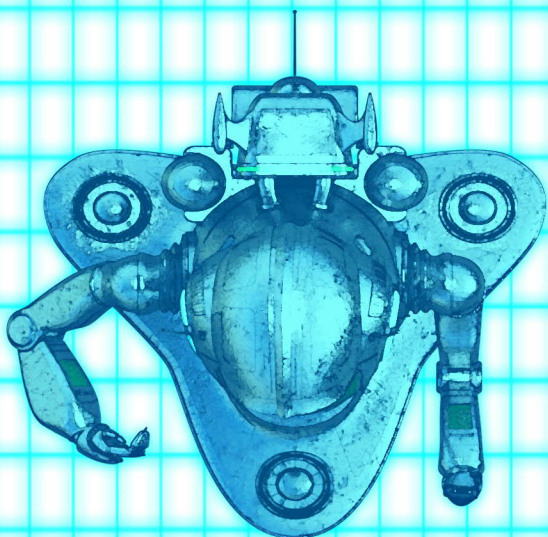
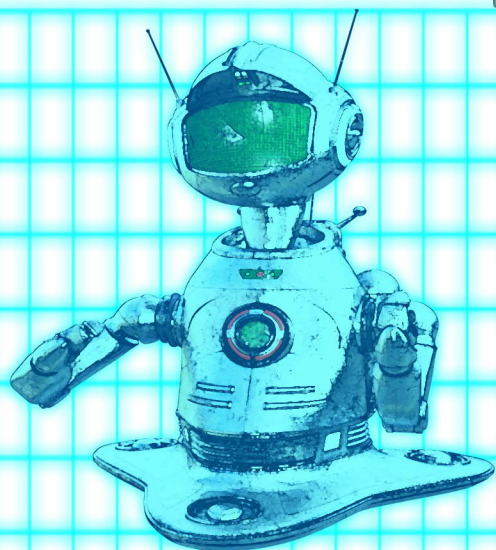

MUTARDS

Frequency: Uncommon

Appearing: 1d4

Lair Occupation: 1d4

Hit Dice: 3d6

Armor Class: 5[14]

Attacks: Claws (1d8 damage), Bite (1d6 damage)

Saving Throw: 15

Special: Night Vision (65'), Enhanced smell (+5 when tracking prey), Radioactive touch (saving throw required or suffer 1 point of damage per day until dead, may be treated and cured at a hospital), Contagion (saving throw required or victim slowly has a craving for flesh and a need to be near radiation, full process takes 1 week, may be cured at hospital, if victim dies while infected, their clone will have the same mutation problem).

Move: 10

Alignment: Chaos

Challenge Level/XP: 3/300

Panz Value: 200

Special Treasure: 1 in 6 chance of coming across 100 panz value or less item or weapon (Game Master's choice)

Mutards are the result of high dose radiation exposure caused by a shuttle crash in the early days of the Eppi colony. Once former residents, these creatures stalk the town of Terminus for prey and breeding. It's hard to tell anymore what is original and what is offspring, but one thing is for sure, mutards are meat eating monsters that have no regard for laws or people. The average mutard is about 6 feet tall and a hulking mass of muscles, teeth and claws. They will bite, claw and smash anything they find worth eating unless they can breed with it, in which case they won't waste any time getting down to business. The Magistrate has been approached on more than one occasion by the colonists who want the mutards wiped out, but due to unknown variable and the real numbers of mutards in existence, no action has been taken. Mutards rarely travel outside of Terminus. Some believe that the hangar bay below Terminus must be a massive breeding ground for the monsters, but no one is

willing to travel into the wasteland and find out. What is known for certain is that mutards can see in the dark and they have an acute sense of smell that is used to hunt prey. They also secrete a radioactive slime that they leave on their victims.



ANDROID POLICE, SILVER

Frequency: Common (Located in any of the automated facilities on the Eppi colony)

Appearing: 1d4

Lair Occupation: 10

Hit Dice: 6d8

Armor Class: 5[14]

Attacks: Punch (1d6)

Saving Throw: 12

Special: Stun Ray: victim must make a save or be paralyzed for 1d4 turns. Electrical attacks (EE) do double damage against androids.

Move: 12

Alignment: Chaos

Challenge Level/XP: 6/90

Panz Value: 180

Special Treasure: Androids usually carry 1d4 Healing Fluids.

These are the standard colony facility police androids. They are programmed to protect the machines that run the colony and make sure that wildlife doesn't damage any of the systems. Silver android police are armed with stun beams. Once their target is incapacitated the androids will take the suspect into custody for interrogation.

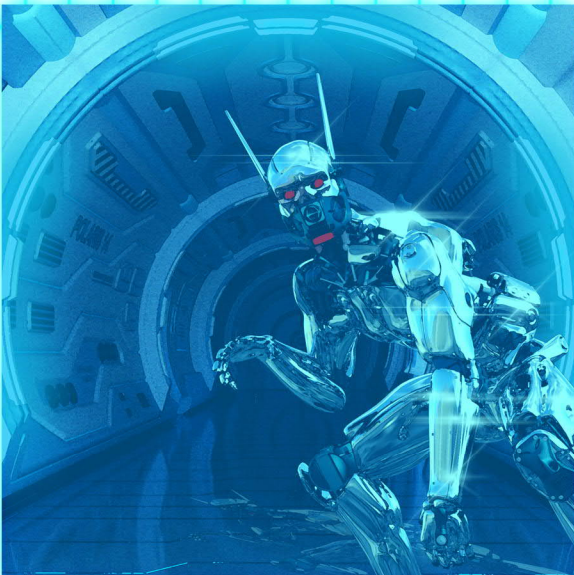
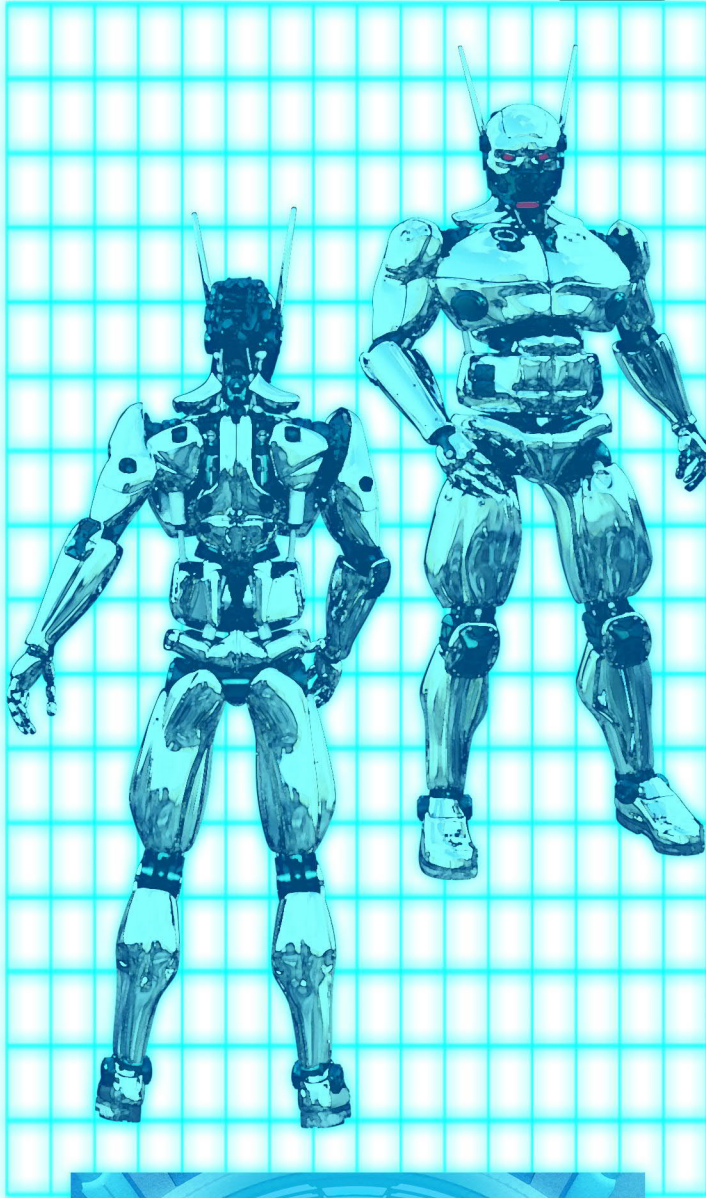



AGENT MISSIONS

Each town in the colony has an 'Agent Station' where agents can go to see if there are missions available. This station is a simple touch screen monitor with voice interface. The agent states their name and the Magistrate scans the speaker to make sure that they are who they say they are. Once the security scan is complete, the agent may access the mission menu. Each mission provides an overview of the assignment and the reward value upon completion. After the agent has carried out the assignment, they return to the 'Agent Station' and file their field report. It is a crime to tamper with an 'Agent Station'. During emergencies the 'Agent Station' will provide information to colonists about what is going on and what they should be doing during the crisis.

Missions with a * next to them mean the mission may be played out multiple times (1d4 times) because the threat keeps coming back.

WANDERING OPTION

Agents may choose to wander the land looking for encounters to level up. These are usually training missions. Roll 1d10 while 'wandering'

- 1-Bandit
- 2-Boar
- 3-Colony Wasps
- 4-Copper Toad
- 5-Deer, Buck
- 6-Fly, Bark
- 7-Mantis, Alus
- 8-Mite Worm
- 9-Spider, Forest
- 10-Wart Worm

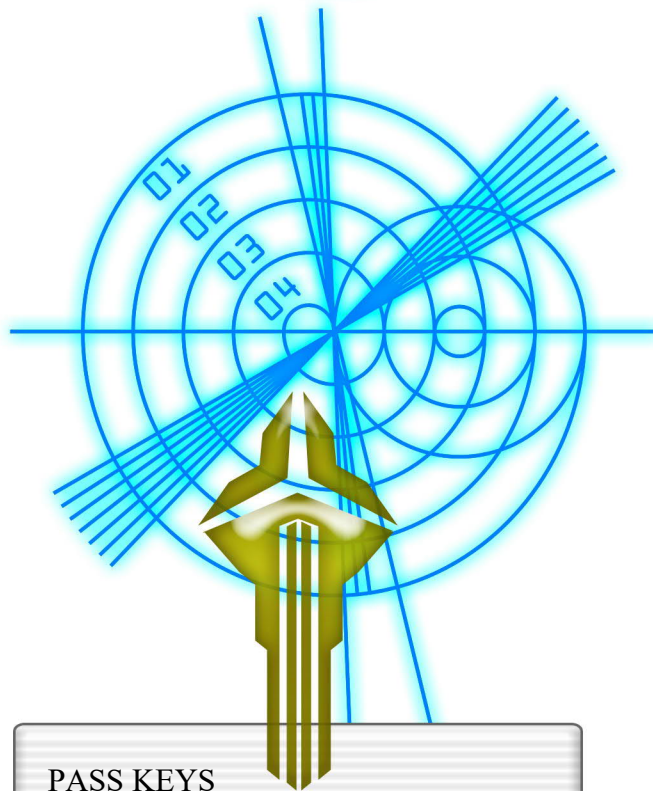
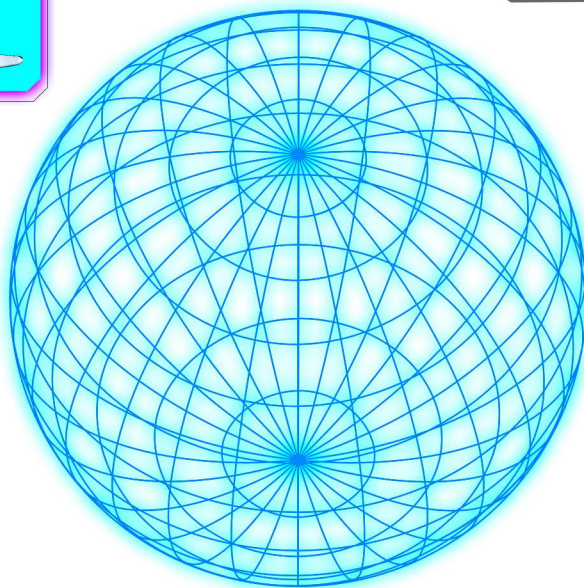

PASS KEYS

- 'BLUE': Protector ONLY access
- 'GREEN': Rayopa Greenhouse
- 'ORANGE': Agriculture facilities
- 'PURPLE': Terminus shuttle bay
- 'RED': Atmosphere Control Tower
Key, Dam
- 'WHITE': Science Guild Facility's
Key, Bio-Plant, Dam release
- 'YELLOW': Agent general access

*RAYOPA: Wart Worm Issue

MISSION: Remove Wart Worms from local farmlands.

DATA: Farmers outside of the town of Rayopa have reported Wart Worms eating up their crops. They have requested an agent to come clear the pests out.

REWARD: 10 panz per Wart Worm, 100 panz upon completion

***GAME MASTER DETAILS:** The lands surrounding Rayopa are test farmlands. Locals have set up small huts around the town and have begun test crops to see what they can grow. The contact person is Munson, a Terran agricultural engineer. When the agents arrive at Rayopa (or if they were already there) they will meet with Munson, who will point out a few areas where the Wart Worms have been popping out (just north and slightly off to the west). He explains the worms mostly appear at night. He also mentions that one of their cows has gone missing, but no one dares go look for it because of the Wart Worms.

Wart Worms: There are 11 worms total, which appear in batches of 1d4 (until they are all killed). They are easy to track because of their slime that is lethal to plants. The worms seem to originate from somewhere west of Rayopa.

The Cow: The body of the cow can be found just before the mountain barrier. It's bloated and slightly decomposed. The ground around it is slimy and an awful smell is coming from the corpse. Closer examination will show the belly of the cow is moving, as if something might be inside. Anyone who gets within 5 feet will be surprised by a Wart Worm that pops out of the cow's rear. Seconds later 1d6 baby Wart Worms will gush out (HP and damage from these worms is HALFED).

Mission Completed When: ALL Wart Worms are dead and agents report back to Munson.

*RAYOPA: Colony Wasp Problem

MISSION: Colony Wasps are trying to build a nest in one of the greenhouses. Eliminate wasps.

DATA: Harvester drones have reported the presence of Colony Wasps inside one of the greenhouses. The insects are trying to build a nest near one of the ventilation units. If they succeed, it will cause the ecosystem inside that greenhouse to fail.

REWARD: 10 panz per Colony Wasp, 100 panz upon completion

***GAME MASTER DETAILS:** The greenhouse operations are mostly automated. Because harvester drones are so valuable, the Magistrate has sent Agents to clear out the problem. The greenhouse's ecosystem must not be disturbed, which is why pesticides can't be used against the insect. The greenhouse in question is located in the south east block of Rayopa. Luckily the greenhouse is one large open space home to apple trees and wheat. Trees line the sides and the wheat is located in the center. The greenhouse uses a watering cycle that floods the floor of the greenhouse once a day, up to three feet deep. The vent that the Colony Wasps are clogging up is located on the south eastern most walls near the ceiling. Engineer Marlo will meet with the Agents and explain the situation better. The wasps first showed up last week. At first it didn't seem like much of an issue, but a harvester drone got attacked later in the week and that's when he knew it was time to call for help. He explains that the wasps are more active during the day and get riled up during the watering cycle. Marlo tried to drive them out by opening the roof, but that just attracted more. He thinks it might be the smell of the apple blossoms. If the vent were to be clogged, the system would overheat and the plant-life inside would die quickly. It could also create a cascade effect through all of Rayopa, blowing out other systems. Once the wasps are dealt with, Marlo plans on installing a better ceiling grid to keep Colony Wasps out.

Colony Wasps: There are 5 total. They will emerge one at a time and swarm whoever kills one of them first.

Mission Completed When: All Colony Wasps are killed.

RAYOPA: Bandits

MISSION: Stop the bandits.

DATA: Bandits have been mugging travelers from Rigel. Until further notice all bridges have been locked and will require a card key to access the other parts of the colony. Agents have been dispatched in each sector to deal with the bandit operations.

REWARD: 50 panz per Bandit, 400 panz upon completion

***GAME MASTER DETAILS:** No one really knows who these bandits are. It is thought that they are part of a movement to shut down the Magistrate and return control to the Terrans. There have been no attacks on the town of Rayopa as of yet, but Engineer Marlo doesn't want to take chances. He's ordered a lockdown of the community until the bandits are dealt with. Two witnesses claim they saw the bandits head off to the eastern barrier wall after attacking.

The bandit camp has three bandits. It is nestled up against a cliff twenty feet up the barrier wall and has an overview of both Rayopa and the bridge to Rigel. There is only one way up and the bandits will drop boulders on anyone who tries to come up that way. The best option is to lure them out. Once the bandits are drawn out they will be easy to pick off. If all the bandits are killed, the mission is complete and the agent gets paid.

IF there is a survivor and that person is interrogated they will reveal that they had been an engineer working with the Science Guild, but they uncovered unauthorized experimentation going on in the Science Guild facility in the northwest of the colony. His family was killed in a freak accident and he managed to escape. The other bandits had similar situations. The

leader of the bandits is trying to expose some sinister scheme and rescue other families that were locked up because of an association with different engineers who had the same knowledge. After he reveals all this, a team of Protectors arrives and takes the man into custody...never to be seen again. If the agents inquire about what the man said, the Magistrate will agree to look into the claims.

Bandits: There are three bandits who will attack using teamwork. None will try and flee unless all of them are together.

Mission Completed When: All bandits are killed and agents report back to the Magistrate.

RAYOPA: Crazy on the loose

DATA: Engineer Marlo has reported that one of his engineers has gone missing just north of Rayopa. He requests agents go looking for him.

REWARD: 200 panz

***GAME MASTER DETAILS:** Karl Nox, an engineer with the Engineers Guild went missing last night. Farmers just north of Rayopa say that Karl has been attacking them at night. Karl has a wife, who will tell agents about her husband's recent claims that he was hearing voices. He was also kept a pet fly that was larger than a normal housefly and it looked terrifying. When she demanded he get rid of it, Karl trashed their home and ran north. Marlo wants the man found before he can do damage to the greenhouses. The area all around Rayopa is made of smaller little communities of farmers. The families just north of Rayopa have spotted Karl and in some cases have been attacked. Two farmers have already been maimed and required a medical evac.

Karl remains hidden in the wooded area just north of the farms. He's easy to track because the grass is all packed down from his back and forth trips. He can be found during the day sitting under a tree talking to a rather large housefly looking creature (SEE Bark Fly). Karl appears to be talking to it. The conversation is

one sided, but most of it is about how he needs to kill in order to be free. Karl seems to be struggling with the discussion because he really doesn't want to kill. More observation suggests that maybe the fly is telling him to kill, or at least that's what Karl thinks. When confronted, Karl will attack almost ruthlessly. If he is captured, the fly will buzz next to him and let off an ear-busting chirp that will kill Karl. If Karl is killed by the agents, then the fly will attack them.

If the agents wait for Karl to come out at night, he'll be doing pretty much the same thing as above, but walking while he does it. He'll also react the same, so will the fly.

Bark Fly: It will stay out of the fight until Karl is defeated or dies. It attacks with a high pitched chirp that is loud enough to burst ear drums. Upon closer examination of the fly the agents will see a strange humanoid mouth on the fly. It might be wise for them to bring it back for the Science Guild to inspect.

Bandit: Use the Bandit stats for Karl. He'll fight like a crazy man, with no real tactic. He's just keep screaming "Must kill, must kill" over and over.

Mission Completed When: Karl and the Bark Fly are defeated. Any inquiries about the fly will be met with silence from the Magistrate, who will just reply "The Science Guild will handle the situation from here."

*RAYOPA: Toadaster!

MISSION: Locate the Copper Toad and terminate it

DATA: A copper toad has been spotted just north of Rayopa, by the river. It has been attacking fishermen. This is causing a disruption in the fish supply chain.

REWARD: 250 panz

***GAME MASTER DETAILS:** The same village that took a beating from Karl is now suffering from attacks by a copper toad that has

decided to set up shop by the fishing dock just northwest of Rayopa. The area around the dock isn't very large. When the fishermen fish; they simply extend the structure part way out onto the river and lower nets. The fish then get caught up and the fishermen pull the nets. The last time they went out on the dock, the copper toad emerged and attacked. Since then it has been camped out eating the fish. The dock requires an 'orange' card key to use. One of the fishermen will accompany the agents to the waterfront and operate the dock and any machines needed.

The copper frog won't emerge unless the dock is extended. Then it will hop up and start lashing out at agents and anyone else who gets in its way as the toad begins to feast.

Copper Toad: Grouchy creature that is there to eat fish. It will use its tongue to attack and to eat. If the dock retracts, it will jump back in the water and stay hidden until the dock is moved back out.

Mission Completed When: Copper toad is killed and taken back to Rayopa for study.

*RAYOPA:

Death from above!

MISSION: URGENT: An Alus mantis is attacking Rayopa, take it out!

DATA: A rather large Alus Mantis is attacking the town.

REWARD: 500 panz

***GAME MASTER DETAILS:** A large Alus Mantis is camped out in the middle of the town causing havoc. People are running for cover as it lashes out trying to grab a meal. When the Agent goes to deal with it, another mantis will swoop down from the sky! It won't land, instead it will strafe for a meal. The trick is to lure the first mantis into an area that keeps the second from swooping in. Once the ground mantis is taken out, the agent can turn their attention to the flying one.

Mantis, Alus: The insect stands almost 20 feet tall and has long arms that make it difficult to

get close. The flying one is quick and only allows for one attack per pass. They are both big and could be tricked into tight spaces, making it hard for them to attack.

Mission Completed When: Both Alus Mantises are killed.

GAME MASTER QUICK BITS

GAME MECHANICS (Quick overview)

The basic mechanic for Swords & Wizardry is

Roll 1d20+Bonus

The basic combat mechanic is

Roll 1d20+Bonus+To Hit Modifier

The result must be higher than the defender's Armor Class (AC).

For Saves the player rolls 1d20 and must roll HIGHER than their Saving Throw number (found on the class table)

CHECKS

Xandoria Gaiden calls for Intelligence checks frequently. Simply roll 1d20 and the number must be equal to or LESS than the character's Intelligence Attribute.

For other checks, follow the same formula, but use the appropriate Attribute's number.

COMBAT ROUNDS

Xandoria Gaiden uses the same basics as Swords & Wizardry when it comes to Initiative and Order of Combat.

Step 1: Check for Surprise

Step 2: Declare DRAW use intent

Step 3: Determine Initiative (Roll 1d6 for each side, then let players choose who goes first)

Step 4: Movement and Missile Fire (shooting attacks)

Step 5: Melee Combat & DRAW use

Step 6: End of round

BONUS/PENALTY

Be it surprise attacks or bad weather, there might be a need to add or subtract from a roll. Use the benchmarks below to determine what should be used.

+5 Ridiculous advantage

+4 Sheer lucky advantage

+3 Lucky bastard advantage

+2 Got the edge

+1 One second quicker

+0 Nadda

-1 One second too slow, semi difficult

-2 Lacking the edge, a little more difficult

-3 Surprised, rough situation

-4 Were you sleeping? Extreme situation

-5 You were already dead, so why roll? Ridiculous situation

TECHNOLOGY

Citizens of the Terran Empire have a basic understanding of technology. But there are also specialists that have an even better understanding. These are explained for Game Masters in terms of rankings:

Rank 0-Primitive

Rank 1-Intelligence of 1-5, early child mind

Rank 2-Intelligence of 6-8, child mind

Rank 3-Intelligence of 9-11, adult with basic education

Rank 4-Intelligence 12-14, adult with some formal training in the engineering or the sciences

Rank 5-Intelligence 15-18, adult with formal training in engineering or the sciences

Rank 6-Intelligence 19-22, adult with superior understanding of engineering or science

Rank 7-Intelligence 23+, AI superiority, Other-worldly being

Keep in mind that the Ranks are the level at which the technology is complex.

DEATH

Characters are going to die. The great part about Xandoria Gaiden is that they may either be revived using DRAW abilities or technology. And if they get wiped out totally, a dead character may be cloned. Use the cloning option for PCs ONLY unless an NPC's return is vital to the story.

STARTING CHARACTERS OFF

Game Masters should supply at least one level 5 mentor to assist the PCs. This NPC should act as a teacher, allowing the new hero to do most of the work.



YIMR

Class: Agent
Alignment: Law
Race: Terran
Age: 30

Hit Points: 19
Saving Throw: 10
Armor Class: 3 [16]
Combat Bonus: +5 to hit, +3 damage
Dance Moves: 3

Ability Scores

Strength: 19
Dexterity: 15
Constitution: 13
Intelligence: 15
Wisdom: 13
Charisma: 12
Racial Abilities: N/A

Equipment: Sword (1d8), Ceramic Vest -4 [+4], Healing Fluid (4), Cure Shot (1)

DATA

Yimr is a 3rd generation agent with the Terran Empire. Her father was part of the original task force assigned to clear land for the Eppi colony. He went missing when Yimr was only two and she has dedicated her life to following in his footsteps and discovering what happened to him. She has worked hard and has earned a reputation as a skilled agent who knows her stuff. Because she is so inquisitive, the Magistrate has assigned her to mentor duty for up and coming agents. When it comes to rookies, Yimr is tough. She doesn't tolerate slackers and has no patience for stupid people. Every now and then she needs to be reminded that agents are there to serve the Magistrate and the good of the colony. Yimr is skilled with a sword and has no problem showing off those skills when necessary. She was raised in Rayopa and has good relations with the people there. She understands agriculture and the need for the greenhouses. Yimr has a slight distrust of Clonora and their DRAW abilities, which might be due to a possible connection between her father's disappearance and the Order of the Lightness.

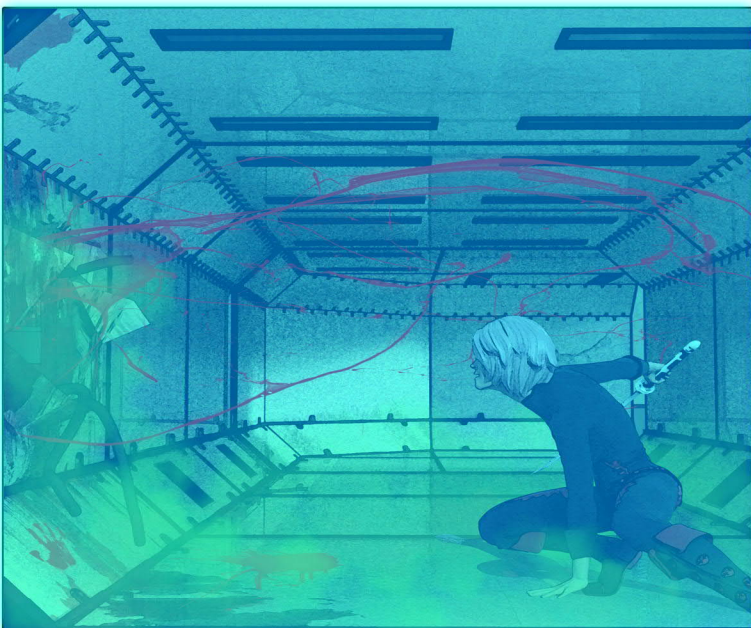

NAME: _____ ALIGNMENT: _____ AGE: _____

RACE: _____ GENDER: _____

PRIME
ATTRIBUTES

CLASS: _____ LEVEL: _____

ABILITY SCORES

**ATTRIBUTE
BONUSES**

STRENGTH []

TO-HIT-MOD
(STR) _____

INTELLIGENCE []

OPEN DOORS
(STR) _____

WISDOM []

DAMAGE BONUS
(STR) _____

CONSTITUTION []

CARRY MODIFIER
(STR) _____

DEXTERITY []

SHOOTING TO HIT
(DEX) _____

CHARISMA []

ARMOR BONUS
(DEX) _____

SAVING
THROW []

HIT POINT BONUS
(CON) _____

BASE HIT
POINTS []

RAISE DEAD
SURVIVAL (CON) _____

EXPERIENCE
BONUS _____

EXPERIENCE POINTS _____

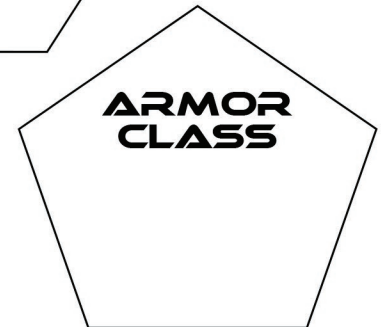
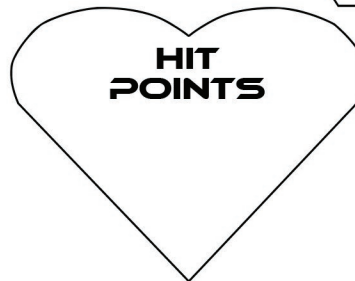
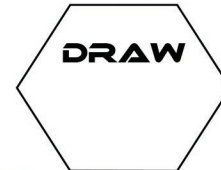
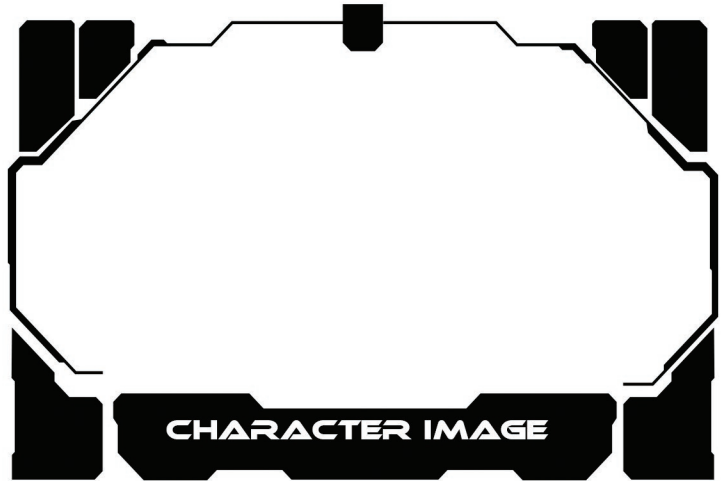

RACIAL BONUS

WEAPONS	DAMAGE	RANGE

CLASS ABILITIES

DANCE MOVES []

DRAW

ARMOR	AC BONUS

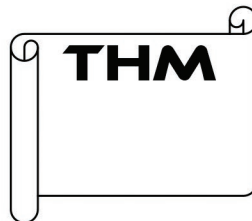

PANZ & TREASURE
PANZ: _____

OTHER: _____

ITEMS & EQUIPMENT

Open Gaming License

The following text is the property of Wizards of the Coast, Inc. and is Copyright 2000 Wizards of the Coast, Inc (“Wizards”). All Rights Reserved.

1. Definitions:

- (a) “Contributors” means the copyright and/or trademark owners who have contributed Open Game Content;
- (b) “Derivative Material” means copyrighted material including derivative works and translations (including into other computer languages), potation, modification, correction, addition, extension, upgrade, improvement, compilation, abridgment or other form in which an existing work may be recast, transformed or adapted;
- (c) “Distribute” means to reproduce, license, rent, lease, sell, broadcast, publicly display, transmit or otherwise distribute;
- (d) “Open Game Content” means the game mechanic and includes the methods, procedures, processes and routines to the extent such content does not embody the Product Identity and is an enhancement over the prior art and any additional content clearly identified as Open Game Content by the Contributor, and means any work covered by this License, including translations and derivative works under copyright law, but specifically excludes Product Identity.
- (e) “Product Identity” means product and product line names, logos and identifying marks including trade dress; artifacts; creatures characters; stories, storylines, plots, thematic elements, dialogue, incidents, language, artwork, symbols, designs, depictions, likenesses, formats, poses, concepts, themes and graphic, photographic and other visual or audio representations; names and descriptions of characters, spells, enchantments, personalities, teams, personas, likenesses and special abilities;

- places, locations, environments, creatures, equipment, magical or supernatural abilities or effects, logos, symbols, or graphic designs; and any other trademark or registered trademark clearly identified as Product identity by the owner of the Product Identity, and which specifically excludes the Open Game Content;
- (f) “Trademark” means the logos, names, mark, sign, motto, designs that are used by a Contributor to identify itself or its products or the associated products contributed to the Open Game License by the Contributor
- (g) “Use”, “Used” or “Using” means to use, Distribute, copy, edit, format, modify, translate and otherwise create Derivative Material of Open Game Content.
- (h) “You” or “Your” means the licensee in terms of this agreement.

2. The License

This License applies to any Open Game Content that contains a notice indicating that the Open Game Content may only be Used under and in terms of this License. You must affix such a notice to any Open Game Content that you Use. No terms may be added to or subtracted from this License except as described by the License itself. No other terms or conditions may be applied to any Open Game Content distributed using this License.

3. Offer and Acceptance

By Using the Open Game Content You indicate Your acceptance of the terms of this License.

4. Grant and Consideration

In consideration for agreeing to use this License, the Contributors grant You a perpetual, worldwide, royalty-free, non-exclusive license with the exact terms of this License to Use, the Open Game Content.

5. Representation of Authority to Contribute

If You are contributing original material as Open Game Content, You represent that Your

Contributions are Your original creation and/or You have sufficient rights to grant the rights conveyed by this License.

6. Notice of License Copyright

You must update the COPYRIGHT NOTICE portion of this License to include the exact text of the COPYRIGHT NOTICE of any Open Game Content You are copying, modifying or distributing, and You must add the title, the copyright date, and the copyright holder's name to the COPYRIGHT NOTICE of any original Open Game Content you Distribute.

7. Use of Product Identity

You agree not to Use any Product Identity, including as an indication as to compatibility, except as expressly licensed in another, independent Agreement with the owner of each element of that Product Identity. You agree not to indicate compatibility or co-adaptability with any Trademark or Registered Trademark in conjunction with a work containing Open Game Content except as expressly licensed in another, independent Agreement with the owner of such Trademark or Registered Trademark. The use of any Product Identity in Open Game Content does not constitute a challenge to the ownership of that Product Identity. The owner of any Product Identity used in Open Game Content shall retain all rights, title and interest in and to that Product Identity.

8. Identification

If you distribute Open Game Content You must clearly indicate which portions of the work that you are distributing are Open Game Content.

9. Updating the License

Wizards or its designated Agents may publish updated versions of this License. You may use any authorized version of this License to copy, modify and distribute any Open Game Content originally distributed under any version of this License.

10. Copy of this License

You MUST include a copy of this License with every copy of the Open Game Content You Distribute.

11. Use of Contributor Credits

You may not market or advertise the Open Game Content using the name of any Contributor unless You have written permission from the Contributor to do so.

12. Inability to Comply

If it is impossible for You to comply with any of the terms of this License with respect to some or all of the Open Game Content due to statute, judicial order, or governmental regulation then You may not Use any Open Game Material so affected.

13. Termination

This License will terminate automatically if You fail to comply with all terms herein and fail to cure such breach within 30 days of becoming aware of the breach. All sublicenses shall survive the termination of this License.

14. Reformation

If any provision of this License is held to be unenforceable, such provision shall be reformed only to the extent necessary to make it enforceable.

15. COPYRIGHT NOTICE

Open Game License v 1.0a Copyright 2000, Wizards of the Coast, Inc.

System Reference Document Copyright 2000-2003, Wizards of the Coast, Inc.; Authors Jonathan Tweet, Monte Cook, Skip Williams, Rich Baker, Andy Collins, David Noonan, Rich Redman, Bruce R. Cordell, John D. Rateliff, Thomas Reid, James Wyatt, based on original material by E. Gary Gygax and Dave Arneson.

Swords & Wizardry Complete Rules, Copyright 2010, Matthew J. Finch

END OF LICENSE