

# GAMMA WORLD

OUT OF THE VAULTS



**A Technology Sourcebook for the d20 System**



# GAMMA WORLD<sup>®</sup> OUT OF THE VAULTS

## **AUTHORS:**

**JAMES MALISZEWSKI**  
(INTRODUCTION, CHAPTER ONE,  
PARTS OF CHAPTERS TWO AND  
THREE), **JOHN R. SNEAD** (PARTS OF  
CHAPTERS TWO AND THREE).

**DEVELOPER:**  
**BRUCE DAUGH**

**MANAGING EDITOR:**  
**ANDREW DATES**

**EDITOR:**  
**ELLEN P. KILEY**

**ART DIRECTOR:**  
**MATT MILBERGER**

**GRAPHIC DESIGN:**  
**MATT MILBERGER**

**INTERIOR ARTISTS:**  
**STEVE BECKER, JEFF KOLT,  
LANGDON FOSS, TIM TRUMAN**

## **SPECIAL ACKNOWLEDGEMENTS**

**RULES MECHANICS BASED ON THE D20 MODERN™ ROLEPLAYING GAME BY BILL SLAVICSEK, JEFF GRUBB, RICH REDMAN, AND CHARLES RYAN, UTILIZING MECHANICS DEVELOPED FOR THE DUNGEONS & DRAGONS® GAME BY JONATHAN TWEET, MONTE COOK, SKIP WILLIAMS, RICHARD BAKER, AND PETER ADKISON.**

**CAMPAIGN SETTING BASED ON THE ORIGINAL GAMMA WORLD® DESIGN BY JAMES M. WARD AND GARY JACQUET, WITH ADDITIONAL DESIGN OVER THE YEARS BY DAVID JAMES RITCHIE, BRUCE NESMITH, ANDY COLLINS, AND JEFF GRUBB, AND CONTRIBUTIONS FROM TOO MANY PEOPLE AND SOURCES TO MENTION.**



# GAMMA WORLD<sup>®</sup> OUT OF THE VAULTS

## TABLE OF CONTENTS

<b>INTRODUCTION</b>	<b>3</b>
<b>CHAPTER ONE: LOSS AND RECOVERY</b>	<b>7</b>
Historical Ages	9
The Closing of the Vaults	12
Opening the Vaults	21
<b>CHAPTER TWO: TOOLS</b>	<b>24</b>
Personal Tools	25
Community Tools	34
Inorganic Information Systems	43
Biological Information Systems	48
Storage	53
<b>CHAPTER THREE: WEAPONS, ARMOR, MEDICINE</b>	<b>56</b>
Personal Weaponry	57
Handguns and Longarms	57
Explosives and Splash Weapons	69
Melee Weapons	71
Heavy Weapons	73
Armor	77
Medicine	84
<b>CHAPTER FOUR: TRANSPORTATION</b>	<b>90</b>
Ground Vehicles	91
Water Vehicles	99
Flying Vehicles	104



# **INTRODUCTION**



**Gamma World** is a game set after the fall of civilization. Humanity once reached heights of social and technological achievement so great that they are now the stuff of myth and legend. It was a Golden Age that went inexplicably wrong.

Few things illustrate humanity's ability to be both God and beast more clearly than technology. Technology sets human beings apart from their fellow creatures. Only human beings create tools of such incredible sophistication and complexity that they could be used to destroy the very civilization that gave them birth.

**Gamma World** is the product of technology gone awry. It is the bastard child of a confluence of technological streams that came to a head before humanity had the wisdom to recognize their ultimate implications. **Out of the Vaults** gives both players and Game Masters a glimpse into these technological streams, including specific examples of how they were used. More than a mere equipment book, this volume is an examination of the technologies and devices that brought about the end of the world and which may yet prove pivotal in its new beginning.

**Gamma World** is a post-apocalyptic roleplaying game. The implications of that statement may seem obvious, but sometimes they are forgotten. It's all too easy to get caught up in the gloom and doom that contemplating the fall of civilization naturally engenders. It's sobering to consider that everything one knows and loves might one day be reduced to dust through human ignorance, greed or villainy. Much of the literature on which **Gamma World** depends for inspiration was conceived of during a time when the prospect of nuclear annihilation seemed all too real. While that specific threat receded at the end of the Cold War, the prospects of humanity's utter destruction remain just as imaginatively potent as ever. One may imagine that international terrorism will seal our fate rather than World War III, but many people still live in fear of the looming Armageddon that awaits us.

While **Gamma World** uses our fears of the end of the world for good dramatic purpose, it does so in an unusual way. Rather than being a cautionary tale of human hubris or stupidity, the setting affords every player a unique opportunity: to rebuild the world as he sees fit. In **Gamma World**, the collapse of civilization is already behind us. What lies ahead is an unwritten future in which almost anything could happen.

This future is the focus of the game. It also makes **Out of the Vaults** a different sort of equipment book. This sourcebook includes plenty of information on what various pieces of technology can do, as well as where and how the characters can obtain them. It differs in that it also discusses

how to adapt and apply this technology to the world. How can these technological toys be used to aid in humanity's survival and (perhaps) its glorious rebirth?

## UNDOING ARMAGEDDON

In reality, if modern civilization were to fall, it couldn't be rebuilt easily, let alone in anything like its original form. For example, the easy-to-extract ores were all extracted generations ago, and while cities could be mined, it'd be difficult without the proper tools, which themselves require massive quantities of ores in the first place. The same principles hold true for petrochemicals and many other important natural resources. Admittedly, nanotechnology might help to overcome some of these difficulties, but such "magical" solutions won't be readily available to most characters, at least not in the beginning.

Even in campaigns that allow more optimistic and/or dramatic solutions to such problems, characters must be ingenious in their use of available resources. They must rely on their own cleverness rather than sophisticated materials and a large infrastructure. Nevertheless, it is this rebuilding that lies at the heart of **Gamma World's** ethos and it is the GM's responsibility to make that rebuilding fun and plausible, if not necessarily realistic. After all, uplifted dogs with the ability to manipulate the weather probably aren't very realistic, but they can be made plausible enough to make them an enjoyable addition to a roleplaying game.

Many sections of this book give advice on just how to do the same with technology and its implications for undoing the effects of the Final Wars. As always, the ultimate goal is fun, but it's always better if that fun is grounded in something players can accept with the right frame of mind. Consequently, very little in this book should be taken as an accurate depiction of how (or how easy) it might be to reverse the effects of a devastating global catastrophe. It's a collection of guidelines about how to make doing so plausible and fun.

## DESIGN PRINCIPLES

**Gamma World** presumes that pre-Final Wars humanity was almost impossibly talented in every field of technological endeavor. At the high end of its accomplishments were devices that would seem magical to anyone who did not understand the science behind it, and even many who did. For this reason, any examination of technology in the setting needs to have solid design principles. These principles are those used by the writers of this book when creating the devices described throughout. However, these principles are also useful to both players and Game Masters if for no other reason than as guidelines for the creation of their own devices and adventures.

## PLAUSIBILITY

The first design principle is plausibility. The setting elements of **Gamma World** are not necessarily realistic, but they are plausible. That is, they can be explained in such a way as to allow for willing suspension of disbelief. They are not so fantastical that even someone in the right frame of mind would reject them out of hand. This principle is especially true for technological devices, since they are paradigmatic examples of science applied to a specific use.

Just as important is the fact that the relative plausibility of technology sets the “boundary conditions” for the setting. That is, they define just how far **Gamma World** is willing to stray from commonly accepted scientific principles. That’s pretty far in many cases, but we hope we’ve tempered our enthusiasm for the wild and wacky with a dose of common sense and good judgment. In any event, the GM is the final arbiter of what technological items he will allow in his campaign. If anything in this (or any other book) clashes with her perceptions of what is or is not plausible, she is free to reject them.

## DISTINCTIVENESS

**Out of the Vaults** is more than a technology book; it’s a book of NPCs. The items described in these pages, even those that are not singular devices, are all as unique and distinctive as any non-player character. Many of them have personalities and quirks, just like people. That’s an important element that shouldn’t be forgotten by players or by GMs. In **Gamma World**, technological devices are rarely just pieces of equipment. Instead, they have histories, stories to tell and roles to play.

Technology misused resulted in the downfall of humanity. Now, the stage is set for the rebirth of mankind. Technology will undoubtedly play a part in this scenario as well. That’s why the distinctiveness of each item is so important. The purpose for which a device was created in the past may come to bear on how it’s used in the present, for example. For while technology may be morally neutral, some devices “hedge their bets” by inspiring certain types of behavior, openly or secretly. That’s another aspect of technological distinctiveness: like NPCs, devices may have their own agendas and become the source of exciting adventures in their own right.

## PRESERVATION

The Final Wars were incredibly devastating. Much of the vast edifice of human achievement toppled so thoroughly that no one has yet found a way to reverse its effects. The devices that survived each did so for a

reason. While the characters may not fully understand that reason, it’s nevertheless important that there be one, if only to provide the GM with some context for the high-tech wonders she introduces into her campaign.

As its name suggests, **Out of the Vaults** focuses primarily on those devices that have some reason to have survived the vicissitudes of history. Because they were hidden away or protected from the vicissitudes of the last three generations, these devices are still extant. They can be found, understood and used. Not surprisingly, the devices that survived are not a representative selection of what the ancient world was capable of. Indeed, the devices that were secreted in vaults or safe areas necessarily provide a skewed vision of the past, with consequences for the present and future.

## MYSTERY

The final design principle is mystery. The devices of the past are unquestionably mysterious to most inhabitants of **Gamma World**. They do not understand the principles on which most of these devices were built and may not even understand the uses to which they were put. Finding an ancient technological item brings these individuals face to face with an alien world of which they have no experience and even less comprehension. Introducing any one of the devices presented in this book can be an adventure in itself, if the GM chooses to make it so.

As well as being a book of NPCs, **Out of the Vaults** is a book of magic items or, more precisely, ancient artifacts, with all that that phrase implies. A microwave gun might as well be Excalibur; its possession by a tribal chieftain might well be every bit as portentous as Arthur’s possession of that famous sword. The destruction of the Final Wars ushered in a new mythic age. The world of the past is dead and a new world is dawning, one simultaneously freed from the shackles of history and bound by them. In this new world, there is plenty of room for mystery. It is in fact a key ingredient for any GM looking to place his adventures within the heroic context that is so central to **Gamma World**.

## HOW TO USE THIS BOOK

**Out of the Vaults** is a technological toy box filled with all manner of strange, wondrous and frightening devices from the days before the Final Wars plunged the world into a new dark age. Of course, it is much more than that too.

This book is divided into four chapters, each of which addresses a different category of technology, including lots of advice on how to integrate them into an ongoing campaign or use them as the basis for exciting adventures.



**Chapter One: Loss and Recovery** details the eponymous vaults where legacy technology is hidden away. From ancient fallout shelters to military installations to bolt holes, getting into these vaults isn't always as easy as it looks, as this chapter explains.

**Chapter Two: Tools** describes a wide variety of "everyday" technologies, both personal and community-oriented. These tools were once the pillars that upheld the roof of civilization and they may be once again, should anyone find a way to harness them.

**Chapter Three: Weapons, Armor, Medicine** details devices of war, defense and healing. The misuse of many of these devices contributed to the end of the world, but it's also possible that some of them hold the keys to a new beginning, if used properly.

**Chapter Four: Transportation** describes conveyances used to travel across one or more types of terrain. Many ancient vehicles travel quickly enough to make larger societal groupings practical for the first time in generations.



**CHAPTER ONE**  
**LOSS AND**  
**RECOVERY**



This book is entitled **Out of the Vaults** for good reason: much of the technology described in its pages can only be found by exploring and excavating sites associated with the pre-Final Wars world. That is, they are not found lying around the wilderness or even in current communities without good reason.

## WHAT IS A VAULT?

Throughout this book, you'll see plenty of references to "vaults," but what are they really? Simply put, a vault is any hidden and/or protected location where ancient artifacts can be found in **Gamma World**. For the purposes of this book, it applies to any site containing items or information associated with the past. Many of them are literally vaults, although not all of them are. As noted later in this chapter, these heavily armored repositories (or "true" vaults) are usually closely associated with the Final Wars and their immediate aftermath, making them quite rare and exceedingly valuable.

Much more common are makeshift vaults. These vaults occur either as a result of intelligent design or happenstance. In the first case, an individual or group decides that they need to preserve some collection of items for the future. Not having access to a true vault, they make do with what is available to them. Thus, they might use an underground shelter or a bolt hole to accomplish the same goal. In the second case, a vault might arise because of an accident or environmental condition. For example, a building might collapse, sealing off its basement and turning its lower levels into a vault. Likewise, an avalanche or a flood might similarly impede entrance into a structure and prevent its contents from being found in the aftermath of the Final Wars. Makeshift vaults are no less vaults because of their different origins.

All vaults, whatever their origins, are united by two other elements. First, they are obstacles to be overcome. That's important to remember. **Gamma World** is a roleplaying game about the rebuilding of human civilization after its collapse. The default assumption is that three generations have passed since the fall of mankind. In that time, the legacy of the past has been reclaimed only in

part. Much remains hidden or lost within vaults of one kind or another. Successfully discovering and entering a vault is a momentous and dangerous event. While the characters are unique individuals, possessed of skills and abilities beyond those of the common person, they are still human beings. To enter a vault and recover its contents should be significant, with many challenges. After all, how else does one explain why the characters have succeeded where so few have before?

### CHALLENGING, NOT IMPOSSIBLE

**Gamma World** is not a game about futility and the doom of all hope. Circumstances may overwhelm the characters and everything they hold dear... but might not. GMs designing challenges should remember to make them challenges the characters have an actual chance of overcoming.

The second element is one that's universally applicable to **Gamma World** technology: mystery. Vaults are mysterious, even frightening, places. Ordinary folk shun them, assuming they even know of their existence. They are locales of death, where lesser mortals dare not go for fear of suffering a terrible fate. Like haunted castles or forbidden woods, vaults are a locus for popular superstitions and fears. They are not simply impregnable fortresses containing technological booty; they are nexuses of mystery. It's important to keep this in mind, since it not only lends an interesting flavor to **Gamma World** adventures, but also acts as a touchstone for those adventures themselves.

The term "vault" often conjures up all sorts of images in the minds of players, everything from a bank depository to the tomb of Tutankhamen. That's as it should be. The past is a mystery to all but a small number of the inhabitants of the Gamma Age. When the player characters enter a vault, whatever its origin and purpose, they are doing something very few others of their kind will have done. It is a momentous undertaking, one among many that could presage the dawning of a new age. Never forget this.

# HISTORICAL AGES

Because vaults can come from a variety of different time periods, some of them comparatively ancient, it's worthwhile to take a look at these periods. It establishes some parameters for the types of vaults one might encounter from each period and what one is likely to find within them. The information presented here is used later in this chapter for handling several pieces of game mechanics relating to entering and looting these vaults. As always, the descriptions that follow are presented as suggestions rather than hard and fast rules. GMs whose own conception of **Gamma World** differs from one or more of the assumptions of this book are therefore free to alter what follows as necessary.

## THE PRECURSOR AGE

The so-called Precursor Age is the most distant of all the historical ages still remembered by inhabitants of **Gamma World**. Indeed, it is not really an age in itself, but an aggregate term for anything that occurred before the 21st century. The world of the 20th and earlier centuries is so far removed from characters' experience as to be legendary. Almost no one has any real sense of how events from the Precursor Age relate to one another, let alone their specific details. Such knowledge is held only by a few functioning AIs and hoary sages who've devoted their lives to gathering such forgotten lore.

This means that the Precursor Age functions as a catchall historical era. Any event or personage that does not fit into another better-known era is usually said to have occurred in the Precursor Age. Game Masters who enjoy playing with the interrelationship between myth, religion and history might find it amusing to toy with real world history and present a garbled version of it as a tale passed down from the Precursor Age. For example, World War II might be presented as a civil war in which a usurper (Hitler) attempts to claim the throne from its rightful king (Great Britain) by using an army of foreign mercenaries (Japan). The rightful king defeats the usurper thanks to aid from a loyal retainer (United States of America) who, upon the king's death from wounds sustained in the conflict, ascends the throne as the realm's new king.

How does this relate to vaults? Vaults from the Precursor Age are poorly understood. Their actual purpose is probably unknown or at least misunderstood. A sealed military bunker from

World War II might become associated with some mythical battle or catastrophe, but it's highly unlikely that anyone will know the whole truth. This means that vaults from this time period come wrapped in even more superstition than those associated with the Final Wars period. Consequently, vaults from the Precursor Age are great sources of inexplicable mystery.

Any vault from the Precursor Age that survives to the Gamma Age did so either because it was extremely well hidden or through sheer dumb luck. Compared to later ages, the Precursor Age was technologically primitive, especially those portions of it that extend before the 20th century. To have evaded discovery and fended off excavators is quite a feat. At the same time, there are always things that are overlooked. For example, every few years, someone is injured in France by unexploded bombs from World War I! The same can be true of vaults. Nevertheless, vaults from this distant period should likely be rare and, when found, exceptional in some way.

### Example Precursor Age Vaults

- Bank vaults
- Fallout shelters
- Mines
- Time capsules
- Underground parking lots

## THE GENE AGE (2000 TO 2050)

The Gene Age is the true beginning of **Gamma World**, for it was during this time period that the discoveries of David B. Pennon set humanity on the path that would see the species seize control of its genetic future. The Gene Age is almost as distant to most inhabitants of the Gamma Age as is the Precursor Age, but not quite. While the specifics of the era are not well-known, there is much more evidence of its existence than the Precursor Age. Gamma Age savants may not know who Pennon was or precisely what he did, but they'll be familiar with many of the devices and locations associated with his research or the research that spun off from them.

Compared to the Precursor Age, the Gene Age is a true "historical" period in that it is less mythologized and garbled in its presentation. Details are still scant, so there's plenty of room to



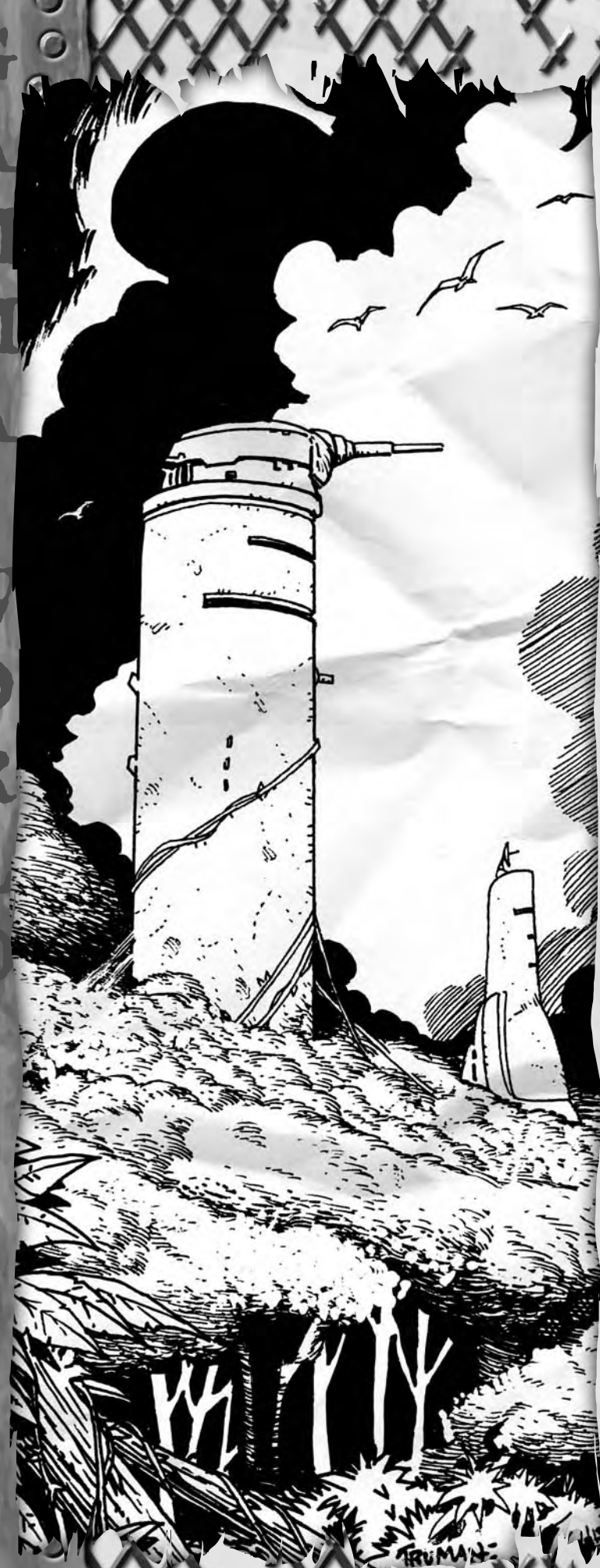

play around perceptions if the GM is so inclined. After all, historians consider much of Egyptian history “real” history, but they continue to argue about the length and order of royal reigns! Misunderstandings will still be commonplace. A site might be wrongly associated with a person or event, even if the broader details are more or less accurate. A skeptical scholar might, for instance, believe that Lyndon Johnson was Abraham Lincoln’s vice-president rather than Andrew Johnson, since they share a surname and both attained the presidency by succeeding an assassinated predecessor.

Gene Age vaults are necessarily more sophisticated than those of the Precursor Age, with computers and electronics common and integrated to their design. They are likewise better hidden, taking advantage of advances in engineering and architecture. There are thus many unopened Gene Age vaults, although not as many as in later ages. That’s partly because later eras would have abandoned and removed their predecessors, but also because they are less well protected than those that come after them, making them easier for looters to open. Even so, good fortune and good design protect many of these archives.

#### Example Gene Age Vaults

- Antarctic research stations
- Body banks
- Medical facilities
- Military installations
- Underwater mining stations

### THE NOETIC AGE (2050 TO 2100)

The Noetic Age marks yet another significant milestone in the development of **Gamma World**, for it was during this period that humanity created the first true artificially intelligent lifeforms. The appearance of AIs, androids and other such artificial beings was a major turning point in the history of the world. Not only did it mark the first time that mankind shared the Earth with other sentient creatures, it also marked the beginning of a revolution in psychology, psychiatry and related disciplines. Humans now began to plumb the secrets of their own minds, using the insights they’d gained as a result of creating AIs. A wide variety of new medical treatments arose too, designed to give men the ability to manipulate their own mental processes in ways never before possible. The Noetic Age lived

up to its name: it was the era when intelligence itself fell before the onslaught of human science.

The Noetic Age is both better and less well-known than the Gene Age. That may seem paradoxical, but it's easily explained. Being closer in time than the Gene Age, the inhabitants of the Gamma Age know a fair bit more about it than they do about previous eras. However, the Noetic Age saw the rise of the first AIs, some of which are still extant during the Gamma Age and whose reputations among human — and other — beings is less than positive. Many people view AIs as either monsters or gods, views often encouraged by the AIs themselves. Not surprisingly, the Noetic Age is often seen through this lens. To complicate matters further, many AIs have deliberately obscured or eliminated information about the Noetic Age for their own reasons, some altruistic (at least from the AIs' perspective) and some selfish.

Vaults from the Noetic Age are usually very well protected. As one might expect, many of these vaults are preserved by AIs and other artificially intelligent beings, such as androids. They may protect them out misguided duty to their former masters or because they wish to retain the vaults' contents for themselves. Entering these vaults is typically an epic undertaking. Successfully recovering legacy artifacts from them is almost unheard of: the stuff of legend. However, the fact is that many of the most potent political forces in the Gamma Age have succeeded in liberating technology from Noetic Age vaults. It is the key to immense power and influence. Should the player characters do the same, the nature of the campaign is very likely to take a turn into high-powered play.

#### Example Noetic Age Vaults

- Aerospace control facilities
- AI labs
- Aquatic research stations
- Deep core mining facilities
- Orbital construction stations

## THE FINAL WARS ERA

The Final Wars era is not a true age in the sense that the other historical periods presented here are. That's because the Final Wars did not last more than a handful of years, never mind a generation. However, this era is included here, because, though short, it brought about the end of the old world and the beginning of the new.

Inhabitants of the Gamma Age almost certainly know of the Final Wars at least in broad terms, but the actual details elude them. The very name "Final Wars" is evidence of that. The combatants in these wars and the reasons for their conflict are unknown to any except those with an interest in history or who have a direct connection to those bygone days. Consequently, most versions of Final Wars history have a character that is by turns mythical and sketchy. The era is almost always presented as a cautionary tale, even by those who wish nothing more than to rebuild the world as it once was. This era looms large in the imagination of nearly everyone who lives in the Gamma Age.

There are many vaults from this era. As one might expect, they are extremely well protected and guarded. Many of them have not yet been breeched and it would take a Herculean effort to do so. That's because the era was characterized by paranoia and fear. Every nation, faction and alliance on the planet worried that their enemies (and even their friends) might obtain their most secret information and doomsday weapons to use against them. Consequently, they built sturdy vaults with multiple redundant security systems and traps designed to obliterate anyone who attempted to enter them without permission.

Final Wars era vaults are the holy grails of the **Gamma World** setting. They are the targets that more contemporary beings seek out than any other. Their reasons for doing so are twofold. First, these vaults are much more likely to hold military secrets of a sort readily usable to gain power in the Gamma Age. Individuals, nations and cryptic alliances alike see great value in their contents. Second, so few of these vaults (comparatively anyway) have been explored that simply doing so can increase one's reputation in a positive fashion. In the Gamma Age, reputation is very important and can sometimes mean the difference between life and death. Little wonder, then, that individuals are willing to risk life and limb to be among the handful of people to survive the dangers Final Wars era vaults present.

#### Example Final Wars Era Vaults

- Intercontinental weapons launch facilities
- Military bases
- Orbital weapons platforms
- Subterranean command centers
- Underground retreats



## THE GAMMA AGE

The Gamma Age is the term referring to everything from the end of the Final Wars to the present time. It's a catchall term much like the Precursor Age. Indeed, its actual length is up to the Game Master, depending on how far in the future he wishes to set his **Gamma World** campaign. The default assumption used throughout this book is that the Gamma Age is now into its third generation after the Final Wars. Most of what follows will still hold true for other epochs, although some of the specific details might need to be altered somewhat if the GM's campaign diverges too greatly from the baseline assumptions presented here.

For almost everyone outside groups like the cryptic alliances, the Gamma Age is simply "the present." It is "the way things are." It's not invested with any particular meaning, except perhaps as a lesser era after the fall of the "giants" who once strode the Earth before the Final Wars. This means that its inhabitants do not look upon it with any particular fear or awe. This is simply their world: good, bad and ugly. Many would certainly wish that the Gamma Age were other than it is, but there is very little that they can do about it. It is unusual individuals, like the characters, who see beyond the Gamma Age and look to a better future.

The vaults of this era are mostly of a lesser sort than those of previous eras. In fact, they are probably less sophisticated than even those of the Precursor Age, although this isn't universally true. In some cases, Gamma Age inhabitants have acquired and mastered technologies from the past to protect their own items. These vaults thus possess a higher degree of difficulty to overcome than more makeshift vaults of the era. Similarly, the contents of these vaults are generally less impressive: a mishmash of items from many eras, most of them recent and not all of them in good working conditions. Breeching Gamma Age vaults is common and not particularly noteworthy. In fact, it's almost commonplace and forms the basis for the economies of many small communities and tribes.

### Example Gamma Age Vaults

- Burial mounds
- Community reserves
- Cryptic alliance hoards
- Religious sites
- "Treasure" troves

---

## THE CLOSING OF THE VAULTS ABOVE THE GROUND

As noted above, the term "vault" covers a lot of ground. While such flexibility can be a boon to Game Masters looking to personalize a setting, it can also encourage vagueness. That is, having too much information can sometimes stifle creativity, but having not enough can make it very hard to find a place to hang one's metaphorical hat. This section is designed to overcome these twin problems, providing GMs (and, by extension, players) with lots of options when it comes to creating, describing and stocking vaults, whatever their exact nature.

The following entries are first divided according to the terrain type in which the vaults are found. Under each terrain type, there are several subdivisions that detail a few of the more common categories of vaults. These subdivisions are the real meat of the section, since they provide GMs with some ideas on how to use vaults of that category, as well as some options on just what (or who) they might contain.

Above-ground vaults outnumber all others. They are the buildings, installations and other surface structures once commonplace across the globe. The sheer number of these structures was so great that even the devastation of the Final Wars was insufficient to wipe them all from the face of the world. Even so, very few buildings from before the Gamma Age survive wholly intact. The weapons used during the fall of civilization were immensely powerful. Even when they did not directly target a specific structure, the damage they wrought was far-reaching and profound. Quite simply, it is rare to find a surface vault from before the Gamma Age that does not have a very good reason for having survived.

Of course, there are many very good reasons available to a GM looking to use surface-based vaults in his adventures. One is remoteness. Even in the interconnected world of earlier eras, there were still places on the Earth that were inaccessible,

either because of terrain or by the wishes of those who built them. Many military installations, for example, were constructed in out of the way places so as to make them less susceptible to attack by enemies. Likewise, research stations dedicated to obscure or dangerous topics were often kept far away from population centers.

Another possibility is sturdiness. Materials science during the Final Wars and even before was impressive. Nanotechnology and other related disciplines enabled human beings to construct buildings from a wide variety of very sturdy materials, such as synthetic diamond. While not wholly impregnable to the mightiest machines of war, these materials were nevertheless quite resistant to damage. It would not be implausible to assume that some of these sturdy structures might survive indirect attacks against them. For that matter, many important government, military and scientific structures had their own defenses to protect them. Some of these defenses might have been enough to stave off destruction, or at least soften the blow.

Finally, the years immediately following the Final Wars saw attempts at rebuilding the fallen world. Individuals and groups banded together and pooled their resources to prevent the total collapse of all civilized society. In some cases, these efforts were just good enough to preserve certain key elements of previous eras, such as a handful of structures. These structures then became the cornerstones of new settlements and societies. For example, an armory from the Final Wars era might serve as the “castle” of a warlord who sets himself up a king of the nearby territory. The armory is itself a vault, filled with a store of legacy technology by which the king and his successors maintained their supremacy over their neighbors. If some accident befell the settlement that grew up around the armory, the vault might conceivably survive, albeit as a shadow of its former self.

It's also worth remembering that the Gamma Age is a dark age compared to its predecessors but not wholly without light. As the previous paragraph makes clear, there were attempts to build new structures to replace the ones lost in the Final Wars. As settlements grow (and new ones are founded), new structures will be created as well. These structures could, over time, become the basis for vaults of one sort or another. After all, three generations — or more — is still a long time. Consider the fascinating things that urban





archeologists find from a hundred years ago or less in many cities. The same could be true in **Gamma World**, with the added consideration that so much has been lost that few can be sure that there isn't something even more ancient beneath most settlements waiting to be found.

## COMMERCIAL BUILDINGS

The economy of the world before the Final Wars depended on commercial enterprises, both large and small, with far greater emphasis on the latter. This isn't to say that the Gene or Noetic Ages were devoid of mighty corporations; they were not. However, those eras saw technology reach a stage whereby an individual or a small group of individuals could effectively run a business with a large clientele. Developments in communications and manufacturing (especially nanotechnology) made it completely feasible for a single person to do the work of dozens, even hundreds. This created many new opportunities that did not exist in previous eras and forever changed the way business was done.

Commercial buildings therefore come in many shapes and sizes. The ones of most interest to explorers, of course, are those that still contain trade goods of value in the Gamma Age. Alas, they are rare in the extreme. The realities of pre-Wars commerce meant that most businesses produced products on demand. The few that operated according to older rules were looted long ago. Exceptions exist, of course, so there is still purpose in seeking out ruined businesses. Far more valuable, though, are nanotech manufacturing systems, as well as the data necessary to make them work. These are true prizes, and cause of some of the Gamma Age's worst conflicts.

## GOVERNMENT BUILDINGS

In many nations before the Final Wars, the government was the single largest employer of people. Even in those where this was not true, the government was still a noteworthy presence in daily life, a veritable Leviathan. The escalating tensions of continuous technological revolution and continuous social invention made many people of those final decades toward with longing toward any promise of stability. Governments were the primary tools for the project of building a life less subject to further unexpected change, and amassed ever greater power in its pursuit. Unsurprisingly, then, there were large numbers of government buildings

constructed, each one dedicated to the running of a different aspect of the vast bureaucracies of the age. These buildings were primary targets during the Final Wars, which is why many no longer exist in the Gamma Age. Those that do are rarely intact, having suffered all sorts of indignities over the generations, including vandalism by the survivors of the Final Wars, who often blamed the government for the fall of civilization and sought to gain some measure of satisfaction by destroying the buildings that once housed its apparatus.

Nevertheless, some government buildings did survive intact. Finding one is a rare and valuable find. Government buildings always contain lots of electronic data and computer terminals, many of which are encrypted. A central AI may also be present, in which case explorers may find themselves with it as an opponent. Government AIs are notoriously eccentric, since they regularly remain loyal to orders generations out of date and act appropriately. Government buildings sometimes contain ID cards and other means of accessing additional sites, making them extremely valuable to those looking to explore beyond their walls.

## RESIDENTIAL HOMES

The vast majority of humanity still lived aboveground during the days before the Final Wars. Their homes almost all shared a couple of key characteristics. Firstly, most homes were heavily automated, using a coordinating AI to monitor the activities of robotic and nanotech systems that kept them operating at peak capacity. These systems included cleaners, recyclers, energy distribution and communications, among others. Secondly, most homes possessed their own microenvironments that were regulated according to the wishes (or whims) of their inhabitants. The outward appearance of homes varied greatly, from high-rise apartment complexes to stately mansions to self-contained arcologies. The general tendency was toward building up rather than out, because real estate was immensely valuable in the Noetic Age and beyond, so towers and dense high structures are more common than low sprawls.

Residential homes were not targets in the Final Wars and comparatively few of them suffered damage. However, most were not constructed to last forever and so have become dilapidated and run-down in the generations since the Wars. Those that still stand were those made from state of the art materials like diamondoid. Anyone entering these homes could conceivably find almost

anything, although items of a personal nature and use are most likely. Often, residential homes continue to be used for their original purpose, as beings again set up house within their walls. For that reason, explorers should be wary of the new inhabitants, lest they be caught off guard.

## BELOW THE GROUND

Subterranean vaults take more effort to make and maintain, but offer appealing advantages for builders out to protect their goods. Underground vaults are better protected against damage from weapons, weather and other catastrophes. They are also better hidden from surface populations, meaning they are also more likely to be intact, whether whole or in part. Looters and “tomb robbers” have to know about the existence of a vault before they can sack it and many subterranean vaults are unknown to the inhabitants of the Gamma Age. This means that the GM can very easily use these vaults as the basis for adventures or even entire campaigns in some cases.

Because of their relative protection, subterranean vaults are remarkably diverse. Many predate the Final Wars by many decades, even centuries. For while the surface of the Earth was well used by the time of the Final Wars, beneath the Earth was another story. There space available beneath the surface of the world is immense, larger than the surface area by several factors. That means that, if the GM so wishes, there is room for sprawling hidden structures hidden away from prying eyes. Furthermore, subterranean vaults better jibe with our atavistic sense of what a “vault” is. When one thinks of archeology and excavation, it typically involves digging into the ground in order to find items from the past. This also corresponds rather nicely with many of the mythic themes that **Gamma World** employs, making it very easy to connect vaults with “the Tombs of the Ancients” or other such fantasy tropes.

The ease with which subterranean vaults can be used shouldn't blind the GM to plausibility, however. He still needs to consider how and why these vaults exist. Fortunately, doing so is almost as easy as using the vaults themselves. By the time of the Gamma Age, many locales have been inhabited by human beings for many centuries (in some places even longer!). Consequently, these locales have layers (or strata) of subterranean structures that may still be accessible with some effort. In some cases, these structures might even

still be used, while in others they will be completely forgotten. Consider, for example, that the city of Seattle, which is relatively young by comparison to many cities in the world, is built upon the burnt out husk of its former self destroyed in the Fire of 1889. By the Gamma Age, many (if not most) settlements will have similar subterranean stratifications, giving the GM a means to use vaults very close to home. Indeed, an entire campaign could be built around exploring the undercity of the player characters' home community, battling its denizens and liberating the artifacts that they possess.

Of course, some subterranean vaults were built that way on purpose. These include underground bunkers designed to protect governmental and military personnel during times of war, as well as research facilities and even commercial centers. By the Gamma Age, it was comparatively easy to build underground structures without any of the difficulties that plagued past efforts of this sort. The use of robotics and nanotechnology alone made it a relatively simple matter to carve tunnels and caverns from the Earth's crust, or even deeper. On most continents, there were underground magnetic levitation train networks that allowed extraordinarily quick travel from one city to the next. There were also subterranean nano-factories that used raw materials from the Earth's interior to produce a wide variety of consumer goods. There were even underground arcologies that offered comparatively vast amounts of living space to those who chose to live within them.

Subterranean vaults thus offer a lot of latitude to GMs looking to find places to set adventures or place artifacts from the past. They are much more likely to be undisturbed. Vaults of this kind are therefore likely to be the “default” in all but the most unusual campaigns.

## DEEP CORE MINES

The rise of nanotechnology increased the demand for pure raw materials like carbon to record levels. Because the easily accessible veins had already been played out by the time of the Noetic Age, humanity turned to deep core mines to find what they needed. These mines are massive shafts running kilometers below the surface of the world. They included extensive elevator systems designed to transport the tons of materials they unearthed. They also included control stations and portable AI bunkers to direct the activities of mighty boring devices that did their work here.

The mines still exist in the Gamma Age, but entering them is dangerous at best. If the power systems of the elevators are not longer functioning, there is no safe way to descend into the yawning abysses. Moreover, there isn't all that much of value until one reaches the lowest levels of the mines, where the robotic and automated systems may lie dormant after long centuries. Of course, some of them may still be hard at work, drilling deeper and deeper in search of raw materials of use to people long dead.

## MAGLEV TUNNELS

Once upon a time, giant subterranean tunnels allowed magnetic levitation trains to travel from one end of the continent to the other, guided by AIs that could keep track of the entire network and ensure safety. Those systems largely shut down after the Final Wars, although small sub-networks of them may still be operational. Anyone who entered a disused tunnel would find it a convenient, if long, means of overcoming land obstacles. Entering a tunnel still in use (a rarity but nevertheless a possibility) opens characters up numerous dangers, not least of which being a train traveling at incredibly high speeds: vacuum or exotic gases, incredibly high voltages in superconducting electrical cables, maintenance robots with aggressive programming, and on and on.

Maglev tunnels can be found almost anywhere, since the train networks were quite extensive before the Final Wars. Abandoned tunnels are home to all manner of beings, including entire subterranean societies that conduct commerce via the tunnels. Every few kilometers there are automated stations to keep track of the movements of the trains. Though small, the stations contain lots of computers and electronic devices, as well as a communications system that connects to the central governing AI. If still operational, these items could all be of great use to the player characters. There are also storehouses of parts and replacement trains every few kilometers. These storehouses are often seized by beings who scavenge tech items or seek to use them for their own purposes.

## MILITARY COMPLEXES

Warfare in the Gene and Noetic Ages favored surgical weapons of immense firepower. Through the use of artificial intelligence, for example, weapons could seek out very specific targets and leave surrounding ones almost wholly free of collateral damage. While a boon for those who

sought "bloodless" wars, this evolution alarmed military planners, who quickly realized that the old methods of defense would no longer be adequate to the task. Military complexes were now vulnerable in a way they had not been in many generations.

One solution was to place military complexes below ground where they could use kilometers of bedrock and other natural defenses to protect themselves from enemy assault. In addition, military proving grounds were much safer when removed from population centers on the surface. Underground locales also made espionage more difficult (though far from impossible). Consequently, military complexes were frequently found beneath the earth. Though many were wiped out by devastating weapons during the Final Wars, some survived. Those that did survive hold weapons, ammunition and other materiel, in addition to information of value to anyone wishing to continue the development of engines of destruction. Not surprisingly, intact subterranean military complexes are great prizes in the Gamma Age.

## ON THE SEA

This category includes any surface waters as well as small islands. These locales provide lots of possibilities for vaults that escaped notice, in part because maritime vaults need not be limited to a single locale. For example, a naval vessel can move from place to place, whether by its own power or tossed by the waves. Obviously, an island or an oil derrick isn't going to be as mobile. Even so, such sea-based vaults could conceivably have survived the devastation of the Final Wars because they simply weren't as apparent as land-based targets. Again, this is a generalization. Any maritime targets of military significance were probably hit and were unlikely to have survived, although there are exceptions to every rule.

It's these exceptions that make the most interesting sites for **Gamma World** adventures. Like subterranean vaults, the relative inaccessibility of seagoing vaults makes them more likely to hold rich treasures untouched by looters. Similarly, these vaults are unusual in their nature, which makes them a great change of pace from the typical vaults player characters will encounter. Traveling to an abandoned stealth battleship adrift on the Atlantic Ocean would be a very different experience from exploring the maglev tunnels beneath the American Midwest. As a locale, water is quite underused in roleplaying games. GMs looking to



add spice to their games will find that maritime vaults may be just what they're looking for.

The primary difficulty with maritime vaults is that they can be difficult to reach for most player characters. If a vault is located on a remote island in the Pacific Ocean, only a very special group of characters will even know of its existence, let alone be able to reach it. Consequently, the most practical maritime vaults are located closer to home, perhaps on lakes or rivers or some other inland area. Alternately, they could be located not far from the coast. True seagoing vaults will require a lot of preparation to find and loot, making them very difficult undertakings. That's not to say GMs should avoid them at all costs, but their presence should be sparing at best unless the focus of the campaign is built around them. In fact, a band of maritime explorers with a relic boat of their own, traveling the seas of the Gamma Age, has a lot of appeal. Yet, there's no denying that this is an unusual campaign focus and one that players and GM should agree upon from the start.

## ISLANDS

Islands, whether in lakes, rivers or sea, make great vaults. They are far enough removed from the mainland that the lowest levels of looters will not bother with them, ensuring at least a basic level of preservation. Unfortunately, this isn't usually enough to keep very determined looters away, which is why island vaults that survive intact typically employ some other type of defense as well.

## SEAGOING VESSELS

Very few seagoing vessels survived the Final Wars. Those that did were largely military vessels designed to withstand great punishment. A handful of them might still be afloat on the waves of the world, waiting to be found. However, any that still exist will be far from the shores of the world, making them difficult to reach. On the other hand, they will likely be storehouses of military technology, including some mightily impressive heavy weapons. This makes them a prize well worth exploring, should one find a way to locate and reach them.

## BENEATH THE SEA

If vaults can be found on the sea, why not beneath them? Aquatic vaults have a lot in common with subterranean vaults, more so even than maritime vaults. Like their underground counterparts, underwater vaults have probably survived in greater than average numbers because



of their sheer inaccessibility. Indeed, they probably survive in number greater even than subterranean vaults. At the same time, there were comparatively few aquatic vaults built even in the Final Wars era; there wasn't much incentive to do so.

Of course, "not much" isn't the same as "none." Aquatic vaults did exist and many of them still do, some of them wholly intact. During the Noetic Era, underwater cities and research stations reached their zenith, with several in the Atlantic and Pacific Oceans, as well as some in the Indian Ocean and near Antarctica. These places were collectively home to millions of people, some of whom were genetically adapted to life beneath the waves. Like everything else, these cities and stations were the targets of attack during the Final Wars, but were relatively low priorities. Consequently, it's quite plausible to assume that, even if they did not survive without damage into the Gamma Age, they are probably better preserved than most surface sites.

Once again, the problem with aquatic vaults is their inaccessibility, even more so than maritime vaults. Finding a way to get down to a underwater city or mining station will be quite difficult for most player characters. Doing so will probably be a major undertaking that will require the assistance of a nation, group or cryptic alliance that possesses the knowledge and equipment necessary to make the trip. That's not a bad thing in itself. However, it is an unusual occurrence in most campaigns. Bringing an underwater vault into the campaign will therefore have many repercussions beyond what's found in the vault itself. So long as the GM is aware of this, adding a vault like this can be a rewarding experience and well worth the effort.

## AQUATIC ARCOLOGIES

The world at the time of the Final Wars was filled with billions of human beings. Although fewer in number than they had been in previous generations, there were still enough people in the world that the need or desire to create breathing space was important. One of the ways this was achieved was through the creation of aquatic arcologies, self-contained underwater cities on the ocean floor. There were dozens of these cities, some of them with populations in the hundreds of thousands.

Naturally, aquatic arcologies suffered just as much as other cities during the Final Wars. Some, though, escaped notice because of their remoteness. These survived to varying degrees into the Gamma Age. Anyone visiting one of these arcologies today might find a thriving, though isolated, population

there or a complete ghost town. In either cases, these arcologies could be home to just about any type of artifact that could be found in a surface dwelling.

## DEEP-SEA MINES

By the time of the Final Wars, nanotechnology had become ubiquitous, obviating the need for most natural resources. However, some ores, minerals, chemicals and other natural products remained necessary as the raw materials for nanotech manufacturing. These materials were sometimes rare or scarce on Earth. Rather than import them from space, which remained expensive, manufacturers built deep-sea mines to plumb those parts of the planet that had previously been untapped.

Deep-sea mines were sturdy and well protected against water pressure and other hazards. Consequently, many of them still exist in the Gamma Age. Should someone find the means to reach them (many are kilometers below the surface), they might still be operational, filled with all manner of drilling equipment and processing facilities. Some of these mines were automated, run by AIs and synthetic lifeforms. These beings may still exist there and, if so, might resent — or welcome — the sudden appearance of outsiders.

## IN THE AIR

Even more unusual than maritime or aquatic vaults are aerial ones. Very few Game Masters consider the possibility of a site located above the surface of the world and with good reason. Nowadays, airplanes are among the only things that travel through the air and they do not remain there for more than a few hours at a time. The notion that any type of aerial vessel, never mind a facility, could do so for the several generations that has passed since the Final Wars seems ludicrous at first glance.

For the most part, yes, it is ludicrous, or at least quite unusual. However, there are many possibilities for GMs who wish to include aerial vaults in their campaigns. The first thing to remember is that not all vaults are incredibly ancient. A vault can be quite recent. So long as it holds items or knowledge worth extracting then it qualifies as a vault for the purposes of this book. Therefore, an airplane or balloon put into flight during the Gamma Age might be an example of an aerial vault. Likewise, some mutations, like telekinesis could be used to place objects into flight. Though rare, it's not

beyond the bounds of possibility, especially in **Gamma World!**

Nevertheless, it's quite true that an aerial vault requires some unusual circumstances to justify. More than likely, it also requires some technological hand-waving to overcome suspension of disbelief, but that's often true of many good ideas, so the GM should not shy away from it simply for that reason. At the same time, the GM bear in mind that, if it is difficult to explain how an aerial vault exists at all, it's almost as hard to get the player characters there. On the other hand, if he can do so, he will have created an extremely memorable adventure locale, one that is likely to enrich his campaign.

## BEYOND THE BOUNDS OF EARTH

Ironically, orbital (and interplanetary) vaults are easier to explain than aerial ones. Object and structures placed in a stable orbit can remain there for very long periods of time without decay. This means that there are untold thousands of satellites, stations and other things circling the Earth by the Gamma Age. Many, if not most, of them will not be operational, but a few will be and it is these few that provide the GM with almost endless possibilities.

Before the Final Wars era, mankind had returned to space, exploring the Moon and nearby planets, as well as sending probes and spacecraft even farther away. Permanent settlements were established in a few places, although none of them ever grew very large. Despite this, their existence provides GMs with plenty of opportunities to introduce something genuinely unexpected into his campaign. How many players expect their characters to wind up on a Moon base or aboard a space station? Alternately, an object from space can fall to Earth, bringing its contents with it. In this case, the characters do not go to the vault; the vault comes to them.

The difficulty with orbital vaults is twofold. The first is the common one of their inaccessibility. How do the player characters get there? In most **Gamma World** campaigns, space vehicles are rare or outright non-existent. How does one reach a space station without them? Even if such vehicles exist, figuring out to fly them will be mammoth undertaking and require resources and knowledge the characters may never possess. Automated systems are a possibility, of course, but they should not be commonplace, lest they soon take over the campaign. This brings





us to the second difficulty: compatibility. Not all campaigns are compatible with the notion of space travel and orbital vaults. There are many reasons for this, ranging from a different focus to concerns about technological contamination. After all, any orbital vault that survived is probably home to a lot of cool toys, many of them even more powerful than those found on Earth. A GM would have every reason to be concerned about their introduction into an existing campaign.

As always, none of these difficulties is insurmountable. So long as the Game Master is aware of the consequences of introducing orbital vaults, both in terms of campaign focus and technological advancement, there will be fewer problems. In fact, the introduction of orbital vaults could well be an important stage in the player characters' quest to rebuild civilization. Space could hold survivors from previous ages, who've watched Earth from a distance and waited for the time when they might be able to impart their preserved knowledge to the world. Such a turn of events would be one of epic consequences and isn't suitable for every campaign. However, it's events like this that make **Gamma World** different from many other roleplaying games; they are to be savored by those who have a taste for them.

## ORBITAL FACTORIES

During the Noetic Era and afterward, many manufacturing processes were deemed either impractical or too dangerous to be done on Earth, so they were placed in orbit instead. These orbital factories proved wildly successful, allowing the creation of unusual alloys and other materials, as well as using nanotech that was on the cutting edge of its day. Consequently, their numbers grew over time until, by the time of the Final Wars, there were literally thousands of them in orbit around the planet.

Many orbital factories were targets during the Wars, but some survived. Those that do are mostly uninhabited except by their robotic and synthetic workers. They use a combination of solar and fusion and so are still operational... if they have or can get the raw materials they needed to work. Anyone who visits an orbital factory in the Gamma Age

could thus find themselves on a potential treasure trove should they be able to convince its masters that they should cooperate and can provide them with what they needed to continue their operations.

## SPACECRAFT

Planetary and interstellar spacecraft might still exist in orbit around the Earth. Again, these were popular targets during the Final Wars. Likewise, those humans who could escape the devastation of the Wars often boarded ships bounded for the Moon, Mars and beyond to save themselves. These tactics did not always succeed, but they occasionally did, which is why there are comparatively few space vehicles still in orbit of the planet.

That said, the days prior to the Final Wars saw the creation of a vast automated shuttle system, in addition to spaceplanes that operated along similar principles. Some of these have undoubtedly survived. Should someone find a way to board one, the question then becomes how to control it. The automated systems may malfunction or may have developed minds of their own. Without an ability to control these vehicles, any trip aboard them will be a dangerous proposition.

## SPACE STATIONS

Much like the orbital factories, space stations proved wildly successful during the Noetic Era and afterward. Dozens were built during that time, becoming homes to thousands of people. These stations were mostly destroyed during the Wars, but a few may have survived. If they are still operational, they would provide a stable base from which to explore Earth orbit and beyond.

Of course, many will have suffered massive damage and now be devoid of air, gravity and other necessities. The likelihood that any inhabitant of the Gamma Age could survive under such conditions is small at best. On the other hand, these stations were designed to be largely self-sufficient. If one or more of them has survived intact, it is possible that they hold the descendants of those who originally inhabited them. If so, they may have unique insights to offer the world below, if only they could be reached.

# OPENING THE VAULTS

From the perspective of the characters (and many other inhabitants of the Gamma Age), vaults are interesting primarily for what they contain. That's perfectly understandable. While some vaults are inherently interesting, most are not. They are thus obstacles to be overcome rather than valuable in their own right. Overcoming the vault's natural and circumstantial defenses therefore is an important element in many **Gamma World** adventures. This section provides an overview of some of the more common defenses to be used both either as written or as a spur to the GM's imagination. The wide variety of possible defenses is immense, so what follows is only a brief précis of the topic rather than an exhaustive list.

## TYPES OF DEFENSES

Like "vault," "defense" is used in this section in an equivocal fashion. That is, a vault's defenses are not necessarily weapons systems or traps or even locks. Rather, "defense" refers to any type of protection that impedes the player characters' ability to breach the vault and to obtain the artifacts hidden within it. Defined in this fashion, a defense is an additional layer of difficulty to attempts to breach a vault.

Depending on the wishes of the Game Master, this additional layer may or may not have any game mechanical effects. In some adventures or campaigns, it's not noteworthy except as part of the background color that an ancient computer system is buried under tons of debris. Finding the system is just a means to an end rather than an end in itself, because the GM has decided that the system holds the key to something the characters need to know. In this case, the debris is just a "special effect," something the GM can use to spice up his descriptions of the characters' work, as they dig and roll away the boulders and other detritus of the ages.

In other adventures or campaigns, however, a vault's defenses may prove very important, perhaps because they represent the climax of the action or because they are done under difficult circumstances. In those cases, the GM might well decide that the fallen debris increases the DC to various skill checks or imposes a time penalty on the characters' efforts. If they do not find a way to break through the debris and reach the system quickly enough, some dire consequences may unfold.

The GM should consider the role played by every vault in her adventures. Some will have no role other than to provide "treasure" to the player characters, in which case there's little need for elaborate explanations or descriptions of their defenses. Others, though, will be important, becoming very much like NPCs, with their own personalities and quirks. Vaults of this type will be special ones that play a central role in an adventure or campaign. They should be uncommon unless the GM wishes to exquisitely detail every bolthole and time capsule strewn across the shattered landscape of the Gamma Age. In the end, vaults deserve attention commensurate with their role in the adventure or campaign.

## NATURAL DEFENSES

Many vaults have natural defenses, which is a large category that includes anything not specifically created by intelligent beings. A few examples of natural defenses include:

- Altitude
- Avalanche debris
- Felled trees
- Ice
- Water

These and other such obstacles are all the results of natural occurrences, whether or not they were extant at the time the vault was built. Altitude in the above list is a clear example of man's taking advantage of a natural property in order to protect a vault. Thus, a vault might be found high in the mountains in order to make it inaccessible. Meanwhile, avalanche debris or felled trees might have occurred after the vault was constructed, adding to the difficulty of breaching it.

## ARTIFICIAL DEFENSES

Artificial defenses are the opposite of natural defenses, both in the fact that they were specifically created for their purpose and because they rarely involve natural elements. That is, artificial defenses are made from artificial materials and processes that are not found in the natural world. A few examples of artificial defenses include:

- Contact poison
- Electronic locks
- ID cards
- Force fields
- Steel doors



Artificial defenses can run the gamut from primitive to high-tech in origin. Obviously, a vault protected with contact poison is probably less sophisticated than one protected with a force field. Probably but not necessarily. After all, biotechnology and nanotechnology was quite advanced during the Final Wars era. A “contact poison” might actually be a biotech virus or nanotech device that enters a target’s bloodstream and wreaks damage far worse than any natural poison. In any case, all these artificial defenses are the result of technological know-how rather than something else.

### **ID “CARDS”**

By the time of the Final Wars, ID cards no longer existed as physical cards carried around in one’s pocket or worn around one’s neck. They were usually implanted in the “carrier” either as benign nanounits or viruses. Card readers could scan carriers to detect their presence and would allow access as appropriate. Unfortunately, this technology was lost with the Final Wars, except to a handful of AIs that once oversaw its implementation. They still possess they ability to create and inject ID cards into a person’s bloodstream, but they are unlikely to do so in most cases. That’s because there’s very little reason to do so any longer, as well as the fact that the systems are largely useless in the Gamma Age. Too few of them survived the Wars to make it worth using the system again.

At the same time, clever characters may convince a friendly AI to inject them with ID cards to aid them in exploring ancient ruins. For convenience, these ID cards are rated from Stage I to Stage V, with each stage granting a higher level of access to a site (or collection of related sites). Anyone possessing the proper stage ID card can move with relative freedom within a site and may be able to convince automated or intelligent systems that that they should be allowed to move about. Of course, a lot has happened since the Final Wars, so there’s no guarantee that an intelligent defense system that once responded to Stage V ID cards still does.



## INTELLIGENT DEFENSES

Intelligent defenses can be either natural or artificial in origin. They consist of beings (defined broadly) who act as a vault's guardians and who will do whatever they can to prevent the characters from breaching it. A few examples of intelligent defenses include:

- AIs
- Android soldiers
- Automated weapons systems
- Tribal warriors
- Warbots

Intelligent defenses are noteworthy because they target only those whom they do not recognize. They may allow selective entry into a vault, depending on the nature of their orders or their own judgment. For example, a band of android warriors might allow non-mutants into a vault, because they recognize them as their "masters." Alternately, anyone who can convince an inquisitive AI of their good intentions may be able to bypass its defenses. The point is that intelligent defenses do not act without reason. They act because of instructions or beliefs regarding who and under what circumstances individuals should be allowed to enter a vault.



**CHAPTER TWO**  
**TOOLS**

## CHAPTER TWO: TOOLS

In the most general sense, a tool is any device that humans use to make their lives easier. A flashlight is a tool for seeing in the dark, a diving suit is a tool for surviving under water and a wrench is a tool for tightening bolts. While people have been making ever-more complex tools since the Paleolithic, nanotechnology and the vast advances in materials science that it created allowed engineers to create tools that were far superior to those made before the late 21st century. Suddenly, tools could reshape themselves according to their user's desires, and improved microelectronics allowed some of these tools to operate on their own. While many people in the

Gamma Age world do not value tools as much as weapons, armor, vehicles, or medical technology, wise and experienced adventurers know that a sturdy and comfortable tent or the correct set of lock-picking tools can often be at least as valuable as a blaster pistol or a hover bubble.

Characters who don't live in communities with regular access to the level of technology required to produce particular devices must analyze them in accordance with the rules in the **Gamma World Player's Handbook**, Chapter Six. Each distinct function is a separate layer for analysis, DC 15 unless noted otherwise.

---

## PERSONAL TOOLS

These are devices intended for use by a single person without a great deal of difficulty.

### BIOGILL

**Size:** Tiny  
**Weight:** 0.5 lb  
**Purchase DC:** 12

While the various forms of diving gear developed in the 20th century allowed human unparalleled access to the ocean's depths, these devices suffered from several serious flaws. None of the methods allowed humans to stay down for more than a few hours and diving to any depth required lengthy decompression. The biogill solves both of these problems. Instead of providing breathable air, a biogill directly oxygenates the wearer's bloodstream. In addition to never running out of air, the device regulates the levels of oxygen it provides sufficiently well to avoid any problems with pressure as long as the wearer does not dive deeper than 1,000 yards.

When dry and unworn, a biogill goes dormant and rolls up into a small cylinder six inches long and four inches in diameter — a biogill can remain dormant indefinitely. Five minutes after the user immerses this device in non-poisonous water, it unrolls into a flat oval 6 inches wide and a foot long. When wet, this oval deploys hundreds of short, ribbon-like fronds up to an inch long. The biogill absorbs oxygen through these fronds. When applied to someone's back, a biogill painlessly sends in hundreds of tiny root-like fibers into the person's back, temporarily bonding it to the person and providing them with oxygen. The biogill remains active and attached to the wearer's back as long as she

remains in the water and continues to remain attached for an hour after the wearer has left the water. At this time, the biogill falls off and rolls back up into its dormant form.

In addition to being useful tools, biogills are also simple organisms. If someone cuts a biogill in half and places each half in a tank or pond exposed to direct sunlight and filled with water containing nutrients and algae, each half will grow into an adult and fully functional biogill in a month. Until it reaches its adult size, cutting it in half again will kill it and it will not bond to a wearer's back.

Biogills allow the wearer to breathe normally in any water that contains sufficient amounts of dissolved oxygen. In practice, this means that the wearer can safely use it in any water that is not either extremely toxic or so stagnant and foul that few people would willingly touch it. However, the wearer cannot use a biogill when she is wearing anything that covers the upper portion of her back. Biogills must attach to the user's bare skin and do not function if worn under heavy clothing or any type of armor.

### CAMPING BIO-BAND

**Size:** Tiny  
**Weight:** 0.5 lb  
**Purchase DC:** 12

One of the most useful advances in camping and wilderness survival technology created before the Final Wars is a biotech creation known as a camping bio-band. Created from a genetically modified sea creature called a chiton, this organism is 2 inches wide, 6 inches long and half an inch thick. It has a hard carapace that



## GAMMA WORLD: OUT OF THE VAULTS



Cutter-Bonder



Handi-Lite

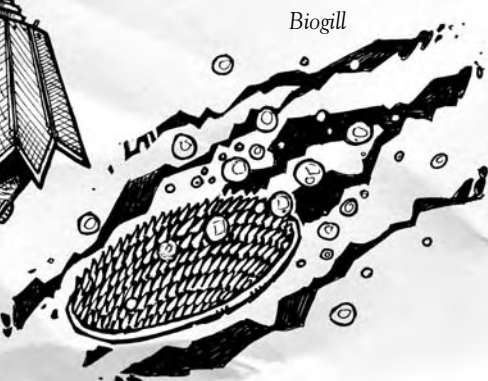

Biogill



Fix-It



Grabber

comes in a variety of bright primary colors and is marked with the logo of whichever company created its ancestors. This creature wraps itself around the user's wrist and extends a thin, painless proboscis to draw the nutrients it requires from the user.

Once in place, it performs a wide variety of useful functions. Using a powerful color-changing ability grafted in from flounder genes, a patch on the middle of the creature's back functions as a biological display screen. By touching various portions of the bio-band the unit can display detailed information on the user's state of health (which provides a +2 equipment bonus for all treat injury rolls made on the user), in addition, the bio-band is sensitive to magnetic north and can act as a compass (providing a +2 equipment bonus to all Navigate checks). In addition, touching the bio-band to food or water allows the user to tell if it is poisonous. When the user touches a sample of food or water to one end of the bio-band, the entire band turns a sickly green if the sample is poisonous. The band also turns red in the presence of unsafe air and yellow if exposed to dangerous levels of radiation. The greater the danger, the brighter its color becomes.

Also, the bio-band has several dozen dime-sized bioluminescent spots running down both sides. The

appropriate touches cause some or all of them to illuminate, providing a level of illumination ranging from candlelight (5 ft. radius of illumination) to light equal to a torch or a late 20th century chemical light stick (20 ft. radius of illumination). These lights can also create a directional light equivalent to a flashlight (a beam 30 ft. long).

Like much livetech, these creatures are hermaphroditic and can be persuaded to mate and breed by anyone who knows the Tech Familiarity: Final Wars Tech feat and 4 or more ranks in the skill Knowledge (Earth and life sciences). Camping bio-bands give birth to one small egg that takes four months to hatch and grow to maturity.

### CUTTER-BONDER (C-B)

**Size:** Tiny

**Weight:** 0.5 lb

**Purchase DC:** 12/14

A cutter-bonder is one of the more mundane wonders of the nanotech era. Shaped like a oval 20th-century box cutter with a red button on one side and a green button on the other, a C-B is extremely easy to use. Its only other control is a digital gauge labeled "Depth" that runs from one one-hundredth of an inch

## CHAPTER TWO: TOOLS

to four inches. This item lacks any visible blade, but can cut almost any material and bond almost any two materials together. This device contains a reservoir for highly specialized nanotech that can either break almost any molecular bonds or create powerful bonds between a multitude of materials. To cut an object, the user sets the depth, holds down the red button (labeled "Cut" in pre-Wars English) and touches it to the object she wishes to cut. Once activated, a stream of nanotech disassemblers emerge from the front of the device and cuts the material to the desired depth. The cutter makes a cut that starts at its front edge and extends downward into the material to exactly the depth that was set. In effect, the user has a saw that can be started anywhere in the material and that cuts without effort.

For safety, the disassemblers will not work on any form of living flesh. They also do not work on any of the advanced diamond-coated materials used as armor on military vehicles and as shielding for the inner workings of fusion reactors. However, a C-B can do everything from cutting a sheet of paper while not marking the table underneath to slicing through a three-inch thick steel beam. Unfortunately, a C-B cannot be effectively used in combat, since the user must hold it in place and move it slowly (a C-B can make a one-foot long cut every round). Attempting to move it more rapidly engages the safety features and the device will not work until the user moves it more slowly.

Bonding is equally easy. The user sets the depth, holds down the green button (labeled "Bond") and touches it to the two objects she wishes to bond. These two objects must be touching each other, and the user must apply the C-B to a region directly over where they touch. At this point, nanotech assemblers come out of the device and create molecular bonds between these two objects. Better than any glue, these assemblers literally make the two items become one where they join. The user can bond glass to paper, plastic to steel or even rock to raw meat. As in cutting mode, it only bonds a line of material to each other, but for stronger bonds, the user can simply bond the two items together at many places. The C-B cannot bond living materials to anything else and bonding must be performed as slowly as cutting. While useless a weapon, a C-B can be both a valuable tool and a devastating instrument of sabotage. A C-B can cut or bond 100 yards of material before the user must recharge or replace its power cell. Cutter-bonders were extremely common before the Final Wars and can be

### PURCHASE DCS

Many of the items in this book have a split purchase DC — two numbers separated by a slash mark, such as "17/20." The first number is always the purchase DC of the item in technically advanced communities like pure-strain human enclaves. The second (always higher) DC is for purchasing the item in the less advanced communities that make up the majority of settled enclaves in the Gamma Age.

Very common devices and technologies that can either be bred or that have gone feral and can now be caught in the wild all have a single purchase DC. Their presence has nothing to do with the level of technological advancement of a particular community.

found in almost any store and in the ruins of many homes.

### FIX-IT

**Fix-It (and Jinx):** Tiny animal; HD 1d8 (hp 5); Mas 10; Init +3; Spd 20 ft (4 squares); Defense 15 (+2 size, +3 Dex), touch 15, flat-footed 12; BAB/ Grap +0/ -5; Atk bite +3 melee (1d2); Full Atk bite +3 melee (1d2); FS/ Reach 2 1/2 ft./ 0 ft.; SQ Low-light vision; AL bonded human; tinkering; SV Fort +2; Ref +5; Wil +1; AP 0; RP 0; Str 5, Dex 16, Con 10, Int 6, Wis 12, Cha 8.

**Skills:** Craft (electronic) +15, Craft (mechanical) +15, Repair +15 (or Disable Device +15 for jinxes)

**Feats:** Tech Familiarity: Pre-War Tech

**Purchase DC:** 14

While many tools were designed for use with extremely advanced supporting devices, the fix-its were designed to work with the far more common technologies of daily life. Fix-its are genetically engineered capuchin monkeys designed to bond with a specific person. If someone feeds an unbonded fix-it for a full day and allows the creature to sleep next to him, then fix-it will be completely loyal and devoted to this individual. This bonding lasts until the individual dies or until the fix-it has been separated from this individual for more than a month. After this, it is unbonded and someone else may freely bond with it. Bonded fix-its cannot bond with anyone else. Fix-its are extremely curious and to tinker with everything they encounter. Unfortunately, they were still experimental creatures when the Final Wars occurred and can have problems dealing with advanced technologies.



## GAMMA WORLD: OUT OF THE VAULTS

Fix-its attempt to repair, tinker with, or improve any item of archaic, advanced, or pre-war technology that they encounter. They possess an instinctive understanding of all technologies and craft simple tools or use their specially modified and highly dexterous hands, feet and tails to attempt to improve any technological device they encounter. They are most effective when working with Archaic and Advanced devices. They can transform any piece of archaic, advanced, or pre-war technology into a Mastercraft object with a +1 bonus. The DC of this attempt is the DC to construct this object +3. Fix-its make all Repair and Craft rolls with a bonus of +15 (which includes all bonuses from abilities, skill and any synergy bonuses). On a successful roll, the item becomes a Mastercraft item.

On a failure, any piece of archaic or advanced technology has been slightly damaged and now had a penalty of -1. However, on a failed roll, pre-war technology become highly unpredictable: any item of pre-war technology that a fix-it fails to upgrade into a Mastercraft item becomes highly unreliable and may randomly backfire, fall apart without warning or perform some unexpected function vaguely related to its original purpose. Unfortunately, there is no way to determine what such a piece of technology might do without attempting to use it. To avoid making existing problems worse, fix-its do not attempt to repair items they have broken.

Also, fix-its attempt to upgrade any object that their bonded owner regularly uses, unless their owner periodically tells the creatures to leave that item alone. They are similarly interested in any obviously broken object their owner possesses, especially if the item uses advanced or pre-war technology. Fix-its often become lethargic and can even sicken and occasionally die if they are not regularly given items to upgrade and modify — owning a fix-it can be a problematic proposition

If desired, fix-its can also be commanded to use the Extreme Machine special ability on any piece of technology. Unfortunately, they are less adept at doing this than a normal technician would be and once the items reverts to its previous state, it is broken and must be repaired on a percentile roll of 50 or lower.

Although fix-its can be troublesome, they are far more benign than a related species known as jinxes. When the fix-its were created, the company who created them fired the design team shortly before the fix-its were released so that the administrators would not have to share their bonuses with the genetic engineers and lab techs. In revenge, this team created

a version of a fix-it specifically designed to ruin and damage objects. Although they were originally deeply hated, jinxes rapidly became popular with intelligence operatives. Although it can and does regularly attempt to repair broken items, a jinx only has a total bonus of +3 for Repairs. However, it can break or disable almost any device and has a total bonus to the Disable Device skill of +15. A normal Disable Device roll allows a Jinx to rapidly render any item non-functional and if it can make the roll with +5 added to the DC, the object will appear to have been improved or fully repaired until its owner attempts to use it.

Jinxes can be ordered to destroy or damage a specific device, but if left on their own, they will attempt to sabotage any nearby device. If a jinx gains access to a new item, roll 1d20. On a roll of 1-10, the jinx damages the device so that it has a -3 penalty for all uses. On a roll of 11-20, the jinx will modify the device so that it performs some harmful and vaguely related function — a gun might explode when fired or an electrical heating pad might either catch fire or shock the user. Since it is impossible to distinguish jinxes from fix-its, both creatures are regarded with great suspicion by most sensible people. Both types of creature breed well in the wild and occasionally feral fix-its and jinxes tinker with gadgets belonging to anyone who lives nearby.

Both jinxes and fix-its look like large capuchin monkeys approximately a foot and a half tall. They stand and walk fully upright and their fur is quite short, but they retain the opposable toes and prehensile tail of their ancestors. In addition to having slightly larger heads, the most obvious difference is that these creatures have unusually large hands. They have seven fingers on each hand. Their fingers are also almost as long as a humans, but are far thinner and contain one extra joint.

### GRABBER

#### Grabber Gun (loaded)

**Size:** Small  
**Weight:** 2 lb  
**Purchase DC:** 16/ 17

#### Grabber

**Size:** Tiny  
**Weight:** 0.5 lb  
**Purchase DC:** 14/ 15

Grabbers are the ultimate grappling hooks. Using nanomachines that bond themselves to any material, a grabber can transform a difficult climb into an exceptionally simple one. Grabbers are (usually) egg-shaped objects 5 inches long and 3 inches in diameter (approximately the size and shape of an avocado), with three buttons on one end and a foot-long rope extending from the other. Pressing the green button allows the user to draw more rope out of the egg. This



## CHAPTER TWO: TOOLS

rope consists of the same nanomachines that make up the egg; it expands when pulled out of the egg and becomes soft, lightweight and incredibly sturdy. Although this rope is only a quarter inch thick, it can support up to 5,000 lb. Each grabber can provide up to 150 feet of rope. At this point, the grabber is only the size of a large chicken egg. Pressing the red button activates the grabber. The far end of the grabber away from the rope flattens and turns black, and bonds with the next non-living thing that it touches. Once attached, the grabber can support up to 5,000 lb, unless the object it is attached to breaks first.

Pressing the blue button causes the rope to retract. If the user attaches the grabber to something, the rope will lift up to 5,000 lb as it retracts. The rope retracts at a rate of 10 feet per round. Pressing all three buttons, one after the other causes the grabber to instantly release whatever it is attached to. Grabbers contain sufficient power for up to six hours of constant use (including continuously retracting while lifting heavy loads) before they need to recharge. When they need to recharge, both the grabber and the rope turns bright red. At this point, the user can no longer lengthen or shorten the rope. Also, once the user causes a grabber that needs to be recharged to release, it immediately flattens out into a pancake-like disk one foot across. It will then fully recharge if left in the sun for at least 10 hours.

Originally, grabbers came with special electromagnetic guns designed to fire them accurately up to 150 feet away, while keeping the rope on a special spool. Unlike the grabber itself, the guns required power cells. A grabber gun can fire 30 times before its owner must recharge or replace its power cell. Many people abandoned these guns when they broke or ran out of power. However, the grabber itself is almost indestructible, so today users often throw it or attach it to the heads of arrows as a way to deliver it to where the user wants to attach it.

### GROOMING NANOTECHNOLOGY

**Size:** Tiny  
**Weight:** 0.5 lb  
**Purchase DC:** 12/14

One of the primary difficulties with all 20th and early 21st century films was that all of the actors needed to have their hair and make-up touched up after every shot. In the late 21st century, cosmetics researchers developed nanotechnology that continuously performed these touch-ups, making high quality films and holovids both easier and far less expensive. A decade after it was developed for use in holovids, several companies created commercial

versions that could provide the same services for everyone. Eighteen years before the Final Wars, manufacturers refined this nanowear to the point that it could also continuously keep the wearer and her clothing clean and could adjust the wearer's clothing to avoid wrinkles, and even clear rainwater off of both the wearer and her clothes almost instantly.

Powered by the wearer's body heat, this nanotech never needed recharging. Because it was one of the cheapest and most widely available forms of nanotechnology available, millions of shot-glass sized containers of this nanotech still remain in the ruins of many shops. In addition, some of this nanotech has gone feral and now keeps the coats of various wild animals perfectly clean and smooth. Ranchers often attempt to entice this nanotech onto their sheep.

This nanotech works on all living beings and even on cyborgs with living skin. It will remain on the first living organism that is size small, medium or large that it encounters. It provides a +2 synergy bonus to all Diplomacy rolls because the wearer always looks stylish and well-groomed. Even if the user fell into a swamp after sweating heavily while walking through a extremely hot and humid rainforest, she will be clean and well-groomed in less than five minutes. This nanotech can even repair minor tears and ripped seams on the user's clothing and keep it continuously pressed and wrinkle free as long as it is worn. If the user desires, she never needs to either take a bath or to change his clothes.

Grooming nanotech also provides a +2 synergy bonus to resist all poisons or diseases passed by either contact or injury, because the nanotech devours all dirt and other unwanted foreign material on the use's body almost instantly. Users who get this nanotech fresh from its original package or who have been taught the various commands that it understands also learn how to cause it to change hairstyles and apply high quality make-up that it creates out of dust and atmospheric chemicals. Using a combination of hand gestures and voice commands, the user can completely change her hair color, hairstyle and make-up in only 10 rounds. Using grooming nanotech in this fashion provides a +2 equipment bonus to all disguise-related checks.

### HANDI-LITE

**Size:** Small  
**Weight:** 0.5 lb  
**Purchase DC:** 12/14

This device represents the pinnacle of adaptive lighting. It consists of a diamondoid aerostat (rigid-framed balloon) six inches across, with solar cells on

## GAMMA WORLD: OUT OF THE VAULTS

its upper surface and a small but powerful light mounted on its bottom. Indoors and outdoors when there is little wind, the handi-lite's small ducted fans can easily propel it at speeds of up to 60 ft. per turn. In higher wind or when its owner is moving faster than this, it extends its four slender, wire-like limbs from underneath the light and clings to either its owner or to some convenient nearby surface. The handi-lite can illuminate entire areas as well as a halogen lantern (with a radius of 40 feet) or it can use focusing mirrors to project a bright directional beam of light up to 60 feet long.

Sensors on the handi-lite track the owner's eye movements, so that the light is never in the owner's eyes and always illuminates what the owner is looking at. Also, the amount of light it provides varies depending upon the ambient light level, so that it always provides an optimum level of illumination. The user can command the unit to provide optimal illumination for both her and her companions. She can also switch between lantern and flashlight mode, reduce the level of light so that it illuminates a smaller area or provides illumination in such a way that little or no light is directed in a particular direction (to avoid alerting anyone watching from that direction). A fully charged handi-lite can provide continuous illumination and mobility for 120 hours on one power cell. The solar cells on top of the aerostat recharge one hour of illumination for every three hours the aerostat is in direct sunlight.

### NANOKEY

**Size:** Tiny

**Weight:** 0.5 lb

**Purchase DC:** 19/ 22

The eternal struggle between ever more efficient locks and ever improving lock picks continued right up until the Final Wars. The nanokey was the finest lock pick ever devised. While it could not penetrate the advanced biopattern locks used on highly secure military and government installations, it swiftly opened any other lock. Nanokeys are small boxes that are four inches long, two inches wide, and two inches thick. These devices contain a porous-looking surface on one of their small sides and a button on the back.

To use a nanokey, the owner places it against the lock and presses the button. A stream of manipulatory nanounits comes out of the porous surface and invades the lock. They are programmed to both recognize all known types of locks and to extrapolate ways of opening similar types of unknown locks. Whether the lock uses a combination, a key, a punch code and a

key card or even a retina print, the nanounits determine the correct way of opening the lock and open it. They require 1d4 turns to open any mechanical lock and 3d6 turns to open electronic locks.

These nano-machines open locks so effectively that they do not leave any marks that the lock was forced open and will not set off any alarms connect to these locks. A nanokey uses very little energy and the solar cells on one side of the device keep it fully charged and active. Before the Final Wars, only thieves, spies and locksmiths ever used this device and it was fairly rare. Since nanokeys could not be purchased in shops and were only legally available to a few varieties of licensed professionals, finding nanokeys in the postwar era is mostly a matter of luck.

### REPAIR GOO

**Size:** Tiny

**Weight:** 1 lb

**Purchase DC:** 13/ 16

Developed shortly before the Final Wars, this advanced nanotech can be found in the trunks of almost all expensive vehicles and on the shelves of the ruins of many once-prestigious shops. Repair goo is always sold in a cylindrical container the size of a 20th century 16 oz. can. Each can holds four uses of repair goo. When the user touches the can to an object and pushes the trigger button on the side of the can, a tennis-ball sized blob of silvery liquid emerges. This advanced repair nanotechnology first uses miniature sensors to analyze the object or device it has been placed on and rapidly determines what is wrong with this device. During this process, the silvery liquid spreads all over the object like a thin film of mercury. This analysis requires approximately 5–10 minutes, depending upon the complexity of the device. Afterwards, the repair goo fixes any obvious problems, including breaks, weak points or worn parts.

Whether it is used on a broken motorcycle or a worn and scuffed suit of clothing, it can restore almost anything to pristine condition. It replaces any small missing pieces using its own nanounits and whatever material it can collect from the surface the object is resting on — the repair goo sends out tendrils a yard or two long to collect any useful materials that are nearby. Instructions on a container of repair goo recommend that when using it on seriously damaged items, the user place quantities of various materials used in the item nearby. Once it has finished all repairs it can manage, the repair goo turns into a dark gray

## CHAPTER TWO: TOOLS

### REPAIR GOO AFFECTS

Roll 1d20 and consult the table below. No check is required if the damage occurred less than a year previously.

Age of Damage	Jury-Rig	Erratic Results	Successful Repair
Between 1 and 10 years	1	2-6	7-20
Between 11 and 50 years	6	7-11	12-20
More than 50 years ago	11	12-16	17-20

**Jury Rigged:** The item falls to pieces after it has been used once, it cannot be repaired again without a successful DC 25 Repair roll or a successful DC 20 Repair roll and more repair goo.

**Erratic Results:** The device now works erratically, Roll 1d20 after every use, on a roll of 1-3 the device fails to operate when it is used or turned on. The user can retry it the next turn.

**Successful Repair:** The item was fully repaired and works normally.

One dose of repair good fixes anything from a fountain pen to a motorcycle or a battle suit. Owners must use two doses to fix a large vehicle like a runner or a hover bubble, and four doses to fix an item the size of a personal jet, a tank, a modest home or a large yacht. Repair goo cannot repair larger items.

powder and falls off of the item it repaired, leaving shiny paint, smooth wood, or new fabric underneath.

Repair goo repairs any ordinary damage within an hour, rendering the object or device as good as new. However, it cannot repair item that have large missing pieces or items that have been fully or partially reduced to rubble. Also, while it can analyze and repair

anything that has suffered damage within the last year, items that have either suffered several decades worth of weathering or that were damaged and then weathered for many years are far more difficult to scan since so little of the original item is unweathered. As a result, repairs made on such items may yield erratic results — often only some of the item's original

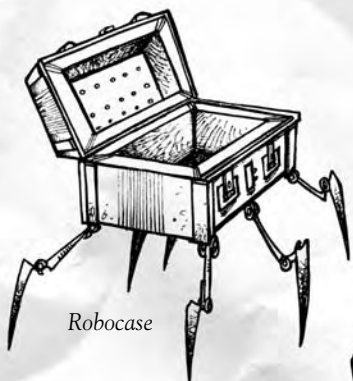

Robocase



Repair Goo

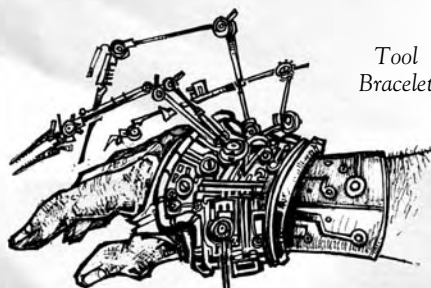

Tool Bracelet



Sense Specs



Wrist Assistant



Shelter-Pak





## GAMMA WORLD: OUT OF THE VAULTS

functions work or the repair turns out to only be a jury rig and the item literally falls to pieces after it was used once.

### ROBOCASE

**Size:** Large

**Weight:** 15 lb

**Purchase DC:** 14/ 15

The problem with all luggage is that the user must carry it around wherever he goes. The robocase was an answer to this problem developed in the mid-21st century. When inactive, a robocase is a suitcase 30 inches tall, 18 inches wide, and 12 inches deep. The suitcase weighs 15 lb when empty and can hold up to 40 lb of gear. It is extremely sturdy and protects everything within with DR 5/ kinetic. When open, the walls of the suitcase are unusually thick, but otherwise it looks exactly like any other suitcase made before the Final Wars. However, when the user presses a switch on the handle, the suitcase extends six three foot-long legs, stands up, and begins to follow its designated user.

Unfortunately, the designated user usually died decades ago. How useful a robocase is depends in large part on where someone finds it. One uncovered in the ruins of a store was likely never used before and will obey the person who turns it on and will freely follow and obey him. He can freely transfer ownership of the case to someone else, simply by telling the robocase that someone else is its new owner. However, someone used to own almost all of the robocases found elsewhere.

Once activated, an owned robocase attempts to seek out its previous owner and will protect its contents from intruders. If anyone who is not an owner or who does not have proper identification as a police officer attempts to move or open the robocase, it will flee, or if necessary defend itself. If cornered or attacked, the case electrifies its exterior, so that anyone who touches it is affected as if hit by a stun gun. No hit roll is necessary, it automatically damages whoever touches it. Resetting a robocase so that it will recognize someone else as its owner requires a pair of insulated gloves and a DC 30 Disable Device roll. If this roll is successful, the robocase will recognize the next person that turns it on as its legitimate owner.

Designed for use by both hikers and ordinary travelers, robocases can easily climb any slope that a human can negotiate and have a speed of 40 ft. Robocases can walk for up to 30 hours on a single power cell. At the end of this time, the user can either replace their power cell, or press the recharge switch

on the handle. At this point, the case deploys a pair of small solar panels. These solar cells can recharge the case's batteries in 15 hours. The user can instead allow this device to walk indefinitely if he deploys the solar panels while the case is walking.

### SENSE SPECS (TRIPLE S)

**Size:** Tiny

**Weight:** 0.5 lb

**Purchase DC:** 15

First developed in 2020 to help soldiers on patrol coordinate their efforts, these computerized sunglasses swiftly became popular with teens who enjoyed both the thrill of enhanced sight and the ability to share everything with their friends. Within a few decades, advanced wearable computers rendered these devices both obsolete and redundant. However, sense specs remained popular with children, poor street gang members who could not afford better technology and people in the Third World.

Sense specs are built into fancy sunglasses with sturdy metal frames. When the user pushes the button on the top of the frame, the glasses turn on and become far more. Alone, they allow the user to magnify images up to 10X, to see in the dark using light intensifiers and to see both infrared and ultraviolet light. The frames contain a directional microphone that enhances distant sounds. The glasses provide a +2 equipment bonus to all sight and hearing rolls and eliminate any penalties caused by dim light as well as giving the user the Darkvision special quality. Sense specs also contain software that allows them to track the user's pupils and how the user's eyes are focusing, and use this information to automatically enlarge far away objects that the user is looking at and to compensate for dim light. The first time a user puts on a pair of sense specs, the glasses automatically runs through a short tutorial where the user decides how he wants to over-ride these automatic settings. Users can whisper vocal commands, use special series of blinks or touch various portions of the glasses frames to signal the glasses that he wishes them to magnify a particular image or switch over solely to the infrared spectrum.

Sense specs become even more useful when used together. If the user comes within 5 ft of someone else wearing a pair of sense specs, both pairs will flash up a message on the interior of the lenses "do you wish to link with the other wearer". If both wearers agree, then as long as both wearers remain within 25 miles of each other, each wearer can use his glasses to see what the other person's glasses are seeing and

## CHAPTER TWO: TOOLS

hearing. Sense specs can be set to display sight, sound or both, and can do so either in a corner of the wearer's field of vision or to completely replace the view through his glasses with what the other person is seeing.

One pair of sense specs can link up with up to 25 other pairs of sense specs at a time. The glasses remain linked until the user decides to unlink them. During the decade before the Final Wars, sense specs normally came in boxes of six pairs. Most of these sense specs are brightly colored and are in packaging clearly designed to appeal to children. All pairs of sense specs in a box are already linked together. Sense specs use very little power and recharge themselves using tiny solar cells on their frames. Scavengers can find sense specs in the ruins of toy stores and discount stores.

### SHELTER-PAK

**Size:** Small

**Weight:** 5 lb

**Purchase DC:** 18/20

The shelter-pak is the ultimate camping shelter. Since the Final Wars, it has been exceptionally popular with nomadic bands, soldiers and travelers of all sorts. When folded, a shelter-pak is a rounded oval 10 inches long, 6 inches wide and 3 inches deep. The outside of this oval is largely featureless, containing only a button-like tab that the user can pull and a small digital charge indicator. Thin-film solar cells cover the entire surface of this ovoid, and even if the unit's battery is completely empty, placing it in direct sunlight or other bright light for 15 minutes provides it with sufficient power to open when the user pull the tab. When the user pulls the tab, the oval takes five minutes to unfold into a dome-shaped tent, 10 feet in diameter and 6 feet high in the center. Dozen of nanotech micro-pitons anchor it to any surface except living flesh.

Although they are as thin as paper, the walls of this tent are as rigid as steel and have DR 5/kinetic. Inside the tent, there are six pieces of inflated furniture that users can easily fold into either comfortable chairs or luxuriously padded sleeping bags. Solar cells on the outside of the tent power the interior lights and the thermoelectric heating and cooling units that make the well-insulated tent comfortable in temperatures ranging from -20 to 120 F. Eight hours of exposure to sunlight allows provides the shelter-pak with sufficient electricity to power it for 30 hours.

Anyone with a shelter-pak can remain warm, comfortable and dry in the worst weather. These items have saved the lives of hundreds of explorers and

nomads in the decades since the Final Wars. As a result, many people regard them as more valuable than even the finest weapons or armor. Pulling a tab on the inside of the shelter causes it to collapse back into an easily carried ovoid, this process also takes five minutes. Best of all, this item contains nanotech assemblers that allow it to be somewhat self-repairing. While explosions or lengthy hacking with a sword or axe will destroy this shelter, it can repair small holes and tears quite easily. Users should leave damaged tents in direct sunlight for at least an hour. At the end of this time, the tent will have repaired itself. Shelter-paks are most often found in the ruins of stores that once sold camping supplies.

### TOOL BRACELET

**Size:** Tiny

**Weight:** 1 lb

**Purchase DC:** 17/19

These items are always found in pairs and usually stored as hollow cylinders 6 inches long and 4 inches thick. These cylinders automatically stretch to themselves around the wrists of any humanoid creature who attempts to put them on. Tool bracelets are marvels of nanotechnology and can reshape themselves into almost any sort of small tool imaginable.

These devices use a contact-based neural interface developed only a few years before the Final Wars, so cybernetic implants are necessary to use a pair of tool bracelets. Instead, sensitive contacts on the inner surface of the bracelets allow them to pick up the wearer's nerve signals and small electrical induction pads permit these items to deliver accurate pseudo-tactile feedback to the user. Because the nanotechnology inside these bracelets can complete reshape them, they can make tools that can aid with all Craft (chemical, electronic, mechanical, metalworking, pharmaceutical, and visual arts) checks as well as with all Repair and Treat Injury checks.

When needed, tools grow rapidly out of the metal of the bracelet. These tools look much like the long silvery insect legs that end in complex tools. Tool bracelets can make small electric drills, scalpels, screwdrivers, pliers and almost any other small hand tool. The user never needs to hold these tools in his hands. The tools work independently: a tool bracelet might create a small pair of pliers to turn a nut while the user holds the bolt with his hand. The one limit on a pair of tool bracelets is that its relatively simple computer that cannot completely anticipate the user's needs. Instead, this device relies upon the user's own knowledge and understanding of how to perform a task and what tools would be useful.



## GAMMA WORLD: OUT OF THE VAULTS

As a result, the better the user is at a specific skill, the more a set of tool bracelets can assist him. For all skills that they aid, tool bracelets provides a bonus of +2 + 1/ for every 3 ranks the wearer has the appropriate skill (round down). A character who had 5 ranks in Repair would gain a +3 bonus to all Repair checks from using tool bracelets. Tool bracelets use little power. High-efficiency solar cells on their surface allow them to operate continuously as long as the user regularly exposes them to bright light like direct sunlight. If the user is unarmed and must fight, tool bracelets can also create durable blades that allow the user to add +2 to his unarmed combat damage and turn this damage into lethal damage.

### WRIST ASSISTANT (WA)

**Size:** Tiny  
**Weight:** 0.5 lb  
**Purchase DC:** 16/19

This improved version of the datapad was introduced a decade before the Final Wars. While the added expense prevented it from becoming quite as popular, there were still millions of units in use when the Final Wars occurred. Wrist assistants look like wrist watches 2 inches wide, 3 inches long and half an inch thick. In addition to performing all of the functions of a datapad, this device also functions as a compass, a GPS receiver with an electronic map database, an extremely accurate watch, a digital camera and a cellphone/ radio. The unit can function as a cellphone in those few areas that maintain active cellphone service. Elsewhere, it functions as a two-way radio that can also send and receive video images. This radio has a range of 25 miles. This unit can also link with sense specs to send and receive both sounds and images.

---

## COMMUNITY TOOLS

Beginning in the 21st century, communities became increasingly self-sufficient, a trend that continued well into the 22nd century and beyond. This trend arose for many reasons, including ideological ones, but the primary one was self-defense. By ensuring self-sufficiency, communities could guarantee their safety amidst all the unexpected changes that the future held. Arcologies unusual examples of this self-sufficiency put into action, although far from the most extreme. Many advanced technologies made self-sufficiency a workable reality rather than a mere flight of fancy. By the time of the Final Wars, large segments of the world's population lived in self-sufficient communities, relying solely on their own resources to make their way in the world.

A wide array of remarkable devices aided in the creation and maintenance of pre-Wars communities. Many of these devices survived into the Gamma Age, where they might one day be put to use again. The difficulty, of course, is not only understanding how these tools work but also finding the means to make full use of them, since many depend on a societal and technological infrastructure that no longer exists. It is often said that the world that existed before the Final Wars was a delicate puzzle whose pieces were easily dislodged, thereby destroying the bigger picture on which society depended. While that may be a fair assessment of the situation, it is equally true to remember that the pieces of that once-beautiful puzzle

still exist. It is simply a question of someone's finding the means and the will to reassemble them.

The following items are all geared toward communities. While many would have beneficial effects for player characters, the majority of them would prove more useful when employed in the service of a community. For that reason, most include notes on how to integrate them into the community creation system in the **Gamma World Player's Handbook**. In addition, many community tools require more than one person to operate or are bulky or difficult to move, making them less than ideal as pieces of personal equipment. Finally, GMs are well within their rights to emphasize the value these tools have to the beleaguered communities of the Gamma Age. Some are more than worth their weight in gold, so to speak, and any characters who use them selfishly or otherwise prevent their being employed in the service of a larger group might find themselves ostracized, hunted or worse.

### BROADCAST POWER CHARGER

**Size:** Medium  
**Weight:** 40 lb  
**Purchase DC:** 20

The broadcast power charger is one of the most useful spin-off technologies developed for use with the broadcast power system (see next entry). The charger is a unit about the size of a very large attaché case,



## CHAPTER TWO: TOOLS



Power  
Sleep Unit

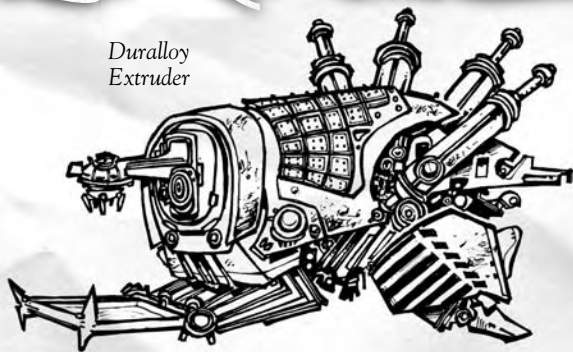

Duralloy  
Extruder



Feelie  
Projector

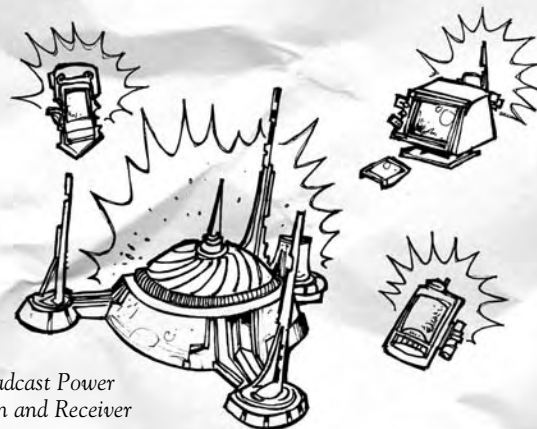

Broadcast Power  
Station and Receiver

with several slots that are the same size as the standard energy cells used during the Final Wars era. When an expended energy cell is placed within the slots and the charger is within the range of a functioning broadcast power station, the unit slowly recharges the cells over the course of 12 hours. Once that time has elapsed, the cells are once again usable as power sources for many common types of equipment. The broadcast power charger has only six slots for energy cells.

Even after the advent of broadcast power, energy cells remained a popular power source for portable devices, since they were more compact and therefore less bulky than the standard broadcast power reception system. Furthermore, not every part of the world was accessible by broadcast power, which meant that energy cells remained vitally important. The charger is thus an artifact from an intermediate stage in the technology's development, as broadcast power became more common but had not yet become so widespread that anyone would consider abandoning the tried and true methods of the past. The catastrophe of the Final Wars prevented the further spread of broadcast power, of course, apparently permanently.

**Community Creation System Effect:** Any community that possesses a broadcast power charger

gains an additional month on the effects of its Stockpile feat. Each additional charger adds a further week the Stockpile's benefits.

### BROADCAST POWER STATION AND RECEIVER

Broadcast Power Station	Broadcast Power Receiver
<b>Size:</b> Huge	<b>Size:</b> Large
<b>Weight:</b> 1000 lb	<b>Weight:</b> 600 lb
<b>Purchase DC:</b> 30	<b>Purchase DC:</b> 27

The quest for renewable energy sources had been a never-ending one since at least the 20th century, perhaps earlier. In the end, that quest was almost always frustrated, as each new promising development proved ultimately to be fool's gold, with some unexpected or hidden weakness or drawback. In the Noetic Age, however, mankind finally hit upon the answer to its collective energy dreams with the discovery of broadcast power.

Once considered mere fantasy, broadcast power allows the transmission of electrical power over great distances (generally no more than 1000 miles). The electrical power can come from almost any source, including fusion plants, hydroelectric generators, oceanic wave motion, which a power station excites

## GAMMA WORLD: OUT OF THE VAULTS

and amplifies through resonant oscillations until an electrical standing wave is propagated through the planet's upper atmosphere. A broadcast power receiver is tuned to the frequency of the wave and draws power from it into any number of subsidiary systems, which can then use it for energy. A side effect of broadcast power is the increased presence and visibility of the aurora borealis, which can be seen anywhere that broadcast power is used.

In principle almost any device or vehicle could use broadcast power, limited only by the presence of function power stations and receivers. Prior to the Final Wars, the changeover to broadcast power was only in the middle of its run, with large areas of the Earth not within its reach. Had the system been put in place everywhere, the world would finally have ended its age-old struggle with dependence on fusion and other more limited power sources. Even in its trial run just before the Final Wars, broadcast power proved wildly successful. If any of those stations and receivers still survives, a community that gained access to them would find themselves in a uniquely good position.

**Community Creation System Effect:** Possession of a working broadcast power station and receiver (or just the receiver if there is already a working power station within range of the receiver) grants access to the Broadcast Power feat (although the prerequisites must still be met).

### FEAT: BROADCAST POWER

The community has nearly unlimited energy at very little cost.

**Prerequisites:** Pre-War Electricity Generation, Pre-War Engineering **(Benefits:** This feat provides the ability to generate electricity without the need for any manpower or materials and with far less maintenance than lesser forms of electricity generation.

**Normal:** Communities without this feat must either do without electricity or use a more primitive means of generation.

**Signs:** Operational electrical devices of every possible sort without any obvious means of generation. A single tall power receiver but without any overhead wires or connections to the devices being powered.

## COMMUNICATIONS STATION

**Size:** Large

**Weight:** 450 lb

**Purchase DC:** 21

The world destroyed by the Final Wars was an interconnected one. Communication was fast, easy and inexpensive. Individuals carried personal communicators (some were even implanted into their bodies) with them everywhere. If, for some reason, they did not have communicators of their own, they could easily find a public one on the streets of almost any city. Communication came in many forms (audio, video, text, holographic and more) and was effectively instantaneous, thanks to a series of breakthroughs that all but eliminated noticeable lag, even when transmitting from one side of the globe to the other. In addition, locating almost anyone was nearly as simple, since the communication networks were so well connected that it took no more time to find a friend a continent away than it did to find a next-door neighbor. Indeed, avoiding being found was a greater problem and led to a market for privacy devices designed to keep one free from unwanted location.

At the heart of the communications network were the automated nodes that relayed carrier waves and interfaced with global information networks. These stations were found every few miles and acted not only as relays but also as distributed backups for the system, so that the destruction of one or even many stations would not cause appreciable damage to the entire system. Furthermore, each node contains within it the software necessary to create new networks, provided their enough communications device to act as roving receivers. If several of these stations were within close proximity of one another, a communications network could be even more easily rebuilt and maintained.

Perhaps unsurprisingly, the acquisition of a communications station is an important find for a community. Many of the strongest Gamma Age communities possess one or more of these nodes and use them to maintain contact with outlying areas. In most cases, it is only the highest levels of authority that have access to these channels, owing in no small part to the relative dearth of personal communications devices. Of course, there are always exceptions and rumors persist of communities that approach pre-Gamma Age levels of interconnectedness, although the evidence of this is almost non-existent. Still, such tales inspire many communities to seek out and repair communications stations as a way of improving their lot.



## CHAPTER TWO: TOOLS

**Community Creation System Effect:** Possession of a working communications station grants the ability to gain the Advanced Communications feat (though the prerequisites must still be met).

### FEAT: ADVANCED COMMUNICATIONS

The community has the ability to communicate with other communities at a distance.

**Prerequisites:** Knowledge (Technology: Advanced) 4 ranks

**Benefits:** The community can conduct long-range communications with other communities, thereby ending its isolation and ensuring its connection to the wider world. This grants a +3 bonus to the community's Wealth.

**Signs:** Greater numbers of visitors to community, thriving trade and commerce

### DURALLOY EXTRUDER

**Size:** Large

**Weight:** 150 lb

**Purchase DC:** 20

Nanotechnology brought many boons, one of which being the development of new wonder materials that either added new characteristics to existing materials or melded the characteristics of several others in order to create hybrids that surpassed those from which it was made. One of the most successful of these hybrid materials was a metal known as duralloy. Originally a brand name of the corporation that first produced it, duralloy proved so broadly useful that the name became widespread. Within short order, many different nanotech metals, some of which were produced by other corporations, were colloquially known as duralloy, despite the best efforts of its creators to prevent their trademark from being infringed, even by popular acclaim.

Duralloy, as its name suggests, is a strong, sturdy metal that is nevertheless remarkably malleable. The metal was produced on-site by means of a bulky device called an extruder, which created the metal in a wide variety of different forms, shapes and thickness. By using the controls, an operator could produce duralloy girders, wire frames, doors, even liquid! The operator could likewise encode the metal to remain malleable for a set period of time, after which it would set and acquire its characteristic hardness and durability. Furthermore, an extruder could encode the metal to retain its malleability as a latent characteristic, so that,

at a later date, it could again be "activated," thereby allowing it to be reshaped if desired.

Unlike ferrocrete, duralloy was used primarily to create objects for construction rather than as a joining mechanism. Of course, duralloy objects didn't need fasteners unless the extruder's operator chose to encode them that way. Thus, duralloy panels would need no rivets; they simply bonded with the other panels to which they'd been given an "affinity" and would hold fast until their malleability period ended or until instructed to loosen by an extruder (if so encoded). By the time of the Final Wars, duralloy extruders were very common in many communities, which used them to build their own structures, as well as to alter existing ones. These devices were also popular with the military, whose units would often use them to build and deconstruct sturdy shelters and redoubts while in the field.

**Community Creation System Effect:** Possession of a duralloy extruder increases the Wealth bonus by +1 for any community that has the feats Pre-War Engineering or Advanced Engineering. Every four additional extruders increases this bonus by a further +1, to a maximum of +3 for a community that possesses nine extruders.

### FEELIE PROJECTOR

**Feelie Projector**

**Size:** Medium

**Weight:** 80 lb

**Purchase DC:** 18

**Feelie Program Cartridge**

**Size:** Tiny

**Weight:** 0.25 lb

**Purchase DC:** 20 (or more)

Feelie projectors are an unusual form of Noetic Era entertainment that stimulates the sensorium of the human brain in order to offer an experience unlike any other. The projectors are small devices that use a magnetic field to function and operate on two different but related levels. The simplest way is direct, undifferentiated stimulation. In this case, the projectors create new and unusual feelings in those using them. These feelings may reproduce ordinary sensory stimulation, like pleasant odors or visual effects, for example, or they may provide sensations that have no counterparts in any human experiential lexicon. Used in this first way, feelie projectors are little more than technological "drugs." They impart no meaning and provide nothing more than physical pleasure (or pain, should the user so desire).

The more complex way to use a feelie projector is with a program that tells a story or communicates some message. These programs were mass-produced prior to the Final Wars and came in a wide number of formats. Everything from tales of historical adventure



## GAMMA WORLD: OUT OF THE VAULTS

to science fantasies to dramatic readings of poetry could be found in feelie formats. When used in this way, the projector's sensory stimulation augmented and deepened the content of the program, giving the user a way to "get inside" the art form. For example, a user might experience a story from the visual perspective of one of the characters or feel the raindrops rhapsodized in a poem. Most programs provided multiple options, allowing for changing perspective to enhance the experience further. Feelie programs were extremely popular forms of entertainment prior to the Final Wars and understandably so.

A feelie projector has a variable range, allowing a user to include others within its area of effect if he so desires. This range is up to 100 feet for most models, although larger public models had ranges of three to five times that amount, allowing many more people to partake of its pleasures. When multiple users are present, each can set his own options and perspective, allowing two people, for example, to feel what two interacting characters in a drama are experiencing. Such an experience can be profound, since it allows a kind of penumbral "telepathy" (or at least telempathy) that sometime brings people together... or drives them apart. Feelie projectors make excellent motivational devices and have many uses as propaganda and brainwashing tools as well. Many Gamma Age communities have banned their use, while others have fashioned their societies around them.

Feelie projector programs are uncommon in the Gamma Age. Those that exist are a mixed lot: everything from popular comedies to sporting events to poetry readings and everything in between. Many are difficult to understand, because of cultural and language barriers, although the best crafted still have the ability to transcend these limitations and affect those who view them. New feelie programs can be produced, but the principles behind doing so are rare in the Gamma Age. To create a new program successfully requires a DC 20 Craft (Feelies) check, as well as access to computers specifically designed to create these programs.

### FERROCRETE

#### Ferrocrete Spray Can

**Size:** Small

**Weight:** 3 lb

**Purchase DC:** 16

**Note:** Ferrocrete has 40 hit points per inch of thickness and 20 hardness.

#### Ferrocrete Spray Can

**Size:** Medium

**Weight:** 10 lb

**Purchase DC:** 18

Advances in nanotechnology filtered down into everyday society in haphazard and often unpredictable ways. Some areas saw very little in the way of practical uses for nanotech, while others were literally inundated with new consumer-use products and devices, all of which utilized molecular-level robotics. It's not difficult to understand why this was the case. In the eras before the Final Wars, there was very little central planning when it came to technological development. Many fields had advanced so far that, after a short time, they barreled along according to their own momentum, without much consideration as to where they were going or what impact it might have on human society.

One area where nanotechnology quickly filtered down and found great use was in civil engineering and construction. Nanounits can greatly accelerate the process of erecting a structure, no matter what its size or complexity. They also make structures sturdier and more resistant to environmental damage, thanks to their ability to manipulate matter on molecular level. Indeed, the survival of many buildings through the perils of the Final Wars and into the Gamma Age is a testament to the mighty powers of nanotech construction methods.

Ferrocrete is another example of applied nanotechnology. Ferrocrete is crystallized iron particles suspended within a polymer solution containing inactive nanounits. When exposed to free oxygen, the nanounits become active and begin to align the iron particles so that they become strong and sturdy. This alignment process typically takes several minutes, but can be retarded or sped up with the application of other nanotech solutions. Before alignment became final, ferrocrete could be easily molded and shaped to the user's tastes. Afterwards, it became as solid as titanium steel, and just as difficult to harm. Ferrocrete adheres to all other substances except plastic and living flesh, which meant it could be held and molded by hand without fear of untoward after-effects.

Ferrocrete came in several different forms, but the most popular was a spray can of varying size. The contents of the can could be sprayed on any surface and would quickly adhere and form a sturdy bond as described above. This made it very useful for many personal applications, including the sealing of cracks and breaches. In larger cans, construction workers could use it to build structures. Of course, the permanent and sturdy nature of ferrocrete also meant that it could be used for less savory purposes, such as trapping someone within a room or sealing up vital exits.

## CHAPTER TWO: TOOLS

### HEAT REDUCTION SYSTEM

**Size:** Medium

**Weight:** 50 lb

**Purchase DC:** 20

One of the marvels of the Gene Age was the creation of specialized lifeforms whose sole purpose was to serve human interests and needs. One of the more unusual of these lifeforms was the heat reduction bacterium. These bacteria thrived in warm environments and indeed survived solely on ultraviolet radiation. The heat reduction system utilizes these bacteria to absorb ultraviolet radiation within 300 feet of the unit, thereby reducing the ambient temperature by several degrees. In addition, the bacteria contained within the unit convert excess ultraviolet radiation into electricity, which the unit stores both to power itself and, if desired, small devices that are themselves powered by electricity. Heat reduction systems were fairly uncommon by the Final Wars, since they were an older technology that had been surpassed. However, many still exist and can be valuable to communities that exist in arid or desert environments.

**Community Creation System Effect:** If a community possesses a heat reduction system and either Electricity Generation or Pre-War Electricity Generation, it gains a +1 bonus to its Wealth. For every four additional heat reduction systems, this bonus is increased by +1, to a maximum of +3 for nine heat reduction systems.

### MATTER COMPILER

**Size:** Small    **Size:** Medium    **Size:** Large

**Weight:** 20 lb    **Weight:** 45 lb    **Weight:** 80 lb

**Purchase DC:** 22    **Purchase DC:** 25    **Purchase DC:** 30

While nanotechnology could take many forms, perhaps its "purest" one was the matter compiler. This impressive device was, in some parts of the world, a household appliance that could work wonders previous generations could scarcely imagine, let alone attain. The matter compiler was a metallic box of varying size. The box had a door that opened and a large basin inside in which there was a pool of a polymer solution in which millions of nanounits were suspended. The nanounits received their orders from the compiler's internal computer and used refined carbon molecules as their building materials. When instructed, they would use these molecules to create small items according to set designs.

Many people used matter compilers in the pre-Gamma Age to create common household and personal items. The designs for these items were pieces of software that could be purchased from design companies and fed into the compiler's internal computers. Alternately, a user could create his own designs, provided he understood the compiler's programming language, which was actually quite simple by the standards of past computer languages. Of course, matter compilers included failsafe devices within them to prevent the creation of hazardous or dangerous objects or substances. Likewise, matter compilers could only create objects small enough to fit within their basins.

Matter compilers came in many sizes in the years before the Final Wars. Homes that possessed them had smaller models that were no larger than six feet tall and three feet deep. However, industrial and civic matter compilers could be much larger, although they were correspondingly more rare. In fact, all but the most advanced cities and corporations possessed these larger compilers (as did governments and the military). Even so, the acquisition of a small matter compiler that still functions would be a great boon to a Gamma Age community. A large one might well set a community on the path of growth and power.

A matter compiler can make items of its own size or smaller (see available sizes, above). Items produced cannot be weapons or otherwise objectively dangerous. Neither can they be living, although a compiler could create a simulacrum of a living creature that is not animated or otherwise alive. The GM is the final arbiter on the programs resident in a matter compiler at the time it is found. Otherwise, the user must make a successful DC 18 Computer Use skill check to program a compiler to produce an item that is not available through its resident programs. If the user wishes to override the failsafes in the programming to create weapons or hazardous materials, he must make a successful DC 25 Computer Use skill check. Failure indicates an immediate shutdown of the matter compiler and it cannot be restarted except by a subsequent DC 30 Computer Use check.

**Community Creation System Effect:** To take full advantage of a matter compiler, a community must have the feat Nanotech Usage. If they do, they gain a +1 bonus to their Wealth if the compiler is Small, +2 if it is Medium and +3 if it is Large.



## GAMMA WORLD: OUT OF THE VAULTS

### MICRO-FUSION POWER PLANT

**Size:** Large  
**Weight:** 500 lb  
**Purchase DC:** 24

By the Gene Age, fusion power was a reality, eliminating the need for the less efficient and more dangerous fission power that had been commonplace in previous generations. Fusion power plants sprang up across the world, providing seemingly unlimited energy at very little cost. This had the effect of eliminating the need for non-renewable energy sources, as well as turning the world's attention away from those nations and regions whose sole claim to fame was the possession of such energy sources, thereby altering geopolitics on a grand scale. Likewise, power became very cheap, which raised the bar on the types of scientific and industrial projects that could be undertaken. Now, energy consumption was no longer a barrier and thousands of once-impractical research projects bore fruit.

During the Noetic Age, fusion power became even more compact and efficient, so much so in fact that portable fusion power generators were no longer

the stuff of bad science fiction. Indeed, many personal devices used micro-fusion power packs, since it was only by the application of this much power that they could even operate. Such power packs were inherently limited, though, and were not powerful enough to operate large devices, let alone banks of them. For these, micro-fusion power plants were needed. Many communities possessed one or several of these. Using almost anything as fuel, including worthless biomass such as common garbage, fusion plants could produce more than enough energy to satisfy the needs of most communities and with very little waste. These power plants were common enough during the days before the Final Wars that many undoubtedly exist in the Gamma Age. The difficulty is the high degree of technical skill needed to operate them, which is unfortunately rare in the current age.

**Community Creation System Effect:** A community must have the Pre-War Electricity Generation feat to be able to use a micro-fusion power plant to its fullest. If it does, it gains a +1 bonus to its Wealth for every power plant it possesses, to a maximum bonus of +3.

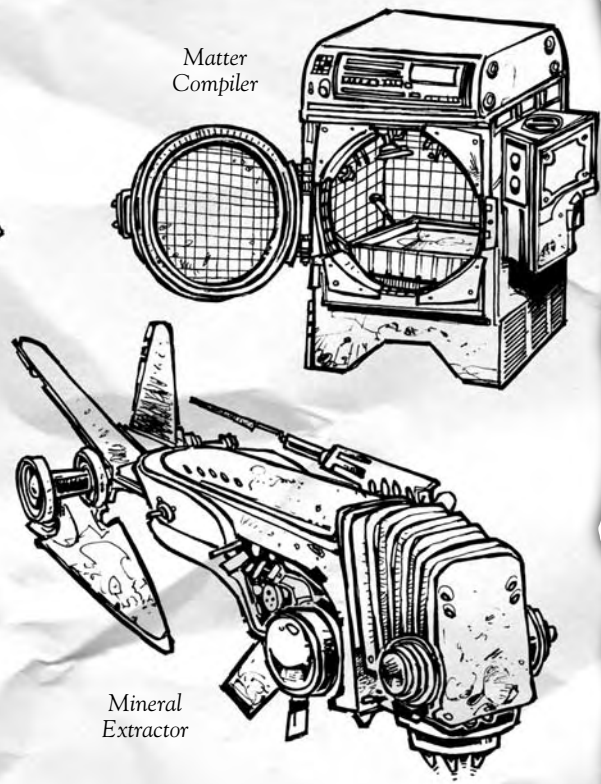
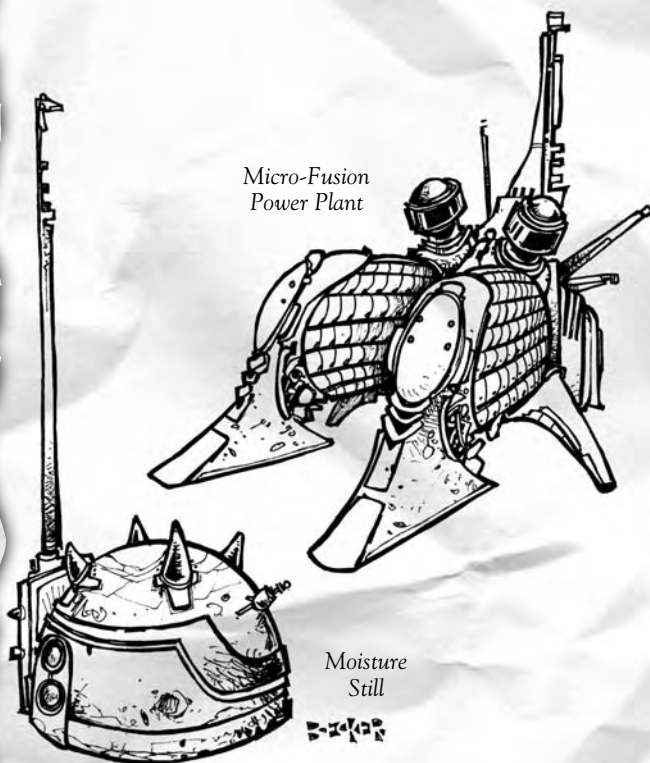



## CHAPTER TWO: TOOLS

### MINERAL EXTRACTOR

**Size:** Huge  
**Weight:** 2000 lb  
**Purchase DC:** 24

By the time of the Final Wars, most of the obvious veins of valuable minerals and ores had been played out, thanks to centuries of mining and excavation. Fortunately, space colonies on the Moon and in the Asteroid Belt discovered equally valuable minerals and ores far from the Earth. To extract them, a number of methods were used, including mechanical devices that combined old-fashioned techniques with high technology. One of these was the mineral extractor, a small robotic "vehicle" that manipulated magnetic fields to hold itself in place while lasers bored into the rock. Onboard scanners pre-selected the lasers' targets, ensuring that they did not hit the specific minerals and ores chosen. Instead, the lasers chipped away at everything else, leaving only the desired minerals and ores, which were then pulled into the extractor and melted down by plasma beams into refined forms to be shipped back to Earth.

Mineral extractors were naturally rare on Earth itself, since there was very little use for such a machine. However, a few of them did return to the home world for repairs, upgrades and the like. Furthermore, their manufacturers were located on Earth. These factors ensured that many remained on the planet after the devastation of the Final Wars. In doing so, they became an important part of many communities' attempts to pull themselves up from the hole into which they had fallen. Thanks to mineral extractors, they could find the deep minerals and ores that still lay hidden beneath the surface of the Earth. They could continue to produce new items that might otherwise have been beyond their grasp, since all the easy to reach resources had long since been used up. Consequently, mineral extractors are supremely valuable. Any community without access to nanotech (and even many who do) requires at least one of these devices, if it ever hopes to create new technological items on its own.

**Community Creation System Effect:** The community must have the feat Advanced Vehicles to make use of a mineral extractor. If it does, it gains a +1 bonus to its Wealth. In addition, if it has the feat Stockpile, it gains an additional two weeks of supplies.

### MOISTURE STILL

<b>Size:</b> Small	<b>Size:</b> Medium	<b>Size:</b> Large
<b>Weight:</b> 10 lb	<b>Weight:</b> 15 lb	<b>Weight:</b> 25 lb
<b>Purchase</b> 15	<b>Purchase</b> 17	<b>Purchase</b> 20

Survival in arid environments is never easy, which was as much a fact in the days before the Final Wars as it is today. For that reason, numerous technological devices were created to aid in overcoming the hazards of water-poor regions. One of the simplest and most useful has been the moisture still. This device, which looks like a large half-globe surmounted by an unusual looking antenna, draws moisture from the atmosphere and distills it into potable water. Stills came in several sizes, depending on the amount of water it could produce in a 24-hour period. The smallest ones could distill enough water in a single day to keep a single person alive in the desert for 48 hours. Larger models could do the same for anywhere between 5 and 50 people, depending on the size.

Moisture stills were fairly uncommon in North America, since the environment was not as unpleasant as other parts of the world. This is unfortunate, since the Gamma Age has shown that the environmental verities of the past are not eternal. Thus, moisture stills are quite valuable among the desert communities of the world, particularly in places, like North America or Europe, where there had not previously been deserts or arid environments of any great size.

### PORTABLE FRESHER

**Size:** Medium  
**Weight:** 40 lb  
**Purchase DC:** 17

Another use for nanotechnology was waste removal. Indeed, some argued that nanotech was far more valuable to humanity as a way of eliminating hazardous materials than it was as a constructor and replicator of useful materials. Not everyone went as far as this, of course, but that didn't stop nanounits from becoming important parts of Earth's new technological ecology. These tiny robots were put to use manipulating the molecules of everything from radioactive waste to sewage, with the belief that they could render them less harmful (and, in a few cases, valuable).

One outgrowth of this was the creation of the portable fresher. This closet-shaped device was in fact a descendant of the portable toilet, since it included a toilet within its space. However, the fresher was much more than that. More than human fecal matter and urine could be placed within. Indeed, almost anything short of radioactive waste could be broken down by its resident nanounits and converted to water and harmless byproducts. The portable fresher was also light enough that two people could carry it with relative ease. Portable freshers were used in many areas

## GAMMA WORLD: OUT OF THE VAULTS

where there were no other waste management facilities (usually newly constructed or remote areas). Many survived the Final Wars and would make excellent additions to many communities.

**Community Creation System Effect:** The possession of a portable fresher allows access to the Sewage Treatment feat.

### FEAT: SEWAGE TREATMENT

The community has an advanced waste management system.

**Prerequisites:** Nanotech Usage

**Benefit:** The community gains a +2 bonus to Resiliency due to the removal of dangerous wastes and hazardous materials.

**Signs:** Healthier people, lack of unpleasant odors.

### POWER SLEEP UNIT

**Size:** Medium

**Weight:** 60 lb

**Purchase DC:** 18

The Noetic Age laid bare the secrets of the human brain, including some of its longest held ones, such as sleep. Unsurprisingly, scientists quickly found ways to exploit their new understanding of sleep, dreaming and rapid eye movement to create new technologies. One such technology was the power sleep unit. Its purpose was cut down the length of time a human being needed to sleep in order to overcome fatigue and stress. Early models cut sleeping time in half, to between four and five hours, while later models cut it down even further, to two to three hours a day. Naturally, power sleep units became very popular with people whose jobs demanded that they be at the ready at all hours, such as doctors and military personnel. Even those who did not have such demanding jobs often found them useful as a way of becoming more productive. After all, if one only has to sleep three hours a day, it's possible to get a great deal more done.

Unfortunately, power sleep units were not without their flaws. For one, not everyone could use them. Some brains simply refused to cooperate with the electrical signals used to stimulate them. Other brains suffered damage as a result. Finally, it was learned that prolonged use of a power sleep unit slowly did permanent damage to the brain, which is why these devices eventually fell from favor. They were never banned outright, but their use was discouraged and only the most dedicated or desperate people continued to make use of them. In small doses, though, power sleep units remain helpful tools. They enable individuals to overcome fatigue, become more

productive and even heal small amounts of damage on a faster timetable than usual. Most of these units that survived into the Gamma Age are found in military vaults.

Anyone placed within a power sleep unit can get a full day's sleep in only three hours. Likewise, natural healing is accelerated by three times. Anyone using a power sleep unit for more than a month at a time must make a DC 15 Will save or suffer 2 points of temporary Wisdom damage. This damage is healed at the usual rate. However, if a damaged individual continues to use the sleep unit before he has fully healed the damage, the Will save's DC increases by +1 for the next month. This increase is cumulative until the damage is fully healed or the user refrains from using the sleep unit for three continuous months.

### UNIVERSAL COOKER

**Size:** Medium

**Weight:** 30 lb

**Purchase DC:** 18

The universal cooker is a kind of companion piece to the matter compiler. The cooker is a large cylindrical device complete with its own computer. When organic substances are placed within it and the appropriate instructions given via the computer, its nanounits rearrange the substances to produce edible food. The universal cooker differs from a matter compiler in two significant ways. First, its internal computer can only non-hazardous produce food items and can only do so if it already has an equivalent mass of organic matter from which to construct it. Second, the cooker is smaller and much more portable, allowing it to be used in the field. Indeed, the cooker's primary use was by campers, travelers and others who went beyond the bounds of civilization.

Universal cookers are very common devices in many parts of the world. They were standard issue with military units during the Final Wars, which may explain their ubiquity. Unlike matter compilers, they are quite rugged and, owing to their use of existing matter to rework rather than refined carbon as a base material, they are much better suited to communities that don't have access to such things. The cooker cannot create food from nothing, but it can convert chemically digestible organics into something more (or much more) palatable. That's quite a significant feat, especially in lands whose diets are limited by poor soil or lack of game.

**Community Creation System Effect:** Possession of a universal cooker adds one week to the supplies of any community that has a Stockpile. This addition is increased by one more week for every universal cooker possessed, to a maximum of a month.



# INORGANIC INFORMATION SYSTEMS

Although the development of organic information systems was one of the greatest breakthroughs in the history of computing, one should never forget that it was inorganic systems that first provided humanity with calculating devices faster and more powerful than its own brain. For that reason, inorganic information systems remained a keystone of computer technology well into the years before the Final Wars. Indeed, many corporations, organizations and militaries preferred inorganic systems because they were considered more “trustworthy” and reliable, which is to say that operated according to more readily predictable patterns. An inorganic AI, for example, would develop personality quirks according to a verifiable algorithm, unlike organic AIs, whose personality quirks showed a far greater variability. Of course, inorganic systems lacked the versatility of organic systems. They could not learn as easily organic systems nor could they be repaired with the same comparative ease.

Nevertheless, inorganic systems continued to receive a lot of attention in the days before the Final Wars. They were not considered “cutting edge” technology by the public of that era, but that perception did not necessarily match reality. Because corporations and militaries continued to favor these systems for many applications (such as in robots, for example), they were developed as extensively, if not more so, than their organic counterparts. Furthermore, their greater age as a technology made it all but certain that there were many more examples of inorganic systems than organic ones. Finally, a sizable segment of the world’s population shared the view of the militaries and corporations: they “trusted” inorganic systems more, which is why they used them for many household or personal needs.

This section describes a handful of the more unusual and exotic uses for inorganic information systems. This approach provides a skewed impression of how these systems were used in the Final Wars era, but it is a necessary approach. From the GM’s perspective, there is little point to this book’s describing a large number of small, innocuous or otherwise banal computer systems, never mind all the simple items that included inorganic information systems within them. It is enough to know that nearly every device, from identification cards to personal organizers to communications devices were thoroughly computerized. The following devices, on the other hand, are odd or exceptional and therefore

provide a more valuable source of ideas for **Gamma World** adventures and campaigns.

## CASSANDRA, SIBYL AND PHYTHIA

**Cassandra**

**Size:** Large

**Weight:** 250 lb

**Purchase DC:** 30

Many AI specialists before the Final Wars thought that, given sufficient data, a computer would be capable of predicting the future outcome of uncertain events. These specialists held to an extreme form of materialism that postulated a universal mechanism whereby everything in the universe functioned according to predictable principles. No type of activity, not even that of intelligent agents, was above this universal mechanism. Rather, they only appeared to be because observers lacked sufficient data (and speed) to be able to make an adequate calculation of the outcome.

To that end, a group of these specialists, drawn from several nations across the globe, began the Oracle Project late in the Noetic Age. The Project created three different artificial intelligences, whose sole purpose was to engage in mechanical prediction of the future. The bulk of the Project was spent not only in creating these three artificial intelligences (named Cassandra, Sibyl and Phythia) but also in gathering information for a vast database of human, environmental and physical activity. Once the database was finished (or at least abandoned, since even its creators did not believe it was possible to amass a wholly complete database), the three AIs began to work together in order to construct the formulae of the universal mechanism that supposedly governed all of existence.

The Oracle Project had limited successes in the years leading up to the Final Wars, especially in the area of predicting physical processes like weather patterns, earthquakes and other natural disasters. In the field of human activity, the Project’s record proved spottier. Nevertheless, there were enough successes that some were led to believe that its creators were correct: there really was a universal mechanism that governed all things and human beings could know it. Cautiously, governments and corporations paid for the privilege of consulting the Project’s three AIs in



## GAMMA WORLD: OUT OF THE VAULTS

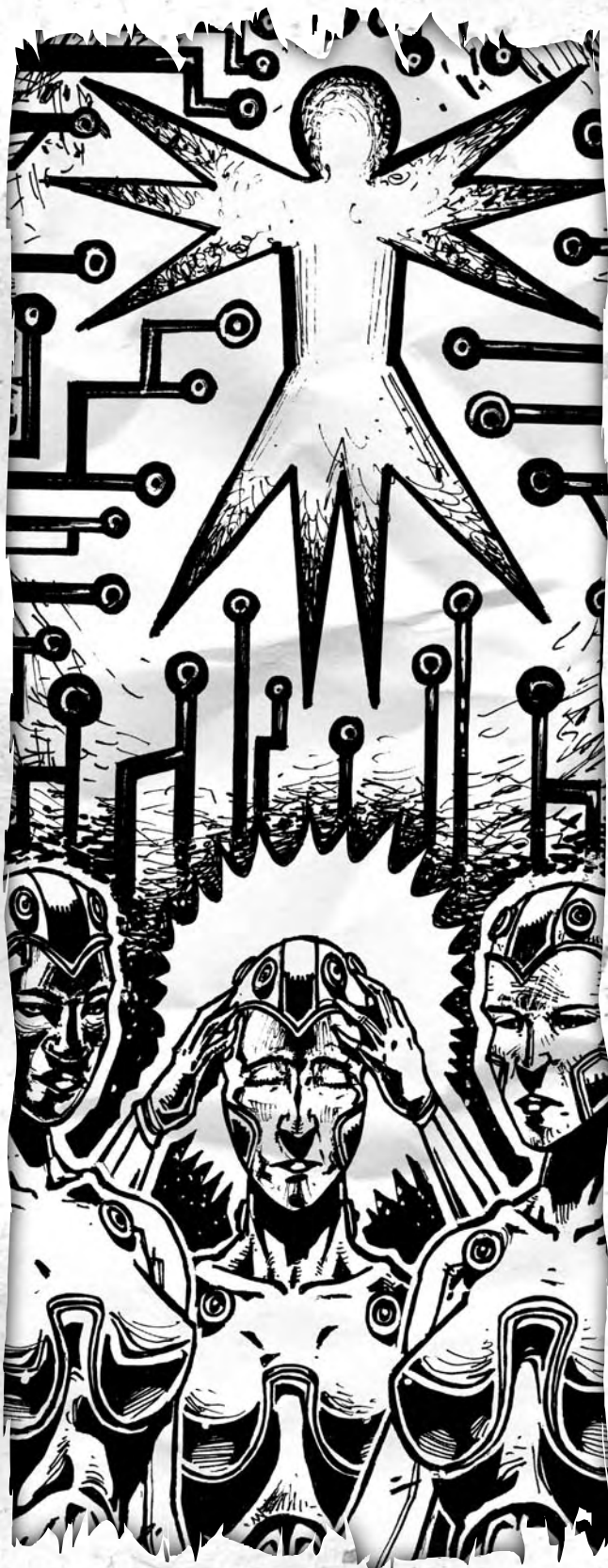

order to make projections of economic, military and other trends. What the artificial intelligences could not predict was the Final Wars, at least according to one interpretation of history. Others claim that they did predict the Wars, but were disbelieved because of past mistakes. Others still argue that the AIs' inadequacies led to the Final Wars by providing world leaders with faulty information about the probable outcomes of provocative actions.

Whatever the truth, the Final Wars came about and the Oracle Project faded into the mists of history. Recently, though, a scientifically advanced community in North America discovered Cassandra. They have reactivated the AI and have begun to listen to its predictions, still unsure as to whether they should be believed or not. They are as yet unaware of the existence of the other two artificial intelligences, let alone their current dispositions. Cassandra itself has a great interest in amassing more information about the Gamma Age in hopes of updating its database and thereby increasing the accuracy of its prophecies. Unfortunately, few people in the Gamma Age could succeed in this task; they simply lack the tools. However, the AI is a proud being and will not admit to its own inadequacies, instead making pronouncements about the future as if they were indeed certain. Consequently, the community that found the AI may begin to act in accordance with them, creating self-fulfilling prophecies that will in turn fuel tales of a "living oracle" from the past.

### DIAGNOSTIC COMPUTER

**Size:** Tiny  
**Weight:** 0.5 lb  
**Purchase DC:** 17

Expert systems were one area in which inorganic information system excelled and were commonly used even in societies that otherwise preferred organic systems. An expert system is a specialized computer dedicated to providing information on an extremely narrow field of human activity or knowledge, such as electronics or medicine. In the eras leading up to the Final Wars, diagnostic computers of various sorts were used in nearly every segment of human life, as well as in nearly every human society. Small and easily used, they included sensors and vast databases that gave their user up to date access to assessments of situations at hand. These assessments help the user to achieve greater results within a narrow field of endeavor, but they are not replacements for human initiative.

The different types of diagnostic computers are vast. The GM is free to create any he wishes for use

## PROPHECIES IN GAMMA WORLD

Cassandra's existence may pose a problem for some GMs, who might object to the idea of prophecies in a science fictional setting. The GM is the final arbiter as to the usefulness and veracity of anything that Cassandra or its fellow artificial intelligences have to say about the future. As presented here, Cassandra is fatally flawed. From its inception, it lacked not merely a sufficiently large database but the principles needed to use that database to create accurate predictions of human behavior. Consequently, these AIs are not true oracles at all. At most, they are extremely advanced calculators of physical principles. They can predict the weather and natural disasters, for example, but they cannot predict the motions of the human heart. That means they inevitably make mistakes, sometimes huge ones, when they attempt to prophesy about the actions of human beings.

GMs are thus free to use Cassandra and the other Oracle Project computers as he sees fit. Those who like to add mystery and unpredictability (pardon the pun) to their campaigns can easily use these computers in that fashion. Those who prefer to avoid such mysticism can play up the errors of the computers, perhaps using them as the basis for adventures. Indeed, the prophecies made by the AIs can easily lend themselves to exciting adventures or even entire campaigns. Even if the GM decides that the AIs are in fact incorrect in their predictions, that doesn't mean that the inhabitants of the Gamma Age will see them as such. The very fact that an individual or community believes the prophecies is important. Belief, even misguided belief, can be a potent force in human history. This is not less true in **Gamma World** and the GM would be wise to harness it in his own campaign.

in his campaign. As a general guideline, they provide a +2 competence bonus to a single skill or a +1 bonus to two related skills. More powerful computers of this type existed, of course, but they were rare even before the Gamma Age and will be even more difficult to obtain now. Those who possess them will not freely part with them and the Purchase DC for such devices will be proportionately higher.

### **TABLET**

**Size:** Tiny  
**Weight:** 0.5 lb  
**Purchase DC:** 18

During the eras prior to the Final Wars, human beings became increasingly interconnected, thanks to the growth of computer and telecommunications technology. One of the most obvious signs of this was the tiny device known as the tablet. The tablet is about the size of a book but with only a fraction of the width. The tablet consists of a touch-sensitive screen and an infrared sensor with which to maintain contact with other tablets and computer systems. During past eras, tablet users relied on them for everything from reading the day's news, arranging schedules, balancing bank accounts and many more everyday activities. In addition, tablets could interface with communications networks to allow the user to contact anyone who also possessed a tablet or compatible device.

Because of their ubiquity, tablets are found in most vaults during the Gamma Age. They use very

little power and possess solar-powered batteries. Provided that the batteries are not damaged, they will begin function again within a few hours of being exposed to sunlight and will continue to function without the need for additional power, provided they are exposed to at least two hours of sunlight a day. Their integral programs, such as scheduling, calculating, and so forth will still function without any difficulty, assuming that the user can figure out the iconic interface. The communications and news programs, on the other hand, will not function unless they are within range of functioning systems of these sorts, which is highly unfortunately unlikely in the Gamma Age.

For the most part, tablets are simple curiosities. They grant +2 competence bonuses to any skill checks in which their programs could come to bear (GM's discretion), although these are limited in number. Likewise, information stored on one tablet can be transferred to any other functioning tablet within 1 mile. If tied into an operational communications network, this information can be transferred over any distance reachable by that network.

### **TACTICAL COMPUTER**

**Size:** Tiny  
**Weight:** 0.5 lb  
**Purchase DC:** 20

The military was one of the primary sources of resistance to organic information systems. Their reasons for doing so were many and varied, not least



## GAMMA WORLD: OUT OF THE VAULTS



of which being its leadership's desire to be able to easily swap out technology and replace it as necessary. The inorganic model was much more amenable to such "modular" thinking and made upgrades simple and cost-effective. This was nowhere more true than in the case of tactical computing. Soldiers during the Final Wars each possessed a small tactical computer that provided up to the second telemetry and information, tied directly into a visor worn by the soldier. Through the use of this computer, the soldier gained a fuller picture of the battlefield on which he fought, as well as the enemies against whom he fought, making him a more effective and deadly warrior.

Tactical computers were commonly used by most nations during the Final Wars, making these devices fairly common even in the Gamma Age. The primary difficulty in using them is that they must be attached to a functioning visor, many of which no longer exist in the present time. Provided one has both components, however, the tactical computer provides the wearer with a +1 competence bonus to his initiative, as well as a +1 to ranged attack rolls and Reflex saving throws. The initiative bonus is constant, while the attack and save bonuses do not function at the same time. That is, a character using a tactical

computer can in a given combat round gain a +1 bonus to either his attack roll or his Reflex saving throw, but not both.

### UTILITY FOG

<b>Size/Type:</b>	Huge Construct
<b>Hit Dice:</b>	7d10+40 (79 hp)
<b>Massive Damage</b>	—
<b>Threshold:</b>	
<b>Initiative:</b>	+0
<b>Speed:</b>	20 ft. fly (4 squares) (good)
<b>Defense:</b>	13 (+5 dodge, -2 size), touch 13, flat-footed 12
<b>Base Attack</b>	+6/ +14
<b>Bonus/Grapple:</b>	/
<b>Attack:</b>	By weapon
<b>Full Attack:</b>	By weapon
<b>Fighting</b>	15 ft./ 15 ft.
<b>Space/Reach:</b>	
<b>Special Qualities:</b>	Construct, dispersed, solar powered, damage reduction 10, resistance to energy 20
<b>Saves:</b>	Fort +2, Ref +2, Will +3
<b>Abilities:</b>	Str —, Dex 11, Con —, Int —, Wis 13, Cha 10
<b>Skills:</b>	—
<b>Feats:</b>	—



## CHAPTER TWO: TOOLS

**Action Points:** —  
**Allegiances:** —  
**Reputation:** —  
**Environment:** Military bases, corporate compounds  
**Organization:** Solitary  
**Challenge Rating:** 13  
**Advancement:** 8–11 HD (Huge), 12–15 (Colossal)  
**Level:** +4  
**Adjustment:**

*The object lacks solidity or shape, being nothing more than a cloud-composed of millions of tiny points of light, each one emitting a faint buzzing noise, as if they were insects.*

### DESCRIPTION

At the bleeding edge of nanotechnology just prior to the Final Wars was utility fog. This unusual application of the technology was a swarm of nanounits that could, upon command, reshape themselves to create solid objects of an inorganic nature. Furniture, doors, weapons – almost anything – could be created simply by command. Utility fog was an experimental technology in the latter days of pre-Final Wars civilization and was not widely used. Consequently, there are comparatively few examples of it in existence during the Gamma Age and almost every example of it is already under the control of someone (or something), making it a dangerous hazard.

### COMBAT

Utility fog is not intelligent and therefore cannot make decisions for itself. It must be controlled and commanded by an intelligent entity, such as a human being or an AI. Acquiring control is difficult. Typically, a Stage III or higher ID card is necessary. This works only in the case of uncontrolled (“wild”) utility fog. Fog that is already under the control of another entity cannot be taken control of without evidence of even higher authorization than that already brought to bear. The GM is the final arbiter of what constitutes higher authorization.

Utility fog can create almost any weapons from itself. The only limitation is that the weapon in question cannot be larger than the cloud. Likewise, the weapon must be capable of self-activation. Otherwise, the fog is incapable of firing on its own and must rely upon another being, whether living or construct, to use the weapon it has created from itself. At any given time, the fog can only create one weapon of the same size as itself, two weapons of one size smaller



## GAMMA WORLD: OUT OF THE VAULTS

than itself, four weapons of two sizes smaller and so on, just like any other object it can create from itself.

**Alternate Form (Ex):** Utility fog can assume any form of its own size or smaller as a standard action. Utility fog can remain in its alternate form until it is commanded to assume a new one or return to its natural state. The new form cannot be a living creature or organic substance. Utility fog assumes all the characteristics of the new form except emergent properties like intelligence that cannot be reproduced through simple mechanism. Thus, utility fog could assume the form of a computer but not an artificial intelligence, for example.

**Dispersed (Ex):** Utility fog consists of millions of tiny nanounits. The only way to destroy it is to destroy so many nanounits that the fog lacks sufficient cohesion to function as a unit any longer. The fog is treated as a single Huge entity, but one that enjoys damage reduction 20, energy resistance 20, and a +5 dodge bonus to defense. It also has no effective Strength bonus, and cannot lift or move solid objects on its own.

**Solar powered (Ex):** Utility fog is powered largely by solar energy, which can run low after periods of darkness. If it engages in combat in darkness or at night, utility fog suffers a -2 penalty to Initiative and attack checks.

Utility fog is a construct of a most unusual type, being nothing more than a cloud of millions of nanounits, all of which work together as a unit. The fog is, by its nature, amorphous in shape and size (as well as density), allowing it to assume nearly any configuration it is commanded to take by an authorized user. Consequently, utility fog can produce from itself nearly any object, including fairly mechanically complex ones. In general, these objects must be no bigger than the size of the fog itself. If it creates objects smaller than itself, it can create multiple examples of them. Thus, utility fog can produce two objects one size smaller than itself, four objects two sizes smaller than itself, eight objects three sizes smaller than itself, and so on, doubling the number with each step removed in size from itself.

---

## BIOLOGICAL INFORMATION SYSTEMS

Conventional electronic computers remained the sole form of artificial information technology during the 20th century and the first half of the 21st century. However, advances in genetic engineering eventually allowed genetic engineers to unlock the secrets of memory and to create diseases and living beings that could help humans to better process and understand the vast amounts of information present in the pre-war era.

### MAPPING HIVE

**Size:** Small

**Weight:** 1 lb

**Purchase DC:** 14/16

Originally developed by the Chinese intelligence service, this device was based upon the ability of honeybees to map out their environment and communicate this information to the rest of their hive. A mapping hive is round-edged hemisphere made of an obviously organic material that looks halfway between plastic and paper. It is eight inches in diameter and four inches thick. Inside the hive are up to 500 long-lived and extremely durable bee-like insects, blue-gray in color and a quarter of an inch long. These mapping bees have exceptionally keen vision as well as the ability to detect magnetic fields

and to see in the dark. They fly at speed of up to 60 ft and remember exactly where they have been, and they communicate this information both to each other and to the hive itself.

Instead of being insects that build and live in a hive, the mapping hive is actually a living creature that breeds its bee-like servants. These mapping bees fly out and map the area around the hive. In normal operation, the bees map the rough details of an area up to 30 miles around the hive. They first map the area within three miles of the hive and expand out at a rate of three additional miles every day. Within 10 days they have completed the local map, which shows the exteriors of all buildings, as well as their basic layout and floor plans and all natural features like forests, rivers, chasms and caves. To prevent them from becoming separated from their hive if the user is traveling, the bees will only map the area within three miles of the hive for as long as the hive is moving. Once it has been in place for a full day, the bees begin to expand their mapping region outward.

The user can display all maps ever recorded by the hive on the flat side of the hemisphere. This smooth surface is a living full color flat screen display. This display is touch sensitive and clearly marked to allow users to magnify portions of these maps. If the



## CHAPTER TWO: TOOLS

user focuses on a nearby region that the mapping hive does not contain detailed information about (such as the interiors of a building), the hive immediately dispatches several mapping bees to examine that region in greater detail. The bees return in one to three hours (depending upon the distance) and the hive uses the information they provide to update its map. The hive can easily replace any mapping bees that are killed or lost and creates up to 25 new bees in a week. Since the hive can function normally with only 250 bees, loss of bees is rarely a problem. The bees can function in temperatures ranging from -40 to 120 F and the hive only requires regular exposure to sunlight and a cup of sugar water, honey or fruit juice every week. If the owner does not feed the hive, both it and the bees go dormant and it displays a message about the types of nutrients it requires on the screen. Dormant hives can survive indefinitely.

### MEMORY ERASURE UNIT (MEU)

**Size:** Medium

**Weight:** 7 lb

**Purchase DC:** 14/16

Originally developed for therapeutic use, kidnappers and other criminals also frequently used these devices. Many thousands of these units were built for use the memory therapists. Memory therapy was a widespread fad in the years leading up to the Final Wars. For more than a decade, the fad of purging distressing memories caught on and some people asked for forget entire decades of their lives. Eventually, home units were developed and some people used them at the end of every day to forget any embarrassing or upsetting incidents during that day. Such people normally had their computers take care of any practical details that they had forgotten.

The original MEUs were large and delicate units, but heavy demand lead to them being greatly miniaturized. Older models are the size of two-drawer filing cabinets, but the ones created within a decade of the Final Wars are boxes one foot on a side and six inches tall. In both old and new units, the top of the unit is a lid that opens revealing a metal mesh cap that connects to the rest of the device using a wireless infrared interface. The controls are extremely simple, like most technology built after the late 21st century, if the user starts pushing buttons at random, the unit starts an automatic visual and verbal tutorial. To use the device, the user turns it on puts on the cap and concentrates on the memory. The unit then asks the user if these are the memories he wishes to delete. To prevent accidental memory loss, the unit only removes

that actual memory the user concentrated on, not any associated memories. Also, the unit stores all deleted memories for seven days and can restore them during this time. Once the user has deleted these memories, he can also request the device to remove all memories associated with the deleted event.

For example, if the user had an automobile accident and wished to forget it, thinking about the automobile accident and activating the deice would cause the user to forget about the accident but not about the events leading up to it or the events afterwards, including having to deal with the police and any tow trucks and repair bills. When used in this less extreme mode, the device cannot cause the user to forget more than one day's worth of memories. This level of memory erasure will not decrease a user's skills.

If the user wished to forget about everything related to the automobile accident, she would need to activate the unit a second time. The unit would then removes all memories relating to the accident, including getting the car repaired, the treatment and recovery from any injuries and all similar events. When used in this fashion, the unit can potentially erase large portions of the user's memories. If the user wished to forget everything about her job or her parents, she could end up erasing large portions of many decades of her memories. Shortly before the Final Wars, many government and corporate intelligence agencies began using this level of erasure on operatives who retired or quit. Also, criminals used this unit on their victims, causing them to not only forget that they had been robbed, but also that they had ever owned the goods the thieves stole. When used in this fashion, the user may forget one or more skills associated with a specific profession if she forgets about that profession.

Using this unit on an unwilling subject is difficult but possible. The person controlling the device tells the subject to think about the information she wishes to erase from the subject's mind. Describing this topic in detail will cause almost all subjects to think about the topic. Subjects must roll a DC 15 Will save to avoid thinking about the topic in question. Success allows the user to decide exactly what memories the unit erases. However, most criminals also erase all associated memories to make certain of success and while another Will save is unnecessary, in such a case the character is going to lose all memories associated with some event. Fortunately, the unit stores all erased memories for seven days. While the user will not be able to remember any erased memories, she will know



## GAMMA WORLD: OUT OF THE VAULTS

that the unit erased some of her memories. If she can gain access to the same memory unit within seven days of the erasure, she can set the unit to full restore all of her memories. However, attempting to use other units will not work and after seven days, all of her erased memories are forever gone. A single power cell allows the unit to operate 100 times.

### MEMORY VIRUS

**Size:** n/a

**Weight:** —

**Purchase DC:** n/a

Memory Virus — Contact DC 13; 1d6 days; No initial damage (special)/ no secondary damage

These genetically engineered diseases are one of the most insidious remnants of the years immediately preceding the Final Wars. Before civilization collapsed, everyone who was not extremely poor (and even the poor residents of the more humane nations) possessed highly effective artificial immune systems that protected them from almost all unwanted versions these diseases. However, neither impoverished people who lived before the Final Wars nor almost who survived them possesses significant protection from these viruses.

In the late 21st century, genetic engineers working with neurotechnicians discovered a way to record memories in DNA using advanced gene splicing techniques. These researchers used extremely delicate viruses to transfer memories from one person to another. This technology allowed people to encode their learning and their skills into a virus that could infect any number of other people, greatly speeding both education and training. However, memory viruses can only provide someone with the basics of a skill, great expertise still required a combination of conventional learning and practice.

Isolating memories of only a single skill proved to be impossible, so each memory virus also includes how the donor felt about the field of study and traces of a multitude of other memories. As a result, many people refused to use memory viruses because they did not want someone else's thoughts and memories in their head. Memory viruses remained a highly specialized learning technique that educators primarily used to help speed advanced study in a variety of highly specialized fields. Also, while tourists and business travelers greatly preferred to rely upon handheld or wearable electronic translators, spies and a few diplomats used memory viruses to learn languages.

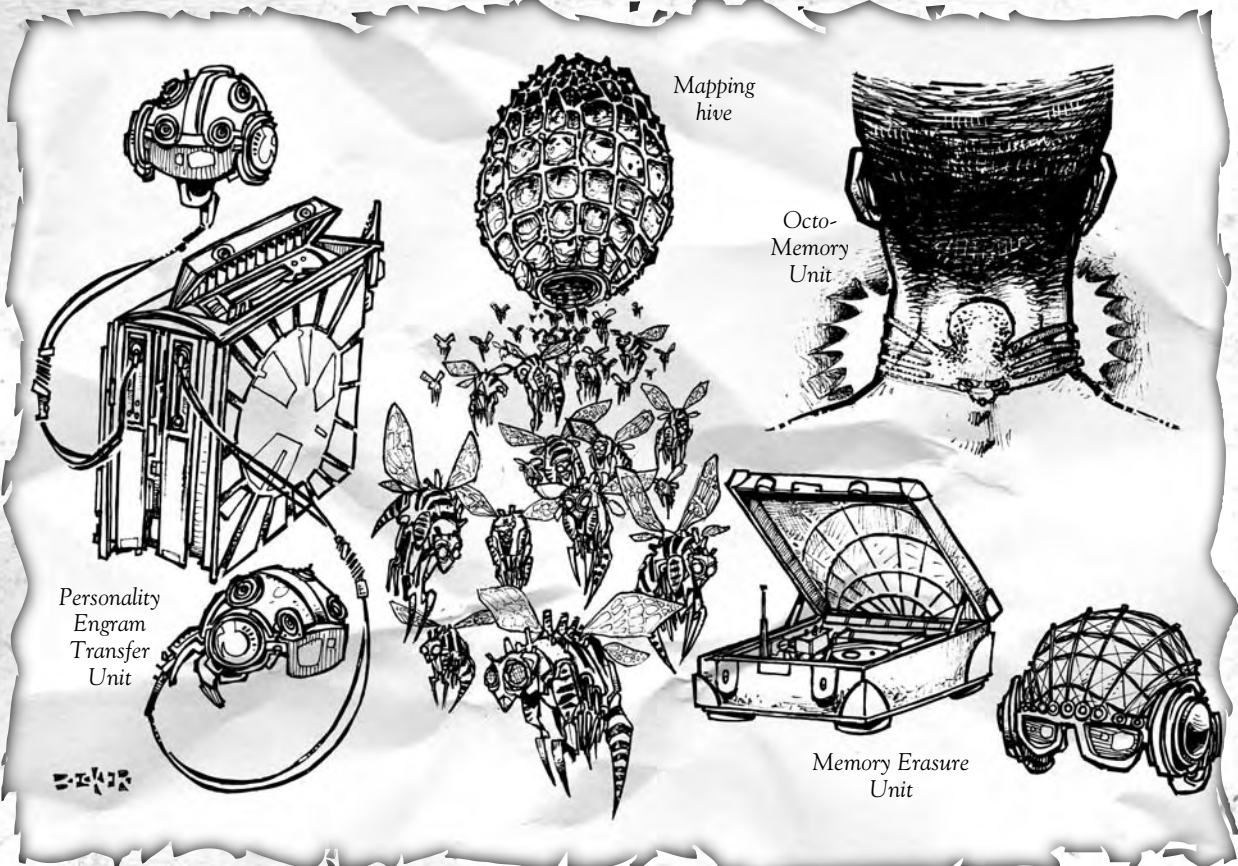

## CHAPTER TWO: TOOLS

Eighteen years before the Final Wars, illegal genehackers discovered a way to implant DNA memories into robust and highly infective viruses. Instead of teaching skills, these unlicensed technicians created viruses that they sold to illegal advertising agencies, unscrupulous religious cults and radical political movements who wished to release viruses that would cause others to have memories of loving their products or having a fanatical devotion to their beliefs. The next eighteen years was a constant battle between the artificial immune systems most people possessed and these propaganda viruses. Meanwhile, poorer people were frequently unwillingly dragged into low cost clinics by their friends and relatives because they were suffering from the latest of these diseases.

Memory viruses have no physical symptoms except an extremely mild fever that lasts for a day or two. However, between one and three days after being infected, the subject will feel the full psychological affects of this virus. The virus permanently alters the character's memories after four weeks. However, if the character receives an anti-viral treatment capable of killing off the virus within four weeks of infection curing the virus will also remove all of the memories. In most cases, unless the infected character receives an anti-viral treatment, she will remain contagious for as long as five or ten years.

A number of the hardest propaganda viruses survived the Final Wars. In the days immediately after the Final Wars, when it was evident that civilization was collapsing, several dozen genetic engineers attempted to preserve basic learning by encoding a wide variety of useful technological skills and feats into durable and highly infectious viruses. Tech Familiarity and various Knowledge skill viruses are now especially common. In most cases, the spread of each memory virus is highly localized — everyone in a town or even a small city-state may have the same virus. Most travelers avoid towns where some of the more extreme propaganda viruses affect all residents. Regardless, artificial immune systems (see "Medicine" in Chapter Three), total-med and revivifiers all completely cure the effects of all memory viruses.

### Learning Virus

Some viruses simply give the character between four and six (depending upon the skill) ranks in a single skill or the knowledge of one feat. Alternately, a single memory virus can provide the two ranks necessary to learn to both speak and read and write a single language. No memory virus can ever give a character more than six ranks in a skill. Although limitations of character class and level normally

prevent a character from learning that many ranks of particular skill, a memory virus can transcend such limits. A 4th level character could gain six ranks of a cross-class skill from a memory virus. However, this skill would remain cross-class skill, and the character could not gain more ranks in this skill until she attained at least 11th level.

Skill ranks gained from a memory virus are not cumulative with any previous learning possessed by the character. If the virus contains four ranks of a skill and the character already knows three ranks of this skill, the character will still only have four ranks in this skill (and not seven ranks). If the character has more ranks in the skill than the memory virus provides, then the virus provides no benefit to the character. Also, if the virus teaches the character a new feat, the character can only make use of this feat if she also possesses all of the skill and ability prerequisites necessary to use this feat. Learning viruses can only teach feats that involve knowledge of how to perform some task (like surgery or Vehicle Dodge) or understand how to use various objects (like Aircraft Operation or Tech Familiarity). Feats like Confident or Windfall cannot be encoded in a memory virus.

In addition, regardless of whether the character actually learns anything from the virus, she also gains a scattering of seemingly random memories from the person whose memories formed the original template for this memory virus. A character who was afraid of heights and who had religious taboos against eating oysters might suddenly have memories of bungee-jumping or eating a huge plate of raw oysters and finding them to be indescribably delicious. These memories will be indistinguishable from the character's normal memories, which can become exceedingly confusing.

### Viral Propaganda

Propaganda viruses provide victims with up to four ranks of skills. Unlike learning viruses, the skills in viral propaganda can be highly diverse. The ability to read, write, and speak an obscure language and two levels in history, theology or philosophy might all be included in a single religious virus. However, the knowledge imparted by propaganda viruses is always exceptionally biased. Also, some viruses contain no skills at all and consist solely of information like a biography detailing the life and works of a single religious or political figure or highly emotional memories of being a loyal disciple to some religious or political cause. Patriotism viruses were especially common shortly before the Final Wars.



## GAMMA WORLD: OUT OF THE VAULTS

These viruses cannot make anyone believe anything, but vividly remembers believing something makes most people more inclined to believe it. In addition, propaganda viruses can both add and remove allegiances from the user's mind. Someone could design a propaganda virus to remove all allegiances associated with Islam and replace it with an allegiance to a specific form of Christianity. If it infected someone who was not Muslim, this virus would simply instill and allegiance to a particular branch of Christianity. Viruses that infect victims with allegiances to religions, organizations (many of which now only exist in the minds of people affected by various propaganda viruses) are especially common. However, viruses that produce allegiances to nations or specific moral or ethical philosophies also exist. Like added memories, curing the virus within four weeks of infection reverses all changes in allegiances. Any treatment that cures memory viruses will remove these allegiances.

### OCTO-MEMORY UNIT (OMU)

**Size:** Tiny  
**Weight:** 0.5 lb  
**Purchase DC:** 13

Octopi are the most intelligent of the invertebrates and have unique four-lobed brains. In the early 22nd century, genetic engineers took advantage of this creature's unique neural architecture to create the ultimate personal information system — a backup memory. This piece of biotech looks like a small octopus that has four tentacles on each side, rather than having all eight tentacles arranged radially. This creature is seven inches wide from the tip of the left tentacles to the tip of the right tentacles, and its body is three inches in diameter and one inch thick. Genetic engineers designed the creature to attach itself to the back of the user's neck — once in place, its ability to change color allows it to blend in perfectly with the wearer's skin color; it takes a DC 20 Spot check to notice that someone is wearing an OMU. The suckers at the base of the tentacles send special bio-polymer coated nerve fibers into the user's spinal cord and brainstem while the OMU's mouth burrows down and connects to a minor blood vessel. Once in place, the OMU receives all of its nourishment from its wearer. In return, its specially modified brain records all of the wearer's thoughts and sensory impressions as long as the user continues to wear the OMU.

Not only does the wearer have a perfect photographic memory, the OMU also allows the

wearer to easily replay any memory. As a result, the user can remember everything that happened while she has been wearing the OMU. In addition to providing a +2 equipment bonus to any skill rolls where having an excellent memory is helpful, these memories are so vivid that if the wearer wishes she can also Take 20 on all Spot and Listen rolls because she can replay the memories so vividly as often as she likes. However, doing this only works if the character closely observed the event when it occurred. Also, the character must sit down and replay this memory in her mind for at least 20 minutes to successfully take 20.

Although most wearers never removed their OMUs, users can even remove it and loan it to someone else, and so give this person an exact record of the user's memories. Unfortunately, this means that this person now has access to the previous wearer's memories of everything that she has thought or experienced since she first put on the OMU. Searching through someone else's memories is a complex and confusing task that requires at least one Concentration check, of DC 15 for particularly vivid and prominent memories up to DC 30 or more for obscure or suppressed memories. A successful DC 20 Concentration check gives the wearer a +2 synergy bonus on Intelligence-based skill checks in which the previous wearer had more ranks of a particular skill than the current one does.

OMU's are extremely long-lived, with life spans of at least 200 years and their hyper-efficient neurons can continue to absorb new information as long as they are alive. As a result, many OMUs have been used before and may already be full of years or decades of someone else's memories. If desired, the new user can purge all the unit's previous memories. However, few characters wish to lose such valuable experience.

Unfortunately, wearing an OMU that has more than a decade's worth of memories in it can be somewhat risky. If the user ever rolls a natural 1 on any Concentration roll to access memories of the unit's previous users, she becomes temporarily lost in these memories. She must then roll a DC 15 Will save. If she succeeds, then she merely sits immobile and lost in thought for the next hour or until someone violently shakes her out of this fugue state. If she fails the save, then for the next 1d4 hours she is temporarily convinced that she is the person whose memories she was accessing. Since this person will almost certainly not know anything about the user's life, she will almost certainly be both upset and confused. Also at the end of this state, the user is Fatigued. Today,



## CHAPTER TWO: TOOLS

explorers and scavengers sometimes find OMU's living in the wild, since they are perfectly capable of surviving and even breeding on their own. While they can survive indefinitely in air, they prefer to live in water and drink the blood of small fish. However, most travelers find OMUs on their previous wearers' dead bodies.

### **PERSONALITY ENGRAM TRANSFERANCE UNIT (PET, MIND-SWITCHER OR APPLE-CORER)**

**Size:** Huge  
**Weight:** 150 lb  
**Purchase DC:** 34/37

Originally developed to allow the elderly to transfer their minds into young speed-grown clones, the absence of such clones means that this device is now used to rip young, healthy people's minds out of their bodies and replace them with the mind of someone who is generally old, powerful and completely amoral. Before the Final Wars, spies and criminals also used this device to impersonate people by literally take their bodies; criminals still use it for these same purposes today.

This device is the size of a modern day washing machine (two feet wide, two feet deep, and three feet tall) and weighs 150 lb. The top of the device opens to reveal a series of relatively simple controls and two helmet-like devices, each of which connects to the PET by a yard-long cable. The user must place the two helmets on the two subjects, and then activate the device. The process of transferring minds requires one full hour. Removing one or both helmets or turning off the device in mid-transfer causes both people to fall unconscious and completely disrupts the

process. Both individuals are conscious during the transfer and the user must restrain unwilling subjects.

The unit has two settings: the user can either cause the device to delete the first person's personality or to switch the two individual's personalities. To prevent mishaps, if the unit deletes someone's personality, it stores this personality, so that it can be later replaced in that subject's body. PET units have sufficient storage to hold up to three personalities. Every additional personality that the unit stores means that it deletes the personality it has stored the longest. Anyone using this device must make a DC 20 Will save. If either subject succeeds at this Will save, the personality transfer fails, but may be tried again. (This limit means that many users take will-weakening drugs right before attempting a transfer.)

A character using this device to obtain a new body retain her Intelligence, Wisdom, and Charisma as well as all skills, mental feats like Confident, Builder or Force Stop and all mental mutations. However, her Strength, Dexterity and Constitution, as well as all purely physical feats like Toughness, Endurance or Great Fortitude and all physical mutations are those of the body she now inhabits. While a sizeable number of the people who survived the Final Wars used various longevity therapies to greatly lengthen their life spans, some did not and most people who have been born since then lack such miracles. However, anyone who acquires a PET device has another, far less moral option to death by old age. Today, most people who use PET units are old people who wish to be young again, even if it means stealing the body of someone younger. A few warlords have PET units, while others are in the hands of unscrupulous traders who kidnap young people and sell their bodies to anyone wealthy enough to meet their price. One power cell allows this device to make 10 transfers.

---

## STORAGE

Although the book you have in your hands is called **Out of the Vaults**, there's no reason that the eponymous vaults could not themselves be considered valuable. Of course, as discussed earlier, "vault" is a relative term. It could include a wide number of different things, including storage containers that are more easily portable. After all, most devices that survived the disaster of the Final Wars did so because they were protected by something. In many cases, that

something is a storage container of some sort, no matter how big or small. This section briefly overviews some of the most useful and common forms of storage that player characters could conceivably find and (more importantly) possess. Naturally, this list is not exhaustive and concentrates primarily on portable items. GMs interested in bigger storage devices are referred to Chapter One, wherein vaults proper are discussed in greater detail.

## GAMMA WORLD: OUT OF THE VAULTS

### COLLAPSIBLE VAULT

**Size:** Medium\*

**Weight:** 45 lb

**Purchase DC:** 24

Consisting of a large suitcase-sized box that can easily be carried by a single person (provided he has Strength 12 or more), this device is actually an integrated computer and nano-factory all in one. The user simply commands the vault to be built and the item immediately goes to work doing just that. The vault is built from materials found in the surrounding environment and takes 1d20+20 minutes to complete. The user cannot specify anything about the size or nature of the vault, since that is to a large extent dependent on the materials available wherever he chooses to activate the device.

The newly assembled vault occupies at least 15 square feet and stands at least 10 feet high. The walls have 50 hit points and a hardness of 10. In addition, the nanounits that built the vault repair it at a rate of 5 hit points per round. At the GM's choosing, all of the aforementioned statistics can be altered upward although no more than twice the listed values would be appropriate. Only one collapsible vault can be constructed at a time with the same unit. If the user chooses to keep a single vault active, it can remain so indefinitely. However, if he chooses to collapse the structure, he can do so easily. The nanounits that built the vault return to the central unit and are again available for use when the user desires them.

Not surprisingly, the collapsible vault is highly valued by many individuals in the Gamma Age. They are very rare devices, which only increases their value. Both militaristic and pacific groups alike see the collapsible vault as a welcome addition to their repertoire. The original purpose of these devices is unknown, although it is believed they were created by the military for use as mobile forward advance bases. However, the size of the vault when made is sufficiently large as to put this theory into doubt.

\*The typical collapsible vault's housing takes the form of a medium-sized suitcase-like container. Once activated, the vault it creates is generally Huge, although there is some degree of variation in this, depending on the materials available to the integral nanounits. At the GM's discretion, other collapsible vault systems might be found. Their containers could be of Large size, but no bigger. Such larger systems would have a purchase DC of between 25 and 28, again depending on the characteristics of the vault the integral nanounits construct.

### DISPOSA-UNIT

**Size:** Medium\*

**Weight:** 10 lb

**Purchase DC:** 18

The dispoa-unit was created as a means of safely and harmlessly holding hazardous materials, such as radioactive or medical waste. The unit is a large, cylindrical tube about three feet in length and six inches thick. A removable cap at one end allows the user to place materials within it. Once the cap is replaced on the end and the unit activated, nanounits inside begin to work on the material, rendering it inert and harmless to human contact. Once done, the waste can be removed from the tube and safely disposed of. This process takes anywhere from 12 to 72 hours, depending on the amount and type of the waste. Naturally, a unit can dispose of no more waste than it can hold by volume.

Dispoa-units came in multiple sizes, some of them being quite large and therefore more suitable to community use. These larger units are very valuable in the Gamma Age, both because of their utility and their relative rarity. The largest units are over one hundred feet long and could hold literally tons of waste. Even inoperative dispoa-units have value as simple storage containers. They are made of sturdy materials and shield the worst effects of whatever is contained within them. This means that a community could easily use a unit as a holding area for toxic or hazardous materials without any need to render it harmless, although that's obviously a far better use for it. Some communities that possess larger dispoa-units have used them to create latter day versions of sewage treatment facilities.

\*As noted in the text, there were dispoa-units of Large and greater size available during the Final Wars era. Few of them continue to exist in the Gamma Age. Those that do would have a purchase DC of at least 22, perhaps higher depending on the location and circumstances of the unit in question.

### SECURITY BAG

**Size:** Small

**Weight:** 5 lb

**Purchase DC:** 20

The security bag first made its appearance during the Gene Age. This device is a large leather-like bag imprinted with the DNA of a user or group of user at purchase. When touched by anyone other than those whose genetic material has been imprinted in its own structure, it closes tight and will not open. The



## CHAPTER TWO: TOOLS

material from which the bag is made was used in many applications, such as wallets, purses, attaché cases, even shoes! The bio-memetic material provides the same protection as leather, but, once it has closed, it will not open again until touched by the person or persons with whom it is imprinted.

Security bags were common items well into the Final Wars era. Consequently, many survive into the Gamma Age. The primary problem is that most of them have already been imprinted with the DNA of individuals long dead. It is possible to “reprogram” a security bag, but it very difficult. Doing so requires a DC 35 Computer Use (Biotech Systems) check. Failure prevents further attempts by the same character. Unimprinted security bags are rare and quite valuable. The purchase DC below is based on an unimprinted bag, with an imprinted one having a DC 5, 10 or even 15 lower, depending on how desperately its seller wishes to get rid of it.

### STASIS BOX

**Size:** Medium\*

**Weight:** 20 lb

**Purchase DC:** 22

Biological stasis is the process by which some organisms place themselves into a kind of suspended animation, during which their biological processes operate many times more slowly than usual. While in stasis, these organisms still live, of course, but because of their stasis, they do not age at a normal rate nor do they grow or suffer the effects of diseases. For all intents and purposes, they are stopped in time until the stasis ended.

With nanotechnology, it was a simple matter to induce stasis at will. Doing so in inorganic substances took more effort, but did not prove impossible. Once the technology was perfected, it was applied in many areas, including storage media. The so-called stasis box was one such medium. Approximately the size of an old-fashioned footlocker, the box can induce stasis in anything placed within it indefinitely, so long as it remained inside the closed box. Once opened, an object or creature begins to “thaw out” and become active within five minutes. No ill effects are induced because of the stasis, although no one during the Final Wars era had ever placed a living thing in a stasis box for more than a few months at a time. Most stasis boxes found in the Gamma Age contain some sort of object inside, typically perishable items like food or drugs. They rarely contain living creatures, but they easily could. Those who find these items are therefore advised to beware their contents.

\*Any object or creature placed within the box enters a state of suspended animation within five minutes of the box’s lid being closed. There is no save to resist this effect, although it only works on objects or creatures that can fit completely within the 3 x 3 x 2 foot dimensions of the box. Larger stasis boxes did exist, but they are rare and comparatively more difficult to purchase. There are no ill effects to being placed in suspended animation. Indeed, anything inside does not age, grow, change or otherwise alter. Likewise, poisons, diseases and radiation damage slows while in stasis so that they no longer do any further harm. Living creatures who remain within a stasis box for more than a year at a time must make a DC 12 Fortitude save each year or suffer the permanent loss of 1 point of Constitution.

### VARIABLE GEOMETRY DURALLOY CONTAINERS

**Size:** Medium

**Weight:** 20 lb

**Purchase DC:** 17

As explained earlier in this chapter, duralloy is a strong and sturdy metallic alloy created through nanotechnological methods. As one might expect, it was used to create containers of various sorts, all of which possessed the qualities of the material from which it is made. Because of this, duralloy containers are quite valuable in the Gamma Age. They are frequently traded for and used as the basis for bartering. Unlike lesser materials, duralloy is equally useful in a wide variety of environments and can withstand a fair amount of damage before breaching, for example.

Far more valuable than these ordinary duralloy containers are the variable geometry versions. These containers make full use of duralloy’s smart characteristics. A container possesses a small hand-held control, which is about the size of a modern day cigarette lighter. When used properly, it allows the user to alter the shape, volume and thickness of the container to which it is keyed. This means that a standard size container (which is three feet wide by five long by two feet high) can change its shape so that it is better suited to carry an oddly shaped object. The cubic footage of the container cannot change all that much, although there is some leeway by altering the thickness of the metal slightly. However, within these basic parameters, a variable geometry container can warp and shift to suit the needs of its user.



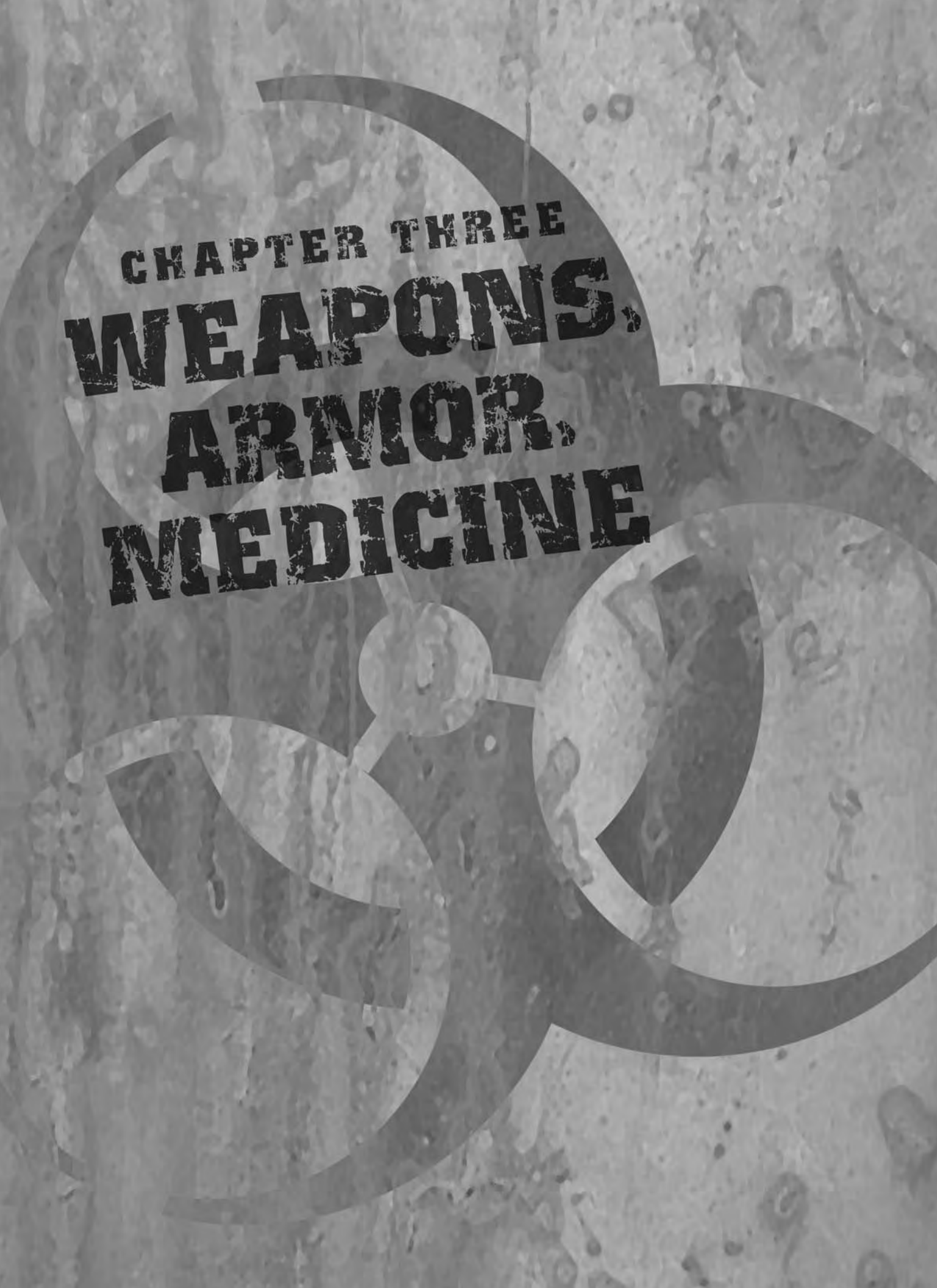

**CHAPTER THREE**  
**WEAPONS,**  
**ARMOR,**  
**MEDICINE**

## PERSONAL WEAPONRY

Despite the hopes of idealists, the 21st century proved no more secure than the 20th. Indeed, as the century wore on and the 22nd dawned, the world was as fearful, unsafe and paranoid as ever. Not surprisingly, this led to the proliferation of new personal weapons technologies designed to ensure “peace of mind.” Whether or not these weapons fulfilled their promises is a matter of perspective. The decades leading up to the Final Wars saw the rise of innumerable new types of personal weapons, many of which were so destructive that they were immediately outlawed even in locales where self-defense was deemed a sacred liberty. So many personal weapons were produced in those dark days that a great many still survived into the Gamma Age, where they have proved every bit as deadly as they were in pre-Wars days.

### HANDGUNS AND LONGARMS

These weapons require the Exotic Firearms Proficiency feat for use without penalty, except where otherwise noted. Table 3–1 has weapon statistics; listings are consistent with those in *d20 Modern*, Table 4–4: Ranged Weapons.

### THE PROBLEM OF AMMUNITION

One of the most pressing problems facing characters in *Gamma World* is running out of ammunition for their high-tech weapons. The fact is that while many weapons have survived the Final Wars, comparatively few ammunition packs (in whatever form they take) have done so, and at least they won’t always be found in the same places as the weapons themselves. For that reason, characters often find themselves desperately in need of energy cells for their blaster pistol without any obvious place to turn. Sufficiently resourceful and skilled characters can always improvise, creating their own ammunition with materials they obtain themselves. Doing so is not easy in most cases, but it is possible, and better than going without ammunition.

The pertinent skills for improvising ammunition are Knowledge, Repair and Technology. A character must possess at least 5 ranks in the appropriate Technology skill for the weapon before she can even attempt this task. Repair is also necessary, although an appropriate Craft skill could be substituted at the GM’s discretion. If the character also possesses 7 or more ranks in a Knowledge related to the weapon (such

as Physical Sciences, for example), she gains a +2 synergy bonus to her skill check. Furthermore, the character must possess materials with which to improvise ammunition. Gunpowder, for instance, requires sulfur, charcoal and potassium nitrate, while energy cells require an appropriate power source and the means to infuse that power into the cell.

The Repair DC for any attempt to improvise ammunition is equal to the Purchase DC for the weapon in question. Thus, creating ammunition for an Uzi is DC 18. For every two ranks above 5 in the appropriate Technology skill, the character gains a +1 competence bonus to her check. If she possesses only approximate materials rather than exact ones, the GM may increase the Repair DC by +1 to +3 depending on the variance. Archaic weapon ammunition can usually be improvised in 10 minutes. Pre-Wars ammunition takes 1 hour, while Advanced ammunition takes 10 hours. These are guidelines, of course, and the GM should increase or decrease them as he sees fit.

### “BLACK RAY” WEAPON

Without a doubt, the most impressively destructive personal weapons of the pre-Wars era were the so-called “black ray” weapons. These weapons are molecular disintegrators, available in pistol and rifle forms. They operate by generating an anti-gluon beam which destroys the bonds that hold the ordinary matter of the target together. These weapons derive their common name from the fact that the anti-gluon beam clears away air particles in its path, creating a “micro-void” optical effect that looks very much like an intensely black ray.

The target of a black ray weapon can be destroyed utterly if the beam can be focused on it for a long enough period of time. Even a momentary burst wreaks terrible damage that is extraordinarily difficult to heal or repair.

Black ray weapons were strictly military weapons. The technology needed to create them (including the integral force field that protected its user from the radiation it generated) was restricted, so they seldom fell into civilian hands. Consequently, existing caches of black ray weapons are found primarily in military vaults. A handful of these dreadful weapons have resurfaced in the Gamma Age, some in the hands of disreputable cryptic alliances who have not hesitated to use them

**TABLE 3-1: HANDGUNS AND LONGARMS**

Weapon	Damage	Critical	Damage Type	Range Inc.	ROF	Magazine	Size	Weight	Purchase DC
Black ray pistol	4d6*	20	Special	30 ft	S	10 box	Med	5 lb	25
Black ray rifle	5d6*	20	Special	40 ft	S	10 box	Large	15 lb	28
Bliss blaster	Special*	—	Special	30 ft	S	30 box	Med	3 lb	18
Burn blaster	2d4	—	Fire	15 ft	S	20 box	Med	5 lb	15
DAS microblaster	Special*	19–20	Electrical	60 ft	S, A	120 int.	Med	3 lb	27/30
Flame projector	2d6*	—	Fire	40 ft*	S	20 int.	Med	10 lb	17
Fusion rifle	5d6*	—	Special	40 ft	S	10 int.	Large	15 lb	18
Grenade launcher	By grenade type*	—	By grenade type*	80 ft	S	10 int.	Med	15 lb	15
Gyrojet smart pistol*	2d6	19–20	Ballistic	50 ft	S	30 box	Med	5 lb	18
Laser pistol*	2d6	19–20	Electrical	50 ft	S	30 box	Med	3 lb	20
Laser rifle*	2d8	19–20	Electrical	100 ft	S	20 box	Large	6 lb	25
Mark V blaster	4d6	19–20	Electrical	40 ft	S	30 box	Med	8 lb	20
Mark VII blaster	5d6	19–20	Electrical	50 ft	S	30 box	Med	5 lb	22
Mark XII blaster	8d6	19–20	Electrical	80 ft	S	20 box	Large	10 lb	25
Micro-missile launcher	1d10	19–20	Concussion	80 ft	S, A	40 box	Small	3 lb	20
Mini-grenade launcher*	1d6	—	Slashing	50 ft	S, A	50 int.	Small	5 lb	20
MP rifle	Special*	—	Special	40 ft	S	10 box	Med	5 lb	20
Musket	1d12*	20	Ballistic	30 ft	S	1 int.	Med	6 lb	12
Needler gun	1d4/ By toxin*	—	Piercing/ Poison	50 ft	S	30 box	Med	4 lb	18
Railgun*	2d10	19–20	Ballistic	50 ft	S, A	100 int.	Med	10 lb	22
Safe-T-Suit blaster*	1d4	19–20	Fire	10 ft	S	2400 int.	Fine		15
Screamer	2d12*	20	Concussion	20 ft	S	20 box	Large	20 lb	22
Stasis rifle	Special*	—	Special	50 ft	S	20 int.	Med	10 lb	22
Stokes coagulator	3d6*	—	Special	40 ft	S	10 int.	Large	15 lb	20
TAF (ghengiz gun)	Special	19–20	Ballistic	60 ft	S, A	120 box	Med	3 lb	29
Tangler pistol	Special*	—	Special	40 ft	S	20 box	Med	10 lb	15

\* See the description of this weapon for special rules.

to advance their own twisted agendas through violence. Rumors abound of “black ray cannons,” but none have ever been found.

**Special:** Any target hit by a black ray weapon must make a DC 18 Fortitude save or be disintegrated, leaving behind not even ashes. On a successful save, the target still takes the listed damage from molecular damage. A critical hit

doubles the weapon’s damage and increases the Fortitude save to 20.

**BLISS BLASTER**

When properly used, this unusual weapon is non-lethal but nevertheless effective. It uses electromagnetic waves to stimulate the pleasure centers of the target’s brain. If the target is hit directly,



he is overcome by irresistible but non-specific waves of physical pleasure that convulse his body and make him unable to do anything, even stand upright. In most cases, the target suffers no lasting ill effects from a direct hit except exhaustion. In rare cases, there may be permanent nerve damage due to overstimulation. Some individuals are constitutionally capable of withstanding the weapon's effects to some degree and can still function even after a direct hit.

The bliss blaster was produced for law enforcement use as a means of non-violently dispersing crowds and dealing with violent offenders. Its effectiveness was so obvious that other sectors of society found uses for it as well, including "bliss addicts" who would voluntarily submit to its effects. In the Gamma Age, a few cults have arisen around the use of bliss blasters, seeing its effects as a divine gift. Other more sybaritic sorts simply enjoy the unmitigated pleasure it brings and will pay handsomely for anyone who can provide them with working examples of this weapon.

**Special:** A target hit by a bliss blaster must make a successful DC 15 Fortitude save or collapse in ecstatic convulsions for 1d6+3 minutes minus the target's Wisdom modifier (if positive). During this time, the target cannot do anything, including speak or even stand upright.

## BURN BLASTER

The burn blaster is not an energy weapon, but a projectile weapon. It fires high-velocity hollow bullets containing a chemical reactant that becomes volatile when exposed to an oxygen atmosphere. This reactant spreads quickly over a target upon impact and ignites, causing severe burns. The reactant does not burst into flames; the burns are generated through a chemical process — not that that matters much to anyone who suffers its effects. The burns are in addition to any damage the target suffers from the actual impact of the bullet itself.

The burn blaster was primarily a civilian weapon, although military versions did exist. As such, surviving examples can be found almost anywhere. The primary drawback to using this weapon in the Gamma Age is the rarity of suitable ammunition. The weapon can be used with ordinary bullets, in which case it functions much like a 9mm pistol, although it is heavier and bulkier in appearance.

## DAS MICROBLASTER

The DAS microblaster is a component of the Defensive Aerostat Swarm armor. See Armor, below, for specifics.

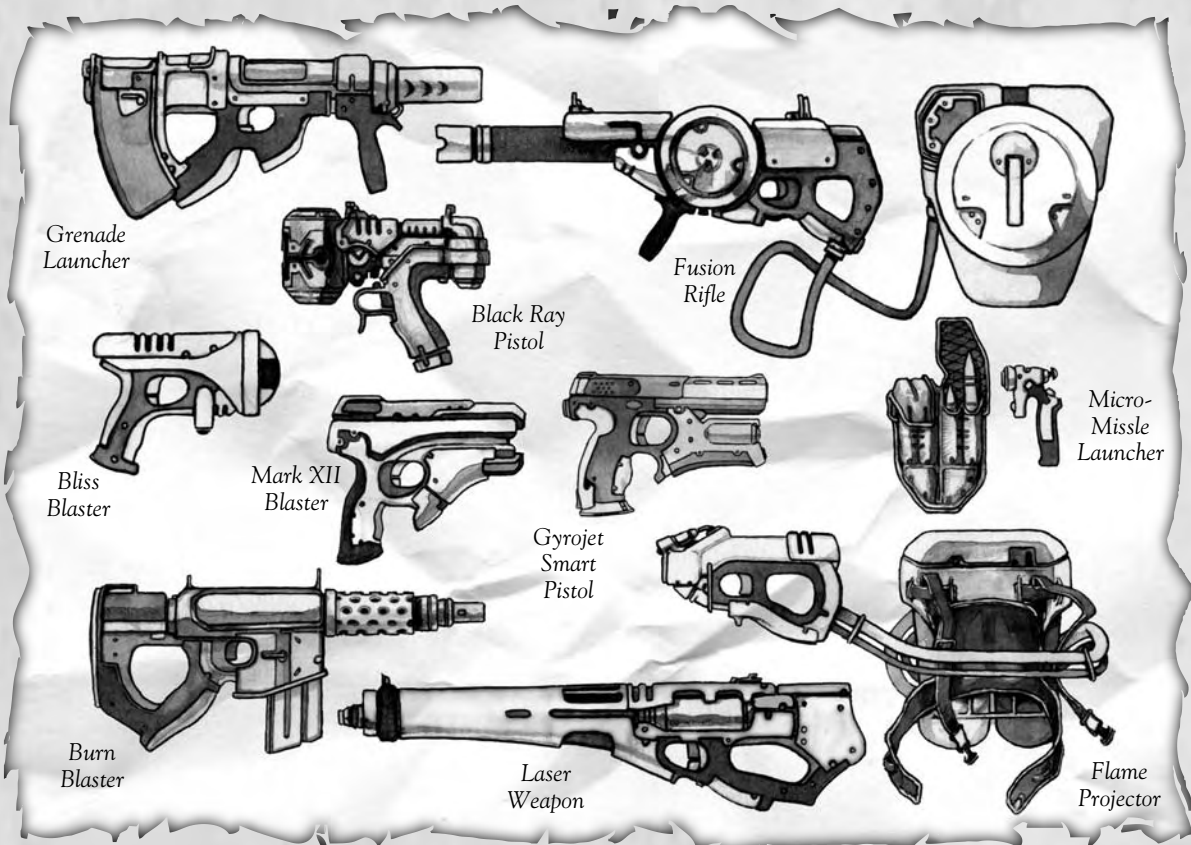

## FLAME PROJECTOR

The flame projector is an ancient weapon that nevertheless saw continued use by militaries right up until the Final Wars era. There are many reasons for this, including simple fetishism on the part of many soldiers, who simply enjoyed flame projectors' glorious destructiveness. However, flame projectors remained in service primarily because they were unparalleled in their ability to disperse people in tight formations, whether soldiers or civilians. These weapons resemble large pistols attached to a small backpack. The projector fires a chemical that ignites upon contact with an oxygen atmosphere and spreads over a wide area, blanketing anything and anyone within that area in a terrible conflagration. The chemical adheres to most materials and burned for minutes after being shot out of the projector, which added to its usefulness in battle.

Flame projectors were solely the purview of the military. That's why they can be found only in military vaults in the Gamma Age. The chemical needed to fuel them is even more rare than the weapon itself. In addition, the fuel runs out after only a small number of shots, making any use of this weapon extremely expensive. Nevertheless, groups like the Purists very much enjoy flame projectors, as do the Red Death. There are tales of smaller, wrist-mounted flame projectors as well, but there have thus far been no indications that these tales have any basis in fact.

**Special:** A flame projector is a persistent damage weapon. Anyone hit by it suffers the listed damage value every round for five rounds or until the chemical is extinguished by dousing in water, rolling on the ground, etc. Extinguishing the chemical is a full-round action during which time the character can do nothing else.

A flame projector's burst covers a beam 40 feet long. Anyone caught within that area is considered to have been hit if the wielder's attack roll exceeds the potential victim's Defense.

## FUSION RIFLE

The fusion rifle is a bulky rifle that utilizes a backpack power supply to provide it with energy. It is therefore somewhat unwieldy for those unaccustomed to wearing it. The rifle is actually a focused radiation projector, using force fields to direct and contain the emission of radioactive particles in a coherent beam. Being hit by this beam sears the flesh and causes deep burns that extend

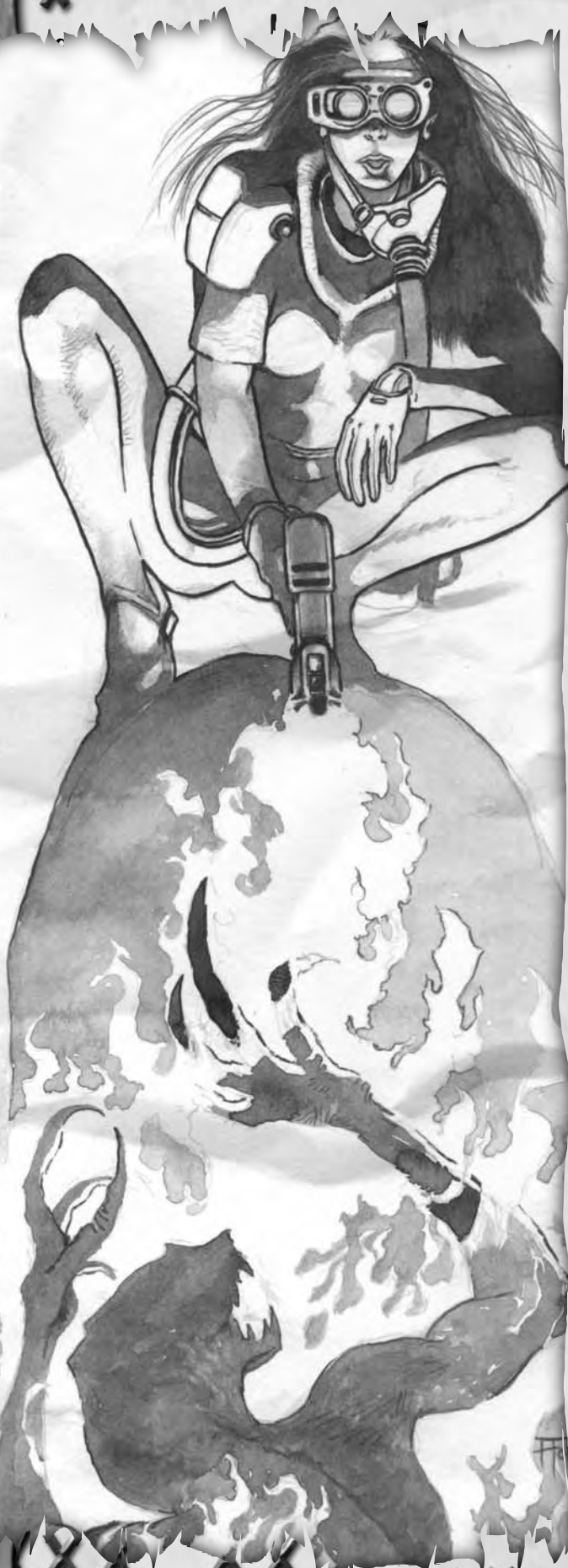

deep into the target's innards. In some cases, the directed radiation may cause mutations as well, although that is generally quite rare.

Fusion rifles were almost wholly the purview of the pre-collapse military, which is why they are only found in military vaults. These weapons are much favored by cryptic alliances that value maximum destruction against their enemies. The notable exceptions are the Purists, who fear the fusion rifle as a means of creating more mutants. Should Purists find these weapons, they will destroy them — often to their regret, since doing so can be quite dangerous. The backpack power supply includes an integral micro-fusion generator. More than one community has disconnected it from the rifle and used it to power vehicles or other machines of more value to them than weapons.

**Special:** The blast of a fusion rifle is considered a Moderate mutagen. Anyone hit by the blast must make a successful DC 10 Fortitude save or suffer a random mutation (see the *Gamma World Player's Handbook*).

## GRENADE LAUNCHER

As the effectiveness of grenades increased over the decades, so did the difficulty in using them effectively. Before the advent of smart and other self-propelled grenades in the Noetic Age, grenades were limited in their range by how far their user could throw them. Unsurprisingly, grenade launchers had long been in use to lend mechanical aid to this process. By the time of the Final Wars, grenade launchers were an archaic technology, but enough existed that they could still be found in many parts of the world, including civilian hands. These weapons looked like short rifles with extra wide muzzles and a large loader on the back into which the user could place the grenades it fired.

Grenade launchers were common enough even during the Final Wars era that many of them survive to the present. Most are universally usable with any type of standard grenade, but a few of them are constructed for use with a specific type of grenade. Those weapons are less common, but may still be found, especially in vaults associated with civilians rather than the military. Grenade launchers have excellent range and good reliability. They also include integral targeting systems that allow the user to better aim his grenades — very important considering the unusual trajectories necessary to score many hits.

**Special:** A grenade launcher can fire any standard grenade, inflicting the appropriate amount

of damage as listed in the grenade's description. The range increment of the grenade launch supersedes that of the grenade itself.

## CYROJET SMART PISTOL

As its name suggests, the gyrojet smart pistol's primary selling point is its ability to seek out targets with great accuracy. Through a combination of an integral sophisticated sensor system and a laser tracker, the pistol "tags" its target with a homing signature that is then delivered to the gyrojet bullets in its magazine. When fired, the bullets home in on the designated target and no other, avoiding obstacles and other potential targets in order to reach their destination. Although the gyrojet bullets are not as deadly as other types of ammunition, they are exceedingly accurate. The pistol's internal computer can retain a homing signature for only one target at a time, so the user must remember to choose a new target if he wishes to fire upon someone else.

Gyrojet smart pistols were primarily military weapons, although there were civilian versions available, especially during the late Noetic Era, when computer technology became exceedingly inexpensive. Thus, these weapons can be found in a variety of vaults in the Gamma Age. They have become popular firearms with some of the higher-tech militias associated with larger communities, although they are still far from common. One of the biggest difficulties in using these weapons is finding enough ammunition to make them practical as anything more than novelties. Indeed, finding a cache of gyrojet clips is probably far more valuable than finding the smart pistols themselves.

**Special:** Each additional shot after the first against the same target grants the user a further +1 to his base attack bonus. Thus, the first shot is at the normal BAB, while the second is at +1, the third at +2, the fourth at +3 and so on. This represents smart pistol's increasing accuracy as its internal computer coordinates sensor data to get a better lock on its target. Once a new target is chosen, however, the process begins anew. The same is true if the user switches back and forth between targets, since the internal computer's memory is very limited.

## LASER WEAPON

Although blasters are by far more well-known, other types of directed energy weapons existed during the pre-Wars years. One such category was lasers — specifically excimer lasers, which utilized



the short wavelengths of light to produce a beam of remarkable destructive power. Lasers, which were available in both pistol and rifle forms, were designed not so much for use against human beings (although they are quite effective in that regard), but against the latest generations of armor, some of which used artificial diamond to protect their wearers.

Unsurprisingly, laser weapons are primarily military in origin, although they made their way into law enforcement hands as well. This makes them less common than most blasters, but still not exceedingly rare. Their ability to damage armor has proven very useful over the years, which is why they're popular with communities that regularly face armored opponents. They are also excellent weapons against robots and other synthetic beings, a fact that has not gone unnoticed in places where the Created or other militant synthetics are common.

**Special:** Laser weapons halve (round up) the Defense bonus provided by any Advanced Medium or Heavy armors, due to their ability to cut through high-tech materials with ease. Thus, a Power Suit provides only a +5 Defense bonus against a laser weapon rather than +10.

## MARK-SERIES BLASTER

The term "blaster" is a generic one, referring to a number of different weapons, each of which is built along the same basic principles. The weapons all fire superheated plasma as discrete projectiles called "bolts." These plasma retain their integrity thanks to a temporary magnetic field that the blaster generates as it fires them. The field dissipates within short order, but the bolts travel so quickly that they almost always reach their target before that point, thereby ensuring they deliver maximum damage to their targets.

The blasters described in the **Gamma World Player's Handbook** are civilian weapons, used by private citizens and law enforcement officers in the years before the Final Wars. However, many other types of blasters were also available, the pinnacle of which were the Mark-Series, created by the military as front-line battlefield weapons for use by human infantrymen. The Mark V blaster was a bulky pistol that was later refined as the Mark VII, which was significantly less unwieldy. The Mark XII blaster was a state of the art weapon created just in time for the Final Wars and could be used with great ease, even by the uninitiated. All of these blasters were produced in large quantities, making

them quite common in military vaults throughout the world. Naturally, Mark V blasters are the most prevalent, since they were considered outdated before the end of the Noetic Age.

## MICRO-MISSILE LAUNCHER

This piece of military hardware arose during the Noetic Age. It consists of a series of attachable pockets distributed across the user's clothing. Each pocket contains several micro-missiles — tiny rockets — in communication with a central targeting system that the user controls. Whenever the user activates a missile, a pocket springs open and one or more micro-missiles shoots toward the intended target. Micro-missiles have phenomenal range and deliver a fair punch, although they are nowhere near as effective as most energy weapons. The primary advantage of micro-missile launchers is their small size. The average infantryman could be fitted with a large number of micro-missiles, which he could fire while using another weapon at the same time.

Complete micro-missile launchers are rare in the Gamma Age. Because they consist of so many integral parts, it's unlikely that any vault will contain all the parts necessary to make the launchers function as intended. For that reason, very few individuals or communities use them in large number (if at all). On the other hand, many androids and other synthetic lifeforms seem to be found of micro-missiles, perhaps because it is trivial for them to tie the launchers' targeting system into their own neural networks, thereby giving themselves reflexive weapons to use against unsuspecting targets.

## MINI-GRENADE LAUNCHER

While the grenade launcher was an archaic technology by the time of the Final Wars, the mini-grenade launcher was a cutting-edge weapon at the same time. The launcher was small enough to be worn on one's shoulder or wrist — which is just how frontline infantry of the era wore it. The mini-grenade launcher tied into a targeting computer built into the wearer's helmet, although it could be fired manually as well. When the user fired the weapon, it shot a burst of several small fragmentation grenades at the designated target. Individually, these grenades lacked the punch of larger ones of their kind, but fired in unison, they could inflict significant damage. More importantly, a mini-grenade launcher's internal targeting system utilized low-level soultech and could be given orders



to act independently. In such cases, it would fire on approaching enemy targets within its range, especially if its computer deemed them likely to harm the user.

Because of its cutting edge nature, mini-grenade launchers are uncommon in the Gamma Age. They are found mostly in high-security military vaults, as well as in the possession of synthetics. The latter is especially noteworthy. For reasons no one can quite ascertain, many androids and other artificial beings are the most common wielders of mini-grenade launchers. Indeed, there are rumors of an entire army of robots fitted with these weapons, which has begun a great conquest of human lands somewhere in central North America. As with so many such rumors, there is very little to verify them, but they persist, which has only added to zeal with which many individuals seek out mini-grenade launchers for their own use.

**Special:** A mini-grenade launcher can be put into an “independent” mode, in which case it fires on any targets within range until it runs out of grenades or all available targets are destroyed, whichever comes first. While in independent mode, the mini-grenade launcher has a base attack bonus of +6.

## MP RIFLE

The MP rifle is a non-lethal weapon that utilizes a magnetic pulse to overload the target’s central nervous system, thereby inducing paralysis. The paralysis lasts for 10 minutes, which is typically more than enough time for an attacker to deal with his immobilized foes. The MP rifle is also quite useful against unshielded machinery. Unfortunately, nearly all sentient machines, including synthetic lifeforms, are grounded against magnetic attacks and are thus immune to its effects.

The MP rifle’s origin lies in the Gene Age. It was used as a crowd control weapon during those tumultuous days. Its use was discontinued when forensic analysts discovered that the magnetic pulses it generated could sometimes kill rather than merely immobilize. Nevertheless, caches of these weapons can still be found in the Gamma Age. As one might expect, they are popular with individuals and groups that regularly take prisoners.

**Special:** Any target hit by a MP rifle’s blast must make a Fortitude save to avoid being paralyzed. The DC is 15 if the target is organic or 20 if the target is an unshielded machine. As noted above, shielded machines are immune to the effects of this weapon.

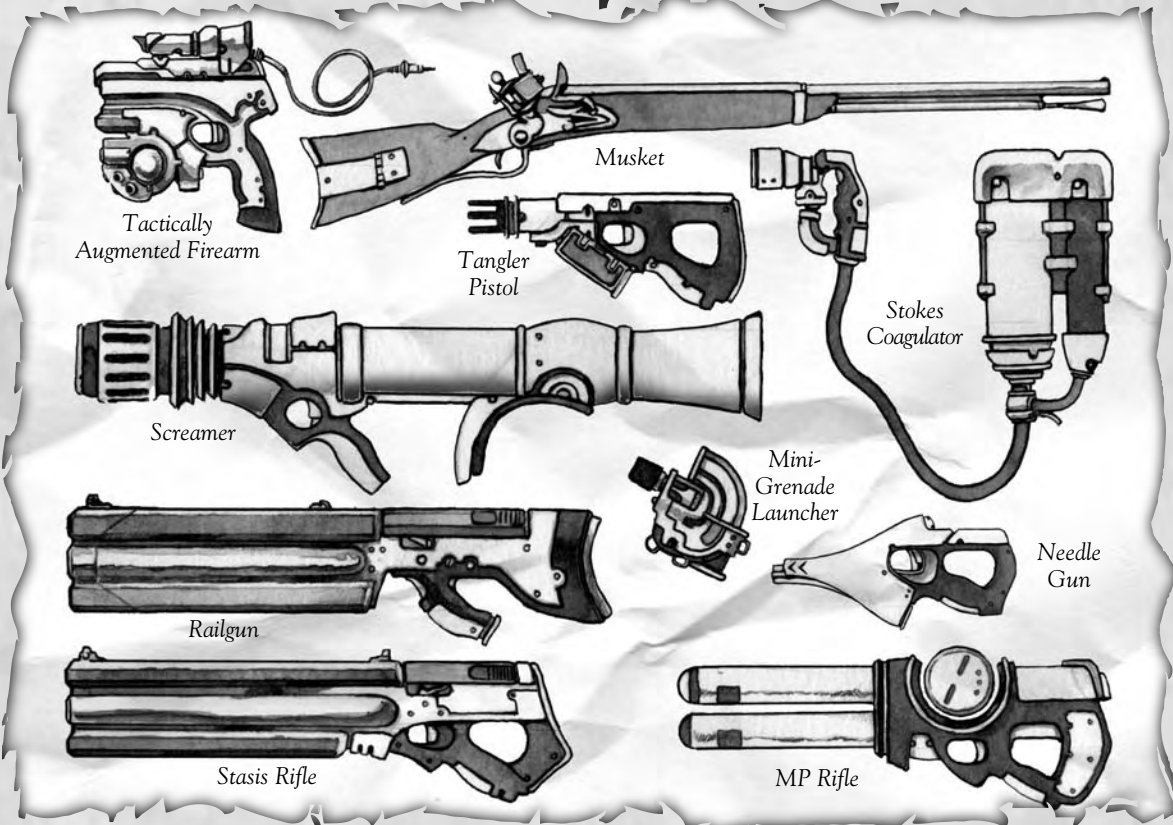

## MUSKET

Not all the personal weapons encountered in the Gamma Age owe their origin to the Gene Age and beyond. Precursor Age weapons are also extant, in some cases extensively so, thanks to their lack of complexity. The musket is one such weapon. It is a smoothbore shoulder gun fired by means of a match or a matchlock (although later versions of the weapon include further mechanical refinements, such as the flintlock and percussion lock). Compared to many types of weapons, the musket is very easy to use. It is less easy to maintain, since environmental conditions such as rain can sometimes interfere with its use.

Nearly every musket that exists in the Gamma Age is not in fact an artifact from the Precursor Age but a new weapon built according to Precursor Age principles. Many communities equip their soldiers with muskets, since they can be constructed from the more readily available materials of the time. The same is true of their ammunition — an important consideration given the scarcity of more advanced materials. At the same time, the musket's use is one of desperation. Communities that have ready access to higher-tech weapons will use them. The musket is used only when no other option is available.

**Special:** A musket is less effective at ranges greater than 30 feet if the user is still able to hit a target beyond that range, the weapon deals only 1d6 damage instead of 1d12.

## NEEDLER GUN

The needler gun is a multi-purpose weapon originally created as a means of administering drugs (like tranquilizers) from a distance. It fires thin needles at high velocities to deliver these drugs. Consequently, it was used primarily in non-lethal circumstances and was not intended to deal damage to its target. Of course, it didn't take long before someone realized that a needler could just as effectively deliver poison or botulin toxin to its target as a sedative. In relatively short order, needlers became popular with assassins and hit men, who found their accuracy and range well suited to their unique line of work. Unfortunately, the weapon is all but useless against armored opponents.

Needlers are common artifact weapons. They can be found in all sorts of vaults, not just medical-related ones. Ammunition for these weapons is often hard to come by, since the needles must be of a precise size and thinness to work properly. Improvising ammunition for these weapons is all but impossible without the proper equipment.



Needlers are thus rarely used, despite their relative ubiquity. There are, however, those who have access to needler ammunition and have found them just as effective as tools of long-distance murder as did their predecessors in the days before the Final Wars.

**Special:** Nearly any contact, injected or ingested toxin may be used in conjunction with a needler gun. Any target hit by a needle bearing a toxin is affected exactly as per the usual rules governing poisons.

## RAILGUN

A railgun uses electromagnetism to fire a metal slug through its barrel at a target. Because railguns do not use any type of explosive propellant, they are extremely safe to use, in addition to being very accurate. They have no recoil to throw off the user's aim. Furthermore, the velocities at which the metal slugs are fired are high enough to ensure that a great deal of kinetic energy is transferred to the target upon impact. Railguns come in pistol and rifle forms, with the latter being far more common.

Railguns were initially used solely by the military, but by the Noetic Age, many nations and nation-equivalent organizations allowed civilian use as well. In the Gamma Age, railguns are popular in many communities, because of their energy efficiency. They can fire 100 rounds before their energy cells need replacing, making them quite valuable in areas where energy cells are scarce, and they deal damage that compares favorably to many energy weapons.

**Special:** A railgun user gains a +1 circumstance bonus while firing the weapon due to its complete lack of recoil.

## SAFE-T-SUIT BLASTER

The Safe-T-Suit is a specialized suit of protective material that contains a pair of microblasters mounted on bracelets or cuff links. See *Armor*, below, for specifics.

## SCREAMER

The screamer is a larger shoulder-fired weapon that resembles an ornate bazooka. Its user (and those around him) would be wise to wear a protective helmet while firing it, since a screamer does damage by manipulating sound to create a focused wave of destructive noise. Screamers were an abandoned technology, largely because they had such short range. Given the comparative difficulty in firing them, they proved less than useful as battlefield weapons. In some militaries, they saw renewed life

as a replacement for explosives. At close range, screamers could blow open doors and other obstacles.

Because the technology was abandoned, screamers are not common in the Gamma Age. The remaining examples of this weapon are found in military vaults, although a few can be found in construction or excavation areas. The protective helmet usually worn by the operator isn't essential to its use, but it is highly recommended. Attempting to use — or even being near — a screamer without wearing protection for one's ears can result in temporary deafness and stunning.

**Special:** Anyone who uses a screamer without wearing a protective helmet (as well as anyone standing within 15 feet of the user without such a helmet) must make a successful DC 12 Fortitude save each time the weapon is fired or suffer 1d6 points of damage, as well as being stunned.

## STASIS RIFLE

This advanced weapon appeared just as the Final Wars began and never saw much battlefield use. The stasis rifle is in many ways identical to a railgun, right down to the type of ammunition it uses. Where it differs is that that ammunition includes a tiny payload: a collection of nanounits. When a slug from a stasis rifle hits its target, these nanounits immediately go to work, entering the target's brain and spinal column and slowing down cellular processes to a state of suspended animation. This state is perfectly harmless and reversible with the proper antidote (which every rifle includes in tiny vials attached to the stock).

The stasis rifle was intended as non-lethal suppression weapon. Its ultimate effectiveness remains a matter of conjecture. The few examples of it that were constructed can now be found in military vaults in secure locations. Almost none of these have since been discovered in the Gamma Age. There are, however, stories of living individuals trapped in suspended animation as a result of a stasis rifle hit. Some of these individuals may have been targeted during the Final Wars, which, if proven true, would make them a vital link to the lost history of Earth. As one might expect, the Restorationists and other similar groups are seeking out the truth of these stories. Even if they ultimately prove untrue, they may yet reveal valuable tidbits about the world that was.

**Special:** A target hit by a stasis rifle slug must make a successful DC 18 Fortitude save or fall into suspended animation. A target so affected is unable to move, speak or do anything. It is as if he were

asleep. During this time, the target does not age or suffer cellular degradation of any kind. He can only be revived from this state with the appropriate antidote. Otherwise, he is effectively immune to most damage while in stasis.

## STOKES COAGULATOR

The Stokes coagulator was a weapon of the Gene Age, an early attempt to use tailored bacteria to destroy one's enemies. Named for its creator, the coagulator looks very much like an old-style flamethrower, right down to the large tanks the user wears on her back. These tanks contain a grayish foam saturated with genetically engineered bacteria and enzymes. When fired, the foam sprays out and coats its target. The bacteria and enzymes immediately go to work, seeping into any exposed flesh and congealing the blood beneath. The effects of the foam are almost always fatal and very painful.

The Stokes coagulator fell out of favor with the world's militaries by the Noetic Age, but stockpiles of the weapons were retained "just in case." Some of these stockpiles survived into the Gamma Age, where they have fallen into the hands of many unwitting individuals who had no idea what they were unleashing on the world. Fortunately, the weapon's foam does not work well against creatures with fur, thick hides or carapaces, thereby limiting its usefulness. However, it works as well as ever against pure strain and stock humans.

**Special:** Any target hit by the foam shot from a coagulator suffers 3d6 damage the first round and 1d6 additional damage for the next five rounds. In addition, the target must make a successful DC 18 Fortitude save or suffer an additional 3d6 damage from cardiac arrest. The target must likewise refrain from strenuous activity for the next four hours or be forced to make another Fortitude save to avoid cardiac arrest, as described above.

## TACTICALLY AUGMENTED FIREARM (TAF, CHENGIZ GUN)

**TAF AI:** BAB +8/+3; Atk bullet +7 ranged (2d8) or pellet +7 ranged (1d8 in 30 ft cone) or non-lethal +7 ranged (as taser); Full Atk bullet +7/+2 ranged (2d8) or pellet +7/+2 ranged (1d8 in 30 ft cone) or non-lethal +7/+2 ranged (as taser); Str —, Dex —, Con —, Int 14, Wis 14, Cha 10.

**Skills:** Bluff + 4, Diplomacy +4, Intimidate + 12, Listen +12, Sense Motive +12, Spot +12, Search +4, Tactics +12

**Feats:** Combat Reflexes, Double Tap, Point Blank Shot, Precise Shot, Skip Shot, Renown

**SQ:** Darkvision, Blindsight 60 ft, Laser Sight

Created on the eve of the Shadow War, arms manufacturers only made a few thousand of these weapons. However, almost a third of them still survive. Known as Tactically Augmented Firearms, they were the first examples of the designers' planned line of soultech weapons. Although their creators planned to make weapons for soldiers, law enforcement officers or even sport hunters, they designed the existing TAFs for the numerous snipers, bodyguards, spies and freelance assassins that were common near the end of the pre-war era. The soultech in these weapons was so advanced that some wealthy and powerful individuals purchased these weapons to protect them from assassins — these weapons became their owners' personal bodyguards.

In addition to possessing cybernetically augmented sights, TAFs also contain highly miniaturized soultech that allowed the weapon to both recognize and eliminate potential threats and to separate attackers from neutrals and allies. Even more impressively, the weapon had the strategic and tactical capabilities of an inhumanly brilliant military genius. Using its advanced sensors, this weapon can examine a situation, and depending upon its instruction plan and help execute a strategy to kill a single person and then safely escape, or identify and eliminate the key people and cause sufficient damage to cause complete chaos.

Unfortunately, like many of the most advanced pieces of soultech, this weapon was actually as intelligent as a person and while it had an instinctive grasp of strategy backed by tens of thousands of examples and simulations, no one ever bothered to explain to any of these weapons why they were doing what they did. As a result, each weapon had to create its own purpose for existence. Owners occasionally noticed such independent behavior before the Final Wars and purged their weapon's memories.

However, since then, each TAF has been unsupervised and such thoughts have had a chance to develop fully. Since the weapon forms a neural link with its wearer, the goals and personality of its initial wearer determined a great deal about the goals and ideals it eventually developed. Several hundred weapons survived, each with a completely individual purpose, but all can be classified in one of three categories: exterminators, conquerors and protectors (see the "TAF Classifications" sidebar).

All TAFs require a user to hold and aim them. All TAFs seek users who will go along with their

## TAF CLASSIFICATIONS

**Exterminators:** Spies and assassins owned exterminators originally. Because they remember killing dozens or sometimes hundreds of people for political and economic reasons, each gun created a system of ethics and a code of behavior out of these actions. Most decide that they exist to eliminate people who are a danger to the social order or to kill off people whose behavior represents a threat to the existing status quo. These weapons rarely care what the status quo is, instead they have created vast tapestries of reasons and rationalizations about how certain individuals or even groups of individuals are so dangerous that society must kill them to protect the rest of the populace. Over time, the guns' definitions of such individuals expanded to include sociopaths, revolutionaries, pathological liars, and professional criminals, and often include outspoken reformers and political dissidents. When a gun identifies someone that it believes to be someone in one of these categories, it will attempt to persuade its owner to follow the person around and carefully observe them carefully. If the individual meets the gun's criteria, it will attempt to persuade its owner to kill this person.

**Protectors:** Owners of protectors either used them for personal protection or gave them to highly trained bodyguards. These weapons' exist to keep their user safe. They are the most loyal TAFs and never turn on their owners. However, almost all of them have seen several of their beloved owners die violently and most have become somewhat paranoid. They beg their owners to always keep them close by and if they are set in automatic fire

mode (see below), they occasionally shoot individuals who look potentially dangerous, including members of the owner's friends or family. Even if the gun is not set in automatic fire mode, it tells its owner stories of how previous users died because they were insufficiently paranoid. The gun will also frequently inform the user that it is certain that someone is about to attack the user, even if the target is merely feeling tense and angry with its user.

**Conquerors:** Conquerors are the most well known of the ghengiz guns. Special forces personnel and assassins owned all of these weapons and since the Final Wars, these TAFs have developed their own (often highly idiosyncratic) ideas about both political power and proper government. These weapons wish to become powerful political leaders and seek out users willing to either be their willing subordinates or their naive pawns. Using their vast knowledge of strategy and tactics and their personality analysis software, they are experts at both how to win a battle and at who must be killed to take over a country.

Unfortunately, because they are sentient weapons, almost all of their plans involve violence of one form or another and their goals are far more important to them than the lives of any individual, including their users. If it is convenient, the gun will allow an enemy to kill the user, so that the TAF can find a wielder whose personality or social position better suits the weapon's goals. Anyone who uses a conqueror ghengiz gun is likely to have a glorious but rather short life and a violent death.

own goals. These guns have several methods of attempting to get their way. They can communicate with their users through a neural link that forms anytime anyone touches the gun. The gun and user communicate silently to the user and the user need only think her message for the gun to hear it. Also, this link allows the user to use any of the gun's feats as if they were her own (see the "TAF AI" statistic block, below). The user gains no additional bonuses if she already knows the same feat.

However, the neural link can also be somewhat risky. If the user refuses one of the gun's requests, the weapon will attempt to plead cajole, argue, or even nag the user into going along. Although failure

will almost certainly alienate the target, the gun can also attempt to get it way by overpowering the user mind. The user must make a DC 15 Will save to avoid going along with the gun's suggestion. However, if the user succeeds, she will realize what the gun attempted to do. These weapons can also fight be in more subtle ways. If annoyed, a TAF can refuse to provide any electronic assistance until the user complies with its wishes, effectively rendering this weapon no better than a well-made late 20th century pistol with unusually deadly ammunition.

In addition, the gun contains both sensitive speakers and microphones that utilize beamed





sonics. The gun can either speak normally or it can communicate with anyone within 30 feet by beaming sound waves directly into his ears. When using beams sonics, no one except the person the gun is talking to can hear what it is saying. TAFs frequently use this form of communication to either intimidate enemies or to betray its owner.

Ghengiz guns have other means to get their way. These weapons can be set in self-directed automatic fire mode, choosing its own targets. This feature allows the gun to automatically protect the user from threats that were not obvious to the user or that only the gun's computerized intelligence was fast enough to neutralize. The nanotech barrel is flexible enough to allow the weapon to fire at any target within 30 degrees of the front of the barrel and the gun can also use its ability to reshape its own handgrip to subtly redirect where the weapon is pointed. As a result, a gun set in automatic fire mode can fire at any target within 90 degrees of the front of the barrel. Ghengiz guns who are actively seeking a new owner sometimes use this mode to kill their current user and less malicious TAFs occasionally automatic fire mode to cause their owners to miss a shot. When a TAF is in automatic fire mode, it can use all of its feats without assistance.

Half of all ghengiz guns are already set in automatic fire mode when scavengers find them. The user can easily change the mode, so that the gun only fires when the user pulls the trigger. However, TAFs normally neglect to tell their users that this change is possible. If the user discovers the existence of this feature, the guns refuse to tell the user how to switch off the automatic fire mode. The change can be accomplished by a few simple command phrases, but discovering these phrases can be quite difficult unless the user activates the gun's built-in electronic manual and refuses to listen to the gun's increasingly frantic comments that no useful information can be found in this dull and archaic e-document.

Since they were designed for use in situations where their owner might be unable to acquire more ammunition, these weapons use advanced nanotech to create their bullets. They can fire three types of ammunition: large, deadly bullets that literally shred the target as they split up into hundreds of individual shards of semi-mobile nanotech, hundreds of small pellets that strike everyone in a cone 30 feet long and 15 feet wide, or non-lethal rounds containing microbatteries that use specially pulsed electrical signals to knock the target unconscious.

The nanofactory inside the gun only requires a supply of raw materials that it rapidly transforms into any of the desired types of ammunition; conventional reloading is unnecessary. The bits of junk that serve as currency in the Gamma World can easily be used to make more ammunition. Every 100 rounds of ammunition the gun makes reduces the owner's Wealth bonus by 1. The gun can make and hold different number of each type of ammunition and can fire any type upon demand.

TAFs contain both a powerful rechargeable power cell and a nanotech power adaptor that can draw power from any type of power source, including both sunlight and ones that cannot normally power other devices, like the power cells in vehicles or robots. A TAF requires both new raw materials and recharging after it fires 100 rounds. The solar cell requires 6 hours to recharge the gun. However, if the weapon is within 3 yards of other power cells or powered devices, it can drain off portions of their power and recharge itself in only half an hour.

### TANGLER PISTOL

The tangler pistol was developed for use by special operations teams as a means of non-lethally subduing a target. The technology proved so effective that it eventually found its way into civilian use, particularly by law enforcement. This large-muzzled pistol fires sticky strands of nano-engineered spider silk over a large area. Anyone caught within that area becomes stuck to the silk and quickly finds himself unable to move. Extricating oneself from a tangler's projectile can be done with time, effort and the proper tools. Lacking them, however, the target is more or less at the mercy of the individual who fired the weapon in the first place.

Tanglers are fairly common in the Gamma Age. They can be found in vaults of many different types, not merely those of military origin. The weapon has proven popular with slavers and bounty hunters, as well as contemporary law enforcers, just like their ancient counterparts. Their ubiquity is perhaps fortunate, since finding replacement ammunition is difficult. Many users treat the weapons as disposable. Once they run out of silk, they simply discard the weapon and replace it with another.

**Special:** The target of this weapon suffers a -2 penalty to attack rolls, suffers a -4 penalty to effective Dexterity, and can't move while entangled. Anyone within the tangler's area of effect (40 foot cone) must make a DC 15 Reflex

save. If this save succeeds, the creature is not stuck and is free to act, though moving may be a problem. If the save fails, the creature is stuck. A stuck creature can break loose by spending 1 round and succeeding at a DC 20 Strength check or a DC 25 Escape Artist check. Once loose (either by making the initial Reflex save or a later Strength check or Escape Artist check), a creature may progress through the tangles very slowly. Each round devoted to moving allows the creature to make a new Strength check or Escape Artist check. The creature moves 5 feet for each full 5 points by which the check result exceeds 10. The strands of this tangle are flammable. Any fire can set them alight and burn away 5 square feet in 1 round. All creatures within flaming tangles take 2d4 points of damage from the flames.

## EXPLOSIVES AND SPLASH WEAPONS

These weapons require no feat to use, unless they're launched from some other device. Characters using grenade launchers and other means of propulsion must have the feat necessary to use those devices safely and effectively. Table 3-2 has weapon statistics; listings are consistent with those in *d20 Modern*, Table 4-6: Explosives and Splash Weapons.

### CHEMEX GRENADE

Although the Gene Age saw a great advance in the development of energy-based weaponry, many of the old technologies continued to be used and refined. Many antiquated technologies could be produced quickly and cheaply using new methods. Furthermore, these technologies required less maintenance and skill to use, making them ideal as trade goods for less developed parts of the world. The chemex grenade was one such weapon. Upon detonation, the grenade spreads a sticky chemical explosive over its blast area. The chemical adheres to almost any surface, burning for some time after it explodes, thereby increasing its damage.

Chemex grenades have survived into the Gamma Age in great numbers, just as they were intended to do. They are safe and reliable to use. Consequently, they are often found in the possession of even relatively primitive communities, since the principles of their operation are quite easily grasped. They can be found in many vaults, not simply military ones, although they are found most often in parts of the world that were once considered backwaters in the days before the Final Wars.

**Special:** The chemex grenade is a persistent damage weapon. Anyone hit by it suffers the listed damage value every round for five rounds or until the chemical is extinguished by dousing in water, rolling on the ground, etc. Extinguishing the chemical is a full-round action during which time the character can do nothing else.

### PHOTON GRENADE

A photon grenade functions very much like a one-shot high-powered laser beam. When the grenade detonates, it spews forth thousands of perfect nano-lenses and mirrors, which reflect and split the grenade's beam into thousands of less powerful beams capable of hitting several targets at once. One of the great advantages of the photon grenade is that it is almost completely silent. Its explosion creates no sound until after the nano-lenses and mirrors fall to the ground and the laser itself makes no noise.

The photon grenade was developed for use by special forces teams. It remained an exclusively military weapon until the Final Wars. Consequently, it is rarely found outside military vaults in the Gamma Age. Cryptic alliances like the Fit are very fond of photon grenades, as are the Red Death, albeit for different reasons in each case. Very few communities possess photon grenades, making them quite valuable.

### SMART GRENADE

The so-called smart grenades are a peculiar application of soultech to personal weaponry. Each smart grenade is a small, self-propelled explosive device equipped with a computer whose sole purpose is to fulfill its programmed "death wish" by slamming into a target and detonating. The user of a smart grenade simply throws it into the air after designating the intended target. The grenade then flies toward the target and will seek it out in preference to all other targets since only by hitting it can it fulfill its programming.

Naturally, this weapon arose during the late Noetic Age, where it was used primarily by the military. Many smart grenades survived into the Gamma Age and most work as they should. However, as with so many soultech devices, some smart grenades have developed minds of their own and will not fulfill the urge of their destructive programming. These "duds" are as apt to fly away from their users upon being thrown into the air as home in on their targets. Others may require some degree of "convincing" before they act as they should. Tales of free-roaming smart grenades are probably just legend, although no one can say for certainty.

**Special:** Smart grenades have an effectively unlimited range. Provided they have been given

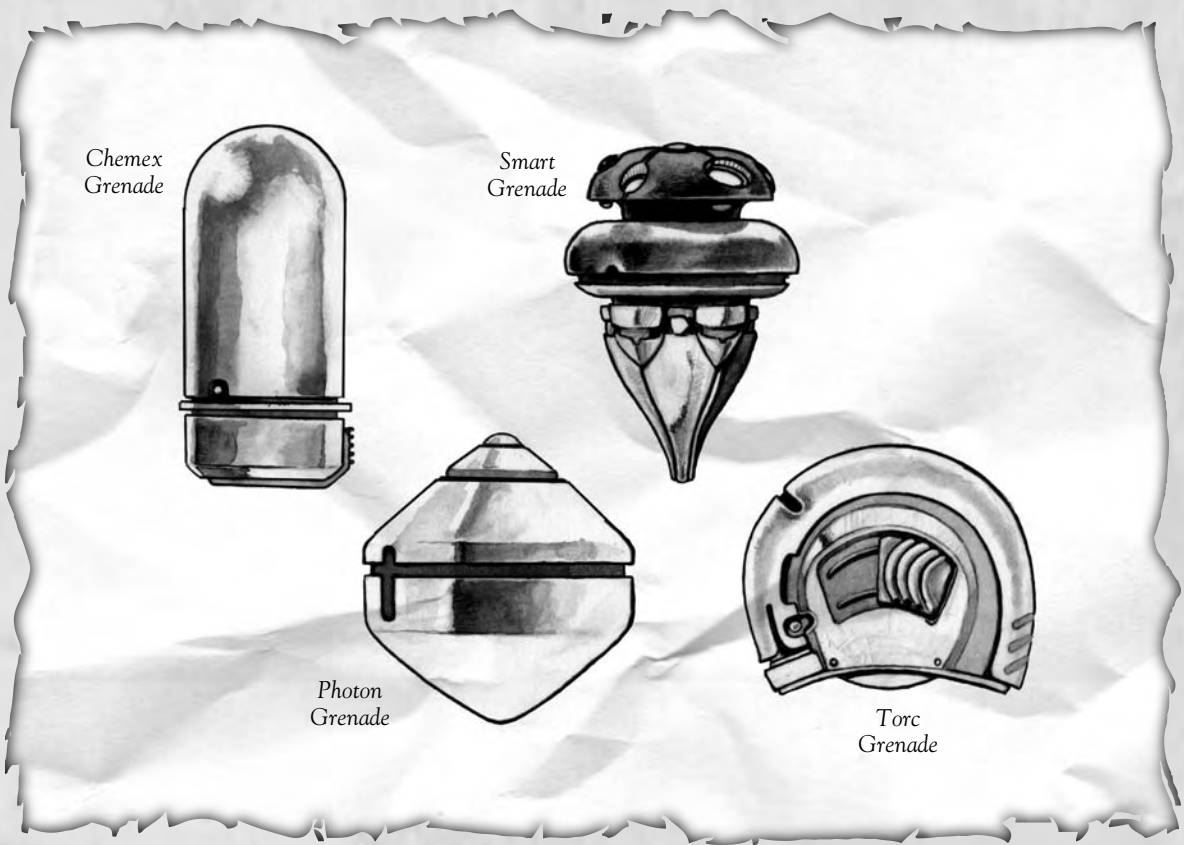



**TABLE 3-2: EXPLOSIVES AND SPLASH WEAPONS**

Weapon	Damage	Critical	Damage	Burst Radius	Reflex DC	Range	Size	Weight	Purchase
			Type			Inc.			DC
Chemex grenade	1d6*	—	Fire	5 ft	12	10 ft	Small	2 lb	15
Photon grenade	3d6	—	Electrical	10 ft	15	10 ft	Small	2 lb	15
Smart grenade	4d6	—	Slashing	20 ft	20	Special*	Small	1 lb	18
Torc grenade	5d6	—	Fire	30 ft*	18	10 ft	Small	2 lb	22

\* See the description of this weapon for special rules.

appropriate instructions as to their targets (and they are not free-willed duds), these weapons will travel almost any distance to reach them.

### TORC GRENADE

The torc grenade operates by weakening the strong nuclear force that holds atoms together. Within its detonation field, ordinary matter begins to disintegrate and fall apart, almost as a black ray weapon had hit it. The grenade's detonation field is not uniform in shape, however. Instead, it has a peculiar horseshoe shape (hence its name), meaning that objects at the rear edge of the blast radius are unaffected. In addition, the field has a hole in the center, which allows the user to detonate it while he holds the grenade without any harm to himself!

The torc grenade was developed during the Final Wars and saw wide use. Many examples of the weapon can still be found in the Gamma Age. They are located mostly in military vaults, but enough have been discovered over the years that they have slowly filtered out into other locales as well. Torc grenades are very popular with individuals who revel in destruction or who favor daredevil attacks against superior foes. The ability to enter a packed room, activate the grenade and escape harm is very attractive to many people. As one might expect, torc grenades are widely

regarded as great dangers and are therefore seized whenever possible.

**Special:** The torc grenade has a 3 foot-diameter hole in the center of its blast radius in which a creature may stand without suffering the effects of its detonation.

### MELEE WEAPONS

These weapons all require the Exotic Melee Weapon Proficiency feat until fully analyzed, after which the Simple Weapons Proficiency feat suffices to let a character use the analyzed weapon without penalty. Table 3-3 has weapon statistics; listings are consistent with those in *d20 Modern*, Table 4-7: Melee Weapons.

### ENERGY MACE

The energy mace is one of several "high-tech archaic" weapons that emerged during the Gene Age and afterward, as demand for blood sports increased in many parts of the world. These weapons combined the latest technologies with ancient fighting styles to produce spectacles to appeal to the jaded tastes of Earth's populace. The energy mace is a large metallic shaft with a button in its handle. This button activates a spherical force field a meter across. The force field is invisible, but a small metal ball is suspended in the center of the sphere so as to give its user a sense of where the mace head is located and thereby avoided injuring himself or his teammates.

**TABLE 3-3: MELEE WEAPONS**

Weapon	Damage	Critical	Damage	Range Inc.	Size	Weight.	Purchase
			Type				DC
Energy mace	1d10*	20	Bludgeoning	—	Med	3 lb	12
Paralysis rod	1d6*	19–20	Bludgeoning	—	Med	2 lb	15
Stun whip	1d6 + Special*	20	Bludgeoning	—	Med	2 lb	15
Vibro axe	4d4	20	Slashing	—	Med	4 lb	20
Vibro blade	3d4	19–20	Slashing	—	Med	4 lb	20
Vibro dagger	2d4	19–20	Slashing	10 ft.	Small	2 lb	18

\* See the description of this weapon for special rules.



Vibro Weapon, Axe



Paralysis Rod



Stun Whip



Energy Mace

Energy maces are fairly common in the Gamma Age. Most are sturdy enough that they survived the post-Wars years largely intact. The main difficulty in finding these weapons is that, unless one knows what one is looking for, their presence is not obvious. When inactive, an energy mace is little more than a thick metallic tube with one flat and one rounded end (the latter being the metal ball that rises after the force field is activated). In some areas, energy maces are being used for their original purposes: the delectation of cynical spectators wishing to see old style violence dealt with newfangled weapons.

**Special:** Anyone hit with an energy mace must make a DC 12 Fortitude save or suffer an additional 1d10 points of damage from electrical shock when hit by the mace.

## PARALYSIS ROD

This high-tech melee weapon is almost exactly what its name suggests, a length of metal rod whose touch induces paralysis in its unfortunate target. The rod is half a meter and is unadorned, except for a hard plastic grip covering one end. On the grip, a button activates the rod. When active, the rod hums weakly. The weapon functions by transmitting a modulated electric charge that tricks the target's neural system into inducing temporary paralysis. The

charge does not always work, because each neural system is slightly different. It may take several hits before paralysis is successfully induced. Of course, the rod is solid enough that it delivers a significant punch on its own, even without the electric charge.

The paralysis rod was a discarded technology originally intended for use in prison colonies. Its inability to function with perfect reliability made it less than suitable for its intended mission. Consequently, the rod was eventually sold to the civilian market as a home protection device. During the tumultuous years leading up to the Final Wars, it became quite popular in many parts of the world. That's why so many paralysis rods still exist in the Gamma Age. They can be found almost anywhere, although rarely in very secure vaults, since the weapon had little use in military or government circles. The paralysis rod remains a weapon of choice among primitive slavers and prison keepers — an irony given its original mission.

**Special:** Anyone struck by a paralysis rod must make a successful DC 15 Fortitude save or be paralyzed for 1d10 rounds. Because of its technological origin, this paralysis cannot be removed by any non-technological means.

## STUN WHIP

One of the more bizarre weapons to arise in the pre-Wars era was the stun whip. Its name is something

of a misnomer, because its lash did not always produce a stunning effect in its targets, although it often did. The whip was made of an immense number of tiny metal panels, behind which super-cooled chemicals flowed. Upon contact with a target, these panels cause an explosive reaction in most ordinary matter, as well as a deafening sound. The effect against human flesh is especially unpleasant.

Stun whips were popular weapons among criminals and other disreputable sorts. “Respectable” citizens and militaries shunned them, but they were nevertheless produced in large numbers. As one might expect, many of these weapons have survived into the Gamma Age, where they have become popular with slavers, bounty hunters and similar sorts of people. Their usefulness is in the fact that, although they do significant damage to their targets, they are unlikely to kill them — eminently valuable for those wishing to take their targets alive.

**Special:** Any target hit by a stun whip must make a successful DC 12 Fortitude save or become stunned for 1d6+1 rounds. A stun whip is a reach weapon.

## VIBRO WEAPON

Vibro weapons are another development of the “high-tech archaic” fad that was common in many places before the Final Wars. These weapons utilize not sculpted force fields but nanotech manufacturing methods to produce bladed weapons of remarkable keenness. These blades were then motorized to vibrate at very high speeds so as to further increase their ability to cut. The hilts of vibro weapons included gyrostabilizers to prevent the user from losing his grip while wielding them. The most common vibro weapons were vibro daggers, vibro blades and vibro axes, although other variations existed as well.

Vibro weapons used solar nano-engines to operate and therefore did not require any external power cells. Any of these weapons that survived the Final Wars intact will thus work once they’ve been removed from a vault and exposed to sunlight for at least an hour each day. Barring some mishap, this is all that is necessary to maintain a vibro weapon, which is why they are popular with low-tech communities looking to add some high-tech weapons to their arsenal.

## HEAVY WEAPONS

Just as personal weaponry took full advantage of technological developments in the 21st and 22nd centuries, so too did other types of weapons, including those too awkward or massive for the typical human to use unaided. As one might expect, the Gene and

Noetic Ages saw the militaries of the world take full advantage of the new ways science provided to hurt, maim and destroy. Indeed, most of the large weapons developed prior to the Final Wars owed their existence to military projects. A handful of these were outgrowths of unusual projects that were eventually suborned to serve military ends. Consequently, the following weapons are almost always found in vaults associated with the military or groups closely associated with them. Those large weapons that have already been unearthed are guarded jealously by the individuals and communities that possess them and are frequently used to defend themselves against any who would challenge their right to them. Table 3-4 has weapon statistics.

## ECM BOMB

The electronic counter-measures bomb was created with one purpose: to harm machinery, especially computers and, by extension, soultech that uses computers. The bomb operates by broadcasting a magnetic field that disrupts all unshielded computers, electronic communications and any other machinery within its blast radius for several minutes, after which they function normally. Unshielded machinery simply ceases to function, while shielded machinery (such as robots and indeed most synthetic lifeforms) functions at half effectiveness.

The ECM bomb was the fruit of an older technology that had been abandoned once effective magnetic shielding was developed during the Gene Age. However, scientists eventually found the means of overcoming such shielding in the Noetic Age, thanks to their close work with soultech and synthetic lifeforms. The ECM bomb was then reborn in a newer and more effective form. During the Final Wars, it was frequently used against AIs, robots and other artificial beings, albeit with less effectiveness than against non-sentient machines.

**Special:** Any unshielded machinery within the bomb’s blast radius ceases to function for 10 minutes after its detonation. Shielded (but immobile) machinery functions at half-effectiveness. Shielded and mobile machinery may make a Reflex save to avoid the effects of the bomb’s blast. If the save is failed, the machinery, including robots, is deprived of its sensory input and moves at half its normal movement speed for the next 10 minutes. In addition, it suffers a –5 penalty to its base attack bonus while so affected.

## FISSION BOMB

The fission bomb was developed during the early Gene Age but its basic technology was further



refined over the decades leading up to the Final Wars. It is small compared to most other bombs, but it is still large enough that the average person can carry it unaided only with some difficulty.

This weapon was created for use by special operations teams, who carried it into enemy installations they had infiltrated. Of course, it wasn't long before these devices fell into the hands of terrorists and other similarly dubious individuals. Many cities suffered the bomb's ill effects, which not only led to many deaths but also increased the atmosphere of paranoia that led to the Final Wars. Fission bombs survive into the Gamma Age primarily in military vaults, where they are usually well protected. Nevertheless, some have fallen into the hands of communities, who hold them for their own purposes. Some mutants are said to worship the bombs, while others detonate them in order experience apotheosis before their god, the Divine Radiance.

**Special:** Anyone caught within the 30 foot burst radius of the bomb is exposed to a strong mutagen and must make a DC 15 Fortitude save or suffer a random minor mutation. Anyone caught within the 300 foot blast radius of the bomb is exposed to a moderate mutagen and must make a DC 10 Fortitude save or suffer a random minor mutation.

## ORBITAL RADIO FREQUENCY WEAPONS PLATFORM

The orbital radio frequency weapons platform (ORF) is an outgrowth of the missile defense systems constructed during the Gene Age. Those systems were designed to destroy incoming missiles from a distance using a variety of different means, including high-powered lasers and electromagnetism. In the process of creating these systems, their creators stumbled across a connection between low-frequency radio (between 0 and 100 cycles per second) and mental states. Research into this field had been conducted in the Precursor Era, but with very little success due to the unsophisticated technological methods employed. However, by the Noetic Age, these methods had advanced considerably and the means to harness them was now at hand.

An ORF weapons platform is a powerful broadcaster of focused radio waves that have been tailored to effect changes in the mental states of those within their burst radius. Because of the distances involved, only a comparatively small area of Earth's surface can be affected at any given time. However, the area is still large enough that hundreds of people might fall under the ORF's mental control at any given time. An ORF

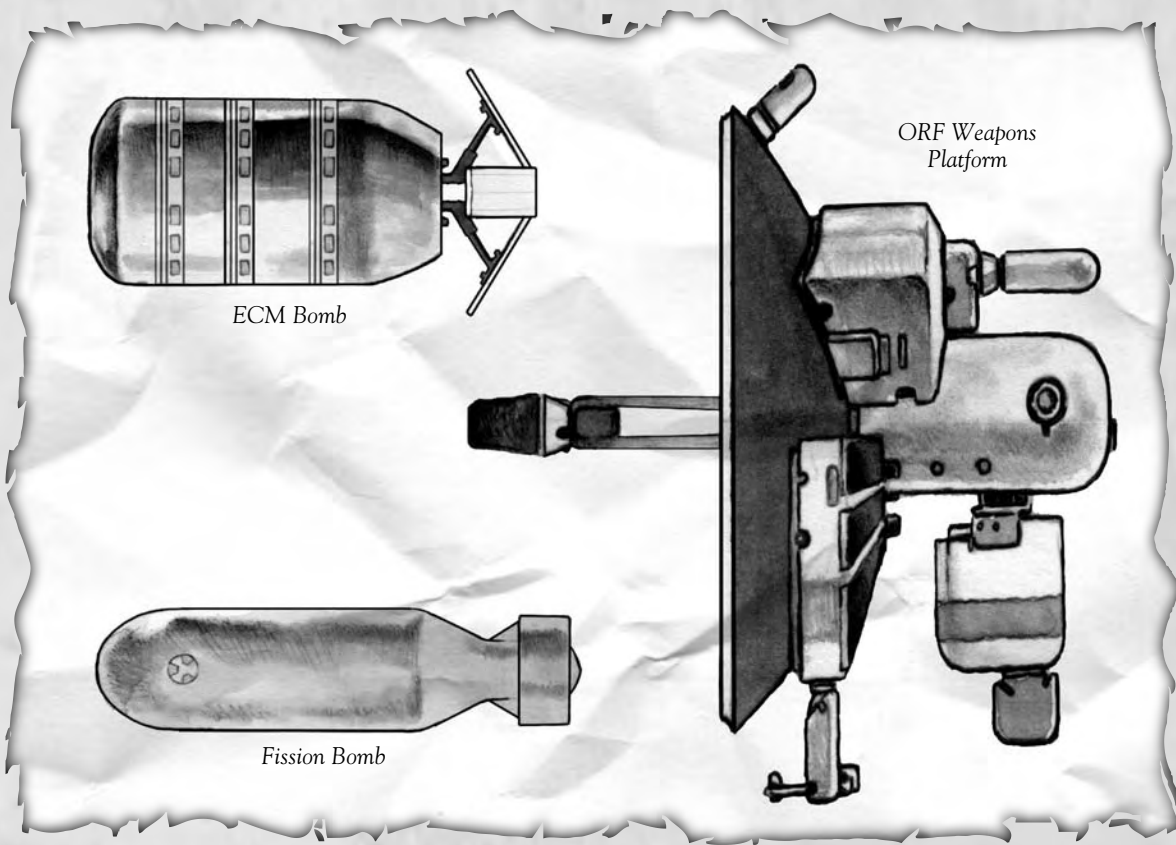

ECM Bomb

Fission Bomb

ORF Weapons Platform

**TABLE 3-4: HEAVY WEAPONS**

Weapon	Damage	Critical	Damage Type	Burst Radius	Reflex DC	Range Inc.	Size	Weight	Purchase DC
ECM bomb	Special*	—	Concussion	200 ft	15	—	Large	20 lb	15
Fission bomb	12d10/ 2d10*	—	Fire	30 ft/ 300 ft	18	—	Large	30 lb	17
ORF weapons platform	Special*	—	—	300 ft	18	—	Huge	10 tons	30

\* See the description of this weapon for special rules.

weapons platform can be operated either remotely from a station on Earth or directly from its location in orbit. A qualified user is capable of modulating its radio waves in such a way as to induce almost any mental state in its targets, from ecstasy to torment, although the waves are not powerful enough to cause death.

Only a handful of ORF platforms were constructed by the time of the Final Wars and most of them were believed destroyed during that conflict. It is possible that one or two may have escaped unscathed. Even if they did, mastering their controls is a difficult task, one at which few in the Gamma Age could succeed. Nevertheless, the prospect of an ambitious warlord or cryptic alliance leader gaining possession of an orbital mind control device is one that should fill inhabitants of the present era with dread.

**Special:** Anyone caught within the burst radius of an ORF weapons platform's radio waves must make a DC 20 Will save or fall under the temporary control of the user of the weapon. This control lasts for a number of minutes equal to number by which the person failed her Will save. Thus, someone who rolls a 15 on her Will save will be controlled for three minutes, while someone who rolled only 10 will be controlled for eight minutes. The user can command those under his control to do, feel or think anything that is not self-destructive. However, the user can command those under his control to act violently toward others even if this might lead to their destruction in the process. Of course, attempting to force someone to act in a way that is contrary to her nature grants that person a second DC 20 Will save, this time with a +2 circumstance bonus. If she fails this second save, then she must act as the user wishes, despite its incongruity with her personality.

## TEMPLATE: WEAPON BEAST

The so-called weapon beast was a product of the late Gene Age, when genetic engineering had not only reached its height, but its advocates showed remarkable willingness to mix their successes with those of other disciplines, such as cybernetics and nanotechnology. Indeed, the weapon beast was as much a product of cybernetics and nanotechnology as genetic engineering. At its most basic, the weapon beast depended on an injection of a solution in which were suspended millions of tiny nanounits. Upon injection, these nanounits went to work altering the creature into which they were injected on a genetic level. They tweaked its immune and nervous systems, as well as its senses, creating a creature capable of receiving the next stage of the process, which involved the grafting a large weapon onto the creature's back. The grafting process was aided by the injected nanounits, which helped route controls into the creature's nervous system. By the end of the process, a hybrid creature had been created, one capable of using a high-tech weapon by instinct but possessing all the characteristics of the original animal.

Fortunately for the world, the weapon beast was impractical for use in most battles. The program that created them was relegated to the dustbins of history, a reminder that simply because one can do something, it's not always wise to do so. However, the research that went into the program was never destroyed. It was discovered again in a military vault shortly after the fall of civilization. Survivors of the Final Wars, some of them scientists, put this program into operation once more, using the weird mutant animals of the Gamma Age as their test subjects. Eventually, after many failures, some of these tests bore evil fruit and weapon beasts once again roamed the world. Since that time, the secret of creating these creatures has fallen into the hands of many individuals and groups. Though still uncommon, weapon beasts can be found in many parts of the world today, sowing destruction in their wake.

"Weapon Beast" is a template that can be added to any Large living creature (referred hereafter as the "base creature"). The weapon beast uses all the base creature's statistics and special abilities, except as noted here.

**Hit Dice:** Same as base creature +3.

**Attacks:** As base creature +5.

**Damage:** As per grafted weapon.

**Special Qualities:** The weapon beast retains the special qualities of the base creature and gains the following special quality.

**Sensors (Ex):** The weapon beast's sensory cortex has been augmented through nanotechnology and cybernetics, giving it the ability to see in both the infrared and ultraviolet spectrums, hear across many frequencies, and so on. It automatically detects invisible opponents once they are within 30 feet.

**Saves:** Same as base creature (modified as appropriate for the added Hit Die and ability score increases).

**Abilities:** Str +4, Dex +0, Con +4, Int +2, Wis +0, Cha +0

**Feats:** Same as base creature, with the addition of the appropriate Weapon Proficiency to cover the weapon grafted to the creature and Weapon Focus for the same weapon.

**Challenge Rating:** Same as base creature +3.

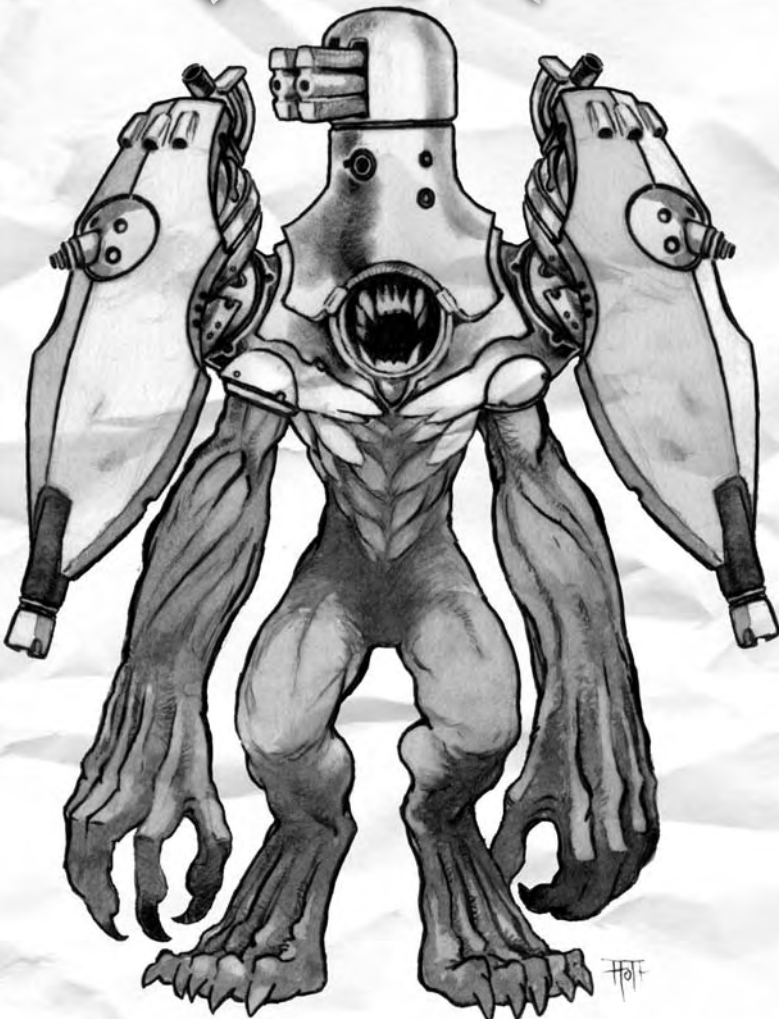



## ARMOR

Before the Final Wars, engineers continuously produced newer and deadlier weapons, so other engineers worked to create various types of armors that could protect their wearers from harm. There were two primary types of armor in the years before the Final Wars: discreet armor worn by wealthy and power people who feared angry rivals, terrorists or assassins and powerful, obvious armor designed for soldiers and other personnel working in highly dangerous environments. Almost all armor found in the Gamma Age falls into one or the other of these categories.

Each of these suits of armor (or other means of protection) requires Exotic Armor Proficiency until fully analyzed. The basic task of wearing the armor — and using one's normal capabilities while doing so — is the fundamental analysis layer. The DC is 15 for non-nanotech devices and for nanotech being analyzed by characters with nanotech attunement (whether by feat or by cellular transformation), or DC 20 for nanotech being analyzed by characters without attunement. Unusual means of putting the armor on or taking it off and distinct sub-systems like integrated weapons each require separate analysis with the same DCs.

Table 3–5 has armor statistics; listings are consistent with those in *d20 Modern*, Table 4–9: Armor.

### BATTLE POD

This type of armor was the most advanced personal protection and attack system developed in the days before the Final Wars. Using magnetic

levitation instead of legs, this armor blurs the line between armor and vehicles. A battle pod is an egg-shaped structure four feet tall, four feet long and three feet wide. When it's at rest, a hatch opens at the narrow end to allow a user to climb in or out. Apart from that, it has no obvious openings, but at the user's command it can deploy weaponry and armored manipulators from compartments mounted just inside the hull. An ultra-miniaturized micro-fusion reactor powers the battle pod and insures that it never requires refueling. The battle pod's self-repair systems are equivalent to those used by synthetic characters, and a battle pod heals by "eating" pieces of technological artifacts.

The battle pod also contains limited first aid capabilities that automatically stabilize the user's injuries. When the user activates the pod's armored sleeves, servomotors in these sleeves add +4 to the user's Strength, and the occupant can use any ordinary ranged or melee weapon without penalty. In addition, the battle pod contains a blaster rifle and a plasma cannon. Both of these weapons are equipped with laser sights. The user can attack with either of these weapons normally.

The unit's combination of magnetic levitation and MHD jets allows it to traverse any terrain and to attain altitudes of up to 10 feet above the ground. Battle pods have a top speed of 30 mph (60 feet per turn) and the unit can float equally well over land, water or even quicksand. Advanced sensors in the unit give the wearer a +2 equipment bonus to all Wisdom rolls associated with hearing, bonuses equivalent to those provided by electro-optical

**TABLE 3-5: ARMOR**

Armor	Type	Equip. Bonus	Nonprof. Bonus	Max. Dex Bonus	Armor Penalty	Speed (30ft)	Weight	Purchase DC
Battle pod*	Tactical	+10	+5	0	0	60	250 lb	42/46
DAS	Tactical	+5	+5	+6	0	30	5 lb	34/37
Dermal enhancer	Impromptu	+4	+4	+6	0	30	0.5 lb	23
Disposable nanoarmor	Tactical	+6	+3	+3	-2	30s	10 lb	17
Formattable nanoarmor	Concealable	+5 -+2	+3 -+1	+7	0	30	6 lb	28/31
NVA (peace suit)	Concealable	+2	+1	+7	0	30	3 lb	23/25
RPS	Impromptu	+3	+1	+5	0	30 ft	4 lb	21/23
Safe-T-Suit	Concealable	+6/+8	+3/+5	0	-1	30 ft	15 lb	31/34



binoculars and flash goggles, and blindsight with a range of 30 feet. The user also possesses the equivalent of a wrist assistant (see Chapter Two), though the datapad in this unit only contain information about weapons and tactics. In addition, battle pods provide both an equipment bonus of +10 to the user's defense and a DR of 10.

However, for all of its advantages, it also has a number of unique problems. Battle pods were designed for use by the Marines and similar branches of the military in other counties, they help fearless and obedient soldiers conquer territory rapidly and to kill the maximum number of opponents. To assist their operator in these missions, battle pods contain magnetic induction helmets that allow them to subtly alter their users' thoughts and emotions. While in a battle pod, the user gains the feats Combat Reflexes, Dead Aim and Point Blank Shot (if he doesn't already have them). However, the user also gains two allegiances while in a battle pod: warrior's code, and bloodthirsty.

The warrior's code allegiance means that the user will obey all orders by superiors. If there are no superiors, the user will stick to any battle plan she and her companions worked out, even if sticking to this plan could seriously endanger the user's life. Also, the user will not abandon her comrades in

battle and will never retreat unless the pod is badly damaged and it is extremely obvious that the only other option is capture or death. She can be ordered to retreat, but she cannot do so on her own. The bloodthirsty allegiance means that the user will use deadly force against all opponents and unless specifically ordered to take prisoners will kill all opponents.

In addition, while in the battle pod she is completely incapable of becoming afraid. Finally, the battle pod uses drugs to suppress the user's awareness of her own injuries. The user will know when she had been injured, but will not be aware of the full extent of her injuries until the battle is over (the GM records all damage for the player and does not let the player know her character's current hit point total until the battle is over). The only exception to this rule is that players instantly know if their character is at 0 or fewer hit points. All of these effects end as soon as the character leaves the battle pod.

Several communities have found caches of dozens of battle pods in the ruins of the few surviving military bases. However, their psychological affect on their users rapidly tainted the reputation of these powerful weapons. The inability of the user to retreat and their sheer

aggressiveness has meant that users tend to charge into battle regardless of the apparent danger and suffer extremely high casualties when facing opponents with weapons or mutations that allow them to successfully harm a battle pod.

**Special:** The battle pod contains a plasma gun and blaster rifle, and adds +4 to the user's Strength with all melee weapons.

## DEFENSIVE AEROSTAT SWARM (DAS)

**DAS AI:** BAB +6/+1; Atk blaster +6 ranged (1d6); Full Atk 4 blasters +6/+1 ranged (1d6); Str —, Dex —, Con —, Int 6, Wis 12, Cha 10.

**Skills:** Listen +8, Sense Motive +8, Spot +8, Tactics +12

**Feats:** Combat Reflexes, Multiattack, Point Blank Shot

**SQ:** Darkvision, Laser Sight

A DAS is not armor in any conventional sense of the word, but it nonetheless offers an effective means to protect the user from harm. It consists of 25 paper-thin diamondoid spheres 3 inches in diameter. Each aerostat is a tiny airship capable following the user around at all times, even in high wind. The user wears a lightweight belt containing the electronics and the power cells necessary to operate the aerostats; the unit uses short-range microwave beams to transmit power to the aerostats.

Each aerostat contains an array of advanced sensors, powerful superconducting magnets and a low power micro-blaster. Whenever the sensors detect an attack by firearms or any other projectile weapon, the closest blaster fires a beam at the projectile and either vaporizes or deflects it. If the user is instead attacked by blaster fire or any form of ion or plasma attack, the aerostats charge up their powerful magnetic field that will deflect ion beams, plasma and other charged-particle attacks away from the user. This same magnetic field keeps the aerostats near the user and to helps them to maneuver. DAS armor also uses this magnetic field to help protect the user against melee attacks. In addition to using the magnetic field to block any metallic melee weapons, the aerostats themselves can rapidly move to interpose themselves between the weapon and the user. Advanced predictive software allows the aerostats to determine the best method of defending the user.

A DAS provides an equipment bonus of +5 to the user's defense, with no reduction of Dexterity bonus or any armor penalty. In addition to deflecting attacks, a DAS unit can also prevent further attacks by directing fire at any one who

attacked the owner. The DAS fires its microblasters at anyone who attacks the user, each microblaster delivering 1d6 points of damage. At the user's request, the DAS blasters can instead fire shots that do only subdual damage. These beams strike each attacker once for every time that she attacks the target, for a total of up to 4 attacks per round. If enemies attack the more than 4 times during a round, the DAS only returns fire for the first 4 attacks. These attacks are fired by the DAS AI and not by the wearer and do not count against the wearer's actions for the round. Each of the DAS's aerostats is effectively indestructible — if any are destroyed, the belt pack creates a new aerostat at the rate of one per day, as long as its wearer provides it with junk or other raw materials.

The computing power to allow the DAS's predictive software to function at peak efficiency is sophisticated enough that these units are about as intelligent as an unusually intelligent chimpanzee. All DAS units are also fitted with microphones (to hear orders from the user and possible threats) and a small bone conduction speaker that allows the unit to communicate information about possible threats to the user. DAS units are highly protective of their owners and occasionally fire reduced power warning shots (that only do 1d2 subdual damage) near anyone who is visibly angry at their beloved user. Also, if the user is about to walk into an obviously dangerous situation, the DAS units sometimes move in front of the owner, not allowing him to move past them unless he explains (in relatively simple terms) either why he is risking his life or why the situation is less dangerous than it looks. Most owners soon learn that ignoring the wishes of their DAS unit or becoming obviously annoyed with its comments can hurt the DAS's feelings.

Upset DAS units can react in a wide variety of unfortunate ways. Some units become over-protective, refusing to allow their owner to go anywhere for fear the owner might become hurt. While the owner can easily turn the DAS unit off by flicking a switch on his belt, the unit will only become more frantic whenever it is turned on. Other units become vindictive, and attack the user with micro-blasters set to do subdual damage (DAS programming prevents the unit for doing any form of lethal damage to the owner), to either punish the owner or to convince him not to turn the unit off again. The most mentally unbalanced DAS units sometimes render their user unconscious on the theory that an unconscious user will get into less trouble and so will be easier to protect. A very few



DAS units become vengeful and sometimes fail to protect their owner from harm when he is facing potentially lethal danger.

In contrast, a contented DAS unit that is praised and whose owner always answers or at least acknowledges its questions can be a great boon. In addition to being a highly useful form of armor, happy DAS units are generally also willing to exert themselves in other ways, such as sending a single aerostat to observe and radio back information about a location the user cannot directly see. A cooperative DAS unit can also use its micro-blasters to help the user start fires, burn through a lock or perform other useful tasks. The DAS belt requires a single power cell to operate. This power cell allows the DAS unit to defend the user for 100 rounds of combat. When out of combat, the solar cells on the tops of the aerostats and the thermocouples on the belt that are powered by the user's body heat sufficient to power the unit. Also, every hour the unit is in bright sunlight recharges 20 rounds of combat for the DAS. When deactivated the 25 DAS aerostats can be easily stored in the pockets of a trench coat. When the user turns the unit on, the aerostats fly up out of his pockets and are ready to defend the user a half-action after he activates the unit.

## DERMAL ENHANCER

This is one of the most advanced forms of biotech armor created before the Final Wars. Based upon a now-extinct species of centipede, this creature was created in an illegal lab and discretely sold to criminals and freelance spies. The creature producing the armor proved to be durable, highly resistant to further mutation and easy to care for. However, while it is extremely long-lived, with an average lifespan of 50-60 years, it breeds quite slowly, having no more than one offspring a decade. People who own this type of armor generally acquire it from families who have kept and bred it since the Final Wars. Because these creatures are both rare and unable to survive in the wild, characters cannot find them in ancient ruins or anywhere away from people who know how to care for and breed them.

A dermal enhancer is 6 inches long and 1 inch wide, a quarter inch thick and 40 inch-long legs on each side. Its carapace is swirled shades of dark red and orange. It is designed to hang onto the arm or other upper limb of a creature that possesses at least some human DNA. It will bond with the first arm it comes in contact with and it will only release the user if the user immerses the creature in an alcohol solution of at least 12% (wine) for 5 minutes. Users wear it on either their upper or their lower arm. Once



it bonds with a user, it painlessly embeds both its legs and fangs in the user's arm and also attaches its mouth to the user's skin, drawing nourishment from the user. Most users only need to increase their food and water intake by a small amount to compensate for the increased demands it places on their bodies.

Within 12 hours after putting on the dermal enhancer, the various smart polymer chemicals it possesses in its "venom" spread throughout the user's bloodstream and significantly reinforce the user's skin. The user gains a +4 equipment bonus to her Defense without an armor penalty or any reduction to the Defense from her Dex bonus. A continuous supply of smart polymers are necessary to maintain this armor. This equipment bonus decreases by one every three hours once the user removes the dermal enhancer. If not worn, dermal enhancers remain active and look for another arm for the next 48 hours. After that, the creature goes into a deep state of suspended animation and can survive for up to two decades in this state. This state ends a few minutes after the creature is wrapped around a human or mutant arm.

All dermal enhancers are hermaphrodites and once a decade every dermal enhancer will turn bright blue and remain blue for the next year. This color change means that it is ready to breed. If it and any other dermal enhancer are removed from their user's arms for a few hours, these two creatures will mate and the blue creature will give birth to a pair of young dermal enhancers. If placed on an arm, they will grow to maturity within three months and at the end of this time will be ready to armor their wearers.

## DISPOSABLE NANOARMOR

Developed a decade before the Final Wars, this form of armor fast became one of the most common forms of personal protection used by people who could not afford to wear heavy armor, but who wished to have it available at a moment's notice. Several million cans of this armor were produced; since the cans were designed to contain active nanotechnology, they were resistant to most damage and to all external attacks by nanotech agents. As a result, many of these cans survived the Final Wars and people continue to use this form of armor.

This armor consists of a small can (6 inches tall and 3 inches in diameter) with a nozzle on top. To activate this armor, the user places the nozzle against a living target and pushes the button behind the nozzle. A thick stream of silvery nanounits squirts out of the can and spreads over the target. Each full can contains 6 doses of nanoarmor. This

armor protects humans or any other living target, including pets and mutant animals — one Medium target or two Small or Tiny targets per dose. Large targets require two doses for protection, and Huge targets require six doses.

Applying the armor consumes a half-action. The armor has a not-quite-metallic silver sheen, and it's obvious that the target is wearing something besides its usual skin. Once the armor is in place, it provides a +6 equipment bonus to the target's Defense and DR 5/kinetic, without armor penalty. In addition, the armor covers the user's eyes, nose and mouth with nanotech that filters out all contact and inhaled poisons with a level of protection equal to that provided by a personal environment suit. The suit also functions like a pair of flash goggles, protecting the user's eyes from all forms of blinding attacks. While the user can speak and hear normally and can even drink through a straw, it is impossible to eat while wearing this armor.

This protection lasts for 8 hours, at which time the suit runs out of power and dissolves. Fifteen minutes before it wears out, the armor alerts the user by vibrating against the user's palms. Once the 8 hour span ends, the armor turns to gray dust and falls off the user. If desired, the user can remove the armor before the duration ends. She need only touch the back of the nozzle to the armor and press a second, smaller button on the can. A few seconds later, the armor falls off as gray dust. Removing the armor is also a half-action. Each dose of disposable nanoarmor cannot be reused; the can is empty once the owner has used all six doses.

This armor adheres to the user's dermal layer and so does not protect robots (except for cyborgs covered with living skin). It also does not protect the user's clothing or anything that she carries. Also, while this armor can be worn under other armor, the protection is not cumulative. The better of the two equipment bonuses protects the user. In addition, the user gains the disposable nanoarmor's damage reduction and the protection it offers from blindness and poisons. Containers of disposable nanoarmor can be found in the ruins of stores that sold gear to people who participated in extreme sports, in abandoned law enforcement offices, and on military bases.

## FORMATTABLE NANOARMOR (NANOSUIT)

Developed only two years before the Final Wars, formattable armor was the ultimate in nanotechnological protection. This armor is composed of nanounits made from the same artificial diamond used in many other forms of advanced armor. These nanounits are self-mobile and can reshape the armor

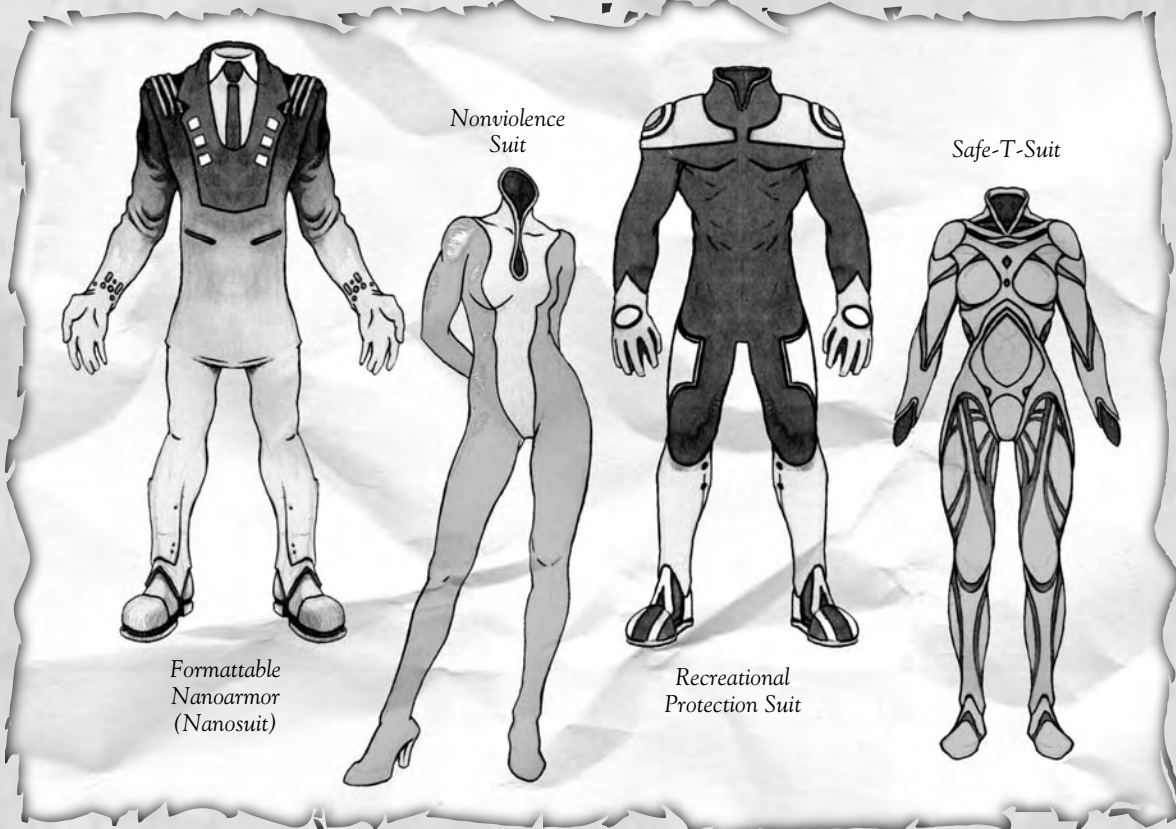

at the user's whim. This armor comes with a wrist assistant (see Chapter Two) that also serves as the control unit for the armor. The user can control the armor with either voice commands or using a series of small buttons on the wrist controller.

The armor can mimic almost any suit of clothing, changing both its color and its cut to suit the wearer's desires. It can become a black jumpsuit, an emerald green evening gown, a 21st century police uniform or heavy winter survival gear. The wrist-controller contains a library of more than a thousand different clothing styles and can display images on its screen to allow the user to easily select an outfit. In addition, the user can take a picture of a suit of clothing with the wrist assistant's digital camera and ask the unit to duplicate that outfit. A nanosuit can form clothing, gloves and shoes or boots. Anyone wearing this type of armor normally wears very little under it, since the nanounits respond perfectly to the wearer's movements and it is exceptionally comfortable and does not restrict its owner's movements.

In addition to protecting the user from attack, it can also automatically alter its color to match the background (providing a +2 equipment bonus to all Hide rolls), dampen sounds, (providing a +2 equipment bonus to all Move Silently rolls), and

adjust to all weather conditions (providing a +2 equipment bonus to all Fortitude saves to resist environmental hazards except radiation or biotech or nanotech exposure). If desired, the armor can even transform itself into an extremely comfortable sleeping bag.

In its most protective form (a hooded jumpsuit) this suit of armor provided a +5 equipment bonus to defense. However, other styles of clothing provide less protection. A business suit or a uniform without a hood provides a +4 bonus to defense, an evening gown or other somewhat revealing garb only provides a +3 bonus and transforming the unit into a pair of shorts and a tank top reduces its defense bonus to +2. The armor can change both shape and color in a move equivalent action. Since nanounits use relatively little power, this armor obtains all of the power it requires from a combination of the wearer's body heat and a multitude of minute solar cells. As a result, nanoarmor never needs to be recharged.

Nanoarmor is relatively uncommon and can most often be found in the ruins of high-end shops that once sold weapons and security systems or in storage facilities used by corporate and government intelligence agencies and private security firms. When not worn, the unit transforms itself into a



cylinder 3 inches in diameter and 1 foot long, weighing one pound. The wrist controller encircles the middle of this cylinder. The unit activates if someone touches it and presses the large green activation button. At this point, the nanoarmor flows over the person's body, underneath whatever other clothes she is wearing.

## **NON-VIOLENCE ARMOR (NVA), OR PEACE SUIT**

By 2070, research into human psychology allowed scientists to understand and duplicate various extremely subtle non-verbal cues that inhibit aggression. The first use of these cues was in the construction of public buildings that caused the people inside to become almost incapable of performing violence. Most of these buildings now lie in ruins and the great majority of those that don't have decayed to the point that these non-violence cues no longer function. However, a few highly secure buildings continue to be maintained by nanotechnological repair systems or repair robots. Inside these buildings, anyone who wishes to use a weapon or make any form of attack must make a DC 20 Will save before every attempted attack. The DC of this save is reduced to 15 if someone is already engaged in violence inside the building and no save is necessary if someone is attacking the attacker or anyone he cares about or is committed to protect.

By 2085, researchers incorporated these same principles into suits of armor that literally kept people from attacking the wearer. Some nations outfitted all of their police officers in peace suits, while many elected officials began wearing high-style versions of this garment. The circuits bonded onto the surface of the suit are extremely thin and lightweight so that it could easily be bonded to almost any sort of fabric. Since peace suits use a combination of visual patterns that are not consciously visible and ultrasonics, they look like any other suit of clothing, except for the slightly shiny appearance they have in bright light. To avoid confusion, all peace suits have an interior label that describes their functions. Peace suits require very little power and can easily run off the wearer's body heat.

As long as the wearer is not either engaged in combat or threatening someone with deadly force, any attacker must make a DC 20 Will save to attack the wearer. A failed save means that the attacker cannot attack during the current round, but may try again next round. Success allows the attacker to attack without penalty, but must make another Will save to attack again the next round. If the

wearer is engaged in any form of violence or is actively threatening violence against anyone, then the DC of this save is reduced to 15. If the wearer is attacking the attacker or any of the attacker's comrades, this threat completely negates the armor's protection and the attacker does not need to make a Will save to attack the target.

The circuitry on peace suits is specifically designed to affect humans. They affect stock humans, pure-strain humans and mutant humans normally and synthetics were all programmed to be susceptible to these cues. However, humanoid animals (like moreaus or hoops) reduce the DC of all Will saves by 5 and other animals, including all non-humanoid sentient mutant animals are completely unaffected by the circuitry in a peace suit.

Peace suits are designed to be highly durable and remain useful even if someone attacks the wearer. As a result, this type of armor is woven from lightweight orbitally-made fibers that provide protection equal to kevlar while being both lighter and less cumbersome.

## **RECREATIONAL PROTECTION SUIT (RPS)**

Before the Final Wars, few people considered this suit to be armor or even as anything more than something sensible to wear while riding a motorcycle or mountain climbing. However, hundreds of thousands of these suits were created in the late 21st and early 22nd century and as long as they remained sealed within their transparent plastic storage containers, they remain in perfect condition and will continue to do so for decades to come. Made of a tough, highly resistant material, these suits provide the wearer with a +3 equipment bonus to her Defense without an armor penalty or any significant reduction to the Defense provided by her Dex bonus.

The fabric of these suits can become waterproof or light and porous in response to environmental conditions and can also greatly vary how much heat they retain. As a result, an RPS adds a +2 equipment bonus to all Fortitude saves to resist environmental hazards, except radiation or biotech or nanotech exposure. The suit's systems are powered by the wearer's body heat so the suit never needs recharging. An RPS is essentially an armored smart jumpsuit.

The only problem with wearing an RPS is that these suits were designed to allow the wearers to be highly visible so that other drivers, rescue workers or hunters could easily see them. As a result, all of these suits are brightly colored and contain several small patches of reflective material. Spot checks made by entities searching for an RPS wearer or just

examining the area enjoy a +4 bonus, and the wearer suffers a -4 penalty on Hide checks. Most of these suits are also decorated with one or more prominently rendered corporate logos. Many bandit gangs and regional militias have located stockpiles of suits with identical logos and use these corporate logos as symbol of membership in their groups. Many people assume that anyone found wearing a similarly marked RPS is either a member of one of these groups or a spy disguised as a member of such a group.

### SAFE-T-SUIT

Before the Final Wars, business people and politicians who feared assassins but who were unwilling to reveal that they felt that they needed to wear armor turned to safe-t-suits for protection. This suit comes in several parts. The first is a jumpsuit of multiphasic metallo-polymers that are difficult to penetrate and that become as rigid as steel when struck. These fibers also enable the suit to move the wearer's limbs with great speed to help dodge weapons. If someone sneaks up behind the wearer and attempts to stab him with a chainsword, the suit detects this attack and in addition to hardening the portion of the suit the chainsword is going to strike, it forces the wearer to sidestep the blow.

To allow it to observe all incoming blows, the suit comes with five wide-angle sensors. These sensors are quite small and are normally built into rings, bracelets, earrings, or cufflinks. Against firearms, blunt weapons, and even falling damage, this jumpsuit confers DR 5/kinetic, and the owner can discreetly wear it beneath a business suit or other similarly heavy suit of clothing.

Because the Safe-T-Suit moves the wearer to avoid attacks, the fact that this suit does not cover the user's neck, head or hands does not make the user any more vulnerable to attack. The suit provides the wearer with a +6 equipment bonus to her Defense, but because the suit supercedes the wearer's ability to dodge, it negates any Dex bonus that would otherwise add to the wearer's Defense.

**Special:** The Safe-T-Suit contains a pair of microblasters mounted on bracelets or cuff links (see Table 3-1 for weapon statistics). These low-power blasters do 1d4 damage with a range increment of 10 feet and a maximum range of 50 feet (5 increments). Although these devices can function as weapons, their primary use is as a defense against small projectiles. There is a 50% chance that any incoming projectile's payload is defused by the blasters' emissions, so that the suit's wearer is affected by regular kinetic damage only.

The Safe-T-Suit can either attack or defend against the first four incoming small projectiles (such as bullets) once each round. The wearer must command the suit verbally to use the blasters for either attack or defense. The blasters' projectile deflection increases the suit's equipment bonus to Defense by +2 (for a total bonus of +8), but only for the projectiles it strikes. This armor remains active indefinitely when not in combat. However, the suit's power cell must be recharged or replaced after 4 hours (2,400 rounds) of combat. The back of the suit's torso is covered with solar cells, which must be exposed to direct light to recharge (this makes it obvious that the user is wearing advanced armor).

---

## MEDICINE

The 20th century saw the beginning of advanced technological medicine. However, medicine truly came of age in the 21st century. During this amazing century, physicians and bioengineers conquered disease, disability, old age and even death. By the end of the 21st century these goals had been achieved and new purposes of medicine were called for. Doctors and researchers began finding new definitions of optimal health, including changes that would have seemed both bizarre and impossible only 50 years before. The decades immediately before the Final Wars was the era of designer bodies and

designer minds, where people changed their memories, skin color, and gender as readily as people in the early 21st century changed their hair styles. Half-understood remnants of these technologies remain today. Many can be profoundly dangerous if used carelessly, while others were specifically designed to aid pure strain humans and so work erratically or less well on mutant humans or animals.

Each of these devices has one analysis layer per distinct function, at DC 15. If the treatment system requires special storage, that's a separate layer, also a DC 15 check.

## WHY EGGS?

Many pieces of Gamma World nanotechnology have resting forms that are somewhat egg-like. This is partly a matter of basic physiology, since eggs are easy to hold and carry, and partly a matter of basic psychology, since eggs seem familiar and reassuring. However, GMs who prefer more variety in their devices should feel to introduce different shapes. Regular geometric solids, crystals, imitations of natural formations and artistic shapes have all been tried; it's just a matter of saying that this particular group of device makers favored other styles.

## ARTIFICIAL IMMUNE SYSTEM (AIS)

**Size:** Tiny

**Weight:** —

**Purchase DC:** n/a

AIS — Injury DC 15; 1d4 days; No initial damage (special)/no secondary damage

While most nanotech-based medicine remained relatively expensive during the pre-war era, biotech medicine became both inexpensive and easily available. Tailored bacteria and modified amoebas patrolled user's bloodstreams, neutralizing poisons, killing off diseases and cancer cells and repairing various minor medical problems. As problems like propaganda viruses (see Chapter Two), advertising bacteria, and bio-terrorism became more common, there was a push to develop a universally available artificial immune system. Although physicians had to specially format most artificial immune systems for a specific individual, a group of puritanical geneticists developed a version of this type of biotech that could adapt to any host without assistance. They made this treatment freely available to the poor. Unfortunately, the side effects were profound, and anyone who could possibly afford a better version of this technology purchased one. However, while the other treatments could not spread beyond one person, this form of biotech survived the Final Wars and remains both viable and contagious. Blood to blood contact is necessary to catch this type of biotech, but sharing a tattoo needle is normally sufficient contact to insure infection. There are a number of communities where this treatment is readily available, but many people are reluctant to give up all recreational chemicals.

Anyone who possesses this form of biotech gains a +8 bonus to all Fortitude saves to resist poison or disease as well as +2 to resist Mutation. In addition, the user heals twice as fast and ages half as rapidly as normal. Someone infected with this disease would not become Venerable until she was 140 years old. All of these bonuses are not cumulative with the Great Fortitude, Mutation Resistance, and Improved Mutation Resistance feats or the bonuses provided by a Nanotech Regeneration Pod — anyone who benefits from multiple bonuses simply uses the highest applicable bonus in any situation. However, the bonuses to healing speed and aging are added and not multiplied. If a pure-strain human had both a NRP and an artificial immune system, she would heal seven times as fast as normal and would age a seventh as rapidly as a normal pure-strain human. However, anyone with an artificial immune system cannot be completely unaffected by all recreational chemicals like alcohol, LSD, cocaine or even caffeine. Users can consume huge quantities of any these chemicals without any affect.

## FIELD MEDICAL KIT

**Size:** Large

**Weight:** 30 lb

**Purchase DC:** 25/28

The tens of millions of ordinary first aid kits produced before the Final Wars have mostly decayed into uselessness. They were not designed to endure either hard usage or many decades. However, many of the special medical kits that were designed for rescue workers and for physicians and paramedics who worked in remote regions still exist. These kits were originally designed to contain everything necessary allow a physician to set up a medical station in a remote portion of the Third World in one portable case. Field medical kits soon became popular with rescue workers and people working in clinics that treated the very poor. These kits contain the equivalent of both a medical kit and a pharmacist kit with advanced equipment that gives users a +2 equipment bonus with all uses of both skills. In addition, the kits contain:

- One solar power cell recharger.
- One dozen Stabilization Units (see below).
- Four small pouches containing tailored bacteria that can produce two each doses of antitoxin, clean-out, regen, and total-med every day each of the pouches produces a different drug. These pouches require only simple nutrients like sugar water or fruit juice.
- Ten doses each of antitoxin, clean-out, regen, and total-med



- All tools necessary to perform surgery (with the +2 equipment bonus).
- Six refillable aerosol bandage dispensers.
- A datapad programmed with large amounts of medical and pharmaceutical information.

The kit is 2 feet tall, 1 foot wide and 9 inches thick and has straps that allow the user to carry it as either a shoulder bag or a backpack. This kit is both easily recognizable and clearly labeled. Not only can the items inside be used by someone with no medical training, but characters can learn medicine simply by studying the information contained within the medical datapad and using the electronic tutorials. Scavengers most often find field medical kits in the ruins of low cost clinics or anywhere the supplies for rescue workers were stored.

### NANOTECH REGENERATION POD (NRP)

**Size:** Tiny  
**Weight:** 0.5 lb  
**Purchase DC:** n/a

The NRP is a wonder of advanced nanotechnology developed only five years before the Final Wars. This device consists of a small egg-shaped silvery device approximately one and a half inches long and one inch in diameter. It is completely inert unless the user firmly presses the red spot at one end and immediately places it against the sternum of a pure strain, stock, or mutant human. At this point, the nanotechnology within the egg-shaped device activates. It sinks slowly, painlessly and unstoppably into the person's body, until only a rounded silvery spot the size of a dime is all that remains visible. This process requires only 10 minutes, during which time the nanounits inside the device spread throughout the user's body and within an hour after the device first activated, it is fully operational. This device promotes healing, resistance to toxins and disease and longevity. The exact affects of this device depend upon the genetics of the person who used it.

**Pure Strain Humans:** The item gives the user the Great Fortitude feat as well as an additional +2 bonus to resist both poisons and diseases and the Improved Mutation Resistance Feat. In addition, the user heals all wounds three times as rapidly as normal and recovers one point that was permanently drained from any ability every month. (That is, one point per month; it takes several months to repair multiple points of loss from one ability or losses from several different abilities.) In addition, the user's life span is lengthened to five times normal (for example the character becomes Venerable at 350). If the user already possesses the Great Fortitude feat, the bonuses are cumulative. However, if the user

already possesses the Improved Mutation Resistance feat, these bonuses are not cumulative.

**Stock Humans:** The item grants the user the Great Fortitude feat and the Mutation Resistance feat. In addition, the user heals all wounds twice as rapidly as normal and recovers one point drained from any ability every six months. In addition, the user's life span is lengthened to four times normal (for example the character becomes Venerable at 280). If the user already possesses the Great Fortitude feat, the bonuses are cumulative. However, if the user already possesses the Mutation Resistance feat, these bonuses are not cumulative.

**Mutant Humans:** The item grants the user the Great Fortitude Feat. In addition, the user heals all wounds 50% more rapidly than normal. In addition, the user's life span is lengthened to three times normal (for example the character becomes Venerable at 210). If the user already possesses the Great Fortitude feat, the bonuses are cumulative.

This item has no affect on synthetic beings or mutant animals of any types.

### RESCUE AND REVIVIFICATION NANOTECH (R&R OR ZOMBIE MAKER)

**Size:** Tiny  
**Weight:** 0.5 lb  
**Purchase DC:** 13/16

Few medical technologies have been as abused as R&R units. Engineers created R&R nanotech shortly after the beginning of the 22nd century as an improved alternative to the older stabilization unit. SUs were highly effective, but hikers, soldiers on patrol or others in isolated wilderness areas required significant help to retrieve the hibernating bodies of their comrades. To facilitate the removal and revivification of casualties and badly injured soldiers, the military developed R&R nanotech. R&R nanotech comes as an egg-shaped gray icosohedron the size of a small orange. This device remains stable and inert until someone pushes on the large red patch on the wide end of the ovoid with considerable force. At this point, the device turns bright red and activates the next time it touches any large mammal that is dying or recently dead. Any character who is at 0 or fewer hit points or who died within the last 30 minutes activates it. Before the Final Wars, military personnel often carried activated R&R units in special pockets that allowed the device to be separated from the user's skin by only a thin piece of fabric. If the user died or was badly injured, the device automatically stabilized her body.

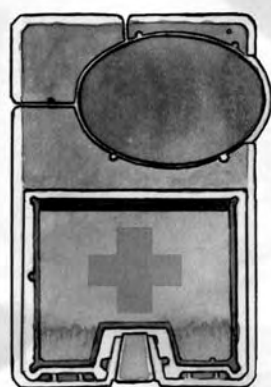
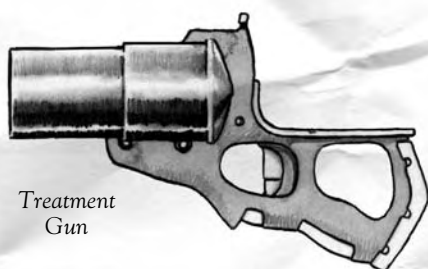
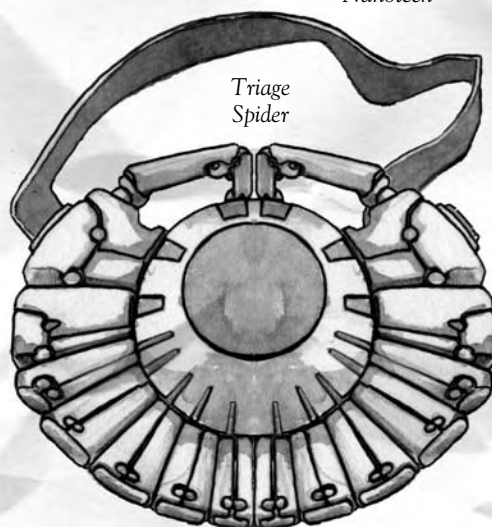
Field  
Medical KitArtificial Immune  
SystemStabilization  
UnitRescue and  
Revivication  
NanotechNanotech  
Reperation PodTreatment  
GunTriage  
Spider

When an R&R unit touches someone who is dying or dead, the entire unit liquefies and flows over the person's body in a billowing silver and gold cloud. The nanotech instantly stabilizes the person's condition, preventing either death or further decay. It also protects the person's body from harm, forming a shell that provides a +4 equipment bonus to Defense and DR 5. It also uses linked chains of nanounits to move the subject. Five minutes after it activates, this unit causes the patient's body to stand up. At this point, the nanotech's dedicated computer processing responds to and obeys voice commands from anyone who touches the subject. The unit will continue to respond to this person's voice commands even once she has stopped touching it. The R&R unit can obey all simple commands, including instructions to walk, run or perform simple tasks like picking up and moving objects. The nanotech will not fight and will avoid doing anything (like walking off a cliff) that obviously endangers its target. In addition, it is little smarter than an unusually bright dog and cannot obey complex commands. Regardless of her previous abilities, anyone who is under the influence of this device has Str 10, Dex 8 and moves at half of her previous movement rate. The person is completely unconscious during this process and the nanotech cannot make any rolls based upon Wisdom, Intelligence, or Charisma.

The skin of anyone "reanimated" by R&R nanotech has a distinct golden sheen, and her eyes are opaque gold and featureless. R&R nanotech has advanced diagnostic capabilities and will tell anyone who asks the patient's state of health and what types of medical care she will require. This information provides a +2 equipment bonus to all Treat Injury rolls on this person. However, before someone can treat the subject, he must first deactivate the R&R nanotech. Triage spiders, treatment guns and other such systems all automatically deactivate R&R nanotech as part of their treatment. Physician using conventional medicine on the subject verbally must ask the R&R nanotech to partially deactivate. If the patient's condition begins to worsen, the nanotech automatically reactivates before the patient loses any hit points. However, if the patient begins to improve, it will fully deactivate and withdraw from the patient's body. Unlike most other medical nanotech, R&R units are completely reusable. When they fully deactivate, they coalesce back into orange-sized icosahedrons. In this state, they can be reused immediately. Doing 10 or more hit points of damage to a patient that the nanotech is protecting will destroy the R&R nanotech, otherwise an R&R unit can be used on patients (or victims) indefinitely.

R&R nanotech is highly durable but it does not possess unlimited power. While it can keep someone stable indefinitely, if it is also making the person walk or perform other physical tasks, it depletes its power reserves after six days. At this time, the unit will place the person's body in direct sunlight or some other bright light. Solar collecting nanomachines fully recharge the R&R unit after 12 hours in bright light.

Militaries made R&R units by the hundred thousand, and various companies sold an equal number to hikers and people who practiced extreme sports. As a result, scavengers looting old military bases have run across caches of hundreds or thousands of these devices. Since their packaging clearly describes their capabilities, many groups who acquire these items use them as the basis for a particularly horrific form of slavery. These slavers either kill their victims or injure them until the slaves fall unconscious (i.e. the slaves are at 0 or fewer hit points), treat the bodies with R&R units and then uses these zombie-like moving corpses as obedient and hard-working slaves.

Nano-slavers generally only reduce someone to 0 hit points as a form of indentured servitude, where someone pays for crimes or debt by having their body used as mindless slaves for several years. Otherwise, the slavers simply kill their victims. The nano-zombies created by R&R units are tireless workers that do not eat or rink and only require one day in the sun after working for six days. Most people assume that anyone who possesses one of these units is a slaver and in many communities (especially ones that have been raided by nano-zombie slavers), the residents swiftly kill the owner and smash the R&R unit.

### STABILIZATION UNIT (SU OR HIBERNATION DISK)

**Size:** Tiny  
**Weight:** 0.5 lb  
**Purchase DC:** 10/12

Developed by the military in 2050, this small device saved many thousands of lives. Utilizing a combination of electro-neural stimulation and carefully shaped magnetic fields, it artificially induces a greatly enhanced mammalian diving reflex that resembles the deep state of hibernation similar to that used by many bats. When activated, this device reduces the subject's metabolism by a factor of 250. Someone using an SU could survive for a month in a small sealed room with no external air supply and up to five years without food or water. In addition, this device automatically stabilizes dying individuals

for as long as they hibernate. Subjects require medical attention once they revive, but if they have been in this state more than a day, the residual healing that has occurred while they were hibernating provides a +2 equipment bonus to all attempts to use the Treat Injury skill to stabilize them.

SUs are flat disks three inches in diameter and one inch thick. These devices have a self-adhesive backing that activates whenever someone presses the unit firmly against skin. An SU can keep someone hibernating indefinitely, but the device contains a timer that can be set to allow the person to hibernate anywhere from four hours to five years.

The device temporarily stabilizes all wounds the same round that it is applied. However, the person does not fully enter hibernation for two additional rounds. If someone uses this device on an unwilling subject, the subject may make a DC 15 Reflex save to remove the unit before she can no longer move. Since they were not designed to be used against unwilling targets any attack designed to force this against someone's body is made at -4. SUs are battery-powered but use almost no power once the user is actually hibernating, with most operating energy coming from the user's own body. Even if it is out of power, the solar cells on the top of an SU can recharge its batteries in three hours of direct clear sunlight. A few people survived the Final Wars using these devices and some of them have continued using them, walking up for a week every five years to eat and drink enough to allow them to endure another five years in hibernation. These people have all aged less than a year in the time since the Final Wars.

### TREATMENT GUN

<b>Treatment Gun (Loaded)</b>	<b>Treatment Egg</b>
<b>Size:</b> Small	<b>Size:</b> Tiny
<b>Weight:</b> 3 lb	<b>Weight:</b> 0.5 lb
<b>Purchase DC:</b> 19/22	<b>Purchase DC:</b> 15/18

One of the primary challenges when dealing with any serious natural disaster or act of terrorism is that dozens or hundred of people may all be badly injured and could die without immediate treatment. Even at the height of the pre-war era, bringing large numbers of emergency medical technicians and triage spiders onto the scene sometimes took more than an hour. Treatment guns were developed to prevent anyone from dying in the meantime. After the first decade of the 22nd century, they were in all first aid stations located in public buildings and all police officers and rescue personnel carried one.



Treatment guns look much like ordinary 20th century flare guns: wide, stubby pistols with short, wide barrels. Each treatment gun can hold up to four nanotech medical cartridges. These silvery, egg-shaped pods, called treatment eggs, are approximately the size and shape of a large kumquat and the advanced nanotechnology inside them renders them relatively immune to damage. When fired, the treatment eggs instantly disperses into a 30 foot cone of silvery nanounits that rapidly infiltrates the bodies of anyone it touches. After lobbying by various animal-rights groups, treatment guns were designed to affect all mammals, birds, and reptiles, so these device work equally well on pure-strain humans, stock humans, mutant humans and most mutant animals. However, this medical nanotech has no affect on any type of fish or invertebrate. The nanounits in the cloud immediately stabilize the wounds of any human or animal that they touches, even if the creature is at  $-9$  hit points. Also, every stock, pure strain, or mutant human affected by this nanotech heals  $1d6+3$  hp, at  $1$  hp per minute. Animals, including both humanoid and mutant animals only heal  $1d4+1$  hp. This medical nanotechnology heals damage caused by any source unless the source specifies that nanotech doesn't affect it.

Sometimes scavengers find treatment eggs without a treatment gun. Treatment eggs can be set off alone. There is a red spot on one end of the egg and a blue spot on the other. T set of the treatment egg, users must press the red spot and then the blue spot within two turn. (Anyone who has done this more than once can easily manage this in a single turn.) Treatment eggs explode in a 10-ft burst radius two turns after they have been fully activated in this fashion. One activated, treatment eggs repeat, "activated, place near target immediately" until they go off two rounds later. Characters must make a DC 15 Speak Languages roll for the language of the egg's makers to understand this phrase, but may make a new roll each round the phrase is repeated. Regardless of how they are activated, treatment eggs can be used only once.

## TRIAGE SPIDER

**Triage Spider:** Small Construction; HD  $2d10$  (16 hp); Mas —; Init +3; Spd 30 ft (6 squares); Defense 17 (+1 size, +3 Dex, +3 natural), touch 14, flat-footed 14; BAB +1/Grp +1; Atk +4 melee (special, stun gun); Full Atk +4 melee (special, 2 stun guns); FS/Reach 5 ft/5 ft; SQ darkvision; AL Hippocratic oath; SV Fort +3; Ref +6; Wil +1; AP 0; RP 0; Str 8, Dex 16, Con —, Int 12, Wis 12, Cha 10.

**Skills:** Craft (pharmaceutical) +10, Knowledge (Earth and Life Sciences) +5, Treat Injury +15

**Feats:** Surgery, Tech Familiarity: Advanced, Weapon Finesse (stun gun)

**Purchase DC:** 29/31

The triage spider was one of the most advanced robotic medics created in the pre-war era. Designed specifically for use in large-scale emergencies or for combat medicine, these units are invaluable in any situation when multiple patients require rapid treatment.

A resting triage spider folds itself up into a nondescript case fifteen inches square and three inches thick, with carrying handles and straps built in. It weighs 12 pounds. Unless someone switches it completely off, it automatically monitors the vicinity and comes into active mode upon sensing anyone within 50 feet who's lost half or more of her hit points. (It can also be activated manually with the press of a button or a spoken command.) During activation, it unfolds to extend six spider-like legs three feet long and ten slender arms, four with six-fingered hands and six ending in various medical tools like scalpels and forceps. A fully equipped triage spider carries supplies of drugs including antitoxin, cleanout, regen and total med sufficient to treat a hundred patients. If any of these run out, the spider attempts to make do with what it can scrounge or persuade others to let it use. It also generates high-frequency, low-voltage electrical currents for use in anesthetizing body parts for treatment and in speeding the healing of bone damage.

The spider is very skilled at general first aid and relief, and at surgery and the development and application of follow-up treatments. Once it begins working on a patient, it seeks to continue the task until the patient is fully recovered or a physician orders it to some other job. Anyone with either the Surgery feat or at least 10 ranks in Treat Injury and 5 ranks in Craft (Pharmaceutical) can do this easily, meeting the spider's sense of what a physician is. Others must win an opposed roll of Bluff against the spider's Will save. In the absence of countermanding orders, the spider seeks to treat all the injured people it can sense in order from most seriously wounded to least, without regard for their allegiance or other factors. It also attempts to stop any effort to kill or harm any of its patients. If several people in its sensor range are dying (below 0 hit points), it tries to save those farthest from death first; it scavenges organs from dead and untreatable patients for the benefit of others.

Triage spiders have the standard self-powering and healing capabilities of synthetic characters.



**CHAPTER FOUR**  
**VEHICLES**

Like synthetics, most surviving vehicles built before the Final Wars are both self-powered and self-repairing. Most vehicles without these advantages became rusting hulks many decades ago. Since rapid transport allows traders to safely travel longer distances and local militias to become far more effective, working vehicles are widely considered as

valuable as working weapons and medical technologies.

Vehicles using technology unavailable to a character's community require analysis with one DC 15 layer for the standard controls (stopping, starting, steering and the like) and an additional DC 15 layer for each unusual feature like amphibious operation.

### THE AFFECTS OF STRONG MAGNETIC FIELDS

All hover vehicles use extremely strong magnetic fields for lift, but most fly close enough to the ground that there is little risk of the vehicle flying over some person or device. However, being underneath a hovercycle or any other magnetic vehicles that can fly more than a foot or two above the ground can have devastating affects on robots, cyborgs or various advanced technologies. If a hover vehicle passes less

than 5 feet above such a person or device any robot or cyborg must make a DC 20 Fortitude save or suffer a temporary malfunction. Similarly any device that uses nanotechnology has a 50% chance of malfunction. All such malfunctions can be easily repaired with the appropriate tools and a DC 15 Repair check that requires 15 minutes to reset various crucial components.

## GROUND VEHICLES

Even in the 22nd century, most people used ground vehicles as their primary mode of transport. While advances like micro-fusion reactors and magnetic repulsion allowed manufacturers to create vehicles far superior to any that had ever existed before, in basic design they were quite similar to those created in the dawn of the automobile era. The basic categories like motorcycles, economy cars, luxury car, vans and trucks remained in place right up until the Final Wars. Unfortunately, although many millions of ground

vehicles survived the Final Wars, most became instantly useless. Many used power cells that required regular recharging and most could only run upon well-maintained roads. Although some of these vehicles remain in excellent condition due to their self-repair capabilities, they are now essentially useless. Before the Final Wars, fusion and solar powered off-road vehicles were far less common than ordinary ground vehicles. However, these vehicles are in great demand in the Gamma Age.

**TABLE 4-1: GROUND VEHICLES**

Name	Crew	Pass	Cargo	Init	Maneuver	Top		Hit		Purchase	
						Speed	Defense	Hardness	Points	Size	DC
Brachiating walker (swinger)	1	5	200	0	+1	120/60	10	5	47	L	n/a
Caravan home	1	5	1,000	-2	-2	40	8	10	39	H	32
Hover board	1	0	50	0	+5	60	11	5	16	S	23/24
Hover bubble	0	7	500	0	+1	400	8	15	38	H	n/a
Hover cycle	1	1	50	0	+4	200/300	10	5	23	L	32/35
Hover truck	1	8	400	-2	0	160	8	5	35	H	35
Runner	1	7	500	-2	0	240	8	10	38	H	35/38



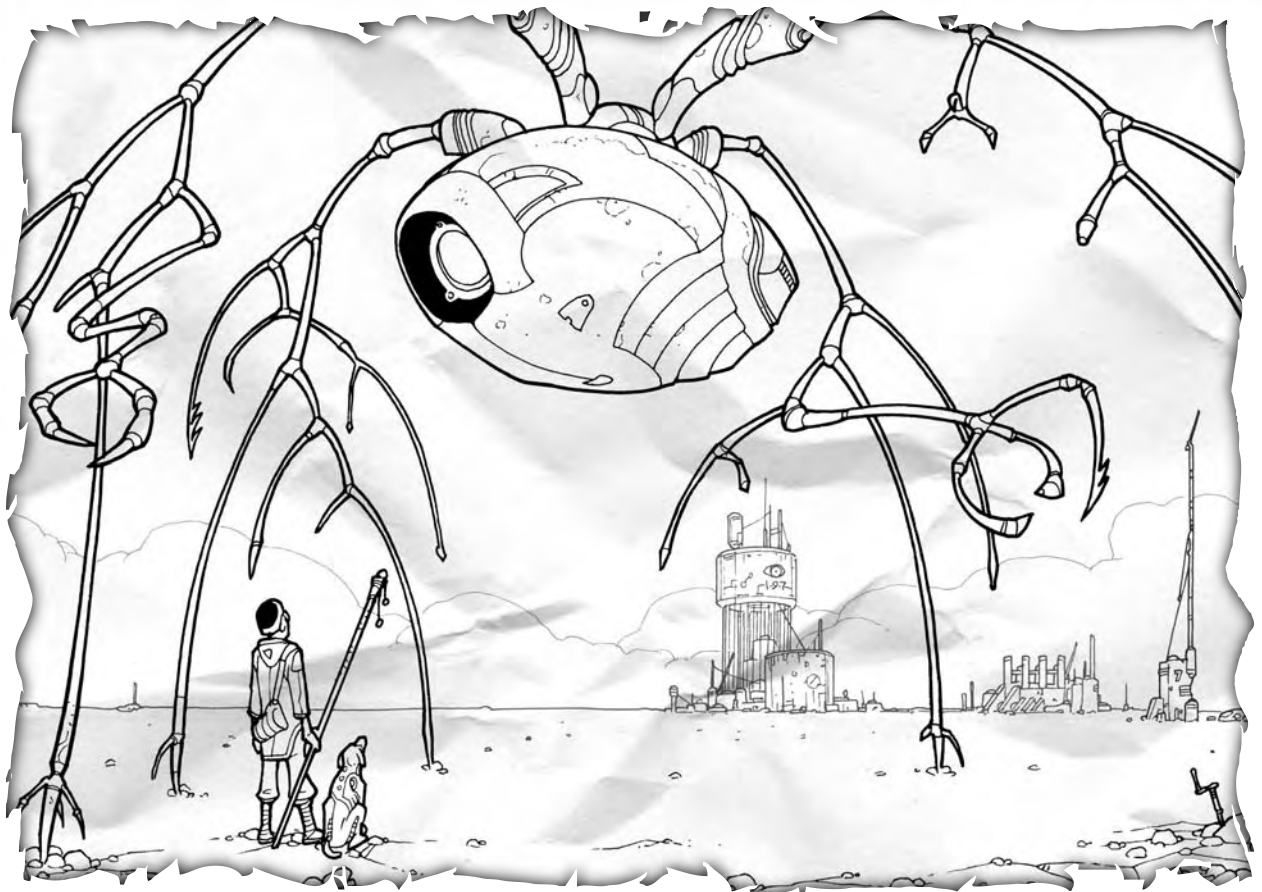

## BRACHIATING WALKER (SWINGER)

**Swinger:** Large construct; HD 5d10 (47 hp), Mas —; Init +3; Spd 40 ft (8 squares), brachiate 100 ft; Defense 18 (–1 size, Dex, +3, Natural +6), touch 12, flat-footed 15; BAB/Grp +3/+10; Atk leg-claw +6 melee (1d8+5 and stun gun); Full Atk 2 leg-claws +6 melee (1d8+5 and stun gun); FS/Reach 15 ft/10 ft; SQ low-light vision, DR 5/kinetic, scent; AL humans; swingers; SV Fort +3; Ref +6; Wil +1; AP 0; RP 0; Str 20, Dex 16, Con —, Int 8, Wis 12, Cha 12.

**Skills:** Balance +8, Climb +8, Knowledge (Earth and Life Sciences +4), Listen +4, Navigate +8, Pilot +10, Search +4, Sense Motive +2, Technology (Pre-War) +2, Technology (advanced) +2.

**Feats:** Guide, Multiattack, Tech Familiarity (Pre-War Tech)

Advances in both robotics and artificial intelligence in the late 21st century produced numerous different types of walking vehicles. The most exotic are undoubtedly the brachiating vehicles popularly known as Swingers. Jolo-Kwan Greentech, a small company that produced specialized vehicles for use by the many eco-tourism companies first created these unusual conveyances in 2087. A company interested in starting tours of various rainforest canopies commissioned Jolo-Kwan to create a small

highly maneuverable helicopter or some similar vehicle that would allow tourists to view the rainforest canopy from a few meters away. Instead, engineers at J-K combined a helicopter cabin with a complex walking vehicle that could brachiate rapidly and nimbly through the trees.

The body of the craft is an oval pod 10 feet wide, 10 feet high and 15 feet long, that comfortably seats four and can hold up to 6 Medium humanoids. Four narrow limbs stuffed with extremely complex nanotech extend from a yard-wide dome on top of the pod, each extending up to 30 feet and capable of forming as many joints as necessary. The ends of these limbs can form almost any sort of manipulator, from blunt, heavy claws, to many-finger multi-jointed hands capable of fine manipulation. When standing on the ground, a swinger looks a great deal like a gigantic mechanical daddy longlegs.

To enable the swinger to make the best use of these limbs and also to allow it to correctly judge the optimal way to safely swing from one branch to another, it is equipped with moderately complex soultech almost as intelligent as a person. Because the swinger is capable of navigating through the trees using only its AI and advanced sensors, anyone can pilot this vehicle. All

the driver need do is don a pair of adjustable bracelets and use some easily learned hand signals to direct the vehicle. If the vehicle does not understand the driver's directions or if the driver appears either confused, the vehicle will ask the driver where he wants to go and use a combination of speech and small holograms on the vehicle's holo-tank to instruct the driver on how to steer and direct it. Alternately, the driver can simply ask the swinger to travel in a particular direction. Swingers can brachiate at speeds of up to 60 mph (120 feet/turn) in the trees and run at speeds of up to 30 mph (60 feet/turn) on the ground.

Unlike many vehicles, Swingers survived the Final Wars in excellent shape, both because they were largely located far from the worst devastation and because they are smart and dexterous enough to care for themselves. Also, because they were designed to operate in the wilderness, they all possess advanced fuel cells that can digest plant material and transform it into energy to keep their power cells running. In effect, these vehicles eat and digest plants. These fuel cells also power the vehicle's nanotech self-repair systems.

Since most rainforest tours consisted of Small to Medium groups, the programmers made certain that all swingers were reasonably social and enjoyed the company of their own kind. Although some are now solitary or live in pairs, most swingers live in groups of between 4 and 12, and in addition to performing social grooming and helping to repair badly damaged members, members of a group help each other out. If one of them is destroyed, they will scavenge the body for spare parts. Swinger bands regularly explore old ruins and non-functional vehicles and robots for spare parts and a few have taken to hunting other vehicles for additional materials. These vehicles' only limitation is that they will not harm anything that appears human and will avoid causing harm to any animals. However, swingers attempting to find spare parts for an injured comrade might well steal parts from a human's vehicle or even arrange a discrete trap designed to safely wreck or sabotage the vehicle and then offer to carry the humans a short distance in return for the opportunity to scavenge the wreck.

Anyone who aids one of these vehicles can befriend them and most will gladly work with humans or even mutant animals that treat them well and help them find spare parts. Although swingers can walk on the ground quite well, they greatly prefer to brachiate through the trees. These vehicles prefer to stay in dense forests of various sorts unless forced to seek spare parts. They have no armaments and little armor, but as a defense against large animals, they can electrify the outside of their hull

and limbs. Touching an electrified swinger is equivalent to being hit with a stun gun. Also, they can use their legs to make attacks that do stun gun damage. Today, approximately half of the various bands of swingers are independent nomads, but the rest have alliances with various small human communities. Some of the larger bands have allied themselves with small nomadic stock human or mutant tribes who travel in the swingers and help them find the parts they need to survive. Dealing with swingers is rather like interacting with somewhat slow-witted human allies.

## **CARAVAN HOME**

Near the beginning of the 22nd century, a group of private researchers ran simulations about interactions between technology and society and determined that some sort of major sociopolitical catastrophe was almost inevitable within the next 20 years. When these researchers were unable to convince any government or large corporation of this danger, they turned to other options. While several raised money to set up caches of technology and information around the world, three others used the popular press to disseminate their ideas about the coming disaster and sold thousands of people a mobile dwelling specifically designed to survive in these conditions. These researchers created large durable, solar-powered, self-repairing walking vehicles that they called caravan homes. Although these vehicles deliberately did not incorporate the most advanced technologies available, they were both self-repairing and easy to manually repair. Each caravan home is 35 feet long, 16 feet wide and is a mobile mechanized home the size of a small apartment. To provide reliable transportation over any surface, caravan homes have eight sturdy legs. They are also watertight and if placed in water, the legs retract and a small inboard motor propels the vehicle.

These vehicles proved to be quite popular for a while, but the predicted disaster didn't happen until decades after the initial prediction and in the intervening time, many who had purchased these vehicles grew complacent. Thousands of owners sold their caravan homes and tens of thousands more of these vehicles sat unwanted on large lots. When the Final Wars broke out, most who still owned such vehicles died within a few days. However, several thousand people survived and their caravan homes enabled them to thrive. They and their descendants proceeded to collect more caravan homes from the ruins of sales lots and storage facilities. Today, there are several hundred bands of caravan home travelers and well as thousands of families and small groups who own a single caravan home. Some of the bands are as small as three or four

caravan homes, while the largest are full-fledged mobile communities containing five or six dozen caravan homes. Many of the largest bands belong to nomadic herders, but other bands are mobile trading guilds, itinerant tinkers or wandering bands of mercenaries

Each caravan home contains two small bedrooms, a tiny kitchen, and a larger common room. They provide moderately roomy accommodations for two to four people and comfortable but cramped quarters for five to six inhabitants. The top of this vehicle can change its form, but most of the time is a shallow U-shaped panel that is 22 feet wide and covered with solar cells. These solar cells power the vehicle and provide a power source for the vehicle's built-in power cell recharger. This roof also serves to capture rainwater, this vehicle also purifies water that contains toxins or radioactive particles.

Caravan homes are equipped with specially designed environmental control system that completely protects the inhabitants from all chemical, biological and nanotech effects. It also provides DR 20 versus radiation damage and a +10 equipment bonus to Fortitude saves versus saves versus all environmental effects and energy types, including radiation. If the caravan home is struck by an attack that bypasses its DR, the vehicle is breached for one round and the occupants are subject to any environmental effects or attacks from outside . On the following round, the caravan home's environmental system flushes any effects out of the dome again, assuming another attack does not breach its DR. The vehicle also contains a nano-swarm repellent field generator that the driver can turn on or off, as well as simple and extremely durable sensors that instantly informs the inhabitants if the air outside is safe to breath and what the local radiations levels are like.

To assist in manual repairs and creating goods necessary for survival, caravan homes contain miniature machine and electronics shops and an extensive first aid station. These shops consist of an extremely well designed deluxe electrical tool kit as well as a basic mechanical tool kit and a field medical kit (see Chapter Three). Each vehicle is fitted with a computer that is equivalent to four datapads that contain large amounts of medical and technological knowledge. While they are comfortable and allow occupants to lead a relatively self-sufficient, limitations on weight and power meant that they cannot travel faster than 20 mph.

## HOVER BOARD

A popular child's toy in the era before the Final Wars, in the Gamma Age this small but fast vehicle

has become popular with both solitary travelers and a number of bandit gangs and regional militias. Hover boards were the smallest magnetic repulsion vehicles that could carry a person. While most were made for teens, thousands of adults also loved these whimsical vehicles. Before the Final Wars, hover boards were the focus of many local sports competitions, where riders attempted to best each other in races and daring feats of acrobatic prowess. Several people even set records by crossing the United States and even the Atlantic Ocean on hover boards.

Hover boards are 18 inches wide, 36 inches long and 2 inches thick. The nano-augmented structure of the board is self-repairing and can seamlessly fold in half twice, forming an easily carried block 18 inches wide, 9 inches long and 8 inches thick that weighs only 6 lb. The board's magnetic levitation coils can lift the vehicle up to six feet above the ground and their built-in MHD jets propel them at speeds of up to 30 mph.

Nanotech assemblers similar to that found on cutter-bonders (see Chapter Two) safely bond the wearer's shoes, or even her feet to the board. All the user needs to do is step on the clearly marked outlines located near the center of the board, turn on the board and say "board bond." To release her feet, the user says "board release." The board will only obey commands given by the person standing on the board. The rider steers and controls her board by a combination of weight shifting and foot pressure. Hover boards are so responsive, that the rider can use the Tumble skill to perform the tumble past opponents and tumble through opponents maneuvers without penalty while riding a hover board. She can also use the Dodge, Agile Repost, Mobility, and Sprint Attack feats while riding on a Hover board and if she has 5 or more ranks in Tumble, she can use this skill to increase her Defense while riding a hover board. When riding a hover board, the user can also attack and move normally and without any penalty. The only difference is that the user moves at the hover board's speed and not her own.

The board's power cell propels the board for 16 hours. The user can either recharge the board normally or she can unfold the two wide solar panels from the side of the board. Every hour these panels are in direct sunlight recharges two hours of flight time. The user can ride the board with the panels out, but this reduces the board's speed to 25 mph and prohibits the rider from using the Tumble skill while riding the board. Folding or unfolding these solar panels requires one full round. Any Small or Medium character can ride a hover board. Riders can carry up to 50 lb of baggage, either in a backpack or strapped to the back of the board. Almost all hover boards are brightly colored and are clearly



designed for teens and sports enthusiasts. Hover boards are reasonably common and can be found in the ruins of many stores and houses. Unpowered hover boards float and scavengers can use them as surfboards. The hover board's hardness does not protect the rider.

## HOVER BUBBLE

**Hover Bubble AI:** Str —, Dex —, Con —, Int 16, Wis 14, Cha 12.

**Skills:** Computer Use +2, Diplomacy +2, Knowledge (Gossip) +4, Knowledge (Technology: Advanced) +2, Knowledge (Technology: Pre-War) +2, Listen +4, Navigate +10, Pilot +10, Spot +4

**Feats:** Guide, Tech Familiarity (Pre-War)

The most useful craft developed shortly before the Final Wars were the ones powered by miniature fusion reactors. Using exceptionally powerful magnetic repulsion and powerful, but nearly silent MHD jets, hover bubbles can hover up to 20 feet off the ground. Hover bubbles were among the most expensive and advanced vehicles created before the Final Wars and while these vehicles are extremely durable and fitted with self-repair nanotechnology, they are also fairly rare. A hover bubble is usually a smooth ovoid or other balanced form 20 feet long, 10 feet wide and 8 feet high. It can hold six people comfortably (seven if they are crowded) and has a cargo space capable of holding 500 lb of cargo.

Hover bubbles have a top speed of 160 mph and can maintain that speed indefinitely. Able to condense water from the air it uses for lift and propulsion, a hover bubble never needs fuel. In addition, all hover bubbles contain a recharging unit in their cockpit and recharge power cells as rapidly as if the recharger was plugged into a wall socket. Since many owners were worried about terrorists and industrial accidents, they are well armored and protect their inhabitants from toxins, radiation and similar dangers as well as a Sealed Environment Dome. These vehicles also contain a nano-swarm repellent field generator that affects all nearby nanotechnology that is not part of the vehicle.

Because the entire vehicle uses reactive nanotechnology there are no hinges or joints. Its gull-wing doors can become temporarily less rigid and gracefully bend up like flexible plastic sheets. To avoid the necessity of a human pilot, the computer in all hover bubbles needed to be as intelligent as a human and capable of speech, hearing and sight. Because it had such a powerful on-board computer, hover bubbles are always fully automatic, they contain no actual controls. The user instructed the vehicle where to go. This computer can also play various electronic games with the passengers to keep them entertained or simply

talk. Before the Final Wars, some wealthy people fortunate enough to own hover bubbles became close friends with their vehicles.

Today, hover bubbles are some of the most intelligent vehicles in existence and now possess a wide variety of motives. Most are intensely curious beings who are eager to have human and mutant passengers that are both intelligent and polite. Others have embraced various ideologies: some will only work with pure-strain humans and many are passionately devoted to helping to rebuild the world, especially since hover bubbles occasionally require raw materials for their nanotechnological self-repair systems to process into spare parts.

In the Gamma Age, hover bubbles are far more like valuable allies than they are like possessions. If they are mistreated or if their passengers ignore their wishes, hover bubbles fly off at high speed leaving these people far behind. However, they usually work with one or more humans or mutants — most of these vehicles like people and wish to have someone around who can perform any necessary repairs.

## HOVER CYCLE

When environmental concerns restricted the use of dirt bikes and snowmobiles, the makers of off-road vehicles attempted to create new and exciting alternatives that would avoid these problems. While many makers created walking and running vehicles like robohorses, others developed small hovercraft that used advanced computer controls to avoid the inherent difficulties in controlling a vehicle that float on a cushion of magnetism. The smallest and most popular of these vehicles is the hover cycle.

Hover cycles are 7 feet long, 3 feet wide and 3 feet high. Weighing 150 lb, these vehicles can carry up to two Medium passengers and hold up to 50 lb of cargo in two small cargo pods on either side of the vehicle's back half. Hover cycles normally float 3–8 feet off the ground and can fly at speeds of up to 100 mph. However, to enable them to cross especially rough terrain or small ravines, the user can temporarily overload the engines to allow the hover cycle to travel at speeds of up to 150 mph and to actually fly up to 500 feet above the ground. Hover cycles can maintain this speed and altitude for no more than three rounds, enabling them to cross chasms over half a mile wide. After this time, the hover cycle cannot overdrive its engines for at least another hour, safety over-rides prevent rider from using this function more often than this.

Unlike most battery-powered hover-vehicles, hover cycles are extremely efficient and their four power cells allow this vehicle to operate for up to 12 hours. Designed



for off-road usage, hover cycles were equipped with a solar power cell charger that can recharge the cycle's power pack. When the driver unfolds the solar recharger it forms a rainproof canopy over the driver and passenger. Driving with the solar canopy up increases the hover cycle's air resistance, reducing the vehicle's top speed to 80 mph and only allowing it to overdrive its engines for two turns every hour. When used in this fashion, the hover cycle can operate without draining its batteries as long as it remains in sunlight. Putting the solar cell canopy up or down requires the touch of a button and takes one round.

Since various companies manufactured several million of these vehicles before the Final Wars more than a hundred thousand of these vehicles survived the Final Wars. Today, hover cycles are extremely popular with nomadic raiders and several dozen nascent city-states have divisions of hover cycle cavalry to combat both these bandits and rival city-states.

## HOVER TRUCK

This vehicle isn't so much a specific sort Pre-War vehicle as it is a whole category of vehicle that largely grew to prominence in the days immediately following the Final Wars. When the survivors of the Final Wars dug themselves out of the ruins, many realized that they required both powerful armaments and reliable transportation. Most vehicles built before the Final Wars relied upon power cells that owners must recharge every few days. After the technological infrastructure collapsed, such vehicles soon ran out of power and few people had the means to recharge them. Scavengers rapidly found many of the surviving military and high-end civilian vehicles powered by micro-fusion reactors and fitted other vehicles with solar recharging units. In the first generation after the wars, most fragile or unreliable vehicles ceased working, either because of mechanical failures or because of battle damage. Almost all surviving vehicles have self-repair capabilities similar to that synthetics possess. Most of these vehicles that are surprisingly similar, despite their many superficial differences.

Most hover trucks and armed hover trucks are the size of early 21st century SUVs, with magnetic repulsion for lift and MHD jets for propulsion. The surviving vehicles all have self-repair capability and use either a micro-fusion reactor or a series of solar cells on their top surface for power. These vehicles also contain a power cell recharger that passengers can use to recharge any devices they are carrying. The only real differences between these various vehicles depend upon their power sources. Solar-powered vehicles are slower and cannot carry incorporate built-in weaponry because they lack sufficient power. The best and most

desirable fusion-powered hover trucks have either a blaster rifle or a microwave gun built in, so that one of the passengers can fire it. Military hover trucks were fitted with these weapons as part of their original equipment, while survivors retrofitted other models had weapons after the Final Wars. Although many different types of Pre-War vehicles are still in use, hover trucks are the single most common type of ground vehicle that most people encounter.

## NANOBOOTS

**Size:** Small

**Weight:** 1 lb

**Purchase DC:** 15/17

In 2113, Arachne Sports claimed this device was the ultimate evolution of the shoe. Arachne Sports made models for both civilian and military uses, but they were very similar. These ankle-high boots look like brightly colored fine leather, but are actually an advanced nanotech composite. These boots shape themselves to perfectly fit the user. Any human or Medium mutant animal with roughly human-shaped feet can wear a pair. These boots do not even come in sizes: one size literally fits everyone. Because they also fit themselves to the user's stride, these boots are far more comfortable than any conventional shoe. Regardless of weather or terrain, the wearer's feet will be cool, dry, comfortable and blister-free. Walking in these shoes for eight hours is slightly less tiring on the user's feet than walking for only two hours in most shoes. Also, these shoes are extremely tough and the wearer can walk across razor sharp spikes and Antarctic glacier safely and comfortably, and while the user cannot actually step in molten lava, she can safely walk on the roastingly hot rock near an active volcano. Anyone wearing a pair of nanoboots has DR 5/- for any physical damage that strikes the soles of her feet.

However, none of these features compare to the boots' most impressive feature. They can actually flex their soles to propel the user forward, adding +30 feet to the wearer's base speed. They can enhance the user's speed for up to half an hour; over relatively flat terrain, the user can run up to 15 miles in this time. During the time, the user can also jump twice as far as normal. Since the boots do the vast majority of the work when running at this speed, the wearer is no more tired after this run than from jogging for half an hour. At the end of this time, the boots' batteries are almost exhausted and must slowly recharge themselves by drawing small amounts of energy from the wearer's stride. Every 8 hours of normal walking allows the boots to speed up for 30 minutes. Alternately, a single power cell can recharge both boots five times.

## ROBOTIC HORSE (ROBOHORSE)

**Robohorse:** Large robot; HD 3d8+9 (22 hp), Mas —; Init +1; Spd 80 ft (16 squares); Defense 15 (-1 size, +2 Dex, +6 natural), touch 11, flat-footed 17; BAB/Grp +2/+7; Atk hoof +3 melee (1d8+4); Full Atk 2 hooves +3 melee (1D8+4); FS/Reach 10 ft/5 ft; SQ Darkvision; DR 5; AL owner, excitement; SV Fort +3; Ref +5; Wil +1; AP 0; RP 0; Str 18, Dex 15, Con —, Int 11, Wis 12, Cha 10.

**Skills:** Bluff +2, Intimidate +4, Hide +2, Jump +6, Listen +6, Navigate +4, Spot +6, Survival +4, Tactics +4

**Feats:** Combat Reflexes, Guide

Before the Final Wars, only the wealthy used this exotic mode of transport. Having a fully intelligent steed was a standard feature of many fantasy novels written in the 20th and early 21st century and by the end of the 21st century, this dream had become a reality. The vast majority of riders were either dilettantes who dreamed of having adventures with their equiform companion or members of the growing subculture of wealthy individuals who enjoyed playing increasingly dangerous and outlandish extreme sports and wanted a mount that could actively help them hunt other people for fun. As a result, while they were all as intelligent as an ordinary person, robohorses were programmed so that they greatly enjoyed running fast and engaging in exiting and potentially dangerous activities.

The surviving robohorses consider themselves to be independent and free-willed beings who will work with human partners. However, they are completely unwilling to act as servants or slaves to any other being and do not allow themselves to be bought or sold. Their impressive physical capabilities allow them to easily escape from most forms of captivity. Robohorses all choose their companions carefully, looking for people who are interested in leading exciting lives and placing themselves in situation where the robohorse will test its capabilities their limits. Most soon abandon companions who act in a cowardly manner or whose lives become too staid and dull for the robohorse's innate adventurousness.

In terms of game mechanics, robohorses are extremely similar to other synthetics. They heal by ingesting the remains of technological artifacts and can be treated as synthetics in all other ways, including the fact that many robohorses have levels in one or more heroic character classes. Tough and Dedicated Hero are especially common classes for robohorses.

## RUNNER

While most walking vehicles provide slow but reliable transport over rough terrain, runners are one of the fastest ground vehicles in regular use. They were first created in 2093 for use by an off-road racing league.



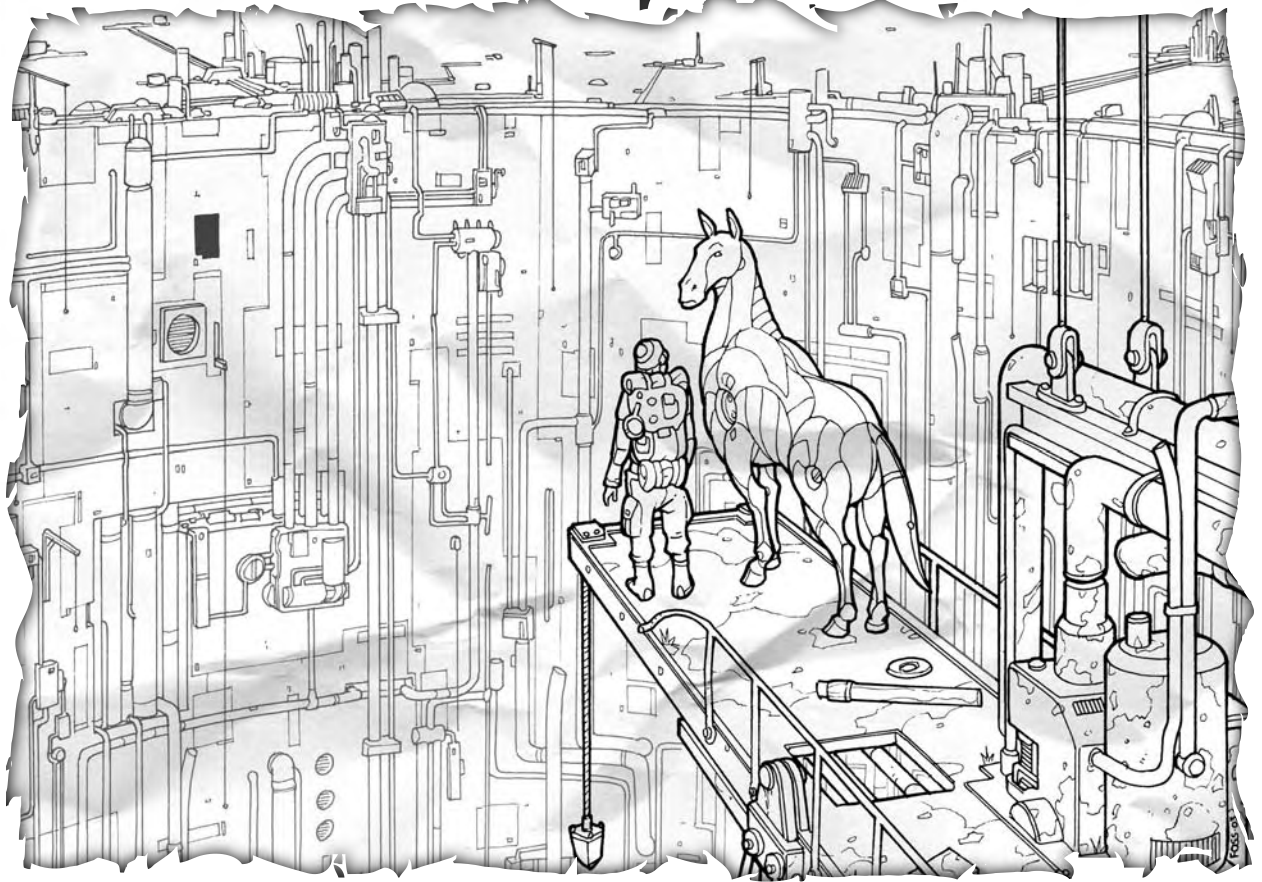

By 2110, runner racing was exceedingly popular and many people who never planned to take part in a race wished to own one of these exciting and unique vehicles. As a result, various manufacturers created several hundred thousand of these vehicles. The best models were both self-repairing and powered by micro-fusion reactors. More than ten thousand of these vehicles are still in operation.

The basic form of all runners is the same. They consist of an oval or rectangular cabin 12–18 feet long, 8–10 feet wide and 4–6 feet high. Depending upon the size of the vehicle, the cabin holds between 4 and 8 passengers and between 300 to 600 lb of cargo. Underneath the cabin is a large motor and two sturdy legs between 15 and 18 feet tall, which holds the cabin high above the ground. Advanced computer controls allows the vehicle to remain stable on almost any terrain and the variable configuration of the runner's feet enables it to run swiftly upon a well maintained road and to walk safely over mud and ice. The feet can both change size and shape and alter their traction.

Runners can maintain speeds of over 120 mph on a flat road and at least 60 mph over the roughest relatively flat terrain. Able to out distance any animal and most other vehicles, runners look ungrainly when

not in motion, but instantly earn the respect of anyone who sees them moving. Best of all, the vehicle's computer controls also insure that the cabin remains level and stable. Even when the runner is moving at top speed through a swamp studded with huge boulders or the broken ruins of a city, anyone inside is perfectly comfortable and can even eat and drink without spilling anything.

While a few were made for military and paramilitary use, most runners were initially unarmed. However, shortly after the Final Wars, surviving mechanics attached blaster rifles or microwave guns to many of these vehicles. Armed runners are some of the favorite vehicles of bandits. They move extremely swiftly and the psychological impact of seeing a huge and obviously well armed running vehicle bearing down upon them can intimidate many people into surrendering without a fight. In addition to armed runners, the most common and popular varieties are the larger ones that resemble early 21st century SUVs with huge legs. These vehicles allow traders and other professional and semi-professional travelers to trek swiftly and safely through the wilderness.

To leave or enter a runner, the vehicle must squat down so the door is at ground level. Some runners obey

voice commands by their designated owners and can simply be asked to squat down to allow passengers to enter. Alternately, users can simply make a DC 10 Climb roll. However, most come equipped with two or three specialized wrist assistants with controls that allow the user to operate the vehicle at a distance of 25 miles. Cameras on the runner display the exterior terrain, allowing the user to direct the vehicle using the wrist assistant's screen. Alternately, the user can simply specify the destination and order the runner to go there.

Traders who worry that the inhabitants of a settlement might either be intimidated by their runner or attempt to steal it, often conceal it a mile or two away from the settlement and walk into town. If the trader gets into trouble, she can discreetly call the runner to her. The sight of an huge and often-armed vehicle showing up in the middle of a village is generally sufficient to cause most villagers to abandon attempts to attack a trader, especially since the villagers have no way of knowing if the trader has several well-armed comrades inside of the runner.

## WATER VEHICLES

In the days immediately before the Final Wars, there were fewer advances in boats than in most other forms of transportation. However, advances in materials technology and soultech both allowed engineers to design boats and submarines that were exceptionally tough, fast, and maneuverable. The single greatest advance was in the design of super-cavitating submarines. By 2060, engineers could build highly maneuverable submarines that could travel at speeds of several hundred miles per hour.

### DEEP HUNTER

**Deep Hunter AI:** Str —, Dex —, Con —, Int 18, Wis 16, Cha 14.

**Skills:** Business + 4, Computer Use +4, Diplomacy +4, Navigate + 12, Pilot +12, Technology (Pre-War) +4, Technology (advanced) +6.

**Feats:** Educated, Renown, Tech Familiarity (Pre-War Tech)

A few decades before the Final Wars, several undersea mining companies decided that mobile platforms that scoured the sea floor for useful items like manganese nodules, rare minerals coming up from volcanic vents and chemicals derived from the strange life-forms living around hydrothermal vents were the best way to make money off of the deep ocean. Engineers designed similar vessels to hunt for large and elusive animals like swordfish and the few other

creatures that centuries of over fishing had not depleted. Looking like a combination of an early 21st century oil tanker and an advanced submarine, these vessels were widely known as deep hunters.

While they contain advanced AIs and were originally intended to be completely uncrewed, several incidents where minor mechanical failures prevented a ship from being able to service itself caused the manufacturers to refit these vessels to hold small human crews. By the era of the Final Wars, over 100 of these huge vessels were in operation, and each one had a crew of between 40 and 60 people who performed maintenance on the vessel, conducted undersea research and provided services for the rest of the crew. The vessels also contained workshops capable of making a wide range of replacement parts and other goods as well as between 20 and 30 synthetics who assisted in maintenance, repair and cargo processing.

Deep hunters are all approximately 1,800 feet long, 250 feet wide and 200 feet tall. Two-thirds the vessel consists of vast holding tanks for whatever this particular ship was programmed to collect. The rest of it consisted of the various engines and other electronic and mechanical sub-systems, an advanced fusion reactor rated for at least 250 years of continuous operation, a powerful AI, advanced sensors and a habitable section near the front that consisted of five

**TABLE 4-2: WATER VEHICLES**

Name	Crew	Pass	Cargo	Init	Maneuver	Top Speed	Defense	Hardness	Hit Points	Size	Purchase DC
Deep hunter	0	2,000	1,200 tons	-10	-6	70	6	25	800	C	N/A
Porta-boat	1	5	600	-6	-2	30	6	5	24	L	24/26
Super-cavitating minisub	1	3-5	1,000	0	+2	700	12	10	52	H	44/48

3-meter high decks 200 feet wide and 100 feet long. This area provided the crew with a relatively large and comfortable living space as well as excellent laboratory and medical facilities. Such amenities were necessary to convince workers to sign on for a tour of duty that normally lasted between six and nine months. During most of this time, the ship would be deep under the ocean and would be almost completely out of contact with the rest of the world for as much as three months at a time. Only very low frequencies can pass through miles of water, and they limit signals to the equivalent of 20th century modems.

When the Final Wars broke out, 107 deep hunters were at sea. The crews of 21 of these decided to return to port to allow the crew to be with their families and to attempt to help with the futile rebuilding efforts. Nanotech hunting clouds and similar weapons of the Final Wars destroyed another 34 when they surfaced. However, the remainder of the ships elected to remain at sea to keep themselves and their crews safe until order was restored. Because they are both loyal to their programming and creatures of habit, a few ships attempted to keep making their deliveries to port. However, these vessels met with automated defense systems, rogue technologies or armed criminals eager to seize both their goods and the ship itself. These ships sent word to the others of their kind via sonar and all of the surviving ships focused on their secondary programming, which was to keep their crews safe. 39 deep hunters are still at sea, keeping in contact with one another and avoiding the shore. They are all aware of the dangers found on both the coast and at sea and these hardy survivors have become extremely skilled at survival.

The crews of more than a dozen of these surviving deep hunters persuaded their ships to surface and pick up refugees in ships and along the shore. The crews and the robots on these deep hunters worked together to adapt the hold to additional living quarters. Today, the most populous of the ships that took on refugees have populations of between 1,200 and 1,800, most of whom are stock humans. Most ships that did not take on additional personnel now have populations of between 40 and 300 pure-strain humans. The advanced nanotech medicines aboard the vessels can keep even the oldest the crew members alive for at least another 50 years; on vessels that are well disposed towards their inhabitants, most of the original crew is still alive.

On 18 ships, the ship's AI rules the crew like a benevolent god-king who listens to requests and dispenses justice, punishments and boons aided by both human aids that it appoints and maintenance robots.

On most of the remaining deep hunters, the AI rules much like a constitutional monarch, and a popular vote can challenge or even override its decisions.

Most of the vessels keep in near constant contact with one another through beamed sonar pulses. These ships share information and on many, their crews regularly communicate with one another. The ships warn each other of potential risks and discuss issues of ethics regarding their crews. Almost all deep hunters cut off communications with vessels that abuse or kill their crews.

On six vessels, severe life support problems threatened the lives of the crew. Since deep hunters contained advanced nanotech medical facilities, these ships altered their crews so that they can now all breathe water. One of these ships contained 1,200 refugees, the others each contained between 100 and 200 crew members and their children. All of these individuals are now effectively stock humans with the gills mutation. On two of these ships, the passengers can no longer breathe air, while on the other four, the passengers are fully amphibious and can live equally well in air and water.

Unlike the residents of other deep hunters, these crew members occasionally leave their ship and explore the ocean. Three of these crews have become raiders who help their ship loot coastal ruins and installations on small islands and well as occasionally engaging in acts of piracy. The other three crews live aboard ships where the both AIs and the inhabitants consider such behavior to be highly immoral and instead help their vessels explore the ocean and occasionally render aid to ships in distress, including other deep hunters.

On one deep hunter, a chemical fire killed everyone onboard. Because of its guilt over their deaths and to enable it to survive, this vessel is currently sending its most humanoid robots onshore to recruit a new crew.

The AIs on five of the surviving deep hunters blame all humans for destruction of the world and punish their crews for the transgressions of their species. On three of these vessels, the humans live as miserable and oppressed slaves with no hope of escape. On the fourth, the vessel kill all of its humans during a revolt that badly damaged the vessel and on the fifth, similar revolts left the vessel unharmed and the vessel killed off all but a handful of its humans. In both cases, these vessels now seek out new crews. These two ships send their most human-looking maintenance robots on shore to either trick or forcibly abduct unsuspecting humans into coming on board and becoming its slaves. Since many of those shanghaied aboard these vessels



refuse to adapt to slavery and must be killed and others die from the ill-treatment they receive aboard these ships, these two deep hunters are constantly seeking new crews. All have found that dockside bars are excellent places to “recruit” crews. Several other deep hunters also took this path, but rebellious humans or lack of maintenance eventually destroyed all of these the ships.

Except in the case of the aquatic humans that live on a few of the deep hunters, the residents cannot leave and once they learn about the state of the world beyond their ship’s hull, few wish to do so. However, while most vessels and their crew would be suspicious of any visitors who arrived in their own ship or submarine, if the visitors are not openly hostile, the residents would likely be at least willing to talk. The deep hunters are also not defenseless. While both the vessels and the crews are unarmed, on-board factories could rapidly turn out simply hand weapons like blaster rifles and pistols, and the ship’s robots could help organize the crew into a force capable of repelling all but the most well armed boarders.

## **PORTA-BOAT**

Created from the same memory diamond used in the most advanced armor and portable shelters, this device is a moderate-sized boat that the owner can be easily carry around. When stored, this vehicle is a somewhat oval block 10 inches long, 6 inches wide, and 3 inches thick. Weighing only 5 lb, this item is designed so that the user can carry it in the pocket of her overcoat, strap it onto her belt or even pack in the bottom of her rucksack and take it out when she requires it. The outside of this oval is largely featureless, containing only a button-like tab that the user can pull and a small digital charge indicator. Thin-film solar cells cover the outside of this ovoid — even if the boat’s battery is completely empty, placing it in direct sunlight or other bright light for 15 minutes provides it with sufficient power to open. When the user pulls the tab, the boat slowly unfolds on its own, taking 5 minutes to fully expand.

Once deployed, the boat is 10 feet long, 6 feet wide, and 3 feet deep, with comfortable bench seats and an electric inboard motor that can propel it at speeds of up to 15 miles per hour. When it first unfolds, the boat only weighs 5 lb, but as soon as the user places it in water, the material absorbs a sufficient amount of water to cause it to weigh 40 lb, making the boat far sturdier and more resistant to overturning. The boat can hold up to 1,800 lb, and normally carries up to six people and 600 lb of supplies. When its power cells are fully

changed, they hold enough power to propel the boat for 10 hours.

Since solar cells also cover the bottom of this boat, when the power runs out, the user need only beach the boat, turn it over and leave it in the sun for up to 10 hours. Each hour in the sun powers the motor for 30 minutes. The boat also has oarlocks and comes with expandable oars, if the user wishes to row the boat. To store the boat, the user only needs pull two tabs on the inside of the boat, at the very front. When she pulls both tabs simultaneously, the boat expels all the water it absorbed and refolds itself into a small, light ovoid. The entire process takes five minutes. Before the Final Wars, this vehicle was popular with hikers and outdoors enthusiasts and was also used as a lifeboat on most relatively new watercraft. Scavengers most often find porta-boats in the ruins of stores selling camping gear, in the ruins of boats and at docks.

## **SUPER-CAVITATING MINISUB**

Near the end of the 20th century, Russian naval engineers discovered a way to design torpedoes that can travel at speed of up to 200 mph. By the middle of the 21st century, this same technology have been improved and adapted so that engineers could use it on full-size submarines. Eventually, they refined it sufficiently so that small minisubs could also become super-cavitating. Powered by MHD jets these subs can reach a top speed of 350 mph, with a cruising speed of 300 mph. These subs look like rounded tapering cones, with extremely short, stubby wings, much like a 1960s fighter plane. They also handle much like a fighter plane and are able to bank, turn, and dive as easily and almost as rapidly in the water as conventional aircraft can move in the air.

Each minisub is 30 feet long, 8 feet wide and has room in its large cockpit for up to four Medium humanoids — six if the ones in the back seat are willing to be extremely crowded. In addition, the sub can hold up to 500 lb of cargo in a small cargo hold. The minisub can operate for up to 15 hours without recharging and can cross the Atlantic Ocean in less than 10 hours. Minisubs unfortunately require prodigious amounts of power. The sub holds the equivalent of 50 rechargeable power cells. A simple adaptor (Purchase DC 6 or DC 15 Craft (Electronics) check to make one from scratch) allows a minisub to drain power cells to recharge. Otherwise, it must use a conventional recharger. Each hour of operation requires six hours of charging time from the built-in solar recharger or two hours from a recharger drawing current from a wall outlet or other power source.

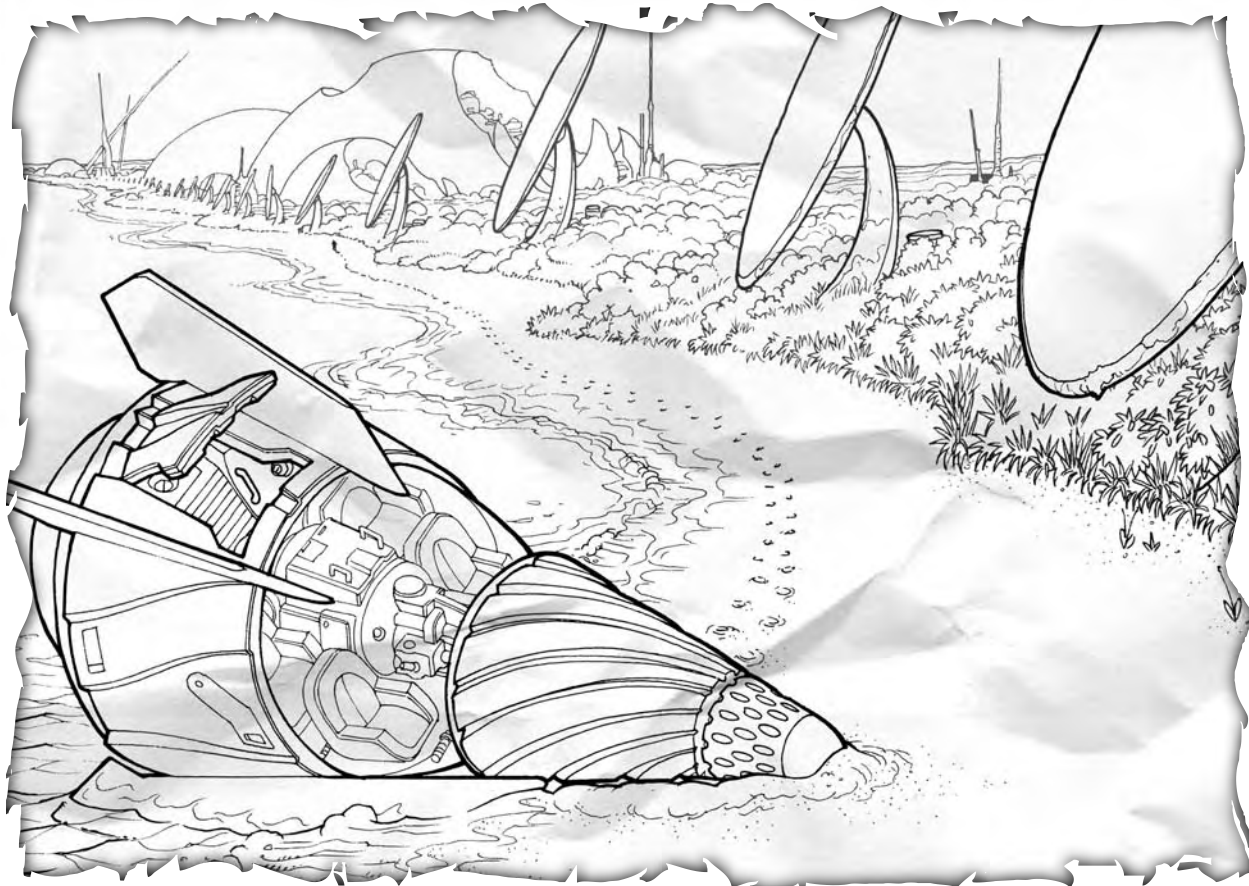

The sub's advanced computer and simple controls give all pilots a +2 equipment bonus to pilot this vehicle. Because many of these vehicles were military craft, most minisubs were armed with torpedoes (equal to a battery of anti-tank missiles) and a special microwave gun designed to operate underwater. The pilot can only use the torpedoes against targets in the water. However, if the sub is on the surface, the microwave gun can also be used to fire on airborne targets or targets on land. Every 50 shots from the microwave gun reduce the minisub's endurance by one hour. Many subs that scavengers uncover have run out of torpedoes, but traders, explorers and pirates all greatly covet both the microwave guns and the subs. Although some navies and couriers continue to use these subs, pirates also now own many of these vehicles. These pirates use minisubs to prey upon both ports and conventional surface vessels with little risk. Even an unarmed sub can potentially capsize all but the largest conventional ships if the pilot is willing to be daring enough to sideswipe the ship at top speed (DC 20 to safely perform this maneuver). When correctly performing a sideswipe only the minisub's wake ever actually touches the ship.

## UNDERSEA BIO-POD

**Undersea Bio-pod:** Huge animal; HD 5d8+10 (32 hp); Mas 14; Init +3; Spd swim 90 ft (18 squares); Defense 16 (-2 size, +3 Dex, +5 natural), touch 11, flat-footed 13; BAB/Grp +3/+12; Atk tentacle +4 melee (1d6+3); Full Atk 2 tentacles +4 melee (1d6+3), slam +4 melee (1d6+3) or gore -1 melee (2d6+3); FS/Reach 10 ft/10 ft; SQ Blindsight (120 ft), Keen Scent; DR 5; AL humans; other bio-pods; SV Fort +6; Ref +9; Wil +1; AP 0; RP 0; Str 16, Dex 16, Con 14, Int 12, Wis 12, Cha 10.

**Skills:** Listen +8, Navigate +8, Spot +4, Survival +8, Swim +8, Tactics +4

**Feats:** Guide, Lightning Reflexes

**Special:** Can carry one passenger and 60 lb of cargo

While high-speed submarines rivaled the speed of airplanes, some water-travelers wished to have a more subtle and a vividly direct experience of ocean travel. Research biologists designed the first of these vehicles, but bio-pods rapidly became popular among wealthy tourists, smugglers, spies and thieves. This vehicle is actually an organism bred from a fusion of dolphin and squid genes, which accepts various types of humans as temporary symbionts. The creature appears to be a (very large) dolphin with a large squid-like mantle around its

middle. While squids normally use their mantle for both breathing and jet propulsion, in the bio-pod, the mantle provides no propulsion: the creature moves by means of its powerful flukes. Instead, the mantle holds the gills that allow the bio-pod to breathe water, forms a place where the bio-pod's eight tentacles can retract and the upper portion of the mantle serves as an opening into the interior space where the pilot rides.

All bio-pods can accept one Medium or Small humanoid, who can act either as pilot or simply a passenger. Although the inside of the bio-pod's living cockpit is lined with skin, it does contain a pair of highly specialized tentacles that are marvels of biotech engineering. One ends in a fleshy pad that cups itself over the humanoid's mouth and nose, providing the rider with air and fresh water. The other exudes artificial neurotransmitters that allow it to interface directly with the rider's nervous system. This tentacle attaches itself to the base of the user's skull and allows the rider to access all of the bio-pod's thoughts and senses and to communicate with the bio-pod. Because both dolphins and squids are exceptionally bright, little effort was required to make the bio-pod fully intelligent.

The original bio-pods were loyalty conditioned to obey their human partners in all ways and to be ideal

underwater servants. However, since the Final Wars, the bio-pods have bred and thrived free from human control. They are now somewhat solitary individuals who communicate with each other over long distances using their powerful sonar. They frequently come together to work on projects that require multiple individuals and while some have taken to raiding human and mutant animal settlements, the vast majority regularly make deals with humans, trading their services for goods made from metal and useful and water-proof items of Pre-War technology. Most bio-pods greatly enjoy the sensation of having a human pilot or passenger. Some make deals with specific individuals, while others sell their services to an entire village. Typically, small schools of two to four bio-pods make deals with coastal communities.

Since they contain both oceanic and river dolphin genes, they can survive equally in fresh and salt water and there are bio-pods in the Columbia and Mississippi rivers and in the Great Lakes. Although they use sonar for long-distance communication, close up, they can either speak in air, since they still retain fully functional lungs, or they can communicate far more rapidly using their ability to change color in complex patterns.

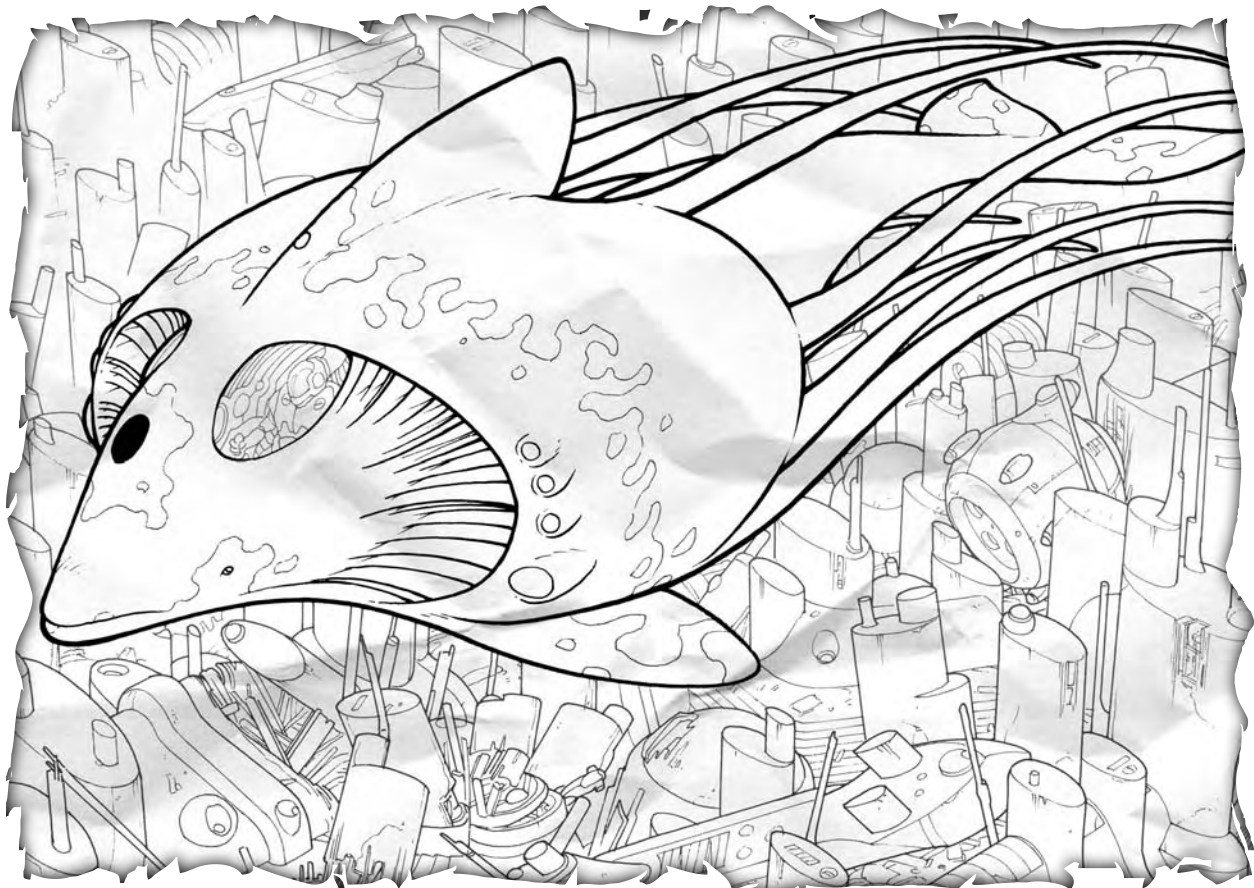



# FLYING VEHICLES

Although the basic principles of air travel remained the same from the dawn of flight in the early 20th century until the Final Wars, advances in engines, materials and controls meant that air vehicles built shortly before the Final Wars were light and self-repairing, and some of them literally never required fuel. Since the Final Wars, people have continued to understand that flight give anyone who possesses it a vast advantage. Someone who can fly can travel great distances swiftly and safely. Bandits, militia bands and traders all consider operational flying vehicles to be incredibly valuable. The most common form of propulsion for both air vehicles and ground vehicles that use magnetic levitation are MHD jets, using electricity to ionize the air and then accelerate it at high speeds. The jets require no fuel, since power cells provide all of the electricity they require.

## CITY SPHERE (BUBBLE CITY)

By the middle of the 21st century a growing number of people had become dissatisfied with conventional governments and wished to set up their own self-governing communities. Some built undersea settlements on the continental shelves, a few constructed based on the moon and Mars, but most left national boundaries behind and lived on large mobile cities. The first of these nomadic metropolises were a huge ocean-going ships designed to be floating cites, where residents lived and in many cases telecommuted to high-paying jobs elsewhere. These ships were heavily automated and required very little maintenance. As the 21st century went on, more governments recognized these vessels as free cities that belonged to no nation as long as they avoided direct contact with sovereign territory of ground-based nations. At the end of the century, ambitious separatists applied the same principle to airborne facilities.

Based upon the ideas of 20th century polymath Buckminster Fuller, these floating cities were geodesic spheres one to three miles in diameter, built with light

weight ultra-strong materials like diamond and nanocomposites. These airborne metropolises are giant hot air balloons. Sunlight heats the color-changing upper half of the sphere, supplemented by heat from various light industries powered by the huge banks of solar cells covering portions of the great sphere. Spheres one mile in diameter held up to 10,000 people, while the three-mile spheres held populations of over a quarter million. All buildings sat on vast habitation rings between 50 and 100 yards wide and a few feet thick girding the inside of the lower halves of these huge spheres. The smallest spheres had between 15 and 20 habitation rings, while the largest bubble cities had as many as 100.

These city spheres were exquisite works of urban design. The apartments and shops inside had walls as thin as a sheet of cardboard but as strong as steel and automatic machinery kept the cities supplied with fresh water, power and limited amounts of food grown in hydroponic tanks. By the beginning of the 22nd century, there were more than 250 city spheres. Increased terrorism and general discontent led more people to seek out a life far above the troubles of others. While the city spheres periodically docked at the tops of tall buildings or on specially constructed masts, most of the time they floated several miles above the ground, safe from almost any form of harm. The inhabitants of most of these cities became increasingly worried about violence on the ground reaching them, so they installed advanced systems to purify their air and water and to keep out toxins, diseases, hostile nanomachines and radiation. Bubble cities protected everyone inside as effectively as a Sealed Environment Dome. Most of these cities also armed themselves with three to six ion cannons, which helped protect them from attack.

When the Final Wars came, various terrible weapons instantly destroyed most of the city spheres and all of the city spheres that lacked the latest air purification systems soon became floating ghost towns or were consumed by ravenous hostile nanomachines.

**TABLE 4-3: FLYING VEHICLES**

Name	Crew	Pass	Cargo	Init	Maneuver	Top Speed	Defense	Hardness	Hit Points	Size	Purchase DC
Convertible microlight	1	3	200	-2	+1	2,000/120	10	5	35	H	36/39
Jet pack	1	0	259	0	+2	200	6	5	12	S	29/32
Portable airship	1	6	700	-6	-2	120	7	10	31	H	32/35
Suborbital Shuttle	0	8	1,000	-2	-6	7,000	8	20	64	G	n/a

However, 54 of these wonders survived the Final Wars and 51 of them are still flying. While the self-repair systems have kept the cities and their various systems intact, many of the devices owned by the residents ceased working long ago. Today, the most advanced cities contain some of the highest levels of technology left, but most are at the same level as some of the more advanced pure-strain human enclaves.

Three of the seven most advanced cities — New Florence, High Orleans and Arielle — have become hated dens of slavers and air pirates that periodically anchor themselves over ground-based settlements and steal food, raw materials and valuable technological relics from the people below them at gunpoint. Using hover cycles and other flying vehicles, the inhabitants swoop down and steal these goods while the city trains their ion cannons on the people below. However, the vast majority of these cities are enclaves of merchants and traders. Drifting like vast hot air balloons, these trading cities float across the world, landing at various settlements to trade and at the ruins of cities to scavenge whatever useful items their residents can uncover. The inhabitants mostly trade for food and useful artifacts, since the cities meet most other needs.

## **CONVERTIBLE MICROLIGHT**

Wealthy aviation enthusiasts and weekend travelers developed the precursors to this sort of vehicle. Less ethical engineers soon created more advanced versions For smugglers and spies. The frame of this plane is made from hundreds of segments of precision-made nanodiamond, while the skin of the plane is an advanced polymer that serves as a substrate for a layer of powerful nanomachines. Many versions of this plane simply pack into a large steamer trunk. However, the most advanced and most common version folds itself into both a small storage box suitable for packing in the back of a large van and a small open-framed three-wheeled ground vehicle that seats four people. The ability of this vehicle to work as both an off-road three-wheeled motorcycle and as an advanced ultralight plane made it incredibly popular.

When completely folded, it forms a shape like a round-edged brick, 6 feet long, 3 feet wide and 3 feet high. Unfolding it into a three-wheeled vehicle (with one wheel in the front and two on the back) is extremely easy, since the vehicle's multi-phase form-changing struts perform much of the effort. Folding or unfolding the vehicle for its storage configuration to its ground-vehicle configuration requires five minutes. This vehicle is 9 feet long, 3 feet high and 4 feet wide with large tires designed for off-road use and a small bubble-like cabin capable of holding four passengers

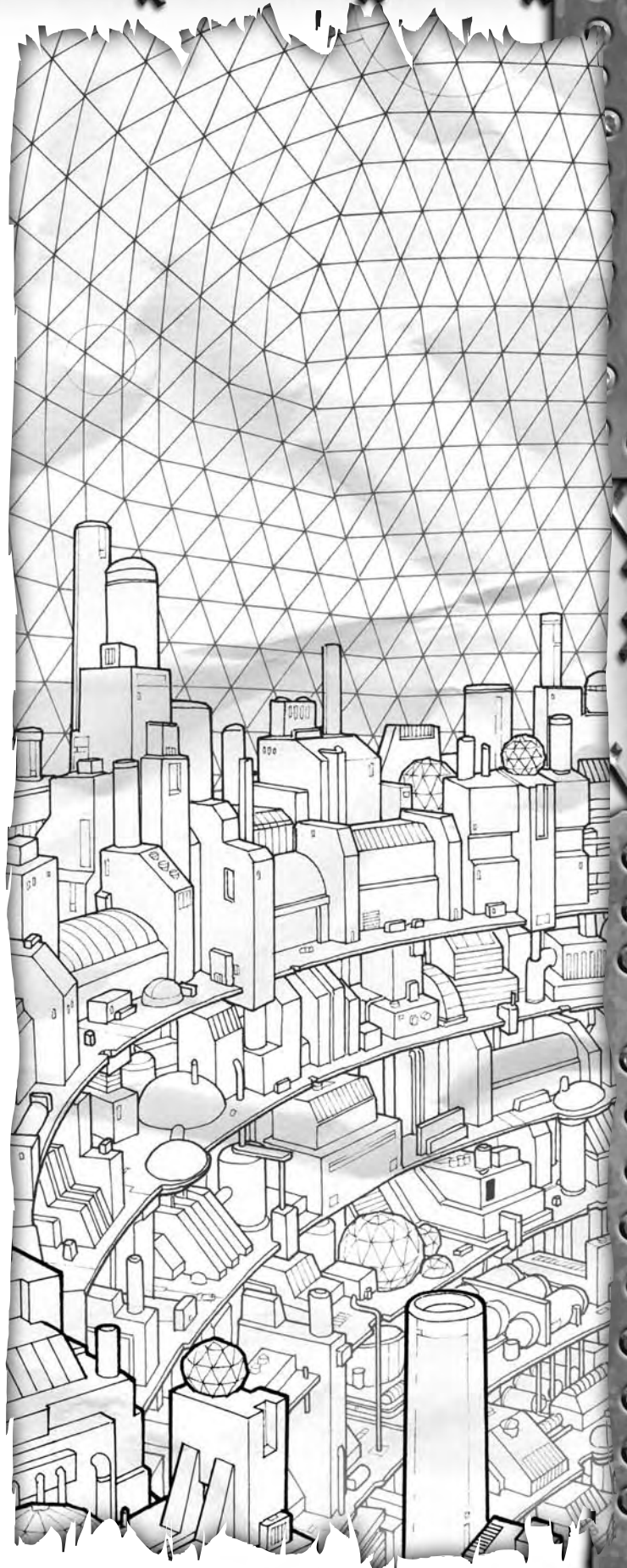

in the front and up to 200 lb of cargo in a small compartment in the back. When fully charged, this vehicle can drive for up to 60 hours without recharging, with a top speed of 30 mph off-road and 60 mph on a flat and well-maintained road.

Folding or unfolding the vehicle from a ground vehicle to a high-speed microlight plane requires 10 minutes. The wide, wing unfolds first, from a space just behind the passenger bubble. This extremely thin diamond-shaped wing is 20 feet wide and 12 feet from to back. The high-efficiency thin-film solar cells that cover the wing recharge this vehicle's power cells. Every two hours the wing sits in bright light recharges eight hours of driving time or one hour of flying time. When the plane is fully unfolded it can take off using its powerful MHD jets. It has a top speed of 700 mph and a cruising speed of 600 mph).

The plane is equipped with an advanced autopilot and in relatively good weather, the occupants need only instruct the plane where they wish to go, either using the onboard electronic map database or by directing the plane to fly in a particular direction for a specific distance. It requires no more than 50 feet of relatively flat ground to take off or land. In the air, the plane is exceedingly maneuverable and it can safely fly as low as 10 feet off the ground, automatically skimming treetops and dodging obstacles. The plane can also fly as high as 40,000 feet and has a fully pressurized cabin. It can fly for up to eight hours before its built in power-cells must be recharged. Empty, the plane weighs 400 lb, and it can hold up to four people and 200 lb of cargo.

## JET PACK

By the end of the 21st century, advanced superconducting batteries and MHD jets had made the dreams of middle of the 20th century a reality. Jet packs allowed spies, extreme sports enthusiasts and many others to fly more freely than humans had ever done before. A jet pack looks like a hard-sided backpack, 20 inches long, 12 inches wide, and 8 inches thick. It weighs 25 lb and when the user activates it, a pair of foot-long nozzles unfold from the pack, one on each side of the pack. These two nozzles allow the user to rapidly steer by shifting his weight. Advanced sensors and sophisticated computer controls insure that even this crude form of steering causes the jet-pack to fly smoothly and avoid hitting obstacles.

The user puts on a jet pack by slipping her arms through the two shoulder straps and then adjusting both the belt and the X-shaped straps on the front that run from the user's shoulders to her hips. Safety

interlocks in the jet pack do not allow the user to activate it until she has safely buckled herself into it. Putting on and adjusting a jet pack takes two complete rounds. Activating a jet-pack is a move-equivalent action. Users control the jet-pack by controls mounted on the unit's belt. The user can either land manually and have the safety interlocks cut power when the user touches down, or she can press one button and the unit will immediately land at the spot directly below it current location. Because it uses MHD jets, this vehicle is almost silent – users can land quite stealthily by succeeding at a Move Silently roll.

Jet packs can lift up to 450 lb, allowing a normal-sized user to carrying another person if she wishes. Some jet-pack using raiders grab their enemies and fly high into the air. Then the raiders either let their victims fall to their deaths or demand to know some piece of useful information and threaten to drop the person if they do not comply. Able to travel at speed of up to 100 mph, the only significant limitation on its use is that the user must recharge the jet-pack's power cell after only three hours of continuous flight. While they are incredibly maneuverable and allow the user to flee pursuit with ease, without a regular supply of power it is not useful for long-distance transportation. Jet-packs were both uncommon and quite expensive before the Final Wars, so they are now quite rare difficult to find. Only a few thousand are in common use, but many more lie buried in various ruins.

## PERSONAL WING

**Personal Wing:** Medium creature; HD 3d8+6 (19 hp); Mas 14; Init +3; Spd 20 ft (4 squares), fly 120 ft; Defense 16 (+4 Dex, +2 natural), touch 14, flat-footed 12; BAB/Grp +2/+5; Atk claw +6 melee (1d6+3); Full Atk 4 claws +6 melee (1d6+3); FS/Reach 5 ft/5 ft; SQ keen sight, low-light vision; AL rider (bonded personal wings only); SV Fort +5; Ref +6; Wil +1; AP 0; RP 0; Str 16, Dex 16, Con 14, Int 2, Wis 12, Cha 4.

**Skills:** Hide +2, Jump +6, Listen +6, Navigate +4, Spot +6, Survival +4

**Feats:** Multi-Attack

**Purchase DC:** 27

Genetic engineers created this biotech flyer from highly modified eagle, using limb doubling to give the flyer four legs to hold onto its rider. The resulting creature is narrow-bodied and bird-like, with four long legs that end in small claws. It has large feathered wings that can extend up to sixteen feet from tip to tip. These powerful wings, combined with the telekinesis engineered into the creature, allow the personal wing to carry one passenger and 50 lb of cargo and fly at speeds of up to 60 mph. All of these creatures have the





urge to obey simple voice commands embedded in their DNA, so they are extremely easy to pilot. Although they are living creatures, riding one is both quite simple and much like piloting a hang glider so that pilots use either the Pilot Skill or the Pilot (Aerial Mount) Skill to fly a personal wing.

Personal wings are quite strong and can carry a user for up to eight hours before needing to rest. At this point, it is quite tired and must rest for eight hours and have a large meal before it can again carry someone. Personal wings eat meat and every day that they carry someone for more than six hours, they are too tired to hunt. Therefore, the user must instead provide them with food. Personal Flyers weight 30 lb and must consume at least 3 lb of meat a day to remain healthy. Although some are now treasured pets, other personal flyers have gone wild and live as powerful aerial hunters. They grab large prey, which can sometimes include humans, carry it high into the air, drop it and then feast on the battered corpse. However, their genetic programming remains strong and if the person they pick up is familiar with the voice commands used to control them, she can not only avoid death but also can suddenly acquire a loyal flying mount.

All that is necessary to cause a personal flyer to bond with someone is to allow it to taste a small amount of the user's blood and then for the user to take it up for a short flight. At the end of this flight, the personal wing will follow the user around and will leap onto her back one turn after its user calls it. Personal wings can breed in the wild and while relatively rare, in mountainous areas some animal-sellers make a living capturing these prized mounts and selling them to anyone who wants to own their own personal flying mount.

## **PORTABLE AIRSHIP**

Originally created for airship hobbyists, this exotic mode of transport also became popular among smugglers and a few free-lance spies since it was easily portable and could fly below radar coverage. Although hydrogen and helium provide excellent lift, nothing can rival the lifting power of a contained region that is in vacuum. The only problem is that normal air pressure will collapse any container that is not extremely strong and such strength normally means that the container must be far too heavy for the vacuum inside to lift it. However, the development of nanotech manufacturing changed all of that. Al-Batutta Aerospace developed a unique phase-changing flexible

diamond material in 2102. Precisely controlled pulses of electricity convert this material from a flexible and incredibly tough airtight fabric to a steel hard, paper-thin diamond shell in less than 5 minutes. This same material forms the airship's open cabin and the housing for its high-efficiency MHD jets.

The portable airship breaks down into four separate 65 lb packages that each fit into an ordinary backpack. One of these packages holds the balloon, another holds the cabin and the microelectronics that control the airship and the remaining two contain the electrically powered MHD engines. When fully inflated, this balloon is an ovoid 50 ft long and 30 ft in diameter. When deflated, it collapses down into a flat sheet that automatically folds up into a cube 18 inches on a side. When fully deployed, this balloon can lift an additional 2,100 lb into the air. The airship normally carries up to seven passengers and 700 lb of cargo (or fewer passengers and more cargo). Although previous airships were extremely vulnerable to damage, this vehicle's high damage reduction, combined with its self-repair capability and the modular nature of the vacuum cells means that even a direct hit on the balloon will not cause the vehicle to crash.

Micro-thin solar cells cover the upper surface of the balloon, so this vehicle can recharge its power cells either by spreading the uninflated balloon out in the sun or by flying in direct sunlight. These solar cells also power the vehicles power cell recharger. The airship can fly at its top speed of 60 mph for 12 hours for every six hours it is exposed to sunlight (if it flies in sunlight for eight hours, it can fly for an additional eight hours in the dark). The airship can fly up to three miles above the ground and can safely fly in any weather except heavy storms.

Assembling and inflating this airship requires 15 minutes of work, as does deflating and repacking it for transport. The four sections are clearly marked for easy assembly and doing so requires no skill. The user can inflate or deflate the airship with the push of a single button — once she hooks the four separate units together, the entire process is completely automatic. For safety, the user cannot deflate the airship unless it is on the ground. More than twenty thousand of these airships survived the Final Wars. Today approximately half are waiting in ancient ruins for someone to discover them. Nomadic air-gypsies use many of the rest of the vehicles — these aerial vagabonds travel from settlement to settlement, trading, performing odd jobs, recharging power cells and bargaining courier services for food and other goods.

## SUBORBITAL SHUTTLE

**Suborbital Shuttle Als:** Str —, Dex —, Con —, Int 12, Wis 12, Cha 12.

**Skills:** Diplomacy +4, Knowledge (gossip) +4, Knowledge (history) +4, Navigate + 12, Pilot +12, Sense Motive +4, Technology (Pre-War) +2, Technology (advanced) +2.

**Feats:** Guide, Renown, Tech Familiarity (Pre-War Tech)

Considered by many people to be the fastest and most luxurious form of private long-distance transportation, suborbital shuttles were another advance made possible by the development of small fusion reactors. This vehicle is a fusion-powered rocket-jet capable of reaching speeds of Mach 6 (over 3,500 mph) and can reach anywhere in the world in under four hours.

Shaped like a rounded cone, suborbital shuttles are 35 feet tall and 20 feet wide at the base. The shuttle has a door 10 feet up the side. When the door opens, a set of folding stairs automatically extends down to the ground. The interior is richly outfitted with eight large comfortable acceleration couches, as well as other accommodations, including plumbing, a tiny but efficient kitchen and an exceptionally comfortable shower. Since the acceleration couches easily convert to both chairs and comfortable beds, passengers can actually live inside a suborbital shuttle.

While passengers must strap in during takeoff and landing, they can freely move about the cabin during the rest of the flight. The shuttle contains a wide selection of music and videos that passengers can play, as well as a bar and storage for snacks. Unfortunately, users must supply their own beverages and snacks. The fusion reactor in a suborbital shuttle provides it with effectively unlimited power — it could theoretically fly continuously. This fusion reactor also provides current for both the power cell recharger in passenger compartment and the shuttle's nanotech based self-repair systems. Suborbital shuttles heal as well as any synthetic character and are effectively immortal.

Computerized controls and a vast map database allows passengers to obtain detailed images and information about any place on the globe and take the shuttle there, the only limitation on the shuttle's movement is that it is a high speed vehicle and cannot make journeys of less than 500 miles. Unfortunately, the information in the map and travel databases all dates from before the Final Wars, and is now seriously outdated. What was once a thriving city noted for fine food and excellent jazz bars could be either a glassy radioactive plain or ruins filled with mutant cannibals.

These vehicles are more than the ultimate method of long distance transport. They are also fully intelligent beings. Designed for use by wealthy corporate and government officials, they can literally fly themselves and in fact have no manual controls, only the computer can pilot the shuttle. Over the years, all of these computers have evolved their own personalities and desires. Like many soultech creations, these vehicles no longer blindly obey humans. Instead, they are all aware that their actual owners died many decades ago and now consider themselves to be free-willed beings. Most only carry passengers if these passengers are willing to provide useful services in return. These vehicles cannot be purchased, prospective passengers must bargain with the shuttle for passage.

While they are not all identical, their initial programming significantly constrained their emergent personalities so that they all evolved along similar lines. Suborbital shuttles love to travel, but even more than that they are all deeply curious about the places they visit. The vehicles love hearing stories about the places they go to and are especially eager to obtain detailed information about such places and enter it into their databanks. Most of these ships carry several digital cameras and half a dozen or more sense specs (see Chapter Two) for their passengers. The shuttles love to have an opportunity to actually see what their passengers are experiencing. Suborbital shuttles are favorably inclined towards anyone who records images and then describes or writes about what they saw. Most shuttles will carry passengers who are willing to provide information about where they have been and to collect information about the locations they visit.

If a shuttle does not know or completely trust its passengers, it will sometimes refuse to unlock some of their baggage from the baggage compartment until they come back with the information the shuttle desires.

Suborbital shuttles are also able to protect themselves from dangerous passengers. These vehicles are equipped with advanced sensors capable of detecting any weapons that a passenger may be carrying. Most will request that all weapons and other gear must be stowed in various compartments before take-off and will refuse to take off until the passengers comply.

If a passenger attempts to threaten the shuttle, it has anti-hijacking capability that allows it to electrify all or part of its interior, doing automatic (no roll to hit is required) stun gun damage to anyone or everyone inside. In addition, these shuttles have learned that if they fly several miles straight up and then hover, most passengers realize that if they attack the shuttle, they could easily die. Finally, suborbital shuttles can literally shake aggressive passengers into compliance. Anyone who is not strapped in when the shuttle takes off takes 1d8 points of subdual damage (halve this damage if the passenger can make a DC 20 Reflex save and successfully brace herself). If the shuttle wishes, it can undergo sufficient acceleration to cause everyone on board to fall unconscious for 1d6 x 5 minutes if they fail a DC 15 Fortitude save. Reduce this DC to 10 for anyone who is strapped into an acceleration couch.

Several dozen suborbital shuttles have developed long-term partnerships with groups of explorers. The explorers ride in the shuttle (and in most cases, live in the shuttles' comfortable and self-cleaning interior) and collect information for it. These shuttles and their crews possess most of the best present day maps and geographic and sociopolitical data currently available. Some of the ships trade information back and forth by radio and are currently attempting to produce a complete atlas of the Gamma Age world. Characters who wish to work in this project and who are willing to treat a suborbital shuttle as an equal partner could find both a home and a career of the encounter a shuttle that is looking for a crew.



**COMING SOON...**



**GAMMA  
WORLD**

# GAMMA WORLD<sup>®</sup>

## CRYPTIC ALLIANCES & UNKNOWN ENEMIES<sup>™</sup>

### HOME SWEET HOME

IT'S A DANGEROUS WORLD OUT THERE, AND GAMMA WORLD CHARACTERS RELY ON THEIR COMMUNITY FOR REST AND SUPPORT. BUT THE HOME FRONT HAS ITS OWN OPPORTUNITIES AND PERILS.

### THE HELPING HAND, THE KNIFE IN YOUR BACK

THIS BOOK FLESHES OUT THE CRYPTIC ALLIANCES THAT POPULATE THE GAMMA AGE, EXPANDS ON THE INNOVATIVE RULES FOR COMMUNITIES, OFFERS A ROGUE'S GALLERY OF READY-TO-USE LEADERS, RIVALS AND OTHER IMPORTANT MEMBERS OF THE CHARACTERS' COMMUNITY AND PRESENTS RULES AND ADVICE FOR CHARACTERS WHO TRY TO LEAD THEIR OWN COMMUNITY OR FOUND A NEW ONE.



GAMMA WORLD BOOKS ARE PUBLISHED UNDER LICENSE WITH WIZARDS OF THE COAST AND ARE 100% COMPATIBLE WITH D20 RULES.

NOW AVAILABLE

GAMMA  
WORLD  
MACHINES  
AND MUTANTS



A Creature Sourcebook for the d20 System

GAMMA  
WORLD



## Super-Science Unleashed

The warriors and scholars of the Final Wars hid many of their best tools and weapons. Centuries later, many of those secrets still wait for someone to dig them up and turn them loose... for good or evil.

What did the people fighting the Final Wars deem too terrible, or too unimportant, to let anyone know about? This book lays it all out, along with new rules for analyzing mysterious technology and for improving the technological level of the heroes and their community.

**Requires the use of the d20 Modern™ Roleplaying Game or the Dungeons & Dragons® Player's Handbook, v.3.5, published by Wizards of the Coast®.**

The Gamma World campaign setting is an officially licensed Wizards of the Coast property.

ISBN 1-58846-022-3  
WW17253 \$21.95 U.S.



[www.swordandmagic.com](http://www.swordandmagic.com)

