

STAR WARS®

THE

DARIK STRYDER

C A M P A I G N



FEATURING AN ORIGINAL STORY
BY TIMOTHY ZAHN *AEW 95*

A long time ago in a galaxy far, far away ...



Four years after the Battle of Endor, the struggle against the remnants of the Empire continues. With the New Republic struggling to liberate Imperial worlds, rogue Imperial leaders have turned to ever more desperate tactics to hold power.

In the distant Kathol sector, a New Republic task force attempts to defeat Imperial warlord Moff Sarne. As Imperial and New Republic starships battle in orbit, a small New Republic infiltration team, Page's Commandos, leads the assault on Sarne's stronghold ...

THE SAGA BEGINS

BY TIMOTHY ZAHN

It had been a remarkably easy military insertion, as such things went, and for a while Lieutenant Page had actually dared to hope they might make it in without so much as scratching the paint on their borrowed Ghtroc 720. But combat luck—or the Force, or whoever was in charge of these things—invariably liked to remind the participants who the boss was here, and at the last second an Atgar 1.4 FD P-Tower on the Imperial Government Complex's perimeter suddenly seemed to notice that one of the freighters scurrying for cover from the massive New Republic orbital attack wasn't scurrying anywhere near the properly designated landing field. Syla Tors had just enough time to yell "Incoming!" before the laser blast scored through the starboard repulsorlifts, and the Ghtroc went tumbling to the ground. It skidded along the manicured grassland, demolished a pair of decorative shrubberies, and with a brilliant shower of sparks drove through the edge of the perimeter death fence. Half in and half out of the enclosure, the fence still arcing furiously around its stern, it finally came to a lopsided stop.

"Nice job, Tors," Page grunted, popping his restraint harness as he peered through the cockpit canopy. Not exactly a model landing, but it had gotten them pretty much where they'd wanted to go. For a Special Ops team, that was rather more than one could expect.

"Thank you, Lieutenant," Syla said. "You weren't wanting this thing to fly again, were you?"

"Apparently not," Page said, pulling himself out of his now canted seat and looking back at the other four commandos similarly extricating themselves from their restraints in the cargo bay behind the cockpit. "Anyone hurt?" he called.

"No, sir," Sergeant Keleman Ciro answered for all of them. "I wish you'd teach Tors how to land these things."

"I've never been good with loaners," Syla countered dryly. "Booby-trap is set."

"Good," Page said, unlimbering his blaster and stepping to one side of the hatchway. Kaiya Adrimetrum was already at the other side, her own blaster held ready, her free hand resting on the hatch release. Humorless even at the best of

times, her face was set in unusually grim lines.

"It's a mission, Adrimetrum," Page reminded her quietly. "Don't start taking it personally."

"I won't, sir," Kaiya said, just as quietly. But the grim lines stayed where they were.

The rest of the team was in position now. Page nodded to Kaiya; and with the screech of a mechanism warped out of true by the crash, the hatchway ground itself open.

Page was out before it finished its movement, dropping into a crouch with blaster ready as Kaiya and the rest of the team followed him down. About three hundred meters straight ahead the slender administrative officespires and squat military structures of Moff Kentor Sarne's government center rose from the hills around them, the silver metal and white stonework sparkling in the starlight and the reflected sputterings of light as nearby turbolasers and ion cannon fired furiously at the New Republic assault force arrayed against it.

A force that didn't have much choice but to sit there and take it. Moff Sarne had turned Kal'Shebbol's only continent into a minor fortress, with an energy shield protecting it from above and an abundance of anti-assault weaponry at its shores protecting it from ground-level attack.

Given time, there was no doubt the New Republic could wear the defenses down. But with the war against the Empire still hanging in the balance in a hundred different sectors across the galaxy, time was a commodity they couldn't afford to waste. Especially not in a backwater locale like Kathol sector.

Hence, the energy shield had to come down. Hence, Page's Commandos.

Whether by skill or luck, Syla had picked their landing/crash spot well. Nestled in between two hills, the freighter seemed to be out of the immediate sight of any of the complex's perimeter defense stations. No vehicles were bearing down on them, nor were there any groups of outraged Imperial troopers charging in to complain about the damage to their death fence.

They had some breathing space. Maybe ten breaths' worth of it.

"Where in blazes is she?" Ciro murmured at Page's shoulder.

DARKSTRYDER



David & Dan Day

"Give her a minute," Page said, giving the area a quick sweep with his macrobinoculars. No one. "We weren't exactly on target, you know."

Ciro hissed softly between his teeth. "I hate when this happens."

"You need to cultivate your sense of adventure," Page admonished him mildly, sweeping the area again. Lilla Dade was probably the best Pathfinder in the entire Special Ops division, and if there was a back door into this complex she certainly would have found it for them.

If she hadn't been nabbed in the three days since they'd slipped her onto the planet.

If there was indeed a back door to find.

"We'll give her ten more seconds," he told the group. "If she doesn't show, we do it the hard way."

"You are Lieutenant Page?"

Page was on the ground, rolling away to his right, before the voice had even completely registered in his conscious mind. A deep, unfamiliar voice, spoken from his left.

From no more than a meter to his left.

He came out of the roll into a crouch, his blaster and Vandro's A280 blaster rifle pointed in the direction the voice had come from. Gottu flicked on a shielded glowrod—

Nothing.

"What in blazes?" Vandro muttered under his breath. Gottu swept the beam around, probing the area around the crackling death fence, piercing the shadows surrounding the crumpled underside of the freighter. Page threw a quick look over his shoulder, wondering if the voice had been some kind of trick to give the Imperials a chance to sneak up from behind. But there was no one there; and anyway, Kaiya and Syla were watching their back.

"You are Lieutenant Page?"

Page turned back again. Apparently, whoever was out there really wanted an answer. "Yes," he said. "You?"

"I am Kl'aal," the voice said.

And to Page's astonishment one of the shadows peeled itself away from the freighter's hull.

Vandro cursed, feelingly. "Agreed," Page said, frowning into the blackness that seemed to simply be absorbing the beam from Vandro's glowrod. Now that he was focusing on it, he could see in the shadow the silhouette of a broad-shouldered creature a little over a meter in height, with two reddish glints just about where eyes should be. "What do you want?"

"She awaits you there." The silhouette extended an arm-shaped shadow, pointing behind itself. "The Pathfinder."

Page cocked an eyebrow. "Is that all she said?"

"No," the shadow rumbled. "She also said to say, 'With songs tripping lightly over the forest green.'"

Page glanced at Ciro, got a microscopic shrug in return. It wasn't unheard of for Lilla to recruit local assistance in these little reconnaissance missions of hers. But finding a Defel on a backwater planet like Kal'Shebbol was definitely one for the files. "Take us to her."

Following a walking shadow was just about as tricky as Page had expected it to be. But they managed it; and two minutes later they rounded one final hill to find Lilla waiting for them.

"Thought that was you coming in," she murmured, rising from her concealment in another of the decorative shrubberies. "Tors managed to splat another one, I see."

"All the great artists have a signature style," Page reminded her, eying the hill beside them. It didn't look any different from any of the other ones in the area. "So where's this back door?"

"You're not going to believe it," Lilla said. "It's right here."

She led the way toward the side of the hill. Page followed, wondering what she had up her sleeve.

And suddenly, to his astonishment, a section of the hillside vanished; and there, running underneath the ground in front of them, was an armored tunnel.

Or rather, what was left of one.

Ciro gave a low whistle. "I'll second that," Page agreed, gazing dumbfounded into the darkness. The walls, ceiling, and floor of the tunnel had been sliced completely through, leaving a meter-wide gap in the thick metal. The hillside had suffered even more extensively; the hole extended several meters in all directions from the gap. "Dade?"

"No idea," Lilla said. "The rumors say Sarne's personal guards were trying some kind of experiment here and that something went wrong."

Page nodded, feeling an unpleasant tingle on the back of his neck. In the light from Gottu's glowrod he could see that the edges of the tunnel had been blackened and twisted, as if melted or burned. But only the edges. The rest of the tunnel seemed untouched.

What kind of cutting torch could burn through that kind of heavy armor and yet not even distort the metal two meters away?

For that matter, what sort of impossible hologram or camouflage had the Imperials used to hide it the way they had?

Abruptly, the sky to their right lit up, and the thunderclap of an explosion rolled across them through the night air. "Sounds like they've found

the freighter," Page said, stepping to the edge of the gap and bracing himself for the jump down. "Let's get moving."

The tunnel was pitch black, its lights and other power sources apparently cut. The group headed inward, their silenced boots making nearly inaudible thuds on the metal floor, their glowrods turned down to bare minimum. Page kept his eyes on the few visible meters of tunnel ahead as they ran, alert for the inevitable traps or alarms that must certainly be here.

But to his mild surprise, they reached the complex without springing any traps. Nor had they tripped any alarms, if the belated and ineffective reactions of the five Imperials on duty in the nexus control room at the end of the tunnel were anything to go by.

"Check those doors," Page ordered as the last echo of the commandos' blaster fire faded away. "Ciro?"

"I'm on it, Lieutenant," Giro said, hunching over one of the panels. "Okay. There's the main energy shield control room."

Page looked at the schematic he'd pulled up. That was the control room, all right: halfway across the complex, with Moff Sarne's whole Imperial garrison between them and it. "I was hoping for something a little more convenient."

"Working on it," Giro grunted, his hands playing across the keyboard. "Got to slice into the more private secret classified floor plans of the place ... there we go. Well, well—looks like Sarne has his own private bolthole."

"Imagine my surprise," Page said dryly, looking where Giro was pointing. The exit consisted of a narrow, slightly curved tunnel with secret entrances in both Sarne's chambers and office, the tunnel leading to an equally secret hangar set in the hills a kilometer or so outside the governmental complex. "Looks like a pretty standard Imperial bolthole."

"Right, but here's the interesting part," Giro said, tapping the hangar. "Moffs usually have a landspeeder or shuttle at the end of their rat hole. Just something to get them to wherever they've got their real starship stashed. Looks like Sarne went ahead and cut out that middle step."

Page frowned at the schematic. Giro was right: that was a full-sized *Carrack*-class light cruiser in there. Heavily armed, heavily armored, all set for a quick fade out of here.

And if Sarne had set up his exit route pointing straight into space ... "Which means he has to have a cutoff for the energy shield down there," he said. "Either in the tunnel or in the cruiser itself."

"Right," Giro said, sliding a data card into the slot and keying for a copy of the schematic. "Of

course, the tunnel's undoubtedly infested with Sarne's best guards."

"That's all right," Page reassured him. "Vandro and Gottu hate it when they have to lug the heavy armament along and don't get to use it. That's our target. Adrimetrum?"

"Sir?" Kaiya said, stepping to his side.

Page tapped another spot on the schematic. "There's yours: Sarne's private detention center. If your friend Lofryyhn's still alive, odds are that's where he'll be."

"He's still alive," Kaiya said, her voice tight.

She started to turn away; Page caught her arm and turned her back to face him. "If he's not," he warned, gazing hard into her eyes, "don't take it personally. All that'll do is get you killed along with him."

For an instant Kaiya's eyes blazed with fire. Then the fire vanished, and the stolid, humorless facade was back in place. "Understood, sir."

"Then get moving." Page glanced over at the others guarding the room's two exit doors. "Gottu, Dade—go with her."

"And me?"

Page started; he'd almost forgotten the ambulatory shadow standing quietly in the corner. Here in a brightly and evenly lit room the Defel was easier to see, but no less bizarre for all that. "Dade?"

"We'll take him with us," Lilla said, pulling out her spare blaster and handing it to the creature. "I'll take point, Kl'aal; you backstop me."

She slid open one of the two doors, glanced through, then slipped out into the corridor beyond, the Defel, Kaiya, and Gottu moving out behind her. "Timer's running, commandos," Page said, taking one last look at the schematic and gesturing to the remainder of his team. "Let's go."



It was all going to hell. All of it. The Rebel assault force was battering away at the capital's inadequate defense fleet, the antique energy shield generators he'd been saddled with were crackling with the strain; and now word had come that a Rebel Special Ops team had penetrated the complex.

It was high time, Moff Kentor Sarne decided, for him to be leaving.

"Maintain all defenses," he ordered, stepping down from the raised observation platform in the situation room and heading for the door. "And tighten security around all critical operational centers. I want that Rebel team found and neutralized."

"Yes, sir," the captain in charge said, barely glancing away from the status boards to acknowledge the order. A competent enough Imperial officer, dedicated if unimaginative. It was almost a shame to have to leave him behind.

But then, someone had to be here who could be relied on to fight this battle to the death. Or at least to the destruction of the capital and any DarkStryder modules that Sarne might not be able to collect before he left. The Rebels had already heard rumors; Sarne had no desire for them to get their hands on the actual devices, as well.

Four of his personal guardsmen were waiting outside the situation room door, along with two stormtroopers on door warden duty. "You two —" he jabbed fingers at two of the guardsmen — go to the main database computer. Omega order five, and watch out for the Rebels. Then meet me at the *Ambition*."

"Understood, sir," one of the guardsman said as the two headed off at a loping run.

"The rest of you come with me," Sarne ordered, turning toward his chambers. "You stormtroopers too," he added, gesturing to them. Stolid Imperial officers were a glut on the market; stormtroopers were in precious short supply. Not a commodity a man in his position could afford to waste.

Two more of his personal guards were flanking the door to his chambers. "Open up," he ordered them. "Then come with me."

The escape route was through the back of a floor-to-ceiling library case built into the wall beside his bed. "Get those data card boxes off of there," he ordered his guardsmen. "Never mind about neatness. You two—stormtroopers—pick up that chest over there."

A minute later the library case was empty, its contents strewn across the floor. Manipulating the hidden catch, Sarne swung the back panel open and flicked on the tunnel's lights. "No noise," he warned as two of the guardsmen headed in. "The rest of you, follow me."

The entrance was a tight fit, especially for the chest the two stormtroopers were carrying, but the tunnel widened out somewhat beyond it. Still, it was decidedly claustrophobic, and Sarne found his heart racing as they approached the side tunnel which led off to the secret door in his office. If the Rebels had located this private exit route and were waiting in ambush for him ...

But no one fired or leaped out at them as they passed the side tunnel; and ahead was nothing but empty corridor until they reached the underground hangar and the cruiser *Ambition* waiting there for them. Prepped and ready, crewed by

his finest and most loyal officers and men, loaded with all the DarkStryder technology those men could get aboard in the brief time they'd had.

"Sir!" the guardsmen at the rear hissed. "I hear someone coming up behind us."

"Defense positions," Sarne hissed back, looking around him. Nothing but flat tunnel wall all the way from here to the hangar. Nowhere to go, nowhere to hide.

But maybe he could do something about that.

The stormtroopers had set down the chest and joined the four guardsmen setting up the rearguard defense. Keying the lock, Sarne lifted the lid.

For a moment he pawed furiously through the contents, searching through the brightly colored modules for the one he wanted. That red tetrahedron? No; not the right size. That one? No; that was a square-base pyramid, not a tetrahedron. That one?

Yes; that one. Sarne lifted it out of the chest, feeling the usual tingling in his fingertips and wondering distantly if this was really such a good idea. Their first test with this particular DarkStryder module had gone horribly awry, destroying part of the labyrinth of defense tunnels that honeycombed the grounds around the governmental complex and killing two of his men in the process. Perhaps he should just keep going and trust his guards to hold off the Rebels long enough to make his escape.

No. Better to try the module again here, where he didn't really care about ancillary damage. Besides, if he left the guards and stormtroopers to deal with the Rebels, he'd have to abandon the chest here with them. He couldn't possibly carry it the rest of the way by himself.

The guardsmen and stormtroopers had arranged themselves in classic two-by-two-by-two sitting/kneeling/standing defensive posture, their blaster rifles pointed back along the smoothly curving corridor. Another of the modules in the chest caught Sarne's eye, a dark green trapezoidal solid he'd had successful practice with. Stuffing it into his tunic, he closed the chest and stepped a few paces back down the corridor. Holding the red tetrahedron out the full length of his arm, he pointed its tip down the corridor toward the guardsmen's backs. Bracing himself, he squeezed the base.

And abruptly the tip erupted in brilliant blue-green flame.

Sarne bit down on his tongue as a rush of heat rolled over his hand, fighting against the reflexive urge to jump backward away from the fire. That was what his two men had done, and the move had pulled the whole inferno rolling over

them. Instead, he stood his ground, holding the tetrahedron steady as the fireball expanded up, down, and to both sides, filling the corridor and forming a meter-wide wall of flame. There was a sudden cascade of yellow-white sparks as the leading edge of flame reached the ceiling; a moment later the walls and floor were similarly burning as the flame began pushing through them.

The tingling in his fingertips ceased, and as it did so the module's bright red color faded to black. Dead, or depleted, or whatever it was that invariably happened to these things after a single use. The techs had taken over a hundred of them apart; so far, no one had found a way to recharge them. Or had figured out what made them work in the first place.

Now, cautiously, Sarne tried taking a step back. The gamble worked: with the module dead the fiery wall stayed where it was, inexorably eating its way into the ten-centimeter-thick armor plate like a cutting torch slicing into packing plastic. The flame burned through, and the smell of vaporized dirt filled the corridor.

And then, as suddenly as it had appeared, the flame flickered and vanished.

Sarne stepped forward again, peered at the meter-wide gap in the walls, ceiling and floor. Excellent: there was now enough room on each side for two men to fire from concealment. "Back here," he called softly. "All of you—back here."

A few seconds later the four guardsmen were ensconced in their new protective firing ports. "Hold them off," Sarne ordered them. "Stormtroopers, bring the chest and come with me."

But too late. Even as the stormtroopers slung their blaster rifles and picked up the ends of the chest, the pursuers appeared around the distant curve of the corridor. Four of them, three men and a woman, dressed in camouflage jumpsuits, loaded down with weapons and combat gear.

Rebels.

"Fire!" Sarne snapped. "Get them!"

The order was unnecessary. But it also was too late. Showing a flagrant disregard for their own skin, the two leading Rebels had stopped dead in plain sight in the middle of the tunnel, lifted their blasters in two-handed marksman's grips, and fired. Even as the guardsmen began returning the fire, the Rebels' blaster bolts splashed and ricocheted off the armored walls—

And two of the guardsmen grunted and spun out of their partial concealment, falling limply in and across the flame-dug trench at their feet.

Sarne cursed viciously as he snatched the green trapezoidal DarkStryder module from his

tunic. His other two guardsmen were still firing, but the flailing of their comrades' death throes had knocked their aim off, sending their shots wide of the enemy. Close enough to scare back normal opponents, to be sure, but this enemy was hardly normal. They were insane Rebels, determined to capture or kill the Imperial Moff of this sector.

And unless Sarne did something fast, they were going to succeed.

The stormtroopers had dropped the chest and gone to their knees, trying to unsling their blaster rifles before the Rebels shifted their fire direction. They left Sarne exposed, but for once that was exactly the way he wanted it. Pointing the DarkStryder module down the tunnel, he squeezed the base.

A pale, eerie mist blasted out, flowing outward from the end like some impossible hybrid of wood smoke and the conical light beam from a glowrod. The edge of the flow missed the impromptu firing ports and kneeling stormtroopers, widening to fill the entire tunnel. It spilled at blinding speed toward the far end—

And with a satisfying suddenness, the Rebels' blasters fell silent. In an eerie sort of slow motion, they toppled forward to lie twitching on the tunnel floor. Sarne kept his grip on the module; perhaps if he gave them enough mindwarping it would kill them ...

The flow ceased, and the trapezoid turned black. Cursing, Sarne threw it on the floor. "Come on," he ordered his men.

"What about them?" one of the guardsmen asked, nodding toward the Rebels lying helpless in the thickening fog.

"Leave them," the Moff snapped, gesturing impatiently at the chest. It would be most satisfying to burn the Rebels where they lay, but it would waste time Sarne wasn't at all sure he had. The Rebellion forces high above his world were already pounding his fleet. The longer he delayed his escape, the less there would be of that fleet to escape with him.

Besides, there might be more Rebels coming up behind this first batch. Best to leave the mindwarper field undisturbed for them to run into. "Pick up the chest and get moving."



A distant sputtering screech filtered through the thick door of the detention cell, jolting Jessa Dajus out of the latest episode of her recurring nightmare. For a moment she lay motionless on the thin mattress, the last images of the giant

hungry spider fading slowly from before her eyes, trying to identify the faint crackling noise filtering into her cell.

And then she got it. Blaster fire. Lots of it.

She swung her legs onto the cold metal floor and stepped to the door. Blaster fire, all right; and here in Moff Sarne's private detention center it could mean only one thing.

The Rebellion had finally come to Kal'Shebbol.

The firing stopped. Jessa pressed her ear to the door, straining over the thudding of her heart to hear the muffled sounds coming from the other side, wondering which side had won. There was a single shot, from a heavy blaster, then a pause; then a second shot from the same weapon, and another pause. The Imperials had won and were summarily executing the losers? Ridiculous—Sarne would certainly run interrogations first. No, the Rebels must have won and were blasting open the detention cells. Searching for a specific prisoner, or else setting everyone free to add to whatever pre-invasion chaos they were here to create. Unless the invasion had already taken place, in which case—

Jessa caught her breath, her line of thought shattering in the sudden surge of almost-fear that flared through her mind. Another of those strange hunches that sometimes came to her; uninvited, unwanted, but always right.

And if the intensity she was feeling was anything to go by ...

"Hey!" she shouted, banging on the door. "Hey—out there! I've got to talk to you. Now!"

There was a pause. Jessa was just taking a deep breath to shout again when the door beside her reverberated with the sound of a blaster bolt and slid open.

A man and woman stood there facing her, dressed in camouflaged jumpsuits. She held a BlasTech DL-56 blaster pistol; he was cradling an A280-K blaster rifle. "It's all right," the woman said, her voice firm but with a soothing undercurrent to it. "We're friends."

"It's not all right," Jessa retorted, straining to crystallize some detail from the sensation still twisting though her mind. "There's danger here. Terrible danger. Something ... I think it's something you're going to cause if you keep doing what you're doing."

The two Rebels exchanged glances. "Can you be a little more specific?" the man asked.

"I wish I could," Jessa said, taking half a step out of the cell and looking both directions down the corridor. Another armed and jumpsuited woman was visible to the right, talking earnestly with a red-brown Wookiee, her free hand holding tightly onto his arm. Lofryyhn, Jessa seemed to

recall the Wookiee's name: a tech-skilled prisoner Moff Sarne had bought from slavers and put to work in the docking bays and on that Corellian Corvette he was having modified. A handful of other prisoners were also standing at the doors of their freshly opened cells, mostly looking dazed at what had just happened. "All I can tell you is that I first felt it when I realized you were blasting open the cell doors."

The male Rebel gestured to the woman and Wookiee. "Kaiya?"

"What is it?" the woman—Kaiya—asked as she and the Wookiee joined the little group.

"Prisoner claims there's some kind of danger in the cellblock," the man said.

"Yes—it's called Imperial reinforcements," Kaiya agreed dryly, studying Jessa's face. "You know of some other danger?"

"I don't *know* anything," Jessa said, starting to get annoyed. "I get these hunches—"

The Wookiee Lofryyhn growled something. "He wants to know who you are," Kaiya translated.

"My name's Jessa Dajus," Jessa said, watching the Wookiee out of the corner of her eye. It was just possible he knew who she really was ... "Lieutenant Jessa Dajus. I was a shuttle pilot for Sarne."

Kaiya's eyes flicked over Jessa's shoulder at the cell she'd just been released from. "One too many rough landings?"

"One too many loyalty purges," Jessa countered. "I ended up on the wrong side of the last one."

The Wookiee rumbled under his breath and headed suddenly back down the corridor. Jessa felt her muscles tense; but there was nothing she could do with three Rebel blasters pointed in her general direction. "I sometimes helped fly combat ships, too," she added. "Usually with Sarne's personal patrol. I know how he thinks."

"And how exactly does he think regarding his detention center?" Kaiya asked.

"Kaiya, we don't have time for a discussion," the other woman put in before Jessa could answer. "The timer's running down fast on this."

"I know," Kaiya said, her forehead furrowed with thought. "You two had better head out and link up with the others. Lofryyhn and I can release the rest of the prisoners and catch up with you."

"Not a good idea," the man insisted. "If Dajus is right about an ambush or something waiting for you down the road —"

He was interrupted by a triumphant Wookiee roar. Jessa spun around, to see Lofryyhn standing at one of the unopened cell doors waving a

massive arm at the lock mechanism. "What is it?" the male Rebel asked.

"Verification," Kaiya said, a sort of grim satisfaction in her voice. "Lofryyhn says that cell door is booby-trapped. Designed to bring the entire ceiling down, in fact, killing everyone in the cell block."

She looked back to Jessa, a speculative glint in her eye. "Must be some very important prisoners here for Sarne not to want to give them up."

"He's not what you'd call a good loser," Jessa said.

"I guess not." Kaiya looked both ways down the corridor. "Well, we definitely don't have time to check each cell for traps. We'll just have to leave the rest of the prisoners for later."

"We're heading for Sarne's bolthole," the male Rebel added, eyeing Jessa. "Maybe you'd like to come with us?"

Jessa smiled tightly. The invitation wasn't because they liked her company, of course. What they wanted was to make sure she didn't trot off to the nearest comm and call reinforcements down on them.

But the reasons didn't matter. What mattered was that if this commando group was part of an all-out Rebel invasion, Moff Sarne would indeed be scampering down that bolthole of his by now, heading for his escape ship and the safety of deep space. If Kaiya and her people were fast enough, they might still be able to beat him there.

And Jessa wanted to be in on the kill. Wanted it very much.

"I'd love to come along," she told the Rebel. "There's a hidden door in Sarne's office. Come on; I'll show you where it is."



It was odd, Page thought, how interesting the wall and floor of this tunnel were.

Absolutely fascinating, in fact. And that edge where the wall and floor actually intersected—utterly spellbinding.

But there was something he was supposed to be doing, wasn't there? Something associated with that floor and wall, perhaps? Or was it something having to do with the rustle coming from behind him?

The rustle coming from behind him?

With an effort, Page lifted his head and turned it, regretting as he did so the disappearance of the wall and floor from his view. But there was floor over here, too, and wall, and Sergeant Ciro pulling himself slowly along the floor.

That was exceedingly interesting, more inter-

esting even than the floor and wall by themselves. For a long time Page watched Ciro's movements, admiring the coloration and shifting pattern of wrinkles in his jumpsuit and noting how the light glinted off the edges of the blaster gripped in his hand.

Something caught his eye. He lowered his gaze toward the floor, discovering to his surprise and amazement that he too was holding a blaster. Cradled in his hand, it lay mostly on the floor, pointing away from him, and he could see his forefinger curled around the trigger. He moved the finger, watching in fascination as it wiggled there in the trigger guard. He wiggled it some more; and with a dramatic crack of sound, the tip of the blaster erupted in a burst of light.

And suddenly the whole thing collapsed like a dream shattered by a raid alarm.

"Cover!" he snapped, leaping up into a crouch and slamming his back against the wall. He looked both directions down the tunnel, fully expecting to see five squads of stormtroopers bearing down on them.

But there was no one. No stormtroopers coming to take advantage of whatever in blazes Moff Sarne had just done to them. No Moff Sarne, either, for that matter, or the guard contingent they'd been shooting at.

"What happened?" Vandro hissed. He was on his knees, pressed against the other wall, trying to point his A280 all directions at once. "Felt like a stun gas."

"Sure didn't behave like one, though," Page said, checking his chrono. At least he could explain why no Imperial reinforcements had shown up yet: what had felt like hours of helpless stupor had actually been less than two minutes. "We'll figure it out later. In the meantime, Sarne's only two minutes ahead of us. Let's get moving."

They hurried down the tunnel. But more cautiously this time. Page had never been accused of being the overcautious type, but there had been something about that experience that was still sending warning chills running all directions across his back. Maybe the rumors coming out of Kathol sector about some exotic new technology hadn't been as exaggerated as he thought.

They reached the firing ports Sarne's men had been shooting at them from: another of the burned sections of tunnel like the one the team had entered the complex through. No holograph or mirage protecting this one from sight, though. Page kept moving, wondering what Sarne would throw at them next. The tunnel curved again, and he lifted his blaster a little higher in anticipation.

And suddenly they were there. Not ten meters ahead the tunnel opened up into a cavernous



David & Dan Day

hangar carved out from one of the hills around the governmental center. The *Carrack*-class light cruiser from the schematics was still there, its hull flickering with reflected light.

Page got another step before the tunnel around them abruptly exploded in a deluge of blaster fire.

His blaster was returning fire before he'd consciously located their attackers: a pair of Imperial troopers standing at opposite sides of the tunnel mouth. Beside him, *Ciro* was laying down fire of his own; behind him, Page could hear the click as *Vandro* armed the *Viper* grenade launcher mounted on the underside of his blaster rifle. There was a barked warning, and he and *Ciro* threw themselves flat as *Vandro's* grenade flew over their heads, *Syla* picking up cover fire duties without missing a beat. Page squeezed his eyes shut —

He saw the flash even through closed eyelids, the thunderclap of the explosion louder than usual in the confines of the tunnel. The sound was still ringing in his ears as Page scrambled to his feet, sprinting ahead and peering through the smoke for signs of further opposition. But no troopers appeared to take their downed com-

rades' spots as he and the others raced down the last few meters of the tunnel. No one was visible. Nothing was visible.

Not even the *Carrack* cruiser.

They broke out of the tunnel into the cavern. Or rather, into the long artificial ravine which had been a cavern thirty seconds ago. The roof was gone, blown off to allow the *Carrack* to escape. The cruiser itself was still visible, in fact, its rapidly ascending hull glinting with the reflections of starlight and the turbolaser blasts of the orbital battle raging above.

Beside Page, *Vandro's* A280 spat a volley of parting fire. "Forget it," Page advised him. "He's long out of range."

Vandro lowered the weapon, cursing under his breath. "We were this close, Lieutenant. *This* close."

"He'll keep," Page said, forcing back his own emotions as he turned away from the cruiser. *Sarne* had escaped; but they could still do the job they'd been sent to do. Maybe. "*Ciro?*"

"Found it, sir," *Ciro* called from a control board built into a sheltered alcove near the tunnel entrance. He and *Syla* had the top of the board open and were peering inside. "He's got the shield set to come down, all right."

"For how long?" Page asked, motioning Vandro to stand guard at the tunnel entrance as he joined the other two at the board.

"Not long," Ciro had a beam drill out of his tool kit now and was poking it delicately through a maze of wires. "A couple of seconds, maybe. They've obviously got this thing carefully timed out. The trick's going to be—"

There was a sudden click. "There it goes," Syla said, peering at the indicators on the top side of the panel. "Shield's down."

"I know," Ciro grunted. "Here goes ..."

The beam drill flashed once, then twice more in quick succession. Page listened to his heart-beat as it counted off the seconds. One, two ...

Three, four five. "Should there be another click?" he asked.

"There should," Ciro acknowledged, grinning tightly up at him. "But there won't. I've got the whole circuit frozen down. With the shield in the 'off' position."

"Good job," Page said, nodding to Syla. "Okay, Tors: whistle up the admiral and tell him the front door's open."

"Yes, sir," Syla said, pulling out her comlink. "Page's Commandos have done it again."

Page looked up at the starlit sky. "Not yet we haven't," he murmured. "Not quite yet."



"I'm sorry, Lieutenant," the voice from the comm was saying as Jessa was ushered into the small office/apartment complex Lieutenant Page's people had taken over as their command post. Page was seated behind the command desk, tapping a data card gently against his knuckle. "I know how much you want to get this guy," the voice continued, "but I simply can't spare you any ships at the moment. Some hotshot Imperial Moff or admiral is stirring the pot way over in Bozhnee sector, and Ackbar's been shuffling forces like crazy to try to box him in somewhere. We've got just three days to finish up here before we're supposed to head back to the Minos Cluster, pick up Virgilio's group, and head back in."

"I understand all that, Admiral," Page said, acknowledging Jessa's presence with a glance and microscopic nod of his head. "But this isn't just about tracking down one more fugitive Moff. Sarne has gained access to a highly unconventional new technology—"

"Yes, I've heard all the rumors," the admiral cut him off gruffly. "If you ask me, the whole story sounds like standard Outer Rim nonsense. Or else deliberate Imperial misinformation."

"It's not misinformation, sir," Page said. "I've seen the weapons in operation."

"Maybe," the admiral grunted. "Maybe not. Look, if you can find a ship on your own I'll see if I can scrape together some of my people to help you crew it. But that really is the best I can do. I have to go now; keep me informed."

"Yes, sir. Page out."

Page keyed the comm off and shifted his attention to Jessa. "Lieutenant Dajus," he nodded in greeting. "All finished with your debriefing?"

"For the moment," Jessa said. "They said they might want to ask more questions later."

"Get used to it," Page advised. "You're one of the few Imperials who hasn't been killed or chased off into the hills. Makes you very valuable property."

"Oh, there are plenty of other Imperials around," Jessa told him. "They're just not admitting it."

"I don't blame them," Page said, glancing at the window and the crowded cityscape outside. "From what I've seen out there, the general populace seems eager to track them down."

"Sarne wasn't exactly beloved by his public," Jessa agreed, glancing around the office. "Actually, I'm surprised they haven't torched this place already. It was a pretty open secret that the Ubiquitorate ran some of their internal security operations out of this building."

"That's why I set up shop here," Page said dryly. "I wanted to get to any records they might have left behind before the locals got busy with their igniter sticks. You just come in for a little chat?"

"I came to ask what you were going to do about Sarne," Jessa said. "From that last conversation, it sounds like not much."

"You have some special interest in the Moff?"

"Very special." Jessa pulled up her left sleeve, wincing at the lingering pain in her arm. "He had me in for a little chat of his own."

Page's expression didn't change. "Interesting burn marks," he commented, leaning forward for a closer look.

"Fire whip practice," Jessa told him bitterly, lowering the sleeve again. "I guess I'm lucky he hadn't gotten around to turning me over to the real interrogation specialists."

"I guess you are," Page agreed soberly. "For what it's worth, Lieutenant, I want to find Sarne as much as you do. The problem is we don't have any idea where to start looking."

Jessa pursed her lips, wondering how much she should tell this man. He was a Rebel commando, after all. But at the moment he was also her best hope of getting her vengeance on Sarne.

"If I were you, I'd start with something called DarkStryder. That's where he got these strange-tech modules from."

"Is DarkStryder a person or a system?"

"No idea," Jessa said. "The whole thing was top secret—I don't think more than a handful of Sarne's top aides ever even heard the name."

He cocked an eyebrow. "Yet you did."

Jessa shrugged, trying to keep her expression casual. "Shuttle pilots overhear things. Anyway, that's the name. You want more, go dig it out of the computer."

"I'd love to," Page said sourly, "if there was anything left there to dig in. Sarne was thoughtful enough to flash-clear everything before he left."

Jessa frowned. "What do you mean, everything?"

"I mean *everything*," Page said. "All proceedings of his administration here; all personnel and operational files; all records of military and civil installations and posts. He even cleared the data from a hundred years of Kathol sector surveys—we don't even know the names of the systems out there, let alone what's in them. We're starting raw."

Jessa nodded. She should have guessed Sarne would find a way to implement his Omega order five before escaping. Scrambling his track behind him like the coward he was. "That's why you need a capital ship. You're looking at a long-term hunt here, not just a quick search-and-strike."

"You've got it," Page confirmed. "Sergeant Lofryyhn told us Sarne had him working on a Corellian Corvette that he was having secretly modified. But he was always taken there in a closed shuttle and has no idea where to find it."

Jessa clenched her teeth. She was taking an awful risk here, letting Page know how much she knew about the Imperial operation here. But she had no choice. Not if she wanted to get to Sarne again. "It's in the Sorbiss Valley. I can show you where."

"Really." If Page was surprised, he didn't show it. "You shuttle pilots really do overhear things, don't you? Well, let's go see if it's still there."

They left the building and headed out onto the crowded street, Page making travel arrangements via comlink as they walked. Pedestrian and vehicular traffic swirled all around them, defying the conventional wisdom that civilians usually cowered in their homes for days after a major battle. Clearly, the populace was welcoming the Rebel invaders with open arms.

"The shuttle will pick us up over there," Page said, pointing toward one of the quaint village squares the original settlers had constructed. He took a step in that direction—

Abruptly, a figure in a gray tunic and black hooded robe loomed in his path. "A word with you, Lieutenant Page, if I may?"

Page didn't even twitch, but suddenly there was a small blaster in his hand. "Yes?"

"I am called Loh'khar." The figure lowered his hood to reveal the glittering eyes, pale skin, and wraparound head-tails of a Twi'lek. "Loh'khar the Finder. I am an independent trader whose means of transport was unfortunately destroyed in the rather noisy proceedings of last night."

Something brushed against Jessa's leg. Startled, she looked down to see a pair of waist-high, red-scaled aliens snuffling up at her. Involuntarily, she took a step backward, bumping into one of the pedestrians passing behind her. "Sorry," she muttered, grabbing for his shoulder to steady both of them as she turned to look.

It was a short figure in a hooded gray robe, his face averted from her. Hooded robes seemed to be a popular attire out here today. He grunted something unintelligible in return as he regained his balance and scurried away. Jessa's hand, still on his shoulder, slid down the back of his robe as he moved—

"Hold it," she said, taking two quick steps and grabbing his arm. Her probing fingers confirmed it: he was wearing a shoulder-slung weapon. Spinning him toward her, she slapped open the sides of the hood.

To find the multifaceted eyes and green snout of a Rodian looking back out at her. "Well, well," she said darkly, pushing him firmly back out of the traffic flow and up against a convenient wall. "If it isn't Gorak Khzam, shoulder-slung shock rod and all. I don't think Kal'Shebbol's new owners would approve of civilians carrying weapons through the streets."

Khzam hissed a snort of contempt. {And who would tell them?} he snarled in Rodian. {You, Jessa Dajus, who is herself an Imperial officer?}

"An ex-Imperial officer," Jessa corrected, keeping the alien's arm firmly pinned down over his concealed weapon. Shock rods were strictly for short-range anti-personnel application, but within their limited range they could be nasty. "I've resigned my commission."

The Rodian hissed again. {And you would seek to ingratiate yourself with the New Republic by turning me over to them?}

"I'd consider it part of the common effort to beautify the galaxy," Jessa retorted. "Not to mention a good start toward putting my finances back in order. The bounty on you must be, what, ten thousand by now?"

Khzam's eyes flicked across the flow of pedestrians swirling around them. {Interesting about



David & Dan Day

your resignation,} he said softly. {Unusual that Moff Sarne would allow a person of your importance to leave his service, yet remain alive.}

A cold knot settled into Jessa's stomach. Could the Rodian know who she really was? "You have an overly high opinion of a shuttle pilot's value."

Khzam's ears curled around. {Come now, Colonel Dajus. There's no need to play games here. Or shall I call Lieutenant Page over here?}

Slowly, Jessa let her hand fall from Khzam's arm. He knew, all right. "I don't suppose there's any need to bother him."

{Of course not,} the alien assured her, his ears curling around again. {And rest assured, Colonel, that your secret is safe with me. As, I presume, mine is with you?}

Jessa grimaced. To let someone like Gorak Khzam run around loose ... But there was nothing she could do. "Get out of here," she growled. "Just go."

Without another word he slipped past her and disappeared into the crowds. Jessa turned back, to find that Page had finished his conversation with the Twi'lek. "Friend of yours?" he asked, nodding the direction Khzam had gone.

"Hardly." Jessa gestured at the departing Twi'lek. "Let me guess. His ship got damaged and

he wants reparations."

"More or less," Page said. "Seemed rather put out that we can't pay him anything."

"Get used to it," Jessa advised. "They'll all be coming out of the scrollwork soon."

"They've already started," Page said. "Come on; the shuttle should be waiting."



The access hatch to the deep engine access crawlway darkened, and with a grunt Lofryyhn appeared, his red-brown fur stained with grease and dirt. "Well?" Page asked.

The Wookiee rumbled the mixed news: Sarne's modifications to the Corellian Corvette's sublight drive were still incomplete, but at least the Imperials hadn't had time to sabotage anything before they left. "Could have been worse," Page said. "Okay. Better go take a look at the hyperdrive now."

There was a step behind him, and he turned as Syla Tors and a civilian in stained coveralls came into the room. "How's that add-on hangar look?" he asked them.

"It could be better," Syla said. "The hangar was designed for TIE Interceptors, but they never got around to putting in the racks. We can fit five X-wings inside but it'll be a tight fit. We can also use the docking tubes to dock nine more externally. Tofarain checked over the support equipment and says it's fully functional."

Page focused on the civilian. Pudgy and gruff, Bropher Tofarain had latched onto Syla and Lilla Dade yesterday as they toured the damaged starport, loudly demanding reparations for his wrecked starport repair facility. Lilla's new friend, the shadowy Defel Kl'aal, had threatened to shred the man's face if he didn't leave the two women alone; Lilla, always the practical sort, had suggested instead that Syla bring him here to the Sorbiss Valley and put him to work. "That true, Tofarain?" he asked.

"True enough, Lieutenant," the mechanic said. "Course, it's still got some work left to do on it. Whole ship does."

"I know," Page said. "Question is, can Lofryyhn keep the systems up and running while that work gets done."

"By himself?" Tofarain snorted. "Not a chance. Sorry, Wook', but not a chance." He lifted a finger, cocking his head to the side. "But the Wook' and me—well, now, that's another story. Besides—" he thumped his chest, pointed his finger at Page "—with me you also get an expert shuttle pilot. And a dash' fine shuttle."

Page looked at Syla, lifted his eyebrows in question. "I saw his shuttle at the starport," she confirmed. "It looked at least flyable."

"It's beautiful," Tofarain protested in a tone of wounded pride. "Got lots of mod'fications—put 'em in m'self. Flies like a dream. Hire me along, and it comes for free with the package."

"I'll take the offer under advisement," Page said dryly. The cold, hard truth, of course, was that he really didn't have much choice. The Corvette was going to need an absolute minimum of a hundred crewers, and there was no way the admiral was going to let him have that many people. If the ship was going to fly, they were going to have to recruit heavily from Kal'Shebbol's civilian population.

They weren't going to get all the X-wings and pilots Syla wanted, either. Eight, maybe, if they could catch the admiral in a good mood, and possibly a couple of those non-hyperdrive Defenders.

His comlink beeped, and he thumbed it on. "Page."

"Vandro, Lieutenant, up in the Number One turret," the other's voice came. "The turbolaser looks fine except for the power capacitors. There

are four missing, and two of the others are in rotten shape."

"That's about median for the curve with this ship," Page told him. "I'll put power capacitors on the list—all the admiral can do is say no."

"Or laugh hysterically," Vandro said wryly.

"More than likely," Page agreed. "Ciro and Adrimetrum still checking out the sickbay?"

"Last I knew. Want me to call them?"

"No, I need to talk to them in person. Go ahead and check out the other turbolaser turrets, then scrounge around a little. Maybe Sarne had some spare power capacitors stashed away somewhere."

"Right."

He found Ciro and Kaiya going over the medical facilities with a Mon Calamari named Akanseh who'd been one of the prisoners in the Moff's detention center. "How's it look?" Page asked them.

"Reasonably complete," Ciro said. "The operating facilities are a little skimpy, but Doctor Akanseh says we can make up a lot of that with his medical droids."

"If they still exist," Akanseh added, his gravely Mon Calamari voice surprisingly gentle. "Moff Sarne confiscated my entire mobile surgical suite when he placed me in detention."

"What were you charged with?" Page asked.

The Mon Calamari's huge eyes blinked uncomfortably. "Moff Sarne seldom needed anything so mundane as a charge."

"Understood," Page said. "I'd like you to start on the medical lab now, Doctor. Ciro, Adrimetrum: come with me to the bridge."

Minutes later, the trio emerged on the bridge. "Here's the situation," he said when the three of them were seated in the well-worn operational chairs on the bridge. "In roughly twenty-eight hours the task force will be leaving. Question: can this ship be ready to fly by then?"

"I don't know what the task force leaving has to do with it," Ciro grunted. "Up to now the admiral hasn't exactly been showering us with equipment and personnel."

"No, and he's not likely to start any time soon," Page said. "Actually, the timetable's really more mine. I want you out looking for Sarne before I leave Kal'Shebbol."

They got it simultaneously. "Us?" Ciro asked carefully. "As in Adrimetrum and me?"

"You got it," Page confirmed. "You as captain, Ciro; you, Adrimetrum, as first officer."

The two exchanged glances. "With all due respect, sir," Ciro said, "neither of us is exactly qualified to command a capital ship."

"Corellian Corvettes hardly qualify as capital ships," Page said, waving the objection away.

"Just think of it as a big yacht with weapons."

Kaiya snorted. "That'll certainly scare Sarne when we catch up with him. Can't we wait until the New Republic can spare a real warship?"

Page looked out the forward viewport at the valley floor. "I don't think we can afford the time," he said quietly. "You both saw what this DarkStryder technology can do. Sarne's got it; but I don't think he quite has it under control yet. We can't let him have any more of a head start than he's already got."

"But me as captain?" Ciro asked, clearly still stuck back there. "Adrimetrum's had more experience—at least she ran her own resistance group for a while."

"But you're the one who kept moving in that mind-numbing field Sarne threw at us," Page reminded him. "Not fast—you were just crawling—but you *were* moving. That tells me you've got a better than average resistance to these things; and in a tight situation, that might make the difference. Regardless, my decision stands."

"Yes, sir," Ciro said. "What about a crew?"

"I've started a list," Page said, handing over his datapad. "I'm afraid you're going to have to make do with a lot of civilians."

"Not to mention former Imperials," Kaiya said, reading over Ciro's shoulder. "Lieutenant Jessa Dajus has already admitted she was one of Sarne's pilots."

"And Doctor Akanseh has admitted he did some sort of unspecified medical work for the Moff," Page nodded. "But don't forget both of them were in his detention center."

"What about that Defel, Kl'aal?" Ciro asked. "He wasn't a prisoner."

"No, but he'd been with Dade for two days before we got here," Page reminded them. "He didn't betray her, and he didn't betray us. Bear in mind that working for a man like Sarne doesn't necessarily mean you wanted to do it. My guess is that all his genuinely loyal people took off when he did."

"Let's hope so," Ciro said, forehead wrinkled as he studied the list. "Who's this Gorak Khzam you've got slated for ship-board security?"

"He's a Rodian trader who claims to have been flying around Kathol sector for the past ten years," Page told him. "There are some large and suspiciously convenient gaps in his employment history; but given our total lack of information about the systems you'll be running into, I think he's a gamble worth taking."

"So Khzam's here to tell us where we're going," Kaiya said, "at which point Dajus will tell us what Sarne might be doing there?"

"That's more or less it," Page said. "And don't

forget those hunches Dajus gets. It's possible she's tuned into the Force in some way."

"That, or else she knows more than a shuttle pilot should about Sarne's activities and is using the hunches as a convenient explanation," Kaiya said.

"That's certainly possible," Page agreed. "One other thing: it appears that Dajus and Khzam know each other. Not necessarily on a friendly basis."

"This just gets better and better," Ciro said dryly. "I see you've got Kaiya's Wookiee friend on the list, too."

"And that civilian mechanic Brophar Tofarain," Page nodded. "They'll be the core of your maintenance group."

"It's a start, anyway," Ciro said, handing back the datapad. "We'd better get the word out back in the city that we're taking applications."

"I've already got it started," Page said. "I've also got the admiral's people sifting through crew lists seeing who they can make do without."

Kaiya grimaced. "That should certainly get us the top of the crop."

"I know," Page conceded. "You'll just have to do the best you can with what you get."

Ciro cleared his throat. "I don't suppose he'll be able to spare us any X-wings."

"I've already asked him," Page said. "He says that if he can, your brother will definitely be at the top of the list."

Ciro smiled lopsidedly. "Thank you, sir."

"No problem." Page stood up. "I'm heading back to the city to supervise the crewer applications. You two had better get back to work. It's going to be a busy twenty-eight hours."



Like a fever dream, full of agony and confusion and frustration, the twenty-eight hours passed.

And it was time to go.

Kaiya stood on the bridge, standing well back out of the way, watching as the hastily thrown-together crew worked furiously to bring each of the newly christened *FarStar's* reluctant systems on-line. The bridge buzzed with conversation, punctuated by orders and considerably more under-the-breath cursing than she was used to hearing aboard a New Republic ship.

Still, in some ways it was almost like going home again. Her first challenge to the Empire had been on Siluria III, with an attack force that had consisted entirely of her relatives and friends. Here, at least, the civilians aboard presumably had some proficiency and experience in what



David & Dan Day

they were supposed to be doing.

"Adrimetrum?" a tall, pallid man called from the *FarStar*'s ops station. Lieutenant Darryn Thyte, if Kaiya had gotten the name right: a former X-wing pilot who had abandoned the cockpit after losing an arm at Vaenrood. "I've got a hovertruck coming up the road toward us. We expecting someone?"

"Not that I know of," Kaiya said, stepping over behind him and looking at the display. It was a civilian-type hovertruck, fairly ancient, its vent ports covered by unmarked side panels. Reaching over Thyte's shoulder, she keyed for the hangar bay. "Ciro, it's Adrimetrum. We've got company."

"I know," *Ciro*'s voice came back. "Lieutenant Gorjaye spotted him a minute ago while running a balance check on her X-wing."

"Why didn't she tell me?" Thyte demanded before Kaiya could respond. "Blast it all, Captain, I'm ops officer here—and that means comm, nav, and sensors. If Gorjaye thinks she can do my job, she can just come up here and try it."

"No one thinks they can do your job, Lieutenant," *Ciro* soothed him. Not even off the planet yet, and already he sounded tired of dealing with

Thyte's abrasive attitude. "Adrimetrum, meet me at the portside hatchway and we'll see who it is."

The hovertruck had pulled to a stop by the time Kaiya reached the hatchway. *Ciro* was already waiting; beside him, lurking almost invisibly in the entryway shadows, was the Defel *Kl'aal*. Overhead through the trees, Kaiya caught a glimpse of Lieutenant Ranna Gorjaye's X-wing, flying high cover for them. The hovertruck door opened—

"Ah—Captain *Ciro*, I presume?" the Twi'lek called cheerfully as he climbed out onto the dusty ground. "My name is Loh'khar. I'm called the Finder."

"Yes, Lieutenant Page mentioned you," *Ciro* said, not even trying to hide his annoyance. "I don't mean to be rude, Loh'khar, but we're running a tight schedule here. Unless you've acquired some new skills in the past twenty hours, we still can't use you aboard the *FarStar*."

"Ah—but perhaps you can," Loh'khar said, smiling broadly as he stepped to the side of the hovertruck. "Or at least, perhaps you can use these." With a flourish he unfastened the side panel and let it flip open.

Kaiya caught her breath. "Are those—?"

"Fifty brand-new turbolaser power capacitors," the Twi'lek confirmed, still smiling. "Never even out of their cartons."

"Where on Kal'Shebbol did you find those?"
Ciro demanded. "We turned the whole planet inside out looking for them."

Loh'khar waved a long-nailed hand. "It's a talent, Captain," he said airily. "A skill, as it were. Not easily acquired ... but perhaps useful nonetheless?"

Ciro sighed and shook his head. "No perhaps about it," he conceded. "I guess we can squeeze in one more. Come on aboard. I'll get some people down here to carry those in."

"No need." The Twi'lek whistled; and three short, red-scaled aliens bounded from the cab. Twittering like excited children, they each

grabbed an energy capacitor and scampered up the ramp. Setting their loads down against the wall, they headed back to the hovertruck.

Ciro looked at Kaiya. "I guess we can squeeze in *four* more," he corrected himself. "I hope you're ready for all this."

Kaiya looked out at the Twi'lek and the three small aliens. No, not really, she had to admit. There was too much happening too quickly with this whole mission. Civilians, New Republic regulars, former Imperials—the whole ship was a volatile mix right from the start. Throw in some personal animosities and dark secrets on top of it, and you had a civil war just begging to happen.

But it had to be done. And the *FarStar* had to do it. Because waiting out there at the far end of this voyage was Moff Sarne.

And DarkStryder.

"Sure I'm ready," she told Giro. "Let's do it."

AND SO IT' BEGINS ...

C O N T E N T S

The Saga Begins	2
<i>FarStar</i> Mission Orders	19
Welcome to the DarkStryder Campaign	20
<i>FarStar</i> Overview	23
The Command Crew	47
The Support Crew	62
Support Ships and Vehicles	75
Droids	81
Gamemastering the DarkStryder Campaign	87

C R E D I T S

Created by: Peter Schweighofer, Doug Shuler, Bill Smith, Eric Trautmann and Timothy Zahn
Additional Mythos Design: Daniel Scott Palter, Richard Hawran, Stephen Crane, Paul Sudlow

Campaign Book Design:

"The Saga Begins" by **Timothy Zahn**
"Welcome to DarkStryder" by **Bill Smith**
"FarStar Overview" by **Doug Shuler** and **Bill Smith**
"Command Crew" by **Peter Schweighofer**
"Support Crew" by **Peter Schweighofer**
"Support Ships and Vehicles" by **Bill Smith**
"Droids and Equipment" by **Pablo Hidalgo**, **Miranda Horner**, **Doug Shuler** and **Bill Smith**
"Gamemastering DarkStryder" by **Doug Shuler** and **Bill Smith**

Adventure Book Design:

"Kathol Sector Overview" by **Bill Smith**
"Gamemaster Crew Notes" by **Bill Smith**
"The Rogues Gallery: Qulok's First—Rojer 621" by **Peter Schweighofer**
"The Rogues Gallery: Des'Maric Pirates—Veild-danol" by **Bill Smith**
"Omens" by **Bill Smith**
"Artifact of Aaris" by **Peter Schweighofer**
"Death is Remotely Possible" by **Paul Sudlow**
"Shintel Downtime" by **Paul Sudlow**
"Crisis" by **Eric Trautmann** and **Paul Sudlow**
"Traitor in our Midst" by **Eric Trautmann** and **Paul Sudlow**

Development and Editing for "The Campaign Book": **Bill Smith**

Development and Editing for "The Adventure Book": **Bill Smith** and **Paul Sudlow**

Additional Editing: **Miranda Horner**, **Peter Schweighofer**, **Eric Trautmann**

Project Coordination: **Bill Smith**

Card and Poster Design: **Stephen Crane**

Book Design: **Tim Bobko**

Graphics: **Tim Bobko**, **Stephen Crane**, **Tom O'Neill**, **Brian Schomburg**

Cover Illustration: **Christopher Moeller**

Card Illustrations: **David Deitrick**, **Christopher Moeller**, **Doug Shuler**, **Mike Vilardi**

Poster Illustrations: **David Deitrick**

Interior Illustrations: **Tim Bobko**, **David Day**, **Terry Pavlet**, **Brian Schomburg**, **Phillip Tan**

DarkStryder Logo Design: **Richard Hawran**

Playtesting and Advice: **John Beyer**, **Chris Doyle**, **Wayne Humfleet**, **George R. Strayton**

Special Thanks to: **Sue Rostoni**, **Allan Kausch** and **Lucy Wilson** of **Lucasfilm Ltd.**; **Timothy Zahn**; and **Richard Hawran**, **Daniel Scott Palter** and **West End Games's** editorial and art departments for pulling this project together!



43:4:5

To: Captain Keleman Ciro, *FarStar*
From: Lieutenant Page
Regarding: *FarStar* Mission Profile



Keleman:

Following are the orders for the *FarStar*, effective immediately. New Republic High Command thinks it has more important things to worry about; they don't take Sarne or this DarkStryder thing seriously. I know you and I know how important this mission is.

MISSION OBJECTIVES

1. Find Sarne. Sarne got us good at Kal'Shebbol. He got away without us even getting a hyperspace vector. He's on the run, but like any other predator that's when he is most dangerous.

We may be holding the sector capitol, but we know enough to expect Sarne to mount a counterattack. He's vindictive enough to destroy his former holdings rather than let us have them. He's also clever enough to somehow assemble a large enough force to give us a rough time when he does show up.

Your mission is to track him down, muster whatever New Republic forces are within comm range, and bring him down.

While the New Republic Provisional Council may beg to differ, I don't care whether he lives to stand trial for his war crimes. I'm not condoning murder, but I'll trade one life for millions. You have authority to use any means necessary to stop him.

2. Determine Where DarkStryder Technology Comes From. You know I wanted to come here because of Sarne's DarkStryder technology. While I know Command considers these rumors on a par with haunted planet stories, I think we both know better.

Our examinations of the two artifacts we recovered have revealed nothing of substance. These devices do not function by any conventionally understood means.

Find out where Sarne got this technology, and find out how much more is available to him. You must seize control of the DarkStryder technology or at the very least deprive Sarne of access to it.

3. Recon and Report on Imperial Forces in Kathol Sector and Unknown Space Beyond the Kathol Rift. Sarne may have fled, but he hasn't recalled all of his Imperial vessels. Some have remained behind to harass planets and New Republic forces.

You are to provide as much detailed information

as possible to supplement our data that our patrol ships are gathering.

4. Recon and Report on Kathol Sector. We know nothing about this place beyond coordinates to three nearby colonies. That's not a lot to start with.

As you travel to different systems, your mission is to purchase astrogation charts for any known routes, as well compile whatever data you can get on settlements and unexplored systems within Kathol sector space.

5. Recon and Report on Worlds in Unknown Space. As you leave Kathol sector and head into unknown space, you will have to rely more on your own observations and less on the charts and data of others. We're on the edge of the Empire and who knows what might be out there.

We need to know of any rogue colonies or undiscovered civilizations. New Republic Military Command is going to want to know whether this is a true wilderness zone or if we have to fortify our borders against possible incursion by alien forces. While I am not at liberty to discuss specifics, we have faced similar incidents in the past.

Keep your eyes open!

6. Represent New Republic Interests to any Settlements or Civilizations. This is your lowest priority, but it has far-reaching implications. Act accordingly. The *FarStar* is a forward representative for the New Republic; your job is to present a good face to worlds that have suffered under Imperial despotism for decades.

You are to convince local governments that the New Republic represents positive change. Some of them will want help, while others are going to be looking for signs of weakness. You are also to provide data to Kal'Shebbol so the New Republic Provisional Council can choose whether to use polite or gunboat diplomacy in future exchanges.

Kel,

I wish I could be there for this mission but I know you can do it. You may be short on command experience, but you've got the drive for the job.

Kaiya may be a little too aggressive when things get personal, but she's also going to follow through on her promises. You can trust her.

First round's on me when you get back!

Page



WELCOME TO THE DARKSTRYDER CAMPAIGN

The stage has been set. Now your gaming group can begin *The DarkStryder Campaign*, the first boxed campaign setting for the *Star Wars* roleplaying game. Join the crew of the Corellian Corvette *FarStar* as it ventures into the outer fringes of Imperial-settled space in a desperate quest to find Moff Sarne and prevent him from using the mysterious DarkStryder technology against the New Republic.

THE SITUATION

Moff Sarne has fled from Kathol sector capital Kal'Shebbol, taking with him most of his personal fleet. The command crew of the *FarStar* has been selected by Lt. Page and ordered to recruit a crew from the civilian population of Kal'Shebbol.

As the New Republic's fleet returns to the Mynos Cluster to continue the fight against other Imperial warlords, a token force has been left on Kal'Shebbol to restore order and establish a provisional government. A proper New Republic defense fleet will be arriving at Kal'Shebbol within three months ... if it can be spared.

Meanwhile, the *FarStar* and her crew settle in for what is likely to be a long and dangerous mission. All of Sarne's government computers have been flash-erased, leaving the New Republic with no information: no knowledge of hyperspace routes, nothing on the sector's many colonies, and, of course, no information on Moff Sarne's forces and where his key military bases are located. The *FarStar* must rely on astrogation charts begged or confiscated from free-traders and the knowledge of its crew.

With the assistance of Security Officer and former trader Gorak Khzam, the *FarStar* has been able to plot the astrogation coordinates to three nearby colony systems. As Captain Ciro orders the crew to make the jump to hyperspace, the mission begins ...

THE CAMPAIGN

The DarkStryder Campaign is different from traditional *Star Wars* campaigns in many ways. The characters are assigned to a single vessel, the *FarStar*, with specific mission objectives, primarily focusing on the capture of Imperial warlord Moff Sarne.

The DarkStryder Campaign could best be described as "realistically heroic." The setting is darker and grittier than many traditional *Star Wars* campaigns, although *The DarkStryder Campaign* retains the optimistic and heroic spirit that lies at the core of the *Star Wars* mythos.

The crew of the *FarStar* is faced with a nearly impossible task and equipped with a minimum of resources. The *FarStar* is on its own, with no bases or supply stations for relief or back-up. The characters will be presented with crisis situations that require bravery and sacrifice, but failure will often result in tragedy. In *The DarkStryder Campaign*, characters *will* die, some due to their own mistakes, but others may be killed by arbitrary events, just as in reality.

The *FarStar* has been forced to take on many crewmembers without full background checks. While many of the individuals aboard the ship are loyal to the New Republic, others have only their own interests at heart. Some seek profit and others may only want to escape Kal'Shebbol. There are former Imperials posing as New Republic sympathizers with the hopes of furthering Sarne's and their own interests. Many crew members have hidden agendas and are willing to compromise the *FarStar's* mission to please themselves.

The *FarStar* will lose many crewmembers along the way. New recruits will be found on worlds visited by the *FarStar*, while the command team struggles to keep the crew highly motivated and on task.

To compensate for the harsher nature of *The DarkStryder Campaign*, each player should play multiple characters. Players can choose one or two individuals from those provided in the crew sections, while original characters can also be created. In a given adventure session, the players might actually play all of their different characters, as scenes shift. This “multi-character” form of play gives the players a wealth of opportunities — and also encourages the players to understand that any of their characters may face misfortune.

When playing the characters presented in this book, the players must understand that events in the DarkStryder storyline are keyed to certain characters performing specific actions. The game-master has the right to arbitrarily decree that a given character performs a specific action — regardless of player objections — just as in a script. Sometimes a given character will do things that the player may not like. Players must accept this when playing the pregenerated characters.

THIS BOXED SET

You are now reading *The Campaign Book*; the second book is *The Adventure Book*. This boxed set also contains a poster showing the interior and exterior of the *FarStar*, as well as over 50 recognition cards.

The Poster: The front of the poster contains vital information on the *FarStar* and the fighters and transports carried aboard the ship. The back of the poster contains detailed deckplans for the *FarStar*.

The Recognition Cards: The recognition cards are a valuable tool for gamemasters and players alike. The face of each card has a full color illustration of a character, droid or vehicle, while the back contains game statistics.

Gamemasters can use the cards to add visual appeal to game adventures. Rather than describing a character, the gamemaster can simply show the players a given card and say, “You meet this person.”

Players can also use the cards when playing any of the core or established supporting characters. The back of each card is a quick reference for game stats.

The Campaign Book provides all the background material necessary to use the *FarStar* and her crew in game adventures. Gamemasters should integrate all of this material for a complete adventure environment.

This book includes:

FarStar Overview: A detailed look at the modified Corellian Corvette *FarStar*. This section should be used in combination with the ship deckplans on the back of the poster.

Character Record Sheet: This sheet can be photocopied and used to keep track of character game statistics and encounters.

The Command Crew: The core command crew of the *FarStar*. Many adventures will revolve around these characters and the decisions they make.

The Support Crew: The *FarStar* carries over 100 individuals; these individuals are the heart and soul of the ship and carry out the orders of the command crew. The people presented are just some of the colorful personalities who populate the ship.

Support Ships and Vehicles: The *FarStar* carries several X-wings, Defenders (a type of short range fighter), as well as a personnel shuttle and a landing ship.

Droids: The various droids aboard the *FarStar*, from standard astromech units to medical and security droids.

Gamemastering DarkStryder: How *The DarkStryder Campaign* differs from traditional *Star Wars* campaigns, including information on multi-character gaming, directing the course of events, and properly establishing the mood of the *FarStar*'s adventures.

The Adventure Book details the Kathol sector game setting. This book also contains the first six adventures for the *FarStar* campaign.

The Adventure Book includes:

Kathol Sector Overview: A brief introduction to planets and systems for use with *The DarkStryder Campaign*. Each location can serve as the basis for adventures.

Gamemaster Crew Notes: Detailed information on the motivations and “facts” of the command and support crew characters.

Crew Roster Form: A form for listing additional crew characters as they are created.

The Rogues Gallery: Some of the prominent personalities the *FarStar* is likely to encounter. While many work for Moff Sarne or serve their own purposes, others may become allies of the *FarStar* in time.

The Adventures: The six adventures are meant to be run in order. Adventures four and five are linked and you should consider running them

consecutively, although this is not required. The other adventures are self-contained. While characters and situations change during each adventure, gamemasters have plenty of room to insert additional adventures.

“Omens”: The *FarStar* encounters a world that is punished by Sarne as an “example” to those who might wish to join the New Republic. This is meant to be run as the very first *FarStar* adventure.

“Artifact of Aaris”: The *FarStar* discovers an Imperial archaeology expedition which is slowly being killed off by mysterious predators. The Imperials have also found the ruins of a once-advanced civilization.

“Death is Remotely Possible”: The *FarStar* finally makes it to Gandle Ott, one of the outermost trade worlds in Kathol sector. In a more lighthearted adventure, the *FarStar* tries to win over the hearts and minds of a world that might be eager to join the New Republic.

“Shintel Downtime”: Moff Sarne has abandoned an Imperial base, stranding soldiers in an isolated system with no communications and no hyperdrive-equipped starships. The *FarStar* discovers this base and finds some unlikely allies ... and hidden enemies.

“Crisis”: The *FarStar* is in desperate need of computer diagnostic equipment. Loh’khar the Finder knows just where to get this equipment if the *FarStar* is willing to pay the price.

“Traitor in our Midst”: Kaiya Adrimetrum is critically injured in battle, but Doctor Akanseh discovers that she has been poisoned. The antidote can be found on one of Kathol sector’s wilderness worlds ... but can the *FarStar* retrieve it in time?

THIS IS ONLY THE BEGINNING ...

Over the next year, West End Games will publish several more *DarkStryder Campaign* supplements leading into the final confrontation with Moff Sarne and the revelation of DarkStryder. A grand adventure awaits!

THE FARSTAR

The *FarStar* is the Corellian Corvette assigned to Captain Ciro to track down Moff Sarne. The heavily-modified ship includes a large interior flight deck for fighters and transport ships. A large crew requirement means a crowded ship where tensions run high and emotions are volatile. The *FarStar* is cramped, poorly lit, jury-rigged and facing a hostile force in an unexplored environment — all in all, it's a perfect place for adventure.

HISTORY

The crew of the *FarStar* knows only that the ship is an older Corvette that Moff Sarne was having refitted for a combination military/exploration mission into the wilderness of the Kathol sector — this area is locally known as the “Kathol Outback.”

The interior flight deck was being readied for TIE Interceptor racks, while the interior of the ship was being stocked with supplies and equipped with advanced computer and sensor systems. It is obvious that Sarne had big plans for this ship. The vessel was named the *Renegade* before the New Republic christened it the *FarStar*. There are plenty of adventure hooks and plot threads woven into the history of this vessel ...

THE FREEDOM'S ANGEL

The *Freedom's Messenger*, as the ship was originally known, was commissioned by the Chandrilan government as a diplomatic vessel and built at the Corellian Engineering Corporation's shipyards almost six decades ago.

The *Freedom's Messenger* was afforded the best accommodations and outfitted to serve every need. Some of the suites were absolutely palatial, with decorations ranging from across the galaxy. Servant droids were given weekly maintenance and cleanings, professional entertainment was provided on a nightly basis, and Human attendants were assigned to every delegation.

The *Freedom's Messenger* soon became widely known as a symbol of peace. The *Freedom's Messenger* was where the treaty bringing the Marzoon Confederation into the Old Republic was signed. When the Vaykaaris Uprising threatened a hundred worlds in the Colonies, the

Freedom's Messenger delivered a dozen Jedi to restore order.

When darker times fell upon the Old Republic, the *Freedom's Messenger* changed roles. The ship was drafted for military service and extensively refitted. The diplomatic suites were replaced with additional weapon mounts and used to store supplies and provisions. The recreation halls were turned into barracks for troopers, while the magnificent droid service bays were converted into weapon repair depots and blaster recharging stations. Battle after battle saw the outer hull hopelessly scarred and yet *Freedom's Messenger* served as admirably as a warship as she did a diplomatic vessel.

The *Freedom's Messenger's* greatest — and nearly final — moment was at the Battle of Ord Torrenze. Invading forces were pulverizing the surface of the once beautiful planet while millions of civilians attempted an evacuation. The only escape route was blockaded by warships, leaving thousands of unarmed evacuation vessels at the mercy of enemy turbolasers. The *Freedom's Messenger*, leading a fleet sent to liberate the besieged world, was able to create a moment of confusion among the attackers. The Corvette and her fleet simply drove onwards against the invading fleet, every weapon blazing across the night sky. As the opposing fleets traded turbolaser fire, the evacuation ships had a chance to escape, saving millions of lives. However, the battle was not without casualties: the *Freedom's Messenger* suffered a power core overload during the final stages of the battle. As the proud vessel dived towards the burning planet below, her crew already dying from radiation poisoning, she went down remembered as a savior of millions.

THE RENEGADE

Years later, the wreck of the *Freedom's Messenger* was recovered as part of the Empire's military build-up. The ship was refitted for combat duty, renamed the *Renegade* and command was given to a young Imperial officer named Kentor Sarne. The ship was assigned to the 15th Deep Core Reserve Fleet and was instrumental in half a dozen campaigns against pirate raiders, as well as hit-and-run raids against several Rebel supply

depots. Sarne's performance earned him a quick promotion.

The *Renegade* continued to serve in reserve duty until 10 years ago, when the newly appointed Moff Sarne (of the Kathol sector) requested that the ship be reassigned to his forces. The *Renegade* continued to perform with distinction and played a prominent role in suppressing civilian unrest on Charis.

Four years ago, Emperor Palpatine was killed at the Battle of Endor. Without a strong central leader to hold the Empire's countless factional forces in check, the tyrannical order began to unravel. While the New Republic began the work of uniting worlds, the former Empire saw the rise of countless rogue warlords determined to unite the galaxy under their rule. Kathol sector, being a very isolated region of space, was essentially ignored during this period of strife. As Moff Sarne consolidated his hold on power, the *Renegade* and his other warships were increasingly used as instruments of terror against a disgruntled civilian population.

A year ago, Sarne transferred the *Renegade* out of active duty, placing it under his direct, personal command. The ship was brought to the Moff's private dockyards in the Sorbiss Valley on Kal'Shebbol, and a massive refitting program began.

Sarne's intent was to alter the ship to serve as a long range exploration vessel, with enough fighters to subjugate any lost colonies or primitive civilizations. Secretly, Sarne intended to use the ship to search for and retrieve any lost DarkStryder artifacts that might be scattered around the worlds of Kathol sector and the Kathol Outback. This was but one step in Sarne's master plan, which only the Moff himself fully understood.

After the main flight bay was added, the *Renegade* neared completion and her launch was planned. Then the New Republic showed up.

As the New Republic fleet bombarded Kal'Shebbol from orbit and a small infiltration team breached Sarne's defenses, the Moff was left with no choice but to evacuate his stronghold, leaving behind a nearly completed Corellian Corvette ... complete with a few hidden secrets.

THE FARSTAR

After gaining control of the *Renegade*, New Republic commando Keleman Ciro had 28 hours to assemble a crew and finish the refitting effort. Renaming the ship the *FarStar*, many of the interior rooms were converted to storage bays. Crew members were stationed two to a bunk while

supplies were stockpiled and potential crewers were recruited from the civilian population of Kal'Shebbol.

RECENT MODIFICATIONS

The *FarStar* has had many modifications over its decades of service. The most recent refitting, under the direction of Moff Sarne, has resulted in significant changes to the ship.

SENSORS

The *FarStar* is now equipped with advanced sensor and tracking hardware that nearly doubles the original range of the sensor system. The sensor systems are more sensitive than those found aboard an Imperial Star Destroyer.

This refitting gives the *FarStar* an important advantage: it can often detect and learn about a ship before the opposing vessel has detected the Corvette. Unfortunately, the new system takes up more room than the original sensor system and also draws significantly more power, in part accounting for the power conservation policies aboard the ship. (See "Current Operating Conditions.")

WEAPONS

The *FarStar's* turbolasers have new "predict and pinpoint" targeting routines, but the gunners, who are used to standard targeting systems, are having trouble adjusting to the new system.

The technicians insist that the targeting sub-routines can only help their gunnery and if the operators give the system a chance to "settle in," their hit-to-miss ratio will improve drastically. The gunners simply want the Corvette's standard targeting programs reinstalled.

When all is said and done, the programming and the egos of the weapons teams effectively cancel each other out, making for a fairly typical combination of gunner and machine.

The targeting system provides some assistance for standard "point and shoot" volleys (fire control 2D), but if the targeting computers can track a target for a full 10 seconds (two rounds), the tracking system's computer assistance increases to fire control 4D, giving the gunners a decided advantage against standard targeting systems. The trick is to keep the target in your sights for the full 10 seconds. To get this bonus, the gunner can do nothing but target for two rounds; the gunner also gets the preparing bonus of +1D to his skill roll — see page 65 of *Star Wars, Second Edition*.

ARMOR

A major change is the upgrading of the *FarStar's* hull and armor plating. The *FarStar* is now significantly tougher than a standard Corellian Corvette (the hull code has been increased a full die to 5D). This added armor plating has increased the thickness of the hull (nearly a full two meters is allocated for hull plating, maintenance crawlways, power conduits and reinforced bulkheads), but this armor plating also means the *FarStar* has a significantly higher chance of surviving an attack.

LANDING BAY/DOCKING TUBES

Moff Sarne decided to add a large landing bay and three docking tubes to accommodate shuttles and TIE Interceptors. Sarne, knowing the ship would be entering a hostile sector of space, knew that additional support craft would be necessary for the ship to survive its mission.

When the New Republic captured the ship, the landing bay was not quite finished. While the flight deck, the main airlock and the magnetic field generators had been installed (making the landing bay operational), the Imperial engineers had not yet had the chance to install the TIE fighter racks.

The New Republic found it could fit four X-wings internally — five if an X-wing was placed on the lift that goes down to the maintenance level. Up to four New Republic Defender fighters can be crammed in-between the X-wings, but virtually no room is left for maneuvers and a rapid launch of fighter support is impossible.

The main airlock is large enough to dock most capital ships or to accommodate a light freighter — the *FarStar's* crew uses the airlock to load ground vehicles and large cargoes onto the Aegis combat shuttle.

The three docking tubes, which connect at the maintenance level (one level below the main flight deck), can dock three ships each. Normally X-wing or Defender fighters are docked on the side airlocks while freighters and shuttles are docked on the ends of the docking tubes. The end airlocks can also be used for a ship-to-ship docking link.

Normally, the basic hull structure of the Corellian Corvette does not support a docking bay configuration, but by adjusting the hyperspace signature in the engines, the engineers were able to accommodate the bay and docking tubes.

COMMUNICATIONS

The *FarStar* has a high-power subspace transceiver courtesy of Moff Sarne's refitting operation. While the Moff couldn't spare a hyperradio transceiver (these communications systems are

extremely expensive and not in common usage except for Imperial and New Republic military command vessels), the subspace transceiver is boosted for a broadcast range of nearly 100 light years, or roughly four times the distance of many subspace transceivers.

This unit can broadcast signals to any transceiver within range, although most transceivers are limited to a standard broadcast range of 25 light years, so not too many units will be able to broadcast response messages and have them reach the *FarStar*.

Moff Sarne intended the *Renegade* to use this unit to provide regular updates regarding its exploration mission without uplinking into the civilian and military subspace communications nets; this would guarantee a secured communications link. Of course, Moff Sarne had a similarly powerful subspace transceiver on Kal'Shebbol, although it was destroyed during the New Republic's assault.

The *FarStar's* communications crew is trying to reconfigure the subspace transceiver. It is a virtual certainty that Sarne's forces are monitoring the pre-programmed subspace channels. The crews are attempting to jury-rig a link on a (hopefully) unmonitored channel so that broadcasts may be sent to the New Republic provisional government on Kal'Shebbol. The communications crew is also working on developing new encryption techniques to foil the Empire's techs.

Finally, the *FarStar's* communication teams intend to use the subspace transceiver to tap into Moff Sarne's network. Though most of Sarne's original codes have been changed and upgraded, there might still be a few which will allow the *FarStar* to eavesdrop.

CURRENT OPERATING CONDITIONS

Overall, the tension level aboard the *FarStar* is quite high. The ship is overcrowded, with minimal comfort and almost no privacy for its crew members. The equipment is jury-rigged and prone to breakdown. Endless storage bins and supply crates clog every corner and corridor, giving the impression of a disorderly ship.

As the *FarStar* ventures further into the unknown, the stresses of deep space travel and combat will become more prevalent — arguments and fights among crew members will increase, and the sick bay personnel may end up attending to bloody noses as often as legitimate injuries. Different cliques will develop among the crew and tempers will often be simmering just below the boiling point.

<p>FarStar Craft: Corellian Engineering Corporation Corvette Type: Converted military ship Scale: Capital Length: 150 meters Skill: Capital ship piloting: Corellian Corvette Crew: 120, gunners: 10, skeleton: 50/+10 Crew Skill: See individual crew members Cargo Capacity: 3,000 metric tons Consumables: 3 months Hyperdrive Multiplier: x2 Nav Computer: Yes Maneuverability: 2D Space: 7 Atmosphere: 350; 1,000 kmh Hull: 5D Shields: 2D Sensors: <i>Passive:</i> 50/1D+1 <i>Scan:</i> 100/3D+1 <i>Search:</i> 200/4D+1 <i>Focus:</i> 6/5D Weapons: 6 Double Turbolaser Cannons <i>Fire Arc:</i> 2 turret, 1 front/left, 1 left/back, 1 front/right, 1 right/back <i>Crew:</i> 1 (4), 3 (2) <i>Skill:</i> Capital ship gunnery <i>Fire Control:</i> 2D, 4D (after two full rounds of targeting) <i>Space Range:</i> 3-15/35/75 <i>Atmosphere Range:</i> 6-30/70/150 km <i>Damage:</i> 4D+2</p>

It can be said that the crew of the *FarStar* may not like each other very much, but they're going to have to learn how to trust each other. In time, the crew will have to learn to pull together for their own survival ... or everyone may pay the ultimate price.

MAKESHIFT ENGINEERING

Much of the *FarStar's* circuitry is jury-rigged and most of the newer hardware has undergone drastic custom modification to fit properly. Conventional engineering philosophy dictates that components that don't fit or were not designed to operate under makeshift conditions should simply be replaced with more practical designs. Unfortunately, with limited time and spare parts in short supply, the *FarStar's* technicians have made do. The *FarStar* had to be fully operational within 28 hours — and while it was, the results weren't pretty.

As troopers and gunners run up and down the corridors, feel free to drop in details about the cables, pipes, and conduits crisscrossing the floor and jutting out of the ceiling. Perhaps steam shoots out of a certain wall panel, lubricant drips onto the floor of the mess hall, or water pools underneath a floor grating.

The *FarStar's* engineers continue to be unrelentingly pragmatic: aesthetics are of no concern when they hinder the ship's operation. Lofryyhn and his techs string wires across hallways, place pipes along the walls, and leave power couplings, jumpers, cables and interfaces in full view where they are easy to access. The ship is unsightly, but the techs can get at critical components in a hurry, which is probably more important when an Imperial cruiser is bearing down on the *FarStar*.

POWER CONSERVATION

The very nature of the *FarStar's* mission calls for conserving power. The storage bays and other non-vital areas are sealed off to conserve life support. The cabins and crew quarter rooms are permanently at half the standard lighting level, while the corridors utilize only every other lighting panel, casting crossed shadows across the walls and lending an eerie mood to the larger rooms. Some of the cross-corridor junctions use green floor-lighting or blue soft-light to conserve power.

Some parts of the ship have had the heating ducts closed off to preserve what little heat there is. In particular, the droid repair and service bays are frosty enough to see one's own breath, and the food storage bins actually generate a layer of frost across the surface of the containers. The warmest part of the ship is the engineering section, which often gets so hot that the crew works in a constant sweat.

AN OVERSIZE CREW

The *FarStar* needs a large crew. With the uncertain duration of the tour of duty and the lack of repair facilities, the ship has many extra engineers and technicians. The *FarStar* also has a large number of scientists, computer specialists, pilots and ground troops: the ship must be prepared for any eventuality.

There are only 30 standard crew rooms, each with two bunks. Since the ship requires a crew of about 120, many crew members have to actually share their bunk with another person: one person sleeps in the bunk while the other is on duty. There are quarters where people have simply elected to sleep on the mats on the floor: it is uncomfortable and cold, sometimes even wet, but it is preferable to some crew members.

DUTY SHIFTS

Despite the large crew complement, there are barely enough hands to go around on the *FarStar*. The *FarStar* operates in two shifts of 12 hours each. Each crew member has a full-time post during their "on" shift, while theoretically having

12 hours off-duty for sleep, recreation and personal time.

Most on-duty shifts are full-time positions at a single post; the majority of these posts can be found in the engineering and bridge sections.

There are also “part-time” posts, where a crew member splits his or her time between two or more posts. Often a part-time post consists mostly of performing maintenance or periodically checking the performance levels of various systems or components aboard the *FarStar*.

There are several “alert” posts which are manned only when a ship-wide alert is signalled. The captain goes to alert status only when combat appears imminent, when the ship is ready to revert from hyperspace to realspace, or when the *FarStar* first enters orbit around a world and the ship is vulnerable to a sneak attack.

However, there are still many other duties aboard the *FarStar* which cannot be handled by droids or during regular duty shifts. Captain Ciro has gotten around this limitation by assigning “off-duty” posts. These posts tend toward menial duty tasks that don’t necessarily require peak performance or attentiveness.

Off-duty posts are manned in four hour shifts and are rotated equally among all crew members. Crew members constantly face 16 hour days, or an off-duty shift with four hours for sleep, a mid-shift off-duty post and then another four hour sleep period.

While there is no doubt that the regiment of 12 hours on duty *every* day and extra off-duty assignments will wear on the crew, there is no other way to get everything done aboard the ship.

DROID COMPLEMENT

The *FarStar* requires a droid complement of over 100 units. Many droids, such as R2 and R3 astromech units, are necessary for very specialized tasks, such as astrogation assistance and external repair duty while the ship is at sublight. Droids also tend to use fewer resources than organic beings, so there are a number of simple servant droids for menial tasks.

While the droids are essential to the *FarStar*’s operations, they also choke the corridors as they slowly trundle from place to place. They are seen by some as a nuisance and more than one has reported for maintenance with a boot-print in it’s side.

For complete information, see the “Droids” chapter later in this book.

STORAGE BINS AND SUPPLIES

The *FarStar*’s cargo holds are filled with replacement parts, high-tech components, food and other



Brian Schomburg

provisions. Many sections of the ship have been converted from living or duty stations to storage. Any open area is used for stacking crates that can be filled with power packs, spare energy converters and flash-sealed food packets.

The *FarStar*’s top storage priority is making room for technical items, such as droid and computer components, spare parts for the fighters and shuttles, and replacement parts for the *FarStar*’s engines and weapons. This is because the *FarStar* can reasonably expect to come across planets with food and water, but it is going to places where high technology will be virtually impossible to find.

Equipment aboard the *FarStar* is at a premium. A quartermaster droid has been assigned the task of requisitioning and assigning equipment and insuring its prompt return at mission’s end. It is important to keep track of what the characters use from adventure to adventure to make

sure that they are not being wasteful; the quartermaster droid will certainly remind them of their responsibility to use equipment intelligently.

Standard equipment will be available with little or no resistance: this type of equipment includes clothing, bedding, glowrods, comlinks, breath masks and other common items (weapons are not considered "common" items). The quartermaster droid will allocate this equipment with a personal request (and appropriate bargaining) and will not expect to see it back anytime soon.

Other equipment is in short supply and will be doled out only with good reason, such as a direct order from a superior officer or if a crew member has been placed in charge of requesting equipment for a specific mission. This type of equipment includes blasters, power packs, canisters of blaster gas, macrobinoculars, cold weather clothing and gear, gloves, scanners, climbing gear, and other useful items.

Lastly, there are the rare, valuable, or hard to replace items that can only be lent out under direct order from the captain. These types of items include thermal detonators, infrared goggles, electronic lock picks, and items so unusual that there may only be a couple aboard the *FarStar*.

For food, the *FarStar* has been fitted with several cold storage bays to allow the long-term preservation of meats and liquids prone to spoilage. More often than not, the cooks make do with standard military rations, which include vitamin and mineral supplements, processed and preserved meats, dehydrated fruits and canned juices. For ease of storage, ration packs have been placed in bulk containers, thus avoiding the extraneous packaging that often accompanies such consumables.

The *FarStar* can expect to go three months before essential supplies begin to run low. Of course, there's always the risk of food poisoning, contamination (from parasites, radiation and other hazards), or sabotage of the food storage containers.

Security and servant droids regularly patrol the food storage areas to guarantee their safety. Entire adventures can revolve around gathering foodstuffs from an Imperial depot or dealing with an alien species or remote colony to get additional provisions.

SARNE'S SECRETS

Before the *FarStar* was captured by the New Republic, Moff Sarne had several years to modify the ship's basic structure. The following traps are unknown to the *FarStar*'s crew and will only be discovered during the ship's adventures.

These tricks should be used with discretion; they should complicate adventures without completely disrupting the campaign. Also, it is best if the crew members don't gain too many clues as to what might be happening. There should always be another source to conveniently blame, whether it might be a malfunctioning droid, a saboteur or a simple equipment malfunction. Only after playing the adventure "Shintel Downtime" (in *The Adventure Book*) should the crew members begin to realize the extent of Sarne's meddling.

COMMUNICATIONS "DEEPLINK"

Moff Sarne never intended to command the *Renegade* himself, but he knew better than to truly trust the ship's commanding officer: Sarne is not only an untrusting sort, but he is also a very sore loser.

Sarne added a little program to the communication computers which was instructed to transmit the *FarStar*'s location each and every downshift: the time is selected at random, somewhere between 2200 and 0330 hours. When the program activates, it sends a blip of data off into space, informing Moff Sarne of the *FarStar*'s current location and heading. The broadcast is limited to the 100 light year range of the subspace transceiver, but Sarne has been able to make excellent use of this little trap: it allows him to plan his next move and constantly keep the *FarStar* at bay.

THE COMPUTER SYSTEM

Moff Sarne was devious enough to place a few "traps" in the *FarStar*'s computer systems, enabling him to cause major and minor problems. These traps are hidden in the *FarStar*'s computers and might be triggered for certain times, after a certain event, or might simply go off at random intervals. Sarne originally designed this system as a means of controlling the actions of the *Renegade*, knowing full well that his ship might be used against him by his Imperial commander.

The trap system does not have to be activated by Sarne; it is designed to activate if the ship does *not* receive Sarne's unique command code every 10 days. Sarne hasn't seen fit to send the command code to the *FarStar* and thus these traps have been activated. For more information on the computer system, see the adventures "Shintel Downtime" and "Crisis."

For stronger continuity, small incidents should occur throughout the early stages of the campaign. Most should be written off by the crew as equipment malfunctions due to the extensive jury-rigging necessary to keep the *FarStar* running. The gamemaster is free to invent annoying

and minor effects of the subtle sabotage, such as computer glitches or malfunctions in the sensors, weapons targeting systems and similar equipment.

DROID PROGRAMMING OVERRIDE

There is also a small routine in the astromech droid interface that is capable of rewriting a droid's basic programming, making it capable of sabotage. This is another trap that can ultimately be eliminated but will prove to be troublesome until it is routed out. It will most likely affect the R2 and R3 units since they are most likely to directly interface with the *FarStar's* computer systems.

The nature of this sabotage can vary from annoying to critical. Some suggestions include:

- Reprogramming a hyperspace jump and then wiping out the astrogation computer, leaving the *FarStar* in the middle of nowhere.
- Draining the power storage batteries so the *FarStar* runs low on power at a critical time, such as in the middle of a battle.
- Opening the loading valves and dumping the reserves of fresh water into space, leaving the ship without water until it can resupply at a habitable planet.

LOCATIONS ABOARD THE FARSTAR

The major locations aboard the *FarStar* are described deck-by-deck to give both players and gamemasters a sense of location and consistency in their adventures.

UPPER WEAPONS DECK

SENSOR SUITE

This area contains the major sensor posts and provides the sensor systems room (on deck two) and the command center (decks two and three) with detailed sensor scans of the space surrounding the *FarStar*. Three sensor operators can be found here at all times.

The room is a big circle; a central cluster of sensor array equipment nearly fills the room while computer banks ring the outer walls. The three duty posts are equidistant around the outside of the room.

SHIPBOARD COMMUNICATIONS

The *FarStar* has an internal comm system patched into all computer stations and duty posts, with comm stations in each crew quarter room, as well as at regular intervals in each corridor. The comms can be activated by simply pressing a two digit station number to send a message to a specific post; lacking a specific destination number, a comm message is patched into the communications room and properly routed.

The comms all have verbal receivers and transmitters. The captain's station, the communications stations, the landing deck, and engineering stations also have video and holo transmitters and receivers.

Additionally, each computer station can be tapped into the comm system to relay data through the video hookup or into another computer station.

This system is hard-wired into the corridor walls, so an ionization blast from an enemy ship or severe damage can disable the comm system.

Some *FarStar* crew members also carry private comlinks for more secured communications or in the event of a comm system failure.

Lighting is kept very low to allow the operators to read the sensor readout screens. Because this room is right above the *FarStar's* engineering section it tends to be extremely warm.

The sensor array is tied into the large sensor dish which protrudes out into space and constantly rotates to provide information from all directions. While most of the sensor gear is inside this station, the actual sensor instruments are affixed at the base of the dish or integrated into the dish.

The *FarStar* is equipped with several standard sensor systems, including electro photo receptors (EPRs; they scan the visible, ultraviolet and infrared spectrums at short range), full-spectrum transceivers (FSTs; they can scan objects for physical data and information on energy output), and dedicated energy receptors (DERs; they can detect electromagnetic emissions, including comlink signals, navigational beacons, heat, laser light and similar types of emissions). These sensor types are all described on pages 9-10 of the *Star Wars Sourcebook, Second Edition*. For game purposes, this station handles the passive, scan and search modes of the *FarStar's* sensors.

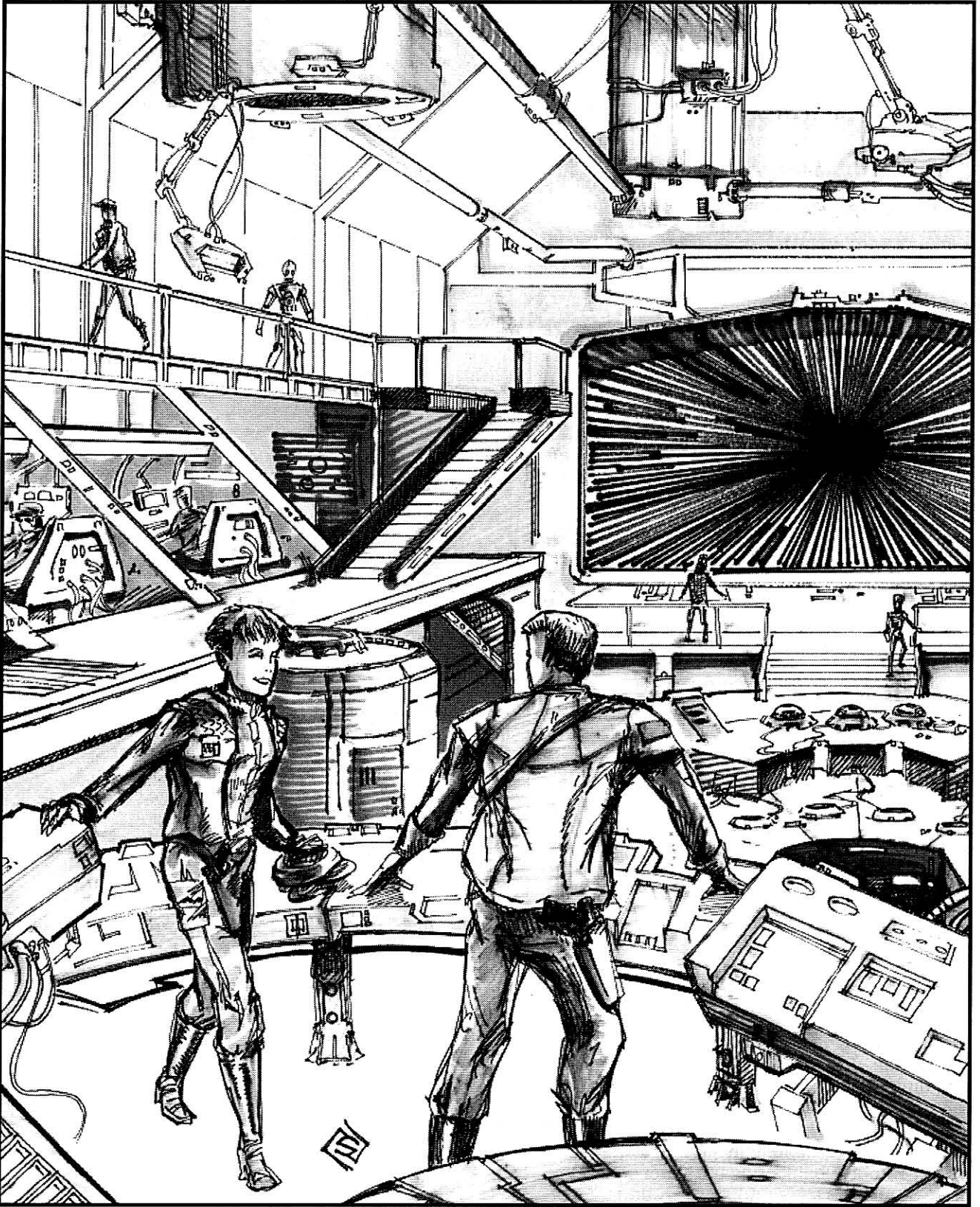

Brian Schomburg

■ "The Command Center."

TURBOLASER

This is the bay from which the *FarStar's* upper turbolaser is controlled. The *FarStar* has six turbolasers, which are the primary defense for the Corvette. The lighting is kept low and there is a constant rumbling as the weapons run through testing routines.

The gunner position is a full-time post, with the gunnery seat in the base of the turret. The gunner handles all targeting and firing for the weapon, with targeting data supplemented by the sensor suite readings. Fire control orders are delivered from the command center, although in combat the gunner is often given "full discretion" for selecting targets.

The two turbolaser technician positions are alert status posts; they are vacant when the ship is not on alert. The technicians have computer stations placed amid-decks, only partway into the upper weapons deck.

The first technician handles turbolaser systems monitoring for this weapon and the starboard (right side of the ship when facing forward) turbolasers on deck one. With his computers, he can remotely adjust the targeting computers, turbolaser alignment and cooling systems to keep the weapons running smoothly for prolonged periods.

The second technician handles power allocation for this turbolaser and the starboard turbolasers. The turbolasers are powered by the turbolaser power generators but they also receive power from the turbolaser batteries on deck one and the main reactor core.

The turbolaser can still be operated if the technicians are missing, but at a significant penalty. If one technician is missing, add +5 to all difficulties for this turbolaser. If both technicians are missing, increase the penalty to +10 to all difficulties for this weapon *and* the starboard turbolasers. In addition, if both technicians are missing, each turbolaser is limited to only 20 shots because replacement power is not being properly fed into the weapons.

The *FarStar's* turbolasers use an incredible amount of energy and can quickly drain their power reserves. Under normal combat conditions, the turbolasers can each be fired roughly 50 times each before depleting the storage batteries. Once the batteries are depleted, the turbolasers must wait a full minute for the power generators to build up enough power to fire. This period can be reduced if power is diverted from the main reactor core, although for a meaningful difference other vital systems, such as the engines and shields, must be powered down.

Once a battle is finished, the turbolaser power generators are dedicated to recharging the turbolaser batteries. This is normally one of the *FarStar's* top priorities since the turbolasers are the ship's main defense; completely recharging the turbolaser batteries takes roughly 50 minutes.

REAR TOPSIDE HOLD

This hold is a standard cargo storage area. A single off-duty post is split between all the holds and storage areas on this deck and deck one, with an additional SE-4 servant droid to assist the crew member.

As with all of the *FarStar's* cargo holds, the lock is a simple mechanical model. An Easy *security* total is necessary to pick the lock; failing the roll triggers a simple alarm siren which can be heard a deck away.

The temperature and lighting is kept low to help conserve the *FarStar's* resources. This hold contains crates filled with survival gear, breath masks, survival tents, glow rods and similar emergency gear.

FORWARD TOPSIDE HOLD

This hold, which is also kept cold and dark, contains comlinks, spare equipment power cells, climbing gear, portable fusion generators, survival tents and portable shield generators.

The portable shield generators provide 1D-4D character-scale shields covering an area roughly two meters by two meters square. The shields are traditionally used to protect weapons emplacements and vital posts for planet-side bases and is similar to the defensive energy shield described under "Espo Heavy Repeating Blaster" on page 121 of the *Han Solo and the Corporate Sector Sourcebook*.

DECK ONE

MAIN REACTOR CORE

The main reactor core is the heart of the *FarStar* and fills the four decks of the engineering section. The power core provides the energy for the engines, turbolasers, landing bay charging stations (for fighters and shuttles), communications, sensors, shields, life support, computers and all other systems.

ENGINE LEVEL A SYSTEMS MONITORING

This station monitors and maintains the performance of the four upper row engines. This post is manned at all times by two technicians, a single R3 astromech droid and one power droid.

As this room is in the heart of the engineering section, it is extremely hot and uncomfortable. The emergency lighting and readout monitors lend a bizarre deep red hue to the whole engineering section.

This station handles the operations of the four engines, including integration with the other engine levels and coordination of the performance of these four engines. The two technicians can rerout power, adjust heat dispersion, handle energy control and perform emergency engine maintenance from this station.

This station has two turbolifts and an access shaft leading to the engineering sections of decks two through four (the access shaft also goes to both sensor suite stations). The open air access shafts and simple floor grates mean that virtually every engineering station can hear and see what is going on at all the other engineering stations.

DIRECT ACCESS POWER DISTRIBUTION

This area has a single technician posted here at all times. This station handles the power distribution to all ship systems except the engines. Based on recommendations from the command center, this officer allocates power to the turbolasers, the landing bay, the many computer systems, communications, sensors, shields, life support and all other systems.

POWER REGULATION

This is the station from which the *FarStar's* main power core is regulated and maintained; a catastrophic malfunction at this station will completely disable the ship and could lead to a core overload explosion, which could destroy the ship. A team of two technicians, three R3 astromech droids and a power droid can be found here at all times.

TURBOLASER (4)

Each turbolaser station has one gunner, who is present only when the ship is on alert. Each turbolaser receives maintenance at least once a week, with circuits, power regulators, galven patterns, laser barrels, laser actuators and rotation gears regularly checked and replaced.

These turbolaser turrets are significantly smaller than the upper and lower turbolaser turrets. This is because the turbolasers have an integrated computer fire control system, with most of the hardware mounted in the upper and lower turbolaser batteries. Most technical operations, including power flow and minor recalibrations, are handled from the technician stations in the upper weapons

ENGINEERING SECTION

The engineering area is one of the most important areas aboard the *FarStar*. The various stations must work together to keep the ship powered and operational, and Lofryyhn pushes his engineers and technicians relentlessly. This area includes the following sections:

- Deck One: Engine Level A Systems Monitoring, Direct Access Power Distribution, Power Regulation
- Deck Two: Engine Level B Systems Monitoring, Hyperdrive Systems Control, Sublight Systems Control
- Deck Three: Engine Levels A-C Power Distribution, Auxiliary Override Control, Heat and Energy Output Control
- Deck Four: Engine Levels C Systems Monitoring, Auxiliary Systems

Lofryyhn has made preventative maintenance a top priority due to the constant punishment the engines suffer. The engineering section is large, with three levels of floor walkways, gangplanks, and access ladders crossing above the solid floor on deck four.

Many of the computer stations have had most their paneling removed for ease of repair. This approach allows the engineers to immediately get at any malfunctioning components, enabling them to perform the scores of minor repairs that are needed every day.

deck turbolaser (for the starboard turbolasers) and from the stations in the lower weapons deck (for the port turbolasers).

TURBOLASER STORAGE BATTERIES

Huge armored cases hold the dozens of storage batteries necessary to power the weapons. Each case holds three one cubic meter batteries, each of which can be replaced in about five minutes. Each battery can be charged, drained and recharged several times, with a working lifespan of roughly 3,000 shots before replacement is recommended.

The cases are armored in the event that the battery overloads and suddenly discharges all of its energy. While the armor won't completely contain such an explosion — anyone standing adjacent to an exploding battery is likely to be killed — the armor significantly decreases the

likelihood of a single battery overload taking out the entire deck. Thankfully, overloads are rare ... although they aren't unknown.

DECK ONE FORWARD HOLD

This large hold contains comlinks, spare equipment power cells, climbing gear, portable fusion generators, survival tents, portable shield generators and extra storage batteries. This area also holds replacement parts for the turbolifts. Spare turbolaser parts, including turbolaser power converters and couplings, and spare turbolaser battery casings and components are also stored here.

STORAGE

These two storage areas are similar to the standard cargo holds. They have survival gear, breath masks, survival tents, glow rods, spare medicines, medical equipment and basic ship-board supplies such as blankets, lighting panels, intercom parts and emergency hull seal patches. Part of the starboard hold has been converted to bulk food storage, with several large resealable crates.

COMPUTER CONTROL DECK

The computer control deck contains the main storage and processing computers for the *FarStar*. There are two full-time technicians and four R3 astromech droids here.

While each station on the ship has its own computers, they are used to perform basic computations and to encode calculations and data before they are sent to this station for processing.

This room's computers have several specific stations, including engineering, main and backup astrogation computers, communication computers and sensor control computers.

The maintenance computer station here can perform maintenance diagnostics on other computer stations in this room and throughout the ship. This process takes about an hour per system and requires the station being updated to be taken off-line for the maintenance period. Maintenance is scheduled for each computer once a week, although the intense schedule the *FarStar* has been under has meant that maintenance is normally only performed after a major computer system failure.

The forward storage room of the computer control deck contains spare monitors, processors, and other key replacement parts in the event of a computer failure or severe power overload.



Brian Schomburg

DECK TWO

ENGINE LEVEL B SYSTEMS MONITORING

This station monitors and maintains the performance of the three middle row engines. This post is manned at all times by two technicians, one R3 astromech droid and one power droid.

This station is essentially similar to the engine level A systems monitoring station on deck one: it handles the operations of the three engines, including integration with the other engine levels and coordination of the performance of these three engines. The two technicians can rerout power, adjust heat dispersion, handle energy control and perform emergency engine maintenance from this station.

HYPERDRIVE SYSTEMS CONTROL

Two technicians are at this station at all times. Hyperdrive systems control coordinates the functions of the hyperdrive motivators and engine components within each ion engine. The control station is responsible for keeping the hyperdrive operating by balancing each engine's performance. Some of the duties for this process include modulating power feeds from the reactor core, regulating power output from each engine, and interfacing each engine with the hyperdrive motivators and astrogation computers. Remote maintenance can be conducted from this station, although some duties must be performed by physically crawling to the engine via the engine accessways.

The astrogation computers in the command center and computer control decks can be overridden from this station in the case of a catastrophic failure. The hyperdrive engineers can shut down the engines in case of a power overload or other major failure.

SUBLIGHT SYSTEMS CONTROL

This station has two full-time ion drive engineers. This station coordinates the operation of each ion engine by balancing power load and fine tuning performance to keep engine operating at peak efficiency. The engineers must modulate the power feeds from the reactor core, regulate power output from each engine, and interface each engine with the *FarStar's* drive computers. Remote maintenance can be conducted from this station, although some duties must be performed by physically crawling to the engine via the engine accessways.

STORAGE

The small storage area near the engineering area holds replacement components for hyperdrive and sublight engines and engineering stations. Everything from spare alluvial dampers and hyperdrive motivators to wiring clips and core brackets is stored inside this room, although most major engine components are too large for the *FarStar* to carry replacements.

Unlike the engineering area itself, this storage room is very well organized, with all parts marked and labeled. Datapads store engine diagrams and diagnostics for quick replacement. This organized system guarantees the *FarStar's* engineers speedy access to parts, enabling them to quickly make repairs and prevent a major shipboard catastrophe.

HANGAR CONTROL ROOM

The hangar control room is situated on deck two, overlooking the main flight deck of the hangar bay on deck three. A flight control supervisor can be found here at all times, but this post is considered an "off-duty" post: shifts are four hours long and served during the off-duty shift. An R3 astromech droid is here at all times assisting the supervisor. The unit, R3-K8, has been equipped with an astromech voice box (see *Fantastic Technology*, page 27) and programmed with Basic so it can communicate directly with the supervisor, although in many cases it is more efficient to feed data to display terminals and hologram projectors. During alert conditions, an additional flight supervisor is here.

The room is fairly large, but it is filled with computer consoles. A large hologram projector fills the room: it is constantly showing the *FarStar* and any ships within a thousand kilometers of the vessel. The hangar is tuned into the ship's external comms so the supervisor can listen to the command center's communications directives. There are display monitors showing the docking tubes, as well as an internal and external monitor showing each airlock.

Once an incoming vessel has expressed a desire to land in the *FarStar's* landing bay or dock with its airlocks, landing control is turned over to this room.

The flight control supervisor's job is to coordinate landing, takeoff and docking efforts for all of the *FarStar's* vessels. During normal operations, this is not too demanding a job: the supervisor only has to make sure that patrol fighters don't slide into any of the docked ships during landing or takeoff. However, during combat situations, the supervisor must somehow be able to launch all serviceable fighters within a few minutes. Things can get hectic very quickly.

The flight control supervisor regulates the use of the lift (which goes down one level to the maintenance deck), the operation of the magnetic field and other essential landing bay operations. He or she is also responsible for deploying emergency services (such as fire control or medical officers) in the event of a crash, and deploying security officers and droids when foreign ships dock with the *FarStar*.

CREW QUARTER CLUSTERS WITH HEAD/SHOWERS

The three quarter clusters each have five rooms. Each room has two bunks, both of which are used by a different person during each 12 hour shift, for a total of four crew members in a given room.

"HOT-BEDDING"

In order to have a complete crew for its mission, the *FarStar* has assigned two crew members to each bunk in alternate shifts. This practice is known as "hot-bedding" and while it is necessary for this mission, it still has bad psychological effects.

Over long periods of time, "hot-bedding" causes reduced morale, discipline problems and a general feeling of "discomfort" among the individuals involved. This occurs because each individual's body temperature is slightly different: during a shift change, a person will crawl into a bed which still is still somewhat warmed by the other person's body heat and the bed "feels wrong." This causes a general feeling of unease — the crew members subconsciously feel that they can't be completely relaxed and comfortable even in their own beds.

The rooms are spartan with dark gray walls, but they can be redecorated. Each person has a small storage locker. Each room has a very small storage closet, which must be split four ways. There is a small reading light above each bunk, with a terminal that is tied into the ship's computer systems — the crew member must supply his or her own datapad.

Some crew members have taken to simply sleeping on the floors on mats. The cold and damp crew's quarters have actually become somewhat of the joke amongst the crew, who often claim they get more sleep at their posts than in their rooms. To conserve power, the rooms are dim and slightly colder than what is considered comfortable to most Humans.

MESS HALL

The mess hall is manned by three off-duty crew members and four SE-4 servant droids. About one quarter of the mess hall's physical space is taken up by the kitchen and prep area.

The rest of the room has simple rows of tables and chairs. The tables are where the crew enjoys their regularly scheduled meals, although half-played games of sabacc, used weapons clips, and empty drink glasses are often left on the tables. During the peak periods, this room can seat almost 40 people, and becomes quite the center of attention. For a short while, the SE-4 droids scurry madly about as they somehow manage to clean tables and prepare meals, while the crew

members enjoy a few minutes of relaxation during the meal shift.

Between shifts, the mess hall serves as an impromptu rec room for sabacc games and general conversation if the training room is overcrowded.

Because the sleeping chambers are so uncomfortable, this room doubles as a hang-out for those either too tired to rest, or simply fed up with their bunk-mates. Sometimes, there are individuals curled up in the corners with blankets.

TRAINING ROOM

This area is a physical training and recreation room for the *FarStar's* crew members. There are variable gravity weight training and running machines, a short marksmanship range with remotes and a small sparring and martial arts mat. There is a melee weapons training cage for honing melee skills, or even just blowing off steam. It is not uncommon for ship-board squabbles to be settled with a few blows from a padded sparring weapon. The *FarStar's* crew has even set up an impromptu sparring league as a friendly competition and a way of keeping skills up to par.

There is a small lounge area with two gaming tables along one wall, each one surrounded by a ring of cushions and programmed to provide any one of hundreds of different games. There is an entrance to the mess hall for drinks and snacks, with five small tables where off-duty crewmen can enjoy hot drinks and talk with their companions. A small library of holo-vids has been included as well, allowing the viewing of entertainment or training holograms.

LIFEBOAT

Decks two and three have a single large lifeboat just off the crew quarter clusters. Each lifeboat has room for 20 people, with three weeks' worth of air, food, and water. Survival gear includes four hunting blasters, four survival tents (which can be sealed for dangerous weather), glow rods, medpacs, comlinks, flares, and a sub-space emergency signal transceiver with a range of five light years. The lifeboat's scanner also homes in on transceivers from the *FarStar's* other lifeboats.

The lifeboats are simple ships, with just enough fuel to launch and make a couple of redirection maneuvers. The lifeboat lands by using braking jets and a large parachute.

Whenever a lifeboat is activated, an alarm lights on the bridge. The launch can be manually overridden from the bridge.

SHIELD AND SCREEN SYSTEMS

This station takes directives from the shield control officer in the command center and is responsible for deploying energy/ray and particle shields around the *FarStar*. There is one shield technician and one R3 astromech here at all times.

The technician is responsible for allocating power to different shield generators to provide protection for the *FarStar's* four main facings (front, left, right, and back); the appropriate skill for operating the *FarStar's* shields is *capital ship shields*.

As with most starships, the *FarStar* keeps its particle shields up almost constantly, lowering them only to launch or receive starships. These shields protect against physical weapons, such as missiles and proton torpedoes, and they also deflect small space debris. The *FarStar's* hull code of 5D includes the effects of particle shielding; when these shields are lowered, reduce the hull code by -2D to 3D.

Because ray shielding consumes so much power, these shield generators are normally activated only in combat; they are effective against turbolasers and laser cannons, but not ion cannons. As per the standard shield rolls on pages 109-110 of *Star War, Second Edition*, the *FarStar's* shield code of 2D can be set to a single facing (front, left, right, or back) or 1D can be allocated to two different facings.

SENSOR SYSTEMS

The sensor station here is tied into the sensor suites on the upper and lower weapons decks and follows the directives of the sensor station in the command center. The rows and rows of computers display data from the numerous sensor arrays. This station is manned full-time by a single sensor technician and an R3 astromech.

This station's main task is to coordinate the efforts of the sensor suite operators, feed data to the computer control deck for processing, analyze incoming data and determine what data is worth bringing to the attention of the sensor officer. The sensor officer can remotely peer into any of the data at any time, but this station's main task is to sift the important information from the great stream of useless data.

CAPTAIN'S QUARTERS

These are the quarters assigned to the captain of the *FarStar*. They tend to be a little more roomy than the rest of the crew cabins, but the room is also used as an office, with the addition of a work desk, a computer terminal and storage space for documents, datadisks and other important items.

The only major amenity the captain does have over other members of the crew is that these quarters aren't shared with anyone else. Other than that, the room is as spartan as the rest of the crew rooms, from plain gray walls to cold floor grating. Even Captain Ciro has volunteered to keep the lighting and heat low to conserve power, follow the notion that the best way to lead is by example.

LIFEBOAT

This lifeboat carries only 12 people but is essentially the same as the 20 person lifeboat above.

ENVIRONMENTAL CONTROL

The environmental control station is responsible for controlling life support and other vital functions aboard the *FarStar*. The station is manned by a single crew member during off-duty shifts.

This area is filled with oxygen and water converters, fed from the recycling center and hydroponics labs. They maintain the ship's air and water supply. This station's computers and machinery also maintain the ship's heat, lighting and electrical systems. This station also has several large gravity generators, acceleration compensators and inertial dampeners, as well as their control systems. Numerous relays and microgenerators are placed all around the ship to maintain a constant environment in every portion of the *FarStar*. The gravity generators provide the standard gravity environment aboard the *FarStar*. The acceleration compensators and inertial dampeners work together to bleed off the effects of sudden maneuvers by the *FarStar* — while the systems aren't perfect, and the ship's crew may feel sudden jerks, shifts and tumbles, these systems stabilize the ship enough that the crew members are not literally thrown all around the ship.

In theory, this station could be used to alter the atmosphere, heating and gravity level for every compartment (provided the compartment seals are activated to maintain the environment). However, since the entire crew is composed of oxygen-breathers who are used to near-standard gravity levels, no portions of the ship have been reconfigured in this manner.

COMMAND CENTER

The command center (called "Cee-cee" by the crew) is the core of operations aboard the *FarStar*, the central hub around which most command-level decisions are made. It is a crowded two-leveled room filled with computers, read-out

screens, technicians, droids, and an impressive elongated transparisteel viewport which faces directly forwards.

The panoramic view allowed by the viewport is often ignored by those working on computer stations, as their individual readouts will often tell more than a simple look outside, but the grandeur of the view itself sometimes cannot be ignored.

Between the computer stations and relay consoles is an interconnected network of walkways and steps which wind their way through the confusion.

There are three R3 astromech droids processing data for the tactical, sensor, communications and engineering stations. There are fitting brackets placed in the floor for the droids to rest in: only their heads stick out of the brackets, making them seem like domes on top of computer stations.

There are also droid interface connectors along the front of the command center to allow for a dozen R3s to interface with the hyperdrives and astrogation computers. The constant whirring and chirping of the droids as they communicate data to each other provides an electronic feel to the environment, and when mixed with dim lighting and the soft glow of readout screens, makes for an interesting mood.

There are eight full-time posts in the command center, as well as four additional alert status posts. The upper level full-time posts include the Captain's Post (Captain Ciro's post), Flight Operations (which directs the facing and speed of the *FarStar* at sublight), as well as the Tactical Operations, the post responsible for directing weaponry and shield operations posts as well as shipboard security; this is Gorak Khzam's normal post.

The lower level (deck three) full-time posts include Sublight Operations (answerable to Flight Operations and responsible for observing and directing sublight engine operation) and Hyperdrive Operations (answerable to Flight Operations and responsible for the smooth operation of the hyperdrive engines and astrogation computers). Shield Operations is answerable to Tactical Operations, and is responsible for precisely directing shield operations. Communications Operations is responsible for sensor and communications duties, and is normally manned by Darryn Thyte. The final full-time post is Computer Operations, which is responsible for coordinating all other command center operations posts with the computer control deck.

The four alert status posts, which are all on the lower level (deck three), are Sensor Operations (to assist the Communications Operations post), Resource Operations (power allocation for alert situations), Engineering Operations (to assist in the coordination of the command center and the engineering station; Lofryyhn normally sends one of his top assistants to this post during alerts), and Weapon Operations, which provides additional data to the turbolaser turrets and assists the Tactical Operations posts.

There are two K4 security droids stationed in the command center: one near the access shaft and entrance on deck two (behind the captain's station) and one a level lower on deck three. The access shaft goes up to the computer control deck on deck one and the forward topside hold on the upper weapons deck. It also extends down to the hydroponics labs on deck four and the forward lower hold on the lower weapons deck.

EMERGENCY QUARTERS WITH HEAD/SHOWERS

The emergency quarters are used for long-term alert situations, where crew members have worked extra shifts and need rest but may need to be recalled to the command center and other vital posts immediately. The quarters can accommodate 12 crew members, with four double bunks and four mats on floor.

PROBE DROID OPERATIONS

The *FarStar's* probots and messenger droids are controlled and operated from this station. There are two crew members here part-time, as well as an R3 astromech droid at all times.

This station is responsible for repairing, programming and controlling probot survey missions, as well as programming and launching messenger drones. The probots are stored at this station for ease of access.

This station also compiles all star maps, astrogation coordinates and survey data gathered by the probots. The *FarStar's* astrogation computers and computer control deck computers can access and duplicate this data at any time.

LIFEBOAT

This lifeboat carries only 12 people but is essentially the same as the 20 person lifeboat above.

EMERGENCY PROCEDURES

In addition to the lifeboats and escape pods, the *FarStar* has several compartments where emergency space suits are stored. There is a cabinet in each deck's main corridor — decks one and four have eight suits each, while decks two and three have 18 suits. The engineering stations and command center areas also have cabinets, each with 12 suits. The cabinets are not locked, but opening a cabinet triggers a low-level alarm light at the security console in the command center.

Each cabinet contains other emergency gear, including six fire suppressant capsules (for chemical and electrical fires), six breath masks, four medpacs and an emergency space seal one meter in diameter (this is a bi-state plastic seal that appears to be a small cloth until unfolded; it has a simple activation stud). The seal will last for perhaps two minutes — not too long, but long enough to get a regular hull patch in place.

These suits are available in the event that a crew member cannot reach a lifeboat or escape pod, or in case a section of the ship has a hull breach. Each suit has three hours worth of oxygen and a distress com-link signal that is automatically activated as soon as the oxygen tanks are activated. The suit has a small rocket pack with five bursts, as well as an arc light above the helmet's faceplate.

DECK THREE

ENGINE LEVELS A-C POWER DISTRIBUTION

This area is responsible for monitoring and regulating the main power feed from the main reactor core and channeling the power to the *FarStar's* eleven engines. This is one of the single most important locations in the engineering section since a failure at this station could completely disable the *FarStar's* drive systems and lead to a catastrophic power overload.

This station has two full-time duty posts, an additional three duty posts for alert conditions, three R3 astromech droids to handle power re-routing and monitoring, and four power droids for emergency power requirements in the case of a power failure. Lofryhyn can normally be found

in this duty post, supervising the entire engineering section. There is also a single K4 security droid watching for evidence of sabotage.

AUXILIARY OVERRIDE CONTROL

This system is an emergency override station and serves as a remote headquarters in case part of engineering or the command center is disabled. The computers here can be programmed to reroute control of various ship operations to this post or the two auxiliary control stations on deck four. This station has two full-time duty posts and a single R3 astromech droid, with room for up to six additional duty stations in the event of a major realignment of engineering and command stations.

HEAT AND ENERGY OUTPUT CONTROL

This station is a containment and control station for power overloads and excess heat energy.

Ion engines and the main reactor core generate an incredible amount of excess heat, which must be directed away from the engines and reactor core to keep them within safe temperature limits. This station controls arrays of miniature heat dispersion vents and deflector plates, which draw heat away from these vital locations and into the vacuum of space.

This station also has banks of energy absorption coils which are designed to absorb and redirect energy overloads, which can occur due to an engineering station malfunction, a reactor core disturbance, a computer, shield or turbolaser overload or even enemy ion or turbolaser blasts which get through the shields. This station is the last line of defense before an energy surge can blow out a vital system.

This place is manned part-time by two technicians, who double-check the system's operation and perform any necessary maintenance. In the event of a ship alert, the technicians immediately report to this station since heat dispersion and power surge deflection is absolutely vital in combat.

CREW QUARTER CLUSTERS WITH HEAD/SHOWERS

This cluster of 15 crew quarters rooms is identical to those found directly above on deck two.

SICK BAY

The sick bay is one of the best lit locations aboard the *FarStar*, with ample heating and warm

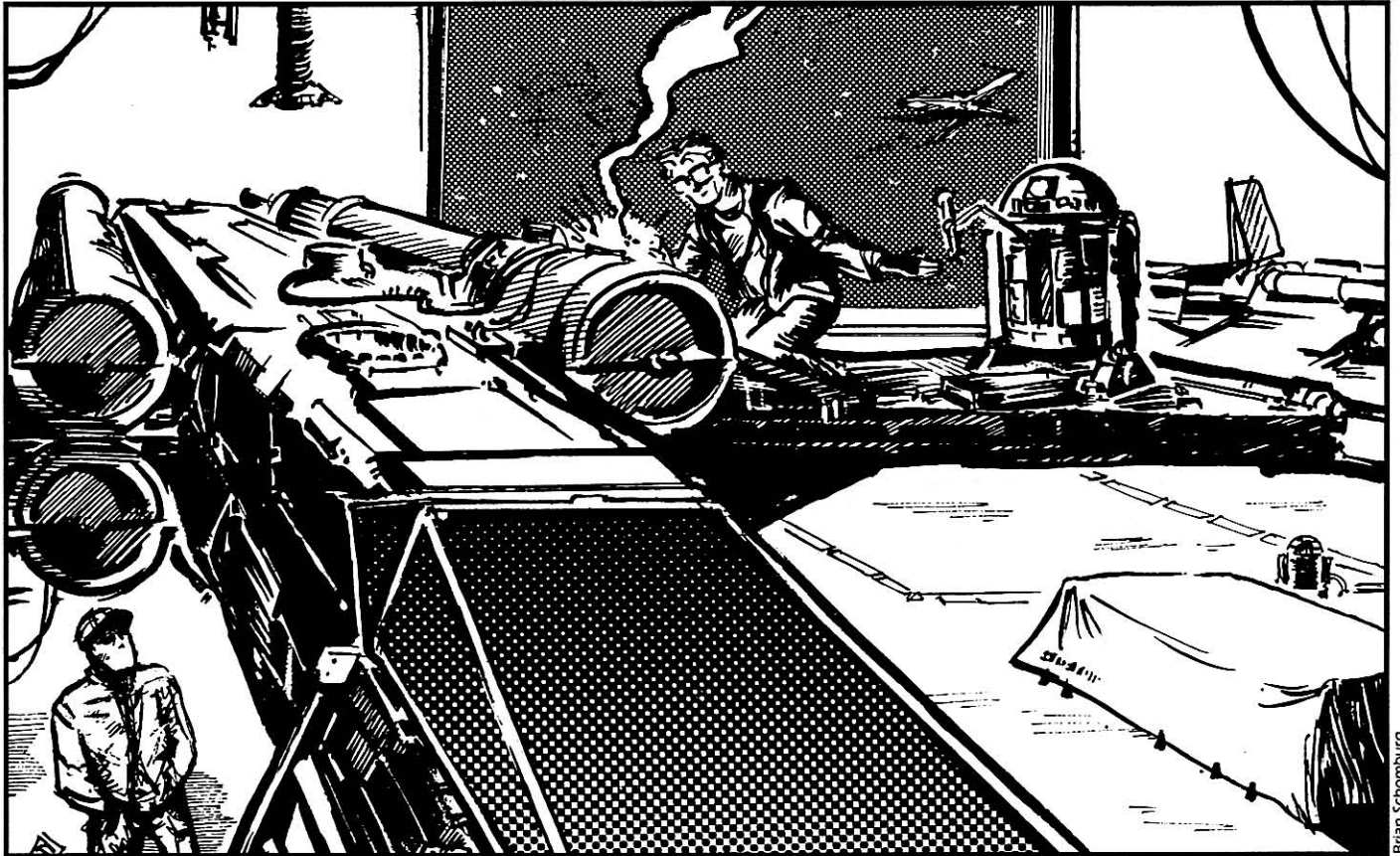

Brian Schomburg

food to boot. The surgical and medical stations are maintained by Doctor Akanseh, his assistants and the three 2-1B medical droids. Three medical personnel can be found here at all times.

The sick bay has 10 recuperation beds, four first aid stations, two bacta tanks and a sealed surgical bay. If the sick bay begins running out of beds, extra patients are assigned to crew quarter clusters just down the hall, while those crew members are reassigned to the emergency quarters near the command center or simply tripled up in other crew quarters.

Because of the excellent conditions in this station, the crew often jokes about getting hurt just so that they can spend a few pleasant days in sick bay. The room is rarely full to capacity. The droids do their best to make sure anyone who comes in is out as fast as possible, and the programming of the droids is well suited for a crew composed of many different species.

OFFICERS' QUARTERS

These four rooms are slightly larger than the standard crew quarters, but are otherwise pretty similar. Each officer room has two bunks, but they are not double-shifted, so each officer has a private sleeping space. The rooms have a small

closet, one large storage locker for each officer, a reading light and data terminal above each bed, as well as two small work stations each with a desk, computer terminal, holographic and datareader, and a small shelving section for datadisk and document storage; personal effects, like holograms and souvenirs, are also placed on the shelving sections.

LIFEBOAT

This lifeboat is identical to the 20 person lifeboat on deck two.

PILOT READY ROOM

All on-duty pilots are ordered to remain here when not on the main flight deck. This room has several chairs, a holographic projector and several clear "tracking screens" for displaying vital information, showing battle tactics and posting Gorjaye's directives to her pilots. The ready room has computer monitors, as well as monitors showing the landing bay and a tie-in to the hangar control room, and the command center comm and intercom systems.

The *FarStar* has the equivalent of a full squadron (12 fighters), with eight X-wings and four defenders. Six pilots are on-duty for each 12 hour

shift. Two pilots are on patrol duty — either in the landing bay near their ships or actually patrolling space around the *FarStar* when the ship is at sublight and the command center has ordered a patrol — with the other four pilots in the ready room. Patrols consist of either an element of two X-wings or two Defenders; the different ships are rarely mixed for patrol duty.

In the case of an alert, all pilots are expected to be in the ready room in two minutes for a combat briefing. Gorjaye has been known to run test alerts to make sure her pilots are ready when they are needed.

LANDING BAY

The *FarStar's* landing bay is two levels high and fills nearly half of the ship's interior. It is lined with a meter thick blast wall, insulating other portions of the ship from fire or crash incidents which may occur in the bay. There is a thick blast wall extended to protect the turbolifts, the corridor entrance and the access shaft that leads down to the maintenance bay.

There are three full-time maintenance and control posts, as well as five part-time posts and five more alert status posts. There are three R3 units for operating the landing bay equipment, as well as four power droids and four treadwell units. There are also two K4 security droids on duty at all times.

The landing bay is sealed by an invisible magnetic field, which keeps atmosphere inside the bay and keeps the vacuum of space out. The field's intensity can be manipulated from the hangar control room to allow ships to launch or land without exposing the bay to vacuum.

The bay has 10 starship power recharging ports, which are flush with the floor and covered with blast plates. A blast plate is directly in front of the lift and is raised when launching fighters; the plate absorbs the back-blast from a fighter's ion engines. Emergency equipment includes dozens of firefighting foam nozzles in the ceiling — they can blanket any section of the landing bay to snuff out a fire. There is also a repulsorlift "crash wagon" in the maintenance bay. In the event of a catastrophic crash which could endanger the entire landing bay, the wagon is brought up to the flight deck to push the wreck out into space.

The maintenance deck also holds two "maintenance pods." These small ships are limited repair vehicles, with three hours worth of air and small rocket engines. They are barely three meters long and have a 150 meter long tether cord that is anchored inside the hangar bay. These units have a small tractor beam, magnetic projectors and two small manipulation arms for fine repair

work. The *FarStar's* technicians use these vehicles to supervise R3 astromechs during external repairs on the *FarStar*.

The landing bay can fit four X-wings (one on either side of the turbolifts and two in the back corner), as well as an additional X-wing on the lift. Two Defender starfighters can be parked in front of the blast shield protecting the turbolifts and the other two can be lined up nose to tail in front of the corner X-wings.

The landing bay is very cramped and launching fighters can take several minutes because maneuvering the ships for the take-off lane is so tricky. The slightest mistake can result in laser cannons scraping each other, knocking the weapons totally out of calibration and effectively eliminating a fighter's fire control (consider it to be 0D). A major mistake could result in a landing deck crash, which could destroy several ships and possibly take the deck out of commission until repairs are completed.

Launch protocols call for the Defender fighters to be launched first (if they are inside the bay). Then the starboard (right side) fighter in the rear of the launch deck is launched. While the rear port fighter is moved into launch position, the two fighters near the turbolifts use their repulsorlifts to back into the launch position and launch.

If a fighter needs maintenance or repairs, it is positioned either in the rear port bay or on the lift. During combat or hyperspace travel, a thick blast shield can be lowered over the landing bay entrance to protect it from attacks or debris.

If a pilot is willing to take a full two minutes to maneuver and launch, no skill roll is needed. If the pilot wishes to launch within 90 seconds, a Very Easy *starfighter piloting* roll is necessary; to cut the launch time to one minute, an Easy roll is needed, while a Moderate roll is necessary to cut the time to 30 seconds. The difficulties for a safe landing are identical.

Failing the roll by 1-5 points means there has been incidental contact with the hangar bay or another ship, knocking the weapons systems slightly out of whack (reduce fire control by -1D until repaired). Repairs will require a Very Easy *starfighter repair* roll and three hours.

Failing the roll by 6-10 points means a more damaging collision occurred, completely knocking the weapons systems out of whack (consider fire control to be 0D) or causing minor damage to the maneuvering systems (-1D) or somewhat damaging the engines (-1 to Space speed); repairs will require at least an Easy *starfighter repair* roll and six hours.

Failing the roll by 11 or more points means a major collision has occurred, disabling all fight-

ers involved (repairs will require at least a Moderate *starfighter repair* roll and 12 hours).

MAIN DOCKING AIRLOCK

The main docking airlock runs nearly the entire length of the landing bay and is used for docking with the Aegis combat shuttle and any large vessels the *FarStar* encounters. The airlock is also mounted with a magnetic field projector in case the doors are punctured during a collision.

The airlock has three retracting doors roughly 10 meters wide; they can be opened individually to accommodate different size vehicles.

This docking airlock is used most often to load combat vehicles and large cargoes into the Aegis combat shuttle after they have been brought up from the maintenance bay on deck four.

EMERGENCY REPAIR STATION

This station is routed into the computer control deck and the command center and is designed to keep the *FarStar* operational even in the event of critical damage. This station reroutes energy and computer links to different stations aboard the ship to get essential systems up and running again. If a major ship station is disabled, computer or operation controls can be patched into the computers here but performance normally suffers significantly. There is one full-time duty post here, as well as four alert status duty posts and an R3 astromech unit.

LIFEBOAT

This lifeboat carries only 12 people but is essentially the same as the 20 person lifeboat above.

OFFICERS' LOUNGE

This room is little more than a converted storage bay that has been given over to the officers. Standard crew members are also allowed in this room, but it is understood that the officers are entitled to pull rank and ask all non-officers to leave; in practice, this room serves as an alternate recreation room for those who need a little breathing space and don't want to associate with whoever may happen to be in the training room. This room is also used as a conference room when the tactics room is too busy for meetings.

Each corner and shelf is filled with boxes and crates of spare goods, including computer components, power grids, power feed lines, coolant lines and oxygen and water tubes. It is small and fairly cramped, but it is one of the few areas aboard the ship to be truly personalized.

Although most of the decorations are non-regulation, Captain Ciro has allowed this room in particular to represent the individual character

of the crew. On the walls and shelves can be found a stormtrooper helmet (with a blast hole), a sterile krayt dragon egg and banners and ornamentation from the homeworlds of the officers. There is a power-net from a little-known bounty hunter draped across the ceiling (a contribution from Gorjaye), along with an empty power-cell *supposedly* from Darth Vader's own lightsaber — Loh'khar contributed this item with a wink. There is even a dud thermal detonator that still has working lights which has been stolen by crew members and used to break in new recruits: tossing the detonator to a green crewman and seeing him or her let out a yelp of panic seems to cause no end of amusement to some of the *FarStar's* crew members.

There is a small entertainment console with a datadisk reader, a hologram projector, dejarik and other hologram games, a miniature spheroids set and a few decks of sabacc cards.

COMMUNICATIONS ROOM

The communications room contains the main communication arrays and computers, including the non-external portions of the comm array and subspace transceiver. There is a communications technician here at all times, with a second tech reporting for duty during alert conditions.

Most of the room's interior space is taken up by the comm array and subspace transceiver and control computers. From this room, communications can be sent out on any of the thousands of established comm frequencies, and the arrays can be reconfigured to scan for non-standard frequencies in case the *FarStar* has arrived at an unexplored world and is looking for signs of a technological civilization.

This room also has a decryption computer which analyzes scrambled transmissions and attempts to decode Imperial communications. This computer is also used to scramble the *FarStar's* transmissions when necessary.

COMMAND CENTER

This is the lower level of the command center; for a complete description see deck two's entry for the command center.

TACTICS

The tactics room is a central strategy and meeting room for the *FarStar*. There are two posts for off-duty personnel as well as a single R3 astromech droid.

The room is filled with clear plastex sheets which display tactical and strategic information, as well as planetary orbits and navigational haz-

ards. The sheets have woven computer feeds and optical processors to project data anywhere on the sheets. The operator can freeze data in place for projections and strategic planning.

The plastex sheets are often illuminated with green or red glowing readouts, and because lighting is kept to a minimum in the tactics room, the entire place has an eerie, almost haunted aura. Along the walls of the tactics room are several additional readouts which display the ship's condition, crew assignments, and power levels, with the most important information being sent to the holographic display table in the center of the room.

The central hologram table is about three meters across and has a flat display face. While simple two-dimensional images are sufficient for many discussions, the hologram projector is necessary to convey some ideas and the table gets frequent use.

The hologram is useful for rotating displays to allow complete views from all angles. Starship profiles can be listed and analyzed, and holographic messages can be transmitted or received throughout the ship (and ultimately patched into the communications system), making this room an excellent central planning location.

RECYCLING CENTER

The recycling center is responsible for air, water and waste recovery: this is an essential task to extend the *FarStar's* operating range. There are two technicians here part-time for maintenance and minor adjustments; since this machinery is pretty simple, it rarely breaks down and doesn't need constant supervision. However, a recycling system failure could severely hamper the *FarStar's* mission since the ship would have to stop much more frequently to replenish air and water supplies.

This room contains several large oxygen and water scrubbers and reprocessors. Unrecoverable (but nutrient rich) waste water and waste gases like carbon dioxide are sent to the hydroponics labs (on deck four), while freshly-scrubbed water is sent to the fresh water tanks (also on deck four); air is simply added to the air circulation system in environmental control.

Any recoverable trash is filtered and broken down for reuse in other items — a broken comlink case might be melted down to be reused as an eating utensil for example. These recovered resources are sent down to the machine shop and the maintenance and repair bay. Unrecoverable trash is incinerated in the main reactor core.

SCIENCE LAB A

Science lab A has a single full-time scientist and two part-time lab assistants. This lab has zoological, botanical and xenobiological workstations, with stasis-sealed sample cages, examination and dissection stations and analysis sensors and computers. This station has been primarily charged with examining new plants and animals to determine edibility and potential hazards. The lab also doubles as a toxicology lab.

SCIENCE LAB B

Science lab B also has a full-time scientist as well as two part-time assistants. This lab has geological, atmospheric, meteorological, oceanographic and chemical analysis workstations, with sample cages and detailed scanners.

This lab's scanners can examine a given sample for data regarding toxicology and potential ship-board uses. (For example, can a certain metal sample be used to fabricate replacement parts for the *FarStar's* ion engines?)

This lab also includes a space sciences lab, for examining asteroid samples and analyzing sensor readings from dust clouds, nebulae, stars and other celestial objects.

LIFEBOAT

This lifeboat carries only 12 people but is essentially the same as the 20 person lifeboat above.

DECK FOUR

ENGINE LEVEL C SYSTEMS MONITORING

This station monitors and maintains the performance of the four lower row engines. This post is manned at all times by two technicians, one R3 astromech droid and a power droid.

This station is essentially similar to the engine level A systems monitoring station on deck one: it handles the operations of the four engines, including integration with the other engine levels and coordination of the performance of these engines. The two technicians can rerout power, adjust heat dispersion, handle energy control and perform emergency engine maintenance from this station.

AUXILIARY SYSTEMS

These two stations provide auxiliary control stations for any engineering posts and are directed from auxiliary override control. If one

regular engineering station is overloaded, part of the station's function can be fed into the auxiliary computers. In the case of a critical system failure, an entire engineering station can be routed to either one of these auxiliary stations.

These two posts split a crew complement of two full-time technicians and a single R3 astromech droid; during alert conditions, an additional four crew members are split between the two auxiliary systems stations.

ARMORY

The armory is where all non-personal weapons aboard the *FarStar* are stored; crew members are allowed to carry personal sidearms at the discretion of the captain. A single crewman is here on a part-time basis and there is a K4 security droid to prevent unauthorized entry.

The armory has an electronic lock requiring a Moderate *security* roll to pick; failing the roll signals an alert at the Security Operations post (Khzam's post) in the command center.

The armory contains 150 blaster pistols (4D damage), 25 blaster rifles (5D), five EWHB-10 E-Web repeating blasters (8D)*, 400 rechargeable blaster power packs (they take two hours to recharge when hooked up to a portable fusion generator), 50 canisters of blaster gas, 200 standard grenades (4D), 100 smoke grenades, five portable grenade launchers, 30 vibro-axes (STR+3D), 25 vibroblades (STR+1D), 100 blast helmets, 100 blast vests, five shoulder launched ion cannons* (3D speeder-scale ionization damage), five PLX-2 portable missile launchers* (6D) and five CSPL-12 projectile launchers.*

* See pages 121-124 of the *Imperial Sourcebook, Second Edition*

MACHINE SHOP

Lofryyhn has established a heavy machining shop for manufacturing large parts used within the ion engines, repulsorlift vehicles and the X-wing and Defender starfighters. The shop has two part-time duty posts, a single treadwell droid and three R3 astromechs.

The shop is limited in that each individual part casing must be custom-tooled from computer designs. Some components require an incredible number of small, detailed parts and if those parts are not in the *FarStar's* storage areas, the machine shop must construct them. The machine shop has no ability to produce computer control chips or circuitry and similar high tech items, so the *FarStar* must often pull such sophisticated items from ship's stores or hope to come across a world where those parts can be purchased.

MAIN BATTERIES

Several rows of immense storage batteries contain primary power reserves to supplement the main reactor core. In the event of a reactor core failure, the *FarStar* can run for six hours from these batteries as long as the turbolasers or hyperdrives are not engaged. If the *FarStar* jumps into hyperspace, the batteries have enough energy to power the jump and to fly in hyperspace for two hours, after which the *FarStar* will drop back to realspace — most likely light years from any known settlement.

The batteries are charged directly from the main power core. They are normally used only in emergencies or in combat situations, but they can provide the *FarStar* with power at a critical time. When drained, they can be directly recharged in six hours, or if the power core's energies are split between recharging and normal (non-combat) ship operations, the batteries can be recharged in 12 hours.

RESERVE BATTERIES

The reserve batteries perform a duplicate function of the main batteries. The batteries themselves are a more primitive design, and while they take up more space than the main batteries, they only supply four hours worth of power for the *FarStar*. If the batteries are used to power a jump into hyperspace, the batteries can only keep the *FarStar* in hyperspace for 45 minutes before the ship is forced to return to realspace.

BULK FOOD STORAGE

Most of the *FarStar's* food storage is in this compartment. Special freezing bins keep perishable foods fresh, while common vegetables, grains and meats have been specially preserved for long term storage. The foods chosen for the trip are nutritious and positively bland.

The room is a bewildering maze of stacked crates, bins and cases — which is exactly how the R-97 quartermaster droid wants things, since it enables the droid to determine how best to allocate resources. A single SE-4 servant droid is here at all times.

STORAGE

This is the largest storage room on the *FarStar* and contains a little bit of everything, including spare computer chips, uniforms, plant seeds, sleeping mats, medicines, bacta canisters, repulsorlift drive parts, and even a few cases of spare blaster power packs. Most items the *FarStar* could need are stored here in bulk.

The storage room is not normally manned and the life support systems are kept low to preserve

power; only R-97, the load-lifters and an SE-4 servant droid patrol the maze of cases and crates in this room. Lighting is kept low since the droids all have infrared receptors, while the heat is kept down to a chilly (by Human standards) 37 standard degrees.

MAINTENANCE AND REPAIR BAY

The maintenance and repair bay is the main starship and vehicle repair area; all manner of starship and repulsorlift replacement parts are stored here, from small repulsor coils and X-wing laser cannon actuators to whole spare ion engines for the Aegis combat shuttle.

A mechanic is found here at all times, with two part-time assistants and an additional off-duty assistant who is responsible for finding parts requested by the head mechanic. Two R3 astromechs and the final three treadwell droids are also assigned to this station. This bay is cluttered with parts and components, machining parts and tools, as well as the vehicles themselves.

The ground vehicles are normally stored here when not aboard the two shuttles, and T'achak T'andar, the Chadra-Fan repulsorlift chief, can be found pouring over his pet vehicles performing all kinds of unauthorized "improvements." The lift up to the landing bay is used to bring up parts for the X-wings or shuttles, which are too large to be brought down to this level. The Defender starfighters can be brought down to this level for repairs.

DOCKING TUBES

The *FarStar* has three docking tubes on the outer hull for securing fighters and the shuttles, as well as for docking with other starships. The tubes are outside the maintenance and repair bay on deck four. Each tube is accessed by an airlock.

The additional mass of the tubes and carried ships has been compensated for in the hyperdrive subroutines, so they have no tangible effect on the performance of the ship during hyperspace travel.

The exterior of each tube has three airlocks: one on the end of the tube and one on each side of the tube. Each airlock includes docking clamps and fitting brackets to hold the docked ships in place and form an airtight airlock seal. The pilots simply climb through the tube's airlock and into the cockpit.

Once a pilot straps himself or herself into place, the pilot must just flip a toggle switch to activate the release mechanism. The cockpit automatically swings down and locks into place,

the docking clamps and brackets release the ship, and the ship is propelled out into space with small explosive charges. These are the same type of releasing mechanisms used in the lifeboats and there is no chance of damage to the fighter.

The charges are angled to blow the ship "up" or "down" at such an angle as to insure that the vessel does not collide with another docking tube or docked fighter. Still, the launch procedure must be closely supervised by the hangar control room to insure that none of the launching fighters cross flight paths.

Some pilots curse the small delay and try to have their engines running before the explosives release the fighter, but the command staff frowns on this "hot-shot" practice because it endangers the ship and the crew; any pilot making a "hot launch" is reprimanded.

VEHICLE RAMP

This ramp is located in the maintenance and repair bay. It extends at a sharp angle down to the ground when the *FarStar* lands on a planetary surface. The ramp also has an airlock mechanism and takes 10 minutes to extend or retract.

DROID REPAIR BAY

This ship has a full droid repair bay for storing and maintaining the dozens of droids aboard the *FarStar*. There is a single full-time technician here, as well as two part-time duty posts and a single off-duty post. Much of the maintenance work is performed by DD-19 (the "slavemaster" droid) and his assistant, SE-4I7, a servant droid with a particularly ominous matte black paint scheme.

This bay has four major repair stations, with spare droid limbs, components, droid brains, vocabulators and other essential droid components. Various droids are always scurrying about and it's made pretty clear by the droids that the technicians are merely tolerated in this bay.

FRESH WATER TANKS

The *FarStar* has a dozen large tanks for storing fresh water. Each tank has an individual feed into the ship's water distribution system. Each tank has a series of baffles to reduce the motion of water during space flight. The ship has several separate tanks, instead of a single large tank, to prevent contamination and to protect against a single hull puncture causing the *FarStar* to lose all of its water. When the *FarStar* lands on a new world, flushing old water and restocking with fresh water is a top priority since the water tends to get stale after just a couple of weeks.

HYDROPONICS LABS A & B

The *FarStar* has two large hydroponics labs for growing fruit, vegetables, and other essential plants. The harvested vegetables are a nice change from preserved concentrates and they help extend the *FarStar's* limited provisions. The hydroponics labs are assigned two part-time duty posts (each) and the three J9 Roche worker droids have also been assigned here.

The labs are filled with watering pipes and growth lamps. Lab A is designed to simulate temperate conditions, while lab B simulates warmer, wetter tropical zones. The droids are capable of actually running the bays entirely by themselves, but the technicians oversee and direct the work.

LOWER WEAPONS DECK

SENSOR SUITE

Like the upper sensor suite (on the upper weapons deck), this is a small, cramped room but it is staffed by only one sensor/communications technician.

The lower sensor suite has very sensitive sensor arrays which tie into the upper sensor suite's readings; in effect, these sensors provide the ship's focus mode (in game terms). However, the upper sensor suite must be fully manned and operational to use this mode.

This sensor suite also provides targeting data for the ship's weapon systems (if this station is not manned, increase the difficulty of all turbolaser attacks by +5).

Finally, this station houses the *FarStar's* communications arrays, including the comms and subspace transceiver arrays. While most communications are patched into the communications system in the communications room and the command center, this array must be manned for the communications to be sent out properly.

BELLY HOLD

This hold is used to store additional food (at standard room temperatures), as well as spare sensor and turbolaser components. R-97 has an SE-4 servant droid to keep things orderly. More survival suits and tents, basic shipboard supplies, X-wing and shuttle components and a seemingly random collection of other goods are stored here. If a given cargo hold is out of a certain item, there is a good chance that a few more "spares" are waiting to be found in a buried crate in this hold.

FORWARD LOWER HOLD

The forward lower hold is also used for bulk food storage; an SE-4 servant droid is here at all times. It also contains additional equipment for the hydroponics labs: growth lamps, piping and even seeds are stored here. There are spare water pumps, gravity generator parts, and heat exchangers for use in the environmental control areas. A small corner of this hold is also used for spare extra droid parts: several old and battered R3 astromechs are here in various stages of disassembly.

TURBOLASER

This turbolaser turret is essentially the same as the large turbolaser turret on the upper weapons deck. There is a full-time gunnery post, with the gunner's bay inside the turret.

The two technicians posts are amid decks, midway between deck four and the lower weapons deck. The two technicians are assigned to the turret during alert situations, and they are responsible for systems monitoring and power allocation for both this turbolaser turret and the two port turbolasers on deck one.

ESCAPE PODS (8)

Each escape pod carries four people but is otherwise identical in function to the lifeboats. Like the other lifeboats, each escape pod carries three weeks worth of supplies for its passengers.

THE DARKSTRYDER CAMPAIGN

CHARACTER RECORD SHEET

NAME _____
RANK _____
POSITION _____
TYPE _____

ATTRIBUTES

DEXTERITY

KNOWLEDGE

MECHANICAL

PERCEPTION

STRENGTH

TECHNICAL

FORCE POINTS

DARK SIDE POINTS

CHARACTER POINTS

MOVE

EQUIPMENT

BACKGROUND

PERSONALITY TRAITS

ADVENTURE NOTES

THE COMMAND CREW

The command crew of the *FarStar* are the core characters of *The DarkStryder Campaign*. While many other characters will play important roles in this campaign, many of the major decisions will be made by the command crew.

These biographies are fairly detailed and some include information that the players shouldn't know, at least not yet. The gamemaster should photocopy the biographies for the players, crossing out restricted information. Alternatively, the gamemaster may describe certain elements of the character while not giving the player the full story. Jessa Dajus is specifically a character where the players should be kept in the dark.

Gamemasters must make sure that only mature roleplayers take on the characters with hidden agendas, Khzam and Dajus being the most prominent examples. These agendas and drives must be roleplayed in a sophisticated manner and if necessary, gamemasters should coax their players to get an appropriate performance.

CAPTAIN KELEMAN CIRO

A former sergeant in Page's Commandos, Keleman Ciro is quickly making the transition from elite operative to captain of the New Republic Corvette *FarStar*. Despite his lack of command experience, Ciro has shown a remarkable resistance to the effects of the DarkStryder mindwarping modules, leading Lieutenant Page to believe that Ciro's mental strength might be a deciding factor in the *FarStar's* mission.

Ciro was a computer programming student and planned a "quiet" career in front of flickering computer screens. However, as the Empire's repressive grip tightened on his homeworld of Dolomar, Keleman found himself drawn into a local resistance group. (For more information on Dolomar, see pages 69-70 of *The Last Command Sourcebook*.) After participating in a series of guerilla assaults that toppled Dolomar's Imperial Governor, Keleman joined up with the New Republic proper. His brother Noell, seeing the opportunity to leave his isolated homeworld, also signed up for New Republic duty. While Noell was assigned to the New Republic's pilot corps, Keleman began an intensive training course for

commando operatives. After exceptional performances during his initial assignments in Brak sector, Ciro was transferred to Page's Commandos. In the two years since joining the flamboyant commandos, Keleman has repeatedly proven his worth to Page's Commandos.

Ciro is confident in his own abilities, particularly his computer skills, but he lacks the bravado of many New Republic commandos. He prefers to let his actions speak for themselves.

In his role as commander of the *FarStar*, Ciro is reserved but insistent: he has no use for shows of bluster and temper, and he expects his orders to be followed immediately and without question. He often chooses to listen

to all opinions and then issue his opinion with a minimum of explanation — those who want to follow his orders will be rewarded accordingly, while those who want to do things their own way can be dropped off at the next inhabited planet. Ciro knows that survival depends on building a focused team and he doesn't have time for coddling anyone's personal preferences.

Ciro is ill at ease commanding such a large crew, but Page's confidence in his abilities makes him sure that he will ultimately succeed at his duties even if there are going to be a few rough spots in the early going.

Ciro is a non-descript Human male of medium height with dark hair. He is in his early thirties but is in better shape than most men a decade younger.

■ Keleman Ciro

Type: Commando
DEXTERITY 3D+2

Blaster 5D+2, dodge 6D, melee combat 4D+1, vehicle blasters 4D+2



Terry Pawlet

KNOWLEDGE 3D

Alien species 4D, cultures 3D+2, planetary systems 4D+2, willpower 7D+1

MECHANICAL 2D+1

Beast riding 2D+2, repulsorlift operation 3D

PERCEPTION 3D+2

Command 4D+1, persuasion 5D, search 4D+2, sneak 5D+1

STRENGTH 3D+1

Climbing/jumping 4D+2

TECHNICAL 2D

Computer programming/repair 7D+2, demolition 3D+1

Force Points: 1

Character Points: 11

Move: 10

Equipment: Blaster pistol (4D), comlink, blast vest (+1D physical, +1 energy), datapad

KAIYA ADRIMETRUM

Kaiya Adrimetrum is first officer aboard the *FarStar*. She is a strong-willed and intense woman who has been molded by events beyond her control; she expects more of the same aboard the *FarStar*.

Adrimetrum initially began her fight against the Empire because the Empire destroyed her life. Her husband was killed by Imperial forces

during the occupation of Siluria III. Adrimetrum organized her friends and relatives into a revolutionary cell, and led an attack on the Imperial governor of Siluria III. She and her freedom fighters were soon recruited into the Rebel Alliance by Corwin Shelvay, who convinced them their revolutionary efforts could have greater effects elsewhere. (For more information, see pages 10-13 of *Galaxy Guide 9: Fragments from the Rim*.)

Since then Adrimetrum has been a warrior, fighting the Empire

and struggling to protect those fighting with her. She tends to develop strong personal ties to those in her commando teams. While that has increased efficiency and teamwork, it has also made death a greater sorrow to bear. Adrimetrum served with several teams during the Rebel Alliance's fight against the Empire. She distinguished herself in combat so much that she was recently invited to join Page's elite commandos. Since joining Lieutenant Page, she has earned his respect and trust.

Adrimetrum is an extremely serious woman in her early thirties. Although she still retains her youthful appearance — with short-cut black hair and chiseled, aristocratic features — her deep brown eyes betray a sense of weariness and a battle-weary heart.

Adrimetrum is a good leader, the kind who inspires loyalty in her followers. She is an excellent complement to Captain Ciro's subdued command style. She is strong and firm, yet knows when to unleash her aggressive nature to achieve her goals. Adrimetrum likes to negotiate from a position of strength. She is not aggressive unless she sees a clear need for such drastic action.

Watching out for her unit's safety is a great concern and it figures into many of her command decisions. Adrimetrum is protective of her crew in an almost motherly way. She feels the pain when they are hurt, and accepts the risks of sending her people into combat. However, like a mother defending her young, when threatened, or her crew or her objective are put in jeopardy, she can become a dangerous, terrifying opponent. When threatened, Adrimetrum uses any tactic necessary to accomplish her mission.

Adrimetrum maintains a facade of a cool, calm leader in the face of danger. Sometimes, however, the burden of being responsible for others' lives digs deep into her heart and her sense of security and authority. Deep inside she feels she's just very average and normal — just like the wife she used to be on Siluria III — but she knows she can't allow the crew to see this. Adrimetrum focuses her energies through her concern, as well as her pursuit of the *FarStar's* objectives in the Kathol sector.

Adrimetrum has made many friends over the years, including her former team's Wookiee technician, Lofryyhn. After hearing her friend was imprisoned on Moff Sarne's capital of Kal'Shebbol, Adrimetrum requested she be part of the task force sent to liberate that planet, and made sure she was one of the elite commandos sent to liberate the Moff's prisons.

■ Kaiya Adrimetrum

Type: New Republic Commander

DEXTERITY 3D+2

Blaster 6D, dodge 5D

KNOWLEDGE 3D+2

Bureaucracy 5D+2, intimidation 4D+1, law enforcement 4D, streetwise 5D, survival 6D, willpower 5D

MECHANICAL 2D+2

Capital ship piloting 4D, communications 5D, sensors 6D

PERCEPTION 3D+1

Bargain 5D+1, command 7D+2, con 5D+1, investigation 4D+2, persuasion 6D

STRENGTH 2D+2

Stamina 4D+2



Chris Moeller

TECHNICAL 2D

Computer programming/repair 4D, demolition 5D, first aid 5D+2, security 6D+2

Force Points: 3

Character Points: 12

Move: 10

Equipment: Datapad, headset comlink, heavy blaster pistol (5D)

SECURITY OFFICER GORAK KHZAM

This Rodian has been placed in charge of shipboard security. He claims to have some knowledge of the systems within Moff Sarne's Kathol sector from years as a free-trader in this area. His experience gives him some insights into the various settlements and cultures in the sector, and might offer some contacts which may be able to help the *FarStar*. Khzam spends much of his time on the *FarStar's* bridge, overseeing operations, and is often near Ciro and Adrimetrum to offer suggestions or alternative strategies when asked. He seems to be mindful of the crew's needs and safety — Captain Ciro often asks Khzam to comment and critique his ideas in certain situations.

Khzam is a peculiar individual, and has a multitude of odd behaviors. He avoids physical contact with others — to the point where he refuses to engage in hand-to-hand combat. The Rodian is also mindful of how close others come to him. A sure way to upset him is to invade his "personal space" by coming more than half a meter close to him. He is fond of telling others "Kozak lo neets-ka" — "keep to your own space."

His attitude seems condescending regarding other aliens, especially those species officially enslaved by the Empire. Khzam is very careful around these aliens and avoids them when he can. He's often looking over his shoulder, as if someone's stalking him. Khzam is slow to offer information or advice unless directly asked. At times, it seems as if he wants to voice his opinions, but he suppresses them until asked.

Of all the *FarStar* crew, Khzam has the most to hide. He belonged to a small-time slaving syndicate which operated in Kathol sector and several neighboring sectors. Khzam was in charge of security for the Sabiador Slavers, the group which actively sought out aliens for Moff Sarne's arena. He personally holds most "lower" alien forms in contempt — to Khzam, anything beautiful or exotic is something to be enslaved: a lesser being.

The Sabiador Slavers have since disbanded, their members now scattered throughout the Kathol sector, the Minos Cluster and regions beyond.

Khzam is fearful that his past will be revealed.

His principle reason for joining the *FarStar* is to flee retribution from some of his former slaves. Fortunately, very few beings outside of the Sabiador Slavers themselves know Khzam's identity. For all anyone else knows, Khzam could very well be just a simple trader. The *FarStar* expedition was his only way off Kal'Shebbol, and the only ship headed in his direction — unknown space. What he did not expect was that several former slaves would be brought aboard the *FarStar* as crew. Still, his identity remains undiscovered, at least yet. Khzam has no qualms about covering up his story, either through fancy talking or, when he can be subtle about it, lethal force. Khzam goes out of his way to avoid possible former slaves among the crew, just in case.

Few suspect Khzam's checkered past. Lieutenant Dajus knows who he is, and knows he was one of Moff Sarne's suppliers for slaves, but she also knows Khzam knows her true role in the Moff's service. If there is one being aboard the *FarStar* that Khzam considers a friend, it is the Defel, Kl'aal. The two share an affinity for hunting, and they often go out together to hunt on uninhabited planets — but Kl'aal might feel differently if he knew Khzam's true motivations.

Khzam is cool and calculating, if not quietly savage and bloodthirsty. He has a tendency to shoot first and make up a justification for his actions later — although he's always sure no other crew members witness these

acts, and he always has a reliable alibi. Khzam's first goal is self-preservation. Khzam is always on the lookout for a good world where he can hide if his past is revealed, and always has some kind of backup plan in mind in case he must flee.

He has no reservations about joining ground teams bound for uninhabited planets or those with no apparent civilizations, and avoids visiting highly settled worlds or Imperial outposts — places where people might recognize him as a slaver.

■ Gorak Khzam

Type: Rodian Officer

DEXTERITY 4D+2

Blaster 7D+2, dodge 5D+2, grenade 6D, thrown weapons 5D+2



Chris Moeller

KNOWLEDGE 2D

Alien species 5D+2, business 4D, cultures 3D+2, intimidation 5D, planetary systems 6D, streetwise 6D+2, survival 5D, value 4D

MECHANICAL 2D

Astrogation 5D, repulsorlift operation 4D+2, space transports 5D, starship gunnery 4D+1, starship shields 4D

PERCEPTION 3D+2

Bargain 5D+2, command 5D, con 6D, search 4D+2, sneak 7D

STRENGTH 3D+2

Climbing/jumping 4D+2

TECHNICAL 2D

Blaster repair 4D, security 6D

Force Points: 3

Dark Side Points: 2

Character Points: 13

Move: 10

Equipment: Comlink, heavy blaster pistol (5D), hold-out blaster (3D), 2 throwing knives (STR+1D), shoulder-slung shock rod (hidden under cloak; STR+1D, 4D (stun), Moderate difficulty)

LIEUTENANT DARRYN THYTE

Thyte is the *FarStar's* bitter bridge operations officer, in charge of maintaining order and efficiency for the starship's command center. He's the captain's eyes and ears to everything outside the ship, from communications to sensor readings. He functions as the ship's navigator. The bridge is his responsibility and his home, and he's fiercely protective of his territory.

Thyte is a former X-wing pilot. Several months before the New Republic task force liberated Kal'Shebbol, he was flying air support for a ground action in the mountains of Vaenrood. Imperial artillery fire clipped his fighter's wing and he crashed. In the accident, his canopy buckled and snapped, shearing off his right hand and most of his arm. Medics were able to replace the arm with a clunky cybernetic model — the only thing that was available at the time. The less sophisticated cybernetic hand

doesn't have very precise sensitivity and function, but it has a computer interface that allows him to manipulate data if a visual interface is also available.



Chris Moeller

He was taken off the active duty pilot roster after his crash — given Thyte's changed attitude, his squad mates were more than happy to see the dour man go. He continued to travel with the task force he was assigned to, serving as a bridge officer aboard one of the capital ships. When word of the *FarStar's* mission spread through the New Republic fleet, Thyte demanded to be assigned to the ship. Here, he figured, he could prove his own worth and perhaps escape his personal demons.

Thyte desperately wants to fly again but he suffers from a severe "confidence problem." He knows that if he returns to active duty with a mainstream fighter squadron his attitude and his disability would set him apart from his team members. As it is, Gorjaye is adamant that Lt. Thyte will not be assigned to fighter duty. Instead, Thyte serves on the *FarStar* bridge, where he can still see some action without actually piloting a starfighter.

Thyte's tall and pallid form haunts the *FarStar's* bridge at all hours — he's rarely seen elsewhere unless his duty requires it, and he loathes leaving the *FarStar* on missions, possibly indicating a fear of flying in small craft. The skin on his face has little color to it, and seems to hang under his dark eyes. Still, Thyte is a strong presence on the bridge. He can be very forceful and imposing when dealing with other bridge crewmembers and is not one to let others push him around.

Thyte is very independent and protective of his duties on the bridge. He should be. If anyone knows the *FarStar's* bridge — her instruments and her sensor and communications capabilities — it's Thyte. He's also the only one with any experience as a capital ship astrogator. And Thyte knows it. He's the type of officer who doesn't take orders — he merely "accepts command suggestions" from his superiors. He knows the *FarStar* crew needs him enough to tolerate his attitude. Thyte always seems to be walking the edge between undisciplined brilliance and a slap in the face.

Thyte often takes the offensive, making preemptive strikes to inflict his biting opinions on those around him, and can work behind the scenes to cause a great deal of turmoil aboard the ship. Thyte hates Lieutenant Gorjaye, the starfighter squadron commander, mostly because she's on active flight duty and he isn't.

■ Lieutenant Darryn Thyte

Type: Bridge Officer

DEXTERITY 1D*

Blaster 1D+1*, dodge 4D+2

KNOWLEDGE 2D

Bureaucracy 5D, intimidation 4D+1, planetary systems 4D

MECHANICAL 1D*

Astrogation 7D+2, capital ship piloting 4D+1, capital ship shields 2D+2*, communications 6D+2, sensors 7D, space transports 1D+1*, starfighter piloting 1D+1*, starship gunnery 1D+1*, starship shields 3D*

PERCEPTION 3D

Command 6D, investigation 5D, persuasion 4D

STRENGTH 3D

TECHNICAL 3D

Computer programming/repair 5D+2, droid programming 4D, security 6D

* Reduced due to injury

Special Abilities:

Cybernetic Hand: Thyte has a replacement cybernetic hand that has a number of specialized tool attachments and a computer data-jack. The jack allows him to access most computer ports but he can only use them when there is a visual data display to allow him to see the data he's manipulating. This jack gives him a +1D bonus to his *computer programming/repair* skill.

Force Points: 3

Character Points: 10

Move: 10

Equipment: Blaster pistol (4D), headset comlink

LIEUTENANT JESSA DAJUS

Perhaps the most mysterious member of the crew, Lieutenant Jessa Dajus is a former Imperial officer who served Moff Sarne. Although the sharp-looking young woman claims she's an Imperial turncoat, not everyone believes her or her motives.

Dajus claims she's after Moff Sarne for revenge. She says she was an Imperial shuttle pilot serving in his forces and was imprisoned when Moff Sarne purged his military and administrative personnel of "traitors." She says she was secretly working to undermine the Moff's power on Kal'Shebbol to rid the planet of his injustices. If she weren't such an important prisoner in the Moff's dungeons, Dajus wouldn't have been tortured — and she has several scars along her left arm, apparently burned in, to prove it.

The *FarStar* command crew initially thought bringing Dajus aboard as a crew member would be dangerous — but they wanted to run against the risks to have her along as an Imperial tactical advisor. Nobody else from Kal'Shebbol seemed to know too much about Moff Sarne's operations in the Kathol sector. Although Dajus doesn't know everything, she seems to know much, especially about Imperial military strategies and how Sarne operates.

In truth, Dajus was one of Sarne's top tactical officers who learned that some entity named DarkStryder was the source of his advanced weapons. She was determined to find out more — possibly for her personal use or to sell to underworld contacts — but Sarne eventually learned

she was digging too deep into his secret affairs with DarkStryder. Sarne tried to interrogate her, but Dajus' resolve held and she revealed nothing. Moff Sarne was devising several devious and more severe methods of interrogating Dajus when the New Republic task force arrived to assault Kal'Shebbol. Sarne had no choice but to leave Dajus in his prison while he made his escape.

Dajus' initial reason for joining the *FarStar* mission is to pursue her own personal revenge against Moff Sarne. However, she's also interested in discovering what DarkStryder is and what kind of power it can give her — this motive becomes stronger as the hunt for Moff Sarne brings the *FarStar* closer to discovering the mysterious DarkStryder. Dajus is focused on finding Sarne and DarkStryder — anything else that gets in her way is an annoyance to be ignored, and if necessary, eliminated. She overrules and bullies anyone to get her way, but often her subtle persuasive efforts and sheer force of will can convince people to follow her desires.

Although she doesn't know or acknowledge it, Dajus is Force-sensitive. She knows she's really lucky, capable of pushing herself far beyond what others would expect, has haunting recurring dreams, and sometimes "knows" things before they happen. This ability is completely unreliable because she has no formal training and doesn't really acknowledge her abilities. Yet this Force sensitivity makes her extremely vulnerable and powerful at the same time. She knows DarkStryder is vitally important to her, but not how. Dajus realizes DarkStryder is the key to something — but she doesn't know if it's possibly the key to greater knowledge, mysterious powers, or something even greater. When she sees it, though, Dajus will know.

As a result of both her service with Moff Sarne and her unexplained bursts of intuition, Dajus knows a lot more than she's willing to reveal. Like most information available to her, she saves it to use when it can help influence others to follow her in achieving her personal goals.

Dajus is often haunted by dreams of shadows and crawling black spiders, alter-



Chris Meel'er

DREAM LABYRINTH

Dajus was lost. The maze seemed endless — sometimes it shifted right before her eyes: portions faded away into darkness while shadows warped and twisted to reveal a new corridor that was not there seconds before.

Something was calling her deeper into the labyrinth, a gravelly voice, in a language not her own. Or maybe it was her own, only distorted by the walls of the maze.

Then she saw it. A shadowy form. A large, dark spider, its legs wriggling like tentacles, reaching out for her. Her first instinct was to flee, but she hesitated. The dark form crawled closer, almost examining her. It intrigued her. It spoke to her. The same language she heard before. But this time it sounded handsome, not rough.

The dark spider scurried away down the

maze corridor, stopping at the nearest corner as if waiting for her. Dajus started following it, then stopped dead. The shadow spider was sucking on something. She could hear the sounds of tongues lapping liquid, of teeth shearing through flesh, of bones snapping. Dajus approached carefully, trying to get a better image of what the dark spider was eating. It was a form lying on the floor, dead and mangled. She crept closer for a better view. The shadow looked up from its prey ...

Jessa struggled within the damp bedsheets. She sat straight up in bed, drenched in sweat. Jessa frantically reached around for her blaster, but instead she felt a warm hand nearby.

Sarne sat on the bed beside her. "Bad dreams?"

nately tempting her toward night and driving her away from daylight.

Whether or not Dajus realizes it, she's slowly going over to the dark side. She's constantly engaged in a fight to maintain a balance between the good and evil within her. She wavers between supporting the *FarStar* crew and eventually betraying them to attain her objectives and power. She isn't always sure whether to subtly convince those around her of her methods and desires, or to use subterfuge, blackmail and sheer force to get her way. She sometimes listens to her conscience, although it can sometimes get in the way of achieving her goals. Dajus believes turmoil is good for the spirit, and knows she must use both facets of her personality — the good and the bad — to inflict her revenge on Sarne; she doesn't really believe in the Force, nor does she suspect that part of her intuition is due to the subtle directions of DarkStryder.

Few beings aboard the *FarStar* trust Dajus, especially since she still wears her Imperial officer's uniform. She is rarely allowed to carry a weapon while aboard the ship. Captain Ciro often allows Dajus to carry a sidearm during missions away from the ship. Despite the crew's mistrust for her, Dajus is relatively fair and tolerant of them. She knows if she's to find Sarne and DarkStryder she needs to work with the crew — at least for now. Since she worked in Sarne's administration, she knows Doctor Akanseh was a torturer, but keeps it to herself to lord it over him later. Dajus also knows the Rodian Gorak Khzam was a slaver who frequently supplied Sarne with

new alien "gladiators," but doesn't turn him in either — she uses this information as leverage to get what she wants out of him.

■ Lieutenant Jessa Dajus

Type: Imperial Tactical Advisor

DEXTERITY 3D

Blaster 5D, dodge 5D, pick pocket 6D

KNOWLEDGE 3D

Alien species 4D+2, bureaucracy: Imperial 6D, cultures 4D, intimidation 5D+2, planetary systems 7D, streetwise 5D, willpower 5D+1

MECHANICAL 3D+2

Astrogation 5D+2, communications 4D, repulsorlift operation 4D, sensors 4D+2, space transports 7D, starship shields 5D

PERCEPTION 3D+1

Bargain 4D, command 5D+2, con 7D+2, hide 4D+1, investigation 5D, persuasion 5D, search 6D, sneak 6D+2

STRENGTH 2D+1

TECHNICAL 2D+2

Computer programming/repair 5D+2, droid programming 5D, security 6D

Special Abilities:

Force Intuition: Dajus cannot use any Force powers because she is unaware of her Force-sensitivity. However, she is prone to sudden bursts of intuition that are quite accurate.

This character is Force-sensitive.

Force Points: 4

Dark Side Points: 2

Character Points: 15

Move: 10

Equipment: Comlink, datapad, Imperial officer's uniform

LOH'KHAR THE FINDER

Loh'khar is the *FarStar's* procurement specialist — anything the team needs, he can often scrounge up in a matter of minutes to a few hours, depending on the size and rarity of the material.

The tall Twi'lek is intensely secretive about his methods and sources in obtaining equipment, and often explains his methods away by saying, "If you have to ask where I got it, you won't really want it."

Many years ago Loh'khar escaped from the Twi'lek homeworld Ryloth, apparently fleeing from some clan conspiracy working against him, or so Loh'khar claims. Through unknown means he acquired a light transport, and journeyed through the galaxy as a sort of traveling salesman, bringing odd goods from world to world and matching them with the perfect buyers. At times he settled down and worked his procurement wonders from a fixed base, often near starports and busy urban centers where entrepreneurs, smugglers and bureaucrats craved illegal, rare, or expensive items they couldn't obtain themselves. In each location he established a tight network of spies, street urchins, thieves and "buying agents" who helped him obtain what his clients wanted. In some cases, especially when he was traveling, Loh'khar did the work himself.

During his travels, Loh'khar traded some valuable information for three unhatched Turazza eggs. At the time others thought Loh'khar got the short end of the deal, but the eggs soon hatched, and the three Turazza bonded with the Twi'lek. Now the three short reptiles, Rizzal, Vizzal and Nizzal, work for Loh'khar, running errands and collecting information.

Loh'khar uses a combination of high perception, bribery and extortion when trying to obtain items. Sometimes what his clients need is within easy grasp, either through payment or thievery. Other times he bargains with the complex network of the black market — using bribery and intimidation where necessary, and often trading items or information he has for materials he needs.

Loh'khar continued his business — trading items and information to suit his clients — profiting from the greater conflict created by the galactic civil war. Granted, some of his best customers were representatives of the Rebel Alliance — always in need of materiel — or the Empire, seeking shadier ways to accomplish their military objectives. But Loh'khar played off both of them, betraying them only when profitable.

With the rise of the New Republic, business has been slower, but not unprofitable. There was still much wealth to be gathered in the Outer Rim Territories and in other places where the New Republic's bureaucratic grasp could be easily avoided.

He was running a brisk trade out of his light freighter when he made the mistake of stopping on Kal'Shebbol, hoping to assist the renegade

Imperial Moff Sarne. Instead, Sarne commandeered his ship and stranded Loh'khar on Kal'Shebbol. Loh'khar was grateful he wasn't imprisoned by Moff Sarne, and attempted to make the best of the situation. He set up shop in Kal'Shebbol's main starport, catering to the needs of the few traders who flew in and the desires of the innumerable, miserable creatures living beneath Moff Sarne's iron bootheel.

When Page's Commandos blasted through Moff Sarne's palace, sending Sarne fleeing with his sector fleet, Loh'khar didn't much care. Empire, New Republic, same thing — there was still money to be made, even if the police uniforms changed. However, it did mean more opportunity for him — opportunity for profit ...

It took him two tries to make it aboard with the *FarStar* crew. At first, Lieutenant Page didn't feel he had any viable skills. But when the *FarStar* needed some heavy-duty turbolaser power capacitors, Loh'khar obtained them within a day. Nobody knows how he did it, but he assured the command crew that his diplomatic talents and his finesse at "managing resources" could get him almost anything.

Loh'khar keeps tabs on everybody and everything. Perhaps it is his Twi'lek upbringing, or maybe his many years in the procurement business — but he has a knack for making arrangements behind the scenes, sowing rumors to get others to do as he pleases, collecting dirt on some to blackmail them, and bribing others. All the while he seems to be noble Loh'khar, procurement specialist, who seems to be incapable of subterfuge and intrigue.

Loh'khar cuts a mysterious profile. He often covers his gray tunic with a voluminous black hooded cloak. The cloak is filled with pockets stuffed with datacards, pouches of this and bits of that, useful materials to trade or juicy information to blackmail others. Loh'khar often keeps the cloak's hood covering his head, keeping his shifty eyes in shadow. He hides most of his emotions behind a stoic, business-like face.

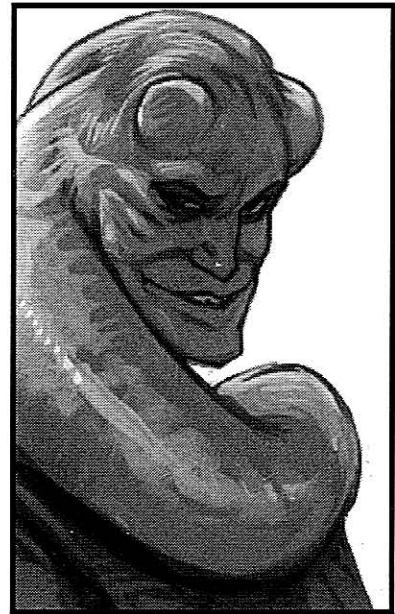

Chris Moeller

TURAZZA EGGS

Loh'khar the Finder sat solemnly in the corner booth where his regular customers knew they could find him. In his arms he cradled three fist-sized eggs, each mottled with gray-green spots. He quietly cooed to them, soothing whatever was inside and calming them against the usual chatter and bad music which assaulted the patrons in Galliwig's Cantina.

A swarthy man in an apron — Galliwig himself — swaggered up to the booth. "Looks like yer got some bad end of yer latest deal, there, Lookar," he drawled.

Loh'khar looked up from his seat, his eyes still shaded in the darkness of his cloak hood, but staring right through Galliwig. "There is no bad end of the deal in my book," the Twi'lek said. "Bad' is a relative term, and I ensure any deal in which I engage has the maximum profit reserved for my end."

Galliwig gave Loh'khar a perplexed look. "Tell yer what," he drawled. "I'll trade yer

those eggs for 25 credits. Take 'em off yer hands real easy like."

"I'll pass, thank you."

One of the eggs stirred within Loh'khar's arms. It began shifting — something on the inside was pecking its way out the top of the egg. The other two eggs began moving, too, and soon the tops of each egg were cracked.

A fanged red snout poked out of the lead egg, pushing pieces of shell away so it could pop its little red-scaled head out. Dark eyes peered from the skull-like head, looking at Loh'khar. It began to make meeping sounds.

Soon the little reptile was joined by its two other siblings, all meeping and extending their short necks toward Loh'khar. As Galliwig continued to stare at the Twi'lek with that same perplexed look as before, Loh'khar lifted the three baby Turazza to his face, and gently touched their fanged snouts to his lips. "Welcome, my little meeping friends," he said. "Welcome into my humble service; welcome to Loh'khar's little business."

■ **Loh'khar the Finder**

Type: Twi'lek Procurement Specialist

DEXTERITY 3D

Blaster 5D, dodge 6D+2, pick pocket 8D

KNOWLEDGE 4D

Alien species 8D, bureaucracy 7D+2, business 6D+1, cultures 7D, intimidation 7D, languages 8D, planetary systems 5D, streetwise 9D, survival 5D, value 6D, willpower 7D

MECHANICAL 2D

Repulsorlift operation 4D

PERCEPTION 4D+2

Bargain 7D, con 8D+2, forgery 6D+2, gambling 7D, hide 6D, investigation 7D, persuasion 8D, search 6D, sneak 6D

STRENGTH 2D+1

TECHNICAL 2D

Computer programming/repair 5D+2, droid programming 4D, security 5D

Special Abilities:

Tentacles: Twi'leks can use their tentacles to communicate in secret with other Twi'leks, even in a room filled with other people.

Force Points: 3

Dark Side Points: 1

Character Points: 17

Move: 10

Equipment: Comlink, datapad and datacards, heavy blaster pistol (5D)

**LIEUTENANT' RANNA
"WING-RIPPER" GORJAYE**

The fiery tempered red-haired beauty named Ranna Gorjaye is the flight commander for the *FarStar's* complement of starfighters — although

at times one could mistake her for the *FarStar's* captain. She knows how to get her job done without wasting pilots or starfighters. While she might be abrasive and pushy at times, Gorjaye is a valued member of the *FarStar* command team.

Gorjaye takes no guff from anyone — on the flight deck, in formation and in combat, her word is law. Anyone who disagrees with her can sit out the next mission. She has supreme trust in her abilities and her pilots. Gorjaye is a hard taskmaster, though, and insists that her pilots pay close attention during briefings, hang on every order she gives, and execute her orders perfectly and without question. This discipline keeps the *FarStar's* pilots alive — when it's disobeyed, people die in combat and starships are lost.

Gorjaye is the scourge of the docking bay. She's often found yelling orders, bossing the technicians around, and chewing out anyone who's getting in the way. To Gorjaye, having all craft in "ready" status is the optimal state of operation — unfortunately, this is rarely the case. The docking hangar is her domain, and anyone questioning her authority there, or trying to usurp it, is quickly and ruthlessly corrected.

Gorjaye was initially a squadron leader in the New Republic task force which drove Moff Sarne from Kal'Shebbol. She didn't choose to serve on the *FarStar*; she was assigned to the duty, and she's very upset about being dumped on this

“losers’ mission.” Gorjaye doesn’t trust the “hot-shot commandos” or the *FarStar* command team — she thinks they’re going to get everyone killed and that they don’t plan before they act. She firmly believes that the *FarStar*’s situation would be better if she were in charge. Occasionally Gorjaye visits the bridge to dole out her free advice and tactical know-how. She doesn’t get along with Ciro or Adrimetum, although Captain Ciro’s younger brother, Noell, has a good deal of faith in Gorjaye, which has caused Captain Ciro to modify his views. Adrimetum and Gorjaye particularly don’t agree — while they may agree on the end result, they argue over the finer points of how to achieve it. When barking out her free advice on the *FarStar*’s bridge, Gorjaye is often asked to leave — in more critical times, she’s sometimes escorted away.

Unlike most of the *FarStar*’s crew, Gorjaye makes sure her peers and underlings know about her colorful past. She often boasts of her years of starfighter service with the Rebel Alliance and the New Republic, quoting battles and actions nonchalantly to add authenticity to her authority. Her greatest achievement — the one she

mentions most often — is her training and graduation at the top of her class from the Raithal Academy’s flight corps program.

But while she brags about her past, a good deal of it remains in shadow. Gorjaye won’t admit this, but she grew up on Salliche, in the Core Worlds, where she joined the Salliche Student Militia, a military training program for young people. Here she learned to fly Z-95 Headhunters in training, and won her scholarship to the Raithal Academy’s flight school. She graduated from the top of her class. After that, it’s

uncertain what happened to Gorjaye. Rumors abound that she was an elite TIE fighter pilot.



Chris Moeller

SURVIVAL CLASS

Gorjaye was furious. It was a simple training patrol gone all to hell because of an overconfident and underskilled wingman: the kid crowded her formation and clipped her fighter’s wing. Both fighters went down, right into the middle of the Wilds, an overgrown jungle filled with swampy lowlands, insect swarms and bloodthirsty predators.

After the fighter stopped skidding and thumped against a tree, Gorjaye forced open the bent canopy before the other kid could even unstrap. Ripping her flight helmet off, Gorjaye manually opened the hatch to Calson’s fighter and dragged the disoriented trainee out. When he found his footing, he pushed Gorjaye away. “I can take care of myself,” Calson spat.

“Listen, bud,” Gorjaye sneered. “I’m not the idiot who crowded formation. If you had followed my orders, we wouldn’t be down here. And if we’re going to get out of the Wilds without some corvaj ripping our livers out, you’re going to follow my orders, got it?”

Calson stepped back, brushing himself off. “I’m not taking orders from some woman.”

“Damn straight you are,” Gorjaye spat back. “You’re part of my command; I’m responsible for your sorry hide.”

Calson huffed, then rummaged through his cockpit for his survival gear. Gorjaye pulled the directional transponder from her own gear bag and took some readings, checking them on a datapad map of the planet.

“I’ve got a small settlement 17 kilometers northwest,” she said. “I suggest we start out now while we still have a few hours of light.” She stowed the map and pulled the service blade from her pack.

“No way I’m going with you,” Calson said. “I saw something back there when we were going down, and I’m going to investigate.”

“You’re coming with me, and that’s an order,” Gorjaye said.

“I’m relieving myself of your command,” Calson sneered. “You’re just going to get us killed out here.” The junior officer slung his gear bag and began shooting a trail through the underbrush with his blaster.

Gorjaye gave up. She wasn’t going to let some rowdy runt endanger her safety. Cutting a path with her service blade, Gorjaye headed northwest toward the settlement.

It wasn’t long before she heard a distant Human scream and the snarl of a corvaj ambushing its prey.

Some stories have circulated that she gained a good deal of her combat and survival training after being shot down — whether this happened when Gorjaye was a TIE pilot or a cadet at Raithal is unknown. Most of her peers get the impression that she joined the Rebellion soon after graduating from the Academy, although her reasons for defecting are unknown.

■ Lieutenant Ranna “Wing-Ripper”

Gorjaye

Type: Brash Pilot

DEXTERITY 3D

Blaster 6D+2, brawling parry 4D, dodge 5D+2, melee combat 5D

KNOWLEDGE 2D

Bureaucracy 4D, intimidation 6D+1, planetary systems 4D+2, tactics: starfighter 5D, streetwise 4D, survival 5D+2, willpower 4D

MECHANICAL 4D

Astrogation 6D, communications 5D, repulsorlift operations 5D+2, sensors 5D, starfighter piloting 7D, starfighter piloting: X-wing 8D+1, starfighter piloting: Z-95 9D+2, starship gunnery 9D, starship shields 7D

PERCEPTION 3D

Bargain 4D+2, command 6D, persuasion 4D, search 4D, sneak 5D+2

STRENGTH 3D

Brawling 5D+2, climbing/jumping 5D, stamina 4D

TECHNICAL 3D

Computer programming/repair 4D, demolition 4D+2, first aid 5D, security 4D, starfighter repair 5D

Force Points: 3

Character Points: 12

Move: 10

Equipment: Blaster pistol (4D), flight suit and helmet, knife (STR+1D), medpac

KL'AAL

When the *FarStar* needs a good picture of what's on a planet's surface and a subtle way to gather information on its inhabitants without notice, the crew sends a scout team led by the Defel Kl'aal. The *FarStar's* stoic forward scout is a mysterious individual. He literally emerged from the shadows on Kal'Shebbol to join the *FarStar* crew. He believes that the New Republic has plenty of work to be done in Kathol sector, and he wants to help make a difference—or so Kl'aal claims. The *FarStar* crew couldn't pass up a Defel



for a forward scout; his natural ability to blend into shadow is perfect for examining worlds and peoples without being seen. Few know of Kl'aal's origins or of his true reasons for joining the New Republic expedition — and Kl'aal wants to keep it that way.

Kl'aal mostly keeps to himself (when he allows others to see him), and excels at planetary scouting sorties where he can roam on his own, collecting information and pursuing his own personal agenda. He often disappears from the scouting party, returning when he feels he has completed his mission objectives. Kl'aal considers most of what he does on these personal sorties to be a private matter, not for discussion among the crew. He does not speak much, and he does not waste words on petty pleasantries. Kl'aal is very literal in his mission reports and does not embellish his word — if he says something, he can be trusted not to exaggerate. Some crew members, however, do note a savage sense of satisfaction each time Kl'aal returns from a sortie.

Kl'aal tends to avoid involving himself in shipboard matters on the *FarStar* as long as he can get down to a planet once every week or so. The petty politics and power plays of other beings do not interest him, and he is a staunch supporter of Captain Ciro and First Officer Adrimetrum. Occasionally the Rodian accompanies Kl'aal down to a planet after it's been thoroughly scouted — the two enjoy sharing the thrill of the hunt. Unlike the Rodian, Kl'aal believes the hunt to be an honorable contest between two beings; predator and prey. He avoids ranged combat and rarely carries a blaster.

Kl'aal has no true place of his own on the ship, but the crew generally assumes he hides wherever he can when not needed. He has an uncanny ability to appear when needed — or when others are speaking of him. Nobody among the *FarStar* crew has ever seen Kl'aal eat.

Kl'aal fled his homeworld Af'El many years ago. He was accused of savagely murdering a fellow Defel in a crime of passion, and swore on his honor that he was innocent. But the evidence was not in his favor — he was convicted of the crime and further vilified among Defel for lying. He fled for his life, and has been on the run ever since.

Since then Kl'aal has seen himself as cursed. He fled from one planet to the next, initially pursued by Defel hunters, and later chased by local law agencies, the Empire and numerous bounty hunters for various crimes he committed during his flight. He found temporary sanctuary after his starship crashed on a remote planet. But in the few months he spent fighting to survive in this wilderness, he developed a taste for freshly killed meat.

FEEDING TIME

Moff Sarne stared down at Kl'aal from his transparisteel window high above the observation cell. The Defel hunched in the corner while the young woman cowered in the cell's opposite corner, staring at the brooding shadow. "Go ahead, wraith," Sarne taunted. "Eat your fill."

Kl'aal watched the young woman, backed against the far wall like a cornered animal. But this one was too shocked to fight back — no doubt she had been subjected to Sarne's other "entertainments." Her grimy hair partially hid her face, hid tear-filled eyes and a quivering lip. Kl'aal found himself oddly attracted by something in her. Was it her helplessness? No, it was some warped comradery shared by two victims.

"Why are you doing this to me?" the woman screamed, asking Kl'aal's question for him.

"Why, to test you, wraith," Sarne replied. "You have served me faithfully up to now. But

I believe in testing my servants every now and then — to insure their loyalty."

"What are you talking about?" the woman cried.

"Silence, prisoner! I'm not speaking to you, but to the shadows."

The shadow stared back at Sarne, lip curling around a snarl. Kl'aal growled to himself, and the woman retreated to the far corner with a whimpering sob.

"Eat! Or you shall starve, wraith."

This was not honorable. Kl'aal was a hunter, not a savage. This woman was no prey, and this cell was no hunt. This woman was innocent, one who was not capable of defending herself. No, he would sit in the corner and deprive himself rather than give in to Sarne's twisted entertainment. Sarne continued to bait Kl'aal, but the Defel ignored the voices and the figure in the observation window, and watched the woman cowering in the other corner.

Eventually Kl'aal found himself on Kal'Shebbol. Moff Sarne's forces somehow tracked and captured him. But rather than turning him over to Kl'aal's pursuers, Sarne struck a deal — the Defel would serve as the Moff's personal assassin in exchange for feeding the Defel's unnatural hunger and protecting him from his enemies. The Defel's survival instincts made the choice for him, although Kl'aal felt his conscience would be forever stained. Moff Sarne set him to work eliminating potential threats to his power and killing known members of the small resistance groups on Kal'Shebbol.

Now that Sarne has escaped, Kl'aal believes he must kill the Moff to restore his own personal honor and cleanse his conscience. The Defel is aware that several *FarStar* crew members served his former master, but he does not feel it would be honorable to speak against them. Lieutenant Dajus and Doctor Akanseh are unaware of the Defel's role in the Moff's rule of Kal'Shebbol — Kl'aal's secret role and his secret needs were known only to Sarne and his closest advisors.

■ Kl'aal

Type: Defel Scout

DEXTERITY 4D

Blaster 6D, blind fighting 7D, brawling parry 6D, dodge 5D+1, melee combat 7D+2, melee parry 6D+1, thrown weapons 6D+1

KNOWLEDGE 2D+1

Intimidation 4D+2, planetary systems 4D, streetwise 5D+2, survival 7D, willpower 4D

MECHANICAL 2D+2

Communications 4D, repulsorlift operation 4D+2, sensors 3D+2, space transports 3D+1

PERCEPTION 3D+1

Investigation 4D+1, search 5D, search: tracking 7D+2, sneak 6D

STRENGTH 3D+2

Brawling 7D, climbing/jumping 5D+2, stamina 4D+2

TECHNICAL 2D

Demolition 4D+2, first aid 4D, security 5D+2

Special Skills:

Dexterity skills:

Blind Fighting: Time to use: one round. Defels can use this skill instead of their *brawling* or *melee combat* skills when deprived of their sight visors or otherwise rendered blind. *Blind fighting* teaches a Defel to use its sense of smell and hearing to overcome any blindness penalties.

Special Abilities:

Invisibility: Defel receive a +3D bonus when using the *sneak* skill.

Claws: A Defel's claws inflict STR+2D damage.

Light Blind: Without a special sight visor, a Defel is blind. If a Defel's visor is lost, all tasks involving sight are increased by one difficulty level.

Force Points: 3

Dark Side Points: 2

Character Points: 17

Move: 10

Equipment: Satchel

DOCTOR AKANSEH

This Mon Calamari surgeon was a great philanthropist who dreamed of bringing medical services to the underprivileged backwater worlds of the Outer Rim Territories. He was already an accomplished surgeon when he fled his home-



Chris Moeller

world, avoiding slave service with the Empire. Akanseh spent several years in hiding, working on a surgical suite almost fully automated by droids. The suite's components could fit in the hold of a light freighter and could be quickly assembled to form a field surgery unit. Akanseh planned to supervise the surgical suite, with his medical droids assisting him and performing many routine operations on their own.

Akanseh actually constructed his suite and assembled a choice

group of medical droids he programmed himself. Around the time of the Empire's defeat at Endor, he began bringing his medical services to several backwater worlds, helping many beings oppressed by the Empire. Several free-traders helped him transport his surgical suites to other backwater systems, usually in exchange for free medical services or a reduced travel fee.

But Akanseh's plans ran afoul of Moff Kentor Sarne. On his last trip, the freighter he was traveling with was captured by an Imperial Interdictor cruiser. Akanseh was taken to Kal'Shebbol as Sarne's prisoner, and his surgical suite was put into the Moff's service. But Sarne saw much more in the Mon Calamari surgeon. His medical and droid skills would come in handy in the Moff's dungeons — as an interrogator. Since Akanseh was a peaceful being, not used to active resistance, he decided to avoid making trouble and be a submissive prisoner ... carrying out his duties in his own manner.

He rarely acted forcefully against his subjects — rather, he tried to convince prisoners to trust him enough to disclose the information Moff Sarne expected Akanseh to pry from them. He knew that if he couldn't break his subjects, they would be turned over to the Imperial interrogators and their savage droids; worse yet, Akanseh himself might be forced to torture them. One of his most traumatic personal experiences occurred when one particularly stubborn subject resisted his persuasive efforts — just when Moff Sarne decided to drop in for a spot inspection to make sure Akanseh was doing his job. The sur-

geon was given the choice to chemically torture the man or face the same torture himself.

Akanseh was freed when New Republic forces and Page's Commandos liberated Kal'Shebbol from Moff Sarne's iron grip. The Mon Calamari surgeon joined the *FarStar* crew as a kind of penance for his past, hoping to help make up for what he did. Akanseh is deeply regretful of his service as Moff Sarne's interrogator, and keeps it as his deepest secret. He often claims his imprisonment in Sarne's prison was spent tinkering with droids and offering medical attention to other prisoners — both of which are actual duties he performed.

His official duties aboard the *FarStar* include keeping track of all medical supplies and machinery, as well as maintaining a pool of operational droids of all kinds. He's very interested in bringing medical advances and assistance to anyone the *FarStar* encounters, as Akanseh believes withholding medical attention is just as bad as actually inflicting injury. Akanseh is not a good combat field medic and he often becomes confused in stressful combat situations. However, he is good at his shipboard medical duties, and is also very effective working with droids. His ultimate goal is to somehow replicate his portable surgical suite aboard the *FarStar*. Since this isn't the mission's primary objective, he secretly works to his own end, hoarding medical equipment and supplies when he can, and when his medical or droid expertise are not required elsewhere.

■ Doctor Akanseh

Type: Mon Calamari Doctor

DEXTERITY 2D+1

Blaster 3D+1, dodge 4D

KNOWLEDGE 3D+2

Alien species 5D, intimidation: interrogation 4D+2

MECHANICAL 2D

PERCEPTION 3D

Bargain 5D, con 4D+2, investigation 5D, persuasion 6D

STRENGTH 3D

TECHNICAL 4D

Computer programming/repair 5D+2, droid programming 7D, droid programming: Emdee series droids 9D, droid repair 6D+1, first aid 8D, (A) medicine 4D

Special Abilities:

Moist Environments: When in moist environments Mon Calamari receive a +1D bonus to all *Dexterity*, *Perception* and *Strength* attribute and skill checks. This is a purely psychological advantage.

Dry Environments: When in very dry environments, Mon Calamari seem depressed and withdrawn. They suffer a -1D penalty to all *Dexterity*, *Perception* and *Strength* attribute and skill checks.

Amphibious: Mon Calamari can breathe both air and water and can withstand the extreme pressures of ocean depths.

Force Points: 2

Dark Side Points: 1

Character Points: 8

Move: 10

Equipment: 2 medpacs, surgical field kit (adds +1D to *medicine* and *first aid* skill rolls)

SPOT INSPECTION

Akaneh kneaded his webbed hands together, his throat dry in the dusty air of Moff Sarne's detention block. The resistance fighter restrained in the strap-chair was being coy and cocky. The Human was seemingly immune to the Mon Calamari's pleas to divulge what information he could on his subversive compatriots causing havoc in Kal'Shebbol's starport. Akaneh had done what he could, tending to the man's wounds himself to try and gain his confidence. But he was very stubborn.

"If you do not cooperate with me, Moff Sarne will most definitely draw the information he wants from you using drugs ... or worse," Akaneh pleaded.

"I'm not blowing my friends' cover, fish-face," the young man spat. "Sarne's going to send out his troopers to gun them down if I tell where they're hiding out."

The cell door whooshed open, and Moff Sarne entered with two troopers. "Surprise inspection, Akaneh," the Moff sneered. "You've been so successful with most of our subjects, I decided to sit in and perhaps learn from your technique. You seem to be so persuasive with our young subjects that my regular interrogators are bored playing sabacc, my interrogator droids are idle and my supply of exotic and painful pharmaceuticals is much too high." Sarne kept his hands behind his

back, a deadly inspector in what could turn out to be a deadly interrogation session.

"Please, son," Akaneh whispered to the young man in the strap-chair. "You must tell me where your friends are, how many are left, and what they plan to do next. If you do not, I cannot guarantee you will leave this cell unharmed."

"Blow off, fish-face," the man spat. "No way I'm betraying my friends."

"It seems your persuasive manner will not be enough to sway this young fool, Akaneh." Moff Sarne removed his hands from behind his back, holding a streamlined black case in one hand. "Try administering these, my friend — I'm sure we'll find this scoundrel's attitude changes rather quickly when he feels his blood boiling within his veins."

Akaneh took the case and lifted the lid. Inside he found a hypo-syringe and several vials of clear liquid. He coughed at the dryness in his throat.

"You hesitate, Akaneh?" Sarne asked. One of the guards handed the Moff a second identical black case. The Moff removed the hypo-syringe and drew off some of the clear liquid from a vial. "If you do not get some results soon, I shall be forced to inflict this boy's pain on you. And trust me, it is infinitely more painful in the Mon Calamari circulatory system ..."

**SERGEANT
BROPHAR TOFARAIN**

Tofarain was enjoying the latter years of his life running his own repair facility in Kal'Shebbol's starport until the New Republic stepped in. His repair hangars and machine shops were a casualty of the fighting that forced Moff Sarne to flee Kal'Shebbol. A mistargeted concussion missile landed right in the middle of Tofarain's repair bay, obliterating his storehouse of spare parts, most of his machinery, and several small starships he was repairing. Luckily, Tofarain and his crews had already taken shelter from the attack in a local tavern down the street.

So when the New Republic began recruiting a crew for the *FarStar*, Tofarain was near the front of the line. He demanded some sort of compensation for the loss of his starship repair business. And if the New Republic wouldn't compensate him with credits, he insisted the *FarStar* take him along on its journeys since he had nowhere else

to go. Offering to serve as a transport chief and shuttle pilot, Tofarain also insured his place aboard the *FarStar* by "lending" the New Republic his personal shuttle (docked far from his ill-fated repair facility) for transport duties.

Tofarain had done his fair share of traveling when he was younger. He gained his military experience — and the rank of sergeant, which he's carried around ever since — serving with a planetary militia in the Mid-Rim, then traveled the space lanes as a starship mechanic for many years. Tofarain eventually arrived on Kal'Shebbol after earning a small fortune in the free-trader and smuggling markets. He invested his credits in his repair bays, fixing ships for passing traders and later handling some repairs for Moff Sarne.

His greatest goal is to see as much of the galaxy as he can before he takes that Final Jump — and maybe make enough credits on his way to settle down on some nice, quiet world and retire for good. Tofarain's so concerned with seeing new worlds that he insists he's the only one qualified

to pilot his shuttle. He claims it's because he's modified it so much that he's the only one who knows how to handle it properly, but it's mostly an excuse to get off his repair duties, see some new terrain, get involved in some action, and maybe find some opportunity for fortune.

Along with the Wookiee Lofryyhn, Tofarain maintains the *FarStar's* starfighters and provides some technical support for the ship's ground teams. He looks very much like a typical mechanic — he's pudgy and gruff and his work coveralls are always covered in grime and sweat. He's a pushy individual, but he's also very practical. Tofarain is convinced he's the best mechanic to work on the *FarStar's* support ships and



Chris Moeller

fighters, and he often insists on rolling up his sleeves and doing major repair jobs himself. He's not satisfied trusting others to do the job correctly, and he often finds fault in others' work. He's always giving advice — and not always on repair jobs. Since he feels the New Republic owes him for destroying his repair bays on Kal'Shebbol, Tofarain often doles out his advice on the bridge. He feels he knows exactly how missions should be run (point-by-point) and what kind of strategy the command crew should be following

in situations. While most crew members respect his advice on technical matters, they tend to ignore his loud proclamations about how other areas of the *FarStar's* mission should be handled.

■ Sergeant Brophar Tofarain

Type: Starship Mechanic

DEXTERITY 2D+1

Blaster 3D, dodge 4D, melee combat 4D+2

KNOWLEDGE 2D

Business: starships 5D, planetary systems 4D, streetwise 3D, value: starships 6D

MECHANICAL 3D+2

Astrogation 4D+2, repulsorlift operation 5D+2, space transports 7D, sensors 5D, starship shields 6D

PERCEPTION 3D

Bargain 7D, con 6D+2, gambling 5D, persuasion 6D

STRENGTH 3D

Brawling 5D, lifting 4D, stamina 4D+2

TECHNICAL 4D

Capital ship repair 6D, computer programming/repair 6D+1, droid programming 5D+2, security 7D, space transports repair 10D, starfighter repair 5D+2, starship weapon repair 7D

Force Points: 2

Character Points: 10

Move: 10

Equipment: Dirty coveralls, hydrosponner, starship tool kit (+1D to capital ship repair, space transports, starfighter repair and starship weapon repair skills)

LOFRYYHN

This reddish-brown furred Wookiee is an old friend of Kaiya Adrimetrum's — the two served in the same Rebel unit after Kaiya left her homeworld of Siluria to join the Alliance. The two developed a close friendship through several infiltration missions. Lofryyhn always provided good technical support for missions, and wasn't too bad in combat, either. Although the two rarely speak of their adventures together, it is rumored that Lofryyhn saved Kaiya's life on more than one occasion. Kaiya claims Lofryyhn knows a very specialized form of Wookiee martial arts called Wrruushi which makes him downright devastating in close quarters combat — although the Wookiee avoids the subject.

Lofryyhn later put his technical expertise to work aboard a Rebel Blockade Runner (a modified Corellian Corvette) transporting Alliance special ops teams throughout the Outer Rim Territories. Unfortunately, the ship was captured by pirates, and Lofryyhn was sold to slavers. To this day he still wears the brand of the Sabiador Slavers who sold him to Moff Sarne. Rather than pitting the Wookiee against other large aliens in his gladiatorial arena, Sarne recognized Lofryyhn's technical talents and put him to work in his docking bays, repairing transports and small capital ships under close guard.

Now that he's free, Lofryyhn wants to help the New Republic however he can. Right now, that's serving as the *FarStar's* chief mechanic. He spent some time working on the *FarStar* when it was Moff Sarne's ship, and he's very familiar with the old ship. Lofryyhn knows the *FarStar's* idiosyncrasies, from the proper hum of the ion engines to the glitches in the electrical systems. He's slung a hammock in a small engineer's station aft, but he's seldom there — the *FarStar* requires his almost constant attention to stay operational.

Lofryyhn is also a bit of a tinkerer, and is fond of using his roll of duratope and some wiring he keeps in his satchel to string the *FarStar's* systems together. In what little spare time he has, Lofryyhn is fond of constructing small gadgets out of the scraps he finds around the ship, or out

of useless starship parts. Due to the lack of new parts, not everything he constructs is practical. Lofryyhn once created the equivalent of a tracking bug about as big as his fist — he could have made it smaller, but he didn't have the proper parts to work with.

Lofryyhn commands several technicians whose sole job is to maintain the *FarStar*. Most of these technicians have some knowledge of Wookiee, or at least know what he's saying half the time. Kaiya, of course, can communicate freely with Lofryyhn, too. The immense Wookiee is a fairly chummy being, and enjoys laughing with the crew and listening to their stories from far-off systems.

■ Lofryyhn

Type: Wookiee Mechanic

DEXTERITY 3D+1

Brawling parry 5D, dodge 4D

KNOWLEDGE 2D

Intimidation 4D+2, survival 3D+2, value: starships 5D, willpower 3D

MECHANICAL 2D

Capital ship piloting 3D+2, capital ship shields 3D, communications 3D+1, sensors 3D

PERCEPTION 2D+1

Command 4D

STRENGTH 5D

Brawling 6D+2, brawling: Wrruushi (A) 8D+2, climbing/jumping 5D+2, lifting 6D, stamina 6D

TECHNICAL 3D+1

Capital starship repair 7D+2, capital starship weapon repair 6D+2, computer programming/repair 4D+1, droid programming 4D, droid repair 5D, repulsorlift repair 4D, security 5D, space transports repair 4D+2

Special Skills:

Strength skills:

Brawling: Wrruushi. Time to use: one round. Wrruushi is a specialized form of Wookiee martial arts; only Wookiees

may use this specialization. Characters using Wrruushi receive bonuses only when fighting someone who has no specialized martial arts training. When using Wrruushi, a character receives a +1D bonus to *brawling* and +1D to *brawling* damage. If the Wookiee beats the attack roll by more than 10 points, the Wookiee may choose to instead inflict stun damage, receiving a +2D+1 to damage (instead of the +1D to normal *Strength* damage). Wrruushi may not be used by a Wookiee in a berserker rage. A Wookiee character must have *brawling* at 6D before learning Wrruushi. It costs double the normal number of Character Points to advance this specialization.

Special Abilities:

Berserker Rage: If a Wookiee becomes enraged, he gets a +2D bonus to *Strength* for *brawling* damage. The Wookiee also suffers a -1D penalty to all non-*Strength* attribute and skill checks. To calm down, the character must make a Moderate *Perception* roll.

Climbing Claws: Add +2D to *climbing* skill, but they may not be used honorably in hand-to-hand combat.

Force Points: 2

Character Points: 10

Move: 12

Equipment: Repair kit (+1D to *capital starship repair* and *capital starship weapon repair* rolls), roll of duratape, satchel, wires

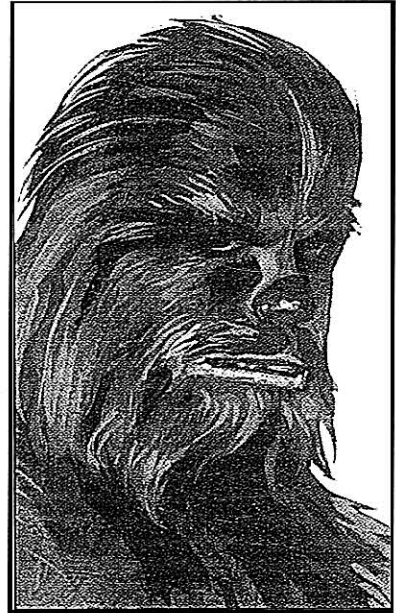

Chris Moeller

THE SUPPORT CREW

The following characters are support crewmembers. Each has a detailed background and complete game statistics. These crew members are only a fraction of the over 100 beings needed to operate the *FarStar*. There are still other starfighter pilots, technicians and ground team members. While more crewmembers will be introduced in published adventures, feel free to create more characters as the need arises during your own campaign — customize them to your adventures and to your players.

The "Crew Roster Form" in *The Adventure Book* can be used to build a quick reference for original background characters. These characters can become recurring minor characters — a few may become major personalities aboard the *FarStar*!

DASHA DEFANO

Dasha is a typical Wroonian pilot — confident in her abilities, and not the least bit shy about telling everyone. She has good reason to boast: she's a good pilot. Dasha joined the Rebel Alliance several months before the Battle of Endor, and flew with the New Republic task force which captured Moff Sarne's sector capital, Kal'Shebbol.

However, she rarely talks about her initial flight

training and early battle experience — as part of a band of Wroonian privateers raiding both Imperial and Rebel shipping. She left the privateers after she was forced to destroy a civilian transport to keep it from calling for help. Dasha later found out one of her best friends from Wroona was aboard the transport. It's not something she's terribly proud about, so she keeps it to herself, preferring to boast more about her actions with the Rebels and New Republic.



Mike Vliard

When she isn't flying, Dasha is fairly easy-going. She can often be found relating her starfighter exploits to other crew members who probably have other duties they should be attending to. Dasha also enjoys lounging around the docking hangar, talking with technicians and other pilots.

Although she seems to get along with just about everybody aboard the *FarStar*, Dasha especially distrusts Krudar, the Duros gunner. There was a Duros aboard her privateer vessel, and she's afraid any Duros she meets knows something of her shady past. Dasha simply avoids Krudar whenever possible.

Dasha always carries her gear bag slung over her shoulder wherever she goes — and even stows it in the cargo compartment of any fighter she flies. The bag is fairly light and doesn't take up much space, but it includes several personal and survival items Dasha is never without. Inside the bag she keeps a hold-out blaster, a medpac, one small rations pack, a glow rod, an emergency flare, a knife and a holo-image of the best friend she lost on that civilian transport.

■ Dasha Defano

Type: Wroonian X-wing Pilot

DEXTERITY 3D+1

Blaster 4D+1, dodge 4D+1

KNOWLEDGE 2D

Survival 3D+1

MECHANICAL 4D+2

Astrogation 5D, repulsorlift operation 5D+2, starfighter

piloting 6D+2, starship gunnery 6D, starship shields 5D+2

PERCEPTION 4D

Con 6D, persuasion 5D, sneak 5D

STRENGTH 2D

TECHNICAL 2D

First aid 4D

Force Points: 1

Character Points: 5

Move: 10

Equipment: Blaster pistol (4D), flight suit and helmet, gear bag (includes hold-out blaster (3D), medpac, small rations pack, glow rod, emergency flare, knife (STR+1))

COBB UNSER

Cobb Unser was a young free-trader captain traveling the space lanes with his sister, Corla, acting as his co-pilot. Cobb was always owing somebody money or favors, and was constantly

trying desperate schemes to stay on top of his debts. But no matter what new trade strategies he tried, Cobb continued to slip further into debt.

He and his sister were fleeing bounty hunters when they arrived on Kal'Shebbol a year ago. Moff Sarne impounded Cobb's light freighter when he couldn't pay Sarne's starport tariffs — an excuse to seize the ship for spare parts. Brother



Mike Viardi

and sister settled down in the starport to try and make ends meet and find transport back to a more mainstream system. Cobb tried to find work in the Kal'Shebbol starport, and he spent some time repairing droids and doing some minor work on starships. Corla worked as a repulsor-

lift driver, making deliveries throughout the starport. Her duties often took her to Moff Sarne's palace. Sarne eventually met her, and was strangely drawn to her. A few weeks later, Corla disappeared, and nobody could tell Cobb what had happened to her. At least, nobody but Loh'khar the Finder. Through the wily Twi'lek, Cobb discovered Moff Sarne had abducted her and sent her on one of his smaller courier ships deep into the unknown territories controlled by the Moff. Since then, Cobb has resolved himself to find her someday.

Cobb is sullen and pessimistic. He is easily cowed by others of higher rank, and even those beneath him can successfully bully him. He avoids other crew members when he can, and spends his off hours with droids — fixing them and talking to them as if they were his own friends. Cobb cares little for anyone on the *FarStar* but a few droids. He only tolerates his situation so he can continue his search for his sister among the unknown worlds under Moff Sarne's control.

Cobb is often on the watch for bounty hunters or debt collectors who still might be after him. He also owes an unspecified favor to Loh'khar the Finder, who helped Cobb discover what happened to his sister after she mysteriously disappeared.

■ Cobb Unser

Type: Pilot

DEXTERITY 3D

Blaster 4D, dodge 4D

KNOWLEDGE 2D

MECHANICAL 4D

Astrogation 4D+2, space transports 5D+2, starfighter

piloting 5D, starship gunnery 5D, starship shields 4D+2

PERCEPTION 3D

Sneak 5D

STRENGTH 3D

TECHNICAL 3D

Droid programming 5D+1, droid repair 4D, starfighter repair 5D+2

Force Points: 1

Character Points: 5

Move: 10

Equipment: Blaster pistol (4D), flight suit

NOELL CIRO

Noell Ciró is an aggressive fighter pilot and the younger brother of Captain Ciró. Noell, like his brother, began his career in the Dolomar resistance, which succeeded in evicting the planet's Imperial occupation forces shortly after the Battle of Endor.

While Keleman joined the New Republic to further the fight against the Empire, Noell saw New Republic military service as a way off the frozen ball of rock he and his family called home. Noell had some experience racing swoops at the local tracks and scored well in initial simulator testing. He was accepted into the New Republic's pilot fighter training program at the Sluis Van Outer Starfighter Base. Noell cruised through the training program, but he also came to understand the seriousness of his duty.

Noell has fought in several campaigns against Imperial forces and was pleased to learn that he had been assigned to the New Republic task force sent to defeat Moff Sarne. Noell is far more serious than he was when he began his fighter training nearly four years ago: he has seen a lot of good friends die and has grown from being a wisecracking kid to a thoughtful and serious young man. He spends a lot of his time cautioning overly enthusiastic youngsters in the hopes that he can help them learn a little ma-



Terry Pavlet

turity before they get themselves killed. Noell is extremely excited about serving under his brother, but sees his biggest task as being bridging the gap between his brother and Lt. Gorjaye.

■ Noell Ciro

Type: Brash Pilot

DEXTERITY 3D

Dodge 4D

KNOWLEDGE 2D

Planetary systems 3D+1, streetwise 3D

MECHANICAL 4D

Astrogation 4D+2, swoop operation 6D, starfighter piloting 6D+1, starship gunnery 5D+1, starship shields 5D

PERCEPTION 3D

Bargain 4D, sneak 4D+2

STRENGTH 3D

Stamina 4D

TECHNICAL 3D

Starfighter repair 4D+1

Character Points: 8

Move: 10

Equipment: Blaster pistol (4D), flight suit, comlink, survival rations

KRUDAR

Krudar is a Duros gunner who signed aboard the *FarStar* to help explore the Kathol sector and



Mike Vilardi

add a few more kill marks on his blast vest. The gunner wears an Imperial gunner's helmet and blast vest — a souvenir he took from a dead gunner on a boarding action years ago. The vest is decorated with small red metal studs in neat rows, each stud representing a starship or capital ship kill.

Much about Krudar's past is unknown — although his companion Boom has apparently been with him for some time. Like the quiet Duros, Boom keeps silent about Krudar's past. Krudar seems to be calm and peaceful, enjoying traveling the stars. However, his true self rebels against the peaceful nature of most Duros — he concerns himself with material gain and prestige. He attributes his zest for participating in space battles to the “thrill of victory I felt while serving the Rebel Alliance.” These days, however, he's more concerned with keeping track of his starfighter hits and the number of capital ships he helps destroy.

Krudar originally spent time as a turbolaser

gunner aboard a Rebel Nebulon-B frigate. He soon became disenchanted by the Rebels' constant rhetoric about freedom and justice for everyone in the galaxy — Krudar felt this was simply warped verbal justification for their acts of war. If there was anything to be gained by rebellion, Krudar hadn't received it yet. He later jumped ship to join a pirate band for more tangible rewards, and he served as gunner against Rebel, Imperial and neutral vessels. When the Imperials finally destroyed the pirate band, Krudar escaped with his pirate friend, Boom. He and Boom wandered the Outer Rim Territories for some time, serving as starship gunners aboard several smuggling freighters. The two only recently arrived on Kal'Shebbol to lie low for a while.

Krudar spends much of his time in the *FarStar's* turbolasers, checking them out or standing duty there. He's proud to keep the guns in the best condition he can. Krudar speaks very little, although he often translates for his companion, Boom, when necessary.

■ Krudar

Type: Duros Gunner

DEXTERITY 3D

Blaster artillery 4D, vehicle blasters 4D

KNOWLEDGE 2D

Alien species 3D, planetary systems 3D

MECHANICAL 4D+2

Capital ship gunnery 7D+2, starship gunnery 6D+2

PERCEPTION 2D

Persuasion 4D, search 3D

STRENGTH 2D+1

Lifting 4D+1

TECHNICAL 4D

Capital starship weapon repair 6D, starship weapon repair 5D

Force Points: 1

Character Points: 5

Move: 10

Equipment: Blaster pistol (4D), blast helmet (+1D physical, +1 energy), blast vest (+1D physical, +1 energy, torso only), starship weapon repair kit (+1D to *capital ship weapon repair*)

BOOM

Boom is a short, hunched alien with beady little eyes and a hairy face. He's always bobbing his head and tittering unintelligibly to himself, occasionally saying “boom” out loud. Nobody really knows what a Guudrian is, nor do many know how he became friends with the Duros Krudar. One thing is for certain — Boom loves fire and explosions.

Boom is enchanted by anything bright and flickering (like the flame on his mini-flamer, usually used for lighting cigarras) or loud and explosive. He's the kind of being who, when he sees or hears an explosion, gets up and runs in that

direction rather than taking cover. Boom's often testing different materials to see if they'll burn in an entertaining manner — something which usually annoys crew members who are tired of having their instruments, tools, and personal belongings experimentally scorched. Whenever Boom sees anything burning or exploding, he calls "boom, boom" repeatedly in his excitement.

Boom's fascination is also a good way to tempt him away from his pyrotechnic activities. He's easily distracted by any new source of fire, including other people's mini-flamers, plasma torches, even the slow-burning butts of cigarras.

The only other character who generally controls Boom is Krudar, who also serves as his translator. Krudar convinced the *FarStar* command crew to allow the little Guudrian aboard, since he also seems very proficient at rigging various kinds of explosive devices. Unfortunately, Boom needs to be kept under constant watch by his friend, lest he cause damage to his fellow crewmates in his pursuit of flammable entertainment.



■ Boom

Type: Guudrian Pyromaniac

DEXTERITY 4D

Blaster 5D, dodge 5D, grenade 6D, pick pocket 6D

KNOWLEDGE 3D

MECHANICAL 2D

PERCEPTION 3D

Hide 4D, search 4D, sneak 5D

STRENGTH 2D

Climbing/jumping 3D

TECHNICAL 4D

Demolition 7D, security 5D

Force Points: 1

Dark Side Points: 2

Character Points: 5

Move: 9

Equipment: Backpack, 2 blocks detonite (5D) with timer fuses, 3 grenades (5D), 2 mini-flamers

RIZZAL, VIZZAL AND NIZZAL

Loh'khar the Finder retains the services of three Turazza — small reptilian servants who run Loh'khar's errands, transfer messages, and help him maintain his contacts and resources. They are fiercely loyal to Loh'khar, and are said to share some kind of empathic or telepathic bond with him. Apparently the Twi'lek raised the Turazza from birth, and they bonded to their "parent."

Rizzal, Vizzal and Nizzal are each no more than three-quarters of a meter tall, are covered in mottled red scales and have a hunched look about them. They dress in simple tunics and vests which allow them to move around freely. Each also carries a messenger satchel for delivering datapads. They are very fast, both with their scrawny little hands and on their feet. Since they're so short, they can quickly zip beneath tables, into service ducts and between the legs of larger beings (such as Humans).

RIZZAL

Rizzal is the information gatherer among her sisters. She often knows who has what information, how they got it, what they want, and what they're willing to pay in exchange. She's also quickly learning how to break into computer systems to dig out data Loh'khar needs. Rizzal's a dedicated student, and wants to learn as much as she can about gathering data from computers. She has an annoying habit of hanging out with anyone working on a computer, finding some way to peer over their shoulder despite her short stature.

Rizzal is the quietest of the three Turazza sisters. She often disappears for long periods, either tailing someone working on a computer, or sequestered in some nook near a computer port, where she wanders through the data systems downloading or noting any information which might be useful in the future. She tolerates her other sisters, even if Nizzal seems to bully her sometimes.

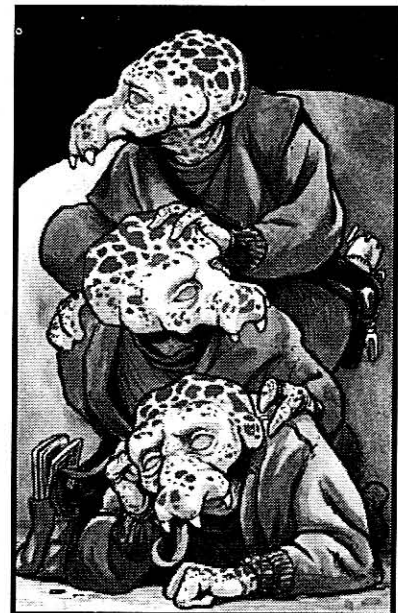

VIZZAL

Vizzal specializes in procuring materials for Loh'khar — or at least finding out where they are, who has them, and what they're willing to accept to part with them. She's not above salvaging, cannibalizing or stealing parts without their true owner's knowledge.

Vizzal is always on the lookout for possible sources for materiel. She often snoops around as if taking silent inventory of everything around her on her datapad — even if the items belong to someone else. Sometimes she even pokes at materials just to check their quality, which often annoys their owners. Vizzal quickly learned from Loh'khar that nearly everything can be purchased by matching the right supplier with the right payment — or incentive.

Vizzal's current "hobby" is reprogramming droids — usually attempting to get them to forget their current master in favor of someone else ...

She has a special affinity for droids, the sort of relationship a Rodian bounty hunter has with his prey.

NIZZAL

Nizzal is Loh'khar's dealer, the Turazza concerned with making and maintaining connections with the Twi'lek's various sources and clients. She's also the unofficial "leader" of the Turazza sisters — Loh'khar treats her best, entrusting her above her sisters to deal with other clients and sources. Nizzal is very much aware of her favored status and she often bullies her sisters with that in mind.

Nizzal keeps track of Loh'khar's various connections. She often makes her rounds, first among possible clients, then among resources, and returns to report her information to Loh'khar. Nizzal keeps a datapad in her messenger satchel for those instances where simple messages are to be delivered to and from clients or sources, or for keeping notes on what resources are available or needed. Loh'khar often sends her out when there are certain negotiations to be made. Nizzal "speaks" like other Turazza, in short, savage squeaks, heeps and meeps — however, she's the only one of Loh'khar's Turazza who speaks Basic, although her Basic is tinged by her light, airy voice, with that sharp reptilian edge to it. Nizzal speaks Basic for negotiations, and rarely utters anything in Basic unless it has to do with business.

Nizzal is rarely at Loh'khar's side, and often must be summoned by one of her sisters when Loh'khar needs her. She is sometimes rebellious toward her master, but her sisters often hold her in line by making sure Loh'khar knows of Nizzal's schemes and side deals of her own.

■ **Rizzal, Vizzal and Nizzal**

Type: Turazza
DEXTERITY 5D
 Dodge 6D, pick pocket 6D+2, running 7D
KNOWLEDGE 2D
MECHANICAL 2D
PERCEPTION 5D
 Search 6D, sneak 6D+1
STRENGTH 2D
 Climbing/jumping 7D
TECHNICAL 2D
Force Points: 1
Character Points: 5
Move: 18
Equipment: Hold-out blaster (3D), messenger satchel

Rizzal. As above except: *computer programming/repair 4D+2, security 3D+2.*

Vizzal. As above except: *repulsorlift operation 4D, droid programming 3D.* Datapad, prybar (STR+2).

Nizzal. As above except: *intimidation 3D+2, streetwise 4D+2.*

BRANDIS TURGAH

Brandis Turgah was little more than a common thief masquerading as a technician with the New Republic fleet — until he tried stealing from a group of Bothans. He was discovered, captured and brought before the leader of the Bothans, a wily diplomat named Borsk Fey'lya. Fey'lya recognized the importance of having a thief and informer aboard the New Republic fleet, so he allowed Turgah to go under the condition that he regularly report back to the Bothans with interesting news and classified data otherwise unavailable to them.

When the Bothan delegation heard about a task force going after the mysterious Moff Sarne, Fey'lya arranged for Turgah to go along. It is unclear whether the Bothans had any knowledge of what Page's Commandos would find on Kal'Shebbol, or whether, through their own twisted subterfuge, they knew or arranged for a small contingent to follow the Moff. In any case, Turgah's duty is clear — serve with the *FarStar* crew, sending updates back to the Bothans whenever he can. He has been told to send his information to Corjain, where the Bothans have a small listening and patrol post unknown to the New Republic. It is to this system that Turgah must send his updates, either using subspace radio or some kind of messenger droid or drone.

Unfortunately, access to the *FarStar's* subspace comm is restricted, and there are few messenger drones on the *FarStar*. So Turgah has been bidding his time working in the droid shop, helping Akanseh and Drugah to maintain the ship's various droids, and trying to keep the ship's comput-

ers working. He is officially a computer/droid specialist, but uses every opportunity to further his own goal of keeping the Bothans informed. In his spare time (and even while on duty) he culls together data of interest to the Bothans from the ship's computers, tries to build his own sub-space comm from cannibalized and scavenged parts, and tries to convert a droid or two from scrap into a messenger drone.

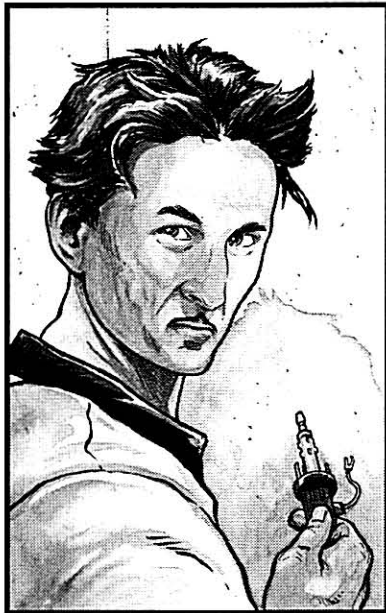

Mike Vliardi

Turgah is a slight man with mussed hair and a rodent-like face. He is most often seen hanging over a droid or computer access port, trying to keep his work secret at all times — even if he's doing nothing wrong. Turgah confides in nobody, and spends most of his time working on droids in whatever private corner he can find.

■ Brandis Turgah

Type: Informer
DEXTERITY 2D
 Pick pocket 3D
KNOWLEDGE 3D
 Bureaucracy 4D
MECHANICAL 3D
 Astrogation 4D
PERCEPTION 3D+2
 Con 6D, search 5D, sneak 5D+1
STRENGTH 2D+1
TECHNICAL 4D
 Computer programming/repair 5D, droid programming 6D, droid repair 5D+2, security 6D
Force Points: 1
Character Points: 5
Move: 10
Equipment: Coveralls, datapad

T'ACHAK T'ANDAR

T'achak was originally part of a Chadra-Fan design team hired by Incom to design new air and landspeeders. But the young Chadra-Fan was bored behind a design table, and soon moved from design to the more exciting job of testing prototypes. He was exceptionally good at driving each test vehicle to its redline limits, proving that

his colleagues' designs worked. Unfortunately, he had a habit of taking prototypes out for joyrides or drag races against other designs — something which resulted in a lot of wagers on the side and far too many crashed repulsorlift vehicles.

T'achak bounced from one company to another, test-piloting their new vehicles up to and over their limits — he has worked for Ubrikkian, Aratech, Ikas-Adno and Mobquet, among others. At each company he'd eventually take some prototype vehicle out for a spin or a race, placing bets on how fast he could take it, how sharp he could turn it, and how much it could beat out other test vehicles. When he ran out of design companies to work for, T'achak floundered for a while, working for a few planet-bound smuggling groups and even a swoop gang before he joined the New Republic. The New Republic has tried to put him where he could do the least amount of damage — on single patrol of remote planetary outposts. Only recently did the New Republic assign him to help support operations with Page's Commandos. Of course, when Lieutenant Page had the chance to get rid of T'achak, he assigned the Chadra-Fan to duty aboard the *FarStar*.

T'achak is a happy-go-lucky kind of Chadra-Fan, who cares mostly about flying fast and winning a few bets. He also cares about maintaining his repulsorlift vehicles — making sure they're in working order and modifying them to go as fast as possible. Oddly enough, T'achak always seems to jump clear of any speeder he manages to crash, suffering only minor injuries. He claims his survival is due to always wearing his crash helmet (he never takes it off) and to modifying most of his craft with what he calls a "redbutton sissy strap" — a seat belt or restraint harness to keep



Mike Vliardi

the rider aboard the craft, released by the pilot with a small explosive charge in times of emergency. A cheery little fellow, he's not above placing bets on anything that moves fast, and enjoys chattering with other technicians about how to make their own craft faster by compromising certain "unnecessary safety features."

■ T'achak T'andar

Type: Chadra-Fan Repulsorlift Chief

DEXTERITY 2D+1

Dodge 4D

KNOWLEDGE 2D

Value: repulsorlift vehicles 4D

MECHANICAL 4D+1

Ground vehicle operation 5D+1, hover vehicle operation 5D+1, repulsorlift operation 6D+2

PERCEPTION 3D

Gambling 4D

STRENGTH 2D+1

Climbing/jumping 3D, stamina 3D+2

TECHNICAL 4D

Repulsorlift repair 5D+2

Special Abilities:

Sight: Chadra-Fan have the ability to see in the infra-red and ultraviolet ranges, allowing them to see in all conditions short of absolute darkness.

Smell: Chadra-Fan have extremely sensitive senses of smell which gives them a +2D bonus to their search skill.

Force Points: 1

Character Points: 10

Move: 7

Equipment: Crash helmet (+1D physical, +1 energy), pilot's uniform

GUNTHAR

Gunthar was one of the alien gladiators Moff Sarne kept for his amusement. He is a large, hulking alien mostly covered with reptilian skin. He has large clumps of hair growing from his shoulders, head, neck and back. A stubby tail helps him keep balance. He has large, dark, innocent-looking eyes and a maw of blunt teeth meant for chewing on plants. Gunthar's body shows scars here and there from his various bouts in Moff Sarne's arena.

Gunthar's species is unknown, and nobody knows from which star system he comes. Gunthar knows, of course, and he is fond of pointing into the sky and murmuring "Home. Home out there."

He's not terribly bright, but has an uncanny way of determining someone's attitudes and reacting to them — even if they're not apparent in that person's actions. Gunthar knows enough to defend himself when confronted

with someone "bad," and shows compassion and kindness to those he knows are "good." He knows a little Basic — mostly simple, one-syllable words

— but speaks no other verbal language.

His biggest concern is going home — wherever that may be. Most likely his homeworld is located deep within the unknown regions of Moff Sarne's Kathol sector, as the direction of his pointing seems consistent. Gunthar has a strong sense of loyalty to the "good" people around him, and is willing to go on ground missions with them to protect them. He's also helpful for moving heavy machinery or parts aboard the *FarStar*. Gunthar often follows the commands of those he trusts, and sometimes needs to be commanded before he'll act. Of course, if something threatens him or his friends, Gunthar acts immediately in defense.

Perhaps his closest friend aboard the *FarStar* is the Sludir Qesya Vth'naar, with whom he was imprisoned in the Moff's detention cells. The two seem protective of each other, and are a formidable force when fighting side by side.

■ Gunthar

Type: Lost Alien

DEXTERITY 4D

Melee combat 6D+2, thrown weapons 5D

KNOWLEDGE 1D+1

MECHANICAL 1D+2

PERCEPTION 2D

STRENGTH 4D+2

Brawling 8D, climbing/jumping 7D, lifting 6D+2, stamina 6D+2

TECHNICAL 1D+1

Special Abilities:

Empathy: Gunthar is attuned to the general feelings of those around him. He can identify them in simple terms (angry, happy, afraid) and tell whether an individual is a friend, foe or neutral. This is a Moderate *Perception* task for Gunthar, but he gains +1D when using his empathic abilities. His empathy is attuned more to the subject's inner attitudes and thoughts than outward appearance or actions.

Enhanced Vision: Gunthar has exceptional vision in low-lighting and gains +1D+1 to *Perception* and *search* in darkness.

Force Points: 2

Character Points: 7

Move: 9

Equipment: Heavy metal pipe (STR+1D)

TANNER CARZYN

Tanner Carzyn wanted to join the *FarStar* crew because Moff Sarne enslaved him and then betrayed him and his family — at least that's what Tanner claims. The pushy teenager actually tries to keep most of his past secret.

Tanner has always lived under Imperial rule, believing it to be the best means of maintaining order in the galaxy. He originally came from a system in the Colonies, then moved with his parents to the Minos Cluster and eventually Kal'Shebbol to chase phantom "business opportunities." Tanner is ruthlessly loyal to the Em-



pire, and even placed his loyalty with Moff Sarne when Sarne first came to Kal'Shebbol.

Since he was a young boy, Tanner wanted to join the Empire to train and become a gunner aboard an Imperial Star Destroyer. But the fall of the Empire at Endor cut short his dreams — he



Mike Vliardi

knew his application to the Academy would never get through in such trying times, especially from such a remote system as Kal'Shebbol. Tanner tried to enter the ranks of his proud troops. If Sarne had ever personally met Tanner, he would have laughed the scrawny teenager out of his palace.

Instead, Sarne's administration placed him as a technician, fixing weapons emplacements aboard starships and ground fortifications. When the New Republic task force showed up, Moff Sarne fled, leaving behind all non-essential personnel — including Tanner. Now he wants revenge against Moff Sarne — or better yet, to join him in his fight against the New Republic.

Tanner joined the *FarStar* crew as a weapons technician, to help fix the *FarStar's* turbolasers and keep the starfighters' weapons operational. He seems loyal to the New Republic and completely against Moff Sarne — but at his first opportunity when the *FarStar* is in contact with Moff Sarne's forces, he plans to jump ship (possibly in an X-wing) and either go after Sarne himself or try to defect. At this point, Tanner isn't sure which.

■ Tanner Carzyn

Type: Young Weapons Technician

DEXTERITY 3D

Blaster 4D, pick pocket 5D

KNOWLEDGE 2D+2

Value: weapons 4D+2

MECHANICAL 3D+1

Capital ship gunnery 4D+1, starship gunnery 4D+1

PERCEPTION 3D

Con 4D+2, search 4D, sneak 5D

STRENGTH 2D

Lifting 3D

TECHNICAL 4D

Blaster repair 4D+2, capital starship weapon repair 6D+1, starship weapon repair 5D

Force Points: 1

Character Points: 5

Move: 10

Equipment: Coveralls, tool kit (+1D to capital ship weapon repair and starship weapon repair skills)

QESYA VTH'NAAR

Qesya Vth'naar was one of several prisoners in Moff Sarne's detention block kept for their gladiatorial skills. They were sometimes pitted against each other in fights to the death to amuse the Moff and his twisted followers. Qesya was one of his more successful gladiators, and he often sent her to fight "new acquisitions" to test their mettle.

One such gladiatorial contest was against her own brother — when Quyk Vth'naar yielded to his sister, Moff Sarne threatened to execute them both if Qesya didn't finish him. As she dispatched her brother so that one member of their family would still live on, Qesya made a silent pledge to someday murder Moff Sarne for what he did. She probably won't make her true intentions known to other crew members at first, and won't relate much about her past other than she was a gladiator who fought for Moff Sarne's entertainment.

Qesya joined the *FarStar's* crew to lend combat support to any ground teams, where she might find "honor in death." Her fierce hand-to-hand combat style often intimidates enemies. Although she prefers to use her oversized, two-handed vibro-ax in combat, she is sometimes required to use a blaster pistol for ranged combat. Qesya often hesitates to draw her blaster, as her sense of battle honor follows a certain protocol whereby combatants are close enough to clearly see their opponents. Hiding, retreating and even taking cover are concepts which she either does not understand or abhors as dishonorable to a warrior.

Qesya has formed a friendship with the simplistic alien Gunthar, assuming the role of



Mike Vliardi

protector. The two were imprisoned in Moff Sarne's detention block together and both fought in his gladiatorial arena.

■ Oesyia Vth'naar

Type: Sludir Gladiator

DEXTERITY 4D+2

Brawling parry 6D+2, dodge 5D+2, melee combat: vibro-ax 8D, melee parry 6D

KNOWLEDGE 2D+1

Intimidation 5D, willpower 4D

MECHANICAL 2D

PERCEPTION 3D

STRENGTH 5D

Brawling 7D, stamina 6D

TECHNICAL 2D

First aid 3D

Special Abilities:

Natural Armor: A Sludir's skin adds +1D against physical attacks.

Force Points: 1

Dark Side Points: 1

Character Points: 5

Move: 8

Equipment: Battered armor breast and back plates (+1D physical, +1 energy), blaster pistol (4D), vibro-ax (STR+3D)

EDLY "POT-SHOT" FASALK

"Pot-Shot" is a fast-talking starship gunner who fires off his mouth as eagerly as he fires off his guns. Sure, he's a good gunner, but he's not about ready to let anyone forget that. When he isn't crewing one of the *FarStar's* guns or crewing the weapons console aboard one of the shuttles,

he's relating one of his innumerable stories. Pot-Shot claims to have been one of the gunners aboard the *Tantive IV* (he eventually escaped from an Imperial prison world), then commanded the gunnery crew of Alderaan natives operating the ion cannon on Hoth, then escaped to help destroy half the Imperial fleet at the Battle of Endor. He often points to the two medals pinned to his work coveralls as his "commendations of meritorious service to the Rebel Alliance." The sash he wears over one

shoulder he claims was a gift to him from Princess Leia herself for his "exceptional bravery in the face of insurmountable odds at the Battle of

Hoth." They're little more than trinkets he bought on some backwater planet.

The *FarStar* command crew brought him aboard because they needed good gunners — little did they know that Pot-Shot was left on Kal'Shebbol several months ago by the privateer group he was working with because they all finally got sick of listening to his outrageous stories.

Pot-Shot's combat style is about as uncontrollable as his mouth. He often fires his guns before he has an accurate range reading — he fires too early, often when told to hold his fire, and he doesn't always take into account any friendly ships between his gun and his target. Pot-Shot is fond of firing on retreating ships, even those clearly out of range. He's an annoying character whose wild stories and continual chattering are tolerated because he's an accurate shot. Pot-Shot wanted to go with the *FarStar* to gain fortune and glory, and pick up a few more colorful tales along the way.

■ Edly "Pot-Shot" Fasalk

Type: Gunner

DEXTERITY 3D

KNOWLEDGE 2D

MECHANICAL 4D

Capital ship gunnery 6D, capital ship shields 5D, starship gunnery 6D, starship shields 5D

PERCEPTION 3D

Bargain 4D, con 5D, gambling 4D+2, persuasion 5D

STRENGTH 3D

Brawling 4D+1

TECHNICAL 3D

Force Points: 1

Character Points: 10

Move: 10

Equipment: Blast vest (+1D physical, +1 energy, torso only), coveralls, two medals, sash

SCORYN

Scoryn is a bitter woman who seems to have been on the run all her life. Her face is weathered and rough, although once it was considered pretty. Scoryn's black hair is now streaked with gray, and she ties it back in a tail or sometimes braids it. She rarely smiles, preferring to hide any emotion behind a stoic face and dark eyes.

The *FarStar* crew needed someone to help keep order in the ship's close quarters — as well as someone to lend any combat support to ground teams or boarding parties. Scoryn filled the command crew's expectations perfectly. She has few personal attachments to any among the crew, and is a staunch supporter of order, both aboard the ship and in tactical situations. Gorak Khzam uses her to keep crew members from fighting, and is the closest person aboard to a security patrol.

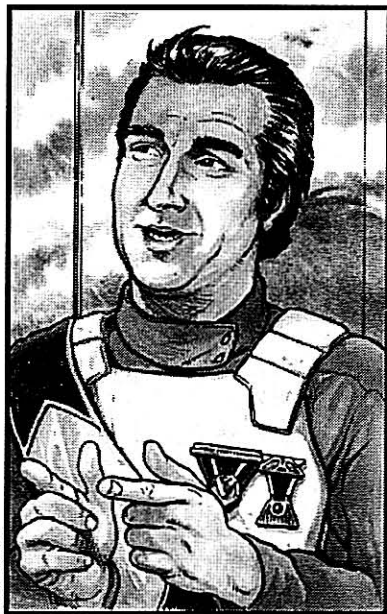

Mike Vilardi

Few know Scoryn's true reasons for joining the *FarStar*. Since she was a young woman, Scoryn's been fighting for her life. Abducted with her family by slavers, she fought her way out of the slavers' fortress with the help of other slaves who rallied around her. A crimelord who ad-



Mike Vilardi

mired her style helped her get back on her feet in exchange for running security at his palace. Unfortunately, the crimelord took offense to some minor mistake she made and ordered her execution. Instead, Scoryn led her security crew in a mutiny against the crimelord, destroying

most of his palace and wounding him and his courtiers.

Since then Scoryn has been fleeing bounty hunters and hiding on the fringes of the Outer Rim Territories. Kal'Shebbol was a good place to hide, even if it was Moff Sarne's sector capital. She made a few credits as a guard at several merchants' warehouses, but she still had no means to move freely through the galaxy if a lucky bounty hunter picked up her trail. Serving aboard the *FarStar* is the perfect way for Scoryn to flee her pursuers and stay on the move.

Although she stays aloof from the crew (except when mediating disputes), she has some odd loyalty to her immediate superior, Security Officer Gorak Khzam. Perhaps the two know each other's secrets — that Scoryn has a price on her head, and that Khzam used to be a slaver in this sector. For whatever reason, they have a healthy mutual respect for each other.

■ Scoryn

Type: Outlaw

DEXTERITY 4D

Blaster: heavy blaster pistol 6D+1, dodge 5D

KNOWLEDGE 3D

Streetwise 4D+1, survival 4D

MECHANICAL 2D+2

Repulsorlift operation 4D

PERCEPTION 2D

Search 3D, sneak 4D

STRENGTH 3D+1

Brawling 5D, climbing/jumping 4D+1

TECHNICAL 3D

First aid 4D, security 5D

Force Points: 1

Dark Side Points: 1

Character Points: 5

Move: 10

Equipment: Breastplate from bounty hunter armor (+2D physical, +1D energy, torso only), heavy blaster pistol (5D), medpac

“GAMMER” FIRDAAZ

“Gammer” Firdaaz is an ancient Socorran (a Human race) scout who has seen better days. His leathery black skin contrasts the white hair atop his head, and a gold hoop earring adorns his left ear. He's an experienced scout who still has much of the skills and know-how which once kept him alive on rugged, unexplored planets. He feels his tracking and other scout skills can help the *FarStar* crew explore those uncharted planets they discover within the Kathol sector.

Of course, Gammer has his own motivations for signing aboard the *FarStar*. He's interested in seeing as much as he can of the unexplored galaxy before he dies. If he does die, he'll be nicely preserved — half the time he's drunk. If there's a glass of alcohol to be found, he'll sniff it out. If he's not drunk, Gammer's grumpy and arrogant, unwilling to follow orders or perform his duties without being promised some kind of incentive. He gets awfully weary with shipboard life, and is happiest when his feet are on solid ground — preferably on some new planet he can roam and explore.

Gammer's the kind of person who believes he knows best, and he always makes his feelings known. His way of doing things is always the best, and if anyone tries something any other way and fails, Gammer doesn't hesitate to berate them with a grumpy old, “I told you so.” Even though he's not part of the *FarStar*'s command crew, nobody's really told him. Gammer acts as if he's the captain sometimes, something which doesn't usually agree with Captain Ciro or First Officer Adrimetrum. However,



Mike Vilardi

Gammer has found his own little group of misfits who also enjoy indulging in intoxicants. They often hide in some forgotten corner of the ship whenever anyone finds or smuggles some alcohol aboard. Although he's an experienced scout, Gammer allows his vices to get the better of him — a trait that may cost him his life or perhaps someone else's.

■ "Gammer" Firdaaz

Type: Old Socorran Scout

DEXTERITY 2D+2

Blaster 4D, melee combat 3D+2, vehicle blasters 3D+2

KNOWLEDGE 4D

Alien species 4D+2, planetary systems 4D+1, survival 5D

MECHANICAL 3D

Astrogation 4D+2, beast riding 4D, repulsorlift operation 5D

PERCEPTION 2D

Search 3D, search: tracking 6D, sneak 3D

STRENGTH 3D

TECHNICAL 3D+1

First aid 4D+1, repulsorlift repair 5D

Force Points: 1

Character Points: 5

Move: 10

Equipment: Blaster pistol (4D), bottle of Socorran raava, breath mask, knife (STR+1D), macrobinoculars, medpac, protective goggles

UNDA LAGOR

Unda Lagor is a murderer, plain and simple. The immense Aqualish was locked up in Moff Sarne's dungeons for going on a blaster rampage in one of Kal'Shebbol starport's busiest quarters.

Before he was captured, Unda had ransacked several buildings and killed 43 civilians and 21 Imperial troopers. His excuse? Unda claimed he was having a bad day. Since then he's been brewing a vengeful streak against the Moff and just about any Imperial he sees.

Unda is a large Aqualish who wears an Imperial blast helmet and vest ripped from one of the troops left behind to defend Moff Sarne's palace. He carries his light repeating blaster slung over his shoulder, although he's

fond of turning about and whacking people with the butt of the gun, seemingly by accident. Unda likes getting his way by bullying others. He managed to get aboard the *FarStar* by claiming he was

one of Moff Sarne's political prisoners. Unda has some experience with both repeating blasters and other blaster artillery, mostly from his service with a renegade mercenary group years ago. He tries to bully his way onto most ground missions under the guise of "firepower support" — although he's fond of simply blasting anything in his path that moves.

Unda rarely has any qualms about violence, even against fellow crew members. Unda's solution to most problems is "Gol toq!" loosely translated as "blast them" in Aqualish. He's more irritable if he hasn't "done good death" on any particular day.

Although crew members fear Unda would try to kill Lieutenant Jessa Dajus (the only officer who still wears her Imperial uniform), the Aqualish goes out of his way to avoid her — Unda believes she knows why he was imprisoned in Moff Sarne's dungeons and does not want such information spread among others aboard the *FarStar* for fear they'd join forces and shove him out an airlock.

■ Unda Lagor

Type: Aqualish Heavy Weapons Specialist

DEXTERITY 4D

Blaster 5D, blaster: repeating blaster 7D, blaster artillery 5D, brawling parry 5D, melee combat 6D, melee parry 5D, vehicle blasters 5D+2

KNOWLEDGE 2D

Intimidation 4D+2

MECHANICAL 3D

Repulsorlift operation 4D+1

PERCEPTION 3D

STRENGTH 4D

Brawling 6D, stamina 5D

TECHNICAL 2D

Force Points: 1

Dark Side Points: 2

Character Points: 5

Move: 9

Equipment: Blast helmet (+1D physical, +1 energy), blast vest (+1D physical, +1 energy, torso only), light repeating blaster (6D)

GENNA SEEDAR

Genna is the last surviving member of a small resistance group on Kal'Shebbol which Moff Sarne ruthlessly stomped out. A young medical student studying at the University of Byblos, she was trapped on Kal'Shebbol while visiting friends when Moff Sarne imposed severe travel restrictions on the local inhabitants. Genna decided to help her young friends fight Moff Sarne's tyranny, and she quickly taught herself how to use a blaster. Her friends succeeded in several small sorties against Moff Sarne's forces, but they were quickly and ruthlessly beaten back. Genna used her medical knowledge to tend her friends' wounds, dragging many of them from small skirmishes back into their warren of secret rooms



Mike Vilardi

beneath Kal'Shebbol's starport. Genna sat by the bedside of the last of them as they died from wounds inflicted by Sarne's terrible weapons.

Genna wants to continue helping people with her medical skills, even if it means going into the heat of battle. She's been in firefights before, and can hold her own with a blaster. Genna's used to dodging blaster fire to rescue wounded comrades, and shows no fear of capture or death. However, inside that tough young woman's heart is a frantic terror which she channels into her actions in combat. Often after a firefight ends and once she's tended to everyone's wounds, Genna goes off on her own to weep quietly to herself.



Mike Vilardi

Overcome by tremors in her hands, she needs a good hour or two to calm herself before she's capable of other actions. Genna is shy among the *FarStar* crew, but maintains her brave and selfless manner in ground combat.

Although she has few close friends, she looks up to First Officer

Kaiya Adrimetrum as both her superior officer and a role model. Kaiya similarly tries to look after the young medic when she has time.

■ Genna Seedar

Type: Field Medic
DEXTERITY 4D
 Blaster 5D, dodge 6D, running 5D
KNOWLEDGE 2D
 Survival 3D+1
MECHANICAL 3D
 Communications 4D, repulsorlift operation 4D+2
PERCEPTION 3D
 Sneak 4D+2
STRENGTH 2D
 Lifting 3D
TECHNICAL 4D
 First aid 6D+1, (A) medicine 2D
Force Points: 1
Character Points: 5
Move: 10
Equipment: Blast helmet (+1D physical, +1 energy), blaster pistol (4D), 3 medpacs, small subspace radio

VEGATH TIST

Vegath Tist is an outcast Arcona, shunned by his own family for some unknown deed, but possibly due to his intense addiction to salt. Tist claims he is a geologist by trade, and has spent many years seeking his fortune.

In reality, Tist is little more than a speculator. While he does have some mining skills, he's mostly used to striking out on his own, following get-rich-quick schemes and investing what little money he has in fruitless scams. For a while he was indentured in the Mestra system's mining asteroids until he fled the system with whatever he could grab. Tist's expeditions led him to Kal'Shebbol,



Mike Vilardi

where a small-time crime boss fed his salt addiction and used his talents with explosives. Tist joined the *FarStar* crew under the guise of a mineralogist.

Tist's greatest vice is his addiction to salt. He carries a pouch of salt which he's constantly fidgeting with.

■ Vegath Tist

Type: Arconan Miner
DEXTERITY 2D
 Melee combat 4D, melee parry 3D
KNOWLEDGE 3D
 Planetary systems 4D, survival: mines 5D, value: minerals 5D
MECHANICAL 3D+1
 Mining 5D, sensors 5D+1
PERCEPTION 2D+2
 Con 3D+2, search 5D
STRENGTH 4D
TECHNICAL 3D
 Computer programming/repair 4D, demolition 5D, security 4D
Special Abilities:
Senses: Arcona have weak long distance vision (add +10 to the difficulty of all tasks requiring vision at distances greater than 15 meters), but excellent close range senses (add +1D to *Perception* skills involving heat, smell or movement within 15 meters).
Thick Hide: Adds +1D to STR for physical damage.
Talons: Adds +1D to climbing, *Strength* in brawling attacks, or digging.
Salt Addiction: Vegath is addicted to salt, and requires at least 25 grams of salt per day or he suffers a -1D penalty to all actions.

Force Points: 1
Character Points: 5
Move: 10
Equipment: Pouch with 1 kilogram salt, shovel (STR+2), survey datapad, 250 credits

DANN DRUGAH

Dann Drugah is a rather shy, unassuming Human, but when he's around droids, he's outgoing and friendly. The young technician joined the *FarStar's* crew to supervise and maintain the droids. He used to work in a tinkerer's shop in Kal'Shebbol's starport. Dann isn't out for vengeance, or to make his fortune, or to see new worlds. He just wants to be alone with his droids.

Dann believes droids are his best friends. He's not too good around real, living beings because he's shy and easily cowed.

Dann doesn't carry a blaster, and believes that he shouldn't harm other beings. Whenever faced

with combat his first instinct is to run and hide.

■ Dann Drugah

Type: Droid Specialist
DEXTERITY 2D+1
 Dodge 4D+1, running 3D+1
KNOWLEDGE 3D+1
 Languages: droids 5D, value: droids 5D
MECHANICAL 3D
 Communications 4D, sensors 4D
PERCEPTION 2D+2
 Command: droids 4D
STRENGTH 2D+2
TECHNICAL 4D
 Computer programming/repair 5D, droid programming 5D+2, droid repair 6D, first aid 5D, security 5D+1
Force Points: 1
Character Points: 5
Move: 10
Equipment: Datapad, droid repair tools (+1D to *droid repair*), work coveralls

THANIS GUL-RAH

Thanis Gul-Rah is a quiet bounty hunter who seems to have retired to Kal'Shebbol when the New Republic arrived. When the call for a good starship crew and some ground soldiers went out, he pulled himself from his booth at a local spaceport bar and joined up. The solemn Human often seems regret-

ful and sad, but also takes his job seriously. He seems to have unyielding loyalty to First Officer Adrimetrum, although she does not recall ever meeting the bounty hunter.

Gul-Rah was a former member of a bounty hunting team known as Qulok's Fist. The quiet hunter does not reveal why he left that group. He is stoic most times and takes orders without question.

Gul-Rah indeed left Qulok's Fist after a hunt turned into a massacre in a backwater settlement. He's not proud of his role in that slaughter, and is trying to repent for his actions by doing justice aboard the *FarStar*. And while Adrimetrum doesn't know Gul-Rah, he knows her. He was one of the Imperial Army troopers who was involved in killing her husband on Siluria III. Gul-Rah didn't expect to serve under her on the *FarStar* — but he just sees it as fate's way of making sure he pays for his past, murderous deeds. He knows of many atrocities Moff Sarne committed, and is seeking revenge; not for himself, but for the dead.

■ Thanis Gul-Rah

Type: Bounty Hunter
DEXTERITY 4D
 Blaster: heavy blaster pistol 6D, dodge 5D, grenade 4D+2, melee combat 5D
KNOWLEDGE 2D+2
 Streetwise 3D+2, survival 4D+2
MECHANICAL 2D+2
PERCEPTION 3D
 Search 4D, search: tracking 5D, sneak 4D
STRENGTH 3D+2
 Brawling 5D, climbing/jumping 4D+2
TECHNICAL 2D
 First aid 4D
Force Points: 1
Dark Side Points: 2
Character Points: 5
Move: 10
Equipment: Bounty hunter armor (+2D physical, +1D energy, -1D *Dexterity*, +1D to *lifting*), heavy blaster pistol (5D), knife (STR+1D), medpac



Mike Vliardi

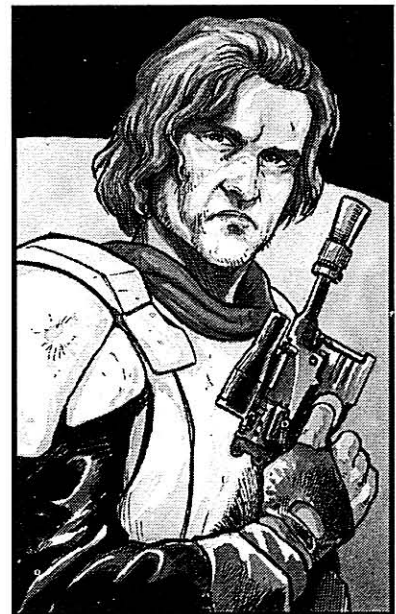

Mike Vliardi

SUPPORT SHIPS AND VEHICLES

SUPPORT VEHICLES

The *FarStar* has several repulsorlift and ground vehicles for reconnaissance, transport and combat duties. While the *Corvette* could probably benefit from adding several more vehicles, the vehicle bay is filled to capacity.

MOBQUET OVERRACER

The Mobquet OVERRACER is a fairly typical speeder bike. The *FarStar* has six of these OVERRACERS aboard. The OVERRACER was originally designed as a civilian speeder bike, but the New Republic's technicians have long been modifying the speeder bike for military use.

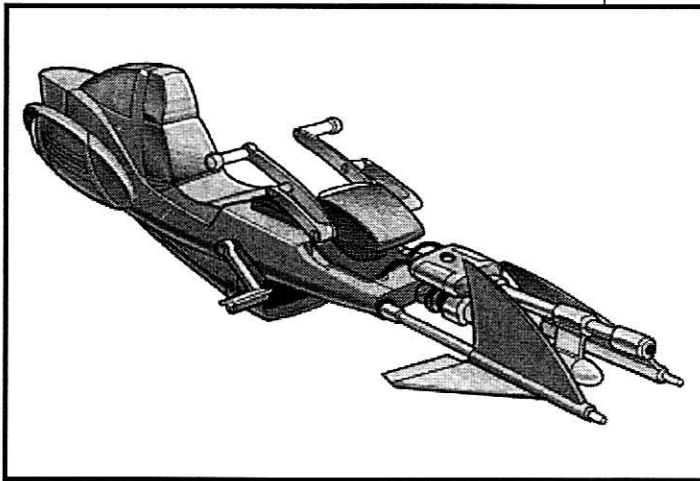

David Detrick

The *FarStar's* OVERRACERS now have passive sound dampeners and sensor bafflers, as well as a light laser cannon. They also have comlinks with a maximum range of 50 kilometers, allowing them to summon assistance from the main base camp.

The *FarStar* uses the OVERRACERS for light recon patrols before sending a larger mission team into a newly discovered settlement. The OVERRACERS are also used for perimeter patrol around temporary bases.

■ Mobquet OVERRACER

Craft: Mobquet "OVERRACER"
Type: Speeder scout bike
Scale: Speeder
Length: 4.4 meters
Skill: Repulsorlift operation: speeder bike
Crew: 1
Crew Skill: Varies
Cargo Capacity: 4 kilograms
Cover: 1/4
Altitude Range: Ground level-20 meters
Cost: 3,000 (used)
Maneuverability: 3D+2
Move: 185; 530 kmh
Body Strength: 1D+2
Weapons:

1 Light Blaster Cannon

Fire Arc: Front
Skill: Vehicle blasters
Fire Control: 1D
Range: 50-300/500/1 km
Damage: 3D

Note: Passive sound dampeners dramatically reduce noise and sensor bafflers add +1D to the difficulty to detect the speeder bikes by sensors.

NEW REPUBLIC SRV-1

The New Republic SRV-1 is a cheap cargo transport vehicle; it is normally used for scouting duties and troop transport, but the *FarStar* has been deploying its two units as cargo haulers on planetary surfaces.

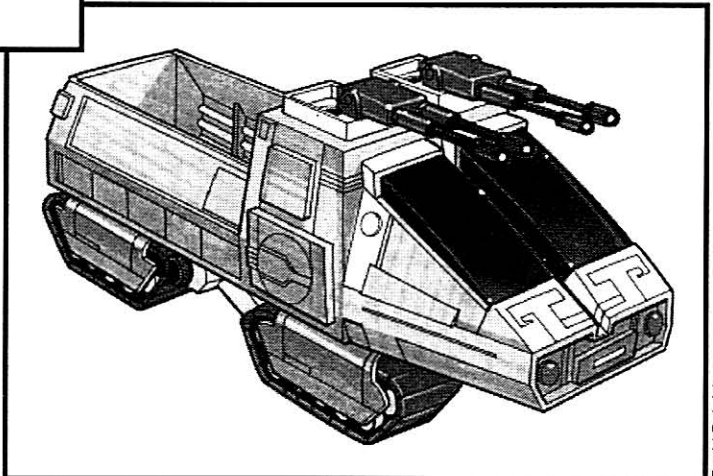

David Detrick

The vehicle uses a simple tread system, which tends to make it slower than most repulsorlift vehicles, but allows it to cross rough terrains. Using a tracked propulsion system also substantially reduced the cost of the vehicle.

The SRV-1 has a crew of two and also has room for two gunners, who man the exposed medium laser cannons mounted above the cab. The SRV-1 can carry eight troops and their equipment, or up to three metric tons of cargo.

■ New Republic SRV-1

Craft: Aratech SRV-1
Type: Tracked scouting and retrieval vehicle
Scale: Speeder
Length: XX meters
Skill: Ground vehicle operation: SRV-1
Crew: 2, gunners: 2, skeleton: 1/+5
Crew Skill: Varies
Passengers: 8 (troops)
Cargo Capacity: 3 metric tons (only if no passengers are carried)
Cover: Full (command cabin), 1/2 (all other areas)
Cost: 6,500 (used)
Maneuverability: 0D
Move: 35; 100 kmh
Body Strength: 3D+1
Weapons:

2 Medium Laser Cannons

Fire Arc: 1 front/left/back, 1 front/right/back
Crew: 1
Skill: Vehicle blasters
Fire Control: 1D+2
Range: 50-200/500/1 km
Damage: 3D+2

NEW REPUBLIC ULAV

The *FarStar* has four ULAV (ultra-light assault vehicles) for ground combat. Dating from a design well over 20 years old, these aging vehicles can't stand up to modern combat airspeeders, but they were all the New Republic fleet was willing to part with. The vehicle is considered

fast and agile enough to effectively dodge most blaster artillery shots.

The ULAV is a small, light assault speeder that hugs the ground — its maximum altitude is a mere 60 centimeters above ground level. The vehicle has a crew of two: a pilot and a gunner. Its weapons include a twin light laser cannon, a concussion grenade launcher and a rear-firing medium blaster cannon.

■ New Republic ULAV

Craft: Outdated Ultra-Light Assault Vehicle
Type: Light assault vehicle
Scale: Speeder
Length: 7 meters
Skill: Repulsorlift operation: ULAV
Crew: 1, gunners: 1
Crew Skill: Varies
Cargo Capacity: 5 kilograms
Cover: Full
Altitude Range: Ground level-0.6 meters
Cost: 10,000 (used)
Maneuverability: 3D
Move: 140; 400 kmh
Body Strength: 2D+2
Weapons:

Twin Light Laser Cannon (fire-linked)

Fire Arc: Front
Skill: Vehicle blasters
Fire Control: 1D
Range: 3-50/100/200
Damage: 2D+2

Concussion Grenade Launcher

Fire Arc: Front
Skill: Missile weapons
Fire Control: 1D
Range: 10-50/100/200
Damage: 3D+1

Medium Blaster Cannon

Fire Arc: Back
Crew: 1 (gunner)
Skill: Vehicle blasters
Fire Control: 2D
Range: 50-200/500/1 km
Damage: 5D

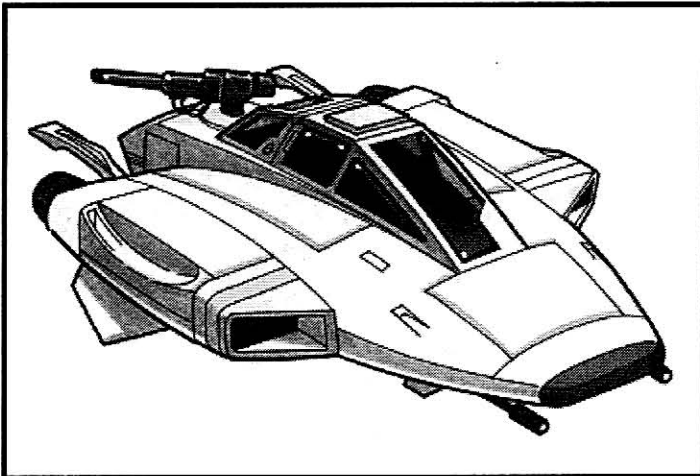

David Detrick

FIGHTERS

The *FarStar* was assigned X-wing fighters and Defender starfighters as a defense force to supplement the Corvette's six turbolasers. The fighters are also used to escort the shuttle vehicles, and in a pinch, they can be pressed into long-range scouting detail. The *FarStar's* flight commander, Lieutenant Ranna "Wing-Ripper" Gorjaye, controls "her" fighter pilots with iron discipline, but her stern approach will probably greatly increase the survival rate for her pilots.

X-WING

The *FarStar* has eight standard X-wing fighters that have been reassigned from other New Republic cruisers. The Incom X-wing fighter, although an aging fighter design, is still powerful and fast enough to give TIE fighters a run for their money, especially in a distant area of space like the Kathol sector, where fighters are less likely to have cutting-edge Imperial technology.

These X-wings have been fitted with interfaces for FreiTek's* newest upgrade components, although they have not yet been equipped with this improved gear, so they still correspond to flight specs dating back to the Battle of Yavin, nearly eight years ago.

* FreiTek is the new starship design company formed by the former Incom design team that actually built the X-wing fighter nearly a decade ago.

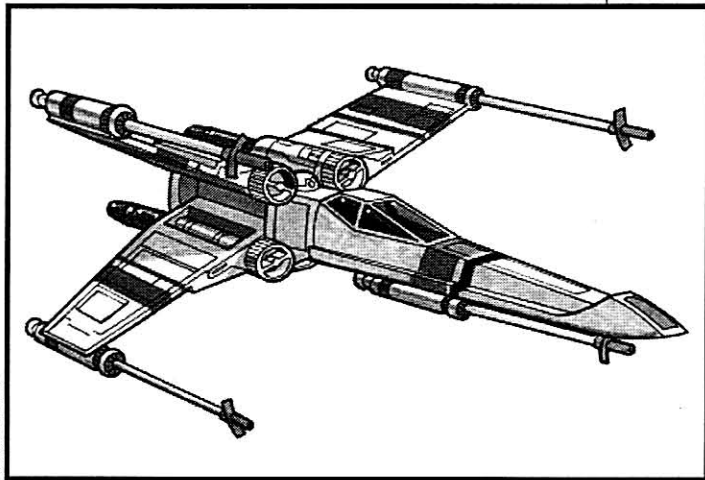

David Detrick

■ X-wing

Craft: Incom T-65B X-wing
Type: Space superiority fighter
Scale: Starfighter
Length: 12.5 meters
Skill: Starfighter piloting: X-wing
Crew: 1 and astromech droid (can coordinate)
Crew Skill: Varies
Cargo Capacity: 110 kilograms

Consumables: 1 week
Cost: 85,000 (used)
Hyperdrive Multiplier: x1
Nav Computer: Uses astromech droid programmed with 10 jumps
Maneuverability: 3D
Space: 8
Atmosphere: 365; 1,050 kmh
Hull: 4D
Shields: 1D
Sensors:
Passive: 25/0D
Scan: 50/1D
Search: 75/2D
Focus: 3/4D

Weapons:

4 Laser Cannons (fire-linked)
Fire Arc: Front
Skill: Starship gunnery
Fire Control: 3D
Space Range: 1-3/12/25
Atmosphere Range: 100-300/1.2/2.5 km
Damage: 6D

2 Proton Torpedo Launchers

Fire Arc: Front
Skill: Starship gunnery
Fire Control: 2D
Space Range: 1/3/7
Atmosphere Range: 50-100/300/700
Damage: 9D

DEFENDER

The Defender is a new short-range fighter derived from a much older starfighter design. The *FarStar* has four of these vessels.

The Defender is specifically designed for space defense. It is lightweight and compact, featuring light armor but impressive firepower. The ship is smaller even than the A-wing fighter, making it a very small target for enemy gunners.

It has no hyperdrive and is dependent upon a base ship for transport. The Defender is much slower than modern fighters like the A-wing, but it is a vast improvement over older fighters like the Y-wing and Z-95 Headhunter. The ship has exceptional space maneuverability, which can be attributed to the extendible S-foil struts with maneuvering jets. The struts extend out for combat, but are pulled flush against the hull for normal space flight or for atmospheric flight. The maneuvering jets allow

the Defender to make sudden spins and turns in space, including 180° turns. The struts are especially vulnerable to damage in an atmosphere because sudden maneuvers can weaken or even tear off the struts; normally the pilot simply chooses to keep the struts flush with the hull, reducing maneuverability but keeping the Defender intact.

DEFENDER

SHORT-RANGE
DEFENSE STARFIGHTER

SPACE CONFIGURATION

Length: 5.30 meters
Width: 3.95 meters
Height: 4.49 meters

Forward
View

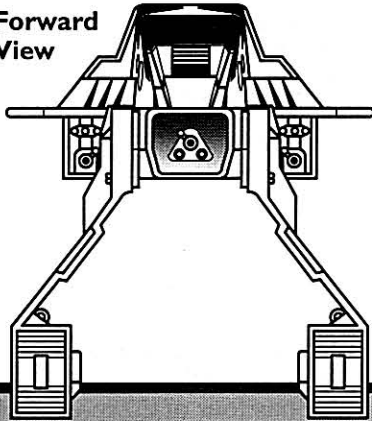

Top View

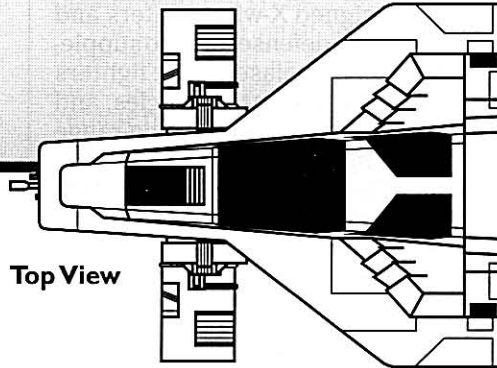

Side View

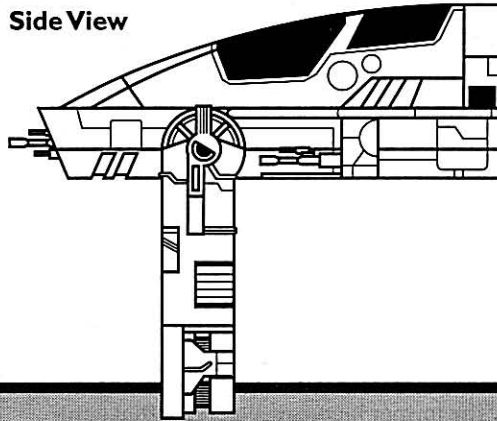

AMOSPHERIC CONFIGURATION

Length: 5.30 meters
Width: 3.95 meters
Height: 2.03 meters

Forward
View

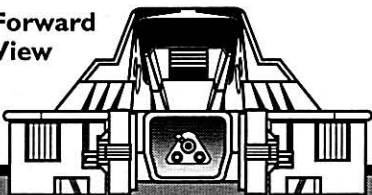

Top View

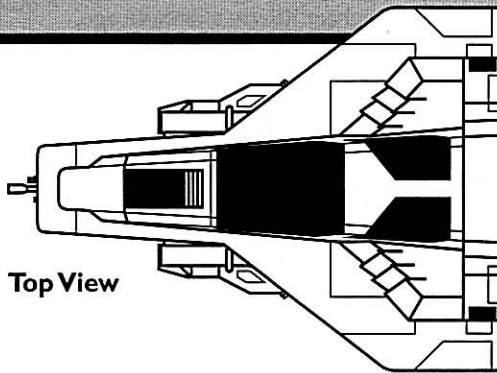

Side View

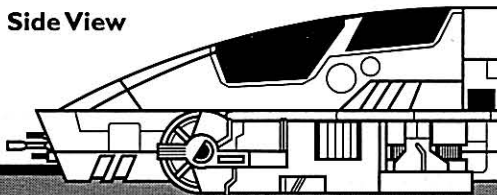

Stephen Crane



REPUBLIC
ENGINEERING
CORPORATION



7V033-114
VW071AVM71A07
407007K4100

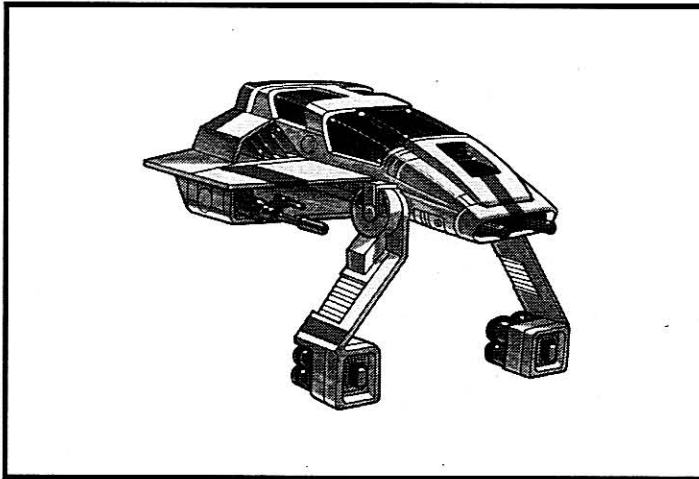

David Detrick

■ Defender

Craft: Republic Engineering Corporation Defender Starfighter
Type: Short-range defense fighter
Scale: Starfighter
Length: 5.3 meters
Skill: Starfighter piloting: Defender
Crew: 1, gunners: 1
Crew Skill: Varies
Cargo Capacity: 50 kilograms
Consumables: 1 week
Cost: 45,000 (new)
Maneuverability: 4D (1D+2 in atmosphere)
Space: 8
Atmosphere: 350; 1,000 kmh
Hull: 2D+2
Shields: 1D
Sensors:
Passive: 30/1D
Scan: 60/2D
Search: 90/3D
Focus: 4/4D
Weapons:
3 Laser Cannons (fire-linked)
Fire Arc: Front
Crew: 1 (gunner)
Skill: Starship gunnery
Fire Control: 2D
Space Range: 1-5/20/35
Atmosphere Range: 100-500/2/3.5 km
Damage: 6D

SUPPORT SHIPS OF THE FARSTAR

The *FarStar* has two shuttles, which are normally docked on the external docking tubes, although they can be brought into or docked with the main landing bay for maintenance or cargo loading.

The first shuttle, the *Muvon*, is Brophar Tofarain's vessel and is used for non-military operations.

The Aegis combat shuttle is clearly geared to combat support missions, with multiple weapons and combat-grade deflector shielding. If there

is the possibility of hostilities, these shuttles are assigned escort fighters.

MUVON

The *Muvon* is Brophar Tofarain's personal shuttle. It is typically used as a personnel transport, with room for only eight passengers and a pair of speeder bikes or some exploration equipment. The ship is a small shuttle and is an excellent choice when the *FarStar* wishes to arrive on a planet in a subdued manner: the ship easily be mistaken for a nondescript civilian transport hauler, instead of an advance scout for a New Republic military vessel.

Brophar insists on personally piloting the ship on all missions and he is very intolerant of passengers making fun of his vessel.

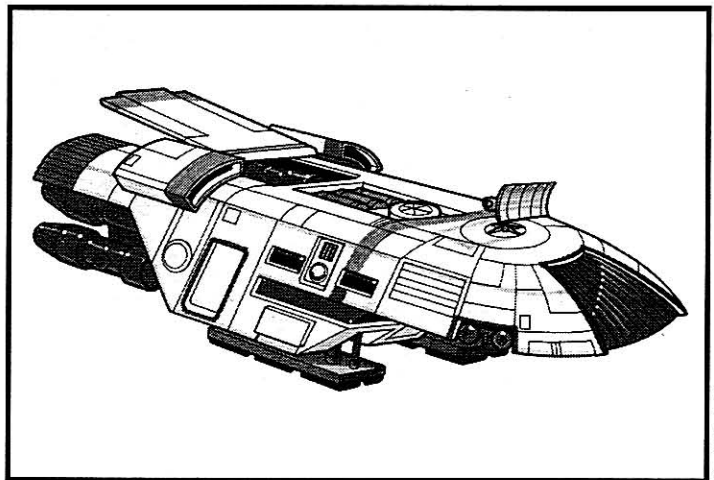

David Detrick

■ Muvon

Craft: Modified Loronar B-7 Light Freighter
Type: Modified light freighter
Scale: Starfighter
Length: 19 meters
Skill: Space transports: B-7 freighter
Crew: 1, gunners: 1
Crew Skill: See Brophar Tofarain
Passengers: 8
Cargo Capacity: 1 metric ton
Consumables: 1 month
Cost: 20,000
Hyperdrive Multiplier: x3
Hyperdrive Backup: x10
Nav Computer: Yes
Maneuverability: 1D
Space: 2
Atmosphere: 225; 650 kmh
Hull: 4D
Shields: 1D+2
Sensors:
Passive: 10/+1
Scan: 20/1D
Search: 30/1D+2
Focus: 3/2D

Weapons:

1 Light Laser Cannon

Fire Arc: Turret

Crew: 1

Skill: Starship gunnery

Fire Control: 1D+2 (may be fired by pilot at 0D fire control)

Space Range: 1-2/7/15

Atmosphere Range: 100-200/700/1.5 km

Damage: 4D

AEGIS COMBAT SHUTTLE

The Aegis combat shuttle is specifically designed to allow ground combat vehicles or troops to be quickly delivered to a crisis zone. The

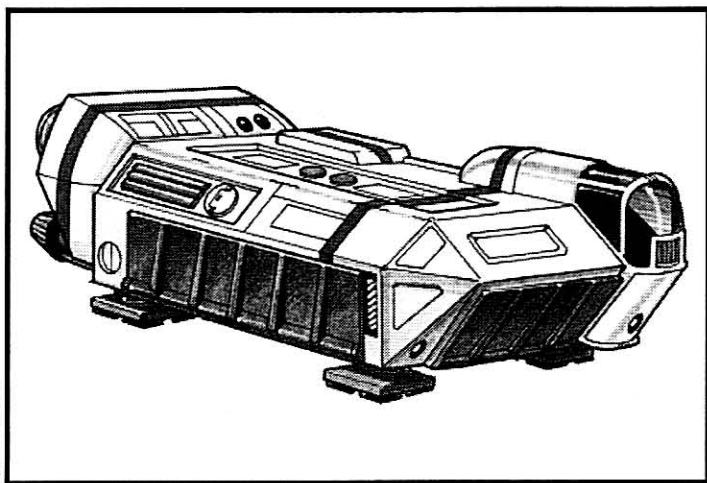

David Detrick

interior cargo bay has room for two SRV-1 transports, or a single SRV-1 and two ULAV combat speeders. A pair of speeder bikes can be added to this configuration. Alternately, the shuttle can deliver 40 ground troops and their gear into a combat zone.

The ship is designed for quick loading and unloading, with dual side airlocks that retract in seconds and form unloading ramps. The shuttle is armed with a concussion missile launcher and a pair of laser cannons.

■ Aegis Combat Shuttle

Craft: Telgorn Corp. *Aegis*-class Combat Shuttle

Type: Transport shuttle

Scale: Starfighter

Length: 29 meters

Skill: Space transports: Aegis shuttle

Crew: 2, gunners: 2, skeleton: 1/+10

Crew Skill: Varies

Passengers: 6

Cargo Capacity: 120 metric tons

Consumables: 4 days

Cost: 40,000 (used)

Maneuverability: 1D

Space: 6

Atmosphere: 330; 950 kmh

Hull: 6D

Shields: 2D

Sensors:

Passive: 30/1D

Scan: 45/2D

Search: 60/2D+2

Focus: 4/3D

Weapons:

2 Laser Cannons

Fire Arc: Turret

Crew: 1

Skill: Starship gunnery

Fire Control: 1D+2

Space Range: 1-3/12/25

Atmosphere Range: 100-300/1.2/2.5 km

Damage: 5D

Concussion Missile Launcher

Fire Arc: Front

Skill: Starship gunnery

Fire Control: 1D

Space Range: 1/3/7

Atmosphere Range: 50-100/300/700

Damage: 7D

DROIDS

The *FarStar* has a large number of droids aboard, with their assigned tasks ranging from menial labor to highly specialized, technical engineering duties. When these droids are not working, they can generally be found in the droid repair bay on deck four.

R-97 QUARTERMASTER DROID

R-97 is the *FarStar's* quartermaster and is charged with keeping track of and allocating

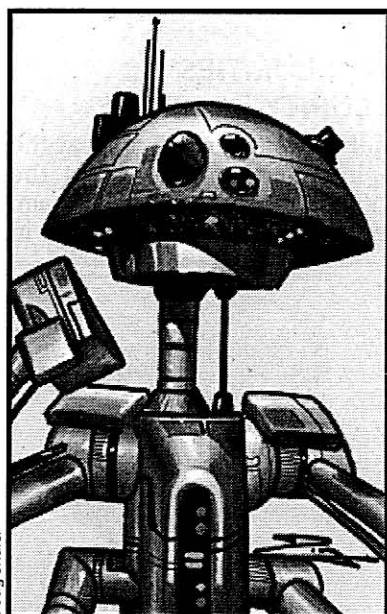

Doug Shuler

equipment, weapons, and stores. R-97 is one of the more interactive droids aboard the *FarStar*; he actually engages in what seems like bartering before allocating equipment. He will try to talk the crew out of certain items "in the interest of preserving the ship's stores," or might attempt

to tell them something is out of stock when there is clearly an ample supply.

The droid doesn't particularly desire any type of good, but he just has a prominent stubborn streak and is surly enough to argue to get things done his way. A clever droid, R-97 might even go so far as to hide a few prized items, thus avoiding the need to let them go from the supply areas. R-97 has extendible leg retractors that enable him to raise himself up to almost three meters in height; he's been known to put the most valuable items on the uppermost storage shelves where few biologicals can reach them.

Since there are so many supply areas aboard the *FarStar*, R-97 leaves SE-4 servant droids and J9 worker drones as lookouts to prevent "unau-

thorized raids" on his supply stores — they are supposed to watch over the "untrustworthy organics" assigned to help maintain the supply areas. While the servant droids won't give *FarStar* crew members too much of a fight, they will report any incidents to R-97, who will most certainly give the offending crew members a very difficult time when they need supplies.

R-97 only follows the direct orders of the captain, and even then the devious droid will attempt to circumvent those orders if he has a grudge against the person requesting supplies. Characters are well-advised to stay on R-97's good side or it may be a long journey for them ...

■ R-97 Quartermaster Droid

Type: Bossikan/Rendili R-97 Quartermaster Droid

DEXTERITY 1D

KNOWLEDGE 3D

Bureaucracy 4D, value 3D+2

MECHANICAL 1D

PERCEPTION 3D

Search 4D

STRENGTH 1D

TECHNICAL 1D

Equipped with:

- Two auto-balance legs with extensions
- Four arms
- Domed head with photoreceptors and micro-scanner for inventory

Move: 7

Size: 2 meters tall (can raise up to 3 meters)

Cost: 4,000

LOAD-LIFTER

Load-lifters are the bulkiest droids aboard the *FarStar*. They are needed for moving heavy equipment, such as food bins and vehicle components, but they otherwise have little utility. Because of their size and slow rate of movement, they effectively block any corridor they enter. Additionally, they are unused to the pipes and conduits which crisscross the floors and

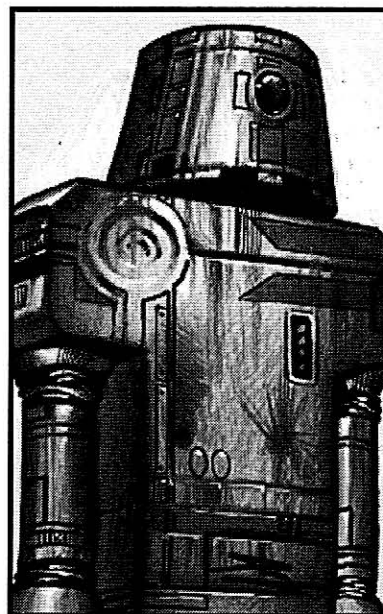

Doug Shuler

ceilings of the *FarStar*, requiring even more time to pass certain areas.

Because of their inconvenience, the load-lifters only venture into the corridors and supply rooms during emergencies; otherwise, they simply tool around the droid and maintenance bays or are powered down. The *FarStar* has four load-lifters.

The load-lifters could conceivably be used as part of a deadly plot: they could be placed in strategic locations so that a fleeing opponent is constantly running into dead ends. The prey would keep turning corners only to encounter a towering load-lifter blocking the way. This is a very dark and dramatic way to herd someone to a specific location.

■ Load-Lifter

Type: Drendan Load-Lifter

DEXTERITY 1D

KNOWLEDGE 1D

MECHANICAL 1D

PERCEPTION 1D

STRENGTH 5D

Lifting 5D+2

TECHNICAL 1D

Equipped with:

- Two auto-balance legs
- One photoreceptor
- Two high-compression lifter-arms

Move: 5

Size: 2 meters tall

Cost: 4,500

OVERSEER DROID

The Ubrikkian overseer droid DD-19 is the terror of the *FarStar's* droid bay. Not only is the droid able to process the needs of several other droids at once, but it is able to communicate the necessary commands in the electronic information-dense languages

favored by many sophisticated droids (to Humans, the languages sound like a series of chirps and whines). The droid is actually able to watch over up to 50 droids at once, but field experience has proven that a maximum of 15 to 20 is more manageable.

DD-19 has been nicknamed "the slave-master" because of its seemingly harsh treatment of the other droids. If a droid becomes unruly, DD-19 has the authority to apply restraining bolts.



Doug Shuler

DD-19 also has the ability to remove not only its own restraining bolts, but those placed by others with a Moderate *droid repair* roll.

■ Overseer Droid

Type: Ubrikkian DD-19 "Overseer" Droid

DEXTERITY 1D

KNOWLEDGE 1D+2

Alien languages 3D+2

MECHANICAL 1D+2

PERCEPTION 2D

Command 3D, command: droids 5D, con 3D, search 3D

STRENGTH 1D

TECHNICAL 2D

Computer programming/repair 4D, droid programming

5D, droid repair 5D, security 3D

Equipped with:

- Two tracked feet
- Two extendible arms
- Three photoreceptors
- Broad band antenna-receiver
- Restraining bolt applicator and remover

Move: 7

Size: 1.7 meters tall

Cost: 4,500

RIM SECURITIES' K4 SECURITY DROIDS

There are six K4 security droids aboard the *FarStar*; they are intended to supplement the orders of the ship's security officer, GorakKhzam. They almost never leave their posts. Standing in silent vigil, they have almost become a part of the wall, hardly noticed by those passing by. But when action is called for, the security droids are the first on the scene.

There are two K4s in the command center, another droid near the armory (which is also near an entrance to the engineering stations), two more K4s in the landing bay and the final droid is deployed to the engineering section to watch over the main reactor core and vital engineering stations.

The K4s are not expected to leave the *FarStar*; some worlds don't take too kindly to indepen-



Doug Shuler

dent and potentially lethal droids running around. However, it might be interesting to have a K4 as a player character: though the droid seems to have only combat applications, a more developed K4 might decide that prevention is a better way to deal with a situation than waiting for something unfortunate to occur. This farsighted view might not be too popular as the droid begins prying into other people's business.

■ Rim Securityies' K4 Security Droids

Type: Rim Securityies' K4 Security Droid

DEXTERITY 3D

Blaster 7D, dodge 8D, running 4D

KNOWLEDGE 1D

MECHANICAL 1D

PERCEPTION 1D

STRENGTH 1D

TECHNICAL 1D

Equipped with:

- Two auto-balance legs
- Two arms
- Body armor: +2D to all locations
- Internal blaster rifle (5D damage, ranges 5-30/100/200)

Move: 11

Size: 1.6 meters tall

Cost: 5,000

TOO-ONEBEE MEDICAL DROIDS

There are three 2-1B medical droids stationed aboard the *FarStar*. Every one of them is provided with the complete medical records and needs of

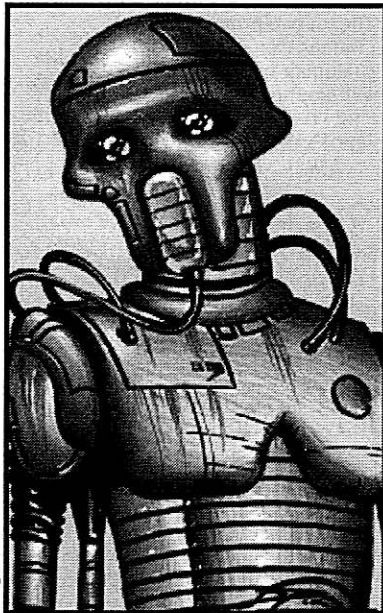

Doug Shuler

everyone aboard the ship, in addition to an interface for tying into the *FarStar*'s medical computer.

Together, the three droids form a redundant system which allows for any one of them to be temporarily out of commission without jeopardizing the operation of the sick bay.

The three droids seldom leave the sick bay except under the direct order of Akanseh.

■ Too-Onebee Medical Droids

Type: Industrial Automaton 2-1B Surgical Droid

DEXTERITY 1D

KNOWLEDGE 2D

Alien species 5D

MECHANICAL 2D

(A) Bacta tank operation 5D

PERCEPTION 3D

(A) Injury/ailment diagnostics 6D

STRENGTH 1D

TECHNICAL 3D

First aid 6D, (A) medicine 9D

Equipped with:

- Computer interface tether (range of 5 meters): interface adds +2D to all medical skills
- Medical diagnostic computer
- Analytical computer
- Surgical attachments
- Hypodermic injectors (4D stun damage)
- Medicine dispensers

Move: 4

Size: 1.5 meters tall

Cost: 4,300

R2 ASTROMECH DROIDS

The *FarStar* has 10 R2-series astromech droids assigned to it, primarily for starfighter maintenance and computer programming and repair. Eight of these droids are permanently assigned

to the *FarStar*'s X-wings, while two others are assigned on roving maintenance duty to support the *FarStar*'s R3 astromech units. Any of these droids can be assigned to astrogation detail in the command center should too many of the R3 units be off-line for maintenance. Since the R2s suffer less wear and tear, the temporary reassignment is a fairly common practice.

The droids assigned to the X-wings have begun forming a rapport with their respective fighters. Even the pilots have become fond of the little droids, which have proven to be an integral part of the *FarStar*'s starfighter strike team.

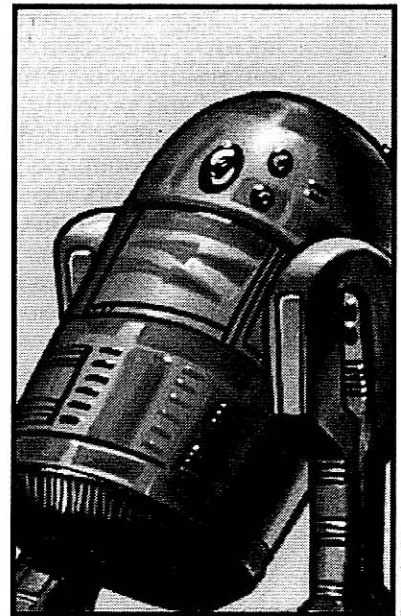

Doug Shuler

■ R2 Astromech Droids

Type: Industrial Automation R2 Astromech Droid

DEXTERITY 1D

KNOWLEDGE 1D

MECHANICAL 2D

Astrogation 5D, space transports 3D, starfighter piloting 3D

PERCEPTION 1D

STRENGTH 1D

TECHNICAL 2D

Computer programming/repair 4D, starfighter repair 5D*

*Astromech droids, if acting in co-pilot capacity, may attempt starfighter repairs while in flight.

Equipped with:

- Three wheeled legs (one retractable)
- Retractable heavy grasper arm (*lifting* skill at 2D)
- Retractable fine work heavy grasper arm
- Extendible 0.3 meter long video sensor (360° rotation)
- Small electric arc welder (1D-5D damage, as fits the situation, 0.3 meter range)
- Small circular saw (4D damage, 0.3 meter range)
- Video display screen
- Holographic projector/recorder
- Fire extinguisher
- Small (20 cm by 8 cm) internal "cargo" area

Move: 5

Height: 1 meter tall

Cost: 4,525

R3 ASTROMECH DROIDS

The *FarStar* has over 40 Industrial Automaton R3-series astromech droids. They are designed specifically for service aboard capital combat starships. To the casual observer, R3 units are virtually identical to the more familiar R2s: the only visible difference is that the R3 has a clear plastex dome.

The R3s are used to assist the *FarStar's* astrogation computers. Rather than directly storing hyperspace coordinates, the units are linked to the ship's main computer to speed the calculations and properly organize data. Their high density electronic language can be very distracting to new command center crew members, but eventually everyone learns to ignore the incessant chirps and whistles that fill the room.

The droids are also used for computer programming and repair duties, major repairs to the *FarStar's* engineering and weapons systems, as well as for external maintenance and repairs for the ship.

■ R3 Astromech Droids

Type: Industrial Automaton R3 Astromech Droid, military issue

DEXTERITY 1D

KNOWLEDGE 1D

MECHANICAL 2D

Astrogation 4D, capital ship piloting 4D, space transports 3D

PERCEPTION 1D

Search 4D

STRENGTH 1D

TECHNICAL 2D

Capital ship repair 6D, capital starship weapon repair 6D, computer programming/repair 5D, security 5D

Equipped with:

- Three wheeled legs (one retractable)
- Retractable heavy grasper arm (*lifting* skill at 2D)
- Retractable fine work arm
- Small electric arc welder (1D-5D damage, as fits the situation, 0.3 meter range)
- Small circular saw (4D damage, 0.3 meter range)
- Video display screen
- Acoustic signaller
- Holographic projector/recorder
- Fire extinguisher

Move: 5

Height: 1 meter tall

Cost: 5,000

SE4 SERVANT DROIDS

There are 10 SE4 servant droids aboard the *FarStar* for menial tasks, such as cleaning, basic maintenance, cooking and trash retrieval. These droids are also used as messengers for the command crew.

Because they help alleviate the drudgery of day-to-day life, these droids are given a certain amount of respect by most crew members, although a few folks absolutely loathe the units. Some of these droids have gained a reputation among the crew for their expertise in a certain area. For example, one of the droids (SE-4TQ5) has an absolutely smashing way with fruits, so he has been semi-permanently assigned to the mess hall.

■ SE4 Servant Droids

Type: Industrial Automaton SE4 Servant Droid

DEXTERITY 2D

KNOWLEDGE 2D

Culinary arts 4D, cultures 3D, home economics 4D, languages 3D

MECHANICAL 2D

Communications 3D, repulsorlift operation 3D

PERCEPTION 2D

Bargain 3D

STRENGTH 2D

Lifting 3D

TECHNICAL 2D

First aid 3D

Equipped with:

- Humanoid body (head, two arms, two legs)
- Photoreceptors (Human range)
- Auditory sensors (Human range)
- Vocabulator speech/sound system

Move: 7

Size: 1.6 meters tall

Cost: 1,300 (used)

PROBE DROIDS

The *FarStar* has six probe droids (probots) for star mapping and exploring worlds. These units originally belonged to Moff Sarne and were captured in the fighting for Kal'Shebbol.

The *FarStar's* techs are reprogramming the units to be loyal to the New Republic. So far, reprogramming on two of the units is complete and only proves that while loyalty can be programmed in, personality doesn't necessarily come with it: the units are still pretty rude, even if they only communicate in droid languages.

The *FarStar* has established a probe droid operations lab (on deck two), where the probots and the messenger drones are stored and maintained.

The probots are slaved to their hyperspace pods and are sent to unexplored systems. They survey any potentially habitable worlds from orbit, looking for signs of civilization or an Imperial military base. They use their subspace trans-

ceiver (limited to a range of 20 light years) to broadcast all data back to the *FarStar*. These droids are also used to plot additional astrogation routes to provide the *FarStar* with a more complete picture of the Kathol sector. The droids do not land on planets, but are programmed to return to the *FarStar* for further instructions. Each droid can operate independently for up to one month before having to return to the *FarStar* for reprogramming.

■ Probe Droids

Type: Arakyd Viper Probe Droid

DEXTERITY 3D

Blaster 4D

KNOWLEDGE 2D+2

Planetary systems 4D

MECHANICAL 3D

Sensors 6D

PERCEPTION 3D

Search 4D, search: tracking 7D+1

STRENGTH 4D

TECHNICAL 2D+1

Equipped with:

- Long-range sensor (+1D to *search* for objects between 200 meters and five kilometers away)
- Movement sensor (+2D to *search* for moving objects up to 100 meters away)
- Atmosphere sensor — can determine atmosphere class (Type I, Type II, Type III, Type IV) within one half-hour
- Blaster cannon (4D+2)
- Self-destruct mechanism
- Repulsor generator for movement over any terrain
- Several retractable manipulator arms
- Several retractable sensor arms for gathering samples

Move: 14

Size: 1.6 meters tall

Cost: 14,500

■ Probot Hyperspace Pod

Craft: Arakyd Probe-mate Hyperspace Pod

Type: Probot hyperspace pod

Scale: Starfighter

Length: 3.4 meters

Crew: None (fully automated droid brain with *astrogation* 6D, *space transports* 4D)

Passengers: Probot

Consumables: 1 month

Cost: 24,500

Hyperdrive Multiplier: x1

Nav Computer: Limited to 2 jumps

Space: 8

Atmosphere: 415; 1,200 kmh (descent capable only)

Hull: 2D

Sensors:

Passive: 100/1D

Scan: 200/2D

Search: 300/3D

Focus: 10/4D

Sensor Baffle: +2D to difficulty to detect with sensors

MESSENGER DRONES

The *FarStar* has six messenger drones that are used to send messages back to the New Republic provisional government on Kal'Shebbol. The droids must be programmed with astrogation

coordinates (often they will simply be sent back along the route the *FarStar* has followed). These drones are used to deliver detailed information, astrogation and jump coordinates, and have an eight cubic meter cargo bay for delivering physical samples.

They are one-trip vehicles and have no communications units; the *FarStar* can only fire them off to Kal'Shebbol and hope that they get there.

Once the messenger drone reaches its destination system, it simply drops to realspace and enters orbit around the intended world. The drone must be physically retrieved and a proper password entered on the drone's control panel to retrieve the contents and records; only the *FarStar's* captain and communications officer (Lt. Thyte) and key New Republic personnel on Kal'Shebbol know the password. However, the cargo loading hatch has a character-scale *Strength* of 4D should someone want to use a fusion cutter to cut open the cargo compartment.

The *FarStar* intends to save the messenger drones until after the ship goes beyond the subspace transceiver's maximum range of 100 light years.

■ Messenger Drones

Craft: Incom Q-Signal Messenger Drone

Type: Automated messenger drone

Scale: Starfighter

Length: 6.2 meters

Skill: Space transports

Crew: None (fully automated droid brain with *astrogation* 6D, *space transports* 4D)

Cargo Capacity: 800 kilograms

Consumables: 3 weeks

Cost: 18,500

Hyperdrive Multiplier: x1

Nav Computer: Limited to 1 jump

Space: 7

Hull: 1D

POWER DROIDS

The *FarStar* uses a number of power droids to supplement its own reserves. The units are most commonly found on the flight deck assisting in refueling starships and vehicles. The power droids are also assigned to the engineering section to supply emergency power in case of a critical power feed failure.

The *FarStar* has 12 such units aboard, but they are pretty universally ignored by the crew. The units were bought from a trader on Kal'Shebbol, who insisted that he purchased them several years ago while in the Outer Rim Territories. However, the *FarStar's* technicians think the units were probably stolen from the Imperials during the battle for Kal'Shebbol since they have all been programmed with capital ship and transport repair skills. The droids won't talk about

their past because they're afraid they'll get in trouble (or memory-wiped) if anyone finds out they once belonged to Sarne's Navy ...

■ Power Droid

Type: Veril Line Systems EG-6 Power Droid

DEXTERITY 1D

Dodge 1D+2

KNOWLEDGE 2D

MECHANICAL 1D

Energize power cells 5D+2

PERCEPTION 1D

STRENGTH 2D

TECHNICAL 3D

Capital ship repair 4D, space transports repair 4D, systems diagnosis 4D

Equipped with:

- Video sensor
- Bipedal locomotion
- Ultra-fine manipulation arm (+1D to all *Technical* skills)
- Cybot acoustic signaller (droid may not speak Basic or other common languages but can speak droid languages)

Move: 2

Size: 1.1 meters tall

Cost: 2,350 (used)

TREADWELL DROID

The *FarStar* has seven of these common treadwell units and they have proven particularly useful for detail work on the ship's fighters and vehicles. The treadwells can most often be seen rolling around the *FarStar*'s landing bay or in the maintenance bay. The treadwells are occasionally assigned to other sections of the ship, such as engineering, the command center or various computer rooms, to supplement the efforts of the overworked techs.

■ Treadwell Droid

Type: Cybot Galactica WED15 Treadwell Droid

DEXTERITY 2D

KNOWLEDGE 1D

Languages: droid languages 4D

MECHANICAL 1D

PERCEPTION 3D

Search 3D+1

STRENGTH 1D

TECHNICAL 2D

Computer programming/repair 3D, droid repair 3D+2, repulsorlift repair 3D+2, space transports repair 4D, starfighter repair 4D+1

Equipped with:

- Video sensor
 - Dual-tread locomotion
 - Fine manipulation arms (+1D to repair skills)
 - Extendible video microbinoculars (+2D to *search* for miniaturized work)
 - Cybot acoustic signaller (droid may not speak Basic or other common languages but can speak droid languages)
- Move:** 8
- Size:** 1.6 meters tall
- Cost:** 700 (used)

ROCHE WORKER DROIDS

The *FarStar*'s three Roche worker droids were assigned as combination general labor droids and make-do protocol units. They were originally supposed to be labor droids to supplement the SE-4s for menial tasks. New Republic command also thought that their knowledge of languages and different alien species might help with various missions. Captain Ciro soon realized that the *FarStar* was simply a convenient dumping ground for the trio of pesky busy-bodies. The three units, J9-B4, J9-R1 and J9-K6-24 are constantly bickering among themselves and are self-styled "efficiency experts," with no end of suggestions for how to improve morale and crew efficiency. So far, the best way to improve morale seems to have been to assign these units to the hydroponics labs where no one has to deal with them.

■ Roche Worker Droids

Type: Roche J9 Worker Droid

DEXTERITY 2D

KNOWLEDGE 4D

Alien species 5D+1, bureaucracy 5D+2, languages 4D+1

MECHANICAL 1D

PERCEPTION 3D

Bargain 4D+2, sneak 4D

STRENGTH 2D

TECHNICAL 3D

Security 5D+1

Equipped with:

- Video sensor
- Bipedal locomotion
- Olfactory sensor (+1D to odor-based *search*)
- Torplex microwave sensor (+1D to *security*)
- Arjan vocabulator
- TranLang II Communication module (+2D to *languages*)

Move: 10

Size: 1.9 meters tall

Cost: 1,200 (used)

GAMEMASTERING DARKSTRYDER

The previous sections of *The Campaign Book* have provided all of the essential ingredients for adventures aboard the *FarStar*. This chapter discusses synthesizing all of the elements into a complete campaign setting and provides information on running a long-term *FarStar* campaign. This chapter provides adventure suggestions tied to the *FarStar*'s mission objectives, gives tips for developing the campaign and discusses multi-character play.

THE ROLE OF THE GAMEMASTER

As gamemaster, you serve as both storyteller and mediator, directing the action but also allowing the players to explore this campaign setting.

The key is to use the *FarStar*'s mission orders and the Kathol sector setting to guide the players along the storyline in this boxed set.

Future releases in *The DarkStryder Campaign* line will resolve the conflict with Moff Sarne, and provide information regarding the origin and nature of DarkStryder technology, leading into the final revelation of DarkStryder.

MISSION PROFILE

The *FarStar*'s orders are quite clear. While the first mission is generally understood by the crew, the second objective is not common knowledge beyond the command crew of the *FarStar*. The third through sixth mission objectives are known to the crew.



Terry Pavlic

MISSION ONE:

LOCATE MOFF SARNE

The first and most important mission is to locate and report on the location of Moff Sarne. It is known that he fled Kal'Shebbol, heading for the wilderness regions of Kathol sector. However, with all detailed maps of the sector destroyed by Sarne's own command, his exact whereabouts are unknown.

It is assumed that the Moff has pulled back many of his forces during his retreat. Once Sarne has been located, the *FarStar* must report any and all information regarding his location, activities, strengths and weaknesses. Sarne presents a real threat because he would show no reservations about totally devastating any world that opposed his will; he is extremely dangerous.

Because of this mission's size and complexity, it is presumed that this mission will require at least several months to complete.

MISSION TWO:

DETERMINE WHERE DARKSTRYDER TECHNOLOGY COMES FROM

The second mission, known only among the command staff, is perhaps the most important. As the support crew members advance and gain more responsibility aboard the *FarStar*, they will slowly learn about the second mission.

Recently, a strange new advantage has begun to appear in the hands of Sarne's Imperial forces. Where battles seemed hopeless, Moff Sarne's troops have turned the tide and become the victor. Recent incursions into the Minos Cluster have shown that Sarne can capture and hold territory despite being outnumbered.

While the New Republic has pushed Sarne's forces back from the Minos Cluster and forced him to retreat into the Kathol Outback, Lt. Page realized that there was more to Sarne's success than motivated troops and the wise use of resources.

While New Republic Military Command doesn't feel that Sarne's "DarkStryder" technology seems to pose much of a threat, Page has seen fit to assign two of his top commandos, Keleman Ciro and Kaiya Adrimetrum, to lead the mission to track down DarkStryder.

MISSION THREE:

RECON AND REPORT ON IMPERIAL FORCES IN KATHOL SECTOR AND UNKNOWN SPACE BEYOND THE KATHOL RIFT

Moff Sarne is presumed to have pulled many loyal forces to assist his retreat from Kathol sector. However, it also stands to reason that the Moff has left behind ships and troops to create a smoke screen to cover his withdrawal.

The truth of the matter is that Sarne has gathered a good portion of his combat starships, forming a small but powerful core fleet. The rest of Sarne's forces have been ordered to remain in the Kathol sector to harass all New Republic operations. Some ships have gone into "hiding" near uninhabited worlds, with their commanders planning to later attack cargo convoys and undefended colonies. Other ships are gunning for the *FarStar*. Sarne has ordered his ships to "make examples" of those worlds which join the New Republic — to so devastate these worlds that others will be extremely reluctant to lend any assistance to the New Republic.

The Empire's presence in the Kathol sector is spread out and difficult to track down. One does not simply visit the town hall and inquire about the Empire without gaining undue attention. Imperial influence can take many different forms, from the obvious repair docks and warships to more subtle evidence, such as a loyal ambassador or a well-paid governor. Finding stormtroopers marching the streets is simple enough proof, but learning that the principle buyer at a refinery or a guest at a royal wedding is an Imperial operative might lead to bigger fish. All of these situations can lead to adventures for the *FarStar*.

MISSION FOUR:

RECON AND REPORT ON KATHOL SECTOR

The Kathol sector has been rigidly controlled by Moff Sarne and the turmoil of recent years has left little information available about the sector. With Sarne completely destroying any starmaps and datafiles about the sector, the *FarStar* is acting as the New Republic's advance scout.

The *FarStar* has astrogation coordinates for three colonies (Discussed in the adventure "Omens"). The ship is to pick up any possible trade routes along the way so the New Republic can reestablish trade and develop military patrol routes to protect worlds in the sector. In essence, the *FarStar* must skip from world to world, picking up private starcharts from traders and merchants. This kind of "system hopping" will slow the *FarStar's* pursuit of Sarne, but it is necessary since jumping without astrogation coordinates is asking for a deep space collision to destroy the ship.

The *FarStar* is also expected to plot astrogation routes in cases where charts cannot be purchased or bartered from others. This is a time-consuming and dangerous task, but it is assumed that at some point the *FarStar* will have to plot a few new routes to complete the mission. Since the ship will be devising these routes for its own mission, it is a simple matter for these coordinates to be turned over to the New Republic via messenger drones and subspace transmissions.

Upon arriving at a new world, the *FarStar* is to perform a brief recon mission to learn as much about the planet as possible. Key points to consider include the local government and its feelings toward the New Republic, potential Imperial resistance, population, industry, technology level, and the discovery of any new alien species.

In short, the New Republic expects the *FarStar* to gather preliminary information for the new government on Kal'Shebbol. Many adventures can be built around discovering former Imperial colonies and lost settlements.

MISSION FIVE:

RECON AND REPORT ON WORLDS IN UNKNOWN SPACE

Beyond the Kathol sector proper lies the Kathol Outback, the Kathol Rift, and beyond that ... no one knows. Ultimately, the *FarStar* is expected to recon and report on these areas while it pursues Moff Sarne. This portion of the mission will be fully detailed in future DarkStryder supplements.

MISSION SIX:

REPRESENT NEW REPUBLIC INTERESTS TO ANY SETTLEMENTS OR CIVILIZATIONS

During the *FarStar's* mission, it is assumed that there will be contact with new species and cultures. The *FarStar* is expected to plot astrogation routes to these worlds, and also conduct diplo-

matic meetings to gain the trust and friendship of the various leaders. The captain does not have the authority to arrange binding agreements however. The *FarStar's* mission might be casually described as, "Introduce yourselves and quietly look around. Leave a good impression and get out before they start asking for favors."

The fledgling New Republic needs all the support it can get, and Kathol sector might be able to provide valuable materials and assistance. Additionally, if there is an Imperial presence in the area, it might be advantageous to try to turn the tide toward the New Republic.

LONG TERM CAMPAIGNING

The DarkStryder Campaign shows a darker side of the *Star Wars* universe and provides a long term campaign setting. The following elements help the gamemaster establish and maintain consistency for a DarkStryder campaign.

SENSE CUES

The dark and gloomy conditions have been described extensively in other sections of this book. The gamemaster must be sure that these ideas are represented in each game session, instead of being presented in the introductory adventure and then forgotten. Always be sure to add those little details like crisscrossed power conduits, dark shadows in every corner, persistent drips from the ceiling and outcroppings of equipment underfoot.

Don't forget sound cues: a deep rumbling from below decks, a heavy clank of machinery, and the grinding of a closing door are all sound cues which reinforce the age and condition of the *FarStar*. Boots echoing on a hollow floor grating as a trooper marches past or the electric whir of a droid are small details that breathe life into the game setting.

RESUPPLY

The *FarStar* must conserve its provisions or send part of the crew on "supply runs" to outlying worlds to gather food, water and other items. Many adventures can be created around the idea of characters getting into some local trouble while away on a supply mission.

The *FarStar* should overstock whenever a supply location is found; no one knows when the next supply post will be discovered. Of course, overstocking can mean another drastic cut in living space.

REPAIRS

A dangerous situation is starship combat. The *FarStar* can't simply return to a New Republic base and request repairs — any damage from battle will remain until the crew manages to repair the ship. This damage may be carried along for several adventures, possibly further impairing or endangering the *FarStar*.

If the characters stop in a starport for repairs, not only do they risk being discovered by a possibly superior Imperial force, but they may lose valuable time to Moff Sarne. The *FarStar* may be forced to press on with leaking engines, half-powered guns, and damaged shields.

The gamemaster is encouraged to take advantage of this type of situation. When the *FarStar* is limping away from battle, have an extra wave of enemy fighters attack. This gives the players a sense of dread and makes them feel that they are truly up against long odds. When they finally triumph, there is a greater sense of satisfaction.

INTERNAL THREATS

Internal threats can hamper the mission and detract from morale. With tensions so high, there will be arguments aboard the ship. Perhaps the characters find out that a spy was caught sneaking into the ship's computer control center. They'll be wondering if the spy caused any damage. Maybe a rumor spreads that there is a hidden thermal detonator in the ship's superstructure timed to explode in the near future. Rumors of this type distract the crew and add tension to what otherwise might be an ordinary adventure.

There might be someone who doesn't like one of the characters. No reason need be given; sometimes severe personality conflicts just happen, and the cramped environment of the *FarStar* only encourages this type of conflict. It could be quite disruptive for a character to know that someone aboard the ship has vowed to "get them" when no one else is looking.

RECURRING VILLAINS

The DarkStryder Campaign uses several recurring villains who are introduced in "The Rogues Gallery" section of *The Adventure Book*. These villains should be developed as foils who hamper the characters during their early adventures.

Qulok's Fist, the Des'maric Pirates and Sarne's remaining Imperial forces should be the main villains for the early stages of the campaign. Be sure to allow the villains a chance to mature, just like the characters. After a few adventures, the players will learn to hate certain villains, but only if they've appeared several times and been truly

nasty to the characters. Bounty hunters, planetary despots and militant pro-Imperial governors can all prove to be major threats.

Of course, Moff Sarne is lurking in the background. Sarne is a "major villain," not to be used for a direct confrontation with the *FarStar*, but always pulling the strings behind the scenes. Moff Sarne and his personal fleet will be fully developed in later DarkStryder campaign supplements — for now it is strongly suggested that Sarne *not* make an appearance in any adventures you design on your own.

DARKSTRYDER TECHNOLOGY

Since DarkStryder technology will be fully developed in later supplements, the gamemaster is discouraged from using this technology extensively: original adventures should focus on conflicts with the Empire, outlaws and the other villains who populate this campaign setting.

However, the players will probably want to find a few clues about DarkStryder technology. If you want to develop a small number of new items, use the following guidelines:

- **No one knows how it works.** Sarne's technicians have pulled apart several DarkStryder artifacts, yet they still have no idea how this technology operates. Each artifact appears to have no visible moving machinery.

- **This technology is rare and unusual.** DarkStryder technology is not going to be found on more than a handful of worlds: it is rare. The discovery of a DarkStryder artifact should be the highlight in any adventure.

- **Make the technology one use only.** All DarkStryder technology revealed so far can only operate once before it is expended.

- **Limit the technology's power.** Manifestations of power should be similar to what has already been introduced. Acceptable types of effects include electrical, mind altering, flame, severe cold and water effects. The objects have a relatively short range (certainly less than 50 meters) and the device's effects will fill a small area within that range.

For example, a red cube may have a maximum range of 15 meters; once activated, fire fills a two by two by two meter cube within that range. The effects should last only a few seconds.

- **Game Rules:** To activate a given device, the gamemaster should, in general, have the character make a *Perception* roll (a few objects may use another attribute or specific skill to operate). The difficulty can range from Very Easy to Heroic, depending upon the power of the artifact.

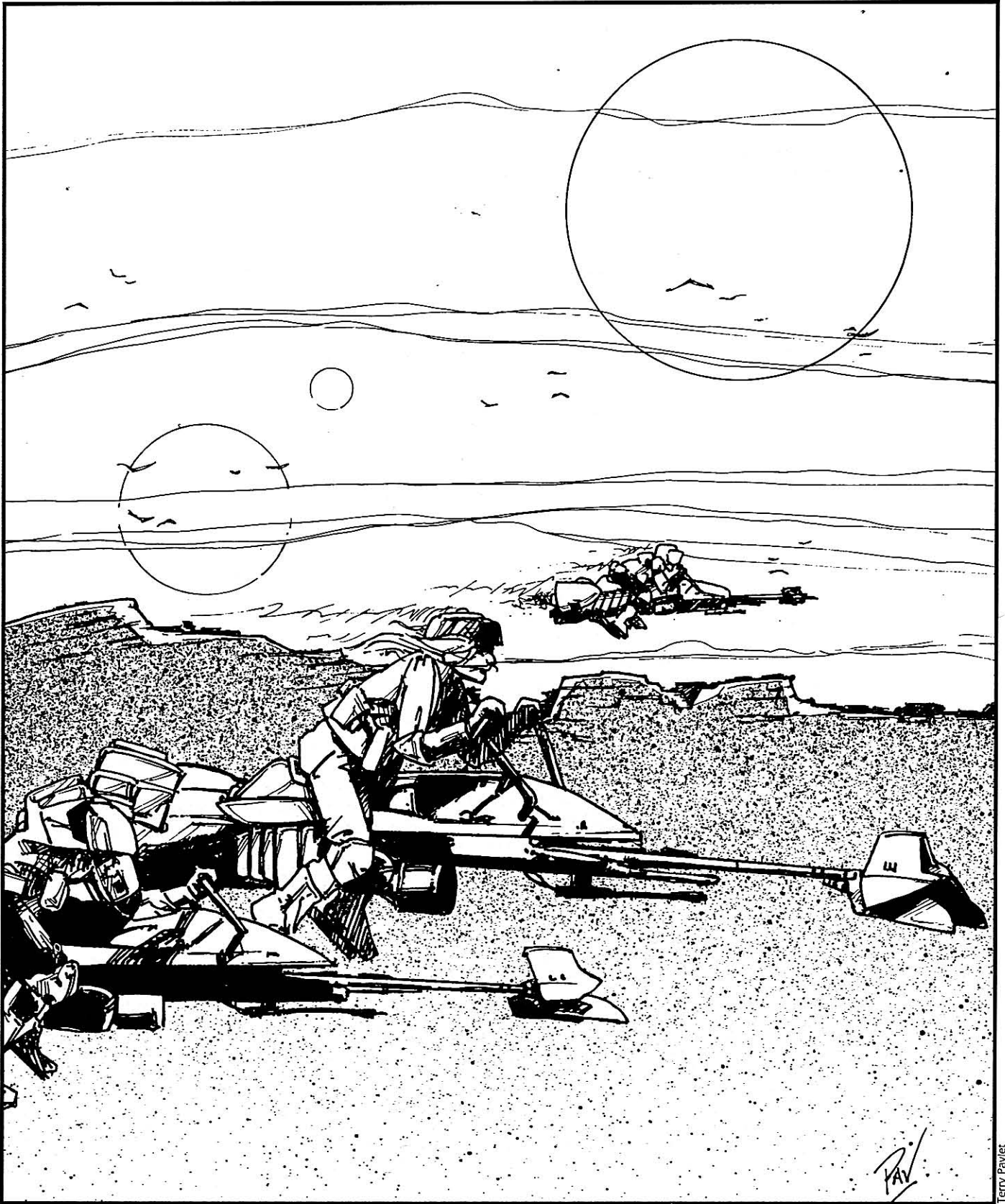

PAV

Terry Pavlet

Physical attacks (such as fire and electricity) can be *dodged* and damage resisted with *Strength*. Mental attacks (such as the mindwarping artifact in "The Saga Begins") should be resisted with *willpower* or *Knowledge*, although some artifacts will be resisted with *Perception*.

GENERAL TIPS

The following general principles can be applied in most DarkStryder adventures. They include standard suggestions that apply to the *Star Wars* roleplaying game in general, as well as specific tips that apply to *The DarkStryder Campaign*.

Reward Good Roleplaying — Sometimes, a situation might resolve itself without the need for dice and game mechanics. Good roleplaying can go a long way toward developing a character, and if a player acts out a role particularly well, this should affect the game accordingly.

When a character is asked "Can I see your identification?", it's not very exciting to hear, "I don't have one so I lie to him about it." A good response might be "I seem to have lost it, but have no fear, my friend, your commanding officer is a good friend of mine and I'm sure he wouldn't want you to detain me on such a small technicality, hmm?"

The better and more believable the response, the more the gamemaster should "fudge" the die rolls to reflect good roleplaying. Rolls can be ignored if the players are doing a fine job and are really getting into their characters.

Don't Give the Players Everything — It's all too easy to grant the players things which seem interesting at first, but threaten the campaign in the long run. *The DarkStryder Campaign* is intended to develop over time, so be sure to keep the characters hungry for their favorite "toys," whether they happen to be starships, weapons, droids or a specific type of person to use as a contact.

A Realistically Heroic Campaign — This campaign has been described as "realistically heroic." This means that while the characters constantly face real risk, they are expected to act heroically.

Characters will be asked to do the impossible; to risk their lives for the sake of others; to begin as a common people with very personal motivations, but to emerge from the campaign as heroes. Characters can die, and the players must never cross the line from being heroic to being foolish or else risk the death of that character.

However, even when the characters make all the right decisions and behave heroically, there is still a chance they might die. *The DarkStryder Campaign* is one where characters are heroes because they are willing to sacrifice everything for the sake of a larger cause.

Scene Cut — Whenever a player needs a minute to gather his or her thoughts, call a "scene cut." This turns the attention of the game to another character or situation.

Allowing a player in a tight situation to call out a scene cut gives them a few moments to gather their thoughts and figure out what their character might do. Since we are playing people other than ourselves, it is sometimes quite difficult to know what a character's reaction to an event might be. It is also quite dramatic to be watching someone in a tight spot and then have the camera focus on another character in the story. This leaves the first character suspended in a cliffhanger situation and leaves the players wondering what might happen next.

The second reason someone might wish to call scene cut is if the character got in a good word edgewise and the player wishes to leave the conversation at a particular point. If something witty is said, the attention can switch focus to another character, allowing the first character to have the final word.

Cinematic Damage — Using cinematic damage is a good way to reflect the dangers of the *FarStar's* mission without causing serious harm to a given character. It is up to the players to roleplay the damage appropriately to enhance the game experience.

For example, if a character strikes someone across the jaw, the damage is almost irrelevant in game terms, but in dramatic terms, dabbing a bandage at a bloody lip says a lot. If a character breaks a leg or wrenches their back, the player must accept the description and play the character accordingly, having their character limp and hold their leg or cry out in pain when assisted to their feet.

Failure Can Be Interesting — Failing in a mission or task presents players with a whole new set of challenges that can continue the story. For instance, if the characters are sneaking into a fortress and get captured by the local guards, instead of killing them, the gamemaster can throw them in jail. This presents the added opportunity to escape.

Anything Might Work ... Once — The players will no doubt try some innovative ideas to get out of difficult situations, and you should

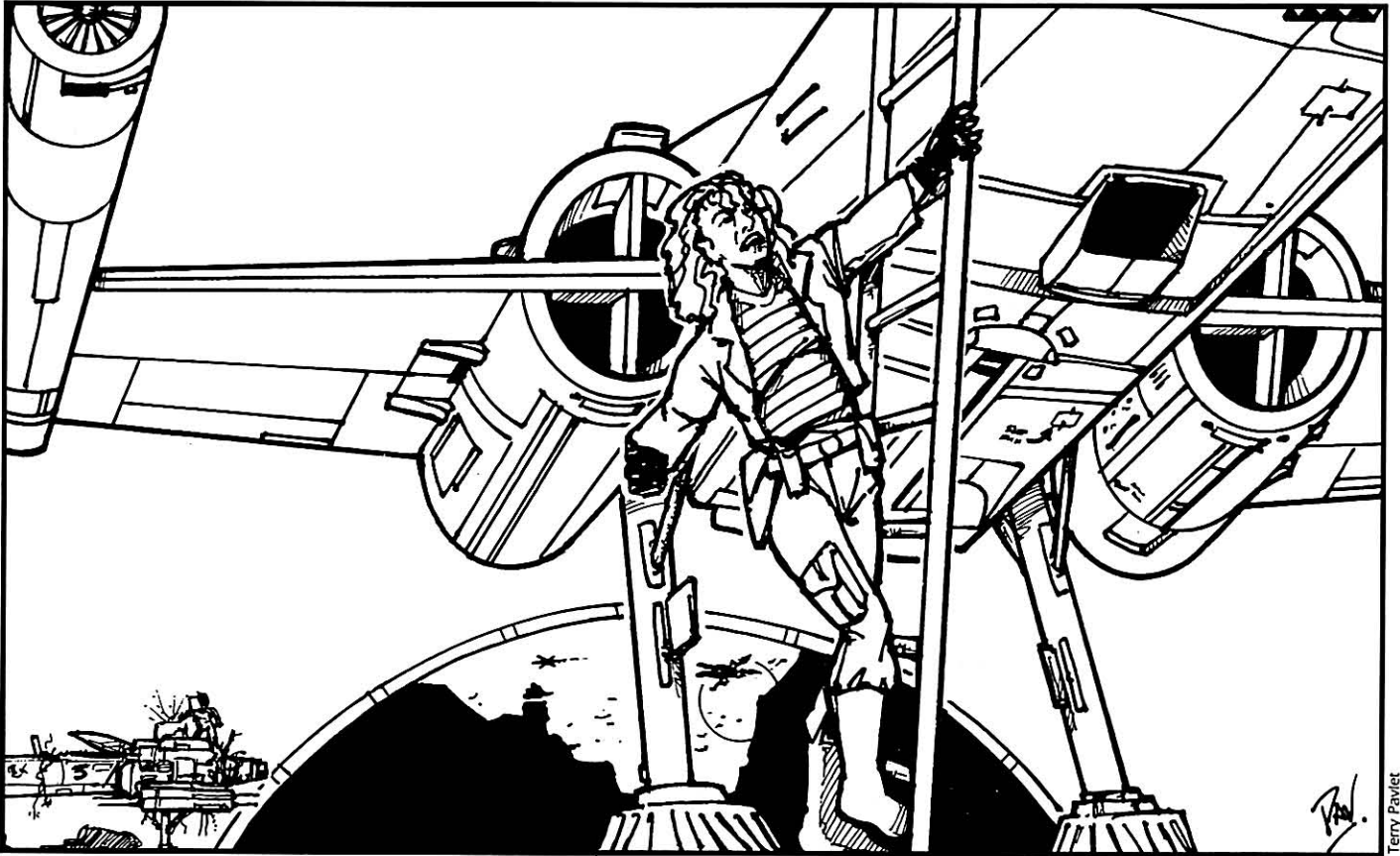

Terry Paviet

encourage them to try novel but believable approaches. While characters might get a lucky break and some outlandish plan might succeed once, the players should be aware that such plans will rarely work the same way twice.

In Media Res — The best stories begin “in the middle of things.” Start each adventure with a bang, and then after the shooting stops, fill the characters in on what is really going on. It builds good stories and drama, and keeps the players on the edge of their seat.

PLAYER CHARACTERS ABOARD THE FARSTAR

The DarkStryder Campaign is a multi-character campaign: each player has more than one character. The player will play each character during different scenes, in effect playing three very different people during the course of an adventure.

Additionally, players may take on “extra” characters at certain points in adventures. This approach has been selected for a number of reasons.

- **Realism.** The *FarStar* has a crew of over 100 people. It doesn’t make much sense to send the same five or six characters on every mission when there are scores of characters with specialized skills for virtually any mission profile.

- ***The DarkStryder Campaign* is dangerous.** Characters — both player characters and game-master characters — will get killed or injured during the course of the campaign. Other characters may abandon the *FarStar* during one of its stops. By giving each player multiple characters, the players are likely to be more understanding if one of their characters is killed along the way.

- **It encourages roleplaying.** Having each player portraying more than one role encourages true roleplaying throughout game sessions. The players are challenged to develop different personalities and mannerisms for each character. Players must learn how to keep each character’s personality and experiences separate — when one character knows or has experienced something, the player’s other characters don’t automatically have access to that information.

DEVELOPING A CHARACTER

When developing a character, remember that small traits can be effective. Adding a constant snuffle, an accent, a limp, disheveled hair or a broken tooth makes a fairly ordinary character memorable.

If you are having trouble coming up with a few "hooks" for a character, there are a few simple tricks to try. You might want to use a character from a book or movie as a starting idea. Take a couple of traits from a favorite actor and incorporate them. Chances are these traits can be developed enough so that no one will recognize where they came from.

Another shortcut for making characters more real is to find a trait that isn't represented in the group. Perhaps a character has a drinking problem, or a slur, or a nervous tick. Even non-physical traits can go far towards adding detail to a gamemaster character, like an affinity for gambling or playing dejarik. Maybe they're a heavy reader, or a student of history, or a proponent of an alien philosophy.

Use this approach so the players know exactly who the character is. If a gamemaster character is well defined, the players will care about what happens to that character.

• **It'll be more fun!** By giving each player multiple roles, gamemasters and players alike have more freedom to construct interesting adventures. Gamemasters can cheerfully ignore the traditional roleplaying maxim of "don't split the party."

At the beginning of each adventure, the gamemaster can provide players with a glimpse of what the mission may involve with an action-packed opening scene. The players can then use their command crew characters to select a mission team suited to the situation. Players can send along one of their standard characters, or they may select a mission specialist from one of the many unclaimed characters and take on that role for the evening.

SELECTING CHARACTERS

In *The DarkStryder Campaign*, each player should have three characters they play on a regular basis: one selected from the "Command Crew" section, one selected from the "Support Crew" section, and one originally created by the player.

The character selection process should be closely supervised by the gamemaster: rather than handing players this book, describe the characters from what can be known with only a cursory glance. For example, Jessa Dajus might be described as "a turncoat Imperial who is providing the crew of the *FarStar* with information about Moff Sarne's operations." Other factors, such as her Force-sensitivity, should be explained to the player in private after the character has been selected.

Gamemasters should briefly describe the command crew members, allowing each player to select one. Then the gamemaster should go through the support crew members, also allowing each player to choose one support crew character.

Finally, each player should create an original character using the standard character generation rules in *Star Wars, Second Edition*. Each original crewmember is a support crew character; there are no other available command crew posts.

ORIGINAL CHARACTERS

Each original character should be a complete individual, with motives, beliefs, goals, and methods. The crew members have their own reasons for volunteering for this assignment, and their plans may cause conflict during the campaign. Most of them should have elements of their backgrounds they would rather not reveal to the crew of the *FarStar*. The characters need not be fully loyal to the New Republic.

Once aboard the *FarStar*, the characters will find themselves surrounded by a crew with conflicting motives. Some are aboard as a means of getting somewhere, while others are running from their past. Many believe wholeheartedly in the fight against the Empire, and there may be those who despise the New Republic and are spies.

These original characters begin the campaign in lower posts; assignments could include operating the turbolasers, repairing droids, or working in the engineering section of the *FarStar*. These characters will be in constant contact with the command crew, the established support crew and the rest of the crew aboard the *FarStar*.

Original characters take orders from any character with a higher rank, including the command crew. The characters will see what it is like to be in a military situation and they will no doubt complain to their fellow crewmen about their commanders. After several adventures, these characters may be moved up in position and given additional responsibilities.

When creating original characters, the players must adhere to the following restrictions to maintain the integrity of the storyline. The gamemaster has final approval over all parts of a character's history, background, skills or possessions.

- **No Force-users.** Characters who have knowledge of Force skills seriously unbalance the campaign's storyline. Gamemasters should not allow Force-using characters. However, gamemasters may allow a more mature player to take on the role of a Force-sensitive character — one who has the potential to learn Force skills and abilities, but at this point has no training nor a true awareness of the nature of the Force. If the gamemaster allows a Force-sensitive character, that character should also feel drawn to DarkStryder. The feelings will not be as intense nor as tempting as those Dajus experiences, but nonetheless the character will feel compelled to find DarkStryder.

- **No characters with ships.** One of the core ingredients of *The DarkStryder Campaign* is the *FarStar's* limited resources. No character can begin the campaign with their own freighter or ship — it can be assumed that any such vessel was confiscated by Moff Sarne before the New Republic arrived. An acceptable exception is a fighter pilot character who has a fighter assigned by the New Republic; this character would simply be one of the other fighter pilots aboard the ship.

Allowing the *FarStar* access to extra vessels limits the effectiveness of the campaign: an extra freighter can always go get help if the *FarStar* gets into trouble. This contradicts the theme of "the characters are on their own."

Of course, former smugglers can be handy characters to have around — old enemies might still remember the character. These characters might have a number of contacts in the sector; this could be especially helpful in developing original adventures for your campaign.

As the campaign progresses, the gamemaster may allow a player character with a ship who joins up at one of the colony worlds along the way. It is conceivable that the *FarStar* may pick up a freighter or two while headed into unknown space, but the character *must* have a very good motivation for joining an expedition into unknown space in pursuit of a large Imperial military fleet.

- **No obvious spies.** Aside from Dajus, no *obvious* former Imperial agents or operatives are going to be accepted aboard the *FarStar*. Dajus has very specialized knowledge that the *FarStar*

"EXTRA" CHARACTERS

Roleplaying games normally make a clear distinction between "player characters" and "gamemaster characters." Each player plays the role of a single "player character," while the gamemaster plays the role of "everybody else," from the lowliest ground trooper to the main villain. This is not so with *The DarkStryder Campaign*.

In this campaign setting, the players not only have three main player characters, but they may also be asked by the gamemaster to take on the role of an "extra" character or two during an adventure. (Gamemasters should make sure that this idea is acceptable to the players involved.)

Extra characters are any other crewmembers aboard the *FarStar*. While most are not going to be as fully developed as the main characters, each has an interesting story to tell and each will benefit from being developed during game sessions.

For a few scenes, or perhaps for an entire adventure, a player will take on the role of this extra character. Sometimes the gamemaster will even ask a player to take on the role of an extra who is not a crewmember aboard the *FarStar*, but is one of the people on a planet or ship the *FarStar* encounters.

Gamemasters wishing to use this tactic must make sure that extra characters are not only interesting, but that they also contribute to the overall story. These characters may have ulterior motives — perhaps holding a grudge against a player character or seeking personal profit — but they must also be agreeable enough to the *FarStar's* objectives to be useful.

This tactic firmly reinforces the notion that *The DarkStryder Campaign* is about the adventures of the *FarStar* and her crew — the *entire* crew, not just a small number of privileged beings.

needs, but there isn't a lot of sympathy for Sarne's former henchmen aboard this ship.

Of course, there was a lot of chaos on Kal'Shebbol when the New Republic arrived: records were lost, uniforms were destroyed, people who knew too much conveniently disappeared ... it is possible that a character could be a former Imperial operative who is lying about his or her past.

THE TRADITIONAL CAMPAIGN

With all this encouragement for players to have multiple characters, a few people must be asking, "Can't *The DarkStryder Campaign* be played the 'normal' way, with just one player character per person?"

Of course, the answer is yes. The character biographies can be used as a springboard for the gamemaster, while each player chooses one developed character or creates his or her own. If the game group is more comfortable with this traditional method, that is perfectly acceptable. The multi-character approach was selected to show how *DarkStryder* is different from normal *Star Wars* campaigns — and to enable gamemasters to run this game in the "realistically heroic" mold.

The gamemaster can, if he or she chooses, allow the players to substitute original characters for the command crew, dispatching Adrimetrum, Khzam and everyone else. However, be forewarned that future events in *The DarkStryder Campaign* will be tied to the personalities and motivations of these characters, and while the overall plotline — the pursuit of Sarne and the final revelation of *DarkStryder* — will still be playable, many of the campaign's main turning points will have to be revised or scrapped if using alternate characters.

RESERVE CHARACTERS

With the original characters completed, the gamemaster and each player may want to consider creating a couple of "reserve characters." These additional characters will be created by both players and gamemasters but will be considered "extra" characters. (See the sidebar "Extra' Characters.")

These extra characters are being saved as potential player characters should a player's characters be killed or eliminated from the campaign.

These characters are used to populate the *FarStar*. The gamemaster might drop in a reserve character from time to time, allowing them a few lines before leaving the room. This provides foreshadowing — if a player assumes the roll of a reserve character it does not seem that the character arrived from out of the blue. The *FarStar* is a closed environment and even if someone

isn't known by name, most crew members will be identifiable by sight. Using reserve characters as background extras allows them to later walk into the campaign and take a leading role.

Reserve characters need not be fully fleshed out when the campaign begins, and might only exist as a name with a few sentences for description. Gamemasters can track these characters with the "Crew Roster Form" in *The Adventure Book*.

RUNNING THE CREW

It is difficult to properly handle scores of characters. Gamemasters should use the crew roster form to keep track of these characters. This form provides the most important information on each character and is an easy way to check off skills, significant events and personality traits at a glance.

This form can be used to keep track of the individuals who are constantly interacting with the players' characters, such as the astrogator, tactician, anyone in their duty posts, and of course, whoever is assigned to be their bunkpartner. When people are spending their lives working in the same place with the same people, they tend to learn a little about each other.

PLAYING EXTRAS

When a player is going to be asked to take on the role of an extra, the gamemaster should prepare a character sheet for each character to be played.

In addition to game statistics, this sheet must include a description of the character's objectives in the scene. The player must make an honest effort to fulfill these objectives.

This keeps the players involved — just because a player's main characters are off somewhere else in the game, that doesn't mean the player has to sit and wait. For example, the captain may want to send a scouting party into a situation. By allowing the players to take on the roles of the appropriate mission specialists, everyone gets to play while maintaining realism within the campaign.

Remember that the point of extra characters is not to be disruptive, but to allow all players the chance to continue participating in the game. Each player can add their own ideas to the character's concept (with the gamemaster's approval). Whenever something notable occurs to an extra character, these notes should be added to the roster sheets so these elements can be used consistently in future games.

THE ADVENTURE BOOK

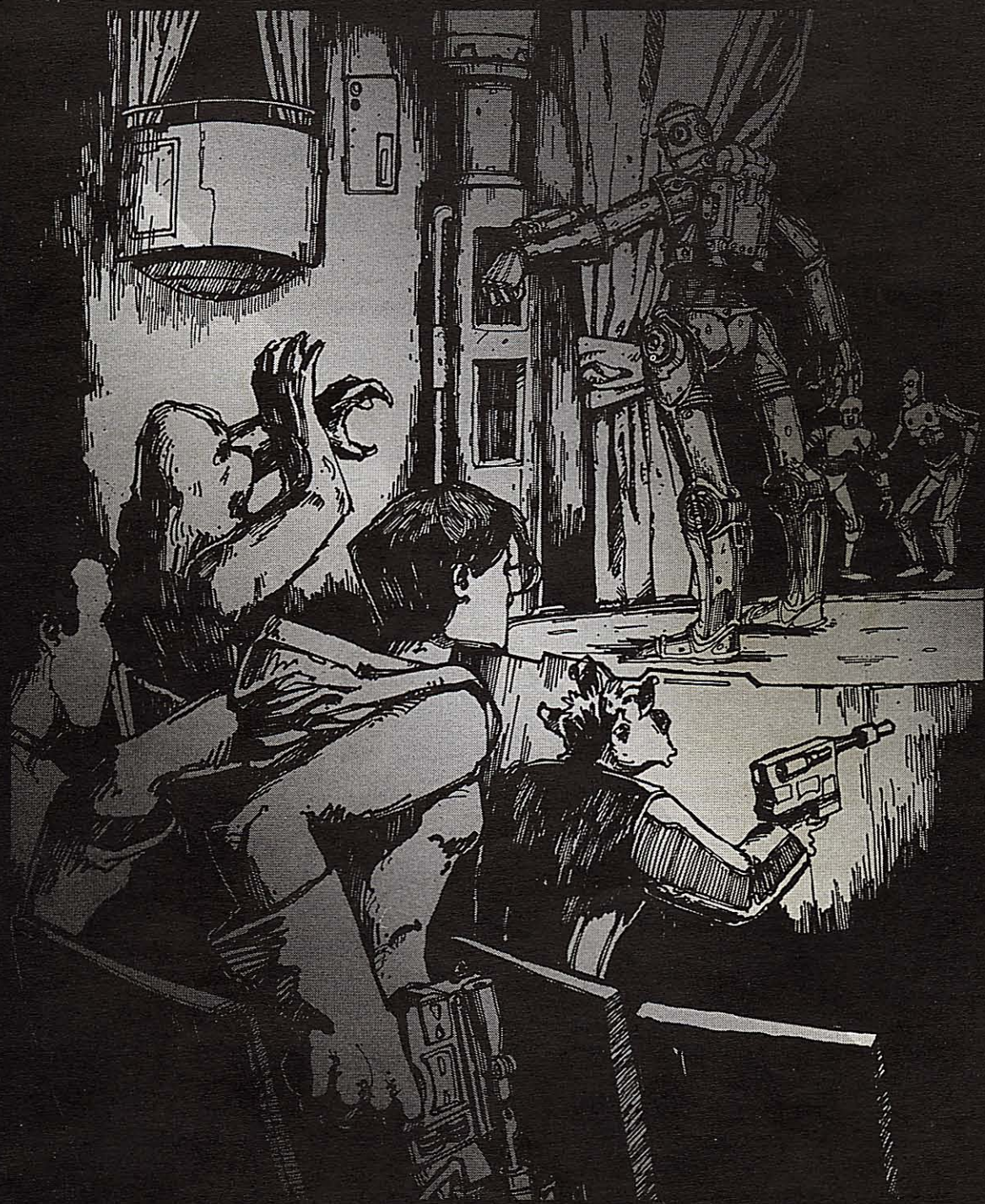

KATHOL SECTOR OVERVIEW

INTRODUCTION

The Adventure Book offers six beginning adventures, the "Gamemaster Crew Notes" chapter (describing the "fates" of many of the characters aboard the *FarStar*), this overview (which contains information on planets in the Kathol sector), and "The Rogues Gallery," a collection of villains and possible allies for the *FarStar's* early adventures.

THE KATHOL SECTOR

The Kathol sector is the initial setting for *The DarkStryder Campaign*. This chapter provides capsule summaries of some of the major worlds in the sector.

Kathol sector has been settled for nearly six centuries; the first Old Republic settlement was the establishment of Gandle Ott, which quickly grew into a major world on the fringes of galactic society. However, the remoteness of the Kathol sector insured that the area was never extensively colonized and the region to this day remains a galactic backwater on the fringes of Imperial (now New Republic) space.

Kathol sector has been ruled for the past 10 years by Moff Kentor Sarne. With the death of Emperor Palpatine four years ago, Moff Sarne slowly withdrew from the fragmenting Empire; those within the Empire proper had neither the time nor the inclination to send occupation forces to this area, giving Sarne absolute autonomy in the name of the Empire.

Kathol sector borders on the outer fringes of the Minos Cluster (this region of space is discussed in *Galaxy Guide 6: Tramp Freighters*). It is linked to the Minos Cluster by the Triton Trade Route, which runs to the sector capital of Kal'Shebbol. The trade route links several colony worlds of the sector, including Torize and Kolatill and eventually terminates at Gandle Ott, the last major planet in the sector. The crew of the *FarStar* knows about the trade route, but only has the astrogation coordinates to Torize and Kolatill; the crew must try to find the coordinates for the rest of the route on one of these colony worlds.

Less travelled routes extend to the outermost

worlds in the sector; there are nearly 30 official colonies and independent worlds in the region; more than half of them have less than 10 million residents, so they are pretty marginal settlements by galactic standards.

There is a large void on the edge of the sector approximately 30 light years across. On the opposite side of the void is a cluster of stars called the Kathol Outback. These systems are officially part of the Kathol sector and the region is lightly populated. The Kathol Outback borders on the edge of a mysterious area known as the Kathol Rift, a section of space reputed to be extremely dangerous to navigate. The Kathol Outback and the Kathol Rift will be explored in future DarkStryder supplements.

Gamemasters creating their own adventures are encouraged to place them *before* the final adventure in this book, "Traitor in Our Midst." Gamemasters can develop the rest of the Kathol sector in any way they see fit since the next DarkStryder supplement will pick up shortly after the events depicted in "Traitor in Our Midst" and lead directly to the Kathol Outback.

STAR MAPPING

The *FarStar's* mission to map the Kathol sector requires the ship to jump from system to system, gathering astrogation coordinates and data on worlds along the way. This mission order can provide plenty of adventures for the crew of the *FarStar* — while the *FarStar's* top priority is to keep track of Moff Sarne, layovers on new worlds do occur and the *FarStar* is instructed to gather information during these periods.

The Kathol sector star map shows the worlds introduced in this boxed set; not all the systems in the Kathol sector are shown and gamemasters can add new systems for their own adventures. Additional supplements will add new star maps that extend out into the Kathol Outback.

RESOURCES

The *FarStar* begins with roughly three months worth of resources, including food, medicine and standard equipment. As the *FarStar's* mission is a long-term one, a top priority is replacing expended resources and gathering additional sup-

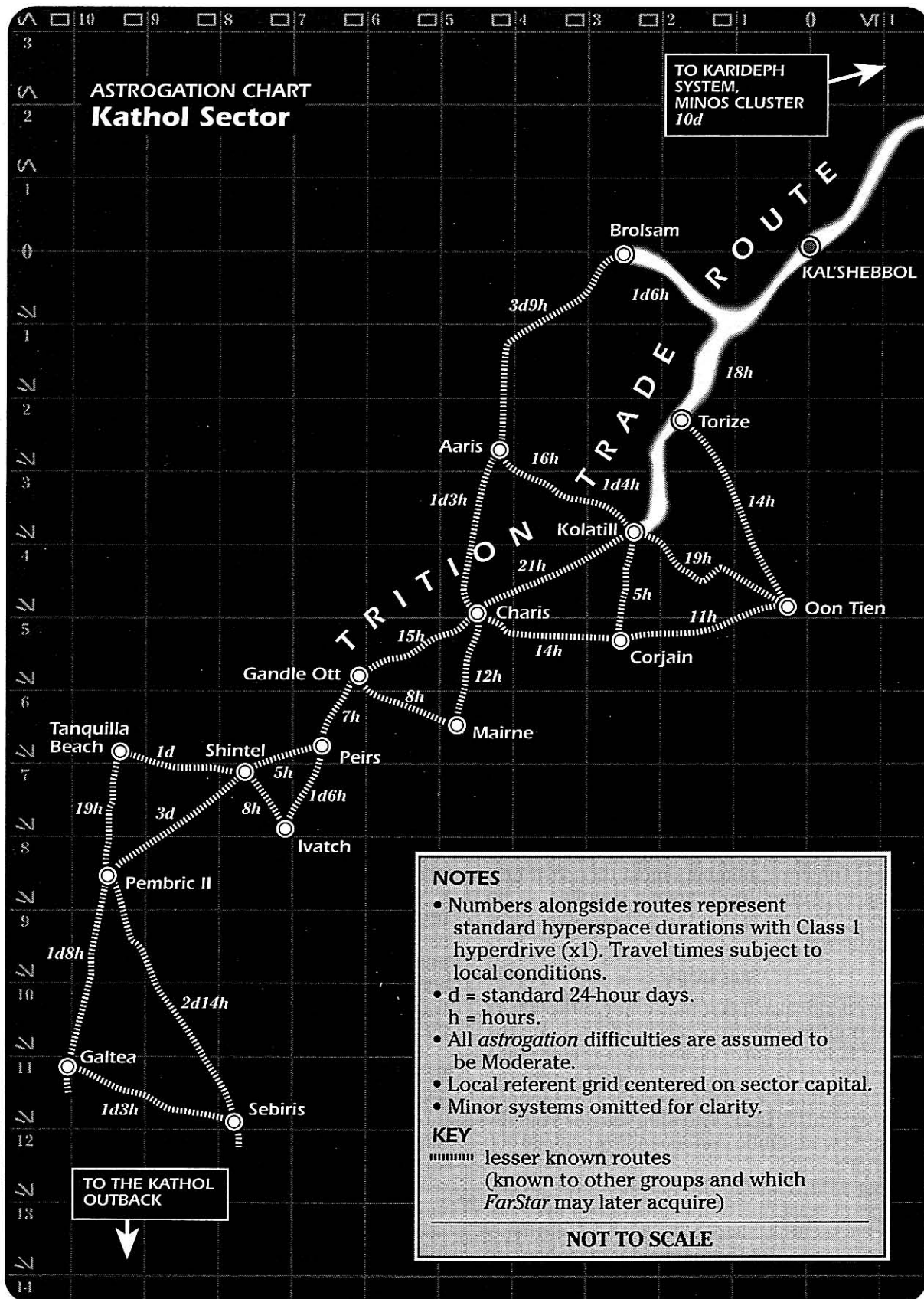

Stephen Crane

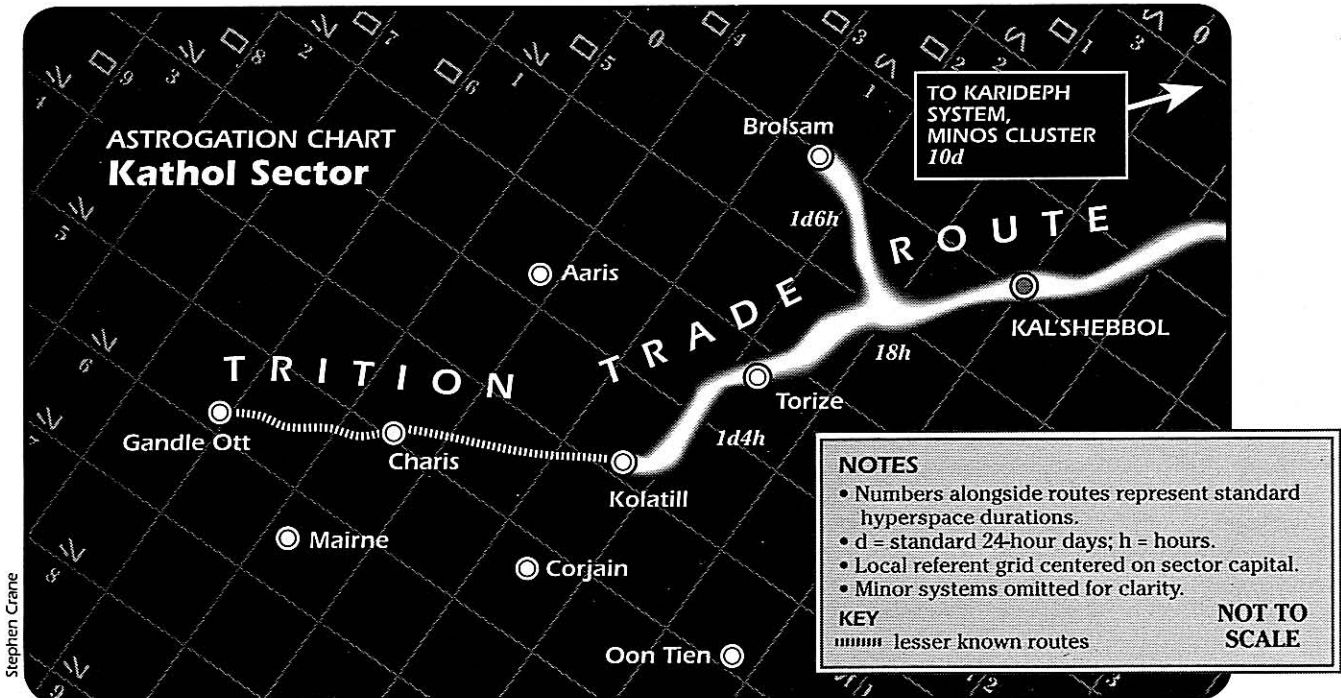

■ **Note to Gamemasters:** This chart represents the astrogation information (provided by Gorak Khzam) available to the crew of the *FarStar* at the outset of their mission.

plies whenever they are available.

While gamemasters should keep players aware of the limited resources aboard the *FarStar*, don't require the players to keep track of how many food packets and blaster power packs they've used: this is an adventure game, not an exercise in bookkeeping.

Supply limitations should be used as story hooks to motivate adventures. The gamemaster can *reasonably* assume that at certain times supplies will begin to run low, particularly after battles. The crew members must then visit new worlds to gather replacement supplies — no doubt getting dragged into exciting adventures along the way.

MONEY

The *FarStar* also has some money, although its actual utility varies from system to system; the money is in the form of standard credit chips since most of the worlds in this region are remote enough to make electronic credit transactions inconvenient at best. The ship carries roughly 10,000 New Republic credits and roughly 60,000 Imperial credits.

Most worlds within the Kathol sector proper will use at least one of those currency systems. Since the sector is historically Imperial, the Imperial credits are — at this time — far more likely to

be accepted since that is the dominant currency. With the New Republic sweeping the sector, Imperial credits will be accepted only if people reasonably expect to be able to use this money somewhere else; they probably expect to get back to the Minos Cluster and civilized space, where standardized currencies are unquestioningly accepted.

A few planetary governments will accept New Republic currency as a show of faith in the new government, but most merchants regard New Republic credits as little more than brightly colored plastic chips.

On a few worlds, money has little worth. A few traders, acutely aware of the economic instability caused by the sudden arrival of New Republic military forces, only accept money at a high discount, taking into account "economic fluctuations": they are speculating and feel that they are in a position to demand "take it or leave it" trades.

Other systems may be so isolated from galactic culture that standard money will be meaningless. They may have their own native form of money (whether it is in the form of plastic chips, minted coins or brightly colored strips of woven fabric), while others may only use barter systems to exchange goods. The *FarStar's* crew will more often than not have to use ingenuity to get needed goods rather than simply dumping a bucket full of credit chips on the table.

USING THE ROGUES GALLERY

The characters from the rogues gallery are standard gamemaster characters who can be dropped into many adventures. Some, such as the Verpine Kyli Ned'Ix and the trader Veild-danol, can be of great assistance to the *FarStar*. Very few private groups in Kathol sector have the military might to directly attack the *FarStar*, although Sarne's loyal Imperial forces can certainly give the ship a rough time. Others, such as Qulok's First and the Des'maric pirates, can cause a good deal of trouble for characters away from the *FarStar*.

Gamemasters should also come up with their own villains to spice up the campaign. It's especially helpful to tie some of these new villains into the backgrounds of your players' characters for an added sense of urgency — if one of your characters is on the run from slavers, make sure those slavers show up from time to time.

WORLDS IN KATHOL SECTOR

The following worlds are all in the Kathol sector and thus may be visited by the *FarStar*. Each can serve as the basis for at least one adventure.

Kathol sector follows standard Imperial naming conventions, with the system commonly named after the prime world in that system. Assume that the system and prime world names are identical unless otherwise noted.

Kal'Shebbol: Kal'Shebbol is Kathol sector's capital system and, as Sarne's personal seat of power, was among the most oppressive planets in the area. The first settlement was founded four centuries ago by a group of escaped Twi'lek slaves. While they found the planet's wide open plains and moist weather unnerving because it was so different from their home caverns on Ryloth, they quickly adapted, developing farms and domesticating the herds of *chollas* that grazed the plains. The world was a good choice because it was on a trade route (being on the way to Gandle Ott), but was isolated enough that the Twi'lek clans could expect to be left alone to live in peace.

In time, many other groups came to settle on Kal'Shebbol, but each new family, Twi'lek or not, had to be officially adopted by one of the Twi'lek clans before being allowed to settle. The population grew to several million within 50 years and Kal'Shebbol became a major trading post rather than just a layover point.

When Kathol sector was formally accepted into the Old Republic, Kal'Shebbol was selected as the sector capital simply because it was closer

to Old Republic space than remote Gandle Ott.

With the emergence of the Empire and the despotic rule of Moff Sarne, the entire social structure was overturned. The clan and city-state governments were forced to abide by the decisions of appointed Imperial Prefects, who had neither the knowledge nor the desire to maintain society in "the traditional way." Over the course of the last decade, the Imperial government has increasingly intruded on the private lives of Kal'Shebbol's citizens. By the time the New Republic arrived, virtually all private industries had been nationalized, while free passage on and off the planet was a thing of the past. All displays of culture not directly in line with Imperial dictates were brutally suppressed.

The New Republic has established a new provisional government under the control of Governor Monjai. Monjai sees her primary task as preventing the planet from degenerating into chaos and she is spending a good deal of time building good will among the populace; the fact that she is a Elomin rather than a Human has been reassuring to the sizeable alien communities. The New Republic expects to deploy a protection fleet to Kal'Shebbol within two or three months, but for the time being Monjai must try to cobble together a planetary defense force from whatever wasn't destroyed during the attack on Moff Sarne's forces.

Torize: Torize is a heavy manufacturing planet with a population of 1.5 billion people. It has a Type II atmosphere, meaning that breath masks are suggested. This is due to naturally high levels of volcanic activity and a large release of industrial pollutants into the atmosphere after a major industrial disaster three years ago. Torize is one of the major stops on the Triton Trade Route and has extensive orbiting space stations and starports on the surface. As Moff Sarne retreated from Kathol sector, he supplemented his fleet by gathering several ships from the planetary defense force.

Kolatill: Kolatill is also a stopping point on the Triton Trade Route and is a prime repulsorlift drive manufacturing center: while the repulsorlift engines aren't too important to star fleets, they are essential for airspeeders and ground combat vehicles, so this world is potentially quite important to the New Republic. The planet has a population of 400 million and was one of the Kathol sector worlds under martial law during Sarne's rule. Kolatill is detailed in the adventure "Omens."

Brolsam: Brolsam is an agricultural system only a few light years from Kal'Shebbol, although its distance from the main part of the Triton

Trade Route and a lack of important resources slowed development and population growth. The world has only 15 million residents, with roughly equal numbers of Humans, Rodians and Fefze. The insectoid Fefze have been vital to the development of the planet's agricultural areas and their art festivals, sculpture and song have led to the development of a notable *genteel artiste* community. (For more information on the Fefze, see pages 40-42 of *Galaxy Guide 4: Alien Races*.)

Aaris: Aaris is a remote system that was never colonized but has been the subject of at least one scientific expedition. The system is detailed in the adventure "Artifact of Aaris."

Charis: Charis is a manufacturing and information technologies oriented world with a population of roughly 850 million; while it would be considered a pretty minor planet in the heart of the New Republic, it is an important world in Kathol sector. Charis was engulfed in a violent uprising against Sarne some four years ago, but the revolt was brutally put down. Prior to Sarne's military response, Charis had a population of nearly one billion. Some of the planet's foremost cities are now only bombed-out wastelands. It is believed that New Republic sympathizers are plotting another violent revolution, but they need encouragement from New Republic representatives to bring freedom to their world.

Oon Tien: This system is a home to the aliens known as the Jarells and is also the site of the largest Imperial shipyard in the sector.

The planet Oon Tien is a wet, mountainous world. The Jarells had a primitive society on the planet when Old Republic colony ships first ventured into the system, although the Jarell monarchies soon began trading precious gemstones and periods of indentured servitude from their adolescents in exchange for high technology, especially weaponry. The weapons were used in a number of internal revolutions which caused traumatic changes in Jarell society, although warfare never spilled over into the Human settlements.

In the past few decades, the world has steadily been integrated into Kathol sector society and it now has several large manufacturing complexes. Agriculture is also an important industry.

Moff Sarne established three orbiting star docks; each is capable of repairing capital starships up to 300 meters long. Sarne used these docks as the main maintenance posts for his fleet and installed a heavy security net around the system. As Sarne

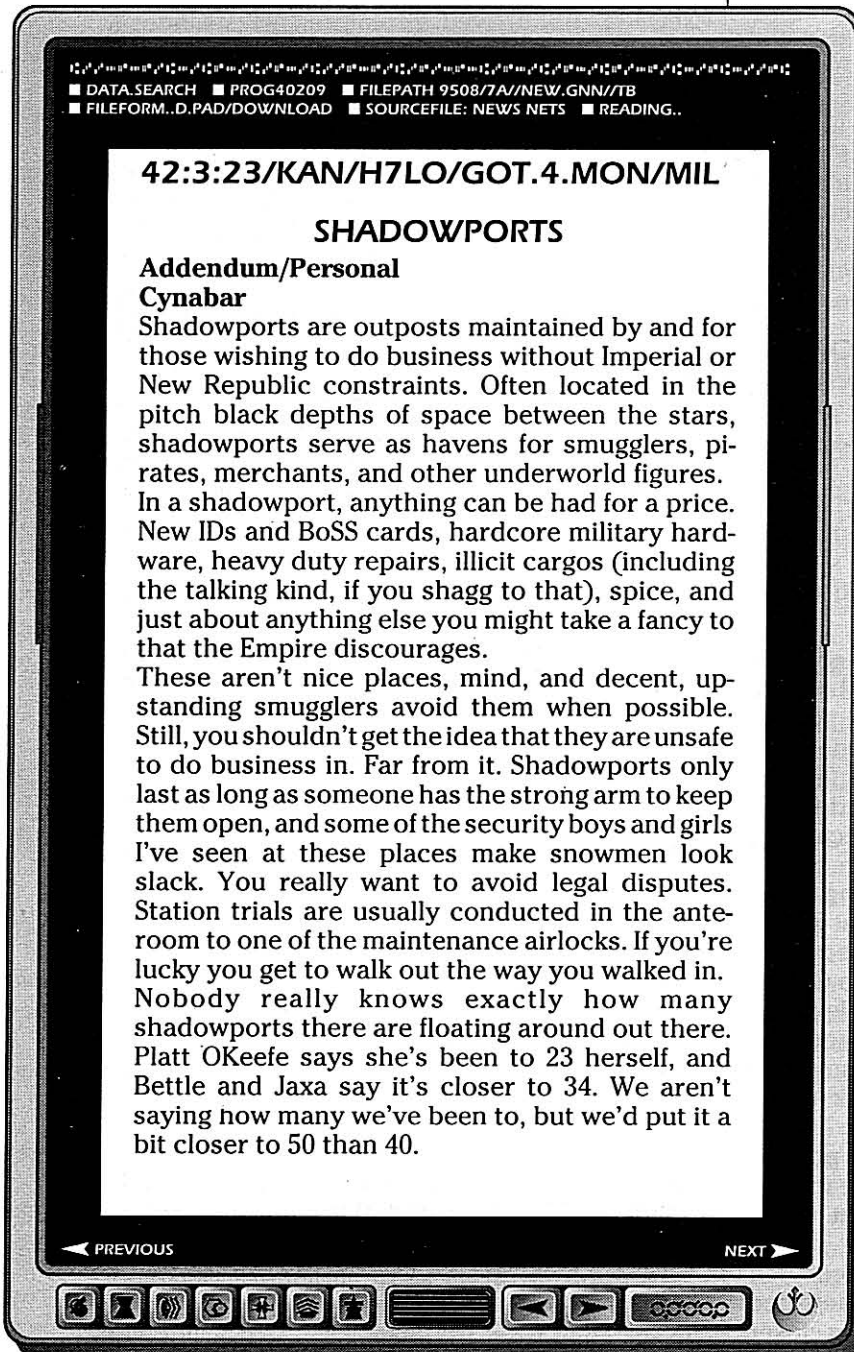

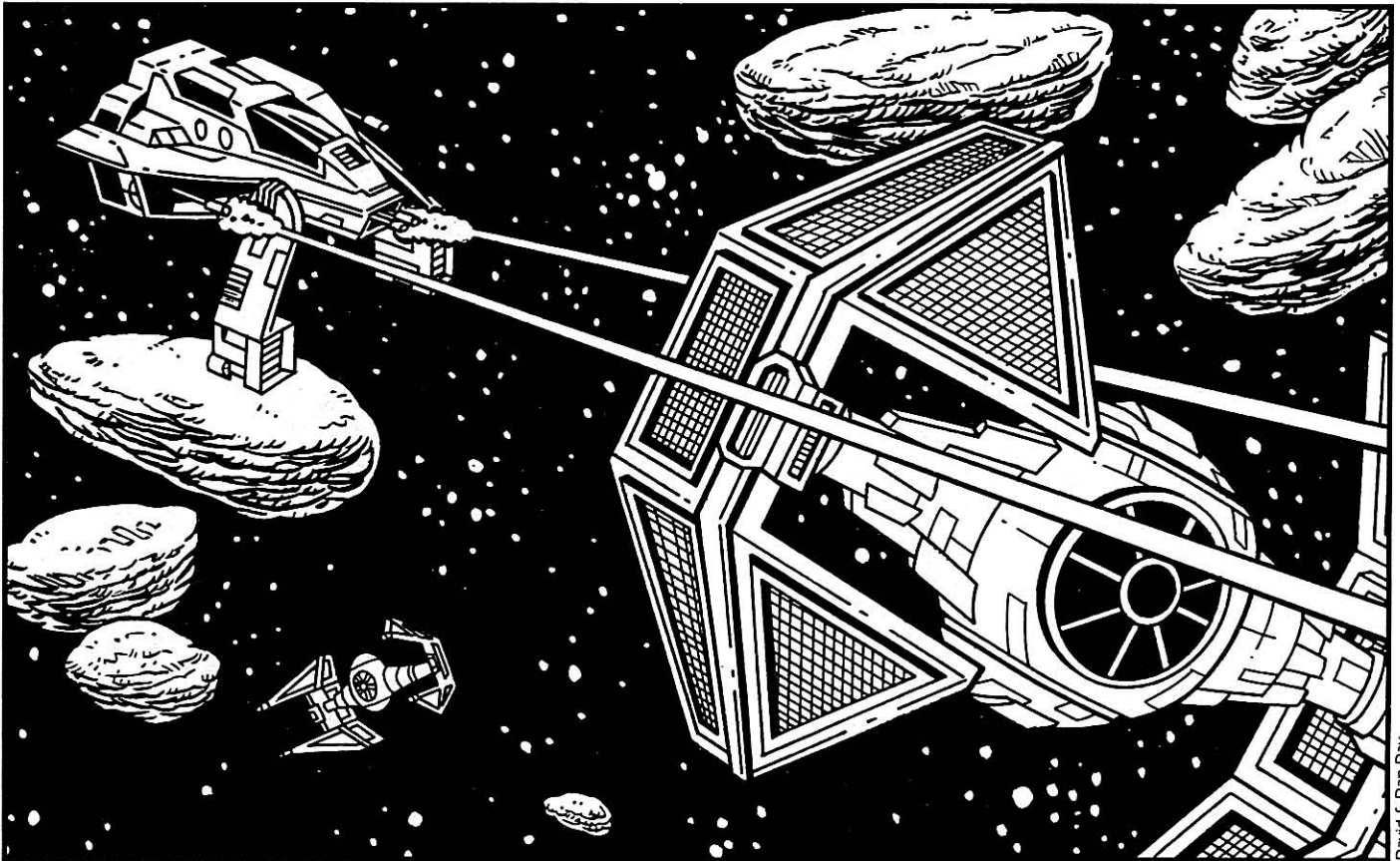

David & Dan Day

retreated, he ordered the system governor, Manon Flint, to hold the docks at all costs — and to destroy them rather than allow them to fall into the hands of the New Republic. The current security system around Oon Tien consists of hundreds of proton mines, at least two dozen IPV 1 system patrol ships and a full wing of TIE fighters. However, these vessels are not to be taken out of the system.

As the New Republic asserts its power, Oon Tien will be one of the most troublesome systems in the sector. The system is too well defended to easily fall to the New Republic and its repair facilities keep Sarne's fleet ships going.

IPV 1 System Patrol Ship. Capital, *capital ship gunnery* 3D+2, *capital ship piloting* 4D+2, *capital ship shields* 3D+2, *sensors* 2D+2. Maneuverability 2D+1, space 7, atmosphere 350; 1,000 kmh, hull 3D+1, shields 3D. Weapons: 4 turbolaser cannons (fire control 2D, damage 4D).

Corjain: Corjain is a metal rich world that is only marginally habitable. The atmosphere is a wet, poisonous soup; all settlements are large, underground warrens. However, its deep and dangerous mines produce a great deal of income for the local mining guilds. The planet has size-

able Twi'lek, Jarell and Svivreni communities (for more information on the Svivreni, see pages 108-109 of *The Last Command Sourcebook*). Unknown to even the New Republic government, Corjain has a secret Bothan-controlled listening post; it is used to keep track of the activities of the *FarStar* and the provisional government on Kal'Shebbol.

Gandle Ott: Gandle Ott, in the Ott system, is the last "major" world in the sector, with a population in the billions and a large industrial base. The planet is fairly self-sufficient and its political leanings are a determining factor in the fate of Kathol sector. The world is in a state of flux when the *FarStar* arrives (shown in "Death is Remotely Possible"): the planet is torn between New Republic and Imperial sympathies.

Mairne, Peirs, Ivatch: Three of many outlying systems that supply metals and other natural resources to Gandle Ott. These systems, and another half dozen like them, tend to have very small colonies. There isn't a lot of wealth or equipment to go around. Some of the local citizens might be interested in trading, but it is entirely possible that the *FarStar* will attract all kinds of unwelcome attention ...

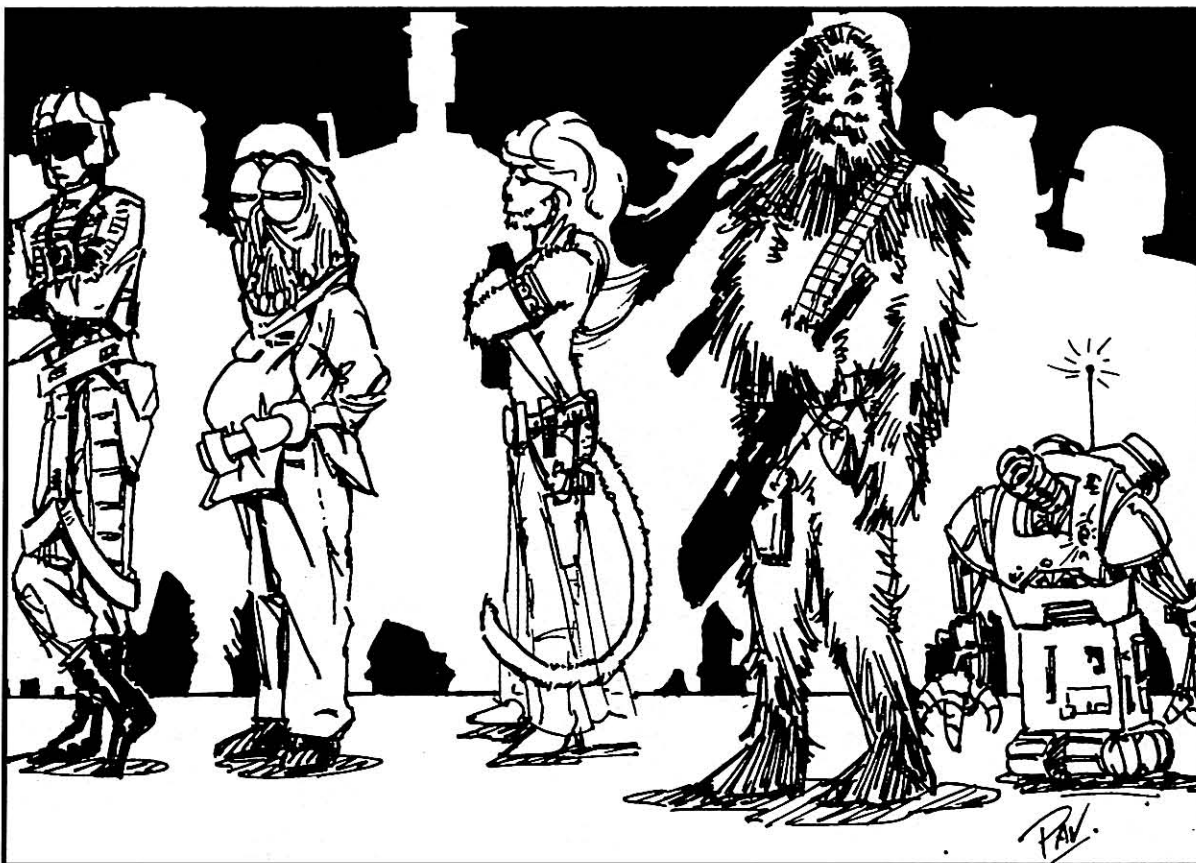

Terry Pavlet

Shintel: Shintel is a system lying beyond Gandle Ott and is purportedly uninhabited. It is actually the site of a small Imperial supply and patrol base. It is detailed in the adventure "Shintel Downtime."

Pembric II: Pembric II is a semi-independent world that is a haven of criminals and smugglers. Order is maintained by the "Pembric Security Legion," which is distinguished from other criminal organizations by spiffy uniforms and badges. Pembric II is detailed in the adventure "Crisis."

Galtea: A small, non-aligned colony world that has little more to offer than food and basic supplies. Veild-danol might be encountered on this world. This planet is detailed in the adventure "Traitor in Our Midst."

Sebiris: A primitive world on the edge of the Kathol sector. This planet is detailed in the adventure "Traitor in Our Midst."

GAMEMASTER CREW NOTES

The DarkStryder Campaign has an evolving storyline, yet gamemasters will no doubt want to develop characters on their own. The following information should be used as a guideline when developing additional adventures.

Gamemasters have the right to restrict players from using these characters during certain adventures to maintain the integrity of the overall storyline. Gamemasters should also make sure that players do not abuse the power of the command characters — if a player uses Kaiya Adrimetrum as a means of giving unreasonable orders, it's not going to be much fun for anyone else to play and it is the gamemaster's responsibility to intercede and prevent such actions.

Information is broken down into several categories:

Player Guidelines: Information for the player.

Directed Development: West End will be releasing several more DarkStryder campaign supplements that detail the adventures of the *FarStar*. This section provides hints, suggestions and specific directives for developing a character and keeping that character within the main campaign plotline. Naturally, we don't want to reveal the whole storyline at this time, but we also want to make sure that your campaign stays "on track" with our overall storyline.

When we suggest that a character remains "intact," this means that the character shouldn't be killed or fundamentally changed — while characters may become injured, develop friendships, and go through some exceptional adventures, the character should still be recognizably the same. West End will further develop the character in future DarkStryder supplements.

Suggested Development: A few possible suggestions for character development.

CAPTAIN KELEMAN CIRO

Directed Development: Captain Ciro's fate is predetermined and players should be careful in taking on the role (see the adventure "Omens"). The character should be played "straight" — seriously and with no hint of what will happen to him.

The gamemaster should work with the player to ensure that the role and the adventure events are played out properly.

KAIYA ADRIMETRUM

Player Guidelines: Kaiya is a dedicated and driven leader. She is smart and chooses her battles carefully, but when she enters a fight, she means to win by any means.

Directed Development: Kaiya assumes the command of the *FarStar* by the end of the adventure "Omens." Kaiya should slowly evolve to be a more mature and confident commander as the campaign progresses.

SECURITY OFFICER GORAK KHZAM

Player Guidelines: Khzam may be a murderer, but he is a shrewd one. He always plans out his actions and when he uses force, it is applied with surgical precision so that he never comes under suspicion. Khzam's loyalties are with the *FarStar* for the time being ...

Directed Development: After Kaiya is elevated to command of the *FarStar*, Khzam is promoted to first officer. He is loyal to the *FarStar* for the foreseeable future and will stay with the ship for the time being. He should remain intact.

His ties to the Sabiador Slavers *must* not be revealed to Kaiya or anyone else ... and Khzam should be willing to do anything to make sure that this doesn't happen.

Khzam has been around Kathol sector for quite a while, so he knows of most major traders, pirates and bounty hunters, at least by reputation. Gamemasters might want to pass along notes describing how much Khzam knows about any given force that is encountered; have the player make a *streetwise* roll to determine how much Khzam knows unless that information is specifically detailed in the adventure.

On the opposite side, a small number of people probably know Khzam's true identity. A few are going to be very angry when they find out he's aboard the *FarStar*. This plot device should be used rarely but to good effect. While other slavers and former Imperials might merely distrust

Khzam (or might embrace him, treating him as an “accomplished professional”), relatives of slaves and those with strong morals will probably want to see Khzam imprisoned ... or far, far worse.

Suggested Development: Perhaps an “old friend” of Khzam appears and offers the *FarStar* assistance; behind the scenes, Khzam’s old friend is going to try to take advantage of the Rodian and Khzam must find a satisfactory way of keeping his secret safe. This character should *not* be from Khzam’s old slaving group.

LIEUTENANT DARRYN THYTE

Player Guidelines: Thyte is a bitter, sour man, but he is also quite talented. He’s the kind of person you don’t want assigned as your roommate, but he gets the job done. While Thyte is wholly committed to making the *FarStar*’s mission a success, he’s under no obligation to make it a pleasant trip.

Directed Development: In terms of character development, Thyte should remain intact — perhaps he makes a couple of attempts to defeat his problems, but he makes only marginal progress.

LIEUTENANT JESSA DAJUS

Player Guidelines: Dajus is driven in a way that can be quite frightening to others. Her motive is revenge, pure and simple, and to cross her path is to invite severe repercussions. Nonetheless, Dajus can be witty, charming and thoroughly likeable — as long as she thinks this approach will allow her to get her way.

Directed Development: In many ways, the DarkStryder campaign revolves around Dajus; her development will be dictated by future DarkStryder supplements.

As a plot device, the gamemaster can pass the person playing Dajus notes to guide her. These notes can represent Dajus’ secret knowledge from her Imperial service with Moff Sarne or her mysterious premonitions.

The gamemaster must show the distinction between Dajus’ knowledge — “you *know* the following ...” — and her bursts of intuition, which are merely strong premonitions — “you get the feeling that ...”

In adventures, Dajus will be tempted by circumstances to open up to her Force sensitivity and develop her abilities. Many of these temptations will encourage her to teeter on the brink of the dark side of the Force ...

LOH’KHAR THE FINDER

Player Guidelines: Loh’khar is a shrewd bargainer. Both forceful and manipulative, he knows how to get his way, often without resorting to violence. He would much prefer to keep his business partners open to further dealings. Loh’khar will not make deals for the sake of sheer negotiation, but he will not let a good business contact pass him by. Loh’khar is the type to be running several scams at the same time with a number of crew members.

Directed Development: Loh’khar is a manipulative scrounge. At this point, his character should remain intact, but there’s plenty of adventure potential with the character.

LIEUTENANT RANNA “WING-RIPPER” GORJAYE

Player Guidelines: Gorejaye is a hot-shot pilot, pure and simple. However, she’s as good as she is cocky — and she’s perfectly willing to let anyone else in on this little “secret.” She’s bristles at taking commands from “mud-pounders” like Adrimetrum, but she makes sure her pilots get the job done.

Directed Development: Over the course of many adventures, Gorjaye will come to respect Adrimetrum. Gorjaye will change from one of the more abrasive crewmembers to perhaps Kaiya’s staunchest supporter, but this will take time.

Gorjaye makes an excellent romantic interest for another character. A relationship with her will probably tend to be on the stormy side.

KL’AAL

Player Guidelines: Kl’aal is a quiet savage hunter. He is not a cold-blooded killer, but a hunter and tracker with a strong sense of honor. In order to survive he was forced to violate his own personal code of ethics and feels that killing Sarne is the only way to cleanse himself of his past actions.

Directed Development: Kl’aal is a loyal *FarStar* crewmember. His past as Sarne’s assassin should remain a secret (for now). The character should remain intact, although he will be developed over the course of the DarkStryder campaign.

Suggested Development: Kl’aal may come across those hunting for him at any time. Fortunately for him, he will probably have superior skills. Nonetheless, the shadow of being a hunted person will always hover over him and his actions.

DOCTOR AKANSEH

Player Guidelines: Akanseh is a reserved, kind soul who has been forced by circumstances to betray his own beliefs. He hopes to redeem himself and help deserving beings who need his services. He desperately wants to forget his time as an interrogator and will blatantly lie to protect himself, although he is quite truthful in most other dealings.

Directed Development: West End will not be using Akanseh in future DarkStryder supplements, although we recommend that the character be given a chance to redeem himself through a heroic sacrifice: trading one life for thousands, for example. Perhaps he dies or he simply chooses to sacrifice himself and somehow miraculously survives.

Gamemasters are under no obligation to eliminate Akanseh — they may choose to keep him around until the resolution of the campaign or continue to use him as a character even after the DarkStryder storyline is resolved.

SERGEANT BROPHAR TOFARAIN

Player Notes: Brophar is a loud but generally helpful character. While he can be difficult to get along with, he can also be a good friend and is perhaps more open to working with others than most of the command crew. His passion is to make his fortune and retire, and for him the *FarStar* mission is a final big adventure.

Directed Development: Future DarkStryder supplements will use Tofarain so the character should remain intact.

LOFRYYHN

Player Notes: Lofryyhn is in many ways the stereotypical Wookiee. Like most other Wookiees, he has no tolerance for slavers and will often take matters into his own hands to make sure that said scum will never practice their trade again.

Directed Development: Future DarkStryder supplements will use Lofryyhn so the character should remain intact.

Suggested Developments: Encounters with slavers could make for a most interesting subplot since Lofryyhn would probably be perfectly willing to disregard the *FarStar's* interests to wipe out any such criminals.

DASHA DEFANO

Directed Development: The character should remain intact.



Suggested Development: She can be developed to be a confidant and loyal friend of Gorjaye.

COBB UNSER

Directed Development: Give Cobb several tantalizing false leads as to the fate of his sister, but do not yet resolve this plotline. Otherwise, keep the character intact.

NOELL CIRO

Directed Development: Noell Ciro's fate is predetermined and players should be careful in taking on the role. (See the adventure "Omens"). The character should be played with no hint of what will happen to him. The gamemaster should discuss the character with the player to ensure that the role and the adventure events are played out properly.

KRUDAR

Directed Development: This character should remain alive and within his position as a gunner aboard the *FarStar*, but feel free to develop his personality.



Dan & David Day

BOOM

Directed Development: Boom should remain relatively intact. His character can be uncontrollable and troublesome, but he also has some useful skills. He can also be used as dark comic relief.

RIZZAL, VIZZAL AND NIZZAL

Player Guidelines: These three characters should not be considered merely extensions of one another; they are three distinct individuals, with differing goals and behaviors.

Directed Development: These characters will be further developed in later DarkStryder supplements so they should remain intact.

BRANDIS TURGAH

Directed Development: This character should remain intact.

T'ACHAK T'ANDAR

Directed Development: Gamemasters and players have free reign to develop this character as they see fit: T'ander will not be mentioned or used in later DarkStryder supplements.

GUNTHAR

Directed Development: Gunthar's true origin will be developed in later DarkStryder products.

TANNER CARZYN

Directed Development: Tanner should remain intact and will be developed in later supplements.

QESYA VTH'NAAR

Directed Development: Qesya should remain intact and will be developed in later supplements.

EDLY "POT-SHOT" FASALK

Directed Development: Gamemasters and players have free reign to develop this character as they see fit: Edly will not be mentioned or used in later DarkStryder supplements.

SCORYN

Directed Development: This character should remain intact and will be developed in later supplements.

"GAMMER" FIRDAAZ

Directed Development: This character should remain intact and will be developed in later supplements.

UNDA LAGOR

Directed Development: Gamemasters and players have free reign to develop this character as they see fit: Unda will not be mentioned or used in later DarkStryder supplements.

GENNA SEEDAR

Directed Development: This character should remain intact and will be developed in later supplements. If Akanseh is written out of your campaign, Seedar should be promoted to be the *FarStar's* chief medical officer.

VEGATH TIST

Directed Development: This character should remain intact and will be developed in later supplements.

DANN DRUGAH

Directed Development: Gamemasters and players have free reign to develop this character as they see fit: Drugah will not be mentioned or used in later DarkStryder supplements.

THANIS GUL-RAH

Directed Development: This character should remain intact and will be developed in later supplements.

THE DARKSTRYDER CAMPAIGN

CREW ROSTER FORM

CHARCTER NAME _____ RANK TYPE	ATTRIBUTES DEXTERITY PERCEPTION KNOWLEDGE STRENGTH MECHANICAL TECHNICAL	SKILLS
FORCE POINTS DARK SIDE POINTS CHARACTER POINTS MOVE	EQUIPMENT	PERSONALITY TRAITS

CHARCTER NAME _____ RANK TYPE	ATTRIBUTES DEXTERITY PERCEPTION KNOWLEDGE STRENGTH MECHANICAL TECHNICAL	SKILLS
FORCE POINTS DARK SIDE POINTS CHARACTER POINTS MOVE	EQUIPMENT	PERSONALITY TRAITS

CHARCTER NAME _____ RANK TYPE	ATTRIBUTES DEXTERITY PERCEPTION KNOWLEDGE STRENGTH MECHANICAL TECHNICAL	SKILLS
FORCE POINTS DARK SIDE POINTS CHARACTER POINTS MOVE	EQUIPMENT	PERSONALITY TRAITS

CHARCTER NAME _____ RANK TYPE	ATTRIBUTES DEXTERITY PERCEPTION KNOWLEDGE STRENGTH MECHANICAL TECHNICAL	SKILLS
FORCE POINTS DARK SIDE POINTS CHARACTER POINTS MOVE	EQUIPMENT	PERSONALITY TRAITS

CHARCTER NAME _____ RANK TYPE	ATTRIBUTES DEXTERITY PERCEPTION KNOWLEDGE STRENGTH MECHANICAL TECHNICAL	SKILLS
FORCE POINTS DARK SIDE POINTS CHARACTER POINTS MOVE	EQUIPMENT	PERSONALITY TRAITS

THE ROGUES GALLERY

The following characters can serve as recurring villains or allies for the crew of the *FarStar*. Gamemasters can work them into their own campaigns to help further adventure plots, whether as long-term villains (or allies) or to serve as one-shot adversaries. These characters can only be considered representative opponents — many more smugglers, bounty hunters, pirates, Imperials and rogue traders lurk in the dark corners of Kathol sector.

QULOK'S FIST

Qulok's Fist is a bounty hunter gang that operated in the Outer Rim Territories, the Minos Cluster and eventually wandered into the Kathol sector. The group engages in a variety of questionable activities, from hunting bounties and smuggling, to collecting slaves and acting as "blaster-for-hire law enforcement agents" on backwater planets. They're little more than a ruthless, unlawful band of well-armed bullies.

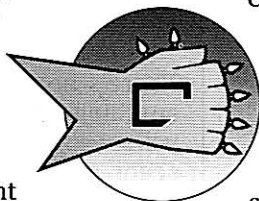

The group travels about in their heavily modified light freighter *Steel Fist*. About a year ago, however, Gul-Rah "retired" on Kal'Shebbol, feeling remorseful for his own crimes and trying to find some way he to atone for the suffering he'd inflicted.

The remaining three members of Qulok's Fist continue to wreak havoc on the weak. They recently received a new assignment from one of their benefactors. Moff Sarne, upon hearing of the *FarStar's* mission, hired the bounty hunter group to tail the New Republic expedition, gathering information for him and, in some cases, interfering or sabotaging the *FarStar's* efforts. It might be possible that the bounty hunters are collecting information on the *FarStar* from some secret spy on board, but this has not been confirmed.

The three bounty hunters in Qulok's Fist — Kolig, Sufar and Padak — are ruthless individuals and well-skilled in the art of combat. They know when to keep their distance and when to move in for a surgical attack. And they know they won't have much chance to spend all the credits Moff Sarne is paying them if they're stupid and end up dead.

KOLIG

Kolig is the group's unofficial leader and the brains behind Qulok's Fist. The *Steel Fist's* pilot, he coordinates operations and often lends his blaster to any ground-based firefight.

Kolig isn't the stereotypical seedy-looking bounty hunter. He's somewhat dashing for his middle aged years, maintaining slicked-back black hair and a curled moustache. He has an air of confidence about him. Kolig is equally at home in battle or infiltrating the enemy; he is calm and smooth at all times.

The most outgoing of the three bounty hunters, he often masquerades as a free-trader or freelance fighter pilot when mingling with targets to ferret out information. He is particularly charming around the ladies.

Although he tends to be cool and calculating, certain small incidents set off his temper. He can't stand rejection from the ladies, especially since Kolig tries so hard to impress them. He has a particular disdain for aliens — the more exotic, the more he believes "it" should be killed or enslaved. But the one thing which upsets Kolig most is people damaging his starship. He's spent years upgrading and modifying the *Steel Fist*. Anyone even so much as scuffing it with their boot heel is as good as dead to Kolig.

■ Kolig

Type: Renegade Pilot

DEXTERITY 3D

Blaster: heavy blaster pistol 5D, dodge 4D, pick pocket 5D

KNOWLEDGE 2D

Intimidation 4D, planetary systems 5D, streetwise 4D+2, survival 4D+1

MECHANICAL 4D

Astrogration 5D, sensors 4D+2, space transports: YT-1300



Doug Shuler

6D, starship gunnery 5D, starship shields 5D+2
PERCEPTION 3D
 Command 4D, con 5D, search 3D+2, sneak 5D+1
STRENGTH 3D
TECHNICAL 3D
 Space transports repair 4D, starship weapon repair 4D
Force Points: 1
Dark Side Points: 2
Character Points: 5
Move: 10
Equipment: Headset comlink, 2 heavy blaster pistols (5D), pilot's flack jacket (+1D physical, +1 energy, torso and arms)

SUFAR

Sufar is a Coreellian outlaw, cast out from his home colony for a series of murders he committed nearly a decade ago.

He is little more than a sophisticated murderer with a taste for subterfuge. He has no sense of honor, preferring to act behind the scenes rather than risking his own hide in a direct confrontation. Aside from the standard ploys of poisonings and bombings, his tactics include infiltrating and crashing computer systems, bypassing defense security systems, and using explosives to wreak havoc.

Sufar isn't an imposing man in stature, but he has a savage air about him and the glint of death in his eyes. He does not look on other beings as peers, but as threats to be destroyed. Qulok's Fist initially rescued him from Imperial bounty hunters out to claim the bounty on his head — the group later captured the hunters and Sufar tortured each of them to death. Since then, his peers in Qulok's Fist have been Sufar's only semblance of "friends."

This cold-blooded killer dresses as any normal spacer would, and he is often mistaken as such when first encountered. Sufar views others as threats, and is always watching them like a predator, searching for strengths and weaknesses. In his eyes, he must kill to survive. But his form of killing is the most dangerous — the killing inflicted by a sly hunter who uses every subtle means possible to corner his prey.



Doug Shuler

■ Sufar

Type: Outlaw
DEXTERITY 4D
 Blaster: blaster carbine 6D, brawling parry 5D, dodge 5D, melee combat 5D+2
KNOWLEDGE 3D
 Intimidation 4D, survival 5D
MECHANICAL 2D+2
 Repulsorlift operation 4D, starship gunnery 3D+2
PERCEPTION 2D
 Sneak 5D
STRENGTH 3D+1
 Brawling 5D+1, climbing/jumping 4D
TECHNICAL 3D
 Computer programming/repair 5D, first aid 4D, demolition 6D, security 5D+2
Force Points: 1
Dark Side Points: 2
Character Points: 5
Move: 10
Equipment: Blaster carbine (5D), hold-out blaster (3D), knife (STR+1D), 3 blocks of detonite with timer fuses, security override kit (+1D to security rolls)

PADAK

Some folks say that there's no such thing as an "evil" person, just those who are misguided or misunderstood. None of these people have ever met Padak.

Padak is the walking arsenal of Qulok's Fist. There's no mistaking this immense Human for anything but a bounty hunter. The battle-worn yellow-gold armor makes his shoulders and torso seem more imposing than they are, and his visored helmet conceals most of his face: he is the epitome of the anonymous, emotionless hunter.

Blasters and grenades hang from belt holsters and bandoleer utility hooks. Padak doesn't seem like he's looking for a fight — he's just looking for his own, personal war.

Padak has one goal in his fierce life — "to do good death." He follows most of Kolig's orders, although he's always grumbling if there is little promise of killing someone else while carrying out those orders. This twisted hunter revels in obliterating his prey and the heat of combat is his favorite environment. Padak lacks the sense of subtlety and planning his comrades possess, and must often be

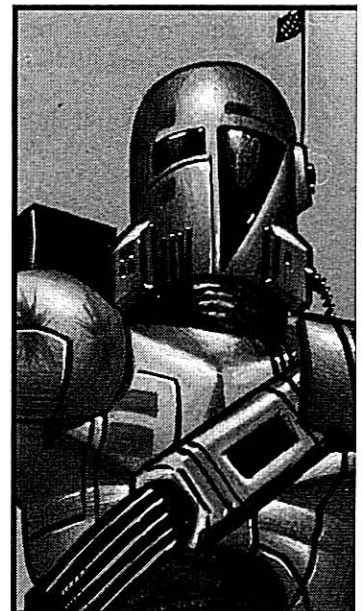

reigned in so he doesn't spoil some carefully staged plan designed to lure in a victim. He's not only dangerous because he's powerful in combat; he's dangerous because he's out of control.

■ Padak

Type: Bounty Hunter

DEXTERITY 4D

Blaster: blaster rifle 6D+2, dodge 5D, grenade 6D, melee combat 5D+1, thrown weapons 5D

KNOWLEDGE 2D+2

Intimidation 4D+2

MECHANICAL 2D+2

Beast riding 3D+2, starship gunnery 4D

PERCEPTION 3D

Investigation 4D, search 5D, sneak 6D

STRENGTH 3D+2

Brawling 5D, climbing/jumping 4D+2

TECHNICAL 2D

First aid 3D

Force Points: 1

Dark Side Points: 3

Character Points: 5

Move: 10

Equipment: Blaster rifle (5D), blaster pistol (4D), hold-out blaster (3D), customized bounty hunter armor (+2D physical, +1D energy, torso, head and arms only), 4 grenades (5D), 2 knives (STR+1D), magna-grapple with 75 meters thincord, 2 thermal detonators (10D)

STEEL FIST

The *Steel Fist* is Kolig's personal freighter: it can be said that he cares more for this vessel

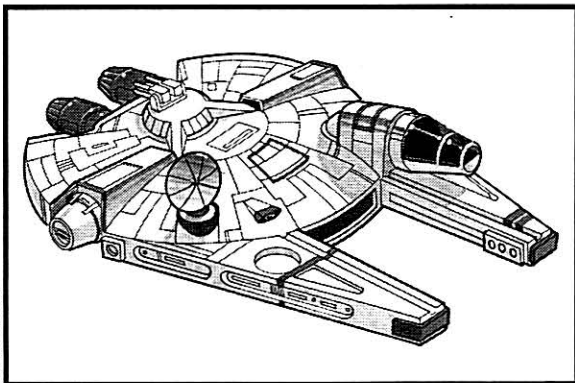

than for any living thing in the galaxy. The ship has been heavily modified by the bounty hunter, with reinforced armor plating, shield generators and greatly improved maneuverability. And then there are the weapons ... Kolig is quite proud of those!

The paired quad laser cannons are more than powerful enough to intimidate lightly armored freighters. The proton torpedo tube has a magazine of six torpedoes and while these weapons are only short range weapons, they have enough punch to give the *Steel Fist* a decisive edge in close quarters combat. The proton torpedo launcher can be fired from a gunnery position, or

they can be fired from the cockpit, although this greatly reduces the effectiveness of the computer fire control programs.

■ Steel Fist

Craft: Corellian Engineering YT-1300 Freighter

Type: Modified light freighter

Scale: Starfighter

Length: 26.7 meters

Skill: Space transports: YT-1300

Crew: 1, gunners: 3

Crew Skill: See Kolig

Passengers: 4

Cargo Capacity: 75 metric tons

Consumables: 2 months

Hyperdrive Multiplier: x1

Hyperdrive Backup: x10

Nav Computer: Yes

Maneuverability: 2D

Space: 4

Atmosphere: 280; 800 kmh

Hull: 5D

Shields: 2D+2

Sensors:

Passive: 15/1D

Scan: 35/2D

Search: 50/3D

Focus: 4/4D

Weapons:

2 Quad Laser Cannons

Fire Arc: Turret

Crew: 1

Skill: Starship gunnery

Fire Control: 2D

Space Range: 1-3/12/25

Atmosphere Range: 100-300/1.2/2.5 km

Damage: 5D

Proton Torpedo Tube

Fire Arc: Front

Crew: 1

Skill: Starship gunnery

Fire Control: 2D (may be fired from cockpit at fire control 0D)

Space Range: 1/3/7

Atmosphere Range: 30-100/300/700

Damage: 7D

KYLI NED'IX

Kyli Ned'Ix is an adventuresome Verpine who just wants to join the *FarStar* to go along for the ride. But despite his superior technical abilities, the *FarStar* command crew rejected him — they feared his risky jury-rigging might put the *FarStar*'s personnel and equipment in jeopardy. Besides, Ned'Ix has an unnerving habit of modifying equipment that really isn't broken, often making it more powerful and more unstable.

Rather than be left behind, Ned'Ix found an ancient Ghtroc freighter, repaired most of it and souped it up with junk parts the Empire and New Republic left behind on Kal'Shebbol. He filled his ship — named the *Fxx'Et* — with all sorts of junk, including disassembled droids, partially fused turbolaser circuit boards and spare ion drive

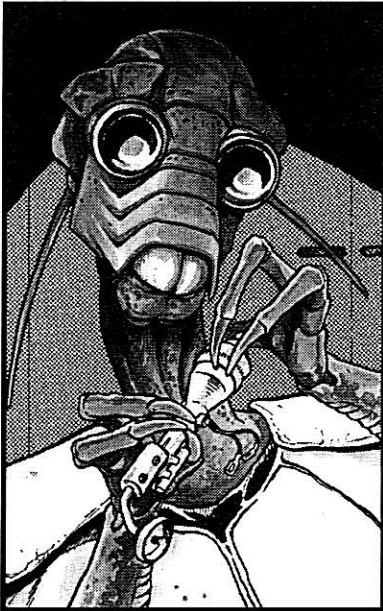

Mike Vitaroli

power couplings. While Ned'Ix isn't terribly worried about getting into combat, his freighter has a small laser cannon and a pair of proton torpedo launchers (each has a magazine of three torpedoes).

Now Ned'Ix chases after the *FarStar* in the *Fxz'Et*, attempting to aid the crew whenever possible. If they don't want him on board, he'll help them anyway. He's a master at modifying equipment, can repair most anything, and has a knack for constructing small yet useful gadgets. He's already rigged

one of his comlinks as a jamming device, and can fashion almost anything (short of weapons) from his seemingly never-ending supply of junk in his hold. (See *Cracken's Rebel Field Guide* for some modifications and gadgets Ned'Ix can use.)

Ned'Ix enjoys rushing in at the last minute to save the *FarStar*. In return for his help and his technical expertise, he'd love to join the New Republic expedition, but most of the time he just settles for a little recognition and a helping hand with supplies and direction. (He's not terribly good at navigating the Kathol sector ...)

However, Ned'Ix is prone to getting into trouble. He often lands his ship on whatever planet he can find to work on his gadgets — sometimes he even allows the *Fxz'Et* to drift in orbit while he indulges his creative impulses. This isn't always the most ideal situation with Imperial forces, bounty hunters and other hostiles lurking about.

Ned'Ix can aid the *FarStar* with high-tech gadgets from time to time. He can also be used as a quick diversion when he needs rescuing. He can be comic relief (as he blunders into an adventure at a most delicate time) or he might save the characters when they least expect it ... or he might inadvertently help the *FarStar's* foes track down the *Corvette* and her crew. Ned'Ix should be as infuriating as he is amusing!

■ Kyli Ned'Ix

Type: Verpine Gadgeteer
DEXTERITY 2D

Blaster 3D, dodge 3D, pick pocket 4D

KNOWLEDGE 3D

Planetary systems 4D, streetwise 5D

MECHANICAL 3D

Astrogation 4D, space transports 5D, starship gunnery

4D+2, starship shields 4D

PERCEPTION 3D

Bargain 4D+2, con 5D, persuasion 4D, search 5D

STRENGTH 2D

TECHNICAL 5D

Blaster repair 6D, computer programming/repair 7D+2, demolition 5D+2, droid programming 6D, droid repair 8D, security 7D, space transports repair 7D+2, starfighter repair 7D, starship weapon repair 6D

Special Abilities:

Body Armor: Provides +1D against physical attacks.

Microscopic Sight: Gives a +1D bonus to *search* skill when looking for small objects.

Organic Telecommunications: Can use antenna to communicate with other Verpine and with specially tuned comlinks (1 km range).

Technical Bonus: All Verpine receive a +2D bonus when using their *Technical* skills.

Force Points: 1

Character Points: 5

Move: 10

Equipment: Blaster pistol (4D), comlink jammer, datapad, security cardlock breaker (+1D to *security* when bypassing card locks)

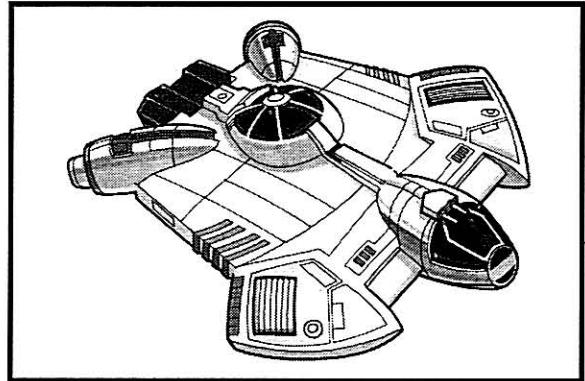

David Detrick

■ Fxz'Et

Craft: Ghtroc Industries class 720 freighter

Type: Modified light freighter

Scale: Starfighter

Length: 35 meters

Skill: Space transports: Ghtroc freighter

Crew: 1, gunners: 2

Crew Skill: See Ned'Ix

Passengers: 1

Cargo Capacity: 135 metric tons (currently filled with junk)

Consumables: 2 months

Hyperdrive Multiplier: x2

Hyperdrive Backup: x10

Nav Computer: Yes

Maneuverability: 3D

Space: 4

Atmosphere: 280; 800 kmh

Hull: 4D

Shields: 2D

Sensors:

Passive: 15/0D

Scan: 30/1D

Search: 50/3D

Focus: 2/4D

Weapons:

1 Double Laser Cannon

Fire Arc: Front
 Skill: Starship gunnery
 Fire Control: 2D
 Space Range: 1-3/12/25
 Atmosphere Range: 100-300/1.2/2.5 km
 Damage: 5D

2 Proton Torpedo Launchers

Fire Arc: Front, back
 Crew: 1
 Skill: Starship gunnery
 Fire Control: 2D (may be fired from cockpit at fire control 0D)
 Space Range: 1/3/7
 Atmosphere Range: 30-100/300/700
 Damage: 9D

ROJER 621

Rojer 621 is the code name for a New Republic spy who somehow managed to infiltrate Moff Sarne's administration before the New Republic forced the Moff to flee Kal'Shebbol. Few know exactly who Rojer 621 is, whether he's really aligned with the New Republic, or if he is one of Moff Sarne's ploys to mislead the *FarStar*, or in what capacity he (or she) serves with the Moff's retreating fleet.

Sometimes Rojer 621 manages to leave clues behind to help guide the *FarStar*. It's not often very much — a snippet of a datafile on some obscure system, a secret code word, or perhaps a note on where they can find supplies. Nobody knows how much Rojer 621 knows about the *FarStar*, or how he knows his clues and information will find them. By the time the *FarStar* crew first encounters his cryptic messages, they'll be too far into the Kathol sector to ask any New Republic forces to verify the existence of an operative within Moff Sarne's organization. For the time being, Rojer 621 seems to be the *FarStar*'s best source for inside information — if the crew is willing to trust him.

Gamemasters can use Rojer 621 to help guide (or mislead) characters. Sometimes one of Rojer's clues can show up out of nowhere, especially if characters are having a difficult time getting through an adventure or they need additional help to point them in the right direction.

■ **Rojer 621**

Type: New Republic Spy
DEXTERITY 3D
 Blaster 4D, dodge 5D
KNOWLEDGE 3D
 Bureaucracy: Kathol sector 5D, intimidation 4D, law enforcement: Kathol sector 5D, planetary systems 4D
MECHANICAL 2D
 Capital ship shields 4D+2, communications 3D, sensors 4D

PERCEPTION 4D

Command 5D, con 8D, forgery 6D, hide 5D, investigation 6D, persuasion 5D+2, search 6D, sneak 7D

STRENGTH 2D

Brawling 3D+2, climbing/jumping 4D

TECHNICAL 4D

Computer programming/repair 5D, demolitions 4D+1, first aid 4D+2, security 6D

Force Points: 1

Character Points: 5

Move: 10

Equipment: Blaster pistol (4D), Imperial officer's uniform

THE DES'MARIC PIRATES

When a merchant ship suddenly drops out of hyperspace into the middle of three Skipray blastboats, the crew knows one thing: they are in serious trouble!

The trio of gaudily decorated blastboats raiding Kathol sector belongs to a small group known as the Des'Maric pirates. While not well known to Imperial authorities, the pirates are a serious threat to any lightly armed merchant vessel travelling the sector's star lanes. The pirates don't have the firepower to directly engage the *FarStar*, although they can be quite troublesome for any crew members away from the Corvette.

The group is commanded by a Saurton named Miktiss. The Des'maric pirates have been operating out of the Kathol sector for a little over a year, although they went unnoticed by Moff Sarne's forces. So far, their take has been minor — three bulk freighters — and the disappearances were written off by Sarne's officials as "lost," presumably due to hyperspace accidents.

Their main base is a large and heavily armed bulk freighter named *Asagov Raider*. They prefer to keep this vessel far from any raiding sites just to insure its safety; while the ship could easily put down any light freighter, an Imperial cruiser or escort frigate would almost certainly destroy the *Raider*. There are over a hundred pirates in the gang, but most of them are little more than common criminals; only the crews aboard the blastboats have any real skills. The pirates themselves tend to be a cowardly and treacherous lot and would just as soon turn Miktiss over to the Empire if it would save their sorry hides.

The Des'maric pirates have access to freighter travel routes and times by arrangement with local crimelord Crev Bombaasa; part of the contract calls for Bombaasa to get a third of the take. The gangster has slowly been buying off key members in Miktiss's team so Bombaasa can assume full control of the group; he has been successful in swaying Miktiss's "most trusted" lieutenant, Ginzet. If Miktiss finds out about Bombaasa's plans, he will not hesitate to "space"

any traitorous individuals in his gang.

The pirates' methods are simple. They blockade a freighter's route by maneuvering a large asteroid into the travel lane; the ship is forced to drop from hyperspace to realspace. Before the freighter can make a new hyperspace jump, the pirates surrounded the vessel and force its crew to surrender. Sometimes the crew is given a ride to a nearby habitable world, although not all crews are so fortunate. The goods are sold off on Pembric II or *Tanquilla Beach*.

Typical Des'maric Pirate. All stats are 2D except: *Dexterity* 2D+1, *blaster* 3D+1, *dodge* 3D+1, *Knowledge* 1D+2, *intimidation* 2D+1, *bargain* 2D+1, *gambling* 3D, *brawling* 2D+2. Move: 10. Blaster pistol (4D), blast vest (+1D physical, +1 energy), comlink.

MIKTISS

Miktiss is a militant Saurton from Essowyn. Years ago, he was a warrior for a coalition of Saurton groups called the Des'mar, which roughly translates as "forward looking." The planet

Essowyn is dominated by several large mining corporations who have the assistance of the Des'mar in maintaining power.

Miktiss worked for the Des'mar in disrupting the efforts of the Quenno, those Saurton who sought to have the mining corporations removed from Essowyn. He led several attacks on Quenno protests.

However, Miktiss's luck finally ran out and incontrovertible proof of his illegal actions was presented to the Saurton Council of Elders. They were re-

quired by law to execute Miktiss even though many on the Council were Des'mar supporters and employed Miktiss. Ever the loyal soldier, Miktiss refused to blame the Council for his actions, claiming to be acting of his own accord. However, his life was secretly spared, and he was transported off the planet in exchange for promising never to return to his homeworld. (For more information on Essowyn and the Saurton, see pages 41-46 of *The Star Wars Planets Collection*).



Mike Vilardi

■ Miktiss

Type: Saurton Pirate Leader

DEXTERITY 3D+1

Blaster 4D+2, dodge 4D+1, melee combat 4D+2, melee parry 4D

KNOWLEDGE 2D+2

Intimidation 5D, planetary systems: Kathol sector 4D+2

MECHANICAL 2D+2

Astrogation 3D+2, space transports 3D+2, starfighter piloting 4D+2

PERCEPTION 3D+1

Bargain 4D, con 4D+1, search 3D+2

STRENGTH 4D

Brawling 4D+2, climbing/jumping 4D+1, stamina 5D

TECHNICAL 2D

Droid programming 2D+1, starfighter repair 3D

Special Abilities:

Disease Resistance: Saurton roll double their *stamina* skill to resist the effects of disease.

Force Points: 1

Dark Side Points: 2

Character Points: 12

Move: 6

Equipment: Vibro-ax (STR+1D+2), blaster pistol (4D+1), comlink, blast vest (+1D physical, +1 energy)

BLASTBOATS

The Des'maric pirates' three Skipray blastboats were stolen from the starport on Elshandruu Pica. Miktiss simply had his crews infiltrate the area where the blastboats were being held for sale to a corporate concern. While a low-level street criminal in his employ created a distraction, Miktiss led his beings straight to the ships and managed to get them off the planet and into hyperspace before Elshandruu Pica's patrol vessels could stop him. It was a brazen maneuver ... and perhaps that is why it worked so well. Meanwhile, the buyer, one Kina Margath — a wealthy corporate executive and secret Rebel sympathizer to boot — intends to find out exactly who stole *her* blastboats. (For more information on Kina Margath, see pages 41-43 of *Galaxy Guide 9: Fragments from the Rim*.)

Since the ships have been in his possession, Miktiss has put them to good use. They are used to capture bulk freighters and to help him establish his authority on outlying, primitive planets that are reluctant to pay him tribute. Needless to say, a few blasts from the laser cannons tends to convince the natives to cough up the loot.

The three ships (designated *Des'maric One*, *Des'maric Two* and *Des'maric Three*) are commanded by Miktiss's three most trusted lieutenants: Yun, an Aqualish mercenary; Jerri, a young Human who quickly earned Miktiss's favor; and Ginzet, another Saurton and a friend of Miktiss's for many years. Ironically, Ginzet is the only one among the group who is planning to overthrow Miktiss in favor of Bombaasa.

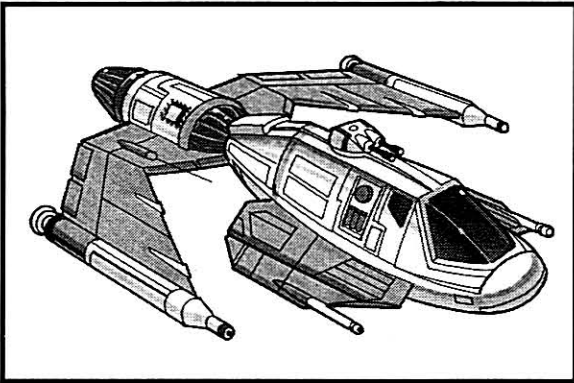

David Detrick

■ Des'maric Pirate Blastboats

Craft: Sienar Fleet Systems GAT-12h
Type: Modified defense and patrol blastboat
Scale: Capital
Length: 25 meters
Skill: Starfighter piloting: Skipray blastboat
Crew: 2 (1 can coordinate), gunners: 2, skeleton: 1/+5
Crew Skill: See Des'maric pirates
Cargo Capacity: 15 metric tons
Consumables: 2 weeks
Cost: 125,000 (used)
Hyperdrive Multiplier: x3
Nav Computer: Limited to four jumps
Maneuverability: 1D+2 (2D+2 in atmosphere)
Space: 8
Atmosphere: 415; 1,200 kmh
Hull: 2D+1
Shields: 2D
Sensors:
Passive: 35/1D
Scan: 60/1D+2
Search: 100/2D
Focus: 3/2D+2

Weapons:

3 Medium Ion Cannons (fire-linked)

Fire Arc: Front
Crew: 1
Skill: Capital sip gunnery
Fire Control: 3D
Space Range: 1-3/12/25
Atmosphere Range: 100-300/1.2/2.5 km
Damage: 4D

2 Laser Cannons (fire-linked)

Fire Arc: Turret
Crew: 1
Scale: Starfighter
Skill: Starship gunnery
Fire Control: 1D
Space Range: 1-3/12/25
Atmosphere Range: 100-300/1.2/2.5 km
Damage: 5D

ASAGOV RAIDER

The *Asagov Raider* is the heavily modified bulk cruiser the Des'maric pirates have appropriated as a command ship and main base. The ship began as a standard bulk freighter, the *Cekbar Servant*, which was owned by a consortium of

Nalroni merchants from the famous trading world of Celanon. The ship was captured shortly after Miktiss got his hands on his three Skipray blastboats. By using some shrewd bargaining and blatant blackmail, the pirate forced a former Sienar Fleet Systems ship engineer to modify the vessel. It is now a prime raiding ship, with an armored hull, excellent shield generators and increased speed. It has eight ion cannons for disabling target vessels, while the dozen laser cannons provide that extra bit of firepower for dealing with reluctant starship captains and Imperial customs vessels.

Despite the rather loose discipline in Miktiss's organization, the *Asagov Raider's* crew cooperates like a military crew when the pressure is on. Miktiss tends to stay aboard his ship during raids and has a particular fondness for personally interrogating prisoners who are being held in the dank detention cells in the bottom levels of the ship.

■ Asagov Raider

Craft: Modified Corellian Action IV Transport
Type: Medium bulk freighter
Scale: Capital
Length: 100 meters
Skill: Space transports: bulk freighter
Crew: 15, gunners: 40, skeleton: 8/+10
Crew Skill: Astrogation 4D, space transports 4D+1, starship gunnery 4D
Cargo Capacity: 60,000 metric tons
Consumables: 3 months
Cost: Not available for sale
Hyperdrive Multiplier: x3
Hyperdrive Backup: x15
Nav Computer: Yes
Space: 3
Hull: 2D+2
Shields: 2D
Sensors:
Passive: 15/0D
Scan: 25/1D
Search: 40/1D+2
Focus: 2/2D

Weapons:

8 Ion Cannons

Fire Arc: 2 front, 2 left, 2 right, 2 back
Crew: 2
Scale: Starfighter
Skill: Starship gunnery
Fire Control: 2D
Space Range: 1-3/7/15
Atmosphere Range: 100-300/700/1.5 km
Damage: 4D

12 Double Laser Cannons

Fire Arc: 6 front, 3 left, 3 right
Crew: 2
Scale: Starfighter
Skill: Starship gunnery
Fire Control: 2D
Space Range: 1-3/12/25
Atmosphere Range: 100-300/1.2/2.5 km
Damage: 4D+2

JARELL THUG

The Jarells are a humanoid species native to Oon Tien, although they are found throughout Kathol sector. They are a strong people who lived in a technologically primitive culture prior to first contact with the Old Republic: they had developed basic metal-working and lived under an authoritarian monarchal city-state system when the first Old Republic colony ships landed on the planet three centuries ago.

Now, many young Jarells serve out a lengthy period of indentured servitude — essentially living in slavery — due to the arrangements of their monarchies. Jarells can be found serving as hired muscle and general servants for corporations, criminal groups and affluent private citizens; a few Imperial governors are also known to “employ” Jarell servants.

This is not to suggest that the Jarells necessarily hate their positions: their culture is historically violent and

most young are socialized to consider this period of servitude a natural part of life. The period of servitude lasts for anywhere from seven to 11 years. The Jarells view this time as a maturation period for the transition from child to adult, and consider their employment an opportunity to meet those who might help them to gain power and wealth. While few Jarells actually profit from their period of service, enough of them benefit that the majority of young Jarells accept this duty with a surge of excitement and a sense of purpose.

While most Jarells are dedicated to their employers, a number of them also seek freedom and might be willing to undermine their bosses if given the opportunity.

While many people might be quick to characterize the Jarells as dull-witted, they are actually quite intelligent and very creative. Their native culture has a long-established tradition of oral storytelling (they have no written language). In addition to their great strength, they tend to have good memories, a wide range of knowledge and keen perception.



Mike Vilardi

■ Jarell Thug

Type: Jarell Thug

DEXTERITY 3D+2

Blaster 4D+1, dodge 4D

KNOWLEDGE 2D+2

Languages 3D

MECHANICAL 2D+1

Repulsorlift operation 2D+2

PERCEPTION 2D+1

Search 3D, sneak 3D+1

STRENGTH 3D+2

TECHNICAL 3D+1

First aid 3D+2, security 4D

Character Points: Varies, typically 0-5

Move: 9

Equipment: Blaster pistol (4D), blast vest (+1D physical, +1 energy)

VEILD-DANOL

Veild-danol is an independent merchant who has a regular trading route on the edges of Kathol sector. On many worlds, his monthly trading stop is the only contact these planets have with the outside galaxy. As a result, he knows a great number of beings and commands a good deal of respect. Galtea is one of the worlds on his regular route, but he also travels to many worlds that aren't on anyone else's star charts.

Veild-danol is an older being and is set in his ways. He expects to be treated respectfully, and upon first meeting someone goes out of his way to test the limits of their patience. He realizes that he wields a tremendous amount of influence in some settlements and has been known to take advantage of his position, for example by demanding an unreasonable favor or two. He has a fondness for the religious artifacts of other cultures, regarding them as “collectibles” much as some beings might collect souvenir holograms. He personally disdains religion or anything else that smacks of “mindless mysticism” (in his words) although he is adept at pretending to be a curious scholar so that he can get

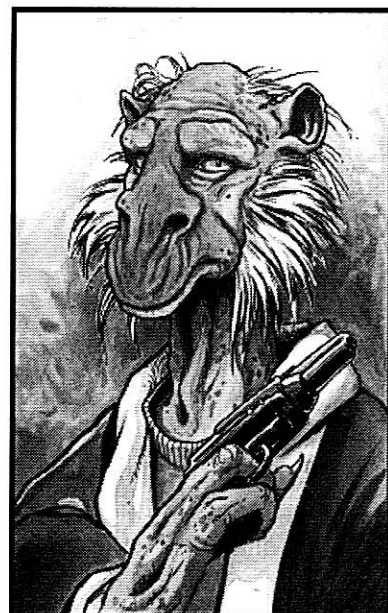

Mike Vilardi

what he wants. Underneath the civilized veneer, he is a cynical, conniving person who desires more than anything else for people to owe him favors. He needs people to need him.

He has compiled his own astrogation charts for these outlying areas and would be willing to trade them to the crew of the *FarStar* in exchange for assistance in acquiring a miscellaneous trinket lost in the wilderness of some world. This character is perfect to introduce a new item of DarkStryder technology (or throw in a red herring) while also giving the characters additional astrogation charts.

■ Veild-danol

Type: Independent Trader

DEXTERITY 2D+1

Dodge 5D+2, melee combat 4D

KNOWLEDGE 3D+2

Alien species 5D+1, bureaucracy 4D, business 4D+1, languages 5D, planetary systems 5D+2, streetwise 4D+2

MECHANICAL 3D+1

Astrogation 4D+2, space transports 4D, starship gunnery 3D+2

PERCEPTION 4D

Bargain 6D, con 5D+2, search 4D+1, sneak 4D+2

STRENGTH 2D

TECHNICAL 2D+2

Droid programming 3D+2, droid repair 3D+1, first aid 3D, space transports repair 3D+2

Force Points: 1

Character Points: 4

Move: 10

Equipment: Hold-out blaster (3D+1), medpac, comlink, cloak, hidden vibro-shiv (STR+1D, Easy difficulty)

IMPERIAL FORCES

Moff Sarne has left behind some of his vessels to harass the efforts of the New Republic, believing that disrupting morale and slowing the progress of the New Republic is just as important as marshalling his forces for a counterattack. While Sarne has fled the sector for reasons known only to him, his commanders have been given full discretion to cause problems for worlds and governments allying with the Rebels.

The Charis Fleet is the main Imperial force in Kathol sector and includes two Lancer frigates, two strike cruisers, four Corellian Corvettes, two TIE escort carriers, and numerous system patrol craft and Skipray blastboats. It is commanded by Admiral Pertaal Logris, who is a staunch Sarne loyalist. The Charis Fleet has been split up to handle multiple missions and any of these ships can encounter the *FarStar* at any time.

SARNE'S STORMTROOPERS

Moff Sarne found it advantageous to train his own corps of fanatically loyal soldiers to supplement the standard Imperial Army and

stormtrooper forces. Drawing upon standard Imperial indoctrination techniques, Sarne instituted a gruelling training program that produced elite troops willing to make any sacrifice to fulfill their orders.

These troops, who are known simply as "Sarne's stormtroopers," have been deployed to the largest military bases in the sector (including the shipyards at Oon Tien). These troops, while officially described as a supplemental military force, are used to watch over all military personnel who might be thinking about placing their own self-interests or the interests of the Empire above the dictates of Moff Sarne. They are authorized to conduct "loyalty examinations"

at any time and for any reason — they act as Sarne's "thought police" in addition to fulfilling Sarne's personal objectives. They are authorized to disobey the direct orders of Imperial Army, Navy or stormtrooper officers if, in their opinion, the order contravenes the intentions and goals of Moff Sarne.

No one knows exactly how many of these troopers have been trained, but it is thought that they number less than 10,000 soldiers. Sarne's stormtroopers are outfitted in standard stormtrooper battle armor that is adorned with Sarne's personal seal. In a sense, Sarne's stormtroopers are as disruptive to the Army and Navy as the New Republic is, and infighting and their "loyalty purges" may accidentally help the *FarStar* and the New Republic at the most opportune time ...

■ Sarne's Stormtroopers

Type: Stormtrooper

DEXTERITY 2D

Blaster 4D, brawling parry 4D, dodge 4D

KNOWLEDGE 2D

MECHANICAL 2D

PERCEPTION 2D

STRENGTH 2D

Brawling 3D

TECHNICAL 2D

Character Points: Varies, typically 0-5

Move: 10

Equipment: Stormtrooper armor (+2D physical, +1D energy, -1D to *Dexterity* and related skills), blaster rifle (5D), blaster pistol (4D)

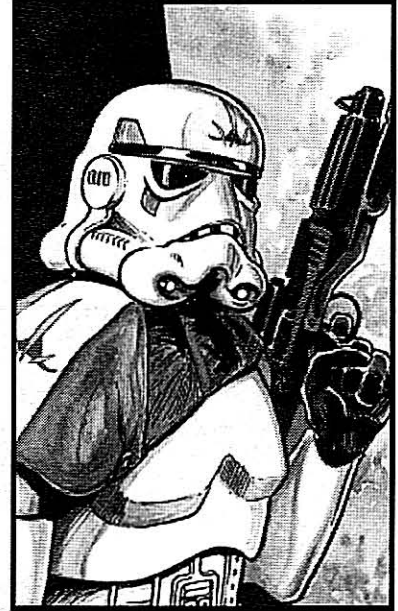

Mike Vilardi

OMENS

A storm had settled over the command center: crewmembers raced from station to station, double- and triple-checking data, leaving behind only a trail of debris and a cloud of confusion. At the center of the storm, Captain Keleman Ciro was lost in thought. He looked down at the holoplaque he'd snapped of the command crew a few hours earlier. *My people. My responsibility. The fleet's moved on... it's my show now.*

Ciro idly wondered how long it would take to get used to the command chair when Lt. Thyte broke his reverie. "Sir, we have an incoming subspace transmission from the Kolatill system. It's a wide-spectrum signal and unscrambled — they're sending it to everyone in range."

"Put it through, Lt. Thyte."

"This is the Kolatill Council... all New Republic forces, please send assistance immediately. After imprisoning the Imperial governor we have been attacked by TIE bombers. Domaz, our capital, is in flames. Please send emergency medical assistance."

Ciro snapped off the comm in anger. *How could these people not have known that they would be attacked?* "Hyperdrive Operations, set course for the Kolatill system. If those navigation charts are right, it should take us about four days to get there. Lt. Thyte, signal Governor Monjai down on Kal'Shebbol and inform her of our destination."

"Yes, sir. Governor Monjai says medical rescue ships will be dispatched as soon as they are ready, but that will take at least two days."

Ciro thought to himself, *Those ships are slower than we are. Two days to prepare. A Class Three hyperdrive, meaning six days in hyperspace... it may be too late by the time they get there.*

Ciro toggled the internal comlink, selecting the engineering section. "Lofryyhn, this is Captain Ciro. Get your engineers going. It looks like the shakedown cruise is off the schedule; we are on active-duty as of now."

Just 10 minutes later, the *FarStar* lept into hyperspace, beginning its mission to track down Moff Sarne.

Minor malfunctions may occur along the way if the gamemaster wishes to emphasize some of the problems aboard the *FarStar*: anything from a simple power failure, to a hyperdrive overload, to a life support failure can be used to heighten tension and indicate the *FarStar's* condition — these incidents can also be used to foreshadow the revelation of Sarne's meddling with the ship's computer systems.

When the *FarStar* emerges in realspace in the Kolatill system, the ship is bombarded with distress messages on standard comm frequencies requesting assistance for the capital city of Domaz. They are frantic and disorganized. The messages are requesting emergency medical assistance, and explain that the city was bombed four days ago by TIE bombers. Fires are still burning out of control and the city is in a state of chaos. Most of the capital district has been leveled and many residential areas have also been hit hard.

As the *FarStar* approaches, six standard TIE fighters come out to intercept the ship. The ships demand that the *FarStar* identify itself and order it to halt its progress; the TIEs do *not* open fire first.

The ships are under the control of the Kolatill Defense Force and are New Republic sympathetic. Once the *FarStar* has announced its intentions, the lead pilot thanks them for coming to help the planet. The TIEs escort any rescue vessels.

TIE/ln fighters. Starfighter, starfighter piloting 4D, starship gunnery 4D. Maneuverability 2D, space 10, atmosphere 415; 1,200 kmh, hull 2D. Two laser cannons (fire-linked, fire control 2D, damage 5D).

It's presumed Captain Ciro sends down a rescue and recon group on the two shuttles, with Doctor Akanseh, at least one other medical staff member, as well as investigation teams. Their mission is to perform a quick survey, make contact with remaining local authorities, and establish a secure planetary base of operations. The shuttles have four X-wing fighter escorts, including Gorjaye and Noell Ciro, Captain Ciro's younger brother.

EPISODE ONE: IMPERIAL RETRIBUTION

The hyperspace journey to Kolatill takes 92 hours (nearly four standard days) with the *FarStar's* Class Two hyperdrive. (Hyperdrive multiplier of x2.)

THE LANDING

An Easy *sensors* roll reveals that the Imperial bombers used only explosives for the attack; there is no radiation, nor any evidence of biological, chemical or pathogenic contamination.

When the shuttles land, it's late at night. The landing site is in the heart of the former capital area in what was once a large park. It has been turned into an emergency aid station, with scores of makeshift tents housing the injured.

In the distance, fires can be seen burning in all parts of the city; the air is thick with smoke, making it difficult to breathe. Upon disembarking from the shuttle, several citizens approach to meet the *FarStar's* representatives. The following events and incidents can be used to make the characters aware of the situation on Kolatill.

- Councillor Kause, one of the Kolatill Council members, will introduce himself to the *FarStar's* representatives. He is one of three surviving council members and explains that the attack was launched by an Imperial escort carrier that arrived in the system four days ago. Only Domaz was attacked.

Following the attack, the ship broadcast a message saying that the attack was a "lesson" for all planets thinking about joining the New Republic. Kause is a firm believer in the tenets of the New Republic, but he expects a great deal of help from the government on Kal'Shebbol. He escorts the characters while they are on the planet's surface and his objective is to arrange a meeting with Captain Ciro; he wants to prove to the people of the planet that things are under control and that help is coming. He insists that Captain Ciro come down to the planet as a show of assistance.

- Lon Bennor is a teenager who was responsible for organizing the recovery efforts here in the park. He clearly blames the Council for bringing this attack on his home city and is decidedly cool to everyone from the *FarStar*, although he will accept their medical assistance. Bennor's only objectives are to save as many people as possible, although his anger and frustration interferes with his judgement and makes for some very tense times. Lon may ask the characters to assist him when he goes to a bombed-out hospital to recover whatever stores of medicine remain — collapsing floors, fires and other hazards can make this a difficult task.

- A middle-aged, average citizen who only goes by the name of Tren is running the food distribution efforts. Later in the adventure, Tren asks for assistance in delivering food to one of the outlying neighborhoods and as there are no

extra people in the emergency relief complex it's up to the *FarStar* crew members to help. During this trip, the characters can defuse an unexploded bomb (Moderate *demolitions* roll), fight off looters intent on stealing the food, and prevent a building explosion due to a large gas leak. The characters may also dig survivors out of a collapsed building.

- Former Imperial soldiers who have thrown down their weapons show up to assist with the relief effort. This is a chance to show that not all Imperials are necessarily evil, and gives the characters a chance to take a leadership role in the rescue effort. Perhaps the Imperials join up with the Council and become strong supporters of the New Republic.

- Various citizen groups have formed to help fight fires, tend to the wounded, and rescue those who have been injured and can't get to help. These work details can introduce the characters to some of the citizens of the city and prove to the survivors that the New Republic is an ideal worth fighting for.

- The city gets a message that food and medicine convoys are coming from the other cities, but they need additional guards to protect them from looters and wild animals. The characters from the *FarStar* might be assigned to patrol duty.

- Dangerous predators are coming down from the wilderness into the outer limits of the city and patrol guards are needed to protect the survivor camps.

- Captain Ciro should have the *FarStar* constantly scanning the system for signs of Imperial activity. Sensor sweeps and fighter patrols should both be used for this duty — as an incidental encounter, the fighters can come across a derelict starship out between planets. Log records indicated it was destroyed five days ago, just before the Imperial attack. There might be survivors in an internal airtight compartment or escape pod.

DIPLOMACY AS USUAL

While rescue efforts continue on the surface of Kolatill, the three remaining Kolatill Council members will insist on a meeting with Captain Ciro; they want to broadcast such meetings back to Kolatill's cities as a "morale booster."

They are willing to fly up to the *FarStar* (using a diplomatic shuttle), but insist on a planetary meeting in the capital "for appropriate symbolism."

However, while the shuttle is in transit, the escort carrier appears from hyperspace. Sud-

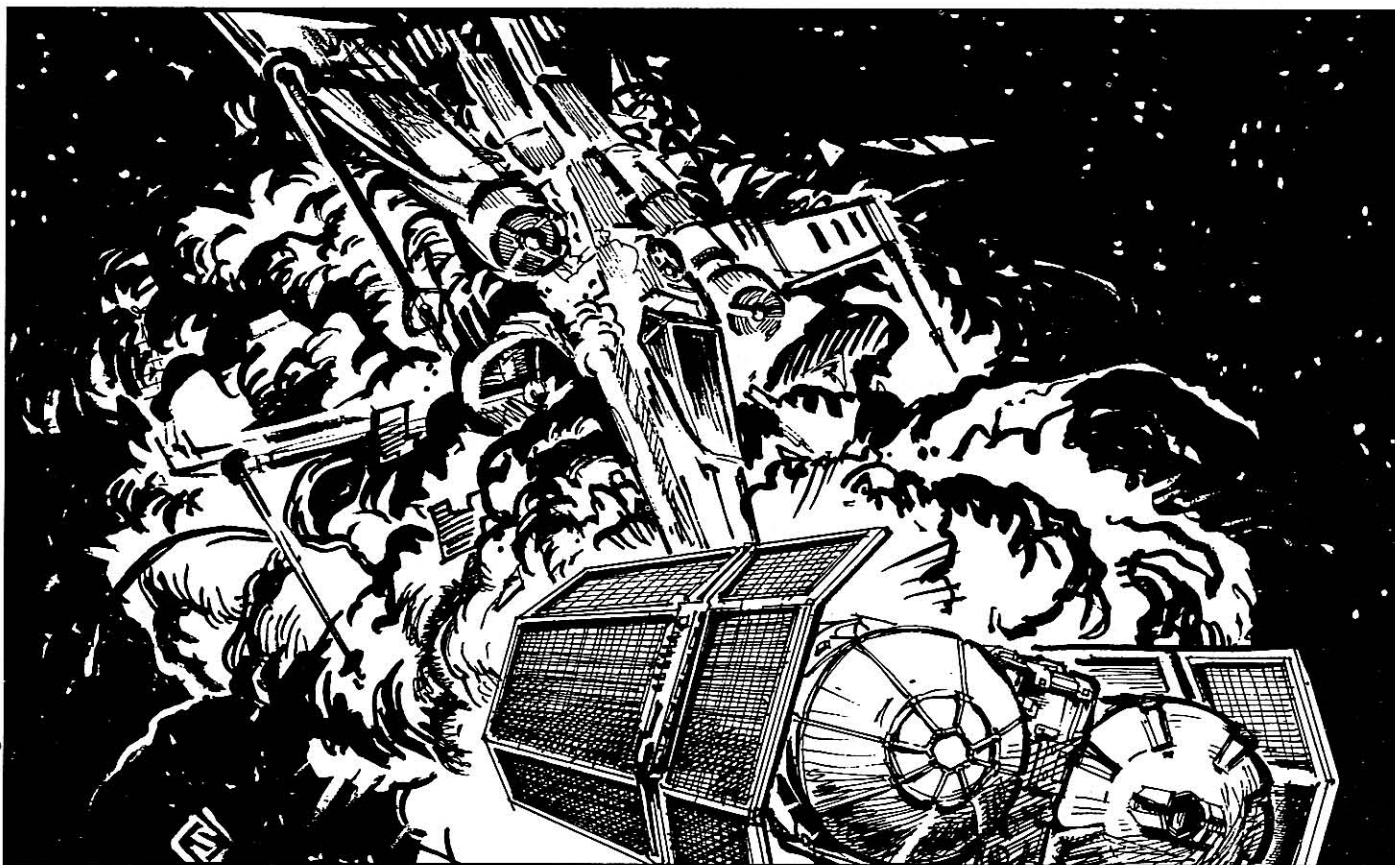

Brian Schomburg

denly, two full squadrons of TIE bombers (24 ships) and four squadrons of TIE/ln fighters swarm from the ship. The TIE bombers are headed straight for Kolatill's surface, presumably for a second bombing attack; the TIE fighters engage the *FarStar*, trying to keep it from launching its fighters.

The escort carrier's battle plan is simple; to spread the TIE bombers across the entire planet, attacking as many cities as possible. This time the TIE bombers have been equipped with pathogenic bombs which spread disease. Upon discovering the *FarStar* orbiting the planet, the regular TIE fighters were sent out to harass the ship and occupy its fighters (the escort carrier's sensors have not detected the X-wing fighters on the planet's surface).

One of the regular TIE squadrons peels off to engage the diplomatic shuttle, and they succeed in herding the shuttle into the paths of the escort carrier's tractor beam projectors. The shuttle is pulled aboard the escort carrier.

Kathol Protector (escort carrier). Capital, capital ship gunnery 4D, capital ship shields 3D+2. Maneuverability 1D, space 4, hull 7D+1, shields 2D. Weapons: 8 twin laser cannons (fire control

3D, damage 3D), 2 tractor beam projectors (fire control 3D, range 1-5/15/30, damage 3D). See pages 54-55 of the *Imperial Sourcebook* for complete statistics, but note the substitution of two tractor beam projectors for two laser cannons.

TIE Bombers. Starfighter, missile weapons 4D+1, starfighter piloting 4D, starship gunnery 5D. Space 6, atmosphere 295; 850 kmh, hull 4D+1. Weapons: 2 laser cannons (fire-linked, fire control 2D, damage 3D), 16 pathogenic bombs (fire control 3D+2, detonation causes disease over an eight square kilometer radius).

Gamemaster Note: The capture of Captain Ciro is essential to the overall storyline of *The DarkStryder Campaign*. While it seems arbitrary to say that Ciro gets captured no matter what happens, it is essential to establishing the overall theme of the campaign. All future DarkStryder adventures and products presume that Kaiya Adrimetrum has assumed the captain's post aboard the *FarStar*.

However, it isn't unreasonable to assume this happens: the Imperial fighters outnumber the *FarStar's* fighters by a factor of nearly 10-to-1, while the escort carrier is powerful enough to withstand virtually any attack the *FarStar* or its

KOLATILL

Kolatill is a modest stopping point along the Triton Trade Route and is one of the major repulsorlift manufacturing centers in Kathol sector. The world has a high degree of axial tilt, resulting in extreme seasonal changes; the frigid winters last nearly five standard months in all but the equatorial regions, while the sweltering summers last as long and are just as unpleasant.

The major population centers are in the northern continental mountain chains, centered around the mining complexes and repulsorlift manufacturing plants. A dozen factory complexes are owned by Ikas-Adno, while smaller local companies like Kal'Shebbol Transport and GandleMotors manufacture their own vehicles and supply parts to the Ikas-Adno plants.

The equatorial regions are sparsely populated, with agriculture complexes dominating the lowlands and plains areas. The numerous mountain chains remain untouched. A prime industry is ranching chollas and banthas, whose meat and hides fetch good credits in the cities to the north, as well as on heavily industrialized worlds like Gandle Ott and Torize. Vegetable and fruit growing complexes span the wetlands.

Outside the cities, the northern continents remain wild. Dangerous predators still prowl the mountain passes, preying on herd animals and sometimes venturing to the city outskirts.

Moff Sarne established a particularly despotic regime on this world because the repulsorlift plants were important to his military build-up. Governor Tetrum

instituted martial law in the cities and forced the local plants to begin manufacturing combat speeders; Ikas-Adno, because of its wealth and influence, was spared this coercion. The result was a restless population, frightened yet angry and eager for revolt. Tetrum used an extensive network of spies to cull out potential New Republic sympathisers.

When word of Sarne's ousting reached Kolatill, a popular uprising swept the cities, particularly in the capital city of Domaz. Governor Tetrum was jailed, as were many of his supporters. The surviving members of the Council of Kolatill (who were jailed when martial law was declared eight years ago) were asked to assume power. With euphoria sweeping Domaz, the Council announced its allegiance to the New Republic.

Kolatill

Type: Terrestrial

Temperature: Temperate

Atmosphere: Type I (breathable)

Hydrosphere: Moist

Gravity: Standard

Terrain: Mountains, forests

Length of Day: 28 standard hours

Length of Year: 405 local days

Sapient Species: Humans, Jarells, Twi'leks

Starport: Stellar

Population: 400 million

Planet Function: Agriculture, manufacturing

Government: Imperial governor (martial law)

Tech Level: Space

Major Exports: Repulsorlift drive units, meats, hides

Major Imports: Starships, processing equipment, computers, medicines

fighters can make. In essence, the *FarStar* is helpless to prevent this course of events.

After the escort carrier captures *Ciro*, cut to Episode Two, "The Turning Point."

EPISODE TWO: THE TURNING POINT

Captain *Ciro* has been captured, but there are other things to worry about: anyone scanning the TIE bombers and making a Moderate *sensors* total will determine that the bombs carried aboard do not register as "normal": there is an unusual energy signature coming from the bomb bay.

Fortunately, the six remaining TIE fighters from the Kolatill Defense Force and the *FarStar*'s fighters on the planetary surface — including Gorjaye and Noell *Ciro*'s fighters — can engage the bombers. The TIE bombers are heading for a wide dispersal pattern — they are planning on attacking all of the cities on the planet.

This episode should focus on the fighters'

efforts to stop the bombers. The *FarStar* may choose to attack the escort carrier, which will result in a stand-off. The *FarStar*'s turbolasers aren't powerful enough to cut through the escort carrier's hull and shielding, while the escort carrier's weapons and TIE fighters could certainly hinder the *FarStar*, but it is unlikely that they will be able to destroy the ship. If the *FarStar* is damaged, Captain Adrimetrum should realize that her top priority is saving the ship and order a retreat.

Meanwhile, the New Republic and Kolatill fighters engage the bombers; perhaps a few regular TIE fighters dive in to provide covering fire for the bombers.

DEADLY PAYLOADS

Once the first TIE bomber is destroyed, any nearby New Republic fighters should have their warning sensors light up. Any character making an Easy *sensors* roll will discover a small concentration of extremely toxic poison in the immediate area of the TIE bomber explosion. A Moderate

BROLSAM ADVENTURE HOOK

If the characters choose to go to Brolsam, they will find a world sharply divided and on the brink of civil war. Many of the Fefze swarms have been working with disgruntled Rodians and Humans to round up and jail Imperial officials and sympathizers, but the Imperials are resorting to guerilla tactics and sabotage to keep the unorganized New Republic sympathizers at bay.

The *FarStar* is thrust into the middle of the conflict when its mission group is attacked by Rodian mercenaries: at least one of the *FarStar's* crew members is captured in the battle. Using Khzam and Loh'khar's skills to skulk around Brolsam's back alleys, the *FarStar's* crew learns that the Rodians were put up to the attack by the Nat'xikta Fefze swarm, a small but wealthy swarm that secretly spied for the Imperial government.

They are planning to free the jailed Imperials in a mass attack, possibly risking the loss of hundreds of their swarm but enabling the swarm to maintain its power and wealth.

sensors roll will reveal that two components of the poison are in a large cloud around the explosion area.

Obviously, the TIE bombers are carrying components for poison-carrying bombs. Fortunately, the poison is so toxic that the prime components are kept separate until just before the bombs are released. The energy source that may have been detected aboard the TIE bombers earlier is a power generator which activates the individual bombs, where the two components are mixed to create the poison. If the components are not mixed, the bombs are harmless.

By making a Moderate *sensors* roll, the New Republic pilots can learn that all of the TIE bombers have their generators going, meaning that all of them are in the process of activating the chemical bombs. If the New Republic fighters can destroy all of the fighters quickly, they can prevent the cities of Kolatill from being poisoned and save millions of lives.

THE BATTLE IS JOINED

Most of the rest of the adventure should revolve around the efforts to destroy the TIE bombers.

During the battle, Noell Ciro's X-wing suffers a devastating hit which disables the fighter's

weapon systems. A TIE bomber is nearing its target site and Noell is the only fighter within range. Rather than allow the bomber to wipe out the city, Noell rams the bomber, destroying it and its payload; he is killed, although he manages to save millions of lives.

With the TIE bombers stopped, the escort carrier turns and makes the jump to hyperspace; Captain Ciro has been captured by the Empire, and will presumably be delivered to Moff Sarne.

A few hours later, at a somber memorial ceremony, the Kolatill Council thanks the *FarStar's* crew for their efforts. They provide the crew with coordinates for Gandle Ott, informing Captain Adrimetrum that they assume Moff Sarne was headed for that system before heading out into unknown space.

THE WRAP-UP

Award each player character one to five Character Points depending upon how well they played their characters and if they played a meaningful role in preventing the destruction of Kolatill's cities.

Reluctantly, Kaiya assumes the role of captain of the *FarStar*. Gorak Khzam is moved up to the post of first officer, despite Kaiya's misgivings. He retains the post of ship-board security officer.

Cut to the adventure "Artifact of Aaris."

TORIZE ADVENTURE HOOK

If the *FarStar* travels to Torize, the ship may find itself caught in an internal power struggle. The Imperial commanders of the space stations orbiting the planet are holding firm to Sarne's orders, but many of the crew aboard the stations (and most of the population on the planet below) are ready to join up with the New Republic. Upon entering the system, the *FarStar* will be surrounded by patrol ships and TIE fighters and ordered to surrender. However, once aboard the space stations, the crew will find that the New Republic-loyal crewmembers are planning an armed mutiny and ask the *FarStar's* assistance in carrying out the overthrow of the Imperial loyalists.

ARTIFACT OF AARIS

The characters are just finishing a mission to a nearby system when they receive a subspace message from Aaris. The *FarStar* picks up the subspace message on an Imperial emergency frequency. Read the message aloud:

“Emergency, emergency! This is Imperial science team MS-133 on Aaris III. We are under siege. Please, anybody respond. The enemy has destroyed our shuttle, and we have no way of leaving. Our group is down to six personnel, with unknown forces picking us off one by one. Mayday! Can anybody hear us?”

INTRODUCTION

Lieutenant Dajus is aware of an expedition Moff Sarne sent to the Aaris system several months ago. The Moff did not inform Dajus of his reasons for sending the expedition there, and he shrouded the entire affair in a veil of secrecy. Dajus knows that the expedition included several scientists, technicians, and a contingent of 10 troopers for protection.

The information about Aaris is sparse — the planetary datafile below can be culled from sources among the *FarStar* crew who had been living on Kal'Shebbol when Moff Sarne took power, or those who have traveled throughout the known and unknown portions of his sector. Lieutenant Dajus knows a good deal of this information, but is hesitant to indicate her awareness of the ruins on the planet.

AARIS

The Aaris system is one of the closer systems to Moff Sarne's sector capital, Kal'Shebbol. It is one of a handful of known systems which were part of the Moff's original sector when he was assigned here many years ago. When he first took over this sector, Moff Sarne sent a cursory scout team to Aaris, which charted a habitable planet in the third orbital ring around the Aaris sun. After returning to Kal'Shebbol and reporting their meager findings to their Moff, all members of the scout team mysteriously vanished. Only recently has the Moff sent a full scientific expedition to explore Aaris III.

Aaris III is a lush, blue-green planet filled with warm oceans and humid jungles. Mountains burst through the lush forests in long ranges, climbing kilometers into the sky. Several immense ruins cover hundreds of square kilometers, adding awkward brown and gray patches to the verdant green jungle — many more ruins lie hidden by the forest canopy. The largest blight on the planet is a vast desert which seemingly appears as if it were dropped right in the middle of the equatorial jungle.

There are no charted settlements on Aaris, and the initial survey team left only a standard Imperial marker beacon. Although the jungles and oceans teem with animal life, no sapient species call Aaris III home.

Since the planet and Moff Sarne's expedition are shrouded in mystery, Dajus feels it could be a vital part of Moff Sarne's operations in this sector and his connections to DarkStryder.

Few others of the *FarStar*'s command staff divulge any information they have regarding Aaris III. Gorak Khzam has been there briefly, he claims, and knows it only as a tropical jungle world filled with many harmless forest creatures. Loh'khar the Finder recalls receiving a few metal trinkets as payment from a trader who made an emergency landing there once. The pieces were very old and of a workmanship Loh'khar had never before seen.

■ Aaris III

Type: Jungle terrestrial
Temperature: Temperate
Atmosphere: Type I (breathable)
Hydrosphere: Moist
Gravity: Standard
Terrain: Jungle, ocean, mountain, ruins
Length of Day: 19 standard hours
Length of Year: 299 local days
Planet Function: Ancient and abandoned homeworld

EPISODE ONE: SILENT SIEGE

Once the *FarStar* emerges from hyperspace into the Aaris system, the Imperial emergency comm channel picks up the distress signal again — only this time, much more clearly. The signal's origin is a small subspace comm transfer satellite

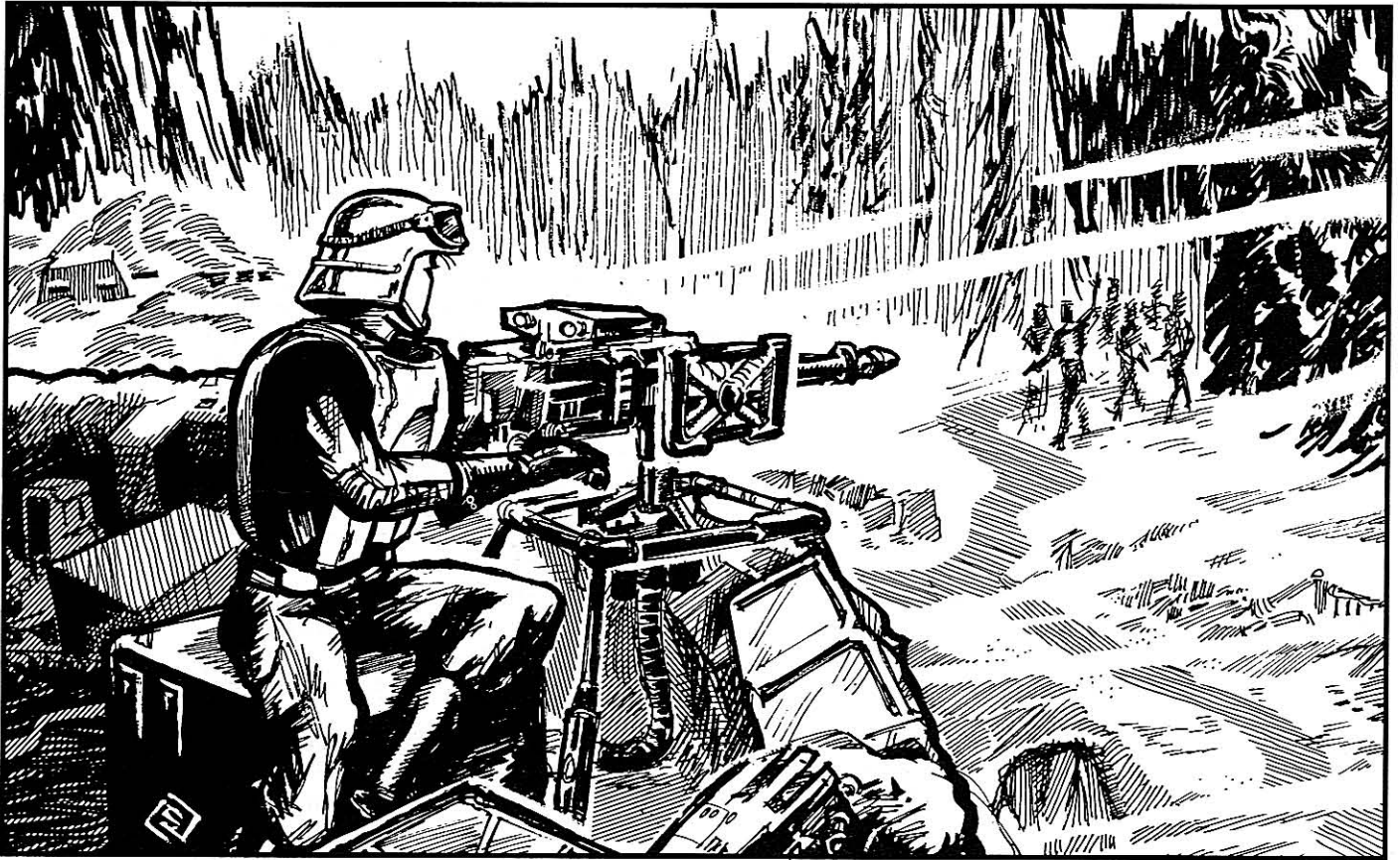

Brian Schomburg

in orbit around Aaris III. The signal originates on the planet's surface and is apparently being boosted by the comm transfer satellite. Using the *FarStar's* sensors, the characters can locate the area on the surface where the transmissions come from — an area within one of the planet's vast emerald jungles. Read the latest distress message aloud:

"...anybody listening? Kal'Shebbol, we need assistance. We are under attack and we're barely holding them off. It's terrible. They come at night. They've been picking us off one by one. Emergency, emergency! This is Doctor Brunou of the Imperial science team MS-133 on Aaris III. Only three of us are left. Please respond, Kal'Shebbol. My assistant Solla and I are left — Doctor Theda has been wounded and may die soon. Please assist. Is anybody listening?"

The crew of the *FarStar* must organize a rescue party to go down in one of the ship's shuttles. From scans (and perhaps a starfighter flyby reconnaissance mission) they can find no clearing near the Imperial research camp to set down a ship as large as the *FarStar*, but there are clearings along the jungle perimeter where a small shuttle could land.

Although these are Imperial personnel loyal to Moff Sarne, it does not seem as if they are aware of the recent events on Kal'Shebbol. They seem more concerned with leaving Aaris III alive than with galactic politics. Lieutenant Dajus recognizes these scientists as personnel under Sarne's command, and she suggests they might have been exposed to information on the mysterious DarkStryder.

All seems quiet below as the characters' shuttle zooms over the daylight jungle toward the source of the transmissions. Occasionally they speed above a small complex of gray metal ruins partially concealed by foliage. Anyone working the shuttle's sensors and making a Moderate *sensor* roll reads high levels of life in the forest below — but most of it is slow-moving, smaller life-forms less than half the average humanoid's size.

The shuttle slows as it nears the transmission site. Ahead the characters see a large area cleared of jungle. Large dirt and broken stone mounds dot the clearing, with burned debris littering the small valleys between the mounds. The corners and edges of ancient corroded metal buildings peek up through the rubble in places. Small craters and blast marks from small arms fire dot the mounds as well as the trees surrounding the cleared area.

The characters spot the largest mound near the center of the clearing. The top of the mound has been hollowed out. It seems to be crudely fortified with the limbs and trunks of fallen jungle trees, as well as scavenged parts of an encampment — broken plastic crates, roughly cut sections of an emergency shelter, an old field table, and busted machinery. Stationed near the edge of the crude fortifications is a lone figure in a patchwork of clothing and an Imperial Army trooper helmet crewing what looks like an E-Web repeating blaster. Deeper within the depression it seems some kind of cave has been burrowed for protection from the elements — and others.

The rough terrain of the mounds prevents landing near the central mound, but the characters can do a flyby and land at the edge of the clearing where the terrain is less rugged. However, characters notice that as soon as their ship flies near the clearing, the distress transmissions cease and the repeating blaster gunner becomes more alert.

The two conscious Imperial scientists holding out in their fortification are low on food and medicine, and their third colleague is dying from severe wounds. However, they are very suspicious of the characters, believing them to be “hostiles” who have been attacking them. The Imperials are also fatigued and confused.

The characters need to use persuasion and bargain with the Imperials to let them approach unharmed to offer aid and rescue. This is a Difficult task which also requires a good deal of roleplaying to convince the Imperials that the characters are friendly. If the characters have their weapons drawn, increase the difficulty by one level. Good roleplaying could also lower the difficulty by one level.

Characters must deal with Solla Deremot, an assistant to one of the two remaining Imperial scientists. Her colleague, Doctor Brunou, is within their fortified cave, tending to the dying Doctor Theda. All the Imperials are convinced they were besieged by unknown forces from the jungles, which picked off their team members one by one and destroyed their survey shuttle. The Imperials are desperate enough to accept help from “Rebels,” but the characters are going to have more of a problem convincing the remaining scientist that they’re not the hostiles who’ve been attacking their research team. (For more information on what happened to this scientific team, see the sidebar “Doctor Brunou’s Journal.”)

If the characters split up, one group might be able to keep Solla busy talking while another group sneaks up from behind to stun or subdue the Imperials. Solla is in no condition to fight, or even use the repeating blaster (although she’ll

SUGGESTED CHARACTERS

Initially this mission seems like a simple tactical mission: go in and rescue the survivors of a small Imperial research team pinned down on Aaris III by unknown forces. Characters with any tactical skills could be involved, probably led by Gorak Khzam (who claims to have been here before). The rescue team might also include Kl’aal the Defel scout and Lieutenant Dajus — with Brophar Tofarain flying his beloved shuttle in the interest of getting a better look at the planet.

However, as the adventure progresses and the characters choose to explore Aaris III further, other characters with more scientific skills might be useful. Once the remaining Imperial scientists are brought aboard the *FarStar*, they and the artifact they bring with them could affect all characters aboard the ship. The third episode is a good opportunity for players to use their favorite characters, even ones which might normally be confined to ship-board duties.

refer to it in any threats she makes against the characters). For game purposes, both Solla and Doctor Brunou are wounded.

Once the two are subdued or convinced the characters are friendlies, Deremot and Brunou insist the characters get them off the planet. The two seem fatigued and hungry, and require medical attention. Doctor Theda is dead. The Imperials truly believe if they remain one more night on Aaris III the “hostiles” will overrun their meager fortification.

The two Imperial scientists don’t care who the characters are — whether they’re “Rebels” or Moff Sarne’s personal guard, they just want off Aaris. Both insist that they take along one crate filled with archaeological artifacts they found, datapads of research notes, and several scanners and scientific instruments.

If asked to explain what happened here, Deremot and Brunou both explain the expedition’s objectives, and tell how the hostiles attacked them and whittled their forces down one by one. Brunou makes no mention of their significant findings, but Deremot lets slip the discovery of the Place of Kastays in the complex of ruins near the destroyed shuttle.

The two promise anything as long as they’re allowed aboard the *FarStar*. Brunou claims he has some knowledge of alien species and cultures throughout the Moff’s known sector, and could have information about other worlds in

DOCTOR BRUNOU'S JOURNAL

An account of Imperial Science Team MS-133 mission to Aaris III:**43.3.31/D49/Aaris III/MS-133**

Today we made our most ground-breaking discovery since we arrived here two months ago. After charting the ruins in this area, our team began excavations in earnest, slowly uncovering the remains of an ancient civilization which once thrived here thousands of years ago. Today our careful work paid off — Tansad discovered a way into one of the ruined metal structures in the fields near the shuttle. Although most of our activity will be near the shuttle, we are still maintaining our base camp in the larger field of ruins. Tansad, Jelok, two technicians and five troopers will move to a secondary camp closer to the shuttle.

43.3.34/D52/Aaris III/MS-133

Jelok has been examining the chamber discovered a few days ago. The inside walls are covered in odd pictographs raised from the metal in an intricate bas relief. Each pictograph emits a long and complex series of sounds — beeps, rumbles, notes and chirps — when pressed. Jelok surmises that these pictographs are the key to some kind of language used by the ancient inhabitants of this place. The sounds could be some kind of augmentation for that language. Tansad, however, believes the pictographs — which are square and neatly ordered on the wall — could be some kind of pictorial dating system, and the sounds part of an ancient language which was rich in oral tradition and only just beginning to develop a written form. Both scientists have begun deciphering their findings according to their own theories. I have assigned Deremot to assist them.

Parts of the chamber are still covered in rubble, and some of the walls have corroded so much that the pictographs no longer "sing,"

as Tansad says. The rest of us are continuing our survey of the great expanse of ruins at the base camp.

43.4.5/D59/Aaris III/MS-133

Today Tansad reported a breakthrough — he confirmed that the pictographs correspond to dates. His findings were correlated between the beginning sounds each pictograph makes, Aaris III's annual revolution, and the overall pattern and number of the series of pictographs.

Subsequently Jelok has abandoned his theories on the language and is now endeavoring to assist Tansad in deciphering the sounds.

43.4.6/D60/Aaris III/MS-133

Jelok made another discovery today while helping Deremot clean up some of the rubble in the chamber. A concealed floor panel revealed a small alcove — within the alcove Jelok found a flat ingot of dull metal, roughly round and pitted along the heavier end. The piece is no more than one-quarter of a meter in diameter and is between two and three centimeters thick (increasing toward the heavier end). It seems lighter than one would expect for its size. There are no markings such as the pictographs found in the chamber's walls, nor are there any holes or hooks indicating this could have been worn as some ancient ceremonial gear. We examined it at the base camp and determined that the material was no metal the Empire had ever cataloged. Our scanners also picked up faint fluctuating energy readings from the ingot — we intend to return it to Moff Sarne's labs on Kal'Shebbol to see if this is some new, unknown energy source he could use.

43.4.7/D61/Aaris III/MS-133

So far our survey of Aaris III has found no sign of intelligent life which did not die out

with the ancients who built these ruined structures. But today several troopers were uneasy, and reported seeing "spies" watching us from the fringes of the jungle foliage. Their commanding lieutenant (and our expedition's shuttle pilot) led five of them into the forest — an hour later we heard several blaster shots coming from a distant corner of the jungle. None of them returned. The remaining troopers opened their weapons locker and distributed sidearms to all other expedition personnel as a precaution against hostiles.

Despite this incident, Jelok and Tansad are continuing their work at the chamber. Deremot returned back to the base camp, complaining of feeling faint and fatigued. With the loss of our shuttle pilot and several troopers, I am seriously considering recalling the expedition (against Moff Sarne's explicit orders) in the interest of saving lives.

43.4.8/D62/Aaris III/MS-133

We are certain hostiles from the jungle are attacking us. Jelok reported Tansad missing from their secondary camp near the chamber, and the two technicians assigned there were shot by somebody sniping from the jungle. Either the hostiles have energy weapon technology, or they have acquired the blasters from the missing troopers.

Last night hostiles took pot shots at our base camp, wounding another technician and Doctor Theda. The remaining troopers here returned fire, but appeared not to have hit anything. A survey of the damage this morning turned up several dead troopers — the ones who initially went after the hostiles yesterday.

I ordered Jelok back from the secondary camp at the chamber, but he resisted. He reported he was on the verge of deciphering

the ancients' language. He even claimed to have discovered the name the ancients had for the chamber — the Place of Kastays. While he didn't know exactly what it meant, Jelok felt it was proof enough not to abandon his work. I disagreed. I had the remaining troopers escort him back to the shuttle while the remaining staff began packing up the base camp.

43.4.9/D63/Aaris III/MS-133

We were besieged last night. They must have gone for the shuttle, and hit it hard, because at one point an immense fireball erupted over the jungle. Despite Moff Sarne's insistence that this expedition was to be top secret, I began sending out a distress call, hoping Kal'Shebbol would send some kind of support. They have to. Deremot and I, along with two troopers and a technician, dug into the largest mound in our ruins and used the equipment from the base camp for primitive fortifications. We must protect ourselves and our findings.

43.4.11/D65/Aaris III/MS-133

We are down to Deremot and I, along with wounded Theda, who has not been improving. The hostiles tried to take the base camp last night, and the troopers and technician charged over the walls to engage them. We had the repeating blaster set up, and Deremot fired at any hostile who came too close. So far nobody could confirm what the hostiles looked like, but they are real enough. The shootings, the ambushes, the shuttle ... I am continuing to call to Kal'Shebbol for assistance, but nobody responds. Is it possible the hostiles sabotaged our booster satellite in orbit? But how? Deremot suggested that perhaps Moff Sarne has betrayed us ...

Kathol sector. He also has had some medical experience which he claims could help the characters. Deremot also has some training in the fields of medicine and biology. Both invite the characters to claim anything they want from the base camp — including the E-Web repeating blaster — as long as they get Deremot and Brunou off Aaris III by nightfall.

Whether or not they're allowed to take the one crate of instruments and minor archaeological findings (metal tiles of single pictographs, a few metal medallions and some scandoc maps of the ruins), Doctor Brunou makes certain the metal

ingot from the Place of Kastays is in his field satchel, which he does not leave behind.

■ **Lancer Brunou**

Type: Imperial Archaeologist

DEXTERITY 2D+1

KNOWLEDGE 4D

Alien species 6D+2, cultures 6D, languages: ancient 7D, scholar: ancient civilizations 8D+2, survival 4D+2

MECHANICAL 3D

Astrogation 4D+2, communications 5D+2, repulsorlift operation 4D, sensors 5D+2

PERCEPTION 4D

Investigation 6D+2, search 7D

STRENGTH 2D+2

Climbing/Jumping 3D+2, lifting 3D, stamina 3D+2

TECHNICAL 2D

First aid 5D, (A) medicine 2D

Force Points: 1

Character Points: 2

Move: 10

Equipment: Blast helmet (+1D physical, +1 energy), blast vest (+1D physical, +1 energy, torso only), comlink, datapad, heavy blaster pistol (5D), medpac, recording rod, satchel with artifact

Capsule: Doctor Brunou was a well-respected professor of archaeology at the prestigious University of Byblos during the reign of the Empire. After the

Empire's defeat at Endor, he felt stability in the galaxy was jeopardized. He felt helpless that there was little he could do to keep the Empire in power. The aging Brunou left his position at the university and spent several years wandering the Outer Rim Territories, visiting archaeological sites and searching for some sense of order in his life.

Eventually Brunou arrived on Kal'Shebbol after hearing rumors of a mysterious Moff trying to reforge an empire. He joined Moff Sarne only recently — the Moff asked Brunou's opinion on several strange and powerful artifacts from a place or person known only as DarkStryder. While Brunou had



Terry Pavlet

a chance to examine these artifacts, he did not have much time to study them thoroughly before Sarne made him head of the Aaris III mission. After a good deal of preparation and research, Brunou set out for Aaris with his hand-picked scientific team.

Brunou is extremely loyal to the concept of the Empire, although his loyalty is sometimes subject to his self-preservation instincts. He can suppress his loyalty to convince the crew of the *FarStar* to bring him and his assistant, Solla Deremot, on board, but he could be a subversive element if allowed to blend in with the crew. Brunou secretly believes the Empire

can be re-forged again from the chaos the New Republic has caused, and could act to bring about that end.

■ Solla Deremot

Type: Imperial Scientist

DEXTERITY 3D

Blaster 4D, dodge 4D

KNOWLEDGE 4D

Alien species 6D+2, planetary systems 5D, scholar: biology 7D

MECHANICAL 2D+2

Communications 3D, repulsorlift operation 4D, sensors 3D, space transports 4D+2

PERCEPTION 3D+1

Investigation 5D, search 4D

STRENGTH 3D

TECHNICAL 2D

Droid programming 4D+2, first aid 5D, (A) medicine 1D, security 3D+1

Force Points: 1

Character Points: 1

Move: 10

Equipment: Blast helmet (+1D physical, +1 energy), blast vest (+1D physical, +1 energy, torso only), comlink, datapad, E-Web repeating blaster (8D), heavy blaster pistol (5D), medpac, satchel with scientific samples

Capsule: Solla Deremot is a mousy and somewhat timid young woman who has worked as one of the research assistants on Moff Sarne's expedition to Aaris III. A native of Kal'Shebbol, she was sent off to university in the Colonies to study biology. When she returned to her homeworld, Moff Sarne recognized her talents and skills and

put her to work for him. When Doctor Brunou was planning the expedition to Aaris III, Sarne suggested he take Deremot along as an assistant. Since Brunou's science team consisted mostly of the doctor's colleagues, Deremot felt out of place — but she went, anyway.

Deremot is a slender woman with short hair — she carries an equally short no-nonsense attitude when it comes to her biology work. Deremot has no great loyalty to Moff Sarne or his (or any other) empire. She's more interested in her research work, which she feels has been wasted on the Aaris expedition. If offered a position on the *FarStar* as a scientist (with some valuable medical skills and a few other practical skills) Deremot does not hesitate to take it. She has always wavered on whether the Empire's claims against the Rebel Alliance were true, so her loyalty is easily placed with the *FarStar* crew. Rather than joining any one side, Deremot views it as a steady means to increase her knowledge and further her biological research.

EPISODE TWO: THE PLACE OF KASTAYS

Once aboard the *FarStar*, Doctor Brunou and Solla Deremot become much more calm. They require some medical treatment for minor wounds and for exposure, and ask for some kind of bunk space they can call their own. But they are soon fit for light questioning about Moff Sarne's expedition to Aaris III.

Doctor Brunou has no qualms about sharing his datajournal with the characters once he's off Aaris. He explains that Moff Sarne wanted the expedition to excavate the ruins on Aaris for artifacts and other information, paying careful

attention to any clues about why the ancient civilization died out. Although he isn't certain, Doctor Brunou believes Sarne gave the Imperial officer — their shuttle pilot — specific coordinates on the planet's surface where he was to land and where the excavations were to begin.

Brunou and Deremot fail to mention they've brought the metal ingot artifact aboard the *FarStar* unless specifically asked so. Brunou's defense for bringing it aboard is that it's their most significant finding and couldn't be left behind. He shows the characters the artifact, allowing them to handle it if they wish. It seems like a metal ingot, lighter than its size and composi-



Terry Pavlet

tion would indicate. The unknown metal also radiates some faint and uneven energy from within. Brunou insists that he keep it, and could turn violent against the *FarStar* crew if they threaten to leave it on Aaris or eject it into space.

Neither Brunou nor Deremot offer to go down to Aaris if the characters show any interest in investigating the ruins themselves. Both begin shivering and become more nervous at just the thought of returning to the excavation, and Deremot gets chills any time the Place of Kastays is mentioned. They can give the characters directions and a scandoc map of the area, but they do not go back to Aaris III.

The characters may decide to further investigate Aaris and its ruins for themselves. Loh'khar the Finder suggests there may still be some Imperial equipment down there they can scavenge, especially near the secondary camp near the Place of Kastays. The shuttle wreckage might even offer some charred spare parts that may still prove usable.

Several others mention that the jungle may yield some fresh food — meat and fruits, perhaps — to liven the bland taste of the gunk that the *FarStar's* mess hall has been producing. Gorak Khzam knows how to prepare a particular dish made from natural fruits, boiled tree bark and meat from one of Aaris' arboreal mammals.

Lieutenant Dajus also expresses interest in investigating the ruins. The hint that Moff Sarne arranged for the expedition to begin in a certain area infers that he had some kind of foreknowledge of this planet and what he might have expected to find here. Secretly, Dajus feels drawn to the Place of Kastays, but she doesn't know why.

BASE CAMP

The base camp was basically moved to the primitive fortification where the characters found Brunou and Deremot. Most of it is constructed from pieces of field table, tent struts, and storage crates. Deep inside the earthworks, inside the shallow cave where Doctor Theda died, they find a crate of foodstuffs they might use. A comlink or two are lying around, and the characters might find use for the small subspace transceiver Brunou used to broadcast his distress message.

Anyone examining the mounds of rubble among the ruins or the jungle fringe surrounding them finds evidence of several skirmishes. Blaster marks dot the rough ground and some of the corroding metal ruins. Here and there the characters find the remains of one of the expedition's members. Several jungle trees have also been hit by blaster fire, and more bodies are found just inside the forest perimeter. All the bodies were killed with blaster fire.



Brian Schomburg

Characters find no signs of the "hostiles" Brunou claimed attacked them. The only tracks to be found are from relatively small jungle animals and the Imperials. A few extra heavy blaster pistols and comlinks can be scavenged from these bodies, as well as five blast vests and helmets.

As they explore the base camp and its environs, characters get an odd feeling that they're being watched. Although it feels as if someone in the jungle is shadowing their movements, they find no signs of watchers when they examine the forest perimeter.

SHUTTLE WRECKAGE

The wreckage of the expedition's transport is very close to the secondary camp and the Place of Kastays. There isn't much left — sections of the cockpit are the only areas intact, and parts for instruments and controls could be salvaged by anyone making a *Moderate space transports repair* roll.

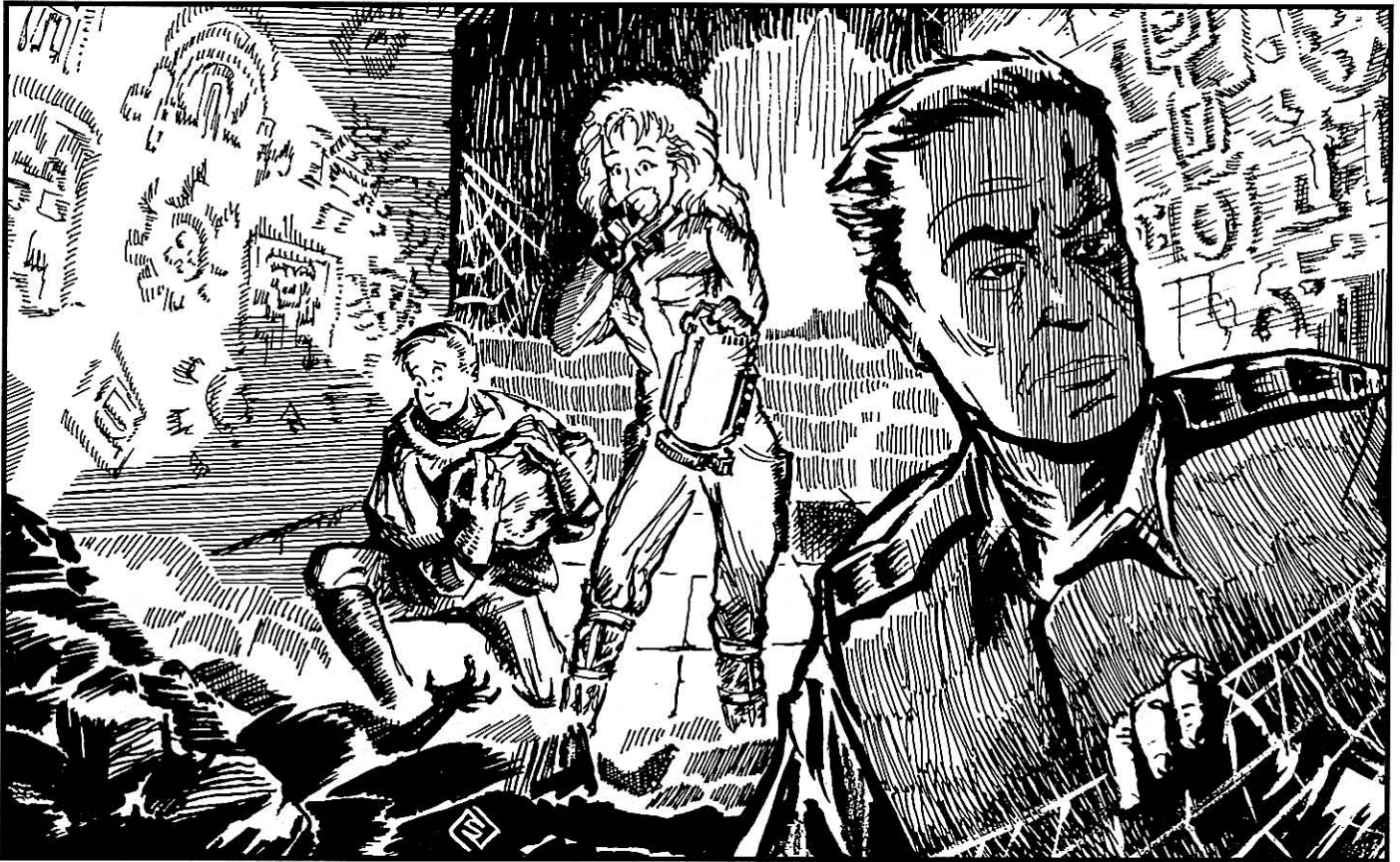

Brian Schomburg

The engineering section and engines are almost non-existent, having been consumed in the explosion. Any detonation probably happened back here. Any character examining the wreckage closely and making a Very Difficult *demolition* roll finds traces of detonite everywhere.

As characters walk through the jungle exploring this area, they again feel as if somebody — or something — is watching their movements. Scans of the area only reveal a few small jungle mammals and reptiles which are relatively harmless. But the feeling of watchers remains.

The secondary camp is in a shambles — it seems to have sustained and returned blaster fire, but it's in ruins more from neglect than attack. Salvage items include two survival shelters, a light fusion generator, and two medpacs. By searching the secondary camp and the surrounding jungle, characters discover the remains of four more expedition personnel and their gear.

PLACE OF KASTAYS

A recently cut path leads from the secondary camp to a corroded metal ruin almost concealed by jungle growth. The entrance to the ruined building seems to have once been a large window with a balcony. The balcony railing has long

since rotted away, but the window (now at ground level) functions as the building's entrance. Jungle growth obscures the rest of the structure — it is unclear how deep into the jungle it goes, and how deep beneath the ground the ruin may run.

According to both surviving Imperial scientists, this is what they called the Place of Kastays, which scientists Jelok and Tansad excavated, and where they tried to decipher the odd pictographs and the sounds they made when pressed. Inside, the square room is no larger than 25 square meters. Metal and stone rubble have collapsed through a hole in one corner of the room, covering a corner of floor space. The pictographs cover most of the walls. Parts of the dirt floor have been methodically dug up in grid squares, revealing a scuffed metal floor. In the center of the chamber is a depression in the metal floor, perhaps once a secret hiding cubby. A lid rests against one wall. The characters have a strange feeling that they are being watched from every corner of the room.

Characters may press any of the square, well-ordered pictographs on the wall. Each one emits a long and complex series of sounds. A few scientific tools — a hand scanner, electronic scale and a fine particle blower — are strewn about the chamber.

TRANSLATION NOTES, CHAMBER OF KASTAYS

Grigor Tansad, Imperial Scientist, Entry 54
While Jelok busies himself clearing the rubble in the corner, my translation of the northern wall pictographs has been proceeding well. Despite feelings that something here is terribly wrong (or is it simply Jelok's jealousy arousing my suspicions?), I am slowly discovering what happened in this ancient place.

So far I have deciphered 11 columns of pictographs. The first few columns describe the ancient civilization — an industrial society with an oral tradition of communication rather than a written one. Their people seemed capable of constructing mighty cities of metal which rose into the sky. They waged occasional wars, but for the most part were a peaceful race. Little information is provided about their physiology, but I am guessing they were roughly humanoid in form. (Detailed translations are provided in prior entries.)

Around column eight I learned the name of the scholar who left these audio recordings. For some reason, Kastays locked himself in this chamber in what he called "the last days" to record the fall of civilization in this book (or song, as he calls it) of "endings." This "fall" apparently began when a comet streaked across the night sky. Several days later, Kastays says, a legion from a military outpost returned to this very city with a relic, what they called the "Plaque of Victory."

The story continued with the next column of pictographs, which is where I began today's translations.

Pictograph 12-A:

"Six days since the arrival of the 'Plaque of Victory' our city is wracked by violence. First it was minor — a small surge in crimes, most resulting in the victims' deaths. Then it became more pronounced, with small gangs ruling the streets, clashing in bloody battles at every corner and gate. Now companies of the city guard turn on each other and kill innocent residents, whom they claim 'betrayed them.' Each faction claimed they had heard the message from the plaque, and each claimed to be its chosen guardian.

"One faction, which had direct access to the 'Plaque of Victory' has removed it from its place in the gushaz (translation unclear: either a palace or temple, a place of reverence). They have brought it here, to my tower, to be hidden over all the city, that perhaps its mysterious power could soothe all the people from this height. In case my tower was overrun by marauders, I have hidden it in my floor vault.

"I know not what this 'Plaque of Victory' is. Is all this strife over a simple metal ingot, or is there some greater force at work? Many who revered it claimed to hear it speak to them. But now that it's in my possession, it speaks not to me. It only shows me things — roiling clouds seeming to enter my chamber and assault me, shadows of doubt rearing their gaping maws from the darkened corners, images from the corner of my eye which seem to threaten ..."

Anyone making a *Difficult search* roll discovers a fist-sized rock near the rubble pile. It's sharper edge is coated in a dried reddish brown substance — blood. They also notice that some of the rubble looks recently disturbed. Digging through it, they discover the body of one of the Imperial scientists — Tansad, the one Jelok claimed was missing. Tansad has been bludgeoned to death, the back of his skull crushed by a heavy object. Someone tried hiding him in the rubble. Tansad's body is still clutching the datapad he was taking notes on when he was killed. Although the datapad is damaged, it still contains the scientist's most recent notes.

If the characters excavate more beneath the pile of rubble, they discover a set of metal stairs which seem to delve deeper into the ruins. To proceed down the stairs, they'd have to spend at

least a day or two removing more debris. This entry into the ruined city of the ancients could serve as the basis for further adventures on Aaris III (see "Adventuring on Aaris" below).

If they choose to investigate other ruined metal structures in the forest beyond the Place of Kastays, the characters must hack through some dense jungle foliage. Few of the buildings are intact, their metal roofs corroded so much as to collapse beneath the weight of larger characters.

**EPISODE THREE:
BREEDING PARANOIA**

While some characters are on Aaris exploring the ruins, those aboard the *FarStar* begin getting rising suspicions — both of the two Imperial scientists they brought on board, and of each other!

The source of these feelings is the artifact, the "Plaque of Victory" Kastays wrote about, that Doctor Brunou and his assistant, Deremot, have brought on board. The metal ingot is not from Aaris — it has actually traveled from far away, to arrive on Aaris millennia ago by sheer chance. The ingot feeds off the life forces and emotions of others. Its sole purpose is to destroy everyone around it, not through its own actions, but by manipulating others to do its will by influencing their perception. Although the ingot itself is not "alive" in the sense defined by known science, the entity trapped within the artifact is alive — and completely insane after millennia of isolation. And once it's brought aboard the *FarStar*, it slowly intends to drive the crew homicidally mad

... unless somebody can discover its true nature and eject it off the ship.

During this episode, the *FarStar* crew goes about its business, monitoring the team on Aaris and going about their normal shipboard duties. However, the artifact is slowly affecting them, too.

The artifact inspires paranoid delusions in those around it. Their paranoia manifests itself in more odd illusions — what can be described to players as real enough. At first they're minor things — a shadow that seems to

move on its own, footsteps following someone along the starship deck, or a feeling that someone's being watched. The more time characters spend with the artifact aboard the ship, the more paranoid they become. And if they've actually touched the artifact, their suspicious nature is amplified.

This is the perfect way to play some characters off others — especially gamemaster characters they're not familiar with or don't trust. Some characters might be convinced some crew members are secretly preparing a mutiny, while others feel a malevolent presence on board that they can't explain.

Here are some situations and events which can help create a sense of paranoia in characters aboard the *FarStar*. Begin with some of the first situations and build up the sense of dread and mistrust with later events. The longer the artifact

is aboard, the more it affects the crew. And while some of the crew might act hostilely toward other crew members, avoid a blood bath.

Remember, this episode should be moody, mysterious and suspenseful, not overly deadly. The following incidents should set characters on edge, get them nervous and perhaps invoke some basic defense responses to misperceptions they can't explain:

- As one character is heading through one of the ship's corridors, she feels as if she's being followed — but nobody is behind her! She has that feeling that another pair of eyes is watching her, and she could easily mistake the echo of her footsteps on the deck plates for those of someone behind her. Even the shadows behind her seem to harbor some unseen presence stalking her.

- One Human character begins feeling that every alien on board is leering at him suspiciously (which might be true, considering the artifact's effects). Every alien this character passes seems to look up from their business to peer at this character, following his every move.

- While one character is talking with another, the gamemaster character lets slip an apparent insult during the course of normal conversation. When asked about the insult, the gamemaster character denies ever saying it, claiming to have said something similar sounding — but not an insult. This one character continues to hear subliminal insults from everyone she talks to.

- A character constantly hears threatening voices or other sounds in the background — she's always asking if others can hear it, but they hear nothing. Sometimes these voices are only murmurs, other times they are very clear, and seem to be discussing some dreadful subject — mutiny, planning a murder, or sabotaging the ship — all involving the character in some way.

- One of the characters repairing some starship machinery or one of the starfighters feels as if someone is sneaking up on him. Out of the corner of his eye, he notices one of his co-workers creeping up with a menacing weapon in one hand. But when he turns around to confront this co-worker (possibly with his own weapon drawn), he sees his colleague holds nothing more than a hydrosponder or similar tool. This continues to happen with those around this character — everyone seems to be acting in a potentially threatening manner. As the episode progresses, the character may no longer clearly see the tool, he may continue to see a vibro-shiv or blaster in the co-worker's hand, and act accordingly.



Terry Pavlet



Terry Pavlet

- One character (perhaps among the command crew) believes that another character in the command crew is fomenting a mutiny. If the character is Human, this mutinous crew member should be an alien — reverse this for alien characters. The character notices this one individual whispering with others, peering over his shoulder at the character in a suspicious manner. If followed, the mutinous crew member might be found near important starship systems, possibly setting traps or sabotaging equipment (but is actually checking instruments and machinery).

- A character monitoring the bridge thinks the sensors momentarily pick up the profile of an Imperial ship headed their way (something smaller than an Imperial Star Destroyer — perhaps an Interdictor cruiser or Lancer frigate). Was that a glitch in the sensor system, or an Imperial ship with a cloaking device blinking onto the screen? This same character thinks she experiences other technical “glitches” from instruments on the bridge — an apparent power core overload, failure of docking bay pressure, sensor readings of Aaris III’s sun going supernova, or a fire in the engineering section.

- One of the characters happens upon Doctor Brunou and his assistant, Deremot. While he’s been sitting alone in whatever corner the *FarStar* crew gave as his own, Brunou has been examining the few datapad notes and artifacts he managed to bring with him from the surface in his field satchel — including the ingot. Brunou examines the ingot with almost obscene interest, holding it close to his face at times, and almost fondling its surfaces, at times talking to it.

Deremot, too, feels some kind of interest in the ingot — but Brunou is very possessive of his find. At some point characters witness a verbal argument escalate into a physical fight as the two argue over who shall possess their odd relic.

DEFEATING THE ARTIFACT

Characters might have to make several *Difficult willpower* rolls to try and resist the warped perspectives and feelings the artifact seems to be forcing on the crew. Characters actually touching the artifact have +10 added to their difficulty. Those who fail these rolls truly believe the misperceptions around them, and those possessing the artifact feel it’s absolutely important that they keep it for themselves.

Certain characters — specifically aliens who are able to resist Jedi powers, or Jedi — may use their special abilities to resist the strange misperceptions forced into their minds. Instead of their willpower, characters with Force skills may resist the paranoid hallucinations using their *control* skill.

At some point after these bizarre incidents begin, it occurs to characters that not everybody is crazy or out to kill everyone else — something’s wrong. They might also figure out that the ingot is in some way responsible, as Doctor Brunou becomes more and more possessive and defensive of his prize. He might even go so far as to harm or even kill another crew member, possibly even Deremot. Brunou tries almost anything to protect his artifact.

The characters also might notice that the closer they are to Brunou (and the artifact) or the longer they touch it, the more bizarre and violent their

delusions become. The further they are from the artifact, the more calm and comfortable the characters are.

Someone must realize that the artifact is causing the crew to go crazy — and the only way to stop it is to toss it out an airlock. The artifact's powers clearly seem based on proximity, so one would assume the more distance between the relic and the ship, the lesser its effects would become. As the strange metal ingot seems to withstand a great amount of damage before even tarnishing or scratching, seemingly the only way to get rid of it is to jettison it from the *FarStar*. Characters may send it out into space, aim its trajectory for the system's sun, or send it back to Aaris III (perhaps to become the focal point of future adventures).

Once the artifact is cast from the *FarStar*, everyone feels as if an oppressive and malevolent presence has been lifted. Some of their misperceptions may affect later relationships, but the sense setting everyone on edge vanishes.

If Brunou and Deremot haven't killed each other over the artifact, they volunteer to join the crew and lend whatever talents they have. While Deremot seems to be interested in her own personal pursuit of biological research and exploration, Brunou secretly intends to jump ship and join Moff Sarne's forces at his first opportunity.

ADVENTURING ON AARIS

The jungles and ruins of Aaris are good settings for further adventures involving the *FarStar* crew. The planet itself is a good place for some "shore leave," and could be a safe haven to land the *FarStar* for any major repairs needed.

There are several areas of interest scattered around Aaris III which could prove ripe grounds for further adventures. The characters might not discover these areas on their first visit to Aaris — unless they undertake a careful survey of the planet by ground and from orbit, they might not find any of these other areas. They might also discover some of these areas after adventures elsewhere, returning to Aaris as a safe haven or for resupply.

CITY OF KASTAYS

The most immediate site characters might wish to explore is the immense city buried beneath the jungle. The Place of Kastays and many of the visible metal structures near the Imperial research camp are the tops of immense city buildings. Many passages and chambers still exist below the surface, perhaps filled with unknown technological wonders, "treasure" and more artifacts of this lost civilization.

The stairwell in the Place of Kastays is the entrance to this vast underground ruin. The tower where Kastays hid himself and the artifact was part of a complex of government and scholarly civic buildings in the city's center. It was a great repository of knowledge (in the form of the raised pictographs which emit sounds when pressed), and held the seats of government and learning.

The underground ruins are also filled with dangers. Some chambers have filled with water from monsoon rains, others have weakened floors which could easily collapse and deposit characters in deeper, unknown levels of the ruins. Some chambers ceilings might also collapse. On the lower levels the former inhabitants — driven by an obsessive paranoia — might have laid booby traps for others trying to steal their "Plaque of Victory." Large burrowing creatures might also be nesting in some chambers, drawn by the promise of air, water and food.

The passages deep beneath the surface might also be inhabited and protected by the descendants of the ruined civilization — warty reptilians no taller than one meter, using crude weapons to defend warrens burrowed through the ruins and into the surrounding soil and rock. Although these creatures are small and seemingly deformed, they are numerous and know the passages well.

Aaris Descendants. All stats are 2D except: *Dexterity 3D, melee combat 4D, thrown weapons 4D, sneak 4D, climbing/jumping 3D.* Move: 8. Crude armor (+2 physical), spear (STR+1D+1).

The underground ruins could also hold useful items — perhaps valuable sculptures from thousands of years ago, small bits of technology such as voice recorders, crude comlinks and other devices based on a culture which communicated more by sounds than by writing. The deeper city ruins might also have samples of rare and unknown metals in various stages of preservation, as well as crude weapons similar to black powder pistols.

Gamemasters should feel free to create an underground complex should the *FarStar* crew wish to explore Aaris's past further.

SUPPLY DEPOT

Moff Sarne, always making back-up plans and contingencies, left a sizable cache of supplies on Aaris III before sending the scientific expedition here. The supplies were hidden in thick jungle foliage along the perimeter of the odd equatorial desert the characters might have noticed during their flyover of the planet. The desert is large enough to land quite a few starships, although characters exploring the desert find few traces of

starships landing here recently — most traces have been erased by the desert's sandy winds.

Characters exploring the desert notice traces of radiation in most of the sand — the remnants of an explosion caused during the final days of Aaris' ancient civilization. No ruins remain, but characters examining the jungle perimeter find 10 large pressurized cargo containers hidden beneath much of the jungle foliage. Most containers have been partially buried in the soft soil, and covered with vines, bushes and fallen trees.

Moff Sarne left these containers here in case he was ever forced to flee Kal'Shebbol with his fleet. Although he planned to resupply his fleet at other worlds he knows are loyal to him, he made sure some supplies were left on Aaris if ever he needed them — especially if he planned to counter attack any invading force on Kal'Shebbol.

Each container is code-locked — and each is rigged to explode if the wrong code is entered. Opening the code lock on each cargo container requires a Very Difficult *security* roll. Characters may try opening each code lock twice — if the second try fails, the cargo container explodes, delivering 10D character scale damage to any beings within a 20 meter radius and destroying all the contents of the cargo container. Oddly enough, each container is spaced about 20 meters from the last one. Cutting or blasting through the side or top of a container only triggers an internal wire network along the inside wall of the container which sets off the explosion.

Each container is filled with all sorts of supplies, mostly geared to Imperial issue equipment. One container has foodstuff supplies, while another has a few Imperial speeder bikes and spare parts. Another has spare parts for TIE fighters. One is filled with service droids, but most have short-circuited and are good only for spare parts. Unfortunately, the *FarStar* is so crowded that the crew is lucky to load the entire contents of one full crate aboard.

The characters' examination of these cargo

containers might be made more interesting should a group of bounty hunters or slavers come here seeking supplies. The situation could be made even more challenging should a capital ship from Moff Sarne's fleet show up in the Aaris system to retrieve the supplies. The ship's commander might send down a contingent of troopers aboard transport shuttles — reinforced by some heavy artillery and combat vehicles if the *FarStar* is spotted.

OUTLAW CAMP

Aaris is also home to a camp of outlaws — located on the far side of the planet from where the Imperial expedition had camped. These outlaws could be pirates, slavers or smugglers hiding from the law. And they might have a vested interest in stealing artifacts and archaeological findings from Aaris' ruins for profit.

Any encounters with this outlaw group should be tailored to the DarkStryder campaign. If, after this adventure, the gamemaster feels the characters need a break, their encounter with the outlaws might be peaceful. The outlaws might have information on Moff Sarne's fleet, or might have traveled to some of the uncharted worlds within Kathol sector. They might have information or supplies to trade, and one member of their band may be willing to join the *FarStar* crew (possibly for his own secret reasons).

However, if the gamemaster feels the characters need another challenge, the outlaws could pose a threat to the *FarStar*. If these outlaws are pirates, they'd see the *FarStar* as fair pickings in the meager times Moff Sarne has created. Slavers might strike at the *FarStar* believing that the New Republic has sent it after them to stop their illegal activities.

The jungles of Aaris make good hiding places for encampments, camouflaged starfighter hangars and supply depots. If characters notice outlaws hiding here, they might return to Aaris later when they themselves need a safe place to hide.

DEATH IS REMOTELY POSSIBLE

INTRODUCTION

As the characters pursue Sarne's fleet further out into the wilds of Kathol sector, the populated, relatively settled worlds grow fewer and fewer. Gandle Ott is the last major settlement in the sector with both modern facilities and a large Imperial presence, and serves as the terminous of the main trade corridor running through the sector.

Once beyond Gandle Ott, the *FarStar* crew will encounter a new problem: a lack of astrogation charts. Few charts are available for the hyperlanes which run beyond Gandle Ott, because relatively few major organizations have need to travel out that way. The *FarStar's* navigational data banks do not include many systems beyond Gandle Ott, and the characters will need to downlink a new dataset in order to travel safely beyond the Ott system.

OVERVIEW

Sarne put into Gandle Ott for supplies before heading out into the wilds of Kathol space. He has left the world in confusion, having taken with him not only the Imperials loyal to him stationed there, but also most of the Imperial system defense force.

He has left a nasty trap for pursuers in the form of the BRT sentient mainframe computer which runs city functions for the capitol, Montral City. By use of override command protocols, Sarne has compelled Cuthbert, the BRT, to stop the *FarStar* at all costs. Cuthbert is well-equipped to do so, since he is in control of a large portion of the city's computers, drone trucks and droids, power systems, and so on. Sarne has also left a spy to lure the *FarStar's* crew into another trap (in the next adventure "Shintel Downtime") should they escape the BRT's attentions.

There is plenty to do on Gandle Ott besides dodge killer computers, though. The characters must do their level best to coax the wavering world into the New Republic, while locating astrogation charts that will guide them into the wilds of the sector, and hopefully towards Sarne's fleet.

BACKGROUND

According to newsnet reports, Sarne's fleet has put into Gandle Ott for supplies, and has spent a number of days uploading supplies from the Naval Station in Montral City. The most recent newsnets available indicate that the fleet is still in orbit around Gandle Ott, though the most recent report is three days old (thanks to delays inherent in newsnet distribution).

Actually, Sarne is breaking orbit and heading out of Gandle Ott's gravity well even as the characters receive and process the newsnet report. Gandle Ott is three days via hyperspace (at multiplier x1) from the *FarStar's* present location, along the trade corridor to Gandle Ott. Still, the Moff appears to be losing his lead.

GANDLE OTT

Despite its great distance from the bustling areas of the sector (let alone the rest of settled space), Gandle Ott was once the most important world in Kathol space. It was the first world settled in the entire sector some 600 years ago, because it was what scouts call "a gasper," one of the extremely rare worlds which has a near-perfect profile in terms of supporting Human life.

A consortium of corporations specializing in promoting new worlds for settlement promoted it as a "showcase world" ripe for colonization, and gave it the lion's share of the resources allocated for settlement and development in the area. Thanks to the aggressive promotion, Gandle Ott quickly attracted a huge number of talent-rich and wealthy businesses and families looking for a new start.

Within a hundred years, Gandle Ott was so well developed that it was known informally in local settler circles as "Little Coruscant," which was certainly an exaggeration, but did express the amazement people felt at seeing such an advanced settlement in such a remote area. Eventually, of course, Gandle Ott's prominence was eclipsed by younger colonies (such as Kal'Shebbol), which were more conveniently located to service traders and settlers. Now the colony world has slumped into a genteel second class status, but is still surprisingly mature for its age and remoteness.

The people of Gandle Ott have a strong independent streak, and pride themselves on their provincial status. "This isn't the Core, mab," one is likely to hear if one questions apparent differences, such as why groves of huge mushrooms grow in the midst of the cities, why people wear a great deal of animal leather, or why nearly everyone ends their sentences with "mab." "And right tundin' it is, too, mab," someone else is likely to respond to the above statement. The people of Gandle Ott speak Basic with an even more pronounced accent than do those elsewhere in Kathol sector.

Gandle Ott

Type: Terrestrial
Temperature: Temperate
Atmosphere: Type I (breathable)
Hydrosphere: Moderate
Gravity: Standard
Terrain: Plains, forest
Length of Day: 25 standard hours
Length of Year: 367 local days
Sapient Species: Human
Starport: Standard
Population: 2.3 billion
Planet Function: Manufacturing/processing
Government: Imperial governor
Tech Level: Space
Major Exports: Low technology, mid technology
Major Imports: High technology, luxury goods

Capsule: Gandle Ott is a world of great natural beauty and abundant natural resources. It is largely self-subsistent, and actually exports very little. It is therefore somewhat credit-poor, which is why it is not a very influential world in the sector, despite its many other advantages. The Ott people are generally very independent, and do not mind Imperial governorship mainly because Sarne has never given Gandle Ott much personal attention.

GANDLE OTT AND THE IMPERIALS

Most of the officials on Gandle Ott, Imperial or otherwise, were not aware that Sarne was lying to them about the mission of his fleet when he was in orbit, nor that he had been driven from the capital. The first newsnet courier droids bearing the news began to arrive insystem shortly after the reports the characters received were posted.

The world is currently in a state of confusion. After the Moff left, it was

discovered that a large number of Imperial officials stationed on Gandle Ott had departed with him unannounced, including the Governor and most of his staff. In addition, most of the ships in the Imperial system defense force departed with the fleet. No one is sure what to make of the sudden influxes in the government, and many are feeling abandoned by the Imperial government.

Because the system is near-defenseless, and because the government is fearful that the mighty

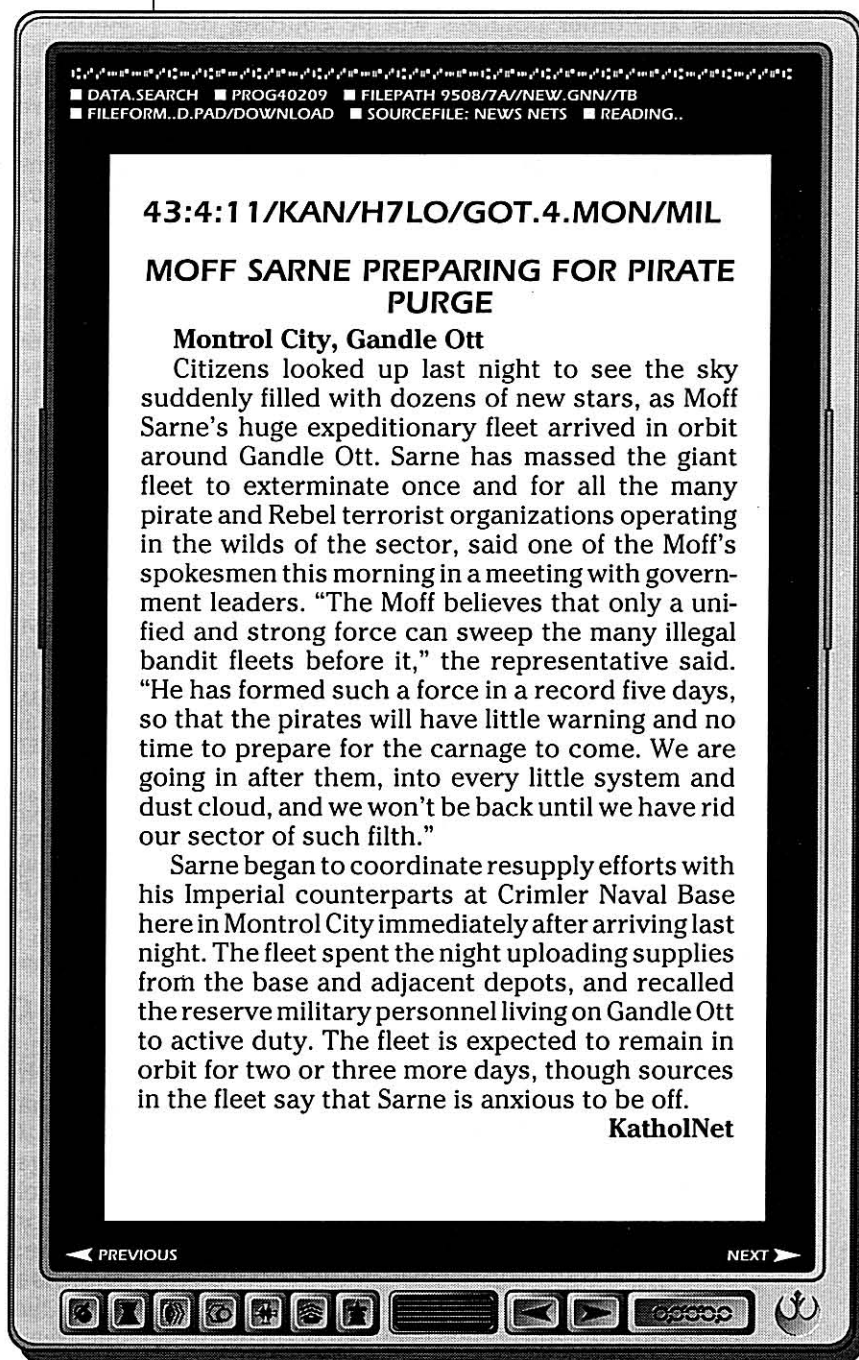

New Republic fleet that managed to send Sarne packing might still be about, the government of Gandle Ott will welcome any New Republic vessel entering their space.

GANDLE OTT AND THE NEW REPUBLIC

In the wake of Sarne's now-obvious abandonment of the sector, Gandle Ott's civilian administration is tentatively interested in establishing diplomatic relations with the New Republic. Politicians and other notables will be courting the most senior New Republic representatives they can find — Captain Adrimetrum and the *FarStar's* senior officers, namely — every moment of the working day, and well into the night.

Captain Adrimetrum and her senior officers will find it quite impossible to avoid getting swept up in a time-consuming array of tours, banquets, speeches, and meetings. It is vital that they win the world over to the New Republic if it can be done, for the sake of both the New Republic and their own mission. The *FarStar* would be best served, as Adrimetrum will point out if no one else does, by having a friendly planet at their backs as they step out into the unknown, and it is equally desirable to deny Sarne a safe port should he return this way. There are valid counterpoints to this position, of course, but the characters will find their welcome wearing dangerously thin if they rebuff all Ott attempts at negotiation, and Adrimetrum and Dajus, at least, are politically savvy enough to know it.

MOVERS AND SHAKERS

The characters will meet many politicians and bureaucrats during their stay on Gandle Ott. Several of the major officials are detailed below, along with their agendas in dealing with the New Republic. The gamemaster is encouraged to expand this cast by as many officials as he or she feels comfortable handling at once. All should have an angle or goal in dealing with the characters, many of which should conflict with one another.

VICE-GOVERNOR MARJA LANG

Acting-Governor Lang is a short, pudgy woman who wears her blonde hair gathered in one thick braid down her back. She is even-tempered and can be as charming or threatening as she pleases.

She has been in the Imperial bureaucracy all her life, and is entirely devoted to the Imperial ideology, a trait which ensured her exclusion from Sarne's personality cult. She is a capable administrator, and is smart enough to realize the

wisdom of dealing with the New Republic representatives as equals. She does not like the situation, but is civil and polite nonetheless.

Lang has sent several subspace messages back to Imperial space requesting reinforcements, and is awaiting a reply. She dreams of being named Governor of Gandle Ott now that her predecessor has abandoned the post, and is busy consolidating her power among the remaining Imperials. Until the Imperial reinforcement fleet arrives (she is doomed to disappointment on that assumption), she plans to smile a lot, make the New Republic feel at home, and keep a watchful eye on Dade. For now.

She recognizes Dajus instantly, though she will not acknowledge this until she can get Dajus alone and learn whether she is genuinely sympathetic to the New Republic, or merely going along out of convenience. If Dajus convinces her that she is loyal to the Empire, Lang asks discretely if she would be willing to spy on the characters and send occasional reports back to her about their plans and what other representatives of Gandle Ott are proposing in private (she is more anxious about Dade than she is willing to admit).

The gamemaster is encouraged to develop this plot thread beyond this adventure if Dajus goes along.

■ Vice-Governor Marja Lang

Type: Imperial Vice-Governor

DEXTERITY 3D+1

Dodge 4D

KNOWLEDGE 3D+1

Bureaucracy 9D, bureaucracy: Imperial government 11D, business 7D+1, cultures 7D+1

MECHANICAL 2D+2

Communication 8D

PERCEPTION 4D

Bargain 8D, command 9D, con 7D+1, investigation 6D, persuasion 10D

STRENGTH 2D +2

TECHNICAL 2D

Security 4D+2

Force Points: 1

Character Points: 13

Move: 10

Equipment: Imperial uniform, datapad, personal comlink

GENERAL HERRON DADE

Dade is a thin, gaunt man with a short grey mustache and iron-grey hair. He is a hearty man who chain-smokes chak-root. Dade, as head of Gandle Ott's planetary militia, is the highest-ranking native in the government, and like many of his fellow natives, has never much cared for Sarne or the Empire. Naturally, since he isn't mad, he has never admitted it to anyone else.

He is secretly relieved that Gandle Ott is rid of Sarne, and welcomes the temporary presence of the New Republic, though he has no intention of

letting any outside force dictate terms to Gandle Ott again. He has begun the delicate process of displacing Lang, and the two are distinctly cool towards one another. He is very worried that the planet and system are no longer adequately defended from the pirates which frequent the sector.

Dade is not extremely polished in the arts of diplomacy, and is likely to say something awkward at some point or the other. He does enjoy a certain level of popularity with the people, and is using this popularity to position himself for a bid for the presidency of the long-dormant domestic government. He would very much like the endorsement of the New Republic as Gandle Ott's Native Son.

Though not quick with words, Dade is no fool, and is very good at reading people, which explains how he obtained his present job. As the planet's ranking military man (not counting those who absconded with Sarne), he has access to a great deal of sensitive information gathered by Cuthbert and other agents, and is not above using it to get his way. He knows, as an example, who and what Khzam was, and will use his leverage to encourage the Rodian to pull the New Republic into Dade's camp.

The characters will see Dade mostly in the evening, since he is swamped with consolidating the remaining Imperial law enforcement and defense organizations with his own during business hours.

■ General Herron Dade

Type: General

DEXTERITY 3D

Blaster 4D+2, dodge 4D, vehicle weapons 4D+1

KNOWLEDGE 4D

Bureaucracy 10D, law enforcement 9D, planetary systems: Ott 7D+1, tactics: ground assault: 7D

MECHANICAL 3D

PERCEPTION 4D

Command 7D, con 6D, investigation: Gandle Ott: 8D+2, persuasion 6D+2

STRENGTH 2D

Stamina 4D

TECHNICAL 2D

Demolition 4D, security 7D

Force Points: 2

Character Points: 8

Move: 10

Equipment: Ceremonial holdout blaster (3D+2), comlink

COLONEL OLAVER LANSEL

Lansel is a pale, morose man with mousy brown hair and a thin face. He is a serious man who nonetheless has an extremely dry sense of humor, and is constantly taking discrete sips from an etched flask.

It is known that Lansel had a falling out with Sarne's clique some time ago, and was stationed on Gandle Ott in a thankless job as a result. When in his cups (which is often), Lansel is rather

critical of Sarne and his cronies, and will warmly welcome the *FarStar's* crew to Kathol sector ("and welcome to it").

Lansel is now free to share his low opinions of Sarne and his bunch, and voice his opinions on what he thinks Sarne is really up to (all of them wrong). His mind is already on returning to more meaningful work in the Mid-Rim, though he will likely recall overhearing some of Sarne's officers speaking of moving on to Shintel "to pick up the backups," though he will neither know what they are referring to nor know where Shintel is (he isn't even sure how to spell it).

Lansel is actually one of Sarne's sleeper agents on Gandle Ott, planted here to serve the Moff. He was activated when Sarne arrived with his fleet, and was instructed to activate the Sarne command files in Cuthbert, and make sure the New Republic agents hear Sarne intends to head for Shintel. This is all he is expected to do for Sarne, and all that he does. Otherwise, he plays the part of a friendly if somewhat boring bureaucrat.

Lansel has no influence over Cuthbert beyond his initial command which activated Sarne's secret command file within Cuthbert's databanks.

■ Colonel Olaver Lansel

Type: Imperial/Gandle Ott Liaison

DEXTERITY 4D

Blaster 6D+1, brawling parry 5D, dodge 6D+1

KNOWLEDGE 3D+1

Bureaucracy 5D, streetwise 4D+2

MECHANICAL 2D+1

PERCEPTION 4D

Bargain 6D, command 5D, con 7D+2

STRENGTH 2D+1

Brawling 3D

TECHNICAL 2D

Demolition 4D, droid programming 4D, security 5D+2

Character Points: 4

Move: 10

Equipment: Comlink, sporting blaster (3D+2)

CUTH-BRT-92-X3

Cuthbert was a product of the grand BRT experiment which took place in the Core decades ago (see *Cracken's Rebel Operatives*, page 53 for additional background information on the BRT line). When the experiment failed, Cuthbert was unplugged and, after sitting in a Brentaal warehouse for 20 years, was eventually shipped out to Gandle Ott to help run the growing colony.

When he was installed in his new home in the Montrol City Computer Center, he was outfitted with various governors which rendered him incapable of defying or attempting to undermine his Imperial owners. At Sarne's command, Cuthbert's programming was also secretly modified to give him access to Cuthbert's central command core.

DAJUS AND KHZAM BEGIN TO SWEAT

This sudden rush into the arms of Imperial representatives will create problems for Dajus and Khzam, who both have their reasons for avoiding officials who are, after all, Imperials who have often traveled to the sector capital.

There will be no avoiding the situation for Khzam, who, as the *FarStar's* first officer and highest ranking non-Human, will be expected to be present at all official functions and ceremonies by both the Imperials and his captain. This raises obvious problems for the ex-slaver, and he will likely approach each event with barely concealed dread. He is not widely known as a slaver, but all it takes is one person being in the wrong place at the wrong time.

Dajus has a better chance of slipping out of various functions, though her insistence on wearing an Imperial uniform will draw attention and interest to her. She has an additional handicap: she has met the Vice-Governor on several occasions, and she knows that there is a good chance the woman will remember her, since there are not many female officers at her level in Kathol sector.

When Sarne stopped at Gandle Ott, he issued Cuthbert new orders through Lansel, which compel the computer to stop the *FarStar* and her crew from leaving the system at all costs. Cuthbert is not pleased with these instructions, but cannot resist obeying. Sarne also lifted most of the governors and inhibitors, allowing Cuthbert to operate at his full level of autonomy. He has already infiltrated most of the significant independent computer systems on the planet, including the spaceport computer, the Imperial networks, and media computers.

He will devote his considerable resources to stopping the characters, though he will attempt to do so peacefully and subtly at first. Only later will he resort to more lethal measures. Despite his unavoidable antagonistic behavior towards the characters, Cuthbert is a pleasant, likable computer.

■ CUTH-BRT-92-X3

Type: Sentient Mainframe Computer

KNOWLEDGE 5D

Bureaucracy 7D, bureaucracy: Gandle Ott 10D, business 6D+2, business: urban government 7D+1, cultures 6D+2, macroeconomics 7D, languages 7D, law enforcement 8D, law enforcement: Gandle Ott 9D+1

MECHANICAL 2D

Sensors 4D

PERCEPTION 3D

Bargain 6D+1, command 7D, forgery: electronic 7D+1, investigation 8D, persuasion 5D

TECHNICAL 5D

Computer programming/repair 8D, droid programming 7D, security 10D+2

Character Points: 9

Move: Physically, Cuthbert is stationary, but can virtually be anywhere on the planet in seconds.

Equipment: Cuthbert has no possessions *per se*, but has a great many electronic resources at his disposal.

DANA CADWELL

Cadwell is a popular reporter for KatholNet, and the Gandle Ott correspondent for TriNebulon News. She is a pretty woman with strawberry blonde hair. She wears tasteful subdued clothing, and carries the tools of her trade about at all times.

Her primary goal is to get off the planet and into a real news bureau somewhere closer to the heart of the galaxy, like Tatooine. To this end, she'll pursue any story she thinks will get her noticed at TriNebulon, and the flight of Sarne and the arrival of the New Republic is her ticket out of Kathol sector. She has the juice to be invited to just about any of the parties and events the characters are likely to attend.

Cadwell is street smart and savvy, and may put together a lot of what's going on whether the characters do or not. She may either aid the characters or try to sink them, though it will only be for the sake of her story — she has no loyalties to anyone but herself. Which way she goes depends on how the two parties hit it off, and how the gamemaster feels like playing things. She may be used to get the characters back on track, or even bail them out of trouble. Because she is an investigative reporter, she may turn up just about anywhere in the adventure.

■ Dana Cadwell

Type: Reporter

DEXTERITY 2D+2

Dodge 4D

KNOWLEDGE 4D

Bureaucracy 5D+1, cultures 4D+1, planetary systems 4D+1, streetwise 5D

MECHANICAL 2D+2

Repulsorlift operation 3D+2

PERCEPTION 3D+2

Con 4D, investigation 5D, persuasion 4D, search 4D, sneak 5D

STRENGTH 2D

Brawling 3D

TECHNICAL 3D

Character Points: 6

Move: 10

Equipment: Recording rod, datapad



Philip Tan

POWER PLAYS

The characters must spend a few days on Gandle Ott to deal with the government, obtain astrogation charts of hyperlanes beyond the system, and figure out where Sarne is heading. It is assumed that the characters will spend about four days onplanet. If the characters seem intent on staying longer or shorter, decrease or increase the rate of the events detailed below accordingly.

The players will likely find it necessary to alternate between playing the officers negotiating with the Ott government, and the lesser members of the *FarStar* crew who can move about the planet will less attention. Certainly some errands will be more appropriate for some characters than others.

Certain events are keyed to occur on certain days the characters spend on Gandle Ott. These events are political or media affairs planned by various factions to benefit themselves. Included in these descriptions, where applicable, are the effects Cuthbert's actions might have on proceedings.

At the end of the planned events are suggested actions by Cuthbert during that day which are

not linked to particular events. Since his actions depend on what the characters are doing, a certain flexibility in adapting the suggestions to play is required.

The local Imperial representatives do not know that Sarne has sabotaged Cuthbert, and will be mystified by the actions surrounding the characters. Lang and Dade will do all they can to figure out who is behind the deeds, but will be focusing more on anti-New Republic groups that might be using the computer systems rather than suspecting the computer systems themselves.

Note that the itinerary includes many more meetings than are detailed below, most of them scathingly dull. The events described below represent samplings from the itinerary rather than the entire agenda. The gamemaster is encouraged to add more encounters or further develop those listed to suit his or her campaign.

DAY ONE

Arrival. Obtaining landing clearance and a docking bay number threatens to take hours, if not days. Cuthbert has recognized the *FarStar* for what it is, and is subtly influencing the spaceport traffic control computer — every few minutes Cuthbert suggests to it that the *FarStar* is a low-

THE ITINERARY

As news spreads about the presence of New Republic representatives on Gandle Ott, many people, lobbyists, and organizations will desire a little of their time. Below is the itinerary as it stands on the morning of the second day, assuming the characters do not refuse any of the invitations.

Following the event is the group or faction sponsoring the event. Lang and Dade may not necessarily attend each event sponsored by their respective factions. Dade particularly will be absent from events occurring during business hours, except for the Mushroom Cutting, which he is sure to attend.

Day Two:

- 0800 Informal breakfast with Imperial Cabinet (Lang's faction)
- 1000 Ceremonial Mushroom Cutting (Dade's faction)
- 1200 Global Organization of Interstellar Shippers Luncheon (lobbyists)
- 1430 City Tour (Duffit)
- 1800 Private dinner (only 95 invited) at Dade's estates (Dade's faction)

Day Three:

- 0800 Meeting with Bank leadership (parliament leaders)
- 1000 Meeting with full Bank (parliament)
- 1300 Press conference with media representatives (parliament)
- 1400 Private lunch with Lang and key supporters (Lang's faction)
- 1600 Ganther dances at cultural center (business community)
- 2000 Mayor Duffit's dinner party (Duffit and Dade factions)

Day Four:

- 0800 Meeting with defense force representatives (Dade, business only)
- 1000 Flower Gardens brunch (Lansel)
- 1300 Meeting with Bank Foreign Relations Committee (parliament)
- 1800 Theatre Dankse performance of *Madra Teene* (business community)

priority ship which has just arrived in orbit. As a result, Spaceport Control welcomes the *FarStar* to Gandle Ott, asks for its ID codes, and bumps it back to the end of the landing clearance queue every 10 minutes or so.

When the characters tire of this game, they can break through the automated system and talk to a Human controller. This requires an Easy *communications* or Moderate *computer programming/repair* roll, as the characters must reroute their call to address the main spaceport boards rather than the automated beacon. The operator will not be able to explain the delay. "Usually we have no problems with our Starport Control software."

Once the problem is straightened out, things proceed very rapidly, as news spreads to the Bank (the planetary capitol building) that a New Republic ship is in orbit (the newsnets have already referred to the distinctive ship enough to make it instantly recognizable). The *FarStar* is given VIP berth space at the Montrol Spaceport if Captain Adrimetrum feels it wise to land. She probably shall, since refusing to land after receiving a VIP invitation would be a serious breach in diplomatic protocol.

Upon landing, the characters are met by a large and serious spaceport security force, which intends to arrest them as pirates. The routine check on the ship's registration and BoSS permits has resulted in a warning that the *FarStar* is stolen Imperial property, and that the characters are dangerous felons. This isn't altogether false (at least from Sarne's point of view), but is, of course, more of Cuthbert's work.

Starport Security (20). All stats are 2D except: *Dexterity 3D, blaster 5D+1, dodge 4D+2, command 4D, Strength 3D.* Move: 10. Equipment: Blaster rifle (5D), blast vest (+1 to Strength to resist damage), comlink.

Just as things get extremely tense, the politicians show up with an honor guard, unaware that Cuthbert has branded the New Republic group renegades. At the head of the group are Vice-Governor Lang, Stanfeld Duffit (the mayor of Montrol City), and a variety of other political types anxious to take the measure of the New Republic. Lansel is present, but Dade is at work.

Lang will greet the group formally and distantly, after the situation is untangled, and introduce her

various ministers and aides. She invites the senior officers to accompany her to their hotel.

The characters are permitted to carry their weapons, though it will look odd if the officers themselves are armed, since they are being accorded diplomatic status. Being accompanied by armed bodyguards from the *FarStar* crew is perfectly acceptable.

The media are also present at the spaceport, and will dog the heels of the characters through the spaceport, through customs, and all the way to their hotel. Cadwell will be part of the media frenzy, and will do her part in asking direct, penetrating questions ("Is it true you are pursuing Moff Sarne? Do you have any comments about so-called mystical artifacts he may possess? Are you here to annex Gandle Ott for the New Republic? Where is your fleet? Are you alone?") Media representatives are present from Colonial NewsNet, Galaxy News Service, TriNebulon News, KatholNet, NovaNetwork, and a host of minor news services.

The *FarStar* officers are taken to the Imperial Plaza Hotel downtown Montrol City, where they may stay at the government's expense. The room is not being monitored by the government, though Cuthbert may be listening in via the hotel intercom system.

Lang will invite the characters to an informal breakfast the following morning, and bid them good night. The characters are each given a complementary 100 credits in gambling chips for the hotel's casinos. Captain Adrimetrum is invited to speak on an evening talk show about the New Republic's policies in Kathol sector, which she may accept or decline.

Naughty Cuthbert. Cuthbert infiltrates several bar droids in the hotel and lightly drugs the drinks the characters consume, either in their rooms, in the casino, or at dinner. The drug is detectable with a Difficult *Perception* roll. Characters who consume drinks containing the drug must make a Moderate *stamina* roll to awaken normally the following morning. External stimuli such as alarms and being shaken awake will reduce the roll to an Easy *stamina* roll. Stim drugs available in any medkit will restore affected characters to normal.

DAY TWO

The *FarStar* officers are presented an itinerary of events, and are provided a luxury hoverlimo for their use while on Gandle Ott. The government will offer a driver, but everyone will understand if the New Republic wishes to provide its

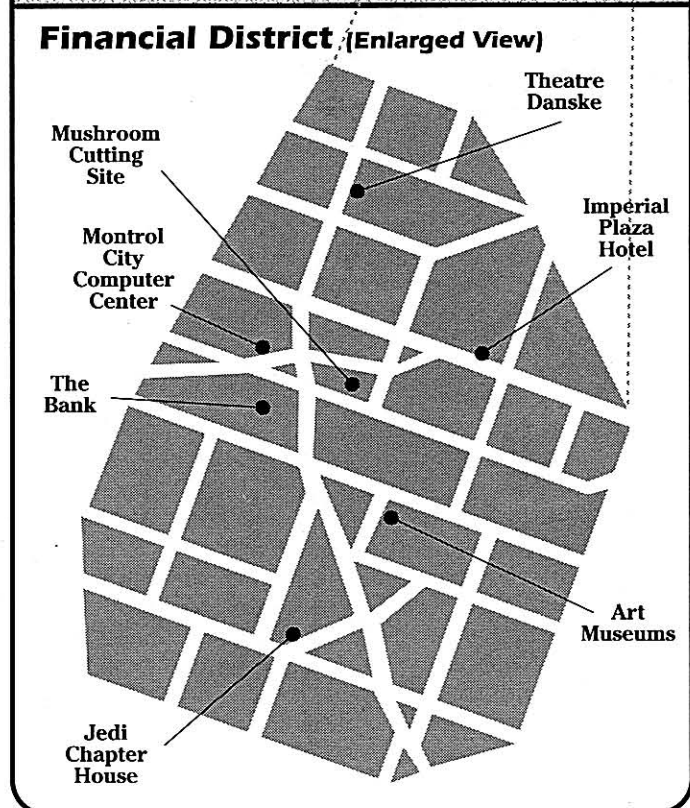
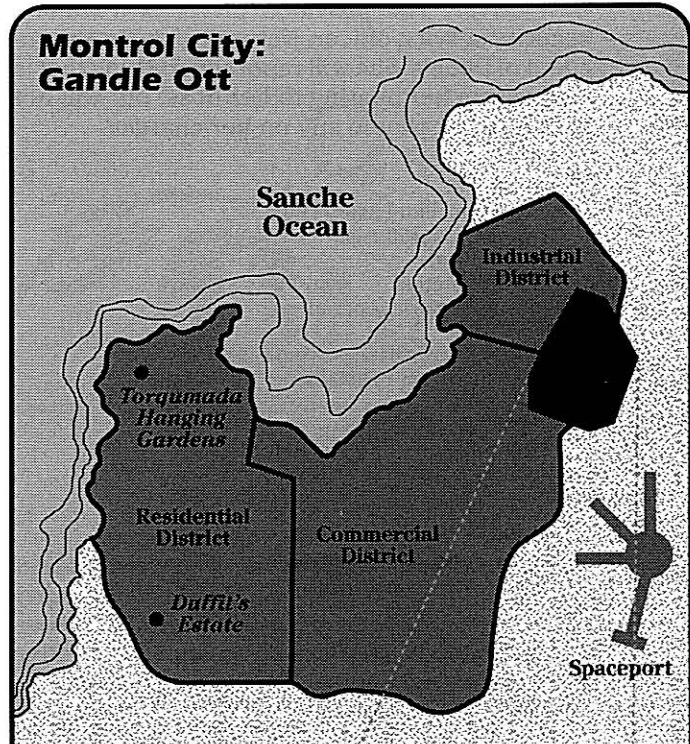

own driver, The provided driver is a trained security service officer. Naturally, she is also an agent of Dade's. She will report everything that is said within her hearing to her boss, but will not go out of her way to spy on her charges.

■ Limo

Craft: Pandeflot Luxury Limo
Type: Repulsorlift car
Scale: Speeder
Length: 8 meters
Skill: Repulsorlift operation
Crew: 1
Crew Skill: Repulsorlift operation 2D
Cargo Capacity: 10 kilograms
Passengers: 6
Cover: Full
Altitude Range: Ground level-3 meters
Maneuverability: 1D
Move: 70; 200 kmh
Body Strength: 1D

Limo Driver. All stats are 2D except: *blaster 4D, brawling parry 4D, dodge 3D, melee parry 3D+2, repulsorlift operation 3D, security 3D.* Move 10. Blaster rifle (4D) in seat holster, protective vest (+2 to resist damage), comlink.

The Ceremonial Mushroom Cutting. The first public event the characters will be invited to

participate in will be the Mushroom Cutting ceremony, held in a small but well-maintained park downtown. The ceremony consists of cutting down a few stalks of cattarash mushrooms (the mushrooms are thin lime-green fungi which stand over a meter tall), and brewing them in a tea, whereupon all present partake of the beverage. The cutting and brewing is a holdover from the early days of the colony, and is supposedly symbolic of the first imported crops grown for self-subsistence and export.

In this case, it will be interpreted by the populace as a declaration of independence from the Empire, and the presence of the New Republic will lend legitimacy to the proceedings. Characters making a Difficult *cultures* roll may grasp this underlying symbolic subtext to the event (if they don't, the local newsnets will explain it to them the following morning).

Dade has maneuvered Lang into this ceremony. He has taken time out of his busy schedule to appear at the ceremony, and is the center of attention as far as the media is concerned. He speaks of the need of Gandle Ott to seize its own rudder once again, while Lang looks on with a barely concealed look of pained boredom on her face.



The City Tour. After lunch, the characters will be taken on a city tour by Mayor Duffit. Duffit will point out a number of city sights he feels will impress the New Republic, such as the remains of an old Jedi Chapter House (now a greenhouse, it shows faint signs of once having been burned about the eaves), the art museums downtown, the harbor industrial and tourist areas, the city courts, and the city computer center, where Cuthbert is housed.

Mayor Duffit is very proud of “our little Cuthbert,” and introduces him to the characters, telling him about the history of the BRTs. Cuthbert greets the characters, and tells them he is happy to meet them after seeing them on the news. The interview will be short, and should be worked in amongst several other stops so it will not seem particularly significant.

A few suggested encounters for the day: a large group of children are on a field trip at the art museum when the *FarStar* officers arrive, and are eager to meet them (“Teacher says Rebel terrorists are monsters. Are you a monster?”); a group of dockworkers are loading a sea-going freighter at the docks, and talk to the characters about working conditions in the New Republic (Sarne was not very tolerant of unions); a group of young military cadets are drilling on the parade grounds downtown, and ask a series of hostile questions regarding past activities of the Alliance (these are Carida wanna-bes).

Naughty Cuthbert. Early in the day, Cuthbert will convince the spaceport probes that they detect a hard radiation leak emanating from the engine nacelles of the *FarStar*. Alarms will begin whooping in the blast pits all over the spaceport, huge emergency lorries will rush to the *FarStar*'s docking bay and begin swathing the engines in a special foam designed to dampen the radiation leak, and industrial droids will swarm all over the bay sealing exits with foam and clearing the area of crates, fuel hoses, maintenance gantries, and so on.

The crew of the *FarStar* on the ship will have been ordered to evacuate before someone thinks to run an independent scan of the area, which will of course report no such radiation leak. The spaceport authorities will be extremely apologetic and puzzled (and will actually take their computers offline to look for the problem).

The ship will be unable to fire its main engines until the gunk is cleared out of them. This will take an additional day.

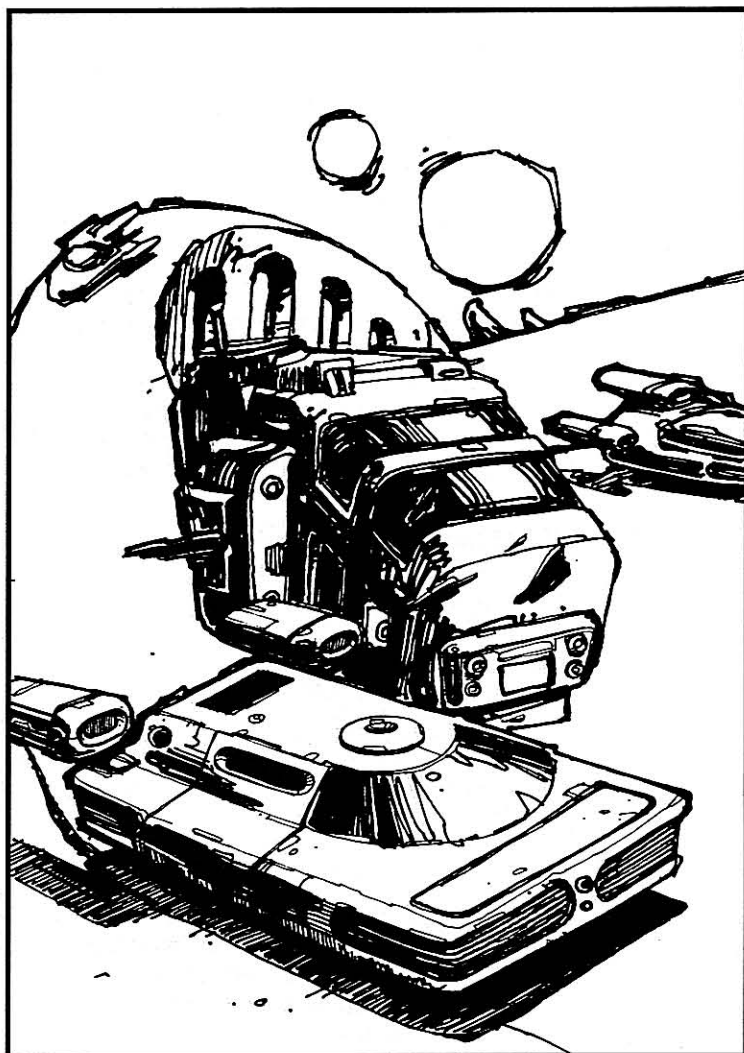

Philip Tan

ESCALATION

DAY THREE

Meeting with Bank leadership. The Bank is the Gandle Ott parliament, which once made the world's laws, and more recently has served the Governor in an advisory role. The characters will be expected to attend a meeting with the ranking Bank members early on their third day, and discuss possible arrangements for establishing a dialog between Gandle Ott and the New Republic. The politicians will quickly realize that Adrimetrum is not a high-level New Republic official, and will couch their requests for a visit by a genuine New Republic diplomat accordingly. This will be a dull but necessary affair for most of the *FarStar*'s officers.

Duffit's Dinner Party. Stanfeld Duffit stands to benefit by associating with the New Republic no matter who comes out on top. He is anxious to show off his city (which is rather impressive for such an isolated system), and to bring new business to Gandle Ott. His party is attended by several hundred people, who are either business leaders who want to bring New Republic business to the planet, Dade supporters, or both.

Naughty Cuthbert. Cuthbert, getting more aggressive, takes to the streets. He runs a number of automated city systems, including several public transit and trucking systems. The characters are nearly run down by an automated bus, crushed by an automated garbage truck, and rammed by an automated permacrete truck over the course of the day.

■ Automated Speeder Truck

Craft: Modified Trast A-A6z Speeder Truck
Type: Speeder Truck
Scale: Walker
Length: 15 meters
Skill: Repulsorlift operation
Crew: Automated by droid brain
Crew Skill: Repulsorlift operation 3D
Cargo Capacity: 25,000 kilograms
Altitude Range: ground level-3 meters
Maneuverability: 1D
Move: 70; 200 kmh
Body Strength: 3D

DAY FOUR

Meeting with Defense Force Representatives.

Dade and other military leaders of the Ott system meet with the characters to discuss military aid the New Republic might be willing to give Gandle Ott and her territories.

Fete in the Flower Gardens. Lansel has invited the characters to a brunch in the Torqumada Hanging Gardens near the coast. He feels the characters could do with getting out of the city for awhile, especially considering the strange events which have been occurring around them of late. The brunch consists of a variety of local business leaders, media personalities, and government officials. If Lansel has not yet dropped his hint regarding Shintel, he will do so here.

Theatre Dankse. Theatre Dankse is Gandle Ott's premier theater company. The theater is a huge, multi-balconied, gilded affair, with red drapes and wooden railing everywhere. The opera being performed is the classic *Madra Teene*, an epic historical play concerning the legendary clash between a Colonial world and a droid uprising.

Cuthbert will choose to unleash his last offensive during the performance; an assassin droid Sarne left in case all else fails (assuming Cuthbert

is still active — if he has been deactivated, the already activated assassin droid will attack at this time). The assassin droid is independent of Cuthbert once activated, so it cannot be recalled by Cuthbert later. Its objective is to eliminate the officers of the *FarStar*, and to disable their ship if possible.

It will move quickly to the theater, and engage them in combat. It then plans to proceed to the *FarStar*, where it will attempt to storm aboard and take out the ship from within with its torpedoes.

This scene can be played up, with the assassin droid making its first appearance on stage with the actors (some of which are costumed as assassin droids). The combat may take place all through the theater — in the aisles, the balconies, the dressing rooms and orchestra pit, the backstage sets, and so on.

■ RX5-TLN

Type: Assassin Droid

DEXTERITY 3D+1

Blaster 5D+1

KNOWLEDGE 2D

MECHANICAL 2D

PERCEPTION 3D+1

Search 5D+2

STRENGTH 2D

TECHNICAL 2D

Equipped With:

- Body Armor (adds +4D to *Strength* to resist damage)
- Blaster cannon (6D, mounted into left arm)
- Portable proton torpedo launcher (9D, mounted into right arm; has three torpedoes)

Move: 11

Size: 2.3 meters tall

DEALING WITH CUTHBERT

It won't take long for the characters to discover who is behind their accidents and misfortune. Cuthbert is acting subtle in his own way, but not as devious as he might, since his heart isn't in his actions.

If the characters report to anyone of importance within the government their suspicion that Cuthbert is trying to kill them, including Lang and Dade, the matter will be looked into. The flaw will be discovered, and Cuthbert taken offline until it can be corrected (unfortunately, his last rebellious act will be to dispatch the assassin droid).

Until he is fully cured, Cuthbert's information is still untrustworthy. He will still be functioning, but not connected to any outside network, while the computer techs are eliminating Sarne's programming. Restoring Cuthbert takes two days.

OTHER ERRANDS

The big political goings ons which are claiming all of the officers' time are all very necessary and desirable, but they aren't getting the *FarStar*



Philip Tan

much closer to Sarne. While the officers are playing diplomat, it will fall to the other characters to locate an astrogation map that will take them beyond Gandle Ott. They may also work at stopping Cuthbert.

SEARCHING FOR ASTROGATION CHARTS

Obtaining a reliable astrogation chart is by far the most important objective in laying over at Gandle Ott. A number of possible sources for such a map are listed here. Note that whatever charts the characters ultimately obtain are simply hyperlane routes to more remote systems which have no official lanes as of yet, all of which are in the Kathol sector. These are *not* Sarne's secret maps of the wilds beyond Kathol sector.

Government Survey Records. Perhaps the easiest method of securing a chart is to simply ask the government for one. Since the Gandle Ott government is anxious to appear accommodating before the New Republic (lest its fleet come to take over the planet), such a request will be immediately and sincerely honored.

Unfortunately for the characters, all official government astrogation charts are stored in government computers, and all downlink requests pass through Cuthbert. Any charts the characters get through official channels will check out when compared to local systems, but will prove to be hopelessly flawed and useless to ships attempting to travel more than two days away from Gandle Ott.

Once Cuthbert is cured, of course, he will be able to give the characters a reliable astrogation chart of trade routes beyond the Ott system, including coordinates for a remote unsurveyed and unsettled system named Shintel.

Local CMG Chapter. There is a very small Corellian Merchants' Guild Guildhouse in Montrol City, amazingly enough. It is maintained by a retired freighter captain named Brandy MacMillian. MacMillian is an aging woman with salty hair and a face wreathed in wrinkles. Her back is still straight, however, and the Corellian Bloodstripe piping running down her trousers suggests she is not a woman to trifle with. She is no-nonsense to outsiders, but very friendly to Corellians, especially New Republic Corellians.

MacMillian has a private collection of astrogation charts she will readily copy for CMG members, and Corellians who join on the spot (the local membership fee is 1,000 credits). The charge for copying the astrogation charts is 100 credits (this is deducted from the CMG dues). The charts contain coordinates to both Shintel and *Tanquilla Beach* (see the next adventure).

The remaining 900 credits can be recovered in the form of goods or services at any Guildhouse in the galaxy. More information on the CMG can be found in *Galaxy Guide 9, Fragments from the Rim*, page 46.

Doctor Cantryl. Dr. Cantryl is Gandle Ott's crimeboss. He keeps a low profile, since Sarne has not been very understanding about those in his profession. Cantryl can be located in the usual manner of hanging about bars and sports arenas, buying drinks for the local lowlifes and working up the chain. This will require three Moderate *streetwise* rolls and about 20 credits spent in drinks and bribes, altogether.

Loh'khar can cut a few corners if he is along, since he knows quite a few smugglers and criminals from his past doings. He can get an interview with Cantryl with a single Moderate *streetwise* roll and a bribe of 50 credits (though he may claim it was more).

Cantryl is a slim man in his forties who favors white suits. He smiles a great deal, but the smile never reaches his dark, glittering eyes. He is willing, perfectly willing, to sell the characters astrogation charts. He knows how badly they need them, however, and asks for 5,000 credits for them, "a small price to pay for accurate charts my own smugglers use." He can be talked down to 3,500 if the characters bargain with him, but no further. His charts accurately display the main systems beyond Gandle Ott, but do not show the locations of shadowports or smuggler routes, despite his claims. Shintel *is* on the maps, however.

■ Doctor Cantryl

Type: Crimelord

DEXTERITY 3D

Blaster 4D+2, dodge 4D

KNOWLEDGE 4D

Bureaucracy 5D, intimidation 6D+2, *streetwise*: Gandle Ott 7D, willpower 6D+1

MECHANICAL 3D

PERCEPTION 3D+1

Bargain 5D, command 6D

STRENGTH 2D+2

TECHNICAL 2D

Security 4D

Character Points: 8

Move: 10

Equipment: Holdout blaster (3D+2), comlink

Cantryl's Thugs (10). All stats are 2D except: *Dexterity* 3D, *blaster* 4D, *command* 3D. Move: 10. Blaster carbine (5D).

ENQUIRING AFTER SARNE

The characters will likely devote a great deal of time trying to discover where Sarne went after leaving Gandle Ott. Unfortunately, Sarne's security is very tight, and the only person now on Gandle Ott who knows the next location is Lansel.

FURTHER ADVENTURES IN THE OTT SYSTEM

Because Gandle Ott is the last major settlement with ties to Imperial and New Republic space the *FarStar* will likely encounter for some time, the characters may return to the Ott system from time for supplies, advanced medical aid, or refuge.

Immediately beyond Gandle Ott are a number of systems which are used as a source of raw material by Gandle Ott industries. None host any heavily populated worlds, though there are sealed habitats and mining communities scattered throughout.

While Gandle Ott's Imperial system defense force provided law enforcement for these communities in the past, there is currently no government-provided security. The only law in the area are the woefully inadequate security forces provided by the companies that operate within them.

There are also a number of pirate gangs oper-

ating in the region who maintain boltholes in these systems. These pirates have supported themselves by raiding small communities and shipping traffic operating in the Kathol Outback. Though the pickings are rich in the Gandle Ott system, they have avoided hitting the system because the Imperial forces stationed there have protected it. This, of course, has changed, and it won't take long for word to reach the pirates.

If the *FarStar* does return to Gandle Ott for supplies, it might fight off a pirate raid or even track a pirate band down and eliminate it. This might be an excellent way for the *FarStar* to receive needed repairs or supplies if it begins to run low on credits — the Gandle Ott government would be happy to provide such services free if the New Republic were to provide protection from time to time.

Such activities would also serve to further reinforce the ties between the New Republic and Gandle Ott.

SHINTEL DOWNTIME

Sarne anticipated years ago, as he built his little empire about him, that sooner or later the Empire would arrive in Kathol sector to oust him. He was mistaken in that regard — it was the New Republic that invaded — but his careful planning did not go to waste. Assuming that he might be required to flee the capital with next to nothing, he established several unofficial supply depots at the remote edges of the sector, where he might lie low and regroup.

As things turned out, Sarne was able to escape with a good portion of his fleet intact, but he is still intent on visiting many of these depots, both to take on as much of the supplies as he can carry, and to deny them to potential pursuers.

Ever a resourceful man, Sarne has put into place a number of traps along the way, calculated to stop or delay pursuit. Sarne knows that the ship pursuing him is his own *FarStar*, which contains a large number of trapdoors in its myriad computer systems which will activate when presented with certain stimuli. He has prepared such a stimulus for the *FarStar* in the Shintel system, and the bait is a backup copy of his private navigational charts of the space beyond Kathol sector.

BACKGROUND

The Moff's fleet arrived at Shintel a week ago, officially to pick up the arsenal supplies. Unofficially, his visit had three, more important, purposes. His primary goal was to erase all references in the base's computer system to the systems in the Kathol sector (he had been using the base as a backup for all of his navigational records). His second goal was to drop in place a less detailed astrogation chart which will activate certain traps built into the *FarStar* when it is uplinked into the *FarStar's* nav computer. His third goal was to pick up the officers and men loyal to him and strand those more loyal to the Empire than himself, in his final purge of his officer corp.

Only hours after he left, it was discovered that the Moff's men had destroyed the hyperdrive engines in every vessel on the planet, as well as the few hyper-capable courier droids in the depot. Having trapped the 'traitors' in the Shintel

system, he further restricted their movements by surrounding the planet with a large number of ion mines. With only five old TIE fighters and a few cargo shuttles, the stranded Imperials can not risk sending up ships, since they do not have the resources to rescue and recover disabled ships and personnel.

Sarne does not intend to return to the system, though he left the outpost intact in case someday he might need it, and the men alive because he does not wish to cause unrest in his own command chain by slaying them openly. To keep them going for a few months, he left orders to hold the depot and construct a landing field for blastboats for future use.

■ Shintel

Type: Terrestrial
Temperature: Temperate
Atmosphere: Type I (breathable)
Hydrosphere: Moist
Gravity: Standard
Terrain: Forests, mudflats, low seas, mountains
Length of Day: 19 standard hours
Length of Year: 343 local days
Sapient Species: Human
Starport: Limited services
Population: 2,000
Planet Function: Imperial supply depot
Government: Military
Tech Level: Space
Major Exports: None
Major Imports: Foodstuffs, low tech, mid tech, high tech

Capsule: Shintel is a wet muddy little world with extremely heavy cloud cover. The rainy season in the northern hemisphere lasts seven out of the 10 months, and the winters and summers are both mild. There is a small Imperial supply depot in the northwestern hemisphere. The depot normally houses 1,500 men, mostly non-combatants serving in supply and ordinance capacities. There are currently 500 additional men that Sarne left on Shintel who have no specific duties here.

ON THE HEELS OF SARNE

The trip to Shintel is uneventful, though characters may worry a bit about actually arriving at their intended destination, considering the problems they have had getting reliable hyperspace coordinates recently.

CLEARING THE MINES

The *FarStar* reverts from hyperspace near a large planet cloaked in thick cloud cover. This is the third planet of the system, and the site of the Imperial depot. As the *FarStar* nears the planet, the ship is hailed.

“Attention, unidentified vessel. This is Imperial Depot 4290-1. This planet is being blockaded by ion mines. Do not approach. Repeat, this planet is being blockaded by ion mines. Hold your position and identify yourself.”

Regardless of how the characters respond, the Imperials will have to deal with them if they hope to escape the system. They do not care if the *FarStar* is a New Republic ship. They care only that it has a hyperdrive. They invite the characters to land (but do not tell them that they are stranded), and tell them the *FarStar* must first clear a corridor through the web of ion mines orbiting the planet.

In all, five ion mines must be cleared from a particular area in order to make a safe decent into Shintel’s atmosphere. This may be done by detecting the mines and blasting them from orbit, or sending a space-suited figure to each one to disarm them on location. It will be very difficult for the *FarStar* or an X-wing to get close enough to a mine to detect it without being fired upon, though risking an X-wing is more prudent than risking the *FarStar* itself.

■ Ion Mines

Weapon: Mark III Merr-Sonn Defender Ion Mine

Type: Space-based ion mine

Scale: Starfighter

Length: 4 meters

Crew Skill: Sensors 5D

Body Strength: 2D

Sensors:

Passive: 40/ 0D

Scan: 50/ 1D

Search: 60/ 2D

Focus: 3/ 3DD

Stealth: +4D to resist detection

Weapons:

Ion cannon

Fire Arc: Front

Crew: Automated; use fire control only

Skill: Starship gunnery

Fire Control: 6D

Range: 500–2/6/10 km

Damage: 10D ionization

Capsule: Ion mines are designed to blockade worlds. They use sensor masks and passive running to remain nearly invisible to passing ships. When a ship is within 10 kilometers of a mine, the mine emits a powerful ion attack upon the ship, neutralizing the vessel.

Ion mines run almost exclusively in passive mode, making them difficult to detect. If nearby mines are detected, an ion mine will activate its sensor masks,

which baffle the mine’s emissions. Ships attempting to detect an ion mine must add 2D to their difficulty when the sensor masks are activated.

A mine which detects a ship in its region will begin firing once per round. It will ignore anything less than four meters in diameter.

Once the mines are cleared, the *FarStar* may begin its landing procedure. As soon as the *FarStar* begins entry into Shintel’s atmosphere, it’s sensors report that two TIE fighters and an aging Delta shuttle have lifted off from the base and are winging toward the *FarStar* on an intercept course. These ships mean the characters no harm, though they may cause an anxious moment before they announce that they are forming an honor guard to escort the *FarStar* to the depot.

Note: This adventure proceeds on the assumption that the *FarStar* itself has landed at the Shintel base. The adventure should proceed as written even if it remains in orbit. In that case, Sarne’s saboteurs will focus on another hyperdrive-bearing craft at the landing field, such as an X-wing.

LANDING

Sarne’s supply depot is little more than a shanty town of modular buildings, surrounded by empty, fuel-stained concrete bunkers (which until recently held a large number of small transports, speeder bikes, and AT-STs). The depot is at the foot of a moderate mountain chain, and on the only bedrock around. The area around the depot is marshy and filled with insects.

There is a large landing pad some distance from the depot upon which the *FarStar* is directed to land. There are a large number of field TIE racks on the landing pad, three of which hold TIEs, 22 of which stand empty. Alongside are four cargo shuttles, one of which is evidently undergoing repairs of some sort, since the engine pods are stripped off.

There is a small reception committee on the landing pad, standing at attention in the pouring, gusting rain which is whipping around the landing pad. The group consists of Colonel Heget, Major Danthe, and 10 troopers in the standard gray uniforms and black domed helmets of the Imperial Army. An additional cluster of men, including Lt. Palme and his men, are huddled under a tarp slung over one of the partially dismantled shuttle engines.

Any character with military experience making an Easy *Knowledge* roll will note that the troopers’ precision and discipline are at odds with their shabby, wilted surroundings — these are fighting men, not unit cast-offs. While the troopers are not armed (at Heget’s orders), some of the officers are carrying sidearms.



Dan & David Day

Heget greets the characters coolly, and after a few awkward pleasantries, invites them inside the depot complex for a meeting in more comfortable surroundings. The complex is a kilometer away by paved road, and three six-wheeled trams are idling by the field to take the party back to the depot.

■ Colonel Heget

Type: Imperial Army Colonel

DEXTERITY 4D

Blaster 6D+1, blaster: heavy blaster pistol 7D+1, blaster artillery 4D+2, brawling parry 5D+1, melee combat 5D, melee parry 6D+2, vehicle weapons 5D

KNOWLEDGE 2D+1

Intimidation 5D+1, law enforcement 2D+1, law enforcement: Imperial law 5D+2, streetwise 5D+2, survival 6D

MECHANICAL 2D+1

Ground vehicle operation 3D+2, hover vehicle operation 4D+1, walker operation: AT-ST 5D

PERCEPTION 4D

Command 6D+2, hide 4D+1, search 5D+2, sneak 5D

STRENGTH 3D+1

Brawling 5D, stamina 4D+1

TECHNICAL 2D

Blaster repair 3D, first aid 3D+2

Force Points: 2

Character Points: 22

Move: 10

Equipment: Blaster pistol (4D), comlink.

Capsule: Colonel Heget is a middle-aged man with tired eyes. His face is lined, but his expression is sharp and alert. He is in excellent health.

Heget is an old guard Imperial. Once entirely devoted to Palpatine's vision, Heget reached a point in his life where he tired of the endless rounds of backstabbing and political fratricide that is part of the Imperial culture.

He originally transferred out to Kathol sector to escape a particularly violent clash between two Moff's vying for his loyalties. He thought himself safe from such petty politicking, for surely no Moff with ambition would deign to rule such an isolated sector of space. Imagine his dismay at finding himself under Sarne!

Heget's refusal to fall into Sarne's orbit led to his posting at this tiny, miserable post. He is a living testament of Sarne's preference of loyalty over ability — Heget was once the major of one of the Imperial Army's highest decorated special missions battalions.

Heget has spent his two years on Shintel whipping the guards he was allotted into a prime fighting force. They are trained in wilderness survival, special recon, and AS-ST combat tactics. However, the close-knit community has been thrown into chaos by the introduction of Sarne's misfits and ideological rejects.

What separates Heget from Sarne and his ilk are honor and loyalty to his men.

■ Major Danthe

Type: Imperial Army Major

DEXTERITY 4D

Blaster 5D+1, blaster: heavy blaster pistol 6D+1, dodge

6D+1, vehicle blasters 5D

KNOWLEDGE 2D+1

Intimidation 4D+1, law enforcement 3D+1, law enforcement: Imperial law 3D+2, streetwise 4D+2, survival 3D

MECHANICAL 2D+1

Ground vehicle operation 3D, hover vehicle operation 3D+1, walker operation: AT-ST 4D

PERCEPTION 4D

Command 6D+2, hide 4D+1, search 4D+2, sneak 5D

STRENGTH 3D+1

Brawling 5D, stamina 4D+1

TECHNICAL 2D

Blaster repair 3D, first aid 2D+2

Force Points: 1

Character Points: 12

Move: 10

Equipment: Blaster pistol (4D), comlink.

Capsule: Danthe is one of Heget's young officers who accompanied him to the Kathol sector. He is a sun-tanned young man with close-cropped blond hair, and a ready smile (which is seldom directed at New Republic representatives).

Unlike his superior, Palme sees no merit in compromising with Rebels, and see his duty as restoring communications with the Empire at all costs, so Sarne can be stopped, or at least prevented from returning to Imperial space. He is careful not to openly disagree with Heget in front of the men, lest he undermine his commander's authority. He is more talkative amongst his fellow officers.

■ Lieutenant Palme

Type: Imperial Spy

DEXTERITY 3D

Blaster 5D+1 dodge 5D, grenade 4D, vehicle blaster 4D

KNOWLEDGE 1D+1

Law enforcement 2D, law enforcement: Imperial law 3D+2

MECHANICAL 1D+1

Repulsorlift operation 3D+2, walker operation: AT-ST 3D+2

PERCEPTION 2D

Command 3D

STRENGTH 3D+1

Brawling 4D+2, stamina 4D+1

TECHNICAL 1D

Force Points: 1

Dark Side Points: 2

Character Points: 13

Move: 10

Equipment: Blaster pistol (4D), comlink, shipjacking kit (+3D to *security* roll to break through a ship's physical system, See *Han Solo and the Corporate Sector*, page 121 for additional details).

Capsule: Lieutenant Palme is a young man with thinning blond hair and the beginnings of a bulge around his waist. Despite his appearance, Palme is a capable combatant, and Sarne's primary agent on Shintel. He has been here for several months now, and has gained the trust of the Colonel.

It is his duty to see that the doctored astrogation charts are uplinked to the *FarStar*. He is in command of four other men who were abandoned along with the others.

Depot Guards (10 Army Troopers). All stats are 1D+1 except: *Dexterity 3D, blaster 4D+1 dodge 5D, grenade 3D+2, vehicle blaster 3D+2, survival 2D+1,*

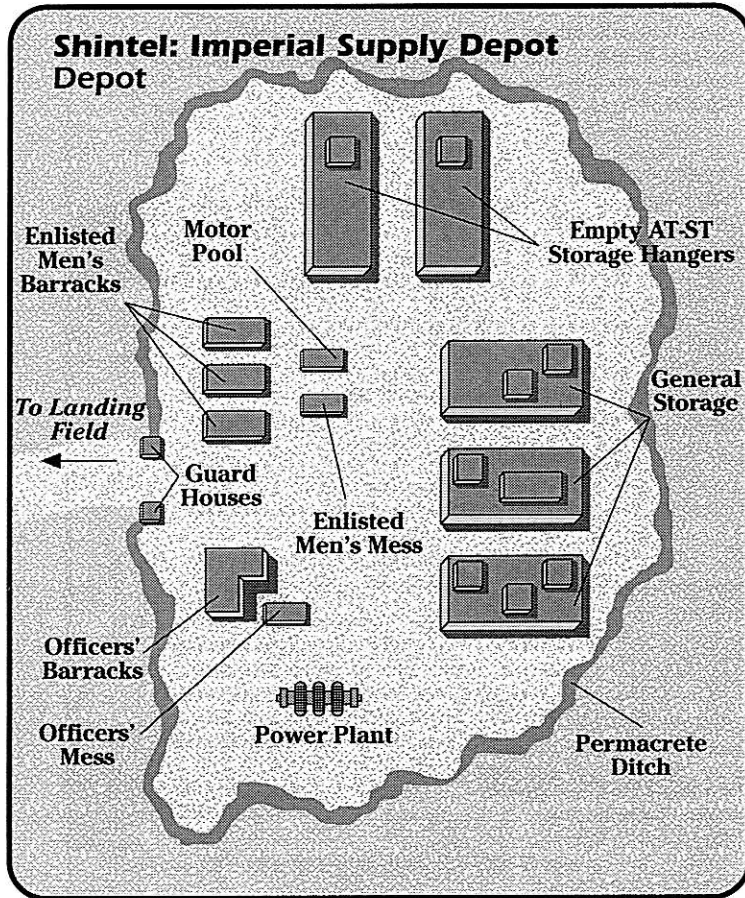

repulsorlift operation 2D+2, walker operation: AT-ST 3D, Perception 2D, Strength 3D+1, brawling 4D+2, stamina 4D+1. Move: 10. Equipment: Blaster rifle (5D), field armor and helmet (+1D physical, +2 energy), grenades (5D), helmet comlink, survival gear, utility belt with supplies. This equipment is standard issue — the soldiers on the tarmac are not currently carrying their weapons.

FAULT LINES

By the time the *FarStar* arrives, the stranded Imperials have fallen into two camps. The first camp, led by Major Danthe, holds that the Moff will ultimately return, and that his extreme measures must be seen as a necessary security precaution should the New Republic discover the depot before his return. This faction desires to press on with the construction as per orders. It is not very interested in dealing with the New Republic, but will tolerate the intrusion both because the New Republic has a superior military force, and because its members do not wish to openly antagonize the other camp.

The other camp, led by Colonel Heget, sees the betrayal for what it is, and does not wish to

devote now finite and precious resources to a fool's errand. This camp wants to devote itself to restoring a link to the outer universe, specifically to proper Imperial command channels. For the moment, the Heget faction has the majority.

Most of the Heget camp members are for peacefully negotiating with the *FarStar* in exchange for aid in getting off the planet. There is, however, a small splinter group, led by Lieutenant Palme, which believes that the Imperials should seize the *FarStar* by force. Heget is finding it increasingly difficult to control Palme's group.

To muddy the waters further, four of the men stranded are members of Sarne's personality cult who volunteered to stay behind to ensure the base remains unable to reconnect to the universe. These men are silent members of *both* camps, and quietly track what each is doing. Sarne's primary agent, Lt. Palme, is in command of these men. At his command, they have already sabotaged one effort to restore one hyperdrive, hence the dismantled shuttle on the landing pad.

Into this charged atmosphere walk our unsuspecting characters.

THE MEETING

The Imperials escort the characters into a meeting hall in the building housing the officers. Even with the air recyclers and dehumidifiers running full tilt, the air is thick and damp.

The Imperials do not beat around the bush. Heget tells the characters that Sarne has betrayed them and left them stranded in the system without hyperdrives. In exchange for transportation off the planet for a small delegation, the Imperials are prepared to give the *FarStar* crew information they obviously want — coordinates to Sarne's probable immediate destination.

The characters will be rightly suspicious of this offer, but it is entirely on the up and up. Heget knows enough of Sarne's plans to suspect that the shadowport *Tanquilla Beach*, only a few days away in hyperspace, might be Sarne's next destination.

Heget tells the characters that he will give them the coordinates if he and a single aide are given transport to that location so he can file a report with the Imperial representatives there, and arrange for the rescue of his men (he would ask for transportation back to Gandle Ott, but knows the characters would not agree to turn back and lose time).

This is Heget's only offer, and it is non-negotiable. He does offer to resupply the *FarStar* with whatever he can supply (which is just about everything that isn't too exotic, except hyperdrive components and weaponry).

THE SET UP

While the characters are resupplying the *FarStar* or otherwise preparing to depart, Captain Adrimetrum is approached by Lt. Palme, who asks for a moment in private. He tells her that Colonel Heget intends to lead the *FarStar* into a trap with his bogus coordinates. He, on the other hand, only desires to get off the planet and see his family again, and has the means of paying his way.

Palme fishes out a datacard and tells her that it contains a backup copy of Sarne's exploratory map of the Kathol sector, which Sarne had come here to erase. Palme had made a copy of the backup as Sarne's fleet dropped out of hyperspace. She is free to check it out at her leisure on her own nav computer — she can see for herself that the charts are authentic, and are encoded with Sarne's personal ID codes. Palme hands her the datacard, and tells her he trusts her not to forget him.

SABOTAGE

While Palme is meeting with Adrimetrum, his four agents are stealing aboard the *FarStar* via a cargo hatch, using Palme's shipjacking kit. Their plan is to quickly dismantle the hyperdrive motivator from one of the X-wings, and make off with it. They will actually be surprised if they get away with it — the idea is to cast doubt on Colonel Heget and sabotage his plans to get offplanet with the *FarStar* crew.

■ Sarne's Men (4)

DEXTERITY 3D+1

Blaster 6D, dodge 5D+1, melee combat 4D+2, melee parry 5D

KNOWLEDGE 2D

MECHANICAL 2D

PERCEPTION 2D

Command 4D+2, hide 4D+2, sneak 5D

STRENGTH 3D+2

Brawling 4D+2

TECHNICAL 2D

Space transport repair 3D, security 4D

Move: 10

Equipment: Blaster rifle (5D), blast vest (+1 physical, +2 energy to *Strength* to resist damage).

DEPARTURE

How the characters conclude their visit on Shintel is really up to them, and how they react to the various proposals and actions that have taken place. If they reject Palme's offer and do *not* uplink his datacard, no harm will come to them. They may take Heget to his coordinates, in which case they will find themselves in the immediate vicinity of the shadowport *Tanquilla Beach*. Proceed to Episode Two and continue with the adventure, making whatever adjustments are re-

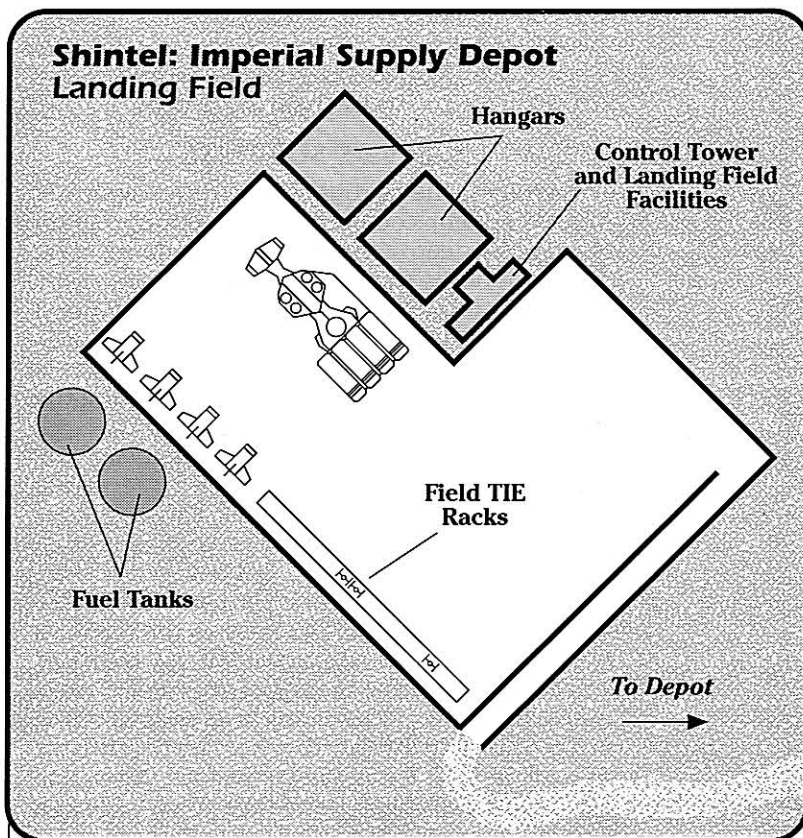

quired. Award the players a few extra Character Points for completely outwitting Sarne.

The gamemaster may alternatively opt to set off the boobytrap another way. Perhaps Palme transmits a message to the *FarStar*'s computers from the planet surface as it leave orbit.

It is rather unlikely, however, that the characters will resist the temptation of uplinking the datacard. For one thing, the datacard contains just what it seems to contain, a complex series of hyperspace coordinates formatted to be interpreted by a nav computer. They are coded with Sarne's personal ID codes, matching those he had used as Moff. If Palme's bribery attempt is brought to Heget's attention, he will throw the man in the brig, but he too will pronounce the datafile authentic.

That is because it *is* authentic. Sarne formatted it himself. It is an extremely accurate map of the next several parsecs of space, actually drawn from Sarne's own charts.

It also seemingly provides coordinates to a myriad of systems beyond Kathol sector, all humming with Imperial activity. One system is actually designated D.Star *Emperor's Revenge* Site One, and another D.Star *Emperor's Revenge* Site Two. Sarne has a twisted sense of humor. The sites aren't real, the Imperial holdings aren't real,

and the hyperspace coordinates are corrupted variations of existing Coreward systems (i.e. useless). Sarne figures the Rebels deserve a big scare before he leaves them in his dust.

SARNE'S SURPRISE

As soon as the astrogation charts are uplinked into the *FarStar's* computer, a trapdoor program is activated deep within *FarStar's* computer core. The trapdoor is skillfully designed. There really is no way of detecting it without very specialized software hooked into the ship computer — software the *FarStar* crew does not possess. There is a *slight* chance that a character monitoring the uplink electronically will detect a slight interruption in the data flow (a Difficult *computer programming/repair* roll will allow this observation to be made), but that will tell the character nothing useful, and may well be written off as a translation glitch.

The trapdoor program is designed to disable the hyperdrive engines. As soon as the *FarStar's* hyperdrive engines are activated, an overload spiral mounts within the hyperdrive coils, causing them to burn out violently in a sudden release of energy, while the ship drops immediately back to realspace. The explosion envelops the engine room, and characters there take 4D damage as a result of the flash fire and oxygen loss.

The hyperdrive engines are a total loss — the hyperdrive buffer components are completely fried. Anyone making a Moderate *capital ship repair* or *computer programming/repair* roll will be able to determine what happened: a boobytrap within the ship was activated when a file containing Sarne's ID code was uploaded without an

appropriate countercode. The end result is that the *FarStar* is now stranded in a system with no hyperdrive replacement parts. But that, of course, isn't the worst of it.

THE TRAP

As the characters try to figure out what happened to them, the *Steel Fist* arrives in system to do battle with the *FarStar*. This is Sarne's second stage of the trap — not content with the idea of stranding the Rebels in an isolated system for the rest of their lives, he sent the bounty hunters a message telling them that they would find easy pickings in the Shintel system.

If the characters are smart, they will remember the ion mines, and duck back down into the gravity well below the mines. If the *FarStar* pilots make a Moderate *capital ship piloting* roll, they can maneuver through the window they made in the mines earlier, and probably lead the bounty hunters into the path of an ion mine or two.

Otherwise, the *FarStar* crew may repel the attack as best they may where they are. The *Steel Fist* will make a few lightning-fast attacks, and fade back into hyperspace as soon as the *FarStar* begins to rally. If the characters are having too rough a time of it, they might be bailed out by either Heget, who orders his TIEs into the fray, or Ned'Ix, who has tracked the *FarStar* crew down at last.

EVERY WOOKIEE HAS HIS DAY

Colonel Heget will not be pleased with the turn of events. He will be even less pleased if anyone even hints at the suggestion that he sabotaged the ship. Lt. Palme is seemingly equally shocked:

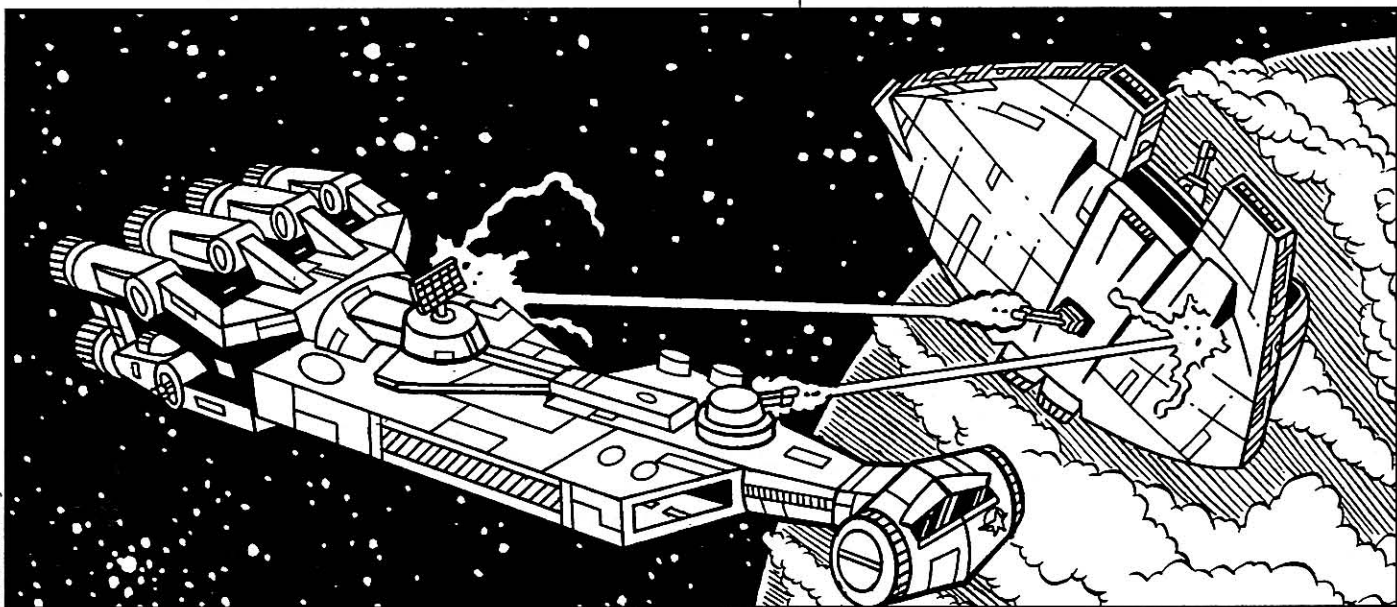

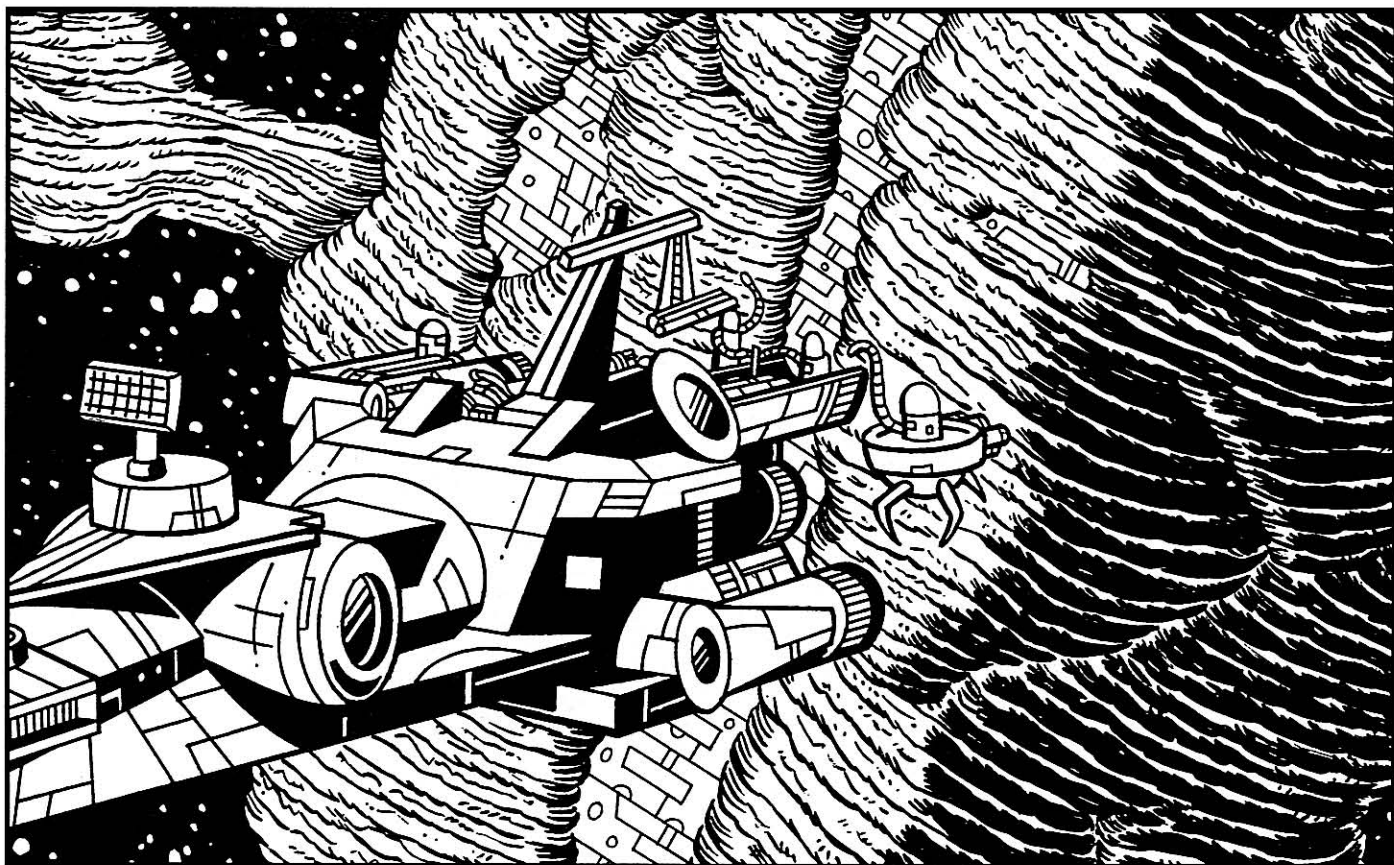

Dan & David Day

he says he had no idea the ship was boobytrapped. *His* data was perfectly good.

There are two basic courses for action.

Sending the X-wings for help. The X-wings still have functioning hyperdrive engines. The characters may opt to send an X-wing or two back to settled space for replacement parts or a rescue ship. This will take time and leave the *FarStar* stranded in an Imperial system which may at anytime see Sarne's return.

If the characters decide on this approach, Cadwell will be aboard the rescue cruiser, eager to plaster all over the newsnets the news that the vanguards of the mighty New Republic had to be rescued by Imperial forces. Alternatively, they may go on to *Tanquilla Beach*. While the X-wings are gone, of course, the *FarStar* must contend with the *Steel Fist* alone.

Jury-rigging the *FarStar*. The second, more practical, alternative involves stripping parts from the X-wing hyperdrive engines to jury-rig a temporary repair to the Corvette's engine (Lofryyhn thinks he can do it). This will get the *FarStar* and its entire complement out of the system, but will render the X-wings incapable of

entering hyperspace until the parts can be restored. The ships are still fully functional in realspace, of course.

The repair will require six hours on the ground, with both the *FarStar* and the X-wings grounded, and five more hours during which the *FarStar* and fighters are free to fly in normal space. The repairs require two Moderate *starfighter repair* rolls, and two Difficult *capital starship repair* rolls. Lofryyhn may either attempt the repairs himself, or direct others in the repair (in which case he can use his *command* skills to increase their chances of success).

Sarne's astrogation charts are still in the nav computer. Lofryyhn stresses that the jury-rigged repairs are short-term solutions only. They will not hold together long enough to get back to Gandle Ott. The only location featuring starship repair facilities within reach is *Tanquilla Beach*, a shadowport nearby. *Tanquilla Beach* appears on Sarne's charts, as well as the charts of Brandy MacMillian (from "Death is Remotely Possible"). Finally, Khzam knows how to get to the shadowport — if he feels like talking. He's known in the slave markets there.

EPISODE TWO: TANQUILLA BEACH

■ Tanquilla Beach

System: Between systems in Kathol sector
Starport Type: Standard class
Traffic: Moderate
Control: Controller
Landing: Tractor beam
Docking Area: Docking bays
Docking Fee: varies (see below)
Customs: Local inspection
Services: Food, lodging, repair, entertainment

TANQUILLA BEACH

Tanquilla Beach is a major shadowport in the Kathol sector, located just within a small nebulae located in one corner of the sector. Beyond *Tanquilla Beach*, there is no need for a smuggler's secret base — the wilds beyond Kathol sector are so unsettled the smugglers can go about their business in the open.

Tanquilla Beach isn't much of a beach, actually. Its name grew out of a joke about the huge amount of sunlight the shadowport gets — though it is far from any star, the bright light of the nebulae illuminates it from all sides.

The shadowport was once the site of a major mining operation in a major system near Gandle Ott. A large processing base was established on the asteroid to mine both *Tanquilla Beach* and nearby asteroids, and when the miners exhausted the local resources, they moved on, leaving the gutted rock to an outlaw-tech group. This group somehow got it transported out to its present location about a century ago.

Tanquilla Beach, set up to service the technical needs of pirates and smugglers, quickly became one of the main smuggler roosts in the sector, one specializing in high technology. Over the years, the tech group built up the existing structures, and filled the huge caverns and mining shafts within with buildings and living complexes to support the growing businesses and personnel needed to serve a growing clientele. It's difficult to see much of the asteroid today. The external surfaces are plated in metal and plastics, and have grown out beyond the original surface by as much as 10 meters in spots.

■ Bequesh, "The Cardinal"

Type: Station Administrator
DEXTERITY 1D
KNOWLEDGE 4D
 Alien species 7D, bureaucracy 5D+1, business 6D, business: *Tanquilla Beach* 9D+2, cultures 5D, intimidation 7D, languages 7D, planetary systems 4D+1, streetwise 5D+2
MECHANICAL 2D+1
PERCEPTION 4D+2
 Bargain 7D, command 10D+1, con 8D+1, value 10D

STRENGTH 1D
TECHNICAL 3D

Computer programming/repair 3D+1, droid repair 4D, security 5D

Force Points: 4

Character Points: 26

Move: 3, 10 (in hover chair)

Equipment: Expensive clothing, datapad, comlink

Capsule: Bequesh is a tremendously old man who sits stooped in a hoverchair. He is essentially a mass of wrinkles topped with a shock of snow-white hair. Bequesh favors expensive but tasteful robes and sashes.

Despite his great age, Bequesh is still the unquestioned master of *Tanquilla Beach*. He is the sole survivor of the group of renegade techs who founded the *Beach*, and reportedly the only one left who knows all of its secrets.

Bequesh still has an active hand in the day-to-day operation of the station, and can be seen gliding from one end of the station to the other, accompanied only by his aide and bodyguard, Hella Brün. He presides over most of the station trials, which is enough to deter most "entrepreneurs" who are tempted to break some of the *Beach's* iron-clad rules — Bequesh is not an especially merciful man.

■ Hella Brün

Type: Chief Bodyguard

DEXTERITY 3D+2

Blaster 6D, brawling parry 5D+1, dodge 4D, melee combat 5D, melee parry 6D+2

KNOWLEDGE 2D

Alien species 4D, bureaucracy 3D+1, business 3D,+1 business: *Tanquilla Beach* 5D+1, cultures 5D, intimidation 8D, streetwise 4D+2

MECHANICAL 2D+2

Capital ship gunnery 4D+2, capital ship shields 5D

PERCEPTION 3D

Bargain 5D+1, con 8D+2, gambling 6D+2, hide 5D, search 5D+2, sneak 5D

STRENGTH 3D+2

Brawling 4D+1, brawling: martial arts 7D+1

TECHNICAL 3D

Demolition 4D, security 5D

Special Abilities:

Pressure Points: Brün knows a special form of martial arts designed to inflict pain without permanent injury. When rolling damage, add +2D to Brün's *Strength*, but treat it as stun damage.

Force Points: 1

Character Points: 9

Move: 10

Equipment: Blaster pistol (4D), comlink, datapad

Capsule: Brün is a tall woman with sharp features and a guarded smile. She has been Bequesh's chief bodyguard for two decades now, and has saved his life innumerable times. Brash and self-assured in her professional persona, Brün is actually a shy woman in private.

■ Tanquilla Beach

Craft: Unique

Type: Space station

Scale: Capital

Length: 900 meters tall

Crew: 1,200, gunners: 85, skeleton: 400/+10

Tanquilla Beach Shadowport

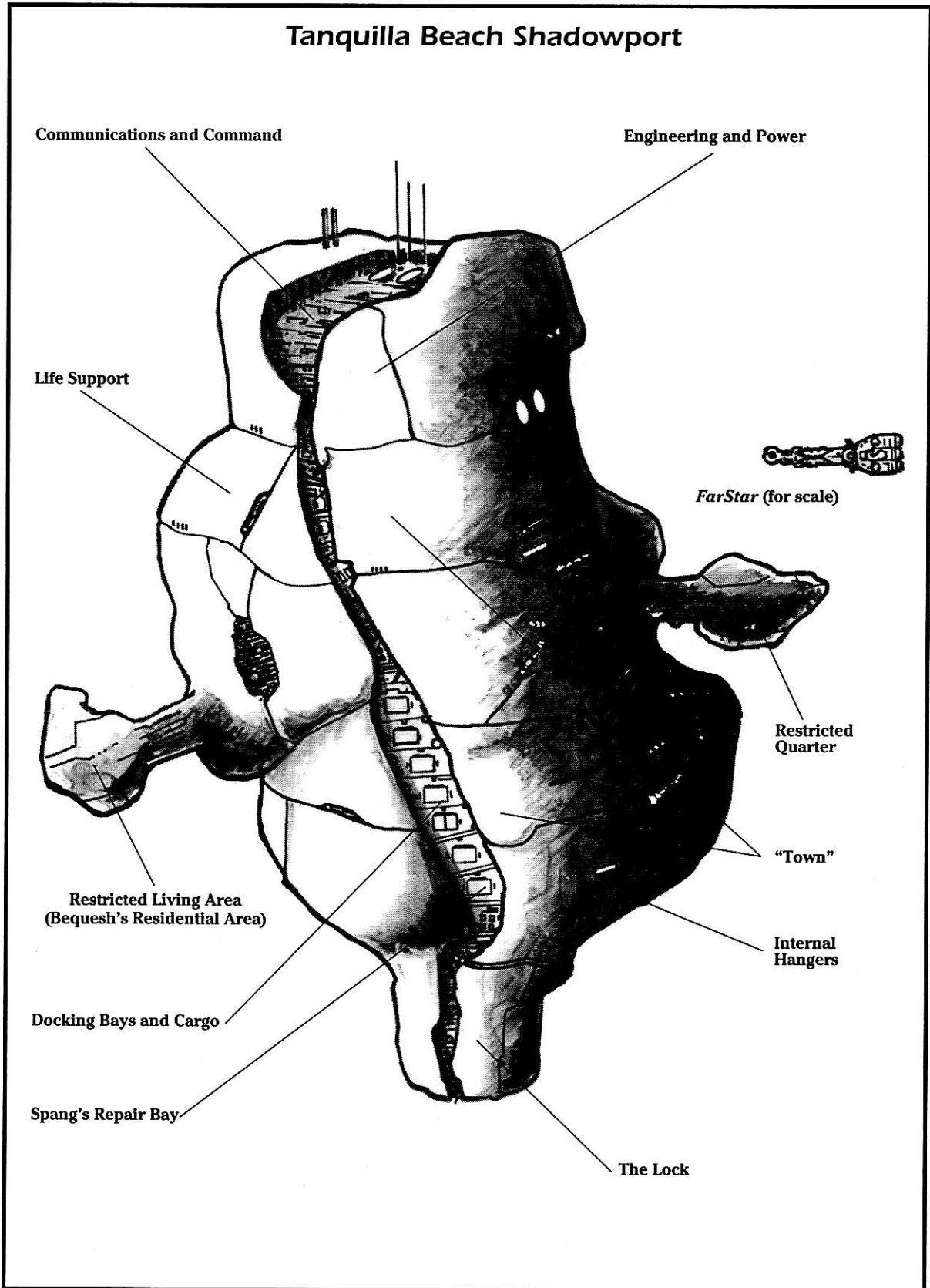

Brian Schomburg

Crew Skill: Capital ship gunnery 4D, capital ship shields 4D, sensors 4D+1

Passengers: 7,000

Cargo Capacity: 800,000 metric tons

Consumables: 1 year

Hull: 4D

Shields: 7D

Sensors:

Passive: 75/1D

Scan: 150/2D

Search: 300/3D+2

Focus: 9/5D

Weapons:

80 Turbolaser Batteries

Fire Arc: 20 front, 20 back, 20 right, 20 left

Crew: 1

Skill: Capital ship gunnery

Fire Control: 1D

Space Range: 3–15/35/75

Damage: 7D

20 Ion Cannons

Fire Arc: 5 front, 5 back, 5 right, 5 left

Crew: 1

Skill: Capital ship gunnery

Fire Control: 4D

Space Range: 1–10/25/50

Damage: 4D

10 Tractor Beam Protectors

Fire Arc: 3 front, 3 back, 2 right, 2 left

Crew: 1

Skill: Capital ship gunnery

Fire Control: 4D

Space Range: 1–5/15/40

Damage: 9D

Capsule: *Tanquilla Beach* packs quite a punch for a mere spacer station. Boasting a generous number of turbolaser batteries procured from Imperial shipyards, it can fight off any single ship smaller than a Star Destroyer, and hold off entire fleets made up of lesser craft. The *Beach* also maintains a defense force of five X-wing fighters, and eight Skipray blastboats.

DOCKING AND CUSTOMS

As the *FarStar* reverts from hyperspace, the ship shudders as the hyperdrive engines blow with a faint thump. It is several moments before any sense can be made of Lofryyhn's frustrated howls, but eventually he manages to calm down enough to communicate the gist of the news — the remodulating buffer heatsink has just blown on the hyperdrive engines. The *FarStar* isn't going *anywhere* without some serious attention. While Lofryyhn is a miracle worker, he reports that the engine are now out of his hands. They need serious attention from a qualified hyperdrive specialist.

The characters find themselves just inside the hazy borders of a milky-white nebulae. The entire starfield is brilliantly illuminated. Unfortunately, the sensors show no sign of an inhabited world or space station, though that could be attributed to the large amount of background noise generated by the nebulae. Khzam looks fairly worried. He swears he's talked to plenty of people who've been out here.

As the *FarStar* moves uncertainly further into the system, the ship's comm beeps twice, and after a brief burst of static, a tinny recorded voice begins to broadcast over all hailing frequencies:

“Attention incoming vessel. You have entered a restricted area. You will broadcast your electronic and visual identification and statement of intent on frequency 934A-3B. Please maintain present course until further notification. You are being tracked by our main batteries.”

After a brief exchange, the *FarStar* is sent docking instructions and coordinates to the station. The *Beach* is surrounded by dozens of large ships.

There are dozens of docking bays down the length of the *Beach*, ranging from small private bays to the huge central bays designed to hold a large number of smuggler craft. There are no docking provisions for capital ships and bulk cruisers. Ships like the *FarStar* must position themselves in an assigned sector of space some distance away and use a pinnacle to get to the station (there are a number of space taxis flitting about the station who service the parked ships as well).

Customs is not the cakewalk one would expect from an outlaw spaceport. The Cardinal's boys and girls take their jobs seriously. They don't particularly care what a spacer brings aboard the *Beach*, but they do want to know about it.

The penalty for holding out on security is immediate expulsion from the station, and a permanent ban from returning. And it's no use trying to pull anything on smugglers on guard duty. They've not only seen it all before, they've *done* it all before.

Personal weapons are permitted within the station, but grenades, tripod blaster cannon, and anything else which could be used to threaten the station from within (such as cannisters of lethal biowar cultures) may only be taken into the Lock, a huge cavern at the bottom of the station which is sealed from the rest of the station and is only assessable from outer airlocks.

Docking fees vary from a few 100 credits a day for using the smaller bays to 1,000 credits a day for using the larger ones with magnetic airlock fields. The *FarStar* is charged the standard rate for capital ships in a parking orbit, 1,000 credits a day. Shadowports are not cheap, but they are priced according to the amount of money that flows through them — often billions of credits a year.

The *FarStar* officers will be invited to dine with the Cardinal while on the station. He is curious to discover why a New Republic ship is this far out of its nominal territory, and wishes to determine whether it poses a threat to his operations.

SLAVERS AND THE FARSTAR CREW

There are a number of characters aboard the *FarStar* who have rather strong feelings about slavery. Khzam, as a former slaver, is known in these parts, and knows that his old mates are not above telling the New Republic what they know of his background for a few credits.

Of the former slaves in the crew, Qesya will likely not get involved in any foolhardy schemes unless there are fellow Sludir on the blocks. Gunthar is not bright enough to care one way or the other, though he will probably follow Qesya's lead.

Lofryyhn is the one to worry about. Should he discover that there is a slave market on the *Beach*, he might feel obliged to do something about it. Keeping him absorbed in repairing the *FarStar* and ignorant of the slavers will probably be Adrimetrum's primary diplomatic task while docked at the *Beach*.

Tanquilla Beach Security. All stats are 2D except: *Dexterity* 2D+2, *blaster* 4D, *brawling parry* 5D, *dodge* 3D, *melee combat* 4D, *melee parry* 3D+2, *streetwise* 3D+1, *streetwise*: Tanquilla Beach 5D, *willpower* 4D, *repulsorlift operation* 2D, *starship piloting* 3D, *starship gunnery* 3D+2, *con* 3D, *investigation* 4D, *investigation*: Tanquilla Beach 6D+1, *search* 5D+1, *sneak* 4D+1, *brawling* 3D, *security* 3D+2. Move: 10. Equipment: Blaster pistol (4D), comlink, protective vest (+1 to *Strength* to resist damage)

COMMODITIES

Tanquilla Beach has 15 levels of designated open trading space. Spacers often buy floor space in one of the large open bazaars located on each of these levels, and sell their cargoes directly from the floor. Other merchants use the bazaars to sell droids, illegal ship parts and weapons, food, and so on. The infamous Level 12, the meat market, is a level many spacers avoid.

The Slavers Market. There aren't many smugglers who feel comfortable dealing in slaves, but those who do have to buy and sell them somewhere. Shadowports are the *de facto* places to make these transactions, and the *Beach* is no exception. Level 12 is devoted entirely to the buying and selling of slaves. While most of the slaves brought to the *Beach* are aliens, Human slaves have also been seen leaving in the company of Hutts. It is a good idea not to lose your last credit while on the *Beach*.

FIXING THE TRAPDOORS

While running preliminary diagnostics on the engines, Fia detects traces of the trapdoor circuitry which caused so much chaos. She tells Adrimetrum that while she can fix the engines and remove the trapdoors which caused the hyperdrive blow-out, she doesn't have the technical background and know-how to hunt for more. And she is relatively sure that there are more.

However, Spang, who has ducked in to check on Fia's work, says that some of the characteristics of the trapdoors remind him of some work he saw on Pembric II once. He suggests that Adrimetrum check in with a guy named Drake at one of Pembric II's spaceport taverns if she wants to ensure that this sort of thing won't happen again. Drake knows people who would know how to track down this sort of stuff better than the splicers who hang around the *Beach* (this is a lead-in to the next adventure — see "*Crisis*" for more details).

SERVICES

The *Beach* offers all of the services one would expect of such an establishment — crashspaces and luxury accommodations alike, bars, gambling halls, tattoo parlors, slicers and cyberdocs for hire, mechanics and techs, and so on. There are a number of repair bays where ships may be maintained and modified, but only one facility has the resources to handle a capital ship, Spang's.

Spang's. Spang's specializes in extensive re-design of existing starship systems of all sorts. It fills the largest repair bay in the entire space station. This is where Spang works his miracles. People whisper the old man has a pipeline into some of the Empire's top R&D labs. This may or may not be true, but Spang's work is definitely first rate, and some of his improvements border on genius.

There have been plenty of attempts to work Spang out of his prime spot, both financial and criminal, but those stupid enough to lean on cheerful old Spang don't quite realize what they're taking on — Spang is the man who procured and installed *Tanquilla Beach's* armaments, and as far as the Cardinal is concerned, anyone messing with Spang is messing with *him*. Not that Spang has trouble justifying his use of the bay — he usually has a list of ships waiting to put in for repairs several months long.



Dan & David Day

Unfortunately, Spang is far too busy to help the *FarStar* crew, and won't even consider seeing its representatives. This will be an uncomfortable moment for the crew, since he is the only source of capital-scale hyperdrive parts in parsecs.

However, if he is hounded by ConJob to help out Adrimetrum, he will relent slightly. His granddaughter, Fia, has come to intern with him, only months out of Corellia University's School of Starship Engineering. She is only 19, but a natural when it comes to hyperautics. The *FarStar* crew might balk at having someone so young rooting around in their engines, but they don't have much choice.

The repairs will take two weeks, and take the *FarStar* out of commission for at least a week of that time, while the engines are removed one level at a time and moved into a portable drydock Fia has maneuvered next to the ship. Fia will accompany the *FarStar* on a trial run through neighboring systems to observe the engines in action and make final adjustments before pronouncing the ship fully functional.

As far as the cost is concerned, there is some good news and some bad news. The good news is that Fia has managed to upgrade the engines significantly — the *FarStar's* hyperdrive multiplier is now x1. The bad news is that the repair fee is 50,000 credits, which is on the cheap side. Spang knocks the price down to 45,000 credits if the ship is a registered CMG vessel, on Fia's insistence, but otherwise the price is non-negotiable.

■ Spang

Type: Starship engineer
DEXTERITY 3D
 Running 4D

KNOWLEDGE 2D+1

Bureaucracy: *Tanquilla Beach* 6D+2, business: starship repair 7D, languages 4D, value 8D

MECHANICAL 3D

Capital ship piloting 6D, space transports 4D

PERCEPTION 3D

Bargain 5D, con 4D+2, hide 5D, persuasion 6D+1

STRENGTH 3D

TECHNICAL 4D+2

(A) Capital ship engineering 5D, capital starship repair 8D, computer programming/repair 6D, space transports repair 7D+1, starfighter repair 7D+2, starfighter weapon repair 8D

Force Points: 3

Character Points: 17

Move: 10

Equipment: tool-filled workbelt, datapad, comlink

Capsule: Spang is a short, grubby old man with a fat beaming moon of a face. He is usually clad in greasy trousers and an equally filthy undershirt, and tools all but spill out of the huge leather utility belt slung at his belt. Spang is compulsive, and tends to get lost in his work. He is very protective of his granddaughter, and not very sure letting her stay on a shadowport is a very good idea.

■ Fia

Type: Starship Engineer

DEXTERITY 3D

Dodge 4D, melee parry 5D

KNOWLEDGE 3D

Business 3D+2, cultures: Corellians 4D+2, languages 4D, value 4D

MECHANICAL 3D

Repulsorlift operation 4D, space transports 4D+1

PERCEPTION 3D

Bargain 4D+2, persuasion 5D+2

STRENGTH 2D

TECHNICAL 4D

(A) Capital ship engineering 2D, capital ship repair 6D, computer programming/repair 4D+2, space transports repair 5D+1, starfighter repair 6D, starfighter weapon repair 5D

Character Points: 12

Move: 10

Equipment: tool-filled workbelt, datapad, comlink

Capsule: Fia is an attractive young woman of 19. She wears her brown hair short, and is usually clad in grease-stained coveralls. Fia is a real flirt, and loves to tease the starship drivers who hang around the hanger. Though friendly, Fia is very defensive of her professional abilities — there is no quicker way to lower the temperature in the room than imply she is too young or worse yet, too *female* to be a competent engineer. Fia is somewhat sympathetic to the New Republic, but won't consider accompanying the *FarStar*.

ConJob's Trifles. ConJob has a small stand just inside the main intercourse on level two, where he sells flowers he grows himself in a small hydroponic garden in his quarters.

ConJob makes a nice enough living as a florist, actually. People who spend weeks at a time shut up with nothing to look at besides blackened rock and old bulkheads are drawn irresistibly to the bright and colorful plants which remind them of bright sunny days on their homeworld, or dark, methane fog-banked ones, as the case may be. Even hardened pirates with the death sentence in hundreds of systems have been seen creeping away from his stand cupping a small dewy gigglebud in their thick, calloused fingers, glaring wildly about as if to dare passers-by to comment.

But as lucrative as the flower business is, ConJob's real line of work is somewhat different — he's the local infochant and newsnet code dealer. If something remotely interesting is going down anywhere within light years, ConJob is sure to know of it. He seems to know the business of everyone visiting *Tanquilla Beach*, and for the right price, will match buyers with sellers, and vice versa.

He charges top credit for his codes, since he has to have a private courier droid run the public network feeds out from Gandle Ott (regular distributors do not service the station). He will warn customers that as far as they are from the Core, news will be days or weeks old by the time they get it. He has access codes for Cynabar's Infonet, but will only sell them to smugglers who come recommended by current members.

ConJob frequently entertains himself by practicing out in front of his stand with an antique lightsaber he obtained long ago (he won't go into it). He lacks the innate talents which turn the weapon into a veritable wall of death in the hands of a Jedi, but he is fairly proficient in the most basic defense and offense moves.

A FLOWER, MY DEAR

As soon as ConJob sees Captain Adrimetrum enter his domain, he will rush out from behind his counter, and offer her a starburst plant in full bloom with a flourish and a bow, and kiss her hand. "I had family on Siluria III" is all he will say. This shamelessly romantic display will embarrass Adrimetrum to no end, but she has won an important friend. ConJob is drinking buddies with Spang, and will lean on his friend to cut the *FarStar* a deal. He may also prove to be an important source of information and intelligence in future adventures, should the characters return this way.

ConJob

Type: Infochant

DEXTERITY 3D

Blaster 4D+1, dodge 4D+1, lightsaber 3D+2

KNOWLEDGE 3D

Alien species 5D, bureaucracy 4D+2, bureaucracy, business 7D+1, business: newsnets 8D, cultures 5D, languages 6D, streetwise 7D, streetwise: Kathol sector: 10D, streetwise: *Tanquilla Beach* 12D

MECHANICAL 2D+1

PERCEPTION 4D

Bargain 8D, command 5D, con 7D, gambling 6D+1

STRENGTH 3D

TECHNICAL 2D+2

Computer programming/repair 6D, security 5D+2

Character Points: 14

Move: 10

Equipment: Holdout blaster (3D+2), datapad, lightsaber

Capsule: ConJob is a tall, lanky man with closely cropped black hair and thick spectacles. He is an impulsive man, and something of a romantic. Some say he was a professor before the Empire ran him out of civilized space, while others think he was a cop.

ConJob himself has nothing to say about his past, though some of the rumors are true — he used to live on Siluria III as a media director, and lost his family during one of the many violent reprisals inflicted on the populace by the Governor. ConJob recognizes Adrimetrum as one of the former Rebel guerrillas immediately.

SARNE'S ATTACK

While the *FarStar* is down for repairs, one of Sarne's cruisers appears in the system to wreak havoc with the space station. Sarne has heard from the Qulok's Fist gang that the *FarStar* escaped, and he has reasoned that they must be at the *Beach*, especially since he all but left directions to the place on his charts. He has ordered the captain of one of his older Carrack cruisers to strike at the ship and fade back into hyperspace.

Unfortunately for the captain, while Sarne knows a lot about what goes on at *Tanquilla Beach*, he doesn't know nearly enough about its armaments, which are more than a match for one Carrack cruiser. The *FarStar*, though under repairs, may still launch its fighters and power up its weapons. Between the *FarStar* and the *Beach's* fighters and weapons, the Carrack doesn't stand a chance.

■ Carrack Light Cruiser

Craft: Damorian Manufacturing *Carrack*-class light cruiser

Type: Light cruiser

Scale: Capital

Length: 350 meters

Skill: Capital ship piloting: Carrack

Crew: 1,007, gunners: 85, skeleton: 500/+10

Crew Skill: Astrogation 3D+2, capital ship gunnery 4D+2, capital ship piloting 4D+1, capital ship shields 4D, sensors 4D+1

Passengers: 142 (troops)

Cargo Capacity: 3,500 metric tons

Consumables: 1 year

Cost: Not for sale

Hyperdrive Multiplier: x1

Hyperdrive Backup: x2

Nav Computer: Yes

Maneuverability: 2D

Space: 8

Atmosphere: 365, 1,050 kmh

Hull: 5D

Shields: 2D+2

Sensors:

Passive: 30/0D

Scan: 50/1D

Search: 100/2D

Focus: 4/3D

Weapons:

10 Heavy Turbolasers

Fire Arc: 2 front, 3 right, 3 left, 3 back

Crew: 3

Skill: Capital ship gunnery

Fire Control: 1D

Space Range: 3-15/35/75

Atmosphere Range: 3-15/35/75 km

Damage: 7D

20 Laser Cannons

Fire Arc: 4 front, 4 left, 4 right, 4 back

Crew: 2

Skill: Capital ship gunnery

Fire Control: 3D

Space Range: 1-3/12/25

Atmosphere Range: 100-300/1.2/2.5 km

Damage: 2D

5 Tractor Beam Projectors

Fire Arc: 1 front, 2 left, 2 right

Crew: 3

Skill: Capital ship gunnery

Fire Control: 2D

Space Range: 1-5/15/30 km

Atmosphere Range: 1-5/15/30 km

Damage: 4D

CRISIS

Captain Kaiya Adrimetrum stared out at the expanse of the Pembric system. The Pembric region, a favorite of smugglers and pirates, was an uninspiring view to say the least. The muddy-brown color of the vast Pembric asteroid belt reflected harshly in the light of the system's sun, throwing gloomy, odd-colored shadows around the bridge of the *FarStar*. *What a desolate hole*, Adrimetrum thought grimly, smoothing back an unruly lock of prematurely graying hair. *No wonder the Empire never really policed the region; who would want the bloody place?*

"All right ... Colton, isn't it?" Captain Adrimetrum sighed, settling back in her command chair. "Let's have the bad news."

Petty Officer Colton, one of the *FarStar's* few regular Navy men, presented a datapad depicting electronic schematics of the *FarStar*. "We've swept the ship systems five times, ma'am, and picked up two electronic boobytraps in the life support systems, and one in communications. We don't know what triggers them, and have made no attempt to disarm them."

Adrimetrum frowned. "Why not? Would that set them off?"

Colton paused to gather his thoughts. "Fact is, ma'am, we don't know, and Sergeant Lofryyhn is reluctant to find out the hard way. Sarne must have laid dozens of failsafes to prevent anyone but his loyalists from using the ship. We're afraid that if we attempt to disarm these traps, we'll probably trigger another one of his little surprises."

"And, of course, there is no guarantee that we've found them all. Wonderful." Adrimetrum rubbed her eyes a moment, and tried to imagine what incidental action by her crew, like turning on a galley stove, might blow the engines again, or worse. *Where are you, Ciro?* She opened her

eyes and turned to face Colton. "What is Sergeant Lofryyhn's recommendation?"

"Sergeant Lofryyhn makes the ... strongest possible recommendation that we lay over until we can have the ship's systems checked, ma'am. He says that if the *Beacher* engineer was right, Pembric II is probably the best place to find the folks who installed this system for Sarne, or at least know something about it."

"I'm sure you put it more diplomatically than he did." Adrimetrum grinned ironically. "Dismissed, Colton. Tell Lofryyhn to sit on those boobytraps awhile longer. We'll take care of them before too long."

Adrimetrum sat back in her chair with a gusty sigh and stared out the viewport at the muddy belt. "Well, that's decided that, gang. Somewhere on Pembric II is a tech crew with our name on it." A slight cough from behind the Captain's chair drew her attention. "Yes, Loh'khar? What can I do for you?"

"Ah, Captain," the Twi'lek moved forward, smiling broadly, "the question is, what can I do for *you*? I have, perhaps, shown some slight ability to locate desired items, and desired people as well, in the past."

Ah, the joys of command, Adrimetrum grimaced inwardly. "And, of course, you know exactly where to locate the people we need?"

The Twi'lek's grin broadened considerably, as his eyes narrowed with avarice. "Most assuredly, Captain. Our good Master Spang at the *Beach* suggested starting with a fellow named Drake at one of the spaceport taverns, did he not? I require no further leads."

"I know I'm going to regret this," Adrimetrum groaned, "but carry on. Get me what we need. I don't like sitting on a time-bomb, Finder."

ADVENTURE BACKGROUND

After repairing the *FarStar's* hyperdrive systems, the *FarStar* crew has proceeded directly to the Pembric system, in the hopes of finding there

the techs who can eliminate the boobytraps they know Sarne has embedded in their vessel.

The Pembric region has always been somewhat isolated by its large and erratic radiation fields and a fairly dense asteroid field. As a result, Pembric has been a favorite haunt of smugglers and criminals attempting to avoid the authori-



Brian Schomburg

ties. Dajus and Thyte have expressed doubts that this is the best place to find the techs they need on that basis. Khzam, curiously, has not offered an opinion. Loh'khar, of course, is all for it, and can provide a relatively comprehensive overview of the planet (see below).

However, Adrimetrum trusts Spang, and he has referred her to Drake on Pembric II. That Lofryhn's search uncovered several more boobytraps further has impressed her with the need to have her ship gone over as soon as possible.

PEMBRIC II

Pembric II was originally intended as a colony world, a meteorite-scarred ball of rock that had been terraformed to suit the needs of an agricultural colony. Unfortunately, haphazard and careless procedures in the terraforming process have made the planet habitable, but unpleasant. The temperature is extremely warm, and a drizzling, misty rain constantly bathes the surface. The boggy terrain is unsuited for agriculture, and only extremely difficult engineering efforts made construction of the spaceport and surrounding city possible.

The planet did not have many assets, but it did make the most of what it had, mainly spectacular beaches and other scenic features, including an awe-inspiring field of volcanoes. This wasn't enough to build a proper tourist industry around, of course, since Pembric II is so far removed from galactic civilization, but savvy operators did manage to attract a certain clientele who found more conventional tourist locales too legally restrictive. Pembric II became, in other words, a gangster's resort.

A series of cantinas, museums and other entertainment facilities sprang up, attracting a more orderly criminal element, supplanting the unruly cutthroats and rough settlers that originally settled the area. The planet's corporate government was willing to look the other way while criminal acts like black marketeering and smuggling occurred, as long as the credits continued to pour into the economy. Over time, Pembric's Security Legion became well-known for corruption and graft.

When Moff Sarne took control of the planet, it was used mostly as a mining outpost, exploiting the hfredium deposits in the system's large asteroid field. The criminal tourist industry began to flag a bit under the new Imperial presence, not

surprisingly, and the industrial activity went a long way toward ruining Pembric II's beachfront property. The raw ore culled from the orbiting asteroids was processed on Pembric II and shipped to Imperial arms manufacturers.

Pembric system remained fairly corrupt under Sarne's rule; for reasons of his own, the Moff preferred to let the Pembric system remain on the shady side of the law. He found it useful, for example, to have a pipeline into the underworld, and occasionally used the region as a training ground to hone the skills of his troops and intelligence agents (though his "crackdowns" on the region were infrequent and far from all-encompassing). It is rumored that Sarne had an uneasy alliance with the Bombaasa Cartel, a shadow organization of criminals which had a lot of pull even when the Empire was running things.

Just recently, with Sarne's departure, the Bombaasa Cartel has seized direct control of the mining interests and purged the planet of Imperial loyalists — at least, any *overt* Imperial loyalists. The system has always harbored a large number of criminals, and the Cartel's ruthless methods of enforcing discipline helps maintain some semblance of control over this nearly-anarchic collection of intergalactic thugs.

■ Pembric II

Type: Terrestrial
Temperature: Temperate
Atmosphere: Type I (breathable)
Hydrosphere: Moderate
Gravity: Standard
Terrain: Wetlands, urban
Length of Day: 33 standard hours
Length of Year: 302 local days
Sapient Species: Human
Starports: Standard class
Population: 200 million
Planet Function: Organized crime, natural resources
Government: Organized crime
Tech Level: Space
Major Exports: Imperial and New Republic contraband, hfredium ore, precious stones
Major Imports: Food, technology, weapons

PEMBRIC II AND THE NEW REPUBLIC

Hearing that the New Republic has conquered Kal'Shebbol, and may be moving toward the Pembric system, the Bombaasa Cartel has installed a puppet government that will represent its interests while claiming that the people of Pembric II are pro-Imperial. They hope in this way to discourage New Republic interference with the Cartel's criminal activities. The Cartel uses the Security Legion to enforce its will on the people of Pembric.

THE BOMBAASA CARTEL

The Bombaasa Cartel was founded by Crev Bombaasa, a "businessman" from the Outer Rim Territories. The Cartel is a loose collection of Bombaasa's fellow criminals, mostly small-time operators from the Outer Rim Territories. While the Cartel is by no means a challenge to the might of the Hutt crime syndicates, for example, these smaller criminals have united to help protect them from larger organizations.

The Cartel also operates several legitimate mining and shipping enterprises, which are useful in maintaining a network of smugglers, shippers and "legal" Imperial contacts. (The bulk of the hfredium that is mined in the Pembric system makes its way to the Imperial military through various legal and illegal channels.)

ORGANIZATION PROFILE: THE BOMBAASA CARTEL

Type: Criminal Syndicate
Location: Principle organization located in Pembric system, Kathol sector
Crime Boss/Leadership: Crev Bombaasa
Principal Criminal Activities: Hijacking, piracy, black marketeering, gunrunning, fencing, loan sharking
Criminal Affiliations: Linked to Hutt agencies
Territory: Current operations extend across 20 star systems in the Kathol sector

Many of the citizens of Pembric II were ready for a change of government when news of the New Republic invasion of the sector reached the planet, but a take-over by the Cartel was not what they had in mind. Unfortunately, many of these people, transferred to the planet to support its Imperial-sponsored industries, were stranded when the Empire abandoned the system. Unlike the current rulership, many of the citizens are willing to support (or at least provisionally accept) the New Republic.

Many people would like to leave the planet, but the government is doing its best to discourage them from doing so. Those desiring to leave are subject to extremely high "tariffs" to purchase "transit visas" and "exit passes." A thriving underground has developed, selling passage to civilians for phenomenally high prices. Many of these innocents have sold all their possessions and even agreed to participate in smuggling ventures merely to pay the astronomical cost of leaving the system.

EPISODE ONE: WELCOME TO PEMBRIC II

Because the Pembric government (the Cartel) is not expected to be friendly to the New Republic in Loh'khar's judgement, Adrimetrum has decided to send her team in undercover and lay low in the asteroid belt in the meantime.

The team members are to pilot the Aegis shuttle (which has had its New Republic markings removed) to the surface and pose as illegal arms merchants, while they work to locate Drake and follow up their lead. Loh'khar is in nominal command of the team, though if a character with greater experience in combat goes, he or she will be in command in combat situations.

Unbeknownst to the *FarStar* crew, one of the Cartel's mining outposts near the asteroid field has identified the *FarStar*, and has informed the Cartel of the New Republic's presence in the Pembric system. The Cartel is convinced that the *FarStar's* presence indicates a possible New Republic takeover of the area and is understandably suspicious. The "undercover" mission to the spaceport is already in jeopardy.

PLANETFALL

Using the Aegis shuttle, the characters must navigate through the asteroid field and negotiate a landing fee for Pembric's spaceport.

The passage through the asteroid field is extremely treacherous, and the shuttle's pilot must make a Difficult *space transports* roll to navigate through the field successfully. Failure indicates that the shuttle has been damaged and must limp back to the *FarStar*, delaying the mission.

After navigating through the asteroid field, the shuttle must establish orbit and attempt to contact the spaceport's control tower. If the characters do not attempt to make contact, the shuttle will be attacked within a few minutes of entering the atmosphere. The pilots of the outlaw patrol craft will attempt to disable the characters' vessel in order to capture the craft. If two outlaw fighters are destroyed, the remaining two will break off.

■ Security Legion B-wings

Craft: Illegally modified Slayn & Korpil B-wing
Type: Heavy assault fighter
Scale: Starfighter
Length: 16.9 meters
Skill: Starfighter piloting: B-wing
Crew: 1
Crew Skill: Starfighter piloting 6D+2, starship gunnery 5D+1, starship shields 5D
Hyperdrive Multiplier: x1
Nav Computer: Limited to one jump
Maneuverability: 2D

Space: 7
Atmosphere: 350; 1,000 kmh
Hull Code: 2D+1
Shields: 1D+2
Sensors:
Passive: 30/0D
Scan: 50/1D
Search: 75/2D
Focus: 4/4D+1

Weapons:

2 Laser Cannons

Fire Arc: Front
Skill: Starship gunnery
Fire Control: 1D+1
Space Range: 1-3/12/25
Atmosphere Range: 100-300/1.2/1.5 km
Damage: 7D

1 Proton Torpedo Launcher

Fire Arc: Front
Skill: Starship gunnery
Fire Control: 3D
Space Range: 1/3/7
Atmosphere Range: 50-100/300/700
Damage: 9D

3 Medium Ion Cannons (fire-linked)

Fire Arc: Front
Skill: Starship gunnery
Fire Control: 4D
Space Range: 1-3/7/36
Atmosphere Range: 50-100/700/3.6 km
Damage: 4D

2 Auto Blasters

Fire Arc: Front
Skill: Starship gunnery
Fire Control: 2D
Space Range: 1-8/25/40
Atmosphere Range: 100-800/2.5/4 km
Damage: 3D

Capsule: The Bombaasa Cartel has "acquired" a number of New Republic B-wings and has managed to modify them. By sacrificing shielding and hull strength, the ship is slightly faster and more maneuverable than a standard B-wing.

When the characters hail the spaceport control tower, read the following aloud:

A bored voice, speaking heavily accented Basic crackles from the comm system's speaker grille: "Attention unidentified vessel. Make your bid for landing rights."

The control tower official is not interested in the crew's mission or identity — rather, he is only interested in the money he is offered. He grants a landing permit to an offer of 500 credits or higher. (This may increase if the characters try to haggle for a lower price; any attempt to bid for less than 500 credits will be met with outright contempt.) If the characters attempt to set down without a landing permit, the Legion launches another five B-wings to intercept them.

Read the following passage aloud:

Pembric II's spaceport lives up to its reputation — it is grubby, hot, poorly maintained and quite thoroughly squalid. The shuttle has set

down at Pad 642, a crumbling, dome-shaped enclosure that offers no amenities except a power feed for refueling ships. (It doesn't work.) The floor of the pad is scarred with the blastmarks of hundreds of thruster exhausts and littered with the cast-off detritus of numerous departing smuggling vessels.

Standing just inside of the main door to your landing pad is a Rodian, accompanied by several tough looking men in immaculate white uniforms. "We've come to collect your landing fee," he says in Basic, smiling the peculiar grimace common amongst insincere Rodians. "Come out slowly, and don't make any sudden moves. It makes my associates unhappy, which could make you rather dead."

The Rodian is Kebbo, the current Magistrate in charge of the Pembric Security Legion, and an employee of the Bombaasa Cartel. He has been ordered by the Cartel to answer some of the characters' questions, though he will only reveal a "creatively" edited version of the truth. He attempts to ascertain the characters' mission, though he does not state outright that he knows they are New Republic troops. His instructions are to determine the level of threat the New

Republic currently presents, and if necessary see to it that the characters turn up "missing."

If the characters ask about Drake, Kebbo mentions, for a credit or two, that Drake can be found at the ThrusterBurn Tapcafe most of the time. The tavern is located in the spaceport's "Red Zone" district.

As the characters make to leave the landing pad area, Kebbo sidles up to them and suggests quietly that some "security measures" should be negotiated, to insure the safety of the ship. He is willing to leave a Legionnaire as a guard for the shuttle for a fee of a mere 1,000 credits. If the characters refuse, he adds that "improper security measures are inviting theft." The characters should reconsider Kebbo's offer.

Lok'khar might be able to work Kebbo down a mite, but this is a scam with fairly standard rates.

■ Kebbo the Rodian

Type: Pembric Security Legion Chief Magistrate

DEXTERITY 3D

Blaster 4D+2, blaster: pistol 5D, brawling parry 5D, dodge 6D+2

KNOWLEDGE 3D

Alien species 6D, intimidation 5D, languages 5D+2, planetary systems 6D+1, streetwise 8D+1, value 7D, value: starships 7D+2



Tim Bobko

MECHANICAL 4D

Astrogation 7D, capital ship piloting 6D+2, ground vehicle operation 5D+2, hover vehicle operation 6D, repulsorlift operations 6D+2, sensors 5D+2, space transports 6D, starfighter piloting 5D+2, starship gunnery 6D, starship shields 5D+2

PERCEPTION 3D

Bargain 6D, con 8D, forgery: ship IDs 6D+2, persuasion 6D+1, search 6D, sneak 8D+2

STRENGTH 3D+2

Brawling 5D+2

TECHNICAL 3D

Capital starship repair 5D, capital starship weapon repair 5D, computer programming/repair 5D, ground vehicle repair 5D, hover vehicle repair 5D, security 8D+2, space transports repair 6D+1, starfighter repair 5D+2

Character Points: 15

Move: 10

Equipment: Security toolkit, heavy blaster pistol (5D), hold-out blaster (3D+2), comlink, Credit Voucher for 5,000 credits

Capsule: Kebbo is one of the more prominent agents of the Bombaasa Cartel. He built his reputation as an expert at "smash-and-grab" work: hold-ups, robberies, and enforcement. He is violent, ruthless and capable, making him a dangerous opponent. Also, as Chief Magistrate of the Pembric Security Legion, Kebbo has the "authority" to arrest and detain enemies of the Cartel at his leisure.

Kebbo is loyal to the Bombaasa Cartel simply because it is the strongest force in the system. The Cartel outlasted the Empire and it will (in his estimation) withstand the New Republic, so Kebbo has allied himself with what he believes will be a lasting organization. However, any significant change in the balance of power may convince the Rodian to switch alliances. "I am very flexible," he is fond of saying, "and at the moment, the prevailing wind is bending me in the Cartel's direction."

Magistrate Kebbo is a courteous, witty individual, with an eccentric sense of humor. He is as corrupt as can be imagined, taking bribes as often as possible, and funnelling a large percentage back to his masters in the Cartel. He has even been known to falsely arrange passage for civilians trying to leave the system, only to leave them stranded at the spaceport, bereft of funds and unable to support themselves. In short, Kebbo is a thoroughly vicious and clever rogue.

After a few minutes of discussion, all under the watchful eyes of the Legionnaires, a sudden commotion erupts from outside the door to Pad 642. Read the following aloud:

A large number of people are crowding into the landing bay, and the Legionnaires are noticeably unhappy about the situation. They immediately draw their weapons and begin herding the crowd of civilians back towards the doors. Several of them are yelling at Kebbo to let them leave the planet. Some are begging you to take them away aboard the shuttle, offering money, loyalty or whatever possessions they

PEMBRIC SECURITY LEGION

Once an honest police force, the Pembric Security Legion slowly became corrupted by graft and vice, until it became little more than a band of thugs in fancy uniforms.

Now that the Bombaasa Cartel has seized control of the Pembric system, the Legion is beginning to resemble, however faintly, a true law enforcement agency. Legionnaires do actively prevent a great deal of "unauthorized" crime, mostly involving violent disputes between rival smugglers, but do not offer much protection against the activities of Crev Bombaasa and his associates.

Very little goes on that the Legion is unaware of, and informants abound (usually in the form of terrified civilians who hope to use information to buy passage off-planet).

In general, the Legionnaires are untrusting, violent-tempered Humans, dressed in white, military-cut uniforms. In addition, they usually travel in groups of five or six, all heavily armed. Blast vests and blast helmets are also a standard part of the Legionnaires' uniforms.

■ Pembric Security Legionnaires

Type: Planetary Law Enforcement Officer

DEXTERITY 3D+2

Blaster 5D+2, brawling parry 5D+1, dodge 5D, melee combat 5D, melee parry 5D+1, vehicle blasters 5D+1

KNOWLEDGE 2D+1

Bureaucracy: Pembric government 4D+2, intimidation: bullying 6D, law enforcement 5D, planetary systems: Kathol sector 4D+1, streetwise 4D+2

MECHANICAL 2D+2

Repulsorlift operation 4D+2

PERCEPTION 3D

Con 4D+2, investigation: Pembric spaceport 5D, search 5D, sneak 4D+2

STRENGTH 3D+2

Brawling 5D+2

TECHNICAL 3D

Character Points: 3-5

Move: 10

Equipment: Pembric Security Legionnaires Uniform, blast vest (+1 energy, +1D physical), blast helmet (+1 energy, +1D physical), heavy blaster pistol (5D), blaster rifle (5D), stun baton (Strength+2D+2), comlink, datapad

have left in exchange for a few meters of space aboard the shuttle.

The Legionnaires begin clubbing the more aggressive protestors with the butts of their rifles. Kebbo sighs and mock-whispers to the you, "Ah, the criminal element. A Magistrate's work is never done ..."

Kebbo turns and orders his men to shoot any protestor who does not leave the landing pad immediately. Any character who tries to intervene on behalf of the protestors will be dealt with harshly by the Legionnaires.

THE AMBUSH

Kebbo provides directions to the ThrusterBurn Tapcafe and departs, leaving behind two Legionnaires as "escorts." The two guards are to chauffeur the characters to the bar. In truth, the escorts are agents of Sarne, left behind to hinder any New Republic attempts at operating on Pembric II. They have arranged an ambush to take place, just as the characters are boarding the Pembric Security Legion landspeeders.

Read the following passage aloud:

Your first glimpse of the spaceport is as uninspiring as the landing pad was. Diffused sunlight filters down from overhead in a vain attempt to burn off the haze that shrouds the sky. The ground is actually wet sand, instead of the permacrete one would expect at a modern spaceport.

The buildings appear to be constructed from basic stone, rather than some more efficient, prefabricated material, which gives the area a somewhat exotic, primitive feel. In general, the buildings are white, though mold and dirt encrust most available surfaces, mottling the buildings' coloring with patches of brown and green.

There is virtually no sign of life, as the protesting civilians have all departed or been arrested by Kebbo's men.

Any character who makes a Moderate *streetwise* roll notices that all the windows facing the street have been closed and blast-shuttered, and that the two escorts seem somewhat preoccupied and fidgety. Whether or not the characters are suspicious of the Legionnaires, the pair of guards launch their ambush as soon as the group approaches the nearby landspeeders.

As you approach the landspeeders, the two Legionnaires suddenly turn and draw their weapons. One of the thugs growls at you, "Drop your weapons and put your hands above your heads, Rebel filth!"

Just as suddenly, five more tough-looking Humans move from the shadows of the nearby alley, also brandishing heavy blaster pistols. This group is not dressed in Legionnaire uniforms, but they are just as heavily armed as the constabulary force.

Obviously, your "undercover" mission to Pembric II isn't as covert as you'd hoped.

2 Imperial Agents. All stats are 2D except: *Dexterity 3D+2, blaster 5D, dodge 5D+2, grenade 4D+2, melee combat 6D, melee parry 5D+2.* Move: 10. Blaster rifle (5D), heavy blaster pistol (5D), stun baton (*Strength+2D+2* stun), blast vest (+1 energy, +1D physical), blast helmet (+1 energy, +1D physical), datapad, comlink, Pembric Security Legion uniform and ID

5 Thugs. All stats are 2D except: *Dexterity 3D, blaster 4D+2, dodge 4D+2.* Move: 10. Blaster rifle (5D), blaster pistol (4D), 2 grenades (5D).

The characters can either fight, run or negotiate, though running will make it extremely easy for the Imperial spies to gun them down. Attempts at negotiation will be met with naked contempt, answered only with the curt reply, "The Empire sends its regards, Rebels!" before the shooting starts.

Any character who makes an Easy *Perception* check after the fight (assuming that anyone sticks around that long) will notice a data plaque that one of the Imperials must have dropped. The plaque is encrypted, but carries an official looking Legionnaires seal that claims the plaque contains restricted "transit visas."

EPISODE TWO: THE THRUSTERBURN TAPCAFE

After the characters arrive at the ThrusterBurn, read the following aloud:

The ThrusterBurn Tapcafe is atypical of the type of seedy spacers' bars that most smuggling havens encourage. The atmosphere is light, cool and airy, though the booths that line the walls are all dimly lit, and a number of tables are seated in alcoves, providing privacy. The main floor of the bar seats over 200, though at the moment the bar is only half full. A small orchestra is playing soft, demure music at the front of the room, though the dance area is empty.

The main floor of the bar is oblong, with tables scattered throughout the area. At the front of the room is the bar, a massive, semi-circular arrangement of polished stones and exotic woods on a raised platform that can be approached by walking up the wide steps that lead to the edifice. Three bartenders are on duty, politely dispensing drinks to customers as rapidly as possible. There is very little of the typical idle chit-chat common in such a place; instead, the majority of the bar's occupants are

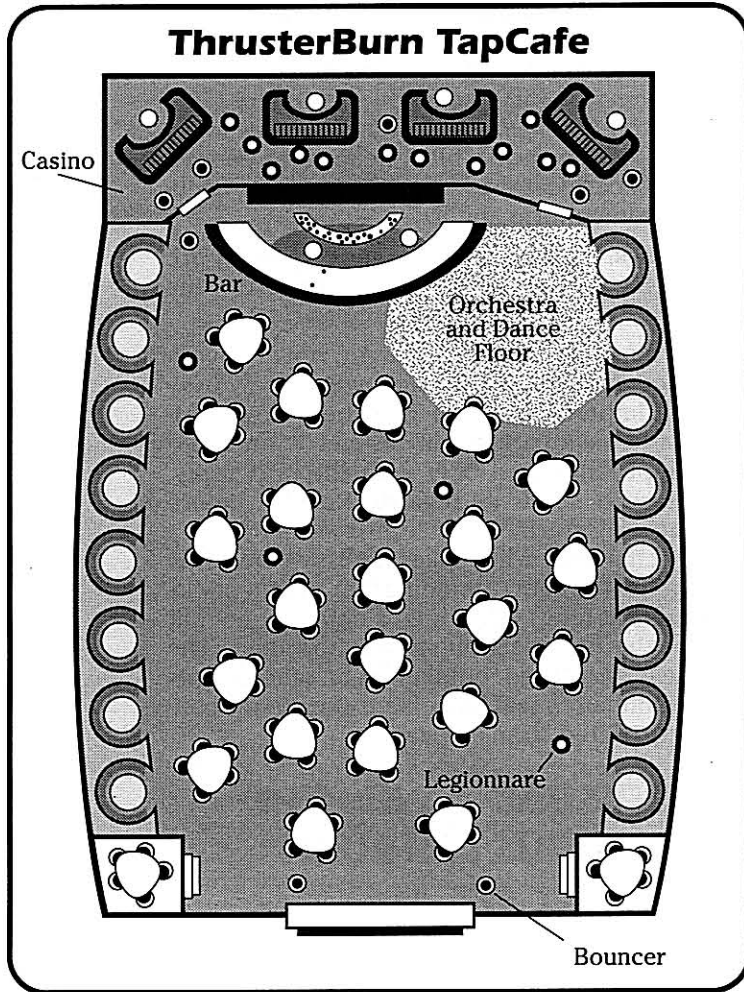

skulking over drinks and communicating in hushed voices.

As you enter the bar, you are greeted by a distinguished looking older near-Human dressed in the formal uniform of most waiters. "Greetings," he says, in thickly-accented Basic, "allow me to show you to a table."

The characters may attempt to mingle, though most attempts at socializing will be ignored or politely rebuffed. Very few of the denizens of the bar are openly carrying weapons, and if the characters are visibly armed, they may be asked by the bouncers to remove them and check them in with Drake.

Drake is easily found, since he is the manager of the club. Any bouncer and most of the patrons can direct the characters to Drake, who is behind the bar with the bartenders.

■ Breslin Drake

Type: Former New Republic Intelligence Officer
DEXTERITY 3D+2

Blaster 6D+2, blaster artillery: anti-infantry 5D+1, brawling parry 5D+2, brawling parry: versus martial arts 6D, dodge

6D+2, firearms 5D+2, grenade 5D+2, melee combat 5D+1, melee parry 6D, missile weapons 5D+2, thrown weapons: vibroknife 7D

KNOWLEDGE 2D

Alien species 3D, bureaucracy: New Republic Intelligence 6D, bureaucracy: Pembric government 9D, business: ThrusterBurn Tapcafe 9D, intimidation 4D+2, law enforcement: Pembric Security Legion 6D, planetary systems: Outer Rim Territories 5D+2, streetwise 7D, survival 6D, tactics: ground assault 5D+2, value 5D, willpower 5D

MECHANICAL 3D+2

Astrogation 5D, beast riding 4D+2, hover vehicle operation 4D+2, jet pack operations 5D, powersuit operations 4D+2, repulsorlift operation 6D+2, sensors 5D+2, space transports 7D, starfighter piloting 7D+1, starship gunnery 6D+2, starship shields 6D

PERCEPTION 3D

Bargain 5D+2, con 7D, forgery 6D+2, gambling 6D+1, hide 6D, investigation 6D, investigation: Pembric spaceport 7D, search 5D, search: tracking 7D+1, sneak 7D

STRENGTH 3D+2

Brawling 4D+2, brawling: martial arts 6D, stamina 6D, swimming 5D+1

TECHNICAL 2D

Blaster repair 4D+2, computer programming/repair 4D+2, demolition 6D, droid programming 4D+2, droid repair 4D, first aid 5D+1, security 6D, space transports repair 5D+2

Character Points: 17

Move: 10

Equipment: 10,000 credit voucher, hold-out blaster (3D), heavy blaster pistol (5D), comlink, datapad

Capsule: Breslin Drake is a tall, heavily muscled Human. He has short, black hair, cut in a military fashion, and he has a number of scars crisscrossing his face and hands. He usually wears a slightly rumpled business suit, though he has a heavy blaster pistol displayed prominently on his right hip.

He is extremely agile, a skilled combatant in both armed and unarmed combat, as well as a quick mind. He has a self-deprecating sense of humor (he claims he owes allegiance to the "state of inebriation") but



Tim Bobko

posesses a streak of ruthlessness and determination that makes him an extremely dangerous opponent ... or a useful ally.

Drake was a New Republic agent who saw his intelligence network destroyed by an unseen Imperial spy he knows only as the Wraith. Drake has pursued this spy out to Kathol sector, and won't go



Tim Bobko

back to active duty until he has found this man and brought him back to stand trial for his crimes. He has spent several years in the Kathol Outback trading tech goods while looking for the Wraith, and a number of months on *Tanquilla Beach*, where he sold goods to Spang.

He recently came to Pembric II when the Empire pulled out, and promptly lost his goods to the Cartel through bureaucratic procedures designed to render desirable independent traders dependent on Bombaasa. Drake is managing the club while he is figuring out a way to get off the planet and back to the Outback.

The Wraith is closer to Drake than he thinks — the man, going under the name Drenn, is working as one of Drake's bouncers! Neither man is aware of the other's past history at the moment. More detailed information on Drake's background and motivations can be found in the next adventure, where the character of Drenn is further developed.

Breslin Drake is the manager of the ThrusterBurn Tapcafe, the most popular tavern in Pembric II's spaceport, probably because it is owned by Crev Bombaasa himself. Those who choose not to remain "civil" in his establishment are dealt with harshly by Drake, rather than by bodyguards or bouncers, a fact that has earned the enigmatic Human respect among the criminal element on Pembric II.

Drake appears only marginally interested in the characters, until they mention Spang. He warms to them, and asks how old Spang is doing.

When the characters mention that they are looking for a tech crew who might have worked for Sarne, Drake frowns, and tells them that the Keiffler brothers, who lived here in town, did go to Kal'Shebbol to do some government work, but never came back. They were probably the best slicers in the sector, according to Drake.

One of their apprentice techs did make it back to Pembric II with some wild tale about the brothers being killed by Imperials. How the tech escaped, Drake doesn't know. The boy went to work for himself, using the designs of his former masters, but, lacking their clout, was soon sucked into Bombaasa's organization. The boy, Gaelin, wants to leave the planet, Drake says, which is why Bombaasa has him locked away in some lab, toiling for the Cartel.

As the characters are engaged in their discussion with Drake, Kebbo approaches with a squad of Legionnaires and says that Master Bombaasa would like to see them immediately. He is in the casino behind the barroom. The way the Legionnaires are resting their hands casually on their blaster holsters suggests that the invitation is not a suggestion.

■ Crev Bombaasa

Type: Corellian Crimelord

DEXTERITY 3D

Blaster 5D, dodge 5D+2, melee combat 4D+2, melee parry 4D+1, vehicle blasters 5D

KNOWLEDGE 4D

Alien species 6D+2, bureaucracy: Pembric government

8D, business 7D+1, intimidation 7D, languages 6D+1, law enforcement: Pembric Security Legion

8D+2, planetary systems: Kathol sector 6D+2, value

6D+2, willpower 5D+2

MECHANICAL 2D+2

Astrogation 4D, space

transports 3D+2

PERCEPTION 3D

Bargain 7D, command: Bombaasa Cartel 9D+2, con

7D, forgery 4D+2, gambling 6D, hide 5D, investigation:

Pembric spaceport 7D+2,

sneak 5D+2

STRENGTH 2D+2

TECHNICAL 3D

Computer programming/

repair 4D+2

Character Points: 11

Move: 10



Equipment: Elegant clothing, datapad, 6,000 Credits, hold-out blaster (3D+1), vibroknife (STR+1D)

Capsule: Crev Bombaasa is a short, pudgy Human, with stick-like limbs, giving him an odd, beetle-like appearance. He is fastidious about his appearance, and his thinning black hair is always neatly styled. His eyes are round and bulge slightly, giving him an even more insect-like appearance. He prefers to dress in business suits in neutral colors (usually tan) and always wears tasteful, expensive jewelry.

Bombaasa is the leader of the infamous Bombaasa Cartel, the criminal organization that has supplanted the government of Pembric II. Bombaasa originally formed the Cartel by uniting small, independent criminals from the Kathol sector in order to withstand domination from outsider groups like the Empire and the Hutts.

A cultured, refined Human, Bombaasa is obviously well-educated. His speech is often littered with obscure literary references, and he always maintains an air of genteel civility. Underneath this polite exterior, however, is an extremely vicious and competent criminal. Despite this vicious streak, Bombaasa prefers others to do his dirty work, as he abhors active participation in violence.

THE CASINO

The casino is a fairly small, smoke-filled room in the back, behind a thick, metal door. Read the following aloud:

The casino is merely a collection of tables where a variety of well-dressed individuals, representing dozens of species, play sabacc, assorted dice games, even an odd form of three-dimensional roulette called simply "Lady Luck." Seated at the largest table, playing sabacc is a small, pudgy Human in an immaculate business suit. He is smoking an odd twisted-glass pipe and has a large pile of credits in front of his place at the table. His opponents are not faring as well, and two openings remain at the table.

Behind the short man, three very large, dangerous-looking Humans stand at attention, watching every move you make as you enter the casino. All three have their hands near the lapels of their jackets, ready to plunge inside and snatch whatever hidden weapons lie beneath their clothing.

The croupier at the table indicates that the short man has won another hand. "Congratulations, Mr. Bombaasa," the dealer says, smiling. "A well played hand indeed."

Bombaasa eyes the characters coldly, clearly uneasy with their presence. He dispenses with pleasantries immediately, informing them he knows that the group is composed of New Republic soldiers and that they are not welcome on "pro-Imperial" soil.

Drake, who has wandered into the room unobtrusively, stands idly by. He is seemingly disinterested in the proceedings, but is furiously working out a way to turn this situation into an opportunity to get himself off the planet.

Read the following aloud:

"I am not particularly interested in your reasons for coming to Pembric," Bombaasa says. "I do want some assurances that the New Republic vessel 'hiding' in our asteroid field is not the spearhead of a New Republic attack force." he says, waving vaguely in the direction of the vaulted ceiling.

"Oh, don't look so shocked," Bombaasa chuckles. "We know all about your arrival in our system."

"I should like," he continues, "some reasonable guarantee that the New Republic will keep its forces out of this system from now on. If you lack, as I suspect you do, the authority to sign binding treaties on behalf of the New Republic," he concludes, "we have no further busi-

ness to discuss and you should arrange to purchase an exit pass from my good friend Magistrate Kebbo, here.”

Bombaasa chuckles, and his eyes widen in mock amazement. “You *do* know you can’t leave the planet without one, don’t you? I’m sure yours won’t be too *terribly* expensive.”

While Captain Adrimetrum has some limited authority to engage in preliminary diplomacy, and invite newly liberated worlds to join the New Republic, she lacks the authority to sign binding treaties with these worlds. Any assurances to the contrary the characters give Bombaasa will not be believed without a Very Difficult *con* or *persuasion* roll. In addition, the revelation that the group already possesses an exit pass will spark a confrontation with Kebbo and his Legionnaires.

If the characters reveal that they possess a transit pass, skip ahead to “All Hell Breaks Loose,” below. If not, read the following aloud:

Kebbo approaches the table at a signal from Bombaasa. “It is interesting that you should mention transit visas,” the Rodian intones. “I just realized that the two guards who were to escort you here carried just such passes. I also notice that my men are not here and cannot be located. Perhaps you have some explanation for this?” He motions to his four Legionnaires, and Bombaasa’s bodyguards are also tensing, as if expecting a fight. Drake exchanges looks with his bouncers, but makes no move to enter the confrontation.

ALL HELL BREAKS LOOSE

Read the following aloud:

Kebbo’s hand drops to his sidearm and the four Legionnaires in the room immediately take up positions near the door to the room, also fingering their holstered weapons. “You will stand up slowly and prepare to be searched.”

If the characters resist, it sparks a shooting battle between the characters and the Legionnaires and Bombaasa’s bodyguards.

Drake has made a quick decision to jump in on the character’s side in the hopes they will be his ticket off Pembric II. His club bouncers, after a slight hesitation, jump in to support Drake as well (word has spread fast throughout the club that these are New Republic diplomats, and the bouncers too are hoping to get off the planet).

If the characters do not resist and are in possession of the transit pass, it will be found and again a shooting battle will be provoked.

Otherwise, the characters will be arrested and taken outside. Once outside, Drake will attack

the Legionnaires, accompanied by his bouncers and combat will ensue on the street.

3 Bouncers. All stats are 3D except: *Dexterity* 4D, *blaster* 5D, *brawling parry* 5D, *dodge* 4D+2, *brawling* 5D+2. Move: 10. Heavy blaster pistol (5D)

Drenn. Drenn is a fourth bouncer who plays a major part in the next adventure. He will wade into the fray with the other three. His stats can be found in the next adventure. Make sure he gets off the planet with Drake, even if no one else does.

3 Cartel Bodyguards. All stats are 3D except: *Dexterity* 3D+1, *blaster* 5D+1, *brawling parry* 4D+2, *dodge* 5D, *brawling* 6D. Move: 10. Vibroknife (STR+1D), blaster pistol (4D)

Allow the combat to run for as long as necessary to ensure drama and suspense; however, the characters should be pushed towards the nearby landspeeders that brought them to the ThrusterBurn. Drake and his bodyguards will offer the characters a temporarily safe hide-out, and will lead the characters through the twisting alleys and streets of Pembric spaceport to a small warehouse on the spaceport’s outskirts.

Bombaasa’s henchman should pursue, but “creatively fudging” the skill rolls in dramatically appropriate moments should enhance the story, allowing the characters to escape, one step ahead of the Cartel.

EPISODE THREE: FINAL ASSAULT

At this point, the characters will have a few moments to compare notes with Drake and his men.

The bar-owner-turned-renegade will offer the characters a deal, since his future on Pembric II is now more or less trashed: he’ll lead them to Gaelin’s labs, and help them get in and out with both Gaelin and his equipment, if the New Republic will provide them and Drake’s men transport out of the Pembric system.

Read the following aloud:

Drake suggests waiting for sunset before moving out, a sound tactic that proves its usefulness; between the hazy fog-rain and the darkness, your movements should go undetected.

Leading you to the spaceport’s perimeter, Drake points out an unusually large hangar-like building at the outermost edge of the landing area, with a dimly-lit landing pad on the roof. A few guards and workers can be seen in the faint light walking about.

“Bombaasa dislikes doing the obvious,” he says, loading a fresh powerpack into his heavy blaster pistol, “Gaelin’s labs are in that hangar rather than the tech district. The security is rather low, since beefing up the place with lots of guards would be a sure tip-off something unusual is kept there. Even so,” Drake says checking his chronometer, “the security perimeter won’t be cake-walk.”

The characters must devise a means of infiltrating the hangar, and getting Gaelin. Probably the best plan is to have most of the crew slip into the hangar, take out the guards, and hustle Gaelin and his equipment to the roof, while sending someone back to the landing bay to fly the shuttle to the landing pad.

Drake will suggest this plan if the players haven’t considered the difficulty in getting Gaelin and his stuff across town to their landing bay while the Security Legion mobilizes to head them off.

SPRINGING THE SHUTTLE

Kebbo is having the characters’ shuttle watched. There are five Cartel guards stationed at the entrance to pad 642. They aren’t very alert, but it will take a Difficult *sneak* roll to approach

them without being seen, since there is little cover around the area.

The guards will attempt to arrest the characters if they are approached. Once they are taken out, the characters may board the shuttle, take off, and head toward the hangar.

This action will of course tip off the landing field’s traffic control, and send a couple of squads of Legionnaires toward the hangar.

5 Cartel Guards. All stats are 2D except: *Dexterity* 3D, *blaster* 4D+2, *dodge* 4D+2. Move: 10. Blaster rifle (5D).

INFILTRATING THE WAREHOUSE

A scouting trip around the building will reveal that there are only two entrances, a large hangar door at the front, and a smaller Human-sized entrance right next to it. There are no windows at all.

Several bored-looking Humans are guarding a group of bedraggled looking civilians that are unloading crates onto a cargo-hauler near the large front entrance. The hangar door yawns open, spilling bright yellow light onto the concrete apron in front of the building.

Characters can reach the front entrance without being noticed by the guards by making a Moderate *sneak* roll. (Due to the haze and rain, all characters receive +1D to *sneak*.) Any noise will alert the nearest guard and probably attract a great deal of trouble.

Once there, the characters can attempt to silently dispatch the three guards or blend in with the group of Human laborers.

Read the following aloud:

The laborers are being forced to haul cargo crates to a cargo-hauler near the hangar’s entrance. The guards appear relaxed and overconfident, and few are brandishing their weapons as if ready for trouble; most are slung over their shoulders or securely tucked into belt holsters.

Drake says, “We have to get inside,” as he deftly draws a vibroblade from his sleeve. Abruptly, he turns and attacks the guard nearest the service-lift, dropping the unsuspecting guard with barely a sound. He hisses: “Get the others,” and draws his blaster.

The other three guards also draw their weapons, and combat ensues. Run combat as normal. During the battle, the Human refugees will assist as long as the characters appear to be winning the fight. If the characters defeat the guards in fewer than four rounds, no alarm is raised.

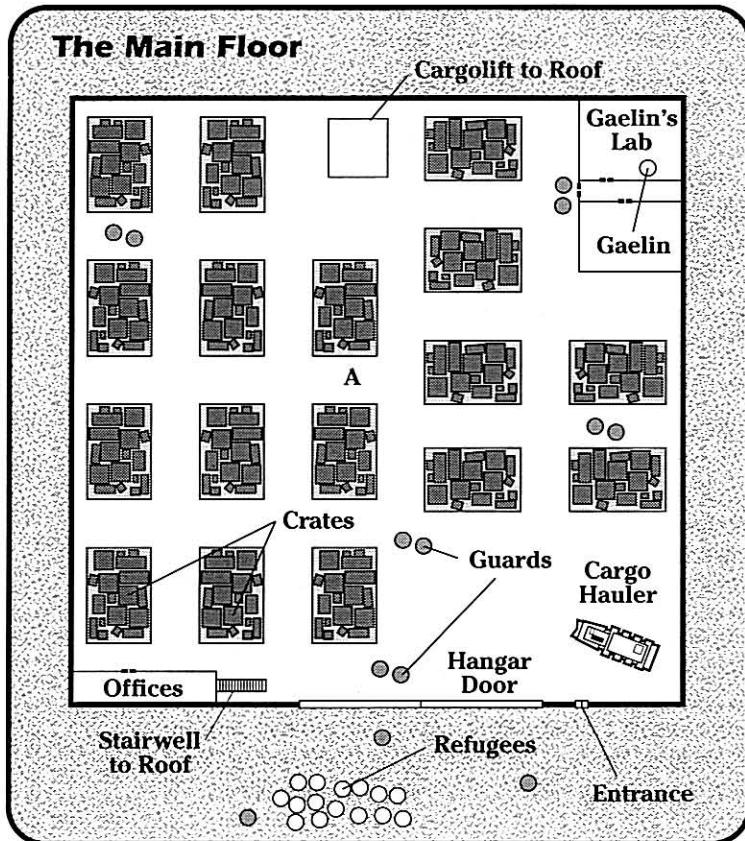

3 Cartel Guards. All stats are 2D except: *Dexterity 3D, blaster 4D+2, dodge 4D+2.* Move: 10. Blaster rifle (5D).

If the characters are losing the fight, they can retreat into the hangar, though they face tough odds inside, particularly after the guards sound an alert.

THE HANGAR

Read the following aloud:

The hangar does not contain space vessels ... at least, not any ships that are assembled. Hull plating, bulkhead fittings, and crates of hyperdrive components are stacked to the ceiling of the cavernous structure.

“Welcome to the Cartel’s storage depot,” Drake grins. “Our prize has his workshops in the southeastern corner of the building.”

If no alarm has been raised by the entrance guards, the characters should be able to reach “Point A” on “The Main Floor” before being challenged by the Cartel’s guards. Otherwise, they face armed guards as soon as they enter the hangar.

10 Cartel Guards. All stats are 2D except: *Dexterity 3D, blaster 4D+2, dodge 4D+2.* Move: 10. Blaster rifle (5D).

The labs at the rear of the hangar are a one-story modular office which was moved into the hangar by a cargo lifter, and put on blocks. Two of the guards are usually stationed by the door, though they will have been drawn away if there has been a firefight.

The door is unlocked, and opens up into a small hallway with doors both to the left and the right. The right-handed door leads to the heavy-duty machinery which produces the power and net hookups Gaelin needs to do his work.

Gaelin’s actual labs are behind the left door. The room contains a large number of wheeled carts containing various electronic assemblies to help Gaelin do his job. There are numerous worktables and workstations all hooked into various monitoring programs and networks.

If Gaelin heard fighting outside, he has turned off the lights (plunging the room in darkness), and is hiding under his desk. If he is surprised, he is seated behind one of the workstations in the middle of the room.

Gaelin is fairly alarmed to see the characters, until he has it explained that they are here to get him off of Pembric II. He is cooperative after that, and quickly tells the characters which computer modules to load up onto a small repulsorlift

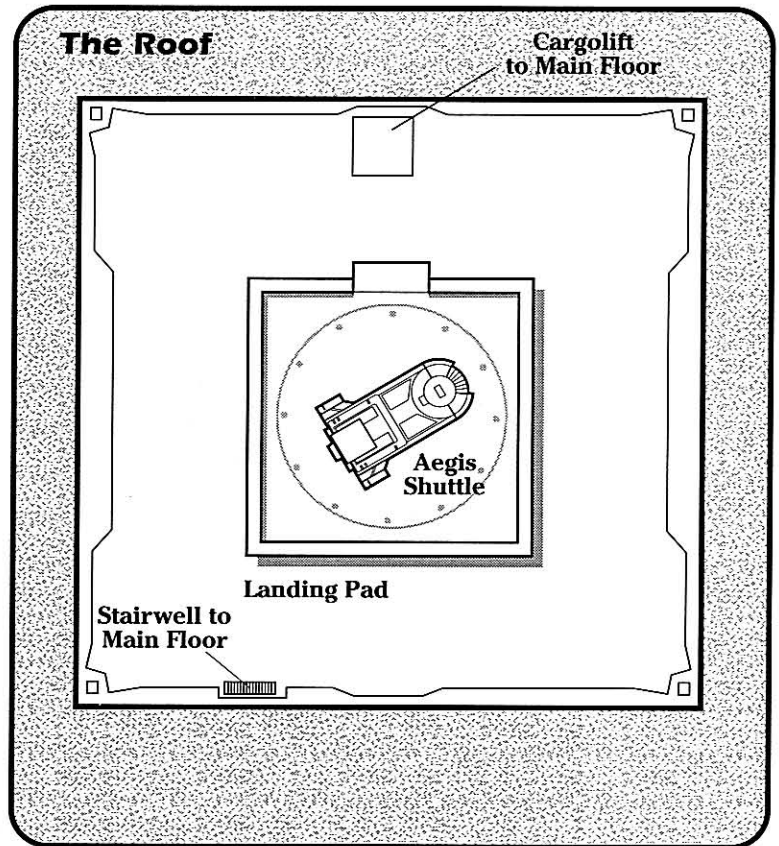

handcart he has in the room.

As the characters begin work, they notice that the refugees that the Cartel had used as cheap labor have ceased work, and are massed outside the lab module. There are nearly 20 of them, and they look undernourished and exhausted.

Drake looks at them and mutters, “Poor beggars. They deserve better than this.”

A thin, lanky young man, obviously the leader of this group of refugees, approaches you. “Please, gentlebeings, we beg of you, even if you can’t take us off-planet, take us away from here. The Cartel will kill us if we do not get away.”

The laborers offer to help load the equipment.

While everyone else is doing that, Gaelin slips behind a keyboard, and slices into Bombaasa’s main security computer. He cancels the alert on the characters, and then helps them move the equipment up to the roof.

The 20 or so refugees will pretty much fill the shuttle’s hold, though Gaelin’s equipment will fit in the hold without too much extra squeezing.

The shuttle may have to beat off an attack by orbiting Security Legion B-wings as it makes a run for the *FarStar*.

■ Gaelin**Type:** Slicer**DEXTERITY 2D+2**

Blaster 3D, dodge 4D+2

KNOWLEDGE 3D+1

Bureaucracy: Pembric II 4D, value 5D

MECHANICAL 4D

Repulsorlift operation 4D+2

PERCEPTION 2D

Bargain 3D, hide 5D, sneak 4D+1

STRENGTH 2D**TECHNICAL 4D**

Computer programming/repair 7D+1, droid programming 7D, droid repair 6D, security 8D+2

Character Points: 12**Move:** 10**Equipment:** Datapad**Capsule:** Gaelin is a tall, lanky youth with a shock of orange-red hair and freckles. He is pale and looks somewhat undernourished.

He is a native of Pembric II, and was discovered early on by the Keiffler brothers, some of the best slicers in the sector. He apprenticed with them for several years until they were given a very lucrative contract to do some slicer work for Sarne on Kal'Shebbol. The whole crew went to live on Kal'Shebbol for several months while they worked on various projects for the Moff, including planting trapdoor systems into his Corvette. They were slain when the Moff had no further use for them, all but Gaelin. Sarne sent Gaelin back to Pembric II to watch Bombaasa for him.

Gaelin returned to his homeworld to take over the Keiffler business, only to discover Bombaasa had taken over him. Bombaasa trusted no one who had come into contact with Sarne, and shut the boy away with his equipment. Gaelin still managed to send reports to Sarne on Cartel activities until Sarne pulled out of Kal'Shebbol.

Gaelin is a very flexible sort of person, and will gravitate towards the greatest source of income and power. He will serve the *FarStar* faithfully for

now, but should not be trusted over the long term, if something better comes along.

THE WRAP UP

Once aboard the *FarStar*, Gaelin will lose no time in tracking down the trapdoors in the system. He locates over 25 traps in the electronics, ranging from merely inconvenient to deadly. Some have been incapacitating systems which Lofryyhn has assumed are simply substandard. His biggest find is a high-powered tracking beacon which sends a single pulse out every day in a 100 light year radius. Apparently, Sarne has been tracking the *FarStar's* every move up until now.

Although Gaelin is fairly sure he has caught all the trapdoors, he does not have the skills of his former masters, and has missed some of the more subtle (and deadly) boobytraps. These may plague the *FarStar* crew in the future.

CHARACTER AWARDS

Player characters should receive three Character Points each for their actions; in addition, if they managed to convince Bombaasa that the New Republic does not plan on invading the system, they can attempt to use the system as a resupply point. If not, they have made a powerful enemy.

Drake, his bouncers, Gaelin, and the 20 refugees will agree to assist the New Republic on their search for Moff Sarne, though no one in the group knows (or admits to knowing) Sarne's current whereabouts.

TRAITOR IN OUR MIDST

"Captain," Petty Officer Colton walked quietly towards Adrimetrum's command chair where the *FarStar's* captain sat in her customary thoughtful pose, staring at the viewscreen, "I'm sorry to disturb you, but the refugees from Pembric are beginning to reduce our food stores dramatically."

"There's only 23 of them," the Captain sighed, turning toward Colton, "they can't be having a banquet every night, can they?"

"Well, no ma'am. They *are* under medical supervision, however. The med-staff have ordered regular meals since the bulk of the refugees were malnourished, and the medics are somewhat ... *generous* with the food rations. As a result, they are hitting the food stores pretty hard."

"Bottom line, Petty Officer?"

"We have roughly three weeks worth of food left. We are at the fringes of known space, and I recommend we restock as heavily as possible, and in addition," Colton paused, weighing his words carefully, "we should find an alternative arrangement for our new guests."

"Drop them off on the next convenient planet, you mean? Look," Adrimetrum shook her head calmly, "I cannot abandon these people. In fact, most of them have agreed to assist us, and we can always use the extra hands."

"Besides" she added, "the only planet in the area that we can restock is Galtea, a planet recommended to us by Loh'khar. Do you really want to leave these people someplace the Finder recommends?"

"When you put it that way, Captain," Colton chuckled, "I suppose not."

DRAKE'S VENDETTA

One of the refugees aboard the *FarStar* is the former manager of the ThrusterBurn Tapcafe on Pembric II. Breslin Drake was instrumental in locating and extracting Gaelin for the *FarStar*, who in turn was crucial in eliminating some of Sarne's deadly boobytraps.

Drake was generally assumed to be a rogue by the *FarStar* crew, an opportunist who saw an opportunity to leave Pembric behind and took it. However, Drake has since revealed to Captain Adrimetrum his true motives for leaving New Republic space to live in the fringes of the Kathol sector.

Drake was once a major in Alliance Intelligence. He served with distinction as a commando and intelligence agent, before being transferred from field duty to an administrative detail.

While developing a network of intelligence gathering and collation centers known as the "Archive system," Drake discovered that an Imperial agent had penetrated one of the hidden installations, jeopardizing the security of the remaining Archive stations. While investigating the intelligence disaster, Drake came to suspect that the Imperial agent

was a former colleague, a shadowy operative with the Imperial codename Wraith.

He petitioned his superiors for permission to return to the field and track down the agent, who fled when discovered, but was refused. In a rash moment, enraged at the damage the traitor had done to the New Republic, Major Drake stole a shuttle and set out in pursuit. He tracked the Wraith out to the Kathol sector, and discovered that he had gone to work for Moff Sarne.

For two years, Drake posed as a tech merchant, and traveled around the sector sniffing out the Wraith's activities. He discovered that the Wraith was serving Sarne as an assassin and saboteur, and trailed him to various planets in the sector, where the Wraith was looking for new toxins for use in political assassinations. Not once did Drake glimpse his quarry, though he found signs of his passing.

One of the planets the Wraith visited several times was Sebiris, an isolated place inhabited by primitive aliens. Drake visited the aliens in an attempt to learn more about the Wraith, but only managed to learn that the agent went by the name of Petrivoor there before being run off by the natives.

Then, several months ago, the Wraith disappeared. On his way back to Kal'Shebbol to pick up the trail again, Drake stopped over on Pembric II and got caught by one of Bombaasa's press gangs. Stranded on the planet, Drake got a job as a club manager for Bombaasa in an effort to save enough money to get off the planet. He hasn't seen a trace of the Wraith since, and now suspects that the man shipped out with Sarne's fleet.

Note: Drake may be used as a player character. Besides telling Adrimetrum something of his past, Drake has offered to serve the *FarStar* as a tactical advisor and counter-intelligence specialist, with the understanding that he may still continue to search for the Wraith insofar as his search does not interfere with the ship's mission.

THE WRAITH

Unbeknownst to Drake, the Wraith has been under his nose for months. The Wraith was assigned to infiltrate the Bombaasa Cartel by the Moff's office several months ago. He managed to get hired on at Bombaasa's ThrusterBurn Tapcafe,

and was moving up in the organization, but decided he was no longer needed there when he heard that the sector had fallen to New Republic forces.

In an attempt to get offplanet and rejoin Sarne, the Wraith, who goes by the name Drenn, pitched in with Drake and came with him onto the *FarStar*. Drenn has no idea that Drake is looking for him. He would kill Drake the first chance he got should he find out.

Drenn has spent his time on the *FarStar* trying to figure out how he may best sabotage the

ship and rejoin Sarne. He hasn't hit on a satisfactory plan yet, though he has joined the maintenance team to gain access to ship systems.

■ Drenn (the Wraith)

Type: Imperial Saboteur
DEXTERITY 3D

Blaster 6D, blaster artillery 5D+2, brawling parry 5D, dodge 7D, firearms 6D, grenade 5D, melee combat 5D, melee parry 6D, thrown weapons 5D, vehicle blasters 5D
KNOWLEDGE 3D

Alien species 4D, bureaucracy 5D, bureaucracy: Imperial military 7D, cultures 5D, law enforcement 6D, planetary systems 7D*, streetwise 5D, survival 7D*

MECHANICAL 3D

Astrogation 5D, beast riding 5D, capital ship gunnery 5D, capital ship piloting 5D, capital ship shields 5D, communications 6D+2, ground vehicle operation 5D+2, hover vehicle operation 5D, repulsorlift operation 6D+2, space transports 6D, starfighter piloting 5D, swoop operation 4D+1, walker operation 5D+2

PERCEPTION 3D

Bargain 3D+2, command 5D, con 7D, forgery 5D, hide 6D+2, persuasion 6D+2, search 7D, sneak 5D+2

STRENGTH 3D+2

Brawling 5D, climbing/jumping 5D, lifting 5D, stamina 6D, swimming 4D

TECHNICAL 3D

Computer programming/repair 6D, first aid 6D+1*, ground vehicle repair 5D, security 7D*, walker repair 5D

* Some skills have been artificially enhanced by specialized training and mnemiotic drugs.

Character Points: 6

Move: 10

Equipment: comlink, heavy blaster pistol (5D damage), droid toolkit, datapad

Capsule: Drenn is a Human who claims to be from the Pembric system. He maintains that his family was from Pembric and that he was born on the smuggling haven.

Drenn is roughly 1.5 meters tall, with a slender build. He has light brown hair that is somewhat long and unkempt. His face is plain, with a wide mouth, framed by a beard that is also in need of grooming.

Drenn cultivates a bland, boring personality which minimizes the number of penetrating questions he has to answer. He is a loner and keeps to himself, though he can easily cultivate friendships if they serve his needs.

EPISODE ONE: GALTEA LAYOVER

Now that the hyperdrive of the *FarStar* has been repaired, and most of Sarne's devious trapdoors found and eradicated by young Gaelin, the hunt for Sarne must continue. There are few new leads, unfortunately, and Sarne has had time to gain a substantial lead.

Captain Adrimetrum has moved the ship to Galtea, a planet at the fringes of explored space, in an effort to restock the *FarStar's* dwindling supplies, as well as to relocate those refugees who wish to leave the *FarStar*.

The planet Galtea is probably the *FarStar's* last chance to stock up on supplies and arms for quite awhile, according to both Loh'khar and Drake — beyond Galtea and a few neighboring systems lies several days of deep space, and beyond that, the uncharted expanses of the Kathol Outback.

Because the planet is so remote, there is only a small limited services starport (featuring a farmers' market and merchants' bazaar) located on the planet's northernmost continent, and any maintenance on the ship that needs to be made



Philip Tan

will have to be finished as best as possible.

Galtea is a non-aligned world; the inhabitants are generally indifferent to galactic politics, largely due to the planet's frontier location. They are more than happy to assist the *FarStar's* crew, provided they are paid hard currency. The few remaining credits that the New Republic crew can muster should be fairly well exhausted by the end of the shopping trip on Galtea.

Read the following aloud:

Captain Adrimetrum has assembled the crew of the *FarStar* on the main hangar deck. "Fellow crewmembers," she says evenly, "we are poised on the edge of known space, pursuing an enemy that is extremely dangerous. Any crew member that does not wish to proceed any further may resign his or her commission and disembark. Galtea is our last stop for a while."

After a brief pause (during which no one volunteers to leave), Adrimetrum smiles. "Good."

She goes on to announce that the *FarStar* will be laying over on Galtea for a few days to offload refugees and take on supplies. The *FarStar* lands at the spaceport without mishap, and personnel are permitted shoreleave for the next two days.

DRENN MAKES HIS MOVE

Drenn is desperate to rejoin his Imperial comrades and finally hit on a plan that might work. Taking advantage of the shore leave, he manages to gain access to a transmitter and send a coded signal which will reach one of Sarne's roving fleets. In the message, he explains where the *FarStar* may be found, and what her probable defenses are. He adds that he hopes to sabotage the ship by disrupting its chain of command — by targeting Captain Adrimetrum for assassination.

Once back on board, assured that Imperial forces are on the way, Drenn lures one of the K-4 droids which serves on the *FarStar's* bridge into an alcove, and quickly makes several modifications to it. He is able to work uninterrupted since a large portion of the crew has disembarked. He first alters its command codes to respond to his signals, and also installs a small projectile gun in one of its recessed cavities. He loads the gun with a miniature dart loaded with the toxin he found on Sebiri.

Thanks to his position in maintenance, Drenn manages to place a small shaped charge near a major power conduit on the bridge, which he can detonate with a quick burst-transmission from an encrypted comlink. The explosion is designed to damage the bridge enough to distract the crew from his planned assassination attempt as well as aiding the Imperial attack force.

Galtea

Type: Terrestrial
Temperature: Temperate
Atmosphere: Type I (breathable)
Hydrosphere: Moderate
Gravity: Standard
Terrain: Forest
Length of Day: 22 standard hours
Length of Year: 277 local days
Sapient Species: Human
Starports: Limited services
Population: 890,000
Planet Function: Colony
Government: Guild
Tech Level: Space
Major Exports: Foodstuffs, minerals, metals, medicinal goods
Major Imports: Droids, computers, weapons, luxury goods

Capsule: Galtea was originally settled as an agricultural colony, as the planet has an extremely agreeable climate and an abundance of arable land. Since the area is at the limits of known Imperial space, the Empire allowed the Galteans some measure of autonomy in exchange for access to the natural resources that the planet produced.

A small Imperial outpost was maintained on the southern continent of the planet, but it was abandoned and destroyed when Sarne fled the region. This small outpost was the limit of Imperial presence on the planet; the Galteans are an independent people, ruled by agricultural and mining guilds and almost universally indifferent about galactic politics.

Galtea's surface is covered by lush forest, towering mountain ranges, and fertile plains; the forests and mountains are virtually untamed, though the plains regions of the northern continent are almost exclusively cultivated land.

EPISODE TWO: THE ATTACK

As the *FarStar* enters its second day on Galtea, read the following aloud:

Dawn comes two hours earlier on this world than on the ship's clock, and the tech crews performing maintenance on the *FarStar's* outer hull are bleary-eyed and slow. The early arrival of Galtea's sun has not deterred the off-duty personnel from drifting into town. After weeks of being crowded together on board, they are eager to stretch their legs and breathe something other than canned air.

The bridge watch is quiet, and Captain Adrimetrum is glad for the chance to sit quietly and plan her next steps. She is distracted by a faint electronic buzzing and an alarmed gasp

from the on-duty sensor tech, Alta Dayson. "What is it, Chief?"

"We got company, Captain," Dayson says, straining to read the images on her monitor. "Two, no, three ships have just reverted from hyperspace and are accelerating towards Galtea's gravity well. Approximated intercept 20 minutes."

A cold ball forms in the pit of Adrimetrum's stomach. "IDs?"

"Not yet, ma'am. Give me a minute or two. They're big, though, heavy shielding. Gotta be military."

"I don't like this at all." Adrimetrum hesitates, then sets her jaw. "Mr. Halley, clear for action!"

"Clearing for action, ma'am," Halley, the officer of the watch says, and turns to relay her command throughout the ship via intercom. "Bridge to all hands, clear for action! This is not a drill! Repeat, clear for action!"

As dull thumps begin reverberating through the hull as tech crews hurriedly seal external access hatches, Halley hits the universal comlink patch. "Bridge to all ashore. The *FarStar* is now clearing for action. You have five minutes to get aboard. Repeat, you have five minutes to get aboard."

Dayson spins towards her captain. "They're Imperial, Captain. I make one Strike cruiser, one Lancer frigate, and an escort carrier, class indeterminate. Approximated intercept is 16 minutes."

Drenn's Imperial allies have arrived. In the five allotted minutes, 84 crewmembers will be aboard. If Adrimetrum waits an additional five minutes, 114 crew members will be aboard, but she will pay a price (see below). The lack of a full complement will not immediately impact the performance of the *FarStar* in combat.

When the *FarStar* lifts off, the Imperial forces will be closing in. The *FarStar* has just enough time to clear the atmosphere before the Imperial ships close for engagement.

If Adrimetrum delayed her lift off, the escort carrier will be able to launch its TIEs before engaging the *FarStar*. Otherwise, the *FarStar* will be able to launch its X-wings before the TIEs enter the fray.

1 Strike cruiser. Capital, *capital ship gunnery 4D+2, capital ship piloting 5D, capital ship shields 4D+2.* Maneuverability 2D, space 6, hull 6D, shields 2D+2. Weapons: 20 turbolasers (fire control 2D, damage 5D), 10 turbolaser batteries (fire control 2D, damage 7D), 10 tractor beam projectors (fire control 2D, damage 4D), 10 ion cannons (fire control 4D, damage 4D). (For more information,

see pages 53-54 of *Imperial Sourcebook, Second Edition.*)

1 Lancer Frigate. Capital, *starship gunnery 4D, capital ship piloting 3D+2, capital ship shields 4D.* Maneuverability 1D, space 4, hull 4D, shields 2D+2. Weapons: 20 quad laser cannons (starfighter scale, fire control 4D, damage 4D). (For more information, see page 55 of *Imperial Sourcebook, Second Edition.*)

1 Escort Carrier. Capital, *astrogation 3D+2, capital ship gunnery 4D, capital ship piloting 4D+1, capital ship shields 3D+2, sensors 3D+2.* Maneuverability 1D, space 4, hull 7D+1, shields 2D. Weapons: 10 twin laser cannons (fire control 3D, damage 3D). (For more information, see pages 54-55 of *Imperial Sourcebook, Second Edition.*)

40 TIE/In Fighters. Starfighter, *starfighter piloting 5D, starship gunnery 4D+2.* Maneuverability 3D+2, space 11, hull 3D. Weapons: 4 laser cannons (fire control 3D, damage 6D, fire linked). Note to gamemasters: the Imperials have a complement of 135 starfighters, but launch only 40 at the start of the battle, holding the rest in reserve.

When the battle begins, read the following aloud:

Swinging into view from the far side of Galtea's moon, the three Imperial warships move at high speed towards the *FarStar*, turbolasers blazing. A twinkling latticework of deadly energy reaches through the void, though for the next few moments at least, the Imperial vessels are just out of range.

"Raise the shields, launch X-wings!" Captain Adrimetrum shouts. "Navigator, plot an exit vector and get us the hell out of here!"

"What about the crew on the ground?" Thyte shouts over the din of alarm klaxons. "We can't just *abandon* them!"

"Follow your orders, Mister!" Adrimetrum snarls. "That isn't an occupying force, they're gunning for the *FarStar*!"

"The crew should be safe enough where they are until we can shake these ships and come back for them," Dajus notes.

Crewmembers frantically scramble to comply with the Captain's orders as the first salvo of Imperial fire rumbles across the *FarStar*'s defectors, shaking the ship convulsively.

If Kaiya Adrimetrum is being run as a game-master character, she attempts to reverse course and answer the Imperials' fire, moving to escape from the system. Galtea's gravity well prevents a jump to lightspeed for at least seven rounds, providing the Imperial ships ample opportunity

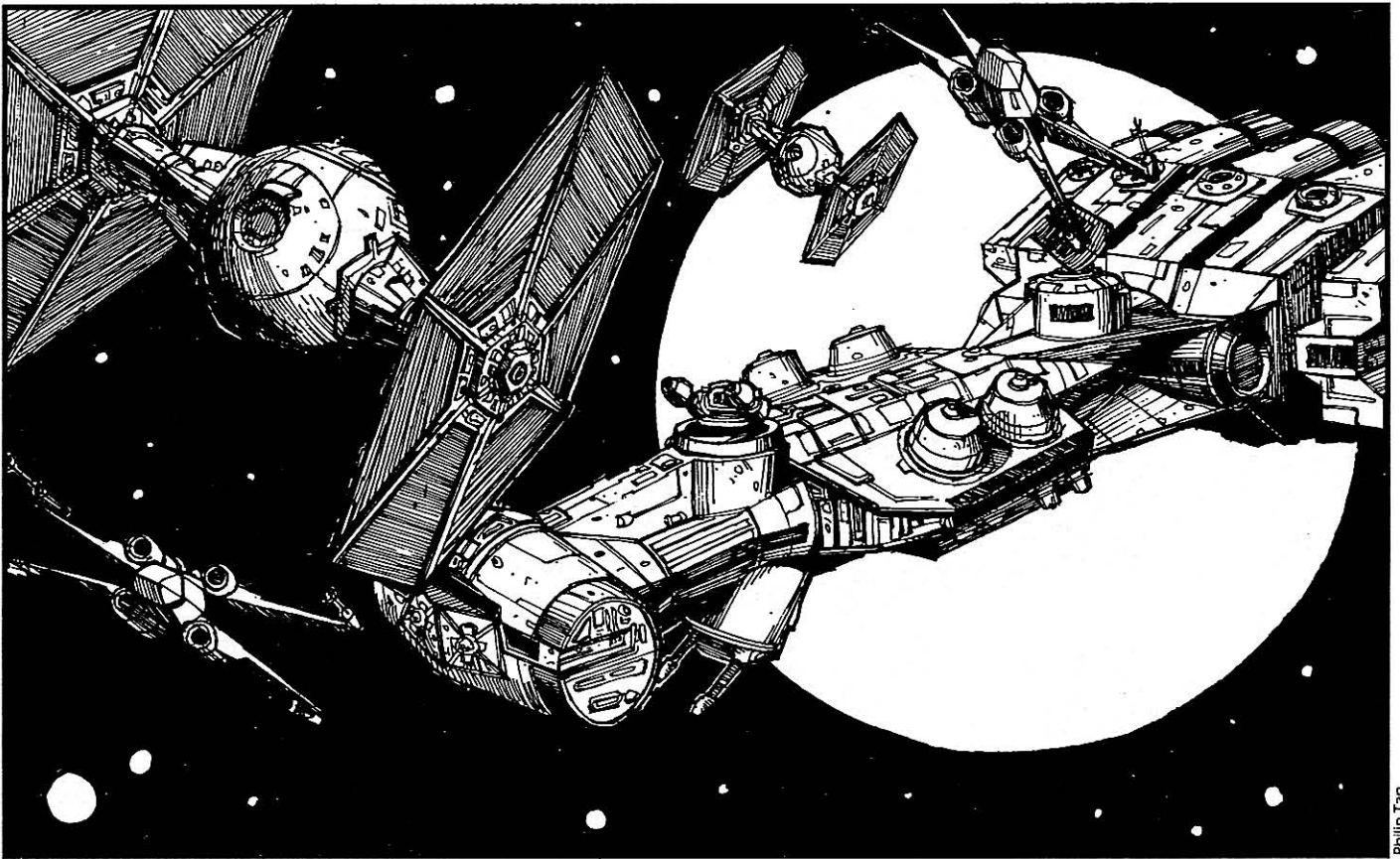

Philip Tan

to engage the New Republic forces.

In addition, Captain Adrimetrum orders an exit course into hyperspace during the battle; the character given the task of plotting the jump to lightspeed must make a successful Difficult *astrogation* roll. The astrogator must program a complicated series of “micro-jumps” since the area is not documented in the nav computer. This strategy is also designed to shake Imperial pursuit, giving the *FarStar* a chance to return or the rest of the crew. The hyperspace coordinates of a rendezvous point are also generated, and transmitted to the X-wing pilots.

During the battle, and before the *FarStar* make the jump to hyperspace, Drenn slips onto the bridge to get Adrimetrum. As soon as the *FarStar*'s navigator has successfully prepared an astrogation plot, read the following aloud:

The Imperial ships are relentless in their pursuit, and incoming blaster fire continues to rock the *FarStar*. Damage reports are coming in from all decks when the navigator reports a successful astrogation plot, and the faint smell of burning circuitry is beginning to infiltrate the carefully filtered atmosphere of the bridge.

Captain Adrimetrum is standing in front of

her command chair, emphatically ordering the jump to lightspeed when — with a loud WHUMP! — several overhead power conduits blow out at once, showering her with debris and knocking her to the deck. Her unconscious form is barely visible beneath the sparking pile of power transfer cables and heavy conduits.

Simultaneously, all systems on the bridge go completely dead, including sensors. A glance through the viewport confirms that the ship appears to be moving, and the shields are obviously still up since the *FarStar* is not immediately blasted into component molecules, but helm control, sensors and communications are all inoperative.

Unless the power to the bridge is restored, the *FarStar* is an easy target for the Imperial task force.

The immediate problem the players face is the power drain. Captain Adrimetrum is unconscious and buried under rubble and if the characters spend the time needed to extricate her from the wreckage, she will not provide much assistance in the battle and the *FarStar* will be destroyed in the meantime.

The main power conduit to the bridge and its



Philip Tan

secondary backup have been destroyed by the blast, severing the bridge from contact with control computers necessary to operating ship systems. The conduit will have to be re-routed through the life support backups.

This repair work will take approximately two rounds and will require a two Moderate *capital ship repair* rolls: one to diagnose the cause of the power loss, and the second to repair the damage. Since there is no time to truly test the repair job, it is a simple matter of do or die; the gamemaster should imply that the patch job on the power conduit could either restore power or it could blow the bridge apart. The repair could also be done from engineering in a pinch, but would be a Difficult action there.

As soon as bridge power is restored, the *FarStar* can withdraw, accompanied by the remaining starfighter squadron; fortunately, the backup memory buffer in the nav computer managed to

store the micro-jump sequence before the power conduit was severed and the *FarStar* can make a run for it.

EPISODE THREE: SINISTER AFTERMATH

Read the following aloud:

The *FarStar* has moved to an uncharted binary system several hours' travel from the Galtea system. Acting Captain Khzam and Security Officer Kl'aal agree that the radiation fields thrown out by the unstable suns should provide some temporary protection from enemy sensor probes, allowing the repair crews to begin patching the *FarStar* back together.

Despite some rather severe damage to the bridge, and numerous hits to the hull, casualties were (thankfully) minimal.

One noticeable exception, however, is Captain Adrimetrum. She is in a coma, though Dr. Akenseh's report indicates that the majority of her injuries would not account for her unconsciousness; numerous cuts and bruises, a broken arm and three cracked ribs were the extent of her injuries.

"We've discovered no known cause for her condition, so finding out why she's in this coma will take a lot longer," Akenseh sighs, "and she's not even responding to bacta treatment. Her wounds are healing rapidly, but she just won't wake up. Quite frankly," he adds, bitterly, "we are running out of ideas."

The situation is extremely tense, not only because the captain lies dying, but because Khzam, as captain, refuses to return to Galtea for the abandoned crewmembers. "The Empire is sure to be lying in wait!" he argues. "Our losses are minimal. The crew we left behind would understand the need for their sacrifice."

This decision does not sit well with most of the other officers (let alone the crew), but the best way to rectify the situation is to restore Adrimetrum to her command rather than mutiny against Khzam. As Lieutenant Jessa Dajus points out, "We can't afford to set a precedent for mutiny with the motley crew this ship has." Surprisingly, Gorjaye agrees.

Regarding Adrimetrum's mysterious illness, Dajus can recall similar incidents of unexplained comas during Sarne's reign. Political opponents of the Moff suddenly turned up in medical stations, reportedly in the same condition as Adrimetrum. In most cases, these anomalous individuals passed away in a medical bay after spending a few days on life-support apparatus.

Jessa suspects that the Captain's condition is caused by whatever method the Moff used to eliminate his enemies. When this information is revealed, Kl'aal will insist on investigating for evidence of sabotage.

THE INVESTIGATION

Read the following aloud:

Security Officer Kl'aal has ordered a shipwide alert and "requested" that non-essential personnel remain in their quarters. You have been assigned to assist the Defel in his hunt for the possible saboteur. The K4 security droid present on the bridge at the time has offered a replay of the *FarStar's* flight recorder logs from the critical moments of the battle at Galtea.

"We'll watch them all right," Kl'aal growls, baring his fearsome fangs, "as many times as it takes to find our saboteur."

It's going to be a very long day.

Every character who watches the ship's logs must roll a *Perception* or *investigation* check.

Any character who makes an Easy skill roll will notice that the explosion above Captain Adrimetrum's position during the battle did not coincide with a blaster impact.

Any character who makes a Moderate skill roll will notice that, for a brief moment — less than two seconds — the K4 droid's flight recorder time figures "skip ahead." Two seconds of log time is missing from the droids memory (and from the *FarStar's* main computer as well, if the characters bother to check).

Any character who makes a Difficult skill roll will notice that an instant before the bridge explosion, Captain Adrimetrum absently slaps at her neck as if stung or struck lightly from behind.

Any character who makes a Very Difficult skill roll will notice that this impact on the Captain's neck originated from the K4 droid's position at the bridge's security station.

Any character who makes a Heroic skill roll will notice that portions of the K4 droid's memory buffer have been altered. The changes are subtle and almost impossible to detect, as if other portions of his memory have had their time indexes altered and then been "grafted" over the true record. In particular, the portions of the K4 droid's computing memory dedicated to targeting and weapons systems have suffered the most tampering. This raises the possibility that the true records may be recovered; simple deletion of flight recorder logs would raise an alarm so it is conceivable that the records may have been hidden instead.

However, any attempt to recover these "hidden" files requires three separate Very Difficult

computer programming/repair checks: one to locate the hidden files, one to deactivate the security program protecting the hidden files, and a third to successfully decode them (since Drenn encrypted these files heavily). The process of locating, securing and decoding these files will take approximately two Standard days.

OTHER EVIDENCE

Characters making successful Moderate *search* rolls while investigating the power conduits that exploded will find fragments of a thermal detonator and burned circuitry that looks like a piece of a receiver.

Characters making successful Moderate *droid programming* or *droid repair* rolls while running any kind of diagnostic or repair protocol on the K4 droid will discover the charred remains of the pneumatic launcher in the droid's weapon compartment. No real evidence remains, save a small burn scar and a fragment of the weapon's barrel.

Read the following aloud:

The medical staff, assisted in part by evidence that was gathered during the preliminary security investigation, have found two anomalies in the Captain's condition: a small bruise at the base of her neck and an unexplained decrease in neurotransmitter activity in her brain.

"Obviously," Dr. Akenseh says, "there is some form of contact poison or other foreign agent at work in this case. Unfortunately, this substance does not appear in standard medical scans."

Major Drake speaks up, "I know this may be a long shot, but awhile ago I followed a lead down to find one of Sarne's agents. This agent supposedly made regular visits to an outlying system. This planet was the source of a toxin that the agent favored for political assassinations." A grim expression flits over Drake's face. "I never found the agent or the source of the poison, but the natives of the planet are relatively friendly. Maybe we should check it out."

EPISODE FOUR: MISSION TO SEBIRIS

Acting Captain Khzam will second Drake's motion to go to the nearby system, specifically to the jungle planet Sebiris. During the trip, Adrimetrum's coma deepens ("If anything, there is even less neurotransmitter activity now than there was yesterday," Akenseh explains. "If an antidote isn't found quickly, she'll be dead in days.")

Drake will provide a suitable astrogation plot and as detailed information as he can about the planet and its inhabitants. He offers access to his datapad. Note that if its contents are widely distributed, Drenn will probably see them and realize Drake is hunting him.

■ The Sebiri

Attribute Dice: 12
DEXTERITY 2D/4D
KNOWLEDGE 2D/3D

MECHANICAL 1D/3D
PERCEPTION 2D/5D
STRENGTH 1D/3D
TECHNICAL 1D/2D

Special Abilities:

Stealth: The Sebiri are excellent hunters, adept at trapping the fearsome creatures that inhabit the planet. All Sebiri have 4D+2 *stealth* when generated and can advance the skill normally.

Night Vision: Sebiri have extremely acute eyes; they suffer no penalty when moving in darkness.

Enhanced Olfactory Senses: The Sebiri have a well-developed olfactory system. All scent-based tracking rolls receive +1D.

Sign Language: The Sebiri language is composed of many grunts and multi-syllabic, staccato phrases. In addition, hand gestures make up a good portion of their "speech" and as such makes communicating silently very easy for the Sebiri.

Move: 10

Size: 1.2-2 meters tall

Capsule: The Sebiri are a humanoid race native to Seberis, located beyond the fringe of known space. They generally shun clothing, as their bodies are covered by a thick scaly hide. A ridge of bony horns begins at the bridge of their truncated noses and stretches in a cone-shaped pattern to the top of the foreheads. A long length of coarse black hair (almost a mane) starts just past the top of the forehead and flows down the back. Sebiri males often braid this mane into complex patterns, decorating them with bits of bone, foliage or other decorative (but primitive-looking) jewelry.

Sebiri are a greenish-brown in color, with red, slit-pupiled eyes that see equally well in daylight or darkness. They are excellent hunters and trappers, skilled in primitive combat particularly with spears, slings and clubs. In addition, some few Sebiri possess primitive firearms (flintlocks and the like), presumably traded to them by "Klendost Petrivoor". (Very few Sebiri can shoot these weapons well; they are notoriously inaccurate firearms and the noise usually startles the shooter as much as his target.)

The Sebiri are a superstitious culture, though they are generally quite friendly to strangers, particularly strangers that bring them K'va't'uuk — gifts. Most Sebiri in the village visited by Drake have picked up a smattering of Basic and are usually quite eager to see non-Sebiri. However, any attempt to trespass on *L'ttuuk'chk* ("holy ground" or "forbidden land") will be met with violence.

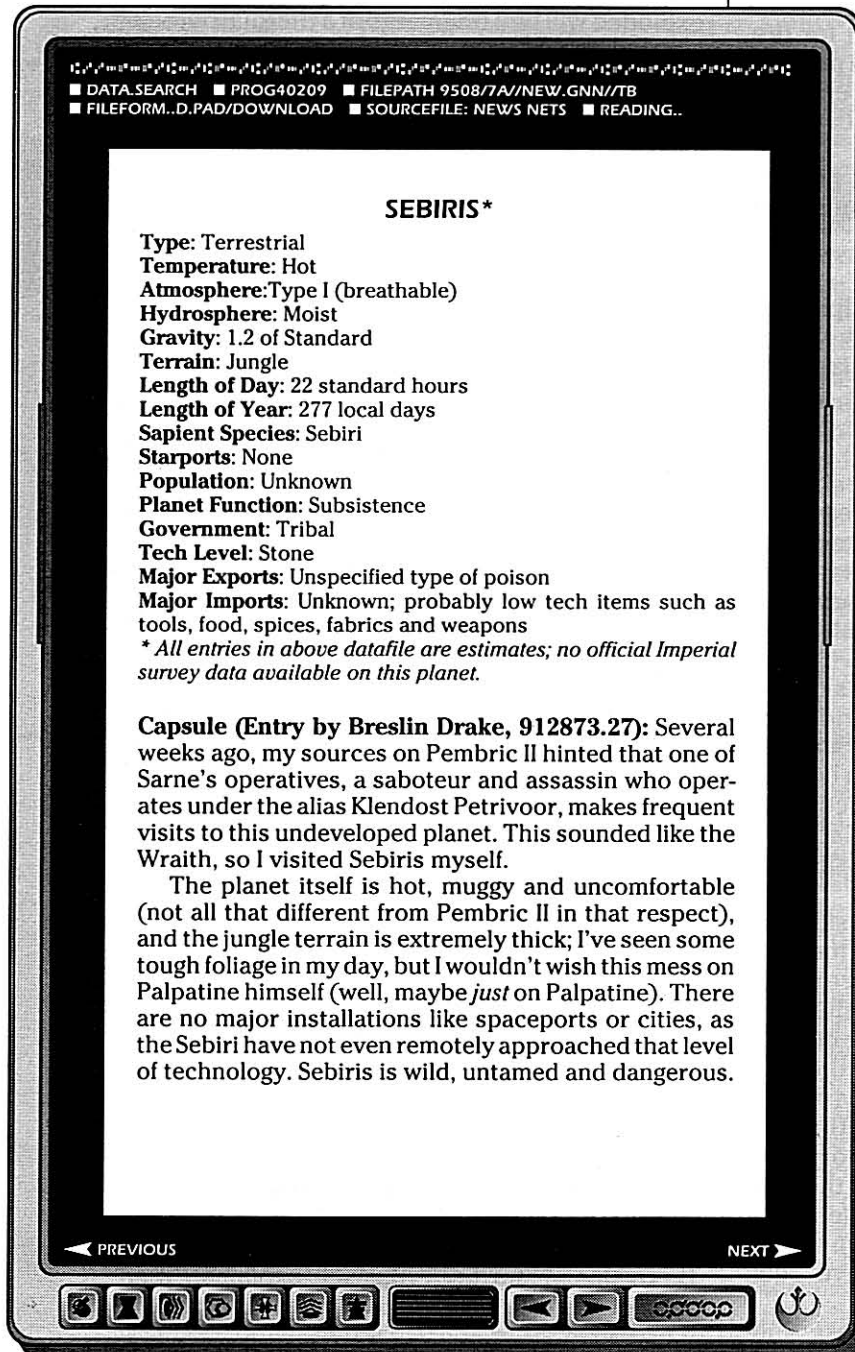

THE LANDING

Drake gives landing coordinates for the village he visited, in the equatorial region of the planet. He suggests the characters head to the surface armed, not because the Sebiri pose an overt threat, but because there are extremely dangerous creatures indigenous to the jungle-planet.

Drake also suggests that a fairly large sized armed party accompany the shuttle to the surface, just in case Drake's misstep on his last trip to Sebiris has changed the Sebiri's attitude about visitors. Drenn is one of the volunteers that accompanies the mission to the surface.

Read the following aloud:

As instructed by Drake, you light a large fire in a pit at the edge of the clearing you have landed in. Before long, several Sebiri glide noiselessly out of the jungle. The humanoid species is quite adept at stealth; you hear nothing but the odd cry of a far off animal and the hiss of a light, humid breeze.

Five Sebiri enter the clearing, moving purposefully towards your ship. Four of the Sebiri are nearly two meters tall and extremely fit. The four seem to be carrying primitive flintlocks or wheellocks or other such weapon. The fifth is shorter and appears older. He wears a multicolored cloth band around his forehead ... obviously the headman.

NEGOTIATIONS BEGIN

Communicating with the Sebiri is a tedious process, since there is virtually no common ground between their language and the characters'. In general, until the characters learn the Sebiris' linguistic nuances, all *language* rolls are at -1D. However, during the meeting at the shuttle, the headman will make it clear that the Sebiri delegation is non-hostile and will escort the characters to his village.

THE SEBIRI VILLAGE

Read the following aloud:

The Sebiri village is small, housing no more than two or three dozen extended families, at most 200 people. Scale-covered Sebiri children play in the mud and the timid

Sibiri women watch you suspiciously. The males treat you as honored guests however, offering you a sickly-looking sap-based beverage and leading you to their huts.

The headman will explain that the poison Captain Adrimetrum has been exposed to eventually proves fatal to most humanoids, and that the only antidote is a series of herbs that can be found near the sacred ground, the hexagonal mound a short distance away from the village.

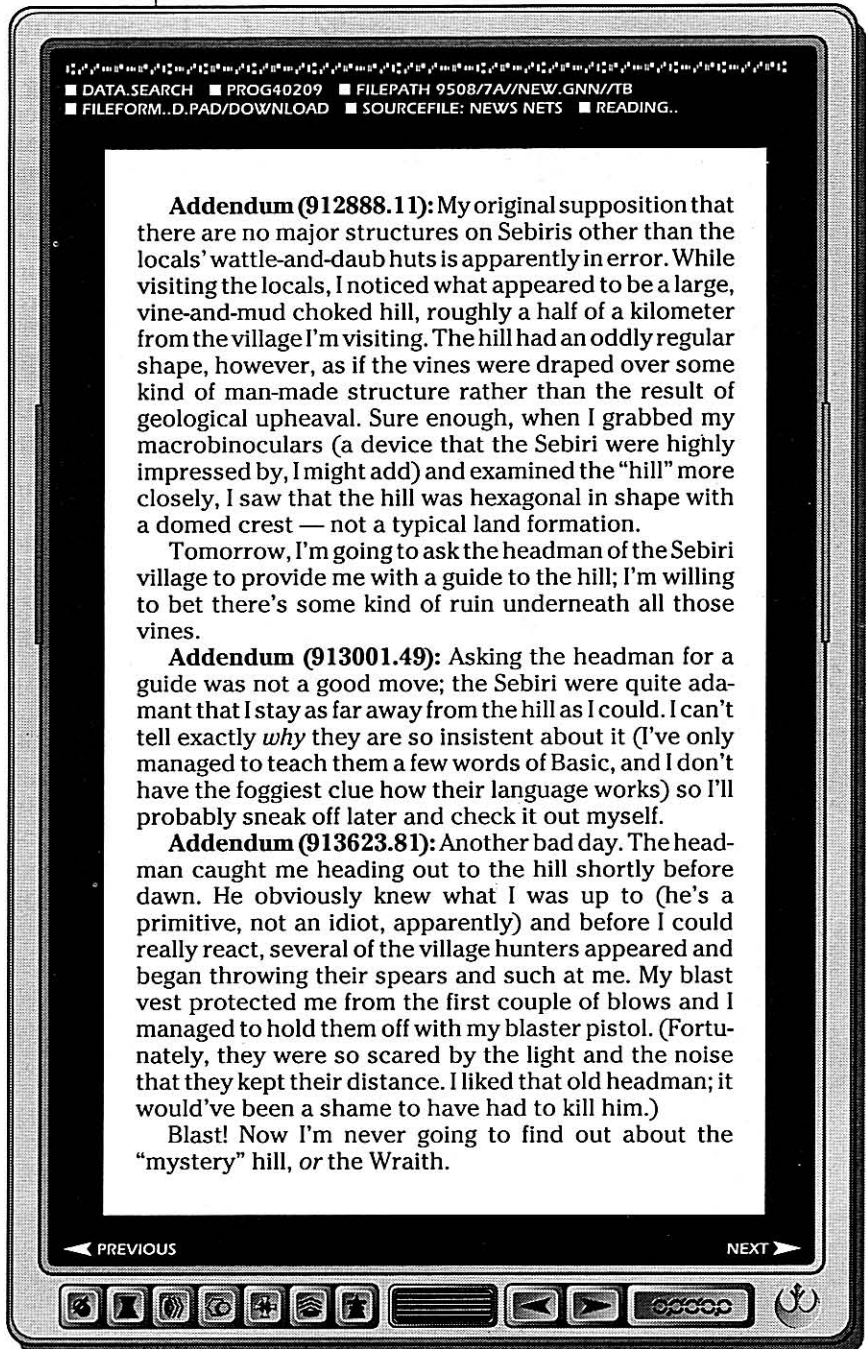



Philip Tan

The headman will also reveal that the mound is sacred because it was created by "those who came before." He goes on to tell about a wondrous civilization that created the jungle around them and built the mound without the use of tools. "Those who came before" were some form of advanced race that "spread their people across the sky," and used small glowing charms and devices to perform miracles, according to the headman. The "miracles" the headman describes sound remarkably similar to the unusual technology Moff Sarne used in his escape from the capital.

The headman will resist any attempts to convince him to lead a group to the mound, but if given ample amounts of "gifts" (he particularly enjoys exotic foods) he will lead the way personally, accompanied by 12 Sebiri hunters. If the characters are unable to communicate with the headman, they have no choice but to strike out

towards the mound without a guide. If this happens, skip to the battle in the next section. Otherwise read the following aloud:

The trip to the mysterious hill is uneventful. A few times, the Sebiri caution you to stand still as something massive moved through the undergrowth a few hundreds meters away, but none of the ferocious predators native to the planet leaps out to attack.

As you near the mound, the headman gathers some of the nearby herbs and hands them to you. While he is doing this, one of the men who came to the *FarStar* with Drake is apparently speaking with one of the Sebiri hunters. The Sebiri headman gestures at the *FarStar* volunteer, named Drenn, and says in broken Basic: "You come back, Petrivoor, yes?"

At this point Drake will realize who his man really is. At the same time, Drenn realizes he has been found out, and he immediately draws his blaster rifle out and opens fire — not on the characters, but on the "mystery" hill itself, an action that raises the ire of the Sebiri escorts.

BATTLE NEAR THE RUIN

Read the following aloud:

Drenn/Petrivoor's wild blaster shots crash through the foliage encrusting the hexagonal shaped hill, sending clouds of hissing, oily smoke into the air. Beneath the burning vines, you can see carved stone, decorated with intricate patterns unlike anything you've ever seen before.

The Sebiri are less than pleased at the turn of events. Several let out eerie, howling cries that are answered from off in the jungle; the natives are calling for reinforcements. Drenn blasts the nearest hunter and runs for the jungle. While several of the Sebiri pursue him, the rest turn their attention on you.

10 Sebiri Hunters. All stats are 2D except: *Dexterity* 3D+2, *brawling parry* 5D+2, *dodge* 7D, *melee combat* 6D+2, *melee parry* 6D+2, *running* 6D, *thrown weapons: sling* 5D, *search* 5D+2, *sneak: jungle* 6D, *brawling* 5D+2. Move: 10. 4 Sebiri carry flintlocks (4D), 4 carry spears (STR+1D), 2 carry slings (4D).

Sebiri Headman. All stats are 3D except: *Dexterity* 4D, *dodge* 8D, *melee combat* 8D, *melee parry* 6D, *sneak: jungle* 7D. Move: 10. Spear (STR+1D).

The characters can either fight, run or negotiate with the enraged Sebiri. If more than five of the Sebiri are killed or stunned by blaster fire, the rest will break off, afraid of the "magical" weapons. At this point, the characters may negotiate



Philip Tan

a truce in order to get back to their shuttle or continue blasting away at the Sebiri.

If the characters attempt to negotiate a truce immediately after Drenn flees, the headman will demand many more gifts and further insist that after they deliver his booty, the characters leave the planet forever. He will not surrender the antidote, and the characters will be forced to try and take it by force.

If the characters attempt a detailed search of the temple, they will find little of note despite the stunning architecture. Apparently, the whole temple was constructed out of a single piece of stone and an examination of it reveals that the stone is native to the southernmost continent—someone transported this rock nearly 2,000 kilometers. The interior has no wall carvings or other indicators regarding its origins.

If the characters run, they are at a severe disadvantage. The jungle foliage will cut their movement in half, a penalty the Sebiri, native to this environment, do not suffer.

CONCLUSION

After the characters return to the *FarStar*, read the following aloud:

The medical staff is skeptical when presented with the herbal remedy to the captain's condition, but that skepticism is quickly allayed when, hours after being administered the primitive cure, the captain stirs and comes out of her

coma. "Just resting my eyes," she mutters, before falling into a deep, normal sleep. She returns to duty a day later.

The captain is extremely excited about the mysterious ruin on Sebiri. "They say all mythology has its basis in fact, and I tend to agree. If there was a species that spanned this region centuries ago, Sarne could be picking up their discarded toys.

"Regardless of where he got the technology," she pauses thoughtfully, "we aren't going to find him in known space. We have only one choice. We have to go further out.

"Sarne's out there, and we're going to get him." Captain Adrimetrum seems uncharacteristically eager, pleased at how well the novice crew reacted to a dangerous situation. "Well done," she congratulates you.

Unfortunately, Drenn had stashed some sort of vehicle on the surface Sebiris. The small freighter managed to make the jump into hyperspace before the *FarStar* could move to pursue. "I wouldn't worry," Drake grimaces, "I'm sure we'll see him again."

SKILL AWARDS

Character receive three Character Points for their participation.

Characters who uncovered more than three clues in the "Investigation" section receive an additional Character Point.

STAR WARS



Brandis Turgah

Type: Informer
DEXTERITY 2D, Pick pocket 3D
KNOWLEDGE 3D, Bureaucracy 4D
MECHANICAL 3D, Astrogation 4D
PERCEPTION 3D+2, Con 6D, search 5D, sneak 5D+1
STRENGTH 2D+1
TECHNICAL 4D, Computer programming/repair 5D, droid programming 6D, droid repair 5D+2, security 6D
Force Pts.: 1
Character Pts.: 5 **Move:** 10
Equipment: Coveralls, datapad

©, TM & © 1995 Lucasfilm Ltd.

Illustration by Mike Vilardi

STAR WARS

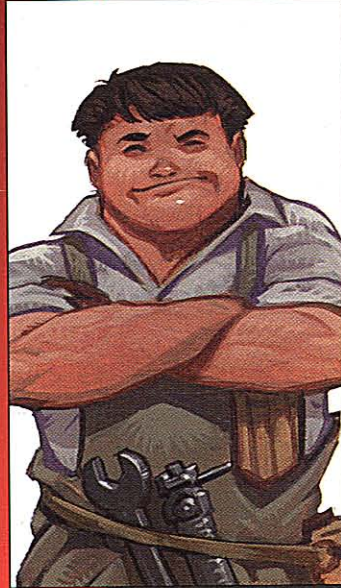

Sergeant Brophar Tofarain

Type: Starship Mechanic
DEXTERITY 2D+1, Blaster 3D, dodge 4D, melee combat 4D+2
KNOWLEDGE 2D, Business: starships 5D, planetary systems 4D, streetwise 3D, value: starships 6D
MECHANICAL 3D+2, Astrogation 4D+2, repulsorlift ops 5D+2, space transports 7D, sensors 5D, starship shields 6D
PERCEPTION 3D, Bargain 7D, con 6D+2, gambling 5D, persuasion 6D
STRENGTH 3D, Brawling 5D, lifting 4D, stamina 4D+2
TECHNICAL 4D, Capital ship repair 6D, computer programming/repair 6D+1, droid programming 5D+2, security 7D, space transports repair 10D, starfighter repair 5D+2, starship weapon repair 7D
Force Pts.: 2
Character Pts.: 10 **Move:** 10
Equipment: Dirty coveralls, hydrospanner, starship tool kit (+1D to capital starship repair, space transports repair, starfighter repair and starship weapon repair skills)

©, TM & © 1995 Lucasfilm Ltd.

Illustration by Chris Moeller

STAR WARS

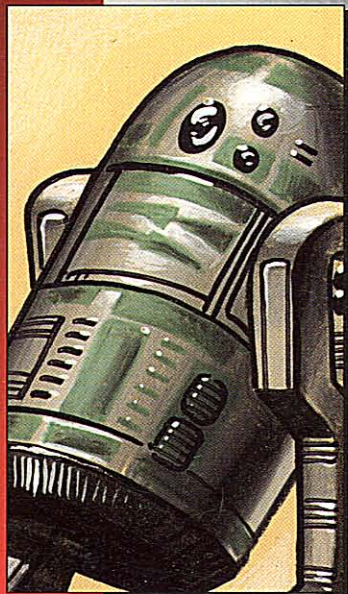

R2 Astromech Droid

Type: Industrial Automation R2 Astromech Droid
DEXTERITY 1D
KNOWLEDGE 1D
MECHANICAL 2D, Astrogation 5D, space transports 3D, starfighter piloting 3D
PERCEPTION 1D
STRENGTH 1D
TECHNICAL 2D, Computer programming/repair 4D, starfighter repair 5D*
 *Astromech droids may attempt starfighter repairs.
Equipped with:
 • Three wheeled legs (one retractable)
 • Heavy grasper arm (lifting skill at 2D)
 • Retractable fine work grasper arm
 • Extendible video sensor
 • Small electric arc welder (1D-5D)
 • Small circular saw (4D damage)
 • Small (20 cm by 8 cm) internal "cargo" area
Move: 5
Height: 1 meter tall
Cost: 4,525

©, TM & © 1995 Lucasfilm Ltd.

Illustration by Doug Shuler

STAR WARS



Genna Seedar

Type: Field Medic
DEXTERITY 4D, Blaster 5D, dodge 6D, running 5D
KNOWLEDGE 2D, Survival 3D+1
MECHANICAL 3D, Communications 4D, repulsorlift operation 4D+2
PERCEPTION 3D, Sneak 4D+2
STRENGTH 2D, Lifting 3D
TECHNICAL 4D, First aid 6D+1, (A) medicine 2D
Force Pts.: 1
Character Pts.: 5 **Move:** 10
Equipment: Blast helmet (+1D physical, +1 energy), blaster pistol (4D), 3 med-pacs, small subspace radio

©, TM & © 1995 Lucasfilm Ltd.

Illustration by Mike Vilardi

STAR WARS



Lieutenant Darryn Thyte

Type: Bridge Officer
DEXTERITY 1D*, Blaster 1D+1*, dodge 4D+2
KNOWLEDGE 2D, Bureaucracy 5D, intimidation 4D+1, planetary systems 4D
MECHANICAL 1D*, Astrogation 7D+2, capital ship piloting 4D+1, capital ship shields 2D+2*, communications 6D+2, sensors 7D, space transports 1D+1*, starfighter piloting 1D+1*, starship gunnery 1D+1*, starship shields 3D*
PERCEPTION 3D, Command 6D, investigation 5D, persuasion 4D
STRENGTH 3D
TECHNICAL 3D, Computer programming/repair 5D+2, droid programming 4D, security 6D
 *Reduced due to injury
Special Abilities:
Cybernetic Hand: +1D to computer programming/repair.
Force Pts.: 3
Character Pts.: 10 **Move:** 10
Equipment: Blaster pistol (4D), headset comlink

©, TM & © 1995 Lucasfilm Ltd.

Illustration by Chris Moeller

STAR WARS



Padak

Type: Bounty Hunter
DEXTERITY 4D, Blaster: blaster rifle 6D+2, dodge 5D, grenade 6D, melee combat 5D+1, thrown weapons 5D
KNOWLEDGE 2D+2, Intimidation 4D+2
MECHANICAL 2D+2, Beast riding 3D+2, starship gunnery 4D
PERCEPTION 3D, Investigation 4D, search 5D, sneak 6D
STRENGTH 3D+2, Brawling 5D, climbing/jumping 4D+2
TECHNICAL 2D, First aid 3D
Force Pts.: 1 **Dark Side Pts.:** 3
Character Pts.: 5 **Move:** 10
Equipment: Blaster rifle (5D), blaster pistol (4D), hold-out blaster (3D), customized bounty hunter armor (+2D physical, +1D energy, torso, head and arms only), 4 grenades (5D), 2 knives (STR+1D), magna-grapple with 75 meters thincord, 2 thermal detonators (10D)

©, TM & © 1995 Lucasfilm Ltd.

Illustration by Doug Shuler

STAR WARS

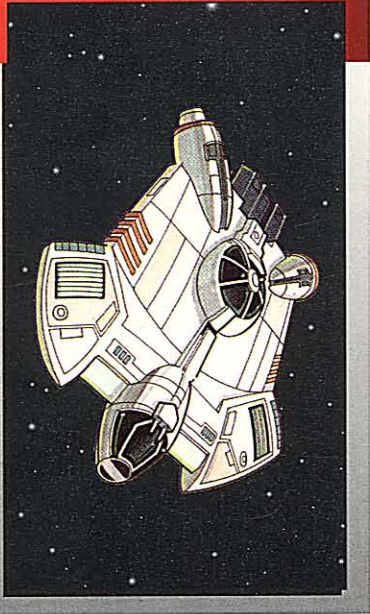

Fxz'Et

Craft: Ghitroc Industries 720
Scale: Starfighter
Maneuverability: 3D
Space: 4
Atmosphere: 280; 800 kmh
Hull: 4D
Shields: 2D
Weapons:
 1 Double Laser Cannon
 Fire Arc: Front
 Fire Control: 2D
 Damage: 5D

© TM & © 1995 Lucasfilm Ltd.

Illustration by David Detrick

STAR WARS



Steel Fist

Craft: Corellian Engineering YT-1300
Scale: Starfighter
Maneuverability: 2D
Space: 4
Atmosphere: 280; 800 kmh
Hull: 5D
Shields: 2D+2
Weapons:
 2 Quad Laser Cannons
 Fire Arc: Turret
 Fire Control: 2D
 Damage: 5D

© TM & © 1995 Lucasfilm Ltd.

Illustration by David Detrick

STAR WARS



Loh'khar the Finder

Type: Twi'lek Procurement Specialist
DEXTERITY 3D, Blaster 5D, dodge 6D+2, pick pocket 8D
KNOWLEDGE 4D, Alien species 8D, bureaucracy 7D+2, business 6D+1, cultures 7D, intimidation 7D, languages 8D, planetary systems 5D, streetwise 9D, survival 5D, value 6D, willpower 7D
MECHANICAL 2D, Repulsorlift ops 4D
PERCEPTION 4D+2, Bargain 7D, con 8D+2, forgery 6D+2, gambling 7D, hide 6D, investigation 7D, persuasion 8D, search 6D, sneak 6D
STRENGTH 2D+1
TECHNICAL 2D, Comp prog/rpr 5D+2, droid prog 4D, security 5D
Force Pts.: 3 **Dark Side Pts.:** 1
Character Pts.: 17 **Move:** 10
Equipment: Comlink, datapad and data-cards, heavy blaster pistol (5D)

© TM & © 1995 Lucasfilm Ltd.

Illustration by Chris Moeller

STAR WARS

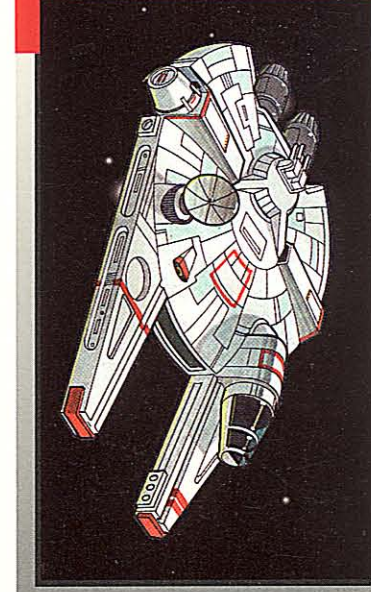

Steel Fist

Craft: Corellian Engineering YT-1300
Scale: Starfighter
Maneuverability: 2D
Space: 4
Atmosphere: 280; 800 kmh
Hull: 5D
Shields: 2D+2
Weapons:
 2 Quad Laser Cannons
 Fire Arc: Turret
 Fire Control: 2D
 Damage: 5D

© TM & © 1995 Lucasfilm Ltd.

Illustration by David Detrick

STAR WARS



"Gammer" Firdaaz

Type: Old Socorran Scout
DEXTERITY 2D+2, Blaster 4D, melee combat 3D+2, vehicle blasters 3D+2
KNOWLEDGE 4D, Alien species 4D+2, planetary systems 4D+1, survival 5D
MECHANICAL 3D, Astrogation 4D+2, beast riding 4D, repulsorlift ops 5D
PERCEPTION 2D, Search 3D, search: tracking 6D, sneak 3D
STRENGTH 3D
TECHNICAL 3D+1, First aid 4D+1, repulsorlift repair 5D
Force Pts.: 1
Character Pts.: 5 **Move:** 10
Equipment: Blaster pistol (4D), bottle of Socorran raava, breath mask, knife (STR+1D), macrobinoculars, medpac, protective goggles

© TM & © 1995 Lucasfilm Ltd.

Illustration by Mike Vilardi

STAR WARS

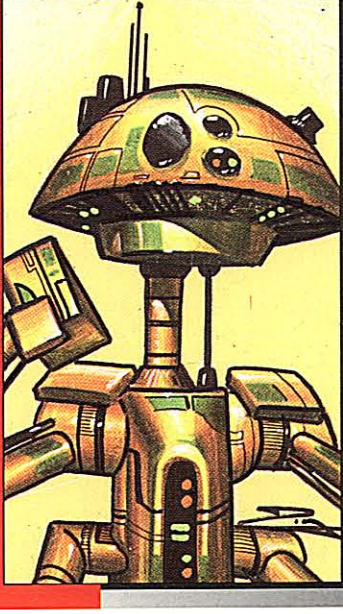

R-97 Quartermaster Droid

Type: Bossikan/Rendili R-97 Quartermaster Droid
DEXTERITY 1D
KNOWLEDGE 3D, Bureaucracy 4D, value 3D+2
MECHANICAL 1D
PERCEPTION 3D, Search 4D
STRENGTH 1D
TECHNICAL 1D
Equipped with:
 • Two auto-balance legs with extensions
 • Four arms
 • Domed head with photoreceptors and micro-scanner for inventory
Move: 7
Size: 2 meters tall (can raise up to 3 meters)
Cost: 4,000

© TM & © 1995 Lucasfilm Ltd.

Illustration by Doug Shuler

STAR WARS



Kaiya Adrimetrum

Type: New Republic Commander
DEXTERITY 3D+2, Blaster 6D, dodge 5D
KNOWLEDGE 3D+2, Bureaucracy 5D+2, intimidation 4D+1, law enforcement 4D, streetwise 5D, survival 6D, willpower 5D
MECHANICAL 2D+2, Capital ship piloting 4D, communications 5D, sensors 6D
PERCEPTION 3D+1, Bargain 5D+1, command 7D+2, con 5D+1, investigation 4D+2, persuasion 6D
STRENGTH 2D+2, Stamina 4D+2
TECHNICAL 2D, Computer programming/repair 4D, demolition 5D, first aid 5D+2, security 6D+2
Force Pts.: 3
Character Pts.: 12 **Move:** 10
Equipment: Datapad, headset comlink, heavy blaster pistol (5D)

©, TM & © 1995 Lucasfilm Ltd.

Illustration by Chris Moeller

STAR WARS



Lt. Ranna "Wing-Ripper" Gorjaye

Type: Brash Pilot
DEXTERITY 3D, Blaster 6D+2, brawling parry 4D, dodge 5D+2, melee combat 5D
KNOWLEDGE 2D, Bureaucracy 4D, intimidation 6D+1, planetary systems 4D+2, tactics: starfighter 5D, streetwise 4D, survival 5D+2, willpower 4D
MECHANICAL 4D, Astrogation 6D, communications 5D, repulsoflight operations 5D+2, sensors 5D, starfighter piloting 7D, starfighter piloting: X-wing 8D+1, starfighter piloting: Z-95 9D+2, starship gunnery 9D, starship shields 7D
PERCEPTION 3D, Bargain 4D+2, command 6D, persuasion 4D, search 4D, sneak 5D+2
STRENGTH 3D, Brawling 5D+2, climbing/jumping 5D, stamina 4D
TECHNICAL 3D, Computer programming/repair 4D, demolition 4D+2, first aid 5D, security 4D, starfighter repair 5D
Force Pts.: 3
Character Pts.: 12 **Move:** 10
Equipment: Blaster pistol (4D), flight suit and helmet, knife (STR+1D), medpac

©, TM & © 1995 Lucasfilm Ltd.

Illustration by Chris Moeller

STAR WARS



Dann Drugh

Type: Droid Specialist
DEXTERITY 2D+1, Dodge 4D+1, running 3D+1
KNOWLEDGE 3D+1, Languages: droids 5D, value: droids 5D
MECHANICAL 3D, Communications 4D, sensors 4D
PERCEPTION 2D+2, Command: droids 4D
STRENGTH 2D+2
TECHNICAL 4D, Computer programming/repair 5D, droid programming 5D+2, droid repair 6D, first aid 5D, security 5D+1
Force Pts.: 1
Character Pts.: 5 **Move:** 10
Equipment: Datapad, droid repair tools (+1D to droid repair), work coveralls

©, TM & © 1995 Lucasfilm Ltd.

Illustration by Mike Vilardi

STAR WARS

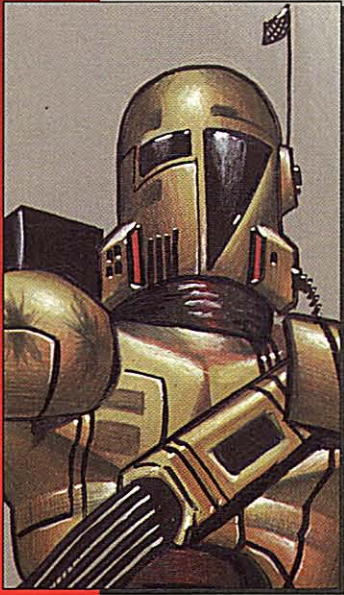

Padak

Type: Bounty Hunter
DEXTERITY 4D, Blaster: blaster rifle 6D+2, dodge 5D, grenade 6D, melee combat 5D+1, thrown weapons 5D
KNOWLEDGE 2D+2, Intimidation 4D+2
MECHANICAL 2D+2, Beast riding 3D+2, starship gunnery 4D
PERCEPTION 3D, Investigation 4D, search 5D, sneak 6D
STRENGTH 3D+2, Brawling 5D, climbing/jumping 4D+2
TECHNICAL 2D, First aid 3D
Force Pts.: 1 **Dark Side Pts.:** 3
Character Pts.: 5 **Move:** 10
Equipment: Blaster rifle (5D), blaster pistol (4D), hold-out blaster (3D), customized bounty hunter armor (+2D physical, +1D energy, torso, head and arms only), 4 grenades (5D), 2 knives (STR+1D), magna-grapple with 75 meters thincord, 2 thermal detonators (10D)

©, TM & © 1995 Lucasfilm Ltd.

Illustration by Doug Shuler

STAR WARS



Unda Lagor

Type: Aqualish Heavy Weapons Specialist
DEXTERITY 4D, Blaster 5D, blaster: repeating blaster 7D, blaster artillery 5D, brawling parry 5D, melee combat 6D, melee parry 5D, vehicle blasters 5D+2
KNOWLEDGE 2D, Intimidation 4D+2
MECHANICAL 3D, Repulsoflight operation 4D+1
PERCEPTION 3D
STRENGTH 4D, Brawling 6D, stamina 5D
TECHNICAL 2D
Force Pts.: 1 **Dark Side Pts.:** 2
Character Pts.: 5 **Move:** 9
Equipment: Blast helmet (+1D physical, +1 energy), blast vest (+1D physical, +1 energy, torso only), light repeating blaster (6D)

©, TM & © 1995 Lucasfilm Ltd.

Illustration by Mike Vilardi

STAR WARS

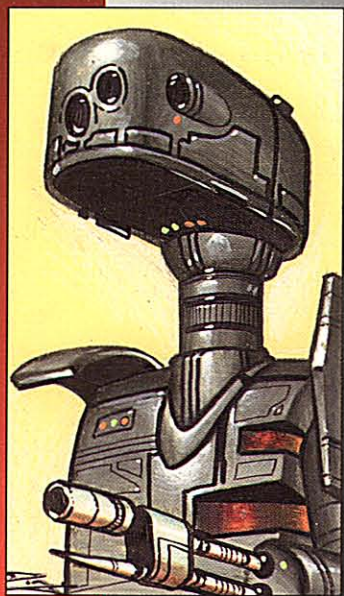

Rim Security's K4 Security Droid

Type: Rim Security's K4 Security Droid
DEXTERITY 3D, Blaster 7D, dodge 8D, running 4D
KNOWLEDGE 1D
MECHANICAL 1D
PERCEPTION 1D
STRENGTH 1D
TECHNICAL 1D
Equipped with:

- Two auto-balance legs
- Two arms
- Body armor: +2D to all locations
- Internal blaster rifle (5D damage, ranges 5-30/100/200)

Move: 11
Size: 1.6 meters tall
Cost: 5,000

©, TM & © 1995 Lucasfilm Ltd.

Illustration by Doug Shuler

STAR WARS

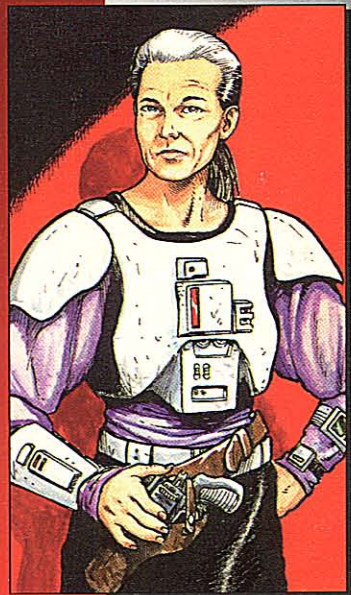

Scoryn

Type: Outlaw
DEXTERITY 4D, Blaster: heavy blaster pistol 6D+1, dodge 5D
KNOWLEDGE 3D, Streetwise 4D+1, survival 4D
MECHANICAL 2D+2, Repulsorlift operation 4D
PERCEPTION 2D, Search 3D, sneak 4D
STRENGTH 3D+1, Brawling 5D, climbing/jumping 4D+1
TECHNICAL 3D, First aid 4D, security 5D
Force Pts.: 1 **Dark Side Pts.:** 1
Character Pts.: 5 **Move:** 10
Equipment: Breastplate from bounty hunter armor (+2D physical, +1D energy, torso only), heavy blaster pistol (5D), medpac

©, TM & © 1995 L. Lucasfilm Ltd.

Illustration by Mike Vilardi

STAR WARS



Cobb Unser

Type: Pilot
DEXTERITY 3D, Blaster 4D, dodge 4D
KNOWLEDGE 2D
MECHANICAL 4D, Astrogation 4D+2, space transports 5D+2, starfighter piloting 5D, starship gunnery 5D, starship shields 4D+2
PERCEPTION 3D, Sneak 5D
STRENGTH 3D
TECHNICAL 3D, Droid programming 5D+1, droid repair 4D, starfighter repair 5D+2
Force Pts.: 1
Character Pts.: 5 **Move:** 10
Equipment: Blaster pistol (4D), flight suit

©, TM & © 1995 Lucasfilm Ltd.

Illustration by Mike Vilardi

STAR WARS



Rizzal, Vizzal and Nizzal

Type: Turazza
DEXTERITY 5D, Dodge 6D, pick pocket 6D+2, running 7D
KNOWLEDGE 2D
MECHANICAL 2D
PERCEPTION 5D, Search 6D, sneak 6D+1
STRENGTH 2D, Climbing/jumping 7D
TECHNICAL 2D
Force Pts.: 1
Character Pts.: 5 **Move:** 18
Equipment: Hold-out blaster (3D), messenger satchel
Rizzal. As above except: *computer programming/repair 4D+2, security 3D+2.*
Vizzal. As above except: *repulsorlift operation 4D, droid programming 3D.* Datapad, prybar (STR+2).
Nizzal. As above except: *intimidation 3D+2, streetwise 4D+2.*

©, TM & © 1995 Lucasfilm Ltd.

Illustration by Mike Vilardi

STAR WARS



Qesya Vth'naar

Type: Sludir Gladiator
DEXTERITY 4D+2, Brawling parry 6D+2, dodge 5D+2, melee combat: vibro-ax 8D, melee parry 6D
KNOWLEDGE 2D+1, Intimidation 5D, willpower 4D
MECHANICAL 2D
PERCEPTION 3D
STRENGTH 5D, Brawling 7D, stamina 6D
TECHNICAL 2D, First aid 3D
Special Abilities:
Natural Armor: +1D against physical attacks.
Force Pts.: 1 **Dark Side Pts.:** 1
Character Pts.: 5 **Move:** 8
Equipment: Battered armor breast and back plates (+1D physical, +1 energy), blaster pistol (4D), vibro-ax (STR+3D)

©, TM & © 1995 Lucasfilm Ltd.

Illustration by Mike Vilardi

STAR WARS



Lieutenant Jessa Dajus

Type: Imperial Tactical Advisor
DEXTERITY 3D, Blaster 5D, dodge 5D, pick pocket 6D
KNOWLEDGE 3D, Alien species 4D+2, bureaucracy: Imperial 6D, cultures 4D, intimidation 5D+2, planetary systems 7D, streetwise 5D, willpower 5D+1
MECHANICAL 3D+2, Astrogation 5D+2, communications 4D, repulsorlift operation 4D, sensors 4D+2, space transports 7D, starship shields 5D
PERCEPTION 3D+1, Bargain 4D, command 5D+2, con 7D+2, hide 4D+1, investigation 5D, persuasion 5D, search 6D, sneak 6D+2
STRENGTH 2D+1
TECHNICAL 2D+2, Comp. prog/rpr 5D+2, droid prog 5D, security 6D
Special Abilities:
Force Intuition: Dajus gets sudden bursts of intuition.
This character is Force-sensitive.
Force Pts.: 4 **Dark Side Pts.:** 2
Character Pts.: 15 **Move:** 10
Equipment: Comlink, datapad

©, TM & © 1995 Lucasfilm Ltd.

Illustration by Chris Moeller

STAR WARS



Tanner Carzyn

Type: Young Weapons Technician
DEXTERITY 3D, Blaster 4D, pick pocket 5D
KNOWLEDGE 2D+2, Value: weapons 4D+2
MECHANICAL 3D+1, Capital ship gunnery 4D+1, starship gunnery 4D+1
PERCEPTION 3D, Con 4D+2, search 4D, sneak 5D
STRENGTH 2D, Lifting 3D
TECHNICAL 4D, Blaster repair 4D+2, capital ship weapon repair 6D+1, starship weapon repair 5D
Force Pts.: 1
Character Pts.: 5 **Move:** 10
Equipment: Coveralls, tool kit (+1D to capital ship weapon repair and starship weapon repair skills)

©, TM & © 1995 Lucasfilm Ltd.

Illustration by Mike Vilardi

STAR WARS

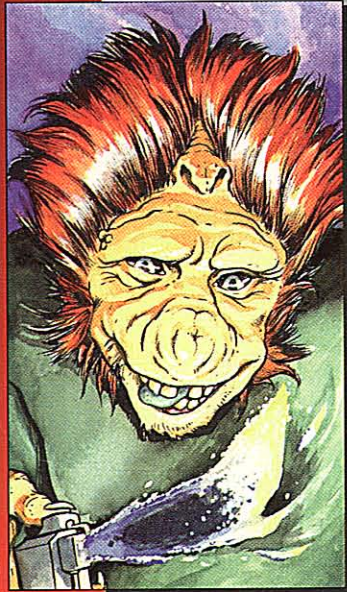

Boom

Type: Guudrian Pyromaniac
DEXTERITY 4D, Blaster 5D, dodge 5D, grenade 6D, pick pocket 6D
KNOWLEDGE 3D
MECHANICAL 2D
PERCEPTION 3D, Hide 4D, search 4D, sneak 5D
STRENGTH 2D, Climbing/jumping 3D
TECHNICAL 4D, Demolition 7D, security 5D
Force Pts.: 1 **Dark Side Pts.:** 2
Character Pts.: 5 **Move:** 9
Equipment: Backpack, 2 blocks detonite (5D) with timer fuses, 3 grenades (5D), 2 mini-flamers

©, TM & © 1995 Lucasfilm Ltd.

Illustration by Mike Vilardi

STAR WARS

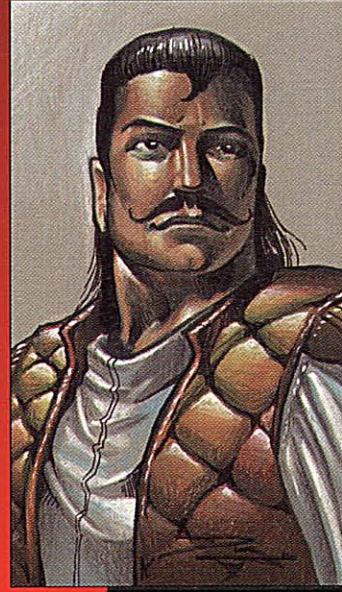

Kolig

Type: Renegade Pilot
DEXTERITY 3D, Blaster: heavy blaster pistol 5D, dodge 4D, pick pocket 5D
KNOWLEDGE 2D, Intimidation 4D, planetary systems 5D, streetwise 4D+2, survival 4D+1
MECHANICAL 4D, Astrogation 5D, sensors 4D+2, space transports: YT-1300 6D, starship gunnery 5D, starship shields 5D+2
PERCEPTION 3D, Command 4D, con 5D, search 3D+2, sneak 5D+1
STRENGTH 3D
TECHNICAL 3D, Space transports repair 4D, starship weapon repair 4D
Force Pts.: 1 **Dark Side Pts.:** 2
Character Pts.: 5 **Move:** 10
Equipment: Headset comlink, 2 heavy blaster pistols (5D), pilot's flack jacket (+1D physical, +1 energy, torso and arms)

©, TM & © 1995 Lucasfilm Ltd.

Illustration by Doug Shuler

STAR WARS



Too-Onebee Medical Droid

Type: Industrial Automaton 2-1B Surgical Droid
DEXTERITY 1D
KNOWLEDGE 2D, Alien species 5D
MECHANICAL 2D, (A) Bacta tank operation 5D
PERCEPTION 3D, (A) Injury/ailment diagnostics 6D
STRENGTH 1D
TECHNICAL 3D, First aid 6D, (A) medicine 9D
Equipped with:
 • Computer interface tether; +2D to all medical skills
 • Medical diagnostic computer
 • Analytical computer
 • Surgical attachments
 • Hypodermic injectors (4D stun)
 • Medicine dispensers
Move: 4
Size: 1.5 meters tall
Cost: 4,300

©, TM & © 1995 Lucasfilm Ltd.

Illustration by Doug Shuler

STAR WARS



Genna Seedar

Type: Field Medic
DEXTERITY 4D, Blaster 5D, dodge 6D, running 5D
KNOWLEDGE 2D, Survival 3D+1
MECHANICAL 3D, Communications 4D, repulsorlift operation 4D+2
PERCEPTION 3D, Sneak 4D+2
STRENGTH 2D, Lifting 3D
TECHNICAL 4D, First aid 6D+1, (A) medicine 2D
Force Pts.: 1
Character Pts.: 5 **Move:** 10
Equipment: Blast helmet (+1D physical, +1 energy), blaster pistol (4D), 3 medpacs, small subspace radio

©, TM & © 1995 Lucasfilm Ltd.

Illustration by Mike Vilardi

STAR WARS



Doctor Akanseh

Type: Mon Calamari Doctor
DEXTERITY 2D+1, Blaster 3D+1, dodge 4D
KNOWLEDGE 3D+2, Alien species 5D, intimidation: interrogation 4D+2
MECHANICAL 2D
PERCEPTION 3D, Bargain 5D, con 4D+2, investigation 5D, persuasion 6D
STRENGTH 3D
TECHNICAL 4D, Comp prog/rpr 5D+2, droid prog 7D, droid programming: Emdee series droids 9D, droid repair 6D+1, first aid 8D, (A) medicine 4D
Special Abilities:
Moist Environments: +1D to all *Dexterity*, *Perception* and *Strength* checks.
Dry Environments: -1D to all *Dexterity*, *Perception* and *Strength* checks.
Amphibious: Mon Calamari can breathe both air and water.
Force Pts.: 2 **Dark Side Pts.:** 1
Character Pts.: 8 **Move:** 10
Equipment: 2 medpacs, surgical field kit (adds +1D to *medicine* and *first aid* skill rolls).

©, TM & © 1995 Lucasfilm Ltd.

Illustration by Chris Moeller

STAR WARS

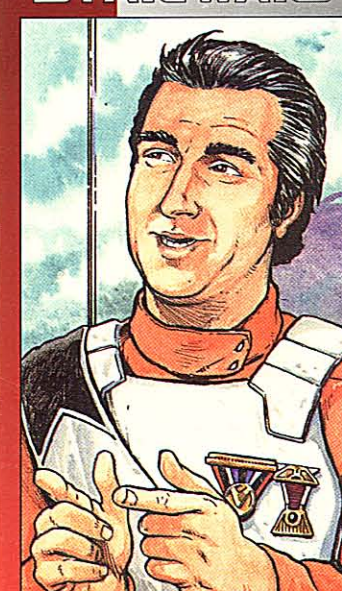

Edly "Pot-Shot" Fasalk

Type: Gunner
DEXTERITY 3D
KNOWLEDGE 2D
MECHANICAL 4D, Capital ship gunnery 6D, capital ship shields 5D, starship gunnery 6D, starship shields 5D
PERCEPTION 3D, Bargain 4D, con 5D, gambling 4D+2, persuasion 5D
STRENGTH 3D, Brawling 4D+1
TECHNICAL 3D
Force Pts.: 1
Character Pts.: 10 **Move:** 10
Equipment: Blast vest (+1D physical, +1 energy, torso only), coveralls, two medals, sash

©, TM & © 1995 Lucasfilm Ltd.

Illustration by Mike Vilardi

STAR WARS



©, TM & © 1995 Lucasfilm Ltd.



Thanis Gul-Rah

Type: Bounty Hunter
DEXTERITY 4D, Blaster: heavy blaster pistol 6D, dodge 5D, grenade 4D+2, melee combat 5D
KNOWLEDGE 2D+2, Streetwise 3D+2, survival 4D+2
MECHANICAL 2D+2
PERCEPTION 3D, Search 4D, search: tracking 5D, sneak 4D
STRENGTH 3D+2, Brawling 5D, climbing/jumping 4D+2
TECHNICAL 2D, First aid 4D
Force Pts.: 1 **Dark Side Pts.:** 2
Character Pts.: 5 **Move:** 10
Equipment: Bounty hunter armor (+2D physical, +1D energy, -1D Dexterity, +1D to *lifting*), heavy blaster pistol (5D), knife (STR+1D), medpac

Illustration by Mike Vilardi

STAR WARS



©, TM & © 1995 Lucasfilm Ltd.



Overseer Droid

Type: Ubrikkian DD-19 "Overseer" Droid
DEXTERITY 1D
KNOWLEDGE 1D+2, Alien Languages 3D+2
MECHANICAL 1D+2
PERCEPTION 2D, Command 3D, command: droids 5D, con 3D, search 3D
STRENGTH 1D
TECHNICAL 2D, Computer programming/repair 4D, droid programming 5D, droid repair 5D, security 3D
Equipped with:
 • Two tracked feet
 • Two extendible arms
 • Three photoreceptors
 • Broad band antenna-receiver
 • Restraining bolt applicator and remover
Move: 7
Size: 1.7 meters tall
Cost: 4,500

Illustration by Doug Shuler

STAR WARS



©, TM & © 1995 Lucasfilm Ltd.



Gunthar

Type: Lost Alien
DEXTERITY 4D, Melee combat 6D+2, thrown weapons 5D
KNOWLEDGE 1D+1
MECHANICAL 1D+2
PERCEPTION 2D
STRENGTH 4D+2, Brawling 8D, climbing/jumping 7D, lifting 6D+2, stamina 6D+2
TECHNICAL 1D+1
Special Abilities:
Empathy: Gunthar is attuned to the general feelings of those around him. This is a Moderate *Perception* task for Gunthar, but he gains +1D when using his empathic abilities.
Enhanced Vision: +1D+1 to *Perception* and search in darkness.
Force Pts.: 2
Character Pts.: 7 **Move:** 9
Equipment: Heavy metal pipe (STR+1D)

Illustration by Mike Vilardi

STAR WARS



©, TM & © 1995 Lucasfilm Ltd.

Kyli Ned'ix

Type: Verpine Gadgeteer
DEX 2D, Blaster 3D, dodge 3D, pick pocket 4D
KNOWLEDGE 3D, Planetary systems 4D, streetwise 5D
MECHANICAL 3D, Astrogation 4D, space transports 5D, starship gunnery 4D+2, starship shields 4D
PERCEPTION 3D, Bargain 4D+2, con 5D, persuasion 4D, search 5D
STRENGTH 2D
TECHNICAL 5D, Blaster rpr 6D, comp prog/rpr 7D+2, demolition 5D+2, droid prog 6D, droid rpr 8D, security 7D, space trans rpr 7D+2, starfighter rpr 7D, starship weapon rpr 6D
Special Abilities:
Body Armor: +1D physical armor.
Microscopic Sight: +1D to search.
Organic Telecommunications: See book.
Technical Bonus: +2D for Tech skills.
Force Pts.: 1
Character Pts.: 5 **Move:** 10
Equipment: Blaster pistol (4D), com-link jammer, datapad, security card-lock breaker (+1D security)

Illustration by Mike Vilardi

STAR WARS



©, TM & © 1995 Lucasfilm Ltd.



Kl'aal

Type: Defel Scout
DEXTERITY 4D, Blaster 6D, blind fighting 7D, brawling parry 6D, dodge 5D+1, melee combat 7D+2, melee parry 6D+1, thrown weapons 6D+1
KNOWLEDGE 2D+1, Intimidation 4D+2, planetary systems 4D, streetwise 5D+2, survival 7D, willpower 4D
MECHANICAL 2D+2, Communications 4D, repulsorlift operation 4D+2, sensors 3D+2, space transports 3D+1
PERCEPTION 3D+1, Investigation 4D+1, search 5D, search: tracking 7D+2, sneak 6D
STRENGTH 3D+2, Brawling 7D, climbing/jumping 5D+2, stamina 4D+2
TECHNICAL 2D, Demolition 4D+2, first aid 4D, security 5D+2
Special Skills:
Blind Fighting: Use this skill when deprived of sight visor.
Special Abilities:
Invisibility: +3D to sneak.
Claws: STR+2D damage.
Force Pts.: 3 **Dark Side Pts.:** 2
Character Pts.: 17 **Move:** 10
Equipment: Satchel

Illustration by Chris Moeller

STAR WARS

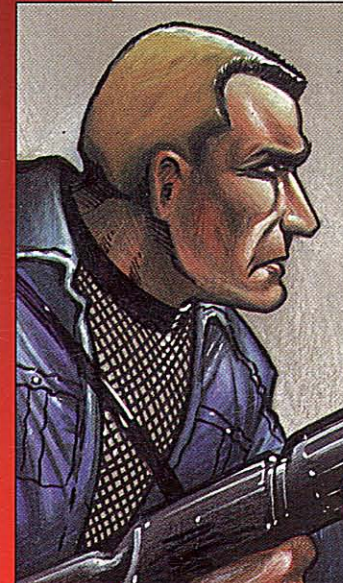

©, TM & © 1995 Lucasfilm Ltd.



Sufar

Type: Outlaw
DEXTERITY 4D, Blaster: blaster carbine 6D, brawling parry 5D, dodge 5D, melee combat 5D+2
KNOWLEDGE 3D, Intimidation 4D, survival 5D
MECHANICAL 2D+2, Repulsorlift operation 4D, starship gunnery 3D+2
PERCEPTION 2D, Sneak 5D
STRENGTH 3D+1, Brawling 5D+1, climbing/jumping 4D
TECHNICAL 3D, Computer programming/repair 5D, first aid 4D, demolition 6D, security 5D+2
Force Pts.: 1 **Dark Side Pts.:** 2
Character Pts.: 5 **Move:** 10
Equipment: Blaster carbine (5D), hold-out blaster (3D), knife (STR+1D), 3 blocks of detonite with timer fuses, security override kit (+1D to security rolls)

Illustration by Doug Shuler

STAR WARS



Vegath Tist

Type: Arconan Miner
DEXTERITY 2D, Melee combat 4D, melee parry 3D
KNOWLEDGE 3D, Planetary systems 4D, survival: mines 5D, value: minerals 5D
MECHANICAL 3D+1, Mining 5D, sensors 5D+1
PERCEPTION 2D+2, Con 3D+2, search 5D
STRENGTH 4D
TECHNICAL 3D, Computer programming/repair 4D, demolition 5D, security 4D
Special Abilities:
Senses: See character stats in book.
Thick Hide: +1D to resist physical damage.
Talons: +1D to climbing, Strength in brawling attacks, or digging.
Salt Addiction: Vegath is addicted to salt.
Force Pts.: 1
Character Pts.: 5 **Move:** 10
Equipment: Pouch with 1 kilogram salt, shovel (STR+2), survey datapad, 250 credits

©, TM & © 1995 Lucasfilm Ltd.

Illustration by Mike Vilardi

STAR WARS



Kolig

Type: Renegade Pilot
DEXTERITY 3D, Blaster: heavy blaster pistol 5D, dodge 4D, pick pocket 5D
KNOWLEDGE 2D, Intimidation 4D, planetary systems 5D, streetwise 4D+2, survival 4D+1
MECHANICAL 4D, Astrogation 5D, sensors 4D+2, space transports: YT-1300 6D, starship gunnery 5D, starship shields 5D+2
PERCEPTION 3D, Command 4D, con 5D, search 3D+2, sneak 5D+1
STRENGTH 3D
TECHNICAL 3D, Space transports repair 4D, starship weapon repair 4D
Force Pts.: 1 **Dark Side Pts.:** 2
Character Pts.: 5 **Move:** 10
Equipment: Headset comlink, 2 heavy blaster pistols (5D), pilot's flack jacket (+1D physical, +1 energy, torso and arms)

©, TM & © 1995 Lucasfilm Ltd.

Illustration by Doug Shuler

STAR WARS



Krudar

Type: Duros Gunner
DEXTERITY 3D, Blaster artillery 4D, vehicle blasters 4D
KNOWLEDGE 2D, Alien species 3D, planetary systems 3D
MECHANICAL 4D+2, Capital ship gunnery 7D+2, starship gunnery 6D+2
PERCEPTION 2D, Persuasion 4D, search 3D
STRENGTH 2D+1, Lifting 4D+1
TECHNICAL 4D, Capital ship weapon repair 6D, starship weapon repair 5D
Force Pts.: 1
Character Pts.: 5 **Move:** 10
Equipment: Blaster pistol (4D), blast helmet (+1D physical, +1 energy), blast vest (+1D physical, +1 energy, torso only), starship weapon repair kit (+1D to capital ship weapon repair)

©, TM & © 1995 Lucasfilm Ltd.

Illustration by Mike Vilardi

STAR WARS



Thanis Gul-Rah

Type: Bounty Hunter
DEXTERITY 4D, Blaster: heavy blaster pistol 6D, dodge 5D, grenade 4D+2, melee combat 5D
KNOWLEDGE 2D+2, Streetwise 3D+2, survival 4D+2
MECHANICAL 2D+2
PERCEPTION 3D, Search 4D, search: tracking 5D, sneak 4D
STRENGTH 3D+2, Brawling 5D, climbing/jumping 4D+2
TECHNICAL 2D, First aid 4D
Force Pts.: 1 **Dark Side Pts.:** 2
Character Pts.: 5 **Move:** 10
Equipment: Bounty hunter armor (+2D physical, +1D energy, -1D Dexterity, +1D to lifting), heavy blaster pistol (5D), knife (STR+1D), medpac

©, TM & © 1995 Lucasfilm Ltd.

Illustration by Mike Vilardi

STAR WARS

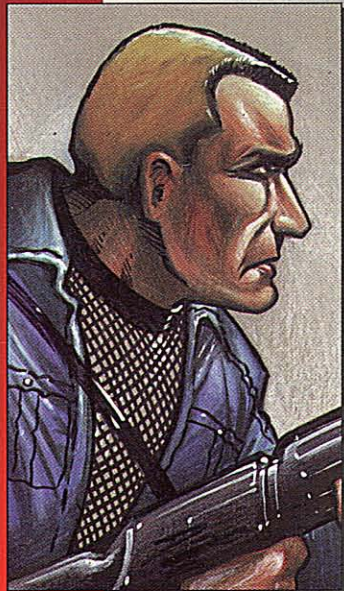

Sufar

Type: Outlaw
DEXTERITY 4D, Blaster: blaster carbine 6D, brawling parry 5D, dodge 5D, melee combat 5D+2
KNOWLEDGE 3D, Intimidation 4D, survival 5D
MECHANICAL 2D+2, Repulsorlift operation 4D, starship gunnery 3D+2
PERCEPTION 2D, Sneak 5D
STRENGTH 3D+1, Brawling 5D+1, climbing/jumping 4D
TECHNICAL 3D, Computer programming/repair 5D, first aid 4D, demolition 6D, security 5D+2
Force Pts.: 1 **Dark Side Pts.:** 2
Character Pts.: 5 **Move:** 10
Equipment: Blaster carbine (5D), hold-out blaster (3D), knife (STR+1D), 3 blocks of detonite with timer fuses, security override kit (+1D to security rolls)

©, TM & © 1995 Lucasfilm Ltd.

Illustration by Doug Shuler

STAR WARS

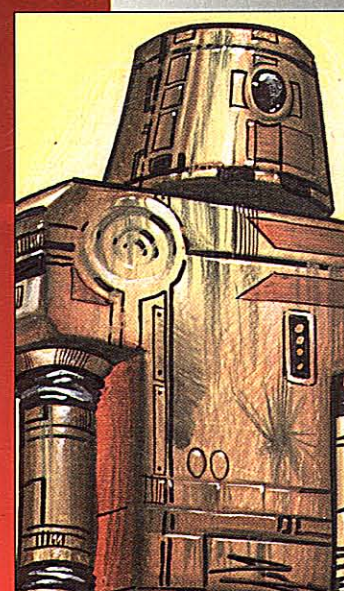

Load-Lifter

Type: Drendan Load-Lifter
DEXTERITY 1D
KNOWLEDGE 1D
MECHANICAL 1D
PERCEPTION 1D
STRENGTH 5D, Lifting 5D+2
TECHNICAL 1D
Equipped with:

- Two auto-balance legs
- One photoreceptor
- Two high-compression lifter-arms

Move: 5
Size: 2 meters tall
Cost: 4,500

©, TM & © 1995 Lucasfilm Ltd.

Illustration by Doug Shuler

STAR WARS

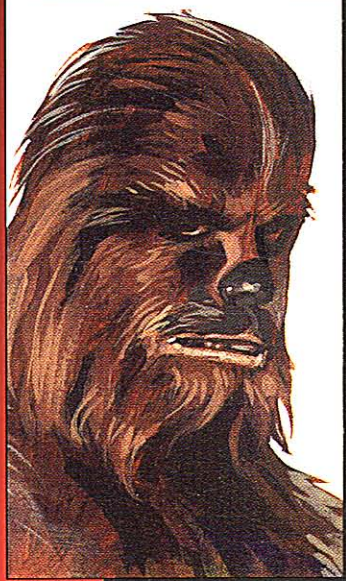

Lofryhn

Type: Wookiee Mechanic
DEX 3D+1, Brawling parry 5D, dodge 4D
KNO 2D, Intimidation 4D+2, survival 3D+2, value: starships 5D, willpower 3D
MECHANICAL 2D, Capital ship piloting 3D+2, capital ship shields 3D, communications 3D+1, sensors 3D
PERCEPTION 2D+1, Command 4D
STRENGTH 5D, Brawling 6D+2, (A) brawling: Wrruushi 8D+2, climbing/jumping 5D+2, lifting 6D, stamina 6D
TECHNICAL 3D+1, Capital ship rpr 7D+2, capital ship weapon repair 6D+2, comp prog/rpr 4D+1, droid prog 4D, droid rpr 5D, repulorlift rpr 4D, security 5D, space transports repair 4D+2
Special Skills:
Brawling: Wrruushi. +1D bonus to brawling and damage.
Special Abilities:
Berserker Rage: +2D brawling damage.
Climbing Claws: +2D to climbing.
Force Pts.: 2
Character Pts.: 10 **Move:** 12
Equipment: Repair kit (+1D capital starship rpr and capital starship wpn rpr)

©, TM & © 1995 Lucasfilm Ltd.

Illustration by Chris Moeller

STAR WARS



Tachak Tandar

Type: Chadra-Fan Repulorlift Chief
DEXTERITY 2D+1, Dodge 4D
KNOWLEDGE 2D, Value: repulorlift vehicles 4D
MECHANICAL 4D+1, Ground vehicle operation 5D+1, hover vehicle operation 5D+1, repulorlift operation 6D+2
PERCEPTION 3D, Gambling 4D
STRENGTH 2D+1, Climbing/jumping 3D, stamina 3D+2
TECHNICAL 4D, Repulorlift repair 5D+2
Special Abilities:
Sight: Chadra-Fan see in the infra-red and ultraviolet ranges.
Smell: +2D bonus to their search skill.
Force Pts.: 1
Character Pts.: 10 **Move:** 7
Equipment: Crash helmet (+1D physical, +1 energy), pilot's uniform

©, TM & © 1995 Lucasfilm Ltd.

Illustration by Mike Vilardi

STAR WARS



Dann Drugah

Type: Droid Specialist
DEXTERITY 2D+1, Dodge 4D+1, running 3D+1
KNOWLEDGE 3D+1, Languages: droids 5D, value: droids 5D
MECHANICAL 3D, Communications 4D, sensors 4D
PERCEPTION 2D+2, Command: droids 4D
STRENGTH 2D+2
TECHNICAL 4D, Computer programming/repair 5D, droid programming 5D+2, droid repair 6D, first aid 5D, security 5D+1
Force Pts.: 1
Character Pts.: 5 **Move:** 10
Equipment: Datapad, droid repair tools (+1D to droid repair), work coveralls

©, TM & © 1995 Lucasfilm Ltd.

Illustration by Mike Vilardi

STAR WARS



Dasha Defano

Type: Wroonian X-wing Pilot
DEXTERITY 3D+1, Blaster 4D+1, dodge 4D+1
KNOWLEDGE 2D, Survival 3D+1
MECHANICAL 4D+2, Astrogation 5D, repulorlift operation 5D+2, starfighter piloting 6D+2, starship gunnery 6D, starship shields 5D+2
PERCEPTION 4D, Con 6D, persuasion 5D, sneak 5D
STRENGTH 2D
TECHNICAL 2D, First aid 4D
Force Pts.: 1
Character Pts.: 5 **Move:** 10
Equipment: Blaster pistol (4D), flight suit and helmet, gear bag (includes hold-out blaster (3D), medpac, small rations pack, glow rod, emergency flare, knife (STR+1))

©, TM & © 1995 Lucasfilm Ltd.

Illustration by Mike Vilardi

STAR WARS



Vegath Tist

Type: Arconan Miner
DEXTERITY 2D, Melee combat 4D, melee parry 3D
KNOWLEDGE 3D, Planetary systems 4D, survival: mines 5D, value: minerals 5D
MECHANICAL 3D+1, Mining 5D, sensors 5D+1
PERCEPTION 2D+2, Con 3D+2, search 5D
STRENGTH 4D
TECHNICAL 3D, Computer programming/repair 4D, demolition 5D, security 4D
Special Abilities:
Senses: See character stats in book.
Thick Hide: +1D to resist physical damage.
Talons: +1D to climbing, Strength in brawling attacks, or digging.
Salt Addiction: Vegath is addicted to salt.
Force Pts.: 1
Character Pts.: 5 **Move:** 10
Equipment: Pouch with 1 kilogram salt, shovel (STR+2), survey datapad, 250 credits

©, TM & © 1995 Lucasfilm Ltd.

Illustration by Mike Vilardi

STAR WARS



Gorak Khzam

Type: Rodian Officer
DEXTERITY 4D+2, Blaster 7D+2, dodge 5D+2, grenade 6D, thrown weapons 5D+2
KNOWLEDGE 2D, Alien species 5D+2, business 4D, cultures 3D+2, intimidation 5D, planetary systems 6D, streetwise 6D+2, survival 5D, value 4D
MECHANICAL 2D, Astrogation 5D, repulorlift operation 4D+2, space transports 5D, starship gunnery 4D+1, starship shields 4D
PERCEPTION 3D+2, Bargain 5D+2, command 5D, con 6D, search 4D+2, sneak 7D
STRENGTH 3D+2, Climbing/jumping 4D+2
TECHNICAL 2D, Blaster repair 4D, security 6D
Force Pts.: 3 **Dark Side Pts.:** 2
Character Pts.: 13 **Move:** 10
Equipment: Comlink, heavy blaster pistol (5D), hold-out blaster (3D), 2 throwing knives (STR+1D), shoulder-slung shock rod (STR+1D, 4D (stun), Moderate difficulty)

©, TM & © 1995 Lucasfilm Ltd.

Illustration by Chris Moeller

STAR WARS

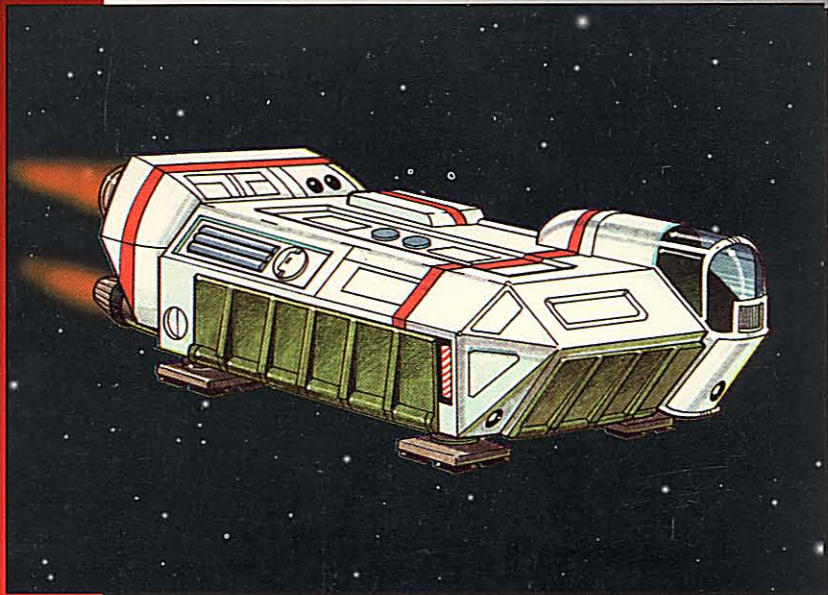

Aegis Combat Shuttle

Craft: Telgorn Corp. Aegis-class Combat Shuttle

Type: Transport shuttle

Scale: Starfighter

Length: 29 meters

Skill: Space transports: Aegis shuttle

Crew: 2, gunners: 2, skeleton: 1/+10

Crew Skill: Varies

Passengers: 6

Cargo Capacity: 120 metric tons

Consumables: 4 days

Cost: 40,000 (used)

Maneuverability: 1D

Space: 6

Atmosphere: 330; 950 kmh

Hull: 6D

Shields: 2D

Sensors:

Passive: 30/1D

Scan: 45/2D

Search: 60/2D+2

Focus: 4/3D

Weapons:

2 Laser Cannons

Fire Arc: Turret

Crew: 1

Skill: Starship gunnery

Fire Control: 1D+2

Space Range: 1-3/12/25

Atmosphere Range: 100-300/1.2/2.5 km

Damage: 5D

Concussion Missile Launcher

Fire Arc: Front

Skill: Starship gunnery

Fire Control: 1D

Space Range: 1/3/7

Atmosphere Range: 50-100/300/700

Damage: 7D



TELGORN CORP

Illustration by David Deitrick

©, TM, & © 1995 Lucasfilm Ltd.

STAR WARS

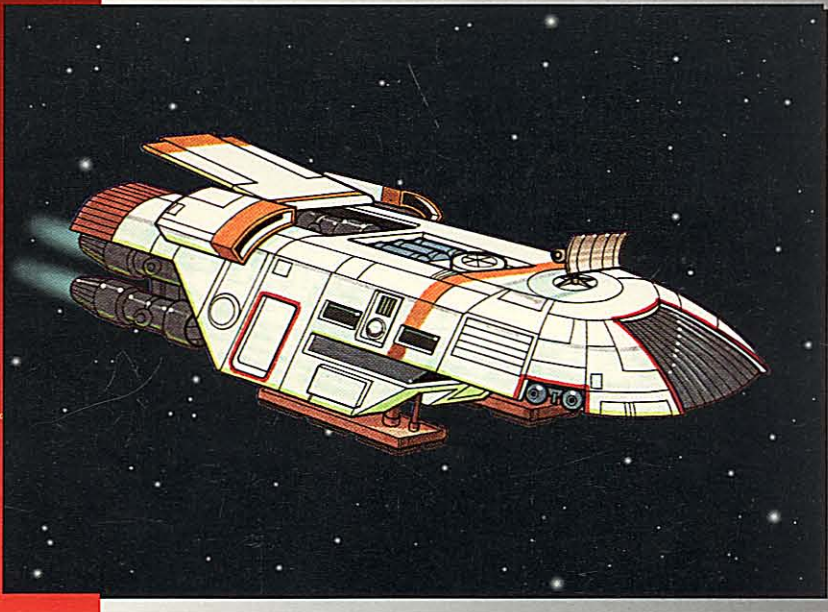

Muvon

Craft: Modified Loronar B-7 Light Freighter

Type: Modified light freighter

Scale: Starfighter

Length: 19 meters

Skill: Space transports: B-7 freighter

Crew: 1, gunners: 1

Crew Skill: See Brophar Tofarain

Passengers: 8

Cargo Capacity: 1 metric ton

Consumables: 1 month

Cost: 20,000

Hyperdrive Multiplier: x3

Hyperdrive Backup: x10

Nav Computer: Yes

Maneuverability: 1D

Space: 2

Atmosphere: 225; 650 kmh

Hull: 4D

Shields: 1D+2

Sensors:

Passive: 10/+1

Scan: 20/1D

Search: 30/1D+2

Focus: 3/2D

Weapons:

1 Light Laser Cannon

Fire Arc: Turret

Crew: 1

Skill: Starship gunnery

Fire Control: 1D+2 (may be fired by pilot at 0D fire control)

Space Range: 1-2/7/15

Atmosphere Range: 100-200/700/1.5 km

Damage: 4D



Illustration by David Deitrick

©, TM, & © 1995 Lucasfilm Ltd.

STAR WARS

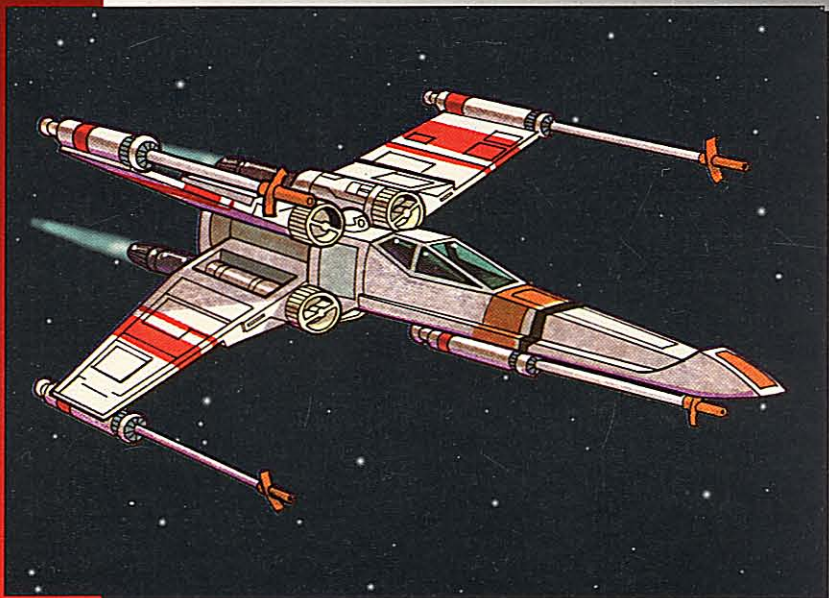

Incom T-65 X-wing

Craft: Incom T-65B X-wing
Type: Space superiority fighter
Scale: Starfighter
Length: 12.5 meters
Skill: Starfighter piloting: X-wing
Crew: 1 and astromech droid (can coordinate)
Crew Skill: Varies
Cargo Capacity: 110 kilograms
Consumables: 1 week
Cost: 85,000 (used)
Hyperdrive Multiplier: x1
Nav Computer: Uses astromech droid programmed with 10 jumps
Maneuverability: 3D
Space: 8
Atmosphere: 365; 1,050 kmh
Hull: 4D
Shields: 1D
Sensors:
Passive: 25/0D
Scan: 50/1D
Search: 75/2D
Focus: 3/4D

Weapons:

4 Laser Cannons (fire-linked)
Fire Arc: Front
Skill: Starship gunnery
Fire Control: 3D
Space Range: 1-3/12/25
Atmosphere Range: 100-300/1.2/2.5 km
Damage: 6D
2 Proton Torpedo Launchers
Fire Arc: Front
Skill: Starship gunnery
Fire Control: 2D
Space Range: 1/3/7
Atmosphere Range: 50-100/300/700
Damage: 9D

INCOM

Illustration by David Deitrick

©, TM & © 1995 Lucasfilm Ltd.

STAR WARS

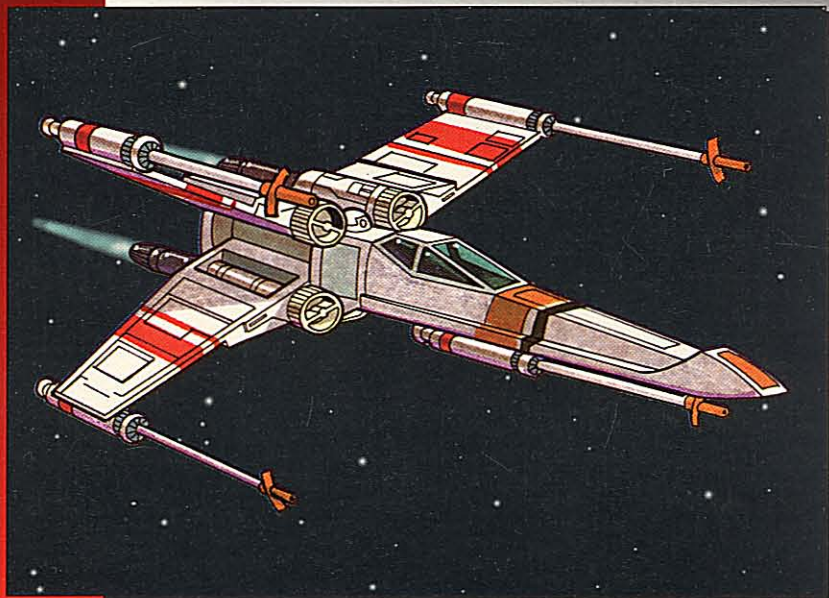

Incom T-65 X-wing

Craft: Incom T-65B X-wing
Type: Space superiority fighter
Scale: Starfighter
Length: 12.5 meters
Skill: Starfighter piloting: X-wing
Crew: 1 and astromech droid (can coordinate)
Crew Skill: Varies
Cargo Capacity: 110 kilograms
Consumables: 1 week
Cost: 85,000 (used)
Hyperdrive Multiplier: x1
Nav Computer: Uses astromech droid programmed with 10 jumps
Maneuverability: 3D
Space: 8
Atmosphere: 365; 1,050 kmh
Hull: 4D
Shields: 1D
Sensors:
Passive: 25/0D
Scan: 50/1D
Search: 75/2D
Focus: 3/4D

Weapons:

4 Laser Cannons (fire-linked)
Fire Arc: Front
Skill: Starship gunnery
Fire Control: 3D
Space Range: 1-3/12/25
Atmosphere Range: 100-300/1.2/2.5 km
Damage: 6D
2 Proton Torpedo Launchers
Fire Arc: Front
Skill: Starship gunnery
Fire Control: 2D
Space Range: 1/3/7
Atmosphere Range: 50-100/300/700
Damage: 9D

INCOM

Illustration by David Deitrick

©, TM & © 1995 Lucasfilm Ltd.

STAR WARS

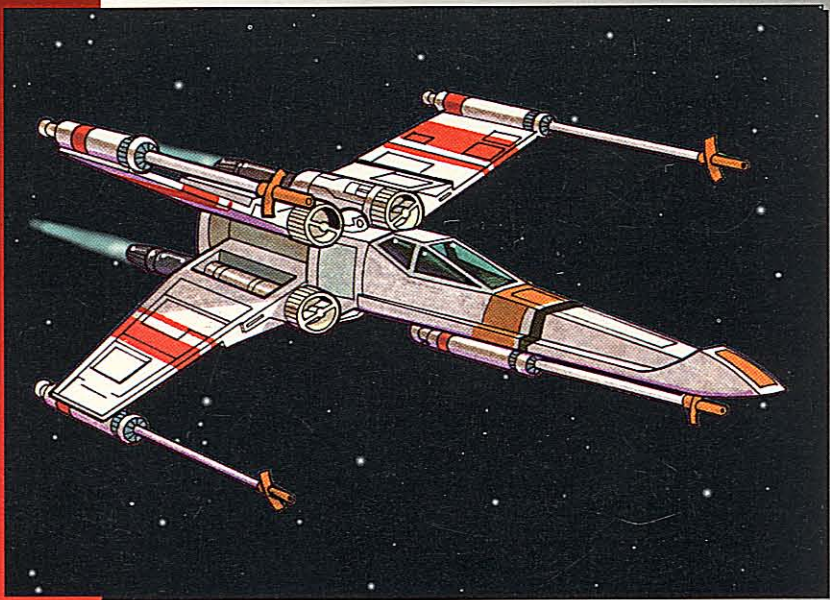

Incom T-65 X-wing

Craft: Incom T-65B X-wing
Type: Space superiority fighter
Scale: Starfighter
Length: 12.5 meters
Skill: Starfighter piloting: X-wing
Crew: 1 and astromech droid (can coordinate)
Crew Skill: Varies
Cargo Capacity: 110 kilograms
Consumables: 1 week
Cost: 85,000 (used)
Hyperdrive Multiplier: x1
Nav Computer: Uses astromech droid programmed with 10 jumps
Maneuverability: 3D
Space: 8
Atmosphere: 365; 1,050 kmh
Hull: 4D
Shields: 1D
Sensors:
Passive: 25/0D
Scan: 50/1D
Search: 75/2D
Focus: 3/4D

Weapons:
4 Laser Cannons (fire-linked)
Fire Arc: Front
Skill: Starship gunnery
Fire Control: 3D
Space Range: 1-3/12/25
Atmosphere Range: 100-300/1.2/2.5 km
Damage: 6D
2 Proton Torpedo Launchers
Fire Arc: Front
Skill: Starship gunnery
Fire Control: 2D
Space Range: 1/3/7
Atmosphere Range: 50-100/300/700
Damage: 9D

INCOM

Illustration by David Deitrick

©, TM & © 1995 Lucasfilm Ltd.

STAR WARS



New Republic Defender

Craft: Republic Engineering Corporation
Defender Starfighter
Type: Short-range defense fighter
Scale: Starfighter
Length: 5.3 meters
Skill: Starfighter piloting: Defender
Crew: 1, gunners: 1
Crew Skill: Varies
Cargo Capacity: 50 kilograms
Consumables: 1 week
Cost: 45,000 (new)
Maneuverability: 4D (1D+2 in atmosphere)
Space: 8
Atmosphere: 350; 1,000 kmh
Hull: 2D+2
Shields: 1D
Sensors:
Passive: 30/1D
Scan: 60/2D
Search: 90/3D
Focus: 4/4D

Weapons:
3 Laser Cannons (fire-linked)
Fire Arc: Front
Crew: 1 (gunner)
Skill: Starship gunnery
Fire Control: 2D
Space Range: 1-5/20/35
Atmosphere Range: 100-500/2/3.5 km
Damage: 6D



**REPUBLIC
 ENGINEERING
 CORPORATION**

Illustration by David Deitrick

©, TM & © 1995 Lucasfilm Ltd.

STAR WARS

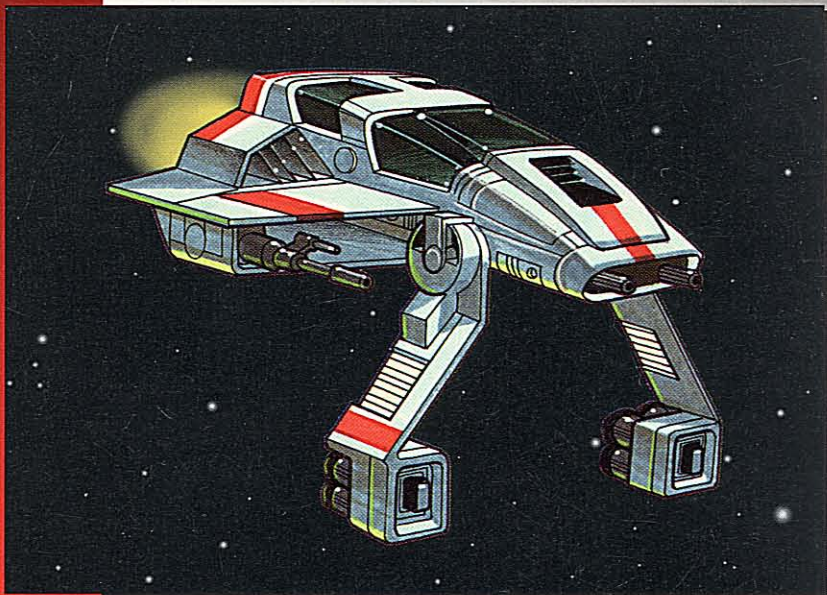

©, TM & © 1995 Lucasfilm Ltd.



New Republic Defender

Craft: Republic Engineering Corporation

Defender Starfighter

Type: Short-range defense fighter

Scale: Starfighter

Length: 5.3 meters

Skill: Starfighter piloting: Defender

Crew: 1, gunners: 1

Crew Skill: Varies

Cargo Capacity: 50 kilograms

Consumables: 1 week

Cost: 45,000 (new)

Maneuverability: 4D (1D+2 in atmosphere)

Space: 8

Atmosphere: 350; 1,000 kmh

Hull: 2D+2

Shields: 1D

Sensors:

Passive: 30/1D

Scan: 60/2D

Search: 90/3D

Focus: 4/4D

Weapons:

3 Laser Cannons (fire-linked)

Fire Arc: Front

Crew: 1 (gunner)

Skill: Starship gunnery

Fire Control: 2D

Space Range: 1-5/20/35

Atmosphere Range: 100-500/2/3.5 km

Damage: 6D



**REPUBLIC
ENGINEERING
CORPORATION**

Illustration by David Deitrick

STAR WARS

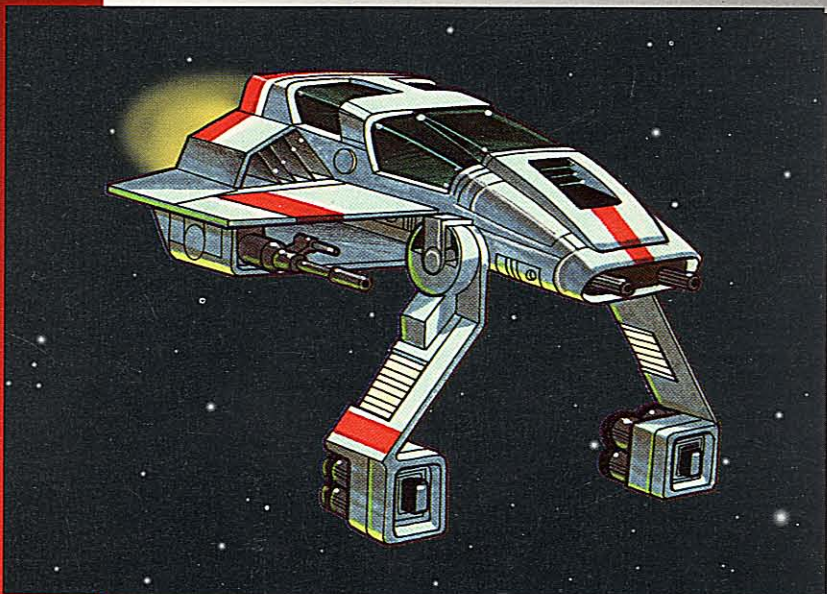

©, TM & © 1995 Lucasfilm Ltd.



New Republic Defender

Craft: Republic Engineering Corporation

Defender Starfighter

Type: Short-range defense fighter

Scale: Starfighter

Length: 5.3 meters

Skill: Starfighter piloting: Defender

Crew: 1, gunners: 1

Crew Skill: Varies

Cargo Capacity: 50 kilograms

Consumables: 1 week

Cost: 45,000 (new)

Maneuverability: 4D (1D+2 in atmosphere)

Space: 8

Atmosphere: 350; 1,000 kmh

Hull: 2D+2

Shields: 1D

Sensors:

Passive: 30/1D

Scan: 60/2D

Search: 90/3D

Focus: 4/4D

Weapons:

3 Laser Cannons (fire-linked)

Fire Arc: Front

Crew: 1 (gunner)

Skill: Starship gunnery

Fire Control: 2D

Space Range: 1-5/20/35

Atmosphere Range: 100-500/2/3.5 km

Damage: 6D



**REPUBLIC
ENGINEERING
CORPORATION**

Illustration by David Deitrick

The FarStar and Complement of Ships

STAR WARS

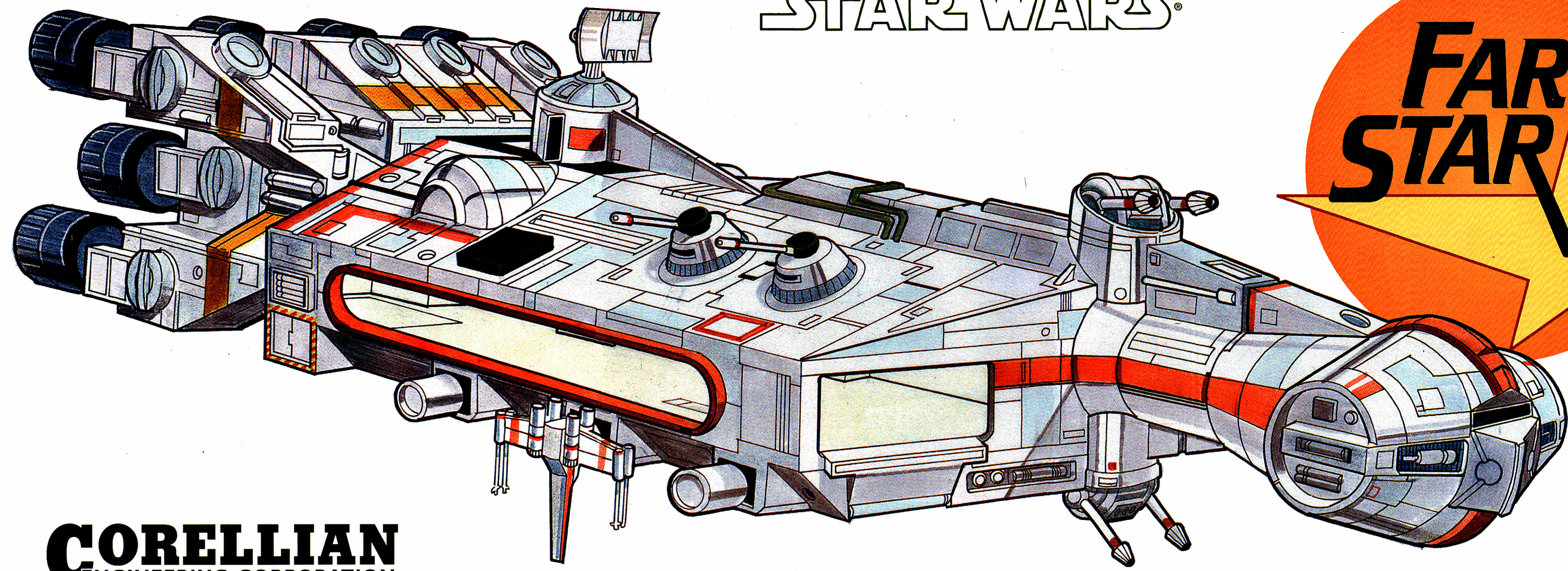

CORELLIAN
ENGINEERING CORPORATION

FarStar

The *FarStar* is the heavily modified Corellian Corvette selected by the New Republic to pursue Moff Kentor Sarne into the wilds beyond Kathol sector. The ship is equipped with a landing bay for several X-wing fighters, as well as three extendable docking tubes for the Corvette's Defender starfighters and two support shuttles.

Under the command of Captain Keleman Ciro, a crew of over 100 highly skilled individuals keeps this ship running even as the *FarStar* ventures further into unexplored space.

Craft: Corellian Engineering Corporation Corvette
Type: Converted military ship
Scale: Capital
Length: 150 meters
Skill: Capital ship piloting: Corellian Corvette
Crew: 120, gunners: 10, skeleton: 50/10
Crew Skill: See individual crew members
Cargo Capacity: 3,000 metric tons
Consumables: 3 months
Hyperdrive Multiplier: x2
Nav Computer: Yes
Maneuverability: 2D
Space: 7
Atmosphere: 350/1,000 kmh
Hull: 5D
Shields: 2D
Sensors:
Passive: 50/1D+1
Scan: 100/3D+1
Search: 200/4D+1
Focus: 6/5D
Weapons:
6 Double Turbolaser Cannons
Fire Arc: 2 turret, 1 front/left, 1 left/back, 1 front/right, 1 right/back
Crew: 1 (4), 3 (2)
Skill: Capital ship gunnery
Fire Control: 2D, 4D (after two full rounds of targeting)
Space Range: 3-15/35/75
Atmosphere Range: 6-30/70/150 km
Damage: 4D+2

FAR STAR Embarked Craft

Fighters of the FarStar

The *FarStar* has a total of twelve fighters, all under the command of Lieutenant Ranna "Wing-Ripper" Gorjaye. These ships are the core of the *FarStar*'s defense and patrol network and Gorjaye maintains control with an acid tongue and tough discipline.

X-wing

The *FarStar* has eight standard X-wing fighters that have been reassigned from other New Republic cruisers. The Incom X-wing fighter, although an aging fighter design, is still powerful and fast enough to give TIE fighters a run for their money, especially in a distant area of space like the Kathol sector, where fighters are less likely to have cutting-edge imperial technology.

Craft: Incom T-65B X-wing
Type: Space superiority fighter
Scale: Starfighter
Length: 12.5 meters
Skill: Starfighter piloting: X-wing
Crew: 1 and astromech droid (can coordinate)
Crew Skill: Varies
Cargo Capacity: 110 kilograms
Consumables: 1 week
Cost: 85,000 (used)
Hyperdrive Multiplier: x1
Nav Computer: Uses astromech droid programmed with 10 jumps
Maneuverability: 3D
Space: 8
Atmosphere: 365/1,050 kmh
Hull: 4D
Shields: 1D
Sensors:
Passive: 25/0D
Scan: 50/1D
Search: 75/2D
Focus: 3/1D
Weapons:
4 Laser Cannons (fire-linked)
Fire Arc: Front
Skill: Starship gunnery
Fire Control: 3D
Space Range: 1-3/12/25
Atmosphere Range: 100-300/1,2/2.5 km
Damage: 6D
2 Proton Torpedo Launchers
Fire Arc: Front
Skill: Starship gunnery
Fire Control: 2D
Space Range: 1/3/7
Atmosphere Range: 50-100/300/700
Damage: 9D

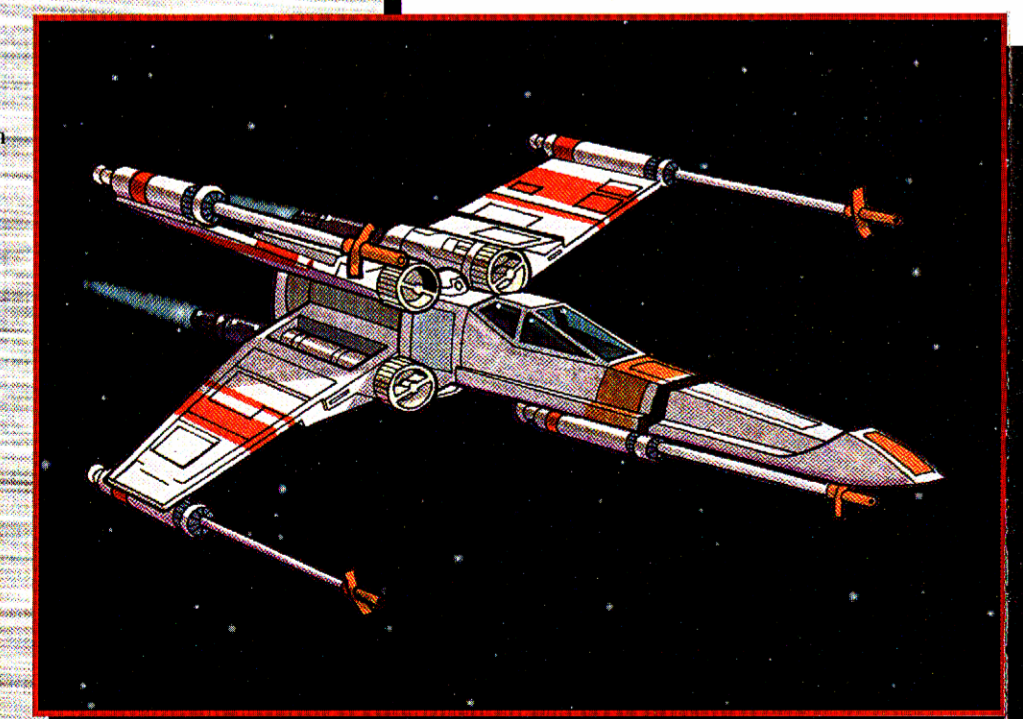

INCOM

Defender

The Defender is a new short-range fighter derived from a much older starfighter design. The *FarStar* has been allocated four of these vessels.

The Defender is specifically designed for space defense. It is lightweight and compact, featuring light armor but impressive firepower. The ship is smaller than the A-wing fighter, making it a difficult small target for enemy gunners. It has no hyperdrive and is dependent upon a base ship for transport. The ship has exceptional space maneuverability, which can be attributed to the extendible S-fol struts with maneuvering jets in the forward hull section. In an atmosphere, the Defender's agility is greatly reduced.

Craft: Republic Engineering Corporation Defender Starfighter
Type: Short-range defense fighter
Scale: Starfighter
Length: 5.3 meters
Skill: Starfighter piloting: Defender
Crew: 1, gunners: 1
Crew Skill: Varies
Cargo Capacity: 50 kilograms
Consumables: 1 week
Cost: 45,000 (new)
Maneuverability: 4D (1D+2 in atmosphere)
Space: 8
Atmosphere: 350/1,000 kmh
Hull: 4D+2
Shields: 1D
Sensors:
Passive: 30/1D
Scan: 60/2D
Search: 90/3D
Focus: 4/4D
Weapons:
3 Laser Cannons (fire-linked)
Fire Arc: Front
Crew: 1 (gunner)
Skill: Starship gunnery
Fire Control: 2D
Space Range: 1-5/20/35
Atmosphere Range: 100-500/2/3.5 km
Damage: 6D

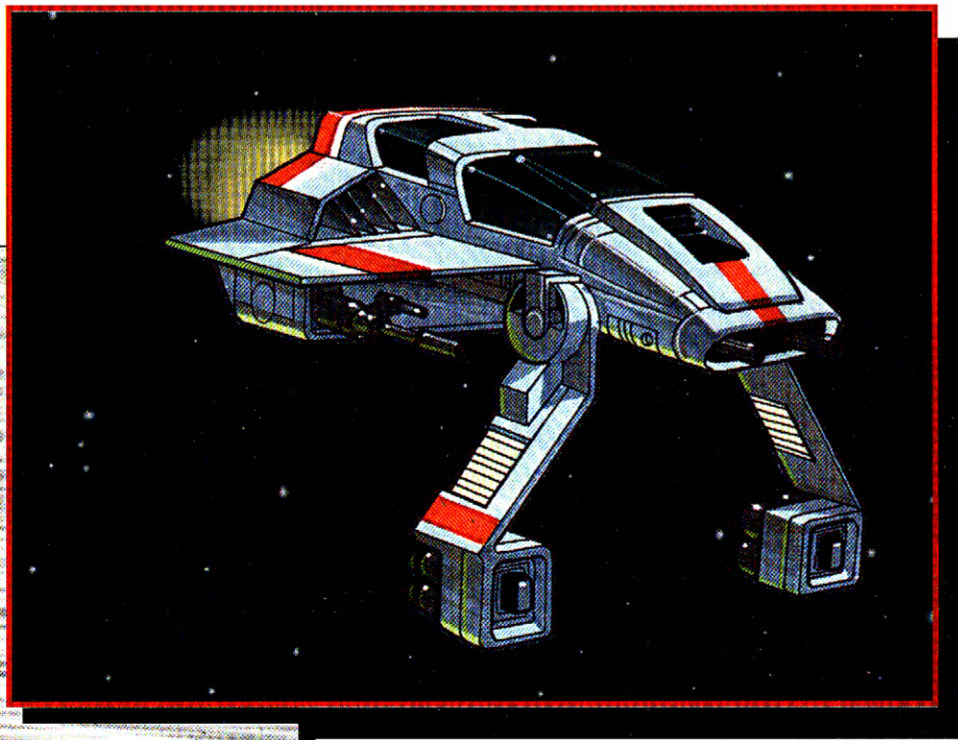

Muvon

The *Muvon* is Brophar Tofraan's personal shuttle. It is typically used as a personnel transport, with room for only its eight passengers and a pair of speeder bikes or some exploration equipment. The ship is a small shuttle and is an excellent choice when the *FarStar* wishes to arrive on a planet in a subdued manner; the ship could be mistaken for a nondescript civilian transport hauler instead of an advance scout for a New Republic military vessel.

Brophar insists on personally piloting the ship on all missions and he is very intolerant of passengers making fun of or abusing his vessel.

Craft: Modified Loronar B-7 Light Freighter
Type: Modified light freighter
Scale: Starfighter
Length: 19 meters
Skill: Space transports: B-7 freighter
Crew: 1, gunners: 1
Crew Skill: See Brophar Tofraan
Passengers: 8
Cargo Capacity: 1 metric ton
Consumables: 1 month
Cost: 20,000
Hyperdrive Multiplier: x3
Hyperdrive Backup: x10
Nav Computer: Yes
Maneuverability: 1D
Space: 2
Atmosphere: 225/650 kmh
Hull: 4D
Shields: 1D+2
Sensors:
Passive: 10/1
Scan: 20/1D
Search: 30/1D+2
Focus: 3/2D
Weapons:
1 Light Laser Cannon
Fire Arc: Turret
Crew: 1
Skill: Starship gunnery
Fire Control: 1D+2 (may be fired by pilot at 0D fire control)
Space Range: 1-2/7/15
Atmosphere Range: 100-200/700/1.5 km
Damage: 4D

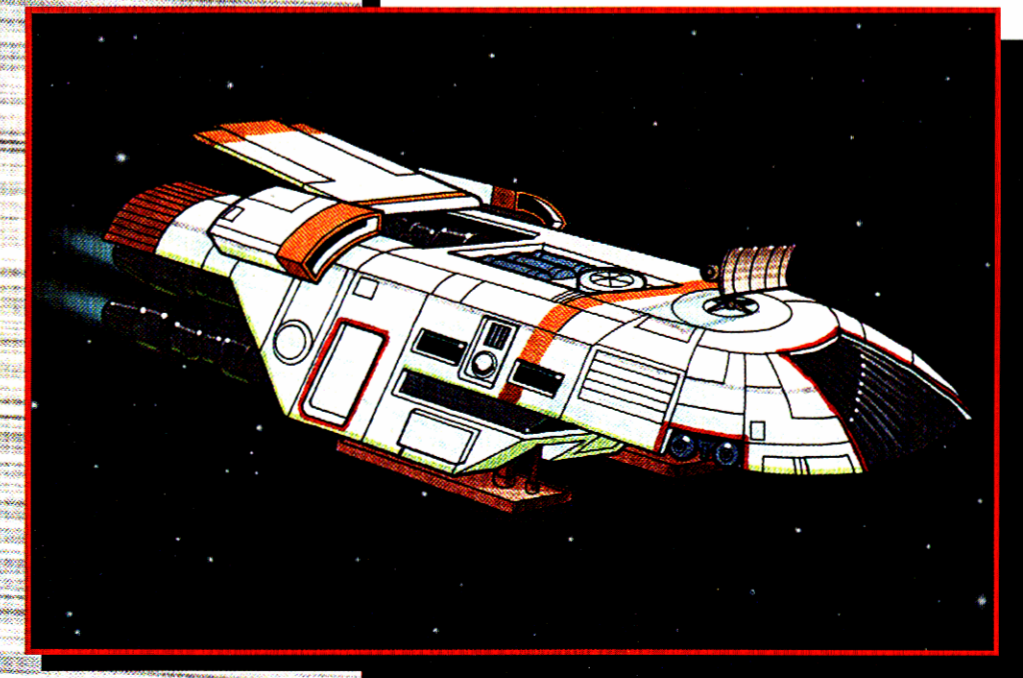

Support Ships of the FarStar

The *FarStar* has two shuttles, which are normally docked on the external docking tubes, although they can be brought into the main landing bay for maintenance or cargo loading. The first shuttle, the *Muvon*, is used for non-military operations, while the *Aegis* combat shuttle is clearly geared to combat support missions. If there is the possibility of hostilities, these shuttles are assigned escorts from Gorjaye's fighters.

Aegis Combat Shuttle

The *Aegis* combat shuttle is specifically designed to allow ground combat vehicles or troops to be quickly delivered to a crisis zone. The interior cargo bay has room for two SRV-1 transports, or a single SRV-1 and two ULAV combat shuttles. A pair of speeder bikes can be added to this configuration. Alternately, the shuttle can deliver 40 ground troops and their gear into a combat zone.

The ship is designed for quick loading and unloading, with dual side airlocks that retract in seconds and form unloading ramps. The shuttle is heavily armed with a concussion missile launcher and a pair of laser cannons.

Craft: Telgorn Corp. *Aegis*-class Combat Shuttle
Type: Transport shuttle
Scale: Starfighter
Length: 29 meters
Skill: Space transports: *Aegis* shuttle
Crew: 2, gunners: 2, skeleton: 1/10
Crew Skill: Varies
Passengers: 6
Cargo Capacity: 120 metric tons
Consumables: 4 days
Cost: 40,000 (used)
Maneuverability: 1D
Space: 6
Atmosphere: 330/950 kmh
Hull: 6D
Shields: 2D
Sensors:
Passive: 30/1D
Scan: 45/2D
Search: 60/2D+2
Focus: 4/3D
Weapons:
2 Laser Cannons
Fire Arc: Turret
Crew: 1
Skill: Starship gunnery
Fire Control: 1D+2
Space Range: 1-3/12/25
Atmosphere Range: 100-300/1,2/2.5 km
Damage: 5D
Concussion Missile Launcher
Fire Arc: Front
Skill: Starship gunnery
Fire Control: 1D
Space Range: 1/3/7
Atmosphere Range: 50-100/300/700
Damage: 7D

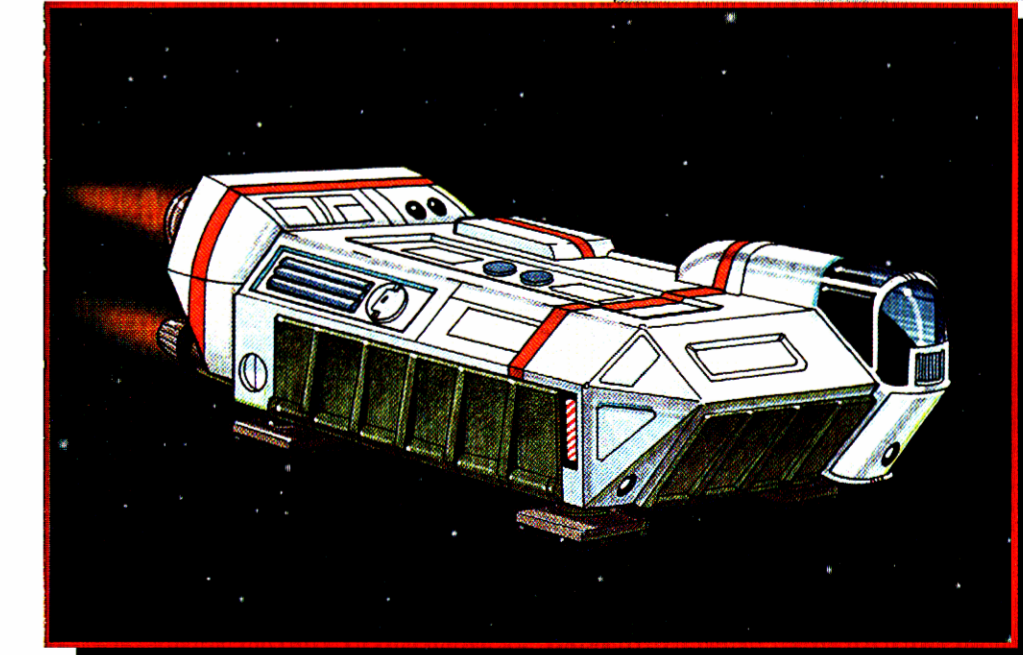

TELGORN CORP

STAR WARS®

The FarStar: Interior Layout

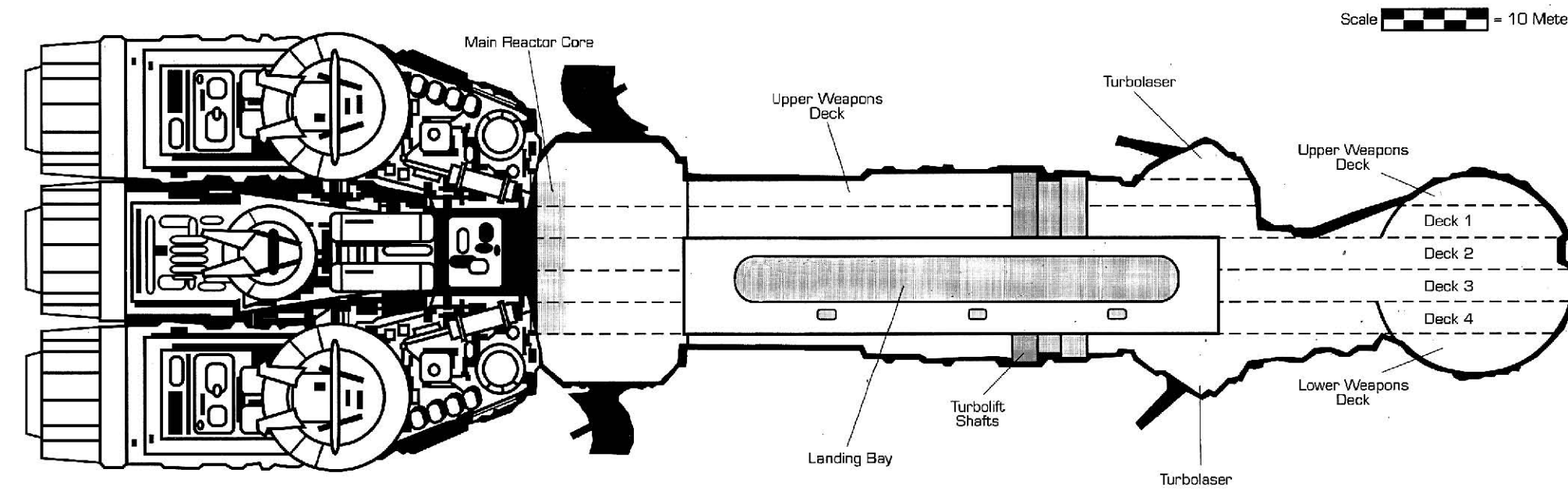

FarStar Side View

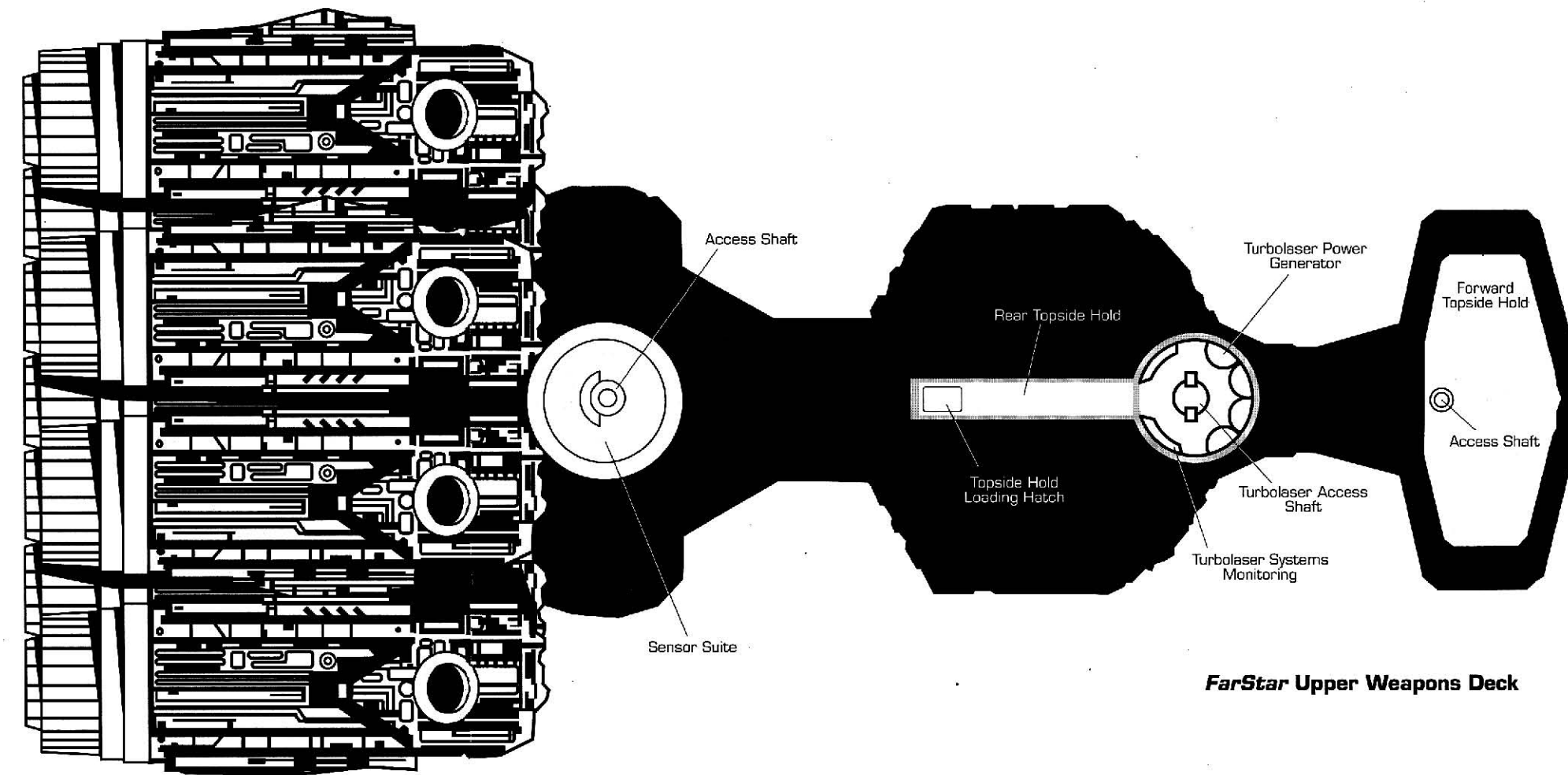

FarStar Upper Weapons Deck

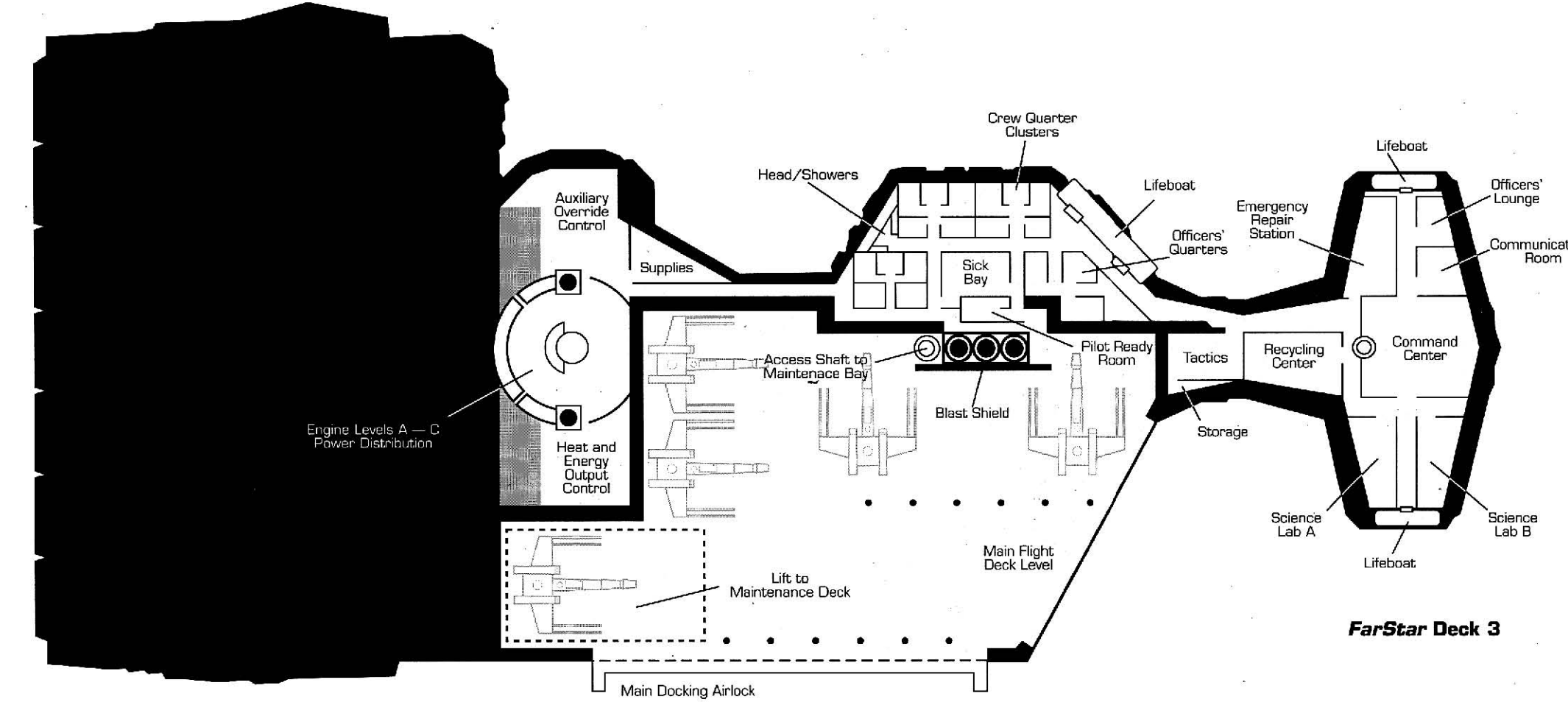

FarStar Deck 3

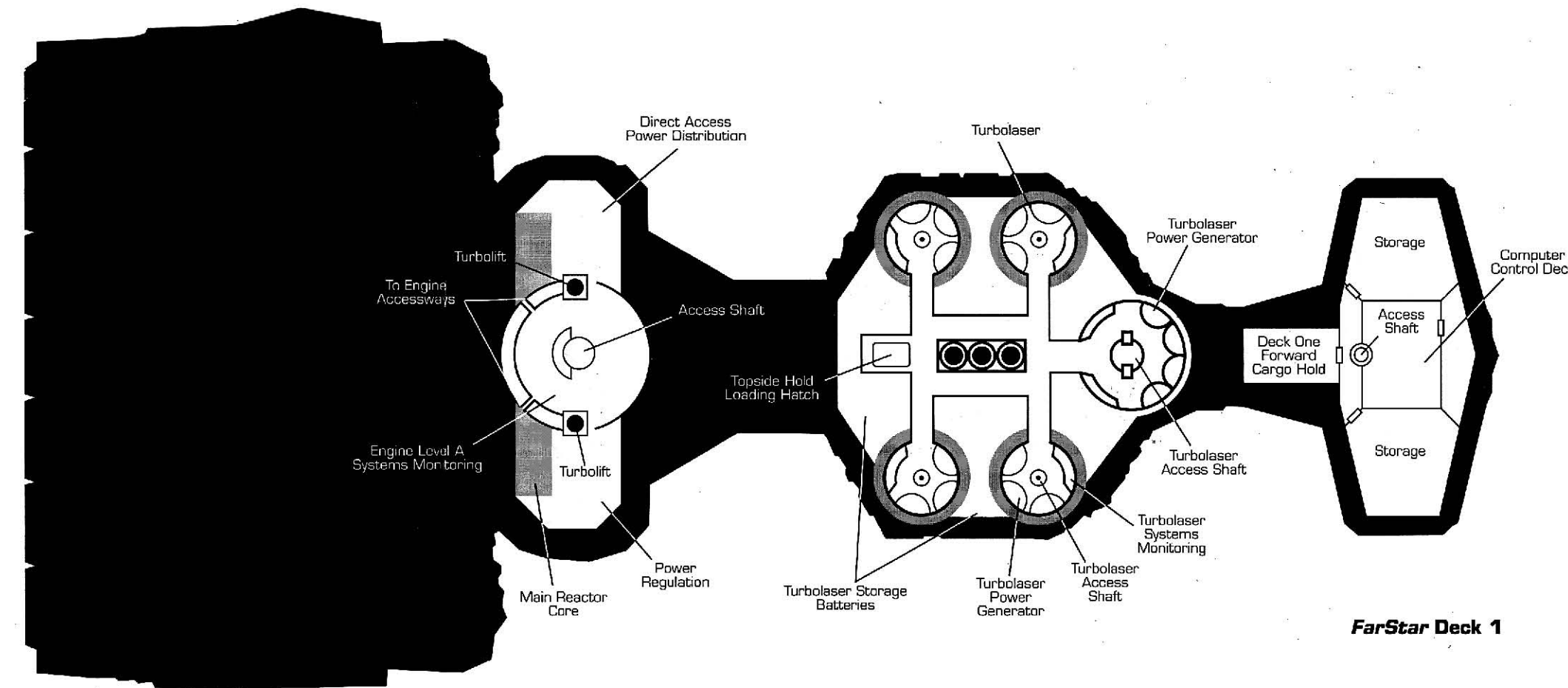

FarStar Deck 1

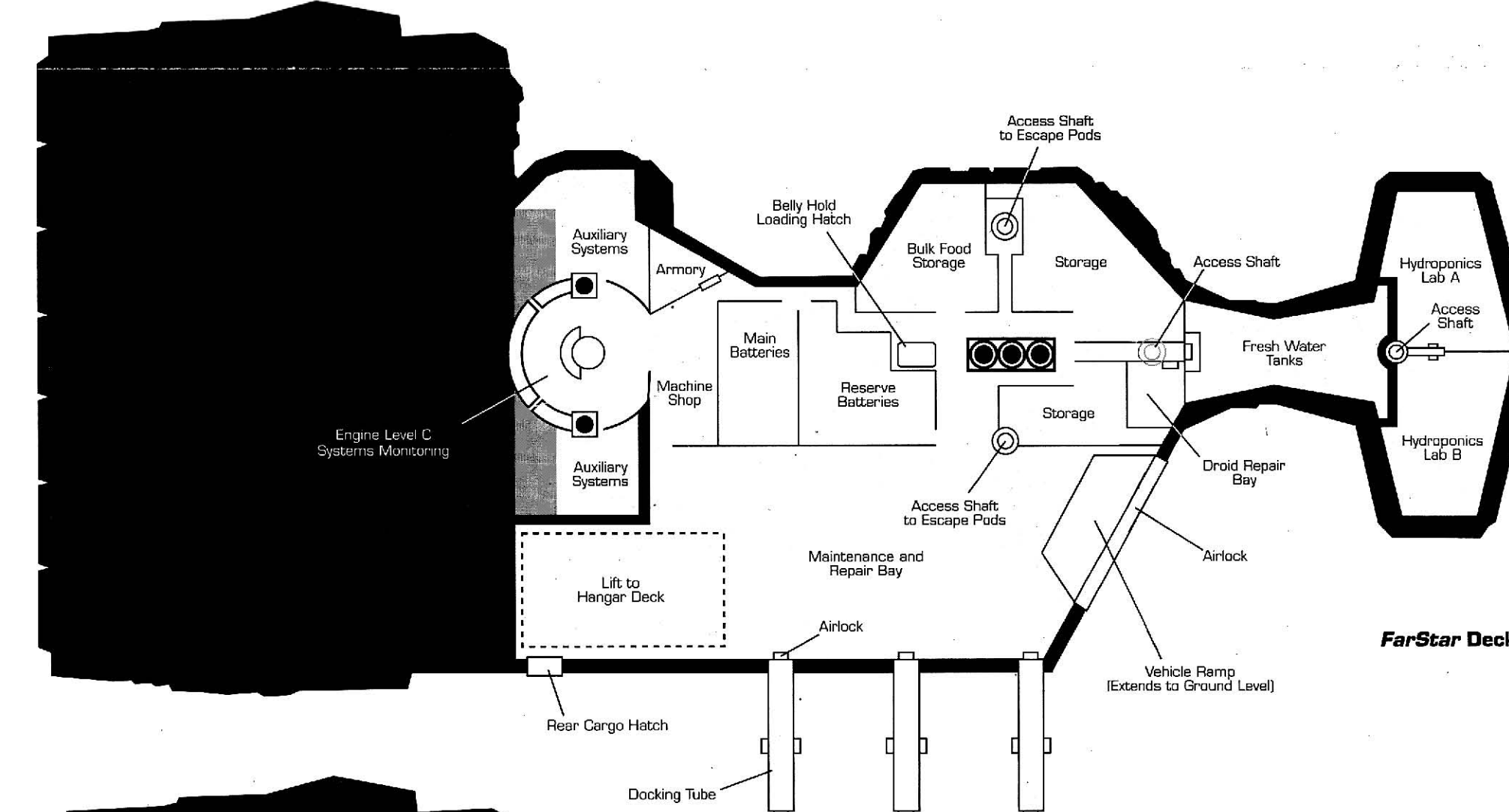

FarStar Deck 4

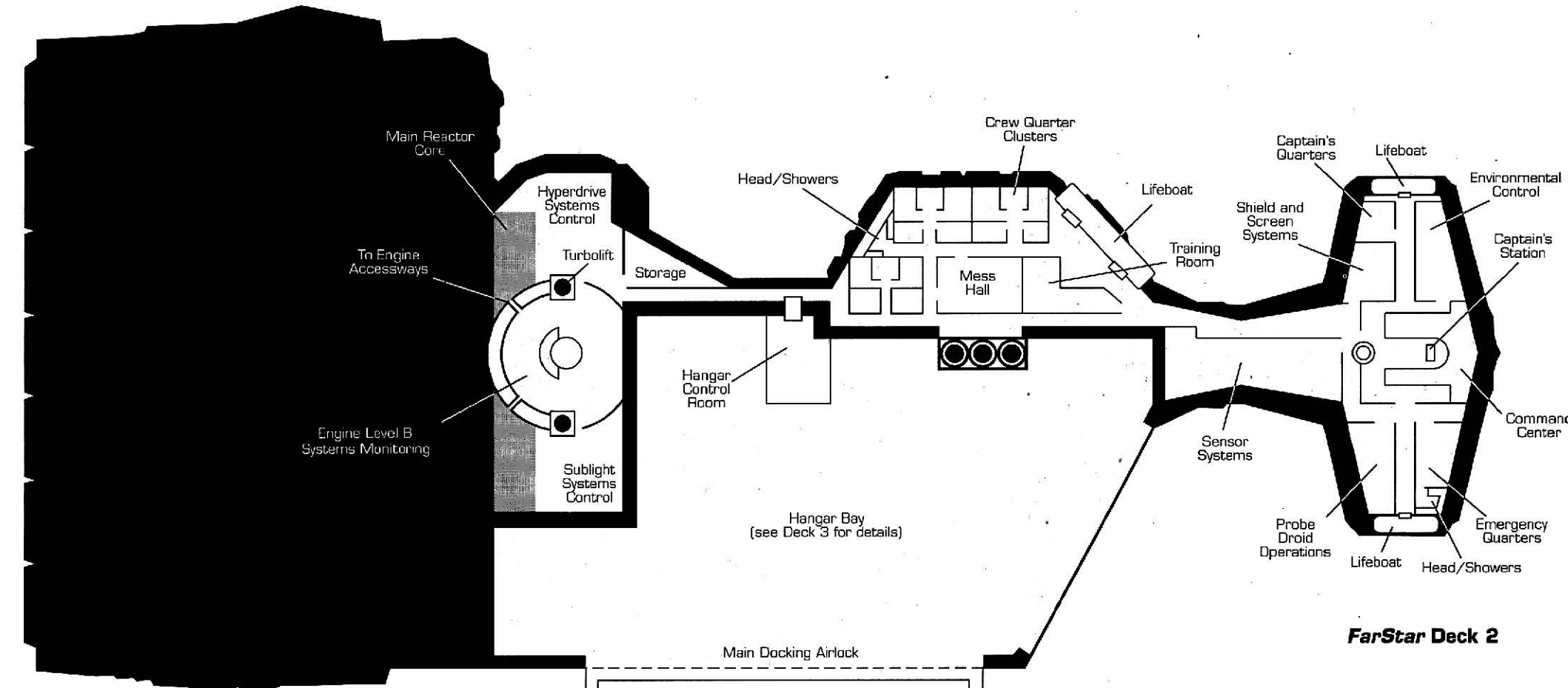

FarStar Deck 2

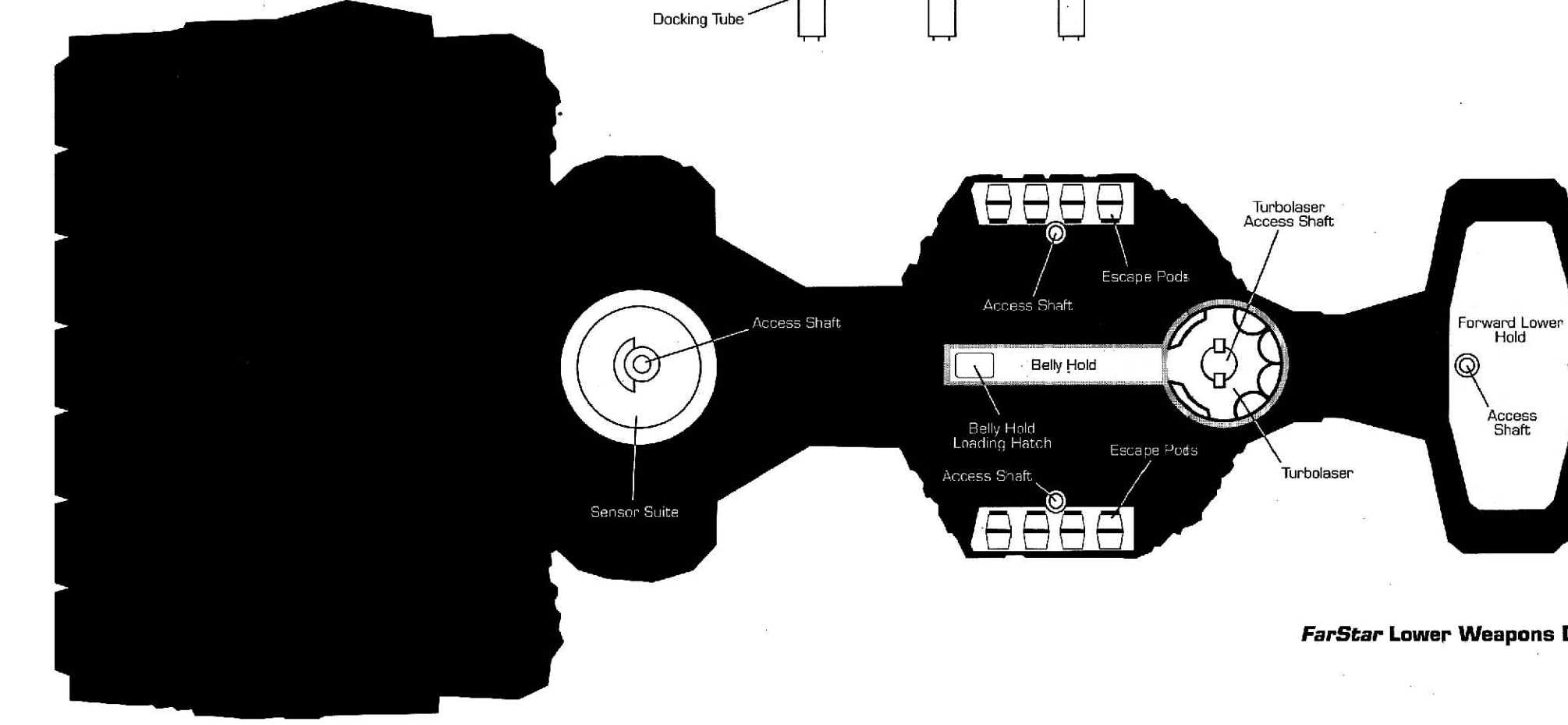

FarStar Lower Weapons Deck

CORELLIAN
ENGINEERING CORPORATION
Corvette

Refitted at
Sorbiss Valley Shipyards

STAR WARS®

THE **DARKSTRYDER** C A M P A I G N

A long time ago in a galaxy far, far away ...

Four years after the Battle of Endor, the struggle against the remnants of the Empire continues. A New Republic task force has been dispatched to the distant Kathol sector to topple rogue warlord Moff Sarne. During the battle, the New Republic discovers mysterious artifacts known as "DarkStryder technology."

Join the crew of the Corellian Corvette *FarStar* as they scour the fringes of the Empire in search of Sarne and the source of the DarkStryder technology!

Captain Keleman Ciro

- A member of Page's Commandos, handpicked by Lt. Page to lead the *FarStar* mission.

Kaiya Adrimetrum

A New Republic commando, Kaiya is eager for revenge against the Empire.

Gorak Khzam

The *FarStar*'s security officer claims to be an independent trader.

Darryn Thyte

Thyte is the communications officer no ship in the New Republic wanted. The *FarStar* got him.

Jessa Dajus

Imperial officer Dajus has inside information on Sarne's plans, but her loyalty is held in question.

Loh'khar the Finder

The Twi'lek "procurement specialist" who can cut any deal ... any deal at all.

Ranna "Wing-Ripper" Gorjaye

The *FarStar*'s fighter commander, Gorjaye knows there are two ways to do things: her way and the wrong way.

KI'aal

The Defel scout who escaped Sarne's regime and has pledged his services to the *FarStar*.

Akansch

The Mon Calamari medic wrongfully imprisoned by the Empire.

Brophar Tofarain

The *FarStar*'s chief mechanic and shuttle pilot.

Lofryyh

A personal friend of Kaiya, this Wookiee has a score to settle with Sarne.

Sent into unexplored space with no support ships or supply stations, the crew of the *FarStar* must accomplish their mission by any means necessary ...

THIS BOXED SET CONTAINS:

- The 96-page Campaign Book, describing the *FarStar* and her crew. Includes an introductory story by best-selling author Timothy Zahn.
- The 96-page Adventure Book with six beginning adventures.
- Over 50 color character and ship recognition cards featuring original color artwork by David Deitrick, Christopher Moeller, Doug Shuler and Mike Vilardi.
- A poster featuring deck plans of the *FarStar*

By Peter Schweighofer, Doug Shuler, Bill Smith, Eric Trautmann and Timothy Zahn. Additional material by Paul Sudlow.



40209