

# STAR WARS<sup>®</sup> MINIATURES BATTLES

## COMPANION



A supplement for use with *Star Wars Miniatures Battles*



# STAR WARS<sup>®</sup> MINIATURES BATTLES COMPANION

## T A B L E O F C O N T E N T S

Introduction .....	3
<i>Star Wars Miniatures Battles</i> Rules Upgrade .....	5
<b>New Rules</b>	
Chapter One: <b>Vehicles</b> .....	12
Chapter Two: <b>Flight</b> .....	29
Chapter Three: <b>Rules Additions</b> .....	36
Chapter Four: <b>Equipment</b> .....	43
Chapter Five: <b>Unit Insignia and Organization</b> .....	49
Chapter Six: <b>Scenarios and Campaigns</b> .....	65
<b>Scenarios</b>	
Scenario: <b>Operation: Retrieval</b> .....	69
Campaign: <b>A Time For Silence</b>	
1. <b>Pulling the Plug</b> .....	75
2. <b>To Seize the Bay</b> .....	77
3. <b>Through the Back Door</b> .....	80
4. <b>King of the Mountain</b> .....	82
<b>Reference Sheets and Templates</b> .....	87
<b>Photo Credits</b> .....	96

Design: **Stephen Crane** • Development and Editing: **Bill Smith**  
 Graphics: **Stephen Crane, Thomas O'Neill** • Cover Photograph: **Lucasfilm Ltd.**  
 Interior Photographs: **Stephen Crane** • Terrain System and Custom Scenery: **Geo-Hex**  
 Figure Painting: **Jay Adan, Stephen Crane, Bill Refsland, T.G.W.P., Jay Wirth**  
 Playtesting and Advice: **Chris Hind [Andrew Hind, James Hind],**  
**Bill Refsland [Cameron, Jamie, Nick ("Thugg"), Steven, Stiggy, Tammy]**

Publisher: **Daniel Scott Palter** • Associate Publisher/Treasurer: **Denise Palter** • Associate Publisher: **Richard Hawran**  
 Senior Editor: **Greg Farshtey** • Editors: **Peter Schweighofer, Bill Smith, Ed Stark** • Art Director: **Stephen Crane**  
 Graphic Artists: **Tim Bobko, Thomas O'Neill, Brian Schomburg** • Sales Manager: **Bill Olmesdahl**  
 Licensing Manager: **Ron Seiden** • Warehouse Manager: **Ed Hill**  
 Accounting: **Karen Bayly, Wendy Lord, Kimberly Riccio** • Billing: **Amy Giacobbe**

Published by



RR 3 Box 2345 • Honesdale PA 18431

40070

**A long time ago in a galaxy far, far away ...**

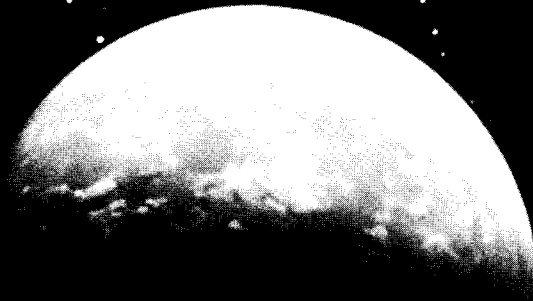

It is a dark time for the Rebel Alliance. The greater their resistance, the more the Empire sends after them. Their efforts have prompted the Emperor to commit his awesome ground fleet to the fray. Not only do the valiant Rebels have to confront the tenacious soldiers of the evil Galactic Empire face-to-face, but they must also contend with the relentlessly droning repulsorlift engines of the Empire's ground assault vehicles. And worse, they must face the fearsome tread of the Emperor's walkers, advancing upon their positions like the booming monotone of Kintarrian Death Drums signalling their demise. Yet, in spite of the seemingly insurmountable odds, the Rebels fight on, flinging their own frail speeders at the might of the Empire. Their courage and resolve add weight to their hopes of turning the dread tide of the New Order and restoring the bright flame of the Old Republic for the good of the galaxy.

# Introduction

As nervous Rebel troopers pepper the forest with blaster fire, the whining pop-pop of their weapons mingles with the crashing roar of their advancing, unseen opponent. Bursting forth from the edge of the wild wood, the Imperial assault craft scatter the broken limbs of the densely packed trees before them.

With a whine of repulsorlifts strained to their limits, the three craft swing around the clearing, raking the Rebels' position with heavy blaster fire as they disappear back into the verdant cover.

But before they can vanish completely, a well-placed shot takes out the lead craft's drive unit, and it plunges into the thick undergrowth with a muffled explosion, leaving the forest once more undisturbed except for the acrid stench of ozone and burning metal.

Another exciting game of *Star Wars Miniatures Battles* is underway!

## A Galaxy Far, Far Away

In sector after sector, valiant Rebels continue the struggle against an evil oppressor. Making their lives harder is the vast array of vehicles the Empire can bring to a planet's surface. The Rebels have only their courage and determination to pit against the awesome amount of materiel available to the Emperor. Even after the fall of the Empire, many of these craft are still in the hands of the Imperials, presenting continuing opposition for the soldiers of the New Republic.

With the *Star Wars Miniatures Battles Companion* you can include the threat of the Imperial ground fleet in your tabletop battles, adding to the thrill and excitement of your miniatures battles. This volume also provides new rules for battlefield action and new equipment to further expand the scope of your games.

## Using This Book

The *Star Wars Miniatures Battles Companion* is a companion volume to *Star Wars Miniatures Battles*. As such, it is intended to complement

and expand the existing rules of that game. It is important to note that this is not a complete game. **You must have the original book in order to use this companion.**

These new rules are designed to be added to the original rules to increase your enjoyment of the game. In addition, this book addresses the ambiguities of the original game, clarifying those rules, and revising them where necessary to provide a more interesting and playable system.

With some exceptions, the rules provided herein may be used selectively. For instance, if you decide to add vehicles to your miniatures game, you will need to include the rules for flight, as most vehicles use repulsorlift propulsion. However, you can choose to ignore flying creatures or aliens. You may pick and choose freely from the rules sections provided in the "Rules Additions" chapter, or from the items in the "Equipment" chapter.

It is suggested, however, that the clarifications in the "Rules Upgrade" be used, as well as the related new rules.

## What This Book Contains

The contents of this book are organized into a number of major sections to make it easier for you to find and peruse those items that most interest you. These sections are listed below along with a brief description.

### Rules Upgrade

As mentioned above, this section clarifies and revises some of the rules in *Star Wars Miniatures Battles*. In addition, the changes necessary to make *Star Wars Miniatures Battles* compatible with *Star Wars: The Roleplaying Game, Second Edition* are discussed.

Clarified and revised rules are presented in the order they appear in the original book.

### New Rules

We have heard from many people wishing to use vehicles in their miniatures game. Due to this



■ A squad of stormtroopers advances under the watchful gaze of one of the Empire's awesome All Terrain Armored Transports.

demand, rules for the inclusion of vehicles in *Star Wars Miniatures Battles* are presented here. There are also rules governing flight — for vehicles as well as creatures and flying aliens. New rules governing different tactical situations (such as prisoners and encumbrance) can be found here. New equipment to make your soldiers more formidable on the battlefield is provided. Finally, the organization of some of the forces involved in the Galactic Civil War is explored. In addition, the units' insignia are explained and illustrated, providing new ways to differentiate your figures and add color to the tabletop.

### Scenarios and Campaigns

Where would your soldiers be without battles to fight? In this section you will find a number of new scenarios covering a range of situations to test your forces and your tactical skill. Most of these also comprise a campaign, consisting of

three separate games leading up to a final climactic battle, as well as details on how to develop and set up a campaign of your own.

### Reference Sheets and Templates

Here you will find all the charts and tables pertaining to the rules in this book, gathered together for easy reference. Some charts and tables from *Star Wars Miniatures Battles* are also reprinted, but expanded to include the new information from this volume. New templates and markers are contained in this section.

### Photo Credits

The "Photo Credits" page gives information on the figures and terrain shown in the photographs in this book. It is hoped that this will give you ideas and spark your creativity so that this hobby can become even more enjoyable to you.

# Rules Upgrade

*Star Wars Miniatures Battles* has been out for a number of years, and over the course of time, situations have come to light that require clarification or correction. In that same span of time, *Star Wars: The Roleplaying Game* has been upgraded to a second edition and revised to provide a more detailed, comprehensive game.

This has led to the revision or clarification of some of the existing rules of this game, as well as the addition of new rules. This was done both to improve the original game and to make it compatible with the revised roleplaying game, making it easier to bring characters back and forth between the two games. Recently, *Star Wars Miniatures Battles* was reprinted, providing the opportunity to incorporate those changes into the game.

But while many of these revisions have been addressed in the second printing of *Star Wars Miniatures Battles*, they are presented here for those players who still use the first edition of this game, and to serve as a quick reference to the second edition changes. In addition, rules revisions are provided here which supersede even those in the second edition.

## Soldiers and Squads

### Skill Revisions

The list of available skills is different. Some skills have been eliminated, others have been added or changed. The differences are listed below.

- **Heavy Weapons:** This skill has been eliminated. It is replaced by the appropriate weapon skill or certain general weapons skills (see "Heavy Weapons," below).
- **Melee:** Now called *melee combat*.
- **Technology:** This skill has been eliminated. Basic knowledge of technology is governed by the *Technical* attribute.
- **Repulsorlift Operation:** Previously used for

driving any type of vehicle, this is now replaced by the relevant vehicle operation skill (such as *ground vehicle operation*, *hover vehicle operation* or *repulsorlift operation*).

- **Hide/Sneak:** This has been split into *hide* and *sneak*. *Sneak* is the skill used to move unseen on the battlefield. *Hide* has no application in this game and so is not listed.

- **Medicine:** This is now *first aid*.

### Skill Specializations

Specializations for any of the skills may be brought over from *Star Wars: The Roleplaying Game, Second Edition*. However, skill specializations in *Star Wars Miniatures Battles* are treated as if they were regular skills. The SGP cost is still one per point of skill above the governing attribute. Each specialization can be increased as if it were a skill, but is increased independently of the skill it is based on.

Finally, each soldier has a Move rating (taken from *Star Wars: The Roleplaying Game, Second Edition*), which represents the soldier's movement capability. This is further modified by the soldier's *Dexterity* (see "Movement," below). The Move is also added into the total SGP cost of the soldier.

### Squad Coherence and Fire Combat

A soldier is considered *separated* from a squad if he is further than his command distance from another member of his squad who can trace a line of command to the commander.

In addition to the +1 modifier to the difficulty for fire combat (see page 12 of *Star Wars Miniatures Battles*), separation affects the way range to a squad is determined. This is explained in "Fire Combat," below.

### Movement

As mentioned above, soldiers now have a Move rating. This determines their Movement Rates. A soldier's Walk Rate is his *Dexterity* added

to half his Move. The Run Rate is the Move plus the *Dexterity*. So a soldier with a Move of 10 and a *Dexterity* of 3 has a Walk Rate of 8" and a Run Rate of 13".

### Barriers

A third type of barrier classification has been added. In addition to the moderate barrier and the difficult barrier, there is now the *impassable barrier*. Impassable barriers are barriers which cannot be moved through at all. Some examples of impassable barriers are extremely high walls or rock formations, force fields, or lava streams.

## Fire Combat

### Range Determination and Separated Squads

Range is determined by measuring the average distance between the soldiers in the firing squad's fire line and the visible members of the target squad. When the target squad has soldiers who are separated, though, only one of its groups may be targeted.

Soldiers who are separated are considered to be different squads for the purposes of fire combat. Any soldiers within command distance of each other, but out of command distance from the group containing the commander, form a separated group. An individual soldier may be a separated group if he is too far away from any of his fellow soldiers.

When the range is being determined for fire combat, the average distance is measured to the particular group of soldiers being targeted, and the separated elements are not considered when working out the average.

Another group of a separated squad may be targeted if the firing squad splits fire, but in that case each fire combat is resolved independently, and each of the separated groups does not affect the range determination to the other.

### Heavy Weapons

The designation "heavy weapon" is no longer used, and the *heavy weapons* skill has been eliminated. To bring skill use more in line with that of *Star Wars: The Roleplaying Game, Second Edition*, either the appropriate weapon skill is used for firing weapons, or certain general skills can be used. Most weapon listings will note the appropriate skill for the weapon.

*Blaster* can be used for any blaster-type weapon on a character scale, and does not cover multi-crew weapons like artillery pieces (use the *blaster artillery* skill) or vehicle-mounted weapons (*vehicle blasters* skill).

*Missile weapons* can be used for any weapon that fires larger-sized individual projectiles, such

### Game Note: Grenade "Scatter" and Deviation

When a soldier fails a *grenade* test, the grenade does not land where he intended it to. Perhaps the soldier, in the heat of battle, threw the grenade wildly and it landed short and to the left of the target point. Or he had the correct range, but threw it too far to the right. Perhaps the grenade did hit the target point, but then bounced further along. This deviation of the grenade from the target point to the point of impact is represented by the scatter roll.

The term "scatter," however, is misleading, implying that the grenade always hits the target point and then bounces elsewhere. While this is perhaps a minor point, it does lead to some confusion in conceptualizing the game mechanics as a real-world action, especially in trying to figure out how a thrown object could bounce the full distance of the throw directly back to the thrower (it didn't, the thrower just dropped it at his feet). The proper term is "deviation" and henceforth, references to grenade scatter will be termed grenade deviation.

as grenade launchers, grappling hook launchers, or proton torpedo launchers.

*Firearms* is used for standard bullet-firing weapons like pistols and rifles, and *archaic guns* is used for more primitive weapons.

Weapons are no longer designated as heavy weapons. Instead, the individual characteristics of "heavy weapons" are given for each weapon to which they apply. The characteristics are:

- **Assembled:** The weapon may only be transported when disassembled and must be assembled before use. The procedure for assembling and disassembling a weapon remains as described on page 23 of *Star Wars Miniatures Battles*. Once assembled, it may only be dragged 1" per Movement Phase (unless it is equipped with a walker mount; see Chapter Four, "Equipment"). It must be disassembled again in order to move at a normal Movement Rate.
- **Crewed:** A crewed weapon requires a number of soldiers to fire effectively. If there are not enough crew, the weapon's efficiency is affected; the particulars are given in the weapon's description. In most cases, a weapon requires a crew of two to carry it and assemble it, and with a full crew is capable of following fire.
- **Following fire:** This is the ability to "sweep" a squad with fire, potentially allowing a weapon to hit more than one target in a squad during a

single Fire Combat Phase. A weapon capable of following fire must have a minimum crew to utilize this ability. Following fire is performed as described on pages 23–24 of *Star Wars Miniatures Battles*.

### Grenade Deviation Range

When rolling for the distance a grenade deviates from its target point, use the “Grenade Scatter Range Table” (or, more properly, the “Grenade Deviation Range Table” — see the sidebar, “Game Note: Grenade ‘Scatter’ and Deviation”). The distance the grenade deviates is as listed in the table, but only up to a maximum of the distance the grenade was thrown.

**Example:** *A Rebel trooper hurls a grenade at a squad of Imperial troops 5" away (medium range), but fails to hit his target. Rolling for grenade deviation yields a "4" (straight back toward the Rebel). Rolling one die for medium range gives a "6," or a distance of 6". Since the grenade was only thrown 5", the grenade can deviate only 5" — the Rebel has dropped the grenade at his own feet.*

### Throwing Grenades Blindly

A soldier *can* throw a grenade at a target point to which he does not have line of sight — that is, blindly. However, he will not be very accurate.

If the player picks a target location to which the figure cannot draw a LOS, the grenade automatically deviates before the *grenade* skill test is attempted. After rolling for deviation, the player makes the skill test, but the difficulty of the throw is increased by 3.

A successful roll indicates that the grenade has landed where the initial deviation roll had placed it. If the skill test is not successful, then roll for deviation again, from the point where the grenade previously “landed.” After determining the final location of the grenade, place the Grenade Burst Area of Effect Template at that point and resolve damage normally.

This procedure has been revised. See Chapter Three, “Rules Additions,” for details.

### Opportunity Fire

A single enemy squad may be targeted by any number of squads using opportunity fire, as long as the firing squads meet the criteria for firing at the target and pass their opportunity fire tests.

### Morale

A squad forced to make a morale test must add 2 to the threat level that turn if the commander is incapacitated or wounded.

## Creating Squads

The notes above concerning a soldier’s Move and the addition of skill specializations should be kept in mind when creating a squad. The Squad Record Sheet has been modified to include a space for the Move, and the skill lists have been modified to reflect the changes described above.

In addition, each attribute has a blank line below it to allow for different types of skills, or the listing of skill specializations.

## Hidden Movement

The last paragraph of this chapter should read: “In games with a gamemaster, he can oversee spotting checks as they are made. In a game without a gamemaster, the player with hidden troops must tell his opponent when spotting rolls are required.”

## Advanced Weapons and Equipment

### Required Skills

Due to the revision of the skill list, the skill required to use certain weapons may have changed. All weapons which have different required skills are listed here for ease of reference.

**Flamethrower:** *Flamethrower.*

**Grenade Launcher:** *Missile weapons;* or the specialization *grenade launcher.*

**Grenades:** If using a launcher, *missile weapons;* or the specialization *grenade launcher.*

**Proton Torpedo Launcher:** *Missile weapons;* or the specialization *proton torpedo launcher.*

### Flamethrower

A flamethrower is a vectored-effect weapon (See “Vectored-Effect Weapons” in Chapter Three, “Rules Additions”). It fires a continuous stream of flaming liquid which spreads out when it hits a target. Any figure between the firer and the target runs the risk of being affected by the stream of burning chemicals.

To reflect this, a Flamethrower Area of Effect Template is provided in the back of this book. Photocopy the template, glue it to a piece of thin cardboard, and cut it out. The template can also be colored appropriately.

To fire a flamethrower, declare the target (before measuring the range), then place the target point of the template — indicated by the asterisk in the center of the wider, hexagonally shaped end — over the designated target (which must be within the firing figure’s Fire Arc). Place the narrower end of the template over the firing figure.

The template must be in contact with the base of the firing figure. If, in placing any portion of the



### Targeting a Flamethrower

The targeted Imperial is well within range.

The targeted Imperial is out of range, as the template cannot be placed over the target and still touch the base of the firing figure.

The targeted Imperial is out of the optimum range, but still close enough to be hit — test against the full *Damage Strength* of the flamethrower.

These figures are also hit by the flamethrower shot.

Flamethrower Effect Template

Flamethrower Effect Template

Flamethrower Effect Template

Stephen Crane

target end of the template over the target figure, the narrow end of the template does not touch the base of the firing figure, then the target is out of range and cannot be hit. Any other figures which fall within the area of effect are still affected, however.

If the target point cannot be placed over the target figure because the figure is too far away, but the target end of the template still overlaps its base, the target is considered to be hit. The target point represents where the firer was aiming, but a figure just beyond that range will still take the full effects of the splashing chemical fire.

If the firer fails his *flamethrower* test, the shot may have missed the target. Use the Vected-Effect Weapon Deviation Template as described in Chapter Three, "Rules Additions." The template is also provided in the back of this book. Adjust the position of the Flamethrower Area of Effect Template according to the deviation template.

A flamethrower no longer has an incidental *Damage Strength*. Any figure whose base lies wholly or partially under the Flamethrower Area of Effect Template must make an opposed *Strength* test against the full *Damage Strength* of the weapon.

After all the flamethrower's attacks have been resolved, place a Flame Effect Template over the target end of the Flamethrower Area of Effect Template, oriented with the direction of the wind and remove the flamethrower template.

If a wind direction is not already in play, determine by placing the Flame Effect Template randomly over the Flamethrower Area of Effect Template and rolling two dice. Reorient the Flame Effect Template to the newly determined wind direction. Or the gamemaster may determine the wind direction.

The area of the Flame Effect Template is now on fire. Treat it according to the regular rules for fire (see "Fire" on pages 77–78 of *Star Wars Miniatures Battles*, and the revised rules on fire below).

### Proton Torpedo Launcher

As described in the revised edition of *Star Wars Miniatures Battles*, a proton torpedo launcher is an *assembled weapon*, although it requires no crew — it can be carried and assembled by one soldier. It is not capable of following fire.

However, the proton torpedo launcher is now considered a vectored-effect weapon. Unlike the

description in the revised *Miniatures Battles*, a soldier who fails the skill test to fire the launcher does not lose the shot. Instead, the Vectored-Effect Weapon Deviation Template is used to determine the new direction of the shot. The Proton Torpedo Area of Effect Template is then rotated to the new direction and damage results, if any, are determined.

### Armor

The term “battle armor” refers to a full or partial suit of armor that provides protection from weapons, as well as from hostile environments. All of the armor types listed in the “Armor Chart” are classified as battle armor.

Sandtrooper armor has been added to the “Armor Chart.” Its STR/DEX modifiers are +1/-1 and it costs 10 SGPs.

### Artillery

Any soldiers not actively crewing the gun may fire other weapons. For example, if a six-man squad armed with heavy blasters were crewing an Atgar 1.4 FD Light Anti-Vehicle Laser Cannon (requiring a crew of 4), two of the soldiers could fire their blasters.

The skill required for firing the Atgar 1.4 FD P-Tower Light Anti-Vehicle Laser Cannon and the Golon Arms Twin DF .9/B Medium Anti-Infantry Battery is *blaster artillery*.

## Heroes

### Special Combat Abilities

As described in the original edition of *Star Wars Miniatures Battles*, heroes can fire at more than one target in a Fire Combat Phase. Heroes are now capable of engaging in close assault combat with multiple opponents (this is new to this volume; it does not appear in the revised edition of *Star Wars Miniatures Battles*).

The combat is resolved in a manner similar to that for multiple targets. In this case, the hero may attack up to three opponents in the Close Assault Combat Phase. The opponents must be within the hero’s front 180-degree arc and in base-to-base contact with the hero.

The hero announces which opponents he is attacking. For each additional opponent attacked, +2 is added to the attack roll of the the opponents (increasing the difficulty of the combat for the hero). Each player rolls the appropriate dice and combat is resolved normally, with the exception that the hero may do damage to any of the attackers whose roll he beat.

**Example:** A Rebel hero is attacked by three stormtroopers. The hero chooses to fight all three. Each of the stormtroopers adds +4 to their rolls when resolving the combat

(+2 for each of the two additional opponents).

### Heroes and the Force

The Force power *life sense* is now *life detection*.

Certain Force powers require that the hero first have one or more other Force powers. These Force powers and their prerequisites are listed below.

- **Remain Conscious:** Requires *control pain*.
- **Receptive Telepathy:** Requires *life detection*.
- **Projective Telepathy:** Requires *receptive telepathy*. **Note:** This requirement was inadvertently left out of the listing of this power on page 63 of *Star Wars Miniatures Battles*.
- **Injure/Kill:** Requires *life detection*.

When a hero is attempting to use the Force powers *life detection*, *receptive telepathy* or *affect mind*, the opposing player makes the opposed test using his **control** skill or *Perception* (not his *sense* skill as previously described).

There is a new “*control* and *sense*” power: *lightsaber combat*. This power allows a hero to use a lightsaber more effectively. It is also required if the hero wishes to parry blaster bolts with a lightsaber. **He cannot do so without this skill.** A description of the skill is provided in the “Lightsaber Combat” sidebar.

### Force Powers Errata

A number of paragraphs were transposed between the *remain conscious* and *detoxify poison* Force powers in the revised *Star Wars Miniatures*

### Lightsaber Combat

This new force power allows a hero to use a lightsaber more effectively. It is used in the Close Assault Combat Phase, just before the hero is involved in combat. The difficulty for the skill test is 6.

If the hero succeeds, he may add his *sense* skill level to his *lightsaber* skill rolls, and add his *control* level to the lightsaber’s *Damage Strength*. These benefits last for the duration of the combat, or until the hero is wounded or incapacitated, whichever comes first.

If the hero does not succeed at the *lightsaber combat* test, he must use his unmodified *lightsaber* skill and the lightsaber’s normal *Damage Strength*. He may not attempt to use *lightsaber combat* again for the duration of the combat.

A hero must have *lightsaber combat* in order to attempt to parry blaster bolts with his lightsaber. He may also try to use this power to enhance his parrying attempt. When a hero is fired upon, and decides to parry the blaster bolt, he may make a *lightsaber combat* skill test against a difficulty of 8. If he succeeds, he gains the enhancements outlined above for the duration of that Fire Combat Phase. The benefits cease if the hero is wounded.

*Battles*. The description of *detoxify poison* ends with the second paragraph of the first column on page 63. Paragraphs three through seven (from “In the Special Actions Phase ...” through “... medpac (see ‘Advanced Equipment’).”) should be read after the first paragraph of the description of *remain conscious*.

### Creating Alien Heroes

As described in *Star Wars Miniatures Battles*, you can create a hero from scratch. The process is essentially the same as that in the roleplaying game. However, if you are creating a hero who is an alien, some additional choices must be made.

The listings of game statistics for alien species present a set number of “attribute dice,” which may be distributed among the alien’s attributes, as well as a range of possible values for the attributes. The die codes listed are the minimum and maximum values that the alien may have for the particular attribute. For example, a Wookiee has 12 attribute dice and its *Dexterity* listing is “DEXTERITY 1D/3D+2.” When creating a Wookiee character, you may allocate as few as 1D and as much as 3D+2 attribute dice to its *Dexterity*.

The procedure is the same for creating a Wookiee hero in *Star Wars Miniatures Battles*. Convert the die codes to *Miniatures Battles* attribute values, rounding additional pips off (e.g., “1D” and “1D+1” become “1” and “1D+2” becomes “2”). When creating a player character alien in the roleplaying game, you distribute an additional 6D among the starting attributes. *Star Wars Miniatures Battles* heroes are the equivalent of player characters, so don’t forget to include the additional 6 points when creating the hero (for a total of 18 points, in the case of the Wookiee).

Most aliens have special abilities. These abilities are usually readily adaptable to the miniatures game; just convert the die codes to number values. If difficulty levels are given for certain abilities, consider “Easy” to be difficulty 4, “Moderate” to be difficulty 6, “Difficult” to be difficulty 8, and so on up or down the scale. Other characteristics can be determined by common sense or by gamemaster interpretation.

More detailed information on creating aliens can be found on pages 15–16 of *Star Wars: The Roleplaying Game, Second Edition*.

### Creatures

A creature now uses its *Strength* when attacking. In addition to its attributes, a creature may also have one or more skills (most commonly *brawling*).

The *Dexterity* attribute is used for determining a creature’s Movement Rate (see below) and if a creature is capable of flight (see Chapter Two, “Flight”).

Like soldiers, creatures have a Move rating. The Movement Rate of a creature is determined by adding its *Dexterity* to its Move. The Move rating is added into the total when calculating the creature’s cost in Squad Generation Points.

### Droids

As with soldiers and creatures, droids now have a Move rating. The Move is included in the total Squad Generation Points. The Droid Record Sheet is also revised to reflect the changes in the skill list.

### Advanced Terrain

#### Fire

When checking to see where flames spread, roll **two** dice and place the new template next to that number on the previous template.

### Troop Lists

All troops listed under “Imperial Forces,” “Neutral Forces” and “Rebel Forces” have a Move of 10, except for Ewoks, whose Move is 8.

Droids and creatures have the following Moves:

**Assassin droid:** 10.

**Probe droid:** 10.

**Security droid:** 10.

**War droid:** 8.

**Bantha:** 5.

**Cracian thumper:** 12.

**Dewback:** 35/7 (the first value is movement during the day, the second is at night; dewbacks become sluggish at night).

**Krayt dragon:** 15.

**Rancor:** 20.

**Tauntaun:** 12.

**Vervikk:** 6.

**Wampa:** 13.

**Womp rat:** 5.

**Yavinian runyip:** 8.

The rancor’s *Strength* has been revised to 7 (10). The parenthetical value is used for determining damage; the rancor’s armored skin adds a +3 to its *Strength* for resisting damage.

### Using This Companion With Star Wars, Second Edition

The changes made to revise *Star Wars: The Roleplaying Game* to its second edition which affect *Star Wars Miniatures Battles* are reflected in the revisions described above.

The rules for vehicles, which are presented for the first time in this volume, are already compatible with those in *Star Wars: The Roleplaying Game, Second Edition*.

However, there are many vehicles described in *Star Wars* adventures and sourcebooks which

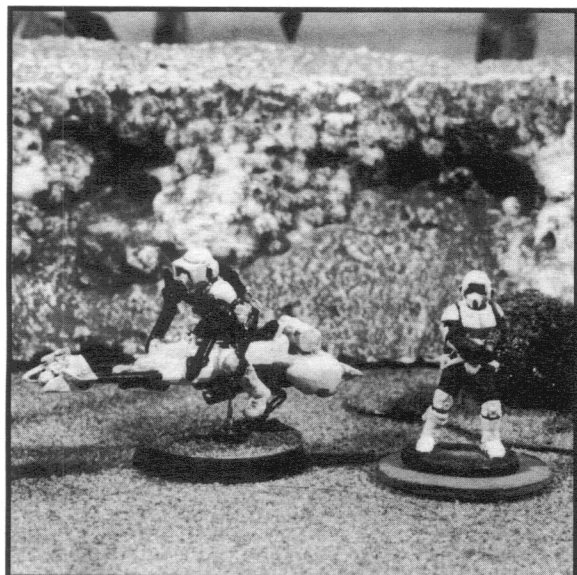

■ An Imperial biker scout sets out on a flanking maneuver while a fellow trooper stands ready to defend the Rebels' objective.

you may wish to use but whose statistics have not yet been revised to second edition. Therefore, the following procedure for converting first-edition vehicles to second edition is provided.

### Converting Vehicles

Most of the statistics in the first edition of *Star Wars: The Roleplaying Game* remain the same in the second edition. The second edition adds many new statistics, some of which are used in *Star Wars Miniatures Battles*.

The major change from first to second edition is the replacing of the Speed Code with the Move. In order to convert a *Star Wars* vehicle from the roleplaying game to the miniatures game, you need to know the Move. To determine a first-edition vehicle's Move, use the following procedure.

First, modify the vehicle's Speed Code according to what type of vehicle it is, using the following chart:

#### Speed Code Modifiers

Airspeeder	0D
Cloud Car	+7D
Glider	-2
Hover	-2D
Landspeeder	-1D
Sail Barge	-1D
Skiff	0D
Speeder Bike	0D
Swoop	0D
Tracked	-2D
Walker	-3D+2
Wheeled	-1D+2

Next, find the vehicle's modified Speed Code on the "Speed Code to Move Conversion Chart" below.

### Speed Code to Move Conversion Chart

Modified Speed Code	Move
-4D	3
-3D+2	5
-3D+1	7
-3D	8
-2D+2	10
-2D+1	14
-2D	18
-1D+2	21
-1D+1	25
-1D	26
-0D+2	28
-0D+1	30
0D	35
0D+1	45
0D+2	55
1D	70
1D+1	80
1D+2	90
2D	105
2D+1	115
2D+2	125
3D	140
3D+1	150
3D+2	160
4D	175
4D+1	185
4D+2	195
5D	210
5D+1	225
5D+2	260
6D	280
6D+1	295
6D+2	330
7D	350
7D+1	365
7D+2	400
8D	415
8D+1	435
8D+2	450
9D	470
9D+1	485
9D+2	505
10D	520

The result is the vehicle's Move, which is used to determine its Cautious, Cruise and Top Speeds.

# Chapter One

# Vehicles

The Empire is vast. The huge tracts of land which make up the planetary surfaces of its millions of worlds require a dedicated, highly mobile force to control. In order to maintain its iron grip over these varied and diverse surfaces, the Empire maintains an immense fleet of ground assault vehicles (GAVs).

To counter this threat, the Rebel Alliance must use and reuse whatever it can get its hands on. Rebel actions tend to be small, quick guerilla strikes, so the Alliance favors the armoring and arming of faster and more easily acquired vehicles, such as landspeeders, airspeeders and speeder bikes.

Starfighters can be used for bombing, strafing and ground support. However, their use is beyond the scope of these rules, as the speeds at which they travel and the power of their weapons are well beyond the scale represented on the average gaming table.

## Availability of Models

We have presented rules for the use of vehicles because much of the fun of playing a *Star Wars* game lies in replaying the movie scenes we like, or variations on those scenes. In order to use vehicles in *Star Wars Miniatures Battles*, though, it may be necessary to do a bit of work. Until recently, there were no metal or plastic kits available in 25mm scale based on *Star Wars* vehicles. West End is now producing an assortment of vehicles, but only the smallest vehicles, such as bikes and speeders, can be produced as metal kits.

In addition to West End's *Star Wars* vehicles, there are some 25mm science-fiction vehicles being produced by other miniatures companies. With a little work, some of these can be modified to produce suitable *Star Wars* vehicles.

Plastic *Star Wars* model kits are now available again. The kits are not actually 25mm scale, but some of them are close enough to pass, and they could be used on the tabletop.

A final option is to actually build your vehicles from scratch. This option requires the most time and effort, but can be an enjoyable hobby in itself and can provide you with any type or variation of vehicle you can imagine.

## Vehicle Listings

Because the type of vehicle used in your battles depends on what type of model you have available, we cannot hope to cover every possibility. What we have provided is a representative sampling of the types of vehicles to be found in *Star Wars* battles.

The vehicles you use can be based on the descriptions provided. You can also extrapolate from a vehicle listing which is similar to the vehicle you wish to use. In addition, by using the information at the end of this chapter concerning the conversion of vehicles from the roleplaying game and the calculation of point values, you can determine a set of game values for any model you are using.

Knowing how the point values are determined also allows you to customize vehicles. You may wish to strip down a couple of Aratech Overracers, reducing their Move (and therefore speed) and armament in order to field extra vehicles. Or you may wish to beef up a basic landspeeder with more armor (*Body Strength* and *Body Points*), speed and weapons.

Vehicle listings can be found in the "Vehicle Chart." Each of these vehicles are described in more detail in *The Star Wars Sourcebook*, the *Imperial Sourcebook* and *The Rebel Alliance Sourcebook*, although you do not need those books to use these vehicles in *Star Wars Miniatures Battles*. In addition, vehicles from any *Star Wars* product may be converted for use in *Star Wars Miniatures Battles* by employing the charts provided in this chapter (see "Converting Other *Star Wars* Vehicles").

A vehicle's listing contains the following information:

- **Craft:** The name and type of the vehicle, as well as any special notes about it.
- **Crew:** The number of crew members needed to operate the vehicle effectively.
- **Passengers:** The number of passengers other than crew the vehicle is designed to carry.
- **Drive System:** The method of locomotion of a vehicle affects the vehicle's movement in different types of terrain.
- **# Turns:** The number of 45-degree turns that a vehicle can make safely during the Movement Phase.
- **Turn Distance:** Governs how tightly a vehicle may turn; it is the distance in inches that a vehicle must travel between making turns.
- **Cautious Speed:** A vehicle's maximum Movement Rate in inches while moving cautiously (see "Movement" below).
- **Cruise Speed:** A vehicle's maximum cruise speed in inches.
- **Top Speed:** A vehicle's maximum Movement Rate in inches in a turn.
- **Accel/Decel:** The amount in inches by which a vehicle can change its Movement Rate during a Movement Phase.
- **Minimum Flight Speed:** If the vehicle is capable of flight, this is the minimum Movement Rate it must move at to remain in the air.
- **Flight Ceiling:** If the vehicle is capable of flight, this is the maximum height at which it may fly.
- **Body Strength:** This is the *Strength* rating used when determining damage.
- **Body Points:** The amount of damage a vehicle can sustain before it is rendered useless.
- **Cover:** This is the amount of protection the vehicle affords its crew and/or passengers. The higher the value, the better the protection for the occupants.
- **Weapons:** A description of the weapons carried, including the fire arc of each weapon. The Fire Control code, *Damage*, and range bands for each weapon can be found in the "Vehicle Weapon Chart."

### Crew

A vehicle needs a complete crew to operate effectively under battle conditions. The "Vehicle Chart" lists the number of crew required. Crew positions always include a driver; additional crew are used to man weapons. Where a vehicle is listed with more crew than these positions, the player must allocate these extra crew as co-drivers or reserve gunners. For example, a Floating Fortress

has a crew of four, but carries only one weapon. One crew member acts as the driver and another as the gunner. The player could allocate one of the other two crew as a reserve driver, and the other as a reserve gunner. Or, he could allocate both as reserve gunners or reserve drivers.

A crewmember's attributes are bought as for any other soldier's. The point value of a vehicle is the total points for the vehicle plus the points values of the crew members (see "Points," below). As each crewmember is assumed to be trained for his position, skill tests are not needed to operate the vehicle in a normal fashion.

There are circumstances which require skill tests, such as when a driver wants to attempt maneuvers or regain control of an out-of-control vehicle, or when a gunner is attempting to fire a weapon. Generally, a driver tests the appropriate vehicle skill (such as *repulsorlift operation*, *ground vehicle operation* or *hover vehicle operation*, which in future references will be designated as [*vehicle*] *operation* for ease of use). Gunners use their *vehicle blasters* skill or specialization to fire vehicle-mounted weapons.

If there is no crewmember available for a function, it cannot be performed. For example, if the gunner in a two-man craft is incapacitated, the weapon may not be fired. The driver could not fire the weapon if the vehicle were in motion, as he would need to pilot the vehicle. If the vehicle were stationary, however, the driver could fire the weapon. Certain vehicles may be configured to allow the driver to also fire a weapon. These are noted in the "Vehicle Chart."

A driver firing a weapon while driving a vehicle uses his *vehicle blasters* skill, but the difficulty of the shot is modified by +1.

### Passengers

Passengers can be carried by certain vehicles. They may board or disembark from vehicles during the Movement Phase (see "Boarding" and "Disembarking" below).

Passengers may take the place of incapacitated crewmembers, if the passenger compartment is connected to the crew compartment. When a crewmember is incapacitated, the owning player may designate a passenger to replace him. It takes the next turn for the passenger to assume the post. During the following turn, the weapon may be fired or the vehicle driven. The passenger uses his appropriate skill or attribute.

**Example:** *One of the gunners in a Floating Fortress is incapacitated during Turn Three. One of the passengers is assigned to take his place. It takes all of Turn Four for the passenger to clear the gunnery station and take up the position. In Turn Five the passenger may fire the weapon.*

Fire directed at an open-topped vehicle is randomized between any exposed riders (crew and/or passengers) and the vehicle itself. How likely the occupants are to be hit depends on just how open-topped the vehicle is. To determine if an occupant or rider has been hit instead of the vehicle, look up the vehicle's Cover rating.

Riders in a vehicle with a Cover value of "F" cannot be hit by fire directed at the vehicle.

If the vehicle has a numerical Cover value, roll a die; if the roll is equal to or greater than the Cover value, a rider is hit. If the fire hits a rider, randomize to determine which rider is hit and then resolve damage.

## Drive Systems

Different drive systems provide different advantages and disadvantages to vehicles, primarily in their ability to traverse various types of terrain. The types of drive systems and their effects are listed below. The effects of terrain on the different drives is summarized in the "Vehicle Terrain Effects Chart."

### Repulsorcraft

Repulsorlift drive systems are by far the most prevalent drives in the *Star Wars* galaxy. By their very nature, repulsorcraft are always "flying," although many of them are considered ground craft. For example, a typical landspeeder has a flight ceiling of two meters. It only follows a planet's surface; it does not have enough lift to carry it over substantial obstacles. It may also remain motionless and hover over the ground.

The effects of flight on movement and combat are described in the "Flight" section. The following rules deal with "Low Level" vehicles only.

Repulsorcraft ignore rough and very rough terrain movement restrictions, with the exception of difficult hills, which are considered rough terrain. Depending on the terrain and/or the repulsorcraft's flight ceiling, impassable terrain may present no obstacle; this can be determined by common sense or the gamemaster's decision.

A repulsorcraft moving at Low Level can cross moderate barriers with no effect if it is moving at its Cautious Speed or less. Otherwise the vehicle goes out of control (see "Out-Of-Control Vehicles" below) on the next turn. Difficult barriers which are unsubstantial in relation to a vehicle (such as barbed wire) may also be crossed at Cautious Speed. Barriers built into but not above the surface (such as trenches) are an obstacle to vehicles which move *on* the ground, but have no effect on speeders.

A repulsorcraft may safely move at up to its Cautious Speed in woods. It is possible to move faster in woods, but the driver must make a difficulty 6 *repulsorlift operation* skill test each

turn he does so. The test is made at +1 to the difficulty in light woods, +2 in medium woods, and +3 in heavy woods.

If the driver fails the test, roll a die to determine the result. Add the difficulty modifier for the appropriate woods type to the roll and consult the table below for results.

- |     |                                          |
|-----|------------------------------------------|
| 1-5 | Goes out of control next turn            |
| 6   | Collision with tree ( <i>Strength</i> 4) |

**Example:** *A speeder bike driver is attempting to move 20" through medium woods. His skill test is made against a difficulty of 8 (difficulty 6, plus 2 for the medium woods).*

*If the driver fails the test, the player rolls a die for the result. If he rolls a 3 or less the driver goes out of control the next turn (3 + 2 [for the medium woods] = 5). If he rolls a 4 or more he has collided with a tree. Work out damage normally (see "Collisions" below).*

Repulsorcraft which begin the Movement Phase with a Movement Rate of 0" can be turned in place to any facing before moving, at a movement cost equal to their Turn Distance in inches.

### Hovercraft

Hovercraft move on a cushion of air created by powerful blowers. Hovercraft move only centimeters above the ground, so they are not considered to be flying.

Hovercraft ignore rough and very rough terrain movement restrictions, with the exception of hills, which are treated normally.

Hovercraft cannot operate in woods, or cross over walls or other barriers. Barriers which have no substantial effect on vehicles—such as barbed wire—may be crossed, but at no more than Cautious Speed.

Hovercraft which begin the Movement Phase with a Movement Rate of 0" can be turned in place up to 90 degrees before moving, at a movement cost equal to their Turn Distance in inches.

### Tracked Vehicles

Vehicles with tracks ignore rough terrain restrictions and treat very rough terrain as rough terrain. Woods are an exception to this rule: light woods are treated as rough terrain; medium woods as very rough terrain; and heavy woods are impassable.

A tracked vehicle can cross moderate barriers with no effect if it is moving at its Cautious Speed or less. Otherwise the vehicle goes out of control on the next turn. Likewise, barriers which are unsubstantial or in the ground (such as barbed wire or trenches) may be crossed at Cautious Speed.

Swamp or marsh (or an equivalent very loose terrain) can cause a vehicle with tracks to bog

down. At the beginning of every Movement Phase that a tracked vehicle is in such terrain, the driver must make a difficulty 6 *ground vehicle operation* skill test. Success means that the vehicle can move this turn. Failure means that the vehicle is now stuck and cannot move unaided. The driver may make successive attempts to move, one at the beginning of each Movement Phase, but each new attempt is at an additional +2 to the difficulty number.

**Example:** *A Mobile Command Base on Taria II becomes bogged down in a swamp during Turn Three. At the beginning of the Movement Phase of Turn Four the driver may again attempt to move by making the skill test*

*against a difficulty of 8. If that fails he can try again on Turn Five with a difficulty of 10, and so on.*

Tracked vehicles which begin the Movement Phase with a Movement Rate of 0" can be turned in place to any facing, at a movement cost equal to their Turn Distance in inches for each 45 degrees (or portion thereof) that they change facing.

**Walkers**

Walkers ignore rough terrain restrictions and treat very rough terrain as rough terrain, with the exception of hills — easy hills remain rough terrain and difficult hills are very rough terrain.

**Vehicle Terrain Effects Chart**

Terrain Type	Drive System						
	Repulsor	Hover	Track	Walker	Wheel	Wide-Wheel	2-Wheel
clear	NE	NE	NE	NE	NE	NE	NE
scrub	NE	NE	NE	NE	< 6" OK	NE	< 6" OK
brush	NE	NE	NE	NE	< 6" OK	NE	< 6" OK
woods							
light	> Cautious test +1	-	2x cost	Cautious	< 6" OK 2x cost	2x cost	< 6" OK; 2x cost
medium	> Cautious test +2	-	4x cost	Cautious	-	-	-
heavy	> Cautious test +3	-	-	Cautious	-	-	-
swamp	NE*	NE*	test or bog down	-	-	test or bog down	-
hill							
easy	NE	2x cost	NE	2x cost	2x cost	NE	2x cost
difficult	2x cost	4x cost	2x cost	4x cost	-	4x cost	-
creek	NE	NE	NE	NE	-	NE	-
stream	NE	NE	2x cost	2x cost	-	NE	-
<b>Barrier Type</b>							
door	-	-	-	-	-	-	-
window	-	-	-	-	-	-	-
wall							
low	Cautious 4"	-	Cautious 4"	NE	-	Cautious 4"	-
high	-	-	-	NE	-	-	-
barbed wire	Cautious 2"	Cautious 2"	Cautious 2"	NE	-	Cautious 2"	-
trench							
shallow	NE	NE	NE	NE	-	-	-
deep	NE	NE	Cautious	NE	-	-	-
<b>Move 0"</b>	180°; Turn Distance	90°; Turn Distance	Turn Distance per 45°	1x45°; Turn Distance	1x45°; Turn Distance	1x45°; Turn Distance	180°; Turn Distance

-: Impassable.

NE: No Effect. \*Modified by foliage.



Walkers also ignore most barriers.

Walkers may only move at up to their Cautious Speed in woods.

Walkers that begin the Movement Phase with a Movement Rate of 0" may change their facing up to 45 degrees before moving, at a cost equal to their Turn Distance in inches.

### Wheeled Vehicles

A wheeled vehicle moving at a Movement Rate of greater than 6" treats rough and very rough terrain as impassable. If a vehicle moves into such terrain at those speeds, it will go out of control for one turn and then stop dead. It can no longer move after stopping.

Wheeled vehicles move at half speed in light woods, and cannot move in medium or heavy woods. Light woods are rough terrain, so the speed restriction of 6" does apply. Therefore, the maximum safe speed for wheeled vehicles in light woods is 3".

Vehicles with wheels may move at half speed on easy hills, with same restrictions as for light woods. They may not travel on difficult hills.

Wheeled vehicles entering a swamp or marsh become bogged down and can no longer move.

Vehicles with wheels cannot cross any barriers. A vehicle attempting to do so instead collides with the barrier, taking the appropriate damage (see "Collisions," below) and reducing its Movement Rate to zero.

Wheeled vehicles that begin the Movement Phase with a Movement Rate of 0" may change their facing up to 45 degrees before moving, at a cost equal to their Turn Distance in inches.

### Wide-Wheeled Vehicles

Many vehicles designed for off-road use or for use in difficult terrain have very large, wide wheels, or "balloon tires." Treat a wide-wheeled vehicle as a tracked vehicle for movement and terrain effects, with the exception that it cannot enter medium or heavy woods, and cannot cross trenches.

Wide-wheeled vehicles that begin the Movement Phase with a Movement Rate of 0" may change their facing up to 45 degrees before moving, at a cost equal to their Turn Distance in inches.

### Two-Wheeled Vehicles

Like repulsorcraft, two-wheeled vehicles which begin the Movement Phase with a Movement Rate of zero can be turned in place to any facing before moving, at a movement cost equal to their Turn Distance in inches. They follow the above restrictions for wheeled vehicles in all other respects.

## Movement

Vehicles move during the Movement Phase. A single vehicle counts as a squad in terms of alternating movement between sides. Terrain may affect the vehicle's movement; terrain effects are described above under "Drive Systems."

### Movement Rates

Unlike ground troops, vehicles do not have a fixed Movement Rate. Vehicles may change their Movement Rate from turn to turn. A vehicle may move at a rate of up to its Top Movement Rate.

Vehicles have three Movement Rates available which affect how difficult it is for them to turn. These are Cautious, Cruise and Top. Their effects on how a vehicle makes turns is described under "Turning."

In a given turn, a vehicle must be moved a distance equal to its current Movement Rate in inches (subject to terrain effects). Before a vehicle begins its movement it may accelerate or decelerate. It may increase its Movement Rate by up to its "Accel" rating or decrease its Movement Rate by up to its "Decel" rating. Keep a record of the vehicle's current speed on the back of the Vehicle Record Sheet or on a piece of scratch paper.

**Example:** *An AT-AT walker with an "Accel/Decel" of "4/8" that begins the Movement Phase with a Movement Rate of 12" may increase its Movement Rate to a maximum of 16" or decrease it to a minimum of 4" this turn.*

### Backing Up

All vehicles, except two-wheeled vehicles, may move backwards during the Movement Phase. To do so a vehicle must have begun the Movement Phase stationary or already backing up. Once it has started to move backwards a vehicle may continue to do so in subsequent turns.

When moving backwards, a vehicle may only move at Cautious or Cruise Speed. If a vehicle is moving backwards faster than its Cautious Speed, the driver must succeed at a difficulty 6 [vehicle] operation skill test. If he or she fails, the vehicle goes out of control (see "Out-Of-Control Vehicles" below), while continuing in a backward direction.

### Turning

Most vehicles cannot turn easily. They must move a certain distance forward in order to turn. This is represented by a series of 45-degree turns. A vehicle must move forward a distance equal to or greater than its Turn Distance before making a turn. For example, a vehicle with a Turn Distance of 1" must move at least 1" between each 45-degree turn. After a vehicle has moved its

Turn Distance or greater, it may be turned by up to 45 degrees. To turn the vehicle, pivot it about its center rear.

Vehicles can only make a certain number of 45-degree turns safely in a game turn. The number of safe turns for each vehicle is given under “# Turns” on the “Vehicle Chart.” A vehicle may also attempt additional turns in a game turn, but each additional turn requires a *[vehicle] operation* test by the driver, at the risk of going out of control. The difficulty of the additional turns is affected by the vehicle’s speed (see “Vehicle Speed” below). A vehicle’s Turn Distance is also affected by its speed.

A vehicle which is already moving at the start of the Movement Phase must move at least its Turn Distance before making a turn.

A vehicle may make tighter turns during the Movement Phase, but at a cost. After moving its Turn Distance, the vehicle can be pivoted an amount from 45 degrees up to 90 degrees. This is known as a “double turn” and requires a *[vehicle] operation* test by the driver. The difficulty level of the test is determined by the vehicle’s speed (see “Vehicle Speed” below). If the test is failed, the vehicle goes out of control.

A vehicle may not make more double turns than its # Turns. For example, a vehicle with # Turns 2 can only attempt two double turns in any one Movement Phase. The double turns may be attempted in addition to the vehicle’s regular turns.

Vehicles that begin the Movement Phase with a Movement Rate of 0” may change their facing before moving. The descriptions of the various drive systems (see above) detail the extent of the facing change and the cost in terms of Movement Rate for each type of drive system.

**Example:** *At the start of the Movement Phase the vehicle is already moving, so it must move its Turn Distance of 2” before making a turn. It must then move forward 2” before making another turn.*

**Vehicle Speed**

If a vehicle is making additional turns in excess of its # Turns, the driver must succeed at a *[vehicle] operation* test for each one. A driver attempting a double turn must make a *[vehicle] operation* test, too.

The difficulty of these tests is determined by the speed of the vehicle. If any test is failed, the vehicle goes out of control (see “Out-of-Control Vehicles”). A vehicle’s speed also affects its Turn Distance.

• **Cautious Speed:** A vehicle uses the listed Turn Distance.

A vehicle traveling at Cautious Speed makes any additional turns at a difficulty of 4. A double

### Turning

**Landspeeder**

---

**# Turns: 2**  
**Turn Distance: 2**

Moving at Cautious Speed

turn is also made at a difficulty of 4.

• **Cruise Speed:** Turn Distance is doubled.

A cruising vehicle makes additional turns at a difficulty of 6. Double turns are also made at a difficulty of 6.

• **Top Speed:** Turn Distance is increased by x4. For example, a one-inch Turn Distance becomes four inches.

Vehicles travelling at faster than Cruise Speed test for additional turns and double turns against a difficulty of 8.

**Maneuvers**

Maneuvers are any actions attempted by the driver of a vehicle to cause the vehicle to go in other than a straight direction. These include actions like turning, jumping, spinning, and, for flying vehicles, climbing and diving.

A vehicle may attempt one maneuver per Movement Phase (except for turns; see “Turning,” above). Each maneuver requires the driver to make a *[vehicle] operation* skill test. The difficulty of the test varies depending on the speed of the vehicle. If the test is failed, the vehicle goes out of control, starting at a point halfway through the attempted maneuver (see “Out-of-Control Vehicles,” below).

The various types of maneuvers and their difficulty are described below, and the difficulty numbers to perform the maneuvers are summarized in the “Maneuver Difficulty Numbers” chart (below and in the “Charts and Tables” section).

• **Slide:** The vehicle slides sideways, shifting its position to the side while maintaining its current facing.

It is easier to slide in a repulsor-driven vehicle; such vehicles may slide a greater distance in a turn. Walkers do not “slide” *per se*, but their locomotive mechanism does allow for a limited “sidestep.”

When performing a slide, the vehicle is moved up to 1" to the side for each 1" of forward movement, to a maximum of 4" sideways movement. All sideways shifts in a turn must be to the same side. A vehicle may not change directions in the middle of a slide. All shifts sideways must be performed consecutively; once a vehicle resumes a motion straight forward, it may no longer slide in that Movement Phase.

Repulsorcraft may slide up to 7" sideways.

Walkers may “slide” up to 2" sideways.

Skill tests for a slide are made at a difficulty of 4 when the vehicle is moving at Cautious Speed, a difficulty of 6 at Cruise Speed and a difficulty of 8 at Top Speed.

• **Bootlegger Turn:** The vehicle spins while sliding, ending up facing in the direction opposite its starting direction.

To perform a bootlegger turn, first move the vehicle half its current Movement Rate. Then turn the vehicle around to face the opposite direction and place it adjacent to the position it occupied at the end of its move. The player may decide on which side to place it. The vehicle may no longer move this Movement Phase.

If a vehicle goes out of control while performing a bootlegger turn, move the vehicle half its current Movement Rate, and turn the vehicle 90 degrees sideways (determine which way randomly). Then apply the out-of-control results to the vehicle, treating it as if it were still moving in the original direction. When rolling for altitude change for a ground vehicle, a result of 1-4 is treated as a “dive” result and the vehicle flips over (see “Out-of-Control Vehicles” below).

Walkers may not perform a bootlegger turn.

A bootlegger turn may not be attempted when a vehicle is moving at less than 20". The skill test is made at a difficulty of 6 when the vehicle is moving at Cautious Speed, at a difficulty of 8 at Cruise Speed and a difficulty of 10 at Top Speed.

• **Jump:** The vehicle runs off the edge of some terrain feature, such as a bridge, chasm, cliff or ramp. The driver is attempting to maintain control of the vehicle when it hits the ground.

When a vehicle moves over the edge of an elevated feature, it begins to fall to the surface of the planet, all the while continuing its forward motion. How far forward it moves is dependent on its speed.

A jumping vehicle will move forward one-quarter of its current Movement Rate for each 1" drop in altitude. Measure the height of the obstruction or other feature from which the vehicle is jump-

### Game Note: Jumping Vehicles

Of course, the rate of descent and distance travelled of a jumping vehicle are dependent on many more factors than just the vehicle’s speed. But rather than burden you with the physics of motion and a host of formulae, we have opted for a quick and playable solution.

However, you may feel free to pull out your protractors and calculators if you want a realistic simulation of a jumping or falling vehicle, but we’d rather just get on with the game.

ing, then determine the distance that the vehicle moves forward. Place the model on the surface at that point and make the driver’s skill test. Apply the results as normal.

Certain features may be high enough that the vehicle does not reach the ground before completing its movement for the phase. In that case, you will have to find a method to indicate that the vehicle is in mid-jump. Using a *Level* marker or noting the vehicle’s location on scrap paper are a couple of suggestions.

**Example:** *A landspeeder moving 18" travels off the edge of a rocky outcropping which is 2" high. The landspeeder is placed on the tabletop 9" from the edge of the outcropping (it moved 4.5" forward for the first 1" drop and another 4.5" for the second), and the driver’s skill test is made.*

*If the driver succeeds at the test, the landspeeder may move another 9", completing its turn. If he fails, the speeder goes out of control from the spot at which it hit the ground.*

**Example:** *A wheeled recon vehicle moving 20" goes careening off the crumbling edge of an elevated roadway that is 5" high.*

*After moving 20" the vehicle has descended to 1" above the tabletop. It is placed on the table 20" from the edge of the road and marked with a scrap of paper indicating that it is still 1" above the ground. It will complete the jump in the next Movement Phase.*

Skill tests for a jump are made at a base difficulty of 8 when the vehicle is moving at Cautious Speed, a base difficulty of 10 at Cruise Speed and a base difficulty of 12 at Top Speed. The difficulty number is increased by 1 for every inch of drop over 2".

**Example:** *The rider of a speeder bike traveling at Cruise Speed off the edge of a*

### Maneuvers

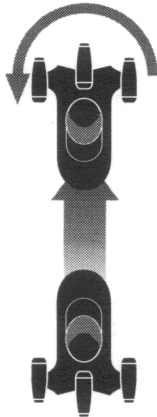

Rotate

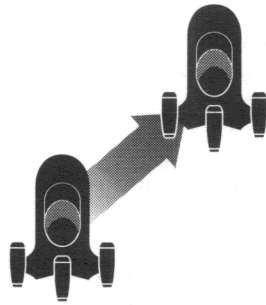

Slide

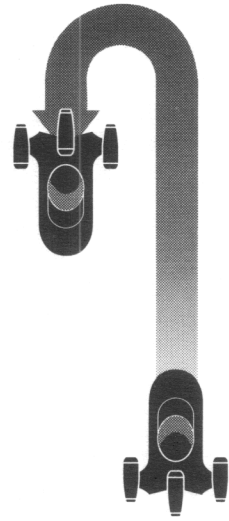

Bootlegger Turn

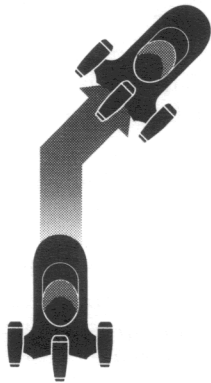

Turn

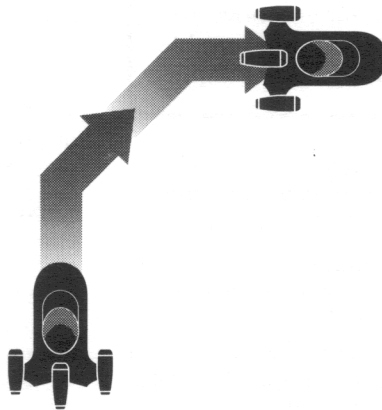

Additional Turn

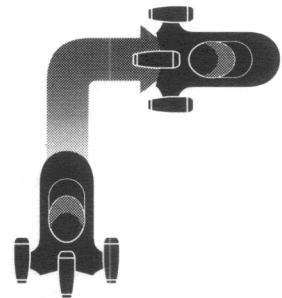

Double Turn

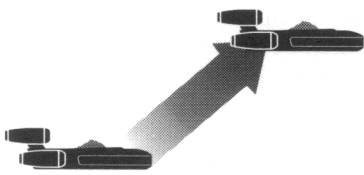

Climb

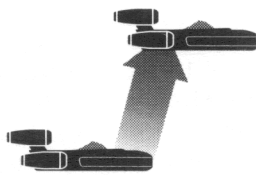

Extreme Climb

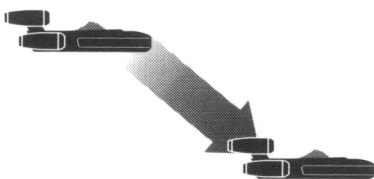

Dive

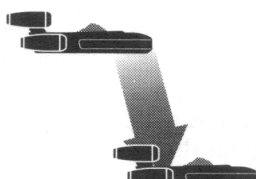

Extreme Dive

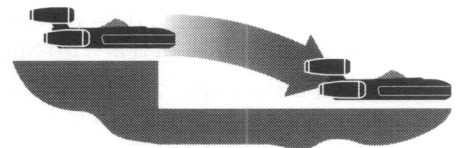

Jump

### Game Note: Repulsorcraft and Jumping

While repulsorcraft seem to fly above the surface of a planet, it is not true flight. How high a repulsorcraft “flies” depends on the power of its repulsorlift engines and on the vehicle’s position relative to the mass of the planet.

Therefore, a landspeeder with a flight ceiling of 1 meter cannot normally rise above that height due to the constraints of its engine, which can only counteract gravity to a limited extent. If the landspeeder were to suddenly find itself above that height, it would begin to fall to the surface of the planet.

Depending on how high it was falling from, the speeder’s repulsor field would not be able to cushion the vehicle sufficiently when it hit the ground. So even though repulsorcraft do move above the surface of a world, they are still susceptible to going out of control if forced to jump.

*ruined temple that is 3" high must make a repulsorlift operation test against a difficulty of 11 in order to retain control of the bike.*

- **Turn:** The vehicle is performing a simple turn to the left or right, ending up facing no more than 45 degrees from its original direction.

This is the basic turn, as described above in the “Turning” section. It is the simplest maneuver, and the easiest to perform safely.

No skill test is required for any turns made up to the # Turns of the vehicle.

- **Additional Turns:** The vehicle is continuing to turn in excess of its # Turns.

Any turns made in the same Movement Phase after the vehicle has made a number of turns equal to its # Turns rating require a skill test. Skill tests for each additional turn are made at a difficulty of 4 when the vehicle is moving at Cautious Speed, a difficulty of 6 at Cruise Speed and a difficulty of 8 at Top Speed.

- **Double Turn:** The driver is attempting a controlled skid in order to make the vehicle change direction more than it normally could by turning — in effect performing a tighter turn.

A vehicle which successfully completes a double turn may be pivoted to face between 45 degrees and 90 degrees from its original direction. A vehicle may not make more double turns in any one Movement Phase than its # Turns.

Skill tests for a double turn are made at a difficulty of 4 when the vehicle is moving at

Cautious Speed, a difficulty of 6 at Cruise Speed and a difficulty of 8 at Top Speed.

- **Rotate:** The vehicle turns up to 360 degrees without changing its direction of movement.

To rotate a vehicle, pivot it about its center to any facing during its movement. The vehicle will continue to move in the direction it was heading when the rotation began, for a distance of half its *remaining* Movement Rate.

In the next Movement Phase, a vehicle which rotated moves in the direction it is now facing. Its new Movement Rate is half the Movement Rate that it was traveling at when it rotated.

Skill tests for rotating are made at a difficulty of 6 when the vehicle is moving at Cautious Speed, a difficulty of 8 at Cruise Speed and a difficulty of 10 at Top Speed.

- **Climb:** The vehicle is increasing its altitude.

A flying vehicle must move at least 16" in order to move up one Flight Level. For each 16" of forward movement, a vehicle may climb another Level. For more details on flying vehicles, see Chapter Two, “Flight.”

No skill test is required for a vehicle climbing at Cautious Speed. The test is made at a difficulty of 4 when moving at Cruise Speed and a difficulty of 6 at Top Speed.

- **Extreme Climb:** The vehicle is attempting to climb at a much steeper angle.

A vehicle may try to climb at a steeper rate, with a concomitant increase in difficulty. To perform an extreme climb, the vehicle advances only 8" before moving up one Level.

Skill tests for an extreme climb are made at a difficulty of 6 when the vehicle is moving at Cautious Speed, a difficulty of 8 at Cruise Speed and a difficulty of 10 at Top Speed.

- **Dive:** The vehicle is decreasing its altitude.

A vehicle must move at least 10" in order to move down one Flight Level. For each 10" of forward movement, a vehicle may dive another Level.

No skill test is required for a dive made at Cautious Speed. The difficulty is 4 when attempted at Cruise Speed and 6 at Top Speed.

- **Extreme Dive:** The vehicle is reducing its altitude much more steeply.

A vehicle moves only 5" forward before dropping one Level when attempting an extreme dive.

Skill tests for an extreme dive are made at a difficulty of 4 when the vehicle is moving at Cautious Speed, a difficulty of 6 at Cruise Speed and a difficulty of 8 at Top Speed.

### Boarding

Ground troops may board a vehicle if the vehicle has space for passengers. A vehicle may only hold as many soldiers as its passenger rating.

**Maneuver Difficulty Numbers**

Maneuver	Speed		
	Cautious	Cruise	Top
Slide	4	6	8
Bootlegger Turn <sup>1</sup>	6*	8	10
Jump <sup>2</sup>	8	10	12
Turn	**	**	**
Additional Turn <sup>3</sup>	4	6	8
Double Turn	4	6	8
Rotate <sup>4</sup>	6	8	10
Climb <sup>5</sup>	**	4	6
Extreme Climb <sup>5</sup>	6	8	10
Dive <sup>5</sup>	**	4	6
Extreme Dive <sup>5</sup>	4	6	8

\*A bootlegger turn may not be attempted at a Movement Rate of less than 20".

\*\*No [vehicle] operation skill test is required for this maneuver.

<sup>1</sup>This maneuver may not be performed by walkers.

<sup>2</sup>The difficulty number for a jump is increased by 1 for every inch of drop over 2".

<sup>3</sup>Turns made in excess of the vehicle's # Turns

<sup>4</sup>This maneuver may only be performed by repulsorcraft and hovercraft.

<sup>5</sup>This maneuver may only be performed by flying vehicles.

In order for a vehicle to be boarded, it must decelerate to zero at the beginning of the Movement Phase. Soldiers may then move up to the vehicle and board it. It costs soldiers half their Movement Rate (Walking or Running) to board a vehicle. A maximum of 10 soldiers may board a vehicle in the Movement Phase.

An exception to these rules is boarding walkers. See below for details.

**Disembarking**

Ground troops may disembark from a vehicle if they begin the Movement Phase on board the vehicle. A vehicle does not have to be stationary for soldiers to disembark. However, it is more dangerous to disembark from a moving vehicle.

If the vehicle is moving 10" or more, then the disembarking soldier must make an opposed *Strength* test against a *Damage Strength* of 3 to see if he sustains damage. The opposing roll is modified by +1 for each 1" over 10" that the vehicle is moving. Use the "Damage Table" to determine damage. If the soldier is wounded, he falls prone at the point at which he disembarked.

It costs a soldier half his Movement Rate (Walking or Running) to disembark. Place the soldier alongside the vehicle when he disembarks. Up to 10 soldiers may disembark during a Movement Phase. A soldier or squad can still move up to half its Movement Rate during the Movement Phase

in which it disembarked.

An exception to these rules is disembarking from walkers. See below for details.

**Boarding and Disembarking Walkers**

Walkers present an obstacle to passengers wishing to board or disembark, due to the height of the passenger compartments above the ground. Therefore, passengers (and crews) in walkers cannot enter or leave the vehicle while it is in motion, and the walker must be readied for them to do so once it is stationary.

In many instances, walkers are used in conjunction with docking platforms, which are situated at a height to match up with hatches in the walkers' sides. In that case, walkers can be boarded or disembarked from as normal, with the standard movement cost. The only restriction is that the walker must be stationary (it must begin the Movement Phase with a Movement Rate of 0).

In order to have soldiers enter or leave walkers from the ground, the following procedures must be followed.

**AT-ATs**

An AT-AT must first "kneel," bringing its body closer to the surface, then lower its boarding ramps to the ground.

To load or off-load passengers, the walker must first come to a stop. If it begins the Movement Phase with a Movement Rate of 0, it may begin to kneel. This takes the entire turn and requires a difficulty 8 *walker operation* test. If the test is not successful, the operation must be started all over again in the next turn.

After the walker has successfully knelt, it takes another turn to lower the boarding ramps, which are located at the rear sides of its body. There is no test for lowering the ramps. The driver may choose to lower only one of the ramps; declare which side is being lowered.

In the following turn, soldiers may board or disembark from the AT-AT, using their full Movement Rate. The walker may remain in this position as long as desired, and troops may come and go freely.

It requires another two turns for the AT-AT to begin moving again. During the first turn it is retracting the boarding ramps, and in the second turn it is rising to its full height. Raising the walker from the kneeling position also requires a difficulty 8 *walker operation* test, with the same result for failure.

Once the AT-AT has achieved a standing posture, it may begin to move in any successive turns.

**AT-STs**

Scout walkers are a little easier to get into and out of. There are also no passengers, so the only

time the procedure is necessary is if the crew were leaving for some reason.

An AT-ST must be lowered to a “squatting” position in order to allow access. This requires one turn and a difficulty 6 *walker operation* test. Failure indicates that the procedure was botched and must be repeated.

In the turn after the walker has been lowered, crewmembers may clamber in or out through the hatch on the top. Soldiers disembarking from the AT-ST may move up to half their Movement Rate. Soldiers wishing to enter the walker must have half their Movement Rate remaining when they reach the walker, or they must wait until the following turn to climb in.

Raising the scout walker also requires one turn and a difficulty 6 *walker operation* test. After the walker has successfully been raised, it may begin to move in successive turns.

#### AT-PTs

All Terrain Personal Transports (AT-PTs) are relics of the Old Republic and are therefore rarely encountered. An AT-PT is a one-being walker, and does not stand very high off the ground (for more information, see pages 121–122 of the *Dark Force Rising Sourcebook*).

The only restriction to entering and exiting this type of walker is that it must be stationary. If the AT-PT begins the turn with a Movement Rate of 0, the driver may enter or exit it at a cost of half her Movement Rate.

## Vehicle Fire Combat

Most vehicles mount weapons. These are specialized weapons which are entitled to “following fire,” as described under “Specialized Weapons” on page 23 in the “Fire Combat” section of *Star Wars Miniatures Battles*. Vehicle weapons also have computer-assisted fire control systems. A weapon’s Fire Control is added to a gunner’s *vehicle blasters* skill when making a skill test to fire the weapon.

Vehicle Fire Combat is resolved like standard Fire Combat.

### Vehicle Weapons

A vehicle may mount one or more weapons. Each weapon has one or more fire arcs, depending on where and how it is mounted. The standard fire arcs are front, back, left, right and turret, designated by F, B, L, R and T, respectively.

Each fire arc is a 90-degree arc originating from the position of the weapon on the model and centered on the direction indicated, with the exception of T — the fire arc of a turret is 360 degrees.

It is possible for a vehicle’s weapon to have multiple fire arcs. For example, a heavy blaster with a fire arc of LR can be fired either to the left or the right during a Fire Combat Phase. A gun with an arc of LBR could fire in any direction other than the 90-degree arc to the front of the vehicle. See the “Multiple Fire Arcs” diagram.

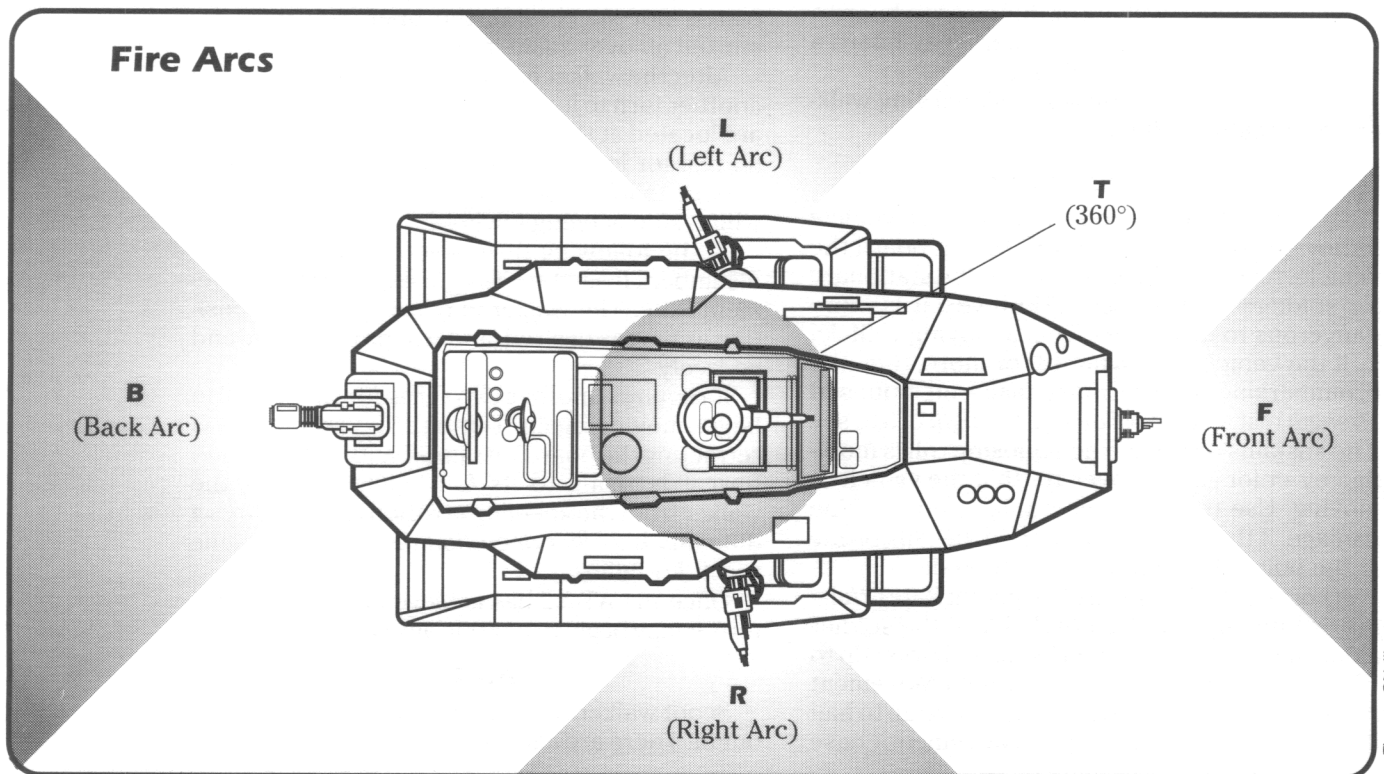

The weapons that a vehicle carries are listed in the “Vehicle Chart,” which also indicates what fire arc(s) the weapon has. The details of a weapon can be found in the “Vehicle Weapons Chart,” which lists its Fire Control code, the damage it does, and the range bands for the weapon.

**Fire-Linked Weapons**

Some weapons are listed as being fire-linked. Fire-linked weapons are two independent weapons of the same type that are wired to the same set of controls. They are fired at the same time at the same target, and are fired by one crewman.

**Firing From A Vehicle**

Some vehicles are capable of carrying passengers. The design of some of these vehicles allows passengers to fire their weapons from the vehicle (because the vehicle is open-topped or has hatches, for example).

Soldiers firing from a moving vehicle cannot fire at targets at long range, and suffer a +1 to their difficulty number for firing from a moving surface.

**Speed Effects**

It is harder to hit a rapidly moving vehicle, and it is also more difficult to fire from one. The table below shows the modifiers to the difficulty level according to the speed of the target and the firer.

Speed Difference	Modifier to Difficulty Number
0–19"	0
20–29"	+1
30–39"	+2
40–49"	+3
50–59"	+4
60+"	+5

The Speed Difference is determined by comparing the Movement Rates of the firer and the target.

If the vehicles are moving towards or away from each other — within 45 degrees of the axis of movement of the other vehicle — then add the Movement Rates of both vehicles together to get the Speed Difference.

If one vehicle is moving across the path of another — within 45 degrees of the perpendicular of the path of the other vehicle — use the target’s Movement Rate as the Speed Difference.

If the vehicles are moving roughly the same direction — again, within 45 degrees of the axis of movement of the other vehicle — subtract the lower Movement Rate from the higher Movement Rate to determine the Speed Difference.

Soldiers firing at vehicles or being targeted by vehicles use the distance they moved in that Movement Phase as their Movement Rate for determining the Speed Difference.

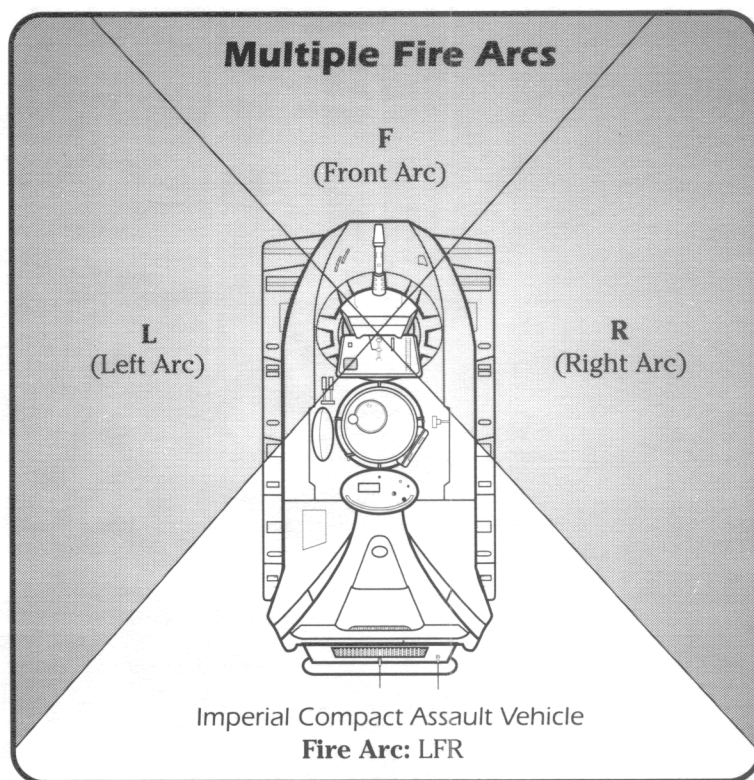

Stephen Crane/Thomas O'Neill

**Damage**

When a vehicle weapon hits a soldier, resolve damage normally. When a vehicle is the target, damage results are handled in a slightly different manner. First, make an opposed skill roll, adding the weapon’s *Damage Strength* to the firing die and the vehicle’s *Body Strength* to the target’s die. Compare the modified rolls and determine the results from the “Vehicle Damage Table” (see below).

**Vehicle Damage Table**

Roll	Effect
DR + 4 ≤ SR	No effect.
DR ≤ SR	Lose 1 <i>Body Point</i> .
DR > SR	Lose <i>Body Points</i> equal to <i>Damage Strength</i> of firing weapon.
DR > SR + 4	Lose <i>Body Points</i> equal to <i>Damage Strength</i> of firing weapon. In addition, the vehicle takes a Critical Hit.

DR = Firer’s Damage Roll  
SR = Target’s *Strength* Roll

**Example:** A stormtrooper fires a blaster rifle (Damage 5) at a Rebel landspeeder (Body Strength 4) and hits it. The Imperial rolls a 4 for a total of 9; the Rebel rolls a 2 for a total 6. The landspeeder loses 5 Body Points.



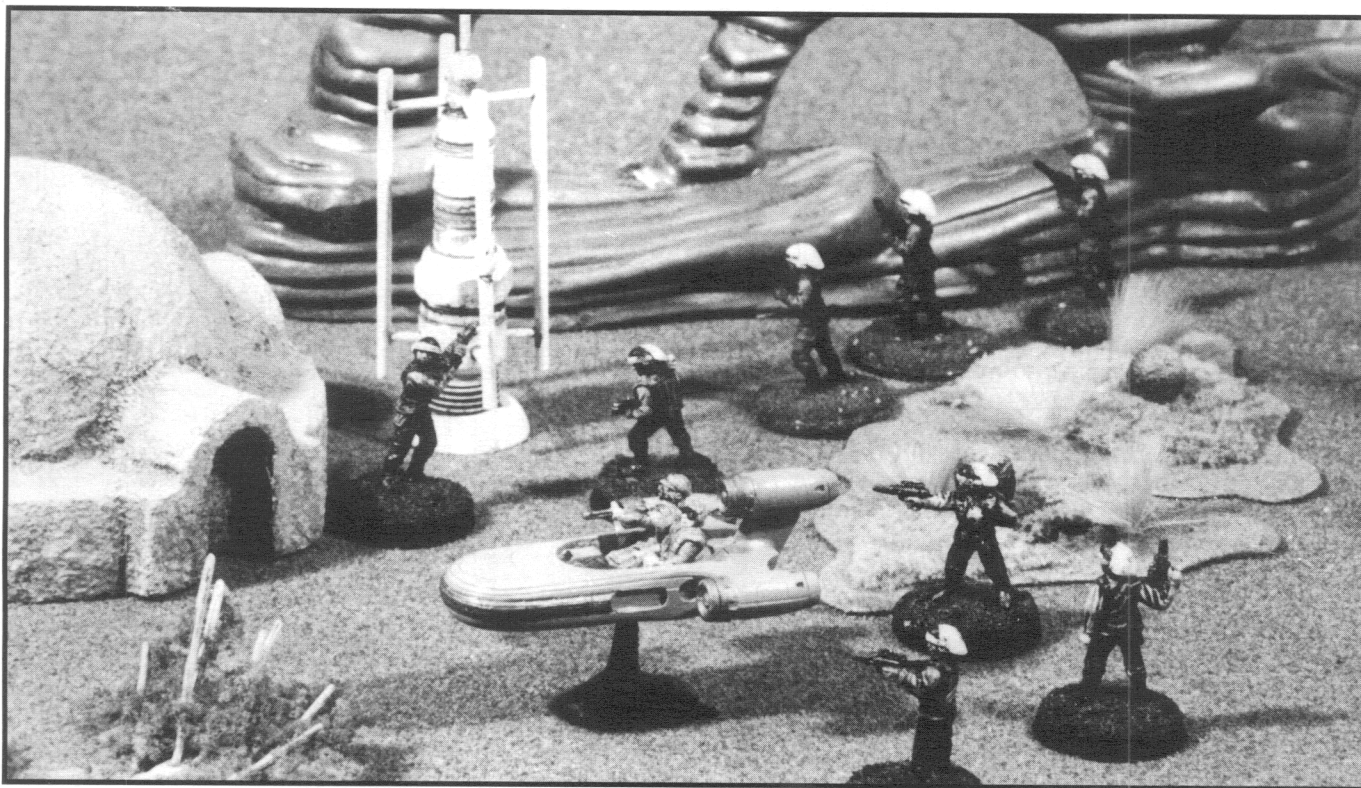

■ A landspeeder leads the Rebel assault on a remote homestead where a pocket of Imperial resistance has become entrenched.

*Body Points* are deducted from the vehicle's current total. If a vehicle's *Body Points* are reduced to zero, the vehicle can no longer function: it cannot move and its weapons cannot fire. It is effectively "Destroyed."

A vehicle which is moving when reduced to zero *Body Points* will move one half its current Movement Rate in a straight line before coming to a halt (or crashing if the vehicle is flying). The model is left on the table as an obstacle and potential shelter. A flying vehicle crashes (see "Flight").

Crew and passengers in a vehicle may be injured when the vehicle is "destroyed," that is, reduced to zero *Body Points*. If the damage to the vehicle was equal to the remaining *Body Points*, the crew and passengers are unharmed. But if the weapon damage was greater than the vehicle's remaining *Body Points*, there is a chance the crew and passengers may suffer damage.

To determine damage to the occupants of a vehicle, a *survival* roll is made for each occupant against a base difficulty number of 8 plus any modifiers. The difficulty number is increased by 1 for every two points of damage above the vehicle's *Body Points* (round any odd results down). Compare the results to the following table.

### Vehicle Occupant Damage Table

Roll	Effect
$SR + 4 \leq DN$	Incapacitated
$SR \leq DN$	Wound
$SR > DN$	No Effect

SR = Survival Roll

DN = Difficulty Number

**Example:** A badly damaged AT-ST (previously reduced to three *Body Points*) is hit by a medium repeating blaster for seven damage points. Three of the seven damage points reduce the AT-ST's *Body Points* to zero, and the occupants of the AT-ST must test for damage.

Dividing the four remaining points of damage by two yields two, which is added to the base survival roll difficulty.

Make a survival roll against a difficulty of 10 for each of the two crewmembers and consult the "Vehicle Occupant Damage Table."

Once a vehicle has been destroyed, the crew and passengers are fired at normally. The vehicle's wreckage counts as medium cover.

**Critical Hits**

Critical hits are those lucky shots that penetrate the hull and damage one of the vehicle's operating systems.

If the "Vehicle Damage Table" indicates that a critical hit occurred, roll a die (including bomb-outs and rollovers) and add the weapon's *Damage Strength*. Look up the results on the "Critical Hit Table."

**Out-Of-Control Vehicles**

Occasionally a vehicle will go out of control (because of a collision or critical damage). When it does, the driver no longer controls its speed or direction. An out-of-control vehicle's weapons may be fired, but at a +1 to the difficulty number. Passengers may not fire from an out-of-control vehicle.

To find out where an out-of-control vehicle moves, roll one die to determine the vehicle's new Movement Rate:

- 1-2 Vehicle decelerates
- 3-4 Movement Rate remains the same
- 5-6 Vehicle accelerates

If the Movement Rate changes, roll one die, and multiply it by two to find out how much it changes by. However, a vehicle cannot change

its Movement Rate by more than its Accel rating or accelerate beyond its Top Speed.

Next, roll a die to determine the vehicle's direction:

- 1 Vehicle turns 90 degrees left
- 2 Vehicle turns 45 degrees left
- 3-4 Vehicle goes straight
- 5 Vehicle turns 45 degrees right
- 6 Vehicle turns 90 degrees right

Finally, one more roll is required to determine its change in altitude:

- 1-2 Vehicle dives one level
- 3-4 Vehicle remains on same level
- 5-6 Vehicle climbs one level

A flying vehicle which dives from Low Level crashes (see "Flight"). Roll for altitude change even if the vehicle is a ground vehicle — a result of 5-6 indicates that vehicle has flipped over. If a vehicle flips, you will have to roll one more time to determine how it ends up:

- 1-2 Flips onto left side
- 3-4 Flips over onto top
- 5-6 Flips onto right side

A vehicle which flips ceases all movement and may not move again. All occupants of the vehicle must make a *survival* skill test against a difficulty

**Critical Hit Table**

Roll	Effect	Explanation
0	None	—
1-7	Targeting Computer Down	Fire Control is lost permanently on a randomly determined weapon. The weapon position is still counted when determining additional hits; if it is selected again, there is no further result.
8-10	Power Coupler Damaged	The vehicle's Movement Rates and Accel/Decel are reduced by half for the rest of the game. This result is cumulative.
11-13	Driver Stunned	The vehicle goes out of control for the next turn.
14-16	Guidance Systems Lock	The vehicle's Turn Distance is doubled.
17-19	Gunner Wounded	A randomly determined gunner is wounded. All future fire is at +1 to the difficulty number. If the gunner is wounded again, he is incapacitated (see next result).
20-21	Gunner Incapacitated	A randomly determined gunner is incapacitated. His weapon may no longer be fired unless another crewmember takes his place.
22-23	Weapon Destroyed	A randomly determined weapon may no longer be fired. This weapon position is still considered when determining additional hits.
24-25	Power Loss	The vehicle stops dead. Weapons may no longer be fired. Crew and passengers may disembark.
26-27	Driver Incapacitated	The vehicle goes out of control for all future turns, unless stopped by collision or random deceleration.
28+	Internal Explosion	The interior of the vehicle is wracked with explosions, incapacitating all crew and passengers. The vehicle may no longer move or fire.

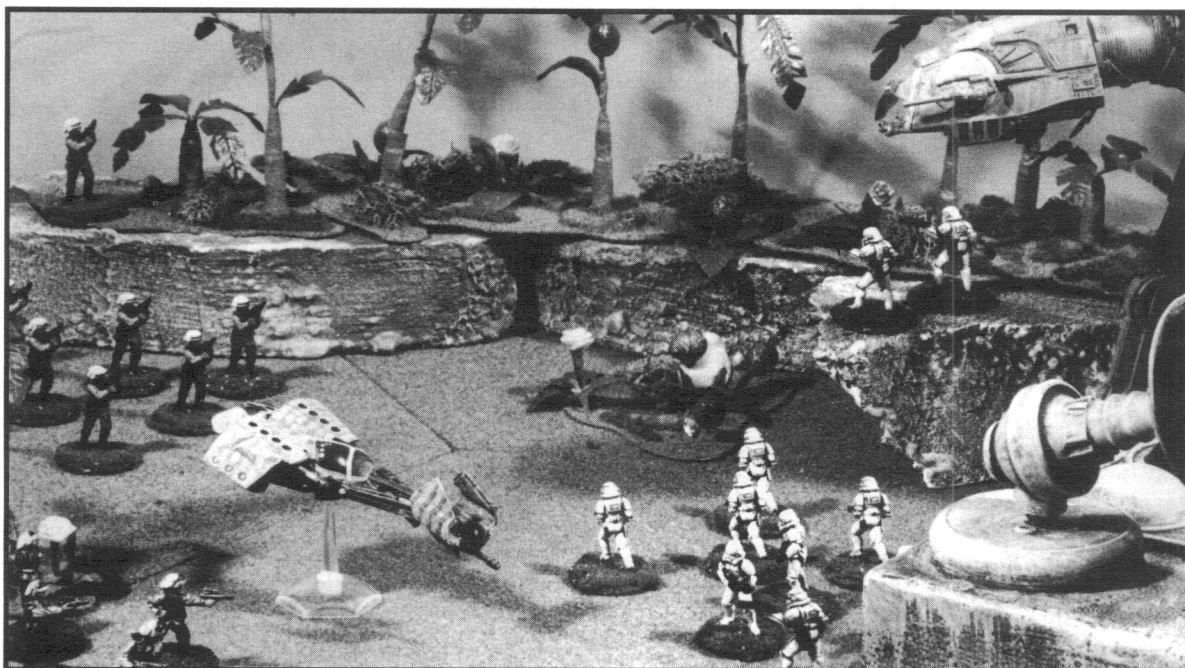

Both sides in a major Rebel assault on an Imperial garrison draw on the support of their respective assault vehicles.

of 8. Determine the results for each crewmember and passenger by consulting the “Vehicle Occupant Damage Table” above.

When a vehicle flips, roll a die for each weapon. On a 1-3, the weapon has been destroyed. If the vehicle flipped over onto its top, side-, front- or rear-mounted weapons which have not been destroyed may still be fired if their gunners have not been incapacitated.

### Regaining Control

At the beginning of the next Movement Phase, the driver can attempt to regain control of the vehicle by making a [vehicle] operation skill test:

Vehicle Speed	Control Test
Cautious	Automatic
Cruise	Difficulty 4
Top	Difficulty 6

If he succeeds, the vehicle may move normally in that Phase. Otherwise, it is moved out of control again. The vehicle will continue to be out of control in following turns until the driver regains control of it.

### Collisions

Collisions occur as a result of a driver losing control of a vehicle, or as a conscious decision of the driver. When a vehicle collides with a soldier, other vehicle, wall, or other obstacle, both the vehicle and whatever it collided with make opposed *Strength* tests as though each were attacking the other. The opposed rolls are modified by

the Movement Rates of the colliding parties.

The Movement Rate used to modify the collision depends on the type of collision. In the case of a head-on collision, the Movement Rates of both parties are added together.

If a vehicle broadsides an object (runs into the side of it) or collides with a stationary object, the vehicle’s Movement Rate is used.

If a vehicle runs into the rear of an object, subtract the object’s Movement Rate from the vehicle’s Movement Rate.

On the “Collision Modifier Chart,” find the range into which the resulting Movement Rate falls. The Damage Modifier next to that range is added to the “attacker’s” roll when making the opposed *Strength* test against the “defender.”

Results are applied normally. If a vehicle loses *Body Points* as a result of a collision, it loses *Body Points* equal to the “attacking” vehicle’s *Body Strength* plus the Damage Modifier.

If a soldier or creature is involved in a collision with a vehicle, the *Strength* of the soldier or creature is used to determine collision damage.

#### Collision Modifier Chart

Movement Rate	Damage Modifier
0–10"	-1
11–20"	0
21–30"	+1
31–40"	+2
41–50"	+3
51–60"	+4

and so on ...

**Example 1:** A Rebel landspeeder with a Movement Rate of 41" goes out of control and rear-ends a slow-moving Imperial CAV (Movement Rate of 9"). The Movement Rate of the CAV is subtracted from the Movement Rate of the landspeeder, yielding a collision Movement Rate of 32". Checking the "Collision Modifier Chart" we find that the Damage Modifier for the collision is +2.

The landspeeder resolves its "attack" first, rolling a "4" and adding its Body Strength of 4 and the Damage Modifier of +2 for a result of 10. The CAV rolls a 2 and adds its Body Strength of 7 for a result of 9. Consulting the "Vehicle Damage Table" reveals that the CAV loses 6 Body Points (the landspeeder's Body Strength of 4, plus the +2 Collision Modifier).

Next the CAV conducts its "attack," rolling a 4 and adding its Body Strength of 7, plus the Damage Modifier of +2 for a result of 13. The landspeeder rolls a 3 and adds its Body Strength of 4 for a total of 7. The landspeeder loses 9 Body Points and must roll for a Critical Damage Effect.

**Example 2:** In this example the landspeeder has collided with a stationary stormtrooper. The landspeeder's Movement Rate is now 32". Because the stormtrooper is stationary, the landspeeder's Movement Rate is used, yielding a Damage Modifier of +2.

The landspeeder rolls a 4 for a result of 10 (4 + 4 + 2). The stormtrooper rolls a 2 and adds his Strength of 3 for a result of 5 (2 + 3). The stormtrooper is incapacitated in a most painful manner.

The stormtrooper rolls a 4 for a total of 9 (4 + 3 + 2) and the landspeeder rolls a 3 for a total of 7 (3 + 4). The landspeeder loses 5 Body Points (the stormtrooper's Strength of 3, plus the +2 Damage Modifier).

## Converting Other Star Wars Vehicles

Vehicles described in any *Star Wars: The Roleplaying Game* adventure or supplement can be converted to use with *Star Wars Miniatures Battles* by using the following guidelines:

- **Crew:** No change.
- **Passengers:** No change.
- **# Turns:** Equal to the vehicle's *Maneuverability Code* for repulsorcraft. A repulsorcraft with 0 maneuverability has 1 turn. If no code is given, use the following chart:

Accel #	Turns
1-8	2
9-16	3
17+	4

The number of turns of other vehicle types is determined as follows:

- Small Walkers (AT-ST size or smaller):* 3 turns
- Large Walkers (larger than AT-ST):* 1 turn
- Tracked Vehicles:* 3 turns
- Hover Vehicles:* 3 turns
- Wheeled Vehicles:* 2 turns
- Wide-Wheeled Vehicles:* 1 turn
- Two-Wheeled Vehicles:* 2 turns

• **Turn Distance:** Determined by "# Turns" as follows:

# Turns	Turn Distance
4	1"
3	2"
2	3"
1	4"

- **Cautious Speed:** Divide the vehicle's Move by 10 and round down.
- **Cruise Speed:** Cautious Speed times 3.
- **Top Speed:** Equal to the vehicle's Move.
- **Accel:** Equal to the vehicle's Cautious Speed.
- **Decel:** Equal to Accel for repulsorcraft; Accel times 2 for other vehicles.
- **Flight Ceiling:** The upper limit of the Altitude Range.
- **Body Strength:** Vehicle's original *Body Strength* times 3 for vehicles at Walker scale; times 2 for vehicles at Speeder scale. Before multiplying, round off the original *Body Strength* (down for one pip; up for two pips).
- **Body Points:** New *Body Strength* times 10.
- **Weapons:** Weapons can be converted directly from their listing in *Star Wars: The Roleplaying Game* products, or can be matched to weapons on the "Vehicle Weapons Chart."

Weapons are converted according to the following guidelines:

*Scale:* The *Damage Strength* of the weapon is modified by its scale. A Speeder-scale weapon has a factor of 2; a Walker-scale weapon has a factor of 3. Multiply the weapon's damage by its scale factor. If no scale is given for the weapon, it is at the same scale as the vehicle mounting it.

*Fire Arc:* No change.

*Crew:* No change. If no crew are listed, the weapon can be fired by the driver.

*Skill:* The skill the gunner must have to be able to effectively fire the weapon. *Vehicle blasters* is the general skill for vehicle-mounted weapons.

*Fire Control:* The number of dice is the Fire Control code for the weapon.

*Range:* Convert the ranges to meters, then divide in half to get the ranges in inches on the tabletop.

*Damage:* Multiply the *Damage* code by the scale factor (see above) to get the *Damage Strength*.

Alternatively, you can match the weapon's Fire Control and *Damage* with weapons on the "Vehicle Weapons Chart," or select one that most closely resembles the weapon needed. This is particularly useful when you are creating your own vehicles or developing the statistics for some other vehicle model.

When comparing to the "Vehicle Weapons Chart," note that the *Damage* has already been multiplied by 2 for weapons at Speeder scale and by 3 for weapons at Walker scale.

• **Cover:** Determine the Vehicle's Cover rating by consulting the following chart:

Cover Code	Cover Rating
Full	F
3/4	6
1/2	5
1/4	4
None	3

### Points

The cost of a vehicle in Squad Generation Points is based on a number of factors. Consult the chart below and add up all the values for the cost of a particular vehicle.

Feature	Cost in SGPs
Body Strength	10 per point
Cruise Speed	1 per inch
# Turns	10 per turn
Passengers	1 per passenger
Cover	5 per rating (F = 50 SGPs)
Weapons	As listed in the "Vehicle Weapons Chart" (or see below)
Crew	Per crew figure

• The SGP cost of a weapon converted from the roleplaying game can be determined in the following manner. Divide the medium range (in meters) by 10 and add the damage code. Then

add 5 points for following-fire capability (most vehicle weapons are capable of following fire) and add 1 point for each point of Fire Control. This yields the cost of the weapon in Squad Generation Points.

### The Vehicle Record Sheet

Provided in the back of this book is a Vehicle Record Sheet. It can be used to keep track of the vehicles you use. It is filled out essentially the same way as Squad Record Sheets and Hero Record Sheets.

Fill in the "Craft," "Crew," "Passengers" and "Drive System" information in the spaces at the top left. Get the Movement Rates, Turn Distance, # Turns and Cover from the "Vehicle Chart" and write them in the circles provided.

At the middle left, write in the *Body Strength* and *Body Points* in the appropriate circles. The box around the *Body Points* circle is for you to keep track of the current *Body Points* as damage is sustained. If the vehicle has a Flight Ceiling, write it in the Flight Ceiling box; otherwise put a "0" there.

Then copy the values from the circles to the appropriate lines for calculating the Squad Generation Point value. Multiply the *Body Strength* by the listed modifier and write in the result.

Fill in the weapons which are mounted on the vehicle in the "Weapon(s) Carried" box at the bottom, and the pertinent information about the weapons from the "Vehicle Weapons Chart." Write in the weapons' cost to the right and total down the column for the Vehicle Cost.

At the bottom of the sheet is a "Critical Hits" box. This is provided for you to note any critical hits (and their effects) taken by your vehicle. It can also be used to note the terrain effects of the vehicle's drive system. Above the box and to the left of the weapons listing is a Fire Arc diagram, provided as a reminder.

Just below the Vehicle Record Sheet is a Crew Record Sheet. This is filled out just like a Squad Record Sheet, and is provided on the same page so that the vehicle and its crew don't get separated.

# Chapter Two

# Flight

Not all planetary battles are restricted to the surface of a planet. While starfighters can be used for bombing, strafing and ground support, their use is beyond the scope of these rules. The speeds at which fighters travel and the power of their weapons are well beyond the scale represented on the average gaming table.

However, many repulsorlift vehicles have a flight ceiling higher than two or three meters. Various creatures and even some alien species are also capable of flight.

The following rules are used to determine how these fliers move and participate in combat.

## Altitude

To simplify things, altitude is divided into levels. *Low Level* is the first three meters of altitude (1.5" in ground scale), measured from the tabletop. It is the height occupied by landspeeders and other repulsorlift vehicles with low flight ceilings. Repulsorlift craft at this altitude follow the rules given for repulsorcraft in the "Vehicles" section.

*Level 1* extends up to 5" above the tabletop, or 10 meters high. Each additional level is 10 meters or 5" higher, so *Level 2* is up to 10" or 20 meters, *Level 3* up to 15" or 30 meters, and so on.

Altitude Levels extend up into space, but for the purposes of this game the maximum height allowable is Level 6. Any flier climbing above that level has left the battle and cannot return.

Vehicles, aliens or creatures at a particular level are assumed to be bobbing up and down within that level, but are considered to be at the top of the level for ease of calculation.

To show the height level of a flying vehicle, alien or creature, use the height level markers provided in the back of this book. These are placed next to a flier to show what altitude it currently occupies. Repulsorcraft at Low Level are not marked. Aliens and creatures may fly at Low Level and therefore should be indicated with a marker. Beings without a marker are as-

sumed to be on the ground.

Another method is to use support stands made with stiff wire. The stands do not have to be in scale with the Altitude Levels, as long as they clearly show the height differences.

## Flight Movement

Flying creatures and vehicles move during the Movement Phase, just as any other creature or vehicle.

Like ground vehicles, flying vehicles do not have a fixed Movement Rate; their Rate can change from turn to turn. The Movement Rate for flying creatures and aliens is determined as for other soldiers, but with a few additional details (see "Flight Characteristics" below). Flying beings may move up to their flying Movement Rate in any Movement Phase.

Flying vehicles may accelerate or decelerate at the beginning of the Movement Phase, and all fliers may turn (change facing) during their movement.

Taking off and landing also occur during the Movement Phase.

Flying vehicles and creatures may not move backward.

## Flight Characteristics

Some of the values listed for a vehicle have a bearing on flight (creatures and aliens which fly are given corresponding values).

### Movement Rates

- **Maximum Flight Rate:** This is the greatest distance a flier can move in any Movement Phase. For a vehicle, this is represented by the Top Speed. For a flying alien, it is equivalent to the Run Rate when on the ground, and is calculated accordingly: the alien's *Dexterity* is added to its flight Move (aliens and creatures capable of flight have a Move value for ground movement and a Move value for flying). A creature's Maximum Flight Rate is equivalent to its Movement Rate

and is its Move plus its *Dexterity*.

- **Average Flight Rate:** Vehicles and creatures do not have an Average Flight Rate. For flying aliens, it is the equivalent to a ground soldier's Walk Rate and is determined in the same manner. The Average Flight Rate is one-half the flight Move plus the *Dexterity* of the alien.

Aliens who are flying as their move in a turn may not engage in fire combat unless they are moving at their Average Flight Rate or less. They may, however, engage in close assault combat even if they are flying at greater than their Average Flight Rate.

- **Minimum Flight Rate:** Some vehicles and most beings must move a certain minimum distance each Movement Phase in order to stay aloft. This is known as their "Minimum Flight Rate." A flier which does not meet its Minimum Flight Rate requirement will lose altitude and risk going out of control.

**Note:** As repulsorlift technology is prevalent in the *Star Wars* galaxy, none of the vehicles presented in these rules has a Minimum Flight Rate (or, more appropriately, their Minimum Flight rate is "0"). The Minimum Flight Rate applies primarily to archaic aircraft and to beings.

Unless equipped with repulsorlift engines, a vehicle's Minimum Flight Rate is its Cruise Speed. An alien's or creature's Minimum Flight Rate is determined by taking half its flight Move and **subtracting** its *Dexterity*.

If a vehicle fails to meet its requirement, it drops two Levels immediately. In the next Movement Phase, the driver must make a *[vehicle] operation* skill test or the vehicle will go out of control until the driver succeeds in a subsequent turn.

If an alien or creature does not meet its Minimum Flight Rate requirement, it immediately drops one Level. In the next Movement Phase it must make a successful *flight* or *Dexterity* test or continue to plummet (falling **two** Levels). In each successive turn, the being will fall two Levels if it does not succeed at its skill test.

Repulsorcraft and other vehicles that hover, as well as beings which can hover, have a Minimum Flight Rate of 0.

Vehicles or beings which fall to the ground determine damage as described in the section on "Crashing" (see below).

#### Other Characteristics

- **Flight Ceiling:** This is the maximum Altitude Level at which the flier may fly. The Flight Ceiling is measured from the ground to the top of the vehicle or being.

For purposes of determining Altitude levels and range, a flier at its Flight Ceiling is considered

to be in the Level which contains the Flight Ceiling. For example, a landspeeder moving along at its Flight Ceiling of 6" is considered to be at Level 2.

- **Turn Distance:** As with ground vehicles, this is the distance in inches a flier must travel in a straight line before it may change its facing.

Even though aliens and creatures move like soldiers on the ground, they are still subject to a Turn Distance. To determine the being's Turn Distance, divide the flight Move by 10 and round off. Then divide that result by the being's *Dexterity* to get the Turn Distance in inches.

- **# Turns:** The number of times a flier may safely change its facing in a turn.

For flying creatures and aliens the # Turns is equal to the being's *Dexterity*. A creature or alien may not attempt additional turns.

### Takeoff and Landing

Fliers take off and land during the Movement Phase.

#### Taking Off

To have a vehicle or being take off, the player announces the fact at the beginning of the Movement Phase. The flier must move at least its Minimum Flight Rate and make a successful skill test to take off. The test has a difficulty of 6. Drivers test the *[vehicle] operation* skill to take off in a vehicle; creatures and aliens must test against their *flight* or *Dexterity* skills.

If the test is successful, the flier is considered to be at Low Level at the end of its move. If not, a vehicle goes out of control, or a creature or alien remains on the ground and moves forward half its remaining Movement Rate. A flier leaves the ground at a point halfway through its move. A vehicle goes out of control or a being moves forward from that point if the takeoff test is unsuccessful.

Repulsorcraft and other vehicles which hover (i.e., have a Minimum Flight Rate of 0) may take off vertically; the difficulty of the test is reduced by 1 and the vehicle may change altitude by up to two Levels without any horizontal movement.

Note that a vehicle not capable of hovering will require three turns to take off from a standing start. The Minimum Flight Rate is equal to the vehicle's Cruise Speed, which is three times the vehicle's Accel rating.

#### Landing

To land, a flier must be at Low Level and must be moving at its Minimum Flight Rate.

The player announces that the flier is landing, and makes a skill test against the relevant skill (*[vehicle] operation* for vehicles, *flight* or *Dexterity* for beings). The difficulty of the test is 6.

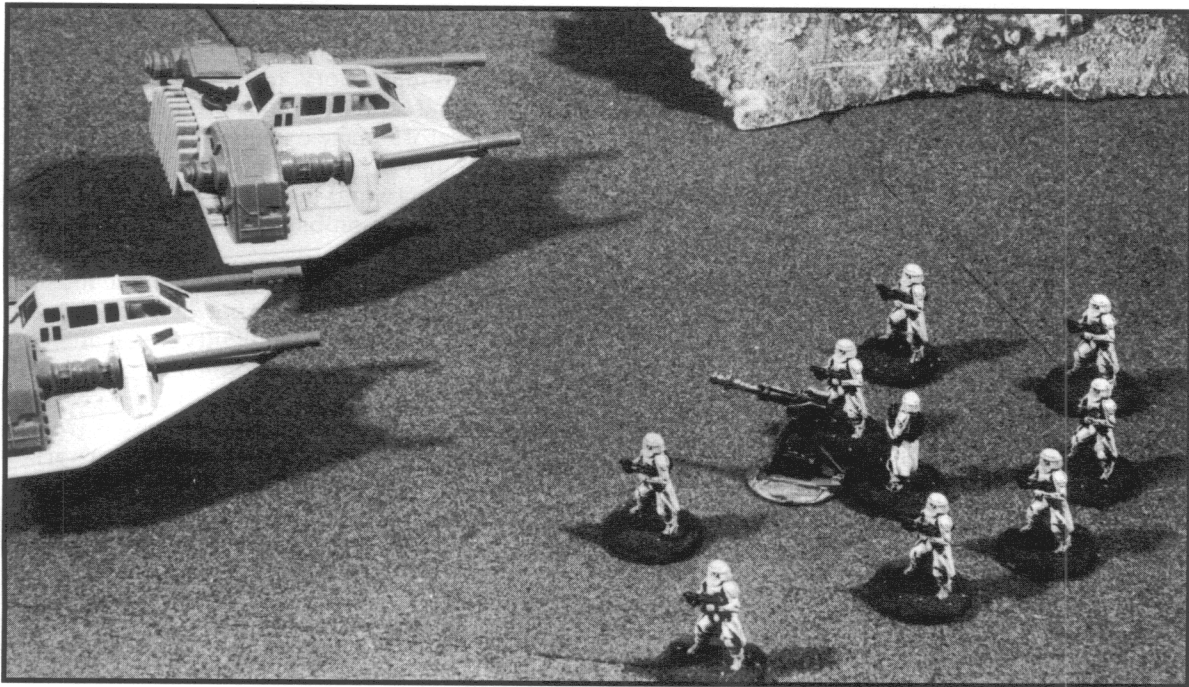

■ Elite battle-hardened Imperial snowtroopers stand firm in the face of a strafing run by Rebel snowspeeders.

Success indicates that the flier lands with no incident; at the end of the move the vehicle or creature is on the ground. The flier is actually considered to be on the ground halfway through its movement, but it must complete its movement on the ground.

Failure means that a vehicle may take damage and goes out of control. A being may be wounded. Make an opposed *Damage* test against a *Damage Strength* of 4, using the vehicle's *Body Strength* or the being's *Strength*. Read the results on the appropriate "Damage Table." A vehicle takes damage equal to the *Damage Strength* of the test. It also goes out of control regardless of the damage it took. It will go out of control from the point it first touches the ground — halfway through its move.

Repulsorcraft and other vehicles which hover may land vertically; the difficulty of the test is reduced by 1 and the vehicle may descend in order to land by up to two Levels without any horizontal movement. Vehicles which go out of control while making a vertical landing do so from the point of landing.

### Changing Altitude

During the Movement Phase, a flier may choose to remain at its current Level, dive down one or more Levels, or climb one or more Levels.

For each 6" of its current Movement Rate, a flier may dive one Level. It may also attempt an

"extreme dive," descending one Level after moving only 3", but this is more difficult and requires a skill test (see "Maneuvers" in Chapter One, "Vehicles").

For each 8" of its current Movement Rate, a vehicle may climb one Level. A vehicle may attempt an "extreme climb," rising one Level after moving only 4", but this is more difficult and requires a skill test (see "Maneuvers" in Chapter One, "Vehicles").

Repulsorcraft and other vehicles which hover (i.e., have a Minimum Flight Rate of 0) may change altitude by up to two Levels per Turn without any horizontal movement.

### Fire Combat

Fire Combat involving fliers occurs as normal, during the Fire Combat Phase.

### Range Determination

The range to or from a flying vehicle or creature is complicated by an additional factor — its altitude. Range is normally based upon the horizontal distance on the tabletop from a point below the firer to a point below the target.

However, the height of the firer or target must be factored in. If you remember your geometry, the distance between firer and target is actually the square root of the sum of the squares of the horizontal distance and the vertical distance between them.



But this is a game, not a math exercise, so an easier (and relatively accurate) way to determine the range is to take half of the lesser component (horizontal distance or vertical distance) and add it to the greater.

This generally yields a range slightly longer than the actual one. For the most part this variation will not make a difference. It only comes into play at the point where the range bands change, but that can be explained as the error factor inherent in firing at or from a flying position.

Vehicles at Low Level are considered to be on the ground for range determination; height is not factored in.

**Example:** *A Rebel soldier on the ground is firing at an Imperial repulsorlift sled which is flying at Level 3 (15"). The sled is above a point 10" away from the Rebel. The lesser component is 10, so we halve this and add it to the height of the sled to get a final range of 20" (15" + 5").*

**Example:** *The repulsorlift sled in the above example has dropped down to Low Level. The Rebel soldier is 11" away from it. The range is 11".*

**Example:** *Having survived the encounter with the Rebel soldier, the repulsorlift sled has climbed to Level 4 (20") and is firing on a speeder bike 28" away at Level 2 (10"). The horizontal distance is 28" and the vertical distance between the two Altitude Levels is 10". The firing range is 33" (28 + half of 10).*

### Modifiers

Once the range has been determined, fire combat is resolved as normal. However, there are additional modifiers which may apply to the combat.

The speed at which the target and the firer are moving affects the difficulty of the shot, as does their angle of movement toward or away from each other. The effects of movement on fire combat are detailed in the "Speed Effects" section of Chapter One, "Vehicles." These effects apply to aerial fire combat. Consult the "Speed Effects" chart in that section or in the "Charts and Tables" section for the appropriate modifiers.

In addition, soldiers firing from a moving surface (which includes firing while they are flying) are subject to a +1 modifier to the difficulty number. They also cannot fire at targets which are at long range.

### Bombing

During the Fire Combat Phase, a flying creature or alien, or a soldier in an appropriately open-topped vehicle (such as a cargo skiff), may elect to drop objects onto a target on the ground.

Bombing is done instead of firing a weapon. The availability of things to drop — rocks, bricks, debris, and machinery, for example — is left to the gamemaster's decision. Grenades and thermal detonators make excellent bombs.

Bombs may be dropped from any Level above Low Level up to and including Level 3. At levels higher than that bombs cannot be dropped effectively.

In order to bomb a target the vehicle must be above the target. The bomber declares his target. Bombing requires a difficulty test against the bomber's *Dexterity* or the *thrown weapons* skill.

**Note:** Firing weapons from a flying vehicle requires the relevant weapon skill and is treated as normal fire combat, with all the appropriate modifiers for movement and range.

#### Bombing Difficulty Chart

Altitude Level	Difficulty Number
Level 1	4
Level 2	6
Level 3	8

Success indicates that the object has hit the target. A dropped object has a base *Damage Strength* of 4. The *Damage Strength* is modified by +1 if the object was dropped from Level 1; by +2 if dropped from Level 2; and by +3 if dropped from Level 3.

Failure means that the object has gone astray and missed the target. Center a Grenade Burst Area of Effect Template over the target point and roll a die to determine the direction in which the object actually fell.

Roll another die and multiply the result by half the Altitude Level the object was dropped from to determine the distance from the target point that the object landed.

If the dropped object lands anywhere on the base of a figure, that figure has been hit and must test for damage.

Grenades or thermal detonators that are dropped explode on impact. Place the center of the Grenade Burst Area of Effect Template over the final target point to determine which figures are affected.

Note that an explosion extends upward as far as its radius of effect; a flier at too low an altitude may be caught in the burst and suffer damage. An easy way to determine this is to fold another Grenade Burst Area of Effect Template along its center so that half the template extends up from the table, then place it over the final position of the template on the tabletop.

### Aerial Close Assault Combat

Flying creatures and/or aliens can engage each other in combat during the Close Assault Combat

**Game Note:  
Aerial Combat**

Aerial combat is much more free-form than surface-bound combat. In spite of that, flying squads must still gather up their courage to dive into close assault combat. And if they fail to engage the enemy once they commit themselves, they will end up confused and unsure, just as if they were charging on the ground.

However, ground troops disengaging from combat must turn their backs on an enemy and really only have one way to go, whereas fliers have three dimensions to disperse into.

Two static lines of miniatures actually represent a weaving, bobbing melee without any definite lines, the dynamics of which can only be abstractly handled in a simple set of rules such as these.

Phase. If they are flying at Low Level, fliers can also attack troops on the ground. Note that unless the fliers have a hovering capability, most such combats will only last one turn due to the Minimum Flight Rate restriction.

**Combat in the Air**

Flying aliens or creatures which end the Movement Phase in base-to-base contact, and are flying on the same Altitude Level, may perform close

assault combat in the Close Assault Combat Phase.

Flying squads must also charge to enter combat, and they must make a morale test. And in other respects, aerial close assault combat is resolved just as for close assault combat on the ground.

If a flying squad moves into contact with another squad for close assault combat, the attacked squad may attempt to use defensive fire (if they have appropriate weapons, and are attacked from the front). Defensive fire is fired when the attackers move into base-to-base contact, and is resolved as explained in "Defensive Fire" on page 27 in the "Close Assault Combat" section of *Star Wars Miniatures Battles*.

Flying squads engaged in close assault combat may disengage without penalty. Most squads will have to do so in the following Movement Phase in order to maintain their Minimum Flight Rate. Their opponents do not get a parting shot at them.

**Attacking Opponents  
on the Ground**

A creature or alien flying at Low Level can attack a creature or soldier that it flies by. This combat takes place in the Movement Phase, as soon as contact is made.

If the flier has multiple attacks it may attack as many opponents as it has Attack Forms. If the creature or alien has enough movement left and can turn tightly enough, it can even attack the original target again with another Attack Form. After the combat is resolved, the flier completes

**Attacking Opponents on the Ground**

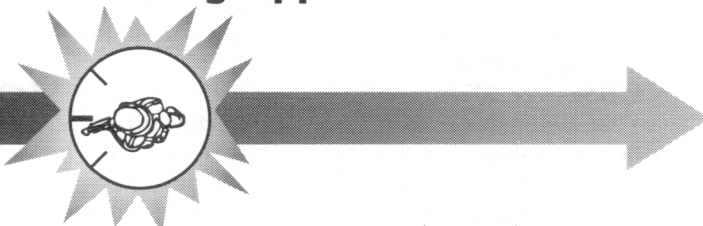

A flying figure may attack a figure on the ground as it flies by.

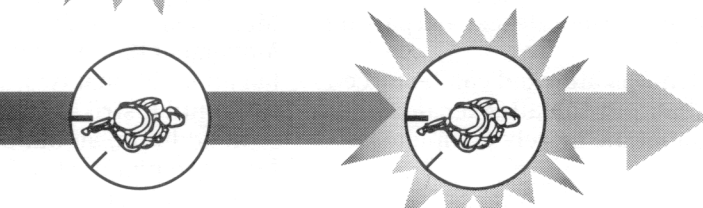

The flying figure may attack only one of the figures on the ground.

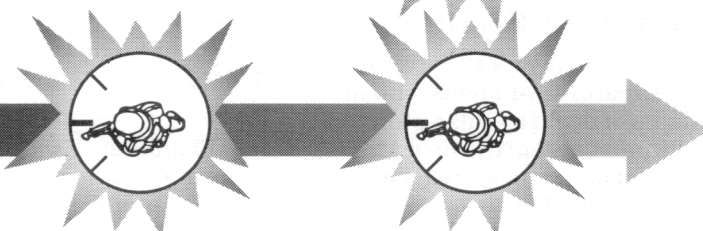

A flying figure with "claw" and "bite" Attack Forms may attack two figures in one fly-by, using one Attack Form per figure attacked.

Stephen Crane

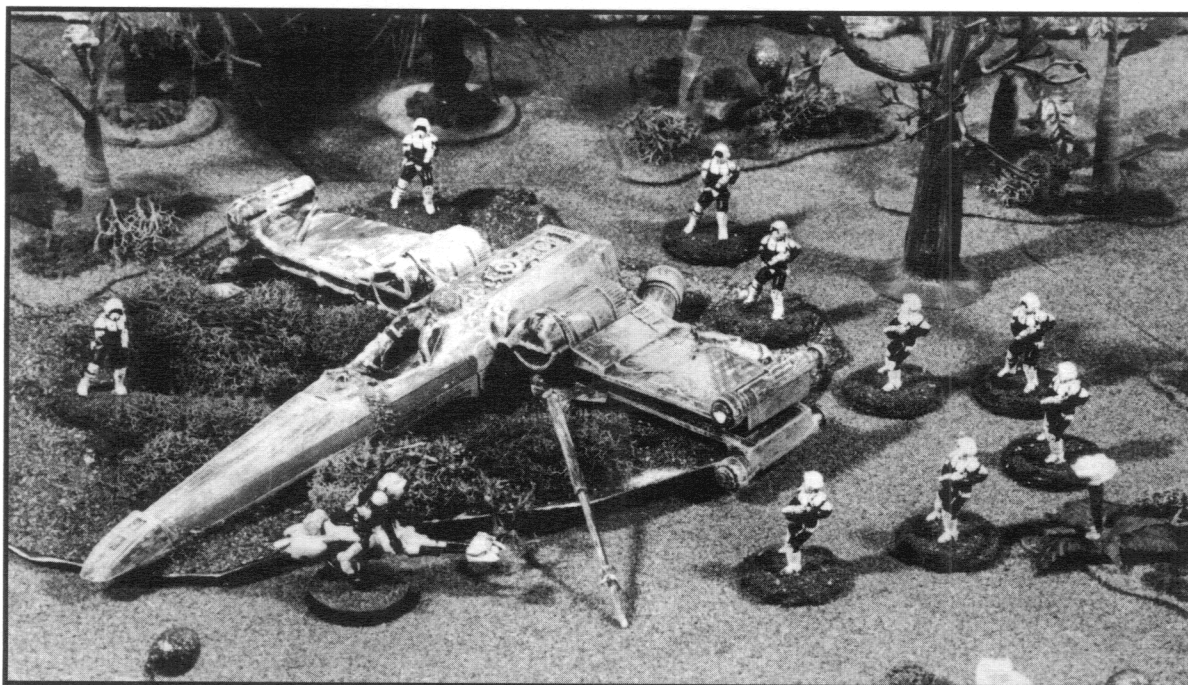

■ An Imperial scouting force — augmented by a speeder bike for faster response — comes upon a prize find. While starfighters and other ships (like this plastic model kit of an X-wing) are beyond the scope of the game, they make excellent objectives for scenarios.

its movement, including any further attacks it might make.

The flier must charge, performing the relevant morale tests, then end up in “base-to-base” contact with the opponent in order to engage in close assault combat. In this situation, base-to-base contact is determined by what the flying figure’s position would be if it were brought down to the tabletop. This is easy to see if you are using Level Markers to represent altitude, as the figure is always on the table.

The first attack is handled like a charge; additional opponents are attacked without the morale tests for a charge. However, **all** opponents get the opportunity to use defensive fire.

After the defensive fire is resolved, resolve the close assault combat. When combat is completed, the fliers finish their move. This is an automatic disengagement without a morale test or a parting shot.

The squad which was attacked can be forced back by the combat, but the attacker does not advance after combat; he merely completes his move.

### Damage While Flying

Damage is resolved normally for the appropriate type of combat. Creatures or aliens who are stunned or wounded will begin to fall. A stunned being drops one Altitude Level in the next Movement Phase. A wounded figure drops two Levels.

If the being has not crashed into the ground in

that Phase it recovers at the beginning of the Morale Phase, as usual. In the next Movement Phase the being may fly in any direction, but must move at least its Minimum Flight Rate. It cannot climb or dive this turn, either.

An incapacitated being keeps falling until it hits the ground. In practice, an incapacitated figure is removed from play.

Damage against vehicles is resolved normally. A damaged vehicle will not be forced to change altitude unless it goes out of control (see “Out-Of-Control Vehicles” in the “Vehicles” section).

### Crashing

Certain situations will see an object crash into the ground. If its *Body Points* are reduced to zero, a vehicle at Low Level will crash in the following Movement Phase after moving half its current Movement Rate. Otherwise it will move half its Movement Rate and fall two Levels, continuing to fall an additional two Levels in each successive turn until it strikes the ground.

In addition, an out-of-control vehicle may be forced to plummet to its doom.

A vehicle crashing into the ground makes an opposed *Damage* test against a base *Damage Strength* of 4. The *Damage Strength* is modified by +1 for each Level above Low Level the vehicle has fallen.

**Example:** A snowspeeder crashing from Level 3 tests for damage against a *Damage Strength* of 7.

## Fliers and Buildings

Buildings not only present an obstacle on the ground, but may also obstruct beings or vehicles in the air. In addition, soldiers may attempt to fire at fliers from a building in order to reduce the range.

For ease of comparison, each Altitude Level above Level 1 is assumed to encompass three floors of a building. Low Level corresponds to the first, or ground, floor. Level 1 covers the second and third floors. A soldier is considered to be at the Level which includes the floor he is on.

**Example:** *A soldier on the fifth floor of a building is firing at a Rishii warrior 16" away who is flying at Level 4. The soldier is considered to be at Level 2, so the firing range is 21" (16" horizontal distance + half the 10" vertical distance).*

**Example:** *A stormtrooper on the roof of a two-story building (the equivalent of the third floor) attempts to fire on a Rebel landspeeder 10" away at Level 1. Since the stormtrooper is at Level 1, the actual distance is the firing distance (10").*

The locations of the different stories of a building are summarized in the following chart:

Building Story	Altitude Level
1	Low
2	1
3	1
4	2
5	2
6	2
7	3
8	3
9	3
10	4

and so on ...

### Landing On A Building

The height of a building or particular floor also comes into play when a flier is attempting to land. There may be times when a creature or alien wants to land on the side of a building, or a vehicle may attempt to land on the roof of a building.

The standard procedure for landing is used

(as described in "Take-Off and Landing" above), except that the flier must be at the same Level as the part of the building it is attempting to land on. The flier must make contact with the building at a point halfway through its move. A vehicle must then complete its move. However, a being may stop short of its full move if it is landing on the top of a building, as long as it has completed at least half of its move.

As with fire combat and charges, a player may not premeasure the distance when attempting to land a flier. If the flier makes contact with the side of a building before having moved half its required Movement Rate, it collides with the building. Determine the damage as for a regular collision. In successive turns, the flier will fall two Levels unless a successful *flight* or *[vehicle] operation* test (as appropriate) is made.

### Taking Off From A Building

A flier may also attempt to take off from a building. When taking off from a roof, the flier must be able to move at least half its Movement Rate on the roof before taking off. If not, it will drop one Level, and must make a successful *flight* or *[vehicle] operation* skill test (as appropriate) next turn or continue to fall.

A creature or alien may attempt to take off from the side of a building without first moving half its move, but the difficulty of the takeoff test is increased by 1.

If a flier takes off successfully, it is considered to be at the same Level as the point from which it took off.

### Colliding With Buildings

During the course of movement, a vehicle or being may collide with a structure, either intentionally or as a result of going out of control. In any case, collisions are resolved as described in the "Collisions" section of Chapter One, "Vehicles," and the fliers may possibly fall, as described in "Landing On A Building," above.

Collisions with a building may also damage the walls of the structure. Resolve the collision using the *Strength* rating of the wall. See the "Obstructions Strength and Security Ratings Chart" on page 79 or page 108 of *Star Wars Miniatures Battles* for the appropriate *Strength* ratings.

# Chapter Three

# Rules Additions

*Star Wars Miniatures Battles* presents a comprehensive, yet relatively simple set of rules for running tabletop battles while maintaining the feel of the *Star Wars* universe. However, many people prefer to move on beyond the basics and add extra layers of detail. While this sometimes acts to slow the game down a bit, it is compensated for by the fact that it adds richness and greater tactical flexibility to the game.

Presented below are new rules that add additional detail to *Star Wars Miniatures Battles*. Some of these rules are additions to the basic system of the game. The balance of the rules presented here can be considered optional.

## New Rules

These are new standard rules which are considered part of the core rules of the game, and supersede previous systems presented in *Star Wars Miniatures Battles*.

### Vectored-Effect Weapons

Most weapons fire projectiles of one sort or another; archaic weapons fire arrows or bullets, and blasters fire discrete packets of energy. But some weapons fire a continuous stream of material or energy, which has an effect along the entire length of the shot. These weapons are classified as *vectored-effect weapons*. In most cases, a vectored-effect weapon has a specified area of effect, which is represented by an area of effect template.

Examples of vectored-effect weapons are flamethrowers and proton torpedo launchers (see “Flamethrowers” and “Proton Torpedo Launchers” in the “Rules Upgrade” section of this book).

Other weapons which do not have an effect along the entire length of the shot can be classed as vectored-effect weapons. These weapons will not have an area of effect template, but follow the rules for deviation of vectored-effect weapons. This represents weapons which may not have an effect along the shot, but will affect targets at the

end of the shot if the firer failed to hit the original target. Some examples are Stokhli spray sticks and ion guns (see Chapter Four for more details).

The procedure for firing a vectored-effect weapon is essentially the same as for other weapons, with the exception that the firer declares the direction (and sometimes a target point) that she is firing. In effect, a vectored-effect weapon can target a specific individual. This varies from regular weapons, for which a target squad is declared, and hits, if any, are distributed randomly through the squad.

To fire a vectored-effect weapon, declare the direction or target point (depending upon the weapon used) and make the skill test. If the test is successful, the shot hits; resolve damage normally. If the test is unsuccessful, the firer was off target; the shot has instead deviated and may injure soldiers other than the intended target. To determine where the shot actually went, use the “Vectored-Effect Weapon Deviation Template” (provided in the back of this book) according to the rules below.

### Vectored-Effect Weapon Deviation Template

When the soldier firing a vectored-effect weapon fails his skill roll, he has instead fired off the mark; the weapon has deviated. To determine where the shot actually went, place the narrow end of the “Vectored-Effect Weapon Deviation Template” against the base of the figure and orient the template with the direction of the shot.

Next, roll one die. Then re-orient the weapon’s area of effect template along the direction indicated by the die roll. That is the final direction of the shot. Now determine the damage done to any figures caught within the weapon’s area of effect.

### Throwing Grenades Blind

There are times when a soldier with a grenade may not be able to see a target, even though he knows it is there. The target may be in a building, or behind a wall or tree. In such cases, he may

wish to lob the grenade near the target, hoping to hit it or flush it out.

If a soldier does not have a line of sight to his target, he can, of course, try to throw the grenade to a point he can see that is near the target, hoping to catch it in the blast radius of the grenade. However, a soldier may also throw a grenade at a point he cannot see, such as behind a wall. This is called "throwing blind."

A soldier throwing a grenade blind nominates a target point that he could reasonably aim for, and that is within the range he can throw.

A grenade thrown blind can only be thrown to a maximum of medium range (10" for grenades, 4" for thermal detonators). A Grenade Area of Effect Burst Template is placed over the target point and a deviation roll is made as if for medium range (regardless of the distance the grenade was thrown). This determines the final target point of the grenade (this is the best the soldier could do, since he cannot see the target). Then make the *grenade* skill test.

If the soldier succeeds at the test, the grenade has hit on the final target point. If the soldier fails the test, place the Grenade Burst Template over the final target point and roll for deviation again (this is a standard deviation roll, and varies depending on the distance the grenade was thrown).

When determining where a grenade deviates to, keep in mind that it can only end up somewhere it could reasonably go. If a barrier or obstruction sits astride the direction of deviation, the grenade will stop at the obstruction.

### Grenades and Woods

It is difficult to throw things accurately any great distance in a woods, as there is a limited field of view and a great deal of obstructions. A soldier attempting to throw a grenade in a woods has the ranges halved. For example, a grenade thrown 7" is tested for at long range (medium range is up to 10", which is halved in the woods to 5").

In addition, the difficulty of the attempt is increased by 1 in heavy woods.

When a soldier throws a grenade into the woods from outside the woods, ranges are normal, but the difficulty of the test is increased by 1, regardless of the density of the woods. Additionally, the grenade can be thrown no further than 4" into the woods. Deviation **can** cause the grenade to travel further into the woods, though.

**Example:** *An Imperial grenadier lobs a Fex-M3 grenade at a Rebel squad in medium woods. The Imperial is 5" from the edge of the woods. The furthest he can throw the grenade is 9" (5" to the edge of the woods plus a maximum of 4" into the woods), and the difficulty of his grenade skill test is modified by +1.*

## Throwing Grenades Blindly

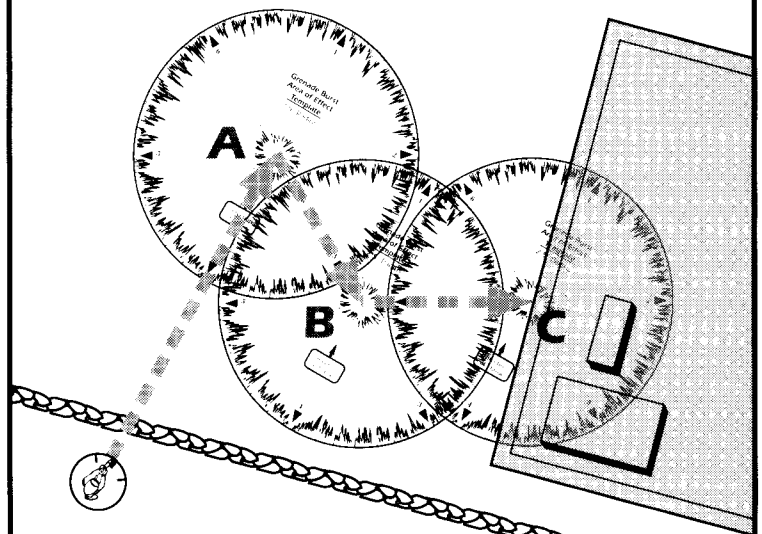

The Rebel wants to throw a grenade over a high wall to point A. The range is 6", before making the *grenade* test, he makes a deviation roll, getting a "3" for direction and a "3" for distance. The template is moved 3" to point B. The Rebel then fails the skill test, so another deviation roll is made, resulting in a "2" for direction and "5" for distance. But the wall of a building is only 3" away from point B in that direction, so the template is moved just the 3", placing the center of the template next to the wall. The grenade lands at point C and explodes.

Stephen Crane

## Optional Rules

The rules presented here can be considered optional. If you are not comfortable with the added complexity or just wish to simply "have at 'em," feel free to ignore these rules.

Each of these rules systems are independent of the others, so you may pick and choose which ones you wish to use. If, for instance, you would like to be able to take prisoners, but feel that keeping track of stun results is too unwieldy, just use the prisoner rules and ignore the stun rules.

The only other criterion for using the optional rules is to discuss them with your fellow players and the gamemaster to be sure that everyone agrees to their use in a game.

### Encumbrance

In order to move and fight effectively, a soldier cannot carry too much gear. Doing so slows her (or him) down and consequently reduces her fighting efficiency. Therefore, there are certain limits as to the amount of equipment a soldier may carry.

A soldier's *Strength* determines his Encumbrance Rating, which in turn determines the normal amount of gear the soldier may carry. Each item of equipment has an Encumbrance

### Game Note: Encumbrance

The aim of *Star Wars Miniatures Battles* is to provide a simple way to run mass combat. A detailed system listing the weights of objects and calculating just how much a given *Strength* could support for how long seems contrary to that idea.

This system for encumbrance is presented for those players who wish to delve into the realm of record-keeping. Be warned: use of this system will slow down your game. It is strongly recommended that this be used only as an optional rule.

For those players who feel that there should be some limit to what can be carried, this more abstract but much simpler system is provided:

A soldier may only carry up to five light items (such as grenades, glowrods, comlinks and the like encumbrance value 1 or 2), three average items (blasters or other weapons encumbrance value 2 to 5) and one bulkier item (such as a component of an *assembled* weapon encumbrance value 6 to 19). A soldier carrying a larger item (something half human-sized encumbrance value 20 or higher) may only move his Walk Rate and a soldier carrying a droid or something man-sized may only move half his Walk Rate.

A soldier carrying an item half man-sized or larger cannot fire a weapon or engage in close assault combat without first dropping the carried item.

Value. The Encumbrance Values are totaled and compared to the soldier's Encumbrance Rating to see what effect, if any, the soldier sustains. The soldier's Movement Rates may be reduced if he is carrying too much equipment.

To determine a soldier's Encumbrance Rating, multiply his *Strength* by 10.

Each item of equipment has an Encumbrance Value (see below). Add together the Encumbrance Values of each item carried and compare the result to the soldier's Encumbrance Rating.

A soldier may carry equipment with Encumbrance Values totaling up to her Encumbrance Rating with no effect.

If the total Encumbrance Value of all items carried is greater than the soldier's Encumbrance Rating, the soldier is affected. For each point of Encumbrance Value greater than the Encumbrance Rating, the soldier's Movement Rates are reduced by 1".

If the total Encumbrance Value is greater than the Encumbrance Rating by more than the soldier's *Strength*, then the soldier may only move at his Walk Rate (which is still modified by all previous reductions to the Walk Rate). Reductions continue to be added if new items are added to the soldier's load.

Armor and other full-body suits (such as environment suits and space suits) may be worn with-

out affecting the amount of equipment which may be carried (i.e., they have an Encumbrance Value of "0"). Some particularly bulky suits may limit the amount of equipment carried; their Encumbrance Value will be noted in their descriptions. Future listings of equipment for *Star Wars Miniatures Battles* will include the Encumbrance Value.

General equipment and weapons that were described in *Star Wars Miniatures Battles* are listed below along with their Encumbrance Values.

#### Equipment Encumbrance Value

Armor	0
Breath Mask	1
Camouflage Suit	2
Combat Sensor	2
Comlink	1
Environment Suit	0
Glowrod	1
Space Suit	0
Medpac	2
Macrobinoculars	2
Targeting Computer	4

#### Weapon Encumbrance Value

Hold-out blaster	3
Sporting blaster	4
Blaster pistol	4
Heavy blaster pistol	5
Hunting blaster	5
Blaster rifle	5
Blaster carbine	4
Repeating blaster	6

#### Heavy Blasters

Repeating blaster	6 per crewmember
Med. repeating blaster	8 per crewmember
Heavy repeating blaster	8 per crewmember

#### Archaic Weapons

Crossbow	5
Longbow	3
Black powder pistol	4
Musket	4
Rifle	5
Submachinegun	5
Bowcaster	6

#### Grenades

Grenade	1
Thermal detonator	2

#### Melee Weapons

Club	2
Gaderffii	2
Spear	2
Vibro-axe	3
Vibroblade	2
Lightsaber	1

You will have to make up a number of markers or counters when keeping track of encumbrance, so that each soldier's modified Movement Rates

are apparent. We would suggest markers labeled *Move -1*, *Move -2*, *Move -3* and so on, in addition to *Walk -3*, *Walk -4* and so on. The *Move -#* markers are used until the *Strength* limit is reached, then switch to the *Walk -#* markers. You will also need to keep track of the current Encumbrance Value of the squad's (or each soldier's) equipment.

Soldiers may also carry larger items, such as droids or other soldiers, depending on the scenario. For purposes of determining encumbrance, a soldier or droid has an Encumbrance Rating of 25.

A soldier carrying an item with an Encumbrance Value of 20 or greater cannot fire a weapon or engage in close assault combat without first dropping the item.

In order to pick up a disabled soldier or droid, a soldier must be in base-to-base contact with it, and then expends half her Movement Rate to pick it up. If she had expended more than half her Movement Rate to get into base-to-base contact, she must wait until the next turn to pick it up.

If a soldier is wounded while carrying a disabled soldier, she must drop him. Use the Grenade Burst Area of Effect Template to determine where the dropped soldier lands: declare a "throw" direction to orient the template, then roll for deviation. Place the dropped soldier alongside the fallen soldier in the direction indicated.

### Stuns

There are times when a soldier does not want to incapacitate a foe, but merely render him less effective or unconscious. He may choose to *stun* his foe.

Most blaster weapons can be set to stun an opponent instead of damaging him. To attempt to stun a target, the firing player must declare that he wants to stun the target before rolling any dice. Then resolve the fire attempt as normal, applying any relevant modifiers, but read the results on the "Stun Table" instead of the "Damage Table."

#### Stun Table

Roll	Result
DS < SR	No effect
DS ≥ SR	Stunned
DS ≥ SR + 4	Stunned; unconscious
DS ≥ SR + 6	Stunned; unconscious for 1D turns

DS = Weapon's *Damage Strength*

Roll SR = Target's *Strength Roll*

#### Effects of Stuns

Stun results range from no effect, through stunned, to stunned and unconscious. Stuns are marked as soon as they occur. However, since all fire takes place simultaneously, they do not take

effect until the end of the Fire Combat Phase.

**No Effect:** The stun blast has had no effect on the target.

**Stunned:** A stunned soldier is treated like a wounded soldier, except that the stun lasts only three turns. The stunned soldier is laid on his side and marked with a *Stun 3* marker. In subsequent Movement Phases he can stand up at a cost of 2". A stunned soldier suffers a -1 penalty to all skills and attributes while stunned, and cannot run.

In each successive turn the *Stun* marker is reduced by one in the Special Actions Phase. For example, a *Stun 3* marker is replaced with a *Stun 2* marker, a *Stun 2* marker is replaced with a *Stun 1* marker, and so on. Note that the *Stun* marker is **not** reduced in the Special Actions Phase of the turn that the soldier was stunned.

**Stunned; Unconscious:** The target is stunned for 5 turns and has been rendered unconscious. The stunned soldier is laid on his side and marked with a *Stun 5* marker. He is unconscious for the next turn and may perform no actions. At the beginning of the Movement Phase of the following turn (the turn in which he is currently marked with a *Stun 4* marker), the soldier has regained consciousness and may take actions, including standing up.

**Stunned; Unconscious for 1D turns:** The target is rendered unconscious for a number of turns equal to the roll of a die. In addition, the target will be stunned for 3 turns after regaining consciousness.



■ After the fall of the Empire, stormtroopers loyal to the self-styled Warlord Grazz — denoted by the circular insignia on their helmets — defend one of the ex-Moff's bunker complexes.



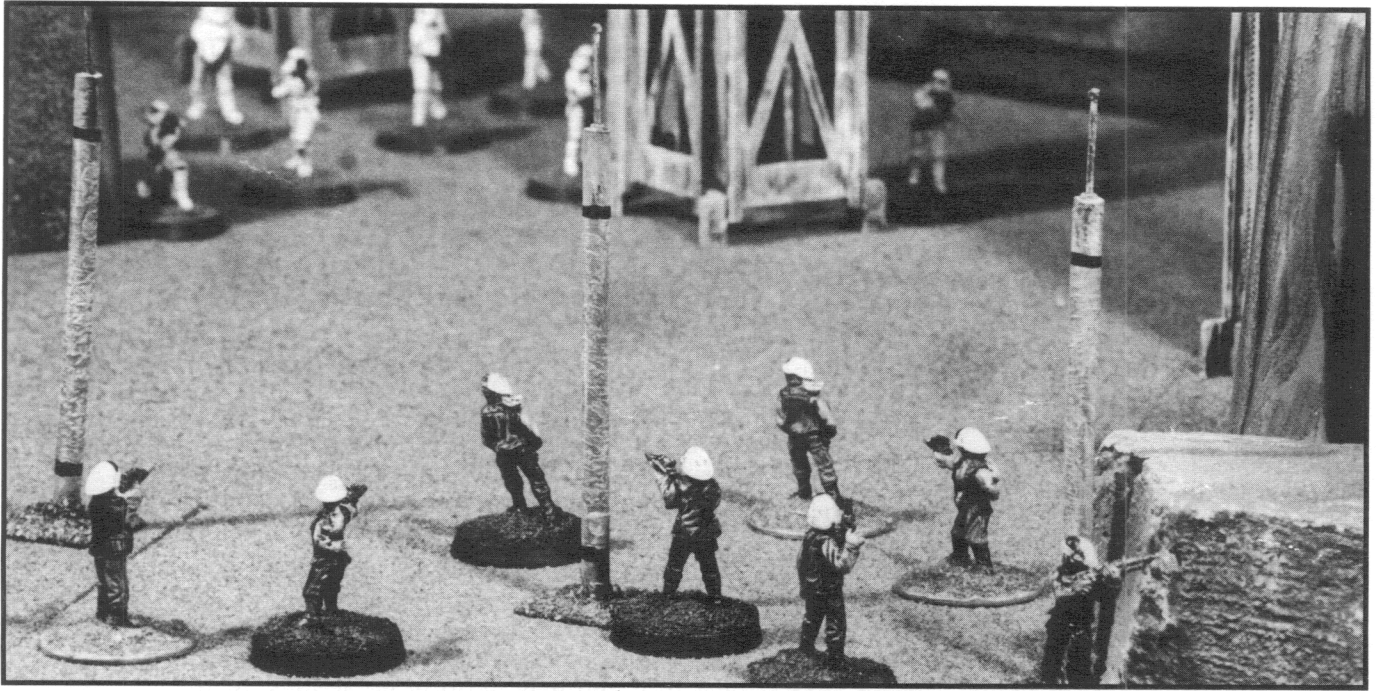

■ A Rebel assault team exploits a breach in the power fence to drive deep into the Imperial base on Altratonne during the “King of the Mountain” scenario.

### Multiple Stuns

Multiple stun results are partially cumulative. For each additional result of “Stunned,” the target is stunned for another turn. So, if a soldier receives three stun results, his skills and attributes suffer a -1 penalty for *five* turns. Use additional *Stun* markers to represent the total number of turns the soldier will be stunned.

In addition, if a target receives more than one “Stunned” result, he may fall unconscious. For each “Stunned” result after the first in a turn, the soldier must roll a die. If he rolls his *Strength* or lower, he is merely stunned (bomb-outs do not apply to this roll). If he rolls higher he also falls unconscious, as outlined in the “Stunned; Unconscious” result above. Each successive “Unconscious” result means that the target remains unconscious for an additional turn.

The same holds true for a soldier who is already unconscious. Make the *Strength* roll to determine if he remains unconscious for any additional turns.

**Example:** *A Rebel commando is hit by a stun blast from a blaster pistol. Her Strength is 3; the Damage Strength of the blaster is 4. The Rebel rolls a “2” and the Imperial who fired at her rolls a “5.” Comparing the totals on the “Stun Table” shows that the Rebel receives a “Stunned; Unconscious” result. She will be unconscious during the following turn, and stunned for five turns.*

*Later in that Fire Combat Phase, the commando is hit twice more by stun blasts, both yielding a “Stunned” result. So she will be stunned for two more turns, a total of seven turns. She must also roll twice against her Strength to see if she will remain unconscious longer. The first roll yields a “2” for no additional effect, but the second roll is a “4.” The commando will be unconscious for two turns. A Stun 2 and a Stun 5 marker are placed next to the figure to keep track of how long she will be stunned.*

### Removing Stuns

Another soldier with a medpac may attempt to resuscitate a stunned soldier, that is, remove the effects of the stun from him. The soldier with the medpac must be in base-to-base contact with the stunned soldier.

During the Special Actions Phase the “healer” makes a difficulty 6 *first aid* test. If he succeeds, the soldier is no longer stunned; all *Stun* markers are removed from the “patient.” If the patient was unconscious, he is now conscious and may act in the following turn. If the healer fails, he may make another attempt in a later turn, provided he has another medpac.

The second attempt is against a difficulty of 7. If that second attempt fails, no further attempts may be made to remove the stun; the effects on the soldier’s system are too widespread for the medpac to treat effectively. However, after the

stun has worn off any new stuns inflicted on the soldier may be treated (limited again to two attempts).

A soldier may attempt to heal himself (provided he is conscious), but the difficulty of the test is increased by 1.

### Prisoners

There are times when an objective is better achieved not by eliminating opposing forces, but by capturing them.

Valuable information concerning troop movements or planned offensives may be obtained from an Imperial officer if Rebel guerillas can "extract" him for intensive questioning. Likewise, Imperial troops might wish to acquire a Rebel operative in order to learn more about the intelligence cells in place on a particular planet.

In order to take a soldier prisoner, the attacker must declare a capture attempt when engaged in close assault combat. A soldier might also be taken prisoner if he is wounded or stunned, or he may be forced to surrender.

### Capture Attempts

Attacking soldiers engaged in close assault combat may attempt to capture the defenders. After opposing figures are paired off, but before any dice are rolled, the attacking player must declare which figures she is attempting to take prisoners.

Close assault combat is then resolved normally, but a modifier of -2 is applied to the die rolls of any figures attempting to capture their opponents. If the attacker achieves a "Wound" or "Incapacitated" result, she has succeeded in capturing the opponent. The opponent does not actually suffer the result. Place a "Captured" marker on the prisoner's base. The prisoner's morale level is reduced by 1, and should be noted on scratch paper for future reference (see "Escape," below). The capturing player must assign a guard to the prisoners (see "Placing Guards," below).

### Capturing Stunned or Wounded Soldiers

A soldier coming within 1" of a stunned or wounded enemy soldier who is still prone and not within command distance of another enemy soldier automatically captures the enemy.

### Surrender

A squad or soldier will surrender if all three of the following conditions exist:

- The squad is forced to rout because its morale has broken.
- It is outnumbered by more than two to one.
- It is unable to move away from any enemy

soldiers (e.g., the squad or soldier is surrounded, or movement is blocked by barriers or terrain).

Soldiers who surrender are taken prisoner. Place a "Captured" marker on their bases, and note their morale level. The capturing player must assign a guard to the prisoners.

### Placing Guards

When a soldier is taken prisoner, the capturing player must place a guard on the prisoner. This is usually the figure which captured the prisoner, but other guards may take over the duty.

Any figure which is not wounded may serve as a guard. A soldier may guard up to five prisoners. All prisoners must be situated within 3" of their guard, but may not be located to the guard's rear. Prisoners are moved by the capturing player; they move with their guard, remaining within the 3" distance.

A different soldier may be assigned to guard a prisoner or group of prisoners. If any friendly soldier comes within 3" of the prisoner(s), the player may declare him to be the guard, and the original guard is free to move on. Prisoners may be guarded by more than one figure.

A guard may not engage in fire combat or close assault combat. If he does, the prisoners may attempt to escape (see "Escape," below).

Enemy troops may fire at a guard, but the guard may not be targeted individually (except by heroes — see "Specific Targeting" on page 62 of *Star Wars Miniatures Battles*). If enemy soldiers do fire at a guard and hit, the hits are allocated randomly to both the guard and the prisoners, just as if they were a squad. If a guard becomes wounded, the prisoners may attempt to escape.

### Executing Prisoners

Although it is not an honorable thing to do, a soldier may kill his prisoners. During the Fire Combat Phase, the owning player may declare that a guard is executing a prisoner. The guard may not have previously fired in the current Fire Combat Phase. Killing a prisoner is automatic. A guard may kill two prisoners in one Fire Combat Phase. The executed prisoners are removed from the table.

If the soldier is guarding more than two prisoners, he may continue to execute them in the next Fire Combat Phase. However, the remaining prisoners may attempt to escape in the following Morale Phase.

Generally, soldiers of the Rebel Alliance or the New Republic do not kill their prisoners, but this action is not beneath most Imperials, pirates, bounty hunters and some mercenaries.

### Escape

Prisoners are usually guarded by an alert and armed soldier, which makes it difficult to escape. There are times, however, when a prisoner sees an opportunity or gets up the nerve to make a run for it.

A prisoner may attempt to escape under the following circumstances:

- If the soldier guarding the prisoner engages in fire combat.
- If the soldier guarding the prisoner engages in or is engaged in close assault combat.
- If the soldier guarding the prisoner becomes wounded.
- If the soldier guarding the prisoner executes prisoners.

A prisoner attempting to escape must make a morale test. The escape morale test occurs in the Morale Phase, and has a threat level of 6. The prisoner uses his *command* skill. If there is more than one prisoner, the highest *command* skill in the group is used.

There are special factors which apply to escape morale tests; these modifiers are listed below. In addition, the standard threat level modifiers for shaken or demoralized soldiers also apply. In the case of a group of prisoners, the worst modifiers apply.

**Example:** *Three Rebel soldiers are being held prisoner by a scout trooper. Two of the Rebels have steady morale, but the third is shaken. If the Rebels have the chance to escape, the threat level will be modified by +1 due to the third Rebel's shaken status, in addition to any other modifiers which may apply.*

Note that in a mixed group of prisoners it will become necessary to keep track of each prisoner's morale level. Scratch paper or notations on the original squad sheet should be adequate. A prisoner's morale level starts at one less than the morale level of the squad he originated in, and will henceforth rise or fall independently of his squad's.

### Escaped Prisoners

If the prisoner successfully makes the morale test (achieves a result of "No effect" or "Morale +1"), he immediately makes a full run move away from the guard, heading in the direction of his designated rally point. If the way to the rally point is blocked, then the escaped prisoner will head toward the nearest unblocked table edge. In the next Movement Phase, he may be moved normally.

### Morale Test Chart: Escape Attempts

Morale Test Type	Threat Level
Escape	6
<b>Standard Threat Level Modifiers</b>	
Shaken	+1
Demoralized	+2
<b>Escape Modifiers</b>	
Additional guard	+1
Guard wounded (per each wounded guard)	-1
Guard engaged in close assault combat	-2
Prisoner executed (per each prisoner executed)	-2

A group of escaped prisoners must remain together, following the rules for squad coherence. They are treated as a squad as they make their way across the table.

Once a prisoner has escaped, he will attempt to make his way back to his original squad. A group of prisoners will work their way back to the squad that the majority of them originated in. If there is no majority, the escaped prisoners will head toward the squad of the soldier with the highest *command* skill.

Prisoners or groups of prisoners whose morale level is 0 will instead rout. Follow all the normal rules for routing squads. They will not attempt to rejoin their squads unless they can rally.

If a non-routing group should pass within 12" of, and have a line of sight to, a squad that some of the prisoners originated in, but which is not the destination squad, then the soldiers from that squad may leave the group and strike off to rejoin their squad.

If all of the soldiers' squads no longer exist, the escaped prisoners will form a new squad. The new squad's morale level is the average of the soldiers' morale levels, rounded down.

Escaped prisoners have no weapons. When a prisoner escapes, remove the "Captured" marker from its base and replace it with an "Unarmed" marker. Escaped prisoners may only engage in close assault combat. They are incapable of fire combat.

If an escaped prisoner makes it back to his original squad, his morale level is adjusted to match that of the squad's, and he will again be armed with the squad's basic weapon.

# Chapter Four Equipment

War is a great catalyst for the development of technology, as the various sides embroiled in the conflict seek newer and better ways to give themselves a definitive edge in the struggle for victory. And as the pace of technological growth increases, newer and more effective equipment finds its way to the troops on the battlefield.

Presented below are more weapons and items of equipment available for use by the soldiers of *Star Wars Miniatures Battles*. Some of these are standard items that have become more available and others represent new developments in the technology of war.

Each entry lists the equipment's cost in Squad Generation Points, the skill required to use the equipment, its *Damage Strength* (if a weapon), its effect in game terms, a brief description, notes about special characteristics and the relevant game rules.

**Note:** Some skill listings will be followed by the parenthetical notation "SW1" and a skill name or skill names. This refers to the skill required to operate the equipment if you intend to use the original skills from the first edition of *Star Wars: The Roleplaying Game* and *Star Wars Miniatures Battles* (see "Soldiers and Squads" in the "Rules Upgrade" for notes about skill use).

## Ion Gun

**Cost:** 10 SGPs.

**Skill:** *Blaster artillery* or *ion gun* specialization (SW1: *heavy weapons*).

**Damage:** 4.

**Effect:** Disrupts vehicles' systems.

**Encumbrance Value:** 8 per crewmember.

**Notes:** *Assembled*; crewed; vectored-effect weapon.

Ion guns were developed as a response to the devastating effect of vehicles on the field of battle. While they are a common element of space battles, their appearance in ground battles has been long in coming due to the cost and complexity of

reducing the weapon to a manageable size. While man-portable ion guns are the ultimate goal, the current version still provides a definite edge for the average "dirtsider."

The ion gun fires high-energy ionized particles which disrupt the sophisticated electronics and computer systems of vehicles. The guns are not intended to destroy vehicles, but rather to disable them. Once disabled, the threat of the vehicle is removed and it may be destroyed or captured when time affords.

An ion gun is an *assembled weapon* and requires a crew (for first-edition *Miniatures Battles*, it is classed as a heavy weapon); it requires two men to transport it, and it must be assembled prior to use. Follow the regular rules for carrying and assembling weapons and for firing those weapons on pages 23–24 of *Star Wars Miniatures Battles*. An ion gun is not capable of following fire.

The ranges for an ion gun are as follows:

Short: 12"

Medium: 30"

Long: 120"

To fire an ion gun, declare a target and make a skill test using the firing soldier's *blaster artillery* skill (or *heavy weapons* skill if using first-edition skills). If the test is successful, the target is hit. If not, the shot was off the mark.

If the shot misses, use the "Vectored-Effect Weapon Deviation Template" to determine in which direction it actually went (see "Vectored-Effect Weapons" in Chapter Three, "Rules Additions"). The shot will only go as far as the distance to the originally declared target (the weapon was calibrated for that distance). The first vehicle (or other target; see below) within range of the shot along the new trajectory is affected.

If a vehicle is hit by an ion gun, make an opposed test, adding the ion gun's *Damage Strength* to the firer's die and the vehicle's *Body Strength* to the target's die. Compare the modified rolls and read the results from the "Ion Gun Effects Table" (see below).

## Ion Gun Effects Table

Roll	Effect
DS < BS	No effect.
DS ≥ BS	Controls ionized.
DS ≥ BS + 4	Controls ionized. In addition, the vehicle takes a Critical Hit.

DS = Firer's *Damage Strength* Roll.  
BS = Target's *Body Strength* Roll.

A result of "controls ionized" means that the vehicle's control systems have been temporarily disrupted. For the rest of this turn and the next the vehicle suffers the following effects:

- The vehicle's # Turns is reduced by 1.
- The vehicle loses Fire Control on all its weapons.
- The *Damage Strength* of the vehicle's weapons is reduced by 1.

The "controls ionized" result is cumulative. A vehicle which has received two "controls ionized" results has its # Turns and its weapons' *Damage Strengths* reduced by 2. However, a vehicle's # Turns or *Damage Strength* may never go below 0.

If the vehicle's # Turns is ever reduced to 0, the vehicle's controls are frozen for the next two turns. A vehicle with frozen controls may make no turns, and may not accelerate, decelerate or fire weapons. It continues in the same direction and at the same speed it was travelling when the controls became frozen.



■ A squad of planetary militia — as indicated by their uniform colors and the unit insignia on their helmets — advances in defense of a generator station on their homeworld.

Droids may also be affected by an ion gun. If a droid is hit by an ion gun, test its *Strength* against the gun's *Damage Strength*. Read the results on the "Ion Gun Effects Table." A "controls ionized" result is treated as a "torso hit" (see the explanation of droid damage effects on page 74 of *Star Wars Miniatures Battles*), which lasts for the duration of the current turn and the next turn. If the result also calls for a critical hit, then roll on the "System Damage Table" to determine the effect on the droid. This effect is permanent, just like normal damage.

Since many biological functions are electrical in nature, Humans and aliens may be injured by an ion gun. However, the nature and size of the ion gun minimizes the damage it can do to a living creature. If a being is the target of an ion gun, its *Damage Strength* is halved. In addition, a result of "Wound" on the "Damage Table" is treated as "No Effect" and an "Incapacitated" result is considered to be a "Wound."

## Jet Pack

**Cost:** 30 SGPs.

**Skill:** *Jet pack operation* (see below).

**Effect:** Jump over obstacles.

**Encumbrance Value:** 5.

A jet pack is a portable unit which is worn strapped to the user's back and which can propel a soldier over intervening obstacles on the battlefield. Combat jet packs are smaller and more compact than many civilian models, so as not to interfere with a soldier's mobility on the ground. As such, they generally do not have the range of some of those jet packs. But while they may not perform like an Aratech Jumper, they do get the job done.

A soldier wearing a combat jet pack may jump up to 30" in a straight line, in any direction within his 90-degree front facing, or 20" straight up. When jumping straight ahead, he reaches a height of 5" at the midpoint of his jump. A soldier jumping with a jet pack may not perform the jump at less than that height.

A soldier may attempt to jump over higher obstacles, but does so at the cost of some of his distance across the tabletop. For every 1" of vertical distance above the 5" minimum height, he loses 2" of horizontal distance. A soldier may jump no higher than the maximum 20" high.

**Example:** *An Imperial jump trooper is attempting to leap over a landing platform which stands 8" high. He will jump 11" high in order to clear it, reducing his horizontal distance to only 18" (11" is 6" more than the minimum jump of 5", so the trooper loses twice that — 12" — from his horizontal distance).*

When a soldier uses a jet pack, declare a destination point — where the soldier intends to land. Then make a skill test against the jump's difficulty.

The base difficulty for using a jet pack is 6. The difficulty of the jump can be modified by a number of factors, which are listed below in the "Jet Pack Jump Modifiers Chart."

**Jet Pack Jump Modifiers Chart**

Condition	Difficulty Modifier
Enemy soldier within 4" of jump-off point	+1
Enemy soldier within 4" of landing point	+1
Jumping in woods	+2
High winds	+2

If the soldier is successful, he lands at the designated point. If he fails the test, you must roll for deviation. Place a Grenade Burst Template over the destination point and orient the Direction of Throw with the direction the soldier was jumping. Roll one die to determine the direction the soldier missed by, then another die to determine how far off the soldier actually landed. However, a soldier may not deviate by more than half the distance of the attempted jump.

When attempting to jump a soldier over an obstacle, the jump must be declared before measuring any distances. The player must declare the direction of the jump and the height the soldier will jump to clear the obstacle. The jump must be at least 2" greater than the height of the obstacle, or the jumper will risk colliding with the obstacle.

In addition, the obstacle must be no further from the soldier than half the distance of the jump. If it is, the soldier will collide with the obstacle on his way down.

**Example:** *If the landing platform in the above example were more than 9" away from the jumprooper's starting position, he would not be able to clear it and would collide with the platform on the way down.*

It will be necessary to use common sense when deciding whether an obstacle can be cleared, as many conditions may apply which cannot be effectively covered here. For instance, an extra-wide obstacle may still prevent a soldier from jumping over it, even if it were only halfway through his jump.

A soldier jumping with a jet pack may carry objects with him. However, heavier object will tend to reduce the effectiveness of the jet pack. If a soldier is carrying an item with an Encumbrance Value of 15 or more when attempting a

jump, the distance he may jump is halved.

A soldier may not fire a weapon or drop objects while jumping with a jet pack; he is too busy controlling the jet pack.

A jet pack carries 10 charges. It is capable of firing 10 bursts, then its fuel is exhausted and the jet pack may no longer be used.

A jet pack must be allowed to cool down for one turn after each use or it will overheat. A soldier may choose to use a jet pack in the turn immediately after its last use, but the jet pack will be rendered useless when the consecutive jump is completed. In addition, roll one die; if the result is a "1" or "2," the jet pack explodes with a *Damage Strength* of 5 and affects any figure within 2.5". Increase the *Damage Strength* by 1 and the blast radius by 1" for each charge remaining in the jet pack.

Even if the jet pack does not explode, the soldier wearing it must make an opposed *Strength* test against a *Damage Strength* of 2, to see if he is injured by the overheating pack.

**Skill Note:** *Jet pack operation* is a new skill, and is not listed in *Star Wars: The Roleplaying Game*. It is based on the *Mechanical* attribute. If a soldier is attempting to use a jet pack, but does not have the *jet pack operation* skill, he must use his *Mechanical* attribute.

**Walker Mount**

**Cost:** 20 SGPs.

**Skill:** *Walker operation* or *walker operation*: *walker mount* (see below).

**Effect:** Makes it easier to move *assembled weapons*.

**Encumbrance Value:** 10.

*Assembled weapons* can be formidable weapons on the battlefield, but their effectiveness is offset by their limited movement capability (an *assembled weapon* may only be dragged 1" during a Movement Phase when assembled).

This recent innovation increases the mobility of larger weapons, though. It combines a double-bipod mount with miniaturized versions of the drive and gearing systems from walker-type vehicles. This setup effectively allows a weapon to move itself.

The crew of a weapon fitted with a walker mount can move the weapon in one of two ways. A soldier may either control the mount directly and move with it (effectively "driving" it), or he may use a control unit for remote movement. The soldier moving the walker mount makes a *walker operation* test against the appropriate difficulty number. If he succeeds, he moves the mount as described below. If he fails, the mount may only be moved half its Movement Rate.

If controlling the unit directly, a soldier must remain in base-to-base contact with the mount

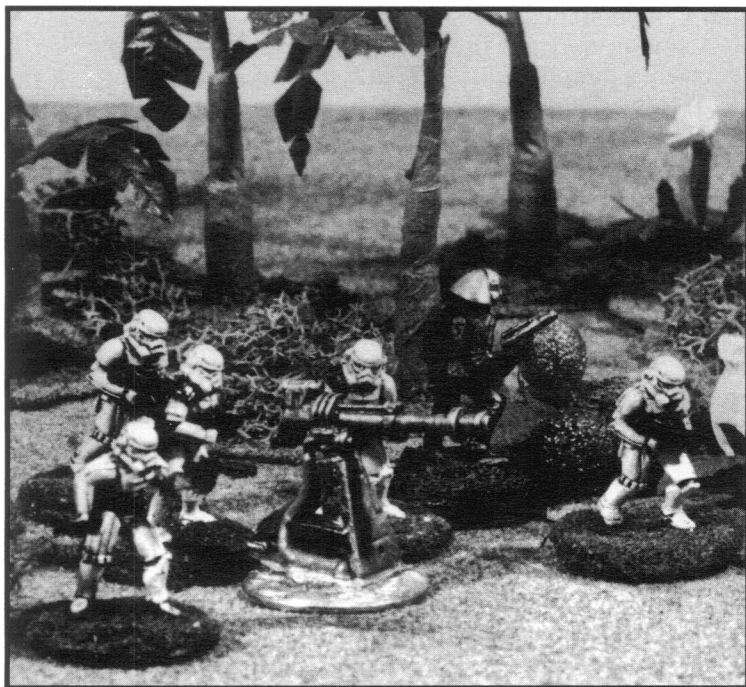

■ A stormtrooper squad armed with a heavy repeating blaster augments a team of Santhe Security troopers in an ambush of Rebel forces.

and the mount and soldier are moved together. The soldier may make no other movement that phase. The difficulty number for moving the mount in this manner is 6.

A soldier may also control the mount by means of a hand-held control unit. Each mount comes with one control unit; it must be assigned to a crew member when the squad is outfitted (*Walker Mount Control Unit* markers are provided to keep track of the controlling soldier).

To move the mount, the controlling soldier must be within 12" of it. The difficulty of *walker operation* test is 8. Then simply move the walker mount as desired, as long as it does not move more than 12" from the controlling soldier. If it should do so, it stops immediately and can move no further that turn.

Walker mounts move as vehicles do. They have a Turn Distance of 1 and # Turns of 2. They may perform no maneuvers other than simple turns, and may not exceed their # Turns.

The controlling soldier does not need to have a line of sight to the walker mount, but if he cannot see where it is or where it is headed, he may only move it in a straight line from where it starts. The difficulty for moving a walker mount without a LOS to its path is 10.

Walker mounts may move up to 5" during a Movement Phase. The weapon may be moved independently of its crew (but of course may not be fired unless sufficient crew return to within 1" of the weapon).

A walker mount is wide and may not be able to pass between certain obstacles if they are too close together. A template is provided in the back of this book to show just how wide the mount is. When a weapon is mounted to a walker mount, place the Walker Mount Template under the weapon to show its position.

If the controlling soldier is incapacitated, the control unit is assumed to be picked up by the nearest crew member in command distance. If none of the other crew members are within command distance, the unit is assumed to be lost.

Any weapon which normally requires a mount of some sort (such as a tripod or bipod), i.e., is an *assembled weapon*, may be equipped with a walker mount. A weapon equipped with a walker mount must also be crewed. A walker mount is a large piece of equipment, and requires a crew of two. So a weapon with a walker mount requires a total crew of three — one to carry the weapon and two to carry the parts of the mount.

A walker mount requires **two** turns to assemble. At the beginning of the first Movement Phase, the three soldiers carrying the weapon must be within 1" of each other. They may not move in the Movement Phases they are assembling the weapon. At the end of the second Movement Phase the weapon is assembled and ready to fire. If the soldiers assembling the weapon are forced to move before the weapon is completed, they must begin again for another two Movement Phases.

An assembled weapon/walker mount can be disassembled. Three soldiers from the same squad must begin their Movement Phase within 1" of the weapon; at the end of the second phase, the weapon is disassembled and may be carried and reassembled as described above.

**Skill Note:** *Walker mount* is a specialization of the *walker operation* skill, which is listed in *Star Wars: The Roleplaying Game, Second Edition*. It is based on the *Mechanical* attribute. If a soldier is attempting to use a walker mount, but does not have the *walker operation* skill, he must use his *Mechanical* attribute.

#### Walker Mount Difficulty Numbers

Movement Type	Difficulty Number
Moving directly	6
Moving remotely	8
Moving remotely without LOS	10

#### Stokhli Spray Stick

**Cost:** 8 SGPs.

**Skill:** *Stokhli spray stick*.

**Damage:** 6 (stun only).

**Effect:** Traps and stuns target.

**Encumbrance Value:** 4.**Notes:** Vectored-effect weapon.

Developed on the planet Manress by the Stokhli people, the spray stick is an effective long-range stun weapon.

It was developed as a hunting weapon and is used chiefly by big-game hunters due to its range and stopping power. While rarely seen on the battlefield, it has been employed with some success on capture missions.

Some of the primary users of the Stokhli spray stick are the Noghri people of the planet Honoghr. The Noghri are natural hunters and warriors who served the Empire for many years as assassins and commandos until released from their servitude by Princess Leia Organa on behalf of the New Republic.

The spray stick is a meter-long weapon which shoots a fine spray mist when the firing stud is pressed. The mist solidifies into sticky tendrils when exposed to air, wrapping the target in its confining strands. The spraynet is also charged with shock-stun juice to render the target unconscious.

A Stokhli spray stick is a vectored-effect weapon and is fired as such: declare a target and make the skill test. If the test fails, determine the direction that the weapon was actually fired using the Vectored-Effect Weapon Deviation Template.

If the soldier hit the target, determine damage normally, remembering that the spray stick only does stun damage.

Even if the target shrugs off the stun, he is still entangled. He is reduced to one-quarter movement until he frees himself from the spraynet. While entangled, a soldier may not fire his weapon or initiate close assault combat. He may roll his opposed skill test if he is attacked in close assault combat; if he beats the attacker's roll he has escaped injury, but does not harm the attacker.

Entangled soldiers attacked in close assault combat receive a -2 modifier to their close assault skill rolls. This modifier is cumulative with other close assault combat modifiers.

**Example:** *A Rebel soldier who has been entangled by a Stokhli spray stick is attacked from the rear. He receives a total of a -4 modifier to his close assault combat roll.*

A soldier may attempt to break free of a Stokhli spraynet during each Special Actions Phase he is entangled. He tests his *Strength* against the tendrils' *Strength* of 6. If he succeeds, he is free. If he fails, he remains entangled until his next attempt.

The ranges of a Stokhli spray stick are:

Short:	25"
Medium:	50"
Long:	100"

## War Beast (Nek)

**Cost:** 20 SGPs per concom; 62 SGPs per nek.**Skill:** *Beast handling* (see below).**Effect:** Special.**Encumbrance Value:** Concom: 1; nek: 20.

The use of war beasts is an ancient tradition among many different species and cultures. While still practiced by some primitive cultures on less-developed worlds, that tradition had mostly fallen into disuse with the advent of modern warfare. Now, however, a modern version of the war beast tradition is available, due to the work of the inhabitants of Cyborrea.

The Cyborreans are a bellicose species, and when not engaged in one of their many local wars or military drills, they indulge in hunting vicious and dangerous creatures in order to keep up their martial prowess. Neks — also known as Cyborrean battle dogs — were originally developed for hunting, but their application has spread to the art of war.

Neks are naturally aggressive creatures native to Cyborrea. Through genetic and cybernetic engineering, their abilities and ferociousness are enhanced, making them formidable weapons. Cyborrea is a heavy-gravity world, and neks have proven to be even more effective on standard-gravity worlds.

Neks are controlled electronically. An integral part of their cybernetic enhancement is governance circuitry, which is controlled by means of a special comlink/transmitter — the concom. Using the concom, the neks' handler directs both their movement and their attacks.

To use Cyborrean battle dogs, one soldier must carry a concom. He is the neks' handler. It is possible to assign additional concoms to other soldiers, but only one soldier at a time may be the handler for a given pack. One pack — up to six neks — may be controlled with a single concom. When not in active use, the neks must remain within 3" of their handler. They may be moved along with their handler, following the normal rules for movement — no skill test is required.

However, if any member of the pack passes within 12" of and has a line of sight to any squads engaged in close assault combat, make a *Perception* test for the neks (one test per pack). The base difficulty for the test is the distance in inches to the combat; the difficulty is modified by -1 for every four soldiers involved in the combat (rounded off).

If the neks notice the combat, their natural aggressiveness is triggered and they will seek to attack the clashing squads. The nek-handler must pass a difficulty 8 *beast handling* test in order to restrain the creatures. If the test is not successful, the neks immediately run towards the near-



est soldiers involved in the combat, up to the extent of their remaining Movement Rate.

If the neks were close enough to engage any soldiers, they may attack the soldiers in the following Close Assault Combat Phase. Otherwise, they continue to run toward the soldiers in following turns. At the beginning of each successive Movement Phase, the nek-handler may again attempt a difficulty 8 *beast handling* test to overcome the neks' natural ferocity and bring them back under control. When the handler is successful, he may have the battle dogs return to within 3" of him, or he may direct them to attack.

Neks attack in the Close Assault Combat Phase. To attack with the battle dogs, the nek-handler must declare a target (or targets) to which he has a line of sight, then make a *beast handling* skill test against a difficulty of 6. If he succeeds, the neks charge the target. If he fails at the test, the neks do not charge.

If the test is failed, roll one die; if the roll is equal to or greater than the number of battle dogs in the pack, there is no further result.

If the roll is less than the number of pack members, the pack runs amok. Follow the rules for "Running Amok" on pages 70-71 of *Star Wars Miniatures Battles*. Each nek in the pack is moved independently. In the following turns the nek-handler may attempt to regain control of the pack by testing his *beast handling* skill against a difficulty of 10. If he succeeds, the pack returns to within 3" of the handler at its maximum Movement Rate. Otherwise, the creatures continue to run amok in succeeding Movement Phases.

As described in *Star Wars Miniatures Battles*, a wounded creature runs amok. If any nek is wounded, the handler must make a difficulty 8 *beast handling* test to prevent the wounded creature from running amok. Otherwise, it will break away from the pack and run amok. In later turns the nek-handler may continue to attempt to regain control of the loose creature by testing his *beast handling* skill against a difficulty of 10. As described above, a successful test means that the nek returns to the pack. Otherwise it continues to run amok.

In the Movement Phase, neks may be directed to break off close assault combat and move elsewhere — even into another attack — if the handler succeeds at a difficulty 8 *beast handling* skill test.

### Nek (Cyborrean Battle Dog)

**DEX:** 2

**STR:** 3 (5)\*

**PER:** 3

**Move:** 12

**Movement Rate:** 14

**Attack Forms:** bite (5), claw (4)

**SGPs:** 62

\*The nek's integral cybernetic body armor adds 2 to its STR for resisting damage.

**Skill Note:** *Beast handling* is a new skill, and is not listed in *Star Wars: The Roleplaying Game*. It is based on the *Mechanical* attribute. If a soldier is attempting to control war beasts, but does not have the *beast handling* skill, he must use his *Mechanical* attribute.

# Chapter Five Unit Insignia and Organization

Throughout history, military and private organizations have sought to identify themselves by means of various symbols and insignia. The reasons are varied and numerous: some symbols are meant to instill a sense of national pride, or pride in some other political body; others, to identify a group or organization to its friends or allies. Still others are intended to intimidate foes on the field of battle.

Many gangs — such as swoop gangs and pirate gangs, among others — proudly emblazon their symbols on their uniforms, both to announce their allegiance and to strike fear into those who recognize them. Likewise, mercenary groups with a reputation, or those seeking to build one, will have their emblems conspicuously displayed.

The use of unit symbols and insignia is encouraged with your tabletop forces, as the impact of a good symbol serves to enhance a game.

Provided below are details of the organization of the major combatants in the Galactic Civil War and the emblems they display, as well as a sampling of the insignia and symbols of some of the other groups that might be involved in actions with those forces.

The organization of the Rebel Alliance and the Empire is discussed to give you ideas for scenarios and their backgrounds, as well as to provide a basis for any campaign games you might wish to run (see Chapter Six, “Scenarios and Campaigns”). The insignia and other symbols are provided so that you can enhance your game visually.

In addition, we provide an alphabet that can be used to create markings and designations for the different forces. One of the aspects that gives *Star Wars* its distinctive feel is its internal consistency — using things that are familiar, but different enough to give the impression of a galaxy far, far away.

A case in point is the use of writing. A number of distinct character sets are used on different vehicles and displays, giving the impression of a wide and varied society. To help you get that feel, the following set of characters is presented.

## The Aurebesh

An Empire spanning a thousand thousand worlds encompasses millions of languages. Each of these languages are represented by their speakers in a wide variety of different written forms.

To make sense of such a vast diversity, it became necessary to establish certain standards, generally by making the most common languages and written forms the standards. Thus was Galactic Basic developed as a common tongue.

But even Basic can be written in a great number of ways, so common alphabets were also developed. While there is one standard language

### Color Designation

Quite naturally, most of the symbols and emblems in use are displayed in various colors. As it is impossible to show colors in a black-and-white book such as this, we have used the following system of cross-hatched lines to represent the different colors comprising the emblems provided in this book.

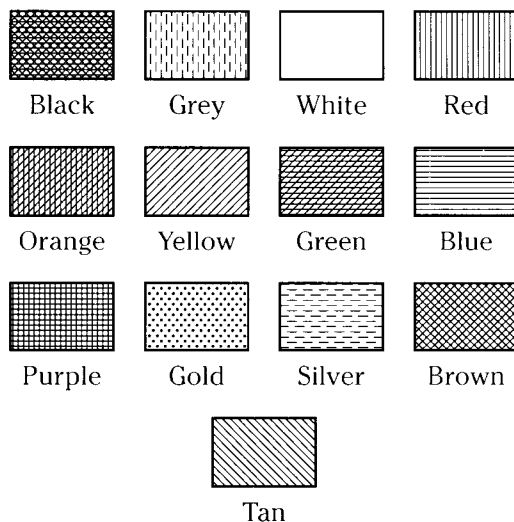

in the galaxy, there are still quite a few ways to represent it. Many of these different character sets developed as a result of varying needs. Some arose as military script, others as a means to record trade and mercantile dealings, others as a means of indicating social standing or to convey specific meanings within very specialized trades or sub-cultures.

One of the more common scripts is the Aurebesh, which is used predominantly by military organizations (many Star Destroyer and Death Star monitors display this alphabet).

The Aurebesh is a fully developed alphabet consisting of 34 characters. In addition to the basic phonetic units, it also contains characters which represent a number of phonetic combinations. See the diagram, "The Aurebesh," for details.

The Aurebesh is in common use by many elements of the Rebel and Imperial armies, as well as by many private concerns, and can be found as part of unit designations, squad emblems, campaign badges and vehicle identification codes.

## Rebel Alliance Organization

The Alliance as a whole does not have one cohesive organization. This is due to the fact that it is still severely shorthanded, both in personnel and materiel. Even as more and more worlds

come over to the Rebel Alliance's side, it cannot hope to match the Empire in terms of raw materials and production capabilities.

Communications is also a major problem for the Alliance, as the Empire still controls the HoloNet. Therefore, each world or system is left to its own devices in terms of its armed forces. The member worlds are free to organize their forces in whichever way they feel is best, as long as they carry out operations required by Alliance High Command as relayed by their sector command.

In addition, because they are so outnumbered, the Alliance must carry on the struggle in terms of guerilla warfare — small units engaged in hit-and-fade operations, reconnaissance, sabotage, and espionage. Such guerilla operations tend to be less structured.

However, the Rebellion does maintain an organized force for those times when large-scale actions are required. These forces are Alliance High Command's SpecForces. They are the forces one usually thinks of when Rebel soldiers are mentioned. The SpecForces line troops are sent whenever the Alliance must achieve an objective, but expects heavy resistance. These troops are also used as marines, assigned on board and guarding ships that carry important cargoes.

Those forces directly under the High Command's authority are organized for ease of command, although even the SpecForces' organization is flexible, being adaptable to different situations as required.

## Divisions



































The Rebel SpecForces are organized into divisions. The number of divisions varies as High Command prefers a more fluid force mix, especially since the number of troops available at any one time fluctuates greatly due to the coming and going of member worlds, the necessity to cross-attach units to various sector commands for extended duty, and the inevitable combat losses.

The division is primarily an organizational unit, as Rebel SpecForces troops are almost never allocated in units of this size. When assigned to an objective, SpecForces soldiers are organized into task forces, for which the commander chooses the soldiers and equipment required to achieve the objective.

Task forces are comprised of regiments or elements of regiments selected from the available divisions. The regiments are chosen for the capabilities and special training required for the mission.

Divisions do not contain a fixed number of regiments—the number may change as resources are reallocated and troops are moved to other theaters of operation.

## The Aurebesh

					
Aurek (a)	Besh (b)	Cresh (c)	Dorn (d)	Esk (e)	Forn (f)
					
Grek (g)	Herf (h)	Isk (i)	Jenth (j)	Krill (k)	Leth (l)
					
Mern (m)	Nern (n)	Osk (o)	Peth (p)	Qek (q)	Resh (r)
					
Senth (s)	Trill (t)	Usk (u)	Vev (v)	Wesk (w)	Xesh (x)
					
Yirt (y)	Zerek (z)	Cherek (ch)	Enth (ae)	Onith (eo)	Krenth (kh)
					
Nen (ng)	Orenth (oo)	Shen (sh)	Thesh (th)		

Stephen Crane

As divisions are primarily organizational units, they are not normally represented by a particular emblem.

### Regiments

The primary component of a division — the regiment — is also the main building block for setting up a task force. Each regiment not only receives basic combat training, but is also trained in a particular specialty. Such special training may consist of marine duty, pathfinder reconnaissance, urban warfare, wilderness combat, infiltration, heavy weapons or a number of other specialties.

Rebel commanders assemble their task forces from the regiments with the necessary skills, mixing and matching elements of those regiments as necessary to put together a balanced force.

Regiments are generally numbered starting from "1," and the number of regiments is determined by the structure of the division to which they belong.

At this level there is still no emblem attached to the unit, although some regiments may have the name of their home system incorporated into their designation if the regiment was raised in its entirety from that system. Examples would be the "Third Calamari Regiment" and the "First Mantooine Regiment."

Each regiment is composed of four companies.

### Companies

The company is the basic unit of a regiment. It is these units which are assembled into task forces for major objectives. All the companies in a regiment receive the same specialist training, but may be cross-attached to other companies for specific purposes.

For example, a task force whose mission is to free a lightly-held planet from occupation by a minimal Imperial garrison might consist of a pathfinder company (to locate and secure a landing site), a tech company (to provide special support and equipment), and three line companies.

### Game Note: Alliance Platoons

Platoons are generally the largest units you will deal with in *Star Wars Miniatures Battles*, as they consist of from 40-45 soldiers. Of course, if you've got a really big table and a lot of time, you *can* play a company-scale game. If you really want to. Let us know how it turns out.

Each company is designated by a letter (A, B, C or D). Since the Aurebesh is in primary use by the military, regiments typically consist of Aurek Company, Besh Company, Cresh Company and Dorn Company. A company's designation is preceded by its regiment number when necessary to distinguish it from other companies in a task force.

A company consists of five platoons. Component units of a company all bear the company's designation as part of their emblem. This emblem can be found on soldiers' uniforms, vehicles and even buildings.

### Alliance Platoons

The platoon is the main unit employed by the commander in the field. When a company hits the ground, it is the platoons which are given specific functions to perform.

While task forces are usually assembled from regiments and companies, it is possible for units to be cross-attached at the platoon level. For example, an assault company might consist of four line platoons and a heavy weapons platoon. Platoons are also occasionally used to fill out task forces. In the task force described above, two of the line companies might have contained one heavy weapons platoon each, or the task force may have had two heavy weapons platoons attached in addition to the five companies described.

Platoons are designated numerically, and this represented by variously shaped escutcheons.

### Platoon Escutcheons

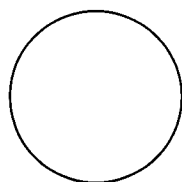

First Platoon

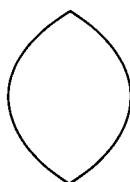

Second Platoon

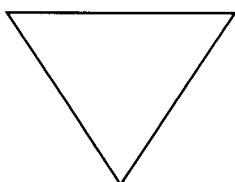

Third Platoon

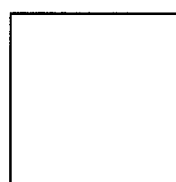

Fourth Platoon

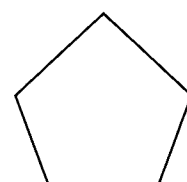

Fifth Platoon

The number of sides the shield has symbolizes the platoon's numerical designation, providing for quick recognition in the field.

A platoon is comprised of four squads. Each squad's emblem consists of its platoon shield with the letter designation of the company it belongs to emblazoned in the center (see the diagrams, "Platoon Escutcheons" and "Representative Squad Emblem").

Platoon escutcheons are also emblazoned on all units within the platoon, and can be found on soldiers' uniforms, vehicles and occasionally buildings.

### Squads

The squad is the basic fighting unit of the SpecForces. When companies and platoons are deployed, it is the squad commanders who must lead their men to achieve their objectives. Each squad typically consists of 10 soldiers, including a commander and sometimes one or two specialists. Current doctrine requires that a squad remain a cohesive unit. Any soldiers who are separated must try to regroup with their squad.

Squads are designated by color, much like the fighter squadrons of Starfighter Command. A platoon may consist of Red Squad, Gold Squad, Blue Squad and Green Squad, for example. The platoon's escutcheon is displayed in the squad's color to form the squad's emblem (see the "Representative Squad Emblem" diagram).

Squad emblems are displayed on the soldiers and equipment comprising the squad.

### Alliance Uniforms and Insignia

The basic uniform in use by Alliance High Command's SpecForces consists of a medium blue shirt and dark grey trousers. A black combat vest is also worn — the vest contains a variety of pockets for carrying different pieces of equipment and additional ammunition.

A white blast helmet protects the head. The helmet has an elongated back so as to protect the

**Game Note:  
Squads**

The squad is the basic fighting unit described in *Star Wars Miniatures Battles*, with which you are already familiar. If you are using four or less squads in a game (which is usually the case), you may want to give them emblems all based on the same platoon, as squads are generally not cross-attached on missions.

However, your scenario may explain why disparate squads are fighting together, or you may just like the way a number of different emblems looks on the tabletop. Feel free to mix and match if that is the kind of game you like.

neck of the soldier. Black boots complete the uniform.

Squad emblems are not required on the uniform by doctrine, but many squads choose to wear them as a matter of pride. Shoulder patches are often worn, but some squads choose instead to display their emblem on the back of the vest. Others will also paint the emblem onto the helmet.

In large battles where many squads are deployed, upper echelons require that squad insignia be displayed, so as to aid in distinguishing one unit from another.

Special-duty uniforms are also issued on a mission-specific basis — usually commando or pathfinder missions. The standard issue is some form of camouflage suited to the environment of the mission, generally in the form of battle fatigues (consisting of heavy-duty trousers and shirt). This can be augmented with a matching combat vest or poncho, depending on conditions and requirements. Supplies being scarce in the Alliance, it is not uncommon to find mix-and-match uniforms — one such combination might be the standard-issue shirt and trousers covered over with a camouflage poncho.

For commando missions, a smaller, lighter helmet is generally provided. The helmet is padded to provide some protection, but is not as effective as the standard-issue helmet. The mission helmet is issued in colors corresponding to the mission fatigues.

One symbol found in general use on many uniforms and equipment is that of the Rebel Alliance itself. It can be found on equipment, supplies and even buildings, as well as on helmets, vests and other items of clothing. Besides the ground troops, starfighter pilots and capital ship crewers wear the symbol of their great fight on their uniforms.

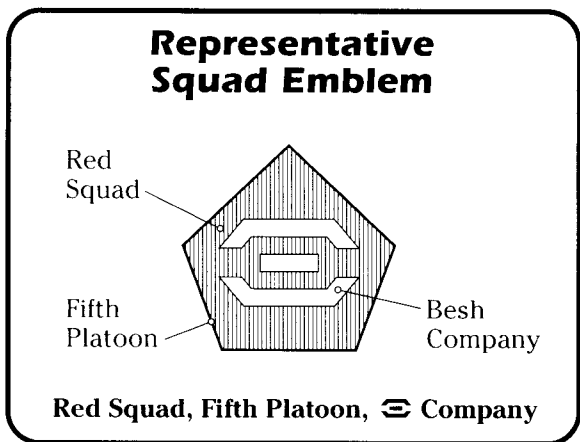

## Rebel Alliance Unit Organization

Red Squad, First Platoon, Aurek Company

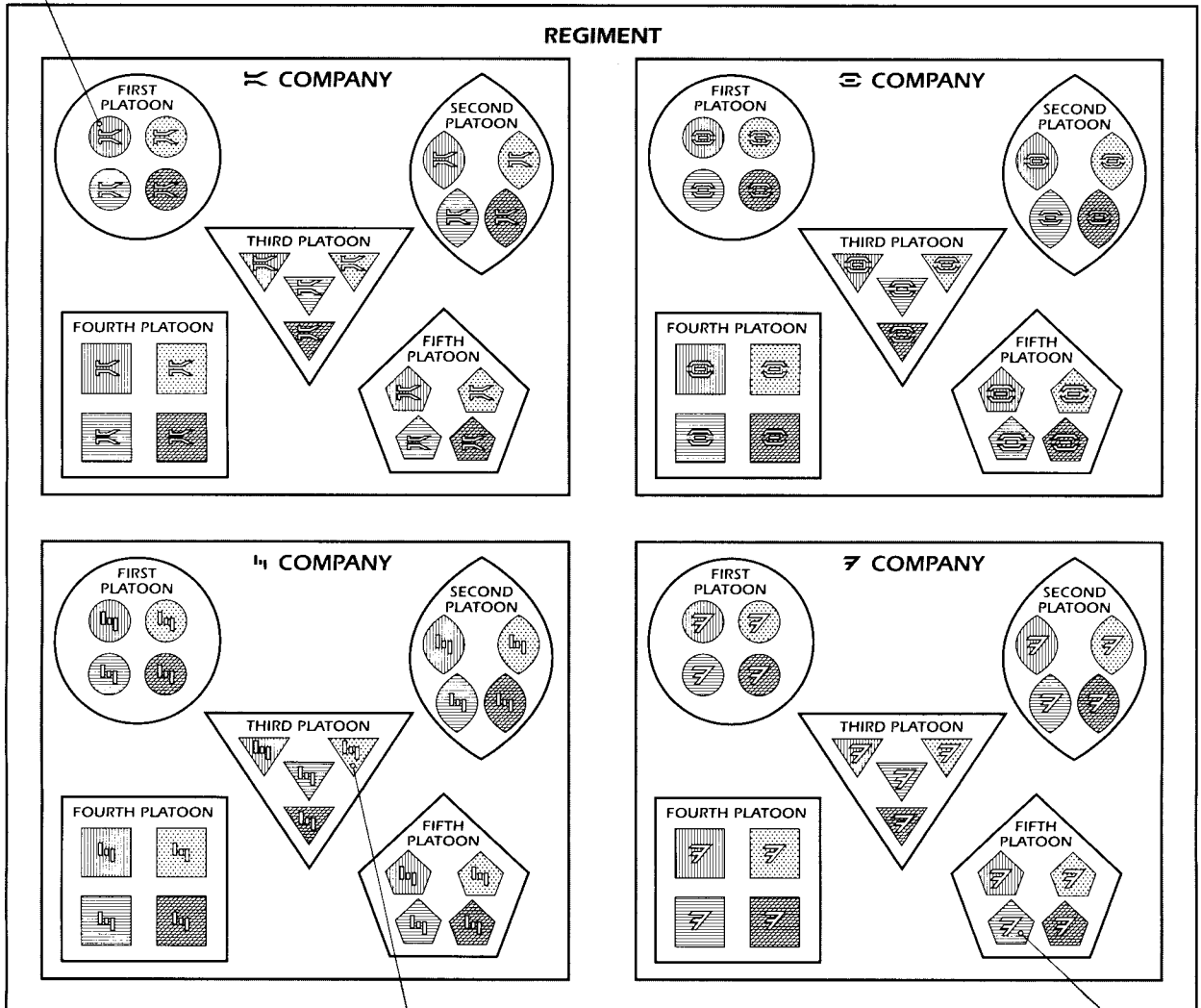

Gold Squad, Third Platoon, Cresh Company

Blue Squad, Fifth Platoon, Dorn Company

Stephen Crane

After the rise of the New Republic, its symbol has replaced that of the Rebellion. The symbol of the New Republic is in fact based on the symbol of the Rebel Alliance (see the “Emblems of the Rebellion and Republic” diagram).

### Vehicle Markings

Unit insignia are also found emblazoned on vehicles assigned to a unit. Squad emblems will usually be found painted on the sides of the vehicles, and occasionally on the top (if there is one). The latter position is to identify the vehicle to high-flying landspeeders and airspeeders.

Other symbols to be found on vehicles are various geometric elements: bands, bars, circles,

diamonds, whatever elements a particular squad or platoon has chosen as its own. Campaign badges are also a common decoration. The survivors of a hard-fought campaign can display the symbol representing their sacrifice for the Rebellion.

For example, the Hitak Harriers have developed their own emblem based on the campaign badge presented to the veterans of the action on Turak IV. The emblem and badge incorporate the volcano symbol which represents the bases hidden in the volcanic Hitak mountains, from which Rebel Forces were able to decimate the elite Imperial armored regiment, Hell’s Hammers.

One of the more common symbols in use is the symbol of the Alliance. This is found emblazoned

## Emblems of the Rebellion and Republic

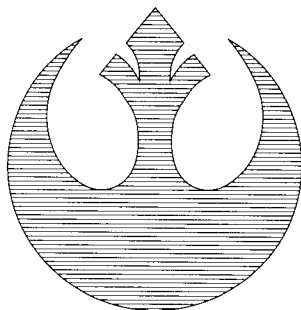

**Alliance to  
Restore the Republic**



**New Republic**

Stephen Crane

on vehicles in addition to the unit's insignia, or is sometimes incorporated as part of the unit's symbol. With the rise of the New Republic, its symbol has replaced that of the Rebellion on its vehicles.

Rebel ground vehicles are frequently camouflaged. They are used primarily in quick hit-and-fade strikes, and they are difficult to replace, so the Rebellion wants to make them as hard to hit as possible. The camouflage pattern varies depending on the environment the vehicles will be used in.

In addition to emblems and camouflage, many vehicles are designated with identification codes, frequently using the Aurebesh. These are usually located higher up on the vehicle, in a reasonably visible position.

### **Game Note: Alliance Sector Forces**

As Sector Forces are so varied, this leaves the way wide open for you to field just about any force you like. If there is a certain uniform or color scheme you'd like to use, set up the scenario so that it involves a Sector Force rather than standard Rebel troopers.

Also remember that the Alliance welcomes any beings to its ranks, whereas there is a strong anti-alien prejudice in the Imperial ranks. So it is entirely possible to field entire units of alien species.

In addition, pretty much any emblems, insignia or color schemes you want to come up with can be used on Sector Forces. Perhaps one Sector Force goes into battle wearing the full-body rainbow warpaint of their distant forebears, or has colored their uniforms to match.

### **Alliance Sector Forces**

As mentioned previously, Alliance High Command leaves local organization to the sector and system commands. As such, the types of uniforms and insignia vary almost as much as the local organizations. Some may use the basic Alliance uniform, but vary the color scheme. Others may use the uniform of a local group or a historical or legendary force. Some may have no set uniform at all.

### **Imperial Organization**

The organization of the Imperial Army will be discussed much more briefly, for two reasons. The first is that it is covered in much more detail in Chapter Eight of the *Imperial Sourcebook*. The second is that the Empire has chosen a look of uniformity and anonymity for its forces, so that there are practically no outward signs of the various levels of organization.

### **Imperial Upper Echelons**

The Imperial military machine is much more vast than that of the Rebel Alliance. It is therefore structured to a much higher level.

The sector army is the sum total of ground soldiers and equipment in the assault fleet of a Sector Group (the total Naval forces committed to a normal sector). It consists of four armies, including the systems army.

The systems army is responsible for tracking and correlating the military resources available in a sector — it does not see combat.

Each army consists of the four different available corps (line, atrisian, armor and mobile).

Each corps is comprised of four to five battlegroups, depending on its mission.

## Imperial Battlegroups

The battlegroup is a new organizational unit which was created to replace the divisions common in the Old Republic. A line battlegroup generally consists of four regiments, although this can vary depending on whether the battlegroup is reinforced, armored or mobile.

## Imperial Regiments

Regiments in the Imperial Army are much larger than those of the Alliance because of their structure. They are composed of four battalions of differing types. Because of the addition of the battalion level of organization, not found in the SpecForces, Imperial regiments do not equate to Rebel regiments.

## Imperial Battalions

The Imperial battalion is closer in size to a Rebel regiment, and its actual size varies depending on its type (line, assault, repulsorlift, artillery, armor and special missions). A battalion is made up of four companies.

## Imperial Companies

A company is the smallest Imperial unit which is capable of independent extended operations. The company is made up of four platoons.

## Imperial Platoons

As with the Rebel Alliance, platoons in the Imperial Army are the units which are deployed to achieve objectives. They are also the basic operational unit for special missions. When such a mission is required, Imperial command assembles the number of platoons it feels are necessary to achieve the goal.

Unlike in the Rebel forces, the platoon is the smallest independent unit in the Imperial Army. The Empire's policy is one of overpowering and intimidation. With its vast resources and manpower, it often forgoes finesse for brute force — sort of like killing a thrifly with a thermal detonator. When something needs to be done on the ground, a platoon is dispatched.

Imperial platoons consist of four squads, in addition to a lieutenant who commands the platoon and a sergeant major.

### Game Note: Imperial Platoons

As mentioned previously, platoons will probably be the largest units you will deal with in *Star Wars Miniatures Battles*. An Imperial platoon consists of 34 soldiers, but if any of the component squads have been augmented, you will have a force pretty much equal in size to the Alliance platoon.

### Game Note: Imperial Squads

Although Imperial doctrine calls for eight-man squads, we generally discuss 10-man squads as the basic fighting unit in *Star Wars Miniatures Battles*. Those interested in sticking to the "historical" Order of Battle can just create their squads with eight members.

Those who prefer to use 10-man squads can justify them as augmented squads — squads which have extra manpower attached to them, usually a heavy weapons team.

## Imperial Squads

The basic unit of the Imperial Army's organization is the squad. Imperial doctrine calls for squads numbering eight soldiers. This is reduced from the 10- and 12-man squads of the Old Republic, but superior training and coordination allow the reduction in manpower without a consequent loss in firepower.

It is rare that a Rebel force will run into a single army squad. Squads operate as parts of a platoon, so that their missions are coordinated with each other in order to achieve the platoon's objectives. Imperial commanders at the squad level are not given the luxury of independent thought and action that their Rebel counterparts enjoy. Orders are transmitted down from the platoon commander and are expected to be followed. Unusual situations require that a squad request new orders.

This makes Imperial squads more rigid — in terms of their responses to a situation — than Rebel squads, but guarantees the Empire tighter controls over its troops. Rebel troops enjoy the advantage of flexibility, being able to react to the changing situation without having to wait for orders.

After the fall of the Empire at the Battle of Endor and the consequent loss of manpower, the fragments of the Empire became more conservative in their expenditures of manpower. Entire platoons were unlikely to be available, so squads were deployed to achieve objectives. Squad commanders were allowed more flexibility, as they might have to work alone.

This situation carried through Grand Admiral Thrawn's campaign to restore the Empire (*particularly* through that period), the battles between Imperial factions, and even through the resurgence of the Empire's forces and the fateful attacks on Calamari.

The Imperial squad includes a commander and may also include one or two specialists.



### Imperial Uniforms and Insignia

The basic uniform of the Imperial Army is a grey coverall reminiscent of a flight suit. The boots and belt are black, and black gauntlets are worn. Army troopers wear a grey helmet which provides protection to the head and neck by means of an extended brim along the back and sides. The helmet is also provided with protective and vision-enhancing goggles, which can be worn over the eyes or placed up on the brim when an unrestricted view is desired.

Squad emblems are almost never seen on Imperial uniforms. The Imperial presence is designed to be that of an anonymous, implacable machine — individuality of any sort is discouraged. While the Empire recognizes that there is a time and a place for unit pride and fierce individuality, that place is not in the army proper.

Soldiers on the battlefield are identified to one another electronically. Comm units constantly monitor ID signals from all elements in the field and feed the information to the troopers' interactive combat arrays, which are built into their helmets. This IFF ("Identify — Friend or Foe") system allows Imperial commanders to be aware of the disposition of their troops while denying the identity of the force to the enemy.

Only one emblem is displayed on the uniform — the emblem of the Empire itself. This overarching symbol is ubiquitous in every branch of service. In the army, the Imperial emblem is worn on both shoulders of the uniform.

### Imperial Vehicle Markings

As with soldiers' uniforms, emblems on vehicles are extremely rare. Electronic IFF systems are also in use by mechanized units, so outward markings are minimized. The Empire's vehicles are almost uniformly painted a light to medium

grey. There is no attempt at camouflage. This serves two purposes.

The first is that it makes the Imperial presence recognizable at a glance. There is no mistaking when the Empire is around.

The second is a factor of the psychological edge that the Empire brings to its rule. The Empire rules through fear. The belief that the Empire is invincible and that it can bring down its might at a moment's notice to crush any opposition is the primary mission of the armed forces. Better to have the populace afraid of the Empire's forces and fearing to do anything to provoke it than to have to expend those forces.

It is this belief, codified in the Tarkin Doctrine, that led to the creation of the two Death Stars, and to the development of the AT-AT as a weapon of war. The lack of camouflage is a further psychological ploy to emphasize the Empire's invincibility and to strike fear into the hearts of its foes. It is as if the Empire were saying it doesn't matter if you see our vehicles coming; they are unbeatable.

Even the Imperial emblem is not often used on the exteriors of vehicles. If used, it can usually be found on the smaller vehicles, mostly on command and staff vehicles. Governmental vehicles tend to be ornamented with the emblem more so than military vehicles.

Identification codes or serial numbers can sometimes be found painted onto the bodies of vehicles, generally small and tucked away, as they are primarily used when the vehicles are being moved to and from storage or in vehicle pools.

Another marking that can sometimes be found is platoon striping. This sort of ornamentation is mostly found in and around the Core Worlds, where the military is more for show than for active use. Platoon striping consists of a band of color running around the body of the vehicle about one third of the way up from the base. The colors used vary depending on which battalions and companies the platoons belong to, and even vary within a Sector Group.

### Exceptions

As described previously, the Empire recognizes that there is a time and a place for individuality. Some platoons and companies have more leeway in their composition and missions, and more freedom in establishing their identities. On planets where it would be easier to subvert the armed forces than to conquer them, for instance, forces which are raised or appropriated there may sometimes be allowed to retain a unit identity and display specific ornamentation.

Some special missions forces that are particularly successful are allowed to have their own emblems.

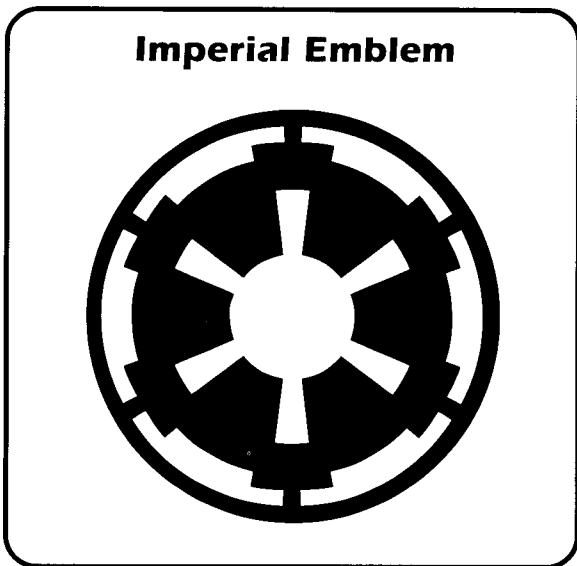

In other cases, forces far from the centralized control of the Army's organization will flout the regulations, and decorate their uniforms or vehicles. Some isolated or remote forces — in particular in the Outer Rim Territories — will camouflage their vehicles when necessary, or prominently display the Imperial emblem, whichever serves their purposes best.

Of course, if the upper echelons ever discovered such actions, the commanders and squads responsible would have to bear the brunt of the Army's disciplinary machine, but the chances of inspection out on the Rim are so slight that those units are willing to take the chance.

In the period after the defeat at Endor, more and more troops and vehicles were camouflaged and/or adorned, as the policy of fear broke down and manpower and materiel became more limited and needed to be conserved. Different Imperial factions sought to recreate the Empire in their own images, adding to the trend of placing symbols on the troops so that allegiances were immediately clear.

Lastly, pirate gangs and mercenary groups which were able to acquire Imperial military vehicles would probably paint them with their own colors and symbols, setting the stage for a variety of colorfully decorated vehicles to be involved in a battle. Tales are told of tiger-striped AT-ATs preying on unwary travelers visiting some remote worlds of the Outer Rims.

## Stormtroopers

If anything symbolizes the Empire, it is the Emperor's elite force of stormtroopers. The white-armored warriors of Imperial subjugation are the epitome of the Empire's anonymous and unstoppable military machine. They are totally loyal to the Emperor and his ideals, and cannot be swayed.

Stormtroopers are organized in a manner similar to the Imperial Army, but with varying quantities of troops, as their organization is distinct from that of the other armed forces.

The basic element of stormtrooper organization is the squad. Unlike in the army, however, a stormtrooper squad is the smallest independent operational unit. While organized into platoons, stormtrooper squads are frequently assigned independent objectives. A squad contains eight or 10 stormtroopers (depending upon mission profile), including a squad commander and possibly some specialists.

The platoon consists of four squads. It is the basic operational unit, although squads may be detached to achieve their own objectives.

A company is made up of four platoons, and three companies comprise a battalion.

Four battalions make up a stormtrooper brigade. The brigade is the equivalent of the Impe-

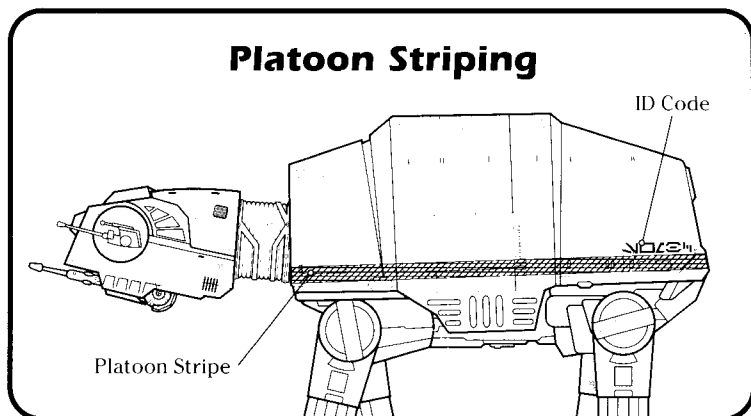

rial Army's regiment.

Stormtrooper brigades are organized into divisions. A division consists of four brigades.

A stormtrooper corps is comprised of four divisions.

Above the corps level the organization of stormtrooper forces is not well known (and the Empire prefers it that way). It is thought that corps commanders have a direct line of communication to the Emperor. Even if that is not the case, they are not far removed from the voice of their master. It is known that stormtrooper organization above the corps level is very fluid, allowing for astounding response times in support of the Emperor's objectives.

The amount of stormtroopers available at organizational levels above the corps is also unknown, but it is said that the total of core stormtrooper forces is greater than the number of all regular troops combined (at least during the height of the Empire).

Stormtroopers are independent of the Imperial Army and Navy chains of command — they have their own command structure and support facilities. There are times, however, when it may be necessary for an army or navy officer to command a stormtrooper squad or platoon. Regular officers can be given command of stormtrooper units if the situation warrants it and the stormtrooper company commander authorizes it.

## Stormtrooper Insignia

Briefly put, there are none. Stormtroopers are the ultimate incarnation of the Empire's policy of a faceless, impersonal military. All stormtroopers (of a particular type) wear identical armor. There are no rank or organizational symbols visible on the armor (with few exceptions, such as the elite Desert Sands forces, whose squad commanders wear a red shoulder guard instead of the standard black). Stormtroopers are not even referred to by name; they are identified by a number. Their armor is equipped with IFF circuitry for

identification and command purposes.

Years after the fall of the Empire, the situation changed somewhat. When Imperial factions were squabbling among themselves to set up a new Empire in their own image, many of the factions had some stormtrooper forces available to them. If they had a legitimate enough claim to Imperial power, they might convince various stormtrooper units to support them. And factions which could get their hands on stormtrooper armor might place regular army soldiers in it, making it appear that they had stormtrooper support.

So it was not unheard of to have stormtroopers battling stormtroopers. In those turbulent days, it was also not uncommon to see stormtroopers sporting some basic form of identification, so that their allegiances were clear. Those identifying emblems generally took the form of color-coded geometric symbols, which were emblazoned on the stormtroopers' helmets, shoulders and/or torso armor.

Even during the height of the Empire's power, a somewhat less likely occurrence was for stormtrooper armor to fall into the hands of mercenaries or pirates. While such an occurrence was rare, some armor did occasionally appear in the "invisible" market. Stormtrooper armor in the hands of these groups was frequently repainted to conform to the organization's colors or insignia (such as the scarlet-colored armor of the Red Guardians bounty hunter syndicate, or the chromed stormtrooper armor worn by the "Brite-Boyz" squad of the Bright Star mercenary company).

### Mercenary Units

In a galaxy at war with itself, it is not hard to find soldiers of fortune willing to fight for someone who can pay their fee. Even at peace, the galaxy is large enough that someone somewhere will require the services of mercenaries to achieve their ends.

#### Game Note: "Black-Market" Armor and Vehicles

Of course, if the Empire's commanders discovered their armor or vehicles in use by other groups, they would act quickly to end that unauthorized use. This could lead to some interesting battles, as white-clad stormtroopers face off with tiger-striped "stormtroopers" across the field of battle. Likewise, Imperial vehicles in standard greys could battle it out with their pirated counterparts, which are painted in the colors of the owning force.

The number of mercenary groups abroad in the reaches of space is enormous. They range from motley collections of social misfits to large, well-trained, effective units with their own support craft. The organization of the units varies almost as much as the units themselves do, although many follow the Imperial or Republic models in order to better integrate themselves into the command structure when they are hired.

The one thing these bands of warriors have in common is the use of insignia. A group which has an illustrious record wants to advertise itself, and wears its emblem proudly (or perhaps arrogantly). Another group may be vicious cutthroats, and revel in it. Their insignia serves as a warning to those they fight, and as a means of intimidation.

Mercenary groups tend to be used for one-shot missions, where the employer is short of manpower or just doesn't want to get its hands dirty. But there are also some mercs who have a long-term contract as a semi-regular part of an established army.

Whatever their status, if the mercs are organized, they will have an emblem or insignia. This symbol will be displayed prominently on their uniforms, equipment and vehicles.

### Using Mercenaries in Star Wars Miniatures Battles

Merc groups open the door to using many other types of soldiers, instead of just Rebels and Imperials. In addition, many mercenary organizations will include alien species, or consist entirely of aliens, broadening the range of miniatures that you can use in the game.

Mercenaries can be used by either the Alliance or the Empire. The Alliance, being critically short of manpower, will sometimes hire mercenaries to get a job accomplished. It will try to hire teams that are reputable, and steer clear of the more vicious groups.

The Empire occasionally hires mercenaries, also. It will do so when the regular forces are required elsewhere, or it is not "cost-effective" to use line troops. The Empire has no qualms about whom it hires, as long as they get the job done.

In many cases, a merc squad will be attached to regular army squads, in order to augment a force. At other times, one or more sides may consist entirely of mercenaries. There *are* some merc forces that are large enough to field an entire platoon or more, such as the First Sun Mobile Regiment, which frequently works for the Empire in the Outer Rim Territories.

Mercenaries are also a good way add color to the tabletop. You can create whatever type of emblems you wish for your mercenary forces, and plaster them all over the uniforms and/or vehicles.

## Representative Mercenary Emblems

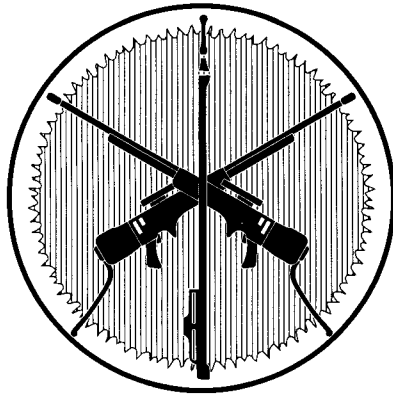

Emblem of the  
First Sun Mobile Regiment

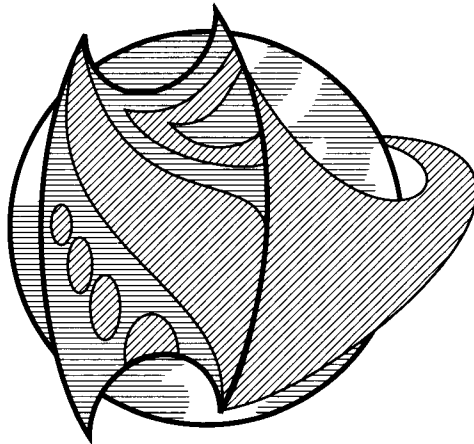

Emblem of the  
Solonar Rangers

Stephen Crane/Thomas O'Neill

Even the uniforms can enliven the game. Many mercenary organizations have their own unit colors, which are reflected in their uniforms as well as their emblems. The colors would also be applied to equipment and vehicles. For instance, the Solonar Rangers identify themselves by their blue and gold uniforms. Their support vehicles, speeder bikes and even heavy weapons are also painted with this combination of colors.

For more ideas on the makeup of mercenary units in the *Star Wars* galaxy, see pages 54–58 of *Galaxy Guide 9: Fragments From the Rim* and pages 62–74 of *Wanted by Cracken*.

## Pirate Gangs

Pirates are the scourge of the space lanes. They prey on the remote hyperspace routes of the galaxy where the Imerial Navy rarely patrols. Some are even so bold as to raid the more populated regions of space. As large as the Imperial Navy is, it cannot hope to cover every cubic meter of the Empire. As long as that remains the case, there will be pirates to deal with.

Pirate gangs managed to survive during the reign of the Empire, and many have found a new lease on life in the era of the New Republic. In fact, pirates and privateers that the Rebellion used to deal with now sometimes raid New Republic shipping. The Republic is still too busy trying to establish itself to be able to effectively deal with these threats to the trade routes.

When pirates are mentioned, the first image to come to the mind of most citizens of the Empire or the Republic is the “blazing claw.” This has been the symbol of pirates for thousands of

years. It has also become a cultural icon, glamorized as it has been in holovid after holovid.

Its origin is lost in time, but it unmistakably expresses the ravaging nature of those who prey on others to survive. Its form has varied over the centuries, but it retains its basic identity: a side-view image of a freestanding claw surrounded by flame. While many pirates still use the stereotypical form of the symbol, others employ variations of it, ranging from abstract versions to multiple images.

In addition, numerous pirate gangs have their own emblems which they are identified with. Many choose to continue the metaphor of the predator. For example, the Eyttyrmin Batiiv pirate armada bore the symbol of the skull of a hunting beast gnawing on the bones of its prey.

The recognition factor of their emblems is a two-fold advantage to the gangs. First, it establishes their identity. The more prominently displayed the emblem is, the more recognizable it becomes. For many pirates that serves a tactical purpose, as explained below. Many others, though, are flamboyant thrill-seekers, and enjoy their notoriety for its own sake — they actively cultivate their reputation. As the pirate Beyla Rus is fond of pointing out, “It is, after all, the only thing a pirate is left with after the loot has been spent.”

Secondly, their emblem announces them to their victims. If they have succeeded in developing a fearsome reputation, the mere appearance of their symbol may be enough to cause the defenders to lay down their arms.

For that reason, the more splashy and forceful the pirates’ emblem, the better.

## Pirate Symbols

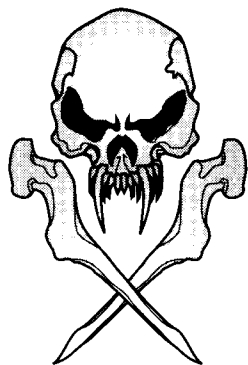

Symbol of the  
Eyttyrmin Batiiv  
Pirate Armada

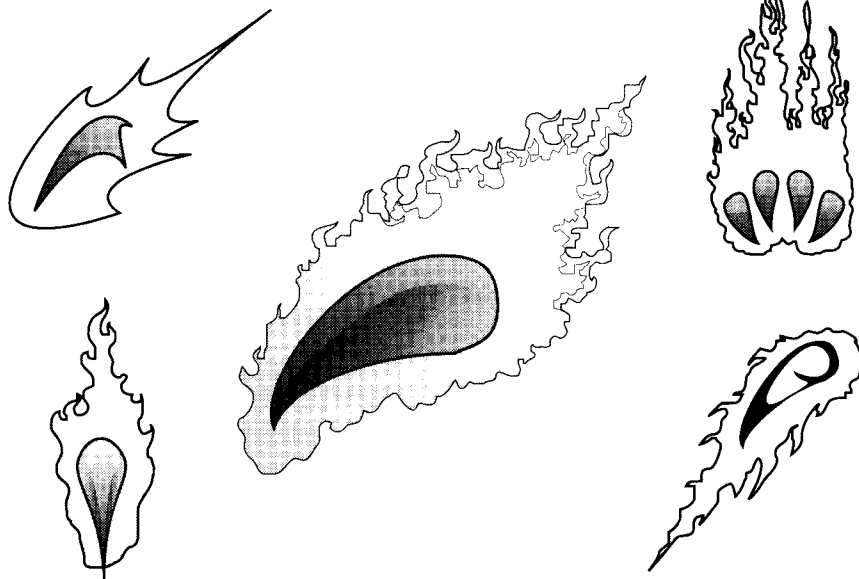

The Blazing Claw and Common Variations

Thomas O'Neill

### Using Pirates in Star Wars Miniatures Battles

Pirate gangs serve much the same purpose in *Star Wars Miniatures Battles* as mercenaries. They provide a change of pace from strict Rebel/Imperial battles and provide an element of color. If anything, they are even more colorful than mercenaries. Pirates tend to dress in very bright, gaudy fashions. Some gangs may actually wear a uniform, but the majority have no concern for their appearance, other than that they be readily noticeable.

And, as mentioned above, their emblem should be highly visible.

Naturally enough, pirates are generally found aboard ships. Therefore, you will most likely use them in boarding actions — either they will be boarding a ship in order to take her (the usual case), or will be defending their own ship against marines or other soldiers who are seeking to cleanse the space lanes.

Pirates *can* be found on the ground. At times they will raid planetary settlements. But the most likely scenario, and an interesting game to play, is that their base is being invaded by Republic or Imperial soldiers intending to eradicate them and/or capture their leaders. A particularly intriguing game can be had by pitting a force of mercenaries against the defending pirates.

For more detailed descriptions of some pirate gangs and their bases, see pages 59–65 of *Galaxy Guide 9: Fragments From the Rim*, pages 37–45 of

*Wanted by Cracken*, and the adventure *Riders of the Maelstrom*.

### Other Units

Imperial and Rebel forces, mercenaries, and pirates constitute the largest concentrations of fighting forces in the galaxy. However, there are various other forces to be encountered as well. Some of these forces rival major armies in their size and organization.

Two examples of other units are detailed below: Bothan clans and Santhe Security. Besides those, further units can also be found in the many products available for *Star Wars: The Roleplaying Game*. For example, the Corporate Sector is a vast area of space and offers numerous opportunities for conflict. The Corporate Sector Authority maintains its own security forces and spacefleet. The Security Police, or Espos, will most likely be involved in any scenarios set within the Corporate Sector.

Espos forces could be pitted against pirates or mercenaries, or even Rebel forces. It is not inconceivable that small conflicts could arise between Espos and Imperial or Republic troops in some of the border areas of the Corporate Sector.

Details on the Corporate Sector and the Espos can be found in the *Han Solo and the Corporate Sector Sourcebook*, as can the symbol of the Corporate Sector Authority (which would be displayed prominently on involved forces and property).

### Bothan Clans

With the emergence of the New Republic, the Bothans have risen to more prominence in the circles of power. They have done this more through background machinations than through overt actions, but the fact remains that they are now a force to be reckoned with, even after Borsk Fey'lya's fall from grace as a member of the New Republic Provisional Council. The Bothans were instrumental in the discovery and destruction of the second Death Star, and so have earned a permanent place in history.

However, Bothans should be dealt with cautiously. Throughout their history, they have learned that the best way to get things done is surreptitiously. Therefore, one never knows exactly where a Bothan stands on an issue or what his actions might be. They are shrewd in their dealings, playing their cards close to their vests. They also prefer not to take any overt actions, biding their time until the situation changes so that they can take advantage of it. And if the situation takes too long to change, they may just nudge it in the proper direction to facilitate the change.

An accurate, but less than gracious assessment of the Bothans is that they are opportunistic manipulators, and they do it very well. However, now that they have had a taste of power by being involved in the creation of the New Republic, some factions have turned to more direct action.

It is very rare to see Bothan forces in action; that is something they are still reluctant to do. But many Bothan factions now hire mercenaries to get things done. At times, the affiliation with the Bothans is secret. At other times a Bothan clan may want it known that they are involved.

In that case, the hired forces will bear the sigil of the clan or clans involved in the action. Many

#### Bothan Clan Sigils



**Sigil of the  
Clan Alya**



**Mark of Borsk Fey'lya**  
(Sigil of the clan Alya  
surmounting the  
signet of Borsk Fey)



**Sigil of the  
Clan Ilya**



**Mark of Tav Breil'lya**  
(Sigil of the clan Ilya  
surmounting the  
signet of Tav Breil)



**Sigil of the  
Clan Askar**



**Mark of Morst Tayl'skar**  
(Sigil of the clan Askar  
surmounting the  
signet of Morst Tayl)

Stephen Crane

#### Game Note: Bothan Forces

The use of Bothan forces is suggested as a way to add an element of alienness to your game of *Star Wars Miniatures Battles*, and to give you a background for staging battles set in the era of the New Republic.

As there are yet no Bothan figures available in the *Star Wars* miniatures line, it would be difficult to use Bothans — but that's all right, they don't want to get actively involved anyway. If you were so inclined, you might be able to find some fantasy figures that would work. But the primary forces employed by Bothans are mercenaries, allowing you to use just about any figures you own.

The important element is to add the Bothan

sigils and emblems to the figures. They can be added temporarily by attaching banners to some of the soldiers or vehicles, or they can be painted on — some mercenary groups have entered into long-term arrangements with Bothan clans.

Another aspect of using Bothan forces is in the scenery. Set up a suitably alien-looking building as the centerpiece of a battlefield and adorn it with clan sigils or faction emblems. The attacking forces will sport different Bothan emblems. Bothans don't plot and scheme against just other species; they've been doing it among themselves for thousands of years.



■ An advance team of Santhe Security troopers scouts the road ahead of a top-secret Imperial shipment, clearly showing the standard uniform and insignia of their organization.

times various clans work together, forming a political faction. These factions often change — sometimes frequently — as the different clans achieve or modify their objectives. Clan sigils are grouped together to form the emblem of the faction they belong to, and the observer familiar with Bothan symbology can tell who is involved in the latest machinations.

Clan sigils and faction emblems are usually emblazoned on the uniforms of the soldiers involved (although more often than not only the sigil of the clan who actually paid for the unit is worn by that particular unit). Faction emblems may be displayed on banners carried by soldiers into battle or mounted on vehicles. The emblems or clan sigils may also be displayed on the vehicles themselves. Buildings which are owned by a clan or faction would also be marked with the appropriate symbol.

### Clan Sigils

Bothan clan sigils are complex networks of interweaving lines which signify to other Bothans the clan's lineage and basic nature (or rather, what the clan wants others to think is its nature). Some believe that the sigil is actually a simplified written form of the rippling of their fur — a metalanguage which expresses their emotions and elaborates on their statements when they speak. They feel that the complex interweaving and colorations convey the same sort of information. Whether this is true or not, the Bothans aren't saying.

The basic structure of the clan sigil is circular. Within the circular shape are a number of broad lines, sometimes adjacent to one another, other times intertwining. Sometimes the lines form subordinate shapes within the overall circle of the sigil. The more complex and intertwining the pattern of lines is, the more venerable and prestigious is the lineage of the clan. See the "Bothan Clan Sigils" diagram.

In Bothan culture, the family unit is subordinate to the clan — the clan itself is considered to be an extended family. Therefore, most Bothans take the clan name as their family name, although it is entirely proper to maintain one's family name. In many such cases, the family name is combined with the clan name to form a compound name.

When used as a signature, the clan sigil is usually modified by the addition of the individual's name, or signet. The signet is another cluster of lines, customarily rectangular in structure, but occasionally following the outline of the sigil. It is generally placed below the sigil, but in more esteemed names, it may wrap up and halfway around the sigil. See the "Bothan Clan Sigils" diagram.

The signet is used when an individual is acting on his or her own. If he is acting on the clan's behalf, it is sufficient to use the sigil. When Borsk Fey'lya signed the Declaration of a New Republic he was signing for his clan (the Clan Alya) rather than just himself, as signified by the fact that he did not include his personal signet under the clan sigil.

The basic representation of a sigil is of the series of lines in a single color. This suffices for everyday use and even for many affairs of state. Many Bothans wear medallions carved with the intricate turnings of their clan sigils, for which straight linework is the best depiction.

Additional subtleties of lineage and attitude are conveyed by the full sigil, in which the lines vary from one color to another, fading from one to the next or changing abruptly. The intertwining of line is overlaid with a delicate interweaving of color to further elaborate on the meaning and history of the sigil. This is the form of the sigil which is reserved for the most important documents, or for display in the most significant structures, such as a clan stronghold.

A faction emblem is a collection of the sigils of the clans who are members of the faction. It can be as simple as an arrangement of sigils in a line, or may be a bit more ornate, with the sigils grouped in some sort of pattern. Faction emblems are rarely displayed with full-color sigils. Most factions do not last long enough to warrant the time involved in producing such an emblem.

**Santhe Security**

One of the largest private security forces in the Empire is Santhe Security. Formed by the wealthy Liann industrialist Kerred Santhe almost a century ago, its original mission was to provide security for Santhe's many corporate holdings. Through the years it has grown in size and repu-

tation to become a major factor in corporate security.

In addition to safeguarding the many Santhe Corporation holdings, Santhe Security leases out forces to other private concerns, and even to some planets. Planetary governments have at times procured the services of Santhe's security forces instead of trying to raise armies or police forces. Santhe Security can provide a ready-made organization of trained and dedicated professionals.

Of course, having security services in place in other corporations or on different worlds was also a good way for Kerred Santhe to learn various secrets, which could be used for extortion or information-brokering. For that reason, Santhe Security has always been held to high standards of outward behavior by the parent corporation. It is in Santhe Corp.'s best interests that the security division appear trustworthy and dependable.

Such artifices have become less of a standard operating procedure under the current owner, Kerred's granddaughter, the Lady Valles Santhe. But the organization's operations and reputation are still held to the highest standards.

Santhe Security is allowed to operate relatively freely and with minimal Imperial interference due to the close ties that Santhe has with the Empire. When Kerred Santhe purchased a controlling interest in Siemar Technologies a century ago, he acquired not only a major technology

**Relationship Among Some Major Holdings of Santhe Corp**

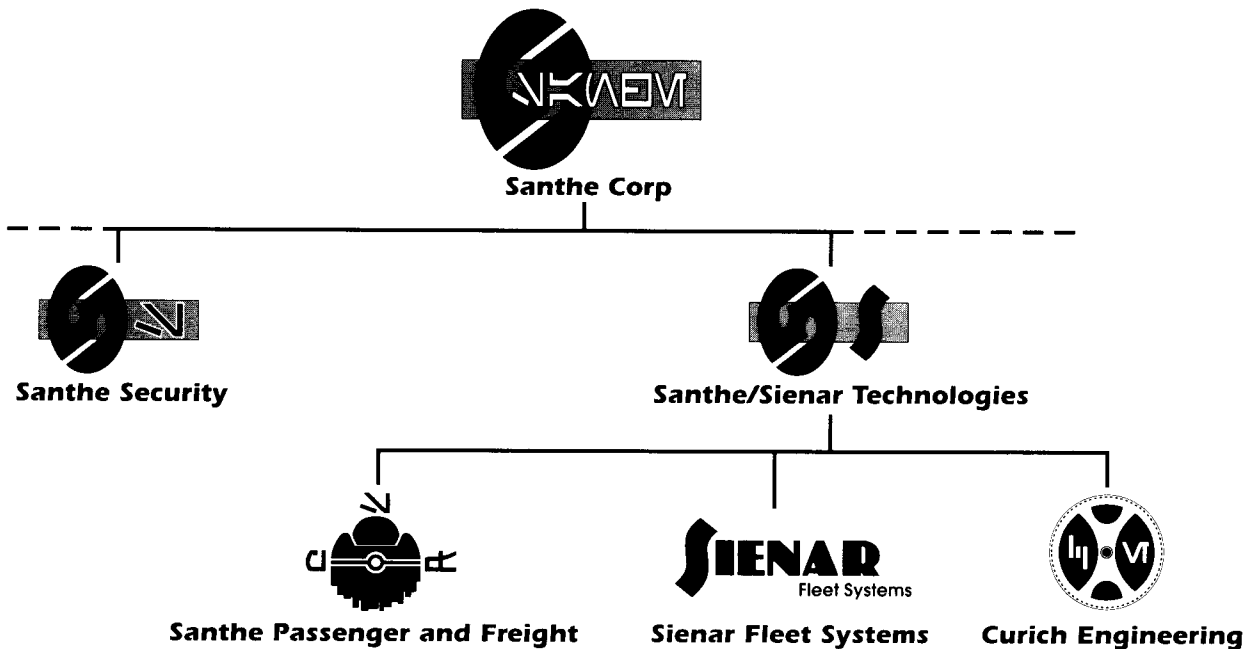

Stephen Crane



### Santhe Corp Logos

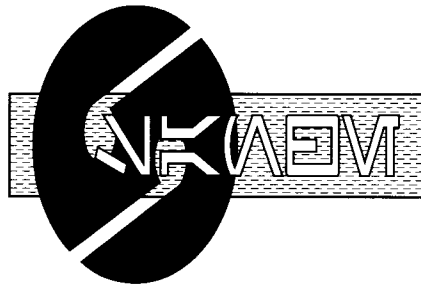

Santhe Corp [full version]

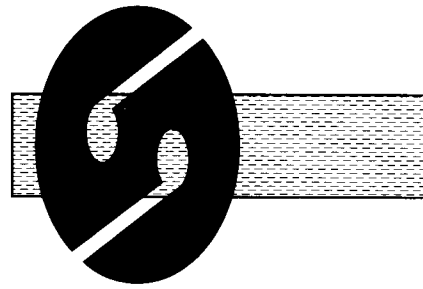

Santhe Corp [simplified version]

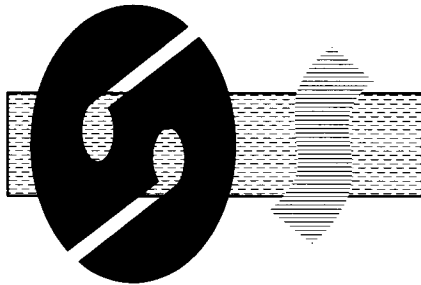

Santhe/Sienar Technologies

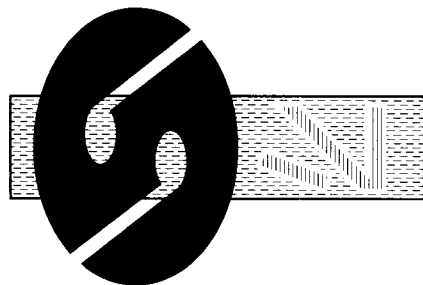

Santhe Security

Stephen Crane

corporation, but also its subsidiary company, Sienar Fleet Systems (SFS). SFS holds the Imperial contract for the manufacture of all of the Empire's TIE fighters, in addition to other defense contracts.

Santhe/Sienar Technologies (as it is now known) has also worked closely with the Empire on developing new cloaking technology for the Imperial Navy.

#### Using Santhe Security in Star Wars Miniatures Battles

Rebel forces can come into conflict with Santhe Security forces in a number of ways. The Rebels may be attacking a Santhe/Sienar Technologies storehouse or factory, in order to slow down the flow of materiel to Imperial forces. Or they may be raiding an Imperial convoy to get their hands on a cloaking device prototype. Santhe Security forces would most likely be assisting the Imperial troops assigned to the convoy.

In another instance, Santhe Security may be providing independent protection to some other target of the Rebel Alliance, unbeknownst to the Rebel forces sent to raid or secure the target.

Other interesting scenarios outside the scope of the Galactic Civil War might involve pirates, mercenaries or bounty hunters raiding a target

which is guarded by Santhe Security. Or, putting the grav-boot on the other foot, Santhe Security may have been hired to seek out and neutralize a pirate base.

#### Santhe Uniforms and Insignia

The basic uniform of Santhe Security forces is similar to the uniform of Imperial naval troopers. Again, because of Santhe Corp's close ties to the Empire, its forces are permitted to wear similar uniforms.

Santhe Security uniforms are black — like Imperial naval troopers uniforms — but have silver piping running down the outside of the shoulders, arms and legs. The boots are black, and the helmets are silver. The simplified Santhe corporate logo or the Santhe Security logo (depending on the squad's mission) is generally emblazoned on the back, so that Santhe soldiers are readily visible to one another. This also helps insure that they are not mistaken for Imperial naval troopers. See the diagram, "Santhe Corp Logos" for examples. When set against black, as on the security uniforms, the oval portion of the Santhe logo is displayed in silver for better visibility.

Note that the various Santhe logos can also be found displayed on vehicles and buildings, both military and commercial.

# Chapter Six

# Scenarios and Campaigns

This section provides a new stand-alone scenario and a four-part campaign allowing you to test the mettle of valiant Rebels against the iron will of the Imperial juggernaut. In addition, it provides guidelines for developing your own campaign, or interlinked series of battles.

Each of the scenarios that follow are presented in a standard format. The particulars of that format are:

**The Situation:** This explains the background leading up to the battle. It explains what each side is striving for and what they hope to achieve.

**The Forces:** The squads and heroes involved in the battle. In cases where specific squads are called for, the name, troop type, skills, weapons, commander, specialists and the point value of those squads are listed. Otherwise the points available to each side are listed, as well as any restrictions or special instructions as to what forces may or may not be used.

**The Battlefield:** A description of the terrain over which the battle will be fought. This is accompanied by a map detailing the table layout.

**The Set-up:** The initial disposition and/or entry conditions for forces on the tabletop at the opening of the battle, and instructions for reinforcements.

**Gamemaster Notes:** Covers special situations or conditions affecting the battle, and explains the victory conditions — how to determine the winner. This section may also contain suggestions for appropriate figures, or painting guides for some of the figures involved.

## Campaigns

A campaign is an exciting way to expand the enjoyment of your miniatures battles. It provides a continuing storyline that changes and develops as the various sides involved experience the ebb and flow of the tactical situation. What a force does early on may lead to an easy victory, or set

up obstacles that must be overcome in a later conflict.

Setting up a series of games is also a way for a group of players to all get a chance to play. The different games making up the campaign can be played by various players, with everyone getting together for the grand finale. Different players can also take turns as gamemaster, so everyone gets a chance to experience the game from several viewpoints.

A campaign, as presented here, is a series of tabletop battles that are related to and affect one another. It usually consists of from two to five separate battles, although more are possible if you are willing to do the planning and keep up with the paperwork involved. The games will generally lead up to a final larger and climactic game.

The campaign can be a straightforward series of games, one leading into the next, or it can be more complex, with different games leading into one common game, which could be the finale, or merely a major conflict along the way to the finale. Just how complex the campaign will be depends on how much work you are willing to put into it and how much imagination you can bring to bear on it.

## Planning a Campaign

The best way to begin planning your campaign is to determine how many figures and what scenery you already have prepared. The number of troops available will limit what you can do — you can't fight the Battle of Hoth with only three or four squads.

Of course, you can always plan to prepare new figures and terrain for your campaign, but you may be so inspired by your ideas that you really don't want to wait that long.

Once you have determined the available forces, start thinking about the best way to use them. Maybe you've got a couple of squads of Mon Calamari, so an aquatic campaign comes to mind; or perhaps an amphibious assault from a beach

or a riverbank. If you've got some spacetroopers you've been dying to use, you might plan to assault an orbiting Rebel headquarters base. Those squads of Rebel commandos and mercenaries you have could be the basis of a campaign to rid Alliance shipping lanes of a particularly vexing band of pirates. If you've also got a good collection of alien creatures, the pirate base may be located on a "death world" — a planet containing flora and fauna which are particularly nasty and deadly — making any battles there especially perilous.

After you've come up with the general idea, it's time to build on that framework. Begin to think about details. Why is the battle taking place. What are the different sides hoping to accomplish, and how should they go about it? Start breaking up the campaign into its component games. Each different part of the overall plan should be a separate game. Decide if you want to have a *linear campaign*, where the games lead one into the other until the final game, or a *convergent campaign*, in which a number of games converge upon one final goal.

As you are developing the campaign, keep in mind the game balance. The earlier games shouldn't be too deadly, especially to the invading side. If the invading forces are wiped out in the beginning, you'll never get to the later games. But that doesn't mean you should make it too easy, either. If the invader makes some tactical mistakes, he should pay for them, and will do so when he reaches the later battles with a seriously depleted force. This may seem difficult to accomplish when you're starting out, but once you've played a while you'll begin to get the feel for it. And if you determine after the games are done that the campaign favored one side, you can always adjust it and play it again, this time switching the sides you play.

Part of planning the individual games is setting the condition by which forces move from one game to the next. Generally any surviving forces will appear in the next game to continue the fight, but you may want to set special conditions that they must meet in order to do so. If some of the earlier games are planned to be particularly deadly, you will need to have provisions for reinforcements in a later game to keep the campaign going. Reinforcements can be linked to particular situations or victory conditions, such as securing a landing pad or a hangar bay in an earlier game.

Once the different games have been determined, think about the interesting details that will spice up each individual game. Are there certain mechanics required, such as how to download information from a computer, or how to breach the security of a blast door? Plan sur-

prises for one or both sides, such as a traitor or spy in their midst. What are the mechanics governing the traitor — how is he activated and how is he used once activated?

When the games and their details are finalized, it is time to establish the table layouts and the force mixes. Then write up the campaign background and the Orders of the Day for all the games. The Orders of the Day should set up the situation for each of the commanders; they are basically a player's brief. Don't let players know what their opponents' objectives are. Of course, they can be misled — intelligence services aren't always 100% accurate. And, of course, don't reveal surprises you have planned for the players.

Now the campaign is completed and the fun can begin.

### A Sample Campaign

As an example, let's assume that you've got those spacetrooper squads, as well as some stormtroopers, Rebels and a collection of bulkheads and blast doors. The basic framework of the campaign is an Imperial assault on an Alliance space station. Why are the Imperials attacking? Just to eliminate Rebels is one answer, but it's pretty basic and doesn't provide a "hook," something to fire up the imagination.

Maybe the base is not only a headquarters, but a communications relay station for a sector command — call it Liintaar Station. As such, its computers contain information on Rebel movements and plans throughout the sector, as well as information from adjoining sectors. If Imperial Intelligence can get their hands on those computers, or at least the information, they could seriously cripple the Rebel Alliance in this portion of the galaxy. As an added objective, perhaps the Imperials are also interested in the new Rebel coding computer which Imperial Intelligence has discovered just happens to be on board while *en route* to another Alliance HQ.

Now that the main objective has been determined, we need to figure out the preliminary objectives. This idea lends itself to a convergent campaign: the Imperials will invade the station from a number of points and rendezvous at the central computers.

The zero-g troopers are good for breaking in to ships and stations and doing damage, but may not be the best troops for carrying off computers or other objectives. Stormtroopers can effect the removal, but their transport ship can be fended off with the station's shields and defensive weapons. So the Imperial plan is to send in the spacetroopers to take out the shield, weapons, and/or power supply, allowing the stormtrooper assault transport to dock and disembark stormtroopers onto the station.

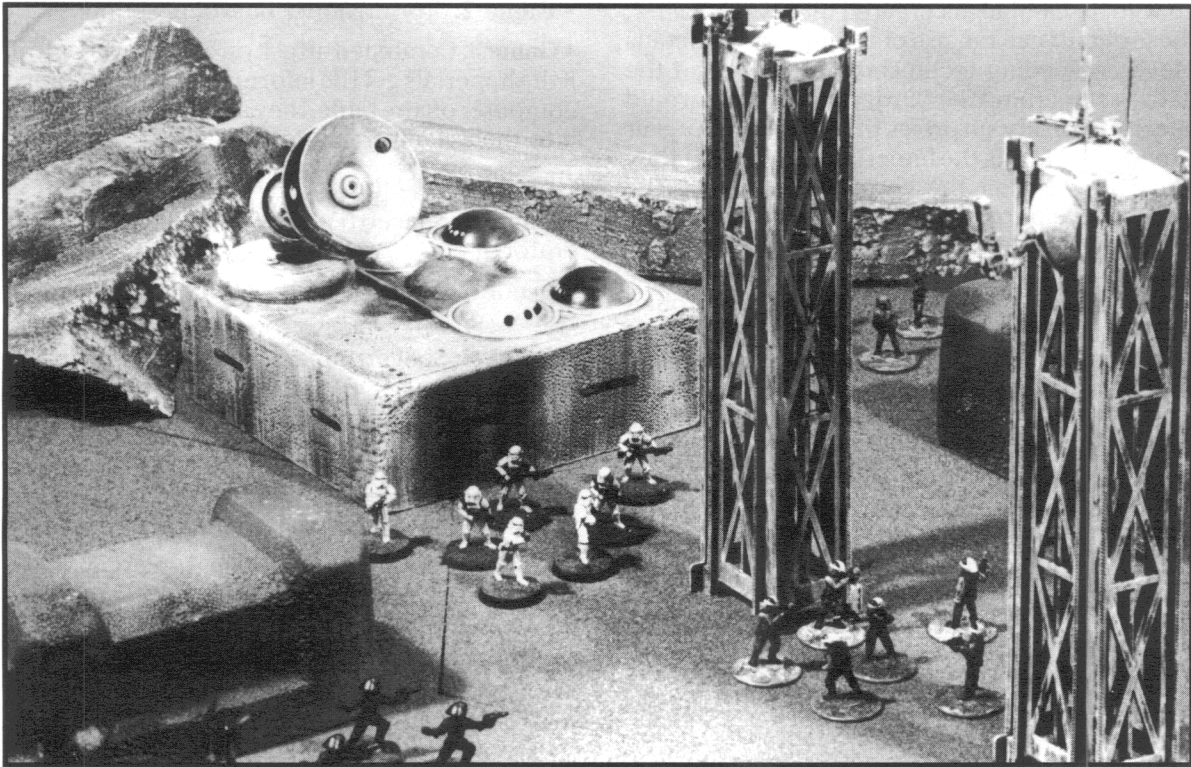

■ Rebel units face heavy resistance from all branches of the Imperial military during the final assault on Altratonne Station in “King of the Mountain.”

Now a number of battles become possible. The initial spacetrooper strikes are preliminary battles. The number of battles depends on how extensive you want the campaign to be. Maybe one assault on the power generators is all that’s required to take out the shields and weapons. Or maybe you want three separate spacetrooper assaults: one team tries to take out weapons control, another is to go after the shield generators, and the third team’s target is the power generators.

If enough of the defensive systems are taken out, the stormtroopers can come aboard. The boarding action can be fought as a battle. The Rebels are attempting to stave off the boarding party. Once all the teams are aboard — spacetroopers and stormtroopers — they all head to the central computer banks to take the information and computers, and provide support for one another. Their objective is gather up their targets and make it back to the assault shuttle to transport them back to Imperial Intelligence.

Now that the individual battles have been determined, it’s time to add the interesting details. How do the spacetroopers accomplish their preliminary missions? What is required to deactivate the shields, or the weapons, or the power generators? Can the assault boat dock if any of

the systems are still active? Perhaps how well the spacetroopers do determines how many turns it takes for the assault transport to break through the defenses to finally dock, and until it does, some of the spacetroopers must hold off the Rebels at the docking bay. If the transport cannot dock, then the spacetroopers must accomplish the mission on their own, and will be seriously hampered.

How do the Imperials succeed at the final mission? What is required to download the information in the computers, or to carry the computers away? Maybe the coding computer is not at the computer center, but in a cargo hold under heavy guard, necessitating another battle just when the Imperials thought they were almost done. Perhaps the Imperials need to have a portable computer to download the information into, and for that it will be necessary to bring along and protect some Imperial technicians. How do the Rebels flush the computer’s memory? They will want to save that as a last resort, so that the information is still available should they repel the Imperial invasion. If they must do it, how is it done and how long will it take?

As you can see, the interesting details are varied, and add a lot of spice to an otherwise ordinary “fight-them-until-they’re-gone” battle. This is where you can really let your imagination

go wild. In campaigns created by a gamemaster, these details can range from complicating details (such as needing technicians to download the data — something the “Orders of the Day” would specify) to nasty surprises that the players never expected (such as the Imperials finding that they must now assault the cargo hold, or that the Rebels have purged the computer’s memory).

Having defined the component battles, it is now time to determine the table layouts and the force requirements, then write up the background and the relevant Orders of the Day. The forces required can be spelled out or a set number of Squad Generation Points can be allotted for the player to assemble his own forces based on the Orders of the Day.

You now have a campaign that can yield a number of interesting games. This particular campaign is also very flexible, allowing for a varied number of games depending on how complex a campaign you want. Two examples are as follows.

#### **Assault on Liintaar — A Short Campaign**

- **Game 1:** Spacetroopers attack the power generator.

- **Game 2:** Stormtrooper boarding action.
- **Game 3:** Combined attack on computer central. If the Imperials get the information and/or coding computer off the table, they are assumed to make it to the assault transport.

#### **Assault on Liintaar — A Long Campaign**

- **Game 1:** Spacetroopers attack the power generator.
- **Game 2:** Spacetroopers attack weapons control.
- **Game 3:** Spacetroopers attack the shield generators.
- **Game 4:** Stormtrooper boarding action.
- **Game 5:** Combined attack on computer central. The Imperials discover that the coding computer is guarded in a secure cargo hold.
- **Game 6:** Combined assault on the cargo hold to retrieve the coding computer.
- **Game 7:** Rebel last stand at the docking bay. The Rebels are attempting to prevent the Imperials from boarding their assault transport with the coding computer and/or stolen information.

# Objective: Retrieval

## The Situation

A bureaucratic foul-up in the Alliance's Ministry of Supply has resulted in good news, bringing to light a previously misplaced bit of information. The location of an Alliance listening post that had to be evacuated in a hurry has been uncovered.

The passive listening post on Rentalles had to be abandoned when the Empire decided to place a supply depot and garrison on that world, unfortunately in close proximity to the listening post. In the rush of the evacuation, supplies and equipment had to be left behind, including the modulator unit of a hyperwave signal interceptor (HSI). These units are currently in short supply.

As chance would have it, the location of the abandoned supplies was misplaced in an inactive datafile and the material was never recovered. Now, however, the location of the supplies has been found and the objects must be recovered.

As there are a number of currently operational listening posts that require such equipment, and Alliance Intelligence reports that the Imperial base is no longer situated on Rentalles, the Rebels assemble a team to go in and retrieve the HSI modulator. In addition, they are to reconnoiter the cache for any other usable equipment or supplies. If there is anything promising to be found, the team is to leave it there for a follow-up mission better equipped to retrieve what's left. They are however, to bring the modulator back, as it is urgently required in other posts.

The Imperial base which forced the abandonment of Rentalles post did not, in fact, remain long. It was moved when a more suitable site was located. Only the final mopping up operation now remains.

The command bunker, or what remains of it, is still standing at the site. All computers and information should have been cleared from it by now. An Imperial platoon is dispatched to certify that all is clear, or if not, to retrieve any data remaining at the base. Three squads of the platoon are

placed on wide perimeter sweep, and the fourth squad is given the task of investigating the former command building.

Unknown to either side, a third party has recently taken up residence in that same portion of Rentalles.

And so the Rebel and Imperial teams approach their chance encounter.

## The Forces

The Rebel player has 1,400 SGPs to assemble two squads. One of the squads may contain a hero. No vehicles are available for this mission.

The Imperial player must also assemble two squads, using a total of 1,200 SGPs. The squads may contain up to 10 men. The reinforcement squad also contains a lieutenant, who may be a hero. No vehicles are available.

## The Battlefield

The encounter takes place in clearing near the base of some rocky foothills. The Rentallian forest is quickly retaking much of the ground cleared for the base. All of the woods on the tabletop are light woods. The brush is rough terrain.

The supply cache that the Rebels are seeking is in the cave in the hillside on the southeast corner of the table. The entrance to the cave is located 2" back from the edge of the woods. The cave is low and broad (three figures abreast can walk the length of the cave) and goes back about 6" before seemingly ending.

There is a concealed passageway in the back of the cave which leads to the Rebel supply cache (the passage continues on to the base of the listening post, which was located higher in the hills). The Imperials discovered the cave when they were preparing the base, but never discovered the secret passage. They did not utilize the cave and it was ignored.

The hills are all easy. The building has been partially dismantled and provides medium cover to anyone sheltering themselves along the walls.

## "Objective Retrieval" Set-up Map

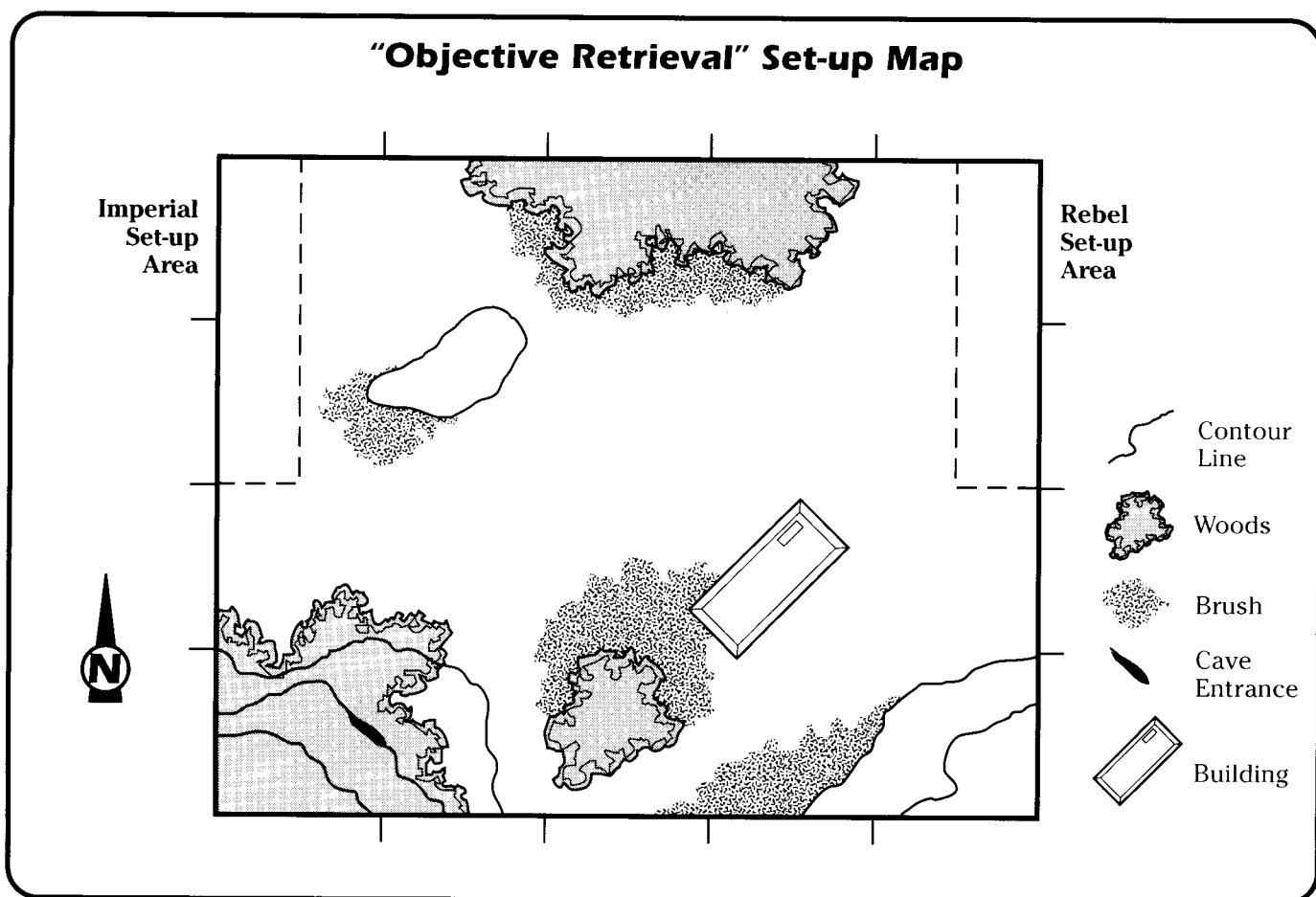

### The Set-Up

The Rebels set up along the top half of the east edge of the table, up to 6" in from the edge.

The Imperials set up along the top half of the west edge of the table, up to 6" in from the edge. The Imperial reinforcement squad may enter the table anywhere along the north edge of the table from the northwest corner up to the woods.

The initial deployment of the first Imperial squad and the Rebel squads should be indicated on a sketch map of the battlefield or on a copy of the set-up map which has been suitably modified. The Rebel set-up map should not show the Imperial set-up area. The Imperial set-up map should not show the Rebel set-up area, nor should undue attention be called to the cave entrance (eliminate the entry in the map key showing the entrance).

Each side should be shown what their objective is prior to plotting their deployment.

### Gamemaster Notes

This scenario differs from the average type of scenario in that the two sides do not set out initially to attack each other. They are sent out on

individual retrieval missions, little knowing that their objectives are within sight of each other. The situation develops from there.

This scenario works best with a gamemaster, and also if the players are not aware of the situation before placing their troops on the field.

Each side should be provided with their Orders of the Day, and must then assemble a force they feel necessary to the task. This can be done before the actual play session, so that the game can begin promptly. The gamemaster should provide a sketch map (or a suitably doctored photocopy of the set-up map) to each player and have them indicate their initial deployment on the map. After both sides have done so, the game can begin.

### Reinforcements

When the Imperial squad arrives on the battlefield, they notice the Rebels and a call for support immediately goes out. Unfortunately for the Imperials, only one squad is close enough to respond soon enough to have any effect.

On Turn Three the Imperial player may bring on his reinforcement squad anywhere along the north table edge between the woods and the northwest corner. The lieutenant comes on with this squad.

The Rebels have no reinforcements to draw upon.

### A Nasty Surprise

What both sides of the impending conflict do not know is that a pack of Rentallian cairnhounds has taken up residence in the cave that leads to the supply cache. Cairnhounds live and hunt in packs, and make their dens in the caves and hillocks that dot the landscape of Rentalles. Though they hunt in packs, they attack individually when confronted with many opponents.

Five cairnhounds are currently holed up in the cave. They will exit the cave if a commotion disturbs them, looking for the source of the disturbance. If any fire combat or close assault combat takes place within 12" of the cave entrance, the cairnhounds will come running out. Fire combat is assumed to take place in that range if a soldier fires his weapon or is hit by a weapon within 12" of the cave.

Three cairnhounds leave the cave the Movement Phase after the combat disturbs them. The remaining two come out in the following Movement Phase.

Upon exiting the cave, the cairnhounds will attack, or run towards with the intention of attacking, the nearest soldiers in their line of sight. If more than one soldier is equally distant from a cairnhound, randomly determine which soldier the hound will attack. If a cairnhound incapacitates the soldier it is attacking, it will then move to attack the soldier nearest to it at that point.

A cairnhound which is wounded will turn and attempt to flee off the southeast corner of the table. It runs at half its Movement Rate. A fleeing cairnhound will attack a soldier directly in its path, but will otherwise ignore any soldiers it passes.

Cairnhounds inside the cave will attack anyone who enters the cave.

Cairnhounds are heavily muscled quadrupeds which stand from 0.8 to 1 meter high at the shoulder. Their statistics are as follows:

#### ■ Rentallian Cairnhound

**DEX:** 3.

**STR:** 3.

*brawling* 4.

**PER:** 2.

**Move:** 14.

**Movement Rate:** 17.

**Orneriness Code:** —

**Attack Forms:** bite (4), claw (3).

**SGPs:** 60.

### Rebel Objective

The Rebels must enter the cave and spend three turns to locate and pack the components of the HSI modulator unit. A minimum of two sol-

diers are required to carry the components. If two soldiers are carrying the components, the equipment has a total encumbrance rating of 50.

If a soldier carrying components is incapacitated, another soldier may pick up the components by remaining in base-to-base contact with the stricken figure while expending half his Movement Rate. He has then picked up the components and may move if he has any remaining Movement Rate.

No equipment can be gathered until the cave is cleared of cairnhounds. If such a combat is necessary, set up a small version of the cave on a side table. The cave is 3.5" wide and 6" deep. The cairnhounds start at the back end of the cave, along the rear wall.

If there are no hounds in the cave, the action does not have to be played out. It will take three Movement Phases to pass through the cave and locate the equipment and pack it up. On the fourth Movement Phase after the soldiers entered the cave, they may begin their move at the mouth of the cave.

If any Imperials follow them into the cave, the encounter will vary depending on when they enter. The first turn the Rebels traverse the cave and enter the secret passage. The next turn they are out of sight of Imperials in the cave. The third turn the Rebels finish packing and head through the cave, ready to leave it in the fourth turn.

If the Imperials' move does not allow them to overtake the Rebels in the first turn, the Imperi-



■ Elements of Red Squad, Fifth Platoon, Besh Company inadvertently run into an Imperial presence while on a reconnoiter-and-retrieve mission.



als cannot find them, otherwise they come on the Rebels from behind in the cave. If the Imperials enter in the second turn, the Rebels are nowhere to be seen. If the Imperials enter in the third turn, they meet the Rebels coming out.



### Orders of the Day Alliance Commander Hov Windell

Prepare two squads for a reconnaissance and recovery mission. You must retrieve the modulator unit of a hyperwave signal interceptor abandoned in an emergency evacuation of our listening post on Rentalles.

You have 1,400 points to build your forces, which may include one hero at no more than 200 points. You may choose any weapons, but no vehicles. Set up your squads within 6" of the north half of the east table edge. Mark your initial deployment on the map supplied. There will be no reinforcements available.

**Victory:** You must get three men (or at least, two) into the cave into the hillside for three turns to recover and pack the HSI modulator. Then get those soldiers off the east table edge.



### Orders of the Day Imperial Commander 451.322/S8

**Commander:** You are hereby ordered to reconnoiter the deserted command bunker on Rentalles in order to determine that no sensitive information was left behind in the withdrawal. Proceed to the building and search it thoroughly, then link up with your platoon for extraction from the planetary surface.

This is a search and confirm mission. High-priority combat missions for stormtrooper units preclude their use.

End Transmission.

You have 1,200 points to spend on your forces. Prepare two 10-man squads. One of the squads will be held in reserve. That squad should also contain an eleventh man — the platoon's lieutenant. He is a hero on whom you may spend no more than 200 points. You may carry any weapons, but may not use stormtroopers or vehicles. You set up one squad within 6" of the north half of the west table edge.

Mark your initial deployment on the map supplied. Your reinforcement squad comes in along the north edge between the woods and the west edge.

**Victory:** Thoroughly search the abandoned building and get at least two of those men off the board along any of your entry edges.

## Imperial Objective

The Imperials need to reach the building and search it one last time. It will take four soldiers three turns to search the building thoroughly enough to determine that all is clear (searching takes place in the Movement Phase). For each additional soldier involved in the search, reduce the number of turns required by one (so six soldiers can search the entire building in just one turn).

Soldiers may do nothing else in that turn; they may not fire, engage in close assault combat, or move. The entire Movement Phase is taken up by the search, so the soldiers must begin the Movement Phase in the building in order to take part in the search.

## Victory Conditions

To succeed in their mission, the Rebels must get all the components of the HSI modulator off the east table edge.

The Imperials succeed at their mission if they can get two of the soldiers who searched the building off the table along the edge in either the set-up area or the north edge between the woods and the set-up area.

It is a victory for the Rebels if they can complete their victory conditions while preventing the Imperials from completing theirs. Likewise, it is a victory for the Imperials if they can complete their victory conditions while preventing the Rebels from completing theirs.

The game is a draw if both sides achieve their victory conditions. Both sides lose if neither is able to complete their mission.

## Variations

This scenario can be modified to suit a campaign, or to be replayed with different forces. Simply vary the forces involved. You can have Rebels and scavengers, Imperials and pirates, or even scavengers and pirates coming upon one another. You can even change the objectives in order to have a game with a different feel.

In addition, another player can be accommodated, or the two players merely confounded, by having the third party be aliens instead of just creatures. Perhaps the action is taking place on what is now considered sacred ground — the aliens will arrive to drive away or exterminate the soulless heathens who are desecrating it.

# ■ A Time For Silence

"A Time For Silence" is a campaign for *Star Wars Miniatures Battles* in four battles. Each battle is a separate game, but the initial three games have a direct effect on the last one.

"A Time For Silence" requires a gamemaster and at least two players. This campaign may be played by more than two players. In that case, different players may command the forces involved in each different game, or the forces of a side may be split up among different commanders in each game. The forces involved may be divided in any manner agreeable to both the players and gamemaster.

The gamemaster's job is to organize the games and keep track of the forces as they fight through each battle and move on to the next. She must also prepare the battlefield and review the force mixes for each battle.

Players who intend to play in this campaign should read no further. To read further will reveal information which would reduce everyone's enjoyment of the games. The gamemaster may read on, however, as she must be familiar with all aspects of the campaign.

To run "A Time For Silence," the gamemaster should read through the entire campaign, and become familiar with the flow of the games. The gamemaster should also prepare the terrain required for each game.

The squads involved should be determined as set forth in the descriptions of the individual games. Once the players have decided on their forces prior to each individual game, the figures can be prepared. They can be supplied by the gamemaster or provided by each player involved.

It should be noted that it is not necessary to have every single soldier used in this campaign. The same figures can be used over in different games to represent different forces. How many soldiers make it to the last battle will determine how many figures are required for the final game.

Once the forces are determined for each game, the gamemaster should review the Squad Record Sheets in order to become familiar with those

forces. He should also reread the particular scenario being played, in order to familiarize himself with its provisions and victory conditions once more. The game is then ready to begin.

## The Situation

The Empire is constructing a secret base on the remote, unpopulated world of Altratonne. It is a new HoloNet relay station, the completion of which will extend the capabilities of the Empire's communications network into reaches of the Outer Rim Territories that are now somewhat isolated. This will serve to increase the response time of the Imperial Navy when operating in this area of the Territories, and will make Imperial transmissions much harder to track and intercept.

The base has not remained a secret, however. Alliance Intelligence has learned of it, and has also learned that the funding for this project was difficult to come by, as the Emperor had previously set a priority on expanding the quantity of military forces available to him. He did this by curtailing development of other projects, including expansion of the HoloNet — he is willing to maintain the network as it stands, since the Empire controls its use.

Only through promises of vastly increased effectiveness of the existing forces in these sectors by the Moffs and admirals involved were they able to sway the Emperor, and then only barely.

Should this station be rendered inoperable, not only would the Empire's reach be prevented from extending too far into some of the hiding places of the Alliance, but quite a few Moffs and admirals would lose influence with the Emperor, if not their positions of power. Such a shake-up in the Imperial power structure would greatly help the cause of the Alliance to Restore the Republic.

In preparation for the construction of the relay station, the Empire has sent a garrison of Imperial troops down to the surface to clear the



### Mission Brief: Alliance Commander Lav Bilsek

**Commander:** You are to prepare a task force to assault the Imperial relay station on Altratonne, currently under construction. The attack is planned as a three-pronged assault on the mountaintop station.

Assemble your task force and divide it into three strike teams (aurek, besh and cresh), one for each of the three approaches to the station — see the relevant Orders of the Day for the mission profiles. Once selected and assembled, your forces will be briefed and placed on standby until a window of opportunity opens for this mission.

You have 5,000 points to spend on your forces. You may have up to three heroes. Your forces can include up to four specialized weapons. You may also include one landspeeder or two speeder bikes, but a maximum of 650 points may be spent on vehicles.

When your forces are assembled, report to the staging area and wait for your deployment orders.

**Victory:** You must destroy the communications array and retrieve the HoloNet coding computer kept in the main relay station building.

area and maintain discipline. Work has already begun on various parts of the station, and more supplies and workers are on the way.

Basic communications and sensor facilities have been installed, and the base's commander is awaiting delivery of the holo-transmission communications gear. The HoloNet transmission frequencies and protocol codes have already been downloaded into a computer in the main communications facility of the station.

The Alliance was preparing an assault on the station, and was hoping to be able to launch the attack before the base's garrison was augmented, when suddenly fortune shined on them. Solar-flare activity from Altratonne Prime, the system's sun, has set up an ionic disturbance in Altratonne's atmosphere, blocking the base's sensors and communications arrays. The disturbance is predicted to last long enough to mask the insertion of the Rebel task force and prevent any call for help from reaching the nearest Imperial base.

The time for action is now!

### Altratonne Station

The relay station is being constructed in a mountain range in the north temperate zone of Altratonne. This site is less noticeable than if the station were an orbital platform, yet it gives the station enough altitude to pick up and relay transmissions.

The relay station itself is located the highest

up on the mountain. Below it, in sheltered locations along the approaches to the base, are the support elements: the power generator and a landing bay.

The Rebel plan is to come up the mountain from just below the station, destroy the power generator so as to cripple the station's defenses, and seize the landing bay to prevent any escape and to allow a Rebel transport to bring any additional troops and/or weapons required.

### Rebel Objectives

The Rebel forces have one basic job: destroy the station's facilities and render it unable to communicate. Their secondary objective is to retrieve the frequencies and protocols already residing in the base's computer.

With this information the Alliance will be able to tap into HoloNet transmissions until the loss of the codes is discovered. That discovery will require a recoding of the entire system in this area of the Empire, setting back Imperial military readiness for some time to come.

The Rebel commander should be given his overall Mission Brief to read, as well as the Orders of the Day for each of the battles. He must then plan the force he will bring to Altratonne, and divide that force up into three strike teams to deal with the three preliminary objectives.

When the forces are allocated, a listing of the strike teams should be presented to the game-master for review and for the gamemaster's information.

### Imperial Objectives

The Imperial forces are posted here as sentries and to enforce discipline. They do not expect an attack, as the existence of the station is secret. In addition, the sensor array is powerful enough (under ordinary circumstances) to give the commander ample warning to request a Star Destroyer be deployed for support.

When the Rebels show up, the troops will have to quickly assume defensive postures and hold out as best they can.

The Imperial commander's initial planning is much the same as for the Rebel. The commander should be given a copy of the Imperial Mission Brief and the Orders of the Day for each of his missions and be allowed to make up his forces within their constraints. He then allocates his forces to their respective posts and waits to see what happens.

### The Campaign

The campaign "A Time For Silence" consists of four games. The first three games are preliminary battles which culminate in the final battle,

the assault on the relay station itself. Any troops surviving the first three battles rendezvous at the station, as planned, for the final assault.

The first three games are considered to take place simultaneously; the action in one game does not affect the action in another.

The games of the campaign are as follows:

### Game 1: Pulling the Plug

A Rebel strike team is assigned to take out the power generator which supplies the station. How well the force does here determines what kind of defense the station can put up in the final game.

### Game 2: To Seize the Bay

Another Rebel strike team is sent to secure the landing bay which has been built into a clearing in the side of the mountain. If the Rebels can secure this landing area, a small transport will attempt a descent through the ionic disturbance to resupply the mission.

### Game 3: Through the Back Door

The third Rebel strike team will attempt to come up another approach located around the back of the station. The going is a little more arduous, but the resistance should be minimal. Unfortunately, the Imperials have just begun to develop this approach.

### Game 4: King of the Mountain

The three strike teams converge on the relay station itself. They must destroy the communications array and retrieve the coding computer. If the Rebels have secured the landing bay, they may retreat to the bay and escape with the computer to complete their mission. Otherwise, they must eliminate all Imperial opposition so that they may be picked up by Rebel transports.



### Mission Brief: Imperial Commander 792.001/Z6

**Commander:** You are hereby placed in charge of the HoloNet relay station currently under construction on Altratonne. This is a secret base and no opposition is expected. You will maintain a light garrison for local surveillance, to protect the HoloNet codes and protocols in your computers and to enforce discipline in the workers.

The station is located high on a mountain, with three approaches. Your base's infrastructure is situated along two of these approaches; the third approach is difficult and unsuitable for your support structures.

You will assemble a force to garrison this station. Assign three patrol groups from your forces to maintain surveillance on the elements of your base (power generator, landing bay and rear approach), in accordance with the appropriate Orders of the Day. In addition, you must maintain a guard contingent at the base proper at all times.

You have 3,500 points to spend on your forces. You may have up to two heroes, three specialized weapons, and a speeder bike (maximum of 400 points for the vehicle). The rest is for your squads. No more than half your squads may be stormtroopers.

### Time Limits

Each of the preliminary scenarios has a time limit (in turns). The Rebel strike teams must complete their missions in time in order to rendezvous at the relay station for the final assault.

The gamemaster should let the Rebel player know that time is of the essence, but keep the actual time limit a secret. Strike teams which take too long to complete their missions will find themselves arriving late at the relay station.

# 1. Pulling the Plug

The Rebels have a simple task before them — shut down the garrison's power generator. Success in this mission will help pave the way to success in the final battle. The Imperials need to prevent the loss of the generator.

## The Situation

The power generator for Altratonne Station is located a bit downslope of the base itself, nestled in a niche in the mountainside. The Imperial garrison maintains a watch on the generator, not so much because they think it is threatened, but because it gives them something to do.

The Rebel strike team has been deposited on the mountainside by a low-altitude transport and

has worked their way up the trail to just below the generator. They are ready to advance on it and attempt to destroy it.

## The Forces

The Rebel forces involved are those allocated by the Rebel commander to Strike Team Aurek when the forces were set up.

The Imperial forces are those troops assigned to guard the generator by the Imperial commander when the garrison was set up.

## The Battlefield

The action takes place along a trail carved deeply into the mountainside. The trail is flanked

## "Pulling the Plug" Set-up Map

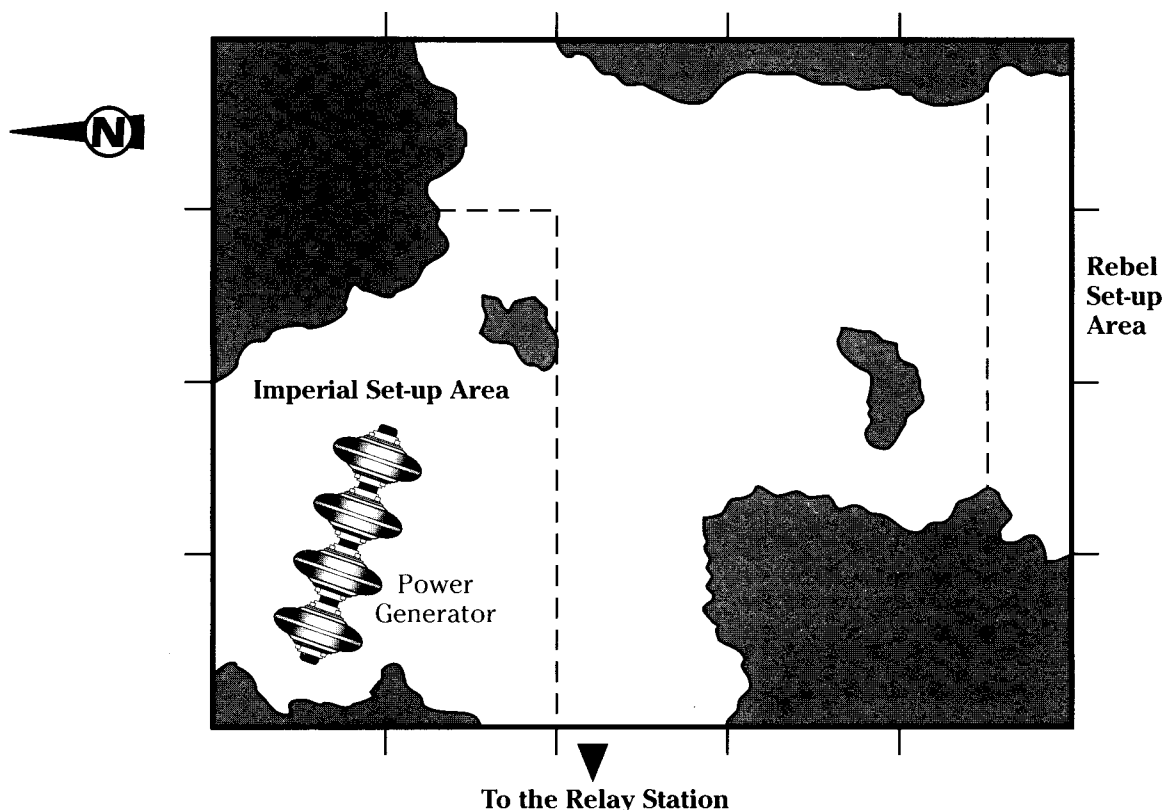

Thomas O'Neill

by large rock walls which are impassable. Additional rock outcroppings also dot the trail, hindering movement.

The power generator is set up in a niche in the wall of the trail, flanked by some outcroppings.

The walls of the trail and all of the outcroppings are impassable. The floor of the trail is relatively free of debris, resulting in clear terrain.

### The Set-up

The Imperials set up first, anywhere within 24" of the north edge of the table and within 36" of the west edge.

The Rebels are then set up anywhere across the trail within 6" of the south edge of the table.

The Rebels have initiative for the first turn of the game. Thereafter determine initiative normally.

### Gamemaster Notes

The Rebels need to destroy the power generator. They may accomplish this by destroying three of the four power coils which make up the generator. Each of the coils has a *Strength* of 8 and 20 *Body Points* (determine damage as for vehicles).

Eliminating one of the coils has no effect. If two of the coils are destroyed, then the power supplied to the station is cut in half. If three of the power coils are destroyed, the generator can no longer supply power to the base.

The Rebels have 10 turns in which to accomplish this objective. Each turn beyond that delays their entry into the final battle.

After destroying the generator, the Rebels must exit the west side of the table, which will lead them up the trail to the station. The Rebels may choose just to bypass the power generator and exit troops off the table in the direction of the relay station. This will make the final battle more difficult for them, however.

Imperial troops may retreat off the south edge of the table. Those that do will be available for the final battle.

The Rebels' rally point is the westernmost edge of their set-up area. The rally point for the Imperials is the northwest corner of the table.

### Victory Conditions

The Rebels must destroy the power generator and exit the table in the direction of the relay station.

**Orders of the Day**  
**Imperial Commander**  
792.664/Z6

**Commander:** You are hereby ordered to detail a patrol to maintain watch over the power generator for the station. Until new ground has been cleared and the structures and additional generators delivered to the site, this remains your only source of power.

No threat is expected. However, your troops should remain in close proximity to the generator while they stand watch.

The Imperials must prevent this from happening.

**Bookkeeping**

When this battle is over, the gamemaster should take note of certain results, as they will be used in a later game.

First, the gamemaster should note during which turn the Rebels actually left the table. This will determine when they arrive at the final battle. The gamemaster also needs to know which of the Rebel soldiers are wounded.

Next, the gamemaster should keep track of any Imperial squads still on the board at the end of the game. The easiest way may be to have the

**Orders of the Day**  
**Alliance Commander,**  
**Strike Team Aurek**

**Commander:** Your team has been assigned to destroy the generator supplying power to the relay station and its defenses. This mission must be accomplished with the utmost dispatch, as your team is also part of the primary assault on the station itself.

The generator is a standard power generator, with multiple redundancy circuits in operation — you must destroy as many of the power coils as possible. It is suggested that you equip your team with demolitions and heavy weapons to facilitate this task.

After the power generator has been dealt with, you are to proceed up the trail to rendezvous with Strike Teams Besh and Cresh for the assault on the relay station.

If necessary, you may break off the attack on the generator in order to proceed up the trail for the rendezvous.

player turn in his Squad Record Sheets, then make notes on them.

The gamemaster will need to know how many soldiers are left in each squad, what the squad's morale level is and which of the soldiers are wounded, as well as whether the squad's commander has been incapacitated. This has a bearing on the soldiers' ability to return to the battle.

## 2. To Seize the Bay

### The Situation

The second strike team, having also been inserted via a low-altitude transport, makes their way up the mountain to assault the landing bay constructed in the mountain.

The bay must be taken so that no Imperial reinforcements may be landed and to provide the Rebels with a resupply point for the mission.

The Rebels make their way up the trail and come upon the Imperial garrison guarding the landing pad.

### The Forces

The Rebel forces involved are Strike Team Besh, assigned to the launch bay mission by the Rebel commander when the forces were set up.

The Imperial forces are those troops assigned to guard the launch pad by the Imperial commander when the garrison was set up.

### The Battlefield

The battle takes place on the same type of rocky trail as the battle for the generator. Most of the trail is flanked by impassable rock walls. An occasional rock outcropping can be found scattered around. Once again, the terrain is clear.

On the side of the landing pad opposite the trail is the control tower. This small building with the attached tower can hold five soldiers, any three of whom can fire out the windows on the east wall. The door is also in the east wall, and has a *Strength* of 4. The walls of the building have a *Strength* of 6. There are also three windows in the west wall. There is no access to the roof of the building or to the tower.

The landing pad itself is clear terrain.

### The Set-up

The Imperials set up first, anywhere within 24" of the west edge of the table. The Rebels set up next, up to 6" in from the southernmost 24" of the east edge and/or 6" in from the first 12" of the

## "To Seize the Bay" Set-up Map

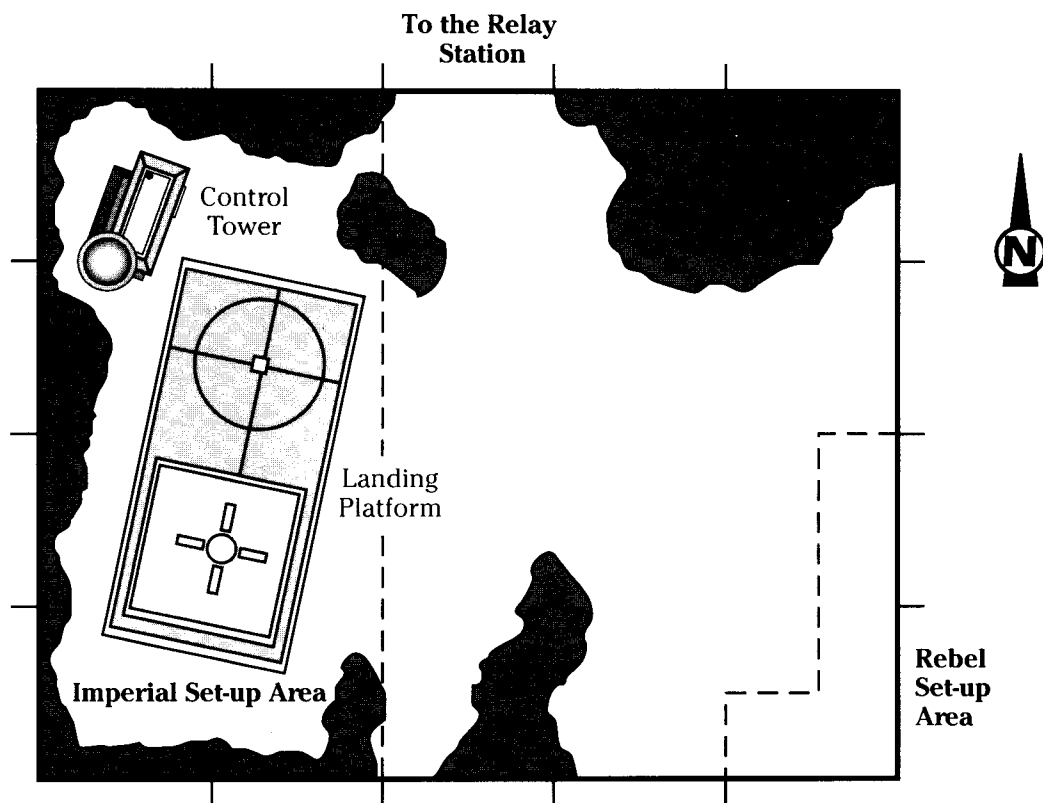

Thomas O'Neill

south table edge.

The Rebels have initiative for the first turn of the game. Thereafter, determine initiative normally.

### Gamemaster Notes

The primary Rebel objective is to exit the table by following the trail off the north edge. The Rebels have 10 turns in which to accomplish this objective. Each turn beyond that delays their entry into the final battle. Before they do this, though, they need to take control of the landing pad.

If the Rebels control the landing pad, a supply transport will be able to land, bringing fresh troops and equipment. If the Rebels fail to gain control of the pad, then an Imperial assault shuttle will bring reinforcements to the mountain.

The Rebels take control the landing pad by forcing all Imperial troops out of their original set-up area and by occupying the control tower with at least two soldiers. If the Rebels can then eliminate the Imperial troops, or if the Imperials retreat off the table, the Rebels can summon the transport to land.

If the Rebels fail to take the landing pad and

opt to exit the table, then an Imperial assault shuttle is able to return to the mountain, bringing a long-range reconnaissance team back in time to join the final battle.

Imperial troops may retreat off the north edge of the table. Those that do will be available for the final battle.

The Rebels' rally point is the southeast corner of the tabletop. The rally point for the Imperials is the control tower. If that is occupied by Rebels, or otherwise blocked by Rebels, the rally point is north edge of the table where the trail leads off the table.

### Rebel Resupply

If the Rebels manage to take control of the landing pad and eliminate Imperial opposition, then a Rebel transport makes it in through the ionic disturbance in order to deliver new supplies. The Rebel player may spend 200 points on new equipment and/or troops.

Troops are deployed along the edge of the landing pad. Equipment may be allocated to any troops still remaining after the battle.

In addition, if the Rebel forces include a vehicle that was damaged in a prior engagement, it



**Orders of the Day  
Imperial Commander  
792.667/26**

**Commander:** You are hereby detailed to stand watch over the landing bay below Altratonne station. No encounters are anticipated; your presence is necessary in order to maintain the condition of the pad — this is the only access for further transports until expansion of the base begins.

You are also to assist Patrol 5274.3 — if necessary — when they return from long-range reconnaissance.



**Orders of the Day  
Alliance Commander,  
Strike Team Besh**

**Commander:** Your team has been assigned the task of taking and clearing the only existing landing bay for the relay station. Doing so will allow a small shuttle to make a resupply run and prevent the return of any Imperial patrols out on long-range recons.

You must clear the Imps from the landing bay and clearing and take possession of the control tower in order to guide the transport in.

After bringing in the shuttle, you must advance along the trail to rendezvous with Strike Teams Aurek and Cresh and assault the relay station. Time is of the essence, so hit 'em hard and hit 'em good.

If necessary, you may bypass the landing pad and advance to the station, but in such a situation we would be unable to resupply you. Good luck.

can be repaired. Choose any one vehicle and roll a die. On a 1–4, the vehicle has half its missing *Body Points* restored; on a 5–6, all of its *Body Points* are restored. Note that a vehicle cannot be restored to more *Body Points* than it started the game with.

Some critical hits may also be repaired. Roll the die again, divide the result in half and round up. The result is the number of critical hits repaired. Choose that many results and ignore their effects (except, of course, for the “Internal Explosion” result — in that case, the vehicle may not be repaired).

If the Rebels succeeded in taking the landing pad and clearing out the Imperials within the 10 turns, the resupply is considered to be executed

so smoothly that the Rebels are not delayed when entering the final battle. The Rebel forces do not have to be physically moved to the edge of the table in this case; they are assumed to exit the battlefield in a timely fashion, as there is no further opposition.

**Imperial Reinforcements**

If the Rebels failed to take the landing pad and left the table, the Imperial shuttle is free to land.

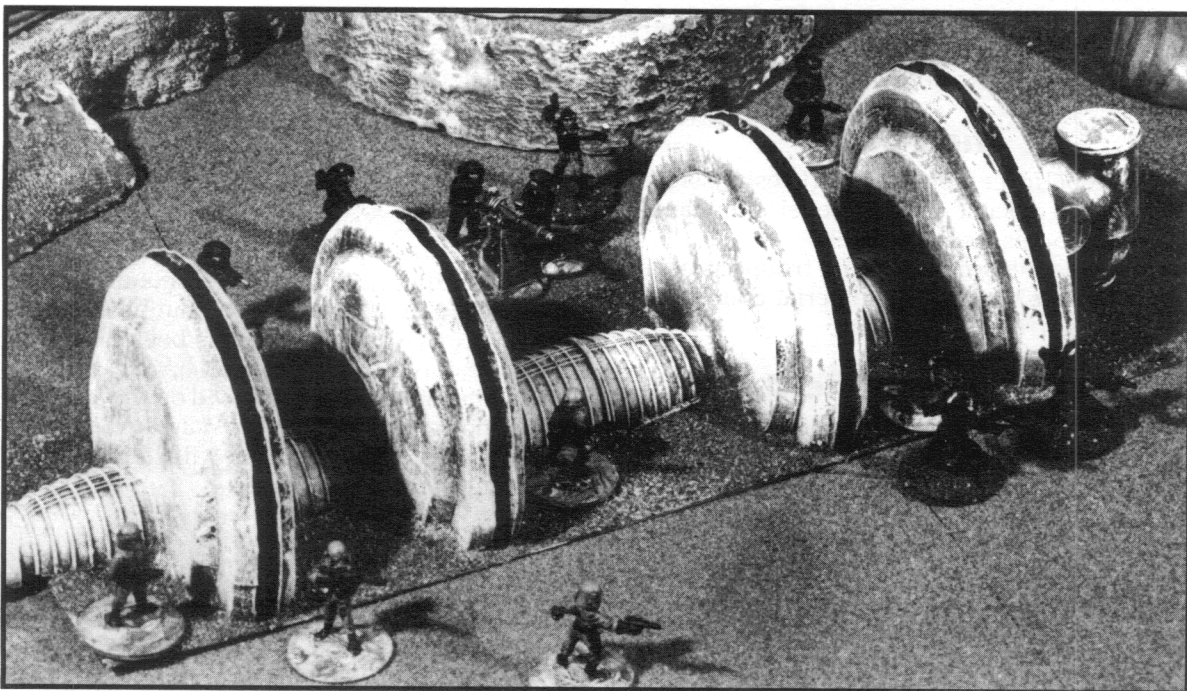

■ Imperial Navy and Army troopers, with the support of a heavy repeating blaster, form a defensive perimeter around Altratonne’s power generator in “Pulling the Plug.”



The Imperial player may then spend 200 points on additional troops, which will enter the final battle behind the Rebel force.

### Victory Conditions

The Rebels must take the landing pad and exit the table in the direction of the relay station.

The Imperials must prevent this from happening.

### Bookkeeping

When this battle is over, the gamemaster should take note of certain results, as they will be used in a later game.

First, the gamemaster should note during which turn the Rebels actually left the table. This will determine when they arrive at the final battle.

The gamemaster also needs to know which of the Rebel soldiers are wounded.

Next, the gamemaster should keep track of any Imperial squads still on the board at the end of the game. The easiest way may be to have the player turn in his Squad Record Sheets, then make notes on them.

The gamemaster will need to know how many soldiers are left in each squad, what the squad's morale level is and which of the soldiers are wounded, as well as whether the squad's commander has been incapacitated. This has a bearing on the soldiers' ability to return to the battle.

The last bit of information is what type of reinforcements the Rebel or Imperial player has acquired. The appropriate player should choose his forces before the final game.

## 3. Through the Back Door

### The Situation

The final approach to the mountaintop base is a rough, difficult climb, with no suitable sites for the placement of station support elements. As such, it is relatively lightly patrolled, and a prime avenue for a strike team to advance along.

Unfortunately for the Rebel strike team, the station commander is a stickler for detail. Not content to accept that the third approach is useless, he has sent a survey party along the trail to make another assessment of the sites along the way. Of course, survey parties are generally not very heavily armed, so they may be in for an unpleasant surprise of their own.

### The Forces

The Rebel force is Strike Team Cresh, assigned to the rear assault by the Rebel commander when the forces were set up.

The Imperial forces are those troops assigned to survey the trail by the Imperial commander when the garrison was set up.

### The Battlefield

The trail here is a narrow defile with high rock walls which are impassable. All table edges are considered impassable, with the exception of the east and south edges, and the northwest corner of the table between the rock outcroppings.

The trail bends around a large cliffside rising up the mountain in the southeast corner of the table. There is a 1-meter high ledge running along the base of the cliff. The ledge is wide enough for two soldiers to walk abreast.

In the middle of the trail is an easy hill standing

2 meters tall at its highest point. To the northwest are two impassable rock outcroppings which frame the outlet to another trail.

The entire trail is subject to rockfalls, and it is strewn with the resultant debris. Each of the patches of rocky debris is rough terrain.

### The Set-up

The Imperials set up anywhere within 6" of the south edge of the table. The Rebels set up within 6" of the east edge.

The initial set-up should be indicated on a copy of the set-up map which has the set-up areas deleted from it. The Rebel and Imperial players should not know where the other is setting up.

After the initial deployment is completed, the gamemaster should run the initial moves as hidden movement. Neither side knows the other is there, and doesn't expect company. Figures are placed on the table once the gamemaster has determined that a line of sight can be drawn to those figures. Once a figure has been placed on the table, it remains revealed.

Figures that have been placed on the table are moved normally, following the standard Sequence of Play. Other figures continue with hidden movement until they are spotted.

### Gamemaster Notes

This is a straightforward encounter that starts out slowly but picks up momentum. The Rebels are attempting to traverse the table and exit by the south edge. The Imperials were not expecting to run into Rebels and must fight a delaying action.

As mentioned above, the northeast corner of the table opens into another trail. Soldiers may leave the table along these edges. Soldiers who do are considered out of play for the remainder of this game and do not appear at the final battle.

The Imperial troops may retreat off the south edge of the board. Soldiers who do so are available in Scenario Four, "King of the Mountain."

The Rebel rally point is the northeast corner of the table. The Imperial rally point is the southwest corner.

In addition to the opposing forces, each side is also in danger from a natural phenomenon.

**Rockfalls**

During the Special Actions Phase of each turn, the gamemaster should roll two dice. If they come up doubles, then a rockfall has occurred. The gamemaster should roll the dice again. One of the dice should be designated as the north-south die, the other as east-west.

Consulting the set-up map and cross-referencing the die rolls (reroll any number that is greater than the numbers along the appropriate side), the gamemaster determines in what square foot of the table the fall originates. She then holds a 2.5" Grenade Burst Area of Effect Template ap-

proximately 12" above the center of that square and lets it fall. Any figure whose base is under the template when it lands is hit by the rockfall and must check for damage against a *Damage Strength* of 8.

The template is then left on the tabletop and is considered rough terrain for the duration of the game (it is suggested that the gamemaster prepare a number of these templates ahead of time).

**Victory Conditions**

The Rebels win if they manage to exit the table along the south edge. The Imperials win if they prevent the Rebels from exiting.

**Bookkeeping**

When this battle is over, the gamemaster should take note of certain results, as they will be used in a later game.

First, the gamemaster should note during which turn the Rebels actually left the table. This will determine when they arrive at the final battle. The gamemaster also needs to know which of the Rebel soldiers are wounded.

Next, the gamemaster should keep track of any Imperial squads still on the board at the end of the game. The easiest way may be to have the

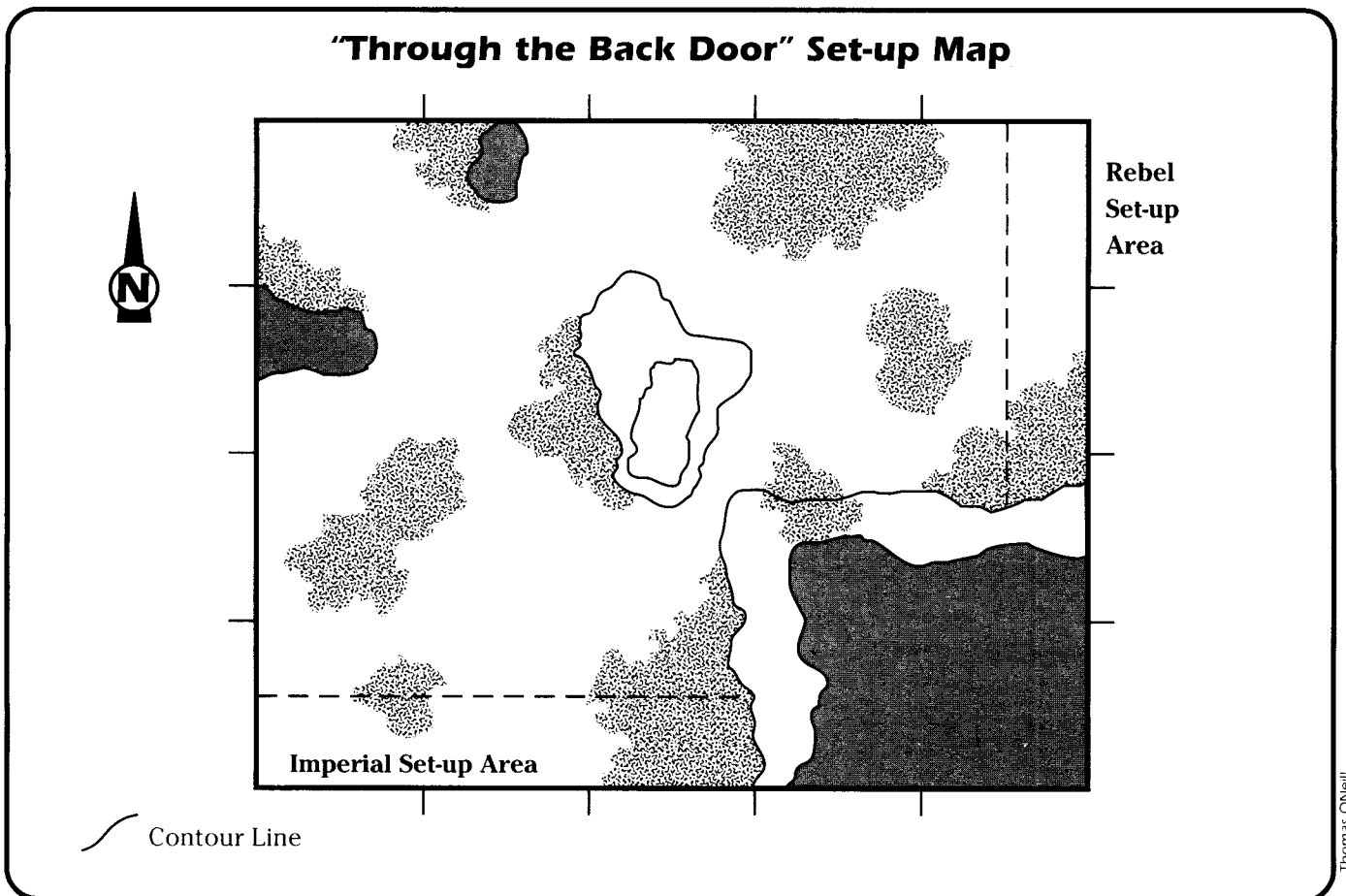

Thomas O'Neill

**Orders of the Day  
Imperial Commander  
793.641/Z6**

**Commander:** You are hereby ordered to detail one or more squads to reconnoiter the unused approach to the station. While previous reports indicate its unsuitability for development, a more thorough inspection may turn up some usable site along this approach.

This is a light recon patrol. Stormtrooper squads are reserved for high-priority duty and so are unavailable to you. Your troops may be equipped with sidearms only; blaster rifles and carbines will be reassigned to troops on an as-needed basis.

**Orders of the Day  
Alliance Commander,  
Strike Team Cresh**

**Commander:** Your team is to provide flanking support for the main assault on the relay station by Strike Teams Aurek and Besh.

You will advance along a little-used rear trail which remains undeveloped due to its rough nature. None of the base's installations have been sited along this approach, so there will be no resistance other than the difficulty of the terrain.

You must not allow the terrain to slow you down, however, as your presence is required for the success of the major assault on the station.

player turn in his Squad Record Sheets, then make notes on them.

The gamemaster will need to know how many soldiers are left in each squad, what the squad's

morale level is and which of the soldiers are wounded, as well as whether the squad's commander has been incapacitated. This has a bearing on the soldiers' ability to return to the battle.

## 4. King of the Mountain

### The Situation

The Rebel strike teams have worked their way up the mountain and are poised to strike a crushing blow against the Imperial relay station. However, the base has had time to prepare some defenses.

How effective the defenses are is dependent on how the Rebels and Imperials did in the earlier battles. As the three strike teams converge on the station, the stage is set for a battle of epic proportions.

### The Forces

The forces available for this battle can vary, and depend on the results of the earlier games in this campaign. The forces that can possibly be available to each side are detailed below.

#### Rebel Forces

The main force available for this assault consists of the squads which succeeded in making their way off the table toward the station in the earlier games. Each strike team comes on the table as directed in "The Set-up," below.

In addition to the original strike teams, the Rebel player may have fresh troops available if he succeeded in taking the landing pad. If he chose to have the transport bring new troops

down to the mountain, they will come onto the table for this final battle with the remaining squads from the assault on the landing bay.

The fresh troops may form their own squad, or they may be distributed among the existing squads from that scenario to bring them back up to full strength.

#### Imperial Forces

The Imperial player's forces may come from a number of different sources.

Whatever troops that the Imperial commander left behind to garrison the station form the core of the defense. These soldiers may be deployed according to the instructions in "The Set-up" below.

In addition, any Imperial soldiers which retreated off the table in previous games before the Rebels moved off are available to be deployed with the garrison troops.

If the Imperials managed to retain control of the landing bay, then they have additional soldiers available. These soldiers are brought into play as described below.

Lastly, any Imperial troops which were left behind on the table in previous battles may be able to make it to the battle.

For each squad left behind in each previous game, the Imperial player makes **two** casualty

morale tests. These tests are made against a Threat Level of 6. Standard modifiers apply. In addition, if the squad lost its commander at any time during the game, the Threat Level is modified by +2. Squads without commanders test using the highest *command* in the squad.

The squad must receive a "No Effect" or better result in both tests in order to be available for this final game. Any morale results from the first test are applied to the second test. For example, if the first morale test yielded a "Morale +1" result, the second test is made with a +1 modifier to the squad's *command*.

Squads which succeed at both tests may take part in the final battle. When they arrive is determined by rolling a die and adding the result to 3. Roll once for each squad. The Imperial squads come onto the table following the Rebel forces they previously fought. How many turns after is equal to the number rolled above for each squad. Do not begin counting turns until the Rebel forces have completed their entry. The Imperials enter the table in the Movement Phase, and are moved as normal squads that turn.

If Imperial reinforcements arrive at the landing bay they enter the table in a similar manner. Roll one die for the entire force and add the result to 3. The reinforcements may enter the table that many turns after the Rebels have done so. The reinforcements may also be withheld for up to three turns after their entry turn; the Imperial commander must succeed at a difficulty 6 *command* test each turn to hold the squad back.

## The Battlefield

As with all the other battles on the mountainside, the terrain is clear and surrounded by impassable rock walls. There are three ways into the rocky basin. Entry Area A to the south is the trail from the generator, Entry Area B in the east wall is the path from the landing bay, and Entry Area C to the north leads from the back trail.

Situated within the confines of the base are a large permacrete structure (the relay station), five prefabricated barracks buildings, the three towers of the communications array and a blaster tower. The blaster tower is an Atgar AP/3 Blaster Turret, an antipersonnel gun similar to the Golon Arms DF .9/B artillery tower, but smaller.

The blaster turret is a three-meter high tower mounting a medium repeating blaster. It requires one gunner, who is shielded within the tower. The tower has a *Body Strength* of 3 and 18 Body Points, and takes damage as for vehicles. The blaster is a standard medium repeating blaster as listed in the "Weapon Chart" and is capable of following fire. The turret-mounted blaster has a 90° fire arc which may be rotated each Movement

Phase by up to 45°. The turret may be turned and still fire in the Fire Combat Phase of that turn.

Across each entry area are a series of 1-1/2"-high pedestals spaced 6" apart. These are the projector units of a power fence. A forcefield is projected between two adjacent pedestals. The series of pedestals allows a forcefield "fence" to be set up. The forcefield prevents all movement across it. In addition, no weapons may fire through the forcefield.

The power fence may not be fully functional; see "Gamemaster Notes" below. Each pedestal/projector has a *Body Strength* of 6 and 20 Body Points. Each section of fence (the forcefield) has a *Strength* of 4 and a *Damage Strength* of 6.

The relay station is a large permacrete structure housing the computers and HoloNet transceivers. The walls have a *Strength* rating of 8. There is one door in the center of the wall facing the communications arrays; it is a security door with a *Strength* rating of 6 and a *security* rating of 6.

The barracks buildings are all identical, with walls that have a *Strength* rating of 6. There is a door in the center of each short end of each barracks. Each door has a *Strength* rating of 4 and a *security* rating of 2.

The communications array consists of three tall, thin masts festooned with all manner of equipment, including transmission relays, power boosters and focusing grids. Each mast has a *Body Strength* of 8 and 25 Body Points. Damage is determined as for vehicles.

## The Set-up

The Imperial player may set up his garrison troops anywhere within 6" of a structure (not including the power fence projectors). One soldier must be assigned to the blaster tower. The garrison troops are any squads assigned to garrison duty initially, as well as any Imperial squads which moved off their table toward the base before the Rebels could do so.

Squads may be deployed in buildings initially. In that case, their locations should be noted by the gamemaster on a copy of the set-up map or a piece of scrap paper. Up to 10 soldiers may occupy a barracks building; the relay station can hold up to 20.

The Rebel player enters his troops onto the table in the entry area corresponding to the battle they previously fought. Whatever Rebel forces survived the assault on the generator come in through Entry Area A to the south. Forces moving on from the engagement at the landing bay enter by way of Entry Area B on the east side of the table. And squads which made the rear ascent come in via Entry Area C to the north.

When the Rebel squads actually come onto the table depends on how quickly they achieved

## "King of the Mountain" Set-up Map

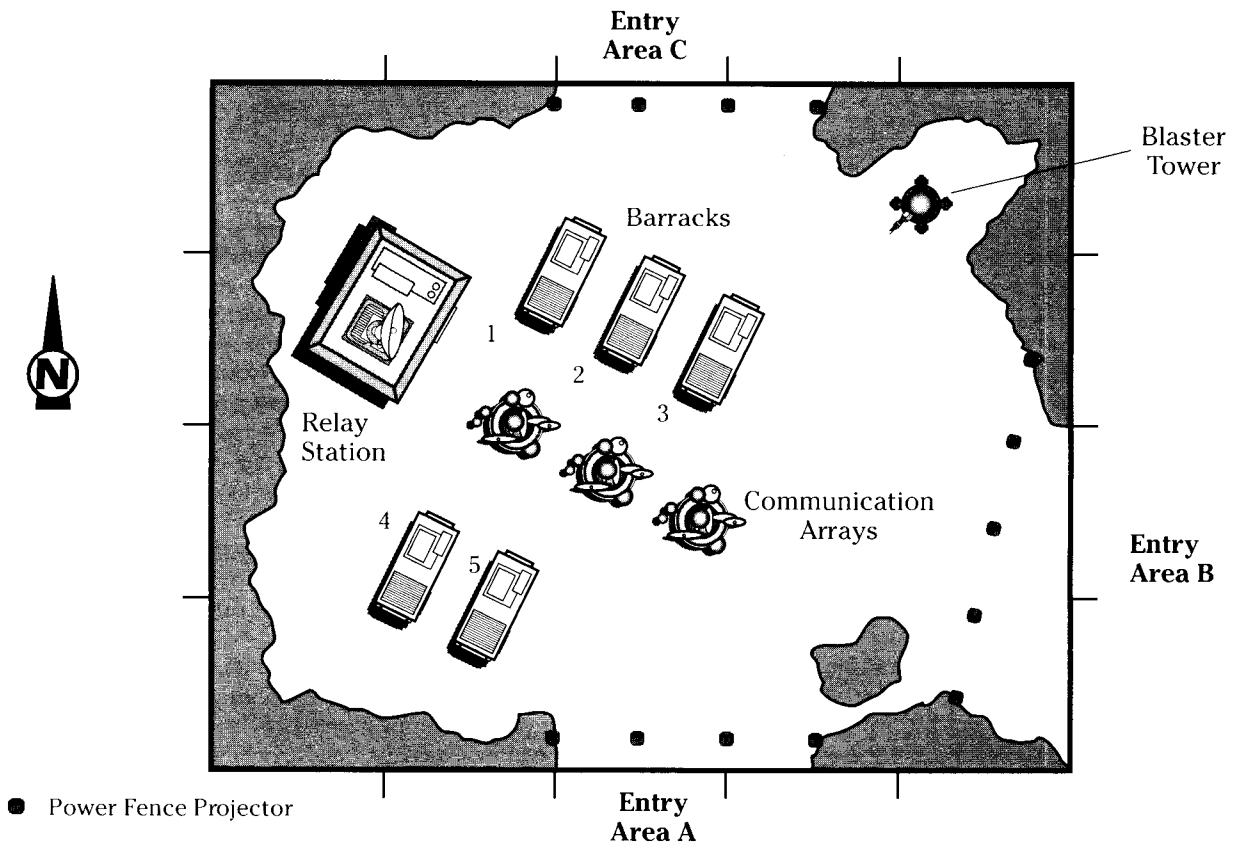

their objectives in the earlier games. For each turn over 10 turns that the Rebel forces took to exit the table in the direction of the base, their entry onto the table for this final battle is delayed one turn. So, if Strike Team Aurek disposed of the generator and moved off the table after 11 turns, they would enter this table at Entry Area A on Turn Two.

If any previous battle ended *before* 10 turns were over, those soldiers only come on the table in Turn One (the teams were scheduled to attack in a synchronized assault, so the earlier teams would have bided their time).

The Rebel squads move onto the table as part of their turn; it is possible that part of the squad may still be off the table at the end of the turn. They may move onto the table in their next Movement Phase.

Imperial stragglers from the previous battles may arrive on the table after the Rebels have come on. See "The Forces," above, for details.

### Gamemaster Notes

The Imperial defenses may be hampered by earlier Rebel successes. If the Rebels managed to take out the power generator in Game One (de-

stroyed three or four power coils), then the base's power is severely curtailed. The blaster tower and the power fences may not be used.

If only two of the power coils were destroyed, then the base is operating at half power. The blaster tower may be used, but its ranges and damage are cut in half (rounded down). In addition, only four of the power fence sections may be turned on. The Imperial player should inform the gamemaster which four are on at the start of the game.

If the power generator remains intact, the base has full power. The blaster tower works normally and all sections of the power fence are available.

### Using the Power Fence

During the Special Actions Phase of a turn, the Imperial player may choose to shut down a section of the power fence. He merely informs the gamemaster which sections he is shutting down. If he wishes to change which section of the fence is active, it requires two turns to do so. In the first Special Actions Phase, he shuts down one or more sections. Then, in the Special Actions Phase of the following turn he may reactivate other

sections by declaring them to be “on.”

Rebel squads will only know if a section of the power fence is active when they approach within 2" of it and make a successful *Perception* test, or if they attempt to fire through the fence. Soldiers who walk into an active section of fence must test for damage against a *Damage Strength* of 6.

Sections of power fence can be eliminated in two ways. The first is by firing at them. If an “incapacitated” result can be achieved against a section of power fence, that section immediately shuts down. It can be reactivated in the Special Actions Phase of the turn following the one in which it was shut down. The other way is to destroy a projector flanking the field. If a projector is destroyed, the fields to either side of it are eliminated and cannot be reactivated.

### Destroying the Communications Array

To win the game, the Rebel must destroy the communications array. This is accomplished by destroying at least two of the array masts. The Rebel can attempt to shoot them down, but that may be a time-consuming operation. The best bet is to try to blow them down with thermal detonators; and the best results can be achieved by getting soldiers to the base of the masts to blow them down using their *demolitions* skill (see pages 79–80 of *Star Wars Miniatures Battles* for details).

The masts are very tall, though — about 48 meters — and when the base of one is destroyed in an explosion, it will fall to the ground. The Rebel player can attempt to control the direction it falls in. If a demolitions charge was set and succeeds in destroying the mast, the Rebel player makes another *demolitions* test for the soldier placing the charge. If successful, the Rebel player can indicate the direction the mast will fall, since the soldier was able to place the charge in just the right way to bring it down as desired.

If the test was failed, use the Grenade Burst Area of Effect Template to determine in which direction the mast falls, orienting the “Direction of Throw” with the direction the Rebel wanted the mast to fall. Roll a die and read the direction on the template.

When a mast falls, measure out 24" from the base of it in the direction of the fall. Anything within 1" of the line of the fall must test for damage against a *Damage Strength* of 12 as the mast falls on it. If the mast falls on a barracks, the entire barracks is destroyed and collapses, inflicting a *Damage Strength* of 12 on any soldiers inside.

If a mast falls on the relay station, the relay station is relatively unaffected. However, any figures inside the station must test for damage

against a *Damage Strength* of 6, as debris from the ceiling showers the interior of the building.

If a mast falls against another mast, it will knock it down. Use the Vectored-Effect Weapon Deviation Template to determine in which direction the next mast falls (orient the “Direction of Throw” with the direction the previous mast was falling).

### Retrieving the Computer

To retrieve the HoloNet codes and protocols, the Rebel player must move soldiers into the relay station, and have them search the place. To do so, make a *search* test against a difficulty of 8. Each additional soldier inside the building and searching adds 1 to the *search* roll.

If there are also Imperial soldiers inside the relay station, the search becomes harder. For each Imperial soldier inside the building, increase the difficulty of the search by 1.

Combat inside the building can be handled in a simplified manner, rather than mapping out the interior of the station. Line up all the soldiers that are in the building on opposite sides of the roof, or alongside the table somewhere. During the Fire Combat Phase, each side declares how many of their soldiers are firing, then resolves fire combat. All soldiers are assumed to have medium cover due to the machinery and furniture inside the relay station. Then randomize the hits and apply damage results as usual.

Rebel soldiers may continue to search for the computer while combat occurs — they may not fire while searching. All the information that is required is currently stored on a portable computer. The computer has an encumbrance value of 10. Once the computer is found (i.e., the *search* was a success), the *searching* soldier is assumed to have picked up the computer and may attempt to get off the table with it.

If the soldier carrying the computer is wounded or incapacitated, another soldier may take it from him by moving into base-to-base contact with him. The second soldier then expends half his Movement Rate to pick up the computer. If he does not have enough movement left to do so, he cannot take the computer until the next Movement Phase.

### Rally Points

The Rebels’ rally point is at the southeast corner of the table in Entry Area B. The Imperial rally point is midway along the west edge of the table, between the relay station and barracks 4.

### Victory Conditions

The Rebels win a decisive victory if they manage to destroy two of the comm array masts *and* carry off the computer with the HoloNet codes.



### Orders of the Day Imperial Commander 792.001/Z6

**Commander:** You are charged with the control and defense of Altratonne Relay Station. While deploying patrols to stand watch over your installations, you must maintain a defensive garrison at the base proper. This base is a secret, but no chances must be taken.

In addition to your troops, you have at your disposal a blaster tower and a power fence. As long as your base is supplied with power these will provide adequate defense. If the power flow is compromised, their effectiveness will drop.

See the gamemaster for the details of operation of the blaster tower and the power fence.

Your troops must be set up within 6" of a structure (not including the power fence pedestals) while on garrison duty. They may also be stationed inside of buildings, although no more than half your forces for this game may begin the game inside a building. At least one soldier must be assigned to man the blaster tower.

**Victory:** The security of this station is of paramount importance. You must preserve the all functions of the HoloNet. Do not allow the communications array to be destroyed or the relay station to be ransacked. Any and all opposition must be eliminated.



### Orders of the Day Alliance Commander Lav Bilsek

**Commander:** After achieving their preliminary objectives Strike Teams Aurek and Besh are to rendezvous with Strike Team Cresh for the assault on the station. Strike Team Aurek will enter from the south trail, Strike Team Besh from the east trail and Strike Team Cresh from the north.

Your objective is to destroy the communications array — this is a series of masts located near the relay station itself. It is necessary to destroy at least two of the three array masts.

Your secondary objective is to retrieve the HoloNet codes and protocols stored in the relay station. You must enter the building and search it until the computer is located, then exit with it.

If you have taken control of the landing pad, you may retreat to that location with the codes after destroying the array. Otherwise you must eliminate all Imperial opposition so that a transport may come in to pick you up.

See the gamemaster for details on destroying the masts and searching the station.

**Victory:** Destroy the array. If you also retrieve the HoloNet codes it is a decisive victory.

They win a substantial victory if they destroy the communications array, but fail to recover the codes. If they get away with the codes, but fail to eliminate the comm array, they have achieved only a marginal victory.

If the Rebels managed to secure the landing bay in Game Two, then the computer is considered carried off when the soldier carrying it exits the table along Entry Area B.

If the Rebels did not take the landing pad, the only way they can win a decisive victory is to eliminate all Imperials in this battle, thereby allowing a Rebel transport to come in afterwards and carry off the computer.

The Imperials win a decisive victory if they prevent the Rebels from achieving both their objectives.

# Reference Sheets

## VEHICLE WEAPON CHART

Model	Dam.	Fire Control	—Range in Inches—			Cost
			Short	Medium	Long	
Mk 1/S Heavy blaster cannon	8	1	20–50	375	750	89
Mk 2/S Heavy blaster cannon	10	1	25–100	450	1000	106
Mk 3/S Heavy blaster cannon	12	1	25–125	375	750	93
Mk 3e/S Heavy blaster cannon	12	2	25–125	375	750	94
Mk 1/S Medium blaster cannon	4	1	1.5–25	50	100	20
Mk 2e/S Medium blaster cannon	6	2	25–50	125	250	38
Mk 3e/S Medium blaster cannon	10	2	25–100	250	500	67
Mk 4e/S Medium blaster cannon	10	2	25–125	375	750	92
Mk 1/S Concussion missile launcher	–	1	5–25	50	100	16
Mk 1e/S Concussion missile launcher	–	2	25–250	750	1500	157
Mk 1/S Concussion missile	6	–	–	–	–	9
Mk 1/S Concussion missile	8	–	–	–	–	11
Mk 1e/S Power harpoon	6	2	12.5–25	50	100	23
Mk 1/S Laser cannon	4	1	25–50	100	250	30
Mk 2/S Laser cannon	6	1	1.5–25	50	100	22
Mk 2e/S Laser cannon	6	2	1.5–25	50	100	23
Mk 3e/S Laser cannon	8	2	25–150	400	750	95
Mk 4e/S Laser cannon	10	2	25–150	400	750	97
Mk 1e/S Heavy laser cannon	10	2	25–250	500	1000	117
Mk 1/W Heavy blaster cannon	9	1	25–200	400	800	95
Mk 2e/W Heavy blaster cannon	15	2	25–250	500	1000	121
Mk 3e/W Heavy blaster cannon	21	2	25–250	500	1000	127
Mk 1/W Medium blaster cannon	6	1	20–75	250	1000	62
Mk 2/W Medium blaster cannon	9	1	25–100	250	500	66
Mk 2e/W Medium blaster cannon	9	2	25–125	375	750	93
Mk 1/W Twin blaster cannon	12	1	5–25	100	250	38
Mk 1/W Twin blaster cannon	12	1	25–100	500	1000	118
MK 1/W Twin light blaster cannon	6	1	25–150	250	500	62
Mk 1/W Concussion grenade launcher	–	1	5–25	50	100	16
Mk 2/W Concussion grenade launcher	–	1	25–50	125	250	31
Mk 1/W Concussion grenade	6	–	–	–	–	9
Mk 2/W Concussion grenade	9	–	–	–	–	12
Mk 3/W Concussion grenade	10	–	–	–	–	13
Mk 4/W Concussion grenade	12	–	–	–	–	15
Mk 1e/W Heavy laser cannon	18	2	25–250	500	1000	125
Mk 2e/W Heavy laser cannon	14	2	25–250	750	1500	169
Mk 3e/W Heavy laser cannon	18	2	25–250	750	1500	175



## VEHICLE CHART

	Crew	Psgs	# Turns	Turn Dist.	Move	Cautious	Speed Cruise	Top	Accel/Decel
<b>Repulsorcraft</b>									
Airspeeder (Incom T-47)**	1*	1†	3	2	225	22	66	225	22/22
Chariot Command Speeder	3	0	2	3	35	3	9	35	3/3
Floating Fortress	4	10†	2	3	70	7	21	70	7/7
Freerunner	4	0	3	2	105	10	30	105	10/10
Heavy Tracker	6	5	2	3	45	4	12	45	4/4
Landspeeder (XP-38)**	1*	1†	2	3	115	11	33	115	11/11
Landspeeder (Arrow-23)	2	5	2	3	140	14	42	140	14/14
Repulsorlift Sled	1*	0	4	1	280	28	84	280	28/28
Skiff**	1	16†	1	4	70	7	21	70	7/7
Snowspeeder	2*	0	3	2	350	35	105	350	35/35
Speeder Bike (Starhawk)**	1*	1†	3	2	140	14	42	140	14/14
Speeder Bike (Overracer)**	1*	0	4	1	185	18	54	185	18/18
Speeder Bike, Military	1*	0	4	1	175	17	51	175	17/17
Speeder Truck	3	25	2	3	55	5	15	55	5/5
ULAV, modified	2*	0	3	2	140	14	42	140	14/14

**Walkers**

AT-AT	5*	40	1	4	21	2	6	21	2/4
AT-ST	2	0	3	2	30	3	9	30	3/6
AT-PT	1	0	3	2	21	2	6	21	2/4

**Tracked Vehicles**

Compact Assault Vehicle	1*	0	3	2	90	9	27	90	9/18
Mobile Command Base	3	7†	3	2	35	3	9	35	3/6

**Hovercraft**

Hoverscout	4	6†	3	2	70	7	21	70	7/14
------------	---	----	---	---	----	---	----	----	------

**Wide-Wheeled Vehicles**

Juggernaut	8	50	1	4	125	12	36	125	12/12
------------	---	----	---	---	-----	----	----	-----	-------

\*Weapon may be fired by driver.

\*\* These vehicles are not normally armed; the versions shown here have weapons mounted by Rebel technicians.

† Passengers may fire from the vehicle.

†† Fire-linked (see "Vehicle Weapons")

Flight Ceiling	Body Str	Body Pts	Cover	Weapons	Fire Arc	SGPs (no crew)	Source^
250m	2	20	F	Mk 2e/S med blaster cannon*	F	205	SWSB2
2m	8	80	F	Mk 2/S laser cannon	F	181	ISB2
2m	15	150	F	Mk 2e/W hvy blaster cannon	T	493	ISB2
				Mk 2e/W hvy blaster cannon	T		
2m	6	60	F	Mk 2/S hvy blaster cannon	LFR	477	RSB2
				Mk 2/S hvy blaster cannon	T		
				Mk 3e/S laser cannon	LBR		
2m	12	120	F	Mk 2e/W hvy laser cannon	T	376	RSB2
2m	2	20	5	Mk 2e/S laser cannon*	F	127	SWSB2
4m	6	60	F	Mk 2/S laser cannon	T	242	RSB2
				Mk 1/S concussion missile lnchr	F		
				3x Mk 1/S concussion missiles			
250m	2	20	4	Mk 2e/S med blaster cannon*	F	202	ISB2
50m	1	10	5	Mk 1/S laser cannon	T	112	SWSB2
250m	3	30	F	2x Mk 4e/S laser cannon††*	F	432	SWSB2
				Mk 1e/S power harpoon	R		
10m	1	10	4	Mk 1/S med blaster cannon*	F	123	SWSB2
20m	4	40	4	Mk 2/S light blaster cannon*	F	216	RSB2
25m	2	20	4	Mk 2e/S laser cannon*	F	154	SWSB2
3m	6	60	F	—	—	170	RSB2
0.6m	6	60	F	2x Mk 2/S laser cannon††*	F	336	RSB2
				Mk 1/S concussion missile lnchr*	F		
				3x Mk 1/S concussion missiles			
				Mk 3e/S med blaster cannon	LBR		
—	18	180	F	2x Mk 2e/W med blaster cannon	F	822	SWSB2
				2x Mk 3e/W hvy laser cannon††	F		
—	9	90	F	Mk 1/W twin lt blaster cannon	F	411	SWSB2
				Mk 2/W twin blaster cannon	F		
				Mk 1/W concussion grenade lnchr	F		
				3x Mk 2/W concussion grenades			
—	2	20	F	Mk 1/W twin blaster cannon	F	187	DFSB
				Mk 1/W concussion grenade lnchr	F		
				3x Mk 2/W concussion grenades			
—	8	80	F	Mk 4e/S med blaster cannon*	LFR	279	ISB2
—	14	140	F	Mk 1e/S hvy laser cannon	LFR	353	ISB2
—	6	60	F	Mk 1/S laser cannon	LFR	501	ISB2
				Mk 3/S hvy blaster cannon	T		
				Mk 2e/S concussion missile lnchr	T		
				6x Mk 1/S concussion missiles			
—	15	150	F	Mk 3/W med blaster cannon	T	967	ISB2
				Mk 1e/W hvy laser cannon	LFR		
				Mk 1e/W hvy laser cannon	L		
				Mk 1e/W hvy laser cannon	R		
				Mk 2/W concussion grenade lnchr	T		
				6x Mk 4/W concussion grenades			
				Mk 2/W concussion grenade lnchr	T		
				6x Mk 4/W concussion grenades			

^SWSB2 = Star Wars Sourcebook, Second Edition; ISB2 = The Imperial Sourcebook, Second Edition;  
RSB2 = Rebel Alliance Sourcebook, Second Edition; DFSB = Dark Force Rising Sourcebook.

## VEHICLE TERRAIN EFFECTS CHART

Terrain Type	Drive System						
	Repulsor	Hover	Track	Walker	Wheel	Wide-Wheel	2-Wheel
clear	NE	NE	NE	NE	NE	NE	NE
scrub	NE	NE	NE	NE	< 6" OK	NE	< 6" OK
brush	NE	NE	NE	NE	< 6" OK	NE	< 6" OK
woods							
light	> Cautious test +1	-	2x cost	Cautious	< 6" OK 2x cost	2x cost	< 6" OK; 2x cost
medium	> Cautious test +2	-	4x cost	Cautious	-	-	-
heavy	> Cautious test +3	-	-	Cautious	-	-	-
swamp	NE*	NE*	test or bog down	-	-	test or bog down	-
hill							
easy	NE	2x cost	NE	2x cost	2x cost	NE	2x cost
difficult	2x cost	4x cost	2x cost	4x cost	-	4x cost	-
creek	NE	NE	NE	NE	-	NE	-
stream	NE	NE	2x cost	2x cost	-	NE	-
<b>Barrier Type</b>							
door	-	-	-	-	-	-	-
window	-	-	-	-	-	-	-
wall							
low	Cautious 4"	-	Cautious 4"	NE	-	Cautious 4"	-
high	-	-	-	NE	-	-	-
barbed wire	Cautious 2"	Cautious 2"	Cautious 2"	NE	-	Cautious 2"	-
trench							
shallow	NE	NE	NE	NE	-	-	-
deep	NE	NE	Cautious	NE	-	-	-
<b>Move 0"</b>	180°; Turn Distance	90°; Turn Distance	Turn Distance per 45°	1x45°; Turn Distance	1x45°; Turn Distance	1x45°; Turn Distance	180°; Turn Distance

-: Impassable.

NE: No Effect. \*Modified by foliage.

## OUT-OF-CONTROL VEHICLE TABLES

<p><b>1. Speed</b></p> <p>1-2 Vehicle decelerates</p> <p>3-4 Movement Rate remains the same</p> <p>5-6 Vehicle accelerates</p> <p>If the Movement Rate changes, roll one die, and multiply it by two to find out how much it changes by.</p>	<p><b>2. Direction</b></p> <p>1 Vehicle turns 90° left</p> <p>2 Vehicle turns 45° left</p> <p>3-4 Vehicle goes straight</p> <p>5 Vehicle turns 45° right</p> <p>6 Vehicle turns 90° right</p>	<p><b>3. Altitude</b></p> <p>1-2 Vehicle dives one level</p> <p>3-4 Vehicle remains on same level</p> <p>5-6 Vehicle climbs one level; ground vehicle flips over</p> <p><b>4. Flip</b></p> <p>1-2 Flips onto left side</p> <p>3-4 Flips over onto top</p> <p>5-6 Flips onto right side</p>
----------------------------------------------------------------------------------------------------------------------------------------------------------------------------------------------------------------------------------------------	-----------------------------------------------------------------------------------------------------------------------------------------------------------------------------------------------	--------------------------------------------------------------------------------------------------------------------------------------------------------------------------------------------------------------------------------------------------------------------------------------------

**CRITICAL HIT TABLE**

Roll	Effect	Explanation
0	None	—
1-7	Targeting Computer Down	Fire Control is lost permanently on a randomly determined weapon. The weapon position is still counted when determining additional hits; if it is selected again, there is no further result.
8-10	Power Coupler Damaged	The vehicle's Movement Rates and Accel/Decel are reduced by half for the rest of the game. This result is cumulative.
11-13	Driver Stunned	The vehicle goes out of control for the next turn.
14-16	Guidance Systems Lock	The vehicle's Turn Distance is doubled.
17-19	Gunner Wounded	A randomly determined gunner is wounded. All future fire is at +1 to the difficulty number. If the gunner is wounded again, he is incapacitated (see next result).
20-21	Gunner Incapacitated	A randomly determined gunner is incapacitated. His weapon may no longer be fired unless another crewmember takes his place.
22-23	Weapon Destroyed	A randomly determined weapon may no longer be fired. This weapon position is still considered when determining additional hits.
24-25	Power Loss	The vehicle stops dead. Weapons may no longer be fired. Crew and passengers may disembark.
26-27	Driver Incapacitated	The vehicle goes out of control for all future turns, unless stopped by collision or random deceleration.
28+	Internal Explosion	The interior of the vehicle is wracked with explosions, incapacitating all crew and passengers. The vehicle may no longer move or fire.

**MANEUVER DIFFICULTY NUMBERS**

Maneuver	Speed		
	Cautious	Cruise	Top
Slide	4	6	8
Bootlegger Turn <sup>1</sup>	6*	8	10
Jump <sup>2</sup>	8	10	12
Turn	**	**	**
Additional Turn <sup>3</sup>	4	6	8
Double Turn	4	6	8
Rotate <sup>4</sup>	6	8	10
Climb <sup>5</sup>	**	4	6
Extreme Climb <sup>5</sup>	6	8	10
Dive <sup>5</sup>	**	4	6
Extreme Dive <sup>5</sup>	4	6	8

\*A bootlegger turn may not be attempted at a Movement Rate of less than 20".

\*\*No [vehicle] operation skill test is required for this maneuver.

<sup>1</sup>This maneuver may not be performed by walkers.

<sup>2</sup>The difficulty number for a jump is increased by 1 for every inch of drop over 2".

<sup>3</sup>Turns made in excess of the vehicle's # Turns

<sup>4</sup>This maneuver may only be performed by repulsorcraft and hovercraft.

<sup>5</sup>This maneuver may only be performed by flying vehicles.

**VEHICLE DAMAGE TABLE**

Roll	Effect
DR + 4 ≤ SR	No effect.
DR ≤ SR	Lose 1 <i>Body Point</i> .
DR > SR	Lose <i>Body Points</i> equal to <i>Damage Strength</i> of firing weapon.
DR > SR + 4	Lose <i>Body Points</i> equal to <i>Damage Strength</i> of firing weapon. In addition, the vehicle takes a Critical Hit.

DR = Firer's Damage Roll

SR = Target's *Strength* Roll

**VEHICLE OCCUPANT DAMAGE TABLE**

Roll	Effect
SR + 4 ≤ DN	Incapacitated
SR ≤ DN	Wound
SR > DN	No Effect

SR = Survival Roll

DN = Difficulty Number

**VEHICLE CONTROL TEST CHART**

Vehicle Speed	Control Test
Cautious	Automatic
Cruise	Difficulty 4
Top	Difficulty 6

**SPEED EFFECTS CHART**

Speed Difference	Modifier to Difficulty Number
0-19"	0
20-29"	+1
30-39"	+2
40-49"	+3
50-59"	+4
60+"	+5

**COLLISION MODIFIER CHART**

Movement Rate	Damage Modifier
0-10"	-1
11-20"	0
21-30"	+1
31-40"	+2
41-50"	+3
51-60"	+4
and so on ...	

**BOMBING DIFFICULTY CHART**

Altitude Level	Difficulty Number
Level 1	4
Level 2	6
Level 3	8

**STUN TABLE**

Roll	Effect
<b>DS &lt; SR</b>	No effect
<b>DS ≥ SR</b>	Stunned
<b>DS ≥ SR + 4</b>	Stunned; unconscious
<b>DS ≥ SR + 6</b>	Stunned; unconscious for 1D turns
DS = Weapon's <i>Damage Strength</i> Roll SR = Target's <i>Strength</i> Roll	

**BUILDING HEIGHT CHART**

Building Story	Altitude Level
1	Low
2	1
3	1
4	2
5	2
6	2
7	3
8	3
9	3
10	4
and so on ...	

**ION GUN EFFECTS TABLE**

Roll	Effect
<b>DS &lt; BS</b>	No effect.
<b>DS ≥ BS</b>	Controls ionized.
<b>DS ≥ BS + 4</b>	Controls ionized. In addition, the vehicle takes a Critical Hit.
DS = Firer's <i>Damage Strength</i> Roll. BS = Target's <i>Body Strength</i> Roll.	

**ENCUMBRANCE VALUE CHART**

Equipment	Enc. Value	Weapon	Enc. Value	Archaic Weapons	Enc. Value
Armor	0	Hold-out blaster	3	Crossbow	5
Breath mask	1	Sporting blaster	4	Longbow	3
Camouflage suit	2	Blaster pistol	4	Black powder pistol	4
Combat sensor	2	Heavy blaster pistol	5	Musket	4
Comlink	1	Hunting blaster	5	Rifle	5
Concom (for neks)	1	Blaster rifle	5	Submachinegun	5
Environment suit	0	Blaster carbine	4	Bowcaster	6
Glow rod	1	Repeating blaster	6	Stokhli spray stick	4
Jet pack	5	Ion gun	8*	<b>Melee Weapons</b>	
Space suit	0	<b>Heavy Blasters</b>		Club	2
Medpac	2	Repeating blaster	6*	Gaderfii	2
Macrobinoculars	2	Med. repeating blaster	8*	Spear	2
Nek	20	Heavy repeating blaster	8*	Vibroaxe	3
Targeting computer	4	<b>Grenades</b>		Vibroblade	2
Walker mount	10	Grenade	1	Lightsaber	1
		Thermal detonator	2		
* per crewmember					

**MORALE TEST CHART**

Morale Test Type	Threat Level
Casualty	4
Charging	6
Receiving a Charge	4
Escaping	6

Standard Threat Level Modifiers*	
Shaken	+1
Demoralized	+2
Each casualty taken this turn	+1
Commander incapacitated this turn	+2
Squad is behind cover	-1
Squad wins turn of close assault	-1
Squad loses turn of close assault	+1

"Charge" Modifiers**	
Attacking enemy's flank or rear	-2
Attacking enemy behind barrier	+1

"Receiving a Charge" Modifiers†	
Attacked in flank or rear	+2
Outnumbered 2:1	+2
Each heavy weapon in the squad	-1

Escape Attempt Modifiers††	
Additional guard	+1
Guard wounded(per each wounded guard)	-1
Guard engaged in close assault combat	-2
Prisoner executed(per each prisoner executed)	-2

\*apply to all situations  
 \*\*apply to charging squads only  
 †apply to squads receiving a charge  
 ††apply to prisoners attempting escape

**JET PACK  
JUMP MODIFIERS CHART**

Condition	Difficulty Modifier
Enemy soldier within 4" of jump-off point	+1
Enemy soldier within 4" of landing point	+1
Jumping in woods	+2
High winds	+2

**FIRE COMBAT MODIFIERS  
CHART**

Target Condition	Difficulty Modifier
In Light Cover	+1
In Medium Cover	+2
In Heavy Cover	+3
Target Prone	+1
Multiple Targets — heroes only	+2
Specific Target — heroes only	+4

Firer Condition	Difficulty Modifier
Walking	+1
Opportunity Fire	+1
Defensive Fire	+1
Following Fire (after 1st shot)	+2
Driver firing weapon while driving	+1
Firing from moving surface	+1
Throwing grenade in heavy woods	+1
Separated from squad	+1
Shaken	+1
Demoralized	+2

**CLOSE ASSAULT COMBAT  
MODIFIERS CHART**

Condition	Skill Modifier
Charging (1st turn only)	+1
Defending barrier	+1
Outnumbering Opponent (per each additional soldier)	+1
Standard melee weapon	+1
Vibroaxe or -blade	+2
Lightsaber	+4
Attacked from side or rear	-2
Prone	-2
Separated from squad	-1
Shaken	-1
Demoralized	-2
Droid Attacking	+1
Attempting capture	-2
Entangled	-2

**WALKER MOUNT DIFFICULTY NUMBERS**

Movement Type	Difficulty Number
Moving directly	6
Moving remotely	8
Moving remotely without LOS	10

CRAFT \_\_\_\_\_

Crew \_\_\_\_\_ Passengers \_\_\_\_\_

Drive System \_\_\_\_\_

**MOVEMENT RATES**

Cautious  Cruise  Top

Accel  Decel  Min. Flight

TURN DISTANCE  # TURNS

**Star Wars Miniatures Battles  
VEHICLE RECORD SHEET**

Body Strength

Body Points

Cover

Flight Ceiling

Body Strength  x 10 =   
Cruise Speed   
# Turns  x 10 =   
Passengers   
Cover  x 5 =   
Crew Cost

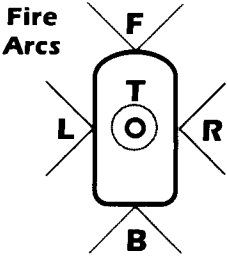

Arc	Weapon(s) Carried	Dam.	F. Con.	Short	Med.	Long

Critical Hits/Notes

VEHICLE COST

VEHICLE \_\_\_\_\_

TROOP TYPE \_\_\_\_\_

TROOP QUALITY

Move: \_\_\_\_\_

DEX: \_\_\_\_\_

Trng ( ) Blaster \_\_\_\_\_

Spec ( ) Blaster Artillery \_\_\_\_\_

Grenade \_\_\_\_\_

Melee Combat \_\_\_\_\_

\_\_\_\_\_

KNO: \_\_\_\_\_

Trng ( ) Survival \_\_\_\_\_

Spec ( ) \_\_\_\_\_

MEC: \_\_\_\_\_

Trng ( ) Beast Riding \_\_\_\_\_

Spec ( ) \_\_\_\_\_

PER: \_\_\_\_\_

Trng ( ) Command \_\_\_\_\_

Spec ( ) Search \_\_\_\_\_

Sneak \_\_\_\_\_

\_\_\_\_\_

STR: \_\_\_\_\_

Trng ( ) Brawling \_\_\_\_\_

Spec ( ) Swimming \_\_\_\_\_

\_\_\_\_\_

TEC: \_\_\_\_\_

Trng ( ) Demolition \_\_\_\_\_

Spec ( ) First Aid \_\_\_\_\_

\_\_\_\_\_

Skills point cost:

Walk Rate  Run Rate  Command Skill  Number in Crew

**MOVEMENT RATES**

Skills point cost (from first column) :

Weapon(s) Carried	Dam.	Short	Med.	Long

Armor: STR/DEX mod.: \_\_\_\_\_ / \_\_\_\_\_

**Star Wars Miniatures Battles  
CREW RECORD SHEET**

Point cost per soldier:

Number in crew:

BASE CREW COST:

ID: \_\_\_\_\_ COMMANDER: Command \_\_\_\_\_

ID: \_\_\_\_\_ SPECIALIST: \_\_\_\_\_

Weapon Carried	Dam.	Short	Med.	Long

ID: \_\_\_\_\_ SPECIALIST: \_\_\_\_\_

Weapon Carried	Dam.	Short	Med.	Long

Other costs: \_\_\_\_\_

Morale Level  9  8  7  6  5  4  3  2  1  0   
Steady E V A Shaken Dem. Broken CREW COST

# Star Wars Miniatures Battles Markers and Templates



(Instructions: Photocopy this page, color if desired, glue to a sheet of cardboard, and cut out.)

LOW LEVEL	LOW LEVEL	LOW LEVEL	LOW LEVEL	LOW LEVEL	LOW LEVEL	LOW LEVEL	LOW LEVEL	LOW LEVEL	LOW LEVEL	LOW LEVEL	LOW LEVEL	LOW LEVEL
LEVEL 1	LEVEL 1	LEVEL 1	LEVEL 1	LEVEL 1	LEVEL 1	LEVEL 1	LEVEL 1	LEVEL 1	LEVEL 1	LEVEL 1	LEVEL 1	LEVEL 1
LEVEL 2	LEVEL 2	LEVEL 2	LEVEL 2	LEVEL 2	LEVEL 2	LEVEL 2	LEVEL 2	LEVEL 2	LEVEL 2	LEVEL 2	LEVEL 2	LEVEL 2
LEVEL 3	LEVEL 3	LEVEL 3	LEVEL 3	LEVEL 3	LEVEL 3	LEVEL 3	LEVEL 3	LEVEL 3	LEVEL 3	LEVEL 3	LEVEL 3	LEVEL 3
LEVEL 4	LEVEL 4	LEVEL 4	LEVEL 4	LEVEL 4	LEVEL 4	LEVEL 4	LEVEL 4	LEVEL 4	LEVEL 4	LEVEL 4	LEVEL 4	LEVEL 4
LEVEL 5	LEVEL 5	LEVEL 5	LEVEL 5	LEVEL 5	LEVEL 5	LEVEL 5	LEVEL 5	LEVEL 5	LEVEL 5	LEVEL 5	LEVEL 5	LEVEL 5
LEVEL 6	LEVEL 6	LEVEL 6	LEVEL 6	LEVEL 6	LEVEL 6	LEVEL 6	LEVEL 6	LEVEL 6	LEVEL 6	LEVEL 6	LEVEL 6	LEVEL 6
Captured	Captured	Captured	Captured	Captured	Captured	Captured	Un-armed	Un-armed	Un-armed	Un-armed	Un-armed	Un-armed
Captured	Captured	Captured	Captured	Captured	Captured	Captured	Un-armed	Un-armed	Un-armed	Un-armed	Un-armed	Un-armed
STUN 1	STUN 1	STUN 1	STUN 1	STUN 1	STUN 1	STUN 1	STUN 1	STUN 1	STUN 1	STUN 1	STUN 1	STUN 1
STUN 2	STUN 2	STUN 2	STUN 2	STUN 2	STUN 2	STUN 2	STUN 2	STUN 2	STUN 2	STUN 2		
STUN 3	STUN 3	STUN 3	STUN 3	STUN 3	STUN 3	STUN 3	STUN 3	STUN 3				
STUN 5	STUN 5	STUN 4	STUN 4	STUN 4	STUN 4	STUN 4	STUN 4					
STUN 5	STUN 5	STUN 5										

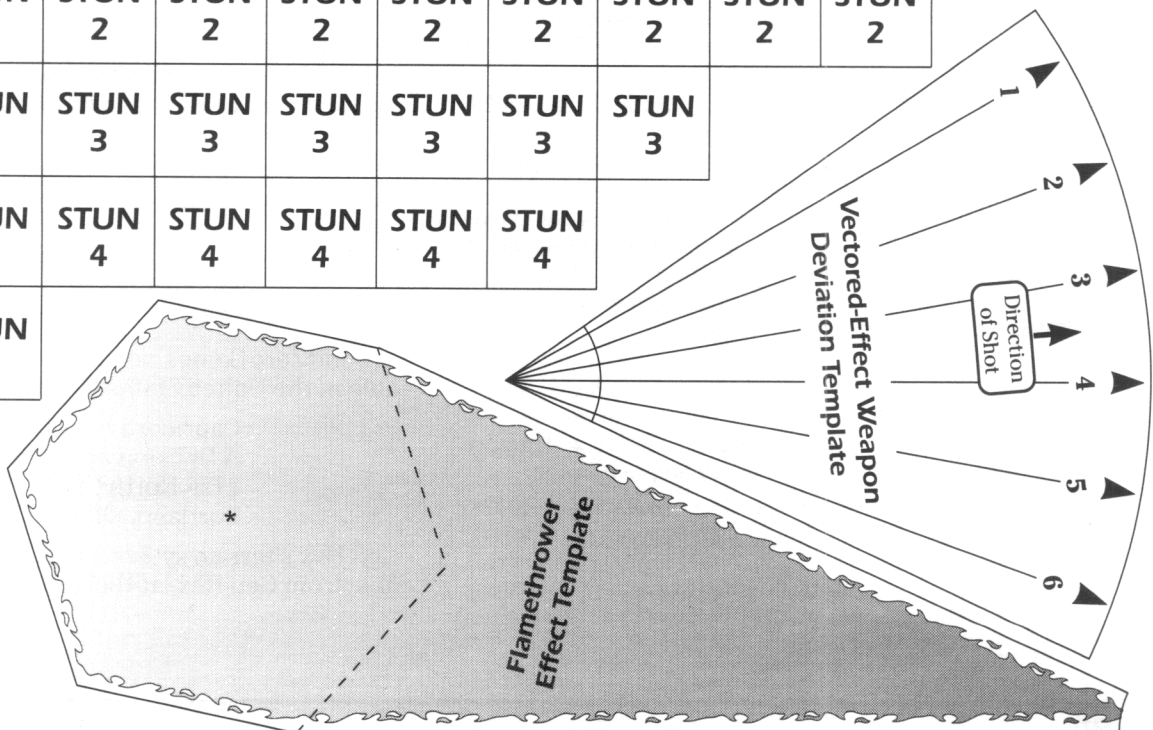
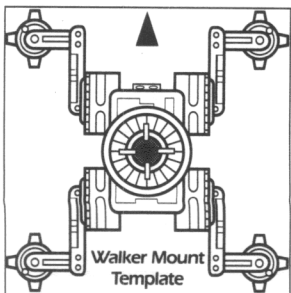



# Photo Credits

**Page 4:** Figures from 40403, *Stormtroopers 1*, 40428, *Sandtroopers*, painted by T.G.W.P.; AT-AT: plastic model kit from MPC, painted by Stephen Crane; terrain system: Geo-Hex; alien trees and plants custom-built by Geo-Hex; conventional trees purchased from a hobby shop; rocky terrain: Bill Refsland; photo by Stephen Crane.

**Page 11:** Scout trooper figure from 40433, *Scout Troopers*, painted by Jay Adan; speeder bike from 40502, *Imperial Speeder Bikes*, painted by Stephen Crane; terrain system: Geo-Hex; alien trees and plants custom-built by Geo-Hex; rocky terrain: Bill Refsland; photo by Stephen Crane.

**Page 24:** Figures from 40405, *Rebel Troopers 1*, 40406, *Rebel Troopers 2*, 40413, *Rebel Troopers 3*, painted by Jay Wirth and T.G.W.P.; terrain system: Geo-Hex; alien trees and plants custom-built by Geo-Hex; rock formations: aquarium decorations purchased from a pet store and painted; building and vaporator scratchbuilt by Stephen Crane; landspeeder: prototype of 40501, *Landspeeder*, painted by Stephen Crane; photo by Stephen Crane.

**Page 26:** Figures from 40405, *Rebel Troopers 1*, 40406, *Rebel Troopers 2*, 40403, *Stormtroopers 1*, 40428, *Sandtroopers*, painted by Jay Wirth and T.G.W.P.; AT-AT: plastic model kit from MPC, painted by Stephen Crane; terrain system: Geo-Hex; alien trees and plants custom-built by Geo-Hex; rocky terrain, building and landspeeder scratchbuilt by Bill Refsland; photo by Stephen Crane.

**Page 31:** Figures from 40431, *Snowtroopers*, 40410, *Heavy Blaster with Imperial Crew*, painted by T.G.W.P., Stephen Crane; terrain system: Geo-Hex; rocky terrain: Bill Refsland; snowspeeders: Kenner Products; photo by Stephen Crane.

**Page 34:** Scout trooper figures from 40433, *Scout Troopers*, painted by T.G.W.P.; speeder bike from 40502, *Imperial Speeder Bikes*, painted by Stephen Crane; terrain system: Geo-Hex; alien trees and plants custom-built by Geo-Hex; conventional trees purchased from a hobby shop; X-wing: plastic model kit from MPC, converted and painted by Bill Refsland; photo by Stephen Crane.

**Page 39:** Figures from 40403, *Stormtroopers 1*, 40428, *Sandtroopers*, painted by T.G.W.P.; terrain system: Geo-Hex; alien trees and plants custom-built by Geo-Hex; building by Bill Refsland; photo by Stephen Crane.

**Page 40:** Figures from 40405, *Rebel Troopers 1*, 40406, *Rebel Troopers 2*, 40413, *Rebel Troopers 3*, 40404, *Stormtroopers 2*, 40416, *Stormtroopers 4*, painted by Jay Wirth, Stephen Crane, Jay Adan; terrain system: Geo-Hex; structures scratchbuilt by Bill Refsland; photo by Stephen Crane.

**Page 44:** Figures from 40411, *Imperial Army Troopers 1*, 40412, *Imperial Naval Troopers 1*, 40415, *Imperial Officers*, 40421, *Rebel Troopers 4*, painted by Bill Refsland; terrain system: Geo-Hex; alien trees and plants custom-built by Geo-Hex; structure scratchbuilt by Bill Refsland; photo by Stephen Crane.

**Page 46:** Figures from 40403, *Stormtroopers 1*, 40428, *Sandtroopers*, 40410, *Heavy Blaster with Imperial Crew*, 40412, *Imperial Naval Troopers 1*, 40419, *Imperial Naval Troopers 2*, painted by T.G.W.P., Jay Wirth, Stephen Crane; terrain system:

Geo-Hex; alien trees and plants custom-built by Geo-Hex; photo by Stephen Crane.

**Page 62:** Figures from 40412, *Imperial Naval Troopers 1*, 40419, *Imperial Naval Troopers 2*, painted by Jay Wirth; terrain system: Geo-Hex; alien trees and plants custom-built by Geo-Hex; road is colored paper; photo by Stephen Crane.

**Page 67:** Figures from 40405, *Rebel Troopers 1*, 40406, *Rebel Troopers 2*, 40413, *Rebel Troopers 3*, 40403, *Stormtroopers 1*, 40404, *Stormtroopers 2*, 40416, *Stormtroopers 4*, 40428, *Sandtroopers*, 40412, *Imperial Naval Troopers 1*, 40415, *Imperial Officers*, 40411, *Imperial Army Troopers 1*, 40418, *Imperial Army Troopers 2*, painted by T.G.W.P., Jay Adan, Stephen Crane; terrain system: Geo-Hex; structures and rocky terrain scratchbuilt by Bill Refsland; photo by Stephen Crane.

**Page 71:** Figures from 40405, *Rebel Troopers 1*, 40406, *Rebel Troopers 2*, 40413, *Rebel Troopers 3*, 40403, *Stormtroopers 1*, painted by Jay Wirth, T.G.W.P.; terrain system: Geo-Hex; alien trees and plants custom-built by Geo-Hex; structures scratchbuilt by Bill Refsland; photo by Stephen Crane.

**Page 79:** Figures from 40412, *Imperial Naval Troopers 1*, 40419, *Imperial Naval Troopers 2*, 40410, *Heavy Blaster with Imperial Crew*, 40411, *Imperial Army Troopers 1*, 40418, *Imperial Army Troopers 2*, 40415, *Imperial Officers*, painted by T.G.W.P., Stephen Crane; terrain system: Geo-Hex; structure and rocky terrain scratchbuilt by Bill Refsland; rock formation: aquarium decoration; photo by Stephen Crane.

**Note:** Five-digit numbers and italicized titles refer to *Star Wars* miniatures blister packs available from West End Games.

■ ■ ■

**The following companies have provided invaluable assistance in the preparation of scenery and figures for this game:**

Ground Zero Games produces an excellent range of resin 25mm science-fiction vehicles, as well as battle-field architecture and other science-fiction figures. Their products are available in the U.K., Europe and the rest of the world from:

Ground Zero Games  
"Fizno"  
Barking Tye  
Needham Market  
Suffolk IP6 8JB  
U.K.

Ground Zero Games' vehicles and architecture are available in the United States from:

Capricorn Space  
A Division of Geo-Hex  
2126 North Lewis  
Portland, OR 97227

Geo-Hex's terrain systems and custom terrain are available from Geo-Hex, at the above address.

# STAR WARS<sup>®</sup> MINIATURES BATTLES

## COMPANION

by Stephen Crane

Snowspeeders streak across the battlefield in a sweeping counterpoint to the terrifying advance of Imperial AT-AT walkers. Weapons blaze and the metallic hides of these modern beasts of war are scored by the burning impact of blaster bolts seeking to penetrate their armored shells. The muffled thud of internal explosions signals the death of one of these great machines.

Finally! Add vehicle combat to your *Star Wars Miniatures Battles* game. This long-awaited supplement has full rules for vehicle combat, flight, a rules upgrade and expansion, new equipment and a miniatures battle campaign. Also included are details of unit insignia and organization for Rebel, Imperial and other forces in the galaxy.

**You must have *Star Wars Miniatures Battles* to use this supplement.**

A supplement for use with *Star Wars Miniatures Battles*.  
Also compatible with *Star Wars: The Roleplaying Game*  
(first and second editions).

**A STAR WARS<sup>®</sup>**  
**S U P P L E M E N T**

For two or more players, ages 12 and up.

©, TM & © 1994 Lucasfilm Ltd. (LFL). All Rights Reserved.  
Trademarks of LFL used by West End Games under authorization.



40070

ISBN 0-87431-216-7



0 18874 40070 3