

[Search](#)
[Home](#) > [Roleplaying Games](#) > [Star Wars: RPG](#)

[Navigation Help](#)

Thursday, October 17, 2002

Arms & Equipment Art Gallery

By Ray and Val Vallese

[Chat](#)
[Message Boards](#)
[Mailing List](#)

Ever wonder what AV-1A Assault Armor looks like? How about a Rodian Throwing Razor? Or maybe you'd like help visualizing a TTS-15 Tutorial Droid, a Razalon FC-20 Speeder Bike, a TholCorp Neuronic Whip, or an Emperiax Walking Throne. Our online art gallery of samples from the new [Arms & Equipment Guide](#) shows you all this and more (including some more familiar items). So check out the illustrations by artist Chris Trevas right now and then look for the guide to help you bring everything you can think of (and a ton of stuff you can't) into your *Star Wars* campaign!



The Star Wars logo in its classic font, with 'WWW.STARWARS.COM' underneath.

Click on any image to see a larger version. All artwork © Lucasfilm Ltd.

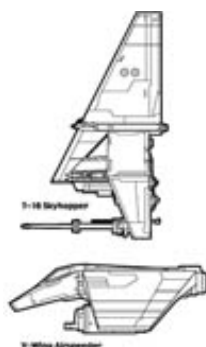

Airspeeders

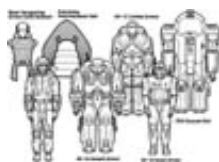

Armor

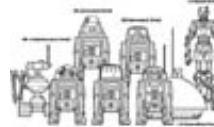

Astromech droids



Blaster pistols

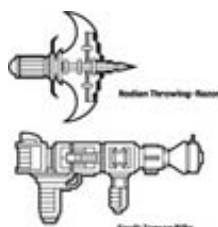

Exotic weapons



Landspeeders

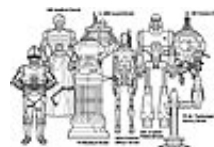

Medical and military droids

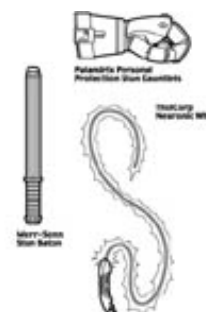

Melee weapons

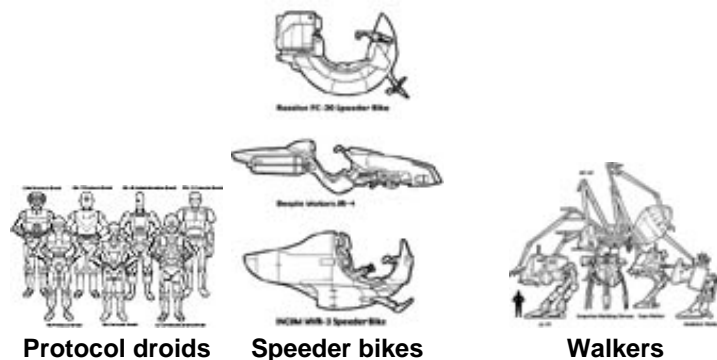

Now that you've seen what some of your favorite items look like, learn more about the corporations that make them in our exclusive [web enhancement](#) of material that was cut from the Arms & Equipment Guide!

[PRIVACY STATEMENT](#)

©2002 Lucasfilm Ltd. & © or TM where indicated. All rights reserved. Used under authorization. visit STARWARS.COM



[Shop](#) [Games](#) [Books](#) [Magazines](#) [Stores](#) [Events](#) [Company](#) [Worldwide](#) [Community](#)

- [RPG Home](#)
- [Learn to Play](#)
- [Products](#)
- [Web](#)
- [Enhancements](#)
- [Archive](#)
- [Living Force](#)
- [Retailer Locator](#)
- [Fan Club Store](#)
- [Character Sheet](#)

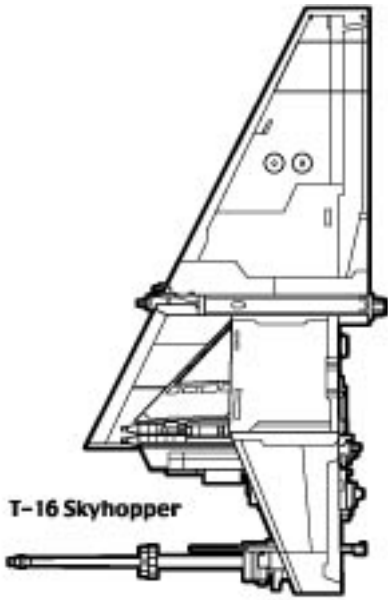

T-16 Skyhopper

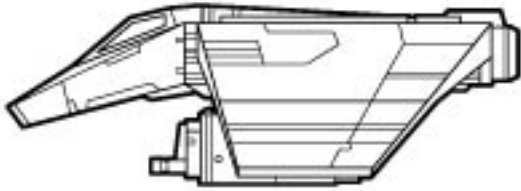

V-Wing Airspeeder

**Blast-Dampening
Armor (with Helmet)**

**Polarizing
Field Insulator Suit**

AV-1C Combat Armor



EVA Vacuum Pod

Camo Scout Armor

AV-1A Assault Armor

AV-1S Scout Armor

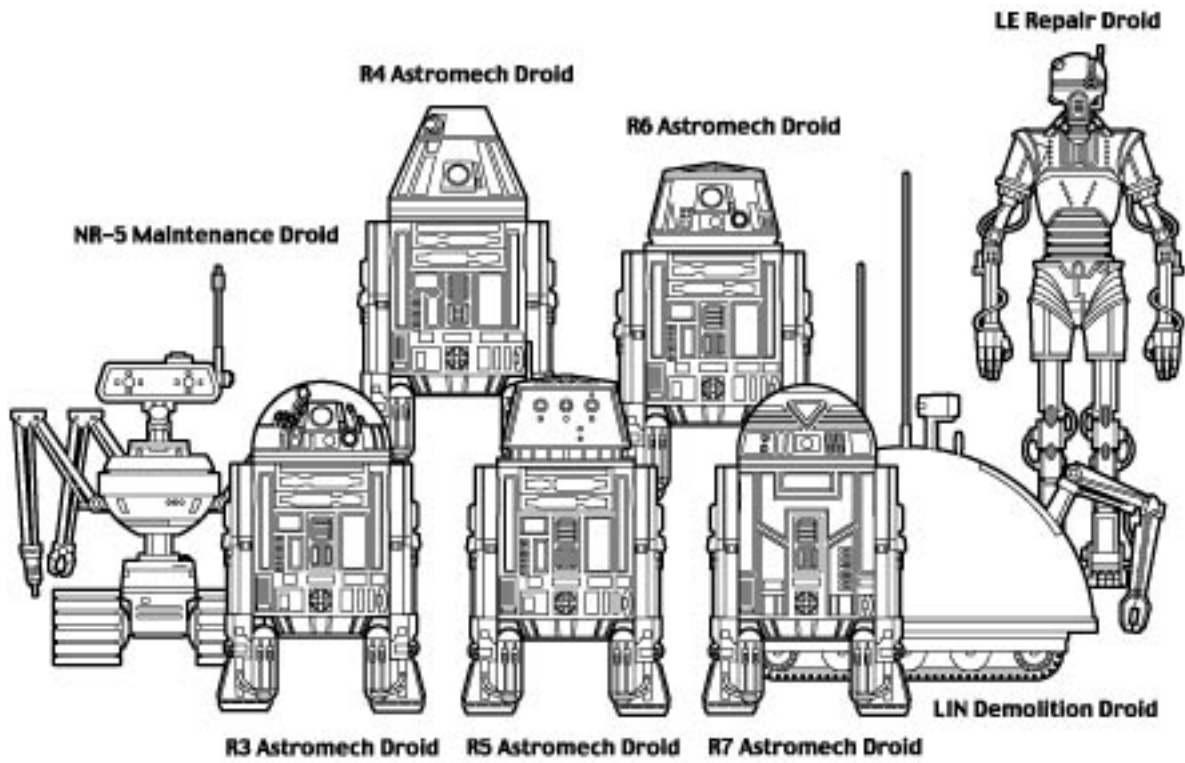



BlasTech DH-17



Merr-Sonn IR5 "Intimidator"

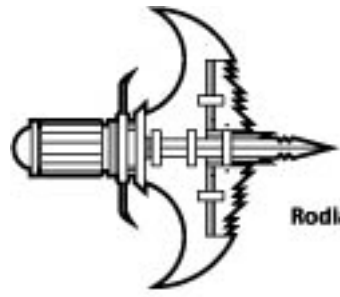

Rodian Throwing-Razor

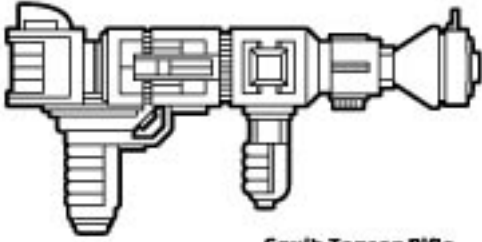

Squib Tensor Rifle

SoroSuub XP-38 Sport Landspeeder

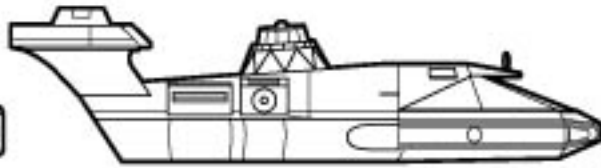
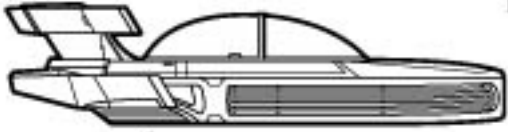

SoroSuub V-35 Courier

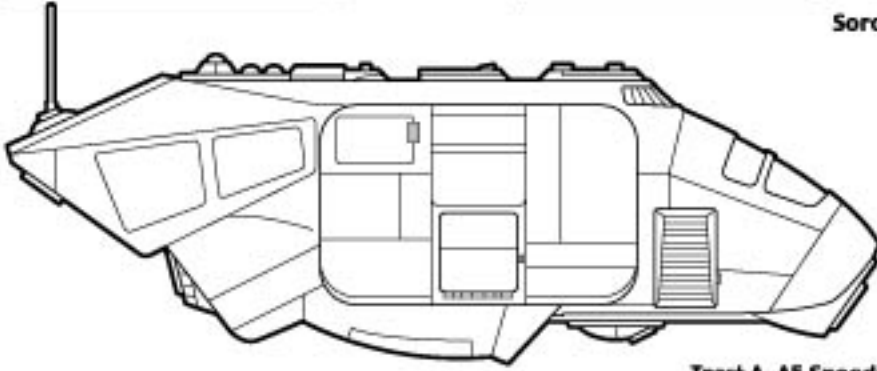

Trast A-A5 Speeder Truck

MD Medical Droid

G-2RD Guard Droid

DZ Tracker Droid

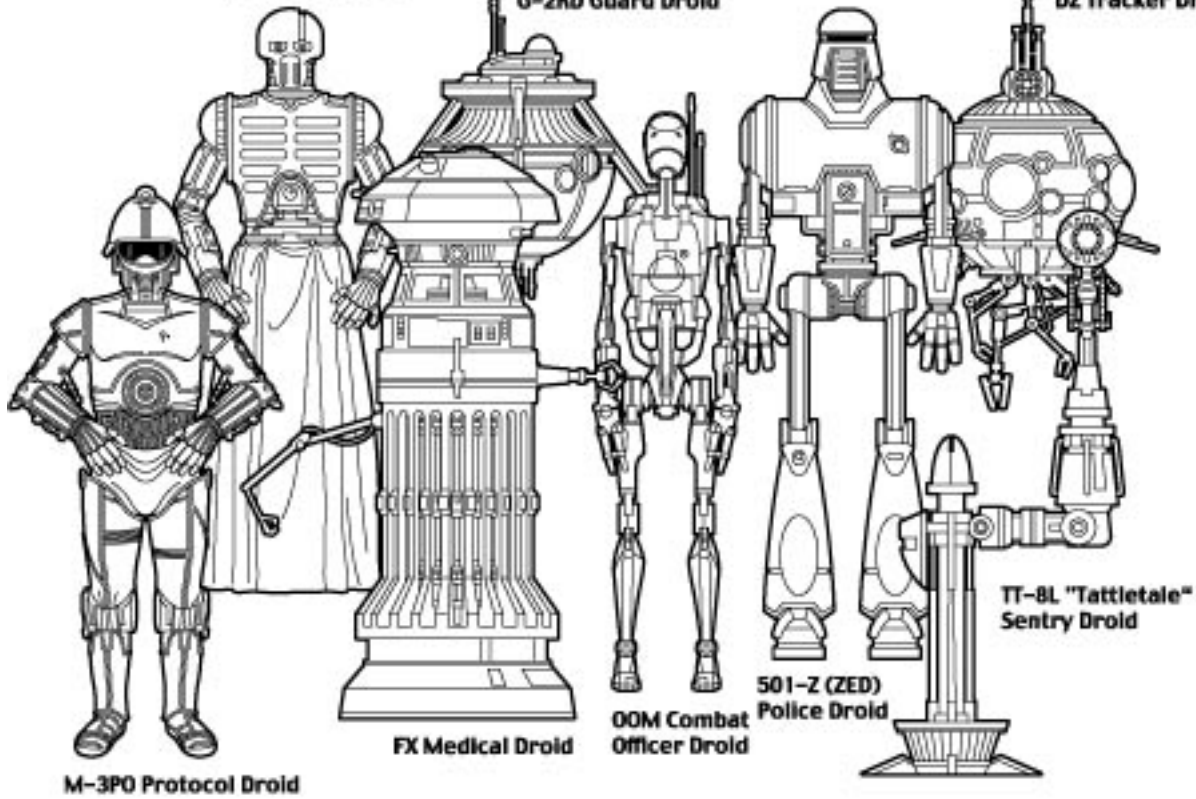

M-3PO Protocol Droid

FX Medical Droid

OOM Combat Officer Droid

501-Z (ZED) Police Droid

TT-8L "Tattletale" Sentry Droid

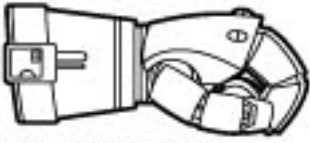

**Palandrix Personal
Protection Stun Gauntlets**



**Merr-Sonn
Stun Baton**

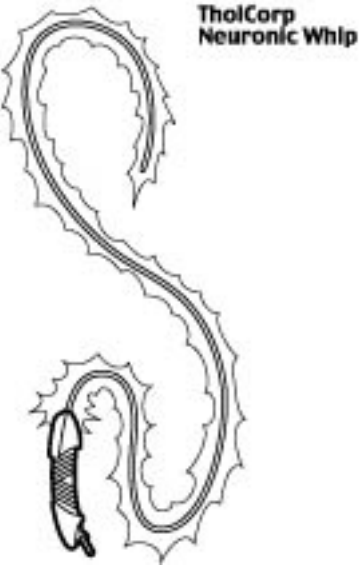

**TholCorp
Neuronc Whip**

LOM Protocol Droid

RA-7 Protocol Droid

3D-4X Administrative Droid

TTS-15 Tutorial Droid

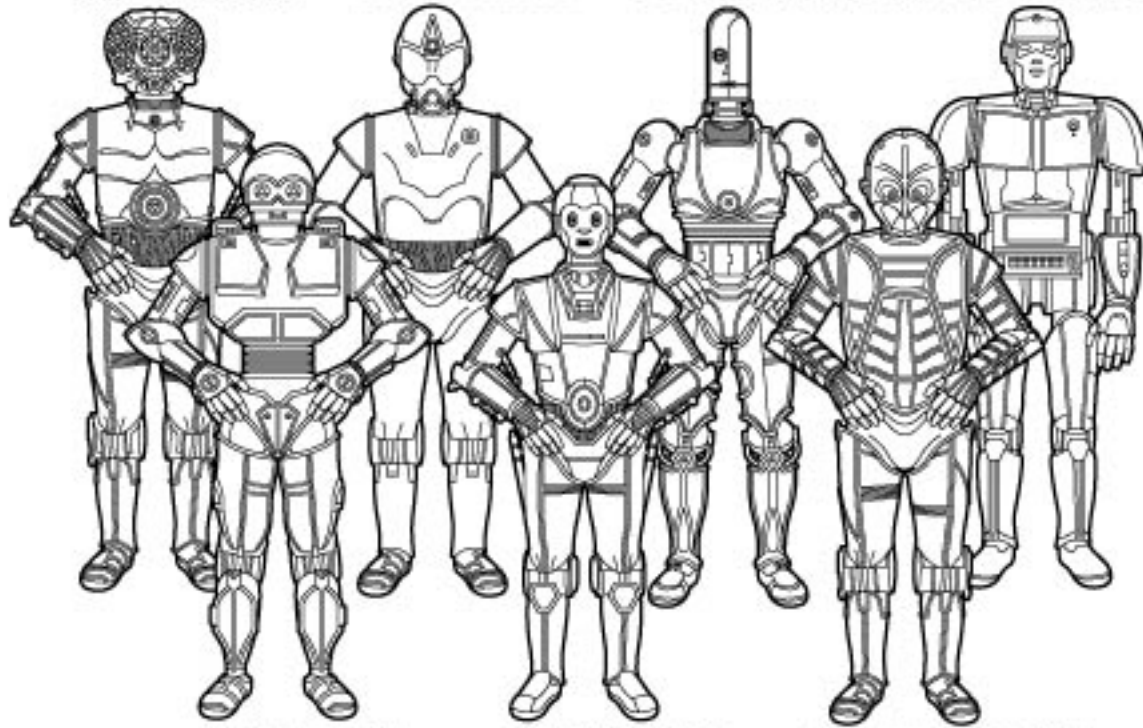

PD Protocol Droid

SE4 Servant Droid

CZ Communications Droid

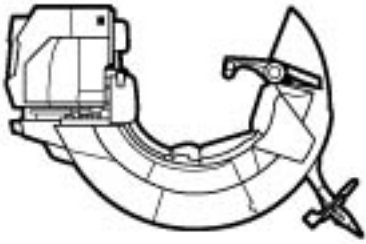

Razalon FC-20 Speeder Bike



Bespin Motors JR-4

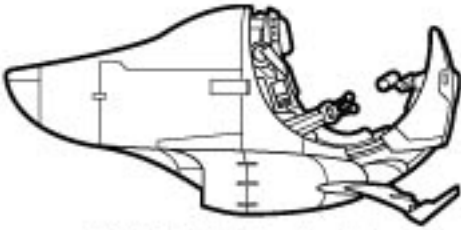

INCOM MVR-3 Speeder Bike

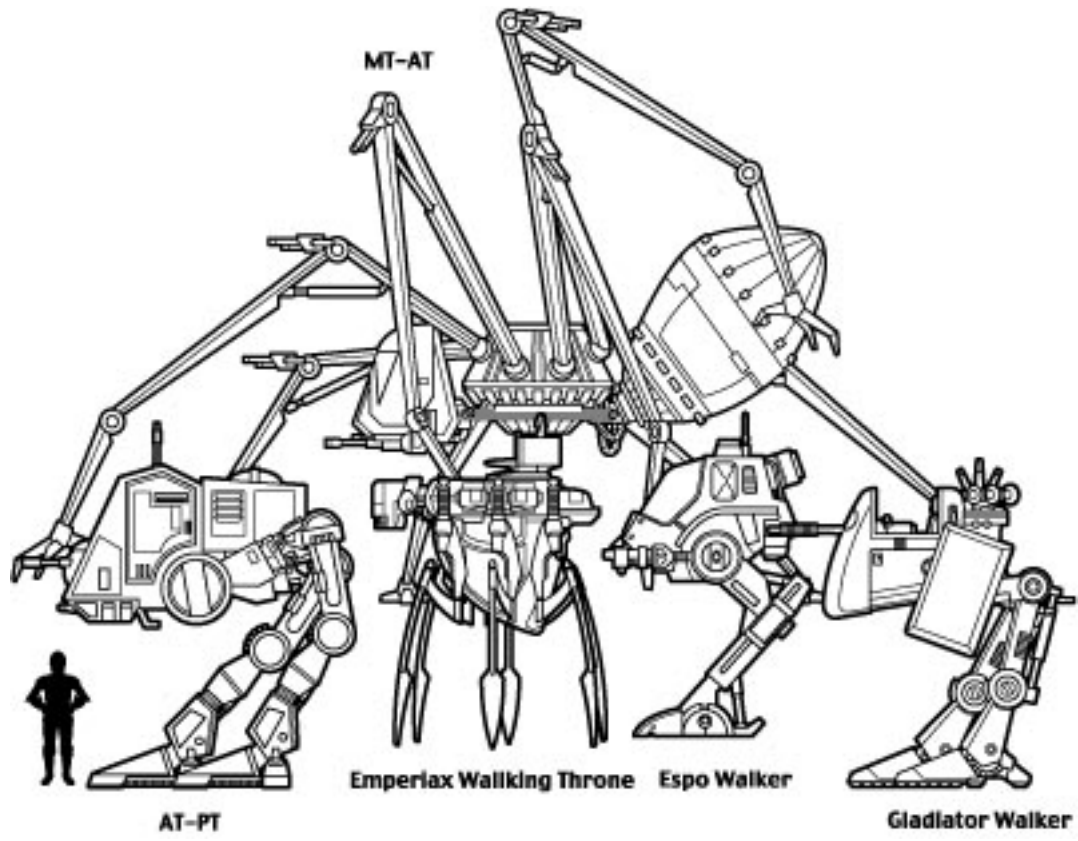

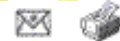

[Home](#) > [Roleplaying Games](#) > [Star Wars: RPG](#)

[Navigation Help](#)

Thursday, October 10, 2002

Wings, Walkers, and Whatnot

A Preview of the *Arms & Equipment Guide*

Sure, *Star Wars* is about fast ships, exotic aliens, mysterious powers, and good versus evil. But it's also about the cool *stuff* that heroes and villains get to use, from weapons and vehicles to armor and droids to all the other kinds of equipment that makes life easier (and more fun). In October, Wizards of the Coast covers all that in the new [Arms & Equipment Guide](#) and we've got the fourth in a series of sneak peeks at the goods!

Here's a look at just a handful of the hundreds of items covered in the book. The codes for "Era" are: [RI] for items available primarily in the Rise of the Empire era, [RE] for items available primarily in the Rebellion era, and [NJ] for items available only in The New Jedi Order era or later.

If you like what you see, be sure to pick up the *Arms & Equipment Guide* this month for more, more, more!

[Chat](#)
[Message Boards](#)
[Mailing List](#)

The 'STAR WARS' logo in a bold, black, sans-serif font, with 'WWW.STARWARS.COM' written in a smaller font below it.



Slayn & Korpil V-wing

Class: Airspeeder	Crew: 1 (Skilled +4)
Size: Gargantuan (12 m long)	Initiative: +0 (-4 size, +4 crew)
Passengers: 0	Maneuver: +0 (-4 size, +4 crew)
Cargo Capacity: 50 kg	Defense: 16* (-4 size, +10 armor)
Cost: 35,000 (new), 7,500 (used)	Shield Points: 0
	Hull Points: 80 (DR 10)
Availability: Specialized, military	Atmospheric Speed: 23 sq./action
Era: [NJ]	Altitude: Suborbital

*Provides full cover to pilot.

Weapon: Double blaster cannon (fire-linked); **Fire Arc:** Front; **Attack Bonus:** +6 (-4 size, +4 crew, +6 fire control); **Damage:** 4d10x2; **Range Increment:** 2,000 m.

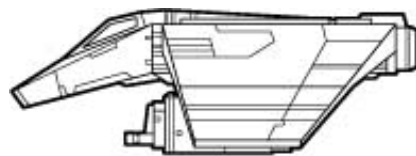

V-Wing Airspeeder

The V-wing is a combat speeder designed for use by the New Republic as a replacement for the less versatile cloud car. It has an impressive altitude -- rare for a true speeder -- which actually allows it to be released in the upper atmosphere of a planet by a transport based on a starship. These transports can carry up to six V-wings at a time, and up to ten transports can be carried aboard a Star Destroyer or similar capital ship. This allows the New Republic to move large numbers of V-wings quickly to defend worlds under attack by starfighters.

The V-wing is lightly armored and carries only two offensive blasters, making it difficult for a V-wing to take on a heavy walker or a true starship. However, the relatively low cost and easy maintenance of the V-wing makes it attractive to the New Republic as a supplement to planetary defenses.

Kuat Drive Yards AT-PT

Class: Walker [Ground]	Crew: 1 (Skilled +4)
Size: Large (4 m long, 3 m tall)	Initiative: +3 (-1 size, +4 crew)
Passengers: 0	Maneuver: +3 (-1 size, +4 crew)
Cargo Capacity: 150 kg	Defense: 13* (-1 size, +4 armor)
Cost: 60,000 (new), 36,000 (used)	Shield Points: 0
	Hull Points: 50 (DR 10)
Availability: Common, military	Speed: 25 m
Era: [RI]	Max Velocity: 60 km/h (1 sq./action)

*Provides full cover to pilot.

Weapon: Double heavy blaster cannon (fire-linked); **Fire Arc:** Front; **Attack Bonus:** +5 (-1 size, +4 crew, +2 fire control); **Damage:** 5d10; **Range Increment:** 200 m.

Weapon: Concussion grenade launcher (8 grenades); **Fire Arc:** Front; **Attack Bonus:** +5 (-1 size, +4 crew, +2 fire control); **Damage:** 4d6+1; **Range Increment:** 20 m (6 m).

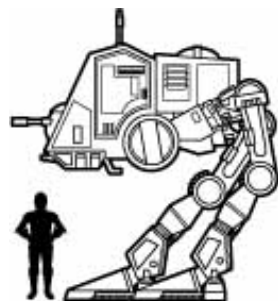

AT-PT

One of the earliest mass-produced lines of walkers was the Old Republic's All Terrain Personal Transport. This one-person fighting machine was designed to turn a single soldier into an unstoppable assault trooper, giving him all the firepower of an assault vehicle while retaining the mobility and versatility of infantry. The AT-PT consists of an armored cockpit with one leg mounted to either side, with enough room for a pilot and (in a pinch) a single passenger. The AT-PT is capable of standing upright to a height of 4 meters, but normally moves in a crouch that makes it about 3 meters tall.

Armed with twin blaster cannons and a concussion grenade launcher, the AT-PT might well have changed the face of warfare, but most of the initial production run was lost when the fleet carrying the walkers was lost after a hyperspace mishap. The Old Republic dissolved before a modified AT-PT could be produced, and the

Empire scrapped the project in favor of the larger AT-ST. Those few AT-PTs that still exist are generally kept in working condition, however, and can prove a nasty surprise to anyone who hasn't faced one before.

Meredex Atmospherics EMS-90 Bubble Cloak

Cost: 800
Weight: 1 kg
Availability: Prevalent
Era: [RI] [RE] [NJ]

The harshest possible environment for most creatures is the vacuum of space. The only hope of survival is a self-contained unit, but escape pods and vac suits are bulky to carry around. The Bubble Cloak solves this problem. It is a thick but fashionable cloak under normal circumstances, but can fan out and seal itself to form a 1.2-meter-diameter survival bubble, tough enough to survive in space and carrying a 2-hour air and power supply. While inside a powered bubble, a character does not suffer any effects from extreme cold in the environment.

BlasTech Blaster Repair Kit

Type: Repair kit/tools
Cost: 125
Weight: 2 kg
Hardness: 2
WP: 2
Break DC: 14
Availability: Prevalent
Era: [RI] [RE] [NJ]

This handy kit provides most of the small tools necessary for the upkeep, repair, and customization of blaster pistols and rifles. The tools include a pulse adapter module tester, a collimator beam fuser, a prismatic crystal aligner, static pulse adapter modules, an energy converter valve, multiple gas valve nozzles, a spare gas container, a spare trigger cable, and a variable pressure adjuster. A full kit has enough space left over to hold three spare power packs.

Having a repair kit counts as proper tools for Repair checks to fix blaster weapons.

Saladar Systems PED-21 Distress Beacon

Cost: 200
Weight: 2 kg
Availability: Common
Era: [RI] [RE] [NJ]

The PED-21 is an emergency distress beacon. It works as a hyperspace-capable transmitter, sending a signal on standard emergency frequencies at a long enough range to cover an entire system and any nearby hyperspace lanes. It broadcasts the emergency signal only and cannot receive signals. Once a ship detects the beacon's signal, it's a simple matter to use the ship's sensors to locate it (Computer Use check DC 15). It has a battery sufficient for ten years of continuous operation.

Check out our free Arms & Equipment Guide [mini-adventure](#) by AEG co-designer Owen K.C. Stephens!



Search

WED00-88 Repair Droid

By [Cory Herndon](#)

WED00-88, or "Weedo" as his owner calls him, is a greatly modified Treadwell unit. The small, easily-upgraded droid has been programmed not only to repair a wide variety of vehicles, weapons, electronics, and starships, but to pilot a freighter as well. Weedo never ventures off on his own (not yet), but always in the company of his owner, Kelko, a 6th-level Rodian fringer. Kelko constantly tinkers with Weedo; the skills shown here represent the droid's most recent setting.

WED00-88: Heavily modified tracked repair droid, Expert 3; Init +2 (Dex); Def 14 (+2 size, +2 Dex); Spd 8m; VP/WP -/12; Atk +2 melee (1d4, tool) or +2 melee (2d6, cutting torch), +3 ranged (3d6, blaster); SV Fort +2, Ref +4, Will +2; SZ S; Rep 0; Str 10, Dex 16, Con 12, Int 8, Wis 8, Cha 6.

Equipment: Blaster mount w/blaster, heuristic processor, diagnostics package, microbinoculars, tool mounts (x5), telescopic appendage, environmental compensation (vacuum), magnetic feet, vocabulator.

Skills: Astrogate +8, Computer Use +6, Disable Device +6, Pilot +6, Read/Write Basic, Repair +9, Speak Basic.

Feats: Starship Operation (transport), Skill Emphasis (repair).

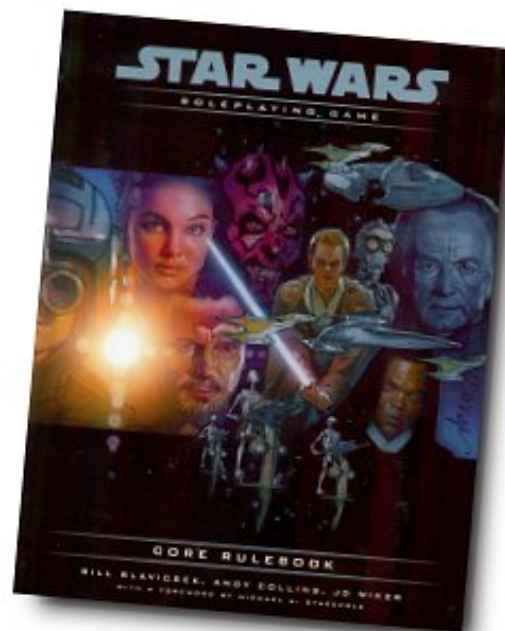

[Site Map](#)
[Navigation Help](#)

STAR WARS
WWW.STARWARS.COM



Find out more about [Kelko the Rodian fringer](#).

[PRIVACY STATEMENT](#)

©2002 Lucasfilm Ltd. & © or TM where indicated. All rights reserved. Used under authorization. visit [STARWARS.COM](#)

Shop Games Books Magazines Stores Events Company Worldwide Community



RPG Home

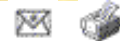

[Home](#) > [Roleplaying Games](#) > [Star Wars: RPG](#)

[Navigation Help](#)

Thursday, September 26, 2002

Weapons and Armor

A Preview of the *Arms & Equipment Guide*

[Chat](#)
[Message Boards](#)
[Mailing List](#)

Arms & Equipment Guide

 10/03/2002 [Stuffed With Stuff](#)

 10/03/2002 [Droids, Droids,](#)
[Droids!](#)

 09/26/2002 [Weapons and](#)
[Armor](#)

 09/19/2002 [Blasters and Rifles](#)

Sure, *Star Wars* is about fast ships, exotic aliens, mysterious powers, and good versus evil. But it's also about the cool *stuff* that heroes and villains get to use, from weapons and vehicles to armor and droids to all the other kinds of equipment that makes life easier (and more fun). In October, Wizards of the Coast covers all that in the new [Arms & Equipment Guide](#), and we've got the second in a series of sneak

peeks at the goods!

Here's a look at just a handful of the hundreds of items covered in the book. The codes for "Era" are: [RI] for items available primarily in the Rise of the Empire era, [RE] for items available primarily in the Rebellion era, and [NJ] for items available only in The New Jedi Order era or later.

If you like what you see, be sure to pick up the *Arms & Equipment Guide* next month for more, more, more!



STAR WARS
WWW.STARWARS.COM



Golan Arms FC1 Flechette Launcher

Weapon Type: Flechette launcher

Proficiency Group: Exotic (flechette launchers)

Cost: 2,000

Damage: 3d8 (antipersonnel); 6d8 (antivehicle)

Critical: 20

Weight: 20 kg

Range Increment: 20 m (4 m) (antipersonnel); 20 m (2 m) (antivehicle)

Type: Slashing

Size: Large

Hardness: 5

WP: 10

Break DC: 15

Availability: Common, illegal

Era: [RE] [NJ]

Special: This weapon fires 6 shots before needing to be reloaded. It is reloaded with flechette canisters (cost 200 per antipersonnel canister or 300 per antivehicle canister). It takes 1 full-round action to reload.

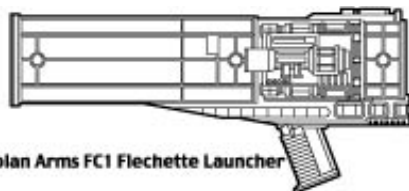

Golan Arms FC1 Flechette Launcher

The FC1 is a barely portable, shoulder-fired weapon that expels canisters of razor-sharp microdarts. Each canister explodes at a predetermined distance from a selected target for maximum effect. The weapon can fire both antipersonnel canisters and antivehicle canisters, and has four barrels. An antipersonnel canister has a larger burst radius but does less damage than an antivehicle canister, which is more lethal but affects a smaller area. Both antipersonnel and antivehicle canisters may be loaded in a weapon at the same time and used as the need arises.

Golan Arms is not known for its innovative designs, and the FC1 reflects some earlier, more powerful fixed artillery pieces designed before the rise of the Empire. Golan Arms threw in with the Rebel Alliance (losing half of its factories to the Empire in the process) and provided the Rebels with these launchers.

Palandrax Personal Protection Stun Gauntlets

Weapon Type: Melee weapon
Proficiency Group: Simple weapons
Cost: 500
Damage: --
Critical: --
Weight: 1.8 kg
Fort DC: 12
Type: Bludgeoning
Size: Medium-size
Hardness: 5
WP: 5
Break DC: 14
Availability: Prevalent
Era: [RI] [RE] [NJ]



Palandrax Personal Protection Stun Gauntlets

The fabric of these heavy gauntlets is interwoven with circuitry to deliver an electric shock when they hit. When they are powered, the gloves glow, and a noticeable electrical discharge is evident around them. The weapon requires two energy cells (one for each glove).

Palandrax makes its stun gauntlets to fit a variety of species, and any set of gloves is considered to be the same size weapon as the size of the species it is made for. The company primarily makes Medium-size gauntlets, though it will do special orders for Large or Small creatures (at ten times the list price).

An attacker wearing stun gauntlets cannot be disarmed. The gloves themselves, however, can be damaged.

Unpowered gauntlets function as normal gloves, providing no special benefit in combat.

Merr-Sonn G-20 Glop Grenade

Weapon Type: Grenade

Proficiency Group: Simple weapons**Cost:** 600**Damage:** --**Critical:** --**Range Increment:** 4 m (4 m)**Weight:** 0.5 kg**Type:** Special**Size:** Tiny**Hardness:** 2**WP:** 2**Break DC:** 15**Availability:** Prevalent, restricted**Era:** [RI] [RE] [NJ]**Special:** This weapon has a timer that allows the grenade to go off in any round up to 3 rounds after being set. The timer can be deactivated with a Demolitions check against DC 15 (a full-round action).

**Merr-Sonn C-20
Glop Grenade**

A spherical grenade, the G-20 sprays its burst radius with an adhesive foam that slows or completely imprisons its targets. It may explode on contact or as many as 3 rounds later and may be recharged (cost 100 to recharge, given proper facilities). Glop grenades do not produce injuries, and as such are advantageous in situations when no collateral damage is desired. They are used extensively in the Corporate Sector.

Those caught within the burst radius of a glop grenade must make a Reflex save (DC 15) or be held immobile by the glop; those who succeed move at half speed until the glop is removed from their bodies. Regardless of the saving throw, those within the area of the glop are entangled (-2 penalty on attack rolls and -4 to Dexterity).

Stuck characters may break free with a Strength check (DC 27) or by dealing 18 points of energy damage to the glop. Freed characters still suffer attack and Dexterity penalties and move at half speed until the glop dries or is removed.

Glop becomes naturally brittle after 5 minutes. It may also be removed by glop dissolver, which frees a stuck character in 1 round and removes glop entirely in 1 round more. Glop dissolver is sold in aerosol packs of four applications for 50 credits. Each application is sufficient to clean up one individual.

Creshaldyne Industries Camo Scout Armor

Armor Type: Medium armor **Proficiency Group:** Medium **Cost:** 6,000 **Damage Reduction:** 4 **Maximum Dex Bonus:** +3 **Armor Check Penalty:** -3 **Speed:** 8 m/4 m **Weight:** 6 kg **Availability:** Specialized **Era:** [RI] [RE] [NJ]



Camo Scout Armor

Camo scout armor is designed to protect the wearer from both attack and discovery. It consists of a series of hard plates over a fabric body suit. Embedded within the armor are miniature photoreactive fibers that allow the armor to absorb light and change color to match its surroundings. As a result, the armor provides a +10 circumstance bonus on Hide checks, regardless of terrain.

GTU AV-1C Combat Armor

Armor Type: Powered armor **Proficiency Group:** Powered **Cost:** 25,000 **Damage Reduction:** 6 **Maximum Dex Bonus:** +0 **Armor Check Penalty:** -6 **Speed:** 8 m/4 m, fly 10 m (average) **Weight:** 25 kg **Availability:** Rare, military **Era:** [RI] [RE] [NJ]

AV-1C Combat Armor



The AV-1C is designed for combat and is popular with well-funded military units for use in front-line infantry actions. It is a fully enclosed suit of armor made of interlocking hard plates that provide complete coverage of the operator's body. It is powered by an extensive set of servomotors.

The armor can operate for 24 hours on a set of four standard power packs, after which time it ceases all function; the operator suffers penalties as if he lacked the Armor Proficiency (powered) feat. It takes 10 minutes to get into this suit of armor and 6 full rounds to get out.

The AV-1C has the following features.

Strength Augmentation: The powered servos give the operator a +4 equipment bonus to Strength. If the operator does not have the Armor Proficiency (powered) feat, not only does this bonus not apply, but the operator suffers a -4 penalty to Strength and Dexterity while in the armor.

Life Support: The suit provides full life support for 24 hours, with an internal air supply and protection against the most extreme environments, including vacuum.

Computerized Targeting: The suit has mounts to carry up to two ranged weapons of size Large or smaller, as built-in parts of the armor. These weapons receive a +2 equipment bonus on all attack rolls. Additional weapons may be carried and used by the suit's wearer, but are not attached to the computer targeting system and do not gain the attack bonus. The wearer may use only one suit-mounted weapon per round.

Repulsorlift: The AV-1C is equipped with a repulsorlift, giving it the ability to fly at a speed of 10 meters with average maneuverability. The repulsorlift has an operational altitude of low (about 1,000 meters).

Sensors: The suit grants its operator low-light vision and darkvision out to 20 meters and provides the benefit of a pair of electrobinoculars, reducing the wearer's penalty on Spot checks to -1 for every 20 meters.

Comlink: The armor's built-in comlink has a range of 50 kilometers and can send and receive encrypted messages.

Powerlamp: The armor includes a powerful lamp able to create a beam of light up to 100 meters long and 50 meters wide.

While you're waiting for the Arms & Equipment Guide, check out other equipment we've featured on this website, including the [Trade Federation droid starfighter](#), the [WEDOO-88 repair droid](#), the [Jedi's Great Holocron](#), and the freighter [Sea Killer!](#)

PRIVACY STATEMENT

©2002 Lucasfilm Ltd. & © or TM where indicated. All rights reserved. Used under authorization. visit STARWARS.COM



Shop Games Books Magazines Stores Events Company Worldwide Community

RPG Home
Learn to Play
Products
Web
Enhancements
Archive
Living Force
Retailer Locator
Fan Club Store
Character Sheet



Trade Federation Droid Starfighter

By [Cory J. Herndon](#)

The cost-conscious Trade Federation realized they could save money on droids by designing their droid starfighters -- which were usually on the vanguard of any attack -- to act in a second capacity: as sentries on the ground. Although not as versatile as a battle or destroyer droid, the walking droid starfighter can be a formidable opponent thanks to its powerful torpedo launchers. While in walking mode, however, the droid's blaster cannons cannot be used effectively.

Use these new droid stats with the description of the Trade Federation droid starfighter in Chapter 1 of [Secrets of Naboo](#).

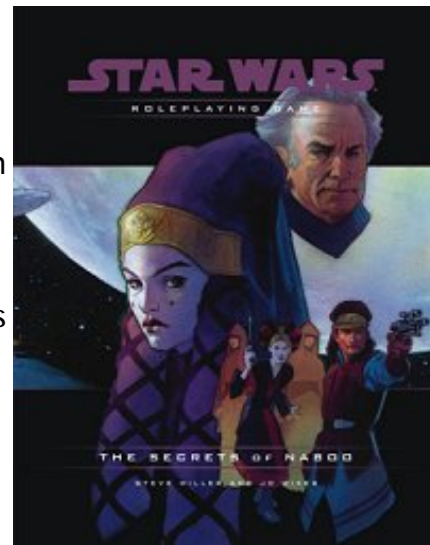

Trade Federation Droid Starfighter: Walking battle droid, Thug 5; Init -3 (-2 remote processor, -1 Dex); Def 19 (+10 armor, +1 class, -1 size, -1 Dex); Spd 18m; VP/WP -/60; Atk +13 melee (dmg 1d6+9, foot), +3 ranged (dmg 9d10x2, range 30m, 8 torpedoes); SQ Variable Geometry, DR 5; SV Fort +29, Ref +0, Will +1; SZ L; Rep 0. Str 28, Dex 8, Con 60, Int 10, Wis 10, Cha 6; Challenge Code: C.

Equipment: Torpedo launchers (2), integrated comlink, remote processor (5,000 km range), armor.

Skills: Intimidate +2, Pilot +4, Spot +2.

Feats: Armor Group Proficiency (light), Starship Operation (starfighter), Weapon Group Proficiency (heavy, simple).

Special Qualities: Variable Geometry -- This droid is the "transformed" walking version of the Trade Federation droid starfighter. As a full-round action, it can convert into starfighter form and vice versa (see droid starfighter description in Chapter 11 of the *Star Wars Roleplaying Game*).

Don't have [Secrets of Naboo](#) yet? Order now!

BUY NOW

[PRIVACY STATEMENT](#)

©2002 Lucasfilm Ltd. & © or TM where indicated. All rights reserved. Used under authorization. visit [STARWARS.COM](#)

Shop Games Books Magazines Stores Events Company Worldwide Community



The Sea Killer

By [Cory Herndon](#)

The freighter *Sea Killer* has seen a few owners in its dozen-odd years of existence. Manufactured by SoroSuub, the ship has an organic appearance that one might liken to a fierce ocean predator. After owning the vessel for a month, its current captain, a Gungan named Toba, had the stylized face of an Opee Sea Killer painted on the nose of the vessel, completing the image. Most other beings think the paint job makes the *Sea Killer* look like a 25-meter flying fish. Toba also installed a "Getaway" missile launcher taken from an old Corellian YG-4400, just in case the *Killer's* speed isn't enough to get him through tight scrapes.

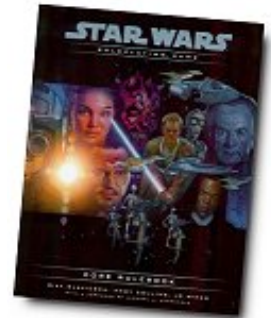

[Site Map](#)
[Navigation Help](#)



STAR WARS
 WWW.STARWARS.COM



Craft: Modified SoroSuub B'zabuu-Class Transport; **Class:** Transport; **Cost:** 95,000 (new); 35,000 (used); **Size:** Small (22 m long); **Crew:** 2 (Toba/R5-R5, +20); **Passengers:** 6; **Cargo Capacity:** 55 metric tons; **Consumables:** 3 months; **Hyperdrive:** x1 (backup x10); **Maximum Speed:** Ramming; **Defense:** 21 (+1 size, +8 armor); **Shield Points:** 30; **Hull Points:** 140; **DR:** 10; **Weapon:** Dual laser cannon; **Fire arc:** Turret; **Attack Bonus:** +13/+8 (+1 size, +10/+5 crew, +2 fire control); **Damage:** 4d10 x2; **Range modifiers:** PB/S -0, M/L n/a; **Weapon:** "Getaway" Mini-Concussion Missile (1 missile); **Fire arc:** Rear; **Attack Bonus:** +12 (+1 size, +10 crew, +1 fire control); **Damage:** 6d10; **Range modifiers:** PB -2, S/M/L n/a

For more new vehicles for your games, check out each issue of [Star Wars Gamer!](#)

[PRIVACY STATEMENT](#)

©2002 Lucasfilm Ltd. & © or TM where indicated. All rights reserved. Used under authorization.
 visit STARWARS.COM

[Shop](#) [Games](#) [Books](#) [Magazines](#) [Stores](#) [Events](#) [Company](#) [Worldwide](#) [Community](#)



RPG Home
Learn to Play
Products
Web
Enhancements
Archive
Living Force
Retailer Locator



The Great Holocron

An Expanded Universe Artifact from Star Wars: Attack of the Clones - The Visual Dictionary, available April 23

By [Cory Herndon](#)

Deep within the Jedi temple on Coruscant, thousands of years of collected Republic history, studiously maintained by the Jedi since the earliest days of the order, resides in the Archives Library. Among the collected histories, records, teachings, and solemn busts depicting Jedi long dead, the Great Holocron awaits all those students of the Force willing to learn from its vast stores of collected knowledge.



[Site Map](#)
[Navigation Help](#)

STAR WARS
 WWW.STARWARS.COM



Unlike some Force artifacts, the twelve-sided Great Holocron was designed specifically for ease of use, especially by young Jedi trainees. Some, including Archives Director Madame Jocasta Nu, have speculated that even Yoda may not yet have learned all its mysteries. Regardless, it is said to be the largest and most powerful holocron in the Archives Library.

Using the Great Holocron

The Great Holocron will not respond to characters without the Force-Sensitive feat. Permission to access the Great Holocron is available to Jedi and those deemed worthy by the Jedi Order, but the artifact does not give up its deepest secrets to the novice. To use the Great Holocron, a character makes an Empathy check (untrained if necessary) with a -12 circumstance penalty (one for each facet of the Holocron's surface) on the table below. The user may choose to add a Force bonus equal to his or her Force-using levels (+12 max). The roll may not be reduced to zero.

Great Holocron Empathy Check Results

Roll	The Great Holocron Will Answer
1-8	One query limited to the factual history of the Republic. Many sections, especially dark side-related information, are still concealed. Basics of lightsaber construction explained.

Expanded Universe Library

Characters from the expanded *Star Wars* universe now online!

[Suubatar](#)
[Lena Cobral](#)
[Iaco Stark](#)
[Greater krayt dragon](#)
[Ilum](#)
[Reti, Salvage Pilot](#)
[Siri Tachi](#)
[Vilmarh Grahrk](#)
[Quinlan Vos](#)

- 9-15 One query that may include history or philosophy. Dark Force secrets still elusive, Sith history and ancient Republic records are not. More complicated lightsaber construction, including double-bladed and variable-length varieties, explored in historical terms.
- 16-20 Two queries in the subjects of combat, history, and philosophy. Dark side explored with some depth, including more intensive techniques to resist its call.
- 21-27 Two queries into combat, history, philosophy, and the dark side. As a Jedi artifact, information on the dark side is rarely complimentary, but at this level is otherwise unrestricted.
- 28-32 Three queries, otherwise the same level of information as 21-27.
- 33+ Four queries, unlimited access. Note that some secrets, such as the deepest workings of the Sith, still may not be contained in the Great Holocron.

Gamemasters are encouraged to override specific questions that they deem sensitive to storyline plans or that delve into events that simply took place too recently. Otherwise, GMs should strive to answer the user's question in a way appropriate to his or her skill level. The Great Holocron will not reveal the secrets of Sith sorcery, for example, to a 14-year-old Human Padawan without an especially strong disturbance in the Force likely to alert the Archives Director. Young students often must be pulled from the Holocron before they sap their vitality.

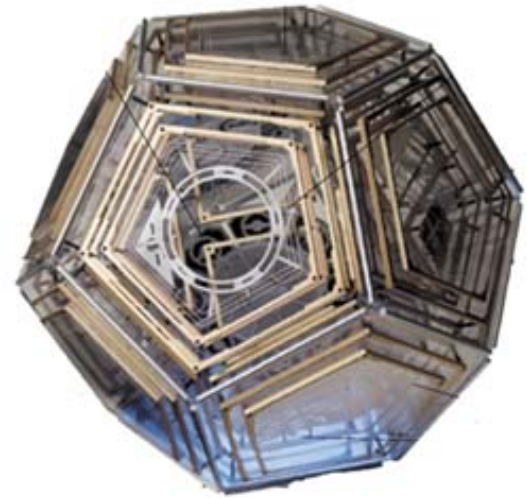

The Great Holocron is available only during the Rise of the Empire era and remains lost in the other eras of play.

Holocrons convey information through holographic Force representations of the Jedi Master whose teachings they hold, so the more cryptic your depiction, the better. And when in doubt you are, recommended is grammar odd.

Preview Star Wars: Attack of the Clones - The Visual Dictionary and Star Wars: Attack of the Clones - Incredible Cross-Sections, [two new books](#) for detail-oriented fans of all ages!

For more exciting ways to expand your enjoyment of the Star Wars Roleplaying Game universe, check out every issue of [Star Wars Gamer](#) and [Star Wars Insider](#) magazines!

[PRIVACY STATEMENT](#)

©2002 Lucasfilm Ltd. & © or TM where indicated. All rights reserved. Used under authorization.

visit STARWARS.COM



Super Star

*An Expanded Universe Starship from Enemy Lines II: Rebel Stand
(Book 12 of Star Wars: The New Jedi Order)*

By [Cory Herndon](#)

One of the New Republic's precious few Super Star Destroyers, the *Lusankya* has a bizarre and storied history. The massive vessel -- equal in almost every way to Darth Vader's flagship *Executor* -- was built under a code name at the Kuat Drive Yards. Once completed, the Emperor himself used the dark side of the Force to hide the *Lusankya* beneath the surface of Coruscant's cityscape. Though intended to serve primarily as a prison (many famous Rebel POWs did time in *Lusankya*, including [Jan Dodonna](#), [Corran Horn](#), and Tycho Celchu), the Super Star Destroyer was quite spaceworthy. She sat fully fueled and upon enormous launch repulsors that eventually allowed the Imperial dictator [Ysanne Isard](#) to take the ship off of Coruscant.

"Iceheart" and her huge ship eventually fell to Rogue Squadron, and the New Republic refitted the vessel with eyes toward research as well as war. The former prison cells have been converted into science labs and biocontainment areas. Many of the New Republic's finest scientific and medical minds work aboard. The troop complement is relatively small (compared to that of an Imperial vessel like the *Executor*), but the *Lusankya*'s shields and hull have been reinforced beyond design specs, and her weapons complement makes the big ship one of the most powerful vessels in the entire Republic navy.

Craft: *Lusankya* (Kuat Drive Yards Super-class Star Destroyer) **Class:** Space Station; **Cost:** Not available for sale; **Size:** Colossal (Huge space station, 12,000 meters); **Initiative:** -4 (-8 size, +4 crew); **Crew:** 198,025 (Skilled +4); **Passengers:** 12,000 (troops), 14,000 (researchers); **Cargo:** 250,000 metric tons; **Consumables:** 6 years; **Hyperdrive:** x2 (x10 backup); **Maximum Speed in space:** Cruising (2 squares/action); **Atmospheric Speed:** n/a; **Maneuvers:** -4 (-8 size, +4 crew); **Defense:** 14 (-8 size, +12 armor); **Shield Points:** 920; **Hull Points:** 1050; **DR:** 40.

Expanded Universe Library

Characters from the expanded *Star Wars* universe now online!

[Aayla Secura](#)
[Great Holocron](#)
[Greater krayt dragon](#)
[Iaco Stark](#)
[Illum](#)
[Kyle Katarn, Jedi Outcast](#)
[Lena Cobral](#)
[Quinlan Vos](#)
[Reti, Salvage Pilot](#)
[Siri Tachi](#)
[Suubatar](#)
[Vilmarh Gahrk](#)

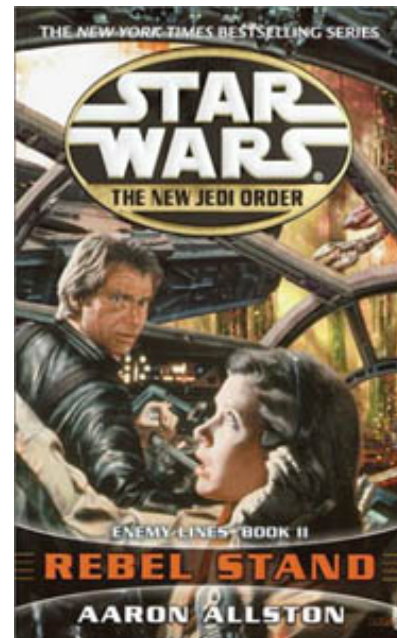

[Site Map](#)
[Navigation Help](#)

STAR WARS
 WWW.STARWARS.COM



Weapon: Turbolasers (250); **Fire arc:** 20 batteries front, 15 batteries right, 15 batteries left; **Attack Bonus:** +4 (-8 size, +4 crew, +4 fire control, +4 battery fire); **Damage:** 7d10x5; **Range modifiers:** PB -6, S -4, M -2, L +0.

Weapon: Heavy turbolasers (250); **Fire arc:** 20 batteries front, 10 batteries right, 10 batteries left, 10 batteries rear; **Attack Bonus:** +8 (-8 size, +4 crew, +8 fire control, +4 battery fire); **Damage:** 10d10x5; **Range modifiers:** PB -6, S -4, M -2, L +0.

Weapon: Assault concussion missile tubes (250, 30 missiles each); **Fire arc:** 10 batteries front, 15 batteries left, 15 batteries right, 10 batteries rear; **Attack Bonus:** +2 (-8 size, +4 crew, +2 fire control, +4 battery fire); **Damage:** 9d10x5; **Range modifiers:** PB -6, S -4, M -2, L n/a.

Weapon: Heavy ion cannons (250); **Fire arc:** 20 batteries front, 10 batteries right, 10 batteries left, 10 batteries rear; **Attack Bonus:** +8 (-8 size, +4 crew, +8 fire control, +4 battery fire); **Damage:** Special; **Range modifiers:** PB -6, S -4, M -2, L +0.

Weapon: Tractor beams (40); **Fire arc:** 20 front, 10 right, 10 left, 10 rear; **Attack Bonus:** +4 (-8 size, +4 crew, +8 fire control); **Damage:** Special; **Range modifiers:** PB -6, S -4, M/L n/a.

The Lusankya appears in Enemy Lines II: Rebel Stand, Book 12 in The New Jedi Order series. [Preview or buy this Del Rey novel now!](#)

PRIVACY STATEMENT

©2002 Lucasfilm Ltd. & © or TM where indicated. All rights reserved. Used under authorization.
visit STARWARS.COM

Shop Games Books Magazines Stores Events Company Worldwide Community



RPG Home

Learn to Play

Products

Web

Enhancements

Archive

Living Force

Retailer Locator

Fan Club Store

SW Insider Update



Starship and Airspeeder Speed Chart

By [JD Wiker](#) and Mike Mikaelian

Starfighters

Vessel	Speed Category	Space Squares/Action	Overall	Atmospheric Squares/Action	Missile Quality
A-9 Vigilance Interceptor	Ramming (+4)	14	1,300 km/h	22	-
A-Wing	Ramming (+4)	14	1,300 km/h	22	-
Arakyd Probe-Mate Pod	Cruising	4	1,190 km/h	20	-
<i>Bail Jumper</i>	Ramming	11	1,100 km/h	18	Marginal (+5)
B-Wing	Ramming	9	950 km/h	16	Marginal (+5)
B-Wing/E2	Ramming	11	920 km/h	15	Marginal (+5)
<i>BulbaBong</i> G-1 Starfighter	Ramming	10	970 km/h	16	Marginal (+5)
Chiss Clawcraft	Ramming (+2)	12	1,220 km/h	20	-
Cloakshape Fighter	Attack	6	950 km/h	16	Marginal (+5)
<i>Crystal</i>	Ramming (+2)	12	1,130 km/h	19	Marginal (+5)
<i>Dicer</i>	Ramming	10	1,150 km/h	19	Good (+15)
Droid Starfighter	Ramming	10	1,180 km/h	20	Ordinary (+10)
Escape Pod	Docking	1	60 km/h	1	-
E-Wing Type B	Ramming (+3)	13	1,300 km/h	22	Ordinary (+10)
Fil'vee Transport Patrol Escort	Attack	7	1,130 km/h	19	-
<i>Freefall</i>	Attack	8	1,170 km/h	20	-
<i>Goonga Munt Goonga</i>	Ramming	10	1,040 km/h	17	Marginal (+5)
<i>Guardian Mantis</i>	Ramming	11	1,300 km/h	22	Marginal (+5)
Gun Tug	Ramming	9	-	-	-
<i>Havoc</i>	Attack	8	1,250 km/h	21	-
I-7 Howlrunner	Ramming (+3)	13	1,300 km/h	22	-
Incom T-36 Skyfighter	Attack	8	990 km/h	17	Ordinary (+10)
Jedi Starfighter	Ramming	10	1,200 km/h	20	Ordinary (+10)
Lambda Shuttle	Attack	8	850 km/h	14	-
<i>Mist Hunter</i>	Attack	8	1,160 km/h	19	-
Miy'til Assault Bomber	Ramming	11	1,080 km/h	16	Ordinary (+10)
Miy'til Fighter	Ramming (+3)	13	1,170 km/h	20	Marginal (+5)
Naboo Bomber	Attack	6	900 km/h	15	-
Naboo N-1 Starfighter	Ramming	9	1,100 km/h	18	Ordinary (+10)
Phoenix Hawk Light Pinnacle	Cruising	4	990 km/h	17	-

[Site Map](#)
[Navigation Help](#)



STAR WARS
 WWW.STARWARS.COM



Preybird	Attack	8	1,150 km/h	19	Ordinary (+10)
<i>Punishing One</i>	Ramming	10	1,110 km/h	19	-
Scimitar Assault Bomber	Ramming	11	850 km/h	14	Marginal (+5)
Sith Starfighter	Ramming	9	1,140 km/h	19	-
Svelte-Class Imperial Shuttle	Ramming	10	810 km/h	14	-
T-65AC4 X-Wing	Ramming (+2)	12	1,120 km/h	19	Ordinary (+10)
TIE Advanced x1	Ramming	11	1,200 km/h	20	-
TIE Bomber	Attack	7	850 km/h	14	Marginal (+5)
TIE Fighter	Ramming	10	1,200 km/h	20	-
TIE Interceptor	Ramming (+2)	12	1,250 km/h	21	-
X-Wing Fighter	Ramming	9	1,050 km/h	18	Ordinary (+10)
Y-Wing Fighter	Attack	8	1,000 km/h	17	Marginal (+5)
Z-95 Headhunter	Ramming	9	1,150 km/h	19	Marginal (+5)

Space Transports

Vessel	Speed Category	Space Squares/Action	Overall	Atmospheric Squares/Action	Missile Quality
Action IV Bulk Freighter	Cruising	3	580 km/h	10	-
<i>Aeon Ranger</i>	Cruising	4	760 km/h	13	Ordinary (+10)
<i>Amanda Fallow</i>	Attack	7	780 km/h	13	Marginal (+5)
Assault Shuttle	Ramming	9	1,050 km/h	18	Marginal (+5)
Barloz Medium Freighter	Cruising	4	950 km/h	16	-
<i>Birthright</i>	Ramming	9	750 km/h	13	-
<i>Blaze of Glory</i>	Attack	8	950 km/h	16	-
<i>BulbaBong</i> BB-2 Shuttle	Cruising	4	840 km/h	14	-
Citadel Cruiser	Attack	6	830 km/h	14	Marginal (+5)
Corellian VCX-350	Attack	5	610 km/h	10	-
Corellian VCX-700	Attack	8	940 km/h	16	Marginal (+5)
Corellian VCX-820	Attack	8	950 km/h	16	Ordinary (+10)
Corellian YT-1300	Attack	8	800 km/h	13	-
Corellian YT-1760	Ramming	10	990 km/h	17	-
Corellian YT-2400	Attack	8	810 km/h	14	-
Corellian YU-410	Cruising	4	830 km/h	14	-
Corellian YV-100	Attack	8	880 km/h	15	-
Corellian YV-929	Cruising	4	650 km/h	11	Marginal (+5)
Corellian YZ-775	Attack	7	780 km/h	13	Marginal (+5)
<i>Courageous</i>	Attack	7	920 km/h	15	-
CRX-Tug	Cruising	4	690 km/h	12	-
<i>Dawn Beat</i>	Attack	7	780 km/h	13	Marginal (+5)
<i>Deathraven</i>	Ramming	10	900 km/h	15	Ordinary (+10)
<i>Emerald Lance</i>	Attack	8	970 km/h	16	Marginal (+5)
<i>Fair Gale</i>	Cruising	4	940 km/h	16	-
Firespray-31	Ramming	10	1,050 km/h	18	-
Gallofree Medium Transport	Cruising	4	650 km/h	11	-
<i>Goshyn Queen</i>	Cruising	4	740 km/h	12	-

<i>Green Palace</i>	Attack	7	980 km/h	16	Marginal (+5)
<i>Guardian-class light cruiser</i>	Attack	7	1,150 km/h	19	-
<i>Hound's Tooth</i>	Ramming	10	1,190 km/h	20	Marginal (+5)
<i>IG-2000</i>	Ramming (+2)	12	1,220 km/h	20	-
<i>Imperial I Star Destroyer</i>	Cruising	3	-	-	-
<i>Jade Sabre</i>	Ramming (+2)	12	1,160 km/h	19	-
<i>Krakana's Claw</i>	Ramming	11	980 km/h	16	Ordinary (+10)
<i>Lady Sunfire</i>	Cruising	4	950 km/h	16	Marginal (+5)
<i>Mantaris</i>	Ramming	9	840 km/h	14	Marginal (+5)
<i>Midnight Star</i>	Ramming	11	830 km/h	14	Ordinary (+10)
<i>Millennium Falcon</i>	Attack	8	1,050 km/h	18	Good (+15)
<i>Miniad</i>	Attack	6	830 km/h	14	-
Neimoidian Shuttle	Cruising	3	870 km/h	15	-
<i>Rabbit's Foot</i>	Ramming	10	1,000 km/h	17	-
Royal Starship	Cruising	4	920 km/h	15	-
<i>Sea Killer</i>	Ramming	9	890 km/h	15	Ordinary (+10)
Sith Infiltrator	Ramming	11	1,180 km/h	20	-
Sith Personnel Carrier	Cruising	4	820 km/h	14	-
Skipray Blastboat	Ramming	10	970 km/h	16	Concussion: Marginal (+5)
					Proton: Marginal (+5)
<i>Slave I</i>	Ramming	12	1,000 km/h	18	Concussion: Ordinary (+10)
					Proton: Good (+15)
<i>Slave II</i>	Ramming (+2)	12	1,280 km/h	21	Good (+15)
Star Shuttle	Cruising	4	610 km/h	10	-
<i>Stinger</i>	Ramming	11	1,150 km/h	19	-
Trade Federation Landing Craft	Cruising	4	680 km/h	11	-
<i>Uwana Buyer</i>	Attack	6	715 km/h	12	-
<i>Vibre-Class Assault Cruiser</i>	Attack	6	640 km/h	11	-
<i>Yorik-vec Assault Cruiser</i>	Attack	8	1,080 km/h	18	-
<i>White Wing</i>	Attack	6	710 km/h	12	-

Capital Ships

Vessel	Speed Category	Space Squares/Action	Overall	Atmospheric Squares/Action	Missile Quality
Action V Bulk Freighter	Cruising	4	650 km/h	11	-
Akorec Strike Cruiser	Attack	6	930 km/h	16	-
Bothan Assault Cruiser	Cruising	4	910 km/h	15	Ordinary (+10)
Carrack Light Cruiser	Cruising	4	-	-	-
<i>Chilastra</i>	Cruising	4	-	-	-
Corellian Corvette	Attack	5	950 km/h	16	-

Corellian Gunship	Attack	6	1,000 km/h	17	Ordinary (+ 10)
Corellian Space Cruiser	Attack	6	900 km/h	15	-
<i>Dead Reckoning</i>	Attack	6	910 km/h	15	Marginal (+ 5)
Defender Star Destroyer	Cruising	4	-	-	Ordinary (+ 10)
Dreadnaught	Cruising (-2)	3	-	-	-
<i>Etherway</i>	Cruising	4	650 km/h	11	-
<i>Executor</i> Super Star Destroyer	Cruising	3	-	-	Ordinary (+ 10)
<i>Freejack</i>	Attack	8	870 km/h	15	-
Hapan Battle Dragon	Attack	7	-	-	-
Hapan Nova Battle Cruiser	Attack	5	-	-	-
Immobilizer 418 Cruiser	Attack	5	-	-	-
Imperial Escort Carrier	Attack	5	-	-	-
<i>Imperial I Star Destroyer</i>	Attack	6	-	-	-
<i>Imperial II Star Destroyer</i>	Attack	6	-	-	-
Imperial Star Galleon	Cruising (-2)	3	-	-	Marginal (+ 5)
<i>Kern's Pride</i>	Attack	6	950 km/h	16	-
Lancer Frigate	Attack	6	-	-	-
<i>Lastri's Ort</i>	Cruising (-2)	3	-	-	Marginal (+ 5)
<i>Marauder</i> Corvette	Attack	5	850 km/h	14	-
Mon Calamari MC80	Cruising	4	-	-	-
Mon Calamari MC90	Cruising	4	-	-	Ordinary (+ 10)
Nebulon-B Escort Frigate	Cruising	3	800 km/h	13	-
Republic Transport Ship	Attack	8	1,200 km/h	20	Ordinary (+ 10)
<i>Singularity</i>	Cruising	4	-	-	-
Sith Battleship	Cruising (-2)	3	800 km/h	13	Marginal (+ 5)
Sith Gunship	Attack	6	850 km/h	14	-
StarForge Station	Docking	1	-	-	-
<i>Starry Ice</i>	Cruising	4	650 km/h	11	-
System Patrol Craft	Attack	8	1,000 km/h	17	-
Torpedo Sphere	Cruising (-4)	2	930 km/h	16	Ordinary (+ 10)
Trade Federation Battleship	Cruising	2	-	-	-
<i>Victory I Star Destroyer</i>	Cruising (-4)	4	-	-	Ordinary (+10)
<i>Victory II Star Destroyer</i>	Cruising	4	-	-	-
Vindicator Heavy Cruiser	Attack	5	-	-	-
<i>Wild Karrde</i>	Cruising	4	950 km/h	16	-

Airspeeders

Vessel	Overall	Atmospheric Squares/Action
Air-2 Racing Swoop	700 km/h	12
Coruscant Air Taxi	191 km/h	3
Coruscant Air Shuttlebus	400 km/h	7
Flurry II	750 km/h	13
Incom T-16 Airspeeder	1,175 km/h	20
Incom T-47 Airspeeder	650 km/h	11
Repulsorlift Service Platform	50 km/h	1
Skyspeeder	350 km/h	6
Snowspeeder	1,000 km/h	17
Shadow V Combat Airspeeder	800 km/h	13
STAP	300 km/h	5
Storm IV Cloud Car	1,000 km/h	17
Swoop	780 km/h	13
V-Wing Airspeeder	1,400 km/h	23

[Return to the main conversion page.](#)

PRIVACY STATEMENT

©2002 Lucasfilm Ltd. & © or TM where indicated. All rights reserved. Used under authorization.
visit STARWARS.COM

Shop Games Books Magazines Stores Events Company Worldwide Community



- RPG Home**
- Learn to Play**
- Products**
- Web**
- Enhancements**
- Archive**
- Living Force**
- Retailer Locator**
- Fan Club Store**
- Character Sheet**



New G-1 Starfighter!

By [Cory Herndon](#)

Built as a joint venture between the spaceworks division of the Gungan BullbaBong firm and the Theed Palace Space Vessel Engineering Corps, G-1 starfighters superficially resemble the royal N-1s (except for their forest green paint jobs). These craft are equipped for long periods of independent operation and sustained combat in-system. To this end, the G-1 sacrifices hyperdrive quality for shielding and weapons control. Most G-1s are owned by the Naboo government, although a few have made it onto the open market and into the hands of private owners.

[Site Map](#)
[Navigation Help](#)



Craft: BullbaBong/Theed Palace Space Vessel Engineering Corps G-1 Starfighter; **Class:** Starfighter; **Cost:** 125,000 (new), 80,000 (used) **Size:** Tiny (11 m long); **Crew:** Normal +2 (1 pilot/gunner; 1 astromech droid); **Passengers:** none; **Cargo Capacity:** 90 kg; **Consumables:** 2 weeks; **Hyperdrive:** x4; **Maximum Speed:** Ramming; **Defense:** 22 (+2 size, +10 armor); **Shield Points:** 40; **Hull Points:** 60; **DR:** 7; **Weapon:** Laser cannons (2 fire-linked); **Fire arc:** Front; **Attack Bonus:** +9 (+2 size, +2 crew, +5 fire control); **Damage:** 5d10 x2; **Range modifiers:** PB -0; S -0; M/L n/a; **Weapon:** Proton torpedo launchers (2 fire-linked); **Fire arc:** Front; **Attack Bonus:** +9 (+2 size, +2 crew, +5 fire control); **Damage:** 10d10 x2; **Range modifiers:** PB -0; S/M/L n/a.

Use this starfighter with [Toba, a Gungan from the Star Wars: Invasion of Theed Adventure Game.](#)

PRIVACY STATEMENT

©2002 Lucasfilm Ltd. & © or TM where indicated. All rights reserved. Used under authorization.
 visit STARWARS.COM

Shop Games Books Magazines Stores Events Company Worldwide Community



RPG Home

Learn to Play

Products

Web

Enhancements

Archive

Living Force

Retailer Locator

Fan Club Store

SW Insider Update



The Mantaris

More *Secrets of Naboo*

By [Steve Miller](#)



In the years following the liberation of Naboo from the Trade Federation invasion force, Queen Amidala, the ruler of the Naboo, and Boss Nass, the leader of the largest Gungan community, continued to look for ways to bring their peoples closer together. The most ambitious of the projects they undertook was a joint colonization effort on Naboo's largest moon. Gungan scientists and Naboo starship engineers worked together under the guidance of Queen Amidala's chief science advisor, Graf Zapalo, to create a number of new technologies, prime among them being the *Mantaris*-class amphibious medium transport. This new class of vessel proved invaluable in the years that followed, as the Gungans migrated first to Naboo's moons and from there to other swamp- and ocean-rich worlds, joining the other civilized sapients of the Republic among the stars.

Thanks to [Owen K.C. Stephens](#); the creators of *The Gungan Frontier*; the good people at Lucas Licensing; and, of course, George Lucas.

You may remember the original *Mantaris* prototype ship from [Lucasarts' *The Gungan Frontier*](#) computer game. Here we describe it for use in your *Star Wars Roleplaying Game* campaigns.

Mantaris Amphibious Transport Prototype

The *Mantaris*-class medium transport was developed for use in colonizing Naboo's primary moon while fostering further union between the Naboo and the Gungans. As such, its design not only reflects the artistic sensibilities of both species, but it is equally capable of functioning under water, in planetary atmospheres, and the frigid depths of space.

The basic design is Gungan, based upon their well-tested submersible cargo vessel. Naboo engineers made the design spaceworthy and improved upon the modularity of the *Bongo*-class submersible to outfit the *Mantaris*-class transport with bubble-shaped, modular sections. These sections could either increase the vessel's cargo capacity by 100 metric tons, add 30 people to its passenger capacity, or carry wildlife ranging from colo claw fish to nuna birds in appropriately outfitted zoological modules. The *Mantaris* can carry up to four pods at a time.

Craft: Theed Palace Space Vessel Engineering Corps/Otoh Gunga Bongowerks
***Mantaris* Amphibious Medium Transport. Class:** Medium Transport. **Cost:** 280,000

[Site Map](#)

[Navigation Help](#)



STAR WARS
WWW.STARWARS.COM



credits. **Size:** Medium (68 m long, plus 30 m long heat sink finials). **Crew:** Normal +2 (1 pilot, 1 navigator/shield operator, 1 communications/security officer, 1 engineer/gunner, 1 astromech droid). **Passengers:** 20, plus additional depending on attached modules. For live animals, a module pod can carry 60 small creatures, 30 medium creatures, 15 large creatures, 7 huge creatures, 3 gargantuan creatures, or 1 colossal creature. **Cargo Capacity:** 250 metric tons, plus additional depending on attached modules. **Consumables:** 3 months, plus additional depending on attached modules. **Hyperdrive:** x2 (backup x8). **Maximum Speed:** Ramming. **Defense:** 20 (+10 armor). **Shield Points:** 30. **Hull Points:** 120. **DR:** 10. **Weapons:** Concussion missile launchers (6 missiles each). **Fire Arc:** 1 front, 1 back. **Attack Bonus:** +4 (+2 crew, +2 fire control). **Damage:** 7d10x2. **Range Modifier:** PB +0, S/M/L na.

[PRIVACY STATEMENT](#)

©2002 Lucasfilm Ltd. & © or TM where indicated. All rights reserved. Used under authorization. visit STARWARS.COM

[Shop](#) [Games](#) [Books](#) [Magazines](#) [Stores](#) [Events](#) [Company](#) [Worldwide](#) [Community](#)



[RPG Home](#)

[Learn to Play](#)

[Products](#)

[Web](#)

[Enhancements](#)

[Archive](#)

[Living Force](#)

[Retailer Locator](#)

[Fan Club Store](#)

[SW Insider Update](#)

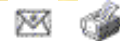

[Home](#) > [Roleplaying Games](#) > [Star Wars: RPG](#)

[Navigation Help](#)

Thursday, October 3, 2002

Making a Full Recovery

A Companion to *The New Jedi Order Sourcebook*

By Craig R. Carey, Jason Fry, and Daniel Wallace

[Chat](#)
[Message Boards](#)
[Mailing List](#)

The New Jedi Order

10/03/2002 [Making a Full Recovery](#)

03/14/2002 [Chat transcript](#)
03/07/2002 [Sourcebook art gallery](#)

02/28/2002 [Sourcebook excerpt: archetypes](#)
02/21/2002 [Mini-adventure](#)

02/07/2002 [Sourcebook excerpt: Vong horrors](#)

02/07/2002 [Web enhancement](#)

02/07/2002 [Creature: Sgauru](#)

01/31/2002 [Creature: Tu-Scart](#)

01/24/2002 [Introduction to the NJO](#)

01/24/2002 [Interview with JD Wiker](#)

01/24/2002 [Sourcebook excerpt: ExGal](#)

Here's a special Jedi goodie, exclusive to our website. You might already know that *The New Jedi Order Sourcebook* brought the events of the first nine novels of that Del Rey series to the *Star Wars Roleplaying Game*. The sourcebook covered everything from the first novel, R.A. Salvatore's *Vector Prime*, through Troy Denning's *Star By Star*.

In December 2001, the first e-book of The New Jedi Order was released - the short story *Recovery*, also by Troy Denning. That tale wasn't a part of *The New Jedi Order Sourcebook*, but now we're bringing it to your campaign at last. The article below details characters, equipment, locations, and plot points from *Recovery*, ready for use in your *Star Wars* game.

Amid the chaos and carnage that is The New Jedi Order era, *Recovery* follows the exploits of Han Solo and the seriously injured Leia Organa Solo as they avoid assassins on Corellia and make their way back to Coruscant to face off against the anti-Jedi contingent within the Senate. During the course of their adventures, Han, Leia and C-3PO encounter danger in the Coronet Medcenter, aboard the *Millennium Falcon*, and in the skies above Coruscant.



Coronet Medcenter

The Coronet Medcenter is the best medical facility on Corellia, even rivaling the legendary hospitals on Rhinnal for patient care. Han Solo, worried that his wife's legs might require amputation following the severe injuries inflicted on her by Yuuzhan Vong warriors, admitted Leia to the Coronet complex under an assumed name. Leia showed signs of healing while in a therapeutic coma, but Roxi Barl and her hired thugs arrived to finish the job that Warmaster Tsavong Lah had started. Following the altercation, Governor-General Thrackan Sal-Solo kicked the Solos off Corellia for good.

Leia stayed in the Coronet Medcenter's isolation ward, found on the top floor of the complex's Recuperation building. The floor can only be reached through a secure turbolift, and, upon exiting the lift, all visitors must undergo chemical and radiation decontamination before being allowed to pass through the decon airlock. Hundreds of rooms line the corridors of the isolation ward, watched over by MD droids at monitoring stations positioned at corridor intersections. Each room can be sealed by entering the appropriate quarantine code at the right monitoring station.

Patients in need of more urgent care can be found in the isolation ward's bacta tank parlors, floating in transparisteel silos filled with the translucent healing fluid. Repulsor chairs and cybernetic exercise braces also help rehabilitate injured patients.

STAR WARS
WWW.STARWARS.COM



Coronet Medcenter Bacta Tank

Due to an under-the-table arrangement with the Xucphra Corporation on Thyferra, the Coronet Medcenter boasts some of the highest-quality bacta found anywhere in the Core. Patients at the Coronet Medcenter recover much faster than do those in lesser facilities. Of course, the Coronet doctors charge much more for their treatments, which has sparked a string of hospital thefts and created a black market for premium bacta.

Cost: 200,000 (for full tank), 2,700 (for 12 hours of treatment);
Weight: 500kg; **Capacity:** 300 liters; **Vitality Points Restored:** 5 per hour; **Wound Points Restored:** 2 per hour.
**1 liter Coronet bacta = 180 credits, 2kg.*

Bacta Tank (Typical)

Cost: 100,000 (for full tank), 1,500 (for 12 hours of treatment);
Weight: 500kg; **Capacity:** 300 liters; **Vitality Points Restored:** 3 per hour; **Wound Points Restored:** 1 per hour.
**1 liter typical bacta = 100 credits, 2kg.*

Portable Bacta Tank (Typical)

"Transport, not treatment" is the principle behind the small, coffin-sized bacta tanks used to move critically injured people between full-service medical facilities. Intended only for short-term use - the fluid in the tanks must be drained and cleaned every twelve hours - portable bacta tanks are often seen aboard infirmary speeders and other rapid-response vehicles. The tank floats on a repulsorlift carriage and can plug into a medical station via data umbilicals. At Thrackan Sal-Solo's request, the tank that bore Eelysa away from Corellia was filled with generic bacta, not the premium Coronet strain.

Cost: 100,000; **Weight:** 170kg; **Capacity:** 100 liters; **Vitality Points Restored:** 1 per hour; **Wound Points Restored:** 0.25 per hour.

Repulsor Chair

Floating repulsor chairs are used in medcenters to transport patients to and from the operating theater. Outside of the hospital environment, repulsor chairs are occasionally seen among those who have damaged their legs and cannot accept cybernetic limb replacements. General Veers of the Imperial Army required permanent use of a repulsor chair following the injuries he sustained in the Battle of Hoth, while Leia Organa Solo needed only the temporary loan of a chair until her wounded legs could heal.

A typical repulsor chair is controlled via a touchpad on the armrest. Most have magnoclamps on the bottom to secure the chair to the hospital floor (or to anchor it to a starship's deck during transit).

Craft: Go-Corp Accron repulsor chair; **Class:** Speeder (ground); **Crew:** 1; **Size:** Medium (1.1 meters long); **Initiative** +0; **Passengers:** None; **Maneuver:** +0; **Cargo Capacity:** none; **Defense:** 10*; **Ground Speed:** 5m; **Shield Points:** 0; **Max Velocity:** 25 km/h; **Hull Points:** 10 (DR 2); **Cost:** 4,000 (new), 1,500 (used).
Weapon: None.

**A repulsor chair provides one-quarter cover to its pilot.*

Cybernetic Exercise Braces

Used by physical therapists to get patients' arms and legs working again, cybernetic exercise braces are powered exoskeletons. A full bracing rig fits around the legs, arms, and torso and supports the wearer in a standing position. The movement of the brace's armature is controlled by the wearer's own muscle movements and can be switched to settings of varying responsiveness. Half-braces are used by those with only upper- or lower-body injuries; Leia Organa Solo used a lower-body cybernetic brace on the Cinnabar Moon to rehabilitate her injured legs.

Cybernetic exercise braces are found in medcenters and medical supply stores, where they can be purchased and used as an unorthodox substitute for powered armor. A healthy wearer of functional cybernetic braces receives a +2 equipment bonus to Strength if she also possesses the Powered Armor Proficiency feat. If the braces aren't powered or are damaged in such a way as to hamper their mobility, the wearer suffers a -2 penalty to Strength and Dexterity.



Type: Genetech G&B Cybernetic Exercise Braces; **Cost:** 3,500; **Damage Reduction:** 4; **Maximum Dex Bonus:** +0; **Armor Check Penalty:** -5; **Speed (10 m):** 8; **Speed (6 m):** 4; **Weight:** 15 kg

Roxi Barl

Roxi Barl was one of the better "independent contractors" in the Corellian sector - that term being a CorSec euphemism for assassin, legbreaker, and all-around thug. Roxi and her sister Deli schemed for years to get rich, and they nearly succeeded when Deli married the vice-president of fleets for CorDuro Shipping. Her husband's fractional ownership of the Kuat Drive Yards corporation made Deli a multimillionaire, but when the man filed for divorce - leaving Deli with nothing - Roxi killed him in revenge. Her actions brought her to the attention of Victor Pomt, chief of staff for the Kuati senator Viqi Shesh. Pomt hired her to murder a comatose Leia Organa Solo in the Coronet Medcenter, where Roxi learned that no Corellian is better in a firefight than Han Solo.

Roxi Barl: Female Human Noble 2/Soldier 6; Init +6 (+2 Dex, +4 Improved Initiative); Defense 18 (+2 Dex, +6 class); Spd 10 m; VP/WP 41/10; 1Atk +7/+2 melee (1d6 crit 20, punch), +10/+5 ranged (3d4+1, hold-out blaster or 3d8+1, light repeating blaster); SQ Favor x1, inspire confidence; SV Fort +5; Ref +4; Will +5; FP 3; DSP 4; Rep +3; Str 11, Dex 15, Con 10, Int 11, Wis 13, Cha 14.

Equipment: Light repeating blaster, hold-out blaster in hidden sleeve holster, falsified ID chip.

Skills: Astrogate +6, Bluff +10, Computer Use +6, Intimidate +12, Knowledge (Corellia) +7, Knowledge (criminal organizations) +7, Listen +2, Pilot +6, Read/Write Basic, Repair +2, Speak Basic, Spot +2, Treat Injury +5.

Feats: Alertness, Armor Proficiencies (light, medium, heavy), Dodge, Improved Initiative, Martial Arts, Mobility, Point Blank Shot, Quick Draw, Weapon Group Proficiencies (simple weapons, blaster pistols, blaster rifles, heavy weapons, vibro weapons).

Staff Chief Pomt

Chief of staff for Senator Viqi Shesh, Victor Pomt was a sour-faced bureaucrat responsible for keeping the senator's calendar - and dirtying his hands arranging Shesh's bribes and covert assassinations. After the fall of Duro, Pomt helped Senator Shesh drum up support for the Senate's Peace Vote (also known as the Appeasement Vote), which would have turned the Jedi over to the Yuuzhan Vong. At the same time, he hired assassin Roxi Barl to eliminate Leia Organa Solo, hoping to bury all evidence linking Viqi Shesh to the collaborationist CorDuro corporation. Pomt met a fitting end when another of Shesh's agents was hired to silence him.

Victor Pomt: Male Human Diplomat 5; Init +0; Def 11 (+1 class); Spd 10 m; VP/WP 0/10; Atk +2 melee (1d3-1, punch), +2 ranged; SV Fort +1; Ref +1; Will +4; FP 1; DSP 2; Rep +1; Str 8, Dex 10, Con 10, Int 15, Wis 14, Cha 12.

Equipment: Comlink, code cylinder, datapad containing Viqi Shesh's schedule.

Skills: Appraise +7, Bluff +11, Computer Use +8, Gather Information +7, Intimidate +2, Knowledge (New Republic government) +9, Knowledge (Kuat) +10, Profession (bureaucrat) +10, Read/Write Basic, Speak Basic.

Feats: Persuasive, Run, Weapon Group Proficiencies (simple weapons, blaster pistols).

Governor-General Thrackan Sal-Solo

Han Solo's cousin through Han's father's side, Thrackan Sal-Solo is the newly elected governor-general of the Corellian sector. His confrontation with Han and Leia in the Corellian medical facility marks the first time that he and his cousin have crossed paths since the Corellian insurrection, during which Thrackan kidnapped Han's children and tried to use the Centerpoint Station superweapon to extort the New Republic. For his part in that failed revolution, Thrackan earned a sentence to the Dorthus Tal correctional facility on Sacorria.

The arrival of the Yuuzhan Vong - and the New Republic's urgent need to reactivate Centerpoint - resulted in the commutation of Thrackan's prison sentence. Despite the fact that his subsequent actions at Centerpoint Station brought about the destruction of the Hapan armada through "friendly fire," Thrackan wiped out a good

portion of the Yuuzhan Vong invasion fleet. Those who remembered him as a hero for standing up to the New Republic during the Corellian Crisis now hailed him as a fearless warrior. In short order, Thrackan received enough votes to head up the Centerpoint political party, and, following the fall of Duro, he replaced Marcha of Mastigophorous as governor-general of the Corellian sector. In the short time since, he has put all his efforts into rearming Centerpoint Station (which has sat silent since the Hapan disaster) to serve as a bulwark against Yuuzhan Vong aggression.

Thrackan Sal-Solo: Male Human Noble 4/Scoundrel 5; Init +0; Def 18 (+5 class); Spd 10 m; VP/WP 32/11; Atk +6/+1 melee (1d3, punch) or +6/+1 ranged (3d4, hold-out blaster); SQ Lucky (1/day), Precise Attack +1, Favor +2, Command +2, Illicit Barter, Inspire Confidence, Resource Access, Coordinate +1, Skill Emphasis (Profession [Corellian bureaucrat]); SV Fort +2; Ref +6; Will +5; FP 1; DSP 7; Rep +10; Str 11, Dex 11, Con 11, Int 14, Wis 14, Cha 17.

Equipment: Comlink, hold-out blaster.

Skills: Astrogate +5, Bluff +12, Computer Use +6, Diplomacy +9, Forgery +4, Gather Information +5, Intimidate +5, Knowledge (alien species) +3, Knowledge (Corellian law enforcement) +2, Knowledge (Corellian streetwise) +4, Knowledge (cultures) +5, Listen +1, Move Silently +3, Pilot +4, Profession (Corellian bureaucrat) +18, Read/Write Basic, Search +5, Sense Motive +7, Speak Basic, Spot +2.

Feats: Armor Proficiency (light), Expertise, Fame, Quick Draw, Starship Operation (space transports), Weapon Group Proficiencies (simple weapons, blaster pistols).



Eelysa

Eelysa was a special Jedi, by anyone's reckoning. Born to non-Force-sensitive parents on Coruscant after the Emperor's apparent demise aboard the second Death Star, she was highly attuned to the Force. It was the perceptive Eelysa who first sensed Master Skywalker's unease when he suffered the impact of a vision received during the mass murders caused by Kueller, some seventeen years before the Yuuzhan Vong thrust into the galaxy.

Years later, Eelysa was chosen by Master Skywalker to undertake a series of dangerous, years-long intelligence missions on behalf of the Jedi. The two did not always agree on matters of the Force, but Skywalker trusted Eelysa and her judgment.

Though trusted, Eelysa was always something of a maverick, and so it came to no one's surprise that during her mission to Barab I, she took the Barabel Saba Sebatyne as her apprentice. (Saba would in turn train her own son, Tesar Sebatyne, as well as the Hara sisters. For more information about Saba, refer to page 140 of *The New Jedi Order Sourcebook*.)

Eelysa's missions were not precise, specifically targeted assignments that she would complete for Master Skywalker and then await further instructions. They were usually complicated and covert, fraught with danger, and often took years to complete. In the dozen or so years she operated in this capacity on behalf of the Jedi, NRI estimates that she went on perhaps five missions. She worked against the Diversity Alliance, broke slave rings in the Outer Rim, and is suspected to have been involved in matters concerning the enigmatic Chiss.

Though allied with the Wild Knights in that her apprentice Saba leads that maverick group, Eelysa did not typically operate with the fighter squadron. Critically injured in combat against Yuuzhan Vong warriors on Corellia after the fall of Duro, Eelysa received a series of bacta treatments and recuperated in time to return to her spy mission in and around Coronet ... only to fall victim to a voxyn.

Eelysa: Female Human Jedi Guardian 12; Init +3; Defense 21 (+3 Dex, +8 class); Spd 10 m; VP/WP 106/16; Atk +13/+8/+3 melee (4d8+1, lightsaber) or +15/+10/+5 ranged (3d6, blaster pistol); SQ Jedi Knight; SV Fort +11, Ref +11, Will +7; SZ M; FP 4; DSP 0; Rep +7; Str 13, Dex 15, Con 14, Int 16, Wis 13, Cha 9. Challenge Code F.

Equipment: Lightsaber.

Skills: Astrogate +7, Computer Use +6, Craft (lightsaber) +4, Disguise +8, Gather Information +7, Knowledge (Corellian underworld) +7, Pilot +8, Read/Write Basic, Read/Write Selonian, Speak Barabel, Speak Basic, Speak Chiss, Speak Selonian, Tumble +7.

Force Skills: Affect Mind +10, Battlemind +11, Deflect (attack -3, defense +2), Enhance Ability +11, Farseeing +5, Force Push +10, Heal Self +8, Move Object +10.

Feats: Blind-Fight, Exotic Weapon Proficiency (lightsaber), Force-Sensitive, Martial Arts, Weapon Group Proficiency (blaster pistols).

Force Feats: Alter, Block, Burst of Speed, Control, Knight Defense, Lightsaber Defense, Sense.

The Wild Knights

Born of a need to serve the galaxy but not from within the ranks of Skywalker's Order, the Wild Knights are a rogue group of starfighter pilots similar in many regards to Kyp Durrone's infamous Dozen. Led by the maverick Jedi Saba Sebatyne, the pilots are all Force-sensitive warriors of considerable skill.

Saba has trained a handful of Force-users in an unorthodox manner as Jedi Knights, and these maverick Jedi fly missions throughout the galaxy in marginally maintained Y-wings, Howlrunners, and other fighters. Though several of the Wild Knights lost their lives in combat against the Yuuzhan Vong during the events of the novel *Star by Star*, the group is still a potent force for good.

Izal Waz

Izal Waz is a paradox: addict and adept, pilot and pariah. He is a capable Arcona freighter pilot, captain of the dilapidated YT-1300 freighter *Sureshot*, and a skilled warrior. His natural affinity in the ways of the Force led him to the Jedi praxeum at Yavin 4. There, however, he succumbed to his species' propensity for salt addiction, stealing and consuming months' worth of salt in the space of a few days. After less than four months of training under Kenth Hamner's tutelage, Izal Waz fled Yavin 4.

Though ashamed of his admitted weakness, Izal still believed he was destined to become a Jedi. It was the unorthodox Barabel Jedi Saba Sebatyne who took Izal as a pupil, teaching him the ways of the light side and even guiding him in the construction of his own lightsaber. Over the years, he and his Barabel allies, along with various other Jedi "misfits," have become a guerrilla force for good. Izal works tirelessly to redeem himself, but he continues to be haunted by his sodium chloride habit.

Izal was crucial to the success of the Solos' escape from the Coronet Medcenter after the fall of Duro, and he also served as a ship's gunner in several battles thereafter against the Yuuzhan Vong. Though several of his team members perished in action against the Yuuzhan Vong, Izal Waz - thus far - has survived to fight another day.

Izal Waz: Male Arcona Jedi Guardian 4; Init +3; Defense 18 (+3 Dex, +4 class, +1 natural); Spd 10 m; VP/WP 30/15; Atk +5 melee (2d8+1, lightsaber), or +0 ranged (3d6, blaster pistol); SQ Addict, claws; SV Fort +4, Ref +4, Will -1*; SZ M; FP 2; DSP 1; Rep +1; Str 12, Dex 16, Con 7,* Int 16, Wis 13, Cha 12. Challenge Code: C.

Equipment: Lightsaber, tattered pilot's tabard.

Skills: Astrogate +7, Computer Use +6, Knowledge (starfighter tactics) +4, Pilot +12, Read/Write Arconese, Read/Write Basic, Speak Arconese, Speak Barabel, Speak Basic.

Force Skills: Battlemind +9, Deflect (attack -4, deflect +1), Enhance Ability +9, Force Push +7, Move Object +7.

Feats: Blind-Fight, Exotic Weapon Proficiency (lightsaber), Force-Sensitive, Weapon Group Proficiency (blaster pistols).

Force Feats: Alter, Burst of Speed, Control, Sense. * Izal's Constitution and Will suffer penalties due to his salt addiction.

The Barabel

Dark, humid Barab I wasn't formally surveyed until twenty years before the Battle of Yavin and didn't become a member of the Galactic Empire for another six years after that. So it was with some surprise that visitors to Barab found that the Barabel knew all about "great warriors from beyond the clouds" who carried "longknives of living light" and could be trusted to settle any dispute.



Jedi Master Kyp Durrone

The truth behind that legend took some time to emerge. Many centuries ago, a Jedi explorer and his retainers stumbled across the Barab system and explored the cloud-shrouded little world circling its red-dwarf sun. On Barab, they found two great clans of the reptilian Barabel preparing for a devastating war and took it upon themselves to mediate the conflict. Who the Jedi explorer was has been lost to history: Barab remained uncharted and unknown during the days of the Republic. But the Barabel didn't forget: When warriors from beyond the clouds finally returned, they were prepared to accept whatever wise counsel might be offered.

The Barabel couldn't know that Emperor Palpatine's dark agents had hunted the Jedi to near-extinction. The new arrivals were ruthless, profit-minded corporate scouts from Planetary Safaris, and they saw Barab's species as ideal subjects for trophy hunts. Planetary Safaris surveyed the Barab system, but the survey omitted the fact that the system contained intelligent life. For five years, decadent big-game hunters descended on Barab, paying Planetary Safaris huge sums to hunt not only the nocturnal beasts known as Shenbit bonecrushers but also bands of Barabel warriors.

One Barabel clan leader, Shaka-ka, refused to stand by while her people were slaughtered. She organized the Barabel into armies of irregulars and attacked the hunters' ships and expeditions. When Planetary Safaris complained to the Albanin sector moff, he dispatched Captain Osted Alater and the Star Destroyer *Crusader's Shield* to restore order. But Captain Alater discovered what Planetary Safaris had been up to; he sent his troops to protect the Barabel and ensured that Barab was admitted to the Empire. Working with Shaka-ka, he then established a modest spaceport, Alater-ka, to accommodate ship traffic.

Alas for the Barabel, they soon found that captains like Osted Alater were rare in the Empire. The Barabel's reputation as fierce fighters attracted Imperial Intelligence recruiters, shockboxing promoters, and mercenary guilds, all of which set up shop in the grim city of Alater-ka to lure Barabel off-world. The New Republic wrested the planet from Imperial control after the Battle of Endor, but the years of callous treatment had left the Barabel touchy and hostile toward the galaxy. The Barabel have gained an unsavory reputation as thugs and soldiers-of-fortune, and Barab has become one of the New Republic's more volatile and less-trusted member worlds.

Into this volatile situation stepped Eelysa, the Coruscanti Jedi who had trained with Luke Skywalker at Yavin 4's Jedi academy. Eelysa was engaged in a lengthy assignment to the remote corners of the galaxy, searching for species whose Force abilities hadn't been discovered or investigated. She found the Barabel's reverence for the Jedi particularly intriguing, sensing the will of the Force behind it. On Barab, she discovered the warrior Saba Sebatyne and took her as an apprentice - a course of action she neglected to report to Master Skywalker.

Eelysa left Barab after the Diversity Alliance began fomenting rebellion against the New Republic, but Saba continued her work, training her son Tesar Sebatyne and his hatchmates Bela Hara and Krasov Hara. Saba also became the leader of a corps of Force-sensitive followers, including the Arcona Izal Waz. Her starfighter squadron, the Wild Knights, battled the Yuuzhan Vong in a number of engagements. Tesar and the two Haras helped a wounded Eelysa escape Corellia with Han Solo and Leia Organa Solo, then joined Anakin Solo's Jedi team in infiltrating a Vong worldship at Myrkr. Of the three Barabel Jedi, only Tesar survived the mission.

A Master's Mistake

Luke Skywalker knew of the Barabel's reverence for the Jedi, having experienced it firsthand in a tapcafe on New Cov. But he disagreed with Eelysa that the species might have Jedi talents, worried about their reputation for aggression, violence and mean-spiritedness. Eelysa argued that if a Wookiee (Lowbacca) could embrace the Jedi Code, some Barabel might as well. Later, Skywalker would admit that his position was in error: despite their unconventional training, the quartet of Barabel Jedi he came to know did the Order proud.

Barabel are impressive warriors, with needle-sharp teeth and claws and black keratin scales that can absorb considerable amounts of damage. (They can also shed their tails if need be, which has been the undoing of many a startled foe.)

The Barabel evolved from nocturnal predators and are avid hunters, loving nothing so much as a stealthy pursuit in darkness. On Barab, they hunt in small packs of hatchmates. Hatchmates who learn to hunt together develop extremely strong bonds and come to know each other so well that they can seem psychic as they pursue their prey. It was this bond, Eelysa saw, that augured well for their ability as Jedi - and indeed, Tesar Sebatyne and the Haras were able to meld their minds with an ease and effectiveness that

some human Jedi Masters would have had trouble matching. The Barabel Jedi were also able to lend that strength to the other Jedi on the mission to Myrkr, proving their worth as far more than just fierce fighters.

Barabel social structures remain alien and mysterious to humans. The intricacies of family are confusing to non-Barabel, and their personalities are a baffling mix. A Barabel's word is bond, and while hatchmates form extremely close bonds, they do not mourn in a Human sense and might even take offense at others' attempts to comfort them in times of loss. Barabel enraptured by the hunt find odd things amusing, and non-Barabel compatriots have to get used to the sound of their hissing laughter even as things go badly awry in the heat of battle.

For stats on the Barabel Jedi who join Anakin's strike force in *Star By Star*, see pages 145 through 147 of *The New Jedi Order Sourcebook*.

Cinnabar Moon Retreat

Until Eelysa determined that their base's security had been compromised, the Wild Knights used the recently abandoned Cinnabar Moon Retreat in the otherwise empty Craeen system as their headquarters. Though no longer professionally maintained, the Retreat is still resplendent in most amenities. However, its complement of wading, exercise, and recuperative pools and saunas have, for the most part, been allowed to dry. Typically, only the subterranean pools are frequented.

Abandoned in the wake of the incoming Yuuzhan Vong invasion, the moon on which the spa is located was chosen for its stunning, naturally occurring mercury flows. The various natatoriums are completely sealed from the potentially poisonous environment but fitted with soaring transparisteel windows to afford guests breathtaking views.

The Retreat proper consists of seven levels. The two lowest levels consist of a trio of natural subterranean geothermal springs, fitted for clients' use. Levels 3 through 5 include small shops and restaurants, as well as more specific services for which the Retreat was renowned: The Ando mud baths were particularly popular with the stuffy Corulag crowd. The top two levels of the Retreat consist of the various rooms and suites used by guests; the Solos made their temporary home in the old bridal suite while operating with the Wild Knights.

Some visitors to the moon avoided the pampered decadence of the Retreat and endeavored to participate in guided tours conducted aboard modified cloud cars. The silver-and-gray modified Storm IVs are fitted with a pilot's station and a rear-facing viewing chair, affording the passenger a unique view of the Cinnabar Moon's mercury flows. Han and Leia Solo pilot such a craft (Cinnabar Moon Cloud Car 53) while fleeing their foes through the skylanes of Coruscant.

Cinnabar Moon Cloud Car

Craft: Bespin Motors Storm IV (Modified); **Class:** Air (Speeder); **Cost:** 22,500 (new); **Size:** Huge (7 meters); **Crew:** 1; **Passengers:** 2; **Cargo Capacity:** 10 kilograms; **Speed:** 350m (max. speed 1,000 km/h); **Altitude:** 100 kilometers; **Defense:** 11 (-2 size, +3 armor); **Hull Points:** 30 (DR 5).
Weapons: None.

[PRIVACY STATEMENT](#)

[©2002 Lucasfilm Ltd. & © or TM where indicated. All rights reserved. Used under authorization. visit STARWARS.COM](#)



[Shop](#) [Games](#) [Books](#) [Magazines](#) [Stores](#) [Events](#) [Company](#) [Worldwide](#) [Community](#)

RPG Home
Learn to Play



Search

Flying High: New Starship Maneuvers

By [Owen K.C. Stephens](#)

Wasn't it cool when Han Solo gave the slip to those Imperial ships by flying through that asteroid field in *The Empire Strikes Back*? Well, now you can do the same thing -- as well as use ships to provide cover for more vulnerable targets, and speed up complex space battles by flying multiple ships together in tight formation -- in your *Star Wars Roleplaying Game* campaign. The new *Starships of the Galaxy* accessory is packed with everything you ever wanted to know about spacefaring vessels, and we're offering you an early look at three new kinds of ship maneuvers described in the book: the flyby, the flying cover, and the tight wing.

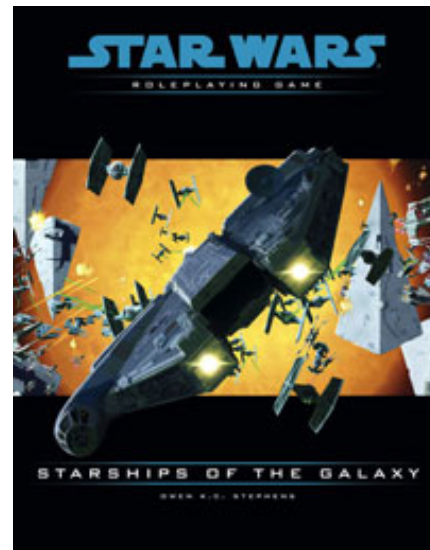

[Site Map](#)
[Navigation Help](#)

STAR WARS
 WWW.STARWARS.COM



Flyby

This maneuver allows a ship that's being pursued to fly very close to an obstacle -- such as an asteroid or a big ship like a Star Destroyer -- thus forcing pursuing ships to fly just as close. The lead ship sets the DC of the Pilot check, determining how close the pursuing ships must get. If the lead ship fails the check, it runs into the obstacle. If the lead ship succeeds, each pursuing ship must make a Pilot check with a +5 bonus (since the pursuing pilots have more time to react). If a pursuing ship fails the roll, it hits the obstacle.

Han Solo used this maneuver when he piloted the *Millennium Falcon* through an asteroid field in *The Empire Strikes Back*. Lando Calrissian used a similar maneuver when navigating the corridors of the second Death Star in *Return of the Jedi*.

Flying Cover

"Flying cover" is a maneuver that allows ships to fly along with and cover other ships, usually larger ones. Flying cover is similar to pursuit, in that once you establish cover on a ship, you automatically remain with it without needing to make maneuver checks. The Pilot check for establishing cover is at DC 20, and it can be attempted only at point blank range. If, for some reason, a ship is trying to prevent you from establishing cover, it can break free with an opposed Pilot check.

A ship flying cover moves constantly, repeatedly attempting to place itself between the covered ship and its opponents. It can't fire or take any action other than maintaining cover. Should the ship flying cover perform any other action, it loses its covering status. Only ships of Small or lesser size can fly cover.

A ship flying cover grants a cover bonus to the Defense of the ship being protected. The flying cover maneuver is generally used to protect ships of Large or Medium size, such as cargo vessels, medical ships, and fighter carriers. It's also used when an attack forces a ship to remain in a small area, such as when fighters make bombing runs. Very large ships are difficult to cover due to their great size. Smaller ships, such as fighters, move too quickly to gain a Defense bonus from cover. As a result, the bonus granted by flying cover depends on the size of the ship being covered and the number of ships providing cover, as determined in the following table.

Defense Bonus from Flying Cover

Size of Covered Ship	Number of Ships Flying Cover					
	1	2	3	4	5	6+
Colossal	0	0	1	2	2	3
Gargantuan	0	1	1	2	2	3
Huge	0	1	1	2	3	3
Large	1	1	2	2	3	3
Medium	1	2	2	2	3	3
Small	1	2	2	3	3	4
Tiny or smaller	1	2	3	4	5	5

Join/Rejoin Tight Wing

The wing formation is a common starfighter maneuver, allowing pilots to trade versatility for increased firepower. The problem with a starfighter wing is that pilots frequently drop out of the wing when they fail to keep up with the wing's maneuvers. Most wings don't survive past the first few moments of a large battle, when individual fighters quickly peel off and fight on their own. Many squadrons consider this a normal and acceptable tactic, granting their pilots the chance to benefit from a wing when combat starts, but assuming they'll pick their own targets shortly after heavy dogfighting begins. However, some squadrons of starfighters have developed a tactic designed to keep two or more starfighters together, allowing them to concentrate their firepower on larger targets.

A tight wing is a closely packed group of starfighters that attacks and maneuvers together. It's essentially the same as a fighter wing, except that the unit acts in unison. The advantage of a tight wing is that it allows a group of fighters to stay together even during the most hectic space combats. The drawback is that the ships in a tight wing can maneuver only as well as the worst pilot's ship. As a result, the maneuver generally is used only by squadrons of elite pilots (who trust the skills of the worst among them) or poor pilots (who lose nothing by depending on their equally unskilled comrades).

Forming a tight wing requires each pilot to make a Pilot check against DC 15. Generally,

Using Tight Wings

If, as the Gamemaster, you find yourself running a space battle with dozens of fighters, you may want to form most of them into tight wings. Since tight wings are formed before a battle, even poor pilots can join by taking 20 on their Pilot checks. In most respects, each tight wing can be treated like a single ship, which saves time when making attack and maneuver rolls. When attacks are made against a tight wing, you can assume the same ship is hit every time until it is destroyed. While this may not be completely realistic, it's faster and helps keep large conflicts moving quickly.

If you want to involve player character fighter pilots in large and dangerous space battles, you may want to assign them to tight wings and allow each player to run one wing. While this prevents the player from using his character's own Pilot

tight wings are made of identical ships that all fire the same weapons. Joining a tight wing made of radically different fighters (fighters of different size categories, for example) increases the DC to 20. No more than six ships can be in a single tight wing.

skill, it also allows him to assign damage to other ships before his own, increasing the character's chance of survival. Some players may not like these limitations, so, as with any advanced rule, you may want to discuss it with your players before bringing it into a game.

A tight wing operates like a single starship in most respects. It needs only a single Pilot check whenever it makes a maneuver, using the worst Pilot check of all its members. If the maneuver is successful, all the ships in the wing succeed. If the maneuver fails, the entire wing fails. It's not possible for a pilot to drop out of a tight wing by failing a maneuver check -- the entire wing succeeds or fails together. When attacking, each ship in the tight wing must fire at the same target. The ships may all fire separately, or they may combine fire like a battery. When a tight wing combines fire, a single starfighter is designated as the primary shooter. Only this ship's attack bonus is used, but it gains a +1 bonus for each additional ship in the tight wing. On a successful hit, damage is rolled only once, using the primary shooter's weapon.

Ships attempting to change their range in relation to a tight wing make a single check to see if they succeed against the entire wing. The same is true of ships attempting to establish pursuit against a tight wing. When a ship in a tight wing is hit, the player running the tight wing is allowed to decide which ship within the wing takes the damage.

For more details on all the rules for new ship maneuvers (and much more), check out the [Starships of the Galaxy](#) accessory for the Star Wars Roleplaying Game!

Get another early scoop on the Starships of the Galaxy accessory with this preview of the [master gunner](#), an exciting new type of character who runs the really big guns on the really big ships!

PRIVACY STATEMENT

©2002 Lucasfilm Ltd. & © or TM where indicated. All rights reserved. Used under authorization. visit STARWARS.COM

Shop Games Books Magazines Stores Events Company Worldwide Community



RPG Home
Learn to Play
Products
Web
Enhancements
Archive
Living Force
Retailer Locator
Fan Club Store



Search

The ER-1 Probe Droid

More Secrets of Naboo

By [Steve Miller](#)

In the months following the expulsion of the Trade Federation's occupation force from Naboo, the Human and Gungan inhabitants undertook several projects geared toward bringing their two peoples closer together. One of these projects involved an effort to create a complete map of the many tunnels that run below the planet's landmasses and ocean floors. Headed by Queen Amidala's Master of Sciences Graf Zapalo, this endeavor may prove the first step in unlocking the astrophysical secret of Naboo's existence -- the world is unique in the galaxy in that it has no molten core, but instead a porous, plasma-rich interior. One of the primary tools in the mapping efforts is the ER-1 model of probe droid. Assisting Zapalo in its development are a Naboo husband-and-wife droid-designer team, who had retired to their homeworld after decades on the staff of Serv-O-Droid.



The ER-1 is motivated by repulsor lifts. It is built to operate under extreme temperatures and pressure conditions and is outfitted with miniaturized versions of the latest sensor, recording, and communications devices. It carries with it two dozen miniaturized, deployable biosensors and a second package of repulsor-motivated sensor and recording equipment slaved to the main unit. The biosensors, designed for short-term use only, are typically not retrieved once the droid has released them. However, the remote sensor platform can be retrieved and dispatched an unlimited number of times during a droid's mission. All data collected by these remotes is transmitted back to the droid, analyzed, and relayed to the droid's masters via subspace. This allows the ER-1 to explore twice the amount of territory that more conventional probe droids can cover. The remote biosensors also allow for a broader, and thus more accurate, sample of data in the droid's general surroundings. Finally, the droid comes equipped with a stun rifle blaster so it can subdue wildlife for close examination.

The ER-1 probe droid remains a cutting-edge technological marvel in the waning days of the Old Republic. Zapalo and his team oversaw the construction of four ER-1 droids. ER-1A, ER-1B, and ER-1D were used to map Naboo's oceanic tunnels, while ER-1C proved invaluable in the colonization efforts of Naboo's primary moon. Like the Naboo N-1 Starfighter, the delicate components of the ER-1 model have to be hand-assembled by skilled craftsmen to make the droid truly effective. As a result, few will ever be built, and even fewer will be offered for sale. Serv-O-Droid has

[Site Map](#)
[Navigation Help](#)



expressed interest in the design, even though millions of research and development credits would have to be spent to create more sophisticated mass-production techniques.

ER-1 Series: Hovering exploration droid, Scout 2; Init +0; Defense 14 (+4 class); Spd 12m; VP/WP 12/12; +0 melee (1d6, claw), +1 range (3d6 stun only, stun blaster rifle); SQ Trailblazing, Bio-Sensors, Remote Sensor Platform; SV Fort +3, Ref +2, Will +4; SZ M; Rep 0; Str 8, Dex 10, Con 12, Int 14, Wis 14, Cha 6. Challenge Code A.

Thanks to the creators of *The Gungan Frontier*; the writers of *Star Wars Episode I: The Visual Dictionary*; the good people at Lucas Licensing; [JD Wiker](#); and, of course, George Lucas.

Equipment: Stun blaster, heuristic processor, improved sensor package, infrared vision, low-light vision, telescopic vision, sonic sensors, comlink, recording unit, environmental compensation (heat, cold, water), rust inhibitor, 24 biosensors, remote sensor platform. **Skills:** Demolitions +6, Hide +4, Knowledge (life sciences) +8, Knowledge (physical sciences) +8, Listen +10, Search +10, Spot +12, Survival +6 **Feats:** Track, Weapon Group Proficiency (blaster rifles)

Unspent Skill Points: 0

Special Qualities: Bio-sensors (24) -- provides droid with +4 to Listen, Search, and Spot checks while it is within 2 km of one or more biosensors. Each sensor operates for three hours before its power pack ceases to function. Once all biosensors have been deployed, the droid has internal storage space of 10 kg.

Remote Sensor Platform -- gives the droid a second set of skill checks in a different place, as far as 10 km away. This platform has the same skill checks and saving throws as the droid. **Cost:** 22,000 credits

Use the ER-1C droid on the Naboo/Gungan lunar research facility in Steve Miller's adventure "Peril in the Ionosphere". Check it out only in [Star Wars Gamer issue 1!](#)

Find out more about the tunnels under Naboo seas in [Secrets of Naboo](#).

PRIVACY STATEMENT

©2002 Lucasfilm Ltd. & © or TM where indicated. All rights reserved. Used under authorization. visit STARWARS.COM

Shop Games Books Magazines Stores Events Company Worldwide Community



- RPG Home**
- Learn to Play**
- Products**
- Web**
- Enhancements**
- Archive**
- Living Force**
- Retailer Locator**
- Fan Club Store**
- SW Insider Update**

[Search](#)
[Home](#) > [Roleplaying Games](#) > [Star Wars: RPG](#)

[Navigation Help](#)

Thursday, October 3, 2002

Droids, Droids, Droids!

A Preview of the *Arms & Equipment Guide*

[Chat](#)
[Message Boards](#)
[Mailing List](#)

Arms & Equipment Guide

 10/03/2002 [Stuffed With Stuff](#)

 10/03/2002 [Droids, Droids,](#)
[Droids!](#)

 09/26/2002 [Weapons and](#)
[Armor](#)

 09/19/2002 [Blasters and Rifles](#)

Sure, *Star Wars* is about fast ships, exotic aliens, mysterious powers, and good versus evil. But it's also about the cool stuff that heroes and villains get to use, from weapons and vehicles to armor and droids to all the other kinds of equipment that makes life easier (and more fun). In October, Wizards of the Coast covers all that in the new [Arms & Equipment Guide](#), and we've got the third in a series of sneak peeks at the goods!

Here's a look at just a handful of the hundreds of items covered in the book. The codes for "Era" are: [RI] for items available primarily in the Rise of the Empire era, [RE] for items available primarily in the Rebellion era, and [NJ] for items available only in The New Jedi Order era or later.

If you like what you see, be sure to pick up the *Arms & Equipment Guide* this month for more, more, more!



The "STAR WARS" logo in a bold, black font, with the website address "WWW.STARWARS.COM" underneath it.



Industrial Automaton R5 Series Astromech Droid

Classification: Small second-degree astromech droid

Cost: 1,500

Availability: Prevalent

Era: [RE]

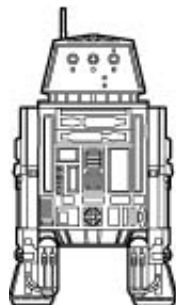

R5 Astromech Droid

The R5 series of droids suffers from one huge design flaw -- it was created without any specific market in mind. Though cheaper than even the R4 series, the R5 is not tough enough to survive long in the harsh environments of the Outer Rim worlds. Though equipped to plug into a starfighter, the R5 isn't of much use once installed. Even worse, the droid picks up personality quirks at an amazing rate. (New R5s already have

one quirk, and used ones have at least two.) Industrial Automaton built the R5 droid for no other reason than to come out with a new model, and the lack of vision shows. Initial sales were abysmal, and the line was discontinued within a few years.

But in that time, hundreds of thousands of R5s were built and sold. The droid is similar in appearance to an R2, but the dome is less graceful -- it's often described as an inverted flowerpot. Because any R-series droid is sometimes better than none, many R5s are modified to become more useful. With extensive reprogramming, R5s are generally serviceable, but they don't compare to most other droids in the R series.

R5 series droids may be allowed as heroic characters.

R5 Series: Tracked astromech droid, Expert 3; Init +0; Defense 12 (+1 class, +1 size); Spd 8 m; VP/WP 0/12; Atk +4 melee (1d4+2, claw) or +4 melee (1d2+2, saw) or +4 melee (2d6, arc welder) or +2 ranged; SV Fort +2, Ref +1, Will +3; SZ S; Face/Reach 2 m by 2 m/2 m; Rep +0; Str 14, Dex 10, Con 12, Int 12, Wis 10, Cha 8. Challenge Code B.

Equipment: Comlink, heuristic processor, sensors (improved sensors, infrared vision, 360-degree vision), diagnostics package, recording unit (holo), tool mounts (x4), telescopic appendage, magnetic feet, internal storage (2 kg), fire extinguisher.

Skills: Astrogate 1 rank (+2), Computer Use 6 ranks (+7), Disable Device 1 rank (+4), Knowledge (astronomy) 6 ranks (+7), Pilot 3 ranks (+3), Read/Write Basic, Speak Basic (understand only), Speak Binary, Repair 6 ranks (+7), Spot 0 ranks (+2).

Unspent Skill Points: 19 (1 unused language).

Feats: Ambidexterity, Cautious, Run, Weapon Group Proficiencies (blaster pistols, simple weapons).

Medtech Industries FX Series Medical Droid

Classification: Medium-size first-degree medical assistant droid

Cost: 2,000

Availability: Prevalent

Era: [R!]

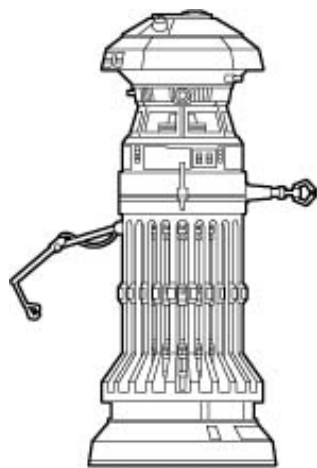

FX Medical Droid

Obsolete by the time of the Empire, Medtech Industries' FX series of medical assistant droids was once thought the greatest boon to the practice of medicine since the development of bacta. The FX droid stands 1.7 meters tall and sacrifices humanoid appearance in favor of utility. It has a single strong telescoping manipulator and is ringed with twenty tool mount arms that can be equipped with injectors, gas masks, lights, surgical instruments, or anything else a doctor might wish an assistant to keep on hand. Its disk-shaped head contains a variety of sensors spaced evenly around it. The FX is immobile, designed to become a permanent

part of a medical office, and must be dragged to new locations.

Though the MD and later 2-1B medical droids have displaced the FX from the cutting edge of medical droid technology, the owners of FX droids have few complaints. They are excellent assistants, a good choice for monitoring patients (especially those in bacta tanks), and invaluable aids to doctors performing delicate or complicated operations. The FX is silent, so it doesn't disturb its doctors, but it can display information on a built-in monitor screen or through any connected computer. Many FX droids remain in operation well into the Rebellion era and beyond, especially on Outer Rim worlds and within underfunded organizations.

FX series droids should not be allowed as heroic characters, because they are immobile.

FX Series: Stationary medical assistant droid, Expert 1; Init +0; Defense 10; Spd 0 m; VP/WP 0/10; Atk +2 melee (1d3+2, tool) or +0 ranged; SV Fort +0, Ref +0, Will +3; SZ M; Face/Reach 2 m by 2 m/2 m; Rep +0; Str 12, Dex 10, Con 10, Int 10, Wis 12, Cha 6. Challenge Code A.

Equipment: Medical diagnostic computer (+2 equipment bonus on Treat Injury checks), sensors (infrared vision, low-light vision, 360-degree vision), telescoping appendage, tool mounts (x20).

Skills: Computer Use 4 ranks (+4), Knowledge (biology) 4 ranks (+4), Profession (medic) 4 ranks (+5), Read/Write Basic, Speak Basic (understand only), Speak Binary, Treat Injury 4 ranks (+7).

Unspent Skill Points: 8.

Feats: Ambidexterity, Surgery, Weapon Group Proficiencies (blaster pistols, simple weapons).

SoroSuub 501-Z "Zed" Police Droid

Classification: Medium-size third-degree security droid

Cost: 15,000

Availability: Specialized

Era: [RI] [RE] [NJ]

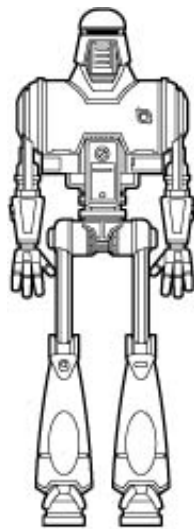

501-Z (ZED)
Police Droid

The 501-Z police droid is one of the most remarkable units ever designed by SoroSuub. Physically, it is as tough and imposing as one would expect a police droid to be, standing nearly 2 meters tall and having a powerful crimson bipedal frame. It is their programming that makes 501-Z droids, often called Zeds, so unusual. Rather than being emotionless and uncaring as most security droids are, Zeds are actually both eager and helpful, with a programmed love of the law that is so strong they are the only security model that cannot be reprogrammed to serve as a bodyguard for a criminal. Zeds think of themselves as having

universal authority, and they often pursue criminals to great lengths -- even to other worlds. Of course, not every government accepts their authority.

Zeds are well equipped for law enforcement, having tough frames that can withstand a great deal of punishment, enhanced sensors, and a holorecording and playback unit that can record crimes in progress or be used to show images of suspects to possible witnesses. Zeds have no built-in weaponry and are typically armed with large macelike stun sticks that essentially function as force pikes -- though Zeds rarely use them as lethal weapons. In fact, Zeds never use force that is likely to kill any sentient living creature. They are, however, willing to use what force is needed to disable a criminal's getaway vehicle or an opposing droid, as long as innocent bystanders aren't put at risk.

The Zed series has built-in armor but is also capable of draping humanoid armor on its frame for added protection. A Zed will do so if this increases its ability to capture particularly dangerous felons.

501-Z droids should only be allowed as heroic characters in high-level campaigns.

501-Z: Walking police droid, Soldier 5; Init +6 (+2 Dex, +4 improved initiative); Defense 17 (+5 class, +2 Dex); DR 3; Spd 12 m; VP/WP 57/20; Atk +10 melee (2d8+5 or DC 15 stun, force pike) or +7 ranged; SV Fort +9, Ref +3, Will +3; SZ M; Face/Reach 2 m by 2 m/2 m; Rep +1; Str 20, Dex 14, Con 20, Int 12, Wis 14, Cha 12. Challenge Code C.

Equipment: Light armor, heuristic processor, locked access, recording unit (holo), sensors (improved sensors, low-light vision), force pike, translator unit (DC 10), vocabulator.

Skills: Computer Use 6 ranks (+7), Gather Information 4 ranks (+8), Knowledge (streetwise) 4 ranks (+5), Listen 3 ranks (+7), Profession (law officer) 8 ranks (+10), Read/Write Basic, Speak Basic, Spot 4 ranks (+8).

Unspent Skills Points: 0 (1 unused language).

Feats: Ambidexterity, Armor Proficiencies (light, medium, heavy), Improved Initiative, Point Blank Shot, Skill Emphasis (Gather Information), Weapon Group Proficiencies (blaster pistols, blaster rifles, heavy weapons, simple weapons, vibro weapons).

Sienar Intelligence Systems Mark VI Scarab Series Assassin Droid

Classification: Diminutive fourth-degree assassin droid

Cost: 20,000

Availability: Illegal

Era: [RI] [RE] [NJ]

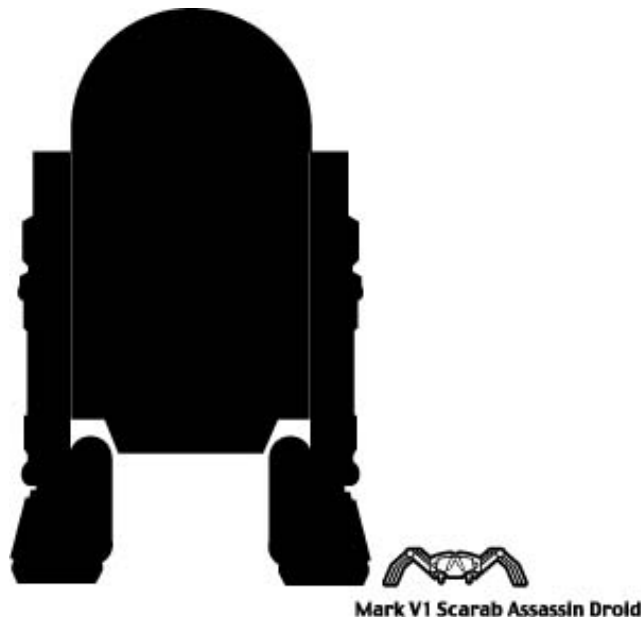

Designed to kill through stealth rather than brute force, the Scarab series of droids became popular during the last days of the Old Republic, often being used by corrupt officials to eliminate political enemies -- a practice that did not end with the rise of the Empire.

The Mark VI Scarab appears to be a mechanical insect. Sized to fit in the palm of a Human's hand, it is equipped with six magnetic feet and is extremely light, allowing it to climb vertical metallic surfaces at will. It has a broad set of sensors, including a sniffer that can be programmed to detect any unique biological creature (if a sample of the creature's bodily fluids is available), giving the droid a +4 equipment bonus on all checks to track that one individual.

Numerous different poisons can be loaded into the scarab's injector, but it has enough space for only two total doses of poison. (See Chapter Twelve of the [Star Wars Roleplaying Game](#) for more about poisons.) Since a single scarab is not always effective, wealthy villains sometimes send a fleet of the little killers against a single target.

Mark VI Scarab droids should not be allowed as heroic characters because of their limited abilities.

Mark VI Scarab Series: Walking assassin droid, Thug 4; Init +4 (Dex); Defense 20 (+2 class, +4 Dex, +4 size); Spd 6 m; VP/WP 0/13; Atk +12 melee (1d4-3, injector) or +12 ranged; SQ: Poison; SV Fort +4, Ref +5, Will +1, SZ D; Face/Reach 0.5 m by 0.5 m/0 m; FP 0; Rep +0; Str 4, Dex 18, Con 10, Int 11, Wis 10, Cha 6. Challenge Code C.

Equipment: Heuristic processor, locked access, magnetic feet, poison injector, self destruct system, sensors (infrared vision, improved sensor package, motion sensors, pheromone sniffer, sonic sensors).

Skills: Climb 3 ranks (+3), Hide 0 ranks (+16), Listen 0 ranks (+4), Move Silently 0 ranks (+16), Spot 0 ranks (+4), Search 0 ranks (+2), Survival 3 ranks (+3).

Unspent skill points: 1.

Feats: Ambidexterity, Toughness, Track, Weapon Finesse (injectors), Weapon Group Proficiencies (blaster pistols, simple weapons).

Check out our [interview](#) with Owen K.C. Stephens and Jeff Grubb, designers of the Arms & Equipment Guide!



BullbaBong BB-2 Shuttle

By [Cory Herndon](#)

The BullbaBong BB-2 Shuttle is manufactured by the spaceworks division of the Gungan firm BullbaBong. This solid in-system ship makes an excellent starting craft for characters who want to move around a lot on one planet. It also serves well as a craft for law-enforcement or paramilitary forces. This shuttle can fit into most Naboo encounters.

[Site Map](#)
[Navigation Help](#)



STAR WARS
 WWW.STARWARS.COM

Craft: BullbaBong BB-2 Shuttle; **Class:** Transport; **Cost:** 25,000 (new), 11,000 (used); **Size:** Small (13 m); **Crew:** +9 (Toba); **Passengers:** 6; **Cargo Capacity:** 550 kg; **Consumables:** 3 days; **Hyperdrive:** None; **Maximum Speed:** Cruising; **Defense:** 17 (+4 size, +3 armor); **Shield Points:** 10; **Hull Points:** 50; **DR:** 5; **Weapon:** 2 blaster cannons (fire-linked); **Fire arc:** front; **Attack bonus:** +7 (+5 Toba, +2 fire control); **Damage:** 2d10; **Range modifiers:** PB -0; S/M/L n/a



Use this shuttle with [Toba](#), a Gungan from the Star Wars: Invasion of Theed Adventure Game.

[PRIVACY STATEMENT](#)

©2002 Lucasfilm Ltd. & © or TM where indicated. All rights reserved. Used under authorization.
 visit [STARWARS.COM](#)

Shop Games Books Magazines Stores Events Company Worldwide Community



RPG Home
Learn to Play
Products
Web
Enhancements
Archive
Living Force
Retailer Locator
Fan Club Store
SW Insider Update

STAR WARS

ROLEPLAYING GAME

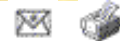
[Home](#) > [Roleplaying Games](#) > [Star Wars: RPG](#)

[Navigation Help](#)

Thursday, September 19, 2002

Blasters and Rifles

A Preview of the *Arms & Equipment Guide*

[Chat](#)
[Message Boards](#)
[Mailing List](#)

Arms & Equipment Guide

 10/03/2002 [Stuffed With Stuff](#)

 10/03/2002 [Droids, Droids,](#)
[Droids!](#)

 09/26/2002 [Weapons and](#)
[Armor](#)

 09/19/2002 [Blasters and Rifles](#)

Sure, *Star Wars* is about fast ships, exotic aliens, mysterious powers, and good versus evil. But it's also about the cool *stuff* that heroes and villains get to use, from weapons and vehicles to armor and droids to all the other kinds of equipment that makes life easier (and more fun). In October, Wizards of the Coast covers all that in the new [Arms & Equipment Guide](#), and we've got the first in a series of sneak peeks at the goods!

Here's a look at just a handful of the hundreds of items covered in the book. The codes for "Era" are: [RI] for items available primarily in the Rise of the Empire era, [RE] for items available primarily in the Rebellion era, and [NJ] for items available only in The New Jedi Order era or later.

If you like what you see, be sure to pick up the *Arms & Equipment Guide* next month for more, more, more!



STAR WARS
WWW.STARWARS.COM



Merr-Sonn Model 434 "DeathHammer"

Weapon Type: Blaster pistol
Proficiency Group: Blaster pistols
Cost: 650
Damage: 3d6+2
Critical: 20
Range Increment: 8 m
Weight: 1.2 kg
Fort DC: 14
Type: Energy
Multifire/Autofire: M
Size: Small
Hardness: 6
WP: 2
Break DC: 15
Availability: Prevalent, licensed
Era: [RI] [RE] [NJ]

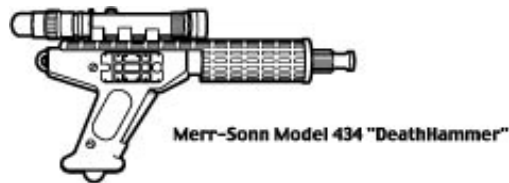

The 434 gained its nickname from bounty hunters who appreciated both the weapon's durability and its stopping power. Its durasteel plating provides additional protection but adds to the weapon's weight. DeathHammers are common among bounty hunters and professional killers, who often decorate them ornately, adding more detail and filigree after every kill.

Imperial Munitions Model 22T4

Weapon Type: Hold-out blaster
Proficiency Group: Blaster pistols
Cost: 360
Damage: 3d4+1
Critical: 20
Range Increment: 4 m
Weight: 0.5 kg
Fort DC: 8
Type: Energy
Size: Tiny
Hardness: 5
WP: 2
Break DC: 16
Availability: Specialized, restricted
Era: [RI] [RE] [NJ]

A tough little weapon with a powerful punch, the 22T4 was made by Imperial-controlled factories using designs provided by Merr-Sonn. Unlike many other such weapons, the 22T4 was subjected to rigorous testing and quality control. The resulting weapon was issued to each member of the Imperial Security Bureau as a personal sidearm (no civilian models were made). Each 22T4 has a serial number contained in a microdot concealed on the underside of the actuating blaster module. Altering the weapon to remove the serial number requires a Repair check (DC 15), but does not count as a modification. Success results in a -1 penalty on attack rolls.

BlasTech 500 "ESPO" Riot Gun

Weapon Type: Blaster rifle
Proficiency Group: Blaster rifles
Cost: 1,000
Damage: 3d8+1
Critical: 19--20
Range Increment: 30 m
Weight: 4.5 kg
Fort DC: 16
Type: Energy
Multifire/Autofire: M/A
Size: Medium-size
Hardness: 5
WP: 5
Break DC: 17
Availability: Specialized, military

Era: [RI] [RE] [NJ]

Special: This weapon provides a -2 penalty on attack rolls when not in autofire mode.

A compact, short-barreled blaster rifle with an open-frame stock, the BlasTech 500 was designed for dealing with large crowds. Its design swaps accuracy for the ability to hit something -- anything -- in its field of fire. Cynics refer to this as "Corporate Sector logic" -- when in doubt, shoot into a crowd.

The BlasTech 500 is manufactured exclusively within the Corporate Sector, for use by the Corporate Sector Security Division -- better known as the ESPOs. These security officers usually fire their weapons on full automatic, so the limitation of the BlasTech 500 is not as severely felt.

N'Gant-Zarvel 9118 Heavy Carbine

Weapon Type: Blaster carbine
Proficiency Group: Blaster rifles
Cost: 990
Damage: 3d8+1
Critical: 19--20
Range Increment: 20 m
Weight: 2.7 kg
Fort DC: 13
Type: Energy
Multifire/Autofire: M
Size: Medium-size
Hardness: 6
WP: 4
Break DC: 16
Availability: Common, military
Era: [RI]



A short-barreled blaster carbine with a heavy stock, the 9118 is an extremely durable weapon suitable for use both in the wild and in urban settings. Produced by a small Rodian operation with distribution through a number of Hutt families, the N'Gant-Zarvel has proved extremely popular with mercenary units and insurrectionists alike. Of particular note is the deep thumping noise this model produces when fired.

Czerka Adventurer

Weapon Type: Slugthrower rifle
Proficiency Group: Slugthrowers
Cost: 360
Damage: 2d8+1
Critical: 20
Range Increment: 30 m
Weight: 4 kg
Type: Piercing
Multifire/Autofire: M
Size: Medium-size
Hardness: 4
WP: 5

Break DC: 16

Availability: Prevalent, licensed

Era: [RI] [RE] [NJ]

Special: This weapon may fire 15 shots before needing to be reloaded. It uses a 15-shot clip of ammunition (cost 6).



A long-barreled projectile rifle with excellent aim over long distances, the Czerka Adventurer is used by bounty hunters such as Aurra Sing, since its presence does not trip as many weapon detectors as a large blaster would. The Adventurer floods its chamber with a rich oxidizer as it detonates its shell, giving the projectile both added punch and extra range. In addition, the weapon breaks down easily for off-planet transportation. It takes only a partial action to fit the barrel back to the stock.

Do you have a question about the rules for the Star Wars Roleplaying Game? Send it to our newest online feature - [Jedi Counseling!](#)

[PRIVACY STATEMENT](#)

©2002 Lucasfilm Ltd. & © or TM where indicated. All rights reserved. Used under authorization. visit STARWARS.COM



Shop Games Books Magazines Stores Events Company Worldwide Community

RPG Home

Learn to Play

Products

Web

Enhancements

Archive

Living Force

Retailer Locator

Fan Club Store

Character Sheet

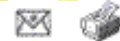

[Home](#) > [Roleplaying Games](#) > [Star Wars: RPG](#)

[Navigation Help](#)

Thursday, October 17, 2002

Arms & Equipment Guide Extras!

By [Jeff Grubb](#)
[Chat](#)
[Message Boards](#)
[Mailing List](#)

There are innumerable companies, corporations, mercantiles, and trade groups within the galaxy, providing myriad goods and services to uncountable sentients. The vast majority of these are confined to one planet, system, or sector of space, and are effectively local operations, their grasp limited and their products (truthfully or not) viewed as substandard. Against this tapestry of lesser lights, there are a number of powerful manufacturers whose names are known to every consumer. The following list provides some background for these manufacturers.



Major Manufacturers

Most of the manufacturers of equipment here have transcended petty local dealings and are now pan-sector corporate giants, having established trade relations with hundreds of systems either directly or through distribution and franchises.

Arakyd Industries

Fields: Weapons, droids

Well-Known Products: Mark VI Inquisitor Seeker

Arakyd Industries was a strong supporter of Palpatine and grew in power during the years of the Empire. It is best known for non-humanoid droids, as it values functionality over appearance. Its work in jet-based propulsion for its droids has allowed it to expand into jet- and rocketpacks. Since the Galactic Civil War, Arakyd has sold its products without concern of political background, but many in the New Republic remember the company as a fervent supporter of the Empire.

Ayelixe/Krongbing Textiles (A/KT)

Fields: Uniforms, armor

Well-known Products: Blast Vest and Helmet, Tuff1 Combat Jumpsuit

A major corporation that concentrates its efforts in clothing, A/KT was formed in the days of the Old Republic of a merger of Ayelixe Fabrico and the larger, struggling Krongbing Interstellar Fashions. Studiously neutral to the point that its employee regulations prevent membership in a political party, Ayelixe/Krongbing sells uniforms to most organized military forces in the galaxy, often supplying both sides in a conflict. It also maintains a thriving consumer division, both with specialized survival clothing and planetary fashion trends.

Baktoid Armor Workshop (BAW)

Fields: Assault weapons, droids

Well-Known Products: Trade Federation Battle droid, AAT battle tank, MTT troop transport A powerful corporation in the time of the Old Republic, Baktoid was the chief arms supplier for the Trade Federation, responsible for various types of battle droids as well as heavy assault vehicles seen in the assault on Naboo. BAW has a reputation for encouraging insurrection and supplying dubious buyers. By the time of the Empire, Baktoid Armor Workshop was a shell of its former self, though its

The Star Wars logo with the text "WWW.STARWARS.COM" underneath it.



equipment was still available, particularly on the Outer Rim.

BioTech Industries

Fields: Medical equipment

Well-Known Products: Fastflesh Medpac, RFX/K Medisensor

A co-operative venture of Neuro-Saav and the Tagge Company, BioTech has become one of the galaxy's top medical and cybernetic manufacturers, trailing behind only Chiewab. BioTech has led the way in biotechnological implants but is best known to galactic consumers for its medpacs and medical scanners. While not able to break the stranglehold of Bacta manufacturers like Zaltin, nor to compete in the area of medical droids, it covers just about everything else.



Blast helmet and vest

BlasTech Industries

Fields: Weapons

Well-Known Products: DH-17 Blaster Pistol, E-11 Blaster Rifle

The market leader in personal energy weapons and light artillery, BlasTech also makes starship weaponry, laser and ion cannons, and missiles. The corporation has benefited from the rise of Palpatine's Empire, and its weaponry has become standard issue for the Empire's stormtroopers. Despite this, the corporation has proved to be extremely even-handed in its dealings, and its weapons are ubiquitous throughout the civilized reaches of the galaxy.

Chiewab Amalgamated Pharmaceuticals Company

Fields: Medical equipment, chemicals

Well-Known Products: GliS Emergency Medpac

A powerful chemical corporation, Chiewab owns over 600 systems outright and is the leader in the biotechnological field. Its strength is in chemistry and electronics, and it excels in this over its leading competitor, BioTech. Aggressive in its research and development, Chiewab is interested in new planets and new substances that it may develop and add to its product family. In addition to drugs and chemicals, Chiewab is deeply invested in agriculture and nutritional supplement.

Cybot Galactica

Fields: Droids

Well-Known Products: 3PO Protocol Droid, WED Treadwell Repair Droid

One of the top two producers of droids in the galaxy (the other being Industrial Automaton), Cybot Galactica has built its success on humanoid droids, in particular the 3PO protocol droid, but its droid empire spans the range from binary load lifters to security droids. Cybot Galactica sells its droids both as finished models and as customizable kits, so individual preferences vary widely. Cybot Galactica's economic power can be felt from the Core Worlds to the Corporate Sector.

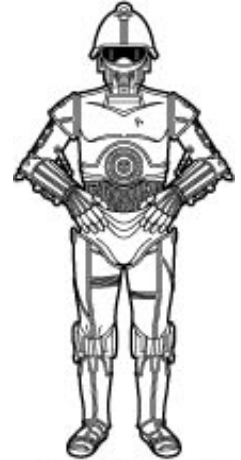

M-3PO Protocol Droid

3PO Protocol Droid

Czerka

Fields: Weapons

Well-Known Products: Flame rifle, Adjudicator, Vibroknucklers

The third largest weapons manufacturer of arms (behind BlasTech and Merr-Sonn), Czerka makes personal energy weapons but has had its greatest success with non-blaster weapons such as flame projectors, vibro-weapons, and slugthrowers. It is the industry leader in the field of "non-standard" munitions. In the days of the Old Republic, Czerka sold to any buyer with the credits, but during the time of the Empire, it has "officially" signed an exclusive distribution deal with the Empire. During this period, a large amount of Czerka munitions found its way out of the warehouses and into aftermarket sales. Following the establishment of the New Republic, it has followed its sales to this new galactic powerhouse and actively courts their business.

Drearian Defense Conglomerate (DDC)

Fields: Weapons

Well-Known Products: Defender sporting rifle, Activv1 Riot Shield

The DDC is a strong presence in the Inner Rim and Expansion Regions and makes a wide variety of weapons, including blasters, grenades, and missiles. The Drearian Defense Conglomerate profits from an agreement to provide munitions and arms designs for the Corporate Sector Authority, which the CSA manufactures. DDC also has arrangements to provide blasters for Arakyd Industries and Cybot Galactica, which are then incorporated into those companies' droids.

Fabritech

Fields: Security and communications equipment

Well-Known Products: PAC20 Visual Wrist com, SE-Vigilant Sensor Beacon

A leader in starship sensor technology for decades, Fabritech manufactures personal comlinks as well as small-scale sensors. Its components are found in equipment from the Old and New Republics, as well as from Empire ships. Able to take the punishment of a variety of planetary environments, Fabritech products enjoy a deep and diverse penetration in a variety of markets.

Golan Arms

Fields: Weapons

Well-Known Products: FC1 Flechette Launcher, RL-40 Stun net launcher

During the rise of the Empire, Golan Arms was a major manufacturer of military weapons. Disputes with the Imperial bureaucracy resulted in a curtailing of its existing contracts, and while the company avoided nationalization, Golan did become a natural ally of first the Rebellion and later the New Republic. Golan Arms designs tend to be copies and refinements of designs of other major manufacturers as opposed to original works, and they have done well in non-blaster-related munitions.

Incom Corporation

Fields: Vehicles, starships

Well-Known Products: MVR-3 Speeder Bike, T-16 Skyhopper, X-wing Fighter

A well-established designer and manufacturer of starships and vehicles, Incom was a long-standing supporter of the Old Republic. As the Old Republic decayed and was replaced by the Empire, Incom did not change with the times, its designers and managers actively resisting Imperial bureaucracy. As a result, the company was nationalized by the Imperial Throne, and most of its design talent joined the Rebellion, taking with them the designs the now-legendary T-65 X-wing Fighter. During the Galactic Civil War, Incom produced designs for the Imperial Navy, and the company has been struggling since to regain its market share in starships and civilian vehicles.

Industrial Automaton

Fields: Droids

Well-Known Products: R2-series Astromech Droid, ASP labor droid

One of the two largest droid manufacturers in the galaxy (the other being Cybot Galactica), Industrial Automaton has built its success on high-AI, dedicated-task machines. Industrial Automaton droids are built to handle a specific task incredibly well, but they also show versatility in dealing with new situations. Industrial Automaton droids dominate the astromech droid category, while its 2-1B Surgical Droid and MD specialist droids are found in most decent hospitals and its inexpensive ASP labor droids are found in systems throughout the galaxy. Hallmarks of Industrial Automaton droids are their expandability and easy maintenance.

Kuat Drive Yards (KDY)

Fields: Heavy military vehicles, starships

Well-Known Products: HAVw A5 Juggernaut, Imperial Star Destroyer

Kuat Drive Yards, a family-dominated business from the Kuat system, has long been a powerful force in starship design as well as planetary defense and mobile assault vehicles. Its executives were strong supporters of first the Old Republic and later the Empire, and during the rule of Palpatine, KDY became the premiere manufacturer of capital ships for the Empire. Shortly before the Emperor's death at Endor, KDY was sold to a group of investors who were believed to be Imperial hard-liners but turned out to be Vaathkree merchants with strong Rebel sympathies. The reorganized Kuat Systems Engineering supports the New Republic, but as with its relationship with the Old Republic and the Empire, the company demands high prices for its goods.

Merr-Sonn Munitions

Fields: Weapons, explosives

Well-Known Products: Class-A Thermal Detonator, G8 Blaster Rifle

BlasTech's chief competitor in weapon sales, Merr-Sonn provides everything from personal weaponry to large ship systems, the latter through its subsidiary Merr-Sonn Mil/Sci. It is best known for its wide variety of grenades and other explosives, and Merr-Sonn is known for having "More boom for the credit." It has a thriving and related civilian arm, Merr-Sonn Industrial Equipment, which makes mining and construction vehicles. Like its rival BlasTech, Merr-Sonn is extremely flexible in dealing with buyers, and the company does not let earlier wars and previous rivalries get in the way of a sale.

Neuro-Saav

Fields: Communications, scanners, cybernetics

Well-Known Products: VXI-3 Electrotelescope

A major electronics and technology firm, Neuro-Saav components are used in many vehicles, vessels, droids, and installations. In addition, the company produces its own line of communication and detection devices for general sale. Its products are found throughout the galaxy and have a solid resale value on the black market. With the Tagge Company, Neuro-Saav owns BioTech, maker of medical equipment and cybernetic devices.

Roche

Fields: Droids

Well-Known Products: J9 Worker Droid

A non-Human corporation founded by the insectoid Verpine, Roche survived the rise of the Empire, when many alien companies suffered. Roche droids are cheap and dependable, which makes up for their often-alien appearance and programming. Roche is the common name for the company; the literal-minded Verpine refer to it as "Roche Hive Mechanical Apparatus Design and Construction Activity for Those Who Need the Hive's Machines."

Santhe/Sienar Technologies

Fields: Droids, military vehicles, starships

Well-Known Products: E522 Assassin Droid, TIE fighter

Sienar has had several incarnations. During the Old Republic, it was known as Republic Sienar Systems and was a successful starship manufacturer. The fall of the Republic brought merger with Santhe and diversification into Sienar Army Systems, Sienar Fleet Systems, and Sienar Intelligence Systems. It has close ties to the Empire and its successor states. Santhe/Sienar works on direct commissions only, so most Santhe/Sienar equipment in common use is second-hand or was purchased on the black market.

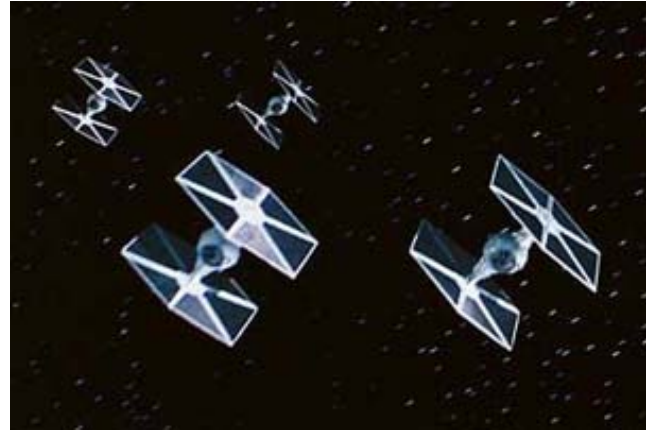

TIE fighters

SoroSuub

Fields: Weapons, droids, vehicles

Well-Known Products: X-34 Landspeeder, V-35 Courier, C1 Comlink

A far-flung galactic corporation with hundreds of subsidiary corporations, SoroSuub is based on Sullust, where it employs over half the native population. SoroSuub enjoys a diversified base, ranging from agriculture and mining to manufacturing armaments, vehicles, starships, and droids. In weapons technology, it is noted for licensing the designs of other corporations for production, but SoroSuub has used those designs to produce original weapons as well. Its products are acclaimed for their durability, and the company is one of the best-known corporations in the galaxy. A strong supporter of the Old Republic, SoroSuub continued to support the Empire even though most of the Sullustan population had Rebel leanings. At the close of the Galactic Civil War, the corporation had evolved into a strong supporter of the New Republic, and it continues to enjoy side distribution throughout the galaxy.

The Tagge Company (Tagge Co.)

Fields: Everything, in particular vehicles, security devices, and computers

Well-Known Products: Air-2 Swoop, Magnacuffs, A-A5 Speeder truck

One of the largest and most diversified corporations in the galaxy, the influence of Tagge Co. (and its majority shareholders, the Tagge family) can be felt on every planet that was once part of the Old Republic. Rising to power with Palpatine, Tagge Co. was a staunch supporter of the Empire. Following the Empire's fall, its operations were supervised by observers from the New Republic. Tagge Co. hides its ownership of agricultural, mining, and manufacturing operations through a variety of names, subsidiaries, and joint ventures. It is the force behind Mobquet Swoops & Speeders, as well as Trast Heavy Transports, Gowix Computers, and the Biscuit Baron restaurant chain. It also controls BioTech Industries with Neuro-Saav.

Ubrikkian Transports

Fields: Vehicles, starships

Well-Known Products: Bantha II Cargo Skiff, Talon I Combat Cloud Car, 9000 Z001 Landspeeder

Ubrikkian Transports is best known for its bulk cargo handlers and its spacious luxury land- and airspeeders. Utilized by large species such as Hutts and by wealthy clients who demand elbow room, Ubrikkian craft are found on most civilized planets and in orbit in most of civilized space. The corporation bases its success on its superior repulsorlift technology and has branched into a number of repulsorlift-equipped goods for industrial and military use.

VargeCorp

Fields: Personal equipment

Well-Known Products: PS-xqt9s Pocket Scrambler

A manufacturing and direct sales conglomerate, VargeCorp's products are of average durability and reliability at best. However, it makes up for its mediocre product through aggressive retailing and franchising, and it sells a wide variety of common personal items. What most people remember is not the product but the firm handshake and high-pressure pitch of the VargeCorp salesbeing.

Veril Line Systems (VLS)

Fields: Droids

Well-Known Products: EG-6 Power Droid

An ancient corporation with a strong corporate heritage of superior industrial products, Veril Line Systems has made its greatest impact with construction and labor droids. The common EG-6, found on almost every planet, is effectively the mascot of this company, which prefers functionality over appearance. VLS has never engaged in making military droids, munitions, or starships, and for that reason has remained on good terms with the various galactic and planetary governments over the years, even through its main headquarters remains on Coruscant.

zZip Product Concepts Ltd.

Fields: Luxury goods for the wealthy

Well-Known Products: Astral-8 Landspeeder, Gladiatorial Walker

While most companies concentrate on selling as much as possible to as many as possible, zZip Product Concepts puts its best effort on providing luxury goods for the elite. Strong, fashionable, and in some cases hand-crafted vehicles are the company's signature pieces and are usually tailor-made for wealthy clients. A used zZip walker or landspeeder usually comes with a story or five about previous well-heeled owners. A subsidiary of zZip, Llahy StarCorporation, makes customized space yachts.

Dead Companies

Not all companies survive in the cutthroat world of galactic business. The following entities have fallen by the wayside, but their equipment is still commonly seen in service.

Imperial Munitions

Fields: Weapons

Well-Known Products: KK-5 Blaster pistol

A company that exists solely in the Rebellion Era, Imperial Munitions is an arm of the Imperial Bureaucracy, whose holdings are made up of smaller companies that the Empire had nationalized. This nationalization was often because of Rebel sympathies, but just as often the company in question had a design or product the Empire wished to make its own. The quality of Imperial Munitions' products ranged widely, as its factories were as often staffed with slave labor as with loyal subjects, and its management was in equal parts ruthlessly brilliant and hopelessly inept. With the fall of the Empire, Imperial Munitions ceased to be a coherent operation, though some stragglers still use that name. Most of the nationalized factories, however, have been returned to their original owners or have formed new corporations.

Medtech Industries

Fields: Droids

Well-Known Products: FX Medical Droid

A long-time manufacturer of medical droids, MedTech went out of business during the Galactic Civil War, despite numerous retrenchments and staff reductions. However, its premiere medical droid, the FX, remains in use throughout the galaxy, primarily in the Outer Rim territories.

Rebaxan Columni

Fields: Droids

Well-Known Products: MSE "Mouse" Droids

Never a major galactic corporate entity, Rebaxan Columni is best known for a single product, the MSE-6

"Mouse" droid. Overproduced in huge numbers, the small, durable MSEs sunk the company, but they still are found, like mechanical vermin, throughout installations in the galaxy.

Serv-O-Droid

Fields: Droids

Well-Known Products: DUM Pit Droids, TT-8L Household Droid

Serv-O-Droid is an ancient company that made its initial mark in heavy labor droids. It branched into a number of other droid models but could not keep itself afloat, eventually going bankrupt. So universal were its droids that its survivors may still be found throughout the galaxy, primarily on backwater worlds where droids survive in brutal conditions. Serv-O-Droid parts are hard to find because the droid design was such that only creative jury-rigging keeps them functional. By the time of the New Republic, the name Serv-O-Droid is used by a remainder house on Elshandruu Pica.

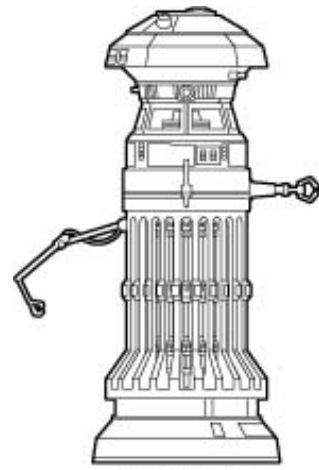

FX Medical Droid

FX medical droid

Small Companies

In addition to the major corporate entities of the galaxy, there are a large number of smaller operations. These companies tend to focus on one particular product line or niche market and are often regarded as the leading edge designers in their fields, whether they dominate the market or not.

- Aermaxis (personal protection devices)
- Aratech Repulsor Company (speeder bikes)
- Bespin Motors (cloudcars)
- Drolan Plasteel (archaic plasteel weapons)
- Gandorthal Atmospherics (survival and atmospheric processing equipment)
- Gorallis Metalworking & Materials (tools)
- Hydrospheres Corporation (submersibles)
- Kamperdine Clothing Specialistics (protective clothing)
- Karflo Corporation (mining equipment)
- LaserHone (vibro-weapons)
- Lerrimore Contracting (household goods)
- Locris Systems (security and personal protection devices)
- Mekuun (heavy vehicles)
- MicroData (information technology)
- Nen-Carvon (sports and recreational equipment)
- Regallis Engineering (tools)
- Tenloss (disruptor weapons)
- Traxes (implants and cybernetics)
- PacNorval Defense Systems (sonic weapons and defense systems)
- Prax Arms (slughthrowers and other projectile weapons)
- Wrokix Works (powered armor)
- Udrane Galactic Electronics (tools)
- Zaltin Bacta Corporation (bacta and bacta tanks)

PRIVACY STATEMENT

©2002 Lucasfilm Ltd. & © or TM where indicated. All rights reserved. Used under authorization. visit STARWARS.COM



Shop Games Books Magazines Stores Events Company Worldwide Community



Search

The Naboo Royal Starship of Queen Amidala

More *Secrets of Naboo*: Web Enhancement

By [Steve Miller](#)

Cartography by [Todd Gamble](#)

[Site Map](#)
[Navigation Help](#)



STAR WARS
WWW.STARWARS.COM



Play Demo



When Queen Amidala ascended to the throne of Naboo, a cutting edge, hand-crafted Royal Starship awaited her pleasure. The ship had been commissioned by her immediate predecessor, King Veruna, to replace the aging yacht of the previous four rulers of Naboo.

Ever concerned with outward appearances, Veruna ordered the Theed Palace Space Vessel Engineering Corps to model the general design around the use of components obtained from the glamorous shipbuilding facilities of the Nubia star system. Not only did the Nubians manufacture some of the finest hyperdrives and sublight engines in the galaxy, but their culture revolved around artistic ethics not dissimilar to those of the Naboo. Veruna handpicked several engineers and sent them to Nubia to secure the drive components and start the process of creating his new ship. The delegation was led by Staven Kremmos, a man long recognized as one of Naboo's finest minds and most creative starship designers.



Naboo Royal Starship

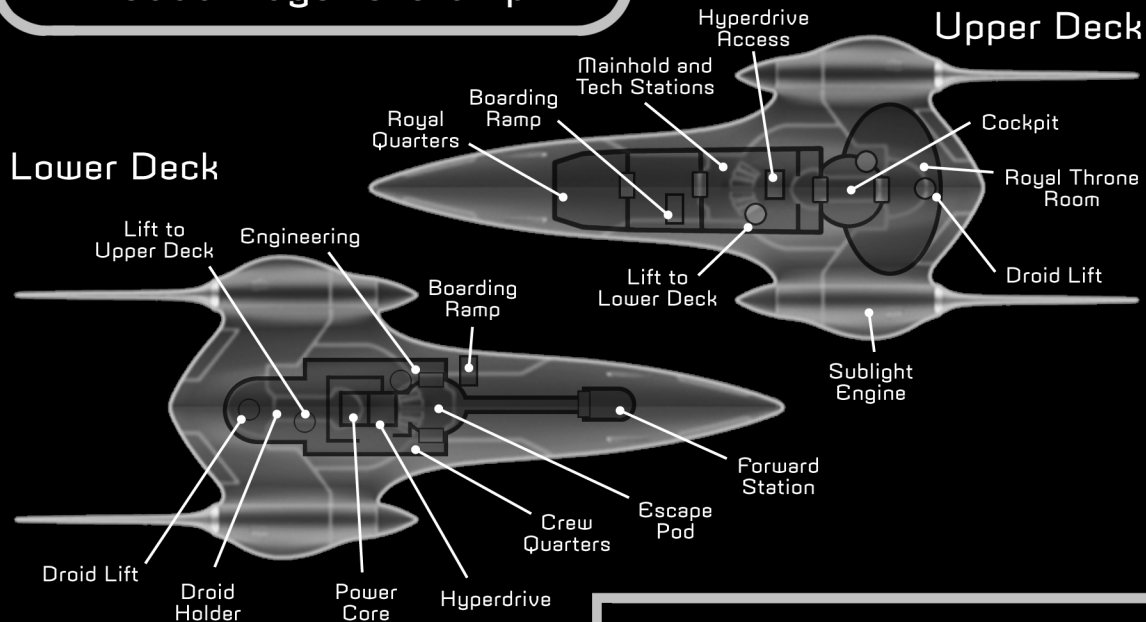

Scale in
Meters

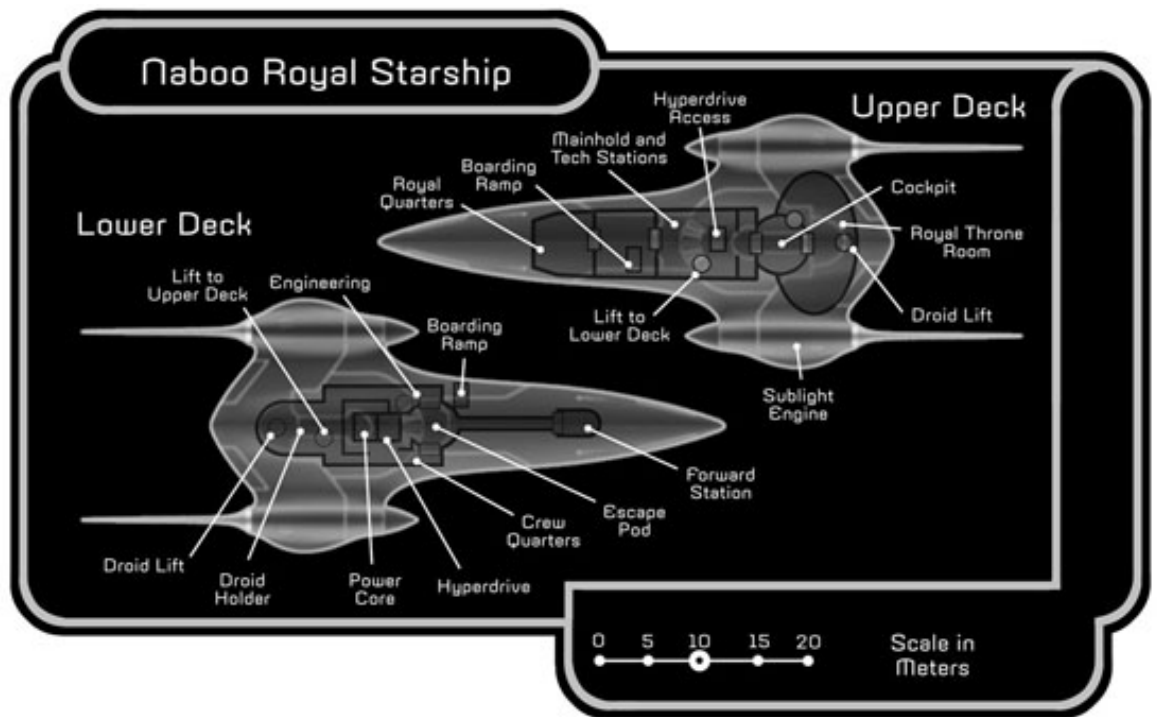

Download a high-quality version of this map: ([.pdf 640k](#)) ([.tif 2.8mb](#))

With the help of Nubian engineers, the Naboo delegation created a new generation of sublight drive that created less pollution than any before them. When they returned to Naboo, they undertook the task of creating the new Royal Starship. From start to finish, the execution of the basic design took six months. However, the exacting construction of the ship took nearly four years, as Naboo workers hand-assembled every component (save the Nubian drives). The unique chromium finish also was painstakingly applied by hand.

As fate would have it, King Veruna took very few trips in the Royal Starship he had commissioned. By the time it was completed, his reign had fallen under siege from a number of offworld organizations (after failing to deliver on promises to them) and from his own advisors (who had grown increasingly resistant to Veruna's push to more firmly involve Naboo in the affairs of the galaxy). Before he was voted out of office and replaced with Queen Amidala, Veruna took only three trips in the new Royal Starship -- two on formal visits elsewhere in the Naboo system, and one whose destination and purpose remains secret today.

Discover more *Secrets of Naboo* with a [new model probe droid](#), the [Mantaris class vessel](#), and an [original adventure hook](#) by Steve Miller.

PRIVACY STATEMENT

©2002 Lucasfilm Ltd. & © or TM where indicated. All rights reserved. Used under authorization.
visit STARWARS.COM

Shop Games Books Magazines Stores Events Company Worldwide Community



Search

Bonus Orbital Shipyard Map

A Rebellion Era Sourcebook Web Enhancement

By Rob Lazzaretti with text by [Owen K.C. Stephens](#)

This map supplements the "Council at Duro" miniadventure in Chapter 1 of the just-released [Rebellion Era Sourcebook](#). Fair warning: You may find it difficult to use the map and the text below in games without this book to reference.



[Site Map](#)
[Navigation Help](#)

Duro Delta Twelve is an aging orbital shipyard in the Duro System. During the days of the Old Republic, DD 12 was a bustling construction yard constantly building new sections and powering down older ones in need of repairs or updating. DD 12 fell to less than half capacity once the Empire rose to prominence, and many of its semi-independent sections were powered down and abandoned.

Its remaining main sections, however, continue to see regular traffic during the Rebellion Era, as merchants drop off freighters for repair, deliver much-needed starship construction material, and temporarily house shipments awaiting new vessels for transport. This combination of high traffic and abandoned areas makes DD 12 a popular location for clandestine meetings of all sorts -- the Rebellion frequently uses it to contact [Duro sympathizers](#). In fact, the meeting that convinced the Duro Shipwright's Guild to support the Rebel Alliance occurred in a forgotten section of DD 12.

A typical abandoned section of DD 12, pictured in this map, contains several airlocks designed for small shuttles and transports. A few crates may be found in hallways and dark rooms, either forgotten supplies or contraband shipments hidden by smugglers. Broken loader droids sit in quiet hallways, and refuse piles up along the walls. Many sections include power generators that provide light and heat for secret meetings and smuggler's dens. Various groups might use a single section at the same time, each claiming a small part of the area. Broken corridors have been protected with transparisteel domes, so air and heat don't escape into the vacuum of space.



Download Now!
[Duro Delta 12 full-color map](#) (288k JPG)

Don't have the *Rebellion Era Sourcebook*? [Buy it now](#) in our online store!

About the Cartographer

Born and raised in the Midwest, Rob Lazzaretti started creating his own fantasy art from an early age. He graduated from Illinois State University, and interned at Game Designers Workshop for two years after college. As studio lead in the Wizards of the Coast cartography department, he says he's fortunate to work with some of the best people in the industry every day. In his work on *Star Wars* and other games, he seeks to push the boundaries of cartography ever farther. His recent credits include maps featured in the new edition of [D&D](#), the [Dark Matter campaign setting](#), and the *Star Wars Roleplaying Game*.



[PRIVACY STATEMENT](#)

©2002 Lucasfilm Ltd. & © or TM where indicated. All rights reserved. Used under authorization. visit [STARWARS.COM](#)

[Shop Games](#) [Books](#) [Magazines](#) [Stores](#) [Events](#) [Company](#) [Worldwide](#) [Community](#)



- [RPG Home](#)
- [Learn to Play](#)
- [Products](#)
- [Web](#)
- [Enhancements](#)
- [Archive](#)
- [Living Force](#)
- [Retailer Locator](#)
- [Fan Club Store](#)
- [SW Insider Update](#)



Expand Your Fleet!

A Web Enhancement for *Starships of the Galaxy*

By [Brian Campbell](#) and [Owen K.C. Stephens](#)

The long-awaited *Starships of the Galaxy* contains new ship descriptions and rules for making ship-to-ship combat a vital element of your games. This web enhancement provides three all-new ships for use with the book: the TIE defender, the YT-1930 freighter, and the shieldship. It also demonstrates how to modify each one of them to create unique vessels tailored to the needs of your campaign. Accompanying each modified starship description and stat block is a set of game stats for the ship's pilot as well, so you can introduce these new vessels into your campaigns without delay. This bonus material is exclusive to our website. Here's a preview....



[Site Map](#)
[Navigation Help](#)

STAR WARS
 WWW.STARWARS.COM



TIE Defender

The TIE defender was developed shortly before the Battle of Endor, but its high cost, as well as various political considerations, prevented it from seeing widespread deployment. Originally, Imperial tacticians decided to deploy TIE defenders in wings of four ships, which could then use their hyperdrives to patrol large areas of space. Had the Empire not begun to collapse following the Battle of Endor, these ships would no doubt have inflicted serious damage to the Alliance. The defender is a radical departure from previous TIE designs, with three sets of solar collection panels, a pair of Novaldex shield generators, a hyperdrive, and a proton torpedo launcher. To make the ship more effective against the armed freighters popular with the Rebellion, medium ion cannons were squeezed into the frame as well.

The TIE defender has an advanced targeting system that allows the pilot to fire the ship's ion cannons simultaneously with its lasers. (Use a single attack roll when firing the lasers and ion cannons together.) A triple array of maneuvering jets connected to the defender's ion engines makes the it one of the most agile fighters in existence, granting its pilot a +3 equipment bonus to all Pilot checks and attack rolls.

Craft: Seinar Fleet Systems TIE defender; **Class:** Starfighter; **Cost:** 200,000; **Size:** Diminutive (6.6 m long); **Initiative:** +8 (+4 size, +4 crew); **Crew:** 1 (Skilled +4); **Passengers:** None; **Cargo Capacity:** 65 kilograms; **Consumables:** 2 days; **Hyperdrive:** x2; **Maximum Speed:** Ramming; **Maneuvers:** +11 (+4 size, +4 crew, +3 engine quality); **Defense:** 24 (+4 size, +10 armor); **Shield Points:** 60; **Hull Points:** 100; **DR:** 5.

Weapon: Laser Cannons (4 fire-linked); **Fire Arc:** Front; **Attack Bonus:** +14 (+4 size, +4 crew, +6 fire control); **Damage:** 6d10 x2; **Range Modifiers:** PB +0, S +0, M/L n/a

Weapon: Medium Ion Cannons (2 fire-linked); **Fire Arc:** Front; **Attack Bonus:** +14 (+4 size, +4 crew, +6 fire control); **Damage:** Special; **Range Modifiers:** PB +0; S +0, M/L n/a

Weapon: Small Proton Torpedo Launcher (2 fire-linked, 4 missiles each); **Fire Arc:** Front; **Attack Bonus:** +12 (+4 size, +4 crew, +4 fire control); **Damage:** 10d10 x2 (proton torpedoes); **Range Modifiers:** PB +0; S/M/L n/a

**The special firing system that allows the defender to fire its laser cannons and ion cannons together qualifies as a minor system. It costs 10,000 credits and takes 2 construction points.*

[Download now!](#) (306k pdf)

Don't own Starships of the Galaxy yet? [Buy it at our online store!](#)

[PRIVACY STATEMENT](#)

©2002 Lucasfilm Ltd. & © or TM where indicated. All rights reserved. Used under authorization.

visit STARWARS.COM

[Shop](#) [Games](#) [Books](#) [Magazines](#) [Stores](#) [Events](#) [Company](#) [Worldwide](#) [Community](#)



RPG Home

Learn to Play

Products

Web

Enhancements

Archive

Living Force

Retailer Locator

Fan Club Store

SW Insider Update