

AN ALPHA DAWN ADVENTURE MODULE

# STAR FRONTIERS

Science Fiction Role-Playing Game

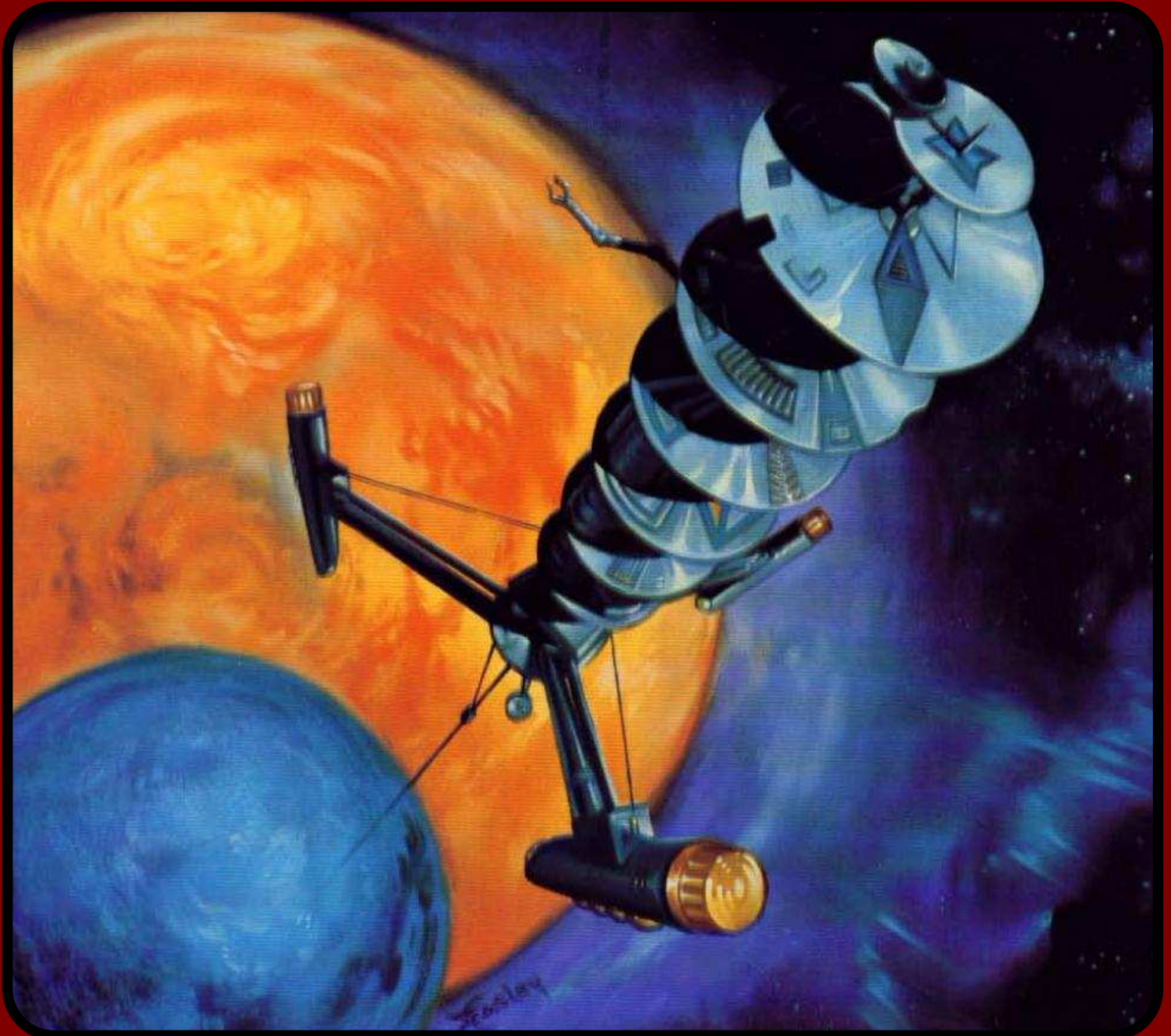

## BUGS IN THE SYSTEM

For 4-8 Characters, Skill Levels 3-4

AN ALPHA DAWN ADVENTURE MODULE

# STAR FRONTIERS

Science Fiction Role-Playing Game



Last Revision: 4.16.2007

# BUGS IN THE SYSTEM

**For 4-8 Characters, Skill Levels 3-4**

STAR FRONTIERS, WIZARDS OF THE COAST, and the WIZARDS OF THE COAST logo are trademarks belonging to Wizards of the Coast, Inc., a subsidiary of Hasbro, Inc., and are used here without permission. © 2001 Wizards of the Coast. All Rights Reserved. The free distribution of this revised edition of the out-of-print game system is not intended to detract income from Wizards of the Coast.



# INTRODUCTION

## ALPHA Section

Bugs in the System is a challenging STAR FRONTIERS Alpha Dawn adventure for 4-8 player characters. It may be fitted easily into an existing STAR FRONTIERS game campaign, and the referee can use it either as a one-off, isolated adventure or as a starting point for further campaign development.

The player characters will need a wide range of skills, and it is essential that some characters have technological skills. As a rough guide, player characters should have skill levels of 3-4 in their primary skill areas (PSAs). Characters should not have any starship skills (as detailed in the STAR FRONTIERS Knight Hawks rules.)

The awarding of experience points at appropriate stages during the adventure has been left to the discretion of the referee. It is recommended that average players should receive about 21 points in total, poor players about 15 points and good players about 27 points.

## THE VENTURI PROJECT

The Belnafaer system (see SYSTEM BRIEF) was first charted by a survey ship under charter by the ByChem Corporation. The survey noted nothing of interest until an atmo probe (an unmanned, atmospheric probe) was sent into the upper atmosphere of the gas giant planet Venturi (see opposite). This not only reported the presence of the expected gases (hydrogen, helium, methane, etc.) but also found low concentrations of several bio-chemicals (including Cys-DiEropadyne and Meta-Trilphidone) that had never been encountered in nature before.

Cys-DE (Cys-DiEropadyne) and Meta-TI (Meta-Trilphidone) are catalysts (compounds which speed up chemical reactions) and are of great value in the manufacture of pharmaceuticals, plastics and bio-electronics. However, they are both extremely unstable and very expensive to produce artificially.

The discovery of Cys-DE and Meta-TI on Venturi had thus provided the ByChem Corporation with a golden opportunity to corner the market with a virtually limitless supply.

The first problem was how to extract the chemicals, since they existed only in very low concentrations. The solution was to divide the operation into two stages: the preliminary extraction process would take place within the atmosphere of Venturi on a floating extraction platform (Jetsom); and purification would be carried out in orbit by the gas mining ship, Moneyspider, spinning around Snobol, one of Venturi's moons (see opposite).

The second problem was secrecy, since many other mining operations would eagerly start bio-chemical extraction on Venturi given the chance. To keep the secret, Jetsom and Moneyspider are registered as research vessels.

## JETSOM (Plan VP / J/ 01)

The extraction platform Jetsom floats like a hot-air balloon in the atmosphere of Venturi, supported by bags of gas heated by atomic reactors. It does not have a fixed position but is blown around by the planet's winds. It does, however, maintain a constant altitude.

Jetsom has a distillation tower that extracts crude forms of Cys-DE and Meta-TI from the atmosphere. The platform is manned by two crews of four (the Alpha and Beta teams) who work 38-day tours of duty with 38-day rest periods on the Moneyspider. The crews are aided by a number of robots and several sapes (see CREATURES - Pull-out Sheet VI) provided as part of a developmental project by Renouf Associates.

Venturi's stormy atmosphere makes normal radio transmission impossible, and so Jetsom has a subspace radio for communicating with the Moneyspider. The automated shuttles (see below) have normal radios and so lose touch with Moneyspider once they enter the atmosphere.

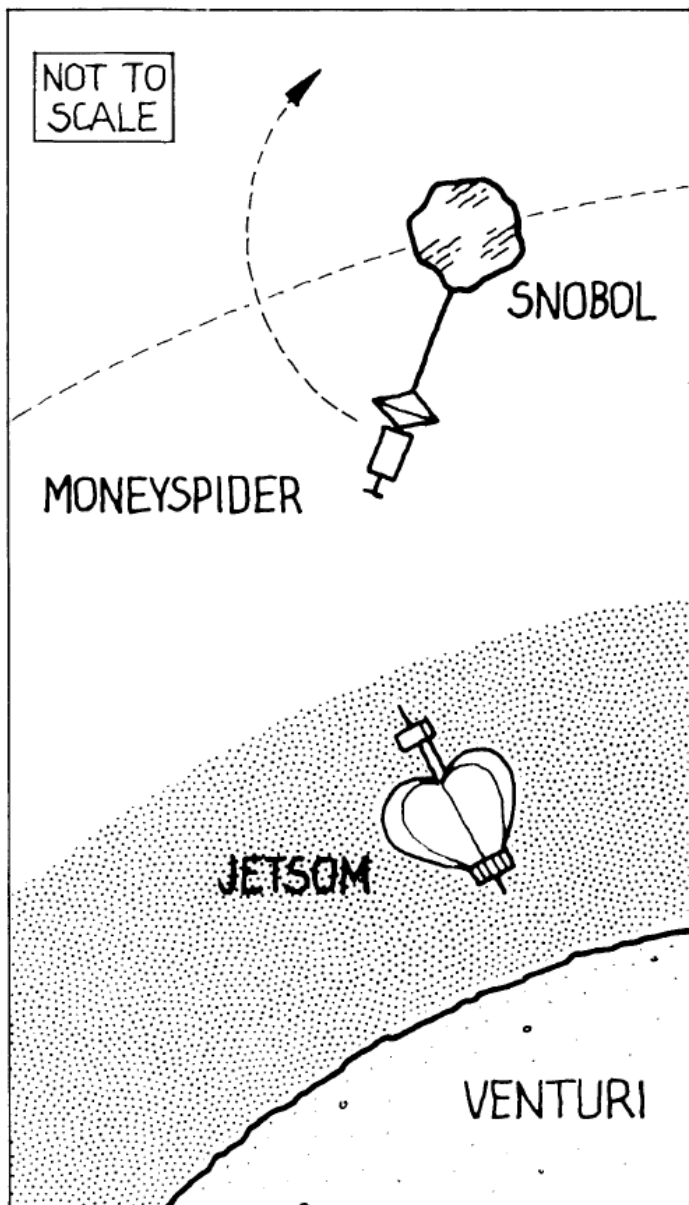

## SNOBOL & MONEYSPIDER (Plan VP/S/02 & VP/M/03)

The Moneyspider is a fully operational starship, but currently serves as the base for the Venturi Project. It whirls around Snobol at the end of a long cable, providing artificial, centrifugal gravity throughout the ship. An elevator runs along the outside of the cable between Snobol and Moneyspider.

The 10-kilometer-long micro-distillation column ("micro-still") that purifies the Cys-DE and Meta-TI runs alongside the cable from the end nearer to Snobol. Inside Snobol itself are docking facilities for starships (area S1), and the automated shuttlecraft (area S4) that ferry personnel, supplies and unrefined chemicals to and from Jetsom.

The automated shuttles can only make the trip to or from Jetsom when Snobol is closest to Venturi (every 38 days). They use blocks of ice from Snobol

as heat shields to avoid burning up in Venturi's atmosphere, and refuel at Jetsom for the return trip. The constant magnetic storms in Venturi's atmosphere occasionally make the shuttle-trips hazardous.

The few starships which come to the Belnafaer system are usually only passing through. Those which call at the project usually dock with Snobol when it is farthest from Venturi and either leave quickly or wait 38 days until the orbit again reaches its highest point.

## SYSTEM BRIEF

**SYSTEM NAME:** Belnafaer  
**Star Color:** Blue  
**Habitable Planets:** None  
**First Exploration:** Survey Ship Astrolabe  
 (report file: BF/119/G).

**Location:** The suggested position for Belnafaer is at one of the four locations for non-binary stars between Scree Fron and Dixon's Star on the Frontier Sector Map. However, it may be located wherever it will best fit in with the referee's campaign.

Belnafaer has only three planets orbiting it. Two of these (Gog and Magog) are in close orbit around the star and are small, hot, rocky and barren. The third planet, Venturi, is a cloud gas giant that orbits Belnafaer at a much greater distance and has an extensive system of moons and rings.

**PLANET NAME:** Venturi  
**Planet Type:** Gas Giant  
**Moons:** 20+  
**Diameter:** 129,000 km  
**Temperature:** -180°C (at top of atmosphere) to -50°C (at top of liquid layer).  
**Rotational Period:** 10 hours

Venturi is a gas giant planet. This means that it is a massive, spherical cloud of gas that becomes denser and denser towards the center until it gradually becomes liquid and finally solid. Because of this, Venturi does not have a surface in the way that other "rocky" planets do.

The outer part of the gas giant (its "atmosphere") is composed mostly of hydrogen with some helium, methane, ammonia and traces of other compounds. These trace compounds include a number of very complex, unstable bio-chemicals which are highly valued as catalysts for industrial processes. The atmosphere is cloudy, very cold, swept by winds of up to 2000 km/hr and frequently blasted by violent magnetic storms.

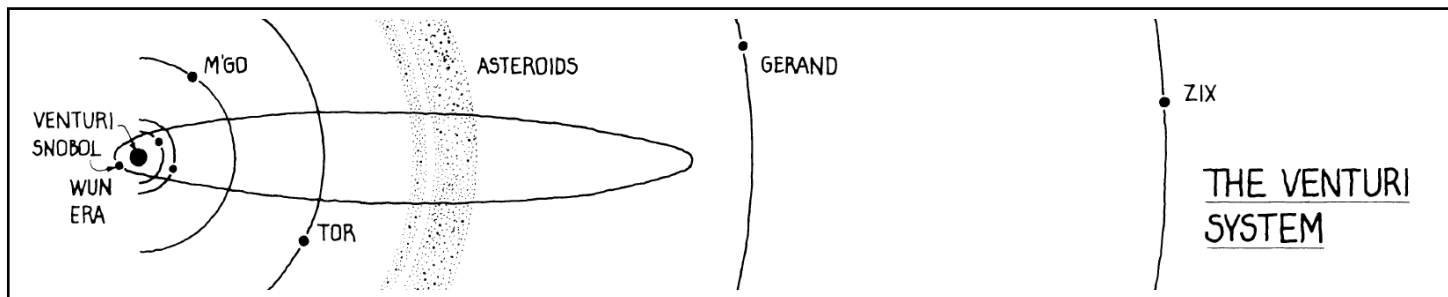

<b>MOON NAME:</b>	Snobol
Diameter:	Average 6 km (irregular)
Atmosphere:	None
Temperature:	-140°C

Snobol is one of the many moons of Venturi, and very small by comparison with the rest. It is a large, lumpy, cold block of frozen water and carbon dioxide ("dry ice"). Snobol was only recently "captured" by Venturi, and is unusual in that it has a very elongated orbit which takes it as close to Venturi as 197,000 km and as far away as 950,000 km. Its orbit takes 38 standard days. Snobol still has the spin which it had before it was "captured", and rotates about its axis once every 4 minutes 45 seconds.

## BUGS IN THE SYSTEM

In their eagerness to begin exploiting Venturi, the ByChem Corporation omitted to consider why complex bio-chemicals should exist in its atmosphere, when they had never been found elsewhere. Had they known the reason, the Venturi Project would probably never have been started.

### THE MATRIX

The stormy atmosphere of Venturi has given birth to "the Matrix", a microscopic, unintelligent life form. In its normal form, the Matrix consists of patterns of electrical impulses that gather together simple compounds from the atmosphere and build up large, complex bio-chemical molecules in which to "live". This form of the Matrix actually creates compounds like Cys-DE and Meta-TI, and is completely harmless.

The matrix can mutate, however, enabling different forms of it to live in electronic circuits, causing malfunctions or giving the circuits strange properties. These forms can spread through circuits and infect other circuits like an electronic virus, and are the cause of most of the dangers that face the characters in this adventure.

### DISASTER ON JETSON

About 66 days before the arrival of the characters in the Belnafaer system, a mutated form of the Matrix found its way into the main computer circuits of Jetsom (Day 6 - see TIME CHART). Once inside, it began to spread and grow, infecting the robots and other systems. At first, it produced only minor malfunctions, which caused no alarm amongst the crewmembers, and the normal changeover of personnel took place when Snobol came near to Venturi 32 days later (Day 38). Unfortunately, the Matrix had already spread to the shuttle computer and so made its way up to Snobol and the Moneyspider.

Meanwhile on Jetsom, in the middle of a magnetic storm 5 days after the changeover (Day 43), the Matrix infection caused a critical failure of the platform's computer and robot systems. In a matter of hours, the members of the Alpha team were either dead or had retreated into freeze fields.

The storm had damaged the subspace antenna (it later ripped it off completely) and so only a garbled distress message reached the Moneyspider. Snobol was already a long way from Venturi but Parl

Kiopta, the Moneyspider's Human co-pilot, volunteered to attempt a rescue by manually piloting a shuttle down to Jetsom. Most of the crew volunteered to go with Parl, but the Vrusk captain, Akizk Kass, chose only three; the astrogator's Vrusk assistant Tak-Arbork, the Dralasite Beta team leader Nimbrus Hool and one of the Beta team technicians, a Human called Midge Arma.

Parl's plan was a dangerous one, since the shuttle was designed to be able to reach Jetsom at Snobol's closest approach and so could carry barely enough fuel for the longer trip. All went well until the shuttle reached Venturi's atmosphere; the shuttle's ice shield was struck by lightning from the storm and shattered. Unprotected, the shuttle burned up, killing all on board.

This left Captain Akizk in a desperate situation. With only six crew remaining (including himself), he

dared not risk another rescue mission. The fate of the Venturi Project hung in the balance.

## THE ADVENTURE

The start is described in BETA SECTION - THE OFFER. It begins with the characters as passengers on a small freighter that is passing through the Belnafer system en route to its final destination. The ship will experience a breakdown, and stop off at Snobol to make repairs.

At first, the characters will not be allowed to leave the ship, but then Captain Akizk will invite them aboard the Moneyspider. He will explain to them about the Venturi Project and as much as he knows about the tragedy on Jetsom. Then he will offer to pay them well if they will go down to Venturi and discover the cause of the disaster. He will offer extra rewards for rescuing any survivors; repairing Jetsom and bringing back the stores of partly refined bio-chemicals.

### EVENTS ON JETSON

This part of the adventure is described in GAMMA SECTION - JETSON PLATFORM. The infection by the Matrix has made Jetsom a dangerous place. After they arrive, the characters must overcome the dangers, gain some idea of the nature of the Matrix, and learn how to destroy it. This will require them to explore the platform in search of information and to gain control of its life-support systems.

### RETURN TO THE MONEYSPIDER

This part of the adventure is described in DELTA SECTION - SNOBOL & MONEYSPIDER. By the time the characters return to the Moneyspider, the Matrix there will have mutated from its original form into a far more sinister one. This new form of the Matrix has not only infected the computers and ordinary robots, but also Baralou Ap-Reaverchan, the ship's astrogator, a very sophisticated anthropomorphic Yazirian cybot. Working through the computers and robots, Baralou will subtly attempt to kill off the characters and crew. The characters must survive the attempts on their lives and then track down their source.

## USING THE MODULE

### PULL-OUT SECTION

The last eight pages of this module (numbered I-VIII) contain information that the referee may need at many points during the course of the adventure, and it is intended that these pages should be removed from the rest of the module booklet for ease of reference.

## ABBREVIATIONS

Statistics for NPC's and robots encountered in this adventure have been abbreviated as follows

<b>ATT</b>	Attack Rating
<b>BODY</b>	The type of body that a robot has
<b>LEVEL</b>	The level of a robot
<b>DEX</b>	Dexterity
<b>DM</b>	Damage
<b>IM</b>	Initiative Modifier
<b>INT</b>	Intuition
<b>LDR</b>	Leadership
<b>LOG</b>	Logic
<b>M</b>	Melee Weapons base chance to hit
<b>MOVE</b>	Mode of movement, normal, max speed
<b>MV</b>	Movement class (Fast, Very Fast, etc.)
<b>PER</b>	Personality
<b>PS</b>	Punching Score
<b>RS</b>	Reaction Speed
<b>RW</b>	Ranged Weapons base chance to hit
<b>SA</b>	Special Attacks
<b>SD</b>	Special Defense
<b>STA</b>	Stamina
<b>STR</b>	Strength

Conditions inside areas of Jetsom, Snobol and Moneyspider have been summarized by the following abbreviations:

<b>Envt</b>	Environment
<b>G</b>	Gravity
<b>O</b>	Oxygen Level
<b>P</b>	Pressure
<b>R</b>	Radiation Level
<b>Std</b>	Standard
<b>T</b>	Temperature

Other abbreviations are:

<b>AD</b>	STAR FRONTIERS Alpha Dawn game
<b>KH</b>	STAR FRONTIERS Knight Hawks game

## TIME CHART

Day	Event
0	(Snobol closest to Venturi) Beta team descends to Jetsom and Alpha team returns to Snobol.
6	The Matrix invades the Jetsom electronic systems.
19	(Snobol furthest from Venturi).
20-37	Minor problems with Jetsom electronic systems.
38	(Snobol closest to Venturi) Alpha team descends to Jetsom and Beta team return to Snobol. Snobol and Moneyspider infected by the Matrix.
43	Disaster on Jetsom. During a magnetic storm, the Matrix takes over Jetsom's systems. The Alpha team is either killed or incapacitated.
44	Parl Kiopta and three others from the Moneyspider are killed attempting to reach Jetsom.
57	(Snobol furthest from Venturi).
72	The characters arrive at Snobol.
75	Captain Akizk makes his offer (see THE OFFER).
76	(Snobol closest to Venturi). The characters descend to Jetsom (see JETSON PLATFORM).
95	(Snobol furthest from Venturi).
114	(Snobol closest to Venturi). The characters return to Snobol (see SNOBOL & MONEYSPIDER).
126	ByChem Corporation relief ship arrives.



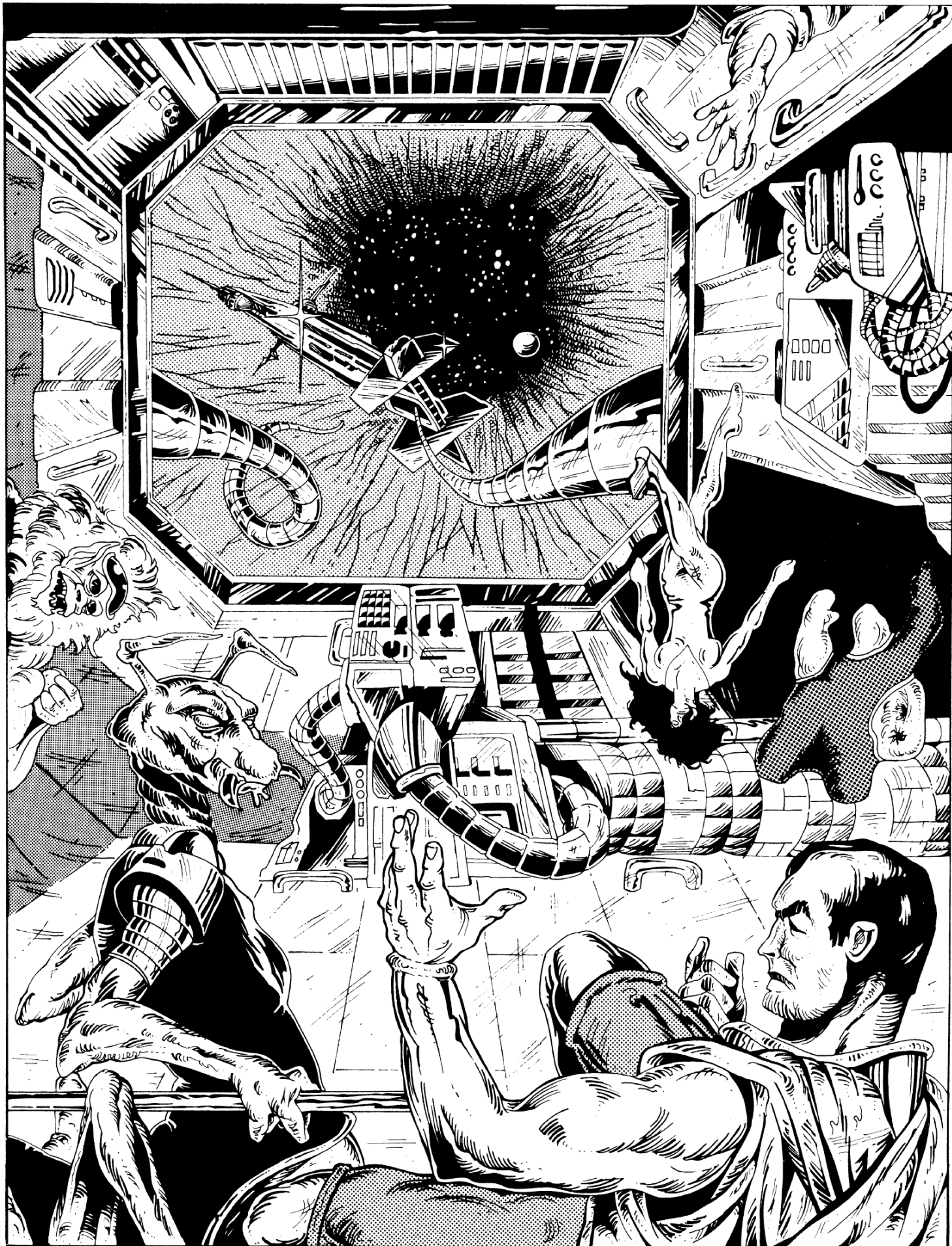

# THE OFFER

## INTRODUCING THE CHARACTERS

This adventure takes place around the planet Venturi in the Belnafaer star system (see SYSTEM BRIEF), and begins when the characters are passing through the system as passengers on a starship en route to some other destination.

A small starship freighter belonging to a person or company with whom the characters have had no previous dealings is the best kind of vessel on which to begin the adventure. Ideally the characters should be the only passengers.

## STOP-OFF FOR REPAIRS

The characters' ship will experience engine problems when it enters the Belnafaer system. At first Captain Akizk on the Moneyspider will be reluctant to allow a ship of a potentially rival company to dock at Snobol, because of the secrecy surrounding the Venturi Project and the need to conceal the problems which the Project is experiencing. His conscience will not allow him to refuse aid to a ship in distress, however, and so he will eventually allow the ship to dock in the starship bay (area S1 - Plan VP/S/02).

The ship will arrive at Snobol on Day 72 (see the TIME CHART), 4 days before Snobol reaches its point of closest approach to Venturi (see THE VENTURI PROJECT). Snobol and Moneyspider are fully described in DELTA SECTION - SNOBOL & MONEYSPIDER details of the crew Are given in CREW OF THE MONEYSPIDER (see Pull-out Sheet - IV to V).

## THE INVITATION

At first, Captain Akizk's desire for secrecy means that he will allow nobody from the freighter to leave the starship dock, and the characters will be

### BETA Section

confined to the ship while the crew carry out repairs. Three days later (Day 75), Captain Akizk will discover that the ship has passengers.

Realizing that these may be able to help him without the need to involve a rival company, the captain will send a message to the ship, inviting the characters to dine with him on the Moneyspider at 1700 hrs.

The referee should remind the players that it would be extremely rude to carry any visible weapons, protective suits or screens to a dinner engagement!

Captain Akizk will wait for the characters in the starship dock control (area S2) at 1700 hours as arranged. With him will be Castuss Wallorr, the Yazirian sape handler. Both will be wearing the uniform of the ByChem Corporation. These uniforms are actually civilian skeinsuits, and each has a vibroknife in a concealed pocket (see Uniforms - Pull-out Sheet IV).

Akizk and Castuss will conduct the characters speedily to the Moneyspider via the transport tube and elevator (area L3). When they reach the Moneyspider, the captain will invite the characters to his cabin (area M5b - Plan VP/M/03), and Castuss will leave.

## DINNER

Dinner will be a simple but elegant meal. During the meal, Captain Akizk will explain the workings of the Venturi Project, asking that the characters treat the information as being strictly confidential. The referee should use the information in the SYSTEM BRIEF and THE VENTURI PROJECT during this conversation. Akizk has absolutely no knowledge of the Matrix and no hint of its existence should be given to the players.

After dinner, the Captain will assume a graver expression and tell the characters that the Venturi Project is close to complete failure. Akizk will tell them as much as he knows about the disaster on



Jetsom and the events before and after it. The referee should use the TIME CHART and the information in BUGS IN THE SYSTEM for this conversation, remembering that Akizk has no detailed information about the events on the platform. He knows about the minor faults that occurred before the crew changeover, and can guess at the fate of Parl Kiopta and the shuttle, but he has only the following garbled, subspace radio message transmitted during the magnetic storm (he will play a recording of it to the characters) to tell what happened:

"...calling Moneyspider, Jetsom... Moneyspider... a major electro-magnetic storm with... failure in... have gone crazy ... hold on much longer... into freeze field but... Akord thought she knew... can't find her..."

The disaster has left the Moneyspider with only six crew, including the captain; barely enough to run the ship and far too few to mount any further rescue/salvage attempts.

The Moneyspider's sensors show that Jetsom has not broken up and is holding a stable position. The ship's heat-sensing, infra-red detectors also show that the buoyancy bags and distillation column are still working, which means that the atomic reactors are still providing power. It is, therefore, possible that some of the crew have survived, making speed vitally important.

## THE OFFER

Once the characters fully understand the situation, Captain Akizk will ask for their help in saving the Venturi Project from disaster. Their task would be: to descend to Jetsom the next morning (0500 hrs, Day 76) at the time of Snobol's closest approach to Venturi; restore the platform's systems to working order; rescue any survivors of the disaster; and bring back as many tanks of crude bio-chemical as possible at the next close approach of Snobol 38 days later (day 114).

The following are Captain Akizk's terms:

1. The characters should not return to the freighter but should remain on the Moneyspider occupying the empty cabins (areas M16, M17, M20 and M22) until it is time to descend to Jetsom. Any baggage that the characters have on the freighter will be transferred to the Moneyspider.
2. The entire incident must be kept secret by the characters after they leave the Belnafer system. The crew of the starship freighter will

be told that the characters have accepted jobs with the ByChem Corporation and will not be continuing their journey. After the mission, transport from Belnafer will be provided for the characters.

3. Each character will be provided with the following equipment, in addition to any which they may have as baggage on the freighter:

- a chillsuit (with 50 SEU) and a breathing mask with 2 oxygen tanks (see NEW EQUIPMENT, PullOut Sheet VI)
- a ByChem Corporation uniform (skeinsuit with vibroknife - see Uniforms, Pull-out Sheet IV)
- a chronocom, a torch and survival rations.

In addition, the characters may use the CRL-E1 maintenance robot (see ROBOTS, Pull-out Sheet V), and divide the following:

- 2 electrostunners, 1 laser rifle, 5 laser pistols
- 1 needler rifle, 2 needler pistols
- 2 albedo screens, 2 gauss screens, 2 sonic screens
- 15 powerclips, 8 power beltpacks, 2 power backpacks
- 18 needleclips (12 pistol, 6 rifle)
- 2 toxy-rad gauges, 2 freeze-fields, 3 ropes, 5 vials of solvaway
- 2 techkits, 2 robcomkits, 2 medkits and 1 envirokit.
- The shuttle computer will be provided with a data file containing technical specifications of Jetsom and other relevant information. The file will be being compiled right up to the time that the shuttle leaves.

5. The payment that the characters receive will depend on how successful they are. For going to Jetsom, and repairing whatever systems are necessary to leave the platform in a stable, working condition, each character will receive 7000 Cr. This does not mean that the characters would be expected to repair all damage, merely that Jetsom should be made habitable, operational and safe. For every crewmember rescued (not including sapes), the characters will receive 1500 Cr each, and for every tank of crude bio-chemical, they will receive 150 Cr each (sapes and Jetsom robots should not be brought back.)

The characters have considerable leverage over Captain Akizk with regard to the level of payment. If they negotiate with the captain, the referee should increase Akizk's offers, up to

maximum levels of 8000, 2000, and 200 Cr respectively.

The characters will not be allowed to keep the equipment they use, but will not have to pay for any which is destroyed or used up during the adventure.

- The characters should expect to remain on Jetsom for 38 days, until the time of Snobol's next close approach to Venturi (Day 114 - see TIME CHART). In dire emergency, however, the characters could take the shuttle into a low orbit around Venturi (the limit of its range) and the Moneyspider would detach itself from Snobol and come down to rescue them. This would ruin the Snobol micro-distillation column, however, and condemn the Venturi Project to becoming a financial failure. If the characters choose to make use of this last resort, and leave Jetsom in this way, they will receive no reward.

## THE INCIDENT

Immediately the negotiations are over, the ship's alarm will sound. The captain will press a button on his chronocom and then listen to it for a few seconds. The characters will not be able to hear what is said. The captain will then rush out of the room, calling to the characters to follow him, and hurry down to the common room (area M25) on deck 6.

The cause of the alarm in the common room is that the GLLR-5 ("Gorilla") recreation robot has gone berserk. During a workout session with Daqor Klarr (a Vrusk crewman - see Pull-out Sheet V) the robot's self-defense program became defective and it started to attack Daqor in earnest. Although the characters and crew do not know it, this is the first sign of the Matrix infection aboard the Moneyspider.

When the characters arrive in the common room, they will find Daqor unconscious on the floor and Fiator Geaus (a Dralasite crewman - see Pull-out Sheet V) in a state of panic, pressed against the far wall. In the center of the room, in a fighting posture, is the robot GLLR-5. Fiator will hurriedly explain what happened, adding "Please don't destroy Gorilla, I'm sure its just a bug in his program".

The robot will attack anyone who approaches it. Although Captain Akizk and Castuss will help to overcome the robot if necessary, they will concentrate on rescuing Fiator and Daqor, leaving the robot to the characters. They will not reveal that they are carrying weapons under any circumstances.

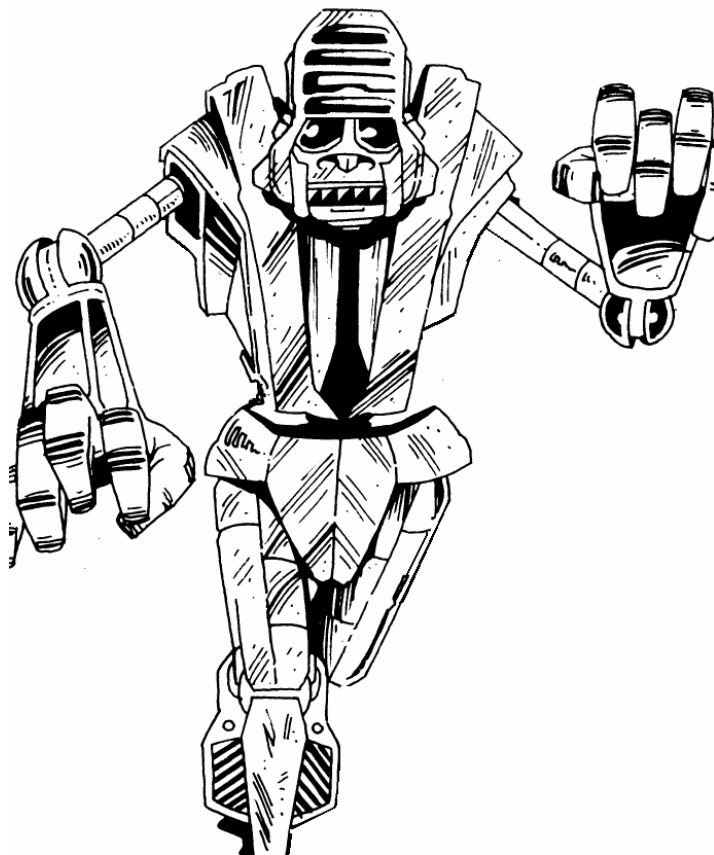

### GLLR-5 ("GORILLA")

<b>Level</b>	Level 4 - Can communicate verbally
<b>Type</b>	Recreation Robot
<b>Body Type</b>	Anthropomorphic (Human)
<b>Parabattery</b>	Type 1
<b>Move Mode</b>	Two Mechanical Legs
<b>Move Rate</b>	10m/turn normal, 60m/turn max.
<b>Limbs</b>	Two Mechanical Arms
<b>IM/RS</b>	+8/80
<b>Stamina</b>	100
<b>Attack</b>	70
<b>Damage Programs</b>	2d10 punching Security Lock, Self-defense (Matrix-infected), Wrestling (custom)
<b>Equipment</b>	--

#### Mission:

Harmlessly participate in sports.

#### Functions:

**Harmlessly:** GLLR-5 can take no action which will result in the harm of a living person. That includes actions which he calculates has a low level of safety. (note: the Self-Defense program has a bug which bypasses this function).

**Participate:** GLLR-5 will make suggestions as to what type of sports people around him would like to play, based on his observations of their moods, energy level, morale, and history of games played with those same people. Otherwise, he will join in any game or sport to which he is invited. He can learn new games (memory limit unknown).

**Sports:** GLLR-5 is programmed with the rules of over 100 sporting games, and can even use a custom program "Wrestling" to pin opponents. GLLR-5 includes non-sporting games such as strategy, card, dice, and boardgames in his programming.



Daqor has suffered 37 points of damage, but will have recovered by the time the characters return from Jetsom (Day 114 - see TIME CHART). The robot will also have been repaired by this time. If characters with robotics skill examine the robot, they will conclude it had developed a simple programming fault.

## PREPARATION

From the end of their dinner with Akizk (about midnight) until the departure of the shuttle at 0500 hours, the characters have only about 5 hours to prepare for the mission. Most of this time will be taken up with checking equipment and resting. If the players are eager to start the adventure, this period need take up very little game time. Alternatively, the players may wish to detail their characters' preparations.

Although the characters will be able to talk to non-player characters before leaving, the referee should remember that the crew will not have much time to stand around talking.

The ship's engineer, Ellen Coopermann, and her assistant, Fiator Geaus, will be busy modifying the shuttle (see THE SHUTTLE), while the Captain will be occupied putting the data file into the shuttle's computer.

Daqor Klarr will be too ill (in the sick-bay) after his fight with the robot to talk to the characters. Castuss Wallorr will spend much of the time treating Daqor and has little technical knowledge about Jetsom.

The referee should be sure not to give the players any information from discussions with the crew other than that on the outside of the module folder.

# JETSOM PLATFORM

## THE SHUTTLE

The shuttle that the characters will use is the last one in the Snobol shuttle dock (area S4). It is fully automated and cannot be piloted manually, except to choose the destination. The options are Jetsom", "Snobol" and "Low orbit, EMERGENCY ONLY". The last option was fitted by Ellen Coopermann on Day 75 (see Preparation). There is also a small panel of indicator lights, a radio, a radar screen and two view ports. Prior to departure, the shuttle has a huge block of ice (from the ice cavern - area S3) fitted to its front end as a heat-shield. The shuttle has ten couches for passengers, and room to stow equipment. There is also a rack for tanks of crude bio-chemicals from Jetsom.

This shuttle was used by the returning Beta team on Day 38 and its computer is infected by the Matrix.

### DESCENT TO JETSOM

Early on Day 76, the characters will be taken to the shuttle dock (area S4). Their equipment will have been stowed already. The shuttle will leave at 0500 hrs.

The descent to Jetsom takes 2 hours. During this time the shuttle's computer will be occupied in guiding the ship, and the characters will not be able to consult the Jetsom data file in the computer's memory (see The Offer). So long as the shuttle is inside Venturi's atmosphere, no radio communication with Moneyspider is possible (see Jetsom).

When the shuttle is deep inside Venturi's atmosphere and has slowed down sufficiently, the remains of the heat-shield are ejected and the characters will be able to use the view ports as the craft files towards Jetsom. The shuttle is on the daylight side of the planet and the characters will see the scudding clouds of Venturi by the feeble light of Belnafaer.

### GAMMA Section

Half an hour before it reaches Jetsom, the shuttle will pass through a small electromagnetic storm. The characters will feel a strange prickling sensation as there is a rapid build-up of static electricity inside the shuttle and the electronic equipment will stop working for about half a minute.

Most of the electronic equipment will return to normal after this time, but the Matrix infection in the computer will have erased most of the Jetsom data file, leaving only the information shown on the outside of the Module Folder. The Matrix will have no other effect on the computer. The information lost cannot be restored.

Minutes later, the Jetsom platform will come into view. The shuttle will approach it quite quickly, but the characters will be able to see the shuttle in the other dock (area D3) and will catch a glimpse of the damage caused by the external maintenance robot (area F2).

After the shuttle has docked, a light on the panel, labeled "Warning: Auto-refueling Malfunction" will begin to flash. This is because the fuel line to the shuttle dock has broken. The shuttle cannot leave until it is refueled (see area A2).

## THE PLATFORM

The Jetsom atmospheric bio-chemical extraction platform (see Plan VP/J/01) floats in the very cold hydrogen atmosphere of Venturi, supported like a hot-air balloon by huge buoyancy bags of heated hydrogen. It does not have a fixed position relative to the planet, but is blown around by Venturi's winds which gust at up to 2000 km/hr and seldom at less than 500 km/hr. It is, however, kept level and maintained at a constant altitude. At this altitude, Jetsom's gravity is a little greater than normal (1.25g). If they wish, referees may take account of this during the adventure.

At Jetsom's altitude, the temperature of the atmosphere is about -120°C, and the pressure is only slightly above normal for the major races. The



gas in the buoyancy bags is kept at -55°C. This is hot in comparison with the atmosphere, but extremely cold by ordinary standards.

The most important part of the Jetsom platform is the central, 184-meter-high, gas distillation column that extracts an impure form of the chemicals Cys-DE and Meta-TI from Venturi's atmosphere. The crew and their sape assistants live and work in insulated, modular compartments supported on a frame that extends outwards from the column, and which also supports the shape of the buoyancy bags. Living conditions for the crew are maintained by life support systems providing air and warmth.

There are six crew compartment modules (A to F) that radiate from the distillation column like slices of a cake. Modules A and D contain docking facilities for shuttle craft; B contains the crew's quarters; C has the maintenance facilities; E has the distillation control room, the main computers and life-support; and F contains stores.

At the bottom of the distillation column (in area E7) are the reactors that provide it with heat, generate power for the platform and heat the buoyancy bags. Around the distillation column, 92 meters above the main part of the platform, is an observation gallery (E8). An elevator (E6) provides access to the reactor room and gallery.

### THE "BUG"

The circuitry of computers, robots and other electronic devices is an ideal home for the Matrix (see Disaster on Jetsom), and it has infected the electrical systems of Jetsom (computers, robots etc.). The Matrix acts like an electronic virus, and has spread across the circuits, often with alarming and dangerous effects on their programming! The circuits themselves are not affected, however, and it is relatively easy to remove the Matrix's effects temporarily (see Defeating the Matrix).

Just like a virus, the Matrix is infectious. It can spread from device to device simply by latching on to the electrical impulses that flow between them.

### THE DISASTER

The Matrix had been present in Jetsom's electronic systems for some time before it caused the disaster (see Disaster on Jetsom) and had, up to then, caused only minor problems to the crew.

However, during a magnetic storm (on Day 43), when the systems were under maximum strain, the Matrix produced some sudden system failures, particularly in the life-support systems, resulting in a dangerous drop in temperature. Two of the crew (Deed Fengall the team leader and Hal Sinclair the

2nd technician) put themselves into freeze fields (in area B2) to escape the effects of the system failure. Deed is still alive in her freeze-field, but the power supply to Hal's was cut off and he is dead.

The sapes in the maintenance module panicked and killed their keeper, Atata Myera (area C3). The sapes themselves have survived. The final crewmember, Akord Zon, who had become suspicious about the cause of the faults, fled to the warmth of the reactor room (E7) but was killed by the radiation. Her notes in the J/GL/IF (information storage) program (see area E7) may help the characters to destroy the Matrix.

### DESCRIPTIONS AND EVENTS

The section ON JETSOM details the standard features of the platform and gives a room-by-room description. JETSOM COMPUTER SYSTEMS (Pull-out Sheet II) describes the platform's computers and programs. Both these sections deal with the situation on Jetsom when the characters arrive. The EVENTS section describes events that occur after the characters' arrival. The timing of the first event has been left to the referee's discretion.

### DEFEATING THE MATRIX

Jetsom is a dangerous and uncomfortable place, since the Matrix infects most of the electrical systems. The Matrix has several effects, including making the robots and security systems dangerous to the characters and lowering the temperature in the modular compartments to 10 degrees below zero.

The characters' first problem will be to overcome these dangers and make the platform more habitable. While they are doing this, the characters should become aware that there is something very seriously wrong with the computer system. It is unlikely that they will realize exactly what the problem is, but the information in the J/GL/IF (information storage) computer program (the notes of Akord Zon - see areas B3 and E7) should be sufficient for them to work out what is wrong and then overcome the Matrix (see Permanent Removal - below). If necessary, the referee may give other hints but since the characters will probably be on the platform for 38 days, there is no hurry.

### DETECTING THE MATRIX

The Matrix cannot be seen since it exists only as a set of electronic impulses inside infected circuitry.

If characters with robotics: listing functions skill on an infected robot, they will discover the robot's original mission/functions. However, they will notice subtle idiosyncrasies in this information and realize that there is a "bug" in the machine's programming.

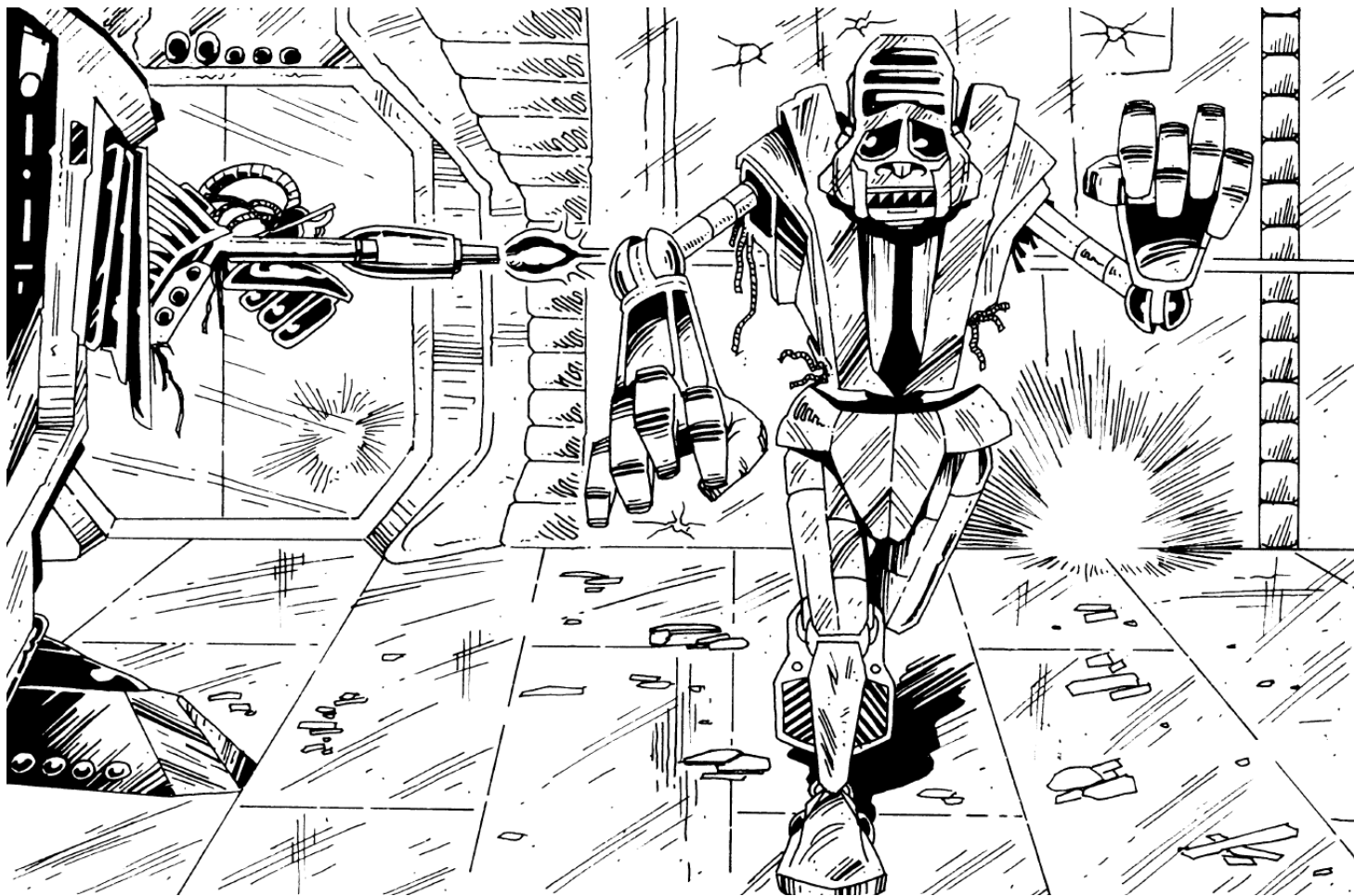

Similarly, characters with computer skills that gains full access (see COMPUTER SYSTEMS - Pull-out Sheet III) to any affected program will realize that the program is somehow malfunctioning (i.e. it has a "bug"). These impressions will not tell the characters exactly how the robot or program is malfunctioning.

### TEMPORARY "CURES"

The effects of the Matrix may be temporarily removed from a computer program if it is "debugged" using manipulating programs skill, or re-written using writing programs skill.

An infected robot may be temporarily "cured" if both its functions and mission are reset (using altering functions and altering missions skills).

These temporary "cures" only remove the effects of the Matrix infection by making the Matrix become dormant. The devices will still be infected and unless the Matrix is permanently destroyed (see below), the Matrix will become active again after 2d10 hours and its effects on the device will resume exactly as before.

Robots, computers and other devices that are not infected when the characters arrive on Jetsom will only become infected as the result of an EVENT.

Once they are infected, however, the above rules will apply.

### PERMANENT REMOVAL

The Matrix originated in the cold atmosphere of Venturi and is vulnerable to heat. The only way of completely destroying it on Jetsom is for the characters to raise the temperature inside the platform to 35°C (uncomfortably hot but not dangerous) or more, for at least an hour by gaining control of the life-support system (see below). The clues to this means of destroying the Matrix are contained in Akord Zon's notes in the J/GL/IF (information storage) program (see area E7 and Pull-out Sheet II).

The external maintenance robot is in an area (F2) that cannot be heated (see Damaged Rooms). It will remain infected by the Matrix unless it is brought into an area heated above 35°C.

The characters can destroy the Matrix in the shuttle's computer using the shuttle's manually adjustable life-support system. Even if they omit to do so, the shuttle will still fly them back to Snobol (assuming it is refueled). The shuttle's life-support system is not powerful enough to affect the temperature of the whole platform.



## LIFE-SUPPORT SYSTEM

The Jetsom platform has two separate life-support systems each consisting of a life-support unit and the program which controls it.

- **System #1** is the main life-support system for the platform. Unit #1 is controlled by the J/MN/LS (life support) program in the J/MN (main) computer and cannot be run manually.
- **System #2** is the back-up life-support system. Unit #2 is controlled by the J/LS/LS (life-support) program in the J/LS (life-support) computer, but also has a manual override control panel.

When the characters arrive at Jetsom, system #1 is working and system #2 is on stand-by.

The life-support units, life-support computer and manual override panel are located in area E3. The main computer is in area E2.

## WORKING THE SYSTEM

Normally, the crew of the platform has three ways of changing conditions inside the platform, but the infection by the Matrix has caused several faults to develop. These will make it difficult for the characters to gain control.

### 1. Through a Life-Support Program (J/MN/LS or J/LS/LS).

If a life-support program is run (using manipulate programs skill), the program allows the operator to change the temperature and oxygen concentration settings for the life-support unit. The temperature range offered is 0°C to 30°C ('normal' is 20°C), and the oxygen level range is 15% to 30% ('normal' is 21%).

Because they are infected, both life-support programs (J/MN/LS and J/LS/LS) tell their units to maintain a temperature of -10°C inside the platform no matter what the setting. They tell the J/MN/BE (bureaucracy) program, however, that the temperature is 20°C ('normal').

### 2. By Using the manual Override Panel (in area E3).

When the "Life-Support Override ON/OFF" switch is flipped on, the panel takes over control of life-support unit #2 from the J/LS/LS (life-support) program.

The manual override panel has two dials labeled "Temp. Control" and "Oxy. Control" which adjusts the temperature and oxygen levels respectively. The ranges available are -10°C to 40°C and 0% to 50%, but all settings outside the ranges available

on the programs (see above) are clearly labeled "DANGER".

When unit #2 comes on, the J/MN/BE (bureaucracy) program should turn off system #1 (unit #1) and program J/MN/LS). However, the Matrix infection in the bureaucracy program means that it will order unit #1 (via the J/MN/LS program) to try to restore conditions to 'normal'. As far as the J/MN/LS program is concerned, 'normal' means -10°C and 21% oxygen. The final result will be the average of what the two systems are trying to achieve. For example, if system #2 is set to 40°C, the temperature will be 15°C (the average of -10°C and 40°C).

### 3. By Changing System.

Normally, the J/MN/BE (bureaucracy) program will turn off system #1 if system #2 is activated. However, the Matrix infection causes 2 faults in the program:

If the J/MN/LS (life-support) program is deactivated, the bureaucracy program will re-activate it. If the J/LS/LS (back-up life-support) program is activated, the bureaucracy program will deactivate it. The J/LS/LS program must obey this command.

## GAINING CONTROL

The program defects can be temporarily "cured" (see Temporary "Cures") and if a life-support program is altered, its range of settings can be increased to those available on the manual override panel (above). The programs' interactions, however, mean that the characters may have to do more than manipulate one of them in order to raise the temperature high enough to destroy the Matrix (see Permanent Removal).

Possible solutions are:

1. Temporarily "cure" the J/MN/BE (bureaucracy) program, activate system #2 with the manual override and set it to a temperature over 35°C.
2. Reprogram the J/MN/LS (primary life-support) program to produce a higher temperature.
3. Activate system #2 with the manual override, set it to a temperature over 35°C and wreck unit #1. Any changes to conditions in the platform will come into effect 10 minutes after a change is made to the settings.

## DAMAGED ROOMS

Damage to Jetsom means that the temperature in areas A2, F1 and F2 (and possibly A1 and A3) is lower than in the rest of the platform.

These will not be affected by changes in the settings of the life-support systems.

## EVENTS

The timing and order of the following events on Jetsom is at the discretion of the referee. Events Ev1-5 involve the Matrix, and will not occur if the infected devices concerned have been "cured" (see Defeating the Matrix).

### EVENT 1. HATCHES LOCK

Every hatch and security door on the platform will close (unless wedged open) and lock (level 1 locks) for 1 hour. This event will only take if the J/MN/IS (installation security) program is infected by the Matrix.

### EVENT 2. ALARMS SOUND

Unless it is free of the effects of the Matrix, the J/MN/AL (alarm) program will cause every alarm on the platform to sound for no reason. This false alarm will last for 2 minutes, during which time, every indicator light will show "red" and/or "DANGER".

### EVENT 3. MATRIX IN THE POWER SOCKETS

From now on, the Matrix infects any power pack recharged from the sockets in the maintenance room (C1) or life-support (E3). The packs will appear to become fully charged, but will provide no power at all when fitted to any equipment. Infected power packs may only be "cured" by heat (see Defeating the Matrix). This event will only take place as long as the J/MT/MT maintenance program remains infected by the Matrix.

### EVENT 4. CRL-E1 INFECTED

The Matrix infects the characters' CRL-E1 robot. Until it is "cured", it will not move and will not obey any instructions from any source. This infection can come from any source so long as the Matrix has not been completely removed from the platform.

### EVENT 5. INFORMATION DISPLAYED

The J/GL/IF (information storage) program will switch on every computer terminal on the platform, make each give out several loud "bleeps" and then display Akord Zon's notes on the Matrix (see area E7) on their screens. Every terminal will be affected, no matter what it is being used for. The notes will remain on each screen until cleared (automatic success) by the characters.

This event may be used as a strong hint, and should only be used by the referee if the characters are being particularly slow in working out how to overcome the problem of the Matrix.

### EVENT 6. SAPES FALL SICK

One of the sapes becomes sick with a -10/D15 disease. Every 10-hour period thereafter, there is a 60% chance that another sape will fall sick (reduced to 40% if healthy sapes are separated from the sick ones). While they are sick, the sapes will not obey orders. Characters with medical skill will have a penalty of 20% if they attempt to use diagnosis or curing diseases skills on the sapes.

### EVENT 7. RADIATION HATCHES LEAK

The hatches of the airlock (E4) begin to leak radiation into the control room (E1). The environment indicator panels on the hatches will not register the radiation level, but unprotected characters in the control room will suffer 1 point of radiation damage every 15 minutes (see Radiation Damage - below). A toxyrad gauge will be able to detect the radiation.

The hatches may be repaired using the repairing machinery skill. If the hatches are repaired, the life-support system will clear the radiation in 1 hour.

## ON JETSOM

The following is a description of Jetsom, as the characters will find it when they first arrive. Subsequent EVENTS (see above) and the characters' actions may change circumstances and conditions.

### PRESSURE, TEMPERATURE AND OXYGEN

At Jetsom's altitude, the pressure of Venturi's atmosphere; of the buoyancy bags; and the crew compartments is the same, and so there will be no problems of decompression even if the outer walls are breached. The Venturi wind, however, (see area F2) is deadly.

A serious threat to the characters will be low temperature. Venturi's atmosphere is very cold, as is the gas in the buoyancy bags. The malfunction in the life-support system (see Life-Support System) mean that the temperature inside most of the platform is 0°C. the effects of cold on characters are given in the specifications of the chillsuit (see Pull-out Sheet VI).

The atmosphere of Venturi is not poisonous but it contains no oxygen. A character without a breathing apparatus will lose consciousness after 2 minutes in

Venturi's atmosphere. After losing consciousness, the character must make a successful stamina check every 30 seconds (5 turns) or die.

## RADIATION DAMAGE

Certain rooms on Jetsom (E4-E7) either are, or can become, radioactive. This radiation causes damage to characters that are exposed to it unless they are protected by an insuit (see NEW EQUIPMENT - Pull-out Sheet VI). Exposed characters automatically suffer a fixed amount of damage each turn, which varies with the intensity of the radiation.

When characters have sustained a total of 5 or more points of radiation damage, they will start to feel dizzy. If they suffer 25 or more points of damage, they will feel horribly nauseous. Radiation damage may only be cured at a hospital.

## HATCHES

Hatches on Jetsom are in pairs (whether in airlocks or the short connecting corridors between modules). As a safety precaution, a hatch is automatically locked (lock level 1) as long as its opposite number is open. Characters may either overcome the lock, or disable the circuit that tells one hatch that the other is open, by using deactivating alarms/defenses skill (level 1 circuits).

On each side of every hatch there is an environment indicator panel that shows the temperature, pressure, oxygen and radiation levels on the far side. Unless otherwise indicated, all these panels give correct readings.

## STRUCTURAL POINTS

The various components of Jetsom have the following structural points:

Structure	Structural Damage Capacity
External walls	350
Internal walls	250
Hatches	250
Ordinary doors	40
Security doors	100

## LIGHTING

When the characters arrive, all rooms inside the Jetsom platform are fully illuminated by lighting panels in the ceiling, unless otherwise stated. Control panels in each room allow the brightness of the lighting to be adjusted.

Outside the platform, the only lighting, if any, will come from Venturi's star, Belnafaer. The atmosphere is so thick and cloudy that Venturi's

daylight takes the form of a dull, twilight glow. Days and nights are each 5 hours long.

## INTERCOM

Each room in the platform has an intercom panel from which any other room can be called. Once connection to a room is made, any sounds in that room may be heard through the intercom. However, until the effects of the Matrix are removed from the J/GL/CN (communications) program, any call made will be connected to a room chosen at random.

## MODULE A: SHUTTLE DOCK 1

### A1. AIRLOCK

Envt: T = -10 (-55); O = Std (Nil); R = 0.

This airlock connects with the hatch in the nose of the characters' shuttlecraft. Characters entering the airlock from the warmth of the shuttle will notice at once how cold it is in here.

The environment indicator panels on either side of the inner hatch leading to the damaged tunnel (A2) are broken, and permanently read "Temperature 25; Pressure Normal; Oxygen Standard; Radiation Nil". As soon as this hatch is opened, the airlock's temperature and oxygen level will drop (to -55 and Nil).

Since the pipes in the tunnel are broken (see area A2), the oxygen level in the airlock can only be restored by opening the hatch to the shuttle (with the tunnel hatch closed). The airlock will take 3 turns to warm up if the tunnel hatch is closed.

A locker here contains: four chillsuits and four breathing masks (one of each for each race), four belt powerpacks and four oxygen tanks for the masks.

### A2. TUNNEL

Envt: T = -55; O = Nil; R = 0.

Only red emergency lights illuminate the tunnel. An explosion in the fuel/oxygen lines, which has also blasted away the walls, has destroyed the main lighting panels and left a 3-meter gap all round. This is spanned only by two power cables, half a meter apart, which ran under the floor.

At this point the tunnel is crossing one of Jetsom's buoyancy bags and through the breach, the characters will be able to see the dome-like top of the bag above and the tapering base below.

Characters may attempt to leap across the gap. Any character that falls into the gasbag will drop and slide down to the atomic heaters at the bottom and



die, but roping characters together, for example, will normally prevent this.

Alternatively, characters may walk across the cables. The insulation on the cables is damaged, however, (a character with technician skill who examines them, has the same chance of noticing this as of repairing machinery) and any character touching either one will suffer 2d10 points of electrical damage, unless protected by a gauss screen. Characters touching both at once will suffer 6d10 points of damage.

The broken ends of the fuel lines to the shuttle dock can be seen clearly (a character with technician skills will automatically recognize them.) Before the shuttle can be refueled to leave, a section of pipe must be fitted across the gap in the fuel line. There is no suitable pipe in this tunnel or in the shuttle. Characters with technician skill have a normal chance of repairing the fuel line with the repairing machinery skill if they use some of the piping from the store (F1). If they take piping from the other tunnel (D2) where the pipes are identical to the damaged ones, they will succeed automatically.

### A3. FOYER

Env: T = -10 (-55); O = Std (Nil); R = 0.

The door into the foyer from the tunnel is a security door with a level 3 lock. The J/MN/IS (installation security) program has reprogrammed the door so that it cannot be opened with the passwords that the characters were given. The program will cause the automated weapons turret in the foyer to fire at the characters as soon as the door is opened.

The temperature and oxygen concentration in the foyer will drop to the same levels as in the tunnel when the security door is opened. Both will be restored in 1minute if the door is closed.

The walls, floor and ceiling of the foyer are scarred by random laser shots which the automated weapons turret on the far wall has fired since the Matrix infected the installation security program.

#### Automated Weapons Turret:

MV Nil; IM 6; STA 120; ATT 60; DM 3d10 laser rifle + grenade launcher (see below - ranges twice normal for characters).

The turret will fire two laser shots and one grenade each turn at randomly chosen targets. It locates its targets with sound sensors and infra-red beams, and can "see" along the entire length of the tunnel. The grenades it fires will be doze, tangler or smoke (chosen at random). The turret has 10 of each. They will be made useless if the turret is destroyed.

## MODULE B: ACCOMMODATION

### B1. COMMON ROOM

Env: T = -10; O = Std; R = 0.

The only occupant of this room is a domestic duties robot. It is infected with the Matrix and has "tidied" the room to a ridiculous extent. It has arranged the furniture in a precise pattern, and has fed all objects in the room smaller than 20 centimeters through its rubbish pulverizer.

The robot will be standing in the far corner when the characters enter the room. It shows no outward signs of malfunction, but will ignore any commands. It will attack in a frenzy if it is attacked, if any attempt is made to interfere with it or if any of the furniture is moved!

While attacking with two arms, its other two arms attempt to grab small objects (weapons, medkits, toolkits and so on) from the characters (30% chance each limb). Any object snatched will be fed into the rubbish pulverizer in the robot's "chest" and destroyed. Any gyrojet ammunition or grenades pulverized will explode (even if inside a weapon), causing their normal damage to the robot. Other ammunition will not harm it.

If any attempt is made to open the robot's access plate, it will start to spin wildly, attacking with all four arms (two attacks per turn). The plate cannot be removed until the robot stops spinning. It can be stopped if wrestled by two characters other than the one attempting to open the panel.

### MLL-1E DOMESTIC DUTIES BOT

<b>Level</b>	Level 2 - cannot communicate verbally
<b>Type</b>	Domestic Duties
<b>Body Type</b>	Standard
<b>Parabattery</b>	Type 1
<b>Move Mode</b>	Wheels
<b>Move Rate</b>	10m/turn normal, 60m/turn max.
<b>Limbs</b>	Four Mechanical Arms
<b>IM/RS</b>	+5/50
<b>Stamina</b>	100
<b>Attack</b>	50 per pair of limbs
<b>Damage</b>	2d10 punching per pair of limbs
<b>Programs</b>	Attack/defense (matrix-infected)
<b>Equipment</b>	--

#### Mission:

Tidy up the place

#### Functions:

**Tidy** - use domestic tools to clean, placing garbage less than 20cm in size in its own holding bin to be emptied when full (in the "place's" refuse room).

**Place** - the building around it - a layout drawing is programmed into the robot to explain limitations.

**DESCRIPTION:** The robot has a cylindrical body, with the rubbish pulverizer hatch half way up. It has four wheels and four limbs arranged like the spokes of a wheel. Its video and audio sensor array is at the top of its body.

This room contains computer terminal Term-6. On the wall above the terminal is a large tri-vid screen. Unless the Matrix is removed from the J/GL/CN (communications) program, this screen will continuously show children's cartoons (running backwards) accompanied by the soundtrack of a teach-yourself-astrogation course.

Until the Matrix is removed from the life-support system, the food dispenser near the terminal will only serve smoked fish with raspberry sauce, and cups of tepid water. It originally could feed up to 12 characters but now can provide enough for only 3 to 12 (d10+2) each day.

## **B2-B4 CABINS**

Each of these three cabins has a bed, table, two chairs and a locker. They were used in turn by members of both crew teams and are rather impersonal:

### **B2. TEAM LEADER'S CABIN**

Envt: T = -10; O = Std; R = 0.

This is the cabin used by the Yazirian team leader, Deed Fengall. The door is locked from the inside (level 2 lock). Inside, are Deed Fengall and Hal Sinclair, the Human second technician. Both are in freeze fields. Hal's freeze field is connected to a power socket in the wall. It is currently working but there was a power failure some days ago and Hal is dead. Deed's is powered by a power backpack and she is still alive. The backpack only has 3 SEU remaining, however, and so Deed will die unless another power supply is fitted within 30 hours. Deed can only be revived at a hospital.

The door of the locker is closed but not locked. Inside are Deed Fengall's personal effects (clothes, mementos, a carefully labeled set of ore samples etc.) along with a geoscanner and a 10-meter roll of insulated wire.

### **B3. COMPUTER OPERATOR'S CABIN**

Envt: T = -10; O = Std; R = 0.

This is the cabin used by Akord Zon. The door is open, and the domestic duties robot (see area B1) has destroyed all the small items that were here except those in the locker.

The locker door is closed and locked (level 2 lock). Akord has also fitted a simple trap (level 1) inside the locker. Unless the trap is detected and deactivated, a doze grenade inside the locker will go off if the door is forced open. The door has 20 structural points.

The locker contains Akord's personal effects, which include a pocket sound recorder. The tape in the recorder contains an unfinished message to a friend of Akord. Most of the letter consists of personal matters only, but the last sentence will be of interest to the characters:

"You wouldn't believe the kind of things that have been happening on this ol' bucket in the past few days. It's really weird. Anyway, I've got it all on comp file and I'll stick it under the old man's nose when we get back up."

Akord was referring to her notes on the J/GL/IF (information storage) program concerning the infection of the platform by the Matrix (see area E7).

### **B4. SECOND TECHNICIAN'S CABIN**

Envt: T = -10; O = Std; R = 0.

This is the room used by Hal Sinclair. Sprawled on the bed is a young adult sape about 1.5 meters tall. He has been separated from his fellow sapes by the blocked tunnel hatch (see Module C: Maintenance).

He is psychologically disturbed and acts like a cub. He will not obey orders. He will regard the first Yazirian character he sees as his mother and cling desperately to that character. If there is no Yazirian, he will ignore the characters. The sape will fight back if he is removed by force from his new "mother" by another character, but if his chosen character forcibly rejects him, he will retreat into a corner in a state of shock.

Any character with psycho-social skill will automatically realize that the sape is mentally disturbed. The sape's disturbance may be removed using the psycho-pathology skill. Because of their physical similarity to sapes, Yazirians will have a bonus of 10% if they try to cure the sape; Dralasites and Vrusk on the other hand will have a 10% penalty.

Once cured, the sape will act in the normal way and obey the characters' instructions (see Sapes - Pull-out Sheet VI), but he will not attack other sapes under any circumstances.

## Young-Adult Sape

MV	Medium;
IM/RS	6/60;
STA	100;
ATT	40 (60 with rage);
DM	2d10 each hand;
SA	Wrestle (DM 3d10 per turn, +5% chance to gain hold, victims have -5% chance to break free).

## B5. SHOWER/WC

Env: T = -10; O = Std; R = 0.

Unless a Matrix-free life support program is in operation, no water can be run in the basins or WCs. The shower will operate but, no matter what setting it is on, will only give scalding water. Any character in the shower will suffer 2d10 points of burns unless they make a reaction speed check (and jump out) in which case the damage is only 1d10.

## MODULE C: MAINTENANCE

The hatch opening into module C from the connecting passage between modules B and C is held open by a toppled chair. Because of this, the hatch into the passage from module B cannot be opened (except by force) unless the locking mechanism is overcome (see Hatches).

## C1. MAINTENANCE ROOM

Env: T = -10; O = Std; R = 0.

Five sapes; two males and three females occupy the maintenance room. Since the disaster befell Jetsom, the food dispenser in the room containing the sapes' pens (C2) has worked only intermittently, and the creatures are hungry and angry.

When they first see the characters, the sapes will be aggressive. Unless the characters attack the sapes, however, the creatures will not attack at once, but will shout loud threats which their poly-voxes will translate as "kill no-furs!", "go! hate!" and so on. The sapes will attack if the characters have not left the room after 4 turns.

Their poly-voxes are working normally, but while they are angry, the sapes will not obey any orders. At any time before the sapes attack, characters with psycho-social skills may attempt to calm them down using the persuasion skill. Each sape must be calmed individually, and each attempt takes 1 turn.

The sapes cannot be calmed while attacking, but if they are restrained during a fight, a psycho-sociologist may attempt persuasion at a -15% penalty.

Any calmed sape will obey normal orders (see Sape - Pull-out Sheet VI) although it will complain of being hungry. Sapes eat twice as much as characters. For every 10-hour period during which a sape is not adequately fed, there is a 20% chance that it will lose its temper and attack the characters. This chance is cumulative (i.e. 40% after 20 hours, 60% after 30 hours etc.) and is doubled if a sape is not fed at all.

## Five Adult Sapes

MV	Medium;
IM/RS	6/60;
STA	120;
ATT	40 (60 with rage);
DM	2d10 each hand;
SA	Wrestle (DM 3d10 per turn, +5% chance to gain hold, victims have -5% chance to break free).

This room contains computer terminals Term-3 and Term-5. An inspection cover near Term-3 is labeled "COMP. J/MT". Behind the cover is the J/MT (maintenance) computer.

The room has the standard machine tools (lathes, etc.), benches and other gear normally found in a small maintenance workshop.

The characters will be able to use the workshop for repairing robots and other equipment. Unlike repairs "in the field", repairs carried out here do not suffer from the chance of breaking down again.

Above one of the benches is a power socket for recharging power beltpacks and backpacks.

## C2. SAPE PENS

Env: T = -10; O = Std; R = 0.

The sape pens have not been cleaned out since the disaster, and there is a correspondingly strong odor in this room.

At the end of the room nearest the door is the sapes' food dispenser. This would normally dispense enough food per day to sustain up to eight sapes (or 16 characters) but, since it is controlled by the Matrix-infected J/MN/LS (life support) program, it will now give out only enough food to satisfy d5+1 sapes (or d10+2 characters) each day. The food is nourishing, but the characters would find it boring and unappetizing.

The six sape pens which take up most of the room each contain a bed of green plastic fiber.



**C3. SAPE-HANDLER'S CABIN**

Envt: T = -10; O = Std; R = 0.

The bones of Atata Myera, the Yazirian sape-handler, are scattered over the floor of this room. He was killed by the sapes when they panicked during the disaster, and since then the ravenous creatures have eaten him. The contents of the cabin were very similar to those of the cabins of the other crewmen, but the sapes have broken most of the smaller (items, including those in the locker. Amongst the debris, the characters will find four boxes of survival rations and Atata's medical pouch. The pouch has been hurled against a wall, which has broken most of its contents except for a can of plastiflesh, 10 doses of biocort and 5 doses of antitox.

**MODULE D: SHUTTLE DOCK 2**

**D1. FOYER**

Envt: T = -10; O = Std; R = 0.

The foyer was the scene of a battle between the installation security system's automated weapons turret and the robot sape warden. The laser on the turret is damaged and can only fire directly down the tunnel (D2) leading to the airlock. It will fire two shots at any target that falls within its line of fire. The turret's grenade launcher is fully operational and can be independently aimed. It will fire one grenade at a randomly chosen target each turn. The grenades it fires will be doze, tangler or smoke (chosen at random). The turret has eight of each. They will be made useless if the turret is destroyed. The turret locates its targets with sound sensors and infra-red beams.

The turret laser has burned away the security door leading to the tunnel (D2), and the airlock hatches at the far end. It has also damaged the shuttle (D3).

**Automated Weapons Turret**

MV Nil; IM 6; STA 77 (damaged); ATT 60; DM 8d10 laser rifle + grenade launcher (see above - ranges twice normal for characters).

The robot sape warden has no weapons but its metallic "skin" is electrified in the same way as a stunstick. Any character hit by, or touching the robot must make a stamina check or be stunned for d100 turns. Characters with gauss screens or anti-shock implants will not be affected.

The robot will attempt to restrain any characters it sees by wrestling them. Wrestled characters must make a successful stamina check every turn in order to resist being stunned. The robot will drag

any wrestled character into the line of fire of the turret laser. The turret has a normal chance to hit the character but if it misses there is a 25% chance that it will hit the robot. The robot will strike with its limbs only as a last resort.

**SW-66 SAPE WARDEN ROBOT**

<b>Level</b>	Level 4 - capable of verbal communication
<b>Type</b>	Security Robot
<b>Body Type</b>	Anthropomorphic
<b>Parabattery</b>	Type 2
<b>Move Mode</b>	Mechanical Legs
<b>Move Rate</b>	10m/turn normal, 90m/turn max.
<b>Limbs</b>	Two Mechanical Arms
<b>IM/RS</b>	+7/70
<b>Stamina</b>	85 (damaged)
<b>Attack</b>	70 per pair of limbs
<b>Damage</b>	2d10 punching per mechanical arm
<b>Programs</b>	Attack/defense (matrix-infected), Security Lock, Restrain
<b>Equipment</b>	Infra-red sensors, electrified dermal plating (treat as stunstick whenever SW-66 touches any character).

**Mission:**

Secure area

**Functions:**

**Secure** - Identify threats to security by watching actions of all living beings in the area. Use electrified dermal plating and wrestling techniques provided by the Restrain program to pacify hostile situations. Resort to Attack/Defense program only when no other option exists. Primary duty is to secure Sape activities (Sape identification is programmed into the robot's memory - visual, audio, and behavioral).

**Area** - the building around it - a layout drawing is programmed into the robot to explain limitations.

DESCRIPTION: The robot is in the shape of a man but has silvery, metallic skin. It has video, audio and infra-red sensors.

**D2. TUNNEL AND AIRLOCK**

Envt: T = -10; O = Std; R = 0.

The laser rifle of the automated weapons turret in the foyer (D1) has shot away the security door leading to the access tunnel, and both hatches of the airlock at the far end, making it completely inoperative. It has also damaged the shuttle (D3). The walls of the turret and airlock are scarred by glancing shots but are generally intact.

If the weapons turret in the foyer has not been destroyed, it will fire at any characters in the tunnel. Characters with technician skill can automatically remove the access panels in the floor and take out sections of the fuel pipes that run beneath it. These may be used to repair the fuel line in the other access tunnel (see area A2).

A locker in the airlock contains; four chillsuits and four breathing masks (one for each race), four belt powerpacks and four oxygen tanks for the masks.

## D3. WRECKED SHUTTLE

Env: T = -10; O = Std; R = 0.

The shuttle docked at airlock #2 was identical to the one used by the characters during their decent from Snobol (see Descent to Jetsom). Although it appears to be undamaged from the outside its controls and system have been wrecked by the turret laser in the foyer (D1) and it is now completely inoperative. The characters will not be able to repair it or salvage any useful equipment except for six 20 SEU power clips in a locker out of the line of fire of the laser. The shuttle cannot be released from the dock by the characters.

## MODULE E: CONTROL

### E1. CONTROL ROOM

Env: T = -10; O = Std; R = 0.

This is the platform's main control and monitoring room. Its only occupant is the general maintenance robot (see below) that will be standing quietly in the center of the room when the characters enter.

The robot is apparently in full working order, but is actually infected by the Matrix, and will always misinterpret any order it is given. If the characters give the robot an order, the referee should have the robot make some mistake. For example, if the robot was ordered to cut four 2-meter lengths of wire, it might cut two 4-meter lengths instead.

The infection has also given it the equivalent of a self-defense program, so it will fight back if it attacked.



## FH-1T MAINTENANCE ROBOT

<b>Level</b>	Level 4 - can communicate verbally
<b>Type</b>	Maintenance Robot
<b>Body Type</b>	Standard
<b>Parabattery</b>	Type 1
<b>Move Mode</b>	Wheels
<b>Move Rate</b>	10m/turn normal, 60m/turn max.
<b>Limbs</b>	2 mechanical arms, 1 multi-tool (cannot be used as a weapon)
<b>IM/RS</b>	+5/50
<b>Stamina</b>	100
<b>Attack</b>	60 per limb
<b>Damage</b>	2d10 punching per pair of limbs
<b>Programs</b>	Security Lock, Self-Defense (matrix-infected)
<b>Equipment</b>	--

### Mission:

Take verbal orders to repair damaged equipment.

### Functions:

**Take Verbal Orders** - The FX-1t is designed to await command from any verbal source (it recognized PanGal as a language only). It has most general tools required to repair most equipment found in the Control Room. It doesn't identify damaged equipment on its own - it waits for someone to give it instructions.

**Repair Damaged Equipment** - It is programmed with schematics and documentation for all electronic equipment in the Control Room, and is equipped with the equivalent of a robcomkit and techkit via a universal multi-tool with replaceable heads.

**DESCRIPTION:** The robot has a conical body with six small wheels hidden beneath the wide base. It has three mechanical arms; two with grabs and one with a multi-tool attachment. The robot's video and audio sensor array is mounted at the top of the cone.

Around the Room are three workstations, each with its own chair:

### Workstation #1: Still and Buoyancy Control.

This consists of computer terminal Term2 and a large panel of gauges and indicator lights showing the condition of the reactors, the bio-chemical still and the platform's buoyancy bags. At present, all the gauges and lights show "green" except for one flashing red light labeled "WARNING: Cryogenic collection tanks full". (This refers to the fact that the tanks of crude bio-chemical in area E5 have been filled up by the still. The characters can replace these with empty tanks from the store (F1) and so collect more crude chemical during their time on Jetsom). This workstation is Matrix-free.

## Workstation #2: External Monitors Screen.

This consists of a large monitor screen that shows the view from any one of the cameras mounted on the outside of the platform. There are 32 cameras in all. Below the screen is the on/off switch, camera selector, contrast and magnification controls. None of these has been infected by the Matrix.

## Workstation #3: Communications Console.

The platform's subspace radio communications equipment is operated from here. The subspace radio is operational and uninfected, but no communication with the Moneyspider will be possible even if the Matrix is removed from the J/GL/CN (communications) program, since the antenna was blown away by a magnetic storm. Two indicator lights at the workstation are glowing red. These are labeled "WARNING: Antenna inoperative" and "WARNING: Communications Program Fault".

## E2. COMPUTER ROOM

Envt: T = -10; O = Std; R = 0.

This room is plain and empty except for a chair, computer terminal Term-1, and the main system and general system computers. The computers are housed in stark, white cabinets whose access panels are labeled "COMP. J/MN" and "COMP. J/GL" respectively (see Pull-out Sheet II).

## E3. LIFE-SUPPORT

Envt: T = -10; O = Std; R = 0.

This room contains a chair, computer terminal Term-4, the J/LS (life-support) computer (behind a panel labeled "COMP.J/LS"), the #1 (main) and #2 (back-up) life-support units (behind panels labeled "LIFE-SUPP.UNIT #1" and "LIFE-SUPP. UNIT #2" respectively), a food dispenser, and a power socket for recharging power backpacks and backpacks.

The food dispenser will not work at all if the Matrix affects the operating life-support program. If the life-support system is "cured" or the Matrix is destroyed, the dispenser will be able to provide sufficient food to sustain up to eight characters.

## E4. AIRLOCK

Envt: T = -10(+5); O = Std; R = 0(1).

The hatch into this airlock from the control room (E1) bears the warning:

"RADIATION HAZARD: INNSUIT ONLY BEYOND INNER HATCH"

This airlock prevents radiation leaking from the bio-chemical still (E5) into the rest of the platform. Apart from this, it operates in the same way as a normal airlock. A locker in the airlock contains seven innsuits (see Pull-out Sheet VI), two for each of the major races except Vrusk, for whom there is only one.

When the hatch into area E5 is opened, the temperature in the airlock will go up to 5°C, the air will become mildly radioactive and unprotected characters will suffer 1 point of radiation damage per turn (see Radiation Damage). When the hatch into E5 is closed, the air will be recycled, removing the radiation and lowering the temperature to -10°C in 1 turn.

## E5. BIO-CHEMICAL STILL

Envt: T = +5; O = Std; R = 2.

This room contains some of the machinery that operates the bio-chemical still and is slightly heated as a result. The still machinery also makes the room moderately radioactive. Any characters in the room that are not wearing innsuits will suffer 2 points of radiation damage per turn.

Because of the warmth in the room, the Matrix has not yet managed to affect the circuitry of the still and its associated machinery. An examination of the still machinery by a character with technician skill will reveal that everything is in perfect order.

Connected by pipes to the machinery of the still are two cylindrical tanks each a meter and a half high and half-a-meter wide (weight 20kg) labeled "CRUDE Cys-DE/Meta-TI". These insulated vessels keep the pressurized, crude bio-chemical gases (extracted by the still) at a low temperature (-100°C). They have dials that show that they are full.

Characters with technician skill can safely disconnect the tanks from the still by using their operating machinery skill. Other characters have a 40% chance of success. Once one tank has been disconnected safely, the character concerned may automatically disconnect the other. Empty tanks from the store (F1) may be fitted by characters with technician skill using their operating machinery skill. So long as the still is operating, it will fill one tank every 2 days.

If any character fails to disconnect one of the tanks safely, the cold, pressurized gas will rush out,



instantly reducing the temperature in the room to -90°C for 5 turns. The gas is an S2/T15 toxin, which is colorless and smells faintly of lemons. Until the gas is cleared by the air recycling system (usually 1 minute), anyone in the room will be poisoned unless they hold their breath or are wearing a gas or oxygen mask (an insuit will not protect a character). Characters who attempt to hold their breath when the gas is released must make a Reaction Speed check. If they fail, they were too slow to avoid breathing the gas and are poisoned.

## E6. ELEVATOR

Env: T = -70/+5/+10; O = Std; R = 0/2/3.

An ordinary elevator with a sliding door and simple controls provides access between the observation gallery (E8), the room with the bio-chemical still (E5) and the reactor room (E7). The elevator can accommodate one vrusk or two members of the other major races. It takes 6 turns to move between E8 and E5, and 4 turns between E5 and E7.

While it is moving, the temperature and radiation level in the elevator remain the same as in the area it has just left. When it reaches its destination, the door opens automatically and the levels change at once to match the new location.

## E7. REACTOR ROOM

Env: T = +10; O = Std; R = 3.

This room houses the atomic reactor that powers the bio-chemical still (see E5) and the six reactors that heat the gas in the buoyancy bags and provide electrical power for the platform.

The heat from the reactors makes this the warmest in Jetsom. Unfortunately, the room is also radioactive. Characters inside the reactor room who are not protected by an insuit will take 3 points of radiation damage each turn.

On one side of the room is the Term-7 computer terminal. Behind an access panel (labeled "COMP.J/CR") is the J/CR (chemical refining/platform stabilizing) computer. Slumped over the terminal is the body of Akord Zon, the Vrusk computer operator. Near Akord is the reactor maintenance robot.

Akord came here for warmth following the disaster but unknown to her, she had torn her insuit and so she died from radiation damage. She is slumped on top of the terminal's keyboard and so it has not turned itself off. The terminal is currently connected to the J/GL/IF (information storage) program via

the J/GL/CN (communication) program. The screen shows the following page of text:

```
----- COMP J/GL -- PROG J/GL/IF -----  
----- FILE: MATRIX -----
```

▶ ANALYSIS - SHOWS 67% PROBABILITY OF COMPUTER/ROBOT FAULTS HAVING SINGLE, CUMULATIVE CAUSE

▶ SPECULATION - FAULTS CAUSED BY MOBILE PROGRAMMING BUG » PROVISIONAL NAME "MATRIX"

▶ SIMULATION - SYSTEM SIMULATION TEST-RUNS SHOW ONLY 2% PROBABILITY OF INTERNAL ORIGIN

▶ CONCLUSION - "MATRIX" HAS EXTERNAL SOURCE

▶ SPECULATION - "MATRIX" PRODUCT OF VENTURI ATMOSPHERIC CONDITIONS

▶ OBSERVATION - FAULTS LEAST AND SLOWEST TO DEVELOP IN WARMEST SYSTEMS - E.G. REACTOR ROOM

▶ SPECULATION - "MATRIX" IS HEAT-SENSITIVE

The warmth in the room has so far prevented the Matrix from affecting the reactor machinery, the computer or the reactor maintenance robot.

The robot obeys both verbal commands and those given via the J/MT/RM (robot management) program. Its current mission concerns routine inspections and maintenance of the equipment in this room and to obey any orders from the crew or robot management program are the general maintenance of the platform.

The robot is mildly radioactive. Any character within 2 meters of it (who is not protected against radiation) will suffer 1 point of radiation damage per turn.

## BBL-1/4 REACTOR MAINTENANCE ROBOT

<b>Level</b>	Level 3 – can communicate verbally
<b>Type</b>	Maintenance Robot
<b>Body Type</b>	Standard
<b>Parabattery</b>	Type 1
<b>Move Mode</b>	2 Mechanical Legs
<b>Move Rate</b>	10m/turn normal, 60m/turn max.
<b>Limbs</b>	2 mechanical arms, 1 multi-probe (cannot be used as a weapon)
<b>IM/RS</b>	+6/60
<b>Stamina</b>	100
<b>Attack</b>	60 if reprogrammed
<b>Damage</b>	2d10 punching if re-programmed
<b>Programs</b>	Security Lock
<b>Equipment</b>	Note: Radioactivity (see above). Standard robcomkit and techkit.

### Mission:

Take verbal orders to repair damaged equipment.

### Functions:

**Take Verbal Orders** – The BBL-1/4 is designed to await command from any verbal source (it recognized PanGal as a language only). It has most general tools required to repair most equipment found in the Reactor Room. It doesn't identify damaged equipment on its own – it waits for someone to give it instructions.

**Repair Damaged Equipment** - It is programmed with schematics and documentation for all electronic equipment in the Reactor Room.

**DESCRIPTION:** The robot has a spherical body supported on three mechanical legs. It has three mechanical arms, two with grabs and one with a multi-probe sensor array (radiation, voltage, temperature etc. sensors). Its video sensor is mounted at the top of its body.

## E8. OBSERVATION GALLERY

Env: T = -70; O = Std; R = 0.

The observation gallery is a circular room running around the distillation column, 92 meters above the main part of the platform. Spaced around the outer walls are six windows that (during Venturi's daylight hours) allow a clear view of the rest of the platform and of the windswept, cloudy atmosphere of Venturi.

Through a window in the roof, a twisted mounting bracket attached to the distillation column can be seen. The bracket held the antenna that was torn off during a magnetic storm, and is clearly beyond repair.

## MODULE F: STORAGE

### F1. STORE

Env: T = -120 (-80); O = Nil (Std); R = 0.

The door leading to the wrecked room (F2) is open and so this storeroom is exposed to the cold, oxygenless atmosphere of Venturi. The room is filled with a gusting wind that swirls in through the door. Although this wind is far less strong than the full blast of Venturi (see F2) and is not dangerous to the characters, it has swept away most small objects in the room. There is a 30% chance each turn that any object weighting 1 kilogram or less will be blown away unless it is held or secured.

Characters attempting to close the door into F2 must make a successful strength check in order to succeed.

Along one wall of the storeroom is a rack with 20 slots. Two of these are empty, the others hold:

- *Three cryogenic tanks filled with crude bio-chemicals. These are identical to the tanks in the bio-chemical still room (E5) except that they are not connected to anything. They each weigh 20kg. If a character opens the valve of a tank, the pressurized, bio-chemical gases inside will rush out. If the door to F2 is still open, the gas will be dispersed harmlessly. If the door has been closed, the characters may be poisoned (see E5).*
- *15 empty cryogenic tanks. These each weigh 12kg. Characters may connect empty tanks to the bio-chemical still output pipes (see room E5) using their operating machinery skill, if the full tanks have been removed.*

Another rack contains standard 2-meter-long pipes (20 pipes, diameters 2-20 centimeters) and girders (30 girders, widths 2-20 centimeters). The pipes may be used to repair the fuel-line in the access tunnel (A2).

There are six lockers in the room. Five of these have blown open and are empty except for:

- *a coil of high-voltage wire (100 meters)*
- *a techkit (complete)*
- *a robcomkit (complete)*
- *a power backpack (fully charged)*

The closed locker contains:

- *a bioscanner*
- *a type 1 parabattery*
- *grenades for laser turrets (5 doze and 5 tangler)*
- *4 laser pistols (each with 20 SEU clip)*

## F2. WINDS OF VENTURI

Envt: T = -120; O = Nil; R = 0.

This room is open to the atmosphere and violent winds of Venturi, since its walls have been cut away by the platform's external maintenance robot. The lighting panels have been destroyed and the only illumination (if any) will be the dim light of the star Belnafer (see SYSTEM BRIEF).

The external maintenance robot has short, magnetic legs and a streamlined body to enable it to withstand Venturi's powerful winds. It never came inside the platform, and was programmed to perform repairs to the outside of the Jetsom platform under the control of the crew from Term-3 (in the maintenance room - C1) via the J/MT/RM (robot management) program.

When the Matrix infected the robot, it took to damaging the platform rather than repairing it. It cut away the outer walls of this room with its laser powertorch (exhausting this in the process) and destroyed everything in the room that the wind did not blow away.

Any character leaving the shelter of the door- or hatchway and going out into the ruined room will suffer 1d10 points of damage from wind-buffeting each turn. This damage is halved if the character has a skeinsuit or inertia screen (which will use up 2 SEU per round). In addition, any characters not tethered to something solid must make a successful strength check every turn or lose their grip. They must then make a dexterity check. If they succeed, they will manage to grasp a new handhold. If they fail, they will be swept off the platform and killed.

The robot will not attack characters, even if attacked, but there is a 20% chance each turn that it will cut a tethering rope if the characters are using any.

## HMDD-3 EXTERNAL MAINTENANCE ROBOT

<b>Level</b>	Level 3 - can communicate verbally
<b>Type</b>	Maintenance Robot
<b>Body Type</b>	Standard
<b>Parabattery</b>	Type 1
<b>Move Mode</b>	10 short magnetic legs
<b>Move Rate</b>	5m/turn normal, 5m/turn max.
<b>Limbs</b>	2 mechanical arms, 1 multi-tool (cannot be used as a weapon), 1 laser powertorch limb (power is exhausted, see below)
<b>IM/RS</b>	+6/60
<b>Stamina</b>	100
<b>Attack</b>	60
<b>Damage</b>	2d10 punching per limb - only if reprogrammed
<b>Programs</b>	Security Lock, matrix-infected
<b>Equipment</b>	--

### Mission:

Repair damaged external equipment.

### Functions:

**Repair** - The HMDD-3 is equipped with a laser powertorch and a universal multi-tool limb (with replaceable heads that comprise a comprehensive robcomkit and techkit all in one). It is programmed with basic understanding of the principles of heat shielding and mechanical structural engineering.

**Damaged** - It can use visual and other sensors to identify damaged equipment without requiring verbal commands (since it's designed to operate in an environment that characters would find dangerous). If verbal instructions are given, it will try to carry them out within the limitations of its programming.

**External Equipment** - It is programmed with schematics and documentation for all electronic and structural equipment external to the Jetsom.

**DESCRIPTION:** The robot has a 2-meter-long horizontal, cylindrical body that tapers to a point at both ends. Its legs give it a firm grip to withstand the wind, and its limbs and sensors (video and infra-red) can be pulled in to lie flush with its body. The powertorch is a powerful laser cutter that can inflict 20d10 of damage per turn. It uses 30 SEU per turn from a special parabattery built into the robot's body. The characters cannot use this powertorch as a weapon.

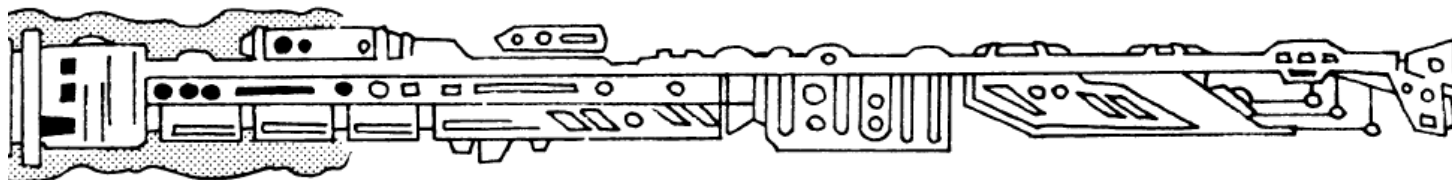



# SNOBOL AND MONEYSPIDER

## DELTA Section

By the time the characters return to Snobol (see the TIME CHART), the freighter that brought them here will have departed, and so they will be unable to leave until the ByChem Corporation relief ship arrives on Day 126 (Event 10).

Once again, the Matrix will put them in danger, since the infection brought up by the Beta team on Day 38 (see TIME CHART) has produced a deadly change in the ship's robot astrogator.

The action consists of a series of EVENTS (below) that occur after the characters return. Snobol and Moneyspider are described in detail, details of the crew and robots are given in CREW OF THE MONEYSPIDER (Pull-out Sheet IV), and the computer systems are described in COMPUTER SYSTEMS (Pull-out Sheet III).

## KILLER ROBOT

When the Matrix first arrived on Snobol/Moneyspider, it has the same form in which it infected Jetsom. It did not thrive this far from its natural habitat, however, and only succeeded in taking over the GLLR-5 recreation robot (see The Incident).

While the characters were on Jetsom, the Matrix on Snobol/Moneyspider mutated into a new form which spread through the installation's electronic circuits. As long as it infected only the computers and ordinary robots, this new form had no adverse effects. However, when it infected Baralou Ap-Reaverchan (the anthropomorphic Yazirian robot astrogator - see MAJOR NPCS, Pull-out Sheet IV), it reacted in a strange way with the special bio-electronic circuits that give her artificial intelligence, and Baralou became self-willed and homicidal.

## BARALOU'S POWERS

Every computer program and robot on Snobol/Moneyspider (with the exception of the CRL-E1 maintenance robot) is infected by the Matrix. Baralou can command ("run") any of these at will, through her tight-beam communication link with the

M/MN/RM (robot management) program (see Pull-out Sheet VII). In addition to commanding infected devices, Baralou can reprogram or manipulate (alter) level 1 computer programs. She can do this through her communication link, without the use of a terminal.

The oxygen consumption sensors of the life-support systems tell Baralou which rooms are occupied. She can hear anything that is said on Snobol or Moneyspider through the intercom system. She can also "see" anything picked up by the video cameras in the captain's office (M5a) and the Deck 5 lobby (M11), and she knows automatically when and how any programmed system is used.

Baralou's appearance, speech and actions are indistinguishable from those of a real Yazirian (see Pull-out Sheet IV). A detailed medical examination, for example, would reveal that she is a robot, but a simple injection would not.

## DESTROYING THE MATRIX

Unlike the Matrix on Jetsom, this new form affects the electronic circuits themselves, rather than their programs. If characters examine programs whose circuits are infected or list the functions of an infected robot (see Detecting the Matrix), they will gain the impression that there is a "hardware fault" (i.e. a problem with the actual electronic components) rather than a "program bug".

The new form cannot be destroyed by heat, nor can its effects be temporarily removed by manipulating/re-writing the programs, or altering missions/functions.

The Matrix can be removed automatically from a computer's circuits by using the repairing computers skill, or from a robot by using the repairing robots skill. In either case the job will take 1d10 hours. The Matrix will not re-infect.



## EVENTS

### A MYSTERY UNFOLDS

This part of the adventure is designed to present the players with an exciting multiple-murder mystery, and to give them an opportunity to role-play their characters to the full. The plot unfolds as Baralou kills off the crew one by one and attempts to eliminate the player characters. It is not necessary (or even desirable) for the players to solve the mystery until they are presented with the final clue (the fact that Baralou is a robot - Event 7), but they should constantly have a sense of danger and the feeling that "something is wrong".

Some of the events will remind them of what happened on Jetsom as a result of the Matrix infection, particularly the "systems failure", but it should also be apparent right from the start (with the captain's murder - Event 1) that there is a purposeful and malicious intelligence behind what happens. For most of the time, the suspicion of the player characters will probably fall on Ellen Coopermann, but she is completely innocent.

Except for the first (Event 1) and last (Event 10), none of the events has a fixed time when it must take place. They should, however, occur in the order given. The exact timing of the events is up to the referee, who should present them in such a way as to maintain a feeling of excitement and mystery for the players.

To avoid any complications that would arise if Baralou lost control of one or more of the computer programs, the player characters should not gain physical access to the M/MN, M/GL, M/LS or M/MT computers until the latter part of the adventure (Event 7). Events can be used by the referee to distract them from the computers if necessary.

### PROTECTING THE COMPUTERS

Since the characters need physical access to the computers to remove the Matrix (see Destroying the Matrix - above), Baralou has programmed the ship's systems to defend the most important ones:

#### M/MN, M/GL AND M/LS.

If, at any time, the characters attempt to enter the strongroom (M15) where the M/MN (main), M/GL (general) and M/LS (life-support) computers are located, they will have to overcome the locked security doors and the DB-0 security robot in the security room (M14). Neither the doors nor the robot will respond to their passwords (which are known only to the captain and Ellen Coopermann).

#### M/MT

If, at any time, characters open the access panel to the M/MT (maintenance) computer in the workshop (M8), the AUD-1a engine maintenance robot (Pull-out Sheet V) has orders to enter the room through the airlock (M9) carrying two radioactive fuel rods. The robot will ignore any orders that the characters give it, and will follow them around the room, concentrating on anyone near the computer. The robot cannot move to any other deck. Any

unprotected character within 2 meters of the robot will suffer 5 points of radiation damage per turn (see Radiation Damage): 1 from the robot itself, plus 2 from each of the rods. Actually touching the robot or rod will cause an additional 2 points per turn. There is nothing in the appearance of the robot or the rods to suggest that they are radioactive (the rods look like metal bars), but the referee should inform the player characters of the symptoms they experience (dizziness etc.) as they suffer radiation damage.

So long as the robots concerned remain operative, these defenses will remain in effect even if Baralou is destroyed.

## THE ACTION

### EVENT 1. ARRIVAL AT SNOBOL

On arrival back at Snobol on day 114 (see the TIME CHART), the characters will be greeted over the shuttle foyer intercom (S5) by the excited but very relieved voice of Captain Akizk. He will congratulate them on their survival and ask them to come to his office (M5a) to report to himself, Baralou and Ellen Coopermann.

### CAPTAIN'S DEATH

Baralou will realize that she must prevent the captain (the only person aboard who knows that she is a robot) from finding out about the Matrix. While the characters are in the elevator (L3), Baralou will kill the captain in his cabin (M5b). She will make the murder look like a suicide by first tranquilizing him with a doze grenade, shooting him at close range with his own laser pistol, then putting the gun in his hand.

To incriminate Ellen (the engineer), Baralou will smear a little graphite lubricant on the pistol. The referee should make a secret intuition check for each player character that examines the pistol to see if the lubricant is noticed.

Before returning to her cabin, Baralou will use the captain's Term2 terminal to type a "suicide note", leaving it displayed on the screen:

*There can be no life without honor and loyalty to the company. The outsiders are returning from Jetsom and everything will be revealed. There is but one thing to do.*

- Akizk

### DISCOVERY

The characters will arrive at the captain's suite (M5) just as Ellen Coopermann is hurrying out after discovering Akizk's body. If they wish, the characters can look inside the captain's room while she alerts Baralou.

The circumstances of the captain's death (he seemed very glad that the characters had returned, for example) should be enough to make the player characters suspect that it was not suicide. If, however, they do not seem suspicious, the referee should make an intuition check for the most intuitive character. If the check is failed, the character will simply notice a strange smell in the air. If the check is successful, the character will recognize it as doze gas.

### MEETING

As second in command, Ellen will insist that it is her duty to take over the running of the ship, and will call a meeting of everybody aboard to discuss events.

The meeting will be held in the common room (M25). Ellen will inform the crew that the captain has killed himself and that she has taken command. Then she will ask the characters to describe what took place on Jetsom. If the characters tell the others about the Matrix, Ellen will be highly skeptical, Baralou will express cautious interest, Daqor Klarr will start to grumble about "getting back at the thing", Fiator Geauis will look scared, and Castuss Wallorr will say that he never did trust "tin boxes". One of the player characters will overhear Castuss mutter, "It's a good thing 'Frosty' isn't in command", and "I'll make sure we've got a way out". Ellen will conclude the meeting by saying that she will contact the ByChem Corporation and ask for a relief ship to be sent (see event 10). After taking command, Ellen will occupy the captain's suite. Until event Ev7, the characters will not be able to convince her of the existence of the Matrix (she thinks that the Jetsom disaster was a simple system failure).

Up until the point (Event 3) where she goes into hiding, Baralou will remain calm and reserved. She will express interest in the Matrix and, if necessary, will distract the characters with questions about the Jetsom disaster.

Following the meeting, a degree of calm will settle over the Moneyspider and its crew. The player characters may investigate the matter of the Captain's death if they wish, but Ellen will oppose any attempts by them to interfere with the ship or its crew. If, for example, the characters consider overpowering Ellen and/or the other crew at this



stage, the referee should remind them that Ellen represents the power of the ByChem Corporation, whose ship they are on, and that a ByChem relief ship is on its way.

## EVENT 2. LIFEBOAT ADRIFT

### CASTUSS' "WAY OUT"

Baralou will have overheard Castuss' muttered comments at the meeting and will have decided that he must die. Her chance to kill him will come when Castuss secretly sneaks to the M2 lifeboat to check his "way out" (while everybody else is occupied or asleep). Baralou will follow Castuss, kill him with her laser pistol and hide the body (dressed in her spare uniform) in the micro-still control room (L1). Here she will also sabotage the life-support unit cooling device (see Ev3).

Then, working through the computer, Baralou will launch the lifeboat. This will sound the ship's alarms. Ellen will rush to the bridge and summon the characters and crew (including Baralou) there. Everyone on the bridge will hear a phony "distress message". This will seem to be coming from Castuss in the lifeboat, but will actually be produced from within the M/MN/CN (communications) and M/MN/LG (languages) programs under Baralou's command. The referee should make secret intuition checks for any characters with psycho-social skill. If they succeed, they will notice that Castuss' voice seems strangely calm.

### DAQOR RUNS RIOT

Immediately after Castuss' death, Daqor will become very angry and agitated, swearing to "get the electric bug that killed my friend", and threatening to smash the ship's electronic systems. Ellen and Fiator will try to calm him, but will fail. Characters with psycho-social skill will also automatically fail if they attempt to use persuasion, hypnosis or psycho-pathology.

Unless the player characters quickly subdue him, Ellen will put Daqor to sleep with a dose of telol. Then, she and Fiator will take Daqor to the sick-bay (M13) and strap him down on a recovery couch.

## EVENT 3. PLAYING DEAD

Baralou's next step will be to take suspicion away from herself by pretending to be dead!

First, she will hide in one of the engine compartments (M10). Then she will use her control of the ship's systems to send the elevator (L3) up to Snobol. A little later, the characters will hear

Baralou calling for help on the intercom - a call the player characters can hardly refuse.

Since Baralou has control of the M/GL/CN (communication) program, this message will seem to come from the control room of the Snobol micro-still (L1), although she is actually in the engine compartment.

Since Baralou has sabotaged the cooling apparatus of the life-support unit in the micro-still control room (L1), she knows it will explode if she commands it to overload. She will start the overload just as the characters begin their trip up to Snobol, and the explosion will occur just before they reach the micro-still (L1).

When the characters investigate, they will find that the room, including the life-support unit and M/CR (chemical refining) computer, has been completely wrecked. They will also find the very badly mutilated remains of a Yazirian wearing Baralou's uniform. The body is actually that of Castuss Wallorr (see Event 2), but it is completely unrecognizable, and the characters should be led to believe that it was Baralou.

The explosion will not breach the outer walls, but as the life-support unit will be destroyed, the air in areas L1 and L2 will become unbreathable 10 minutes after the explosion. However, the characters will notice this in time to leave or to put on breathing masks.

## EVENT 4. ELEVATOR FAILURE

As they pass the mid-point on their journey back to the Moneyspider, the characters will notice that the elevator (L3) is not slowing down properly. This is because Baralou has changed the M/EV/TR (transport) program.

The characters have about 2 minutes to slow the elevator before it hits the Moneyspider. Otherwise, it will crash at 110 meters/turn. Any character attempting to slow the elevator using technician skill must make a successful operating machinery roll at a bonus of 10%. If the character succeeds, the collision speed will be reduced by  $d100+(10 \times \text{technician skill level})$  meters/turn. When the elevator hits the Moneyspider, all characters inside will suffer 1d10 points of damage for each 20 meters/turn of its speed (rounded down). Skeinsuits and inertia screens will halve this damage. Since the M/EV/TR (transport) program has been changed, it cannot be used to slow the elevator.

Neither the elevator nor the Moneyspider will be appreciably damaged by the collision, and Baralou

(still hidden) will restore the M/EV/TR program back to normal.

## EVENT 5. DEATH OF DAQOR

While the player characters are away, Baralou will distract the attention of Fiator and Ellen with a temporary, but very noisy, fault in the communication system on the bridge.

While Fiator and Ellen are on the bridge, Baralou will sneak to the sickbay and kill Daqor with a large injected overdose of anesthetic. Next, she will go to Fiator's room and take the filters out of his gas mask (see Ev6). Then she will return to the engine compartment (M10).

Any character with medical skill that makes a successful diagnosis will be able to identify the cause of Daqor's death as poisoning by anesthetic. If Ellen and/or Fiator are accused of killing Daqor, they will deny it and will say that they were together all the time.

## EVENT 6. GAS LEAK

Baralou will next manipulate the M/MN/LS (life support) program (see Pull-out Sheet VIII) to bypass the poison filters in the life-support unit and then order the DB-0 security robot (Pull-out Sheet V) to release toxic Cys-DE gas into the air, by shooting holes in the gas tanks in the strongroom (M15).

The gas will reach a toxic level throughout the ship 15 turns after it is released. In the first 2 turns thereafter, any character not wearing a gas mask or breathing mask will suffer 1 point of poison damage. In the next 2 turns, the damage will be 2 points. Poisoned characters will continue to suffer damage for 2 turns after their last breath of poisoned air (unless given a dose of antitox).

If the characters are looking at a toxyrad gauge, it will warn them of the gas 5 rounds after it is first released. If not, the referee should make a secret intuition check for the most intuitive player character. If the check is successful, the character will notice the gas after  $d5+15$  turns. If the check fails, characters will not notice the gas until they have suffered 5 points of damage.

As soon as the gas is noticed, Ellen and Fiator will recognize it and rush to their cabins (M5 and M23 respectively) for their gas masks. Both will find their masks, but Fiator's has been sabotaged by Baralou (see Ev5) and he will die of poisoning soon after he reaches his cabin. Any character that examines

Fiator's mask after his death will notice that the filters are missing. To avoid complicating this event unnecessarily, the referee should have it occur when Fiator is separated from the player characters.

The air in the ship will be de-toxified in 5 minutes if the M/MN/LS program is manipulated back to normal or life-support system #2 in room M26 is turned on manually.

## EVENT 7. BARALOU UNMASKED

After the death of Fiator, Ellen (as the only survivor) will almost certainly be the character's prime suspect. If accused, she will plead her own innocence and, if necessary, will even submit to a dose of telol to prove it.

At this point, Ellen will finally start to believe the characters' tale about the Matrix, and will suggest that the Matrix must be responsible for the deaths on Moneyspider and Snobol. She will argue that the only way to survive will be to remove the Matrix infection.

Ellen will help the party as much as she can in their attempts to overcome the Matrix, but the tactics that worked on Jetsom (manipulating/reprogramming through command channels, and/or eating) will have no effect (see Destroying the Matrix).

After they have been working on the problem of the Matrix for some time, Ellen will remember the "Captain's Computer/Robot Systems Manual" (in the locker in the captain's cabin - M5b) and consult it in an attempt to find a solution. This should happen before the characters start to make any significant progress, but it is up to the referee to decide, exactly when. Ellen will discover that Baralou is listed amongst the ship's robots, and will tell the characters at once. If, for example, Ellen is dead or has been locked by the characters, the characters will learn of the existence of the manual by means of prompts from the computer while they are working on it (e.g. "WARNING: Invalid Procedure. Refer to CAPTAIN'S SYSTEMS MANUAL"). When they find the manual, the characters will learn the truth about Baralou.

Once the characters discover that Baralou is a robot, it should be obvious that she was not killed in the micro-still control room explosion (Ev3) and that she is still alive. It should also be apparent that Baralou was responsible for everything that has occurred. The hunt will begin!

## EVENT 8. HUNT FOR BARALOU

Baralou's access to the intercom and other systems (see Baralou's Powers) means that she will know at once that her secret is out. Her exact response will depend on the circumstances, but she will only wait to be found as a last resort. If possible, she will take the fight to the characters, attacking them when they are unprepared, preferably in small groups. Her knowledge of where characters are and what they are saying and planning, will give her a considerable advantage, and the referee should exploit it to the full.

Baralou will normally rely on her built-in weapons and defenses and her skeinsuit uniform (see Pull-out Sheet IV), but will use any other means that come to hand. If they are still under her control and operational, Baralou will enlist the aid of the DB-0 (security), GLLR-5 (recreation) and AUD-1a (engine maintenance) robots, although the latter cannot actually flight.

## EVENT 9. ELIMINATING THE MATRIX

Even if Baralou is destroyed, the Matrix will remain in the program circuits and robots from which it has not been removed. Although it will produce no further dangers, it can still be detected as a "hardware fault". It is up to the referee about the Matrix (with a few minor system malfunctions, for example).

## EVENT 10. RELIEF SHIP AND FUTURE EVENTS

The relief ship sent by the ByChem Corporation will arrive on Day 126 (see TIME CHART). The events that follow will depend on how the referee wishes the campaign to develop. For example, the characters could simply be paid off and taken to the nearest starport, never again to hear of the Matrix or the Venturi project. Alternatively, they could be hired by the ByChem Corporation and become involved in restoring the project to full working order. If the Matrix spreads from Venturi (in the freighter which brought the characters, for example), the characters might become enmeshed in a whole series of adventures concerned with stamping out the "virus" in a variety of forms across the Galaxy!

## DETAILS OF SNOBOL & MONEYSPIDER

Snobol was chosen as a base for the Venturi Project because of its orbit around Venturi (see SYSTEM BRIEF) and its slow rotation, which meant that the starship Moneyspider could be given artificial gravity by whirling it around Snobol on a long cable.

The Snobol/Moneyspider installation has three main components: the docking and other facilities inside Snobol; the Moneyspider where the crew can live in relative comfort; and the micro-distillation column mounted on the cable between the two.

### STANDARD FEATURES

#### STRUCTURAL POINTS

The hatches, doors and walls of the Snobol/Moneyspider installation have the same structural points as those on Jetsom.

#### AIRLOCKS & HATCHES

On Snobol/Moneyspider, airlock hatches have automatic locks. As long as one hatch into an airlock is open, any others are automatically locked (level 3 lock).

The hatches on Snobol and Moneyspider have the same environment indicator panels as those on Jetsom. In addition, all hatches which open into vacuum have a flashing "DANGER: VACUUM" warning sign. On the Moneyspider, where the artificial gravity can fling characters off the ship (see Lost in Space), the warning signs on all the external hatches say "DANGER: VACUUM & NON-ZERO GEE".

Each airlock on the Moneyspider has a locker containing eight space suits (two for each of the major races.)

#### INTERCOMS

Every room on Snobol and the Moneyspider has an intercom panel from which any other room may be called.

#### VACUUM

Snobol and the Moneyspider are surrounded by the vacuum of interstellar space. Detailed rules for dealing with decompression are given in the Knight Hawks rules but, unless they are very foolish, characters should not be exposed to this danger during this adventure. If they are, the referee should follow the simple rule that any character exposed to total vacuum will die in 1 turn.



## SNOBOL

Snobol is composed of frozen water (ice) and carbon dioxide at  $-140^{\circ}\text{C}$ . The chambers that have been excavated along Snobol's axis (the Starship Dock and the Shuttle Dock), gain no artificial gravity from its rotation, and since Snobol has no noticeable gravity of its own, both have zero-G.

### TRANSPORT TUBES

Envt: P = Std; T = 15; O = Std; G = 0-0.2

Passengers (up to five at a time) are carried between boarding points in self-propelled capsules (each tube has one) at 100 meters per turn. Each boarding point has a "call" button to summon the capsule.

## STARSHIP DOCK

### S1. DOCKING CHAMBER

Envt: P = 0; O = Nil; G = 0

The starship dock is a huge, unpressurized, artificial ice-cave. It has two docking bays, each of which can accommodate the largest of starships. Ships are guided in by navigation beacons around the open mouth of the dock.

### S2. DOCK CONTROL

Envt: P = Std; T = 15; O = Std; G = 0

Starships in the dock are connected to this room by hydraulically powered, flexible docking tubes. When connected to a ship's airlock, the tubes are pressurized and heated; otherwise they are open to vacuum. Characters can move along the tubes and around this room by means of hand-holds.

Pipes running alongside the docking tubes allow ships to be refueled (with hydrogen). Refueling, and the movements of the docking tubes, are controlled from this room.

## SHUTTLE DOCK

### S3. ICE MINE

Envt: P = 0; O = Nil; G = 0

This is an unpressurized artificial chamber cut into Snobol. The ice here is cut into specially shaped blocks by the HKK-R2 ice-cutter robot (see ROBOTS - pull-out Sheet V). These are then ferried to the shuttle dock and used as heat shields for shuttles descending to Venturi.

### S4. DOCKING CHAMBER

Envt: P = 0; O = Nil; G = 0

The shuttle dock is an unpressurized artificial chamber with a central docking jetty (see S5) at which up to four automated shuttlecraft can dock at once.

The shuttles are guided into the dock by navigation beacons around the entrance, and are fueled from large, pressurized oxygen and hydrogen tanks at one side of the dock.

### S5. FOYER/DOCKING JETTY

Envt: P = Std; T = 15; O = Std; G = 0

The two transport tubes open onto a simple foyer that leads to a tunnel running the length of the docking jetty. Characters can move in the foyer and tunnel by means of hand-holds.

There is a life-support unit here that maintains the temperature and oxygen levels in this room, as well as in the transport tubes and the starship dock (S2). There are also the Term-9 computer terminal and the M/SD (Snobol Dock) computer that controls the life-support unit and the HKK-R2 robot.

## "MICRO-STILL"

The cable between Snobol and Moneyspider provides an ideal mount for the 10-kilometer-long, low-gravity micro-distillation column ("micro-still") which extracts pure Cys-DE and Meta-TI from the crude chemical shipped up from Jetsom.

The pure bio-chemicals are collected at the distillation column control center at the top of the column (the end nearest Snobol). Snobol's spin gives an artificial gravity of one fifth normal (0.2g) here. "Up" is towards the center of Snobol.

### L1. FOYER AND CONTROL ROOM

Envt: P = Std; T = 15; O = Std; G = 0.2

The transport tubes and hatch from the elevator (L3) open into a foyer/corridor. The hatch opens into vacuum when the elevator is not in the bay beyond. The security door between the foyer and control room has a level 3 lock.

The control room contains the Term-8 computer terminal, the M/CR (chemical refining) computer (behind a panel labeled "COMP.M/CR"), and a life-support unit controlled by the M/CR/LS (life-support) program. The terminal allows manual control of the distillation column and the life-support manual control unit that are otherwise controlled by the M/CR computer. The life-support unit serves only areas L1 and L2.

## L2. DISTILLATION MACHINERY

Envt: P = Std; T = 15; O = Std; G = 0.2

The machinery in this room is very much like that in the Bio-Chemical Still room on Jetsom (area E5) except that it is not radioactive.

There are 24 chemical storage tanks here, of the same kind as those on Jetsom (area F1). Twenty of these are "CRUDE Cys-DE/Meta-TI" tanks. One is half full, and is connected to the input pipe of the distillation apparatus. The others are empty. Of the remaining four tanks, two are labeled "PURE Cys-DE" and the other two "PURE Meta-TI". Two tanks (one of each type) are connected to output pipes and are nearly full of their respective chemicals. The others are empty.

Rules for connecting/diconnecting tanks and the consequences of releasing crude gas are given in the Jetsom description (area E5). Releasing pure bio-chemical gas has the same cooling effect as the crude gas, but pure Cys-DE is an S6/T15 toxin. Meta-TI is non-toxic.

## L3. ELEVATOR

Envt: P = Std; T = 15; O = Std; G = 0.2-1

The elevator is a spacious, self-propelled vehicle similar to a monorail car, except that the rail (which runs alongside the Moneyspider tethering cable) is vertical. Its operation is monitored by the M/EV/TR (transport) program, but it can be controlled manually from inside, by using terminal Term-11 and 'called' from the boarding points (areas L1 and M1) at either end of the cable.

The elevator accelerates steadily to a maximum speed of 400 meters/turn at the mid-point of its journey and then slows to a halt over the remainder. The whole trip takes eight and a half minutes.

The elevator has its own life-support unit, controlled by the M/EV/LS (life-support) program in the M/EV (elevator) computer. Both are behind a panel near the terminal.

## MONEYSPIDER

The Moneyspider is a fully operational starship. Since it is whirled around Snobol every 4 minutes 45 seconds, the centrifugal force produces standard (1g) artificial gravity on the ship, with Deck 1 being at the "top".

## LOST IN SPACE

The Moneyspider has workpods (see area M8) and spacesuits (in the airlocks) that are used for

working outside the ship when it is in zero-G. These pieces of equipment are fully described in the Knight Hawks rules, but the artificial gravity means that anyone (or anything) going outside the ship will be flung off like a slingshot into space and lost (killed).

## LADDER SHAFT

The shaft that extends through the length of the Moneyspider has a ladder on either side. In an emergency, the hatches leading into the shaft can be closed, and there are hatches across the shaft that can be closed between each deck. These hatches cannot be locked.

## DECK 1: AIRLOCK

### M1. AIRLOCK

Envt: P = Std(0); T = 20(N/A); O = Std; G = 1

### M2. LIFEBOAT

Envt: P = Std; T = 20; O = Std; G = 1

This is a standard automated starship lifeboat. Its range is insufficient to take it to any other starship of a habitable planet before the life-support system gives out. A warning sign ("DANGER - NO SAFE DESTINATION WITHIN RANGE") flashes on the control panel.

## DECK 2: BRIDGE/ADMIN

### M3. BRIDGE

Envt: P = Std; T = 20; O = Std; G = 1

A large observation dome in the ceiling dominates the bridge. The captain's chair is on a platform under the center of the dome, giving a clear view. Incorporated into the captain's chair is computer terminal Term-2. The bridge also contains the astrogator's chair (with terminal Term-3, and screens displaying information from the navigation instruments) and the pilot's chair (with terminal Term-1).

### M4. ADMIN OFFICE

Envt: P = Std; T = 20; O = Std; G = 1

This office is the center for coordinating the Venturi Project's chemical extraction processes (scheduling, planning, record-keeping etc.). Work centers around the Term-7 computer terminal. The M/SM (Snobol Monitoring) computer is here.

### M5. CAPTAIN'S SUITE

Envt: P = Std; T = 20; O = Std; G = 1

**M5a.** Meeting Room. This uncluttered room contains a conference table and several chairs. The room is scanned by a concealed camera/microphone (see M5b). The combination of the level 4 lock on the security door into the captain's cabin (M5b), is known only to Captain Akizk, Ellen Coopermann and Baralou.

**M5b.** Captain's Cabin. The cabin is a comfortable room containing a bed, chairs, table and lockers. The decoration reflects the character of Captain Akizk (souvenirs of his career as a space pilot etc.). On the table is a general access computer terminal (Term-12). A hidden switch makes the terminal screen show what is happening in the meeting room (M5a) as seen by the hidden camera.

### **M6. ASTROGATOR'S CABIN**

Env: P = Std; T = 20; O = Std; G = 1

Baralou Ap-Reaverchan's cabin is very Spartan, containing only simple furniture (bed, chairs, table etc.) and the Term-4 computer terminal. There are no traces of personalization in the form of decoration, personal souvenirs and so on. Hidden beneath the bed is a socket from which Baralou can recharge her parabatteries while "sleeping". Characters with robotics or technician skill will recognize this for what it is.

## **DECK 3: ENGINEERING**

### **M7. CONTROLS**

Env: P = Std; T = 20; O = Std; G = 1

The status and operations of the ship's engines are indicated on panels located around the walls of this room. The engines are controlled through the Term 10 computer terminal here.

## **DECK 4: MAINTENANCE**

### **M8. WORKSHOP**

Env: P = Std; T = 20; O = Std; G = 1

This room contains the standard machine tools (lathes, laser cutters, drills etc.), benches and other gear normally found in a small, maintenance workshop. Repairs carried out here do not suffer from the chance of breaking down that applies to repairs "in the field".

There are two external hatches here, leading to workpods (one-man, self propelled, short-range space craft, used for carrying out repairs in space). Both hatches have warning signs (see Airlocks & Hatches). If any character enters a workpod and attempts to operate it, a warning sign will flash inside the pod: "EXTREME DANGER: Pod Unsuitable

For Use Except In Zero-Gee). If the character persists, the pod will fall away from the ship and the character will be killed (see Lost in Space).

At one side of the room is the Term-5 computer terminal. Nearby is the M/MT (Maintenance) computer.

### **M9. AIRLOCK**

Env: P = Std; T = 25; O = Std; G=1; R=0(1)

This standard airlock protects the crew against the radiation in the engines and access corridors (M10). A locker in the airlock contains eight inssuits (see Pull-out Sheet VI - two for each of the major races). While the hatch leading to area M10 is open, unprotected characters in the airlock will suffer 1 point of radiation damage per turn.

### **M10. ENGINES & ACCESS CORRIDORS**

Env: P = Std; T = 25; O = Std; G = 1; R = 1

Characters without special spaceship engineering skill will not understand the workings of the engines, and cannot repair, operate or modify them. In this area, unprotected characters will suffer 1 point of radiation damage per turn. The AUD-1a engine maintenance robot (see Pull-out Sheet V) is here.

## **DECK 5: SICK BAY/STRONGROOM**

### **M11. LOBBY**

Env: P = Std; T = 20; O = Std; G = 1

There is a concealed video-camera in the lobby, operated by the M/MN/IS (installation security) program, which notifies the DB-0 robot in the security room (M14) of events.

### **M12. AIRLOCK**

Env: P = Std(0); T = 20(N/A); O = Std; G = 1

### **M13. SICK-BAY**

Env: P = Std; T = 20; O = Std; G = 1

The sick bay has all the equipment needed by characters with medical skill to heal sick or wounded characters. There are four recovery couches (each with a freeze field), and equipment and supplies equivalent to 10 medkits. In a corner of the room is a general access computer terminal (Term-12). The sick bay does not count as a hospital for the purposes of curing radiation damage, turning off freeze-fields, etc.



## M14. SECURITY ROOM

Env: P = Std; T = 20; O = Std; G = 1

Both security doors into this room have level 3 locks. The DB-0 security robot (see Pull-out Sheet V) is normally here.

## M15. STRONGROOM

Env: P = Std; T = 20; O = Std; G = 1

This room houses the M/MN (Main), M/GL (General) and M/LS (Life-support) computers. There are 10 chemical storage tanks (identical to those on Jetsom - area E5) in a rack against one wall. Five are labeled "PURE Cys-DE" and the other five "PURE Meta-TI". Two of each type are full of their respective chemicals. The others are empty. Releasing the gas has the same cooling effects as the crude gas (see Jetsom -area E5) but pure Cys-DE is an S6/T15 toxin. Meta-TI is non-toxic.

## DECK 6: ACCOMMODATION

### M16-23. CABINS

Env: P = Std; T = 20; O = Std; G = 1

The crew cabins are relatively simple in their furnishings, containing only beds, chairs, a table and lockers. The decoration of the rooms and the personal possessions in them reflect the occupations, races and personalities of their occupants. The rooms of the Jetsom team members (M16-19) are used alternately by corresponding members of the two teams. The officers' cabins (marked with \*) have private WC/showers.

#### Jetsom Team Members' Cabins.

- **M16** \*(unoccupied). Team Leaders: Nimbrus Hool (Dralasite, dead) and Deed Fengall (Yazirian, in freeze field - Jetsom area B2).
- **M17** (unoccupied). Computer Operators: Midge Arma (Human, dead) and Akord Zon (Vrusk, dead).
- **M18** (occupied). Technicians: Daqor L. Klarr (Vrusk) and Hal Sinclair (Human, dead).
- **M19** (occupied). Sape Handlers: Castuss Wallorr (Yazirian) and Atata Myera (Yazirian, dead).

#### Moneyspider Crew Cabins.

- **M20** \*(unoccupied). 2nd Officer: Parl Kopta (Human, dead).
- **M21** \*(occupied). Chief Engineer: Ellen Coopermann (Human).
- **M22** (unoccupied). Astrogator's Assistant: Tak-Arbork (Vrusk, dead).
- **M23** (occupied). Technician: Fiator Geauis (Dralasite).

## M24. GALLEY

Env: P = Std; T = 20; O = Std; G = 1

Contains a food and drink processor/dispenser, cutlery and utensils.

## M25. COMMON ROOM

Env: P = Std; T = 20; O = Std; G = 1

**M25a.** Main Area. Parts of this recreation area can be partitioned off with moveable screens, and there are facilities for watching films, and playing computer games and sports. The GLLR-5 recreation robot (see Pull-out Sheet V) is normally in this room, and there are two general access (Term-12) computer terminals.

**M25b.** Stores. Sports equipment, film tapes and so on that are used in the common room are stowed here.

## DECK 7: LIFE-SUPPORT

### M26. LIFE-SUPPORT

Env: P = Std; T = 20; O = Std; G = 1

Contains life-support units #1 and #2. Unit #2 has a manual override switch (see Life-Support Systems).

### M27. AIRLOCK

Env: P = Std(0); T = 20(N/A); O = Std; G = 1

### M28. LIFE BOAT.

Identical to M2.

## DECK 8: CARGO CONTROL

### M29. CARGO CONTROL

Env: P = Std; T = 20; O = Std; G = 1

Contains the control panel for the mechanical cargo pod grab. The pods still on the ship are either empty or else contain life-support supplies.

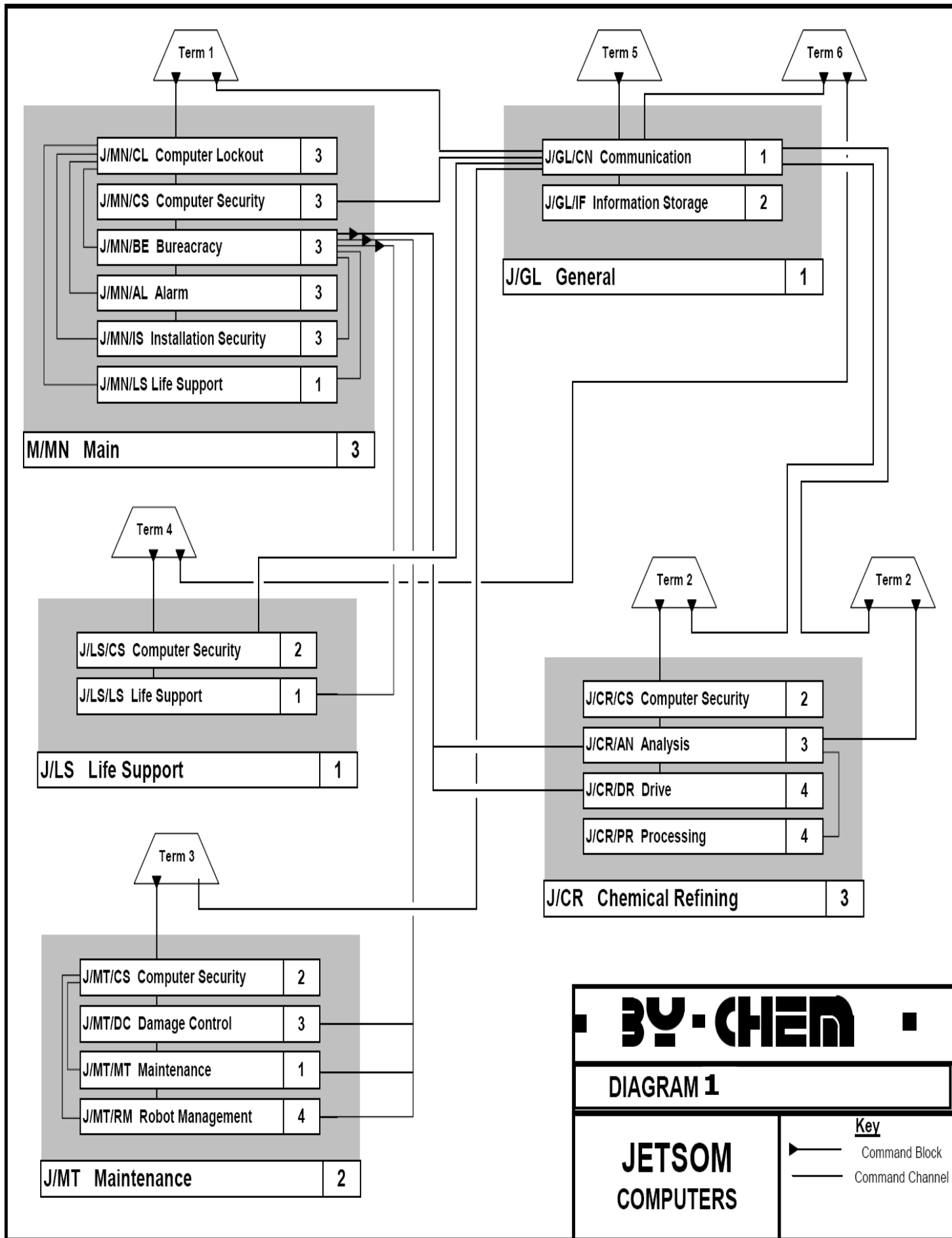

Pull-Out Sheet I

# STAR FRONTIERS

## JETSOM COMPUTER SYSTEMS

### J/MN Main System Computer (3) Location: Module E - Computer Room

This is the main computer of the platform. As well as handling many of the important systems directly, it commands many programs in other computers. It has the following programs:

#### J/MN/CL Computer Lockout (3)

Standard lockout program (see Starship Programs - Pull-out Sheet III). The Matrix infection means that it will still respond to its original password if this is used from terminal Term-1, but not from any other source.

#### J/MN/CS Computer Security (3)

Standard security program. The Matrix prevents it from responding to its original password.

#### J/MN/BE Bureaucracy (3)

This co-ordinates many of the programmed functions of the platform. Its infection by the Matrix is responsible for many of the hazards that the characters experience. Its influences on the life-support systems are described in Life-Support System.

#### J/MN/AL Alarm (3)

Receives status data from all the programmed systems on the platform.

#### J/MN/IS Installation Security (3)

Controls the platform's defenses. The Matrix infection means that this program will automatically regard the characters as intruders and direct the platform's security devices (security doors and automated weapons turrets) against them.

#### J/MN/LS Life-Support (1)

Main life-support program, controlling life-support system #1. Most of the malfunctions caused by the Matrix are described in Life Support System. In addition, this program will cause malfunctions in the showers, WCs and food dispensers.

### J/GL General System Computer (1) Location: Module E - Computer Room

This computer handles the platform's library, computer records, and entertainment. Its programs are:

#### J/GL/CN Communication (1)

Controls intercom and radio communication, provides entertainment and permits access to J/GL/IF (information storage) program. The Matrix infection causes the program to make calls via the intercom random (see Intercom), and makes the view-screen in the common room (B1) show strange things. Access to the information storage program is not affected.

#### J/GL/IF Information Storage (2)

The platform's library and records system. Since the Matrix infects it, it will not display its file index. Since information can only be recalled from a file if its name is known, this malfunction will effectively prevent the characters from using the program.

### J/LS Life-Support Computer (1) Location: Module E - Life-support

This controls the back-up life-support system. Its programs are:

#### J/LS/CS Computer Security (2)

Standard security program. The Matrix prevents it from responding to its original password.

#### J/LS/LS Life-Support (1)

Back-up life support program controlling life-support system #2. Most of the malfunctions caused by the Matrix are described in Life Support System. In addition, this program will cause malfunctions in the showers, WCs and food dispensers.

### J/CR Chem. Refining/Platform Stabilizing Comp(3) Location: Module - E, Reactor Room

This computer handles two very complex functions; operating the still that extracts bio-chemicals from Venturi's atmosphere, and controlling and balancing the buoyancy of Jetsom so as to keep it level. It will not be affected by the Matrix. Its programs are as follows:

#### J/CR/CS Computer Security (2)

Standard security program. It will respond to its original password.

#### J/CR/AN Analysis (3)

This program assimilates data from the platform's sensors (regarding its orientation, the external conditions and so on) and calculates the adjustments necessary to maintain the stability of the platform and the bio-chemical extraction process.

#### J/CR/DR Drive (4) (modified)

This modified drive program controls the atomic reactors that heat the gas in Jetsom's buoyancy chambers. It also controls the vents that equalize the buoyancy.

#### J/CR/PR Processing (4)

This controls the distillation column that performs the primary stages in extracting bio-chemicals from Venturi's atmosphere.

### J/MT Maintenance Computer (2) Location: Module C - Maintenance Room

This computer handles the maintenance (routine and emergency) of the platform. Its programs are as follows:

#### J/MT/CD Computer Security (2)

Standard security program. The Matrix prevents it from responding to its original password.

#### J/MT/DC Damage Control (3)

Damage control program modified from the normal starship version to co-ordinate emergency repairs to Jetsom. It operates through the J/MT/MT (maintenance) program. The infection by the Matrix has not affected this program at all.

#### J/MT/MT Maintenance (1)

This is a standard maintenance program that ensures the day-to-day upkeep of the platform. The infection of this program by the Matrix means that it will not take action to correct any faults that may occur.

#### J/MT/RM Robot Management (4)

This sends commands to the external, general and reactor maintenance robots. Since it became infected by the Matrix, there is a 30% chance that any orders which the characters give to these robots through this program will be changed (the referee must decide how) so as to make the robot do something else. Note that while the external and general maintenance robots are themselves affected by the Matrix, they will ignore commands from this program.

## LOCATIONS OF TERMINALS TABLE

Terminal	Module	Location
Term-1	Module E	Computer Room
Term-2	Module E	Control Room
Term-3	Module C	Maintenance Room
Term-4	Module E	Life-Support Room
Term-5	Module C	Maintenance Room
Term-6	Module B	Common Room
Term-7	Module E	Reactor Room



# COMPUTER SYSTEMS

The computer systems on Jetsom and the Moneyspider form an important part of this adventure, and the ways in which these particular systems work are detailed below. Characters accustomed to other types of computer systems may need hints in order to take full advantage of any computer skills that they may have.

## Starship Programs

The following programs in the Jetsom and Moneyspider computer systems are for use on starships or in similar situations (they are fully described in the Knight Hawks rules):

- **Alarm:** Monitors all programmed systems on the ship and raises the alarm if a malfunction occurs.
- **Astrogation:** Used by the ship's astrogator (navigator) to perform the complex calculations necessary for journeying through space.
- **Computer Lockout:** Prevents unauthorized control of a starship. It works in a very similar way to a computer security program and can be defeated or bypassed in the same way.
- **Damage Control:** Co-ordinates efforts to repair damage to the ship.
- **Drive:** Handles the highly complex task of ensuring that the ship's engines respond to the pilot's commands.
- **Processing:** Operates the machinery etc. needed to process or refine raw materials.

## The Computer Systems

The systems are shown schematically in Diagrams 1 and 2 (Pull-out Sheets I and VII) and their components are described on Pull-out Sheets II and VIII. Each consists of several terminals and computers linked by command channels (see below). Each computer holds several programs whose functions relate to a particular aspect of the workings of the ship or platform.

## Command Channels and Blocks

The Jetsom and Moneyspider computer systems have two special features; command channels and command blocks.

Command Channels are the routes by which instructions are relayed from terminals to programs or between programs. New command channels may be installed by characters using the interfacing computers skill, but can only be connected to a computer through the program at the top of its list (usually a security program).

Command blocks are devices fitted into command channels. They allow computer commands (including attempts to operate computers, write programs, defeat security, display information or manipulate programs) to pass in only one direction. They may be removed from command channels by a successful attempt to interface computers.

Command blocks are physically located inside the computers as shown on the diagrams.

## Terminals

Terminals each consist of a display screen and keyboard. They have time-switches and, unless otherwise indicated, a terminal will be shut-down when the characters find it. Characters must successfully operate computer in order to activate the terminal. They will then receive the following information (Characters may automatically select which one they want):

- The identification number (e.g. "Term- 4") of the terminal.
- The code-names (e.g. "J/MN") of the computers which it can access directly.

## Operating the System

Most tasks using computer skills (i.e. operating computers, writing programs, defeating security, displaying information and manipulating programs) can only be carried out from a terminal. The others (i.e. bypassing security, interfacing computers and repairing computers) are only possible if the character can physically reach the unit(s) concerned.

## Access and Lines of Communication

In order for characters to work on a computer or program from a terminal there must be a line of communication to it from that terminal.

A line of communication can run through any combination of command channels and security, lockout, communication or bureaucracy programs so long as any remaining command blocks on the line are pointing away from the terminal. All terminals, therefore, have a line of communication with the computers to which they are connected.

Any security or lockout program in a line of communication will block the passage of commands unless its password is known or it is defeated or bypassed.

Characters may attempt to use the defeating security and manipulating programs (see Pull-out Sheet III) skills on any program linked to their terminals by a line of communication.

A computer is only fully accessed if all computer security or computer lockout programs along the communication line between the terminal and it are defeated or bypassed. If the first program inside a computer that a line of communication reaches is a security or lockout program, this must also be overcome before the computer is accessed.

It is possible to access a computer indirectly, through a line of communication built up from another computer that has already been accessed. To do this it will usually be necessary to overcome security or lockout programs and maybe even to remove command blocks (see above) and/or manipulate programs (see Pull-out Sheet III).

## Displaying Information

A successful attempt to display information on a computer that is accessed will reveal one of the following pieces of information (whichever is closest to the information being sought). Each piece of information requires a separate, successful attempt to display it. For each computer, the information available is:

- Its full designation and level (e.g. "Main System (3)")
- Its location (e.g. "module E - Computer Room")
- A list of the code-names (e.g. "J/MN/BE") of its programs
- A list of terminals and their locations (e.g. "Term-13; Module E - Control Room")
- A list of the code-names (e.g. "M/LS") of the other computers it is connected to by a command channel.

For each program within a computer, available information is:

- Its type and level (e.g. "bureaucracy (3)")
- Its command links, both with terminals (e.g. "Command from Term-5") and with programs; i.e. the code-names of which programs command it (e.g. "Command from M/MN/C") and which ones it commands (e.g. "Command to J/LS/LS")
- Its purpose (the original purpose will always be given, regardless of the effects of the Matrix)

Information storage programs can give many kinds of information (see descriptions - Pull-out Sheets II & VIII).

## Manipulating Programs

Any program to which a line of communication connects may be run, purged or altered by successful use of the manipulating programs skill, from the terminal at the other end of the line. Security or lockout programs must be defeated before they can be manipulated. Manipulating programs is a means of temporarily removing the effects of the Matrix on them (see Defeating the Matrix).

## Writing Programs

Programs can only be written on a computer linked directly to the computer operator's terminal and only if the computer has been accessed.

## COMPUTER SYSTEMS

The computer systems of Jetsom platform and Snobol/Moneyspider are shown schematically in Diagram 1 and 2 (see Pull-out Sheets I & VII), and are described in detail on Pull-out Sheets II & VIII.

Each computer has a two-part code (e.g. "J/MN"). The first letter gives its general location (J for Jetsom, M for Snobol/Moneyspider), and the second two are an abbreviation of its full name (e.g. "MN" for Main). Each program has a three-part code (e.g. "J/MN/LS"). The first three letters refer to the program's computer, and the last two are an abbreviation of the program type (e.g. "LS" for Life-support).

## THE CREW OF THE MONEYSPIDER

**Uniforms** - The uniform of the ByChem Corporation is a neat, grey, one-piece overall. It is plain except for a thick blue braid running along the outer edges of the sleeves and legs, and a patch on the chest showing the wearer's name and rank. The uniforms are civilian skeinsuits, indistinguishable from normal clothing. The braiding can also conceal a vibroknife inside a special pocket.

**Weapons** - Each crewmember has two sets of weapons listed in his or her statistics. The "Normal" weapons are those carried at all times. The Emergency" weapons are those which the crew will carry in case of emergency, and the place where the weapon is kept is given in brackets. If necessary, the crew will use any weapon that comes to hand.

### AKIZK TAARK KASS - Captain (Vrusk Male)

STR/STA	35/45	PS	2
DEX/RS	65/65	IM	7
INT/LOG	50/40	RW	33
PER/LDR	55/71	M	33

**Special Abilities:**

Ambidexterity, Comprehension (21%)

**Skills:** (Technological PSA)

Computer 2, Psycho-social 1, Robotics 2, Medical 1, Technician 6, Beam weapons 3, Piloting 4, Melee weapons 2, Engineering 2, Projectile weapons 1

**Equipment:**

Normal - vibroknife, 20 SEU (in uniform); Emergency - laser pistol & 20 SEU clip (M5b), Uniform, A/S implant.

**Description:**

Akizk is a middle-aged, male Vrusk with many years service to the ByChem Corporation. He is determined to make the Venturi Project a success, and deeply regrets the loss of the Alpha team and rescue party. He knows that Baralou is a robot (see below), and knows all the security passwords.

### CASTUSS WALLORR - Sape Handler (Yazirian Male)

STR/STA	61/45	PS	4 (+3)
DEX/RS	35/45	IM	5
INT/LOG	45/35	RW	18
PER/LDR	37/25	M	31

**Special Abilities:**

Battle rage (10%), Gliding, Night vision.

**Skills:** (Biosocial PSA)

Melee weapons 2, Environmental 3, Martial Arts 3, Medical 2, Psycho-social 4

**Equipment:**

Normal - vibroknife, 20 SEU (in uniform); stunstick, 20 SEU for controlling sapes); Emergency - sonic sword 20 SEU (M19), Uniform, A/S implant

**Description:**

Castuss is a young, muscular Yazirian assigned to the Venturi Project by his employers, Renouf Associates, who breed sapes (see SAPE - Pull-out Sheet VI). He dislikes robots and computers, and, given the chance, he will talk for hours about the advantages of sapes over "soulless tin-boxes".

### DAQOR L. KLARR - Crewman (Vrusk Male)

STR/STA	35/45	PS	2
DEX/RS	55/45	IM	5
INT/LOG	40/50	RW	28
PER/LDR	35/45	M	28

**Special Abilities:**

Ambidexterity, Comprehension (15%)

**Skills:** (Military PSA)

Beam weapons 2, Computer 1, Melee weapons 2, Robotics 3, Demolitions 1, Technician 1

**Equipment:**

Normal; - vibroknife, 20 SEU (in uniform); Emergency - laser pistol, 20 SEU (M18), Uniform

**Description:**

Daqor is an early-middle aged Vrusk of military bearing. He feels deeply ashamed not to have gone on the ill-fated rescue mission and would give anything to "have a go" at whatever killed his "comrades".

### ELLEN COOPERMANN - Chief Engineer (Human Female)

STR/STA	35/45	PS	2
DEX/RS	62/50	IM	5
INT/LOG	55/55	RW	31
PER/LDR	45/55	M	31

**Special Abilities:**

None

**Skills:** (Technological PSA)

Computer 2, Technician 5, Robotics 2, Engineering 4

**Equipment:**

Uniform

**Description:**

Ellen is second-in-command of the Moneyspider and knows the passwords for the security programs and security doors. She adopts a very professional attitude while on duty but is otherwise relaxed and friendly, Ellen detests violence of any kind.

### FIATOR GEAUIS - Crewman Technician (Dralasite)

STR/STA	35/25	PS	2
DEX/RS	61/45	IM	5
INT/LOG	40/50	RW	31
PER/LDR	45/35	M	31

**Special Abilities:**

Elasticity (7 limbs), Lie Detection (13%)

**Skills:** (Technological PSA)

Robotics 2, Thrown weapons 4, Technician 1

**Equipment:**

Normal - vibroknife, 20 SEU (in uniform), Uniform, A/S implant.

**Description:**

Fiator is a young Dralasite determined to make a career in engineering. His multiple limbs are often very useful in his job. He is no hero, and the events on Jetsom and the loss of the rescue team have frightened him. His thrown weapons skill comes from the fact that he is a champion zero-G darts thrower.

## BARALOU AP-REAVERCHAN

<b>Level</b>	Level 6 - can communicate verbally and can control robots of levels 1-5
<b>Type</b>	Cybernet Robot (Yazirian - Female)
<b>Body Type</b>	Anthropomorphic (Yazirian)
<b>Parabattery</b>	Type 2
<b>Move Mode</b>	2 anthropomorphic legs
<b>Move Rate</b>	10m/turn normal, 30m/turn max
<b>Limbs</b>	2 anthropomorphic arms with Yazirian "wings"
<b>IM/RS</b>	+9/90
<b>Stamina</b>	100
<b>Attack</b>	90
<b>Damage</b>	2d10 punching per limb - or by weapon
<b>Programs</b>	Security Lock, Attack/Defense, Computer Link, Special (see below)
<b>Equipment</b>	uniform, A/S implant, infra-red goggles, vibroknife & 20 SEU. Last resort will use built-in weapons: right hand has a sonic disruptor, left hand has a laser pistol, chest houses an albedo screen (all internal weapons connected to 50 SEU beltback)

**Description:**

Baralou has the appearance of a young, female Yazirian, but is actually a highly sophisticated cybot. Only the captain knows that she is a robot; the others regard her as one of the crew. Like all cybots she is a combination of organic and mechanical components.

**Mission & Functions:**

Unlike normal robots, however, her special bio-electronic circuits give her a limited intelligence (INT/LOG 25/75) instead of a pre-programmed mission and function, and the ability to perform the functions of an astrogator at level 4. She has no other skills, however.

**Personality:**

Her artificial personality (PER/LDR 25/20) is poorly developed. Baralou's cold curt manner has earned her the nickname "Frosty".

## AUD-Ia: Engine Maintenance Bot

<b>Level</b>	Level 3 - Can communicate verbally
<b>Type</b>	Maintenance Robot
<b>Body Type</b>	Standard
<b>Parabattery</b>	Type 1
<b>Move Mode</b>	Wheels
<b>Move Rate</b>	10m/turn normal, 60m/turn max.
<b>Limbs</b>	Two Mechanical Arms, 1 multi-sensor probe
<b>IM/RS</b>	+6/60
<b>Stamina</b>	100
<b>Attack</b>	60 (only if reprogrammed)
<b>Damage</b>	2d10 punching (only if reprogrammed)
<b>Programs</b>	Security Lock
<b>Equipment</b>	Note - radioactive (see below)

### Mission:

Monitor and assist in repair of engines, follow verbal commands.

### Functions:

General functions defining where the engines are, schematics and structural drawings for engine rooms, etc.

### Description:

Simple, upright cylindrical body with a video/audio sensor array mounted on the top. The multi-sensor probe is a set of instruments that allow AUD-Ia to monitor the workings of the Moneyspider's engines. While working on the engines, the robot has become mildly radioactive. Any unprotected character within 2 meters of it suffers 1 point of radiation damage per turn (see Radiation Damage).

## CLR-E1 Maintenance Robot

<b>Level</b>	Level 3 - Can communicate verbally
<b>Type</b>	Maintenance Robot
<b>Body Type</b>	Standard
<b>Parabattery</b>	Type 1
<b>Move Mode</b>	3 mechanical legs
<b>Move Rate</b>	10m/turn normal, 60m/turn max.
<b>Limbs</b>	3 Mechanical Arms
<b>IM/RS</b>	+5/50
<b>Stamina</b>	100
<b>Attack</b>	50
<b>Damage</b>	2d10 punching (only if reprogrammed)
<b>Programs</b>	Security Lock, self-defense
<b>Equipment</b>	albedo coating (treat as albedo suit), IR goggles

### Mission:

Assist in maintenance efforts, follow verbal commands.

### Functions:

General functions defining where the tools and spare parts are, schematics and structural drawings for many ship components.

### Description:

Body in the form of a cone with its point downwards. It has IR sensors in addition to video and audio ones. It can carry up to 75 kg of stores strapped on top of its body.

## DB-0 Security Robot

<b>Level</b>	Level 4 - Can communicate verbally
<b>Type</b>	Security Robot
<b>Body Type</b>	Standard
<b>Parabattery</b>	Type 1
<b>Move Mode</b>	2 mechanical legs
<b>Move Rate</b>	10m/turn normal, 90m/turn max.
<b>Limbs</b>	2 Mechanical Arms
<b>IM/RS</b>	+7/70
<b>Stamina</b>	100
<b>Attack</b>	70
<b>Damage</b>	2d10 punching per arm
<b>Programs</b>	Security Lock, Attack/Defense
<b>Equipment</b>	electrified body, albedo screen w/50 SEU backpack, laser rifle, electro-stunner, 10 doze gren., 10 tangler gren., 100 SEU backpack.

### Mission:

Patrol area, defend against enemies.

### Functions:

General functions defining layout of area and identification of "enemies" - using various sensors.

### Description:

Upright cylindrical body. Its metallic "skin" is electrified like a stunstick. Anyone touched must make a Stamina check or be stunned d100 turns (unless protected by a gauss screen or A/S implant). The skin is powered by the same battery as the screen.

## GLLR-5 ("Gorilla")

<b>Level</b>	Level 4 - Can communicate verbally
<b>Type</b>	Recreation Robot
<b>Body Type</b>	Anthropomorphic (Human)
<b>Parabattery</b>	Type 1
<b>Move Mode</b>	Two Mechanical Legs
<b>Move Rate</b>	10m/turn normal, 60m/turn max.
<b>Limbs</b>	Two Mechanical Arms
<b>IM/RS</b>	+8/80
<b>Stamina</b>	100
<b>Attack</b>	70
<b>Damage</b>	2d10 punching
<b>Programs</b>	Security Lock, Self-defense (Matrix-infected), Wrestling (custom)
<b>Equipment</b>	--

### Mission:

Harmlessly participate in sports.

### Functions:

**Harmlessly:** GLLR-5 can take no action which will result in the harm of a living person. That includes actions which he calculates has a low level of safety. (note: the Self-Defense program has a bug which bypasses this function).

**Participate:** GLLR-5 will make suggestions as to what type of sports people around him would like to play, based on his observations of their moods, energy level, morale, and history of games played with those same people. Otherwise, he will join in any game or sport to which he is invited. He can learn new games (memory limit unknown).

**Sports:** GLLR-5 is programmed with the rules of over 100 sporting games, and can even use a custom program "Wrestling" to pin opponents. GLLR-5 includes non-sporting games such as strategy, card, dice, and boardgames in his programming.

### Description:

Although this robot has an anthropomorphic body, it is very obviously a robot. It is specially designed to play games and sports and to help in combat training. It can wrestle and has enhanced reaction speed and initiative modifier

## HKK-R2 Ice-Cutter Robot

<b>Level</b>	Level 2 - Cannot communicate verbally
<b>Type</b>	Maintenance Robot
<b>Body Type</b>	Heavy Duty
<b>Parabattery</b>	Type 2
<b>Move Mode</b>	Gas jets
<b>Move Rate</b>	20m/turn accel/decel (zero-G only)
<b>Limbs</b>	2 Mechanical Arms, 1 laser powertorch
<b>IM/RS</b>	+6/60
<b>Stamina</b>	500
<b>Attack</b>	60 (if reprogrammed)
<b>Damage</b>	6d10 punching (if reprogrammed)
<b>Programs</b>	Security Lock
<b>Equipment</b>	Laser powertorch (can cause 20d10 if used as a weapon after reprogramming the robot, 33 shots remaining), Second Type 2 parabattery for powering the laser powertorch.

### Mission:

Keep Ice from forming on the interior of Snobol.

### Functions:

General functions defining how to identify "Ice" using thermal and visual sensors, diagrams of the floorplan of snobol, and definition for use of powertorch, returning to a docking bay for replacement of parabattery as needed.

### Description:

This robot's body is roughly spherical. It has gas jets rather than legs, wheels or tracks since it works in vacuum under weightless conditions cutting blocks of ice from the interior of Snobol.



### BREATHING MASK

**Mass** - mask negligible; tanks 1kg each  
**Cost** - mask 100Cr/tank 50Cr; tank re-fill 10Cr

A breathing mask protects characters from the effects of poisonous gases in the same way as a gas mask. It also has a small, pressurized oxygen tank (connected to the mask by a tough, slender, 2-meter, flexible pipe) that enables characters to breathe even where the atmosphere contains little or no oxygen.

Each oxygen tank contains enough gas for 2 hours. After this time, the empty tank can be replaced in 1 turn if a full one is available. Unlike a spacesuit (see KH - p28) a breathing mask will not protect the wearer in any way from the effects of vacuum or extremes of temperature.

### CHILLSUIT

**Mass** - 1kg (plus power source)  
**Cost** - 400Cr

A chillsuit is designed to protect its wearer from conditions of extreme cold. It consists of a close-fitting suit of thin, insulating material that completely covers the wearer's body and head. Incorporated into the suit are a digital thermometer, clear plastic dome-like goggles and a special heat-retaining filter for breathing through. In addition, the material of the suit and the filter can be electrically heated to provide extra protection. The energy is provided by a power backpack or backpack. The rate at which the suit uses energy depends on the setting (0, 1, 2 or 4 SEU per hour) that also determines the level of protection.

The INJURY FROM COLD TABLE gives the rates at which characters wearing normal clothing or a chillsuit (at various settings) will lose stamina points when exposed to different levels of cold. Unless otherwise stated, rates of loss are per hour. The table assumes dry conditions with fairly still air; rain, wind, etc., will lower the effective temperature dramatically. For the purpose of curing, this injury counts as a wound.

A chillsuit offers no protection other than from cold, but it can be worn under a skeinsuit or albedo suit and will not interfere with defensive screens. A gas mask or breathing mask may be worn with a chillsuit, as may infra-red goggles or sun goggles.

### INJURY FROM COLD TABLE

Temperature (Centegrade)	Normal Clothing	Setting	Setting	Setting	Setting
		0	1	2	4
		SEU/hr	SEU/hr	SEU/hr	SEU/hr
Above 0	0	0	0	0	0
0 to -20	1	0	0	0	0
-21 to -50	6	1	0	0	0
-51 to -100	20	6	2	0	0
-101 to -150	2/min	20	12	4	2
-151 to -200	2/turn	2/min	30	20	6

### SAPE



<b>Type</b>	Medium Omnivore
<b>Number</b>	varies (see below)
<b>Move</b>	Medium (20m/turn walk, 40m/turn run)
<b>IM/RS</b>	+6/60
<b>Stamina</b>	120
<b>Attack</b>	40% (60% with rage)
<b>Damage</b>	Punch 2d10, Wrestle 3d10/turn
<b>Special Attack</b>	Rage, Wrestle (see below)
<b>Special Defense</b>	None
<b>Native World</b>	Yazirian homeworld, bred on Scree Fron

**DESCRIPTION:** Sapes (or "super apes") are a specially-bred strain of 2-meter-tall, muscular, ape-like creatures originating on the Yazirian's home planet. They have been bred by Renouf Associates of Hakosoar (Scree Fron) as an alternative to robots in certain applications. Sapes are currently being tested in a wide variety of settings (hidden from the prying eyes of the larger corporations), hence their presence on Jetsom. Renouf Associates hope to be able to sell sapes on the basis of their cheapness (about 2500 credits each), low running costs (about 10Cr/day), versatility, strength and agility. The corporation also maintains that members of the major races (especially Humans and Yazirians) will prefer sapes to robots, especially when working in isolated situations. At present, however, sapes are generally mistrusted by people and governments. Ownership of a sape is illegal without a license, and such licenses are only granted to large corporations.

Sapes are about as intelligent as a four-year-old Human and learn quickly, especially by mimicry. They speak their own language which consists entirely of simple, one- or two-word phrases, and normally wear poly-voxes programmed to translate Sape into Pan-Galactic and vice versa. They are bred to be docile and obedient and will normally obey any one- or two-word command given by a member of one of the major races unless this will expose the sape to obvious danger. Thus sapes will not normally obey orders to attack, and they will never attack other sapes. Sapes will ignore commands given via intercoms etc., or from robots.

Despite their breeding, sapes retain vestiges of their primitive origins and will resort to violence under extreme conditions. A sape can attack with bare hands and feet - either to kick/punch or wrestle. Kicking/punching allows a sape two attacks per turn each inflicting 2d10 points of damage. When wrestling, sapes have a +5% chance of gaining a hold. Wrestled victims have a -5% penalty on attempts to escape and suffer 3d10 points of damage per turn. At the start of any combat, sapes have a 50% chance of going into battle rage which gives them a +20% bonus to hit in melee.

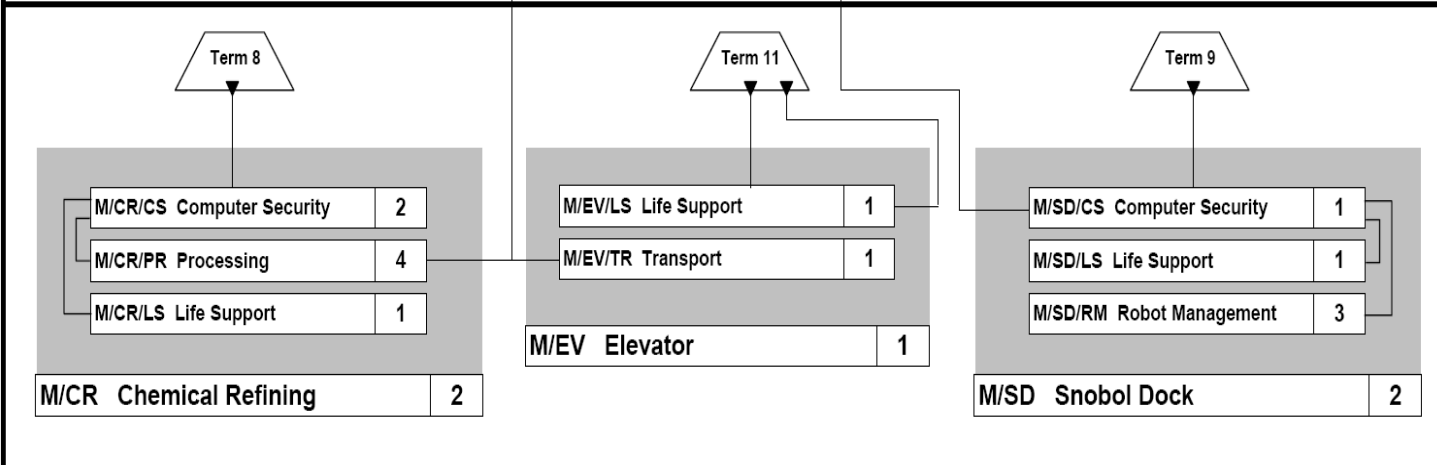
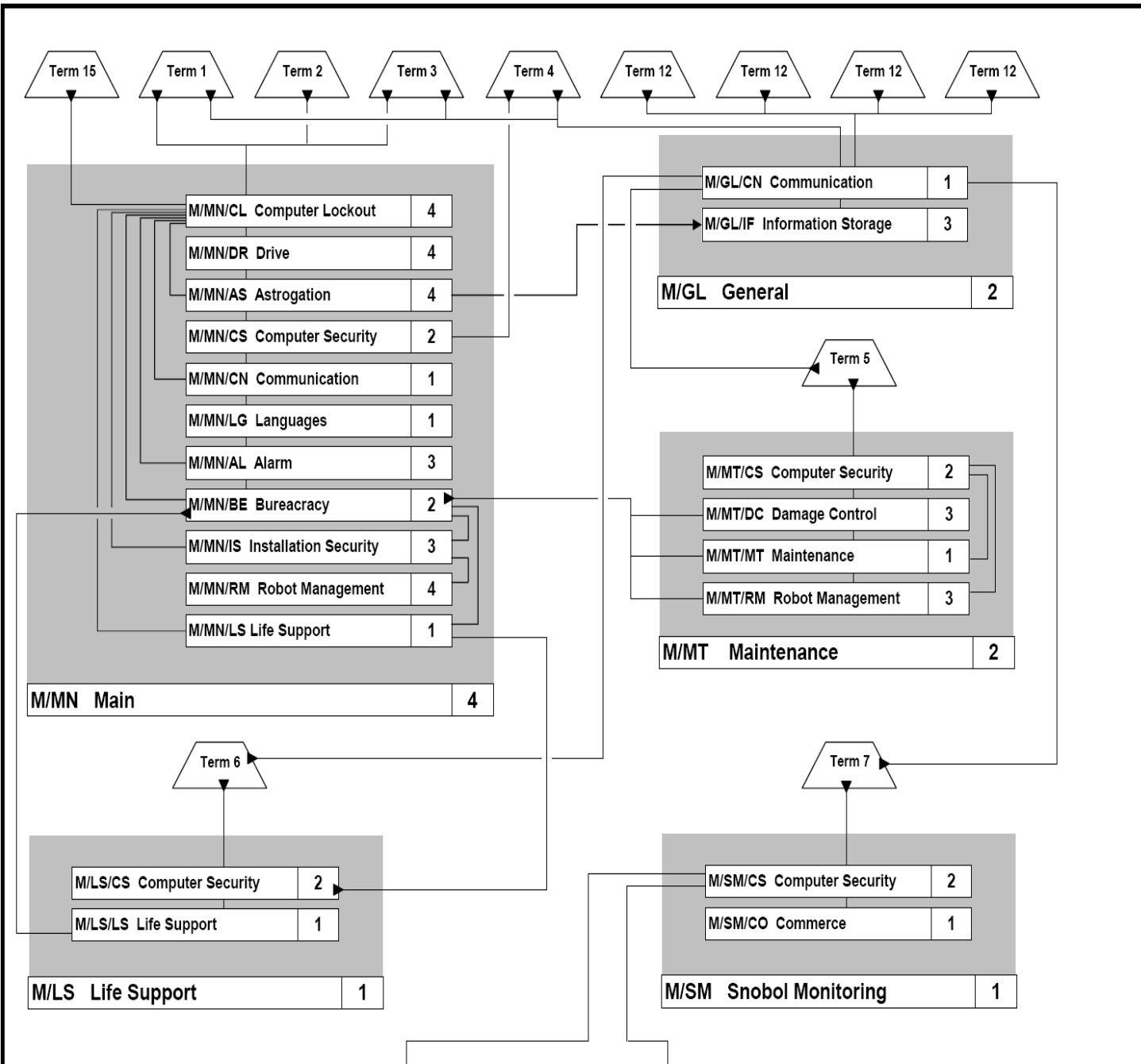

**M/MN Main System Computer (4)**  
**Location: Deck 5 - Strongroom**

The ship's main computer, handling all of the major functions. Its programs are:

**M/MN/C Computer Lockout (4):**  
Standard security program. Only Captain Akizk and Ellen have the password.

**M/MN/DR Drive (4):**  
Operates the ship's drives.

**M/MN/AS Astrogation (4):**  
Monitors the navigation instruments and handles the complex calculations necessary for navigation in space.

**M/MN/CS Computer Security (2):**  
Standard security program. Only Akizk, Ellen and Baralou have the password.

**M/MN/CN Communications (1):**  
Operates the subspace radio and the ship's long-range sensors.

**M/MN/LG Languages (1):**  
Translates communications to or from most common languages.

**M/MN/AL Alarm (3):**  
Monitors all programmed systems and raises the alarm if a fault or unusual event occurs.

**M/MN/BE Bureaucracy (2):**  
Co-ordinates the actions of the programs with which it is linked.

**M/MN/IS Installation Security (3):**  
Monitors security doors etc. and controls the DB-0 security robot (see Pull-out Sheet V) through M/MN/RM.

**M/MN/RM Robot Management (4):**  
Controls the DB-0 security robot and provides Baralou Ap-Reaverchan with a tight-beam communication link into the M/MN (Main) computer.

**M/MN/LS Life-Support (1):**  
Monitors/controls life-support unit #1.

**M/GL General System Computer (2)**  
**Location: Deck 5 - Strongroom**

General access computer, acting as a library, entertainment database and intercom switchboard. Its programs are:

**M/GL/CN Communication (1):**  
Operates the intercom system, controls access to the M/GL/IF (information storage) program, and provides entertainment (games, videos, etc.)

**M/GL/IF Information Storage (3):**  
The ship's electronic library.

**M/LS Life Support Computer (1)**  
**Location: Deck 5 - Strongroom**

Controls and monitors the back-up life-support system. Its programs are:

**M/LS/CS Computer Security (2):**  
Standard security program. Only Captain Akizk, Baralou and Ellen have the password.

**M/LS/LS Life-Support (1):**  
Monitors and operates life-support unit #2, the back-up system.

**M/MT Maintenance Computer (2)**  
**Location: Deck 4 - Maintenance**

Monitors the mechanical systems of the ship and co-ordinates routine and emergency repairs. Its programs are:

**M/MT/CS Computer Security (2):**  
Standard security program. Captain Akizk, Ellen Coopermann and Castuss Wallor have the password.

**M/MT/DC Damage Control (3):**  
Co-ordinates emergency repairs through the M/MT/MT (maintenance) program.

**M/MT/MT Maintenance (1):**  
Controls and co-ordinates the ship's repair systems.

**M/MT/RM Robot Management (3):**  
Controls the AUD-la engine maintenance robot.

**M/SM Snobol Monitoring (1)**  
**Location: Deck 2 - Admin Office**

Allows the refining and other processes carried out by the micro-still and inside Snobol to be monitored and controlled from the Moneyspider. Its programs are:

**M/SM/CS Computer Security (2):**  
Standard security program. Only Captain Akizk, Ellen Coopermann and Baralou Ap-Reaverchan have the password.

**M/SM/CO Commerce (1):**  
Takes care of bookkeeping, stock control etc. for the entire Venturi Project.

**M/CR Chemical Refining (2)**  
**Location: Micro-Still - Control Room**

**M/CR/CS Computer Security (2):**  
Standard security program. Akizk, Ellen and Baralou have the password.

**M/CR/PR Processing (4):**  
Handles the delicate temperature balances in the micro-still.

**M/CR/LS Life-Support (1):**  
Monitors and controls the life-support system for the micro-still control room.

**M/SD Snobol Dock Computer (1)**  
**Location: Snobol - Shuttle Dock**

Monitors and controls programmed systems inside Snobol. Its programs are:

**M/SD/CS Computer Security (1):**  
Standard security program. Akizk, Ellen and Baralou have the password.

**M/SD/LS Life-Support (1):**  
Monitors/controls the life-support unit serving the interior of Snobol.

**M/SD/RM Robot Management (2):**  
Controls the HKK-R2 ice-cutter robot that works in the ice mine (S3).

**M/EV Elevator Computer (1)**  
**Location: Cable Elevator**

This computer runs the elevator and its life-support unit. Its programs are:

**M/EV/LS Life Support (1):**  
Monitors and operates the elevator's independent life-support system.

**M/EV/TR Transport (1):**  
Controls the movements of the elevator.

### LOCATIONS OF TERMINALS

Terminal	Location
Term-1	Deck 2 - Bridge
Term-2	Deck 2 - Bridge
Term-3	Deck 2 - Bridge
Term-4	Deck 2 - Astrogator's Cabin
Term-5	Deck 4 - Maintenance
Term-6	Deck 7 - Life-Support
Term-7	Deck 2 - Admin Office
Term-8	Micro-Still - Control
Term-9	Snobol - Shuttle Dock
Term-10	Deck 3 - Engineering
Term-11	Micro-Still - Elevator
Term-12	(General access - 4 terminals) Deck 2 - Captain's Cabin; Deck 5 - Sick Bay; Deck 6 - Common Room (2)



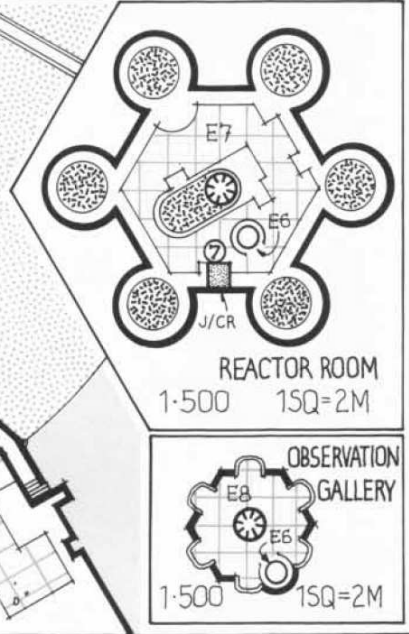
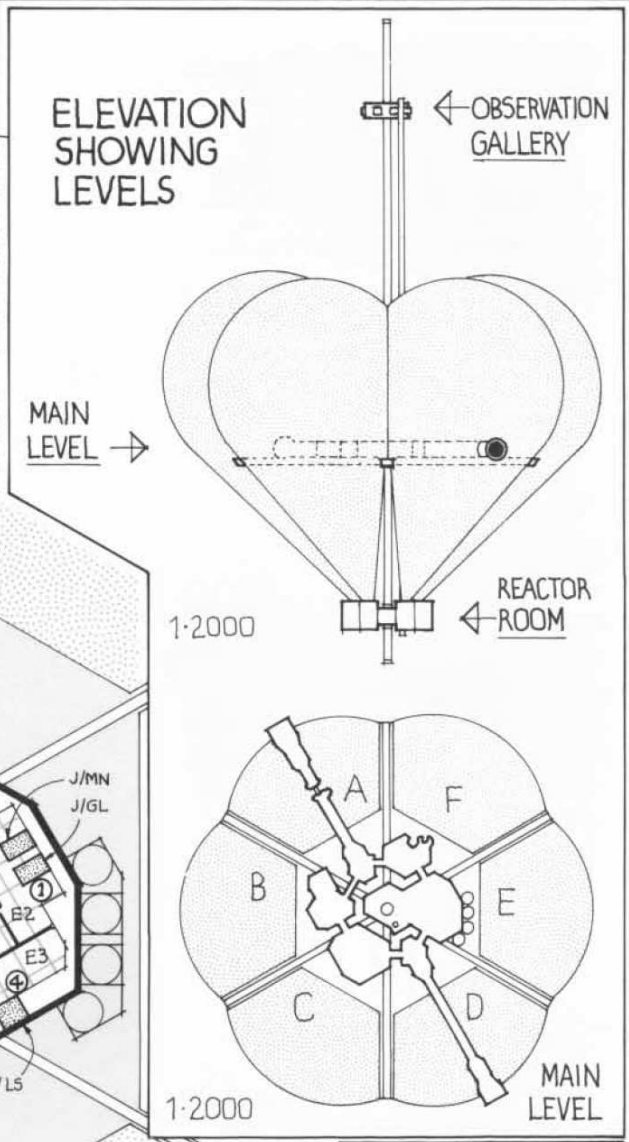
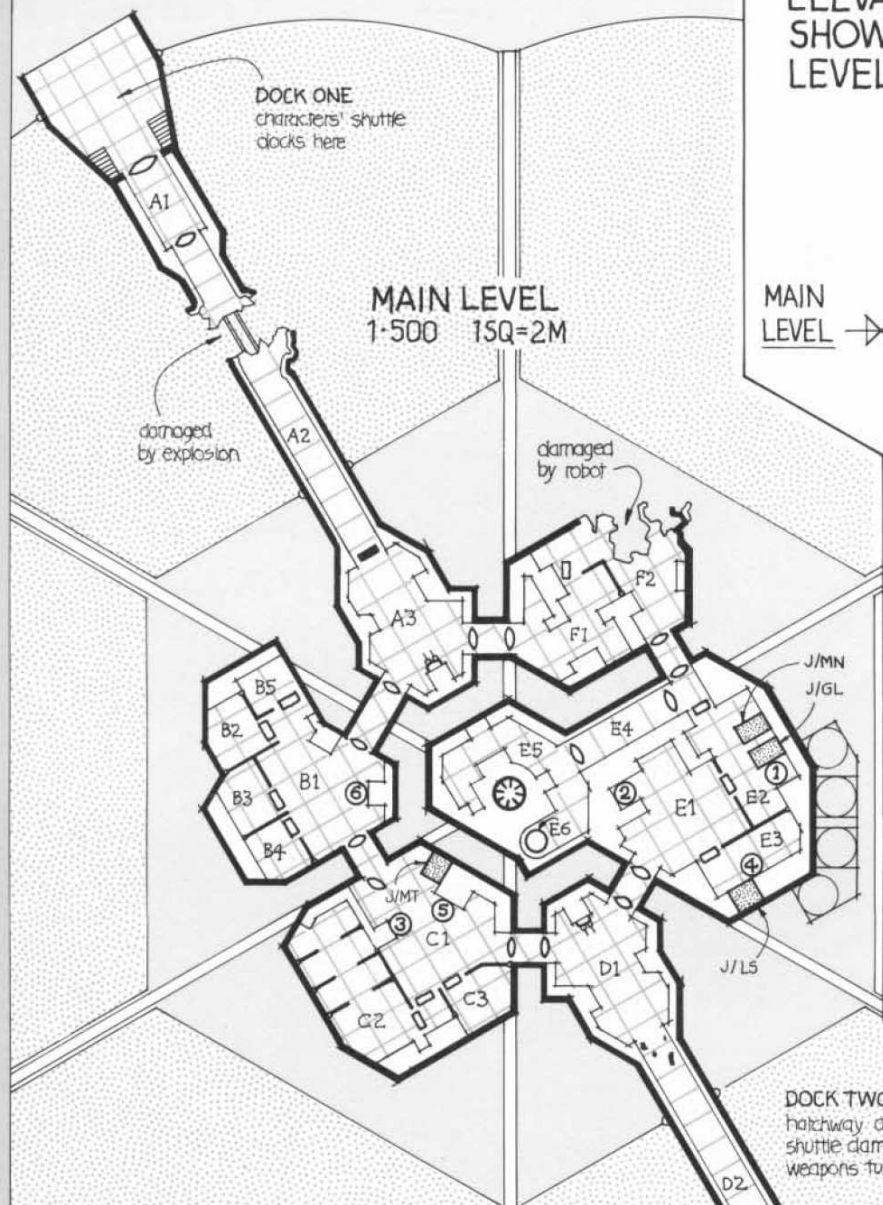

**BY-CHEM**  
 the venturi project  
**JETSOM**  
 ELEVATION AND LEVELS  
 scale 1:500 1:2000 drawing no. VP/J/01

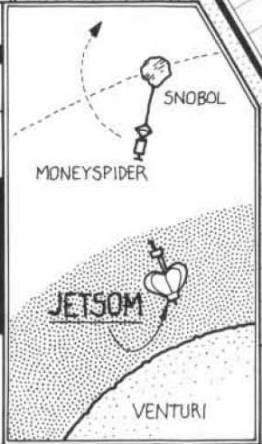

©1985 TSR, Inc. All Rights Reserved.



## BY-CHEM

### the venturi project

#### SNOBOL DETAILS OF INSTALLATIONS

scale  
1:500 1SQ=2M

drawing no.  
VP/S/02

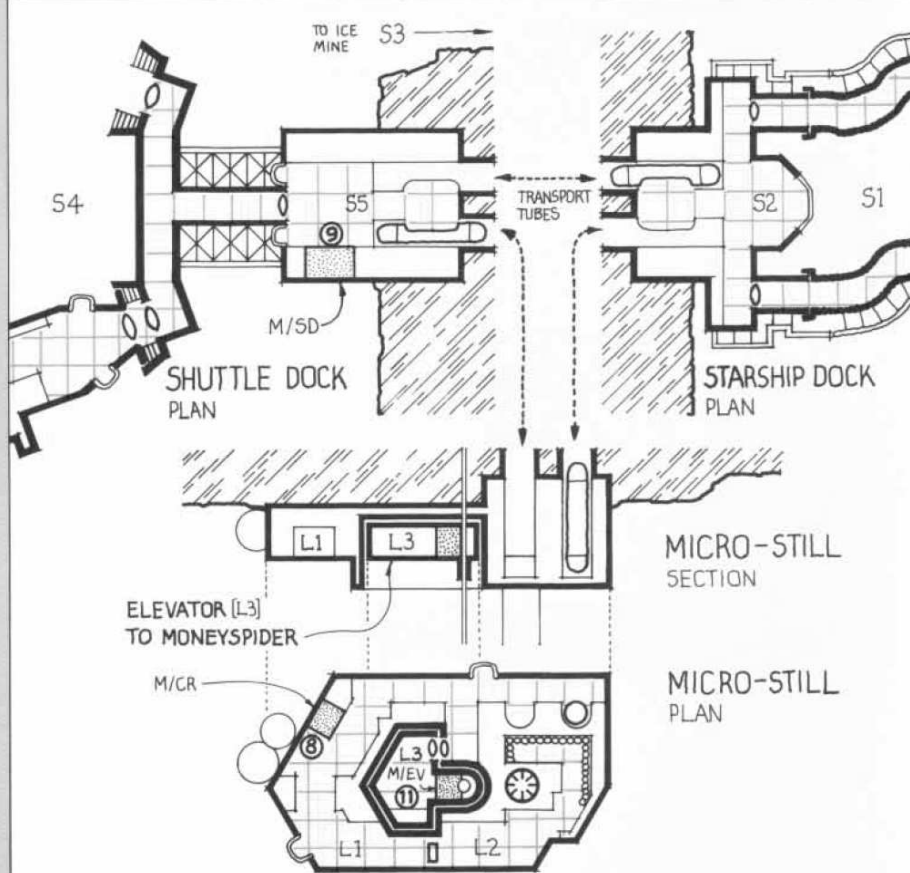
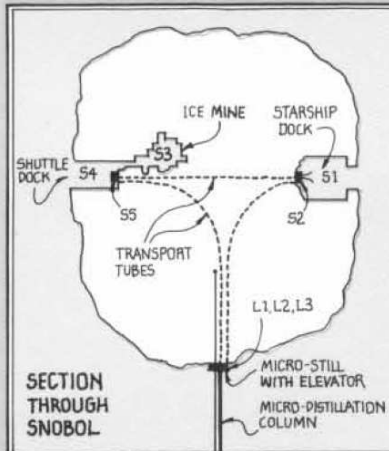
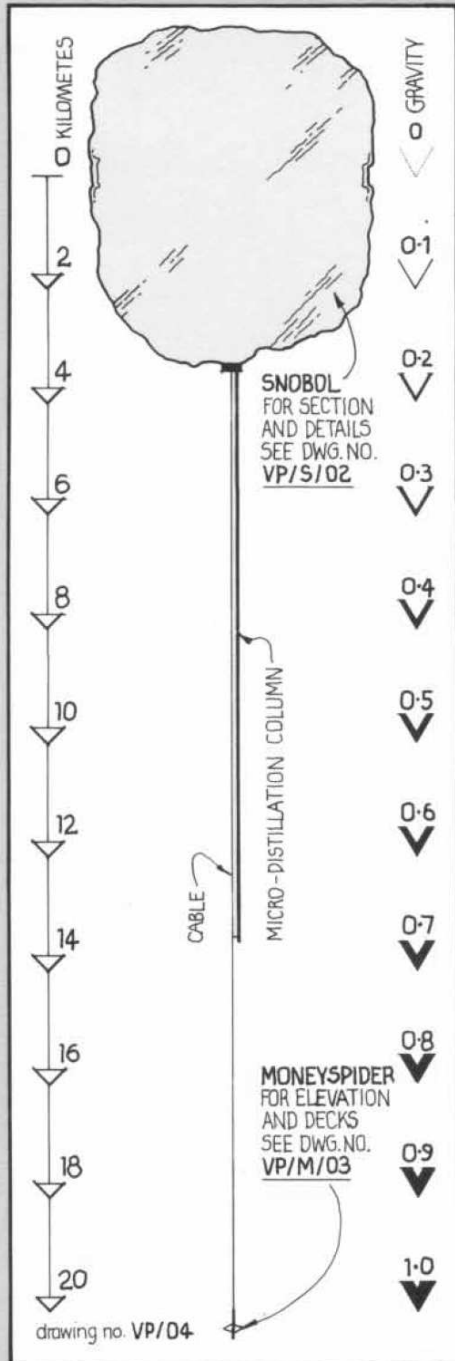

#### SCHEDULE OF COMPONENTS

drawing no. VP/05

	external wall (350 STRUCTURAL POINTS)		reactor		shower / w.c.
	internal wall / partition (200 STRUCTURAL POINTS)		distillation column		elevator
	systems and services		hatch (250 STRUCTURAL POINTS)		ladder column
	gas balloons		security door (100 STRUCTURAL POINTS)		capsule in transport tube
	computer terminal		door (40 STRUCTURAL POINTS)		automated weapons turret
	computer		windows		ice

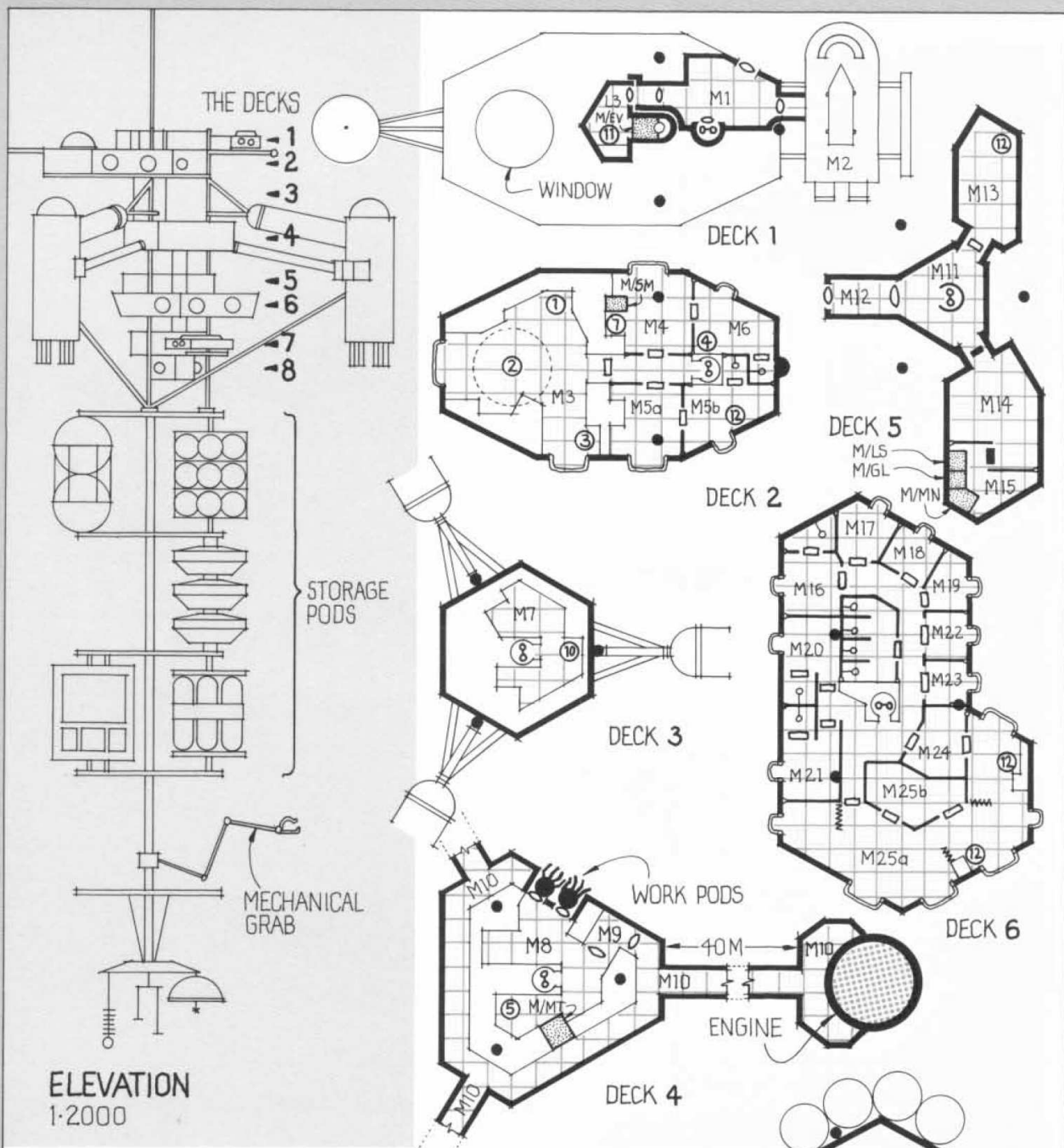

ELEVATION  
1-2000

**BY-CHEM**

the venturi project

MONEYSPIDER  
ELEVATION AND DECKS

scale  
1-500 1-2000

drawing no.  
VP/M/03

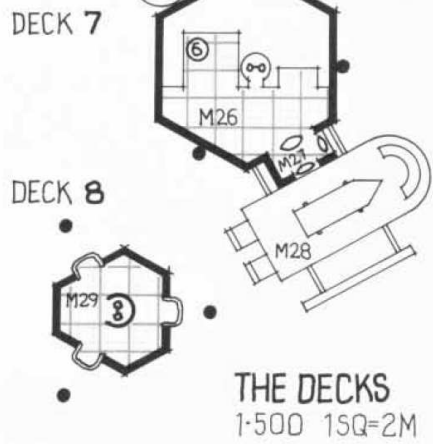
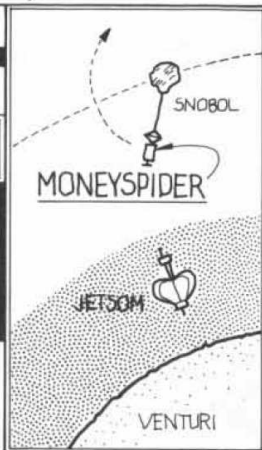

THE DECKS  
1-500 15Q=2M

©1985 TSR, Inc. All Rights Reserved.



# SHUTTLE COMPUTER DATABASE

Following the storm during the descent to the Jetsom Platform, only the following fragments of the Jetsom Database remain in the memory of the shuttle computer.

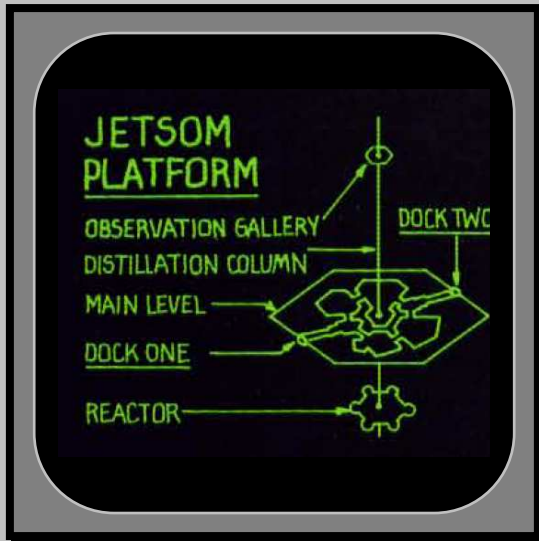

<b>JETSOM TEAM ALPHA</b>			
Leader ▶	Deed Fengall	Yaz	F
Technician ▶	Hal ISinclair	Hm	M
Sape Handler ▶	Atata Myera	Yaz	M
Computer Op ▶	Akord Zon	Vsk	F
<b>JETSOM TEAM ALPHA</b>			
Leader ▶	Nimbrus Hool	Dra	--
Technician ▶	Daqor L. Klarr	Vsk	M
Sape Handler ▶	Castuss Wallorr	Yaz	M
Computer Op ▶	Midge Arma	Hm	F

<b>ROBOTS</b>	
FX-1t	General Maintenance
BBL-1/4	Reactor Maintenance
HMDD-3	External Maintenance
SW-66	Sape Warden
MLL-1e	Domestic Duties
<b>COMPUTERS</b>	
J/MN	Main
J/GL	General
J/LS	Life Support
J/CR	Chemical Refining
J/MT	Maintenance

<b>PASSWORDS</b>	
Security Doors	- 56:43:88
J/MN	- 98:47:74
J/GL	- 64:88:43
J/LS	- 95:34:02
J/CR	- 05:03:55
J/MT	- 23:11:07

<b>ROBOT CRL-E1</b>	
Manufacturer	Pan-Galactic Corp.
Model	"Charlie" series Mk IV
Type	Maintenance (modified)
Level	4
Programs	Security Lock; Self-Defense
Power Source	Type 1 Parabattery
Last Service	2544:59:00

<b>SHUTTLE FLIGHT PLAN</b>	
	Dy:Hr:Mn
Depart Snobol	00:05:00
Radio Communication Lost	00:06:15
Arrive Jetsom	00:07:00
Shuttle Refuelling Complete	00:08:20
Depart Jetsom	38:13:30
Communication Restored	38:14:15
Arrive Snobol	38:15:30



# AN ALPHA DAWN ADVENTURE MODULE

---

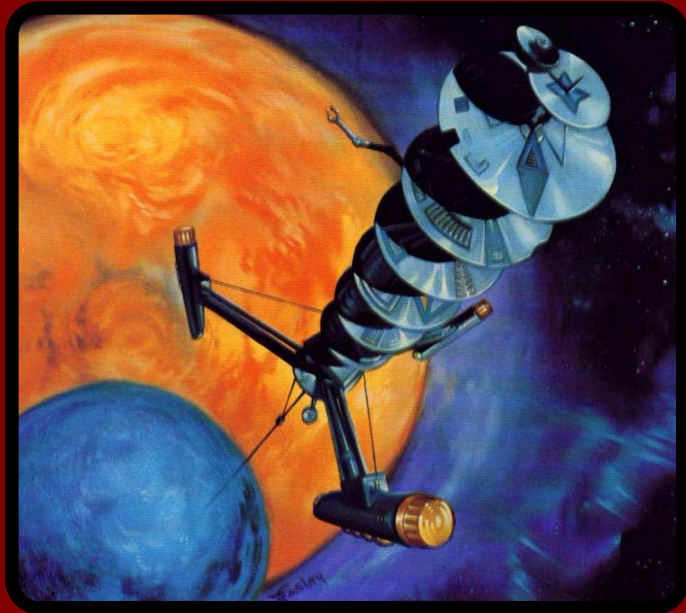

*"Venturi is a gas giant – a huge ball of gas that tried to be a star, but never quite made it. Now it just moans and grumbles and throws out magnetic storms once in a while. The atmosphere would suffocate you except that you'd probably freeze first, or be torn apart by the thousand kilometer an hour winds. You can't even land there because it hasn't got a surface, not unless you count an ocean of liquid hydrogen.*

*"But, we didn't let that stop us, not while there were all kinds of valuable chemicals swirling around in that gas-ball. That's where the Jetson extraction platform comes in. It bobs around like a cork in the upper atmosphere, sucking in gas and distilling out the good stuff. Trouble is, there's something very wrong down there. I don't know what it is, but it's already cost eight good crewmen.*

*"Are you really sure you want this job?"*

**Bugs in the System is a fast-moving adventure for use with the STAR FRONTIERS Alpha Dawn game and can only be played with those rules.**

---

# BUGS IN THE SYSTEM

SF5