

SPACEMASTER



BLASTER LAW™



Mayhem — sci-fi style!

BLASTER LAW™

Author:

Robert J. Defendi

Editing & Development:

Heike A. Kubasch & Brian Olson

Cover Illustration:

Kevin Wasden

Interior Illustrations:

Tyler Walpole, Craig Mrusek,
John Grigni, Stephen Farris, Eric Pence

Original Standard System Design:

Coleman Charlton, John Curtis, Pete Fenlon,
Steve Marvin

Project Specific Contributions:

Art Direction: Jason O. Hawkins;

Pagemaking: David Robinson;

Trade Dress: Jessica Ney-Grimm;

Content Editor: C. Charlton;

Proofreading: THE Howard Huggins.

Production Coordination:

Jason O. Hawkins

Cover Graphics:

David Robinson

ICE Staff —

President: Heike A. Kubasch; *CEO:* Bruce Neidlinger;

Managing Editor: Heike A. Kubasch;

Development & Production Staff:

Steve Hardy, Jason Hawkins, Heike A.

Kubasch, Bruce Neidlinger, Monica Wilson,
Gandalf T. Cat;

Sales, Customer Service, & Operations Staff:

Steve Hardy;

Corporate Mascot: Gandalf T. Cat

ICE Cheering Section and Moral Support:

Karl & Helga Kubasch, John Seal, Claudia Aulumn,
Elike Lubbert, Inge Bendfeldt, Judy & Hasmukh
Shah, John Ross, Tim Dugger, and all ICE fans
everywhere: Thanks for keeping the faith!

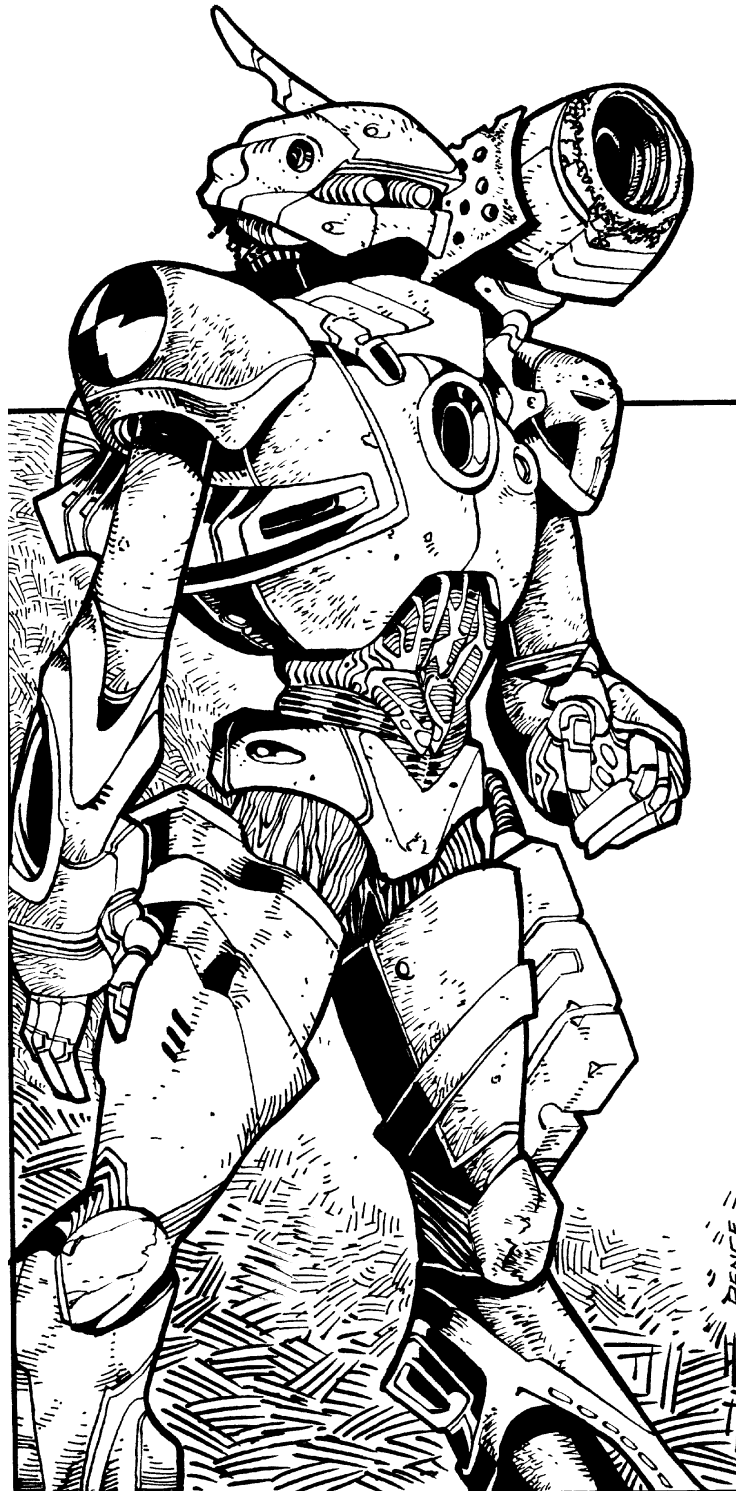

Copyright 2002 by Aurigas Aldbaron, LLC... All rights reserved. ... No reproductions without permission.

Produced and distributed by Mjolinir LLC, dba Iron Crown Enterprises, 112 Goodman Street, Charlottesville, VA 22902



TABLE OF CONTENTS

1.0 INTRODUCTION	4	3.0 LASER ATTACK TABLES ..	23	6.0 STUNNER ATTACK	65
1.2 An Energy Weapon Primer	5	Spectrum Arms Competitor LE 1 ..	25	TABLES	65
1.2.1 How These Weapons		Spectrum Arms Sunspot LE 2	26	Security Systems Mark I Stunner ..	66
Work	5	H & K LP 5 LE 3	27	Security Systems Mark II Stunner .	67
1.2.2 Game Applications	6	Beretta Flashpoint LE 4	28	Security Systems Mark III Stunner .	68
1.3 Energy Weapon Terminology	7	Spectrum Arms L-15 LE 5	29	Security Systems Mark IV Stunner	69
2.0 THE RULES	8	Steyr-Klough L-11 LE 6	30	Security Systems Mark V Stunner .	70
2.1 Sequencing Actions in a Round	8	Steyr-Klough L-15 LE 7	31	7.0 CRITICAL & FUMBLE	71
2.2 Attacks	9	Arluph Arms Marksman LE 8	32	TABLES	71
2.2.1 Ranged Attacks	11	Spectrum Arms L-41 LE 9	33	7.1 Ballistic Armor Piercing Critical	
2.3 The Skills	14	H & K K-47 LE 10	34	Strike	73
2.3.1 Weapon Skills	14	Spectrum Arms Colossus LE 11 ...	35	7.2 Ballistic Hollow Point Critical	
2.3.2 Armor Skills	14	Spectrum Arms Light Blade LE 12	36	Strike	74
2.3.3 Other Skills	14	Spectrum Arms Pulsar LE 13	37	7.3 Ballistic Impact Critical Strike .	75
2.4 Personal Armor	14	4.0 BLASTER ATTACK	38	7.4 Ballistic Puncture Critical Strike .	76
2.4.1 Kinetic Armor	16	TABLES	38	7.5 Ballistic Shrapnel Critical Strike .	77
2.4.2 Combat Armor	16	H & K Contender BE 1	40	7.6 Blaster Critical Strike	78
2.4.3 Armor Add-Ons	17	Beretta Nova BE 2	41	7.7 Burn Through Critical	79
2.5 Attack Actions	18	Spectrum Arms A-4 BE 3	42	7.8 Burst Critical	80
2.5.1 Single Shot	18	Beretta Commando BE 4	43	7.9 Large Animal Ballistic Critical	
2.5.2 Extended or Double Shot		H & K X-25 BE 5	44	Strike	81
.....	18	Steyr-Klough T-26 BE 6	45	7.10 Large Animal Energy Critical	
2.5.3 Tracking Shot or Spread		Spectrum Arms S-12 BE 7	46	Strike	82
Burst	18	Spectrum Arms S-13 BE 8	47	7.11 Laser Critical	83
2.5.4 Continuous Fire or		Steyr-Klough Predator BE 9	48	7.12 Plasma Critical	84
Aimed Burst	18	Steyr-Klough Violator BE 10	49	7.13 Powered Armor Critical	85
2.5.5 Variable Power Expendi-		H & K Annihilator BE 11	50	7.14 Radiation Critical	86
ture	18	H & K Justifier BE 12	51	7.15 Raking Critical	87
2.6 Special Maneuvers	19	H & K Apocalypse BE 13	52	7.16 Scorch Critical	88
2.6.1 Rapid Fire	19	5.0 PLASMA ATTACK TABLES	53	7.17 Stun Critical Strike	89
2.6.2 Aimed Rapid Fire	19	53	7.18 Super Large Animal Ballistic	
2.6.3 Suppression Fire	19	Spectrum Arms 83 PE 1	55	Critical Strike	90
2.7 Reloading Action	20	Spectrum Arms 1280 PE 2	56	7.19 Super Large Animal Energy	
2.8 Hunting Classification	20	Spectrum Arms 2105 Table PE 3 ..	57	Critical Strike	91
2.9 Aperture Energy	20	Spectrum Arms 3100 PE 4	58	7.20 Energy Weapon Fumble	92
2.9.1 Laser Energy	20	Chrometech P-30 PE 5	59	7.21 Firearm Fumble	93
2.9.2 Blaster Energy	20	Chrometech P-33 PE 6	60		
2.9.3 Plasma Energy	21	H & K SPC-25 PE 7	61		
2.9.4 Sonic Stunner	21	H & K SPC-30 PE 8	62		
2.10 Cover	21	H & K Fusion PE 9	63		
2.11 eight of Energy Cells and Acces-		H & K Solar Flare PE 10	64		
sories	21				
2.12 Practical Effects	21				
2.12.1 Laser Weapons	21				
2.12.2 Blasters	21				
2.12.3 Plasma Weapons	22				
2.12.4 Sonic Stunners	22				
2.13 Radiation	22				



**8.0 ENERGY WEAPON
DESIGN AND
CONVERSIONS 94**

8.1 Creating Your Own Weapons ..94

8.1.1 Tech Levels: Weapons...
.....95

8.2 *Privateers* Weapon Tables 104

Privateers Assault Blasters 105

Privateers Assault Lasers 106

Privateers Assault Plasma Carbines ...
..... 107

Privateers Blaster Pistol 108

Privateers Hunting/Sniping Blaster
..... 109

Privateers Hunting/Sniping Laser 110

Privateers Hunting/Sniping Plasma
Carbine 111

Privateers Laser Pistol 112

Privateers Plasma Pistol 113

Privateers Sonic Stunner 114

Privateers Subassault Blaster 115

Privateers Subassault Laser 116

Privateers Subassault Carbine 116

Privateers Support Blaster 117

Privateers Support Laser 118

Privateers Support Laser Cannon 119

Common *Imperial* Blaster Weapons ..
..... 120

Common *Imperial* Laser Weapons
..... 121

Common *Imperial* Plasma 122

8.3 *Silent Death* Weapon Tables . 123

Pre-brood Blaster Weapons..... 124

Pre-brood Laser Weapons 125

Pre-brood Plasma Weapons 126

Common House Colos Weapons . 127

Common Yoka-Shan Warworld
Weapons 127

Common Sigurd Archdiocese
Weapons 127

**Spacemaster Product Listing ...
..... 128**

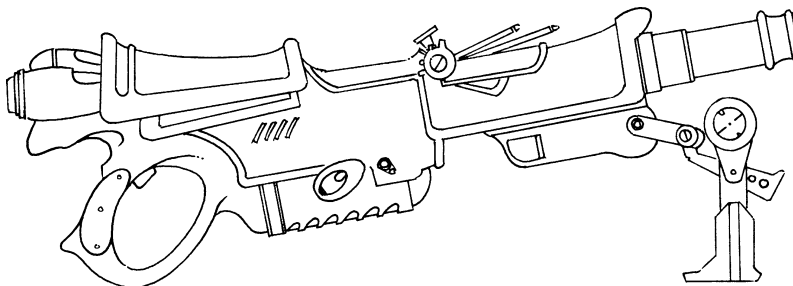
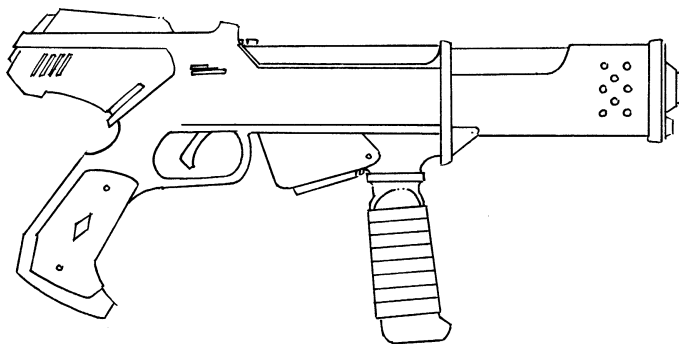
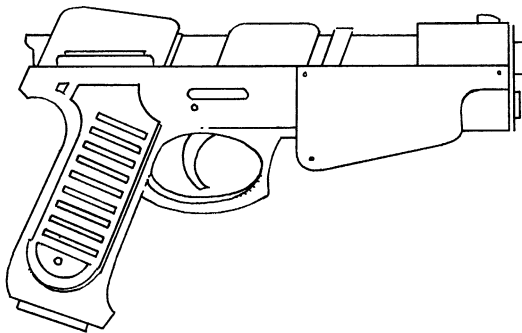



1.0

INTRODUCTION

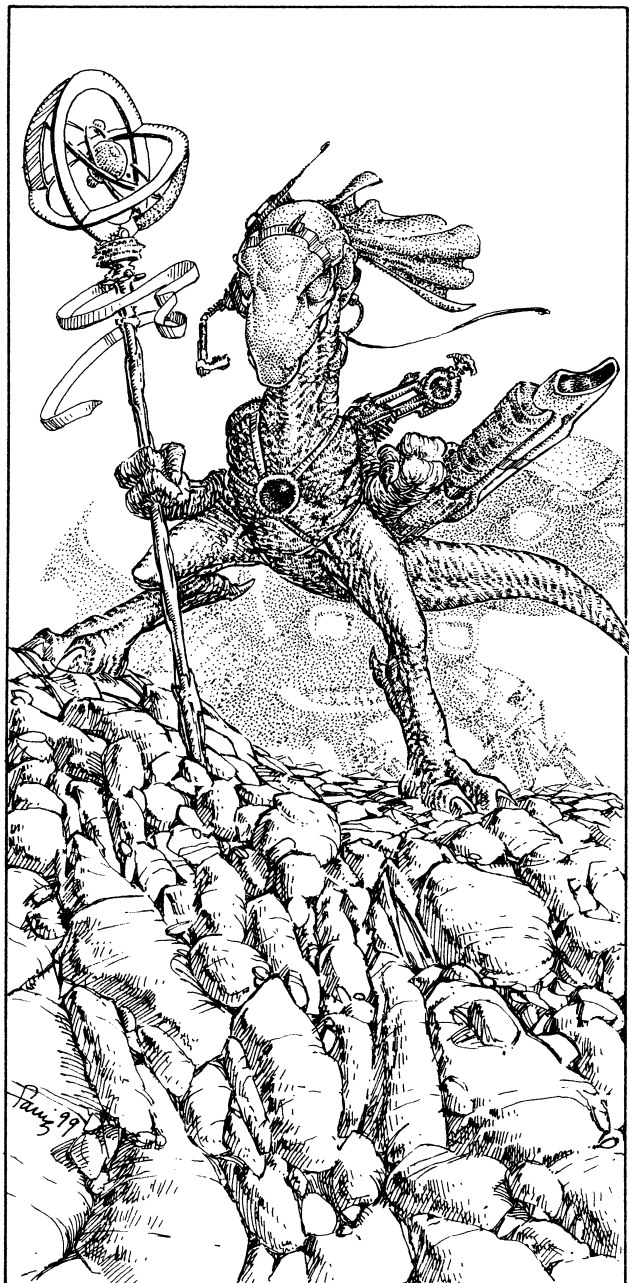

Blaster Law is designed to bring futuristic weapons and armor into a role-playing game. This can have many uses, ranging from a certain death for Mr. Bond when in the clutches of Goldfinger, to arming the player's latest Flash Gordon look-alike with the proper array of blasters and other ray guns.

This is a core-book around which all futuristic gaming will take place. This book will provide all the energy weapons necessary to run a science fiction campaign. This, in conjunction with the rules presented in *Spacemaster: Privateers*, will give all the tables, charts, and rule systems necessary to run an *sf* campaign.

These weapons are probably only used in an *sf* campaign, but this doesn't mean they are completely useless in other settings. The critical tables in particular would be useful in many types of campaigns, as would certain attack tables (a person can be attacked by a laser in a modern setting; it is just rare).

Note: For readability purposes, *Blaster Law* uses standard masculine pronouns when referring to persons of uncertain gender. In such cases, these pronouns are intended to convey the meanings: he/she, her/his, etc.

SPECIAL THANKS

I would like to give special thanks to Gil Travish, Physicist, INFN-LASA-, Italy. His experience with lasers and particle beams has proved invaluable to this humble author.

I would also like to thank my playtesters. Mike "I'm not making another character" Renstrom, Scott "I need a bigger gun" Llewelyn, Gary "I never met a war game I didn't like" Llewelyn, Matt "I'm not a power gamer, I make tactically superior characters" Fitt, Aaron "There goes another character" Brown, Chris "That's Toothpaste Man to you, bub" Brashier.

1.1 A FUTURE HISTORY

But why *Energy Weapons*? Won't firearms, as a long-suffering technology, always be one step ahead of energy weapons?

The following is a brief sample history of the technologies involved in this book. It will give a GM an idea of how energy weapons might be introduced (at least historically) into a setting.

FUTURE HISTORY

As man moved into space, the advantage of energy weapons became increasingly important. Man-portable lasers and particle beams were invented during the High Cyber Age (Tech Level 17) for the side arms and weapons of ship security. Ship hulls were hardened accordingly, decreasing the chance of hull breaches and thus the risk to noncombatants.



Then late in the High Cyber Age (Tech Level 17), the final death knell of the firearm was sounded. Kinetic armor had been invented, and by the early Spacefaring Age (Tech Level 18) everything had changed.

Kinetic armor was devastating to ballistics in general. Bullets, shrapnel, and shot were all stopped by this high-tech armor. Flexible when not under attack, sudden blows to kinetic armor cause it to harden like steel, perfectly distributing the force of a round across the target. A bullet doesn't have that much energy. A bullet's value lies in its ability to penetrate flesh. Take away that ability, and a bullet becomes less useful than a well-placed kick.

Thus, the age of the energy weapon began. Personal troops, outfitted with kinetic armor and beam weapons, were seemingly unstoppable. Slowly, the world's infantry was rearmed, until all carried lasers, blasters and the like.

The firearm was dead. Long live the blaster.

1.2 AN ENERGY WEAPON PRIMER

For many GMs, running many games, it will matter little how these weapons work. Others will already understand the basics.

For the rest, the following section has been included. This will explain the basics of these weapons and how they work. This may be of vital importance to a GM, or merely a curiosity. At any rate, it is here.

WHAT IS A D.E.W.?

DEW stands for Directed Energy Weapon. These weapons harness and focus a form of energy into a concentrated attack. The following are the most common DEWs. They are covered in this work:

LASERS

LASER stands for Light Amplified by Stimulated Emission of Radiation. These weapons fire beams of coherent light. They have good but not infinite range, especially in an atmosphere. Lasers have cooling problems.

BLASTERS

These are rugged, particle beam weapons. They are useful in that, first of all, they don't suffer all the heat problems of a laser. In addition, they tend to be more effective against reflective armor. They may or may not cause radiation damage. These weapons have poor range in an atmosphere.

PLASMA WEAPONS

These weapons fire a super-heated material (usually helium or nitrogen, because they're relatively inert). This plasma burns through its victim, causing tremendous damage. These weapons are generally complicated and have

exceedingly poor range. They are, however, the deadliest pieces of directed, man-portable military hardware ever developed.

SONIC STUNNERS

These weapons hit the target with a sonic attack. These sonic attacks cause the foe to fall asleep.

1.2.1 HOW THESE WEAPONS WORK

These weapons all require power to run. Some require larger amounts of power than others. The individual mechanisms are as follows:

LASER WEAPONS

The typical laser works as follows. A cylinder containing a gas is surrounded by some sort of an energy source, such as a light. One end of this cylinder is capped with a mirror, the other with a partial mirror.

When energy is added to this cylinder, the gas is energized. As the individual molecules discharge, they send a photon off in a random direction. When one hits either mirror, it begins bouncing back and forth, causing other molecules to discharge and add their photons to the bouncing energy.

Thus the fledgling beam bounces back and forth until it gains enough power to pass through the partial mirror. The result is a coherent beam of light.

Lasers are good weapons. They have great range. However, because of atmospheric lensing, it is not infinite in an atmosphere (about twice that of a comparable firearm). "Visible" lasers, while not exactly visible, are often foiled by perfect mirrors.

Lasers powerful enough to be treated in this book cause a considerable, atmospheric disturbance. This disturbance makes a crackling sound, much like lightning, and causes the air to glow in its path. The more powerful the laser, the louder the sound and the brighter the light.

BLASTER WEAPONS

A blaster weapon is much like a laser, except that it fires a particle beam suspended in a laser. These particle beams can have many different properties. They are, however, typically short range (causing more atmospheric lensing) and destroy reflective surfaces.

Particle beams can, depending on their nature, sometimes cause radiation damage. Some fire heavy particles while others are simply lasers with special properties.

The most important thing about particle beams is that they can be tuned to channel the heat away from the weapon. This means that it is possible to build a particle beam weapon capable



of continuous fire with much less cooling gear than a laser of comparable power.

PLASMA WEAPONS

These weapons superheat a material and then accelerate it to supersonic velocities. This has catastrophic effects on its target. Plasma weapons have a poor range, as they tend to shed energy quickly. Once they strike a target, however, the plasma clings to it, burning it on subsequent rounds. Since the plasma is traveling faster than sound, it causes a crackling sound (from its sonic boom).

SONIC STUNNERS

Research has shown that patterns of light and sound can force a human being into an unconscious state. This research, in a futuristic campaign, has been refined to the point where tones alone are capable of forcing a human into unconsciousness. Since these are tonal, it is possible to neutralize these weapons with counter tones. If a proper counter tone is set up, it nullifies the tones and the target hears either nothing, or a form of warbling garbage.

1.2.2 GAME APPLICATIONS

LASER WEAPONS

Lasers are visible in an atmosphere. They have a range about twice that of a comparable firearm. They make a crackling sound when fired, and are vulnerable to reflective armor.

BLASTER WEAPONS

These weapons have about half the range of comparable firearms and are visible in an atmosphere. They are not vulnerable to reflective armor. Because of the ability to tune them to

dissipate their heat, they are more practical for continuous fire weapons. They make the same crackling sound as a laser.

PLASMA WEAPONS

These weapons fire a burst of plasma. They lose energy quickly, and their effective range is equal to about one quarter that of a comparable firearm. They are radiantly visible, with or without an atmosphere, and make an audible crackling sound when fired. The plasma clings to its victims causing damage on subsequent rounds.

SONIC STUNNERS

These weapons use tones to knock their targets unconscious. A nullifier can be placed in the target's ear to protect him.

1.2.3 VISIBILITY

Laser weapons are typically tuned to a visible frequency. These colored lasers are more susceptible to reflective armor but have better range. An infrared laser, in contrast, would be highly resistant to reflective surfaces but would lose energy quickly in the atmosphere, and therefore have very poor range. In addition, it would likely cause the atmosphere to glow.

With plasma weapons, the heat of the plasma will determine the color of the beam. All charged particles, such as the electrons in the human body for instance, emit energy in the form of light when they change direction. Therefore, just by having a temperature, a human being is glowing, as the molecules vibrate and bounce around. At body temperature, the frequency of this light is in the *infrared range*. As the temperature increases, the color moves into the visible spectrum, starting as deep red and moving toward blue as it heats up.

Particle beam weapons will normally be visible in an atmosphere. It will generally be a special laser/particle beam, which uses particle emissions to carry off heat. These weapons do not use particles that would cause radioactive damage.

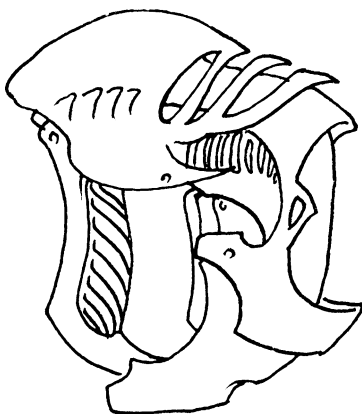



1.3 ENERGY WEAPON TERMINOLOGY

Assault Blaster – This is a medium-sized blaster. It is two-handed, generally capable of continuous fire, and the favored weapon of the infantryman.

Assault Laser – This is a medium-sized laser. It is two-handed, generally capable of auto-fire, and is used by infantrymen.

Assault Plasma Carbine – This is a medium-sized plasma weapon. It is two-handed, generally capable of auto-fire, and is popular with infantrymen.

Automatic – This action causes the weapon to fire in a repetitive, continuous fashion. It is useful for assault weapons, and because of the downtime as the weapon cycles, it generates less heat than continuous fire.

Blaster Pistol – This is a rugged, particle beam side arm. It is popular among military officers.

Combat Armors – This type of armor mimics older, more archaic plate armors. It is made out of advanced composites instead of metal.

Continuous Fire – This mode of fire causes the weapon to fire a continuous stream of energy. These scathing beams are dangerous to a foe's life and limb.

Energy Units – These are the generic energy units stored in weapon cells. Each unit is in the 1-10 megawatt range (though DC instead of AC). This makes tampering with the weapon cells very dangerous.

Hunting/Sniping Blaster – This weapon is generally a semi-automatic particle beam weapon. It is not favored over laser weapons, due to range. It is two-handed.

Hunting/Sniping Laser – This weapon is generally a semi-automatic laser weapon. It is favored above all other types of hunting/sniping weapons due to its range. It is two-handed.

Hunting/Sniping Plasma Carbine – This weapon is generally a semi-automatic plasma weapon. It is not favored over laser weapons due to range. It is two-handed.

Kinetic Armors – This flexible armor becomes rigid when dealt a blow. This greatly reduces the effects of projectiles.

Laser – A beam of coherent light. Intense lasers can cut through nearly any substance.

Lasers have great range, but are prone to heating problems.

Laser Pistol – This is a pistol that fires a laser beam. They are not particularly popular.

Particle Beam – This weapon fires a stream of particles. These particles can be tuned to channel much of the heat away from the weapon.

Plasma – The fourth state of matter. In its energy-weapon application, it is a superheated material capable of transferring great amounts of energy to a foe.

Plasma Pistol – This is a pistol capable of firing super-heated plasma.

Semi-Automatic – With this action the gun is left in a state of readiness after firing. This means that all that's necessary to fire again is to pull the trigger.

Sonic Stunners – These weapons use tones to force an opponent into unconsciousness.

Subassault Blaster – This blaster is bigger than a pistol but smaller than an assault weapon. It is a good cross between damage and concealability.

Subassault Laser – This laser is bigger than a pistol but smaller than an assault weapon. It is a good cross between damage and concealability.

Subassault Plasma Carbine – This plasma weapon is bigger than a pistol but smaller than an assault weapon. It is a good cross between damage and concealability.

Support Blaster – This is a very large blaster, barely man-portable. It is used to attack infantry, large robots, small vehicles and the like.

Support Laser – This is a very large laser, barely man-portable. It is used to attack infantry, large robots, small vehicles and the like.

Support Plasma Cannon – This is a very large plasma weapon, barely man-portable. It is used to attack infantry, large robots, small vehicles and the like.

Weapon Cell – This energy cell is designed for use in energy weapons. It is about the size of a modern day "clip."

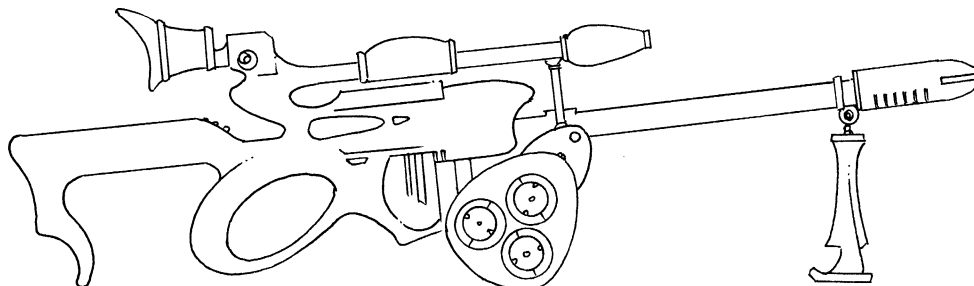



2.0 THE RULES

DIE ROLLING CONVENTIONS

Each die used in *Spacemaster (SM)* is a 10-sided that gives a result between 0 and 9. If two of these dice are used, a variety of results can be obtained. However, results between 1 and 100 are the primary basis of *Spacemaster* – it is a “percentile” system.

PERCENTILE ROLLS (“1-100,” “1D100”)

1-100 Roll (1d100) – Most of the rolls in *Spacemaster* are “1-100” rolls (also called “d100” rolls). To obtain a 1-100 result roll two dice together – one die is treated as the “ten’s” die and the other as the “one’s” die (designate before rolling, please). Thus a random result between 01 and 100 (a “00” is treated as 100) is obtained.

2-20 Roll (2d10) – Initiative is handled a little differently. With these rolls, the dice are added together, giving a number between 2 and 20 (a “0” is treated as a 10).

2.1 SEQUENCING ACTIONS IN A ROUND

While each action takes a percentage of a character’s activity for a round, it is important to keep in mind that *when* an action is resolved is not determined by the percentage activity it requires. Rather, the sequencing of an action is based upon how fast the character is attempting to accomplish the action and the character’s initiative roll.

How fast the character is attempting to accomplish his action is abstracted into a simple decision for each character. Is the action:

A snap action? resolved earlier with a -20 modification.

A normal action? resolved normally.

A deliberate action? resolved later with a +10 modification.

MOVEMENT LIMITATIONS

Movement can take up to 100% activity for a round. However, depending upon the phase in which it is resolved (i.e., snap, normal, or deliberate), the % activity for a specific movement action is limited. More than one movement action can be taken in a given round.

- A snap movement action can take no more than 20% activity (i.e., up to 20% of your movement rate).

- A normal movement action can take no



more than 50% activity (i.e., up to 50% of your movement rate).

- A deliberate movement action can take no more than 80% activity (i.e., up to 80% of your movement rate).

THE BATTLE ROUND SEQUENCE

Actions are normally performed in the following order during a round:

- 1) Action Declaration Phase
- 2) Initiative Determination Phase
- 3) Snap Action Phase
- 4) Normal Action Phase
- 5) Deliberate Action Phase

ACTION DECLARATION PHASE

At the beginning of each round, each player should state or write down (the GM must decide which) which actions he wishes his character to perform that round. Each combatant may declare up to one of each of the three types of actions, but his total declared activity percentage may not exceed 100%. He must also indicate during which phases each action will occur.

At the same time, the GM should decide what actions the non-player characters will take. The actions are then resolved in the order specified by the sequence above. The following sections describe how to resolve the various actions.



INITIATIVE DETERMINATION PHASE

Each character must make an initiative roll:
2d10 + Qu Bonus + Modifications

Condition	Modification
Surprised	-4
Taken more than 50% of hits	-4
Declared Movement ... -1 per 10% of maximum movement activity (based on declared pace).	

In each phase (Snap, Normal, Deliberate) the character with the highest initiative roll takes his action (if any) first, then the character with the next highest roll takes his action, and so on until all actions for that phase have been resolved.

BATTLE ROUND SEQUENCE

TABLE T-3.1

- 1) **Action Declaration Phase** – Declare all actions: snap actions, normal actions, and deliberate actions. Each combatant may declare up to one of each of the three types of actions, but the total activity percentage of all of his declared actions may not exceed 100%. If a melee attack or a primitive missile parry is declared, parry proportions must also be declared.
- 2) **Initiative Determination Phase** – Each combatant must make an *initiative roll*: (2d10 + Qu Bonus + modifications)
- 3) **Snap Action Phase** – Resolve all snap actions in the order indicated by initiative rolls. 20% is the maximum activity for a movement action.
- 4) **Normal Action Phase** – Resolve all normal actions in the order indicated by initiative rolls. 50% is the maximum activity for a movement action.
- 5) **Deliberate Action Phase** – Resolve all deliberate actions in the order indicated by initiative rolls. 80% is the maximum activity for a movement action

2.2 ATTACKS

This section describes attacks and the process used to resolve attacks. Attacks occur when a character (the attacker) attempts to affect or harm an opponent (the defender or target).

ATTACK RESOLUTION

An attack is resolved by the attacker making an open-ended attack roll (1d100), adding any applicable modifications, and then applying the modified roll to the appropriate attack table. Attack, critical, and fumble/failure tables can be

found later in this book. A successful attack can result in:

- Hits delivered
- Fumbles
- Critical Strikes.

The last two results will usually require a second roll on a fumble table or a critical table.

UNMODIFIED ROLLS

When an attack roll before modification falls within an “Unmodified” (UM) range for the attack table being used, no modifications are made to the attack roll. This includes “open-ended” modifications (i.e., such a roll is not treated as being “open-ended” – do not roll again).

Unmodified results can only be achieved if the unmodified roll falls within these ranges. Modified rolls falling into these ranges are treated as the next higher (or lower) result.

There are two main unmodified ranges.

FUMBLES OR FAILURE

If the roll is within the fumble range, then the attack fails and a roll is made on the appropriate column of the appropriate fumble table. The results are applied immediately.

Open-Ended Rolls

If a 96-00 is rolled, then the roll is open-ended. Roll again and add the result. If another 96-00 is rolled, roll *again* and add the result. There is no theoretical limit to how many times a person can roll open-ended. After the final result is determined, *then* begin adding modifiers to the attack.

MAXIMUM AND MINIMUM RESULTS

Each attack table has a maximum and a minimum result. If a modified attack roll exceeds the maximum result, the roll is treated as the maximum result. If a modified attack roll is less than a minimum result, the roll is treated as the lowest result that is not a fumble (assuming they *didn't* fumble).

- On all of the attack tables, the minimum result is one more than the unmodified fumble/failure result.
- On all the attack tables the maximum result is 150.
- On Fumble Tables, minimum is 1 and maximum is 100. Since these tables aren't open-ended and have no modifications, this shouldn't be an issue.

SUMMARY

- 1) The attacker makes an open-ended attack roll.
- 2) If an unmodified result is obtained, either keep rolling (in case of open-ended rolls) or go to the fumble table.



- 3) All applicable modifications are made to the roll.
- 4) The modified roll is applied to the appropriate attack table.
- 5) The result may require a roll on a second table.

EFFECTS OF "STUN" ROUNDS

During play, a combatant may be *stunned* for a number of rounds due to critical strikes (this includes all "Stunned" rounds, all *Stunned No Parry* rounds, and all *Down or Out* rounds). All of these *stuns* due to multiple critical strikes are cumulative. Normally the total number of rounds of "stuns" decreases by one each round, with the most severe type of *stun* taking effect first. For every round of *stun* removed/relieved (due to a psion, a skill, a drug, etc.) the total number of rounds of *stun* decreases by one. A stunned character remains stunned until his total number of rounds of *stun* is reduced to zero.

While stunned, the target may not attack and may only parry with half of his offensive bonus. The only other actions allowed are movement and maneuvering (modified by -50 plus three times the character's SD stat bonus).

A combatant will lose consciousness if his total number of accumulated rounds of *stuns* exceeds:

$$10 + (2 \times \text{Co stat bonus}).$$

If not unconscious due to some other cause, a combatant will regain consciousness when his total accumulated rounds of *stun* becomes less than the total above.

OFFENSIVE CAPABILITIES

The success of an attack will depend heavily on offensive capabilities possessed by the attacker. The offensive factors that can affect an attack roll include: skill bonuses, superior/inferior weapon(s), special equipment, position, status of the defender, and status of the attacker.

A combatant making an attack can add his offensive bonus (OB) for that attack to the attack roll. This section describes the factors that contribute to a combatant's OB.

SKILL BONUSES

For an attack, the attacker's OB is his skill bonus for that attack. For information on converting skills in non *Spacemaster* games into an OB, see the conversion notes at the end of this book.

SPECIAL ITEMS

There may be special items (usually technologically enhanced) in a GM's campaign that will impart an OB modification to their possessor. These may range from unique, super high quality scopes to special technological aids. Their design/strength is subject to the GM's devising.

WEAPON QUALITY

High quality weapon construction or workmanship may add a bonus to a combatant's OB (or a penalty for inferior weapons). It is suggested that bonuses for superior quality weapons rarely exceed +10 or +15.

POSITION & STATUS

At the GM's discretion, a bonus or penalty may adjust a combatant's attack roll if his position and status are determined to be somehow superior or inferior to his opponent's. See the Offensive Capabilities Table T-3.5.

Unless stated otherwise, position bonuses are cumulative. For example, a surprise rear attack would get a total position bonus of at least +55: +20 for surprise, +20 for rear attack, and +15 for a flank attack. A non-surprise rear attack would get a total position bonus of +35.

RANGE

There is a modification to an attacker's attack roll for a ranged or psychic attack based upon the distance from the attacker to the target. These modifications range from +30 to -75 and are provided on the individual attack tables.

The ranges given on each of the attack tables are the maximum ranges for which each of the given OB modifications applies. In addition, each weapon has its individual ranges listed (in case they differ from those on the chart).

OB PENALTIES FROM NON-ATTACK ACTIVITY

Any ranged attack action normally requires 60% of a round's activity; however, such an action can take as little as 30% of the round's activity. A ranged attack OB receives a penalty equal to 60 minus the percentage of activity actually used to make the attack.

$$\text{OB Penalty} = (\% \text{ activity used for attack}) - 60$$

Note that both of these modifications are penalties – neither can be positive regardless of how much activity is used.

DEFENSIVE CAPABILITIES

In combat, there are many variables that affect the severity of an attack. The defender has several factors that can work in his favor, including: armor, shield, quickness, special items, and the ability to parry. Armor is the basic classification of protection, while all other defensive capabilities are expressed in terms of a defensive bonus (DB) that will modify the attacker's combat roll in the defender's favor.

ARMOR QUALITY

Especially good armor in terms of material or construction does not change that armor's basic type, but rather adds a bonus to the



wearer's DB. Conversely, shoddy armor will incur a penalty to the wearer's DB. It is highly recommended that superior armor bonuses rarely exceed +10 or +15.

ARMOR PENALTIES

Due to its weight and constrictive nature, there are penalties associated with wearing armor while attempting to maneuver, defend, and throw/fire missiles. These penalties are detailed in the Armor Table T-3.3.

SHIELDS & WEAPONS

Shields are represented in combat by a bonus to the wielder's defensive bonus. In addition, when fighting with one or two weapons, one weapon may be used as a *shield*, but may not be used for an attack in the same round. A shield bonus from a weapon or arm-mounted shield may only be used against one opponent's attack(s) per round. Other shields affect all opponents. These bonuses and other factors concerning shields and parrying are summarized in the Defensive Capabilities Table T-3.6 (p. 17).

HELMETS

A helmet gives bonuses against certain criticals. It is also necessary for an airtight suit.

GREAVES

Greaves are a type of armor that covers the arms and legs. They are included in ATs IV, VII, IX, and X. Greaves can affect certain critical results.

COVER & POSITION

The GM may award a variable bonus to a combatant's DB if his position is judged to be advantageous. Penalties due to a defender's disadvantageous position are reflected in modifications to the attacker's offensive bonus.

Cover bonuses against ranged attacks should be based upon the percentage of the defender's body that is protected and the ability of cover to stop incoming fire. Sample bonuses are summarized in the **Defensive Capabilities Table T-3.6** (p.17).

Note: *If a combatant is completely protected by cover, and is making no attack, the GM may rule that no attack may be made against him.*

QUICKNESS STAT MODIFICATION

A combatant's DB is modified by three times his Quickness stat bonus or penalty. If the defender is wearing certain types of cumbersome armor, this tripled Quickness stat bonus may be reduced or eliminated completely by the armor's Armor Quickness Penalty (but never below zero); see the Armor Table T-3.3. A defender only has three times his Quickness stat bonus factored into his DB if he is aware that he is in a combat situation and is free to move.

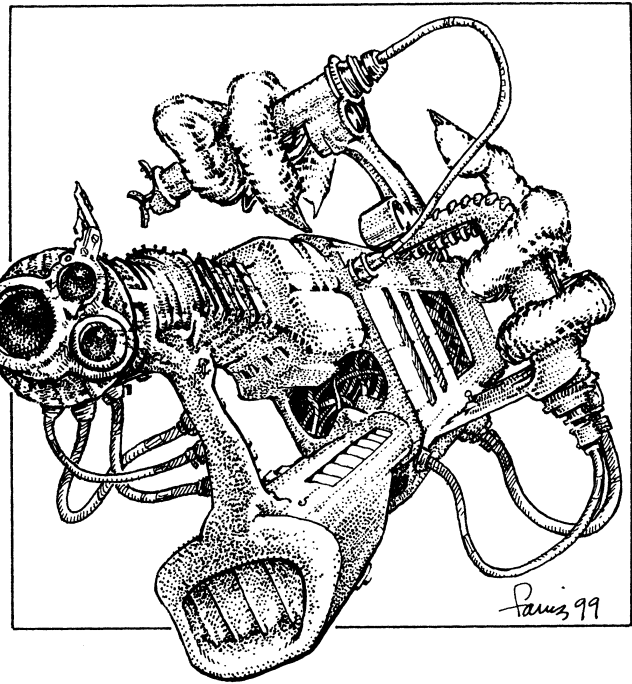

SPECIAL ITEMS

There may be special items in a GM's campaign that will impart a DB to characters wearing them. Shields are a good example, but other technologies (camouflage fields, spacial manipulators, etc.) may exist.

2.2.1 RANGED ATTACKS

FIREARMS

These weapons accelerate a slug or needle to high, usually supersonic, velocities. This can be done with electro-chemical means, gunpowder, or even magnetism. The overall effect is the same. Get a surgeon.

ENERGY WEAPONS

These weapons fire a beam of coherent energy at the target. These could be light, particle beams, sonics, or plasma (although some of those aren't, strictly speaking, pure energy). Most of these weapons cause horrible, penetrating burns. Except for the sonics, these attacks all travel at, or at least approach, the speed of light.

RESOLVING ENERGY WEAPON AND FIREARM ATTACKS

These attacks are resolved on their appropriate attack tables.

ARMOR RANGED ATTACK PENALTIES

A combatant making a ranged attack receives a penalty to his OB if he is wearing armor that covers his arms. This includes armor types III, IV, VII, IX, X, and Powered. The specific penalties are given below and on the Armor Table.



DEFENSIVE BONUS

The sum of all bonuses and penalties that affect the defender's susceptibility to being hit and damaged in melee and missile combat is called the Defensive Bonus. It is the number that is subtracted from the attacker's combat roll. The **Defensive Capabilities Table T-3.6** (p. 17) summarizes the primary factors that affect a defender's DB.

- Defensive Bonus for Ranged Attacks =
- + Armor Quality Bonus
 - + (3 x Quickness Stat Bonus
 - Armor Quickness Penalty [*minimum of 0*]
 - + Half of Adrenal Defense Skill Bonus
 - + Position and Cover Bonuses
 - + Special Item Bonuses
 - + Shield Bonus

Offensive Bonus

The Offensive Bonus is added to the attacker's combat roll during the resolution of a given attack. The Offensive Capabilities Table T-3.5 (below) summarizes the primary factors that affect an attacker's OB.

Offensive Bonus for Ranged Attacks =

- + Skill Bonus
- + Special Item Bonuses
- + Position Bonuses
- ± Status Bonuses/Penalties
- ± Range Modifications (on attack table)
- Ranged Attack Penalty (Armor Table T-3.3, p. 15)
- 1 per 1% activity under 60% not used for the attack

OFFENSIVE CAPABILITIES TABLE T-3.5					
Factor	Melee	Ranged	Basic	Directed	Special
			Psions	Disciplines	
Skill Bonus	full	full	none	full	OB for weapon or psion.
Skill Rank	none	none	full	none	Skill rank in the psion.
Special Items	full	full	full	full	Varies due to type of item.
Weapon Quality	full	full	none	none	This is normally part of the OB.
Using Less Than Max % Activity	varies	varies	none	none	-1 mod for each 1% less than the max used.
Position:					
Flank Attack	+15	0	0	0	Cumulative with other position mods.
Rear Attack	+20	0	0	0	Cumulative with other position mods.
Surprise Attack	+20	0	0	0	Cumulative with other position mods.
Advantageous Position	varies	0	0	0	Cumulative with other position mods.
Target Status:					
Static Target	0	0	+10	+30	Applies to prone and/pro surprised targets not moving and with no cover. Target gets no Qu bonus to his DB.
Stunned Target	+20	+20	0	0	Not cumulative with other target status mods.
Downed Target	+30	+30	0	0	Not cumulative with other target status mods.
Prone Target	+50	+50	0	0	Not cumulative with other target status mods.
Attack Status:					
% of Hits Taken:					
26-50%	-10	-10	-5	-10	Not cumulative with other Hits Taken mods.
51-75%	-20	-20	-10	-20	Not cumulative with other Hits Taken mods.
76-100%	-30	-30	-20	-30	Not cumulative with other Hits Taken mods.
% of Exhaustion Points Taken:					
26-50%	-10	-10	-5	-10	Not cumulative with other ExPs Taken mods.
51-75%	-20	-20	-10	-20	Not cumulative with other ExPs Taken mods.
76-90%	-30	-30	-15	-30	Not cumulative with other ExPs Taken mods.
91-99%	-60	-60	-20	-60	Not cumulative with other ExPs Taken mods.
100%+	-100	-100	-30	-100	Not cumulative with other ExPs Taken mods.
Range Modifiers:	none	varies	varies	varies	Based on attack used.
Armor Penalties:	none	varies	none	none	Based on armor worn (Armor Table T-3.3, p. 15).



HANDLING FIREARM ATTACKS

Many people don't own *Weapons Law: Firearms*, so the following section is included for those people.

The firearm attack tables have not been included, but the critical tables have. Not to worry because there are tables in this book similar enough to the firearm tables to be used in their place.

SLUG THROWERS

These weapons propel a slug at their target. They attack on their corresponding blaster table. They do Ballistic Puncture criticals.

If the person is wearing modern armor (AT I-IV), then check to see if the critical affects a body location covered by the armor. If it does, apply the same number to the Ballistic Impact Table. This will result in a critical to the same location, but with reduced effects, to represent the distributing effects of the kevlar. If the target is armored in more locations than not, you can check the Ballistic Impact chart first, and apply a Ballistic Puncture if the location is not armored.

If the person is using Armor Piercing rounds, then the Armor Piercing criticals are applied no matter where the bullet hits. The armor just slows it down (as represented by the reduced hits).

If the person is using Hollow Points, Ballistic Hollow Point crits are used on unarmored locations. Armored locations are treated the same.

This changes with futuristic armor. Kinetic armor (AT V-VII) ignores all firearm criticals that hit an armored location, Armor Piercing or not. Simply toss out the results.

Combat armor *is* affected by armor piercing rounds; resolve the criticals normally (it is not as specialized as kinetic armor). All other crits are ignored, unless a Shrapnel critical is caused by armor piercing rounds, in which case the Shrapnel critical can be applied normally.

It might seem a bit complicated, but it will make sense after a little play. Below are listed conversions, so that modern weapons can be used with futuristic armor (even if *Weapons Law* is used, it doesn't handle AT V-X).

SLUGTHROWER CONVERSION CHART					
ME*	BE*	ME	BE	ME	BE
1	1	11	6	21	9
2	2	12	6	22	10
3	2	13	7	23	10
4	2	14	7	24	11
5	3	15	8	25	11
6	3	16	8	26	12
7	4	17	8	27	12
8	4	18	9	28	12
9	5	19	9	29	13
10	5	20	9		

*ME: Muzzle Energy

*BE: Blaster Energy

SHOTGUNS

Shotguns cause Shrapnel criticals. For AT 1-20, apply the critical normally.

For AT I-IV, roll the critical and check the location. If the location is armored, move the critical over to the Ballistic Impact Table. Again, it might be easier with II and IV to check Ballistic Impact first, and move criticals to unarmored locations over to the Shrapnel Table.

Against AT V-X, any critical that effects an armored location is ignored. If somehow armor piercing buckshot is introduced (!), then VII-X is still vulnerable to armor piercing effects.

The plasma weapon tables in this book follow the same basic paradigm as the shotgun charts, although the damage and criticals don't quite match up. There are two options on how to handle converting shotguns to *Blaster Law*. The first option yields damage equivalent to the damage in *Weapons Law*, but slightly higher criticals. It's recommended if *Blaster Law* is used alone. It's easy enough to assume that advances in weapon technology have created shot with better penetration characteristics.

The second option yields a bit less on the damage but produces comparable criticals. This is more appropriate if you intend to use *Weapons Law* for all armor types except V and higher. This is the recommended situation.

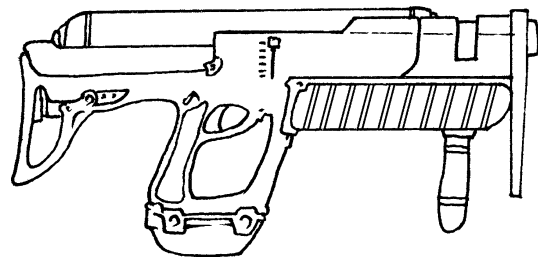
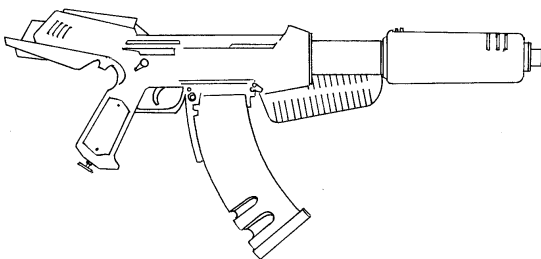



SHOTGUN CONVERSION CHART							
Option 1				Option 2			
SG*	PE*	SG	PE	SG	PE	SG	PE
1	1	11	5	1	1	11	4
2	1	12	5	2	2	12	4
3	2	13	5	3	2	13	5
4	2	14	6	4	3	14	5
5	3	15	6	5	3	15	5
6	3	16	6	6	3	16	5
7	4	17	6	7	4	17	5
8	4	18	6	8	4	18	5
9	4	19	7	9	4	19	6
10	5	20	7	10	4	20	6

*SG: Shotgun
*PE: Plasma Energy



2.3 THE SKILLS

It is easy to incorporate the skills necessary to use this book. They are as follows.

2.3.1 WEAPON SKILLS

Gamemasters need only be concerned with two skill categories from the Weapon group: Weapon • 1-Handed Energy and Weapon • 2-Handed Energy. These two skill categories both use the stat bonuses of Ag/Ag/Ag and use the standard progressions. Note that one skill would be

required for each different type of weapon in the category (laser pistol, plasma pistol, etc.).

Some weapons may require two skills from different categories. For instance, a subassault blaster could be developed to fire both 1-Handed and 2-Handed.

2.3.2 ARMOR SKILLS

All the armor types in *Rolemaster's Arms Law* are still valid, representing either ancient or natural armor types. In addition, ballistic cloth will probably exist in any campaigns that are modern or later, so all the armor types from *Weapons Law: Firearms* are still valid.

Class V is a kinetic armor and covers the torso only. Class VI is a kinetic armor covering the torso and includes arms and upper legs. Class VII is a full suit of kinetic armor. Class VIII is a light, combat armor, breastplate. Class IX is a combat armor, breastplate with greaves. Class X is a full suit of combat armor or powered armor.

Skills for futuristic armor are developed using all three categories. Armor • Light (for armor types I - VI), Armor • Medium (for armor types VII and VIII), and Armor • Heavy (for armor types IX and X).

2.3.3 OTHER SKILLS

The same skills that come with firearms can be used with energy weapons. They are as follows:

Awareness • Senses skill category: Situational Awareness (Ammunition). This can be used with energy cells as well as firearms.

Combat Maneuvers skill category: Suppression Fire (Ag), Rapid Fire (SD). These skills can be used with energy weapons or firearms.

2.4 PERSONAL ARMOR

There are 30 different type of armor in *Spacemaster*. These are divided into eight categories.

To review the other types of armor, briefly:

Skin (AT 1): Normal clothing, assumed if other covering is not specified.

Robes (AT 2): Full-length robes normally worn by fantasy spell users and certain other combatants.

Light Hide (AT 3): The natural hide of certain animals (e.g., Deer, Dog, Wolf). †

Heavy Hide (AT 4): The natural hide of certain animals (e.g., Buffalo, Elephant, Bear). †

Soft Leather Base

AT 5 and AT 6 are heavy outer garments normally worn only for protection from the weather. AT 7 and AT 8 are worn for combat protection by some militia and irregulars.

Leather Jerkin (AT 5): A heavy leather coat without arms and reaching only to the waist or mid-thigh.



Leather Coat (AT 6): A heavy leather coat covering the arms and torso to mid-thigh.

Reinforced Leather Coat (AT 7): A heavy leather coat covering the arms and torso to mid-thigh, but with either rigid-leather sections or metal sections sewn in for reinforcement.

Reinforced Full-Length Leather Coat (AT 8): A reinforced leather coat (as above) that covers to the lower leg.

Rigid Leather Base

Rigid leather armor and the rigid hide covering of certain reptiles and of other creatures such as Dragons.

Leather Breastplate (AT 9): A rigid breastplate covering the torso to mid-thigh and part of the upper arms.

Leather Breastplate & Greaves (AT 10): As above, but with leather greaves covering the forearms and lower legs.

Half-Hide Plate (AT 11): Rigid-leather armor that covers the body completely; includes the hide of creatures that contain at least a few rigid plates (e.g., Rhinoceros, Alligator). ‡

Full-Hide Plate (AT 12): As half-hide plate (above), except that the rigid leather or plates are harder and/or more plentiful (e.g., Turtles, Dragons, Giant Crabs). ‡

Chain Mail Base

Chain link armor, scale armor, and the hides of certain fantastic creatures.

Chain Shirt (AT 13): A chain mail shirt covering the torso to mid-thigh and half of the upper arms.

Chain Shirt & Greaves (AT 14): As above, but with greaves on the forearms and lower legs.

Full Chain (AT 15): Chain mail covering most of the body and legs in the form of a shirt and leggings.

Chain Hauberk (AT 16): A full-length, chain mail coat split from the waist in the front and back to facilitate movement.

Plate Base

Rigid armor of metal plates and the heaviest animal hides.

Metal Breastplate (AT 17): A metal breastplate plus smaller plates covering torso to mid-thigh and part of the upper arms.

Metal Breastplate & Greaves (AT 18): As above, but with greaves on the forearms and lower legs.

Half Plate (AT 19): Rigid plate armor covering the body, but with chain mail between the plates, at the joints, and covering the legs.

Full Plate (AT 20): Rigid plate armor as half plate above, but with plates overlapping at joints, and plate armor covering the legs.

ARMOR TABLE T-3.3				
Armor Type	Maneuver Mod*	Maneuver Mod.†	Missile Attack Penalty‡	Quickness Penalty§
1	0	0	0	0
2	0	0	0	0
3	0	0	0	0
4	0	0	0	0
5	0	0	0	0
6	0	-20	5	0
7	-10	-40	15	10
8	-15	-50	15	15
9	-5	-50	0	0
10	-10	-70	10	5
11	-15	-90	20	15
12	-15	-110	30	15
13	-10	-70	0	5
14	-15	-90	10	10
15	-25	-120	20	20
16	-25	-130	20	20
17	-15	-90	0	10
18	-20	-110	10	20
19	-35	-150	30	30
20	-45	-165	40	40
I	0	0	0	0
II	-5	-40	0	0
III	-10	-60	5	5
IV	-15	-80	10	10
V	0	0	0	0
VI	-5	-40	0	0
VII	-10	-60	5	5
VIII	-10	-70	0	5
IX	-20	-100	10	10
X	-30	-130	20	15
Powered	-25	-160	20	15

* – Minimum maneuver modification applied to a combatant fully trained in maneuvering while wearing the given armor type.
† – Maximum maneuver modification applied to a combatant totally untrained in maneuvering while wearing the given armor type.
‡ – The attack penalty acts as a modification to the ranged OB for a combatant wearing the given armor. This is meant to reflect the disadvantageous effect of armor worn on the arms of a combatant.
§ – An armor Quickness penalty can reduce or cancel a combatant's Quickness stat bonus for his DB. Unlike the penalties above, this penalty can only reduce the armor wearer's Quickness stat bonus. It will not reduce a combatant's overall DB below the level that it would be at with a zero Quickness stat bonus.

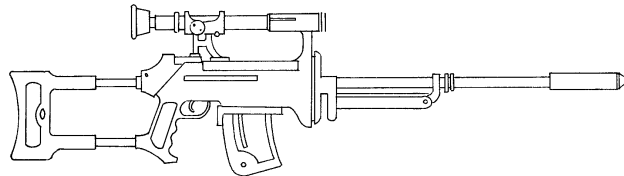
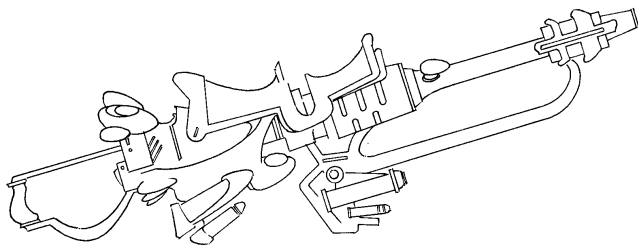

Armored Cloth

Kevlar coverings to protect against ballistic attacks. This armor becomes obsolete with the invention of kinetic armor.

Flack Vest (AT I): This is often the classification of light, ballistic armor. It covers only the torso. Armored clothing and armored underclothing is typically this class of armor.

Extended Flack Vest (AT II): This is the heavier ballistic cloth. It covers the torso and shoulders, and is thicker than class I. Armored winter gear, overcoats, and other heavier material often fit this classification.

Reinforced Flack Vest (AT III): This is heavy, ballistic cloth with metal plates. It covers torso, shoulders and thighs. It is hard to conceal as clothing, but bulky clothing, such as overcoats are sometimes made of this type of armor.

Reinforced Flack Armor (AT IV): This is heavy, full bodied ballistic cloth with metal plates. It covers the entire body. Armored vac suits are often this type of armor.

2.4.1 KINETIC ARMORS

This flexible armor becomes rigid when dealt a blow. This greatly reduces the effects of projectiles. It absorbs some of the energy from an energy weapon, but is most useful against firearms.

Kinetic Vest (AT V): This kinetic armor is worked into a vest, covering the torso from the waist up.

Kinetic Jacket (AT VI): This kinetic armor is worked into a jacket. It covers the torso, arms, groin, and upper legs.

Kinetic Suit (AT VII): This kinetic armor is designed as a full suit. It covers the entire body, and comes complete with gloves, boot coverings and a transparent polymer helmet. It is the preferred armor of bomb squads.

2.4.2 COMBAT ARMORS

The type of armor mimics archaic plate armor. It is made from a hardened composite shell. It is relatively lightweight, and is efficient both at energy dispersal and projectile deflection. These are designed specifically to foil energy weapons. They are the only type designed specifically for armor add-ons.

Combat Breast Plate (AT VIII): This combat armor consists of a one piece, full torso covering, including front, back, and sides.

Combat Breast Plate & Greaves (AT IX): This combat armor includes greaves. Therefore it is more restrictive to movement, but includes greater areas of coverage, including most everything except hands, feet, and joints. This is the armor of choice for SWAT teams.

Combat Armor (AT X): This combat armor covers the entire body. It includes an under suit and at least rudimentary joint coverage. It also includes gloves and boot covers. This armor type is often made into powered versions, including full, waldo-enhanced movement, built-in weapons, sensors or weapons.

POWERED ARMOR

Powered armor can be handled in different ways, depending on the size of the armor. If the armor is relatively light, then simply treat it as normal armor; in a heavy mechanical suit it's the suit that takes damage, not necessarily the occupant.

If the armor takes damage, this too can be handled two different ways. Which way depends on the size of the suit.

If the armor is relatively man-sized, the armor takes no hits, since man-portable weapons aren't much of a threat, and damage is determined by the criticals. Resolve the attack on the character normally, but ignore all damage. Resolve the critical on the Powered Armor Critical Strike Table. Any hits or bleeding caused by the critical are applied to the armor's occupant. Any penalties are applied to the armor itself, and are not applied to the occupant at all once he evacuates the armor.

Larger suits of powered armor might be treated as vehicles. In this case, only vehicle-sized weapons would damage them, but they would have hits. Vehicle weapons are beyond the scope of this work.

Use the Powered Armor Critical Strike Table for *all* criticals. If the attack was burst fire and shrapnel, add five to the critical result. For raking attacks, add ten.

Some criticals cause additional criticals to be rolled against the occupant. All the effects of these secondary criticals are applied to the occupant alone. They do not affect the armor.



DEFENSIVE CAPABILITIES TABLE T-3.6

Factor	Basic			Directed	
	Melee	Ranged	Psions	Disciplines	Special
(Qu Stat Bonus) x 3	full	full	none	full	Modified due to armor worn.
Adrenal Defense	full	half	none	half	Special restrictions.
Special Items	full	full	full	full	Varies due to type of item.
Armor Quality	full	full	none	full	–
Shield:					
Buckler	+20	+5	0	+5	+10 vs. primitive missile attacks.
Normal	+20	+15	0	+15	+20 vs. primitive missile attacks.
Full	+25	+20	0	+20	+25 vs. primitive missile attacks.
Absorption	+30	+30	0	+30	Affects all attacks.
Barrier	+60	+70	0	+90	+90 vs. energy attacks. Affects all targets.
Deflector	+5	+40	0	+60	+60 vs. energy attacks, +15 vs. primitive missiles.
Velocity	+30	+60	0	+0	+0 vs. energy attacks, +45 vs. primitive missiles.
Weapon:					
Hazzok	+15*	0	0	0	May parry melee attacks.
Main Gauche	+15*	0	0	0	May parry melee attacks.
1-Handed Weapon	+5*	0	0	0	May parry melee attacks.
2-Handed Weapon	+5*	0	0	0	May parry melee attacks. Only up to 50% can be used vs. 1-handed weapons.
Pole Arm	-5*	0	0	0	May parry melee attacks. Only up to 50% can be used vs. 1-handed weapons.
Cover:					
Full Soft Cover†	+40	+30	+20	+30	See Cover Chart for a breakdown of Cover Bonuses.
Half Soft Cover‡	+20	+15	+10	+15	See Cover Chart for a breakdown of Cover Bonuses.
Partial Soft Cover§	+10	+10	0	+10	See Cover Chart for a breakdown of Cover Bonuses.
Full Hard Cover†	+100	+60††	+20	+60	See Cover Chart for a breakdown of Cover Bonuses.
Half Hard Cover‡	+30	+30††	+10	+30	See Cover Chart for a breakdown of Cover Bonuses.
Partial Hard Cover§	+15	+15††	0	+15	See Cover Chart for a breakdown of Cover Bonuses.
Full Hardened Cover†	+100	+90††	+20	+90	See Cover Chart for a breakdown of Cover Bonuses.
Half Hardened Cover‡	+30	+45††	+10	+45	See Cover Chart for a breakdown of Cover Bonuses.
Partial Hardened Cover§	+15	+25††	0	+25	See Cover Chart for a breakdown of Cover Bonuses.
Full Impenetrable Cover†	+100	+120††	+20	+120	See Cover Chart for a breakdown of Cover Bonuses.
Half Impenetrable Cover‡	+30	+60††	+10	+60	See Cover Chart for a breakdown of Cover Bonuses.
Partial Impenetrable Cover§	+15	+30††	0	+30	See Cover Chart for a breakdown of Cover Bonuses.

* – Can only be used if weapon is not used to attack or if 100% of OB is used to parry.
† – The target is detected but not sighted. This target is usually being acquired through some technological, but imprecise, method.
‡ – 01-49% of the target can be seen.
§ – 50-75% of the target can be seen.
†† – Primitive missile weapons cannot fire through hard cover. All cover that is not soft is considered “impenetrable.”

2.4.3 ARMOR ADD-ONS

Armor add-ons are coatings applied to combat armor (plate could be used as well). They are designed to foil specific types of weapons.

Reflective Armor: This outer coating gives advantages only against laser attacks. A great deal of the energy is dispersed or reflected away when a laser strikes an armored area. The attack does the same amount of damage, but all criticals to armored areas are resolved as Burn Through criticals (roll the critical, and if the area is armored, the critical is resolved as a Burn Through with the same roll, if not, it is resolved as a Laser critical).

Ablative Armor: This outer coating gives advantages only against particle beams. When struck with a blaster it dissipates the energy around the entire outer covering which reduces the power of the attack by ablating it into vapor. Because of this, these coatings have a limited number of uses before the coating is gone. The attack does the same amount of damage, but all criticals to armored areas are resolved as Burn Through criticals (roll the critical, and if the area is armored, the critical is resolved as a Burn Through with the same roll; if not, it is resolved as a Blaster critical). This armor is bought in coats, which operate like “charges.” Every time the armor absorbs a blaster attack, mark off one coat.



2.5 ATTACK ACTIONS

When attacking with energy weapons, the same basic facts apply that apply to firearms. In review:

First of all, it is assumed that all attacks are aimed. This means that the person firing the attack has a specific target in mind. If the character is simply spraying an area, then this is probably a Suppression Fire action (see Section 2.6.3).

In addition there are only three phases in a round. This provides an upper limit to the amount of aimed shots possible in a round.

Note (*): *If less than the maximum listed % of activity indicated on the Energy Weapons Actions Percentage Activity Chart is used, the attack has a -1 modification for every 1% under the maximum.*

2.5.1 SINGLE SHOT

This represents pointing the weapon at a target and firing once. This causes damage exactly equal to the result dictated on the appropriate table, and causes whatever critical is most appropriate for the weapon (Laser, Blaster, etc.). This takes 30-60% activity*.

2.5.2 EXTENDED OR DOUBLE SHOT

With this shot, the character aims the weapon and holds the trigger down for two beats for a continuous weapon or fires twice for a semi-automatic (also called a double-tap). This causes the target to take up to the equivalent of two attacks. Typically, three shots for a continuous weapon or two from a semi-automatic make up an Extended Shot.

The attacker makes two attack rolls. The first is a normal action, and the second has a -15 penalty (-30 for firearms). The two attacks are resolved separately. This requires 50-90% activity*. If less than 90% activity is used to take this action, then the penalty (-1 for each 1% activity below 90%) is applied to *both* attack rolls.

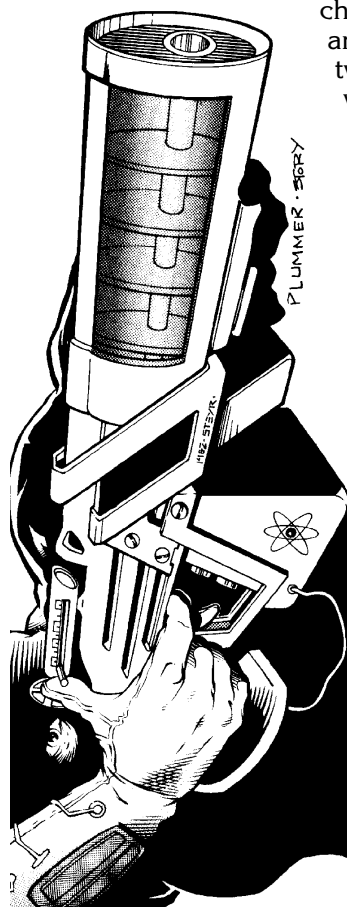

2.5.3 TRACKING SHOT OR SPREAD BURST

With this action, the attacker is either spraying an area with weapons fire in an attempt to hit a single target, or letting the energy fly, then homing the beam in. This typically takes about 10 shots for a continuous fire weapon, or 5 for an automatic weapon.

The attacker receives a special +30 bonus, but only gets to use half of his OB. In addition, the critical is reduced by one level (an 'A' becomes an 'A'-25). This requires 30-60% activity*.

Note: *This action cannot be performed by a weapon in short burst or three-round burst mode.*

2.5.4 CONTINUOUS FIRE OR AIMED BURST

With this action the player aims his weapon, then lets loose with a continuous stream of fire or an aimed burst, attempting to cause devastating damage that will slice through flesh and bone. These are some of the most deadly attacks possible with man-portable weapons.

This attack drains 10 shots for a continuous stream or 5 for a burst. It takes 50-90% activity*. This attack receives a -10 penalty (-20 for firearms) due to the inherent inaccuracy of the maneuver. These cause normal damage. All criticals, however, are Raking for Continuous Fire or Burst for an Aimed Burst as opposed to Laser or Blaster. For firearms, these cause Shrapnel criticals.

Note: *This action can be performed in short burst or three-round burst mode. However, this action can only be used with these modes if the range to the target does not exceed medium.*

2.5.5 VARIABLE POWER EXPENDITURE

Some Gamemasters might find that a set ammo drain from extended bursts is unrealistic. For them, use the following rules:

Note: *When using these rules, Tracking Shots and Spread Burst actions do not receive a set +30 bonus. They receive a +5 per shot drained for a Spread Burst and for every two shots drained in a Tracking Shot.*

Note: *Unless otherwise stated, automatic energy weapons have a Three Shot Burst or Short Burst mode. When this is used, they drain only 3 shots in burst fire mode and six shots in continuous mode.*

With an Extended Shot, roll d3+1. This is the amount of shots expended. If this exceeds the amount left in the cell, then the cell is drained, but the Extended Shot is still resolved as long as there are two shots left.

Spread Bursts and Aimed Bursts expend



d5+3 shots. If this exceeds the remaining ammo, then, the cell is drained or the clip is empty. If the result is exceeded with an Aimed Burst, this is resolved as a Single Shot. With a Spread Burst, the bonus becomes +5 per shot expended.

Tracking Shots and Continuous Fire expend d10+6 shots. If this exceeds the remaining charge in the cell, then, the cell is drained. If the result is exceeded with Continuous Fire, this is resolved as a Single Shot. With a Tracking Shot, the bonus becomes +5 per 2 shots expended.

Option: If the character makes a successful Situational Awareness (Ammunition) check, he can receive the full +30 bonus for Tracking or Spread Bursts.

Note: *The action cannot be canceled after the expenditure is rolled. The trigger has already been pulled. Live with it.*

SITUATIONAL AWARENESS (AMMUNITION)

If the character has this skill, he may make a static maneuver in addition to his attack (with no declaration or percentage of activity). If the maneuver is successful, he may roll twice for expenditure and take the result he prefers.

2.6 SPECIAL MANEUVERS

This section contains special maneuvers that can be performed with energy weapons. It contains Rapid Fire, Aimed Rapid Fire, and Suppression Fire.

2.6.1 RAPID FIRE

The time may come when a character wishes to expend the ammo in his semi-auto weapon as fast as possible. In most cases, it's possible to empty a weapon each round by pulling the trigger multiple times. Roll a Rapid Fire static maneuver. If the maneuver is successful, then the weapon was emptied. Check for breakage numbers.

2.6.2 AIMED RAPID FIRE

Normally, an attack assumes that the character is aiming between each shot. When the character has time to properly prepare, it's possible to aim, and then empty the gun.

To make an aimed, Rapid Fire action the character must spend an entire round aiming (100% activity). The following round, he may attempt to empty his gun at the enemy. The character makes a Rapid Fire static maneuver. If successful, the attack is resolved as a Continuous Fire or Aimed Burst action. If not, the attack is resolved as a Single Shot.

RAPID FIRE

If the character has the Rapid Fire skill, he may add his bonus to Rapid Fire static maneuvers. Rapid Fire is a Combat maneuver.

2.6.3 SUPPRESSION FIRE

Suppression Fire means that the character is firing into an area, not to hit anything specifically, just to put a lot of energy into the area (generally to hit people or to keep them from moving around). To perform a Suppression Fire maneuver, the character must have at least five shots left in his weapon for burst actions, 10 for continuous fire. (Section 2.5.5 gives optional rules for ammunition expenditure; use aimed burst or continuous fire figures).

When a character decides to perform Suppression Fire, he must begin by stating what range he wishes to fire at. Each range has a different arc of coverage. At point blank range, a 45° arc is sprayed. At short range, a 30° arc is covered. At medium range, a 15° arc is covered. Suppression Fire may not be used at a longer range.

Option: A character can attempt to cover a wider arc, at a -10 penalty per 5° of arc covered.

Suppression Fire is resolved as a static maneuver. The result of the static maneuver determines the OB modifier that is added to the attack. After making a static maneuver, consult the chart below for the OB modification.

Option: A character can use more than 5 shots in a Suppression Fire action. (or two shots in continuous fire mode) above 5 (or 10 in continuous fire mode), the character gains a +1 bonus to the Suppression Fire static maneuver.

Every person in the area has two options. They can either take cover (if cover is available), or chance being hit. After each character has determined whether or not to take cover, the attacker can make a +0 OB attack (plus the OB modifier) against everyone in the area.

Option: Allow all targets between the attacker and the target range to be affected. Characters at point blank range are attacked with a -10 penalty (-7 in continuous fire mode). Characters at short range are attacked with a -30 penalty (-20 versus continuous fire).

Characters who decide to take cover receive double the benefits of that cover (double all DB modifiers provided by the cover). However, they lose all remaining activity that round and may only act at 50% next round.

If a character did not dive for cover, he takes the attack. If he already had cover, he can claim it, but he is at 75% activity next round. He can take actions this round normally.



SUPPRESSION FIRE

If the character has the Suppression Fire skill, he may add its bonus to the static maneuver. Suppression Fire is a Combat maneuver.

Note: *Suppression Fire is classified as Everyman for all characters.*

SUPPRESSION FIRE RESULTS CHART	
Static Maneuver Results	OB Mod
Burst Fire Weapons:	
Spectacular Failure	-40
Absolute Failure	-25
Failure	-10
Continuous Fire Weapons:	
Spectacular Failure	-25
Absolute Failure	-15
Failure	-5
Unusual Event:	
Unusual Event	+0
Partial Success	+0
Unusual Success	+30*
Near Success:	
Near Success	+10
Success	+20
Absolute Success	+30
Unusual Event:	
Unusual Event	+0
Partial Success	+5
Unusual Success	+45†
Near Success:	
Near Success	+15
Success	+30
Absolute Success	+45
*One random target in the arc gets a +50 OB modification; all others get +30.	
†One random target in the arc gets a +75 OB modification; all others get +45.	

2.7 RELOADING ACTION

Reloading an energy weapon takes a variable amount of activity based on whether it's powered by a pack or weapon cell. See the *Actions: Percentage Activity Chart*, to determine how much activity is needed to reload. Note that reloading can be spread out over more than one round, if necessary (especially for switching packs).

Option: A character that has reduced the percentage of activity in a reload (i.e., spent less than the maximum activity) can choose to reduce the fumble modification by -1 for a -5 from the next attack (this can't get lower than the normal fumble range). For example, if the fumble range was increased by 5 points the character could take a -25 penalty to his next attack to remove the 5-point increase.

ACTIONS: PERCENTAGE ACTIVITIES CHART

Attack Action	% of Total Activity
Single Shot	30-60%*
Double or Extended Shot	50-90%*
Spread Burst or Tracking Shot	30-60%*
Aimed Burst or Continuous Fire	50-90%*

Special Action	% of Total Activity
Rapid Fire	varies (GM's discretion)
Aimed Rapid Fire	special
Suppression Fire	varies (GM's discretion)

Reloading Action	% of Total Activity
Swapping energy cells or clips	10-25%†
Swapping back pack cells	100-150%†

* – If less than the maximum % of activity indicated is used, the attack has a -1 modification for every 1% under the maximum (See *SM* Section XX.X.X).

† – If less than the maximum % activity indicated is used, the next attack made with the weapon has its fumble range increased by one for every 5% under the maximum.

2.8 HUNTING CLASSIFICATION

Hunting classifications have been adapted to energy weapons. Hunting classifications I, II, or III are considered very, high-powered weapons.

Weapons with a hunting class of I gain a special +20 modification to any attack made on a large or bigger target. Hunting Class II grants a +25 bonus. Hunting Class III grants a +50 bonus.

2.9 APERTURE ENERGY

Each weapon is rated with an aperture energy. When a weapon is fired, check the appropriate table based on that aperture energy.

2.9.1 LASER ENERGY

Lasers are rated with an LE number. The higher the LE number, the easier it is to burn through the target. LE numbers range from 1-13.

2.9.2 BLASTER ENERGY

Blasters are rated with a BE number. The higher the BE number, the easier it is to damage the target, and if the weapon has radioactive side effects, these are more extreme as well. BE numbers range 1-13.



2.9.3 PLASMA ENERGY

Plasma weapons are rated with a PE number. The higher the PE number, the hotter, the faster and more damaging the plasma energy. PE numbers range from 1-10.

2.9.4 SONIC STUNNER

Sonic Stunners are rated with a SS number. This determines the power of the sonics. They are rated from 1-5.

2.10 COVER

If cover is available, then a character may choose to dive behind it. Gamemasters should increase the difficulties by two levels for a character attempting to take cover while under fire (the base difficulty is Light). While under Suppression Fire, Gamemasters should increase the difficulty by four levels.

If the character receives any result in his maneuver not resulting in a failure, then he receives a bonus to his DB equal to the cover modifier (as shown on the cover chart) times the percentage determined by the maneuver. In other words, if a character receives an 80 on the maneuver table, he will receive 80% of the appropriate cover bonus.

All other rules for cover apply.

Note: *Corwin is standing in the open as the hit squad opens up with continuous fire. He decides to dive behind a metal desk. The GM decides that this will be full hard cover and the maneuver is resolved with the Tumbling skill. This would normally be a Light maneuver but is increased two levels to Hard. Corwin's total maneuver roll is 104. He only gets 70% of the full hard cover.*

2.11 WEIGHT OF ENERGY CELLS AND ACCESSORIES

It should be noted that the weight of weapons and weapon cells can be very important in many games. Generals throughout the ages have been concerned about weighing down their soldiers.

Most weapons have their weights listed for them, and the charts in the back of this book will give a good place to start. Assume weapon cells weigh .1 kilograms and packs weigh 10 kg.

2.12 GAME EFFECTS

The game effects of the various weapons are listed below. This section also covers weapon mechanics.

COVER CHART					
Type of Cover	Tables*				
	1-5	6-10	11-15	16-20	21-25
Full Soft Cover	+50	+40	+30	+20	+10
Half Soft Cover	+25	+20	+15	+10	+5
Partial soft cover	+15	+10	+10	+5	+5
Full Hard Cover	+100	+80	+60	+40	+20
Half Hard Cover	+50	+40	+30	+20	+10
Partial Hard Cover	+25	+20	+15	+10	+5
Full Hardened Cover	+150	+120	+90	+60	+30
Half Hardened Cover	+75	+60	+45	+30	+25
Partial Hardened Cover	+40	+30	+25	+15	+10
Full Impenetrable Cover	+200	+160	+120	+80	+40
Half Impenetrable Cover	+100	+80	+60	+40	+20
Partial Impenetrable Cover	+50	+40	+30	+20	+10

Note: Hardened cover is any material that is hardened to weapons fire. Impenetrable cover cannot be penetrated by these weapons and is only used when the character is moving to cover.

* – Sonic stunners are only affected as soft cover. Multiply SS by 5 and PE by 3 for use on this chart.

2.12.1 LASER WEAPONS

Laser weapons cause Laser criticals. In burst fire mode, they cause Burst criticals. In continuous fire mode, they cause Raking criticals.

If the target is wearing reflective armor, then a great deal of the laser's penetrating ability is deflected. The laser does the same damage, but the criticals change. Laser and Burst criticals become Burn Through criticals. Raking criticals become Scorch criticals.

2.12.2 BLASTERS

Blasters cause Blaster criticals. In burst fire mode, they cause Burst criticals. In continuous fire mode, they cause Raking criticals.

If the target is in ablative armor, then a great deal of the Blaster's penetrating ability is deflected. The Blaster does the same damage, but the criticals change. Blaster and Burst criticals become Burn Through criticals. Raking criticals become Scorch criticals.



2.12.3 PLASMA WEAPONS

Plasma weapons cause Plasma criticals. In burst fire mode, they cause Burst criticals. They cannot be fired in continuous fire mode.

Plasma clings to a foe, even after the initial strike. When an attack is resolved, note the critical level and roll. Each round after the initial attack, the target takes a critical with the same roll, but of one severity less. After the critical reaches an "A" severity, the result of the roll drops by 25 until it is less than 1 (ignore the description of the criticals, just apply the effects; this is the method on large and super large crits as well).

If the target is in type I-X armor, then a great deal of the plasma weapon's penetrating ability is deflected. The plasma does the same damage, but the initial critical changes from Plasma to Burn Through or from Burst to Scorch. After the first round, the plasma burns through the armor and begins causing normal (Plasma) criticals. If the character removes the armor before the second round of damage (GM discretion, but 10 seconds from the moment of the attack is a good rule of thumb), then no additional criticals are taken, but the armor is destroyed.

The GM should decide the manner in which a plasma weapon is recharged. This could either be through periodic maintenance or a built-in plant that separates the gasses out of the atmosphere.

2.12.4 SONIC STUNNERS

Sonic stunner attacks are resolved on the Sonic Stunner tables. If this is a directed attack, then the attacker uses his OB. If it is an omnidirectional stunner, it should be given a base OB for the purposes of affecting people within earshot.

People can use earpieces to counter the effects of these weapons. These earpieces typically completely nullify the attack, and therefore, they should probably be illegal in most campaigns, as the only people who use them tend to use them with illegal intent.

A final note: Sonic stunners do not have large or super large charts. This is because they typically have no effect on creatures that aren't sapient. If a sonic stunner *does* affect a large or super-large creature, then use the normal criticals. The large or super large creature should probably have a high Co, and therefore it will take more stun to put it down.

2.13 RADIATION

Blasters are particle beam weapons. Some may be designed to cause radioactive damage to their foes. For practicality, the GM should assign a percentage, between 0-100%. Every time a character takes damage, he takes REM equivalent to that percentage of the damage, if the *Spacemaster Law* rules are being used.

However, a comprehensive treatment of

radiation is beyond the scope of this work. If a GM wishes to have radioactive side effects, he could cause a Radiation critical, either equal to the Blaster critical taken, or 1, 2, 3, etc. levels of severity less.

These rules are unrealistic, and should only be used in a space opera style game. In a hard science game, the GM should use the rules in *Spacemaster Law*, according to the guidelines above. If the GM does not possess *Spacemaster Law*, then weapons should probably not cause radiation damage in a hard science game.

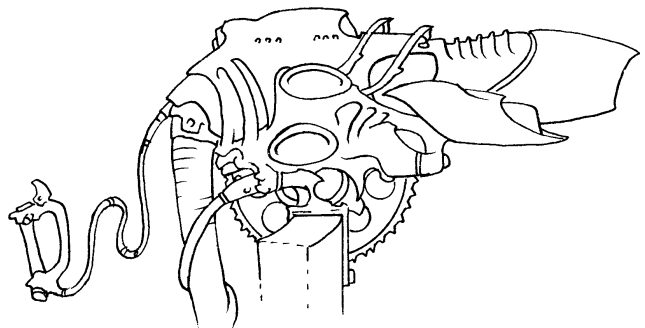
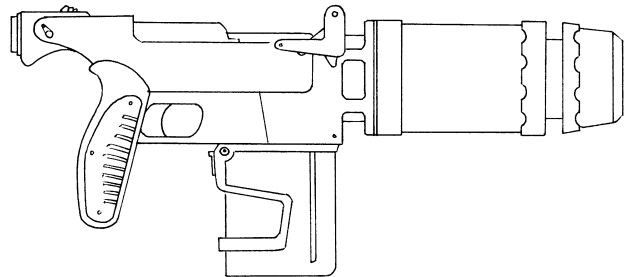
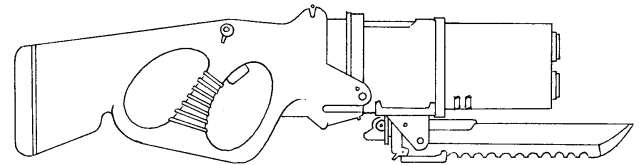
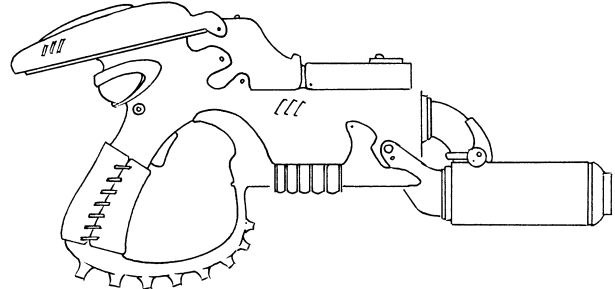



3.0 LASER ATTACK TABLES

INTRODUCTION

This section contains an introduction, a key to the tables, and 13 laser attack tables.

HOW TO USE THESE TABLES

To resolve an attack, the attacker makes a high open-ended roll. If this roll is within the fumble range of the weapon, then a non open-ended roll is made on the appropriate fumble table. Otherwise, all appropriate modifications (such as skill, range, injuries, bonuses and foe's DB) are added to the roll and the result is cross-indexed on the column appropriate to the foe's armor type.

The table will yield one of three results: a miss (i.e., "-"), a normal hit (e.g., "3"), or a critical strike (e.g., "3A"). A miss is just that, a miss. The attack fails and there are no effects other than the expended energy. In the event of a normal hit, the number is applied as damage to the opponent. In the event of a critical strike, the number is applied as damage to the foe, and a critical is rolled. The critical is resolved on the Laser Critical Strike Table, with the letter denoting the severity of the critical (read: the column it's rolled on). The effect of the critical is then applied to the opponent.

In the event that the critical result is a severity higher than "E" then the chart below will list the secondary and tertiary criticals applied. Note that these criticals are not rolled individually; the primary roll is merely compared to the charts for the secondary and tertiary effects.

	Combat Armor			Kinetic Armor			Armored Clothing		
	X	IX	VIII	VII	VI	V	IV	III	II
148 - 150	1A	1B	1C	2A	2B	3C	3B	3C	3C
145 - 147	1A	1B	1C	2A	2B	3C	3B	3C	3C
142 - 144	1A	1B	1C	2A	2B	3C	3B	3C	3C
139 - 141	1A	1B	1C	2A	2B	3C	3B	3C	3C
136 - 138	1A	1B	1C	2A	2B	3C	3B	3C	3C
133 - 135	1A	1B	1B	2A	2B	3B	3B	3C	3C
130 - 132	1A	1B	1B	2A	2B	3B	3B	3B	3C
127 - 129	1A	1A	1B	2A	2A	3B	3A	3B	3E
124 - 126	1A	1A	1B	2A	2A	3B	3A	3B	3E
121 - 123	1	1A	1A	2	2A	2A	3A	3B	3E
118 - 120	1	1A	1A	2	2A	2A	3A	2B	2E
115 - 117	1	1A	1A	2	2A	2A	2A	2A	2E
112 - 114	1	1A	1A	2	2A	2A	2A	2A	2E
109 - 111	1	1	1A	2	2	2A	2	2A	2A
106 - 108	1	1	1	2	1	2	2	2A	2A
103 - 105	1	1	1	1	1	2	2	2A	2A
100 - 102	1	1	1	1	1	2	2	2A	2A
97 - 99	1	1	1	1	1	2	2	2	2A
94 - 96	1	1	1	1	1	1	2	2	2A
91 - 93	1	1	1	1	1	1	2	2	1A
88 - 90	1	1	1	1	1	1	2	1	1
85 - 87	1	1	1	1	1	1	1	1	1
82 - 84	1	1	1	1	1	1	1	1	1
79 - 81	1	1	1	1	1	1	1	1	1
76 - 78	1	1	1	1	1	1	1	1	1
73 - 75	1	1	1	1	1	1	1	1	1
70 - 72	1	1	1	1	1	1	1	1	1
67 - 69	1	1	1	1	1	-	1	1	1
64 - 66	1	1	-	1	1	-	1	1	1
61 - 63	1	1	-	1	-	-	1	1	-
58 - 60	1	1	-	-	-	-	1	-	-
55 - 57	1	-	-	-	-	-	1	-	-
52 - 54	1	-	-	-	-	-	-	-	-
49 - 51	-	-	-	-	-	-	-	-	-
46 - 48	-	-	-	-	-	-	-	-	-
43 - 45	-	-	-	-	-	-	-	-	-
40 - 42	-	-	-	-	-	-	-	-	-
0 - 39	-	-	-	-	-	-	-	-	-
Fumble Range:		3		Range Modifiers:					
Breakage #s:		3							
Reliability:		95							

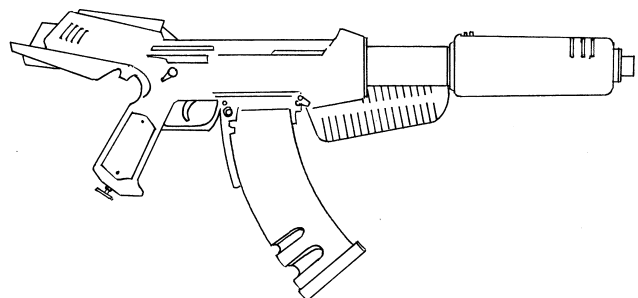



SECONDARY/TERTIARY CRITICALS

Crit Result	Secondary Tertiary
F	A Heat
..... none
G	B Heat
..... none
H	C Heat
..... none
I	D Heat
..... none
J	E Heat
..... none
K	E Heat
.....	A Puncture
L	E Heat
.....	B Puncture
M	E Heat
.....	C Puncture

If these tables are unavailable, use Burn Through or Scorch Critical Table(s), whichever is more appropriate, for secondary and tertiary criticals.

KEY TO THE TABLES

At the top of each table is a box that contains some information for a typical weapon that uses this table. See Section 8.4 for a more comprehensive listing of weapons and their stats. Each piece of information is listed below, along with a description of its purpose.

1) **Attack Table Number:** This is a unique number, which identifies the table.

2) **Laser Energy Indicator:** This indicates the relative aperture energy of the table. The higher the number, the more powerful the weapon.

3) **Fumble:** This shows the chance of fumbling the weapon in an attack. If the unmodified roll falls within this range, then the attacker fumbles and must roll on the appropriate column of the Fumble Table.

4) **Breakage #s:** These numbers show how often the weapon should be checked for breakage. Anytime the attacker rolls doubles of the numbers shown (e.g., 11, 22, 33, etc.) the weapon must be checked for breakage.

5) **Reliability:** The typical reliability of a weapon of this type. Whenever the breakage numbers indicate a breakage check, an open-ended d100 should be rolled. The reliability of the weapon is then added. If the result is higher than 100, then the weapon functions normally. Otherwise, the weapon malfunctions and cannot be used until repaired. (If using *Tech Law: Equipment Manual*, the malfunction can be determined using the rules therein, see page 93, Section 18).

6) **Range Modifiers:** These are the modifiers used when the attacker's target is at a certain range. This shows the range and the modifier applied.

7) **Concussion Damage:** This is an example of a result, which only deals concussion damage.

8) **Critical Strike:** This is an example of an attack that deals both concussion damage and a critical (of the severity indicated).

LIST OF LASER ATTACK TABLES

Spectrum Arms Competitor/ Prrrrig Tock Attack Table LE-3.1
Spectrum Arms Sunspot/Karrrr Tock Attack Table LE-3.2
H & K LP 5/ Jarrrl Tock Attack Table LE 3.2
Beretta Flashpoint/ Marrrrr Tock-ar Attack Table LE-3.4
Spectrum Arms L-15/ Larrum Tock Attack Table LE-3.5
Steyr-Klough L-11/ Trrrrratak Rrrng Attack Table LE-3.6
Steyr-Klough L-15/ Mrrrras Rrrng Attack Table LE-3.7
Arluph Arms Marksman/Varrrr Tang Attack Table LE-3.8
Spectrum Arms L-41/Tanik Pock Attack Table LE-3.9
H & K K-47/Narrrr Tang Attack Table LE-3.10
Spectrum Arms Colossus/Barrrrr Thang Attack Table LE-3.11
Spectrum Arms Light Blade/Prrrimis Thang Attack Table LE-3.12
Spectrum Arms Pulsar/Brrrasack Thang Attack Table LE-3.13

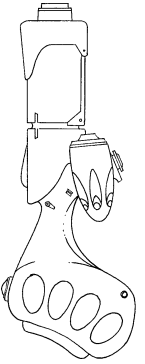
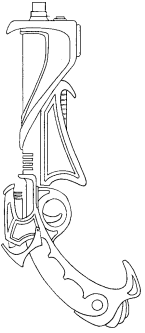

	Combat Armor			Kinetic Armor			Armored Cloth			Plate Armor			Chain Armor			Rigid Leather			Soft Leather			Natural			Clothing				
	X	IX	VIII	VII	VI	V	IV	III	II	I	20	19	18	17	16	15	14	13	12	11	10	9	8	7	6	5	4	3	2
148 - 150	3B	3C	4D	7B	8C	10D	7C	8D	9D	10D	3B	3C	3C	4C	5C	6C	6C	6D	6D	7D	7D	7D	8D	9D	8D	9D	11D	12D	
145 - 147	3B	3C	4D	7B	8C	10D	7C	8D	9D	10D	3B	3C	3C	4C	5C	6C	6C	6D	6D	7D	7D	7D	8D	9D	8D	9D	11D	12D	
142 - 144	3B	3C	4D	7B	8C	10D	7C	8D	9D	10D	3B	3C	3C	4C	5C	6C	6C	6D	6D	7D	7D	7D	8D	9D	8D	9D	11D	12D	
139 - 141	3B	3C	4D	7B	8C	9D	7C	8D	9D	9D	3B	3C	3C	4C	5C	6C	6C	6D	6D	7D	7D	7D	8D	9D	7D	8D	10D	11D	
136 - 138	3B	3C	4C	7B	7C	9C	7C	7C	8D	9D	3B	3C	3C	4C	5C	6C	6C	6D	6D	7D	7D	7D	8D	9D	7D	8D	10D	11D	
133 - 135	3A	3B	4C	6A	7B	9C	6B	7C	8C	9D	3B	3C	3C	4C	5C	5C	5C	5D	5D	6D	6D	6D	7D	7D	7D	9D	10D	10D	
130 - 132	3A	3B	4C	6A	7B	8C	6B	7C	8C	8C	3A	3B	3C	4C	5C	5C	5C	5D	5D	6D	6D	6D	7D	7D	7D	9D	9C	9C	
127 - 129	3A	3B	3B	6A	6B	8B	6B	7C	7C	8C	3A	3B	3B	4B	4C	4C	5C	5C	5C	6C	6C	6D	6D	7D	7D	7C	9C	9C	
124 - 126	3A	3B	3B	6A	6B	7B	6B	6B	7C	7C	3A	3B	3B	3B	4B	4B	5B	5C	5C	5C	6C	6C	7C	7C	6C	8C	8C	8C	
121 - 123	3	3A	3B	5	6A	7B	5A	6B	7C	7C	3A	3B	3B	3B	4B	4B	5B	5C	5C	4C	4C	5C	5C	6C	6C	8C	8C	8C	
118 - 120	3	2A	3A	5	6A	7A	5A	6B	6B	7C	3A	3B	3B	3B	4B	4B	4B	4C	4C	4C	5C	5C	6C	6C	5C	7C	7C	7C	
115 - 117	2	2A	3A	5	5A	6A	5A	6B	6B	6C	3	3B	2B	3B	4B	4B	4B	4C	4C	4C	5C	5C	6C	6C	5B	7C	7C	7C	
112 - 114	2	2A	3A	5	5A	6A	5A	5A	6B	6B	3	2A	2B	3B	4B	4B	4B	4C	4C	4C	5C	5C	6C	6C	4B	5B	6C	6B	
109 - 111	2	2	3A	4	5	6A	5	5A	5B	6B	2	2A	2A	3B	4B	4B	4B	4B	4B	4B	4C	5C	6C	6C	4B	6B	6B	6B	
106 - 108	2	2	2	4	4	5	4	5A	5B	5B	2	2A	2A	3A	3B	3B	4B	4B	4B	4B	4C	5C	6C	6C	4B	6B	6B	6B	
103 - 105	2	2	2	4	4	5	4	4A	4A	5A	2	2A	2A	3A	3B	3B	4B	4B	4B	4B	4C	5C	6C	6C	3B	5B	5B	5B	
100 - 102	2	2	2	4	4	4	4	4A	4A	4A	2	2A	2A	3A	3A	3A	3A	3B	3B	3B	3B	4B	4B	5B	3A	3A	4B	4B	
97 - 99	2	2	2	3	4	4	4	4	4A	4A	2	2A	2A	3A	3A	3A	3A	3B	3B	3B	3B	4B	4B	4B	3A	3A	4B	4A	
94 - 96	2	2	2	3	3	4	3	4	4A	4A	2	2A	2A	3A	3A	3A	3A	3B	3B	3B	3B	4B	4B	4B	2A	2A	4B	4A	
91 - 93	2	2	2	3	3	3	3	3	3A	3A	2	2	2	2A	2A	2A	2A	2A	2A	2A	2A	3B	3B	3B	2A	2A	4B	4A	
88 - 90	2	1	2	3	3	3	3	3	3	3A	2	2	2	2A	2A	2A	2A	2A	2A	2A	2A	3B	3B	3B	2A	2A	3A	2A	
85 - 87	2	1	1	3	2	3	3	3	3	3A	2	2	1	2	2A	2A	2A	2A	2A	2A	2A	3B	3B	3B	1	1A	3A	2A	
82 - 84	1	1	1	2	2	2	3	3	2	2A	2	2	1	2	2A	2A	2A	2A	2A	2A	2A	3B	2B	2A	3A	1	2A	1A	
79 - 81	1	1	1	2	2	2	2	2	2	2	2	2	1	2	2	2	2A	2A	2A	2A	2A	2A	2A	2A	2A	1	2A	1	
76 - 78	1	1	1	2	2	2	2	2	2	2	2	1	1	2	2	2	1A	1A	1A	1A	1A	2A	2A	2A	2A	1	1A	1	
73 - 75	1	1	1	2	1	1	2	2	2	1	1	1	1	2	1	1	1	1	1	1	1A	1A	2A	2A	2A	1A	1A	1	
70 - 72	1	1	1	1	1	1	2	1	1	1	1	1	1	2	1	1	1	1	1	1	1A	1A	2A	2A	2A	1A	1A	1	
67 - 69	1	1	1	1	1	1	1	1	1	1	1	1	1	1	1	1	1	1	1	1	1	1A	1A	1A	1A	1	1	1	
64 - 66	1	1	1	1	1	1	1	1	1	1	1	1	1	1	1	1	1	1	1	1	1	1A	1A	1A	1A	1	1	1	
61 - 63	1	1	1	1	1	1	1	1	1	1	1	1	1	1	1	1	1	1	1	1	1	1A	1A	1	1	1	1	1	
58 - 60	1	1	1	1	1	1	1	1	1	1	1	1	1	1	1	1	1	1	1	1	1	1A	1A	2A	2A	1A	1A	1	
55 - 57	1	1	1	1	1	1	1	1	1	1	1	1	1	1	1	1	1	1	1	1	1	1A	1A	1A	2A	1A	1A	1	
52 - 54	1	1	1	1	1	1	1	1	1	1	1	1	1	1	1	1	1	1	1	1	1	1A	1A	1A	1A	1A	1A	1	
49 - 51	1	1	1	1	1	1	1	1	1	1	1	1	1	1	1	1	1	1	1	1	1	1A	1A	1A	1A	1A	1A	1	
46 - 48	1	1	1	1	1	1	1	1	1	1	1	1	1	1	1	1	1	1	1	1	1	1A	1A	1A	1A	1A	1A	1	
43 - 45	1	1	1	1	1	1	1	1	1	1	1	1	1	1	1	1	1	1	1	1	1	1A	1A	1	1	1	1	1	
40 - 42	1	1	1	1	1	1	1	1	1	1	1	1	1	1	1	1	1	1	1	1	1	1	1	1	1	1	1	1	
0 - 39	1	1	1	1	1	1	1	1	1	1	1	1	1	1	1	1	1	1	1	1	1	1	1	1	1	1	1	1	

Fumble Range: 3
Breakage #s: 4
Reliability: 85

Range Modifiers:
0m-15m: +10
16m-25m: +0
26m-40m: -25
41m-65m: -50
66m-175m: -100

Spectrum Arms
Sunspot
LE 2



	Combat Armor			Kinetic Armor			Armored Cloth				Plate Armor				Chain Armor				Rigid Leather				Soft Leather				Natural			Clothing	
	X	IX	VIII	VII	VI	V	IV	III	II	I	20	19	18	17	16	15	14	13	12	11	10	9	8	7	6	5	4	3	2	1	
148 - 150	7C	8D	10E	17C	21D	25E	17D	19E	22E	25E	7C	8D	9D	10D	13D	13D	14D	14D	14E	16E	17E	17E	17E	18E	19E	14E	21E	27E	28E		
145 - 147	7C	8D	10E	17C	21D	25E	17D	19E	22E	25E	7C	8D	9D	10D	13D	13D	14D	14D	14E	16E	17E	17E	17E	18E	19E	14E	21E	26E	27E		
142 - 144	7C	8D	10E	16C	20D	24E	16D	18E	21E	24E	7C	8D	9D	10D	13D	13D	14D	13D	13E	15E	16E	16E	16E	17E	18E	13E	20E	25E	26E		
139 - 141	7B	8D	9D	16B	19D	23D	16D	18E	20E	23E	7C	8D	9D	10D	12D	12D	13D	13D	13E	15E	16E	16E	16E	17E	18E	13E	19E	24E	25E		
136 - 138	7B	7C	9D	15B	18C	22D	15C	17D	19D	22E	7B	8D	8D	9D	12D	12D	13D	12D	12E	14E	15E	15E	16E	17E	12E	18E	23E	24E			
133 - 135	6B	7C	9D	15B	18C	21D	15C	16D	19D	21D	7B	7C	8C	9C	12D	11D	12D	12D	12D	13E	14E	15E	15E	16E	11D	17D	22E	21D			
130 - 132	6A	7C	8C	14A	17C	20C	14C	16D	18D	20D	6B	7C	8C	8C	11C	11C	12C	11D	11D	13D	14E	14E	14D	15D	16D	11D	16D	21D	21D		
127 - 129	6A	7B	8C	13A	16B	19C	14B	15C	17D	19D	6A	7C	7C	8C	11C	11C	11C	11C	11D	12D	13D	14D	14D	15D	10D	15D	20D	20D			
124 - 126	6A	6B	8B	13A	15B	18B	13B	14C	16C	18D	6A	7C	7C	8C	10C	10C	11C	10C	10D	12D	12D	13D	13D	14D	10D	14D	19D	19D			
121 - 123	6	6B	7B	12	15B	17B	13B	14C	15C	17D	6A	6B	7C	7C	10C	10C	10C	10C	10D	9D	11D	12D	13D	14D	9C	13C	18D	18D			
118 - 120	5	6A	7B	12	14A	16B	12A	13B	15C	16C	6A	6B	7B	7C	10C	9C	10C	9C	9C	10D	11D	12D	12D	13D	8C	12C	17D	16C			
115 - 117	5	6A	6A	11	13A	15A	12A	12B	14C	15C	5	6B	6B	7B	9B	9B	9C	9C	8C	10C	11C	12D	11D	12D	8C	11C	16C	15C			
112 - 114	5	5A	6A	11	12A	14A	11A	12B	13B	14C	5	6B	6B	6B	9B	8B	9B	8C	8C	9C	10C	11D	11C	11C	7C	10C	15C	14C			
109 - 111	5	5	6A	10	12	13A	10	11A	12B	13C	5	5A	6B	6B	8B	8B	8B	8C	7C	9C	9C	10C	10C	11C	7B	9B	14C	13C			
106 - 108	4	5	5	9	11	12	10	11A	11B	12B	5	5A	5A	6B	8B	8B	8B	7C	7C	8C	9C	10C	10C	10C	6B	8B	13C	11B			
103 - 105	4	4	5	9	10	11	9	10A	11B	11B	5	5A	5A	5B	8B	7B	7B	7B	6B	7C	8C	9C	9C	10C	5B	7B	12C	10B			
100 - 102	4	4	5	8	9	10	9	9A	10A	10B	4	5A	5A	5A	7A	7B	7B	6B	6B	7B	7B	9C	8C	9C	5B	6B	11B	9B			
97 - 99	4	4	4	8	9	9	8	9	9A	9B	4	4A	4A	4A	7A	6A	6A	6B	5B	6B	6B	8C	8C	8C	4A	5A	10B	8B			
94 - 96	4	4	4	7	8	8	8	8	8A	8B	4	4	4A	4A	6A	6A	6A	5B	4B	6B	6B	8C	7B	8B	4A	4A	9B	7B			
91 - 93	3	3	4	7	7	7	7	7	7A	7A	4	4	4	4A	6A	6A	5A	5A	4B	5B	4B	7B	7B	7B	3A	3A	8B	5A			
88 - 90	3	3	3	6	6	6	7	7	7	7A	4	4	4	4A	6A	5A	4A	4A	3A	4B	5B	7B	6B	6B	2A	2A	7B	4A			
85 - 87	3	3	3	5	5	5	6	6	6	6A	3	3	3	3	5A	5A	4A	4A	3A	4A	4B	6B	6B	6B	2	1A	6A	3A			
82 - 84	3	3	2	5	5	5	6	5	5	5A	3	3	3	3	5	4A	4A	3A	2A	3A	4A	6B	5B	5B	1	1	5A	2A			
79 - 81	3	2	2	4	4	4	4	5	4	4	3	3	3	2	4	4	4	3A	2A	3A	3A	5B	4B	4A	1	-	4A	1			
76 - 78	2	2	2	4	3	3	4	4	4	3	3	3	2	2	4	3	3	2A	1A	2A	2A	4B	4A	4A	-	-	3A	-			
73 - 75	2	2	1	3	3	2	4	3	3	2	3	3	2	2	4	3	3	2	1	1A	2A	4A	3A	3A	-	-	2A	-			
70 - 72	2	2	1	3	2	1	3	3	2	1	3	2	2	1	3	3	2	1	1	-	1	3A	3A	3A	-	-	1	-			
67 - 69	2	1	1	2	1	-	3	2	1	-	2	2	1	1	3	2	2	1	1	-	-	3A	2A	2A	-	-	-	-			
64 - 66	1	1	-	1	1	-	2	2	1	-	2	2	1	1	2	2	1	1	1	-	-	2A	2A	1A	-	-	-	-			
61 - 63	1	1	-	1	-	-	2	1	-	-	2	2	1	-	2	1	1	-	-	-	-	2A	1A	1	-	-	-	-			
58 - 60	1	1	-	-	-	-	1	-	-	-	2	1	1	-	2	1	-	-	-	-	-	1A	1	-	-	-	-	-	-		
55 - 57	1	-	-	-	-	-	1	-	-	-	2	1	-	-	1	1	-	-	-	-	-	1	-	-	-	-	-	-	-		
52 - 54	1	-	-	-	-	-	-	-	-	-	1	1	-	-	1	-	-	-	-	-	-	-	-	-	-	-	-	-	-		
49 - 51	-	-	-	-	-	-	-	-	-	-	1	1	-	-	1	-	-	-	-	-	-	-	-	-	-	-	-	-	-		
46 - 48	-	-	-	-	-	-	-	-	-	-	1	-	-	-	1	-	-	-	-	-	-	-	-	-	-	-	-	-	-		
43 - 45	-	-	-	-	-	-	-	-	-	-	1	-	-	-	-	-	-	-	-	-	-	-	-	-	-	-	-	-	-		
40 - 42	-	-	-	-	-	-	-	-	-	-	1	-	-	-	-	-	-	-	-	-	-	-	-	-	-	-	-	-	-		
0 - 39	-	-	-	-	-	-	-	-	-	-	-	-	-	-	-	-	-	-	-	-	-	-	-	-	-	-	-	-	-		

Fumble Range: 3
Breakage #s: 3
Reliability: 105
Range Modifiers: 0m-17m: +10
 18m-28m: +0
 29m-44m: -25
 45m-72m: -50
 73m-193m: -100

H & K
LP 5
LE 3

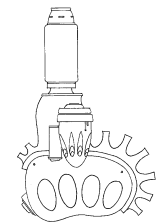
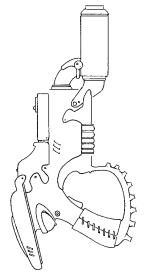

	Combat Armor		Kinetic Armor			Armored Cloth				Plate Armor			Chain Armor			Rigid Leather			Soft Leather			Natural			Clothing					
	X	IX	VIII	VII	VI	V	IV	III	II	I	20	19	18	17	16	15	14	13	12	11	10	9	8	7	6	5	4	3	2	1
148 - 150	15D	18E	22F	36D	45E	54F	36E	42F	48F	54F	15D	17E	20E	22E	28E	30E	30E	30F	31F	35F	36F	37F	37F	42F	46F	31F	46F	57F	60F	
145 - 147	15D	18E	22F	35D	44E	52F	35E	41F	47F	52F	15D	17E	20E	22E	28E	29E	29E	29F	30F	34F	35F	36F	36F	41F	45F	30F	44F	55F	58F	
142 - 144	15D	17E	21F	34D	42E	50F	34E	40F	45F	50F	15D	16E	19E	21E	27E	27E	28E	28F	28F	33F	34F	35F	35F	40F	43F	29F	42F	53F	55F	
139 - 141	14C	17D	20E	33C	41D	48E	33D	38E	43F	48F	14C	16E	19E	20E	26E	26E	27E	27E	28F	32F	32F	34F	34F	38F	42F	27F	40F	51F	53F	
136 - 138	14C	16D	19E	32C	39D	46E	32D	37E	42E	46E	14C	15D	18D	19E	25E	25E	26E	26E	27F	30F	31F	33F	33F	37F	40F	26E	38E	49F	50E	
133 - 135	13B	15D	18D	30B	37D	44D	31D	35E	40E	44E	13C	15D	17D	19D	24D	24D	25D	25E	25E	29E	30E	32F	31E	35E	39E	25E	36E	47E	47E	
130 - 132	13A	15C	18D	29B	36C	42D	30C	34D	38E	42E	13B	14D	17D	18D	23D	23D	24D	24E	24E	28E	28E	30E	30E	34E	37E	23E	34E	45E	45E	
127 - 129	12A	14C	17C	28A	34C	40C	28C	33D	36D	40E	13B	14C	16D	17D	23D	22D	23D	23E	23E	26E	27E	29E	29E	32E	36E	22D	32D	42E	42E	
124 - 126	12A	14B	16C	27A	33B	38C	27B	31C	35D	38D	12A	13C	15C	16D	22D	21D	22D	22E	22E	25E	26E	28E	28E	31E	34E	21D	30D	40E	40D	
121 - 123	11	13B	15B	26	31B	36B	26B	30C	33D	36D	12A	13C	15C	16C	21C	20C	21D	21D	21D	20D	24D	27E	26E	30E	32E	19D	28D	38D	37D	
118 - 120	11	12B	14B	24	29B	34B	25B	28C	31C	34D	11A	12C	14C	15C	20C	19C	20C	20D	19D	22D	23D	26E	25D	28D	31D	18D	26D	36D	34D	
115 - 117	10	12A	14B	23	28A	32B	24A	27B	30C	32D	11	12B	13C	14C	19C	19C	19C	19D	18D	21D	22D	25D	24D	27D	29D	17C	23C	34D	32D	
112 - 114	10	11A	13A	22	26A	30A	23A	26B	28C	30C	10	11B	13B	13C	18C	18C	18C	18D	17D	20D	20D	23D	23D	25D	28D	15C	21C	29C	29C	
109 - 111	9	10	11	21	25	28A	22	24B	26B	28C	10	11B	12B	13B	17B	17C	17C	17C	15C	18C	19D	22D	21D	24D	26D	14C	19C	29C	27C	
106 - 108	9	10	11	20	23	26	20	23A	24B	26C	10	10A	11B	12B	17B	16B	16C	15C	15C	14C	17C	21D	20D	22D	25D	13B	17B	27C	24C	
103 - 105	9	9	10	18	21	24	19	21A	23B	24C	9	10A	11A	11B	16B	15B	15B	14C	13C	16C	16C	20D	19C	21C	23C	11B	15B	25C	21C	
100 - 102	8	9	10	17	20	22	18	20A	21B	22B	9	9A	10A	10B	15B	14B	14B	13B	13C	12C	14C	19C	18C	20C	21C	10B	13B	23C	19B	
97 - 99	8	8	9	16	18	20	17	18	19A	20B	9	9A	9A	9A	14B	13B	13B	12B	12B	10B	13C	17C	17C	18C	20C	9A	11B	21C	16B	
94 - 96	7	8	8	15	17	18	16	17	18A	18B	8	8	8	8	13A	12A	12B	11B	11B	9B	12B	16C	15C	17C	18C	7A	9A	19B	14B	
91 - 93	7	7	7	13	15	16	15	16	16A	16A	8	8	8	8	12A	11A	11A	10B	10B	8B	11B	15C	14C	15C	17C	6A	7A	16B	11A	
88 - 90	6	6	6	12	13	13	14	14	14	14	7	7	7	7	7A	10A	10A	9A	9B	7B	9B	14C	13B	14B	15B	5A	5A	14B	8A	
85 - 87	6	6	6	11	12	11	12	13	12	11A	7	7	7	6	11A	10A	9A	8A	8A	5A	8B	13B	12B	12B	14B	3	3A	12B	6A	
82 - 84	5	5	5	10	10	9	11	11	11	9A	6	6	6	6	10	9A	8A	7A	7A	4A	7A	12B	10B	11B	12B	2	1	10A	3A	
79 - 81	5	5	4	9	9	7	10	10	9	7	6	6	5	5	9	8	7	6A	6A	3A	5A	10B	9B	10B	10B	1	-	8A	1	
76 - 78	4	4	3	7	7	5	8	7	7	5	5	5	4	4	8	7	6	5A	5A	2A	4A	9B	8B	8A	9A	-	-	6A	-	
73 - 75	4	3	2	6	5	3	8	7	6	3	5	5	4	3	7	6	5	4	4	1	3A	8B	7A	7A	7A	-	-	3A	-	
70 - 72	4	3	2	5	4	1	7	6	4	1	5	4	3	3	6	5	4	3	3	-	1	2A	7A	5A	6A	-	-	1	-	
67 - 69	3	2	1	4	2	-	5	4	2	-	4	4	3	2	6	4	3	2	2	-	1	6A	4A	4A	4A	-	-	-	-	
64 - 66	3	2	-	3	1	-	4	3	1	-	4	3	2	1	5	3	2	1	1	-	-	4A	3A	2A	3A	-	-	-	-	
61 - 63	2	1	-	1	-	-	3	1	-	-	4	3	1	-	4	2	1	-	-	-	-	3A	2A	1	1	-	-	-	-	
58 - 60	2	1	-	-	-	-	2	-	-	-	3	2	1	-	3	1	-	-	-	-	-	2A	1	-	-	-	-	-	-	
55 - 57	1	-	-	-	-	-	1	-	-	-	2	1	-	-	2	1	-	-	-	-	-	1	-	-	-	-	-	-	-	
52 - 54	1	-	-	-	-	-	-	-	-	-	2	1	-	-	1	-	-	-	-	-	-	-	-	-	-	-	-	-	-	-
49 - 51	-	-	-	-	-	-	-	-	-	-	2	1	-	-	1	-	-	-	-	-	-	-	-	-	-	-	-	-	-	-
46 - 48	-	-	-	-	-	-	-	-	-	-	2	-	-	-	-	-	-	-	-	-	-	-	-	-	-	-	-	-	-	-
43 - 45	-	-	-	-	-	-	-	-	-	-	1	-	-	-	-	-	-	-	-	-	-	-	-	-	-	-	-	-	-	-
40 - 42	-	-	-	-	-	-	-	-	-	-	1	-	-	-	-	-	-	-	-	-	-	-	-	-	-	-	-	-	-	-
0 - 39	-	-	-	-	-	-	-	-	-	-	-	-	-	-	-	-	-	-	-	-	-	-	-	-	-	-	-	-	-	-

Fumble Range: 3
Breakage #s: 4
Reliability: 85

Range Modifiers:
0m-5m: +10
6m-50m: +0
51m-100m: -25
101m-250m: -50
251m-500m: -100

Spectrum
Arms L-15
LE 5

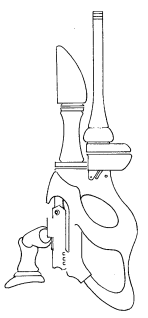
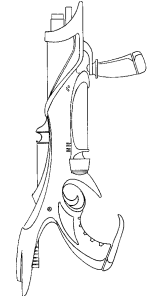



	Combat Armor		Kinetic Armor			Armored Cloth				Plate Armor			Chain Armor			Rigid Leather			Soft Leather			Natural			Clothing					
	X	IX	VIII	VII	VI	V	IV	III	II	I	20	19	18	17	16	15	14	13	12	11	10	9	8	7	6	5	4	3	2	1
148 - 150	23E	28F	34G	56E	69F	83G	56F	64G	73G	83G	23E	26F	30F	34F	43F	46F	46F	46G	47G	53G	55G	57G	57G	65G	70G	47G	70G	88G	92G	
145 - 147	23E	28F	33G	55E	67F	80G	55F	62G	71G	80G	23E	26F	30F	33F	42F	45F	45F	45G	46G	52G	53G	56G	56G	63G	68G	45G	67G	85G	88G	
142 - 144	22D	27F	32F	53D	65F	77F	53F	60G	68G	77G	22E	25F	29F	32F	41F	43F	43F	43G	44G	50G	51G	54G	54G	61G	66G	43G	64G	82G	84G	
139 - 141	21D	26E	31F	51E	62E	74F	51E	58F	66F	74G	22D	24E	28F	31F	40F	39F	42F	42G	42G	48G	49G	52G	52G	59G	63G	41F	61F	78G	80G	
136 - 138	21C	25E	30E	49C	60E	71E	49E	56F	63F	71F	21D	23E	27E	30E	38E	38E	40E	40F	40F	46F	47F	50G	50G	57G	61G	39F	58F	75F	76F	
133 - 135	20B	24D	28E	47B	57D	68E	48D	54E	60F	68F	20C	23E	26E	29E	37E	37E	39E	38F	38F	44F	45F	48F	48F	54F	59F	37F	55F	72F	72F	
130 - 132	19B	23D	27D	45B	55D	65D	46D	52E	58E	65F	20C	22D	25E	27E	36E	35E	37E	37F	36F	42F	43F	47F	46F	52F	56F	35E	51E	68F	68F	
127 - 129	19A	22C	26D	43A	52C	61D	44C	49D	55E	61E	19B	21D	24D	26D	34E	34E	36E	35E	34E	40F	41F	45F	44F	54F	54F	33E	48E	65F	64E	
124 - 126	18A	21C	25C	41A	50C	58C	42C	47D	53E	58E	18B	20D	23D	25D	33D	32D	34D	33E	32E	38E	39E	43F	42F	48F	51F	31E	45E	62E	60E	
121 - 123	17	20B	23C	40	47B	55C	40B	45D	50D	55E	18A	20C	22D	24D	32D	31D	32D	32E	31E	36E	37E	41E	40E	46E	49E	29D	42D	58E	56E	
118 - 120	16	19B	22B	38	45B	52B	39B	43C	47D	52D	17A	19C	21C	23D	30D	30D	31D	30E	29E	34E	35E	39E	38E	43E	47E	27D	39D	55E	52D	
115 - 117	16	18A	21B	36	42A	49B	37A	41C	45D	49D	17	18C	20C	21C	29C	28C	29D	28D	27D	32D	33E	37E	37E	41E	44E	25D	35D	52D	48D	
112 - 114	15	17A	20A	34	40A	46A	35A	39B	42C	46D	16	17B	19C	20C	27C	28C	27D	27D	25D	30D	31D	36E	35E	39E	42E	23C	32C	48D	44D	
109 - 111	14	16	18A	32	37	43A	33	36B	40C	43C	15	16B	18B	19C	27C	25C	26C	25D	23D	28D	29D	34D	33D	37D	39D	21C	29C	45D	40C	
106 - 108	14	15	17	30	35	39	31	34A	37B	39C	15	16B	17B	18B	25C	24C	25C	23C	21C	26D	27D	32D	31D	34D	37D	19C	26C	42D	36C	
103 - 105	13	14	16	28	33	36	30	32A	34B	36C	14	15A	16B	17B	24B	23B	23C	22C	19C	24C	25D	30D	29D	32D	35D	17B	23B	38C	32C	
100 - 102	12	14	15	26	30	33	28	30A	32B	33C	13	14A	15A	16B	23B	21B	21B	20C	17C	22C	23C	28D	27D	30D	32D	15B	20B	35C	28C	
97 - 99	12	13	13	24	28	30	26	28	29A	30B	13	13A	14A	14B	21B	20B	20B	19B	19C	16C	20C	21C	27D	25C	28C	30C	13B	16B	32C	24B
94 - 96	11	12	12	23	25	27	24	26	27A	27B	12	13	13A	13A	20A	19B	18B	17B	17B	14B	18C	19C	25C	23C	26C	28C	11A	13A	20B	20B
91 - 93	10	11	11	21	23	24	23	24	24A	24B	12	12	12	12	12A	17A	17A	15B	15B	12B	16B	17C	23C	21C	23C	25C	9A	10A	25B	16B
88 - 90	9	10	10	19	20	20	21	21	21	20A	11	11	11	11A	19A	16A	15A	14B	14B	10B	14B	15B	21C	19C	21C	23C	7A	7A	22B	12A
85 - 87	9	9	8	17	18	17	19	19	19	17A	10	10	10	10	16A	14A	14A	12A	12A	8A	12B	13B	19C	18C	19B	20B	5	4A	18B	8A
82 - 84	8	8	7	15	15	14	17	17	16	14A	10	9	9	8	15	13A	12A	10A	10A	6A	10A	11B	17B	16B	17B	18B	3	1	15A	4A
79 - 81	7	7	6	13	13	11	15	15	14	11	9	9	8	7	14	12	10	9A	9A	4A	8A	9A	16B	14B	15B	16B	1	-	12A	1
76 - 78	7	6	5	11	10	8	14	13	11	8	8	8	7	6	12	10	9	7A	7A	2A	6A	7A	14B	12B	12B	13B	-	-	8A	-
73 - 75	6	5	3	9	8	5	12	11	8	5	8	7	6	5	11	9	7	5	5	1	4A	5A	12B	10B	10A	11A	-	-	5A	-
70 - 72	5	4	2	7	5	2	10	8	6	2	7	6	5	4	10	7	6	4	4	-	2	3A	10A	8A	8A	8A	-	2	-	-
67 - 69	4	3	1	6	3	-	8	6	3	-	7	6	4	2	8	6	4	2	2	-	1	8A	6A	6A	6A	-	-	-	-	-
64 - 66	4	2	-	4	1	-	6	4	1	-	6	5	3	1	7	5	3	1	1	-	-	7A	4A	3A	4A	-	-	-	-	-
61 - 63	3	1	-	2	-	-	5	2	-	-	5	4	2	-	6	3	1	-	-	-	-	5A	2A	1	1	-	-	-	-	-
58 - 60	2	1	-	-	-	-	3	-	-	-	5	3	1	-	4	2	-	-	-	-	-	3A	1	-	-	-	-	-	-	-
55 - 57	2	-	-	-	-	-	1	-	-	-	4	3	-	-	3	1	-	-	-	-	-	1	-	-	-	-	-	-	-	-
52 - 54	1	-	-	-	-	-	-	-	-	-	3	2	-	-	2	-	-	-	-	-	-	-	-	-	-	-	-	-	-	-
49 - 51	-	-	-	-	-	-	-	-	-	-	3	1	-	-	1	-	-	-	-	-	-	-	-	-	-	-	-	-	-	-
46 - 48	-	-	-	-	-	-	-	-	-	-	2	-	-	-	2	-	-	-	-	-	-	-	-	-	-	-	-	-	-	-
43 - 45	-	-	-	-	-	-	-	-	-	-	2	-	-	-	-	-	-	-	-	-	-	-	-	-	-	-	-	-	-	-
40 - 42	-	-	-	-	-	-	-	-	-	-	1	-	-	-	-	-	-	-	-	-	-	-	-	-	-	-	-	-	-	-
0 - 39	-	-	-	-	-	-	-	-	-	-	0	-	-	-	-	-	-	-	-	-	-	-	-	-	-	-	-	-	-	-

Fumble Range:	3	Range Modifiers:	0m-5m:	+10
Breakage #s:	4		6m-50m:	+0
Reliability:	95		51m-100m:	-25
			101m-500m:	-50
			501m-1,000m:	-100

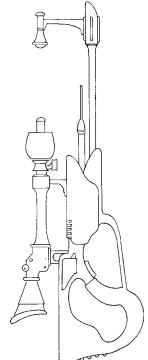

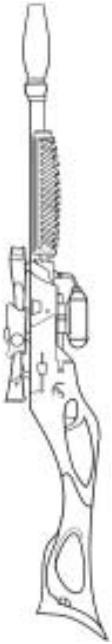

	Combat Armor			Kinetic Armor			Armored Cloth			Plate Armor			Chain Armor			Rigid Leather			Soft Leather			Natural			Clothing				
	X	IX	VIII	VII	VI	V	IV	III	II	I	20	19	18	17	16	15	14	13	12	11	10	9	8	7	6	5	4	3	2
148 - 150	26F	33G	40H	65F	81G	97H	65G	75H	86H	97H	26F	31G	35G	40G	50G	55G	55G	55H	56H	62H	65H	67H	76H	83H	56H	83H	103H	108H	
145 - 147	26F	32G	39H	63F	79G	94H	63G	73H	83H	94H	26F	31G	34G	39G	49G	54G	54G	54H	54H	60H	63H	65H	74H	81H	54H	80H	100H	104H	
142 - 144	25E	31F	36G	61E	76F	90G	61F	70G	80H	90H	25E	30G	33G	38G	47G	52G	52G	52H	52H	58H	61H	63H	71H	78H	52H	76H	96H	99H	
139 - 141	24D	30F	36G	59D	73F	86G	59F	68G	77G	86G	24E	29F	32F	35F	46G	50G	50G	50H	50H	56H	58H	61H	69H	75H	49G	72G	92H	94G	
136 - 138	23D	29E	35F	57E	70F	83F	57E	65F	74G	83G	24D	28F	31F	36F	44F	48F	48F	48G	48G	53G	56G	59G	66G	72G	47G	68G	88G	90G	
133 - 135	23C	28E	33E	55C	67E	79E	55E	63F	71F	79G	23D	27E	30F	34F	43F	46F	46F	46G	45G	51G	53G	57G	64G	69G	44G	65G	84G	85G	
130 - 132	22B	27D	32E	52B	64D	75E	53D	60E	68F	75F	22C	28E	29E	32E	41F	44F	44F	44G	43G	49G	51G	55G	61G	67G	42F	61F	80G	80F	
127 - 129	21A	26D	30D	50A	61D	72D	51D	58E	65F	72F	22B	25E	27E	31E	40E	39E	42E	42E	42F	41F	46F	49F	52G	58G	39F	57F	76F	76F	
124 - 126	20A	25C	29D	48A	58C	68D	49C	55D	62E	68F	21B	24D	26D	29E	38E	38E	40E	40E	40F	39F	44F	46F	50F	56F	37E	53E	72F	71F	
121 - 123	19	24C	27C	46	55C	64C	47C	53D	59E	64E	20A	23D	25D	28D	37E	36E	39E	38E	38F	36F	42F	44F	48F	53F	35E	50E	68F	66E	
118 - 120	19	22B	26B	44	53B	61B	45B	50C	56D	61E	19A	22C	24D	27D	35D	34D	37D	36E	34E	39E	41E	45F	51F	55F	32E	48E	64E	62E	
115 - 117	18	21A	24B	41	50A	57B	43A	48C	53D	57E	19	21C	23C	25D	34D	33D	35D	34D	32E	37E	39E	44F	43F	48E	30D	42D	60E	57E	
112 - 114	17	20A	23A	39	47A	53A	41A	45B	50D	53D	18	20C	22C	24C	32D	31D	33D	32D	30E	35E	37E	42E	41E	45E	27D	38D	57E	52D	
109 - 111	16	19	21A	37	44	50A	39	43B	47C	50D	17	20B	20C	22C	31C	30C	31C	30D	27D	32D	34E	40E	38E	43E	25C	34D	53D	47D	
106 - 108	15	18	20	35	41	46	36	40A	43C	46D	17	19B	19B	21C	29C	28C	29C	28C	28D	25D	30D	38E	36E	40E	22C	31C	49D	43D	
103 - 105	15	17	19	33	38	42	34	38A	40B	42C	16	18A	18B	20B	28C	26C	27C	26C	26D	23D	28D	35E	34D	38D	20C	27C	45D	38C	
100 - 102	14	16	17	30	35	39	32	35A	37B	39C	15	17A	17A	18B	26B	25B	25C	24C	24C	21C	25D	33D	32D	35D	18B	23B	41D	33C	
97 - 99	13	15	16	28	32	35	30	33	34A	35B	14	16A	16A	17A	25B	23B	24B	22C	18C	23C	25C	31D	30D	32D	15B	19B	37C	29B	
94 - 96	12	14	14	26	29	31	28	30	31A	31B	14	15	15A	15A	17A	23B	21B	20B	20C	16C	21C	29D	27D	30C	13A	16B	33C	24B	
91 - 93	11	13	13	24	27	28	26	27	28A	28B	13	14	14	14A	22A	20A	20B	18B	18B	14B	18C	27C	25C	27C	10A	12A	29C	19B	
88 - 90	11	11	11	22	24	24	24	24	25	24A	12	13	12	13A	20A	18A	18A	16B	16B	12B	16B	25C	23C	25C	8A	8A	25B	15A	
85 - 87	10	10	10	19	21	20	22	22	22	20A	12	12	11	11	19A	17A	16A	14A	14B	9B	14B	23C	21C	22C	5	4A	21B	10A	
82 - 84	9	9	8	17	18	16	20	20	19	16A	11	11	10	10	17	15A	14A	12A	12A	7A	11B	20C	18C	19B	3	1	17B	5A	
79 - 81	8	8	7	15	15	13	18	17	16	13	10	10	9	8	16	13	12	10A	10A	5A	9A	18B	16B	17B	1	-	14A	1	
76 - 78	7	7	5	13	12	9	16	15	13	9	9	9	8	7	14	12	10	8A	8A	3A	7A	16B	14B	14B	-	-	10A	-	
73 - 75	7	6	4	11	9	5	14	12	10	5	9	8	7	6	13	10	9	6	6	1	4A	5A	14B	12B	12B	-	6A	-	-
70 - 72	6	5	2	9	6	2	12	10	7	2	8	8	5	4	11	9	7	4	4	-	2	3A	12B	9A	9A	-	2	-	-
67 - 69	5	4	1	6	3	-	9	7	4	-	7	7	4	3	10	7	5	2	2	-	-	1	10A	7A	7A	-	-	-	-
64 - 66	4	3	-	4	1	-	7	5	1	-	7	6	3	1	8	5	3	1	1	-	-	-	8A	5A	4A	-	-	-	-
61 - 63	3	2	-	2	-	-	5	2	-	-	6	5	2	-	7	4	1	-	-	-	-	5A	3A	1	1	-	-	-	-
58 - 60	3	1	-	-	-	-	3	-	-	-	5	4	1	-	5	2	-	-	-	-	-	3A	1	-	-	-	-	-	-
55 - 57	2	-	-	-	-	-	1	-	-	-	5	3	-	-	4	1	-	-	-	-	-	1	-	-	-	-	-	-	-
52 - 54	1	-	-	-	-	-	-	-	-	-	4	2	-	-	2	-	-	-	-	-	-	-	-	-	-	-	-	-	-
49 - 51	-	-	-	-	-	-	-	-	-	-	3	1	-	-	1	-	-	-	-	-	-	-	-	-	-	-	-	-	-
46 - 48	-	-	-	-	-	-	-	-	-	-	2	-	-	-	-	-	-	-	-	-	-	-	-	-	-	-	-	-	-
43 - 45	-	-	-	-	-	-	-	-	-	-	2	-	-	-	-	-	-	-	-	-	-	-	-	-	-	-	-	-	-
40 - 42	-	-	-	-	-	-	-	-	-	-	1	-	-	-	-	-	-	-	-	-	-	-	-	-	-	-	-	-	-
0 - 39	-	-	-	-	-	-	-	-	-	-	-	-	-	-	-	-	-	-	-	-	-	-	-	-	-	-	-	-	-

Range Modifiers:
 0m-5m: +10
 6m-75m: +0
 76m-150m: -25
 151m-750m: -50
 751m-1,500m: -100

Fumble Range: 2
Breakage #s: 3
Reliability: 95

Arluph Arms
Marksman
 LE 8



	Combat Armor		Kinetic Armor		Armored Cloth				Plate Armor		Chain Armor				Rigid Leather				Soft Leather				Natural		Clothing					
	X	IX	VIII	VII	VI	V	IV	III	II	I	20	19	18	17	16	15	14	13	12	11	10	9	8	7	6	5	4	3	2	1
148 - 150	34F	43G	52H	84F	105G	126H	84G	98H	112H	126H	34F	40G	46G	52G	65G	71G	71G	71H	72H	81H	84H	87H	87H	99H	107H	72H	107H	134H	140H	
145 - 147	33F	42G	51H	82F	102G	122H	82G	95H	108H	122H	34F	39G	45G	51G	64G	69G	69G	69H	70H	78H	81H	85H	85H	96H	104H	69H	103H	129H	134H	
142 - 144	32E	41F	49G	79E	98F	117G	79F	92G	104H	117H	33E	38G	43G	49G	62G	61G	67G	66G	67H	75H	78H	82H	82H	93H	100H	66H	98H	124H	128H	
139 - 141	31D	39F	47G	76D	94F	112G	76F	89G	100G	112G	32E	37F	42F	47F	60G	59G	64G	64G	64H	72H	75H	79H	79H	89H	97H	63G	93G	119H	122G	
136 - 138	30D	38E	46F	73D	90E	107F	74E	85F	96G	107G	31D	36F	40F	45F	58F	57F	62F	61F	61G	69G	72G	76G	76G	86G	93G	60G	89G	114G	116G	
133 - 135	29C	36E	43E	70C	87E	103E	71E	82F	92F	103G	30D	35E	39E	43E	56F	55F	59F	59F	59G	66G	69G	74G	73G	83G	89G	57G	83G	109G	110G	
130 - 132	28B	35D	41E	68B	83D	98E	68D	79E	88F	98F	29C	33E	37E	42E	54F	53F	57F	56F	56G	63G	66G	71G	70G	79G	86G	54F	78F	104G	104F	
127 - 129	27A	33D	39D	65A	79D	93D	66D	75E	84F	93F	28B	32E	36E	40E	52E	51E	55E	54E	54F	60F	63F	68G	67G	76G	82G	51F	73F	99F	98F	
124 - 126	26A	32C	37D	62A	75C	88D	63C	72D	80E	88F	27B	31D	34D	38E	50E	49E	52E	51E	51F	49F	57F	60F	65F	64F	72F	47E	69E	94F	92F	
121 - 123	25	31C	35C	59	72C	83C	60C	69D	76E	83E	26A	30D	33D	36D	48E	47E	50E	49E	49F	47F	54F	56F	63F	61F	69F	44E	64E	89F	86E	
118 - 120	24	29B	33B	56	68B	79B	58B	65C	72D	79E	25A	29C	31D	34D	46D	45D	47D	46E	44E	44E	51E	53E	60F	58F	66F	41E	59E	84E	80E	
115 - 117	23	28A	32B	53	64A	74B	55A	62C	68D	74E	24	27C	30C	33D	44D	42D	45D	44D	44E	41E	48E	50E	57F	56F	62E	38D	54D	79E	74E	
112 - 114	22	26A	30A	51	60A	69A	52A	59B	64D	69D	23	26C	28C	31C	42D	40D	42D	41D	41E	38E	45E	47E	54E	53E	59E	35D	49D	73E	67D	
109 - 111	21	25	28A	48	57	64A	50	56B	60C	64D	22	25B	27C	29C	40C	38C	40C	39D	39D	35D	42D	44E	51E	50E	56E	32C	44D	68D	61D	
106 - 108	20	23	26	45	53	60	47	52A	56C	60D	22	24B	25B	27C	38C	36C	38C	36C	36D	32D	39D	41D	49E	47E	52E	29C	39C	63D	55D	
103 - 105	19	22	24	42	49	55	44	49A	52B	55C	21	23A	24B	25B	36C	34C	35C	33C	33D	29D	36D	38D	46E	44D	49D	26C	35C	58D	49C	
100 - 102	18	21	22	39	45	50	42	46A	48B	50C	20	21A	22A	23B	34B	32B	33C	31C	31C	26C	33D	35D	43D	41D	45D	22B	30B	53D	43C	
97 - 99	17	19	20	36	42	45	39	42	44A	45B	19	20A	21A	22B	32B	30B	30B	28C	28C	24C	30C	32C	40D	38D	42D	19B	25B	48C	37B	
94 - 96	16	18	18	34	38	40	36	39	40A	40B	18	19	19A	20A	30B	28B	28B	26B	26C	21C	27C	28C	38D	35D	39C	16A	20B	43C	31B	
91 - 93	15	16	16	31	34	36	34	36	36A	36B	17	18	18	18A	28A	26A	26B	23B	23B	18B	24C	25C	35C	32C	35C	13A	15A	38C	25B	
88 - 90	14	15	14	28	30	31	31	32	32	31A	16	17	16	16A	26A	24A	23A	21B	15B	15B	21B	22B	32C	29C	32C	10A	10A	33B	19A	
85 - 87	13	13	13	25	27	26	28	29	28	26A	15	16	15	14	24A	21A	21A	18A	18B	12B	18B	19B	29C	27C	29C	7	5A	28B	13A	
82 - 84	12	12	11	22	23	21	26	26	24	21A	14	14	13	13	22	19A	18A	16A	16A	9A	15B	16B	26C	24C	25B	4	1	23B	7A	
79 - 81	11	11	9	19	19	16	23	23	20	16	13	13	12	11	20	17	16	13A	13A	6A	12A	13B	24B	21B	22B	1	-	17A	1	
76 - 78	10	9	7	17	15	12	20	19	16	12	12	12	10	9	18	15	13	11A	11A	3A	9A	10A	21B	18B	18B	-	-	12A	-	
73 - 75	8	8	5	14	12	7	17	16	12	7	11	11	9	7	16	13	11	8	8	1	6A	7A	18B	15B	15B	-	-	7A	-	
70 - 72	7	6	3	11	8	2	15	13	8	2	10	10	7	5	14	11	9	6	6	-	3	4A	15B	12A	12A	-	-	2	-	
67 - 69	6	5	1	8	4	-	12	9	4	-	9	8	6	4	12	9	6	3	3	-	1	13A	9A	8A	9A	-	-	-	-	
64 - 66	5	3	-	5	1	-	9	6	1	-	9	7	4	2	10	7	4	1	1	-	-	-	10A	6A	5A	5A	-	-	-	-
61 - 63	4	2	-	2	-	-	7	3	-	-	8	6	3	-	8	5	1	-	-	-	-	-	7A	3A	2	2	-	-	-	-
58 - 60	3	1	-	-	-	-	4	-	-	-	7	5	1	-	6	3	-	-	-	-	-	-	4A	1	-	-	-	-	-	-
55 - 57	2	-	-	-	-	-	1	-	-	-	6	4	-	-	4	1	-	-	-	-	-	-	1	-	-	-	-	-	-	-
52 - 54	1	-	-	-	-	-	-	-	-	-	5	2	-	-	2	-	-	-	-	-	-	-	-	-	-	-	-	-	-	-
49 - 51	-	-	-	-	-	-	-	-	-	-	4	1	-	-	1	-	-	-	-	-	-	-	-	-	-	-	-	-	-	-
46 - 48	-	-	-	-	-	-	-	-	-	-	3	-	-	-	-	-	-	-	-	-	-	-	-	-	-	-	-	-	-	-
43 - 45	-	-	-	-	-	-	-	-	-	-	2	-	-	-	-	-	-	-	-	-	-	-	-	-	-	-	-	-	-	-
40 - 42	-	-	-	-	-	-	-	-	-	-	1	-	-	-	-	-	-	-	-	-	-	-	-	-	-	-	-	-	-	-
0 - 39	-	-	-	-	-	-	-	-	-	-	-	-	-	-	-	-	-	-	-	-	-	-	-	-	-	-	-	-	-	-

Fumble Range: 4
Breakage #s: 4
Reliability: 85

Range Modifiers:
 0m-5m: +10
 6m-75m: +0
 76m-150m: -25
 151m-750m: -50
 751m-1,500m: -100

Spectrum
Arms L-41
LE 9

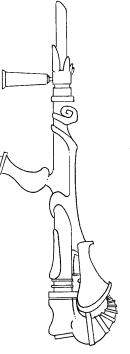

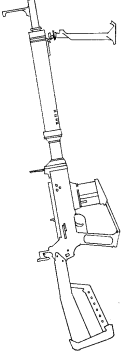

	Combat Armor			Kinetic Armor			Armored Cloth				Plate Armor			Chain Armor			Rigid Leather			Soft Leather			Natural			Clothing						
	X	IX	VIII	VII	VI	V	IV	III	II	I	20	19	18	17	16	15	14	13	12	11	10	9	8	7	6	5	4	3	2	1		
148 - 150	40F	50G	61H	101F	127G	154H	101G	119H	136H	154H	40F	47G	54G	61G	78G	78G	85G	85G	87H	98H	101H	105H	105H	105H	105H	120H	131H	164H	172H			
145 - 147	39F	49G	59H	98F	123G	149H	98G	115H	132H	149H	39F	46G	53G	59G	76G	76G	83G	82G	84H	95H	98H	102H	102H	102H	116H	127H	126H	158H	165H			
142 - 144	38E	47F	57G	95E	118F	143G	95F	111G	127H	143H	38E	45G	51G	57G	74G	73G	80G	79G	79H	81H	91H	99H	98H	98H	112H	123H	120H	152H	158H			
139 - 141	37D	45F	55G	91D	114F	137G	92F	107G	122G	137G	37E	43F	49F	55F	71G	71G	77G	76G	76H	77H	87H	90H	95H	95H	108H	118H	114G	146H	150G			
136 - 138	36D	44E	53F	88D	109E	131F	89E	103F	117G	131G	36D	42F	47F	53F	69F	68F	74F	73F	73G	74G	84G	87G	92G	91G	104G	114G	108G	140G	143G			
133 - 135	34C	42E	50E	84C	105E	125E	85E	99F	112F	125G	35D	41E	46F	51F	67F	66F	71F	70F	70G	70G	80G	83G	88G	88G	100G	109G	102G	133G	135G			
130 - 132	33B	40D	48E	81B	100D	119E	82D	95E	107F	119F	34C	39E	44E	49E	64F	63F	68F	67F	67G	67G	76G	79G	85G	84G	96G	105G	96F	127G	128F			
127 - 129	32A	39D	46D	78A	96D	114D	79D	91E	102F	114F	33B	38E	42E	47E	62E	61E	65E	64E	64F	63F	73F	75F	82G	81G	92G	100G	61F	90F	121F	120F		
124 - 126	31A	37C	44D	74A	91C	108D	76C	87D	98E	108F	32B	36D	40D	44E	60E	58E	62E	61E	61F	60F	69F	72F	79F	77F	88F	96F	57E	84E	115F	113F		
121 - 123	29	35C	41C	71	87C	102C	72C	83D	93E	102E	31A	35D	38D	42D	57E	56E	59E	58E	58F	56F	65F	68F	75F	74F	84F	91F	53E	78E	108F	105E		
118 - 120	28	34B	39B	67	82B	96B	69B	79C	88D	96E	30A	34C	37D	40D	55D	53D	57D	55E	55E	53E	62E	64E	72F	70F	80F	87F	50E	72E	102E	98E		
115 - 117	27	32A	37B	64	78A	90B	66A	75C	83D	90E	28	32C	35C	38D	52D	51D	54D	52D	49E	49E	58E	60E	69F	67F	75E	82E	46D	66D	96E	90E		
112 - 114	26	30A	35A	61	73A	84A	63A	71B	78D	84D	27	31C	33C	36C	50D	48D	51D	49D	49E	46E	54E	57E	65E	63E	71E	78E	62D	60D	90E	83D		
109 - 111	25	29	32A	57	69	78A	60	67B	73C	78D	26	29B	31C	34C	48C	46C	48C	46D	46D	42D	51D	53E	62E	60E	67E	73E	38C	54D	84D	75D		
106 - 108	23	27	30	54	64	73	56	63A	68C	73D	25	28B	30B	32C	45C	43C	45C	43C	43D	39D	47D	49D	59E	56E	63E	69E	35C	48C	77D	68D		
103 - 105	22	25	28	50	59	67	53	59A	64B	67C	24	27A	28B	30B	43C	41C	42C	40C	40D	35D	43D	45D	55E	53D	59D	65D	31C	42C	71D	60C		
100 - 102	21	24	26	47	55	61	50	55A	59B	61C	23	25A	26A	27B	41B	38B	39C	37C	37C	32C	40D	42D	52D	49D	55D	60D	27B	36B	65D	53C		
97 - 99	20	22	24	44	50	55	47	51	54A	55B	22	24A	24A	25B	38B	36B	36B	34C	34C	28C	36C	38C	49D	46D	51D	56D	23B	30B	59C	45B		
94 - 96	18	20	21	40	46	49	43	47	49A	49B	21	22	22A	23A	36B	33B	33B	31C	31C	25C	32C	34C	45D	42D	47C	51C	19A	24B	52C	38B		
91 - 93	17	19	19	37	41	43	40	43	44A	43B	20	21	21	21A	34A	31A	30B	28B	28B	21B	29C	30C	42C	39C	43C	47C	16A	18A	46C	30B		
88 - 90	16	17	17	33	37	38	37	39	39	38A	19	20	19	19A	31A	28A	28A	25B	25B	18B	25B	27B	38C	35C	39C	42C	12A	12A	40B	23A		
85 - 87	15	15	15	30	32	32	34	35	34	32A	18	17	17	17	29A	26A	25A	22A	22B	14B	21B	23B	35C	32C	35C	38C	8	6A	34B	15A		
82 - 84	14	14	12	27	28	26	31	31	30	26A	16	17	15	15	26	23A	22A	19A	19A	11A	18B	19B	32C	28C	30B	33B	4	1	27B	8A		
79 - 81	12	12	10	23	23	20	27	27	25	20	15	15	14	13	24	21	19	16A	16A	7A	14A	15B	28B	25B	26B	29B	1	-	21A	1		
76 - 78	11	10	8	20	19	14	24	23	20	14	14	14	12	10	22	18	16	13A	13A	4A	10A	12A	25B	21B	22B	24B	-	-	15A	-		
73 - 75	10	9	6	16	14	8	21	19	15	8	13	13	10	8	19	16	13	10	10	1	7A	8A	22B	18B	18B	20B	-	-	9A	-		
70 - 72	9	7	3	13	10	2	18	15	10	2	12	11	8	6	17	13	10	7	7	-	3	4A	18B	14A	14A	15A	-	-	3	-		
67 - 69	7	5	1	10	5	-	14	11	5	-	11	10	6	4	15	11	7	4	4	-	-	1	15A	11A	10A	11A	-	-	-	-		
64 - 66	6	4	-	6	1	-	11	7	1	-	10	8	5	2	12	8	4	1	1	-	-	-	12A	7A	6A	6A	-	-	-	-		
61 - 63	5	2	-	3	-	-	8	3	-	-	9	7	3	-	10	6	1	-	-	-	-	-	8A	4A	2	2	-	-	-	-		
58 - 60	4	1	-	-	-	-	5	-	-	-	8	6	1	-	8	3	-	-	-	-	-	-	5A	1	-	-	-	-	-	-		
55 - 57	3	-	-	-	-	-	2	-	-	-	7	4	-	-	5	1	-	-	-	-	-	-	2	-	-	-	-	-	-	-		
52 - 54	1	-	-	-	-	-	-	-	-	-	6	3	-	-	3	-	-	-	-	-	-	-	-	-	-	-	-	-	-	-		
49 - 51	-	-	-	-	-	-	-	-	-	-	4	1	-	-	1	-	-	-	-	-	-	-	-	-	-	-	-	-	-	-		
46 - 48	-	-	-	-	-	-	-	-	-	-	3	-	-	-	3	-	-	-	-	-	-	-	-	-	-	-	-	-	-	-		
43 - 45	-	-	-	-	-	-	-	-	-	-	2	-	-	-	-	-	-	-	-	-	-	-	-	-	-	-	-	-	-	-		
40 - 42	-	-	-	-	-	-	-	-	-	-	1	-	-	-	-	-	-	-	-	-	-	-	-	-	-	-	-	-	-	-		
0 - 39	-	-	-	-	-	-	-	-	-	-	-	-	-	-	-	-	-	-	-	-	-	-	-	-	-	-	-	-	-	-		
Fumble Range:	2																										Range Modifiers:		0m-15m:		+10	
Breakage #s:	3																										16m-225m:		+0			
Reliability:	105																										226m-450m:		-25			
																											451m-2,250m:		-50			
																											2251m-4,500m:		-100			
																										H & K						
																										K-47						
																										LE 10						



	Combat Armor		Kinetic Armor		Armored Cloth				Plate Armor				Chain Armor				Rigid Leather				Soft Leather				Natural			Clothing		
	X	IX	VIII	VII	VI	V	IV	III	II	I	20	19	18	17	16	15	14	13	12	11	10	9	8	7	6	5	4	3	2	1
148 - 150	52G	62H	72I	120G	141H	183I	120H	141I	162I	183I	52G	56H	64H	72H	93H	93H	102H	102H	102H	102H	120I	120I	124I	124I	143I	156I	104I	156I	195I	204I
145 - 147	51G	60H	70I	116G	136H	177I	117H	137I	157I	177I	51G	55H	62H	70H	91H	90H	99H	99H	99H	99H	116I	116I	121I	121I	139I	151I	100I	149I	188I	196I
142 - 144	49F	58G	67H	112F	131G	170H	113G	132H	151I	170I	50F	53H	60H	67H	88H	87H	96H	95H	95H	96I	108I	112I	117I	116I	134I	146I	95I	142I	181I	187I
139 - 141	48E	56G	65G	108E	126G	163G	109G	127H	145H	163H	48E	51G	58G	65G	85G	84G	92G	92H	92H	92H	103H	107H	113I	112I	129I	141I	91H	135H	173H	178H
136 - 138	46D	54F	62G	104D	121F	156G	105F	122G	139H	156H	47E	50G	56G	62G	79G	81G	89G	88G	88H	88H	99H	103H	109H	108H	124H	135H	86H	128H	166H	169H
133 - 135	45C	52E	59F	100C	116E	149F	101E	118G	134G	149H	45D	48F	54F	60G	78G	85G	84G	84H	84H	84H	95H	98H	105H	104H	119H	130H	82G	121G	158H	160H
130 - 132	43B	50E	57E	96B	111E	142E	98E	113F	128G	142G	44C	47F	52F	57F	77F	75F	82F	81G	81G	80G	90G	94G	101H	100H	114H	125H	77G	114G	151G	151G
127 - 129	41B	48D	54E	92B	106D	135E	94D	108F	122F	135G	43C	45E	50E	55F	74F	72F	78F	77F	77G	77G	86G	89G	97G	96G	109G	119G	73F	107F	144G	142G
124 - 126	40A	46C	51D	88A	101C	128D	90C	103E	116F	128F	41B	43E	48E	52E	71E	69F	75F	73F	73G	71G	82G	85G	93G	91G	104G	114G	68F	100F	136G	134F
121 - 123	38	44C	49C	84	96C	121C	86C	99D	110E	121F	40A	42D	46E	50E	68E	66E	71E	70F	70F	67F	77F	80F	89G	87G	100G	109G	64F	93F	129F	125F
118 - 120	37	42B	46C	80	91B	114C	82B	94D	105E	114F	38A	40D	43D	47E	65E	63E	68E	66E	66F	63F	73F	76F	85G	83F	95F	103F	59E	86E	121F	116F
115 - 117	35	40B	44B	76	86B	107B	78B	89C	99D	107E	37	38C	41D	45D	62D	60D	64E	62E	62E	59E	69F	72F	81F	79F	90F	98F	55E	78E	114F	107E
112 - 114	33	38A	41A	72	81A	100A	75A	84C	93D	100E	35	37C	39C	42D	60D	57D	61D	59E	59E	55E	64E	67E	77F	75F	85F	93F	50D	71D	107E	98E
109 - 111	32	36	38A	68	76	93A	71	80B	87C	93D	34	35B	37C	40C	57D	54D	57D	55D	55E	50E	60E	63E	73F	71F	80E	87E	46D	64D	99E	89D
106 - 108	30	34	36	64	71	86	67	75B	81C	86D	33	33B	35B	37C	54C	51C	54D	51D	51D	46D	56E	58E	69E	67E	75E	82E	41C	57C	92E	80D
103 - 105	29	31	33	60	66	79	63	70A	76C	79D	31	32A	33B	35C	51C	48C	50C	48D	48D	42D	51D	54D	65E	62E	70E	77E	37C	50C	84D	71D
100 - 102	27	29	30	56	61	72	59	65A	70B	72C	30	30A	31B	32B	48B	45C	47C	44C	44D	38D	47D	49D	61E	58E	65D	71D	32B	43C	77D	63C
97 - 99	25	27	28	52	56	65	55	61	64B	65C	28	28A	29A	30B	46B	42B	43B	41C	41C	34C	43D	45D	57D	54D	61D	66D	28B	36B	70D	54C
94 - 96	24	25	25	48	51	58	52	56	58A	58B	27	27	27A	27B	43B	39B	40B	37C	37C	30C	38C	40C	53D	50D	56D	61D	23B	29B	62C	45B
91 - 93	22	23	22	44	46	51	48	51	53A	51B	26	25	24	25A	40A	36B	36B	33B	33B	25B	34C	36C	49D	46D	51D	55D	19A	22A	55C	36B
88 - 90	21	21	20	40	41	45	44	46	47	45B	24	23	22	22A	37A	33A	33A	30B	30B	21B	29B	32C	45D	42C	46C	50C	14A	15A	47C	27B
85 - 87	19	19	17	36	36	38	40	42	41	38A	23	22	20	20	34A	30A	29A	26B	26B	17B	25B	27B	41C	38C	41C	45C	10	8A	40B	18A
82 - 84	17	17	15	32	31	31	36	37	35	31A	21	20	18	17	31	27A	26A	22A	22A	13A	21B	23B	37C	34C	36C	39C	5	1	33B	9A
79 - 81	16	15	12	27	26	24	32	32	29	24	20	18	16	15	29	24	23	19A	19A	9A	16A	18B	33C	29C	31B	34B	1	-	25A	1
76 - 78	14	13	9	23	21	17	29	27	24	17	18	17	14	12	26	21	19	15A	15A	5A	12A	14A	30B	25B	26B	29B	-	-	18A	-
73 - 75	13	11	7	19	16	10	25	23	18	10	17	15	12	10	23	18	16	11	11	1	8A	9A	26B	21B	22B	24B	-	-	10A	-
70 - 72	11	9	4	15	11	3	21	18	12	3	16	13	10	7	20	15	12	8	8	-	3	5A	22B	17B	17A	18A	-	-	3	-
67 - 69	10	7	1	11	6	-	17	13	6	-	14	12	8	5	17	12	9	4	4	-	-	1	18A	13A	12A	13A	-	-	-	-
64 - 66	8	5	-	7	1	-	13	8	1	-	13	10	5	2	15	9	5	1	1	-	-	-	14A	9A	7A	8A	-	-	-	-
61 - 63	6	3	-	3	-	-	9	4	-	-	11	8	3	-	12	6	2	-	-	-	-	-	10A	5A	2	2	-	-	-	-
58 - 60	5	1	-	-	-	-	6	-	-	-	10	7	1	-	9	3	-	-	-	-	-	-	6A	1	-	-	-	-	-	-
55 - 57	3	-	-	-	-	-	2	-	-	-	9	5	-	-	6	1	-	-	-	-	-	-	2	-	-	-	-	-	-	-
52 - 54	2	-	-	-	-	-	-	-	-	-	7	3	-	-	3	-	-	-	-	-	-	-	-	-	-	-	-	-	-	-
49 - 51	-	-	-	-	-	-	-	-	-	-	6	2	-	-	1	-	-	-	-	-	-	-	-	-	-	-	-	-	-	-
46 - 48	-	-	-	-	-	-	-	-	-	-	4	-	-	-	-	-	-	-	-	-	-	-	-	-	-	-	-	-	-	-
43 - 45	-	-	-	-	-	-	-	-	-	-	3	-	-	-	-	-	-	-	-	-	-	-	-	-	-	-	-	-	-	-
40 - 42	-	-	-	-	-	-	-	-	-	-	1	-	-	-	-	-	-	-	-	-	-	-	-	-	-	-	-	-	-	-
0 - 39	-	-	-	-	-	-	-	-	-	-	-	-	-	-	-	-	-	-	-	-	-	-	-	-	-	-	-	-	-	-

Fumble Range: 4
Breakage #s: 4
Reliability: 105
Range Modifiers: 0m-50m: +10
51m-750m: +0
751m-1,500m: -25
1,501m-7,500m: -50
7,501m-15,000m: -100

Spectrum Arms
Colossus

LE 11



	Combat Armor			Kinetic Armor			Armored Cloth			Plate Armor			Chain Armor			Rigid Leather			Soft Leather			Natural			Clothing					
	X	IX	VIII	VII	VI	V	IV	III	II	I	20	19	18	17	16	15	14	13	12	11	10	9	8	7	6	5	4	3	2	1
148 - 150	56G	70H	84I	140G	176H	212I	140H	164I	188I	212I	56G	64H	75H	84H	108H	108H	118H	118H	120I	139I	140I	144I	144I	166I	180I	120I	180I	226I	236I	
145 - 147	55G	68H	81I	136G	170H	204I	136H	159I	182I	204I	55G	63H	73H	82H	105H	105H	114H	114H	116I	134I	135I	140I	140I	161I	174I	115I	172I	218I	226I	
142 - 144	53F	66G	78H	131F	164G	196H	132G	153H	175I	196I	53F	61H	71H	79H	102H	102H	110H	110H	111I	129I	130I	135I	135I	155I	168I	110I	164I	209I	216I	
139 - 141	51E	63G	75G	128E	158G	188G	127G	148H	168H	188H	52E	59G	68G	76G	99G	98G	106G	106H	108H	124H	125H	131I	130I	150I	162I	105H	156H	201H	206H	
136 - 138	50D	61F	72G	122D	151F	180G	123F	142G	162H	180H	50E	57G	66G	73G	95G	95G	102G	102G	102H	119H	120H	126H	125H	144H	156H	100H	148H	192H	195H	
133 - 135	48C	59E	69F	117C	145E	172F	118E	137G	155G	172H	49D	55F	63F	70G	92G	91G	98G	97G	97H	113H	115H	122H	120H	138H	150H	94G	140G	184H	185H	
130 - 132	46B	56E	66E	112B	139E	164E	114E	131F	148G	164G	47C	53F	61F	67F	89F	88F	94F	93G	93G	108G	109G	117H	116H	133H	144H	89G	131G	175G	175G	
127 - 129	44B	54D	63E	107B	132D	156E	109D	126F	141F	156G	46C	51E	58E	64F	86F	84F	90F	89F	89G	103G	104G	112G	111G	127G	138G	84F	123F	166G	165G	
124 - 126	43A	52C	60D	103A	126C	148D	105C	120E	135F	148F	44B	49E	56E	61E	82E	81F	86F	85F	85G	98G	99G	108G	106G	121G	131G	79F	115F	158G	154F	
121 - 123	41	49C	57C	98	120C	140C	100C	115D	128E	140F	43A	47D	53E	58E	79E	77E	82E	81F	81F	93F	94F	103G	101G	116G	125G	74F	107F	149F	144F	
118 - 120	39	47B	54C	93	114B	132C	96B	109D	121E	132F	41A	45D	51D	55E	76E	74E	78E	76E	76F	87F	89F	99G	96F	110F	119F	68E	99E	141F	134F	
115 - 117	38	45B	51B	89	107B	124B	91B	104C	115D	124E	40	44C	48D	52D	72D	70D	74E	72E	72E	88E	82F	94F	92F	104F	113F	63E	90E	132F	124E	
112 - 114	36	42A	48A	84	101A	116A	87A	98C	108D	116E	38	42C	46C	49D	69D	67D	70D	68E	68E	77E	78E	89F	87F	99F	107F	58D	82D	124E	113E	
109 - 111	34	40	45A	79	95	108A	82	93B	101C	108D	37	40B	43C	46C	66D	63D	68D	64D	64E	58E	72E	85F	82F	93E	101E	53D	74D	115E	103D	
106 - 108	32	38	41	74	88	100	78	87B	94C	100D	35	38B	41B	43C	63C	60C	62D	59D	59D	53D	67E	80E	77E	87E	95E	47C	66C	106E	93D	
103 - 105	31	35	38	70	82	92	73	82A	88C	92D	34	36A	38B	41C	59C	56C	58C	55D	55D	48D	61D	76E	72E	82E	88E	42C	58C	98D	83D	
100 - 102	29	33	35	65	76	84	69	76A	81B	84C	32	34A	36B	38B	56B	53C	54C	51C	51D	44D	56D	71E	68E	76D	82D	37B	50C	89D	72C	
97 - 99	27	31	32	60	70	76	65	71	74B	76C	31	32A	33A	35B	53B	49B	50B	47C	47C	39C	51D	62D	63D	70D	76D	32B	41B	81D	62C	
94 - 96	26	28	29	56	63	68	60	65	68A	68B	29	30	31A	32B	50B	46B	46B	43C	43C	34C	46C	62D	58D	65D	70D	27B	33B	72C	52B	
91 - 93	24	26	26	51	57	60	56	59	61A	60B	27	28	29	29A	46A	42B	42B	38B	38B	29B	40C	57D	53D	59D	64D	21A	25A	63C	42B	
88 - 90	22	24	23	46	51	51	51	54	54	51B	26	26	26	26A	43A	39A	38A	34B	34B	24B	35B	37C	53D	48C	53C	16A	17A	55B	31B	
85 - 87	20	21	20	41	44	43	47	48	47	43A	24	25	24	23	40A	35A	34A	30B	30B	20B	30B	48C	44C	48C	52C	11	9A	46B	21A	
82 - 84	19	19	17	37	38	35	42	43	41	35A	23	23	21	20	36	32A	30A	26A	26A	15A	25B	26B	43C	39C	42C	6	1	38B	11A	
79 - 81	17	17	14	32	32	27	38	37	34	27	21	21	19	17	33	28	26	22A	22A	10A	20A	21B	39C	34C	36B	39B	1	29A	1	
76 - 78	15	14	11	27	26	19	33	32	27	19	20	19	16	14	30	25	22	17A	17A	5A	14A	16A	34B	29B	31B	33B	-	21A	-	
73 - 75	14	12	8	23	19	11	29	26	21	11	18	17	14	11	27	21	18	13	13	1	9A	11A	30B	24B	25B	27B	-	12A	-	
70 - 72	12	10	5	18	13	3	24	21	14	3	17	15	11	8	23	18	14	9	9	-	4	6A	25B	20B	19A	21A	-	3	-	
67 - 69	10	7	2	13	7	-	20	15	7	-	15	13	9	5	20	14	10	5	5	-	-	1	20A	15A	14A	15A	-	-	-	-
64 - 66	8	5	-	8	1	-	15	10	1	-	14	11	6	2	17	11	6	1	1	-	-	-	16A	10A	8A	9A	-	-	-	-
61 - 63	7	3	-	4	-	-	11	4	-	-	12	9	4	-	14	7	2	-	-	-	-	-	11A	5A	2	3	-	-	-	-
58 - 60	5	1	-	-	-	-	6	-	-	-	11	7	1	-	10	4	-	-	-	-	-	-	7A	1	-	-	-	-	-	-
55 - 57	3	-	-	-	-	-	2	-	-	-	8	6	-	-	7	1	-	-	-	-	-	2	-	-	-	-	-	-	-	-
52 - 54	2	-	-	-	-	-	-	-	-	-	9	4	-	-	4	-	-	-	-	-	-	-	-	-	-	-	-	-	-	-
49 - 51	-	-	-	-	-	-	-	-	-	-	6	2	-	-	1	-	-	-	-	-	-	-	-	-	-	-	-	-	-	-
46 - 48	-	-	-	-	-	-	-	-	-	-	5	-	-	-	-	-	-	-	-	-	-	-	-	-	-	-	-	-	-	-
43 - 45	-	-	-	-	-	-	-	-	-	-	3	-	-	-	-	-	-	-	-	-	-	-	-	-	-	-	-	-	-	-
40 - 42	-	-	-	-	-	-	-	-	-	-	2	-	-	-	-	-	-	-	-	-	-	-	-	-	-	-	-	-	-	-
0 - 39	-	-	-	-	-	-	-	-	-	-	-	-	-	-	-	-	-	-	-	-	-	-	-	-	-	-	-	-	-	-

Fumble Range:	4	Range Modifiers:	0m-50m:	+10
Breakage #s:	4		51m-750m:	+0
Reliability:	105		751m-1,500m:	-25
			1,501m-7,500m:	-50
			7,501m-15,000m:	-100

Spectrum Arms	
Light Blade	
LE 12	

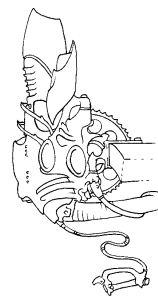

	Combat Armor		Kinetic Armor		Armored Cloth				Plate Armor				Chain Armor				Rigid Leather				Soft Leather				Natural			Clothing		
	X	IX	VIII	VII	VI	V	IV	III	II	I	20	19	18	17	16	15	14	13	12	11	10	9	8	7	6	5	4	3	2	1
148 - 150	64K	81L	96M	159K	199L	240M	159H	186M	213M	240M	64K	74L	85L	96L	123L	123L	134L	134L	134M	137M	153M	159M	164M	164M	189M	205M	137M	205M	257M	268M
145 - 147	63J	79L	93M	154J	192L	231M	154H	180M	206M	231M	63J	72L	83L	93L	120L	120L	130L	130L	130M	132M	148M	154M	159M	159M	183M	199M	132M	196M	248M	257M
142 - 144	61I	76K	89L	149I	185K	222L	149G	174L	198L	222L	61I	70K	80K	90K	116K	116K	125K	125L	125L	127L	142M	148M	154M	154M	177M	192M	126L	187L	238L	245L
139 - 141	59H	73J	86K	143H	178J	213K	144G	168K	191K	213L	59H	68J	77K	86K	112K	112K	121K	120K	120L	121L	136L	142L	149L	148L	170L	185L	120L	178L	228L	234L
136 - 138	57F	71I	82J	138F	171I	204J	139F	161J	183K	204K	58G	66J	74J	83J	109J	108J	116J	115K	115K	116K	131L	136L	144L	143L	164L	178L	114K	168K	218K	222K
133 - 135	55E	68H	79I	133E	164H	195I	134E	155I	175J	195K	56F	63I	71I	80J	105J	104J	112J	111J	111K	110K	125K	130K	138K	137K	157K	171K	108J	159J	209K	210K
130 - 132	53D	65G	75H	127D	157G	186H	129E	149I	168I	186J	54E	61H	69I	76I	101I	100I	107I	106J	106J	105J	119K	124K	133K	132K	151K	164K	102J	150J	199J	199J
127 - 129	51B	63F	72G	122B	150F	177G	124D	143H	160I	177I	52D	59H	66H	73H	97I	96I	103I	101I	101J	99J	113J	118J	128J	126J	144J	157J	96I	140I	189J	187I
124 - 126	49A	60E	68F	117A	143E	168F	119C	136G	153H	168I	51C	57G	63G	70H	94H	92H	98H	96I	96I	94I	108J	112J	123J	121J	138J	150J	90H	131I	179I	175I
121 - 123	47	57D	65E	111	136D	158E	114C	130F	145G	158H	49B	55F	60G	66G	90G	88H	93H	91H	91I	88I	102I	106I	117J	115J	132I	143I	84H	122H	170I	164H
118 - 120	45	54C	61D	106	128C	149D	109B	124E	137G	149H	47A	53E	57F	63G	86G	84G	89G	87H	87H	83H	96I	101I	112I	110I	125I	136I	78G	112G	160H	152H
115 - 117	43	52B	58C	101	121B	140C	104B	118E	130F	140G	45	50E	55E	60F	82F	80F	84G	82G	82H	77H	90H	95H	107I	104I	119I	129I	72F	103G	150H	140G
112 - 114	41	49A	54B	95	114A	131B	99A	111D	122E	131G	44	48D	52E	58F	79F	76F	80F	77G	77G	72G	85H	89H	102H	99H	112H	122H	66F	94F	140G	129G
109 - 111	39	46	51A	90	107	122A	94	105C	115E	122F	42	46C	49D	53E	75E	72E	75F	72F	72G	66G	79G	83G	96H	93H	106H	115H	60E	84E	131G	117F
106 - 108	37	44	47	84	100	113	88	99B	107D	113E	40	44C	46C	50D	71E	68E	71E	67F	67F	61F	73G	77G	91G	88G	99G	108G	54E	75E	121F	105E
103 - 105	35	41	44	79	93	104	83	92A	99C	104E	38	42B	43C	46D	68D	64D	66E	63E	63E	55E	67F	71F	86G	82G	93G	101G	48D	66D	111F	94E
100 - 102	33	38	40	74	86	95	78	86A	92C	95D	37	39A	41B	43C	64C	60D	61D	58E	58E	50E	62F	65F	81G	77F	86F	94F	42C	56D	101E	82D
97 - 99	31	36	37	68	79	86	73	80	84B	86D	35	37A	38B	40C	60C	56C	57C	53D	53D	44D	56E	59E	76F	72F	80F	87F	36C	47C	92E	70D
94 - 96	29	33	33	63	72	76	68	74	77A	76C	33	35	35A	36B	56B	52C	52C	48D	48D	39D	50E	53E	70F	66F	74E	80E	30B	38B	82D	59C
91 - 93	27	30	30	58	64	67	63	67	69A	67C	31	33	32	33A	53B	48B	48B	44C	44C	33C	44D	48D	65E	61E	67E	73E	24A	28B	72D	47C
88 - 90	25	27	26	52	57	58	58	58	61	58B	30	31	29	30A	49A	44B	43B	39C	39C	28C	39D	42D	60E	55E	61E	66E	18A	19A	62C	35B
85 - 87	23	25	23	47	50	49	53	55	54	49A	28	28	27	26	45A	40A	39A	34B	34B	22B	33C	36C	55D	50D	54D	59D	12	10A	53C	24A
82 - 84	21	22	19	42	43	40	48	49	46	40A	26	26	24	23	41	36A	34A	29B	29B	17B	27C	30C	49D	44D	48D	52D	6	1	43B	12A
79 - 81	19	19	16	36	36	31	43	42	39	31	24	24	21	19	38	32	29	24A	24A	11A	22B	24B	44D	39C	41C	45C	1	-	33B	1
76 - 78	17	17	12	31	29	22	38	36	31	22	23	22	18	16	34	28	25	20A	20A	6A	16B	18B	39C	33C	35C	38C	-	-	23A	-
73 - 75	16	14	9	26	22	13	33	30	23	13	21	20	15	13	30	24	20	15	15	1	10A	12A	34C	28C	28B	31B	-	-	14A	-
70 - 72	14	11	5	20	15	4	28	23	16	4	19	17	13	9	27	20	16	10	10	-	4A	6A	28B	22B	22B	24B	-	-	4A	-
67 - 69	12	9	2	15	8	-	22	17	8	-	17	15	10	6	23	16	11	5	5	-	1	23B	17B	16A	17A	-	-	-	-	-
64 - 66	10	6	-	9	1	-	17	11	1	-	16	13	7	3	19	12	7	1	1	-	-	-	18A	11A	9A	10A	-	-	-	-
61 - 63	8	3	-	4	-	-	12	5	-	-	14	11	4	-	15	8	2	-	-	-	-	-	13A	6A	3A	3A	-	-	-	-
58 - 60	6	1	-	-	-	-	7	-	-	-	12	9	1	-	12	4	-	-	-	-	-	-	7A	1	-	-	-	-	-	-
55 - 57	4	-	-	-	-	-	2	-	-	-	10	6	-	-	8	1	-	-	-	-	-	-	2	-	-	-	-	-	-	-
52 - 54	2	-	-	-	-	-	-	-	-	-	9	4	-	-	4	-	-	-	-	-	-	-	-	-	-	-	-	-	-	-
49 - 51	-	-	-	-	-	-	-	-	-	-	7	2	-	-	1	-	-	-	-	-	-	-	-	-	-	-	-	-	-	-
46 - 48	-	-	-	-	-	-	-	-	-	-	5	-	-	-	-	-	-	-	-	-	-	-	-	-	-	-	-	-	-	-
43 - 45	-	-	-	-	-	-	-	-	-	-	3	-	-	-	-	-	-	-	-	-	-	-	-	-	-	-	-	-	-	-
40 - 42	-	-	-	-	-	-	-	-	-	-	2	-	-	-	-	-	-	-	-	-	-	-	-	-	-	-	-	-	-	-
0 - 39	-	-	-	-	-	-	-	-	-	-	-	-	-	-	-	-	-	-	-	-	-	-	-	-	-	-	-	-	-	-

Fumble Range: 4
 Breakage #: 4
 Reliability: 105

Range Modifiers:
 0m-50m: +10
 51m-750m: +0
 751m-1,500m: -25
 1,501m-7,500m: -50
 7,501m-15,000m: -100

Spectrum Arms
 Pulsar
 LE 13



4.0 BLASTER ATTACK TABLES

INTRODUCTION

This section contains an introduction, a key to the tables, and 13 blaster attack tables.

HOW TO USE THESE TABLES

To resolve an attack, the attacker makes a high open-ended roll. If this roll is within the fumble range of the weapon, then a non open-ended roll is made on the appropriate fumble table. Otherwise, all appropriate modifications (such as skill, range, injuries, bonuses and foe's DB) are added to the roll and the result is cross-indexed on the column appropriate to the foe's armor type.

The table will yield one of three results: a miss (i.e., "-"), a normal hit (e.g., "3"), or a critical strike (e.g., "3A"). A miss is just that, a miss. The attack fails and there are no effects other than the expended energy. In the event of a normal hit, the number is applied as damage to the opponent. In the event of a critical strike, the number is applied as damage to the foe, and a critical is rolled. The critical is resolved on the Blaster Critical Strike Table, with the letter denoting the severity of the critical (read: the column it's rolled on). The effect of the critical is then applied to the opponent.

In the event that the critical result is a severity higher than "E," then the chart below will list the secondary and tertiary criticals applied. Note that these criticals are not rolled separately, the primary roll is merely compared to the charts for the secondary and tertiary effects.

SECONDARY/TERTIARY CRITICALS

Crit Result	Secondary Tertiary
F	A Heat none
G	B Heat none
H	C Heat none
I	D Heat none
J	E Heat none
K	E Heat A Puncture
L	E Heat B Puncture
M	E Heat C Puncture

If these tables are not available, use Burn Through or Scorch Critical Table(s), whichever is more appropriate, for secondary and tertiary criticals.

KEY TO THE TABLES

At the top of each table is a box that contains some information for a typical weapon that uses this table. See Section 8.4 for a more comprehensive listing of weapons and their stats. Each piece of information is listed below, along with a description of its purpose.

- 1) **Attack Table Number:** This is a unique number, which identifies the table.
- 2) **Blaster Energy Indicator:** This indicates the relative aperture energy of the table. The higher the number, the more powerful the weapon.
- 3) **Fumble:** This shows the chance of fumbling the weapon in an attack. If the unmodified roll falls within this range, then the attacker fumbles and must roll on the appropriate column of the fumble table.
- 4) **Breakage #s:** These numbers show how often the weapon should be checked for breakage. Anytime the attacker rolls doubles of the numbers shown (e.g., 11, 22, 33, etc.) the weapon must be checked for breakage.
- 5) **Reliability:** The typical reliability of a weapon of this type. Whenever the breakage numbers indicate a breakage check, an open-ended d100 should be rolled. The reliability of the weapon is then added. If the result is higher than 100, then the weapon functions normally.



Otherwise, the weapon malfunctions and cannot be used until repaired. (If using *Future Law*, the malfunction can be determined using the rules therein).

- 6) **Range Modifiers:** These are the modifiers used when the attacker's target is at a certain range. This shows the range and the modifier applied.
- 7) **Concussion Damage:** This is an example of a result, which only deals concussion damage.
- 8) **Critical Strike:** This is an example of an attack that deals both concussion damage and a critical (of the severity indicated).

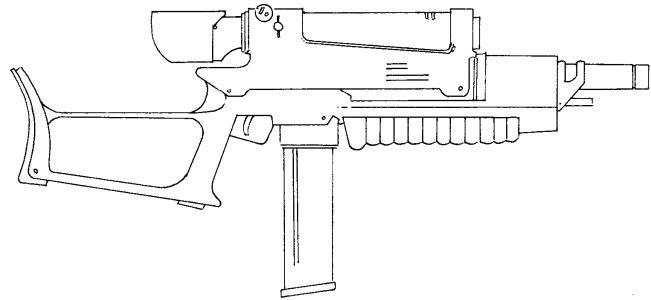

	Combat Armor			Kinetic Armor			Armored Cloth				Plate Armor				Chain Armor				
	X	IX	VIII	VII	VI	V	IV	III	II	I	20	19	18	17	16	15	14	13	12
148 - 150	1A	1B	1C	2A	2B	3C	2A	2B	2B	3C	1B	1C	1C	1C	1C	1C	2C	2C	2C
145 - 147	1A	1B	1C	2A	2B	3C	2A	2B	2B	3C	1B	1C	1C	1C	1C	1C	2C	2C	2C
142 - 144	1A	1B	1C	2A	2B	3C	2A	2B	2B	3C	1B	1C	1C	1C	1C	1C	2C	2C	2C
139 - 141	1A	1B	1C	2A	2B	3C	2A	2B	2B	3C	1B	1C	1C	1C	1C	1C	2C	2C	2C
136 - 138	1A	1B	1B	2A	2B	3B	2A	2B	2B	3C	1B	1C	1C	1C	1C	1C	2C	2C	2C
133 - 135	1A	1B	1B	2A	2B	3B	2A	2B	2B	3C	1B	1C	1C	1C	1C	1C	2C	2C	2C
130 - 132	1A	1A	1B	2A	2A	3B	2A	2A	2A	3C	1A	1C	1C	1C	1C	1C	2C	2C	2C
127 - 129	1	1A	1B	2	2A	3B	2	2A	2A	3B	1A	1B	1B	1C	1C	1C	2C	2C	2C
124 - 126	1	1A	1A	2	2A	3A	2	2A	2A	3B	1A	1B	1B	1B	1B	1B	2C	2C	2B
121 - 123	1	1A	1A	2	2A	2A	2	2A	2A	2B	1A	1B	1B	1B	1B	1B	2B	2B	2B
118 - 120	1	1A	1A	2	2A	2A	2	2A	2A	2B	1A	1B	1B	1B	1B	1B	2B	2B	2B
115 - 117	1	1A	1A	2	2A	2A	2	2	2A	2B	1A	1B	1B	1B	1B	1B	2B	2B	2B
112 - 114	1	1	1	2	2	2	2	2	2	2B	1A	1B	1B	1B	1B	1B	2B	2B	2B
109 - 111	1	1	1	2	2	2	2	2	2	2A	1	1A	1B	1B	1B	1B	2B	2B	2B
106 - 108	1	1	1	1	1	2	2	1	1	2A	1	1A	1A	1B	1B	1B	1B	1B	1B
103 - 105	1	1	1	1	1	2	1	1	1	2A	1	1A	1A	1A	1B	1B	1B	1B	1B
100 - 102	1	1	1	1	1	2	1	1	1	2A	1	1A	1A	1A	1A	1A	1B	1B	1A
97 - 99	1	1	1	1	1	1	1	1	1	1A	1	1A	1A	1A	1A	1A	1A	1B	1A
94 - 96	1	1	1	1	1	1	1	1	1	1A	1	1A	1A	1A	1A	1A	1A	1A	1A
91 - 93	1	1	1	1	1	1	1	1	1	1A	1	1	1A	1A	1A	1A	1A	1A	1A
88 - 90	1	1	1	1	1	1	1	1	1	1	1	1	1A	1A	1A	1A	1A	1A	1A

LIST OF BLASTER ATTACK TABLES

H & K Contender/Harrzit Tock Attack Table BE-4.1

Beretta Nova/Trazzt Tock-ar Attack Table BE-4.2

Spectrum Arms A-4/Prrrl Tock Attack Table BE-4.3

Beretta Commando/Grazzzin Tock Attack Table BE-4.4

H & K X-25/Herrrnick Rrrng Attack Table BE-4.5

Steyr-Klough T-26/Rrrral Rrrng Attack Table BE-4.6

Steyr-Klough Ranger/Farrl Pock Attack Table BE-4.7

Spectrum Arms S-13/Harrfung Tang Attack Table BE-4.8

Steyr-Klough Predator/Kitrrrip Tang Attack Table BE-4.9

Steyr-Klough Violator/Arrrig Tang Attack Table BE-4.10

H & K Annihilator/Hassell Thang Attack Table BE-4.11

H & K Justifier/Garrrrr Thang Attack Table BE-4.12

Apocalypse/Kitock Thang Attack Table BE-4.13

	Combat Armor			Kinetic Armor			Armored Cloth					Plate Armor			Chain Armor			Rigid Leather			Soft Leather			Natural			Clothing				
	X	IX	VIII	VII	VI	V	IV	III	II	I	20	19	18	17	16	15	14	13	12	11	10	9	8	7	6	5	4	3	2	1	
148 - 150	3B	3C	4D	7B	8C	10D	7B	8C	9C	10D	3C	3D	3D	4D	5D	5D	6D	6D	6D	6D	7D	7D	7D	7D	8D	9D	8D	9D	11D	12D	
145 - 147	3B	3C	4D	7B	8C	10D	7B	8C	9C	10D	3C	3D	3D	4D	5D	5D	6D	6D	6D	6D	7D	7D	7D	7D	8D	9D	8D	9D	11D	12D	
142 - 144	3B	3C	4D	7B	8C	10D	7B	8C	9C	10D	3C	3D	3D	4D	5D	5D	6D	6D	6D	6D	7D	7D	7D	7D	8D	9D	8D	9D	11D	11D	
139 - 141	3B	3C	4C	7B	8C	9C	7B	8C	8C	9D	3C	3D	3D	4D	5D	5D	6D	6D	6D	6D	7D	7D	7D	7D	8D	7D	8D	10D	11D	11D	
136 - 138	3A	3B	4C	6A	7B	9C	7A	7B	8B	9D	3B	3D	3D	4D	5D	5D	6D	6D	6D	6D	7D	7D	7D	7D	8D	7D	8D	10D	10D	10D	
133 - 135	3A	3B	4C	6A	7B	8C	6A	7B	8B	8C	3B	3C	3D	4D	5D	5D	6D	6D	6D	6D	7D	7D	7D	7D	8D	7C	7C	9C	9C	10D	
130 - 132	3A	3B	4B	6A	7B	8B	6A	7B	8B	8C	3B	3C	3C	4C	5C	5C	6D	6D	6D	6D	7D	7D	7D	7D	8D	6C	7C	9C	9C	9C	
127 - 129	3	3B	3B	6	6B	8B	6	6A	7B	8C	3B	3C	3C	3C	4C	4C	5C	5C	5C	5C	6C	6C	6C	6C	7C	6C	6C	8C	8C	9C	
124 - 126	3	3A	3B	5	6A	7B	6	6A	7A	7C	3A	3C	3C	3C	4C	4C	5C	5C	5C	5C	6C	6C	6C	6C	7C	5C	6C	8C	8C	8C	
121 - 123	3	3A	3A	5	6A	7A	5	6A	6A	7C	3A	3C	3C	3C	4C	4C	5C	5C	5C	5C	6C	6C	6C	6C	7C	5C	6C	7C	7C	7C	
118 - 120	3	2A	3A	5	5A	6A	5	6A	6A	6B	3A	3B	2C	3C	4C	4C	4C	4C	4C	4C	5C	5C	5C	6C	6C	5B	5B	7C	7C	7C	
115 - 117	2	2A	3A	5	5A	6A	5	6A	6A	6B	3A	2B	2B	3C	4C	4C	4C	4C	4C	4C	5C	5C	5C	6C	6C	4B	5B	7C	7C	6B	
112 - 114	2	2	3	4	5	6	5	5	5	6B	2A	2B	2B	3B	4B	3B	4C	4C	4C	4C	5C	5C	5C	6C	6C	4B	4B	6B	6B	6B	
109 - 111	2	2	2	4	5	5	4	5	5	5B	2	2B	2B	3B	4B	3B	4B	4B	4B	4B	5C	5C	5C	6C	6C	4B	4B	6B	6B	5B	
106 - 108	2	2	2	4	4	5	4	4	5	5B	2	2A	2B	2B	3B	3B	3B	3B	3B	3B	4B	4B	4B	4B	5B	3A	3B	5B	5B	5B	
103 - 105	2	2	2	4	4	4	4	4	4	4A	2	2A	2B	2B	3B	3B	3B	3B	3B	3B	4B	4B	4B	4B	5B	3A	3A	5B	5B	4B	
100 - 102	2	2	2	3	4	4	4	4	4	4A	2	2A	2A	2B	3B	3B	3B	3B	3B	3B	4B	4B	4B	4B	5B	2A	2A	4B	4B	3A	
97 - 99	2	2	2	3	3	4	3	4	4	4A	2	2A	2A	2A	3B	3B	3B	3B	3A	2A	2B	3B	3B	4B	4B	2A	2A	4B	4B	3A	
94 - 96	2	2	2	3	3	3	3	3	3	3A	2	2A	2A	2A	3A	2A	3B	2B	2A	2A	2B	3B	3B	4B	4B	2A	2A	4B	4B	3A	
91 - 93	2	1	2	3	3	3	3	3	3	3A	2	2	2A	2A	2A	2A	2A	2B	2A	2A	2B	3B	3B	4B	4B	1	1A	3A	3A	2A	
88 - 90	2	1	1	2	2	2	3	3	3	3	2	2	2	2A	2A	2A	2A	2A	2A	1A	2A	2A	3B	3B	3A	1	1	3A	1A	1A	
85 - 87	1	1	1	2	2	2	3	2	2	2	2	2	2	1	1A	2A	2A	2A	2A	1A	1A	1A	2A	2A	3A	1	1	2A	1	1	
82 - 84	1	1	1	2	2	2	2	2	2	2	2	1	1	1	1A	2A	2A	2A	1A	1A	1A	1A	2A	2A	2A	1	1	2A	1	1	
79 - 81	1	1	1	2	2	2	2	2	2	2	2	1	1	1	1A	2A	2A	2A	1A	1	1A	1A	2A	2A	2A	1	1	2A	1	1	
76 - 78	1	1	1	1	1	1	2	2	1	1	1	1	1	1	1	1A	1A	1A	1	1	1A	1A	2A	2A	2A	1	1	2A	1	1	
73 - 75	1	1	1	1	1	1	2	1	1	1	1	1	1	1	1	1	1A	1A	1	1	1	1	2A	1A	1A	1	1	2A	1	1	
70 - 72	1	1	1	1	1	1	1	1	1	1	1	1	1	1	1	1	1	1	1	1	1	1A	1A	1A	1A	1	1	1A	1	1	
67 - 69	1	1	1	1	1	1	1	1	1	1	1	1	1	1	1	1	1	1	1	1	1	1A	1A	1A	1	1	1	1	1	1	
64 - 66	1	1	1	1	1	1	1	1	1	1	1	1	1	1	1	1	1	1	1	1	1	1A	1	1	1	1	1	1	1	1	
61 - 63	1	1	1	1	1	1	1	1	1	1	1	1	1	1	1	1	1	1	1	1	1	1	1	1	1	1	1	1	1	1	1
58 - 60	1	1	1	1	1	1	1	1	1	1	1	1	1	1	1	1	1	1	1	1	1	1	1	1	1	1	1	1	1	1	1
55 - 57	1	1	1	1	1	1	1	1	1	1	1	1	1	1	1	1	1	1	1	1	1	1	1	1	1	1	1	1	1	1	1
52 - 54	1	1	1	1	1	1	1	1	1	1	1	1	1	1	1	1	1	1	1	1	1	1	1	1	1	1	1	1	1	1	1
49 - 51	1	1	1	1	1	1	1	1	1	1	1	1	1	1	1	1	1	1	1	1	1	1	1	1	1	1	1	1	1	1	1
46 - 48	1	1	1	1	1	1	1	1	1	1	1	1	1	1	1	1	1	1	1	1	1	1	1	1	1	1	1	1	1	1	1
43 - 45	1	1	1	1	1	1	1	1	1	1	1	1	1	1	1	1	1	1	1	1	1	1	1	1	1	1	1	1	1	1	1
0 - 42	1	1	1	1	1	1	1	1	1	1	1	1	1	1	1	1	1	1	1	1	1	1	1	1	1	1	1	1	1	1	1

Fumble Range:	3	Range Modifiers:	0m-3m: +10
Breakage #s:	7		4m-5m: +0
Reliability:	55		6m-8m: -25
			9m-13m: -50
			14m-35m: -100
Beretta			
Nova			
BE 2			

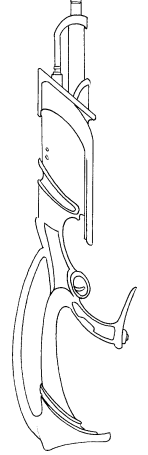
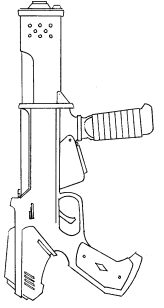

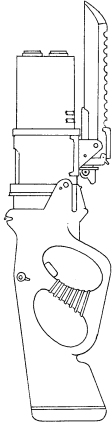
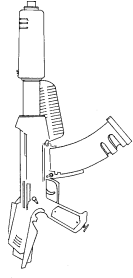

	Combat Armor			Kinetic Armor			Armored Cloth			Plate Armor			Chain Armor			Rigid Leather			Soft Leather			Natural			Clothing					
	X	IX	VIII	VII	VI	V	IV	III	II	I	20	19	18	17	16	15	14	13	12	11	10	9	8	7	6	5	4	3	2	1
148 - 150	7C	8D	10E	17C	21D	25E	17C	19D	22D	25E	7D	8E	9E	10E	13E	14E	14E	14E	14E	16E	17E	17E	17E	18E	19E	14E	21E	27E	28E	
145 - 147	7C	8D	10E	17C	21D	24E	17C	19D	22D	24E	7D	8E	9E	10E	13E	14E	14E	14E	14E	16E	17E	17E	17E	18E	19E	14E	20E	26E	27E	
142 - 144	7C	8D	10E	16C	20D	23E	16C	18D	21D	23E	7D	8E	9E	10E	13E	13E	13E	13E	13E	15E	16E	16E	17E	18E	13E	19E	25E	26E		
139 - 141	7B	8C	9D	16B	19C	22D	16B	17C	20C	22E	7C	8E	9E	9E	12E	13E	13E	13E	13E	15E	15E	16E	17E	17E	13E	18E	24E	25E		
136 - 138	7B	7C	9D	15B	17C	19C	15B	17C	19C	21D	7C	7D	8E	9E	12E	12E	12E	12E	12E	14E	15E	15E	16E	17E	13E	17D	23E	23E		
133 - 135	6A	7C	9C	14A	18C	20C	15A	16C	18C	20D	6C	7D	8D	9D	11D	11D	11D	11D	11D	13D	14D	15E	16E	17E	11D	16D	22D	22D		
130 - 132	6A	7B	8C	14A	17B	19C	14A	15B	17B	19D	6B	7D	8D	8D	11D	11D	11D	11D	11D	13D	13D	14D	15D	15D	11D	15D	21D	21D		
127 - 129	6	7B	8B	13	16B	18B	13	15B	17B	18D	6B	7D	7D	8D	10D	10D	11D	11D	10D	12D	13D	13D	14D	15D	10D	14D	20D	19D		
124 - 126	6	6B	7B	13	15B	17B	13	14A	16B	17C	6B	6C	7D	8D	10D	10D	10D	10D	10D	11D	12D	13D	13D	14D	9C	13C	19D	18D		
121 - 123	5	6A	7B	12	14A	16B	12	13A	15A	16C	6A	6C	7C	7C	10D	10D	10D	10D	10D	9D	11D	12D	13D	13D	9C	12C	18D	17C		
118 - 120	5	6A	7A	11	14A	15A	12	13A	14A	15A	5A	6C	6C	7C	9C	9C	9C	9C	9C	8C	10C	11C	12D	13D	8C	11C	17C	15C		
115 - 117	5	5A	6A	11	13A	14A	11	12	13A	14C	5A	6C	6C	6C	9C	9C	9C	9C	9C	8C	9C	10C	11C	12C	7C	10C	15C	14C		
112 - 114	5	5	6	10	12	13	11	11	12	13B	5A	5B	6C	6C	8C	8C	8C	8C	8C	7C	9C	9C	10C	11C	7B	9B	14C	13C		
109 - 111	5	5	5	10	11	12	10	11	12	12B	5	5B	5B	6C	8C	8C	8C	8C	8C	7C	8C	9C	10C	10C	11C	6B	8B	13C	11B	
106 - 108	4	5	5	9	10	11	9	10	11	11B	5	5B	5B	5B	7B	7C	7C	7C	7C	6B	8C	8C	9C	9C	10C	5B	7B	12C	10B	
103 - 105	4	4	5	8	10	10	9	9	10	10B	4	5A	5B	5B	7B	7B	7C	7C	7B	5B	7B	7B	8C	9C	5A	6B	11B	9B		
100 - 102	4	4	4	8	9	9	8	9	9	9A	4	4A	4B	5B	7B	6B	6B	6B	6B	5B	6B	7B	8C	8B	4A	5A	10B	7B		
97 - 99	4	4	4	7	8	8	8	8	8	8A	4	4A	4A	4B	6B	6B	6B	6B	6B	4B	6B	7B	8C	7B	3A	4A	9B	6A		
94 - 96	3	3	3	7	7	7	7	7	7	7A	4	4A	4A	4A	6B	6B	5B	5B	5B	4B	5B	7B	7B	7B	3A	3A	8B	5A		
91 - 93	3	3	3	6	6	6	7	7	7	7A	4	4	4A	4A	5A	5B	4B	4B	4A	3A	4B	5B	7B	6B	2	2A	7A	4A		
88 - 90	3	3	3	5	6	5	6	6	6	6	3	3	3A	3A	5A	4A	4A	4A	2A	4A	4A	4A	6B	5B	6B	1	6A	2A		
85 - 87	3	3	2	5	5	4	5	5	5	4	3	3	3	3A	4A	4A	3A	3A	2A	3A	3A	3A	5B	5B	5B	1	5A	1		
82 - 84	3	2	2	4	4	3	5	5	4	3	3	3	3	2A	4A	4A	3A	3A	1A	2A	3A	5B	4B	4A	4A	-	3A	-		
79 - 81	2	2	2	4	3	2	4	4	4	3	2	3	2	2	4A	3A	2A	2A	2	1	2A	4A	4A	4A	4A	-	2A	-		
76 - 78	2	2	1	3	2	1	4	3	2	1	3	2	2	2	3	2A	2A	2	-	1A	1A	4A	3A	3A	3A	-	1	-		
73 - 75	2	1	1	2	2	-	3	3	2	-	2	2	2	1	3	2	2	1A	-	1	1	3A	2A	2A	2A	-	-	-		
70 - 72	2	1	-	2	1	-	3	2	1	-	2	2	1	1	2	1	1	1	-	-	-	3A	2A	2A	2A	-	-	-		
67 - 69	1	1	-	1	-	-	2	1	-	-	2	2	1	1	2	1	-	-	-	-	-	2A	1A	1	1	-	-	-		
64 - 66	1	1	-	1	-	-	1	1	-	-	2	1	1	-	1	1	-	-	-	-	-	1A	1	-	-	-	-	-		
61 - 63	1	-	-	-	-	-	1	-	-	-	2	1	-	-	1	1	-	-	-	-	-	1	-	-	-	-	-	-		
58 - 60	1	-	-	-	-	-	-	-	-	-	1	1	-	-	1	-	-	-	-	-	-	-	-	-	-	-	-	-		
55 - 57	1	-	-	-	-	-	-	-	-	-	1	1	-	-	-	-	-	-	-	-	-	-	-	-	-	-	-	-		
52 - 54	-	-	-	-	-	-	-	-	-	-	1	1	-	-	-	-	-	-	-	-	-	-	-	-	-	-	-	-		
49 - 51	-	-	-	-	-	-	-	-	-	-	1	-	-	-	-	-	-	-	-	-	-	-	-	-	-	-	-	-		
46 - 48	-	-	-	-	-	-	-	-	-	-	1	-	-	-	-	-	-	-	-	-	-	-	-	-	-	-	-	-		
43 - 45	-	-	-	-	-	-	-	-	-	-	1	-	-	-	-	-	-	-	-	-	-	-	-	-	-	-	-	-		
0 - 42	-	-	-	-	-	-	-	-	-	-	-	-	-	-	-	-	-	-	-	-	-	-	-	-	-	-	-	-		

Fumble Range: 3
Breakage #s: 7
Reliability: 55

Range Modifiers:
 0m-1m: +10
 2m-10m: +0
 11m-20m: -25
 21m-50m: -50
 51m-100m: -100

Spectrum
Arms A-4
BE 3

	Combat Armor		Kinetic Armor				Armored Cloth				Plate Armor				Chain Armor				Rigid Leather				Soft Leather				Natural				Clothing	
	X	IX	VIII	VII	VI	V	IV	III	II	I	20	19	18	17	16	15	14	13	12	11	10	9	8	7	6	5	4	3	2	1		
148 - 150	11C	13D	16E	26C	33D	40E	26C	31D	35D	40E	11D	12E	14E	16E	20E	22E	22E	22E	22E	22E	27E	27E	27E	31E	33E	22E	33E	42E	44E			
145 - 147	11C	13D	16E	26C	32D	39E	26C	30D	34D	39E	11D	12E	14E	16E	20E	22E	22E	22E	22E	22E	26E	27E	27E	30E	32E	21E	32E	41E	42E			
142 - 144	11C	13D	15E	25C	31D	37E	25C	29D	33D	37E	11D	12E	14E	15E	19E	21E	21E	21E	21E	21E	25E	26E	26E	29E	31E	20E	30E	39E	40E			
139 - 141	10B	12C	15D	24B	30C	36D	24B	28C	32C	36E	11C	11E	13E	15E	19E	20E	20E	20E	20E	20E	24E	25E	25E	28E	30E	19E	29E	37E	38E			
136 - 138	10B	12C	14D	23B	28C	34D	23B	27C	30C	34D	10C	11D	13E	14E	18E	19E	19E	19E	19E	19E	23E	24E	24E	27E	29E	18D	27D	36E	36E			
133 - 135	10A	11C	13C	22A	27C	32C	22A	26B	29C	32D	10C	11D	12D	14D	17D	19D	18E	18E	18E	18E	20D	22D	23E	26E	28E	17D	25D	34D	34D			
130 - 132	9A	11B	13C	21A	26B	31C	21A	25B	28B	31D	10B	10D	12D	13D	17D	18D	18D	17D	17D	17D	19D	22D	22D	25D	26D	16D	24D	32D	32D			
127 - 129	9	10B	12B	20	25B	29B	20	24B	26B	29D	9B	10D	11D	12D	16D	17D	17D	17D	17D	18D	20D	21D	21D	24D	25D	15D	22D	31D	30D			
124 - 126	9	10B	12B	19	23B	28B	19	23A	25B	28C	9B	9C	11D	12D	15D	16D	16D	16D	16D	16D	17D	20D	20D	23D	24D	14C	21C	29D	28D			
121 - 123	8	9A	11B	18	22A	26B	19	22A	24A	26C	9A	9C	10C	11C	15D	16D	15D	15D	15D	15D	18D	19D	19D	21D	23D	13C	19C	27D	26C			
118 - 120	8	9A	10A	17	21A	24A	18	20A	22A	24C	8A	9C	10C	11C	14C	15C	14D	14D	14D	14D	17C	18D	18D	20D	22D	12C	17C	25C	24C			
115 - 117	8	8A	10A	16	20A	23A	17	19	21A	23C	8A	8C	9C	10C	13C	14C	13C	13C	13C	13C	15C	17C	17D	19C	20C	11C	16C	24C	22C			
112 - 114	7	8	9	15	18	21	16	18	20	21B	8A	8B	9C	9C	13C	13C	12C	12C	12C	12C	15C	17C	17C	18C	19C	10B	14B	22C	20C			
109 - 111	7	8	8	14	17	19	15	17	18	19B	7	8B	8B	9C	12C	13C	12C	12C	12C	12C	14C	16C	16C	17C	18C	9B	12B	20C	18B			
106 - 108	7	7	8	13	16	18	14	16	17	18B	7	7B	8B	8B	11B	12C	11C	11C	11B	11B	13C	15C	15C	16C	17C	8B	11B	19C	16B			
103 - 105	6	7	7	13	15	16	13	15	16	16B	7	7A	7B	8B	11B	11B	11B	10C	10B	10B	12B	14C	13C	15C	16C	7A	9B	17B	14B			
100 - 102	6	6	7	12	13	15	12	14	14	15A	6	6A	7B	7B	10B	10B	10B	9B	9B	7B	9B	10B	13C	12C	14B	6A	8A	15B	11B			
97 - 99	5	6	6	11	12	13	12	13	13	13A	6	6A	6A	6B	9B	10B	9B	8B	8B	6B	8B	9B	12C	11B	12B	5A	6A	14B	9A			
94 - 96	5	5	5	10	11	11	11	12	12	11A	6	6A	6A	6A	9B	9B	8B	7B	7B	6B	8B	11B	10B	11B	12B	4A	4A	12B	7A			
91 - 93	5	5	5	9	10	10	10	10	10	10A	6	5	5A	5A	8A	8A	7B	7B	7A	5A	6B	7B	10B	9B	10B	3	3A	10A	5A			
88 - 90	4	4	4	8	8	8	9	9	9	8	5	5A	5A	5A	7A	7A	6B	6B	6A	4A	5A	6A	9B	8B	9B	2	1	8A	3A			
85 - 87	4	4	3	7	7	6	8	8	8	6	5	5	4	4A	7A	7A	6A	5A	5A	3A	4A	5A	8B	7B	8B	1	-	7A	1			
82 - 84	4	3	3	6	6	5	7	7	6	5	5	4	4	3A	6A	6A	5A	4A	4A	2A	3A	4A	7B	7B	7A	-	-	5A	-			
79 - 81	3	3	2	5	5	3	6	6	6	5	4	4	3	3	5A	5A	4A	3A	3	1	2A	3A	7A	6A	6A	-	-	3A	-			
76 - 78	3	2	2	4	3	2	5	5	4	2	4	3	3	2	5	4	3A	2A	2	-	1A	2A	6A	5A	5A	-	-	2	-			
73 - 75	3	2	1	3	2	-	5	4	2	-	4	3	2	2	4	4	3	2A	2	-	1	1	5A	4A	3A	4A	-	-	-	-		
70 - 72	2	2	-	2	1	-	4	3	1	-	3	3	2	1	3	3	2	1	1	-	-	4A	3A	2A	2A	-	-	-	-	-		
67 - 69	2	1	-	1	-	-	3	2	-	-	3	2	1	1	3	2	1	-	-	-	-	3A	2A	1	1	-	-	-	-	-		
64 - 66	2	1	-	1	-	-	2	1	-	-	3	2	1	-	2	1	-	-	-	-	-	2A	1	-	-	-	-	-	-	-		
61 - 63	1	-	-	-	-	-	1	-	-	-	2	2	-	-	1	1	-	-	-	-	-	1	-	-	-	-	-	-	-	-		
58 - 60	1	-	-	-	-	-	-	-	-	-	2	1	-	-	1	-	-	-	-	-	-	-	-	-	-	-	-	-	-	-		
55 - 57	1	-	-	-	-	-	-	-	-	-	2	1	-	-	-	-	-	-	-	-	-	-	-	-	-	-	-	-	-	-		
52 - 54	-	-	-	-	-	-	-	-	-	-	1	1	-	-	-	-	-	-	-	-	-	-	-	-	-	-	-	-	-	-		
49 - 51	-	-	-	-	-	-	-	-	-	-	1	-	-	-	-	-	-	-	-	-	-	-	-	-	-	-	-	-	-	-		
46 - 48	-	-	-	-	-	-	-	-	-	-	1	-	-	-	-	-	-	-	-	-	-	-	-	-	-	-	-	-	-	-		
43 - 45	-	-	-	-	-	-	-	-	-	-	1	-	-	-	-	-	-	-	-	-	-	-	-	-	-	-	-	-	-	-		
0 - 42	-	-	-	-	-	-	-	-	-	-	-	-	-	-	-	-	-	-	-	-	-	-	-	-	-	-	-	-	-	-		

Fumble Range:	3	Range Modifiers:	0m-3m: +10
Breakage #s:	5		4m-5m: +0
Reliability:	75		6m-8m: -25
			9m-13m: -50
			14m-35m: -100
Beretta			
Commando			
BE 4			

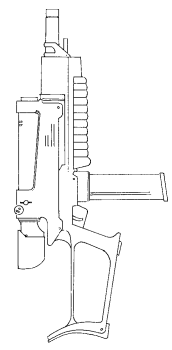
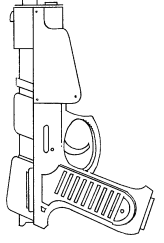

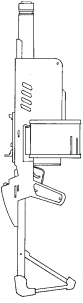
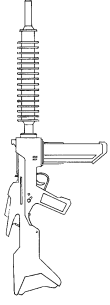

	Combat Armor		Kinetic Armor				Armored Cloth				Plate Armor				Chain Armor				Rigid Leather				Soft Leather				Natural				Clothing	
	X	IX	VIII	VII	VI	V	IV	III	II	I	20	19	18	17	16	15	14	13	12	11	10	9	8	7	6	5	4	3	2	1		
148 - 150	15D	18E	22F	22D	45E	54F	36D	42E	48E	54F	15E	17F	20F	22F	28F	30F	30F	30F	31F	35F	36F	37F	37F	42F	46F	31F	46F	57F	60F			
145 - 147	15D	18E	22F	22D	44E	52F	35D	41E	47E	52F	15E	17F	20F	22F	28F	29F	29F	29F	29F	30F	34F	35F	36F	41F	45F	30F	44F	55F	58F			
142 - 144	15C	17E	21E	21C	42E	50E	34C	39E	45E	50F	15E	16F	19F	21F	27F	28F	28F	28F	28F	28F	29F	33F	34F	35F	39F	29F	42F	53F	55F			
139 - 141	14C	17D	20E	20C	40D	48E	33C	38D	43D	48F	14D	16F	18F	20F	26F	27F	27F	27F	27F	27F	31F	32F	34F	38F	42F	27F	40F	51F	52F			
136 - 138	14B	16D	19D	19B	39D	46D	32B	36D	41D	46E	14D	15E	18E	19E	25E	26E	26F	28F	26E	26E	30F	31F	33F	32F	36F	40F	26E	37E	48E	49E		
133 - 135	13A	15C	18D	19A	37C	44D	30A	35C	39C	44E	13C	15E	17E	18E	24E	25E	25E	25E	25E	25E	28E	29E	31E	31E	35E	24E	35E	46E	46E			
130 - 132	13A	15C	17C	18A	35C	41C	29A	33C	38C	41E	13C	14E	16E	18E	23E	24E	24E	24E	24E	24E	27E	28E	30E	30E	33E	23E	33E	44E	44E			
127 - 129	12	14B	16C	17	34B	39C	28	32B	36B	39D	12C	14D	16D	17E	22E	23E	23E	23E	23E	23E	26E	27E	29E	28E	32E	21D	31D	41E	41D			
124 - 126	12	13B	16B	16	32B	37B	27	30B	34B	37D	12B	13D	15D	16D	21D	22D	22E	21E	21D	21D	24E	25E	28E	27E	30E	20D	28D	39D	38D			
121 - 123	11	13A	15B	15	30A	35B	26	29A	32B	35D	12B	13D	14D	15D	20D	21D	20D	20D	20D	20D	23D	24D	26E	26E	29D	18D	26D	37D	35D			
118 - 120	11	12A	14A	15	28A	33A	24	27A	30A	33C	11A	12C	14D	14D	19D	20D	20D	19D	19D	18D	21D	22D	25D	24D	27D	17C	24C	34D	32D			
115 - 117	10	12A	13A	14	27A	30A	23	26	28A	30C	11A	12C	13C	14D	18D	19D	19D	18D	18D	17D	20D	21D	24D	23D	26D	16C	22C	32D	30C			
112 - 114	10	11	12	13	25	28	22	24	27	28C	10A	11C	12C	13C	17C	18C	17D	17D	17C	16C	19D	19D	23D	22D	24D	14C	19C	30C	27C			
109 - 111	9	10	11	12	23	26	21	23	25	26B	10	11B	11C	12C	16C	17C	16C	16C	16C	14C	17C	18C	21D	21D	23D	13B	17B	27C	24C			
106 - 108	9	10	10	11	22	24	20	21	23	24B	9	10B	11B	11C	16C	16C	15C	15C	15C	13C	16C	17C	20D	19C	21C	11B	15B	25C	21B			
103 - 105	8	9	10	11	20	22	18	20	21	22B	9	10B	10B	10B	14C	15C	14C	13C	13C	12C	14C	15C	19C	18C	20C	10B	13B	23C	18B			
100 - 102	8	8	9	10	18	19	17	18	19	19B	9	9A	9B	9B	15B	14B	13C	12C	12B	10B	13C	14C	18C	17C	18C	8A	10B	21B	15B			
97 - 99	7	8	8	9	16	17	16	17	18	17A	8	8A	9A	9B	13B	13B	12B	11C	11B	9B	12B	12B	16C	15C	17C	7A	8A	18B	13B			
94 - 96	7	7	7	8	15	15	15	15	16	15A	8	8A	8A	8B	12B	12B	11B	10B	10B	8B	10B	11B	15C	14C	15B	5A	6A	16B	10A			
91 - 93	6	6	6	8	13	13	13	14	14	13A	7	7A	7A	7A	11B	11B	10B	9B	9A	6A	9B	9B	14C	13B	14B	4	4A	14B	7A			
88 - 90	6	6	5	7	11	11	12	12	12	11	7	7A	7A	6A	10A	10A	9B	8B	8A	5A	7B	8B	13B	11B	12B	2	1	11A	4A			
85 - 87	5	5	4	6	10	9	11	11	10	9	6	6	6	5A	9A	9A	8A	7B	7A	4A	6A	7A	11B	10B	11B	1	-	9A	1			
82 - 84	5	5	4	5	8	6	10	9	8	6	6	6	5	5A	8A	8A	7A	5A	5A	2A	5A	5A	10B	9B	9B	10B	-	7A	-			
79 - 81	4	4	3	4	6	4	4	6	7	4	6	5	4	4	7A	7A	6A	4A	4	1	3A	4A	9B	7B	8A	8A	-	4A	-			
76 - 78	4	3	2	4	4	2	7	6	5	2	5	5	4	3	6	6	4A	3A	3	-	2A	2A	8A	6A	6A	7A	-	2	-			
73 - 75	3	3	1	3	3	-	6	5	3	-	5	4	3	2	5	5	3	2A	2	-	1	1	6A	5A	5A	-	-	-	-			
70 - 72	3	2	-	2	1	-	5	3	1	-	4	4	2	1	4	4	2	1	1	-	-	-	5A	4A	3A	3A	-	-	-			
67 - 69	2	1	-	1	-	-	4	2	-	-	4	3	2	1	4	3	1	-	-	-	-	-	4A	2A	2	2	-	-	-			
64 - 66	2	1	-	1	-	-	3	1	-	-	3	3	1	-	3	2	-	-	-	-	-	-	3A	1	-	-	-	-	-			
61 - 63	1	-	-	-	-	-	1	-	-	-	3	2	-	-	2	1	-	-	-	-	-	-	1	-	-	-	-	-	-			
58 - 60	1	-	-	-	-	-	-	-	-	-	3	2	-	-	1	-	-	-	-	-	-	-	-	-	-	-	-	-	-			
55 - 57	1	-	-	-	-	-	-	-	-	-	2	1	-	-	-	-	-	-	-	-	-	-	-	-	-	-	-	-	-			
52 - 54	-	-	-	-	-	-	-	-	-	-	2	1	-	-	-	-	-	-	-	-	-	-	-	-	-	-	-	-	-			
49 - 51	-	-	-	-	-	-	-	-	-	-	1	-	-	-	-	-	-	-	-	-	-	-	-	-	-	-	-	-	-			
46 - 48	-	-	-	-	-	-	-	-	-	-	1	-	-	-	-	-	-	-	-	-	-	-	-	-	-	-	-	-	-			
43 - 45	-	-	-	-	-	-	-	-	-	-	1	-	-	-	-	-	-	-	-	-	-	-	-	-	-	-	-	-	-			
0 - 42	-	-	-	-	-	-	-	-	-	-	-	-	-	-	-	-	-	-	-	-	-	-	-	-	-	-	-	-	-			

Fumble Range: 3
Breakage #s: 7
Reliability: 85

Range Modifiers:
0m-1m: +10
2m-11m: +0
12m-22m: -25
23m-110m: -50
111m-220m: -100

H & K
X-25

BE 5

	Combat Armor		Kinetic Armor			Armored Cloth			Plate Armor			Chain Armor			Rigid Leather			Soft Leather			Natural			Clothing						
	X	IX	VIII	VII	VI	V	IV	III	II	I	20	19	18	17	16	15	14	13	12	11	10	9	8	7	6	5	4	3	2	1
148 - 150	19E	23F	28G	46E	57F	68G	46E	53F	61F	68G	19F	22G	25G	28G	35G	38G	38G	38G	39G	44G	46G	47G	47G	54G	58G	39G	58G	72G	76G	
145 - 147	19E	23F	27G	45E	55F	66G	45E	52F	59F	66G	19F	22G	25G	27G	34G	34G	37G	37G	38G	43G	45G	46G	46G	53G	56G	38G	56G	70G	73G	
142 - 144	18D	22E	26F	43D	50E	57E	43D	50E	57E	63G	18E	21G	24G	26G	33G	33G	36G	36G	36G	41G	43G	44G	44G	51G	54G	36G	53G	67G	69G	
139 - 141	18C	21E	25F	42C	48E	55E	42C	48E	55E	60F	18E	20F	23F	25G	32G	32G	34G	34G	34G	34G	39G	41G	43G	43G	49G	52G	34F	50F	64G	66F
136 - 138	17B	20D	24E	40B	46D	52D	40B	46D	52D	57F	17D	20F	22F	24F	31F	31F	33F	33F	33F	37F	39F	41G	41G	47F	50F	32F	47F	61F	62F	
133 - 135	16B	19D	23D	38B	47D	55D	39B	44D	50D	55F	17D	19F	21F	22F	29F	30F	32F	31F	31F	36F	37F	40F	39F	45F	48F	30F	44F	58F	59F	
130 - 132	16A	19C	22D	37A	45C	52D	37A	42C	48C	52E	17D	18E	20E	22F	29F	28F	30F	30F	30F	34F	36F	38F	38F	43F	46F	29E	41E	55F	55E	
127 - 129	15	18C	21C	35	42C	49C	36	40B	45C	49E	16C	18E	19E	21E	27E	27E	29E	28E	28E	32F	34F	36F	36F	41F	44F	27E	39E	52E	52E	
124 - 126	15	17B	20C	33	40B	46C	34	38B	43B	46E	15B	17D	19E	20E	26E	26E	28E	27E	27E	26E	30E	32E	35F	34E	39E	42E	25D	36E	49E	48E
121 - 123	14	16B	19B	32	38B	44B	33	36A	41B	44D	15B	16D	18D	19E	25E	25E	26E	26E	26E	24E	29E	30E	33E	33E	37E	40E	23D	33D	46E	44D
118 - 120	13	15A	18A	30	36A	41A	31	35A	38A	41D	14A	16D	17D	18D	24D	24E	25E	24E	24D	23D	27E	28E	32E	31E	35E	38E	21D	30D	43E	41D
115 - 117	13	15A	16A	28	34A	38A	29	33	36A	38D	14A	15C	16D	17D	23D	22D	23D	23D	23D	21D	25D	27D	30E	29E	33E	35E	19C	27D	40D	37D
112 - 114	12	14	15	27	32	35	28	31	34	35C	13A	14C	15C	16D	22D	21D	22D	21D	21D	19D	23D	25D	28E	28D	31D	33D	18C	24C	37D	34C
109 - 111	12	13	14	25	29	33	26	29	31	33C	12	14C	14C	15C	20D	20D	21D	20D	20C	18C	22D	23D	27D	26D	29D	31D	16C	21C	35D	30C
106 - 108	11	12	13	23	27	30	25	27	29	30B	12	13B	13C	14C	19C	19C	19C	18D	18C	16C	20D	21D	25D	24D	27D	29D	14B	19B	32C	27C
103 - 105	10	11	12	22	25	27	23	25	27	27B	11	12B	12B	13C	18C	18C	18C	17C	17C	14C	18C	19C	24D	23D	25D	27D	12B	16B	29C	23B
100 - 102	10	11	11	20	23	24	22	23	24	24B	11	11A	12B	12B	17C	16C	17C	15C	15C	13C	16C	17C	22D	21C	23C	25C	10A	13B	26C	19B
97 - 99	9	10	10	19	21	22	20	21	22	22A	10	11A	11B	11B	16B	15B	15C	14C	14B	11B	15C	16C	21C	19C	21C	23C	8A	10A	23B	16B
94 - 96	8	9	9	17	19	19	19	19	20	19A	10	10A	10A	10B	15B	14B	14B	13C	13B	9B	13B	14B	19C	18C	19C	21C	7A	7A	20B	12A
91 - 93	8	8	8	15	16	16	17	18	17	16A	9	9	9A	9B	14B	13B	12B	11B	11B	8B	11B	12B	17C	16C	17C	19C	5	4A	17B	9A
88 - 90	7	7	7	14	14	13	15	16	15	13	9	9	9A	8A	12A	12B	11B	10B	10A	6A	9B	10B	16C	14B	15B	17B	3	1	14B	5A
85 - 87	7	6	6	12	12	11	14	14	13	11	8	8	7	7A	11A	10A	10A	8B	8A	4A	8B	8B	14B	13B	14B	14B	1	-	11A	2
82 - 84	6	6	4	10	10	8	12	12	11	8	8	7	6	6A	10A	9A	8A	7A	7A	3A	6A	7A	13B	11B	12B	12B	-	-	8A	-
79 - 81	5	5	3	9	8	5	11	10	8	5	7	7	5	5	9A	8A	7A	5A	5	1	4A	5A	11B	9B	10A	10A	-	-	5A	-
76 - 78	5	4	2	7	6	2	9	8	6	2	6	6	5	4	8	7	6A	4A	4	-	2A	3A	9B	8A	8A	8A	-	-	2	-
73 - 75	4	3	1	5	3	-	8	6	4	-	6	5	4	3	7	6	4	2A	2	-	1	1	8A	6A	6A	6A	-	-	-	-
70 - 72	4	2	-	4	1	-	6	4	1	-	5	5	3	2	5	4	3	1	1	-	-	-	6A	4A	4A	4A	-	-	-	-
67 - 69	3	2	-	2	-	2	5	2	-	5	5	4	2	1	4	3	1	-	-	-	-	-	5A	3A	2	2	-	-	-	-
64 - 66	2	1	-	1	-	-	3	1	-	4	4	3	1	-	3	2	-	-	-	-	-	-	3A	1	-	-	-	-	-	-
61 - 63	2	-	-	-	-	-	2	-	-	-	4	3	-	-	2	1	-	-	-	-	-	-	2	-	-	-	-	-	-	-
58 - 60	1	-	-	-	-	-	-	-	-	-	3	2	-	-	1	-	-	-	-	-	-	-	-	-	-	-	-	-	-	-
55 - 57	1	-	-	-	-	-	-	-	-	-	3	1	-	-	-	-	-	-	-	-	-	-	-	-	-	-	-	-	-	-
52 - 54	-	-	-	-	-	-	-	-	-	-	2	1	-	-	-	-	-	-	-	-	-	-	-	-	-	-	-	-	-	-
49 - 51	-	-	-	-	-	-	-	-	-	-	2	-	-	-	-	-	-	-	-	-	-	-	-	-	-	-	-	-	-	-
46 - 48	-	-	-	-	-	-	-	-	-	-	1	-	-	-	-	-	-	-	-	-	-	-	-	-	-	-	-	-	-	-
43 - 45	-	-	-	-	-	-	-	-	-	-	1	-	-	-	-	-	-	-	-	-	-	-	-	-	-	-	-	-	-	-
0 - 42	-	-	-	-	-	-	-	-	-	-	-	-	-	-	-	-	-	-	-	-	-	-	-	-	-	-	-	-	-	-

Fumble Range:	3	Range Modifiers:	0m-1m: +10
Breakage #s:	7		2m-10m: +0
Reliability:	65		11m-20m: -25
			21m-100m: -50
			101m-200m: -100

Steyr-Klough
T-26

BE 6

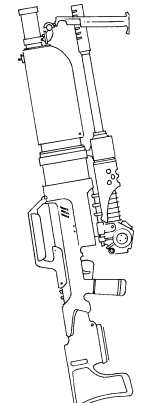
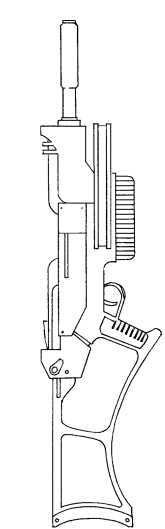

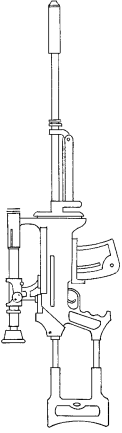

	Combat Armor		Kinetic Armor		Armored Cloth				Plate Armor		Chain Armor		Rigid Leather		Soft Leather		Natural		Clothing											
	X	IX	VIII	VII	VI	V	IV	III	II	I	20	19	18	17	16	15	14	13	12	11	10	9	8	7	6	5	4	3	2	1
148 - 150	23F	28G	34H	56F	69G	83H	56F	64G	73G	83H	23G	26H	30H	34H	43H	43H	46H	46H	46H	47H	53H	55H	57H	57H	65H	70H	70H	70H	88H	92H
145 - 147	23F	28G	33H	54F	67G	80H	55F	62G	71G	80H	23G	26H	29H	33H	42H	42H	45H	45H	45H	45H	45H	51H	53H	55H	55H	63H	68H	67H	85H	88H
142 - 144	22E	27F	32G	53E	64F	77G	53E	60F	68F	77G	22F	25H	28H	32H	41H	41H	43H	43H	43H	43H	49H	51H	54H	54H	53H	65H	64H	81H	84H	
139 - 141	21D	26F	31F	50D	62F	73F	51D	58E	65F	73G	22F	24G	27G	31G	39G	39G	42H	41H	41G	41G	47H	49H	52H	52H	51H	63H	60G	78G	80G	
136 - 138	21C	25E	29F	48C	59E	70F	49C	55E	62E	70G	21E	23G	26G	29G	38G	38G	40G	40G	40G	39G	45G	47G	50G	49G	56G	60G	57G	74G	75G	
133 - 135	20B	24D	28E	46B	56D	67E	47B	53D	60D	67F	20E	22F	25G	28G	36G	36G	38G	38G	38G	37G	43G	45G	48G	47G	54G	58G	53F	71G	71G	
130 - 132	19A	23D	27D	44A	54D	63D	45A	51C	57D	63F	20D	22F	24F	27F	35F	35F	37G	36G	36F	35F	41G	42G	46G	45G	51G	55G	50F	67F	67F	
127 - 129	18	22C	25D	42	51C	60D	43	48C	54C	60F	19C	21E	23F	26F	34F	34F	35F	34F	34F	33F	39F	40F	44G	43F	49F	53F	46F	64F	62F	
124 - 126	18	21B	24C	40	49B	57C	41	46B	51C	57E	18C	20E	22E	24F	32F	32F	33F	33F	33F	31F	37F	38F	42F	41F	47F	50F	30E	43E	60F	58E
121 - 123	17	20B	23B	38	46B	53B	40	44A	49B	53E	18B	19E	21E	23E	31E	30E	32F	31F	31E	29E	34F	36F	40F	39F	44F	48F	28E	40E	56E	54E
118 - 120	16	19A	21B	36	43A	50B	38	42A	46A	50D	17B	18D	20E	22E	29E	29E	30E	29E	29E	27E	32E	34E	38F	37F	42E	45E	25D	36D	53E	49E
115 - 117	15	18A	20A	34	41A	46A	36	39	43A	46D	16A	18D	19D	21E	28E	27E	28E	27E	27E	25E	30E	32E	36E	35E	40E	43E	23D	33D	49E	45D
112 - 114	15	17	19	32	38	43	34	37	40	43D	16A	17C	18D	19D	26D	26D	27E	26E	26D	23D	28E	29E	34E	33E	37E	40E	21C	29D	46D	41D
109 - 111	14	16	17	30	35	40	32	35	37	40C	15	16C	17C	18D	25D	24D	25D	24D	24D	21D	26D	27D	33E	31E	35E	38E	19C	26C	42D	36D
106 - 108	13	15	16	28	33	36	30	32	35	36C	14	15B	16C	17C	24D	23D	23D	22D	22D	19D	24D	25D	31E	29D	33D	35D	17B	22C	39D	32C
103 - 105	12	14	15	26	30	33	28	30	32	33B	14	14B	15C	16C	22C	22C	22D	20D	20C	17C	22D	23D	29D	27D	30D	33D	14B	19B	35C	28C
100 - 102	12	13	13	24	28	30	26	28	29	30B	13	13B	14B	14C	21C	20C	20C	19D	19C	15C	20C	21C	27D	25D	28D	30D	12A	15B	31C	23B
97 - 99	11	12	12	22	25	26	24	26	26	26A	12	13A	13B	13B	19C	19C	18C	17C	17B	13B	17C	19C	25D	23D	26C	27C	10A	12A	28C	19B
94 - 96	10	11	11	20	22	23	23	23	24	23A	12	12A	12A	12B	18B	17B	17C	15C	15B	11B	15C	16C	23C	21C	23C	25C	8A	9A	24B	15B
91 - 93	9	10	9	18	20	20	21	21	21	20A	11	11	11A	11B	17B	16B	15B	13C	13B	9B	13B	14B	21C	19C	21C	22C	6	5A	21B	11A
88 - 90	9	9	8	16	17	16	19	19	18	16	10	10A	10A	9A	15B	14B	13B	12B	12A	7A	11B	12B	19C	17C	19B	20B	3	2	17B	6A
85 - 87	8	8	7	14	14	13	17	16	15	13	10	9	9	8A	14A	13A	12B	10B	10A	5A	9B	10B	17C	15B	16B	17B	1	-	14A	2A
82 - 84	7	5	12	12	12	9	15	14	13	9	9	9	7	7A	12A	11A	10A	8B	8A	3A	7A	8A	15B	13B	14B	15B	-	-	10A	-
79 - 81	6	6	4	10	9	6	13	12	10	6	8	8	6	6	11A	10A	8A	6A	6	1	5A	6A	13B	11B	11B	12B	-	-	6A	-
76 - 78	6	5	3	8	7	3	11	10	7	3	8	7	5	4	9	7A	5A	5A	5	-	3A	3A	11B	9B	9A	10A	-	-	3	-
73 - 75	5	4	1	6	4	-	9	7	4	-	7	6	4	3	8	7	5	3A	3	-	1	1	9B	7A	7A	7A	-	-	-	-
70 - 72	4	3	-	4	1	-	7	5	1	-	6	5	3	2	7	5	3	1	1	-	-	-	8A	5A	4A	5A	-	-	-	-
67 - 69	3	2	-	2	-	-	6	3	-	-	6	5	2	1	5	4	2	-	-	-	-	-	6A	3A	2	2	-	-	-	-
64 - 66	3	1	-	1	-	-	4	1	-	-	5	4	1	-	4	2	-	-	-	-	-	-	4A	1	-	-	-	-	-	-
61 - 63	2	-	-	-	-	-	2	-	-	-	4	3	-	-	2	1	-	-	-	-	-	-	2	-	-	-	-	-	-	-
58 - 60	1	-	-	-	-	-	-	-	-	-	4	2	-	-	1	-	-	-	-	-	-	-	-	-	-	-	-	-	-	-
55 - 57	1	-	-	-	-	-	-	-	-	-	3	1	-	-	-	-	-	-	-	-	-	-	-	-	-	-	-	-	-	-
52 - 54	-	-	-	-	-	-	-	-	-	-	2	1	-	-	-	-	-	-	-	-	-	-	-	-	-	-	-	-	-	-
49 - 51	-	-	-	-	-	-	-	-	-	-	2	-	-	-	-	-	-	-	-	-	-	-	-	-	-	-	-	-	-	-
46 - 48	-	-	-	-	-	-	-	-	-	-	1	-	-	-	-	-	-	-	-	-	-	-	-	-	-	-	-	-	-	-
43 - 45	-	-	-	-	-	-	-	-	-	-	1	-	-	-	-	-	-	-	-	-	-	-	-	-	-	-	-	-	-	-
0 - 42	-	-	-	-	-	-	-	-	-	-	-	-	-	-	-	-	-	-	-	-	-	-	-	-	-	-	-	-	-	-

Fumble Range:	2	Range Modifiers:	0m-5m: +10
Breakage #s:	5		6m-75m: +0
Reliability:	75		76m-150m: -25
			151m-750m: -50
			751m-1,500m: -100
Steyr-Klough Ranger			
BE 7			

	Combat Armor		Kinetic Armor		Armored Cloth				Plate Armor			Chain Armor			Rigid Leather			Soft Leather			Natural			Clothing						
	X	IX	VIII	VII	VI	V	IV	III	II	I	20	19	18	17	16	15	14	13	12	11	10	9	8	7	6	5	4	3	2	1
148 - 150	26F	33G	40H	65F	81G	97H	65F	75G	86G	97H	26G	31H	35H	40H	50H	50H	55H	55H	56H	62H	65H	67H	67H	76H	83H	56H	83H	103H	108H	
145 - 147	26F	32G	39H	63F	78G	94H	63F	73G	83G	94H	26G	31H	34H	39H	49H	49H	54H	53H	53H	54H	60H	63H	65H	65H	74H	80H	54H	79H	99H	103H
142 - 144	25E	31F	37G	61E	75F	90G	61E	70F	80F	90H	25F	30H	33H	38H	47H	47H	52H	51H	51H	52H	58H	60H	63H	63H	71H	77H	51H	75H	95H	98H
139 - 141	24D	30F	36F	59D	72F	86F	59D	67E	77F	86G	24F	29G	32G	36G	46G	45G	50H	49H	49G	49G	55H	58H	61H	60H	68H	74H	49G	71G	91G	93G
136 - 138	23C	29E	34F	56C	69E	82F	57C	65E	73E	82G	24E	28G	31G	35G	44G	44G	48G	47G	47G	47G	53G	55G	58G	58G	66G	71G	46G	67G	87G	88G
133 - 135	22B	27D	33E	55B	66D	78E	55B	62D	70D	78F	23E	27F	29G	33G	42G	42G	46G	45G	45G	44G	50G	53G	56G	56G	63G	68G	43F	63F	83G	83G
130 - 132	21A	27D	31D	52A	63D	74D	52A	59C	67D	74F	22D	26F	28F	32F	41F	40F	44G	43G	43F	42F	48G	50G	54G	53G	60G	65G	41F	59F	78F	78F
127 - 129	21	25C	30D	49	60C	70D	50	57C	64C	70F	21C	25E	27F	30F	39F	39F	42F	41F	41F	40F	45F	48F	52G	51F	57F	62F	38E	55F	74F	73F
124 - 126	20	24B	28C	47	57B	66C	48	54B	60C	66E	21C	24E	26E	29F	37F	37F	40F	39F	39F	37F	43F	45F	49F	49F	55F	59F	35E	51E	70F	68E
121 - 123	19	23B	26B	45	54B	62B	46	51A	57B	62E	20B	23E	25E	27E	36E	35E	38F	37F	37E	35E	40F	42F	47F	46F	52F	56F	33E	47E	66E	63E
118 - 120	18	22A	25B	42	51A	58B	44	49A	54A	58D	19B	22D	23E	26E	34E	33E	36E	35E	35E	32E	38E	40E	45F	44F	49E	53E	30D	43D	62E	58E
115 - 117	17	21A	23A	40	48A	54A	41	46	51A	54D	18A	21D	22D	24E	32E	32E	34E	33E	33E	30E	35E	37E	43E	41E	46E	50E	28D	39D	58E	53D
112 - 114	16	20	22	38	45	50	39	43	47	50D	18A	20C	21D	23D	31D	30D	32E	30E	30D	28D	33E	35E	40E	39E	44E	47E	25C	35D	53D	48D
109 - 111	16	18	20	35	42	46	37	41	44	46C	17	19C	20C	21D	29D	28D	30D	28D	28D	25D	30D	32D	38E	37E	41E	44E	22C	30C	49D	43C
106 - 108	15	17	19	33	38	42	35	38	41	42C	16	18B	18C	20C	27D	27D	28D	26D	26D	23D	28D	30D	36E	34D	38D	41D	20B	26C	45D	38C
103 - 105	14	16	17	31	35	39	33	35	38	39B	15	17B	17C	18C	26C	25C	26D	24D	24C	20C	25D	27D	34D	32D	35D	38D	17B	22B	41C	33C
100 - 102	13	15	16	28	32	35	30	33	34	35B	15	16B	16B	17C	24C	23C	24C	22D	22C	18C	23C	24C	31D	30D	33D	35D	14B	18B	37C	27B
97 - 99	12	14	14	26	29	31	28	30	31	31A	14	15A	15B	15B	22C	22C	22C	20C	20B	16B	20C	22C	29D	27D	30C	32C	12A	14A	33C	22B
94 - 96	11	13	12	24	26	27	26	27	28	27A	13	14A	14A	14B	21B	20B	20C	18C	18B	13B	18C	19C	27C	25C	27C	29C	9A	10A	28B	17B
91 - 93	11	11	11	21	23	23	24	25	24	23A	12	13	12A	12B	19B	18B	18B	16C	16B	11B	15B	17B	25C	23C	24C	26C	7	6A	24B	12A
88 - 90	10	10	9	19	20	23	22	22	21	19	12	12	11A	11A	18B	16B	16B	14B	14A	8A	13B	14B	22C	20C	22B	23B	4	2	20B	7A
85 - 87	9	9	8	17	17	15	19	19	18	15	11	11	10	9A	16A	15A	14B	12B	12A	6A	10B	12B	20C	18B	19B	20B	1	16A	2	2
82 - 84	8	8	6	14	14	11	17	17	15	11	10	10	9	8A	14A	13A	12A	10B	10A	4A	8A	9A	18B	15B	16B	17B	-	-	12A	-
79 - 81	7	7	5	12	11	7	15	14	11	7	9	9	7	6	13A	11A	10A	7A	7	1	5A	6A	16B	13B	13B	14B	-	-	7A	-
76 - 78	6	6	3	10	8	3	13	11	8	3	11	10	8A	5A	11	10	8A	5A	5	-	3A	4A	13B	11B	11A	11A	-	-	3	-
73 - 75	6	4	2	7	5	-	11	9	5	-	8	7	5	3	9	8	6	3A	3	-	1	1	11B	8A	8A	8A	-	-	-	-
70 - 72	5	3	-	5	2	-	9	6	2	-	7	6	4	2	8	6	4	1	1	-	-	-	9A	6A	5A	5A	-	-	-	-
67 - 69	4	2	-	3	-	3	6	3	-	-	6	5	3	1	6	4	2	-	-	-	-	-	7A	4A	2	2	-	-	-	-
64 - 66	3	1	-	1	-	1	4	1	-	-	6	4	1	-	4	3	-	-	-	-	-	-	4A	1	-	-	-	-	-	-
61 - 63	2	-	-	-	-	-	2	-	-	-	5	3	-	-	3	1	-	-	-	-	-	-	2	-	-	-	-	-	-	-
58 - 60	1	-	-	-	-	-	-	-	-	-	4	2	-	-	1	-	-	-	-	-	-	-	-	-	-	-	-	-	-	-
55 - 57	1	-	-	-	-	-	-	-	-	-	3	1	-	-	-	-	-	-	-	-	-	-	-	-	-	-	-	-	-	-
52 - 54	-	-	-	-	-	-	-	-	-	-	3	1	-	-	-	-	-	-	-	-	-	-	-	-	-	-	-	-	-	-
49 - 51	-	-	-	-	-	-	-	-	-	-	2	-	-	-	-	-	-	-	-	-	-	-	-	-	-	-	-	-	-	-
46 - 48	-	-	-	-	-	-	-	-	-	-	1	-	-	-	-	-	-	-	-	-	-	-	-	-	-	-	-	-	-	-
43 - 45	-	-	-	-	-	-	-	-	-	-	1	-	-	-	-	-	-	-	-	-	-	-	-	-	-	-	-	-	-	-
0 - 42	-	-	-	-	-	-	-	-	-	-	-	-	-	-	-	-	-	-	-	-	-	-	-	-	-	-	-	-	-	-

Fumble Range:	2	Range Modifiers:	0m-1m: +10
Breakage #s:	5		2m-15m: +0
Reliability:	75		16m-30m: -25
			31m-150m: -50
			151m-300m: -100

Spectrum
Arms S-13
BE 8

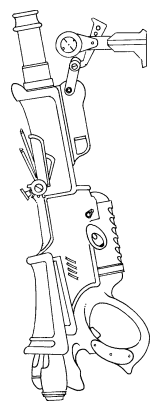

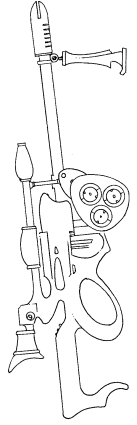

	Combat Armor			Kinetic Armor			Armored Cloth				Plate Armor			Chain Armor			Rigid Leather			Soft Leather			Natural			Clothing					
	X	IX	VIII	VII	VI	V	IV	III	II	I	20	19	18	17	16	15	14	13	12	11	10	9	8	7	6	5	4	3	2	1	
148 - 150	40F	50G	61H	101F	127G	154H	101F	119G	136G	154H	40G	47H	54H	61H	78H	78H	85H	85H	85H	87H	98H	101H	105H	105H	120H	131H	87H	131H	164H	172H	
145 - 147	39F	49G	59H	98F	123G	148H	98F	115G	131G	148H	39G	46H	53H	59H	76H	76H	82H	82H	82H	84H	95H	98H	102H	102H	116H	127H	83H	125H	158H	164H	
142 - 144	38E	47F	57G	94E	118F	142G	95E	111F	126F	142H	38F	45H	51H	57H	73H	73H	79H	79H	79H	80H	91H	94H	98H	98H	112H	122H	79H	119H	151H	156H	
139 - 141	37D	45F	54F	91D	113F	136F	91D	107E	121F	136G	37F	43G	49G	55G	71G	71G	76H	76H	76H	76G	87H	90H	95H	94H	107H	117H	75G	112G	145G	148G	
136 - 138	35C	43E	52F	87C	108E	130F	88C	102E	116E	130G	36E	42G	47G	52G	68G	68G	73G	73G	73G	73G	83G	86G	91G	91G	103G	113G	71G	106G	136G	140G	
133 - 135	34B	42D	50E	83B	103D	123E	84B	98D	111D	123F	35E	40F	45G	50G	66G	65G	70G	69G	69G	69G	79G	82G	88G	87G	99G	108G	67F	99F	131G	132G	
130 - 132	33A	40D	47D	80A	99D	117D	81A	94C	106D	117F	34D	39F	44G	48F	63F	63F	67G	66G	66G	66F	75G	78G	84G	83G	94G	103G	63F	93F	125F	124F	
127 - 129	31	38C	45D	76	94C	111D	78	90C	100C	111F	32C	37E	41F	46F	60F	60F	64F	63F	63F	61F	71F	74F	81G	80F	90F	98F	59E	86F	118F	116F	
124 - 126	30	36B	42C	73	89B	105C	74	85B	95C	105E	31C	36E	39E	43F	58F	57F	61F	60F	60F	58F	67F	70F	77F	76F	86F	94F	55E	80E	111F	108E	
121 - 123	29	35B	40B	69	84B	98B	71	81A	90B	98E	30B	34E	38E	41E	55E	55E	58F	56F	56E	54E	63F	66F	74F	72F	81F	89F	51E	74E	105E	100E	
118 - 120	28	33A	38B	65	79A	92B	67	77A	85A	92D	29B	33D	36E	39E	53E	52E	55E	53E	53E	50E	59E	62E	70F	68F	77E	84E	47D	67D	98E	92E	
115 - 117	26	31A	35A	62	74A	86A	64	73	80A	86D	28A	31D	34D	37E	50E	49E	52E	50E	50E	46E	55E	58E	67E	65E	73E	79E	43D	61D	91E	84D	
112 - 114	25	29	33	58	70	80	61	68	75	80D	27A	30C	32D	34D	48D	47D	49E	47E	47D	43D	51E	54E	63E	61E	68E	75E	39C	54D	85D	76D	
109 - 111	24	28	31	55	65	73	57	64	69	73C	26	28C	30C	32D	45D	44D	46D	44D	44D	39D	48D	50D	59E	57E	64E	70E	34C	48C	78D	68C	
106 - 108	22	26	28	51	60	67	54	60	64	67C	24	27B	28C	30C	42D	41D	42D	40D	40D	35D	44D	46D	56E	54D	60D	65D	30B	41C	71D	60C	
103 - 105	21	24	26	47	55	61	50	56	59	61B	23	25B	26C	28C	40C	39C	39D	37D	37C	32C	40D	42D	52D	50D	55D	60D	26B	35B	65C	52C	
100 - 102	20	22	23	44	50	55	47	51	54	55B	22	24B	24B	25C	37C	36C	36C	34D	34C	28C	36C	38C	49D	46D	51D	56D	22B	28B	58C	43B	
97 - 99	19	20	21	40	46	48	44	47	49	48A	21	23A	22B	23B	35C	33C	33C	31C	31B	24B	32C	34C	45D	42D	47C	51C	18A	22A	51C	35B	
94 - 96	17	19	19	37	41	42	40	43	44	42A	20	21A	21A	21B	32B	31B	30C	27C	27B	20B	28C	30C	42C	39C	42C	46C	14A	16A	45B	27B	
91 - 93	16	17	16	33	36	36	37	39	38	36A	19	20	19A	19B	21B	20B	28B	27B	24C	17B	24B	26B	38C	35C	38C	42C	10	9A	38B	19A	
88 - 90	15	15	14	29	31	30	33	34	33	30	18	18	17A	16A	27B	25B	24B	21B	21A	13A	20B	22B	35C	31C	34B	37B	6	3	32B	11A	
85 - 87	13	13	12	26	26	23	30	30	28	23	16	17	15	14A	24A	23A	21B	18B	18A	9A	16B	18B	31C	28B	29B	32B	2	-	25A	3	
82 - 84	12	12	9	22	21	17	27	26	23	17	15	15	13	12A	22A	20A	18A	14B	14A	5A	12A	14A	28B	24B	25B	27B	-	-	18A	-	
79 - 81	11	10	7	19	17	11	23	22	18	11	14	14	11	10	19A	17A	15A	11A	11	2	8A	10A	24B	20B	21B	23B	-	-	12A	-	
76 - 78	10	8	4	15	12	5	20	17	13	5	13	12	9	7	17	15	12A	8A	8	-	4A	6A	21B	17B	16A	18A	-	-	5	-	
73 - 75	8	6	2	11	7	-	16	13	7	-	12	11	7	5	14	12	9	5A	5	-	1	2	17B	13A	12A	13A	-	-	-	-	
70 - 72	7	5	-	8	2	-	13	9	2	-	11	9	6	3	12	9	6	2	2	-	-	-	-	13A	9A	8A	8A	-	-	-	-
67 - 69	6	3	-	4	-	-	10	5	-	-	10	8	4	1	9	7	3	-	-	-	-	-	-	10A	5A	3	4	-	-	-	-
64 - 66	4	1	-	1	-	-	6	1	-	-	8	6	2	-	6	4	-	-	-	-	-	-	6A	2	-	-	-	-	-	-	-
61 - 63	3	-	-	-	-	-	3	-	-	-	7	5	-	-	4	1	-	-	-	-	-	-	3	-	-	-	-	-	-	-	-
58 - 60	2	-	-	-	-	-	-	-	-	-	6	3	-	-	1	-	-	-	-	-	-	-	-	-	-	-	-	-	-	-	-
55 - 57	1	-	-	-	-	-	-	-	-	-	5	2	-	-	-	-	-	-	-	-	-	-	-	-	-	-	-	-	-	-	-
52 - 54	-	-	-	-	-	-	-	-	-	-	4	1	-	-	-	-	-	-	-	-	-	-	-	-	-	-	-	-	-	-	-
49 - 51	-	-	-	-	-	-	-	-	-	-	3	-	-	-	-	-	-	-	-	-	-	-	-	-	-	-	-	-	-	-	-
46 - 48	-	-	-	-	-	-	-	-	-	-	2	-	-	-	-	-	-	-	-	-	-	-	-	-	-	-	-	-	-	-	-
43 - 45	-	-	-	-	-	-	-	-	-	-	1	-	-	-	-	-	-	-	-	-	-	-	-	-	-	-	-	-	-	-	-
0 - 42	-	-	-	-	-	-	-	-	-	-	-	-	-	-	-	-	-	-	-	-	-	-	-	-	-	-	-	-	-	-	-

Fumble Range:	2	Range Modifiers:	0m-5m: +10
Breakage #s:	6	6m-75m: +0	
Reliability:	65	76m-150m: -25	
		151m-750m: -50	
		751m-1,500m: -100	

**Steyr-Klough
Violator**

BE 10

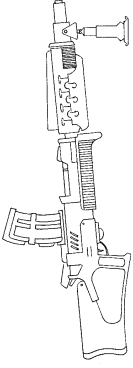

	Combat Armor		Kinetic Armor		Armored Cloth					Plate Armor					Chain Armor					Rigid Leather					Soft Leather					Natural			Clothing	
	X	IX	VIII	VII	VI	V	IV	III	II	I	20	19	18	17	16	15	14	13	12	11	10	9	8	7	6	5	4	3	2	1				
148 - 150	48G	60H	72I	120G	151H	183I	120G	141H	162H	183I	48H	56I	64J	72K	80L	88M	96N	102O	108P	114Q	120R	124S	124I	124J	124K	104I	104J	156I	195I	204I				
145 - 147	47F	58H	70I	116F	146H	176I	116F	136H	156H	176I	47H	55I	62J	70K	78L	86M	94N	100O	106P	112Q	118R	124S	124I	124J	124K	100I	100J	149I	188I	195I				
142 - 144	45E	56G	67H	112E	140G	169H	112E	131G	150G	169H	46G	53I	60J	67K	74L	81M	88N	95O	102P	108Q	114R	120S	124I	124J	124K	95I	95J	141I	180I	185I				
139 - 141	44D	54F	64G	108D	134F	161G	108D	126F	144F	161H	44F	51H	58I	64J	71K	78L	85M	92N	99O	106P	113Q	120R	124I	124J	124K	90H	90I	133H	172H	176H				
136 - 138	42C	52F	61F	103C	129F	154F	104C	121E	138F	154H	43F	49H	56I	62J	69K	76L	83M	90N	97O	104P	111Q	118R	124I	124J	124K	85H	85I	126H	164H	166H				
133 - 135	41B	50E	58F	99B	123E	148F	100B	116E	132E	146G	42E	48G	53H	59I	66J	73K	80L	87M	94N	101O	108P	114Q	120R	124I	124J	80G	80H	118G	158H	157G				
130 - 132	39A	48D	56E	95A	117D	139E	96A	111D	126D	139G	40D	46G	51H	56I	63J	70K	77L	84M	91N	98O	105P	112Q	118R	124I	124J	75G	75H	110G	148G	147G				
127 - 129	38	46C	53D	90	111C	132D	92	106C	119D	132F	39D	44F	49G	54H	61I	68J	75K	82L	89M	96N	103O	110P	117Q	124I	124J	70F	70G	103F	140G	138F				
124 - 126	36	44C	50C	86	106C	124C	88	101B	113C	124F	38C	42F	47G	51H	58I	65J	72K	79L	86M	93N	100O	107P	114Q	121R	128I	65F	65G	95F	132F	128F				
121 - 123	35	41B	47C	82	100B	117C	84	96B	107B	117E	36B	41E	44F	48F	55G	62H	69I	76J	83K	90L	97M	104N	111O	118P	61E	61F	87E	124F	118F					
118 - 120	33	39A	44B	78	94A	109B	80	91A	101B	109E	35B	39E	42E	46E	53F	60G	67H	74I	81J	88K	95L	102M	109N	116O	56E	56F	80E	116F	109E					
115 - 117	31	37A	42A	73	88A	102A	76	86	95A	102D	33A	37D	40E	43E	50F	57G	64H	71I	78J	85K	92L	99M	106N	113O	51D	51E	72D	109E	99E					
112 - 114	30	35	39	69	83	94	72	81	89	94D	32A	35D	38D	40E	47F	54G	61H	68I	75J	82K	89L	96M	103N	110O	46D	46E	64D	101E	90D					
109 - 111	28	33	36	65	77	87	65	76	83	87C	31	34C	35D	38D	40E	47F	54G	61H	68I	75J	82K	89L	96M	103N	41C	41D	57C	93E	80D					
106 - 108	27	31	33	60	71	80	64	71	76	80C	29	32C	33C	35D	38D	40E	47F	54G	61H	68I	75J	82K	89L	96M	36C	36D	49C	85D	71C					
103 - 105	25	29	30	56	65	72	60	66	70	72C	28	30B	31C	32C	34D	36E	38F	40G	42H	44I	46J	48K	50L	52M	31B	31C	41C	77D	61C					
100 - 102	24	27	28	52	60	65	56	61	64	65B	27	28B	29B	30C	31D	32D	33D	34D	35D	36D	37D	38D	39D	40D	26B	26C	34B	69C	51C					
97 - 99	22	24	25	48	54	57	52	56	58	57B	25	27A	27B	27C	28C	29C	30C	31C	32C	33C	34C	35C	36C	37C	17A	17B	22A	61C	42B					
94 - 96	21	22	22	43	48	50	48	51	52	50A	24	25A	24B	24C	24D	25D	26D	27D	28D	29D	30D	31D	32D	33D	17A	17B	22A	53C	32B					
91 - 93	19	20	19	39	43	43	44	46	46	43A	22	23	22A	22B	22C	23C	24C	25C	26C	27C	28C	29C	30C	12	11A	11A	14A	23A						
88 - 90	18	18	16	35	37	35	40	41	39	35	21	21	20A	19A	19B	19C	20C	21C	22C	23C	24C	25C	26C	7	3	37B	13A							
85 - 87	16	16	14	30	31	28	36	36	33	28	20	20	18	16A	16B	16C	17C	18C	19C	20C	21C	22C	23C	2	-	29B	4							
82 - 84	14	14	11	26	25	20	32	31	27	20	18	18	15	14A	14B	14C	15C	16C	17C	18C	19C	20C	33C	28B	30B	32B	-	22A	-					
79 - 81	13	12	8	22	20	13	27	26	21	13	17	16	13	11	11	11	12A	13A	14A	15A	16A	17A	18A	28B	24B	25B	27B	-	14A	-				
76 - 78	11	10	5	18	14	5	23	21	15	5	16	14	11	8	8	8	9A	10A	11A	12A	13A	14A	15A	24B	19B	19A	21A	-	6	-				
73 - 75	10	8	2	13	8	-	19	16	9	-	14	13	9	6	6	6	7A	8A	9A	10A	11A	12A	13A	20B	15A	14A	16A	-	-	-				
70 - 72	8	5	-	9	2	-	15	11	3	-	13	11	6	3	3	3	4A	5A	6A	7A	8A	9A	10A	16A	11A	9A	10A	-	-	-				
67 - 69	7	3	-	5	-	-	11	6	-	-	11	9	4	1	1	1	2A	3A	4A	5A	6A	7A	8A	12A	6A	4	4	-	-	-				
64 - 66	5	1	-	1	-	-	7	1	-	-	10	7	2	-	2	2	3A	4A	5A	6A	7A	8A	9A	7A	2	-	-	-	-	-				
61 - 63	4	-	-	-	-	-	3	-	-	-	9	6	-	-	2	2	3A	4A	5A	6A	7A	8A	9A	3	-	-	-	-	-	-				
58 - 60	2	-	-	-	-	-	-	-	-	-	7	4	-	-	-	-	-	-	-	-	-	-	-	-	-	-	-	-	-	-	-			
55 - 57	1	-	-	-	-	-	-	-	-	-	6	2	-	-	-	-	-	-	-	-	-	-	-	-	-	-	-	-	-	-	-			
52 - 54	-	-	-	-	-	-	-	-	-	-	5	1	-	-	-	-	-	-	-	-	-	-	-	-	-	-	-	-	-	-	-			
49 - 51	-	-	-	-	-	-	-	-	-	-	3	-	-	-	-	-	-	-	-	-	-	-	-	-	-	-	-	-	-	-	-			
46 - 48	-	-	-	-	-	-	-	-	-	-	2	-	-	-	-	-	-	-	-	-	-	-	-	-	-	-	-	-	-	-	-			
43 - 45	-	-	-	-	-	-	-	-	-	-	1	-	-	-	-	-	-	-	-	-	-	-	-	-	-	-	-	-	-	-	-			
0 - 42	-	-	-	-	-	-	-	-	-	-	-	-	-	-	-	-	-	-	-	-	-	-	-	-	-	-	-	-	-	-	-			

Fumble Range: 4
Breakage #s: 7
Reliability: 75

Range Modifiers:
0m10m: +10
11m-150m: +0
151m-300m: -25
301m-1,500m: -50
1,501m-3,000m: -100

H & K
Annihilator
BE 11



	Combat Armor			Kinetic Armor			Armored Cloth				Plate Armor			Chain Armor			Rigid Leather			Soft Leather			Natural			Clothing				
	X	IX	VIII	VII	VI	V	IV	III	II	I	20	19	18	17	16	15	14	13	12	11	10	9	8	7	6	5	4	3	2	1
148 - 150	56G	70H	84I	140G	166H	212I	140G	164H	188H	212I	56H	65I	75I	84I	108I	108I	118I	118I	120I	135I	140I	144I	144I	166I	180I	120I	180I	226I	236I	
145 - 147	55F	68H	81I	135F	160H	204I	136F	159H	181H	204I	55H	63I	73I	81I	105I	105I	114I	114I	115I	130I	135I	140I	139I	160I	174I	115I	172I	217I	225I	
142 - 144	53E	66G	78H	130E	154G	195H	131E	153G	174G	195I	53G	61I	70I	78I	101I	101I	110I	110I	110I	125I	129I	135I	134I	154I	167I	109I	163I	208I	214I	
139 - 141	51D	63F	75G	125D	148F	187G	126D	147F	167F	187H	52F	59H	68H	75H	98H	97H	106H	105H	105H	119H	124H	130I	129I	148H	161H	104H	154H	199H	203H	
136 - 138	49C	61F	71F	120C	141F	178F	122C	141E	160F	178H	50F	57H	65H	72H	94H	94H	101H	101H	100H	114H	118H	125H	124H	142H	154H	98H	145H	190H	192H	
133 - 135	47B	58E	68F	115B	135E	170F	117B	135E	153E	170G	48E	55G	62G	69G	91H	90H	97H	96H	96H	108H	113H	120H	119H	136H	148H	87G	136G	181H	181G	
130 - 132	46A	56D	65E	110A	129D	161E	112A	129D	146D	161G	47D	53G	60G	66G	87G	86G	93G	92G	90G	103G	107G	115H	114H	130G	141G	87G	127G	172G	170G	
127 - 129	44	53C	62D	105	122C	152D	107	123C	139D	152F	45D	51F	57F	63G	84G	83G	89G	87G	87G	84G	98G	111G	109G	124G	135G	81F	119F	162G	159F	
124 - 126	42	51C	58C	100	116C	144C	103	118B	131C	144F	44C	49F	55F	60F	80F	79F	84G	83G	83F	79F	92G	106G	104G	118G	128G	75F	110F	153F	148F	
121 - 123	40	48B	55C	95	110B	135C	98	112B	124B	135E	42B	47E	52F	56F	76F	75F	80F	78F	78F	74F	87F	101G	99G	112F	122F	70E	101E	144F	137F	
118 - 120	38	46A	52B	90	103A	127B	93	106A	117B	127E	40B	45E	49E	53E	73F	72F	76F	74F	74F	69F	81F	96F	94F	106F	115F	64E	92E	135F	126E	
115 - 117	37	43A	48A	85	97A	118A	89	100	110A	118D	39A	43D	47E	50E	69E	68E	72E	69F	69E	64E	76E	91F	89F	100F	109F	59D	83D	126E	115E	
112 - 114	35	41	45	80	91	109	84	94	103	109D	37A	41D	44D	47E	66E	64E	67E	65E	59E	71E	74E	86F	84F	94E	102E	53D	74D	117E	104D	
109 - 111	33	38	42	75	85	101	79	88	96	101C	36	39C	41D	44D	62D	61E	63E	60E	60D	54E	65E	81E	78E	88E	96E	47C	65C	107E	93D	
106 - 108	31	36	39	70	78	92	74	82	89	92C	34	37C	39C	41D	59D	57D	59D	56E	56D	48D	60D	77E	73E	82E	89E	42C	57C	98D	82C	
103 - 105	29	33	35	65	72	84	70	77	81	84C	32	35B	36C	38C	55D	53D	55D	51D	51D	43D	54D	72E	68E	76D	83D	36B	48C	89D	71C	
100 - 102	28	31	32	60	66	75	65	71	74	75B	31	33B	34B	35C	52C	50C	50D	47D	47C	38C	49D	67D	63D	70D	76D	30B	39B	80C	59C	
97 - 99	26	28	29	55	59	66	60	65	67	66B	29	31A	31B	32C	48C	46C	46C	42D	42C	33C	44C	62D	58D	64D	70D	25A	30B	71C	48B	
94 - 96	24	26	26	50	53	58	56	59	60	58A	28	29A	28B	28B	44B	42C	42C	38C	38B	28B	38C	57D	53D	58C	63C	19A	21A	62C	37B	
91 - 93	22	24	22	45	47	49	51	53	53	49A	26	27	26A	25B	41B	39B	37B	33C	33B	23B	33C	52D	48C	52C	57C	14	12A	52B	26A	
88 - 90	20	21	19	40	40	41	46	47	46	41	24	25	23A	22A	37B	35B	33B	29B	29B	18B	27B	47C	43C	46C	50C	8	3	43B	15A	
85 - 87	19	19	16	35	34	32	41	41	39	32	23	23	21	19A	34A	31B	29B	24B	24A	12A	22B	43C	38C	40B	44B	2	-	34B	4	
82 - 84	17	16	12	30	28	23	37	36	31	23	21	21	18	16A	30A	27A	25A	20B	20A	7A	17A	38C	33B	34B	37B	-	-	25A	-	
79 - 81	15	14	9	25	22	15	32	30	24	15	20	19	15	13	27A	24A	20A	15A	15	2	11A	33B	28B	28B	31B	-	-	16A	-	
76 - 78	13	11	6	20	15	6	27	24	17	6	18	17	13	10	23	20	16A	11A	11	-	6A	28B	23B	22A	24A	-	-	7	-	
73 - 75	11	9	3	15	9	-	23	18	10	-	16	15	10	7	19	16	12	6A	6	-	1	2	23B	17A	16A	18A	-	-	-	-
70 - 72	10	6	-	10	3	-	18	12	3	-	15	13	7	4	16	13	8	2	2	-	-	18A	12A	10A	11A	-	-	-	-	
67 - 69	8	4	-	5	-	-	13	6	-	-	13	11	5	1	12	9	3	-	-	-	-	13A	7A	4	5	-	-	-	-	-
64 - 66	6	1	-	1	-	-	8	1	-	-	12	9	2	-	9	5	-	-	-	-	-	9A	2	-	-	-	-	-	-	-
61 - 63	4	-	-	-	-	-	4	-	-	-	10	7	-	-	5	2	-	-	-	-	-	4	-	-	-	-	-	-	-	-
58 - 60	2	-	-	-	-	-	-	-	-	-	8	5	-	-	2	-	-	-	-	-	-	-	-	-	-	-	-	-	-	-
55 - 57	1	-	-	-	-	-	-	-	-	-	7	3	-	-	-	-	-	-	-	-	-	-	-	-	-	-	-	-	-	-
52 - 54	-	-	-	-	-	-	-	-	-	-	5	1	-	-	-	-	-	-	-	-	-	-	-	-	-	-	-	-	-	-
49 - 51	-	-	-	-	-	-	-	-	-	-	4	-	-	-	-	-	-	-	-	-	-	-	-	-	-	-	-	-	-	-
46 - 48	-	-	-	-	-	-	-	-	-	-	2	-	-	-	-	-	-	-	-	-	-	-	-	-	-	-	-	-	-	-
43 - 45	-	-	-	-	-	-	-	-	-	-	1	-	-	-	-	-	-	-	-	-	-	-	-	-	-	-	-	-	-	-
0 - 42	-	-	-	-	-	-	-	-	-	-	-	-	-	-	-	-	-	-	-	-	-	-	-	-	-	-	-	-	-	-

Fumble Range:	4	Range Modifiers:	0m10m: +10
Breakage #s:	7		11m-150m: +0
Reliability:	75		151m-300m: -25
			301m-1,500m: -50
			1,501m-3,000m: -100
H & K			
Justifier			
BE 12			

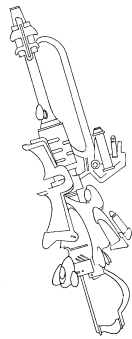

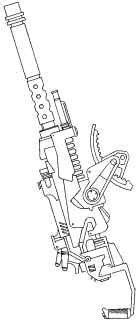

	Combat Armor		Kinetic Armor		Armored Cloth				Plate Armor				Chain Armor				Rigid Leather				Soft Leather				Natural		Clothing											
	X	IX	VIII	VII	VI	V	IV	III	II	I	20	19	18	17	16	15	14	13	12	11	10	9	8	7	6	5	4	3	2	1								
148 - 150	64K	75L	96M	159K	199L	240M	159K	186L	213L	240M	64L	74M	85M	96M	123M	123M	134M	134M	134M	139M	153M	159M	164M	164M	189M	204M	137M	205M	257M	268M								
145 - 147	62J	73K	93L	154J	192K	231L	154J	180K	205K	231M	63K	72M	83M	93M	119M	119M	130M	129M	129M	134M	147M	153M	159M	159M	183M	197M	131M	195M	247M	256M								
142 - 144	60H	70J	89K	148H	184J	221K	149H	173J	197J	221L	61J	70L	80L	89L	115L	115L	125L	124L	124L	128L	141L	147L	153M	153M	176M	190M	125L	185L	237L	243L								
139 - 141	58G	68I	85J	142G	177I	211J	143G	167I	189I	211K	59I	68K	77L	86L	111L	111L	120L	119L	119L	122L	135L	141L	148L	147L	169L	182L	118K	175K	226L	231L								
136 - 138	56E	65H	82I	137E	169H	202I	138E	160H	181H	202K	57H	65K	74K	82K	107K	107K	115K	114K	114K	116K	129K	134K	142L	141L	162L	175L	112K	165K	216K	218K								
133 - 135	54C	62G	78H	131C	162G	192H	133C	153G	173G	192J	55G	63J	71J	79K	103K	103K	110K	109K	109K	110K	123K	128K	137K	136K	155K	168K	105J	155J	205K	206J								
130 - 132	52B	60F	74G	125B	154F	182G	127B	147F	165F	182I	54F	61I	68J	75J	99J	98J	105J	104J	104J	104J	117J	122J	131K	130K	149K	160K	99I	145I	195J	193J								
127 - 129	50	57E	70F	120	147E	172F	122	140D	157E	172I	52E	58I	65I	72I	95J	94J	101J	99J	99J	98I	111J	116J	126J	124J	142J	153J	93I	135I	185J	181I								
124 - 126	48	54D	67E	114	139D	163E	117	133C	149D	163H	50D	56H	62H	68I	91I	90I	96I	94I	94I	92I	105I	109I	120J	118J	135J	146J	86H	125H	174I	168H								
121 - 123	46	52C	63C	108	131C	153C	111	127B	141C	153G	48C	54G	59H	64H	87H	86I	91I	89I	89H	86H	98I	103I	115I	112I	128I	138I	80G	115G	164I	155H								
118 - 120	44	49B	59B	103	124B	143B	106	120A	133B	143G	46B	51G	56G	61H	83H	82H	86H	84H	84H	80H	92H	97H	109I	107I	121I	131I	73G	105G	153H	143G								
115 - 117	42	46A	55A	97	116A	133A	101	113	125A	133F	44A	49F	53F	57G	79G	77G	81H	79H	79G	74G	86H	90H	104I	101H	114H	123H	67F	99F	143G	130G								
112 - 114	40	44	52	91	109	124	95	107	116	124E	43A	47E	50F	54G	75G	73G	76G	73G	73G	68G	80G	84G	98H	95H	108H	116H	60E	85E	132G	118F								
109 - 111	38	41	48	86	101	114	90	100	108	114E	41	44D	47E	50F	71F	69F	72G	68G	68F	62F	74G	78G	93H	89G	101G	109G	54D	74E	122F	105E								
106 - 108	36	38	44	80	94	104	84	93	100	104D	39	42D	44E	47E	67F	65F	67F	63F	63E	56E	68F	72F	87G	83G	94G	101G	48D	64D	112F	93E								
103 - 105	34	36	40	74	86	95	79	87	92	95C	37	40C	41D	43E	63E	61E	62E	58F	58E	50E	62F	65F	82G	78F	87F	94F	41C	54C	101E	80D								
100 - 102	31	33	37	69	79	85	74	80	84	85C	35	37B	38C	40D	59D	56E	57E	53E	53D	44D	56E	59E	76F	72F	80F	87F	35B	44C	91E	67C								
97 - 99	29	30	33	63	71	75	68	74	76	75B	33	35B	35C	36D	55D	52D	52D	48E	48C	38D	49E	53E	71F	66F	73E	79E	28B	34B	80D	55C								
94 - 96	27	28	29	57	63	65	63	67	68	65A	32	33A	32B	32C	51C	48D	47D	43D	43C	32C	43D	47D	65E	60E	67E	72E	22A	24A	70D	42B								
91 - 93	25	25	25	52	56	56	58	60	60	56A	30	31	29A	29B	46C	44C	42C	38D	38C	26C	37C	40C	59E	55E	60D	64D	15	14A	60C	30B								
88 - 90	23	23	22	46	48	46	52	54	52	46	28	28	26A	25B	42B	40C	38C	33C	33B	20B	31C	34C	54D	49D	53D	57D	9	4	49C	17A								
85 - 87	21	20	18	40	41	36	47	47	44	36	26	26	23	22A	38B	35B	33B	28C	28A	14A	25B	28B	48D	43D	46C	50C	3	-	39B	5								
82 - 84	19	17	14	35	33	26	42	40	36	26	24	24	20	18A	34A	31A	28B	23B	23A	8A	19B	21B	43D	37C	39C	42C	-	-	28A	-								
79 - 81	17	15	10	29	26	17	36	34	27	17	22	21	17	15	30A	27A	23A	17B	17	2	13A	15A	37C	31C	32B	35B	-	-	18A	-								
76 - 78	15	12	7	23	18	7	31	27	19	7	21	19	14	11	26	23	18A	12A	12A	-	7A	9A	32C	26B	26B	28B	-	-	7	-								
73 - 75	13	9	3	18	11	-	26	20	11	-	19	17	11	8	22	19	13	7A	7	-	1	3	26B	20B	19A	20A	-	-	-	-								
70 - 72	11	7	-	12	3	-	20	14	3	-	17	14	8	4	18	14	9	2	2	-	-	-	21B	14A	12A	13A	-	-	-	-								
67 - 69	9	4	-	6	-	-	15	7	-	-	15	12	5	1	14	10	4	-	-	-	-	-	15A	8A	5	5	-	-	-	-								
64 - 66	7	1	-	1	-	-	9	1	-	-	13	10	2	-	10	6	-	-	-	-	-	-	10A	2	-	-	-	-	-	-								
61 - 63	5	-	-	-	-	-	4	-	-	-	11	7	-	-	6	2	-	-	-	-	-	-	4	-	-	-	-	-	-	-								
58 - 60	3	-	-	-	-	-	-	-	-	-	10	5	-	-	2	-	-	-	-	-	-	-	-	-	-	-	-	-	-	-	-							
55 - 57	1	-	-	-	-	-	-	-	-	-	8	3	-	-	-	-	-	-	-	-	-	-	-	-	-	-	-	-	-	-	-							
52 - 54	-	-	-	-	-	-	-	-	-	-	6	1	-	-	-	-	-	-	-	-	-	-	-	-	-	-	-	-	-	-	-							
49 - 51	-	-	-	-	-	-	-	-	-	-	4	-	-	-	-	-	-	-	-	-	-	-	-	-	-	-	-	-	-	-	-							
46 - 48	-	-	-	-	-	-	-	-	-	-	2	-	-	-	-	-	-	-	-	-	-	-	-	-	-	-	-	-	-	-	-							
43 - 45	-	-	-	-	-	-	-	-	-	-	1	-	-	-	-	-	-	-	-	-	-	-	-	-	-	-	-	-	-	-	-							
0 - 42	-	-	-	-	-	-	-	-	-	-	-	-	-	-	-	-	-	-	-	-	-	-	-	-	-	-	-	-	-	-	-							
Fumble Range:	4		4		0m-10m:				+10				0m-10m:				+10				0m-10m:				+10		0m-10m:		+10		0m-10m:		+10		0m-10m:		+10	
Breakage #s:	7		7		11m-150m:				+0				11m-150m:				+0				11m-150m:				+0		11m-150m:		+0		11m-150m:		+0		11m-150m:		+0	
Reliability:	75		75		151m-300m:				-25				151m-300m:				-25				151m-300m:				-25		151m-300m:		-25		151m-300m:		-25		151m-300m:		-25	
					301m-1,500m:				-50				301m-1,500m:				-50				301m-1,500m:				-50		301m-1,500m:		-50		301m-1,500m:		-50		301m-1,500m:		-50	
					1,501m-3,000m:				-100				1,501m-3,000m:				-100				1,501m-3,000m:				-100		1,501m-3,000m:		-100		1,501m-3,000m:		-100		1,501m-3,000m:		-100	

**H & K
Apocalypse**



5.0 PLASMA ATTACK TABLES

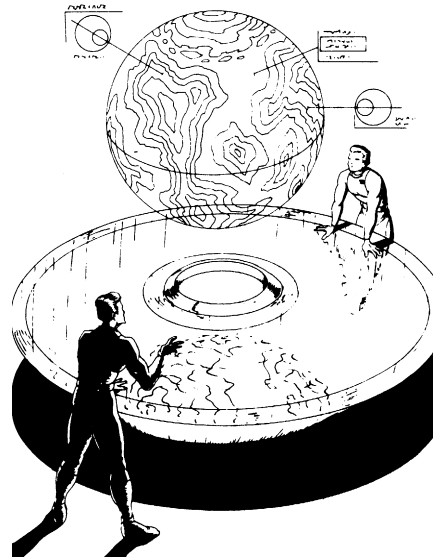

INTRODUCTION

This section contains an introduction, a key to the tables, and 10 plasma attack tables.

HOW TO USE THESE TABLES

To resolve an attack, the attacker makes a high open-ended roll. If this roll is within the fumble range of the weapon, then a non open-ended roll is made on the appropriate fumble table. Otherwise, all appropriate modifications (such as skill, range, injuries, bonuses and foe's DB) are added to the roll and the result is cross-indexed on the column appropriate to the foe's armor type.

The table will yield one of three results: a miss (i.e., "-"), a normal hit (e.g., "3"), or a critical strike (e.g., "3A"). A miss is just that, a miss. The attack fails and there are no effects other than the expended energy. In the event of a normal hit, the number is applied as damage to the opponent. In the event of a critical strike, the number is applied as damage to the foe, and a critical is rolled. The critical is resolved on the Blaster Critical Strike Table, with the letter denoting the severity of the critical (read: the column it's rolled on). The effect of the critical is then applied to the opponent.

In the event that the critical result is a severity higher than "E," the chart below will list the secondary and tertiary criticals applied. Note that these criticals are not rolled separately, the primary roll is merely compared to the charts for the secondary and tertiary effects.

SECONDARY/TERTIARY CRITICALS

Crit Result	Secondary Tertiary
F	A Heat none
G	B Heat none
H	C Heat none
I	D Heat none
J	E Heat none
K	E Heat A Heat
L	E Heat B Heat
M	E Heat C Heat

If these tables are not available, use the Burn Through Critical Table for secondary and tertiary criticals.



KEY TO THE TABLES

At the top of each table is a box that contains some information for a typical weapon that uses this table. See Section 8.4 for a more comprehensive listing of weapons and their stats. Each piece of information is listed below, along with a description of its purpose.

1) **Attack Table Number:** This is a unique number, which identifies the table.

2) **Plasma Energy Indicator:** This indicates the relative aperture energy of the table. The higher the number, the more powerful the weapon.

3) **Fumble:** This shows the chance of fumbling the weapon in an attack. If the unmodified roll falls within this range, then the attacker fumbles and must roll on the appropriate column of the fumble table.

4) **Breakage #s:** These numbers show how often the weapon should be checked for breakage. Anytime the attacker rolls doubles of the numbers shown (e.g., 11, 22, 33, etc.) the weapon must be checked for breakage.

5) **Reliability:** The typical reliability of a weapon of this type. Whenever the breakage numbers indicate a breakage check, an open-ended d100 should be rolled. The reliability of the weapon is then added. If the result is higher than 100, then the weapon functions normally. Otherwise, the weapon malfunctions and cannot be used until repaired. (If using *Future Law*, the malfunction can be determined using the rules therein).

6) **Range Modifiers:** These are the modifiers used when the attacker's target is at a certain range. This shows the range and the modifier applied.

7) **Concussion Damage:** This is an example of a result, which only deals concussion damage.

8) **Critical Strike:** This is an example of an attack that deals both concussion damage and a critical (of the severity indicated).

	Combat Armor			Kinetic Armor			Armored Cloth				Plate Armor				Chain Armor				Ri
	X	IX	VIII	VII	VI	V	IV	III	II	I	20	19	18	17	16	15	14	13	
148 - 150	2A	2B	3C	5A	6B	8C	5B	6C	7C	8C	2B	2C	3C	3C	4C	4C	5C	5C	5C
145 - 147	2A	2B	3C	5A	6B	8C	5B	6C	7C	8C	2B	2C	3C	3C	4C	4C	5C	5C	5C
142 - 144	2A	2B	3C	5A	6B	8C	5B	6C	7C	8C	2B	2C	3C	3C	4C	4C	5C	5C	5C
139 - 141	2A	2B	3C	5A	6B	8C	5B	6C	7C	8C	2B	2C	3C	3C	4C	4C	5C	5C	5C
136 - 138	2A	2B	3B	5A	6B	7C	5B	6B	7B	7C	2B	2C	3C	3C	4C	4C	5C	5C	5C
133 - 135	2A	2A	3B	5A	5A	7C	5A	5B	6B	7C	2B	2C	3C	3C	4C	4C	5C	5C	5C
130 - 132	2	2A	3B	5	5A	7B	5A	5B	6B	7B	2B	2B	3C	3C	4C	4C	4C	4C	4C
127 - 129	2	2A	3A	4	5A	7B	4A	5B	6B	7B	2A	2B	3B	3B	4C	4C	4C	4C	4B
124 - 126	2	2A	2A	4	5A	6B	4A	5A	6A	6B	2A	2B	3B	3B	4B	3B	4B	4B	4B
121 - 123	2	2A	2A	4	5A	6B	4A	5A	5A	6B	2A	2B	3B	3B	3B	3B	4B	4B	4B
118 - 120	2	2	2A	4	4	6B	4	4A	5A	6B	2A	2B	3B	3B	3B	3B	4B	4B	4B

LIST OF PLASMA ATTACK TABLES

Spectrum Arms 83/Tarrig Tock Attack Table PE-5.1

Spectrum Arms 1280/Karrig Tock Attack Table PE-5.2

Spectrum Arms 2105/Marrif Tock Attack Table PE-5.3

Spectrum Arms 3100/Tarrum Tock Attack Table PE-5.4

Chrometech P-30/Kathrack Rrrng Attack Table PE-5.5

Chrometech P-33/Mang Rrrng Attack Table PE-5.6

H & K SPC-25/Jarraff Pock Attack Table PE-5.7

H & K SPC-30/Kalurrr Pock Attack Table PE-5.8

H & K Fusion/KimirrrTang Attack Table PE-5.9

H & K Solar Flare/ Grrramas Thang Attack Table PE-5.10

	Combat Armor		Kinetic Armor					Armored Cloth					Plate Armor					Chain Armor					Rigid Leather					Soft Leather					Natural			Clothing	
	X	IX	VIII	VII	VI	V	IV	III	II	I	20	19	18	17	16	15	14	13	12	11	10	9	8	7	6	5	4	3	2	1							
148 - 150	2A	2B	3C	5A	6B	8C	5B	6C	7C	8C	2B	2C	3C	3C	4C	4C	5C	5C	5C	5C	5C	6C	6C	7C	7C	5C	7C	9C	9C	9C							
145 - 147	2A	2B	3C	5A	6B	8C	5B	6C	7C	8C	2B	2C	3C	3C	4C	4C	5C	5C	5C	5C	5C	6C	6C	7C	7C	5C	7C	9C	9C	9C							
142 - 144	2A	2B	3C	5A	6B	8C	5B	6C	7C	8C	2B	2C	3C	3C	4C	4C	5C	5C	5C	5C	5C	6C	6C	7C	7C	5C	7C	9C	9C	9C							
139 - 141	2A	2B	3C	5A	6B	8C	5B	6C	7C	8C	2B	2C	3C	3C	4C	4C	5C	5C	5C	5C	5C	6C	6C	7C	7C	5C	7C	9C	9C	9C							
136 - 138	2A	2B	3B	5A	6B	7C	5B	6B	7B	7C	2B	2C	3C	3C	4C	4C	5C	5C	5C	5C	5C	6C	6C	7C	7C	5C	7C	9C	9C	9C							
133 - 135	2A	2A	3B	5A	5A	7C	5A	5B	6B	7C	2B	2C	3C	3C	4C	4C	5C	5C	5C	5C	5C	6C	6C	7C	7C	5C	7C	9C	9C	9C							
130 - 132	2	2A	3B	5	5A	7B	5A	5B	6B	7B	2B	2B	3C	3C	4C	4C	4C	4C	4C	4C	4C	5C	5C	6C	6C	4B	6B	7C	7C	7C							
127 - 129	2	2A	3A	4	5A	7B	4A	5B	6B	7B	2A	2B	3B	3B	4C	4C	4C	4C	4C	4C	4C	5C	5C	6C	6C	4B	5B	7C	7B	7B							
124 - 126	2	2A	2A	4	5A	6B	4A	5A	6A	6B	2A	2B	3B	3B	4B	4B	4C	4C	4C	4C	4C	5C	5C	6C	6C	4B	5B	7C	7C	6B							
121 - 123	2	2A	2A	4	5A	6B	4A	5A	5A	6B	2A	2B	3B	3B	4B	4B	4B	4B	4B	4B	4B	5B	5C	5C	6C	4B	5B	6B	6B	6B							
118 - 120	2	2	2A	4	4	6B	4	4A	5A	6B	2A	2B	3B	2B	3B	3B	4B	4B	4B	4B	4B	5B	4B	5B	4B	4B	4B	6B	6B	6B							
115 - 117	2	2	2	4	4	6B	4	4	5A	6B	2A	2B	2B	2B	3B	3B	4B	4B	4B	4B	4B	5B	4B	5B	4B	4B	4B	6B	6B	6B							
112 - 114	2	2	2	4	4	5A	4	4	5	5A	2A	2A	2B	2B	3B	3B	3B	3B	3B	3B	3B	4B	4B	5B	3A	4A	5B	5B	5B	5B							
109 - 111	2	2	2	3	4	5A	3	4	4	5A	2	2A	2A	2B	3B	3B	3B	3B	3B	3B	3B	4B	4B	5B	3A	4A	5B	4A	4A	4A							
106 - 108	2	1	2	3	4	5A	3	4	4	5A	2	2A	2A	2A	3B	3B	3B	3A	3A	3A	3B	4B	4B	4B	3A	3A	5B	4A	4A	4A							
103 - 105	1	1	2	3	3	5A	3	3	4	5A	2	2A	2A	2A	3A	3A	3B	3A	2A	2A	2A	3B	4B	4B	3A	3A	4B	4A	4A	4A							
100 - 102	1	1	1	3	3	4A	3	3	4	4A	2	2A	2A	2A	3A	2A	3A	3A	2A	2A	2A	3B	3B	4B	3A	2A	4B	3A	3A	3A							
97 - 99	1	1	1	3	3	4A	3	3	3	4A	2	1A	2A	2A	2A	3A	2A	2A	2A	2A	2A	3B	3B	4B	3A	2A	4A	3A	3A	3A							
94 - 96	1	1	1	3	3	4	3	3	3	4	2	1	2A	2A	2A	2A	2A	2A	2A	2A	2A	3A	3B	3B	2	2	3A	2A	2A	2A							
91 - 93	1	1	1	2	3	3	3	3	3	3	1	1	2	2A	2A	2A	2A	2A	2A	2A	2A	3A	3A	3B	2	2	3A	2A	2A	2A							
88 - 90	1	1	1	2	2	3	2	2	2	3	1	1	2	1A	2A	2A	2A	2A	1A	1A	2A	3A	3A	3A	2	2	3A	2	2	2							
85 - 87	1	1	1	2	2	3	2	2	2	3	1	1	1	1	1	1	1	1	1	1	1	2A	2A	2A	2A	2	2	2A	1	1	1						
82 - 84	1	1	1	2	2	3	2	2	2	3	1	1	1	1	1	1	1	2	1	1A	1A	2A	2A	2A	2A	2	2	2A	1	1	1						
79 - 81	1	1	1	2	2	2	2	2	2	2	1	1	1	1	1	1	1	1	1	1	1	2A	2A	2A	2A	2	2	2A	1	1	1						
76 - 78	1	1	1	2	1	2	2	2	2	2	1	1	1	1	1	1	1	1	1	1	1	2A	2A	2A	2A	1	1	1A	1	1	1						
73 - 75	1	1	1	2	1	2	2	1	1	1	1	1	1	1	1	1	1	1	1	1	1	2A	1A	2A	2A	1	1	1	1	1	1						
70 - 72	1	1	1	1	1	2	1	1	1	1	1	1	1	1	1	1	1	1	1	1	1	2A	1A	2A	1A	1	1	1	1	1	1						
67 - 69	1	1	1	1	1	1	1	1	1	1	1	1	1	1	1	1	1	1	1	1	1	1A	1A	1A	1A	1	1	1	1	1	1						
64 - 66	1	1	1	1	1	1	1	1	1	1	1	1	1	1	1	1	1	1	1	1	1	1	1	1	1	1	1	1	1	1	1						
61 - 63	1	1	1	1	1	1	1	1	1	1	1	1	1	1	1	1	1	1	1	1	1	1	1	1	1	1	1	1	1	1	1						
58 - 60	1	1	1	1	1	1	1	1	1	1	1	1	1	1	1	1	1	1	1	1	1	1	1	1	1	1	1	1	1	1	1						
55 - 57	1	1	1	1	1	1	1	1	1	1	1	1	1	1	1	1	1	1	1	1	1	1	1	1	1	1	1	1	1	1	1						
52 - 54	1	1	1	1	1	1	1	1	1	1	1	1	1	1	1	1	1	1	1	1	1	1	1	1	1	1	1	1	1	1	1						
49 - 51	1	1	1	1	1	1	1	1	1	1	1	1	1	1	1	1	1	1	1	1	1	1	1	1	1	1	1	1	1	1	1						
46 - 48	1	1	1	1	1	1	1	1	1	1	1	1	1	1	1	1	1	1	1	1	1	1	1	1	1	1	1	1	1	1	1						
43 - 45	1	1	1	1	1	1	1	1	1	1	1	1	1	1	1	1	1	1	1	1	1	1	1	1	1	1	1	1	1	1	1						
40 - 42	1	1	1	1	1	1	1	1	1	1	1	1	1	1	1	1	1	1	1	1	1	1	1	1	1	1	1	1	1	1	1						
0 - 39	1	1	1	1	1	1	1	1	1	1	1	1	1	1	1	1	1	1	1	1	1	1	1	1	1	1	1	1	1	1	1						

Fumble Range:	5	Range Modifiers:	0m-1m:	+10
Breakage #s:	7		2m:	+0
Reliability:	55		3m:	-25
			4m:	-50
			5m-9m:	-100
Spectrum				
Arms 83				
PE 1				

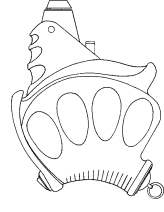



	Combat Armor			Kinetic Armor			Armored Cloth					Plate Armor			Chain Armor			Rigid Leather						Soft Leather			Natural			Clothing	
	X	IX	VIII	VII	VI	V	IV	III	II	I	20	19	18	17	16	15	14	13	12	11	10	9	8	7	6	5	4	3	2	1	
148 - 150	2B	3C	4D	8B	11C	14D	8C	10D	12D	14D	2C	3D	3D	4D	6D	6D	7D	7D	7D	7D	8D	8D	9D	10D	11D	11D	7D	11D	15D	16D	
145 - 147	2B	3C	4D	8B	11C	14D	8C	10D	12D	14D	2C	3D	3D	4D	6D	6D	7D	7D	7D	7D	8D	8D	9D	10D	11D	11D	7D	11D	15D	16D	
142 - 144	2B	3C	4D	8B	11C	14D	8C	10D	12D	14D	2C	3D	3D	4D	6D	6D	7D	7D	7D	7D	8D	8D	9D	10D	11D	11D	7D	10D	14D	15D	
139 - 141	2A	3C	4C	8A	10C	13D	8C	9C	11C	13D	2C	3D	3D	4D	6D	6D	7D	7D	7D	7D	8D	8D	9D	10D	10D	10D	7D	10D	14D	14D	
136 - 138	2A	3C	4C	7A	10B	13D	7B	9C	11C	13D	2C	3D	3D	4D	6D	6D	7D	6D	6D	6D	7D	7D	8D	9D	10D	10D	7D	9D	13D	14D	
133 - 135	2A	3B	4B	7A	10B	12C	7B	9C	10C	12C	2B	3C	3C	4D	6D	6D	6D	6D	6D	6D	7D	7D	8D	9D	10D	10D	6C	9C	13D	13C	
130 - 132	2	3B	3B	7	9B	12C	7B	8B	10B	12C	2B	3C	3C	4C	5C	5C	6C	6C	6C	6C	7C	7D	8D	8D	9D	9D	6C	8C	12D	12C	
127 - 129	2	3A	3B	7	9A	11C	7A	8B	10B	11C	2B	3C	3C	4C	5C	5C	6C	6C	6C	6C	6C	6C	7C	7D	8D	9D	6C	8C	12C	12C	
124 - 126	2	3A	3A	6	8A	11C	6A	8A	9B	11C	2B	3C	3C	3C	5C	5C	6C	5C	5C	5C	6C	6C	7C	7C	8C	8C	6C	7C	11C	11C	
121 - 123	2	2A	3A	6	8A	10B	6A	7A	9A	10B	2A	3B	3C	3C	5C	5C	5C	5C	5C	5C	6C	6C	7C	7C	8C	8C	5B	7B	10C	10C	
118 - 120	2	2	3A	6	8	10B	6	7A	8A	10B	2A	3B	3B	3C	5C	5C	5C	5C	5C	5C	6C	6C	7C	7C	8C	8C	5B	6B	10C	10B	
115 - 117	2	2	3	6	7	9B	6	7	8A	9B	2A	3B	2B	3B	4B	4B	5C	5C	5B	4B	5C	6C	6C	7C	7C	5B	6B	9C	9B		
112 - 114	2	2	2	5	7	9B	5	6	7	9B	2A	2B	2B	3B	4B	4B	5B	4C	4B	4B	5B	6C	6C	6C	7C	5B	5B	9C	8B		
109 - 111	2	2	2	5	7	8A	5	6	7	8B	2	2A	2B	3B	4B	4B	4B	4B	4B	4B	5B	5C	6C	6C	7C	4A	5B	8B	7B		
106 - 108	2	2	2	5	6	8A	5	6	7	8A	2	2A	2A	3B	4B	4B	4B	4B	4B	4B	4B	4B	5B	5C	6C	4A	4A	8B	7B		
103 - 105	1	2	2	5	6	8A	5	5	6	8A	2	2A	2A	2B	4B	4B	4B	4B	4B	4B	4B	4B	5B	5B	6B	4A	4A	7B	6A		
100 - 102	1	2	2	4	5	7A	4	5	6	7A	2	2A	2A	2A	4A	3B	4B	3B	3A	3A	4B	4B	5B	5B	5B	4A	3A	6B	5A		
97 - 99	1	2	2	4	5	7A	4	5	5	7A	2	2A	2A	2A	3A	3A	3B	3B	3A	3A	3B	3B	4B	4B	5B	3A	3A	6B	5A		
94 - 96	1	1	1	4	5	6	4	4	5	6	2	2	2A	2A	3A	3A	3B	3A	2A	2A	3A	3B	4B	4B	5B	3	2	5B	4A		
91 - 93	1	1	1	4	4	6	4	4	5	6	1	2	2	2A	3A	3A	3A	3A	3A	2A	2A	3A	4B	4B	4B	3	2	5A	3A		
88 - 90	1	1	1	3	4	5	3	4	4	5	1	2	2	2A	3A	3A	2A	2A	2A	2A	3A	4B	4B	4B	3	1	4A	3			
85 - 87	1	1	1	3	3	5	3	3	4	5	1	2	1	2	3A	2A	2A	2A	2A	2A	2A	3A	3B	3B	4B	2	1	4A	2		
82 - 84	1	1	1	3	3	4	3	3	3	4	1	2	1	1	2	2A	2A	2A	2	1	2A	2A	3A	3A	3A	2	1	3A	1		
79 - 81	1	1	1	3	3	4	3	3	3	4	1	1	1	1	2	2	2A	2A	2	1	2A	2A	3A	3A	3A	2	-	2A	1		
76 - 78	1	1	1	2	2	3	2	2	2	3	1	1	1	1	2	2	2	1A	1	1	1	1A	3A	2A	2A	2	-	2A	-		
73 - 75	1	1	1	2	2	3	2	2	2	3	1	1	1	1	2	2	2	1A	1	1	1	1A	2A	2A	2A	1	-	1	-		
70 - 72	1	1	1	2	2	2	2	2	2	2	1	1	1	1	2	1	1	1	1	1	1	1A	2A	2A	2A	1	-	1	-		
67 - 69	1	-	-	2	1	2	2	1	1	2	1	1	1	1	2	1	1	1	1	-	-	1	2A	1A	1A	1	-	-	-		
64 - 66	1	-	-	1	1	2	1	1	1	2	1	1	1	1	1	1	1	1	1	-	-	1	1A	1A	1A	1	-	-	-		
61 - 63	1	-	-	1	1	1	1	1	1	1	1	1	1	1	1	1	1	1	-	-	-	1	1	1	1	1	-	-	-		
58 - 60	-	-	-	1	1	1	1	1	1	1	1	1	1	1	1	1	1	1	1	1	1	1A	2A	2A	2A	1	-	-	-		
55 - 57	-	-	-	1	1	1	1	1	1	1	1	1	1	1	1	1	1	1	1	1	1	1A	2A	2A	2A	1	-	-	-		
52 - 54	-	-	-	1	1	1	1	1	1	1	1	1	1	1	1	1	1	1	1	1	1	1	1A	1A	1A	1	-	-	-		
49 - 51	-	-	-	1	1	1	1	1	1	1	1	1	1	1	1	1	1	1	1	1	1	1	1A	1A	1A	1	-	-	-		
46 - 48	-	-	-	1	1	1	1	1	1	1	1	1	1	1	1	1	1	1	1	1	1	1	1A	1A	1A	1	-	-	-		
43 - 45	-	-	-	1	1	1	1	1	1	1	1	1	1	1	1	1	1	1	1	1	1	1	1	1	1	1	-	-	-		
40 - 42	-	-	-	1	1	1	1	1	1	1	1	1	1	1	1	1	1	1	1	1	1	1	1	1	1	1	-	-	-		
0 - 39	-	-	-	1	1	1	1	1	1	1	1	1	1	1	1	1	1	1	1	1	1	1	1	1	1	1	-	-	-		

Fumble Range: 3
 Breakage #s: 7
 Reliability: 55

Range Modifiers:
 0m-2m: +10
 3m: +0
 4m: -25
 5m-7m: -50
 8m-18m: -100

Spectrum
 Arms 1280
 PE 2

	Combat Armor		Kinetic Armor					Armored Cloth				Plate Armor				Chain Armor				Rigid Leather				Soft Leather				Natural			Clothing	
	X	IX	VIII	VII	VI	V	IV	III	II	I	20	19	18	17	16	15	14	13	12	11	10	9	8	7	6	5	4	3	2	1		
148 - 150	7C	8D	10E	17C	21D	25E	17D	19E	22E	25E	7D	8E	9E	10E	13E	13E	14E	14E	14E	15E	16E	17E	17E	17E	20E	21E	15E	20E	26E	28E		
145 - 147	7C	8D	10E	17C	21D	25E	17D	19E	22E	25E	7D	8E	9E	10E	13E	13E	14E	14E	14E	15E	16E	17E	17E	17E	20E	21E	15E	20E	26E	27E		
142 - 144	7B	8D	10D	16B	20D	24E	16D	18E	21E	24E	7D	8E	9E	10E	13E	13E	14E	13E	13E	14E	15E	16E	16E	16E	19E	20E	14E	19E	25E	26E		
139 - 141	7B	8C	9D	16B	19C	23E	16C	18D	20D	23E	7D	8E	9E	9E	12E	12E	13E	13E	13E	14E	15E	16E	16E	16E	18E	19E	14E	18E	24E	25E		
136 - 138	7A	7C	9C	15A	19C	22D	15C	17D	19D	22D	7C	8D	8D	9E	12E	12E	13E	12E	12E	13E	14E	15E	15E	15E	18E	19E	13D	17D	23E	24D		
133 - 135	6A	7B	8C	15A	18B	21D	15B	16C	19C	21D	7C	7D	8D	9D	12D	11D	12D	12E	12E	12D	13D	14E	15E	15E	17E	18E	13D	16D	22D	22D		
130 - 132	6	7B	8B	14	17B	21D	14B	16C	18C	21D	6C	7D	8D	8D	11D	11D	12D	11D	11D	11D	12D	13D	14D	14D	16D	17D	12D	15D	21D	21D		
127 - 129	6	6A	8B	14	16A	20C	14A	15B	17B	20D	6B	7C	7D	8D	11D	11D	11D	11D	11D	11D	12D	13D	14D	14D	16D	16D	12C	14D	20D	20D		
124 - 126	6	6A	7A	13	16A	19C	13A	14B	16B	19C	6B	7C	7C	8D	10D	10D	11D	10D	10D	11D	12D	12D	13D	13D	15D	16D	11C	13C	19D	19C		
121 - 123	5	6A	7A	13	15A	18C	13A	14A	16B	18C	6B	6C	7C	7C	10C	10C	10D	10D	10C	10C	11D	12D	13D	12D	14D	15D	11C	12C	18D	18C		
118 - 120	5	5	6A	12	14	17C	12	13A	15A	17C	6A	6C	7C	7C	10C	9C	10C	9D	9C	9C	10C	11D	12D	12D	14D	14D	10C	11C	17C	16C		
115 - 117	5	5	6	12	13	16B	12	12	14A	16B	5A	6B	6C	7C	9C	9C	9C	9C	9C	9C	10C	11C	12C	11D	13D	14D	10B	10B	16C	15C		
112 - 114	5	5	5	11	13	16B	11	12	13	16B	5A	6B	6B	6C	8C	8C	8C	8C	8C	8C	9C	10C	11C	11C	12C	13C	9B	10B	15C	14B		
109 - 111	4	5	5	10	12	15B	10	11	13	15B	5	5B	6B	6B	8B	8C	8C	8C	8C	8B	8B	9C	10C	10C	12C	12C	9B	9B	14C	13B		
106 - 108	4	4	5	10	11	14A	10	11	12	14B	5	5A	5B	6B	8B	8B	7C	7C	7B	7B	8B	9C	10C	10C	11C	11C	8A	8B	13C	11B		
103 - 105	4	4	4	9	11	13A	9	10	11	13A	5	5A	5A	5B	8B	7B	7B	7C	7B	6B	7B	8C	9C	9C	10C	11C	8A	7A	12B	10B		
100 - 102	4	4	4	9	10	12A	9	9	10	12A	4	5A	5A	5B	7B	7B	7B	6B	6B	6B	7B	7B	8C	8C	10C	10C	7A	6A	11B	9A		
97 - 99	3	3	3	8	9	11A	8	9	9	11A	4	4A	4A	4A	5A	5A	6B	6B	6A	5A	6B	7B	8B	8B	9C	9C	7A	5A	10B	8A		
94 - 96	3	3	3	8	8	11	8	8	9	11	4	4	4A	4A	6A	6A	6B	5B	5A	5A	6B	6B	8B	8B	8B	9B	6	4	9B	7A		
91 - 93	3	3	3	7	8	10	7	7	8	10	4	4	4	4	6A	6A	6A	5B	5A	4A	5A	6B	7B	7B	8B	8B	6	3	8B	5A		
88 - 90	3	2	2	7	7	9	7	7	7	9	4	4	4	4A	6A	5A	4B	4A	4A	3A	4A	5B	7B	6B	7B	7B	5	2	7A	4		
85 - 87	2	2	2	6	6	8	6	6	6	8	3	3	3	3	5A	5A	4A	4A	4A	3A	4A	4B	6B	6B	6B	6B	5	1	6A	3		
82 - 84	2	2	1	6	5	7	6	5	6	7	3	3	3	3	5	4A	4A	3A	3	2	3A	4A	6A	5B	5B	6B	4	1	5A	2		
79 - 81	2	2	1	5	5	7	5	5	5	7	3	3	3	2	4	4	4	3A	3	2	3A	3A	5A	4A	5A	5A	4	-	4A	1		
76 - 78	2	1	1	4	4	6	4	4	4	6	3	3	2	2	4	3	2A	2	2	1	2	2A	4A	4A	4A	4A	3	-	3A	-		
73 - 75	2	1	-	4	3	5	4	3	3	5	3	3	2	2	4	3	2A	2	1	1	1	2A	4A	3A	3A	4A	3	-	2	-		
70 - 72	1	1	-	3	2	4	3	3	3	4	3	2	2	1	3	3	2	1	1	-	1	1A	3A	3A	3A	3A	2	-	1	-		
67 - 69	1	-	-	3	2	3	3	2	2	3	2	2	1	1	3	2	2	1	1	-	-	1	3A	2A	2A	2A	2	-	-	-		
64 - 66	1	-	-	2	1	2	2	2	1	2	2	2	1	1	2	2	1	1	1	-	-	-	2	2A	1A	1A	1	-	-	-		
61 - 63	1	-	-	2	-	2	2	1	-	2	2	2	1	-	2	1	1	1	-	-	-	2	1	1	1	1	1	-	-	-		
58 - 60	-	-	-	1	-	1	1	-	-	1	2	1	1	-	2	1	1	-	-	-	-	1	1	1	-	-	-	-	-	-		
55 - 57	-	-	-	1	-	1	1	-	-	1	2	1	1	-	1	1	1	-	-	-	-	1	1	-	-	-	-	-	-	-		
52 - 54	-	-	-	-	-	-	-	-	-	-	1	1	-	1	-	-	-	-	-	-	-	-	-	-	-	-	-	-	-	-		
49 - 51	-	-	-	-	-	-	-	-	-	-	1	1	-	1	-	-	-	-	-	-	-	-	-	-	-	-	-	-	-	-		
46 - 48	-	-	-	-	-	-	-	-	-	-	1	1	-	1	-	-	-	-	-	-	-	-	-	-	-	-	-	-	-	-		
43 - 45	-	-	-	-	-	-	-	-	-	-	1	-	-	-	-	-	-	-	-	-	-	-	-	-	-	-	-	-	-	-		
40 - 42	-	-	-	-	-	-	-	-	-	-	1	-	-	-	-	-	-	-	-	-	-	-	-	-	-	-	-	-	-	-		
0 - 39	-	-	-	-	-	-	-	-	-	-	-	-	-	-	-	-	-	-	-	-	-	-	-	-	-	-	-	-	-	-		

Fumble Range:	3	Range Modifiers:	0m-2m: +10
Breakage #s:	7		3m: +0
Reliability:	55		4m: -25
			5m-7m: -50
			8m-18m: -100

Spectrum
Arms 2105
PE 3





	Combat Armor		Kinetic Armor			Armored Cloth				Plate Armor			Chain Armor			Rigid Leather			Soft Leather			Natural			Clothing					
	X	IX	VIII	VII	VI	V	IV	III	II	I	20	19	18	17	16	15	14	13	12	11	10	9	8	7	6	5	4	3	2	1
148 - 150	22E	26F	30G	47E	57F	68G	47F	54G	61G	68G	22F	24G	27G	30G	37G	40G	40G	40G	41G	45G	47G	48G	48G	48G	55G	59G	41G	56G	73G	76G
145 - 147	22D	28F	29G	46D	56F	66G	46F	53G	59G	66G	22F	24G	27G	29G	36G	36G	39G	39G	40G	44G	46G	47G	47G	47G	54G	57G	40G	54G	71G	73G
142 - 144	21C	25E	28F	44C	54E	64G	44E	51F	57F	64G	21F	23G	26G	28G	35G	35G	38G	38G	38G	38G	42G	44G	45G	45G	52G	55G	39G	51G	68G	70G
139 - 141	20B	24E	27E	43B	52E	62F	43E	49F	55F	62F	21E	22F	25F	27F	34G	34G	36G	36G	36F	37F	40G	42G	44G	44G	50G	53G	37F	49F	65G	67F
136 - 138	19A	23D	25E	41A	50D	60F	41D	47E	53E	60F	19D	22F	24F	26F	33F	33F	35F	35F	35F	39F	41F	42F	42F	42F	48G	51G	36F	46F	62F	63F
133 - 135	19A	22C	24D	40A	48C	57E	40C	45D	51D	57F	19D	21E	23F	25F	32F	32F	34F	33F	33F	33F	37F	39F	41F	40F	46F	49F	34E	44F	60F	60F
130 - 132	18	21C	23C	38	46C	55E	38C	44D	49D	55E	19D	20E	22E	24E	31F	30F	32F	32F	32E	35F	37F	39F	39F	39F	44F	47F	33E	41E	57F	57E
127 - 129	17	20B	22C	37	44B	53E	37B	42C	47C	53E	18C	19E	21E	23E	30E	29E	31E	30F	30E	30E	34E	35F	38F	37F	42F	45F	32E	39E	54E	53E
124 - 126	16	19A	20B	35	42A	51D	35A	40B	44C	51D	18C	19D	20D	22E	29E	28E	30E	29E	29E	28E	32E	34E	36E	36F	40F	43F	30D	36D	51E	50E
121 - 123	16	18A	19A	34	40A	48D	34A	38B	42B	48D	17B	18D	19D	21D	27E	27E	28E	28E	28D	27D	30E	32E	35E	34E	39E	41E	29D	34D	49E	47D
118 - 120	15	17	18A	32	38	46C	32	36A	40A	46D	16B	17C	19D	20D	26D	26D	27D	26E	26D	25D	29D	30E	33E	32E	37E	39E	27C	31D	46E	43D
115 - 117	14	16	17	31	36	44C	31	34	38A	44C	16A	17C	18C	19D	25D	24D	25D	25D	25D	23D	27D	28E	32E	31E	35E	37E	26C	28C	43D	40D
112 - 114	13	15	15	29	34	42C	29	33	36	42C	15A	16C	17C	18C	24D	23D	24D	23D	23C	22C	25D	27D	30D	29E	33E	35E	25C	26C	40D	37C
109 - 111	13	14	14	28	32	39B	28	31	34	39B	15	15B	16C	17C	23C	22C	23C	22D	22C	20C	24D	25D	29D	28D	31D	33D	23B	23B	37D	34C
106 - 108	12	13	13	26	30	37B	26	29	32	37B	14	15B	15B	16C	22C	21C	21C	20D	20C	19C	22C	23D	27D	26D	29D	31D	22B	21B	35C	30B
103 - 105	11	12	12	25	28	35A	25	27	30	35B	13	14A	14B	15B	21C	20C	20C	19C	19B	17B	20C	21D	26D	24D	27D	29D	20A	18B	32C	27B
100 - 102	10	11	10	23	26	33A	23	25	27	33A	13	13A	13A	14B	20B	18B	19C	18C	18B	15B	18C	20C	24C	23D	25D	27D	19A	16A	29C	24B
97 - 99	10	10	9	22	24	30A	22	24	25	30A	12	12A	12A	13B	18B	17B	17B	16C	16B	14B	17B	18C	22C	21C	24C	25C	17A	13A	26C	20A
94 - 96	9	8	8	20	22	28	20	22	23	28	12	12	11A	12A	17B	16B	16B	15C	15A	12A	15B	16C	21C	20C	22C	23C	16	11	24B	17A
91 - 93	8	8	7	19	20	26	19	20	21	26	11	11	11A	11A	11A	15A	15A	15B	13B	13A	10A	13B	14C	19C	18C	20C	15	8	21B	14A
88 - 90	7	7	5	17	18	24	17	18	19	24	10	10	10	10A	15A	14A	13A	13B	12A	9A	12A	13B	18B	16C	18C	19C	13	6	18B	10
85 - 87	7	6	4	16	16	21	16	16	17	21	10	10	9	9	14A	12A	12A	10B	10A	7A	10A	11B	16B	15B	16B	17B	12	3	15A	7
82 - 84	6	5	3	14	14	19	14	14	15	19	9	9	8	7	13	11A	10A	9A	9	5	8A	9B	15B	13B	14B	15B	10	1	13A	4
79 - 81	5	4	2	13	12	17	13	13	13	17	9	8	7	6	12	10	9	8A	8	4	7A	7A	13B	12B	12B	13B	9	-	10A	1
76 - 78	4	3	1	11	10	15	11	11	10	15	8	7	6	5	11	9	8	6A	6	2	5	6A	12A	10B	10B	11B	8	-	7A	-
73 - 75	4	2	-	10	8	12	10	9	8	12	7	7	5	4	9	8	6	5A	5	1	3	4A	10A	8A	9A	9A	6	-	4	-
70 - 72	3	1	-	8	6	10	8	7	6	10	7	6	4	3	8	6	5	3	3	-	2	2A	9A	7A	7A	7A	5	-	1	-
67 - 69	2	-	-	7	4	8	7	5	4	8	6	5	3	2	7	5	4	2	2	-	-	1	7A	5A	5A	5A	3	-	-	-
64 - 66	1	-	-	5	2	6	5	4	2	6	6	5	3	1	6	4	2	1	1	-	-	-	6	4A	3A	3A	2	-	-	-
61 - 63	1	-	-	4	-	3	4	2	-	3	5	4	2	-	5	3	1	-	-	-	-	-	4	2	1	1	1	-	-	-
58 - 60	-	-	-	2	-	1	2	-	-	1	4	3	1	-	4	2	-	-	-	-	-	-	3	1	-	-	-	-	-	-
55 - 57	-	-	-	1	-	-	1	-	-	-	4	2	-	-	3	1	-	-	-	-	-	-	1	-	-	-	-	-	-	-
52 - 54	-	-	-	-	-	-	-	-	-	-	3	2	-	-	2	-	-	-	-	-	-	-	-	-	-	-	-	-	-	-
49 - 51	-	-	-	-	-	-	-	-	-	-	3	1	-	-	1	-	-	-	-	-	-	-	-	-	-	-	-	-	-	-
46 - 48	-	-	-	-	-	-	-	-	-	-	2	-	-	-	-	-	-	-	-	-	-	-	-	-	-	-	-	-	-	-
43 - 45	-	-	-	-	-	-	-	-	-	-	1	-	-	-	-	-	-	-	-	-	-	-	-	-	-	-	-	-	-	-
40 - 42	-	-	-	-	-	-	-	-	-	-	1	-	-	-	-	-	-	-	-	-	-	-	-	-	-	-	-	-	-	-
0 - 39	-	-	-	-	-	-	-	-	-	-	-	-	-	-	-	-	-	-	-	-	-	-	-	-	-	-	-	-	-	-

Fumble Range:	3	Range Modifiers:	0m-1m:	+10
Breakage #s:	8		2m-5m:	+0
Reliability:	45		6m-10m:	-25
			11m-50m:	-50
			51m-100m:	-100
Chrometech				
P-30				
PE 5				

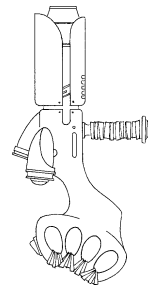



	Combat Armor			Kinetic Armor			Armored Cloth				Plate Armor			Chain Armor			Rigid Leather			Soft Leather			Natural			Clothing				
	X	IX	VIII	VII	VI	V	IV	III	II	I	20	19	18	17	16	15	14	13	12	11	10	9	8	7	6	5	4	3	2	1
148 - 150	43F	53G	63H	100F	126G	153H	100G	119H	134H	153H	43G	50H	57H	63H	82H	82H	88H	88H	88H	90H	100H	103H	107H	107H	122H	132H	90H	124H	164H	172H
145 - 147	42E	52G	61H	97E	122G	148H	97G	115H	130H	148H	42G	49H	56H	61H	80H	80H	85H	85H	85H	87H	97H	100H	104H	104H	118H	128H	87H	119H	158H	165H
142 - 144	41D	50F	58G	94D	118F	143H	94F	111G	125G	143H	41F	48H	54H	59H	78H	77H	82H	82H	82H	82H	93H	96H	101H	100H	114H	123H	84H	113H	152H	158H
139 - 141	39C	48E	56F	91C	113E	138G	91E	107F	120F	138G	40F	46G	52G	57G	75G	75G	79G	79H	79G	80G	89G	92H	97H	97H	110H	119H	81G	108G	146H	150G
136 - 138	38B	46D	53E	88B	109D	133G	88D	103E	116F	133G	39E	45G	50G	55G	73G	72G	76G	76G	76G	76G	85G	88G	94G	93G	106G	114G	78G	102G	140G	149G
133 - 135	36A	44D	50D	85A	105D	128F	85D	99E	111E	128F	38E	43F	48F	53G	70G	69G	73G	73G	73G	72G	82G	84G	90G	90G	102G	110G	75F	96F	133G	138F
130 - 132	35	42C	48D	81	100C	123F	81C	95D	106D	123F	36D	42F	46F	50F	68F	67F	70G	70G	70F	66F	78G	81G	87G	86G	98G	105G	72F	91F	127G	128E
127 - 129	33	40B	45C	78	96B	118E	78B	91C	102D	118E	35D	40E	44E	48F	65F	64F	67F	66F	66F	65F	74F	77F	84F	83G	93G	101G	69E	85E	121F	120F
124 - 126	32	38A	42B	75	91A	113E	75A	87B	97C	113E	34C	39E	42E	46E	63E	61F	64F	63F	63E	62E	70F	73F	80F	79F	88F	96F	68E	79E	115F	113E
121 - 123	30	36A	40A	72	87A	108D	72A	83B	92B	108D	33B	37D	41E	44E	60E	59E	61E	60F	60E	58E	67E	69F	77F	75F	85F	92F	63D	74D	108F	105E
118 - 120	29	34	37A	69	83	103D	69	79A	88B	103D	32B	36D	39D	42E	58E	56E	58E	57E	57E	54E	63E	65E	73F	72F	81F	87F	59D	68D	102E	98D
115 - 117	27	32	35	65	78	98C	65	75	83A	98D	31A	34C	37D	39D	55D	53D	55E	54E	54D	51D	59E	62E	70E	68E	77E	83E	56C	62D	96E	90D
112 - 114	26	30	32	62	74	93C	62	71	78	93C	28A	33C	35C	37D	53D	51D	52D	51E	51D	47D	55D	58E	67E	65E	73E	78E	53C	57C	90E	83D
109 - 111	24	28	29	59	69	88B	59	67	74	88C	28A	31B	33C	35C	50D	48D	49D	48D	48D	44D	52D	54E	63E	61E	68E	74E	50B	51C	84D	75C
106 - 108	23	26	27	56	65	83B	56	63	69	83B	27	30B	31B	33C	48C	45C	46D	44D	44C	40C	48D	50D	60D	58E	64E	69E	47B	46B	77D	68C
103 - 105	22	24	24	53	61	78B	53	59	64	78B	26	28A	29B	31C	45C	43C	43C	41D	41C	36C	44C	46D	56D	54D	60D	65D	44A	40B	71D	60B
100 - 102	20	22	21	49	56	73A	49	55	60	73A	25	27A	27B	28B	43B	40C	40C	38C	38B	33B	40C	42D	53D	50D	56D	60D	41A	34A	65C	53B
97 - 99	19	20	19	46	52	68A	46	51	55	68A	24	25A	26A	26B	40B	38B	37B	35C	35B	29B	37C	39C	49C	47D	52D	56D	38A	29A	59C	45A
94 - 96	17	18	16	43	47	63	43	47	50	63	22	24	24A	24B	38B	35B	34B	32C	32B	26B	33B	35C	46C	43C	48C	51C	35	23	52C	38A
91 - 93	16	16	14	40	43	58	40	43	46	58	21	22	22	22A	35A	32B	31B	29B	29A	22A	29B	31C	43C	40C	43C	47C	32	17	46B	30A
88 - 90	14	14	11	37	39	53	37	39	41	53	20	21	20	20A	33A	30A	28A	26B	26A	18A	25B	27B	39C	36C	39C	42C	28	12	40B	23
85 - 87	13	12	8	33	34	48	33	35	36	48	19	19	18	17	30A	27A	25A	22B	22A	15A	22A	23B	36B	33C	35C	38C	25	6	34B	15
82 - 84	11	10	6	30	30	43	30	31	32	43	18	18	16	15	28	24A	22A	19B	19	11	18A	20B	32B	29B	31B	33B	22	1	27A	8
79 - 81	10	8	3	27	25	37	27	27	27	37	17	16	14	13	25	22	19	16A	16	8	14A	16B	29B	25B	27B	29B	19	-	21A	1
76 - 78	8	6	1	24	21	32	24	23	22	32	15	15	12	11	23	19	16	13A	13	4	10	12A	26A	22B	23B	24B	16	-	15A	-
73 - 75	7	4	-	21	17	27	21	19	18	27	14	13	11	9	20	16	13	10A	10	1	7	8A	22A	18A	19B	20B	13	-	9	-
70 - 72	5	2	-	18	12	22	18	15	13	22	13	12	9	6	18	14	10	7	7	-	3	4A	19A	15A	14A	15A	10	-	3	-
67 - 69	4	-	-	14	8	17	14	11	8	17	12	10	7	4	15	11	7	4	4	-	-	1	15A	11A	10A	11A	7	-	-	-
64 - 66	2	-	-	11	3	12	11	7	4	12	11	9	5	2	13	8	4	1	1	-	-	-	12	8A	6A	6A	4	-	-	-
61 - 63	1	-	-	8	-	7	8	3	-	7	9	7	3	-	10	6	1	-	-	-	-	-	8	4	2	2	1	-	-	-
58 - 60	-	-	-	5	-	2	5	-	-	2	8	6	1	-	8	3	-	-	-	-	-	-	5	1	-	-	-	-	-	-
55 - 57	-	-	-	2	-	2	2	-	-	2	7	4	-	-	5	1	-	-	-	-	-	-	2	-	-	-	-	-	-	-
52 - 54	-	-	-	-	-	-	-	-	-	-	6	3	-	-	3	-	-	-	-	-	-	-	-	-	-	-	-	-	-	-
49 - 51	-	-	-	-	-	-	-	-	-	-	5	1	-	-	1	-	-	-	-	-	-	-	-	-	-	-	-	-	-	-
46 - 48	-	-	-	-	-	-	-	-	-	-	4	-	-	-	4	-	-	-	-	-	-	-	-	-	-	-	-	-	-	-
43 - 45	-	-	-	-	-	-	-	-	-	-	2	-	-	-	-	-	-	-	-	-	-	-	-	-	-	-	-	-	-	-
40 - 42	-	-	-	-	-	-	-	-	-	-	1	-	-	-	-	-	-	-	-	-	-	-	-	-	-	-	-	-	-	-
0 - 39	-	-	-	-	-	-	-	-	-	-	0	-	-	-	-	-	-	-	-	-	-	-	-	-	-	-	-	-	-	-

Fumble Range:	3	Range Modifiers:	0m-1m: +10
Breakage #s:	8		2m-8m: +0
Reliability:	/ 5		9m-17m: -25
			18m-83m: -50
			84m-165m: -100

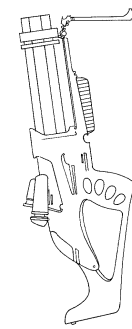

H & K
SPC-25
PE 7



	Combat Armor										Kinetic Armor					Armored Cloth				Plate Armor										Chain Armor										Rigid Leather										Soft Leather					Natural			Clothing		
	X	IX	VIII	VII	VI	V	IV	III	II	I	20	19	18	17	16	15	14	13	12	11	10	9	8	7	6	5	4	3	2	1	20	19	18	17	16	15	14	13	12	11	10	9	8	7	6	5	4	3	2	1										
148 - 150	57G	69H	82I	127G	161H	195I	127H	152I	170I	195I	57H	66I	75I	82I	107I	114I	114I	114I	114I	117I	129I	133I	138I	138I	157I	169I	117I	159I	210I	220I																														
145 - 147	56F	67H	79I	123F	156H	189I	123H	147I	165I	189I	56H	65I	73I	80I	104I	104I	111I	110I	110I	110I	113I	125I	129I	134I	134I	152I	164I	113I	152I	203I	211I																													
142 - 144	54E	64G	76H	119E	150G	183H	119G	142H	159H	183H	54G	63H	71I	77I	101I	101I	107I	106I	106I	108I	120I	124I	130I	129I	147I	158I	109H	145H	195I	201I																														
139 - 141	52C	62F	72G	115C	145F	176H	115F	137G	153G	176H	53G	61H	68H	74H	98H	97H	103H	102H	102H	103H	115H	119H	125H	125H	141I	152I	105H	138H	187H	192H																														
136 - 138	50B	59E	69F	111B	139E	170G	111E	132F	147F	170G	51F	59G	66H	71H	95H	94H	99H	98H	98H	99H	110H	114H	121H	120H	136H	146H	101G	131G	179H	182H																														
133 - 135	48A	57D	65E	107A	133D	163G	107D	127E	141F	163G	50E	57G	63G	68G	91G	90G	95H	94H	94G	94G	105H	109H	116H	115H	131H	141H	97G	123G	171H	173G																														
130 - 132	46	54C	62D	103	128C	157F	103C	122D	135E	157F	48E	55F	61G	65G	88G	87G	91G	90G	90G	89G	100G	104G	112G	111H	125H	135H	93F	116F	163G	163G																														
127 - 129	44	51B	59C	99	122B	150F	99B	117D	129D	150F	47D	53F	58F	62F	85G	83G	87G	86G	86F	85F	96G	99G	108G	106G	120G	129G	89F	109F	155G	154F																														
124 - 126	42	49B	55B	95	117B	144E	95B	112C	123C	144E	45C	51E	56F	60F	82F	80F	83F	82G	82F	80F	91F	94G	103G	102G	115G	123G	85E	102E	147G	144F																														
121 - 123	40	46A	52A	91	111A	138E	91A	106B	117C	138E	43C	49E	53E	57F	78F	76F	80F	78F	78F	75F	86F	89F	99F	97G	109G	118G	81E	94E	139F	134E																														
118 - 120	38	44	48A	87	105	131D	87	101A	111B	131D	42B	47D	51E	54E	75E	73E	76F	74F	74E	71E	81F	84F	94F	92F	104F	112F	77D	87D	131F	125E																														
115 - 117	36	41	45	83	100	125D	83	96	105A	125D	40A	45D	48D	51E	72E	70E	72E	70F	70E	66E	76E	79F	90F	88F	99F	106F	73D	80D	123E	115D																														
112 - 114	34	38	41	79	94	118C	79	91	99	118C	39A	43C	46D	48D	69D	66E	68E	66E	66D	61D	71E	74E	86E	83F	93F	100F	69C	73C	115E	106D																														
109 - 111	32	36	38	75	88	112C	75	86	93	112C	37	41C	43C	45D	65D	63D	64D	62E	62D	57D	67D	69E	81E	79E	88E	95E	65C	66C	107E	96C																														
106 - 108	30	33	35	71	83	105B	71	81	87	105B	36	39B	41C	42C	62D	59D	60D	57E	57C	52C	62D	65E	77E	74E	83E	89E	61B	58B	99D	87C																														
103 - 105	28	31	31	67	77	99B	67	76	82	99B	34	37B	38B	40C	59C	56C	56D	53D	53C	47C	57D	60D	72D	69E	77E	83E	57B	51B	91D	77C																														
100 - 102	26	28	28	63	72	93A	63	71	76	93A	33	35A	36B	37C	56C	52C	52C	49D	49C	43C	52C	55D	68D	65D	72D	77D	53A	44A	83D	67B																														
97 - 99	24	26	24	59	66	86A	59	65	70	86A	31	33A	33A	34B	52B	49C	48C	45C	45B	38B	47C	50D	64D	60D	67D	72D	49A	37A	75C	58B																														
94 - 96	23	23	21	55	60	80	55	60	64	80	30	31	31A	31B	49B	45B	45B	41C	41B	33B	42C	45C	59C	56D	61D	66D	45	29	67C	48A																														
91 - 93	21	20	18	50	55	73	50	55	58	73	28	29	29	28A	46A	42B	41B	37C	37A	29A	38B	40C	55C	51C	56D	60D	41	22	59B	39A																														
88 - 90	19	18	14	46	49	67	46	50	52	67	26	27	26	25A	43A	38A	37B	33B	33A	24A	33B	35C	50C	46C	50C	54C	37	15	51B	29																														
85 - 87	17	15	11	42	44	60	42	45	46	60	25	25	24	22	39A	35A	33A	29B	29A	19A	28A	30B	46B	42C	45C	49C	33	8	43B	20																														
82 - 84	15	13	7	38	38	54	38	40	40	54	23	23	21	20	36	32A	29A	25B	25	15	23A	25B	42B	37C	40C	43C	29	1	35A	10																														
79 - 81	13	10	4	34	32	48	34	35	34	48	22	21	19	17	33	28	25	21A	21	10	18A	20B	37B	33B	34B	37B	25	-	27A	1																														
76 - 78	11	7	1	30	27	41	30	30	28	41	20	19	16	14	30	25	21	17A	17	5	13	15A	33A	28B	29B	31B	21	-	19A	-																														
73 - 75	9	5	-	26	21	35	26	24	22	35	19	17	14	11	26	21	17	13A	13	1	9	10A	28A	23B	24B	25B	17	-	11	-																														
70 - 72	7	2	-	22	15	28	22	19	16	28	17	16	11	8	23	18	13	9	9	-	4	5A	24A	19A	18A	20A	13	-	3	-																														
67 - 69	5	-	-	18	10	22	18	14	10	22	16	14	9	5	20	14	10	5	5	-	-	1	20A	14A	13A	14A	9	-	-	-																														
64 - 66	3	-	-	14	4	15	14	9	4	15	14	12	6	2	17	11	6	1	1	-	-	-	15	10A	8A	8A	5	-	-	-																														
61 - 63	1	-	-	10	-	9	10	4	-	9	12	10	4	-	13	7	2	-	-	-	-	-	11	5	2	2	1	-	-	-	-																													
58 - 60	-	-	-	6	-	3	6	-	-	3	11	8	1	-	10	4	-	-	-	-	-	-	6	1	-	-	-	-	-	-	-	-																												
55 - 57	-	-	-	2	-	-	2	-	-	-	9	6	-	-	7	1	-	-	-	-	-	-	2	-	-	-	-	-	-	-	-	-																												
52 - 54	-	-	-	-	-	-	-	-	-	-	8	4	-	-	4	-	-	-	-	-	-	-	-	-	-	-	-	-	-	-	-	-																												
49 - 51	-	-	-	-	-	-	-	-	-	-	6	2	-	-	1	-	-	-	-	-	-	-	-	-	-	-	-	-	-	-	-	-																												
46 - 48	-	-	-	-	-	-	-	-	-	-	5	-	-	-	-	-	-	-	-	-	-	-	-	-	-	-	-	-	-	-	-	-																												
43 - 45	-	-	-	-	-	-	-	-	-	-	3	-	-	-	-	-	-	-	-	-	-	-	-	-	-	-	-	-	-	-	-	-																												
40 - 42	-	-	-	-	-	-	-	-	-	-	2	-	-	-	-	-	-	-	-	-	-	-	-	-	-	-	-	-	-	-	-	-																												
0 - 39	-	-	-	-	-	-	-	-	-	-	-	-	-	-	-	-	-	-	-	-	-	-	-	-	-	-	-	-	-	-	-	-																												

Fumble Range:	4	Range Modifiers:	0m-1m: +10
Breakage #s:	8	2m-8m: +0	
Reliability:	75	9m-17m: -25	
		18m-83m: -50	
		84m-165m: -100	

H & K
SPC-30

	Combat Armor	Kinetic Armor	Armored Cloth	Plate Armor	Chain Armor	Rigid Leather	Soft Leather	Natural	Clothing																					
	X	IX	VII	VI	V	IV	III	II	I	20	19	18	17	16	15	14	13	12	11	10	9	8	7	6	5	4	3	2	1	
148 - 150	71G	86H	101I	154G	195H	237I	154H	185I	206I	237I	71H	82I	93I	101I	132I	132I	140I	140I	140I	144I	158I	163I	169I	169I	192I	206I	144I	194I	256I	268I
145 - 147	69F	83H	97I	150F	189H	230I	150H	179I	199I	230I	70H	80I	90I	98I	128I	128I	136I	135I	139I	139I	153I	157I	164I	164I	186I	199I	140I	186I	247I	257I
142 - 144	67E	80G	93H	145E	182G	222H	145G	173H	192H	222H	68G	78H	87I	94I	124I	124I	131I	130I	133I	147I	151I	159I	158I	179I	192I	135H	177H	237I	245I	
139 - 141	64C	77F	89G	140C	175F	214H	140F	167G	185G	214H	66G	75H	84H	91H	120H	120H	126H	125H	127H	141H	145H	153H	153H	173I	185I	130H	168H	227H	234H	
136 - 138	62B	74E	85F	135B	168E	206G	135E	161F	178F	206G	64F	73G	81H	87H	116H	115H	121H	120H	121H	135H	139H	148H	147H	166H	178H	125G	159G	218H	222H	
133 - 135	59A	70D	80E	130A	161D	198G	130D	154E	171F	198G	62E	70G	78G	84G	112G	111G	117H	115H	116G	129H	133H	143H	141H	160H	171H	120G	150G	208H	210G	
130 - 132	57	67C	76D	125	155C	191F	125C	148D	163E	191F	60E	68F	75G	80G	108G	107G	112G	110G	110G	123G	127G	137G	136H	153H	164H	115F	142F	198G	199G	
127 - 129	55	64B	72C	120	148B	183F	120B	142D	156D	183F	58D	66F	72F	77F	104G	103G	107G	105G	105F	117G	121G	132G	130G	147G	157G	110F	133F	188G	187F	
124 - 126	52	61B	68B	115	141B	175E	115B	136C	149C	175E	56C	63E	69F	73F	100F	98F	102F	100G	100F	111F	115G	126G	124G	140G	150G	105E	124E	179G	176F	
121 - 123	50	57A	64A	110	134A	167E	110A	129B	142C	167E	54C	61E	66E	70F	96F	94F	98F	95F	95F	105F	109F	121F	119G	134G	143G	100E	115E	169F	164E	
118 - 120	47	54	59A	105	127	159D	105	123A	135B	159D	52B	58D	63E	66E	92E	90E	93F	90F	90E	97E	103F	116F	113F	127F	136F	95D	106D	159F	152E	
115 - 117	45	51	55	100	121	152D	100	117	127A	152D	50A	56D	60D	63E	88E	86E	88E	85F	85E	81E	93E	110F	108F	120F	129F	90D	97D	150E	140D	
112 - 114	42	48	51	96	114	144C	96	111	120	144C	48A	53C	57D	59D	84D	81E	83E	80E	80D	75D	87E	105E	102F	114F	122F	85C	89C	140E	129D	
109 - 111	40	45	47	91	107	136C	91	104	113	136C	46	51C	54C	56D	80D	77D	78D	75E	75D	70D	81D	99E	96E	107E	115E	80C	80C	130E	117C	
106 - 108	38	41	43	86	100	128B	86	98	106	128B	44	48B	51C	52C	76D	73D	74D	70E	70C	64C	76D	94E	91E	101E	108E	75B	71B	120D	105C	
103 - 105	35	38	38	81	93	120B	81	92	99	120B	42	46B	48B	49C	72C	69C	69D	65D	65C	58C	70D	89D	85E	94E	101E	70B	62B	111D	94C	
100 - 102	33	35	34	76	87	112A	76	86	92	112A	41	44A	44B	45C	68C	64C	64C	60D	60C	52C	64C	83D	79D	88D	94D	65A	53A	101D	82B	
97 - 99	30	32	30	71	80	105A	71	79	84	105A	39	41A	41A	42B	64B	60C	59C	55C	55B	47B	58C	78D	74D	81D	87D	60A	45A	91C	70B	
94 - 96	28	28	26	66	73	97	66	73	77	97	37	39	38A	38B	60B	56B	55B	50C	50B	41B	52C	72C	68D	75D	80D	55	36	82C	59A	
91 - 93	26	25	22	61	66	89	61	67	70	89	35	36	35	35A	56A	52B	50B	45C	45A	35A	46B	67C	62C	68D	73D	50	27	72B	47A	
88 - 90	23	22	17	56	59	81	56	61	63	81	33	34	32	31A	52A	47A	45B	40B	40A	29A	40B	62C	57C	62C	66C	45	18	62B	35	
85 - 87	21	19	13	51	53	73	51	55	56	73	31	31	29	28	48A	43A	40A	35B	35A	24A	34A	56B	51C	55C	59C	40	9	52B	24	
82 - 84	18	16	9	46	46	66	46	48	48	66	29	29	26	24	44	39A	35A	30B	30	18	28A	51B	46C	48C	52C	35	1	43A	12	
79 - 81	16	12	5	41	39	58	41	42	41	58	27	26	23	20	40	35	31	25A	25	12	22A	45B	40B	42B	45B	30	-	33A	1	
76 - 78	13	9	1	37	32	50	37	36	34	50	25	24	20	17	36	30	26	20A	20	6	16	40A	34B	35B	38B	25	-	23A	-	
73 - 75	11	6	-	32	25	42	32	30	27	42	23	22	17	13	32	26	21	15A	15	1	10	35A	29B	29B	31B	20	-	13	-	
70 - 72	9	3	-	27	19	34	27	23	20	34	21	19	14	10	28	22	16	10	10	-	4	7A	29A	23A	22A	24A	15	-	4	-
67 - 69	6	-	-	22	12	27	22	17	12	27	19	17	11	6	24	18	12	5	5	-	-	24A	17A	16A	17A	10	-	-	-	-
64 - 66	4	-	-	17	5	19	17	11	5	19	17	14	8	3	20	13	7	1	1	-	-	18	12A	9A	10A	5	-	-	-	-
61 - 63	1	-	-	12	-	11	12	5	-	11	15	12	5	-	16	9	2	-	-	-	-	13	6	3	3	1	-	-	-	-
58 - 60	-	-	-	7	-	3	7	-	-	3	13	9	2	-	12	5	-	-	-	-	-	8	1	-	-	-	-	-	-	-
55 - 57	-	-	-	2	-	-	2	-	-	-	11	7	-	-	8	1	-	-	-	-	-	2	-	-	-	-	-	-	-	-
52 - 54	-	-	-	-	-	-	-	-	-	-	10	5	-	-	4	-	-	-	-	-	-	-	-	-	-	-	-	-	-	-
49 - 51	-	-	-	-	-	-	-	-	-	-	8	2	-	-	1	-	-	-	-	-	-	-	-	-	-	-	-	-	-	-
46 - 48	-	-	-	-	-	-	-	-	-	-	6	-	-	-	-	-	-	-	-	-	-	-	-	-	-	-	-	-	-	-
43 - 45	-	-	-	-	-	-	-	-	-	-	4	-	-	-	-	-	-	-	-	-	-	-	-	-	-	-	-	-	-	-
40 - 42	-	-	-	-	-	-	-	-	-	-	2	-	-	-	-	-	-	-	-	-	-	-	-	-	-	-	-	-	-	-
0 - 39	-	-	-	-	-	-	-	-	-	-	-	-	-	-	-	-	-	-	-	-	-	-	-	-	-	-	-	-	-	-

Fumble Range:	4	Range Modifiers:	0m-6m: +10
Breakage #s:	8	7m-83m: +0	
Reliability:	75	84m-165m: -25	
		166m-825m: -50	
		826m-1,650m: -100	



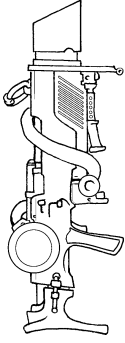

	Combat Armor		Kinetic Armor			Armored Cloth				Plate Armor			Chain Armor			Rigid Leather			Soft Leather			Natural			Clothing						
	X	IX	VIII	VII	VI	V	IV	III	II	I	20	19	18	17	16	15	14	13	12	11	10	9	8	7	6	5	4	3	2	1	
148 - 150	85K	102L	120M	181K	230L	279M	181L	218M	242M	279M	85L	98M	111M	120M	157M	157M	166M	166M	166M	171M	187M	193M	200M	200M	227M	243M	171M	229M	302M	316M	
145 - 147	83I	99K	115L	176I	222K	270M	176K	211L	234L	270M	83L	96M	108M	116M	153M	152M	161M	161M	161M	161M	165M	180M	186M	194M	194M	220M	235M	166M	219M	291M	303M
142 - 144	80G	95J	110K	170G	214J	261L	170J	204K	226K	261L	81K	93L	104L	112L	148L	147L	155L	155L	155L	158L	173L	179M	188M	187M	187M	212M	227M	160L	209L	280L	289L
139 - 141	77E	91I	105J	164E	206I	252K	164I	196J	217J	252K	79J	90K	101K	108L	143L	142L	150L	149L	149L	151L	166L	172L	181L	181L	180L	204L	219L	154K	198K	268L	275K
136 - 138	74C	87G	100H	158C	198G	243J	158G	189I	209I	243K	76I	87J	97K	104K	138K	137K	144K	143K	143K	144K	159K	165L	175L	174L	174L	197L	210L	148J	188K	257K	282K
133 - 135	71A	83F	95G	153A	190F	234J	153F	182G	200H	234J	74H	84J	93J	100J	134J	132K	138K	137K	137J	137J	152K	158K	169K	167K	167K	189K	202K	142J	177J	245K	248J
130 - 132	68	80E	90F	147	182E	224I	147E	174F	192G	224I	72G	81I	90I	95J	129J	127J	133J	131J	130J	145J	151K	162K	162K	160K	181K	194K	136I	167I	234J	234I	
127 - 129	65	76C	85D	141	174C	215H	141C	167E	183F	215H	69F	78H	86I	91I	124I	122I	127I	125J	125J	124I	138J	143J	156J	154J	173J	186J	130H	157H	222J	220I	
124 - 126	62	72B	80C	135	166B	206G	135B	160D	175E	206H	67E	75G	82H	87H	119I	117I	121I	119I	119I	117I	131I	136J	149J	147J	166J	177J	124G	146H	211I	207H	
121 - 123	59	68A	75B	130	158A	197G	130A	152C	167C	197G	65D	72G	79G	83H	115H	112H	116H	113I	113H	110H	124H	129I	143I	140I	158I	169I	118G	136G	199I	193G	
118 - 120	57	64	70A	124	150	188F	124	145A	158B	188F	62C	69F	75G	79G	110G	107H	110H	107H	107H	103G	117H	122I	137I	134I	150I	161I	113F	125F	188H	179G	
115 - 117	54	60	65	118	142	178E	118	138	150A	178E	60B	66E	71F	74G	105G	102G	104G	101H	101G	96G	110G	115H	130H	127H	142I	152I	107E	115E	176H	165F	
112 - 114	51	57	60	112	134	169D	112	130	141	169E	58A	64D	68E	70F	100F	97F	99G	95G	95G	89F	103G	108H	124H	120H	135H	144H	101D	105E	165G	152E	
109 - 111	48	53	55	106	126	160D	106	123	133	160D	55	61D	64D	66E	96F	92F	93F	89G	89E	83E	96F	101G	118G	114H	127H	136H	95D	94D	153G	138E	
106 - 108	45	49	50	101	118	151C	101	116	124	151C	53	58C	60D	62E	91E	87E	87E	83F	83E	76E	89F	93G	111G	107G	119G	128G	89C	84C	142F	124D	
103 - 105	42	45	45	95	110	142B	95	108	116	142B	51	55B	57C	58D	86D	82E	82E	78F	78D	69D	82E	86F	105F	100G	111G	119G	83B	73B	130E	110C	
100 - 102	39	41	40	89	102	132A	89	101	107	132B	48	52A	53B	54C	81D	76D	76D	72E	72D	62D	75E	79F	98F	94F	104F	111F	77A	63B	119E	97C	
97 - 99	36	37	35	83	94	123A	83	94	99	123A	46	49A	49B	49C	77C	71C	70D	66E	66C	55C	68D	72E	92E	87F	96F	103F	71A	53A	108D	83B	
94 - 96	33	34	30	78	86	114	78	86	91	114	44	46	46A	45B	72C	66C	65C	60D	60B	48B	61C	65E	86E	80E	88E	94E	65	42	96D	69A	
91 - 93	30	30	25	72	78	105	72	79	82	105	41	43	42	41B	67B	61B	59C	54D	54B	42B	54C	58D	79D	74E	80E	86E	59	32	85C	55A	
88 - 90	28	26	20	66	70	96	66	72	74	96	39	40	38	37A	62A	56B	53B	48C	48A	35A	47B	51D	73D	67D	73D	78D	54	21	73C	42	
85 - 87	25	22	15	60	62	86	60	64	65	86	37	37	35	33	58A	51A	48A	42C	42A	28A	40B	43C	66C	60D	65D	70D	48	11	62B	28	
82 - 84	22	18	10	54	54	77	54	57	57	77	34	34	31	28	53	46A	42A	36B	36	21	33A	36C	60C	54C	57D	61D	42	1	50B	14	
79 - 81	19	15	5	49	46	68	49	49	48	68	32	32	27	24	48	41	36	30B	30	14	26A	29B	54B	47C	50C	53C	36	-	39A	1	
76 - 78	16	11	1	43	38	59	43	42	40	59	30	29	24	20	43	36	31	24A	24	7	19	22B	47B	40B	42C	45C	20	-	27A	-	
73 - 75	13	7	-	37	30	50	37	35	31	50	28	26	20	16	39	31	25	18A	18	1	12	15A	41A	34B	34B	36B	24	-	16	-	
70 - 72	10	3	-	31	22	40	31	27	23	40	25	23	16	12	34	26	19	12	12	-	5	8A	35A	27B	26B	28B	18	-	4	-	
67 - 69	7	-	-	26	14	31	26	20	15	31	23	20	13	7	29	21	14	6	6	-	-	1	28A	20A	19A	20A	12	-	-	-	
64 - 66	4	-	-	20	6	22	20	13	6	22	21	17	9	3	24	16	8	1	1	-	-	-	22	14A	11A	12A	6	-	-	-	
61 - 63	1	-	-	14	-	13	14	5	-	13	18	14	5	-	20	11	2	-	-	-	-	-	15	7	3	3	1	-	-	-	
58 - 60	-	-	-	8	-	4	8	-	-	4	16	11	2	-	15	6	-	-	-	-	-	-	9	1	-	-	-	-	-	-	-
55 - 57	-	-	-	2	-	-	2	-	-	-	14	8	-	-	10	1	-	-	-	-	-	-	3	-	-	-	-	-	-	-	-
52 - 54	-	-	-	-	-	-	-	-	-	-	11	5	-	-	5	-	-	-	-	-	-	-	-	-	-	-	-	-	-	-	-
49 - 51	-	-	-	-	-	-	-	-	-	-	9	2	-	-	1	-	-	-	-	-	-	-	-	-	-	-	-	-	-	-	-
46 - 48	-	-	-	-	-	-	-	-	-	-	7	-	-	-	-	-	-	-	-	-	-	-	-	-	-	-	-	-	-	-	-
43 - 45	-	-	-	-	-	-	-	-	-	-	4	-	-	-	-	-	-	-	-	-	-	-	-	-	-	-	-	-	-	-	-
40 - 42	-	-	-	-	-	-	-	-	-	-	2	-	-	-	-	-	-	-	-	-	-	-	-	-	-	-	-	-	-	-	-
0 - 39	-	-	-	-	-	-	-	-	-	-	-	-	-	-	-	-	-	-	-	-	-	-	-	-	-	-	-	-	-	-	-

Fumble Range: 4	Range Modifiers:
Breakage #s: 8	0m-6m: +10
Reliability: 75	7m-83m: +0
	84m-165m: -25
	167m-825m: -50
	826m-1,625m: -100
H & K	
Solar Flare	
PE 10	



6.0

SONIC STUNNER ATTACK TABLES

INTRODUCTION

This section contains an introduction, a key to the tables, and 5 sonic stunner attack tables.

HOW TO USE THESE TABLES

To resolve an attack, the attacker makes a high open-ended roll. If this roll is within the fumble range of the weapon, then a non open-ended roll is made on the appropriate fumble table. Otherwise, all appropriate modifications (such as skill, range, injuries, bonuses and foe's DB) are added to the roll and the result is cross-indexed on the column appropriate to the foe's armor type.

The table will yield one of three results: a miss (i.e., "-"), a normal hit (e.g., "3"), or a critical strike (e.g., "3A"). A miss is just that, a miss. The attack fails and there are no effects other than the expended energy. In the event of a normal hit, the number is applied as damage to the opponent. In the event of a critical strike, the number is applied as damage to the foe, and a critical is rolled. The critical is resolved on the Blaster Critical Strike Table, with the letter denoting the severity of the critical (read: the column it's rolled on). The effect of the critical is then applied to the opponent.

KEY TO THE TABLES

At the top of each table is a box that contains some information for a typical weapon that uses this table. Each piece of information is listed below, along with a description of its purpose.

- 1) **Attack Table Number:** This is a unique number, which identifies the table.
- 2) **Sonic Stunner Energy Indicator:** This indicates the relative aperture energy of the table. The higher the number, the more powerful the weapon.
- 3) **Fumble:** This shows the chance of fumbling the weapon in an attack. If the unmodified roll falls within this range, then the attacker fumbles and must roll on the appropriate column of the fumble table.

- 4) **Breakage #s:** These numbers show how often the weapon should be checked for breakage. Anytime the attacker rolls doubles of the numbers shown (e.g., 11, 22, 33, etc.) the weapon must be checked for breakage.
- 5) **Reliability:** The typical reliability of a weapon of this type. Whenever the breakage numbers indicate a breakage check, an open-ended d100 should be rolled. The reliability of the weapon is then added. If the result is higher than 100, then the weapon functions normally. Otherwise, the weapon malfunctions and cannot be used until repaired. (If using *Future Law*, the malfunction can be determined using the rules therein).
- 6) **Range Modifiers:** These are the modifiers used when the attacker's target is at a certain range. This shows the range and the modifier applied.
- 7) **Concussion Damage:** This is an example of a result, which only deals concussion damage.
- 8) **Critical Strike:** This is an example of an attack that deals both concussion damage and a critical (of the severity indicated).

Note: AT may only be claimed if the appropriate helmet is worn.

LIST OF SONIC STUNNER ATTACK TABLES

Security Systems Mark I Stunner Attack Table
SS-6.1

Security Systems Mark II Stunner Attack Table
SS-6.2

Security Systems Mark III Stunner Attack Table
SS-6.3

Security Systems Mark IV Stunner Attack Table
SS-6.4

Security Systems Mark V Stunner Attack Table
SS-6.5



	Combat Armor		Kinetic Armor		Armored Cloth					Plate Armor					Chain Armor					Rigid Leather					Soft Leather					Natural		Clothing	
	X	IX	VIII	VII	VI	V	IV	III	II	I	20	19	18	17	16	15	14	13	12	11	10	9	8	7	6	5	4	3	2	1			
149 - 150	0A	0A	0A	0A	0A	0A	0A	0A	0A	0A	0A	0A	0A	0A	0A	0A	0A	0A	0A	0A	0A	0A	0A	0A	0A	0A	0A	0A	0A	0A	0A		
147 - 148	0A	0A	0A	0A	0A	0A	0A	0A	0A	0A	0A	0A	0A	0A	0A	0A	0A	0A	0A	0A	0A	0A	0A	0A	0A	0A	0A	0A	0A	0A	0A	0A	
145 - 146	0A	0A	0A	0A	0A	0A	0A	0A	0A	0A	0A	0A	0A	0A	0A	0A	0A	0A	0A	0A	0A	0A	0A	0A	0A	0A	0A	0A	0A	0A	0A	0A	
143 - 144	0A	0A	0A	0A	0A	0A	0A	0A	0A	0A	0A	0A	0A	0A	0A	0A	0A	0A	0A	0A	0A	0A	0A	0A	0A	0A	0A	0A	0A	0A	0A	0A	
141 - 142	0A	0A	0A	0A	0A	0A	0A	0A	0A	0A	0A	0A	0A	0A	0A	0A	0A	0A	0A	0A	0A	0A	0A	0A	0A	0A	0A	0A	0A	0A	0A	0A	
139 - 140	0A	0A	0A	0A	0A	0A	0A	0A	0A	0A	0A	0A	0A	0A	0A	0A	0A	0A	0A	0A	0A	0A	0A	0A	0A	0A	0A	0A	0A	0A	0A	0A	
137 - 138	0A	0A	0A	0A	0A	0A	0A	0A	0A	0A	0A	0A	0A	0A	0A	0A	0A	0A	0A	0A	0A	0A	0A	0A	0A	0A	0A	0A	0A	0A	0A	0A	
135 - 136	0A	0A	0A	0A	0A	0A	0A	0A	0A	0A	0A	0A	0A	0A	0A	0A	0A	0A	0A	0A	0A	0A	0A	0A	0A	0A	0A	0A	0A	0A	0A	0A	0A
133 - 134	0A	0A	0A	0A	0A	0A	0A	0A	0A	0A	0A	0A	0A	0A	0A	0A	0A	0A	0A	0A	0A	0A	0A	0A	0A	0A	0A	0A	0A	0A	0A	0A	0A
131 - 132	0A	0A	0A	0A	0A	0A	0A	0A	0A	0A	0A	0A	0A	0A	0A	0A	0A	0A	0A	0A	0A	0A	0A	0A	0A	0A	0A	0A	0A	0A	0A	0A	0A
129 - 130	0A	0A	0A	0A	0A	0A	0A	0A	0A	0A	0A	0A	0A	0A	0A	0A	0A	0A	0A	0A	0A	0A	0A	0A	0A	0A	0A	0A	0A	0A	0A	0A	0A
127 - 128	0A	0A	0A	0A	0A	0A	0A	0A	0A	0A	0A	0A	0A	0A	0A	0A	0A	0A	0A	0A	0A	0A	0A	0A	0A	0A	0A	0A	0A	0A	0A	0A	0A
125 - 126	0A	0A	0A	0A	0A	0A	0A	0A	0A	0A	0A	0A	0A	0A	0A	0A	0A	0A	0A	0A	0A	0A	0A	0A	0A	0A	0A	0A	0A	0A	0A	0A	0A
123 - 124	0A	0A	0A	0A	0A	0A	0A	0A	0A	0A	0A	0A	0A	0A	0A	0A	0A	0A	0A	0A	0A	0A	0A	0A	0A	0A	0A	0A	0A	0A	0A	0A	0A
121 - 122	0A	0A	0A	0A	0A	0A	0A	0A	0A	0A	0A	0A	0A	0A	0A	0A	0A	0A	0A	0A	0A	0A	0A	0A	0A	0A	0A	0A	0A	0A	0A	0A	0A
119 - 120	0A	0A	0A	0A	0A	0A	0A	0A	0A	0A	0A	0A	0A	0A	0A	0A	0A	0A	0A	0A	0A	0A	0A	0A	0A	0A	0A	0A	0A	0A	0A	0A	0A
117 - 118	0A	0A	0A	0A	0A	0A	0A	0A	0A	0A	0A	0A	0A	0A	0A	0A	0A	0A	0A	0A	0A	0A	0A	0A	0A	0A	0A	0A	0A	0A	0A	0A	0A
115 - 116	0A	0A	0A	0A	0A	0A	0A	0A	0A	0A	0A	0A	0A	0A	0A	0A	0A	0A	0A	0A	0A	0A	0A	0A	0A	0A	0A	0A	0A	0A	0A	0A	0A
113 - 114	0A	0A	0A	0A	0A	0A	0A	0A	0A	0A	0A	0A	0A	0A	0A	0A	0A	0A	0A	0A	0A	0A	0A	0A	0A	0A	0A	0A	0A	0A	0A	0A	0A
111 - 112	0A	0A	0A	0A	0A	0A	0A	0A	0A	0A	0A	0A	0A	0A	0A	0A	0A	0A	0A	0A	0A	0A	0A	0A	0A	0A	0A	0A	0A	0A	0A	0A	0A
109 - 110	0A	0A	0A	0A	0A	0A	0A	0A	0A	0A	0A	0A	0A	0A	0A	0A	0A	0A	0A	0A	0A	0A	0A	0A	0A	0A	0A	0A	0A	0A	0A	0A	0A
107 - 108	0A	0A	0A	0A	0A	0A	0A	0A	0A	0A	0A	0A	0A	0A	0A	0A	0A	0A	0A	0A	0A	0A	0A	0A	0A	0A	0A	0A	0A	0A	0A	0A	0A
105 - 106	0A	0A	0A	0A	0A	0A	0A	0A	0A	0A	0A	0A	0A	0A	0A	0A	0A	0A	0A	0A	0A	0A	0A	0A	0A	0A	0A	0A	0A	0A	0A	0A	0A
103 - 104	0A	0A	0A	0A	0A	0A	0A	0A	0A	0A	0A	0A	0A	0A	0A	0A	0A	0A	0A	0A	0A	0A	0A	0A	0A	0A	0A	0A	0A	0A	0A	0A	0A
101 - 102	0A	0A	0A	0A	0A	0A	0A	0A	0A	0A	0A	0A	0A	0A	0A	0A	0A	0A	0A	0A	0A	0A	0A	0A	0A	0A	0A	0A	0A	0A	0A	0A	0A
99 - 100	-	-	-	-	-	-	-	-	-	-	-	-	-	-	-	-	-	-	-	-	-	-	-	-	-	-	-	-	-	-	-	-	-
97 - 98	-	-	-	-	-	-	-	-	-	-	-	-	-	-	-	-	-	-	-	-	-	-	-	-	-	-	-	-	-	-	-	-	-
95 - 96	-	-	-	-	-	-	-	-	-	-	-	-	-	-	-	-	-	-	-	-	-	-	-	-	-	-	-	-	-	-	-	-	-
93 - 94	-	-	-	-	-	-	-	-	-	-	-	-	-	-	-	-	-	-	-	-	-	-	-	-	-	-	-	-	-	-	-	-	-
91 - 92	-	-	-	-	-	-	-	-	-	-	-	-	-	-	-	-	-	-	-	-	-	-	-	-	-	-	-	-	-	-	-	-	-
89 - 90	-	-	-	-	-	-	-	-	-	-	-	-	-	-	-	-	-	-	-	-	-	-	-	-	-	-	-	-	-	-	-	-	-
87 - 88	-	-	-	-	-	-	-	-	-	-	-	-	-	-	-	-	-	-	-	-	-	-	-	-	-	-	-	-	-	-	-	-	-
85 - 86	-	-	-	-	-	-	-	-	-	-	-	-	-	-	-	-	-	-	-	-	-	-	-	-	-	-	-	-	-	-	-	-	-
83 - 84	-	-	-	-	-	-	-	-	-	-	-	-	-	-	-	-	-	-	-	-	-	-	-	-	-	-	-	-	-	-	-	-	-
81 - 82	-	-	-	-	-	-	-	-	-	-	-	-	-	-	-	-	-	-	-	-	-	-	-	-	-	-	-	-	-	-	-	-	-
79 - 80	-	-	-	-	-	-	-	-	-	-	-	-	-	-	-	-	-	-	-	-	-	-	-	-	-	-	-	-	-	-	-	-	-
77 - 78	-	-	-	-	-	-	-	-	-	-	-	-	-	-	-	-	-	-	-	-	-	-	-	-	-	-	-	-	-	-	-	-	-
75 - 76	-	-	-	-	-	-	-	-	-	-	-	-	-	-	-	-	-	-	-	-	-	-	-	-	-	-	-	-	-	-	-	-	-
0 - 74	-	-	-	-	-	-	-	-	-	-	-	-	-	-	-	-	-	-	-	-	-	-	-	-	-	-	-	-	-	-	-	-	-

AT may only be claimed if appropriate helmet is worn

Range Modifiers:

- 0m-1m: +10
- 6m-5m: +0
- 76m-10m: -25
- 151m-20m: -50
- 751m-50m: -100

Fumble Range: 2

Breakage #s: 1

Reliability: 150

Security Systems
Mk I Stunner
SS 1

	Combat Armor		Kinetic Armor					Armored Cloth					Plate Armor					Chain Armor					Rigid Leather					Soft Leather					Natural			Clothing	
	X	IX	VIII	VII	VI	V	IV	III	II	I	20	19	18	17	16	15	14	13	12	11	10	9	8	7	6	5	4	3	2	1							
149 - 150	OB	OB	OB	OB	OB	OB	OB	OB	OB	OB	OB	OB	OB	OB	OB	OB	OB	OB	OB	OB	OB	OB	OB	OB	OB	OB	OB	OB	OB	OB	OB						
147 - 148	OB	OB	OB	OB	OB	OB	OB	OB	OB	OB	OB	OB	OB	OB	OB	OB	OB	OB	OB	OB	OB	OB	OB	OB	OB	OB	OB	OB	OB	OB	OB						
145 - 146	OB	OB	OB	OB	OB	OB	OB	OB	OB	OB	OB	OB	OB	OB	OB	OB	OB	OB	OB	OB	OB	OB	OB	OB	OB	OB	OB	OB	OB	OB	OB						
143 - 144	OB	OB	OB	OB	OB	OB	OB	OB	OB	OB	OB	OB	OB	OB	OB	OB	OB	OB	OB	OB	OB	OB	OB	OB	OB	OB	OB	OB	OB	OB	OB						
141 - 142	OB	OB	OB	OB	OB	OB	OB	OB	OB	OB	OB	OB	OB	OB	OB	OB	OB	OB	OB	OB	OB	OB	OB	OB	OB	OB	OB	OB	OB	OB	OB						
139 - 140	OB	OB	OB	OB	OB	OB	OB	OB	OB	OB	OB	OB	OB	OB	OB	OB	OB	OB	OB	OB	OB	OB	OB	OB	OB	OB	OB	OB	OB	OB	OB						
137 - 138	OB	OB	OB	OB	OB	OB	OB	OB	OB	OB	OB	OB	OB	OB	OB	OB	OB	OB	OB	OB	OB	OB	OB	OB	OB	OB	OB	OB	OB	OB	OB						
135 - 136	OB	OB	OB	OB	OB	OB	OB	OB	OB	OB	OB	OB	OB	OB	OB	OB	OB	OB	OB	OB	OB	OB	OB	OB	OB	OB	OB	OB	OB	OB	OB						
133 - 134	OB	OB	OB	OB	OB	OB	OB	OB	OB	OB	OB	OB	OB	OB	OB	OB	OB	OB	OB	OB	OB	OB	OB	OB	OB	OB	OB	OB	OB	OB	OB						
131 - 132	OB	OB	OB	OB	OB	OB	OB	OB	OB	OB	OB	OB	OB	OB	OB	OB	OB	OB	OB	OB	OB	OB	OB	OB	OB	OB	OB	OB	OB	OB	OB						
129 - 130	OB	OB	OB	OB	OB	OB	OB	OB	OB	OB	OB	OB	OB	OB	OB	OB	OB	OB	OB	OB	OB	OB	OB	OB	OB	OB	OB	OB	OB	OB	OB						
127 - 128	OB	OB	OB	OB	OB	OB	OB	OB	OB	OB	OB	OB	OB	OB	OB	OB	OB	OB	OB	OB	OB	OB	OB	OB	OB	OB	OB	OB	OB	OB	OB						
125 - 126	OB	OB	OB	OB	OB	OB	OB	OB	OB	OB	OB	OB	OB	OB	OB	OB	OB	OB	OB	OB	OB	OB	OB	OB	OB	OB	OB	OB	OB	OB	OB						
123 - 124	OA	OA	OA	OA	OA	OA	OA	OA	OA	OA	OA	OA	OA	OA	OA	OA	OA	OA	OA	OA	OA	OA	OA	OA	OA	OA	OA	OA	OA	OA	OA						
121 - 122	OA	OA	OA	OA	OA	OA	OA	OA	OA	OA	OA	OA	OA	OA	OA	OA	OA	OA	OA	OA	OA	OA	OA	OA	OA	OA	OA	OA	OA	OA	OA						
119 - 120	OA	OA	OA	OA	OA	OA	OA	OA	OA	OA	OA	OA	OA	OA	OA	OA	OA	OA	OA	OA	OA	OA	OA	OA	OA	OA	OA	OA	OA	OA	OA						
117 - 118	OA	OA	OA	OA	OA	OA	OA	OA	OA	OA	OA	OA	OA	OA	OA	OA	OA	OA	OA	OA	OA	OA	OA	OA	OA	OA	OA	OA	OA	OA	OA						
115 - 116	OA	OA	OA	OA	OA	OA	OA	OA	OA	OA	OA	OA	OA	OA	OA	OA	OA	OA	OA	OA	OA	OA	OA	OA	OA	OA	OA	OA	OA	OA	OA						
113 - 114	OA	OA	OA	OA	OA	OA	OA	OA	OA	OA	OA	OA	OA	OA	OA	OA	OA	OA	OA	OA	OA	OA	OA	OA	OA	OA	OA	OA	OA	OA	OA						
111 - 112	OA	OA	OA	OA	OA	OA	OA	OA	OA	OA	OA	OA	OA	OA	OA	OA	OA	OA	OA	OA	OA	OA	OA	OA	OA	OA	OA	OA	OA	OA	OA						
109 - 110	OA	OA	OA	OA	OA	OA	OA	OA	OA	OA	OA	OA	OA	OA	OA	OA	OA	OA	OA	OA	OA	OA	OA	OA	OA	OA	OA	OA	OA	OA	OA						
107 - 108	OA	OA	OA	OA	OA	OA	OA	OA	OA	OA	OA	OA	OA	OA	OA	OA	OA	OA	OA	OA	OA	OA	OA	OA	OA	OA	OA	OA	OA	OA	OA						
105 - 106	OA	OA	OA	OA	OA	OA	OA	OA	OA	OA	OA	OA	OA	OA	OA	OA	OA	OA	OA	OA	OA	OA	OA	OA	OA	OA	OA	OA	OA	OA	OA						
103 - 104	OA	OA	OA	OA	OA	OA	OA	OA	OA	OA	OA	OA	OA	OA	OA	OA	OA	OA	OA	OA	OA	OA	OA	OA	OA	OA	OA	OA	OA	OA	OA						
101 - 102	OA	OA	OA	OA	OA	OA	OA	OA	OA	OA	OA	OA	OA	OA	OA	OA	OA	OA	OA	OA	OA	OA	OA	OA	OA	OA	OA	OA	OA	OA	OA						
99 - 100	-	-	-	-	-	-	-	-	-	-	-	-	-	-	-	-	-	-	-	-	-	-	-	-	-	-	-	-	-	-							
97 - 98	-	-	-	-	-	-	-	-	-	-	-	-	-	-	-	-	-	-	-	-	-	-	-	-	-	-	-	-	-	-							
95 - 96	-	-	-	-	-	-	-	-	-	-	-	-	-	-	-	-	-	-	-	-	-	-	-	-	-	-	-	-	-	-							
93 - 94	-	-	-	-	-	-	-	-	-	-	-	-	-	-	-	-	-	-	-	-	-	-	-	-	-	-	-	-	-	-							
91 - 92	-	-	-	-	-	-	-	-	-	-	-	-	-	-	-	-	-	-	-	-	-	-	-	-	-	-	-	-	-	-							
89 - 90	-	-	-	-	-	-	-	-	-	-	-	-	-	-	-	-	-	-	-	-	-	-	-	-	-	-	-	-	-	-							
87 - 88	-	-	-	-	-	-	-	-	-	-	-	-	-	-	-	-	-	-	-	-	-	-	-	-	-	-	-	-	-	-							
85 - 86	-	-	-	-	-	-	-	-	-	-	-	-	-	-	-	-	-	-	-	-	-	-	-	-	-	-	-	-	-	-							
83 - 84	-	-	-	-	-	-	-	-	-	-	-	-	-	-	-	-	-	-	-	-	-	-	-	-	-	-	-	-	-	-							
81 - 82	-	-	-	-	-	-	-	-	-	-	-	-	-	-	-	-	-	-	-	-	-	-	-	-	-	-	-	-	-	-							
79 - 80	-	-	-	-	-	-	-	-	-	-	-	-	-	-	-	-	-	-	-	-	-	-	-	-	-	-	-	-	-	-							
77 - 78	-	-	-	-	-	-	-	-	-	-	-	-	-	-	-	-	-	-	-	-	-	-	-	-	-	-	-	-	-	-							
75 - 76	-	-	-	-	-	-	-	-	-	-	-	-	-	-	-	-	-	-	-	-	-	-	-	-	-	-	-	-	-	-							
0 - 74	-	-	-	-	-	-	-	-	-	-	-	-	-	-	-	-	-	-	-	-	-	-	-	-	-	-	-	-	-	-							

Fumble Range: 2
Breakage #s: 1
Reliability: 150

Range Modifiers:
0m-1m: +10
6m-5m: +0
76m-10m: -25
151m-20m: -50
751m-50m: -100

AT may only be claimed if appropriate helmet is worn

Security Systems
Mk II Stunner
SS 2

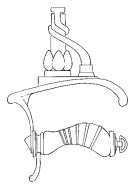

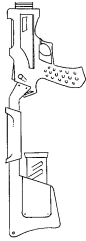

Item #	Combat Armor		Kinetic Armor					Armored Cloth					Plate Armor					Chain Armor					Rigid Leather					Soft Leather					Natural			Clothing	
	X	IX	VIII	VII	VI	V	IV	III	II	I	20	19	18	17	16	15	14	13	12	11	10	9	8	7	6	5	4	3	2	1							
149 - 150	OC	OC	OC	OC	OC	OC	OC	OC	OC	OC	OC	OC	OC	OC	OC	OC	OC	OC	OC	OC	OC	OC	OC	OC	OC	OC	OC	OC	OC	OC							
147 - 148	OC	OC	OC	OC	OC	OC	OC	OC	OC	OC	OC	OC	OC	OC	OC	OC	OC	OC	OC	OC	OC	OC	OC	OC	OC	OC	OC	OC	OC	OC	OC						
145 - 146	OC	OC	OC	OC	OC	OC	OC	OC	OC	OC	OC	OC	OC	OC	OC	OC	OC	OC	OC	OC	OC	OC	OC	OC	OC	OC	OC	OC	OC	OC	OC						
143 - 144	OC	OC	OC	OC	OC	OC	OC	OC	OC	OC	OC	OC	OC	OC	OC	OC	OC	OC	OC	OC	OC	OC	OC	OC	OC	OC	OC	OC	OC	OC	OC						
141 - 142	OC	OC	OC	OC	OC	OC	OC	OC	OC	OC	OC	OC	OC	OC	OC	OC	OC	OC	OC	OC	OC	OC	OC	OC	OC	OC	OC	OC	OC	OC	OC						
139 - 140	OC	OC	OC	OC	OC	OC	OC	OC	OC	OC	OC	OC	OC	OC	OC	OC	OC	OC	OC	OC	OC	OC	OC	OC	OC	OC	OC	OC	OC	OC	OC						
137 - 138	OC	OC	OC	OC	OC	OC	OC	OC	OC	OC	OC	OC	OC	OC	OC	OC	OC	OC	OC	OC	OC	OC	OC	OC	OC	OC	OC	OC	OC	OC	OC						
135 - 136	OC	OC	OC	OC	OC	OC	OC	OC	OC	OC	OC	OC	OC	OC	OC	OC	OC	OC	OC	OC	OC	OC	OC	OC	OC	OC	OC	OC	OC	OC	OC						
133 - 134	OC	OC	OC	OC	OC	OC	OC	OC	OC	OC	OC	OC	OC	OC	OC	OC	OC	OC	OC	OC	OC	OC	OC	OC	OC	OC	OC	OC	OC	OC	OC						
131 - 132	OB	OB	OB	OB	OB	OB	OB	OB	OB	OB	OB	OB	OB	OB	OB	OB	OB	OB	OB	OB	OB	OB	OB	OB	OB	OB	OB	OB	OB	OB	OB						
129 - 130	OB	OB	OB	OB	OB	OB	OB	OB	OB	OB	OB	OB	OB	OB	OB	OB	OB	OB	OB	OB	OB	OB	OB	OB	OB	OB	OB	OB	OB	OB	OB						
127 - 128	OB	OB	OB	OB	OB	OB	OB	OB	OB	OB	OB	OB	OB	OB	OB	OB	OB	OB	OB	OB	OB	OB	OB	OB	OB	OB	OB	OB	OB	OB	OB						
125 - 126	OB	OB	OB	OB	OB	OB	OB	OB	OB	OB	OB	OB	OB	OB	OB	OB	OB	OB	OB	OB	OB	OB	OB	OB	OB	OB	OB	OB	OB	OB	OB						
123 - 124	OB	OB	OB	OB	OB	OB	OB	OB	OB	OB	OB	OB	OB	OB	OB	OB	OB	OB	OB	OB	OB	OB	OB	OB	OB	OB	OB	OB	OB	OB	OB						
121 - 122	OB	OB	OB	OB	OB	OB	OB	OB	OB	OB	OB	OB	OB	OB	OB	OB	OB	OB	OB	OB	OB	OB	OB	OB	OB	OB	OB	OB	OB	OB	OB						
119 - 120	OB	OB	OB	OB	OB	OB	OB	OB	OB	OB	OB	OB	OB	OB	OB	OB	OB	OB	OB	OB	OB	OB	OB	OB	OB	OB	OB	OB	OB	OB	OB						
117 - 118	OB	OB	OB	OB	OB	OB	OB	OB	OB	OB	OB	OB	OB	OB	OB	OB	OB	OB	OB	OB	OB	OB	OB	OB	OB	OB	OB	OB	OB	OB	OB						
115 - 116	OA	OA	OA	OA	OA	OA	OA	OA	OA	OA	OA	OA	OA	OA	OA	OA	OA	OA	OA	OA	OA	OA	OA	OA	OA	OA	OA	OA	OA	OA	OA						
113 - 114	OA	OA	OA	OA	OA	OA	OA	OA	OA	OA	OA	OA	OA	OA	OA	OA	OA	OA	OA	OA	OA	OA	OA	OA	OA	OA	OA	OA	OA	OA	OA						
111 - 112	OA	OA	OA	OA	OA	OA	OA	OA	OA	OA	OA	OA	OA	OA	OA	OA	OA	OA	OA	OA	OA	OA	OA	OA	OA	OA	OA	OA	OA	OA	OA						
109 - 110	OA	OA	OA	OA	OA	OA	OA	OA	OA	OA	OA	OA	OA	OA	OA	OA	OA	OA	OA	OA	OA	OA	OA	OA	OA	OA	OA	OA	OA	OA	OA						
107 - 108	OA	OA	OA	OA	OA	OA	OA	OA	OA	OA	OA	OA	OA	OA	OA	OA	OA	OA	OA	OA	OA	OA	OA	OA	OA	OA	OA	OA	OA	OA	OA						
105 - 106	OA	OA	OA	OA	OA	OA	OA	OA	OA	OA	OA	OA	OA	OA	OA	OA	OA	OA	OA	OA	OA	OA	OA	OA	OA	OA	OA	OA	OA	OA	OA						
103 - 104	OA	OA	OA	OA	OA	OA	OA	OA	OA	OA	OA	OA	OA	OA	OA	OA	OA	OA	OA	OA	OA	OA	OA	OA	OA	OA	OA	OA	OA	OA	OA						
101 - 102	OA	OA	OA	OA	OA	OA	OA	OA	OA	OA	OA	OA	OA	OA	OA	OA	OA	OA	OA	OA	OA	OA	OA	OA	OA	OA	OA	OA	OA	OA	OA						
99 - 100	-	-	-	-	-	-	-	-	-	-	-	-	-	-	-	-	-	-	-	-	-	-	-	-	-	-	-	-	-	-	-						
97 - 98	-	-	-	-	-	-	-	-	-	-	-	-	-	-	-	-	-	-	-	-	-	-	-	-	-	-	-	-	-	-	-						
95 - 96	-	-	-	-	-	-	-	-	-	-	-	-	-	-	-	-	-	-	-	-	-	-	-	-	-	-	-	-	-	-	-						
93 - 94	-	-	-	-	-	-	-	-	-	-	-	-	-	-	-	-	-	-	-	-	-	-	-	-	-	-	-	-	-	-	-						
91 - 92	-	-	-	-	-	-	-	-	-	-	-	-	-	-	-	-	-	-	-	-	-	-	-	-	-	-	-	-	-	-	-						
89 - 90	-	-	-	-	-	-	-	-	-	-	-	-	-	-	-	-	-	-	-	-	-	-	-	-	-	-	-	-	-	-	-						
87 - 88	-	-	-	-	-	-	-	-	-	-	-	-	-	-	-	-	-	-	-	-	-	-	-	-	-	-	-	-	-	-	-						
85 - 86	-	-	-	-	-	-	-	-	-	-	-	-	-	-	-	-	-	-	-	-	-	-	-	-	-	-	-	-	-	-	-						
83 - 84	-	-	-	-	-	-	-	-	-	-	-	-	-	-	-	-	-	-	-	-	-	-	-	-	-	-	-	-	-	-	-						
81 - 82	-	-	-	-	-	-	-	-	-	-	-	-	-	-	-	-	-	-	-	-	-	-	-	-	-	-	-	-	-	-	-						
79 - 80	-	-	-	-	-	-	-	-	-	-	-	-	-	-	-	-	-	-	-	-	-	-	-	-	-	-	-	-	-	-	-						
77 - 78	-	-	-	-	-	-	-	-	-	-	-	-	-	-	-	-	-	-	-	-	-	-	-	-	-	-	-	-	-	-	-						
75 - 76	-	-	-	-	-	-	-	-	-	-	-	-	-	-	-	-	-	-	-	-	-	-	-	-	-	-	-	-	-	-	-						
0 - 74	-	-	-	-	-	-	-	-	-	-	-	-	-	-	-	-	-	-	-	-	-	-	-	-	-	-	-	-	-	-	-						
Fumble Range:	2		Range Modifiers:																																		
Breakage #s:	1		0m-1m: +10																																		
Reliability:	150		6m-5m: +0																																		
			76m-10m: -25																																		
			151m-20m: -50																																		
			751m-50m: -100																																		
			AT may only be claimed if appropriate helmet is worn																																		
			Security Systems																																		
			Mk III Stunner																																		
			SS 3																																		

	Combat Armor		Kinetic Armor					Armored Cloth				Plate Armor				Chain Armor				Rigid Leather				Soft Leather				Natural			Clothing	
	X	IX	VIII	VII	VI	V	IV	III	II	I	20	19	18	17	16	15	14	13	12	11	10	9	8	7	6	5	4	3	2	1		
149 - 150	OD	OD	OD	OD	OD	OD	OD	OD	OD	OD	OD	OD	OD	OD	OD	OD	OD	OD	OD	OD	OD	OD	OD	OD	OD	OD	OD	OD	OD	OD		
147 - 148	OD	OD	OD	OD	OD	OD	OD	OD	OD	OD	OD	OD	OD	OD	OD	OD	OD	OD	OD	OD	OD	OD	OD	OD	OD	OD	OD	OD	OD	OD	OD	
145 - 146	OD	OD	OD	OD	OD	OD	OD	OD	OD	OD	OD	OD	OD	OD	OD	OD	OD	OD	OD	OD	OD	OD	OD	OD	OD	OD	OD	OD	OD	OD	OD	
143 - 144	OD	OD	OD	OD	OD	OD	OD	OD	OD	OD	OD	OD	OD	OD	OD	OD	OD	OD	OD	OD	OD	OD	OD	OD	OD	OD	OD	OD	OD	OD	OD	
141 - 142	OD	OD	OD	OD	OD	OD	OD	OD	OD	OD	OD	OD	OD	OD	OD	OD	OD	OD	OD	OD	OD	OD	OD	OD	OD	OD	OD	OD	OD	OD	OD	
139 - 140	OD	OD	OD	OD	OD	OD	OD	OD	OD	OD	OD	OD	OD	OD	OD	OD	OD	OD	OD	OD	OD	OD	OD	OD	OD	OD	OD	OD	OD	OD	OD	
137 - 138	OD	OD	OD	OD	OD	OD	OD	OD	OD	OD	OD	OD	OD	OD	OD	OD	OD	OD	OD	OD	OD	OD	OD	OD	OD	OD	OD	OD	OD	OD	OD	
135 - 136	OC	OC	OC	OC	OC	OC	OC	OC	OC	OC	OC	OC	OC	OC	OC	OC	OC	OC	OC	OC	OC	OC	OC	OC	OC	OC	OC	OC	OC	OC	OC	
133 - 134	OC	OC	OC	OC	OC	OC	OC	OC	OC	OC	OC	OC	OC	OC	OC	OC	OC	OC	OC	OC	OC	OC	OC	OC	OC	OC	OC	OC	OC	OC	OC	
131 - 132	OC	OC	OC	OC	OC	OC	OC	OC	OC	OC	OC	OC	OC	OC	OC	OC	OC	OC	OC	OC	OC	OC	OC	OC	OC	OC	OC	OC	OC	OC	OC	
129 - 130	OC	OC	OC	OC	OC	OC	OC	OC	OC	OC	OC	OC	OC	OC	OC	OC	OC	OC	OC	OC	OC	OC	OC	OC	OC	OC	OC	OC	OC	OC	OC	
127 - 128	OC	OC	OC	OC	OC	OC	OC	OC	OC	OC	OC	OC	OC	OC	OC	OC	OC	OC	OC	OC	OC	OC	OC	OC	OC	OC	OC	OC	OC	OC	OC	
125 - 126	OC	OC	OC	OC	OC	OC	OC	OC	OC	OC	OC	OC	OC	OC	OC	OC	OC	OC	OC	OC	OC	OC	OC	OC	OC	OC	OC	OC	OC	OC	OC	
123 - 124	OB	OB	OB	OB	OB	OB	OB	OB	OB	OB	OB	OB	OB	OB	OB	OB	OB	OB	OB	OB	OB	OB	OB	OB	OB	OB	OB	OB	OB	OB	OB	
121 - 122	OB	OB	OB	OB	OB	OB	OB	OB	OB	OB	OB	OB	OB	OB	OB	OB	OB	OB	OB	OB	OB	OB	OB	OB	OB	OB	OB	OB	OB	OB	OB	
119 - 120	OB	OB	OB	OB	OB	OB	OB	OB	OB	OB	OB	OB	OB	OB	OB	OB	OB	OB	OB	OB	OB	OB	OB	OB	OB	OB	OB	OB	OB	OB	OB	
117 - 118	OB	OB	OB	OB	OB	OB	OB	OB	OB	OB	OB	OB	OB	OB	OB	OB	OB	OB	OB	OB	OB	OB	OB	OB	OB	OB	OB	OB	OB	OB	OB	
115 - 116	OB	OB	OB	OB	OB	OB	OB	OB	OB	OB	OB	OB	OB	OB	OB	OB	OB	OB	OB	OB	OB	OB	OB	OB	OB	OB	OB	OB	OB	OB	OB	
113 - 114	OB	OB	OB	OB	OB	OB	OB	OB	OB	OB	OB	OB	OB	OB	OB	OB	OB	OB	OB	OB	OB	OB	OB	OB	OB	OB	OB	OB	OB	OB	OB	
111 - 112	OA	OA	OA	OA	OA	OA	OA	OA	OA	OA	OA	OA	OA	OA	OA	OA	OA	OA	OA	OA	OA	OA	OA	OA	OA	OA	OA	OA	OA	OA	OA	
109 - 110	OA	OA	OA	OA	OA	OA	OA	OA	OA	OA	OA	OA	OA	OA	OA	OA	OA	OA	OA	OA	OA	OA	OA	OA	OA	OA	OA	OA	OA	OA	OA	
107 - 108	OA	OA	OA	OA	OA	OA	OA	OA	OA	OA	OA	OA	OA	OA	OA	OA	OA	OA	OA	OA	OA	OA	OA	OA	OA	OA	OA	OA	OA	OA	OA	
105 - 106	OA	OA	OA	OA	OA	OA	OA	OA	OA	OA	OA	OA	OA	OA	OA	OA	OA	OA	OA	OA	OA	OA	OA	OA	OA	OA	OA	OA	OA	OA	OA	
103 - 104	OA	OA	OA	OA	OA	OA	OA	OA	OA	OA	OA	OA	OA	OA	OA	OA	OA	OA	OA	OA	OA	OA	OA	OA	OA	OA	OA	OA	OA	OA	OA	
101 - 102	OA	OA	OA	OA	OA	OA	OA	OA	OA	OA	OA	OA	OA	OA	OA	OA	OA	OA	OA	OA	OA	OA	OA	OA	OA	OA	OA	OA	OA	OA	OA	
99 - 100	-	-	-	-	-	-	-	-	-	-	-	-	-	-	-	-	-	-	-	-	-	-	-	-	-	-	-	-	-	-	-	
97 - 98	-	-	-	-	-	-	-	-	-	-	-	-	-	-	-	-	-	-	-	-	-	-	-	-	-	-	-	-	-	-	-	
95 - 96	-	-	-	-	-	-	-	-	-	-	-	-	-	-	-	-	-	-	-	-	-	-	-	-	-	-	-	-	-	-	-	
93 - 94	-	-	-	-	-	-	-	-	-	-	-	-	-	-	-	-	-	-	-	-	-	-	-	-	-	-	-	-	-	-	-	
91 - 92	-	-	-	-	-	-	-	-	-	-	-	-	-	-	-	-	-	-	-	-	-	-	-	-	-	-	-	-	-	-	-	
89 - 90	-	-	-	-	-	-	-	-	-	-	-	-	-	-	-	-	-	-	-	-	-	-	-	-	-	-	-	-	-	-	-	
87 - 88	-	-	-	-	-	-	-	-	-	-	-	-	-	-	-	-	-	-	-	-	-	-	-	-	-	-	-	-	-	-	-	
85 - 86	-	-	-	-	-	-	-	-	-	-	-	-	-	-	-	-	-	-	-	-	-	-	-	-	-	-	-	-	-	-	-	
83 - 84	-	-	-	-	-	-	-	-	-	-	-	-	-	-	-	-	-	-	-	-	-	-	-	-	-	-	-	-	-	-	-	
81 - 82	-	-	-	-	-	-	-	-	-	-	-	-	-	-	-	-	-	-	-	-	-	-	-	-	-	-	-	-	-	-	-	
79 - 80	-	-	-	-	-	-	-	-	-	-	-	-	-	-	-	-	-	-	-	-	-	-	-	-	-	-	-	-	-	-	-	
77 - 78	-	-	-	-	-	-	-	-	-	-	-	-	-	-	-	-	-	-	-	-	-	-	-	-	-	-	-	-	-	-	-	
75 - 76	-	-	-	-	-	-	-	-	-	-	-	-	-	-	-	-	-	-	-	-	-	-	-	-	-	-	-	-	-	-	-	
0 - 74	-	-	-	-	-	-	-	-	-	-	-	-	-	-	-	-	-	-	-	-	-	-	-	-	-	-	-	-	-	-	-	
Fumble Range:	2		Range Modifiers:		0m-1m:		+10		AT may only be claimed if appropriate helmet is worn																							
Breakage #s:	1		6m-5m:		+0																											
Reliability:	150		76m-10m:		-25																											
			151m-20m:		-50																											
			751m-50m:		-100																											

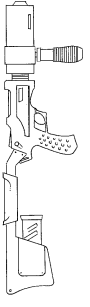

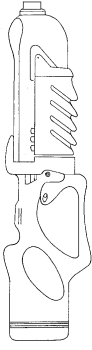

	Combat Armor		Kinetic Armor					Armored Cloth					Plate Armor					Chain Armor					Rigid Leather					Soft Leather					Natural					Clothing				
	X	IX	VIII	VII	VI	V	IV	III	II	I	20	19	18	17	16	15	14	13	12	11	10	9	8	7	6	5	4	3	2	1												
149 - 150	0E	0E	0E	0E	0E	0E	0E	0E	0E	0E	0E	0E	0E	0E	0E	0E	0E	0E	0E	0E	0E	0E	0E	0E	0E	0E	0E	0E	0E	0E	0E											
147 - 148	0E	0E	0E	0E	0E	0E	0E	0E	0E	0E	0E	0E	0E	0E	0E	0E	0E	0E	0E	0E	0E	0E	0E	0E	0E	0E	0E	0E	0E	0E	0E	0E										
145 - 146	0E	0E	0E	0E	0E	0E	0E	0E	0E	0E	0E	0E	0E	0E	0E	0E	0E	0E	0E	0E	0E	0E	0E	0E	0E	0E	0E	0E	0E	0E	0E	0E										
143 - 144	0E	0E	0E	0E	0E	0E	0E	0E	0E	0E	0E	0E	0E	0E	0E	0E	0E	0E	0E	0E	0E	0E	0E	0E	0E	0E	0E	0E	0E	0E	0E	0E										
141 - 142	0E	0E	0E	0E	0E	0E	0E	0E	0E	0E	0E	0E	0E	0E	0E	0E	0E	0E	0E	0E	0E	0E	0E	0E	0E	0E	0E	0E	0E	0E	0E	0E										
139 - 140	0D	0D	0D	0E	0E	0E	0E	0E	0E	0E	0E	0E	0E	0E	0E	0E	0E	0E	0E	0E	0E	0E	0E	0E	0E	0E	0E	0E	0E	0E	0E	0E										
137 - 138	0D	0D	0D	0D	0D	0D	0E	0E	0E	0E	0D	0D	0D	0D	0D	0D	0D	0D	0D	0D	0D	0D	0D	0D	0D	0D	0D	0D	0D	0D	0D	0D	0D									
135 - 136	0D	0D	0D	0D	0D	0D	0D	0D	0D	0D	0D	0D	0D	0D	0D	0D	0D	0D	0D	0D	0D	0D	0D	0D	0D	0D	0D	0D	0D	0D	0D	0D	0D									
133 - 134	0D	0D	0D	0D	0D	0D	0D	0D	0D	0D	0D	0D	0D	0D	0D	0D	0D	0D	0D	0D	0D	0D	0D	0D	0D	0D	0D	0D	0D	0D	0D	0D	0D									
131 - 132	0D	0D	0D	0D	0D	0D	0D	0D	0D	0D	0D	0D	0D	0D	0D	0D	0D	0D	0D	0D	0D	0D	0D	0D	0D	0D	0D	0D	0D	0D	0D	0D	0D									
129 - 130	0C	0C	0C	0C	0C	0C	0C	0C	0C	0C	0C	0C	0C	0C	0C	0C	0C	0C	0C	0C	0C	0C	0C	0C	0C	0C	0C	0C	0C	0C	0C	0C	0C									
127 - 128	0C	0C	0C	0C	0C	0C	0C	0C	0C	0C	0C	0C	0C	0C	0C	0C	0C	0C	0C	0C	0C	0C	0C	0C	0C	0C	0C	0C	0C	0C	0C	0C	0C	0C								
125 - 126	0C	0C	0C	0C	0C	0C	0C	0C	0C	0C	0C	0C	0C	0C	0C	0C	0C	0C	0C	0C	0C	0C	0C	0C	0C	0C	0C	0C	0C	0C	0C	0C	0C	0C								
123 - 124	0C	0C	0C	0C	0C	0C	0C	0C	0C	0C	0C	0C	0C	0C	0C	0C	0C	0C	0C	0C	0C	0C	0C	0C	0C	0C	0C	0C	0C	0C	0C	0C	0C	0C								
121 - 122	0C	0C	0C	0C	0C	0C	0C	0C	0C	0C	0C	0C	0C	0C	0C	0C	0C	0C	0C	0C	0C	0C	0C	0C	0C	0C	0C	0C	0C	0C	0C	0C	0C	0C								
119 - 120	0B	0B	0B	0C	0C	0C	0C	0C	0C	0C	0C	0C	0C	0C	0C	0C	0C	0C	0C	0C	0C	0C	0C	0C	0C	0C	0C	0C	0C	0C	0C	0C	0C	0C								
117 - 118	0B	0B	0B	0C	0C	0C	0C	0C	0C	0C	0C	0C	0C	0C	0C	0C	0C	0C	0C	0C	0C	0C	0C	0C	0C	0C	0C	0C	0C	0C	0C	0C	0C	0C								
115 - 116	0B	0B	0B	0C	0C	0C	0C	0C	0C	0C	0C	0C	0C	0C	0C	0C	0C	0C	0C	0C	0C	0C	0C	0C	0C	0C	0C	0C	0C	0C	0C	0C	0C	0C								
113 - 114	0B	0B	0B	0B	0B	0B	0C	0C	0C	0C	0C	0C	0C	0C	0C	0C	0C	0C	0C	0C	0C	0C	0C	0C	0C	0C	0C	0C	0C	0C	0C	0C	0C	0C	0C							
111 - 112	0B	0B	0B	0B	0B	0B	0C	0C	0C	0C	0C	0C	0C	0C	0C	0C	0C	0C	0C	0C	0C	0C	0C	0C	0C	0C	0C	0C	0C	0C	0C	0C	0C	0C	0C							
109 - 110	0A	0A	0A	0B	0B	0B	0C	0C	0C	0C	0C	0C	0C	0C	0C	0C	0C	0C	0C	0C	0C	0C	0C	0C	0C	0C	0C	0C	0C	0C	0C	0C	0C	0C	0C							
107 - 108	0A	0A	0A	0B	0B	0B	0B	0B	0B	0B	0B	0B	0B	0B	0B	0B	0B	0B	0B	0B	0B	0B	0B	0B	0B	0B	0B	0B	0B	0B	0B	0B	0B	0B	0B							
105 - 106	0A	0A	0A	0B	0B	0B	0B	0B	0B	0B	0B	0B	0B	0B	0A	0A	0A	0A	0A	0A	0A	0A	0A	0A	0A	0A	0A	0A	0A	0A	0A	0A	0A	0A	0A							
103 - 104	0A	0A	0A	0B	0B	0B	0B	0B	0B	0B	0B	0B	0B	0B	0A	0A	0A	0A	0A	0A	0A	0A	0A	0A	0A	0A	0A	0A	0A	0A	0A	0A	0A	0A	0A							
101 - 102	0A	0A	0A	0A	0A	0A	0A	0A	0A	0A	0A	0A	0A	0A	0A	0A	0A	0A	0A	0A	0A	0A	0A	0A	0A	0A	0A	0A	0A	0A	0A	0A	0A	0A	0A							
99 - 100	-	-	-	0A	0A	0A	0A	0A	0A	0A	0A	0A	0A	0A	0A	0A	0A	0A	0A	0A	0A	0A	0A	0A	0A	0A	0A	0A	0A	0A	0A	0A	0A	0A	0A							
97 - 98	-	-	-	0A	0A	0A	0A	0A	0A	0A	0A	0A	0A	0A	0A	0A	0A	0A	0A	0A	0A	0A	0A	0A	0A	0A	0A	0A	0A	0A	0A	0A	0A	0A	0A							
95 - 96	-	-	-	0A	0A	0A	0A	0A	0A	0A	0A	0A	0A	0A	0A	0A	0A	0A	0A	0A	0A	0A	0A	0A	0A	0A	0A	0A	0A	0A	0A	0A	0A	0A	0A							
93 - 94	-	-	-	0A	0A	0A	0A	0A	0A	0A	0A	0A	0A	0A	-	-	-	-	-	-	-	-	-	-	-	-	-	-	-	-	-	-	-	-	-							
91 - 92	-	-	-	0A	0A	0A	0A	0A	0A	0A	0A	0A	0A	0A	-	-	-	-	-	-	-	-	-	-	-	-	-	-	-	-	-	-	-	-	-							
89 - 90	-	-	-	-	-	-	0A	0A	0A	0A	-	-	-	-	-	-	-	-	-	-	-	-	-	-	-	-	-	-	-	-	-	-	-	-	-	-						
87 - 88	-	-	-	-	-	-	0A	0A	0A	0A	-	-	-	-	-	-	-	-	-	-	-	-	-	-	-	-	-	-	-	-	-	-	-	-	-	-						
85 - 86	-	-	-	-	-	-	0A	0A	0A	0A	-	-	-	-	-	-	-	-	-	-	-	-	-	-	-	-	-	-	-	-	-	-	-	-	-	-						
83 - 84	-	-	-	-	-	-	0A	0A	0A	0A	-	-	-	-	-	-	-	-	-	-	-	-	-	-	-	-	-	-	-	-	-	-	-	-	-	-						
81 - 82	-	-	-	-	-	-	0A	0A	0A	0A	-	-	-	-	-	-	-	-	-	-	-	-	-	-	-	-	-	-	-	-	-	-	-	-	-	-						
79 - 80	-	-	-	-	-	-	-	-	-	-	-	-	-	-	-	-	-	-	-	-	-	-	-	-	-	-	-	-	-	-	-	-	-	-	-	-						
77 - 78	-	-	-	-	-	-	-	-	-	-	-	-	-	-	-	-	-	-	-	-	-	-	-	-	-	-	-	-	-	-	-	-	-	-	-	-						
75 - 76	-	-	-	-	-	-	-	-	-	-	-	-	-	-	-	-	-	-	-	-	-	-	-	-	-	-	-	-	-	-	-	-	-	-	-	-						
0 - 74	-	-	-	-	-	-	-	-	-	-	-	-	-	-	-	-	-	-	-	-	-	-	-	-	-	-	-	-	-	-	-	-	-	-	-	-						
Fumble Range:	2		Range Modifiers:																	AT may only be claimed if appropriate helmet is worn																						
Breakage #s:	1		0m-1m:																	+10																						
Reliability:	150		6m-5m:																	+0																						
			76m-10m:																	-25																						
			151m-20m:																	-50																						
			751m-50m:																	-100																						
Security Systems																																										
Mk V Stunner																																										
SS 5																																										



7.0

CRITICAL & FUMBLE TABLES

INTRODUCTION

This section contains a key to all the tables in this section, 19 critical tables and 2 fumble tables. In addition, at the bottom of each table, there is a key for all of the symbols used in these tables.

HOW TO USE THESE TABLES

To resolve most critical hits, roll d100 (not open-ended) and cross-index the result on the appropriate column of the chart.

The exceptions to this method are the large and super large critical tables. When attacking a target of those sizes, you must ascertain the type of weapon used. Cross-index a high open-ended d100 roll with the type of weapon used.

To resolve a fumble, simply roll a d100 (not open-ended) and cross-index the result with the type of weapon that generated the fumble.

KEY TO THE TABLES

All of the tables in this section have two different types of information: descriptions and mechanics.

• The description information describes the critical hit (usually including a body location). The GM should feel free to alter the description to more appropriately fit the type of attack.

• The mechanics information, at the bottom of the critical, gives the game effects of the critical. The GM should rarely, if ever, alter these results. They are in the following format:

$$+\beta H - \beta \text{☀} - \beta \text{⊗} - \beta \text{◆} - \beta(-a) - \beta(+a)$$

Where a and β are numbers. In general:

H=hits

☀=rounds of stun

⊗=rounds of no parry

×=rounds of must parry

◆=hits per round

(-a) =penalty

(+a) =bonus

7.1 BALLISTIC ARMOR PIERCING CRITICALS

B	C	D
Forearm scratches across the back of the hand. But foe thinks twice. +1H - ×	Shot nicks foe's hand. Any item held now has a hole in it. +1H - × - (-5)	Shot goes through foe's hand bones and leaving a dripping glove. +1H
Shot nicks him in the arm, but not deep enough to bleed. You gain initiative and control. +1H - × - ◆	Shot passes cleanly through foe's forearm, tearing tendons. Any item held in that hand is unwillingly thrown by foe. +2H - × - ◆ - (-5)	Bullet passes clean through arm, damaging muscles and tendons. Activities with this arm suspended until healed. +3H
Bullet grazes foe's upper arm and does some muscle damage. +1H - × - (-5)	Shot passes clean through upper arm, doing some minor muscle damage. Now the arm is bleeding. +2H - 2× - ◆ - (-5)	Shot to foe's elbow breaks tendons. Arm useless. +2H -
Foe dodges a major arm hit. But he is still hurt. +1H - × - (-5)	Good shot, right through the arm, causes major muscle damage. +4H - 2× - ◆ - (-5)	A not so funny shot right through the bone. Bones broken and arm is useless. +5H
Bullet hits foe on the shoulder. +3H - × - (-5)	Well-placed shot goes right through foe's shoulder. Muscles and tendons are damaged. +5H - 2× - 2◆ - (-10)	Lucky shot through foe's shoulder only damages muscles and also nicks a major artery. +3H -
Bullet right on foe's clavicle spins him 360°. +8H - 3× - (-15)	Well-aimed shot breaks foe's clavicle and his sternum. Move along. Nothing to see here. +12H - 4× - (-20)	Shot hits foe in his shoulder, breaking the bone. Bullet passes through the bone. +12H
Bullet grazes foe's thigh causing him to limp. +2H - 4× - (-10)	Bullet passes clean through foe's upper leg. +15H - × - ◆ - (-10)	Shot passes through foe's thigh before it damages muscles and a major artery. +8H -
Bullet grazes foe's knee, but does not hit the bone. Minor muscle damage. +2H - × - (-5)	Next time aim higher. Bullet goes through calf, damaging muscles and tendons. +5H - × - 2◆ - (-10)	Shot grazes foe's shin, hitting the bone. Bone is still intact. Foe will now have a limp. +12H -
Bullet hits a toe right off of foe's foot. +2H - × - (-5)	Foe's shoe is no more. Shot hits the middle of his foot and breaks several small bones. +8H - 2× - (-10)	Ouch! Bullet breaks foe's foot. If using a hull, foot is severed. Regear instantly. +10H
Bullet grazes foe's hip bone, but does not hit it. +3H - 2× - (-5)	Bullet puts a hole in foe's hip. Every step is painful now. +8H - 2× - × - (-15)	Foe needs to lose a few rounds through foe's hip. +12H - 3
Shot grazes foe's head. Foe is alive, but dazed for a week. +8H - (-25) - (+25)	Shot hits foe right on the bridge of his nose and then passes out the back of his head. Foe is dead, though it takes him 3 rounds to fall over. (+25)	Bullet enters through a side of the head. Unfortunately, many trying to slide out of the hole. +12H - 4
Shot shatters foe's knee cap. +3H - × - (-15)	Bullet passes clean through foe's knee cap, but doesn't shatter it! -10 to all moving maneuvers. +7H - 2× - (-10)	Bullet leaves knee cap hanging. +12H - 4
Bullet grazes foe's stomach. +1H - × - (-5)	Bullet passes right through foe's stomach (making eating difficult now). +3H - 2× - 2◆ - (-5)	Gut shot passes through causing internal bleeding pain. +3H - 2
Bullet grazes foe's lung. +3H - 2× - (-5)	Bullet breaks a rib in two places (one on the way in, the other on the way out). Muscles and tendons suffer minor damage as the shot passes through. +7H - 2× - (-10)	Bullet puts a hole in foe's chest. Passes right through the lung. +6H -
Bullet grazes foe's chest. +3H - × - 2◆ - (-5)	Shot puts a hole in foe's lung. He can taste the blood with every breath. +5H - 2× - 3◆ - (-10)	Just a little lower and you'd have a major internal organ hit. +8H - 3
Bullet grazes foe's chest. +3H - × - 2◆ - (-5)	Clean perforation of foe's lung. Rib broken as well. +5H - 2× - 3◆ - (-10)	Sternum now has a hole. Shot passes within an inch of the heart. +8H - 3



Sometimes, the second and third items are combined, such as $\beta \otimes$. Also, sometimes the third item is replaced with $\beta(\times -a)$ (you will never have a \otimes and a \times entry). Below are detailed descriptions for each of the entries.

- $+\beta H$ – This indicates that the target takes an additional β hits.

- $\beta \otimes$ – This indicates that the target is stunned for β rounds. When stunned, the target may only parry with half of his OB; the only other allowable actions are maneuvering (modified by at least -50). When no number is specified, it is assumed to be 1.

- $\beta \otimes$ – This indicates how long, after the attack, the target is not permitted to parry. The only allowable actions are maneuvering (modified by at least -75). This result is often modified by a \otimes result (see above). When a duration is not specified, assume it lasts 1 round.

- $\beta(\times -a)$ – This indicates that the target must parry for the next β rounds with a penalty of $\%$. When no time is indicated assume it lasts 1 round. When $\%$ isn't specified, assume no penalty.

- $\beta \blacklozenge$ – This indicates that the target is bleeding β hits per round. This represents not only blood loss, but increasing pain, shock, etc. When β is not specified, assume it to equal 1.

- $\beta(-a)$ – This indicates that the target suffers from a penalty equal to a for β rounds. If β is not specified, assume it to be permanent until healed.

- $\beta(+a)$ – This indicates that the attacker receives a bonus, equal to a , for β rounds. If no duration is specified, assume that it is only for the next round.

LIST OF CRITICAL AND FUMBLE TABLES

7.1 Ballistic Armor Piercing Critical Strike Table

7.2 Ballistic Hollow Point Critical Strike Table

7.3 Ballistic Impact Critical Strike Table

7.4 Ballistic Puncture Critical Strike Table

7.5 Ballistic Shrapnel Critical Strike Table

7.6 Blaster Critical Strike Table

7.7 Burn Through Critical Table

7.8 Burst Critical Table

7.9 Large Animal Ballistic Critical Strike Table

7.10 Large Animal Energy Critical Strike Tables

7.11 Laser Critical Table

7.12 Plasma Critical Table

7.13 Powered Armor Critical Table

7.14 Radiation Critical Table

7.15 Raking Critical Table

7.16 Scorch Critical Table

7.17 Stun Critical Strike Table

7.18 Super Large Animal Ballistic Critical Strike Table

7.19 Super Large Animal Energy Critical Strike Table

7.20 Energy Weapon Fumble Table

7.21 Firearm Fumble Table



7.1 BALLISTIC ARMOR PIERCING CRITICAL STRIKE TABLE

	A	B	C	D	E
01-05	Bullet passes between foe's fingers, but does no extra damage. +0H	Just a mere scratch across the back of the hand. But foe thinks twice. +1H - X	Shot nicks foe's hand. Any item held now has a hole in it. +1H - X - (-5)	Shot goes through foe's hand breaking bones and leaving a dripping hole in foe's glove. +1H - 2X - ● - (-10)	Foe has a gaping hole in the middle of his hand. Ouch. +3H - 2● - (-15)
06-10	Lower arm strike leaves only a scratch, but you have the initiative next round. +0H	Bullet only nicks him in the arm, but causes him to bleed. You gain initiative next round. +1H - X - ●	Shot passes cleanly through foe's forearm, tearing tendons. Any item held in that hand is unwillingly thrown by foe. +2H - X - ● - (-5)	Bullet passes clean through foe's lower arm, damaging muscles and tendons. All activities with this arm suffer a -10 penalty until healed. +3H - ● - ● - (-10)	Shot in lower arm hits the bone! Arm is broken (and tendons are torn). Foe drops any item he was carrying and loses initiative for two rounds. +4H - 2● - 3● - (-20)
11-15	Bullet passes between upper arm and armpit. Boy that was close! +1H	Shot grazes foe's upper arm and does minor muscle damage. +1H - X - (-5)	Shot passes clean through upper arm, doing some minor muscle damage. Now he's bleeding. +2H - 2X - ● - (-5)	Shot to foe's elbow breaks bone and tears tendons. Arm useless. +2H - 4● - 2● - (-20)	Bullet enters foe's bicep and then breaks the bone underneath. Muscles and tendons are torn. + 8H - 4● - 3● - (-20)
16-20	Just a nick. +1H	Foe barely dodges a major arm hit. But he still takes some minor muscle damage. +1H - X - (-5)	Good shot, right through the arm, causes major muscle damage. +4H - 2● - ● - (-5)	A not so funny shot right on foe's funny bone. Bones broken and tendons torn. Arm is useless. +5H - 4● - (-15)	Foe is spun sideways as shot rips open foe's upper arm. Blood is everywhere. Bone is broken, muscles are torn, tendons are ripped. Great shot! + 12H - 6● - 3● - (-25)
21-30	Foe tucks his shoulder just in time. +1H	Glancing hit on foe's shoulder. +3H - X - (-5)	Well-placed shot goes right through foe's shoulder. Muscles and tendons are damaged. +5H - 2● - 2● - (-10)	Lucky shot through foe's shoulder not only damages muscles and tendons, but also nicks a major artery. +3H - 2● - 3● - (-20)	Practically no damage... except that severed artery that is gushing like a fountain. +1H - 10● - (-5)
31-40	Just a flesh wound. +1H	Solid hit right on foe's clavicle spins him around 360°. +8H - 3● - (-15)	Well-aimed shot breaks foe's clavicle and his sternum. Move along. Nothing to see here. +12H - 4● - (-20)	Shot hits foe in his shoulder and knocks him backwards. Bullet passes clean through the bone. +12H - 3● - (-25)	Incredible shot breaks foe's clavicle and completely fractures the entire shoulder joint. Foe may never lift his arm again. +10H - 5● - 3● - (-25)
41-50	He now has a hole in his pocket. Just a few more inches and you might have actually hit him. +1H	Bullet grazes foe's thigh causing him to stagger. Slight muscle damage. +2H - 4X - (-10)	Bullet passes clean through foe's upper leg. +15H - X - ● - (-10)	Shot passes through foe's thigh, but not before it damages muscles and tendons and a major artery. +8H - 4X - 3● - (-10)	Powerful shot knocks foe off his feet and breaks his thigh bone. Artery is severed. Hope he has a belt handy. +11H - 4● - 7● - (-50)
51-55	Barely got him in the lower leg. +2H	Shot barely misses foe's knee, but does nick his calf. Minor muscle damage. +2 H - X - (-5)	Next time aim higher. Bullet goes through calf, damaging muscles and tendons. +5H - ● - 2● - (-10)	Shot grazes foe's shin, then passes through the calf. Bone is fractured. He will now have a limp. +12H - 2● - 3X - (-15)	Shot goes right through foe's shin! Bone is splintered and muscles are torn. Foe falls and can't get up. +15H - 3● - 3● - (-30)
56-60	Close but no cigar. Foe easily dodges. +1H	Shot blasts a toe right off of foe's foot. +2H - X - (-5)	Foe's shoe is no more. Shot hits the middle of his foot and breaks several small bones. +8H - 2● - (-10)	Ouch! Bullet breaks foe's ankle and tears his tendons. If using a hunting class of III, foot is severed. Regardless, foe drops instantly. +10H - 3● - ● - (-20)	Incredible shot! Ankle is shattered and tendons are torn. If using a hunting class of II or greater, foot is severed. Regardless, foe won't be walking home. +12H - 4● - 4● - (-25)
61-65	Near miss around foe's mid-section. +2H - X	Shot bounces off of foe's hip bone, fracturing it in the process. +3H - 2● - (-5)	Bullet puts a hole in foe's hip. Every step is painful now. +8H - 2● - X - (-15)	Foe needed to lose a few pounds anyway. Shot rips through foe's waist and doubles him over. +12H - 3● - 3● - (-20)	Good shot at foe's waist causes a major fracturing of foe's hip. Wait for the ambulance. +15H - 5● - (-50)
66	Amazing shot passes cleanly through foe's backside. How did you do that? +7H - (-5)	Is there anything in there? Bullet goes in one ear and out the other. Foe is alive, but in a coma for a week. +8H - (-25) - (+25)	Shot hits foe right on the bridge of his nose and then passes out the back of his head. Foe is dead, though it takes him 3 rounds to fall over. (+25)	Bullet enters through a small hole in his gut. Unfortunately, many organs are trying to slide out of the gaping hole in his back. +12H - 4● - 6● - (-30)	There are no children in foe's future. Groin shot leaves all within 15' groaning in sympathy for foe (everyone stunned for one round). +12H - 5● - 4● - (-30)
67-70	Shot passes right between foe's knees. +1H - X	Well-placed shot shatters foe's knee cap. Get a cane. +3H - ● - (-15)	Bullet passes clean through foe's knee cap, but doesn't shatter it! -10 to all moving maneuvers. +7H - 2● - (-10)	Bullet leaves knee cap hanging from foe's knee. +12H - 4● - ● - (-15)	Shot rips knee cap from foe's knee. Severe tendon damage leaves foe with a funny hitch in his step. +15H - 4● - (-25)
71-75	Shot passes cleanly through foe's gut, doing no major damage. +1H	Right in the gut! Minor muscle damage as bullet passes through without too much resistance. +1H - X - (-5)	Bullet passes right through foe's stomach (making eating difficult now). +3H - 2● - 2● - (-5)	Gut shot passes through several organs causing internal bleeding and a lot of pain. +3H - 2● - 3● - (-10)	Nice shot pierces foe's kidney. The bleeding looks like it will never end. +8H - 4● - 6● - (-15)
76-80	Lucky for foe, no vitals were hit as bullet passes through his side. +3H - X	Rib snaps as bullet nearly misses a lung. +3H - 2● - (-5)	Bullet breaks a rib in two places (one on the way in, the other on the way out). Muscles and tendons suffer minor damage as the shot passes through. +7H - 2● - (-10)	Bullet puts a hole in foe's liver as it passes right through the rest of the body. +6H - 2● - 3● - (-10)	Foe's appendix ruptures as bullet passes right through it. +8H - 3● - 6● - (-20)
81-85	Foe doubles over as you hit him squarely in the gut. Luckily for him, no major damage. +3H - X - (-5)	Foe's belly button, must have had a bulls-eye painted on it. Minor wounds in abdominal organs. +3H - X - 2● - (-5)	Shot puts a hole in foe's lung. He can taste the blood with every breath. +5H - 2● - 3● - (-10)	Just a little lower and you could have had the family jewels! You will have to settle for major internal organ damage. +8H - 3● - 4● - (-15)	Spine is severed as shot passes cleanly through it. Foe is paralyzed. +12 H - 2● - (-75)
86-90	Shot passes near foe's lung, but only does minor muscle damage. +3H - X - (-5)	Rib snaps from the impact, but bullet continues through. Minor bleeding. +7H - 2● - ● - (-10)	Clean perforation of foe's lung. Rib broken as well. +8H - 2● - 3● - (-15)	Sternum now has a bullet-sized hole in it. Shot passes within an inch of foe's heart (nicking an artery). +8H - 3● - 6● - (-30)	Right in the heart. Foe grips his chest, then dies. (+20)
91-95	Incredible shot puts a bullet-sized hole in the middle of foe's ear! Foe now hears at -20. +1H	Bullet leaves a furrow in foe's skull (and parts foe's hair in the process). +3H - 2●	Bullet grazes foe's skull on one side, ripping the flesh off. Foe's eardrum is permanently damaged in that ear. +6H - 2● - 3● - (-10)	Bullet passes through foe's skull! He immediately drops into a coma for a month. When he wakes, he will be blind and unable to speak. +8H - 6●	Shot enters in the center of foe's forehead and blows off the back of his skull. What a mess. (+20)
96-99	Shot through foe's jaw dislodges d10 teeth. +3H - 2● - (-5)	Bullet shatters foe's jaw. Get a straw. +5H - 2● - 2● - (-10)	Shot hits just below the chin, destroying foe's voice box. Take up pantomime. +6H - 3● - 2● - (-15)	Bullet passes right through foe's neck. Foe clutches his throat, but will have trouble stopping this bleeding. +2H - X - 10● - (-10)	Shot separates foe's brain from his spine. He is paralyzed while the blood pours from the wound. +6H - 12● - (-75)
100	Shot through foe's mouth! Foe looks quite surprised, then dies. (+20)	Shot cleanly drops foe. He falls silently, then expires quietly. (+20)	Foe's brains have just seen the light! You still have half a round left to act. (+20)	Bullet enters through foe's eye and exits through his ear. The blast knocks him backwards 10'. The corpse twitches. (+20)	Foe's head completely implodes as bullet passes through. (+25)

Key: Bx=must parry β rounds; B●=no parry for β rounds; B* =stunned for β rounds; B●=bleed β hits per round; (-β)=foe has -β penalty; (+β)=attacker gets +β next round.



7.2 BALLISTIC HOLLOWPOINT CRITICAL STRIKE TABLE

	A	B	C	D	E
01-05	Shoot item in foe's hand. He must make a Light maneuver to hold on to it. +1H	Nice shot hits whatever foe was holding. He must make a Medium maneuver to hold on to it. +2H - x	Surprise shot hits object in foe's grasp. He must make a Hard maneuver to hold on to it. +3H - 2x - (-10)	Shot goes through foe's hand, destroying any item he was holding. +5H - 3* - 3* - (-15)	Shot hits whatever foe was holding. The object explodes in foe's hand and causes much pain. +7H - 4* - (-25)
06-10	Just a scratch. You gain initiative next round. +2H	Deep cut on foe's forearm. You gain the initiative next round. +5H - 2x - 2*	Nasty gash on foe's lower arm does minor tendon damage. Now his grip is weak. +6H - 2* - 3* - (-15)	Bullet passes cleanly through foe's forearm. But not before doing minor muscle and tendon damage. +7H - 3* - 4* - (-20)	Shot explodes in foe's forearm. Bone is broken and tendons are torn. Foe drops any items he was carrying and loses initiative for two rounds. +10H - 5* - 6* - (-40)
11-15	A nasty burn is all it leaves. +2H	Shot barely grazes foe's biceps, causing minor muscle damage. +5H - 2x - (-5)	Right in the arm! Foe has major muscle damage from the hit. +10H - 3* - 3* - (-15)	That's not funny! Bullet rips through foe's elbow, breaking bone and tearing tendons. Arm is useless. +8H - 4* - 2* - (-20)	Bullet strikes the bone in foe's upper arm. Muscles and tendons are damaged. Foe cannot lift his arm. +20H - 6* - 5* - (-40)
16-20	He raised his arm at just the right time. +2H	Shot goes through foe's upper arm causing minor muscle damage. +5H - 2x - (-5)	Solid hit on foe's upper arm causes major muscle damage. +8H - 2* - 3* - (-15)	Ouch! Shot destroys foe's elbow. Any movement of the arm hurts badly! +4H - 4* - 2x - (-25)	Nice shot breaks foe's upper arm. Muscles and tendons are torn. Arm is useless. +20H - 6* - 4* - (-40)
21-30	Foe tucked his shoulder, avoiding a great shot. +3H	Shot nearly missed, but does catch foe in the shoulder, spinning foe around. +5H - 2* - (-10)	Bullet rips open foe's shoulder. He looks amazed and muscles and tendons are hanging loose. +12H - 4* - 2* - 2* - (-15)	Bullet leaves a gaping hole in foe's shoulder. +12H - 4* - 6* - (-25)	You can now see through the huge hole in foe's shoulder. But will the bleeding ever stop! +5H - 10* - (-10)
31-40	Almost got him. +3H	Foe falls down just in time to avoid a nasty shot to the neck. +4H - 2*	Shot explodes on foe's clavicle, breaking it. +12H - 3* - (-15)	Shot destroys the top half of foe's shoulder. Great shot! +20H - 3* - (-25)	Explosion breaks foe's clavicle and completely destroys the shoulder joint. Give up on that pitching career. +25H - 5* - 3* - (-40)
41-50	Shot grazes foe's thigh, leaving a hole in his pocket. +2H	Shot barely nicks his thigh, but leaves a torn muscle behind. +6H - (-10)	Luckily bullet doesn't fragment. But it is now lodged in foe's thigh. -25 to all moving maneuvers until it is removed. +12H - 2* - (-15)	Shot removes half of foe's thigh. Muscles and tendons are damaged. Minor artery damage as well. +20H - 3* - 3* - (-25)	Solid shot to foe's thigh breaks the femur and does major arterial damage. Foe falls into a pool of his own blood. +25H - 5* - 8* - (-75)
51-55	Bullet grazes foe's calf. +2H	Bullet passes through foe's lower leg. Minor muscle damage. +2 H - x - (-5)	Nice hit on foe's lower leg does muscle and tendon damage. +5H - * - 2* - (-10)	Bullet strikes the tibia, fracturing it. That's gotta hurt. +12H - 2* - 3x - (-15)	Calf hit spins foe around. Bone is broken and muscles are torn. +15H - 3* - 3* - (-30)
56-60	Keep foe dancing as the shot lands between foe's feet. +3H	Cruel! Shot blasts off two of foe's toes. He'll need a new pair of shoes. +6H - 2x - (-5)	Shot hits right in the middle of foe's foot, breaking lots of bones. +15H - 3* - (-20)	Shot to foe's ankle sends foe to the ground. Bones break and tendons tear. +18H - 4* - 2* - (-30)	If using a hunting class 1 or better, foe's foot goes flying behind him. Otherwise, ankle is completely destroyed. Foe falls. +25H - 6* - 4* - (-50)
61-65	That shot was close! Make some "wide load" remark. +5H - x	Shot hits foe in the hip. Lucky for him it didn't fragment. It only fractured the bone. +8H - 2* - (-5)	Shot barely fragments after hitting foe in the hip. Walking will cause d10 hits per minute. +15H - 3* - 2* - (-15)	Gaping hole around foe's hip. He tries to hold it all together. +20H - 4* - 3* - (-25)	Shot destroys foe's hip. +30H - 6* - (-50)
66	Shot to the posterior. Nice shooting, Tex. Foe needs a pillow to sit on. +15H - (-15)	Shot hits foe's shoulder, but a bone chip flies into foe's ear and lodges near foe's brain. Foe in coma for d10 days. +20H - (-40) - (+25)	Shot hits foe squarely between the eyes... then his head explodes. (+25)	Incredible shot leaves foe's whole abdomen open. Major damage to all kinds of internal organs; before they start spilling onto the floor. +40H - 8* - 15* - (-75)	Ooohhhh. Shot right between the legs leaves a bloody pulp on foe's groin. All within sight are stunned for one round in sympathy. +40H - 15* - 8* - (-75)
67-70	Shot passes just to the left of foe's knee. +2H - x	Shot fails to fragment on foe's kneecap. But it still hurts. +7H - * - (-10)	Shot rips the flesh off of foe's knee. +15H - 3* - (-20)	Kneecap shattered and tendons are damaged. Get a crutch. +20H - 5* - 2* - (-25)	Foe didn't need that knee anyway. Severe tendon damage. +25H - 6* - (-30)
71-75	Close shot nicks foe across the stomach. +3H	Bullet passes cleanly through foe's abdomen, doing minor muscle damage. +5H - 2* - (-10)	Right in the gut. Shot leaves a fist-sized hole and minor muscle/organ damage. +8H - 3* - 4* - (-15)	Good hit right in the stomach causes lots of bleeding. +8H - 4* - 6* - (-15)	Kidney shot. Foe is bleeding internally and externally. +15H - 5* - 8* - (-20)
76-80	If foe were a little thinner, this shot would have missed. +6H - 3x - (-5)	Shot barely catches foe on the side. But fragmentation still breaks d5 ribs. +8H - 3* - (-10)	Shot to foe's side breaks d5 ribs. Muscles and tendons suffer major damage. +15H - 4* - (-20)	Shot passes between two ribs, but one of them is broken in the fragmentation. Lung is severely damaged. +15H - 4* - 7* - (-15)	Lucky foe has another lung (as this one was just permanently deflated). Lots of broken ribs. +15H - 5W* - 9* - (-30)
81-85	Unfortunately, the bullet failed to fragment. Abdomen hit will simply leave a small scar. +6H - 2* - (-10)	Major strike to foe's gut causes major internal damage. +8H - 3* - 4* - (-15)	Gaping hole in foe's abdomen is going to cause him difficulty. +10H - 3* - 5* - (-15)	Yack! Bloody mess around foe's mid-section is a result of major internal and external damage. +20H - 5* - 7* - (-25)	Shot explodes through foe's gut, severing foe's spine. +25 H - 4*
86-90	Solid shot in the chest causes minor muscle damage. +8H - 2* - 2* - (-5)	Nice hit in the chest breaks d5 ribs and causes major muscle and tendon damage. +15H - 3* - 2* - (-15)	Chest strike breaks d10 ribs and collapses one lung. +15H - 3* - 5* - (-25)	Chest hit cracks sternum and causes a lot of internal damage. Lucky to be alive at all! +18H - 4* - 8* - (-30)	Shot explodes in foe's chest. The heart just can't take that much abuse. Foe dead. (+20)
91-95	Foe's ear is blasted off. +3H	Lucky for foe, bullet fails to fragment when it hits his skull. +5H - 3* - (-5)	Shot cracks the side of foe's skull. Lots of bleeding and permanent loss of hearing in that ear. +10H - 3* - 6* - (-15)	Bullet cracks open foe's head. Foe is in a coma for d10 weeks and loses one level's worth of experience. +30H - 9*	Foe head turns into a fine mist. The body remains standing until someone knocks it over. (+20)
96-99	Shot barely glances off of foe's face. Scar leaves foe with a -10 to his Appearance. +6H - 3* - (-5)	Shot cracks foe's jaw. He cannot talk until it healed. The scar looks like a second set of teeth! +8H - 3* - 2* - (-15)	Shot to foe's mouth leaves foe voiceless and toothless. +10H - 4* - 5* - (-25)	Shot passes just under foe's chin. Where did all that blood come from! +8H - 2x - 12* - (-10)	Shot goes in through foe's mouth and out through his neck. Foe's spine is severed, paralyzing him. +12H - 20* - (-75)
100	Shot enters foe's head through the eye. His brain hurts. He is dead. (+20)	Foe dies instantly when his brain turns to jello after shot enters the foe's ear. It's a Kodak moment. (+20)	Foe's head is no more. You have half the round left to act. (+20)	Shot explodes on foe's face. It takes a second or two, but he drops in much agony. After d10 rounds, he drops into a coma for d5 years. (+20)	Foe's head is severed from his body. The head shoots up to the sky, then lands back in place. A surprised, but dead foe, falls over. (+25)

Key: Bx=must parry B rounds; B∅=no parry for B rounds; B* =stunned for B rounds; B* =bleed B hits per round; (-B)=foe has -B penalty; (+B)=attacker gets +B next round.



7.3 BALLISTIC IMPACT CRITICAL STRIKE TABLE

	A	B	C	D	E
01-05	Blast to foe's hand. If he was holding an item, might drop it. +0H	You shot foe's hand. He must make a Light maneuver to hold onto it. +0H - x	Shot hits whatever foe was holding. The item flies out of his grasp. +1H - 2x	The item in foe's hand is hit. Make a breakage check for the item and it flies 10' behind foe. +2H - 2x - (-5)	Shot hits foe's hand. Bones break. Hand is useless. +3H - 3* - (-15)
06-10	Ah, well. Maybe next time. +0H	Forearm wound causes foe to flinch and bruise. You gain initiative next round. +2H - x	Forearm wound bruises tears tendons. If foe is carrying an item, he must make a Medium maneuver to hold onto it. +2H - x - (-5)	Forearm shot fractures wrist. Foe drops any items he was carrying with this arm. +4H - 2* - (-10)	Forearm shot crushes bone and which tears tendons. Foe drops any items he was carrying and loses initiative for two rounds. +5H - 3* - 2* - (-15)
11-15	Not even a bruise. +0H	Nick foe's biceps causing minor bruising damage. +2H - x - (-5)	Biceps hit causes major bruising damage. +4H - 2* - (-10)	Elbow hit breaks bone and tears tendons. Arm useless. +3H - 4* - 2x - (-20)	Biceps hit breaks bone. Arm useless. + 8H - 6* - * - (-25)
16-20	Come on, I can "punch" harder than that. +0H	Nick foe's triceps causing minor bruising damage. +2H - x - (-5)	Triceps hit causes major bruising damage. +4H - 2* - (-10)	Elbow hit breaks bone and tears tendons. Arm useless. +3H - 4* - 2x - (-20)	Triceps hit breaks bone. Arm useless. + 8H - 6* - * - (-25)
21-30	A bruise on the shoulder. +1H	Shoulder hit. Minor bruising damage. +1H - x (-5)	Bullet solidly impacts shoulder, foe spins and falls down. +5H - 2* - x - (-10)	Bullet solidly impacts shoulder, foe spins and falls down. Foe loses initiative next round. +5H - 3* - 2x - (-15)	Impact pops foes arm from his shoulder. +5H - 4* - (-20)
31-40	Shot to the shoulder gives only a slight dent. +1H	Bullet bruises foes clavicle +4H - 2x - (-5)	Bullet breaks clavicle. +10H - 3* - (-15)	Bullet solidly impacts shoulder, foe spins and falls down. Foe loses initiative next round. +5H - 3* - 2x - (-15)	Impact pops foes arm from his shoulder. +5H - 4* - (-20)
41-50	Ho. Hum. +0H	Hard hit to the thigh. Foe must make a Medium maneuver or fall down. +4H - (-5)	Hard hit to the thigh. Foe must make a Hard maneuver or fall down. +6H - x - (-5)	Hard hit to the thigh. Foe must make a Very Hard maneuver or fall down. That'll leave a mark. +8H - 2* - (-10)	Bullet impacts squarely and breaks femur. Foe falls. +10H - 4* - (-40)
51-55	Lower leg hit results in just a minor scratch. +1H	Hard hit to the calf. Foe must make a Medium maneuver or fall down. +1H - x	Hard hit to the calf. Foe must make a Hard maneuver or fall down. +4H - x - (-5)	Bullet strikes calf. Tibia fractured. Foe must make a Very Hard maneuver or fall down. +10H - 2* - x - (-15)	Calf strike breaks bone. Foe falls. +8H - 3* - (-30)
56-60	Foe is lucky he has quick feet. +1H	Foe has a crushed toe. +4H - x - (-5)	Foot hit breaks several small bones. +8H - 2x - (-10)	Ankle strike fractures bone. Foe falls. +10H - 3* - (-15)	Ankle strike breaks bone which tears tendon. If caliber is large enough (hunting class of II or greater) ankle is crushed (+20H). Foe falls. +12H - 4* - 2* - (-25)
61-65	Shot punches foe in waist. +2H - x	Bullet strikes foes hip causing a minor fracture. +4H - * - (-5)	Hip strike causes much bruising and a small fracture. +8H - 2* - x - (-10)	Hip strike fractures pelvis. He tries not to shimmy. +12H - 3* - (-20)	Foe's hip joint shattered. +20H - 5* - (-50)
66	Bullet to his seat causes foe to jump. He loses initiative next round. +8H - 2*	Wild shot bounces off of foe's armor, hits a rock, then goes right back to foe's head. Foe is unconscious for 3d10 hours. +10H - (-10) (+25)	And you thought this short of shot was a myth ... Foe takes it right between the eyes. His skull is cracked. He's down for the count. +20H (+25)	Chest hit breaks several ribs which cause internal bleeding. +20H - 4* - 4* - (-30)	Funny, you never thought your opponent could hit a note that high. You are stunned for 1 round in sympathy. +30H - 12* - 2* - (-75)
67-70	Almost a great hit on the knee. +1H - x	Knee shot fractures bone. +4H - * - (-5)	Bullet fractures knee and bruises tendons. +7H - 2* - (-10)	Bullet breaks kneecap and causes minor tendon damage. +12H - 4* - (-20)	Bullet shatters foe's knee. Sever tendon damage. +18H - 6* - 4* - (-30)
71-75	Right in the gut: except for that armor. +1H	Bullet impacts foes abdomen causing minor muscle bruising. +2H - x - (-5)	Abdomen hit causes minor muscle and organ damage. +4H - 2* - * - (-10)	Lower abdominal shot leaves a large bruise and causes some bleeding. +5H - 3* - 2* - (-10)	Kidney shot. Opponent bleeding pretty bad internally. +8H - 4* - 5* - (-20)
76-80	Shot to the side leaves foe slightly off-balance. +3H - 2x	Side hit breaks two ribs. +4H - 2* - (-10)	Bullet glances off two ribs, breaking them in the process. +8H - 3* - (-10)	Bullet breaks three ribs. +10H - 4* - (-10)	Foe has two ribs and his spleen crushed by the impact. +12H - 3* - 5* - (-20)
81-85	Center abdomen hit causes minor muscle bruising. +3H - x	Bullet impacts high on foes abdomen. Foe loses initiative for three rounds +4H - * - (-5)	Upper abdominal hit bruises some internal organs. +6H - 2* - (-10)	Bullet breaks a rib which punctures a lung. +8H - 3* - 3* - (-15)	Bullet hits foe in back causing major busing. Foe at -20 until a chiropractor looks at his back. +15H - 2* - (-10)
86-90	Chest hit causes minor muscle bruising. +3H - x	Chest hit breaks rib. Major muscle and tendon damage. +8H - 2* - * - (-10)	Chest strike breaks rib and collapses lung. +8H - 3* - 3* - (-15)	Chest Hit breaks sternum. +10H - 3* - (-30)	Heart strike crushes sternum and lodges bone shards near foe's heart. Call a good surgeon. +15H - 4* - 4* - (-40)
91-95	Foes ear is now a little flatter. Foe hears at -10. +2H	Bullet glances off foe's skull. +3H - 3*	Bullet to side of foes head. Temporary (2 days) loss of hearing in that ear. +6H - 2* - (-10)	Bullet hits foe smack dab in the forehead. Foe unconscious for three hours. +12H - (-10)	Bullet caves in the front of foe's skull. Death is instantaneous. (+20)
96-99	Bullet breaks foe's cheek. Foe has trouble talking. He suffers a -5 to his Appearance. +4H - 2* - (-5)	Bullet breaks foes jaw. Foe cannot talk until healed. He suffers a -15 to his Appearance. +6H - 2* - * - 2* - (-10)	Bullet to foes throat. Trachea crushed. Foe will suffocate in six minutes without medical attention. +6H - 3* - * - (-15)	Bullet crushes corradid artery. Foe will die in six minutes without surgery +3H - 3* - (-15)	Bullet breaks foes neck. Foe paralyzed. +8H - (-75)
100	Bullet crushes foes eye. Permanent vision loss in that eye. +5H - 2* - (-10) (+20)	Foe's ear is crushed and several bones broken in his skull. Not fun ... for him. +6H - 3* - (-10) (+20)	Shot caves in the side of foe's head. He's dead, but you have half a round left to act. (+20)	Foe gets strange look on face as bullet breaks foes nose and drives cartilage into his brain. Foe is in coma for next two years. (+20)	Bullet crushes foes fore-lobes. Foe dies instantly. Carry on soldier. (+25)

Key: Bx=must parry B rounds; B∞=no parry for B rounds; B*∞=stunned for B rounds; B*∞=bleed B hits per round; (-B)=foe has -B penalty; (+B)=attacker gets +B next round.



7.4 BALLISTIC PUNCTURE CRITICAL STRIKE TABLE

	A	B	C	D	E
01-05	Graze foe's hand. If foe is carrying an item, he must make a Routine maneuver to hold onto it. +0H	Graze foe's hand. If foe is carrying an item, he must make a Light maneuver to hold onto it. +1H - X	Shot hits foe's hand. If foe is carrying an item, he must make a Medium maneuver to hold onto it. +1H - 2X (-10)	Shot goes through foe's hand breaks bones and tears tendons. If foe is carrying an item, he must make a Hard maneuver or drop it. +3H - 2X - 2♣ (-10)	Shot through foe's hand breaks bone and tears tendons. If foe drops any items he was carrying with this hand. +5H - 3♣♣ (-20)
06-10	Forearm graze causes foe to flinch. You gain initiative next round. +1H	Forearm wound causes foe to grimace and bleed. You gain initiative next round. +3H - X - ♣	Forearm wound tears tendons. If foe is carrying an item, he must make a Hard maneuver to hold onto it. +4H - ♣ - 2♣ (-10)	Forearm shot tears muscles and tendons. Foe drops any items he was carrying with this arm. +5H - 2♣ - 3♣ (-15)	Shot to forearm breaks bone and tears tendons. Foe drops any items he was carrying and loses initiative for the next three rounds. +7H - 3♣♣ - 4♣ (-25)
11-15	Graze foe's biceps. Keep that arm very still. +1H	Nick foe's biceps causing minor muscle damage. +3H - X (-5)	Shot tears through the upper arm causing major muscle damage. +5H - 2♣ - 2♣ (-10)	That's gotta hurt! Elbow hit breaks bone and tears tendons. Arm useless. +3H - 4♣ - 2♣ (-20)	Biceps hit breaks bone, tears muscles and tendons. He cannot even lift his arm. +12H - 6♣ - 3♣ (-25)
16-20	Scratches foe's triceps. Get a bandage. +1H	Rip through foe's triceps causing minor muscle damage. +3H - X (-5)	Major muscle damage is done as the shot hits foe's triceps. +5H - 2♣ - 2♣ (-10)	Elbow hit breaks foe's funny bone and tears tendons. Arm useless. +3H - 4♣ - 2X (-20)	Triceps hit breaks bone, tears muscles and tendons. Arm useless. +12H - 6♣ - 3♣ (-25)
21-30	Bullet grazes foe's shoulder. Foe staggers from the shock. +2H	Shoulder hit. Minor muscle damage. +2H - ♣ (-5)	Bullet goes through foe's shoulder, tearing muscle and tendons. Foe is spun around and may fall down. +7H - 3♣ - ♣ (-10)	Bullet tears muscles tendons on its way through foe's shoulder. Tears a major artery. +7H - 3♣ - 5♣ (-20)	Bullet goes clean through without major damage, except for that severed artery. Blood is everywhere! +3H - 10♣ (-5)
31-40	Bullet grazes foe's shoulder. Don't lift any heavy objects. +1H	Bullet drives into foe's clavicle +4H (-5)	Bullet cracks foe's clavicle with a smart shot to the neck. +8H - X (-10)	Great shot lodges in the foe's shoulder. Surgeon will have to chip away a little bone to get this one out. +12H - 2♣ - 3♣ (-15)	Bullet breaks clavicle and destroys shoulder joint. Arm useless. +12H - 4♣♣ - 7♣ (-50)
41-50	Nick foe's thigh. Running will hurt. +2H	Thigh wound tears muscle. +4H - 2♣	Bullet lodges in foe's thigh. Running is very painful (-25 to Moving Maneuvers until bullet is removed). +10H - 3♣ (-15)	Bullet tears muscle and tendons in the thigh. Femoral artery damaged as the bullet went through. +15H - 3♣♣ (-25)	Bullet breaks femur and severs femoral artery. Foe falls. Hope he has a belt handy. +12H - 5♣♣ - 3♣ (-25)
51-55	Bullet grazes foe's calf. Walking proves painful. +2H	Bullet nicks calf. Minor muscle damage causes foe to drop to one knee and grimace very loudly. +2H - X (-5)	Bullet passes cleanly through foe's calf. Muscle and tendon damage. +5H - ♣ - 2♣ (-10)	Bullet strikes calf. Tibia fractured. +12H - 2♣ - 3X (-15)	Calf hit breaks bone and tears muscle. Foe staggers then falls. +15H - 3♣♣ - 3♣ (-30)
56-60	Foe hops as bullet brushes foot. Need a new shoe. +2H	Incredible shot rips a toe from foe's foot. +4H - X (-5)	Let me see you dance! Shot hits foe's foot and breaks several small bones. +10H - 2♣ (-15)	Ankle strike breaks bone and tears tendon. Foe falls and cannot get up. +12H - 3♣ - ♣ (-20)	Ankle strike breaks bone and tears tendon. If using an hunting class of II or greater, foot is severed. Foe falls. +15H - 4♣♣ - 4♣ (-25)
61-65	Foe is reminded to diet as bullet nicks his hips. +3H - X	Bullet strikes foe's hip causing a minor fracture. Cancel those dancing lessons. +5H - ♣ (-5)	Bullet lodges in foe's hip making walking difficult (-30 to Moving Maneuvers until the bullet is removed). +10H - 2♣ - ♣ (-15)	Hip strike fractures pelvis and nicks artery. He tries not to shimmy when he walks. +15H - 3♣♣ - 3♣ (-20)	Foe's hip joint shattered by your incredible shot. +20H - 5♣♣ (-50)
66	Bullet goes through both cheeks. Foe will have trouble sitting down for a while due to muscle damage. +10H (-10)	Bullet seems to have a mind of its own, ricocheting off a rock and entering foe's head just below his ear. Foe is in a coma for three days. +12H (-25) (+25)	And you thought this short of shot was a myth! Foe takes it right between the eyes. Foe Dies instantly, then falls over next round. (+25)	Bullet bounces around in foe's chest cavity. Major wounds to heart, liver, spleen, stomach, and both lungs. Foe is in shock for a minute, then dies. +25H - 6♣♣ - 10♣ (-50)	Foe's sexual prowess is now in doubt. You are stunned for 1 round in sympathy. +30H - 12♣♣ - 7♣ (-75)
67-70	Foe feels stiff breeze as bullet leaves a feathery touch on his knee. +1H - X	Knee shot fractures bone and gives foe a limp. +5H - ♣ (-10)	Bullet lodged in knee. Ouch. +10H - 2♣ (-15)	Bullet shatters kneecap. Minor tendon damage. Strangely, the scar left by the bullet looks just like a rose.... +15H - 4♣♣ - ♣ (-20)	Bullet shatters foe's knee. Severe tendon damage. +20H - 6♣ - 4♣ (-30)
71-75	Shot graze foe's abdomen, leaving an interesting scar. +2H	Bullet enters foe's abdomen doing minor muscle damage. +3H - ♣ (-5)	Abdomen hit causes minor muscle and organ damage. +5H - 2♣ - 3♣ (-10)	Lower abdominal shot causes much bleeding (internal and external). +5H - 3♣♣ - 4♣ (-15)	Kidney shot. Opponent bleeding profusely. If foe attempts to talk, blood will leak out from the corners of his mouth. +10H - 4♣♣ - 7♣ (-20)
76-80	Bullet pierces foe's "love handles." Perhaps next time he will stick to his diet. +4H - 2X (-5)	Shot in the side breaks two ribs. +5H - 2♣ (-10)	Bullet glances off ribs, breaking a couple in the process. Major muscle and tendon damage as it passes through. +10H - 3♣ (-15)	Bullet breaks a rib and proceeds to lodge in foe's liver. Foe needs doctor, badly. +7H - 2♣ - 6♣ (-10)	Foe really didn't need his spleen anyway. +10H - 3W♣ - 8♣ (-20)
81-85	Center abdomen hit causes minor muscle wound. Scar will look like a second belly button. +4H - ♣ (-5)	Bullet passes into foe's abdominal cavity causing minor wounds to foe's intestines. +5H - ♣ - 3♣ (-10)	Upper abdominal hit perforates internal organs. +8H - 2♣ - 4♣ (-10)	Bullet glances off rib and passes down through foe's abdomen causing major bleeding and tissue damage. +10H - 4♣ - 2♣ - 6♣ (-15)	Bullet passes through foe's gut lodging in his spine. Foe is paralyzed until it is removed, and then still suffers a -30 to all moving maneuvers. +15H - 2♣
86-90	Chest hit causes minor muscle damage. You missed his heart by only a hand's width. Just a little to the left.... +5H - ♣ (-5)	Chest hit breaks ribs. Major muscle and tendon damage. +10H - 2♣ - ♣ (-10)	Chest strike snaps ribs and collapses a lung. +10H - 3♣ - ♣ - 4♣ (-15)	Chest hit breaks sternum and lodges near heart. +12H - 3♣♣ - 7♣ (-30)	Heart strike. Foe is dead. Very sad. (+20)
91-95	Foe's ear has a new piercing. All hearing maneuvers suffer a special penalty of -20. +2H	Bullet glances off foe's skull, taking a clump of hair with it. +5H - 3♣ (-5)	Bullet to side of foe's head. Lots of bleeding and permanent loss of hearing in that ear. +7H - 2♣ - 4B (-10)	Bullet lodged in brain. Foe is in a coma for 3 weeks. +10H - 8♣	Bullet lodges deep in foe's brain. Death is instantaneous (but my isn't that look on his face precious!) (+20)
96-99	Bullet goes through foe's cheek. Foe has trouble talking (-10 to temporary Appearance). +4H - 2♣ (-5)	Bullet breaks foe's jaw. Foe cannot talk until he is healed. -10 to temporary Appearance and -5 to potential Appearance. +6H - 2♣ - ♣ - 2♣ (-10)	Bullet to foe's throat. Trachea destroyed. Sorry about that singing career. +7H - 3♣♣ - 2♣ (-15)	Bullet goes through major artery in foe's neck. +3H - X - 10♣ (-10)	Bullet passes through throat and spine. Foe paralyzed. +8H - 20♣ (-75)
100	Bullet through the eye and into the brain. Foe is very dead. (+20)	Foe drops immediately from strike to brain through his ear. Very nice. (+20)	Shot through foe's brain kills foe. You have half a round left to act. (+20)	Foe gets a strange look on face as bullet ricochets off his jaw and into his brain. Foe is in coma for next two years. (+20)	Bullet through foe's eye. Foe dies instantly. Carry on soldier. (+25)

Key: B×=must parry B rounds; B♣=no parry for B rounds; B♣z=stunned for B rounds; B♣=bleed B hits per round; (-B)=foe has -B penalty; (+B)=attacker gets +B next round.



7.5 BALLISTIC SHRAPNEL CRITICAL STRIKE TABLE

	A	B	C	D	E
01-05	Foe's hand is hit! If he is holding an item, it must immediately check for breakage. +3H	Foe's hand is hit! If he is holding an item, it must immediately check for breakage with a -10 penalty. +3H - 2x	Foe's hand is hit! If he is holding an item, it must immediately check for breakage with a -20 penalty. +4H - 2x (-10)	Foe's hand is hit! If he is holding an item, it must immediately check for breakage with a -30 penalty. +8H - 4x - 3x (-20)	Foe's hand is hit! If he is holding an item, it automatically breaks. +15H - 5x - (-50)
06-10	Forearm strike burns! You gain the initiative next round. +5H	Strike to foe's lower arm starts to bleed. His grip may slip! You gain the initiative next round. +7H - 3x - 2x	Forearm wound tears muscle and tendons. If foe is holding an item, it must check for breakage with a -20 penalty. +8H - 3x - 3x (-15)	Forearm shot tears muscles and tendons. Foe drops any held items and they check for breakage. +10H - 4x - 4x (-25)	Incredible blast to foe's arm completely rips off his hand and lower arm! Foe faints and is out for 10 rounds. +15H - 7x - 8x (-50)
11-15	Lots of hot air over foe's arm. +3H - x	Deep scratches on foe's biceps cause minor muscle damage. +7H - 3x (-5)	Serious gash on upper arm causes major muscle damage. +15H - 4x - 2x - 4x (-20)	Foe's elbow takes the brunt of the blast. Broken bone and torn tendons are the price. His arm is useless. +10H - 4x - 2x (-20)	Only dangling flesh is left on foe's arm. It is completely useless. +25H - 7x - 4x (-40)
16-20	An incredible shot leaves only minor scratches. +4H - 2x	Upper arm strike leaves foe with minor muscle damage. +7H - 2x - (-10)	Foe's triceps take the blast. He will need a doctor for that major muscle damage. +12H - 3x - 3x (-25)	Right on the elbow! Blast breaks bone and tears tendons. Arm useless. +12H - 4x - 2x - 3x (-20)	Boned foe's arm just like a chicken. Arm is useless. +30H - 6x - 5x (-60)
21-30	Shrapnel grazes foe's shoulder. That will leave a mark. +5H - 2x	Shoulder hit. Minor muscle damage. The strips on his uniform are ripped off. +8H - 3x (-10)	Shrapnel goes through foe's shoulder, tearing muscle and tendons. He will feel that one for a while. +16H - 4x - 2x (-15)	Shrapnel tears muscles tendons on its way through foe's shoulder. Nicks a major artery. +18H - 5x - 6x (-25)	Foe really didn't need that arm anyway. Foe is unconscious for six hours. +25H - 10x (-50)
31-40	Shrapnel grazes foe's shoulder, spinning him around. +5H - 2x	Shrapnel glances off clavicle. Foe looks surprised to still have a head. +7H - 2x - (-10)	Shrapnel breaks collar bone. He will never wear a tie again! +12H - 3x - (-15)	Shrapnel lodges in the foe's shoulder. Surgeon will have to chip away a little bone to get this one out. +20H - 3x - (-25)	Shrapnel breaks clavicle and destroys shoulder joint. His arm will hang limp until healed. +30H - 6x - 3x (-40)
41-50	Graze foe's thigh. Now those nice pants are ripped. +3H - x	Thigh wound tears muscle and leaves foe with a minor limp. +6H - 2x - (-10)	Shrapnel lodged in thigh. Running very painful. -25 to Moving Maneuvers until Shrapnel is Moved. +8H - 3x - 3x (-15)	Shrapnel tears muscle and tendons in the thigh. Foe is knocked backward 5 feet from the blast. +16H - 3x - (-25)	foe's leg severed at the thigh. Foe falls. Hope he has a belt handy. +40H - 4x - 4x (-40)
51-55	Shrapnel grazes foe's calf and causes him to stagger. +4H - x	Several wide cuts on foe's calf, but none are deep. Unfortunately, the muscles have minor damage. +8H - 2x - 2x (-10)	Shrapnel goes clean through the back of foe's lower leg. He is knocked over and now has muscle and tendon damage. +15H - 3x - 3x (-15)	Shrapnel strikes calf. Broken bones have ripped through the flesh of the leg. +25H - 4x - 3x (-25)	Foe blown back 15'. When he rises, he realizes that he now has a ragged stump below his knee (and he can't stand up). +35H - 6x - 10x (-75)
56-60	Blast near foe's feet causes him to dance. +4H - x	Lucky shot on foe's foot takes off all of his toes! Now his shoe won't fit. +7H - 2x - (-10)	Solid blast to foe's foot. The sound of breaking bone is very clear. The several toes have been lost. +25H - 4x - (-25)	Ouch! Right on the ankle. Bones break and tendons torn. Foe falls and will have trouble standing. +24H - 4x - (-30)	Foot bone ain't connected to the leg bone no mo'. Blast rips the foot off at the ankle. +35H - 6x - 4x (-50)
61-65	Close shot at foe's hip. Maybe it is time to start that diet. +7H - 2x	Blast strikes solidly on foe's hip. Luckily his bones are strong and it is only a minor fracture. +10H - 2x - (-5)	Shrapnel goes deep into foe's hip (lodging against the bone). Walking proves massively painful. +25H - 4x - (-20)	Strong blast to foe's hip fractures his pelvis. He now has a funny walk. +30H - 5x - 4x (-25)	Blast completely shatters foe's hip. Foe is thrown back 15'. +34H - 7x - 5x (-50)
66	Shrapnel imbedded in foe's buttocks. He will need a special pillow just to sit down. +20H - (-15)	Blast to foe's head! Amazingly, foe's head is mostly intact. He will just be in a coma for three days. +20H - (-40) + (+25)	Foe forget to duck. He takes shrapnel in the eyes. Foe spins head over heels backwards and will die in 10 rounds if not tended to by a doctor. +10H - 5x - (-30) + (+25)	Abdominal blast knocks foe through the nearest wall. Major internal damage to all kinds of organs. Hope a doctor is on hand. +50H - 8x - 15x (-75)	Surprise shot to foe's groin. Foe no longer needs his "little black book". You are stunned for 3 rounds in sympathy. He collapses and won't get up until tomorrow. +50H - 15x - 15x (-75)
67-70	Foe's knee is peppered with shrapnel. Amazingly, no permanent damage. +3H - x	Knee strike fractures bone. Very impressive. +7H - x - (-10)	Great shot to foe's leg causes him to drop. +20H - 3x - 3x (-20)	Blast to foe's leg shatters his knee cap. He will have a bad limp until the major tendon damage is healed. +25H - 5x - 4x (-30)	Blast annihilates foe's leg below the knee. Wow! +35H - 6x - 8x (-50)
71-75	Blast in the gut throws foe backwards 10'. +5H - x	Shot in the stomach does minor muscle damage. But the scar looks like a turnip... +7H - 2x - (-10)	Abdominal hit causes muscle and organ damage. Foe flies off his feet. +12H - 3x - 5x (-20)	Lower abdominal shot causes much internal damage to internal organs. +12H - 4x - 7x (-20)	Blast rips out foe's kidney. Who needs a surgeon. +35H - 6x - 10x (-40)
76-80	Blast in foe's side leaves a mass of flesh dangling. Surprising, it only leaves a small scar. +8H - 3x - x - (-10)	Shrapnel finds a home in foe's side, breaking a few ribs in the process. +12H - 3x - (-10)	Solid shot to foe's ribs is followed by the sound of breaking bone. There is also major muscle and tendon damage. +20H - 4x - (-20)	Shrapnel breaks ribs and lodges inside foe. The bleeding just won't seem to stop! Get a medic. +35H - 4x - 7x (-20)	Gut shot rips out several organs. Find a donor, quickly. +35H - 6x - 15x (-40)
81-85	Impressive shot right in the abdomen knocks foe backwards. +10H - 3x - 2x - 2x (-10)	Blast rips into foe's gut and causes major damage to everything it finds there. +15H - 4x - 5x (-20)	Upper abdominal hit damages internal organs and muscles. +14H - 3x - 6x (-20)	Blast in the gut leaves a gaping hole. Amazing, foe is still standing! +25H - 6x - 9x (-30)	Shrapnel passes clean through foe's abdomen and lodges in his spine. Foe is paralyzed until it is removed, and then still suffers a -30 penalty to all maneuvers. +35H - 6x
86-90	Chest strike rips all of foe's buttons off his shirt. +12H - 3x - 3x (-10)	Blast in the chest breaks ribs and tears muscles and tendons. Get a new shirt. +15H - 3x - x - 3x (-15)	Foe is wheezing as blast perforates a lung. +25H - 4x - 6x (-25)	Shrapnel lodges near foe's heart. Sternum is shattered. +25H - 4x - 8x (-30)	Blast through foe's chest and destroy his heart. Foe flies 20' and everyone is stunned for two rounds. (+20)
91-95	Blast to foe's head rips off one ear. Foe hears at -30. +8H - 3x - 2x - (-10)	Shrapnel strikes foe's head. Luckily he has a mighty skull and only loses his hair. +8H - 3x - x - (-5)	Shrapnel to side of foe's head. He can no longer hear or see from that side of the head. +15H - 4x - 6x (-20)	Blast cracks foe's skull. He is in a coma for 3 weeks then awakens with amnesia (and a headache). +40H - 10x	Blast tears off the top of foe's head. Death is instantaneous. (+20)
96-99	Shrapnel peppers foe's jaw and leaves several holes. Foe has trouble talking because of damage to the tongue. +12H - 4x - (-15)	Blast shatters foe's jaw. He cannot talk until healed. He suffers a -10 to his temporary Appearance and -5 to his potential Appearance. +11H - 3x - 3x - (-15)	Blast rips through foe's throat. He is now a mute. +20H - 4x - 6x (-25)	Shrapnel destroys foe's neck (and wind pipe). He will probably die before he suffocates. +25H - 5x - 12x (-20)	Foe is left with nothing on top of his neck. Anyone got a mop? (+20)
100	Shrapnel passes through the ear and into the brain. Foe is very dead. (+20)	Foe's face is ripped off; right before he dies from shrapnel in the brain. (+20)	Foe's head is opened from the blast. He is quite dead. You have half a round left to act. (+20)	Strong blast to foe's head cracks his skull. He is in coma for next two years. (+20)	Don't loose your head! Ooops. Too late... (+25)

Key: βx=must parry β rounds; β⊗=no parry for β rounds; β⊛=stunned for β rounds; β●=bleed β hits per round; (-β)=foe has -β penalty; (+β)=attacker gets +β next round.



7.6 BLASTER CRITICAL STRIKE TABLE

	A	B	C	D	E
01-05	Beam grazes foe's hand. Foe must make a Routine maneuver to hold onto anything held by it. +0H	Beam nicks foe's hand. If foe is holding something, it is a Light maneuver to hold on to it. +1H - x	Beam pierces foe's hand. If foe is holding an object, he must make a Medium maneuver or drop it. +1H - 2x - (-10)	Beam passes through bones, muscles, and tendons in hand. If foe is holding anything, he must make a Hard maneuver or drop it. +3H - 2x - (-10)	Beam slices through foe's hand, slashing bones and tendons. Foe drops anything he was holding in that hand. +5H - 3x - (-20)
06-10	Forearm graze causes foe to flinch. He loses initiative next round. +1H	Forearm wound causes foe to grimace. +3H - x	Forearm strike separates muscles and tendons. Foe emits a startled gasp. If he is holding anything, he must make a Hard maneuver to hold onto it. +4H - x - (-10)	Beam slices through muscles and tendons in foe's forearm. The arm begins to spasm, and foe drops anything that he was holding. +5H - 2x - (-15)	Beam slices through bones and tendons in foe's forearm. Foe drops anything he was holding. +7H - 3x - (-25)
11-15	Beam grazes foe's upper arm. Wound is cauterized. +1H	Beam causes minor muscle damage to biceps. +3H - x - (-5)	Beam causes major muscular damage to upper arm. +5H - 2x - (-10)	Foe emits a scream of anguish as beam passes through bone and tendons in his elbow. Arm is useless. +3H - 4x - 2x - (-20)	Beam slices through biceps, bone, and tendons. Arm is completely useless. +12H - 6x - (-25)
16-20	Beam nicks foe's triceps. Could have been worse. +1H	Beam rips through triceps. He didn't like that one. +3H - x - (-5)	Major muscle damage to foe's triceps. +5H - 2x - (-10)	Elbow hit shatters elbow. Arm is useless. Foe shrieks like a banshee. +3H - 4x - 2x - (-20)	Beam cuts deep through bone, triceps, and tendons. Arm is useless. +12H - 6x - (-25)
21-30	Beam nicks foe's shoulder. Foe becomes nauseous from the pain. +2H	Shoulder hit. Minor damage, but a lot of pain. +2H - x - (-5)	Beam passes through shoulder, severing muscles and tendons. +7H - 3x - (-10)	Beam slices through muscles and tendons on its way through shoulder. Looks like you got an artery. +7H - 2x - 2x - (-20)	Beam passes through shoulder, missing everything but that artery. +3H - 9x - (-5)
31-40	Beam just misses clavicle. That was lucky. +2H	Beam cuts a chunk out of foe's clavicle. +4H - (-5)	Beam cracks foe's clavicle. He stumbles in shock. +8H - x - (-10)	Beam catches bone, muscle, and tendon in foe's shoulder. +12H - 2x - (-20)	Beam slices through shoulder and destroys joint. Arm is useless. +12H - 4x - 6x - (-50)
41-50	A tiny piece of foe's thigh evaporates. +2H	Thigh wound burns through muscle. +4H - 2x	Beam slices muscles in foe's thigh. Ouch. +10H - 3x - (-15)	Beam cuts deep into thigh, nicking the femoral artery. +15H - 3x - 6x - (-25)	Beam slices through femur, catching femoral artery. Foe collapses. +12H - 5x - 6x - (-25)
51-55	Beam grazes calf. Nice limp. +2H	Beam passes through calf. Foe sucks air and drops to one knee. +2H - x - (-5)	Beam passes cleanly through foe's calf. Muscles and tendons are severed. +5H - x - (-10)	Beam passes through calf and tibia. +12H - 2x - 3x - (-15)	Beam slices through bone and bone. Foe goes down with a startled look on his face. +15H - 3x - (-25)
56-60	Beam pierces foe's boot. +2H	Shot neatly severs foe's toe. +4H - x - (-5)	Beam slices through several small bones in foe's foot. That's gotta hurt. +10H - 2x - (-15)	Ankle strike slices through bone and tendon. Foe's leg folds like a good map. +12H - 3x - (-20)	Ankle strike slices through bone and tendon. If using a hunting class II or better, foot is removed. +15H - 4x - 6x - (-25)
61-65	If foe had been watching his weight, that would have never hit. +3H - x	Beam hits foe's hip joint, causing it to crack. +5H - x - (-5)	Beam chips foe's hip. All moving maneuvers are at -30 until chips are removed. +10H - 2x - (-15)	Hip strike slices through pelvic girdle. He'll probably never walk right again. +15H - 3x - (-20)	Beam shatters hip joint with heat expansion. It's a Kodak moment. +20H - 5x - (-50)
66	Beam pierces both cheeks. Biggest muscle in the body, ya know. +10H - (-10)	Beam hit foe right between his eyes. Beam somehow passes through head without hitting anything too vital. Foe is in a coma for three days. +12H - (-25) - (+25)	Beam hits foe right between the eyes. Foe stumbles and falls, dead. Well done, David. (+25)	Heat shatters sternum, sending shards of bone through his lungs, liver, spleen, and stomach. The beam continues through the heart, adding insult to injury. (+25)	Beam strikes foe's groin, severing vitals. You are stunned for one round in sympathy. +30H - 12x - 6x - (-75)
67-70	Crackling path of beam brushes foe's knee. +1H - x	Knee fracture causes foe severe pain. That'll probably be able to predict the weather. +5H - x - (-10)	Cracked knee. Guess he's dropping out of the NFL draft. +10H - 2x - (-15)	Beam shatters kneecap, damaging muscles and tendons. Looks like his dancing career is over. +15H - 4x - (-20)	Beam shatters foe's kneecaps, sending shards through muscles and tendons. +20H - 6x - 4x - (-30)
71-75	Shot creates an interesting extension to foe's appendix scar. +2H	Beam passes through abdomen, causing only muscle damage. +3H - x - (-5)	Abdominal hit severs muscles and intestines, but it feels a lot worse than it is. +5H - 3x - (-15)	Lower abdominal strike causes internal bleeding. +5H - 3x - 6x - (-15)	Beam slices through kidney. Foe is bleeding badly. +10H - 4x - 4x - (-20)
76-80	Beam hits foe's love handle, causing fat to boil away. He should thank you. +4H - 2x - (-5)	Heat from beam cracks two ribs. +5H - x - (-10)	Beam slices through ribs, causing secondary muscle and tendon damage. +10H - 3x - (-15)	Beam passes through rib and liver. He's bleeding black. Not good. +7H - 2x - 3x - (-10)	Spleens are highly overrated. +10H - 3x - 5x - (-20)
81-85	Beam passes through abdomen without critical damage. New belly button? +4H - x - (-5)	Beam passes through abdominal cavity, causing minor damage to intestines. +5H - x - (-10)	Beam perforates intestines in the upper abdomen. Talk about heart burn. +8H - 2x - 6x - (-10)	Beam passes through ribs, piercing organs and veins on its way through the body. +10H - 4x - 2x - 3x - (-15)	Beam slices through spine, paralyzing foe. +15H
86-90	Beam pierces chest, missing heart by a hand's width. Toying with him? +5H - (-5)	Chest strike severs ribs, causing major muscle damage to boot. +10H - 2x - (-10)	Beam slices through ribs, muscles, tendons, and a lung. Nice sucking chest wound. +10H - 3x - 6x - (-15)	Beam cracks sternum and grazes heart. +12H - 3x - 6x - (-30)	Beam neatly pierces heart. Send flowers. (+20)
91-95	You slice his earlobe off. -20 to all hearing maneuvers. +2H	Beam creases foe's skull. That's gonna be a nice scar. +5H - 3x - (-5)	Beam glances off skull. Blood, permanent hearing loss (in one ear), and disorientation are just the beginning. +7H - 2x - 6x - (-15)	Beam grazes brain. Foe drops into a coma for three weeks. +10H - 7x	Beam neatly dissects brain. (+20)
96-99	Beam pierces cheek. Foe has difficulty talking. His Appearance is modified by -10 until healed. +4H - 2x - (-5)	Beam cracks foe's jaw. Foe can't talk. -10 to temporary Appearance, -5 to permanent Appearance. +6H - 2x - 6x - 2x - (-10)	Beam neatly destroys foe's voice box. And he was worried about smoking . . . +7H - 3x - (-15)	Beam passes through major artery in foe's neck. +3H - x - 9x - (-10)	Beam passes through throat and spine. Foe is mute and paralyzed. +8H - 19x - (-75)
100	Beam passes through eye. Foe collapses without so much as a twitch. (+20)	Beam pierces ear and kills foe instantly. (+20)	Beam burns a deadly path through foe's brain. Say goodnight, Gracie. (+20)	Beam slices some excess tissue from foe's brain. Foe is in a coma for two years. (+20)	Beam passes through foe's eye. Foe dies instantly. You wish you had a camera. (+25)

Key: Bx=must parry B rounds; B⊗=no parry for B rounds; Bx=stunned for B rounds; B♣=bleed B hits per round; (-B)=foe has -B penalty; (+B)=attacker gets +B next round.



7.7 BURN THROUGH CRITICAL STRIKE TABLE

	A	B	C	D	E
01-05	His hand gets warm. +0H	Hot spot forms on hand. Foe must make a Light maneuver to hold onto whatever he's holding. +0H - X	Shoot object in foe's hand. Foe is burned as the object flies free. +1H - 2X (-5)	Item in foe's hand is hit. Check for breakage. Item is dropped as foe takes second degree burns. +2H - 2X (-10)	Shot cuts through foe's armor and several bones in his hand. Hand is useless. +3H - 3X (-20)
06-10	Nice and toasty. +0H	Hot spot on forearm causes foe to twitch and lose initiative next round. +2H - X	Hot spot causes second degree burns on foe's forearm. Foe must make a Medium maneuver or drop anything he is holding. +2H - X (-10)	Blast burns through armor, causing third degree burns to foe's wrist. +4H - 2X (-15)	Shot slices through armor and cuts bone in foe's forearm. Foe drops anything he was holding and loses initiative for two rounds. +5H - 3X (-20)
11-15	Watch it, that almost left a mark. +0H	Foe's biceps are burned. +2H - X (-5)	Burn through causes second degree burn to biceps. +4H - 2X (-10)	Shot to elbow transfers enough heat for third degree burns. +3H - 4X - 2X (-15)	Attack cuts through armor, biceps, and bone. Bone fractures. +8H - 6X (-25)
16-20	Foe shifts uncomfortably. +0H	Hot spot causes minor burn on foe's triceps. +2H - X (-5)	Hot spot causes second degree burns to foe's triceps. +4H - 2X (-10)	Burn through inflicts third degree burns to upper arm. +3H - 4X - 2X (-15)	Attack cuts through armor, triceps, and bone. Bone fractures. +8H - 6X (-25)
21-30	Foe's had worse sun burns. +1H	Shoulder hit. Burn through causes minor damage. +1H - X (-5)	Armor doesn't quite distribute the energy right. Second degree burns to foe's shoulder. +5H - 2X - X (-10)	A dangerous amount of energy transfers to foe's shoulder, causing third degree burns. +5H - 3X - 2X (-15)	Attack cuts through armor and cracks shoulder joint. Ain't heat expansion a pain? +5H - 4X (-20)
31-40	Minor burn on shoulder. +1H	Hot spot manages to cause a burn on foe's clavicle. +4H - 2X (-5)	Second degree burn right on foe's clavicle. Ouch. +5H - 3X (-10)	A blast of heat sears its way into foe's clavicle, causing third degree burns. +5H - 3X - 2X (-15)	Attack cracks foe's shoulder joint. Ouch. +5H - 4X (-20)
41-50	Maybe you have this thing on the wrong setting. +1H	Deep thigh burn angers foe. +4H (-5)	Second degree burns to foe's thigh. +6H - X (-10)	Armor sears its way into foe's thigh, leaving third degree burns. +8H - 2X (-15)	Massive heat transfer causes terrible burns and fractures femur with uneven heat expansion. +10H - 4X (-40)
51-55	Minor burn on foe's calf. +1H	Hot spot burns through to foe's calf. +1H - X	Second degree burns to foe's calf. +4H - X (-10)	Armor cooks foe's calf, leaving third degree burns. +10H - 2X - X (-15)	Heat transfer is extreme. Calf burned and bone broken. +8H - 3X (-30)
56-60	Foe jerks his foot out of the way. +1H	Heat burns through to foe's toe. +4H - X (-5)	Hot spot on foe's foot causes second degree burns. +8H - 2X (-10)	Foe's ankle receives third degree burns. +10H - 3X (-15)	Foe's ankle takes terrible burns. If weapon is hunting class II or greater, ankle shatters (+20H). +12H - 4X (-25)
61-65	Hot point forms over waist. He sucks air for a round. +2H - X	Heat burns through to foe's hip. +4H - X (-5)	Deep, second degree burns to foe's hip. +8H - 2X - X (-10)	Heat bakes third degree burns into foe's hip. +12H - 3X (-15)	Foe's hip joint shatters from rapid heat expansion. +20H - 5X (-50)
66	Hot point on rump causes a nasty burn. +8H - 2X	Stress flaws cause armor to shatter. Shock sends foe to the ground, where the impact sends foe unconscious. The coma lasts d10 days. +10H (-10) (+25)	Shot finds flaw in foe's head armor. Blast cuts deep into foe's skull, causing a large crack. Foe is down for the count. +20H (+25)	Attack finds flaw in armor. Blast cuts deep into foe's chest, causing internal bleeding. +20H - 4X - 1 (-30)	Shot to groin transfers an undue amount of heat. Foe is now sterile . . . permanently. You are stunned for one round in sympathy. +30H - 12X (-50)
67-70	Hot point forms over knee. +1H - X	Heat causes deep burn to knee. +4H - X (-5)	Deep, second degree burns to foe's knee. +7H - 2X (-10)	Attack digs deep into foe's knee, leaving third degree burns. +12H - 4X (-15)	Heat shatters foe's knee. The burns are horrible. +18H - 6X - 4X (-30)
71-75	Nice little burn to his gut, there. +2H	Hot spot causes burn to foe's abdomen. +2H - X (-5)	Hot spot burns deep into abdomen. Blisters, blisters everywhere. +6H - 2X (-10)	Lower abdominal strike causes third degree burns. +5H - 3X (-15)	Attack manages to penetrate armor, cutting into foe's kidney. This is bad. +8H - 4X - 2X (-20)
76-80	Hot point causes foe to clutch his side. +3H - 2X	Side hit burns flesh right to the ribs. +4H - 2X (-5)	Hot spot blisters foe's side. +8H - 3X (-10)	Blast burns deep into foe's side. Burns are third degree. +10H - 4X (-15)	Attack cuts through armor and four ribs. +12H - 3X - 2X (-20)
81-85	Hot point scalds foe's belly. +3H - X	Foe scorched high on abdomen. He loses initiative next round. +4H - X (-5)	Energy flash causes second degree burns across foe's gut. +6H - 2X (-10)	Attack burns deeply into foe's side. +8H - 3X (-15)	Third degree burns to foe's back. +15H - 2X (-10)
86-90	Hot spot burns foe's chest. +3H - X	Hot spot burns deep, causing penetrating second degree burns. +8H - 2X (-10)	Armor fails to distribute energy correctly. Third degree burns to chest. +10H - 3X (-15)	Armor fails to distribute heat properly. Burns to foe's sternum are very severe. +10H - 3X (-30)	Attack penetrates foe's armor, cutting through sternum and nicking artery. +15H - 4X - 1 (-40)
91-95	Foe's ear is burned. +2H - X	Burns to foe's head. +3H - 3X	Second degree burns to foe's ear. +6H - 2X (-10)	Severe burns peel flesh off foe's forehead. Extreme pain causes foe to pass out for three hours. +12H (-15)	Attack cuts through armor, skull, and brain. Death is quite instantaneous. (+20)
96-99	Nasty burn to foe's cheek takes 5 off his Appearance until healed. +4H - 2X (-5)	Burns cause blisters to rise on foe's face and lips. -10 to foe's Appearance until healed. +6H - 2X - X (-10)	Flaw in foe's armor lets just enough energy through to open foe's carotid artery. Foe will die in ten minutes without medical aid. +6H - 3X (-15)	Blast finds flaw in foe's armor. Trachea badly damaged. Foe will choke to death from fluids in six minutes without medical attention. +3H - 3X (-20)	Attack cuts through armor, spine, and spinal cord. Foe is paralyzed. +8H (-75)
100	Flash of heat burns foe's eye. It is now blind. +5H - 2X - X (-10) (+20)	Foe's ear suffers second and third degree burns. Foe gasps in anguish. +6H - 3X - X (-10) (+20)	Blast finds flaw in foe's armor, carving into the side of foe's head. Foe is quite dead. (+20)	Flaw in foe's helmet lets just enough energy through the helmet to damage brain. Foe is in a coma for two years. (+20)	Attack finds flaw in helmet, cutting straight through armor, then bouncing around inside, turning foe's brain to a charred mess. (+25)

Key: $\beta \times$ =must parry β rounds; $\beta \otimes$ =no parry for β rounds; $\beta \otimes \otimes$ =stunned for β rounds; $\beta \bullet$ =bleed β hits per round; $(-\beta)$ =foe has $-\beta$ penalty; $(+\beta)$ =attacker gets $+\beta$ next round.



7.8 BURST CRITICAL STRIKE TABLE

	A	B	C	D	E
01-05	Attack hits foe's hand. If he is holding something, check for breakage. +3H	Burst hits foe's hand. If foe is holding something, it should check for breakage with a -10 penalty. +3H - 2x	Burst catches foe in the hand. If foe is carrying anything, it must make a breakage check at -20. +4H - 2x - (-10)	Foe is hit in hand. If he is carrying anything, it must check for breakage at -30. +8H - 4x - (-20)	Foe's hand takes the burst. Anything in it is automatically broken. +15H - 5x - (-50)
06-10	Attack catches foe's forearm. You gain initiative next round. +5H	Burst tears through foe's arm. You gain initiative next round. +7H - 3x	Burst catches foe in forearm. If foe is holding an item, it must check for breakage at -10. +8H - 3x - (-15)	Burst tears through muscles and tendons in forearm. Foe drops whatever he's holding. +10H - 4x - (-25)	Blast severs foe's lower arm and hand. Foe passes out for 10 rounds. +15H - 7x - 7 - (-50)
11-15	Foe catches a piece of the attack in his upper arm. +3H - x	Burst catches foe in biceps, causing minor muscle damage. +7H - 3x - (-5)	Burst catches foe in biceps, causing major muscle damage. +15H - 4x - 2 - (-20)	Burst burns through foe's elbow, tearing up bones and tendons. +10H - 4x - (-20)	Foe's arm is reduced to a mangled scrap of flesh. Icky. +25H - 7x - (-40)
16-20	Attack to upper arm leaves only minor burns. +4H - 2x	Upper arm strike causes minor muscle damage. Weak. +7H - 2x - (-10)	Burst tears up foe's triceps, causing major muscle damage. +12H - 3x - (-25)	Foe takes burst right above elbow. Bones and tendons are broken. Arm is, naturally, useless. +12H - 4x - 2 - (-20)	Arm falls, useless, to the ground. Nice shootin', Tex. +30H - 6x - 7 - (-60)
21-30	Attack grazes foe's shoulder. Foe winces, but manages. +5H - 2x	Burst catches foe in his shoulder. Minor muscle damage. +8H - 3x - (-10)	Burst tears through shoulder, destroying both muscles and tendons. +16H - 4x - (-15)	Burst tears through muscles in foe's shoulder, catching an artery on the way through. +18H - 5x - 3 - (-25)	Blast to shoulder leaves arm as a useless piece of flesh. On the ground. +25H - 10 - (-50)
31-40	Foe catches a bit of the burst in his shoulder. He perseveres. +5H - 2x	Burst bounces off foe's clavicle. Was he supposed to survive that? +7H - 2x - (-10)	Burst tears through foe's shoulder, wrecking his collarbone in the process. That's gotta hurt. +12H - 3x - (-15)	Burst tears up foe's collarbone. The noise he makes is not pleasant. +20H - 3x - (-25)	Clavicle and shoulder joint destroyed. Arm is hanging uselessly. +30H - 6x - 1 - (-40)
41-50	Burst brushes foe's thigh. You ruined his slacks. +3H - x	Burst catches foe in the thigh. Nice limp. +6H - 2x - (-10)	Burst catches foe in the thigh, really messing up his mobility. +8H - 3x - (-25)	Burst tears up muscles and tendons in foe's thigh. +16H - 3x - (-25)	Foe's leg comes off at thigh. Messy. +40H - 4x - 3 - (-40)
51-55	Burst grazes foe's calf. Foe staggers. +4H - x	Several burns on foe's calf. None are too terrible. +8H - 2x - (-10)	Burst slices right through foe's calf. He very nearly drops. +15H - 3x - (-15)	Burst tears through calf, severing bones on the way. +25H - 4x - (-25)	Burst removes leg at the knee. Foe falls over, startled. +35H - 6x - 9 - (-75)
56-60	Burst causes foe to shift his stance. +4H - x	Poorly aimed blast takes off five of foe's toes. +7H - 2x - (-10)	Burst riddles foot, removing all its toes and leaving few bones intact. He won't be dancing anymore. +25H - 4x - (-25)	Burst tears through foe's ankle, shattering bones and damaging muscles and tendons alike. Foe falls, complete with startled look. +24H - 4x - (-30)	His shoe falls off. Wait, no. That's his foot. Can you say, "Oops?" +35H - 6x - 1 - (-50)
61-65	Burst grazes foe's hip. Maybe he should try some aerobics. +7H - 2x	Burst catches foe in hip. Foe escapes with only minor fractures. +10H - 2x - (-5)	Burst tears up foe's hip. Every step is agony. +25H - 4x - (-20)	Burst attack to hip breaks pelvic girdle. Foe drops with a gasp. +30H - 5x - 1 - (-25)	Burst shatters foe's hip. Foe goes down like a leaky skiff. +34H - 7x - 2 - (-50)
66	Burst catches foe full in the posterior. He won't be sitting down for a long time. +20H - (-15)	Burst sprays foe's head. Miraculously, he merely slips into a three-day coma. +20H - (-40) - (+25)	Foes takes burst full in the face. Shock causes him to fly back to a spot where he will die in ten rnds. +10H - 5x - (-30) - (+25)	Burst opens up foe's abdomen. Intestines spill out. Foe tries to poke them back in. Got a stick? +50H - 8x - 14 - (-75)	Burst leaves large hole where foe's groin used to be. You are stunned for three rounds in sympathy. +50H - 15x - 14 - (-75)
67-70	Burst peppers foe's knee. Remarkably, there's no permanent damage. +3H - x	Burst cracks foe's kneecap. That could have been much better. +7H - x - (-10)	Foe takes burst in knee. It folds backward and he collapses. +20H - 3x - (-20)	Burst shatters knee, tearing muscle and tendons. In the future, that knee will predict the weather. +25H - 5x - 1 - (-30)	Blast leaves foe with one and a half legs. Maybe he should try knickers. +35H - 6x - 7 - (-50)
71-75	Burst catches foe in gut, with remarkably weak results. +5H - x	Burst catches foe in the stomach, causing minor muscle damage and forming a dotted line of scars. +7H - 2x - (-10)	Abdominal hit tears up foe's muscles and organs. Foe collapses in a pool of blood. +12H - 3x - 3 - (-20)	Burst to lower abdomen causes considerable organ damage. Most of the bleeding is internal. +12H - 4x - 6 - (-20)	Blast removes kidney. Quick, anyone got a dialysis machine? +35H - 6x - 9 - (-40)
76-80	Blast in side tears foe up a bit. Remarkably, he's still intact. +8H - 3x - (-10)	Burst catches foe in the side, breaking several ribs. +12H - 3x - (-10)	Burst to foe's side slices up ribs, muscles, and tendons. +20H - 4x - (-20)	Burst slices through several ribs. Lungs too. Call him "Wheezy." +35H - 4x - 6 - (-20)	Gut shot opens up the foe's belly. Look at all those intestines! +35H - 6x - 14 - (-40)
81-85	Impressive attack to foe's abdomen only makes him double over. +10H - 3x - 2 - (-10)	Burst passes through abdomen, damaging many really important things. +15H - 3x - 2 - (-20)	Burst to upper abdomen tears through muscles and organs. Foe is covered in blood. +14H - 3x - 3 - (-20)	Burst open up foe's gut. He's still standing. What's he on? +25H - 6x - 8 - (-30)	Burst flies through gut, severing spine. Can you say, paralyzed? I knew you could. +35H - 5x
86-90	Chest strike tears up foe's shirt. +12H - 3x - (-10)	Burst tears through foe's chest, slicing up ribs, muscles, and tendons. It looks worse than it is. +15H - 3x - 1 - (-15)	Staccato burst tears through foe's lung. He'll have to give up smoking. +25H - 4x - 3 - (-25)	Burst shatters sternum and damages heart. You and foe are both amazed he's alive. +25H - 4x - 7 - (-30)	Burst turns foe's heart to ribbons. Wow. He's quite dead. (+20)
91-95	Burst neatly takes off one ear. Foe's hearing is at -30. +8H - 3x - (-10)	Burst doesn't penetrate foe's skull. He is quite scalped, however. +8H - 3x - (-5)	Burst tears up foe's face. Foe is now blind and deaf on that side of head. +15H - 4x - 3 - (-20)	Burst cracks skull. Foe slips into coma for 3 weeks. When he wakes up, he has amnesia. +40H - 9x	Burst removes top of foe's head. You thought that only worked in cartoons. (+20)
96-99	Burst peppers foe's jaw. Foe now has trouble talking due to damage to his tongue. +12H - 4x - (-15)	Burst shatters foe's jaw. He's mute until healed. -10 to his appearance. +11H - 3x - (-15)	Burst catches foe in the throat. Somehow, he survives, but his singing career is over. He's mute. +20H - 4x - 3 - (-25)	Burst reduces foe's neck and airway to pulp. Bet on whether he suffocates before he bleeds out? +25H - 5x - 11 - (-20)	Foe is decapitated. Now <i>that's</i> messy. (+20)
100	Burst passes through foe's ear, skull, and brain. (+20)	Foe's face becomes a window to his now-shredded brain. (+20)	Burst opens foe's head. All its contents spill out. Bye-Bye. (+20)	Burst cracks foe's skull. Try on a two-year coma. (+20)	You know he had a head around here somewhere . . . (+25)

Key: Bx=must parry B rounds; B⊗=no parry for B rounds; B⊗=stunned for B rounds; B♠=bleed B hits per round; (-B)=foe has -B penalty; (+B)=attacker gets +B next round.



7.9 LARGE ANIMAL BALLISTIC CRITICAL STRIKE TABLE

	PUNCTURE	HOLLOWPOINT	ARMOR PIERCING	IMPACT	SHRAPNEL
01-05	Gee, Jim, that grazing shot appears to have made it angry. Shame your weapon jammed. +10H	You tore a lot of skin away. Shame your weapon jammed. +12H	What a nice whole in his skin. Perhaps you should go into business piercing ears. +2H	They put body armor on a what? +1H	The little wholes you make in his skin are more a wound to his pride than his body. +7H
06-10	Solid hit. It now knows where you are. +4H	Solid hit. It now knows where you are. +6H	Solid hit with good penetration. It now knows where you are. +3H	I think you got its attention. +1H	Nice shot. Several shards lodge in his skin. +6H
11-20	Rough shot glances off foe's side. He looks around to see where the bullet came from. +6H	Rough shot glances off foe's side tearing flesh as it goes. He looks around to see where the bullet came from. +8H	Rough shot glances off foe's side. He looks around to see where the bullet came from. +3H	Rough shot glances off foe's side. He looks around to see where the bullet came from. +2H	Rough shot splatters against side. He looks around to see where the bullet came from. +9H
21-30	Solid hit to foe's forearm causes it to rear back. +7H	Solid hit to foe's forearm causes it to rear back. A small drip of blood can be noticed. +9H - ●	Solid hit to foe's forearm causes it to rear back. +4H	Solid hit to foe's forearm causes it to rear back. +2H - ✕	Solid hit to foe's arm and chest causes it to rear back. +10H - ✕
31-40	Shot to foe's chest glances off a rib. +14H	Shot to foe's chest glances off a rib. If only you had hit him a little to the left. +14H	Shot to foe's chest breaks a rib. +14H - ● - (-10)	Shot glances off foe's side +5H	Shrapnel glances off several ribs. +20H - ✕ - 2● - (-5)
41-50	Shot to foe's side. He leaps back and away from you. +15H	Shot to foe's side. He leaps back and away from you. +10H - 2●	Shot to foe's side. He leaps back and away from you. +10H - 2●	Shot to foe's side startling him. +6H - ✕	Shrapnel pierces foe's side. He leaps back and away from you. +20H - ✕ - 3●
51-65	Bullet slams into foe's leg. He grimaces (if possible) in pain +15H - 4●	Bullet slams into foe's leg/ Muscles tear and tendons shred in a satisfying manner. +15H - 4● - (-10)	Bullet goes through foe's leg without hitting anything vital. +10H	Bullet slams into foe's leg. He grimaces (if possible) in pain +7H - (-5)	Shrapnel ribs, tra-la-la, through foe's leg muscles. +20H - 4● - (-10)
66	Well done, Old Boy. Got him right in the neck. Hope he dies before he charges us. +8H - 20●	Got him right in the neck. He appears to be gargling his own blood. +15H - 20●	Nice shot, but a round that can go through his neck really isn't all that effective. +4H - 5●	The good news is that you get the effects below if they didn't armor the beast's mouth. If they did, then disregard this crit. +8H - 2● - 6● - (-10)	That was an interesting way to perform a tracheotomy +30H - 6● - 30● - (-30)
67-70	Foe's leg catches your shot at the right moment. He should feel that one. +18H	Foe's leg catches your shot at the right moment. He should feel that one. +20H - 2●	Foe's leg catches your shot at the right moment. He should feel that one. +14H	Foe's leg catches your shot at the right moment. He should feel that one. +11H - ✕ - (-10)	Shrapnel rips through foe's leg leaving bone exposed. +25H - 3● - 2● - (-10)
71-80	Arm shot penetrated deep. +15H - 3●	Arm shot takes away great gobs of flesh. +20H - 2● - (-10)	Arm shot penetrated deep. +12H - 3●	Arm shot fractures bone. +15H - 2● - (-15)	Shrapnel exposes bone in foe's arm. +20H - 2● - 3● - (-10)
81-90	Gut shot staggers foe. Make the next one count. +15H - 2● - (-10)	Gut shot staggers foe. +16H - 2● - (-10)	Gut shot staggers foe. Make the next one count. +13H - ● - (-10)	Gut shot sends foe to his knees. Hit him while he is down. +12H - 2● - (-10)	Gut shot staggers foe. Make the next one count. +15H - 2● - (-10)
91-95	Shot pierces artery in leg. Foe is bleeding badly (assuming he bleeds at all that is). +15H - 2● - 7● - (-10)	Shot pierces artery in leg. Foe is bleeding badly (assuming he bleeds at all that is). +18H - 3● - 8● - (-30)	Shot pierces artery in leg. Foe is bleeding badly (assuming he bleeds at all that is). +12H - ● - 7●	Leg hit leads to massive bruising and a cracked bone. +15H - 2● - (-15)	Artery severed in foe's leg. +25H - 3● - 12● - (-15)
96-98	Heart shot. Foe dies instantly of shock. —	Heart destroyed. Foe dies instantly of shock. —	Heart shot. Foe dies instantly of shock. —	Chest shot cracks sternum. +35H - 6● - (-75)	Center chest shot sends shrapnel ripping through foes internal organs. Foe looks surprised, then dies. —
99 - 100	Shot through both lungs. Foe is in shock and drowns in his own blood after 6 rounds. +15H - (+20)	Shot through both lungs. Foe is in shock and drowns in his own blood after 12 rounds. +16H - (+20)	Shot through both lungs. Foe drowns in his own blood after 9 rounds. +12H - (+20)	Side shot breaks several ribs. Foe is bleeding internally. +25H - 3● - 4● - (-35) - (+20)	Shrapnel rips through both lungs. Foe is in shock and drowns in his own after 3 rounds blood. +15H - (+20)
101 - 150	Shoulder hit spins foe. +25H - 2● - (-35)	Shoulder hit spins foe and knocks him to the ground. He will have some difficulty standing back up. +30H - 3● - 2● - (-45)	Shoulder hit spins foe shattering bone as it goes through. +25H - 4● - (-55)	Shoulder hit spins foe, bruising bone and muscle. +12H - ● - (-10)	Shoulder hit shreds muscles and tendons. +35H - 4● - 6● - (-45)
151 - 175	Shot to foe's abdomen perforates his kidneys. Amazingly, he is up an fighting for six rounds before dying of shock. Have fun. —	Shot to foe's abdomen leaves a great bloody wound. Foe bellows in pain. +25H - (-15)	Shot to foe's abdomen perforates his kidneys. Amazingly, he is up an fighting for six rounds before dying of shock. Have fun. —	Abdominal shot leaves foe bruised and staggering. +25H - 2● - (-15)	Shrapnel perforates foes kidneys. Amazingly, he is up an fighting for three rounds before dying of shock. Have fun. —
176 - 200	Bullet pierces abdominal arteries. foe's blood covers the ground. +25H - 25● - (+25)	Bullet lodges in foe's hip. +25H - (-30) - (+25)	Bullet pierces abdominal arteries. foe's suffers massive internal bleeding. Sorry these things have so many hit points. +18H - 14● - (+25)	Bullet to abdomen crushes muscle. Foe is slowly bleeding to death. +25H - 7● - (-45) - (+25)	Foe appears to have been disemboweled. Blood and entrails are spread all over the field. +325H - 7● - 30● - (-45) - (+25)
201 - 250	Shot to forelimb breaks bone and severs an artery. Foe is up and fighting, at least until he bleeds to death. +25H - 15● - (-10)	Shot to forelimb nicks bone and an artery. Foe is up and fighting, at least until he bleeds to death. +35H - 8● - (-10)	Shot to forelimb shatters bone and severs an artery. Foe is up and fighting, at least until he bleeds to death. +25H - 15● - (-35)	Forearm shot crushes bone. +25H - 2● - 6● - (-10)	Shot to forelimb shatters bone and destroys an artery. Leg useless. +33H - 5● - 15● - (-35)
251+	Beautiful shot takes foe right between the eyes, leaving him less than alive. You spend the next two rounds admiring your handiwork. —	Beautiful shot takes foe right between the eyes, shame the round can't penetrate his skull. +25H - 4● - 2● - (-5)	Beautiful shot takes foe right between the eyes and exits out the back of the skull. (+25)	Beautiful shot takes foe right between the eyes knocks foe unconscious for the next six rounds. +30H - (-15) - (+25)	Sharpnel appears to sand all the flesh off of foes face. Thankfully, some pieces when into his eyes and brain, killing him instantly. —

Key: B✕=must parry B rounds; B∅=no parry for B rounds; B✕=stunned for B rounds; B●=bleed B hits per round; (-B)=foe has -B penalty; (+B)=attacker gets +B next round.



7.10 LARGE ANIMAL ENERGY CRITICAL STRIKE TABLE

	BLASTER	LASER	PLASMA	BURN/SCORCH	BURST/RAKING
01-05	Beam cuts deep, making him very angry. Looks like you fried your weapon cell. +10H	Nice hole. Trying to be decorative? +2H	Not a bad shot. Too bad your weapon cell fried. +12H	Don't tell me someone armored this thing? +1H	The attack is more a wound to his pride than his body. +7H
06-10	Nice shot. He knows where you are, now. +4H	Good penetration. Got its attention. +2H	Respectable hit. You have its attention. +6H	It knows you're here, now. +1H	Nice shot. Foe's skin is a bit torn up. +6H
11-20	Beam cuts deep into foe's side. He looks around, trying to find you. +6H	You get a piece of him. He looks around to see where that shot came from. +3H	Plasma cuts through foe's side, tearing flesh as it goes. He looks around to see where the shot came from. +8H	Slight burn to foe's side. He looks around. +2H	Wild attack splatters against foe's side. He looks around for the source. +9H
21-30	Strong forearm hit causes him to rear back. +7H	Solid forearm hit causes him to rear back. +4H	Solid blast to foe's forearm. It rears back. +9H	Burn to foe's forearm causes it to rear back. +2H - X	Foe catches blast in the arm and the chest. Foe rears back. +10H - X
31-40	Beam hits rib, but doesn't quite penetrate. +14H	Shot manages to break a rib. +14H (-10)	Foe's rib catches the plasma. A little to the left, and you would have had him. +14H	Shot heats up foe's side. +5H	Attack glances off several ribs. +20H - X (-5)
41-50	Beam catches foe in the side. He leaps away from you. +15H	Beam catches him in the side. He leaps back and away. +10H	Plasma hits foe's side. He leaps back. +15H	Burns to foe's side startles him. +6H - X	Attack tears up foe's side. Foe leaps back and away. +20H - X
51-65	Beam cut through foe's leg, nicking an artery. +15H - 6	Beam passes through leg without hitting anything vital. +10H	Plasma burns through foe's leg, tearing muscles and tendons in the process. Nice. +15H (-10)	Hot spot burns deeply into foe's leg. +7H (-5)	Attack tears through legs and ribs. Significant muscle damage. +20H - 6 (-10)
66	Well done, old boy. Beam passes through foe's neck. Better take cover. He may charge. +8H - 19	Beam passes through neck. He'll die . . . eventually. +4H - 2	Plasma burns into his neck. If you can stay away from him long enough, you've got it made. +15H - 18	If they didn't armor this thing's mouth, you get the effects below. If they did, you're out of luck. +8H - 2 - 3 - (-10)	Nice tracheotomy. You studying medicine? +30H - 6 - 30 - (-30)
67-70	Beam hits foe's leg hard. Not bad. +18H	Good leg hit. Too bad you missed everything vital. +14H	Well-aimed shot catches him right in the leg. Good hit. +20H	Hot spot burns into his leg. He felt that. +11H - X (-10)	Attack tears up leg, exposing the bone. +25H - 2 - (-10)
71-80	Shot to arm cuts deep. +18H	Arm shot bites deep. +12H	Arm shot causes minor muscle damage. +20H (-10)	Hot spot burns deep into arm. +15H - 2 - (-15)	Attack tears flesh off foe's arm. +20H - 2 - (-10)
81-90	Gut shot catches foe off guard. +15H - 2 - (-10)	Gut shot staggers foe. Work fast. +13H - 1 - (-10)	Nice gut shot. He looks angry. +16H (+10)	Hot spot burns into foe's gut. +12H - 2 - (-10)	Blast to foe's gut sends him reeling. +15H - 2 - (-10)
91-95	Beam passes through an artery in foe's leg. If foe has blood, it's pouring all over the place. +15H - 2 - 6 - (-10)	Shot catches artery in foe's leg. If foe has blood, then it's bleeding badly. +12H - 1 - 6	Plasma burns right through major artery in leg. If foe is capable of bleeding, he bleeds badly. +18H - 3 - 4 - (-30)	Hot spot causes painful burn to foe's leg. +15H - 2 - (-15)	Attack severs artery in foe's leg. +25H - 3 - 11 - (-15)
96-98	Heart shot. Foe dies instantly. -	Heart shot. You've done this before. -	Plasma burns right into foe's heart. Well done. -	Shot finds flaw in foe's armor. Sternum cracked. +35H - 6 - (-75)	Attack tears through several very important organs. Very sad. -
99-100	Beam passes through both of foe's lungs. He collapses as his lungs begin to fill. He dies after 6 rounds. +15H (+20)	Beam passes through both lungs. Foe drowns in its own blood after 9 rounds. +16H (+20)	Plasma passes through both lungs. Foe collapses, drowning in his own blood after 12 rounds. Maybe you should put him down. +16H (+20)	Attack finds flaw in foe's armor. Several ribs are cut and foe is bleeding internally. +25H - 3 - 6 - (-35) (+20)	Blast rips through both foe's lungs. Foe collapses and dies after 3 agonizing rounds. +15H (+20)
101-150	Shoulder hit drops foe for a moment. +25H - 2 - (-35)	Shoulder hit shatters bone. Foe collapses. +25H - 4 - (-55)	Plasma burns deeply into foe's shoulder. He drops and will have difficulty standing. +30H - 3 - (-45)	Attack burns into foe's shoulder, causing deep tissue damage. +12H - 1 - (-10)	Attack shreds muscles and tendons in foe's shoulder. +35H - 4 - 3 - (-45)
151-175	Beam passes through kidneys. Foe continues fighting for six rounds before dying of shock. Enjoy. -	Beam passes through both kidneys. Foe fights for six rounds out of spite, then dies. -	Plasma to foe's abdomen leaves a great gaping wound. He is <i>not</i> happy. +25H (-15)	Abdominal burns leave foe stunned. +25H - 2 - (-15)	Attack tears through abdomen, devastating foe's kidneys. He manages to continue fighting for 3 rounds before dying. Have fun. -
176-200	Beam slices through several major arteries. This thing's got a lot of blood. +25H - 24 - (-25)	Beam slices through internal arteries. Foe's bleeding badly, internally. +18H - 13 - (-25)	Plasma burns deep into foe's hip. He turns to look at you. +25H (-30) (+25)	Beam finds flaw in armor. Abdominal strike leaves foe bleeding to death. +25H - 6 - (-45) (+25)	You disemboweled him. Very icky. +35H - 7 - 29 - (-45) (-25)
201-250	Beam passes through forelimb, breaking bones and arteries. Foe can still fight. +25H - 14 - (-10)	Forelimb shot shatters bone and cuts artery. Foe perseveres. +25H - 14 - (-35)	Shot passes through forelimb, nicking bone and rupturing artery. +35H - 4 - (-10)	Beam finds flaw in armor and slices bone in foe's forearm. +25H - 2 - 3 - (-10)	Shot to forelimb shatters bone and destroys artery. Leg is useless. +33H - 5 - 14 - (-35)
251+	Beam catches foe right between eyes. Now that was a thing of beauty. -	Beam enters between foe's eyes. It exits out the back of foe's head. Can you say, "Dead?" +25	Beautiful shot catches foe right between the eyes. Too bad it doesn't burn through its skull. +25H - 4 - 2 - (-5)	Blast of heat catches foe between the eyes. Foe is knocked unconscious for 6 rounds. +30H (-15) (+25)	Attack very thoroughly removes foe's face. Looks like some of it got into his brain, too. -

Key: β×=must parry β rounds; β∅=no parry for β rounds; β⊗=stunned for β rounds; β●=bleed β hits per round; (-β)=foe has -β penalty; (+β)=attacker gets +β next round.



7.11 LASER CRITICAL STRIKE TABLE

	A	B	C	D	E
01-05	Beam pierces the skin between foe's fingers. +0H	Beam grazes hand. Foe flinches. +1H - X	Beam nicks foe's hand, piercing anything he carries. +1H - X - (-5)	Shot burns through hand, missing almost everything vital. +1H - 2X - (-10)	Foe has a burn clean through his hand. That must smart. +3H - 2☉☉ - (-15)
06-10	Forearm burn leaves only slight damage. You have the initiative. +0H	Beam creases forearm. The wound is cauterized. +1H - X	Beam slices through tendons in forearm. Foe screams in surprise. +2H - X - (-5)	Hole burns through muscles in foe's forearm. Foe grips it in pain. +3H - ☉ - (-10)	Beam burns clean through forearm, slicing bone in two. Arm is useless. Foe drops anything he's carrying. +4H - 2☉☉ - (-20)
11-15	Beam grazes inner arm. +1H	Minor muscle damage to foe's upper arm. Better luck next time. +1H - X - (-5)	Beam cauterizes its way through biceps, doing some small amount of damage. +2H - 2X - (-5)	Laser passes through elbow, slicing the joint and tendons. Arm is useless. +2H - 4☉ - (-20)	Beam cuts through bicep, slicing bone in two and severing muscles and tendons. +8H - 4☉ - (-20)
16-20	That'll leave a mark. +1H	Shot nicks foe's bicep. His flinch only makes it worse. +1H - X - (-5)	Beam slices deep into biceps. Instant tattoo removal. +4H - 2☉☉ - (-10)	Funny bone cracks from heat. Muscles and tendons severed. Say "Mommy." +5H - 4☉☉ - (-15)	Foe grasps arm as beam cuts bone, tendons, and muscles. Burned and mangled flesh hangs in a grizzly mess. lck. +12H - 6☉ - (-25)
21-30	You got a piece of his shoulder, but only barely. +1H	Beam pierces shoulder, but only barely. +3H - X - (-5)	Clean shoulder wound. Muscles and tendons bare the brunt of the damage. +3H - 2☉☉ - (-10)	Laser cuts through shoulder, damaging muscles and tendon, but cauterizing all damage. +3H - 2☉ - (-20)	You missed the bone and the biceps. If it wasn't for the artery, that would have been a waste of a shot. +1H - 9☉ - (-5)
31-40	Beam takes a chunk out of foe's shoulder. +1H	Beam takes a piece out of foe's clavicle. He screams like a small child. +8H - 3☉☉ - (-15)	Beam passes clean through foe's clavicle. That arm ain't hanging right. +12H - 4☉☉ - (-20)	Beam passes clean through clavicle. That must've hurt. +12H - 3☉☉ - (-25)	Clavicle and shoulder joint are nearly a complete write off. Better find a really good surgeon. +10H - 5☉☉ - (-25)
41-50	Beam brushes foe's hip. +1H	Slight muscle damage to foe's thigh. Foe's leg almost crumples out from underneath him. +2H - 4☉ - (-10)	Beam passes straight through foe's thigh. +5H - X - (-10)	Beam burns a neat little hole through thigh, cutting muscle and tendon. +12H - 4X - (-10)	Scything beam of light severs thigh bone and artery. Foe collapses like a bag of wheat. +11H - 4☉☉ - 6☉ - (-50)
51-55	You take a piece out of foe's calf. +2H	Beam only nicks foe's calf, severing a single tendon. +2H - X - (-5)	Beam strikes straight through calf, severing muscle and tendon. That'll leave a mark. +5H - ☉ - (-10)	Beam slices through shinbone and calf, fracturing bone and severing muscle. +12H - 2☉ - 3X - (-15)	Agonizing shot burns through shin bone and muscles. Foe goes down . . . hard. +15H - 3☉☉ - (-30)
56-60	Foe moves his foot just in time. +2H	Were you trying to make him dance or something? Beam slices off foe's toe. +2H - X - (-5)	Beam passes effortlessly through foe's foot. Several bones are cut. Foe looks at you in shock. +8H - 2☉☉ - (-10)	Slicing path through ankle breaks bone and tendons. Foe looks down in shock. +10H - 3☉☉ - (-20)	You think he was Achilles? Beam slices through ankle and tendon, disconnecting the foot completely. Ouch. +12H - 4☉☉ - 6☉ - (-25)
61-65	Barely grazed his belly. +2H	Beam passes cleanly through foe's hip bone. Minor damage. Foe takes a step and the hip bone snaps. +3H - 2☉☉ - (-10)	You leave a very nice hole in foe's hip. +8H - 2☉☉ - (-15)	Surgical removal of foe's love handles. You smell boiling fat. +12H - 3☉☉ - (-20)	Slice hip bone in two. Foe mews pitifully. +15H - 5☉☉ - (-50)
66	They told him to watch his six. Now he won't be sitting down for days. Pitiful. +7H - (-5)	Beam passes clean in one ear and out the other. Foe drops in coma for one week. +8H - (-25) - (+25)	Laser makes neat incision in foe's nose. Beam continues through spine, brainstem, and back of head. Check out the look on his face. (+25)	You waved that one around just enough to open beautiful slices in front and back of foe. Those look like intestines. +12H - 4☉☉ - 3☉ - (-30)	Slicing blow to groin vaporizes vitals. All within 15 feet are stunned, dumbfounded, for one round. +12H - 5☉☉ - 6☉ - (-30)
67-70	Beam brushes foe's knee. +1H - X	Beam cracks kneecap in two. Foe manages to shift his weight just in time. +3H - ☉ - (-10)	Very neat hole in foe's knee. He won't be making the team this fall. +7H - 2☉☉ - (-10)	Surgical strike almost completely removes kneecap. +12H - 4☉☉ - (-15)	Kneecap shatters from intense heat. Tendon damage adds insult to injury. +15H - 4☉☉ - (-25)
71-75	Beam goes right through foe's abdomen, miraculously missing everything. +2H	Beam passes through abdomen, perforating foe's intestine. +1H - X - (-5)	Beam passes through foe's stomach. Talk about a perforated ulcer. +3H - 2☉☉ - (-5)	Wound opens in torso, slicing through kidneys and intestines. Foe gasps in pain. +3H - 2☉☉ - (-10)	Beautiful little hole through kidney. Even with the cauterization, there's blood. +8H - 4☉☉ - 3☉ - (-15)
76-80	Laser pierces foe's side. Nothing important is damaged. +3H - X	Beam takes out rib, but just misses lung. +3H - 2☉☉ - (-5)	Beam cuts two ribs in half. Muscle and tendon damage result. +5H - 2☉☉ - (-10)	That black blood probably means you hit his liver. Not good. +6H - 2☉☉ - 6☉ - (-10)	Nice appendectomy. You go to med school? +8H - 3☉☉ - 3☉ - (-20)
81-85	Beam passes through gut, nicking an intestine. +3H - X - (-5)	Shot to foe's belly-button turns his outie into an innie. Minor damage to intestines. +3H - X - (-5)	Beam pierces foe's lung. Can you say, "sucking chest wound?" I knew you could. +5H - 2☉☉ - (-10)	Slicing shot to pelvic girdle. He's actually bleeding from this one. Good work. +8H - 3☉☉ - 6☉ - (-15)	You managed to miss all the important stuff. Well, except the spinal cord. Foe collapses, paralyzed. +12H - (-75)
86-90	Almost got his lung with that one. Minor muscle damage. +3H - X - (-5)	Rib cracks as beam passes through it. +7H - 2☉☉ - (-10)	Rib and lung pierced. Life stinks sometimes. +8H - 2☉☉ - (-15)	Drilled straight through sternum. Unfortunately, it was an artery you clipped, not the heart. +8H - 3☉☉ - 6☉ - (-30)	Beam drills right through heart. It takes foe two rounds to realize he's dead. (+20)
91-95	You clip off a piece of foe's ear. It feels worse than it is. +2H - ☉☉	Beam leaves crease in foe's head. His hair is smoldering. +3H - 2☉☉	Beam slices through side of head, piercing inner ear and damaging eye. -10 to Awareness maneuvers. +6H - 2☉☉ - (-10)	Surgical blow to the brain severs several nerve bundles. Foe drops, unconscious, for two months. When he awakes, he's deaf. +8H - 3☉	Beam slices right through brain pan. Very surgical. Foe almost survives. (+20)
96-99	Beam cracks foe's jaw, but just slightly. +3H - 2☉☉ - (-5)	Beam crack's foe's jaw. It'll have to be wired shut. +5H - 2☉☉ - (-10)	Surgical removal of voice box. Wow. +6H - 3☉☉ - (-10)	Beam severs carotid artery. Foe tries to staunch the flow, but it pours out through his fingers. +2H - X - 9☉ - (-10)	Beam catches jugular and spine. He can't even reach up to try to stop the blood. +6H - X - 11☉ - (-75)
100	Beam pierces skull in non-vital area. If he hadn't twitched, he would have lived. (+20)	Beam pierces foe's eye. Foe drops like a puppet with its strings cut. (+20)	Beam pierces brain, damaging multiple areas. Poor sap dies instantly. (+20)	Beam enters eye. A flick of the wrist brings beam out side of head. Sad. (+20)	You missed. No wait. Is that a burn between his eyes? Foe crumples, dead. (+25)

Key: B*X=must parry B rounds; B☉=no parry for B rounds; B☉☉=stunned for B rounds; B☉=bleed B hits per round; (-B)=foe has -B penalty; (+B)=attacker gets +B next round.



7.12 PLASMA CRITICAL STRIKE TABLE

	A	B	C	D	E
01-05	Blast hits item in foe's hand. A Light maneuver will allow him to hold onto it. +1H	Blast hits whatever he was holding. A Medium maneuver, and he might even hold onto it. +2H - x	Plasma catches object in foe's hand. He must make a Hard maneuver to hold onto it. +3H - 2x - (-10)	Shot burns through foe's hand and anything he was holding. +3H - 3x - (-15)	Blast detonates whatever foe was holding, sending shrapnel through hand. +7H - 4x - (-25)
06-10	Light burns. You gain initiative next round. +2H	Deep burn on foe's forearm, you get the initiative next round. +5H - 2x	Glancing shot burns through tendon in foe's forearm. +6H - 2x - (-15)	Blast burns through muscles and tendons in foe's forearm. +7H - 3x - (-20)	Blast burns through both bones in forearm, rendering arm useless. +10H - 5x - 2 - (-40)
11-15	Blast leaves a nasty burn. +2H	Plasma grazes foe's biceps, causing a painful burn. +5H - 2x - (-5)	Plasma burns deeply into foe's biceps. +10H - 3x - (-15)	Plasma burns through bone and tendon, making foe wonder why it's called the humerus. +8H - 4x - (-20)	Blast burns through upper arm, eating through bone and tendon. Foe cannot lift his arm. +20H - 6x - 1 - (-40)
16-20	Foe's arm catches a bit of it. +2H	Blast causes a painful burn to foe's triceps. +5H - 2x - (-5)	Solid hit burns through triceps. +10H - 3x - (-15)	Plasma effectively destroys elbow. Medical attention required. +4H - 4x - 2x - (-25)	Penetrating blast burns through upper arm and bone. Arm is useless. +20H - 6x - (-40)
21-30	Foe moved at the last moment. You barely got a piece of him. +3H	Shot burns foe's shoulder. +5H - 2x - (-10)	Blast burns deep into foe's shoulder, dissolving muscles and tendons alike. +12H - 4x - 2x - (-15)	Plasma burns through shoulder and out other side. +12H - 4x - 2 - (-25)	You just burned a hole in his shoulder big enough to put your fist through. That's a gusher. +5H - 8 - (-10)
31-40	He almost felt that one. +2H	Plasma burns foe's neck. +4H - 2x	Blast burns clean through foe's clavicle. +12H - 2x - (-25)	Plasma burns out top of foe's shoulder. +20H - 3x - (-25)	Plasma burns shoulder joint to the nub. That arm will never be right again. +25H - 3x - (-30)
41-50	Shot grazes foe's thigh, leaving an ugly mark. +2H	Plasma burns into foe's thigh. Minor muscle damage. +6H - (-10)	Plasma burns deep into foe's thigh. +12H - 2x - (-25)	Shot burns through thigh, removing half the muscles, burning tendons, and cooking through arteries. +20H - 3x - (-25)	Blast to thigh burns through bone and arteries. Foe drops into an expanding pool of blood. +25H - 5x - 6 - (-75)
51-55	Blast grazes foe's calf. That must smart. +2H	Plasma burns a chunk out of foe's calf. Minor muscle damage. +2H - x - (-5)	Shot to foe's calf burns through muscle and tendons. +5H - x - (-10)	Shot burns through foe's tibia. That leg isn't gonna be the same again. +12H - 2x - 3x - (-15)	Shot hits lower leg, burning through bone and sinew. Leg folds like a lawn chair. +15H - 3x - (-30)
56-60	Blast just misses, but plasma splatters onto foot. +3H	Plasma grazes foe's foot, burning off two toes. +6H - 2x - (-5)	Plasma catches foe in center of foot, burning through bone and muscle, and melting into the ground. +15H - 3x - (-20)	Plasma burns through most of ankle, bones, and tendons. +18H - 4x - 2 - (-30)	If using hunting class I or greater, foot is burned right off. Otherwise, ankle is destroyed. +25H - 6x - (-50)
61-65	Close shot. Good thing those hips weren't any wider. +5H - x	Shot catches foe's hip. Heat expansion cracks hip. Ouch. +8H - 2x - (-5)	Plasma causes cracks in foe's femur. Walking will cause d10 hits per minute. +15H - 3x - 2x - (-15)	Plasma burns through foe's hip joint. +20H - 4x - (-25)	Foe's hip is destroyed. +30H - 6x - (-50)
66	Shot catches foe in the rear. Those burns look painful. +15H - (-15)	Blast hits foe in shoulder, but splashing plasma catches foe in ear, causing brain damage. Foe is in a coma for d10 days. +20H - (-40) - (+25)	Plasma burns straight into foe's forehead, then down into foe's neck. Very sad. (+25)	Shot burns through abdomen. Any organs not burned out begin spilling on the ground. +40H - 4x - 13 - (-75)	Blast to foe's groin burns all vitals to a nub. All within sight are stunned in sympathy for one round. +40H - 15x - 6 - (-75)
67-70	Plasma grazes foe's knee. +2H - x	Blast burns deep into foe's knee, but fails to cause more damage. +7H - x - (-10)	Blast burns flesh off foe's knee. +15H - 3x - (-15)	Plasma burns out kneecap. Muscles and tendons are damaged as well. +20H - 5x - (-25)	Knee joint destroyed. Tendons are not doing much better. +25H - 8x - (-30)
71-75	Close shot grazes foe's stomach. +3H	Foe catches a piece of it in his abdomen. Minor damage. +7H - 2x - (-10)	Shot burns fist-sized hole through foe's abdomen. +8H - 3x - (-15)	Major damage to stomach causes bleeding in spite of cauterization. +8H - 4x - 2 - (-15)	Blast blows through kidney. Blood bubbles out of wound and begins filling abdomen. +15H - 5x - 6 - (-30)
76-80	Plasma burns off a random love handle. +6H - 3x - (-5)	Foe dodges most of the blast, but it still burns through d5 ribs. +8H - 3x - (-10)	Blast burns through d5 ribs. Muscles and tendons are badly burned. +15H - 4x - (-20)	Blast bursts through ribs, crippling a lung. Hope he has a good medical plan. +15H - 4x - 3 - (-15)	Good thing God gave him two lungs. Several ribs are burned away. +15H - 5W - 7 - (-30)
81-85	Only a piece of that caught him. He'll have a new appendix scar. +6H - 2x - (-5)	Foe takes it in the gut. The internal damage is significant. +8H - 3x - (-15)	Plasma burns a grapefruit-sized hole in foe's abdomen. +10H - 3x - 1 - (-15)	Blast makes a gory mess of foe's midsection. +20H - 5x - 3 - (-25)	Blast blows through foe's gut. His spine dissolves, leaving him paralyzed. +25H
86-90	Blast splashes onto chest as it passes. +8H - 2x - (-5)	Solid hit burns through d5 ribs and causes muscle and tendon damage. +15H - 3x - 2 - (-15)	Plasma burn through d10 ribs wrecks foe's lung. +15H - 3x - 1 - (-25)	Sternum manages to channel plasma around heart, but both lungs and various other organs are damaged. +18H - 4x - 4 - (-30)	Blast burns straight through foe's sternum. Talk about a heart attack. (+20)
91-95	Foe's ear is removed. +3H	Plasma doesn't quite burn through foe's skull. +5H - 3x - (-5)	Plasma burns deep into foe's skull, wrecking foe's hearing in that ear for good. +10H - 3x - 2 - (-15)	Plasma burns hole in skull. Foe slips into a coma for d10 weeks and loses a level's worth of experience. +30H - 7	Foe's head just sort of boils away. Foe is too shocked to fall over. (+20)
96-99	Shot leaves burn marks across foe's face. Scar will shave 10 off his Appearance. +6H - 3x - (-5)	Plasma burns through foe's jaw. Naturally, he can't talk. Take 20 off his Appearance. +8H - 3x - (-5)	Blast to foe's mouth burns through jaw and teeth. +10H - 4x - 1 - (-15)	Plasma burns foe's jaw away. That's a lot of blood for a burn-wound. +8H - 2x - 10	Plasma burns straight through foe's mouth and out through his spine. Foe is paralyzed. +12H - 18 - (-75)
100	Blast enters through eye, burning out half his brain. Neat. (+20)	Plasma enters foe's ear and hollows out his skull. Wow. (+20)	You burn foe's head down to a nub. Carry on. (+20)	Blast catches foe dead in the face, melting it right off. Ick. (+20)	Foe's neck just sort of disintegrates, leaving his head hanging in the air for a beat. (+25)

Key: Bx=must parry B rounds; B⊗=no parry for B rounds; B⊗=stunned for B rounds; B●=bleed B hits per round; (-B)=foe has -B penalty; (+B)=attacker gets +B next round.



7.13 POWERED ARMOR CRITICAL STRIKE TABLE

	A	B	C	D	E
01-05	You dust its hand. +0H	A blemish! You left a blemish. Damn you! +0H	Blast catches foe in the hand. Malfunctions run up and down his arm. +1H - (-10)	Attack to foe's hand. Any weapons on that arm are at -15. +2H - (-10)	Attack catches foe in the hand. It looked like that stung. +3H - (-10)
06-10	You scrape the paint off his forearm. +0H	Attack hits foe's forearm. Know a good body shop? +2H	Attack hits foe in forearm. Built in weapons in that arm are at -25 +2H - (-10)	Attack catches foe in the forearm. It could have been worse. +4H - (-10)	Attack catches foe in the lower arm. +5H - (-10)
11-15	You made a dent in his upper arm. Could have been better. +0H	Attack leaves iron filings filling the air. He felt that one. +2H	Attack catches foe in the upper arm. Waldos are sluggish. +4H - (-10)	Attack damages armor's upper arm. +3H - (-10)	Blast catches foe in the upper arm. +8H - (-5)
16-20	Attack leaves a nasty scar on the armor's upper arm. +0H	All the lights flicker, and foe hears a buzzing sound. Foe loses initiative for three rounds while he checks diagnostics. +2H - (-5)	Attack catches foe's upper arm. The suit is sluggish now. +4H - (-10)	Foe takes one in the upper arm. +4H - (-10)	Attack catches foe in the upper arm. Now weapons in that arm will not fire until repaired. +8H - (-15)
21-30	Blast to shoulder transfers some energy into foe. +1H	Blast hits shoulder. Waldos become a bit sluggish. +1H - (-5)	Attack catches foe in shoulder. Barrier shield drops to half strength. +5H - (-10)	Shoulder hit damages waldos. +5H - (-10)	Shoulder hit knocks out comm and drops shields to one quarter power. +5H - (-15)
31-40	Armor catches most of it, but a little gets through to foe's clavicle. +1H	Shoulder hit causes Comm problems. All Comm actions are at -50. +4H - (-5)	Shoulder hit cuts power to all weapons in one area. +10H - (-10)	Shoulder hit damages shield generator. Shield at half power. +5H - (-15)	Shoulder hit knocks out power to all weapons in one section. +5H - (-15)
41-50	You scratch up foe's thigh armor pretty badly. +1H	Attack hits foe's thigh. He twitches. +4H - (-5)	Attack catches foe in thigh. Could have been worse. +6H - (-10)	Attack catches armor in mid-thigh. +8H - (-15)	Attack catches foe in the thigh. +10H - (-15)
51-55	You hit foe in lower leg. A little of the energy transfers through. +1H	Attack catches foe in lower leg. +1H - (-5)	Attack catches foe in the calf. The damage is bad, but not irreparable. +4H - (-10)	Attack catches armor in the calf. Energy surge damages foe. +10H - (-5)	Attack catches armor in the calf. Sparks fly. +11H - (-15)
56-60	You shot him in the foot. Impressive. +1H	You shot him in the foot. That takes skill. +4H - (-5)	Hey, you shot him in the foot, slick. +5H - (-5)	Attack to foot damages all sorts of secondary systems. +10H - (-10)	You shot him in the foot. He yelps and jumps into the air. +12H - (-15)
61-65	Attack catches foe on the region of the hip and waist. +2H	Comm system takes damage as fuses short. Foe can send but not receive. +4H - (-5)	Blast to waist drops shield to one quarter power. +8H - (-15)	Attack to waist damages both hips. Foe is having a great deal of trouble moving. +12H - (-70)	Attack to waist causes a small electrical fire. Foe takes an 'A' electrical and 'B' heat crit. +20H - (-15)
66	Attack hits foe in the posterior. Foe takes an 'A' electrical critical as systems short. +8H - (-10)	Attack sends wild electrical shocks throughout the armor. Foe passes out for 3d10 hours. +10H - (-25) - (+25)	Flames and current fill the suit. Foe takes an 'E' electrical and an 'A' heat critical, then devotes the next round to fire control. +20H - (+25)	Foe takes an 'E' electrical and 'B' heat critical every round until a Very Hard damage control (electronics) maneuver is made. +20H - (-70)	Major electrical fire. Foe takes an 'E' and an 'A' electrical and a 'B' heat crit. The heat crits continue until the foe evacuates the suit and drops and rolls (a Medium maneuver). The suit is totalled. +30H - (-75)
67-70	Blast catches foe in knee. That stung a bit. +1H	Attack to foe's knee causes system wide calibration problems. +4H - (-30)	Attack damages foe's knee. He is less than happy. +7H - (-15)	Damage to foe's knee. +12H - (-15)	Attack to knees causes occupants to take an 'A' electrical critical. +18H - (-20)
71-75	Shot catches foe in the gut. Good thing he's been doing sit-ups. +1H	Gut shot drops any energy shield to half effectiveness. +2H - (-10)	Gut shot damages foe's shield. It will operate for three more rounds. +4H - (-15)	Attack knocks out foe's shield generator. +5H - (-15)	Attack to suit's gut leaves a hole too big to autoseal. Foe is exposed to the environment. +8H - (-20)
76-80	Attack catches foe in torso. The computer slips in its timing a bit. +3H - (-5)	Computer damage causes calibration problems. +4H - (-10)	Attack catches foe in the torso. Systems flicker on and off. +8H - (-15)	Sparks fly. Foe takes an 'A' electrical critical. Shields out. +10H - (-15)	Attack causes foe to take a 'C' electrical critical. +12H - (-20)
81-85	Attack catches foe in the torso. It's responding sluggishly. +3H - (-5)	Any shields are knocked out for ten rounds. +4H - (-10)	The suit handled that pretty well. You're impressed. +6H - (-15)	Attack catches foe in the torso. There is extensive damage. +8H - (-25)	Attack leaves shoulder joints non-functional. +15H - (-75)
86-90	If it wasn't for the armor, that probably would've punctured a lung. The suit is a bit damaged. +3H - (-5)	All systems twitchy. +8H - (-10)	Communications knocked out. Maybe if you shout really loud... +8H - (-15)	It takes 2 rounds for autoseals to work. Foe takes any effects from environment. There is one minute of life support left. +10H - (-20)	Energy fills foe's armor. He takes a 'B' electrical critical every round. +15H - (-90)
91-95	Attack hits armor in the side of the head, cracking the visor. Foe loses initiative next round trying to decide if his environment was compromised. +2H - (-5)	Shield knocked out. System wide problems become prevalent. +3H - (-10)	Suit loses integrity for 1 round, until autoseals compensate. Take any appropriate crits for exposure. Life support will last for 5 rounds. +6H - (-15)	An odd rattle sounds. Penalty increases by -10 per round until it hits -100. The the suit shuts down. +12H - (-10)	Suit grinds to a sudden halt. Hope he's not claustrophobic. (+20)
96-99	Attack hits where the jaw meets the neck. Foe gasps at the energy transfer. +4H - (-5)	Ration tubes explode in foe's face. He is blind for two rounds. +6H - (-15)	Attack to side of foe's head blows several major systems. Suit will power down after 1 minute. +6H - (-15)	Suit shuts down. Life support quits. Foe has one minute of air left. +3H - (-20)	Helmet is wrecked. Foe is exposed and unconscious for two hours. +8H - (-150)
100	Attack hits foe in helmet, shorting out the HUD. A cascade failure causes all electrical systems to go dead. Anyone got jumper cables? +5H - (-110) - (+20)	All systems shut down. Current flickers over armor. Foe takes 'B' electrical criticals for five rounds. He can't even blow the hatch until then. (+20)	Suit decides that foe would make a pretty good ground. He takes a 'C' electrical crit every round until the suit is powered down or abandoned. (-120) - (+20)	Massive attack knocks power plant offline. If power plant is capable of overload, everyone has 5 minutes to get to minimum safe distance. (+20)	Armor is coming apart. Armor takes an 'E' electrical critical every round until shut down. (+25)

Key: Bx=must parry β rounds; B∅=no parry for β rounds; B*?=stunned for β rounds; B♣=bleed β hits per round; (-β)=foe has -β penalty; (+β)=attacker gets +β next round.



7.14 RADIATION CRITICAL STRIKE TABLE

	A	B	C	D	E
01-05	What radiation? +0H	They're only sub-atomic particles. +0H	Nothing worse than a flight to Denver. +0H	He looks a little peeked. +0H	Luckiest man alive. +0H
06-10	A warm breeze. +0H	Zip. +0H	You must have a genetic resistance. +0H	This damage won't heal without anti-rad treatments. +3H	It must have been those cool sunglasses. +5H
11-15	The experts say it's nothing to worry about. +0H	Target has very little to worry about. +0H	Insignificant damage. +0H	Skin damage requires anti-rad treatments to heal +4H	Target's mustache falls out. +8H
16-20	That probably took a week off his life. +0H	Ah...you've had x-rays that were worse. +0H	Foe has a mild headache. (-1)	Mild irradiation. Foe won't feel himself again without anti-rad treatments. +0H - (-10)	Sickness persists until anti-rad treatments. +0H - (-10)
21-30	Has he been using a tanning bed? +0H	His little rad-badge is turning all black. +0H	Damage is permanent until foe receives anti-rad treatments. +4H	Foe will get cancer in the next 5 years. +0H	Horrible sores form, requiring anti-rad treatments. +10H - 6 - (-60)
31-40	Microbes on target's skin have a tough time of it. +0H	Foe is nauseous for 6 hours. +2H - (-5)	Mild radiation sickness. Hair falls out in three days. +0H - (-30)	Target's vision is messed up. Damage and vision persist until anti-rad treatment. +5H - (-30)	Severe damage. Foe weakened and ill until anti-rad treatment. +0H - 6 - (-70)
41-50	A few cells have their DNA shattered. They die before they mutate. +0H	12 hours of nausea. 50% chance of tumor within five years. +0H - (-10)	Target has 10% chance of fainting each minute. Then he is out for 1-10 hours, and sick for 5 days. +0H - (-20)	Organ damage. One of foe's organs will fail within d10 hours. +0H	Radiation sickens foe and drops MPs by d10. Anti-rad treatments are required. +15H - (-50)
51-55	In one hour target will feel queasy, it will last for four hours. +0H - (-10)	24 hours of intense nausea. +0H - (-15)	Mild radiation sickness. Hair falls out, sores develop in 1-5 days. 50% chance of cancer within a year. +0H - (-30)	Sickness weakens foe. This persists until anti-rad treatment. +0H - (-40)	Foe nearly unconscious until anti-rad treatments are administered. +17H
56-60	Target will feel unwell for about a week. +0H - (-10)	36 hours of nausea, lose d10 MPs for the duration. +0H - (-20)	Foe will develop cancer by year end. +0H	Damage and brief nausea are intense. Damage cannot be healed without anti-rad treatments. +20H - 6 - (-80)	Foe's skin cracked and blackened. Guess what sort of treatment he needs... +10H - 4 - (-80)
61-65	Foe starts vomiting after 6 hours, for about 3 hours. +0H - (-10)	48 hours of nausea. Intense headache lasts d10 hours. +0H - (-20)	Nice headache, got any aspirin? Lose 1-10 MPs. +0H - (-15)	Psychic powers may not be used for one day. Sickness lasts until anti-rad treatments are administered. +0H - (-20)	Damaged skin and optic nerve leaves foe bleeding and blind. Normal treatments will not heal this damage. +15H - 6 - (-50)
66	Foe will never produce offspring. His reproductive organs are very sterile. +0H - (+25)	Terrible cancer develops. Foe dies after two months. (+25)	Cancer causes death after one month. Sad. (+25)	Target will die in one hour due to massive organ damage. (+25)	Cellular and neural damage are extensive. Foe slips into a coma and will die in d10 minutes. +40H - (+25)
67-70	Minor loss of hand-eye coordination for the next 2 days. +0H - (-15)	Nausea and loss of hand-eye coordination for 72 hours. +0H - (-25)	Target's hand-eye coordination goes to hell. Condition persists until treated. +0H - (-30)	Target dazed. Sickness persists until anti-rad treatments. +0H - (-20)	Foe suffers all effects of radiation sickness. +0H - (-90)
71-75	Foe looks a bit green. He suffers a 12 hour bout of nausea after one hour. +0H - (-15)	Intense nausea for 4 days. Foe has trouble concentrating. +0H - (-25)	Sores appear until treated. +0H - (-30)	Radiation sickness. Hair, nails, and teeth fall out. Sores form within one day. Target loses d10 MP, and will die within d10 days. +10H - (-40)	Foe bed ridden until specially treated. The prognosis is bad. +30H - (-100)
76-80	Foe is nauseous for 12 hours. Minor skin cancer will develop within one year. +0H - (-15)	Nausea lasts 5 days. The dehydration and malnutrition are an issue. +4H - (-25)	Lingering radiation sickness. +0H - (-35)	Foe will get malignant tumor within 6 months. Sickness persists until restored. +0H - (-40)	Severe radiation sickness. Target will die within 24 hours unless treated. +12H - (-50) - (+25)
81-85	Nausea for 24 hours. There is a 50% chance of cancer within 5 years. +0H - (-20)	Six days of nausea. They might want to put him on an IV diet. +7H - (-25)	Damage won't heal without anti-rad treatments. +7H - (-30)	Damage to optic nerve leaves foe blind. All effects persist until anti-rad treatments are administered. +15H	After 10 minutes, foe is struck by severe nausea. This lasts for d10 days, then he dies. +0H - (-60)
86-90	Nausea for 36 hours. +0H - (-25)	Seven days of intense nausea, followed by complete hair loss. +0H - (-30)	Damage causes a random organ to cease functioning in d10 days. This can be treated normally. +0H	Cracked flesh and sores resist healing by all but anti-rad treatments. +17H - 3 - (-30)	Target blinded and sent into a coma. He will die within 24 hours. (+20)
91-95	Nausea for 48 hours. Damaged skin will flake off in two weeks. +4H - (-30)	Foe's skin cracks. The nausea lasts 8 days. His hair falls out to boot. He could use an IV. +0H - 6 - (-30)	Foe's vision is no longer quite right. +0H - (-40)	Foe blinded. He will die within one day unless treated. 10 - (-60) - (+20)	Horrible damage kills foe after 24 hours of intense nausea. +19H - (-70) - (+25)
96-99	Nausea for 72 hours. Damaged skin will flake off in two weeks. +5H - (-35)	Foe loses vision for d10 hours. Nausea lasts for 9 days. His hair falls out. He is not a happy camper. +0H - (-35)	Heavy radiation sickness persists until anti-radiation treatment is administered. +0H - (-40)	Neural damage. Foe slips into a coma and dies in d10 hours. (+20)	A variety of organs fail. Foe drops and dies in d10 rounds. No psychic abilities may be used without drastic neural procedures. (+20)
100	Extreme nausea for 96 hours. Damaged skin will flake off in two weeks. +10H - (-40) - (+20)	Foe will develop terminal cancer and die within 6 months. Nausea lasts 10 days and hair falls out. +0H - (-35) - (+20)	Heavy radiation sickness. Hair and teeth fall out. Foe dies of cancer after one month. +0H - (-45) - (+20)	Neural tissue ceases functioning. Foe dies in 6 rounds. (+20)	Massive neural failure. Foe slips into a coma and dies after 6 rounds. (+25)

Key: β×=must parry β rounds; β⊗=no parry for β rounds; β⚡=stunned for β rounds; β♠=bleed β hits per round; (-β)=foe has -β penalty; (+β)=attacker gets +β next round.



7.15 RAKING CRITICAL STRIKE TABLE

	A	B	C	D	E
01-05	Hit to foe's hand. If foe is holding something, it should check for breakage at -10. +3H - 2x	Slicing hit to foe's hand. If foe is carrying anything, it must make a breakage check at -20. +4H - 2x - (-10)	Biting strike to foe's hand. If he is holding anything, it must check for breakage at -30. +8H - 4x - (-20)	Hit mangles hand pretty thoroughly. Anything foe is holding is destroyed. +15H - 5x - (-50)	Foe's hand is sliced in two. Anything in foe's hand is destroyed. +15H - 7x - (-50)
06-10	Foe's arm is torn. You gain initiative next round. +7H - 3x	Cut goes almost the whole way through the forearm. If foe is holding an item, it must check for breakage at -10. +8H - 3x - (-15)	Tearing strike through muscles and tendons in forearms. Foe drops whatever he is holding. +10H - 4x - (-25)	Attack lops off foe's lower arm and hand. Foe passes out for ten rounds. +15H - 7x - (-50)	Attack lops off foe's hand just above his wrist. Feel free to make a Darth Vader joke. +15H - 8x - (-50)
11-15	Nick to foe's biceps, causing minor muscle damage. +7H - 3x - (-5)	Deep bicep cut, causing major muscle damage. +15H - 4x - 2x - (-20)	Attack slices deep into foe's elbow, tearing up bones and tendons. +10H - 4x - (-20)	Foe's arm is sliced lengthwise. +25H - 7x - 6x - (-40)	Foe's arm is sliced off at the biceps. +30H - 6x - 7x - (-60)
16-20	Weak upper arm strike causes minor muscle damage. +7H - 2x - (-10)	Triceps are torn up, causing major muscle damage. +12H - 3x - (-25)	Deep cut into arm just above the elbow. The arm is useless. +12H - 4x - 2x - (-20)	Foe's arm is chopped off. Cool. +30H - 6x - 7x - (-60)	You very efficiently remove foe's arm, several inches above the elbow. +30H - 6x - 7x - (-60)
21-30	Glancing hit to foe's shoulder. Minor muscle damage. +8H - 3x - (-10)	Slice to foe's shoulder messes up muscles and tendons. +16H - 4x - (-15)	Slice through muscles in foe's shoulder, catching an artery to boot. +18H - 5x - 3x - (-25)	Foe's arm is lopped off at the shoulder. +25H - 10x - (-50)	Hit turns arm, shoulder, and foe into three separate pieces. Arm and shoulder fall to ground. +30H - 7x - 11x - (-60)
31-40	Take out a piece of foe's clavicle. That should have done more. +7H - 2x - (-10)	Foe's collar bone is chopped up. Nice carving job. +12H - 3x - (-15)	Foe is less than pleased by cut down into collarbone. +20H - 3x - (-25)	A section of the shoulder joint is removed, leaving arm hanging uselessly. +30H - 6x - 7x - (-60)	Foe watches as you lop off arm, shoulder, and a chunk of his side. +30H - 7x - 11x - (-60)
41-50	Strike just brushes foe's thigh. Oops. +6H - 2x - (-10)	Deep cut to foe's thigh. Ouchy. +8H - 3x - (-25)	Slicing hit through muscles and tendons in foe's thigh. +16H - 3x - (-25)	Foe's leg falls to the ground, severed at the thigh. +40H - 4x - 3x - (-40)	Foe's leg is severed at the thigh. +40H - 4x - 6x - (-60)
51-55	Glancing hit to foe's calf. The burns are nothing very serious. +8H - 2x - (-10)	Slice through foe's calf almost drops him. +15H - 3x - (-15)	Attack slices right through the calf, severing bones along the way. +25H - 4x - (-25)	Slice clean through foe's knee. Foe falls over, looking at the stump. +35H - 6x - 9x - (-75)	You cut off foe's leg at the knee. +40H - 7x - 10x - (-75)
56-60	Beam neatly removes all of the toes from foe's foot. +7H - 2x - (-10)	Strike slices toes off foot, then bounces around slicing up bones. His expression is priceless. +25H - 4x - (-20)	Cut through foe's ankle slices muscles, tendon, and bone. Foot flaps like a torn rag. +24H - 4x - (-30)	Strike scythes right through foe's ankle. The foot bounces a couple of feet away. +35H - 6x - 7x - (-50)	Foe is stunned when you slice off his foot. +40H - 7x - 3x - (-60)
61-65	Cut to foe's hip cracks the bone. +10H - 2x - (-5)	Deep cut to foe's hip. Foe manages to keep his feet, but every step is agony. +25H - 4x - (-20)	Hip hit slices pelvic girdle. Foe's stance no longer has the integrity it once did. +30H - 5x - 7x - (-25)	Slice up foe's hip removes all integrity from the joint. +34H - 7x - 2x - (-50)	Attack slices down through the hip. Foe's leg falls to the ground. +40H - 7x - 6x - (-60)
66	Foe yelps as hit slices off some posterior. +30H - (-25)	Strike to foe's head. Miraculously, he merely slips into a three day coma. +60H - (-60) - (+25)	Deep slice into foe's face. Muscle spasms cause him to fly backward to a spot where he will die in ten rounds. +15H - 8x - (-45) - (+25)	Slice opens up foe's abdomen. Intestines begin spilling out. Foe is vainly trying to push everything back in. (+25)	Slice through groin is lost in the mess made by taking off both of his legs as well. Foe is oh so dead. (+25)
67-70	Strike glances off kneecap, cracking it badly. +7H - 3x - (-10)	Deep cut into foe's knee folds it the wrong way. He collapses. +20H - 3x - (-20)	Hit to the knee nearly severs the leg. In the future, that knee will predict the weather. +25H - 5x - 7x - (-30)	Strange, foe's leg is missing below the knee... +35H - 6x - 7x - (-50)	You slice foe's knee in two. Leg falls, dead, to the ground. +40H - 8x - 8x - (-60)
71-75	Strike almost cuts deep into foe's stomach. It only leaves a straight scar. +7H - 2x - (-10)	Strikes slices up foe's abdomen, wreaking havoc with muscles and organs. Foe collapses. +12H - 3x - 3x - (-20)	Slice through lower abdomen leaves blood everywhere. +12H - 4x - 6x - (-20)	Slice through foe's kidney leaves a mark. +35H - 6x - 9x - (-40)	Deep cut into foe's side slices through intestines, kidneys, and spine. He'll need medical aid, and quickly. +40H - 8x - 10x - (-60)
76-80	Hit slides down foe's side, messing up several ribs. +12H - 3x - (-10)	Attack slices up ribs, muscles, and tendons. +20H - 4x - (-20)	Hit to foe's side cuts through ribs and into his lung. +35H - 4x - 6x - (-20)	This is what they call disemboweling. +35H - 6x - 14x - (-40)	Foe is nearly cut in two. Intestines scatter everywhere. +40H - 8x - 15x - (-40)
81-85	Deep hit into abdomen, causing significant organ damage. That had to hurt. +15H - 3x - 2x - (-20)	Hit to upper abdomen tears through muscles and organs. Foe is messed up. +14H - 3x - 3x - (-20)	His gut opens like an over-ripe grapefruit. Is he actually still standing? +25H - 6x - 8x - (-30)	Beam slices through gut, severing spine. Foe is paralyzed. Got a wheelchair? +35H - 5x	Beam slices foe into two halves, top and bottom. (+20)
86-90	A clean slice through bones, muscles, and tendons without hitting a single organ. What are the odds? +15H - 3x - x - (-15)	The strike slides into chest and through lung. Is there a doctor in the house? +25H - 4x - 3x - (-20)	Sternum catches most of the hit, but foe's heart is damaged and his sternum is shattered. Someone's looking out for this guy. +25H - 4x - 7x - (-30)	Beam slices foe's heart in two. Very sad. (+20)	Beam slices foe in two at chest level. (+20)
91-95	Sliding strike across foe's scalp. Make a bad cowboys and indians joke. +8H - 3x - (-5)	Beam wreaks havoc with foe's face. Foe is now blind and deaf on that side of his head. +15H - 4x - 3x - (-20)	Attack cracks the skull. Foe slips into a coma for three months and loses three levels worth of experience. +40H - 9x	Slice chops off foe's head. At eye level. (+20)	Slice to the head goes right through the brain. So sad. (+20)
96-99	Hit to foe's jaw makes a mess. He's mute, -10 to appearance, -5 to potential appearance. +11H - 3x - (-15)	Slice into foe's voice box mutes foe. Very surgical. +20H - 4x - 3x - (-25)	Slice through most of foe's neck. His head seems to be sticking to his body more from habit than physics. +25H - 5x - 11x - (-20)	Slice right through foe's neck knocks the head clear. (+20)	Head is cleanly removed by beam. It bounces twice. (+20)
100	Foe's face is sliced off, and his brain falls out. (+20)	Strike dissects foe's head like a frog. All of its contents fall out. (+20)	Strike into foe's head tells him. He'll wake up in a year or two. (+20)	Foe's head is sliced into five pieces. (+25)	Foe's head is sliced and diced. (+25)

Key: Bx=must parry B rounds; B@=no parry for B rounds; B*x=stunned for B rounds; B@=bleed B hits per round; (-B)=foe has -B penalty; (+B)=attacker gets +B next round.



7.16 SCORCHED CRITICAL STRIKE TABLE

	A	B	C	D	E
01-05	You burn his hand. Foe must make a Light maneuver to continue holding onto anything. +1H	Burn foe's hand. He must make Medium maneuver to continue holding onto anything. +1H - 2X	Beam catches foe's hand and object in it. Object drops to ground and must check for breakage. +2H - 2* - (-10)	Foe's hand, and anything in it, is hit. Object is dropped and must check for breakage. +4H - 4X - (-20)	Beam cuts through foe's armor and several bones in foe's hand. Hand is held together by a scrap of flesh. +6H - 6* - 3 - (-40)
06-10	That'll leave a mark. +1H	Raking attack is caught by forearm armor. The burns are painful. +4H - 2X	Raking attack causes an extensive second-degree burn across foe's forearm. +4H - 2X - (-20)	Blast heats up forearm, causing extensive third-degree burns to foe's wrist. +8H - 4* - (-30)	Beam cuts through armor, slicing two bones and nearly removing foe's arm just above the wrist. +10H - 6* - 3 - (-40)
11-15	Painful burn to foe's biceps. +1H	First-degree burn to foe's biceps. +4H - 2X - (-10)	Tremendous heat causes second-degree burns to foe's biceps. +8H - 4* - 2 - (-20)	Beam nearly cuts through foe's armor at elbow. Third-degree burns. +6H - 8* - 4X - (-30)	Beam cuts through foe's armor, carving through biceps and bone, nearly severing arm. +16H - 12* - 6 - (-50)
16-20	Foe makes a sucking sound. +1H	Heat causes a painful burn to foe's triceps. +4H - 2X - (-10)	Blistering attack leaves second-degree burns on foe's triceps. +8H - 4* - 2 - (-20)	Scaling attack burns through triceps, nearly exposing the bone. +6H - 8* - 4X - (-30)	Beam slices through triceps, breaking bones and nearly severing arm. +16H - 12* - 6 - (-50)
21-30	Heat transfers painfully to foe's shoulder. +2H	Burn scalds foe's shoulder, leaving first-degree burns. +2H - 2X - (-10)	Lots of energy transfers through armor, leaving second-degree burns on foe's shoulder. +10H - 4* - 2X - (-20)	Terrible burn to foe's shoulder nearly exposes the bone. +10H - 6* - 4X - (-30)	Beam finds a flaw in foe's armor, slicing through shoulder joint and nearly removing arm. +10H - 8* - (-40)
31-40	Painful burn to foe's shoulder. +2H	Beam causes first-degree burns to foe's shoulder. +8H - 2* - (-10)	Beam causes second-degree burn right on foe's clavicle. +10H - 6* - (-20)	Beam of intense heat causes third-degree burn nearly to the bone. +10H - 6* - 4X - (-30)	Armor fails, allowing beam to cut through foe's clavicle. +10H - 8* - (-40)
41-50	Heat burns foe's thigh. +1H	Beam is caught by armor, causing first-degree burn to foe's thigh. +8H - (-10)	Beam transfers a great deal of heat, scorching foe's thigh with second-degree burns. +12H - 2X - (-20)	Beam transfers energy into foe's thigh armor, causing third-degree burns to the bone. +16H - 4* - (-30)	Beam manages to carve through armor. Beam slices through thigh and bone, nearly severing his leg. +20H - 8* - (-50)
51-55	Beam catches shin armor, burning foe's flesh. +2H	Beam is caught by shin armor, but heat transfer still causes burns. +2H - 2X	Beam heats up leg armor, giving foe second-degree burns. +8H - 2X - (-20)	Armor burns foe's shin, nearly exposing bone. +20H - 4* - 2X - (-30)	Beam manages to carve its way through armor, slicing through a shin bone, nearly severing leg. +16H - 6* - (-50)
56-60	Foot armor is heated up considerably. +2H	Armor heats up, causing first-degree burns across foe's foot. +8H - 2X - (-10)	Heating armor causes second-degree burns to foe's foot. +16H - 4X - (-20)	Terrible burns to foot nearly expose bone. +20H - 6* - (-30)	Armor fails. If weapon is Hunting Class I or greater, the foot is lost. +24H - 8* - (-50)
61-65	Foe is scalded at the waist +4H - 2X	Beam causes large first-degree burns across foe's hip. +8H - 2* - (-10)	Blistering attack leaves second-degree burns across hip. +16H - 4* - 2X - (-20)	Deep third-degree burns cook all the fat off foe's hip. +24H - 6* - (-30)	Armor fails. Foe's leg is nearly removed at the hip. +40H - 10* - (-75)
66	Scalding blast to foe's rump makes him leap into the air with a yelp. +16H - 4*	Raking attack explodes nearby rock. Foe slips into a coma for 2d10 days. +20H - (-20) - (+25)	Shot finds flaw in foe's head armor. Raking attack cuts deeply into foe's skull, killing him instantly. (+25)	Attack finds flaw in armor. Beam cuts deeply into foe's chest, causing internal bleeding. +40H - 8* - 2 - (-60) - (+25)	Raking attack to foe's groin. Armor fails. Everyone within sight is stunned for one round. +60H - 24* - (-75)
67-70	Hot point forms over knee. +2H - 2X	Heat causes deep burn to knee. +8H - 2* - (-10)	Deep, second-degree burns to foe's knee. +14H - 4* - 2 - (-20)	Attack digs deeply into foe's knee, leaving third-degree burns. +24H - 8* - (-30)	Heat shatters foe's knee. The burns are horrible. +36H - 12* - 8 - (-50)
71-75	Hot swath scalds foe's belly. +2H	Armor causes first-degree burns to foe's stomach. +4H - 2X - (-10)	Deep blister burns are baked into foe's abdomen. +12H - 4* - 2 - (-20)	Strike turns lower abdomen into one massive third-degree burn. +10H - 6* - (-30)	Armor fails. Quick placement of the hand is all that keeps the foe's intestines in place. +16H - 8* - 4 - (-75)
76-80	Raking attack heats foe's side. +6H - 2	Burns to foe's ribs are first-degree at best. +8H - 4* - (-10)	Second-degree burns scald foe's side. +16H - 6* - 3 - (-20)	Deep burns to foe's side expose several ribs. +20H - 8* - 4 - (-30)	Armor fails and several ribs are severed. +24H - 6* - 4 - (-40)
81-85	Scalding burns to foe's stomach. +6H - 2X	First-degree burns to foe's abdomen force him to give up initiative next round. +8H - 2* - (-10)	Blistering assault leaves second-degree burns across foe's gut. +12H - 4* - 2 - (-20)	Attack burns into foe's side, exposing several ribs. +16H - 6* - (-30)	Armor fails. Burns to foe's back are so severe his spine is exposed. +30H - 4* - 2 - (-20)
86-90	Scalding first-degree burns to foe's chest. +6H - 2X	Particularly extreme attack spreads second-degree burns across foe's chest. +16H - 4* - 2 - (-20)	Armor nearly fails. Third-degree burns damage several ribs. +20H - 6* - (-30)	Horrible, scalding attack burns right through to foe's sternum. +20H - 6* - (-60)	Attack penetrates armor and sternum. It's a miracle he survives. +30H - 8* - 2 - (-75)
91-95	Foe's ear is nearly burned off. +4H	First-degree burns to foe's head. +6H - 6* - 3	Second-degree burns to foe's head and ear. +12H - 4* - 2 - (-20)	Severe burns peel flesh off foe's forehead and cheeks. Foe passes out for six hours. +24H - (-30)	Helmet armor fails. Resulting attack slices through foe's brain. (+20)
96-99	Nasty burn to foe's cheek takes 10 off his appearance until healed. +8H - 4* - 2 - (-10)	Burns cause blisters to rise on foe's face and lips. -20 to foe's appearance until healed. +12H - 4* - 2 - (-20)	Beam pierces armor and trachea. Foe collapses and will drown in his own fluids after three minutes without medical attention. +12H - 6* - (-30)	Flaw in foe's armor lets just enough energy through to open foe's carotid artery. Foe will die in five minutes without medical aid. +6H - 6* - (-40)	Attack cuts through armor, spine and spinal cord. Foe is paralyzed. +16H - (-75)
100	Flash of heat burns both of foe's eyes. He is now blind. +10H - 4* - (-100) - (+20)	Blast fuses foe's ear to foe's helmet. +12H - 6* - (-20) - (+20)	Beam slices through helmet, cutting deep into foe's brain. (+20)	Beam slices through helmet. Foe is in a coma for three years and mental stats and pot. are halved. (+20)	Beam slice through helmet, cutting foe's head in half. (+25)

Key: βx=must parry β rounds; β∅=no parry for β rounds; β*β=stunned for β rounds; β•=bleed β hits per round; (-β)=foe has -β penalty; (+β)=attacker gets +β next round.



7.17 STUN CRITICAL STRIKE TABLE

	A	B	C	D	E
01-05	Maybe you'll get a second chance. +0H	Foe shrugs it off. +0H	Foe shakes his head to clear it. +0H	Foe turns his ankle. +2H	Foe reaches out to steady himself. +0H - ✪
06-10	No effect. +0H	Foe staggers. +1H	Foe is dazed a moment. +0H - ✪	Foe has a hard time functioning for three rounds. +0H - ✪ - 3(-20)	Foe falls to one knee. +0H - 3✪✪
11-15	Foe stumbles. +1H	Foe is a little off for three rounds. +0H - 3(-10)	Foe has a hard time with his hand-eye coordination for 4 rounds. +0H - 2✪ - 4(-20)	Foe leans against the nearest object for support. +0H - 3✪	Foe's coordination is messed up for 2 days. +0H - 5✪ - (-10)
16-20	Foe is shaken. +0H - ✪	Foe is dazed. +1H - ✪ - (x -20)	Foe looks at you, surprised. +0H - 3✪	Foe loses the use of his arm for 24 rounds. He stumbles. +4H - 5✪ - 24(-20)	Foe's legs stop working for 3 days. +0H - 8✪ - (-25)
21-30	Foe is somewhat dazed. +0H - 2✪	Foe looks around, confused. +0H - 2✪	Foe is stunned. +0H - 4✪ - 4(x -10)	Foe is paralyzed from the waist down for 7 rounds. If standing, he takes the damage below. +5H - 7(-50)	Foe loses control of his neck muscle and his head falls asleep for 12 rounds. +0H - 12✪
31-40	Foe is stunned. +0H - 2✪	Foe is disoriented. +0H - 3✪ - (x -20)	Foe falls to one knee, struggling to remain conscious. +0H - 5✪✪	Foe is having a hard time concentrating. +0H - 8✪	Foe wanders off, confused, for 16 rounds. +0H - 16✪✪
41-50	Foe is having trouble. +0H - 3✪	Foe reaches out to steady himself. +0H - 4✪	Foe has a problem with hand-eye coordination for 1 hour. +3H - 6✪	Foe falls, hard. +6H - 9✪✪	Foe is disoriented and confused. +0H - 20✪ - 10✪
51-55	Foe is confused. +0H - 2✪ - (x -20)	Foe is knocked to his knees. Penalty only applies next round. +0H - 5✪ - 1(-30)	Foe's limbs feel wooden for 7 rounds. +0H - 7✪ - 7(-30)	Foe collapses, stunned. +0H - 10✪✪	Foe is lost and unable to cope with his surroundings. +0H - 24✪✪
56-60	Well done. +0H - 3✪	Foe staggers and falls against something pointy. +3H - 6✪	Foe has a hard time moving right for about 12 rounds. +0H - 8✪ - 12(-20)	Foe is incapacitated for 11 rounds. +0H - 11✪✪	Foe goes down, hard. +0H - 28✪✪
61-65	Foe falls to one knee. +0H - 4✪ - ✪	Foe's arms cease functioning for 7 rounds. +0H - ✪	Neural pathways disrupted. Foe is blind for 9 rounds. Foe falls. +5H - 9✪✪	Foe drops to the ground in a grand mal seizure. It lasts 12 rounds. +7H - 12✪✪	Foe does a face plant. Graceful. +10H - 32✪✪
66	Foe falls. He isn't orienting well at all. +7H - 10✪ - 5✪ - (+25)	Foe collapses, landing wrong. He looks like that hurt. +10H - 15✪✪ - (+25)	Attack takes all the life out of foe's limbs. He falls, paralyzed, for 20 rounds. +13H - 20✪✪ - (+25)	Foe collapses, snapping an arm in the process. He is unresponsive for 24 rounds. +18H - 24✪✪ - (-40) - (+25)	Foe collapses in a coma for 20 days. Penalty lasts an additional 20 days. +25H - (-30)
67-70	Foe drops his weapon. +0H - 5✪	Foe is dazed. He drops anything in his hands and stares into space, completely unresponsive, for 8 rounds. +0H - 8✪	Foe begins drooling all over himself as he collapses, paralyzed. Pathetic. +0H - 10✪✪	Foe collapses into a quivering pile for 13 rounds. His equipment is scattered. +0H - 13✪✪	Foe collapses on his equipment, causing random damage. +0H - 36✪✪
71-75	Foe falls to one knee. +1H - 6✪ - 3✪	Foe's legs fold underneath him. His legs refuse to work for 10 rounds. +0H - 9✪	Foe falls to his knees. He is not doing well. +0H - 11✪ - 11(x -50)	Strike wrecks foe's coordination for 14 rounds. +0H - 14✪✪ - 14(-50)	Foe loses control of his limbs for 40 rounds. Guess he'll have to use harsh language. +0H - 40(-50)
76-80	Foe is really disoriented. +0H - 10✪	Muscles give out. Foe is paralyzed for 10 rounds. +0H - 10✪✪	Foe is messed up. He can't quite move right for 15 rounds. +0H - 12✪ - 15(-40)	Foe's neurons begin misfiring. He isn't himself for 20 hours. +0H - 15✪✪ - (-50)	Foe is uncoordinated for two days. +0H - 45✪✪ - (-50)
81-85	Foe is knocked down. +2H - 8✪✪	Foe falls to his knees. +0H - 11✪ - 3✪	Foe manages to stay upright for three rounds, after which he collapses for 10 rounds, paralyzed. +6H - 3✪✪	Attack leaves one half of foe's body paralyzed for 16 rounds. +0H - 19(-70)	Something goes terrible wrong. Foe's heart goes into arrest. Immediate medical attention should save him. He has 10 rounds. +0H - (-20)
86-90	Foe is really out of it. +0H - 9✪✪	Foe collapses as his muscles give out. He is paralyzed for 12 rounds. +0H - 12✪✪	Foe is uncoordinated for 5 hours. +0H - 14✪ - (-20)	Foe is paralyzed, but fully conscious, for 17 rounds. +9H	Foe falls hard. He slips into a 30-day coma. +20H
91-95	Foe is lost. Penalty lasts for one hour. +0H - 10✪✪ - (-25)	Sonics scramble foe's brain. His body doesn't work right for 24 hours. +0H - 15✪ - (-20)	Foe's eyes won't focus. All actions involving vision are penalized for 1 day. +0H - 18✪ - (-50)	Foe wishes he were dead. +0H - 18✪✪	Motor control is spotty at best. Foe is unable to fight for 24 hours. +0H
96-99	Foe is out cold for 15 rounds. +4H	Foe collapses, cutting himself. He cannot move for 20 rounds. +5H - 20✪✪ - ♠	Foe collapses, paralyzed, for 24 rounds. He then tries on a 10-day coma. +0H - 24✪✪	Foe is incapable of all but the briefest moments of lucidity for 3 days. +0H	Foe folds like a bad poker hand. He will not regain consciousness for 30 days. +0H
100	Foe begins to spasm. He has whiplash. He won't completely shake this off for 3 hours. +0H - 10✪✪ - (-40) - (+20)	Foe is knocked cold for 24 rounds. When he wakes up, it takes 6 hours for his coordination to come back. +0H - (-50) - (+20)	Foe feel his legs go out from underneath him. He lands hard, and doesn't shake off the effects for 24 hours. +8H - 30✪✪ - (-40) - (+20)	Foe goes down like the Titanic. +15H - 50✪✪ - (+20)	Foe falls, hitting his head and causing tremendous blunt trauma. Foe dies. (+25)

Key: B✪=must parry B rounds; B✪✪=no parry for B rounds; B✪✪=stunned for B rounds; B♠=bleed B hits per round; (-B)=foe has -B penalty; (+B)=attacker gets +B next round.



7.18 SUPER LARGE ANIMAL BALLISTIC CRITICAL STRIKE TABLE

	PUNCTURE	HOLLOWPOINT	ARMOR PIERCING	IMPACT	SHRAPNEL
01-05	What are you trying to do, scare him to death? +0H	You really weren't trying to hurt him were you? +0H	Bad shot. At least you used a decent bullet. +3H	This is really unfair, isn't it? +0H	Well, you have managed to scratch several of his itches at once. Maybe he will let you live. +0H
06-10	It bounced right off his hide. Very impressive, that. +2H	I'm not sure it felt that one. +0H	Okay, it isn't laughing anymore. +3H	Wow, that armor is really impressive. Sorry you didn't want to hear that. +0H	Nice shot. He has a few minor cuts. +2H
11-20	Rough shot glances off foe's side. He might have noticed that one. +3H	Rough shot glances off foe's side tearing a little skin. He looks around to see where the bullet came from. +2H	Rough shot penetrates foe's side. He looks right at you in anger. +4H	Rough shot glances off foe's side. He farts in your general direction. +0H	Rough shot splatters against side. He swings his head from around. +4H
21-30	Solid hit to foe's forearm stirs foe. +4H	Don't you wish you were using different ammunition. Even his forearm's have blubber. +2H	Solid hit to foe's forearm causes it to rear back. +8H	Solid hit to foe's forearm causes it to rear back. +1H - X	Solid hit to foe's arm and chest causes it to rear back. +4H - X
31-40	Shot to foe's chest glances off a rib. +5H	Shot to foe's chest is pretty ineffective. +3H	Shot to foe's chest breaks a rib. +14H - 1 - (-10)	Shot glances off foe's side +3H	Shrapnel glances off several ribs. +13H - X - 1 - (-5)
41-50	Shot to foe's side. He leaps back and away from you. +7H	Shot to foe's side. He leaps back and away from you, and then sets for a charge. +5H - 1	Shot to foe's side. He shuffles back in obvious pain. +10H - 2	Shot to foe's side startling him +3H	Shrapnel pierces foe's side. He leaps back and away from you. +10H - X - 2
51-65	Bullet slams into foe's leg. He bellows in pain +8H	Bullet slams into foe's leg. You seem to have done some minor muscle damage. +7H - 1 - (-5)	Bullet goes through foe's leg without hitting anything vital. +15H	Bullet slams into foe's leg. He grimaces (if possible) in pain +5H	Shrapnel ribs, tra-la-la, through foe's leg muscles. +15H - 2 - (-10)
66	Well done, Old Boy. Got him right in the neck. Hope he dies before he charges us. +15H - 20	Got him right in the neck. He appears to be gargling his own blood. +4H - 5	Nice shot, but a I think you lodged it near his spine +15H - 2 - (-15)	The good news is that you get the effects below if they didn't armor the beast's mouth. If they did, then disregard this critical altogether. +18H - 2 - 6 - (-10)	That was an interesting way to perform a tracheotomy +40H - 6 - 30 - (-30)
67-70	Foe's leg catches your shot at the right moment. He should feel that one. +12H	Foe's leg catches your shot at the right moment. He should feel that one. +9H - 1	Foe's leg catches your shot at the right moment. He is in serious pain. +14H - (-15)	That'll leave a nasty bruise. +7H - X - (-10)	Shrapnel rips through foe's leg tearing muscle and tendon. +12H - 2 - 2 - (-10)
71-80	Arm shot got decent penetration. +12H - 2	Arm shot rips at muscles and tendons. +10H - 2 - (-10)	Arm shot penetrated deep, nicking bone. +12H - 3 - (-10)	Arm shot hits with crushing force, assuming you weren't shooting at such a large target. +8H - 1 - (-5)	Shrapnel makes some really interesting tendrils out of his skin. +12H - 1 - 3 - (-10)
81-90	Gut shot staggers foe. Make the next one count. +10H - 1 - (-10)	Gut shot staggers foe. +6H - 1 - (-10)	That one went deep. +20H - 2 - (-10)	Foe drops to one knee. Hit him while he is down. +8H - 1 - (-10)	Shrapnel confuses and stuns foe. Make the next one count. +15H - 2 - 1 - (-10)
91-95	Shot nicks artery in leg. Foe is bleeding slowly (assuming he bleeds at all that is). +12H - 2 - 3 - (-10)	Shot destroys major muscle. +18H - 3 - 4 - (-30)	Shot pierces artery in leg. Foe is bleeding badly (assuming he bleeds at all that is). +12H - 1 - 7	Leg hit leads to massive bruising and a cracked bone. +10H - 1 - (-15)	Artery severed in foe's leg. +20H - 3 - 12 - (-15)
96-98	Bullet nicks foe's heart. He should slowly bleed to death. Have fun. +20H - 12	Bullet lodged near heart. Foe is in lots of pain. +20H - 4 - 6 - (-20)	Heart shot. Foe dies instantly of shock. —	Chest shot cracks sternum. +35H - 6 - 1 - (-75)	Center chest shot sends shrapnel ripping through foe's internal organs. Foe looks surprised, then dies. —
99 - 100	Shot penetrates foe's lungs. Foe is in shock for 6 rounds. +15H - 20 - (-20)	Shot collapses one of foe's lungs. +30H - 3 - 8 - (-30) - (+20)	Shot through both lungs. Foe drowns in his own blood after 9 rounds. +12H - (+20)	Side shot breaks several ribs. Foe is bleeding internally. +25H - 3 - 4 - (-35) - (+20)	Shrapnel rips through both lungs. Foe is in shock and drowns in his own after 3 rounds blood. +15H - (+20)
101 - 150	Shoulder hit staggers foe. +15H - 2 - 1 - (-15)	Shoulder hit spins foe. +12H - 1 - 2 - (-10)	Shoulder hit spins foe shattering bone as it goes through. +25H - 4 - 1 - (-55)	Shoulder hit spins foe, bruising bone and muscle. +12H - 1 - (-10)	Shoulder hit shreds muscles and tendons. +35H - 4 - 1 - 6 - (-45)
151 - 175	Shot to foe's abdomen perforates his kidneys. Amazingly, he is up an fighting for six rounds before dying of shock. Have fun. —	Shot to foe's abdomen leaves a great bloody wound. Foe bellows in pain. +25H - (-15)	Shot to foe's abdomen perforates his kidneys. Amazingly, he is up an fighting for six rounds before dying of shock. Have fun. —	Abdominal shot leaves foe bruised and staggering. +25H - 2 - (-15)	Shrapnel perforates foe's kidneys. Amazingly, he is up an fighting for three rounds before dying of shock. Have fun. —
176 - 200	Bullet pierces abdominal arteries. foe's blood covers the ground. +15H - 25 - (+25)	Bullet lodges in foe's hip. +20H - (-30) - (+25)	Bullet pierces abdominal arteries. foe's suffers massive internal bleeding. Hey, you'd be dead from this bleeding pretty quick. +18H - 14 - (+25)	Bullet to abdomen crushes muscle. Foe is slowly bleeding to death. +25H - 7 - (-45) - (+25)	Foe appears to have been disemboweled. Blood and entrails are spread all over the field. +35H - 7 - 1 - 30 - (-45) - (+25)
201 - 250	Shot to forelimb breaks bone and severs an artery. Foe is up and fighting, at least until he bleeds to death. +20H - 15 - (-10)	Shot to forelimb nicks bone and an artery. Foe is up and fighting, at least until he bleeds to death. +15H - 8 - (-10)	Shot to forelimb shatters bone and severs an artery. Foe drops. +25H - 15 - (-55)	Forearm shot crushes bone. +25H - 3 - 1 - 6 - (-20)	Shot to forelimb shatters bone and destroys an artery. Leg useless. +33H - 5 - 1 - 15 - (-45)
251+	Beautiful shot takes foe right between the eyes, leaving him less than alive. You spend the next two rounds admiring your handiwork. —	Beautiful shot takes foe right between the eyes, shame the round can't penetrate his skull. +25H - 4 - 2 - (-5)	Beautiful shot takes foe right between the eyes and exits out the back of the skull. (+25)	Beautiful shot takes foe right between the eyes knocks foe unconscious for the next six rounds. +30H - (-15) - (+25)	Shrapnel appears to sand all the flesh off of foe's face. Thankfully, some pieces when into his eyes and brain, killing him instantly. —

Key: Bx=must parry B rounds; B∅=no parry for B rounds; B⚡=stunned for B rounds; B1=bleed B hits per round; (-B)=foe has -B penalty; (+B)=attacker gets +B next round.



7.19 SUPER LARGE ANIMAL ENERGY CRITICAL STRIKE TABLE

	BLASTER	LASER	PLASMA	BURN/SCORCH	BURST/RAKING
01-05	You trying to <i>scare</i> the life out of him? +0H	Well . . . that could have been better. +3H	You weren't intending to kill him or anything, were you? +0H	Good grief! They armored <i>that!</i> +0H	You managed to scratch all it's itches. Maybe it won't kill you. +0H
06-10	Looks like it didn't even get through his hide. Impressive. +2H	You got his attention. +3H	I don't think he even noticed you. +0H	That looks like body armor. +0H	You cause a few minor abrasions. +2H
11-20	Shot glances off foe's side. You might have gotten his attention. +3H	Shot bites deep into foe's side. I think you made him mad. +4H	Plasma burns through some skin. He looks around. +2H	Um . . . life's a bitch, ain't it? +0H	Attack spatters against foe's side. He turns to look at you. +4H
21-30	Solid forearm hit stirs foe. +4H	Respectable forearm hit causes foe to rear back. +8H	Too bad plasma has such poor penetration properties. +2H	Looks like a bit of that got through. +1H - X	Solid chest and arm hit. It rears in anger. +4H - X
31-40	Beam glances off foe's rib. +5H	Shot cuts through foe's rib. +14H - (-10)	Ineffective chest shot. +3H	Shot glances off foe's side. +3H	Attack doesn't quite break ribs. +13H - X - (-5)
41-50	Shot catches foe in his side. He leaps back. +7H	Shot catches foe in the side. He shuffles back in obvious pain. +10H	Shot to foe's side. He leaps back and sets for a charge. +5H	Foe catches blast in his side. He's burned. +3H	Attack pierces foe's side. He leaps back. +10H - X
51-65	Respectable hit to foe's leg. He bellows in pain. +8H	Beam passes through foe's leg, missing all vitals. +15H	Plasma burns into foe's leg. Minor muscle damage. +7H - (-5)	Hot spot causes a significant burn. +5H	Attack tears through foe's leg muscles. +15H - (-10)
66	Nice shot. You caught him right in the neck. You think he'll die before he charges? +15H - 19	Shot to spine nearly paralyzes foe. +15H - 2 - (-15)	Blast catches him in his neck. Blood oozes from the wound. +4H - 0	Hit foe in mouth. If mouth is armored, then ignore this crit. Otherwise: +18H - 2 - 3 - (-10)	Very innovative way to perform a tracheotomy. +40H - 6 - 29 - (-30)
67-70	Good leg hit. It looks like that smarts. +12H	Attack catches foe's leg at exactly the right moment. He felt that one. +14H - (-15)	Plasma caught foe's leg at just the right moment. It looks painful. +9H	Looks like a nasty burn. +7H - - (-10)	Attack rips through foe's leg, tearing up muscles and tendons. +12H - 2 - (-10)
71-80	Arm shot gets decent penetration. +12H	Beam cuts deep, taking a piece out of foe's arm. +12H - (-10)	Arm shot rips through muscles and tendons. +10H - (-10)	That burn would have crippled a smaller foe. +8H - - (-5)	Attack tears up skin, but does little else. +12H - - (-10)
81-90	Gut shot staggers foe. That stopped him for a round. +10H - - (-10)	Attack bites deep. +20H - 2 - (-10)	Gut shot staggers foe. +6H - (+10)	Foe drops to one knee. Now's your chance. +8H - - (-10)	Attack stuns foe. Here's your chance. +15H - 2 - (-10)
91-95	Shot nicks artery in leg. If foe can bleed, he is oozing blood. +12H - 2 - 0 - (-10)	Beam pierces artery in foe leg. If foe has blood, it's leaking all over the place. +12H - - 6	Attack destroys a major muscle. +18H - 3 - (-30)	Leg hit leads to terrible burn. +10H - - (-15)	Attack clips major artery in foe's leg. +20H - 3 - 11 - (-15)
96-98	Beam nicks foe's heart. He should probably bleed to death . . . eventually. Take cover. +20H - 11	Beam passes through foe's heart. He is ever so dead.	Plasma burns through, almost to foe's heart. Foe is in pain. +20H - 4 - 2 - (-20)	Attack finds flaw in armor. Sternum is shattered. +35H - 6 - (-75)	Attack tears through several internal organs. Foe makes a startled sound, then dies.
99-100	Beam passes through both lungs. Foe dies after 6 unpleasant rounds. +15H - 19 - (+20)	Beam passes through both lungs. Foe will drown in his own blood after 9 rounds. +12H - (+20)	Plasma collapses one of foe's lungs. +30H - 3 - 4 - (-30) - (+20)	Attack cuts through armor. Foe is bleeding ever so slowly. +25H - 3 - 0 - (-35) - (+20)	Attack tears through foe's lungs. Foe collapses and dies after 3 rounds of drowning. +15H - (+20)
101-150	Shoulder hit causes foe to stagger. +15H - 2 - 0 - (-15)	Beam slices through shoulder, shattering bone as it passes. +25H - 4 - 0 - (-55)	Shoulder hit burns foe. +12H - - 0 - (-10)	Foe bellows as shoulder hit causes a deep burn. +12H - - (-10)	Shoulder shreds muscles and tendons. +35H - 4 - 0 - 3 - (-45)
151-175	Beam passes through foe's kidneys. Foe manages to continue fighting for 6 rounds before dropping.	Beam cuts through foe's abdomen and kidneys. He manages to keep fighting for 6 rounds before dropping.	Shot to gut leaves a charred wound. +25H - (-15)	Abdominal burns stun foe. +25H - 2 - (-15)	Attack shreds kidneys. Somehow, the foe manages to fight for three rounds before dying.
176-200	Beam passes through several very important abdominal arteries. +15H - 24 - (-25)	Beam slices through abdomen, damaging several major arteries. The internal bleeding is considerable. +18H - 13 - (+25)	Plasma burns deeply into foe's hip. +20H - (-30) - (+25)	Attack finds flaw in armor. Attack cuts into foe's abdomen. +25H - 6 - (-45) - (+25)	Way to disembowel him. That's really messy. +35H - 7 - 29 - (-45) - (+25)
201-250	Shot to forelimb severs a major artery. Foe is still fighting, however. +20H - 14 - (-10)	Beam cuts through forelimb, shattering bone and severing arteries. +25H - 14 - (-55)	Plasma burns deep into foe's forelimb. At least he's bleeding. +15H - 4 - (-10)	Forearm attack cuts through armor and bone. +25H - 3 - 0 - (-20)	Forelimb attack shatters leg and destroys arteries. Leg is a write-off. +33H - 5 - 0 - 14 - (-45)
251+	Beam passes right between foe's eyes. Foe drops dead immediately. Well done.	Beam passes neatly through foe's skull. Foe is quite dead. (+25)	Right between the eyes. Too bad it can't burn through foe's skull. +25H - 4 - 2 - (-5)	Attack hits foe right between the eyes. Foe is knocked unconscious for 6 rounds. +30H - (-15) - (+25)	Attack tears foe's face off. He stumble two steps, then falls . . . dead.

Key: Bx=must parry B rounds; B0=no parry for B rounds; Bst=stunned for B rounds; B0=bleed B hits per round; (-B)=foe has -B penalty; (+B)=attacker gets +B next round.



7.20 ENERGY WEAPON FUMBLE TABLE

	Mini Weapons	1-Handed Energy	2-Handed Energy	Fully Automatic
01-05	Where'd that little thing go?	In a bizarre display of tactics, you choose not to fire this round. Maybe next round you'll feel like taking a shot.	You hesitate a moment too long. The round passes.	You had it on the wrong setting. One shot flies wild.
06-10	You fumble with your weapon. You miss your opportunity.	You're almost positive that there is a trigger around here somewhere.	You quite thoroughly miss.	The power cell runs dry, mid burst. Did you remember to change that thing? Your attack hits, does half damage, a critical of one level less severity.
11-15	You are distracted by a flicker of light.	You are frightened by a spider. Wisely, you squeeze off a couple of shots at the nasty beast.	You pull the trigger while the weapon is still pointing at the sky. You are so startled, you fail to attack this round.	What were you firing at, elves?
16-20	Your grip is uncertain. You elect not to fire this round.	In a moment of dyslexia, you aim and fire with your empty hand. Maybe you'd look better if you said, "Zap!"	You fire into the nearest inanimate object. You are stunned for one round by your own stupidity.	You draw the line of death in the ground. That was what you were intending to do, wasn't it?
21-30	Didn't evolution give you an opposable digit?	What does that little flashing red light mean? You spend a round trying to figure it out.	Well, that wasn't a good grip at all.	Fully automatic firing is no longer possible. It looks like it's broken. Have you been developing your rapid fire skill?
31-40	Just before firing the weapon, you realize that you were holding it backwards. That was a close one!	Why won't it fire? Oh, yeah. The safety.	You are stunned for one round by your own incompetence.	The weapon doesn't fire. You might want to check the safety.
41-50	Boy, that little thing is hard to hold on to.	Whoops! There goes the energy cell. Hope it doesn't bounce too far.	Your shot flies wild. Reroll the attack on the person nearest your target.	The weapon cell is ejected. It skitters away. It will take you two rounds to retrieve it.
51-60	You manage to catch the slippery little bugger just before it hits the ground. Was it fragile?	You are stunned for one round by the complexity of the weapon. Maybe you should take one of those gun classes.	You fire the weapon firmly into the ground. You might want to try saying something like, "Yep, it works alright."	You accidentally touch the barrel. You take 10 hits and are stunned for three rounds. Got any aloe?
61-65	That is one patch of ground that will never hurt anyone again. Good job, Tex.	You put a tiny hole through the fist of your nearest ally. Hope he believes your story.	Your shot travels under the nose of the nearest ally. Get a good excuse ready.	You accidentally whack the gun against a solid object. The sights no longer work. -10 to attacks.
66	You are so happy to find a place to put all of your fingers that you don't realize that one is over the barrel. You should probably look for that finger. 10 hits, stunned for three rounds.	You spin your weapon around and deliver a point blank attack on yourself (+0 OB). Hope you're wearing some armor.	You move your hand in front of the barrel, which accidently discharges. Deliver a +100 attack to your hand.	You fire prematurely, delivering a +100 OB attack on your nearest ally. This is very bad.
67-70	Hey, that was the button that pops out the power cell. Swift.	You cough loudly. As you move your hand to cover your mouth, you chip a tooth. You are stunned for two rounds.	You are stunned for 2 rounds as you nearly blow your foot off.	Coolant malfunctions cause the barrel to warp from heat. Weapon is now -25.
71-80	Weapon flies a good 3 or 4 meters before skidding to a halt.	You threw the gun right at him. Maybe that wasn't the wisest of moves. You have a spare, right?	Painful muscle spasm. You take 12 hits, are stunned for 2 rounds, and perform an unintentional rapid fire action.	The weapon slips and you swiftly drop kick it 5 meters. Add 4 to the breakage number and check for breakage.
81-85	Weapon flies into the air, landing on a really hard patch of ground. Check for breakage.	Your fingers are thoroughly twisted up. It takes three rounds to extract yourself from your weapon.	You spin, smashing the weapon aperature against the nearest solid surface. Roll for breakage.	Coolant malfunction warps barrel, giving the weapon a -30 penalty.
86-90	You stumble and fire into the heavens. You are so shocked by your actions that you are stunned for two rounds. What were you thinking?	You spin to fire, trip, and let the energy fly. You're not sure what you hit because of your sudden, violent acquaintance with the ground. Stunned for 2 rounds.	Your weapon comes apart in your hand, for easy storage. You are stunned a round. Then take two rounds putting it back together. Maybe nobody noticed.	The firing mechanism jams. After the first cell empties, you might want to have a weapon tech look at it before inserting another one.
91-95	You drop your weapon, and step on it while scrambling after it. Check for breakage. You are stunned for three rounds.	You just shot yourself in the foot. You are more stunned by the irony than the pain. +10 hits. Stunned for 5 rounds. Bleed 2 hits per round.	You fire at an imaginary man-eating plant. You miss.	The gun bursts. Take a 'C' Ballistic Puncture critical. Wow.
96-99	Your fingers get all stuck in the mechanism. You lose three rounds getting the gun to work again.	You blast away at your own knee. 20 hits, stunned for 5 rounds, bleed one per round.	Your hand slides too far forward. You burn yourself on the barrel. Take 9 hits and 2 rounds of stun.	Deliver an aimed burst (+0 OB) into your own foot.
100	In a grand display of your pathetic abilities, you blow your ear off. Take 5 hits. Bleed 2 per round.	You blast a nearby rock. It explodes. Take 30 hits and bleed 5 more each round.	You expertly fire the weapon into your own foot. 20 hits. 3 rounds of stun. 7 hits per round of bleeding.	The weapon grounds. Take an 'E' Electricity critical every round until someone kicks it out of your hand.

Key: β×=must parry β rounds; β⊗=no parry for β rounds; β⊗=stunned for β rounds; β●=bleed β hits per round; (-β)=foe has -β penalty; (+β)=attacker gets +β next round.



7.21 FIREARM FUMBLE TABLE

	1-Handed Firearms	2-Handed Firearms	Muzzle Loaders	Revolvers	Full Automatics	Semi-Automatics
01-05	Mysteriously, you elect not to fire during this phase.	A moment's hesitation loses you the opportunity to fire this phase.	Wet powder. Reload.	Dud round. You may fire again normally next phase.	Dud round prevents fire this round. You must manually clear the chamber (10% activity) before firing again.	Dud round. You must manually clear the chamber (10% activity) before firing again.
06-10	Your clumsy maneuvers prevent an effective shooting opportunity. Try again next phase.	Poor grip and nasty kickback really do a number on your shoulder. You miss and take 10 hits.	Spilled powder out of the pan onto the ground. Re-prime (10% activity) and you can try again.	Dud round. You waste the rest of the round swearing.	Dud in the middle of firing burst. You get half the effect you wanted this round (half damage and one less critical severity). Clear the chamber (10% activity) before firing.	Dud round. Lose the rest of this round being annoyed. You must manually clear the chamber (10% activity) before firing again.
11-15	Distracted by a passing bird, you fail to fire this round.	You pull the trigger while aiming at the sky. If there is anything directly above you, you may make an attack on it.	Ooops. Forgot to prime. Prime the pan and you can try again.	Round goes off normally, but splits the casing. Next reload action will take an extra 30% activity.	Split round in the middle of the firing burst. You get half the effect you wanted this round (half damage and one less critical severity). It will take a 50% activity to clear the chamber.	Weapon fires, but casing splits. Take 50% activity to clear the round before you may fire again.
16-20	Get your eyes checked. Momentary double vision convinces you that it would wait out the rest of this round. You are at -50 for the rest of the round.	You empty a round into the ground. You are stunned for one round (and quite surprised).	Powder not properly tamped down. Shot goes off as normal, but does half damage and one less critical severity.	Poor powder quality sends an underpowered shot down range. Half concussion damage and one less critical severity.	Bad ammo cost you a full effect. You get only half the effect you wanted out of this burst (half damage and one less critical severity)	Poorly made round inflicts only half damage this round (and one less critical severity)
21-30	For a moment you think your opponent is your old friend. You lower your weapon instead of firing.	The gun is suddenly quite heavy! The barrel dips too low to fire this round.	Pulled the arm back too hard. You grimace as you hear the lock spring snap. Gun will not fire until repaired.	You cocked the hammer too fast and snapped the main spring. Gun will not fire until repaired.	Operating action is defective. This gun may now only be fired in semi-automatic mode and 10% activity must be spent to cycle the rounds manually.	Recoil spring is defective. You must spend 10% activity between each shot to cycle the rounds manually.
31-40	Your spastic shooting hits 3 yards short of the target. You are at -30 for the next round while you recover.	Slight sprain to your non-weapon wrist causes all further 2-handed attacks to be at -20. Take 5 hits from the jolting	Sear breaks. Gun will no longer lock the hammer. Gun may still be fired, but with a -20 penalty.	Sear snaps off. Gun cannot be fired in a double-action mode. Hammers must be held back manually (-20 to OB).	Sear damaged beyond repair. Gun may only be fired in full-auto mode until repaired.	Sear breaks off. Gun will now act as an auto weapon (full-auto only).
41-50	Chose wrong target. Reroll the attack against a target (friend or foe) closest to the person you thought you were attacking.	Shot goes wide. Reroll the attack against a target who is nearest to the person you thought you were attacking.	Lock's springs were loose. Mechanism spills out onto the ground. Gun will not fire until you find the pieces and repair	Cylinder pin breaks, dropping it at your feet. Gun will not fire until you get it repaired.	Clip release brokes and drops on the ground. Rounds may be reloaded manually. Gun will only fire in single shot mode.	Clip snaps off and is now lost. Rounds may be manually loaded (taking 50% activity).
51-60	Apparently, you were aiming at a bird, not your target. If you survive, you have dinner.	You didn't even see that rabbit before he jumped in front of your bullet to save your target from certain death.	Too much powder sends an extra thick cloud of smoke through the touch hole. You squint your eyes in pain. Take 3 hits and are stunned for 2 rounds.	Round had too much power. You wince in pain. Take 5 hits and are stunned for 1 round.	Recoil is almost too much for you. You might consider going with a smaller caliber. Take 10 hits and are stunned for 3 rounds.	Round had too much power. You wince in pain. Take 5 hits and are stunned for 1 round.
61-65	Shot goes straight down, barely missing your foot. Don't blame me, you rolled this result.	Shot goes wide, ricochets off a tree and barely misses your closest ally. He is not happy.	Heavy recoil causes no damage to you, but wrenches the barrel out of alignment. Gun is at -25 to all shots until repaired.	Sight is out of alignment. -25 to OB until it is replaced or re-adjusted.	Sight is shaken out of alignment. -10 to all shots until you can repair it.	How did your sight get out of whack. -25 to all shots until you get it fixed.
66	You artfully spin the weapon in your hand and deal a point-blank attack on yourself (with +0 OB). Say "Goodnight, Gracey."	Poor grip sends weapon crashing back into your shoulder. Take an attack on the Fall/Crush Table with a +40 OB.	Heavy recoil sends gun flying. There is a 50% chance it hits a nearby friend for 15 hits and an 'A' Krush critical.	You didn't expect that. The severe recoil sends the gun flying. There is a 50% chance that it hits a nearby friend for 10 hits and an 'A' Krush critical.	Gun is out of control! It recoils back and flies out of your grip. There is a 50% chance it hits a nearby ally for 15 hits and a 'C' Krush critical.	Heavy recoil sends gun flying. There is a 50% chance it hits a nearby friend for 15 hits and an 'A' Krush critical.
67-70	Poke yourself in the eye while trying to get fancy. Take 8 hits and are stunned for 2 rounds.	Break a finger. Take 8 hits. All weapon attacks with that hand suffer a -35 penalty.	Stock is split by the recoil. If it was a pistol, it now fires at -30 to all shots. Rifles or muskets suffer a -40 penalty.	That custom grip is split by the recoil. This gun now has a -15 to all shots.	Severe recoil splits the grip. Now this gun has a special penalty of -25 to all shots.	Grip is split by the recoil. All shots suffer a penalty of -15.
71-80	You weren't supposed to throw the weapon. Foe dodges easily. Check to see if your weapon broke.	I see your master plan now, throw the weapon at your opponent's feet and then hit him while he is suprised. What? No?	Stock splits in two from the recoil and tears your arm. Take a 'C' Slash critical.	Those revolver are a little tough to get a grip on. You gracefully drop the thing and it bounces a good 2 yards. Roll for breakage.	You fumble with your weapon and send it spinning end over end a good 5 yards. Add 4 to its breakage number and check for breakage.	I didn't know you could juggle! Ooops. Gun hits you in the head. Take an 'C' Krush critical.
81-85	Fingers mysteriously entangled in weapon cause you some consternation. You are stunned for 3 rounds while you figure it out.	Whirling around for no apparent reason, you bash your weapon against a nonaggressive surface. Roll for breakage.	Bullet deforms in gun causing immense fouling. The weapon is at -30 until cleaned.	Bullet deforms in gun causing damage to the barrel. The weapon is at -20 until cleaned.	Bullet deforms in gun defacing the barrel. All shots suffer a -30 until the weapon is cleaned.	Bullet deforms in gun. You suffer a -30 penalty to all shots until the gun is cleaned.
86-90	You spin to take aim at your target, and trip over your own two feet. You are down and stunned for one round.	Shot mysteriously goes wide. You eye your gun suspiciously for one round while you are stunned.	Over pressure blows off tip of gun. The weapon is at -30 and has 3 added to its breakage number.	Bad round blows the end off of the barrel. The weapon is at -30 and has 3 added to its breakage number.	Gun barrel gets too hot and deforms. The weapon now fires at -30 and has 3 added to its breakage number.	Over pressure blows off tip of gun. The weapon fires at -30 and has its reliability lowered by 15.
91-95	While daydreaming, you put your hand in front of the barrel. Lose a finger. Take 10 hits and you are stunned for 2 rounds. You are bleeding 5 hits per round as well.	As you raised the weapon to fire, you managed to crack yourself in the jaw. Take 15 hits and are stunned for 2 rounds (and unable to parry for one).	Over pressure blows out side of barrel. Take a 'B' Slash critical.	The side of the gun explodes! Take a 'B' Slash critical.	The gun explodes! Take a 'B' Heat critical and a 'C' Shrapnel critical.	Jam causes gun to blow out the side of the barrel. Take a 'B' Slash critical.
96-99	You didn't really need that kneecap anyway. Take 20 hits, 5 rounds of stun, and a 3 per round bleeder. You fall down.	You had your hand too far forward and burn yourself on the hot barrel. Take 9 hits and are stunned for 2 rounds.	Barrel explodes near lock. Take 'C' Heat and Slash criticals.	Barrel explodes! Take 'C' Heat and Slash criticals.	For some unknown reason, the barrel explodes. Take an 'E' Heat and Shrapnel criticals.	Why me! The gun explodes. Take 'C' Heat and Slash criticals.
100	Bullet ricochets off a rock, and comes right back at you. Make a new roll (with a +50 OB) against yourself.	You pull the trigger fire the weapon inot your own foot. Take 20 hits, 3 rounds of stun, and an 8 per round bleeder.	Barrel explodes shattering stock and your hand. Take 'D' heat and slash criticals. You have lost 1d5 fingers.	Whole gun explodes in your hands. Take 'D' Heat and Slash criticals. You have lost 1d5 fingers.	The whole weapon flies into small pieces in an explosion. Take 'E' Heat, Slash, and Shrapnel criticals. Say good-bye to your hand.	The stock shatters in your hand. Take 'D' Heat and Slash criticals. You have lost 1d5 fingers.

Key: β×=must parry β rounds; β⊗=no parry for β rounds; β⚡=stunned for β rounds; β●=bleed β hits per round; (-β)=foe has -β penalty; (+β)=attacker gets +β next round.



8.0

ENERGY WEAPON DESIGN AND CONVERSIONS

INTRODUCTION

This section serves two purposes. First of all, it gives an overview of how energy weapons might progress through time, including weapon creation rules. In addition, it gives a set of sample weapons both for the *Silent Death* and *Privateers* universes.

HOW THE TABLES ARE ORGANIZED

These tables are organized by weapon type and by manufacturer. If the GM is running a game in one of these universes, then these charts will supply everything he needs. In other universes, the GM can either use the provided weapon here (if the universe is of a comparable tech level) or create his own using these rules.

KEY

Name: The name and manufacturer of the weapon.

Class: This states the class of the weapon, heavy, light, etc.

BE, LE, Etc.: This lists the aperture energy of the weapon. The aperture energy determines which table resolves the attack.

B#: The average breakage number of the weapon.

R#: The average reliability of the weapon.

F#: The fumble range of the weapon.

H#: The Hunting Classification of the weapon.

Bonus: Any bonus the weapon typically gets.

Action: The type of recycling action of the weapon.

Pwr: The number of cells the weapon uses, or if the weapon uses a pack, this is noted.

Shts.: The number of shots this weapon gets from a full load of weapon cells.

Wt.: The typical weight of the weapon.

Ranges: The number of meters to gain the appropriate range modification.

PB: Point Blank range (+10).

Sh: Short range (+0).

Md: Medium range (-25).

Lg: Long range (-50).

Ex: Extreme range (-100).

8.1 CREATING YOUR OWN WEAPONS

There are fifteen main steps in creating an energy weapon. They are deceptively simple, but a thorough world system would have many different manufacturers and brand names with their own strengths, weaknesses etc.

The basic steps are as follows:

- 1) **Name the Weapon:** Give the weapon a name and, if appropriate, a manufacturer.
- 2) **Choose Weapon Class:** Decide what sort of weapon it will be. Possible examples are blaster pistol, assault blaster, or sniping laser.
- 3) **Choose Appropriate Tech Level:** Choose the Tech Level at which the weapon was created.
- 4) **Choose Aperture Energy:** Based on the Weapon Class and the Tech Level, choose the weapon's aperture energy (BE, LE, etc.).
- 5) **Choose Fumble Range:** Select the weapon's fumble range.
- 6) **Choose Bonus:** Select any accuracy bonus or penalty.
- 7) **Choose Action:** Choose the weapon's action (semi-auto, full-auto, continuous).
- 8) **Choose Breakage Number:** Choose the weapon's breakage number.
- 9) **Choose Reliability:** Decide the reliability of this particular weapon.
- 10) **Calculate the Hunting Classification:** Compare the weapon's energy to the Hunting Classification Chart to determine the Hunting classification.
- 11) **Choose Power Source:** Choose the weapon's power source. If this is a weapon cell, then note how many.
- 12) **Calculate Number of Shots:** From the number of energy units available to the weapon, calculate how many shots it can fire before depleting its power source.



- 13) **Calculate the Weapon's Weight:** From the choices above, calculate the weapon's weight.
- 14) **Calculate the Weapon's Ranges:** From the class of weapon, select the base ranges, then adjust for weapon quality.
- 15) **Calculate Cost:** From the steps above, calculate the retail value of the weapon.

NAME THE WEAPON

The first step in weapon creation is to name the weapon. Naming the weapon is generally fairly straightforward. It should be noted that there is no set convention for naming a weapon. Each manufacturer has its own methods.

Therefore the GM should decide what naming conventions the manufacturer uses. If this is a fictional manufacturer, the GM may have to invent the conventions himself.

Example: John decides to invent a new weapon for his game. Since the manufacturer is a fictional one that he has named Mitchell Arms, he can invent any naming convention he pleases. He decides that the first assault plasma weapon designed by Mitchell Arms was named the P-20 (all smaller weapons have been given smaller numbers). Since then, new models have been given sequential numbers. This new model will be called the P-28.

CHOOSE WEAPON CLASS

This step should be fairly straightforward, as the designer should probably know what kind of weapon he is designing. There are several general classifications.

8.1.1 TECH LEVELS: WEAPONS

This section is included to review the tech levels, with concentration on how they affect the development of weapon technology

14 Middle Industrial Civilization — Jet power becomes practical. The rocket is invented. Radar is invented. Submarine detection methods are invented. Electronic countermeasures, as well the proximity fuse, are invented. The machine gun rules the battlefield. The tank puts an end to trench warfare. Helicopters are invented, but not put to widespread use. Atomic weapons are first developed.

15 High Industrial Civilization — The helicopter enters warfare. Increases in medical techniques are the greatest improvements in warfare. Nuclear power is put to use in naval vessels.

16 Low Cyber Age — (Our present.) The rocket is brought into wide use, and the helicopter becomes a combat vehicle. Ballistic body armor is invented, as are improved chemical and incendiary arms. Increased computer technology

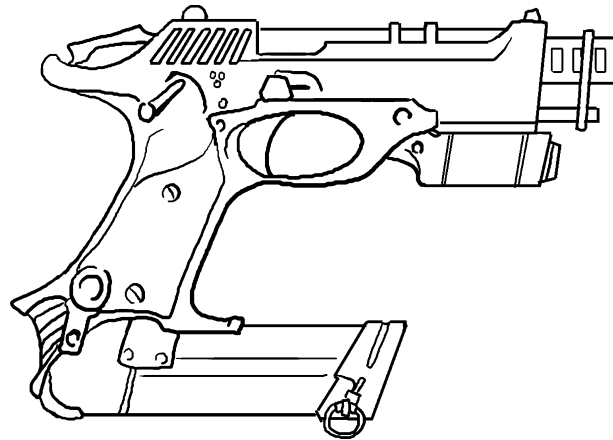

allows more accurate use of missiles. The spy satellite comes into full usage. The ICBM is the nuclear delivery system of choice.

17 High Cyber Age — Military lasers and particle beams are brought into use. Electrochemical propulsion replaces gunpowder. Cybernetic advancements allow the creation of a new "Super Soldier." Orbital weapons begin to be utilized. Further advances in computer telemetry processing allow for increased long range, combat capabilities. Gauss weapons are invented. Kinetic armor is invented, and the usefulness of the firearm begins to wane.

18 Spacefaring Age — Man-portable lasers and particle beams become the infantry weapon of choice, on the scale of light support weapons. Planetary-based mass drivers replace atomic weapons in interplanetary defense. Reflective armor and aerosol screens become useful in personal defense. Genetic engineering, on a minor scale, is used to produce the next generation of soldier. Genetically engineered bio-weapons achieve new levels of effectiveness. VT tanks are first built.

19 Starfaring Age — The first space combat vessels are built, though not brought into widespread use. Plasma weapons enter widespread use. Ablative body armor is developed to combat particle beam weapons. A new generation of genetic "super soldier" is produced. Laser and particle beams are miniaturized to the scale of Assault Weapons.

20 Star Colonial Period — The discovery of the tachyon leads to *faster than light* scanning equipment. The missile nearly becomes obsolete in light of *faster than light* developments. Space combat vehicles are brought into ready use. Advanced SI computers are now small enough to create automated combat vehicles. The combat 'droid is developed. Laser and particle beams are miniaturized to the scale of Subassault Weapons.



21 Anti-Matter Age — Weapons become smaller and deadlier. Anti-matter power is used to run more and more powerful space combat vessels. The potential of tachyon sensors begins to be fully realized. Star combat is now the norm. Combat armor evolves to the point where orbital drops are possible, bringing about a new breed of paratrooper. Land invasions become more and more obsolete, as space superiority takes a central role in warfare. Genetic super soldiers and combat 'droids vie for supremacy on the battlefield. Medical technology can heal most wounds. Laser and particle beams are miniaturized to the scale of side arms.

22 Age of Artificial Gravity — Artificial gravity allows longer terms on space-situated, weapons platforms. Men can be kept in fighting trim even in space. Increased gravity can be used for physical training. Neural pathway, reconstruction therapy allows soldiers to be revived and saved after much longer periods of time. The miniaturization of energy weapons plateaus.

23 Quantum Age — Full utilization of vacuum energy brings a freedom to space-based weapons they have never had before. Major brain reconstruction is now possible. Increased weapons, armor and genetic technologies bring about the obsolescence of the combat 'droid. Energy weapon advances are still plateaued. Little miniaturization is accomplished.

24 Age of Force — Force screens become useful for both large vehicles and personal defense. Direct manipulation of alloys, on a molecular level, increases the effectiveness of fighting vessels. Weapon and armor technologies vie for superiority, but the personal shield has changed everything. Energy weapons begin a rapid growth that proceeds until Tech Level 30.

25 Gravitic Age — Anti-Gravity allows the creation of hover tanks and other low altitude, all terrain craft. Inertial dampers allow space combat to achieve new levels of maneuverability. The dogfight is reinvented.

26 Age of Terraforming — Terraforming allows large scale, holocaustic weapons to be employed with greater impunity.

27 Age of World Building — Zero fault technology makes fighting implements more durable and effective. Improvements in engineering make things harder and harder to destroy. For the first time in history it appears it may, one day, be easier to create than to destroy.

28 Dysonian Age — Entire worlds can now be built, giving whole new territories to take. Force technology increases to the point where active destruction is becoming more and more difficult.

29 Cosmic Age — The discovery of cosmic energy allows offensive technology to outstrip defensive technology.

30 Age of Omnipotence — Direct, mathematical manipulation of reality is possible. Creating and destroying are now one
31+ And Beyond . . . — Unknown.



Pistol – These are small, hand-held weapons. They are the side arms of the energy weapons, about the size of a modern pistol. They are sometimes capable of auto or continuous fire. They use the Pistol template. These weapons are, in addition, broken into the subclasses: Hold-Out, Light, Medium, and Heavy. These sub-categories determine the relative size of the pistol. They come in blaster, laser or plasma varieties.

Subassault Weapon – These weapons are smaller than assault weapons, about the size of a modern submachine gun. They are usually capable of auto or continuous fire. They use the Subassault template. They are further broken into the subclasses of: Light, Medium, and Heavy. They come in blaster, laser or plasma varieties.

Hunting Weapon – These weapons are about the size of a modern rifle. They are readily available to the public and popular with sportsmen. They are almost always restricted to semi-automatic fire. They use the Assault template. They are further broken into the subclasses of: Light, Medium, and Heavy. They come in blaster, laser or plasma varieties.

Assault Weapon – These are the standard weapons of the infantryman. They are about the size of a modern assault rifle. They are always capable of, at the minimum, autofire. They use the Assault template. They are further broken into the subclasses of: Light, Medium, and Heavy. They come in blaster, laser or plasma varieties.

Sniping Weapon – These are military sniping weapons. They vary in size between a hunting weapon and a support weapon. They are usually only capable of semi-automatic fire. They use the Assault or Support template. They are typically broken up as follows. A light sniping weapon uses the light or medium assault weapon template. A medium sniping weapon uses the heavy assault or light support template. A heavy sniping weapon generally follows the medium or heavy support templates. They come in blaster, laser or plasma varieties, though lasers are the most common.



These templates determine the power and base weight of the weapon, however the classification of sniping weapon is typically highly subjective. To make a sniping weapon, the designer will want to increase the range characteristics of the weapon, and perhaps even give it a bonus due to its accuracy.

Support Weapon – These weapons are not entirely “support” weapons. They are the large arms, capable of attacking both humans and vehicles alike. They are the size of the large, .50 caliber, military firearms, and other machine guns, such as the M-60. They are further broken into the subclasses of: Light, Medium, and Heavy. They come in blaster, laser or plasma varieties.

Sonic Stunner – These weapons emit focused sound in a narrow arc (a beam is not quite possible). This arc causes the target to take Stun criticals. It is favored by Law Enforcement officers and is often added as a feature to other weapons.

Sometimes weapons will be created with more than one weapon system. If that is the case, choose the size and type of the primary weapon, and the nature of the weapons. For instance, the designer might decide to make a heavy assault blaster with an underbarrel laser for long range attacks.

Example: The Mitchell Arms P-28 is going to be an Assault Weapon. It is plasma based, and a medium-sized weapon, so he writes down Medium Assault Plasma Carbine. It will also have dual weapon systems, adding a built in sonic stunner. The P-28 will be an SWAT weapon, so John has decided it must be capable of both deadly and non-deadly force (for hostage situations).

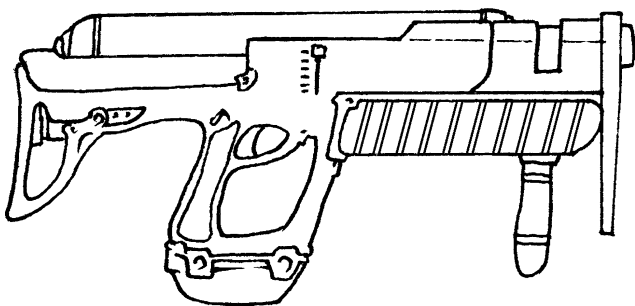

CHOOSE APPROPRIATE TECH LEVEL

The designer should then decide the tech level at which the weapon is created. If the weapon is designed by a major arms manufacturer, the tech level should be the same as the tech level of the culture creating it.

It is possible for this to vary slightly. The manufacturer may be pioneering a new field of arms technology or have information provided by, or stolen from, a more advanced culture. Such

weapons would probably be top secret.

On the other hand, if the designer is building the weapon without a corporation to back him, the weapon might very well be much lower in tech level than the culture of the designer. Joe Revolutionary, working from his garage, is not going to create a weapon on a par with the most advanced arms dealer in the world.

Manufacturer	Tech Level
Cutting edge, top secret design+	+1-1 Tech Level
Alien guidance	GM Discretion
Top manufacturer	0 Tech Levels
Established manufacturer	0 Tech Levels
Limited manufacturer	-.5 Tech Levels
Wealthy citizen*	-1 Tech Level
Avid amateur*	-2 Tech Levels
Brilliant beginner*	-3 Tech Levels

*These classifications refer to the equipment available to the designer, not the skill.

Example: Mitchell Arms is a top manufacturer. John decides that the P-28 is a top of the line weapon. This is a Tech Level 25 culture, so the P-28 will be a Tech Level 25 weapon.

CHOOSE APERTURE ENERGY

Each weapon is restricted by basic volume. A light pistol can hold far less in the way of beam generating and cooling equipment than an assault rifle. In addition, as the tech level of the culture progresses, the parts become smaller and more efficient allowing more power to be packed into a smaller space.

Therefore, to determine the maximum power of the weapon, the GM must compare the weapon’s class and tech level to the charts below. This will show which chart the weapon will use, and therefore the maximum amount of damage that this weapon can produce. It is not necessary for the weapon to actually have this high an aperture energy. A manufacturer may want to reduce the amount to save cost, increase the number of shots, etc.

If the GM decides that the tech level is a fraction of a tech level higher than the base level, .4 for instance, then he needs to adjust these numbers. Simply multiply the difference in the power levels for that weapon by the decimal to receive the increase in power. Round to the nearest whole number (this is typically more useful with energy technology than weapon technology, which often raises only a few points a level).

It may be that the designer wishes to create a weapon with multiple weapon systems. In this case, the weapons should be built separately and all additional ones should be at least one full category smaller. For instance, if someone were



designing a Light Assault Blaster with a laser attached, the laser should be, at the most, as big as a Light Subassault Laser.

Note: *Sonic Stunners, even by Tech Level 18, can be built about the size of a cigarette lighter. Assume that a sonic stunner of any size can be that small.*

POWER TEMPLATE: LASERS/BLASTERS												
Tech	Pistol			Subassault			Assault			Support		
Level	Lt*	Md	Hv	Lt	Md	Hv	Lt	Md	Hv	Lt	Md	Hv
18	-	-	-	-	-	-	-	-	-	-	-	1
19	-	-	-	-	-	-	-	-	-	-	-	1
20	-	-	-	-	-	-	-	-	-	1	1	1
21	-	-	1	1	1	2	2	2	3	3	3	4
22	-	1	2	2	2	3	3	3	4	4	4	5
23	1	2	3	3	4	5	5	6	7	7	8	9
24	2	3	4	4	5	6	6	7	8	8	9	10
25	3	4	5	5	6	7	7	8	9	9	10	11
26	4	5	6	6	7	8	8	9	10	10	11	12
27	8	10	12	13	15	17	18	20	22	23	25	27
28	16	18	20	21	23	25	26	28	30	31	33	35
29	32	34	36	37	39	41	42	43	45	46	48	50

*A holdout pistol is half as powerful as a light pistol.

Example: *The P-28 is a medium-sized Assault Plasma Carbine. It is also Tech Level 25. This gives the weapon a base aperture energy of 7. John writes PE 7 on a sheet of paper. He also adds on a sonic stunner with variable settings (it's illegal in this universe to use a high-powered sonic stunner on men over forty, due to the occasional heart failures).*

CHOOSE FUMBLE RANGE

Each weapon has a fumble range. This fumble range is a function of the size and bulkiness of the weapon. Consult the chart below for the fumble range of the weapon:

Weapon Type	Fumble Range
Hold-Out Pistol	1-5
Pistol	1-3
Hunting/Sniping Weapon	1-2
Assault/Subassault Weapon	1-3
Support Weapon	1-4
Sonic Stunner	1-2

POWER TEMPLATE: PLASMA WEAPONS												
Tech	Pistol			Subassault			Assault			Support		
Level	Lt*	Md	Hv	Lt	Md	Hv	Lt	Md	Hv	Lt	Md	Hv
18	-	-	-	-	-	-	-	-	-	-	-	1
19	-	-	-	-	-	-	-	-	-	-	-	1
20	-	-	-	-	-	-	-	-	-	1	1	1
21	-	-	-	-	-	1	1	1	2	2	2	3
22	-	-	1	1	1	2	2	2	3	3	3	4
23	-	1	2	2	2	3	3	3	4	4	4	5
24	1	2	3	3	4	5	5	6	7	7	8	9
25	2	3	4	4	5	6	6	7	8	8	9	10
26	3	4	5	5	6	7	7	8	9	9	10	11
27	4	5	6	6	7	8	8	9	10	10	11	12
28	8	10	12	13	15	17	18	20	22	23	25	27
29	16	18	20	21	23	25	26	28	30	31	33	35

*A holdout pistol is half as powerful as a light pistol.

If two weapons are combined, use fumble range of the *larger* weapon, not the *higher* fumble range. Add one to this number for every additional weapon, unless that weapon is a sonic stunner. Sonic stunners add little in the way of unwieldiness.

Example: *The P-28 is an assault weapon. It therefore has a fumble range of 1-3. The sonic stunner adds little to this number, so it can be ignored.*

CHOOSE BONUS

There are two ways to apply a bonus to a weapon. The first is to make the weapon more accurate and easier to use. The second is to apply excess force, rendering armor and cover less effective.

The most common bonus comes from the accuracy and ease of use. There are many ways to accomplish this, from putting more accurate sights on a weapon to making it fit better into the human hand, to pre-ionizing the path of the beam.

It's not necessary to define the source of the bonus, although doing so will give the weapon a lot more character. The designer must simply define what the bonus is. The maximum bonus applicable has a ceiling, based on the tech level of the weapon:

Bonus	Required Tech Level
-50 - +5	18
+6 - +10	19
+11 - +15	20
+16 - +20	21
+21 - +25	22
+26 - +30	23
+31 - +35	24
+36 - +40	25
+41 - +45	26
+46 - +50	27
+50+	28



In addition, if the character reduces the aperture energy but not the power of the weapon, the amount of the decrease is applied as a bonus. This is called *focusing*. For instance, if a designer drops the aperture energy of a weapon from 10 to 5, it would attack on the BE, PE, or LE 5 table, but the energy would still drain 10 energy units per shot. The beam has been concentrated, and does little more damage to a target than a lesser beam (a hole is a hole). However, the more concentrated application of energy burns through armor better.

Focusing is hardly ever used except where the power of a weapon is higher than the highest chart in the book. At higher tech levels they often find that making a more powerful beam no longer has any additional effect. Making the beam more concentrated, however, can burn through armor that a lesser beam could not.

Example: The P-28 is going to be a good weapon. Mitchell Arms has a reputation for highly accurate products. John decides that the P-28 uses an advanced technology that accelerates the plasma to higher than normal speeds. This has little effect on damage (the heat of the plasma is responsible for most of the damage). It does make the weapons line of fire flatter and less vulnerable to atmospheric vagaries. John gives the P-28 a +10 bonus. The sonic stunner is given no additional bonus.

CHOOSE ACTION

The action of the weapon determines how fast it fires. There are three types of actions. They are semi-automatic, automatic (or fully automatic), and continuous.

The primary problem with energy weapons is that, to create that much energy, they will also create a great deal of heat. The base energy of each weapon assumes only enough cooling gear to allow for semi-automatic fire. For higher rates of fire, more cooling gear must be fitted into the same amount of space.

Therefore, if a weapon is to be made capable of automatic or continuous fire, the size of the weapon core must be reduced to make room for cooling equipment. The amount that it must be reduced depends on the rate of fire and type of weapon:

Rate of Fire	Aperture Energy Penalty
Blasters	
Auto-Fire	-1
Continuous	-3
Laser and Plasma Weapons	
Auto-Fire	-2
Continuous (Laser only)	-5

This reduction not only determines the drop in the weapon's core size, but as you might have guessed, the weapon's power as well. Subtract the penalty from the aperture energy of the weapon.

Note: Sonic stunners generate no heat. They are always in continuous fire mode, though this doesn't matter unless the attacker attempts suppression fire or a spread burst. An aimed burst has no additional effect.

Example: The P-28, as an assault weapon, will be useless if it isn't at least fully automatic. Being a plasma weapon, it can't be designed for continuous fire. John therefore subtracts the penalty (-2) from the base power of the weapon (7). The result is 5. The P-28 will have a PE rating of 5. The sonic stunner is, by default, continuous. This has no effect on the power of the weapon.

CHOOSE BREAKAGE NUMBER

Choosing the breakage number consists of two main factors. The first is the basic type of weapon: blaster, laser or plasma. The second is the action of the weapon: semi-auto, automatic, or continuous.

The basic type of weapon will give the base breakage number of the weapon. This number represents how often something unexpected happens in the action of the weapon. Consult the chart below for the base number:

Weapon Type	Breakage Number
Blaster	5
Laser	3
Plasma	7
Sonic Stunner	1*

*This number is not effected by the weapon's action.

The action of the weapon (chosen below) will affect the breakage number of the weapon. They are as follows:

Action Type	Breakage Number Modifier
Semi-Automatic	+0
Automatic	+1
Continuous	+2

If two weapons are combined into one, use the breakage number of the weapon currently being used.

Example: The P-28 is fully automatic. That means that, being a plasma weapon, it has a base breakage number of 7. The fact that this is a fully automatic weapon raises the number to 8. The Sonic Stunner has a breakage number of 1. It is not affected by the action of the weapon.



CHOOSE RELIABILITY

The next thing to choose is the reliability of the weapon. This functions the same way as the breakage number. First of all, the base reliability of the weapon is based upon the general type of weapon. These numbers are as follows:

Weapon Type	Base Reliability
Blaster	75
Laser	95
Plasma	55
Sonic Stunner	150*

*Action has no effect on this number.

The second step is to adjust the weapon's reliability according to the weapon's action. The adjustments are as follows:

Action Type	Reliability Modifier
Semi-Automatic	+0
Automatic	-10
Continuous	-20

Unlike the breakage number of a weapon, its reliability can be affected by the designer. High quality weapons are the goal of every weapon manufacturer (at least in theory). Although the manufacturer can't stop the unexpected from happening, he can build the weapon so that when the inevitable irregularities occur in the weapon's power or particle/plasma feeds, the weapon can handle the problem without blowing a circuit or burning out a mechanism.

While lasers, particle beams and the like are generally solid-state electronics with few moving parts, they inevitably push the envelope of how much power they can draw through their circuits. These weapons are some of the highest performance pieces of technology available.

The various adjustments to the weapon's reliability are listed below. These adjustments require a minimum tech level. The manufacturer can only raise the reliability as much as his tech level allows.

These adjustments to a weapon's reliability also affect the weapon's cost. Therefore, a manufacturer will often produce a weapon of sub-standard reliability to reduce cost. The Tech-9 is a modern day example of how a manufacturer can reduce a weapon's reliability to produce the weapon cheaply.

Reliability Adjustment

Tech Level

-50 - 0	18
+1 - +35	19
+36 - +65	20
+66 - +90	21
+91 - +110	22
+111 - +125	23
+126 - +135	24
+136 - +140	25
+141 - +144	26
+145 - +147	27
+148 - +149	28
+150	29

If two weapons are combined, their reliability is noted separately for the different weapons. The weapon being fired is the only one whose reliability matters.

The P-28 is made by Mitchell Arms, and they pride themselves on high-quality arms. The base reliability for a plasma weapon is 55. The fact that it fires fully automatic drops this to a 45. John adds 30 to this, raising the reliability to 75. He won't raise it any higher because he wants this weapon to be within the reach of a more ordinary consumer. He leaves the Sonic Stunner's reliability at 150.

CALCULATE THE HUNTING CLASSIFICATION

Calculating the Hunting Classification of a weapon is fairly straightforward. Simply consult the chart below:

Power	Hunting Class
Laser/Blaster	
1-3	-
4-7	I
8-12	II
13	III
Plasma	
1-2	-
3-5	I
6-9	II
10	III

Note: Sonic Stunners do not have a hunting classification.

Example: *Since the P-28 uses the PE 4 Attack Chart, it is a Class I weapon. If it wasn't for the fully automatic action, it would probably be legal in most universes (though why someone would hunt with a plasma weapon is beyond John).*



CHOOSE POWER SOURCE

The amount of power in a weapon cell depends upon the tech level of the cell. The chart below shows the number of energy units by tech level.

POWER CELL CAPACITY

Tech Level	Energy Units
17	1
18	2
19	4
20	8
21	16
22	32
23	64
24	128
25	256
26	512
27	1,024
28	2,048
29	4,096

Every time a weapon is fired, each shot drains the power cell of a number of shots equal to its aperture energy. For example, if a blaster with a BE of 7 is fired, it drains 7 energy units from the cell. Therefore, the number of units in a cell can be divided by the energy of the weapon to determine how many shots that a single weapon cell can supply. Plasma weapons drain double their aperture energy. Sonic Stunners, regardless of the aperture energy, can run for a number of days equal to the number of energy units in the cell (they often use smaller, utility cells because of this).

Sometimes, one weapon cell won't provide enough shots to meet the weapon's needs. In this case, it might be necessary to make a weapon that uses multiple weapon cells. These cells could be mated together or loaded separately, depending on the manufacturer (mated packs would have to be purchased or put together in a holder especially for that weapon).

At this time, determine exactly how many energy cells the weapon uses. This will help determine the maximum shots in the next step.

If necessary, the weapon can be designed to use a pack instead. An energy pack is the equivalent of 100 weapon cells.

In addition, as of Tech Level 22, a micro-power generator can be built within the size of a pack, providing limitless power. As of Tech Level 23, the same can be done in a support weapon. As of Tech Level 24, the same can be done in an assault weapon. As of Tech Level 25, the same can be done in a subassault weapon. As of Tech Level 26, the same can be done with any weapon.

Multiple use weapons should probably have separate weapon cells for each individual weapon system contained within. If the additional weapon is a sonic stunner, this can be ignored.

Example: *The P-28 is a Tech Level 25 weapon, therefore the weapon cell has 256 energy units. Since the P-28 is a plasma weapon, its PE 5 drains 10 energy units per shot (5 x 2). This means that the P-28 can fire 25 shots from a single weapon cell. This seems fine to John. The Sonic Stunner could operate for 256 days under continuous use, so this has little effect on the weapon's number of shots.*

CALCULATE NUMBER OF SHOTS

Add together the energy units of all the weapon cells each weapon system uses. Divide this by the aperture energy of the weapon (times two for plasma weapons). This is the number of shots the weapon gets. Repeat for each weapon system.

Note: *Plasma weapons need "matter" to heat into plasma as well as the weapon cell. In many cases, the GM can just ignore this fact, but in a campaign where such things matter, assume that the weapon's "material supply" needs to be replaced every 10 weapon cells (this technology increases hand in hand with energy technology).*

Example: *If John had added more than one energy cell, he'd have to recalculate the total number of shots now. He didn't, however, so he moves on.*

CALCULATE THE WEAPON'S WEIGHT

Each weapon has a weight based upon its size and type. To determine the base weight of a weapon, use the following:

Weapon	Weight (in kg)
Holdout Pistol	0.1
Light Pistol	0.2
Medium Pistol	0.4
Heavy Pistol	0.6
Light Subassault Weapon	2.5
Medium Subassault Weapon	3
Heavy Subassault Weapon	3.5
Light Hunting/Assault Weapon*	3
Medium Hunting/Assault Weapon*	3.5
Heavy Hunting/Assault Weapon*	4
Light Support Weapon*	6
Medium Support Weapon*	12
Heavy Support Weapon*	18
Sonic Stunner	0.01

*Sniping weapons use the weight of the assault or support weapon whose power template they used.



This gives the base weight of the weapon. The type of weapon further modifies the weight:

Weapon Type	Weight Multiplier
Blaster	1
Laser	0.8
Plasma	1.3

Multiply the base weight by the weapon weight multiplier to determine the weapon's final weight. For weapons with multiple weapon systems, calculate each weapon system's weight separately. Then multiply the smaller system by .8 and add this to the larger system. This is your final weight.

This is the optimum weight of the weapon. Some manufacturers, however, will try to keep the weight of a weapon down. The weight can be reduced by as much as 50%, although this will affect the price of the weapon later.

Example: The P-28 has two weapon systems. The first is a medium assault plasma carbine. Its base weight is 3.5 kg. This is multiplied by 1.3 (for being a plasma weapon) for a result of 4.55. The sonic stunner is added onto this weight after being multiplied by .8. The new value is 4.558. (The .008 is hardly worth considering). This is just a touch too heavy for John. He reduces the weight by 10%, although he knows this will hurt when the price is calculated. This drops the weight to 4.1022. John rounds this off to an even 4.1 kg. And writes it down.

CALCULATE THE WEAPON'S RANGES

To calculate the weapon's ranges, it's first necessary to determine the base ranges. This is a function of both the weapon's class and type. Consult the chart below.

Weapon	PB	Sh	Me	Lo	Ex
Hold-Out Pistol	1	3	4	7	18
Pistol	3	5	8	13	35
Subassault	1	10	20	50	100
Hunting/Sniping	1	15	30	150	300
Assault	1	10	20	100	200
Support	1	15	30	150	300
Sonic Stunner	1	5	10	20	50

This will give you the base ranges for the weapon. These base ranges are adjusted by the type of weapon. Consult the chart below for the multiplier:

Weapon Type	Multiplier
Blaster	1
Laser	5
Plasma	0.5

Multiply each range by the multiplier. This will result in the weapon's range categories.

A weapon's manufacturer can also adjust the weapon's ranges when designing it. Sniping weapons, for example, often have their ranges increased through superior design. A weapon's range can be increased by up to 500%. This increase will affect the final price, however.

Example: The P-28 is an assault weapon. This gives it a base set of ranges of 1, 10, 20, 100, and 200. Because this is a plasma weapon, the ranges are multiplied by .5. That makes the ranges .5, 5, 10, 50, and 100. This isn't quite enough for John. He increases the ranges by 50%. That makes the ranges .75, 7.5, 15, 75, and 150. He rounds these to 1, 8, 15, 75, and 150. The Sonic Stunner's ranges are 1, 5, 10, 20, and 50. He leaves these alone.

CALCULATE COST

Calculating the eventual retail value of a weapon is, by far, the most complicated part. Begin by selecting the weapon's base cost.

Weapon	Cost
Hold-Out Pistol	\$700
Light Pistol	\$350
Medium Pistol	\$400
Heavy Pistol	\$550
Light Subassault Weapon	\$500
Medium Subassault Weapon	\$800
Heavy Subassault Weapon	\$1,100
Light Assault/Hunting Weapon*	\$400
Medium Assault/Hunting Weapon*	\$500
Heavy Assault/Hunting Weapon*	\$700
Light Support Weapon*	\$1,200
Medium Support Weapon*	\$2,000
Heavy Support Weapon*	\$5,000
Sonic Stunner	\$300

*Sniping weapons use the price of the weapon whose power template they used.

Once the base price of the weapon is determined, the designer must start adding up all the adjustments to the weapon's design. These adjustments come in the form of percentages, all of which are added together before applying them to the price of the weapon. For example, a weapon with a +10, and +100 and a -50 would have 60% added to its price (10 + 100 - 50 = 60). The factors are as follows:

Weapon Type: Laser weapons subtract 20%. Plasma weapons add 50%.

Tech Level: This will only affect the weapon if the tech level is higher than is standard for the culture. This adds 1000 times the tech level's increase. For instance, a weapon with a .5 tech



level increase would add 500% to the weapon's value.

Aperture Energy: If the aperture energy is purposely reduced below its maximum *before adjusting for the weapon's action*, subtract ten times the amount of reduction.

Accuracy Bonus: If the weapon gains its bonus by focusing the beam, there is no effect on cost. If the weapon has had its accuracy increased, the square of the bonus is added to the cost.

Action: The weapon's action adds to its price. This amounts to +50% for automatic and +100% for continuous fire. These adjustments do not apply to sonic stunners.

Reliability: Square the value of the bonus or penalty applied to the weapon. If it is a bonus, this is added to the value. If it is a penalty, it is subtracted from the weapon's value.

Power Source: Multiple weapon cells add nothing to the cost of the weapon. A pack adds \$1,000. A pack-sized micro-generator adds 10,000%. A built in micro-power generator adds 100,000%, but since the weapon will never run out of shots, the rich and powerful value these weapons. If it was possible to build the micro-generator into the weapon a tech level earlier, then the cost is reduced to one tenth.

Weight: Square the amount that the weapon's weight was reduced. This is added to the cost.

Ranges: If the weapon's ranges were increased, the amount of the increase is added to the price of the weapon.

Other: The GM will often see the need to increase or decrease the cost further. This is usually because of the reputation or practices of the manufacturer, but other factors may come into play.

Note: Only the manufacturer can reduce the price of a weapon below 50%. A weapon cannot be reduced farther, but the manufacturer can cut its own profit margin by selling the weapon for a lower price.

Design Factor	Adjustment (In %)
Laser Weapon	-20
Plasma Weapon	+50
Tech Level	+1000 x Increase
Aperture Energy	-10 x Decrease
Bonus	+Bonus Squared
Fully Automatic*	+50
Continuous Fire*	+100
Reliability	+/- the Adjustment Squared
Power Pack	+\$1,000
Micro-Generator Pack	+10,000†
Built-In Micro-Generator	+100,000†
Weight	+Reduction Squared
Other	GM Discretion

*Not applicable to sonic stunners.

†If the weapon could have had the micro-generator built earlier than the current tech level, the cost is reduced to one-tenth.

For weapons with multiple systems, calculate the value of both of the weapons. Add them together. Multiply by 1.1 for the final cost.

Example: Okay, let's see what the damage is. John starts with the base value of the weapon, \$500 dollars. The fact that it's a plasma weapon adds 50%. The +10 bonus adds 100%; 50% for fully automatic; 900% (!) for the increase in reliability. 100% for weight. John decides that since Mitchell Arms got the Special Forces contracts, they've been able to add 20% for their reputation. John jots down these numbers to help remind himself.

Base Cost	\$500
Laser Weapon	n/a
Plasma Weapon	+50
Tech Level	0
Aperture Energy	0
Bonus	+100 (10 x 10)
Fully Automatic	+50
Continuous Fire*	+100
Reliability	+900 (30 x 30)
Power Pack	n/a
Micro-Generator Pack	n/a
Built-In Micro-Generator	n/a
Weight	+100 (10 x 10)
Other (Reputation)	+20
Subtotal	+1320

Thirteen hundred and twenty percent. That's a heck of an increase. That adds 6,600 dollars to the value of the weapon. John writes this down.

Base Cost	\$500
Adjustment	+\$6,600 (1320% of 500)
Subtotal	\$7,100

But he's not done yet. The P-28 is a weapon with multiple systems. This adds the cost of the second system. Since the Sonic Stunner costs \$300, and has no adjustments (he didn't add any), this is straightforward. John finishes the calculation.

Plasma Weapon	\$7,100
Sonic Stunner	\$300
Subtotal	\$7,400
Combined Systems	\$8,140 (7,400 x 1.1)

It's finally done. John rounds it up to \$8,199 dollars, because the weapon is pricey enough anyway, and calls it good. Expensive, but not so expensive that it's out of reach of the discerning arms consumer.



8.2 PRIVATEERS WEAPONS

The most common weapons from *The Privateers* universe are listed below. This is by no means a comprehensive list, but it is a list of the weapons made by the biggest manufacturers. Weapons from *The Privateers* universe are at the very end of the Tech Level 25 era. They use the Tech Level 25 template. Power technology varies however. ISC weapon cells contain 375 energy units. Imperial weapon cells contain 140 energy units.

There are many weapons circulating which are up to 80 years old. Many of these older weapons, while still in fine working condition, are slightly outdated. If the number of shots has a second number in parenthesis, this is the number of shots available when using a modern cell. If this number is 0, then the weapon cannot use modern cells, and must use the cells produced in its era. Some weapons do not have good enough power regulation equipment to handle modern cells.

All prices are given in ISC credits.





PRIVATEERS ASSAULT BLASTER TABLE

Weapon Name	Class	Cost	BE	SS	B#	R#	F#	H#	Bonus	Action	Pwr†	Shts.	Wt.	PB	Range in Meters			Year	
															Sh	Md	Lg		
Arluph Arms ABR	Medium	¢750	6	-	6	65	3	I	0	Auto	1	21 (0)	3.5	1	10	20	100	200	201
Arluph Arms ARS	Heavy	¢1,050	7	-	6	65	3	I	0	Auto	1	18 (0)	4	1	10	20	100	200	203
Arluph Arms BNG	Medium	¢750	7	-	6	65	3	I	0	Auto	1	53	3.5	1	10	20	100	200	284
Arluph Arms CCD	Heavy	¢1,050	7	-	6	65	3	I	0	Auto	1	20 (0)	4	1	10	20	100	200	231
Arluph Arms DKS	Medium	¢750	6	-	6	65	3	I	0	Auto	1	24 (0)	3.5	1	10	20	100	200	237
Arluph Arms HAL	Heavy	¢1,050	8	-	6	65	3	II	0	Auto	1	46	4	1	10	20	100	200	285
Arluph Arms MIMG	Heavy	¢1,050	8	-	6	65	3	II	0	Auto	1	36 (0)	4	1	10	20	100	200	269
Arluph Arms Triple Z	Medium	¢750	7	-	6	65	3	I	0	Auto	1	41 (0)	3.5	1	10	20	100	200	272
Chrometech A-5	Medium	¢2,000	4	-	7	55	3	I	0	Continuous	Pack	3,200 (0)	13.5	1	10	20	100	200	203
Chrometech A-9	Medium	¢2,000	4	-	7	55	3	I	0	Continuous	Pack	3,600 (0)	13.5	1	10	20	100	200	229
Chrometech A-13	Medium	¢2,000	5	-	7	55	3	I	0	Continuous	Pack	5,760 (0)	13.5	1	10	20	100	200	259
Chrometech A-15	Medium	¢2,000	5	-	7	55	3	I	0	Continuous	Pack	7,500 (0)	13.5	1	10	20	100	200	285
H & K X-10	Light	¢4,000	3	-	7	75	3	-	+10	Continuous	1	42 (125)	2.7	1	11	22	110	220	200
H & K X-13	Light	¢4,000	3	-	7	75	3	-	+10	Continuous	1	48 (125)	2.7	1	11	22	110	220	227
H & K X-16	Light	¢4,000	4	-	7	75	3	I	+10	Continuous	1	72 (93)	2.7	1	11	22	110	220	259
H & K X-18	Light	¢4,000	4	-	7	75	3	I	+10	Continuous	1	93	2.7	1	11	22	110	220	280
H & K X-20	Medium	¢8,500	4	-	7	85	3	I	+15	Continuous	1	32 (93)	3.2	1	11	22	110	220	201
H & K X-22	Medium	¢8,500	4	-	7	85	3	I	+15	Continuous	1	36 (93)	3.2	1	11	22	110	220	226
H & K X-24	Medium	¢8,500	5	-	7	85	3	I	+15	Continuous	1	51 (75)	3.2	1	11	22	110	220	258
H & K X-25*	Medium	¢8,500	5	-	7	85	3	I	+15	Continuous	1	75	3.2	1	11	22	110	220	281
Steyr-Klough T-1	Light	¢1,300	3	-	7	65	3	-	+5	Continuous	1	42 (125)	3	1	10	20	100	200	200
Steyr-Klough T-4	Medium	¢2,000	4	3	7	65	3	I	+10	Continuous	1	32 (93)	3.5	1	10	20	100	200	200
Steyr-Klough T-5	Heavy	¢2,275	5	-	7	65	3	I	+5	Continuous	1	25 (75)	4	1	10	20	100	200	201
Steyr-Klough T-8	Light	¢1,300	3	-	7	65	3	-	+5	Continuous	1	48 (125)	3	1	10	20	100	200	229
Steyr-Klough T-10	Medium	¢2,000	4	3	7	65	3	I	+10	Continuous	1	36 (93)	3.5	1	10	20	100	200	230
Steyr-Klough T-12	Heavy	¢2,275	5	-	7	65	3	I	+5	Continuous	1	28 (75)	4	1	10	20	100	200	230
Steyr-Klough T-13	Light	¢1,300	4	-	7	65	3	-	+5	Continuous	1	72 (93)	3	1	10	20	100	200	260
Steyr-Klough T-17	Medium	¢2,000	5	3	7	65	3	I	+10	Continuous	1	57 (75)	3.5	1	10	20	100	200	260
Steyr-Klough T-20	Heavy	¢2,275	6	-	7	65	3	I	+5	Continuous	1	48 (62)	4	1	10	20	100	200	261
Steyr-Klough T-21	Light	¢1,300	4	-	7	65	3	I	+5	Continuous	1	93	3	1	10	20	100	200	279
Steyr-Klough T-23†	Medium	¢2,000	5	3	7	65	3	I	+10	Continuous	1	75	3.5	1	10	20	100	200	280
Steyr-Klough T-26	Heavy	¢2,275	6	-	7	65	3	I	+5	Continuous	1	62	4	1	10	20	100	200	280
Ultimate Arms LAB	Light	¢150 K	4	1-5	7	105	3	I	+25	Continuous	✓	✓	1.5	2	20	40	200	400	279
Ultimate Arms MAB	Medium	¢170 K	5	1-5	7	105	3	I	+25	Continuous	✓	✓	1.75	2	20	40	200	400	279
Ultimate Arms HAB	Heavy	¢190 K	6	1-5	7	105	3	I	+25	Continuous	✓	✓	2	2	20	40	200	400	279

*Standard military issue.

†The number of weapon cells that can be loaded at once. Pack means weapon is powered by backpack. ✓ Means weapon is powered by micro-generator.



PRIVATEERS ASSAULT LASER TABLE

Weapon Name	Class	Cost	LE	SS	B#	R#	F#	H#	Bonus	Action	Pwrt†	Shots	Wt.	PB	Range in Meters			Ex	Year
															Sh	Md	Lg		
Spectrum Arms AL-3	Light	¢520	4	-	4	85	3	1	0	Auto	1	32 (93)	2.4	5	50	100	500	1,000	200
Spectrum Arms AL-6	Medium	¢650	5	-	4	85	3	1	0	Auto	1	25 (75)	2.8	5	50	100	500	1,000	201
Spectrum Arms AL-8	Light	¢520	4	-	4	85	3	1	0	Auto	1	36 (93)	2.4	5	50	100	500	1,000	233
Spectrum Arms AL-10	Medium	¢650	5	-	4	85	3	1	0	Auto	1	28 (75)	2.8	5	50	100	500	1,000	232
Spectrum Arms AL-13	Light	¢520	5	-	4	85	3	1	0	Auto	1	28 (75)	2.4	5	50	100	500	1,000	255
Spectrum Arms AL-15	Medium	¢650	6	-	4	85	3	1	0	Auto	1	24 (62)	2.8	5	50	100	500	1,000	254
Spectrum Arms AL-17	Light	¢520	5	-	4	85	3	1	0	Auto	1	75	2.4	5	50	100	500	1,000	279
Spectrum Arms AL-20	Medium	¢6500	6	-	4	85	3	1	0	Auto	1	62	2.8	5	50	100	500	1,000	280
Steyr-Klough L-1	Light	¢1,320	4	-	4	95	3	1	+10	Auto	1	32 (93)	2.4	5	50	100	500	1,000	203
Steyr-Klough L-2	Medium	¢2,150	5	3	4	95	3	1	+10	Auto	1	25 (75)	2.8	5	50	100	500	1,000	202
Steyr-Klough L-3	Heavy	¢2,320	6	-	4	95	3	1	+10	Auto	1	21 (62)	3.2	5	50	100	500	1,000	201
Steyr-Klough L-4	Light	¢1,320	4	-	4	95	3	1	+10	Auto	1	36 (93)	2.4	5	50	100	500	1,000	232
Steyr-Klough L-5	Medium	¢2,150	5	3	4	95	3	1	+10	Auto	1	28 (93)	2.8	5	50	100	500	1,000	231
Steyr-Klough L-6	Heavy	¢2,320	6	-	4	95	3	1	+10	Auto	1	24 (75)	3.2	5	50	100	500	1,000	230
Steyr-Klough L-7	Light	¢1,320	5	-	4	95	3	1	+10	Auto	1	57 (75)	2.4	5	50	100	500	1,000	260
Steyr-Klough L-8	Medium	¢2,150	6	3	4	95	3	1	+10	Auto	1	48 (62)	2.8	5	50	100	500	1,000	259
Steyr-Klough L-9	Heavy	¢2,320	7	-	4	95	3	1	+10	Auto	1	36 (53)	3.2	5	50	100	500	1,000	258
Steyr-Klough L-10	Light	¢1,320	5	-	4	95	3	1	+10	Auto	1	75	2.4	5	50	100	500	1,000	283
Steyr-Klough L-11	Medium	¢2,150	6	3	4	95	3	1	+10	Auto	1	62	2.8	5	50	100	500	1,000	282
Steyr-Klough L-15	Heavy	¢2,320	7	-	4	95	3	1	+10	Auto	1	53	3.2	5	50	100	500	1,000	281
Ultimate Arms LAL	Light	¢140 K	5	1-5	4	135	3	1	+25	Auto	✓	✓	1.2	10	100	200	1,000	2,000	280
Ultimate Arms MAL	Medium	¢150 K	6	1-5	4	135	3	1	+25	Auto	✓	✓	1.4	10	100	200	1,000	2,000	280
Ultimate Arms HAL	Heavy	¢160 K	7	1-5	4	135	3	1	+25	Auto	✓	✓	1.6	10	100	200	1,000	2,000	280

†The number of weapon cells that can be loaded at once. Pack means weapon is powered by backpack. ✓ Means weapon is powered by micro-generator.

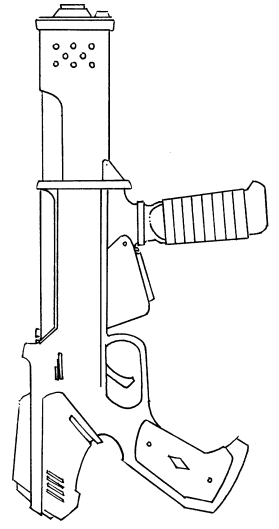

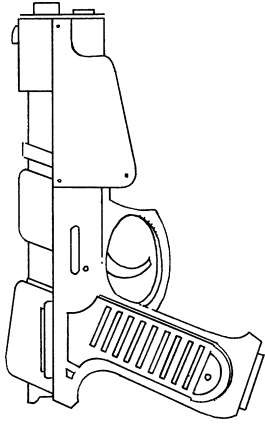

PRIVATEERS ASSAULT PLASMA CARBINE TABLE

Weapon Name	Class	Cost	PE	SS	B#	R#	F#	H#	Bonus	Action	Pwr†	Shots	Wt.	PB	Range in Meters			Ex	Year
															Sh	Md	Lg		
Chrometech P-2	Light	¢1,800	3	-	8	45	3	I	0	Auto	Pack	1066 (0)	13.9	1	5	10	50	100	200
Chrometech P-5	Medium	¢2,000	4	-	8	45	3	I	0	Auto	Pack	800 (0)	14.6	1	5	10	50	100	200
Chrometech P-6	Heavy	¢2,400	5	-	8	45	3	I	0	Auto	Pack	640 (0)	15.2	1	5	10	50	100	201
Chrometech P-10	Light	¢1,800	3	-	8	45	3	I	0	Auto	Pack	1200 (0)	13.9	1	5	10	50	100	231
Chrometech P-11	Medium	¢2,000	4	-	8	45	3	I	0	Auto	Pack	900 (0)	14.6	1	5	10	50	100	232
Chrometech P-13	Heavy	¢2,400	5	-	8	45	3	I	0	Auto	Pack	720 (0)	15.2	1	5	10	50	100	230
Chrometech P-16	Light	¢1,800	4	-	8	45	3	I	0	Auto	Pack	900 (0)	13.9	1	5	10	50	100	255
Chrometech P-17	Medium	¢2,000	5	-	8	45	3	I	0	Auto	Pack	1280 (0)	14.6	1	5	10	50	100	256
Chrometech P-18	Heavy	¢2,400	6	-	8	45	3	II	0	Auto	Pack	600 (0)	15.2	1	5	10	50	100	254
Chrometech P-22	Light	¢1,800	4	-	8	45	3	I	0	Auto	Pack	2342 (0)	13.9	1	5	10	50	100	284
Chrometech P-30	Medium	¢2,000	5	-	8	45	3	I	0	Auto	Pack	1875 (0)	14.6	1	5	10	50	100	285
Chrometech P-33	Heavy	¢2,400	6	-	8	45	3	II	0	Auto	Pack	1562 (0)	15.2	1	5	10	50	100	284
Steyr-Klough APC-7	Light	¢4,800	3	-	8	75	3	I	+10	Auto	2*	21 (62)	3.9	1	5	10	50	100	203
Steyr-Klough APC-9	Medium	¢7,000	4	5	8	75	3	I	+10	Auto	2*	16 (46)	4.6	1	5	10	50	100	200
Steyr-Klough APC-10	Heavy	¢8,400	5	-	8	75	3	I	+10	Auto	2*	12 (37)	5.2	1	5	10	50	100	204
Steyr-Klough APC-15	Light	¢4,800	3	-	8	75	3	I	+10	Auto	2*	24 (62)	3.9	1	5	10	50	100	230
Steyr-Klough APC-16	Medium	¢7,000	4	5	8	75	3	I	+10	Auto	2*	18 (46)	4.6	1	5	10	50	100	228
Steyr-Klough APC-17	Heavy	¢8,400	5	-	8	75	3	I	+10	Auto	2*	14 (37)	5.2	1	5	10	50	100	231
Steyr-Klough APC-22	Light	¢4,800	4	-	8	75	3	I	+10	Auto	2*	32 (46)	3.9	1	5	10	50	100	258
Steyr-Klough APC-23	Medium	¢7,000	5	5	8	75	3	I	+10	Auto	2*	25 (37)	4.6	1	5	10	50	100	256
Steyr-Klough APC-24	Heavy	¢8,400	6	-	8	75	3	II	+10	Auto	2*	21 (30)	5.2	1	5	10	50	100	259
Steyr-Klough APC-25	Light	¢4,800	4	-	8	75	3	I	+10	Auto	2*	46	3.9	1	5	10	50	100	279
Steyr-Klough APC-26	Medium	¢7,000	5	5	8	75	3	I	+10	Auto	2*	37	4.6	1	5	10	50	100	279
Steyr-Klough APC-27	Heavy	¢8,400	6	-	8	75	3	II	+10	Auto	2*	30	5.2	1	5	10	50	100	280
Ultimate Arms LAPC	Light	¢180 K	4	1-5	8	95	3	I	+25	Auto	✓	✓	1.95	1	10	20	100	200	281
Ultimate Arms MAPC	Medium	¢210 K	5	1-5	8	95	3	I	+25	Auto	✓	✓	2.3	1	10	20	100	200	281
Ultimate Arms HAPC	Heavy	¢240 K	6	1-5	8	95	3	II	+25	Auto	✓	✓	2.6	1	10	20	100	200	281

*These weapons load the two cells separately. Simply replacing one only restores half of the shots.

†The number of weapon cells that can be loaded at once. Pack means weapon is powered by backpack. ✓ Means weapon is powered by micro-generator.



PRIVATEERS BLASTER PISTOL TABLE

Weapon Name	Class	Cost	BE	SS	B#	R#	F#	H#	Bonus	Action	Pwr†	Shots	Wt.	PB	Range in Meters			Ex	Year
															Sh	Md	Lg		
Arluph Arms BIA	Light	€350	2	-	5	75	3	-	0	Semi-Auto	1	64 (10)	.2	3	5	8	13	35	203
Arluph Arms BIC	Medium	€400	3	-	5	75	3	-	0	Semi-Auto	1	42 (10)	.4	3	5	8	13	35	204
Arluph Arms BIG	Heavy	€550	4	-	5	75	3	-	0	Semi-Auto	1	32 (10)	.6	3	5	8	13	35	205
Arluph Arms BLB	Light	€350	2	-	5	75	3	-	0	Semi-Auto	1	72 (10)	.2	3	5	8	13	35	229
Arluph Arms BLC	Medium	€400	3	-	5	75	3	-	0	Semi-Auto	1	48 (10)	.4	3	5	8	13	35	230
Arluph Arms BLG	Heavy	€550	4	-	5	75	3	-	0	Semi-Auto	1	36 (10)	.6	3	5	8	13	35	231
Arluph Arms BMA	Light	€350	3	-	5	75	3	-	0	Semi-Auto	1	85 (10)	.2	3	5	8	13	35	238
Arluph Arms BMC	Medium	€400	4	-	5	75	3	-	0	Semi-Auto	1	72 (10)	.4	3	5	8	13	35	259
Arluph Arms BMG	Heavy	€550	5	-	5	75	3	-	0	Semi-Auto	1	57 (10)	.6	3	5	8	13	35	260
Arluph Arms BPA	Light	€350	3	-	5	75	3	-	0	Semi-Auto	1	93	.2	3	5	8	13	35	281
Arluph Arms BPC	Medium	€400	4	-	5	75	3	-	0	Semi-Auto	1	125	.4	3	5	8	13	35	282
Arluph Arms BPG	Heavy	€550	5	-	5	75	3	-	0	Semi-Auto	1	75	.6	3	5	8	13	35	283
Beretta Alpine Fire	Heavy	€1,100	2	-	7	55	3	-	0	Continuous	1	144 (187)	.6	3	5	8	13	35	259
Beretta Auto Pistol	Heavy	€775	4	-	6	65	3	-	0	Auto	1	72 (93)	.6	3	5	8	13	35	259
Beretta Commando*	Medium	€800	4	-	5	75	3	-	+10	Semi-Auto	1	93	.4	3	5	8	13	35	285
Beretta Compact	Medium	€400	3	-	5	75	3	-	0	Semi-Auto	1	42 (125)	.4	3	5	8	13	35	200
Beretta Elite	Light	€350	2	-	5	75	3	-	0	Semi-Auto	1	72 (187)	.2	3	5	8	13	35	229
Beretta Equalizer	Heavy	€550	5	-	5	75	3	-	0	Semi-Auto	1	75	.6	3	5	8	13	35	286
Beretta Guardian	Medium	€400	3	-	5	75	3	-	0	Semi-Auto	1	48 (125)	.4	3	5	8	13	35	230
Beretta Hammer	Heavy	€550	5	-	5	75	3	-	0	Semi-Auto	1	57 (75)	.6	3	5	8	13	35	259
Beretta Harasser	Light	€350	2	-	5	75	3	-	0	Semi-Auto	1	128 (187)	.2	3	5	8	13	35	255
Beretta Hold-Out (203)	Hold-Out	€700	1	-	5	75	3	-	0	Sp	1	12 (37)	.1	1	3	4	7	18	203
Beretta Hold-Out (228)	Hold-Out	€700	1	-	5	75	3	-	0	Sp	1	14 (37)	.1	1	3	4	7	18	228
Beretta Hold-Out (256)	Hold-Out	€700	1	-	5	75	5	-	0	Sp	1	25 (37)	.1	1	3	4	7	18	256
Beretta Hold-Out (284)	Hold-Out	€700	1	-	5	75	3	-	0	Sp	1	37	.1	1	3	4	7	18	284
Beretta Instigator	Light	€350	2	-	5	75	3	-	0	Semi-Auto	1	187	.2	3	5	8	13	35	284
Beretta Light Sword	Heavy	€1,100	1	-	7	55	3	-	0	Continuous	1	128 (375)	.6	3	5	8	13	35	201
Beretta Nova	Heavy	€1,100	2	-	7	55	3	-	0	Continuous	1	187	.6	3	5	8	13	35	285
Beretta Pepper Box	Heavy	€775	3	-	6	65	3	-	0	Auto	1	42 (125)	.6	3	5	8	13	35	201
Beretta Raptor	Medium	€400	4	-	5	75	3	-	0	Semi-Auto	1	64 (93)	.4	3	5	8	13	35	256
Beretta Scythe	Heavy	€1,100	1	-	7	55	3	-	0	Continuous	1	144 (375)	.6	3	5	8	13	35	232
Beretta Staccato	Heavy	€775	3	-	6	65	3	-	0	Auto	1	48 (125)	.6	3	5	8	13	35	232
Beretta Super-Nova	Heavy	€775	4	-	6	65	3	-	0	Auto	1	93	.6	3	5	8	13	35	285
Beretta Terminator	Heavy	€550	4	-	5	75	3	-	0	Semi-Auto	1	32 (93)	.6	3	5	8	13	35	201
Beretta Ultra-Compact	Light	€350	2	-	5	75	3	-	+15	Semi-Auto	1	64 (187)	.2	3	5	8	13	35	202
H & K B-3	Heavy	€3,000	4	-	5	105	3	-	+15	Semi-Auto	1	32 (93)	.54	3	6	9	14	39	201
H & K B-5	Medium	€2,500	3	-	5	105	3	-	+15	Semi-Auto	1	42 (125)	.36	3	6	9	14	39	202
H & K B-7	Light	€2,000	2	-	5	105	3	-	+15	Semi-Auto	1	42 (187)	.18	3	6	9	14	39	203
H & K B-12	Heavy	€3,000	4	-	5	105	3	-	+15	Semi-Auto	1	36 (93)	.54	3	6	9	14	39	228
H & K B-14	Medium	€2,500	3	-	5	105	3	-	+15	Semi-Auto	1	48 (125)	.36	3	6	9	14	39	229
H & K B-16	Light	€2,000	2	-	5	105	3	-	+15	Semi-Auto	1	72 (187)	.18	3	6	9	14	39	230
H & K B-21	Heavy	€3,000	5	-	5	105	3	-	+15	Semi-Auto	1	51 (75)	.54	3	6	9	14	39	257
H & K B-23	Medium	€2,500	3	-	5	105	3	-	+15	Semi-Auto	1	85 (125)	.36	3	6	9	14	39	258
H & K B-25	Light	€2,000	2	-	5	105	3	-	+15	Semi-Auto	1	96 (125)	.18	3	6	9	14	39	259
H & K B-30	Heavy	€3,000	5	-	5	105	3	-	+15	Semi-Auto	1	75	.34	3	6	9	14	39	281
H & K B-32	Medium	€2,500	4	-	5	105	3	-	+15	Semi-Auto	1	93	.36	3	6	9	14	39	282
H & K B-34	Light	€2,000	3	-	5	105	3	-	+15	Semi-Auto	1	125	.18	3	6	9	14	39	283
H & K Contender	Light	€25 K	1	-	5	125	3	-	+30	Semi-Auto	1	375	.1	9	15	24	39	105	272
Pract Bloody Claw	Medium	€400	4	-	5	75	3	-	0	Semi-Auto	1	42 (125)	.4	3	5	8	13	35	201
Pract Defender	Medium	€400	4	-	5	75	3	-	0	Semi-Auto	1	93	.4	3	5	8	13	35	283
Pract Devastator	Heavy	€550	5	-	5	75	3	-	0	Semi-Auto	1	57 (75)	.6	3	5	8	13	35	259
Pract Long Tooth	Medium	€400	4	-	5	75	3	-	0	Semi-Auto	1	64 (93)	.4	3	5	8	13	35	258
Pract Peacemaker	Heavy	€550	5	-	5	75	3	-	0	Semi-Auto	1	75	.6	3	5	8	13	35	284
Pract Ripper	Heavy	€550	4	-	5	75	3	-	0	Semi-Auto	1	32 (93)	.6	3	5	8	13	35	202
Pract Talon	Medium	€400	3	-	5	75	3	-	0	Semi-Auto	1	42 (125)	.4	3	5	8	13	35	201
Pract Vengeance	Medium	€400	3	-	5	75	3	-	+10	Semi-Auto	1	48 (125)	.4	3	5	8	13	35	230
Steyr-Klough X-2	Light	€1,100	2	-	5	75	3	-	+10	Semi-Auto	1	64 (187)	.2	3	5	8	13	35	206
Steyr-Klough X-3	Medium	€1,250	3	-	5	75	3	-	+10	Semi-Auto	1	42 (125)	.4	3	5	8	13	35	206
Steyr-Klough X-4	Heavy	€1,550	4	-	5	75	3	-	+10	Semi-Auto	1	32 (93)	.6	3	5	8	13	35	206
Steyr-Klough X-9	Light	€1,100	2	-	5	75	3	-	+10	Semi-Auto	1	72 (187)	.2	3	5	8	13	35	229
Steyr-Klough X-10	Medium	€1,250	3	-	5	75	3	-	+10	Semi-Auto	1	48 (125)	.4	3	5	8	13	35	229
Steyr-Klough X-11	Heavy	€1,550	4	-	5	75	3	-	+10	Semi-Auto	1	36 (93)	.6	3	5	8	13	35	229
Steyr-Klough X-16	Light	€1,100	3	-	5	75	3	-	+10	Semi-Auto	1	96 (125)	.2	3	5	8	13	35	259
Steyr-Klough X-17	Medium	€1,250	4	-	5	75	3	-	+10	Semi-Auto	1	72 (93)	.4	3	5	8	13	35	259
Steyr-Klough X-18	Heavy	€1,550	5	-	5	75	3	-	+10	Semi-Auto	1	75	.6	3	5	8	13	35	286
Steyr-Klough X-23	Light	€1,100	3	-	5	75	3	-	+10	Semi-Auto	1	125	.2	3	5	8	13	35	286
Steyr-Klough X-24	Medium	€1,250	4	-	5	75	3	-	+10	Semi-Auto	1	93	.4	3	5	8	13	35	286
Steyr-Klough X-25	Heavy	€1,550	5	-	5	75	3	-	+10	Semi-Auto	1	75	.6	3	5	8	13	35	286
Ultimate Arms Elite	Heavy	€1 Mil	5	-	1-5	100	3	-	+25	Semi-Auto	>	>	>	6	10	16	26	70	286

*Standard military issue.
†The number of weapon cells that can be loaded at once. Sp means the weapon has a special, tiny, power cap. - Means weapon is powered by micro-generator.

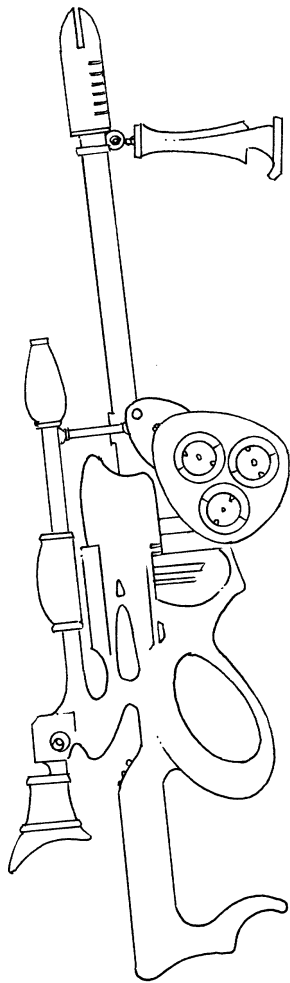

PRIVATEERS HUNTING/SNIPING BLASTER TABLE

Weapon Name	Class	Cost	BE	SS	B#	R#	F#	H#	Bonus	Action	Pwrr†	Shts.	Wt.	PB	Range in Meters						Year
															Sh	Md	Lg	Ex			
Steyr-Klough Bandit	Md Shp	ø8,400	9	-	5	75	2	II	+10	Semi-Auto	1	28 (41)	6	5	75	150	750	1,500	258		
Steyr-Klough Interdictor	Hv Shp	ø37.5 K	9	-	6	65	2	II	+10	Auto	1	16 (41)	18	5	75	150	750	1,500	235		
Steyr-Klough Marauder	Md Shp	ø8,400	8	-	5	75	2	II	+10	Semi-Auto	1	16 (46)	6	5	75	150	750	1,500	200		
Steyr-Klough Raider	Md Shp	ø8,400	8	-	5	75	2	II	+10	Semi-Auto	1	18 (46)	6	5	75	150	750	1,500	235		
Steyr-Klough Ranger	Lt Shp	ø3,500	8	-	5	75	2	II	+10	Semi-Auto	1	46	3.5	5	75	150	750	1,500	284		
Steyr-Klough Rogue	Hv Shp	ø37.5 K	10	-	6	65	2	II	+10	Auto	1	25 (37)	18	5	75	150	750	1,500	258		
Steyr-Klough Scout	Lt Shp	ø3,500	7	-	5	75	2	II	+10	Semi-Auto	1	18 (53)	3.5	5	75	150	750	1,500	200		
Steyr-Klough Sentinel	Lt Shp	ø3,500	7	-	5	75	2	II	+10	Semi-Auto	1	20 (53)	3.5	5	75	150	750	1,500	235		
Steyr-Klough Sentry	Lt Shp	ø3,500	8	-	5	75	2	II	+10	Semi-Auto	1	32 (46)	3.5	5	75	150	750	1,500	258		
Steyr-Klough Transgressor	Hv Shp	ø37.5 K	9	-	6	65	2	II	+10	Auto	1	14 (41)	18	5	75	150	750	1,500	200		
Steyr-Klough Predator	Md Shp	ø8,400	9	-	5	75	2	II	+10	Semi-Auto	1	41	6	5	75	150	750	1,500	284		
Steyr-Klough Violator	Hv Shp	ø37.5 K	10	-	6	65	2	II	+10	Auto	1	37	18	5	75	150	750	1,500	285		
Ultimate Arms LSB	Lt Shp	ø150 K	5	-	7	105	2	I	+25	Continuous	∞	∞	1.75	6	90	180	900	1,800	282		
Ultimate Arms MSB	Md Shp	ø200 K	6	-	7	105	2	I	+25	Continuous	∞	∞	3	6	90	180	900	1,800	282		
Ultimate Arms HSB	Hv Shp	ø500 K	8	-	7	105	2	II	+25	Continuous	∞	∞	9	6	90	180	900	1,800	282		

*Standard military issue.

†The number of weapon cells that can be loaded at once. Pack means weapon is powered by backpack. ∞ Means weapon is powered by micro-generator.



PRIVATEERS HUNTING/SNIPING LASER TABLE

Weapon Name	Class	Cost	LE	SS	B#	R#	F#	H#	Bonus	Action	Pwr+	Shots	Range in Meters				Year	
													PB	Sh	Mid	Lg		Ex
Arluph Arms Adventurer	Light	¢320	6	-	3	95	2	I	0	Semi-Auto	1	21 (0)	5	75	150	750	1,500	202
Arluph Arms Campaigner	Heavy	¢560	8	-	3	95	2	II	0	Semi-Auto	1	18 (0)	5	75	150	750	1,500	232
Arluph Arms Excursion	Heavy	¢560	8	-	3	95	2	II	0	Semi-Auto	1	32 (0)	5	75	150	750	1,500	260
Arluph Arms Expedition	Heavy	¢560	8	-	3	95	2	II	0	Semi-Auto	1	16 (0)	5	75	150	750	1,500	203
Arluph Arms Explorer	Light	¢320	7	-	3	95	2	I	0	Semi-Auto	1	53	5	75	150	750	1,500	285
Arluph Arms Marksman	Medium	¢400	8	-	3	95	2	II	0	Semi-Auto	1	46	5	75	150	750	1,500	284
Arluph Arms Mountaineer	Light	¢320	6	-	3	95	2	I	0	Semi-Auto	1	24 (0)	5	75	150	750	1,500	231
Arluph Arms Pathfinder	Light	¢320	7	-	3	95	2	I	0	Semi-Auto	1	41 (0)	5	75	150	750	1,500	259
Arluph Arms Safari	Heavy	¢560	9	-	3	95	2	II	0	Semi-Auto	1	41	5	75	150	750	1,500	286
Arluph Arms Sharpshooter	Medium	¢400	7	-	3	95	2	I	0	Semi-Auto	1	18 (0)	5	75	150	750	1,500	201
Arluph Arms York	Medium	¢400	7	-	3	95	2	I	0	Semi-Auto	1	20 (0)	5	75	150	750	1,500	230
Arluph Arms Long Arm	Medium	¢400	8	-	3	95	2	II	0	Semi-Auto	1	32 (0)	5	75	150	750	1,500	258
H & K K-1	Lt Snp	¢2,500	7	-	3	105	2	I	+15	Semi-Auto	1	18 (53)	15	225	450	2,250	4,500	203
H & K K-3	Mid Snp	¢6,000	8	-	3	105	2	II	+15	Semi-Auto	1	16 (46)	15	225	450	2,250	4,500	202
H & K K-5	Hv Snp	¢10 K	9	-	3	105	2	II	+15	Semi-Auto	1	14 (41)	15	225	450	2,250	4,500	201
H & K K-15	Lt Snp	¢2,500	7	-	3	105	2	I	+15	Semi-Auto	1	20 (53)	15	225	450	2,250	4,500	231
H & K K-17	Mid Snp	¢6,000	8	-	3	105	2	II	+15	Semi-Auto	1	18 (46)	15	225	450	2,250	4,500	230
H & K K-19	Hv Snp	¢10 K	9	-	3	105	2	II	+15	Semi-Auto	1	16 (41)	15	225	450	2,250	4,500	229
H & K K-29	Lt Snp	¢2,500	8	-	3	105	2	II	+15	Semi-Auto	1	36 (46)	15	225	450	2,250	4,500	259
H & K K-31	Mid Snp	¢6,000	9	-	3	105	2	II	+15	Semi-Auto	1	28 (41)	15	225	450	2,250	4,500	258
H & K K-33	Hv Snp	¢10 K	10	-	3	105	2	II	+15	Semi-Auto	1	25 (37)	15	225	450	2,250	4,500	257
H & K K-43	Lt Snp	¢2,500	8	-	3	105	2	II	+15	Semi-Auto	1	46	15	225	450	2,250	4,500	286
H & K K-45	Mid Snp	¢6,000	9	-	3	105	2	II	+15	Semi-Auto	1	41	15	225	450	2,250	4,500	285
H & K K-47	Hv Snp	¢10 K	10	-	3	105	2	II	+15	Semi-Auto	1	37	15	225	450	2,250	4,500	284
Ultimate Arms LHL	Light	¢130 K	7	-	3	145	2	I	+25	Semi-Auto	-	-	15	225	450	2,250	4,500	285
Ultimate Arms MHL	Medium	¢140 K	8	-	3	145	2	II	+25	Semi-Auto	-	-	15	225	450	2,250	4,500	285
Ultimate Arms HHL	Heavy	¢150 K	9	-	3	145	2	II	+25	Semi-Auto	-	-	15	225	450	2,250	4,500	285
Ultimate Arms LSL	Lt Snp	¢150 K	8	-	3	145	2	II	+25	Semi-Auto	-	-	25	375	750	3,750	7,500	284
Ultimate Arms MSL	Mid Snp	¢200 K	9	-	3	145	2	II	+25	Semi-Auto	-	-	25	375	750	3,750	7,500	284
Ultimate Arms HSL	Hv Snp	¢250 K	11	-	3	145	2	II	+25	Semi-Auto	-	-	25	375	750	3,750	7,500	284

†The number of weapon cells that can be loaded at once. Pack means weapon is powered by backpack. Means weapon is powered by micro-generator.

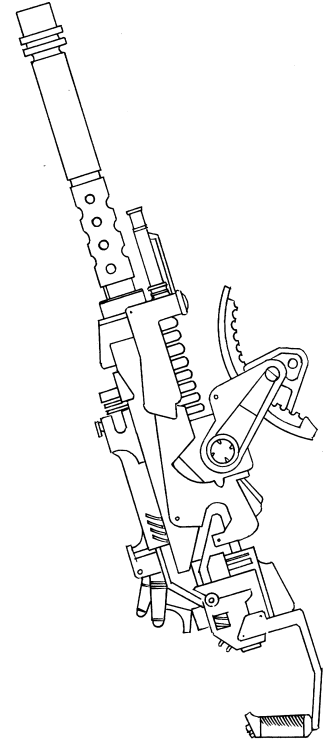

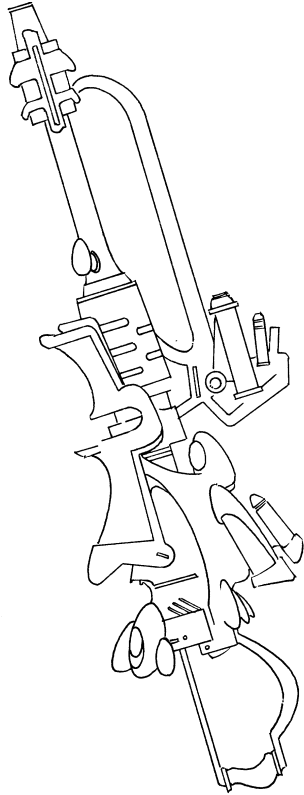

PRIVATEERS HUNTING/SNIPING PLASMA CARBINE TABLE

Weapon Name	Class	Cost	PE	SS	B#	R#	F#	H#	Bonus	Action	Pwr†	Shts.	Wt.	PB	Range in Meters				Year
															Sh	Md	Lg	Ex	
Chrometech P-105	Lt Snp	¢2,750	6	-	7	55	2	II	0	Semi-Auto	1	10 (31)	4.6	3	38	75	375	750	203
Chrometech P-106	Md Snp	¢6,600	7	-	7	55	2	II	0	Semi-Auto	1	9 (26)	7.8	3	38	75	375	750	202
Chrometech P-107	Hv Snp	¢27,500	9	-	7	55	2	II	0	Semi-Auto	1	7 (20)	23.4	3	38	75	375	750	201
Chrometech P-115	Lt Snp	¢2,750	6	-	7	55	2	II	0	Semi-Auto	1	12 (31)	4.6	3	38	75	375	750	230
Chrometech P-116	Md Snp	¢6,600	7	-	7	55	2	II	0	Semi-Auto	1	10 (26)	7.8	3	38	75	375	750	229
Chrometech P-117	Hv Snp	¢27,500	9	-	7	55	2	II	0	Semi-Auto	1	8 (20)	23.4	3	38	75	375	750	228
Chrometech P-125	Lt Snp	¢2,750	7	-	7	55	2	II	0	Semi-Auto	1	20 (26)	4.6	3	38	75	375	750	260
Chrometech P-126	Md Snp	¢6,600	8	-	7	55	2	II	0	Semi-Auto	1	18 (23)	7.8	3	38	75	375	750	259
Chrometech P-127	Hv Snp	¢27,500	10	-	7	55	2	III	0	Semi-Auto	1	12 (18)	23.4	3	38	75	375	750	258
Chrometech P-135	Lt Snp	¢2,750	7	-	7	55	2	II	0	Semi-Auto	1	26	4.6	3	38	75	375	750	286
Chrometech P-136	Md Snp	¢6,600	8	-	7	55	2	II	0	Semi-Auto	1	23	7.8	3	38	75	375	750	285
Chrometech P-137	Hv Snp	¢27,500	10	-	7	55	2	III	0	Semi-Auto	1	18	23.4	3	38	75	375	750	284
Ultimate Arms LSPC	Lt Snp	¢150 K	7	-	7	105	2	II	+25	Semi-Auto	4	4	2.3	3	45	90	450	900	285
Ultimate Arms MSPC	Md Snp	¢200 K	8	-	7	105	2	II	+25	Semi-Auto	4	4	3.9	3	45	90	450	900	285
Ultimate Arms HSPC	Hv Snp	¢275 K	10	-	7	105	2	III	+25	Semi-Auto	4	4	11.7	3	45	90	450	900	285

*These weapons load the two cells separately. Simply replacing one only restores half of the shots.

†The number of weapon cells that can be loaded at once. Pack means weapon is powered by backpack. 4 Means weapon is powered by micro-generator.



PRIVATEERS LASER PISTOL TABLE

Weapon Name	Class	Cost	LE	SS	B#	R#	F#	H#	Bonus	Action	Pwr†	Shts.	Wt.	Range in Meters						Year
														PB	Sh	Md	Lg	Ex		
Beretta Dart	Medium	¢320	3	3	3	95	3	-	0	Semi-Auto	1	48 (125)	3.2	15	25	40	65	175	231	
Beretta Flashpoint	Medium	¢320	4	3	3	95	3	1	0	Semi-Auto	1	93	3.2	15	25	40	65	175	280	
Beretta Pulse	Medium	¢320	3	3	3	95	3	-	0	Semi-Auto	1	42 (125)	3.2	15	25	40	65	175	200	
Beretta Scorch	Medium	¢320	4	3	3	95	3	-	0	Semi-Auto	1	72 (93)	3.2	15	25	40	65	175	259	
H & K LP 2	Light	¢2,500	2	-	3	105	3	-	+15	Semi-Auto	1	64 (187)	1.4	17	28	44	72	193	201	
H & K LP 3	Light	¢2,500	2	-	3	105	3	-	+15	Semi-Auto	1	72 (187)	1.4	17	28	44	72	193	230	
H & K LP 4	Light	¢2,500	3	-	3	105	3	-	+15	Semi-Auto	1	85 (125)	1.4	17	28	44	72	193	258	
H & K LP 5	Light	¢2,500	3	-	3	105	3	-	+15	Semi-Auto	1	125	1.4	17	28	44	72	193	284	
H & K LP 7	Medium	¢3,000	3	-	3	105	3	-	+15	Semi-Auto	1	42 (125)	2.9	17	28	44	72	193	202	
H & K LP 8	Medium	¢3,000	3	-	3	105	3	-	+15	Semi-Auto	1	48 (125)	2.9	17	28	44	72	193	231	
H & K LP 9	Medium	¢3,000	4	-	3	105	3	1	+15	Semi-Auto	1	72 (93)	2.9	17	28	44	72	193	259	
H & K LP 10	Medium	¢3,000	4	-	3	105	3	1	+15	Semi-Auto	1	93	2.9	17	28	44	72	193	285	
H & K LP 12	Heavy	¢3,500	4	-	3	105	3	1	+15	Semi-Auto	1	32 (93)	4.3	17	28	44	72	193	202	
H & K LP 13	Heavy	¢3,500	4	-	3	105	3	1	+15	Semi-Auto	1	36 (93)	4.3	17	28	44	72	193	231	
H & K LP 14	Heavy	¢3,500	5	-	3	105	3	1	+15	Semi-Auto	1	57 (75)	4.3	17	28	44	72	193	259	
H & K LP 15	Heavy	¢3,500	5	-	3	105	3	1	+15	Semi-Auto	1	75	4.3	17	28	44	72	193	285	
Spectrum Arms Competitor	Light	¢3,000	1	-	3	95	3	-	+25	Semi-Auto	1	375	1.6	15	25	40	65	175	283	
Spectrum Arms Flare*	Heavy	¢10 K	1	-	5	75	3	-	0	Continuous	1	375	4.8	15	25	40	65	175	284	
Spectrum Arms Sunspot	Medium	¢750	2	-	4	85	3	1	0	Auto	1	187	3.2	15	25	40	65	175	286	
Spectrum Arms Ultra	Hold-Out	¢560	1	-	3	95	5	-	0	Semi-Auto	Sp	37	.08	5	15	20	35	90	286	
Ultimate Arms Armag'ddon	Heavy	¢1 Mil	5	1-5	3	145	3	-	+25	Semi-Auto	1	—	4.8	30	50	80	130	350	286	

*This weapon utilizes cutting edge technology. It is the first of the tech level 26 weapons.

†The number of weapon cells that can be loaded at once. Sp means the weapon has a special, tiny, power cap. — Means weapon is powered by micro-generator.

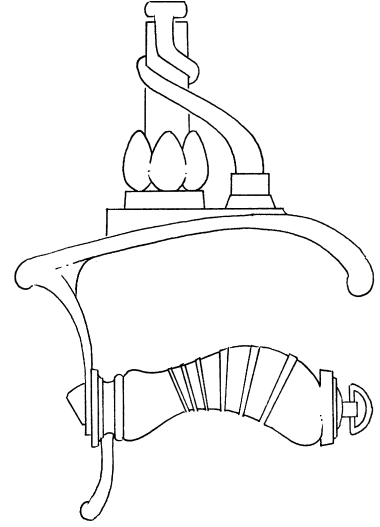

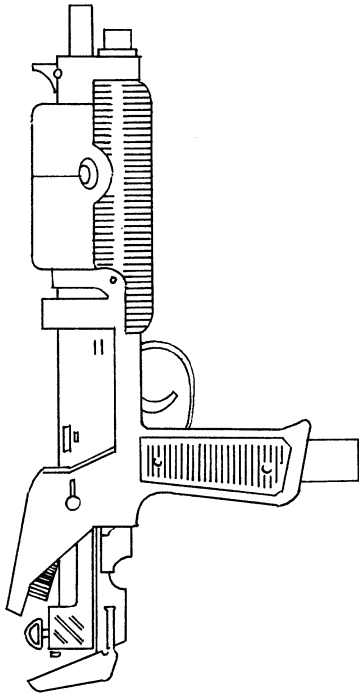

PRIVATEERS PLASMA PISTOL TABLE

Weapon Name	Class	Cost	PE	SS	B#	R#	F#	H#	Bonus	Action	Pwr†	Shts.	Wt.	PB	Range in Meters				Ex	Year
															Sh	Md	Lg			
Spectrum Arms 51*	Hold-Out	¢1,500	1	1	7	55	5	-	0	Semi-Auto	Sp	6 (18)	.1	1	2	3	4	9	205	
Spectrum Arms 63*	Hold-Out	¢1,500	1	1	7	55	5	-	0	Semi-Auto	Sp	7 (18)	.1	1	2	3	4	9	240	
Spectrum Arms 72	Hold-Out	¢1,500	1	1	7	55	5	-	0	Semi-Auto	Sp	14 (18)	.1	1	2	3	4	9	265	
Spectrum Arms 83	Hold-Out	¢1,500	1	1	7	55	5	-	0	Semi-Auto	Sp	18	.1	1	2	3	4	9	286	
Spectrum Arms 1251	Light	¢1,000	1	2	7	55	3	-	0	Semi-Auto	1	64 (187)	.3	2	3	4	7	18	204	
Spectrum Arms 1263	Light	¢1,000	1	2	7	55	3	-	0	Semi-Auto	1	72 (187)	.3	2	3	4	7	18	239	
Spectrum Arms 1272	Light	¢1,000	2	2	7	55	3	-	0	Semi-Auto	1	72 (93)	.3	2	3	4	7	18	264	
Spectrum Arms 1280	Light	¢1,000	2	2	7	55	3	-	0	Semi-Auto	1	93	.3	2	3	4	7	18	285	
Spectrum Arms 2074	Medium	¢1,100	2	3	7	55	3	1	0	Semi-Auto	1	32 (93)	.5	2	3	4	7	18	203	
Spectrum Arms 2086	Medium	¢1,100	2	3	7	55	3	1	0	Semi-Auto	1	36 (93)	.5	2	3	4	7	18	238	
Spectrum Arms 2095	Medium	¢1,100	3	3	7	55	3	1	0	Semi-Auto	1	48 (62)	.5	2	3	4	7	18	263	
Spectrum Arms 2105	Medium	¢1,100	3	3	7	55	3	1	0	Semi-Auto	1	62	.5	2	3	4	7	18	284	
Spectrum Arms 3072	Heavy	¢1,300	3	4	7	55	3	1	0	Semi-Auto	1	21 (62)	.8	2	3	4	7	18	202	
Spectrum Arms 3081	Heavy	¢1,300	3	4	7	55	3	1	0	Semi-Auto	1	24 (62)	.8	2	3	4	7	18	237	
Spectrum Arms 3090	Heavy	¢1,300	4	4	7	55	3	1	0	Semi-Auto	1	36 (46)	.8	2	3	4	7	18	262	
Spectrum Arms 3100	Heavy	¢1,300	4	4	7	55	3	1	0	Semi-Auto	1	46	.8	2	3	4	7	18	283	
Ultimate Arms Demolisher	Heavy	¢1 Mil	4	1-5	7	105	3	1	+25	Semi-Auto	1		.4	3	5	8	13	35	286	

*These weapons are underpowered. All criticals are reduced by two levels of severity. A "B" becomes an "A" -25. An "A" becomes an "A" -50.

†The number of weapon cells that can be loaded at once. Sp means the weapon has a special, tiny, power cap. _ Means weapon is powered by micro-generator.



PRIVATEERS SONIC STUNNER TABLE

Weapon Name	Cost	SS	B#	R#	F#	H#	Bonus	Action	Pwr†	Wt.	Range in Meters					Year‡
											PB	Sh	Md	Lg	Ex	
Security Systems Mark I Stunner (HH)*	¢300	1	1	150	2	-	0	Continuous	1	.01	1	5	10	20	50	203
Security Systems Mark I Stunner (UB)*	¢310	1	1	150	2	-	0	Continuous	1	.01	1	5	10	20	50	203
Security Systems Mark II Stunner (HH)*	¢310	2	1	150	2	-	0	Continuous	1	.01	1	5	10	20	50	203
Security Systems Mark II Stunner (UB)*	¢320	2	1	150	2	-	0	Continuous	1	.01	1	5	10	20	50	203
Security Systems Mark III Stunner (HH)*	¢320	3	1	150	2	-	0	Continuous	1	.01	1	5	10	20	50	203
Security Systems Mark III Stunner (UB)*	¢330	3	1	150	2	-	0	Continuous	1	.01	1	5	10	20	50	203
Security Systems Mark IV Stunner (HH)*	¢330	4	1	150	2	-	0	Continuous	1	.01	1	5	10	20	50	203
Security Systems Mark IV Stunner (UB)*	¢340	4	1	150	2	-	0	Continuous	1	.01	1	5	10	20	50	203
Security Systems Mark V Stunner (HH)*	¢340	5	1	150	2	-	0	Continuous	1	.01	1	5	10	20	50	203
Security Systems Mark V Stunner (UB)*	¢350	5	1	150	2	-	0	Continuous	1	.01	1	5	10	20	50	203
Security Systems Deluxe Stunner (HH)*	¢400	1-5	1	150	2	-	0	Continuous	1	.01	1	5	10	20	50	203
Security Systems Deluxe Stunner (UB)*	¢450	1-5	1	150	2	-	0	Continuous	1	.01	1	5	10	20	50	203

*HH Stands for Hand Held. UB Stands for Under Barrel

†These items do not use standard weapon cells. They use tiny utility cells. These can operate for several days without interruption.

‡ The Security System's Stunners have changed little in practical effects over the years.

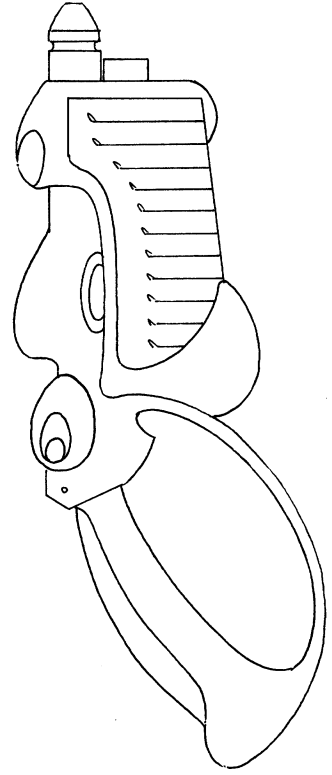



PRIVATEERS SUBASSAULT BLASTER TABLE

Weapon Name	Class	Cost	BE	SS	B#	R#	F#	H#	Bonus	Action	Pwr†	Shots	Wt.	PB	Range in Meters			Ex	Year
															Sh	Md	Lg		
Arluph Arms PAB	Light	¢1,000	3	-	6	65	3	-	0	Auto	1	42 (0)	2.5	1	10	20	50	100	201
Arluph Arms PBS	Medium	¢1,600	4	-	6	65	3	1	0	Auto	1	32 (0)	3	1	10	20	50	100	201
Arluph Arms PCG	Heavy	¢2,200	5	-	6	65	3	1	0	Auto	1	25 (0)	3.5	1	10	20	50	100	201
Arluph Arms QAD	Light	¢1,000	3	-	6	65	3	-	0	Auto	1	48 (0)	2.5	1	10	20	50	100	229
Arluph Arms QBS	Medium	¢1,600	4	-	6	65	3	1	0	Auto	1	36 (0)	3	1	10	20	50	100	229
Arluph Arms QDD	Heavy	¢2,200	5	-	6	65	3	1	0	Auto	1	28 (0)	3.5	1	10	20	50	100	229
Arluph Arms RTA	Light	¢1,000	4	-	6	65	3	1	0	Auto	1	64 (0)	2.5	1	10	20	50	100	256
Arluph Arms RUD	Medium	¢1,600	5	-	6	65	3	1	0	Auto	1	51 (0)	3	1	10	20	50	100	256
Arluph Arms RVS	Heavy	¢2,200	6	-	6	65	3	1	0	Auto	1	42 (0)	3.5	1	10	20	50	100	256
Arluph Arms SBA	Light	¢1,000	4	-	6	65	3	1	0	Auto	1	93	2.5	1	10	20	50	100	279
Arluph Arms SBG	Medium	¢1,600	5	-	6	65	3	1	0	Auto	1	75	3	1	10	20	50	100	279
Arluph Arms SBM	Heavy	¢2,200	6	-	6	65	3	1	0	Auto	1	62	3.5	1	10	20	50	100	279
H & K SB 1	Light	¢13 K	1	1	7	95	3	-	+15	Continuous	1	128 (375)	2.3	1	11	22	55	110	205
H & K SB 3	Medium	¢19 K	2	3	7	95	3	-	+15	Continuous	1	64 (187)	2.7	1	11	22	55	110	206
H & K SB 5	Heavy	¢26 K	3	5	7	95	3	-	+15	Continuous	1	42 (125)	3.1	1	11	22	55	110	207
H & K SB 15	Light	¢13 K	1	1	7	95	3	-	+15	Continuous	1	144 (375)	2.3	1	11	22	55	110	230
H & K SB 17	Medium	¢19 K	2	3	7	95	3	-	+15	Continuous	1	72 (187)	2.7	1	11	22	55	110	231
H & K SB 19	Heavy	¢26 K	3	5	7	95	3	-	+15	Continuous	1	48 (125)	3.1	1	11	22	55	110	232
H & K SB 29	Light	¢13 K	2	1	7	95	3	-	+15	Continuous	1	128 (187)	2.3	1	11	22	55	110	256
H & K SB 31	Medium	¢19 K	3	3	7	95	3	-	+15	Continuous	1	85 (125)	2.7	1	11	22	55	110	257
H & K SB 33	Heavy	¢26 K	4	5	7	95	3	1	+15	Continuous	1	64 (93)	3.1	1	11	22	55	110	258
H & K SB 43	Light	¢13 K	2	1	7	95	3	-	+15	Continuous	1	187	2.3	1	11	22	55	110	280
H & K SB 45	Medium	¢19 K	3	3	7	95	3	-	+15	Continuous	1	125	2.7	1	11	22	55	110	281
H & K SB 47	Heavy	¢26 K	4	5	7	95	3	1	+15	Continuous	1	93	3.1	1	11	22	55	110	282
Spectrum Arms A-3	Light	¢1,000	2	-	7	55	3	-	0	Continuous	1	187	2.5	1	10	20	50	100	284
Spectrum Arms A-4*	Medium	¢1,600	3	-	7	55	3	-	0	Continuous	1	125	3	1	10	20	50	100	284
Spectrum Arms A-5	Heavy	¢2,200	4	-	7	55	3	1	0	Continuous	1	93	3.5	1	10	20	50	100	285
Ultimate Arms LSB	Light	¢110 K	2	-	7	105	3	-	0	Continuous	-	-	1.3	2	20	40	100	200	279
Ultimate Arms MSB	Medium	¢150 K	3	-	7	105	3	-	0	Continuous	-	-	1.5	2	20	40	100	200	279
Ultimate Arms HSB	Heavy	¢190 K	4	-	7	105	3	1	0	Continuous	-	-	1.8	2	20	40	100	200	279

*Standard military issue.

†The number of weapon cells that can be loaded at once. Pack means weapon is powered by backpack. _ Means weapon is powered by micro-generator.



PRIVATEERS SUBASSAULT LASER TABLE

Weapon Name	Class	Cost	LE	SS	B#	R#	F#	H#	Bonus	Action	Pwr†	Shts.	Wt.	Range in Meters			Ex	Year	
														PB	Sh	Md			Lg
Spectrum Arms L-1	Light	¢650	2	-	4	85	3	-	0	Auto	1	64 (187)	2	5	50	100	250	500	201
Spectrum Arms L-2	Medium	¢1,040	3	-	4	85	3	-	0	Auto	1	42 (125)	2.4	5	50	100	250	500	201
Spectrum Arms L-3	Heavy	¢1,430	4	-	4	85	3	I	0	Auto	1	32 (93)	2.8	5	50	100	250	500	202
Spectrum Arms L-5	Light	¢650	2	-	4	85	3	-	0	Auto	1	72 (187)	2	5	50	100	250	500	231
Spectrum Arms L-6	Medium	¢1,040	3	-	4	85	3	-	0	Auto	1	48 (125)	2.4	5	50	100	250	500	231
Spectrum Arms L-7	Heavy	¢1,430	4	-	4	85	3	I	0	Auto	1	36 (93)	2.8	5	50	100	250	500	232
Spectrum Arms L-9	Light	¢650	3	-	4	85	3	-	0	Auto	1	85 (125)	2	5	50	100	250	500	257
Spectrum Arms L-10	Medium	¢1,040	4	-	4	85	3	I	0	Auto	1	64 (93)	2.4	5	50	100	250	500	257
Spectrum Arms L-11	Heavy	¢1,430	5	-	4	85	3	I	0	Auto	1	51 (75)	2.8	5	50	100	250	500	258
Spectrum Arms L-13	Light	¢650	3	-	4	85	3	-	0	Auto	1	125	2	5	50	100	250	500	280
Spectrum Arms L-14	Medium	¢1,040	4	-	4	85	3	I	0	Auto	1	93	2.4	5	50	100	250	500	280
Spectrum Arms L-15	Heavy	¢1,430	5	-	4	85	3	I	0	Auto	1	75	2.8	5	50	100	250	500	281
Ultimate Arms LSL	Light	¢140 K	3	1-5	4	135	3	-	+25	Auto	✓	✓	1	10	100	200	500	1,000	284
Ultimate Arms LML	Medium	¢160 K	4	1-5	4	135	3	I	+25	Auto	✓	✓	1.2	10	100	200	500	1,000	284
Ultimate Arms LHL	Heavy	¢180 K	5	1-5	4	135	3	I	+25	Auto	✓	✓	1.4	10	100	200	500	1,000	284

†The number of weapon cells that can be loaded at once. Pack means weapon is powered by backpack. ✓ Means weapon is powered by micro-generator.

PRIVATEERS SUBASSAULT PLASMA CARBINE TABLE

Weapon Name	Class	Cost	PE	SS	B#	R#	F#	H#	Bonus	Action	Pwr†	Shts.	Wt.	Range in Meters			Ex	Year	
														PB	Sh	Md			Lg
Arluph Arms PPA	Light	¢1,000	1	-	8	45	3	-	0	Auto	1	64 (0)	3.3	1	5	10	25	50	207
Arluph Arms PPG	Medium	¢1,600	2	-	8	45	3	-	0	Auto	1	32 (0)	3.9	1	5	10	25	50	206
Arluph Arms PPH	Heavy	¢2,200	3	-	8	45	3	I	0	Auto	1	11 (0)	4.6	1	5	10	25	50	205
Arluph Arms QPA	Light	¢1,000	1	-	8	45	3	-	0	Auto	1	72 (0)	3.3	1	5	10	25	50	238
Arluph Arms QPG	Medium	¢1,600	2	-	8	45	3	-	0	Auto	1	36 (0)	3.9	1	5	10	25	50	237
Arluph Arms QPH	Heavy	¢2,200	3	-	8	45	3	I	0	Auto	1	24 (0)	4.6	1	5	10	25	50	236
Arluph Arms RPA	Light	¢1,000	2	-	8	45	3	-	0	Auto	1	72 (0)	3.3	1	5	10	25	50	261
Arluph Arms RPG	Medium	¢1,600	3	-	8	45	3	I	0	Auto	1	48 (0)	3.9	1	5	10	25	50	260
Arluph Arms RPH	Heavy	¢2,200	4	-	8	45	3	I	0	Auto	1	36 (0)	4.6	1	5	10	25	50	259
Arluph Arms SPA	Light	¢1,000	2	-	8	45	3	-	0	Auto	1	93	3.3	1	5	10	25	50	286
Arluph Arms SPG	Medium	¢1,600	3	-	8	45	3	I	0	Auto	1	62	3.9	1	5	10	25	50	285
Arluph Arms SPH	Heavy	¢2,200	4	-	8	45	3	I	0	Auto	1	46	4.6	1	5	10	25	50	284
Ultimate Arms LSPC	Light	¢140 K	2	1-5	8	95	3	-	+25	Auto	✓	✓	1.6	1	10	20	50	100	282
Ultimate Arms MSPC	Medium	¢160 K	3	1-5	8	95	3	I	+25	Auto	✓	✓	2	1	10	20	50	100	282
Ultimate Arms HSPC	Heavy	¢180 K	4	1-5	8	95	3	I	+25	Auto	✓	✓	2.3	1	10	20	50	100	282

†The number of weapon cells that can be loaded at once. Sp means the weapon has a special, tiny, power cap. ✓ Means weapon is powered by micro-generator.



PRIVATEERS SUPPORT BLASTER TABLE

Weapon Name	Class	Cost	BE	B#	R#	F#	H#	Bonus	Action	Pwr†	Shts.	Wt.	PB	Range in Meters			Ex	Year
														Sh	Md	Lg		
Arluph Arms PUA	Light	¢4,600	5	7	55	4	I	0	Continuous	Pack	2,560 (0)	6	1	15	30	150	300	202
Arluph Arms PUD	Medium	¢7,000	6	7	55	4	I	0	Continuous	Pack	2,133 (0)	12	1	15	30	150	300	202
Arluph Arms PUF	Heavy	¢15,000	7	7	55	4	I	0	Continuous	Pack	1,828 (0)	18	1	15	30	150	300	202
Arluph Arms QUA	Light	¢4,600	5	7	55	4	I	0	Continuous	Pack	2,880 (0)	16	1	15	30	150	300	231
Arluph Arms QUD	Medium	¢7,000	6	7	55	4	I	0	Continuous	Pack	2,400 (0)	22	1	15	30	150	300	231
Arluph Arms QUF	Heavy	¢15,000	7	7	55	4	I	0	Continuous	Pack	2,057 (0)	28	1	15	30	150	300	232
Arluph Arms RUA	Light	¢4,600	6	7	55	4	I	0	Continuous	Pack	4,266 (0)	16	1	15	30	150	300	258
Arluph Arms RUD	Medium	¢7,000	7	7	55	4	I	0	Continuous	Pack	3,657 (0)	22	1	15	30	150	300	258
Arluph Arms RUF	Heavy	¢15,000	8	7	55	4	II	0	Continuous	Pack	3,200 (0)	28	1	15	30	150	300	259
Arluph Arms SUA	Light	¢4,600	6	7	55	4	I	0	Continuous	Pack	6,250	16	1	15	30	150	300	284
Arluph Arms SUD	Medium	¢7,000	7	7	55	4	I	0	Continuous	Pack	5,357	22	1	15	30	150	300	385
Arluph Arms SUF	Heavy	¢15,000	8	7	55	4	II	0	Continuous	Pack	4,687	28	1	15	30	150	300	286
H&K Annihilator‡	HvyWeapon	¢500 K	11	7	75	4	II	0	Continuous	External	—	50	10	150	300	1,500	3,000	282
H&K Justifier‡	HvyWeapon	¢1 Mil	12	7	75	4	II	0	Continuous	External	—	100	10	150	300	1,500	3,000	283
H&K Apocalypse‡	HvyWeapon	¢1.5 Mil	13	7	75	4	III	0	Continuous	External	—	150	10	150	300	1,500	3,000	284
Spectrum Arms S-2	Light	¢13,900	5	7	65	4	I	+5	Continuous	_Pack	—	16	1	15	30	150	300	202
Spectrum Arms S-3	Medium	¢16,500	6	7	65	4	I	+5	Continuous	_Pack	—	22	1	15	30	150	300	209
Spectrum Arms S-4	Heavy	¢26,250	7	7	65	4	I	+5	Continuous	_Pack	—	28	1	15	30	150	300	219
Spectrum Arms S-5	Light	¢13,900	5	7	65	4	I	+5	Continuous	_Pack	—	16	1	15	30	150	300	230
Spectrum Arms S-6	Medium	¢16,500	6	7	65	4	I	+5	Continuous	_Pack	—	22	1	15	30	150	300	239
Spectrum Arms S-7	Heavy	¢26,250	7	7	65	4	I	+5	Continuous	_Pack	—	28	1	15	30	150	300	250
Spectrum Arms S-8	Light	¢13,900	6	7	65	4	I	+5	Continuous	_Pack	—	16	1	15	30	150	300	258
Spectrum Arms S-9	Medium	¢16,500	7	7	65	4	I	+5	Continuous	_Pack	—	22	1	15	30	150	300	267
Spectrum Arms S-10	Heavy	¢26,250	8	7	65	4	II	+5	Continuous	_Pack	—	28	1	15	30	150	300	276
Spectrum Arms S-11*	Light	¢13,900	6	7	65	4	I	+5	Continuous	_Pack	—	16	1	15	30	150	300	279
Spectrum Arms S-12*	Medium	¢16,500	7	7	65	4	I	+5	Continuous	_Pack	—	22	1	15	30	150	300	281
Spectrum Arms S-13*	Heavy	¢26,250	8	7	65	4	II	+5	Continuous	_Pack	—	28	1	15	30	150	300	286
Ultimate Arms LSB	Light	¢200 K	6	7	105	4	I	+25	Continuous	—	—	3	1	15	30	150	300	285
Ultimate Arms MSB	Medium	¢250 K	7	7	105	4	I	+25	Continuous	—	—	6	1	15	30	150	300	285
Ultimate Arms HSB	Heavy	¢400 K	8	7	105	4	II	+25	Continuous	—	—	9	1	15	30	150	300	285

*Military Issue.

†The number of weapon cells that can be loaded at once. Pack means weapon is powered by backpack. 4 Means weapon is powered by micro-generator. 4 Pack means the weapon is powered by a micro-generator pack.

‡None of these weapons are man-portable. While out of the scope of the normal weapons of this book, they are included for the sake of completeness.



PRIVATEERS SUPPORT LASER TABLE

Weapon Name	Class	Cost	LE	B#	R#	F#	H#	Bonus	Action	Pwr†	Shts.	Wt.	Range in Meters				Year	
													PB	Sh	Md	Lg		Ex
Spectrum Arms L-30	Light	¢2,560	6	4	85	4	I	0	Auto	Pack	2,133	15	5	75	150	750	1,500	203
Spectrum Arms L-31	Medium	¢3,600	7	4	85	4	I	0	Auto	Pack	(0)	20	5	75	150	750	1,500	212
Spectrum Arms L-32	Heavy	¢7,500	8	4	85	4	II	0	Auto	Pack	1,828 (0)	25	5	75	150	750	1,500	221
Spectrum Arms L-33	Light	¢2,560	6	4	85	4	I	0	Auto	Pack	2,400 (0)	15	5	75	150	750	1,500	230
Spectrum Arms L-34	Medium	¢3,600	7	4	85	4	I	0	Auto	Pack	(0)	20	5	75	150	750	1,500	239
Spectrum Arms L-35	Heavy	¢7,500	8	4	85	4	II	0	Auto	Pack	2,057 (0)	25	5	75	150	750	1,500	248
Spectrum Arms L-36	Light	¢2,560	7	4	85	4	I	0	Auto	Pack	3,657 (0)	15	5	75	150	750	1,500	257
Spectrum Arms L-37	Medium	¢3,600	8	4	85	4	II	0	Auto	Pack	(0)	20	5	75	150	750	1,500	266
Spectrum Arms L-38	Heavy	¢7,500	9	4	85	4	II	0	Auto	Pack	3,600 (0)	25	5	75	150	750	1,500	276
Spectrum Arms L-39	Light	¢2,560	7	4	85	4	I	0	Auto	Pack	5,357 (0)	15	5	75	150	750	1,500	280
Spectrum Arms L-40	Medium	¢3,600	8	4	85	4	II	0	Auto	Pack	4,687	20	5	75	150	750	1,500	285
Spectrum Arms L-41	Heavy	¢7,500	9	4	85	4	II	0	Auto	Pack	4,166	25	5	75	150	750	1,500	286
Spectrum Arms Colossus†	Hvy W/pn	¢500 K	11	4	105	4	II	0	Auto	External	—	50	50	750	1,500	7,500	15,000	282
Spectrum Arms Light Blade‡	Hvy W/pn	¢1 Mil	12	4	105	4	II	0	Auto	External	—	100	50	750	1,500	7,500	15,000	281
Spectrum Arms Pulsar‡	Hvy W/pn	¢1.5 Mil	13	4	105	4	III	0	Auto	External	—	150	50	750	1,500	7,500	15,000	283
Ultimate Arms LSUL	Light	¢180 K	7	4	135	4	I	+25	Auto	—	—	2.4	10	150	300	1,500	3,000	284
Ultimate Arms MSUL	Medium	¢230 K	8	4	135	4	II	+25	Auto	—	—	4.8	10	150	300	1,500	3,000	284
Ultimate Arms HMUL	Heavy	¢380 K	9	4	135	4	II	+25	Auto	—	—	6.2	10	150	300	1,500	3,000	284

*Military Issue.

†The number of weapon cells that can be loaded at once. Pack means weapon is powered by backpack. _ Means weapon is powered by micro-generator. _ Pack means the weapon is powered by a micro-generator pack.

‡None of these weapons are man-portable. While out of the scope of the normal weapons of this book, they are included for the sake of completeness.

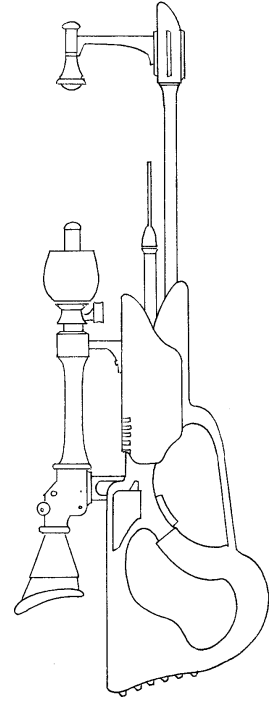

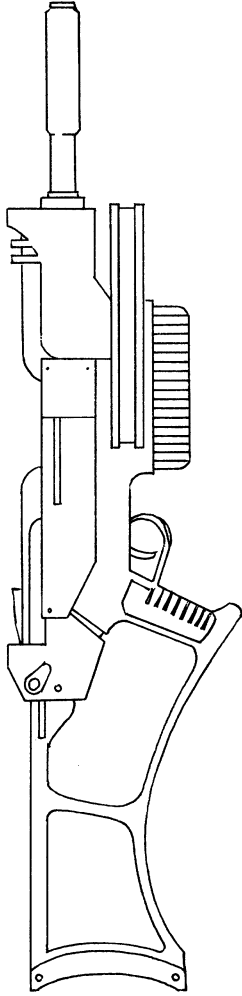

PRIVATEERS SUPPORT PLASMA CANNON TABLE

Weapon Name	Class	Cost	PE	B#	R#	F#	H#	Bonus	Action	Pwr†	Shts.	Wt.	PB	Range in Meters			Year	
														Sh	Md	Lg		Ex
H & K SPC-2	Light	¢17.8 K	5	8	75	4	I	+10	Auto	Pack	1,280 (0)	17	1	8	17	83	165	203
H & K SPC-5	Medium	¢29 K	6	8	75	4	II	+10	Auto	Pack	1,066 (0)	24	1	8	17	83	165	202
H & K SPC-6	Heavy	¢71 K	7	8	75	4	II	+10	Auto	Pack	914 (0)	31	1	8	17	83	165	201
H & K SPC-10	Light	¢17.8 K	5	8	75	4	I	+10	Auto	Pack	1,440 (0)	17	1	8	17	83	165	231
H & K SPC-13	Medium	¢29 K	6	8	75	4	II	+10	Auto	Pack	1,200 (0)	24	1	8	17	83	165	230
H & K SPC-17	Heavy	¢71 K	7	8	75	4	II	+10	Auto	Pack	1,028 (0)	31	1	8	17	83	165	229
H & K SPC-20	Light	¢17.8 K	6	8	75	4	II	+10	Auto	Pack	2,400 (0)	17	1	8	17	83	165	259
H & K SPC-22	Medium	¢29 K	7	8	75	4	II	+10	Auto	Pack	2,057 (0)	24	1	8	17	83	165	258
H & K SPC-23	Heavy	¢71 K	8	8	75	4	II	+10	Auto	Pack	1,800 (0)	31	1	8	17	83	165	256
H & K SPC-24	Light	¢17.8 K	6	8	75	4	II	+10	Auto	Pack	3,125	17	1	8	17	83	165	283
H & K SPC-25	Medium	¢29 K	7	8	75	4	II	+10	Auto	Pack	2,678	24	1	8	17	83	165	282
H & K SPC-30	Heavy	¢71 K	8	8	75	4	II	+10	Auto	Pack	2,343	31	1	8	17	83	165	280
H & K Fusion‡	Hvy Weapon	¢750 K	9	8	75	4	II	+10	Auto	External	—	75	6	83	165	825	1,650	281
H & K Solar Flare‡	Hvy Weapon	¢1.5 Mil	10	8	75	4	III	+10	Auto	External	—	150	6	83	165	825	1,650	281
Ultimate Arms LSUPC	Light	¢220 K	6	8	95	4	II	+25	Auto	—	—	3.9	1	15	30	150	300	284
Ultimate Arms MSUPC	Medium	¢270 K	7	8	95	4	II	+25	Auto	—	—	7.8	1	15	30	150	300	284
Ultimate Arms HSUPC	Heavy	¢420 K	8	8	95	4	II	+25	Auto	—	—	11.7	1	15	30	150	300	284

*Military Issue.

†The number of weapon cells that can be loaded at once. Pack means weapon is powered by backpack. _ Means weapon is powered by micro-generator. _ Pack means the weapon is powered by a micro-generator pack.

‡None of these weapons are man-portable. While out of the scope of the normal weapons of this book, they are included for the sake of completeness.



COMMON IMPERIAL BLASTER WEAPONS

Weapon Name	Class	Cost	BE	B#	R#	F#	H#	Bonus	Action	Pwr†	Shots	Wt.	PB	Sh	Range in Meters			Ex
															Md	Lg	Ex	
Blaster Pistols:																		
Harrzit Tock	Hold-Out	¢700	1	5	75	5	-	0	Semi-Auto	Sp	28	.1	1	3	4	7	18	
Prrrl Tock	Light	¢350	3	5	75	3	-	0	Semi-Auto	1	93	.2	3	5	8	13	35	
Grazzzin Tock	Medium	¢400	4	5	75	3	I	0	Semi-Auto	1	70	.4	3	5	8	13	35	
Trraal Tock	Heavy	¢550	5	5	75	3	I	0	Semi-auto	1	56	.6	3	5	8	13	35	
Subassault Blasters:																		
Trazztt Tock-ar	Light	¢1,000	2	7	55	3	-	0	Continuous	1	140	2.5	1	10	20	50	100	
Grrrrll Tock-ar	Medium	¢1,600	3	7	55	3	-	0	Continuous	1	93	3	1	10	20	50	100	
Arrrl Tock-ar	Heavy	¢2,200	4	7	55	3	I	0	Continuous	1	70	3.5	1	10	20	50	100	
Assault Blasters:																		
Grrrral Rrrng	Light	¢800	4	7	55	3	I	0	Continuous	1	70	3	1	10	20	100	200	
Herrrnck Rrrng	Medium	¢1,000	5	7	55	3	I	0	Continuous	1	56	3.5	1	10	20	100	200	
Rrrrral Rrrng	Heavy	¢1,400	6	7	55	3	I	0	Continuous	1	46	4	1	10	20	100	200	
Sniping Blasters:																		
Harrffung Tang	Light	¢2,500	8	5	75	2	II	0	Semi-Auto	1	35	3.5	5	75	150	750	1,500	
Kitrrrp Tang	Medium	¢6,000	9	5	75	2	II	0	Semi-Auto	1	31	6	5	75	150	750	1,500	
Arrrig Tang	Heavy	¢27,500	10	6	65	2	II	0	Auto	1	28	18	5	75	150	750	1,500	
Support Blasters:																		
Yarrl Pock	Light	¢3,400	6	7	55	4	I	0	Continuous	Pack	4,666	26	1	15	30	150	300	
Farrl Pock	Medium	¢5,000	7	7	55	4	I	0	Continuous	Pack	4,000	32	1	15	30	150	300	
Garrzrg Pock	Heavy	¢11,000	8	7	55	4	II	0	Continuous	Pack	3,500	38	1	15	30	150	300	
Heavy Weapons†:																		
Hasscill Thang	Light	¢50 Mil	11	7	55	4	II	0	Continuous	External	∞	50	10	150	300	1,500	3,000	
Garrrrr Thang	Medium	¢100 Mil	12	7	55	4	II	0	Continuous	External	∞	100	10	150	300	1,500	3,000	
Kitock Thang	Heavy	¢150 Mil	13	7	55	4	III	0	Continuous	External	∞	150	10	150	300	1,500	3,000	

†The number of weapon cells that can be loaded at once (Imperial weapon cells are twice as big as ISC cells). Pack means weapon is powered by backpack. ∞ Means weapon is powered by micro-generator. Sp means the weapon uses a special power cap.

‡None of these weapons are man-portable. While out of the scope of the normal weapons of this book, they are included for completeness sake.

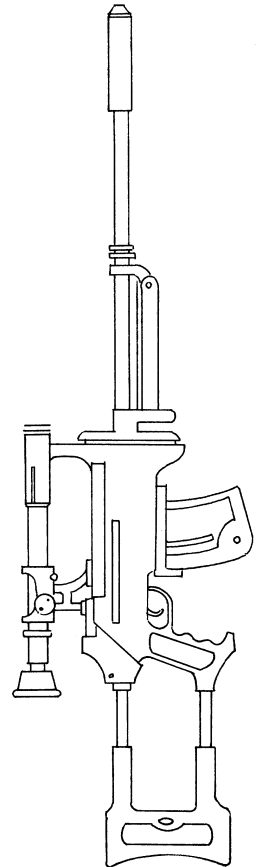



COMMON IMPERIAL LASER WEAPONS

Weapon Name	Class	Cost	LE	B#	R#	F#	H#	Bonus	Action	Pwr†	Shts.	Wt.	PB	Range in Meters			Ex
														Sh	Md	Lg	
Laser Pistols:																	
Prrrig Tock	Hold-Out	¢560	1	3	95	5	-	0	Semi-Auto	Sp	28	.1	5	15	20	35	90
Jarrl Tock	Light	¢200	3	3	95	3	-	0	Semi-Auto	1	93	.2	15	25	40	65	175
Karrl Tock	Medium	¢520	2	4	85	3	-	0	Auto	1	140	.3	15	25	40	65	175
Larrum Tock	Heavy	¢440	5	3	95	3	I	0	Semi-Auto	1	56	.5	15	25	40	65	175
Subassault Lasers:																	
Frrrr Tock-ar	Light	¢650	3	4	85	3	-	0	Auto	1	93	2	5	50	100	250	500
Marrrr Tock-ar	Medium	¢1,040	4	4	85	3	I	0	Auto	1	70	2.4	5	50	100	250	500
Warrl Tock-ar	Heavy	¢1,430	5	4	85	3	I	0	Auto	1	56	2.8	5	50	100	250	500
Assault Lasers:																	
Krrrr Rrrng	Light	¢520	5	4	85	3	I	0	Auto	1	56	2.4	5	50	100	500	1,000
Trrrratak Rrrng	Medium	¢650	6	4	85	3	I	0	Auto	1	46	2.8	5	50	100	500	1,000
Mrrrras Rrrng	Heavy	¢910	7	4	85	3	I	0	Auto	1	40	3.2	5	50	100	500	1,000
Sniping Lasers:																	
Varrl Tang*	Light	¢900	8	3	95	2	II	0	Semi-Auto	1	35	2.8	10	150	300	1,500	3,000
Zarrl Tang*	Medium	¢2,160	9	3	95	2	II	0	Semi-Auto	1	31	4.8	10	150	300	1,500	3,000
Narrl Tang*	Heavy	¢9,000	10	3	95	2	II	+5	Semi-Auto	1	28	14.4	10	150	300	1,500	3,000
Support Lasers:																	
Grrrras Pock	Light	¢2,560	7	4	85	4	I	0	Auto	Pack	4,000	24.8	5	75	150	750	1,500
Jarral Pock	Medium	¢3,600	8	4	85	4	II	0	Auto	Pack	3,500	29.6	5	75	150	750	1,500
Tanik Pock	Heavy	¢7,500	9	4	85	4	II	0	Auto	Pack	3,111	34.4	5	75	150	750	1,500
Heavy Weapons†:																	
Barrl Thang	Light	¢500 K	11	4	85	4	II	0	Auto	External	✓	50	50	750	1,500	7,500	15,000
Prrrrimis Thang	Medium	¢1 Mil	12	4	85	4	II	0	Auto	External	✓	100	50	750	1,500	7,500	15,000
Brrrasack Thang	Heavy	¢1.5 Mil	13	4	85	4	III	0	Auto	External	✓	150	50	750	1,500	7,500	15,000

†The number of weapon cells that can be loaded at once (Imperial weapon cells are twice as big as ISC cells). Pack means weapon is powered by backpack. ✓ Means weapon is powered by micro-generator. Sp means the weapon uses a special power cap.

‡None of these weapons are man-portable. While out of the scope of the normal weapons of this book, they are included for the sake of completeness.



COMMON IMPERIAL PLASMA WEAPONS

Weapon Name	Class	Cost	PE	B#	R#	F#	H#	Bonus	Action	Pwr†	Shots	Wt.	PB	Sh	Range in Meters			Ex
															Md	Lg	Ex	
Plasma Pistols:																		
Tarrig Tock	Hold-Out	¢1,050	1	7	55	5	-	0	Semi-Auto	Sp	14	.1	1	2	3	4	9	
Karrig Tock	Light	¢525	2	7	55	3	-	0	Semi-Auto	1	70	.3	2	3	4	7	18	
Marrif Tock	Medium	¢600	3	7	55	3	I	0	Semi-Auto	1	46	.5	2	3	4	7	18	
Tarrum Tock*	Heavy	¢825	4	7	55	3	I	0	Semi-Auto	1	35	.8	2	3	4	7	18	
Subassault Carbines:																		
Harris Tock-ar	Light	¢1,000	2	8	45	3	-	0	Auto	1	70	3.3	1	5	10	25	50	
Warris Tock-ar	Medium	¢1,600	3	8	45	3	I	0	Auto	1	46	3.9	1	5	10	25	50	
Takang Tock-ar*	Heavy	¢2,200	4	8	45	3	I	0	Auto	1	35	4.6	1	5	10	25	50	
Assault Carbines:																		
Pirrig Rrrng	Light	¢800	4	8	45	3	I	0	Auto	1	35	3.9	1	5	10	50	100	
Kathrack Rrrng	Medium	¢1,000	5	8	45	3	I	0	Auto	1	28	4.6	1	5	10	50	100	
Mang Rrrng*	Heavy	¢1,400	6	8	45	3	II	0	Auto	1	23	5.2	1	5	10	50	100	
Sniping Carbines:																		
Harrn Tang	Light	¢2,200	7	7	55	2	II	0	Semi-Auto	1	20	4.6	3	38	75	375	750	
TarragTang	Medium	¢2,750	8	7	55	2	II	0	Semi-Auto	1	17	7.8	3	38	75	375	750	
KimirriTang	Heavy	¢3,850	9	7	55	2	II	0	Semi-Auto	1	15	23.4	3	38	75	375	750	
Support Cannon:																		
Kas Pock	Light	¢3,400	6	8	45	4	II	0	Auto	Pack	2,333	7.8	1	8	15	75	150	
Jarraf Pock	Medium	¢5,000	7	8	45	4	II	0	Auto	Pack	2,000	15.6	1	8	15	75	150	
Kalurr Pock*	Heavy	¢11,000	8	8	45	4	II	0	Auto	Pack	1,750	23.4	1	8	15	75	150	
Heavy Weapons:†																		
Firris Thang	Light	¢500 K	9	8	45	4	II	0	Auto	External	✓	50	5	75	150	750	1,500	
Grrramas Thang	Medium	¢1 Mil	10	8	45	4	III	0	Auto	External	✓	100	5	75	150	750	1,500	
Hyphurr Thang*	Heavy	¢1.5 Mil	10	8	45	4	III	+5	Auto	External	✓	150	5	75	150	750	1,500	

*Military Issue.

†The number of weapon cells that can be loaded at once (Imperial weapon cells are twice as big as ISC cells). Pack means weapon is powered by backpack. ✓ Means weapon is powered by micro-generator. Sp means the weapon uses a special power cap.

‡None of these weapons are man-portable. While out of the scope of the normal weapons of this book, they are included for the sake of completeness.



8.3 SILENT DEATH WEAPONS

When the empire of man crumpled in the wake of the Night Brood, it had firmly achieved Tech Level 26. There were thousands of weapons manufacturers throughout the various imperial houses, perhaps making millions of different weapons.

The first three tables, labeled *Pre-Brood*, are a list of some of the most popular weapons. These were produced in a large enough volume to still be in common use throughout human space.

Note: *Sonic stunners rarely differ greatly, one from the other. Therefore, the ones included in the Privateers section are just as valid in Silent Death.*

Post-Imperial Warfare

Below is a treatment of energy weapons developed by different houses after the fall of the imperial core. As much as the ASP would like to claim that the march of science proceeds (and it *does* proceed), the orphaned children of the empire are still a good way away from crossing the threshold into Tech Level 27.

HOUSE COLOS

With the reclamation of the Colosian homeworld, weapon production has begun in earnest. The reclamation of fallen worlds requires significant infantry movement. Brood warrens have to be cleansed and breeding areas destroyed, etc. House Colos prefers particle beam weapons for this task. In addition to many of the old, basic designs, they are currently producing the following:

HOUSE RED STAR

House Red Star despises the use of ground forces. It goes against their eco-sensibilities. What ground forces they do use are typically armed with Imperial weapons purchased from the Yoka-Shan Warworld.

HOUSE TOKUGAWA

The Tokugawans also despise ground warfare. They accordingly don't produce many ground weapons. Any that they need could easily be supplied by the Yoka-Shan Warworld.

YOKA-SHAN WARWORLD

If there were a house out there with a larger weapon production than the Warworld, it would have to be the Technocracy. The Warworld produces more military hardware than many other houses combined.

Warworld weaponry is high quality stuff. Whereas the Technocracy fills their weapons with cutting edge technology, Warworld weaponry is treasured for the pure craftsmanship of its manufacture. Any Warworld weapon is certain to have been tested in a dozen campaigns.

KASHMERE COMMONWEALTH

The Kashmeri don't need to build their own weapons. They are busy selling everyone else's (whether acquired legally or not).

HIBERNIA FREEHOLD

The Freeholders have a constant flow of data moving to Yoka-Shan. This has resulted in a constant flow of money moving back. It's only natural that Hibernia would have plenty of Warworld weaponry floating around. That plus trading deals with the Kashmeri have left Freeholders to develop more valuable commodities, like a working economy.

ASP TECHNOCRACY

The Technocracy has never dropped off in weapons manufacture. They still produce all the weapons that they did during the Imperial days. All weapons now have Artificiance™ links for those with the proper cyberware (see *Tech Law: Robotics Manual* for a detailed list of possible cyberware).

DATA SPHERE

The Data Sphere produces its own weapons, which are known by a simple bar code. Use *ThaanComp's* weapon statistics, as Data Sphere's weaponry is thoroughly generic. They can get all the ASP weapons they want, as well.

SIGURD ARCHDIOCESE

The Archdiocese has developed a taste for plasma weaponry for its ground forces. Though blasters are still popular, you can't swing a dead heretic without hitting a discarded blaster in the wake of the Night Brood. They have therefore begun production of plasma weaponry on a large scale. Application of their gauss technology has helped reduce the production costs dramatically.

UNKULUNKULU ARCHIPELAGO

The Archipelago does not need more weapons. Everyone brings his own. There is such an abundance of weapons that the Kashmeri barely try even to sell them there anymore. Ship weapons on the other hand

Q'RAJ PROTECTORATE

The Protectorate has a very close link with the Warworld. Warworld weaponry is more common in the hands of private citizens than that produced by the Protectorate itself.

LUCHES UTOPIA

Luches acquires many of its weapons through unknown means. Piracy is the most likely. At any rate, weapons are common in the hands of the government, uncommon in the hands of the citizens. There are more weapons from before the fall of the Empire than new weaponry.



PRE-BROOD BLASTER WEAPONS

Weapon Name	Class	Cost	BE	B#	R#	F#	H#	Bonus	Action	Pwr†	Shts.	Wt.	PB	Range in Meters			Ex
														Sh	Md	Lg	
Blaster Pistols:																	
ASP 010 Blaster	Hold- Out	1,400	2	5	75	5	-	+10	Semi-Auto	Sp	25	.1	1	3	4	7	18
ASP 101 Blaster	Light	700	4	5	75	3	I	+10	Semi-Auto	1	128	.2	3	5	8	13	35
ASP 1101 Blaster	Medium	800	5	5	75	3	I	+10	Semi-Auto	1	102	.4	3	5	8	13	35
ASP 1111 Blaster	Heavy	1,100	6	5	75	3	I	+10	Semi-Auto	1	85	.6	3	5	8	13	35
ThaanComp Ace	Hold- Out	700	2	5	75	5	-	0	Semi-Auto	Sp	25	.1	1	3	4	7	18
ThaanComp Slimline	Light	350	4	5	75	3	I	0	Semi-Auto	1	128	.2	3	5	8	13	35
ThaanComp Negotiator	Medium	400	5	5	75	3	I	0	Semi-Auto	1	102	.4	3	5	8	13	35
ThaanComp Sidekick	Heavy	550	6	5	75	3	I	0	Semi-Auto	1	85	.6	3	5	8	13	35
Subassault Blasters:																	
ASP 100010 Subassault Blaster	Light	1,500	3	7	55	3	-	+10	Continuous	1	170	2.5	1	10	20	50	100
ASP 100101 Subassault Blaster	Medium	2,400	4	7	55	3	I	+10	Continuous	1	128	3	1	10	20	50	100
ASP 101011 Subassault Blaster	Heavy	3,300	5	7	55	3	I	+10	Continuous	1	102	3.5	1	10	20	50	100
ThaanComp Surprise	Light	1,000	3	7	55	3	-	0	Continuous	1	170	2.5	1	10	20	50	100
ThaanComp Room Broom	Medium	1,600	4	7	55	3	I	0	Continuous	1	128	3	1	10	20	50	100
ThaanComp Equalizer	Heavy	2,200	5	7	55	3	I	0	Continuous	1	102	3.5	1	10	20	50	100
Assault Blasters:																	
ASP 1100101 Assault Blaster	Light	1,200	5	7	55	3	I	+10	Continuous	1	102	3	1	10	20	100	200
ASP 1100110 Assault Blaster	Medium	1,500	6	7	55	3	I	+10	Continuous	1	85	3.5	1	10	20	100	200
ASP 1100111 Assault Blaster	Heavy	2,100	7	7	55	3	I	+10	Continuous	1	73	4	1	10	20	100	200
ThaanComp City Assault	Light	800	5	7	55	3	I	0	Continuous	1	102	3	1	10	20	100	200
Weapon	Medium	1,000	6	7	55	3	I	0	Continuous	1	85	3.5	1	10	20	100	200
ThaanComp Blade	Heavy	1,400	7	7	55	3	I	0	Continuous	1	73	4	1	10	20	100	200
ThaanComp Widow Maker																	
Support Blasters:																	
ASP 11101010 Support Blaster	Light	3,600	7	7	55	4	I	+10	Continuous	1	73	6	1	15	30	150	300
ASP 11101100 Support Blaster	Medium	6,000	8	7	55	4	II	+10	Continuous	1	64	12	1	15	30	150	300
ASP 11101101 Support Blaster	Heavy	15,000	9	7	55	4	II	+10	Continuous	1	56	18	1	15	30	150	300
ThaanComp Annihilator	Light	2,400	7	7	55	4	I	0	Continuous	1	73	6	1	15	30	150	300
ThaanComp Death's Hand	Medium	4,000	8	7	55	4	II	0	Continuous	1	64	12	1	15	30	150	300
ThaanComp Armageddon	Heavy	10,000	9	7	55	4	II	0	Continuous	1	56	18	1	15	30	150	300

†The number of weapon cells that can be loaded at once. Sp means the weapon uses a special power cap.

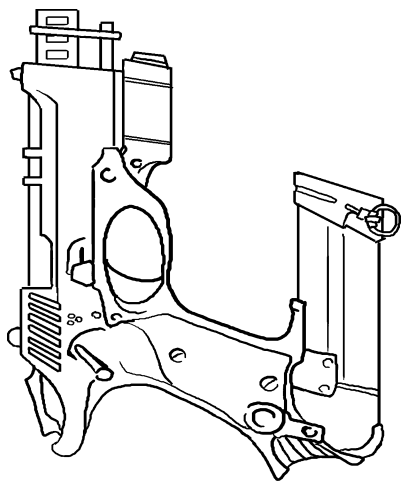

PRE-BROOD LASER WEAPONS

Weapon Name	Class	Cost	LE	B#	R#	F#	H#	Bonus	Action	Pwr†	Shts.	Wt.	PB	Sh	Md	Lg	Range in Meters	
																	Ex	Ex
Laser Pistols:																		
ASP 10010 Laser	Hold- Out	1,260	2	3	95	5	-	+10	Semi-Auto	Sp	25	.1	5	15	20	35	90	
ASP 10101 Laser	Light	630	4	3	95	3	I	+10	Semi-Auto	I	128	.2	15	25	40	65	175	
ASP 10110 Laser	Medium	720	5	3	95	3	I	+10	Semi-Auto	I	102	.4	15	25	40	65	175	
ASP 10111 Laser	Heavy	990	6	3	95	3	I	+10	Semi-Auto	I	85	.5	15	25	40	65	175	
ThaanComp Derringer	Hold- Out	560	2	3	95	5	-	0	Semi-Auto	Sp	25	.1	5	15	20	35	90	
ThaanComp Competitor	Light	280	4	3	95	3	I	0	Semi-Auto	I	128	.2	15	25	40	65	175	
ThaanComp Quick Draw	Medium	320	5	3	95	3	I	0	Semi-Auto	I	102	.4	15	25	40	65	175	
ThaanComp Fat Boy	Heavy	440	6	3	95	3	I	0	Semi-Auto	I	85	.5	15	25	40	65	175	
Hunting Lasers:																		
ASP 100101 Hunting Laser	Light	720	8	3	95	2	II	+10	Semi-Auto	I	64	2.4	5	75	150	750	1,500	
ASP 100110 Hunting Laser	Medium	900	9	3	95	2	II	+10	Semi-Auto	I	56	2.8	5	75	150	750	1,500	
ASP 100111 Hunting Laser	Heavy	1,260	10	3	95	2	II	+10	Semi-Auto	I	51	3.2	5	75	150	750	1,500	
ThaanComp Scout	Light	320	8	3	95	2	II	0	Semi-Auto	I	64	2.4	5	75	150	750	1,500	
ThaanComp Ranger	Medium	400	9	3	95	2	II	0	Semi-Auto	I	56	2.8	5	75	150	750	1,500	
ThaanComp Predator	Heavy	560	10	3	95	2	II	0	Semi-Auto	I	51	3.2	5	75	150	750	1,500	
Sniping Lasers:																		
ASP 110110110 Sniping Laser	Light	1,400	9	3	95	2	II	+10	Semi-Auto	I	56	2.8	10	150	300	1,500	3,000	
ASP 110110111 Sniping Laser	Medium	3,360	10	3	95	2	II	+10	Semi-Auto	I	51	4.8	10	150	300	1,500	3,000	
ASP 110110000 Sniping Laser	Heavy	14,000	12	3	95	2	II	+10	Semi-Auto	I	42	14.4	10	150	300	1,500	3,000	
ThaanComp Long Arm	Light	900	9	3	95	2	II	0	Semi-Auto	I	56	2.8	10	150	300	1,500	3,000	
ThaanComp Transgressor	Medium	2,160	10	3	95	2	II	0	Semi-Auto	I	51	4.8	10	150	300	1,500	3,000	
ThaanComp Assassin	Heavy	9,000	12	3	95	2	II	0	Semi-Auto	I	42	14.4	10	150	300	1,500	3,000	

†The amount of weapon cells that can be loaded at once. Sp means the weapon uses a special power cap.



PRE-BROOD PLASMA WEAPONS

Weapon Name	Class	Cost	PE	B#	R#	F#	H	Bonus	Action	Pwr†	Shots	Wt.	PB	Sh	Range in Meters			Ex
															Md	Lg	Ex	
Plasma Pistols:																		
ASP 11010 Plasma Pistol	Hold- Out	1,750	2	7	55	5	-	+10	Semi-Auto	Sp	12	.1	1	2	2	4	9	
ASP 11011 Plasma Pistol	Light	875	3	7	55	3	I	+10	Semi-Auto	1	85	.3	2	3	4	7	18	
ASP 11100 Plasma Pistol	Medium	1,000	4	7	55	3	I	+10	Semi-Auto	1	64	.5	2	3	4	7	18	
ASP 11101 Plasma Pistol	Heavy	1,375	5	7	55	3	I	+10	Semi-Auto	1	51	.8	2	3	4	7	18	
ThaanComp Flash	Hold- Out	1,050	2	7	55	5	-	0	Semi-Auto	Sp	12	.1	1	2	2	4	9	
ThaanComp Flare	Light	525	3	7	55	3	I	0	Semi-Auto	1	85	.3	2	3	4	7	18	
ThaanComp Star	Medium	600	4	7	55	3	I	0	Semi-Auto	1	64	.5	2	3	4	7	18	
ThaanComp Sun Spot	Heavy	825	5	7	55	3	I	0	Semi-Auto	1	51	.8	2	3	4	7	18	
Subassault Plasma Carbines:																		
ASP 101010 Subassault Plasma Carbine	Light	1,500	3	8	45	3	I	+10	Auto	1	85	3.3	1	5	10	25	50	
ASP 101101 Subassault Plasma Carbine	Medium	2,400	4	8	45	3	I	+10	Auto	1	64	3.9	1	5	10	25	50	
ASP 101111 Subassault Plasma Carbine	Heavy	3,300	5	8	45	3	I	+10	Auto	1	51	4.6	1	5	10	25	50	
Assault Plasma Carbines:																		
ThaanComp Fire Flash	Light	1,000	3	8	45	3	I	0	Auto	1	85	3.3	1	5	10	25	50	
ThaanComp Prominence	Medium	1,600	4	8	45	3	I	0	Auto	1	64	3.9	1	5	10	25	50	
ThaanComp Harbinger	Heavy	2,200	5	8	45	3	I	0	Auto	1	51	4.6	1	5	10	25	50	
Assault Plasma Carbines:																		
ASP 1110101 Assault Plasma Carbine	Light	1,200	5	8	45	3	I	+10	Auto	1	51	3.9	1	5	10	50	100	
ASP 1110110 Assault Plasma Carbine	Medium	1,500	6	8	45	3	II	+10	Auto	1	42	4.6	1	5	10	50	100	
ASP 1110111 Assault Plasma Carbine	Heavy	2,100	7	8	45	3	II	+10	Auto	1	36	5.2	1	5	10	50	100	
ThaanComp Nova	Light	800	5	8	45	3	I	0	Auto	1	51	3.9	1	5	10	50	100	
ThaanComp Death Walker	Medium	1,000	6	8	45	3	II	0	Auto	1	42	4.6	1	5	10	50	100	
ThaanComp Super-Nova	Heavy	1,400	7	8	45	3	II	0	Auto	1	36	5.2	1	5	10	50	100	
Support Plasma Cannons:																		
ASP 11111010 Support Plasma Cannon	Light	3,600	7	8	45	4	II	+10	Auto	1	36	7.8	1	8	15	75	150	
ASP 11111100 Support Plasma Cannon	Medium	6,000	8	8	45	4	II	+10	Auto	1	32	15.6	1	8	15	75	150	
ASP 111111101 Support Plasma Cannon	Heavy	15,000	9	8	45	4	II	+10	Auto	1	28	23.4	1	8	15	75	150	
ThaanComp Terror																		
ThaanComp Terror	Light	2,400	7	8	45	4	II	0	Auto	1	36	7.8	1	8	15	75	150	
ThaanComp Karmic Death	Medium	4,000	8	8	45	4	II	0	Auto	1	32	15.6	1	8	15	75	150	
ThaanComp Cleanser	Heavy	10,000	9	8	45	4	II	0	Auto	1	28	23.4	1	8	15	75	150	

†The number of weapon cells that can be loaded at once. Sp means the weapon uses a special power cap.

COMMON HOUSE COLOS WEAPONS

Weapon Name	Class	Cost	AE*	B#	R#	F#	H	#	Bonus	Action	Pwr†	Shts.	Wt.	PB	Range in Meters						Notes
															Sh	Md	Lg	Ex			
C-15 Military Side Arm	Medium Blaster Pistol	400	5	5	75	3	1	0	Semi-Auto	1	102	.4	3	5	8	13	35	35	Standard blaster.		
C-23 Fury	Heavy Blaster Pistol	1,100	3	7	55	3	-	0	Continuous	1	170	.6	3	5	8	13	35	35	Used for close encounters.		
C-45 Special Ops Weapon	Medium Subassault Blaster	1,600	4	7	55	3	1	0	Continuous	1	128	3	1	10	20	50	100	Portable and deadly			
C-53 Assault Blaster	Assault Blaster	1,000	6	7	55	3	1	0	Continuous	1	85	3.5	1	10	20	100	200	An old stand-by.			
C-101 Political Enforcer	Heavy Sniping Laser	31K	12	3	95	2	II	+25	Semi-Auto	1	42	14.4	5	75	150	750	1,500	Used by the "Political Arm."			
C-67 Heavy Weapon	Heavy Support Blaster	10,000	9	7	55	4	II	0	Continuous	1	56	18	1	15	30	150	300	Lops arms off battle droids.			

*Aperture Energy. Apply to appropriate chart (BE, LE, etc.)

†The number of weapon cells that can be loaded at once. Sp means the weapon uses a special power cap.

COMMON YOKA-SHAN WARWORLD WEAPONS

Weapon Name	Class	Cost	AE*	B#	R#	F#	H#	Bonus	Action	Pwr †	Shts.	Wt.	PB	Range in Meters						Notes
														Sh	Md	Lg	Ex			
WW-6 Heavy Blaster	Heavy Blaster Pistol	1,925	5	6	85	3	I	+10	Auto	1	102	.5	3	5	8	13	35	35	Man's best friend.	
WW-18 Insurgency Weapon	Medium Subassault Blaster	3,600	4	7	75	3	I	+10	Continuous	1	128	2.7	1	10	20	50	100	100	Favored by special ops.	
WW-25 Assault Blaster	Medium Assault Blaster	2,000	6	7	75	3	I	+10	Continuous	1	85	3.2	1	10	20	100	200	200	Standard issue.	
WW-32 Peacemaker	Heavy Sniping Laser	46 K	12	3	11	2	II	+10	Continuous	1	42	13	5	75	150	750	1,500	Assassination is public		
WW-99 Escort	Light Support Blaster	20 K	7	7	5	4	I	+10	Continuous	1	73	16.2	1	15	30	150	300	300	One per squad.	

*Aperture Energy. Apply to appropriate chart (BE, LE, etc.)

†The number of weapon cells that can be loaded at once. Sp means the weapon uses a special power cap.

COMMON SIGURD ARCHDIOCESE WEAPONS

Weapon Name	Class	Cost	AE*	B#	R#	F#	H#	Bonus	Action	Pwr †	Shts.	Wt.	PB	Range in Meters						Notes
														Sh	Md	Lg	Ex			
Draupnir	Heavy Plasma Pistol	5	7	65	3	1	0	0	Semi-Auto	1	51	.8	2	3	4	7	18	18	Named for Odin's ring.	
Jarm Grieper	Heavy Subassault Plasma Carbine	5	8	55	3	1	0	0	Auto	1	51	4.6	1	5	10	25	50	50	Named for Thor's Gauntlet	
Try's Hand	Heavy Assault Plasma Carbine	7	8	55	3	II	0	0	Auto	1	36	5.2	1	5	10	50	100	100	Named for . . . well, you know.	
Meginjarder	Heavy Support Plasma Cannon	9	8	55	4	II	0	0	Auto	1	28	23.4	1	8	15	75	150	150	Named for Thor's girdle.	

*Aperture Energy. Apply to appropriate chart (BE, LE, etc.)

†The amount of weapon cells that can be loaded at once. Sp means the weapon uses a special power cap.





SPACEMASTER: SCI-FI GAMING AT ITS BEST

SPACEMASTER: PRIVATEERS

Spacemaster Privateers is the perfect way to start your sci-fi adventures. Take a journey into the future with this new *Rolemaster*-based system! Set in the tumultuous Privateers universe, this is a unique setting designed especially for *Spacemaster*. You and your players can take part in a last, desperate gamble to win a war against an evil driven by insanity.

This 272-page volume contains all you need for character creation, combat, starships, and even psychic powers-you can start to play right away. Once you're involved, there are a number of *Spacemaster* support books that can add more flavor, detail, action and excitement to your games.

ST 4500 \$30.00

PRIVATEERS: RACES & CULTURES

Available Fall 2002

A must for any *Spacemaster* game, this book details the races of the Privateers universe. Find out what the races are really like in detail; from culture to physiology to role playing, everything you wanted to know about the: Falanar, the Kagoth, the Oort, the Tular, the Valiesans the Xatosians and of course humans. What will our own species be like in the future?

ST 4600 \$22.00

FUTURE LAW

**Available Fall 2002*

Add the power of expanded character development to your game with *Future Law*. *Future Law* is the ultimate Player's Guide to *Spacemaster*, giving new character professions and hundreds of new character options. Get the most out of your characters and feel the power of the *Spacemaster* system with this exciting core support book.

ST 4515 \$22.00

ROBOTICS MANUAL

Soulless cybernetic beings? Friendly, helpful droids? Devastating combat juggernauts? Whatever your vision of robots, it's in the *Robotics Manual*.

The third *Tech Law* book, the *Robotics Manual* covers all types of robots and cybernetics. It details advances in robotics and cybernetics through the ages and into the future, how to use them in your campaign, and how to make them work as characters.

ST 4511 \$20.00

EQUIPMENT MANUAL

Strap on your jet packs and your anti-gravity boots and take the plunge into the wild and wonderful world of sci-fi gadgets! Gadgets are the heart and soul of a science fiction role playing game, and the *Equipment Manual* is chock full of 'em. We've got everything from anti-gravity chairs to vacuum suits, so don't get stuck with last years tech! For tech neophytes and experts alike, the *Equipment Manual* is the ultimate shopping and consumer guide to the Privateers universe.

The Equipment Manual is one of the three books that make up *Tech Law*, the technology supplements for *Spacemaster*. This book covers all types of equipment, including weapons, medical gear, clothing, communications, computers, survival equipment and power sources. It also includes general discussions on the advance of technology, alien technologies, malfunctions, repairs, availability and how to use technology in different types of science fiction campaigns.

ST 4512 \$20.00

TECH LAW: VEHICLE MANUAL

So 'fess up, What's your sci-fi fantasy? A sleek, ultra-luxurious space yacht with accommodations for a few select friends? Perhaps you prefer to rough it in a converted freighter or a surplus military vessel or a smuggler's ship? No? Well maybe we can tempt you to climb into the cockpit of the newest and most advanced deep space fighter. We can even arrange a command for you on a star destroyer. Nothing says "sci-fi" like "starship." The *Vehicle Manual* lets you fly to the nearest star, planet, or across the galaxy. Explore the weird swamp you found on the third moon, hop across town to buy some groceries, or if you prefer move entire populations across the galaxy. The *Vehicle Manual* gives you the power. The third *Tech Law* book, the *Vehicle Manual* covers all types of vehicles: cars, boats, rockets, planetary shuttles, deep space fighters, interstellar destroyers. The manual includes sample vehicles, vehicle design, combat rules, and salvage and repair guidelines.

ST 4513 \$25.00



IRON CROWN ENTERPRISES
112 Goodman Street
Charlottesville, VA 22902
USA

WWW.IRONCROWN.COM

phone: 434.244.9381
fax: 434.244.2661

SPACEMASTER:™

Sci-fi Power³

Erik stumbled to the side, his numb barely-working fingers fumbling for an energy cell. The laser fire stopped for a moment as his opponents waited for him to show himself. They wouldn't give up their cover. They'd wait for him to move.

After several, agonizing seconds, he managed to slide a new power cell into his blaster. The burns along the left side of his body made the slightest movement agony. His muscles twitched spasmodically, as nerves died. His burned flesh twitched as it cracked and flaked away.

***This was bad.** He took a deep breath and checked his blaster's setting. There was no room left for tactics. He could make a final charge on continuous fire. If he was really lucky, he might live long enough to kill one of his foes. Maybe two. It was either that or wait for his life to ooze out half a dozen small laser wounds.*

Screaming with more bravado than he felt, he swung around the corner, firing wildly. Beams of coherent light began seeking him out as he charged headlong, his blaster pulsing in his hand.

Revel in MORE POWER! Blaster Law is the complete guide to energy weapons and their use in combat. Spacemaster: Privateers has a ton of combat and power, but Blaster Law takes this to the max, expanding directed energy weapons. It uses a tech level system and gives complete weapon creation rules, for use with anything from primitive spacefaring worlds to power weapons invented by worlds on the cutting edge. Blaster Law includes:

- 13 Laser Attack tables
- 13 Blaster Attack tables
- 10 Plasma Weapon Attack tables
- 5 Sonic Stunner Attack tables
- 20 Critical and Fumble tables

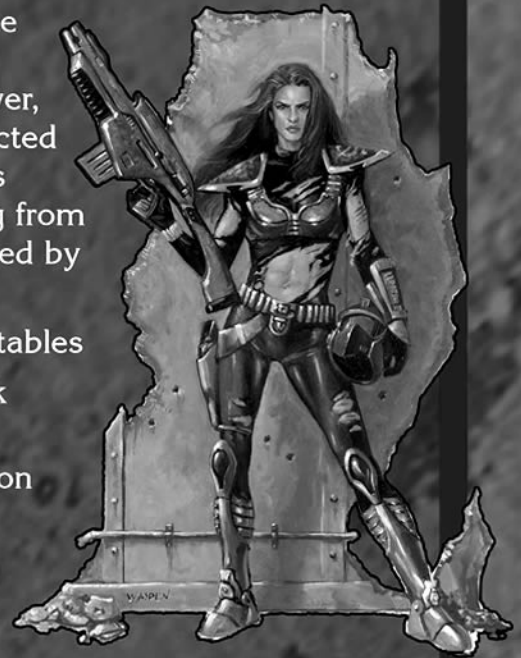

Produced and distributed by



Iron Crown Enterprises
112 Goodman Street
Charlottesville, VA 22902
USA 434-244-0881

<http://www.ironcrown.com>

55006 567-9 ICE 1100

This specially-priced
PDF is available
through the ICE
Online Store at
www.ironcrown.com

Made in USA #4515P

BLASTER LAW™