

SILENT DEATH™

ANNEX

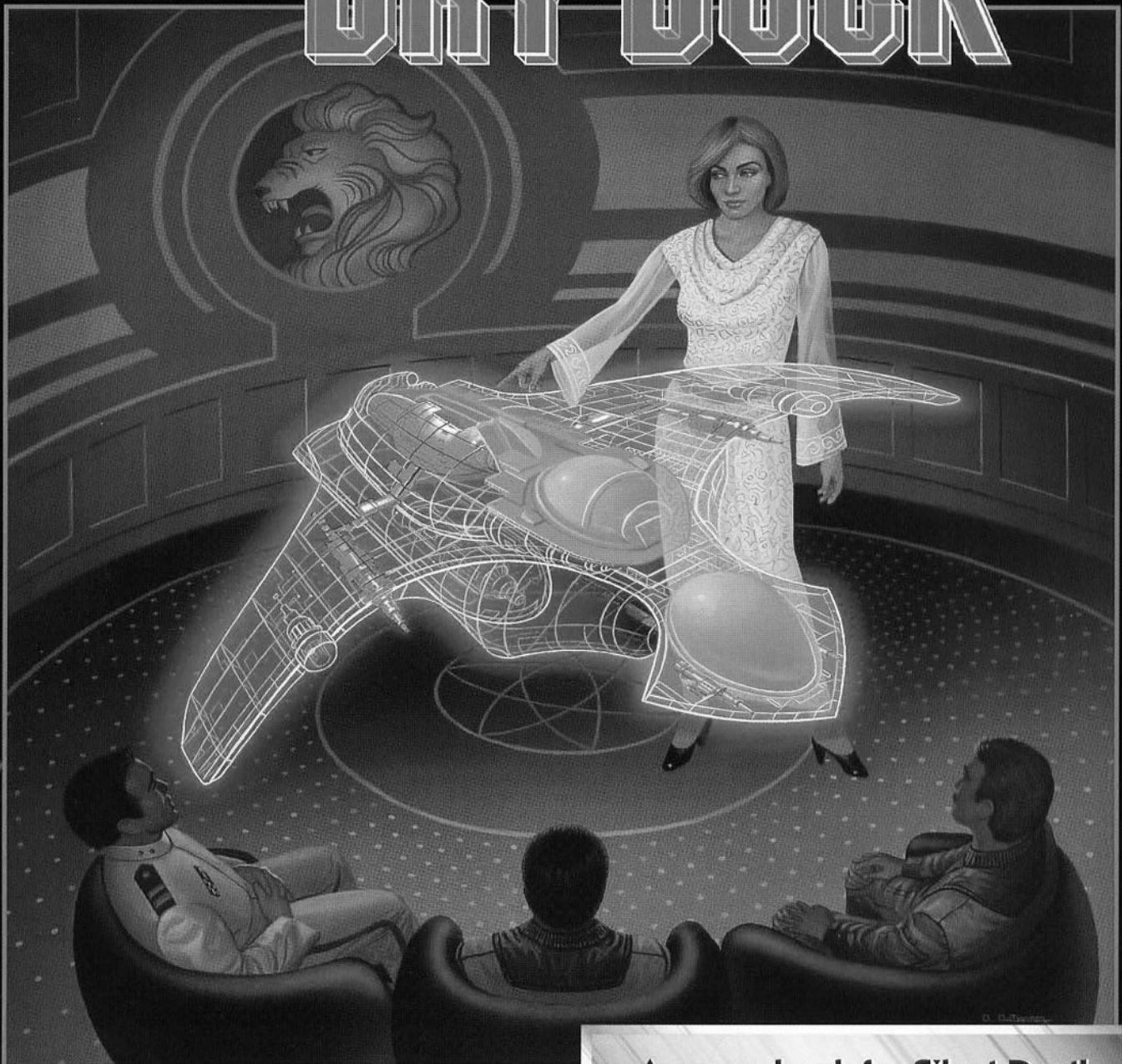

OPERATION: DRY DOCK™



**A sourcebook for Silent Death
with 23 fighter variants.**

Operation: Dry Dock™

Silent Death



Copyright © 1997 by
Iron Crown Enterprises.
All rights reserved.
No reproductions without
the express written
consent of **Iron Crown
Enterprises.** Produced
and distributed by **Iron
Crown Enterprises, Inc.,**
P.O. Box 1605,
Charlottesville, VA 22902.
Phone: (804) 295-4280.
Fax: (804) 977-4811.
Internet e-mail:
askice@aol.com
walsfeo@aol.com

Credits

Original System Design: Kevin Barrett

Night Watch Authors: Craig Marek,
Bob Starr, Doug Bertram,
Heike Kubasch

Cover Illustration: Alan Gutierrez

Interior Illustration: Dan Smith

Miniatures Sculptor: Bob Naismith

Series Editor: Donald G. Dennis

Art Direction: Jessica Ney-Grimm

Assisting Art Direction: Jason O. Hawkins

Cover Design: Nick Morawitz

Pagemaking: Steven Arensberg,
Mike Dunbar, Wendy Frazer,
Sherry Robinson

Editorial Contributions: Bruce Neidlinger.

ICE Staff:

CEO: Bruce Neidlinger;

President: Pete Fenlon;

Managing Editor: Coleman Charlton;

Sales Manager: Deane Begiebing;

Sales, Customer Service and Operations: Becky Blanton, Steve Hardy,
Olivia Johnston, Dave Platnick,
Karina Swanberg, Monica Wilson;

Editing, Production, and Development:

John Curtis, Donald G. Dennis,
Wendy Frazer, Jason Hawkins,
Bob Mohney, Nick Morawitz,
Jessica Ney-Grimm, Michael Reynolds;

Shipping and Receiving: Dave Morris,
Daniel Williams, Chad McCully.

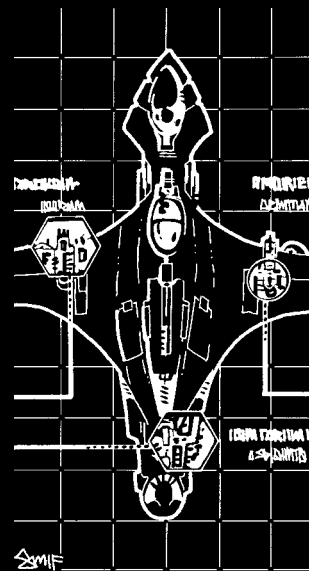

Silent Death

Contributors:

Don Dennis, Steve Arensberg, Jay Moisant, Don Jenkins, Jim Eisent, Andrew Thompson, Paul Carrul, Allen Nuss, Chris Kuhn.

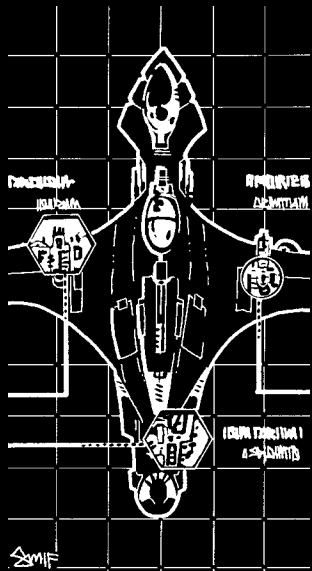

Introduction

Operation: Dry Dock details the composition of the space fleets maintained by the Twelve. Since the fall of the Empire many unusual ships and variants have seen active duty in the various forces across inhabited space. Training ships and old versions of previously upgraded ships have had more active use since many shipyards were destroyed by Hatchlings.

Modifications to the displays

Each display has been modified to facilitate quicker game play. They are still compatible with earlier Next Millennium displays. The gray border has been removed for cleaner photocopies, and other technical changes have been made as well.

Weapon Ranges

Weapon ranges have been included in each weapon box now to add speed to game play. The Pulse Laser that has a ranges of; Short Range 1-3 (+1 To Hit), Medium Range 4-9, and Long Range 10 (-1 To Hit) is now listed in the weapon box as Range: 3/9/10. While this was done primarily for the benefit of gunboats and escorts where there is no room for range to be listed with the critical chart, it was found so useful that it is now also used on the fighters.

Target Speed Restrictions

All weapons that suffer from Target Speed Restrictions have them listed beneath the ranges. The Turbo Laser that has a Target Speed Restriction of ≤ 8 , is listed as Target SR ≤ 8 . Weapons that do not have Target Speed Restrictions do not include this line.

Tonnage

Each display has been modified to show the starcraft's tonnage. This will be useful for Tractor Beams as well as Escort fighter bays and hooks.

Warhounds

K Arcs

Calling the arc of the Keel Cannon forward is not an accurate representation of the weapons abilities and limitations. To better represent a single line arc out the front of the ship, the designation (KF) will be used. If a weapon is only able to fire along a single line to the aft, instead of forward, the ark would be designated (KA). Keel Cannons may be purchased to fire forward (KF) or aft (KA).

Escort Weapon Ranges

Ranges have been modified as above to maintain consistency with the fighters.

Crew Hits

You will notice that on the escort displays almost half of the crew hits now have the head filled in. This is for the Attacker Chooses Crew Hit optional rule. If you are not using this optional rule, ignore the difference between the two symbols.

Either player may kill crew from active weapons, weapons that are no longer operational, Damage Control, ECM arrays, and so on. Neither player may choose the Captain, the Pilot, or fighter crew for a empty Fighter Bay.

Tractor Beams

There are no Tractor Beams strong enough to affect Escort class vessels.

Optional Rule

Attacker Chooses Crew Hit

When damage reaches a crew hit marker with the head filled in, the attacker decides which crew is hit. The attacker may not choose the Captain or the Pilot or fighter crew for a empty Fighter Bay.

Fleet Composition

Here is a listing of known fleet compositions for each of the Twelve and the Promeathians. It is broken down first by house, and then by fighter categories; SPAC, TPAC, MPAC, and Escort. The Twelve may have access to other ships in smaller quantities, or through mercenary units.

Colos

- Hell Bender, Kosmos, Night Hawk, Spirit Rider, Talon, Thunder Bird, Thunder Bird II.
- Death Wind, Death Wind II, Glaive, Lance Electra, Pharsii II, Revenge, Salamander, Seraph, Teal Hawk.
- Drakar, Star Raven.
- Aoshu, Constellation, Fletcher, Megafortress, Narwhal II, Stingray.

Red Star

- Blizzard, Blizzard II, Dart, Dart II, Night Hawk, Night Hawk II, Pit Viper.
- Revenge, Salamander, Salamander II, Seraph, Seraph II.
- Beta Fortress, Beta Fortress Alpha, Epping Prime, Epping.
- Aoshu, Stingray, Constellation, Megafortress.

Tokugawa

- Dart, Kosmos, Kosmos II, Thunderbird, Thunderbird II.
- Glaive, Glaive II, Sentry, Sorenson II.

- Betafort, Betafort Alpha, Epping Prime.
- Aoshu, Constellation, Fletcher, Megafortress, Narwhal II, Stingray.

Yoka-Shan

- Blizzard, Hell Bender, Hell Bender II, Night Hawk, Thunderbird.
- Death Wind, Sentry.
- Betafortress, Betafortress Beta, Epping Prime, Epping.
- Aoshu, Constellation, Fletcher, Megafortress, Narwhal II, Stingray.



Silent Death

Kashmere

- Dart, Hell Bender, Hell Bender II, Spirit Rider, Spirit Rider II, Talon, Talon II, Thunderbird
- Death Wind, Lance Electra, Lance Electra II, Salamander, Salamander II.

Hibernia

- Night Hawk, Pit Viper, Talon, Talon II.
- Lance Electra, Lance Electra II, Pharsii II, Pharsii, Salamander, Salamander II, Seraph, Seraph II, Shryak Shuttle, Shryak Shuttle II.
- Star Raven.
- Aoshu, Constellation, Fletcher, Megafortress, Narwhal II, Stingray.

ASP

- Night Hawk, Thunder Bird.
- Pharsii, Pharsii II, Sorenson II, Sorenson III, Tealhawk, Tealhawk II.
- Drakar, Drakar Alpha, Epping Prime.

Data Sphere

- Dolphin, Night Hawk, Night Hawk II, Teal Hawk.
- Salamander, Sentry.
- Orca.

Sigurd

- Blizzard, Dart, Hell Bender, Night Hawk, Talon.
- Pharsii II, Revenge, Revenge II Sentry, Sentry II, Sorenson III.
- Betafortress, Drakar, Epping, Star Raven, Star Raven Alpha.
- Aoshu, Constellation, Fletcher, Megafortress, Narwhal II, Stingray.

Unkulunkulu

- Blizzard, Dart, Hell Bender, Pit Viper, Pit Vipert T, Spirit Rider, Spirit Rider II, Talon.
- Lance Electra, Revenge, Salamander, Sorenson III.
- Betafortress, Drakar, Star Raven, Star Raven Alpha.

Q'raj

- Kosmos, Kosmos II, Talon, Talon II, Thunderbird.
- Sentry, Sentry II, Shryak Shuttle, Sorenson III, Teal Hawk, Teal Hawk II.
- Epping
- Aoshu, Constellation, Fletcher, Stingray.

Luches

- Blizzard, Blizzard II, Dart, Hell Bender, Kosmos, Pit Viper, Pit Viper T, Spirit Rider.
- Glaive, Pharsii, Pharsii II, Salamander II, Shryak Shuttle, Shryak Shuttle II, Sorenson II, Sorenson III.
- Epping Prime.
- Aoshu, Constellation, Fletcher, Megafortress, Stingray.

Primates/Devon

- Blizzard, Dart, Dart II, Kosmos, Pit Viper, Spirit Rider, Talon.
- Death Wind, Glaive, Lance Electra, Revenge, Salamander II, Seraph.
- Drakar, Star Raven, Star Raven Alpha.

Draconian

- Kosmos, Pit Viper, Spirit Rider.
- Death Wind, Glaive, Pharsii II, Revenge, Revenge II, Salamander, Salamander II, Seraph.
- Drakar.

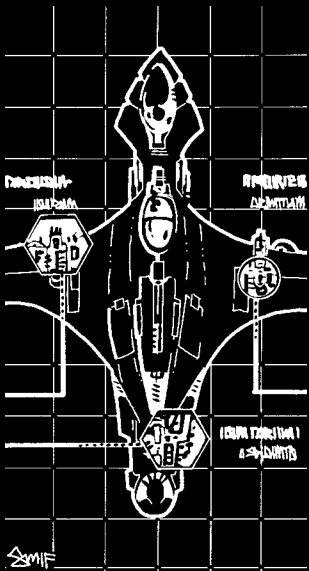

Starcraft Point Cost Table

Starcraft	Basic Point Value	Crew	Starcraft	Basic Point Value	Crew
Saucer Shuttle	6	1	Salamander	66	2
Pit Viper T	8	1	Salamander II	66	2
Pit Viper	12	1	Sorenson III	68	2
Wind Jammer	13	1	Avenger	78	2
Spirit Rider II	17	1	Epping Prime	78	4
Blizzard II	18	1	Sentry	80	3
Borax 1000t Frieghter	18	1	Sentry II	80	3
Spirit Rider	18	1	Glaive	106	2
Blizzard	19	1	Glaive II	107	2
Dart II	20	1	Pharsii	110	4
Dart	21	1	Epping	119	4
Thunder Bird II	24	1	Revenge	120	2
Thunder Bird	25	1	Revenge II	120	2
Wave Cutter	25	1	Pharsii II	120	3
Kosmos	27	1	Seraph	121	2
Kosmos II	29	1	Seraph II	121	2
Curtis Shuttle	30	1	Drakar	121	5
Hell Bender	32	1	Scorpion	122	4
Hell Bender II	33	1	Star Raven	125	4
Talon	33	1	Drakar Alpha	125	5
Shryak Shuttle	34	2	Star Raven Alpha	128	4
Shryak Shuttle II	34	2	Spider	129	3
Talon II	38	1	Catastrophe	142	4
Blood Hawk	41	1	Eagle	170	5
Teal Hawk	43	2	Conestoga	215	5
Night Hawk	47	1	Betafortress	216	5
Sorenson II	47	2	Betafortress Alpha	218	6
Teal Hawk II	47	2	Betafortress Beta	220	6
Night Hawk II	55	1	Megafortress	482	22
Crescent	55	3	Stingray	551	25
Death Wind	60	2	Narwhal Mk. II	623	27
Lance Electra	60	2	Aosho	764	42
Lance Electra II	60	2	Constellation	806	35
Havok	61	2	Fletcher	894	37
Death Wind II	64	2			

The Next Millennium

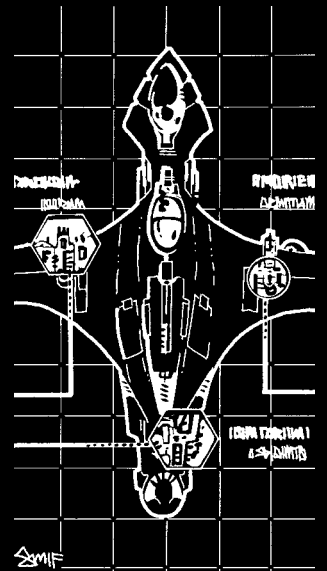

Silent Death

BetaFortress

Red Star, Sigurd, Tokugawa, Unkulunkulu, Yoka-Shan.

BetaFortress Alpha

Red Star, Tokugawa.

BetaFortress Beta

Yoka-Shan.

Pyramidis Shipyards 340 Model B/C "Betafortress"

Crew: 5
Maneuvering Thrust: 0.067 km/s/s
Mass: 1500 tons
Translight Capability: 5 light-years/day
Armor: Reinforced Crystanium
Atmospheric Capability: None
Armaments:

- 2 x Mk. 10 Plazguns
- 4 x Mk. 15 Blatguns
- 8 x Mk. 10 Splatterguns
- 3 x Missile Launchers
(Magazines: 20 missiles)
- 5 x Mk. 50 Torp Loads
- 10 x Mk. 10 Torp Loads

Pyramidis Shipyards 340 Model B/C-a "Betafortress Alpha"

Crew: 6
Maneuvering Thrust: 0.067 km/s/s
Mass: 1500 tons
Translight Capability: 5 light-years/day
Armor: Reinforced Crystanium
Atmospheric Capability: None
Armaments:

- 2 x Mk. 10 Plazguns
- 4 x Mk. 15 Blatguns
- 8 x Mk. 10 Splatterguns
- 1 x Mk. 10 Disruptorgun
- 3 x Missile Launchers
(Magazines: 20 missiles)
- 5 x Mk. 50 Torp Loads
- 10 x Mk. 10 Torp Loads

Pyramidis Shipyards 340 Model B/C-b "Betafortress Beta"

Crew: 6
Maneuvering Thrust: 0.067 km/s/s
Mass: 1500 tons
Translight Capability: 5 light-years/day
Armor: Reinforced Crystanium
Atmospheric Capability: None
Armaments:

- 2 x Mk. 10 Plazguns
- 4 x Mk. 15 Blatguns
- 10 x Mk. 10 Splatterguns
- 1 x Mk. 10 Disruptorgun
- 3 x Missile Launchers
(Magazines: 20 missiles)
- 5 x Mk. 50 Torp Loads
- 10 x Mk. 10 Torp Loads

Commentary: House Ptolemus's own Pyramidis Shipyards originally built this exceptional gunboat, but with the house's destruction, the design has passed into the public domain. The "Betafort," as its crews often refer to it, packs a double wallop with two Plazgun turrets, while blast cannons and missile launchers round out its point defenses.

Though the Betafortress carries a hyperdrive, this is often removed by in-system defense forces. In its place, an extra gunner can staff a handy, rear-mounted Disruptorgun or twin Splatterguns. Such field modifications are commonly made by tech-crews during wartime, and these altered ships are generally termed the Betafort Alpha and Betafort Beta.

What more can be said? Huge, plodding and very, very deadly, the Betafort defines the upper limits of gunboat parameters. Any half-decently crewed Betafort will cost over 250 points; too expensive for many low-valued force purchases. Tactical limitations will prevent its arrival in all but the largest conflicts. Its torp attacks can be glorious and should not be ignored. Bank on the Betafort being able to cripple or destroy two enemy ships per turn of engagement.

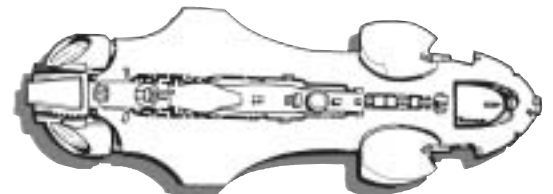
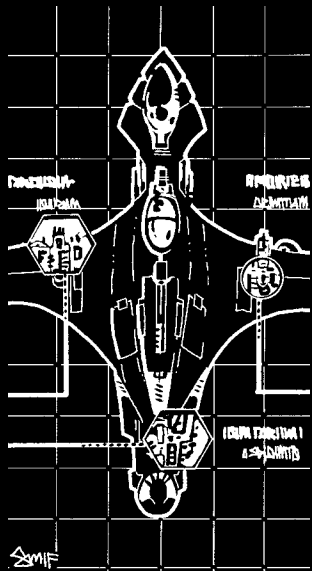
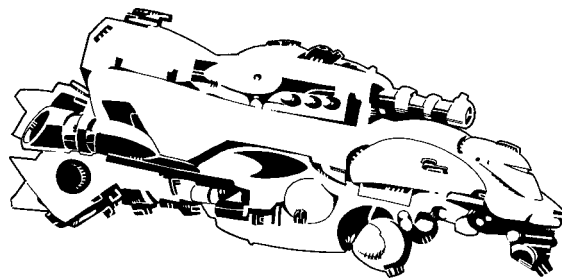

TPV

Mk. 50 Torps

Mk. 10 Torps

Gunner C
4 Splatterguns (FQL) (RQL)
To Hit: 2D6+ADB+3
Damage: Medium+6
Range: 2/6/10

Gunner C
Missile Launcher (FQL) (RQL) (R)
Lock-on < _____

Decoys:

P-D: 1-7 (6)
Dmg Con: 1-8
Tons: 1500

Pilot
4 Blatguns (F)
To Hit: 2D6+ADB+3
Damage: High+6
Range: 4/10/15
Target SR ≤13

Pilot
Missile Launcher (F)
Lock-on < _____

Gunner A
1 Plazgun (360°)
To Hit: 2D6+ADB
Damage: All ¥
Range: 2/4/10

Gunner B
1 Plazgun (360°)
To Hit: 2D6+ADB
Damage: All ¥
Range: 2/4/10

Crew
PILOT
Plt: _____
Gnr: _____
Luck: _____

GUNNER A
Gnr: _____

GUNNER B
Gnr: _____

GUNNER C
Gnr: _____

GUNNER D
Gnr: _____

GUNNER E
Gnr: _____

FRONT DAMAGE TRACK

			W			3			W			4		
	*			2				T						
	t			1										
w													w	
		w		X		w								X

LEFT SIDE DAMAGE TRACK

4					w						
	t	*			t						
	3	t				w					
	t										
	T	2	T					w			W
	t		1								
	*		-1								
		w			t		X				
	t										
	t										

RIGHT SIDE DAMAGE TRACK

					w						
	t	*			t						
	3	t				w					
	t										
	T	2	T								W
	t		1								
	*		-1								
		w			t		X				
	t										
	t										

Gunner D
4 Splatterguns (FQR) (RQR)
To Hit: 2D6+ADB+3
Damage: Medium+6
Range: 2/6/10

Gunner D
Missile Launcher (FQR) (RQR) (R)
Lock-on < _____

Gunner E
Disruptorgun (R)
To Hit: 2D8+ADB
Damage: Medium §
Range: 1/2/6

Defensive Value 10



Drive: 7

Tight Turn Cost: _____ +4

3

REAR DAMAGE TRACK

-1	1				3		-1			*			2	w	-1
		t		-1		X		-1		-1					*

FRONT CRITICAL HITS

- 2 — Blatguns damaged. Penalize To Hit attempts by -2 and reduce Damage rating to High+2.
- 3 — Plazgun B loses power. Weapon may not fire until after next turn.
- 4 — Too tough! No extra damage.
- 5 — Too tough! No extra damage.
- 6 — Plazgun A loses power. Weapon may not fire until after next turn.
- 7 — Pilot's Missile Launcher malfunctions. Lose 1D10 of remaining missiles.
- 8 — Pilot dazed. Betafort may not move nor fire Pilot's weapons until after next game turn.

LEFT SIDE CRITICAL HITS

- 2 — Major structural damage. Take 5 more hits on Left and Right Damage Tracks.
- 3 — Torp Targeter damaged. No torps can be fired until after next game turn.
- 4 — Shields damaged. Reduce Defensive Value by 1.
- 5 — Too tough! No extra damage.
- 6 — Missile Launcher C hit. Lose 1D10 of remaining missiles.
- 7 — Minor structural damage. Take 3 more hits on this Damage Track.
- 8 — Electronic Warfare gone. Betafort cannot jam torps. Reduce Defensive Value by 2.

RIGHT SIDE CRITICAL HITS

- 2 — Major structural damage. Take 5 more hits on Left and Right Damage Tracks.
- 3 — Torp Targeter damaged. No torps can be fired until after next game turn.
- 4 — Shields damaged. Reduce Defensive Value by 1.
- 5 — Too tough! No extra damage.
- 6 — Missile Launcher D hit. Lose 1D10 of remaining missiles.
- 7 — Minor structural damage. Take 3 more hits on this Damage Track.
- 8 — Electronic Warfare gone. Betafort cannot jam torps. Reduce Defensive Value by 2.

REAR CRITICAL HITS

- 2 — Rear bulkhead collapse. Take 8 more hits on this Damage Track.
- 3 — Energy Cannon power interrupted. No cannons may be fired until after next turn.
- 4 — Shields damaged. Reduce Defensive Value by 1.
- 5 — Engine chokes. Drive reduced by 2 next turn.
- 6 — Maneuver Thrusters hit. All turns cost 1 extra movement point to perform.
- 7 — Gunner E killed. His or her weapons may not be fired.
- 8 — Reactor detonates. The mighty Betafort passes into the void.

TPV	

Mk. 50	Mk. 10
Torps	Torps
○	○
○	○
○	○
○	○

Pilot
4 Blatguns (F)
To Hit: 2D6+ADB+3
Damage: High+6
Range: 4/10/15
Target SR ≤13

Pilot
Missile Launcher (F)
Lock-on <_____
○ ○ ○ ○ ○ ○ ○ ○ ○ ○ ○ ○ ○ ○

Gunner A
1 Plazgun (360°)
To Hit: 2D6+ADB
Damage: All ¥
Range: 2/4/10

Gunner B
1 Plazgun (360°)
To Hit: 2D6+ADB
Damage: All ¥
Range: 2/4/10

Crew
PILOT
Plt: _____
Gnr: _____
Luck: _____
GUNNER A
Gnr: _____
GUNNER B
Gnr: _____
GUNNER C
Gnr: _____
GUNNER D
Gnr: _____
GUNNER E
Gnr: _____

Gunner C
4 Splatterguns (FQL) (RQL)
To Hit: 2D6+ADB+3
Damage: Medium+6
Range: 2/6/10

FRONT DAMAGE TRACK									
									4
		W				3			W
*				2					
	t						T		
				1					
w									w
	w			X		w			X

Gunner D
4 Splatterguns (FQR) (RQR)
To Hit: 2D6+ADB+3
Damage: Medium+6
Range: 2/6/10

Gunner C
Missile Launcher (FQL) (RQL) (R)
Lock-on <_____
○ ○ ○ ○ ○ ○ ○ ○ ○ ○ ○ ○ ○ ○

LEFT SIDE DAMAGE TRACK			
4			w
t	*		
	3	t	
t			w
		2	T
T			W
	t		
*			1
			-1
	w		t
t			X
	t		
	t		

			4		
			(F)		
			Defensive Value 10		
			(R)		
			Drive: 7		
			Tight Turn Cost _____ +4		
			3		

RIGHT SIDE DAMAGE TRACK			
			w
4			
t	*		
	3	t	
t			w
		2	T
T			W
	t		
*			1
			-1
	w		t
t			X
	t		
	t		

Gunner D
Missile Launcher (FQR) (RQR) (R)
Lock-on <_____
○ ○ ○ ○ ○ ○ ○ ○ ○ ○ ○ ○ ○ ○

Gunner E
2 Splatterguns (R)
To Hit: 2D6+ADB+1
Damage: Medium+2
Range: 2/6/10

REAR DAMAGE TRACK															
-1															
	1														
		t													
		-1													

- ### FRONT CRITICAL HITS
- 2 — Blatguns damaged. Penalize To Hit attempts by -2 and reduce Damage rating to High+2.
 - 3 — Plazgun B loses power. Weapon may not fire until after next turn.
 - 4 — Too tough! No extra damage.
 - 5 — Too tough! No extra damage.
 - 6 — Plazgun A loses power. Weapon may not fire until after next turn.
 - 7 — Pilot's Missile Launcher malfunctions. Lose 1D10 of remaining missiles.
 - 8 — Pilot dazed. Betafort may not move nor fire Pilot's weapons until after next game turn.

- ### LEFT SIDE CRITICAL HITS
- 2 — Major structural damage. Take 5 more hits on Left and Right Damage Tracks.
 - 3 — Torp Targeter damaged. No torps can be fired until after next game turn.
 - 4 — Shields damaged. Reduce Defensive Value by 1.
 - 5 — Too tough! No extra damage.
 - 6 — Missile Launcher C hit. Lose 1D10 of remaining missiles.
 - 7 — Minor structural damage. Take 3 more hits on this Damage Track.
 - 8 — Electronic Warfare gone. Betafort cannot jam torps. Reduce Defensive Value by 2.

- ### RIGHT SIDE CRITICAL HITS
- 2 — Major structural damage. Take 5 more hits on Left and Right Damage Tracks.
 - 3 — Torp Targeter damaged. No torps can be fired until after next game turn.
 - 4 — Shields damaged. Reduce Defensive Value by 1.
 - 5 — Too tough! No extra damage.
 - 6 — Missile Launcher D hit. Lose 1D10 of remaining missiles.
 - 7 — Minor structural damage. Take 3 more hits on this Damage Track.
 - 8 — Electronic Warfare gone. Betafort cannot jam torps. Reduce Defensive Value by 2.

- ### REAR CRITICAL HITS
- 2 — Rear bulkhead collapse. Take 8 more hits on this Damage Track.
 - 3 — Energy Cannon power interrupted. No cannons may be fired until after next turn.
 - 4 — Shields damaged. Reduce Defensive Value by 1.
 - 5 — Engine chokes. Drive reduced by 2 next turn.
 - 6 — Maneuver Thrusters hit. All turns cost 1 extra movement point to perform.
 - 7 — Gunner E killed. His or her weapons may not be fired.
 - 8 — Reactor detonates. The mighty Betafort passes into the void.

Silent Death

Blizzard

Luches, Red Star, Sigurd, Primate, Unkulunkulu, Yoka-Shan.

Blizzard II

Luches, Red Star.

Imperial Transtar IO10 series E "Blizzard"

Crew: 1

Maneuvering Thrust: 0.156 km/s/s

Mass: 150 tons

Translight Capability: None

Armor: Crystanium w/belt

Atmospheric Capability: Full

Armaments:

1 x Mk. 10 Disruptorgun

4 x Mk. 10 Torp Loads

Commentary: As with all of Imperial Transtar's ships, the fall of the Terran Empire has cast the Blizzard's design into the public domain, as there remains no entity, corporate or otherwise, to lay claim to the copyrights and patents. Predecessor to Transtar's line of "Hawk" fighters, the Blizzard is a very rugged, well-tested and popular design. The Disruptorgun main armament restricts this interceptor to close-in work, but the supplementary torpedoes provide a flexibility rare in such small combat machines. Tried and tested, the Blizzard is currently produced by shipyards across Terran space.

Characteristic of the smaller fighters, the Blizzard is fast and lightly armored. Fortunately, it holds its weapon for 12 hits. That weapon, the Disruptorgun, is best suited for close-quarters fighting. To ensure maximum effectiveness, a flight of Blizzards demand a good squadron leader so that the initiative will bring late-moving fighters right up to their targets for point-blank shots. The 4-torp load gives the Blizzard great flexibility, as few opponents can manage to laugh off a complete salvo.

Imperial Transtar IO10 series F "Blizzard II"

Crew: 1

Maneuvering Thrust: 0.156 km/s/s

Mass: 150 tons

Translight Capability: None

Armor: Crystanium w/belt

Atmospheric Capability: Full

Armaments:

1 x Mk. 10 Splattergun

4 x Mk. 10 Torp Loads

Commentary: A Blizzard refit that also predated Transtar's "Hawk" fighters was the Blizzard II. It offers the longer range of the Splatterguns and is less expensive. With the rise of the "Hawk" fighter line and its heavy use of Blast Cannons, the Blizzard II also became easier to maintain. Transtar had expected the same acceptance for the Blizzard II as the original Blizzard had received and, as a result, the Blizzard II was initially overproduced. While it is present in many lesser factions, Luches Utopia and House Red Star have a great number of 1010Fs in their fighter wings.

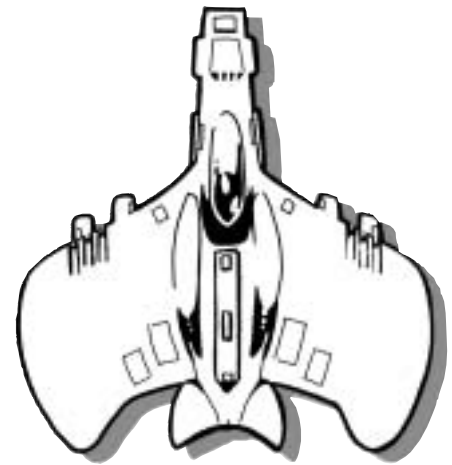
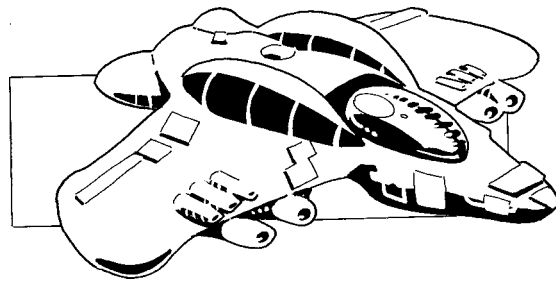
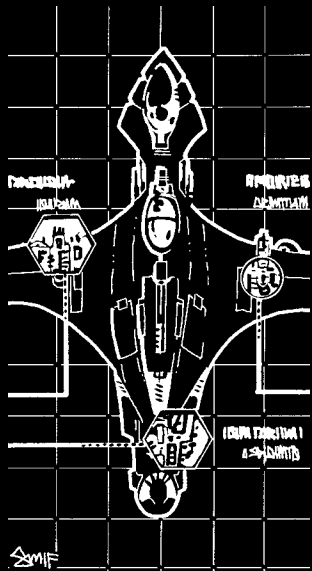

BLIZZARD

I.D.

BPV: 19

TPV

Pilot
1 Disruptorgun (F)
 To Hit: 2D8+ADB
 Damage: Medium S
 Range: 1/2/6

Crew
PILOT
 Plt: _____
 Gnr: _____
 Luck: _____

Mk. 10
 Torps

○
○
○
○

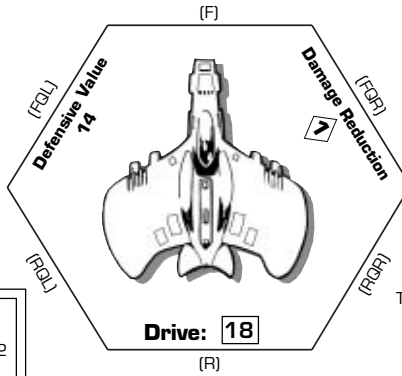

Tight Turn Cost: _____+3

Decoys: ○○
 P-D: —
 Dmg Con: 1-2
 Tons: 150

DAMAGE TRACK

18	t	1	*	16	t	14	12
t	10	8	w	6	1	t	×

BLIZZARD

I.D.

BPV: 19

TPV

Pilot
1 Disruptorgun (F)
 To Hit: 2D8+ADB
 Damage: Medium S
 Range: 1/2/6

Crew
PILOT
 Plt: _____
 Gnr: _____
 Luck: _____

Mk. 10
 Torps

○
○
○
○

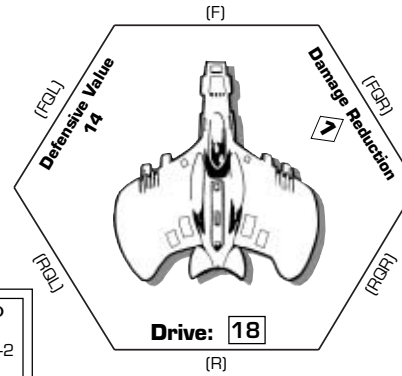

Tight Turn Cost: _____+3

Decoys: ○○
 P-D: —
 Dmg Con: 1-2
 Tons: 150

DAMAGE TRACK

18	t	1	*	16	t	14	12
t	10	8	w	6	1	t	×

BLIZZARD

I.D.

BPV: 19

TPV

Pilot
1 Disruptorgun (F)
 To Hit: 2D8+ADB
 Damage: Medium S
 Range: 1/2/6

Crew
PILOT
 Plt: _____
 Gnr: _____
 Luck: _____

Mk. 10
 Torps

○
○
○
○

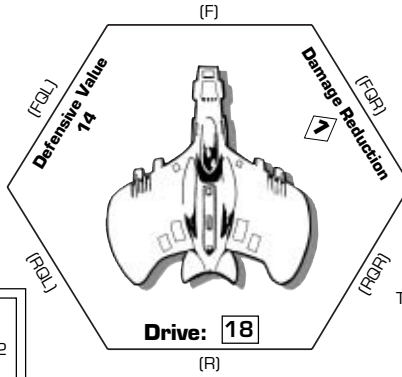

Tight Turn Cost: _____+3

Decoys: ○○
 P-D: —
 Dmg Con: 1-2
 Tons: 150

DAMAGE TRACK

18	t	1	*	16	t	14	12
t	10	8	w	6	1	t	×

BLIZZARD

I.D.

BPV: 19

TPV

Pilot
1 Disruptorgun (F)
 To Hit: 2D8+ADB
 Damage: Medium S
 Range: 1/2/6

Crew
PILOT
 Plt: _____
 Gnr: _____
 Luck: _____

Mk. 10
 Torps

○
○
○
○

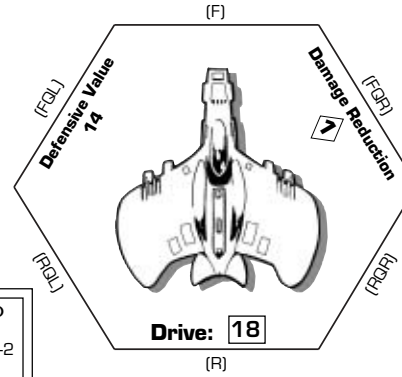

Tight Turn Cost: _____+3

Decoys: ○○
 P-D: —
 Dmg Con: 1-2
 Tons: 150

DAMAGE TRACK

18	t	1	*	16	t	14	12
t	10	8	w	6	1	t	×

CRITICAL HITS

- 2 — **Pilot killed.** Blizzard may perform no further actions. Defensive Value drops to 5.
- 3 — **Torp Loads jettison.** Remove any remaining torp loads.
- 4 — **Electronic Warfare knocked out.** Blizzard may no longer jam torps. Reduce Defensive Value by 3.
- 5 — **Major Structural Damage inflicted.** Blizzard takes 1D4 more hits.
- 6 — **Shields damaged.** Reduce Defensive Value by 2.
- 7 — **Disruptorgun Targeter hit.** Reduce chance To Hit by 1.
- 8 — **Evade Thrusters hit.** Reduce Defensive Value by 4.
- 9 — **Hull compromised.** Reduce Defensive Value by 5.
- 10 — **Engines damaged.** Blizzard reduced to a Drive value of 1. Reduce Defensive Value by 6.
- 11 — **Pilot dazed.** Blizzard may not move or fire until after the next game turn.
- 12 — **Reactor hit.** A blizzard of scrap metal is all that's left.

DISRUPTORGUN SPECS

Short Range: 1 hex (+1 To Hit).
Medium Range: 2 hexes.
Long Range: 3-6 hexes (-1 To Hit).
S If target's Defensive Value has not been reduced by a critical hit, add 1 to its Defensive Value. Also, completely ignore the target's Damage Reduction when resolving a hit.

TPV

Pilot

1 Splattergun (F)
To Hit: 2D6+ADB
Damage: Medium
Range: 2/6/10

Crew

PILOT
Plt: _____
Gnr: _____
Luck: _____

Mk. 10 Torps

○ ○ ○ ○ ○

Decoys: ○ ○
P-D: —
Dmg Con: 1-2
Tons: 150

(F) Defensive Value 14 (FGR) Damage Reduction 7 (FGR)
(R) Drive: 18 (R)

Tight Turn Cost: _____+3

DAMAGE TRACK

→	18	t	1	*	16	t	14	12
	t	10	9	w	6	1	t	×

TPV

Pilot

1 Splattergun (F)
To Hit: 2D6+ADB
Damage: Medium
Range: 2/6/10

Crew

PILOT
Plt: _____
Gnr: _____
Luck: _____

Mk. 10 Torps

○ ○ ○ ○ ○

Decoys: ○ ○
P-D: —
Dmg Con: 1-2
Tons: 150

(F) Defensive Value 14 (FGR) Damage Reduction 7 (FGR)
(R) Drive: 18 (R)

Tight Turn Cost: _____+3

DAMAGE TRACK

→	18	t	1	*	16	t	14	12
	t	10	9	w	6	1	t	×

TPV

Pilot

1 Splattergun (F)
To Hit: 2D6+ADB
Damage: Medium
Range: 2/6/10

Crew

PILOT
Plt: _____
Gnr: _____
Luck: _____

Mk. 10 Torps

○ ○ ○ ○ ○

Decoys: ○ ○
P-D: —
Dmg Con: 1-2
Tons: 150

(F) Defensive Value 14 (FGR) Damage Reduction 7 (FGR)
(R) Drive: 18 (R)

Tight Turn Cost: _____+3

DAMAGE TRACK

→	18	t	1	*	16	t	14	12
	t	10	9	w	6	1	t	×

TPV

Pilot

1 Splattergun (F)
To Hit: 2D6+ADB
Damage: Medium
Range: 2/6/10

Crew

PILOT
Plt: _____
Gnr: _____
Luck: _____

Mk. 10 Torps

○ ○ ○ ○ ○

Decoys: ○ ○
P-D: —
Dmg Con: 1-2
Tons: 150

(F) Defensive Value 14 (FGR) Damage Reduction 7 (FGR)
(R) Drive: 18 (R)

Tight Turn Cost: _____+3

DAMAGE TRACK

→	18	t	1	*	16	t	14	12
	t	10	9	w	6	1	t	×

CRITICAL HITS

- 2 — **Pilot killed.** Blizzard may perform no further actions. Defensive Value drops to 5.
- 3 — **Torp Loads jettison.** Remove any remaining torp loads.
- 4 — **Electronic Warfare knocked out.** Blizzard may no longer jam torps. Reduce Defensive Value by 3.
- 5 — **Major Structural Damage inflicted.** Blizzard takes 1D4 more hits.
- 6 — **Shields damaged.** Reduce Defensive Value by 2.
- 7 — **Splattergun Targeter hit.** Reduce chance To Hit by 2.
- 8 — **Evade Thrusters hit.** Reduce Defensive Value by 4.
- 9 — **Hull compromised.** Reduce Defensive Value by 5.
- 10 — **Engines damaged.** Blizzard reduced to a Drive value of 1. Reduce Defensive Value by 6.
- 11 — **Pilot dazed.** Blizzard may not move or fire until after the next game turn.
- 12 — **Reactor hit.** A blizzard of scrap metal is all that's left.

SPLATTERGUN SPECS

Short Range: 1-2 hexes (+1 To Hit).
Medium Range: 3-6 hexes.
Long Range: 7-10 hexes (-1 To Hit).

Red Star Dynamics C.A.L. 220 flash "Dart"

Crew: 1

Maneuvering Thrust: 0.194 km/s/s

Mass: 140 tons

Translight Capability: None

Armor: Crystanium w/belt

Atmospheric Capability: None

Armaments:

2 x Mk. 10 Pulse Lasers

1 x Mk. 10 Minigun

(Ammo: 9,000 rounds)

Commentary: Despite the fact that it's small and lightly armored, the Dart deported itself well during the Terran-Hatchling War. Although Darts often serve as part of an escort for a larger ship, a handful of these zippy crafts can act as an excellent strike force. Often they've been and gone before the target has any time to come up with a response.

The Dart may not take much damage, but it's the toughest fighter to hit, and it tenaciously holds its speed up to the very end. Since it has no torpedoes to use against larger craft, the Dart is best used against small opponents like the Pit Viper and Blizard. Its weapons really don't have enough punch to allow it to brawl with vessels out of its class.

Still, there is something to be said for sheer force of numbers. It is not unheard of for even a mighty Betafortress to fall to a large enough force of Darts. It's similar to hive of bees attacking a human. A single sting is rarely enough to do any real damage, but after a while, the effect of all those tiny jabs add up.

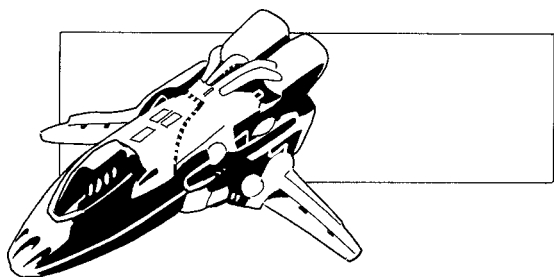

Red Star Dynamics C.A.L. 220.1 flash "Dart II"

Crew: 1

Maneuvering Thrust: 0.194 km/s/s

Mass: 140 tons

Translight Capability: None

Armor: Crystanium w/belt

Atmospheric Capability: None

Armaments:

3 x Mk. 10 Minigun

(Ammo: 27,000 rounds)

Commentary: House Red Star was one of the first to come to the aid of House Ptolemus when it came under assault from House Colos. In less than one year over 400 of these light craft were replenishing depleted squadrons. House Colos has not yet forgiven House Red Star for their intervention. Since then the Dart has remained in production, and while common elsewhere is never seen in the Colos Arsenal.

Due to plant sabotage and subsequent loss of Pulse Laser production during Imp 475, the Dart design was altered for a limited time. Of the over 400 Darts produced before the end of Imp 476 about 100 were C.A.L. 220.1. The Pulse Laser array, some Point Defense protection, and Damage Control capability were sacrificed for a stronger striking weapon and lower cost. While this model was very successful, it lacked the versatility and staying power of C.A.L. 220 due to its dependency on ammunition and lack of Damage Control. Production reverted to C.A.L. 220 when Pulse Laser production was again possible. Since then many smaller militaries have opted for the additional striking power of the Dart II, so it continues to be produced on a semi-regular basis.



The Next Millennium

Dart

Kashmere, Luches, Primate, Red Star, Sigurd, Tokugawa, Unkulunkulu.

Dart II

Primate, Red Star.

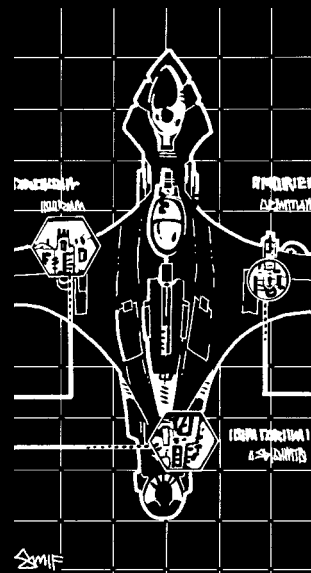

DART

BPV: 21

I.D.

Pilot

2 Pulse Lasers (F)
To Hit: 2D8+ADB+1
Damage: Low +1
Range: 3/9/10

Pilot

1 Minigun (F)
To Hit: 2D6+ADB
Damage: Low †
Range: 2/5/12
○○○○

Crew

PILOT

Pit: _____
Gnr: _____
Luck: _____

TPV

Drive: 19

Tight Turn Cost: _____+3

Decoys: ○
P-D: 1-6 (1)
Dmg Con: 1-2
Tons: 140

DAMAGE TRACK

→ [] [] [] [19] [18] [17] [1] [*] [15] [W] [11] [7] [X]

DART

BPV: 21

I.D.

Pilot

2 Pulse Lasers (F)
To Hit: 2D8+ADB+1
Damage: Low +1
Range: 3/9/10

Pilot

1 Minigun (F)
To Hit: 2D6+ADB
Damage: Low †
Range: 2/5/12
○○○○

Crew

PILOT

Pit: _____
Gnr: _____
Luck: _____

TPV

Drive: 19

Tight Turn Cost: _____+3

Decoys: ○
P-D: 1-6 (1)
Dmg Con: 1-2
Tons: 140

DAMAGE TRACK

→ [] [] [] [19] [18] [17] [1] [*] [15] [W] [11] [7] [X]

DART

BPV: 21

I.D.

Pilot

2 Pulse Lasers (F)
To Hit: 2D8+ADB+1
Damage: Low +1
Range: 3/9/10

Pilot

1 Minigun (F)
To Hit: 2D6+ADB
Damage: Low †
Range: 2/5/12
○○○○

Crew

PILOT

Pit: _____
Gnr: _____
Luck: _____

TPV

Drive: 19

Tight Turn Cost: _____+3

Decoys: ○
P-D: 1-6 (1)
Dmg Con: 1-2
Tons: 140

DAMAGE TRACK

→ [] [] [] [19] [18] [17] [1] [*] [15] [W] [11] [7] [X]

DART

BPV: 21

I.D.

Pilot

2 Pulse Lasers (F)
To Hit: 2D8+ADB+1
Damage: Low +1
Range: 3/9/10

Pilot

1 Minigun (F)
To Hit: 2D6+ADB
Damage: Low †
Range: 2/5/12
○○○○

Crew

PILOT

Pit: _____
Gnr: _____
Luck: _____

TPV

Drive: 19

Tight Turn Cost: _____+3

Decoys: ○
P-D: 1-6 (1)
Dmg Con: 1-2
Tons: 140

DAMAGE TRACK

→ [] [] [] [19] [18] [17] [1] [*] [15] [W] [11] [7] [X]

- CRITICAL HITS**
- 2 — **Structural collapse.** Dart folds up. It is destroyed.
 - 3 — **Engines severely damaged.** Reduce Dart's Drive value to (1D4+1).
 - 4 — **Electronic Warfare knocked out.** Dart may no longer jam torps. Reduce Defensive Value by 4.
 - 5 — **Maneuver Thrusters malfunction.** Dart may no longer make Tight Turns.
 - 6 — **Shields damaged.** Reduce Defensive Value by 2.
 - 7 — **Minigun Ammo destroyed.** Gun may no longer fire.
 - 8 — **Evade Thrusters hit.** Reduce Defensive Value by 3.
 - 9 — **Pulse Laser Capacitors overheat.** Dart takes one more hit on damage track due to internal flash fire.
 - 10 — **Controls momentarily lock up.** Dart must move straight ahead at maximum speed next Movement Phase. Afterwards, Dart may move normally.
 - 11 — **Pilot killed.** Dart may perform no further actions. Defensive Value drops to 5.
 - 12 — **Reactor hit.** This Dart is gone.
- PULSE LASER SPECS**
- Short Range: 1-3 hexes (+1 To Hit).
Medium Range: 4-9 hexes.
Long Range: 10 hexes (-1 To Hit).
- MINIGUN SPECS†**
- Short Range: 1-2 hexes (+1 To Hit).
Medium Range: 3-5 hexes.
Long Range: 6-12 hexes (-1 To Hit).
† Whenever two of the Attack Dice roll doubles, multiply base damage by 2.

DART II

TPV

Pilot
3 Miniguns (F)
 To Hit: 2D6+ADB+2
 Damage: Low+2 †
 Range: 2/5/12
 ○ ○ ○ ○ ○ ○

Crew
PILOT
 Plt: _____
 Gnr: _____
 Luck: _____

Decoys: ○
 P-D: 1-5 (1)
 Dmg Con: —
 Tons: 140

Defensive Value 16
 Damage Reduction 7

Drive: 19

Tight Turn Cost: _____+3

DAMAGE TRACK

→ [] [] [] [19] [18] [17] [1] [*] [15] [w] [11] [7] [X]

DART II

TPV

Pilot
3 Miniguns (F)
 To Hit: 2D6+ADB+2
 Damage: Low+2 †
 Range: 2/5/12
 ○ ○ ○ ○ ○ ○

Crew
PILOT
 Plt: _____
 Gnr: _____
 Luck: _____

Decoys: ○
 P-D: 1-5 (1)
 Dmg Con: —
 Tons: 140

Defensive Value 16
 Damage Reduction 7

Drive: 19

Tight Turn Cost: _____+3

DAMAGE TRACK

→ [] [] [] [19] [18] [17] [1] [*] [15] [w] [11] [7] [X]

DART II

TPV

Pilot
3 Miniguns (F)
 To Hit: 2D6+ADB+2
 Damage: Low+2 †
 Range: 2/5/12
 ○ ○ ○ ○ ○ ○

Crew
PILOT
 Plt: _____
 Gnr: _____
 Luck: _____

Decoys: ○
 P-D: 1-5 (1)
 Dmg Con: —
 Tons: 140

Defensive Value 16
 Damage Reduction 7

Drive: 19

Tight Turn Cost: _____+3

DAMAGE TRACK

→ [] [] [] [19] [18] [17] [1] [*] [15] [w] [11] [7] [X]

DART II

TPV

Pilot
3 Miniguns (F)
 To Hit: 2D6+ADB+2
 Damage: Low+2 †
 Range: 2/5/12
 ○ ○ ○ ○ ○ ○

Crew
PILOT
 Plt: _____
 Gnr: _____
 Luck: _____

Decoys: ○
 P-D: 1-5 (1)
 Dmg Con: —
 Tons: 140

Defensive Value 16
 Damage Reduction 7

Drive: 19

Tight Turn Cost: _____+3

DAMAGE TRACK

→ [] [] [] [19] [18] [17] [1] [*] [15] [w] [11] [7] [X]

- CRITICAL HITS**
- 2 — **Structural collapse.** Dart folds up. It is destroyed.
 - 3 — **Engines severely damaged.** Reduce Dart's Drive value to (1D4+1).
 - 4 — **Electronic Warfare knocked out.** Dart may no longer jam torps. Reduce Defensive Value by 4.
 - 5 — **Maneuver Thrusters malfunction.** Dart may no longer make Tight Turns.
 - 6 — **Shields damaged.** Reduce Defensive Value by 2.
 - 7 — **Minigun Ammo destroyed.** Gun may no longer fire.
 - 8 — **Evade Thrusters hit.** Reduce Defensive Value by 3.
 - 9 — **Minigun jam.** Mark off 1 ammo. Minigun may not fire until after next game turn.
 - 10 — **Controls momentarily lock up.** Dart must move straight ahead at maximum speed next Movement Phase. Afterwards, Dart may move normally.
 - 11 — **Pilot killed.** Dart may perform no further actions. Defensive Value drops to 5.
 - 12 — **Reactor hit.** This Dart is gone.
- MINIGUN SPECS †**
- Short Range: 1-2 hexes (+1 To Hit).
 Medium Range: 3-5 hexes.
 Long Range: 6-12 hexes (-1 To Hit).
 † Whenever two of the Attack Dice roll doubles, multiply base damage by 2.

Silent Death

Death Wind

Colos, Draconian, Kashmere, Primates, Yoka-Shan.

Death Wind II

Colos.

Delta Combine PKM-221 "Death Wind"

Crew: 2

Maneuvering Thrust: 0.140 km/s/s

Mass: 400 tons

Translight Capability: None

Armor: Crystanium w/belt

Atmospheric Capability: Full

Armaments:

1 x Mk. 15 Ion Ram

2 x Mk. 10 Splatterguns

1 x Mk. 10 Minigun

(Ammo: 24,000 rounds)

4 x Mk. 20 Torp Loads

Commentary: The Death Wind is a powerful combatant, particularly when facing medium fighters. The Ion Ram makes short work of most foes, while the second crewmember can keep enemy vessels off the Death Wind's tail. Many aces owe their status to this fighter's balance of armor and firepower, which insures that the Death Wind will operate for many years to come. Delta Combine was an independent Imperial producer, but they've fallen on hard times. At one time, the PKM-221 was only sold to a few favored Provincial powers, but these days, they'll sell them to anyone willing to buy.

One of many medium fighters, the Death Wind is distinguished by the impressive Ion Ram. In conjunction with the Minigun, Splatterguns and a Drive of 14, the Death Wind can hold its own against light and medium opponents. Note that after some initial armor is overcome, the Death Wind falls apart rapidly, and it's apt to lose its main armament quickly.

Delta Combine PKM-221.1 "Death Wind II"

Crew: 2

Maneuvering Thrust: 0.140 km/s/s

Mass: 400 tons

Translight Capability: None

Armor: Crystanium w/belt

Atmospheric Capability: Full

Armaments:

1 x Mk. 15 Ion Ram

2 x Mk. 10 Splatterguns

1 x Missile Launcher

(Magazine: 25 missiles)

4 x Mk. 20 Torp Loads

Commentary: House Colos secretly commissioned this version of the Death Wind from Delta Combine. Delta Combine's designers, understanding the Colosians' "particular style of interaction," chose to accentuate the Death Wind's already considerable strengths rather than to shore up its weaknesses. Removing the Minigun and its ammunition, the Delta Combine engineers installed a front firing Missile Launcher in its place. Through the use of an ingenious belly-mounted magazine, the Death Wind II can carry 25 missiles (a load previously unheard of for a fighter of this size), with no appreciable gain in mass or loss in maneuverability. The magazine's placement does, however, make the Launcher as vulnerable as the Ion Ram to an early disabling hit.

Overall, the Death Wind II's pilot has better options for damage-dealing than in the previous incarnation of this vessel, though depletion of the Missile magazine still leaves the Ion Ram vulnerable. However, since a foe must choose between the Ion Ram and a loaded Missile Launcher, it is possible that the Death Wind II's Ion Ram will survive longer in engagements than its predecessor's did.

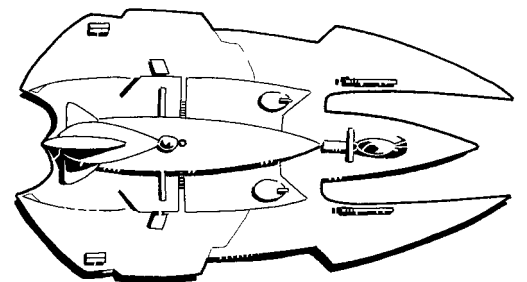
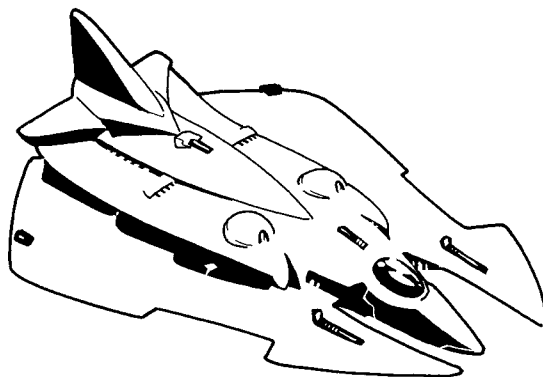
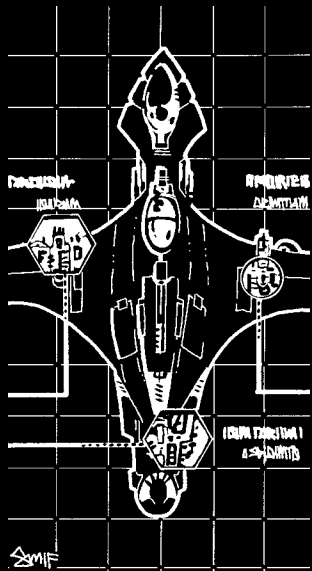

DEATH WIND

I.D.

BPV: 60

TPV

Mk. 20 Torps
○
○
○
○

Pilot
1 Ion Ram (F)
To Hit: 2D8+ADB
Damage: All
Range: 5/13/15
Target SR ≤15

Pilot
1 Minigun (F)
To Hit: 2D6+ADB
Damage: Low †
Range: 2/5/12
○○○○○○○○○○

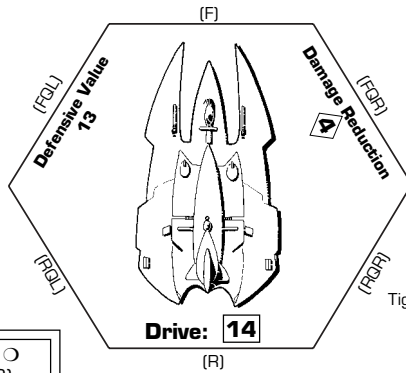

Tight Turn Cost: _____ +3

Decoys: ○ ○
P-D: 1-4 (2)
Dmg Con: 1-5
Tons: 400

Gunner
2 Splatterguns
(RQL) (R) (RQR)
To Hit: 2D6+ADB+1
Damage: Medium+2
Range: 2/6/10

DAMAGE TRACK

→	4		t	3	*	14		W	
	13						2	11	w
		t	10		*	1	9	w	8
		7	t	6	5	3	1		×

Crew
PILOT
Pit: _____
Gnr: _____
Luck: _____
GUNNER
Gnr: _____

DEATH WIND

I.D.

BPV: 60

TPV

Mk. 20 Torps
○
○
○
○

Pilot
1 Ion Ram (F)
To Hit: 2D8+ADB
Damage: All
Range: 5/13/15
Target SR ≤15

Pilot
1 Minigun (F)
To Hit: 2D6+ADB
Damage: Low †
Range: 2/5/12
○○○○○○○○○○

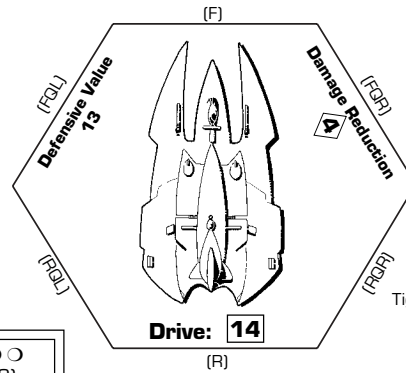

Tight Turn Cost: _____ +3

Decoys: ○ ○
P-D: 1-4 (2)
Dmg Con: 1-5
Tons: 400

Gunner
2 Splatterguns
(RQL) (R) (RQR)
To Hit: 2D6+ADB+1
Damage: Medium+2
Range: 2/6/10

DAMAGE TRACK

→	4		t	3	*	14		W	
	13						2	11	w
		t	10		*	1	9	w	8
		7	t	6	5	3	1		×

Crew
PILOT
Pit: _____
Gnr: _____
Luck: _____
GUNNER
Gnr: _____

CRITICAL HITS

- 2 — **Pilot killed.** Death Wind may not move, nor may the pilot's weapons fire. Defensive Value drops to 5.
- 3 — **Engine sputters.** Death Wind has Drive 4 next game turn. Reduce Defensive Value by 4 due to other damage.
- 4 — **Electronic Warfare knocked out.** Death Wind may no longer jam torps. Reduce Defensive Value by 3.
- 5 — **Maneuver Thrusters damaged.** All turns cost 1 extra point to perform.
- 6 — **Shields damaged.** Reduce Defensive Value by 2.
- 7 — **Minigun hit.** Lose half its remaining ammo.
- 8 — **Ion Ram Targeting malfunction.** Modify Ion Ram To Hit attempts by -2.
- 9 — **Hull buckles.** Reduce Defensive Value by 3.
- 10 — **Gunner killed.** Splatterguns cannot be used.
- 11 — **Controls lock up.** Death Wind may not move nor fire until after next game turn.
- 12 — **Reactor detonates.** Death Wind is no more.

MINIGUN SPECS †

Short Range: 1-2 hexes (+1 To Hit).
Medium Range: 3-5 hexes.
Long Range: 6-12 hexes (-1 To Hit).

SPLATTERGUN SPECS

Short Range: 1-2 hexes (+1 To Hit).
Medium Range: 3-6 hexes.
Long Range: 7-10 hexes (-1 To Hit).

ION RAM SPECS

Short Range: 1-5 hexes (+1 To Hit).
Medium Range: 6-13 hexes.
Long Range: 14-15 hexes (-1 To Hit).
Target Speed Restriction: Target's Drive value must be ≤15.

GAME TURN RECORD TRACK

1	2	3	4	5	6	7	8	9	10	11	12	13	14	15	16	17	18	19	20
---	---	---	---	---	---	---	---	---	----	----	----	----	----	----	----	----	----	----	----

DEATH WIND II

I.D. ■

BPV: 64

TPV

Pilot
1 Ion Ram (F)
 To Hit: 2D8+ADB
 Damage: All
 Range: 5/13/15
 Target SR ≤15

Crew
PILOT
 PIt: _____
 Gnr: _____
GUNNER
 Gnr: _____

Mk. 20
Torps

Pilot
Missile Launcher (F)
 Lock-on < _____

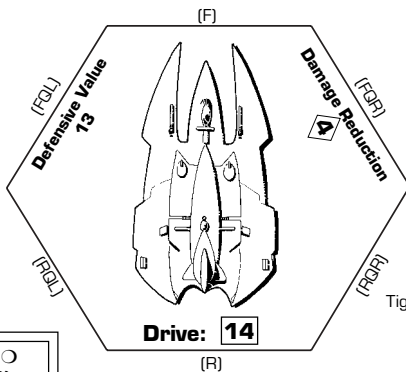

Decoys: ○ ○
 P-D: 1-4 (2)
 Dmg Con: 1-5
 Tons: 400

Gunner
2 Splatterguns
 (RQL) (R) (RQR)
 To Hit: 2D6+ADB+1
 Damage: Medium+2
 Range: 2/6/10

DAMAGE TRACK

→	4		t	3	*	14		W	
	13						2	11	w
		t	10		*	1	9	w	8
		7	t	6	5	3	1		×

DEATH WIND II

I.D. ■

BPV: 64

TPV

Pilot
1 Ion Ram (F)
 To Hit: 2D8+ADB
 Damage: All
 Range: 5/13/15
 Target SR ≤15

Crew
PILOT
 PIt: _____
 Gnr: _____
GUNNER
 Gnr: _____

Mk. 20
Torps

Pilot
Missile Launcher (F)
 Lock-on < _____

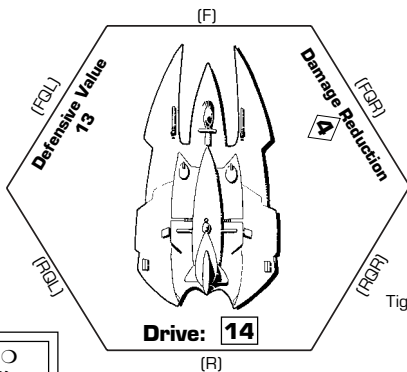

Decoys: ○ ○
 P-D: 1-4 (2)
 Dmg Con: 1-5
 Tons: 400

Gunner
2 Splatterguns
 (RQL) (R) (RQR)
 To Hit: 2D6+ADB+1
 Damage: Medium+2
 Range: 2/6/10

DAMAGE TRACK

→	4		t	3	*	14		W	
	13						2	11	w
		t	10		*	1	9	w	8
		7	t	6	5	3	1		×

CRITICAL HITS

- 2 — **Pilot killed.** Death Wind may not move, nor may the pilot's weapons fire. Defensive Value drops to 5.
- 3 — **Engine sputters.** Death Wind has Drive 4 next game turn. Reduce Defensive Value by 4 due to other damage.
- 4 — **Electronic Warfare knocked out.** Death Wind may no longer jam torps. Reduce Defensive Value by 3.
- 5 — **Maneuver Thrusters damaged.** All turns cost 1 extra point to perform.
- 6 — **Shields damaged.** Reduce Defensive Value by 2.
- 7 — **Missile Launcher hit.** Lose half its remaining missiles.
- 8 — **Ion Ram Targeting malfunction.** Modify Ion Ram To Hit attempts by -2.
- 9 — **Hull buckles.** Reduce Defensive Value by 3.
- 10 — **Gunner killed.** Splatterguns cannot be used.
- 11 — **Controls lock up.** Death Wind may not move nor fire until after next game turn.
- 12 — **Reactor detonates.** Death Wind is no more.

ION RAM SPECS

Short Range: 1-2 hexes (+1 To Hit).
Medium Range: 3-6 hexes.
Long Range: 7-10 hexes (-1 To Hit).
Target Speed Restriction: Target's Drive value must be ≤15.

SPLATTERGUN SPECS

Short Range: 1-2 hexes (+1 To Hit).
Medium Range: 3-6 hexes.
Long Range: 7-10 hexes (-1 To Hit).

GAME TURN RECORD TRACK

1	2	3	4	5	6	7	8	9	10	11	12	13	14	15	16	17	18	19	20
---	---	---	---	---	---	---	---	---	----	----	----	----	----	----	----	----	----	----	----

Krote-Khol Systems SFX20-d "Drakar"

Crew: 5

Maneuvering Thrust: 0.078 km/s/s

Mass: 1000 tons

Translight Capability: None

Armor: Crysteel Double Hull

Atmospheric Capability: None

Armaments:

1 x Heavy Plazgun

1 x Railrepeater

(Ammo: 4000 rounds)

6 x Mk. 10 Pulse Lasers

2 x Missile Launchers

(Magazine: 10 missiles each)

2 x Mk. 10 Torp Loads

Commentary: The Drakar is a MPAC design produced by the House LeGrange affiliate, Krote-Khol Systems. Known more for their Escort Class vessels, Krote-Khol has succeeded with this production model gunboat. The Drakar usually sees duty with heavy fighter wings. Considering that it usually faces smaller vessels in combat, its Heavy Plazgun weapon turret can be irresistible. Due to House LeGrange's losses in the Terran-Hatchling War, it no longer manufactures the ship, but it has licensed the design to several independent manufacturers, ensuring a steady supply.

Though it initially strikes one as being very powerful, the Drakar is vulnerable in many areas. The Pulse Lasers and small Missile Launchers aren't powerful enough to fend off hordes of attrition fighters, and the Heavy Plazgun, though devastating, can only engage other gunboats. Support each Drakar with a few smaller fighters if you want to keep it around.

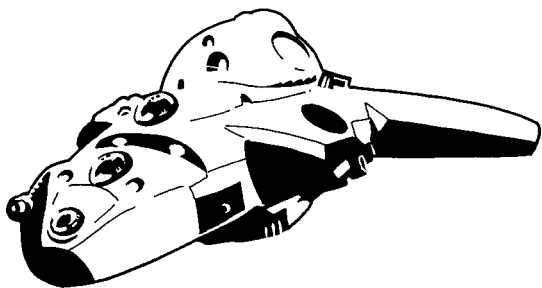

Krote-Khol Systems SFX20-d "Drakar Alpha"

Crew: 5

Maneuvering Thrust: 0.078 km/s/s

Mass: 1000 tons

Translight Capability: None

Armor: Crysteel Double Hull

Atmospheric Capability: None

Armaments:

1 x Heavy Plazgun

1 x Protobolt Projector

(Ammo: 5 protobolts)

6 x Mk. 10 Pulse Lasers

2 x Missile Launchers

(Magazine: 20 missiles each)

4 x Mk. 10 Torp Loads

Commentary: A recent redesign of the original Krote-Khol Systems Drakar, the Drakar Alpha has yet to see much action, though House Devon's field-testing of it has met with some success. Engineers replaced the inferior Missile Launchers with higher-capacity turrets, and pulled the Railrepeater in favor of a Protobolt Projector.

The Drakar Alpha's increased missile and torp load give it somewhat better staying power against masses of fighters than the original. The Protobolt Projector is effective against more foes than the Railrepeater, but is still useless against small, quick ships. The Protobolter's best use: slow enemy craft so the Gunner can bring the Heavy Plazgun to bear on them.

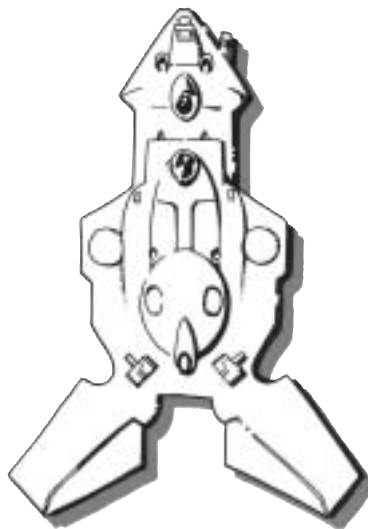

The Next Millennium

Drakar

ASP, Colos,
Draconian, Primates,
Sigurd, Unkulunkulu.

Drakar Alpha

ASP.

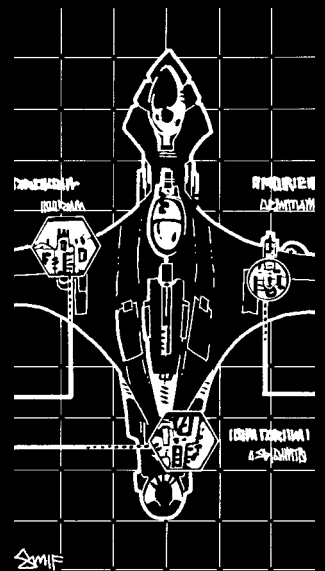

DRAKAR ALPHA

I.D.

BPV: 125

TPV

--

Decoys: ○○○○
P-D: 1-6 (6)
Dmg Con: 1-8
Tons: 1000

Pilot
1 Protobolt Projector (F)
To Hit: 2D6+ADB
Damage: 10/8/6
Range: 5-8/12/16
Target SR ≤14
○○○○○

Gunner A
1 Heavy Plazgun (360°)
To Hit: 2D6+ADB
Damage: All x 2 ♯
Range: 4/8/15
Target SR ≤11

Mk. 10 Torps

○
○
○
○

Crew

PILOT
Plt: _____
Gnr: _____
Luck: _____

GUNNER A
Gnr: _____

GUNNER B
Gnr: _____

GUNNER C
Gnr: _____

GUNNER D
Gnr: _____

Gunner B
2 Pulse Lasers (FQL) (F)
To Hit: 2D8+ADB+1
Damage: Low+1
Range: 3/9/10

Gunner C
2 Pulse Lasers (F) (FQR)
To Hit: 2D8+ADB+1
Damage: Low+1
Range: 3/9/10

FRONT DAMAGE TRACK

		t		4		*		w		
3			w					2		w
			w	1						
		t		X						X

LEFT SIDE DAMAGE TRACK

			t	
		3		
	*			w
		2		
t			-1	1
	*			
		w		
			-1	
				X
w				X

4 (F)

Defensive Value 12

3 (RQL) 3 (FQR)

3 (RQL) 3 (FQR)

Drive: 8 (R)
Tight Turn Cost: _____+4

RIGHT SIDE DAMAGE TRACK

			t	
		3		
	*			w
		2		
t			-1	1
	*			
		w		
			-1	
				X
w				X

Gunner B Missile Launcher (FQL) (RQL)
Lock-on < _____

○○○○○
○○○○○
○○○○○
○○○○○

Gunner C Missile Launcher (FQR) (RQR)
Lock-on < _____

○○○○○
○○○○○
○○○○○
○○○○○

Gunner D
2 Pulse Lasers (R)
To Hit: 2D8+ADB+1
Damage: Low+1
Range: 3/9/10

REAR DAMAGE TRACK

		-1		t		2		*		-1		1		*		w	-1		-1
w				X			-1			-1	t		-1		w	-1			X

- FRONT CRITICAL HITS**
- 2 — Pilot dazed. Drakar may not move nor fire Protobolter until after next game turn.
 - 3 — Plazgun power loss. No firing until after 2 game turns.
 - 4 — Shields damaged. Reduce Defensive Value by 1.
 - 5 — Too tough! No extra damage.
 - 6 — Protobolter knocked off line. Weapon may not fire until after next game turn.
 - 7 — Gunner A killed. The Heavy Plazgun may not be fired.
 - 8 — Cockpit Controls smashed. Drakar may not move.

- LEFT SIDE CRITICAL HITS**
- 2 — Ouch! Take 5 more hits here.
 - 3 — Pulse Laser B damaged. Weapon suffers a -2 To Hit.
 - 4 — Shields damaged. Reduce Defensive Value by 1.
 - 5 — Launcher B hit. Mark off 10 missiles.
 - 6 — Launcher B jams. Weapon out until after next game turn.
 - 7 — Gunner B killed. Lose use of Gunner B's weapons.
 - 8 — Electronic Warfare gone. Drakar cannot jam torps. Reduce Defensive Value by 2.

- RIGHT SIDE CRITICAL HITS**
- 2 — Ouch! Take 5 more hits here.
 - 3 — Pulse Laser C damaged. Weapon suffers a -2 To Hit.
 - 4 — Shields damaged. Reduce Defensive Value by 1.
 - 5 — Launcher C hit. Mark off 10 missiles.
 - 6 — Launcher C jams. Weapon out until after next game turn.
 - 7 — Gunner C killed. Lose use of Gunner C's weapons.
 - 8 — Electronic Warfare gone. Drakar cannot jam torps. Reduce Defensive Value by 2.

- REAR CRITICAL HITS**
- 2 — Heavy Structural Damage. Take 15 hits on rear; 5 hits to Left and Right Damage Tracks.
 - 3 — Heavy Plazgun hit. Weapon may only fire after 3 turns.
 - 4 — Shields damaged. Reduce Defensive Value by 1.
 - 5 — Gunner D's Pulse Lasers hit. Reduce chance to hit by 2.
 - 6 — Maneuver Thrusters hit. All turns cost +1 movement point.
 - 7 — Gunner D killed. Lose use of Gunner D's Pulse Lasers.
 - 8 — Reactor Detonates. History.

Silent Death

Epping Prime

ASP, Luches, Red Star, Tokugawa, Yoka-Shan.

Epping

Q'raj, Red Star, Sigurd, Yoka-Shan.

Arc Gotha MPAC-17 c "Epping"

Crew: 4

Maneuver Thrust: 0.109 km/s/s

Mass: 1000 tons

Translight Capability: None

Armor: Fortified Crysteel

Atmospheric Capability: Full

Armaments:

- 1 x Mk. 20 Meld Laser Cannon
- 12x Mk. 10 Pulse Laser Cannons
- 3 x Missile Launchers
(Magazine: 30 each)
- 4 x Mk. 30 Torp Load

Commentary: A gunboat design from Arc Gotha of House Devon, the Epping is now a formidable gunboat, as its laser defenses are no longer underpowered. The missile launchers are the most formidable of any fielded by this class of vehicle or smaller. For added bite a barage of four Mk 30 torps were added, and its defenses shored up. Unfortunately the upgrade in damage reduction didn't reinforce the weak internal structure this vessel has always suffered from. While the Epping now comes on like a bulldog, it still has a very fragile glass jaw.

The Epping is commonly available, and is excellently priced, as it is still having problems overcoming the poor reputation of its predecessor.

Even when the gunners are good, this gunboat has to get in close to be effective. Many of its potential targets can easily engage it from beyond 10 hexes. But when the range is right and all three of those launchers lock-on, watch out. Best keep the Epping on smaller opponents.

Arc Gotha MPAC-17 c "Epping Prime"

Crew: 4

Maneuver Thrust: 0.109 km/s/s

Mass: 1000 tons

Translight Capability: None

Armor: Fortified Crysteel

Atmospheric Capability: Full

Armaments:

- 1 x Mk. 20 Meld Laser Cannon
- 3x Mk. 10 Pulse Laser Cannons
- 3 x Missile Launchers
(Magazine: 20 missiles each)
- 10 x Mk. 10 Torp Load

Commentary: It's amazing that any of these have survived anywhere in Terran space, other than in a museum, or a junkyard. This original Epping design possesses perhaps the most gaping hole in defenses of any ship in current use. Countless numbers of these ships have crumbled like paper from even half-hearted attacks to their vulnerable rear quarters. Often, the prospect of flying one of these vessels in combat caused more fear in the crew than did any enemy they would face.

In its defense, the Epping Prime is cheaper than the Epping currently in use. Also, the Epping Prime has proven somewhat effective against the Brood, because of its three Missile Launchers. Unfortunately, the Brood have proven equally effective against the Epping: Brood beam weapons have arcing fire, which allow all Brood at short range to target the Epping's rear. But if you have no choice but to fly one, protect its rear with a couple tough fighters, and unload its missiles early. You might not get a second chance.

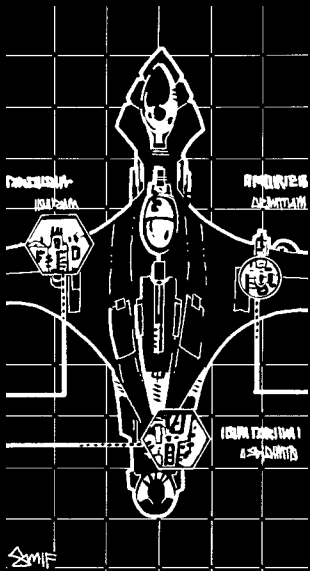
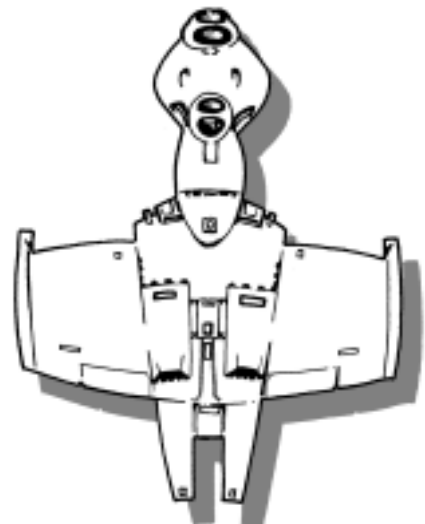
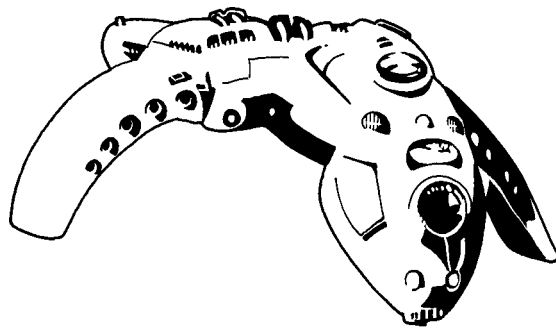

TPV

Decoys: ○○○○
P-D: 1-7 (3)
Dmg Con: 1-7
Tons: 1000

Pilot
1 Meld Laser (F)
To Hit: 2D8+ADB
Damage: Medium
Range: 6/18/20
Target SR ≤12

Gunner A
Missile Launcher
(360°)
Lock-on < _____
○ ○ ○ ○ ○
○ ○ ○ ○ ○
○ ○ ○ ○ ○
○ ○ ○ ○ ○
○ ○ ○ ○ ○
○ ○ ○ ○ ○

Mk. 30 Torps
○
○
○
○

Crew
PILOT
Pit: _____
Gnr: _____
Luck: _____
GUNNER A
Gnr: _____
GUNNER B
Gnr: _____
GUNNER C
Gnr: _____

Gunner B
4 Pulse Lasers
(FQL) (RQL) (R)
To Hit: 2D8+ADB+3
Damage: Low+3
Range: 3/9/10

FRONT DAMAGE TRACK

		4		t				3	W	-1
*		2				w		1	t	
*				-1		w				
t				×	w		w			×

Gunner C
4 Pulse Lasers
(FQR) (RQR) (R)
To Hit: 2D8+ADB+3
Damage: Low+3
Range: 3/9/10

Gunner B
Missile Launcher
(360°)
Lock-on < _____
○ ○ ○ ○ ○
○ ○ ○ ○ ○
○ ○ ○ ○ ○
○ ○ ○ ○ ○
○ ○ ○ ○ ○
○ ○ ○ ○ ○

LEFT SIDE DAMAGE TRACK

			3	t
	*			
2	W	-1		
1	*			-1
		w		
-1		×		w
-1				
w			×	

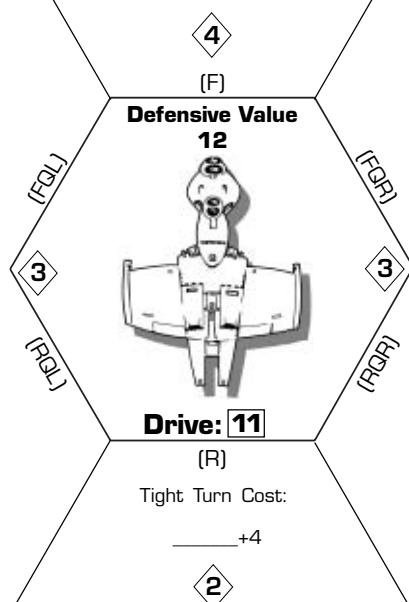

RIGHT SIDE DAMAGE TRACK

			3	t
	*			
2	W	-1		
				-1
1	*			
		w		
-1		×		w
-1				
w			×	

Gunner C
Missile Launcher
(360°)
Lock-on < _____
○ ○ ○ ○ ○
○ ○ ○ ○ ○
○ ○ ○ ○ ○
○ ○ ○ ○ ○
○ ○ ○ ○ ○
○ ○ ○ ○ ○

REAR DAMAGE TRACK

	-1			*	2	-1				-1	*	-1	×	-1
	-1		1	w				w		w		-1		×

- FRONT CRITICAL HITS**
- 2 — Pilot killed. Epping may not move nor fire Meld Laser. Defensive Value drops to 5.
 - 3 — Missile Launcher A malfunctions. Lose 1D10 missiles.
 - 4 — Shields damaged. Reduce Defensive Value by 1.
 - 5 — Pulse Laser A damaged. Reduce chance To Hit by 1.
 - 6 — Meld Laser Targeters damaged. Weapon may not fire until after next game turn.
 - 7 — Gunner A killed. Lose use of Gunner A's weapons.
 - 8 — Fatal Chain Reaction Explosion. Blast guts vessel from the front to the back. Epping is destroyed.

- LEFT SIDE CRITICAL HITS**
- 2 — Engine sputters. Epping only has Drive 2 next turn.
 - 3 — Missile Launcher B malfunctions. Lose 1D10 missiles.
 - 4 — Shields damaged. Reduce Defensive Value by 1.
 - 5 — Pulse Laser B damaged. Reduce chance to hit by 1.
 - 6 — Missile Launcher B damaged. Weapon may not fire until after next game turn.
 - 7 — Gunner B killed. Lose use of Gunner B's weapons.
 - 8 — Structural Damage. Take 10 more hits on this Damage Track and 8 more on the Right Side Damage Track.

- RIGHT SIDE CRITICAL HITS**
- 2 — Engine sputters. Epping only has Drive 2 next turn.
 - 3 — Missile Launcher C malfunctions. Lose 1D10 missiles.
 - 4 — Shields damaged. Reduce Defensive Value by 1.
 - 5 — Pulse Laser C damaged. Reduce chance to hit by 1.
 - 6 — Missile Launcher C damaged. Weapon may not fire until after next game turn.
 - 7 — Gunner C killed. Lose use of Gunner C's weapons.
 - 8 — Structural Damage. Take 10 more hits on this Damage Track and 8 more on the Left Side Damage Track.

- REAR CRITICAL HITS**
- 2 — Structural Collapse. Hull ruptures and gunboat is lost.
 - 3 — Electronic Warfare gone. Epping cannot jam torps. Reduce Defensive Value by 2.
 - 4 — Shields damaged. Reduce Defensive Value by 1.
 - 5 — Good Hit! Add another 5 points of damage.
 - 6 — Maneuver Thrusters damaged. All turns cost 1 extra movement point.
 - 7 — Pilot dazed. Epping may not move nor fire Meld Laser until after next game turn.
 - 8 — Reactor Hit. Epping disappears in a ball of hot gasses.

TPV

Decoys:

P-D: 1-7 (5)
Dmg Con: 1-6
Tons: 1000

Gunner B

1 Pulse Laser (FQL) (R)
To Hit: 2D8+ADB
Damage: Low
Range: 3/9/10

Gunner B

Missile Launcher (360°)
Lock-on < _____

Pilot

1 Meld Laser (F)
To Hit: 2D8+ADB
Damage: Medium
Range: 6/18/20
Target SR ≤12

Gunner A

1 Pulse Laser (F)
To Hit: 2D8+ADB
Damage: Low
Range: 3/9/10

Gunner A

Missile Launcher (360°)
Lock-on < _____

Crew

PILOT
Pit: _____
Gnr: _____
Luck: _____

GUNNER A
Gnr: _____

GUNNER B
Gnr: _____

GUNNER C
Gnr: _____

Gunner C

1 Pulse Laser (FQR) (R)
To Hit: 2D8+ADB
Damage: Low
Range: 3/9/10

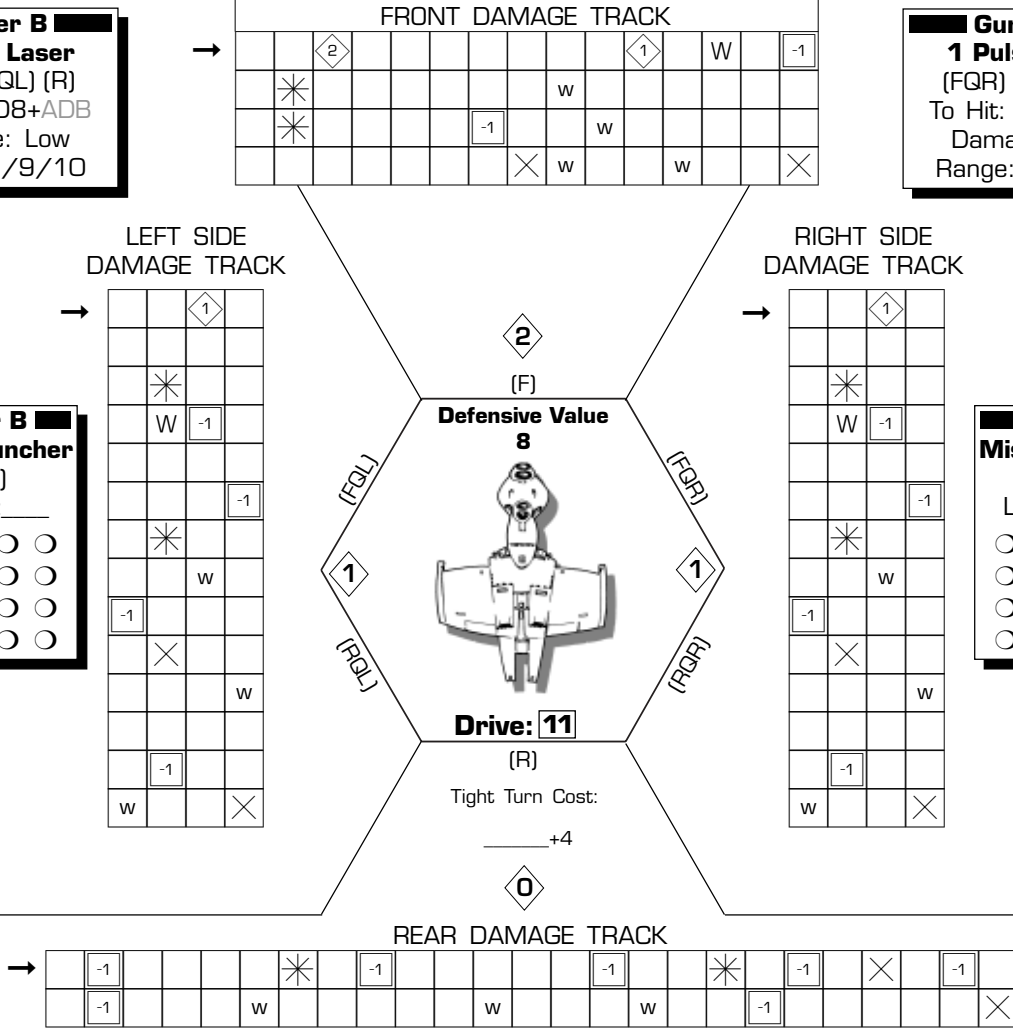

- FRONT CRITICAL HITS**
- 2 — Pilot killed. Epping may not move nor fire Meld Laser. Defensive Value drops to 5.
 - 3 — Missile Launcher A malfunctions. Lose 1D10 missiles.
 - 4 — Shields damaged. Reduce Defensive Value by 1.
 - 5 — Pulse Laser A damaged. Reduce chance To Hit by 1.
 - 6 — Meld Laser Targeters damaged. Weapon may not fire until after next game turn.
 - 7 — Gunner A killed. Lose use of Gunner A's weapons.
 - 8 — Fatal Chain Reaction Explosion. Blast guts vessel from the front to the back. Epping is destroyed.

- LEFT SIDE CRITICAL HITS**
- 2 — Engine sputters. Epping only has Drive 2 next turn.
 - 3 — Missile Launcher B malfunctions. Lose 1D10 missiles.
 - 4 — Shields damaged. Reduce Defensive Value by 1.
 - 5 — Pulse Laser B damaged. Reduce chance to hit by 1.
 - 6 — Missile Launcher B damaged. Weapon may not fire until after next game turn.
 - 7 — Gunner B killed. Lose use of Gunner B's weapons.
 - 8 — Structural Damage. Take 10 more hits on this Damage Track and 8 more on the Right Side Damage Track.

- RIGHT SIDE CRITICAL HITS**
- 2 — Engine sputters. Epping only has Drive 2 next turn.
 - 3 — Missile Launcher C malfunctions. Lose 1D10 missiles.
 - 4 — Shields damaged. Reduce Defensive Value by 1.
 - 5 — Pulse Laser C damaged. Reduce chance to hit by 1.
 - 6 — Missile Launcher C damaged. Weapon may not fire until after next game turn.
 - 7 — Gunner C killed. Lose use of Gunner C's weapons.
 - 8 — Structural Damage. Take 10 more hits on this Damage Track and 8 more on the Left Side Damage Track.

- REAR CRITICAL HITS**
- 2 — Structural Collapse. Hull ruptures and gunboat is lost.
 - 3 — Electronic Warfare gone. Epping cannot jam torps. Reduce Defensive Value by 2.
 - 4 — Shields damaged. Reduce Defensive Value by 1.
 - 5 — Good Hit! Add another 5 points of damage.
 - 6 — Maneuver Thrusters damaged. All turns cost 1 extra movement point.
 - 7 — Pilot dazed. Epping may not move nor fire Meld Laser until after next game turn.
 - 8 — Reactor Hit. Epping disappears in a ball of hot gasses.

Jasper Machines Y910b G1 / U1 "Glaive"

Crew: 2

Maneuvering Thrust: 0.119 km/s/s

Mass: 900 tons

Translight Capability: None

Armor: Reinforced Crysteel

Atmospheric Capability: None

Armaments:

1 x Mk. 10 Plazgun

1 x Mk. 10 Splatterguns

1 x Protobolt Projector
(Ammo: 4 protobolts)

2 x Missile Launchers
(Magazine: 20 missiles each)

3 x Mk. 40 Torp Load

Commentary: The Glaive was originally produced by House Ptolemus, but has now fallen into the public domain. Combat testing proved that the Glaive could both take it and dish it out, particularly with its burgeoning Plazgun weapon mount. Most analysts originally predicted that the design would fail because it incorporated so many different weapon technologies into one craft. Jasper Machines proved these skeptics wrong—dead wrong. Too bad they're not around to reap the fruits of their labor.

A stock heavy fighter, the Glaive is a good match for the Pharsii, since its powerful Plazgun helps make up for only having one gunner. With an added point-defense system and increased missile and torp payloads, the Glaive has become a superior two-man dogfighter. Its strength lies in its size, which helps it absorb considerable damage. Here the shortcomings are its low drive, and how easy it is to hit.

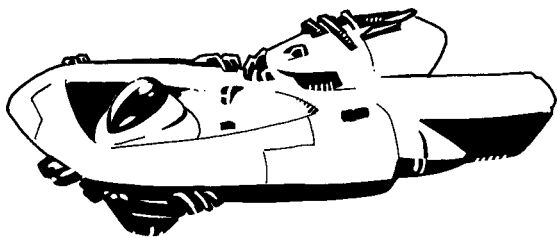

Jasper Machines Y910b G1 / U2 "Glaive II"

Crew: 2

Maneuvering Thrust: 0.119 km/s/s

Mass: 900 tons

Translight Capability: None

Armor: Reinforced Crysteel

Atmospheric Capability: None

Armaments:

1 x Mk. 15 Ion Ram

1 x Mk. 10 Splatterguns

1 x Protobolt Projector
(Ammo: 8 protobolts)

2 x Missile Launchers
(Magazine: 20 missiles each)

3 x Mk. 40 Torp Load

Commentary: The Glaive II performs head and shoulders above the standard Glaive against heavy fighters, though is somewhat weaker against fast vehicles like the Dart or Wavecutter. The Plazgun was replaced with an Ion Ram, trading the higher traverse speed of the Plazgun for the greater accuracy and potential damage of the Ion Ram. This also allowed room for a larger Protobolt magazine. The original design team at Jasper Machines would be very impressed by the Glaive II.

The stopping power of the Glaive II is not to be denied. On one occasion three Glaive IIs devastated two Betafortress Betas without receiving significant damage to more than one Glaive. The true weakness of the Y910b G1/U2 is light torpedo fighters like the Blizzard. Conversely, the Glaive II makes an excellent core to a flight of light fighters.

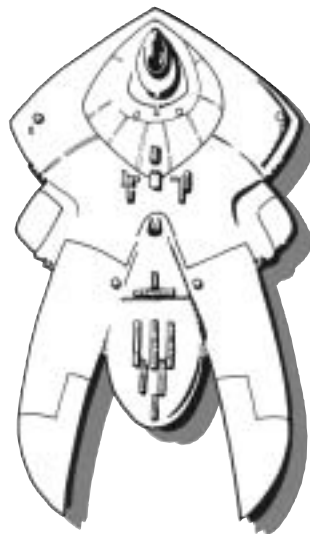

The Next Millennium

Glaive

Colos, Luches, Draconian, Primate, Tokugawa.

Glaive II

Tokugawa.

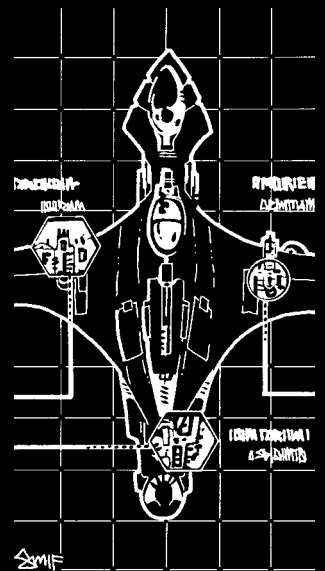

TPV

Pilot
1 Plazgun (F)
 To Hit: 2D6+ADB
 Damage: All ¥
 Range: 2/4/10

Crew
PILOT
 PIt: _____
 Gnr: _____
 Luck: _____
GUNNER
 Gnr: _____

Mk. 40 Torps

Pilot
1 Protobolt Projector (F)
 To Hit: 2D6+ADB
 Damage: 10/8/6
 Range: 5-8/12/16
 Target SR ≤14

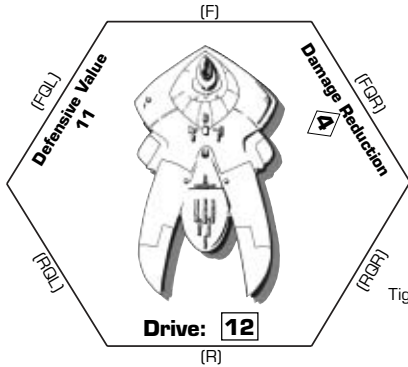

Decoys: ○○○○
 P-D: 1-6 (2)
 Dmg Con: 1-6
 Tons: 900

Gunner
1 Splattergun
 (RQL) (R) (RQR)
 To Hit: 2D6+ADB
 Damage: Medium
 Range: 2/6/10

Gunner
Missile Launcher (360°)
 Lock-on < _____

Gunner
Missile Launcher (360°)
 Lock-on < _____

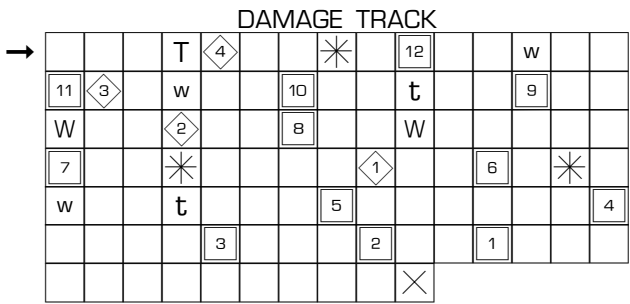

TPV

Pilot
1 Plazgun (F)
 To Hit: 2D6+ADB
 Damage: All ¥
 Range: 2/4/10

Crew
PILOT
 PIt: _____
 Gnr: _____
 Luck: _____
GUNNER
 Gnr: _____

Mk. 40 Torps

Pilot
1 Protobolt Projector (F)
 To Hit: 2D6+ADB
 Damage: 10/8/6
 Range: 5-8/12/16
 Target SR ≤14

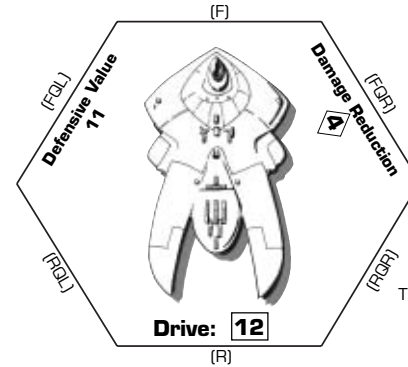

Decoys: ○○○○
 P-D: 1-6 (2)
 Dmg Con: 1-6
 Tons: 900

Gunner
1 Splattergun
 (RQL) (R) (RQR)
 To Hit: 2D6+ADB
 Damage: Medium
 Range: 2/6/10

Gunner
Missile Launcher (360°)
 Lock-on < _____

Gunner
Missile Launcher (360°)
 Lock-on < _____

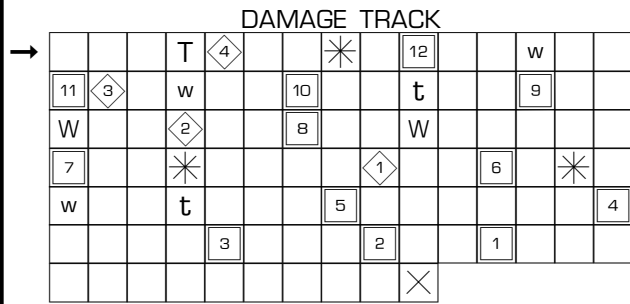

CRITICAL HITS

- 2 — Crew killed. Glave may perform no further actions. Defensive Value drops to 5.
- 3 — Major Structural Damage inflicted. Mark off 2D10 more hits of damage.
- 4 — Electronic Warfare lost. Glave may no longer jam torps. Reduce Defensive Value by 2.
- 5 — Maneuver Thrusters damaged. All turns cost 1 extra point to perform. Reduce Defensive Value by 2.
- 6 — Shields damaged. Reduce Defensive Value by 1.
- 7 — Armor too tough! No extra damage.
- 8 — Protobolt misfire. Mark off one remaining Protobolt.
- 9 — Missile Launcher damaged. Lose 1D8 of remaining missiles in one (random) functioning Missile Launcher.
- 10 — Plazgun Targeter damaged. Reduce To Hit chance by 2.
- 11 — Controls lock up. Glave may not move nor fire cannons until after next game turn. Reduce Defensive Value to 5 during this period.
- 12 — Catastrophic Structural Collapse. Glave dissolves.

PLAZGUN SPECS ¥

Short Range: 1-2 hexes (+1 To Hit).
 Medium Range: 3-4 hexes.
 Long Range: 5-10 hexes (-1 To Hit).

SPLATTERGUN SPECS

Short Range: 1-2 hexes (+1 To Hit).
 Medium Range: 3-6 hexes.
 Long Range: 7-10 hexes (-1 To Hit).

PROTOBOLT SPECS

Short Range: 5-8 hexes (+1 To Hit).
 Medium Range: 9-12 hexes.
 Long Range: 13-16 hexes (-1 To Hit).
 Target Speed Restriction: Target's Drive value must be ≤14.

TPV

Pilot
1 Ion Ram (F)
 To Hit: 2D6+ADB
 Damage: All
 Range: 5/13/15
 Target SR ≤15

Crew
PILOT
 PIt: _____
 Gnr: _____
 Luck: _____
GUNNER
 Gnr: _____

Mk. 40 Torps

Pilot
1 Protobolt Projector (F)
 To Hit: 2D6+ADB
 Damage: 10/8/6
 Range: 5-8/12/16
 Target SR ≤14

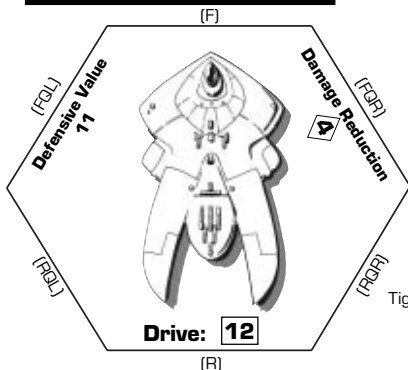

Tight Turn Cost: _____+3

Decoys:

P-D: 1-6 (2)
 Dmg Con: 1-6
 Tons: 900

Gunner
1 Splattergun
 (RQL) (R) (RQR)
 To Hit: 2D6+ADB
 Damage: Medium
 Range: 2/6/10

Gunner
Missile Launcher (360°)
 Lock-on < _____

Gunner
Missile Launcher (360°)
 Lock-on < _____

DAMAGE TRACK

			T	4		*	12		w		
11	3	W		10		t		9			
w		2		8		W					
7		*		1		6		*			
w		t		5						4	
			3		2		1				
											X

TPV

Pilot
1 Ion Ram (F)
 To Hit: 2D6+ADB
 Damage: All
 Range: 5/13/15
 Target SR ≤15

Crew
PILOT
 PIt: _____
 Gnr: _____
 Luck: _____
GUNNER
 Gnr: _____

Mk. 40 Torps

Pilot
1 Protobolt Projector (F)
 To Hit: 2D6+ADB
 Damage: 10/8/6
 Range: 5-8/12/16
 Target SR ≤14

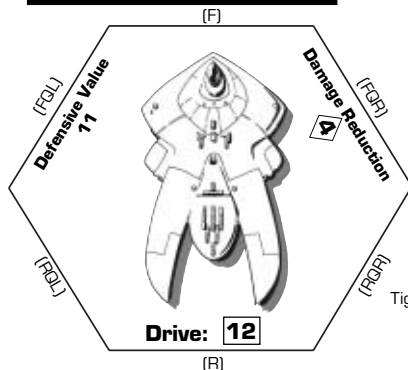

Tight Turn Cost: _____+3

Decoys:

P-D: 1-6 (2)
 Dmg Con: 1-6
 Tons: 900

Gunner
1 Splattergun
 (RQL) (R) (RQR)
 To Hit: 2D6+ADB
 Damage: Medium
 Range: 2/6/10

Gunner
Missile Launcher (360°)
 Lock-on < _____

Gunner
Missile Launcher (360°)
 Lock-on < _____

DAMAGE TRACK

			T	4		*	12		w		
11	3	W		10		t		9			
w		2		8		W					
7		*		1		6		*			
w		t		5						4	
			3		2		1				
											X

CRITICAL HITS

- 2 — Crew killed. Glave may perform no further actions. Defensive Value drops to 5.
- 3 — Major Structural Damage inflicted. Mark off 2D10 more hits of damage.
- 4 — Electronic Warfare lost. Glave may no longer jam torps. Reduce Defensive Value by 2.
- 5 — Maneuver Thrusters damaged. All turns cost 1 extra point to perform. Reduce Defensive Value by 2.
- 6 — Shields damaged. Reduce Defensive Value by 1.
- 7 — Armor too tough! No extra damage.
- 8 — Protobolt misfire. Mark off one remaining Protobolt.
- 9 — Missile Launcher damaged. Lose 1D8 of remaining missiles in one [random] functioning Missile Launcher.
- 10 — Ion Ram Targeter damaged. Reduce To Hit chance by 4.
- 11 — Controls lock up. Glave may not move nor fire cannons until after next game turn. Reduce Defensive Value to 5 during this period.
- 12 — Catastrophic Structural Collapse. Glave dissolves.

ION RAM SPECS

Short Range: 1-2 hexes (+1 To Hit).
 Medium Range: 3-4 hexes.
 Long Range: 5-10 hexes (-1 To Hit).
 Target Speed Restriction: Target's Drive value must be ≤15.

SPLATTERGUN SPECS

Short Range: 1-2 hexes (+1 To Hit).
 Medium Range: 3-6 hexes.
 Long Range: 7-10 hexes (-1 To Hit).

PROTOBOLT SPECS

Short Range: 5-8 hexes (+1 To Hit).
 Medium Range: 9-12 hexes.
 Long Range: 13-16 hexes (-1 To Hit).
 Target Speed Restriction: Target's Drive value must be ≤14.

Silent Death

Hell Bender

Colos, Kashmere, Luches, Sigurd, Unkulunkulu, Yoka-Shan.

Hell Bender II

Kashmere, Yoka-Shan.

Ironhorse F/S II-a "Hell Bender"

Crew: 1

Maneuvering Thrust: 0.142 km/s/s

Mass: 300 tons

Translight Capability: None

Armor: Crysteel w/belt

Atmospheric Capability: Full

Armaments:

1 x Mk. 20 Meld Laser

1 x Mk. 20 Autocannon

(Ammo: 16,000 rounds)

2 x Mk. 9 Pulse Lasers

2 x Mk. 30 Torp Loads

Commentary: Ironhorse was a subsidiary of House Colos, but when the Colosians escaped to the stars during the Terran-Hatchling War, they left the people of Ironhorse behind, and they became independent. The Hell Bender, along with many other Ironhorse designs, is in operational use in just about every space navy inside the frontier. As an all-purpose fighter it stands up well to any other in its class. The pair of Mk. 30 torps gives it an impressive boost in firepower. The fighter's Autocannon is a standard repeating mass driver, but the ammo load is, as always, restrictive.

The Hell Bender offers its pilot many weaponry options. Using the optional rule that permits a crew member to fire multiple cannon systems each turn makes the Bender even deadlier. The Bender's bane is a crit on the eighth hit. Use the Bender to draw fire from light fighters while maneuvering for shots against primary targets. The torps are effective and should be used wisely. Discharge them close-up and personal.

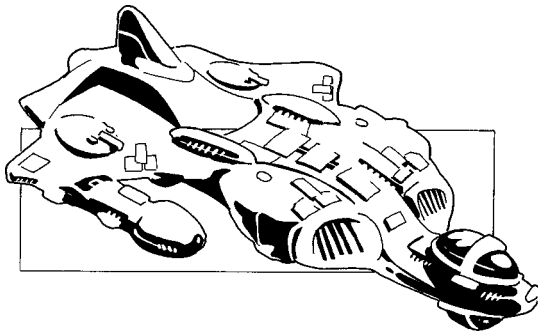

Ironhorse F/S II-b "Hell Bender II"

Crew: 1

Maneuvering Thrust: 0.142 km/s/s

Mass: 300 tons

Translight Capability: None

Armor: Crysteel w/belt

Atmospheric Capability: Full

Armaments:

1 x Mk. 20 Meld Laser

1 x Mk. 10 Impulsegun Ion Cannon

1 x Missile Launcher

(Magazine: 20 missiles)

2 x Mk. 30 Torp Loads

Commentary: Several incarnations of the Hell Bender have been produced since Colos left Ironhorse to fend for itself. This particular Hell Bender is a favorite of the mercenaries of Yoka-Shan, who wanted their Hell Bender a little more, well, "righteous."

The Warworlders kept the Meld Laser for use against larger, slower opponents, but dumped the Pulse Lasers in favor of the bigger punch of an Impulsegun. Best of all, they yanked the Autocannon in favor of the much more useful Missile Launcher (more ammo, more damage—what more could a warrior want?) And, for good measure, they kept the reassuring weight of those two Mk. 30 torpedoes.

All in all, they've designed a ship with enough fury to handle the cause of the week, whatever it might be.

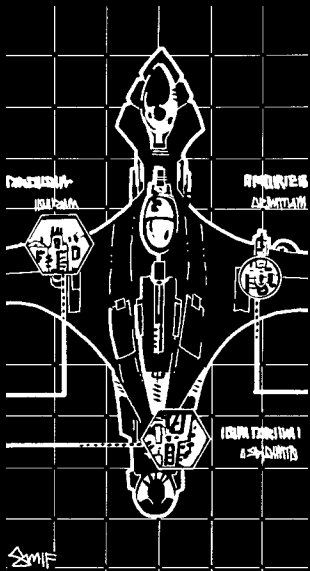
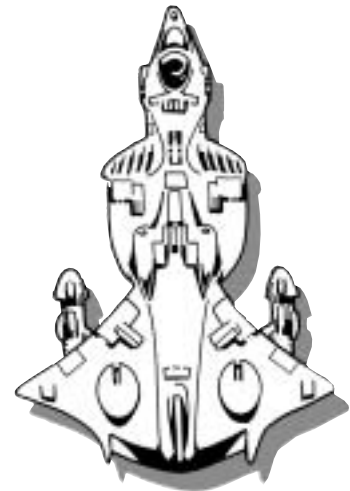

HELL BENDER

I.D. ■

BPV: 32

TPV

Pilot
1 Autocannon (F)
 To Hit: 2D6+ADB
 Damage: Medium †
 Range: 3/10/24
 Target SR ≤10
 ○○○○○○○○

Crew
PILOT
 Plt: _____
 Gnr: _____
 Luck: _____

Pilot
2 Pulse Lasers (F)
 To Hit: 2D8+ADB+1
 Damage: Low+1
 Range: 3/9/10

Pilot
1 Meld Laser (F)
 To Hit: 2D8+ADB
 Damage: Medium
 Range: 6/18/20
 Target SR ≤12

Mk. 30 Torps
 ○
 ○

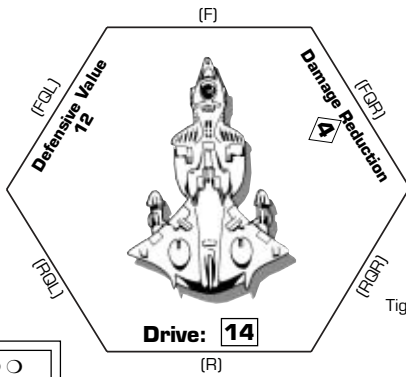

Tight Turn Cost: _____+3

Decoys: ○ ○
 P-D: —
 Dmg Con: 1-3
 Tons: 300

DAMAGE TRACK

→	4	14	*	3	13	w	12	2	11	t	10	W
	9	1	8	7	*	6	t	5		w	4	
		3		2		1					×	

HELL BENDER

I.D. ■

BPV: 32

TPV

Pilot
1 Autocannon (F)
 To Hit: 2D6+ADB
 Damage: Medium †
 Range: 3/10/24
 Target SR ≤10
 ○○○○○○○○

Crew
PILOT
 Plt: _____
 Gnr: _____
 Luck: _____

Pilot
2 Pulse Lasers (F)
 To Hit: 2D8+ADB+1
 Damage: Low+1
 Range: 3/9/10

Pilot
1 Meld Laser (F)
 To Hit: 2D8+ADB
 Damage: Medium
 Range: 6/18/20
 Target SR ≤12

Mk. 30 Torps
 ○
 ○

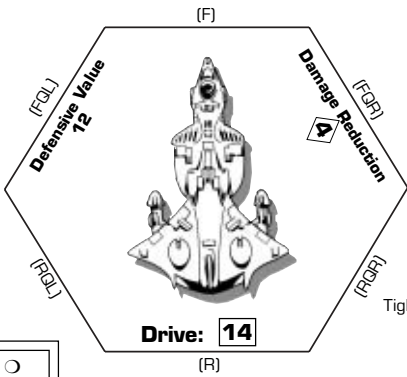

Tight Turn Cost: _____+3

Decoys: ○ ○
 P-D: —
 Dmg Con: 1-3
 Tons: 300

DAMAGE TRACK

→	4	14	*	3	13	w	12	2	11	t	10	W
	9	1	8	7	*	6	t	5		w	4	
		3		2		1					×	

CRITICAL HITS

- 2 — **Pilot killed.** Hell Bender may perform no further actions. Defensive Value drops to 5.
- 3 — **Engines sputter.** Hell Bender may only use 3 movement points next game turn.
- 4 — **Electronic Warfare knocked out.** Hell Bender may no longer jam torps. Reduce Defensive Value by 2.
- 5 — **Pulse Lasers lose power.** Pulse Lasers may not be fired until after next game turn.
- 6 — **Shields damaged.** Reduce Defensive Value by 1.
- 7 — **Autocannon hit.** Lose half of remaining ammo.
- 8 — **Meld Laser Targeting damaged.** Modify Meld Laser To Hit attempts by -3.
- 9 — **Minor Hull Breach inflicted.** Reduce Defensive Value by 2.
- 10 — **Torp Loads jettison harmlessly.** Remove all torps.
- 11 — **Pilot dazed.** Hell Bender may not move or fire until after the next game turn.
- 12 — **Reactor explodes.** Hell Bender is destroyed.

PULSE LASER SPECS

Short Range: 1-3 hexes (+1 To Hit).
Medium Range: 4-9 hexes.
Long Range: 10 hexes (-1 To Hit).

AUTOCANNON SPECS†

Short Range: 1-3 hexes (+1 To Hit).
Medium Range: 4-10 hexes.
Long Range: 11-24 hexes (-1 To Hit).
Target Speed Restriction: Target's Drive value must be ≤10.

MELD LASER SPECS

Short Range: 1-6 hexes (+1 To Hit).
Medium Range: 7-18 hexes.
Long Range: 19-20 hexes (-1 To Hit).
Target Speed Restriction: Target's Drive value must be ≤12.

† When two Attack Dice come up doubles, multiply base damage by 2.

GAME TURN RECORD TRACK

1	2	3	4	5	6	7	8	9	10	11	12	13	14	15	16	17	18	19	20
---	---	---	---	---	---	---	---	---	----	----	----	----	----	----	----	----	----	----	----

HELL BENDER II

I.D.

BPV: 33

TPV

Pilot
1 Meld Laser (F)
 To Hit: 2D8+ADB
 Damage: Medium
 Range: 6/18/20
 Target SR ≤12

Crew
PILOT
 Plt: _____
 Gnr: _____
 Luck: _____

Pilot
Missile Launcher (F)
 Lock-on < _____
 ○○○○○○ ○○○○○○
 ○○○○○○ ○○○○○○

Pilot
1 Impulsegun (F)
 To Hit: 2D8+ADB
 Damage: High
 Range: 3/8/10

Mk. 30 Torps
 ○
 ○

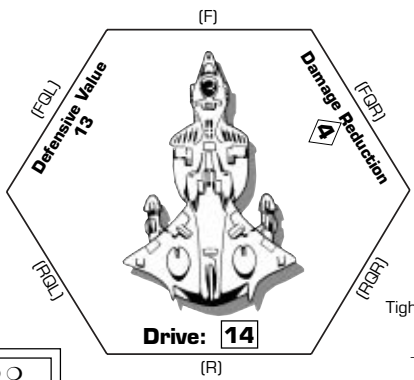

Tight Turn Cost: _____+3

Decoys: ○ ○
 P-D: —
 Dmg Con: 1-3
 Tons: 300

DAMAGE TRACK

→	4	14	*	3	13	w	12	2	11	t	10	W
	9	1	8	7	*	6	t	5		w	4	
		3		2		1					×	

HELL BENDER II

I.D.

BPV: 33

TPV

Pilot
1 Meld Laser (F)
 To Hit: 2D8+ADB
 Damage: Medium
 Range: 6/18/20
 Target SR ≤12

Crew
PILOT
 Plt: _____
 Gnr: _____
 Luck: _____

Pilot
Missile Launcher (F)
 Lock-on < _____
 ○○○○○○ ○○○○○○
 ○○○○○○ ○○○○○○

Pilot
1 Impulsegun (F)
 To Hit: 2D8+ADB
 Damage: High
 Range: 3/8/10

Mk. 30 Torps
 ○
 ○

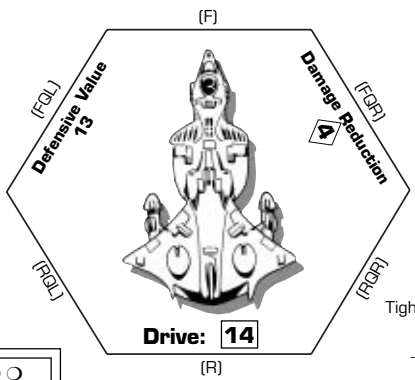

Tight Turn Cost: _____+3

Decoys: ○ ○
 P-D: —
 Dmg Con: 1-3
 Tons: 300

DAMAGE TRACK

→	4	14	*	3	13	w	12	2	11	t	10	W
	9	1	8	7	*	6	t	5		w	4	
		3		2		1					×	

CRITICAL HITS

- 2 — **Pilot killed.** Hell Bender may perform no further actions. Defensive Value drops to 5.
- 3 — **Engines sputter.** Hell Bender may only use 3 movement points next game turn.
- 4 — **Electronic Warfare knocked out.** Hell Bender may no longer jam torps. Reduce Defensive Value by 2.
- 5 — **Impulsegun loses power.** Impulsegun may not be fired until after next game turn.
- 6 — **Shields damaged.** Reduce Defensive Value by 1.
- 7 — **Missile Launcher hit.** Lose half of remaining missiles.
- 8 — **Meld Laser Targeting damaged.** Modify Meld Laser To Hit attempts by -3.
- 9 — **Minor Hull Breach inflicted.** Reduce Defensive Value by 2.
- 10 — **Torp Loads jettison harmlessly.** Remove all torps.
- 11 — **Pilot dazed.** Hell Bender may not move or fire until after the next game turn.
- 12 — **Reactor explodes.** Hell Bender is destroyed.

IMPULSEGUN SPECS

Short Range: 1-3 hexes (+1 To Hit).
 Medium Range: 4-8 hexes.
 Long Range: 9-10 hexes (-1 To Hit).

MELD LASER SPECS

Short Range: 1-6 hexes (+1 To Hit).
 Medium Range: 7-18 hexes.
 Long Range: 19-20 hexes (-1 To Hit).
 Target Speed Restriction: Target's Drive value must be ≤12.

GAME TURN RECORD TRACK

1	2	3	4	5	6	7	8	9	10	11	12	13	14	15	16	17	18	19	20
---	---	---	---	---	---	---	---	---	----	----	----	----	----	----	----	----	----	----	----

Operation: Dry Dock

© 1996 by Iron Crown Enterprises, Inc. Permission granted to photocopy for personal use.

Caladyne Industries BUUR-3 (export) "Kosmos"

Crew: 1

Maneuvering Thrust: 0.168 km/s/s

Mass: 250 tons

Translight Capability: None

Armor: Crystanium w/belt

Atmospheric Capability: Full

Armaments:

1 x Mk. 9 Minigun

(Ammo: 18,000 rounds)

1 x Missile Launcher

(Magazine: 10 missiles)

Commentary: The Kosmos was manufactured in the Imperium for over twenty years. Full production of this model ceased years ago, as upgrades to its design could not keep pace with new models built by other defense contractors. Nevertheless, the Kosmos has managed to hang on while many newer models have faded away due to the machine's relative ease of repair and the availability of necessary parts. This particular export model, which has upgraded engines, is favored by House Colos.

An enigma in fighter designs, the Kosmos relies completely on ammunition-dependent armaments, leaving it no resort in case of depletion. Its staying power in combat is woefully short-lived, so use it to make a quick strike with the Missile Launcher, then dance around with the smaller opponents for Minigun shots and pray for doubles. Don't waste your precious time sending Kosmos fighters against heavy hitters like gunboats—they won't get the job done.

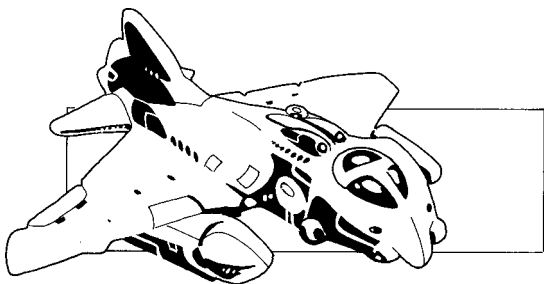

Caladyne Industries BUUR-4 (export) "Kosmos II"

Crew: 1

Maneuvering Thrust: 0.168 km/s/s

Mass: 250 tons

Translight Capability: None

Armor: Crystanium w/belt

Atmospheric Capability: Full

Armaments:

1 x Mk. 10 Disruptorgun

1 x Missile Launcher

(Magazine: 20 missiles)

Commentary: The first upgrade to the Caladyne Industries BUUR-3 craft was to make most efficient use of the space used by the missile launcher. The additional ammo not only added more tooth to the Kosmos, but also doubled the potential missile volleys.

Next, the designers addressed the ammo dependency of its other weapon. The original Kosmos was restricted to ammo-dependent weapons because its power plant couldn't stand the drain required by any energy weapon. The antiquated power plant was replaced and a Disruptorgun was put in place of the Minigun. The increased missile payload, limitless shots available, greater targeting accuracy, better damage and the already high speed of the Kosmos keep the short range of the Disruptorgun from being an insurmountable handicap in this latest design.

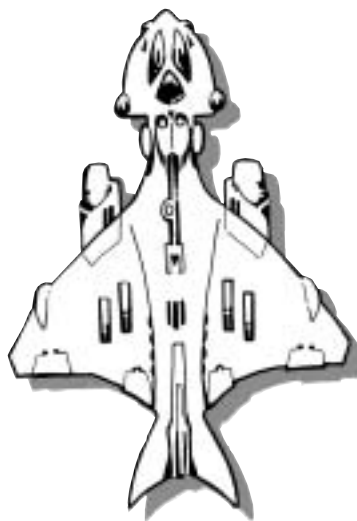

The Next Millennium

Kosmos

Colos, Draconian,
Luches, Primate, Q'raj,
Tokugawa.

Kosmos II

Q'raj, Tokugawa.

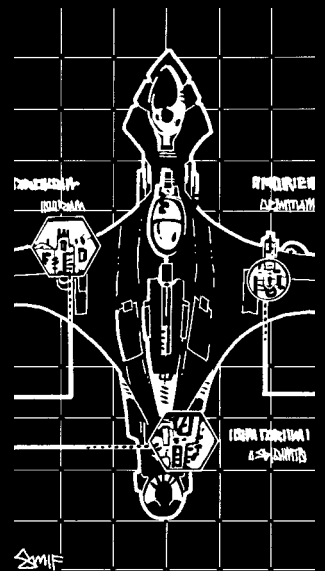

TPV

Pilot
Missile Launcher (F)
 Lock-on < _____
 ○ ○ ○ ○ ○
 ○ ○ ○ ○ ○

Crew
PILOT
 Plt: _____
 Gnr: _____
 Luck: _____

Pilot
1 Minigun (F)
 To Hit: 2D6+ADB
 Damage: Low †
 Range: 2/5/12
 ○ ○ ○ ○ ○ ○

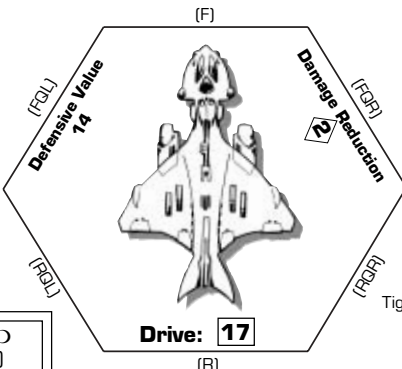

Tight Turn Cost: _____+3

Decoys: ○ ○
 P-D: 1-5 (1)
 Dmg Con: 1-2
 Tons: 250

DAMAGE TRACK

→			17	2		16	*	W	1
	15		14		12	*	10	8	W
	5		3		2		1	X	

TPV

Pilot
Missile Launcher (F)
 Lock-on < _____
 ○ ○ ○ ○ ○
 ○ ○ ○ ○ ○

Crew
PILOT
 Plt: _____
 Gnr: _____
 Luck: _____

Pilot
1 Minigun (F)
 To Hit: 2D6+ADB
 Damage: Low †
 Range: 2/5/12
 ○ ○ ○ ○ ○ ○

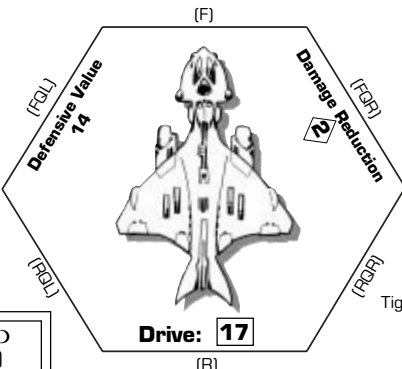

Tight Turn Cost: _____+3

Decoys: ○ ○
 P-D: 1-5 (1)
 Dmg Con: 1-2
 Tons: 250

DAMAGE TRACK

→			17	2		16	*	W	1
	15		14		12	*	10	8	W
	5		3		2		1	X	

CRITICAL HITS

- 2 — **Pilot killed.** Kosmos may perform no further actions. Defensive Value drops to 5.
- 3 — **One Engine destroyed.** Reduce current Drive value by half, ignore fractions. Reduce Defensive Value by 3.
- 4 — **Electronic Warfare knocked out.** Kosmos may no longer jam torps. Reduce Defensive Value by 4.
- 5 — **Minigun jams momentarily.** Minigun may not be fired until after next game turn.
- 6 — **Shields damaged.** Reduce Defensive Value by 2.
- 7 — **Minigun Targeters damaged.** Reduce chance To Hit by 1.
- 8 — **Missile Launcher jams momentarily.** Missiles may not be fired until after next game turn.
- 9 — **Forward Hull cracks.** Reduce Defensive Value by 3 and mark off 3 more hits.
- 10 — **One Engine sputters.** Reduce current Drive value by 3 until after next game turn.
- 11 — **Pilot dazed.** Kosmos may not move or fire until after the next game turn.
- 12 — **Reactor detonates.** Gruesome flash erupts from destroyed Kosmos.

MINIGUN SPECS†

Short Range: 1 hex (+1 To Hit).
Medium Range: 2 hexes.
Long Range: 3-6 hexes (-1 To Hit).
 † Whenever two of the Attack Dice roll doubles, multiply base damage by 2.

GAME TURN RECORD TRACK

1	2	3	4	5	6	7	8	9	10	11	12	13	14	15	16	17	18	19	20
---	---	---	---	---	---	---	---	---	----	----	----	----	----	----	----	----	----	----	----

KOSMOS II

I.D. ■

BPV: 29

TPV

Pilot
Missile Launcher (F)
 Lock-on < _____
 ○ ○ ○ ○ ○
 ○ ○ ○ ○ ○
 ○ ○ ○ ○ ○
 ○ ○ ○ ○ ○

Crew
PILOT
 Plt: _____
 Gnr: _____
 Luck: _____

Decoys: ○ ○
 P-D: 1-5 (1)
 Dmg Con: 1-2
 Tons: 250

Pilot
1 Disruptorgun (F)
 To Hit: 2D8+ADB
 Damage: Medium §
 Range: 1/2/6

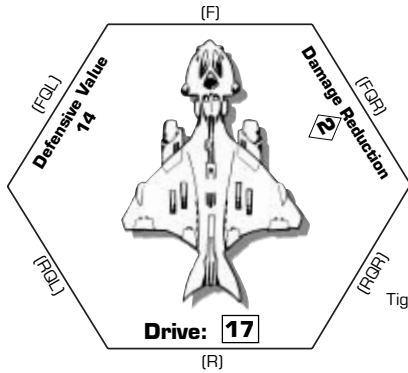

Tight Turn Cost: _____+3

DAMAGE TRACK

→			17	◇		16	*	W	◇	1	
	15		14			12	*	10	8	W	
			5			3		2		1	×

KOSMOS II

I.D. ■

BPV: 29

TPV

Pilot
Missile Launcher (F)
 Lock-on < _____
 ○ ○ ○ ○ ○
 ○ ○ ○ ○ ○
 ○ ○ ○ ○ ○
 ○ ○ ○ ○ ○

Crew
PILOT
 Plt: _____
 Gnr: _____
 Luck: _____

Decoys: ○ ○
 P-D: 1-5 (1)
 Dmg Con: 1-2
 Tons: 250

Pilot
1 Disruptorgun (F)
 To Hit: 2D8+ADB
 Damage: Medium §
 Range: 1/2/6

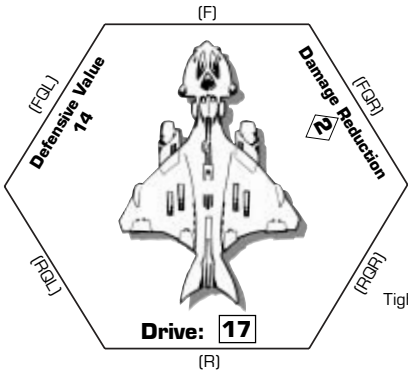

Tight Turn Cost: _____+3

DAMAGE TRACK

→			17	◇		16	*	W	◇	1	
	15		14			12	*	10	8	W	
			5			3		2		1	×

CRITICAL HITS

- 2 — **Pilot killed.** Kosmos II may perform no further actions. Defensive Value drops to 5.
- 3 — **One Engine destroyed.** Reduce current Drive value by half, ignore fractions. Reduce Defensive Value by 3.
- 4 — **Electronic Warfare knocked out.** Kosmos II may no longer jam torps. Reduce Defensive Value by 4.
- 5 — **Disruptorgun shorts.** Disruptorgun may not be fired until after next game turn.
- 6 — **Shields damaged.** Reduce Defensive Value by 2.
- 7 — **Disruptorgun Targeters damaged.** Reduce chance To Hit by 1.
- 8 — **Missile Launcher jams momentarily.** Missiles may not be fired until after next game turn. Lose 5 missiles.
- 9 — **Forward Hull cracks.** Reduce Defensive Value by 3 and mark off 3 more hits.
- 10 — **One Engine sputters.** Reduce current Drive value by 3 until after next game turn.
- 11 — **Pilot dazed.** Kosmos II may not move or fire until after the next game turn.
- 12 — **Reactor detonates.** Gruesome flash erupts from destroyed Kosmos II.

DISRUPTORGUN SPECS§

Short Range: 1 hex (+1 To Hit).
Medium Range: 2 hexes.
Long Range: 3-6 hexes (-1 To Hit).
 § If the target's Defensive Value has not been reduced by a critical hit, add 1 to its Defensive Value. Also, completely ignore the target's Damage Reduction when resolving a hit.

GAME TURN RECORD TRACK

1	2	3	4	5	6	7	8	9	10	11	12	13	14	15	16	17	18	19	20
---	---	---	---	---	---	---	---	---	----	----	----	----	----	----	----	----	----	----	----

Silent Death

Lance Electra

Colos, Hibernia, Kashmere, Primate, Unkulunkulu.

Lance Electra II

Hibernia, Kashmere.

Palomar-Lockheed CR5000 (export) "Lance Electra"

Crew: 2

Maneuvering Thrust: 0.12 km/s/s

Mass: 420 tons

Translight Capability: None

Armor: Crysteel w/belt

Atmospheric Capability: None

Armaments:

2 x Protobolt Projectors
(Ammo: 4 protobolts each)

1 x Mk. 10 Pulse Laser

1 x Missile Launcher
(Magazine: 20 missiles)

2 x Mk. 30 Torp Loads

2 x Mk. 10 Torp Loads

Commentary: When the Hatchlings arrived, Palomar-Lockheed was an old, struggling Imperial firm. The Lance Electra was their attempt to regain status in the fiercely competitive fighter industry. Unfortunately, the Electra has never performed up to promised design specifications, being relatively slow and lacking combat staying power. Still, since the design is now in the public domain, you're fairly certain to see this ship around for some time to come.

Think of the Electra purely as a strike fighter. Close with the target, unleash two full spreads of Protobolts and the Mk. 30s, then "get the hell out of Dodge." The Missiles are best used for self-defense while inbound and outbound from the target. The low-powered Pulse Laser is only useful under very limited circumstances—it's nothing to be relied upon. The Lance Electra isn't keen for a dogfight, so don't get embroiled in one.

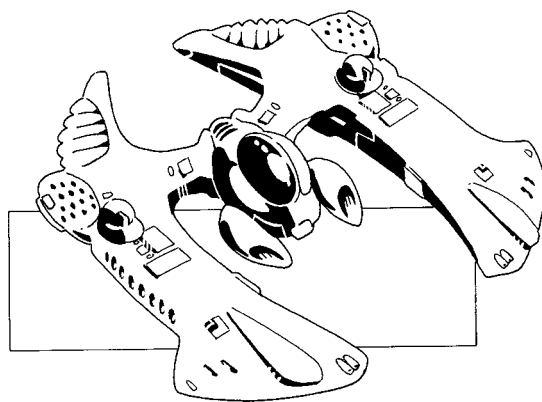

Forge CR5000.A "Lance Electra II"

Crew: 2

Maneuvering Thrust: 0.12 km/s/s

Mass: 420 tons

Translight Capability: None

Armor: Crysteel w/belt

Atmospheric Capability: None

Armaments:

1 x Mk. 10 Impulsegun Ion Cannon

1 x Protobolt Projector
(Ammo: 7 protobolts)

1 x Mk. 10 Pulse Laser

1 x Missile Launcher
(Magazine: 20 missiles)

2 x Mk. 30 Torp Loads

2 x Mk. 10 Torp Loads

Commentary: That Palomar-Lockheed is no longer in the fighter industry speaks volumes about the design of the original Lance Electra. Sure the Hatchlings killed them off, but the poor design of the ship was achieving the same thing. Still, because of the abundance produced this substandard craft worked its way into the common market.

Primary complaints include lack of speed or sustainable offensive punch, not to mention that it is obscenely easy to hit. Still, any craft that are so commonly available as this will spawn refits. No ship needed it more than the Lance Electra.

The Forge design team shifted control of the pulse laser to the gunner, already a significant improvement. Then they yanked out the Pilot's Protobolt Projector, attaching it's ammo to the Gunner's. Forge replaced the Pilot's Protobolt Projector with an Impulsegun. These three changes have dramatically increased the combat presence of the Lance Electra.

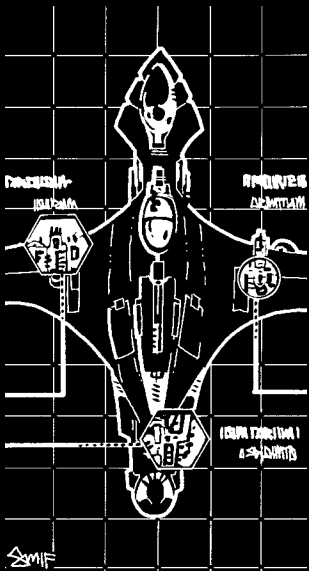
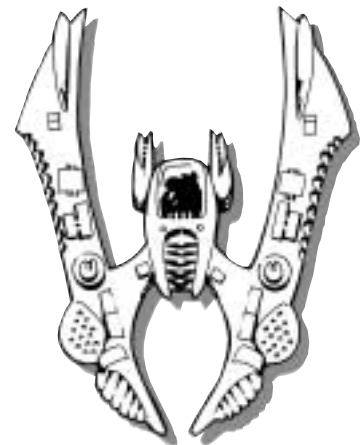

LANCE ELECTRA

I.D.

BPV: 60

TPV

Pilot
1 Pulse Laser (F)
 To Hit: 2D8+ADB
 Damage: Low
 Range: 3/9/10

Crew
PILOT
 Plt: _____
 Gnr: _____
 Luck: _____
GUNNER
 Gnr: _____

Mk. 30
 Torps

Pilot
1 Protobolt Projector (F)
 To Hit: 2D6+ADB
 Damage: 10/8/6
 Range: 5-8/12/16
 Target SR ≤14

Mk. 10
 Torps

Gunner
1 Protobolt Projector (F)
 To Hit: 2D6+ADB
 Damage: 10/8/6
 Range: 5-8/12/16
 Target SR ≤14

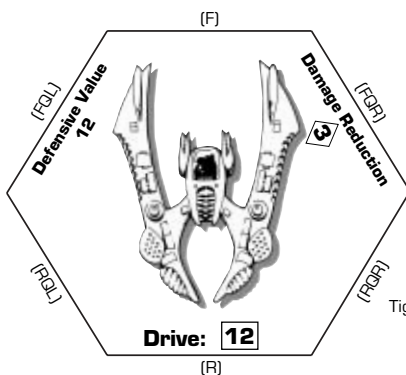

Decoys:
 P-D: 1-4 (2)
 Dmg Con: 1-5
 Tons: 420

Gunner
Missile Launcher (360°)
 Lock-on < _____

DAMAGE TRACK

→				3		t	12	*	t	
11	w	T		2	10	w	t		*	
9		W		8		1	7	6	*	
5	w	4	2	X						

LANCE ELECTRA

I.D.

BPV: 60

TPV

Pilot
1 Pulse Laser (F)
 To Hit: 2D8+ADB
 Damage: Low
 Range: 3/9/10

Crew
PILOT
 Plt: _____
 Gnr: _____
 Luck: _____
GUNNER
 Gnr: _____

Mk. 30
 Torps

Pilot
1 Protobolt Projector (F)
 To Hit: 2D6+ADB
 Damage: 10/8/6
 Range: 5-8/12/16
 Target SR ≤14

Mk. 10
 Torps

Gunner
1 Protobolt Projector (F)
 To Hit: 2D6+ADB
 Damage: 10/8/6
 Range: 5-8/12/16
 Target SR ≤14

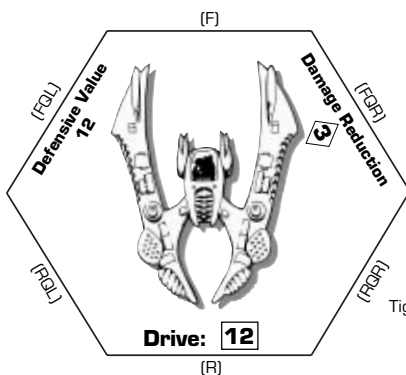

Decoys:
 P-D: 1-4 (2)
 Dmg Con: 1-5
 Tons: 420

Gunner
Missile Launcher (360°)
 Lock-on < _____

DAMAGE TRACK

→				3		t	12	*	t	
11	w	T		2	10	w	t		*	
9		W		8		1	7	6	*	
5	w	4	2	X						

CRITICAL HITS

- 2 — **Pilot dazed.** Electra may not move or fire Pilot's Projector or Pulse Laser until after next game turn.
- 3 — **Engines sputter momentarily.** Electra's Drive value is reduced to 3 until after next game turn.
- 4 — **Electronic Warfare knocked out.** Electra may no longer jam torps. Reduce Defensive Value by 3.
- 5 — **Maneuver Thrusters damaged.** All turns, including tight turns, cost 1 extra movement point to perform.
- 6 — **Shields damaged.** Reduce Defensive Value by 1.
- 7 — **Pilot's Protobolter hit.** Lose half its remaining ammo.
- 8 — **Torp Targeting Scanner damaged.** Cannot launch torps until after the next game turn.
- 9 — **Left Hull buckles.** Pilot's Projector loses 2 Protobolts. Reduce Defensive Value by 3.
- 10 — **Right Hull buckles.** Gunner's Projector loses 2 Protobolts. Reduce Defensive Value by 3.
- 11 — **Gunner dazed.** Electra may not fire Gunner's Projector or Missile Launcher until after next game turn.
- 12 — **Massive structural collapse.** Lance Electra breaks up into chunks of useless scrap metal.

PROTOBOLT SPECS

Short Range: 5-8 hexes (+1 To Hit).
 Medium Range: 9-12 hexes.
 Long Range: 13-16 hexes (-1 To Hit).
 Target Speed Restriction: Target's Drive value must be ≤14.

PULSE LASER SPECS

Short Range: 1-3 hexes (+1 To Hit).
 Medium Range: 4-9 hexes.
 Long Range: 10 hexes (-1 To Hit).

LANCE ELECTRA II

I.D.

BPV: 60

TPV

Mk. 30 Torps

○
○

Mk. 10 Torps

○
○

Pilot

1 Impulsegun (F)
To Hit: 2D8+ADB
Damage: High
Range: 3/8/10

Gunner

1 Pulse Laser (F)
To Hit: 2D8+ADB
Damage: Low
Range: 3/9/10

Gunner

1 Protobolt Projector (F)
To Hit: 2D6+ADB
Damage: 10/8/6
Range: 5-8/12/16
Target SR ≤14
○○○○○○○○

Gunner

Missile Launcher (360°)
Lock-on < _____
○○○○○○ ○○○○○○
○○○○○○ ○○○○○○

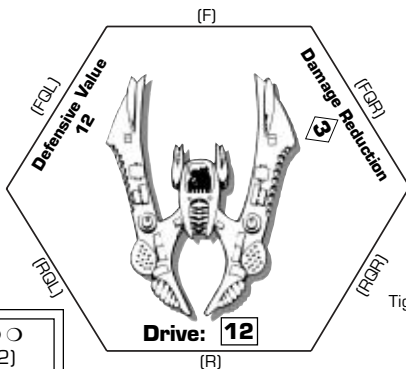

Decoys: ○○
P-D: 1-4 (2)
Dmg Con: 1-5
Tons: 400

DAMAGE TRACK

			3		t	12	*	t	
11	w	T	2	10	W	t	*		
9		w		8	1	7	6	*	
5	w	4	2	X					

Tight Turn Cost: _____+3

LANCE ELECTRA II

I.D.

BPV: 60

TPV

Mk. 30 Torps

○
○

Mk. 10 Torps

○
○

Pilot

1 Impulsegun (F)
To Hit: 2D8+ADB
Damage: High
Range: 3/8/10

Gunner

1 Pulse Laser (F)
To Hit: 2D8+ADB
Damage: Low
Range: 3/9/10

Gunner

1 Protobolt Projector (F)
To Hit: 2D6+ADB
Damage: 10/8/6
Range: 5-8/12/16
Target SR ≤14
○○○○○○○○

Gunner

Missile Launcher (360°)
Lock-on < _____
○○○○○○ ○○○○○○
○○○○○○ ○○○○○○

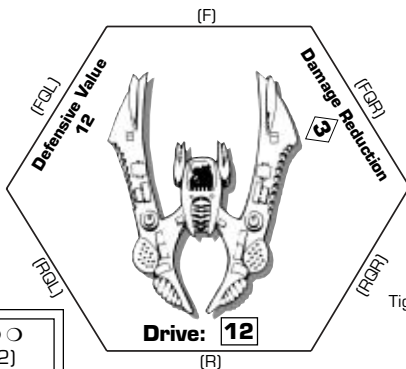

Decoys: ○○
P-D: 1-4 (2)
Dmg Con: 1-5
Tons: 400

DAMAGE TRACK

			3		t	12	*	t	
11	w	T	2	10	W	t	*		
9		w		8	1	7	6	*	
5	w	4	2	X					

Tight Turn Cost: _____+3

CRITICAL HITS

- 2 — **Pilot dazed.** Electra may not move or fire Pilot's Impulsegun until after next game turn.
- 3 — **Engines sputter momentarily.** Electra's Drive value is reduced to 3 until after next game turn.
- 4 — **Electronic Warfare knocked out.** Electra may no longer jam torps. Reduce Defensive Value by 3.
- 5 — **Maneuver Thrusters damaged.** All turns, including tight turns, cost 1 extra movement point to perform.
- 6 — **Shields damaged.** Reduce Defensive Value by 1.
- 7 — **Impulsegun hit.** Reduce Damage to Medium.
- 8 — **Torp Targeting Scanner damaged.** Cannot launch torps until after the next game turn.
- 9 — **Left Hull buckles.** Pilot's Projector loses 2 Protobolts. Reduce Defensive Value by 3.
- 10 — **Right Hull buckles.** Gunner's Projector loses 2 Protobolts. Reduce Defensive Value by 3.
- 11 — **Gunner dazed.** Electra may not fire Gunner's weapons until after next game turn.
- 12 — **Massive structural collapse.** Lance Electra breaks up into chunks of useless scrap metal.

IMPULSEGUN SPECS

Short Range: 1-3 hexes (+1 To Hit).
Medium Range: 4-8 hexes.
Long Range: 9-10 hexes (-1 To Hit).

PROTOBOLT SPECS

Short Range: 5-8 hexes (+1 To Hit).
Medium Range: 9-12 hexes.
Long Range: 13-16 hexes (-1 To Hit).
Target Speed Restriction: Target's Drive value must be ≤14.

PULSE LASER SPECS

Short Range: 1-3 hexes (+1 To Hit).
Medium Range: 4-9 hexes.
Long Range: 10 hexes (-1 To Hit).

Imperial Transtar 1220 series A "Night Hawk"

Crew: 1

Maneuver Thrust: 0.150 km/s/s

Mass: 300 tons

Translight Capability: None

Armor: Crystanium w/belt

Atmospheric Capability: Full

Armaments:

6 x Mk. 10 Splattergun Blast Cannons

1 x Mk. 20 Meld Laser Cannon

Commentary: Transtar's Night Hawk is the attrition fighter of choice for nearly every military force. Its Meld Laser is well equipped to engage larger vessels, while its Splatterguns makes short work of enemy SPAC Fighters at short range. With its design now in the public domain, the Night Hawk's lack of warheads actually works in its favor in locales where such ordnance is hard to come by and supply ships may be few and far between. It is a strong and persevering craft.

Ah, the Night Hawk! How many pilots have that reaction when they discover they'll be flying one? It's those devastating Splatterguns that really get the adrenaline flowing. The psychological damage you inflict on your opponent when you fire this weapon is as important as the shot's results. But there is a good reason why the Night Hawk is so cheap: susceptibility to torp attacks. The Night Hawk's Splatterguns force a headlong rush toward enemy ships, but that is quickly curtailed by three or four torps dropped head-on at 15-20 hex range. Oddly enough, the best counter to a Night Hawk is the lowly Thunder Bird or a pair of Spirit Riders.

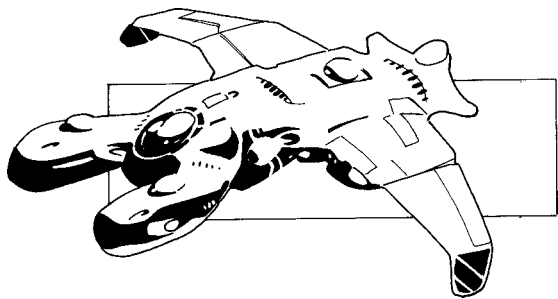

1220 series B "Night Hawk II"

Crew: 1

Maneuver Thrust: 0.150 km/s/s

Mass: 300 tons

Translight Capability: None

Armor: Crystanium w/belt

Atmospheric Capability: Full

Armaments:

6 x Mk. 10 Splattergun Blast Cannons

Commentary: The Night Hawk is a deadly ship crucial to the Hiberian's Fighter Squadrons. This very strength, however, results in disproportionate losses as enemy forces attempt to overwhelm these ships before they can bring their tremendous firepower to bear. In a desperate attempt to reduce these staggering losses which the economically strapped Hiberians can ill afford, the Night Hawk II was created. The meld laser was removed to make room for improved point defense and damage control—range sacrificed for staying power.

This refit has had great success against light fighters as the Night Hawk II is no longer as vulnerable to torpedoes. Now ships like the Blizzard and Spirit Rider may no longer be assured of keeping Night Hawks at bay with a small salvo of torps. Against gunboats it is a different story. With the standoff power of the Night Hawk II compromised, the ship's effectiveness against Gunboats and heavy fighters has dropped significantly.

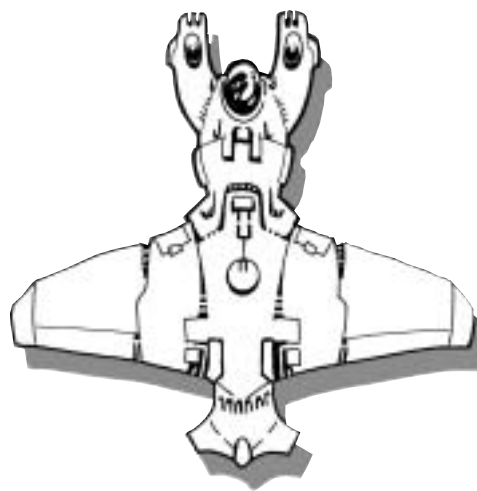

The Next Millennium

Night Hawk

ASP, Colos, Data Sphere, Hibernia, Red Star, Sigurd, Yoka-Shan.

Night Hawk II

Data Sphere, Red Star.

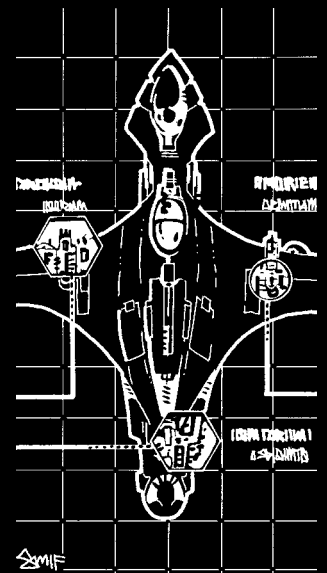

NIGHT HAWK

I.D. ■

BPV: 47

TPV

Pilot
6 Splatterguns (F)
 To Hit: 2D6+ADB+5
 Damage: Medium+10
 Range: 2/6/10

Crew
PILOT
 Plt: _____
 Gnr: _____
 Luck: _____

Pilot
1 Meld Laser (F)
 To Hit: 2D8+ADB
 Damage: Medium
 Range: 6/18/20
 Target SR ≤12

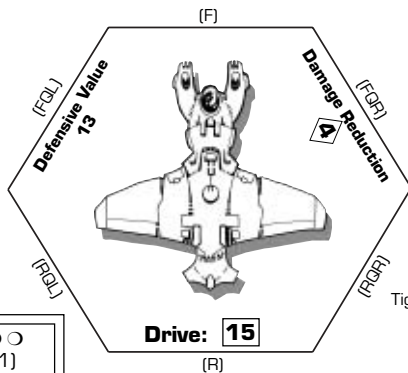

Tight Turn Cost: _____+3

Decoys: ○ ○
 P-D: 1-3 (1)
 Dmg Con: 1-3
 Tons: 300

DAMAGE TRACK

→	15	4	*	14	3	13	W	2
	12	1	11	10	*	9	W	8
	7	6	5	4	3	1		×

NIGHT HAWK

I.D. ■

BPV: 47

TPV

Pilot
6 Splatterguns (F)
 To Hit: 2D6+ADB+5
 Damage: Medium+10
 Range: 2/6/10

Crew
PILOT
 Plt: _____
 Gnr: _____
 Luck: _____

Pilot
1 Meld Laser (F)
 To Hit: 2D8+ADB
 Damage: Medium
 Range: 6/18/20
 Target SR ≤12

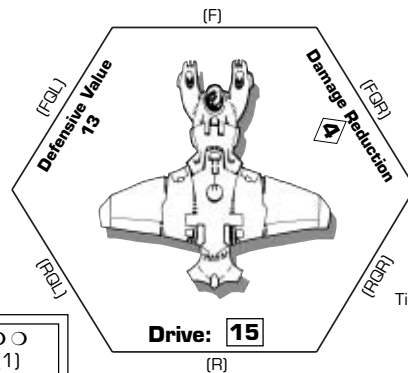

Tight Turn Cost: _____+3

Decoys: ○ ○
 P-D: 1-3 (1)
 Dmg Con: 1-3
 Tons: 300

DAMAGE TRACK

→	15	4	*	14	3	13	W	2
	12	1	11	10	*	9	W	8
	7	6	5	4	3	1		×

CRITICAL HITS

- 2 — **Pilot killed.** Night Hawk may perform no further actions. Defensive Value drops to 5.
- 3 — **Engines sputter.** Night Hawk may only use 3 movement points next turn. Reduce Defensive Value by 6.
- 4 — **Electronic Warfare knocked out.** Night Hawk may no longer jam torps. Reduce Defensive Value by 5.
- 5 — **Maneuver Thrusters damaged.** All turns, including tight turns, cost one extra movement point to perform.
- 6 — **Shields damaged.** Reduce Defensive Value by 2.
- 7 — **Meld Laser Targeters damaged.** Reduce chance To Hit by 1.
- 8 — **Splattergun Targeters damaged.** Splatterguns may not be fired until after the next game turn.
- 9 — **Hull compromised.** Reduce Defensive Value by 4.
- 10 — **Severe structural damage.** Reduce Defensive Value by 6. Modify Night Hawk's further To Hit attempts by -4.
- 11 — **Pilot dazed.** Night Hawk may not move or fire until after the next game turn.
- 12 — **Reactor hit.** Night Hawk explodes and is utterly destroyed.

SPLATTERGUN SPECS

Short Range: 1-2 hexes (+1 To Hit).
Medium Range: 3-6 hexes.
Long Range: 7-10 hexes (-1 To Hit).

MELD LASER SPECS

Short Range: 1-6 hexes (+1 To Hit).
Medium Range: 7-18 hexes.
Long Range: 19-20 hexes (-1 To Hit).
Target Speed Restriction: Target's Drive value must be ≤12.

GAME TURN RECORD TRACK

1	2	3	4	5	6	7	8	9	10	11	12	13	14	15	16	17	18	19	20
---	---	---	---	---	---	---	---	---	----	----	----	----	----	----	----	----	----	----	----

BPV: 55 I.D. NIGHT HAWK II

TPV

Pilot
6 Splatterguns (F)
 To Hit: 2D6+ADB+5
 Damage: Medium+10
 Range: 2/6/10

Crew
PILOT
 Plt: _____
 Gnr: _____
 Luck: _____

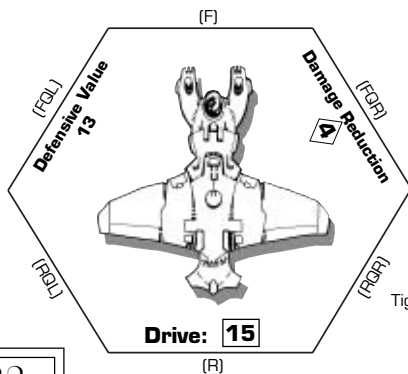

Tight Turn Cost: _____+3

Decoys: ○ ○
 P-D: 1-5 (3)
 Dmg Con: 1-3
 Tons: 300

DAMAGE TRACK

→	15	4	*	14	3	13	2
	12	1	11	10	*	9	w 8
	7	6	5	4	3	1	×

BPV: 55 I.D. NIGHT HAWK II

TPV

Pilot
6 Splatterguns (F)
 To Hit: 2D6+ADB+5
 Damage: Medium+10
 Range: 2/6/10

Crew
PILOT
 Plt: _____
 Gnr: _____
 Luck: _____

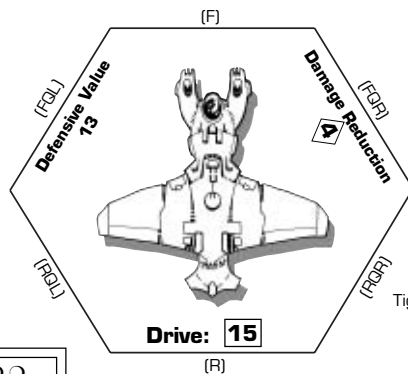

Tight Turn Cost: _____+3

Decoys: ○ ○
 P-D: 1-5 (3)
 Dmg Con: 1-3
 Tons: 300

DAMAGE TRACK

→	15	4	*	14	3	13	2
	12	1	11	10	*	9	w 8
	7	6	5	4	3	1	×

CRITICAL HITS

- 2 — **Pilot killed.** Night Hawk may perform no further actions. Defensive Value drops to 5.
- 3 — **Engines sputter.** Night Hawk may only use 3 movement points next turn. Reduce Defensive Value by 6.
- 4 — **Electronic Warfare knocked out.** Night Hawk may no longer jam torps. Reduce Defensive Value by 5.
- 5 — **Maneuver Thrusters damaged.** All turns, including tight turns, cost one extra movement point to perform.
- 6 — **Shields damaged.** Reduce Defensive Value by 2.
- 7 — **Point Defense System destroyed.** Night Hawk may no longer P-D torpedoes.
- 8 — **Splattergun Targeters damaged.** Splatterguns may not be fired until after the next game turn.
- 9 — **Hull compromised.** Reduce Defensive Value by 4.
- 10 — **Severe structural damage.** Reduce Defensive Value by 6. Modify Night Hawk's further To Hit attempts by -4.
- 11 — **Pilot dazed.** Night Hawk may not move or fire until after the next game turn.
- 12 — **Reactor hit.** Night Hawk explodes and is utterly destroyed.

SPLATTERGUN SPECS

Short Range: 1-2 hexes (+1 To Hit).
Medium Range: 3-6 hexes.
Long Range: 7-10 hexes (-1 To Hit).

GAME TURN RECORD TRACK

1	2	3	4	5	6	7	8	9	10	11	12	13	14	15	16	17	18	19	20
---	---	---	---	---	---	---	---	---	----	----	----	----	----	----	----	----	----	----	----

Silent Death

Pharsii

ASP, Hibernia, Luches.

Pharsii II

ASP, Colos, Draconian, Hibernia, Luches, Sigurd.

Heavy Metals PWHa2 “Pharsii II”

Crew: 3

Maneuver Thrust: 0.141 km/s/s

Mass: 900 tons

Translight Capability: None

Armor: Crystanium w/belt

Atmospheric Capability: Full

Armaments:

- 1 x Mk. 30 Turbo Laser Cannon
- 8 x Mk. 10 Splattergun Blast Cannons
- 1 x Missile Launcher (Magazine: 20)
- 1 x Mk. 20 Explosive Torpedo
- 2 x Mk. 10 Explosive Torpedoes

Commentary: A *tour de force* production by an up-and-coming armaments manufacturer, the Pharsii II is a truly powerful design. Based upon an earlier, undergunned version, this newer edition of the craft has an increased weapons load at the cost of its predecessor's larger crew complement, electronics array and engines. The tradeoff has been worthwhile, however, as the Pharsii II is now in extensive use throughout all of Terran space.

The Pharsii is a real powerhouse, but its expense will deter most purchasers. That doesn't mean that the cost isn't justified, though. It's more than deserved, simply by virtue of the design's potential to launch missiles and torps and take three quality gun shots—all at once. The second gunner comes in handy during close-quarters fighting, while the generous damage track keeps it in the battle after weaker opponents have fallen to its hammering Splatterguns. A superb dogfighter that most pilots would be happy to fly.

Heavy Metals PWHa “Pharsii”

Crew: 4

Maneuver Thrust: 0.154 km/s/s

Mass: 900 tons

Translight Capability: None

Armor: Crystanium w/belt

Atmospheric Capability: Full

Armaments:

- 1 x Mk. 30 Turbo Laser Cannon
- 3 x Mk. 10 Splattergun Blast Cannons
- 1 x Missile Launcher (Magazine: 20)
- 1 x Mk. 20 Explosive Torpedo
- 2 x Mk. 10 Explosive Torpedoes

Commentary: The Pharsii (Heavy Metals PWHa) was a promising design, on the drawing board. It had excellent drive for a ship of its size, and heavy armor for durability. Many of these craft found their way into forces throughout the Outer Provinces, though none made it into the Imperial fleet. Shortly after production it proved to be a step behind the power curve. It was certainly able to hold its own against other fighters it was designed to fight, like the original Epping, Kosmos, or Thunderbird. Unfortunately, it came up lacking against newer craft like the Night Hawk, the Salamander, and the Glaive.

Now the Pharsii is found in Planetary Guard units for several of the Twelve, and in a heavy strike fighter role scattered throughout the backnet, where heavy fighters of this size and speed are the exception, not the rule.

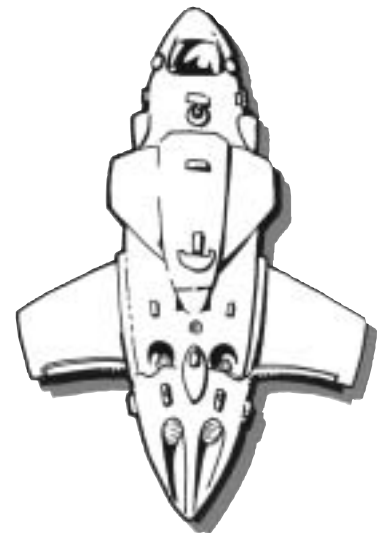
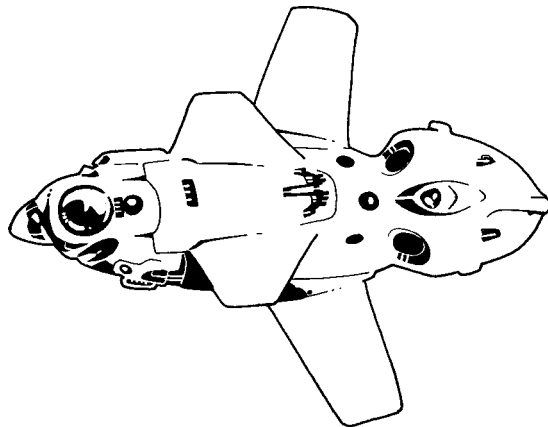
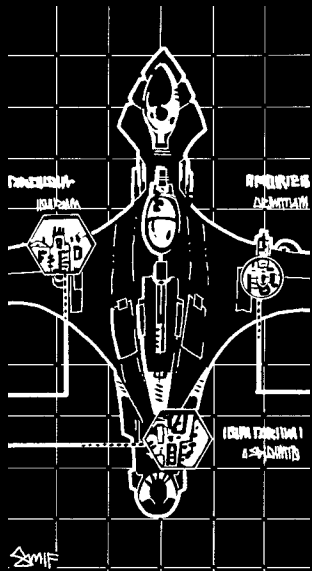

PHARSII

I.D.

BPV: 110

TPV

Gunner B
Missile Launcher
(FQL) (F) (FQR)
Lock-on <

Pilot
1 Turbo Laser (F)
To Hit: 2D8+ADB
Damage: High
Range: 9/25/30
Target SR ≤8

Gunner A
2 Splatterguns (F)
To Hit: 2D6+ADB+1
Damage: Medium+2
Range: 2/6/10

Crew
PILOT
Pit: _____
Gnr: _____
Luck: _____

GUNNER A
Gnr: _____

GUNNER B
Gnr: _____

GUNNER C
Gnr: _____

Decoys:

P-D: 1-6 (2)
Dmg Con: 1-5
Tons: 900

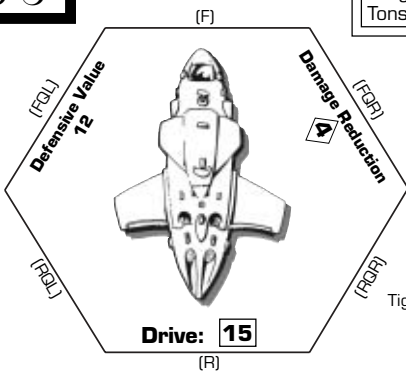

Mk. 20
Torp

Mk. 10
Torps

Gunner C
1 Splattergun (R)
To Hit: 2D6+ADB
Damage: Medium
Range: 2/6/10

DAMAGE TRACK

			14		4		*		13	t
	w	3			12		T			
11			W	10	2				9	
	*	8		w	7	1				
	6			5					4	
		3	*	t	2	w				
	1									

PHARSII

I.D.

BPV: 110

TPV

Gunner B
Missile Launcher
(FQL) (F) (FQR)
Lock-on <

Pilot
1 Turbo Laser (F)
To Hit: 2D8+ADB
Damage: High
Range: 9/25/30
Target SR ≤8

Gunner A
2 Splatterguns (F)
To Hit: 2D6+ADB+1
Damage: Medium+2
Range: 2/6/10

Crew
PILOT
Pit: _____
Gnr: _____
Luck: _____

GUNNER A
Gnr: _____

GUNNER B
Gnr: _____

GUNNER C
Gnr: _____

Decoys:

P-D: 1-6 (2)
Dmg Con: 1-5
Tons: 900

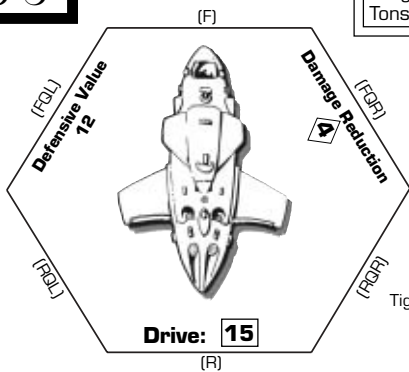

Mk. 20
Torp

Mk. 10
Torps

Gunner C
1 Splattergun (R)
To Hit: 2D6+ADB
Damage: Medium
Range: 2/6/10

DAMAGE TRACK

			14		4		*		13	t
	w	3			12		T			
11			W	10	2				9	
	*	8		w	7	1				
	6			5					4	
		3	*	t	2	w				
	1									

CRITICAL HITS

- 2 — **Pilot dazed.** Pharsii may not move or fire the Turbo Laser until after the next game turn. The gunners may still fire while the pilot is dazed.
- 3 — **Gunner C dazed.** Gunner C may not fire weapons until after the next game turn.
- 4 — **Electronic Warfare knocked out.** Pharsii may no longer jam torps. Reduce Defensive Value by 3.
- 5 — **Maneuver Thrusters damaged.** All turns, including tight turns, cost one extra movement point to perform.
- 6 — **Shields damaged.** Reduce Defensive Value by 1.
- 7 — **Decoys blown away.** Pharsii loses all its decoys.
- 8 — **Torp Targeting Scanner damaged.** No torpedoes may be fired until after the next game turn.
- 9 — **Missile Launcher damaged.** Lose 1D10 remaining missiles.
- 10 — **Gunner A dazed.** Gunner A may not fire weapons until after the next game turn.
- 11 — **Turbo Laser performance impeded.** Reduce damage rating to Medium.
- 12 — **Reactor hit.** With a blinding flash, the Pharsii is destroyed.

TURBO LASER SPECS

Short Range: 1-9 hexes (+1 To Hit).
Medium Range: 10-25 hexes.
Long Range: 26-30 hexes (-1 To Hit).
Target Speed Restriction: Target's Drive value must be ≤8.

SPLATTERGUN SPECS

Short Range: 1-2 hexes (+1 To Hit).
Medium Range: 3-6 hexes.
Long Range: 7-10 hexes (-1 To Hit).

PHARSII II

I.D.

BPV: 120

TPV

Gunner A Missile Launcher
(FQL) (F) (FQR)
Lock-on < _____

<input type="checkbox"/>	<input type="checkbox"/>	<input type="checkbox"/>	<input type="checkbox"/>
<input type="checkbox"/>	<input type="checkbox"/>	<input type="checkbox"/>	<input type="checkbox"/>
<input type="checkbox"/>	<input type="checkbox"/>	<input type="checkbox"/>	<input type="checkbox"/>
<input type="checkbox"/>	<input type="checkbox"/>	<input type="checkbox"/>	<input type="checkbox"/>
<input type="checkbox"/>	<input type="checkbox"/>	<input type="checkbox"/>	<input type="checkbox"/>

Pilot
1 Turbo Laser (F)
To Hit: 2D8+ADB
Damage: High
Range: 9/25/30
Target SR ≤8

Gunner A
4 Splatterguns (F)
To Hit: 2D6+ADB+3
Damage: Medium+6
Range: 2/6/10

Crew
PILOT
Plt: _____
Gnr: _____
Luck: _____
GUNNER A
Gnr: _____
GUNNER B
Gnr: _____

Decoys: ○○○○
P-D: 1-6 (2)
Dmg Con: 1-5
Tons: 900

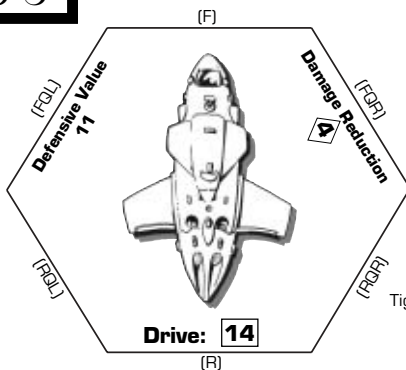

Mk. 20 Torp

Mk. 10 Torps

Gunner B
4 Splatterguns (R)
To Hit: 2D6+ADB+3
Damage: Medium+6
Range: 2/6/10

DAMAGE TRACK

			14			4		*		13	t
	w		3			12			T		
	11			W	10		2				9
		*		8		w	7			1	
		6			5						4
				3	*	t	2		w		
		1									

PHARSII II

I.D.

BPV: 120

TPV

Gunner A Missile Launcher
(FQL) (F) (FQR)
Lock-on < _____

<input type="checkbox"/>	<input type="checkbox"/>	<input type="checkbox"/>	<input type="checkbox"/>
<input type="checkbox"/>	<input type="checkbox"/>	<input type="checkbox"/>	<input type="checkbox"/>
<input type="checkbox"/>	<input type="checkbox"/>	<input type="checkbox"/>	<input type="checkbox"/>
<input type="checkbox"/>	<input type="checkbox"/>	<input type="checkbox"/>	<input type="checkbox"/>
<input type="checkbox"/>	<input type="checkbox"/>	<input type="checkbox"/>	<input type="checkbox"/>

Pilot
1 Turbo Laser (F)
To Hit: 2D8+ADB
Damage: High
Range: 9/25/30
Target SR ≤8

Gunner A
4 Splatterguns (F)
To Hit: 2D6+ADB+3
Damage: Medium+6
Range: 2/6/10

Crew
PILOT
Plt: _____
Gnr: _____
Luck: _____
GUNNER A
Gnr: _____
GUNNER B
Gnr: _____

Decoys: ○○○○
P-D: 1-6 (2)
Dmg Con: 1-5
Tons: 900

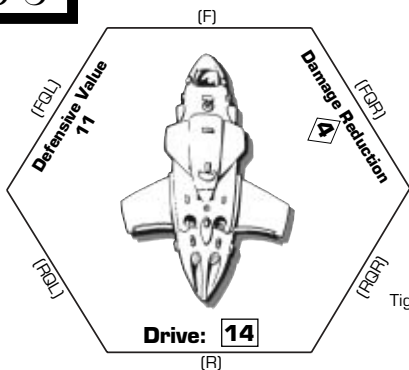

Mk. 20 Torp

Mk. 10 Torps

Gunner B
4 Splatterguns (R)
To Hit: 2D6+ADB+3
Damage: Medium+6
Range: 2/6/10

DAMAGE TRACK

			14			4		*		13	t
	w		3			12			T		
	11			W	10		2				9
		*		8		w	7			1	
		6			5						4
				3	*	t	2		w		
		1									

CRITICAL HITS

- Pilot dazed.** Pharsii II may not move or fire the Turbo Laser until after the next game turn. The gunners may still fire while the pilot is dazed.
- Gunner B dazed.** Gunner B may not fire weapons until after the next game turn.
- Electronic Warfare knocked out.** Pharsii II may no longer jam torps. Reduce Defensive Value by 3.
- Maneuver Thrusters damaged.** All turns, including tight turns, cost one extra movement point to perform.
- Shields damaged.** Reduce Defensive Value by 1.
- Decoys blown away.** Pharsii II loses all its decoys.
- Torp Targeting Scanner damaged.** No torpedoes may be fired until after the next game turn.
- Missile Launcher damaged.** Lose 1D10 remaining missiles.
- Gunner A dazed.** Gunner A may not fire weapons until after the next game turn.
- Turbo Laser performance impeded.** Reduce damage rating to Medium.
- Reactor hit.** With a blinding flash, the Pharsii is destroyed.

TURBO LASER SPECS

Short Range: 1-9 hexes (+1 To Hit).
Medium Range: 10-25 hexes.
Long Range: 26-30 hexes (-1 To Hit).
Target Speed Restriction: Target's Drive value must be ≤8.

SPLATTERGUN SPECS

Short Range: 1-2 hexes (+1 To Hit).
Medium Range: 3-6 hexes.
Long Range: 7-10 hexes (-1 To Hit).

Vott-Messerschmitt VMe.310g "Pit Viper"

Crew: 1

Maneuver Thrust: 0.185 km/s/s

Mass: 90 tons

Translight Capability: None

Armor: Crysteel w/belt

Atmospheric Capability: Full

Armaments:

3 x Mk. 8 Pulse Laser Cannon

Commentary: An indigenous House Devon design, the Pit Viper has proven a popular point defense fighter within its home province, as well as in those to which it has been exported. Pilots like its acceleration, while procurement officers like the low price tag. There are no foreign licensing agreements to build the Pit Viper at this time, but many shadier firms took advantage of the Devonians' absence during the Terran-Hatchling War to pirate the design for themselves.

The best thing that the Pit Viper has going for it is that it's cheaper than dirt. Due to the fact that its design has more or less fallen into the public domain (despite House Devon's protests to the contrary), parts are plentiful and readily available. There's little worse than having to try to fix up a ship when you're light-years away from the parts you need to effect the repairs. That's not a problem with this ship.

The Pit Viper is purely a nuisance fighter. Don't plan to bring the house down with these little guys. Pit Vipers are useless against any vessel with strong armor, so keep that in mind when you're allocating their attacks.



Vott-Messerschmitt VMe.310t "Pit Viper T"

Crew: 1

Maneuver Thrust: 0.185 km/s/s

Mass: 90 tons

Translight Capability: None

Armor: None

Atmospheric Capability: Full

Armaments:

1 x Mk. 8 Pulse Laser Cannon

Commentary: One surprising craft to see in use is the Pit Viper Trainer. This craft was never designed to see active duty, instead being a training version of the (slightly) more combat worthy Pit Viper. The T model has several advantages, the most important being price and availability. Any military that utilized Pit Vipers to any extent before the fall of the Imperium easily has a squadron or more Model T Vipers in use. These training vehicles may also be repaired using standard Pit Viper parts, making them as easy to maintain as acquire. Another bonus is that until engaged or inspected on the ground they are indistinguishable from the VMe.310g model. On more than one occasion Luches Utopia has mixed squadrons to help maintain the facade of a full strength fighting force.

The weakness of the craft is obvious. It was not meant to take the punishment of a real combat situation, nor is it able to do worthwhile damage to an enemy. It also has no Decoys or Damage Control. Though they are useful for fleshing out a flight of standard Pit Vipers, do not expect to win the day with these ships or even hurt an unwounded opponent. These guys will rarely penetrate even the weakest armor.

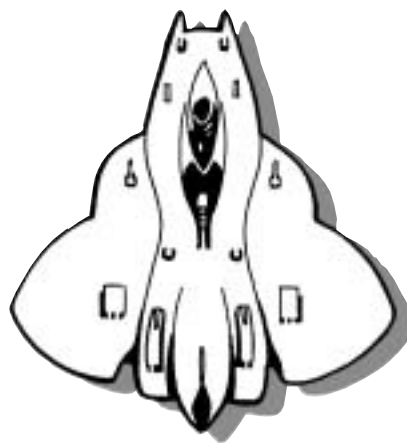

The Next Millennium

Pit Viper

Draconian, Hibernia, Luches, Primate, Red Star, Unkulunkulu.

Pit Viper T

Luches, Unkulunkulu.

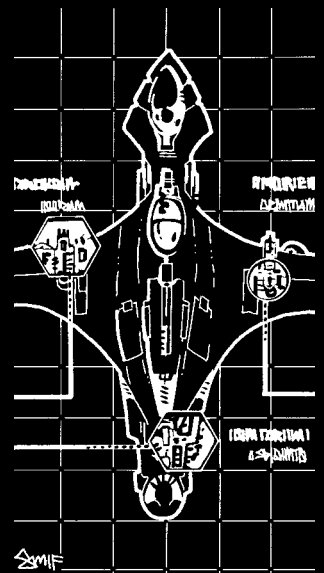

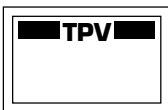

Pilot
3 Pulse Lasers (F)
 To Hit: 2D8+ADB+2
 Damage: Low+2
 Range: 3/9/10

Crew
PILOT
 Plt: _____
 Gnr: _____
 Luck: _____

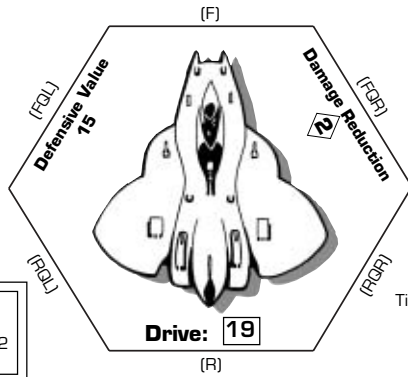

Tight Turn Cost: _____+3

Decoys: ○
 P-D: —
 Dmg Con: 1-2
 Tons: 90

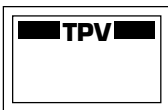
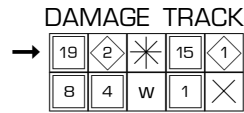

Pilot
3 Pulse Lasers (F)
 To Hit: 2D8+ADB+2
 Damage: Low+2
 Range: 3/9/10

Crew
PILOT
 Plt: _____
 Gnr: _____
 Luck: _____

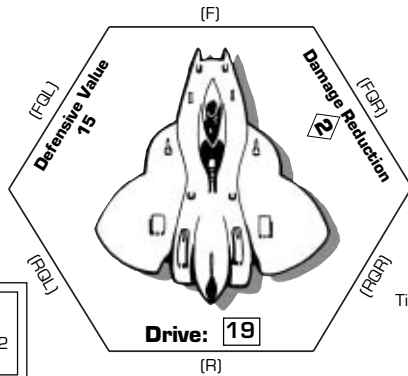

Tight Turn Cost: _____+3

Decoys: ○
 P-D: —
 Dmg Con: 1-2
 Tons: 90

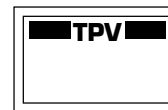

Pilot
3 Pulse Lasers (F)
 To Hit: 2D8+ADB+2
 Damage: Low+2
 Range: 3/9/10

Crew
PILOT
 Plt: _____
 Gnr: _____
 Luck: _____

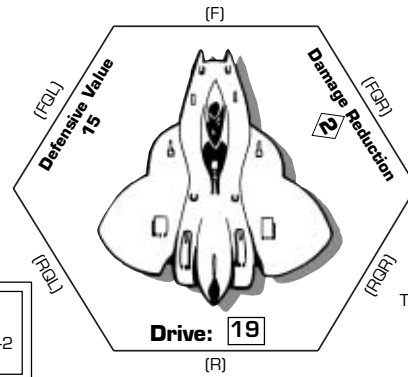

Tight Turn Cost: _____+3

Decoys: ○
 P-D: —
 Dmg Con: 1-2
 Tons: 90

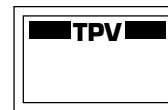

Pilot
3 Pulse Lasers (F)
 To Hit: 2D8+ADB+2
 Damage: Low+2
 Range: 3/9/10

Crew
PILOT
 Plt: _____
 Gnr: _____
 Luck: _____

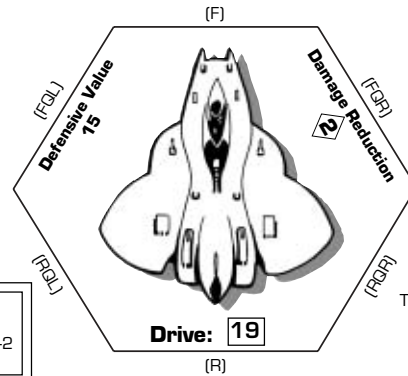

Tight Turn Cost: _____+3

Decoys: ○
 P-D: —
 Dmg Con: 1-2
 Tons: 90



CRITICAL HITS

- 2 — **Pilot killed.** Pit Viper may perform no further actions. Defensive Value drops to 5.
- 3 — **Pilot dazed.** Pit Viper may not move or fire until after the end of the next game turn.
- 4 — **Electronic Warfare knocked out.** Pit Viper may no longer jam torps. Reduce Defensive Value by 5.
- 5 — **Maneuver Thrusters hit.** Pit Viper may no longer make Tight Turns.
- 6 — **Shields damaged.** Reduce Defensive Value by 3.
- 7 — **Pulse Laser damaged.** Reduce chance To Hit by 1.
- 8 — **Evade Thrusters hit.** Reduce Defensive Value by 4.
- 9 — **Engines severely damaged.** Pit Viper reduced to a Drive value of 1. Reduce Defensive Value by 7.
- 10 — **Engines destroyed.** Pit Viper may not move or turn. Reduce Defensive Value to 5.
- 11 — **Hull breached.** Reduce Defensive Value by 5. At the end of next game turn, Pit Viper will disintegrate and be destroyed.
- 12 — **Reactor hit.** Power generator detonates; Pit Viper is destroyed.

PULSE LASER SPECS

Short Range: 1-3 hexes (+1 To Hit).
 Medium Range: 4-9 hexes.
 Long Range: 10 hexes (-1 To Hit).

PIT VIPER ↑

I.D. ■

BPV: 8

TPV

Pilot
1 Pulse Laser (F)
 To Hit: 2D8+ADB
 Damage: Low
 Range: 3/9/10

Crew
PILOT
 Plt: _____
 Gnr: _____
 Luck: _____

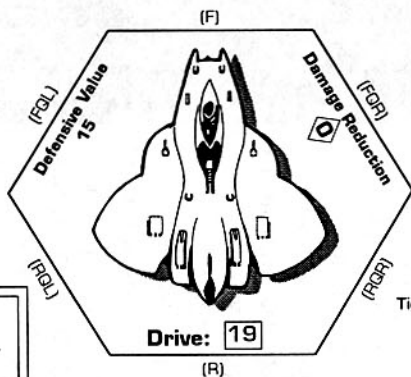

Decoys:
 P-D: —
 Dmg Con: —
 Tons: 90

DAMAGE TRACK



PIT VIPER ↑

I.D. ■

BPV: 8

TPV

Pilot
1 Pulse Laser (F)
 To Hit: 2D8+ADB
 Damage: Low
 Range: 3/9/10

Crew
PILOT
 Plt: _____
 Gnr: _____
 Luck: _____

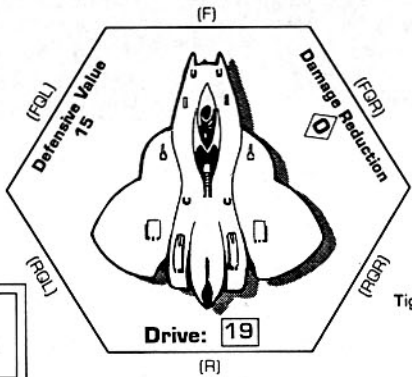

Decoys:
 P-D: —
 Dmg Con: —
 Tons: 90

DAMAGE TRACK



PIT VIPER ↑

I.D. ■

BPV: 8

TPV

Pilot
1 Pulse Laser (F)
 To Hit: 2D8+ADB
 Damage: Low
 Range: 3/9/10

Crew
PILOT
 Plt: _____
 Gnr: _____
 Luck: _____

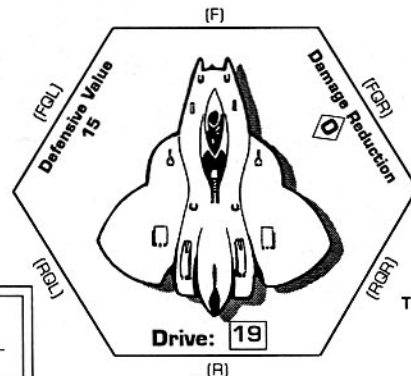

Decoys:
 P-D: —
 Dmg Con: —
 Tons: 90

DAMAGE TRACK

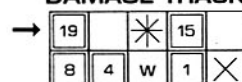

PIT VIPER ↑

I.D. ■

BPV: 8

TPV

Pilot
1 Pulse Laser (F)
 To Hit: 2D8+ADB
 Damage: Low
 Range: 3/9/10

Crew
PILOT
 Plt: _____
 Gnr: _____
 Luck: _____

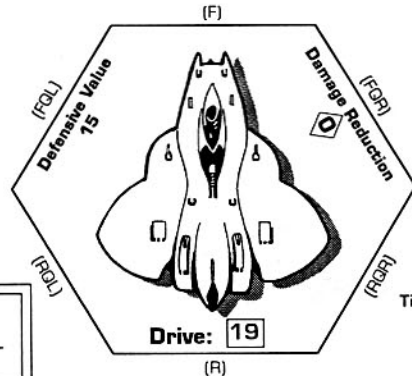

Decoys:
 P-D: —
 Dmg Con: —
 Tons: 90

DAMAGE TRACK

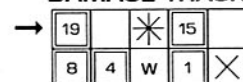

CRITICAL HITS

- 2 — **Pilot killed.** Pit Viper may perform no further actions. Defensive Value drops to 5.
- 3 — **Pilot dazed.** Pit Viper may not move or fire until after the end of the next game turn.
- 4 — **Electronic Warfare knocked out.** Pit Viper may no longer jam torps. Reduce Defensive Value by 5.
- 5 — **Maneuver Thrusters hit.** Pit Viper may no longer make Tight Turns.
- 6 — **Shields damaged.** Reduce Defensive Value by 3.
- 7 — **Pulse Laser damaged.** Reduce chance To Hit by 2.
- 8 — **Evade Thrusters hit.** Reduce Defensive Value by 5.
- 9 — **Engines severely damaged.** Pit Viper reduced to a Drive value of 1. Reduce Defensive Value by 7.
- 10 — **Engines destroyed.** Pit Viper may not move or turn. Reduce Defensive Value to 5.
- 11 — **Hull breached.** Reduce Defensive Value by 5. At the end of next game turn, Pit Viper will disintegrate and be destroyed.
- 12 — **Reactor hit.** Power generator detonates; Pit Viper is destroyed.

PULSE LASER SPECS

Short Range: 1-3 hexes (+1 To Hit).
 Medium Range: 4-9 hexes.
 Long Range: 10 hexes (-1 To Hit).

Silent Death

Revenge

Colos, Draconian, Primate, Red Star, Sigurd, Unkulunkulu.

Revenge II

Draconian, Sigurd.

Caladyne Industries FUUG-1 (export) "Revenge"

Crew: 2

Maneuver Thrust: 0.126 km/s/s

Mass: 770 tons

Translight Capability: None

Armor: Crystanium w/belt

Atmospheric Capability: Full

Armaments:

3 x Missile Launchers
(Magazine: 5 missiles each)

10 x Mk. 50 Explosive Torpedoes

Commentary: The Revenge is a medium two-person vessel converted from an Imperial stealth ship into the ultimate strike fighter. This TPAC is something of an enigma: marketed as strike vessel—it carries an impressive torpedo load, particularly for a ship in its class—but its staying power is severely restricted by the light missile capacity. The Revenge is rarely seen operating without other fighters, and it is best used with these escorts.

Equipped with the sometimes hard-to-find missile torpedo, the Revenge has proven itself to be an effective fighter against the Hatchling scourge. Whereas its traditional torps are nearly useless against the Grub's unique defenses, the missiles from the retrofitted torpedoes pack enough of a punch to severely wound or possibly destroy even a mighty Muskellunge with a single attack.

If ever there was a design with a single purpose, the Revenge is it. Purely a war-head carrier, the Revenge's ten Mk. 50s will kill what they're fired at. Think of it as a strike fighter which has to release its salvo before it starts taking too much damage.

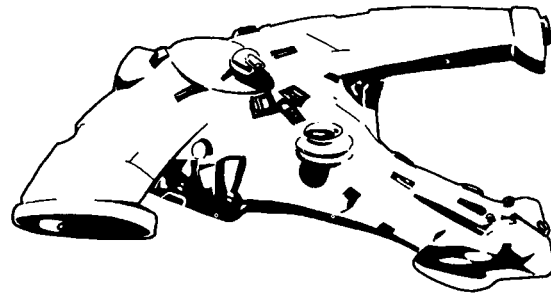

Caladyne Industries FUUG-2 (export) "Revenge II"

Crew: 2

Maneuver Thrust: 0.126 km/s/s

Mass: 770 tons

Translight Capability: None

Armor: Crystanium w/belt

Atmospheric Capability: Full

Armaments:

3 x Missile Launchers
(Magazine: 20 missiles)
(Magazine: 2x10 missiles)

10 x Mk. 50 Explosive Torpedoes

Commentary: The original modification of the Revenge from a stealth vehicle to a combat vessel was done on very short notice. Nonetheless the Revenge is very good at what it does: carry torpedoes. Originally fitted with minimal missile launchers, the Revenge was almost a one-shot vessel with a pilot that was of no use in a fire-fight. Now, instead of 15 missiles the Revenge carries 40, and the Pilot controls one of the Launchers. This allows the Revenge to fire more than one volley of missiles at a time. Still, the Revenge is rarely seen operating without other fighters, and it is best used with these escorts.

This version of the Revenge is even more effective against the Hatchlings than the previous one.

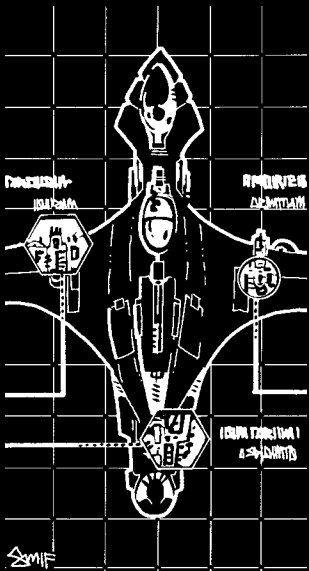
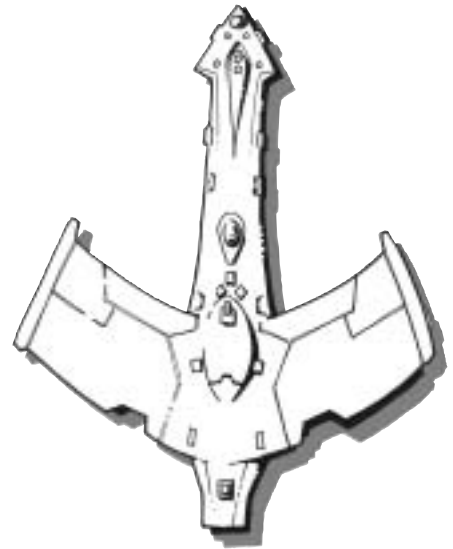

REVENGE

I.D.

BPV: 120

TPV

Decoys: ○ ○ ○ ○ ○
P-D: 1-6 (3)
Dmg Con: 1-5
Tons: 770

Crew

PILOT
Pit: _____
Gnr: _____
Luck: _____

GUNNER
Gnr: _____

Mk. 50 Torps

○ ○ ○ ○ ○ ○ ○ ○ ○ ○

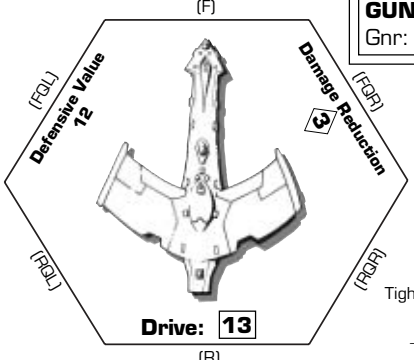

Defensive Value 12

Damage Reduction 3

Drive: **13**

Tight Turn Cost: ____+3

Gunner

Missile Launcher
(360°)
Lock-on < _____
○ ○ ○ ○ ○ ○ ○ ○

Gunner

Missile Launcher
(360°)
Lock-on < _____
○ ○ ○ ○ ○ ○ ○ ○

Gunner

Missile Launcher
(360°)
Lock-on < _____
○ ○ ○ ○ ○ ○ ○ ○

DAMAGE TRACK

→				13		t	12	*	3	w	11
		t		10	w	t	9	t	*		
	8		2	t	7	w	t		6		
	1		5	t	4	t	3	2	*		
	t										1
			t								×

REVENGE

I.D.

BPV: 120

TPV

Decoys: ○ ○ ○ ○ ○
P-D: 1-6 (3)
Dmg Con: 1-5
Tons: 770

Crew

PILOT
Pit: _____
Gnr: _____
Luck: _____

GUNNER
Gnr: _____

Mk. 50 Torps

○ ○ ○ ○ ○ ○ ○ ○ ○ ○

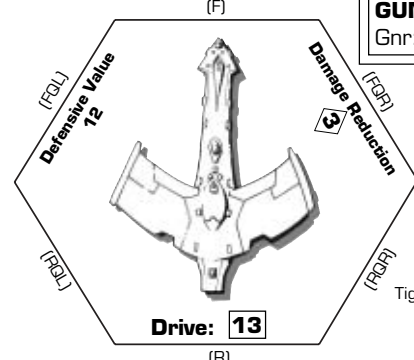

Defensive Value 12

Damage Reduction 3

Drive: **13**

Tight Turn Cost: ____+3

Gunner

Missile Launcher
(360°)
Lock-on < _____
○ ○ ○ ○ ○ ○ ○ ○

Gunner

Missile Launcher
(360°)
Lock-on < _____
○ ○ ○ ○ ○ ○ ○ ○

Gunner

Missile Launcher
(360°)
Lock-on < _____
○ ○ ○ ○ ○ ○ ○ ○

DAMAGE TRACK

→				13		t	12	*	3	w	11
		t		10	w	t	9	t	*		
	8		2	t	7	w	t		6		
	1		5	t	4	t	3	2	*		
	t										1
			t								×

CRITICAL HITS

- 2 — **Crew killed.** Revenge may perform no further actions. Defensive Value drops to 5.
- 3 — **Engines destroyed.** Vessel's Drive value is reduced to 0; reduce Defensive Value to 5.
- 4 — **Electronic Warfare knocked out.** Revenge may no longer jam torps. Reduce Defensive Value by 2.
- 5 — **Hull breached.** Reduce Defensive Value by 3. Also, lose 1D4 torpedoes.
- 6 — **Torp Targeting Scanner damaged.** No torpedoes may be fired until after the next game turn.
- 7 — **Missile Launcher malfunctions.** One random Launcher loses 2 missiles.
- 8 — **Shields damaged.** Reduce Defensive Value by 1.
- 9 — **Maneuver Thrusters damaged.** All turns, including tight turns, cost one extra movement point to perform.
- 10 — **Gunner killed.** All Missile Launchers become unusable.
- 11 — **Pilot dazed.** Revenge may not move until after the next game turn. The gunner may still fire while the pilot is dazed.
- 12 — **Reactor hit.** Revenge breaks into a number of unusable pieces.

GAME TURN RECORD TRACK

1	2	3	4	5	6	7	8	9	10	11	12	13	14	15	16	17	18	19	20
---	---	---	---	---	---	---	---	---	----	----	----	----	----	----	----	----	----	----	----

REVENGE II

I.D.

BPV: 120

TPV

Pilot
Missile Launcher (F)
 Lock-on < _____
 ○○○○○ ○○○○○
 ○○○○○ ○○○○○

Crew
PILOT
 Plt: _____
 Gnr: _____
 Luck: _____
GUNNER
 Gnr: _____

Mk. 50 Torps
 ○ ○
 ○ ○
 ○ ○
 ○ ○
 ○ ○
 ○ ○

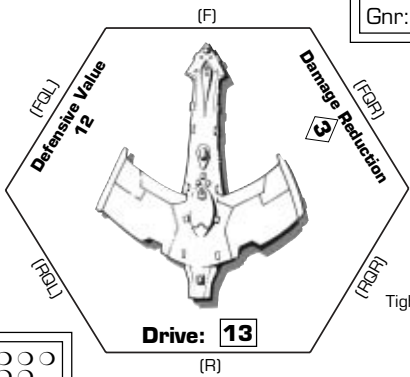

Tight Turn Cost: _____+3

Decoys: ○ ○ ○
 ○ ○ ○
 P-D: 1-6 (3)
 Dmg Con: 1-5
 Tons: 770

Gunner
Missile Launcher (360°)
 Lock-on < _____
 ○ ○ ○ ○ ○ ○
 ○ ○ ○ ○ ○ ○

Gunner
Missile Launcher (360°)
 Lock-on < _____
 ○ ○ ○ ○ ○ ○
 ○ ○ ○ ○ ○ ○

DAMAGE TRACK

→				13		t		12	*	3	w	11
		t		10	W	t		9	t		*	
		8		2	t	7	w	t		6		
		1		5	t	4	t	3	2		*	
		t										1
				t								×

REVENGE II

I.D.

BPV: 120

TPV

Pilot
Missile Launcher (F)
 Lock-on < _____
 ○○○○○ ○○○○○
 ○○○○○ ○○○○○

Crew
PILOT
 Plt: _____
 Gnr: _____
 Luck: _____
GUNNER
 Gnr: _____

Mk. 50 Torps
 ○ ○
 ○ ○
 ○ ○
 ○ ○
 ○ ○
 ○ ○

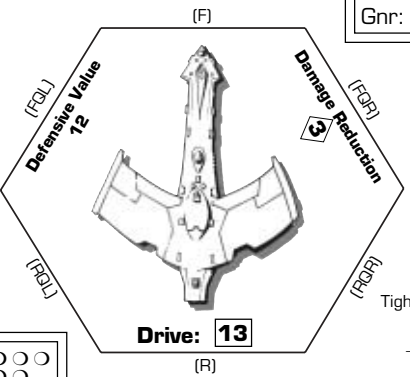

Tight Turn Cost: _____+3

Decoys: ○ ○ ○
 ○ ○ ○
 P-D: 1-6 (3)
 Dmg Con: 1-5
 Tons: 770

Gunner
Missile Launcher (360°)
 Lock-on < _____
 ○ ○ ○ ○ ○ ○
 ○ ○ ○ ○ ○ ○

Gunner
Missile Launcher (360°)
 Lock-on < _____
 ○ ○ ○ ○ ○ ○
 ○ ○ ○ ○ ○ ○

DAMAGE TRACK

→				13		t		12	*	3	w	11
		t		10	W	t		9	t		*	
		8		2	t	7	w	t		6		
		1		5	t	4	t	3	2		*	
		t										1
				t								×

CRITICAL HITS

- 2 — Crew killed. Revenge may perform no further actions. Defensive Value drops to 5.
- 3 — Engines destroyed. Vessel's Drive value is reduced to 0; reduce Defensive Value to 5.
- 4 — Electronic Warfare knocked out. Revenge may no longer jam torps. Reduce Defensive Value by 2.
- 5 — Hull breached. Reduce Defensive Value by 3. Also, lose 1D4 torpedoes.
- 6 — Torp Targeting Scanner damaged. No torpedoes may be fired until after the next game turn.
- 7 — Missile Launcher malfunctions. One random Launcher loses D6 missiles.
- 8 — Shields damaged. Reduce Defensive Value by 1.
- 9 — Maneuver Thrusters damaged. All turns, including tight turns, cost one extra movement point to perform.
- 10 — Gunner killed. Gunner's Missile Launchers become unusable.
- 11 — Pilot dazed. Revenge may not move or use Pilot Missile Launcher until after the next game turn. The gunner may still fire while the pilot is dazed.
- 12 — Reactor hit. Revenge breaks into a number of unusable pieces.

GAME TURN RECORD TRACK

1	2	3	4	5	6	7	8	9	10	11	12	13	14	15	16	17	18	19	20
---	---	---	---	---	---	---	---	---	----	----	----	----	----	----	----	----	----	----	----

Vanguard XFiii "Salamander"

Crew: 2

Maneuver Thrust: 0.159 km/s/s

Mass: 400 tons

Translight Capability: None

Armor: Crystanium alloy w/belt

Atmospheric Capability: Full

Armaments:

1 x Mk. 10 Impulsegun Ion Cannon

1 x Mk. 10 Pulse Laser Cannon

2 x Mk. 10 Splattergun Blast Cannons

1 x Mk. 20 Explosive Torpedo

4 x Mk. 10 Explosive Torpedoes

Commentary: This TPAC Fighter is a well-rounded combatant, well-liked by its pilots and weapons officers. Originally of outer provincial design and production, the Salamander forms the backbone of many heavy fighter squadrons based on the frontier. Vanguard has managed to keep an iron grip on the rights to the design of this extremely popular ship. This had kept the price up, but hasn't prevented those who have the means from adding a number of these ships to their arsenals. Thanks to Vanguard's agreements with the Kashmere Commonwealth, parts and supplies for the Salamander are almost always readily available for those that might find themselves in need of them.

All things considered, the Salamander has to be the best all-purpose fighter currently around. With a moderate price tag, good mix of weapons, that all-important gunner and a good torp load, the Salamander should be your vehicle of choice when a scenario's objective is unclear at the time of force purchases.

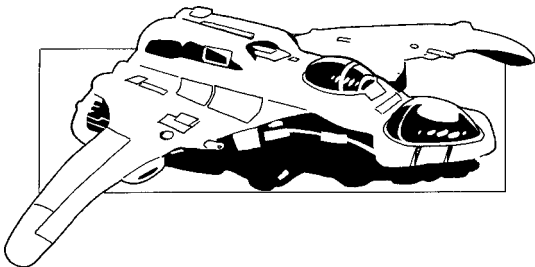

Vanguard XFiii.II "Salamander II"

Crew: 2

Maneuver Thrust: 0.159 km/s/s

Mass: 400 tons

Translight Capability: None

Armor: Crystanium alloy w/belt

Atmospheric Capability: Full

Armaments:

1 x Mk. 10 Impulsegun Ion Cannon

3 x Mk. 10 Pulse Laser Cannon

2 x Mk. 10 Splattergun Blast Cannons

1 x Mk. 20 Explosive Torpedo

4 x Mk. 10 Explosive Torpedoes

Commentary: The Salamander II was refit with one idea in mind: improving the punch of the Pulse Lasers without sacrificing targeting ability or leaving any arcs completely exposed. This was done by replacing the single Pulse Laser with a triple Pulse Laser mount and sacrificing some of its arcs. As the Arcs sacrificed are covered by the Splatterguns, this is seen as a small sacrifice by most, though it has proven a fatal one against nimble craft like the Dart.

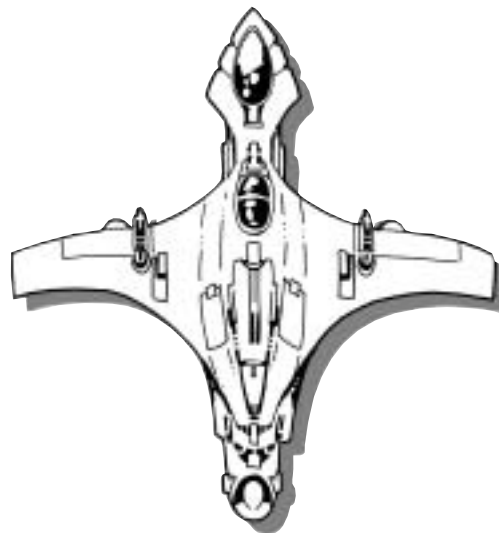

The Next Millennium

Salamander

Colos, Data Sphere, Draconian, Hibernia, Kashmere, Red Star, Unkulunkulu.

Salamander II

Draconian, Hibernia, Kashmere, Luches, Primate, Red Star.

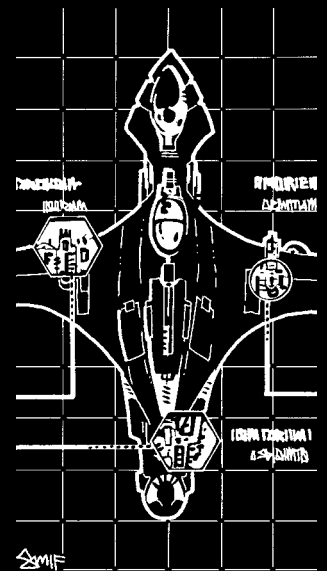

SALAMANDER

I.D.

BPV: 66

TPV

Pilot
1 Impulsegun (F)
 To Hit: 2D8+ADB
 Damage: High
 Range: 3/8/10

Crew
PILOT
 Plt: _____
 Gnr: _____
 Luck: _____
GUNNER
 Gnr: _____

Mk. 20
 Torp

Mk. 10
 Torps

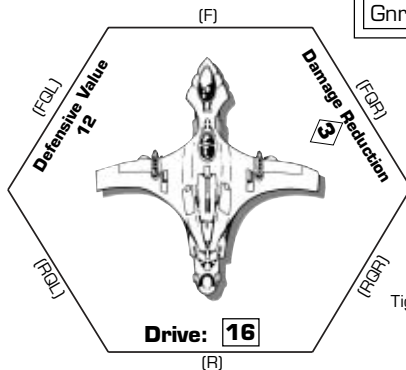

Tight Turn Cost: _____+3

Decoys: ○ ○
 P-D: 1-7 (2)
 Dmg Con: 1-6
 Tons: 400

Gunner
1 Pulse Laser (360°)
 To Hit: 2D6+ADB
 Damage: Low
 Range: 3/9/10

Gunner
2 Splatterguns
 (RQL) (R) (RQR)
 To Hit: 2D6+ADB+1
 Damage: Medium+2
 Range: 2/6/10

DAMAGE TRACK

		16		15	3	w	14	*	13	t	2	12
W		11		1	t	10	*	T	9		8	w
7	6		5	t	4		3	2	1	t		×

SALAMANDER

I.D.

BPV: 66

TPV

Pilot
1 Impulsegun (F)
 To Hit: 2D8+ADB
 Damage: High
 Range: 3/8/10

Crew
PILOT
 Plt: _____
 Gnr: _____
 Luck: _____
GUNNER
 Gnr: _____

Mk. 20
 Torp

Mk. 10
 Torps

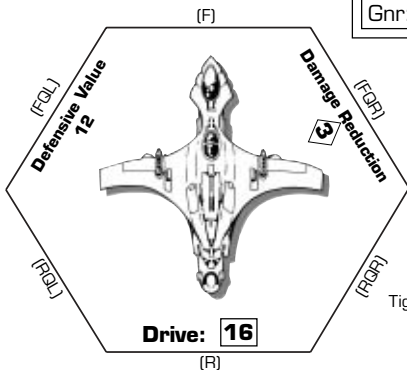

Tight Turn Cost: _____+3

Decoys: ○ ○
 P-D: 1-7 (2)
 Dmg Con: 1-6
 Tons: 400

Gunner
1 Pulse Laser (360°)
 To Hit: 2D6+ADB
 Damage: Low
 Range: 3/9/10

Gunner
2 Splatterguns
 (RQL) (R) (RQR)
 To Hit: 2D6+ADB+1
 Damage: Medium+2
 Range: 2/6/10

DAMAGE TRACK

		16		15	3	w	14	*	13	t	2	12
W		11		1	t	10	*	T	9		8	w
7	6		5	t	4		3	2	1	t		×

GAME TURN RECORD TRACK

1	2	3	4	5	6	7	8	9	10	11	12	13	14	15	16	17	18	19	20
---	---	---	---	---	---	---	---	---	----	----	----	----	----	----	----	----	----	----	----

CRITICAL HITS

- Crew killed. Salamander may perform no further actions. Defensive Value drops to 5.
- Engines sputter. Salamander may only use 3 movement points next game turn. Reduce Defensive Value by 5 due to additional damage.
- Electronic Warfare knocked out. Salamander may no longer jam torps. Reduce Defensive Value by 3.
- Maneuver Thrusters damaged. All turns, including tight turns, cost one extra movement point to perform.
- Shields damaged. Reduce Defensive Value by 2.
- Ionizers fizzle. Reduce Impulsegun's Damage to Medium.
- Torp Targeting Scanner damaged. No torpedoes may be fired until after the next game turn.
- Hull buckles. Reduce Defensive Value by 4 and lose one torp of the pilot's choice.
- Gunner killed. Salamander may no longer use the Pulse Laser or Splatterguns.
- Pilot dazed. Salamander may not move or fire the Impulsegun until after the next game turn.
- Reactor hit. Salamander explodes into oblivion.

IMPULSEGUN SPECS

Short Range: 1-3 hexes (+1 To Hit).
 Medium Range: 4-8 hexes.
 Long Range: 9-10 hexes (-1 To Hit).

SPLATTERGUN SPECS

Short Range: 1-2 hexes (+1 To Hit).
 Medium Range: 3-6 hexes.
 Long Range: 7-10 hexes (-1 To Hit).

PULSE LASER SPECS

Short Range: 1-3 hexes (+1 To Hit).
 Medium Range: 4-9 hexes.
 Long Range: 10 hexes (-1 To Hit).

SALAMANDER II

I.D. ■

BPV: 66

TPV

Pilot
1 Impulsegun (F)
 To Hit: 2D8+ADB
 Damage: High
 Range: 3/8/10

Crew
PILOT
 Plt: _____
 Gnr: _____
 Luck: _____
GUNNER
 Gnr: _____

Mk. 20
 Torp

Mk. 10
 Torps

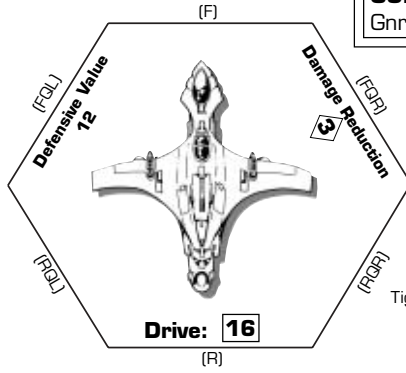

Decoys: ○ ○
 P-D: 1-7 (2)
 Dmg Con: 1-6
 Tons: 400

Gunner
3 Pulse Lasers
 (FQL) (F) (FQR)
 To Hit: 2D6+ADB+2
 Damage: Low+2
 Range: 3/9/10

Gunner
2 Splatnerguns
 (RQL) (R) (RQR)
 To Hit: 2D6+ADB+1
 Damage: Medium+2
 Range: 2/6/10

DAMAGE TRACK

		16		15	3	w	14	*	13	t	2	12
W		11	1	t	10	*		T	9		8	w
7	6		5	t	4		3	2	1	t		×

SALAMANDER II

I.D. ■

BPV: 66

TPV

Pilot
1 Impulsegun (F)
 To Hit: 2D8+ADB
 Damage: High
 Range: 3/8/10

Crew
PILOT
 Plt: _____
 Gnr: _____
 Luck: _____
GUNNER
 Gnr: _____

Mk. 20
 Torp

Mk. 10
 Torps

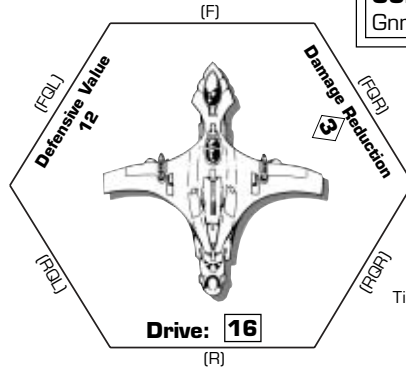

Decoys: ○ ○
 P-D: 1-7 (2)
 Dmg Con: 1-6
 Tons: 400

Gunner
3 Pulse Lasers
 (FQL) (F) (FQR)
 To Hit: 2D6+ADB+2
 Damage: Low+2
 Range: 3/9/10

Gunner
2 Splatnerguns
 (RQL) (R) (RQR)
 To Hit: 2D6+ADB+1
 Damage: Medium+2
 Range: 2/6/10

DAMAGE TRACK

		16		15	3	w	14	*	13	t	2	12
W		11	1	t	10	*		T	9		8	w
7	6		5	t	4		3	2	1	t		×

CRITICAL HITS

- Crew killed. Salamander may perform no further actions. Defensive Value drops to 5.
- Engines sputter. Salamander may only use 3 movement points next game turn. Reduce Defensive Value by 5 due to additional damage.
- Electronic Warfare knocked out. Salamander may no longer jam torps. Reduce Defensive Value by 3.
- Maneuver Thrusters damaged. All turns, including tight turns, cost one extra movement point to perform.
- Shields damaged. Reduce Defensive Value by 2.
- Ionizers fizzle. Reduce Impulsegun's Damage to Medium.
- Torp Targeting Scanner damaged. No torpedoes may be fired until after the next game turn.
- Hull buckles. Reduce Defensive Value by 4 and lose one torp of the pilot's choice.
- Gunner killed. Salamander may no longer use the Pulse Laser or Splatnerguns.
- Pilot dazed. Salamander may not move or fire the Impulsegun until after the next game turn.
- Reactor hit. Salamander explodes into oblivion.

IMPULSEGUN SPECS

Short Range: 1-3 hexes (+1 To Hit).
 Medium Range: 4-8 hexes.
 Long Range: 9-10 hexes (-1 To Hit).

SPLATTERGUN SPECS

Short Range: 1-2 hexes (+1 To Hit).
 Medium Range: 3-6 hexes.
 Long Range: 7-10 hexes (-1 To Hit).

PULSE LASER SPECS

Short Range: 1-3 hexes (+1 To Hit).
 Medium Range: 4-9 hexes.
 Long Range: 10 hexes (-1 To Hit).

GAME TURN RECORD TRACK

1	2	3	4	5	6	7	8	9	10	11	12	13	14	15	16	17	18	19	20
---	---	---	---	---	---	---	---	---	----	----	----	----	----	----	----	----	----	----	----

Silent Death

Sentry

Data Sphere, Q'raj, Sigurd, Tokugawa, Yoka-Shan.

Sentry II

Q'raj, Sigurd.

Pyramidis Shipyards 270 Model S/T "Sentry"

Crew: 3

Maneuvering Thrust: 0.099 km/s/s

Mass: 690 tons

Translight Capability: None

Armor: Crystanium alloy belt

Atmospheric Capability: None

Armaments:

2 x Mk. 15 Blatguns

8 x Mk. 10 Splatterguns

Commentary: The Sentry was built by the Ptolemeans in response to the need for stronger, more defensively-oriented fighters. It serves well in this role, but it is utterly incapable of undertaking raids or deep strike missions against enemy formations. It is considered something of a miracle that Pyramidis Shipyards was able to go from initial concept to full production in just under 200 days. Upgrades to the design have virtually ceased since then, because with the design now fully in the public domain, it's difficult to make any changes and guarantee that spare parts will be universally available.

"A flying brick with a hefty throw weight" is the best way to describe this heavy point-defense fighter. Tactically the Sentry is very limited. Move it to the area you have to defend and keep it there till the game's over or it's dead. The Sentry's greatest enemy is a Heavy Plazgun, though a couple of well-placed Ion Ram shots will ruin its day, too. Good anti-torp systems will eliminate warheads as a threat until it's too late to matter. Expensive, but warranted in certain situations.

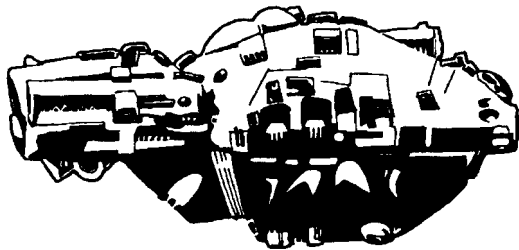

Pyramidis Shipyards 270 Model S/T "Sentry II"

Crew: 3

Maneuvering Thrust: 0.099 km/s/s

Mass: 690 tons

Translight Capability: None

Armor: Crystanium alloy belt

Atmospheric Capability: None

Armaments:

1 x Mk. 16 Disintegrator

8 x Mk. 10 Splatterguns

Commentary: Though the Terrans have not chosen to redesign the sentry, the Draconians thought it worth the investment. When this powerful (but unbalanced) craft was supplied to Draconians in large numbers by the Colosians, the first thing they noticed was its warhead deficiency. True, this craft had a heavy punch if it could get all of its guns to bear, but it had no warheads to launch, and was a choice target for both Missile Launchers and Torpedo salvos.

In order to improve the point defense and damage control systems of these ships, the draconian engineers replaced the twin Blatguns with a Disintegrator. While the Disintegrator has a lower traverse speed than the Blatguns, the Splatterguns usually bring potential targets down to targetable speeds. Overall this has been a very successful refit.

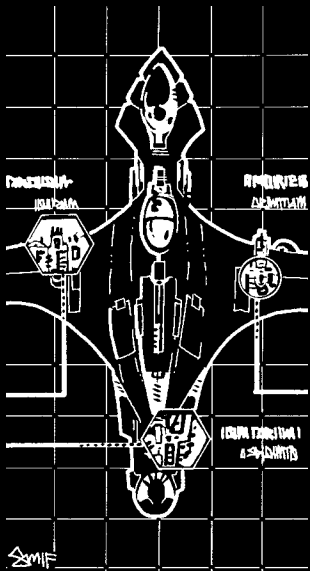
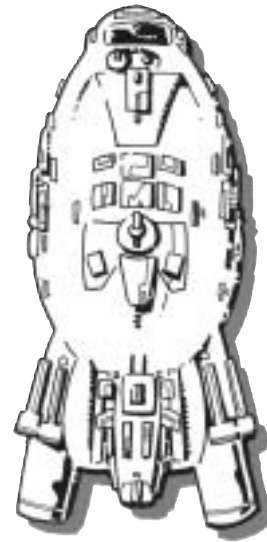

TPV

Pilot
2 Blatguns (F)
 To Hit: 2D6+ADB+1
 Damage: High+2
 Range: 4/10/15
 Target SR ≤13

Crew
PILOT
 Plt: _____
 Gnr: _____
 Luck: _____
GUNNER A
 Gnr: _____
GUNNER B
 Gnr: _____

Decoys: ○○○○
 P-D: 1-7 (3)
 Dmg Con: 1-4
 Tons: 690

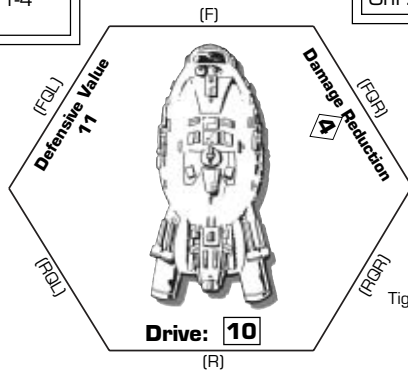

Tight Turn Cost: _____+3

Gunner A
4 Splatterguns
 (RQL) (FQL) (F)
 To Hit: 2D6+ADB+3
 Damage: Medium+6
 Range: 2/6/10

Gunner B
4 Splatterguns
 (F) (FQR) (RQR)
 To Hit: 2D6+ADB+3
 Damage: Medium+6
 Range: 2/6/10

DAMAGE TRACK

				10		4			W	
*	9			3		8			w	
		7		2		6		*	5	
	w		1		4					
	3							2		
				1						
										×

TPV

Pilot
2 Blatguns (F)
 To Hit: 2D6+ADB+1
 Damage: High+2
 Range: 4/10/15
 Target SR ≤13

Crew
PILOT
 Plt: _____
 Gnr: _____
 Luck: _____
GUNNER A
 Gnr: _____
GUNNER B
 Gnr: _____

Decoys: ○○○○
 P-D: 1-7 (3)
 Dmg Con: 1-4
 Tons: 690

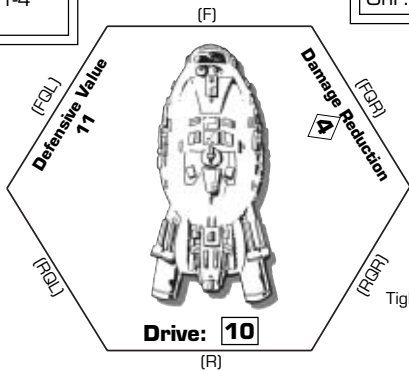

Tight Turn Cost: _____+3

Gunner A
4 Splatterguns
 (RQL) (FQL) (F)
 To Hit: 2D6+ADB+3
 Damage: Medium+6
 Range: 2/6/10

Gunner B
4 Splatterguns
 (F) (FQR) (RQR)
 To Hit: 2D6+ADB+3
 Damage: Medium+6
 Range: 2/6/10

DAMAGE TRACK

				10		4			W	
*	9			3		8			w	
		7		2		6		*	5	
	w		1		4					
	3							2		
				1						
										×

CRITICAL HITS

- 2 — **Armor Belt shingles off.** Reduce Damage Reduction by 1. Reduce Defensive Value by 2. Sentry takes 5 more hits.
- 3 — **Engines sputter momentarily.** Sentry's Drive value is reduced to 2 until after next game turn.
- 4 — **Electronic Warfare knocked out.** Sentry may no longer jam torps. Reduce Defensive Value by 2.
- 5 — **Gunner B's Splatterguns damaged.** Further To Hit attempts by this weapon suffer a -3 penalty.
- 6 — **Shields damaged.** Reduce Defensive Value by 1.
- 7 — **Stabilizers hit.** All turns cost 1 extra movement point.
- 8 — **Gunner A's Splatterguns damaged.** Further To Hit attempts by this weapon suffer a -3 penalty.
- 9 — **Blatgun Power Feed malfunctions.** Reduce Blatgun Damage rating to Medium+2.
- 10 — **Gunner dazed.** One random gunner may not fire his weapon until after the next game turn.
- 11 — **Temporary Maneuvering Thruster malfunction.** If the Sentry moves at all next Movement Phase, it may not make a turn.
- 12 — **Massive structural collapse.** Sentry buckles and explodes.

BLATGUN SPECS

Short Range: 1-4 hexes (+1 To Hit).
Medium Range: 5-10 hexes.
Long Range: 11-15 hexes (-1 To Hit).
Target Speed Restriction: Target's Drive value must be ≤13.

SPLATTERGUN SPECS

Short Range: 1-2 hexes (+1 To Hit).
Medium Range: 3-6 hexes.
Long Range: 7-10 hexes (-1 To Hit).

GAME TURN RECORD TRACK

1	2	3	4	5	6	7	8	9	10	11	12	13	14	15	16	17	18	19	20
---	---	---	---	---	---	---	---	---	----	----	----	----	----	----	----	----	----	----	----

TPV

Pilot
1 Disintegrator (F)
 To Hit: 2D6+ADB+1
 Damage: High §
 Range: 1/3/12
 Target SR ≤11

Crew
PILOT
 Plt: _____
 Gnr: _____
 Luck: _____
GUNNER A
 Gnr: _____
GUNNER B
 Gnr: _____

Decoys: ○○○○
 P-D: 1-7 (6)
 Dmg Con: 1-4
 Tons: 690

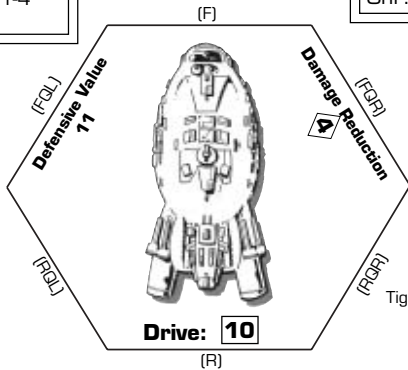

Tight Turn Cost: _____+3

Gunner A
4 Splatterguns
 (RQL) (FQL) (F)
 To Hit: 2D6+ADB+3
 Damage: Medium+6
 Range: 2/6/10

Gunner B
4 Splatterguns
 (F) (FQR) (RQR)
 To Hit: 2D6+ADB+3
 Damage: Medium+6
 Range: 2/6/10

DAMAGE TRACK

				10		4			W	
*	9			3		8			w	
		7	2		6	*		5		
	w	1		4						
	3					2				
			1							

TPV

Pilot
1 Disintegrator (F)
 To Hit: 2D6+ADB+1
 Damage: High §
 Range: 1/3/12
 Target SR ≤11

Crew
PILOT
 Plt: _____
 Gnr: _____
 Luck: _____
GUNNER A
 Gnr: _____
GUNNER B
 Gnr: _____

Decoys: ○○○○
 P-D: 1-7 (6)
 Dmg Con: 1-4
 Tons: 690

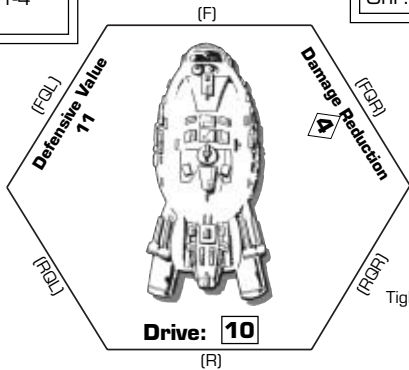

Tight Turn Cost: _____+3

Gunner A
4 Splatterguns
 (RQL) (FQL) (F)
 To Hit: 2D6+ADB+3
 Damage: Medium+6
 Range: 2/6/10

Gunner B
4 Splatterguns
 (F) (FQR) (RQR)
 To Hit: 2D6+ADB+3
 Damage: Medium+6
 Range: 2/6/10

DAMAGE TRACK

				10		4			W	
*	9			3		8			w	
		7	2		6	*		5		
	w	1		4						
	3					2				
			1							

CRITICAL HITS

- Armor Belt shingles off. Reduce Damage Reduction by 1. Reduce Defensive Value by 2. Sentry takes 5 more hits.
- Engines sputter momentarily. Sentry's Drive value is reduced to 2 until after next game turn.
- Electronic Warfare knocked out. Sentry may no longer jam torps. Reduce Defensive Value by 2.
- Gunner B's Splatterguns damaged. Further To Hit attempts by this weapon suffer a -3 penalty.
- Shields damaged. Reduce Defensive Value by 1.
- Stabilizers hit. All turns cost 1 extra movement point.
- Gunner A's Splatterguns damaged. Further To Hit attempts by this weapon suffer a -3 penalty.
- Disintegrator Power Feed malfunctions. Reduce Blatgun Damage rating to Medium.
- Gunner dazed. One random gunner may not fire his weapon until after the next game turn.
- Temporary Maneuvering Thruster malfunction. If the Sentry moves at all next Movement Phase, it may not make a turn.
- Massive structural collapse. Sentry buckles and explodes.

DISINTEGRATOR SPECS

Short Range: 1 hex (+1 To Hit).
 Medium Range: 2-3 hexes.
 Long Range: 4-12 hexes (-1 To Hit).
 Target Speed Restriction: Target's Drive value must be ≤11.
 § If the target's Defensive Value has not been reduced by a critical hit, add 1 to its Defensive Value. Also, completely ignore the target's Damage Reduction when resolving a hit.

SPLATTERGUN SPECS

Short Range: 1-2 hexes (+1 To Hit).
 Medium Range: 3-6 hexes.
 Long Range: 7-10 hexes (-1 To Hit).

GAME TURN RECORD TRACK

1	2	3	4	5	6	7	8	9	10	11	12	13	14	15	16	17	18	19	20
---	---	---	---	---	---	---	---	---	----	----	----	----	----	----	----	----	----	----	----

Augustus Naval 317dire "Seraph"

Crew: 2

Maneuver Thrust: 0.151 km/s/s

Mass: 800 tons

Translight Capability: None

Armor: Crystanium w/belt

Atmospheric Capability: Full

Armaments:

1 x Mk. 30 Turbo Laser Cannon

6 x Mk. 10 Pulse Laser Cannons

1 x Missile Launcher (Magazine: 20)

1 x Mk. 50 Explosive Torpedo

4 x Mk. 10 Explosive Torpedoes

Commentary: This TPAC Fighter is a truly impressive combat machine. With a well-rounded array of armaments, it really only suffers from the lack of another crew member to supplement its already impressive firepower.

The Seraph was originally a product of House Augustus-Hayes, a government not well known for its arms industry nor, unfortunately for it, for its military abilities. The Seraph's popularity has outlasted its creators by a number of years.

This is one tough machine, capable of handling opponents of any size. Use the Seraph's Pulse Lasers against light opponents, its torps against medium foes and the Turbo Laser against heavy gunboats. Because the Seraph is undergunned for its size, you must play to its singular strength: durability. Use the Seraph to draw enemy fire away from your more crucial units. Because it strikes such an imposing figure in a game, your opponent may forget that its bark is worse than its bite.

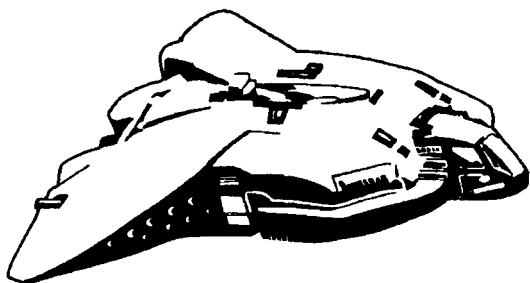

Augustus Naval 317dire "Seraph II"

Crew: 2

Maneuver Thrust: 0.151 km/s/s

Mass: 800 tons

Translight Capability: None

Armor: Crystanium w/belt

Atmospheric Capability: Full

Armaments:

2 x Mk. 20 Meld Lasers

1 x Mk. 10 Disruptorgun

5 x Mk. 10 Pulse Laser Cannons

1 x Missile Launcher (Magazine: 20)

1 x Mk. 50 Explosive Torpedo

4 x Mk. 10 Explosive Torpedoes

Commentary: The Seraph II is a prime example of Hibernian economy: take a design which already works well, and with a few low-cost modifications, improve the ship's function in a variety of situations. The Seraph II retains the strong armor and good compliment of weapons of the original. Though the original Turbo Laser dealt more damage at greater range, the new twin Meld Lasers are more effective against faster opponents, and are a bit more accurate in general. The gunner's single Pulse Laser mount, largely redundant next to the Quad Pulse Lasers already on the ship, has been replaced by a Disruptorgun, which not only delivers more damage, but also bypasses armor and shields to deliver that damage directly to enemy vessels.

Like its predecessor, the Seraph II is meant to take a beating, pound its opponents, and still manage to limp home when the battle is over.

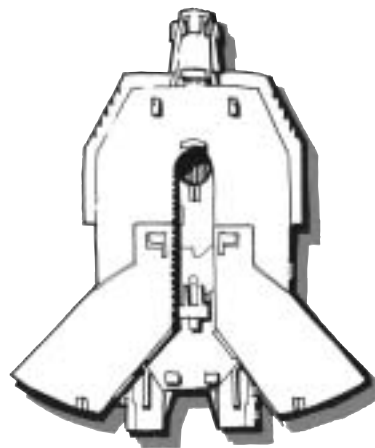

The Next Millennium

Seraph

Colos, Draconian, Hibernia, Primate, Red Star.

Seraph II

Hibernia, Red Star.

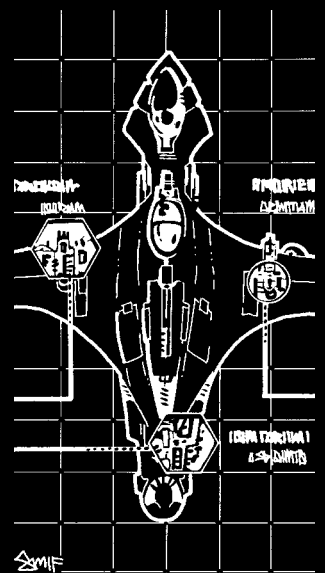

TPV

Mk. 50 Torp

Mk. 10 Torps

Pilot
1 Turbo Laser (F)
 To Hit: 2D8+ADB
 Damage: High
 Range: 9/25/30
 Target SR ≤8

Pilot
1 Pulse Laser (F)
 To Hit: 2D8+ADB
 Damage: Low
 Range: 3/9/10

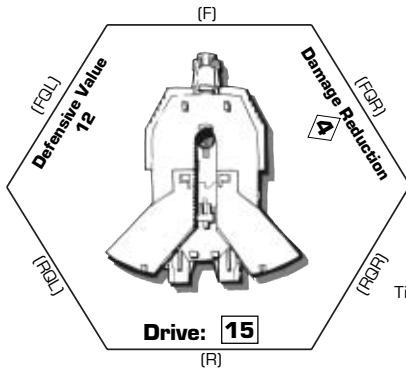

Tight Turn Cost: _____+3

Decoys: ○○○○
 P-D: 1-6 (2)
 Dmg Con: 1-6
 Tons: 800

Gunner
1 Pulse Laser (R)
 To Hit: 2D8+ADB
 Damage: Low
 Range: 3/9/10

Gunner
4 Pulse Lasers
 (RQL) (R) (RQR)
 To Hit: 2D8+ADB+3
 Damage: Low+3
 Range: 3/9/10

Gunner
Missile Launcher
 (360°)
 Lock-on < _____

○ ○ ○ ○
 ○ ○ ○ ○
 ○ ○ ○ ○
 ○ ○ ○ ○
 ○ ○ ○ ○
 ○ ○ ○ ○

DAMAGE TRACK

					15			w		14	t	
w		13	*		t	12		W				11
		4		10		3		9	T	w		8
2		7	*		t			1	6			
				5						4		
w				3	*		t					2
				1			×					

TPV

Mk. 50 Torp

Mk. 10 Torps

Pilot
1 Turbo Laser (F)
 To Hit: 2D8+ADB
 Damage: High
 Range: 9/25/30
 Target SR ≤8

Pilot
1 Pulse Laser (F)
 To Hit: 2D8+ADB
 Damage: Low
 Range: 3/9/10

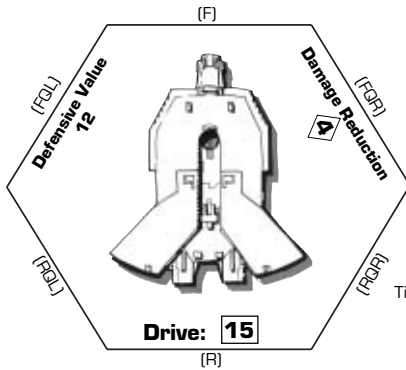

Tight Turn Cost: _____+3

Decoys: ○○○○
 P-D: 1-6 (2)
 Dmg Con: 1-6
 Tons: 800

Gunner
1 Pulse Laser (R)
 To Hit: 2D8+ADB
 Damage: Low
 Range: 3/9/10

Gunner
4 Pulse Lasers
 (RQL) (R) (RQR)
 To Hit: 2D8+ADB+3
 Damage: Low+3
 Range: 3/9/10

Gunner
Missile Launcher
 (360°)
 Lock-on < _____

○ ○ ○ ○
 ○ ○ ○ ○
 ○ ○ ○ ○
 ○ ○ ○ ○
 ○ ○ ○ ○
 ○ ○ ○ ○

DAMAGE TRACK

					15			w		14	t	
w		13	*		t	12		W				11
		4		10		3		9	T	w		8
2		7	*		t			1	6			
				5						4		
w				3	*		t					2
				1			×					

CRITICAL HITS

- 2 — **Pilot dazed.** Seraph may not move or fire the pilot's weapons until after the next game turn. The gunner may still fire while the pilot is dazed.
- 3 — **Missile Launcher jam.** Seraph's Missile Launcher may not be fired until after the next game turn.
- 4 — **Electronic Warfare knocked out.** Seraph may no longer jam torps. Reduce Defensive Value by 3.
- 5 — **Maneuver Thrusters damaged.** All turns cost 1 extra movement point to perform.
- 6 — **Shields damaged.** Reduce Defensive Value by 1.
- 7 — **Decoys blown away.** Seraph loses all its decoys.
- 8 — **Torp Targeting Scanner damaged.** No torpedoes may be fired until after the next game turn.
- 9 — **Torp Discharger malfunction.** Lose 1D4 remaining torps of the pilot's choice. Reduce Defensive Value by 2.
- 10 — **Gunner dazed.** Gunner may not fire weapons until after the next game turn.
- 11 — **Turbo Laser performance impeded.** Reduce Damage rating to Medium.
- 12 — **Reactor hit.** Sadly, the Seraph is no more.

TURBO LASER SPECS

Short Range: 1-9 hexes (+1 To Hit).
Medium Range: 10-25 hexes.
Long Range: 26-30 hexes (-1 To Hit).
Target Speed Restriction: Target's Drive value must be ≤8.

PULSE LASER SPECS

Short Range: 1-3 hexes (+1 To Hit).
Medium Range: 4-9 hexes.
Long Range: 10 hexes (-1 To Hit).

SERAPH II

I.D.

BPV: 121

TPV

**Mk. 50
Torp**

**Mk. 10
Torps**

Pilot

1 Pulse Laser (F)
To Hit: 2D8+ADB
Damage: Low
Range: 3/9/10

Pilot

2 Meld Lasers (F)
To Hit: 2D8+ADB+1
Damage: Medium+1
Range: 6/18/20
Target SR ≤12

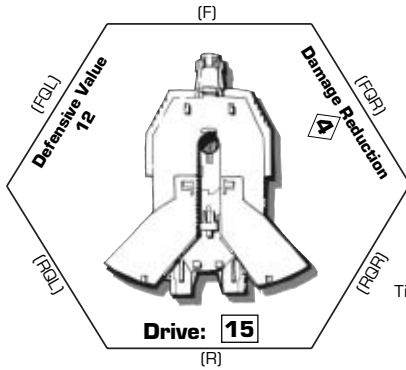

Tight Turn Cost: _____+3

Decoys: ○○○○
P-D: 1-6 (2)
Dmg Con: 1-6
Tons: 800

Gunner

1 Disruptorgun (R)
To Hit: 2D8+ADB
Damage: Medium §
Range: 1/2/6

Gunner

4 Pulse Lasers
(RQL) (R) (RQR)
To Hit: 2D8+ADB+3
Damage: Low+3
Range: 3/9/10

Gunner

Missile Launcher
(360°)
Lock-on < _____

DAMAGE TRACK

					15			w		14	t	
w		13	*		t	12		W				11
		4		10		3		9	T	w		8
2		7	*		t			1	6			
				5						4		
w				3	*		t					2
				1			×					

SERAPH II

I.D.

BPV: 121

TPV

**Mk. 50
Torp**

**Mk. 10
Torps**

Pilot

1 Pulse Laser (F)
To Hit: 2D8+ADB
Damage: Low
Range: 3/9/10

Pilot

2 Meld Lasers (F)
To Hit: 2D8+ADB+1
Damage: Medium+1
Range: 6/18/20
Target SR ≤12

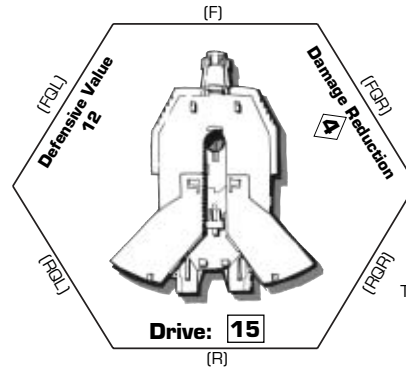

Tight Turn Cost: _____+3

Decoys: ○○○○
P-D: 1-6 (2)
Dmg Con: 1-6
Tons: 800

Gunner

1 Disruptorgun (R)
To Hit: 2D8+ADB
Damage: Medium §
Range: 1/2/6

Gunner

4 Pulse Lasers
(RQL) (R) (RQR)
To Hit: 2D8+ADB+3
Damage: Low+3
Range: 3/9/10

Gunner

Missile Launcher
(360°)
Lock-on < _____

DAMAGE TRACK

					15			w		14	t	
w		13	*		t	12		W				11
		4		10		3		9	T	w		8
2		7	*		t			1	6			
				5						4		
w				3	*		t					2
				1			×					

CRITICAL HITS

- 2 — Pilot dazed. Seraph may not move or fire the pilot's weapons until after the next game turn. The gunner may still fire while the pilot is dazed.
- 3 — Missile Launcher jam. Seraph's Missile Launcher may not be fired until after the next game turn.
- 4 — Electronic Warfare knocked out. Seraph may no longer jam torps. Reduce Defensive Value by 3.
- 5 — Maneuver Thrusters damaged. All turns cost 1 extra movement point to perform.
- 6 — Shields damaged. Reduce Defensive Value by 1.
- 7 — Decoys blown away. Seraph loses all its decoys.
- 8 — Torp Targeting Scanner damaged. No torpedoes may be fired until after the next game turn.
- 9 — Torp Discharger malfunction. Lose 1D4 remaining torps of the pilot's choice. Reduce Defensive Value by 2.
- 10 — Gunner dazed. Gunner may not fire weapons until after the next game turn.
- 11 — Meld Laser performance impeded. Reduce Damage rating to Low.
- 12 — Reactor hit. Sadly, the Seraph is no more.

DISRUPTORGUN SPECS

Short Range: 1 hex (+1 To Hit).
Medium Range: 2 hexes.
Long Range: 3-6 hexes (-1 To Hit).
§ If the target's Defensive Value has not been reduced by a critical hit, add 1 to its Defensive Value. Also, completely ignore the target's Damage Reduction when resolving a hit.

MELD LASER SPECS

Short Range: 1-6 hexes (+1 To Hit).
Medium Range: 7-18 hexes.
Long Range: 19-20 hexes (-1 To Hit).
Target Speed Restriction: Target's Drive value must be ≤12.

PULSE LASER SPECS

Short Range: 1-3 hexes (+1 To Hit).
Medium Range: 4-9 hexes.
Long Range: 10 hexes (-1 To Hit).

Silent Death

Shryak Shuttle

Hibernia, Luches, Q'raj.

Shryak Shuttle II

Hibernia, Luches.

Aerex SA4000(mod) "Shryak Shuttle"

Crew: 2

Maneuver Thrust: 0.081 km/s/s

Mass: 275 tons

Translight Capability: 13 light-years/day

Armor: Crysteel w/Ordium II belt

Atmospheric Capability: Full

Armaments:

4 x Mk. 10 Pulse Laser Cannons

1 x Missile Launcher (Magazine: 10)

Commentary: This smuggler's craft is a modified version of a stock Inner Provincial hypershuttle. Since it is most often used by blockade runners operating in garrisoned areas, it has been combat-tested time and again and not come up wanting. The Shryak Shuttle is capable of holding its own against smaller military craft for short periods of time, but it requires escorts on missions where the risk of entanglements with the local law are high.

An odd design, the Shryak is best used as a moving fire base. The 360° quad Pulse Lasers are the primary armament, and given this shuttle's incredibly tough armor, the guns keep firing to the bitter end. Use the Shryak to defend against intruding flights of small fighters.

With its high Damage Reduction, use this ship to draw fire from your more fragile vessels. It can shrug off shots that would cause pieces to start falling off less-solid ships. Due to its slowness, though, you may need to use your other ships to lure your opponents within the Shryak Shuttle's range. This is one ship that won't be chasing another fighter down.

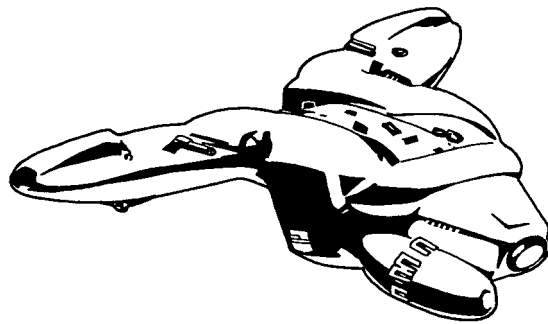

Aerex SA4000(mod) "Shryak Shuttle II"

Crew: 2

Maneuver Thrust: 0.122 km/s/s

Mass: 275 tons

Translight Capability: 13 light-years/day

Armor: Crysteel w/Ordium II belt

Atmospheric Capability: Full

Armaments:

1 x Mk. 10 Impulsegun Ion Cannon

1 x Missile Launcher (Magazine: 10)

Commentary: Though no sensible military force would consider the Shryak Shuttle for regular combat duty, those with limited resources, capital, or foresight might use the Shryak for occasional missions where staying power rather than speed is required.

This version of the Shuttle forgoes the hyperdrive technology of the original in favor of increased impulse engines, but the Shuttle is still among the slowest of ships of this size. Its extra decoy and improved Point Defense systems make it better able to resist torpedo or missile attacks. However, its main weapon, the Impulsegun, is little more effective than the quad Pulse Lasers on the original.

Overall, the Shryak Shuttle II is little more than a glorified puddle-jumper, much like its predecessor. And for this Shuttle, the jumping is limited to planet-to-planet transit. For most combats, your money is better spent elsewhere.

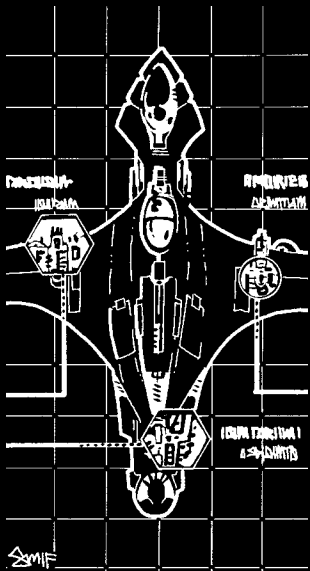
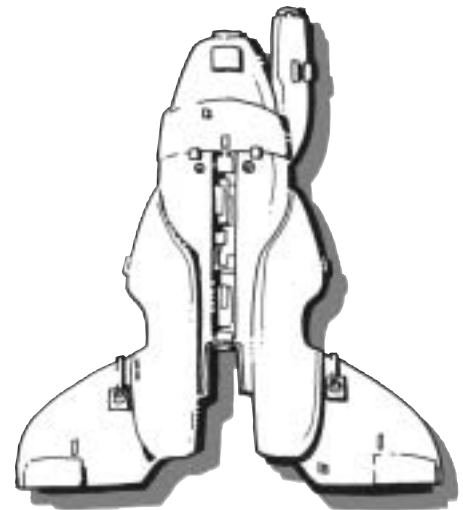

BPV: 34 I.D. ■ SHRYAK SHUTTLE

TPV

Pilot

Missile Launcher (F)

Lock-on < _____

○ ○ ○ ○ ○

○ ○ ○ ○ ○

Crew

PILOT

Pit: _____

Gnr: _____

Luck: _____

GUNNER

Gnr: _____

Defensive Value 10

Damage Reduction 5

Drive: 8

Tight Turn Cost: ____+3

Decoys: ○ ○

P-D: 1-4 (4)

Dmg Con: 1-7

Tons: 275

Gunner

4 Pulse Lasers (360°)

To Hit: 2D8+ADB+3

Damage: Low+3

Range: 3/9/10

DAMAGE TRACK

→								8		w		5
	7	*		4	6						3	5
			w	2	4		3	1	2	1		×

TPV

Pilot

Missile Launcher (F)

Lock-on < _____

○ ○ ○ ○ ○

○ ○ ○ ○ ○

Crew

PILOT

Pit: _____

Gnr: _____

Luck: _____

GUNNER

Gnr: _____

Defensive Value 10

Damage Reduction 5

Drive: 8

Tight Turn Cost: ____+3

Decoys: ○ ○

P-D: 1-4 (4)

Dmg Con: 1-7

Tons: 275

Gunner

4 Pulse Lasers (360°)

To Hit: 2D8+ADB+3

Damage: Low+3

Range: 3/9/10

DAMAGE TRACK

→								8		w		5
	7	*		4	6						3	5
			w	2	4		3	1	2	1		×

- CRITICAL HITS**

 - 2 — **Pilot dazed.** Craft may not move and Missile Launcher may not be fired until after the next game turn.
 - 3 — **Engines sputter.** Shryak Shuttle may only use 2 movement points next game turn. Reduce Defensive Value by 4 due to additional damage.
 - 4 — **Electronic Warfare knocked out.** Shryak Shuttle may no longer jam torps. Reduce Defensive Value by 3.
 - 5 — **Maneuver Thrusters damaged.** All turns, including tight turns, cost one extra movement point to perform.
 - 6 — **Shields damaged.** Reduce Defensive Value by 1.
 - 7 — **Armor is too tough!** No extra damage.
 - 8 — **Pulse Laser Targeters damaged.** Pulse Lasers may not be fired until after the next game turn.
 - 9 — **Missile malfunction.** Missile Launcher loses 1D4 of its remaining missiles.
 - 10 — **Gunner killed.** Shryak Shuttle may no longer fire its Pulse Lasers.
 - 11 — **Armor Plate compromised.** Damage Reduction equals 0.
 - 12 — **Reactor hit.** Shryak Shuttle suffers cataclysmic destruction.
- PULSE LASER SPECS**

Short Range: 1-3 hexes (+1 To Hit).

Medium Range: 4-9 hexes.

Long Range: 10 hexes (-1 To Hit).

GAME TURN RECORD TRACK

1	2	3	4	5	6	7	8	9	10	11	12	13	14	15	16	17	18	19	20
---	---	---	---	---	---	---	---	---	----	----	----	----	----	----	----	----	----	----	----

BPV: 34 I.D. ■ SHRYAK SHUTTLE II

TPV

Pilot
Missile Launcher (F)
 Lock-on < _____
 ○ ○ ○ ○ ○
 ○ ○ ○ ○ ○

Crew
PILOT
 Plt: _____
 Gnr: _____
 Luck: _____
GUNNER
 Gnr: _____

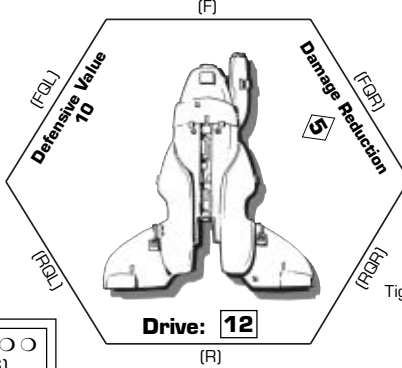

Tight Turn Cost: _____+3

Decoys: ○ ○ ○ ○
 P-D: 1-6 (6)
 Dmg Con: 1-6
 Tons: 275

Gunner
1 Impulsegun (360°)
 To Hit: 2D8+ADB
 Damage: High
 Range: 3/8/10

DAMAGE TRACK

→	12			11				W	9	5
	*		8	4			7		3	6
	5	W	2	4		3	1	2	1	X

TPV

Pilot
Missile Launcher (F)
 Lock-on < _____
 ○ ○ ○ ○ ○
 ○ ○ ○ ○ ○

Crew
PILOT
 Plt: _____
 Gnr: _____
 Luck: _____
GUNNER
 Gnr: _____

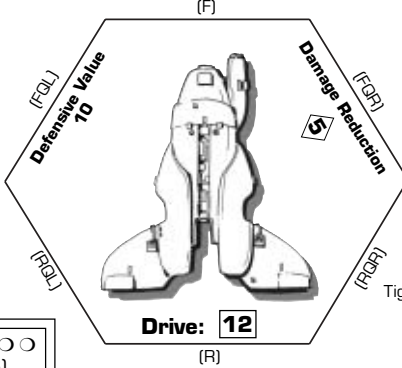

Tight Turn Cost: _____+3

Decoys: ○ ○ ○ ○
 P-D: 1-6 (6)
 Dmg Con: 1-6
 Tons: 275

Gunner
1 Impulsegun (360°)
 To Hit: 2D8+ADB
 Damage: High
 Range: 3/8/10

DAMAGE TRACK

→	12			11				W	9	5
	*		8	4			7		3	6
	5	W	2	4		3	1	2	1	X

CRITICAL HITS

- 2 — **Pilot dazed.** Craft may not move and Missile Launcher may not be fired until after the next game turn.
- 3 — **Engines sputter.** Shryak Shuttle may only use 2 movement points next game turn. Reduce Defensive Value by 4 due to additional damage.
- 4 — **Electronic Warfare knocked out.** Shryak Shuttle may no longer jam torps. Reduce Defensive Value by 3.
- 5 — **Maneuver Thrusters damaged.** All turns, including tight turns, cost one extra movement point to perform.
- 6 — **Shields damaged.** Reduce Defensive Value by 1.
- 7 — **Armor is too tough!** No extra damage.
- 8 — **Impulsegun Targeters damaged.** Pulse Lasers may not be fired until after the next game turn.
- 9 — **Missile malfunction.** Missile Launcher loses 1D4 of its remaining missiles.
- 10 — **Gunner killed.** Shryak Shuttle may no longer fire its Pulse Lasers.
- 11 — **Armor Plate compromised.** Damage Reduction equals 0.
- 12 — **Reactor hit.** Shryak Shuttle suffers cataclysmic destruction.

IMPULSEGUN SPECS

Short Range: 1-3 hexes (+1 To Hit).
 Medium Range: 4-8 hexes.
 Long Range: 9-10 hexes (-1 To Hit).

GAME TURN RECORD TRACK

1	2	3	4	5	6	7	8	9	10	11	12	13	14	15	16	17	18	19	20
---	---	---	---	---	---	---	---	---	----	----	----	----	----	----	----	----	----	----	----

Transprovincial S I436b "Sorenson III"

Crew: 2

Maneuver Thrust: 0.135 km/s/s

Mass: 600 tons

Translight Capability: None

Armor: Crysteel w/belt

Atmospheric Capability: Full

Armaments:

4 x Mk. 15 Blatgun Blast Cannons

4 x Mk. 20 Explosive Torpedoes

3 x Mk. 10 Explosive Torpedoes

Commentary: The Sorenson III is a full combat version of a design originally intended only for customs and patrol duty with armed forces throughout the inner provinces. As a stopgap conversion distributed widely through arms dealer networks, even its upgraded design is mediocre. It fails in the close combat role, and it is really only useful as a standoff warhead delivery system.

Despite its shortcomings, the Sorenson III has seen duty with militaries throughout Terran space, if often for no other reason than it happened to be available when it was needed.

The Sorenson has been strengthened as a dogfighter by replacing the rear Pulse Lasers with dual 360° Blatguns. At the beginning of a battle, it should be used to manipulate your opponent's moves by sending out harassing salvos of torpedoes. Near the end of a battle, send the Sorenson in to finish off cripples with the Blatguns. However, during the height of a battle, keep this vessel far away from larger craft. It will not survive if pressed into that role.

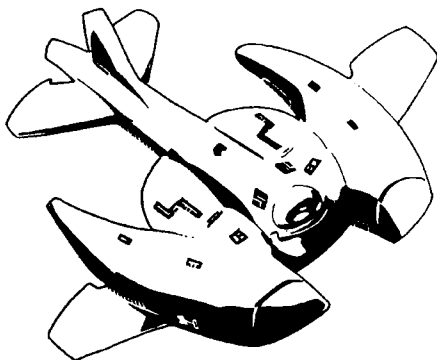

Transprovincial S I436a "Sorenson II"

Crew: 2

Maneuver Thrust: 0.135 km/s/s

Mass: 600 tons

Translight Capability: None

Armor: Crysteel w/belt

Atmospheric Capability: Full

Armaments:

2x Mk. 15 Blatgun Blast Cannons

1 x Mk. 10 Pulse Laser Cannons

4 x Mk. 20 Explosive Torpedoes

3 x Mk. 10 Explosive Torpedoes

Commentary: The Sorenson II was used in great numbers around the Unkulunkulu Archipelago as a customs and police cruiser. Despite the replacement of its defensive equipment and programming it is still an easy target. As a customs vessel it is not the strongest of fighter craft, but it does have something most fighters lack: cargo space. This cargo space can be used to carry a small assault team, contain criminals, or even to transport contraband claimed from smugglers or pirates. The Sorenson II was given an impressive torpedo load because police and customs officers rarely have the advanced training that a true fighter pilot would have, and torpedoes are the ultimate "fire and forget" weapon — no gunner accuracy needed.

The Sorenson II is a weak assault vessel, and should be used in a support role. Its best tactic is, once the opposing force has been softened up by a light fighter strike, to fire its torps and follow them in.

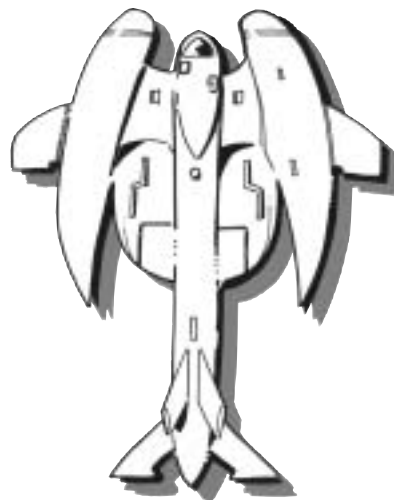

The Next Millennium

Sorenson II

ASP, Luches, Tokugawa.

Sorenson III

ASP, Luches, Q'raj, Sigurd, Unkulunkulu.

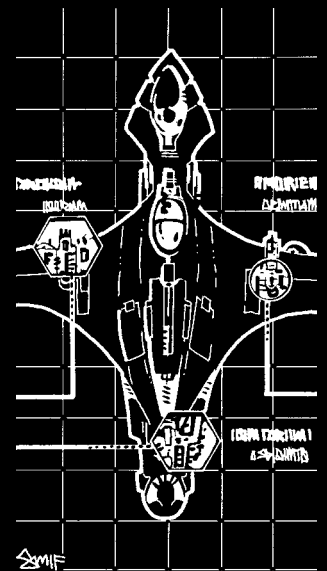

SORENSEN III

I.D. ■

BPV: 68

TPV

Mk. 20 Torps

Mk. 10 Torps

Decoys: ○
 P-D: 1-4 (2)
 Dmg Con: 1-3
 Tons: 600

Pilot
2 Blatguns (F)
 To Hit: 2D6+ADB+1
 Damage: High+2
 Range: 4/10/15
 Target SR ≤13

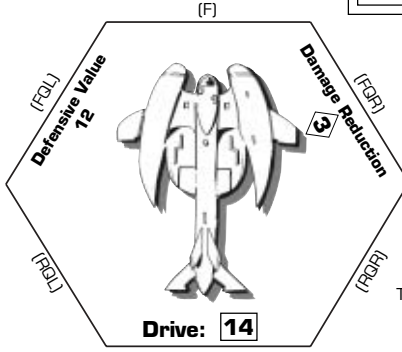

Tight Turn Cost: _____+3

Gunner
2 Blatguns (360°)
 To Hit: 2D6+ADB+1
 Damage: High+2
 Range: 4/10/15
 Target SR ≤13

DAMAGE TRACK

→			14	t	3	*		13	T		12	t
	W		11	*		t	10	2	9		8	T
		7			6	w	5	t	4	*	1	3
			2				1					t
												×

GAME TURN RECORD TRACK

1	2	3	4	5	6	7	8	9	10	11	12	13	14	15	16	17	18	19	20
---	---	---	---	---	---	---	---	---	----	----	----	----	----	----	----	----	----	----	----

SORENSEN III

I.D. ■

BPV: 68

TPV

Mk. 20 Torps

Mk. 10 Torps

Decoys: ○
 P-D: 1-4 (2)
 Dmg Con: 1-3
 Tons: 600

Pilot
2 Blatguns (F)
 To Hit: 2D6+ADB+1
 Damage: High+2
 Range: 4/10/15
 Target SR ≤13

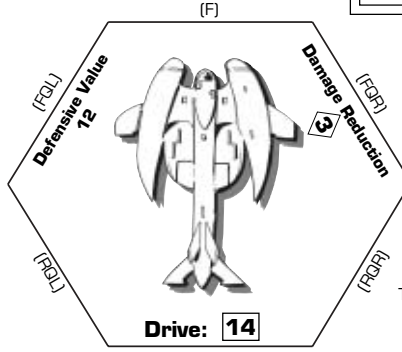

Tight Turn Cost: _____+3

Gunner
2 Blatguns (360°)
 To Hit: 2D6+ADB+1
 Damage: High+2
 Range: 4/10/15
 Target SR ≤13

DAMAGE TRACK

→			14	t	3	*		13	T		12	t
	W		11	*		t	10	2	9		8	T
		7			6	w	5	t	4	*	1	3
			2				1					t
												×

CRITICAL HITS

- 2 — **Crew killed.** Sorenson III may perform no further actions. Defensive Value drops to 5.
- 3 — **Engines sputter.** Sorenson III may only use 2 movement points next game turn. Reduce Defensive Value by 3 due to additional damage.
- 4 — **Electronic Warfare knocked out.** Sorenson III may no longer jam torps. Reduce Defensive Value by 2.
- 5 — **Maneuver Thrusters damaged.** All turns, cost one extra movement point to perform.
- 6 — **Shields damaged.** Reduce Defensive Value by 1.
- 7 — **Blatguns damaged.** Reduce chance To Hit by 2 on random Blatgun system.
- 8 — **Torp Targeting Scanner damaged.** No torpedoes may be fired until after the next game turn.
- 9 — **Hull breached.** Reduce Defensive Value by 3 and lose two torps of the pilot's choice.
- 10 — **Gunner killed.** Gunner Blatguns may no longer be fired.
- 11 — **Pilot dazed.** Sorenson III may not move or fire the Blatguns until after the next game turn. The gunner may still fire while the pilot is dazed.
- 12 — **Reactor hit.** Sorenson III bursts into an array of dust and space junk.

BLATGUN SPECS

Short Range: 1-4 hexes (+1 To Hit).
Medium Range: 5-10 hexes.
Long Range: 11-15 hexes (-1 To Hit).
Target Speed Restriction: Target's Drive value must be ≤13.

SORENSEN II

I.D.

BPV: 47

TPV

Pilot
2 Blatguns (F)
 To Hit: 2D6+ADB+1
 Damage: High+2
 Range: 4/10/15
 Target SR ≤13

Crew
PILOT
 Plt: _____
 Gnr: _____
 Luck: _____
GUNNER
 Gnr: _____

Mk. 20
 Torps

Mk. 10
 Torps

Decoys: ○
 P-D: —
 Dmg Con: 1-3
 Tons: 600

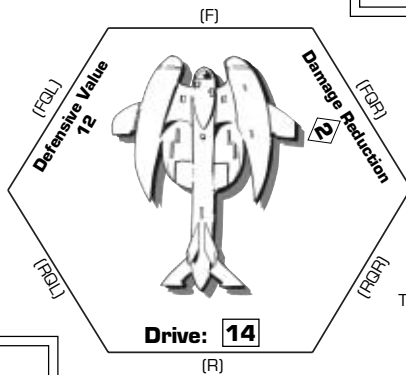

Gunner
1 Pulse Laser
 (RQL) (R) (RQR)
 To Hit: 2D8+ADB
 Damage: Low
 Range: 3/9/10

Tight Turn Cost: _____+3

DAMAGE TRACK

→			14	t	2	*		13	T		12	t
w		11	*		t	10		9			8	T
	7			6		w	5		t	4	*	3
	2				1							t
												×

SORENSEN II

I.D.

BPV: 47

TPV

Pilot
2 Blatguns (F)
 To Hit: 2D6+ADB+1
 Damage: High+2
 Range: 4/10/15
 Target SR ≤13

Crew
PILOT
 Plt: _____
 Gnr: _____
 Luck: _____
GUNNER
 Gnr: _____

Mk. 20
 Torps

Mk. 10
 Torps

Decoys: ○
 P-D: —
 Dmg Con: 1-3
 Tons: 600

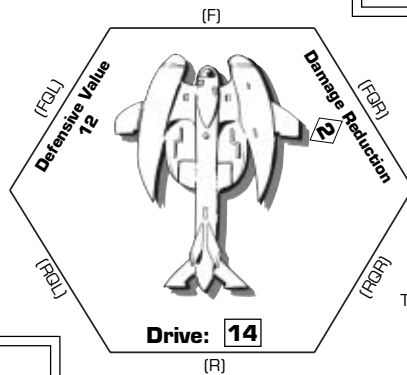

Gunner
1 Pulse Laser
 (RQL) (R) (RQR)
 To Hit: 2D8+ADB
 Damage: Low
 Range: 3/9/10

Tight Turn Cost: _____+3

DAMAGE TRACK

→			14	t	2	*		13	T		12	t
w		11	*		t	10		9			8	T
	7			6		w	5		t	4	*	3
	2				1							t
												×

CRITICAL HITS

- 2 — **Crew killed.** Sorensen II may perform no further actions. Defensive Value drops to 5.
- 3 — **Engines sputter.** Sorensen II may only use 2 movement points next game turn. Reduce Defensive Value by 3 due to additional damage.
- 4 — **Electronic Warfare knocked out.** Sorensen II may no longer jam torps. Reduce Defensive Value by 2.
- 5 — **Maneuver Thrusters damaged.** All turns, cost one extra movement point to perform.
- 6 — **Shields damaged.** Reduce Defensive Value by 1.
- 7 — **Pulse Laser damaged.** Reduce chance To Hit by 2.
- 8 — **Torp Targeting Scanner damaged.** No torpedoes may be fired until after the next game turn.
- 9 — **Hull breached.** Reduce Defensive Value by 3 and lose two torps of the pilot's choice.
- 10 — **Gunner killed.** Gunner Pulse Laser may no longer be fired.
- 11 — **Pilot dazed.** Sorensen II may not move or fire the Blatguns until after the next game turn. The gunner may still fire while the pilot is dazed.
- 12 — **Reactor hit.** Sorensen II bursts into an array of dust and space junk.

BLATGUN SPECS

Short Range: 1-4 hexes (+1 To Hit).
Medium Range: 5-10 hexes.
Long Range: 11-15 hexes (-1 To Hit).
Target Speed Restriction: Target's Drive value must be ≤13.

PULSE LASER SPECS

Short Range: 1-3 hexes (+1 To Hit).
Medium Range: 4-9 hexes.
Long Range: 10 hexes (-1 To Hit).

GAME TURN RECORD TRACK

1	2	3	4	5	6	7	8	9	10	11	12	13	14	15	16	17	18	19	20
---	---	---	---	---	---	---	---	---	----	----	----	----	----	----	----	----	----	----	----

Silent Death

Spirit Rider

Colos, Draconian, Kashmere, Luches, Primate, Unkulunkulu.

Spirit Rider II

Kashmere, Unkulunkulu.

Gilliam Y700 "Spirit Rider"

Crew: 1

Maneuver Thrust: 0.147 km/s/s

Mass: 125 tons

Translight Capability: None

Armor: Crystanium w/belt

Atmospheric Capability: None

Armaments:

2 x Mk. 10 Splattergun Blast Cannons

2 x Mk. 10 Explosive Torpedoes

Commentary: This is a strong entry into the SPAC Fighter market from House Gilliam—a noted weapon systems producer that managed to survive the Terran-Hatchling War. The design is tried and true, and best of all, it's cheap. Gilliam's aggressive "products placement" program has insured that the Spirit Rider will continue to see extensive, long-term service across Terran space, and plans are in development to take this craft into Promethean space as well.

A wonderfully cheap but effective craft, the Spirit Rider's obvious strength lies in a good set of guns which should be enough to penetrate just about any armor. But don't forget those two Mk. 10 torpedoes, which are the fighter's greatest asset. Few other light fighters have them. A swarm of Riders can overwhelm most defenders by sending out waves of small torps and following them up with well-placed, concentrated Splattergun fire. A late crit and weapon hit add to the Spirit Rider's overall appeal. When you've got a few points left over after purchasing your larger ships, the Spirit Rider is a solid bet for some additional support.

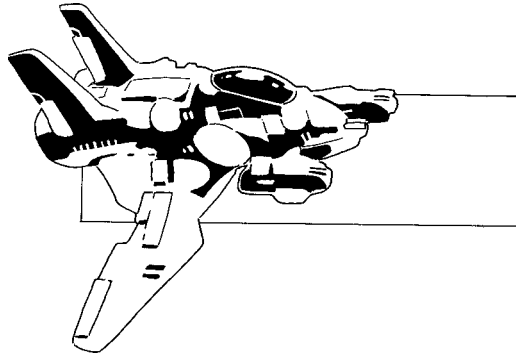

Gilliam Y700.A "Spirit Rider II"

Crew: 1

Maneuver Thrust: 0.159 km/s/s

Mass: 125 tons

Translight Capability: None

Armor: Crystanium w/belt

Atmospheric Capability: None

Armaments:

2 x Mk. 10 Splattergun Blast Cannons

2 x Mk. 10 Explosive Torpedoes

Commentary: The Kashmere Commonwealth approached House Gilliam with the request for a revision of the Spirit Rider. By doing away with the Damage Control systems entirely, the Spirit Rider had its engines refitted with a more powerful drive. This modification is used to the exclusion of Y700 by the Kashmere Commonwealth. The Y700.A has proved itself as an excellent convoy escort.

The Spirit Rider II is perfect for short-term field or escort duty. In long-term field use they have not proven as reliable. The Unkulunkulu Archipelago has also purchased the Spirit Rider II in great quantities, and initially found them to be an excellent craft. Eventually their near neglect of the Y700.A caused them some aggravation, as maintenance on the Spirit Rider II is more of a problem. Because many of the self-correcting systems have been downgraded, these craft have shown a need for more regular maintenance. Because the Kashmere have always run a regular and frequent maintenance schedule, their Y700.As rarely suffer from poor mechanical reliability.

In spite of these problems the Spirit Rider II has become a popular craft with the pilots that fly it. House Gilliam is beginning to export these in great numbers. Don't be surprised if this model eclipses the original Spirit Rider.

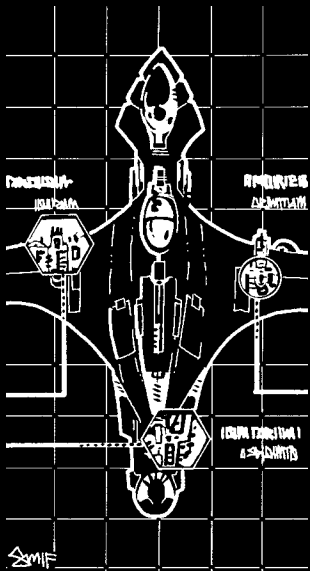

TPV

Pilot
2 Splatterguns (F)
 To Hit: 2D6+ADB+1
 Damage: Medium+2
 Range: 2/6/10

Crew
PILOT
 Plt: _____
 Gnr: _____
 Luck: _____

Mk. 10 Torps

Decoys: ○
 P.D: —
 Dmg Con: 1-3
 Tons: 125

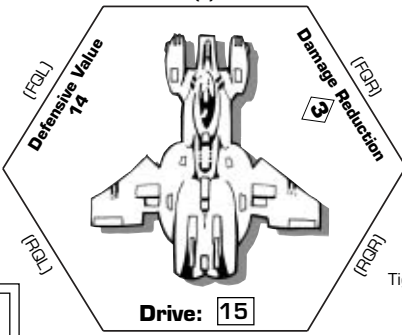

Defensive Value 14
 Damage Reduction 3
 Drive: 15

Tight Turn Cost: _____+3

DAMAGE TRACK

→	3	15			2	12
	1	9	w	*	6	2

TPV

Pilot
2 Splatterguns (F)
 To Hit: 2D6+ADB+1
 Damage: Medium+2
 Range: 2/6/10

Crew
PILOT
 Plt: _____
 Gnr: _____
 Luck: _____

Mk. 10 Torps

Decoys: ○
 P.D: —
 Dmg Con: 1-3
 Tons: 125

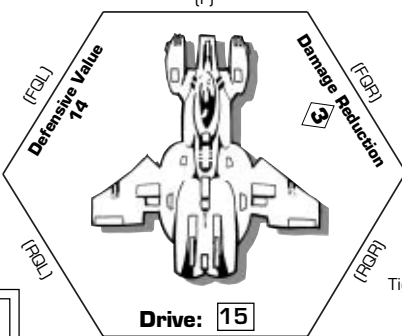

Defensive Value 14
 Damage Reduction 3
 Drive: 15

Tight Turn Cost: _____+3

DAMAGE TRACK

→	3	15			2	12
	1	9	w	*	6	2

TPV

Pilot
2 Splatterguns (F)
 To Hit: 2D6+ADB+1
 Damage: Medium+2
 Range: 2/6/10

Crew
PILOT
 Plt: _____
 Gnr: _____
 Luck: _____

Mk. 10 Torps

Decoys: ○
 P.D: —
 Dmg Con: 1-3
 Tons: 125

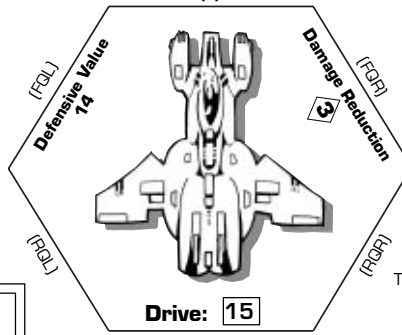

Defensive Value 14
 Damage Reduction 3
 Drive: 15

Tight Turn Cost: _____+3

DAMAGE TRACK

→	3	15			2	12
	1	9	w	*	6	2

TPV

Pilot
2 Splatterguns (F)
 To Hit: 2D6+ADB+1
 Damage: Medium+2
 Range: 2/6/10

Crew
PILOT
 Plt: _____
 Gnr: _____
 Luck: _____

Mk. 10 Torps

Decoys: ○
 P.D: —
 Dmg Con: 1-3
 Tons: 125

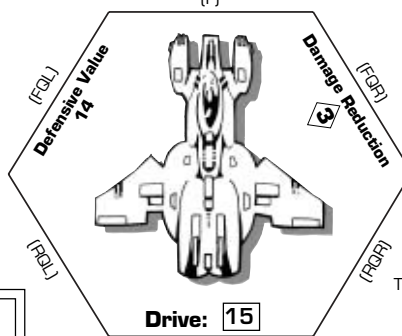

Defensive Value 14
 Damage Reduction 3
 Drive: 15

Tight Turn Cost: _____+3

DAMAGE TRACK

→	3	15			2	12
	1	9	w	*	6	2

CRITICAL HITS

- 2 — **Pilot killed.** Spirit Rider may perform no further actions. Defensive Value drops to 5.
- 3 — **Engines destroyed.** Spirit Rider may not move or turn. Reduce Defensive Value to 5.
- 4 — **Electronic Warfare knocked out.** Spirit Rider may no longer jam torps. Reduce Defensive Value by 5.
- 5 — **Maneuver Thrusters hit.** Spirit Rider may no longer turn.
- 6 — **Shields damaged.** Reduce Defensive Value by 2.
- 7 — **Splattergun Targeters hit.** Reduce chance To Hit by 2.
- 8 — **Evade Thrusters hit.** Reduce Defensive Value by 3.
- 9 — **Hull compromised.** Reduce Defensive Value by 4.
- 10 — **Engines severely damaged.** Spirit Rider reduced to a Drive value of 1. Reduce Defensive Value by 7.
- 11 — **Pilot dazed.** Spirit Rider may not move or fire torps until after the next game turn.
- 12 — **Reactor hit.** Power supply detonates; Spirit Rider is destroyed.

SPLATTERGUN SPECS

Short Range: 1-2 hexes (+1 To Hit).
 Medium Range: 3-6 hexes.
 Long Range: 7-10 hexes (-1 To Hit).

BPV: 17 I.D. SPIRIT RIDER II

TPV

Pilot
2 Splatterguns (F)
 To Hit: 2D6+ADB+1
 Damage: Medium+2
 Range: 2/6/10

Crew
PILOT
 Plt: _____
 Gnr: _____
 Luck: _____

Mk. 20 Torp

Decoys: ○
 P.D: —
 Dmg Con: —
 Tons: 125

Tight Turn Cost: _____+3

DAMAGE TRACK

→	3	16		2	13
1	9	w	*	6	2

BPV: 17 I.D. SPIRIT RIDER II

TPV

Pilot
2 Splatterguns (F)
 To Hit: 2D6+ADB+1
 Damage: Medium+2
 Range: 2/6/10

Crew
PILOT
 Plt: _____
 Gnr: _____
 Luck: _____

Mk. 20 Torp

Decoys: ○
 P.D: —
 Dmg Con: —
 Tons: 125

Tight Turn Cost: _____+3

DAMAGE TRACK

→	3	16		2	13
1	9	w	*	6	2

BPV: 17 I.D. SPIRIT RIDER II

TPV

Pilot
2 Splatterguns (F)
 To Hit: 2D6+ADB+1
 Damage: Medium+2
 Range: 2/6/10

Crew
PILOT
 Plt: _____
 Gnr: _____
 Luck: _____

Mk. 20 Torp

Decoys: ○
 P.D: —
 Dmg Con: —
 Tons: 125

Tight Turn Cost: _____+3

DAMAGE TRACK

→	3	16		2	13
1	9	w	*	6	2

BPV: 17 I.D. SPIRIT RIDER II

TPV

Pilot
2 Splatterguns (F)
 To Hit: 2D6+ADB+1
 Damage: Medium+2
 Range: 2/6/10

Crew
PILOT
 Plt: _____
 Gnr: _____
 Luck: _____

Mk. 20 Torp

Decoys: ○
 P.D: —
 Dmg Con: —
 Tons: 125

Tight Turn Cost: _____+3

DAMAGE TRACK

→	3	16		2	13
1	9	w	*	6	2

CRITICAL HITS

- 2 — **Pilot killed.** Spirit Rider may perform no further actions. Defensive Value drops to 5.
- 3 — **Engines destroyed.** Spirit Rider may not move or turn. Reduce Defensive Value to 5.
- 4 — **Electronic Warfare knocked out.** Spirit Rider may no longer jam torps. Reduce Defensive Value by 5.
- 5 — **Maneuver Thrusters hit.** Spirit Rider may no longer turn.
- 6 — **Shields damaged.** Reduce Defensive Value by 2.
- 7 — **Splattergun Targeters hit.** Reduce chance To Hit by 2.
- 8 — **Evade Thrusters hit.** Reduce Defensive Value by 3.
- 9 — **Hull compromised.** Reduce Defensive Value by 4.
- 10 — **Engines severely damaged.** Spirit Rider reduced to a Drive value of 1. Reduce Defensive Value by 7.
- 11 — **Pilot dazed.** Spirit Rider may not move or fire torps until after the next game turn.
- 12 — **Reactor hit.** Power supply detonates; Spirit Rider is destroyed.

SPLATTERGUN SPECS

Short Range: 1-2 hexes (+1 To Hit).
 Medium Range: 3-6 hexes.
 Long Range: 7-10 hexes (-1 To Hit).

Bellicose Design Conglomerate V27c "Star Raven"

Crew: 4

Maneuvering Thrust: 0.111 km/s/s

Mass: 1200 tons

Translight Capability: None

Armor: Crysteel Double Hull

Atmospheric Capability: None

Armaments:

1 x Mk. 16 Disintegrator

4 x Mk. 20 Meld Lasers

16 x Mk. 10 Pulse Lasers

1 x Missile Launcher

(Magazine: 25 missiles)

2 x Mk. 50 Torp Loads

4 x Mk. 20 Torp Loads

Commentary: The Star Raven is a popular Bellicose Design product which was conceived to combat small and medium fighters. In that role, it does quite well. However, against its own class of vessels it fares rather poorly, mostly due to a lack of heavy armament. Despite all this, the Bellicose Conglomerate has had to step up production of the Star Raven, since in the current market any well-supported ships are in high demand.

Though not armed with the Plazgun armaments of other gunboats, the Star Raven is still an effective design. Engage more threatening gunboats at long range with the Meld Lasers, then use the Raven's superior speed to close for a close-range shot with the Disintegrator, which ignores enemy armor—a real plus against other gunboats. The Pulse Lasers can be used offensively when concentrated forward, or defensively against pesky light fighters.

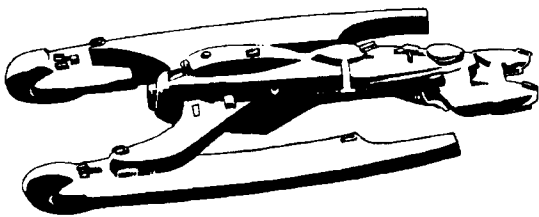

Bellicose Design Conglomerate V27c "Star Raven Alpha"

Crew: 4

Maneuvering Thrust: 0.111 km/s/s

Mass: 1200 tons

Translight Capability: None

Armor: Crysteel Double Hull

Atmospheric Capability: None

Armaments:

3 x Mk. 16 Disintegrator

16 x Mk. 10 Pulse Lasers

1 x Missile Launcher

(Magazine: 25 missiles)

2 x Mk. 50 Torp Loads

4 x Mk. 20 Torp Loads

Commentary: Attempting to hold on to their small territory against both outsiders and the Underground, the Luches Utopian Navy has had to make maximum use of whatever assets it can get its hands on. To this end it has begun a comprehensive refit program designed to give its forces an edge. The first ship to be taken in hand was the Star Raven, because it was both an important major combatant and its numbers were small enough to make the new program manageable.

The goal was to retain its lethality against small ships, but increase its effectiveness against heavier ships. To accomplish this goal, both twin Meld Lasers were replaced with Disintegrators. The Mk. 50 torps were replaced by Mk. 30s and the point defense was improved. The Pulse Laser secondary armament was unchanged.

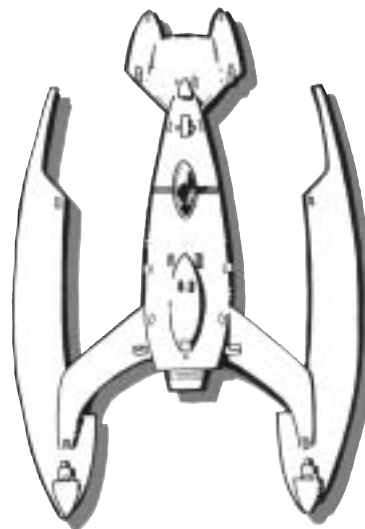

The Next Millennium

Star Raven

Colos, Hibernia, Primates, Sigurd, Unkulunkulu.

Star Raven Alpha

Primates, Sigurd, Unkulunkulu.

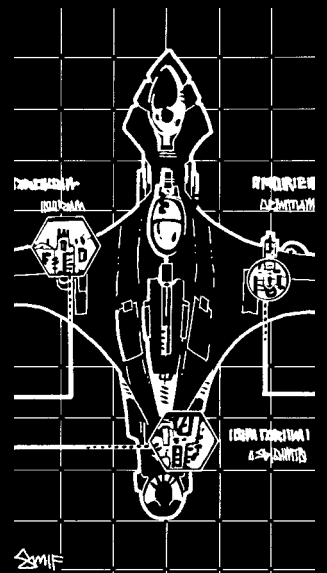

TPV

**Mk. 30
Torps**

○
○

**Mk. 20
Torps**

○
○
○
○

Pilot

1 Disintegrator (F)
To Hit: 2D8+ADB
Damage: High §
Range: 1/3/12
Target SR ≤11

Gunner A

1 Disintegrator (F)
To Hit: 2D8+ADB
Damage: High §
Range: 1/3/12
Target SR ≤11

Pilot

4 Pulse Lasers (F)
To Hit: 2D8+ADB+3
Damage: Low+3
Range: 3/9/10

Gunner B

1 Disintegrator (F)
To Hit: 2D8+ADB
Damage: High §
Range: 1/3/12
Target SR ≤11

Crew

PILOT
Plt: _____
Gnr: _____
Luck: _____

GUNNER A
Gnr: _____

GUNNER B
Gnr: _____

GUNNER C
Gnr: _____

Gunner A

4 Pulse Lasers (FQL) (F)
To Hit: 2D8+ADB+3
Damage: Low+3
Range: 6/8/20

FRONT DAMAGE TRACK

		4			3		w	2	
	t		1				w		t
	t	t		t		*		W	
	w								
w			×		*				×

Gunner B

4 Pulse Lasers (F) (FQR)
To Hit: 2D8+ADB+3
Damage: Low+3
Range: 6/8/20

LEFT SIDE
DAMAGE TRACK

		2				1	
		*				-1	
		t				w	
		*		w			
	×		-1		t		
							×

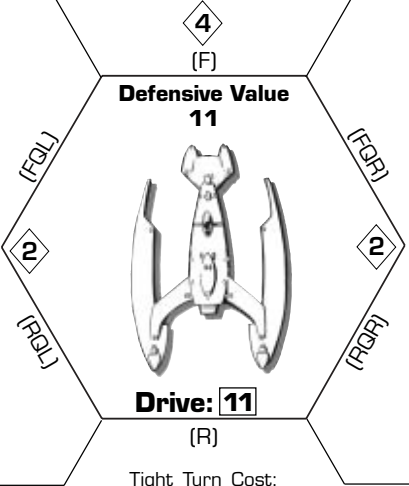

RIGHT SIDE
DAMAGE TRACK

		2				1	
		*				-1	
		t				w	
		*		w			
	×		-1		t		
							×

Decoys: ○○○○

P-D: 1-7 (6)

Dmg Con: 1-7

Tons: 1200

Gunner C

Missile Launcher (360°)
Lock-on < _____

○ ○ ○ ○ ○ ○ ○ ○ ○ ○

○ ○ ○ ○ ○ ○ ○ ○ ○ ○

○ ○ ○ ○ ○ ○

Gunner C

4 Pulse Lasers (RQL) (R) (RQR)
To Hit: 2D8+ADB+3
Damage: Low+3
Range: 6/8/20

REAR DAMAGE TRACK

			2		-1	1		-1	*	-1		-1		W		-1	
	×		-1		*		w	-1		-1		-1	w	-1	-1		×

- FRONT CRITICAL HITS**
- Pilot dazed.** Raven may not move nor fire Pilot weapons until after next game turn.
 - Torps jettison.** All remaining torps are lost.
 - Shields damaged.** Reduce Defensive Value by 1.
 - Meld Lasers Targeting system hit.** Reduce each Meld Laser's chance To Hit by 1.
 - Disintegrator loses power.** It cannot fire until after next turn.
 - Heavy structural damage.** 3 hits on each Damage Track.
 - Pilot killed.** Raven cannot fire Pilot weapons or move. Defensive Value drops to 5.

- LEFT SIDE CRITICAL HITS**
- Structural damage.** 5 hits on the Left and 2 on the Right.
 - Gunner A's Disintegrator damaged.** Weapon system suffers -3 To Hit.
 - Shields damaged.** Reduce Defensive Value by 2.
 - Structural damage.** Take 3 hits to the Front damage track.
 - Gunner A's Pulse Lasers damaged.** Weapon system suffers -2 To Hit.
 - Gunner A killed.** His or her weapons may not be fired.
 - Electronic Warfare gone.** Raven may no longer jam torps. Reduce Defensive Value by 2.

- RIGHT SIDE CRITICAL HITS**
- Structural damage.** 5 hits on the Right and 2 on the Left.
 - Gunner B's Disintegrator damaged.** Weapon system suffers -3 To Hit.
 - Shields damaged.** Reduce Defensive Value by 2.
 - Structural damage.** Take 3 hits to the Front damage track.
 - Gunner B's Pulse Lasers damaged.** Weapon system suffers -2 To Hit.
 - Gunner B killed.** His or her weapons may not be fired.
 - Electronic Warfare gone.** Raven may no longer jam torps. Reduce Defensive Value by 2.

- REAR CRITICAL HITS**
- Rear bulkhead collapses.** Take 10 more hits on this Damage Track.
 - Gunner C's Pulse Lasers damaged.** Weapon system suffers -1 To Hit.
 - Shields damaged.** Reduce Defensive Value by 1.
 - Missile Launcher hit.** It loses 1D6 missiles.
 - Maneuver Thrusters hit.** All turns cost 1 extra movement point to perform.
 - Gunner C killed.** His or her weapons may not be fired.
 - Reactor detonates.** Star Raven is completely destroyed.

Silent Death

Talon

Colos, Hibernia, Kashmere, Sigurd, Unkulunkulu, Primate, Q'raj.

Talon II

Hibernia, Kashmere, Q'raj.

Bellicose Design Conglomerate T5b "Talon"

Crew: 1

Maneuvering Thrust: 0.153 km/s/s

Mass: 270 tons

Translight Capability: None

Armor: Crystanium w/belt

Atmospheric Capability: None

Armaments:

2 x Mk. 10 Disruptorgun

2 x Mk. 10 Pulse Lasers

1 x Mk. 10 Torp Load

Commentary: Bellicose Designs is a long-standing, independent production house that's willing to supply just about anyone with innovative designs, as long as they can pay the sometimes exorbitant bills. More than once, Bellicose has been forced to hire the Warworlders to collect on an outstanding invoice.

The Talon spent many years on the drawing board and was rushed into production when House Colos demanded it for their war against House Ptolemus. Deliveries were made to front line units in late Imp 475 where it was sent into battle relatively untested. After some teething problems were fixed, the Talon served adequately, and it proved its worth several times over in the course of the Terran-Hatchling War.

The Talon bridges the gap between light and medium fighters. Its high Defensive Value should help ward off some crucial closing defensive fire as it maneuvers for its point-blank Dual-Disruptorgun shot. Use small groups of Talons to corral and intimidate your foe, but save your best pilot for a sturdier mount.

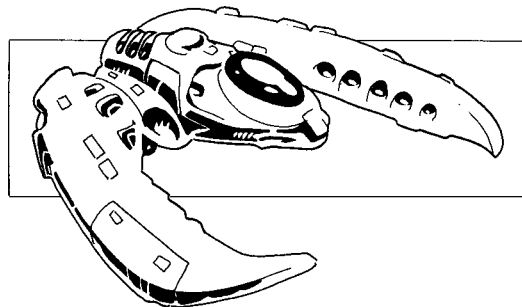

Bellicose Design Conglomerate T5c "Talon II"

Crew: 1

Maneuvering Thrust: 0.158 km/s/s

Mass: 270 tons

Translight Capability: None

Armor: Crystanium w/belt

Atmospheric Capability: None

Armaments:

2 x Mk. 10 Disruptorgun

2 x Mk. 10 Pulse Lasers

4 x Mk. 10 Torp Load

Commentary: Bellicose Designs created this version of the Talon for the Kashmere Collective, in exchange for as yet undisclosed Kashmere "favors." The original Talon design was modified to match the quickness of the smaller fighter craft favored by the pirates that often plague Kashmere transports. The torp load was increased to give the Talon II more presence against larger ships as well.

Sacrificing some of its armor for quickness and maneuverability, the new Talon is as quick as most light fighters. Its increased torp load should help soften up larger foes, so the Talon II can swoop in and finish them with a close-range disruptor barrage.

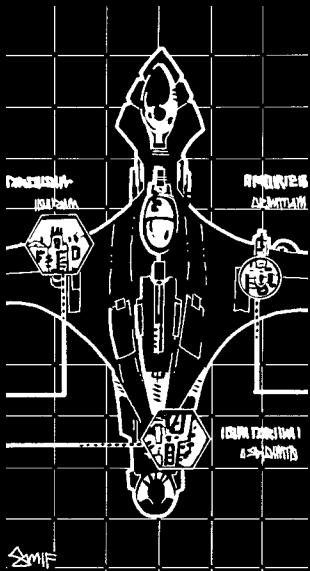

TALON**I.D.****BPV: 33**

TPV

Pilot
2 Disruptorguns (F)
 To Hit: 2D8+ADB+1
 Damage: Medium+1 §
 Range: 1/2/6

Crew
PILOT
 Plt: _____
 Gnr: _____
 Luck: _____

Mk. 10
Torp

Pilot
2 Pulse Lasers (F)
 To Hit: 2D8+ADB+1
 Damage: Low+1
 Range: 3/9/10

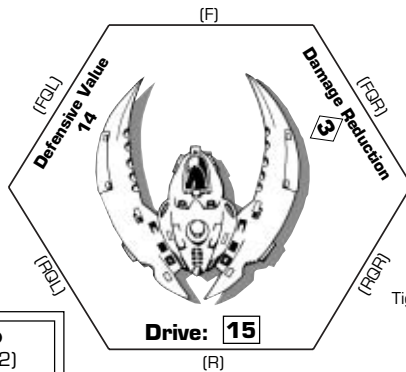

Tight Turn Cost: _____+3

Decoys: ○
 P-D: 1-5 (2)
 Dmg Con: 1-3
 Tons: 270

DAMAGE TRACK

→	3		2	15	*	1	14	13	12	11	
		W	10	*		9		w		8	
			7		6	5	3	1	t		×

TALON**I.D.****BPV: 33**

TPV

Pilot
2 Disruptorguns (F)
 To Hit: 2D8+ADB+1
 Damage: Medium+1 §
 Range: 1/2/6

Crew
PILOT
 Plt: _____
 Gnr: _____
 Luck: _____

Mk. 10
Torp

Pilot
2 Pulse Lasers (F)
 To Hit: 2D8+ADB+1
 Damage: Low+1
 Range: 3/9/10

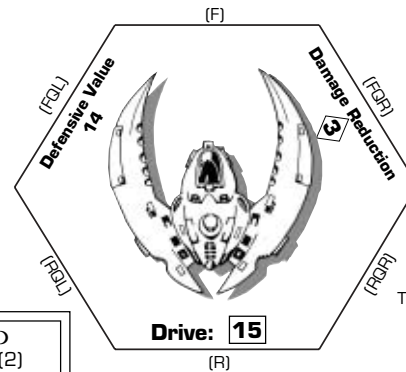

Tight Turn Cost: _____+3

Decoys: ○
 P-D: 1-5 (2)
 Dmg Con: 1-3
 Tons: 270

DAMAGE TRACK

→	3		2	15	*	1	14	13	12	11	
		W	10	*		9		w		8	
			7		6	5	3	1	t		×

CRITICAL HITS

- 2 — **Pilot killed.** Talon may perform no further actions. Defensive Value drops to 5.
- 3 — **Hull breached.** Reduce Talon's Defensive Value by 6.
- 4 — **Electronic Warfare knocked out.** Talon may no longer jam torps. Reduce Defensive Value by 4.
- 5 — **Maneuver Thrusters damaged.** All turns cost 1 extra movement point to perform. Reduce Defensive Value by 2.
- 6 — **Shields damaged.** Reduce Defensive Value by 1.
- 7 — **Stabilizers damaged.** All turns cost 1 extra movement point.
- 8 — **Evade Thrusters hit.** Reduce Defensive Value by 2.
- 9 — **Disruptorgun Targeters damaged.** All further Disruptorgun To Hit attempts suffer a -2 modifier.
- 10 — **Engines momentarily lose power.** Reduce current Drive value to 4 until after next game turn.
- 11 — **Pilot dazed.** Talon may not move or discharge any weapon until after the next game turn.
- 12 — **Reactor hit.** Talon explodes into a ball of molten slag.

DISRUPTORGUN SPECS

Short Range: 1 hex (+1 To Hit).
Medium Range: 2 hexes.
Long Range: 3-6 hexes (-1 To Hit).
 § If target's Defensive Value has not been reduced by a critical hit, add 1 to its Defensive Value. Also, completely ignore target's Damage Reduction when resolving a hit.

PULSE LASER SPECS

Short Range: 1-3 hexes (+1 To Hit).
Medium Range: 4-9 hexes.
Long Range: 10 hexes (-1 To Hit).

GAME TURN RECORD TRACK

1	2	3	4	5	6	7	8	9	10	11	12	13	14	15	16	17	18	19	20
---	---	---	---	---	---	---	---	---	----	----	----	----	----	----	----	----	----	----	----

TPV

Pilot
2 Disruptorguns (F)
 To Hit: 2D8+ADB+1
 Damage: Medium+1 §
 Range: 1/2/6

Crew
PILOT
 Plt: _____
 Gnr: _____
 Luck: _____

Mk. 10
Torp

Pilot
2 Pulse Lasers (F)
 To Hit: 2D8+ADB+1
 Damage: Low+1
 Range: 3/9/10

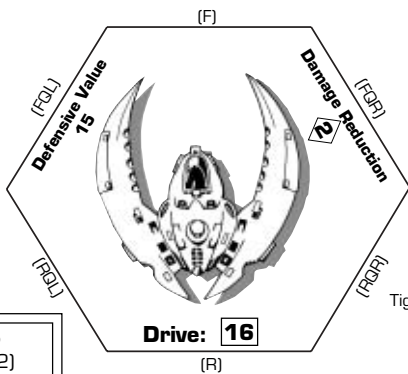

Tight Turn Cost: _____+3

Decoys: ○
 P-D: 1-5 (2)
 Dmg Con: 1-3
 Tons: 270

DAMAGE TRACK

→	t	16	2	t	15	*	1	14	13	12	11
	W		10		*	t	9		w		8
		7		6	5	3	1	t			×

TPV

Pilot
2 Disruptorguns (F)
 To Hit: 2D8+ADB+1
 Damage: Medium+1 §
 Range: 1/2/6

Crew
PILOT
 Plt: _____
 Gnr: _____
 Luck: _____

Mk. 10
Torp

Pilot
2 Pulse Lasers (F)
 To Hit: 2D8+ADB+1
 Damage: Low+1
 Range: 3/9/10

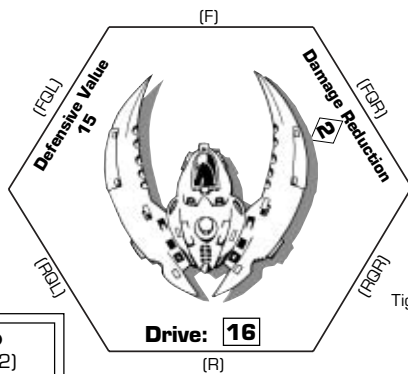

Tight Turn Cost: _____+3

Decoys: ○
 P-D: 1-5 (2)
 Dmg Con: 1-3
 Tons: 270

DAMAGE TRACK

→	t	16	2	t	15	*	1	14	13	12	11
	W		10		*	t	9		w		8
		7		6	5	3	1	t			×

CRITICAL HITS

- 2 — **Pilot killed.** Talon may perform no further actions. Defensive Value drops to 5.
- 3 — **Hull breached.** Reduce Talon's Defensive Value by 6.
- 4 — **Electronic Warfare knocked out.** Talon may no longer jam torps. Reduce Defensive Value by 4.
- 5 — **Maneuver Thrusters damaged.** All turns cost 1 extra movement point to perform. Reduce Defensive Value by 2.
- 6 — **Shields damaged.** Reduce Defensive Value by 1.
- 7 — **Stabilizers damaged.** All turns cost 1 extra movement point.
- 8 — **Evade Thrusters hit.** Reduce Defensive Value by 2.
- 9 — **Disruptorgun Targeters damaged.** All further Disruptorgun To Hit attempts suffer a -2 modifier.
- 10 — **Engines momentarily lose power.** Reduce current Drive value to 4 until after next game turn.
- 11 — **Pilot dazed.** Talon may not move or discharge any weapon until after the next game turn.
- 12 — **Reactor hit.** Talon explodes into a ball of molten slag.

DISRUPTORGUN SPECS

Short Range: 1 hex (+1 To Hit).

Medium Range: 2 hexes.

Long Range: 3-6 hexes (-1 To Hit).

§ If target's Defensive Value has not been reduced by a critical hit, add 1 to its Defensive Value. Also, completely ignore target's Damage Reduction when resolving a hit.

PULSE LASER SPECS

Short Range: 1-3 hexes (+1 To Hit).

Medium Range: 4-9 hexes.

Long Range: 10 hexes (-1 To Hit).

GAME TURN RECORD TRACK

1	2	3	4	5	6	7	8	9	10	11	12	13	14	15	16	17	18	19	20
---	---	---	---	---	---	---	---	---	----	----	----	----	----	----	----	----	----	----	----

Imperial Transtar I320 series F "Teal Hawk"

Crew: 2

Maneuver Thrust: 0.177 km/s/s

Mass: 300 tons

Translight Capability: None

Armor: Crystanium w/belt

Atmospheric Capability: Full

Armaments:

2 x Mk. 15 Blatgun Blast Cannons

1 x Mk. 10 Explosive Torpedo

Commentary: Another production model of Transtar's relatively successful "Hawk" line of fighters, the late-coming Teal Hawk has not proven to be nearly as popular as its predecessors. Its main weapon system is not well suited to typically heated SPAC dogfights, while the second crewmember is largely extraneous. Still, in some parts of Terran space, the Teal Hawk is the cutting edge of starfighter tech, and in these isolated pockets, it does well.

More of these pockets cropped up after the Terran-Hatchling War. Many governments were happy to have anything for their military to fly, and so the Teal Hawk survives.

Despite its bad press, the Teal Hawk is a great fighter to have waiting in the wings. As a battle progresses, use the Teal Hawk to swoop in and pick-off damaged opponents. Its excellent speed ensures that it will escape torps and hounding fighters whenever necessary. Because there is only a small chance that you will have to switch gunners after the first crit, it is generally a good idea to give the Pilot or Gunner a Gunnery value of 1 to save on points.

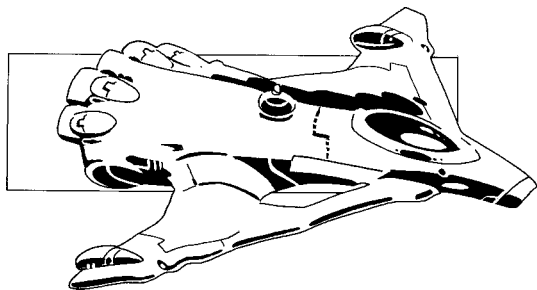

Imperial Transtar I320.2 series F "Teal Hawk II"

Crew: 2

Maneuver Thrust: 0.177 km/s/s

Mass: 300 tons

Translight Capability: None

Armor: Crystanium w/belt

Atmospheric Capability: Full

Armaments:

2 x Mk. 15 Blatgun Blast Cannons

4 x Mk. 10 Explosive Torpedoes

Commentary: Since the Teal Hawk has not seen significant use in any but the most outlying areas, Imperial Transtar has slowed production of the Teal Hawk in recent years to concentrate on its other fighter lines. Transtar currently has no plans for an official redesign of the vessel.

The Teal Hawk II is an example of the most commonly found retrofit of the original Hawk, typically performed by the ship technicians of the various groups that still use it. Designed to give the Teal Hawk extra punch against fighters which typically out-gun it, the larger torp load has created an additional benefit: the placement of the torps has balanced the bird, giving the Teal Hawk II a better maneuverability (and therefore Defensive Value) than its predecessor.

While still not as useful as other fighters in its class, the Teal Hawk II is still an adequate ship in a reserve wing. The second crew member is still extraneous, so save some points and give the Pilot or Gunner a Gunnery of 1.

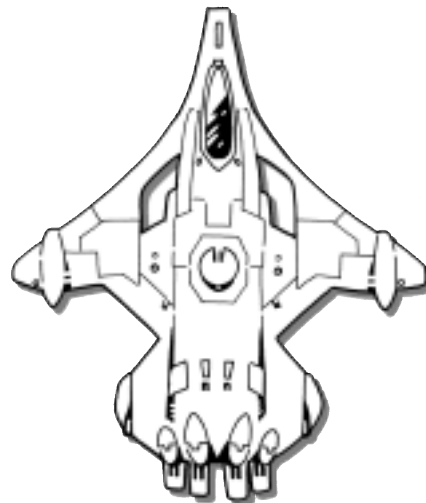

The Next Millennium

Teal Hawk

ASP, Colos, Data
Sphere, Q'raj.

Teal Hawk II

ASP, Q'raj.

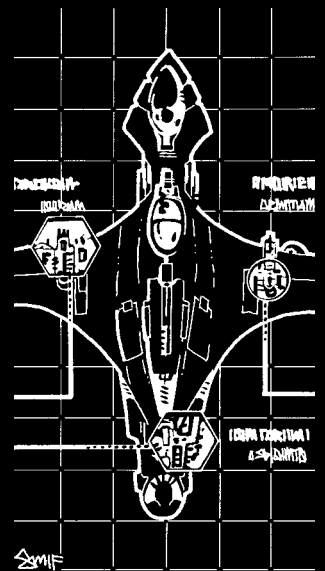

BPV: 43 I.D. ■ TEAL HAWK

TPV

■ Pilot or Gunner ■
2 Blatguns (F)
 To Hit: 2D6+ADB+1
 To Hit: 2D6+ADB+1
 Damage: High+2
 Range: 4/10/15
 Target SR ≤13

■ Crew ■
PILOT
 Plt: _____
 Gnr: _____
 Luck: _____
GUNNER
 Gnr: _____

Mk. 10
Torp

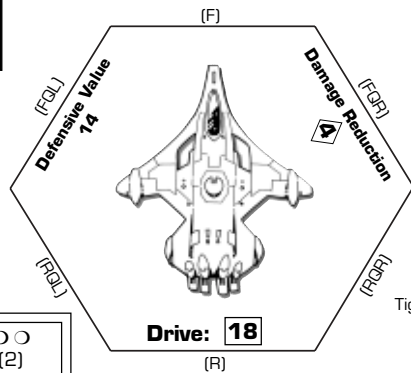

Decoys: ○ ○
 P-D: 1-3 (2)
 Dmg Con: 1-3
 Tons: 300

DAMAGE TRACK

→		18		4	*	17		16	3	t		15
	2		14	1			13	w	12		11	
	10		9	8	7	6	5	4	3	2	1	×

BPV: 43 I.D. ■ TEAL HAWK

TPV

■ Pilot or Gunner ■
2 Blatguns (F)
 To Hit: 2D6+ADB+1
 To Hit: 2D6+ADB+1
 Damage: High+2
 Range: 4/10/15
 Target SR ≤13

■ Crew ■
PILOT
 Plt: _____
 Gnr: _____
 Luck: _____
GUNNER
 Gnr: _____

Mk. 10
Torp

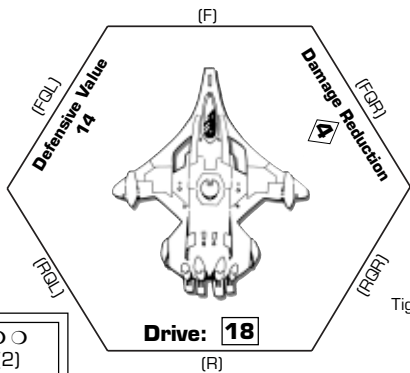

Decoys: ○ ○
 P-D: 1-3 (2)
 Dmg Con: 1-3
 Tons: 300

DAMAGE TRACK

→		18		4	*	17		16	3	t		15
	2		14	1			13	w	12		11	
	10		9	8	7	6	5	4	3	2	1	×

CRITICAL HITS

- 2 — Crew killed. Teal Hawk may perform no further actions. Defensive Value drops to 5.
- 3 — Engines sputter. Teal Hawk may only use 4 movement points next game turn. Reduce Defensive Value by 6 due to additional damage.
- 4 — Electronic Warfare knocked out. Teal Hawk may no longer jam torps. Reduce Defensive Value by 5.
- 5 — Maneuver Thrusters damaged. All turns, including tight turns, cost one extra movement point to perform.
- 6 — Shields damaged. Reduce Defensive Value by 2.
- 7 — Pilot's Trigger Mechanism jams. Pilot may not use Blatguns.
- 8 — Blatgun Targeters damaged. Blatguns may not be fired until after the next game turn.
- 9 — Hull compromised. Reduce Defensive Value by 4.
- 10 — Gunner killed. Teal Hawk may not use the gunner's ADB for the Blatgun weapon system.
- 11 — Pilot dazed. Teal Hawk may not move until after the next game turn. Only the gunner may fire the Blatguns while the pilot is dazed.
- 12 — Reactor hit. Teal Hawk explodes and is destroyed.

BLATGUN SPECS

Short Range: 1-4 hexes (+1 To Hit).
Medium Range: 5-10 hexes.
Long Range: 11-15 hexes (-1 To Hit).
Target Speed Restriction: Target's Drive value must be ≤13.
Special Note: The Teal Hawk's Blatgun weapons may be fired by the Pilot or the Gunner, and the firer may change turn to turn. Use the correct ADB.

GAME TURN RECORD TRACK

1	2	3	4	5	6	7	8	9	10	11	12	13	14	15	16	17	18	19	20
---	---	---	---	---	---	---	---	---	----	----	----	----	----	----	----	----	----	----	----

BPV: 47 I.D. ■ TEAL HAWK II

TPV

■ Pilot or Gunner ■
2 Blatguns (F)
 To Hit: 2D6+ADB+1
 To Hit: 2D6+ADB+1
 Damage: High+2
 Range: 4/10/15
 Target SR ≤13

■ Crew ■
PILOT
 Plt: _____
 Gnr: _____
 Luck: _____
GUNNER
 Gnr: _____

Mk. 10
Torps

○
○
○
○

Drive: **18**

Tight Turn Cost: _____+3

Decoys: ○ ○
 P-D: 1-3 (2)
 Dmg Con: 1-3
 Tons: 300

DAMAGE TRACK

→	t	18		4	*	17		16	3	t		15	
	2		14	1	t		13	*	w	12		11	t
	10		9	8	7	6	5	4	3	2	1		×

BPV: 47 I.D. ■ TEAL HAWK II

TPV

■ Pilot or Gunner ■
2 Blatguns (F)
 To Hit: 2D6+ADB+1
 To Hit: 2D6+ADB+1
 Damage: High+2
 Range: 4/10/15
 Target SR ≤13

■ Crew ■
PILOT
 Plt: _____
 Gnr: _____
 Luck: _____
GUNNER
 Gnr: _____

Mk. 10
Torps

○
○
○
○

Drive: **18**

Tight Turn Cost: _____+3

Decoys: ○ ○
 P-D: 1-3 (2)
 Dmg Con: 1-3
 Tons: 300

DAMAGE TRACK

→	t	18		4	*	17		16	3	t		15	
	2		14	1	t		13	*	w	12		11	t
	10		9	8	7	6	5	4	3	2	1		×

CRITICAL HITS

- 2 — **Crew killed.** Teal Hawk may perform no further actions. Defensive Value drops to 5.
- 3 — **Engines sputter.** Teal Hawk may only use 4 movement points next game turn. Reduce Defensive Value by 6 due to additional damage.
- 4 — **Electronic Warfare knocked out.** Teal Hawk may no longer jam torps. Reduce Defensive Value by 5.
- 5 — **Maneuver Thrusters damaged.** All turns, including tight turns, cost one extra movement point to perform.
- 6 — **Shields damaged.** Reduce Defensive Value by 2.
- 7 — **Pilot's Trigger Mechanism jams.** Pilot may not use Blatguns.
- 8 — **Blatgun Targeters damaged.** Blatguns may not be fired until after the next game turn.
- 9 — **Hull compromised.** Reduce Defensive Value by 4.
- 10 — **Gunner killed.** Teal Hawk may not use the gunner's ADB for the Blatgun weapon system.
- 11 — **Pilot dazed.** Teal Hawk may not move until after the next game turn. Only the gunner may fire the Blatguns while the pilot is dazed.
- 12 — **Reactor hit.** Teal Hawk explodes and is destroyed.

BLATGUN SPECS

Short Range: 1-4 hexes (+1 To Hit).
Medium Range: 5-10 hexes.
Long Range: 11-15 hexes (-1 To Hit).
Target Speed Restriction: Target's Drive value must be ≤13.
Special Note: The Teal Hawk's Blatgun weapons may be fired by the Pilot or the Gunner, and the firer may change turn to turn. Use the correct ADB.

GAME TURN RECORD TRACK

1	2	3	4	5	6	7	8	9	10	11	12	13	14	15	16	17	18	19	20
---	---	---	---	---	---	---	---	---	----	----	----	----	----	----	----	----	----	----	----

Silent Death

Thunder Bird

ASP, Colos, Kashmere, Q'raj, Tokugawa, Yoka-Shan.

Thunder Bird II

Colos, Tokugawa.

Imperial Transtar 1020 series H "Thunder Bird"

Crew: 1

Maneuver Thrust: 0.155 km/s/s

Mass: 200 tons

Translight Capability: None

Armor: Crystanium w/belt

Atmospheric Capability: Full

Armaments:

4 x Mk. 10 Pulse Laser Cannons

1 x Mk. 20 Explosive Torpedo

4 x Mk. 10 Explosive Torpedoes

Commentary: The Thunder Bird is an aging Imperial SPAC Fighter which is now widely used throughout Terran space. Though an adequate design, this vessel has been bolstered by the introduction of an increased torp load. A popular ship, it can be found in many of the Twelve's militaries, as well as in the forces of mercenaries and pirates across all of Terran space.

Many pundits of the starcraft industry consider the Thunder Bird to be a piece of junk, but if you can avoid enemy attention for a few game turns, it's easy to exploit this design's advantages. Just don't get too eager with this ship, and you'll eventually get your chance to use it.

Even so, the Thunder Bird's far from a useless vessel. First of all, it's fast, and second, it carries five torpedoes. Use the Thunder Bird to outflank opponents, then launch torps to drive foes into the guns of your better ships.

Taking a crit after four hits is this craft's bane, but the key to using the Thunder Bird is not taking fire until after its job is done. Use it well, and it won't fail you.

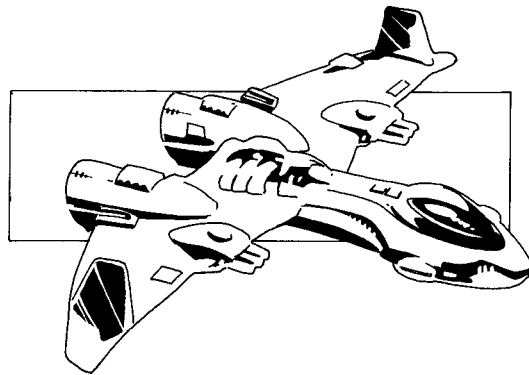

Imperial Transtar 1020.1 series H "Thunder Bird II"

Crew: 1

Maneuver Thrust: 0.155 km/s/s

Mass: 200 tons

Translight Capability: None

Armor: Crystanium w/belt

Atmospheric Capability: Full

Armaments:

1 x Mk. 9 Minigun

(Ammo: 18,000 rounds)

1 x Missile Launcher

(Magazine: 10 missiles)

1 x Mk. 20 Explosive Torpedo

4 x Mk. 10 Explosive Torpedoes

Commentary: Ever mindful of their pledge to reclaim Mars, the leaders of the Red Star Navy realized the need to maximize the firepower of their ships. All their refits bear this goal in mind.

The Thunderbird is a highly effect light ship, but the damage potential of its lasers is not up to that necessary to take on the Grubs. To increase this firepower, the quad Pulse Lasers were replaced with the quad Miniguns. It was felt that the slight decrease in accuracy and the dependence on ammo would be more than compensated for by the increased range and destructive potential of the new mount. To further increase the ship's firepower, the Mk. 20 torp was sacrificed for a Missile Launcher with 10 missiles.

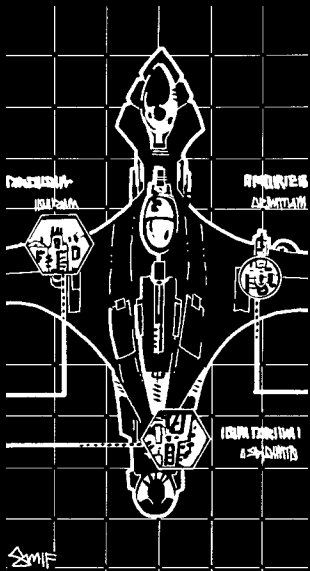
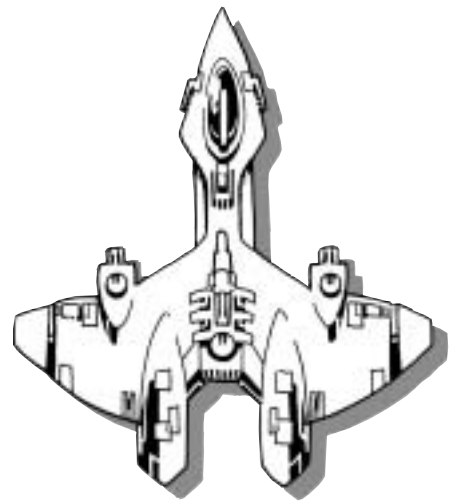

BPV: 25 I.D. THUNDER BIRD

TPV

Pilot
4 Pulse Lasers (F)
 To Hit: 2D8+ADB+3
 Damage: Low+3
 Range: 3/9/10

Crew
PILOT
 Plt: _____
 Gnr: _____
 Luck: _____

Mk. 20
Torp

Mk. 10
Torps

Decoys: ○ ○
 P-D: 1-5 (2)
 Dmg Con: 1-3
 Tons: 200

Drive: **16**

Tight Turn Cost: _____+3

DAMAGE TRACK

→	16	1	*	14	t	11		
	T	*		9	w	5	t	1

BPV: 25 I.D. THUNDER BIRD

TPV

Pilot
4 Pulse Lasers (F)
 To Hit: 2D8+ADB+3
 Damage: Low+3
 Range: 3/9/10

Crew
PILOT
 Plt: _____
 Gnr: _____
 Luck: _____

Mk. 20
Torp

Mk. 10
Torps

Decoys: ○ ○
 P-D: 1-5 (2)
 Dmg Con: 1-3
 Tons: 200

Drive: **16**

Tight Turn Cost: _____+3

DAMAGE TRACK

→	16	1	*	14	t	11		
	T	*		9	w	5	t	1

BPV: 25 I.D. THUNDER BIRD

TPV

Pilot
4 Pulse Lasers (F)
 To Hit: 2D8+ADB+3
 Damage: Low+3
 Range: 3/9/10

Crew
PILOT
 Plt: _____
 Gnr: _____
 Luck: _____

Mk. 20
Torp

Mk. 10
Torps

Decoys: ○ ○
 P-D: 1-5 (2)
 Dmg Con: 1-3
 Tons: 200

Drive: **16**

Tight Turn Cost: _____+3

DAMAGE TRACK

→	16	1	*	14	t	11		
	T	*		9	w	5	t	1

BPV: 25 I.D. THUNDER BIRD

TPV

Pilot
4 Pulse Lasers (F)
 To Hit: 2D8+ADB+3
 Damage: Low+3
 Range: 3/9/10

Crew
PILOT
 Plt: _____
 Gnr: _____
 Luck: _____

Mk. 20
Torp

Mk. 10
Torps

Decoys: ○ ○
 P-D: 1-5 (2)
 Dmg Con: 1-3
 Tons: 200

Drive: **16**

Tight Turn Cost: _____+3

DAMAGE TRACK

→	16	1	*	14	t	11		
	T	*		9	w	5	t	1

CRITICAL HITS

- 2— **Pilot killed.** Thunder Bird may perform no further actions. Defensive Value drops to 5.
- 3— **Engines severely damaged.** Thunder Bird reduced to a Drive value of 1. Reduce Defensive Value by 7 due to additional damage.
- 4— **Electronic Warfare knocked out.** Thunder Bird may no longer jam torps. Reduce Defensive Value by 5.
- 5— **Maneuver Thrusters damaged.** All turns, including Tight Turns, cost one extra movement point to perform.
- 6— **Shields damaged.** Reduce Defensive Value by 2.
- 7— **Pulse Laser Targeters damaged.** Reduce chance To Hit by 4.
- 8— **Laser Targeters damaged.** Pulse Lasers may not be fired until after the next game turn.
- 9— **Torp Load jettison.** Thunder Bird loses 1D4 remaining torps of the pilot's choice.
- 10— **Engines sputter.** Thunder Bird may only use 2 movement points next game turn. Reduce Defensive Value by 6 due to additional damage.
- 11— **Pilot dazed.** Thunder Bird may not move or fire until after the next game turn.
- 12— **Reactor hit.** Thunder Bird detonates and is destroyed.

PULSE LASER SPECS

Short Range: 1-3 hexes (+1 To Hit).
Medium Range: 4-9 hexes.
Long Range: 10 hexes (-1 To Hit).

THUNDER BIRD II

I.D.
BPV: 24

Pilot
Missile Launcher (F)
Lock-on <
○○○○○
○○○○○

Pilot
4 Miniguns (F)
To Hit: 2D6+ADB+3
Damage: Low+3 †
Range: 2/5/12
○○○○○

Crew
PILOT
Plt: _____
Gnr: _____
Luck: _____

Decoys: ○○
P-D: 1-5 (2)
Dmg Con: 1-3
Tons: 200

TPV

Mk. 10 Torps
○○○○○

DAMAGE TRACK

→	16	1	*	14	t	11		
W	*		9	w	5	t	1	×

THUNDER BIRD II

I.D.
BPV: 24

Pilot
Missile Launcher (F)
Lock-on <
○○○○○
○○○○○

Pilot
4 Miniguns (F)
To Hit: 2D6+ADB+3
Damage: Low+3 †
Range: 2/5/12
○○○○○

Crew
PILOT
Plt: _____
Gnr: _____
Luck: _____

Decoys: ○○
P-D: 1-5 (2)
Dmg Con: 1-3
Tons: 200

TPV

Mk. 10 Torps
○○○○○

DAMAGE TRACK

→	16	1	*	14	t	11		
W	*		9	w	5	t	1	×

THUNDER BIRD II

I.D.
BPV: 24

Pilot
Missile Launcher (F)
Lock-on <
○○○○○
○○○○○

Pilot
4 Miniguns (F)
To Hit: 2D6+ADB+3
Damage: Low+3 †
Range: 2/5/12
○○○○○

Crew
PILOT
Plt: _____
Gnr: _____
Luck: _____

Decoys: ○○
P-D: 1-5 (2)
Dmg Con: 1-3
Tons: 200

TPV

Mk. 10 Torps
○○○○○

DAMAGE TRACK

→	16	1	*	14	t	11		
W	*		9	w	5	t	1	×

THUNDER BIRD II

I.D.
BPV: 24

Pilot
Missile Launcher (F)
Lock-on <
○○○○○
○○○○○

Pilot
4 Miniguns (F)
To Hit: 2D6+ADB+3
Damage: Low+3 †
Range: 2/5/12
○○○○○

Crew
PILOT
Plt: _____
Gnr: _____
Luck: _____

Decoys: ○○
P-D: 1-5 (2)
Dmg Con: 1-3
Tons: 200

TPV

Mk. 10 Torps
○○○○○

DAMAGE TRACK

→	16	1	*	14	t	11		
W	*		9	w	5	t	1	×

CRITICAL HITS

- 2 — **Pilot killed.** Thunder Bird may perform no further actions. Defensive Value drops to 5.
- 3 — **Engines severely damaged.** Thunder Bird reduced to a Drive value of 1. Reduce Defensive Value by 7 due to additional damage.
- 4 — **Electronic Warfare knocked out.** Thunder Bird may no longer jam torps. Reduce Defensive Value by 5.
- 5 — **Maneuver Thrusters damaged.** All turns, including Tight Turns, cost one extra movement point to perform.
- 6 — **Shields damaged.** Reduce Defensive Value by 2.
- 7 — **Missile Launcher Targeters hit.** -2 on all Lock-on attempts.
- 8 — **Minigun Targeters damaged.** Miniguns may not be fired until after the next game turn.
- 9 — **Torp Load jettison.** Thunder Bird loses 1D4 remaining torps.
- 10 — **Engines sputter.** Thunder Bird may only use 2 movement points next game turn. Reduce Defensive Value by 6 due to additional damage.
- 11 — **Pilot dazed.** Thunder Bird may not move or fire until after the next game turn.
- 12 — **Reactor hit.** Thunder Bird detonates and is destroyed.

MINIGUN SPECS †

Short Range: 1-2 hexes (+1 To Hit).
Medium Range: 3-5 hexes.
Long Range: 6-12 hexes (-1 To Hit).
 † Whenever two Attack Dice roll doubles, multiply base damage by 2.

TPV

Gunner A
1 Disruptorgun
 (BRQL) (BFQL) (F)
 To Hit: 2D8+ADB
 Damage: Medium§
 1/2/3-6

Torp Crew G
2 Torpedo Tubes

 (BFQL)

Gunner A
Missile Launcher
 (BRQL) (BFQL) (F)
 Lock-on < ____
 ○ ○ ○ ○ ○
 ○ ○ ○ ○ ○
 ○ ○ ○ ○ ○
 ○ ○ ○ ○ ○

Gunner B
1 Disruptorgun
 (F) (BFQR) (BRQR)
 To Hit: 2D8+ADB
 Damage: Medium§
 1/2/3-6

Torp Crew F
2 Torpedo Tubes

 (BFQR)

Gunner B
Missile Launcher
 (F) (BFQR) (BRQR)
 Lock-on < ____
 ○ ○ ○ ○ ○
 ○ ○ ○ ○ ○
 ○ ○ ○ ○ ○
 ○ ○ ○ ○ ○

Crew
CAPTAIN
 Cpn: _____
PILOT
 Plt: _____
GUNNER A
 Gnr: _____
GUNNER B
 Gnr: _____
GUNNER C
 Gnr: _____
GUNNER D
 Gnr: _____
GUNNER E
 Gnr: _____
T CREW F
 Gnr: _____
T CREW G
 Gnr: _____

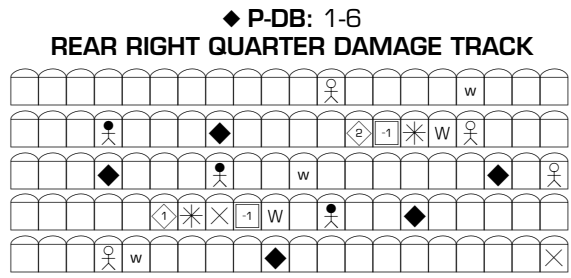
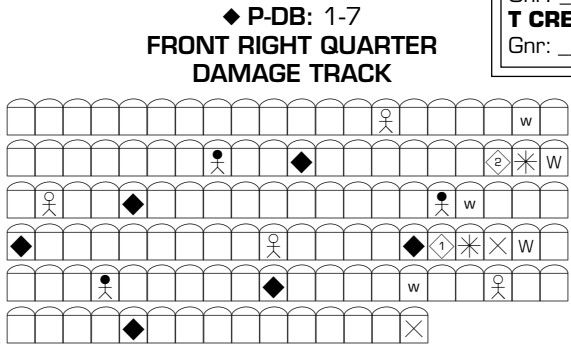
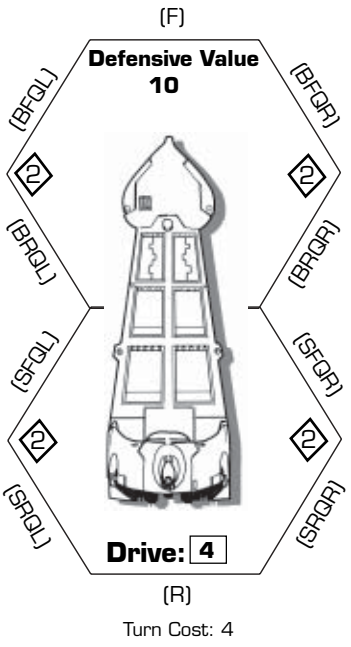
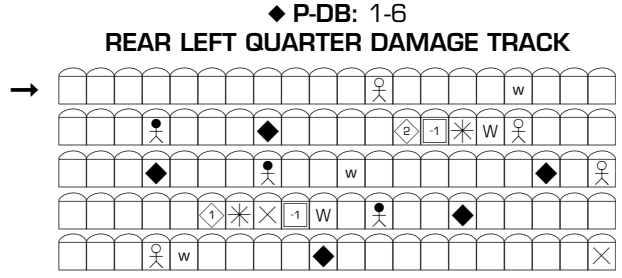
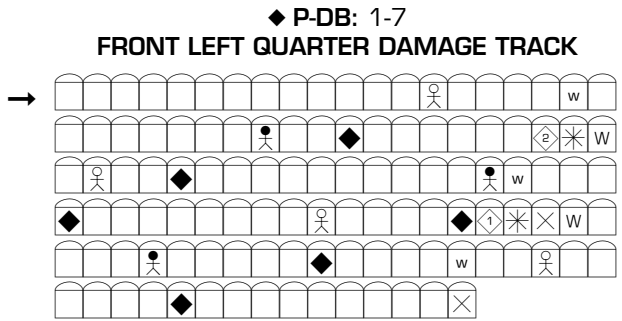

Gunner C
1 Disruptorgun
 (SFQL) (SRQL) (R)
 To Hit: 2D8+ADB
 Damage: Medium§
 1/2/3-6

Gunner C
Missile Launcher
 (SFQL) (SRQL) (R)
 Lock-on < ____
 ○ ○ ○ ○ ○
 ○ ○ ○ ○ ○
 ○ ○ ○ ○ ○
 ○ ○ ○ ○ ○

Gunner E
6 Pulse Lasers
 (SFQL) (SRQL) (R) (SRQR) (SFQR)
 To Hit: 2D8+ADB+5
 Damage: Low+5
 1-3/4-9/10

Gunner D
1 Disruptorgun
 (R) (SRQR) (SFQR)
 To Hit: 2D8+ADB
 Damage: Medium§
 1/2/3-6

Gunner D
Missile Launcher
 (R) (SRQR) (SFQR)
 Lock-on < ____
 ○ ○ ○ ○ ○
 ○ ○ ○ ○ ○
 ○ ○ ○ ○ ○
 ○ ○ ○ ○ ○

FRONT LEFT CRITICAL HITS

- 2— **Electronic Warfare gone.** Aoshu may no longer jam torps. Reduce Defensive Value by 2.
- 3— **Port torpedo room explosion.** Torpedo room loses 1 crew and 2 torpedoes.
- 4— **Fighter bay hit.** Roll on Fighter Bay Hit Table.
- 5— **Torpedo Room loses power.** No torpedoes may be launched until after next turn. All of the Aoshu's DXH torps detonate.
- 6— **Buckled armor.** Reduce Damage Reduction by 1.
- 7— **Disruptorgun A loses power.** Weapon may not fire next turn.
- 8— **Missile Launcher A malfunction.** Lose 1D10 Remaining missiles.
- 9— **Torpedo Magazine hit.** 1D10 torpedoes are destroyed.
- 10— **Gunner A killed.** This gunner's weapons may not be fired.
- 11— **Bridge hit!** Bridge crew is stunned. Aoshu may not move next turn.
- 12— **Major structural damage.** Take 15 more hits on this track.

AOSHO

Bow Torpedo Magazine

Mk. 10	Mk. 20	Mk. 100
○ ○	○ ○ ○ ○	○ ○
○ ○	○ ○ ○ ○	○ ○
○ ○	○ ○ ○ ○	○ ○
○ ○	○ ○ ○ ○	○ ○
○ ○	○ ○ ○ ○	○ ○

Fighter Bay 1

400-ton Fighter
○ ID: _____

Type: _____

Fighter Bay 2

400-ton Fighter
○ ID: _____

Type: _____

FRONT RIGHT CRITICAL HITS

- 2— **Electronic Warfare gone.** Aoshu may no longer jam torps. Reduce Defensive Value by 2.
- 3— **Starboard torpedo room explosion.** Torpedo room loses 1 crew and 2 torpedoes.
- 4— **Fighter bay hit.** Roll on Fighter Bay Hit Table.
- 5— **Torpedo Room loses power.** No torpedoes may be launched until after next turn. All of the Aoshu's DXH torps detonate.
- 6— **Buckled armor.** Reduce Damage Reduction by 1.
- 7— **Disruptorgun B loses power.** Weapon may not fire next turn.
- 8— **Missile Launcher B malfunction.** Lose 1D10 Remaining missiles.
- 9— **Torpedo Magazine hit.** 1D10 torpedoes are destroyed.
- 10— **Gunner B killed.** This gunner's weapons may not be fired.
- 11— **Bridge hit!** Bridge crew is stunned. Aoshu may not move next turn.
- 12— **Major structural damage.** Take 15 more hits on this track.

REAR LEFT CRITICAL HITS

- 2— **Bridge hit!** The captain is killed. Aoshu may no longer use Captain die.
- 3— **Major structural damage.** Take 10 more hits on this damage track.
- 4— **Bulkhead collapse.** Take 5 more hits on this track.
- 5— **Disruptorgun C damaged.** Weapon suffers -2 penalty to hit.
- 6— **Fighter bay hit.** Roll on Fighter Bay Hit Table.
- 7— **Missile Launcher C malfunction.** Lose 1D10 missiles.
- 8— **Engineering hit!** Damage Control is not available until after next turn.
- 9— **Power coupling severed.** No weapons may be fired next turn.
- 10— **Gunner C killed.** This gunner's weapons may not be fired.
- 11— **Engineering section destroyed.** Damage control is no longer available.
- 12— **Reactor hit.** Aoshu becomes a gaseous cloud.

Electronics

Jam: 1-2 on 1D4
ECM: 1-5(5)

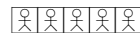

Bridge

Captain: _____
Pilot: _____
TOC: None

Fighter Bay 3

400-ton Fighter
○ ID: _____

Type: _____

Fighter Bay 4

400-ton Fighter
○ ID: _____

Type: _____

Fighter Bay 5

400-ton Fighter
○ ID: _____

Type: _____

Fighter Bay 6

400-ton Fighter
○ ID: _____

Type: _____

Engineering

Damage Control 1-6

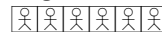

REAR RIGHT CRITICAL HITS

- 2— **Bridge hit!** The captain is killed. Aoshu may no longer use Captain die.
- 3— **Major structural damage.** Take 10 more hits on this damage track.
- 4— **Bulkhead collapse.** Take 5 more hits on this track.
- 5— **Disruptorgun D damaged.** Weapon suffers -2 penalty to hit.
- 6— **Fighter bay hit.** Roll on Fighter Bay Hit Table.
- 7— **Missile Launcher D malfunction.** Lose 1D10 missiles.
- 8— **Engineering hit!** Damage Control is not available until after next turn.
- 9— **Power coupling severed.** No weapons may be fired next turn.
- 10— **Gunner D killed.** This gunner's weapons may not be fired.
- 11— **Engineering section destroyed.** Damage control is no longer available.
- 12— **Reactor hit.** Aoshu becomes a gaseous cloud.

■ **TPV** ■

■ **Gun Crew E** ■
3 Laztubes (BRQL) (BFQL) (F)
 (BFQR) (BRQR)
 To Hit: 2D10+ADB+3
 Damage: (High+3) x 2
 1-10/11-20/21-40
 Target SR ≤ 6

■ **Gunner A** ■
2 Disruptorguns
 (BRQL)(BFQL)(F)
 To Hit: 2D8+ADB+1
 Damage: Medium+1S
 1/2/3-6

■ **Torp Crew F** ■
2 Torpedo Tubes
 (BFQL)

■ **Gunner A** ■
Missile Launcher
 (BRQL)(BFQL)(F)
 Lock-on < ____
 ○ ○ ○ ○ ○
 ○ ○ ○ ○ ○
 ○ ○ ○ ○ ○
 ○ ○ ○ ○ ○
 ○ ○ ○ ○ ○

■ **Gunner B** ■
2 Disruptorguns
 (F)(BFQR)(BRQR)
 To Hit: 2D8+ADB+1
 Damage: Medium+1S
 1/2/3-6

■ **Torp Crew G** ■
2 Torpedo Tubes
 (BFQR)

■ **Gunner B** ■
Missile Launcher
 (F)(BFQR)(BRQR)
 Lock-on < ____
 ○ ○ ○ ○ ○
 ○ ○ ○ ○ ○
 ○ ○ ○ ○ ○
 ○ ○ ○ ○ ○
 ○ ○ ○ ○ ○

■ **Crew** ■
CAPTAIN
 Cpn: _____
PILOT
 Plt: _____
GUNNER A
 Gnr: _____
GUNNER B
 Gnr: _____
GUNNER C
 Gnr: _____
GUNNER D
 Gnr: _____
CREW E
 Gnr: _____
T CREW F
 Gnr: _____
T CREW G
 Gnr: _____

◆ P-DB: 1-6
**FRONT LEFT QUARTER
 DAMAGE TRACK**

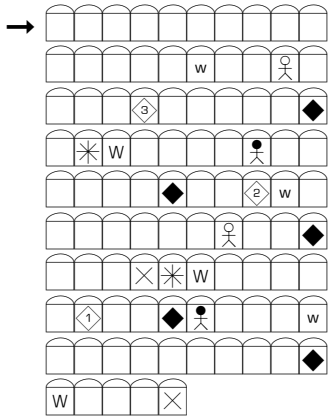

◆ P-DB: 1-6
**REAR LEFT QUARTER
 DAMAGE TRACK**

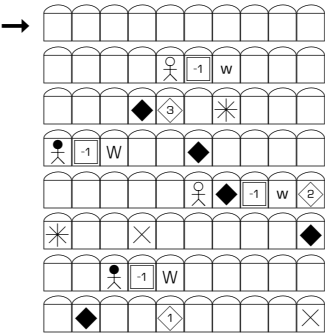

■ **Gunner C** ■
Missile Launcher
 (SFQL) (SRQL) (R)
 Lock-on < ____
 ○ ○ ○ ○ ○
 ○ ○ ○ ○ ○
 ○ ○ ○ ○ ○
 ○ ○ ○ ○ ○
 ○ ○ ○ ○ ○

■ **Gunner C** ■
2 Disruptorguns
 (SFQL) (SRQL) (R)
 To Hit: 2D8+ADB+1
 Damage: Medium+1S
 1/2/3-6

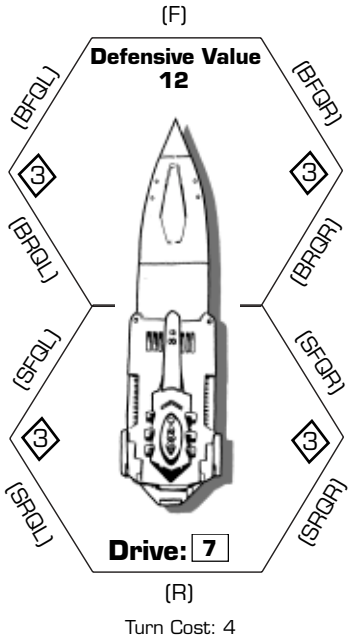

◆ P-DB: 1-6
**FRONT RIGHT
 QUARTER
 DAMAGE TRACK**

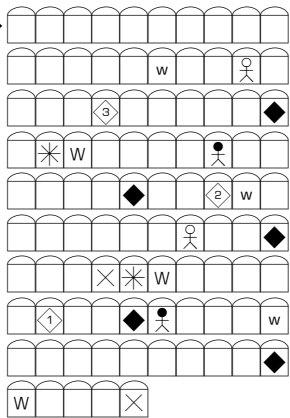

◆ P-DB: 1-6
**REAR RIGHT QUARTER
 DAMAGE TRACK**

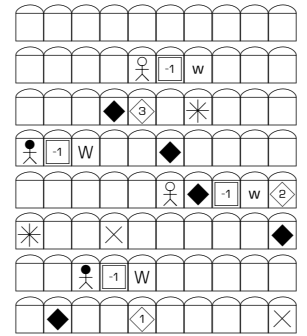

■ **Gunner D** ■
Missile Launcher
 (SFQR) (SRQR) (R)
 Lock-on < ____
 ○ ○ ○ ○ ○
 ○ ○ ○ ○ ○
 ○ ○ ○ ○ ○
 ○ ○ ○ ○ ○
 ○ ○ ○ ○ ○

■ **Gunner D** ■
2 Disruptorguns
 (SFQR) (SRQR) (R)
 To Hit: 2D8+ADB+1
 Damage: Medium+1S
 1/2/3-6

FRONT LEFT CRITICAL HITS

- 2— **Electronic Warfare gone.** Constellation may no longer jam torps. Reduce Defensive Value by 2.
- 3— **Port torpedo room explosion.** Torpedo room loses 1 crew and 2 torpedoes.
- 4— **Gunner A killed.** This gunner's weapons may not be fired.
- 5— **Torpedo magazine hit.** 1D10 torpedoes are destroyed.
- 6— **Missile Launcher A malfunction.** Lose 1D10 Remaining missiles.
- 7— **Twin Disruptorgun A loses power.** Weapon may not fire until after next turn.
- 8— **ECM destroyed.** Ship may no longer perform screening.
- 9— **Torpedo Room loses power.** No torpedoes may be launched until after next turn. All live DXH torps detonate.
- 10— **Bridge hit!** Bridge crew is stunned. Constellation may not move next turn.
- 11— **Triple Laztube crew killed.** 1D3 crew are killed.
- 12— **Major structural damage.** Take 15 more hits on this track.

LEFT RIGHT CRITICAL HITS

- 2— **Bridge hit!** The captain is killed. Player may no longer use Captain die.
- 3— **TOC destroyed.** Constellation may no longer add TOC bonus initiative roll.
- 4— **Power coupling severed.** No weapons may be fired next turn.
- 5— **Shields damaged.** Reduce Defensive Value by 2.
- 6— **Twin Disruptorgun C damaged.** Weapon suffers -2 penalty to hit.
- 7— **Missile Launcher C malfunction.** Lose 1D10 missiles.
- 8— **Engineering hit!** Damage Control is not available until after next turn. Lose D3 engineers.
- 9— **Drives sputter.** Reduce drive by 2 until after next turn.
- 10— **Gunner C killed.** This gunner's weapons may not be fired.
- 11— **Engineering section destroyed.** Damage control is not available. Lose D4 engineers.
- 12— **Reactor hit.** Constellation becomes a gaseous cloud.

CONSTELLATION

Bow Torpedo Magazine

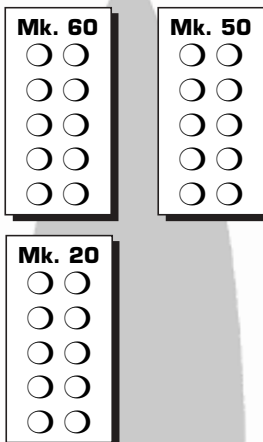

Electronics

Jam: 1-2 on 1D4
ECM: 1-6(4)

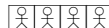

Bridge

Captain: _____
Pilot: _____
TOC: +4

Engineering

Damage Control 1-8



FRONT RIGHT CRITICAL HITS

- 2— **Electronic Warfare gone.** Constellation may no longer jam torps. Reduce Defensive Value by 2.
- 3— **Starboard torpedo room explosion.** Torpedo room loses 1 crew and 2 torpedoes.
- 4— **Gunner B killed.** This gunner's weapons may not be fired.
- 5— **Torpedo magazine hit.** 1D10 torpedoes are destroyed.
- 6— **Missile Launcher B malfunction.** Lose 1D10 Remaining missiles.
- 7— **Twin Disruptorgun B loses power.** Weapon may not fire until after next turn.
- 8— **ECM destroyed.** Ship may no longer perform long-range jamming.
- 9— **Torpedo Room loses power.** No torpedoes may be launched until after next turn. All live DXH torps detonate.
- 10— **Bridge hit!** Bridge crew is stunned. Constellation may not move next turn.
- 11— **Triple Laztube crew killed.** 1D3 crew are killed.
- 12— **Major structural damage.** Take 15 more hits on this track.

REAR RIGHT CRITICAL HITS

- 2— **Bridge hit!** The captain is killed. Player may no longer use Captain die.
- 3— **TOC destroyed.** Constellation may no longer add TOC bonus initiative roll.
- 4— **Power coupling severed.** No weapons may be fired next turn.
- 5— **Shields damaged.** Reduce Defensive Value by 2.
- 6— **Twin Disruptorgun D damaged.** Weapon suffers -2 penalty to hit.
- 7— **Missile Launcher D malfunction.** Lose 1D10 missiles.
- 8— **Engineering hit!** Damage Control is not available until after next turn. Lose D3 engineers.
- 9— **Drives sputter.** Reduce drive by 2 until after next turn.
- 10— **Gunner D killed.** This gunner's weapons may not be fired.
- 11— **Engineering section destroyed.** Damage control is not available. Lose D4 engineers.
- 12— **Reactor hit.** Constellation becomes a gaseous cloud.

TPV

Gunner A
5 Pulse Lasers
 (BRQL) (BFQL) (F)
 To Hit: 2D8+ADB+4
 Damage: Low+4
 1-3/4-9/10

Torp Crew G
2 Torpedo Tubes
 (BFQL)

Gunner A
Missile Launcher
 (BRQL) (BFQL) (F)
 Lock-on < ____
 ○ ○ ○ ○ ○
 ○ ○ ○ ○ ○
 ○ ○ ○ ○ ○
 ○ ○ ○ ○ ○

Gun Crew E
2 Ion Cannons
 (BRQL) (BFQL) (F)
 [BFQR] [BRQR]
 To Hit: 2D8+ADB+1
 Damage: (All+2) x 2
 1-8/9-16/17-30
 Target SR ≤6

Gunner B
5 Pulse Lasers
 (BRQR) (BFQR) (F)
 To Hit: 2D8+ADB+4
 Damage: Low+4
 1-3/4-9/10

Torp Crew H
2 Torpedo Tubes
 (BFQR)

Gunner B
Missile Launcher
 (BRQR) (BFQR) (F)
 Lock-on < ____
 ○ ○ ○ ○ ○
 ○ ○ ○ ○ ○
 ○ ○ ○ ○ ○
 ○ ○ ○ ○ ○

Gun Crew F
Keel Cannon
 (KF)
 To Hit: 2D8+ADB
 Damage: All x 3
 1-10/11-15/16-20

Crew
CAPTAIN
 Cpn: _____
PILOT
 Plt: _____
GUNNER A
 Gnr: _____
GUNNER B
 Gnr: _____
GUNNER C
 Gnr: _____
GUNNER D
 Gnr: _____
CREW E
 Gnr: _____
CREW F
 Gnr: _____
T CREW G
 Gnr: _____
T CREW H
 Gnr: _____

◆ P-DB: 1-7
FRONT LEFT QUARTER DAMAGE TRACK

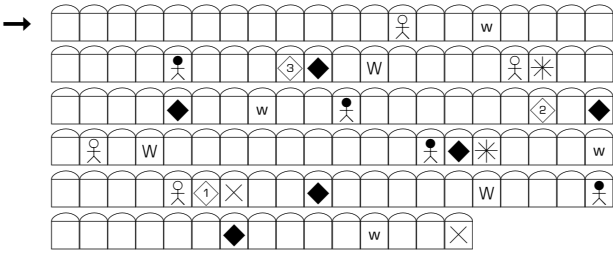

◆ P-DB: 1-6
REAR LEFT QUARTER DAMAGE TRACK

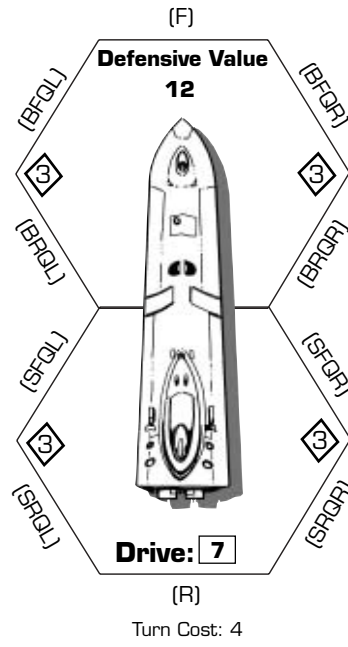
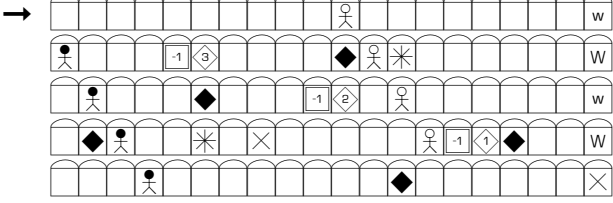

◆ P-DB: 1-7
FRONT RIGHT QUARTER DAMAGE TRACK

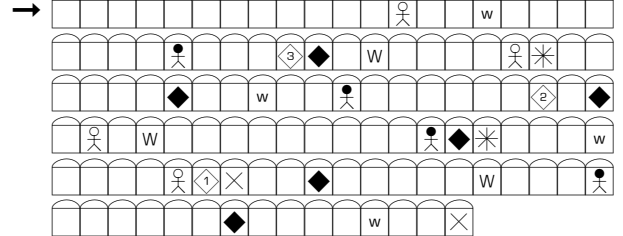

◆ P-DB: 1-6
REAR RIGHT QUARTER DAMAGE TRACK

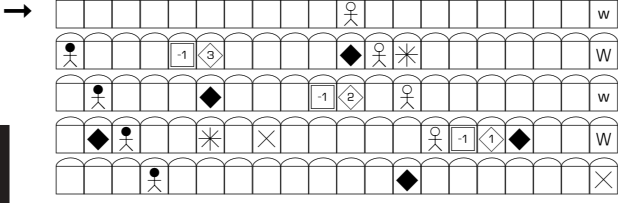

Gunner C
5 Pulse Lasers
 (SFQL) (SRQL) (R)
 To Hit: 2D8+ADB+4
 Damage: Low+4
 1-3/4-9/10

Gunner C
Missile Launcher
 (SFQL) (SRQL) (R)
 Lock-on < ____
 ○ ○ ○ ○ ○
 ○ ○ ○ ○ ○
 ○ ○ ○ ○ ○
 ○ ○ ○ ○ ○

Gunner D
Missile Launcher
 (R) (SRQR) (SFQR)
 Lock-on < ____
 ○ ○ ○ ○ ○
 ○ ○ ○ ○ ○
 ○ ○ ○ ○ ○
 ○ ○ ○ ○ ○

Gunner D
5 Pulse Lasers
 (R) (SRQR) (SFQR)
 To Hit: 2D8+ADB+4
 Damage: Low+4
 1-3/4-9/10

FRONT LEFT CRITICAL HITS

- 2— **ECM destroyed.** Fletcher may no longer perform screening.
- 3— **Crew killed.** Lose D4 crew.
- 4— **Port torpedo room hit.** 1D10 torpedoes are destroyed.
- 5— **Torpedo Magazine hit.** 1D10 torpedoes are destroyed.
- 6— **Missile Launcher A malfunction.** Lose 1D10 Remaining missiles.
- 7— **Quint Pulse Laser A loses power.** Weapon may not fire until afternext turn.
- 8— **Torpedo Room loses power.** No torpedoes may be launched until after next turn. All of Fletchers command guided torps detonate.
- 9— **Ion Cannon power flickering.** Reduce Ion Cannon's damage to (High +2) x 2.
- 10— **Keel Cannon damaged.** Penalize to Hit attempts by -2.
- 11— **Bridge hit!** Bridge crew is stunned. Fletcher may not move next turn.
- 12— **Keel Cannon crew killed.** 1D4 crew are killed.

REAR LEFT CRITICAL HITS

- 2— **Bridge hit!** The captain is killed. Fletcher may no longer use Captain die.
- 3— **TOC destroyed.** Fletcher may no longer add TOC bonus initiative roll.
- 4— **Shields damaged.** Reduce Defensive Value by 2.
- 5— **Power coupling severed.** No weapons may be fired next turn.
- 6— **Quint Pulse Laser C damaged.** Weapon suffers -2 penalty to hit.
- 7— **Missile Launcher C malfunction.** Lose 1D10 missiles.
- 8— **Engineering hit!** Damage Control is not available until after next turn.
- 9— **Drives sputter.** Reduce drive by 2 until after next turn.
- 10— **Gunner C killed.** This gunner's weapons may not be fired.
- 11— **Engineering section destroyed.** Damage control is not available.
- 12— **Reactor hit.** Fletcher becomes a gaseous cloud.

FLETCHER

Bow Torpedo Magazine

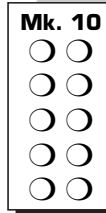
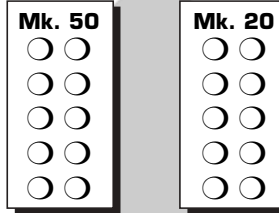

Electronics

Jam: 1-2 on 1D4

ECM: 1-7(4)

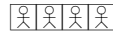

Bridge

Captain: _____

Pilot: _____

TOC: +4

Engineering

Damage Control: 1-6

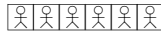

FRONT RIGHT CRITICAL HITS

- 2— **ECM destroyed.** Fletcher may no longer perform long-range jamming.
- 3— **Crew killed.** Lose D4 crew.
- 4— **Starboard torpedo room hit.** 1D10 torpedoes are destroyed.
- 5— **Torpedo Magazine hit.** 1D10 torpedoes are destroyed.
- 6— **Missile Launcher B malfunction.** Lose 1D10 Remaining missiles.
- 7— **Quint Pulse Laser B loses power.** Weapon may not fire until afternext turn.
- 8— **Torpedo Room loses power.** No torpedoes may be launched until after next turn. All of Fletchers command guided torps detonate.
- 9— **Ion Cannon power flickering.** Reduce Ion Cannon's damage to (High +2) x 2.
- 10— **Keel Cannon damaged.** Penalize to Hit attempts by -2.
- 11— **Bridge hit!** Bridge crew is stunned. Fletcher may not move next turn.
- 12— **Keel Cannon crew killed.** 1D4 crew are killed.

REAR RIGHT CRITICAL HITS

- 2— **Bridge hit!** The captain is killed. Fletcher may no longer use Captain die.
- 3— **TOC destroyed.** Fletcher may no longer add TOC bonus initiative roll.
- 4— **Shields damaged.** Reduce Defensive Value by 2.
- 5— **Power coupling severed.** No weapons may be fired next turn.
- 6— **Quint Pulse Laser D damaged.** Weapon suffers -2 penalty to hit.
- 7— **Missile Launcher D malfunction.** Lose 1D10 missiles.
- 8— **Engineering hit!** Damage Control is not available until after next turn.
- 9— **Drives sputter.** Reduce drive by 2 until after next turn.
- 10— **Gunner D killed.** This gunner's weapons may not be fired.
- 11— **Engineering section destroyed.** Damage control is not available.
- 12— **Reactor hit.** Fletcher becomes a gaseous cloud.

TPV

Gunner A
4 Blatguns
 (BFQL) (F) (BFQR)
 To Hit: 2D6+ADB+3
 Damage: High+6
 1-4/9-10/11-15
 Target SR ≤13

Gunner A
Missile Launcher
 (BFQL) (F) (BFQR)
 Lock-on < ____
 ○ ○ ○ ○ ○
 ○ ○ ○ ○ ○
 ○ ○ ○ ○ ○
 ○ ○ ○ ○ ○

Torp Crew G
2 Torpedo Tubes
 (BFQL)

Torp Crew H
2 Torpedo Tubes
 (BFQR)

Gunner B
1 Heavy Plazgun ¥
 (BRQL) (BFQL) (F)
 (BFQR) (BRQR)
 To Hit: 2D6+ADB
 Damage: All x 2
 1-4/5-8/9-15
 Target SR ≤11

Gunner C
1 Heavy Plazgun ¥
 (BRQL) (BFQL) (F)
 (BFQR) (BRQR)
 To Hit: 2D6+ADB
 Damage: All x 2
 1-4/5-8/9-15
 Target SR ≤13

Crew
CAPTAIN
 Cpn: _____
PILOT
 Plt: _____
GUNNER A
 Gnr: _____
GUNNER B
 Gnr: _____
GUNNER C
 Gnr: _____
GUNNER D
 Gnr: _____
GUNNER E
 Gnr: _____
CREW F
 Gnr: _____
T CREW G
 Gnr: _____
T CREW H
 Gnr: _____

Gun Crew F
3 Blast Cannons
 (BFQL) (F) (BFQR)
 To Hit: 2D8+ADB+2
 Damage:
 (Medium+4) x 2
 1-8/9-20/21-25
 Target SR ≤7

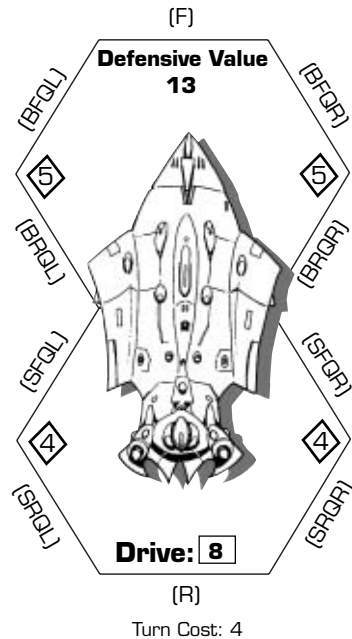

◆ P-DB: 1-5
**FRONT RIGHT QUARTER
 DAMAGE TRACK**

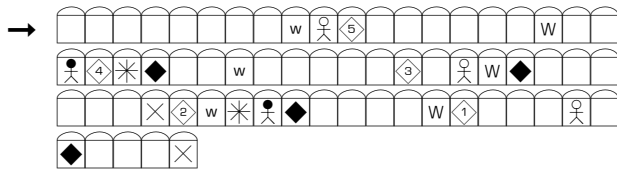

◆ P-DB: 1-5
**REAR RIGHT QUARTER
 DAMAGE TRACK**

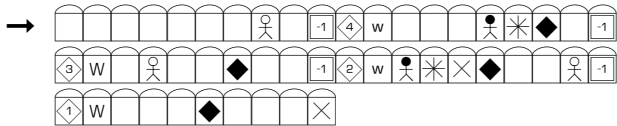

◆ P-DB: 1-5
**FRONT RIGHT QUARTER
 DAMAGE TRACK**

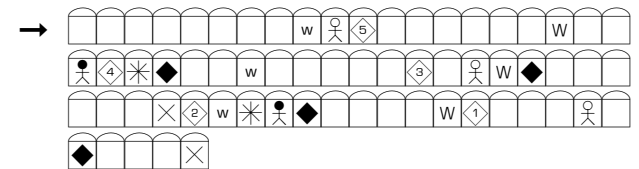

◆ P-DB: 1-5
**REAR RIGHT QUARTER
 DAMAGE TRACK**

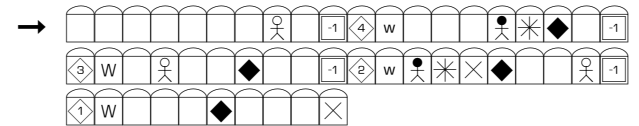

Gunner D
4 Splatterguns
 (SFQL) (SRQL) (R)
 To Hit: 2D6+ADB+3
 Damage: Medium+6
 1-2/3-6/7-10

Gunner D
Missile Launcher
 (SRQL) (R) (SFQL)
 Lock-on < ____
 ○ ○ ○ ○ ○
 ○ ○ ○ ○ ○
 ○ ○ ○ ○ ○
 ○ ○ ○ ○ ○

Gunner E
4 Splatterguns
 (R) (SRQR) (SFQR)
 To Hit: 2D6+ADB+3
 Damage: Medium+6
 1-2/3-6/7-10

Gunner E
Missile Launcher
 (R) (SRQR) (SFQR)
 Lock-on < ____
 ○ ○ ○ ○ ○
 ○ ○ ○ ○ ○
 ○ ○ ○ ○ ○
 ○ ○ ○ ○ ○

FRONT RIGHT CRITICAL HITS

- 2— **Electronic Warfare gone.** Megafortress may no longer jam torps. Reduce Defensive Value by 2.
- 3— **Blast Cannon crew killed.** Both crew killed. Blast Cannon may not be fired.
- 4— **Minor structural damage.** Take 5 more hits on this track.
- 5— **Heavy Plazgun loses power.** Weapon may not fire until after next turn.
- 6— **Quad Blatgun loses power.** Weapon may not fire until after next turn.
- 7— **Missile Launcher A malfunction.** Lose 1D10 Remaining missiles.
- 8— **Torpedo Magazine hit.** 1D10 torpedoes are destroyed.
- 9— **Torpedo room G hit.** Torpedo room loses 1 crew.
- 10— **Gunner A killed.** This gunner's weapons may not be fired.
- 11— **Gunner B killed.** This gunner's weapons may not be fired.
- 12— **Bridge hit!** Bridge crew is stunned. Megafortress may not move next turn.

REAR LEFT CRITICAL HITS

- 2— **Bridge hit!** The captain is killed. Megafortress may no longer use Captain points.
- 3— **Major structural damage.** Take 10 more hits on this damage track.
- 4— **Engine ports hit.** Reduce Drive by 2 and take 5 more hits to this track.
- 5— **Quad Splattergun D damaged.** Weapon suffers -2 penalty to hit.
- 6— **Shields damaged.** Reduce Devensive Value by 2 until after next turn.
- 7— **Missile Launcher D malfunction.** Lose 1D10 missiles.
- 8— **Drives sputter.** Reduce Drive by 2 until after next turn.
- 9— **Gunner D killed.** This gunner's weapons may not be fired.
- 10— **Engineering hit!** Damage Control not available.
- 11— **Engineering section destroyed.** Damage control is not available. Lose 2 engineers.
- 12— **Reactor hit.** Megafortress becomes a gaseous cloud.

MEGAFORTRESS

Bow Torpedo Magazine

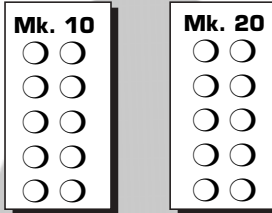

Electronics

Jam: 1-2 on 1D4
ECM: none

Bridge

Captain: _____
Pilot: _____
TOC: None

Engineering

Damage Control 1-6

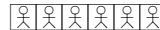

FRONT RIGHT CRITICAL HITS

- 2— **Electronic Warfare gone.** Megafortress may no longer jam torps. Reduce Defensive Value by 2.
- 3— **Blast Cannon crew killed.** Both crew killed. Blast cannon may not be fired.
- 4— **Minor structural damage.** Take 5 more hits on this track.
- 5— **Heavy Plazgun loses power.** Weapon may not fire until after next turn.
- 6— **Quad Blatgun loses power.** Weapon may not fire until after next turn.
- 7— **Missile Launcher A malfunction.** Lose 1D10 Remaining missiles.
- 8— **Torpedo Magazine hit.** 1D10 torpedoes are destroyed.
- 9— **Torpedo room H hit.** Torpedo room loses 1 crew.
- 10— **Gunner A killed.** This gunner's weapons may not be fired.
- 11— **Gunner C killed.** This gunner's weapons may not be fired.
- 12— **Bridge hit!** Bridge crew is stunned. Megafortress may not move next turn.

REAR RIGHT CRITICAL HITS

- 2— **Bridge hit!** The captain is killed. Megafortress may no longer use Captain points.
- 3— **Major structural damage.** Take 10 more hits on this damage track.
- 4— **Engine ports hit.** Reduce Drive by 2 and take 5 more hits to this track.
- 5— **Quad Splattergun E damaged.** Weapon suffers -2 penalty to hit.
- 6— **Shields damaged.** Reduce Defensive Value by 2 until after next turn.
- 7— **Missile Launcher E malfunction.** Lose 1D10 missiles.
- 8— **Drives sputter.** Reduce Drive by 2 until after next turn.
- 9— **Gunner E killed.** This gunner's weapons may not be fired.
- 10— **Engineering hit!** Damage Control not available.
- 11— **Engineering section destroyed.** Damage control is not available. Lose 2 engineers.
- 12— **Reactor hit.** Megafortress becomes a gaseous cloud.

TPV

Gunner A
Missile Launcher
 (BRQL) (BFQL) (F)
 Lock-on < ____
 ○ ○ ○ ○ ○
 ○ ○ ○ ○ ○
 ○ ○ ○ ○ ○
 ○ ○ ○ ○ ○

Gunner A
5 Pulse Lasers
 (BRQL) (BFQL) (F)
 To Hit: 2D8+ADB+4
 Damage: Low+4
 Range: 3/9/10

Gunner A

Gun Crew E
2 Torpedo Tubes

 (F)

Gunner B
5 Pulse Lasers
 (F) (BFQR) (BRQR)
 To Hit: 2D8+ADB+4
 Damage: Low+4
 Range: 3/9/10

Gunner B

Gunner B
Missile Launcher
 (F) (BFQR) (BRQR)
 Lock-on < ____
 ○ ○ ○ ○ ○
 ○ ○ ○ ○ ○
 ○ ○ ○ ○ ○
 ○ ○ ○ ○ ○

Crew

CAPTAIN
 Cpn: _____
PILOT
 Plt: _____
GUNNER A
 Gnr: _____
GUNNER B
 Gnr: _____
GUNNER C
 Gnr: _____
GUNNER D
 Gnr: _____
T CREW E
 Gnr: _____
T CREW F
 Gnr: _____
T CREW G
 Gnr: _____

◆ P-DB: 1-5
FRONT LEFT QUARTER
DAMAGE TRACK

→

◆ P-DB: 1-5
REAR LEFT QUARTER
DAMAGE TRACK

→

(F)

Defensive Value
12

(BFQL) (BFQR) (SFQL) (SFQR) (SRQL) (SRQR)

Drive: **11**

(R)

Turn Cost: 4

◆ P-DB: 1-5
FRONT RIGHT QUARTER
DAMAGE TRACK

→

◆ P-DB: 1-5
REAR RIGHT QUARTER
DAMAGE TRACK

→

Gun Crew F
2 Torpedo Tubes

 (SFQL)

Gunner C
5 Pulse Lasers
 (SFQL) (SRQL) (R)
 (SRQR) (SFQR)
 To Hit: 2D8+ADB+4
 Damage: Low+4
 Range: 3/9/10

Gunner C

Gunner C
Missile Launcher
 (SFQL) (SRQL) (R)
 (SRQR) (SFQR)
 Lock-on < ____
 ○ ○ ○ ○ ○
 ○ ○ ○ ○ ○
 ○ ○ ○ ○ ○
 ○ ○ ○ ○ ○

Gunner D
1 Disintegrator

 (SRQL) (R) (SRQR)
 To Hit: 2D8+ADB
 Damage: High §
 Range: 1/3/12
 Target SR ≤ 11

Gun Crew G
2 Torpedo Tubes

 (SFQR)

FRONT LEFT CRITICAL HITS

- 2 — **Major structural damage.** Take another 15 hits on this track.
- 3 — **Buckled armor.** Reduce Reduction by 2.
- 4 — **Quint Pulse Laser loses power.** Weapon may not fire until after next turn.
- 5 — **Torpedo Magazine hit.** 1D10 torpedoes are destroyed.
- 6 — **Cargo bay hit.** 1D4 units of cargo are destroyed. Attacker gets value of cargo in victory points.
- 7 — **Missile Launcher A malfunction.** Lose 1D10 remaining missiles.
- 8 — **Quint Pulse Laser A damaged.** Penalize to Hit attempts by -3.
- 9 — **Fighter rack destroyed.** Ship may no longer dock fighters.
- 10 — **ECM destroyed.** Narwhal may no longer perform long-range jamming.
- 11 — **Gunner A killed.** This gunner's weapons may not be fired.
- 12 — **Bridge hit!** Bridge crew is stunned. Narwhal may not move next turn.

REAR LEFT CRITICAL HITS

- 2 — **Reactor hit.** Narwhal becomes a gaseous cloud.
- 3 — **Engineering hit!** Damage Control is not available until after next turn. Lose D4 engineers.
- 4 — **Minor structural damage.** Take 5 more hits on this damage track.
- 5 — **Torpedo magazine hit.** 1D10 torpedoes are destroyed.
- 6 — **Quint Pulse Laser C loses power.** Weapon may not fire until after next turn.
- 7 — **Missile Launcher C malfunction.** Lose 1D10 missiles.
- 8 — **Disintegrator loses power.** Weapon may not fire until after next turn.
- 9 — **Torpedo room F hit.** Torpedo room F loses a crew.
- 10 — **Gunner B killed.** This gunner's weapons may not be fired.
- 11 — **Gunner D killed.** This gunner's weapons may not be fired.
- 12 — **Bridge hit!** The captain is killed. Player may no longer use Captain die.

NARWHAL

Tons: 6100

Bow Torpedo Magazine

Mk. 10



10 units
of cargo
capacity

100 Ton
Fighter rack
Crew:
BRQR

Electronics

Jam: 1-2 on 1D4

ECM: 1-5 (5)



Bridge

Captain: _____

Pilot: _____

TOC: None

Engineering

Damage Control: 1-8



Mk. 30



Mk. 20

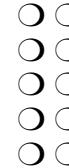

Stern Torpedo Magazine

FRONT RIGHT CRITICAL HITS

- 2 — **Major structural damage.** Take another 15 hits on this track.
- 3 — **Buckled armor.** Reduce Reduction by 2.
- 4 — **Quint Pulse Laser loses power.** Weapon may not fire until after next turn.
- 5 — **Torpedo Magazine hit.** 1D10 torpedoes are destroyed.
- 6 — **Cargo bay hit.** 1D4 units of cargo are destroyed. Attacker gets value of cargo in victory points.
- 7 — **Missile Launcher B malfunction.** Lose 1D10 remaining missiles.
- 8 — **Quint Pulse Laser B damaged.** Penalize to Hit attempts by -3.
- 9 — **Fighter rack destroyed.** Ship may no longer dock fighters.
- 10 — **ECM destroyed.** Narwhal may no longer perform long-range jamming.
- 11 — **Gunner B killed.** This gunner's weapons may not be fired.
- 12 — **Bridge hit!** Bridge crew is stunned. Narwhal may not move next turn.

REAR RIGHT CRITICAL HITS

- 2 — **Reactor hit.** Narwhal becomes a gaseous cloud.
- 3 — **Engineering hit!** Damage Control is not available until after next turn. Lose D4 engineers.
- 4 — **Minor structural damage.** Take 5 more hits on this damage track.
- 5 — **Torpedo magazine hit.** 1D10 torpedoes are destroyed.
- 6 — **Quint Pulse Laser C loses power.** Weapon may not fire until after next turn.
- 7 — **Missile Launcher C malfunction.** Lose 1D10 missiles.
- 8 — **Disintegrator loses power.** Weapon may not fire until after next turn.
- 9 — **Torpedo room G hit.** Torpedo room G loses a crew.
- 10 — **Gunner C killed.** This gunner's weapons may not be fired.
- 11 — **Gunner D killed.** This gunner's weapons may not be fired.
- 12 — **Bridge hit!** The captain is killed. Player may no longer use Captain die.

TPV

Gunner A Missile Launcher
(BFQL) (F) (BFQR)
Lock-on < ____
○ ○ ○ ○ ○
○ ○ ○ ○ ○
○ ○ ○ ○ ○
○ ○ ○ ○ ○

Gunner A 2 Splatterguns
(BFQL) (F) (BFQR)
To Hit: 2D6+ADB+1
Damage: Medium+2
1-2/3-6/7-10

Gun Crew E Plazprojector
☒ ☒ ☒ ☒
(BFQL)(F)(BFQR)
To Hit: xD8+ADB
Damage: All
-/-1-5/-

Gun Crew D 2 Ion Cannons
☒ ☒ ☒
(BFQL) (F) (BFQR)
To Hit: 2D8+ADB+1
Damage: (All+2) X 2
1-8/9-16/17-30
Target SR ≤ 6

Crew
CAPTAIN
Cpn: _____
PILOT
Plt: _____
GUNNER A
Gnr: _____
GUNNER B
Gnr: _____
GUNNER C
Gnr: _____
CREW D
Gnr: _____
CREW E
Gnr: _____
T CREW F
Gnr: _____
T CREW G
Gnr: _____

◆ P-DB: 1-6
FRONT LEFT QUARTER DAMAGE TRACK

◆ P-DB: 1-5
REAR LEFT QUARTER DAMAGE TRACK

(F)
Defensive Value 13
(BFQL) (BFQR)
(SFQL) (SFQR)
(SRQL) (SRQR)
Drive: 8
(R)
Turn Cost: 4

◆ P-DB: 1-6
FRONT RIGHT QUARTER DAMAGE TRACK

◆ P-DB: 1-5
REAR RIGHT QUARTER DAMAGE TRACK

Gunner B Missile Launcher
(SFQL) (SRQL) (R)
Lock-on < ____
○ ○ ○ ○ ○
○ ○ ○ ○ ○
○ ○ ○ ○ ○
○ ○ ○ ○ ○

Gunner B 2 Splatterguns
(SFQL) (SRQL) (R)
To Hit: 2D6+ADB+1
Damage: Medium+2
1-2/3-6/7-10

Torp Crew F 2 Torpedo Tubes
☒ ☒
(SFQL)

Torp Crew G 2 Torpedo Tubes
☒ ☒
(SFQR)

Gunner C 2 Splatterguns
(SFQR) (SRQR) (R)
To Hit: 2D6+ADB+1
Damage: Medium+2
1-2/3-6/7-10

Gunner C Missile Launcher
(SFQR) (SRQR) (R)
Lock-on < ____
○ ○ ○ ○ ○
○ ○ ○ ○ ○
○ ○ ○ ○ ○
○ ○ ○ ○ ○

FRONT LEFT CRITICAL HITS

- 2— **Electronic Warfare gone.** Stingray may no longer jam torps. Reduce Defensive Value by 2.
- 3— **Point defense system destroyed.**
- 4— **Minor structural damage.** Take 5 more hits on this track.
- 5— **Plazprojector loses power.** Weapon may not fire next turn.
- 6— **Hull stability compromised.** -3 Defensive Value
- 7— **Missile Launcher A malfunction.** Lose 1D10 Remaining missiles.
- 8— **Twin splatterguns A damaged.** Penalize to Hit attempts by -2.
- 9— **Plazprojector damaged.** Penalize to Hit attempts by -2.
- 10— **Gunner A killed.** This gunner's weapons may not be fired.
- 11— **Plazprojector crew killed.** Blast kills 1D4 crew.
- 12— **Bridge hit!** Bridge crew is stunned. Stingray may not use bridge functions next turn.

REAR LEFT CRITICAL HITS

- 2— **Bridge hit!** The captain is killed. Player may no longer use Captain die.
- 3— **Major structural damage.** Take 10 more hits on this damage track.
- 4— **Torpedo magazine hit.** 1D10 torpedoes are destroyed.
- 5— **Twin Splattergun B damaged.** Weapon suffers -2 penalty to hit.
- 6— **Torpedo room loses power.** No torps may be fired next turn.
- 7— **Missile Launcher B malfunction.** Lose 1D10 missiles.
- 8— **Engineering hit!** Damage Control is not available until after next turn.
- 9— **Torpedo room hit.** Torpedo room loses a crew.
- 10— **Gunner B killed.** This gunner's weapons may not be fired.
- 11— **Engineering section destroyed.** Damage control is not available. Lose 1D4 crew.
- 12— **Reactor hit.** Stingray becomes a gaseous cloud.

STINGRAY

Electronics

Jam: 1-2 on 1D4
ECM: none

Bridge

Captain: _____
Pilot: _____
TOC: None

Engineering

Damage Control: 1-5

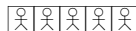

Mk. 20

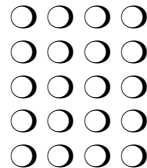

**Stern Torpedo
Magazine**

FRONT RIGHT CRITICAL HITS

- 2— **Electronic Warfare gone.** Stingray may no longer jam torps. Reduce Defensive Value by 2.
- 3— **Point defense system destroyed.**
- 4— **Minor structural damage.** Take 5 more hits on this track.
- 5— **Plazprojector loses power.** Weapon may not fire next turn.
- 6— **Hull stability compromised.** -3 Defensive Value
- 7— **Missile Launcher A malfunction.** Lose 1D10 Remaining missiles.
- 8— **Twin splatterguns A damaged.** Penalize to Hit attempts by -2.
- 9— **Plazprojector damaged.** Penalize to Hit attempts by -2.
- 10— **Gunner A killed.** This gunner's weapons may not be fired.
- 11— **Ion cannon crew killed.** Blast kills 1D4 crew.
- 12— **Bridge hit!** Bridge crew is stunned. Stingray may not use bridge functions next turn.

REAR RIGHT CRITICAL HITS

- 2— **Bridge hit!** The captain is killed. Player may no longer use Captain die.
- 3— **Major structural damage.** Take 10 more hits on this damage track.
- 4— **Torpedo magazine hit.** 1D10 torpedoes are destroyed.
- 5— **Twin Splattergun C damaged.** Weapon suffers -2 penalty to hit.
- 6— **Torpedo room loses power.** No torps may be fired next turn.
- 7— **Missile Launcher C malfunction.** Lose 1D10 missiles.
- 8— **Engineering hit!** Damage Control is not available until after next turn.
- 9— **Torpedo room hit.** Torpedo room loses a crew.
- 10— **Gunner C killed.** This gunner's weapons may not be fired.
- 11— **Engineering section destroyed.** Damage control is not available. Lose 1D4 crew.
- 12— **Reactor hit.** Stingray becomes a gaseous cloud.

Silent Death Accessories

Fine Pewter Ships from RAFM

Core ships (\$5 per pack)

- 601 Spirit Rider (3)
- 602 Thunder Bird (2)
- 603 Night Hawk (2)
- 604 Seraph (2)
- 605 Salamander (2)
- 606 Epping (2)
- 607 Teal Hawk (2)
- 608 Sorenson III (2)
- 609 Revenge (2)
- 610 Pharsii II (2)
- 611 Pit Viper (3)
- 612 Shryak Shuttle (2)
- 613 Blizzard (3)
- 614 Kosmos (2)
- 615 Hell Bender (2)
- 616 Death Wind (2)
- 617 Glaive (2)
- 618 Drakar (2)
- 619 Dart (3)
- 620 Talon (2)
- 621 Lance Electra (2)
- 622 Sentry (2)
- 623 Star Raven (2)
- 624 Betafortress (1)

Renegades (\$5 per pack)

- 625 Saucer Shuttle (4)
- 626 Blood Hawk (3)
- 627 Crescent (3)
- 628 Eagle (2)
- 629 Scorpion (1)
- 630 Conestoga (1)

Warhounds (\$5 per pack)

- 631 Narwhal(1)
- 632 Aosho (1)
- 633 Stingray (1)
- 634 Fletcher (1)
- 635 Mega Fortress (1)
- 636 Constellation (1)

Sunrunners (\$5 per pack)

- 637 Avenger (2)
- 638 Wavecutter (4)
- 639 Havok (2)
- 640 Catastrophe (2)
- 641 Windjammer (4)
- 642 Spider (2)

Night Brood: First Contact (\$5 per pack)

Available now

- 0643 Tiger Moth (3)
- 0645 Dragonfly (2)
- 0647 Shaggai (4)
- 0648 Thistle (4)

Available February

- 0656 Larva (3)
- 0657 Remora (2)
- 0658 Lamprey (2)
- 0659 Squidge (2)
- 0660 Manta (2)
- 0661 Muskellunge (2)

Universal Night Watch (\$5 per pack)

- 0649 Hornet (2)
- 0650 Javelin (2)
- 0651 Rattler (3)
- 0652 Equalizer (3)
- 0653 Praying Mantis (2)
- 0654 Firebat (4)
- 0646 Muckworm (4)
- 0666 Vartak (3)

Sigurd Archdiocese

Available in March

- 0668 Longboat
- 0669 Hound
- 0670 Dagger
- 0671 Hammer
- 0672 Storm
- 0673 Iceberg

Night Brood: Armageddon

Available late 1997

- 0644 Worm Pod (2)
- 0662 Eel (2)
- 0663 Scarab (3)
- 0664 Skree (2)
- 0665 Bright Thorn (2)
- 0667 Monarch (1)

The Next Millennium

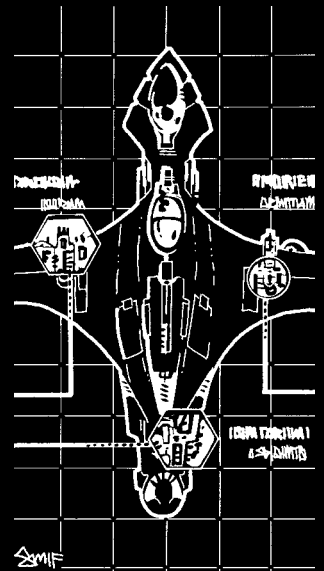



OPERATION: DRY DOCK™

ID flags appeared under the blips on Rand's screen as the Commander's voice broke the silence. "Two Glaives coming in range. Hold your torps! They are out of protobolts and there is no way they can tag us with their Plazguns from this..." He was cut off as an Ion Ram from the lead Glaive slammed into his ship. The second Glaive quickly followed suit and the Commander's ship disappeared in an Ion storm.

OPERATION: DRY DOCK™

Since the Fall of the Empire over a decade ago, many standard Imperial ship designs have become commonplace. Almost every fleet has a few Salamanders. However, within the past five years most of these ships have undergone refits more suited to the fighting styles of the houses using them. *Operation: Dry Dock* reveals 23 previously unseen ship variants, and provides updated sheets for the original 26 fighters.

Operation: Dry Dock includes:

- 23 new Terran fighter variants
- 26 updated Terran fighters
- 6 updated Escort displays
- Tonnage on every ship display
- Escort rules clarifications
- Optional rules

SILENT DEATH™
THE NEXT MILLENNIUM



Produced
and distributed by:

 ICE, Inc.
P.O. Box 1605
Charlottesville, VA 22902 USA

and
distributed
in the UK by

 HobbyGames LTD
Unit 54, Rudford Industrial Estate,
Ford Airfield, NR. Arundel,
West Sussex, BN18 0BD, U.K.

ICE 7.00

This specially-priced
PDF is available
through the ICE
Online Store at
www.ironcrown.com

Made in U.S.A.

ST# 7215P