

SHADOWRUN™ 7309

IMAGO

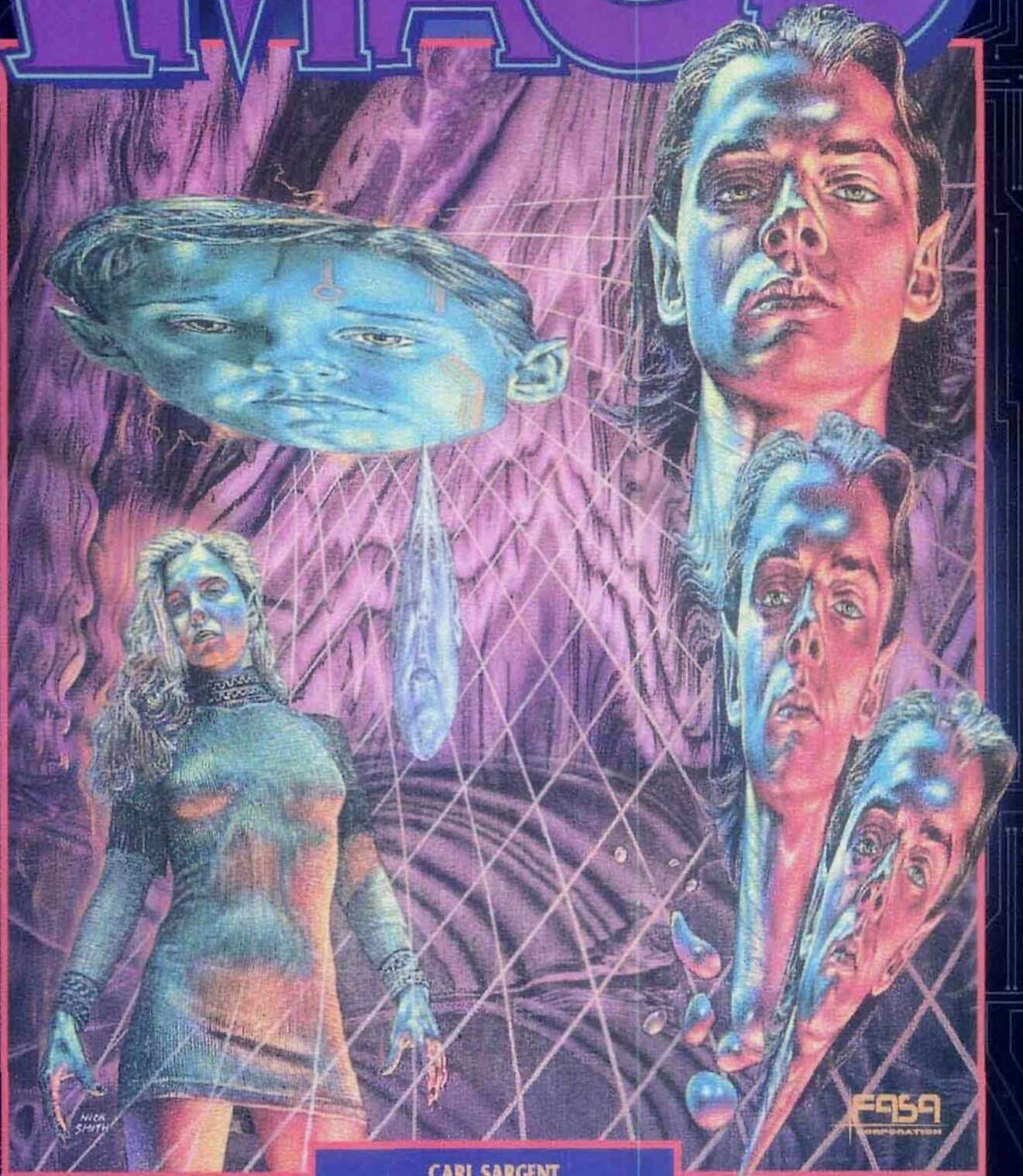

NICK SMITH

FASA CORPORATION

CARL SARGENT

WAGO

FASA CORPORATION

CONTENTS

SEEING BEYOND: A Prologue	4
INTRODUCTION	5
Gamemaster's Notes	5
Shadowrun Rules	5
Making Success Tests	6
Success Tables	6
How to Use This Book	6
Preparing the Adventure	6
Plot Synopsis	7
Gamemaster's Note	8
U.K. Weather	8
Adventure Hooks	8
THEADVENTURE	9
So It Begins...	9
Welcome to Bonny Scotland	11
Hamish's Bar	15
Child In the Matrix	20
Taking Care of Paperwork	23
Getting Wheels	24
Prime Scotch Beef 22	24
Halls of Academe	29
Death In Queen's Street	31
Over the Sea to Skye	34
Weird Science	38
Say Hello to Nessie	40
Dr. Knox's Body Shop	43
Morag MacDonald	44
Castle Laidon	45
Samurai Strike	50
Bringing the Child Home	52
Squaring the Circle	53
Talking to the Laird	55
Set My Soul Free	58
PICKING UP THE PIECES	62
Awarding Karma	62
Team Karma	62
Individual Karma	62
LEGWORK	63
Contacts	63
The Corporation	63
Transys Neuronet (General)	63
Transys Neuronet (Tidbits)	64
Major Characters	64
Alasdair Cameron	64
Angus MacNab	64
Professor Amelia Richardson	65
Morag MacDonald	65
Sir Iain MacDonald	65
Quicksilver	65
Locations	65
Quicksilver's Deck	65

Physical Examination	66
Mystical Examination	66
CAST OF SHADOWS	67
Alasdair Cameron	67
Angus MacNab	68
Professor Amelia Richardson	68
Morag MacDonald	69
Sir Iain MacDonald	70
Quicksilver	71
PLAYER HANDOUTS	71
MAPS	76
ANARCHY IN THE U.K.	79
Controlled Weapons and Equipment	79
British Slang	79
Scots Dialect	79

CREDITS

Writing

Carl Sargent

Development

Tom Dowd

Editorial Staff

Senior Editor

Donna Ippolito

Associate Editor

Slwon Turner Mulvihill

Editorial Assistant

Diane Piron

Production Staff

Art Director

Jeff Uiubenstein

Project Manager

Joel Biske

Cover Art

Nick Smith

Maps

Aardvar< Studios

Layout

Carol Brozman / Mark Ernst

Keyline / Art / Pasteup

Ernesto Hernandez

Cover Design

Joel Biske

Illustration

Joel Biske

Dan Smith

Karl Waller

SHADOWPUM, MATRIX and IMACO are trademarks of FASA Corporation
 Copyright © 1995 FASA Corporation. All Rights Reserved. Printed in the
 United States of America.

Illustrated by
 FASA Corporation
 P.O. Box 6930
 Chicago IL 60680



SEEING BEYOND

Outside, rain began to fall from a near-cloudless sky. Refracted light caught the elf's eye as he spoke.

"What does your research tell you? You've read the evidence, from Stevenson's work in the 1970s, through hypnotic regression, to metaplanar research. Is it for real?" The elf leaned forward on the couch, reaching toward the transparent table. Magellan's map of the world lay below it. His drink rested atop. He curled his long fingers around the slim stem of the Spanish-made crystal glass and took a long sip of Rhone wine. He was teasing her with his question, because he knew the answer.

"We can't say for sure, Quicksilver. The evidence suggests this is real. At least, I think so. But I can't prove it scientifically. Not yet, anyway. It's a strong probability - that's all I can say." She smiled at him.

He shook his head gently. "You're hung up on the wrong kind of science. You study hermetics and shamans here, and the druids - as much as they'll allow. You'd be really good, you know, if you didn't get bogged down in earning a living in the machine."

She grimaced. "We need the money. I have to do the enchanting; the department needs funding. It's only temporary. When the Beaumont Fund ran out, we had to make ends meet. The corporates have their research, and we try to keep to our own perspective."

The tall elf grinned. "You people always tell yourselves that. You're trapped. You want corporate money, but you also want to stay virgin-pure academics. You've never taken what you want from the corporates, like I took space from Transys. They had to let me in. Know what you want, and know how to get it! I spent three years learning how to hack them. Now they take anything I choose to give them. But they won't get what I'm on to now, Amelia, it's too precious."

The woman stared at him, brushing back her long fair hair with one hand. "I thought I saw a spark in you, old friend. I thought a woman in your life might be causing it. But it's not a woman, is it?"

"Ah, Amelia, you're not so perceptive as you sometimes think. There is a woman, but also more. We speak of rarefied things, you and I. We've talked about astrology, hermetics, the Tarot, the Golden Dawn, great spirits and the metaplanes - a hundred sources of wisdom, and still you don't see me as I am. I am possessed by love, old friend, and that love has brought me to something truly surpassing." The elf brought the glass to his lips again, with the barest hint of a dramatic flourish. As he returned it to the table, his cybereyes held the American's gaze. She lit a Lite as she looked back at him.

"Tell me," she said gently. The elf heard in her voice the desire of one friend to know the heart of another. "I sensed your quietness, at least. Tell me."

"I've thought long and hard about life returning. I've seen myself in ancient times, in Karnak and Thebes, Athens and Beijing. Rome and Jerusalem. I've caught glimpses of my past selves, and though I fought against those glimpses. I sensed her in them, too. I even sensed you, once or twice. We are old souls, you and I: she is young, but still I am drawn to her. Transformation brings a new

promise to more than metahumans; that both of you have lived in those ancient places proves it. I have yet to discover every one of my past lives, but I have found a way to become all of those people and more. Forever. *Forever.*" He sounded triumphant, yet she heard an underlying sadness in his voice. He seemed exhausted by his timelessness, bent with the weight of ages, sad with a yearning that extended into an unseen future. Yet his eyes shone with hope and expectation.

"What have you found? Quicksilver, tell me what you have done."

"I am making myself immortal, Amelia. Where I have been, what I feel, what I can see and reach for, and who I am becoming. I make images and unrealities and ghosts, my dear, inside the Matrix; it becomes my servant. I know how to Become again, without me need for frail flesh. I have stripped away every layer of myself, down to the child, and hidden myself away, still becoming. I have done this and made this for myself, but I must leave my work with others. I've given my masters enough. My time grows short." Suddenly, he grinned at her. "I'll leave my deck with you, as always. Others also have pieces of me, but I may never need to call _____ on _____ them."

He stood up. "I'm off again. Not Skye this time; I've had enough of corporate security. I've learned how to get rid of them. Now I am greater than myself, and I want to stay with her." His white teeth flashed in the lamplight as he smiled, and he swept her into a friend's embrace.

She hugged him back, sensing his strange delight as she held him, still not sure of what or whom he had spoken. She could not know that she would never see him again. In this life, he had five days left to live.

Outside, the rain fell harder from a sky still strangely empty of clouds.



INTRODUCTION

Imago is a roleplaying adventure set in the world of **Shadowrun**.

The year is 2053. Advances in technology are astonishing, *with humans able to blend with computers and travel through the netherworld of data known as the Matrix*. Even more astonishing is the return of magic. Elves, dragons, dwarfs, orks, and trolls have assumed their true forms, while megacorporations (rather than superpowers) rule much of the world. Moving among it all like whispers in the night are the shadowrunners. No one admits their existence, but no one else can do their secret work.

This story takes place in the city of Edinburgh and the lands of Scotland in the United Kingdom. The **London Sourcebook** contains a wealth of information on the U.K. world of **Shadowrun**, but **Imago** can be played without reference to this sourcebook (though players and gamemasters may find it useful).

GAMEMASTER'S NOTES

Imago is, to put it bluntly, a strange adventure. It is a story of love between two people; both dead, and one become a strange and bewildering entity. **Imago** demands more from the gamemaster and players than the standard, straightforward **Shadowrun** adventure, involving the characters in a tale of love, nobility, and treachery. Which way the story swings, to pathos or bathos or the triumph of cynicism over love, depends on the players, but the gamemaster plays the pivotal role in telling this strange story. Unfolding this adventure will make unusual demands on his or her skills.

This adventure strips away from the runners their usual equipment and contacts. The gamemaster must improvise to make some parts of the adventure suit the individual group. The runners may feel out of their element and in over their heads, but that is okay.

Imago uses a decision-tree format like other **Shadowrun** adventures, but the connections between some sections may seem tenuous when viewed from outside the story. The gamemaster should be prepared to prod the characters and players in a certain direction if they need a little push. The **Plot Synopsis** below describes the most likely sequence of events. To run this adventure, the gamemaster needs a thorough knowledge of the contents of this book, as well as a working familiarity with the basic **Shadowrun, Second Edition (SRII)** rules. This book's contents are for the gamemaster's eyes only, except for those items marked as **Player Handouts**. The book includes everything needed to roleplay **Imago**.

Imago is designed for a shadowrunning team of five to eight player characters. The group should contain at least one skilled decker, and two will give the team a real advantage. Ideally, the group should contain an elven character, and at least one shaman (not a street shaman), though two would be better. Major portions of this adventure require no firepower, but street samurai have an opportunity to shine on key occasions. If the group seems a little weak on firepower, the adventure provides a chance to hire some.

Finally, the team's chances of success improve if it contains a character with good social skills (especially Negotiation), because the group must work hard to acquire contacts and resources through persuasion (and payment, of course).

This adventure assumes that the runners hail from one of the North American nations (or anywhere else in the world apart from the U.K.), and are not native British folks (hereafter referred to as Brits). Conducting legwork and finding contacts requires far more effort in **Imago** than in other **Shadowrun** adventures: a UCAS runner may have a trustworthy Mr. Johnson in Seattle, but that means absolutely zip in Scotland. In brief, foreign runners have no contacts in this adventure save for those they develop during the game. On the other hand, if the player characters are Brits, then the gamemaster may allow these characters to obtain far more information through "background contacts" than foreigners could hope to acquire. In this case, the gamemaster must devote a lot more work and thought to how much information he allows the characters to obtain through such contacts. Running Brit characters in **Imago** poses other problems, however. All Brit mages must be licensed, and Brit shamans use different totems than UCAS shamans. All in all, allowing Brit player characters into **Imago** makes things more difficult for the gamemaster.

Most encounters in this adventure are planned out and described in detail, and hints for gamemastering the various situations appear in the individual encounters.

Part of this adventure takes place in the Matrix. The **Virtual Realities** sourcebook will help gamemasters deal with this material, but even the formal **Shadowrun** rules cannot entirely prepare either gamemaster or players for some of their characters' encounters with the adventure's key character, Quicksilver. Quicksilver's *Imago* (this term is explained later) behaves within the Matrix in unique ways sometimes not quantifiable within the **Shadowrun** rules. Quicksilver's nature goes beyond rules and formulae, and the gamemaster and players must accept this to play the adventure. The **Plot Synopsis** below gives additional guidelines for dealing with the bizarre way Quicksilver's chips function in gameplay, as does a section in **Legwork**, p. 64.

One additional book useful for this adventure is the second edition of the **Grimoire (Grimoire II)**, which will prove helpful for roleplaying free spirits and their powers.

SHADOWRUN RULES

Imago uses the **Shadowrun, Second Edition (SRII)** rules. All information, specifically game statistics, appears in that format. Gamemasters still using the first-edition **Shadowrun** rules will need to make a few adjustments, mostly to non-player character statistics and weapon and spell statistics. If the adventure presents a situation in which a significant difference exists between the first edition and **SRII** rules, the text provides method for resolving that situation according to the first-edition rules.

MAKING SUCCESS TESTS

During the course of *Imago*, the players will make a number of Success Tests using a skill and a given target number. These Success Tests are indicated by the name of the appropriate skill and the target number. For example, a Stealth (4) Test refers to a Stealth Success Test with a Target Number of 4.

Imago often suggests a Skill Test to replace or augment specific roleplaying encounters. Gamemasters may ignore these dice rolls if not needed, making that judgment based on the player characters and the circumstances. When used, these tests usually require the player character involved to test his or her skill against a non-player character using the same skill. This is an opposed test (p. 68, **SRII**). In an opposed test, two characters use the same skill, or an opposing skill, against one another, with only one of them able to actually succeed in the effort. Usually, the character generating the greater number of successes achieves his goal. Negotiation is a typical situation for this type of test. Opposed tests are indicated by the name of the appropriate skill and the rating of the opponent's skill to be used as a larger number. For example, in a Negotiation (Willpower) Test, the initiating character rolls a number of dice equal to his Negotiation Skill against a target number equal to his opponent's Willpower Rating. The opponent makes the same test using a number of dice equal to his Negotiation Skill and a target number equal to the player character's Willpower Rating. The character that generates the most successes wins the opposed test and adjusts the outcome in his or her favor. The difference in successes generated, or the net successes, determines the final result of the action.

SUCCESS TABLES

At times, the gamemaster will use success tables to determine how much information the players receive from their inquiries and investigations. Each success table lists different information for different numbers of die roll successes. Rolling a high number of successes always reveals the information for the lower numbers of successes as well. For example, a character rolling 3 successes would learn the information for 3 successes as well as the information for both 1 and 2 successes.

HOW TO USE THIS BOOK

The gamemaster should read through this entire book before beginning the adventure, and should also carefully examine all maps, plans, and diagrams. Where appropriate, letters and numbers on a map link an area to its description in the text.

This book tries to cover all the events likely to occur during this adventure. The Plot Synopsis below summarizes in detail both the story background and the course the adventure was designed to follow. Within this synopsis, the first mention of names of people important to the adventure appears in **boldface** type.

The adventure begins with the sections entitled **So It Begins** and **Welcome to Bonny Scotland**. These sections bring the runners from outside the U.K. into the adventure setting, followed by 18 short sections describing each of the encounters the players will face, or are likely to face, in the course of roleplaying *Imago*.

Most of the encounters begin with a section entitled **Tell It To Them Straight**. This describes the team's location and what is happening to them as though the player characters were actually there. Any special instructions to the gamemaster are printed in **boldface** type. Some encounters may occur at different stages of the adventure, or more than

once. Depending on the actions of the player characters, the gamemaster may need to adapt the description in **Tell It To Them Straight** to better fit the current situation.

Tell It To Them Straight is followed by a new section called **Hooks**. This section gives the gamemaster an emotional background to fill out the facts of an encounter, providing hints and tips about imagery to use in the scene, emotions to convey, sounds, sensations, textures, and so on. Gamemasters can use **Hooks** to bring color to the encounters. The information provided varies in form and content from scene to scene, ranging from general themes to specific emotions.

Next comes the information entitled **Behind the Scenes**. The real story exists here, and only the gamemaster knows what is really going on at any given moment in an adventure. Straightforward encounters presenting no important plot complications (for example, hiring a vehicle or street samurai and so on), may skip this section. If the players or gamemaster need a map to play this encounter, it appears in this section. Minor non-player character stats needed to roleplay the encounter also appear here.

Finally, each encounter includes hints for running the encounter entitled **Debugging**. This section suggests ways to get the story back on track if things go too far wrong. For example, most gamemasters will not want the player characters to get too discouraged or killed off too easily. The gamemaster can, of course, ignore these hints and let the chips fall where they may. In *Imago*, debugging is especially important for keeping the adventure on crack.

Legwork contains the information the player characters can obtain through their contacts or through the public data nets. As noted, this adventure assumes the player characters have no contacts within the U.K. The main adventure sections detail the information the characters can obtain through the new contacts they develop.

Stats for important non-player characters appear in **Cast of Shadows**. Minor non-player character stats appear in the appropriate encounter within the adventure.

Picking Up the Pieces sums up the results of the adventure, depending on the characters' actions, and provides tips on awarding Karma.

Player Handouts contains general information and maps for the players, as well as different newsnet items, depending on the outcome of the adventure. **Anarchy In the U.K.** provides information on Shadowrun's Britain for gamemasters working without the **London Sourcebook**, including the all-important import restrictions, and British slang and Scots dialect for atmosphere. The final **Maps** section is for the gamemaster.

PREPARING THE ADVENTURE

It is impossible to create a published adventure that provides the appropriate opposition level for every diverse group of player characters. Some groups are inherently more powerful than others.

The gamemaster must adjust the game statistics and capabilities of the opposition to provide an appropriate level of difficulty for the group. If the adventure does not suit the player characters' strengths and weaknesses, the gamemaster may use it as an outline to develop an adventure of his own. Or, if it works well except for a tweak needed here and there, the gamemaster can change any part of the plot and events to make the adventure a better one for his group of players.

The adventure suggests Threat and Professional Ratings for each of the NPCs. Per the **SRII** rules, use Threat Rating dice in plate of Dice Pools for NPCs (p. 187. **SRII**). Gamemasters should adjust the actual Threat Ratings to better reflect the level of opposition presented by the player characters.

Such manipulation will be crucial to running some of the firefights in this adventure at a manageable level. The fights in **Imago** work best choreographed like an action movie. Though lead and magic flies everywhere, only a few of the bad guys actually get a clean shot at the heroes at any one time. That limitation, and applying the **SRII** Professional Rating rules, should help keep large fights under control.

For gamemasters using the first-edition **Shadowrun** rules, the Professional Rating system works as follows. NPCs With a Professional Rating of 1 will withdraw from a fight after taking a Light wound. Those rated at 2 will withdraw after taking a Moderate wound, those with a Professional Rating of 3 withdraw from the fight after a Serious wound, and those rated at 4 will fight until unconscious or dead.

PLOT SYNOPSIS

Transys Neuronet is a British megacorporation specializing in experimental communication systems, advanced cyberware, and Matrix software. They have always gone to great lengths to acquire and keep the very best British researchers, and they usually succeed. In 2048, they recruited an unusual new employee.

Transys knew the elf only as **Quicksilver**. Attempts to trace his past proved unsuccessful; he came to the company by hacking past the most vicious IC in existence right into the CPU of the Transys Edinburgh system, then asked the company for a job. Impressed, Transys gave him one. Quicksilver's salary quickly became astronomical as he developed cyberware and Matrix innovations of extraordinary complexity and power.

A loner by nature, Quicksilver was a strange individual prone to introspection and stormy emotions. He counted no real friends within Transys, not least because no one could comprehend what he was doing most of the time. One fellow employee, a young technician named **Alasdair Cameron**, became the closest thing to a friend that Quicksilver had at Transys. Cameron allowed Quicksilver his own space and simply liked being around the elf when he was in one of his rare gregarious moods. Quicksilver also formed a friendship of sorts with **Professor Amelia Richardson**, an expatriate from Seattle and a researcher in the Occult Sciences Department at the University of Edinburgh. Professor Richardson's work focused on life after death and reincarnation, two subjects that obsessed Quicksilver. This mutual interest in the survival of the soul formed the basis of their friendship.

Late in 2052, Quicksilver's life turned upside down. Dragged along to a social function by Cameron, he met **Morag MacDonald**, daughter of a Transys board member, **Sir Iain MacDonald** of Glencoe. Morag was a wild young elf, intense and passionate, and Quicksilver found himself overwhelmed by his feelings for her. The two met in a series of clandestine encounters, keeping their relationship secret not so much because they needed to, but because they shared a passion for secrecy. Falling ever more deeply in love, Quicksilver stole more and more time from his work to be with Morag. During his frequent trips to the Highlands, ostensibly taken to recuperate and "recharge his batteries," he evaded the corporate security assigned to protect him and trav-

eled to see Morag instead. Revitalized by his time with her, he wandered further and further afield in order to contact the druids and spirits to whom he entrusted part of his extraordinary final work. These travels proved his undoing.

Not unexpectedly, Quicksilver earned enemies within Transys. Fellow employees envied his prestige and success. He had enemies in other corporations, too, who wanted him out of the way to check Transys' burgeoning growth. In particular, the megacorporation **Zett-ImpChem**, beginning to branch out into Matrix research, wanted to end Transys' dominance of the British research market. When their agents within Transys learned how anxious corporate security was becoming at his absences they spared no effort to follow the elf. They tracked him to Castle Laidon on Rannoch Moor near Glencoe, murdered Morag MacDonald before her lover's eyes, then killed Quicksilver as he tried to flee for his life. They covered up the elf's death, and disguised Morag's death as part of the deadly Campbell-MacDonald clan feud. Operating on the principle that the only good witness is a dead witness, they left behind the bodies of a few Campbells along for the ride, and removed the bodies of their own men slain in the fight.

No one, except for Professor Richardson (and she has no details), suspects that Quicksilver's obsession with life after death and reincarnation drove him to conduct the most extraordinary experiment of his life; encoding himself into chips and programs. He created revolutionary hardware capable of encoding his personality into a set of programs he named the Affect program (feelings), the Memory program, the Perception program, and the Integrative-Executive program. Quicksilver continuously updated these unique programs and chips using a high-resolution telemetry link between his brain and his cyberdeck, and so they contain everything he knew and felt right up to his death. When the chips with these programs are slotted into Quicksilver's cyberdeck, his personality reintegrates as a full "person."

Quicksilver's current prolonged absence mystifies Transys, who does not know that he is dead. The few people Quicksilver calls friends have become increasingly anxious about his disappearance, and begin looking for clues. Alasdair Cameron, marginally aware of Quicksilver's concerns and research, hopes to find something existing as a free or mobile element in the Transys system that might provide a clue to the whereabouts of Quicksilver's missing research files. He hires the runners through an intermediary in Seattle, choosing to use outsiders rather than Brits for reasons of security (and freedom of action). Cameron is only backing a hunch that something important still exists in the system; he does not know what he expects to find, and counts on the runners to come up with something.

Imported into the U.K., the runners check the Transys system and encounter Quicksilver's **Imago**, a free presence in the Matrix which appears as an amnesic, almost autistic child. The child can only speak the name Amelia and ask to be taken to her. With a little legwork and a few contacts, the runners establish this name as a reference to Amelia Richardson, who holds Quicksilver's cyberdeck. She knows only that Quicksilver hid unique chips to be integrated into the deck, not what they contain or where he concealed them.

In an effort to erase all connections with Quicksilver, Zett-ImpChem agents within Transys assassinate Alasdair Cameron, leaving the runners without an employer and on their own. Pointers from Richardson and contacts made at **Hamish's Bar** in Edinburgh send the team to the Scottish Highlands, where they can trace **Fiona Mac Mhulrich**, the druid with whom Quicksilver left his Affect program chip. The runners must talk her into parting with the chip, and she asks a symbolic price for it—if she gives



them something of Quicksilver, they must participate in a druidic ritual and leave something of themselves in return. After slotting the Affect chip into Quicksilver's cyberdeck, the runners must lure the imago out of the Transys system and into the deck, and this time the player characters will probably have to face the system's IC. (The last time they penetrated the system, they had Alasdair's ID codes to protect them.) When the imago arrives at the deck, the decker engages the Affect program.

Now the imago sends out waves of terrible anguish: without memory, the imago feels the pain of his lover's death but possesses no recollection of the specific event that caused this anguish. The runners must next find the Memory chip, which is protected by a free spirit living on the shores of Loch Ness. This encounter will test the runners' nerve and integrity.

Integrating the Memory chip into the deck allows the imago to recall events but not their specific contexts (that requires the Perception program and chip). The imago knows he lost someone he loved more than life itself, but can only recall random emotional details. The Memory chip allows the imago to point the runners toward Morag Mac-Donald's existence and death.

With Morag Mac-Donald's name, the runners can trace the Perception chip to Castle Laidon, where Quicksilver and Morag died. They may acquire the chip through force, negotiation, dealing with Morag's ghost, and/or persuading her father to let them get the chip. When the runners integrate the Perception chip with the imago in Quicksilver's cyberdeck, the child develops enough to provide the final clue to the Integrative-Executive chip's location, which is in Amelia's university office.

With all the chips in place, Quicksilver reintegrates, a whole person once again. He asks the runners to take his deck to Castle Laidon and allow him to use the mind and spirit of a living decker to emerge from the deck, take form, and—in effect—die again with Morag's ghost so that the pair can pass over into the afterlife together. The decker who agrees to help Quicksilver undergoes an exhausting ordeal while the rest of the runners keep a swarming

team of Zeta-ImpChem agents at bay. The runners may die here, but if they survive, they are first in line for some powerful Karma.

GAMEMASTER'S NOTE

Beware this tale: imagos cannot and do not exist; no such free forms roam the Matrix, and Quicksilver's cyberdeck obeys no standard design principles. Accept Quicksilver as a unique entity. Like Harlequin and Ehman of the Harlequin campaign book, Quicksilver is a virtually timeless being of unique skills and abilities. What happens in **Imago** does not set precedents for other **Shadowrun** adventures—it is one of those stories that no one will believe.

Why did Quicksilver scatter his chips across Scotland? Why did he leave the elements of his personality with an academic, a druid, a spirit, and a wild young elven noblewoman? Read about him in the **Cast of Shadows**, chummer. He was following his own personal karma, and this soul's been around long enough to know that you don't buck that.

U.K. WEATHER

One final note. The weather, a popular topic of British conversation, actually matters in this adventure. Roads in the Scottish Highlands often remain impassable from late September through late March, and the freezing fogs and mists that roll suddenly and unexpectedly down from the mountains make traveling in a chopper a great way to commit suicide. It makes life a lot easier for everyone involved if this adventure is set between April and October.

ADVENTURE HOOKS

Though each encounter provides **Hook** Information pertinent to that scene, following are a few general statements regarding the theme, direction, and feel of **Imago**. The series of events related here are unique. Quicksilver accomplished something no one else has been able to. The nature and success of his experiment evoke the spirit of a time when the mana flowed stronger, when emotions ran closer to the surface, and people saw the world as a place of inexplicable wonder.

This feeling of "otherness" should run strongly through **Imago**, dominated by a sense of oddness, that things are not as they should be, or were. The key is to make the runners' environment feel different, but not necessarily foreboding or worrisome.

The events of **Imago** take place in a magic-rich atmosphere, and the runners should encounter the effects of that atmosphere regularly. Most encounters detail specific increases in mystical ambiance for the gamemaster, but gamemasters should keep a lookout for other opportunities to make the runners aware of the magic.

Several thematic thrusts should be at least symbolically evident throughout the adventure: lost love, fragmentation, despair, love that transcends time, and rebirth. Make the runners aware of these themes casually: passers-by may talk about being unwilling to live without a recently departed loved one. A child complains that he dropped his doll and now cannot find all the parts. A man may remark that his newborn son looks just like his own departed father. One of the runners drops a glass and it shatters into thousands of pieces.

The gamemaster should create flaunting, disquieting images, but ones that ultimately speak of final transformation and transcendence.

SO IT BEGINS...

TELL IT TO THEM STRAIGHT

For a person lacking gainful employment there are worse things to do than eat out at the Red Lobster Restaurant at Seattle's Stouffer-Madison hotel. The foods great and what's more, the place is full of businessmen and fixers likely to be seeking some hired help. You're just settling into your second round of Harvey Wallbangers when you notice a gray-suited, prosperous-looking man making his way toward your table. His wiry, graying hair and five o'clock shadow look familiar. He grins as he sets his aluminum briefcase down beside the chair he's pulling up.

"Good evening, people. I'm guessing your credit balances could do with some refreshment. I'm acting as an agent for someone who would like to offer you the chance for delightful foreign travel, a pleasant work environment, and something in the way of payment. One or two of you remember me, I'm sure. Peter Albrecht's the name. Can we talk? I have a suite on the eighth floor. Please bring your drinks. I'll get the waiter to deliver your meals to my room if you've already ordered."

You've heard of Albrecht. He's a fixer who acts as an intermediary for corporations who for some reason don't want to use their own negotiators. Sometimes that's bad news, but it's logical if Albrecht's fronting for a foreign outfit. And he mentioned payment. Is there a sweeter word in the American language?

You exit the elevator and make yourself comfortable in Albrecht's suite. He's comfortable, too, relaxed, no sign of stress. You're happy to hear him out. He might even pick up your dinner tab.

"I represent a British citizen who is anxious about a missing person. My contact wishes for you to travel to Britain, investigate this person's disappearance, and determine at least if he is dead or alive. My contact works for a British corporation and can give you access to relevant information. Because the person who wishes to hire you is acting privately, you won't be employed by the corporation itself, and so the remuneration is less than might be expected. As it stands, you will receive round-trip tickets on the suborbital to Britain, all travel expenses, and five hundred nuyen per person per day for a minimum employment of one week. My client doesn't anticipate any violence or danger on this job, but if it becomes likely, payment will be revised accordingly."

Albrecht smiles broadly. "Come on, chums, this is a piece of cake. You want the money, even if it isn't a lot. And Scotland's lovely this time of year. Best whisky in the world and the men wear skirts. It's a pushover."

Your lobsters arrive. Albrecht looks satisfied enough to pay for them if you agree to his proposition.

HOOKS

The beginning of this job seems much like the start of any other adventure, which means nothing happens to tip the player characters off to what is in store. As the smallest possible hint, a woman looking for her lost purse may enter the restaurant as the runners are leaving. All that she was is in that purse, she wails. Without it, she is nothing.



Play out the meeting in full. Give Albrecht some character. Enjoy the looks on the players' faces when he quotes the proposed pay rate.

BEHIND THE SCENES

Alasdair Cameron hired Albrecht to find some foreign runners to investigate Quicksilver's disappearance. Cameron is acting on his own initiative, and is prepared to sink some nuyen into finding out what happened to his friend. Albrecht knows very little about the job, because Cameron himself has only a vague idea of the direction the investigation may take. Play this initial encounter very straightforwardly. If the runners ask for more information, Albrecht tells them the following.

If the runners want the name of their contact in the U.K., Albrecht reveals Cameron's name. If any runner makes one or more net successes in an opposed Negotiation (Willpower) Test with Albrecht (Negotiation Skill 4), Albrecht tells the runners that Cameron works for Transys Neuronet, a British megacorporation. If the runners decide to check on Transys, provide the information available in **Legwork** (p. 64). Albrecht does not know the name or nature of the missing person, and does not have enough information to make a guess.

If the team asks why the employer wants foreign runners, Albrecht points out that British runners are a rare species. Massive red tape and a bureaucratic eagle eye watching British citizens makes life tough for the SINless. British employers often import foreign runners to work their shadows.

If the runners try to take the easy way out and pump Albrecht for information about the U.K., he looks pained and tells them in a voice dripping sarcasm to check the public bulletin boards and computerized information services; in Seattle this is SeaSource, operated by Renraku. This information appears in **Legwork**, p. 64. but the players receive certain items in the form of **Player Handouts** if they make specific checks: a map of Scotland (p. 75), a street map of central Edinburgh (p. 76), a chunk of general information about Edinburgh and the U.K. (pp. 72-73), and information about importing restricted items into the U.K. (**Anarchy In the U.K.**, p. 79). If the runners fail to check for restrictions on controlled items, Albrecht can brief them on the subject. On the other hand, the gamemaster might decide to reach the runners to be more thorough by busting them for possession at Edinburgh International Airport and hitting them with some hefty fines.

Albrecht tidies up the paperwork if the runners agree to the job, arranging to provide forged passports and British visas to get the team into the country. These will be available the following day, but Albrecht points out that the papers remain valid only for a short time. When the runners finish the job for which he hired them, the passports and visas expire. (The forged passports appear on equally forged credsticks and appear valid only because someone illicitly inserted the proper datafile into one or more of the numerous British credstick/ID verification system databases. The verification systems access these databases every time a holder uses a credstick/ID, for example, at airports. For more information on credstick use and verification, see **Sprawl Sites**, p. 126. For an updated source, see the **Neo-Anarchists' Guide to Real Life**, p. 103.)

The runners also need valid licenses for all personal cyberware in order to enter Britain. Albrecht arranges this as well, but he needs to know what enhancements the runners carry in order to get the small print right. Albrecht refuses to provide the runners



forged licenses for weaponry of any kind, including knives. Brits check these licenses very carefully, and Albrecht considers the risk of discovery too great. If the runners end up needing weapons, they must make appropriate contacts in Edinburgh.

The Brits frown on visitors carrying cyber-weaponry such as razors, spurs, or weapon-assisting systems such as smartlinks. Albrecht plans to represent these enhancements as similar pieces of legal augmentation. He assumes that in the general rush through airport security, the security sensor readings will be close enough to the notations on the runners' passports to avoid security's suspicions.

DEBUGGING

Little can go wrong here, unless the runners refuse the job. They may wish to negotiate the fee with Albrecht. If so, make an opposed Negotiation (Willpower) Test for the runner haggling with Albrecht. Adjust the final nuyen by 5 percent per net success. per person per day.

The runners may also express doubt about the quality of their forged permits. If so, Albrecht retires to his bedroom, makes a personal telecom call, and reassures the runners by informing them that he has Raul Esterhazy doing the work for him. Any runner making an Etiquette (Street) (3) Test recognises this name as one of the best forgers in North America. On the weapons front, the runners must simply go naked. Albrecht tries to reassure them by pointing out that the U.K. is a lot less street-violent than American nations, and Edinburgh is so amazingly peaceful that very few policemen routinely carry automatic weapons. Really. (Would we lie?)

When the runners agree to the job and take care of any **Legwork** (p. 631 they wish to conduct, go to the next section, **Welcome to Bonny Scotland**. Albrecht needs the runners to leave the day after this meeting, which gives them plenty of time to access SeaSource and do some quick checks on general information about Transys Neuronet, if desired.

WELCOME TO BONNY SCOTLAND

TELL IT TO THEM STRAIGHT

When the characters debark in Scotland, read the following:

You arrive at Edinburgh International Airport on the suborbital; it was 1000 hours when you left and it's 2100 local time after a two-hour flight. The Ghost travels fast. Edinburgh is cold, gray, damp, and everything else you'd associate with a British summer.

You're hurried down the gangways onto the passenger coach and unceremoniously dumped at Terminal 3. Before you stand the serried ranks of grim-faced British Customs and Immigration officials and a handful of lightly armed British police. The queues are at least as long as you'd been warned. Behind the acres of barriers, tables, and security devices a tall red-haired man waves to you; it appears that Alasdair Cameron's here in person. Just like you were told, he's actually wearing a skirt. The tartan is distressingly red, with lumps of green threaded with yellow. You remember that Scots call their skirts "kilts," and you make a note to do the same when you meet your employer. First, though, you've got to get through the bureaucracy. The outcome of the next few hours depends on the forged licenses, neat little plasheen cards containing an encased chip. These should get you through the security checks, along with the duplicate hard copy you have as back-up. Boy, Brits just love red tape...

"OK, matey, business or tourist?" You try not to sweat as they open your suitcases.

When the characters pass through customs, read the following:

It's taken two hours to get through the red tape, but the wait obviously didn't faze your employer. Alasdair Cameron greets each runner with a vigorous handshake that engulfs your suddenly puny digits in red-furred, shovel-sized hands. He quickly ushers you into a waiting limo and tells his driver to head for Queens Street, and your mind is distracted from wondering how he got to be so huge. The low-rise residential districts of suburban Edinburgh surprise you, especially the number of buildings made of stone. Graffiti is rare and the roads are well cared for. This isn't Seattle, that's for sure. As the limo passes through the center of the city, Alasdair points out a massive rock outcrop called Arthur's Seat, on which stands the impressive might of Edinburgh Castle. Sweeping down a hillside, the car moves through Princes Street, turns a bend, and arrives in Queens Street.

"I thought we could talk in my flat," Cameron says quickly, "but I've booked you into the Royal Muirfield Hotel in Castle Terrace. Fascinating place—used to be a theatre, and now the balcony restaurant provides the best prime Angus beefsteaks in the city." He's talking a little too fast and seems slightly uncomfortable, but that doesn't last long. To be precise, it dissipates after he knocks back "two wee drams" of malt whisky. You discover yourselves that it has a pleasant, warming effect.

"Thank you for coming. It's hard to find British, ah, operatives

who aren't in the pay of some corporate or official interest. I work for a research company called Transys Neuronet, and my boss has gone missing. I need you to find him, but the circumstances are rather odd. He used to go off to the Highlands alone on occasion, getting back to nature and all that, but company security always went with him. In the last few months, he'd taken to disappearing for several days at a time, efficiently evading the security force. He spoke to no one about where he was going or what he was doing. Now he's been gone for two weeks, but he would never leave voluntarily for so long without informing the company. I'm absolutely sure of that. Obviously, the company is doing what it can to find him, and it has a pretty long reach. My boss was a very gifted man, though, and I think there may be people in the company who don't want him back. Just petty jealousy, I can't name the names, but it's possible that more than one person might be sabotaging the effort to locate him. I want him back just because I liked him. Quicksilver was an amazing person, very intense, and a complete genius. I don't think he was really close to anyone, but I think he liked me and I admired him very deeply."

Cameron finishes on a sudden note of tenderness, making you feel he really cared about Quicksilver. You begin to warm to this gruff, slightly shy Scot.

"I can give you one solid lead and one other path of investigation. I know that Quicksilver sometimes had a late-night drink at Hamish's Bar at the bottom of Princes Street, just 'round the corner from here. His corporate security always waited outside. I haven't gone there myself to ask any questions—I didn't want to chance being seen by someone from Transys who doesn't want to find Quicksilver. You could try asking there.

"I can also give you a set of Matrix ID codes that will get you into the Transys system safely and allow you to explore it. Quicksilver was a brilliant decker and programmer, and I just can't believe that he didn't leave something in the system that will give us a clue. He was paranoid and secretive by nature, but he always created duplicate, even triplicate files so that he would never lose anything. Whatever is there will be hidden very carefully if my hunch is right. There's no risk for you because you'll have the proper codes to go where Quicksilver probably left his work, but I don't have access to the codes for the system structures where they keep the big-nuyen information. I'm taking a real chance with this—I wish I had the skills to check it out myself, but I don't.

"The only other information I have that might help you is that I know Quicksilver had a friend in Edinburgh University. I know it was a woman, and the relationship was platonic—they talked philosophy, from what I could gather. But that's all I know. As I said, Quicksilver was very, very secretive about himself.

"Albrecht reported that you came to an agreement on the terms of the job. I've booked you into the Royal Muirfield to start, which includes your room and meals." A fleeting grin crosses his face, "But I can't handle you ordering twenty bottles of chilled Bollinger a day, all right? If you need more money for traveling or

SCOTLAND GAMEMASTER'S MAP

- Dundee ● City
- Glasgow ● Major City
- Iona ★ Magical Site
- Major Roads
- Minor Roads
- Scotsprawl
- ▨ Scottish Habitable Zone
- ▧ Scottish Fringe Toxic Zone
- ▩ Scottish Irradiated Zone

Items in ALL CAPS are important IMAGO areas.

0 Miles 50

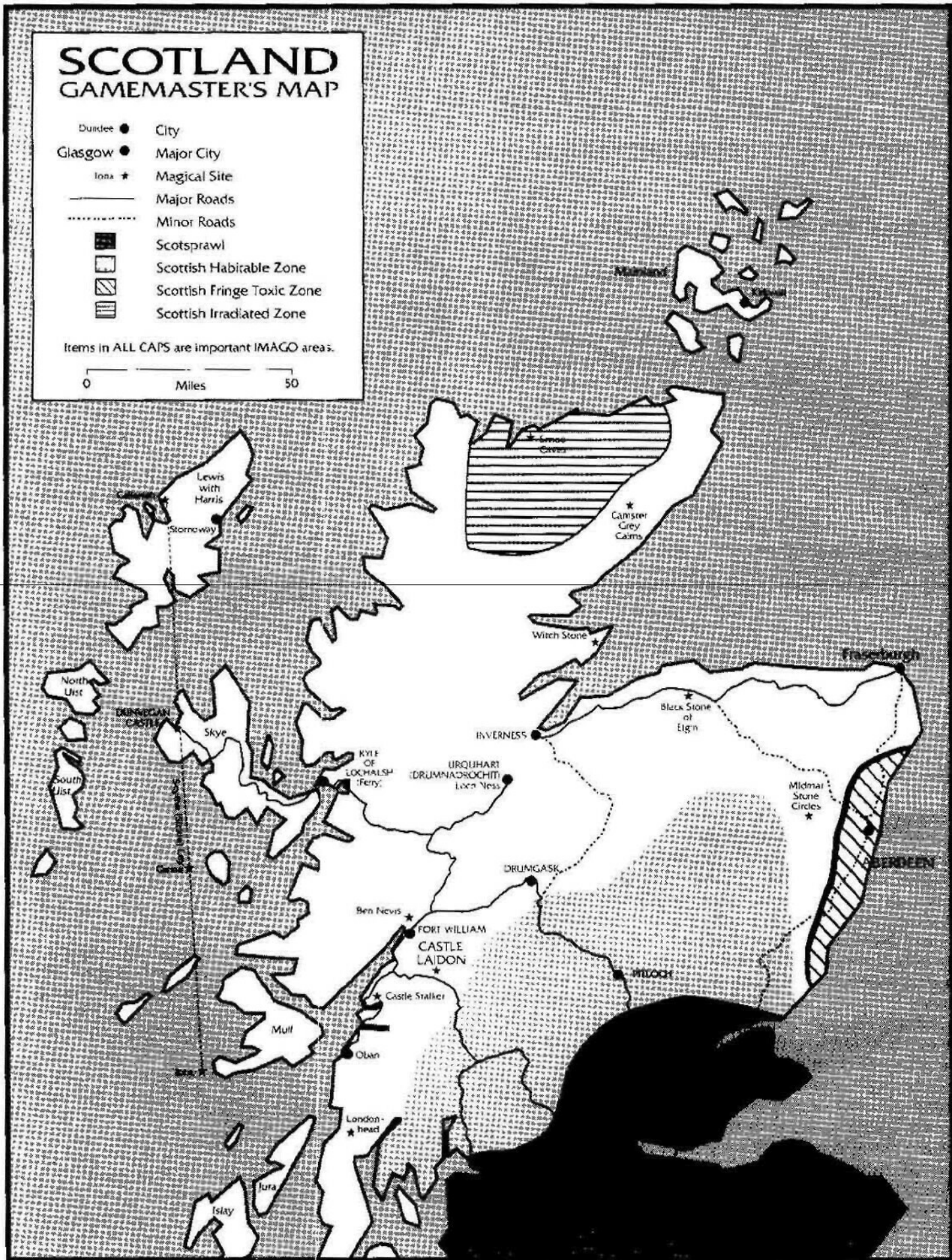

paying someone for information, get back to me. Here's my telecom number.

"Oh, and let me give you a picture of Quicksilver. He was really tall even for an elf—around two meters. He had short silver hair with a small black streak on the left temple. He carried a lot of cyberware, jacks and such around his neck which he used to conceal by wearing a blue silk scarf. He had blue-silver cybereyes, which were pretty distinctive. He also liked black a lot, he usually wore plenty of it, and this year he'd taken to wearing a silver signet ring on his left index finger."

HOOKS

Immerse the runners in the following situations and moods:

In the airport, they encounter confusion, bureaucracy, culture clashes, and men in skirts.

With Cameron the runners experience initial discomfort, which quickly turns to affection and concern.

In general, the runners feel like strangers in a very strange land, like fish out of water eyeing the frying pan.

BEHIND THE SCENES

The beginning of this scene simply serves to move the runners through Customs and Immigration. If stupid enough to try to import anything restricted or illegal, the gamemaster can relieve the offending runner of plenty of nuyen here. The team also meets Alasdair Cameron, their employer, who explains the nature of their task (see **The Cameron Connection**, following).

GETTING PAST THE BUREAUCRATS

If the runners try to conceal anything on the list of controlled substances and items (see **Anarchy in the U.K.**, p. 79), the security systems automatically detect the item. Brits have extremely good security devices, especially in the airports. The runners may be able to slip through a very small item which is normally difficult to detect. The gamemaster can use his judgment here. If the possibility exists that such an item might pass through security, have the officials make an Intelligence (4) Test using a target number appropriate to the item in question. However, airport security automatically discovers all magical items, no matter how small. Covert bureaucratic mages constancy assense the airport, and at least one of them will detect the item despite any masking the runner who owns focuses. If the runner is an initiate (see **Grimoire II**, p. 38), assume the customs staff includes an assensing Grade 2 mage with a Magic Attribute Rating of 7.

Have the official handling each cyberware license make an Intelligence (9) Test. With 1 success, the official decides that the license somehow looks odd, deliberates over it, and passes it around, muttering, "This look odd to you, MacDougal?" and so on.

For some reason the hard copy appears slightly different than the electronic check they run on the license card.

The above circumstances do not apply to any runner carrying a cybergun, which the security system automatically detects. The runner pays the appropriate fine, and the officials lock up the equipment permanently using a neat little electromagnetic device. For now, the weapon is useless, but the gamemaster might allow the runner to get it repaired when he gets home. Bad move, terms.

Make the runner carrying the cybergun sweat a little here. Have the officials and the runner make opposed tests, using the officials Interrogation Skill (Rating 4) and the Negotiation Skill of

the runner and a Target Number of 4 for both parties. If the runner achieves more successes in the test than the officials, he improvises a plausible excuse for his equipment, or perhaps just blathers and bores the officials into letting it pass.

If the officials achieve more successes than the player character, the runner may be in trouble. The officials do not spot the license as a forgery, but they decide that it "does not conform to British regulations" and say so. Have the runner make an opposed Charisma (Willpower) Test against the officials. If he achieves more successes than the officials, they just confiscate the item involved if possible. If the officials achieve more successes than the runner, they confiscate the item and levy an on-the-spot fine as well. If unable to confiscate the item (personal cyberware being an obvious example), they levy a fine and force the runner to complete an application for a license, warn the runner not to use the item in question, and demand the runner provide an address at which he or she can be reached during his stay in the UK. (Actually, that's just a bluff—even British officials can't trace everyone everywhere.) Because the runner needs a license for each individual restricted item, the gamemaster may use this opportunity to relieve the runner of whatever he wishes by calling down the laws of confiscation. Fines appear in the **Anarchy in the U.K.** section, p. 70.

Gamemaster's Note: Allow the team's "licensed" cyberdeck(s) to pass this check automatically. The runners must have decking resources for this adventure, and cannot afford to lose their cyberdeck here.

THE CAMERON CONNECTION

Alasdair Cameron is exactly what he appears to be—an honest guy who wants to find out what happened to his friend. His belief that some people within Transys prefer Quicksilver to remain lost is valid: these people know Quicksilver is dead, and so continue to detour all investigations down blind alleyways. These unsavory characters enter the frame of the story later on; ignore this information for now. For details about Alasdair, see **Cast of Shadows**, p. 67.

QUESTIONS AND ANSWERS

Like any good investigative team, the player characters want to get all the information they can before they begin. Alasdair provides the following information in response to appropriate queries concerning specific topics.

Quicksilver

"Quicksilver joined the company five years ago. His past seems to be a complete mystery. At least, I know the company checked him out and found nothing. He has a British passport, but these things can be forged, as I think you know. The company stopped caring after a while, because he was so damned good at his job. He began working with neural skills, but later specialized in wetware research, biological chips with intrinsic pseudo-intelligence capabilities. He also got involved with recombinant technologies and smart viruses as elements of wetware. He was the cutting edge of research in that field. No one knew what Quicksilver was doing until he decided to reveal it. He was a real perfectionist—it took him more than two years to build his cyberdeck, and he always carried it around with him in a battered blue briefcase. He never answered anyone's questions about what it could do."



Quicksilver's Retreat

Specifically, where did Quicksilver go when he wanted to get away from it all before he began evading corporate security? The Isle of Skye. The company owns a couple of hostels along the east coast. I'm sure the company alerted security to look for him there and follow him up all the time he's been evading corporate security. Simple.

Quicksilver's House

Where did Quicksilver live? "In Marchmont Road, out past Melville Drive. The company has already gone over his flat with the finest-toothed comb imaginable. You'll find nothing there."

Gamemaster's Note: Any investigation at his flat will be utterly fruitless, even if the runners break in, interrogate neighbors, and so on.

Transys Neuronet

Alasdair looks rather uncomfortable about answering questions about his company. Have the runner who asked the question make an opposed Charisma (Willpower) Test. If the runner achieves at least 1 net success, Alasdair paraphrases the information on Transys available in **Legwork** (p. 63), but refuses to say anything more. Yes, this is odd in view of the fact that he is giving them access to a peripheral part of the company's computer system, but Alasdair has irrational elements in his personality, just like any other human being.

Number of Runners

The runners may wonder why Alasdair imported so many team members if all he really needs is a decker to hunt for clues in the Transys system. If the team includes a street samurai, for example, the muscle may wonder about his role in the job. Alasdair replies simply that he does not know where the investigation may end up. Quicksilver often wandered the Highlands, and if the investigation follows him there, people with skills other than decking may become important. Alasdair wants to cover his bases from the outset.

Weapons

The runners probably feel naked without the protection of their weapons. The initial stages of the job hold no dangers, but the team should begin the process required to acquire weapons early on. Alasdair refers the runners to Hamish's Bar as the best place he knows for them to make contacts. He also warns the runners not to carry any visible weapons within Scotsprawl because doing so constitutes an offense against the law.

General Information

If the runners failed to do enough legwork on Scotland, and Edinburgh in particular, Alasdair provides a street map of central Edinburgh and a map of Scotland, (See **Player Handouts**.) Paraphrase information from the other relevant player handouts (on the U.K., Edinburgh, and soon) for Alasdair's replies if the runners have absolutely no clue.

When the runners feel they have acquired sufficient information from Alasdair, they should spend the rest of the day in the hotel recovering from jet lag. It is, after all, almost 2230 local time. If they feel up to it, they can go to **Hamish's Bar** (p. 15) this evening, and start the job the next day. When their decker jacks into the Transys system, he or she discovers the **Child In the Matrix** (p. 20). If part of the team wants to begin arranging medical insurance, licenses and permits, and so on for each of the player characters, go to **Taking Care of Paperwork**, p. 23. If the team wants to hire a vehicle (unlikely at this stage), go to **Getting Wheels**, p. 24. If they decide to wander aimlessly around Edinburgh like poorly organized tourists, taking in the sights and sounds and dropping into bars at random, the **Legwork** section, p. 63, includes tips on picking up contacts and provides specific information about Edinburgh available from plodding the streets. If they decide to check out Alasdair Cameron or Quicksilver, consult **Legwork** as well.

DEBUGGING

If the runners find themselves too low on nuyen to pay a spot fine for their weapons at the airport, Alasdair Cameron can cover their costs up to £10,000 (but 50 percent of the fine comes out of the team's fee). Leaving the airport only poses a major problem if the runners foolishly try to import heavy weapons or explosives, which carry massive penalties if discovered. Any runner carrying such an item automatically gets frog-marched off to prison, no trial. The gamemaster now has a non-player character on the prison island of Flatholme off the Somerset coast. This situation does not affect runners with functioning brains smart enough to leave such items at home unless they go out of their way to prove they are connected to the criminal party.

The runners' course for beginning the investigation is clear. Quicksilver's flat (a total waste of time) and the mysterious female with whom he used to conduct philosophical discussions represent potential red herrings, but the player characters will probably take the obvious routes: a promising location to visit (the bar) and a solid lead to follow (decking). But players are contrary beasts. If the runners try to find the mystery girl in the Philosophy Department of the university (located in George Square in 2053), they draw a total blank. No one there has ever heard of Quicksilver.

HAMISH'S BAR

TELL IT TO THEM STRAIGHT

You keep your expressions under tight control as you walk past the kilted trolls looming next to the lurid blue neon signs advertising Hamish's Bar. The bill of fare outside promises you 82 different malt whiskies and the best heavy in town, whatever that is. Inside, you notice the subdued lighting and genuine sawdust on the floor. The tables look like real, darkly stained old wood. You resist the impulse to touch one as you pass. You can tell you've beat the after-work crowd, because the bar surface still looks clean. Looking around, you see a fair mix of people, a pair of trolls clenching their massive fists around pewter quart mugs, two elves at a side table who studiously avoid looking at you, a young elf woman sitting alone, and a scattering of scruffy-looking street people in tartans, leathers, denim, and metal. Not much cyberware or corporate fashion in this place. Trying to look confident, you walk up to the bar. The hulking ork barman stands with his arms crossed, glaring as you approach.

"Pints of heavy, is it?" he half-snarls at you. "Great, thanks." you reply, trying to hide your accents and the fact that you have no idea what you just ordered. The ork fills a series of glasses with foaming, warm beer the color of mahogany. Though not what you're used to, the brew is rich and malty. Halfway through the glass, you realize this stuff has a real kick to it. Clutching your pint of heavy, you sit down at one of the empty tables and take a long look around.

HOOKS

Surround the runners with the smells of a pub: old wood, sawdust, beer and ale. Fellow patrons provide a background of laughter, arguments, the soft, low buzz of private conversations, the clinking of beer mugs, and the occasional sound of breaking glass.

A sense of displacement shadows this encounter. The runners do not belong here, and everyone knows it.

BEHIND THE SCENES

Use the Bar Archetype from *Sprawl Sites*, p. 14, for this location. The runners meet three important non-player characters at Hamish's Bar: if the gamemaster wants the runners to meet any of these contacts in some other place, he has to *get* the runners there. The team *must* contact these three principal NPCs. Duncan the Fixer serves as a source for street purchases and general assistance, Fionnghuala Colquhoun provides a lead on the Affect chip, and Hamish the barman gives the runners important information about Edinburgh and its environs. Obviously, the runners meet Hamish upon entering the bar, but they can meet the other two whenever the plot needs moving along. The gamemaster need only make sure that these characters appear when needed. For example, if the runners hit Hamish's Bar before encountering

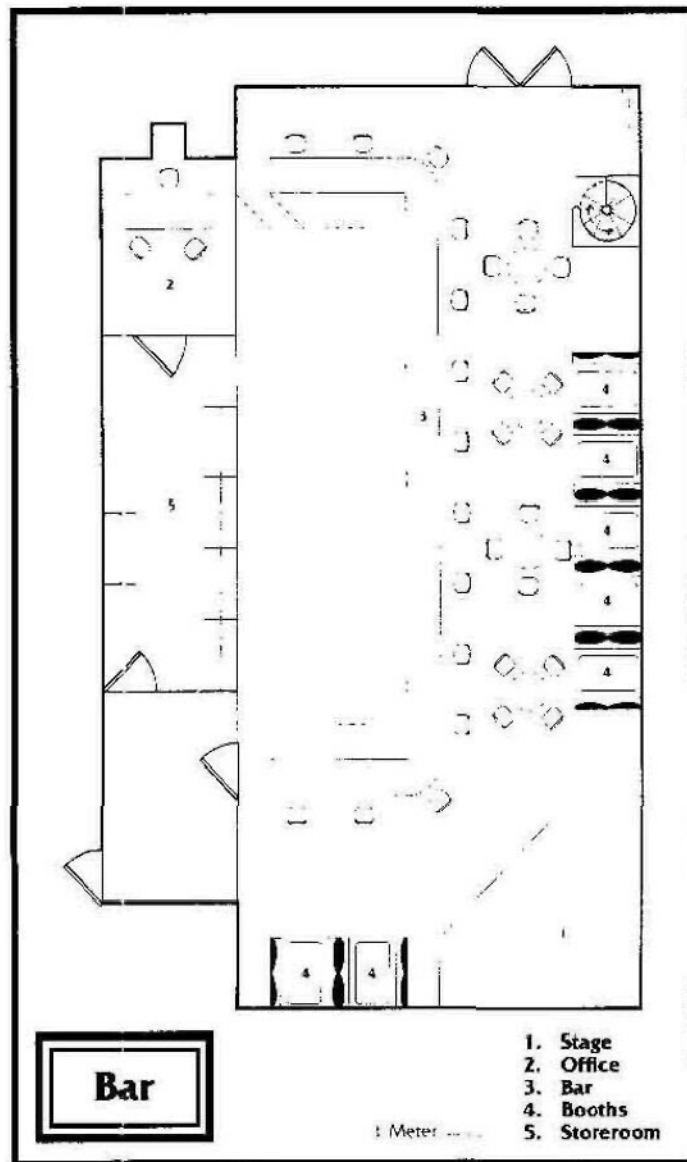

Child in the Matrix, p. 20. they should meet Duncan but not Fionnghuala. Because she leads the runners to the first chip, the runners should not meet Fionnghuala before meeting the Child and possibly talking to Professor Amelia Richardson (**Halls of Academe**, p. 29). Of course all this may not happen during the runners' first two drinks—they may need to make Hamish's their regular watering hole.

Initially, the patrons of Hamish's Bar ignore the runners, accepting them as just another set of tourists. The descriptions of each main player character below indicate what he or she knows and provide guidelines on what that character may say. As on every first date, the NPCs keep their lips shut, and the runners may need to meet with them

more than once to gain any information. The gamemaster may reflect this reticence by having the runner make an opposed test using his or her Intelligence against a target number equal to the NPC's Negotiation Skill. If the runner achieves more successes than the NPC, the runner knows that the character may be hiding information. Armed with that knowledge, the runners should press their advantage until they learn something more.

Though the runners may meet other interesting characters at Hamish's, as described in **Legwork**, p. 63, the point of the encounter is to bring the runners together with Duncan and Fionnghuala. Quick to recognize a potential customer, Duncan will most likely approach the runners himself, but they may have to work their way through the entire bar to contact Fionnghuala. One of the easiest ways to play this encounter is for nearly every character in the bar to tell the runners in a prominent Scottish accent that they can "rakk off, we don't like talking to seps in here!"

Depending on what time the team leaves Hamish's Bar, they can head in several directions. If they have not decked into the Transys system, they should do so now: go to **Child In the Matrix**, p. 20. If they get the name from Fionnghuala, they may want to talk to Professor Amelia Richardson of the Occult Sciences Department of the University; go to **Halls of Academe**, p. 29. If they decide they need a vehicle, go to **Getting Wheels**, p. 24. To find weapons or hire muscle, go to **Prime Scotch Beef**, p. 27; to make other logistical arrangements for their stay, such as arranging medical insurance, go to **Taking Care of Paperwork**, p. 23. When the runners decide to trace Quicksilver's druidic friend in the Highlands, go to **Death In Queen's Street**, p. 31.

HAMISH MACLEOD

B	Q	S	C	I	W	E	R	Armor
7	4	6	2	1	2	6	2	5/3

Initiative: 2 + 1D6

Threat/Professional Rating: 2/2

Skills: Armed Combat 4, Firearms 4, Etiquette (Street) 4, Unarmed Combat 4

Special Skills: Rumormill 5, Sympathetic Listening 2

Gear: Armor jacket (5/3), Claymore [two-handed sword: Concealability 2, Reach 2, (Str - 2)S]

Notes: Hamish has natural low-light vision, and a mild allergy to sunlight (Nuisance)

the men, at least. (He tends to treat all women as pretty young things.) Hamish hates people incapable of holding their drink.

Hamish represents a rich source of general information about Edinburgh and about people the runners may want to check out. See **Legwork**, p. 63, for the rules on acquiring contacts. If Hamish takes a liking to the runners, reduce all target numbers for their inquiries about Alasdair Cameron, Quicksilver, Fionnghuala Colquhoun, and Duncan the Fixer by 1.

Getting onto Hamish's good side takes time. On a second visit, have the friendliest runner make a Charisma (9) Test; if this is an ork runner, reduce this target number by 1. If the player achieves at least 1 success, treat Hamish as a contact. Players can make this test on each successive bar crawl, assuming their characters drink, pay, and tip well, until one of them makes a successful test.

The **Shadowrun** rules do not include guidelines for playing Hamish's Rumormill Skill. If needed, the gamemaster can use Hamish to toss out red herrings or other tangential clues. If the runners make a habit of dropping into the bar often, Hamish can be a great plot-advancing device, but he never knows anything specific.

DUNCAN THE FIXER

B	Q	S	C	I	W	E	R	Armor
2	4	2	2	4	3	6	3	(3/5)

Initiative: 3 + 1D6

Threat/Professional Ratings: 1/1

Skills: Armed Combat 3, Etiquette (Street) 4, Negotiation 4, Unarmed Combat 3

Gear: Ares Viper [Heavy Pistol, 30 (clip), SA/BF, 9S(f)], Armor jacket (3/5, worn only when expecting trouble), Knife (2L)

Twenty-nine years old, Duncan the fixer is a short, thin, rat-faced fellow with a sallow complexion and a revoltingly pencil-thin mustache. He wears black satin shirts open to the navel to reveal an expanse of hairless chest and a gold Celtic medallion, and favors trousers in the hideous pink and green Crawford clan tartan. Duncan poses as a Crawford just so he can wear the most hideous tartan in existence. He keeps an eye out for foreigners, knowing that many eventually end up at Hamish's: he sells them his considerable services for cold, hard cash. Though his fees are excessive, he never gives people bad contacts, shoddy gear, or misleading advice (at least, not intentionally). Likely to approach the runners or his own, Duncan offers his help in the following areas.

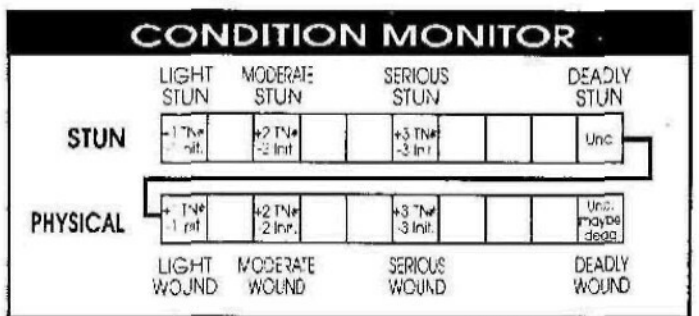
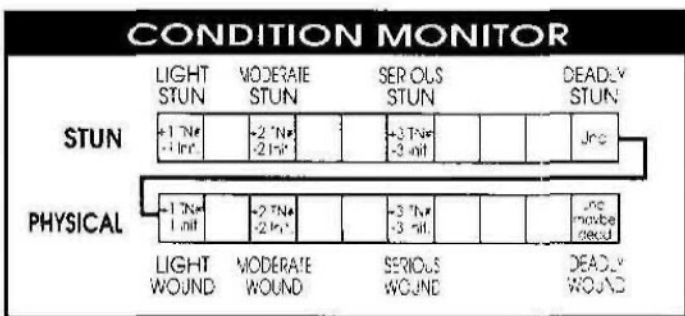

Hamish MacLeod, the Ork proprietor of Hamish's Bar, is twenty years old, tough and grizzled, and a sliver under two meters worth of solid meat, Hamish stands for no nonsense on his premises. The claymore over the bar does not hang there just for decoration; when things get out of hand, Hamish uses it. Close-mouthed with strangers. Hamish never divulges more than basic information about any of his regulars, but he is friendly enough, to

Information

Duncan's services as a contact are available to anyone who can pay £400, his standard "consulting fee." For £400, he will provide general info on locations around Edinburgh and for £400 a throw, info on Fionnghuala, Alasdair Cameron, or Quicksilver. See **Legwork**, p. 63. Another £400 buys the runners the name of the best vehicle-hire man in Edinburgh: Jackie Stewart of Stewart's Hyperdrive In Leith Walk (see **Getting Wheels**, p. 26). According

to Duncan, Stewart often deals with foreigners unfamiliar with British red tape. ("Nudge nudge, wink wink, know what I mean? just say that Duncan from Hamish's Bar sent you.") For £600, Duncan gives the runners the name of Angus MacNab, a useful contact for weapons, armor, and so on. Angus hangs out at The Arbroath Smokie, a rough-tough pub in Lauriston Place ("just along from the Royal Infirmary Hospital, ha ha.") Duncan assures the runners that MacNab is one tough piece of work (see **Prime Scotch Beef**, p. 27). For £800 Duncan provides the address of **Dr. Knox's Body Shop**, p. 43.

Duncan comes across as whining and obsequious, spinning even the measliest fragment of information into a tale to justify his exorbitant fees, even when all he can offer are the barest scraps. As usual, if a runner makes a successful opposed Negotiation (Willpower) Test against Duncan, the fixer reduces his price by 10 percent per net success.

Resources

Provided they pay him in advance, Duncan can get weapons or other items directly from Angus MacNab and sell them to the runners for a 25 percent markup on Angus' prices (see **Prime Scotch Beef**, p. 27). This arrangement makes Duncan nervous, however, for two reasons. First, his markup shoots the prices through the roof and Duncan is too cowardly to face down runners angry at being ripped off: second, Duncan fears being caught by the police. Only if the runners pay in advance, including his 25 percent fee, will Duncan agree to act as the team's intermediary.

Raising Cash

Having accepted a low-paying job to begin with, and finding the cost of doing business fairly steep, the runners may find themselves in dire financial straits at some point, especially after Alasdair Cameron dies (see **Death In Queen's Street**, p. 31). If Duncan knows of their connection with Transys Neuronet, he offers to purchase weapons and cyberware for them in return for a nonnegotiable 50 percent of the action they bring out of the Matrix. He pays 40 percent of the going street price for the equipment and hands the runners a suitably inflated bill. He needs 14 hours to raise any amount above £4,000 for such purchases.

FIONNGHUALA COLQUHOUN

B	Q	S	C	I	W	E	R	Armor
2	4	2	3	6	2	5.3	2	--

Initiative: 2 + 1D6

Threat/Professional Rating: 0/1

Skills: Biological Sciences 7, Biotech 5, Cybertechnology 3, Etiquette (Corporate) 3, Negotiation 3, Physical Sciences 3

Cyberware: Datajack with 200 Mp memory

Gear: Fashionable Clothing, Knife (2LJ)



A small, slender, female elf, Fionnghuala (pronounced, fin-ell-lah) is 28 years old but looks only 19. Fionnghuala was born and raised in Edinburgh, where her father holds the Chair of Neurophysiology at the University of Edinburgh and conducts research at the Royal Infirmary. During this adventure, Professor Colquhoun is on sabbatical at the University of Johannesburg. Fionnghuala's interest in neurophysiology prompted her to work as her father's research assistant and led to her acquaintance with Quicksilver. Despite the fact that she lives in Edinburgh, Fionnghuala firmly believes in getting back to nature. If the runner speaking with Fionnghuala is a shaman with a rural totem or an elf who makes a plausible nature-lover, reduce by 1 all target numbers for Social Skill Tests made in conversation with her. An elven decker will not fit this bill.

CONDITION MONITOR				
	LIGHT STUN	MODERATE STUN	SERIOUS STUN	DEADLY STUN
STUN	+1 TN* -1 nit.	+2 TN* 2 nit.	+3 TN* -3 nit.	Jnc.
PHYSICAL	+1 TN* -1 nit.	+2 TN* -2 nit.	+3 TN* -3 nit.	Jnc. no body good
	LIGHT WOUND	MODERATE WOUND	SERIOUS WOUND	DEADLY WOUND

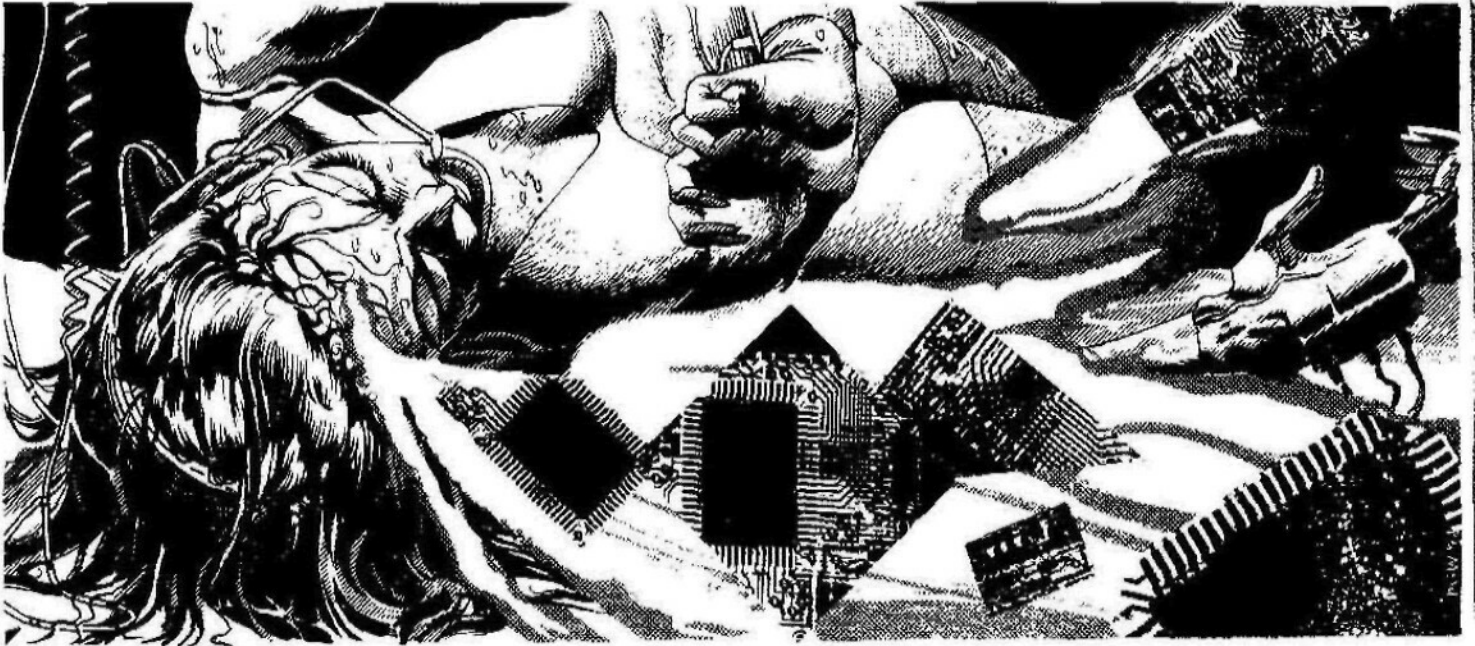

Fionnghuala enjoyed a few evenings of conversation with Quicksilver, though she knows him only as Erewan. Only if the runners describe Quicksilver will she recognize the cybereyes, the blue scarf, or the streak of black in his silver hair. If a runner rolls 1 success in a Charisma (6) Test, or 1 or more net successes in an opposed Negotiation (Willpower) Test, Fionnghuala admits that she knows Quicksilver. In order to coax vital information out of her, the runners must convince her that they truly care about Quicksilver's safety and that they fear violence against him. If the runners lie (claiming to know more than they do, for example), Fionnghuala makes an opposed Intelligence (Charisma) Test against the lying runner. One or more successes tells her that the runners are lying, and she accuses them accordingly. If this happens, increase the target numbers for all subsequent Social Skill Tests by +2. Make the player characters work even harder to connect with her. Fionnghuala will not accept bribery.

The runners need the information in the following paragraphs. The gamemaster can make it difficult for the players to learn the information, but they make a Success Test only to find out about Quicksilver's romantic involvement.

Information

Fionnghuala knows that Quicksilver worked as a programmer. In their frequent discussions of the medical aspects of cyberware research, he impressed her with his vast knowledge of skillssofts and neuromodulator research. These conversations naturally turned to discussions of spiritual philosophies. Quicksilver had studied astrology and several mystical traditions in depth, and his interest in reincarnation and the fate of the soul after death bordered on obsession. In their most recent conversation, Quicksilver spoke of life after death with an extraordinary intensity and passion. She knows that he often discussed such matters with a friend at the University of Edinburgh, and she tries to remember the name: "Richards, or Richardson, I can't remember, but she's a woman. A human."

Fionnghuala last saw Quicksilver three weeks ago. If the runner talking to her rolls 1 or more successes in an opposed Charisma (Willpower) Test, Fionnghuala says mournfully, "He told me he had found someone, a girl. I think he only saw me as a friend he could talk to. He played with a silver ring when he spoke of her.

I guess she meant a lot to him." At this point, the runners realize that Fionnghuala was half in love with Quicksilver.

"There's one other thing I remember. He once mentioned a druid with whom he'd talked about astrology, Fiona something, her name was, but he didn't speak of her as if she was a friend. More like a passing acquaintance, or a colleague. I know he spent time on the Isle of Skye, and I think this Fiona person lives there." She hesitates, looking puzzled. "He said something really weird. He told me he might leave his feelings there. He had a premonition that things would soon go wrong. He looked half-crazy when he said it. I guess he was always half-crazy, in a special kind of way."

Resources

If the runners remain on good terms with Fionnghuala (they tell the truth) and ask her for medical supplies, the player must make an opposed Negotiation (Negotiation) Test. If the player rolls 1 or more successes, Fionnghuala supplies the runners with a minor item from the Royal Infirmary, provided they convince her that she is stealing for a good cause. ("We have to head into the Highlands. The paranaturals might eat us alive, the terrain is hazardous, and medical insurance is worth squat out there. Please help us!") For £500 Fionnghuala can supply the runners with a medkit, or two Rating 5 antidote patches and two Rating 6 trauma patches for 150 percent of the price listed on page 263 of **SRII**. As she can smuggle only a few small items away from the Infirmary at a time, these limits are absolute.

DEBUGGING

The runners may become discouraged if they fail to make contacts on their first visit to Hamish's. In this event, Alasdair Cameron encourages them to try again; Scots are dour folk and persistence pays off. Paranoid (or very careful) runners might suspect Duncan the Fixer of being a corporate plant or undercover police agent. Hey—the hideous trousers alone could put a man with a weaker stomach off his feed. If they refuse to deal with Duncan, invent another NPC with a similar profile and contacts who can fill Duncan's shoes and give the runners the same key leads.

HAMISH'S BAR



CHILD IN THE MATRIX

TELL IT TO THEM STRAIGHT

You're back in Alasdair Cameron's plush flat, getting your gear ready for a Matrix run into the Transys system. Nervous, jumpy, clearly worried about this whole operation, Cameron gives you a set of ID codes for bypassing the IC infesting the research subsystem used by Quicksilver and his fellow researchers.

"Beyond the CPU is an SPU that leads into other research monitoring and data storage systems," Cameron mutters. "I have no access to that. Don't head that way, or all hell will break loose. Those systems have enough alarms and IC to nail you, no matter what you've got." Knowing Transys' reputation, you decide to take Alasdair's advice.

Fingertips on the console, you brace for the decking run. It feels weird to invade a corporate system with ID codes up your sleeve, without knowing what you're looking for. Better make sure you've got fast-analysis programs to check those datastores, chummer.

HOOKS

Aside from the bio-organic look of some of Transys' sculpted system, the run should feel fairly normal until the Child appears. His arrival brings a sense of mystery and strangeness, the same sensations of brushing the edge of another dimension that people feel upon seeing a ghost. For example, the gamemaster might inform the decker that he or she feels a slight breeze in the Matrix when the Child appears. If the decker asks, the breeze feels cold.

If the players or gamemaster need additional inspiration for the look and feel of the bio-organic parts of the Transys computer system, take a look at H. R. Giger's designs for the motion picture *Alien*.

BEHIND THE SCENES

Alasdair warns to keep tabs on the runners to prevent them from downloading the Transys research secrets. Using his own cyberdeck, he prowls the system directly behind them. (Treat the deck as a Cyber-4 with Response Increase (1). See p. 32, **Virtual Realities**.) Using his own deck allows him to handle security and alarms should the need arise while the decker investigates the system. The gamemaster should make sure that Alasdair and the decker stay within Contact Range. If the runner offers to let Alasdair use a hitcher jack, Alasdair will refuse. Alasdair's Matrix persona appears as a gray-robed old man.

If the gamemaster uses the **Virtual Realities** sourcebook, treat the subsystem the decker enters as a sculpted system (p. 51, **Virtual Realities**). The system looks biological; nothing within it appears manufactured. IC will look like predatory animals or micro-organisms, nodes look like organic entitles (viscera or with sculpted sulci like the outside of the cortex, for example, or even

as verdant woodland), and so on. The bio-organic reality affects the decker's persona (see p. 52, **Virtual Realities**), changing anything metallic or manufactured. If the decker's persona appears as an armored knight, for example, the armor becomes leather or cloth.

The research subsystem map appears below, along with explanations of important system details. If the players and gamemaster agree to use the Options rules for programs (p. 42, **Virtual Realities**), then all IC uses the hardened-defense option explained on page 22 of that sourcebook.

RESEARCH SUBSYSTEM

Because Alasdair has provided the passcodes for this cluster, the decker need not make tests against any of the cluster's white or gray IC. This absolute freedom strikes the decker as odd, and makes the ambush by what looks like a corporate decker (see **Combat**, p. 22) even more shocking.

For players using the System Load rules from **Virtual Realities**, the Maximum Load Rating and Current Load for each of the nodes is listed in parentheses following the Security Rating.

Despite Alasdair's passcodes, changes in overload or slowdown in any node set off an alert (see pp. 14-15, **Virtual Realities**).



CHILD IN THE MATRIX

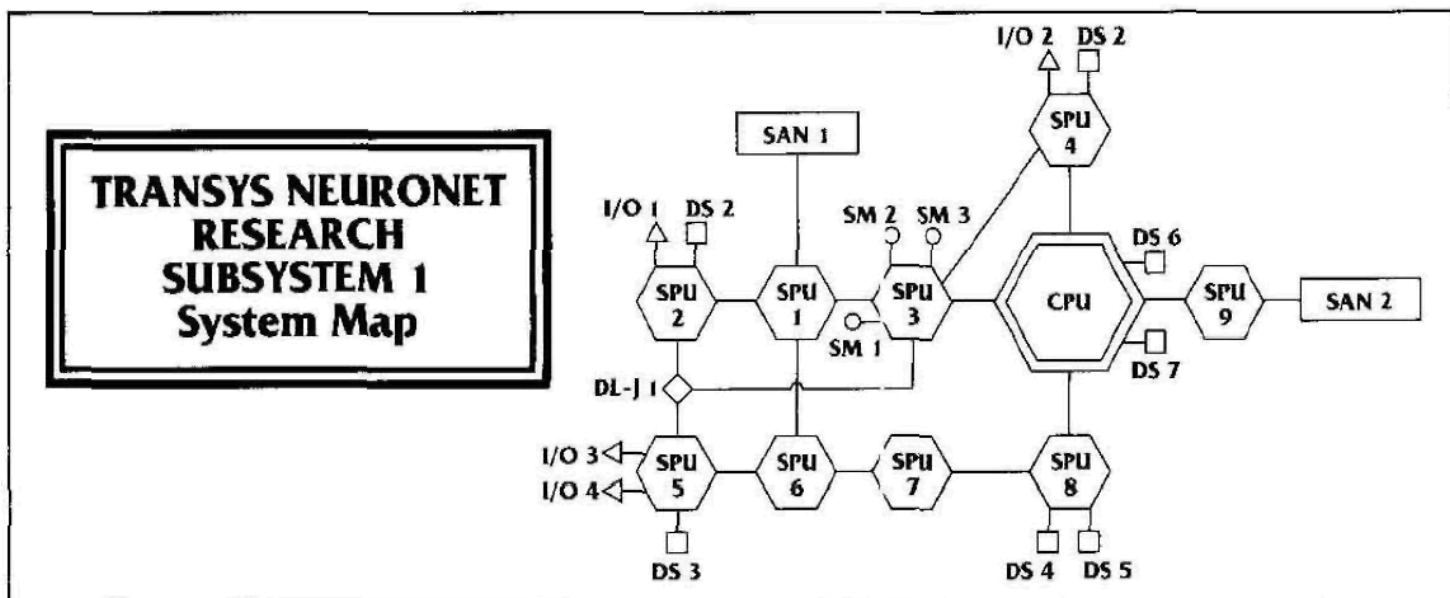

Transsys Neuronet System Map

CPU= Central Processing Unit

DS = Datastore

I/O P - Input/Output Port

SM = Slave Module

SPU = Sub-Processor Unit

SAN-1: Directory (31 1)411, Unlisted, Green-3 (Load 6/4), Access 4, Trace and Report 4,

SPU-1: Data routing, Orange-4 (Load 12/10), Access 4, Tar Pit 4,

SPU-2: Administration, Red-3(Load 12/10), Barrier 5, Probe 4,

Jammer 4,

DS-1: Basic records/files, Orange-4 (Load 12/6), Tar Pit 4,

I/O P-1: Terminals, Orange-4(Load 12/6), Access 5, Trace and Dump

4, **SPU-3:** Security, Red-3 (Load 12/7), Access 7, Black 4,

SM-1: Sensors, Orange-4(Load 12/5), Probe 4, Trace and Report 3,

SM-2: Cameras, Orange-4 (Load 12/8), Access 4, Blaster 4,

SM-3: Maglocks (interior), Orange-4 (Load 12/8), Access 4,

Blaster 4, **SPU-4:** Personnel, Orange-5 (Load 15/8), Barrier 5, Trace and Report 4, Acid 4,

DS-2: Personnel records, Orange-4(Load 12/10), Barrier 6, Blaster 5,

I/O P-2: Terminals Orange-4 (Load 12/4), Access 5, Trace and Report 4, **SPU-5:** Ongoing research, Red-3 (Load 12/9), Access 6, Killer (S) 4.

DS-3: Updating buffer, Red-3 (Load 12/9), Scramble 6, Blaster 4,

I/O P-3: Biological monitors, Red-3 (Load 12/8), Access 6, Jammer 5,

I/O P-4: Terminals, Red-3 (Load 12/9), Access 6, Blaster 4,

SPU-6: Data routing. Orange-4 (Load 12/6), Access 5, Tar Baby 4.

SPU-7: System security. Red-3 (Load 12/10), Acid 4, Blaster 4.

SPU-8: R&D master node. Red-3 (Load 12/3), Black 3.

DM: Ongoing research data (400 Mp). Red-2 (Load 8/3), Black 3.

DS-6: Research projections (150 Mp). Red-2 (Load 12/3), Black 3.

CPU: Red-5 (Load 20/13). Killer (S) 7, Trace and Dump 6.

DS-5: Backup files (800 Mp). Red-4 (Load 16/11), Barrier 6.

THE CHILD

If the decker uses a browse program to analyze datastores for references to Quicksilver, he finds nothing. No files belonging to, about, or created by the elf remain in the system. That someone would purge the subsystem of all references to Quicksilver astonishes and frightens Alasdair. He simply cannot believe that no trace of his friend's contribution to the corporation exists. Something of the elf himself remains, however, as the decker soon discovers.

Gamemaster's Note: The decker may encounter the Child in DS-5, DS 6, DS-7, or in the CPU. Time the Child's appearance to give the decker a chance to map at least half of the system: this map becomes important later in the adventure.

When the Child appears, read the following paragraph aloud:

An elven child materializes in front of you. He has short silver hair and silver-blue cybereyes that look strange in his sad face. He gazes through you rather than at you, reaching out with his small hands. "Amelia," he pleads. "Help me. Bring me to Amelia." And then he disappears. His persona didn't leave, he simply vanished. You know that can't happen. But it just did.

The Child represents Quicksilver's imago. This unique construct cannot function without the chips onto which Quicksilver encoded the other pieces of his personality. The Child is Quicksilver's template: the Integrative-Executive chip cannot properly integrate the other functions of Quicksilver's mind without it. Quicksilver programmed his deck to activate the imago if he failed to key in the deck's suppression codes at specific intervals. Though the runners know nothing of this, they immediately recognize Quicksilver from the picture Alasdair showed them. The hair and eyes give him away. If Alasdair stays within Contact Range of the decker, he also sees the imago and recognizes Quicksilver. Alasdair has never seen anything like the imago before.

For technically minded players, the imago functions as a unique smart frame (see pp. 44-45. **Virtual Realities**) created

its appearance apparently does not alter the node's load really scares some Transys deckers.

COMBAT!

Of course, the decker cannot get out of the system without a fight. Once he reaches SPU-2 or SPU-6 on his way out, a gray-robed, hooded figure enters Contact Range and attacks the decker's persona. The figure ignores Alasdair, who runs for the SAN. Decker dogfight!

Transys Decker (1)

B	Q	S	C	I	W	E	R	Armor
2	3	2	1	6	4	5.5	7	NA

Initiative: 7+2D6

Threat/Professional Rating: 3/4

Skills: Computer 6

Cyberware: Datajack with 30 Mp memory

Gear: Fuchi Cyber-4 cyberdeck

Fuchi Cyber-IV

MPCP	Hardening	Active Memory	Storage	Load Speed	I/O
6	3	100	500	20	20

Persona: Bod 5, Evasion 4, Masking 4, Sensors 5

Programs: Armor 4, Attack 5, Poison 4, Shield 4

Notes: Response Increase (1), Load Rating 4

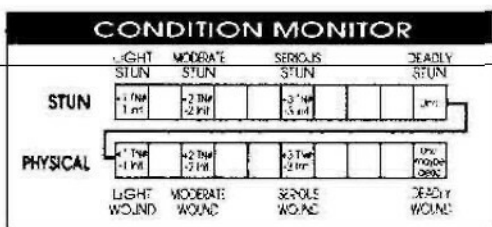

When his MPCP damage reaches the Serious level, the hostile decker disengages from combat and retreats through the system CPU and SPU-9 into a second research subsystem. As the runners have no ID codes or passwords for the subsystem, the team decker cannot follow his or her assailant.

The sudden attack panicked Alasdair at first, as he could think of no reason to expect hostile action. After thinking it through, he points out to the team that because the system IDs had not changed, the hostile decker could roam the system freely, but the company itself did not have the standard measures against expected intruders in place. Let the runners draw this obvious implication on their own: like Alasdair, someone within Transys is acting on his own initiative. Who attacked them, and why?

PAYDATA

Predictably, the decker may try to increase his remuneration a little by skimming a datastore somewhere along the way. The relevant datastores, D5-4 through DS-7, contain research data on medical cyberware developments, specifically neurophysiological implants and monitors. The value of that information averages about 5,000 nuyen per 10 Mp of downloaded data. Though Alasdair specifically asked the decker not to skim from Transys, he will tolerate one turn of data downloading, yielding data equal to the I/O Speed Rating of the cyberdeck. If the decker gets greedy and tries for more, Alasdair either demands that the decker download the data into Alasdair's cyberdeck via the I/O link or else

simply deletes the stored information.

The decker may be able to extort concessions from Alasdair by pointing out that the hostile decker must have been operating from within Transys, because the attacker fled from combat by vanishing within the system. A forcefully stated "You said it was safe, and I walked into an ambush. More suspicious people might wonder how that guy found me. I think you owe me a little hazard pay!" might carry some weight. Have the team decker make an opposed Charisma (Etiquette) (Corp) Test against Alasdair; if the decker rolls a higher number of successes, Alasdair lets the decker keep a maximum of 100 Mp of data.

MOVING ALONG

Where the runners go from here depends on where they have already been. If they already paid a visit to Hamish's Bar and made some contacts, they might decide to track down Quicksilver's academic friend, Amelia Richardson. If they do, go to **Halls of Academe**, p. 29. If they want to go vehicle or weapon hunting, go to **Getting Wheels**, p. 24. or **Prime Scotch Beef**, p. 27. To arrange for medical insurance, drivers' licenses, weapon permits, and so on, go to **Taking Care of Paperwork**, p. 23. If they feel like going druid-hunting in Skye at this point, talk them out of it. Alasdair insists he needs to rethink a few things in light of what happened in the Transys system, and asks the runners to meet him the following day to discuss their next move.

DEBUGGING

If the decker succeeds in downloading massive amounts of paydata to his deck and ignores Alasdair's demand that he or she hand it over, Alasdair pulls out all the stops, even pleading with the runners not to steal the data and betray his trust. If they ignore his appeals, Alasdair informs them with great dignity that if they keep the data, he can no longer employ them. If they still refuse to give up their ill-gotten gains, the adventure ends here. Alasdair takes his first opportunity to inform the authorities of the runners' true identities and their forged papers, which include fake licenses for unlicensed cyberware, magic, and so on. When the runners try to go home, airport security intercepts them and escorts them to Edinburgh's New Tollbooth Prison, where they spend the next five years or so. They deserve it.

At some point the decker may try to get past SPU-9 into the other research subsystems. The gamemaster must improvise the details of that other system, but make sure it carries plenty of gray and black IC.



TAKING CARE OF PAPERWORK

After the initial run on Transys, the runners realize this job could take a while. If they decide to get coverage for themselves while in Britain, this section explains how to take care of the most important types of paperwork.

MEDICAL INSURANCE

The runners can arrange medical cover for themselves by dialing 818-806-2222 (Careline) or 715-715-0715 (BUCM) and downloading the appropriate payment through a credstick transfer to a certified account register. Fees run £600 per person per week for the equivalent of DocWagon Gold service, and £1,500 per person per week for the equivalent of DocWagon Platinum service. Note that this coverage does not apply to the Wild Lands: there are no medical facilities in the Wild Lands, and the terms of all insurance policies become invalid if the runners enter these areas. If the player characters sustain injuries within the Wild Lands, they cannot receive medical treatment under their policy unless they make it back to the Habitable Zone; they also need a plausible story to explain how they received their injuries without referring to the Wild Lands. This explanation becomes particularly difficult if the runners get bitten by Nessie.

DRIVING LICENSES

Runners who maintain international driving licenses are rare, though any rigger in a group automatically carries an IDL. Visitors to the U.K. can apply for an IDL by presenting a North American drivers license at the Lord Protector's Licensing Bureau in Queensferry Road, but the IDL takes at least seven days to arrive (6 + 1D6 days). If an applicant tries to speed up the process by bribing an official, that official summons a security officer and assesses a spot fine of £5,000. The Bureau deports the runner if he cannot pay the fine. Really! If the player characters want to take a shortcut, they must find an appropriate contact (i.e., Duncan the Fixer at **Hamish's Bar**, p. 15).

WEAPON PERMITS

The Lord Protector's Administrative Bureau, also in Queensferry Street, issues weapon permits. Any runner checking into this will fairly scream, No way, chummer. Any weapon-permit application, even for a pistol, involves filling out triplicate versions of a Z96-item form that demands to know everything from the applicant's parents' dates of birth to the exact uses for which the licensed weapons are intended and a whole stack of personal information into the bargain. Forget it.

TALISMONGERS

No talismonger in Edinburgh will sell anything to a customer who does not hold a license from the Lord Protector's Administrative Bureau, and the runners cannot obtain such licenses. This adventure does not make allowances for characters picking up magic from street talismongers, but the runners could buy magic from a contact such as Duncan the Fixer. They find very little available through these sources, however, and will end up paying at least triple the prices listed in the **SR11** and **Grimoire II** rules. British talismongers refuse to deal with the runners directly and will sell only through intermediaries such as Duncan (who may add 25 percent to the price for himself if the gamemaster wishes).

The gamemaster may take pity on the runners and allow them to do a little talismongering themselves.

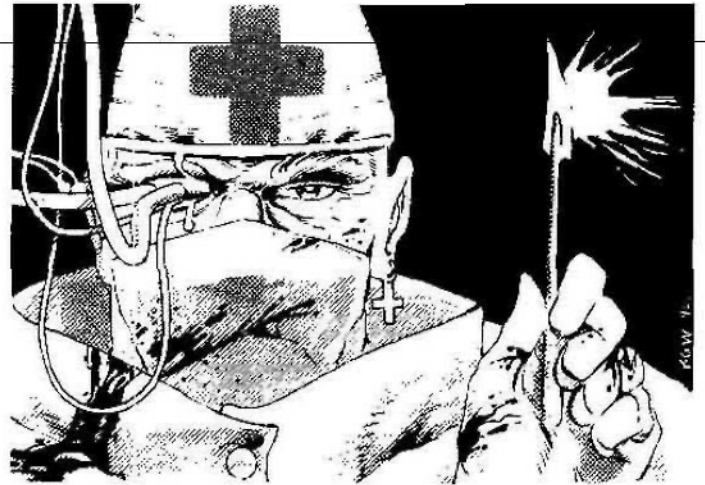

CHANGING MONEY

The wrong money always makes a rookie stand out in a crowd, so changing money is a wise move, chummer. Runners can change nuyen into pounds sterling at a rate of 1 nuyen = £2.45 at any one of the many Scottish banks (Royal Bank of Scotland, Clydesdale Bank, and so on) dotted around the streets of Edinburgh. Only major stores and banks accept nuyen, and bars only accept Scottish or English pounds (this also applies to Habitable-Zone locations). Barmen may take pity on runners caught without pound notes to pay for drinks in a bar, charitably giving them the princely exchange rate of 1 nuyen = £1. Of course, the gamemaster can have the bartender throw the runners out instead.

Street vendors will accept nuyen at an exchange rate of 1 nuyen = £2, but only if the runner making the purchase rolls 1 more success than the vendor in an opposed Negotiation (Willpower) Test. Otherwise, it's back to the old 1 to 1.

GETTING WHEELS

TELL IT TO THEM STRAIGHT

The showroom on Leith Walk is smaller than what you're used to, but you see a good range of autos right in front—cars, bikes, a limo as centerpiece, a couple of durable-looking Land Rovers and vans. At the back is a busy garage, with a lot of repairs and spray jobs and such going on. Stewart's Hyperdrive is a busy place, and it clearly gets a lot of business. You wait a few minutes before an ork mechanic notices you and points you out to his boss, a sallow-faced, long-haired man in dirty overalls. He strides over to talk to you, rubbing his oily hands in a manner not altogether reassuring.

"Visitors, I see. Jackie Stewart's the name. Best autos in the whole of Scotland. We've got the wheels if you've got the credstick. Want tae talk business?" He ushers you into his cramped office and demands cups of tea from his dowdy, paper-swamped secretary.

"Driving license?" he says expectantly.

HOOKS

The sounds and ambiance of a busy car dealership and repair shop surround the runners.

BEHIND THE SCENES

The runners are likely to want to hire at least one vehicle during their stay in the U.K. If they lease a car for driving around Edinburgh, they will still need something more practical for getting around the Highlands. Duncan the Fixer in **Hamish's Bar** (p. 15) may recommend Jackie Stewart at Stewart's Hyperdrive; if not, then general contacts (such as Hamish himself) or public information (C-net) also point them to the Hyperdrive.

DOING BUSINESS

If the runners do not have an international driver's license, Stewart still wants to do business with them, but ups all his rental rates by 10 percent. Add +1 to the target numbers of any tests runners must make while dealing with him. Because he insists the runners must get an IDL, have one runner make an opposed Negotiation (Willpower) Test against Stewart. If the runner achieves at least 1 more success than Stewart, Stewart admits that he can arrange a "temporary IDL" (a forgery that will go undetected for two to three weeks). A temporary IDL takes 24 hours to produce and costs the runners £6,000. The fee is not negotiable. Rental charges (as with purchase fees) can be reduced by 5 percent (rather than the standard 10 percent) if a runner achieves 1 more success than Stewart in a separate opposed Negotiation (Willpower) Test.

With the IDL question out of the way, Stewart discusses with the runners what kind of transportation they need. If they lack a firm idea of what that is, Stewart describes what he has available, which

is plenty. Allow the runners access to any car, bike, or van except articulated trucks. Stewart's markup makes the purchase terms 105 percent of the prices listed in the above sources. Rental costs 2.5 percent of the vehicle's value per week for use within Scotsprawl, and 6 percent of its total value per week for any travel outside of Scotsprawl. Stewart does not rent bikes, he only sells them. Obviously, the runners will need vehicles at some stage of this adventure, and unless they carry big, bulging credsticks, they settle for renting rather than buying. The rental fee includes insurance, but the runners must deposit 25 percent of the vehicle's value in a holding account as security. If they go back to Alasdair Cameron for money (assuming they reach him while he is still alive), he gives them enough money to pay one week's rental, up to a £4,000 maximum (he really cannot afford more than that). He



throws in 75 percent of the necessary deposit, and the runners can squeeze an extra 10 percent out of him if they generate at least 1 more success than Cameron in an opposed Negotiation (Willpower) Test.

If the runners try for something a little special, for example, an armored vehicle or an ACV, they learn that Stewart does not deal in any nonstandard vehicles, and he has no access to vehicle weapons. If the runners tell him they need a vehicle for Highlands travel, he suggests a van—the Nissan- Holden Brumby, the Rover Tourman (equivalent profile to the Gaz-Willys Nomad from p. 25, **Rigger Black Book**), or the Land Rover 2046 should work as long as the runners stick to the roads as much as possible. As an alternative, the runners may each buy a bike (again, allow them any bike from **SRII** or the **Rigger Black Book**, but no weapons). Both the bikes and the van are built to withstand some off-road travel, but not enough to get the runners where they need to be.

The runners' best option is a hover vehicle. Have the runner suggesting this make an opposed Etiquette (Street) (Charisma) Test. If he or she mentions that Duncan from Hamish's Bar said that Jackie could help them out, modify that runner's target numbers for the opposed test by +1. If the player rolls 1 or more net successes, Stewart admits he might be able to help. Though he "ne'er deals i' that type o' vehicle" himself, his brother Angus keeps a hover vehicle in his garage in Pitlochry. Jackie warns them that "You need a special license for one of those. I can't arrange a temporary license for a hover vehicle of sufficient, um, quality. You'd need weeks tae get permission from the authorities. Angus might let you rent his if you stay outside the sprawl. You'll have to pick it up at Pitlochry and head off from there. If you tell me where you want to go, I can tell you the best route. You'd best stick tae the roads: the wilder areas are crawlin' with paranaturals. Avoid the police or they'll snag you for sure. You understand, of course, none of this comes cheap."

Angus owns a Nissan Hovertruck, and charges £2,500 per day in rent. If the runner handling the bargaining makes a successful opposed Negotiation (Willpower) Test, Stewart reduces his price to £2,250 per day. The runners must pay for a week in advance and deposit £50,000 in a holding account as insurance.

If the runners tell Stewart they are heading for Skye, he suggests they take the A9 to Drumgask, then the A86 to Spean Bridge, the A82 to Invergarry, then the A87 to the Kyle of Lochalsh, where the runners can catch the ferry to Skye.

Finally, any vehicle the runners rent comes with a half tank of gas or appropriate fuel, but they pay to fill up. Stewart's modifies all its vehicles to include additional fuel storage facilities equal to two full tanks of gas. If the runners plan to spend any time in the Highlands, they will need that kind of fuel reserve. They can buy extra fuel at standard rates in Edinburgh or the Habitable Zone. In the Wild Lands, they find fuel only at a handful of settlements such as the Kyle of Lochalsh and Drumgask where it costs 150 percent of standard prices.

SUCH A DEAL

If the runners come to an agreement with Stewart, he begins the paperwork, including the thumbprint scan for the runner hiring the vehicle, if appropriate. As soon as they begin signing the papers, the team hears yells and the sounds of breaking glass from the garage forecourt outside. Stewart has refused to pay "insurance premiums" to a street gang working the Leith Walk area, and the gangers have come to inflict some damage. Through the office windows, the team sees a throng of leather-jacketed gang mem-

bers smashing windows and attacking garage workers with iron bars and pick-axe handles. If the runners just sit tight, the police arrive within four minutes and arrest the few gang members left behind—most fled, leaving broken windows and broken limbs behind. If the runners want to get on Stewart's good side, this is their chance.

The runners need 1 Combat Turn to pick up tools to use as clubs or knives, whatever each runner prefers to use. They need 1 additional Combat Turn to reach the gang members attacking the mechanics. Six gang members, traditional Scottish xenophobes all jump the runners. The gang leader also sends his vicious pit bull terrier into the fray (use the Large Dog profile, p. 199, **SRII**). The gang members have Professional Ratings of 3, which means that they will fight until they take Serious Stun or Physical damage. When at least four of the six gang members facing the runners suffers this level of damage, the whole gang runs for it.

This fight must remain an unarmed combat. If any runner pulls a firearm, Stewart shouts out, "Don't use it." because a gun means the police get involved. The runners also need to avoid casting area-effect spells, because the gang members and mechanics are rolling around in melee combat. If at least one runner gets involved in the fight, Stewart warns the runners off pursuing the fleeing gang.

Lending A Hand

If the runners jumped right into the brawl, Stewart thanks them quickly and hustles them off the property. "They won't be back after that. Get away before the police arrive." One of his mechanics screeches a limo out of the garage. "Get in, tell Jocky where you want tae go. Come back tomorrow. I'll have a better deal fer ye." If the runners return the following day, their IDL has already arrived, and Stewart reduces rental fees by 50 percent for one week and/or lowers any arranged purchase price by 10 percent.

Not My Problem, Mate

If the runners sit on their hands during the brawl, Stewart will still get them out of his garage before the police arrive, telling them it's best not to hang around when British police start taking statements. If the runners return the next day, any IDL or vehicle arrangement takes place at the previously agreed-upon costs.



GETTING WHEELS

Gang Member* (6)

B	Q	S	C	I	W	E	R	Armor
3	4	4	3	3	4	6	3	4/2

Initiative: 3 + 1D6

Threat/Profession*! Rating: 3/3

Skills: Armed Combat 2, Etiquette (Street) 5, Firearms 2, Unarmed Combat 4

Gear: Club (5M Stun), Heavy Leather Jackets (4/2), Knife (4L)

The Tartan Army street gang extorts protection money from businesses in and around their patch, Leith Walk. They only accept rude, obnoxious humans as members. Their leather jackets bear the emblem of a white thistle above a stuck-out red tongue. They never use firearms, preferring to do their dirty work without chancing police involvement.

Electronics 4, Electronics (B/R) 6, Etiquette (Street) 3, Ground Vehicles (B/R) 8, Negotiation 4.

Cyberware: Datajack, VehicleControl Rig (1),

Gear: Ares Predator [Heavy Pistol, 15 (clip), SA, 9M], Armor jacket (5/3), Knife (4L)

Jackie Stewart is 37 years old, of medium build and height, with a sallow complexion, dark, lank hair, and brown eyes. Born and raised in Inverness, he spent the last five years making his business the leading vehicle rental and repair firm in Edinburgh. Though cheerful and honest, Stewart keeps a definite reserve when dealing with foreigners. He has a disconcerting habit of looking slightly away from a person when talking to him or her, making the man seem shifty to those who do not know him.

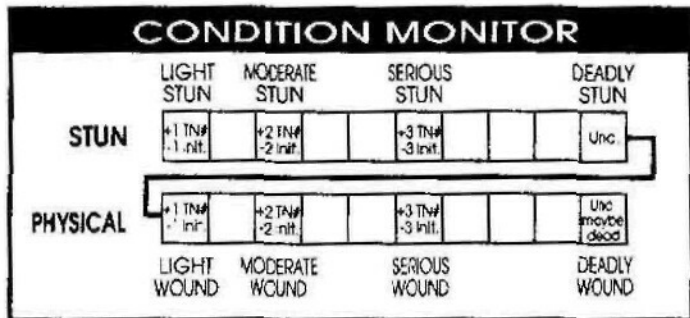
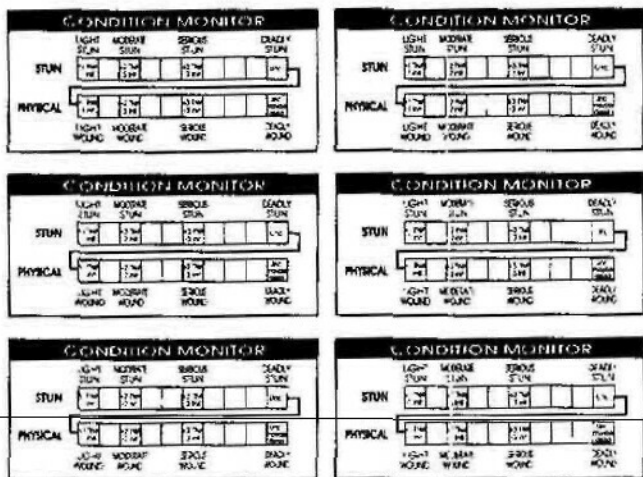

CHECKING THE VEHICLE

If the runners hire a vehicle here or the hover-truck from Pitlochry, they may want to check its roadworthiness. If they do, the vehicle works fine. If a rigger checks the vehicle, he has the usual odds of finding the tracking signal bug with a concealability Rating of 6, which is stuck behind the dashboard. With a range of 300 kilometers, this bug packs a powerful signal. A standard bug scanner may find the tracker, of course, and a standard jammer blocks it. Such tracking bugs are a common security device, and Stewart maintains that that is its only function. (For once, someone is telling the absolute truth; the bug has no other purpose than to help Stewart keep track of his vehicles.)

MOVING ALONG

From here, the runners' options depend on their actions so far. Apart from doing **Legwork**, p. 64, revisiting **Hamish's Bar**, p. 15, and similar general activities, they may want to locate Quicksilver's university contact (**Halls of Academe**, p. 29), pick up some weapons (**Prime Scotch Beef**, p. 27), check out the Transys system under Alasdair's watchful eye (**Child in the Matrix**, p. 20), or they may be ready (perhaps after waiting a day) to head for the Highlands. If they choose this last option, go to **Death In Queen's Street**, p. 31.

JACKIE STEWART

B	Q	S	C	I	W	E	R	Armor
2	4	4	3	3	3	4.8	4	5/3

Initiative: 4 + 1D6

Threat/Professional Ratings: 2/2

Skills: Armed Combat 3, Computer 3, Computer Theory 4,

DEBUGGING

The text of this encounter covers most of the angles. If the runners use firearm specific consequences. Edinburgh trideo and other media report the fracas, making special mention of gun-toting, trigger-happy Americans. This notoriety makes getting in touch with general contacts and any attempt to develop new ones even more difficult for the runners during the following week, as all Edinburghers regard Americans with more suspicion. To reflect this situation, increase the target numbers for all Success Tests by 1. The same penalty applies to dealing with people at Hamish's Bar. In addition, Stewart suddenly withdraws his offer of the hover vehicle and demands a 20 percent surcharge on security deposits. If the runners act like they don't know a thing about it, make 'em pay for it. The only thing they have going for them is that the police won't get on their tails. Yet.

In the unlikely event that the runners cannot afford to either rent or purchase a vehicle, they can still manage a trip to Skye by coach. See **Over the Sea to S k y**, p. 34.

PRIME SCOTCH BEER

TELL IT TO THEM STRAIGHT

The Arbroath Smokie doesn't have a meat bouncer outside the door. It doesn't need one. Everyone inside looks more than capable of taking care of themselves. Everywhere you look, you see extra-heavy body armor, blatant cyberware, and hard attitudes. The air is blue with tobacco smoke and most people here act as though they've drunk half their body weight in beer at lunch-time, and now they're just topping up. A toothless troll vendor flings unidentifiable flat things at customers, who rip them apart with their hands and shove them down their throats. After a moment, you realize that these are the famous Arbroath smokies for which the pub is named; herrings that have beer dried, salted, and smoked for, oh, several years, you guess. They look more like shoes for street rats than fish.

You summon up enough cool to walk to the bar, being fragging careful not to jostle anyone, and order pints of heavy. The barmen all have razor claws retracted along their forearms, and you guess they need them. You don't want to hang around in here any longer than you have to, so you tell one of the scowling barmen that you're looking for a gentleman by the name of Angus MacNab.

The room freezes. All eyes turn to look at you. An ork spits thick brown phlegm at your feet. A troll the size of a rhino with skin texture to match shoves through the throng at the bar. Heeeyes you up and down, plants his vast fists on his hips, and spits his words at you. "Did ye call me a gentleman, ye rakkin' septics?"

HOOKS

Man, this is a tough bar. A lesser man's limbs could get accidentally broken here and no one would think anything of it. The poor sap got what he deserved for coming in here, didn't he?

Harsh voices, loud laughter, the damp thwack of an occasional punch, the sounds of glass breaking and wood splintering, spitting, coughing, more laughing. Not a good place to crack an ork or troll joke, though other races do drink here.

BEHIND THE SCENES

A troll street samurai for hire, Angus MacNab bills himself as the source for unlicensed weapons and armor. If the runners buy him and his entourage enough drinks (say, £200 worth). Angus graciously decides to hear them out rather than throw them out. The following are his basic terms.

PERSONAL HIRE

Angus charges £5,000 per day, plus the cost of any ammunition expended, repair to any of his items damaged on the job, and soon. This arrangement covers almost any job apart from a clearly

suicidal venture, though Angus may decline an offer he thinks might bring him up against heavy or military weapons. If the runners want to hire him, have one team member make an opposed Negotiation (Willpower) Test. If Angus achieves more net successes than the runner doing the negotiating, the troll ups his rate by 10 percent, initiated by the runner's haggling.

As an almost casual aside, Angus warns the runners against trying to cheat him or doublecross him. Read the following as part of Angus' standard introductory spiel:

"And if ye have any thoughts about backstabbing me, ferget 'em. My clan never forgets treachery. My Uncle Murdo got boxed by a bunch of seps who took his weapons and cyberware. My American cousins, good old boys from the Confederated States, they got the rakkies who did it. Hunted 'em for two years and trapped 'em like rats. They pulled the heed right off the pixie, sent it tae me in one of them nice Federal Express boxes." Angus leers meaningfully at any elf among the runners.

WEAPONS

Angus can supply any type of weapons and ammunition for the runners except for lasers, heavy weapons, or military weapons. He charges 150 to 200 percent of the listed cost of any item in **SRII** or the **Street Samurai Catalog**. Use the standard Availability/Street Index rules given in those sources to determine whether or not the runners have access to the items they request. Armor other than heavy armor is also available with the same price markup.

In all cases, weapon availability is subject to gamemaster discretion. The runners only need heavy firepower at the very end of the adventure, and the gamemaster may wish to restrict access to more powerful weapons until the runners close in on the story's climax.

These costs may send the runners back to Alasdair Cameron (again, assuming he is still alive) to ask him to cover their expenses. If alive and solvent, Alasdair agrees to pay for standard pistols, hand guns, and basic armor, provided the runners agree to sell them back at the end of the run to a suitable contact (such as Duncan the Fixer) and give Alasdair the money. If the runners want to buy anything more powerful, he wants a damned good reason why they need it (a reason they are unlikely to have at this stage). If the runners make an opposed Negotiation (Willpower + 2) Test, Alasdair reluctantly pays 50 percent of the cost of a more powerful weapon. Alasdair refuses to pay for Angus' services under any circumstances: the troll costs too much, and his imported runners ought to have enough muscle of their own.

INFORMATION

According to his professional ethics, Angus refuses to provide information about any other NPCs. He makes this pointedly clear if the runners try to pump him ("Ye should nae ask that. I keep mae



crap shut. Ye'd do weel to dae the same yersel.")

If the runners ask Angus about unlicensed body shops, street docs, and so on, Angus does not give away his contact, but tells the team. "If ye hae need o' it, I'll get ye to the right fella." Angus knows Dr. Knox (see **Dr. Knox's Body Shop**, p. 43), and will supply his name to the runners if they get badly banged up and have no insurance, or cannot risk hospital treatment (because they pulled firearms at Stewart's Hyperdrive, for example).

When they leave the Arbroath Smokie, the runners can head in several directions. Depending on their previous actions, the obvious possibilities include **Child In the Matrix**, p. 20, **Halls of Academe**, p. 29, **Getting Wheels**, p. 24, and **Death In Queen's Street**, p. 31. For Angus MacNab's stats, see **Cast of Shadows**, p.

67. The Arbroath Smokie uses the Bar Archetype on p. 12, **Sprawl Sites** and the same bar map as **Hamish's Bar**, p. 15.

DEBUGGING

This encounter presents a fairly straightforward opportunity for the runners to get badly needed gear. Only if they behave offensively or aggressively will they get into trouble. If they do, the bar patrons dump the runners outside on the pavement, beaten to a pulp and Seriously Stunned. Some fifty hard-drinking, hard-living men toss back beers in the Arbroath Smokie on any given day, and they do not tolerate outsiders well.



TELL IT TO THEM STRAIGHT

You walk-up several flights of cold stone steps, past porters who eye you with suspicion, and stand on a landing from which corridors lined with closed office doors lead in all directions. It takes you a few minutes to find the name plaque reading "Prof. Amelia Richardson" on a plain, panelled door at the far end of one of those interminable passages. You knock politely. A voice with a familiar accent calls "Come!" so you turn the doorknob and walk in.

Amelia Richardson is a tall woman with elegant features, probably in her mid-40s. Every surface in her office overflows with real books—remember them?—and countless objects and ornaments featuring traditional Celtic designs. The brass model of the solar system and the huge trid horoscope display tell you she has an interest in astrology, but she's clearly no flake. From behind her imposing desk, which is itself dwarfed by the trideo and computer monitors on its surface, she gives you a bright-eyed and attentive look of calm intelligence.

"Are you the mixed-course students?" she asks. You'd bet a nuyen to a British penny that voice came from Seattle. Ain't that nice in a city of strangers?

HOOKS

Stretch the image of a sprawling, stuffy British university to the utmost here. Tiny, narrow hallways branch off big, drafty ones in a bewildering maze. Quiet murmuring from the students and instructors in the classrooms and hallways echo down the corridors. People passing by give the player characters odd looks (they're—umm—different). The whole place looks and feels genteelly shabby, like a once-grand manor house whose owners cannot quite afford to keep it up properly.

BEHIND THE SCENES

In this encounter, the runners meet Professor Amelia Richardson of the Occult Sciences Department at the University of Edinburgh campus located in George Square. Several sources lead to her. Fionnghuala at **Hamish's Bar**, p. 15, can provide the name "Richards(on)," and the **Child in the Matrix**, p. 20, asks for Amelia. The runners can trace Amelia Richardson from either source fairly easily, though the gamemaster can complicate things (and toss in a few red herrings) by giving the runners a list of a dozen or so Richardses and Richardsons to wade through if the team works from that name alone. In the team's fastest route of inquiry, they can use C-net to access the university LTG directory. Far fewer people named "Amelia" appear in the university listings even than Richards(on).

Amelia Richardson is a vital contact for the player characters.

(For details on Amelia, see **Cast or Shadows**, p. 68. The runners must cultivate her carefully, and deal with her openly and honestly. If they conceal relevant information, have Amelia make an opposed Perception (Charisma) Test against the runner hiding the facts. If Amelia achieves more net successes than the runner, she voices her suspicions.

To explain their interest in Quicksilver, the runners tell Amelia that someone hired them to find out what happened to him. So far, they know very little, but they obviously know of her friendship with the elf if they encountered the Child/Imago before meeting Amelia. They should reveal this, too. Though Amelia admits to knowing Quicksilver, she wants to hear them out before she says anything more.

As a condition for volunteering word one about Quicksilver, Amelia demands to know the name of the runners' employer. If the runners lie, have Amelia make an opposed Perception (Charisma) Test. If she rolls 1 more success than the runner doing the talking, she suspects a lie and grows angry. She is from Seattle: she understands runner-employer loyalty, and she only wants basic information. When the runners reveal Alasdair Cameron's name, Amelia recognizes the name of Quicksilver's research assistant and opens up to the runners (a little).

JUST GOOD FRIENDS

Now that Amelia knows that Alasdair already told the runners a few things, she provides other general information about Quicksilver readily enough. If the runners ask about her relationship with Quicksilver, Amelia smiles fondly and says they were friends who shared a mutual interest in certain magical and occult traditions. Have the runner doing the talking make an opposed Negotiation (Willpower) Test; if he or she generates more net successes than Amelia, the professor says a little bit more.

Successes	Result
1	"He had an interest in astrology, an area some of my colleagues study. As you may guess, my interests lie in that field, too."
2-	"Quicksilver was also interested in past lives, another of my pet subjects. Reincarnation intrigued him."

If asked about her work, Amelia admits to a wide range of interests within occult sciences. "Unfortunately, I spend more time than I'd like doing enchanting work. This department gets less corporate sponsorship than it used to; we lost a major funder last year. My enchanting helps pay the bills."

THE CHILD

If the runners have met the Child/Imago, they may ask if she has any idea why it specifically mentioned Amelia and asked to be brought to her. This question makes Amelia Richardson uneasy. Any runner making a successful Perception (4) Test notices her discomfort.

If the runners ask Amelia why the Imago mentioned her Specifically, read the following:

"I don't feel that I can share the reason for that with you just yet. I mean, I only met you a few minutes ago." Amelia is concealing the fact that Quicksilver's cyberdeck is back in her apartment, connected to the Matrix. She's noticed some activity on the deck's displays quite recently, but believes Quicksilver was accessing it remotely.

MISSING IN ACTION

Amelia last saw Quicksilver three weeks ago. "I think he was on his way to see a woman...a lover. I don't know where. He wouldn't say much about her." Amelia has no idea what has happened to Quicksilver, and feels anxious about him. She wants to believe the runners are the good guys, but refuses to blindly believe in their abilities.

THE DRUIDESS

From talking to Fionnghuala at **Hamish's Bar** (p. 15), the runners know that Quicksilver knew a druid named Fiona who lived on the Isle of Skye, and may remember his cryptic remark to Fionnghuala that he was considering leaving his feelings there. Amelia, obviously startled by this revelation, confirms that Quicksilver often visited Skye, and that he did so before she sensed the recent change in him that she attributed to romance. He never mentioned anyone named Fiona to her, but she knows that he met with druids on Skye and discussed astrology with them. "You'd most likely find Fiona at Dunvegan Castle on the west side of the island. The castle is a major religious site on the Sickle Ley Line. Even if you don't find her, ten to one you'll find someone there who knows where she is."

The gamemaster should field other queries that the players come up with using the details for Amelia in **Cast of Shadows**, p. 67, but be conservative. Amelia gives nothing away until she thinks things through. By the time the runners return from Skye she has decided to give them more information and help. Before they leave the University, she asks them for a contact number where she can leave any information that occurs to her later.

This conversation only needs one runner talking at a time, and the rest might find looking around the office quite interesting. Assensing the place reveals two magical power foci (Celtic medallions, Rating 3) in a glass case. If a player specifically announces that he wants to scan the bookshelves, he finds several volumes on the following important subjects: enchanting, reincarnation cases and theory, spirit survival of bodily death and astral metaplane research, and ancient occult traditions.

After this encounter, a visit to Skye should be next on the runners' agenda. At this point they probably have encountered the Child/Imago, but still may need to get a vehicle (go to **Getting Wheels**, p. 24) and weapons (go to **Prime Scotch Beef**, p. 27) in preparation for the trip. If they are already tooled up and think they know where to go, they have a shock in store. Go to **Death In Queen's Street**, p. 31.

DEBUGGING

Play this encounter as a cat-and-mouse game. Amelia does not want to give much information away, creating the distinct impression that she needs both time and more evidence of their good intentions toward Quicksilver to convince her to offer the runners significant help.

The runners must find the clues pointing to the Isle of Skye to take the next step in their Quicksilver hunt. If they have not yet visited Hamish's Bar, they should do so soon. If they visited the bar and missed meeting Fionnghuala, Amelia tells the team that Quicksilver knew druids on Skye and suggests that they investigate that island because it was one of Quicksilver's frequent haunts. Allow the runners time to get this information from Fionnghuala, but if they fail to do so, send a telecom message from Amelia to point them in the right direction.



DEATH IN QUEEN'S STREET

TELL IT TO THEM STRAIGHT

Alasdair Cameron's worried face appears on your telecom screen. "Listen, something's going on. I think Transys changed some of the system ID codes, and I can't raise the people down in R&D. Quicksilver's enemies may be on to me; we need to decide what to do. Get round here as soon as you can. I don't think it would be safe for me to leave right now; I hope I'm just being paranoid. Please come round right away."

The message ends. You'd better head for Queen's Street fast, chummers.

HOOKS

Horror overwhelms the runners. Cameron's body hardly looks human; it's a twisted, burned monstrosity. The choking reek of burned flesh fills the flat. Other than the small circle burned around what's left of Alasdair, the apartment is undamaged. The everyday sounds of the street enter the room through the open balcony doors, their very ordinariness seeming macabre in light of the charred lump on Alasdair's floor.

There's something definitely weird about the way his dead arm points toward the sky.

BEHIND THE SCENES

When the runners get ready to set off for Skye, they stop by their hotel room and find an hours-old telecom message from Alasdair Cameron.

Cameron's reeling that someone suspects him proves tragically well founded. Discovering that Cameron hired a band of American runners to investigate Quicksilver's death, Zeta-Imp Chem agents within Transys killed the research assistant, and intend to frame the runners for the murder rather than attempting to kill them, too. They even used magic for the murder, a risky proposition in the U.K., to more firmly plant the idea that brash Americans committed this crime. No Brit in his right mind kills using magic—why bother when a knife does the job just as well?

When the runners arrive at Cameron's flat, they find the door locked. No one answers their knocking, and so the runners must break in or somehow fool the Rating 4 maglock on the door (also linked to a PANICBUTTON system). Inside, they find Cameron's remains in the front room. His body and the area immediately around him look scorched; whatever killed him burned his body so horribly that bits of it crumble to ash every time the runners take a step. Only an autopsy can conclusively prove that this charred lump was once Alasdair Cameron, but the runners do not doubt for a minute that this is Alasdair's corpse. The body type and shape look right, and they recognize the few personal effects left intact on the body.

Cameron lies neat the center of the room, his mouth open in an eternal, silent scream. His arched back lifts the body slightly off the floor, and his head lies close to the balcony. His right arm extends upward past his head, pointing toward the balcony. If the runners attempt to determine where the dead hand is pointing, they can reach only one conclusion: the sky. (This sign comes as a very odd coincidence, spooking the runners and especially the magicians. The runners should make the obvious connection between "sky" and "Skye.")

Even the most casual examination of the body forces the team to conclude that Alasdair Cameron died by magic. To hammer home this point, any magician present making a Sorcery (4) or Magic Theory (6) Test and achieving 3 or more successes knows that the killer used a combat spell with an elemental effect.

Further examination reveals little more than the cause of death. A magician assensing the area learns that Alasdair died slowly and painfully. The resonances of his death agonies still fill the room. To avoid becoming violently, physically ill, the assensing magician must make a successful Willpower (2) Test. For another hour or so, at least, the room retains a Background Count of 1 (see p. 89. **Grimoire II**, for more information).

A resourceful shamanic player character might think of one other possible source of information and summon and question the hearth spirit that dwells in Alasdair Cameron's home. When Alasdair died, the spirit began fading away, returning to its home plane (see p. 93. **Grimoire II**), but a shaman can still summon it. Doing so, however, yields no information. Though a nature spirit technically exists at a location, unless someone summoned it to actually be present on either the etheric or physical plane, it knows little. In this case, the hearth spirit knows only that someone died by magic. Because the hearth spirit was only present "in spirit," it knows only general information. (The same holds true for the relationship of any nature spirit to the events that transpire within its domain whenever the spirit is not actually present.)

If the runners leave immediately after discovering Alasdair's body, they easily get away before the police arrive. If they decide to stay and check the flat, count the number of Combat Turns (loosely linked to actions) that they spend hanging around. The map of Cameron's flat shown below indicates the positions of some key items the runners may want. Describe the map completely for the runners: they spent time in the flat before and know its layout.

Atop Cameron's desk sits the smashed and useless shell of his Cyber-4 deck, the only sign of vandalism in the flat and a big clue, at least for the runners, to the party responsible for his death. The desk's second drawer yields, in addition to a lot of papers and bric-a-brac, a small, sealed plastic wedge containing a chip with a Rating 6 Sleaze program. The desk has four drawers, and it takes a runner 2 Combat Turns to search the contents of each drawer.

A wall-sized painting of the Monarch of the Glen (of no value) hanging in the living room conceals a shallow wall safe. To find the

**ALASDAIR
CAMERON'S
(Second Floor)
FLAT**

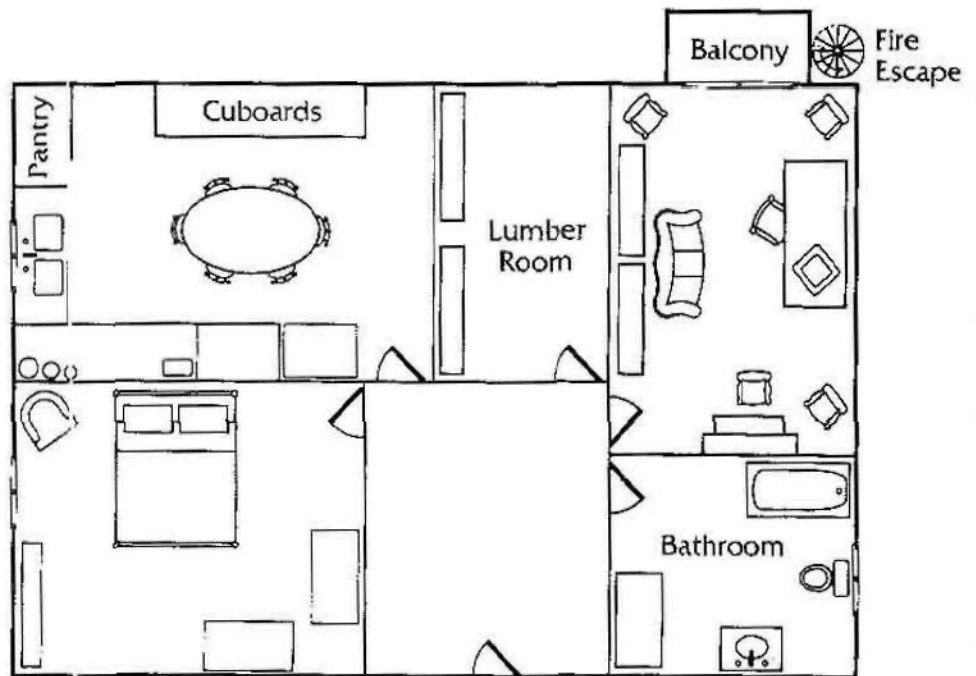

safe, players must state specifically that they look behind the painting. They must force open the safe with a suitable implement (a crowbar, for example: the runners have no explosives). For each Combat Turn during which he tries to force the safe each runner should make a Strength (9) Test. On 1 success, the safe springs open. Inside, the runners find £28,000 in cash (in £100 notes), a certified credstick good for 5,500 nuyen, and a velvet-lined box containing family heirloom gold jewelry. The jewelry has a base value of £10,000, but the runners cannot hope to get its top price in a foreign country with so few contacts. They might as well fence the jewels through Duncan the Fixer at Hamish's Bar, who offers 40 percent of top street value.

In the bedroom, the runners find Alasdair's wallet inside his jacket. The wallet contains £1,525 in a variety of bank note denominations, from £5 up to £100. It also contains personal photo IDs of various sorts, which are useless to the runners. Checking the room and finding these items takes the runners 1 Combat Turn.

Unfortunately for the runners, the assassins called the Edinburgh police, and those worthies may turn up at any moment. For each Combat Turn beyond the second one that the runners stay in the flat, roll 2D6. (Make these rolls before beginning play to keep the players from becoming suspicious.) If the total of the 2 dice equals a number less than the number of Combat Turns elapsed, the police arrive. Have each player character make a Perception (4) Test to hear the distinctive wail of the police siren. The highest number of successes rolled in this test equals the number of Combat Turns (about 5 seconds each) that pass between the time the runners first hear the siren and the arrival of the police in front of the building. It takes the police five additional Combat Turns to leave their vehicles and reach the apartment.

Four policemen turn up, tipped off by the assassins, who watched

from across the road for the runners to enter the building. If the runners are still around at this point, they are in deep dreck: the police demand that the characters surrender to be taken in for questioning. The runners face three choices: fight, run away via the fire escape, or surrender. If they decide to surrender, the adventure ends here. They land in prison, wait six months for trial, receive a "Not Proven" verdict (which in Scots law means, "you're guilty as hell but we can't pin the rap on you,") and get deported. Go to **Picking Up the Pieces**, p. 62. If the runners fight, they had best be prepared to take the heat: the Edinburgh police shoot to kill. If they run, they get away, but the police chase and shoot at them as they flee down the fire escape into the back streets of Edinburgh. If any of the runners takes a Serious wound (or worse), the group stumbles across a hapless old man getting out of his car and commander it to get away. Smart runners will leave the apartment before the police show, or at least run as soon as they hear the sirens.

If the runners ran from the police or got out before the police arrived, the evening video broadcast runs an item on Cameron's murder along with a vague description of a bunch of Americans wanted for questioning. The description remains too vague to identify the runners, but it definitely makes them nervous. Add +1 to all target numbers for all Social Skill Tests the runners make when dealing with contacts from this point on.

If the runners fought and defeated the police, they are in real trouble. Precise descriptions of them circulate throughout the news media, making the runners prime targets for identification by every bounty hunter and casual observer in the sprawl. They need to take cover fast. For a fee of £5,000, Duncan the Fixer or Angus MacNab can arrange a safe place for them to stay overnight, no questions asked, but they need to get out of Edinburgh *right fragging now*. Allow the runners to reach either Duncan or Angus; they cannot risk running around anywhere else.

However this encounter plays out, make sure that the runners

learn through trideo broadcasts or contacts that the authorities plan to triple-check the papers of all Americans heading out of Scotland for a while. That news should keep them from chickening out and going home.

The trip to the Isle of Skye makes a perfect excuse for the runners to get out of town; go to **Over the Sea to Skye**, p. 34. Should they be foolish enough to try leaving the country at this point, go to **Picking Up the Pieces**, p. 62.

POLICE (4)

B	Q	S	C	1	W	E	R	Armor
4	4	4	2	3	3	5.5	3	4/3

Initiative: 3 + 1D6

Threat/Professional Rating: 2/2

Skills: Armed Combat 2, Etiquette (Street) 4, Firearms 3, Unarmed Combat 3

Special Skills: Police Procedures 5

Cyberware: Smartlink

Gear: Bond & Carrington Premier [Heavy Pistol, 14 (clip). SA. 9M, w/extra clip. Internal Smartgun Adapter], Plated Vest (4/3), Stun Baton (Reach 1, 6S Stun)

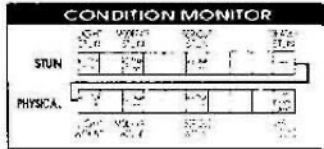
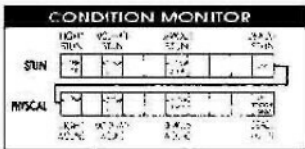
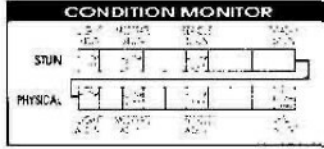
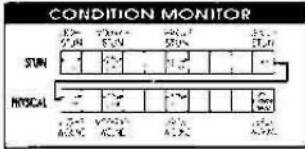

DEBUGGING

If the runners surrender to the police, the adventure ends. When the wimps get out of jail, go to **Picking Up the Pieces**, p. 62.

Unless they scrounged some loot from Alasdair Cameron's flat, the runners find cash flow a major problem by this time. Could be a good time to sell some items, chummer. In extremis, they might even sell a bodily organ or two; either Angus MacNab or Duncan the Fixer can direct them to a suitable source (go to **Dr. Knox's Body Shop**, p. 43). The body shop may also be their next destination if the police managed to fire some accurate pot shots. If the runners downloaded any worthwhile data from Transys in the course of running **Child In the Matrix**, p. 20, they can try selling it through their contacts back home. (If these dire straits prompt the runners to go back into the Transys system to search for more paydata, they find the passcodes altered and the system on passive alert.) If all else fails, they can try mugging some old ladies for a few bob in the more provincial areas of Scotsprawl. You know what they say—no matter what, the show must go on.



OVER THE SEA TO SKYE

TELL IT TO THEM STRAIGHT

As the runners prepare to leave Edinburgh, read them the following:

It's time to leave Edinburgh, chummers. Your lead to the Isle of Skye may be tenuous, but it's all you've got. Your employer's been boxed, and now someone's putting the heat on you. Alasdair's last message tipped you off that someone within Transys Neuronet might be on to you. If he was right, that someone might be the person who had him killed. You can't even quit and make for home; the police and officials hunting down Alasdair Cameron's killers would just love to talk to you. They'd surely scrutinize your documents a lot more thoroughly than they did on your way in, and this time around you might get busted for fake licenses. Ain't life grand? Time to leave town and lie low; it's better for your health.

HOOKS

The trip to Skye passes uneventfully. Perpetual thunderclouds loom in the sky, but the threatened storm never breaks. Nothing unexpected happens.

The meeting with the druids of Dunvegan is another story. Their initial contact with the druids may convince the runners that the druids are charlatans with little real power. As the encounter continues, their very real power becomes more and more obvious, especially to any magician assensing the area. The druids seem harmless and even silly in the beginning, but quickly become frightening, even alien. The runners dealing with them face a level and application of power they never suspected possible. Magicians, especially, should feel trepidation (if not outright panic) at the thought of participating in a druidic rite.

Much of the feel and texture of the druids and their ritual is given below in the respective descriptions. A sense of fantastic power, in use and in reserve, overrides all other feelings. Though the runners had begun to suspect it, this encounter convinces them that the events surrounding their investigation carry repercussions beyond anything they have ever encountered.

BEHIND THE SCENES

Several options exist for traveling from Edinburgh to Skye. The team can take an internal flight from Edinburgh airport to the Kyle of Lochalsh (£650 per person); they can travel to Pitlochry by bus (£60 per person) or rail (£125 per person) and collect their hired hover vehicle: or drive an auto, most likely a van, from Edinburgh to Lochalsh along the road route shown in the players' version of the Scotland map, p. 75. From Lochalsh, a 15-minute ferry trip takes them to Kyleakin on the Isle of Skye, and from there they can hop a bus to Dunvegan Castle. If they have no vehicle of

their own, they can figure out travel options and charges by checking with C-net.

TRAVEL TO LOCHALSH

If the runners take a plane, they reach the Kyle of Lochalsh uneventfully.

If the runners use a hover vehicle, it takes them 14 hours of driving along the road route to reach Lochalsh. If they use an auto, they need two days to make the trip, because the roads have not been repaired properly in years and the runners end up making periodic detours across patches of inhospitable terrain.

If they choose hover or auto travel, the runners get to see the wonderful Scottish countryside, complete with heather-covered hillsides, old pine forests, the new forest that the druids have begun to regenerate, pure cold streams and rivers, the bracken-covered plain and the Glens to the west, and the fabled lochs, narrow fresh-water lakes with pebbled or rocky shorelines. They also see a couple of well-armed convoys of police on powerful bikes protecting the route, because tourists head this way on occasion if they cannot afford the plane fare. They may pass a small number of well-armored touring vans on the road. If they travel by auto, Drumgask makes a logical stopover. They can get overnight accommodation including dinner and breakfast there for £85 per person (two to a room).

The Kyle of Lochalsh is a small fishing village with a population of some 550 souls. Before heading for the druids, the runners book accommodation. £100 per person per night, two to a room, including supper and breakfast, and a garage for their vehicle if they have one (£25 per night for a car or van, £35 for a hover vehicle). They must take public transportation across the water: the druids of Dunvegan Castle govern Skye, and only allow one coach to operate on their island.

The ferry trip across Loch Alsh is glorious. This salt-water loch offers a pure, still sea, the sun shines brightly, and the ancient ferry travels little faster than walking pace, making the trip idyllic. The runners probably breakfasted on kippers (smoked herrings), oatmeal cakes, real salted bacon, fresh eggs, and lashings of cold toast. Make them feel good; the stronger their sense of well-being, the easier it will be to catch them off guard later. The ferry trip costs £8 per person, and the coach trip from Kyleakin to Dunvegan Castle costs \$15 round trip per person.

DRUIDS OF DUNVEGAN

If the runners know nothing of Dunvegan Castle, everyone they talk to at the Kyle of Lochalsh tells them that Dunvegan is the headquarters of the druids on Skye. Locals respond to all inquiries about the druids with a patronizing, "Ye'll see. Ye're too eager tae ken aa." If the runners ask specifically about a druid named Fiona, the question provokes peals of laughter and the reply, "that's an awfa common name roond heer."

Dunvegan Castle stands on a promontory overlooking the sea, and tourists never set foot inside it. At the foot of the

promontory stands a stone circle some 40 feet in diameter, set with 30 stones each between five and ten feet high. As the coachload of tourists disembarks, seven druids emerge from the castle and make their way toward the circle. (For more details about druids and their regalia, see pp. 33-36, 143-45, the **London Sourcebook**.) Scots druids generally form loosely organized groups, but one elf clearly leads these white- and gray-robed druids in a procession. He carries a pair of ank-h-tipped staffs, one of oak and one of ash.

It is immediately obvious to any shaman or mage that the "ceremony" the druids celebrate in the circle (featuring dramatic gesturing and recitations) is a show put on purely for the benefit of the tourists, who applaud politely at the end of it and deposit money in a golden bowl shoved in front of them for this purpose. When the ceremony ends, the druids immediately prepare to return to their castle. This is the runners' only opportunity to contact the druids.

Initially, the "lead" elf (whose name is Finniaen MacNaughton) waves them away with a weary expression, but any mages or shamans in the group catch his attention, and he turns back. He scowls at any street shaman with the group, and gives any player character with an Essence of less than 1 (due to cyberware) the cold shoulder. Assuming the runners' group includes a mage or shaman, the elf addresses himself exclusively to these characters.

If the runners try to break the ice by making a polite general query about the druids and their group, the elf gives them a "don't waste my time, what do you want?" reply. If the runners ask for a druid named Fiona, the elf thinks for a moment and asks why they wish to see her. If the runners ask for a druid belonging to the elf's group who knows Quicksilver (whether they know the name Fiona or not), he tells them to wait and returns to the castle. The runners must use the name Quicksilver to get any action from the elf.

Finniaen rejoins the runners with Fiona Mac Mhuirich a few minutes later. She listens quietly to whatever the runners say, offering no response to any questions at first. In the end, the runners must reveal everything they know- the meeting in die Matrix, Quicksilver's friendship with Amelia Richardson, the works. As the runners talk, Finniaen casts a Force Rating 7 analyze truth spell and whispers his findings to Fiona toward the end of the runners' explanation. The player characters gain nothing by lying, and if they go beyond slightly embroidering the truth. Finniaen warns them against further attempts at subterfuge.

When the runners begin to run out of things to say, Fiona speaks. Read the following as her reply:

"I have part of Quicksilver. He left something of himself with me at the last solstice; I have not seen him since. (**Gamemaster's Note:** The last solstice predates the last date on which the runners know Quicksilver was alive.) What he gave me is part of his life's essence. If I give part of him to you, you must give of yourself to me, for how else will I know you are fit to hold him?"

If the runners do not simply accept her terms, but ask what she means, read the following:

"I cannot give you what he gave to me unless I trust you, unless I know that you believe that what I hold is precious. The best proof of that trust is your willingness to give of yourself. Only by that giving will you understand what he gave to me. Only by that giving will you be bound to cherish what he gave."

Specifically, Fiona requires that the most talented magician among the runners (preferably a shaman: a mage is second best, a street shaman unacceptable) participate in a druidic ritual within the circle at midnight. Agreeing to her terms without being told what the ritual involves is the only proof of trust Fiona will accept. The runners have no other option: attacking the castle is suicide (and the gamemaster should set a few dozen nature spirits on the runners if they try).

The druids return to the castle, giving the runners time to think over their options but they really have no choice. The druids re-emerge from the castle shortly before midnight. The runners can wander around Skye while they wait (interesting but uneventful), and may even think to try the best tactic available for getting information about the upcoming ordeal: astrally asserting the area.



ASTRAL ASSENSING AND AURA READING

If the player-character magician attempts any form of aura reading, he or she immediately detects within the earth a powerful line of magical energy that runs across the island. The castle and stone circle lie on its path. This territory lies on the Sickle Ley and has a Background Count of 3 (pp. 33 and 89. **Grimoire II**). Background count makes assensing difficult, because the magician must sort through more "static" to find the information he wants. Use a Target Number of 7 for all aura reading and other assensing Success Tests or add 3 to the player character's standard target numbers for these tests, whichever makes the tests more difficult. Use the following tables to determine the information available on objects and people the magician might try to assense/read.

Sickle Ley Line

Successes	Result
1-2	The background count represents regenerative earth magic. Its power refertilizes the land.
3+	The energy of the ley line has a specifically druidic affinity, and some affinity with conjuring.

The Ifsiids

Successes	Results
1-2	The druids are shamans. Their leader possesses an enchanted golden-sickle focus.
3+	The druids are making preparations to enact a magical ritual at midnight. They belong to the Bear, Eagle, and Wolf shamanic totems. The group's leader is attuned to Eagle as his totem.

Fiona Mac Mhurlrch

Successes	Results
1 -3	Fiona knows Quicksilver and feels a strong affection for him. Her totem is Eagle.
4+	Fiona is inclined to trust the runners, but needs proof of their trustworthiness. Her instinct instructs her to ask of the runners something of their being, to be given in a way that corresponds in some sense to the part of Quicksilver she holds. She holds in her mind the image of a sealed wooden box, which, by the strength of the image, is very dear to her.

These assensing attempts yield odd results because they reveal a level of information not usually available from assensing. One goal of assensing is to detect the presence of magical objects. However, a magician assensing Fiona may see an image of a sealed wooden box, clearly mundane, associated with her aura. The runners may attribute this unusual effect to the presence of the ley line, or may come up with some other explanation.

Assensing The Castle And Circle

Both the castle and the druidic circle have Barrier Ratings of 9, making any form of astral assensing very tricky indeed. Any successes simply reveal that these sites carry as much powerful magic as the ley line; the castle contains beings with magical energies (the druids) and magical items, and the circle itself shows latent magical power in addition to the energies of the ley line.

COMETH THE HOUR...

Twelve druids, including Fiona, arrive at the circle shortly before midnight, following Finniaen in procession. Each carries a golden sickle, a small golden bowl, and a lit torch, and each wears a medallion engraved with a different zodiacal symbol (if the runners ask, Finniaen wears the ram of Aries, Fiona the Cancerian crab). The druids demand that any street shaman, among the runners and anyone with an Essence of less than 2 withdraw from the circle at least 100 yards. They give the rest of the team permission to remain near the circle, but the druids warn them not to interrupt the ceremony. The druids stand just within the circle, with Aries at the one o'clock position and Pisces at the twelve o'clock position.

When everyone present has taken his or her place, Fiona hails the runner magician and invites him or her into the center of the circle of druids. Read the following:

"Stone, sea, fire, and air call on you. The earth herself calls on you. You must answer by giving to her. You must decide how much you can give. Come before us."

The magician moves to the center of the circle. As soon as he reaches the exact center, twelve manifest spirits (six mountain and six forest, in apparent violation of the rules of domain, p. 65. **Grimoire II**) erupt from the earth around the circle, one behind each druid (if the runners outside the circle decide to attack the druids, they have to go through the manifest spirits to do it).

When the runner magician reaches the center of the circle and

the spirits appear, read the following:

You're standing in the center of a circle of stones, druids, and spirits. You're scared and shaking. The druids begin chanting, and melodious, sweet sound that ripples and runs around and around the circle. Your head hurts like the beginning of a migraine and your body feels heavy. It's hard to stay upright, and sweat breaks out on your forehead. The earth feels like it's pulsing below your feet. The raw power surrounding you sets your pulse racing, your nerve endings on fire. How long can you take it?

How Much Can One Person Give?

The druids are draining the magician, both to draw energy into the circle and to probe the magician's honesty and the integrity of his motive regarding Quicksilver. Fiona knows she has something very precious to Quicksilver: she wants the magician to know what it feels like to give away something that dear.

During each turn of the ceremony, the magician must make a successful Magic (4) Test or else lose something of himself here. Modify the target number according to the following circumstances;

- 1 if the magician/runners mentioned Amelia, the Child, and Fionnghuala to Fiona.
- 1 if the magician is a Bear or Wolf shaman.
- 2 If the magician is an Eagle shaman.
- +1 if the magician prepared specific defenses before entering the circle (using aura masking, any magic spell or item that creates a barrier, and so on). Interpret this strictly according to the rules.
- +1 *each* for Turns 8 through 10.

The magician can choose to break the ritual at any time. Make sure the player understands this. The magician need only step away from the center of the circle. The ritual affects the magician for a maximum of 10 Combat Turns, but because this is a test of courage and will, neither the player nor the character knows this **limit**.

Once the magician fails a Magic Test, he or she feels increasingly unwell and nauseous but suffers no permanent ill-effects. When the magician fails a test, the following effects occur in sequence;

On the first failure, the magician takes one box of Stun damage, accompanied by intense stomach sickness and cardiac pains.

On the second failure, the magician loses 1 point of Karma, preferably from Good Karma, but from the Karma Pool if that is the character's only available Karma. If the team agrees, take the point from the Team Karma Pool. Transient blindness accompanies this Karma loss and lasts for the rest of the ceremony and for 6 turns after it ends,

On a third failed Magic Test, the magician loses 1 point of his or her Magic Attribute and collapses, unconscious. Consciousness returns 12 turns later. While unconscious, the magician experiences a vision with both a visual and emotional component. The magician feels desperate, devastating grief and sees a young elven woman slumped on a set of stone steps, her white blouse stained with blood, wearing a skin made of red tartan. (This picture appears on the back cover of this book, so show it to the player.)

The ritual ends when the magician chooses to step away from the center of the circle; when 10 turns elapse; or when he falls unconscious, whichever comes first. However, even if the magician manages to make successful Magic Tests on all 10 turns, he or she still loses one point of Karma on the final turn—the earth demands something from this ceremony. On each failure, the magician can feel the earth drawing away something of his own being, increasing its own inherent magic power.

After The Ritual

When the ritual ends, the spirits disappear and the druids gather around the magician to support him while he recovers. The magician experiences one more sudden shock: his body shakes and convulses for one turn as he recovers, and he experiences great pain in his back and chest, as if bullets were ripping through him. Then the sensation vanishes.

Fiona holds the magician's head in her hands and tells him softly that now he knows something of what Quicksilver left with her. Now she is willing to part with what she holds. Fiona goes to the castle and returns with a small black box sealed with wax and a silver clasp.

When Fiona returns with the box, read the following:

This is part of Quicksilver. He knew that someone would come for it one day. He did not expect you, I think, but he believed it would be a magician." She smiles and gives the box to the runner. "I can also tell you one more thing. He followed the ley not long ago, and I know he met a presence at the lochside—at Loch Ness. I do not know what happened there; he did not deal with our druidic brethren at the Loch. I do not know what it is I give to you, but care for it well."

The druids return to their castle. The runners face spending the rest of the night out in the cold before they can get the coach and ferry back to Lochalsh, but they have the first piece of Quicksilver.

THE BOX

If the magician assenses or reads the aura of the box, he feels mixed emotions (no test needed): love, longing, despair, and pain. The magician also feels a violent physical shock, as if bullets were plowing through his body, and then a sudden radiant warmth and release. This happens only the first time the box is assensed; any subsequent efforts reveal nothing. If the magician tries to read or assense the box (or its contents) a second time before leaving Skye, the background count may disguise the fact that the box appears "lifeless." If the magician makes a successful Perception Test, he or she can distinguish between the background count and the inert box. (See p. 89. **Grimoire II.**)

To open the box, simply break the seal and unfasten the catch. Inside, packed in cushioning foam, is a blue crystalline chip linked to a tiny rod (a telemetry link), sealed within a small cube of iron-hard transparent plastic. Any runner with Computer, Electronics, or Cybertechnology Skill immediately recognizes that this is unlike anything they have ever seen. If such a thing were possible, the runner could believe the chip was alive. It appears fluid and changeable, and while obviously made of some silicon-based substance, the structure looks more like the inside of a magnified frying cell than a standard deck chip. The runner also knows without a doubt that using this thing lies utterly beyond his ability.

The runners should recognize this chip as something very, very weird. They should not try to tamper with it, but they do need to find out more about it. Any attempt to use the chip produces no results; it has no function outside of Quicksilver's own cyberdeck. Fiona's comment might be enough to send them on a trip to Loch Ness next (go to **Say Hello To Nessie**, p. 40) or they might decide to contact Amelia Richardson again (go to **Weird Science**, p. 38). If their magician collapsed during the ceremony and had the vision of Morag MacDonald, they may decide to trace her instead (go to **Morag MacDonald**, p. 44).

FIONA MAC MHUIRICH

	B	Q	S	C	I	W
E	M	R	Armor			
	3	3	3	5	4	6
6	6	3	—			

Initiative: .3 + 1D6

Threat/Professional Rating: 3/3

Skills: Conjuring 7, Enchanting 2, Etiquette (Druidic "Tribal") 5, Magical Theory 2, Sorcery 5, Stealth 3, Unarmed Combat 3

Gear: Golden sickle (fetish), Mistletoe (fetish), Robes

Totem: Eagle

Spells: Heal 4, Hibernate 2, Levitate Item 2, Treat 4

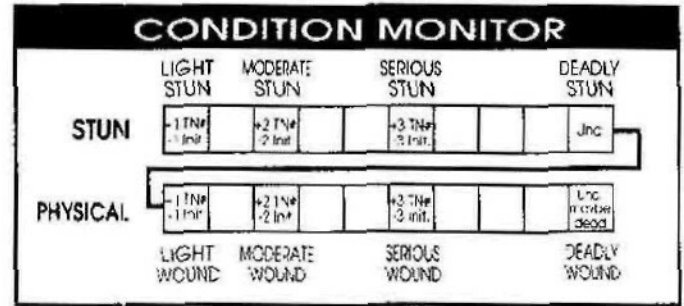

Fiona's 25 years old, of above-average height, slim, with long blond hair and green eyes. Skye born and bred, she looks slightly wild, and knows little of the outside world. That innocence made up part of Quicksilver's attraction to her and hers to him; he was sophisticated and worldly, and found her naive in the best sense of that word—open, happy, and blessed with an inner harmony that made him feel at peace. He told her little of his work, but gave her the Affect chip simply because he trusted her. He asked her not to part with it until the time felt right, and assured her she would know when that time came. Fiona recognizes that now is the right time. She does not know that Quicksilver is dead, but she trusts the runners.

DEBUGGING

Apart from doing something really stupid like attacking the druids, the potential exists for the runners to make a couple of mistakes in this situation. The magician might back off from the circle before he suffers any loss, though this is unlikely—the runner has no reason to quit unless he is suffering. If the player announces that his magician is backing out before he gives anything of himself (i.e., loses any points), the gamemaster should question the player seriously; remind the player that his character has suffered no serious effects; is he absolutely sure he wants to back out? Repeat the question, if the magician chickens out, the adventure ends, unless another suitable character steps in and offers himself for the ritual. If not, Fiona regards the runners as completely untrustworthy and says so. No way forward from here, chummers.

A second danger is that the runners may tamper with the chip. If they try to liberate it from its plastic cube: the gamemaster should point out the danger of this—the chip is clearly fragile. They do not know what it is, and the plastic coat clearly protects it. Point out the wisdom of finding out what it is before they fool around with it. Nothing appears to happen if they try using it in a standard deck, which may be enough to keep them from destroying it. After all, why come this far just to throw away what they came for? If the player characters damage or destroy the chip, once again they have reached the end of the adventure. Without this chip they cannot reconstitute Quicksilver and the adventure falls apart. Dumb move.

WEIRD SCIENCE

TELL IT TO THEM STRAIGHT

You started out looking for a missing person, and so far all you've found is some very weird silicon which you've been told is part of that missing person. The only other trace of Quicksilver you've seen was that bizarre manifestation in the Matrix. You know he was supposed to be a computer wiz-kid, but there's something going on here that's way beyond your experience. Seems to you that the person who knew him best, and who certainly knows more than she was saying, is the one to contact. It's time to talk with Amelia Richardson again.

HOOKS

Most of this encounter is very straightforward. When the runners place the chip(s) in Quicksilver's cyberdeck, that feeling of mystery and eeriness returns immediately. The theoretical implications of the cyberdeck and its chips are frightening enough, but what they create together goes nearly beyond description and comprehension.

BEHIND THE SCENES

The runners can get back in touch with Amelia Richardson in one of two ways. They can return to Edinburgh. They may need to do this anyway if one or more of the team members needs medical care. Angus MacNab or Duncan the Fixer probably referred them to **Dr. Knox's Body Shop** (p. 43) for first aid. If the team took out

medical insurance, then they need to get back within the Habitable Zone to call Careline or BUCM. Returning to Edinburgh proves to be easy if they did not encounter the police during **Death in Queen's Street** (p. 31), and they can travel straight back to Edinburgh and consult with Richardson at her university office.

If the runners fought the police in **Death in Queen's Street**, the runners know that Edinburgh is now a very, very dangerous place for them. Even if they ran from the police in that encounter and remained completely isolated since, simply calling Amelia Richardson confirms their suspicions that they are wanted. Amelia warns the runners that vaguely accurate descriptions of them are circulating on all news media. If they fought the police, Richardson tells them that the police are circulating their exact descriptions as suspects in a murder. She believes in the runners' innocence, mainly because killing Cameron makes no sense for the team. If the runners' return to Edinburgh poses too many risks, Richardson offers to fly out to meet them. In this case, the team meets her in the Kyle of Lochalsh, which makes a better base for their operations now anyway.

BACK TO EDINBURGH

If the runners made it through **Death In Queen's Street** without meeting the police, they travel to Edinburgh uneventfully. If the police may be looking for the team, the gamemaster should build on their paranoia. Police cruisers seem to be everywhere. Beat cops outnumber average citizens. The runners make it back, but they sweat every minute of the trip, especially if they fly in. In fact, the gamemaster may decide to give the runners a real dose of airport-phobia by having an official notice them at the airport and give chase. Of course, the runners get away, but they cause a big commotion and experience massive stress. The way they handle this encounter with the police could dig them into an even deeper pit, and so they must be cautious.

OUT OF THE VAULT

The runners have at least one of Quicksilver's chips at this stage, and so Amelia brings a battered blue briefcase with her to the meeting. Eager to hear all about what the group has done and learned since they last met, she waits to produce Quicksilver's cyberdeck until after they show her the chip(s). What a deck! It looks like a Fairlight Excalibur with a couple of hitcher jacks, but one look inside reveals that the skills of whoever modified the deck go far beyond that of any decker in the group. Nothing the decker knows helps him decipher the interior of this thing. The deck's insides also expose four one-inch cubic depressions, and even the least intelligent runner can figure out that the team slots the chip(s) into those spaces. It also becomes obvious that four of these chips exist.

If this team of shadowrunners follows the norm for their kind, they slot the chip(s) in their possession as soon as possible. They have the Affect chip (from Skye) and possibly the Memory chip [from Loch Ness]. A decker who jacks into the deck and inserts the



chip(s), in any order, experiences the following results.

Regardless of whether or not the deck is hooked up to the Matrix, the decker emerges into a very confined space. The decker feels as if his or her icon's visibility and travel area are restricted to the deck. A ghostly figure appears before him, in the exact shape of the Child/Imago (**Child in the Matrix**, p. 20) but lacking all detail. As soon as the first chip is slotted into place, the deck stops broadcasting to the Matrix and remains isolated at least until all the chips are present. What the decker experiences (described in the following paragraphs) takes place entirely within the confines of the deck. If the decker slots the chips without jacking in to the deck, he or she can tell that the deck is running, but experiences no other effects.

If the decker places the Affect chip into the deck by itself, he or she immediately experiences the most terrible anguish. He feels the pain of death, a profound despair, and intense, overwhelming grief, as if he lost a loved one to violent death. This affects the decker as an attack with a Power of 4, and does Serious Stun damage. The decker can resist this damage using Willpower. If the decker is Seriously Fatigued by this experience, he or she automatically and reflexively jacks out, taking no further damage.

If the decker slots only the Memory chip, he or she sees Morag MacDonald lying dead (see **Cast of Shadows**, p. 67). The decker views this scene in a weirdly detached way, experiencing no emotion at this terrible image except the fleeting sadness of an uninvolved observer looking on. Through the Memory chip the decker learns the woman's name, Morag MacDonald.

If the runners manage to get the Perception chip and slot only that chip at this time, the decker sees the same scene as provided by Memory, but with clearer details and again, no emotion. The Perception chip also provides details of the location of Castle Laidon, where the murder took place.

Obviously, the runners may slot several combinations of the chips. For example, if the decker places the Memory and Affect chips into the deck together, then the feelings from the Affect chip receive context from the memories of the second chip. The decker sees the loved one and knows she is Morag MacDonald (provide Morag MacDonald's description from **Cast of Shadows**, p. 67). She is the object connected to the feelings of love and anguish, but only the Perception chip gives a context to the memory of her death. The Memory chip also holds the pain of Quicksilver's death. The decker feels his heart pumping like a racing engine and adrenaline rushing violently through his body, and then the agony of death as bullets burst through his body. If the decker engaged both the Affect and Memory chips, the effect equals an attack with a Power of 4 that does Serious Physical damage. Again, the decker resists using Willpower. If the decker is Seriously Wounded, he or she automatically and reflexively jacks out before taking any further damage.

This deck cannot be used to run the Matrix. Without all four chips, it effectively has no functions. But jacking into it sure shakes the decker up some!

At this point the runners need to realize the implication of the Child/Imago's plea to bring him to Amelia—Amelia has the cyberdeck, and only the cyberdeck can rescue the Child from the Transys system. Use Amelia Richardson to prompt the runners to reach this conclusion if necessary. Assuming they repeated to her the Child's remarks from when they first encountered him, Richardson makes the connection. When the runners decide to bring the Child to the deck, go to **Bringing the Child Home**, p. 52.

From here, the runners may try Loch Ness (go to **Say Hello to**



Nessie, p. 40) or may begin to investigate Morag MacDonald. If they already tried Castle Laidon, they may want to approach Morag's father (go to **Talking to the Laird**, p. 55). Their other option is to go to **Bringing the Child Home**, p. 52. If Amelia Richardson met the team at the Kyle of Lochalsh, she returns to Edinburgh immediately after the meeting, taking the cyberdeck with her. If the runners want to meet with her again, she arranges to take time off from her work. The team may also want to plan ahead and arrange a time and place for a later meeting, Amelia still strongly recommends against meeting in Edinburgh.

DEBUGGING

As is frequently the case with shadowrunners, the team's downfall in this encounter may be greed. Someone in the group will surely recognize the cyberdeck's value, but should also recognize its lack of street value. No street contact in Britain will handle it; the deck is too weird to appraise accurately. The runners' best option lies in finding a powerful corporate contact and selling it to one of Transys Neuronet's rival corporations, but this would prove very difficult indeed (and expose them to the risk of double-crossing).

The point remains moot, however, because Amelia does not allow the cyberdeck out of her possession. If the runners foolishly try to take it from her by force, she simply warns them that she keyed duplicate electronic messages to be transmitted to the police within 12 hours unless she personally cancels them. The messages accurately identify the runners and detail their actions and location. An intelligent, worldly woman, Amelia considered the possibility that the runners might get greedy. She continues to cooperate with the runners if they stay on the trail of the remaining chips, but this incident puts her on her guard, and she makes sure she covers all the angles from here on out. She wants to put the other chips together with the deck out of respect for Quicksilver's memory, and because what the team has uncovered so far intrigues her, but she no longer trusts the runners and refuses to expose herself to any danger if they get into trouble. And she hangs on to the cyberdeck at all times.

SAY HELLO TO NESSIE

TELL IT TO THEM STRAIGHT

The road peters out as soon as you approach the forest on the west bank of Loch Ness. This is the deep, dark woods of fairy tales, a very heavy deciduous forest. You can't even see the loch until you get within a few yards of the shoreline. All you know is that you're looking for a "presence" here, which you assume is some kind of spirit. The loch stretches for miles—all kinds of Awakened critters and animals probably lurk in the forests, not to mention what might be in the water.

HOOKS

Geez, this is *Loch Ness*! What do you think it's going to be like? The runners are in the heart of the magic, a primordial place of power where mystic forces run wild and alliteration is king.

BEHIND THE SCENES

If the runners rented a hover vehicle and decide to travel on the surface of the loch, Nessie surfaces about fifty yards to their rear and follows them (her stats appear below). She will not attack the runners except in self-defense, but her appearance should scare the runners out of their wits. The scare may also help them recognize the remote chances of finding a spirit while inside a hover vehicle. If using public transportation, they take the bus to Invergarry and walk to the loch from there.

The runners meet a free spirit in this encounter. The second edition of the **Grimoire** (pp. 76-83) presents valuable information on these entities, and the section on **Astral Metaplanes** (p. 93) in **Grimoire II** may also prove helpful. Quicksilver gave his Memory chip to the free spirit, who he trusted based on their shared experiences. Quicksilver meditated in the spirit's domain occasionally, and the spirit communed with him. Quicksilver freely offered his Karma to the spirit, and in return it took him to its own metaplane, where Quicksilver confronted events apparently set in what the elf believed to be his own past lives. The spirit introduces the runners to the same type of experience.

CONJURING AND ASSENSING

An obvious strategy for finding the "presence" is for a shaman to try to conjure and communicate with (or command to a service) a nature spirit in the area. For a shaman making this attempt who has a totem other than Wolf, Bear, or Eagle, increase all his or her target numbers by +3 for tests involving spirits while in this area. Any conjuring attempts require the magician to make an opposed Conjuring Skill Test against the spirit's Force Rating. No conjured spirit (or commanded elemental) will perform a service in any way opposed to the interests of the locale (i.e., damaging the forest, assaulting native creatures, and so on).

The loch is a very large area to astrally assense, and the assensing magician must make a Perception Test to determine if he can filter out the interference of the Background Count (3). Several free nature spirits roam the forests around the loch; they observe the runners, but do not interfere with them. Astral perception allows a magician to see these spirits, and 1 success in a Perception (6) Test informs him or her that these are nature spirits of the forests and mountains. If the magician achieves 4 or more successes in the Perception Test, he knows these are free spirits. The spirits have a chance to detect that they are being assensed. Make a Force Test for the spirit, using twice the magician's Magic Attribute modified by -3 (the background count improves the spirit's perceptions) as the target number. If the spirit achieves at least 1 success, it knows it is being assensed and moves away from the runners.

THE DRUIDS

Druids share this area with the spirits, but they remain hidden from the runners. They know the runners' location at all times, however, because their unique detection network of little watcher spirits (p. 73, **Grimoire II**) keeps them informed. An assensing magician may detect these spirits, but they simply observe the runners, taking no action.

When the player characters reach the area, they can look for the presence, "the great free spirit who protects Quicksilver's Memory chip, in two ways: by wandering around the lochside or using astral projection.

WANDERING FREE

If the runners simply shamble about, working their way along the lochside on foot, they meet the great free spirit in its manifest form when they approach the ruins of Castle Urquhart. Details on the great spirit appear at the end of this section. As soon as the runners near the castle, the great spirit commands them to stop, and then asks several of the runners to join it on the astral plane. The spirit knows why the runners came to it and tells them so up front. It invites all runners with Essence 2 or higher to its metaplane, using its astral gateway power (p. 79, **Grimoire II**) to permit all runners to project into astral space. The physical body of those travelers goes into a trance. If the entire team possesses Essences of 2 or higher (extremely unlikely), the spirit allows two player characters to stay behind to protect the bodies of those traveling in astral space.

If the runners approach the great spirit using this method rather than astrally projecting, a huge plasma (**Paranormal Animals of North America**, pp. 126-7) that escaped from a guard installation on the naval base at Inverness may attack the runners. Roll 2D6 for every kilometer the group travels along the loch shoreline. On a result of 11 or 12, the plasma appears. The plasma is a huge, sabre-toothed, bear-like creature that is by nature hungry, stupid, and hostile, it likes to eat people, but will break off its attack and try to flee if it suffers damage of

Seriously Fatigued/Wounded.

Fighting and/or killing the plasma does not offend the druids of the loch. The runners' actions constitute self-defense, and the creature does not belong to either the loch or the forest.

Plasma

B Q S C I W E R Attacks
 11/4 4x5 13 — 2/4 4 6 4 9D2, +1 Reach

Initiative: 4 + 2D6

Threat Rating: 4

Powers: Enhanced Physical Attributes (Strength or Quickness, once per day each, allowing critter to increase one of those Attributes by a number equal to its Essence Rating for [Essence x 2] x D6 turns). Enhanced Reactions (adds [Essence + 2] to Initiative Roll), Enhanced Senses (Thermographic Vision, Wide Band Hearing).

Weaknesses: Allergy (Sunlight, Nuisance)

CONDITION MONITOR				
	LIGHT STUN	MODERATE STUN	SERIOUS STUN	DEADLY STUN
STUN	-1 TN* -1 Init.	+2 TN* -2 Init.	+3 TN* -3 Init.	Inc.
PHYSICAL	-1 TN* -1 Init.	+2 TN* -2 Init.	+3 TN* -3 Init.	Inc. maybe dec.
	LIGHT WOUND	MODERATE WOUND	SERIOUS WOUND	DEADLY WOUND

ASTRAL PROJECTION

The second way for the runners to meet the great free spirit of Loch Ness is by astral projection. The great free spirit immediately approaches any player-character magician using astral projection to enter the etheric realm, assuming the spirit did not actually issue an invitation for the magician to appear on the astral plane. It asks several runners to undertake a minor astral quest, choosing those with Essence 2 or higher and using its astral gateway power as noted earlier.

THE ASTRAL QUEST

The spirit draws the astral runners to its own metaplane (land, forest). Before they reach the metaplane, they find themselves floating in a dark void, where they encounter the Dweller on the Threshold (p. 93, **Grimoire II**). The Dweller knows all about the runners, and reveals at least one personal secret about each runner to the group as a challenge to their worthiness to enter a metaplane (tailor this encounter to suit the particular group). Each runner on the quest must make a Success Test using a skill or Attribute chosen by the gamemaster against a Target Number of 6. For every 2 successes a player character generates, that character's Karma Pool increases by 1 for the duration of the Quest Test to come. The Dweller dismisses from the astral plane any runner who fails to achieve at least 1 success. A shaman of the Bear or Wolf totem automatically adds 1 Karma Pool die to his total for this test. A shaman of the Eagle totem automatically adds 2 Karma Pool dice to his total for this test.

The great spirit then guides the runners to his metaplane and to the Place of the Past, where each runner must face a re-enactment of the most painful or threatening experience of his life. The gamemaster must create this scene using his knowledge of the runners' histories. For many, this experience may be a combat situation. Those runners faced with combat stand together, but

each laces his own personal terror or nemesis. Only when a runner vanquishes his own enemy may he aid another runner.

A solitary, non-combat situation may more accurately represent some runners' experiences. For example, a decker may re-enact a terrifyingly dangerous Matrix run, or a character may relive the agonizing loss of a close friend, and so on. Grueling ordeals such as these must be raced alone. For a non-combat Quest Test a character must make a successful Willpower (8) Test to pass the ordeal.

If runners "die" during their ordeal, their astral bodies return abruptly to their meat bodies, but they suffer no permanent ill effects. They have, however, failed their ordeal in the Place of the Past.

This adventure cannot offer a precise script for this scene, because the gamemaster must devise threats and ordeals drawn from the past of each individual runner. However, one thematic twist should be a part of each runner's test; the characters see themselves in the clothing and settings of some historical period. A street samurai may appear as a medieval knight in armor, using a longsword to battle his nemesis-enemy. Though both the character and his enemy fight using the equipment of a bygone age, use the standard rules of combat. A decker on a dangerous run, for all he may be sitting at a 21st-century cyberdeck, will find himself in ancient Thebes or Atlantis, in appropriate garb, and his Matrix persona will reflect his surroundings. An elven mage will walk the forests and towns in the age of John Dee and the Elizabethan astrologers and alchemists, and so on. This improvisation demands a lot of work from the gamemaster, but the powerful scenes that result will reward both the runners and the gamemaster. Avoid sending the runners into hopeless situations—do not pit a street samurai in single-handed combat against a great feathered serpent. When a character knows he can only lose, resignation takes the edge off his fear. True fear comes from the hope of living when the odds are against it.

When each character either passes or falls his or her ordeal, the great spirit returns the runners to the mundane world and demands payment in Karma for giving them Quicksilver's Memory chip. It asks for 5 points of Karma, less one point for every Quest Test the runners passed, to a minimum of 1 point. If they pay the price, the spirit materializes a green Memory chip similar in appearance to the Affect chip (see **Over the Sea to Skye**, p. 34).

The Karma to be given to the spirit should be drawn from the characters' Good Karma, but the points can also be removed, permanently, from the Karma Pool. The player character cannot give the spirit Karma from the Team Karma Pool.

The team may not have the requisite amount of Karma. If not, the spirit asks them to accept a Karmic Debt. Paying the spirit Karma in the form of a Karmic Debt reduces the runners' Karma to a negative value. For each negative point of Karma, they must spend 2 points of Karma to raise the value back to zero. The characters must erase the negative Karma value in this manner and then acquire more Karma in order to use it for any other purpose.

Of course, no encounter at Loch Ness is complete without an appearance by Nessie. If they did not meet her as they arrived, the monster dutifully appears, splashing about in the water, as the runners depart. Nessie's stats appear below just in case the runners provoke the poor monster into attacking.

With the Memory chip in hand, the runners may decide to get in touch with Amelia Richardson (go to **Weird Science**, p. 38.) or they may be ready to search for Quicksilver's dead object of affection, the only unexplored clue remaining (go to **Morag McDonald**, p. 44). If any of their number suffered serious injury in this encounter, first aid takes first priority. Safety lies either

SAY HELLO TO NESSIE

within the Habitable Zone, for access to Careline/BUCM, if the runners took out insurance, or **Dr. Knox's Body Shop** (p 43) if not.

Nessle (Gigantic Freshwater Serpent)

B **Q** **S** **C** | **W** **E** **R** **Attack***
 14/1 5x3 9 — 1/3 3 6 5 6S2 -1 Reach

Initiative: 5 - 1 D6

Threat Rating: 7

Powers: Enhanced Physical Attributes (adds Essence Rating to Body, Quickness, or Strength each once per day for 12 turns), Fear, Immunity to Normal Weapons, Sonic Projection,

Weaknesses: Dietary Requirement (Loch Mess waterweed, Nuisance).

		CONDITION MONITOR			
		LIGHT STUN	MODERATE STUN	SERIOUS STUN	DEADLY STUN
STUN	+1 TN	+2 TN	+3 TN	+4 TN	+5 TN
	1 int.	2 int.	3 int.	3 int.	Jnd.
PHYSICAL	+1 TN	+2 TN	+3 TN	+4 TN	+5 TN
	1 int.	2 int.	3 int.	3 int.	1 int. 2v26 3v26
		LIGHT WOUND	MODERATE WOUND	SERIOUS WOUND	DEADLY WOUND

Great Free Spirit

B **Q** **S** **C** **I** **W** **E** **R**
 18 24 18 14 14 14 14(A) 12

Initiative: F-2(+10/-20)+1D6

Powers: Accident, Astral Gateway, Concealment, Confusion, Dispelling, Fear, Immunity to Normal Weapons, Personal Domain (Loch Ness).

Note: F refers to current Force. For Physical Attributes, Force represents the current Force Rating plus Spirit Energy. For example, this critter has an initial B(ody) of 48. Hey—we said it was a real tough bugger.

The "presence" the runners look for at Loch Ness turns out to be a great free forest spirit, very powerful and willful. It recognized Quicksilver as a being of power and wisdom, whos a willingly sacrificed Karma gave the spirit significantly greater gains in Spirit Energy than normal sources of Karma. This spirit also acquired a great deal of Karma in the course of its long association with the local druids—this spirit is a real tough bugger. Its current Force Rating is 14 and its Spirit Energy is 30 while on the shores of Loch Ness, its personal domain (see p. 80. **Grimoire II**).

DEBUGGING

In order to get the Memory chip from the spirit, the runners must agree to the quest the spirit gives them. Because each character's quest in the Place of the Past is unique, the gamemaster must handle his own debugging for the metaplanes.

The runners may refuse to sacrifice Karma to the spirit. If they do, remind any shaman in the group that this remains the one well-known way of bargaining with a spirit: if the runners want the chip, they must oblige. If they continue to refuse, no chip appears. Go to **Picking Up the Pieces**, p. 62.

If the runners take a notion to attack Nessie, the creature sinks out of sigh: as soon as it suffers damage of Seriously Wounded/Fatigued. Add 2 to the target numbers of all Success Tests the runners make in this location after the attack, including those for the quest. Bad move, terms. The druids' displeasure with this action compounds the personal penalties the runners suffer.

Because the runners are unlikely to fight the monster, this adventure does not script a druidic counterstrike against the runners. Given a reason to seek revenge, druids tend to ponder their course of action, and so the gamemaster should carry this out as he sees fit. Keep in mind that the (elven) Scots druids most likely have friends in Tir Taimgire, the Salish-Shidhe Council, or other North American lands. Revenge could be a long time coming.

If the runners attack the great free spirit, it quickly smears them all over the lochside. The gamemaster can run a combat if he wishes, but he can save time instead by simply informing all the runners that they died in this place.



DR. KNOX'S BODY SHOP

TELL IT TO THEM STRAIGHT

Your contact in Hamish's Bar told you about the estimable Dr. Knox's Body Shop, which enjoys a fairly good reputation among the bar's clientele. The doc does great work as long as he's slightly steaming (that's drunk to you). If he's sober, he shakes, and if he's really steaming he tends to confuse one clump of viscera with another. Hey—be grateful that he's given up his stimulant habit. Another point in his favor is that the clinic's clean inside, and it looks like the doc sterilizes his equipment. It's also the only choice you've got.

BEHIND THE SCENES

This section provides a place for the runners to go if they sustain serious injury and did not pick up U.K. insurance, or if they risk too much by calling for the service the insurance provides—if the police are looking for the runners, they may arrive with the medical team. As an alternative, Duncan the Fixer (for his standard fee) or Angus MacNab can put the runners in touch with a contact for Dr. Knox. The story assumes the runners return to Edinburgh to visit the doc, but if the police are putting on the heat, the runners may have to get the doc out to visit them. Obviously, this means the team pays his traveling and living expenses plus £1,000 a day in addition to all other charges. Apply the appropriate standard modifiers for providing medical care without the proper facilities. The doc carries only a limited amount of equipment on a house call, and so the gamemaster must decide how much Dr. Knox can pack in his bag.

Dr. Knox uses unmodified target numbers (per p. 113, **SR II**) for all Success Tests made while working in his clinic; modify his target numbers by +2 (or more) if he goes to where the runners are holed up in a hotel room at the Kyle of Lochalsh. Dr. Knox charges standard fees for repairing damage and treating wounds (p. 113, **SR II**), which is the extent of medical care available from him. His business does not induce implanting cyberware or conducting other fancy operations.

I., after three days of treatment (of any type), the runners still need more recovery time in the body shop, Knox begins to complain about the risk he is taking: the trideo continually broadcasts the runners' likenesses as the suspects in an ongoing murder investigation. Their presences make him nervous. He jacks his price up to double his standard fees, a minimum of £1,500 per day, before the runners can convince him to allow them to stay. After another 48 hours, even the extra money cannot keep Doc's nerves under control, and he starts drinking very heavily, making any further treatment from him useless. The runners may try to force him to stop drinking, but he just falls to pieces from anxiety and fear. Time to hit the road, chummers.

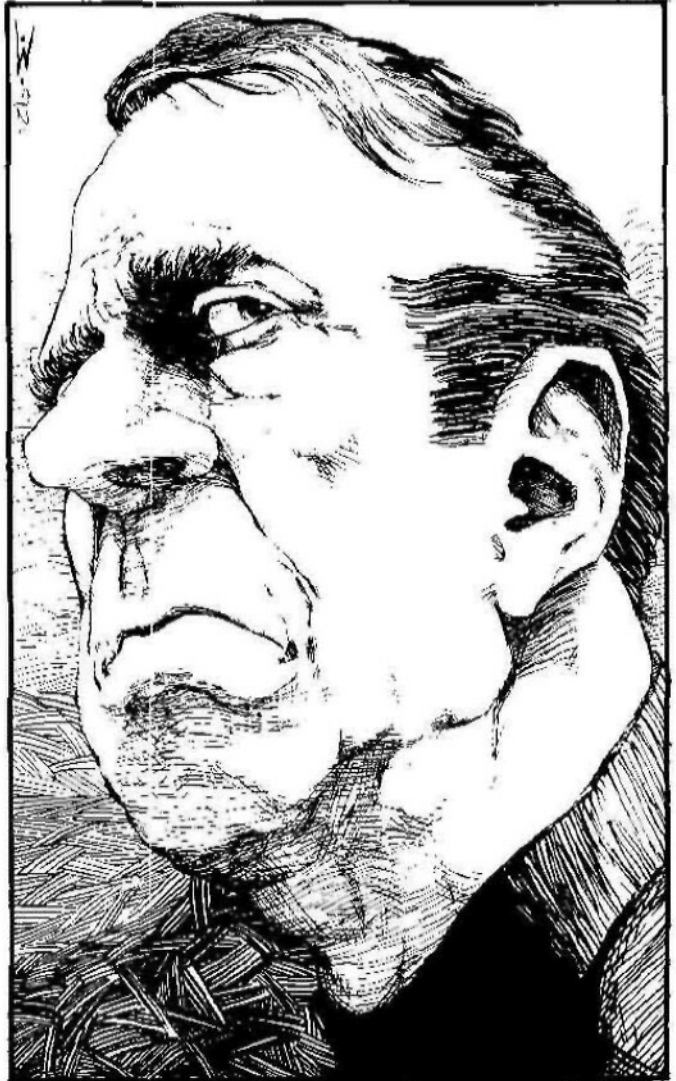

DR. KNOX

Use the standard Street Doc Archetype for Dr. Knox (p. 211, **SR II**). Doc Knox is about 50 years old, of slight build, balding, with gray hair and watery blue eyes. He smells slightly of whisky.

At the gamemaster's discretion, Knox offers the following items to the runners at 200 percent of the price listed in **SR II**, p. 263: one medkit, two extra vials of drugs for a medkit, a box of three Rating 5 stimulant patches, and 3 single Rating 7 trauma patch (loath to part with this. Knox charges the runners £3,000 for this baby). Runners who roll 1 net success in an opposed Negotiation (Negotiation) Test can reduce these prices by the standard 10 percent, but Knox's fees for treating the wounded runners are nonnegotiable.

MORAG MACDONALD

BEHIND THE SCENES

The runners can find out about Morag MacDonald two ways. If they install only the Memory chip into Quicksilver's cyberdeck, they learn her name. If the runners slotted both the Affect and Memory chips into the deck, they know what she looks like, but not who she is, and they guess she may be dead. If the team's magician collapsed during the ritual at the Isle of Skye, he or she saw Morag and knows the tartan of the skirt she wore. If the runners learned of Morag this way, then they know for sure that she is dead. Investigating Morag probably requires a two-step process, depending on what the runners already knew: they may need to work from the specific clue of the tartan to discover her name and they certainly need to check her history once they figure out her identity.

MACDONALD TARTAN

The runners can learn about the tartan two ways. Any character making a successful Intelligence (8) Test describes the tartan with sufficient accuracy to a native Scot for that person to recognize the tartan of MacDonald of Glencoe. (The decker or *magician* who actually saw the tartan makes an Intelligence (6) Test.) The runners may prefer to check C-net. The computer service offers many relevant files on Scotland, including a program of tartan patterns from which the decker can identify the tartan on a successful Computer (4) Test. Either way, the runners now know Morag's surname.

LONESOME DEATH OF A MACDONALD

C-net newsdata archives (accessible without a Computer Skill Test) provide information on deaths/murders of MacDonalds (including Morag, if they know her name) and public data registers of all births and deaths to date. Either route of inquiry reveals that Morag MacDonald died 13 days before this adventure began. Because the public registers do not provide cause of death, the runners must access newsdata archives for more information (if necessary, have a non-player character such as Amelia Richardson point the runners in the right direction). When the characters go to the news archives, give the players Player Handout 3, which reports Morag MacDonald's death.

The runners might think to access general information on the Campbell-MacDonald clan feud on the off chance that Morag's death resulted from that ancient struggle. The runners can piece together the history of the feud from several C-net entries on history, sociology, and other related subjects. Give the decker the information below as a summary.

The Campbell-MacDonald clan feud originated with the Glencoe massacre of 1692. King William's agents commanded Maclan MacDonald, Jacobite chieftain of the MacDonalds of Glencoe, to present himself and his clan leaders at Inverary in Argyll, the Campbell citadel, to swear allegiance to King William. He did this, but those same agents rejected his signature and loyalty as too little, too late. Paid by the King's men, a force of 120 men led by Captain Campbell of Glenlyon arrived at Glencoe on February 1, 1692, asking for shelter there while collecting taxes. After enjoying MacDonald hospitality for a fortnight, the men commanded by Campbell rose in the night and murdered all the MacDonalds they could find. Only 38 MacDonalds died at the hands of Campbell's force, but many others perished of exposure in the snow-covered mountains while trying to escape.

The cold-blooded murder of Scots by Scots at the behest of the English king's agents fired rage and outcry all across Scotland. This tragic incident inflamed the common religious and regional divisions between the MacDonalds (Catholic Highlanders) and the Campbells (Protestant Lowlanders), and the resulting feud has run almost continuously since that time. Each side actively ignores the other, but outright violence and murders remain relatively rare. The massacre of 14 Campbell clan members by William MacDonald and his cousins in 2022 is the most infamous modern exception. However, scheming and intrigue are the rule rather than the exception for these clans.

This episode should send the runners to **Castle Laidon**, p. 45, though they may decide to get the Memory chip instead if they have not yet acquired it (go to **Say Hello to Nessie**, p. 40).

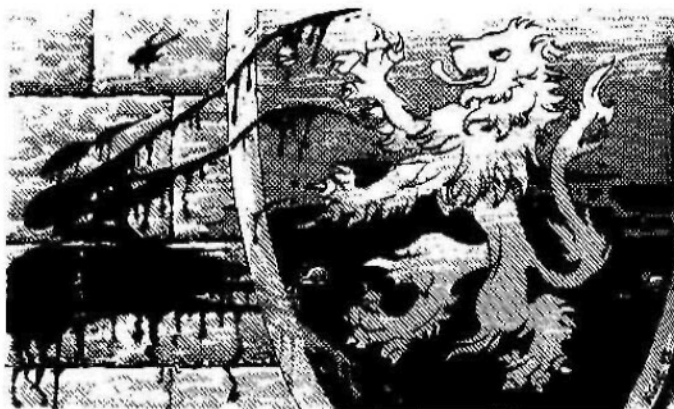



TELL IT TO THEM STRAIGHT

Glencoe is a magnificent sight. The hillsides surrounding the valley of the glen aren't that high, the forests aren't exceptional, and the pure water of the brook at the bottom of the valley doesn't ravel over waterfalls or provide other visual delights. But there is a majesty and a deep sense of melancholy history here that you can almost breathe. The old MacDonalds never built a castle here—they didn't need one, protected as they were by the natural defenses of the terrain. The early-21st-century MacDoralds moved with the times. Castle Laidon is fairly small—building costs are too high for real indulgence—but Castle Laidon is a stout-looking fortified keep. The outside is surrounded by razor wire and surveillance cameras, and you assume the laird has some meat and machinery inside protecting his property, too. You'd be willing to bet that Castle Laidon is not open to tourists.

HOOKS

Glencoe radiates a deep sense of history that feels completely alien to runners born and bred in Seattle. The castle gives the area a decidedly anachronistic feel, because modern conveniences and security systems surround a structure built in the traditional style.

Even more noticeable than the sense of history is the magic, from the claymore that projects a Rating 7 barrier spell to protect the castle to the ghostly presences, and of course Morag herself. Again, as throughout this adventure, play up the mystery and the mysticism of this land and people.

BEHIND THE SCENES

How the runners approach this encounter and what they find out here varies considerably depending on previous events. Inventive roleplaying can pay big dividends here, because the team may need to visit the castle more than once to get everything they need. The runners need their own transport to reach Castle Laidon: coach service does not run through Glencoe. If they never picked up a vehicle, or have already trashed it, the team may be forced to walk across the Scottish hills and glens. They see some lovely scenery, but the gamemaster should feel free to interrupt the runners' nature walk with a hostile paranormal, or even a whole flock of 'em.

The runners get no assistance (or even an audience) from Sir Iain MacDonald if they contact him before this episode (see **Talking to the Laird**, p. 55). They need their meeting with Morag's ghost (**Meeting Morag MacDonald**, p. 48) to make an impression on him. The runners have only three options to get what they want: breaking into the castle, using assensing and astral projection/perception, and talking to the people inside the castle. The

possibilities these strategies offer to the runners appear below, following a quick guided tour of the castle itself. The senior MacDonalds left the glen after the murders here and subsequent funerals, and have stayed away. Their absence leaves security and manpower at lower levels than usual, and so the runners could get lucky if they try to break in. Most important, the mage in charge of protecting the castle died in the recent Zeta-ImpChem strike, and so the runners face no magical opposition.

CASTLE LAIDON MAP KEY

The castle may be new, but the family boasts a long, illustrious history. Castle Laidon contains too many interesting details, nooks, and crannies to be explored here. Add a liberal clusting of stag's heads, tartan drapes, wall-mounted shields and claymores, museum-quality stuffed animals in glass cases, antique pistols, sets of bagpipes, and so on.

Basements

The entire floor level of the castle consists of cellars and basements, including cold storage for lots of food stuffs, cedars full of wine and whisky, and a holding cell (B1) used for confining poachers until the local authorities come to pick them up.

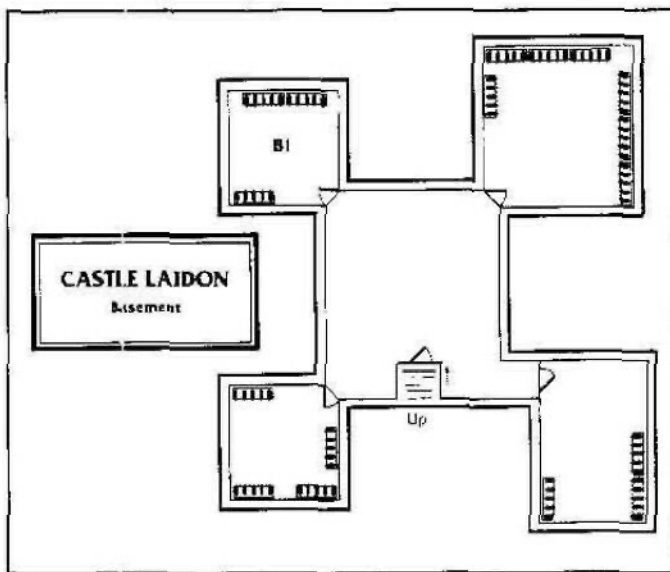

First Floor

Four MacDonald fighting men have personal rooms in F1 and F2. At any time, one of them is asleep in one of these areas. Stats for the fighting MacDonalds follow the map key. The area marked F3 functions as a lair for the Laird's six Scottish staghounds (use the Large Dog stats from **SR II**, p. 233). Someone inside lets the dogs loose to deal with intruders when necessary. Area F4 contains the kitchen, presided over by a pair of elderly domestics who act as

CASTLE LAIDON

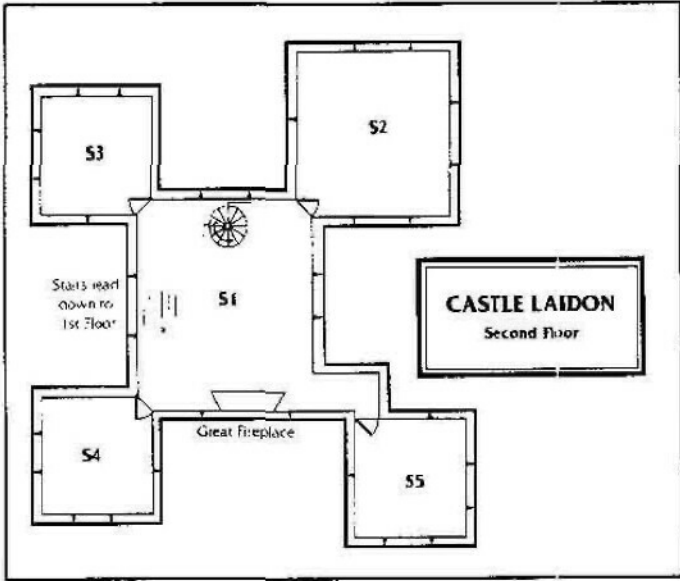

cook and butler, and their personal rooms. The garage outside houses a Land Rover 2046 and two antique (but functional) British Industrial PLC Hunter-Wagner bikes (use the Harley Scorpion stats from the **Rigger Black Book**, p. 21). All vehicle fuel tanks are full. An emergency electricity generator connected to a tank containing 612 gallons of fuel oil takes up the remaining space in the garage. Two Rating 4 maglocks secure the garage door.

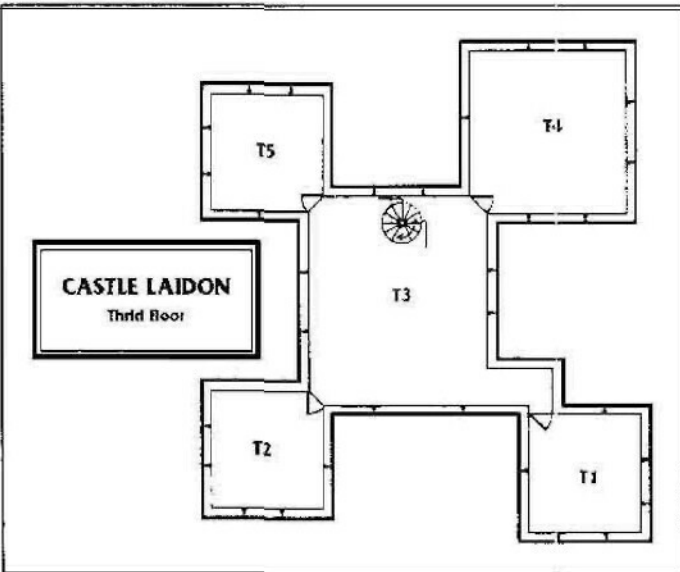

Second Floor

The Zeta-ImpChem goons killed Morag MacDonald on the great staircase leading from the Greeting Hall (F5) to the Feast Hall (S1), and her ghost remains here for the runners to encounter if they penetrate the castle physically rather than astrally (see **Meeting Morag Mac Donald**, p. 48). Quicksilver concealed his Perception chip in her bedroom (S2). Note that the Laird bricked up the window to this room and left the room exactly as it was on the day of her death; her father maintains it as a shrine to her memory. Room S3 contains the hardware, terminal, and monitors for the castle security system. Two more MacDonald fighting men occupy this room, one of whom possesses enough rudimentary Computer/Electronics skills (not shown in stats) to operate the

system. Rooms S4 and S5 are the personal rooms of the MacDonald seniors: James MacDonald currently occupies S4, and he acts as the senior spokesman for the castle occupants when dealing with the runners.

In the Feast Hall (S1), a huge claymore hangs over the fireplace; it is a family heirloom and possesses special magical qualities. It creates an effective Rating 7 barrier against magic-based attacks within the castle, and adds +1 to the target numbers of non-MacDonald magicians attempting to use magic (spells and skills) within the castle.

Castle Laidon Security System Key

The letter designation attached to killer IC indicates (M)oderate, (S)erious, or (D)eadly staging. See **Virtual Realities**, pp. 20. 43.

CPU = Central Processing Unit

DS = Datastore

I/O P = Input/Output Port

SM = Slave Module

SPU = Sub-Processor Unit

SAN: Orange-2 (Load 6/0).

SPU-1: Security monitoring, Orange-4 (Load 12/6). Access 4, Trace and Dump 4,

I/O P-1: External cameras. Orange-2 (Load 6/0).

I/O P-2: Maglocks. Orange-2 (Load 6/0).

SPU-2: Active security and internal monitoring. Orange-4 (Load 12/5), Barrier 4, Acid3.

I/O P-3: Front gate guns. Orange-2 (Load 6/0).

I/O P-4: Internal cameras (roof and basement). Orange-2 (Load 6/0).

I/O P-5: Terminal, monitor display. Orange-2 (Load 6/0).

CPU: Orange-5 (Load 15/8), Killer (M) 5. Binder 3.

DS-1: General data storage (no commercial value). Orange-2 (Load 6/0).

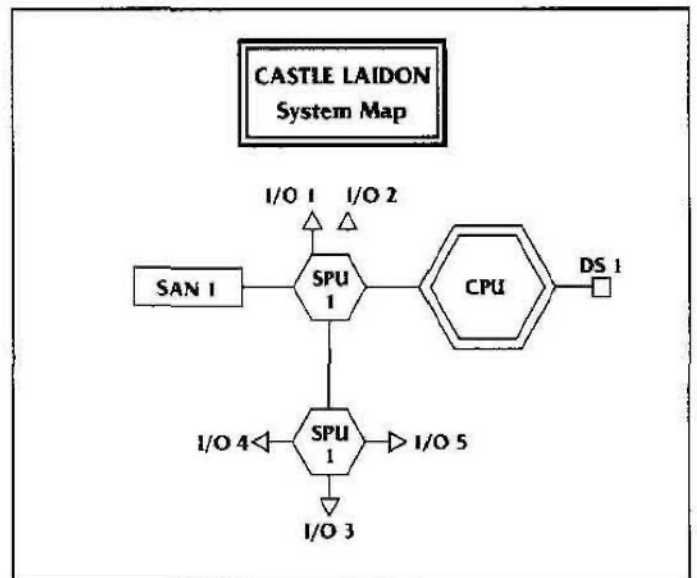

Third Floor

This floor contains the personal rooms of MacDonald family members. Room T1 belongs to a MacDonald the family would prefer to forget; Mad John MacDonald, a psychopathic, brain-



damaged brute they shipped in after the murders to protect the household. Unfortunately, Mad John proved so unpredictable and senselessly violent that the family sedated him and keeps him under lock and key. Naturally, if the runners attack the castle, it will be the one time the domestics forget to give him his medication, so Mad John will be at full strength and mad as hell. James gives him his armor and weapons to battle the runners.

MacDonald Fighting Men (6)

B	Q	S	C	I	W	E	R	Armor
5	4	6	2	5	5	5.5 (3.5)	4 (6)	5/3

Initiative: 4 + 1 D6 (6 + 2D6)

Threat/Professional Rating: 2 (3)/3

Skills: Armed Combat 4, Bike 2, Etiquette (Clan "Tribal") 3, Firearms 4, Stealth 3, Unarmed Combat 5

Cyberware: Smartlink; two men have Wired Reflexes (1)

Gear: Armor Jacket (5/3), Sword (Reach 1, 8M), Stun Baton (Reach 1, 6S Stun), (6) Tracking Signals. Waldegrave-Stevas Heavy Pistol [Heavy Pistol, 26 (clip), 9M, w/2 extra clips. External Smartlinks]

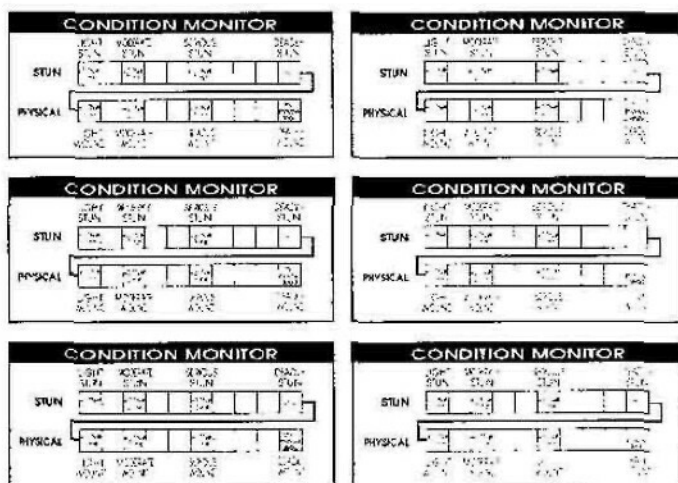

CASTLE SECURITY SYSTEM

Four-meter-high razor-wire fencing surrounds the perimeter of the castle. The runners need some form of area effect (explosives, a summoned elemental of the right type, a suitable combat or manipulation spell, and so on) to get past this stuff. Forget bolt

cutters. This wire recoils unpredictably when cut. Want a severed throat, chummer? (Damage is 8M if the character runs into the wire. 6M if they walk into it, and 4M if they grab it. Whipping razor wire does 6M damage. Impact armor protects against it.)

At each of the regular intervals marked on the map, a rotating infrared camera monitors a 120-yard area, set to detect anything bigger than a rat during frequent, overlapping scans. Anything moving into the area automatically triggers an alarm. The main gates also mount infrared monitor cameras, and a pair of maglocks keyed with a retinal ID system linked to the computer system inside the castle. The main gateposts mount a pair of SMGs, hidden within the pillars, that rotate and swivel to fire on anyone assaulting the gates. Each gun fires on a 60-degree arc, and uses 5M3 ammo from a store of 200 shots. The servo-system operating the guns uses Firearms Skill of 4 (the gamemaster may also use the dumb-gun rules from p. 89 of the *Neo-Anarchists' Guide to Real Life*). Again, the gates yield to an area-effect damage tactic (explosives and so on), which gets the runners into the compound if they decide to crash the place. Of course, hacking the castle's computer system disables the defenses and eliminates at least some of these problems. Once inside the compound, the runners can get into the castle through the window or other openings.

PULL UP THE DRAWBRIDGE

The runners may decide to try a nonviolent approach. If they try to talk their way into the castle, a disembodied voice angrily demands through an intercom speaker that they leave MacDonald land. At this point, the team needs to convince James MacDonald himself to speak with them. Various ruses may accomplish this. The runners may claim, for example, to know information relevant to the castle murders. A sneaky approach might also work, like claiming that a bear mauled one of the group members (a big bottle of SynthiTomato Relish and some good acting could clinch this one) and he or she desperately needs rest in a safe place. If the runners take the sob-story approach, have the runner doing the talking make an opposed Charisma (Negotiation) Test against James MacDonald. Reduce the runner's target number by 1 if the group came up with a plausible reason for being allowed to enter the place. If the runner and James MacDonald roll an equal number of successes, James allows only one or two runners to enter. If the runner generates more successes, James lets them all inside. At the main castle door, four fighting MacDonalds brandishing heavy pistols demand that the runners hand over all their weapons before they enter. Better do it, chummers, or they start shooting—this is a feudal state, not a democracy. If James rolls more success than the spokesperson/runner in the opposed Charisma (Negotiation) Test, he tells the runners, to get off his lands before five minutes are up, or the machine guns open fire. Time to back off, chummers.

If one of the runners really suffered an injury while traveling to Glencoe, James puts the injured party in a third-floor bedroom. If the team faked the injury, have James make a Perception (6) Test to realize this. On 1 success, he detects the dishonesty and gets angry, which adds -1 to all target numbers for all subsequent opposed rests any runners make against this character.

However the runners get in, they must make a strong case for staying. Once James realizes their goal was to get inside, he demands to know what they want at Castle Laidon. The truth makes the best story at this point, unbelievable as it may sound.

CASTLE LAIDON

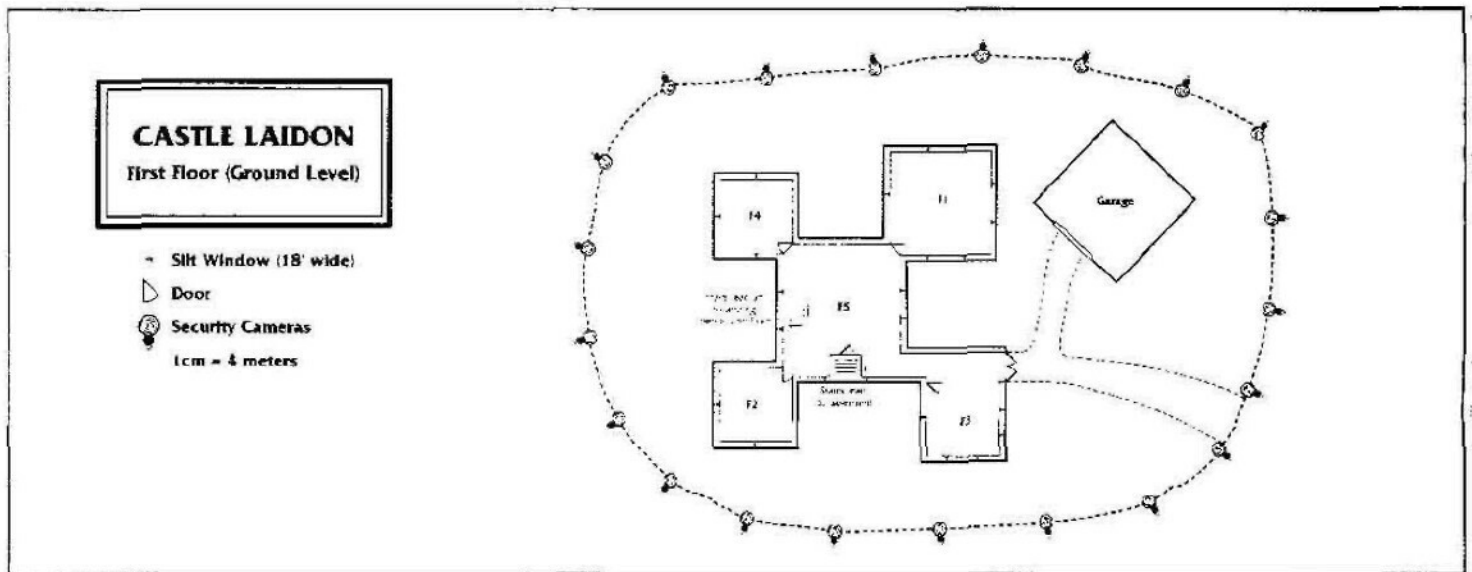

The runners should tell James what they know of Morag's murder, and that they believe her death has some connection to a missing person they were hired to trace. The runners may even mention the chip(s) they acquired and show one to James. He looks skeptical at their weak story, but agrees to hear them out.

"Och, well. But what dae ye want?" he asks again. He wants the runners to tell him what they want to do or expect to find in the castle. If they ask to search certain locations, he says the police and the clan already examined every inch of the murder site. There is nothing left to see. He offers to show the runner's where Morag died, but refuses to give them free run of the castle.

If the runners assensed the castle, they can tell James that a troubled soul wanders within it. Having a Highlander's respect for magic and the Sight, he listens carefully to that claim. If the runners ask to stay in the castle to try to contact the soul, have one runner make an opposed Charisma (Willpower) Test against James. If the runner achieves more successes than James, James allows one runner per net success to stay at the castle (a minimum of one runner stays). The others must wait outside. James allows the runner(s) who stay up to 24 hours to contact the soul they claim to sense.

Astral Assensing and Projecting

If a magician uses astral projection or perception, remember the effects of the claymore in location S1. If the magician makes an Astral Perception Test, 2 or more successes tell him that a collective ghostly entity surrounds the castle and acts as a Rating 7 barrier. If the runners took care of the appropriate legwork, the magician identifies the entity as the collective ghosts of the victims of the Glencoe massacre of 1692. Still slowly passing from this world, these souls possess almost no astral awareness and little remains of their presence.

If the magician makes a successful Magic (8) test while using astral perception, he sees the ghostly form of Morag MacDonald. Reduce the target number by 1 for each of Quicksilver's chips the runners are carrying, and reduce the target number by 2 if the magician experienced a vision of Morag on Skye. Though the magician can see Morag, her ghost does not communicate: it seems unaware of the magician's presence.

If the magician astrally projects, a successful Magic (8) Test (modified as above) allows him or her to meet the ghost and talk with her. If he has already seen the ghost with astral perception, he automatically finds the ghost when he astrally projects.

If the runners encounter Morag MacDonald's ghost, the next section tells how to converse with her.

MEETING MORAG MACDONALD

As an alternative to direct astral contact, the runners can meet Morag's ghost at the stroke of midnight on the stairs where she died. Regardless of how the runners got into Castle Laidon, whether by talking their way around James MacDonald or forcing their way in, Morag speaks to them. Her ghost remains unaware of events in the castle after her death, so she does not notice if overenthusiastic runners blow away her relatives in order to get to the bottom of the mystery.

The ghost takes a barely visible spectral form but the runners can easily read the anguish on her face (see **Cast of Shadows**, p. 68). Desperate to communicate its plight, the ghost can only communicate with the runners by possessing one who agrees to the possession freely. If the ghost possesses a runner, the runner speaks with Morag's anguished voice and behaves with her mannerisms. The ghost talks at rather than with the runners.

When Morag possesses one of the runners, read the following:

"They came for him, I know they did. They weren't Campbells. Oh, they wore the Old Colors of tartan, but their eyes weren't Campbell eyes. Bloody murder! They gunned him down as he fled, when he hadn't so much as a dirk to defend himself. I saw it as I breathed my last. Oh God, to die like this... He left his eyes, he said he would always see me, he left something of himself and I don't know where it is. He said he would always see me..."

During this brief possession, the possessed runner must make two Astral Body Attribute (6) Tests. If he or she fails either test, when Morag disappears the runner collapses into unconsciousness and does not awaken for 12 turns.

If James MacDonald watches this incident, it affects him profoundly. Uncertain of what he should do, he offers to put the

CASTLE LAIDON

runners in touch with Sir Iain MacDonald, the Laird and clan chieftain, currently in Edinburgh. If the runners risk arrest by returning to Edinburgh, James suggests they meet Sir Iain at the Invergordon Hotel in Pitlochry.

If the runners ask to search the castle after this encounter, a reluctant James agrees if a runner rolls at least one more success than MacDonald in an opposed Negotiation (Willpower) Test. Quicksilver hid the Perception chip in the immense headboard of Morag MacDonald's bed, in a depression behind the shield of the MacDonald coat of arms. Successful astral perception reveals only its presence as a magical object, but no details. The runners can also find the chip by searching the room physically; in this case, each runner searching makes a Perception (8) Test. If none of the runners make a successful test, they may return to the castle after talking to Sir Iain MacDonald and search again. The Perception chip looks like the others, except yellow.

After this encounter, the runners may still need to acquire the Memory chip (go to **Say Hello to Nessie**, p. 40), or they may want to meet Sir Iain MacDonald (go to **Talking to the Laird**, p. 55). They may also need to meet Amelia Richardson for more work with the cyberdeck (go to **Weird Science**, p. 38. or **Squaring the Circle**, p. 53). Whatever course of action they choose, trouble meets them on the way (surprise, surprise). Go to **Samurai Strike**, p. 50.

JAMES MACDONALD

B Q S C I W I R Armor
3 3 4 4 6 5 6 4 5/3

Initiative: 4 + 1D6

Threat/Professional Rating: 4/3

Skills: Armed Combat 2, Etiquette (Street) 2, Etiquette (Clan "Tribal") 5, Leadership 2, Negotiation 5

Gear: Armor Vest (5/3), Ares Predator [Heavy Pistol. 15 (clip). 9M], Stun Baton (Reach 1, 6S Stun)

Younger brother of Sir Iain MacDonald, James is 40 years old and of medium height, with sandy brown hair and brown eyes. Estate manager for the MacDonalds of Glencoe, James oversees property, land rights, and so on. Though cautious, hesitant, and not overly bright, he is honest and brave.

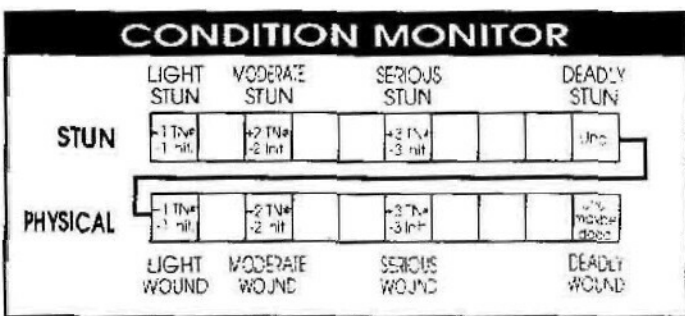

MAD JOHN MACDONALD

B Q S C I W I R Armor
6(8) 4 5 2 5 5 1.5 4 (8) 5/3

Initiative: 4(8) + 3D6

Threat/Professional Rating: 5/4

Skills: Armed Combat 4, Bike 1, Etiquette (Street) 4, Etiquette (Clan "Tribal") 5, Firearms 5, Stealth 4, Unarmed Combat 6

Cyberware: Dermal Plating (2), Retractable Hand Razors, Smartlink.

Wired Reflexes (2)

Gear: Amor Vest (5/3), Stun Baton (Reach 1, 6S Stun) Sword (Reach 1, 7M), Uzi III [SMG. 24 (clip). 6M, w/Internal Smartlink, Sound Suppressor]

Cousin of James and Iain. Mad John is a hulking brute with buck teeth, freckles, brown hair and eyes, and weather-beaten skin that makes him look older than his 32 years. Mildly psychopathic at the best of times, Mad John carries no gear unless James gives it to him; normally, James stores Mad John's gear in his own room.

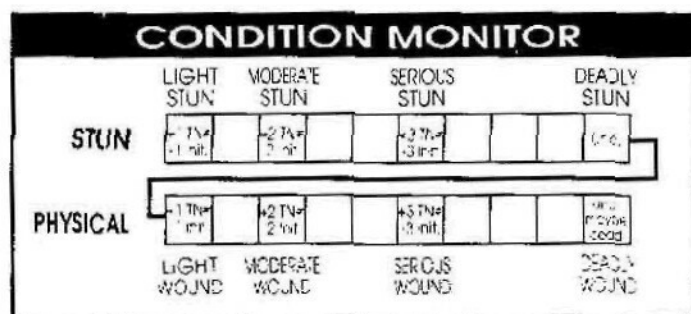

DEBUGGING

The runners may choose violence for this encounter. If they do, they may still meet Morag's ghost and find the Perception chip, but they cripple their chances of doing business with Sir Iain MacDonald later on. Though not fatal to the outcome, this mistake costs them heavily at the end of the adventure. If they overcome the castle occupants without seriously harming them, Sir Iain may agree to talk with the runners later (see **Talking to the Laird**, p. 55), but the gamemasters should increase the team's target numbers for negotiations with Sir Iain by a number proportional to the damage they did.

The runners may not agree to allow Morag to possess one of them. In this case, the gamemaster can cheat; the ghost should get its message across. If necessary, use the procedure described on p. 80 of **Grimoire II** for free spirits with possession power.

Lastly, the runners may not find the Perception chip. This only becomes a problem if they chose to shoot their way in, which makes getting back in later on one tough proposition. If they played nice getting into the castle, they should be able to negotiate a chance to search again.



SAMURAI STRIKE

TELL IT TO THEM STRAIGHT

Adjust this section as needed to reflect the runners' situation when the drek hits the rotating blades.

After the fun and games at Castle Laidon, you take off again: you know the job's not finished yet. Unfortunately, you find out the hard way that other people want to rejoin the party. Just as you hear the whine of a chopper that's zig-zagging in your direction, as if scanning the terrain, it spots you. The chopper dives straight at your team, guns blazing. Too bad your social skills can't get you out of this mess.

HOOKS

Guns, guns, and more guns.

BEHIND THE SCENES

Alerted by the runners' activities in the U.K. and their obvious interest in Quicksilver, Zeta-ImpChem agents have tracked the runners to Castle Laidon, where they launch their first strike as the team is leaving. The outcome of this combat depends on several factors: the runners' decisions, whether they are on foot or in a vehicle, and so on. If necessary, the samurai in the chopper tries to disable the runners' vehicle(s) before going in for the kill. If the runners have enough survival sense to spread out and take cover in the nearby forest, they force the chopper to land and the samurai to hunt the runners on foot.

The eight-man IWS (Integrated Weapon Systems) chopper mounts two hardpoints with FN-HARs, their massive cartridges packing 1,000 rounds apiece. A security system uses thumbprint and retinal ID checks through scanners located on the control panels to prevent unauthorized access to the chopper. The craft carries five street samurai, a rigger, and a combat mage, all of whom wear wrist radios in order to communicate with the chopper while on the ground. Their orders are to kill the runners, and this team keeps coming until they accomplish their mission or until at least half of the strike team loses radio communication. The rigger stays inside the chopper, and one samurai stands guard within 50 yards of it to foil a possible sneak attack.

In order to survive, the runners must take cover, which they find easily in the woods by the castle. Because the Zeta-Impchem strike team most likely packs superior firepower, the runners will probably need magic to win the day. Fortunately, the strike team lacks subtlety; they nuke anything that moves.



SAMURAI (5)

B Q S C I W E R Armor
6(8) 4(5) 6(7) 2 5 5 .1 5(9) 5/3

Initiative: 9 + 3D6

Threat/Professional Rating: 4/3

Skills: Armed Combat 3. Bike 2. Etiquette (Local) 4. Firearms 5, Stealth 4. Unarmed Combat 6

Cyberware: Cybereyes, Low-Light, Dermal Plating (2), Muscle Replacement (1), Retractable Hand Razors (7L), Smartlink, Wired Reflexes (2)

Gear: Armor Jacket (5/3). Ares Predator [Heavy Pistol. 15 (clip). SA, 9M, W/2 extra clips. External Smartlink]. Uzi III [SMG. 24 (clip), 6M. w/2 extra clips. External Smartlink]

SAMURAI STRIKE

RIGGER (1)

B Q S C I W E R Armor
5 6 4 4 6 5 1.3 6 (10)* 5/3

Initiative: 6 (10)* + 1D6 (+ 3D6)* (*applies only when rigging)

Threat/Professional Rating: 3/3

Skills: Bike 4, Car 5, Computer 3, Electronics 3, Etiquette (Corp) 1, Firearms 2, Ground Vehicles (B/R) 2, Gunnery 4

Cyberware: Cybereyes, Low-Light w/Thermographic and Flare Compensation. Datajack, Radio, Smartlink, Vehicle Control Rig (2)

Gear: Armor jacket (5/3), Waldegrave-Stevas pistol [Heavy Pistol. 25 (clip). SA, 9M. w/2 extra clips. External Smartlink]

CONDITION MONITOR				
	LIGHT STUN	MODERATE STUN	SERIOUS STUN	DEADLY STUN
STUN	+1 TN# -1 Init	+2 TN# -2 Init	+3 TN# -3 Init	Inc. may be dead
PHYSICAL	+1 TN# -1 Init	+2 TN# -2 Init	+3 TN# -3 Init	Inc. may be dead
	LIGHT WOUND	MODERATE WOUND	SERIOUS WOUND	DEADLY WOUND

COMBAT MAGE (1)

B Q S C I W E M R Armor
2(3) 4 2 2 5 5 5.8 6(9) 4 5/3

Initiative: 4+1D6

Threat/Professional Rating: 3 (4)/3

Skills: Conjuring 3, Etiquette (Corp) 2, Firearms 3, Magical Theory 4, Sorcery 6, Unarmed Combat 2

Cyberware: Cybereyes, Low-Light w/Thermographic

Gear: Armor Jacket (5/3), H&K 227 [SMG. 28 (clip), SA/BF, 7M. w/1 extra clip, Laser Sight (-1 target number modifier)], Power Focus (3), Specific Spell Focus (Powerball 2), Spell Lock (Armor/2 successes), Spell Lock (Personal Combat Sense/4 successes*)

Spells: Armor 3, Clairvoyance 3, Confusion 3, Detect Enemies 2, Heal 3, Increase Reaction (+2) 2, Mana Bolt 4, Manaball 4, Personal Combat Sense 5, Powerball 4

*For non-player characters, increase Threat Rating by 1 for every 4 successes rolled when using the combat sense spell.

CONDITION MONITOR				
	LIGHT STUN	MODERATE STUN	SERIOUS STUN	DEADLY STUN
STUN	+1 TN# -1 Init	+2 TN# -2 Init	+3 TN# -3 Init	Inc. may be dead
PHYSICAL	+1 TN# -1 Init	+2 TN# -2 Init	+3 TN# -3 Init	Inc. may be dead
	LIGHT WOUND	MODERATE WOUND	SERIOUS WOUND	DEADLY WOUND

UTILITY HELICOPTER

Handling Speed B/A Sig APilot
5 170/250 4/1 4 2

Seating: Twin bucket seats + 2 folding benches

Access: 2 standard + 1 double-sized

Armament: 2 FN-HARs [Assault Rifle. BF/FA, 8M. 1,000 rounds (clip)], forward firing, mounted one on each side.

VEHICLE CONDITION MONITOR

▲	▲	▲	▲
LIGHT	MODERATE	SERIOUS	DESTROYED

At the end of this skirmish the runners may need medical help, in which case they must risk going back to the Habitable Zone or to Dr. Knox's Body Shop (or convince someone to make a house call). If Zeta-ImpChem trashed their vehicle, they may return to Castle Laidon (p. 45) to borrow or steal one. They may just hole up at the castle if team members need time to heal. If the team escaped relatively unscathed, they may **Say Hello to Nessie** (p. 40) or, if they want to place a new chip in Quicksilver's cyberdeck, go to **Squaring the Circle** or **Weird Science**, p. 53 and 38, respectively.

DEBUGGING

If the runners get blown away, go to **Picking Up the Pieces**, p. 62. Even if they get incredibly lucky and snag themselves a functional chopper by defeating the Zeta-ImpChem gang, the security devices keep them from doing much with it. The only result of the team getting the chopper is another attack—the vehicle's long-range tracking signals tell their enemies where they are. Make the opposition tougher the second time, because the chopper gives the runners better weaponry and gear. Because the likelihood of the runners successfully hijacking the chopper is so slim, a second attack is not scripted here.



BRINGING THE CHILD HOME

TELL IT TO THEM STRAIGHT

When the team decker finds the Child/Imago again, read the following:

Your persona whispers, "Come to Amelia," to the strange, fey Child, and he takes your hand. He looks at you with the trust a child has for its parent, seeking protection and succor. Waving away the IC icons, he follows you to the SAN. As you prepare to jack out, you see yourself disappearing into your own deck with the Child still holding your hand. You've never had that kind of out-of-body experience before when decking, and just for a moment a chill runs down your spine.

HOOKS

By this time, the decker's encounters with the Child/Imago should feel almost mystical. Play up that feeling.

BEHIND THE SCENES

Depending on whether or not the runners persuade Sir Iain MacDonald to allow them access to the subsystem they explored in **Child in the Matrix**, p. 20, this section may play out several ways. Having his permission makes this encounter a cakewalk, though the runners cannot make side trips to pilfer paydata as they did on their last visit. To prevent the team decker from pulling any fast ones, a pair of exceptional MacDonald deckers with Fuchi Cyber-6 (Response Increase 2) deck equivalents accompany the decker in the system.

If Sir Iain has denied the team access to the system, or if they have not yet talked to him, then the team decker must access the system without ID codes. For details of the system, see **Child in the Matrix**, p. 20. The decker encounters the Child/Imago in the third datastore that the decker hacks into. Of course, valuable data still exists for the taking throughout the system, and the decker can try to download it for sale across the Matrix to a distant contact. This kind of haul can net the runners a good chunk of cash, with which they can buy or rent a good vehicle, hire Angus MacNab, and accomplish plenty of other things. If the decker failed to find the Child/Imago on the first run, the system automatically goes on passive alert. If the decker fails this time around, he or she may get one more chance by talking to Iain MacDonald (**Talking to the Laird**, p. 55).

If the decker finds the Child/Imago, he or she need not make any tests to get out of the subsystem. Incredibly, the Child neutralizes any IC it passes with a wave.

The decker can transfer the Child into Quicksilver's cyberdeck by connecting the appropriate I/O ports of the runner's deck to those of Quicksilver's deck. If the decker jacks into Quicksilver's cyberdeck after transferring the Child there, he notices the imago beginning to look more adult. If the Memory chip has been loaded,

the Child's expression appears more knowing. If the deck contains the Affect chip, the Child shows signs of hurt and fear, but smiles uncertainly from time to time. If the decker slotted the Perception chip, the Child looks about him constantly. Each time the decker subsequently jacks into Quicksilver's deck, the Child looks and acts more adult, as if regaining faculties and relearning skills and memories (as in fact, he is). The team decker cannot use Quicksilver's cyberdeck, and once the Child returns to it, any chip placed within the deck can no longer be removed. The Child is taking back what belongs to him.

When the deck contains the Affect, Memory, and Perception chips, go to **Squaring the Circle**, p. 53.

DEBUGGING

Failing to retrieve the Child from the Transys subsystem this time may make the team's decker too discouraged to make any further attempts. If Sir Iain MacDonald gives the runners official access to the Transys system (and they still need it), this should inspire the decker to give it another shot (see **Talking to the Laird**, p. 55). Push the runners to ask for his help if they need it. If they give up, they have wimped out. **Go to Picking Up the Pieces**, p. 62.



SQUARING THE CIRCLE

TELL IT TO THEM STRAIGHT

You have three of the four unique chips that Quicksilver left with those he loved and trusted. You've slotted the chips into Quicksilver's deck, and watched the Child from the Matrix grow. Curious, you jack in to see what the Child is up to now. Usually he doesn't speak or react to you; he just looks around, apparently utterly absorbed in himself. This time he's drawing, creating a scintillating image in the enclosed Matrix space within the deck. He's sketching a Zodiac wheel. After he draws the signs, he places the planets in their proper Houses, and then draws a glowing red line through the tail end of Sagittarius and says, "I rose here as a Man." Then he looks at you and says simply, "Heaven, Amelia. Find heaven."

HOOKS

As always when encountering the imago, mystery and mysticism pervade the scene.

BEHIND THE SCENES

In his usual enigmatic style, Quicksilver has drawn the birth chart for what he believes was his last human life. The only thing missing from his chart is heaven, the MC or Mid-heaven of the horoscope. To recognize this omission, the team mage or another runner with astrological knowledge must make a successful Magical Theory (8) Test. For a magician player character, reduce the target number by 1 for every grade of initiation he or she holds within a magical group (see p. 38, **Grimoire II**). If present, Amelia Richardson immediately recognizes the gap in Quicksilver's chart, but she waits to see if any of the runners identifies it before pointing it out.

To solve this final puzzle, Amelia must key the position of all the planets and Quicksilver's rising sign at birth into the huge trid horoscope wheel in her office, traveling back to Edinburgh if necessary. Amelia's computer calculates the MC as the first degree of Scorpio. As soon as Amelia enters that final element into her trid horoscope, the electronic displays for three signs—Libra, Scorpio, and Sagittarius—shift, flow, and fuse into a single mass like running mercury. The melded signs form the Integrative-Executive chip, and the wheel shatters, leaving the chip behind. This scene is very dramatic, so if the runners cannot get to Edinburgh, have Amelia trideo it and play it back to them. The I/E chip looks like the other three, except that it is brilliant red.

Once any character slots the I/E chip into the cyberdeck along with the other three, the deck starts humming softly. If the team decker jacks in, he sees the adult Quicksilver sitting with his head in his hands, inconsolable. With the integration of the I/E chip, Quicksilver remembers his and Morag's violent deaths, and recounts the murders to the decker. At this point the decker must make a Willpower (6) Test. If he fails, the

decker feels Quicksilver's overpowering anguish at seeing the person he most loved murdered, torn from him in her prime. Quicksilver's hands touch the head of the decker's persona, and the reality the elf sees overwhelms the decker. He or she sees Quicksilver standing with Morag in the moonlight at Glencoe, hears a lone piper play "Flowers of the Forest," feels the despair of a soul barely united with its other half before violent death tears them apart. The decker watches grim-faced samurai mow Morag down on the steps of Castle Laidon, sees Quicksilver running for the door, feels his dying agony as bullets rip through him. These sensations, as real as any of the decker's personal experiences, leave the decker reeling with a sense of utter desolation.

Whether the decker succeeds or fails at the Willpower (6) Test, read the following:

"I knew I would die soon, but not so quickly or so violently I need to die with her. Take me to Morag. I know she still lingers at Glencoe. I need your help. Don't forsake me."

TELL US MORE..

The runners need information from Amelia Richardson at this point, some trivial and some essential.

Knowledgeable players may hassle the gamemaster for the horoscope details (actually unimportant). Give them the following to shut them up: Sun at 19 degrees Sagittarius, rising sign at 25 degrees Sagittarius. Moon at 9 degrees Libra. Mercury at 1 degree Sagittarius, Venus at 1 degree Aquarius. Mars at 15 degrees, Aquarius, Jupiter at 12 degrees Taurus, Saturn at 24 degrees Libra. Uranus at 18 degrees Cancer. Neptune at 23 degrees Libra. Pluto at 23 degrees Leo. Curious players may also wonder why it was the Libra-Scorpio-Sagittarius axis that fused to yield the final chip. Amelia tells them that the major indicators in a horoscope are Sun, Moon, rising sign, and MC, and the fusion of these three signs brought all those elements together into the Integrative function.

The horoscope details make interesting trivia; more importantly, the runners must find out from Amelia what Quicksilver's cryptic words meant. Amelia speculates that Quicksilver somehow knows that Morag still exists as a ghost, probably by making a connection between her violent death and the ghostly presences in the background at Glencoe. The injunction "Take me to Morag" obviously means that Quicksilver wants the runners to take him (the deck) to Castle Laidon. But what does he mean by, "I need to die with her"?

After thinking long and hard, Professor Richardson answers, "I think I understand. He wants us to bring his astral form to the place where Morag's astral form remains. And then he wants to die so they can be together. But some part of his astral form must surely be linked with the deck now. He needs that part set free, and somehow he needs your help to do it. I have no idea how he re-created himself within this deck. But somehow, you'll have to free him from it."

The runners must now choose between two options: go back to Castle Laidon (go to **Set My Soul Free**, p. 58) or refuse Quicksilver's request. If they look doubtful about taking this on, Amelia offers them her own spell foci as payment. Amelia does not guess the dangers involved, but if her friend Quicksilver needs the runners, she will do her best to see that he gets them. If the team declines this final adventure, go to **Picking Up the Pieces**, p. 62. Amelia keeps the cyberdeck and looks for runners with more guts. If the runners try to steal the cyberdeck, Amelia stops them in their tracks using the threats described in the Debugging section of **Weird Science**, p. 38. If they agree to help Quicksilver, they may need to ask Sir Iain MacDonald for assistance, if they have not already done so. Go to **Talking to the Laird**, p. 55.

If a magically active character attempts to assense the cyberdeck, or cast some form of detection spell on it, he or she discovers nothing odd or unexpected. Quicksilver's unique metaphysical ties cannot be astrally perceived; as long as his imago lives, it traps him between existence and nonexistence, and he cannot rest.

DEBUGGING

This encounter can only go wrong if the runners refuse to help Quicksilver. Amelia Richardson already offered them a bribe and some information: no one else will offer more. If they back out now, after all that has happened, let the miserable cowards suffer the consequences. Go to **Picking Up the Pieces**, p. 62.



TALKING TO THE LAIRD

TELL IT TO THEM STRAIGHT

Sir Iain's impressive residence offers overwhelming but not ostentatious security. Cameras and scanners lie concealed in the foliage outside, and the two kilted MacDonalds at the front door fairly bristle with cyberware. Now you know what Scotsmen wear under their kilts: weird and threatening implants. I/R beams, detection lasers and a few other surprises you assume escaped your notice cover all the windows. The unsmiling guards search you very thoroughly indeed. They find every weapon you're packing that's bigger than a nail file. It takes you several minutes to drag yourself up the massive staircase to the top floor, passing quite a few guards on your way. The clansmen on the top floor carry SMGs, and one even totes a gas-grenade launcher. Even though you were invited to be here, the sight of all this protection makes you nervous. Telling yourself firmly to stop being silly, you head for the huge study at the end of the passage.

The man standing in the study doorway gives you a token welcome and handshake. Leading you inside, Sir Iain MacDonald sits down by a real fire and passes crystal tumblers of whisky around his circle of guests. That induces you and eight pistol-gripping MacDonald clanelders who keep you firmly in their sights.

"Weel," says the Laird in a rich Highland burr, "ye'd better hae somethin tae say feryersel. The polis will be interested if ye dinna. I'll gie ye ten minutes."

HOOKS

Welcome to the world of big business. Sir Iain wields the immense power that comes with control over vast sums of money, and he does not appreciate people who waste his time. His crack security guards stand ready to react to any potential threat. Tension and danger fill the air; make the runners feel as though a single wrong word might get them shot between the eyes.

BEHIND THE SCENES

How the runners deal with Sir Iain MacDonald determines how easy or difficult they find the final stages of this adventure. Though the team can succeed without Sir Iain's aid, it makes life simpler. This encounter depends on three important elements; how the runners manage to meet Sir Iain, what information of value they can offer him, and what the runners can gain from him in return.

MEETING SIR IAIN

The runners' meeting with Sir Iain can come about in two ways. If they visited Castle Laidon and James MacDonald witnessed Morag's ghost possessing one of the runners, James

arranges a meeting in Edinburgh. If the runners dare not go to Edinburgh for fear of arrest, then Sir Iain agrees to meet them in Pitlochry. Lacking James MacDonald's assistance, the runners can contact Sir Iain themselves. They make the initial contact by telecom, reaching Sir Iain at Transys Neuronet's offices in the company's Meadows complex or at his home at Holyrood Court. Before they dial the number, the runners had better come up with a damned good reason why Sir Iain should meet them. If the runners claim to have information about Quicksilver, especially his cyberdeck, Sir Iain definitely sits up and takes notice. Claiming to have information about the true circumstances of Morag's death, on the other hand, may not be enough to catch his attention. The runner doing the talking must make an opposed Negotiation (Willpower) Test. If he or she rolls fewer successes than Sir Iain, the laird calls the player a crank and cuts the connection. If the team claims to have information about Quicksilver and can actually describe the elf's cyberdeck before Sir Iain hangs up, MacDonald changes his mind. If the runners can interest Sir Iain in what they have to say, he agrees to meet them at Holyrood Court, warning them that he maintains tight security and that the runners must come unarmed. The text of this encounter assumes that the runners meet Sir Iain at Holyrood Court; if they meet at Pitlochry, Sir Iain books an entire small hotel for the evening, wires the place for surveillance, and stuffs it full of MacDonalds for cover.

The runners may meet more than once with Sir Iain, but probably not more than twice. For example, if, after a first unproductive meeting, the runners go to Castle Laidon and meet Morag's ghost, and if James sees Morag possess a runner, a second and more favorable meeting with Sir Iain might take place. If events between meetings reveal more information, the second meeting might find him more willing to help.

Once the runners arrive at the meeting, they must make several successful opposed Negotiation (Willpower) Tests in order to get Sir Iain's help in various specific ways. They begin each test with a +2 modifier to their target numbers: they can reduce this penalty by offering certain information. The following sections suggest possible results.

Morag's Death

If James MacDonald witnessed Morag's possession at Castle Laidon, modify the runners' target numbers by -2. James' description of the scene affects Sir Iain profoundly. If the runners describe a meeting with the ghost that James did not witness, reduce their target numbers by 1, unless they mention that Morag specifically said the Campbells were wearing the Old Colors of the tartan. This detail was not part of the public record and is not common knowledge. If the runners mention the tartan, reduce their target numbers for all subsequent tests by 1 additional point.

Quicksilver's Death

Sir Iain had no idea that his daughter loved Quicksilver. Because of the connection to Morag, news of Quicksilver's death interests and saddens Sir Iain, but has no other effect.

Quicksilver's Cyberdeck

If the runners describe Quicksilver's deck clearly to Sir Iain and roll at least one more success than Sir Iain in an opposed Charisma (Willpower) Test, their knowledge impresses him. To reflect his reaction, modify subsequent target numbers for the team by -1. If they present Sir Iain with the deck, they automatically receive this modifier, but the runners may consider their position more advantageous if they do not bring the deck. After all, he might just take it from them. (He wouldn't, but the players don't know that.)

Quicksilver's Research

In general, tales of dealings with druids, spirits, and the like leave Sir Iain cold. However if the runners give an accurate account of their meeting with the druids of Skye, Sir Iain rubs his chin and mutters. "Aye, he was awfa in wi' them. Ye're tellin' me wha I ken tae be true." Reduce subsequent target numbers for the group by 1.

Alasdair Cameron

If the runners admit that Cameron hired them to find Quicksilver, Sir Iain looks displeased but says nothing. If they point out that someone changed the subsystem ID codes just before Cameron's death, Sir Iain replies that a corporate decker detected an unauthorized presence in the Matrix, and changed the system checks and alerts according to standard procedure. No information about Alasdair can tilt the odds in favor of the runners. However, mentioning that Alasdair suspected the presence of elements within Transys that were actively hostile to Quicksilver earns a nod of recognition from Sir Iain, and brings the runners to the following point.

Attack On The Runners

If the runners came under attack when they left Castle Laidon, reporting this assault to Sir Iain does not affect subsequent Negotiation (Willpower) Tests. But if the runners take a bolder tack, displaying a half-healed wound or two and blaming the injuries on rogue elements within Transys who killed Cameron and now appear to be after them, Sir Iain listens to them. If he agrees to allow them to visit Castle Laidon, he protects them from a repeat attempt by providing the runners with a personal chopper and an escort of two MacDonald fighting men (for the MacDonalds' stats use the Street Samurai Archetype, p. 62. **SR II**).

The above examples cover the only information the runners have to offer that might convince Sir Iain to help them. However, the runners might try to accomplish a few other things in this encounter.

Stonewall

The runners may try to pump Sir Iain for more information about Quicksilver. No dice. Sir Iain gives nothing away.

Garbage In, Garbage Out

If the runners have not yet downloaded the Child/Imago into Quicksilver's cyberdeck, they can avoid the hazards of the sub-

system defenses if they convince Sir Iain to give them the subsystem's new ID codes. Have the runners make an opposed Negotiation (Willpower) Test. If the team rolls more successes than Sir Iain, he agrees to allow them access only if the team guarantees that its decker will not attempt to download any data. Sir Iain's cousin, Hugh MacDonald (use the Decker Archetype, p. 51. **SR II**, for Hugh's stats), will accompany the runner in the Matrix to ensure the decker's safety (and keep an eye on him).

Have Fun Storming The Castle

If the runners meet Sir Iain early in the adventure, before they go to Castle Laidon, they may decide to ask his permission to go there to investigate the scene of Morag's death. If the runners make this request, add a +1 modifier to their target numbers for the opposed Negotiation (Willpower) Test. If they roll more successes than Sir Iain, he approves a visit to the castle for the team, accompanied by an additional half-dozen MacDonald fighting men.

Eventually, the runners may need to take Quicksilver's cyberdeck to the castle in order to free the elf (see **Set My Soul Free**, p. 58) and finish their job. Because what they intend to do will put Quicksilver beyond the reach of Transys forever, they need a plausible cover story to convince Sir Iain to let them back into the castle. Sir Iain knows very little about how decks work; the runners could easily convince him that Quicksilver's unique chips must be integrated at the castle to relive and dispell the trauma of Morag's and Quicksilver's deaths. Actually, the runners' descriptions of recent events simply solidifies Sir Iain's suspicions that enemy agents lurk within the company. Someone killed Alasdair Cameron, Quicksilver has disappeared, someone altered the subsystem's ID codes, and so on. Whoever masterminded these events could easily have murdered Sir Iain's daughter. Sir Iain plans to use the runners as bait to flush out the murderers (see below). To build suspense, the gamemaster can roll some dice and have Sir Iain



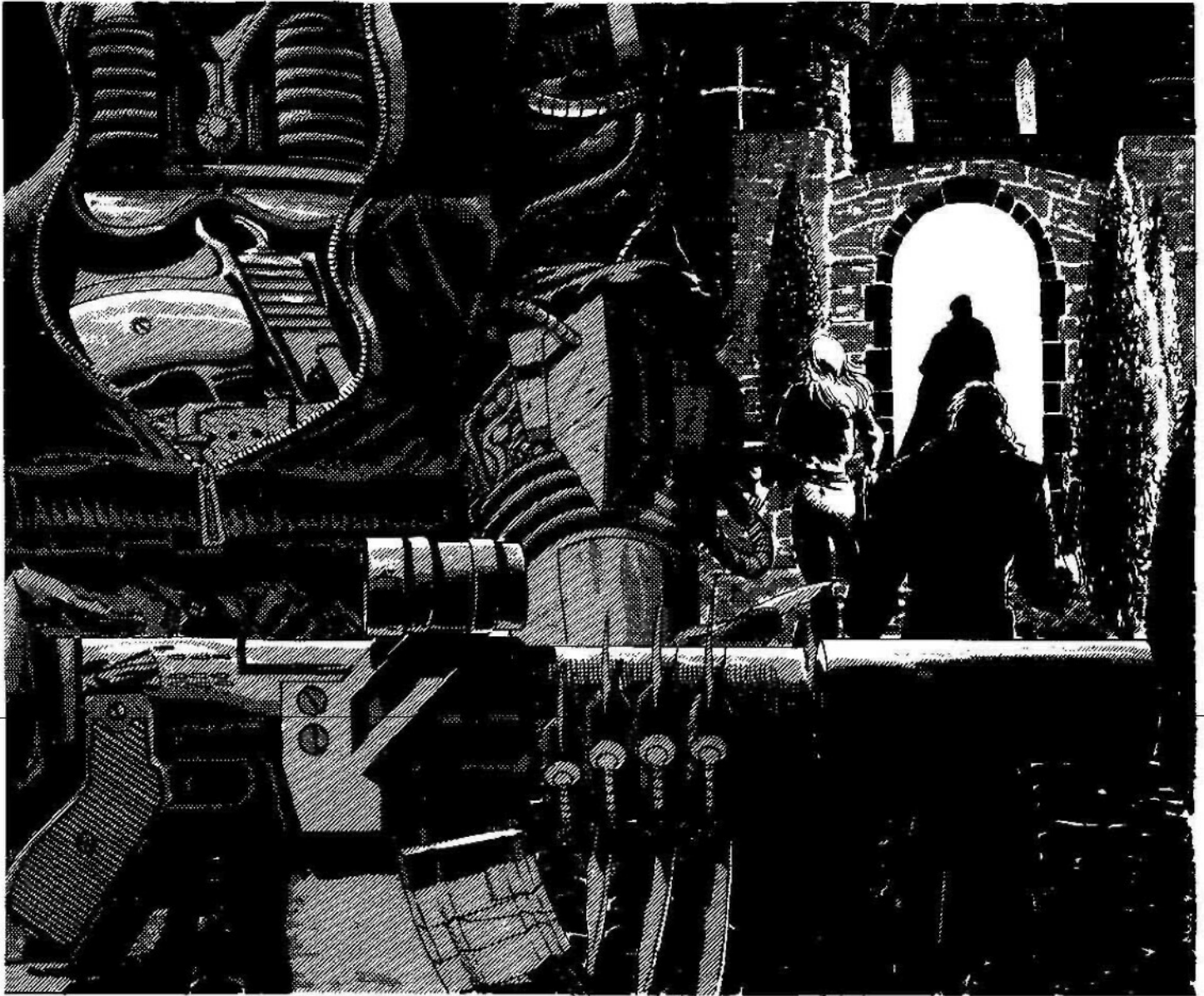

equivocate, but he sends the players to Castle Laidon. He cares nothing for their fate, and remains unconvinced of Morag's existence as a ghost, but he knows a chance to exact revenge when he sees one. The MacDonalds live for revenge.

Help!

If the runners meet with Sir Iain early in the adventure, he refuses all their requests for money, weapons, muscle, autos, or anything else. If the players approach him closer to the final scene (**Set My Soul Free**, p. 58), Sir Iain provides a company chopper and two MacDonald fighting men (use the Street Samurai Archetype, p. 62, **SR II**, for stats) as escorts. "Though he can get medical attention for a desperately wounded runner, the gamemaster must decide how willing he would be to do so early in the adventure.

When the runners finish all their explanations and end by asking for help, Sir Iain asks them, "What's in it for the company, then?" The runners should be ready for this question. For example, they might play up the tech angle, claiming that the cyberdeck will be priceless to Transys once it works properly. Their work also could lead Sir Iain to the hostile elements within Transys who killed Quicksilver, Alasdair Cameron, and Sir Iain's

daughter (he winces at that).

When the runners take off for Castle Laidon in **Set My Soul Free**, p. 58, Sir Iain tips off one or two other top board members about the trip and its purpose. He counts on the runners' presence at the castle to flush the enemy out.

From this meeting the runners most likely go to **Bringing the Child Home**, p. 52, **Set My Soul Free**, p. 58, or **Castle Laidon**, p. 45.

DEBUGGING

Make it clear to the runners that Sir Iain holds all the cards. They are in no position to make demands. They must act honestly and thoughtfully, expressing themselves carefully. In most cases, failure to roleplay this scene effectively simply means that Sir Iain refuses to help them. If they threaten him, he turns them over to the authorities. Either those authorities or Transys agents pick up Amelia Richardson at the same time, and the situation is resolved without the runners. The Scottish authorities ship the runners back to North America in disgrace.

Go to **Picking Up the Pieces**, p. 62.

SET MY SOUL FREE

TELL IT TO THEM STRAIGHT

You arrive at Castle Laidon with Amelia Richardson and the cyberdeck, all four chips in place. You've been traveling under leaden gray skies; now mist begins to roll down the hillsides into the glen. Fine drizzle drifts into your faces as you walk past the razor wire and approach the gates. You don't know what will happen here, and nothing you've ever experienced prepares you for it. Keep up your courage, chummers. You'll need it.

HOOKS

Magic, mysticism, majesty, and mayhem. Play this encounter as the ultimate big finish. Don't skimp.

BEHIND THE SCENES

If the runners killed the occupants of Castle Laidon in a previous visit, the place is deserted. The runners will have to bluff their way through an explanation for the empty castle that Amelia Richardson will accept.

If the runners do not have permission from Sir Iain to visit, they must negotiate with James MacDonald to get into the castle and free Quicksilver. Amelia Richardson adds a strong argument for laying Morag's ghost to rest. Make the runners sweat a bit while talking to James, but he makes no serious objections to the runners going in—he just stays out of the way. If the runners have permission from Sir Iain, they walk right in. The two MacDonald clansmen Sir Iain sent with them will come in handy later. If any MacDonalds still occupy the castle, the fighting men (except for the two escorting the runners) take up positions outside the castle as a precaution: the runners came under attack not far from here on their last trip. James MacDonald stands on guard inside the castle with the two extra men from Sir Iain, if available. The runners must begin the ritual at midnight and, of course, the Zeta-ImpChem agents within Transys will launch a final all-out strike right at the climax. Surprise, surprise.

The gamemaster should structure this final scene with the following elements in mind: the final, midnight decking session; the possibility of combat; the strike by Zeta-ImpChem agents from within Transys; and the arrival of the MacDonald cavalry.

Of course, the cavalry cannot arrive if the runners wiped out the castle's residents in an earlier encounter.

JUST BECAUSE YOU'RE PARANOID...

The runners may anticipate a corporate strike during their final decking session. Find out precisely now they intend to defend against it. Allow the players' ingenuity free rein; they might board

up the windows of rooms, pour oil from the electric generator in the garage onto the stairs in the classic "oil slick defense," prepare oil pots to light and fling down onto the attackers from the castle windows, set up trip wires, and so on. When the team complete their preparations, make a judgment call. Did the runners plan feebly or not at all, reasonably well, or brilliantly? The gamemaster's verdict affects the final fight and Karma awards.

MIDNIGHT

If the runners jack into Quicksilver's cyberdeck to check in with him soon after arriving at the castle, his image appears and says, "We're here. Midnight. She always comes to her room at midnight." The runners figure out that whatever is going to happen will happen at midnight, and Quicksilver wants it to take place in Morag's room. In fact, the exact location does not matter as long as the team and the cyberdeck stay within the castle, but nothing happens until shortly before midnight.

Deckers should be jacked into the cyberdeck; for a team with more than one decker, the additional player(s) uses a hitcher jack, Quicksilver's deck is unique, but a runner using a hitcher jack is still only along for the ride. Amelia Richardson stays close to the deck, her spell foci ready to use as needed. She sets protective spells to keep enemies away from the cyberdeck and shield the deckers as they work. James and one of Sir Iain's MacDonald escorts stand guard outside the room where the deckers work. The players may place the second MacDonald escort (and Angus MacNab, if present) wherever they wish. (Use miniatures or some other visual representation to organize the positions of the runners in this final scene.)

When the decker jacks into the cyberdeck near midnight, Quicksilver appears immediately and places his hands on the head of the decker's persona. "I need you. If there is another decker around, use a hitcher jack, and he can help us. I need your mind and spirit to help me free myself, so I can be with her. I could not die with her before; the machine kept alive what I had saved of myself. Now I have reached the next turn of the Wheel. Your soul will be my medium. Be strong, my friend." Quicksilver's image shifts to the Child/Imago and joins hand(s) with the decker(s).

On the stroke of midnight, the spectral form of Morag's mute ghost begins to materialize within the room. When she appears, the decker feels an intense rush of thoughts and emotions, as Quicksilver struggles within the deck to free his self from the encoded chips. Quicksilver must use the soul of a living decker to translate his own personality back into reality and transform himself. He takes the decker through hell and back mentally and emotionally. The decker(s) cannot jack out; Quicksilver controls the deck and the decker. Black IC has nothing on this experience.

During the first stage of his transformation, Quicksilver extracts his

SET MY SOUL FREE

perceptual skills, to see the ghost and guide himself. The decker must make a Reaction (6) Test. If he rolls at least 1 success, he experiences a passing sensation of blindness, deafness, and numbness, as if floating in a bubble isolated from the world. If he fails to roll any successes, the decker feels blind, deaf, and numb throughout the entire ordeal, wholly at the mercy of whatever happens to Quicksilver.

In the second stage, Quicksilver extracts his memories and shares them with Morag's ghost. A multitude of images zips through the decker's mind's eye. (Yes, his life really does pass before his eyes in the blink of an eye.) The decker must make an Intelligence (8) Test. If the decker fails to roll any successes, he loses his sense of time and personal place for the duration of the ordeal, losing all knowledge of who he is or what is happening. If the decker rolls at least 1 success, he or she suffers this disorientation only momentarily.

In the third stage, Quicksilver frees his emotions, and conveys to the ghost the depth of his love for her. This experience nearly wipes out the decker. He relives every intense feeling, positive and negative, that he ever felt for any other person. As Quicksilver's emotions leave the deck, all feeling drains away. The decker must make a Willpower (8) Test. If he fails to roll any successes, the decker experiences existence stripped of all emotion, a horrifyingly desolate condition. At least 1 success makes this a fleeting experience, but the decker still finds it excruciating.

In the final stage of the process, Quicksilver must take apart his own being, represented by the I/E chip, and transform it outside the deck. Essentially, this process mimics death and rebirth. Though death still frightens Quicksilver, he experienced it once before. The decker has no similar experience to draw on; he suffers complete disintegration. No other form of isolation is as terrifying. Have the decker make an Essence (6) Test (rounding down the character's Essence Rating). At least 1 success means that the decker suffers no long-term effects from his or her experience. If the decker fails to roll any successes, he suffers temporary damage, losing 11 point of Essence. He must pay 5 points of Karma to regain it. Until he does, the decker suffers twice the standard Essence loss from any cyberware implanted in the interim. Despite his successful or unsuccessful tests, the ordeal leaves the decker wiped out, unconscious, and barely breathing.

If a second decker is using a hitcher jack, reduce the target numbers for the above tests by 1. Both deckers must make the tests independently; Quicksilver's ordeal affects them both. If more than one additional decker rides along using hitcher jacks, each decker must make the tests described above using those target numbers. Anyone connected to the cyberdeck feels the effects of Quicksilver's transformation. Each character can spend his or her own Karma Pool when making these tests, but only one of the deckers (if the team has more than one) may use points from the Team Karma Pool for each test.

In addition to the mental hell the decker(s) goes through, two other effects occur. At each of the four stages of transformation, the decker(s) suffers as if hit by a Force 4 stun bolt spell. The decker resists this spell normally, but can receive no mystical assistance from any of his companions; the bolt is not really a spell, merely an effect. Even if according to his Condition Monitor he is unconscious, he does not lapse into unconsciousness (or die) until the end of the transformation, but his pain is visible. Each decker connected to Quicksilver's deck experiences a moment of disintegration, but none as strongly as the (primary) decker.

Amelia and any non-decking runners in the room see the Child/

Imago emerge from the deck as an astral form. His eyes begin to shine (Perception); looking around him, he sees the ghost and moves toward her (Memory), and embraces her (Affect). Finally, the Child shifts into Quicksilver's adult form (Integrative-Executive, the final chip). United, the two astral forms look back at the slumped decker. They touch his face with their hands, healing the worst damage (that is, the decker's Condition Monitor returns to normal, but he remains unconscious and helpless). The ghosts look at the runners, and suddenly the team hears gunfire and the sound of approaching choppers. Yells, screams, and prolonged bursts of automatic gunfire echo through the castle; a mortar shell rips into the roof. The ghosts fade; enraptured by each other, they seem unaware of the mayhem outside. Their forms fade, but a presence still lingers in the area. But the runners have other things to worry about.

The runners must now survive a brutal attack. The Zeta-ImpChem strike team has dispatched the MacDonalds outside (if any), breached the front doors, and readied the first floor. The enemy consists of six street samurai, two troll street samurai, and two combat mages.

SAMURAI (6)

B Q S C I W E R Armor
6(8) 4(5) 6(7) 2 5 5 .1 5(9) 5/3

Initiative: 9 + 3D6

Threat/Professional Rating: 3/3

Skills: Armed Combat 3, Bike 2, Etiquette (Local) 4, Firearms 5, Stealth 4, Unarmed Combat 6

Cyberware: Cybereyes, Low-Light; Dermal Plating (2), Muscle Replacement (1), Retractable Hand Razors (7L), Smartlink, Wired Reflexes (2)

Gear: Ares Predator [Heavy Pistol, 15 (clip), w/2 extra clips. SA, 9M, External Smartlink], Armor Jacket (5/3), Uzi III [SMG, 24 (clip), w/2 extra clips. 6M, External Smartlink]

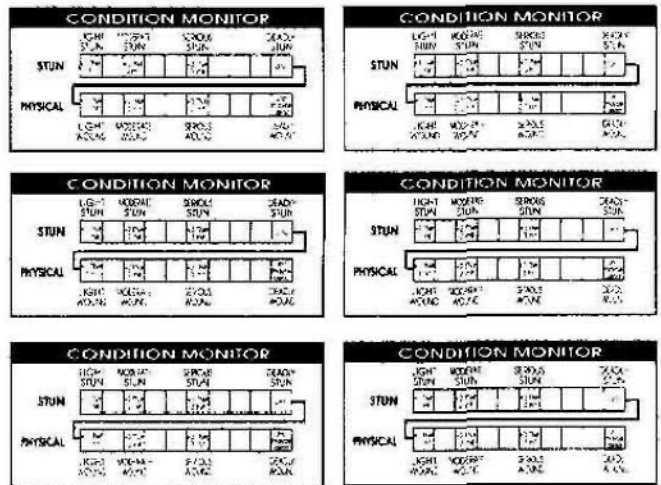

TROLL SAMURAI (2)

B Q S C I W E R Armor
7(8) 3(7) 6(10) 11 2 11 0 2(4) 5/3

Initiative: 4 + 2D6

Threat/Professional Rating: 3/3

Skills: Armed Combat 5, Bike 3, Etiquette (Local) 3, Firearms 5, Stealth 4, Throwing 5, Unarmed Combat 6

Cyberware: Muscle Replacement (4), Wired Reflexes (1)

SET MY SOUL FREE

Gear: Ares Predator [Heavy Pistol, 15 (clip), w/2 extra clips, SA, 9M, External Smartlink], Armor jacket (5/3), (4) Concussion Grenades. Uzi III [SMG, 24 (clip), 6M, w/2 extra clips, External Smartlink]

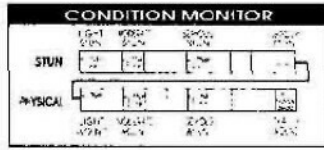
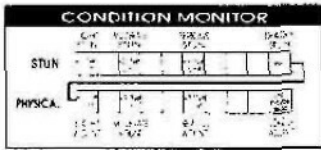

MAGES (2)

B	Q	S	C	I	W	E	M	R	Armor
2	4	2	2	5	5	6	6(10)	4	5/3

Initiative: 4 - 1D6

Threat/Professional Rating: 3/3

Skills: Conjuring 3, Etiquette (Corp) 2, Firearms 3, Magical Theory 4, Sorcery 6, Unarmed Combat 2

Gear: Armor Jacket (5/3), H&K 227 [SMC, 28 (clip), SA/BF, 7M. w/ 1 extra clip, LaserSight (-1 target number modifier)]. Power Focus (4), Specific Spell Focus (Powerball 2)

Spells: Armor 3, Clairvoyance 3, Confusion 3, Detect Enemies 2, Heal 3, Increase Reaction (+2) 2, ManaBolt 4, Manaball 4, Personal Combat Sense 5, Powerball 4

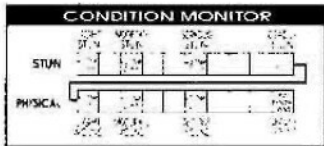
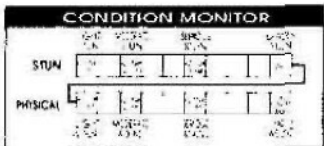

The street samurai make a frontal assault, backed up by the combat mages. The two troll street samurai outside attempt to **throw** concussion grenades (4 each) through the window of any room occupied by the runners. If the runners boarded up the windows, the trolls use assault cannon rounds first to blow the boards apart. This attempt takes them up to 4 Combat Turns, after which they enter the castle through the front doors and head for the runners.

The runners must hold out against this savage assault for 10 turns. If the gamemaster judges the runners well prepared for a possible strike, reduce the time by 1 turn; if they prepared brilliantly, reduce the time by 2 turns. If they stationed an elemental or spirit outside the castle as protection, subtract 1 additional turn to account for the delay this entity causes the attackers, and reduce the time the troll street samurai have to attack and throw the grenades to 2 turns.

If the runners got permission from Sir Iain to go to the castle, 2 turns before the time limit runs out, the runners hear what sounds like a fleet of choppers, the noise rising above the gunshots and screams echoing down the castle halls. This is the cavalry, but if the runners assume the choppers carry enemy reinforcements, let 'em sweat. If the runners did not get permission to enter Castle Laidon from Sir Iain, the choppers do not arrive, and the runners face a fight to the death.

If the cavalry does arrive, a horde of kilted MacDonald street samurai floods into the castle, wiping out every Zeta-ImpChem operative. The MacDonalds know what the runners look like, and avoid shooting at them. The MacDonald force automatically kills two enemies per turn, and reduces the Condition Monitors of two others by one Damage Level. As they work through the ground floor toward the runners, they take out the enemies nearest them.



Half the surviving Zeta-Impchem force turns to fight the MacDonalds, and the other half maintains the attack on the runners. This combat is a fight to the finish.

SPIRITS OF GLENCOE

Shortly after the body of the last enemy falls to the ground, the surviving runners see Sir Iain MacDonald enter the castle. Flanked by a piper and six of the largest human beings in existence, all resplendent in the MacDonald tartan. Sir Iain reaches the doorway of the room where the decking took place and surveys the carnage. As he opens his mouth to speak, ghosts begin to shimmer into perceptible spectral forms. Describe this scene carefully: it could easily degenerate into bathos, but the players should feel too battered and bruised to react cynically.

Quicksilver and Morag reappear smiling and holding hands. A vast great Spirit of Man towers above and behind them, appearing as a MacDonald clan leader circa 1692, old and gnarled but with fierce pride in his eyes, and wearing a claymore. From either side of the room, a procession of MacDonald ghosts enters. 37 in all, who walk toward the great spirit and rise into the ether above and beyond him. When the last specter disappears, Quicksilver and Morag fade once more. The great spirit swings his claymore in a wide circle and vanishes, leaving only the distant sound of a piper's lament hanging in the air.

This visitation stuns the living MacDonalds. They drop their weapons; these hard men hold their heads in their hands and weep. Sir Iain initially reacts the same way, but draws to his full height and salutes the great spirit as it sweeps the sword through the air.

After a long silence, the Laird turns to his men, "Dinna jist stand about. Put these braw lads and lassies into the ambulances." Turning to the runners, he says nothing of what just transpired, but says simply, "I think we'll have that funny deck if ye dinna mind. If that strange fella's with my Morag and gone, I'd like tae have what's left af him." He touches the deck gently, as a father would a young child. "I'll be lookin' after ye, dinna ye feart."

DEBUGGING

Once the final decking session begins, this encounter runs itself. The runners will have a very hairy time trying to fend off a powerful strike force. If they hang in there, Sir Iain's choppers, equipped with Rating 6 stabilization units, will fly any seriously injured runner to the Royal Infirmary Hospital, where they receive intensive care at Sir Iain's expense. Apply every positive modifier possible, then go to **Picking Up the Pieces, p. 62.**

The runners may feel unsure about handing over the deck, but they find it hard to refuse with all those MacDonalds waving big guns around. Any character using astral assensing or Computer Skill finds that the special chips within the deck are inert. Quicksilver is gone. Somewhere in the metaplanes, something extraordinary may be happening. Who can say?



PICKING UP THE PIECES

AFTER THE ADVENTURE

If the runners back off from the adventure at any stage, and/or kill the folks at Castle Laidon, they have to get out of the U.K. The document check is just as tough on the way out as on the trip into Scotland. For one reason or another, the police want the runners; how difficult they find it to leave the U.K. depends on what they are wanted for. As with any shadowrun, possible reasons for arrest are too numerous to list here: the gamemaster will have to play it by ear. Generally speaking, if the runners use their brains, they can leave. If not, they get caught.

However much they might like to, the police cannot prove that the runners killed Alasdair Cameron. After spending six months in remand (no bail), the U.K. court system hands down a "not proven" verdict and orders the team deported. If they tried mixing it up with the police at any stage, the runners receive a minimum of seven years imprisonment. Let them sweat. At some point early in the team's prison term, the British government offers them a job, promising their freedom in return for the work. Make this a tough assignment, with plenty of possibilities for things to go fatally wrong.

If the runners played out the final scenes with Sir Iain MacDonald, he sends them back to Seattle (or wherever they live) in a private suborbital plane. If they handed Sir Iain the cyberdeck, he gives them a little something extra. Once back at their hotel, or back home, the team receives a hefty package containing a Transsys Barrie model cyberdeck with the following components: MPCP 8, Hardening 4, Memory 120, Storage 500, Load 50, I/O 30 and Response Increase (2) with two hitcher jacks. The deck is worth around 400.000€. Every surviving member of the group also receives a gold-trimmed, quartz crystal, certified credstick bearing a tiny Transsys logo and good for 75.000 nuyen. A big, big haul, right? Not really. Sir Iain MacDonald is a rich, rich man and the runners went through hell. All things considered, the pay is decent, but not excessive.

Transsys built a special alarm into the Barrie. If the decker ever tries to hack a Transsys system, the MPCP sends a signal to the system's SAN directories, which automatically alerts the system to the intruder's presence. Unless he or she examines the deck and makes a successful Computer (B/R) (9) Test, the decker remains unaware of this safeguard. The decker can remove the offending part of the MPCP by making another successful Computer (B/R) (9) Test. If the decker fails to roll any successes, he damages the computer's MPCP so that it loses 1 Rating Point. Back to the Cyber-4 if you want to hack Transsys, chummer.

AWARDING KARMA

Award Karma as shown below. If Angus MacNab shared much or all of the adventure with the runners, he should receive a small slice of the Team Karma reward. Round fractions up.

TEAM KARMA

The team surrenders peacefully to the police at Cameron's flat	1
The team rails the final ordeal	4
The team succeeds in the final ordeal"	12
The team prepares carefully and thoroughly for a strike at Castle Laidon	1
Survival	2

"Reduce this award to 8 points if Amelia Richardson's offer of magical items bribed the runners into accepting the ordeal. Be flexible about this: if the team agreed to the ordeal and a team magician cadged a single item to help them out, do not penalize the runners.

These higher-than-normal awards reflect the fact that the runners worked under tougher conditions than usual. Coping with few to no contacts, hard-to-get weapons, and the strange rules of the shadows in a foreign country ought to earn them some extra Karma. The big 12-point reward for ultimate success reflects the fact that the runners touched the level of great-spirit Karma in this adventure: it demands much, and gives much in return.

INDIVIDUAL KARMA

Award Individual Karma per p. 199. SR II, with the following additions

Drama

Double the usual Drama award.

Magicians

If the magician in the ritual on Skye showed guts and made it through, award him or her an extra Karma point.

Astral Quest

All the runners who toughed out the astral quests and tests at Loch Ness get an extra Karma point.

LEGWORK

To follow up on or investigate clues in this adventure, the player characters need to investigate people, places, and situations. One of the best ways for runners to get the information they need is through their contacts.

CONTACTS

Imago presents the runners with a problem: they have no access to their usual contacts while in Scotland. Instead, the runners must establish new contacts during the adventure. Generally, the story specifies the contacts they make, for example, the non-player characters, such as Duncan the Fixer or Fionnghuala, who the players may encounter at Hamish's Bar. One or more runners may also want to spend some down time trawling for contacts among Edinburgh's social circles. The sections that focus on decking, when the rest of the players may be twiddling their thumbs, provide one such opportunity. For each full evening (or equivalent) they spend out on the town, have each runner make a Charisma (9) Test. If a player rolls 1 or more successes, that runner meets someone who fits into whichever **SR II** contact profile the gamemaster deems appropriate. Make the contact plausible—a bartender makes perfect sense, but a yakuza boss strains credibility. (Yaks in Scotland? Not bloody likely.) Be inventive in improvising these encounters. For example, if an elf runner pays a visit to the Scottish Museum of Metahuman Arts and Crafts, the gamemaster might allow him to bump into a friendly elven decker (though this person may not admit to being a decker right off the bat). Treat these acquaintances as temporary, superficial contacts. The target numbers given for using these contacts for legwork reflect this superficiality. The Scottish contacts listed below simply allow the runners long-shot chances to dig up additional information if they get lucky, rather than functioning in the same way as standard resource contacts in other adventures.

Runners who want to use British contacts must use a Target Number of 8 for all appropriate Success Tests. Use Negotiation or one of the Etiquette Skills: Interrogation does not work well in this country. Because the high target number mainly reflects a lack of familiarity and trust, bribery may work wonders. A bribe of at least £250 reduces the target number by 1, and a bribe of £750 or more reduces the target number by 2.

THE CORPORATION

TRANSYS NEURONET (GENERAL)

The following information is available from SeaSource (Seattle) or C-net (U.K.).

Appropriate Contacts

Company Man, Dwarf Technician, Fixer, Mr. Johnson, Street Doc

Home Office Location: Edinburgh, Scotland

President/CEO: Sir Iain Greig

Principal Division: Transys Neuronet GB

Division Head: Jonathan Cooper

Chief Products/Services: Experimental communication systems, lasers, advanced cyberware. Matrix software, neural skillssofts, medical cyberware

Brief Corporate Profile

Between 2013 and 2017, four separate British hi-tech companies merged their operations to form Transys Neuronet, specifically to stabilize the British research base in key fields dominated by American and Japanese companies. Since its inception, Transys has made a determined effort to retain the best British research brains within the U.K., and has generally succeeded. Within the past five years the corporation has increased its market share in European medical cyberware from 11 percent to 24 percent, and regards this area as a major field of corporate growth. Transys maintains a network of small laboratories across the U.K. that specialize in military, medical, and personal-enhancement research for various clients. Reflecting its privileged position in the British economy, Transys Neuronet has received several permits from the Lord Protector's Administrative and Licensing Bureaus for the deployment of a versatile range of intrusion countermeasures technology within its computer systems.





TRANSYSNEURONET (TIDBITS)

Random information available in Seattle and Scotland. Adjust target numbers accordingly.

Appropriate Contacts (Target Number 5 In Seattle, 6 In Scotland)

Any decker or technician type, any corporate type.

Successes	Result
0	"Wadda I look like? The library >"
1	"British outfit. Very secretive, very hi-tech. The guys in one office don't always know what the guys in the other offices are up to. I've heard there's a lot of infighting among the higher-ups there, jockeying for favorite-son position within the outfit."
2	"Transys? I heard they got a superduper whizkid working for 'em, just came in out of the blue a few years back. Lots of rumors about what he's working on. They got a big payoff in medical research not long ago. Maybe he had something to do with that."
3	"They make damn good cyberdecks and computers in that place in Scotland, what's it called, Silicon Glen? I heard they were on the verge of something mind-boggling, some kind of biological cyberdeck, but then I heard that about Renraku a while back too. Persistent rumor though."

MAJOR CHARACTERS

The runners might want information on several characters, but none of it comes easy. To get it, they have two options: official sources and legwork (contacts). Because most Brits prize personal privacy, most datanets restrict access even to trivial personal information, and hacking into such sources will not turn up anything much. Except for specific instances given in the main text, contacts reveal very little information about other characters.

ALASDAIR CAMERON

Appropriate Contacts (Target Number 8)

Corporate Decker, Decker, Corporate Secretary, Dwarf Technician, Former Company Man, Technician.

Successes	Result
0	"Does he host a vid show?"
1	"Name doesn't ring a...wait a minute. I've heard of a chap who does research for that Transys bunch. Just a company man, I think. Reliable and dull."
2	"Medical researcher, I think. Been with the company a good few years. Happy, honest kind of guy. Born bachelor."
3	"I hear he's involved in some hush-hush work with new cyberware, but you get that rumor every day. Seems a bit too staid for a genius."

ANGUS MACNAB

Appropriate Contacts (Target Number 6)

Detective, Bounty Hunter, Elf Hitman, Fixer, Gang Boss, Gang Member, Metahuman Rights Activist, Street Samurai, Troll Bouncer.

Successes	Result
0	"Ain't heard of him. Lend me some money"
1	"jeez! Are you for real? He's serious muscle. Watch your step with Angus. Even the police keep clear of him. He'll deal fair and square with you, though, long as you don't cross him."
2+	"You want heat, take Angus and pay what he asks. Don't haggle with him, he doesn't like it. He's got some good contacts of his own if you ask nicely. Very nicely."

PROFESSOR AMELIA RICHARDSON

Appropriate Contacts (Target Number 8)

Any clerical (religious) or media type, mage, shaman or druid

Successes Results

- 0 "Sorry, term, the spirits aren't speaking to me today."
- 1 "Works at the university, in their occult department. She's a sep—sorry, American. Caught her lecture on reincarnation at Pollock Hall last year. Very sensible. Nice lady."
- 2+ "She's a magician herself. Does enchanting work, I think, helps the Department's funds along. Used to have a Sassenach boyfriend—that's English to you—but that was years ago. She's well thought of in the university, I hear. Been there about ten years."

MORAG MACDONALD

Appropriate Contacts (Target Number 6)

Almost anyone; her murder was public news.

Successes Result

- 0 "Yea, rattles me knoggin, but I can't help ya."
- 1 "Oh, yes, she was one of the MacDonalds killed at the Laidon massacre a few weeks back. Father's a big noise in some corp or another. It's The Campbell-MacDonald clan feud again. Poor young thing, she was only about 20 years old. Terrible business."
- 2+ "Aye, a terrible shame. There's a nasty rumor that the killing had something to do with her dad's business. He's a big boy at Transys, don't ya know. Name of Iain MacDonald."



SIR IAIN MACDONALD

Appropriate Contacts (Target Number 6)

Any company/corporate type, Decker, Detective, city official type.

Successes Result

- 0 "Sorry, term, no comprende 'sep,'"
- 1 "The Laird of the MacDonalds of Glencoe: the clan chieftain. Big noise in Transys Neuronet, sits on their board. Straight as a die. Doesn't smile a lot,"
- 2* "Well of course you know the Campbells murdered his daughter. Sir Iain told the trid guys it was a personal matter. All the MacDonalds will be looking to him now. They'll strike back, but these black-hearted feuds are a long time in the scheming."

QUICKSILVER

Appropriate Contacts (Target Number 8)

Any street type.

Successes Result

- 0 "Gawd, not another bloody street name. Rak off, eh?"
- 1+ "Weirdo. Takes a very, very occasional drink in Hamish's Bar at the end of Princes Street. No one dates lay a hand on him; they all respect him. I'm not sure why. I've heard he's fey, born to faeries in the Highlands."

LOCATIONS

Runners may ask contacts for information about the Isle of Skye, the Kyle of Lochalsh, Laidon Castle, Holyrood Court, Loch Ness, Pitlochry, the Occult Sciences Department, Stewart's Hyperdrive and many other places. The information available corresponds fairly closely to tourist brochures. If a contact might know the place in question, lift one or two lines of superficial information from the location's description in the appropriate encounter(s).

QUICKSILVER'S DECK

Runners being who and what they are, they will tinker with Quicksilver's deck if Amelia Richardson allows them near it for long enough. They can probably convince her to let them examine it (in her presence) by pointing out that the deck seems to be a critical piece of the puzzle, and might yield some important clues.



PHYSICAL EXAMINATION

If a decker or some other techno-geek checks out the cyberdeck, have him or her make a Computer (B/R) (6) Test, and consult the following table.

Successes	Result
0	It's a cyberdeck. Who'd they think it was?
1-2	It has a Fairlight Excalibur case, and the usual standard external jacks, but that's about it. Inside, the only recognizable pieces are circuit boards (of some kind) and components (maybe...). State of the art equipment, but it's hard to say which art.
3+	Stunned silence. Could it be... ? (On a roll of 3 or higher, have the decker make a Computer Theory (8) Test and consult the following table.)

Successes	Result
0	It's a cyberdeck, but with one hell of a non-standard basic operating principle. The boards and components are unique.
1-	Looks like the heart of this fragger is some sort of bio-computer, maybe a biological interface processor. If so, this deck is worth a small fortune.

Further examination reveals that the deck is built like a regular cyberdeck, with active memory, persona chips, and so on, but the execution differs radically from the standard design. The deck works only if the team decker slots one or more of Quicksilver's special chips.

MYSTICAL EXAMINATION

Examining the deck from astral space reveals nothing until someone slots in the various chips. Each chip brings Quicksilver closer to existence, and increases the chance that a magician will notice something odd.

Without the chips, nothing odd exists to see. If the deck contains any of the chips, have the team magician make an Astral Perception Test against a Base Target Number of 12, minus 2 per chip present in the deck. For results, consult the following table.

Successes	Result
0	It's a cyberdeck, butt-brain. Surprise.
1-2	Yes, there is something oddly magical about it. The "magic" feeling centers around the weird chips, but there's no way to determine what it means.
3-4	It almost feels like a presence lingers around the deck. Kind of the same feeling a magician might get assensing a haunted house...but that's impossible. Isn't it?
5+	Whatever is there isn't part of the deck. It feels like an effect of something the deck has done, or can do. But the presence is definitely not the deck itself.

Neither the chips nor the deck radiate what could be considered magic or life energy per se. Only subtle, direct assensing by an actual magician will reveal anything mystical about the deck.

CAST OF SHADOWS

The following NPCs play important roles in this adventure. Because they will appear more than once during the course of the adventure, their statistics, descriptions, and resources are grouped here for convenience. Information about these characters required to play out encounters appears in the main text. Use the supplementary information provided in this section to flesh out the character further.

Descriptions and statistics for other, minor characters are given in the encounter in which they make their appearance.

ALASDAIR CAMERON

Alasdair Cameron is 31 years old, taller than average, of medium build, with sandy brown hair and hazel eyes. Born and educated in Aberdeen, Alasdair took a job with Transys Neuronet at the age of 24 after earning a Ph.D. in molecular biology and cybernetics. Alasdair has traveled on company business to several European and American nations, but prefers to stay at home. His clan ties are tenuous; he had a row with two of his brothers over an inheritance some years in the past, and has lost touch with his family.

Though loyal to the company he works for, Alasdair's powerful affection and admiration for Quicksilver transcends this loyalty. He has rationalized these two conflicting feelings by telling himself that finding out all he can about Quicksilver's disappearance and the elf's research can only be in the company's interests. He chose to act alone in order to avoid the scrutiny of agents within Transys whom, he suspects, may not want to know what happened to Quicksilver.

A shy man, Alasdair spends little time pubbing or clubbing, though he opens up in company. Though fond enough of women, he prefers his bachelor lifestyle.

Attributes

Body: 3	Intelligence: 6
Quickness: 4	Willpower: 4
Strength: 4	Essence: 5,4
Charisma: 3	Reaction: 5

Initiative: 5+ 1D6

Threat/Professional Rating: 2/2

Skills

Biology: 4	Electronics: 4
Biotech: 6	Electronics (B/R): 3
Biotech (B/R): 4	Etiquette(Corporate):33
Computer: 5	Negotiation: 3
Computer(B/R):3	Physical Sciences: 3
Computer Theory: 6	Unnamed Combat: 2



Cyberware

Beta-Customized Headware Memory (100Mp) (p. 98, **Street Samurai Catalog**)

Datajack

Gear

Fuchi Cyber-4 (with Response Increase 2)

(6) Kilts (Cameron tartan)

Programs:

- | | |
|----------------|------------|
| Analyse: 6 | Medic 4 |
| Autoexecute: 4 | Restore: 4 |
| Bod: 5 | Scanner: 5 |
| Browse: 6 | Sensors: 5 |
| Compressor: 4 | Sleaze: 6 |
| Evasion: 4 | Smoke: 6 |
| Masking: 2 | |

		CONDITION MONITOR			
		LIGHT STUN	MODERATE STUN	SERIOUS STUN	DEADLY STUN
STUN	+1 Tnt -1 Int	+2 Tnt -2 Int	+3 Tnt -3 Int	Jrc	
	+1 Tnt -1 Int	+2 Tnt -2 Int	+3 Tnt -3 Int	Inc probe Gears	
PHYSICAL	+1 Tnt -1 Int	+2 Tnt -2 Int	+3 Tnt -3 Int	Inc probe Gears	
	+1 Tnt -1 Int	+2 Tnt -2 Int	+3 Tnt -3 Int	Inc probe Gears	
		LIGHT WOUND	MODERATE WOUND	SERIOUS WOUND	DEADLY WOUND

ANGUS MACNAB

Angus MacNab is 26 years old, 2.89 meters tall, and impressively wide even for a troll. He has slicked-back black hair and dark brown eyes, and hails from Fraserburgh. Despite the fact that he is a troll, he takes pride in being able to trace his human ancestors back to the hereditary abbots of St. Fillan's near Loch Earn (in Gaelic, MacNab means "Son of the Abbot"). If asked (and frequently if not), he can reel off an apparently endless list of famous MacNabs. Examples within the past three and a half centuries include Sir Allan MacNab (1798-1862), Prime Minister of Canada ("afore ye seps stole off wi' oor lands across the sea"). Robert MacNab, Minister of Justice in New Zealand during the First World War, and "Black Gerald MacNab the wife poisoner," whose nefarious activities touched off the clan's major 21st-century scandal.

Angus never talks about his employers or his assignments. Coin or credstick from any employer buys his silence. He will, however, happily (and endlessly) recite Gaelic fairy tales about any part of Scotland the runners happen to end up in, and provided he gets enough money and a few gallons of heavy now and then, is a brave and loyal employee. Angus only packs all the weaponry and gear he owns while actually on a job; he certainly does not carry an SMG around the streets of Edinburgh!



Attributes

Body: 7 (8) Intelligence: 2
 Quickness: 3 (6) Willpower: 1
 Strength: 6 (9) Essence: 0.3
 Charisma: 1 Reaction: 2 (4)

Initiative: 4+2D6

Threat/Professional Rating: 5/4

Skills

Armed Combat: 4 Stealth: 3
 Bike: 2 Throwing: 5
 Etiquette (Street): 5 Unarmed Combat: 7
 Firearms: 5

Cyberware

Muscle Replacement (3)
 Retractable Razors
 Smartlink
 Wired Reflexes (1)

Gear

Armor Vest (5/3)
 BUCM Medical Insurance (equivalent to DocWagon Platinum)
 Bond & Carrington Hallmark with Smartgun Adapter (equivalent to Remington Roomsweeper)
 Dermal Armor (1)
 Enfield AS-7 Shotgun
 Great Claymore (treat as Monofilament Sword with +2 Reach)
 Grenades:
 (2) Defensive
 (3) Smoke
 Heckler & Koch HK227 SMG
 Shurikens (8)
 Wallacher Combat Axe (p. 12, *Street Samurai Catalog*)
 Vast quantities of ammunition

Notes: Base+1 Reach, Armed/Unarmed Combat, natural thermographic vision

Weaknesses: Allergy (Silver: Moderate)

CONDITION MONITOR				
	LIGHT STUN	MODERATE STUN	SERIOUS STUN	DEADLY STUN
STUN	-1 HP -1 mt	-2 HP -2 mt	-4 HP -3 mt	die
PHYSICAL	-1 HP 1 mt	-2 HP -2 mt	-3 HP -3 mt	die maybe crawl
	LIGHT WOUND	MODERATE WOUND	SERIOUS WOUND	DEADLY WOUND

PROFESSOR AMELIA RICHARDSON

Amelia Richardson is 42 years old. She wears her light brown hair long and straight, which draws attention to her blue-gray eyes. Her personal style must be described as dowdy, but she wears good-quality clothes; she favors mostly tweeds and wools. She grew up in one of the less impressive neighborhoods of Bellevue in Seattle and worked as a trideo researcher before going to the University of Washington, where she discovered and developed her magical talents. She received her Ph.D. in Occult Sciences from the University in Edinburgh and has lived there for

CAST OF SHADOWS



BUCM Medical Insurance (equivalent to DocWagon Platinum;
 Honda -CM 3220 ZX
 Power Focus (4)
 Specific Spell Focus: Analyze Truth (3)
 Specific Spell Focus: Mask (4)
 Specific Spell Focus: Personal Physical Barrier (4)
 Weapon Focus: Orichalcum Dirk
 Flat in Cramond Road

Spells

Combat

Increase (Physical) Attribute: +1
 Personal Physical Barrier: 6
 Stun Bolt: 4

Detection

Analyze Truth: 6
 Clairvoyance: 4

Manipulation

Levitate Item: 4
 Use B/R Electronics: 6

Illusion

Mask: 6
 Overstimulation: 4

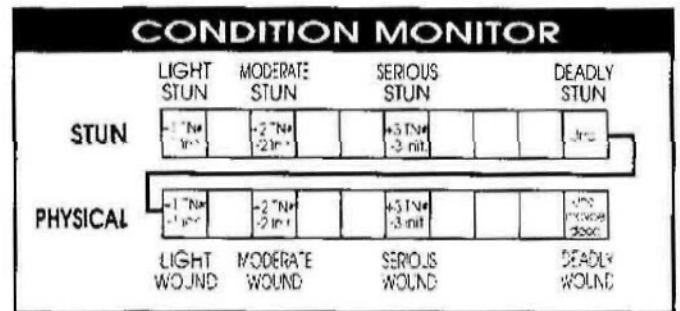

MORAG MACDONALD

Morag's ghost appears as a young, female elf of about 19 years, with long, curly, honey-blond hair, blue-green eyes, and ivory skin. She has long hands with slender fingers and almond-shaped nails. While alive, she radiated extreme emotional intensity, which intensified after her death. She wears a laced cotton blouse, a MacDonald tartan skirt, and silver earrings, brooch, and finger rings owned by the MacDonald family for more than 300 years.



the past eleven years. She specializes in enchantment and enjoys reading pre-Awakening parapsychological literature, notably work on reincarnation and survival after death. She also studies esoteric astrology and mystical traditions and belongs to the Edinburgh University Sidgwickites, a magical group that conducts soul-survival research and astral studies.

Amelia Richardson loves Scotland and considers it her adopted home. She likes its sense of history, the gruffness of the people, even the climate. She cares little for modern-day Seattle, or any other North American nation. Her deceased parents left her enough money to provide for her future, so that she can teach and study for the love of it as much as for a salary. Despite her freedom to bury herself in the academic life she loves, Amelia resents the amount of enchanting work her superiors ask her to do to raise money for the cash-strapped Occult Sciences Department.

Amelia Richardson leads a quiet life without romantic involvement, and would like a little adventure. She is tough, intelligent, willful, well-organized, and resourceful. Save for the final expedition to Castle Laidon, however, she prefers not to accompany the runners on their field trips.

Attributes

Body: 2	Will power: 3
Quickness: 1	Essence: 6
Strength: 3	Magic: 6
Charisma: 3	Reaction: 4
Intelligence: 5	

Initiative: 4 + 1 D6

Threat/Professional Rating: 1/Z

Skill*

Biology: 3	Magical Theory: 7
Conjuring: 3	Negotiation: 3
Enchanting: 8	Psychology: 6
Etiquette (Corporate): 11	Sorcery: 5

Gear

Ares Predator [Heavy Pistol. 15 (clip)]. 3 extra clips
 Armor Jacket (2/1)

Unless she contacts Quicksilver's spirit, Morag cannot find peace. If a magician tries to use Conjuring Skill to put her to rest, he will not succeed. Because of her location and the background spirits of Glencoe, Morag has more power than most apparitions.

Attributes

Body: n/a Intelligence: 4
 Quickness: n/a Willpower: 8
 Strength: n/a Essence: 6
 Charisma: 5 Reaction: 5

Initiative: 15/25 + 1D6

Powers

Compulsion Possession
 Fear Psychokinesis
 Manifestation

Special Effect

Morag's ghost has a version of the personal domain power normally restricted to free spirits (see p. 80. **Grimoire II**). Increase all target numbers for actions made against her by +4 whenever she is inside or within half a mile of Castle Laidon.

		CONDITION MONITOR			
		LIGHT STUN	MODERATE STUN	SERIOUS STUN	DEADLY STUN
STUN	+1 TNW	+2 TNW	+3 TNW	Unc.	
	-1 Init	-2 Init	-3 Init		
PHYSICAL	+1 TNW	+2 TNW	+3 TNW	Inc. maybe dead	
	-1 Init	-2 Init	-3 Init		
		LIGHT WOUND	MODERATE WOUND	SERIOUS WOUND	DEADLY WOUND

SIR IAIN MACDONALD

Iain MacDonald is 47 years old, of average height, with receding silver hair and brown eyes. His wife died in 2047, and the recent loss of Morag has aged him beyond his years; his face is lined, his posture slightly slumped. He possesses a strong sense of clan honor and duty, however. As Laird and Clan Chieftain of the MacDonalds of Glencoe, Sir Iain is deeply involved in plotting revenge against the Campbells for the killings at Castle Laidon. Given the two clans' history of mutual hatred, the Campbells refuse to communicate with the MacDonalds, and clan pride would not let them admit they had nothing to do with the murders. The MacDonalds will take whatever time necessary to plan suitable vengeance; after all, the feud has lasted for almost 400 years.

Blunt, practical, and honest by nature, Sir Iain also has a cautious streak. He prefers that others do the talking. On the Transys board, he acts primarily as a financial controller with responsibility for some minor overseas research projects. His habit of staring straight at people while negotiating has proven an effective technique for driving a hard bargain.



Attributes

Body: 3 Intelligence: 6
 Quickness: 2 Willpower: 5
 Strength: 4 Essence: 5
 Charisma: 5 Reaction: 3

Initiative: 3 + 1D6

Threat/Professional Rating: 2/3

Skills

Corporate Accountancy: 8
 Etiquette (Clan Tribal): 7
 Etiquette (Corporate): 7
 Interrogation: 5
 Leadership: 9
 Negotiation: 6
 Unarmed Combat: 3

Cyberware

Beta-Customized Headware Memory (200 Mp)
 Datajack

Contacts

MacDonalds of Glencoe, MacDonalds of the Isles, MacDonalds of Sleat, MacDonalds of Clanranald, MacDonalds of Kingsburgh

Gear

- BUCM Super-Elite Medical Insurance (this provides comprehensive coverage, including automatic entry to a Beta Shadow Clinic (see p. 99, **Street Samurai Catalog**))
- Fleet of Rolls-Royce Phaeton limos
- Holyrood Court (Sir Iain's home in Edinburgh)
- 12 percent stake in Transys Neuronet
- Unbelievably vast sums of money

CONDITION MONITOR				
	LIGHT STUN	MODERATE STUN	SERIOUS STUN	DEADLY STUN
STUN	-1 TN# -1 Int.	+2 TN# -2 Ins.	+3 TN# -3 Int.	Unc.
PHYSICAL	+1 TN# -3 Int.	+2 TN# -2 Int.	+3 TN# -3 Int.	Unc. T-ONce dead
	LIGHT WOUND	MODERATE WOUND	SERIOUS WOUND	DEADLY WOUND

QUICKSILVER

Quicksilver is the chosen name of a unique elven entity born in 2021 on the coast of South Wales near a complex of old Nubian/Egyptian temples (see "Knights of Rage," p. 112, **London Sourcebook**). Having grown to adult size and abilities by the age of 10, Quicksilver traveled extensively in the Welsh and Scottish Wild Lands, Tir Tairngire, Aztlan, California Free State, Tir Nan Og, and the Middle East.

The Quicksilver entity sees his current life as a short incarnation in which he must make further progress around the Wheel of Rebirth by mastering his own Becoming. This belief led him to encode himself within a unique set of biochips. Because his personal karma requires that whatever benefits him must benefit others, he must trust others by leaving these pieces of himself with them. Quicksilver believes that only by demonstrating such trust will the powerful karmic forces allow his new creation to achieve beneficial ends.

Quicksilver believes that he has lived through several past incarnations, often with Amelia Richardson as a close friend, though he cannot be as open with her in this incarnation as in previous lives. Because of their mutual history, he left his cyberdeck and the master I/E chip with her. He recognized Fiona Mac Mhuirich and the great free spirit of Loch Ness as friends from previous lives, and considers the spirit to be a spiritual guardian. He left part of himself with each of them. He believes Morag MacDonald to be his soul mate, whose successive incarnations have been symbolically, and sometimes literally, related to his own. (For instance, both were born elves in this life.) He also feels that Morag's soul is significantly younger than his, and feels he must protect her by keeping their relationship secret. He believes that his personal karma and spiritual growth depends upon his love for Morag.

Quicksilver has no stats: he needs none.

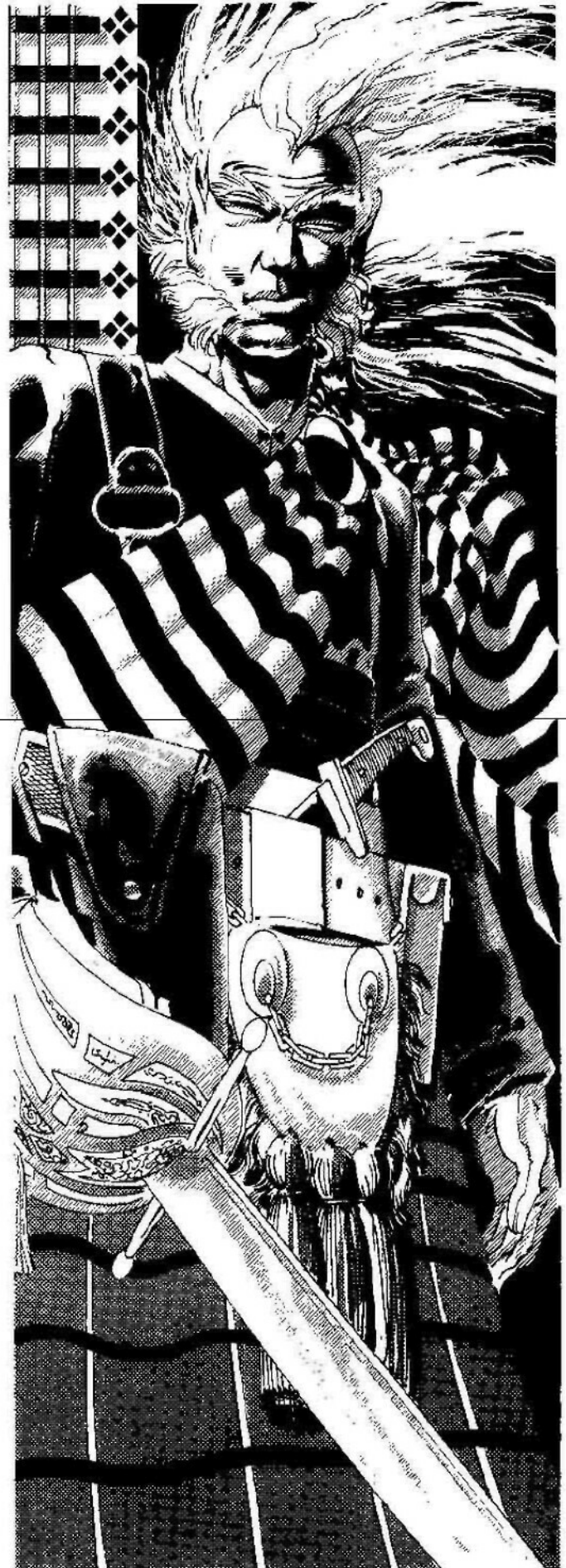

THE UNITED KINGDOM: FACTS AT YOUR FINGERTIPS

"The following information was compiled by SeaSource, a subsidiary of Renraku Computer Systems.

POLITICS

Monarchistic democracy, ruled by King George VIII presiding over the two Houses of Parliament. The House of Commons has 540 Members of Parliament, casting one vote each. The House of Nobles has a variable number of non-elected nobility: some seats are hereditary. The Green Party controls the current government, and national elections are held for all Commons MPS on average every 4-5 years.

DEMOGRAPHICS

Total population estimated at 47 million, though estimates from non-sprawl territories may be significantly in error. **Capital city:** London (pop. approx. 9.7 million). **Regional capitals:** Cardiff, in Wales (pop. 500,000+), Edinburgh, in Scotland (pop. 1 million+). Estimated total percent of humans: 76 percent (percentage may vary significantly by region).

ECONOMY

For reasons of national security, GNP/GDP figures remain under classified status by order of the major official economic departments of the U.K. government. Estimated average per capita income: £90,000 (pounds sterling) per annum. **Currency:** the pound sterling, stabilized at an exchange rate close to £2.50 = 1 nuyen. Major foreign corporate presences in the U.K. include Aztechnology, Fuchi Industries U.K., Renraku U.K., and Amalgamated Technologies and Telecommunications. Major corporations with majority British ownership include British Industrial PLC, Grenville-Adams PLC, Hildebrandt-Kleinfort-Bernal, Integrated Weapons Systems PLC, Transys Neuronet, and Zeta-ImpChem, an Anglo-Swiss joint venture.

MEDICAL AND LEGAL INFORMATION

The U.K. public National Health Service provides emergency care for 24 hours and ongoing basic maintenance care for non-U.K. nationals. Further treatment is provided only if the embassy of the appropriate nation can ensure payment from the patient upon his return home. Medical insurance with non-U.K. organizations may not apply within the U.K.; check before leaving on your trip. Medical Insurance is available for visitors within the U.K.: for information, contact 818-808-2222 (Careline) or 715-715-0715 (BUCM).

LAW AND LAW ENFORCEMENT

The British legal system has certain unique features, notably the banning of contingency arrangements with lawyers. Foreigners who run afoul of British law should contact one or more of the following:

British Council for Civil Liberties: 711-446-4444
American Allied Legal Defense Inc.: 711-285-2233
Legal Network: 711-333-3888

PUBLIC INFORMATION SERVICES

The major British public information source is the national C-net, which stores update news, transport information and schedules, weather forecasts, information on public events, public service announcements, and so on.

TRAVEL WITHIN THE UK

Air travel is expensive by American standards. As a rule of thumb, expect to pay £150 for the first 50 kilometers traveled on internal U.K. flights and £100 per additional 50 kilometers. Major internal U.K. airlines include British Midair, Geordie Airlines, British Comet, and Sindair Skies. Use of private aircraft requires a U.K. pilot's license and 7-day advance notification of travel plans to be filed with the local offices of the Lord Protector's Administrative and Licencing Bureaus. International licenses are not valid in the U.K.

A single national operator, BritRail, handles all rail travel. Fares vary between 40-70 percent of corresponding air fares.

Major freeways within the U.K., called motorways by the British, tend to be in poor condition, with lanes frequently closed for repairs. To foreign drivers, roads within cities and away from freeways will seem extremely narrow. Road signs are often illegible, vandalized, or simply inaccurate. Several local-route firms can easily arrange coach and bus travel within and between cities, at an average price of 20-25 percent of corresponding air fare.

A visitor with an international driving license can hire a vehicle from local operators for travel within cities and/or on major freeways, though the owning company may require a substantial security deposit. Vehicle hire for use outside these designated areas is subject to the discretion of the local operator and may be difficult in dangerous districts. Security deposits for such hire may equal the cost of the vehicle.

BASIC COSTS IN THE U.K.

The prices below are U.K. averages estimated as of January, 2054. Costs within London exceed those listed by 10-15 percent in most districts. On average, costs in Birmingham and Edinburgh exceed those listed by 5 percent.

Moderate hotel room: £70
Hotel breakfast (including 10 percent gratuity): £14
Lunch at moderate restaurant, including half a bottle of wine and 10 percent gratuity: £30
Dinner at same (including a bottle of wine): £70
Typical half-day city sightseeing tour: £12
Nightclub membership, one week: £75
Admission to museum or historical site: £3-£8
Moderately-priced ticket to major sporting event: £35-£50
Car rental per week in restricted areas, including insurance: £450
Taxi ride, per kilometer (including 15 percent gratuity): £3
Pair of jeans, average quality: £45-£60
Pair of shoes, moderate quality: £65
Pair of shoes, specially ordered: £400
Medical insurance, one week, full coverage: £600+

SCOTLAND AND EDINBURGH: FACTS IN BRIEF

The following information was compiled by SeaSource, a subsidiary of Renraku Computer Systems.

GENERAL INFORMATION

A semi-autonomous nation within the United Kingdom, Scotland has an estimated population of 6.6 million (72 percent human) and an estimated per-capita average income of £51,000. Its capital city is Edinburgh. Major elements of Scotland's national economy include research industries, tourism, specialty foods and whisky.

Scotland is usually divided into the following zones: industrial/residential Scotsprawl (including Edinburgh and Glasgow), the habitable zones to either side of the sprawl, the Fringe Toxic Zone on the east coast, the Irradiated Zone on the north coast, and the Wild Lands. Tourists should avoid the Wild Lands, which are inhabited by a number of dangerous paranatural creatures. Ongoing efforts by Scottish druids to reforest and regenerate the Highlands may someday make Scotland's blighted wilderness once again suitable for human habitation. Visitors are warned that the rule of British law does not extend far into the Wild Lands. Hereditary aristocrats, many of whom are the chieftains of Scottish clans, own large tracts of Scottish territory. To this day, the scions of these clans use their wealth and power to perpetuate ancient feuds.

The last census counted Edinburgh's population at 1.044 million, 28 percent of whom are metahumans. Per capita income is estimated at £58,000 per annum. The National Museum of Scotland and the National Portrait Gallery still stand in Edinburgh, along with many other cultural institutions. A major center for medical and cyberware research, the University of Edinburgh boasts world-wide expertise in collaboration with the Royal Infirmary Hospital in several research areas. Holyrood House, the official residence of George VIII, lies in Edinburgh, as does the official meeting-place of the Scottish Regional Parliament, in Edinburgh Castle.

CLAN MURDERS BLAMED ON ANCIENT FEUD

The slaying of 14 members of the MacDonald clan and their servants at Castle Laidon in Glencoe, family seat of Clan Chieftain Sir Iain MacDonald, threatens to reignite the Campbell-MacDonald clan feud. The bodies of two assailants killed at the scene have been identified by police this morning as those of Robert and Donald Campbell of Argyll. Among the MacDonalds slain were Alexander and Rory MacDonald, thirteen-year-old twin nephews of Sir Iain, and Sir Iain's daughter Morag. The assailants used automatic and heavy weapons in the savage attack.

From his offices in the Transys Neuronet complex in Edinburgh where he holds a seat on the board of this prestigious international company, Sir Iain publicly stated through a company spokesperson that the killings are "a private matter to the MacDonalds, and we will settle it in our own time." Though police have interviewed several Campbells and MacDonalds concerning the killings, they have no immediate suspects. Local authorities fear that the MacDonald clan is planning a major reprisal at the site of the infamous mass murders of 1692, and believe that the clan will eventually take its revenge.



TODAY'S HEADLINES:

INTERNATIONAL

PORTUGAL— In Lisbon today, Johnny Spinrad announced the planned acquisition of the Principality of Monaco. Said Mr. Spinrad, "Everybody's gotta have a hobby."

ENTERTAINMENT

WHO'S NEWS: NEW SOHO, Manhattan, Lower Westside. 3:27 A.M. — Discovered while leaving a noted luxury hotel through a questionable portal, noted entrepreneur, restaurateur, hair stylist and bon vivant. Johnny Pomp-Adore, said yesterday to our reporter. "Buzz off, you atrocious bit of a phlem. You disgust me on a...oh, is this on? Hi there. Didn't we meet at The Bog Knobi Club? You were gulping down a bowl of Voodoo Chili and chatting with an attractive bit of skirt.. I recommended a Vitmoe and you passed out." I admonished him with a quick synopsis of his potential nocturnal activity, and he responded. "Bad hair like yours hardly needs acknowledgement." Thus equipped with today's **CELEBRITY NEWS NUGGET**, I responded, "That's, news to me." Ho Hum. For current profile, see Section 6B, **"LIFESTYLES OF THE RICH AND ORGANIC."**

SPORTS

Everybody, lost.

BOARD CHANGES IN POWERFUL U.K. CORPORATION

C. Sargent

The Transys Group home office in Edinburgh, Scotsprawl today announced sweeping changes in the Board of Directors of Transys Neuronet U.K. Together with six senior executives within his division, Finance Director Donald Menzies has been dismissed from the board, as has the research staffs senior director, James McLaughlin, and several senior research scientists. The Transys group has promoted Director Sir Iain MacDonald to Deputy President, confirming him as the heir apparent to ailing President Sir Iain Greig and giving him effective control of this cutting-edge research outfit. Announcing the changes, a spokesperson for the president called them "a necessary rationalization and harmonization of upper-echelon relations in the context of an optimal integration of disparate administrative functions." This vague statement suggests that Sir Iain MacDonald will transform Transys Neuronet U.K. into a tighter, leaner organization.

Meanwhile, speculation continues about a possible link between the deaths of fourteen members of the MacDonald clan at Castle Laidon, Glencoe, and rumored breakthroughs at Transys in artificial intelligence research. Speaking for Sir Iain, a company spokesperson stated that the deputy president had no comment on these matters.

LONE STAR ANNOUNCES USE OF LAVS

T. Dowd

NewsNet (Seattle)—Lone Star spokesperson Jules Nedich announced today that Lone Star Security, the major security provider for the city of Seattle, had acquired and deployed at least three GMC *Banshee* VILAVs. Configured for security duty, the *Banshee* VIs include such state-of-the-art hot control equipment as tear and stungas dispensers and water and stun-slug cannons. The crew for each vehicle consists of six to eight riot officers. Mr. Nedich stated that Lone Star would not use the LAVs as patrol craft, but would instead station them at various locations around Seattle for use in situations requiring rapid emergency response. When asked if the deployment of military-surplus, low-altitude vehicles signaled a shift in Lone Star policy toward more active patrolling, Nadich repeated his statement that the LAVs were not patrol craft, but made no further comment.

Governor Schultz's office publicly expressed support for Lone Star's acquisition of the LAVs, though one official stated that the security firm must backup its equipment purchase with increased training of its officers; "Otherwise, those LAVs will just be fraggin' big stun batons."

CEO'S SON MISSING

P. Daza

NewsNet (Seattle)—Lone Star Security has reported no leads in the search for Robert Cray Bear, 14, son of David Gray Bear, president of Gaetronics Corporation and brother of Harold Cray Bear, Chief of the Salish-Shidhe Council.

Though rumors earlier this week suggested that the boy's disappearance was gang-related, Lone Star officials now indicate the boy may have been kidnapped. The elder Gray Bear maintains that no one has threatened him or his family, and that he has received no demands for Robert's release. Pointing to lack of evidence, Lone Star sources discount the continuing rumors of foul play.

Despite the lack of progress in the case, Lone Star officials predict that the boy will be found and his kidnapers arrested by the end of the week. "We have officers working around the dock on this case." one official stated. "If anyone can find him (Robert), Lone Star will."

David Cray Bear has offered a 20,000¥ reward for any information leading to his son's whereabouts. Mr. Gray Bear could not be reached for further comment.

TODAY'S HEADLINES:

INTERNATIONAL

PORTUGAL— In Lisbon today, Johnny Spinrad announced the planned acquisition of the Principality of Monaco. Said Mr. Spinrad, "Everybody's got to have a hobby."

ENTERTAINMENT

WHO'S NEWS: NEW SOHO, Manhattan, Lower Westside, 3:27 A.M. — Discovered while leaving a noted luxury hotel through a questionable portal, noted entrepreneur, restaurateur, hair stylist and bon vivant, Johnny Pomp-Adore, said yesterday to our reporter, "Buzz off, you atrocious bit of phlem. You disgust me on a.. .oh. is this on? Hi there. Didn't we meet at The Bog Knobi Club? You were gulping down a bowl of Voodoo Chili and chatting with an attractive bit of skirt. I recommended a Vitmoe and you passed out." I admonished him with a quick synopsis of his potential nocturnal activity, and he responded, "Bad hair like yours hardly needs acknowledgment." Thus equipped with today's **CELEBRITY NEWS NUGGET**, I responded, "That's news to me." Ho Hum- For current profile, see Section 6B, **"LIFESTYLES OF THE RICH AND ORGANIC"**

SPORTS

Everybody lost.

BRITISH CORPORATION IN TURMOIL

C. Sargent

The sudden resignation of Transys Neuronet U.K.'s Director, Sir Iain MacDonald, on the grounds of ill health has severely shaken Britain's world-wide leader in specialized cyberware and medical research. Though the corporation's ailing President Sir Iain Greig retains nominal control, the day-to-day running of the troubled giant appears to have fallen to Donald Menzies of the Financial Division. Menzies moved swiftly to confirm the promotion of Senior Research Director James McLaughlin to Acting Board Chairman, and rumor points to Menzies as the force behind the elevation of John Cawdor from junior research director to full Director with a seat on the board.

Financial analysts report that Transys may succumb to a takeover bid from Anglo-Swiss megagiant Zeta-ImpChem, which has taken an active interest in Transys Neuronet's research division for some years. According to an official statement by the company spokesperson at Zeta-ImpChem's Interlaken HQ, Zeta-ImpChem "has always been interested in acquiring gold-chip research." President/CEO Harald Meier was unavailable for comment. London's top firm of financial analysts, HKB, kept strangely quiet about the situation. Some industry insiders suggest that HKB may be planning its own Transys buyout, possibly acting as agents for a third party.

LONE STAR ANNOUNCES USE OF LAVS

T. Dowd

NewsNet (Seattle)—Lone Star spokesperson Jules Nedich announced today that Lone Star Security, the major security provider for the city of Seattle, had acquired and deployed at least three CMC *Banshee* VILAVs. Configured for security duty, the *Banshee* V's include such state-of-the-art riot control equipment as tear and stun gas dispensers and water and stun-slug cannons. The crew for each vehicle consists of six to eight riot officers. Mr. Nedich stated that Lone Star would not use the LAVs as patrol craft, but would instead station them at various locations around Seattle for use in situations requiring rapid emergency response. When asked if the deployment of military-surplus, low-altitude vehicles signaled a shift in Lone Star policy toward more active patrolling, Nedich repeated his statement that the LAVs were not patrol craft, but made no further comment.

Governor Schultz's office publicly expressed support for Lone Star's acquisition of the LAVs, though one official stated that the security firm must back up its equipment purchase with increased training of its officers: "Otherwise, those LAVs will just be fraggin' big stun batons."

CEO'S SON MISSING

P. Daza

NewsNet (Seattle)—Lone Star Security has reported no leads in the search for Robert Gray Bear, 14, son of David Cray Bear, president of Gaetronics Corporation and brother of Harold Gray Bear, Chief of the Salish-Shidhe Council.

Though rumors earlier this week suggested that the boy's disappearance was gang-related, Lone Star officials now indicate the boy may have been kidnapped. The elder Gray Bear maintains that no one has threatened him or his family, and that he has received no demands for Robert's release. Pointing to lack of evidence, Lone Star sources discount the continuing rumors of foul play.

Despite the lack of progress in the case, Lone Star officials predict that the boy will be found and his kidnappers arrested by the end of the week. "We have officers working around the clock on this case," one official stated. "If anyone can find him (Robert), Lone Star will."

David Gray Bear has offered a 20,000¥ reward for any information leading to his son's whereabouts. Mr. Gray Bear could not be reached for further comment.

MAPS

GAMEMASTER'S NOTE: Both player and gamemaster versions of the Edinburgh street map appear in this section, along with the player's map of Scotland. The gamemaster map of Scotland appears on p. 12. Take care not to reveal the additional locations marked on the gamemaster maps to the players before the adventure!

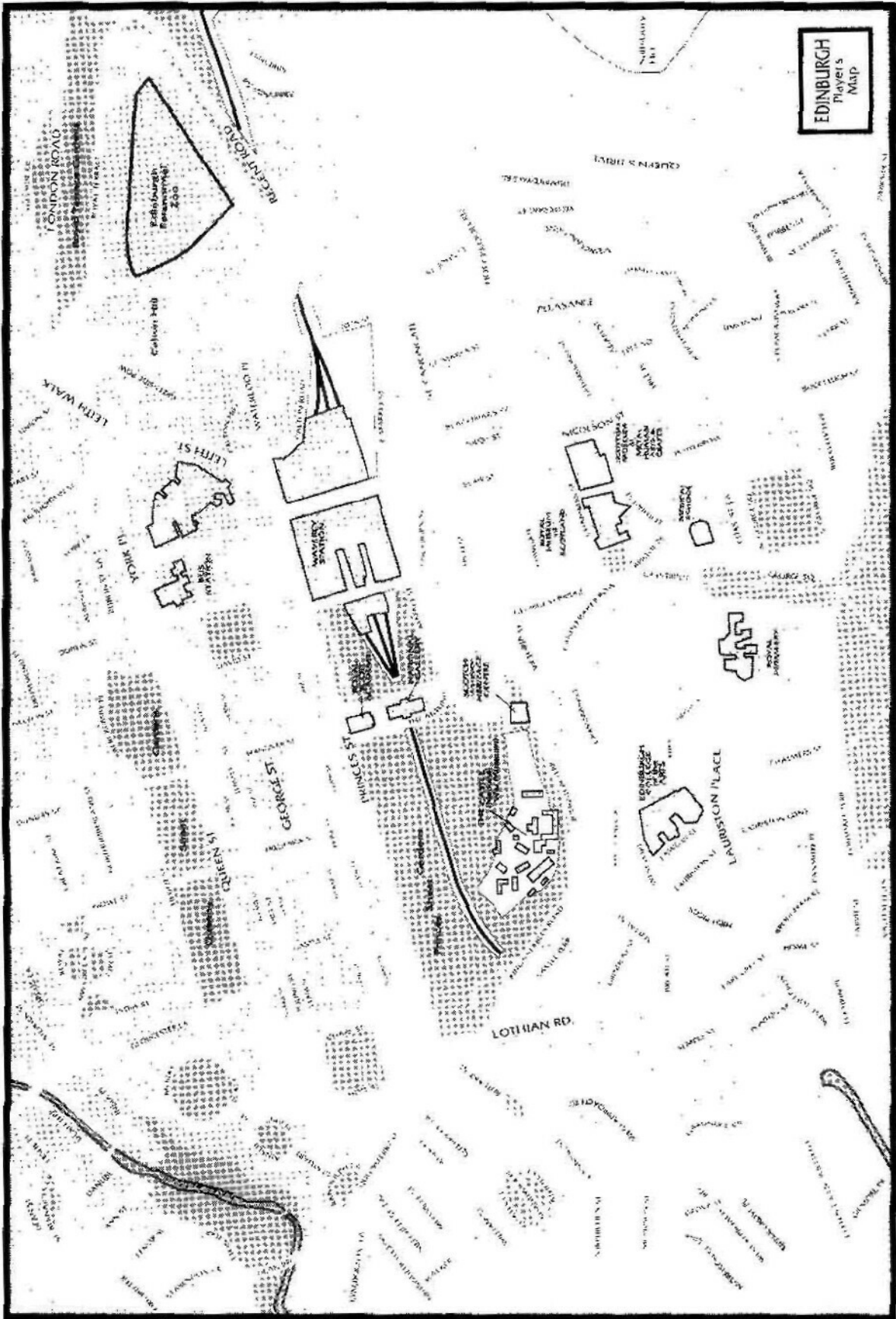

SCOTLAND PLAYER'S MAP

- Dundee ● City
- Glasgow ● Major City
- Iona ★ Magical Site
- Major Roads
- Scotsprawl
- ▨ Scottish Habitable Zone
- ▧ Scottish Fringe Toxic Zone
- ▩ Scottish Irradiated Zone

0 Miles 50

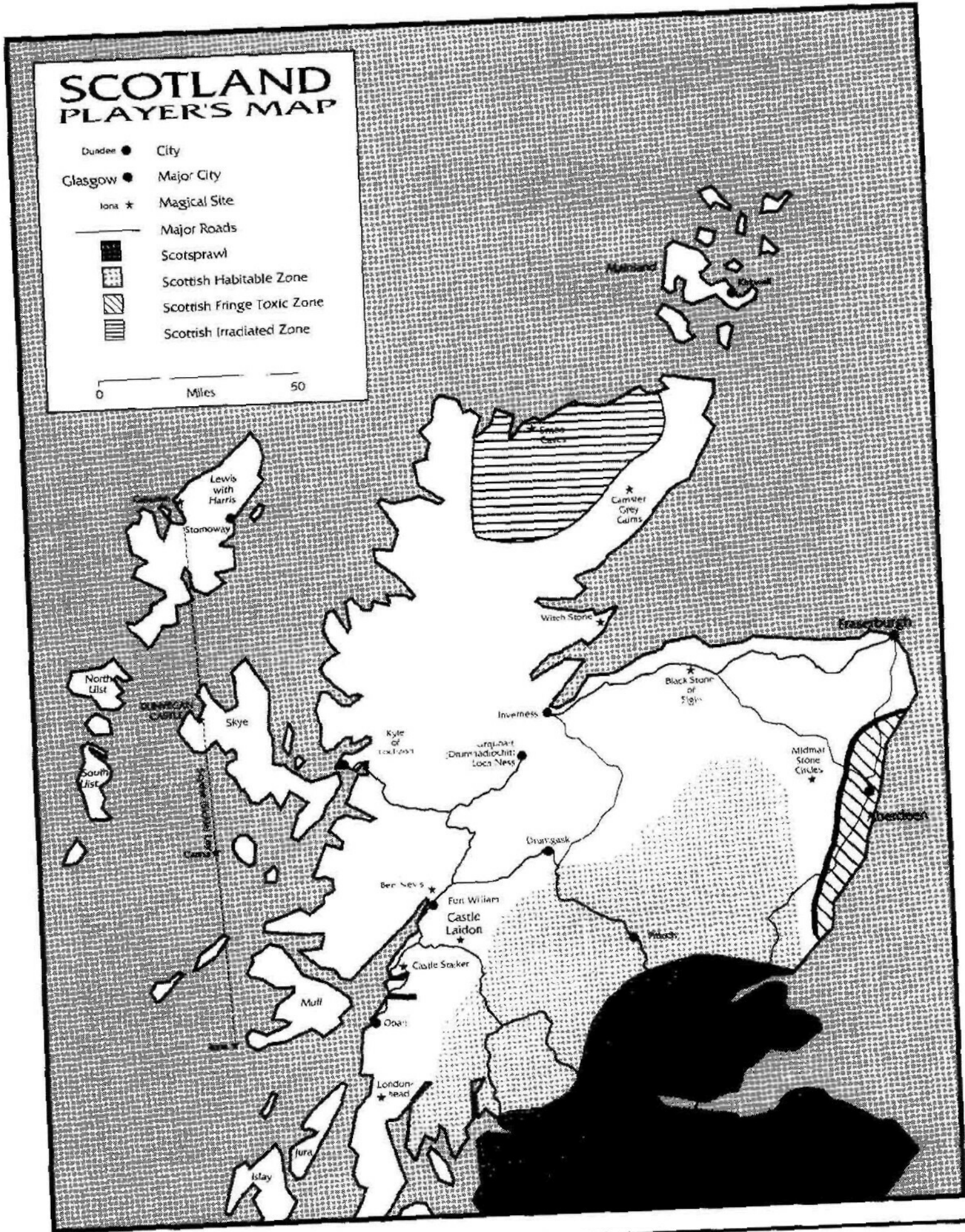

MAPS



ANARCHY IN THE U.K.

This appendix summarizes information about the U.K. In addition to that given in the Player Handouts section. The gamemaster may wish to use the information provided in this section, such as penalties for importing restricted items without a license, British slang, and the like, in order to add extra depth and color to the game,

CONTROLLED WEAPONS AND EQUIPMENT: IMPORT PENALTIES

The penalties listed below apply if Customs officials catch the runners with any of the specified items. Of course, import penalties also apply to exporting these items.

Item

Penalty (Fine/Prison Term)	
Small Bladed Weapon	£200
Large Bladed Weapon	£400
Blunt Weapon	£100
Projectile Weapon	£2,000
Pistol	£7,000
Rifle	£10,000
Automatic Weapon	£20,030/18 months
Heavy Weapon	£30,000/2 years
Explosives	3 years
Military-issue Weapons	3 years
Military Issue Armor	£7,000
Ammunition	£5,000
Controlled Substance/Biotech	£10,000/18 months
Nonaddictive Substance	£1,000
Unlicensed Magical Items	£1,000-£20,000
Class A Cyberware, Unlicensed	£25,000
Class B Cyberware, Unlicensed	£20,000
Class C Cyberware, Unlicensed	£60,000/2 years
Unlicensed Deck/Matrix Software	£5,000-£40,000

"In some cases, these penalties differ from those on page 25 of the **London Sourcebook**, Scottish law and penalties do differ slightly from the English versions, and the punishment for violations sometimes lies between those listed for Possession and Threat/Danger in the **Weapon Fines and Punishment Table**, p. 25, **London Sourcebook**. Particularly for items such as heavy weapons, importation carries a stiffer sentence than possession.

BRITISH SLANG

The terms listed below are those most likely to crop up during the adventure. Terms marked with an asterisk are strictly street

lingo. For a more complete listing of British street slang, see pp. 136-37 of the **London Sourcebook**. Gamemasters should use these terms as needed: certainly, use *matey* and *term* to replace The American word *chummer*. The main text of the adventure uses slang sparingly, but the gamemaster may add as much as he or she wants to get a more authentic atmosphere.

***Ace, acing** *adj.* Rubbish.

Aggro *n.* Trouble.

***Bagger, baggie** *n.* Policeman.

Blood *n.* Doctor.

***Box** *v.* To kill.

Box, the *n.* Trideo screen.

***Boxed** *adj.* Dead, broken, useless.

Demi-tech *n.* Cannibalized technology.

Fluff *n.* Pollution, bad weather.

***FRO** *v.* (vulgar) Go away.

Gopping *adj.* Dirty, polluted.

Jammie *n.* Vehicle.

Matey *n.* Friend/acquaintance.

Mellow *n.* Stupid, air-headed person (derogatory).

Oppos *n.* Enemies.

Pixie *n.* Elf (derogatory).

***Plazzy** *n.* Useless.

***Rags** *n.* Cigarettes.

Rak, rakkie *n.* jerk, suburbanite, hick (derogatory).

Rak off *v.* Go away (derogatory); also **Rakking** *adj.* Useless.

Roller *n.* Rich person.

Rub *v.* To have sex. also **Rubbing** (*adj.*) and **Rub off/out** (*v.*)

***Sandal** *n.* Druid (derogatory).

Sep, septic *n.* American.

Sherbet *n.* Alcoholic drinks.

Spammed *v.* Made to look foolish.

Steaming *adj.* Drunk.

Swiss *adj.* Expensive.

Term *n.* Friend, dusted person.

Terminal *adj.* Good, great.

***Trancer** *n.* Chip addict.

Trid *n.* Trideo.

SCOTS DIALECT

The gamemaster may want to use a Scots dialect for Scots non-player characters, especially street characters, in their negotiations with the runners. Keep it to small doses, though, or it will become a parody. As with British slang, the main text generally confines this dialect to street types. The following are a handful of basic Scots terms.

Aa *adj.* All ("I've forgotten aa my school learnin.")

Aboot *adv.* About.

Affa, awfy *adv.* Awfully ("That wad be an affa hard thing tae dae ")

Baim *n.* Child.

Big baggits *n.* Large stomach ("Och, that troll has awfa big baggits." [English] "I say, that troll chappie has an impressively large tummy.")

Canny, cannae *v.* Cannot.

Dae *v.* Do ("I dinna ken what tae dae wi it.")

Dinna ken *v.* Don't know (see above example).

Doon *adj.* Down,

Fae *prep.* From ("He's fae a foreign land.")

Feart *adj.* Afraid ("I'm nae feart a ye!")

Fella *n.* Man.

Forrit *adj.* Forward.

Gaun *v.* Going.

Heed *n.* Head.

Ken *v.* Know; also **kens** *v.* knows.

Masel *n.* Myself.

Nae *adv.* No, not ("That's nae clever o ye-")

O *prep.* Of (see above example).

Puddens *n.* Guts.

Sae *adv.* So.

Sassenach *n.* English, Englishman.

Stane *n.* Stone.

Tae *prep.* To ("I'm going tae pull his heed off!")

Totle *adj.* Very small.

Wad *v.* Would,

Wee *adj.* Small.

Weel *adj.* Well ("He's a weel-dressed fella.")

Ween *n.* Child.

Wi *prep.* With.

Ye *n.* You.

Yersel *n.* Yourself ("Ye could shoot yersel, ye daft rakkie!")



IMAGO

GREAT BRITAIN AWAITS!

There's bound to be trouble when Seattle-based shadowrunners are imported to take care of business in the United Kingdom. A valuable employee of one of Britain's largest megacorporations may be missing, and Transys Neuronet will be damned if they're going to let anyone on their side of the pond know about it.

The search takes the runners through Scotland, the city of Edinburgh, and to darker corners of the Matrix than they ever dreamed existed. It's a complex puzzle of betrayal, friendship, isolation, hatred, blinding love, vengeance, and, in the most bizarre twist of all—life after death.

Imago is an adventure for Shadowrun. It includes high-level dealings with the realms of magic and the Matrix, separately and in unique combination. **The London Sourcebook, Virtual Realities, and The Grimoire** are recommended for play, but not required. **Imago** has been designed for use with **Shadowrun, Second Edition**, but can be used with the first-edition rules.

FASA
CORPORATION



SHADOWRUN 7309

SHADOWRUN is a Registered Trademark and IMAGO is a Trademark of FASA Corporation. Copyright © 1992 FASA Corporation. All Rights Reserved. Printed in the U.S. of A.