

# The IRON WIND™



A  
Series  
Of  
Adventures  
In The  
World Of  
LOREMASTER™

The Iron Wind returns in a new, expanded edition! Journey once again to the chill north where the hardy peoples of the Mur Fostisyr combat the cruel minions of that terrifying force known as...the Iron Wind.

The Iron Wind is one of the Loremaster Series, suitable for use with the ROLEMASTER Role-playing system. Inside are seven detailed layouts, three cities and an area map of the Mur Fostisyr in full color, the Tale of Elor, adventure suggestions and charts covering poisons, herbs, language, and more.





# The IRON WIND

## CONTENTS

### 1.0 NOTES ON THE FEATURES AND USE OF THE LOREMASTER SERIES

#### 1.1 THE WORLD OF LOREMASTER

- 1.12 The Lands
- 1.13 The Waters
- 1.14 The Weather
- 1.15 The Flows of Essence
- 1.16 Flora and Fauna
- 1.17 Peoples of the World

#### 1.2 A BRIEF HISTORY OF THE CONTINENT OF JAIMAN

### 2.0 OF THE MUR FOSTISYR

#### 2.1 THE ENVIRONMENT OF THE MUR FOSTISYR

- 2.11 The Lands
- 2.12 The Waters
- 2.13 Weather in the Mur Fostisy

#### 2.2 FLORA AND FAUNA OF THE MUR FOSTISYR

- 2.21 Beasts
- 2.22 Plantlife

### 3.0 THE TALE OF ELOR ONCE DARK

#### 3.1 THE LAND OF THE MUR FOSTISYR

#### 3.2 OF THE IRON WIND

- 3.21 The Priests Arnak
- 3.22 The Messengers of Syrkakang
- 3.23 The Ordainers

#### 3.3 OF THE PEOPLES

- 3.31 The Fustir-Gost
- 3.32 The Syrkakar
- 3.33 The Ky'taari
- 3.34 The Udahir

#### 3.4 OF THE PLACES OF POWER

- 3.41 Syclax: City of the Syrkakang
- 3.42 Var Ukaak: Tower of Susymog
- 3.43 Taurkytaal: Hold of the Demonlord
- 3.44 Aalk Gaath: Citadel of the Dragon
- 3.45 A-Arnaar: High Temple of the Ky'taari
- 3.46 Kaldaraak-Vaar: Holy Site of the Ky'taari

### 4.0 PLANS OF THE CITADELS OF THE MUR FOSTISYR

- 4.1 SYCLAX
- 4.2 VAR UKAAK
- 4.3 TAURKYTAAL
- 4.4 AALK GAATH
- 4.5 A-ARNAAR
- 4.6 KALDARAAK-VAAR
- 4.7 UDA TYYGK
- 4.8 THARG JIRONAK

### 5.0 NOTES AND CHARTS

#### 5.1 COMBAT SUMMARIES

- 5.11 Master Military Chart
- 5.12 Prominent Persons Chart
- 5.13 Beasts of the Mur Fostisy

#### 5.2 USEFUL CHARTS

- 5.21 Poisons
- 5.22 Healing Herbs
- 5.23 Food and Lodgings Price List
- 5.24 Syrkakar and Ky'taari Vocabulary

#### 5.3 ITEMS OF NOTE

### 6.0 ADVENTURING IN THE MUR FOSTISYR

#### 6.1 PLAYER-CHARACTER BACKGROUND POSSIBILITIES

#### 6.2 SCENARIOS

- 6.21 For Lower Level Characters (1-5)
- 6.22 For Medium Levels (6-10)
- 6.23 For Upper Levels (11-15)

### 7.0 GLOSSARY

If you wish to convert this module to your own FRP system, ICE will be happy to send you detailed conversion notes. Just write to the address below.

IRON CROWN ENTERPRISES  
P.O. BOX 1605  
CHARLOTTESVILLE, VA 22902

Please include a stamped, self-addressed envelope.

## CREDITS

**Author/Designers:** Peter C. Fenlon, Terry K. Amthor

**Editor:** Terry K. Amthor.

**Contributing Designers:** Olivia H. "Udahir are perfect" Johnston, Heike Kubasch, Stephen E. "Squat Pet" Moffatt.

**Cover Art:** Chris White.

**Map of the Mur Fostisy:** Pete Fenlon.

**Interior Art:** Peter C. Fenlon, Charles Peale, Richard H. Britton, Terry K. Amthor.

**Floorplans/Layouts:** Terry K. "Dancin' with my Se - Elf" Amthor (special thanks to James "Yes, I'm a young liberal" Blevins for coloring in and *Rubyliths!*).

**Production:** John David Ruemmler, Larry "Oh, Well" Simms, Chris "Which ones are these guys?" Christensen.

Copyright© 1984 IRON CROWN ENTERPRISES, Inc.,  
Charlottesville, VA.

**Cover Graphics:** Terry K. Amthor.

**Editorial Contributions:** John "David," not "D" Ruemmler, Bwucie R. Neidlinger, S. Coleman "That's Just Stupid" Charlton.

**Special Contributions:** Howard "Iron Wind? I'll get right on it" Huggins, Peter C. "Sure, I'll Rewrite My Part" Fenlon, Bruce R. "No Bestiary" Neidlinger, John "Mondo Bizarro" Ruemmler, Terry K. "Who's Punk?" Amthor, Coleman "Wonderin" Charlton, Richard H. "Get Udahir!" Britton, Deane "Simon-Nick-John-Roger-Andy! SQUEEEAL!!" Begiebing, Steven "I'm not in Cloudlords!?" Bouton, and "Business Betsy."

Printed by **Spencer Printing Company**

Typesetting by **Graphic Communications, Inc.**

Special thanks to all the millions who so patiently waited for the **Second Edition.**

# 1.0 INTRODUCTION

This is the second edition of the first book in the new *Loremaster* series, an ongoing sequence of modules designed to detail specific sections of the world of *Loremaster*. Each module will cover a small area of the world, whether it is an island, an isolated keep, or an entire realm. Although there will be great variation from package to package, all will fit into the overall mosaic which is the world; as areas are detailed, the total picture will become clear.

While the size and scope of the *Loremaster* modules may vary, all will be designed around the **Rolemaster** Fantasy Role Playing system, and all character statistics, as well as spells, combat abilities, etc., will be provided along the guidelines of that system. Of course, if the GM should wish to alter some of the statistics and situations he should not feel that these are absolute restrictions. However, care must be taken to maintain the play balance which has been established.

## 1.1 THE WORLD OF LOREMASTER

### 1.12 THE LANDS

The world has a relatively small percentage of land to ocean and the land areas that do exist are fragmented and scattered: most of the land masses are better described as large island chains rather than true land masses, although there are a few of the latter. The world is large (about 30,000 miles in circumference) but a dearth of some of the heavier elements serves to counter this as far as gravity is concerned. The lack of metals has also had an effect on the development of most of the civilizations, as the inhabitants have been forced to turn to means other than technology to improve their lives. There are no known chemical explosives or ways to manufacture such without the direct use of Essence.

It is apparent that the world was cruelly tortured by unusually heavy volcanic and seismic activity in her infancy, thus explaining the extensive and severe mountain chains and the large number of islands of volcanic origin. There are also many active volcanoes about, as well as countless dormant ones. Both poles are covered by solid ice caps which grow and recede with the seasons. The northern pole is the more extensive, though there are considerable glacial formations near both poles.

### 1.13 THE WATERS

Even as there are a few dominant continental masses in the world, there are not many unbroken expanses of ocean. Early seismic activity has so convoluted the surface of the planet that there are few stretches of water wider than one thousand miles unbroken by a formidable island or series of islands. Also common are the atoll chains, strings of sheer black volcanic rock isles, uninhabited, but presenting formidable navigational barriers. Many a ship has been wrecked upon these dark crags, either in not detecting them in the night or unable to veer away in time — for the currents of the world's seas are often swift and ever-changing. Cruel, they have been called; it cannot be denied that they are fickle. Coral reefs are also the bane of many a sea navigator, and they are common off the coasts of most of the major island chains within 5,000 miles of the equator.

### 1.14 THE WEATHER

The axial tilt of the world is approximately 30 degrees, causing fairly definite seasonal weather changes. The world holds in orbit five moons: one very large and close, presenting an easily discernible disk and even some features on its (apparently) dead surface. The other four moons are relatively small and more distant, with less visible disks. The smallest is in fact a satellite of the largest moon, not of the world itself. Orbiting nearly on the equator five times per year, the largest moon has regular and noticeable phases and profound tidal effects on the tides of the world. The others have less tidal effect, but in conjunction the five act to create very strong and varying ocean currents and weather systems.

### 1.15 THE FLOWS OF ESSENCE

Perhaps the most fascinating aspect of the world is the Essence, that force which allows 'magic' to exist in its myriad forms. The Essence is an unseen, normally undetectable aura projected by all things. It is a form of radiation, and it is produced mainly by living things. Certain beings, through aptitude and training, have learned to tap the Essence of their environment and mold it to suit their purposes. Alternatively, some utilize the Essence of their own 'psyche' and channel it in effective ways.

### 1.16 FLORA AND FAUNA

Just as there are elements which are common to many worlds, we must rationalize that evolution will run in parallels. The likelihood of this will not be argued. However, just as there are races very human in nature, most of the flora and fauna of the world are much like our own. Unique plants or animals will be detailed within the specific module, as is appropriate.

### 1.17 PEOPLES OF THE WORLD

The intelligent races living on the world are myriad and varied. Most are isolated from each other by the barriers of the world itself, especially mountain ranges and broad seas, and are thus unaware of each others' existence. Long ago the lands of the world were one continent, and the human inhabitants were rather homogeneous. There was a resurgence in tectonic instability, however, and, amid violent earthquakes the continent was broken. Continental drift took over, and peoples were sundered — adrift, so to speak — and left to evolve in isolated microcosms. This also accounts for the commonplace existence of certain peoples and animals in some areas, while the same beings and creatures are virtually legendary in others.

## 1.2 A BRIEF HISTORY OF THE CONTINENT OF JAIMAN

Jaiman is one of the largest single continental masses in the world, embracing several large islands and island clusters. This mighty land mass is also the furthest west of the "Known Lands"; beyond Jaiman lies the *Malvin Tesea* (E. "endless seas"), the widest ocean in the world. But for jagged atolls and a strong north-south flow of the invisible yet dangerous force called Essence the ocean is unbroken, and sailing it is extremely difficult and perilous.

*Utha was the first of the Masters of the Flows. Power lay in his hands, and shaping lands was for him and his followers, an easy task. The world was then young and warm with red-hot rock running like rivers across the steppes. Utha and his people were wise and sought to calm the wild earth. But there were those among the masters, led by a woman, Kadena (E. "the Slayer"), who sought to disrupt their ways, and a great conflict arose. This was later known as the First Age of Ire.*

*Lydek Terisonen  
2267 Third Age (of Ire)*

This excerpt is from the annals of one of the great Loremasters, Lydek Terisonen, now vanished and said to be mad. These fragmented tales provide the only certain information available from the First Age, for other Loremasters will not speak of it. The annals of that Age tell of the Lords of Essence and the conflict which arose between them over the forming of the World; nearly all of the records kept during that long Age were destroyed in a great cataclysm, an upheaval which set the lands in shapes which have changed little since. It is believed that the Lords of Essence looked like men in their natural form but were able to assume any shape they desired at will, for they held awesome powers over Essence itself. The Sages of Nomikos, who long studied the Lords of Essence, believe that there were two groups of Lords, one led by Utha and the other by Kadena, and that these two orders existed for quite some time unaware of each other, gathering power and followers. Years passed, and it was discovered that indeed their Essence-skill could be genetically inherited. Some of the Lords left their lands, and the power was spread amongst other people. However, only the first Lords appeared to stop aging, and indeed proved to be immortal, dying only when killed.

After thousands of years, Kadena and her followers developed the power to shape the land and began to reform their environment. It was not long before their activities came to the attention of Utha, for Kadena's idea of a fit environment was a land tortured by earthquakes and flowing lava. After attempting to control Kadena's whimsical destruction, Utha decided that the only way to save the World was to kill her and destroy her evil order.

The ensuing struggle shook the World to its core. Continents sank, and lands long under the seas were thrust up again. Entire races were destroyed by flames and tidal waves. Battles raged for an entire year, and at the end, when great clouds of smoke and plumes of steam began to clear, no one stirred. However, conflicting tales again arise. Some say that members of both groups escaped to distant hiding places, fearing they would be killed; they may be hiding still. There is little question that both Utha and Kadena and all of the immortal first-lords are dead, for if they had lived, their power would be felt. Now the only Essence-users are shadows of the powers which once walked the land. Thus ended the First Age of Ire.

The Second Age began with the slow healing of the lands and the gradual dispersal of mile-high clouds of steam, mists generated from the evaporation of much of the waters of the oceans in the great fires and explosions each Order had cast upon the other. Slowly, plantlife began to grow again on the new lands, now cleansed by rains. Animal life recovered and multiplied. The level of the sea rose, and lands which had been connected were sundered by new waterways. The few peoples who survived the cataclysm were without order or civilization, barely clinging to life itself. Winds and tides suddenly shifted; the orbits of the moons were unstable, and the flows of Essence ever-changing, making travel perilous. The duration of this period is uncertain, but the Loremasters say that it lasted for perhaps a hundred millenia. In the last two thousand years of the Age starting changes began to take place, and the Loremasters came forth.

### THE APPEARANCE OF THE LOREMASTERS

Without fanfare or apparent unity the Loremasters came to Jaiman. They took many forms and spoke many tongues, and all were very wise, knowing that which the infant peoples of the world needed most. Only the Loremasters themselves know from where they came, or indeed how many they were; Loremasters will not speak of their origins. Unmatched masters of the Essence, Loremasters can tap directly into the Flows at will, transporting themselves and channeling great forces of nature. Rarely do they indulge in such displays. Loremasters wander from place to place, rarely staying with a single culture for more than a decade or two.

Under the tutelage of the Loremasters, civilizations flourished: peoples learned new languages, agriculture prospered, and the working of stone and metals reached new heights. Centuries passed, and Loremasters came and went. They taught only things which the peoples were readily able to grasp; no great leaps of social advancement or technology were offered. Some believe that these teachers were not different generations of Loremasters but the same individuals, circulating through the widely separated lands and returning only after centuries.

### THE COMING OF THE UNLIFE

With the help of the Loremasters, many civilizations stood on a firm footing, settling and exploring the wide lands. The world seemed a peaceful place — until the coming of the Unlife.

The Unlife feeds on death and destruction. It is a thirst unquenched and unslakable; indeed, the more it consumes, the more it requires. It has no source, but is everywhere, waiting for a tool to allow it to act. Through the surviving followers of Kadena, who for long years licked their wounds in hidden places, the Unlife found its instruments. These souls, desperate for power, eagerly accepted the offers of energy from the Unlife and grew strong in dark places, gathering and creating hideous minions of many types. Evil Cults and Orders of varied origins and membership took form; great Demons were first fashioned by the most powerful of the Lords.

Soon the young mannish peoples faced difficult choices: they were offered great knowledge by the new Cults, more than the Loremasters were willing to impart. Some servants of the Unlife even impersonated the Loremasters, gaining the trust of the naive cultures in this way. The teachings of the false sages were different, however. They spoke of killing and whispered tales of hostile peoples close by, readying to attack. Thus were the seeds of suspicion sown. The Loremasters attempted to rectify those misdeeds, but they seemed too few and were unable (or unwilling) to assault the servants of the Unlife. Some peoples responded to their warnings, however, and battle lines were drawn for the conflict which would end the Age.

### THE WARS OF DOMINION

Like one beast, the peoples and creatures under the sway of the Unlife rose up and attacked those who remained free of dark domination. Great Demons and hosts of creatures, led by tainted Priests, Essence Masters and the elite servants of the Unlife, lashed out, attempting to destroy utterly what the Loremasters had nurtured for so long.

These wars lasted for nearly three centuries, and though the powers unleashed during this conflict were small compared to those of the battle between the Lords of Essence, much was destroyed that had taken long years to build. Many valiant leaders fell before the chill shadow of the Unlife. Terrors unnumbered and unspeakable walked the lands and flew in the high airs. In desperation, some of the Loremasters matched their strength against that of the Unlife. Most perished in the effort; though without this aid the peoples would almost certainly have fallen. However, the Loremasters and the peoples of Light were victorious. Greatly-weakened survivors retreated once again into themselves, only on the necessities of survival. Thus ended the Second Age of Ire.

## THE THIRD AGE OF IRE AND THE COMING OF THE WINDS OF SHADOW

Brief was the respite for the peoples of Jaiman, for barely had a thousand years passed when new followers of evil sprang into existence. These new servants, however, seemed bent upon ways other than brute force to achieve their ends; deception and subterfuge were their tools. The Loremasters, fewer and weakened in number, moved among the lands as simple gatherers of information, only speaking a word of warning, advice, or encouragement. Their lordly past was forgotten by all but a few.

Chill winds now blow out of the north, harbingers of a new assault. Dark religions grow and flourish, gathering new followers with each passing day. The servants of the Unlife take many forms in myriad lands, but their foul purposes run parallel, seeking nothing less than the destruction of all life itself.

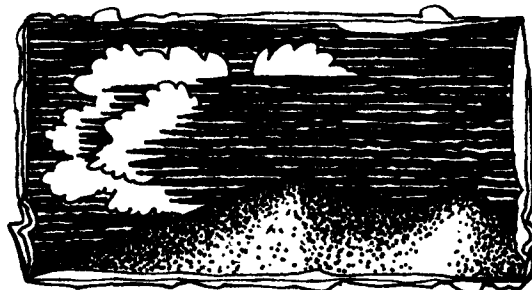

## 2.0 THE MUR FOSTISYR

### 2.1 THE ENVIRONMENT OF THE MUR FOSTISYR

An island cluster lying to the north and east of the continent of Jaiman, the Mur Fostisyr (Um. "Land of the Blue Light") is a curious area born of volcanic eruptions, where nights last for months and the peoples fight an ongoing battle to survive against the elements and the forces of the Unlife: the Iron Wind.

#### 2.11 THE LANDS

##### The Mountains

Only a small percentage of the land of the Mur Fostisyr is not mountainous. The slopes of the Barl Syrnac rise immediately out of the icy waters of the Fuir Gaath Ku, soaring miles into the sky. Fortunately for the inhabitants, the soil is rich, and there are many sheltered vales within which hardy crops can be nurtured.

The outward-facing shores of the land, pounded for ages by the harsh waves, are beautiful beaches of fine black sand, while the inner shores are a mixture of this sand and large broken igneous rocks. Along the Shore of Taliraan, one of the regions in the land of the Ky'taari, there is a white beach, formed of powdered ky'tal, the white translucent marble which is the primary building material of that people. Apparently this sedimentary rock, formed long ago deep under the ocean, was thrust up in the quakes and eruptions which formed the lands themselves. It is in the hills just above that the ky'tal is quarried. Trapped within the depths of the hills are many other materials, including gold, silver, and the enchanted materials *laen* and *eog*, which are formed in the natural volcanic furnaces.

##### Volcanic Activity

There are no *active* volcanoes in the Mur Fostisyr, yet the people there would almost certainly perish if it were not for the several dormant ones which do exist, providing heat to warm the enclosed valleys, creating hot springs, and making the interior of the Uda Tyygk, the secret city of the Udahir, livable. Thus there are always clouds and steams rising from the land, betraying the geothermal warmth without which the Mur Fostisyr would be a cold, barren cluster of dark rocks.

##### Sheltered Vales

Vales are the havens of life in this Land of Blue Light, locked in and protected from the bitter polar winds by the hard flanks of the Barl Syrnac. Warmed by the steams of natural hot springs produced by subterranean volcanic activity, the many isolated valleys in the Mur Fostisyr are centers of civilization and growing things which would not survive the long cold winters on more exposed ground. Even with the springs, however, the vales are not exactly tropical jungles: in the winter of the long night (eight months of the year in which the sun does not show its face) it is chilly, to say the least. Only during the brief summer are the vales truly temperate.



## 2.12 THE WATERS

The waters of the Mur Fostisyr fall into two natural categories: the many freshwater lakes and streams, and the sea which divides and surrounds the land.

### The Lakes

Aside from the small thermally warmed pools in the vales, the freshwater streams and lakes which lace the land are without exception bitterly cold throughout the year. The sources of the rivers are varied, including melting glaciers and snows on the mountain peaks (the rivers fed by these snows are obviously much broader and faster moving during the summer months, when the snows have a chance to melt). During the winter, the surfaces of nearly all the lakes and rivers freeze over to a depth of up to two feet.

### The Seas

The salt waters that hold this land separate from the rest of the world are chill and filled with strange currents and flows. This northern sea is unusually low in salt, especially in the two primary bays: the *Ky'taari Shay* (K. "Bay of the Ky'taari"), and the *Yalf Yorn* (Um. "Bay of Glass Spires"), which freeze over completely with the coming of each dark winter. It is in fact probably lucky for the Ky'taari and the few remaining Fustir that this occurs, for the uncertain plains of ice dissuade invaders from roaming too deeply into the western lands of the Mur Fostisyr.

The seas about the perimeter of the land rarely freeze, and never does a solid sheet form over these churning waters. Huge icebergs commonly drift from even more northerly areas, floating serenely past like unmanned frozen fleets. The northern and western coasts are beset by the more turbulent waters, due to the tidal flows, as well as the pull of the undersea currents.

## 2.13 WEATHER IN THE MUR FOSTISYR

As has been mentioned, the weather in the Land of Blue Light is unusual to those unaccustomed to the seasonal changes which occur near the poles of a globe. Here, the night lasts longer than winter itself, and all inhabitants — man and animal, tree and flower — await the brief and infrequent summer.

### The Seasons

The world of Loremaster has an axial tilt of about thirty degrees, creating seasonal weather changes similar to those in our own world, including extended periods of almost total darkness at and near the poles. The Mur Fostisyr is no exception, and the peoples's lives are heavily shaped by these seasonal changes. It should be mentioned that the world's largest moon by far, *Orhan*, orbits the planet at the rate of five times per year. (The year being 350 days long, each month therefore lasts seventy days). *Orhan* is very large, though more distant than the Earth's moon. Its path is nearly equatorial, and so it shows regular phases easily discernable to inhabitants of the world. The orbital rate of *Orhan* is used by most of the inhabitants of the Mur Fostisyr as the basis for their calendar, and allows them to divide their seasons. The most sophisticated calendar is that of the Ky'taari, and it is used in the weather chart below.

The year begins with spring, *lanaar*, the day on which *Orhan* first shows his full face; at that time the sun rises at least partially over the horizon, cause for a religious holiday among the Ky'taari. The spring is relatively swift, lasting at most one half of a phase of *Orhan*, during which the sun daily is above the horizon for longer and longer periods. When *Orhan* shows no face, *larish* (summer) begins. There follows one full month of summer, at the height of which the sun is in the sky four-fifths of the day, and even when she is down, there is a bright twilight. The next full showing of *Orhan* marks midsummer. There is no 'autumn' for the Ky'taari. After a full month, summer descends very quickly into winter, called *oryk*. The sun appears less and less, so that by the next new moon the average temperature has already begun to plummet. The next three and one half months mark winter in which, at its darkest, there is only four hours of twilight to relieve twenty hours of total darkness. The deep night, Midwinter, falls at this time, and when *Orhan* shows no face. A dark night indeed.

An interesting meteorological effect, common in the polar regions and especially visible during the dark winters, is the presence of *Aurora Borealis* ("northern lights"), called the *dakuralani* ('lights of night') by the Ky'taari; huge luminous tendrils of light swirl and waver across the sky. These are (according to the Ky'taari) the flows of Essence, kindled by *Ariaana* as she passes the globe south of the Mur Fostisyr. They believe that their goddess sets fire to the Flows to hearten them and remind her people that, though she must be far to the south, she has not forgotten her favorite people, and will return with the spring. The night of Midwinter, when *Orhan* is new, is invariably one of the most spectacular displays of the *dakuralani*.

The five months of the year run from new moon to new moon, and the Ky'taari have given them the following names: *Tirilif* ("moon-"), the midpoint of which is the beginning of spring; *Arif* ("sun-"), the month of summer; *Norinif* ("shadow-"), the beginning of winter; *Dakurif* ("dark-"), the last day of which is the Deep Night of Midwinter; and *Ilaarif* ("star-"), which is the last portion of winter, returning to *Tirilif* and the spring.

### Temperature and Precipitation

Month	Northern Coasts	Southern Coasts	Vales	Upper Altitudes
1) <i>Tirilif</i> (spring)	35 – 60° Moderate	45 – 65° Very Heavy	65 – 75° Heavy	-20 – 0° Dry
2) <i>Arif</i> (summer)	45 – 65° Dry	55 – 75° Heavy	60 – 80° Moderate	-10 – 10° Dry
3) <i>Norinif</i> (winter)	25 – 40° Moderate	30 – 45° Moderate	50 – 60° Moderate	-20 – -5° Dry
4) <i>Dakurif</i> (winter)	15 – 30° Dry	20 – 35° Moderate	40 – 50° Moderate	-30 – -20° Dry
5) <i>Ilaarif</i> (winter)	5 – 20° Very Dry	15 – 30° Moderate	45 – 55° Dry	-40 – -30° Very Dry

*Precipitation Codes:* Very Dry = less than two inches; Dry = two to four inches; Moderate = four to six inches; Heavy = eight to ten inches; Very Heavy = over ten inches. The inches refer to inches of rainfall in that area over the period of the seventy day month.

## 2.2 FLORA AND FAUNA OF THE MUR FOSTISYR

Despite the brutal temperatures and the unkind seasons in this land, many types of hardy plant and animal life survive. Indeed a few manage to flourish in the land of Blue Light.

### 2.21 BEASTS

There are a variety of animals which inhabit the islands of this land, ranging from the small, domesticated *Koylarini*, kept by the Ky'taari as pets, to the huge Sea-drakes lurking in the waters in and about the chill bays. In addition to the animals mentioned below, foxes, seals, antelope, and several varieties of cold-adapted bird live there.

#### Snow Wolf

These large, white-furred animals live mostly in small caves in the hills of *Mur Brya* (Um. "Land of Trees"), high in the more densely forested areas. A few also live on *Kyvinaar*, but almost exclusively along the southern coast. Snow wolves hunt in packs, usually subsisting on White Deer, hare, *Torkaani*, and an occasional unwary *Syrkakar* or *Ky'taar*.

#### White Hawk

White hawks choose lofty cliffsides for their eyries, nesting above the crashing waves along the coasts of the Mur Fostisyr and above the higher vales. A few have been domesticated by the *Syrkakar* for hunting purposes, and a variant strain of black hawks act as trained surveillance scouts for the Messengers of *Syrkakang* (see sec. 3.32). In general the hawks grow to achieve about a three foot wingspan, and feed on snow hare and mice.

#### Thyfur

These lordly birds are the mounts of the *Thyfuliak*, protectors of the hidden city of the *Udahir*. They are highly intelligent, and are extremely loyal to their rider, who is, in turn, devoted to his bird. More details about the *Thyfur* are available in sec. 3.34.

#### Weasel

A relatively small animal with a long, sinuous body, and small paws, this variety of weasel, like its brethren, feeds on smaller mammals. It has very sharp teeth and claws, though is not really dangerous to man. The pelts of this animal, which are a beautiful blue-white during the winter, are highly prized and bring a great price on the mainland.

#### Koylarin





















Most commonly found as the domesticated pet of the Ky'taari, the *Koylarin* is a very small dog about the size of a rabbit. The *Koylarin* grows fine, silky fur at an amazing rate, which is much of the reason for its favor, for the fur can be made into a very beautiful silk-like cloth. The dogs are gentle vegetarians and very popular with children.











## BASIC COLOR AREA MAP KEY

The scale for the color map is 1 inch = 20 miles





### TOPOGRAPHY

- (1) **Buttes and Plateaus** =  ;
- (2) **Caverns** =  ;
- (3) **Desert** is represented by a creamy coloring  ;
- (4) **Dunes** =  ;
- (5) **Hills** =  ;  
Usually the surface area immediately adjoining these rises is rugged;
- (6) **Mountains** =  ;
- (7) **Passes** =  ;
- (8) **Reefs** =  ;
- (9) **Ridge Faces, Downs and Escarpments** =  ;  
On the high side, there is a gentle slope away from the top;
- (10) **Rock Fields** =  ;
- (11) **Shoals** =  ;
- (12) **Volcanoes** are shown using a brick red symbol  ;
- (13) **Broadleaf Forests** are depicted by the green symbol  ;
- (14) **Cultivated areas** are depicted in deep green or with the symbol  ;
- (15) **Heath** is depicted by brownish or yellowish groundcolor  ;
- (16) **Jungle** is depicted by the yellow-green symbol  ;
- (17) **Mixed Plain and Forest**  ;
- (18) **Needleleaf Forests** are denoted with the blue-green symbol  ;
- (19) **Scrub Forests** are depicted with the brown-green symbol  ;
- (20) **Thickets, Hedgerows, and Brush** =  ;













### WATER

- (21) **Dry or Periodic Lakes** =  ;
- (22) **Falls** =  ;
- (23) **Glaciers** =  ;
- (24) **Intermittent Watercourses** =  ;
- (25) **Lakes** =  ;
- (26) **Primary Rivers** are blue with black outlining  ;
- (27) **Rapids** =  ;
- (28) **Secondary Rivers** are blue with black outlining on only one shore.
- (29) **Shallows and Sand Bars** are denoted by the symbol  ;
- (30) **Streams** are blue and have no outlines.
- (31) **Swamps** =  . All marshlands of significant size fall into this category.

### ROADS

- (32) **Bridges** =  ;
- (33) **Fords** =  ;
- (34) **Primary Roads** =  ;
- (35) **Secondary Roads** =  ;
- (36) **Trails and Tracks** =  ;

### STRUCTURES

- (37) **Barrows, Cairnfields, and Burial Caves** =  ;
- (38) **Cave Cities** =  ;
- (39) **Citadels and huge castle complexes** =  ;
- (40) **Cities** =  and their relative size is dependent on the width of the symbol. The red coloring signifies a non-military (civilian) settlement;
- (41) **Fortified Towns** =  ;
- (42) **Inns and Trade Houses** =  ;
- (43) **Manor Houses** =  ;
- (44) **Monasteries** =  ;
- (45) **Observatories** =  ;
- (46) **Ruins** =  ;
- (47) **Signal Towers** =  ;
- (48) **Small Castles, Holds, Towers, Keeps** =  ;
- (49) **Towns** =  ;

Note that the symbols described above are applicable to all the view maps contained within this module, whether color or black and white. The scale of miles, however, may not be applicable.

### Ovir

Giant polar bears growing to a standing height as awesome as twelve feet, the Ovir reside in caves throughout the land. Their webbed paws allow them to glide through the chill waters with graceful ease, while their huge claws make climbing ice and rocks no challenge. A keen sense of smell and superior sight (including excellent night vision) allow the Ovir a relatively easy time hunting their meals, which include fish, deer, hare, snow wolves (if antagonized) and even an occasional human snack, though they rarely attack men unless provoked. Their fur is pure white during the winter months, though it thins slightly and transforms to a yellowish color in the spring, darkening to a tawny brown in the summer. Usually traveling in family groups of five, the Ovir are not to be tangled with. If any of the children is hurt, the parents become ferocious; if a mate is severely injured or killed, the partner flies into a blind fury, striking at anything or anyone in the area with awesome force.

### Torkaan

This fat, wooly animal is one of the most useful in the Mur Fostisy, for not only does it grow thick fur (which can be woven into a wool with superior insulation qualities) but it also gives milk. The meat of the Torkaan is delicious when broiled or stewed. Resembling nothing so much as a large, overweight sheep with oversized hooves, the Torkaan is not known for its intelligence. They are for the most part domesticated and herded by the Ky'taari.

### Snowshoe Hare

A rather large member of the rabbit family, the Snowshoe Hare has no other particularly distinguishing features other than the fact that it provides food for many animals higher in the food chain, including men. Tasty when roasted, the Snowshoe Hare has provided many a welcome meal for daring adventurers lost in the wilds.

### White Deer

The graceful white deer, with their silvery branched antlers, are not often seen in any great numbers in the Land of Blue Light anymore. Most likely the ecology of the land cannot support very many, and their population has stabilized at a low number. Their silver-grey coats and strong antlers are valuable, however, and the deer are often the target of a Syrkakar hunting party. Fortunately, however (for the deer) these animals seem to have an almost human intelligence and can sense whether or not nearby humans or animals are threatening. They have an uncanny skill at eluding pursuit. The only sound that the white deer have ever been heard to make is an eerie, high-pitched whine which rises and falls, almost like a song.

### Kiri Dog

Resembling large huskies, the Kirii are the workhorses of many Ky'taari, serving as expert herders of the Torkaani, scouts for trackers, and general companions and guards for the traders. Unlike the Koylarin, they are not often house pets, preferring to have space to run. They are loyal, intelligent and easily trained, though they possess none of the bizarre tendencies of the White Deer. The senses of the Kirii are acute, especially their sense of smell; their night sight is also excellent.

### Sea Drake

Sea Drakes are among the most terrifying creatures in all of the world; these giant, serpentlike beasts, which grow to more than 200 feet in length, live in the icy waters in and about the Mur Fostisy. Of course, descriptions may be inaccurate, as the fear which these monsters instill is such that details such as size and ferocity may be exaggerated.

Also confusing the issue is the fact that the Ordainers (see sec. 3.23) are also known to be capable of free movement underwater, bursting to the surface without warning to destroy an unwary ship. Though much smaller than the Drakes, the Ordainers are intelligent and possess many powers over the Essence. The Drakes can only be blamed for random destructiveness, though they do take their toll on helpless merchant ships. Even the thickest layers of ice are no impediment to the Sea Drakes, as they use their large horned heads and clawed arms to shatter the surface barrier as though it were thin glass. Oddly, these creatures normally feed on algae and microscopic plantlife which live in the deeper waters. Why they occasionally surface is unknown, but they seem to have an uncanny ability to do so immediately adjacent to a ship. Even the Ky'taari iceboats, skimming across the frozen surface, are not safe, as the beasts can somehow perceive them through the ice. Perhaps they possess some form of sonar, for their eyesight is not believed to be very good.



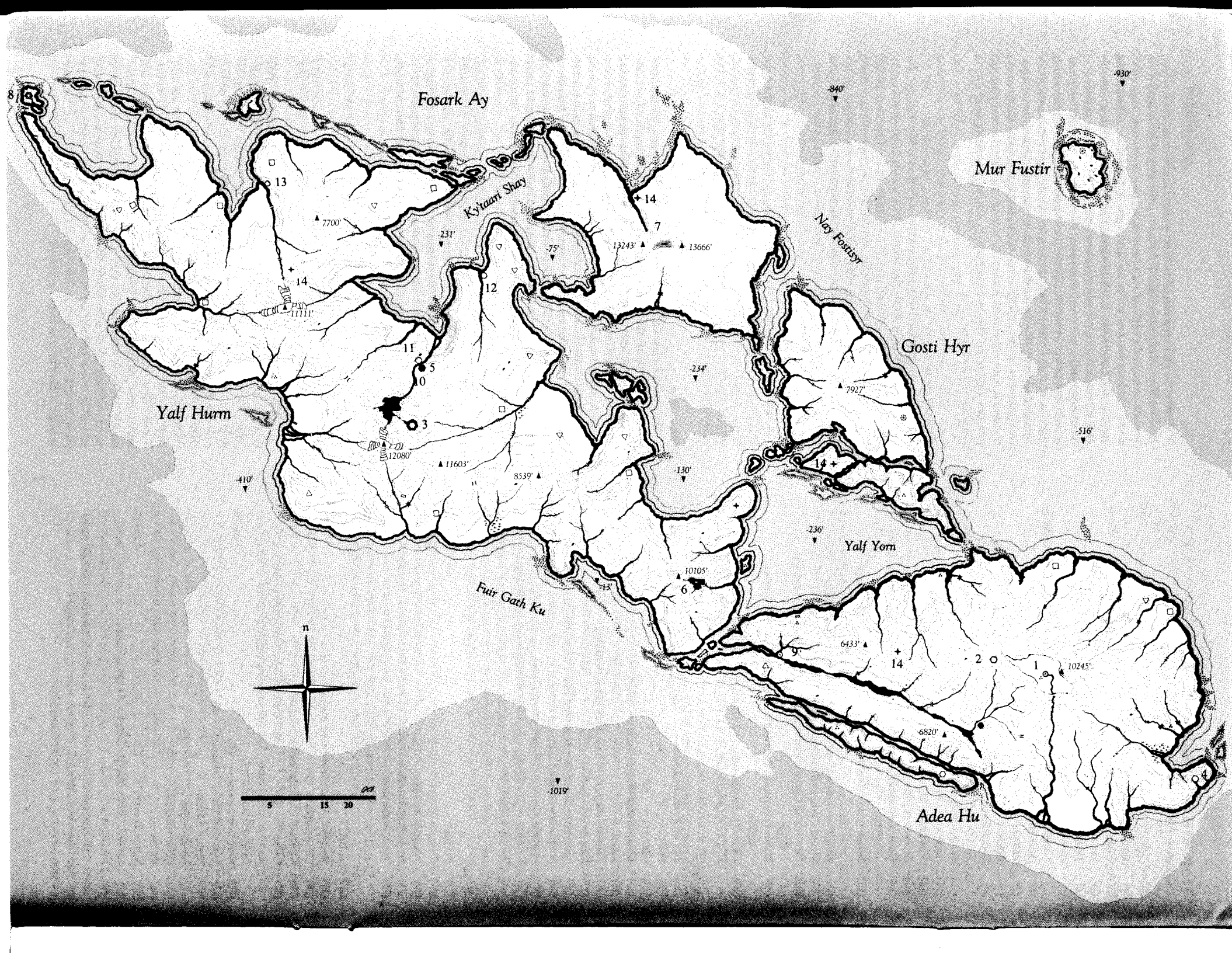



## 2.22 PLANTLIFE

The Mur Fostisyr does support a variety of plant types, all hardy and adapted to the unusual climatic conditions, most importantly, the day/night relationship. The most prominent and crucial of these flora are discussed here, with special attention paid to their usefulness to the peoples of the area.

### UKUR

A small shrub which yields up a surprising number of large nuts, each one of which is capable of providing a man with one day's nutrition.

### TONAK

A variety of pine especially useful to the Ky'taari not only as a building material and firewood of long duration, the pulp of the wood is used to make a very strong, fine paper, for which that people is famous.

### SHIR

Similar to winter wheat, shir sprouts early in the spring (having been planted the preceding fall) and grows very rapidly. It is the staple of the Ky'taari and other Mur Fostisyr groups.

### LOTANAK

The lotanak bush is similar in appearance to a rhododendron, and a very hardy plant it is, surviving year-round in all but the most inhospitable areas. It provides a continuous supply of very nutritious berries.

### AGAATH

Very important to the Udahir, the small Agaath plant grows high in the mountains, and its berries, when ingested, greatly improve the body's efficiency in absorbing oxygen, crucial at higher altitudes.

## GAMESMASTER'S REFERENCE MAP

The black and white map on the preceding page is gridded and keyed to serve as a reference for the GM. All of the major citadels, cities, and other places of interest are included.

### REFERENCE MAP KEY

- 1 - Syclax: City of the Syrkakang
- 2 - Var Ukaak: Tower of Susmog
- 3 - Taurkytaal: Hold of the Demonlord
- 4 - Aalk Gaath: Citadel of the Dragon
- 5 - A-Arnaar: High Temple of the Ky'taari
- 6 - Kaldarak-Vaar: Holy Site of the Ky'taari
- 7 - Uda Tyygk: City of the Udahir
- 8 - Tharg Jironak: Tower of the Astrologer
- 9 - Brya Sug
- 10 - Palace of the Ataarn
- 11 - A-Tykaar: Ky'taari Capital
- 12 - Itaraan (A Ky'taari city)
- 13 - Taartayn (A Ky'taari city)
- 14 - Navigator Obelisk

The scale for the black and white area map is 1 inch = 20 miles

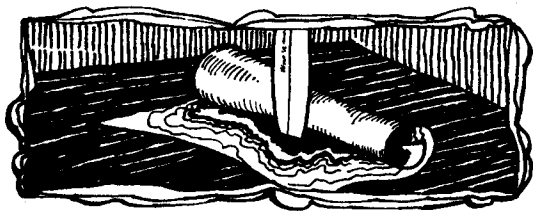

## 3.0 THE TALE OF ELOR ONCE DARK

*I am called Elor Once Dark. The knowledge of that which is not known is my trade. In my youth, I travelled many roads knew many masters, loved many causes, and betrayed more than one who called me friend. That I must live with even now, although those days were long ago, when the Lords of Essence walked the earth. My penance is truth and teaching. Tonight I am but a simple bard, here to speak of the Land of Blue Light — the Mur Fostisyr — of its peoples, and of the perversion that is the Iron Wind.*

## 3.1 THE LAND OF THE MUR FOSTISYR

*No land that I have ever seen has failed to affect its inhabitants; still the Mur Fostisyr has an exceptional impact upon its people. Each race that makes their home there shares a rugged, almost defiant existence which makes them considerable forces, despite their modest numbers. The hunters and craftsmen of the Land of Blue Light live in a very special world.*

*Its four sizable islands and a score of smaller islets lie clustered around a central bay in the icy waters off the northwest coast of Jaiman. They are isolated by storms and cold most of the year. It is harsh place that sits astride the line where the trees stop growing and the brilliant heath marches toward the eerie lights of the dark northern sky. Nonetheless, I saw variety everywhere I went. Scattered forests of fir dot the slopes and isolated coastal plains in the South, while wild and spongy moor-like plains sweep across the northern flank. Everywhere, volcanic peaks, bubbling geysers, and frigid fjords dominate the course of twisted paths. To say that there are mountains in the Mur Fostisyr is inaccurate; the peaks of the mighty Harl Syrna are the land. The great black massifs rise miles straight out of the sea, holding back the waters of the Fuir Gath Ku. Dominating the area is the Yalf Hurm ("Land of the Glass Spires"), a long and often breathtaking island which is cut lengthwise by a chain of jagged spires. This range is carpeted with dark forests on the southern decline, and appears wild and untameable from the North. I was there in the Spring, when the heavy rains, snows, and ice storms pound rocky fields of colorful wildflowers and spawn a plethora of thundering streams. Two sizable rivers allow for passage into the interior. This northern domain borders both the Fuir Baath Ku and the Ky'taari Shay ("Waters of the Ky'taari"). The latter bay lies in the northwest and forms the core of Kyvinaar, the land of the Ky'taari proper. It is the westernmost realm of the Mur Fostisyr. Jaded with myriad lakes and silvery glaciers, it is to me the most beautiful place on the isles.*

*Southeast of the Yalf Hurm, across the Yalf Yorn ("Bay of Glass Spires") and Yon Vu ("Straits of Death"), lies the second largest of the principal islands — the Adea Hu ("Pillars of Black Ice"). This is the home of the numerous and warlike Syrkakar clans. The Adea Hy is formed out of the same series of peaks that give birth to the Yalf Hurm, although it is not nearly so rugged as its larger companion isle. It is the most forgiving land in the Mur Fostisyr. This is in part due to the one huge mountain rises from its center, an uplift the natives call Kanga Syrn ("Mountain Father"). Relatively gentle slopes and sheltered valleys create accessible havens along the coast, and permit commerce to cross reasonably passable ridges. Perhaps more importantly, two protected vales lie guarded within the mountain's bizarre womb. One is a long expanse of pine and rich grass which parallels northwesterly mountain-course and sits nestled between the Kanga Syrn and a long wooded ridge known locally as the Hegra Surm ("Bark Wall"). The other valley rests within the dry caldera of the Mountain Father. What was once a volcanic cone surging with molten terror is now a moss and tree covered oval, surrounded on all sides by steep cliffs of glassy rock. Hundreds of hard crystalline pillars protrude from this natural fence, and give the island its name. The Syrkakar apparently realize that the natural defenses, fertile soil, and wonderful views are unique gifts, because they make their capital in this beautiful bowl. Syclax ("Town of Five Gates") is the city, and the valley is the Yon Syclax. Their kingdom is called the Mur Brya ("Land of Trees"). I will always hold it in awe.*

*North of the Adea Hy, across the Fuir Gath Ku, lies Gosti Hyr ("Isles of Green Light"). It is actually a collection of three medium sized islands which are separated by narrow channels. Each is has steep faces which rise quickly from the shallows and rise to a single sharp summit. Like most of Kyvinaar and the Yalf Hurm, these are rocky, treeless places carpeted by vivid heather and wildflowers, moss, lichens, and scrub pines. My stay there was brief, lasting only one Winter day, but I understood why it was given its name. Every night a halo of diffused green light illuminated the northern horizon and gave the cold sea the texture of black silk.*

*Gosti Hyr is in part populated by a wandering race who hunt, fish, travel, and sleep in sturdy ice boats. These stocky folk, the Fustir-Gost, roam to the north and appear to be spread across many lands. Some of their kind occupy another isle northeast of the the watery reaches that compose the Nay Fostisyr ("Waters of Blue Light"). Its pumicy shores are called Mur Fustir ("Land of the Cold Ones"), and unlike the other mountainous isles, it appears totally barren. Dark grey, cave-riddled rocks are all that peek out from the swirling ice flows born of the Fosark Ay ("North-east Sea").*

Of all the spots of the Mur Fostisyr, the fourth big island is undoubtedly the most bizarre. It is a ribbed volcanic cinder cone sown with tall gold grass and surmounted by two high needle-like spires set ten miles apart. Like a great crown placed in a swelling sea, it can be seen from most anywhere. I am sure it is the highest point in the Land of Blue Light, and perhaps all the northern sea. Its residents the Udahir have named it Zjeth Hyyd ("Seat of the Stars"); within its dormant womb they carved their precous secretive settlement Uda Tyygk ("Hidden City").

The people of the Mur Fostisyr are not many. The Ky'taari of Kyvinaar and the Syrkakar of Adea Hu have a number of settlements, but all are small by the standards of the men to the south. The Fustir-Gost of Gosti Hyr and Mur Fustir are scattered bands who scrape out a modest living. Zjeth Hyyd's Udahir are few and cloistered, relying on great skill and carefully managed resources in order to maintain their rich culture. All these races live on resources that wax and wane with the seasons. Yet all have proven able to cope with obstacles that would stay or kill lesser men. I respect them; they are to be reckoned with, just as the servants of the Iron Wind have discovered.

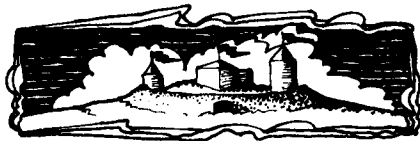

### 3.2 OF THE IRON WIND

Close the windows and bar the doors if you would have me speak of the Iron Wind. It is not wise to know too much of the Unlife, and less wise still to advertise your knowledge. Two thousand years ago, at the beginning of the Third Age of Ire, its presence was felt, coming from nowhere and everywhere at once, yet always in the background. It is not the way of the Iron Wind to show itself to man; it acts but through its pawns.

It was the wars of man that opened the door to this evil in the north, for had the Umli, the Lotan and the Palach not fought among themselves, they might have guarded against the Unlife. About the year 1000, the denizens of the Harl Syrna first beheld the Priests Arnak, whose creed of a holy evil easily seduced these lesser folk. Too late the Umli and the Palach realized their peril as the warlike darkness spread from the Harl Syrna and many fled. Many more went dark, and peace descended upon the region again: the peace of death.

Within the Harl Syrna the very earth seemed to revolt against its new masters. Great torrents of lava and ash spewed forth to cover once fertile lands. Waves of ice descended through the valleys, casting villages into the abyss of death. Whole sections of the range were transformed, and the men who lived to talk of this metamorphosis were taken with awe into the fold of darkness. The Iron Wind's unsubtle hand persuaded them that resistance was less than useless. And they were but the first to quake before shadow; the power that was the Iron Wind moved southward across the frozen wastes, reaching ever outward for new lands and cowed adherents. By 1200 the whole of the Barl Synrac felt their sway; and, in the succeeding years the peoples of the taiga forests also fell, the Syrkakar among them. Few races avoided enslavement, and still fewer remained whole.

#### 3.21 THE PRIESTS ARNAK

The Iron Wind is known only as a power - and only through its minions. The least of these are the Priests Arnak (of High Imla Arna - "The Evil High Priests"), and they are the first to enter a given land that is marked for conversion. They wear the garb of the culture they infiltrate and spread the power of their master not through violence, but by intrigue and knowledge of the superstitions of the people. In the Harl Syrna, among the simple peoples they destroyed the existing society, supplanting the traditional leaders of the people with words fair-seeming and insidious guile.

Few who have seen these priests will speak of them, but what reports there are seem to indicate that they may be of Elven character. They are learned in geography, language, mathematics, religion and the arts. They must spend much time in preparation for their missions, for they rely on a thorough knowledge of the target culture to wreak their destruction upon it. In areas where they have manifested themselves, these missionaries have permeated society at every level, going so far as to become integral parts of the people's everyday lives. Some have aspired to become the advisors of the secular leaders, but the more powerful perhaps remain, like their masters, in the shadows.

The Priests are of six distinct orders, and carry rings to identify themselves accordingly. These rings each embrace great power, but their force is channeled toward multiplying the power of their master. Each ring is tied to its brethren, and the presence of a bearer is known by his comrades such that the pain of one is spread amongst all: Priests Arnak are but tentacles of the larger body, the order. The rings themselves have many tactical powers.

ORDER	SYMBOL	FOCUS
1) Gaath	Dragon	Mountain Folk
2) Lyak	Hawk	Riverine Cultures
3) Yarthraak	Sea Drake	Coastal/Island Peoples
4) Athimurl	Snow Lion	Taiga Forest Peoples
5) Dansart	Desert Dog	Desert Areas
6) Thargondaak	Great Horse	Prairie Societies

#### THE RINGS OF THE PRIESTS ARNAK

- 1) X2 PP enhancer
- 2) Allows wearer to cast three firebolts 100 feet each day.
- 3) Allows wearer to understand any written text, even if he has never seen the script of language before.
- 4) Allows wearer to speak the Elven tongues with fluency.
- 5) Detects magic.
- 6) Allows wearer to halve the adverse effects of fire and cold.
- 7) Protects wearer as AT 4 (-10)

### 3.22 MESSENGERS OF SYRKAKANG

The Messengers of Syrkakang bear only death. These assassins understand not such human things as compassion or pain, save only how to use them on others. They appear singly, or in groups of no more than six, riding great fell creatures through the night. The Messengers wear reversible cloaks of dark green and grey over their black armor, making them almost invisible against the night - their stalking time. The plate is of dragon skin and covers their upper bodies, while flat black helms of steel cover their heads, and their fists are enshrouded in gauntlets of such fine steel that a blow from one is like a hammer strike. Their weaponry is varied as suits their task.

#### MESSENGERS OF SYRKAKANG: USUAL EQUIPMENT

War Hammer +15	Dragonskin Armor +15 (AT 11-15)
Short Sword +10	Helm of Invisibility
3 Daggers +5	Cloak +15 hiding
Long Bow +5	Boots +15 maneuvers
Short Bow +5	Gauntlets, Spiked

Each Messenger is accompanied by a black eagle, his servant and scout.

### 3.23 THE ORDAINERS

The Ordainers are the closest servants of the Iron Wind, and of them only six are known. They are the viceroys of Unlife in its domains and rarely leave the strongholds that are built for them, preferring to send the Messengers to remove those who oppose them or the Priests Arnak. They themselves come forth only in situations where immense power is called for and whole armies would be impractical. They are the demonic masters of such power and it is in consideration of their immense priestly might that my blood recoils, for they are but the servants of the Iron Wind.

The origin of these lords is unknown at present, and will probably remain so for all time. They appear to have become enamored of evil at an early time during the First Age of Ire, seduced by a greater power than is now apparent. Their character gave new shape to their bodies, and they gradually assumed a form that was in all ways without beauty. Normally, they appear as winged demons of some 12-18 feet in height, bearing a weapon in each hand. They have the power of self-immolation, allowing their bodies to become bathed in intense flames which will burn those that come within six feet. Their flesh is all but immune to cold, and the monsters are able to swim with ease beneath the waves in the icy waters about the Mur Fostisyr, able even to burst through the thick ice effortlessly. In addition to their physical might, they also possess the power to modify their form, even becoming invisible. They can survive tremendous punishment, above that of the greatest giant and of the level of the gods themselves, yet they serve the Iron Wind.

The Ordainers possess great intelligence and a love of hate and evil; they revel in violence. Their massive size gives them yet another ability in combat with those fools who would resist them, for unless their mammoth feet are successfully avoided, they will crush a foe, enjoying the dying screams of agony, for no man could possibly survive even an instant under their massive bulk.



*The power that is the Iron Wind must be truly awesome to control such minions, but it goes not abroad on the face of the earth; or if it does, nothing lives to tell the tale.*

#### POWERS OF THE ORDAINERS

- 1) Immolation: They may burn all within six feet with a fire of from 10-20 levels.
- 2) They have the power to cast bolts of fire 100'. The fire is of 20-30 levels.
- 3) They have the ability to modify their size and shape at will, assuming a fair-seeming form should they so desire.
- 4) They may become invisible at will.
- 5) They have the power of great Presence. Upon first sight, those who have never seen them before will be stunned for a minute unless they have some inner saving defense.
- 6) They have the power to "ordain" — to absolve their foes. Treat as **Absolution** on the Evil Channeling lists.
- 7) Their tough outer skin acts as heavy hide plate; At 12 (-30).
- 8) They may fly, and indeed this is their favored form of movement, at speeds of up to 30 feet per second.
- 9) Should they be disarmed, their natural strength and hide allow them to use their very hands as maces + 15. Otherwise, they will strike twice in a round, once with a huge battle axe (which he wields with one hand) that is +30, and once with a whip that is also +30. When the whip strikes, it delivers a flame strike of 10th-15th level each time it impacts.

### 3.3 OF THE PEOPLES

#### 3.31 OF THE FUSTIR-GOST

*The Fustir-Gost have dwelled in the far North for thousands of years and will probably be there thousands of years hence. The Ky'taari say that the Fustir are masters of the Ice Seas, for no other mannish race can stand amid the fury of their bitter frost. It is better said that these waters are master of all men but the Fustir. Untameable nomads, they wander the North in search of food and life. They seek no control themselves, only survival, and this they have found.*

*Legends speak of Dwarven blood among the Fustir, an age old infusion from a time when they lived in the lands of warmth. This is a falsehood mired in the character of the Fustir-Gost. Like the Dwarves, they are rugged and warlike, introspective and conservative, suspicious and jealous of wealth; but they are nonetheless Men. Perhaps their constant warfare with the Elves of the mainland have given birth to this myth.*

*Actually, the Fustir are a remnant of a large group of mannish tribes who once dominated coastal plains of northeast Jaiman. They were a seafaring lot who used their small, stout ships to gather food from the ocean and raid the settlements of their neighbors. Their greed proved to be their downfall. Chronic warfare with the Jaimani-elves sapped their strained resources, notably their few and precious warriors. When their thirst for others' wealth finally touched off simultaneous hostilities with nearly all of the tribes of the Lotan and Chegra, they began a long retreat which carried them across the biting waters of the Northern Sea, to the isles of the Mur Fostisyr. A long peace followed. Fustir groups adapted to a world where swirling flows of ice and rolling walls of nearly impenetrable mists greeted those bold enough to try their luck upon the seas. Later, the Syrkakar and Ky'taari — descendants of the Fustir's Lotan and Jaimani-elves — made the same journey, and pushed the Fustir-Gost further northward, to the frigid wastes and tortured isles upon which they now reside.*

*Flight has remained a way of life among the Fustir, for they have always been lacking in numbers and political unity. Their plight has been one of a people always inheriting less desirable lands, but they have nonetheless proven indomitable, ever-bending yet never succumbing to seemingly stronger foes. Harsh winds carry them and guard them. The Ky'taari bards often sing of these men who relish untameable seas and sail across the rugged ice as if flying upon the breath of the gods.*

#### THE HOME OF THE FUSTIR

*The Fustir-Gost live in a domain that is part land, but mostly a changing swath of cold sea. They have refuges on the Isles of Green Light (Gosti Hyr) and within the caves of the remote Land of the Cold Ones (Mur Fustir), yet they spend most of their time chasing across the Northern Sea between the two havens.*

#### The Fosark Ay, the Northern Sea

*The Northern Sea is considered a wicked place by nearly all but Fustir cultures, for its riches are hidden and its dangers most evident. Six months of the year its waters are covered with huge spirals of thick, moving ice. Bands of glassy whites, blues, and silvers shade the translucent surface and are punctuated by walls and pillars of glistening icy outcroppings. Frequent dustings of crystalline snow add a dreamlike quality to the scene. Still, all this blessed beauty lies amidst vengeful perils. Sudden ice storms spring forth without warning, tempests capable of grinding the stoutest stone and carving hide and flesh as if with a wide, coarse blade.*

*The swirls of ice — traveling in ways designed to mystify and stupefy the best of men — separate and give birth to awful chasms whose mouths are often covered with facades created by gentle snows. Mirror-like mists can gather in seconds and send the unwary blindly into the unseen teeth of myriad ice traps with walls like steel and jutting random spikes ready to impale the foolhardy.*

*Just before and after the long dark winter, there are periods of four to five weeks when the ice and water battle for supremacy. Huge blocks, bergs, and floating fields of crushed ice sweep the sea, hidden amidst the foamy whitecaps. This is a time when a thorough knowledge of the circuitous currents is the only aid which a traveller can safely lean upon. Hail and sleet storms reinforce the terror, in part due to their severity, and in part because of the often near-horizontal nature of the precipitation. High winds add to the excitement. Once I was told of a Syrkakar vessel which was lost in such an assault, its pilot's face torn away by knives of sleet before the ship ran afoul of floating ice. The crew perished, however, when the gales cast the boat up and over, and the waves and wind combined to send the splintering mass tumbling across the seacaps like a disintegrating toy.*

*During the three months of Summer the northern waters are free of ice. Crashing waves mark a swift cold current which rushes always westward. This is a time when the Fustir sail like any other people and spend their time hunting whales and fishing in the well-guarded shallows. Still, problems with frequent fogs and heavy rains make the Fustir sole guardians of the Fosark Ay.*

#### The Isles of Gosti Hyr and Mur Fustir

*The Isles of Green Light are rocky places where the flowering spongy heath gives life to an otherwise stark landscape. Their marshy soil is akin to tundra, frozen three-quarters of the year. During brief periods of thaw, the white carpet disappears to reveal isles laced with rivers, bogs, and lakes. An explosion of festive wildflowers paint the fields. In the winter great flat plains of snow stretch across the land, and herds of antelope gallop over the tundra, following primordial migration routes. Snowshoe hares, wolves and foxes populate the expanse, while seals live below the frozen water. All are prey for the Fustir and the Ovir, the great white bear who is king of the North.*

*North of the Gosti Hyr lies the Land of the Cold Ones, a seemingly barren rock of vast proportions. Like a huge boulder rising out of the northern sea, the Mur Fustir is an active volcanic outlet where vents of hot gasses reach through a maze of lava tubes and intricate gas caverns. The whole island is one great rock which is blessed with criss-crossing caves naturally bored in some remote age long ago. No trees grace the slopes of this isle; only lichens, heather, and columns of steam creep out from the rock.*

#### THE MIND AND SPIRIT OF THE FUSTIR-GOST

*Light and sound dominate the life of the Fustir-Gost. These elements are strong features for all northern peoples, since the contrasts associated with these factors become exceptionally pronounced as one travels north. I will never fail to be enthralled with the complete quiet found on a vast, still plain of snow, or with the always-dark Winter skies found near the poles. These unnerving absences of sound and light are like no other; the feeling reaches deep within the soul. In the North a noise or ray from the sun pierces the shell of this void like the dawn bears the day.*

*Yet there are times where the light and sound are unyielding. The dark Winter sky is often ablaze with the blue and green fires of the Northern Lights, while Summer days are always bright and only the shadows serve to protect the tired eye. Where the seas meet the land or the unstoppable wind drives across the landscape, one's ears ring until they are numb. While among those of the Mur Fostisyr, I always sensed these elements, and likened their coming and going to the opening and closing of a door.*

*It is not strange, then, that the most northerly of these folk, the Fustir, worship light and sound. These elements are as gods, and are viewed as manifestations of the powerful spirits that dictate life and death. Sounds are of the spirit and are masculine phenomena, while the feminine light is a sign of the fate that rules all.*

#### The Sound and the Spirit

*To the Fustir all living persons have a spirit within them, and those of the same family are part of the same spirit. These collective souls speak as one only through the family head, commonly a man between the ages of thirty and fifty. Such a man is called the "Mouth" (Lus), and it is he who rules the household and settles all disputes. His father, or the elder male in his line, loses this power when the younger man comes of age. Instead, the older men become the interpreters of the spirits of others, specifically the souls and sounds found in the wild.*

Sounds of nature are associated with the lost households, and therefore with spirits which have no mouths. There are many dead households in this cruel land, so the voices of the mouthless spirits are many. Where they speak loudest — by the seashore, beneath waterfalls, or in narrow canyons — stand the most sacred of places. In these hallowed spots the elders talk with the spirits and hope to glean some knowledge of things to come. Thunder and the roaring wind show the anger of these spirits and portend terrible cataclysms: avalanches, tidal waves, storms, and the like. Soft breezes and caressing whistling invariably forebode good times.

Since younger sons cannot rule the households in which they are born, many seek new homes. In this way they can become the mouths of new families and carve out their own destinies. This is a most peculiar concept which I can only characterize as unique. Since this practice reduces stress and allows a new home for the lost spirits who enter the new households, I suppose it is good.

#### The Light and the Fate

Women are the interpreters of Fate (Lufig). Their role in this realm is critical, since the Fustir believe that Fate is the power that binds and rules all things. It is as a supernatural force which composes all of the energy that is neither spirit nor solid. Fire is like the hand of Fate and gives life to the spirit in the cold of the North, but pure Light (Syr) guides the hand and opens paths in the Dark.

Sometime between the ages of ten and twenty, women choose whether or not they wish to marry and bear children or whether to enter the Order of Sages (Clur Lufir). Those choosing the latter course begin their relationship with Fate when they are twenty. Ten years of midwifery and apprenticeship follow before these women reach the revered age of thirty. Then they become the seers and mages of the Fustir and serve as the arbiters of the views of what should and will be. From the age of thirty on, Sages travel with their families and spend their time watching the lights in the earth and the sky for signs that guide the path of Fustir society.

I must say that the most unusual of lights tend to speak of doom, although the Ky'taari have told me that the Fustir fear blue light and warm to shades of yellow and green. White light is apparently neutral, while the oranges and red associated with fire are marks of birth and maturity, respectively.

#### THE FUSTIR LIFESTYLE

Fustir life is a nomadic existence, tied to their famous boats. These 25'-50' clinker-built vessels are called Silver Claws (Lahiri Kuf) because of their blade-like ice runners. Strong gut and hide triangular sails and hollow metal runners (which are buoyant in open water) add speed and flexibility to a design which is strong enough to cut through most floating ice. These boats are comfortable enough to accommodate a family of fifteen.

#### Trade and Subsistence

Throughout the Winter the Fustir hunt reindeer, antelope, and seal from their rugged boats, surrounding the herds and slaying as many as they can before the survivors break free. They eat, sleep, and raise their children in the Lahiri Kuf and only return to land for their monthly festivals, or in times of unusual danger. Some Fustir groups migrate southwestward to the coasts of Yalf Hurm. There I have seen them trade with the Ky'taari who were once their sworn enemies. The Fustir acquire paper, silk, wood, and high grade metals in return for gems, bone, hide, and spice. My Ky'taari friends spoke of a peace made between the two peoples not long after the coming of the Iron Wind, and in this, the Ky'taari are the only true friends of the insulated Fustir-Gost.

In spring, when the lands yield grudgingly to growing things, the Fustir settle into camps upon the shores of the Gosti Hyr and Mur Fustir. They live in cleverly-hewn caves and oblong stone houses whose high, pitched quartzite roofs rest upon short, earth-covered granite walls. This is a time for gathering spices and harvesting the wild grains called Kulwek. Festivals and trading dominate the long, warm days, while extended fishing and whaling parties take sail during periods where the storms rise. The boats supplement the diet and provide bulk for the emergency winter stores.

A few antelope and deer are domesticated, but the major portion of the Fustir summer diet comes from Kulwek, Lotank berries, and the ever-present gifts from the sea. Winter sustenance is derived from big game and whatever stores remain after the gathering season. Beer mixed with a spiced mineral water is the favored drink, although, Ky'taari wine, deer milk and various mineral "juices" (Bektis) are also consumed.

#### Order and Kinship

There seem to be five tribes of Fustir-Gost. A sixth group is maintained on Mur Fustir, but it is no more than an amalgamation of those too sick to travel, those who guard the tribal stores, and certain apprentice Sages. Each tribe has about one thousand people and is divided into clans of 200-500. The clans are, in turn, broken down into kindreds or collections of families.

Those families I encountered off the shores of Yalf Hurm were extended groups of about thirty folk. My Ky'taari guide spoke of them as typical, each having a leader, or Mouth, who received his right of power or "spokesmanship" upon reaching the age of thirty. His position is one of great honor since the Fustir are all but illiterate and rely on a refined oral tradition. Nonetheless, women are prominent figures. Like all the Fustir, they can own property from birth. They rarely fight, but often aid in sailing. Older women are also keepers of records and manage the family resources. Some hunt, but most spend their time making clothing and gear or raising offspring. As I noted earlier, they also have access to the Order of Sages.

These nomads need no coin, and barter is their way. The standard of payment is one hide, which is equivalent to twenty-five pounds of raw fish. This system of exchange is also the basis of their legal system. Of course, order among scattered families is rarely a problem, and the norms are almost always adequate to keep the wild one in rein. Still, the Fustir have a simple way of settling their disputes. When a member of one's kindred commits a crime against another, their responsible kindred must pay the victim's family restitution considered equal to the transgression. Each member of the culprit's kindred is responsible for a portion equal to their status in life. Some crimes, however, cannot be erased with goods, so the perpetrator is occasionally required to become the slave of the victim or his family. The ultimate sanction, death, appears to be rare or non-existent.

Decisions at a higher level are infrequent. Survival is usually left to the family, and this notion reinforces their feeling for their own collective spirit. In the upper echelons the Fustir work through two groups, an advisory council of clan heads, and the Sages. Sages actually meet as a group and elect a leader for a season, usually their eldest capable member. Her word becomes law when the clan council (Fusawkir) declares that the time requires a reading of the Fate, which occurs in times of war, or when the Sages find the Light speaks of doom. I find this latter procedure strange, and am tempted to agree with the Syrkakar adage about the Fustir being ruled by old women. But then again, I am no reader of Fate. For me, the Northern Lights are like a curtain reaching down from the place of gods, intended to dance and to entertain us.



FUSTIR WARRIOR



### THE FUSTIR-GOST

**Racial Origins:** The Fustir trace their origins back to the hardy Umli peoples, whose homeland is the extreme north.

**Home Region:** Only in the Land of Blue Light are the Fustir known to live as a culture, although there are rumors of small settlements of the race along the northern coast of Jaiman.

**Favored Ecosystem:** As with all of the Umli, the Fustir have the unique ability among the Mannish races (that is, excluding the Elven and Dwarven peoples) to resist the icy northern blasts. Here they live in relative comfort.

**Political Structure:** A loose clan structure is all that exists of a government for the Fustir-Gost, unless one includes the Lord Warrior, but his power is only real when the Fustir are at war, and even then his sway is limited to decisions related to war.

**Social Structure:** The extended family is the basic unit for this people, and beyond that few rules or rigid customs affect their lives.

**Settlement Pattern:** The Fustir are nomadic during the winter months, returning to their stone clan dwellings every summer to tend and harvest what crops they can.

**Military Structure:** No structure exists, although beginning at the age of nine, children of both sexes receive basic training in skills with the axe and short bow. As mentioned earlier, the greatest warrior among the people is acknowledged as military head.

**Currency:** None. Barter is the norm.

**Language:** The Fustir-Gost utilize an Umli-related tongue.

**Appearance:** Short and stocky, the Fustir men range in height from 5' to 6', and weigh between 130 and 200 pounds. The women average 5' in height, and their weight is around 100 lbs. All have pale skin (more so in the late winter and early spring), grey eyes, and most possess silvery-white hair, the others having hair which is raven-black.

**Housing:** When not in their nomadic period living in tents fashioned of antelope hide, the Fustir reside in domed circular structures of stone.

**Diet:** The staples of the Fustir diet are fish and any Lotanak berries they can gather, though they supplement this with antelope, seal, and a variety of edible wild plants.

**Worship:** More a collection of ritualized superstitions than a religion, the Fustir believe in many gods which direct and control various aspects of their everyday lives.

### 3.32 OF THE SYRKAKAR

*Given the incredible nature of the Mur Fostisyr I was not surprised to find that many of its inhabitants were suitably extraordinary. The fact that the average Ky'taari and Udahir were uniformly magnificent and powerful nonetheless proved startling. Their vigor and grace, their enchanted cultures, stand in stark contrast to the rude societies of mainland north-west Jaiman. This great strength is of necessity, however, for the noble free-men of the Land of Blue Light have to combat more than just nature; each day is also a constant struggle against the persistence of the people known as the Syrkakar, the "Lords of the Blue Forest."*

*The Syrkakar are the most numerous of the peoples of the Mur Fostisyr. Tenacious and warlike, they conquered the whole of the relatively fertile isle of Adea Hu ("Pillars of Black Ice") within a year of their arrival, and they have wasted little time letting their neighbors know that they intend to claim all of the isles as their own. The Syrkakar count no allies among the peoples of the Land of Blue Light. They have brought suspicion and war — and worse, they now serve the ends of the cold Iron Wind. Still, theirs is no simple story, and their tale is as much one of sadness as it is one of hate.*

#### THE ORIGIN OF THE SYRKAKAR

*I first encountered stories of the Syrkakar while recovering among the Haid tribes some decades ago. The Haidac bards spoke of the many offspring of their culture, and the Syrkakar figured prominently as a group of northern clans whose ancestry was tied to both the Haid and the Haid's ancient foes, the Fustir.*

#### The Tale of Ugus Fost

*Long ago, in the Blue Forest that divided the Haid and Fustir hosts, a Haidac warrior called Ugus Syr wed the captured Fustir queen Kufina Smei and became Ugus Fost. Ugus was a rough man, and given to bouts of tremendous rage, often brought on by drinking too much Juhur. It was apparently not unusual for him to call his men to war, and his fiery manner led to strife with both the Fustir and the Jaimani-elves who occupied the dark and sacred wood known as the Blue Forest (Syrkya). Legend says that Ugus understood the long-standing rivalry between his two enemies and used it to forge a new kingdom. Leading but a single clan of spearmen and accompanied by the war wolves the Syrkakar have since made infamous, Ugus broke the hallowed ban on entry into the forest. He crushed the Elves and surprised the Fustir lord Lahira Gul. All the Fustir were slain, and Ugus returned in triumph with his foe's young bride. His ten clans swore by him as king of both the Haid and the Fustir peoples and called for their brethren to acknowledge him as overlord.*

*The Haid balked though, and the fifty clans of the five tribes refused Ugus' claim. They drove Ugus and his people into the depths of the Blue Wood. There they stayed and built their own realm using the remnants of the Elven holds and the women they took from the defeated Fustir. After centuries of isolation the ten clans became known as the "Syrkakar," the Lords of the Blue Forest.*

#### The Migration and Perversion of the Syrkakar

*My curiosity was stirred by tales of a folk who so thoroughly vanquished the formidable Jaimani-elves, but I was forced to leave the Haid and did not hear of the Syrkakar again until I came upon the Ky'taari and the Land of Blue Light. The Ky'taari are kin to the ancient Jaimani-elves in the North and they have not forgotten the wrong done their forebearers by the clans of Ugus Fost. More than a few stirring, lyrical Ky'taari songs tell of their enemy's history and coming.*

*Two hundred years ago great changes came to northwestern Jaiman and the heirs of Ugus Fost, led by Uka Ciosk, were forced out of their homes in the Blue Forest. They resolved to seek territory which could not be assailed, so they embarked on a migration northward across the sea to islands reputedly rich in stands of great trees and blessed with the wealth of many kingdoms. Taking everything with them the Syrkakar crossed the waters during the calm of summer, making the voyage on their large lake ships. No one contested their movements and most of the low, wide vessels landed safely on the southern side of Adea Hu. Their scouts had proved true; the scattered Fustir Gost were caught unaware and lacked the invaders' numbers. The Syrkakar conquered the island, and drove the hunters onto the northern ice.*

*A proud and independent people, the Syrkakar had little trouble adapting to the unique clime of the Mur Fostisyr. This self-sufficiency proved to be the salvation of their neighbors, however, for with the establishment of their new homes and the call for resolve against the Ky'taari and Fustir Gost the ten clans began to quarrel. Uka Ciosk, the ninth Syrkakang, was murdered by his nephew, and the precious and mystical Collar of the Great King (Twy Syrkakang) was lost. It has never returned, although it is said that it disappeared with the nephew in wastes of the Gosti Hyr ("Isles of Green Light").*

*In the decades following the Clan-war the Syrkakar clans went their own way and carved out their own small realms. The Ky'taari speak of this time with favor, for there was peace and a number of the Syrkakar sought to trade with the other races of the region. The straits between the islands were free from ships of war. During this placid era the Syrkakar clans turned to their ancient councils for advice, choosing to act in unison or on their own as need be.*

*Only a few years ago this quiet was broken. The Ky'taari have mourned this changing, although they cannot place the exact time or cite the means of transformation. They only know that the rise of the tenth Syrkakang was spawned by the evil breath of the Iron Wind. A new union has been forged among the clans, one born of steel and aimed at the conquest of all the Land of Blue Light.*

#### ADEA HU, ISLE OF THE SYRKAKAR

*Adea Hu appears as a series of intertwined wooded ridges which rise quickly from a narrow coastal shelf and reach upward toward the island's center like the convex spokes of a crippled wheel. The ridges fan out from the protected valley that crowns the heights and, nestled between these forested spines, lie deep canyons which embrace an abundance of thundering mountain water. Tall blue-grey spruce and cedar can be seen everywhere, and those viewing the isle's shores from afar might mistake*

the rugged topography for a gentle grey carpet. I was astounded at the density of the wood, for in all my travels I have rarely seen such a closely spaced grouping of trees. On Adea Hu it is not unusual to walk for hours beneath a solid roof of pine, interwoven limbs joining a seemingly endless parade of two hundred foot firs. Soft mosses peek out from the deep sea of needles and only the occasional beams of penetrating light produce any sort of undergrowth.

The island is a little over a hundred miles long, and spans fifty miles at its widest. Although it is an island dominated by trees, its size naturally produces a bit of isolated variety: frequent outcroppings of dark rock forge clearings along the slopes; quiet bays, sandy beaches, and small river deltas lie along the seaside, under the shadow of steep black cliffs which shine like glass. The most important features are, however, the two great valleys where the Syrkakar grow their staples and base their strength.

#### **The Yalg Kway, Valley of Pools**

A long, relatively low ridge runs for fifty miles along the southwestern coast of Adea Hu. I first mistook it for a huge, sleeping cat, but I had perhaps too much of my Ky'taari hosts' revelry. In any case, one sailing on the warm waters cannot help but see the ridge as a sort of rampart. The Syrkakar call the three thousand foot high ridge Hegra Surm, the "Bark Wall," because of the thick black trunks of the hundred foot Ukur trees that dominate its flanks. They are the only broadleaves of note on Adea Hu and they are revered for their many seemingly enchanted gifts.

Behind the Bark Wall — between the ridge and the great central highland called the Kanga Syrn ("Mountain Father") — lies the "Valley of Pools," the long and narrow Yalg Kway. This U-shaped vale runs from the southern reaches of Adea Hu in a northwesterly direction and is about forty-five miles long. Within its bowels are dozens of deep lakes, most little more than pools cut into deep rock. These are warm waters which are heated by the earth's fire deep below, and the Syrkakar have long relied on their rich nutrients and soothing ways to provide nourishment and comfort. In addition, the larger lakes are connected by fast but navigable streams and allow for commerce. They empty into the sea at Brya Sug ("Door of Trees"), the Syrkakar's chief market and port city.

The Syrkakar have built a network of small gardens and orchards along the waterways of the Yalg Kway. Here I found the source of food for much of the population. Boundaries of deep grey stone separate 50' x 50' plots set in carefully tended clearings. Stands of fruit and nut-bearing trees line the elevated pathways of the vale, routes whose foundations double as defense perimeters. I was never surprised to see such elaborate provisions against attack, for all the Syrkakar I encountered were suspicious of other men, even their own, and remembered well the wars and clan-strife of old. This fear has led them to build their settlements along the heights which overlook the valley. Each of the five clans which live in the region maintain their homes on the mountain ridges, or on the occasional islets and hillocks which are sprinkling in the network of lakes. While traveling southeast out of Brya Sug, I could see scores of small trails leading off across the valley and up into ravines where the only sign of habitation was a column of bluish smoke rising out of the dense Ukur forest. Occasional pallisades crowned the hills along the valley floor. Each guarded clusters of five-sided huts and a single stone refuge, Syrkakar versions of village life.

#### **THE YALG SYCLAX, THE VALLEY OF THE FIVE GATES**

The second settlement area found on Adea Hu is called the Yalg Syclax or the "Valley of the Five Gates." Syrkakar legends speak of a time when this great bowl-shaped vale was filled with a lake, before the Spirit Urkanga picked up the island and consumed the water as if he were drinking from a long-handled cup. From that day on it has been a blessed refuge and a place of enchantments.

I first looked upon the valley after a tortuous climb up the northern side of the Kanga Syrn. My guide was a young man called Wudus Pode, a congenial fellow who hailed from a small settlement located in the northeast of Adea Hu. His tracking skills were extraordinary even by the Syrkakar's high standards, so he was able to locate vestiges of even the oldest tracks and trails. Ostensibly, this eased our ascent, although the great abutments made each switchback wind through treacherous pillars and along unsettling cliffs. From a small, grass covered ledge set just inside and below the narrow rim we could clearly see the whole of the Yalg Syclax. It is shaped like an elongated pear which is about thirteen miles long and eight miles wide. Gentle hills cover the bottom where a wealth of streams, pools, rocks, and stands of trees break the flow of a uniform carpet of grey-green grass and stunning wildflowers. The sparkling waters of the Yon Syclax ("Five Gates River") meander across the vale and exit through a pass to the southeast. There, beneath a 900 foot natural arch called the Urm Lyvug, it plunges over a series of cliffs before making its way to the sea.

This placid spot is set amidst some of the most spectacular scenery I have ever witnessed, and is akin to the calm eye in a beautiful, shadowy storm. The sweep of graceful fir boughs is everywhere set against a backdrop of ribbon-like waterfalls and sheer walls of black glass. Our ledge was like a thousand others, for the entire valley is surrounded by 900-1500 foot cliffs composed of volcanic lyhur ("Armor-glass"). Spires and arches jut out all along the wall and add splendor to an already breathtaking setting. Still, they only enhance the feeling that the Yalg Syclax is a wonderful prison. Only five narrow passes break the ring of hard rock and allow access to the rest of the world.

#### **SYRKAKAR LIFE AND CULTURE**

The Syrkakar are a violent people who hunt and fish for much of their food. Agriculture is limited to the potatoes and barley grown in Adea Hu's two arable valleys: the Yalg Kway and the Yalg Syclax. Nuts of the Ukur variety are the only other cultivated crop. Some herd animals are kept, but for the most part the diet of the Syrkakar is met by his hunting and foraging, be it in the highland forests or among the towns and fields of the neighboring lowlands. Masters of the woodland trails, the Syrkakar track the elusive Nemmi ("Mottled Grey Deer") through the vast taiga forest, much the way their ancestors on Jaiman hunted the beautiful striped Jaiabu stag. The one and a half ton Nemmi will feed many a hungry mouth during the long northern winter and is used to make stew, steak, and broths. Its horn is prized as a tool of storage and sound, while its gut and sinew (tendon) are used to make thread and facings on the Syrka's short composite hunting bows.

#### **THE SYRKAKAR**

**Racial Origins:** The Syrkakar originated on the mainland of Jaiman, in an area dominated by the 'Blue Forest', hence their name: *Lords of the Blue Forest*. They are a result of the blending of two racial groups, the Haid and the Fustir.

**Home Region:** Currently the Syrkakar inhabit Adea Hu, the largest isle in the Mur Fostisyr.

**Favored Ecosystem:** Though they prefer a slightly warmer climate than that offered by the Mur Fostisyr, the Syrkakar are very adaptable and have had little trouble carving out a niche for themselves.

**Political Structure:** Ten clans (*Olzaw*) divide the Syrkakar, each ruled by a *Kakar*, and the clans are tied into two groups of five, each group having its center in a metropolitan area. One group's focus is *Syclax*, the other *Brya Sug*. There is also a 'High King' of the Syrkakar known as the *Syrkakang*.

**Military Structure:** The five clans under the sway of *Syclax* are far more militaristic and hostile towards others. They maintain armies, and the city itself is heavily defended. The *Brya Sug* clans have a more commercial bent, and their city is a trade center. In both cases, boys are trained in the use of

short sword, composite bow and pole arms from the age of seven. Syrkakar tend to wear rigid leather breastplate or chain shirt, both sleeveless to allow arm freedom for bow use.

**Currency:** Syclax mints a silver, bronze and copper coinage.

**Appearance:** Short and stocky, the Syrkakar rarely grow to more than five and a half feet in height. They have ruddy complexions and reddish-brown hair. The men often wear beards and many go bald in their early manhood.

**Housing:** Five-sided structures are the norm for these people, all of their homes having partially excavated entries to help conserve internal heat. The pentagonal design persists from the rudest rural hut to the great meeting towers in the cities.

**Diet:** The Syrkakar are a violent people; they hunt and fish for their food. Agriculture is limited to potatoes and barley grown in the Yalg Kway, and nuts gathered from the Ukur Valley.

**Worship:** Not really possessing a unified religion, the Syrkakar are on a more superstitious level. Lately, however, they have fallen under the sway of the Iron Wind and they turn to their new Syrkakang with an almost worshipful vigour.



### The Ten Clans ("Olzaw")

Syrkakar society is based on the Olzaw (clan), and each clan resides in a separate unit of villages. These units lie in the central area of the clan's territory and, aside from the interclanish city holds of Brya Sug and Syclax, no clan settles nearer than 5 miles to its closest neighbor. All of the clans are tied to the land and maintain their spiritual centers in the relative wilds. Those folk that move to the two cities are more worldly than their rural brothers, but they still return to the countryside during the few days of spiritual celebration and unity. Political and religious power remains the province of the conservative villagers. Neither Brya Sug or Syclax serves as a clan center, although the Ukasur of the latter town have begun to assert control of the rural elements of their clan.

There are ten self-sufficient clans and each Olzaw has as a symbolic focus a specific type of tree. All of the Olzaw's representative forms stem from this tree-colors, patterns, rites of passage, etc. The names of the clans (in order of size) are:

- |             |          |             |
|-------------|----------|-------------|
| 1) Kasir    | 4) Atir  | 8) Ukasur   |
| 2) Umlatir  | 5) Ulir  | 9) Huralir  |
| 3) Sarkasir | 6) Tavir | 10) Olkusir |
|             | 7) Olzir |             |

Within each Olzaw are two distinct divisions (moieties) which are traditionally divided between the "dark" (Y) and the "light" (U). The first Syrka I ever encountered was of the Y-kasir ("Dark Kasir") moiety, from the Yalg Kway's Kasir clan. Regardless of clan, the dark group is concerned with domestic affairs: the raising of crops, caretaking of the village, child-bearing, etc. The light group deals with external affairs such as trade, diplomacy, hunting and war. Both embrace like social patterns, and none of the Syrkakar are permitted to marry within their moiety. From what I can tell, almost all take mates from the other group within their clan, avoiding marriage with others.

Just as they believe there is power in the color blue, the Syrkakar revere the numbers "2" and "5". As a result, they have divided many of their social units into groups based upon these numbers. Thus a structure of ten clans (2 groups of 5), each with 2 divisions, has arisen. Among the Syrkakar, only men are counted; women are considered little more than important chattel. Males may take two wives, but they must keep them in separate homes in unique locales (usually in separate villages).

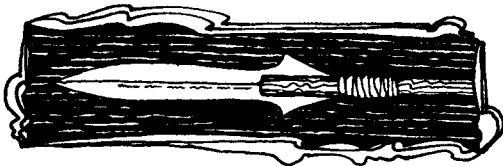

### Syrkakar Government

The Syrkakar are politically united but philosophically independent; only the brute hand of the current Syrkakang holds the clans together. Traditional government was effective and the closest thing to a governing body was the Syrn Gwor ("Blue Hall"), composed of two representatives from each of the Olzaw. The Gwor served as an advisory unit in times of profound stress and as a mediation group whenever there was a serious dispute among the Olzaw. Although it still meets on the Nights of No Moon ("Kjijurl"), it has not served the needs of the Syrkakar since the days of Ugus Fost.

Today, the actual power and authority of the Syrkakar is spread out among the Kakkar (the "Forest Lords"). These men, each a Kakar of a clan, have absolute power over their people. When a Kakar takes power, he must choose his successor from the men then living, thus a new leader will owe his position to no living man; The Kakar will then hold power until death, at which time his appointee, the Ryrk ("Shadowy One"), steps forward. The Kakar also chooses the Nyrs Gwor ("Grey Hall"), a body composed of five elders, all men, who serve one year terms. They aid the Kakar in preserving the independence of the Olzaw, and these advisors from within the clan cannot simultaneously serve on the Syrn Gwor, or be the Kakar's successor (the Ryrk).

The two representatives to the Syrn Gwor are also appointed by the Kakar. The senior member must be one who served in the Nyrs Gwor under a previous Kakar. His partner, the junior member of the two, is the successor to the current Kakar — the Ryrk. The senior representative is chosen for life, and is called by the title of Lostyrk ("Wise Dark-purple One"). The junior member serves until his death or his rise to the position of Kakar, whichever comes first.

### The Tenth Syrkakang

The Iron Wind was, at least at first, a force unseen amidst the turmoil of Syrkakar infighting. In recent times the Olzaw often found themselves quarreling and often at war. Those of the Yalg Kway suffered the most and part of Brya Sug were frequently put to the torch. Even the interclanish town of Syclax was beset by rioting. All over Adea Hu, Syrkakar religious and political leaders died in odd ways, usually well before their time. Basic institutions broke down until the rise of a new force turned the tide of chaos. He was Jyka Brust, the twentieth Kakar of the Ukasur clan.

Local legends say that Jyka Brust was born in the Wasyclax about fifty years ago, but I am not convinced of the story. My Ky'taari friends have long sought an answer for his origin and power and note the strange nature of his rise. About twenty years ago he took control of the Ukasur when his predecessor and father was killed by mobs at the market in the Irm Ukasur district of Syclax. Acting quickly, Jyka seized the hour and united his clan against their brethren. Ukasur warriors crushed the unrest and clan-strife in Syclax. Wasting no time, they marched on the outlying centers of the other four clans of the Yalg Syclax. Within a month of his accession, Jyka had control of Adea Hu's heart land. Under his influence all of the other four Olzaw decided to join in service to a new lord, the tenth Syrkakang ("Overlord Of The Blue Forest"). The strange and shadowy figure was revered as a teacher and unifier by Jyka and his forces and they called him "Saaymog" (Sy. "Great Sky Fist"). No one had ever seen him, but his servants were many and his army ruthless. Most importantly, the entirety of Syclax's social fabric had been infiltrated by those who looked to him as lord and master. I for one believe he was, and is, of the Iron Wind, for even today he does not show himself. Instead, he prefers to dwell in Var Ukaak ("Unseeing Eye"), the great tower in the valley of the Yalg Kusir ("Valley of Red Needles").

As recent years passed, the forces of the Syrkakang have subjugated the other four Olzaw as well. These lowland clans resisted force, but were swayed by the authority and power of their fervent brethren. They pay a great tithe to the Syrkakang, and oft times send their armies forth to do battle for causes associated with the expansion of the rule of the Iron Wind. Still, the people of the Yalg Kway are considerably more independent than the folk of the Yalg Syclax.



Syrkakar Warrior

### Syrkakar Warfare

The Syrkakar have long been known as great warriors among the tall trees of the northern taiga. They train their men in the use of arms and the skills of trapping and tracking from their early youth, giving an hour or two of outdoor instruction six days of each week (their weeks being of one full cycle of Vello, the second largest moon, which orbits once every ten days). Short swords are their favored weapons and leather breastplates their armor; elite units — notably among the Ukasur clan — use war hammers and may wear the hide plate mail created from the skin of the Hojarga, a powerful drake-like beast indigenous to the clefts of the Kanga Synn. All of their garb is dyed a grey-blue, although members of each Olzaw wear a colored cloak unique to their clan. Nonetheless, the reversible inner side of this long, protective draping is always camouflaged: dark green in the summer, and greyish-white in the winter.

Their armies are modest in size, and rarely number more than 1000, despite the numbers of the Syrkakar. Usually they fight in 50-man units known as Lirds ("Packs"), and this is their normal raiding force. Each Lird is a self-sufficient machine of war, and employs 10 wolves and 10 hawks to aid in the chores of keeping watch and trailing their prey. A more complete listing of their military organization would be:

Name of Unit Type	Number of Men
Lirk (Small Pack)	5
Lirm (Lesser Pack)	10
Lird (Pack)	50
Surm (Lesser Force)	200
Surd (Force)	1000



### Syrkakar Architecture

I have never lived among the Syrkakar, nor should I ever wish to, but I passed some time on their isle. They are a poor people and live in five-sided houses, the Vyrtan ("Closed Huts"). They are built of wood and bark, and have two shells laid over two connected frameworks. The foundation is a raised earth and stone mound, an artificial hill, with the walls on the lower edges of the slopes. Entering one for the first time was an experience, for, to preserve the heat inside, the entry is a trench of three feet in depth and the Vyrtan is built on a level several feet above the ground; thus, I found myself staring at an eye-level floor as I came in. The walls are at the outside of the hill to break the first blast of the wind, while the sloping ground and a series of hide baffles contribute to the calm inside. One inventive feature found in many of the Vyrtan and most all other Syrkakar structures is the chimney; most are weed, coated with the resin from the fire-resistant Ukur tree; preventing fires from getting out of control.

The ceremonial structures of the Syrkakar have ten sides and are often quite large. Some, rising as high as five stories, serve the entire Olzaw. The highest hill in the clan's territory is always occupied by the Burkik Mug ("Hill-hold of the Great Stone"). It is always the largest building of the Olzaw and serves as a meeting hall when they assemble. This occurs in time of danger or at each full face of the year's "largest moons".

The Turm Kug ("Hill Watches") are the sole stone Syrkakar military structures outside of Syclax, with the exception of the fortified residence of the Syrkakang. These ugly warts upon the landscape are 50 to 150 feet in diameter and 30 to 100 feet in height, and are constructed entirely of fitted blocks. So far as I could tell, the Syrkakar know not of mortar, being skilled carvers and rarely working with traditional stone architecture. These people employ wood and carved rock for their abodes. Where the terrain does not bless them with natural housing like that found at Syclax, they resort to the gifts of the forest. The near entirety of Brya Sug is of wood.

Under the new Syrkakang, however, this practice may be changing. With unity comes the power to build ambitious structures and, as I departed the land of the Syrkakar, I noted a few watchtowers on the western coast of Adea Hu that appeared to be of stone construction. Since my carrier would not weigh anchor in the narrow coastal canyons that are illuminated by their watch-fires, I felt it better to return and explore them at another time — perhaps when the Iron Wind has died.

### 3.33 THE KY'TAARI

Upon the very edge of the great northern Ice Plains, yet within the valleys embraced by the northern mountains lies the land of the Ky'taari ("Ice People"). Here it is that the winters are so dark and long, and the summer so fleeting, that the precious sun is worshipped as a Goddess. I found my way to their secluded land by paying passage upon one of their Ky'farni, the ice boats the Ky'taari learned to build from the native Fustir. These small ships are equipped with outriggers edged with long runners fashioned of a fine steel which does not rust. These craft are capable of transferring from ice to water and the reverse with ease, moving at great wind-driven speeds, for the northern blasts are quite fierce.

At first the Ky'taari were wary of me when I attempted to pay for my passage in gold (little did I know that gold was a holy metal among these people!). Thinking fast, I made an offering of all my gold to their goddess, who, I had fortunately learned earlier, was Ariaana, keeper of the sun. The traders realized that they must have misunderstood me initially, and when they perceived my rich offering, the Ky'taari welcomed me openly and would accept no payment for the ride. Such is the life of a Loremaster, filled with improvisation. It is a wonder I have lived so long.

The traders told me of their people, as we glided swiftly across the frozen lakes upon the Ky'farn. The Ky'taari trade elegant paper and pottery in the south, their finely crafted stoneware calling forth memories of the distant Elven lands. To dispell the darkness and cold of the voyage, they sang to me of the past, telling of how these people of Elven blood became residents of a realm of ice.

The great migrations were a time of turmoil, and the Elven kindreds were sundered. Some abandoned the journey south, to abide with those peoples who already had settled so near the pole, teaching and learning the skills of the ice. 4000 years ago, by my reckoning, for they have no need of one among themselves, they befriended the Umli, who delight in the many fair things that the Ky'taari fashion with their hands. The Fustir taught the Ky'taari the way of the Ky'farni, and the Ky'taari increased the speed and strength of the boats with their forging skills. An unusual friendship was thus born, for of all peoples of the north, only the Ky'taari can claim the friendship of the Fustir.

But for their alliance, both races would have perished in the face of the Iron Wind. Soon after the upheavals of the Barl Synnak, its many servants issued forth like an overflowing wave and splashed upon the mountain peoples. Together, the Fustir and the Ky'taari held them off, until the dark master, turning his minions to more fruitful targets, moved away from their gates. To this day they boastfully await the return of the Iron Wind and tell tales of their continued independence, but I have seen the might they wish to conquer, and it cannot be done.

Many tales and many days later, as we moved across the frozen surface of a narrow river with breathtaking speed, I caught a glimpse of something white and gold glistening on the face of a cliff a few miles ahead. When I asked the captain, Talfar, what it was, he smiled and told me to be patient. As we approached, the sun rose fully and the object on the cliffside burst into blinding glory, outshining the snowcapped peak above. Only then did I realize the nature of it: a great keep, clinging tenaciously to the sheer cliff face. Fashioned of pure white stone, called Ky'taal ("Ice Stone"), with roofs sheathed in gold, it appeared as a huge jewel set in the mountainside. Seeing the question yet on my face, Talfar told me it was the palace of the Ataarn, the King of his people. Overlooking the capital city, which rested on a lower shelf of the mountain, it stood guard for a people. The Ky'taar directed my gaze further upward, and after a moment I saw, upon the very brow of the cliff, another glint of gold and silver-white amidst the snowy peak. There was a slender tower adjoining a small rectangular building, both shining in the sun. This, the captain told me, was the A-Anaar, the high temple of the Ky'taari: the symbolic home of Ariaana, goddess of the sun.

Soon we came to the capital city, sheltered behind a large bluff, all but invisible until one has nearly passed it. The entire city seemed to be made of a marvelous stone, carved and gilded with amazing intricacy. The captain and my guide, Talfar, offered me lodging during my stay, for his people received few strangers, and as well he wished to spare me any expense. I gratefully accepted, and was to learn much of the Ky'taari from the captain and his family.

The Ky'taari are predominately human, though I noted the classic Elven grace and finely boned faces of that race among them. The men are beardless, and their hair color ranges from a sandy-brown to white-blond, usually cut just below the ears. They are tall and frail-seeming, again as Elves, though no race that could survive up here could be such.





## Ky'taari Warrior Monk

*It is true that they are not exceptionally strong, but their agility is to be marvelled at, and they seem to have inherited a resistance to cold from their immortal ancestors. Among these people, only the royal family have eyes that are not blue; it is said that those lords bear eyes with irises of golden amber; indeed the Ky'taari are truly a people of light, gaining strength with the presence of the sun.*

*The Ky'taari emphasize peaceful pursuits: their culture can be divided into the following professions: Farmers, Traders, Fishermen, Master Craftsmen, and those who would choose a religious profession: the monks and Ryanni.*

*The Farmers, the largest group by far, spend their summer cultivating the rocky soil of the area. Although the land is poor, the farmers have found two plants that can draw nourishment from the cold soil: shir, a hardy grain resembling wheat, and lotanak berries. Shir is sown in the fall, much as winter wheat in other lands. When the spring comes, the temperature rises slightly and the shir begins to grow, the first shoot appearing even as snow still covers the ground. The lotanak are dark brown, and slightly larger than a walnut in appearance. They have a hard outer shell, and a firm, juicy inner core. Harvested all year round, they are a crucial part of the Ky'taari diet.*

*In the winter farmers aid in making a paper of fine quality from the bark of the tonak tree. These trees are harvested in the summer, for the crops of the Ky'taari grow almost in spite of human aid. Stored in caves, they are ground to pulp and mixed with water to form a milky liquid. Screens of fine mesh silk are drawn through the liquid by the skilled papermakers, collecting the long fibers of the pulp through the water to form an even layer. This substance is cast upon a large table of ky'taal, pressed under another, thinner flat sheet of stone, and is kept warmed by fires beneath. Dried in this way, the substance is bonded into an almost featureless and strong paper that the Ky'taari have been known for in regions as far away as the sea coasts of the main continent for generations.*

*The Ky'taari have domesticated two small animals whose fur they shear and use for clothing. The torkaan is a large woolly sheep-like creature that seems to feed on almost anything, foraging about for itself, and gives milk in the bargain. The smaller koylarin requires more care and is often the pet of the Ky'taari children. The weavers of the Ky'taari shear these animals frequently and produce from the torkaan a thick wool, which is used for over-robos, as well as being a very popular export. The fine*

*strands of the koylarin are woven into a silken cloth which is used to make the decorative, windbreaking clothing that modesty forces the cold-immune Ky'taari to wear.*

*The basic garment of the Ky'taari is a short tunic, belted at the waist with the lower part hanging to the mid-to upper thigh. These are of the silk-like koylarin fur, very light in weight. Bleached pure white, and embroidered about the borders and belt in deep blue, green or gold, they show the light temperament of the people. The most elaborate of these tunics have many pleats and folds and are quite skillfully constructed, to the credit of the weavers.*

*The warrior monks wear a slightly different garment. Because of their style of combat, they require clothes which allow total freedom of movement, yet full coverage of the body. To fulfill these requirements, the monks are clad in breeches of loose oylarin, the bottoms of which are gathered within the cloth wrappings thus sealing the lower legs from water. Their shirt sleeves fall just below the elbow at rest, so as not to interfere with the armbands which cover the entirety of the monk's lower arms. The shirt itself is of a wrap-around design, overlapped at the front and closed by a belt, loosely fitting to provide maximum free movement of the torso and shoulders.*

*Without doubt the most rugged and adventurous of the Ky'taari are the traders, braving the open wastes of the frozen plains and facing numerous threats unknown. Using the Ky'farni to glide swiftly across the lakes and bays of the Mur Fostisy, they trade most often with the Fustir-Gost, their friends of old, exchanging their paper, oylarin silk, and Torkaan wool for rope, leather, and various high protein foods. They also make occasional forays to the main continent of Jaiman in the south, seeking spices and exotic foods, though generally trade with those peoples is handled at the trade city of the Syrkakar, Brya Sug. Free traders of all nations tend to be skilled at arms and the Ky'taari are no exception, being proficient in the use of sword, bow and whip. Adapting themselves to the northern wastes, these traders are also powerful ice skaters, and will use that ability often to outrun a Syrkakar raiding party.*

*The fishermen of the Ky'taari provide the bulk of the diet when the water is clear or the ice is thin enough to cut and fish through. In the winter, when the ice covers the lakes, they repair their damaged boats, or, if it has been an easy season on their craft, they help in the papermaking, which requires much unskilled labor to support the jobs of the papermakers themselves.*

*The Stoneworkers build and maintain the cities of the Ky'taari, as you might imagine. They use ky'taal (K. "Ice Stone"), which can be shaved very thin, to the point of translucence, and yet retains the structural strength needed for their buildings. In large panels it is used in the walls of the great edifices and homes, creating a luminous atmosphere about the walls when the sun shines upon them. The impression from a distance is that the homes of the Ky'taari shine like a second sun, and this is as the people wish it would truly be, for the personification of that golden orb.*

*Men and women are accepted as equal in most things among the Ky'taari, although the male is the traditional head of the household. A youth chooses a profession by the time he or she is eighteen and begins his or her apprenticeship then. The old tend to take care of the young, and the economy is based on a system of mutual obligation and barter, for the most part. Should all else fail, a silver currency is minted by the government, but the Ky'taari prefer to get along without it among themselves whenever possible.*

*The Ky'taari are without exception a very religious people, worshipping Ariaana, the goddess of the Sun. The A-Ryaan is the supreme religious authority, presiding over all major religious events and being mistress of all the temples. Each temple is locally controlled by a Ryaan (chosen by the A-Ryaan) and staffed by between 33 and 99 monks. The monks are chosen during the spring ceremonies, in which the Ryaan of a temple visits every seventeen-year old boy in the adjacent city, and offers those who she deems worthy membership in the temple, the number equaling that of the monks who had died in the past year. Service to the Temple is not required, but is usually considered an unrefusable honor. Once a monk, the lad is tested as to his particular aptitude: whether he be a scholar to copy and maintain the sacred texts, one of intense receptivity to aid the Ryaan in healing and other clerical duties, or of manual skill, to learn the ways of forging magical metals into weapons and ornaments of beauty and power. Whichever of these he be, the new monk is taught the method of warfare which so confounds all the foes of the Ky'taari. Striking swiftly and with precise blows, they often disarm and render helpless their foe before he can react. Unfortunately, few have the true agility or the essence of Ariaana within them to learn the skills.*

One day of every week is one of freedom from the rigors of religious training for the monks, and they are permitted to reside in the adjacent city for that time. In this way, the monks may marry and sire children. Although the wife of a monk sees her husband but once a week, it is still a much-sought position. (In my time among the Ky'taari I had occasion to visit several of the wives of monks to inquire about their dedication, and all proudly enumerated the benefits of prestige and the security of temple protection.) A new Ryaan, or the new A-Ryaan, chooses a mate from among the young monks, and the A-Ryaan's first daughter is born with the gold eyes to mark her as the successor.

The Ataarn is the ultimate authority in the Ky'taari society, and administers his people through the Lords of the Cities (Taarni), who are appointed by the A-Ryaan. Five advisory ministers are also worthy of note here - State, Agriculture, Religion, Craftsmen, and Defense - but the decision-making is in the hands of the King alone. He is succeeded by his eldest son, with the A-Ryaan acting as regent should the new Ataarn not have reached his 24th year. The Ataarn, or his eldest son if he is too old, commands the Ataarn Katashaarn (the "King's Men Of the Blades"), who are scattered about the Ky'taari lands in groups of no more than 300. Should either of the lines that hold the major power among the Ky'taari fall vacant, a child of the other shall establish a new line. An excerpt from the BOOK OF THE KY'TAARI follows:

In the days when men and Elves first saw the beauty of the world, and all was new, Ariaana bore the Sun into the sky for the first time.

Many who were living in the mountains of the north saw the golden orb and worshipped it for its warmth and light.

Perceiving these people, who were of mixed human and Elven blood, Ariaana found them pure of heart, and worthy of her blessing. Thus did Ariaana leave the Sun and come to earth.

The chosen leader of the Ky'taari was Aratur, the strongest, wisest, and most fair of their people. Ariaana came in the guise of a tall woman with golden blonde hair, tanned skin, and eyes of gold. Aratur took the lady of the Sun to be his bride, for he loved her and she him above all others. Of their union were born two mighty children, one of each sex in the image of the parents but with eyes of gold.

Ariaana and Aratur departed the world as the children of the Sun came of age, leaving behind the fair to continue their rule. Aasan, their son, became the first Ataarn of the Ky'taari, and he was a great warrior, never stayed in battle. Aara, the daughter of the Sun, beheld before all others the true religion — the worship of the Sun — and brought this wisdom to her people. And in the keeping of each, to safeguard her people, Ariaana left a great artifact: a sword for Aasan and for Aara a pendant of crystal.

#### The Pendant Taynaar

- 1) x6 Channeling PP enhancer.
- 2) Stores any six Clerical spells.
- 3) User is immune to heat and cold.
- 4) Intelligent beyond measure, add +30 to all RRs.
- 5) Acts as an orb of seeing, revealing any point in the realm.
- 6) Can be summoned to hand from wherever it may be by speaking its name (A-Ryaan only).

#### The Sword Ashaanaar

- 1) 2 Handed +30, clear Laen.
- 2) Flaming or Cold, as desired (delivers a heat or cold critical in addition to any regular critical strike delivered).
- 3) Fires three Fire or Ice bolts per day.
- 4) User is immune to heat and cold.
- 5) Intelligent beyond measure, add 30 to all RRs.
- 6) Can be summoned to hand from wherever it may be by speaking its name (Ataarn only).

### THE KY'TAARI

**Racial Origins:** The exact ancestry of the Ky'taari is unclear and may never be known for certain. Elven blood is evident in them, for a purely mannikin people of such build and lack of protection would have long expired. Subtleties of their appearance also betray this. It has been theorized that a tribe of Elves, having moved east during the Great Migrations several thousand years ago, came upon a group of men who had fled to the Mur Fostisyr, and were seeking a haven from some threat on the mainland of Jaiman. The Elves felt such pity for this group that they remained and, using their unique skill and powers over living things, allowed the men to survive where they would have certainly perished alone. Over the centuries the two races have intermarried, and a hybrid race has arisen.

**Home Region:** The Ky'taari are a unique people, living, as far as is known, only in the Land of Blue Light.

**Favored Ecosystem:** With their virtual immunity to natural cold, the Ky'taari do not find the Mur Fostisyr as inhospitable a place as do other peoples and have made a secure place for themselves here.

**Political Structure:** The governmental system is a simple Monarchy, the King being succeeded by his eldest son. There are five advisory ministers, but they have no political power. If the King's son is a minor when his father dies, the A-Ryaan acts as regent until the prince reaches the age of 20. Also, if the king should die without siring a male heir, the A-Ryaan's eldest son is named king.

**Social Structure:** Basically patrilineal but matrilocal: the husband tends to live with the wife's family — although there are exceptions to this. Marriage is outside the immediate family. A unique institution is marriage to monks, who are only allowed leave the temple once per week. This arrangement is still appealing to many Ky'taari women, as the merits of marriage to a monk (such as social status and material wealth, not to mention the fact that those worthy of being monks of Ariaana are invariably superior individuals in every way) usually outweigh the inconvenience.

**Settlement Pattern:** The culturally sophisticated Ky'taari prefer to live in an urban setting, which offers many different facilities and skilled workers within a small area. Cities are almost invariably located along a coast. Of course there are also farmers who reside in more isolated homesteads.

**Military Structure:** The Ataarn Katashaan (K. "King's Men of Arms") is a standing, highly trained military organization distributed throughout the land. It also acts as the internal police force when necessary. In addition, there are the Warrior-Monks of the Temples, skilled in unarmed combat.

All traders are trained in the use of various weapons, and most are practiced in some guerilla tactics.

**Currency:** Barter is the preferred norm, but there also exists a silver currency minted by the King.

**Language:** Kayvis is the principal tongue of the people, though most have at least a working knowledge of Umlri and a lesser Elven tongue.

**Appearance:** The Ky'taari unquestionably resemble the immortal Elves in many ways including a slender build, high cheekbones and delicate features, not to mention a genetic immunity to cold temperatures. These people are also, on the average, fairer of appearance than mortal men, and maintain a youthful mein. Smiles are ever upon their faces, and a song on their lips. The males are beardless, and range in height from 5'9" to 6'9", though their weight is usually between 120 and 200 pounds. Ky'taari women are only slightly shorter, averaging around 6', and 120 lbs. All have brilliant blue eyes, except those of the lines of the king and high priestess: their eyes are amber-gold. An especially unusual feature about this race is that they can apparently survive for weeks during the summer on only drinking water, as their bodies literally gain energy from solar radiation. In manner of dress, the Ky'taari usually wear short, belted tunics of white silk often trimmed in gold or blue. The traders' and Monks' clothing consists of loose pants and a wrap-shirt. Pants are bound to the calves with strips of cloth, overlapping the boots to make the lower legs water-resistant.

**Housing:** Homes are almost without exception of stone, especially in the cities. The finest are of Ky'taal (K. "ice stone"), a white translucent marble which is very strong but light. Graceful in design and usually built around a central courtyard, homes are spacious and efficient. In some cases, multi-story constructions house several small families in separate units. Only the isolated farm homesteads are ever constructed of wood, and they commonly have a stone foundation.

**Diet:** The Ky'taari are principally vegetarians, their diet consisting of grain products, berries, nuts, tubers, fish, and milk products from the Torkaan.

**Worship:** A complex religious structure dominates the Ky'taari worship patterns. There are four major religious holidays, including the first day of spring (Abaar), when Ariaana the sun first reappears (this holiday actually lasts three days); as well as the longest day, in midsummer; then the last day that the sun shows at all; and finally, a solemn day: the Deep Night, in mid-winter, when the moon is new and the sun is farthest to the south, only providing four hours of twilight at the brightest. This is marked by a solemn candlelight ceremony outdoors under the displays of the Dakuralani.

### 3.34 THE UDAHIR

Last evening, if you will recall, I spoke of the Selkar Karlan, the Iron Wind. The Lotani of the southern plains will ever tell of the devastations it wrought upon the lands and the even greater scars it left upon their people in days gone by. The saddest of their tales tells of the once proud civilization of Zjethrin (zyeth-rin), which dared to stand against the power of Unlife and paid the price for its folly, losing tall cities and valiant horsemen forever.

Once, years past, I determined to trace the remains of the lost civilization, for an entire people does not perish at a stroke. Departing my Lotani hosts, I made my way to the land of Zjethrin. I followed the clues of ancient poems and turned by horse north, in the footsteps of their last epic flight. Centuries make memories grow dim, and but few even of the Loremasters held clues to the passage of the Zjedrahir in the thousands of miles over which I followed them. I had nearly given up hope as I arrived at the Harl Syrna, the island-mountains on the edge of the world. Further weeks of travel through the Mur Fostisyr brought me within sight of a mighty mountain, its crown destroyed; and beyond, the sea. Nature, or perhaps the Iron Wind had raised at last a rampart which could not be passed. Huddled before the advance of winter, I turned south at last, having given up my false trail and reflecting that perhaps the thorough malice of the Selkar Karlan had achieved its end. But for the Iron Wind I should never have encountered Ydirak (i-deer-ak), the Thyfuriak. The evening after my admission of defeat, I chanced upon him by a river, unconscious and wounded from Syrkakar arrows, still mounted upon a great dead bird, whose fate he might have shared. Finding his heart still beating, I staunching wounds and tended him for two days until his eyes opened and I knew that he would live.

From the moment he gained consciousness, though he could not even move at first, he was in control. He would not be moved, but had us remain in the countryside, sheltered by a grove of trees, until he could walk. One morning before dawn he built a fire and cast upon it a strange dust that called forth a bluish mist, barely visible against the sky. The birds that responded to his beacon were the like of nothing else on earth, being larger than horses yet capable of flight; Thyfur were these mighty creatures called. Upon the back of each, a saddle held a warrior: a Thyfuriak, (U. "rider of great eagles") they were according to my companion, and they seemed to remain there at the sufferance of their steeds rather than through control. They located us quickly, for Ydirak's brother was amongst them and the two had a mental link, and I found myself forcefully invited to come with them and be rewarded for my ministrations.

Having no experience with the great eagles, I was none too eager, but they insisted that I would be trapped by the advancing winter if I tried to escape the northern valleys on the ground. Acquiescing, I was bound to a saddle lest I fall, a precaution I noted my companion also took. We flew, to my surprise, towards the great mountain. Nearer the barrier we gained height, miles certainly, and my breathing became labored as we entered the mists surrounding the peaks that rose above the rest of the mountain. The master of my bird stuffed a berry into my mouth and placed a circlet upon my head as I complained bitterly, and the mists melted before my eyes, revealing the desolation through which I had been traveling.

Had I not been so engrossed in the magnificent view, I might have noticed that my breathing had eased also, but the landscape held my attention. Though I was too high for my eyes and ears to register naturally all below me, I could feel the terrain from above through my now artificially enhanced senses. The air was filled with the roaring and crashing of mighty glaciers as they fell into the sea, and their icy surfaces covered with twisting, shifting chasms. The sea was an eerie pattern of blue and white as the ice floes formed a constantly changing maze upon the water. The jutting glaciers formed little bays and inlets, some quiet, others frothing and wildly agitated with maelstroms. The patterns of the fjords were an intricate labyrinth of hidden connections, and I thought that the ships below must surely become entrapped in one of the many fjords filled with whirlpools, but when I spoke of my fears to the pilot, he only laughed. Thyfuriak scouts had long since mapped the safe routes through the maze, and at times flew guard above.

As we closed with the mountain, its twin spires commanded my attention, sparkling like gems in the morning sunlight. Many years ago it had been an immense volcano. Now all that remained of it were two tall crystal spires ten miles apart, and jagged cliffsides. We descended into the crater and, instead of the expected desolation, I beheld terraced fields where crops were being harvested: an island of life in this forbidding world.

My Thyfur landed near the center of the crater by a huge gaping hole that led down to the seventh level of the city. Ydirak explained that I must first be purified, for Uda Tyygk was the sanctuary of his people. I was conducted through three rooms with pools of water where my face and hands were ritually cleansed, and was thence led to the throneroom of the Tanhuz, as Ydirak called his king. The Tanhuz was handsome, in the way of all Thyfuriak, and courteous of word as well, as he thanked me for saving the life of Ydirak, who was leader of the Thyfuriak. He explained that, with the winter setting in, it would be unwise for me to travel, and extended the hospitality of his people, whom he called the Udahir. Upon hearing of my quest for the lost Zjethrin, he smiled and spun me a tale to answer all my queries.

In ages past, Zjethrin ("Where the Stars Touch the Earth") was the motherland of the Udahir. The Zjedrahir (zyed-ra-heer) dwelt in cities and on the plains, and many came to see their marvels. Oond Tyygk ("The Caravan City") was their metropolis and marketplace, and to it came merchants from the corners of the world to buy and sell the most marvelous of wares; if one could not find what one sought in Oond Tyygk, it could not be purchased on earth. Alongside the merchants to Zjethrin came the scholars and students of the plains, to dwell in Svedra Tyygk ("The City of Temples") and learn the mysteries of the stars, for the Zjedrahir were acknowledged as being among the world's foremost astronomers.

The wealth of the people grew from the rich black earth near Jand Narain ("Crystal Waterfall"). Here, on riverwashed farms, dwelt most of the Zjedrahir, content in their simple crops and proud of their markets, their temples and their impenetrable citadel of Zjeth Hyyd ("The Seat of the Stars"), wherein dwelt the Tanhuz. Their happy innocent prosperity was perhaps too much for an envious evil to forbear, and the maliced fist of the Selkar Karlan fell upon them.

The peace of Ydirak's ancestors was shattered twelve hundred years ago by a rain of death. The sky turned black and a thick poisonous ash fell upon them, asphyxiating many and envenoming their lands. Slaughtering indiscriminately, it fell for months, blinding them as well, for they could not see the stars for guidance. Even the lifting of the rain of death brought no relief, for in its wake the Iron Wind sent armies.

The Zjedrahir did not despair, but gathered about Zjeth Hyyd to defend their homes. For a century they fought, dwindling ever, yet the hosts sent by the Iron Wind were numberless, and when, despairing of victory, the Tanhuz led his horsemen out to attack, a cold dark cloud blew out of the east and destroyed them all, together with those they assailed.

That night, the stars shone upon the Zjedrahir and a beacon appeared. The Chintakari, the high priestess of the stars, announced it was a sign that they must follow. "Go away," they told her, "We have lost our loved ones and will mourn them. It cannot be that we are called upon to surrender what they have died for." The Chintakari said, "I have spent my life with the stars and know them better than you." She left that very night and only the ten thousand of the faithful that followed her escaped of all the Zjedrahir, for the cloud returned at dawn and the people of Zjethrin ceased to be.

So confident was the enemy of the totality of his victory that it was centuries before he realized their escape from his wrath, and in the end, 10,000 Zjedrahir were a little thing to the Selkar Karlan compared with the legend of their utter destruction. Unpursued, the survivors marched north for a generation and more, as the weak died and soon the weaker of the strong perished also. For weeks the people marched across frozen straits of ice, linking islands in the far north. At the end, the beacon star rested between the two peaks in the distance, eerie in the mist above the volcano, never to appear again.

With foreboding the Zjedrahir approached their future home, a huge volcano which had blown off most of its crown, leaving two tall spires to contest the clouds for mastery of the sky. Even at half its height, the Zjedrahir knew it to be impassable, but as they camped for the night, a young boy saw an ovir, the great white bear of the northern wastes, and followed him towards the fjord that ends against the mountain. Winter being almost upon them, the fjord was frozen and the night an ovir led them out on the thick, cracking ice to a great cavern in the side of the mountain, the entrance to the volcanic tunnels inside.

The caverns then were not as they are now; the first years were a struggle to survive with the meager aid of their mountain windbreak, but outside none could have survived at all when the real winter of the Harl Syrna closed in. With no place else to go, the Zjedrahir took the mountain to dwell in until such time as the Iron Wind shall have passed from the earth.



Having tasted the fruit of folly once, they became the Udahir (oo-da-heer), the "Hidden People," and resolved to survive in Uda Tyygk, their "Hidden City," until the stars shall shine upon them once more. The Udahir, by now the last 5,000 of a race, have a mission — survival — and possess a sense of purpose that manifests itself in a society of cooperation and obedience.

The first years in Uda Tyygk were marked by struggles to survive within the mountain. Food had to be found, and before the diet could be stabilized, they were reduced to eating their surviving horses. The other denizens of the mountain were slain or driven off, save only one, a marvelous insect called the Sjith spider, which provides the Udahir with the fine silk that constitutes most of their wardrobe. Sjithra silk is light enough for comfort in the volcanic caverns, while outside it is warm enough to withstand all but the bitterest winds when worn in many layers. With the addition of wood pulp, baked onto a form, it is suitable for light footwear or baskets. Trousers of silk are worn by both sexes under layered and billowing tunics that, shifting across their bodies, accentuate every reality of movement. Though the Udahir, as befits a race of exiles, are silent more than gay, they add color to their lives when they can; the silk is dyed and often embroidered, and the proud Udahir will display a badge upon his tunic denoting guild membership.

The impression given by the people is one of steady purpose and silent destiny, a destiny of life and building, not decay. They are marvelously adaptable, as you might imagine from their successful transition to the mountain after the life of the open plains. The words of the Chintakari, "I have spent my life with the stars and know them better than you," are a maxim among the Udahir, who are highly specialized within their guilds and defend their specific competences vigorously.

The trials of the Zjedrahir have left their mark on the mountain dwellers; those that have survived the ordeals are strongest and bravest of a people. Their skin is of mahogany, a vestige of their southern heritage. They are majestically tall and the smooth energy of their bodies flows down their lean muscular arms toward lesser men; one has but to be in the presence of one of the dark-haired giants to understand that they are constantly wresting life from a begrudging world. They are strong, but it is perhaps a flaw in them that they accept themselves as superior to all about them: correct, but bordering on arrogance. Remember always that the Udahir, for all their grace and power, are but fugitives before the Iron Wind.

The life of an Udahir is governed by the season, as indeed you might think, for to go outside in winter is to invite death. The relative warmth of summer is a time of living things, of festivals and joy, as the Udahir try to live a year in a few short months. The people of the mountain use the brief thaw to go abroad on the neighboring bays and fjords and net huge numbers of fish returning to spawn. The growing season is short, but the crater of the volcano, fed by meltwater from the peaks, is suitable to a plant they call jakir (ya-keer), which is prepared in a hundred different ways and tastes dreadful in all of them. Inside they grow a fungus called ljirds (leerds), which I think is the key to their health, though they do not know such things. Complementing a diet that is otherwise but fish and dried fruit, ljirds keep the Udahir strong through the winter.

The taste of winter in the mountains is but a pale shadow of its presence outside. I arrived at Uda Tyygk as it was setting in and saw this shadow on the people. Coincident with my arrival, they were gathering in the last of the harvest and staging their final great festival of summer, a remembrance to sustain them through the winter. In my first few weeks under the mountain, everything changed. The food went from fair to poor, and the tastes and enthusiasm of the people themselves seemed to follow. They still danced and told stories of their past, but these were ritualistic; spontaneity was missing, the flavor of life was gone. Mentioning this to Ydirak, I discovered that, with the advent of winter, the classes of society polarized. Before, all the Udahir had been farmers and fishermen together; now they were confined to their different guilds. Their work and ritual were their recreation. As they returned to their guildwork, the mountain became again their prison and not their home.

The rituals of the Udahir are not law but strong custom. Everyone is born into a guild, his father's or her mother's as the case may be; occupational mobility is not possible for an Udahir unless he is chosen for the Thyfuriak or the Seers. Adolescence is training for your guild and learning to respect the customs of your ancestors with absoluteness. Entrance into adult life is marked by two ceremonies, the Vision Seeking and Marriage. The mate of an Udahir is invariably a member of his paternal grandmother's guild and he must be of her maternal grandmother's. Cross-

cousin marriages are preferred to maintain the unity of the family. Before he can marry, however, the Udahir must make a pilgrimage to the vision rooms. There, the adolescent will fast and meditate, a process he may repeat often in his life. When he is mature enough, the adult Udahir will receive his first vision, often of the Masterwork of his career, and then descend to take his place in the guild.

The first of the four guilds is the Hall Carvers. Uda Tyygk lies in a series of natural volcanic caverns that have been enlarged and connected over the centuries by these successors to the Zjedrahir stonemasons. As in all Udahir society, the family dominates, and in every man-made edifice in the city is a symbol of the line that, from father to son or from mother to daughter, created that piece of Uda Tyygk, a symbol of pride in their guild and their line. In the last several centuries, with the need for living space satisfied, they have competed amongst themselves to create intricate and extensive defense systems within the mountain. In the lowest cavern of the city, the only one accessible to those who cannot fly, are two massive and insoluble mazes to entrap intruders; they represent the Masterworks of rival lineages over past centuries. Two dozen lineages, comprising nearly a thousand members, work all through the winter on the home of the Udahir, perhaps more than is now needed, but caste succession among the Udahir molds them to that task.

The Hall Carvers have adapted themselves well to life within the mountain, for stone is the principal material of the Udahir, being ever present in abundance. In addition to their principal occupation, from which they derive their name, they are skilled in extracting the lighter rocks from the mountain and creating a variety of household items, such as chairs, doors and tables. They have the skill and, more important, the time to shave stone to a thin lightness where it is suitable for such items. Where portability is not required, more substantial objects can be turned into the artwork which is the pride of many a Hall Carver of the Udahir.

In their quarrying, the Udahir have uncovered metals in the mountain. Iron, Copper, Nickel, Silver and Gold are among the elements they have found, and the ancient and honorable profession of Metalsmith has its place among the guilds of Uda Tyygk. As a world traveler, I must note that their products are only fair, but they operate under tremendous handicaps; they lack fuel for proper forges and instead must use volcanic pools, and they have not the advantage of trade to learn new ways. They are not unskilled, however, and when the uncontrolled heat of a lava forge is not too serious an impediment, they are capable of superior work.

The principal interest the Metalsmiths of Uda Tyygk have for me is in their possession of a material called Eog ('ee-og'). Eog is very rare in the Harl Syrna and almost unknown elsewhere, and among the Udahir, to be accorded the privilege of working with it is a high honor, bestowed on only a few in a generation. Eog is extremely hard and so brittle that, in its pure form, it is useless. Alloyed with iron and traces of copper, it forms a super-hard yet forgeable steel. Such Eog-steel, I am told, repels enchantments and resists the most extreme temperatures, an extraordinary advantage in the Udahir environment, where steel has been known to freeze and break. Nothing made of Eog is not a Masterwork, the best the artisan had to offer, and it is so rare and cherished that the only artifacts I saw that were of the grey metal were the marvelous weapons of the Tanhuz.

The largest guild by far is that of the Silkweavers, comprising almost half of the Udahir. The craft of harvesting the threads left by the tiny Sjith was the natural inheritance of the cotton weavers of Zjethrin, once the source of much pride within the mercantile nation. Everything among the Udahir that can be cloth is made of silk; tapestries and rugs colored with herb dyes abound. The sails of their small fishing fleet, and the nets too, are also the gifts of the spiders, and a cloak, interwoven with gold and silver is a Silkweaver's Masterwork, swirling like an awesome sunset in the light.

Over one of the Guildhalls in Uda Tyygk is set a woven band of colored glass: Laen ('lane') it is called by the Udahir. Smoother than ordinary glass, and yet stronger than steel, its transformation into weapons and jewelry represents the pinnacle of achievement in the smallest, yet not the least, of the Udahir guilds. Most of the Laenworkers never touch the substance, but create objects of normal glass or gems, for Laen cannot be made and by custom only the greatest of them may use it.

Laen well merits its special rarity, formed as it was solely by the powers that shaped the earth. Laen itself is neither rock nor metal, but magic, the trapped energy of the unmaking of the world within a mineral. Impurities in the host rock give varied colors and properties, as a rainbow depends upon dust for its beauty. Conjure an image of frozen light and you behold Laen, the greatest natural treasure of the world.

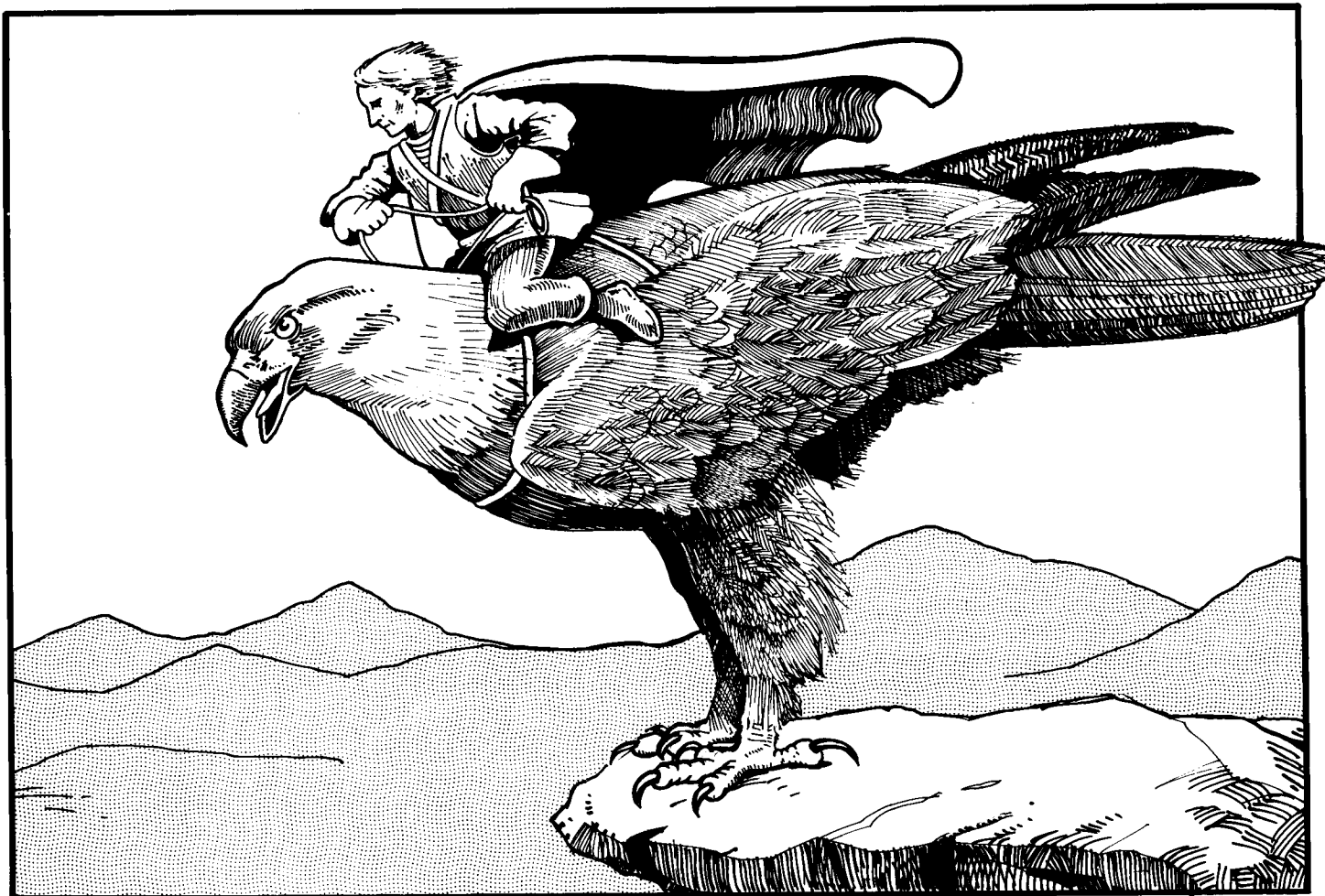

## Thyfuriak

*Nature guards her hoard well: Laen can only be hewn from the surrounding basalt with the utmost patience before it will assume the shape for which it is prized. Pride is taken not only in the finished product, but in the effort and materials whereby it was created. White Laen, which is actually clear, predominates, for it is both the most available and the strongest variety, being pure. Other prevalent varieties among the Udahir are red, green and blue (which resist fire, magic and cold respectively), and a much rarer silver Laen, which is neutral and extremely receptive to enchantment.*

*I had thought here to describe the beauty of the Laen sword my companion, Ydirak, showed to me, but words do not suffice. Ages ago, a high Laenworker with his own hands recovered the magic rock. Perhaps he endured the frustration of a dozen or more smeltings before he found a sample containing raw Laen. Heating it to a point where the ordinary rock around it melted away, he began to work it to the desired shape, for Laen can not be cast, and must be caressed to form. With Eog tools it may then be sculpted to perfection. Years later a Seer had blessed it and imbued it with magical power. In but an instant it could cut through plate armor without dulling its magnificent edge, and lucky was Ydirak to win the right to bear it.*

*Most of the Laen products of the Udahir are not for war: the mountain dwellers fashion it into jewelry, where its natural beauty is not sullied by any bloody purpose. Often Laen jewels are enchanted, as was the one in the circlet I wore during the flight on the giant Thyfur, and these devices that enable the Udahir to see in the darkness of the city or through the mists outside are essential to everyday life in Uda Tyygk. The greater part of all Laen, however, is dedicated to Valkir, the Creator, and remains cached in the vaults of the Seers or in the Temple of the Stars, where it is Valkir's alone, to the sorrow of the world.*

*In the peaks of the Harl Syrna live the Thyfur, the giant eagles upon which the Udahir warriors ride. They are highly intelligent and empathic, so much as that they seem to have adopted the Thyfuriak as brothers. These near-immortal creatures are capable of an astounding degree of communication with their riders, and it seems at times that the Thyfuriak are closer to their birds than to the people they protect.*

*Among the Udahir the Thyfuriak are considered the greatest heroes, for they must give up all the normal rites of life. A young man, or (rarely) woman, going for his or her first vision-quest may encounter the image of a giant Thyfur. The potential Thyfuriak is tested for the strength and empathic powers necessary for him to command so great an eagle as the proud Thyfur. Confirmed, his vision will lead him up the western spire to the Temple of Heavenly Winds where he will learn the use of weapons, particularly the bow. From the first day to the end of his service, the Thyfuriak is expected to share the cave of his mount whenever possible, eating that portion of its prey that is provided, and becoming truly a brother to his giant eagle.*

*As you might imagine, the life of a Thyfuriak is hard, and only the most rugged can endure it. He lives by his brains and his muscles, at the absolute command of the Tanhuz, who at a moment's notice may send him on a winter patrol. The Udahir maintain watch stations in many of the surrounding peaks, and duty there for months at a time is even more isolated than the normal life of a Thyfuriak, for he is cut off from all but a few of his comrades as well as from his people. It is through this isolation from distraction that a Thyfuriak is supposed to draw his strength.*

*The isolation of the Thyfuriak is broken only at the two great religious festivals, when they are permitted to descend into the city. Thyfuriak in the city seem much out of place, and the older of them are perhaps eager to get back to their eagles. Thyfuriak are forbidden to wed, but to be taken as a lover or to have a child by a Thyfuriak is an honor that any Udahir maid would seek. After the World Renewal and Midsummer festivals, at which particularly the younger warriors make contact with their families, they depart once again from the city of the Udahir to their lofty exile.*

*The king of the Udahir, the Tanhuz, is selected by the Thyfuriak in what they call the Finding Ceremony. Within the Temple of the Heavenly Winds, the 100 Thyfuriak convene on their thrones and meditate on each other's merits until a vision of the man who would make the best king is clear in all their minds. Upon his election, the new Tanhuz must embark on a quest for the good of his people, to prove himself worthy to rule them. A typical quest for an Udahir king might be the retrieval of some artifact of the Zjethran heritage; upon his return, he is acknowledged the greatest of all the Udahir.*

Within the Udahir society, the Tanhuz is the judge of all secular matters. A small, confined community cannot tolerate the pressure that occasionally builds up among the competitive Udahir. Any criminal activity is punished swiftly and severely. The Tanhuz is also, of course, responsible for the defense of the city, and controls the Thyfuriak in this capacity. An equally important tool for securing the mountain is an orb of white Laen that sits before his throne in the Temple of the Heavenly Winds. Through it, the Tanhuz can see for great distances, an invaluable aid, for the security of the Udahir rests on their ability to maintain secrecy, to avoid harmless travelers and to ensure that the threatening ones disappear.

Above even the Thyfuriak in the esteem of the Udahir are the Seers, the religious leaders of the Udahir. Like the Thyfuriak, a potential Seer is revealed by a vision and tested. Their education may take a generation, for the young woman or (rarely) man, must learn astronomy and the proper uses of inherent empathy, as well as the traditional clericism, spending most of one's life on the seventh and eighth levels of the city.

The Udahir perceive a strong dichotomy between their world deep within the earth and the unreachable arena of the stars. High above the apex of the Star Temple, beyond the reach of all but the Seers' telescopes and the mind of the Chintakari, lives Valkir, the Creator, manifested as the brightest star in the northern sky. In his earthly form, Valkir is a great ovir, who can sometimes be seen moving upon the face of the glaciers in the moonlight. The Zedran religion seeks to unite the Udahir with the stars so that they might dwell forever in the realm of Valkir.

The Udahir have long perceived the influence of the stars upon the happenings of men and use this knowledge to learn of the events of the outside world. The Udahir religion is a complex philosophy based on the divination of past, present and future through the stars. The Seers view the heavens through Laen and obsidian telescopes from the tip of the eastern spire, far above the clouds where the air is thin and clear. The Chintakari, however, is the only one who has the power to commune directly with Valkir, and in times of crises, she will speak with Valkir, seeking counsel. Religion permeates every aspect of Udahir's life: the Vision Questing is a religious ceremony, but it is the festivals that are the most interesting to me as an outsider.

The Udahir believe that the world loses energy from summer to winter as the hours of sunlight go from over 20 to less than 4 in the depths of winter. As they approach the winter solstice, they conserve energy of all types, refraining from sexual activity and all but the lightest work. On the morning of the Longest Night, all the Udahir gather in the Main Temple to dedicate the Masterworks completed during the year to Valkir, the Creator. Then they begin to dance, slowly at first, for the world cannot absorb energy too quickly in its weakened state. Gradually the dancing increases in tempo, sending energy into a weary world. At midnight, the Tanhuz is ritually united with a young woman who represents the Chintakari; when the power of the stars, symbolized by the maiden, is united with the power of the air, represented by the Tanhuz, intense energy is released which is absorbed by the universe. The sun once again has the energy to rise, and the world is renewed.

The Midsummer festival, I am told, celebrates life and fertility, for the world is at its full power at this time. During the summer, all the youths and maidens take lovers, for the Udahir believe that the fertility of the earth depends on the fertility of its people, and even the Seers and Chintakari take part. On Midsummers, the Lightest Day, all the people climb into the crater and sing, dance and laugh until the full morning when everyone staggers back into the cavern, confident that the crops will ripen and the world will continue.

The seeking of visions is a significant part of Udahir religion and culture, for they believe that inspiration can be sought from Valkir through rituals of fasting in solitude. For three days the seeker eats nothing and bathes in Waters of Purification. On the fourth day, he is led to a Vision Chamber, deep within the mountain, where he remains in solitude, staring into a small fire, and drinking Vision Tea, his only sustenance. Not until Valkir causes an image to appear within the mysterious flames, which may take many days, will the seeker of visions return to the city.

The leader of the Zedran religion is a maid of exceptional intelligence, the Chintakari. Upon the occasion of her 50th birthday, she seeks a vision of her successor, a bare child who is taken amongst the Seers. From the beginning, the child is taught the ways of magic, clericism, astronomy, empathy, and the lore of her people, a much more intensive course of study than her colleagues must follow. Most of all, the novitiate must learn the language of the stars and the mysteries of the Star Valkir. By the

age of 25, she has mastered all the lore of the Chintakari, and the performance of all the rituals, and most of all she can interpret the messages of the stars.

Before she can attain the office of Chintakari, however, the novitiate must embark upon a quest to retrieve one of the items of power lost to the Zjedrahir. On such a quest, she is accompanied only by the Thyfuriak who is to become the Tanhuz. Together they have done much, over the centuries, to revive the fortunes of the Udahir; of the 24 artifacts lost by the Zjedrahir to the malice of the Iron Wind, nineteen now reside in the holy places of the Uda Tyygk.

Rising above the mountain are the twin spires, the two most holy places of the city. Towering six miles above the lands about, they are enshrouded by mists, except at the tips, which overlook the clouds of Earth and gaze into the depths of the heavens. The eastern pinnacle is of pure Laen; inside this glittering peak is the Temple of the Stars. The light of the sun, moon, and stars shines into the Laen temple, refracting off the crystalline shapes carved into the walls, creating the effect of being inside a prism. The interior is as a geode, completely lined with crystals that Hall Carvers long ago shaped with Eog tools. Iridescent lights shimmer through the angular walls, for the lights of the heavens penetrate all corners of the temple. Just to stand within this opalescent tower inspires awe and the belief in the divinity of the stars, for this temple is as close to being a star as anything on earth.

Outside, near the apex of the spire, a balcony encircles the temple from which the Seers observe the stars. Within the temple, on its first floor, is the Library of the Udahir, filled with texts of ancient lore. Carved into the walls over the Library are small alcoves, each containing a great Masterwork or one of the items of power retrieved from the ruins of Zjethrin. Above the observatory, the walls are carved with 101 thrones; whenever the Seers and the Chintakari must meet, they gather in these thrones where the power of the Laen gives them spiritual strength.

Within the very apex of the holy spire sits the throne of the Chintakari and the Scepter of the Mists. Her throne, too, is carved of white Laen, and it overlooks the Scepter, facing towards the Star Valkir. The Chintakari alone may use the more subtle powers of the Scepter, for only her mind can withstand its might. Nor may the Scepter be removed from the temple, for its power is based on the fact that the Laen spire in which it stands is holy.

To the west is the spire of the Tanhuz. The Temple of the Heavenly Winds is made entirely of red Laen, so that the sun shines through it like fire. Standing within the Temple of the Heavenly Winds is akin to standing within a flame: deep reds, golds, and ambers reflect off the carved Laen crystals as the sun shines through the fiery spire. On the first level of the temple is the Hall of Counsels, where the Thyfuriak report and take counsel. In the walls of the Hall, as in the Library, are small alcoves which contain magic weapons and armor, which are safeguarded here until such time as they are needed. Within the summit of the spire is the Hall of Long Sight, where 100 thrones lie carved into the fiery Laen walls. Here too is the Orb of Long Sight, the most powerful item of the Tanhuz. And above the spire, which sparkles in the sky with a strange beauty, is only the deep blue firmament and the stars.

For one thousand years the Udahir have remained in complete isolation, secluded from the world in their asylum in the mountain. Over the centuries, they have been gathering and storing weapons and magic, waiting for the day when they have achieved the strength to reclaim the greatness of their lost heritage. Within both the Temple of the Stars and the Temple of the Heavenly Winds, as well as in the vaults of the guild temples, they have stored all the Masterworks wrought over the generations, kept against the time when they seek retribution from the Iron Wind. It is their desire to reclaim their own. Even after a thousand years, their strength is not complete, but the time has come to begin gathering allies for the coming battles. Already they have sent out preliminary envoys into the world to test the dispositions of potential associate nations. Some of the envoys have been sent to lands far to the south, near ancient Zjethrin; more have been sent to lands in the east and west. On is now among the Fustir, and soon an envoy may be sent to the Ky'taari, who have been neighbors for centuries past, yet never knew of the Udahir's existence. Even the Dwarves have received visitors from the solitary nation. They have not yet fully revealed their existence to the world, for the envoys always travel in the guise of wanderers. The Udahir hope that soon they will establish a network of allies so that all may rise up together against the Iron Wind and cleanse the evil from the land.



## THE UDAHIR

**Racial Origins:** The Udahir were once the *Zjedrahir* ("people of the stars"), and dwelt in a land known as *Zjethrin*, which, it is believed, no longer exists. It sank beneath the oceans nearly a thousand years ago. Perhaps it was a large island to the east and south of the Mur Fostisy; the Udahir will not speak of their original home.

**Favored Ecosystem:** Though the Udahir are originally acclimated to a more temperate climate, they survive here in the chill Land of Blue Light.

**Political Structure:** Absolute rulership is shared between the Tanhuz and the Chintakari, the former being the secular head of the people, the latter holding a position best described as 'High Priestess'. The Tanhuz is responsible for defense of the city, and is the master of the Thyfuriak. The Chintakari is religious leader and mistress of the Seers.

**Social Structure:** A complex and rigid caste system dominates Udahir society. See the text, section 3.34, for details.

**Military Structure:** The military, aside from an internal guard hierarchy, is limited to the Thyfuriak.

**Currency:** None; a communal environment precludes any need for such.

**Language:** Amongst themselves the Udahir converse in their native tongue, though some, particularly the Seers, are still taught tongues of other peoples with which the *Zjedrahir* had contact, such as the Elves.

**Appearance:** A physically imposing people, the Udahir men range in height from 6'2" to 7', and weigh between 180 and 280 lbs, none of it fat. Women of the race are hardly smaller, averaging 6'4" tall and 160 lbs. All have dark brown or auburn hair, and their complexion is almost mahogany in its red-brown richness.

**Housing:** All live within homes carved out of the volcanic rock of the *Uda Tyygk*.

**Diet:** Primarily fish and *jaktir* (a leafy plant which can be prepared in a number of ways) supplemented by a fungus grown within the caves, and what fruit they can grow, some of which is dried for the winter.

**Worship:** the Udahir worship *Valkir*, who takes the form of a huge ovir in this northern area. He also is represented by a star in the sky; astrology is an integral part of the religion, mastered by the Chintakari and the Seers. See the general text for details of the religious festivals.

## 3.4 OF THE PLACES OF POWER

*I have faced many a danger in my long life, but perhaps the most perilous holdings in all Jaiman lie here, in the Land of Blue Light. All of the castles which serve the Iron Wind did I visit in my way, though only once did the residents discover my presence, thanks to skills of stealth learned long ago. The hidden places of the Ky'taari I explored after first altering my appearance to resemble one of their race; so disguised, I managed to thoroughly explore even the Kaldarak-Vaar and escape unnoted.*

*Later in this tome you will find detailed plans, keyed to a text, carefully copied by my notes by a trusted associate. Immediately below are more general commentaries concerning my overall impressions of the places.*

### 3.41 SYCLAX: CITY OF THE SYRKAKANG

*Over a year did I spend in the cruel city which was Syclax, striving to discover all the while the nature of its master, the overlord of the Syrkakar and the man who holds sway over all the Yalf Hurm (Um. "Land of Glass Spires").*

*At the center of the valley there are five great pillars of the glassy stone surrounded by a 250' wide rock-lined dry moat. There — lining the channels, covering the escarpments, and spanning the empty spaces of this remarkable formation — I beheld the city of Syclax, the heart of the Syrkakar. It is a town cut from natural towers that were the hardest part of the ancient core of the Kanga Syrn. Arranged like shards from a shattered purple jewel, these impenetrable piers form a circle and elevate the spiritual center of the Syrkakar. I cannot recall a more formidable site.*

*Because of the hardness of its rock base, Syclax's builders worked with, and not against, the surfaces. They constructed the town to complement the caves, ledges, and lesions. Here architecture revolves around the use of carved stone stairways and sloping causeways which are cut into the narrow channels of the high rocks. Most of these streets are narrow and intended only for pedestrians. Lesser cross streets are often little more than*

*5' wide defiles or tunnels. There are, however, a few main thoroughways in each quarter, winding roads where One-horn Oxen (Sy. "Roggi") or Woolly Ponies (Sy. "Torri") are permitted. These routes permit heavy goods to reach most areas, although the vast bulk of goods are moved along an elaborate pulley system that runs through a network of chosen hollows and lava tubes. Like the wells, most of this system is open to the public and access rooms and courtyards abound.*

*The residents live in a wide variety of dwellings, most of which complement the rock bed upon which they are constructed. Traditional five-sided Vyrtan (Sy. "Closed Huts") cluster along the flanks of the spires in the lower quarters and house half the population. Caves and overhangs are used by those who live in more elaborate lodgings. Black, blue, and purple stone is abundant at the base of the valley's cliffs and is used for the walls of Syclax's high watches, citadel, and mansions. Almost all these structures are pentagonal and proportioned like squat towers, for the town land is limited; thus the feeling that Syclax is clinging to, or tumbling down, the sides of the great rock piers. In keeping with the Syrkakar fascination for color, all the set stone is placed to form artistic patterns in the walls. Limitations on the number of shades make the scheme tasteful. Wudus told me that each design had meaning and corresponded to a mythical or spiritual theme, but I could see no more than abstract designs.*

*Each of the five pillars holds a district and bridges link the areas of the town. These arched causeways add an aura of enchantment, since they are all covered with polished copper roofs and are surmounted by graceful watchtowers. They glisten and reflect the sunlight off the adjoining cliffs of purple glass. Many of the town's buildings are also roofed with metal, particularly those in the High Quarter (S. "Mar Irm"), so the overall effect is striking. I was even more moved after dusk, for the dancing fires create eerie, dreamlike images.*

*Syclax's largest area is set at between 400 and 300 feet on a pair of larger, gentler rocks. These two districts are often referred to as the lower city; but they are more properly called the Irm Tavar and Irm Olzir, for the clans who reside there. They lie west of the 500 foot center spire, which houses the Olkusir clan and the principal marketplace. East of the Irm Olkusir is the 450 foot Irm Huralir, and north of the center pier rises the Irm Ukasur. The Ukasur are the strongest Syrkakar clan and their home befits them; its crown is 600 feet above the surrounding plain. It is here that the 90' Citadel of Syclax (Sy. "Wasyclax") sits, in a cleft astride the town's largest volcanic shaft. From this shaft secret tunnels, each located in a lava tube, knife through the rock and link key outposts. Wudus told me that the fertile springs that give birth to the Yon Syclax lie at the bottom of this hallowed chasm.*

*The Wasyclax commands the main approach to the city, a paved stone highway that enters the valley from the southeast and winds around Syclax's east side. It passes over the Yon Syclax on a pair of five-arched stone bridges and then crosses the wide dry moat by way of a gently vaulted span which has a rock frame and a removable wooden roadway. Two great winged statues stand guard on the valley side of the moat. They are the largest stone beasts in the assortment that surrounds Syclax which is collectively called the Var Huir ("Glassy Eyes"). I realized that their vigil was genuine when Wudus told me tales of the town's history. It seems that during the Syrkakar Clan-war the attacking forces were turned back by the spray from the mouths of these statues. Fed by the steaming waters from Adea Hu's hot subterranean springs, they can be formidable obstacles. Wudus' description made me understand that they are no more than outlets for channeled geysers, but this secret often escapes the outsider, or even the common Syrkakar.*

### 3.42 VAR UKAAK: TOWER OF SYSMOG

*In an isolated vale stands the imposing stone edifice which is Var Ukaak (Um. "Unseeing Eye"), the tower of Susymog. A Demonic lord and one of the Ordainers, he is a terror unspeakable. I have seen him (though not on this excursion) and my heart quails even now at the memory as I write of it.*

*The night was overcast as I approached the tower, blue-black clouds churning uneasily across the cold sky. It would snow within ten hours, but I should be away by then, and my path would be covered. As I neared the tower, the huge skull mounted atop the roof flickered red in the night. The light swelled and steadied, and the ghastly features glowed a deep crimson, no doubt visible for many miles. I was certain that this event had nothing to do with my presence, yet there is always the nagging uncertainty. . . .*

Avoiding the main door, I found the lower balcony much more to my liking. The two Syrkakar guards in black chain armor did not see the shadow among shadows, which was my form, slip through the open doorway. Room by room, I toured this place, the rumor of which brings fear to all the peoples of the Mur Fostisyr. It was silent, as if abandoned. I knew better. Many items and books of interest I examined, though none did I take. I avoided a confrontation, that is until I entered the quarters of the Priest of Yarhraak. Though his back was to the door, hunched over a small glowing orb, he addressed me as I entered (I thought) in stealth.

"You are bold to venture here alone." He spoke softly, his back still to me. His voice was unquestionably Elven.

"Perhaps, but you are the greater tragedy, my kinsman. You have betrayed your people." My mind raced. He might kill me at any moment.

He turned slowly and stood to face me, circling the small table on which rested the glowing orb, placing it between us. His ornate robes rustled stiffly, his handsome face revealed no emotion.

"My master would no doubt enjoy conversing with you, Loremaster."

He was more perceptive than even I would have guessed, able to discern that much about me. I smiled, fighting to maintain my composure. "That is an interview which I would prefer to avoid," I said, and in that moment cast my spell: his orb flashed blindingly bright, as he cried out, the sudden light searing his optic nerves, I was out the door.

By comparison, the stupid Syrkakar were easy to avoid, and I pelted across the vale with alarms ringing in my ears. The snow began to fall in large flakes, muffling my departure.

### 3.43 TAURKYTAAL: HOLD OF THE DEMONLORD

I anchored my small ice sloop, on loan from a friend of Talfar's, in a small inlet within sight of the Taurkytaal (K. "Dark Ice-stone"). The sheer stone walls of the castle glowed eerily, reflecting the beautiful prismatic displays of the northern lights, called by the Ky'taari dakuralani (K. "lights of night") which filled the black sky. Clad all in white, I slithered across the ice plain towards my objective.

At the edge of the crevasse which surrounded the citadel, I cast my cloak about me and vanished from sight. Then, allowing it to furl out I leapt off the precipice. Drifting like a flake of snow caught in a warm draft, I floated down silently to one of the guard platforms which jutted from the side of the pit. I landed directly behind the attentive guards, ready at their ballista to fire upon any intruder, and I was down the hall in a moment, hoping that Aztaur — the demonic master of this holding — was out. As it was, I surveyed and mapped the entire place without incident, including the orb of seeing in its secret chamber. A scant few hours later I was skimming across the sleek ice lake, heading back to the warm homes of the Ky'taari.

### 3.44 AALK GAATH: CITADEL OF THE DRAGON

Astride twin peaks of sheer stone rests the tower of Oran Jatar, (S. "Lord Dragon of the Forge"). From this citadel, the White Drake commands his priests Arnak: the Order of Gaath. Jatar is master of the creation of artifacts of power as well as a lord of mind and arms. Greatest among his items is perhaps his helm: fashioned after the form of a dragon's head, it allows him to assume human form and yet allow him to utilize his deadly breath at full potential. Chill he is of lungs and mind, and his minions know no mercy for those who would stand against the Dragonlord. I know, for I have faced Oran Jatar, and it was one of the rare occasions of my life during which I knew true fear. Jatar is a terror beyond even the Ordainers in some ways for he — as one of the Dragonlords — is not one of the creations of the Unlife, but an independent being who serves the Iron Wind willingly. Those are the most dangerous of its brood, for they are most wily and clever.

The palace of Oran Jatar also houses the six priests of Gaath, their High Priest, and the elite of the Order of Athimurl. Although Jatar is not their master, his voice carries weight amongst their ranks as well. In the caves below the tower they perform their dark rituals of sacrifice and torture by the flickering light of smoky torches.

More of the Aalk Gaath I will not tell, it is such an unpleasant memory. To those foolish enough to seek riches and adventure (and indeed, there is an ample supply of both) I wish good luck, and suggest that they set all their affairs in order first.

### 3.45 A-ARNAAR: HIGH TEMPLE OF THE KY'TAARI

Next came my assignment to infiltrate the places of the Ky'taari. No harm do I mean to the people, but in the interest of knowledge I explored places seen before by only the sanctified of the Religion. No gods do I recognize, only the tenets of my Order — and the instructions of the Ruling Council are not to be disobeyed.

With practiced care I wove my spells of illusion, and when I was through my countenance was that of a young monk of the Ky'taari race. In the midst of the spring festivals, when virtually all these fair people are dancing and singing outdoors under the sun which they love so dearly, drunk on its energy (and a variety of strong spirits) I stole up the road to the cliff above the Palace of the King. On the brow of the pinnacle rested A-Arnaar, the main temple of the people, and secondary residence of the High Priestess. I approached the white marble structure, its gilded roof glowing golden in the warm sun. I could not fight off a slight pang of guilt at violating the sanctity of the temple, even though I held firmly in my mind my Loremaster training, remembering that, as we meant no harm and did not interfere, we had nothing to fear. (Easy enough to say; to do is another thing entirely.)

I approached the imposing double doors which sealed the entrance and laid my hand upon the gold-alloy plates set in them where the doors met. At the warm touch the magical lock activated, and the marble doors slid slowly apart with a distant rumbling and a breath of displaced air. Inside the sanctuary I spent no time admiring the fine carving of the ice-stone or the yellow sunlight filtering through the tall, tinted windows, instead going straight to the large gold sunburst plaque mounted on the wall above the altar. I pressed firmly on the metal sculpture, it clicked, and the huge slab of marble which comprised the center of the altar ground slowly to one side, revealing beneath it a stair down.

From the bottom of the spiral stair I proceeded to explore the entirety of the subterranean complex, slipping without a sound down the dim, silent corridors to investigate vault and library, sanctuary and forge. The quarters of the monks were more comfortable than I expected, being richly appointed and elegantly designed, yet never did I have the feeling that luxury had been taken to excess.



Palace of the Ataar

## 4.0 PLANS OF THE CITADELS OF THE MUR FOSTISYR

### 4.1 SYCLAX

See color layout of "Syclax" at the end of the book.

#### Districts:

- A. **Irm Tavir:** Peak elevation + 325 feet; part of the "Lower Quarter" (Sy. "Tar Irm").
- B. **Irm Olzir:** Peak elevation + 398 feet; also part of the Lower Quarter.
- C. **Irm Olkusir:** Peak elevation + 502 feet; the central spire and principal market and gathering area; part of the "High Quarter" (Sy. "Mar Irm").
- D. **Irm Huralir:** Peak elevation + 451 feet; the easternmost spire and part of the High Quarter.
- E. **Irm Ukasur:** Peak elevation + 600 feet; the northernmost rock and last line of defense; home of the Citadel of Syclax (Sy. "Wasyclax"); highest part of the High Quarter.

#### Routes and Structures:

1. **Marey Ly:** (Sy. "Purple Highway"). Constructed of flat purple stone set over sand and gravel, this grand, durable road is unique. Actually, it is a pair of 10' wide lanes which run between Brya Sug and Syclax and enter the Yalg Syclax at the vale's southeast corner.
2. **Ao Nyvar:** (Sy. "Bridge of Sleep"). Five arch span constructed of blue basalt, with ornamentation of purple Jyhur (Sy. "Armor-glass"). It is 120' long and 25' wide.
3. **Nyvar Hulen:** (Sy. "Placid Bridge"). Built like the Ao Nyvar, it is 140' long.
4. **Var Huir:** (Sy. "Glassy Eyes"). A series of stone representations of beasts which surround the city and are set at 50' intervals. They are controlled by the Essence-masters of the Wasyclax, Mage-women who know of the ways of the geysers. They gaze from above and manipulate levers set in a miniature stone version of the city and, in this way, can release the steaming waters from beneath Syclax. This water explodes out of the mouths of the statues with the effect of scalding Water-bolts (Usual Impact crit + Heat crit of one step less in severity). The pair of larger statues that guard the entryway across the Nyvar Lywyvr can be rotated and release 1-10 times the steaming spray of the lesser stones.
5. **Nyvar Lywyvr:** (Sy. "Hold's Bridge"). Constructed of blue basalt and black Jyhur, it is 25' wide and 320' long. Five 20' x 50' sections of removable wood make up most of the roadway.
6. **Rowon:** (Sy. "Dry-moat"). This 250' wide channel is 50' deep in places. Lined with grey-brown granite slabs, it provides attackers with a hard, barren traverse. The moat can be filled with water from the Yon Syclax within minutes (see 7 below).
7. **Yon Syclax:** (Sy. "Five Gates River"). Rising from a spring beneath the Wasyclax, this stream leaves the flanks of the Irm Ukasur by way of a 75' waterfall. It then drops rapidly and crosses the Rowon by way of a raised 25' wide aqueduct. The aqueduct has five gates on each side which are controlled from the Water-room in the Wasyclax. When fully opened, they release two torrents of water which encircle the town in about 1 minute and fill the Rowon within 15 minutes.
8. **Lywyvr Symax:** (Sy. "Great-gate of the Hold"). This is actually nothing more than a 25' wide opening in the city's outer wall. It can be closed by using a smooth, cylindrical 5 ton blue basalt boulder which is winched along a track. The wall itself is a 4' high blue basalt structure, with crenelations and firing slits for kneeling (or very short) shortbowmen.
9. **Nobrey Murm:** (Sy. "Spire Street"). This 25' wide roadway is composed of fitted, dark grey basalt blocks and has a gentle incline. It serves as the chief artery and connects the five districts.
10. **Briga Nomrey:** (Sy. "Avenue of Flowers"). The Briga Nomrey climbs the northern side of the spire of the Irm Huralir and, like all avenues, is a pair of 10' wide lanes separated by a median strip. Like all of Syclax' higher streets, it is built out of dark grey cobble-stones. Its center strip contains numerous groupings of scarlet (Kurye) or blue flowers (Syrre).
11. **Arr Nomrey:** (Sy. "Avenue of Men"). This is the main route for merchants entering and leaving the city, for it connects the entry road with the central square in the Irm Olkusir district. Typically, Syclax' most prominent men are buried in their own stone images and set upon the median strip which divides the lanes of this avenue.
12. **Wy Nomrey:** (Sy. "Avenue of the Hold"). A small creek runs down a trough in the center of this steep road. This is the city's chief ceremonial route.
13. **Yrkajef Nomrey:** (Sy. "Avenue of Steam"). Geyser vents line the median strip at 50' intervals all along this road's ascent up to the Irm Olzir.
14. **Rag Nomrey:** (Sy. "Avenue of Metals"). This road climbs up to the Irm Tavir, where most of the city's metalwork is done. Its median strip is lined with 5' high copper figures derived from the mythology of the Syrkakar.
15. **Wal Rajef:** (Sy. "Fires' Place"). Metalworkers and smiths, most of whom are of the Tavir, ply their trade here and work around hearths set about the square.
16. **Wal Yrkajef:** (Sy. "Steam Place"). Hot steam baths and taverns surround this square; thus its reputation as Syclax' entertainment center.
17. **Mawy Wal:** (Sy. "Place of the Great-hold"). Religious and political gatherings and festivals are held in this beautiful square. Stone and metal mosaics are woven into its light grey rock surface.
18. **Wasyclax:** (Sy. "Citadel of Syclax"). Five stories and 90' in height, this 100 room fortress serves as the home for the Kakar of the Ukasur. In addition, two Messengers of Syrkakar reside here and keep watch over the town.
19. **Ad Wal:** (Sy. "White Place"). This square is surrounded by trees and beds of flowers. Since it lies in the southeastern quarter, it is considered to be the most sun-oriented square. The majority of Syclax' gardens are situated nearby.
20. **Wal Ef:** (Sy. "Center Place"). Here lies Syclax' chief market area, where traders gather every other day.



### 3.46 KALDARAAK-VAAR: HOLY SITE OF THE KY'TAARI

*Long and treacherous was my way to Dawnwater's Edge. It is well hidden in a misty vale, and nearly escaped even my powers of detection. Picking my way carefully along a steep slope above a lake which resembled very much the last several lakes and fjords I had explored, I was about to give up on this one as well: nothing in sight but a few small herds of Torkaani cavorting over the grassy hills. The sky in the east was growing lighter by the moment; night (my favored time to travel) was nearly over, for it was spring and the sun rose and set with regularity. Abruptly the grey vale turned to yellow-gold as the sun ignited the fog and damp grass. Far out on the water the mists shredded in a morning breeze, revealing for a fleeting instant a tiny isle, and perched upon it a strange manor.*

*I spread my arms, and in a moment that body which was Elor was gone, and only an arctic tern stood at the edge of the water where I had been. Though this transformation consumed much of my power I dared not use a lesser trick to reach the Kaldaraak-Vaar unnoticed. With a rush of white feathers I was airborne and sweeping low over the calm waters, my sharp avian eyes picking out every detail of the landscape. In just a few minutes I arrived at the dense mist, and a moment later burst through it to a clear area. There stood Dawnwater's Edge. I perched upon the peaked roof of the house to assess the situation.*

*This is the most holy place of the Ky'taari, as it was the home of Ariaana when she came to live within the realm of the Ice People. Its incredible age is betrayed in part by the method of construction: the strange, interlocking stone of the ancient Syrkakar masons. The blocks themselves are roughly hewn, yet fitted together with the utmost skill by the first Ky'taari, who learned their abilities from the Syrkakar before that race degenerated into its current state. It is a monastery of the utmost security and power, invincible to all but the most fierce attack. On the first day of spring of each year the A-Ryaan travels here, and Ariaana returns for a day to give her blessings and advise the Priestess.*

*Year round, thirty-three monks are in residence: the elite of the monasteries of the nation, guarding this most sacred of places and creating great works of text and gold. Here also is kept the master orb of the seeing stones of the Ryaani, able to view any site within the realm at the command of the A-Ryaan, or the Lord Monk, who rules here in her stead.*

*Monks indeed there were: several in the sheltered courtyard, and I could sense others patrolling within the roofed parapets. At first I searched in vain for an open window, and despaired of an easy entrance. At last, however, a monk threw open the wide sashes along the eastern face. Alighting on a sill, I peered within, and the moment he left the room I glided in and to a shadowy corner. I stood, Elor again, and with a shrug of my cloak I vanished from sight. Within the actual fortress the residents would not be as wary, and (hopefully) none will be casting spells which allow them to detect those unseen. Silent and invisible as a wraith, I investigated the hallowed chambers of this most holy of places. Undetected, I left as I had come, with no trace behind to betray my intrusion.*



## 4.2 VAR UKAAK: The Tower of Susymog

Note: all doors in the Var Ukaak, save the main entrance, are made of a dark wood, bound and hinged with iron. The locks are all the same, and should be considered Medium (+0) to pick.

1. **Entry.** The door is fashioned of black iron with a large "S" rune emblazoned on it. It will only open to the word "open".
2. **Combat corridor.**
3. **Reception room.** A large hall with grey marble floor and steel lamps. Furnishings are sparse and utilitarian.
4. **Guardroom.** Three garrison guards on duty at all times. The area also serves as their quarters, and houses six off-duty guards (nine in all, in each room).
5. **Guest quarters.** Relatively crude accommodations. Of course, Susymog rarely entertains guests.
6. **Mess hall/lounge.** Serving the garrison.
7. **Kitchens.**
8. **Storage/Armory.** Contains basically dry goods and equipment.
9. **Foyer.**
10. **Stairs up.**
11. **Processional corridor.**
12. **Secret panel.** Locked, Hard (-10) to pick. Within is a wood box containing a black iron amulet. Its sole power (which is not obvious) is to control the golems in 15.
13. **Secret door.**
14. **Throne room.** The throne is equipped with three control switches on the left arm: one which controls the doors into the room; one which pivots the throne to face any direction; and the third lowers a circular laen wall to surround the throne and dais, protecting the lord.
15. **Foyer.** Note the statues at either end. They are in fact iron golems, and are controlled by the wearer of the black amulet found in cache 12. See the Master Military chart for their abilities.
16. **Grand balcony.** Overlooking the valley below.
17. **Lounge.** Very comfortably furnished, this is the entry room to the quarters of the two Priests Arnak who serve Susymog.
18. **Council chambers.** Dominated by a rectangular table, this room is the setting for consultations between Susymog and his lieutenants.
19. **Armory.** Holding items of special use to the Priests.
20. **Map room.** Filled with maps and charts not only of the Mur Fostisyr, but most of Jaiman.
21. **Anteroom.** To the bedroom of High Priest Ayric. Richly furnished.
22. **Bedroom.** Of High Priest Ayric. Red velvet is used copiously in decorating this chamber.
23. **Sitting room.** Of High Priest Wylzun. In the center of the room is a small table, on which is set a small orb — a scrying device which aids Wylzun in his evil Communing.
24. **Bedroom.** Of High Priest Wylzun. This chamber is more stark than its counterpart, but is still elegant in its way.
25. **Small balcony.**
26. **Library.** Within is a small collection of volumes, none magical, and most of interest only to Susymog.

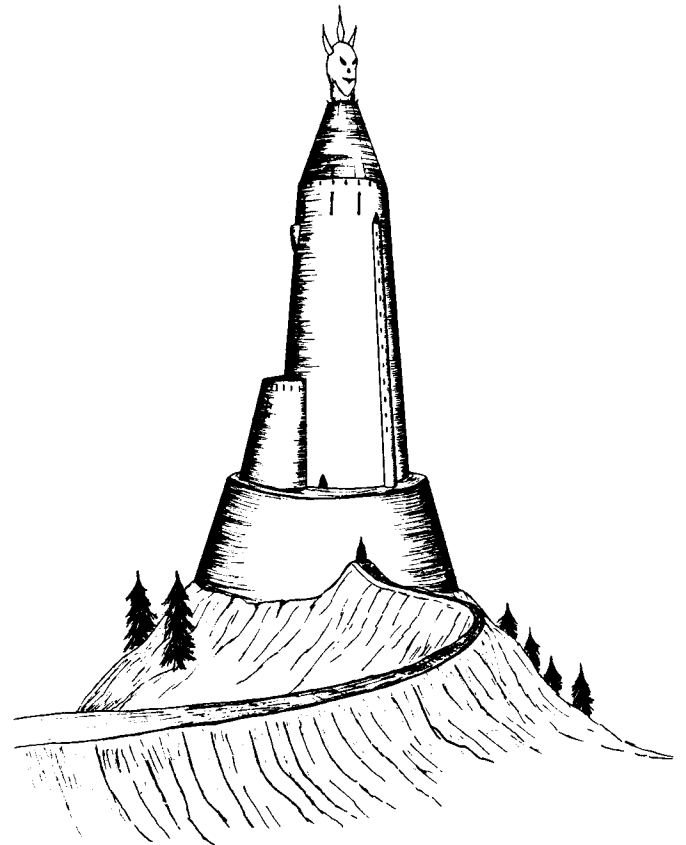
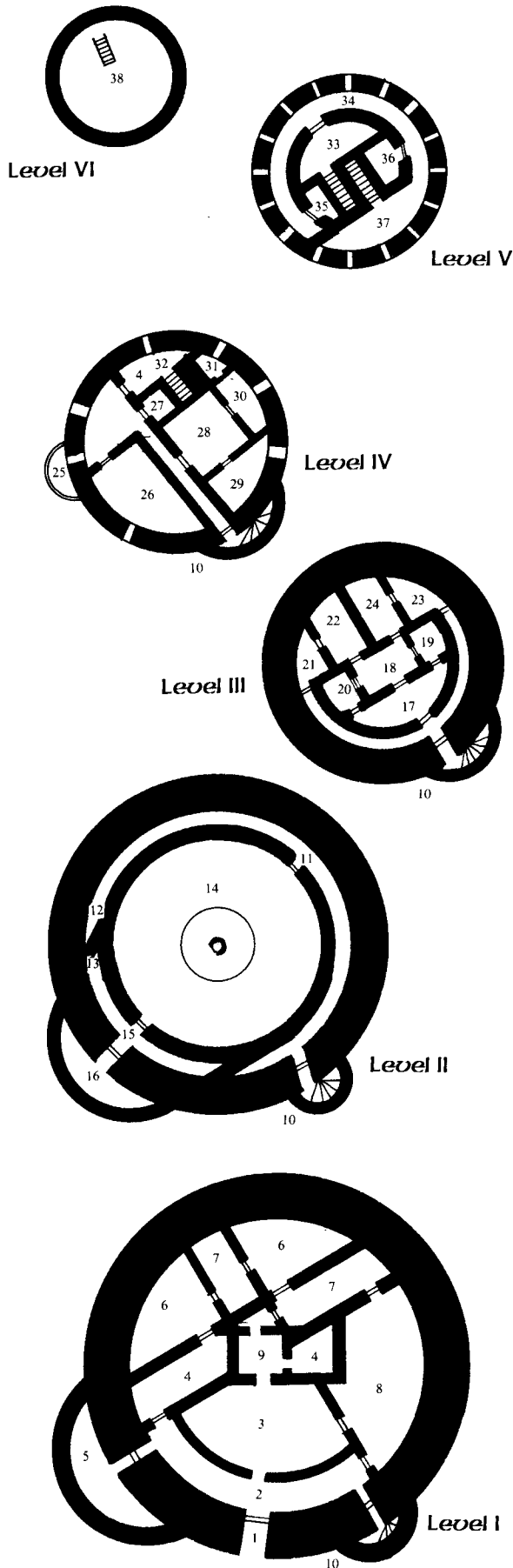

Var Ukaak

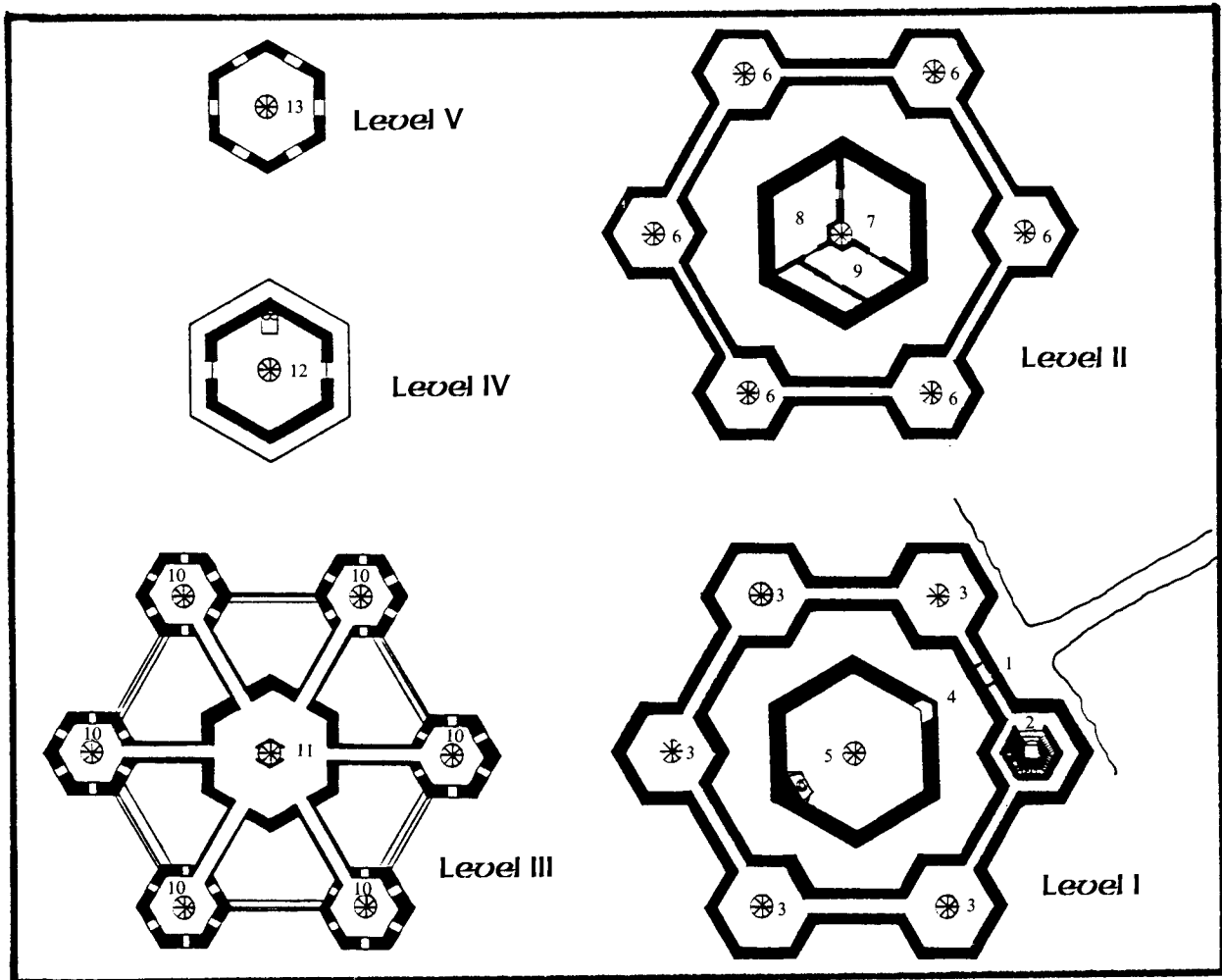

## Taurkytaal: Upper Citadel

27. **Guest Room.** Much more comfortable than room 5, this chamber is usually used to house a visiting priest.
28. **Susymog's reception room.** An anteroom to the Ordainer's private quarters.
29. **Susymog's bedroom.** Perhaps surprisingly, the furnishings are rather stark and crude.
30. **Elite guardroom.** Housing six guards, two on call at all times.
31. **Treasury.** Behind a secret door is a heavy steel one, locked and Extremely Hard (-30) to pick. Within are held, in three chests, 5,000 gp. and several magical items. See Items of Note for details.
32. **Stairs.** To level five.
33. **Lower altar.**
34. **Combat corridor.** Hung along the perimeter are several heavy crossbows, and ammunition for firing through the slits. (All garrison guards are trained in H.C.)
35. **Elite guardroom.** Two guards on duty at all times.
36. **Meditation room.** Furnished only with a low bench.
37. **Laboratory.** Standard chemical apparatus.
38. **Temple of the Ordainer.** Stairs lead up into the skull above. Within is a brazier, and an urn full of red powder which, if thrown into the fire cause a uniform red glow which emanates from the skull features and can be seen for many miles at night. The two perimeter stairs lead to the upper temple.

### 4.3 TAURKYTAAL ("DARK ICE-STONE")

Based upon the form of a hexagon, the citadel of Aztaur the Demonlord rests upon a sheer pedestal of ice, surrounded on all sides by a bottomless chasm. The only land access to the castle is across a narrow ice bridge.

1. **The main gate.** Inset in the smooth stone face, the gate entranceway is fifteen feet deep, with secret doors opening onto wall passages on either side. The outer gate is a set of hollow reinforced steel doors six inches thick, which slide on a track into the wall on the sides. The inner gate is of steel also (four inches thick) which operates similarly to the outer gate. Just in front of this inner gate is a steel portcullis which may be lowered for added security. This arrangement is to allow any intruders to be trapped between the two gates and attacked by the guards via the secret doors; or to be fired upon from inside the courtyard through the portcullis. All gate operations are controlled by mechanisms in the hall directly above, where there are small viewing slits.

2. **Tower.** This tower is the only one without a stair from the first level to the second: the stair here begins on the second level. Instead, on this level is the counterbalance elevator to the lower halls, and an alternate stair to the lower level. This entire circulation system may be closed by means of a stone secret door lowered from above, and a steel door within this.
3. **Towers, level 1.** Each of the other five towers is identical, with access passages to the two adjacent towers. On the first floor, the room itself serves as a dining area for the 18 guards housed in that tower. Each also has a spiral stair running the height of the tower. The towers may be isolated by pulling a lever, adjacent to the portal, which raises a steel door up through the floor and locks it in place.
4. **Gate.** The central keep gate is hidden from the outside while closed, and slides up into the wall above, activated by a lever just inside the door (or by saying "Open, by Aztaur", while outside).
5. **First level.** This is the main staging area. Here Aztaur assembles his troops for general meetings and large banquets.
6. **Towers, level 2.** All six towers are identical from here up: these are the sleeping quarters for the guard. Doors here are identical to those on the floor below, except that they slide out of the adjacent wall.
7. **Lounge.** Richly furnished with the finest quality chairs, tables and desks.
8. **Library.** The walls are covered with bookshelves containing texts on astronomy, astrology, history, medicine, poisons and diseases, works of fiction, mathematical studies, and engineering volumes. However, all of the pages appear to be blank unless one is wearing the magical spectacles which are in a secret compartment within the only book on the desk in the center of the room. The compartment is in the binding, and the entire text of the book is death runes. (12 of them) Also on the desk is a pitcher and a glass. When (and only when) the liquid in the pitcher is poured in the glass and drunk, the drinker can read at 4 times speed for five hours. Two doses in one day will cause permanent blindness.
9. **Pantry and kitchen.**
10. **Towers, level 3.** These are lookout/firing rooms for the guard, three being on duty in each tower at a time. The stair continues up to the roof of the towers, each of which holds a ballista on a pivoting platform which allows full directional flexibility. Each tower on this platform has access via a stone bridge to the central keep, which is the captain of the guard's security headquarters. There are also secret doors from the towers opening onto the tops of the walls.
11. **Security area.** From a desk next to the stairwell, the captain is able to control all of the doors onto the stone bridges, as well as a steel door to slide shut over the opening in the floor up through which comes the spiral stair. There is a small crystal orb which allows the captain to communicate with Aztaur at any time.
12. **Aztaur's quarters.** The stair here can be closed off by a steel panel sliding across the opening in the floor. Steel panels may also be closed over the glass doors which open onto the balcony. All of these panels are controlled by levers located adjacent to the bed.
13. **Viewing room.** Although they are invisible from the exterior, this room has six windows facing out across the plains.

## THE LOWER HALLS

- Secret door.** Within the right tower flanking the ice bridge there is a secret panel in the central pillar which opens to reveal a small, rectangular room which, with the aid of counterweights, can be lowered 120' down into the lower halls. Alternately, there is a stairway concealed within the wall around the lift, and access downward may be achieved in that way.
- Entry hall.** The floor is covered in a deep blue carpet, and the hall has in its center a large gong suspended by a wooden frame, with a mallet hanging beside. Only if the gong is struck will the larger doors open (the others being secret). The gong itself, oddly enough, makes no sound.
- Lookouts.** Guarding the second crosswalk, 120' below the icebridge, are four platforms easily accessible from the guard room, equipped with ballistas to eliminate any intruders who might attempt to fly or climb down the abyss. It should be noted that the platforms are slightly recessed and so invisible from the icebridge above.
- Double metal doors.** Locked, Very Hard (-20) to open, they slide apart along a metal track when unlocked. Beyond is a short hall ending in an open platform. Here is a bottomless abyss, rising out of the center of which is a hexagonal pillar, crowned by three thrones. On the wall of this short passageway are three identical levers. The first causes a bridge to extend out to the central pillar. The second triggers a trap which slams the metal doors behind the luckless adventurer, and the floor suddenly dumps him into the abyss. The third sounds an alarm in the guardrooms, though it cannot be heard here.
- The pillar itself.** Three thrones rest atop it, two of human size. The third, central throne is large enough for a creature of perhaps twelve feet in height, and is on a dais one foot above the rest of the pillar. Each of the other thrones is fashioned of stone, with a back six feet high; and each has a lever at its side. When the lever is pulled forward, the throne spins around 180 degrees. When the lever is pushed back the throne resumes its original position. The left throne is that of Darath, the Evil High Priest. The right one is the seat of Ryykaar the mage, and the central throne is, of course, the seat of Aztaur the Demonlord. Beside this throne are three levers. The first acts as do the levers of the other two thrones. When reversed, this throne (made of glassy material resembling ice, but strong as steel) with its ten foot high back, acts as a missile shield from possible foes on the platform, lending 50 to the seated one's DB. The second lever has six positions, one for each of the three bridges in the retracted or extended position. The third activates the trap on platform 4, and sounds a general alarm. All of these thrones act as "safe return" places to which the lords teleport.
- The room of Seeing.** First, a locked - Very Hard (-20) - steel door slides up, beyond which is a stone door, locked Extremely Hard (-30) to open (which it does by sliding up), with a 10th level *Death Rune* on it for all those folk who are not Aztaur the demon (he is immune). The third and final door is steel, locked Medium (+0) and trapped. Failure to defeat the Extremely Hard (-30) mechanism will cause the stone door (weighing several tons) to fall into place, its opening mechanism disengaged on the inside, and the room fills with poisonous (Trikassa) gas for one hour, after which the gas is bled out and the door opens. Within the room is a pedestal of finely wrought gold, resembling a small tree. Held within the intertwined branches is a sphere 9" in diameter, of clear crystal. (The tree and orb are of Elven design, forged in a time long past). The orb, if commanded by one of strong will, shows visions of places as far as 300 miles away, acting as if the user were utilizing the Seer spells *Watch* or *Long Eye*. Those of less will are shown either random or deceptive visions. The walls of the room are covered by curtains of black velvet, behind which are 10th level *Death Runes*.

- Foyer.** A secret door opens into the teleport chamber. There is one control lever in this hall, which acts to extend the bridge to the pillar. A secret door allows access to the great hall.
- Great hall.** At the front of this room is a throne similar to the large one in the teleport chamber, although this one has but two levers. The first swiftly lowers a clear *Laen* (Laen is an enchanted glass stronger than the best steel) wall between the throne and the rest of the room. The second lever closes and seals the main door into the hall, leaving the demon an escape route through the side door on the stage. The rest of the hall is furnished with long tables and benches in typical banquet hall fashion. The walls are covered with tapestries depicting Aztaur victorious in battle against a variety of foes.
- Foyer.** A wooden door swings open to provide entry into hall #7, but only if one discovers and disarms the Very Hard (-20) pit trap in the floor. Disarmament involves twisting the torch-holder at either end of the hall counterclockwise. If this is not done, one may find oneself at the bottom of a 30' deep pit filled with acid, delivering 3-30 hits per round of contact. There is also a dead end wooden door which, if opened, will cause the ceiling to fall in the entire short hall, causing 1-10 Fall/Crush attacks +30. Another wooden door, locked and Very Hard (-20) to open, allows access to the bedroom of Ryykaar the Magician. The fourth doorway from this foyer, allows access onto a corridor which in turn leads to a secret door opening near doors #4.
- Ryykaar's bedroom.** The room is furnished with a large bed, a chest of drawers, a desk and a laboratory table with flasks, etc. In a false drawer bottom in the dresser is a set of robes (red with black runes on the borders) which protect the wearer as AT 2-50 (plus any quickness bonus) yet cause no movement encumbrance. Within the desk, in a secret compartment trapped - Hard (-10) to discover and disarm - with a poison needle (Sharduvaak), is an iron wand, very crudely made, with a large, flawed ruby (1" diameter) set in the end, roughly cut. This is a wand of *Firebolts*. It has but seven charges left in it, though there is no way of knowing that. On the lab table, there are potions in the following doses: 1 of 2x strength (doubles hits delivered) for 6 battle rounds; 2 of healing (2-20 hits each); 1 of permanent infravision; and 1 of cold immunity for one day. There are also 5 vials of poison: 2 of Karfar; and 1 of Jegga. These poisons are, of course, indistinguishable from the beneficial potions.
- Kitchen.** The main kitchen for the lower halls, which includes quarters for the cooks, and a small dumbwaiter to move supplies from the castle above.
- Trap.** Past the first set of metal doors (locked: Extremely Hard (-30) to pick, they slide open when unlocked), down the stairs is a second set of doors, also locked, Very Hard (-20) to open and set with three traps, each of which must be detected and disarmed separately and is treated as Extremely Hard (-30): 1. A pit trap in the floor at the bottom of the stairs, falling 60' down, delivering 1-10 Fall/Crush attacks +40. 2. The ceiling collapses, delivering (again, if necessary) the same damage as the pit. 3. The outer doors close, and the entire hall fills with water. Even if all these traps are disarmed and the inner door is unlocked, it slides up into the ceiling to reveal a potent (20th level) *Death Rune*.
- Quarters.** Of the captain of the guard, a 15th level fighter named Tarfoth.
- Guard quarters.** Three men per room. Note that outside these rooms are two dead-end corridors equipped with Hard (-10) to discover pit traps delivering damage similar to #12.
- Main temple.** The only furnishings are a large altar and a pedestal at the front of the room on a two step platform. The pedestal is covered by a single slab of granite with a drainage trough around the edge. The slab is stained with dried blood (human).

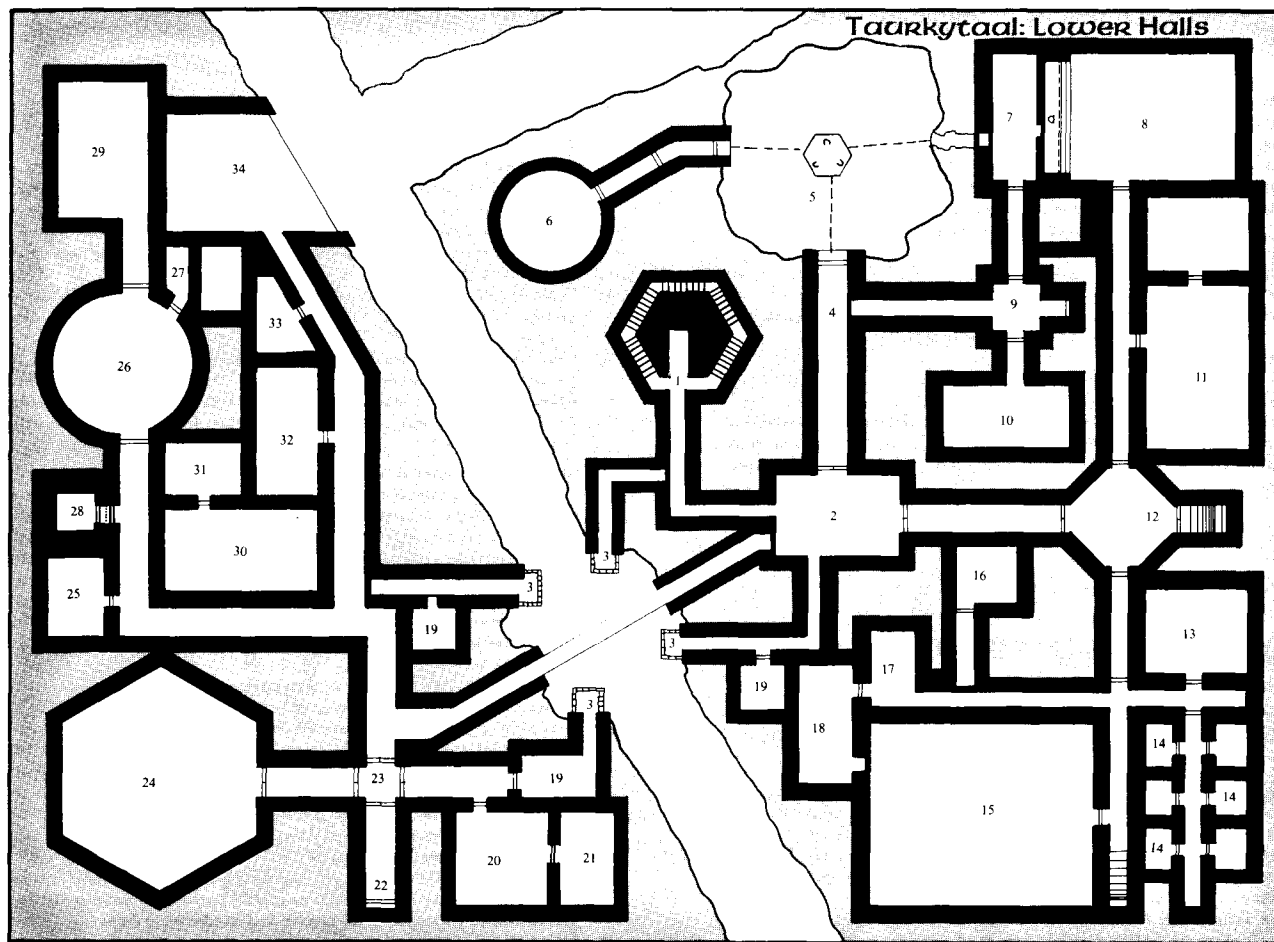



16. **Quarters.** Of Darath's personal bodyguard: a demon of the Second Pale.
17. **Anteroom to Darath's quarters.** Sumptuously furnished with tapestries, velvet upholstered furniture, etc.
18. **Darath's bedroom.** Also expensively furnished. One wall is covered with bookshelves (tomes on local history, and texts on demonology). In a secret compartment behind one section of books is a book of Channeling spells. The first page contains a 10th level *Death Rune*, as do all of the oddly numbered pages, and page 12. The other evenly numbered pages contain the runes for all of the Evil Base Cleric Spells to 20th level: one of each, and each useable one time only. Also, hidden in one of the posts of the four poster bed is a staff. Made of black wood and bound at the ends with steel, it strikes as a quarterstaff +20, and is a guardian weapon, giving the wielder an additional 20 to his frontal melee DB. The staff is also a x4 enhancer to Channeling spells. Hidden within the fixture of a torch holder is a ring, made of gold and set with a diamond. This ring will cast one *Cold Ball*, 4x damage, 100' range, per day. The ring also protects the user totally from magical flame. A chest at the foot of the bed holds 1,000 gp. worth of gems.
19. **Guardroom.**
20. **Torture room.** Equipped with a hearth (for warming 'utensils'), and the most advanced equipment of persuasion.
21. **Dungeon cell.** With manacles to accommodate six prisoners. The door to this room is kept locked, Very Hard (-20) to pick. Only the Captain of the Guard and Darath (a master torturer) have a key.
22. **Trap.** Attempting to open the inner wooden doors without disarming the Extremely Hard (-30) trap will cause the floor to open onto a chute which deposits the victim out into the bottomless crevasse nearby.
23. **Central hall.** The door nearest the bridge is of stone, and lowers into the floor when the word "Open" is said. The opposite door, also of stone, opens when the plaque on the wall beside it is slid to the left. The plaque is engraved with the words: *Halls of faceted abundance* in Elvish. (The abyss is flanked by walls of crystalline forms of ice, though the phrase is of course meant to make the PCs believe that there is a treasure of jewels behind this door.) The wood doors on either side open when the rivets on one of the iron reinforcing bands are pressed in the correct order [treat as a lock, Very Hard (-20)].
24. **Extensive library.** Including texts on demonology, astrology, the nature of ice and the lands of cold, plans of the upper levels of this castle, a total history of a large portion of the world, and texts about Magic, Channeling and Mentalism (though no spells). The pool in the center of the room, when drunk from, allows reading at 4x speed for 5 hours, but if used a second time in one day will cause permanent blindness. The other pool, when its contents are splashed in the eyes, will allow the reading of any language, and when drunk will allow speech of same.
25. **Quarters.** Of the assistant forger (Chryaaktar).
26. **Main forge.** With magical anvil and firepits, and a pool of instant cool water which does not crack the metal (the magic here is within the receptacle, not the water).
27. **Storeroom.** For valuable raw materials: *Laen*, gold, silver, very strong steel, and small amounts of *Keron* and *Kregora*.
28. **Vault.** Entry is gained by defeating the three Extremely Hard (-30) locks in the first door, saying "Open" to the portcullis in *Iruaric* (by drinking the speech-potion in the library if necessary), and disarming the Sheer Folly (-50) trap in the last door and so avoiding the three poison (Loryaak) darts which fire as rapiers +80. The last door also must be unlocked — Sheer Folly (-50). Inside is a treasury of magic items either made by Aztaur or stolen by him over the ages. See Items of Note, section 5.3, for details.
29. **Storage.** Of common forging materials; also a general armory.
30. **Quarters.** Of three stone Trolls. (the bodyguard of the Lord Demon.)
31. **Refuse room for the Trolls.**
32. **Quarters.** Of the inner elite guard, which is composed of six fighters.
33. **Anteroom for the Demonlord.**
34. **Aztaur's bedroom.** In addition to the huge bed, a dresser, and a pool of unholy water, there are two chests filled with a fortune in gold and gems (some 15,000 gp. worth). Each chest is trapped: one yields a *Cold Ball* at point blank range; the other, if the victim fails to resist vs 10th level Channeling, will crystallize him as an ice statue. Each trap is Extremely Hard (-30) to detect and disarm. Facing the chasm is a large window wall, which can be made to slide up entirely into the ceiling by pulling a lever next to it. This allows the demon to enter his bedroom via his wings, without being forced to go through the complex.

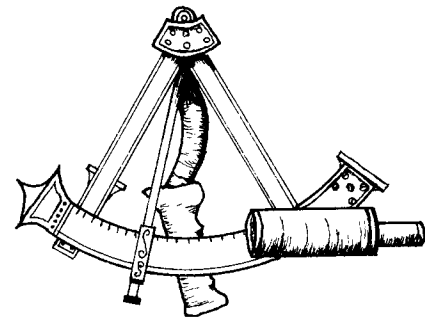

Compass of the Varn-kye

#### AZTAUR THE DEMON LORD

... and of six Pales were demons made, the sixth being the most strong and fierce, and the first the least in might. But also there were the great demons: those who were beyond the Pale. Of these there were always few in number, but their strength in arms and magic is to be feared. For the most part they were aligned to a certain element of the world, be it fire, ice, earth or air. Mighty among them was Aztaur, the Lord Demon of cold. His was the realm of chilling ice, the far North, and his reign was of utter terror. Little has been learned of his fate after the Wars of Dominion, and many assume he was slain by the lord of Ky'taari in the final battle. . .

The Texts of Arduvaal of Vraniis  
Year 2361, Second Age of Ire

Aztaur is indeed a Lord among demons, and as such, beyond the Pale. Little is known of his current motives, and indeed, whether he is aligned with the Iron Wind. It is sure, however, that he seeks revenge against the insult he has been paid by the Ky'taari. . .

Aztaur's attributes and powers are listed below:

- 1) His skin is as full hide plate: AT 12 (-50).
- 2) He fights hand-to-hand with matched +20 swords of cold.
- 3) Possessed of huge, batlike wings, he is able to fly at speeds of up to 40 miles per hour.
- 4) From his eyes he can fire streams of cold (as icebolts, x4 damage) 3x per day.
- 5) He has the sight of things invisible.
- 6) He is immune to cold.
- 7) He regenerates 1-10 hits per round, as an aura of cold heals his wounds.
- 8) He is able to shrink to human size (6 feet tall) at will. Naturally, his powers are greatly reduced at this size; but it facilitates maneuvering.

#### 4.4 AALK GAATH ("Citadel of the Dragon")

Outside the tower, the Dragonlord has placed several unusual structures of power to aid in the defense of his home: six sculptures of black iron surround the hold, altars of summoning which call six Messengers of Syrkakang should the citadel be threatened. Also, straddling the road to the tower is an archway of smooth, black slag, upon which is mounted a mithril orb. If one intends to enter the hold of Oran Jatar, only after passing through this gate will he be permitted to penetrate the portal of the castle, for this archway is aware and senses the nature of the guest, communicating that knowledge to the entrance beyond. Only those whose essence has been detected by the arch shall be allowed to enter; all others suffer a 30th level Absolution.

1. **Entry hall.** A strip of laen runs across the floor, walls and ceiling. This is the inner portal, and all those who did not pass under the arch must roll a RR versus a 30th level Absolution. Beyond is a door, locked, Hard (-10) to open, which rises into the ceiling.
2. **Foyer.** In the center is a fiery pit and corridors lead to the lower temples of the Priests Arnak and to the spiral stair up into the tower above.
3. **Prayer hall.** Of the Order of Athimurl, a two step altar of black stone rests in the center, embraced by three pits of fire.
4. **Caves.** Within which twelve snow lions reside (two in each). They are highly trained, and attack on command by their priests. The portculli are controlled by a lever which flanks each cave entrance. Stairs in the caves lead up to the tower.
5. **Prayer hall.** Of the Order of Gaath, it is identical to that of the Athimurl.
6. **Forges of Muul Chort.** Each cave contains the tools necessary for forging: one of heat, one of cold, and one for magical items.
7. **Storage.** For the raw materials of forging.

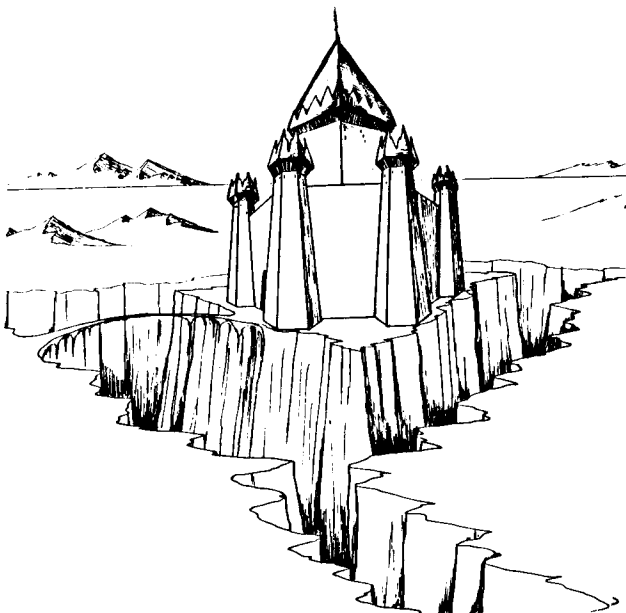

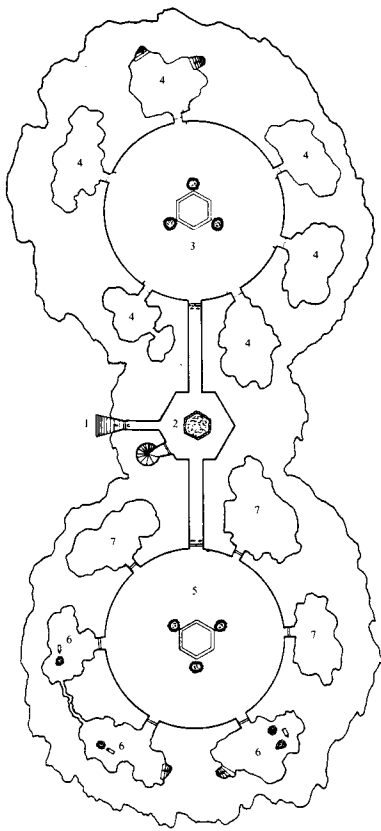

8. **Throne room.** Beside the throne are three levers: the first causes a wall of clear laen to enclose the throne dais; the second controls the doors flanking the throne room; and the third sounds a general alarm in the citadel. The throne itself is of slick, black stone.
9. **Guardroom.**
10. **Waiting area.** For those wishing an audience with the Dragonlord.
11. **Stairs.** To the second tower level. Doors and portculli to throneroom are locked, Medium (+0), and fashioned of steel.
12. **Quarters.** For the six elite Priests of Athimurl.
13. **Foyer.** Stairs lead down to the cave below.
14. **Kitchens.**
15. **Lounge/dining area.**
16. **Quarters.** For the six elite Priests of Gaath.
17. **Foyer.** Stairs down to forges.
18. **Halls.** Doors to temple are silver plated, and those on the left bear the rune of Athimurl; those on the right are inscribed with the symbol of Gaath. All are locked, Very Hard (-20), and trapped, Hard (-10) to disarm. Failure to overcome the mechanism causes long spikes to stab out of the flanking walls. Roll 1-10 rapier +100 attacks.
19. **Lower temple of Arnak.** Inner doors are opened by twisting both flanking torch holders clockwise simultaneously. For discovering this, treat as a Very Hard (-20) lock. The two perimeter stairs lead to the upper temple.
20. **Hall of Arms.** Various weapons are displayed on the walls (none magical).
21. **Guard room.** Staffed at all times by 3 garrison guards.
22. **Sitting room.** Of Oran Jatar's quarters.
23. **Oran Jatar's bedroom.** Furnished in a stark yet elegant manner.
24. **Laboratory.**
25. **Vaults.** Behind secret door, which is locked — Extremely Hard (-30) — and trapped [Very Hard (-20)]. Failure to disarm yields a poisoned needle in the hand (Loryaak). See sec 5.3 for details of the vault contents.
26. **Hall of Arts.** Many objects of beauty, taken from cultures now destroyed by the Iron Wind, are displayed.
27. **Libraries.** All texts are in the Dark Tongue of Kugor.
28. **Upper sanctuary.** The temple of the High Priests of Gaath and Athimurl.
29. **Guardrooms.** Manned at all times by three garrison guards.
30. **Sitting room.**
31. **Chambers.** Of the High Priest of Athimurl. The Priest possesses a staff of white wood with a silver cap carved in the likeness of a snow-lion head, symbol of his position. The staff multiplies his spell points by an additional x2 (in conjunction with his ring — thus a total of x6), is capable of storing as many as three tenth level spells at a time, and in addition will *Summon Storm* once per week. The storm takes the form of a blizzard of 10 mile radius and one hour duration. Snowfall is blinding, and accumulation is one foot. The priest's robes, like those of his underlings, is of heavy white cloth, and his emblem and trim is embroidered with silver thread.

## Aalk Gaath: Lower Halls



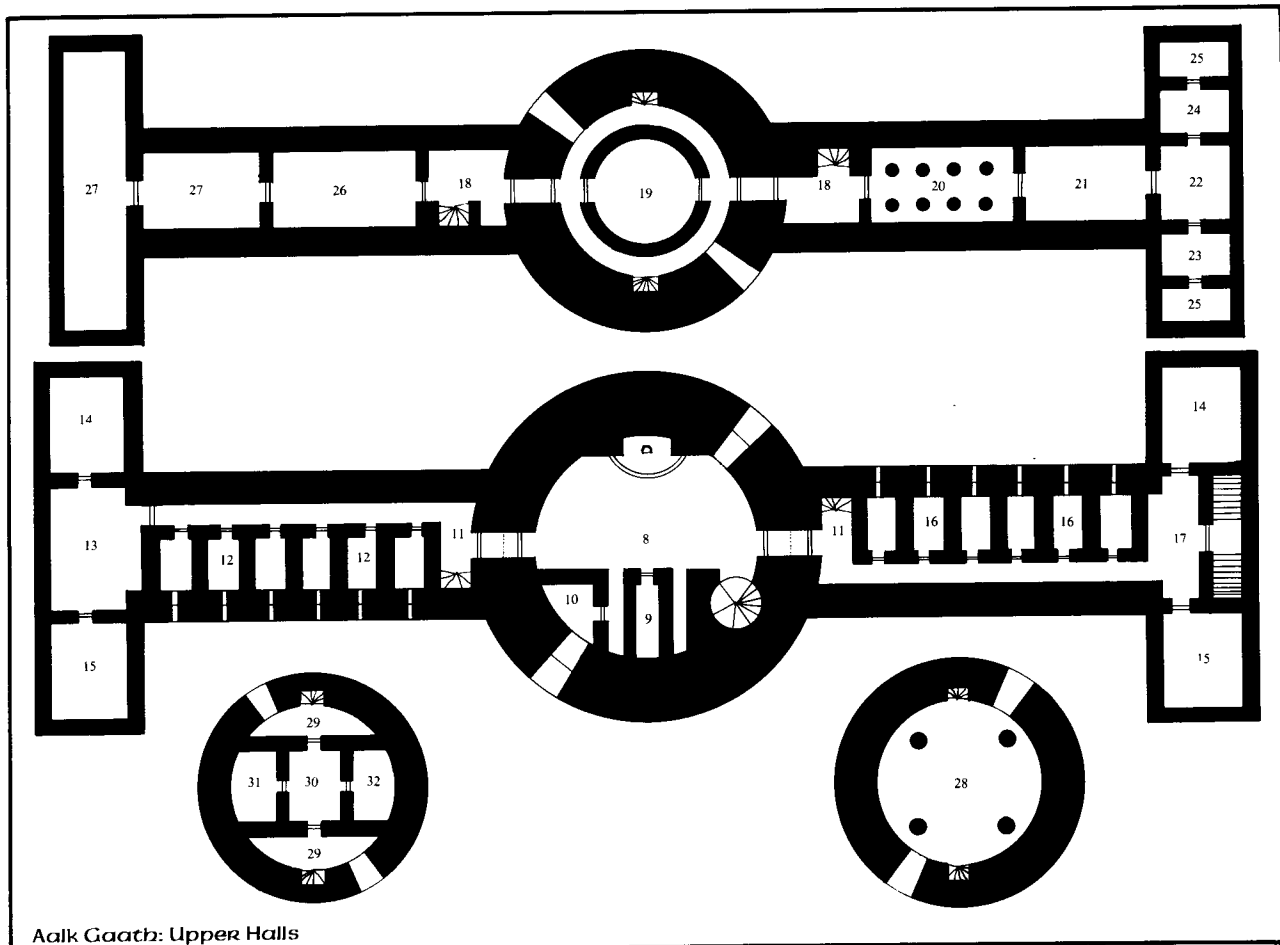

Aalk Gaath: Upper Halls

32. **Chambers.** Of the High Priest of Gaath. The symbol of Gaath is the Dragon, and the High Priest's black wood staff is capped with a gold carved dragon head. The powers of his staff are identical to those of Athimurl's, except instead of summoning a snowstorm, Gaath may *Call Cold (Base Magician Ice Law)* in a 30 foot sphere as far as 100' from himself, as often as once per day. Gaath's robes are grey, trimmed with black thread.

## 4.5 A-ARNAAR ("High Holy Temple")

### THE A-ARNAAR (Upper Level)

The A-Arnaar, situated on a bluff above the capital city of the Ky'taari, is their main temple complex. The above-ground section is acutally quite simple, as can be seen in the plan. It is the underground area which is the heart of the day-to-day operation of the place, and where the staff spend most of its time. The sanctuary is used during the weekly ceremonies: an early 'morning' one including only the monks and the A-Ryaan, and two later ones, attended by the populace of the city below (the two later services are duplicates, as the Temple cannot accommodate the entire city at one time).

- Entry.** Large double doors plated with gold. They are opened by simply placing a hand on the central metal plate set in their surfaces. The warmth triggers a magical lock, and they slide into the adjacent walls.
- Sanctuary.** A huge vaulted chamber furnished with rows of pews made of polished wood. The floor, walls and ceiling are all of various thicknesses of *kytaal* trimmed in gold leaf.
- Altar.** A raised dais spans the front of the room. In the center is a wide podium, and on the back wall is a large flat metal sculpture depicting a multi-rayed sun: the symbol of the religion of Ariaana. If one presses against the sun sculpture it triggers a secret door mechanism. The center section of the back wall slides to one side, providing access to the foyer. The trigger to this door is Extremely Hard (-30) to find.
- Foyer.** A Very Hard (-20) to detect secret panel in the floor slides away, revealing the spiral stair down to the lower halls. The secret foyer also has doors which open into rooms 5 and 6. The doors to these chambers are also secret.
- A-Ryaan's office.** Elegantly furnished, this room is only used by the A-Ryaan when she is meeting with someone from outside of the church (as they are not permitted in the lower halls).
- Head Monk's office.** Similar to 5, it serves the same purpose for the Head Monk.

### A-Arnaar: Upper Temple

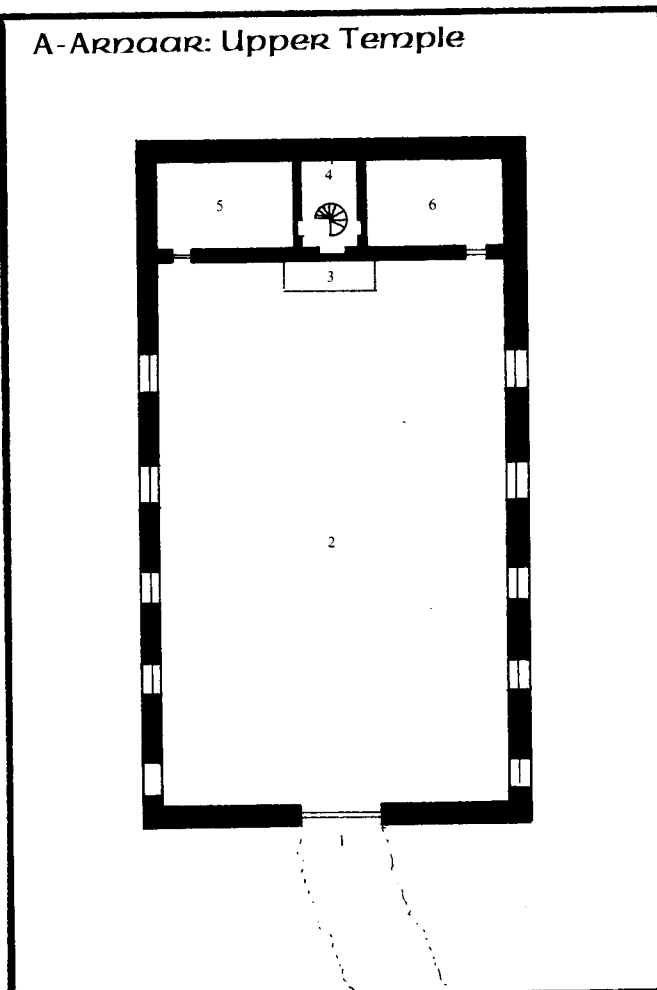

## A-Arnaar: Lower Halls

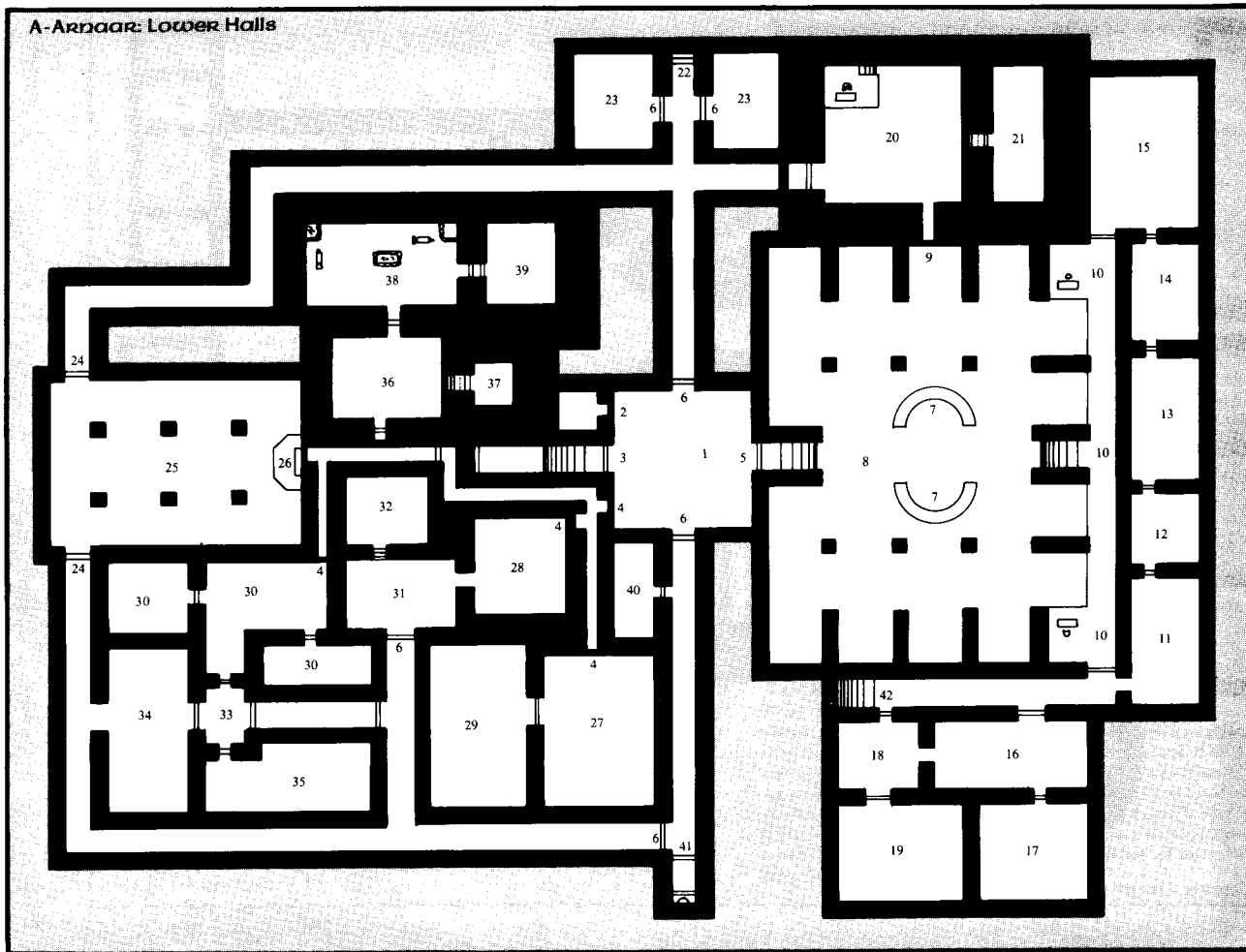

### LOWER HALLS OF THE A-ARNAAR ("HIGH TEMPLE")

1. **Altar.** On the wall above the altar on the above-ground temple is a large sculpture of the sun in gold. When this is pressed, the stone altar slides to one side, revealing a spiral staircase down.
2. **Secret stone door.** It is trapped, Extremely Hard (-30) to detect and disarm. If not disarmed before the door is opened the offender takes three ballista bolts (treat as heavy crossbows +60 and three times damage at point blank range).
3. **Double steel doors.** Locked and Very Hard (-20) to pick, they lead down a corridor to a false steel door. Once the first person steps on the floor halfway down the hall, the ceiling collapses, yielding 1-10 Fall/Crush attacks, each at +50.
4. **Secret door.** Trapped, Very Hard (-20) to disarm. Failure yields a poisoned (Klytun) needle in the hand.
5. **Doors.** Identical to 3, yet leading down into the main library.
6. **Doors.** Of iron bound wood, locked and Hard (-10) to pick.
7. **Library card catalogue.** Books indexed by author, title, and subject.
8. **Library.** All books are in the high tongue. 100,000 volumes, including Ky'taari history, religion, city plans, forging texts, linguistic knowledge of all of the commonly known languages in the Mur Fostisyr area, very detailed astronomy texts, especially in reference to the sun (eclipses, etc.)
9. **Secret door.** Behind a section of bookshelves, which is opened by pulling out a book to the left of the door entitled "Origins of the Tales Involving the Magical Texts of Ur." Replacing the book (which is blank) closes the door ten seconds later.
10. **Platform.** Elevated 6 feet above the library floor, with an iron railing. The desks are for the chief librarian-monks. (Aantor and Thalfaan).
- 11-15. **Workrooms.** Spaces for the binding and copying of books.
- 16, 18. **Offices.** Of the chief librarians.
- 17, 19. **Quarters.** Of the chief librarians.
20. **Outer secret library.** Mentalist, Channeling and Astrological texts of levels below eleventh. The desk is for the A-Ryann, who usually employs the texts.
21. **Secret door.** Steel door with a 20th level *Death Rune* (only the A-Ryann is immune) is locked, Extremely Hard (-30) to pick. It rises vertically; the portcullis beyond opens when the name "Ariaana" is spoken. The gold-alloy door is locked, Sheer Folly (-50) to pick, and is trapped (failure to disarm the Extremely Hard (-30) mechanism yields a x4 damage *Fireball* point blank). It rises vertically. The inner room contains upper level Mentalism, Channeling, and Astrological texts, and a crystal orb of viewing, which communicates with its counterparts in the other temples.
22. **False steel door.** Trapped; failure to disarm the Very Hard (-20) mechanism yields a deadfall yielding 1-10 Fall/Crush attacks, each at +50.
23. **Monk quarters.** Each of these is subdivided to house 20 younger monks.
24. **Steel doors.** With the Ky'taari symbol (a multi-rayed sun); open when "Ariaana" is said.
25. **Lower temple.** Here are held the secret rites of the monks.
26. **Secret door.** Behind the altar, it opens when the gold Ky'taari symbol on the wall is twisted counter-clockwise. Clockwise twisting causes the floor to open, and the intruder is dropped 60' onto a bed of spikes (a Fall/Crush strike +60 and 1-10 +80 rapier strikes).
27. **Private sitting room of the A-Ryann.** Wood paneled walls and carpeted floor, as well as exquisitely carved wooden furnishings.
28. **Office of the A-Ryann.**
29. **Bedroom.** Of the A-Ryann and her husband, the Lord Monk. Furnished in a similar style to the sitting room.
30. **Quarters.** Of the elder monks, subdivided to house 33.
31. **Office.** Of the A-Ryann's secretary.
32. **Quarters.** Of the A-Ryann's secretary.
33. **Foyer.**
34. **Monk quarters.** Subdivided to house 22.
35. **Kitchens.**
36. **Common forge.**
37. **Secret door.** Locked and Extremely Hard (-30) — Indestructible gold alloy door with two traps (must be detected and disarmed separately, treat each as Extremely Hard (-30) to detect and disarm) 1. Failure yields three poison (Klytun) darts in the hand (roll three dagger +100 strikes, target must resist vs the poison for each critical delivered). 2. Failure yields a point blank x5 damage *Lightning Bolt*, as the door becomes a major conductor. Each person in the corridor or within 15 feet of the secret door takes a Bolt; roll separately. Beyond is a *Laen* portcullis, locked and Sheer Folly (-50) to pick. The inner door has two traps, each Extremely Hard (-30) to detect and disarm. Both have the same effect: no immediate result, but when one person steps on the floor of the vault, the outer door seals and the room fills with poisonous gas (effect as 30th level *Karfar*) for ten minutes, then empties. Within this vault are most of the Artifacts of the Ky'taari. See Items of Note (sec. 5.3) for details. Only the A-Ryann has the keys to this vault, and only she or the Lord Monk have knowledge of disarming the traps.
38. **Forge.** For creating magical items.
39. **Steel door.** With two locks, which must be opened simultaneously [treat entire disarm as Absurd (-70)], or a deadfall seals the room vs. further intrusion (deadfall can only be lifted using controls in the inner magic vault #37). Second door holds a 20th level *Death Rune* (monks and Ryaani are immune) and a Sheer Folly (-50) lock. The vault is filled with a fortune (30,000 gp.) in pure gold, mined by the monks. Only the A-Ryann, Lord Monk, and Master Alchemist have keys.
40. **Monk guardroom.** Three are on duty at all times.
41. **Double steel doors.** Very Hard (-20) to detect pit trap 60' down (yielding a Fall/Crush strike, +60), then the ceiling collapses on top (delivering another 1-10 Fall/Arush attacks, each at +50.) If both of these are disarmed, the second doors open to reveal a 10th level *Death Rune*.
42. **Stairs.** They are made of paper, painted to look like stone (treat as a Extremely Hard (-30) to detect trap). Failure results on a fall 60' onto spikes, and damage as #26.



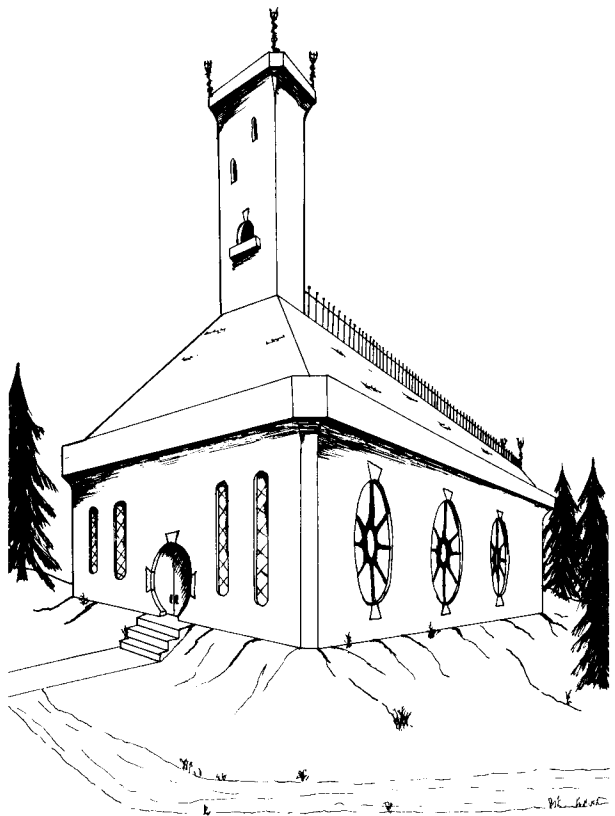

A-Arnaar

#### 4.6 KALDARAAR-VAAR ("DAWNWATER'S EDGE")

1. **Foyer.** Paneled in *Tonak* wood (as are all of the finer rooms here). The main door is 6" thick, of steel bound wood. It will only open to the name "Ariaana".
2. **Guardroom.** Three monks are stationed here at all times.
3. **Corridors.** Hidden within the walls. They are protected by secret doors.
4. **Practice combat room.**
5. **Guard quarters.** Room for six monks in each.
6. **Guest quarters.**
7. **Throne room of the A-Ryaan.** The throne is of the *Kytaal* (K. "ice stone") and set into the right arm are three control switches. The first operates the doors to the throne room. The second raises the throne up through the ceiling into the A-Ryaan's quarters above. The third sounds an alarm in the guardroom.
8. **Armory and magical forge.**
9. **Kitchen.**
10. **Secret doors.** Permit access to hidden stairways, which lead from the first to the second floors and up onto rooftop battlements.
11. **Treasury.** Past two locked [Extremely Hard (-30)] steel doors, each of which will yield a x4 damage fireball if the trap on it is not disarmed, are a collection of lovely magic items: six sets of bracers: gold, +20 to monk defense; twenty +15 *Ikashaan*; ten +15 golden short swords; three x3 Channeling PP enhancer staves.
12. **Covered firing halls.** Note stair in hall to lower level.
13. **Library-reading room.** In the center is a pedestal of *kytaal*, and when a hidden panel on it is pressed, the Orb of seeing emerges.
14. **Armory.**
15. **Upper guard quarters.** Six men reside here. Note closeable panel over entry.
16. **Guard stations.** Two monks at all times at each.
17. **Monk quarters.** Two monks reside in each chamber.
18. **Quarters of the Lord Monk.** Elegantly appointed.
19. **Bedroom of the A-Ryaan.** Also richly furnished. A secret panel in the wall reveals a small safe which is locked [Sheer Folly (-50)] and trapped [Very Hard (-20)]. Failure to disarm yields a point blank icebolt x4 damage. Within is a +30 golden war hammer which can be thrown 100' and will return to the user if he/she is of the religion of Ariaana. Also there is a gold ring set with a single ruby: it provides total protection for the wearer from heat and flames. A secret door allows access for the A-Ryaan to the throne room.
20. **Holy throne room.** It is here that Ariaana appears annually upon the pedestal before the throne.

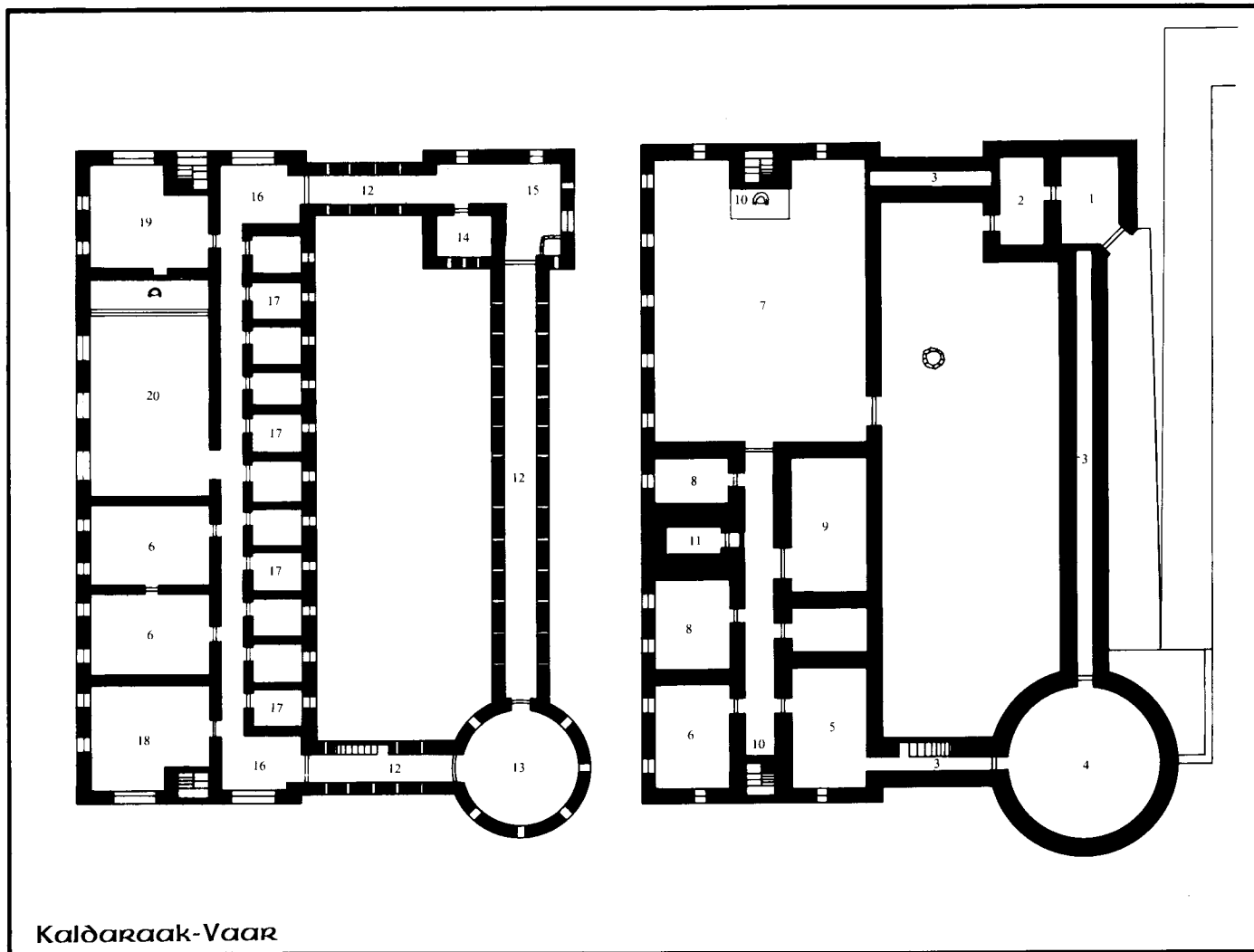

Kaldaraak-Vaar

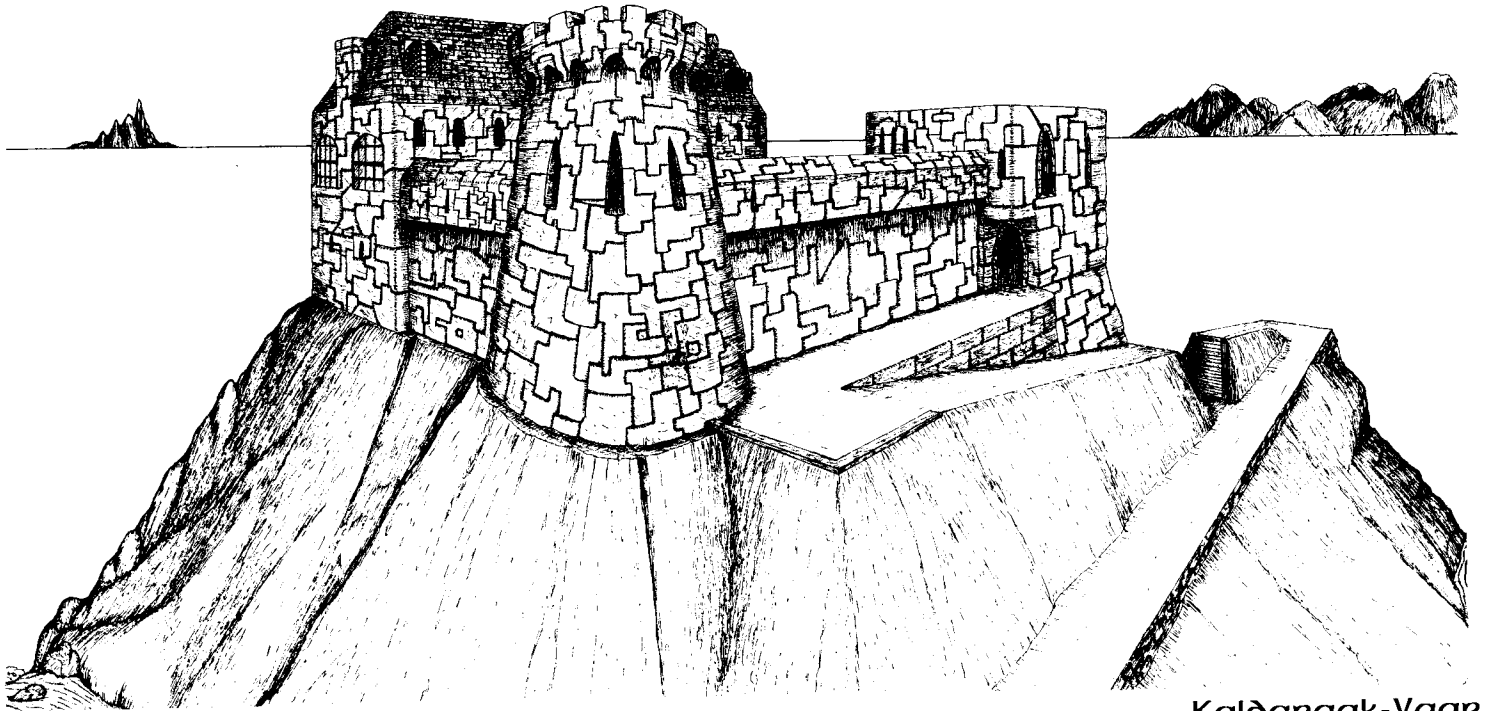

Kaldaraak-Vaar

4.7 UDA TYYGK

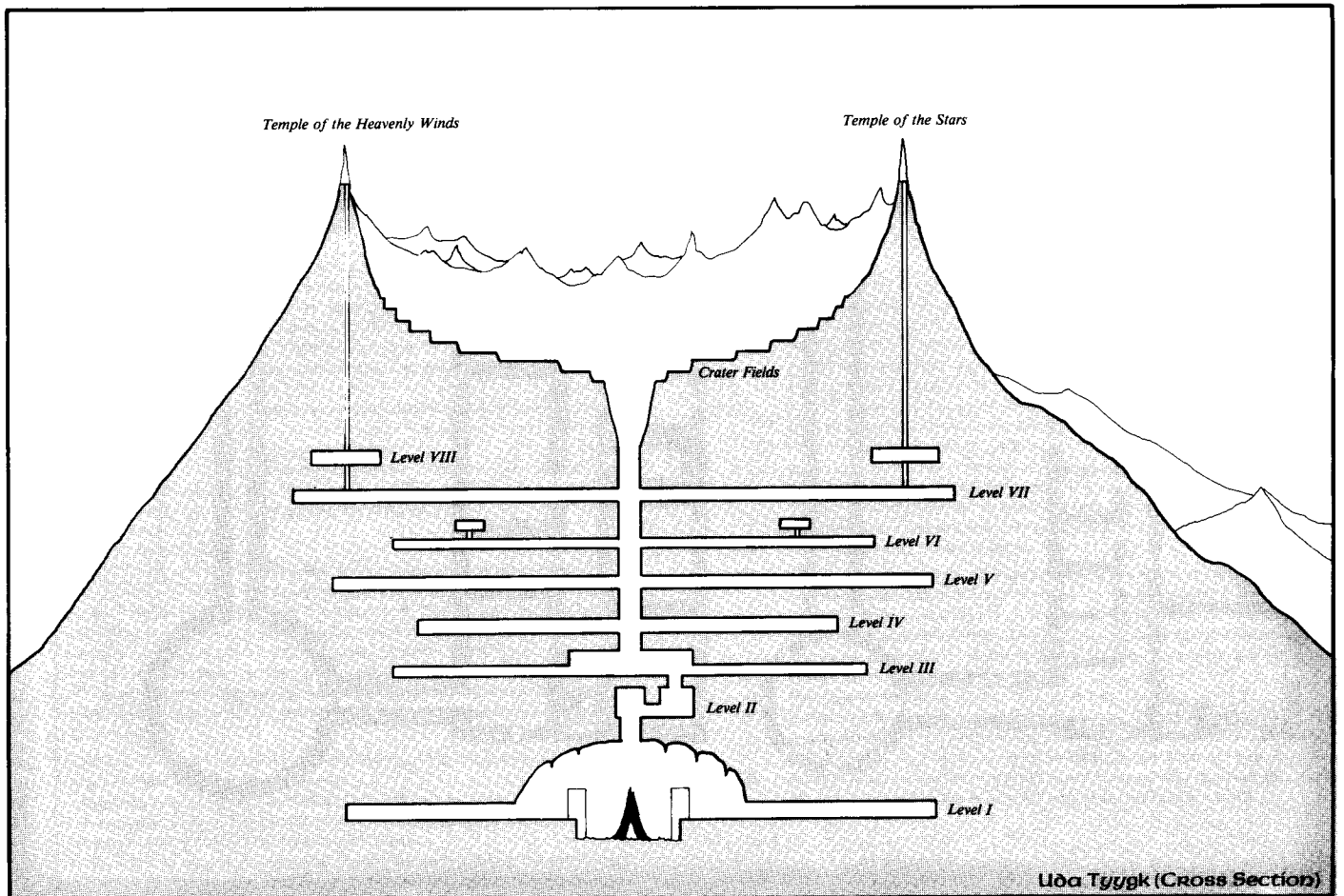

Uda Tyggk (Cross Section)

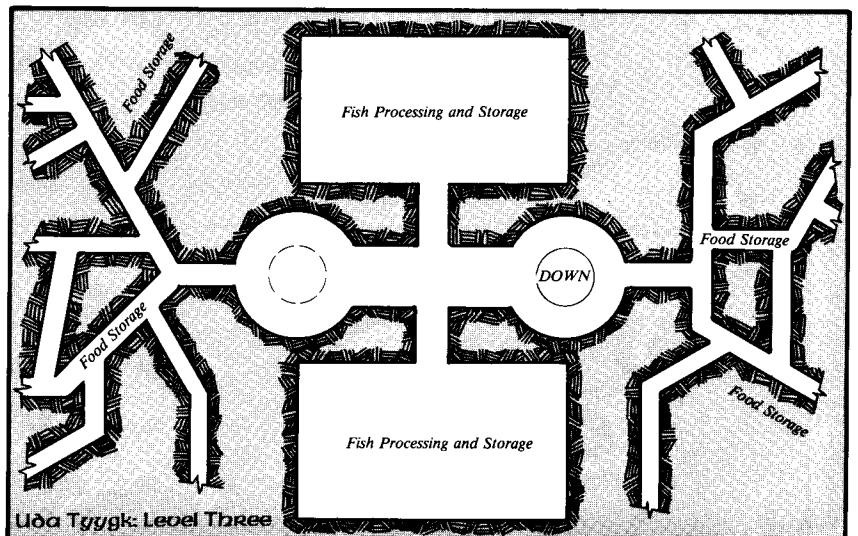
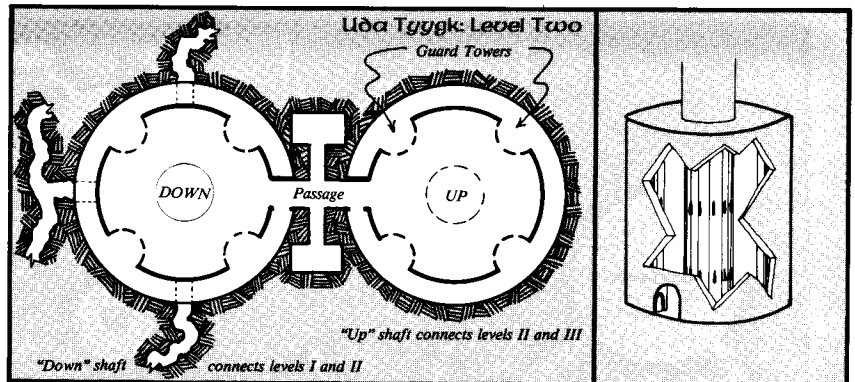
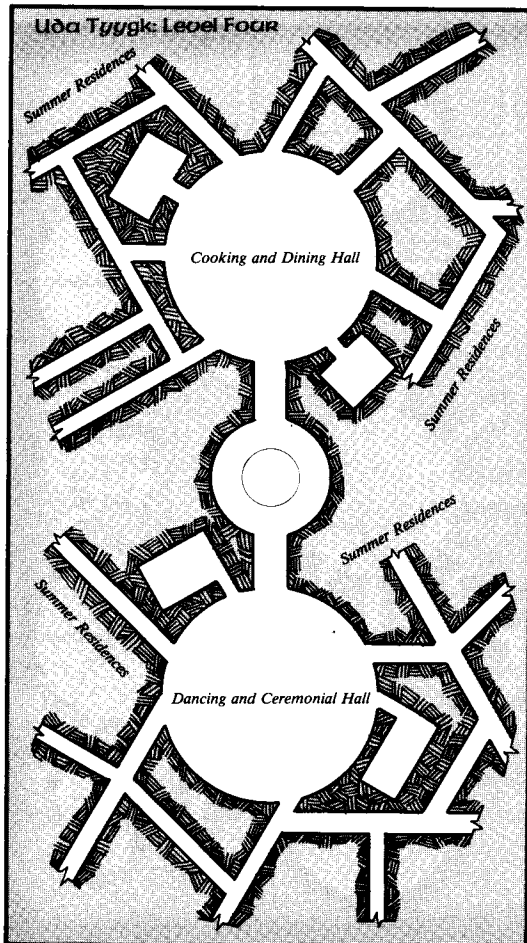
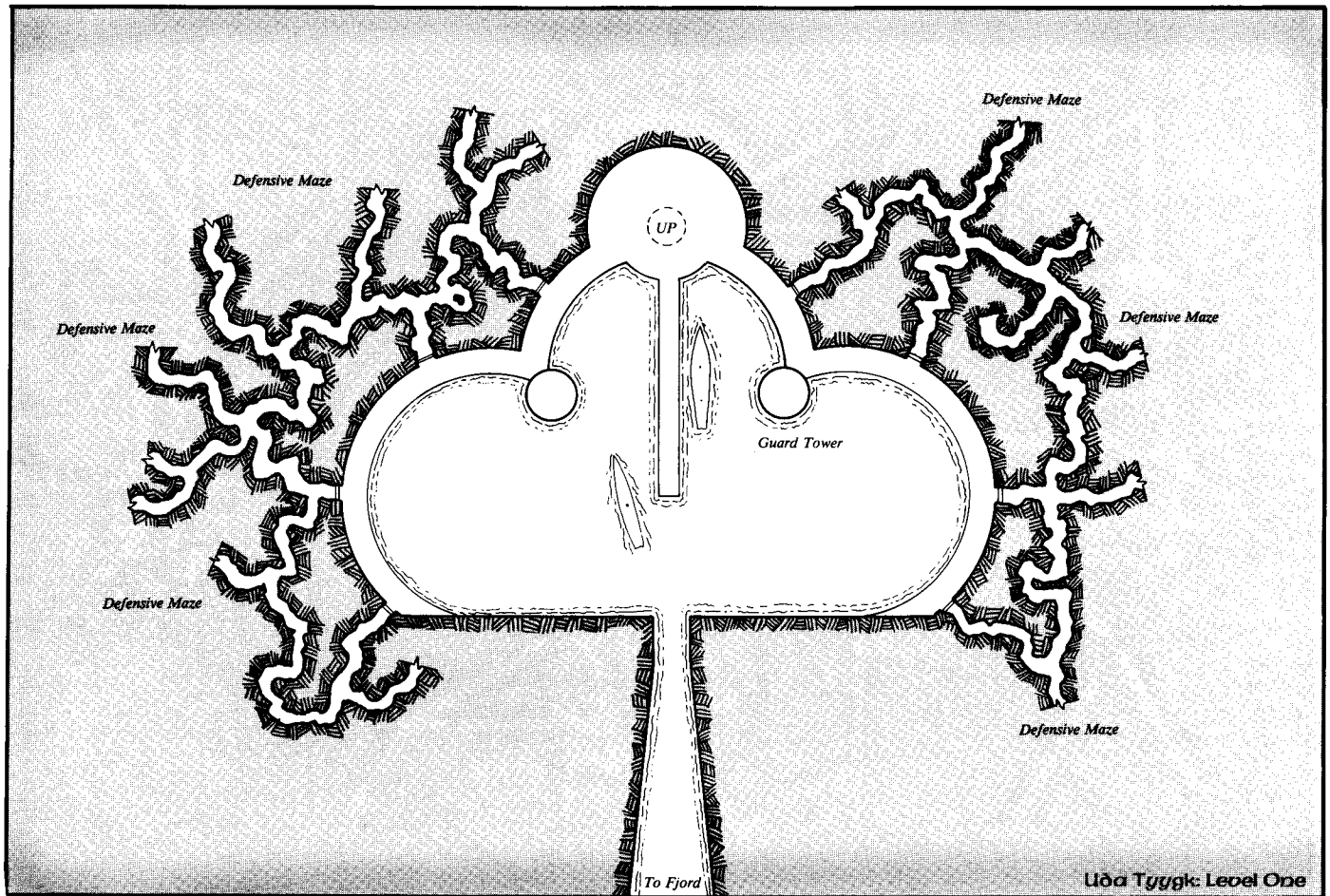





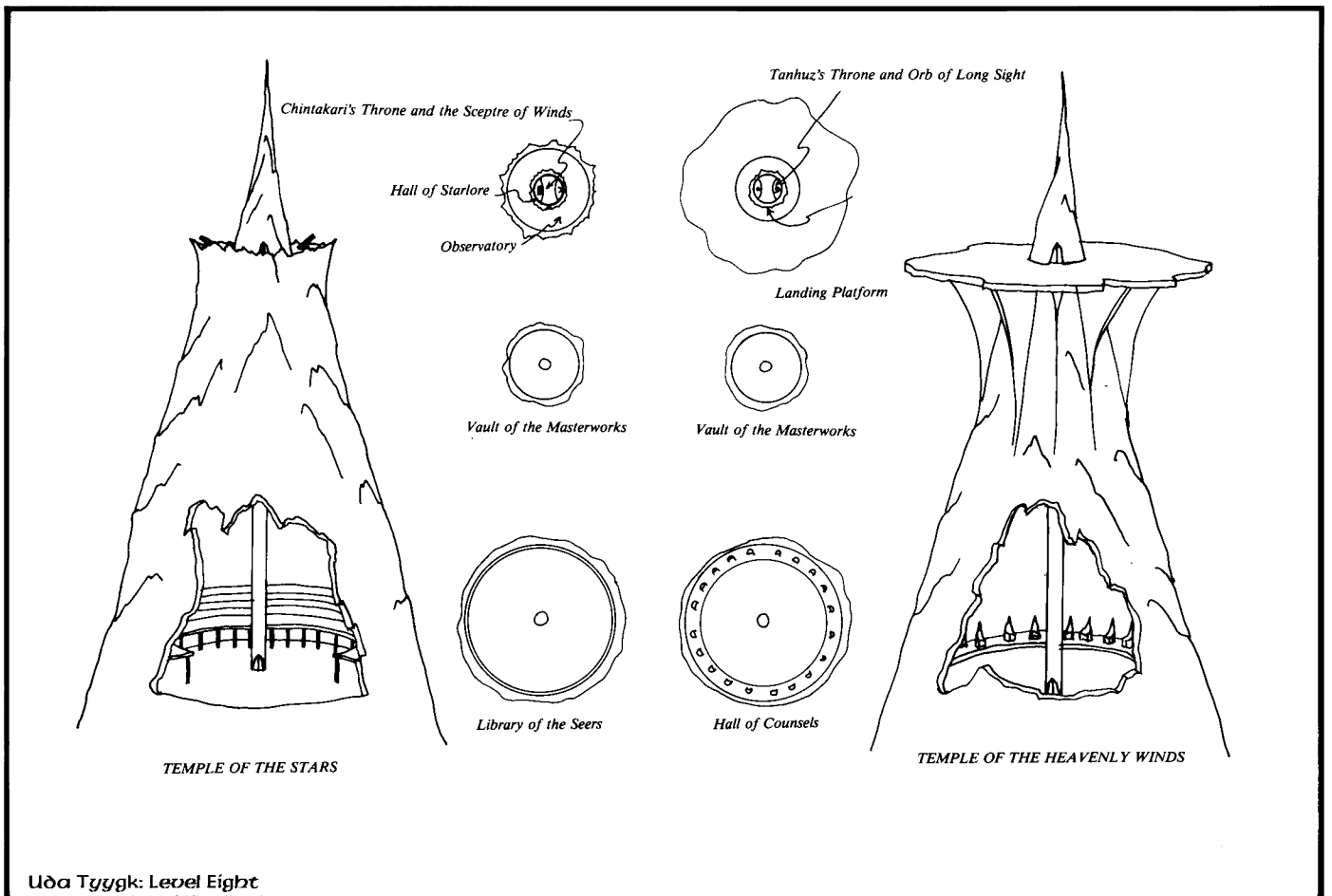
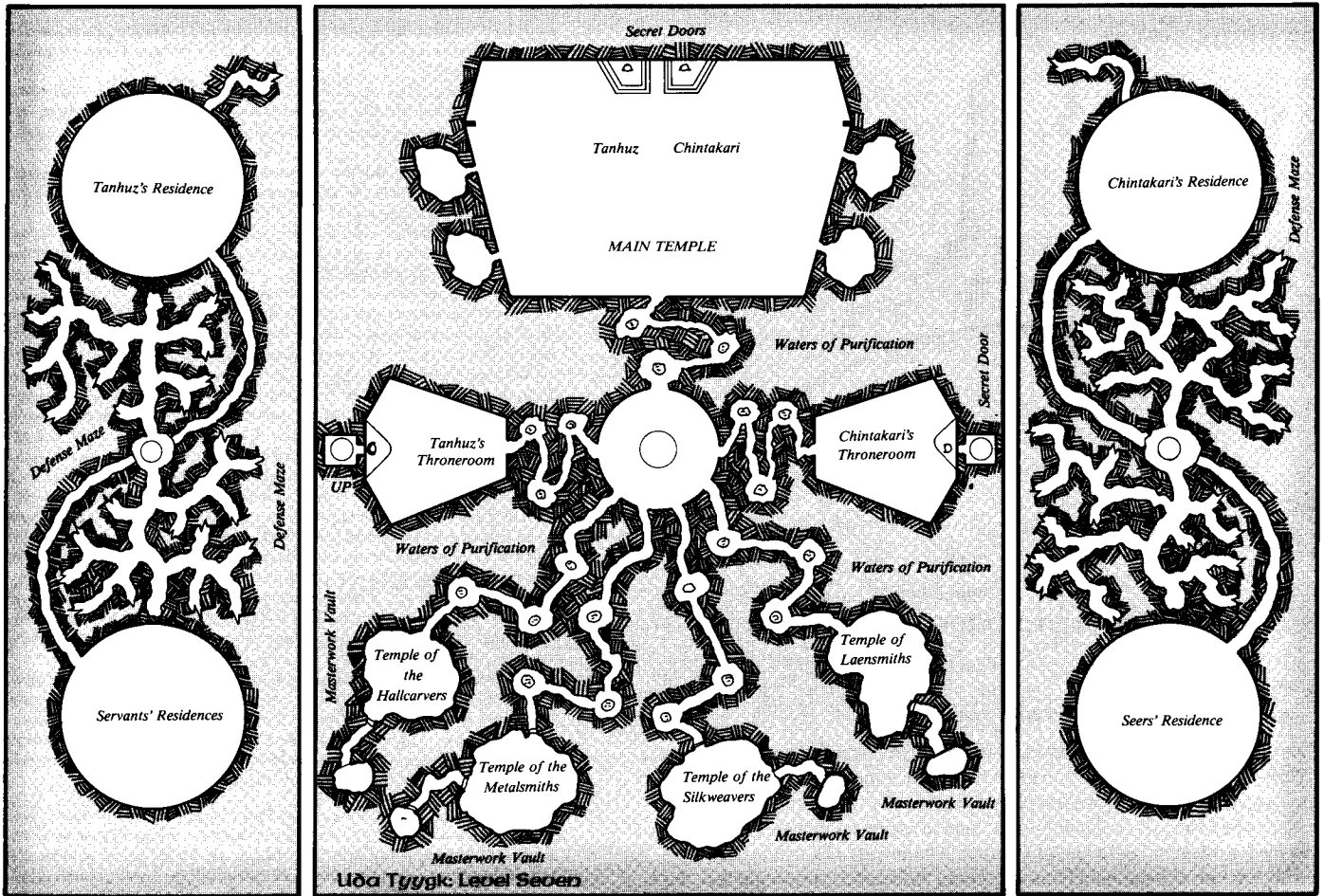

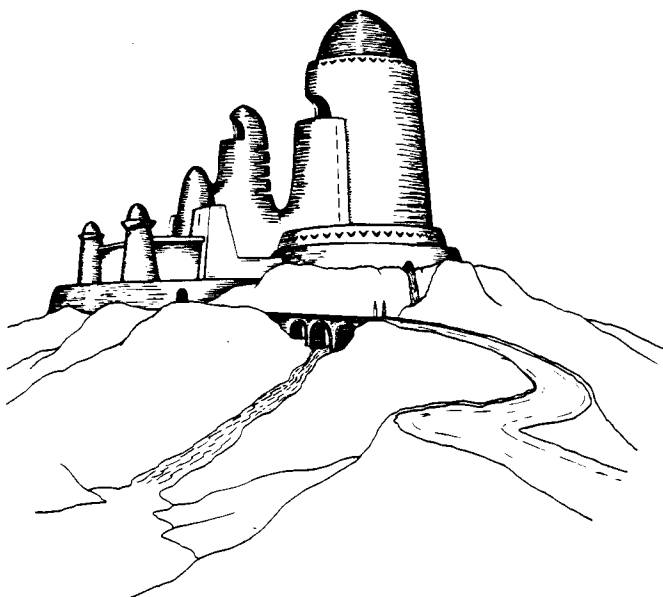

## Tower of the Astrologer

### 4.8 THARG JIRONAK: TOWER OF THE ASTROLOGER

This unusual citadel is the home of Deniroik, at one time a *Navigator* of the Vurn-kye Guild. Deniroik 'retired' to this castle some time ago, yet did not relinquish his *Compass* as is traditional (and required). The Guild acted to recover the *Compass* by force, but (to their great surprise) were driven off by the Astrologer's rather strong garrison. The unfortunate truth is that Deniroik has fallen to the seductions of the Iron Wind, and in return for his personal immortality and protection from the avenging Guild he serves that dark force. His home is defended by dozens of traps and guards, and it holds many items and texts of power.

The tower itself is of very unusual design, and is extremely old (though Deniroik has refitted most of the interior areas). There are no visible seams anywhere on the surface, and it would almost seem that the entire citadel was carved from a single mass of rock. In truth, the ancient engineers developed a mixture of powdered stone and other materials which could be easily shaped, then hardened in a few hours to a material even stronger than normal solid rock. Using huge molds and forms, they shaped the daring lines of the *Tharg Jironak* ("watchful retreat"). As a final treatment, the builders coated the grey outer surface with a dark glaze which gives it a glassy, almost obsidian appearance. Climbing the sheer faces should be considered *Absurd (-70)* at best.

1. **Main gate.** A small door, deeply inset in the wall, it is of black reinforced steel. Ten feet high, the door is a single panel which slides into the right wall on a track. The portal is magical in nature, and can only be opened by speaking the words "By Deniroik, let me pass" in Iruaric. There is, in addition, a mechanical lock, Extremely Hard (-30) to pick. (It is normally left unlocked, however.) Only Deniroik and the captain of the guard have keys, which are iron and very large.
2. **Processional hall.** A long corridor with floor of polished blue marble, it is lit by many lamps.
3. **Firing room.** Entered through a secret door, this room is always staffed with 4 guards. Twin ballistas (H. Crossbow +30, 2x damage) are mounted to fire upon intruders through concealed slits. Stored in the room are two spare ballistas and 60 quarrels. The rear section of the room is a lounge area.
4. **Secret corridor.** Leading to the tower stair. The three small towers are identical, consisting entirely of an interior stair allowing access to this small courtyard, the low wall, and at the top, the narrow walkway which surrounds it.
5. **Stores.** Holding miscellaneous supplies (uniforms, dry goods, etc.)
6. **Lesser armory.** General issue armor and weapons for the garrison.
7. **Stairs.** To the tower above (see #4).
8. **Guard quarters.** Housing 12.
9. **Closet.**
10. **Guardroom.** Three men are stationed here, primarily to back up guards in room 3.
11. **Dining hall.** Serving the garrison.
12. **Stairs.** To the tower above see #4 for details.
13. **Kitchen.** Food for the guards is prepared here. Also serves as quarters for cooks.
14. **Reflections hall.** Guarded by double doors of polished chrome which are locked. Extremely Hard (-30) to pick, this room is filled with floor-to-ceiling mirrors in panels of varying width, so set as to form a maze (many of the mirror positions are not shown). Unless intruders make a successful *Absurd (-70)* Perception roll, they will wander the entire perimeter of the room back to the door without realizing that there is an inaccessible area hidden in the center. Strange, random winds blow through the chaotic halls, strong enough to remove trails (left by PCs who think they are so smart) of all but the heaviest material. Corners (often at very acute angles) are extremely sharp, and can cut any but the strongest rope.

15. **Secret vault.** Behind an Extremely Hard (-30) to discover panel (assuming someone is looking for one) is a small vault, locked and Extremely Hard (-30) to open. For the contents, see sec. 5.3, Items of Note.
16. **Secret compartment.** Hidden in a similar fashion as #15 but more difficult — Sheer Folly (-50) — to locate, it is much smaller, being only a small cubbyhole. It is also locked, being Extremely Hard (-30) to pick. Descriptions of the contents may be found in sec. 5.3.
17. **Secret corridor.**
18. **Lesser audience chamber.** The floor of this low-ceilinged room is covered in a fine red carpet, and the columns are sheathed in black marble. Deniroik uses this room when interviewing guests whom he plans to dispose of without delay.
19. **Throne.** On a low dais rests a throne of black stone (actually Black Eog, which will cancel all spells of Essence by a nonevil caster). On the right arm are five small switches. Their functions are as follows: (from front to back) A. opens a 10' x 10' pit between the columns (where guests are directed to stand) dropping 60' into an underground stream, which connects to the larger river. Treat an uncontrolled fall as a Fall +50; B. fires a spray of darts from the two columns. All caught between the columns catch 1-10 Dagger attacks +40. All darts are tipped with Luku; C. Opens/closes the doors to the chamber. When closed, the doors, which are made of 2" thick steel, are magically locked and can only be opened via this switch (or a powerful spell); D. Triggers a *Fog* to erupt from the Pools of Regret. The mist fills the room in two rounds, and all must resist vs. a 10th level poison or suffer total amnesia of the events of the last 1-10 hours and unconsciousness lasting 1-2 hours. Thus are innocent fools rendered harmless and removed (Deniroik is immune). E. Causes the throne to pivot 180°, presenting the high back, on which is engraved a 20th level Rune of Blinding. All in the room must resist (though a bonus might be given to those who would not get a clear view of the rune).
20. **Pools of regret.** Tendrils of mist rise at all times from these pools. To inhale the fumes (and fail to resist vs. a 10th level poison attack) is to have a momentary memory blackout — though one might not even notice. To drink and fail to resist is to lose all memory of the last 1-10 days (including why one is here). Long-term memory, including spells, is retained.
21. **Bronze doors.** These huge (20' tall) double doors of hammered bronze have no visible latch or lock. There are, however, small plates of bronze set in the walls on either side of the doors which, when simultaneously pressed, trigger the opening mechanism. The doors then roll slowly back along a track into their slots in the adjacent walls.
22. **Stairs.** Of black marble with railings of brass, these twin stairways connect to the upper levels of the tower. Note that the third step from the bottom on each side is trapped, Extremely Hard (-30) to discover and disarm. Although it is probably easier to just step over if discovered, each can be disarmed by twisting the knob at the end of the brass rail. If either step is trod upon (and not disarmed) a cruel spike stabs from the wall, striking the one on the step with a Mounted Lance +50 attack. The spike retracts after doing its grisly deed.
23. **Throne room.** With a high arched ceiling and floor of large purple and blue marble tiles, this is a truly regal chamber. Dim light is provided by chandeliers hanging high near the ceiling. On a three step dais covered in blue carpet rests a huge throne of misty dark glass, within which can be seen occasional flickers of light like stars. In this room the Astrologer oversees 'religious' gatherings. Here also Deniroik interviews those among his faithful and those he wishes to impress. The doors to rooms 24 and 29 are of hammered bronze with bas relief panels, kept locked — Hard (-10) to pick. All religious personnel, as well as Deniroik and his two aides have keys.
24. **Acolyte gathering and robing room.** Deniroik's novice servants gather here to don their ritual vestments in preparation for the weekly (every 10 days) ceremonies.
25. **Records chamber.** General information such as records on all staff, garrison and acolytes.
26. **Green room.** The floor of this chamber is carpeted in rich moss, and from the walls and ceiling hang dark vines. Light is dim, and the source is difficult to determine. Of particular interest, however, are the many healing herbs which grow about the perimeter of the room — but one must be wary of the vines, for they are active and carnivorous (see Master Military chart). They will attack anyone who enters the room who does not bear a *Vinestaff* (see garrison issue equipment).
27. **Infirmary.** Deniroik's healing center, where, in addition to caring for injured or sick underlings, he occasionally indulges in 'experimental surgery' (carving up prisoners for fun). He is assisted in this by his aide, Rogir, who is at least as bloodthirsty.
28. **Secret stair.** Accessible from a concealed door next to the throne, it leads to Deniroik's personal Robing Room (#32), as well as room #30.
29. **Drawing room.** A plush chamber, the walls covered in rich tapestries, the floor with fine carpets, and the furniture is upholstered in red velvet.
30. **Cleansing room.** A ritual chamber, through which runs an underground stream (it exits from the side of the tower, as can be seen in the sketch). The water is chill and runs swiftly; Deniroik washes his hands and face in the waters to symbolically cleanse himself before presiding over his rituals. A small stone bridge crosses the stream. Note that the door to this room from the Drawing Room is secret.
31. **Meditation chamber.** The walls of this room are draped in black velvet (including a drape which can be pulled across the door when closed) and the floor is covered in a thick sable rug. The only furnishing is a single chair, upholstered in black as well. Here Deniroik mentally prepares himself for services.
32. **Robing room.** Several tall wardrobes are set in the walls of this plush room, as well as a number of full-length mirrors. The Astrologer dons his ritual vestments here.
33. **Foyer.** The floor of this hall is covered with brick-colored ceramic tiles. Multipaned glass doors lead out onto the veranda; sturdy wooden shutters are mounted across the portals also, and can be closed and locked to protect the glass. The doors can be bolted from within; treat as *Absurd (-70)* to open from outside.
34. **Veranda.** Tiled like the foyer, a low parapet runs the perimeter of this wide balcony. Two guards are stationed here at all times, and patrol back and forth.
35. **Lesser vault.** A locked — Extremely Hard (-30) — to pick steel door, behind which stands a portcullis, also locked, Very Hard (-20) to open, protects a store of superior weapons: five +10 broadswords, sixty +10 arrows, eight +5 target shields, four +10 chain shirts.
36. **Dining hall.** Very elegant, with a crystal chandelier hanging from the ceiling, a long polished oak table with seating for as many as twelve. Fine tapestries hang on the paneled walls.
37. **Kitchen.** The kitchen staff also lives here, in a loft area.
38. **Entry hall.** A large, paneled wood door separates this room from the foyer. The door can be locked, Extremely Hard (-30) to pick. The room itself, including the long hall into the adjacent tower, is floored with blue granite tiles, highly polished. The walls are sheathed in black, gold-veined marble, and the long hall is vaulted with gothic (pointed) arches. Note the positions of the two guards on duty in the entryway.

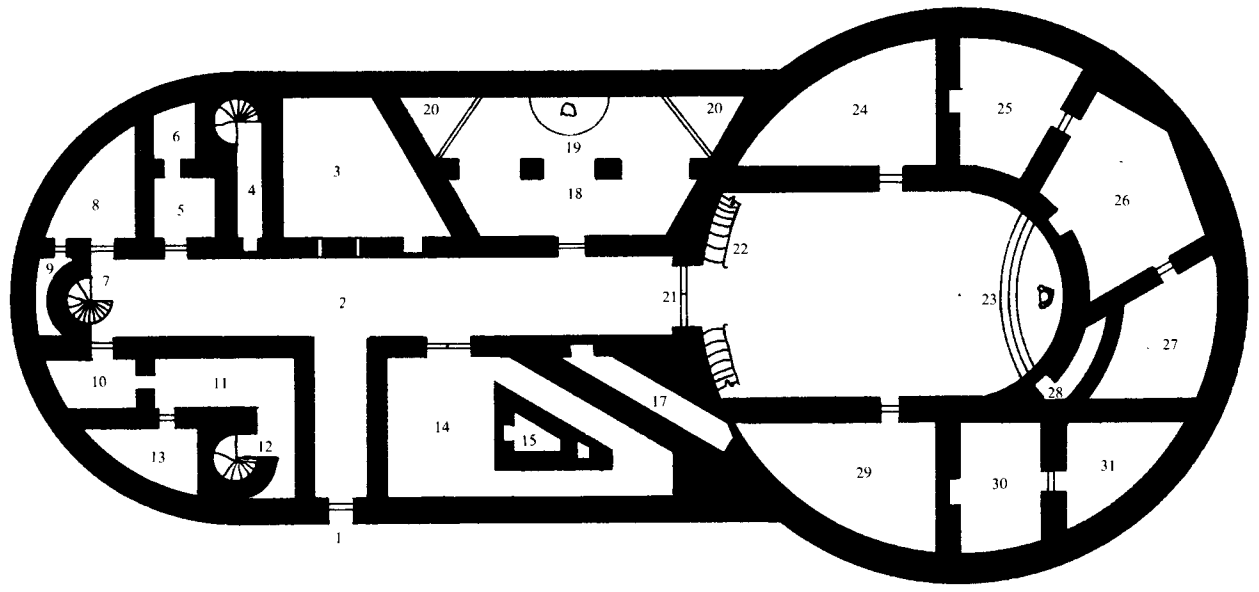
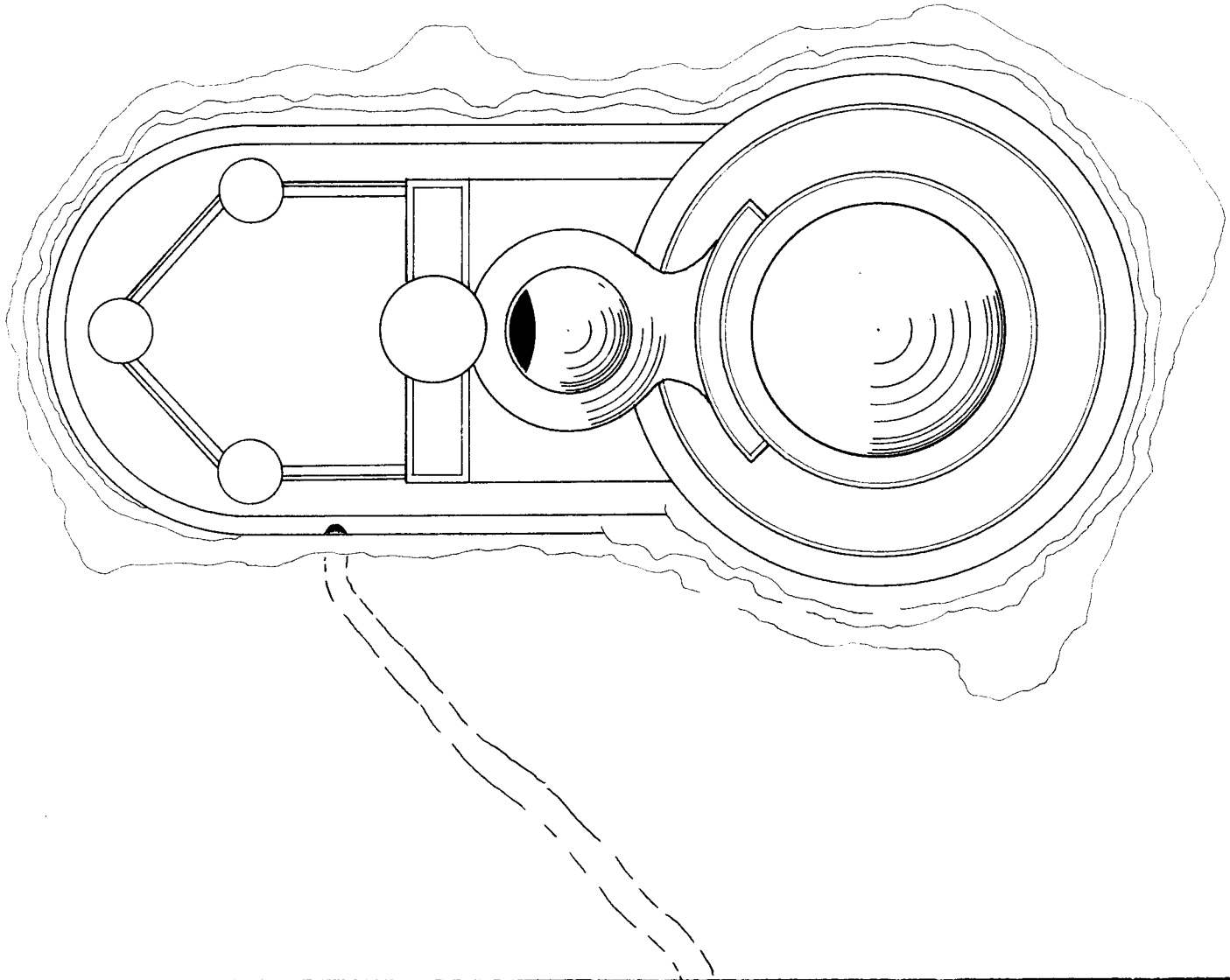

Level I

Tharg Jironak

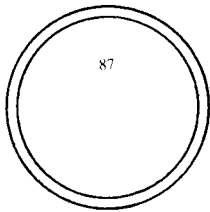

Level VIII

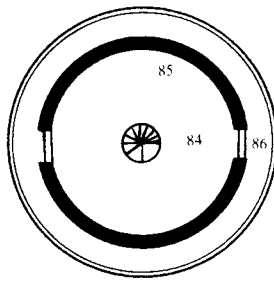

Level VII

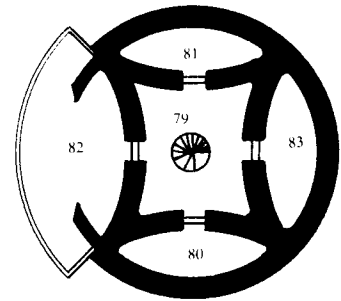

Level VI

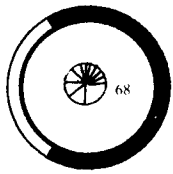

Level V

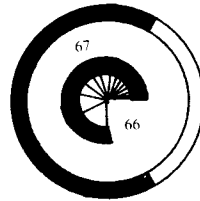
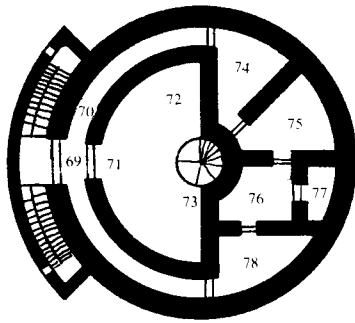

Level IV

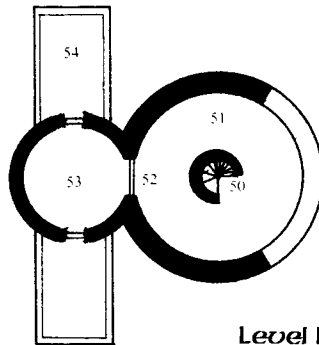
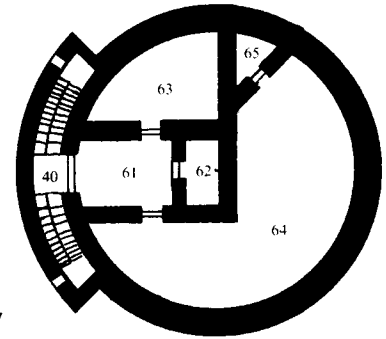

Level III

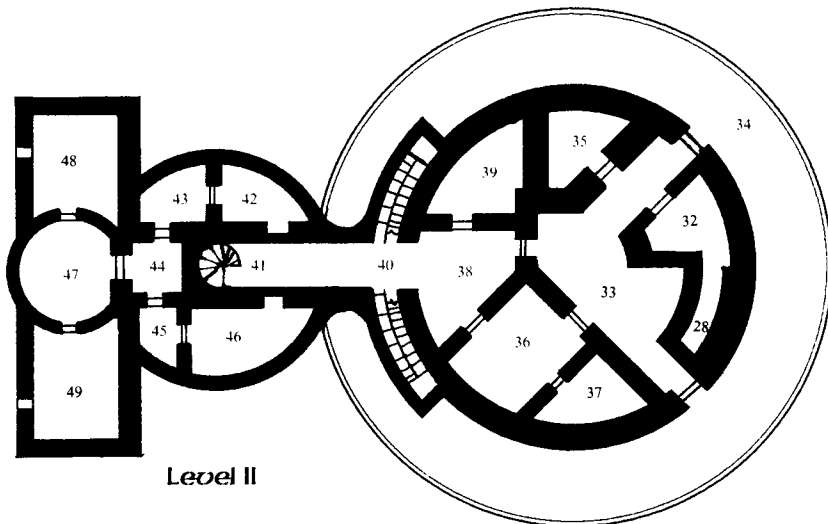
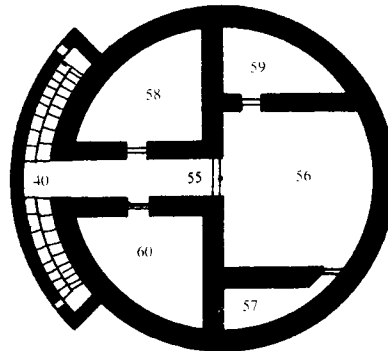

Level II



39. **Storage.** Dry goods, uniforms, various supplies for the garrison are stored here.
40. **Stairs.** Connecting to stair #22, these connect the levels of the main tower.
41. **Spiral stair.**
42. **Guardroom.** Three guards are on duty at all times.
43. **Guard quarters.** Bunks for nine.
44. **Anteroom.**
45. **Guard quarters.** As #43.
46. **Guardroom.** As #42.
47. **Dining hall.** General mess for the garrison.
48. **Kitchen.**
49. **Guard lounge.** Rest and recreation area.
50. **Spiral stair.** Continuation of 41.
51. **Gallery.** Along one third of the perimeter of this room runs a window, about two feet high. (#67 has a similar window.) The floor is laid with white marble, the walls and ceiling pure white plaster. Set about the room on pedestals are a number of small sculptures in stone and metal, including busts of various individuals (there are two of Deniroik), small animals and birds.
52. **Golden doors.** Great arched doors of gold (actually gold plated; the doors themselves are of a very strong alloy), they are locked and Sheer Folly (-50) to pick successfully. In addition, they are trapped, Extremely Hard (-30) to defeat. Failure to disarm not only disengages the lock (rendering the doors unopenable by normal means) but fires a barrage of darts from the many bosses on the doors. All standing in front of the ten foot wide portal take 1-10 + 50 rapier attacks. The darts are poisoned with Jubled. Only Deniroik has a key, which automatically disarms the trap when used.
53. **Compass chamber.** To all appearances this chamber is completely empty. The doors to either side are of clear laen (translucent, smoky laen when looked through from the outside) and are locked, Sheer Folly (-50) to pick. The actual lock is set in a metal plate on the wall next to the door. (There is a plate on the outside wall on the balcony as well.) The locks are trapped, Extremely Hard (-30) to disarm. Triggering the trap disengages the counterbalance mechanism which lifts the door, making it a dead weight in its metal track. (These ten foot high, 3' thick laen doors weigh about a thousand pounds each.) The floor of the room is composed of two-foot wide hexagonal tiles of black marble fitted together. The walls are of varnished oaken paneling in vertical strips, and the domed ceiling is of some black, glassy material. One of the oak strips is a Very Hard (-20) to detect hinged secret panel, behind which is a sliding lever, with three possible positions. It is currently in the top position. Moving it to the center (it 'clicks' into place) causes the hexagon in the center of the room to slowly rise, as it is actually a column of black marble eight feet high. Sliding the lever to the bottom position triggers a trap: a deadly needle tipped with Gaggur stabs from the end of the control into the manipulator's hand. Roll a +100 rapier attack for the needle attack. The needle itself is Sheer Folly (-50) to detect before the trap has been triggered. Close examination of the marble pillar will reveal a cunningly hidden secret panel, treat as Extremely Hard (-30) to detect. Within is a black velvet bag, and within it is Deniroik's *Compass*, which, as with all of the *Compasses* of the Vurnkye, resembles a very elaborate and ornate sextant, made of silver, gold and platinum, and fitted with many tiny jewels. In the back of the compartment is the black leather shoulder-shoulder in which the *Navigators* often carry their *Compass*. (Of course, if Deniroik is away on a long journey he has his *Compass* with him, and so this compartment is empty. This is the room which the *Astrologer* teleports to and from when using the *Compass*). As with most *Compasses*, this one is very powerful, yet also very dangerous in the hands of someone inexperienced and — perhaps most importantly — unattuned to it. The device could randomly teleport the entire group (or parts of it) almost anywhere. One small reassurance: there is no danger of teleporting into solid rock when using a *Compass*. Other than that, it is almost uncontrollable when used by the untrained. (Great fun at parties).
54. **Balcony.** Paved with granite tiles, a low wall runs the perimeter.
55. **Bronze doors.** Twenty feet high and fifteen wide, with inset panels depicting various scenes in the *Mur Fostisyri* in bas relief. They are normally kept locked, the mechanism being Hard (-10) to pick. All of the 'Brothers', as well as Deniroik, Jalor and Rogir have keys.
56. **Library.** A richly appointed room, the walls of which are covered with fine shelves of dark birch, filled with thousands of volumes. Topics include: Astrology, astronomy, medical arts, anatomy, flora and fauna texts, histories, and atlases. None are magical, however.
57. **Rare Books Vault.** Protecting this vault is a two inch thick steel door (faced with a paneled oak veneer), locked, Extremely Hard (-30) to pick. Just beyond is a portcullis which is also locked, and Sheer Folly (-50) to pick. It is also trapped. If the trap is not disarmed, the moment the portcullis begins to rise a long blade sweeps out from the wall at a height of 5' (about neck level for most people). All those in the entryway, unless they make a successful Extremely Hard maneuver roll, are struck by the blade, with results as determined by the GM (though they should be pretty obvious). Within are rune books covering all *Astrologer* Base lists to 20th level, as well as all *Mentalism* and *Channeling* to 10th. Each tome is two feet high, 16" wide, 3" thick and weighs 20 lbs. Trying to rip or cut out individual pages will only render the entire book useless and destroy the runes therein.
58. **Quarters of the Acolytes.** Subdivided to house the twenty younger Brothers who serve the religion of the *Astrologer*.
59. **Quarters of the Brothers.** Here reside the four elder members of the Brotherhood. See the *Master Military Chart* for details. It is subdivided, the individual chambers very comfortable.
60. **Guest room.** Elegantly furnished.
61. **Silver doors.** Large panels plated with silver, they are locked, Sheer Folly (-50) to pick. Only Deniroik, Jalor, Rogir and the *Guard Captain* have keys.
62. **Guardroom.** Two garrison guards, as well as the *guard captain* on duty are stationed here.
63. **Servant quarters.** Subdivided, all twelve of the castle servants live here.
64. **Deniroik's quarters.** A door of some black, glassy material (black laen; enchanted and virtually indestructible) guards the room. It is locked, not only by a Sheer Folly (-50) to pick mechanism, but also a magical lock. Deniroik has a key — the only key — (also of laen) which takes care of both. When unlocked the door slides along a track into the adjacent wall, and exactly five seconds later slides shut. Inside is an incredibly plush room. The floor is covered in pale blue carpet, the furnishings are in rare white *Jyrl* woods, including a desk and display case near the door, a huge curtained bed, two wardrobes and three large dressers. Concealed in a secret panel in the desk are five sheets of rune paper, two capable of holding 10th level runes, the others 5th level. There are many mirrors, and the walls are covered with white marble. Brass lamps light the room.
65. **Bathroom.** All black marble and gold-plated fixtures. Fresh water is magically pumped from the river below, and magically heated if so desired. Very sophisticated facilities.
66. **Spiral stair.** Continuation of # 50.
67. **Art gallery.** Dozens of fine paintings of every type hang from the walls of this room. Some are quite old, most have been stolen by Deniroik from various parts of the world.
68. **Chamber of Voices.** The top room of this smaller tower has been especially designed (and perhaps magically enhanced) so that the voice of anyone speaking in this room is amplified many times over. From here one can speak in a normal tone of voice and be heard clearly as far as a mile away.
69. **Steel doors.** Double doors of reinforced steel, they are normally locked, Very Hard (-20) to pick. Only Jalor, Rogir and Deniroik have keys.
70. **Access hall.**
71. **Laen doors.** Magical in nature, these frosted, translucent blue doors open only to those who wear the *Starmoon* pendant (Deniroik, Jalor and Rogir). They slide along a curved track into the side walls.
72. **Hall of images.** This room is filled with dozens of glass tubes, two feet in diameter and running from floor to ceiling; each with a curved glass door on the side, opened by a simple latch. About a third are empty, but in the remaining two-thirds are full-size "images" of different people, men and women of many different races from all over Jaiman. They are without exception very handsome specimens. All appear to be asleep. In truth they are not images but real people kidnapped or otherwise "acquired" by Deniroik, and placed within these tubes which perfectly preserve (similar to "Lifekeeping") them until they are removed, at which time they revive. Thus does the *Astrologer* have a living gallery of different people. Among others there are a Duranaki, a Xori warrior, several Elves, and a Myri. All in all there are 37 different people in suspended animation here. All are dressed in their native clothing, but are unarmed and have no magical items.
73. **Spiral stair.** Begins here and provides access to levels above this one. Surrounding the stair is a laen tube, which continues with the stair to the top. On each floor is a door of the same material, so made that the hinges and lock mechanism (of a strong steel alloy) are protected. The lock on each door is Sheer Folly (-50) to pick. Only Deniroik, Jalor and Rogir have keys (which are also, by the way, of *Laen*).
74. **Jalor's sitting room.** Very elegant, with a purple carpet and fine oak furnishings.
75. **Jalor's bedroom.** A sumptuous chamber, it is furnished with several wardrobes in addition to the large bed, chairs and couch covered with velvet cushions. Jalor is a clotheshorse and somewhat of a fop; his wardrobe is even more extensive than Deniroik's, and the closets are packed with brightly-colored garments of silk and other valuable cloths.
76. **Dressing room.** Jalor and Rogir share this room, though Jalor's presence is more evident. In addition to full length mirrors, there is a long dresser covered with an array of cosmetics (all Jalor's) and backed by a gigantic silver and glass mirror (very fine workmanship).
77. **Bathroom.** Shared by Deniroik's two aides, it is nearly as luxurious as his own.
78. **Rogir's chambers.** Utilitarian by comparison with Jalor's, Rogir's room is still very elegant. The floor is covered in a pale grey carpet, and all the furniture is of some metal with a dull finish and grey velvet and leather.
79. **Foyer.** This curiously shaped chamber is thirty feet tall, and has no visible exits (except on up the stairway) as all the doors to the perimeter rooms are secret. In each of the four corners stands an eight foot tall steel golem (see *Master Military chart*). They are activated the moment anyone steps on the floor (treat as a Extremely Hard (-30) to detect trap). The golems will attempt to kill anyone in the room not wearing a *Starmoon* pendant.
80. **Viewing room.** Behind the secret door is one of copper, with an inset handle in the center. One simply grips the handle and pulls up, and the door rises smoothly into the ceiling, aided by a counterbalance. No trap, no lock. Inside is a beautiful carved oak chair with a velvet seat, and a small oval table of obsidian, set in the top of which is an orb of dark crystal three feet in diameter. It allows anyone of the realm of *Mentalism* (this includes Deniroik, as he is a Hybrid) to use the *Seer Sense Through Others* list to 50th level. Animals and persons used as vision targets must be previously located (D. has the *Mentalist Base List Presence* to 10th level and uses it for this purpose). User must use his own PPs to fuel the orb; treat it as untransportable (spells such as *Levitate* and *Fly* seem to have no effect on it).
81. **High vaults.** Behind this secret door is one of steel, locked and Extremely Hard (-30) to pick. Beyond it is a portcullis of steel, and in each bar is hidden a fine filament of *Kregora*, enough to prevent spells from working on the door, and anyone from casting such spells as *Long Door* and *Teleport* through it. The portcullis has two locks, each is Hard (-10), but both must be opened *simultaneously* or neither will operate. Treat one person trying to do it as Absurd (-70); two in tandem as Extremely Hard (-30). See the *Items of Note* section for the wondrous contents of this vault.
82. **Balcony.** Beyond the secret door is a large stone door, locked and Very Hard (-20) to pick. This door swings out, allowing access onto this balcony.
83. **High meditation room.** The secret door into this chamber is Hard (-10) to locate. Behind it is an *illusion* of a steel door identical to the one into the Viewing room. One simply steps through it as if it weren't there. The walls, floor and ceiling of this room are all coated with a matte black material which seems (to some extent) to absorb light. The only furnishing is a very plush reclining couch of steel and upholstered in black velvet (resembling a dentist's chair). Set in the ceiling directly above the chair is a ten foot diameter disk of some luminous, translucent material (the only light in the room). Deniroik comes here to rest and meditate, staring at the disk, which generates restful geometric patterns. Ten minutes of meditation will completely refresh and restore the PPs of any user of *Mentalism* (or *Mystics* or *Astrologers*). Pure *Channeling* users receive no benefits. Essence users are *drained* of their points for one week (though they are unaware of it until after the meditation). Those of no realm of Power lose 1-10 temporary Memory points.
84. **Mechanical room.** The spiral stair (See #73) ends here, but the tube extends to the ceiling. The door out of the tube is locked like the one below, and must be unlocked with the key even from the inside. In addition, this chamber is filled with the mechanisms which control the movement of the room above and the roof (see #87). There are large interlocking gears and a number of cables, as well as the extensive counterbalance weights.
85. **Ladder.** Connect the mechanical level to the observatory.
86. **Balcony.** Accessible from the mechanical room via either of two reinforced wood doors, locked and Very Hard (-20) to pick from the outside (easily opened from inside).
87. **Observatory.** Dominated by a large reflector telescope, this is perhaps the most unusual room in the citadel. The entire floor can be made to pivot 360°, as can the domed roof. The roof is actually made up of overlapping triangular steel panels, reinforced and attached at the apex. These panels can be slid back over each other in such a way that three quarters of the roof can be open to the sky. Very complex, magically-aided counterbalance mechanisms operate both floor and roof. The operations are controlled by a set of levers near the base of the telescope.

# 5.0 NOTES AND CHARTS

## 5.1 COMBAT SUMMARIES

### 5.11 MASTER MILITARY CHART

TYPE/RANK	HOME/RACE	#	LVL	HITS	AT(DB)	SHIELD	MELEE OB	MISSILE OB	NOTES
<b>KYVINAAR</b>									
<b>A-LIRFAN PALACE GUARD</b>									
Captains	Ky'taari	3	15	150	15(-55)*	Y10	150bs	145lb	Magical golden chain (nonencumbering; +15) +15 sword, longbow
Sergeants	Ky'taari	30	8	110	15(-25)	Y	100bs	90lb	
Guards	Ky'taari	90	4	60	15(-25)	Y	80bs	60lb	
<b>ATAARN</b>									
<b>KATASHAAN ARMED FORCES</b>									
Captains	Ky'taari	3	18	160	17(-60)*	Y15	170bs	170lb	Magical golden armor, +15 sword and bow. Carry ice skates.
Lieutenants	Ky'taari	30	12	120	15(-30)	Y5	120bs	110lb	Carry ice skates.
Sergeants	Ky'taari	120	8	100	15(-25)	Y	90bs	85lb	Carry ice skates.
Soldiers	Ky'taari	1200	2	25	10(-20)	Y	40bs	25lb	Carry ice skates.
<b>ARINASHAAN KALDARAAK-VAAR GARRISON</b>									
Lord Monk	Ky'taari	1	20	160	1(-140)	N	130mar/tw	145ts	Employs defensive spells.
Monks	Ky'taari	33	10	110	1(-90)	N	90mar/tw	110ts	Employ defensive spells.
<b>RINASHAAN A-ARNAAR (Temple) GARRISON</b>									
Elder Monks	Ky'taari	33	12	120	1(-100)	N	100mar/tw	120ts	Employ defensive spells.
Initiates	Ky'taari	66	3	40	1(-40)	N	50mar/tw	60ts	Employ defensive spells. Their max. Martial arts rank is 2.
<b>FUSTIR</b>									
Lurd Leaders	Fustir	10	12	110	10(-30)	Y	110ss	90sp	+10 sword.
Lurd (pack; 10 each)	Fustir	100	6	80	10(-20)	Y	80ss	65sp	
<b>SYRKAKAR</b>									
Surd (1000) Leaders	Syrkakar	5	15	140	13(-40)	Y	150ss	140cb	+10 armor, sword.
Surm (200) Leaders	Syrkakar	25	10	110	13(-30)	Y	110ss	100cb	
Lird (50) Leaders	Syrkakar	100	8	85	9(-35)	Y	90ss	80cb	
Lirm (10) Leaders	Syrkakar	500	5	60	9(-30)	Y	85ss	75cb	
Lirk (5) Leaders	Syrkakar	1000	3	25	9(-25)	Y	60ss	50cb	
Lirk Warriors	Syrkakar	3500	1	20	9(-25)	Y	40ss	30cb	
<b>UDA 1YYGK</b>									
Thyfurik Leaders	Udahir	10	15	150	5(-45)	Y	140bs	150sb	+15 armor, sword, bow. Equally skilled with bows from Thyfur-back. All possess magic items to enhance breathing, vision, etc. See text for details.
Greater Thyfur	Great Eagle	10	20	250	4(-60)	N	HC1160/LPi120	—	See Beasts chart for OB details.
Thyfurik	Udahir	60	8	100	5(-40)	Y	90bs	110sb	+5 equipment; see 'Thyfurik Leaders' note.
Lesser Thyfur	Great Eagle	60	10	220	4(-50)	N	HC1140/LPi100	—	See Beasts Chart for OB details.
<b>THARG JIRONAK GARRISON</b>									
Elder Brothers	Elves	4	6	40	10(-20)	Y	50ma	10cb	All possess Channeling lists, x3 PP multipliers.
Acolytes	Elves	20	3	25	1(-20)	N	40ma	-25	Some have Channeling lists, x2 PP multipliers.
Guard Captain	Elf	1	12	126	15(-35)	Y10*	130bs*	140cb	+10 Shield, +20 magic sword, +20 bow. Blue jade ring, casts <i>Haste V</i> once per day. Earplug, continuous <i>Slyears</i> .
Elite Guards	Elves	6	8	95	15(-20)	Y	100bs	105cb	+10 bows. All wear blue jade ring.
Garrison Troops	Elves	36	4	60	15(-20)	Y	70bs	80cb	All wear blue jade ring.
Vines	Animate Plant	1	(20)	200	4(-40)	N	LGr100	—	Capable of up to 6 simultaneous attacks, does not stun or bleed.
<b>VAR UKAAK GARRISON</b>									
Elite Guards	Syrkakar	12	6	85	15(-30)	Y	90ss	80cb	
Garrison Guards	Syrkakar	18	3	30	15(-25)	Y	65ss	50cb	
<b>AALK GAATH GARRISON</b>									
Priests of Gaath	Elves	6	6	70	11(-30)	N	60ra	30ts	+10 long knife (as rapier). Also, each has a signet ring. See chart in sec 3.21 for details.
Priests of Athimurl	Elves	6	6	70	11(-30)	N	65ra	-25	+10 long knife (as rapier). Also, each has a signet ring. See chart in sec 3.21 for details.
Guards	Elves	18	4	60	15(-20)	Y	85ss	45cb	Ultimately loyal to Oran Jatar.
Messengers of Syrkakang	Elves	18	12	110	12(-40)*	Y*	145ss/ha	140lb	See sec 3.22 for details of their items and powers.
<b>TAURKYTAAL GARRISON</b>									
Guard Captain	Syrkakar	1	15	150	13(-40)	Y	160ss	140cb	+15 sword.
Upper Garrison	Syrkakar	30	6	60	13(-30)	Y	90ss	65cb	
Lower Elite Guard	Syrkakar	6	8	90	13(-35)	Y	100ss	88cb	
Lower Garrison	Syrkakar	18	5	65	5(-30)	Y	80ss	70cb	
Darath's Bodyguard	Demon IV	1	13	120	8(50)	N	120ma/LBa100	—	2x damage with weapon.
Troll Bodyguard	Ice Trolls	3	20	150	11(50)	Y	170ba/LBa	130	2x damage with weapon (use battle-axe one-handed).

#### CODES AND COMMENTS

- Shields equal to 20 or 25 of DB. An \* means that armor is magical or specially made.
- Note defensive bonuses include Quickness and shield. Shield references include quality bonuses (e.g. "Y5" means "yes, a +5 shield"). Combatants untrained in a type of weaponry suffer a penalty of -25 when attacking. Melee and missile offensive bonuses include the bonus for the combatant's best weapon in that category.
- Weapon abbreviations follow OBs: ss — short sword, bs — broadsword, sc — scimitar, th — two hand sword, ra — rapier, ma — mace, ha — hand axe, wh — war hammer, ba — battle axe, wm — war mattock, qs — quarter staff, da — dagger, sp — spear, ml — mounted lance, la — javelin, sl — sling, sp — composite bow, sb — short or horse bow, lb — long bow, lcb — light crossbow, hcb — heavy crossbow, bo — bola, ge — ge, ts — throwing star. Animal attacks are abbreviated using codes from Claw Law.
- Unless otherwise stated, mounted troops have fully effective OBs when fighting from horse.
- Unless otherwise noted, the OB given for Martial Artists (abbr. 'mar') is for rank four. The letter following indicates skill in either strikes (t) or sweeps and throws (w). If both letters are present, this indicates that he or she is skilled in both.

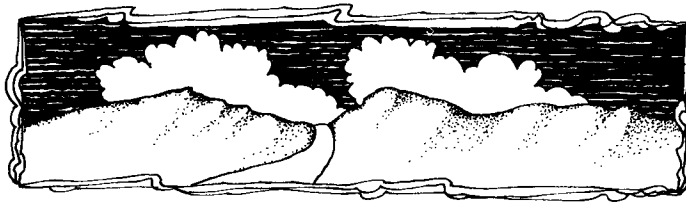

## 5.12 PROMINENT PERSONS CHART

Name	Lvl	Hits	AT	DB	Sh	Melee OB	Missile OB	Notes
<b>Kyvinaar</b>								
LARAN (the Ataarn)	24	160	17	90*	Y30	210bs/th	180lb	Ky'taari warrior-lord. +30 Sword of changing: flaming or cold, delivers additional app. crit., Fire/Cold Bolt 3x/day, intelligent, +30 to all RRs; +30 gold alloy armor and shield. SD86, Co97, Ag99, Me69, Re77, St100, Qu101, Pr98, In84, Em78.
TARLEN (crown prince)	10	100	17	80*	Y20	120bs	110lb	Ky'taari Fighter. +20 golden alloy sword, armor and shield. SD81, Co99, Ag100, Me56, Re49, St99, Qu101, Pr100, In85, Em76.
IRISTA (the A-Ryaan)	22	90	2	110*	N	100da	60ts	Ky'taari Astrologer. Pendant: +30 to all Channelling attacks, x6 spells, intelligent, orb of seeing; robes, +30 to DB; ring, +10 to DB; headband, of invisibility 3x/day. PP: 264. Spells: All Astrologer Base, Channelling: Barrier Law, Sound's Way, Blood, Bone Muscle Law; Mentalist: Cloaking, Mind's Door, Movement, Detections, Delving. SD78, Co86, Ag96, Me87, Re66, St59, Qu100, Pr101, In99, Em89.
<b>Taurkytaal</b>								
AZTAUR the Demon	30	200	12	50	N	180bs	Icebolt +80	Demon. Use Large Creature critical table. SD70, Co98, Ag100, Me50, Re87, St102, Qu101, Pr100, In85, Em90.
RYYKAAR the Mage	15	80	2	90	N	40da	-25	Human Magician. Robes, +30 to DB; staff, +4. 30PPs +4. Spells: All Magician Base, Lofty Bridge, Invisible Ways, Unbarring Ways; Evil Magician: Matter Disruption, Dark Summons. SD56, Co88, Ag99, Me87, Re66, St49, Qu97, Pr67, In85, Em96.
DARATH the Cleric	12	75	10	30	Y10	80ma	-25	Human Cleric. +10 leather armor, shield and mace. Ring, x3. 72PP. Spells: Base Cleric: Summons, Communal Ways; Channelling: Lore, Calm Spirits, Barrier Law, Light's Way, Weather Ways; Evil Cleric: Dark Channels, Curses, Necromancy. SD67, Co87, Ag89, Me63, Re61, St84, Qu89, Pr75, In97, Em67.
<b>Var Ukaak</b>								
SUSYMOG THE ORDAINER	50	300	12	90	N	240th/wh	--	Ordainer (Lord Demon; alias the Syrakang) Use Super Large Critical Hit table. See powers, sec 3.23. SD90, Co101, Ag100, Me90, Re89, St102, Qu101, Pr105, In85, Em85.
Priest AYRIC	10	50	11	50	N	80da	-25	Elf Sorcerer/Priest Arnak (see sec. 3.21 for items, abilities). Collar, +25 to DB; +15 dagger. Orb, +30 to Demonic 'Force' (Evil Mag. <i>Dark Contacts</i> ) rolls. 60PP. Spells: All Base Sorcerer; Evil Magician: Dark Summons; Essence: Lofty Bridge, Invisible Ways. SD45, Co77, Ag89, Me79, Re52, St60, Qu97, Pr81, In98, Em95.
Priest WYLZUN	12	60	11	60	N	100da	-25	Elf Cleric/Priest Arnak (see sec. 3.21 for items, abilities). Headband: +30 to DB, protects head as helm; +20 dagger. 108PP. Spells: All Evil Base Clerical; Lore, Weather Ways, Delving, Lofty Movements SD78, Co84, Ag96, Me86, Re49, St87, Qu95, Pr88, In99, Em87.
<b>Aalk Gaath</b>								
ORAN JATAR (human)	35	150	4	80	Y20	210bs/th	60ge	Dragon Lord, Sorcerer/Alchemist. Helm, allows wearer to assume human or dragon form (helm is invisible while wearer a dragon) allows wearer to deliver deadly breath while human, x6 PP; Robes, as hide, +20 to DB; +20 shield, +25 sword of changing (bs or th); +20 ge of Elflaying. 420PP. Spells: All Base Sorcerer; All Base Alchemist; all Essence. SD87, Co99, Ag100, Me83, Re78, St101, Qu99, Pr100, In98, Em100.
(Dragon form)	35	300	12	60	N	200HCl	80 fireball	Use Super-Large critical table.
HIGH PRIEST OF GAATH	20	120	11	60	Y10	120bs	-25	Elf Cleric/Priest Arnak (see sec. 3.21 for items, abilities). Staff, addit'l x2PP (ttl x6), stores 3 spells, will <i>Summon Storm</i> (blizzard) 1x/wk.; +10 sword and shield, collar, +10 to DB. 240PP. Spells: All Evil Cleric; Channelling: Weather Ways, Lore, Barrier Law, Sound's Way, Light's Way, Locating Ways. SD87, Co93, Ag97, Me73, Re67, St80, Qu95, Pr91, In99, Em86.
HIGH PRIEST OF ATHIMURL	20	125	11	70	Y15	100ss	80lb	Elf Animist/Priest Arnak (see sec. 3.21 for items, abilities). Staff, addit'l x2PP (ttl x6), stores 3 spells, will <i>Call Cold</i> , 30' r. sphere, 100' range 1x/day. +15 sword and shield; +10 bow. Collar, allows him to change into a white wolf for 4 hours 1x/day. 240PP. Spells: All Base Animist; Base Evil Cleric: Dark Channels; Channelling: Nature's Law, Barrier Law, Spell Defense. SD71, Co89, Ag97, Me71, Re91, St88, Qu96, Pr100, In98, Em76.
<b>Uda Tyygk</b>								
TANHUZ	25	170	1	80	Y20	220	170cb	Udahir Fighter-King, +35 laen sword; belt, +30 to DB. Headband, protects as a helm, allows free breathing in high altitudes and clear vision through the densest mists. Cloak, casts <i>Levitate</i> at will, or automatically if wearer begins to fall. Small telescope; +30 bow, no penalty when used Thyfur-back. SD71, Co98, Ag99, Me69, Re65, St100, Qu99, Pr97, In85, Em79.
CHINTAKARI	20	100	2	90	N	100da	-25	Udahir Seer. Robes, +40 to DB; +25 laen dagger; laen tiara, x5PP; Mirror, allows use of Astrologer Base <i>Time's Bridge</i> to 30th lvl. 1x/week. 300PPs. Spells: All Base Seer; Delving, Cloaking, Sense Mastery, Liquid Manipulation, Mind's Door, Movement, Detections. SD65, Co87, Ag100, Me88, Re67, St67, Qu99, Pr101, In88, Em67.
YDIRAK	15	155	1	60	Y10	180	160cb	Udahir Warrior, head of the Thyfuriai. +30 laen sword, +25 bow, all other items as Tanhuz. SD67, Co99, Ag98, Me45, Re39, St100, Qu99, Pr85, In71, Em60.

Name	Lvl	Hits	AT	DB	Sh	Melee OB	Missile OB	Notes
<b>Tharg Jironak</b> DENIROIK	22	110	4	100	N	120ra	+70 starfire	Half-Elf Astrologer. +30 galvorn rapier, belt; +40 to DB; headband, acts as helm; surcoat protects as AT 4; leather glove, lessens chance of 1h melee fumble by 2; Compass (Vurnn-Kye); Scarf, renders neck/shoulder criticals ineffective 50% of the time; Moonstone amulet, x5 PP, speaks of phases of the moons, allows use of <i>Starfires</i> (Astrologer Base Starlights) 1x/day w/o star source. 220PP. Spells: All Astrologer Base; Mentalist: Movement, Mind's Door, Cloaking, Attack Avoidance. SD56, Co92, Ag99, Me84, Re74, St87, Qu100, Pr99, In94, Em73.
JALOR	8	90	1	70	N	50da	+45 firebolt	Elf Mystic. +20 dagger; silk tunic, +30 to DB; collar, +5 spells; earring, stores 2 spells; blue jade ring, allows use of one <i>Mind's Door</i> spell/day to 10th lvl. at no cost. 16PP +5. Spells: All Mystic Base, Essence: Invisible Ways, Lofty Bridge, Unbarring Ways, Delving Ways SD73, Co59, Ag100, Me83, Re87, St76, Qu100, Pr99, In89, Em96.
ROGIR	7	110	4	60	Y10	120ss	100cb	Human Rogue. +20 sword and bow; +10 shield; nonencumbering leather tunic and pants, AT 4-20; black leather glove, casts <i>Touch of Disruption</i> (Sorcerer Base Flesh Destruction) at will; Cloak, casts <i>Invisibility I</i> 3x/day. SD47, Co97, Ag99, Me61, Re88, St95, Qu100, Pr85, In49, Em23.
JAED the Navigator	15	120	1	80	N	90bs	80da	Bard/Nav. of the Daruni Olkanin. Amulet Compass; +20 <i>keron</i> sword; flute, doubles range and duration of all Bardic spells; +15 throw and return (100') dagger; bracelet, x4 PP; Surcoat, +40 to DB; headband, acts as helm; 180PP. Spells: All Bardic Base; Mentalist: Mind's Door, Movement, Cloaking, Attack Avoidance, Self Healing. SD78, Co94, Ag100, Me78, Re84, St96, Qu100, Pr101, In78, Em91.

Notes: Weapon and shield codes are the same as found on the Master Military Chart. An \* indicates enhanced clothing or armor adds to DB, or in the case of the shield column, a "Y\*" indicates that the person in question utilizes either a magic shield or a shield spell. PP = power points. "+" and "x" symbols preceding magic item descriptions refer to its spell adding or PP multiplying capabilities. For spell list summaries: the list is given, followed by the level to which the list is known; lists divided by "/". Certain aged, gifted or special NPCs may deviate from the usual rules regarding access to lists.

NOTE: Stats given for large and super-large creatures are often approximations and not directly applicable to Character Law charts, except in the case of RRs. Give an additional bonus of 30 to all Large Creatures and a +60 to all Super-large for the purpose of RRs.

### 5.13 BEASTS OF THE MUR FOSTISYR

Type	Level	#	Sz/Speed	Hits	AT	DB	Primary	Secondary	Tertiary	Other	Crit Table
ARCTIC SEAL (on land)	2	1-5	M/M	50	3	10	SBi 40	-	-	-	Norm
(in water)	-	-	/F	30	-	-	-	-	-	-	-
KIRI DOG	2	1	M/F	60	4	30	MBi 40	SCl 30	-	-	Norm
KOYLARIN	1	1	S/M	25	3	0	T 20	-	-	-	Norm
OVIR (grappling)	10	1-5	L/F	250	4	30	HGr 100	HCl 100	LBa 80	-	Large
(charging)	-	-	-	-	-	50	HBa 150	-	-	-	-
SEA DRAKE	10	1	L/F	300	12	30	HBi 150	HCl 120	HBa 90	-	Super Large
SNOW WOLF	3	1-10	M/VF	120	4	30	LBi 80	-	-	-	Norm
THYFUR (wild)	10	1-10	L/VF	200	4	40	HCl 100	LFi 80	-	-	Large
TORKAAN	1	1-30	M/S	40	3	0	SBi 20	-	-	-	Norm
WEASEL	1	1	S/VF	35	3	40	SBi 50	-	-	-	Norm
WHITE DEER	2	1-10	M/VF	80	3	40	MHo 40	-	-	-	Norm
WHITE HAWK	2	1	M/VF	35	1	60	MCl 40	SPi 30	-	-	Norm

CODES: Sz/Speed = Size and Attack Speed, respectively; 1st symbol: s - small, m - medium, l - large, vl - very large, h - huge; 2nd symbol: s - slow, m - medium, f - fast, vf - very fast. Attack Modes and OB's = 1st letter: T - tiny, S - small, M - medium, L - large, H - huge; 2nd letters: Ba - bash, Bi - Bite, Cl - claw, Cr - crush, Gr - grapple, Pi - beak or pincher, Ho - Horn, Tl - tiny teeth; number equals offensive bonus using given attack mode. Categories reflect probability beast will use given attack mode. See also Claw Law. Crit Table = Type of table used when critical strike is resolved against the creature. See Arms Law.

## 5.2 USEFUL CHARTS

### 5.21 POISONS

NAME	AFFLICTION	SOURCE	FORM	APPEARANCE	EFFECT	LEVEL	FREQUENCY
Dynallca	Poison	Vine Leaves	Powder	Tan	Destroys hearing	4	Rare
Gaggur	Poison	Plant Sap	Fluid	Green	Instant Death	10	Very Rare
Jegga	Poison	Bat Venom	Powder	Brown	1-100 hits	6	Rare
Jubled	Poison	Flower	Powder	Blue	10-100 hits	10	Rare
Karfar	Poison	Plants	Powder	Red	Kills in 1-10 rnds.	10	Very Rare
Klytun	Poison	Shrub Root	Paste	Golden	Three day coma	2	Moderate
Loryaak	Poison	Mushroom	Juice	Brown	Bleed to death through pores	4	Very Rare
Luku	Poison	Moss Extract	Powder	Green	Death in 6 rounds	5	Rare
Sharduvaak	Poison	Berries	Liquid	Brown	Kills in one day	20	Very Rare
Trikassa	Poison	Nuts	Flakes	White	Kills Brain (1-100%)	5	Very Rare
Vyurk	Poison	Pollen	Powder	Yellow	Sneeze to death	5	Rare
Yosis	Poison	Manure	Paste	Green	Uncontrolled spasms for 1 AR, followed by death	15	Very Rare



## 5.22 SPECIAL HERBS

NAME	CODES	FORM	PREP/APPLY	COST	EFFECT
<b>Sense Enhancement</b>					
Agaath	fM30NW	berry	chew	5gp	Breathe with low oxygen (25% +) 12 hrs. Once per day.
Ezrin	mV2SU	flower	chew	30gp	Subtracts 30 from maneuver and melee. Adds 50 to spell and missile attacks. Euphoric. (1 hr).
Hristo	cC5N	leaf	crush/burn	30gp	Allows mental summons of one known sentient friend (100 feet x level of user).
Jiri	mO15W	lichen	rub (on eyelids)	10gp	Infravision (one hour)
Kylan	fW20N	berry	chew	45gp	2x strength (double concussion damage, +10 to hit) 4 rnds.
Oranto	tU20E	mushroom	eat	100gp	Haste (6 rnds) user takes 20 hits due to drug reaction 10 rounds after being taken.
Gort	hJ25S	leaf	powder/inhale	2gp	Mild euphoria. Add 10 to all Presence RRs. (1 hr). Psychologically addictive.
<b>Concussion Relief</b>					
Anneke	cH15N	flower	chew	30gp	Heals 5-50
Blenna	cC7N	fruit	eat	70gp	Heals 10-100.
Darric	cM80U	berry	chew	10gp	Heals 10 (instant effect).
Kenja	tD80U	leaf	brew/drink	3sp	Heals 1-4.
Purg	mD10NW	nectar	dissolve/drink	30gp	Heals 20.
Shuab	eW10M	leaf	poultice	30gp	Heals 2-20. Doubles healing of all major wounds. Antiseptic.
<b>Antidotes</b>					
Alzo	tF15U	leaf	chew	27gp	Antidote for Yosis.
Deon	hO5S	root	eat	110gp	Antidote for Loryaak.
Ikbal	mF2U	crystal	dissolve/drink	300gp	Antidote for any poison if taken within one hour.
Nega	mS80N	leaf	brew/drink	80gp	Slows effect of any poison 10x. Lasts 24 hours.
Tevy	mO20S	leaf	boil/inhale	25gp	Antidote for Vyrk. Cures Hurothgaar.
<b>Stat Modifiers</b>					
Sahn	cA3NE	flower	chew	500gp	Allows one to increase any one stat's potential by 4 (up to 100), but 10 must be deducted from any other one stat of the imbiber's choice. Effect lasts one year exactly.
<b>Specific Repairs</b>					
Amar	tS20U	leaf	poultice	70gp	Stops bleeding by clotting and sealing wound (up to 5 hits/rnd; more severe wounds are unaffected). Wound is closed and healed; will not reopen.
Cellane	tH85U	leaf	boil/inhale	2sp	Decongestant. Adds 20 to resistance versus cold and pneumonia.
Cicala	mT30M	grass	poultice	40gp	Mends one muscle (instant).
Daral	tO90U	leaf	poultice	1gp	Cures fever.
Efrid	hJ10S	flower	place in mouth	250gp	Massive nerve regeneration. One hour.
Ghiloa	eG2NE	flower	crush/soak	10gp	Cures frostbite.
Gursamel	tS3N	stalk	cr/po	30gp	Mends bone. Takes one minute.
Inxes	mD20SW	leaf	poultice	70gp	Stops bleeding of any one wound instantly.
Irit	mM20NE	berry	salve	5sp	Local anesthetic. Lasts 4-5 hours.
Jaymis	tM10SW	algae	dry/eat	60gp	Allows free breathing underwater (as well as in air). Lasts five hours.
Jes	cH16N	flowers	salve	255gp	Joins severed limbs. Takes one day.
Kiva	tD30S	nodule	poultice	40gp	Mends bone instantly.
Naycek	mS10W	flower	place in mouth	30gp	Lifekeeping (one hour).
Nizzar	mV15S	root	poultice	80gp	Repairs one bone shatter. Takes one day.
Nya	eG1NE	flower	place in mouth	850gp	Lifegiving for Elves. Will act as Lifekeeping on anyone, lasting 10 days.
Reslyn	tO35SW	kelp	poultice	90gp	Cures blindness (if eyes not destroyed). Instant effect.
Rumar	fM25U	berry	chew	60gp	Relieves up to 3 rounds accumulated stun. Takes effect one round after ingestion.
Saluda	mO3W	flower	place in mouth	1000gp	Lifegiving.
Sebron	cF45N	root	chew	5gp	General anesthetic. Lasts 10-12 hours. Level 5 attack.
Starza	tC23U	resin	dissolve/soak	25gp	Cures frostbite. Heals 2-20 cold related hits.
Sterben	tH40S	nut	eat	60gp	Stimulant. Add 10 to quickness for 5 rounds. Assures wakefulness for next 10 hours.
Suman	mD8N	gold berry	place in mouth	200gp	Lifekeeping 30 days.
Taline	mD40S	berry	crush/poultice	15gp	Blood vessel repair.
Turfik	sW10U	leaf	boil/poultice	50gp	Regenerates one bone (and attached tissues such as cartilage and tendon). Takes one day.
Ujama	tM30U	leaf	poultice	10gp	Repairs sprain. Effect immediate.
Zaklar	tM80U	leaf	boil/inhale	3sp	Restores free breathing.
Zorm	mS15N	grass	poultice	150gp	Shatter repair. Takes one round.

**Climate Codes:** arid = a; semi-arid = s; hot and humid = h; mild temperate = m; cool temperate = t; cold = c; severe cold (frigid) = f; everlasting cold = e.

**Locale Codes:** Glacier/snowfield = G; Alpine = A; Mountain = M; Heath/scrub = H; Coniferous (evergreen) forest = C; Deciduous/mixed forest = D; Jungle/rainforest = J; Short grass = S; Tall grass = T; Breaks/wadis = B; Waste = W; Desert = E; Freshwater coasts and banks = F; Ocean/saltwater coasts = O; Volcanic = V; Underground (caverns) = U

**Frequency:** Based on a scale of 1-100 (100 being very common; 1 very rare). These numbers are indicative of availability in the wild. Price shows purchase availability in towns and other 'shopping areas'.

**Compass Code:** Last code in sequence shows area of the main continent where herb is indigenous, or most common. "U" equals universal. "M" indicates mid-continent.

**Preparations Codes:** bo = boil; br = brew; ch = chew; cr = crush; dr = drink; eat = ingest; in = inhale; po = poultice.

**To Compute price/availability use the following steps:**

- (1) Find compass area.
  - (a) Mid-continent is always one away from adjacent regions.
  - (b) Universal Herbs are uniformly distributed.
  - (c) Remaining regions are based on compass points (N, NE, E, SE, S, SW, W, NW). Cost is based upon main home, but any region containing compass point (e.g. E is in NE, SE and E) uses base price. Regions 1 step away use 2x cost; areas 2 steps away use 4x cost.
- (2) Use cost multipliers below:
 

Market/Availability:

  - ½x if market oversupplied in good
  - 1x if normal/cosmopolitan market
  - 2x if rural market
  - 3x if isolated/black market
  - 10x if insulated/inaccessible market
- (3) When selling an herb to a merchant or interested (and rich) individual, employ two more factors (it's not that bad, really):
  - (a) If the herb is not 'universally' available it may be hard to sell, particularly where cheap local equivalents are available.
  - (b) Prices are computed as normal where there is a demand. Where there is no demand, the herb will bring 50% of the price of the cheapest equivalent locally in demand and available. All price fractions here should be rounded down.
  - (c) Unless otherwise stated, (due to culture, locale, circumstance, etc.) PCs deduct 50% of the price when selling the herb.
- (4) Weights should be calculated at ½ ounce per dose. This might vary in certain cases within the GM's discretion.

**FINDING AN HERB IN THE WILD:**

- A) This formula allows the GM to determine the number of doses a group could find after a 10 hour search in previously unexplored territory (not exploited in last 6 months) which is a suitable locale for the herb sought.
- B) A united group gets one roll for an organized search. Roll randomly to see how many doses a given individual finds.
- C) For a group which separates into smaller units, each group makes a separate roll. The individuals or parties must cover entirely separate areas, usually out of earshot, and not contact each other during the period in question.
- D) Formula: #doses = [(1-100) on open-ended D100] + modifiers + frequency # -100] divided by 5 OR the frequency #, whichever is LOWER.
- E) Modifiers:
 

Searching in area searched in last 6 months	-50
Searching in compass code area adjacent to home of herb	-50
Each Animist in group	+30
Each Ranger in group	+20
Each additional searcher	+02
Each day spent unsuccessfully searching	+05

**NOTE:** When used too frequently most herbs will cause either dependence or a negative allergic reaction in the imbiber. The frequency necessary and ramifications should be determined by the GM. However, use of any of these herbs on the average of more than once per day for more than a week should be dangerous. Alternatively, using the herb a given number of times within any given period may trigger addiction.

**Some possible afflictions:**

- a) dependence forces user to imbibe drug once/ day or face violent, unpleasant withdrawal.
- b) drug ceases to be effective; more and more doses required at once to be effective.
- c) imbiber develops allergy to drug, and cannot take drug without a reaction (from sneezing fits or hives, to a serious overall swelling, trouble breathing, and even a chance of heart attack or death.
- d) imbiber who frequently uses, for instance, a 'haste' herb in "tense" situations may, in a "tense" situation in which he does *not* use the herb, trigger a withdrawal reaction, such as *slowed* movement.

It is also important to note that the PCs will not necessarily be aware of the possibility of becoming addicted, or else they will take precautions.



**5.23 FOOD AND LODGINGS PRICE LIST**

	Cheap Meal	Good Meal	Fine Meal	Fresh Rations	Dried Rations	Cheap Room	Good Room	Private Room	Ale	Wine (Cheap)	Wine (Good)
A-Tykaar	5b	1s	5s	10s	20s	2s	4c	10s	3c	5c	1b
Brya-Sug	1s	2s	—	1g	3g	1s	3s	12s	3c	4c	12c
Syclax	1s	2s	6s	15s	4g	1s	4s	15s	4c	5c	15c
Fustir Village	4b	8s	—	9s	—	8b	5s	—	2c	4c	—

**Note:** Ky'taari consider gold to be a holy metal, and it cannot be used as currency among them. Gold presented in ignorance is assumed to be a tithe to the church. The bill is still due, however. 10 silver = 1 gold, 10 bronze = 1 silver, 10 copper = 1 bronze. A coin is assumed to be approximately 1/2 ounce. Rations are for 1 week per unit, room fee is for one night.

## 5.24 SYRKAKAR AND KY'TAARI VOCABULARY

### SYRKAKAR LANGUAGE

Speech, like all aspects of Syrkakar life, is patterned around color. The sharp contrasts between the brilliant hues of the brief northern summer and the somber tones of their long winter have apparently given these people a belief that color reflects a creation's internal power. I think that this concept has ancient roots, although the influence of color on their language may be more recent. In any case, the pattern is unique, for in all my travels I encountered nothing like it.

#### Nouns

Syrkakar nouns are composed of three parts: (1) the root, which indicates inner character; (2) the core, which is descriptive of outward appearance; and (3) the joint, which joins the other two parts and denotes plurals.

**EXAMPLE:** The noun "Sevay" means "Channel" and is composed of three parts. root "Se" (light blue) + joint "v" (opening) + core "ay" (open water).

#### Roots

There are ten primary roots in Syrkan and they are broken into two groupings of five:

##### DARK (MALE) ROOTS

Ky — Black  
Sy — Blue  
Hy — Green  
Ly — Purple  
Ny — Grey

##### LIGHT (FEMALE) ROOTS

Ad — White  
Pu — Orange  
Ku — Red  
Ju — Yellow  
Hu — Clear

The ten secondary roots are all based on subtle shade combinations and variations dominant in the North and commonly denote the hidden or unspectacular:

##### DARK (COOL) ROOTS

Go — Dark brown  
Ro — Brown  
To — Tan  
No — Dark grey  
Ho — Dark green

##### LIGHT (COLD) ROOTS

Da — Yellowish white  
Sa — Bluish white  
Ra — Cream  
Se — Light blue  
Ne — Light grey

These roots precede modifiers which create nouns based on the color theme. For example, the "clear" root is indicative of transparency: Hur = "glass"; Hu = "(clear) ice"; Hul = "gem".

#### Cores

In Syrkan, a word's core is tied to the physical shape of the subject. This is initially confusing, since the Syrkakar often link beasts that I would never consider even remotely similar; however, I eventually learned their pattern of families and constructs and can now classify unique subjects with some hope of accuracy. Since the cold Mur Fostisyr embraces relatively few species and focuses on familiar themes, I think a few examples will permit the reader a good deal of insight. Keep in mind that cores fall at the end of words and are not capitalized; thus the Syrkakar avoid confusing them with similar or identical roots.

##### WATER CORES

ay - Open water  
on - Narrow water  
en - Running water  
oy - Stagnant water  
yr - Mist  
yn - Dew  
y - Cool

##### ICE CORES

u - Icy  
ku - Black ice  
su - Blue ice  
hu - Clear ice  
du - White ice  
nu - Grey ice  
umu - Extreme cold

##### EARTH CORES

ur - Earth  
mur - Land/Continent  
urm - Height  
ri - Isle  
wy - Hold  
ug - Stone  
ag - Metal

##### FIRE CORES

kef - Warm heat  
pef - Medium heat  
jef - Fire  
ref - Molten lava  
hef - Poison

##### ANIMAL CORES

gi - Ox  
ri - Pony/horse  
li - Bear  
ji - Deer  
ar - Man

##### PLANT CORES

ya - Tree  
ra - Wood  
gra - Bark  
ye - Flower  
ga - Lichen

#### Joints

Joints connect the roots and cores, allowing the completion of the idea and the formation of the word. I believe these to be the most complex word parts and still have trouble with those used least frequently. Wudus got many a laugh out of my occasional verbal missteps. The two most common Syrkan word joints follow:

#### MODIFYING JOINTS\*

m - great  
r - collection  
t - diminutive  
br - array  
w - enclosed  
s - variable opening  
v - opening  
c - five  
cr - pair/two  
z - slow  
b - fast

#### BASIC JOINTS

e - connects preceding root consonant and following core vowel  
a - connects preceding root consonant and following core consonant  
n or l - connect preceding root vowel and following core vowel\*\*  
ka - connects compound words

\* The doubling of the first consonant of the core denotes a simple, unspecific plural.

\*\* Roots which end in vowels often lose the vowel when formed as part of a complete word. Thus, a lone "H" may carry the same meaning as the root "Hu".

#### Verbs

Verbs are constructs of lone vowels or vowel groups which are based on concepts of feeling, weight, or motion. The verb "e" means "run" and is based on the concept of "lightness".

e - run	u - open	o - cool	i - cry
a - stay	y - obscure	ae - freeze	eu - warm
ey - go	uy - turn	yu - trade	aa - die*
ay - at	oo - swim	yo - fly	ee - try
ii - mourn	ui - strike	aa - sleep*	au - listen

\*These are the same, distinguished only by a subtle inflection, as the Syrkakar believe sleep and death to be similar states.

Since verbs only combine with joints that serve as adverbs, they generally stand alone. I remember this and noted their position in the sentence whenever I sought to avoid confusing them with vowels that serve as noun cores or joints. Anyone dealing with Syrkan should follow suit, and always remember that the Syrkakar have no diphthongs; all Syrkan sounds or letter representations are distinct and pronounced separately. Generally, they translate as "long" rather than "short" units.

**EXAMPLE:** "oo" or "swim" is pronounced "o...o" and is a pair of long sounds.

#### Rules of Speech

My own experience with Syrkan was rather pleasant, for it is a simple — albeit harsh — tongue. The rules below will help illuminate its manner.

**Formation of Concepts:** Adjectives follow the nouns they modify and are formed out of a joint and core or a lone root. Verbs and adverbs are also ordered according to this pattern.

**EXAMPLE:** "Sevay Maji" means "Great-deer Channel"; is an adjective composed of the modifying joint "m" (great) and the core "ji" (deer); the basic joint "a" connects the two. "Ez" means "fast run".

**Point of Speech:** Speech is assumed to be in first person unless the statement is preceded by "Mag" (second person) or "Sag" (third person). A shift back into first person is marked by the word Ag.

**EXAMPLE:** "Mag Sevay Maji ay" means "You (are) at Great-deer Channel." The term "Mag" shifts the point of speech to second person; thus the preceding "You".

**Tense indicators:** Speech is assumed to be present and active. Passive tenses involve shifting the verb and adverb combination to the position preceding the subject. Past tense is achieved by beginning the statement with the word "E" (e.g., "Sag-e" = past and third person); future tense employs the use of the word "I". A shift back into present tense requires use of the word "O". These are all long sounds.

**EXAMPLE:** "Mag-e Sevay Maji ay" translates into "You were at Great-deer Channel."

**Inquiry modifiers:** A statement is considered to be a question if it is followed by the sound "A".

**EXAMPLE:** "Mag Sevay Maji ay, A" means "You (are) at Great-deer Channel?"

**Sentence Pattern:** (speaker/person) + tense indicator + subject + subject adjective + object + object adjective + verb + adverb (+ inquiry modifier).

**EXAMPLE:** "Sag-e Hul Jef Sevay Maji al, A" is from the point of view of the third person and translates as: (he said) "The Fire Gem laid beside the Great-deer Channel?"

## KYTAARI VOCABULARY AND PRONUNCIATION

The language of the Ky'taari is soft and lyrical, with many whisperings like the sound of wind through the pines. Overall, the tongue is very onomatopoeitic, the words imitating the things they describe. The structure of the language is similar in many aspects to Elvish, and it would almost classify as a dialect rather than an independent tongue. Below I have listed a very brief index of Ky'taari words and word-parts, hopefully to convey the flavor of the language.

ale - kel  
armor - chaka  
arrow - jak  
  
birth - karilin  
black - nor  
blade - ashaan  
blanket - falith  
blind - ornok  
blizzard - kronof  
blood - thun  
blue - lun  
boat - faryn  
book - tanaar  
bow - trin  
burn - urk

castle - kritaal  
cave - norok  
chasm - yorn  
cheerful - tarin  
child - laan  
chill - lam  
city - tykaar  
cloud - fui  
cold - krak  
common - tan

darkness (not night) - kur  
day (daylight) - arlir  
death - aynon  
dread - runak

edge - ynka  
enter - nin  
ever - oi  
evil - anja  
eye - klyn

fair (beautiful) - arin  
fall - jirik  
fire - nar  
fish - nyfan  
fly - ika  
forge - korth  
freeze - kryk

glacier - arkoy  
glitter - kyran  
gold - araan  
good/pure - thir  
green - kali

hair - fin  
hand - rin

heal - jan  
hidden - nak  
high (supreme) - a  
hill - vitan  
holy - aria  
home - itaal  
husband - atan  
ice (clear) - ky  
ice (cloudy) - ku  
ice (treacherous) - kon  
initiate (monk) - tarn  
iron - chort

jewel - tayn

king - ataarn

lamp - kaalin  
language - star  
library - tashishen  
light (glow) - alan  
look - nyk  
lord - taarn

man - ta  
monk - taranak  
month - rif  
moon (generic) - tiril  
mountain - vintaarn  
night - dakur

pain - anka  
paper - frof  
people - taari  
plain, field - kalash  
priestess - ryaan

rain - katik  
red - thi  
river - fath  
road - tal  
robe - thon  
run - iral

shadow - norin  
sharp - akish  
shield - fon  
short - kun  
sight - ril  
silver - itil  
skate - shik  
ski - shar  
sky - lir  
small - koy  
snow (wet) - krof

snow (dry) - krilf  
snow (falling) - klroyf  
song - liraan  
spring - lanaar  
star - ilaar  
steel - torl  
stone - taal  
strong - atur  
sun - ar

tall - arn  
temple - arnaar  
three - kayn  
town - tyka  
tree - tonak  
twilight - yial

uniform (monk's) - kej  
  
valley - lain  
vision - siril  
  
walk - faynar  
warm - rish  
water (still) - kaldar  
water (moving) - fath  
weak - il  
wheat - shir  
whip - jrok  
wife - aran  
wine - oryk  
woman - ana

### A few notes on pronunciation:

"A" at the beginning of any word is said 'ay'. For example, the Ky'taari word for pain is pronounced "aynka". A double "a" is said in the same manner, with a slight break to accent it. 'Lord' is said ta-arn (the break is very subtle and should not sound like gagging).

"Y", when beginning a word or flanked by consonants, is always said like eye. The word for town is said teyeka. When next to an "n"; however, it is a soft ya sound. 'Boat' in Ky'taari is pronounced far-yin.

"O" and "I" are said short as in bomb and tin.

"U" is always pronounced in the long form. The word for dark is said koor.

To pluralize a noun, the letter "i" is used as a suffix; hence lamp (kaalin) becomes lamps (kaalini, pronounced ka'alinee).

## 5.3 ITEMS OF NOTE

### VAR UKAAK (#31, sec. 4.2)

**Two-handed Sword:** Of *Keron*, this sword is +30 and weighs half what an average sword of its size would. Due to the nature of *keron*, treat as 'enchanted'.

**Shield:** A full shield made of a polished alloy, it is totally weightless and +15 to user's DB (in addition to the usual subtraction).

**Bracelet:** A delicately engraved band of gold one inch wide, it is a x3 Essence PP enhancer.

**Mace:** Fashioned of a silver alloy, the handle is inlaid with strips of ebony. It is a +20 mace and glows with a dim blue light constantly. It cannot be made invisible. In addition, it will deliver an Electricity critical equal to any normal critical given when striking a servant of the Unlife. It rests in a reinforced wood box with an Extremely Hard (-30) lock, and a trap which fires a needle tipped with Loryaak.

### ITEMS IN THE VAULTS OF TAURKYTAAL (#28, sec. 4.3)

**Black Opal Ring:** Set in heavy, shadowy gold setting. A x3 Clerical PP enhancer, it will cast *Dark Lore* (origin and nature — no powers) 1x per day. Wearer can see in total darkness at will, and can cast 500' radius *Utterdark* (Evil Magician) once per day. Summoning the *Utterdark* may alert nearby Unlife Servants, however...

### THREE ORBS:

- Grey Mist:** broken, it creates (in 20 minutes) a 5-mile radius grey cloud which then unleashes a thunderstorm for 1 hour, before dispersing.
- Green Mist:** broken, it creates a one mile radius dense fog (100' radius the first round, etc.) which lasts one hour, then vanishes.
- Red Mist:** broken, creates a 50' radius combination *Woodfires* and *Call Flame*, (all flammables ignite, all within take one "A" crit/rnd). Lasts 6 rounds.

**Tree Staff:** Five feet long, it has a head of cast gold in the form of a tree with very thick trunk and dense branches. Tiny emeralds are sprinkled over it as occasional 'leaves'. The bottom of the staff is tapered and appears to be a twisted single stalk. If tapped against stone and so commanded, however, the tip splits into several 'roots', these roots instantly burrowing into stone and crushing it to powder. The staff can powder up to 100 cubic feet of stone per use, and can be used 3x per week. Also works on ice.

**Broadsword:** +20, it is highly intelligent with a female disposition. Any time the wielder finds himself in combat using the sword, he must make a RR vs. a 10th level Mentalism attack, or become Frenzied, due to the enchanted persuasion of the sword. The effect is: +30 to OB, can take double normal concussion hits, and deliver double normal concussion damage. The frenzied person cannot parry and has no DB except for armor (no shield bonus). If the wielder of the sword succeeds in his initial resistance he is fine throughout the fight (assuming he *wishes* to resist). If he fails, he is frenzied until all foes are incapacitated or out of sight, at which time the frenzy departs, the sword sated.

**Axe:** +20, can be thrown as far as 50 feet, from whence it will magically return to the thrower. It has a head of green Laen and handle of ebony.

#### CONTENTS OF THE VAULTS AT AALK GAATH (#25, sec. 4.4)

**Glove:** Of black leather with studs; no fingers. Reduces fumble chances with 1-H melee or thrown weapon (using that hand) by 1.

**Glove:** of silvery black cloth. Will cast *Touch of Disruption* (Sorcerer **Flesh Destruction**) at will. Alternately, glove will cast *Pain* (Evil Magician **Physical Erosion**) 100' range. Fun torture device.

#### ITEMS IN THE HIGH VAULT OF THE A-ARNAAR (#37, sec. 4.5)

**Rod:** two feet long, of gold (weighs five pounds). In the hands of a Cleric with the **Repulsions** list, it will cast *Repel Undead True* once per full turning of Orhan, and as many more times per day as user has PPs (irregardless of his level) The rod essentially allows safe overcasting for that spell.

**Cup:** When filled with water and commanded to do so, it will transform the water into any nonenchanted beverage the commander is familiar with. Usable six times per day.

**Arm, Leg Bracers:** Made of leather and set with rectangles of gold alloy, they act as greaves w/no corresponding encumbrance.

#### THE TREASURY OF THE KALDARAK-VAAR (#11, sec. 4.6)

**Moonstone:** Set in a gold rim with a fine golden chain, it is slightly rounded, three inches in diameter. Astrologer x4 PP adder. Shows phases of moon (Orhan) at a thought; glows, from dim to very bright, depending on lunar phase.

**Earrings:** Yellow Topaz in gold sets. Will act automatically to close and heal bleeding criticals on the wearer of up to ten hits per day. When in sunlight, the wearer appears to have a *True Aura* (+15 to DB vs. all attacks). Not good for invisible persons, as it is continuous and uncontrollable. Must wear both, one in each ear.

#### TREASURIES OF UDA TTYGK (sec. 4.7)

**Orb of Mighty Vision:** Allows user to see great distances (4 miles per level). To places the user has been in person the range is 40 miles per level. User must be at least 10th level.

**Sceptre of the Mists:** Allows user to communicate directly with Valkir, the Udahir deity. Allows one *High Prayer* (Astrologer Base) per day. User must be at least 10th level.

**Circlets:** To be worn about the head, each circlet has a small laen jewel which acts to enhance the senses. The most common type allow *Nightvision*. Less common ones, worn by hunters and fishers, allow *Nightvision* and *Fogvision*. Circlets worn by the Thyfuriak provide the wearer with *Nightvision*, *Fogvision* and *Terrain Feel* (a special spell which allows the rider to sense in great detail the terrain below him).

**Silken Cloak:** With a blue laen clasp, this cloak will protect the wearer against cold and wind-chill to -150°.

**Green Laen Sword:** A truly fabulous weapon, it possesses the unheard-of bonus of +50, and will protect the wielder from all Elemental Attack spells. However, if the sword is taken out of the city it *changes*. The bonus drops from +50 to +20, the spell immunity alters so that the wielder is only immune to *Fireballs*, and at 2 random times each day a *Fireball* erupts from the sword (GM rolls % for times of day when the spells go off). Wielder is immune but all within 20 feet take the hit. There is no way of knowing that the sword will do this. The Udahir know, of course, and keep the sword at home.

**Telescopes:** Laen and obsidian precision instruments, their effective range is 20 miles across land. When stargazing, the user will sense future star patterns, enabling him or her to essentially cast *Commune I* once per week. They also allow trained Udahir Seers to cast any spell through them on a target focused in the telescope, Target does get a +30 to RR vs such attacks.

**Broadswords:** Ten Eog swords, +20 in quality.

**Silken Boots:** allow perfect, uninjured landing, even when falling from great heights.

**Laen Dagger:** A +25 item, it also is able to cast a spell 3x per day. Caster has a choice of any combination of the following: *Spin*, *Fumble*, *Unbalance* (Mystic Base).

**Armor:** Two sets of plate, four of chain, the armor is of Eog, allowing a +20 to both maneuver bonus (non-static) and DB.

#### THARG JIRONAK VAULTS (sec. 4.8)

##### Misc. Items:

**Vinestaff:** Deniriok, Rogir, Jalor and all of the Brothers (not Acolytes) possess one. In appearance vinestaffs are plain wood staves four feet long. Their only purpose is to tame the vines in the Green room (#26). Anyone is safe in this room while he holds a Vinestaff.

**Small Vault (#15) Contents:** Visor: clear or tinted laen, like sunglasses. Automatically darkens in reaction to bright light, adding +50 vs. blinding light attacks; also 50% chance any eye critical ineffective.

**Earplug:** Will cast *Slyears* Three times per day. Made of Laen, Shaalk and some Ithloss alloy.

**Compartment (#16) Contents:** Sapphire Ring: Gold set, analysis reveals that it 'preserves' and 'protects' wearer. When put on finger, turns him/her to stone. They are invulnerable and the body is *Preserved* (Cleric Base) also very heavy; does not *Lifekeep*, though.

##### High Vault (#81) Contents:

**Fire Opal Ring:** Round, set in delicate gold setting. While worn, it absorbs all fire in a 20 foot radius. Fires lit will extinguish in one round, their light sucked into the ring. Magical fires (failing vs. 10th level) divert to the ring and puff out. (Wearer takes 1-10 hits of backlash each time.) After one day of continuous wear (and no fires to absorb), the ring begins to drain body heat, and so CON (1 point per hour). After three days, permanent Con. begins to lower, until wearer removes ring or dies. If the ring is replaced on same person, effect resumes with immediate permanent drains. It grows darker and less 'fiery' when low on power.

**Glove:** Of red leather, this otherwise plain glove allows the wearer to cast a specialized *Telekinesis 10 lb.* once per day, 100' range. The specialization is that the spell is instantaneous and the item acted upon simply comes to the glove. Glove glows and cannot be invisible while spell active. Keep in mind applicable RR's when target item is held; treat the glove spell as 10th level.

**Scarf:** Eight feet long, one wide, of black cloth sewn with metallic threads. It is capable of casting *Lightning Armor* once per day on wearer, and has the additional property of neutralizing neck criticals 25% of the time.

**Bowguard:** +10 to all attacks using a comp, long or short bow. Reduces chances of bow fumble by 1.

**Daggers:** A set of three, all having a +10 steel blade and green silk hilts. Each has delicate engraving, saying: *Of Slaying Wolves*, *Of Slaying Bats*; and *Of Slaying Birds*. Each has the power indicated. The daggers are together in a fine, flat tonak box, each with its own place.

**Dagger with Amber Pommel:** No add (blade is of steel, but has no real edge) but has secret message compartment in hilt. Amber has a tiny dragonfly in it. When hurled and a name called, the dagger turns into a huge dragonfly (dagger strapped to back) and goes to the called one at the rate of 50mph (no range limit). Will do so five more times (round trip). Note that the 'Target' must have been previously seen *in person* by the sender, and concentrated on while the sender holds the dagger.

**Quiver:** It and contents (arrows only, as many as 20) do not encumber.

**Necklace:** Gold with ten red coral beads. Each bead will cast *Water-breathing*, with a four hour duration. Six have been used.

#### SYRKAKAR HEIRLOOMS:

**Twy Syrkakang:** Mystical collar, symbol of office of the Syrkakang. Fashioned of polished inlays of several kinds of wood set in gold rectangles linked together by intricate chains, it is a beautiful item. It confers upon the wearer a +30 to DB, Perception and Tracking bonuses. In addition, it will create a *True Aura* about the wearer at will, and can turn him invisible as often as 3x per day.

**Spear:** With a shaft of tonak wood and head of Eog, this spear can be thrown as far as 100' without distance penalty, and will also return to the hand of the caster. It is +20 and of *Slaying Elves*.



## 6.0 ADVENTURING IN THE MUR FOSTISYR

The island cluster known as the Mur Fostisy is a rich environment for adventuring and can provide a setting for an entire campaign.

Two organizations hold jurisdiction over the entire World of Loremaster. Their influence on Mur Fostisy, while indirect, is pertinent with regard to PCs and their relationship to the land and its inhabitants. If the GM is planning a relatively short campaign the Navigators will probably not have a very significant role, since the campaign can be restricted to the boundaries of this land. If on the other hand, the GM wishes to begin an extended campaign or to employ the Mur Fostisy as a continuation of an already active campaign, the Navigators may prove important as a mode of transport.

Later in this section can be found detailed suggestions for PC backgrounds for native Mur Fostisyrians and scenarios for several levels of play.

### THE NAVIGATORS

As has been stressed before, there are many forces (both natural and supernatural) which divide the World of Loremaster into distinct areas, making travel over long distances nearly impossible. That is the case only for 'unskilled' travelers, however. Scattered throughout the world are a number of arcane organizations commonly known as *Navigators*. At least one of these groups is composed completely of Elves, though many have mortal members. The function of Navigators is, as one may guess, to guide the unwary through barriers otherwise impassable.

These Navigator 'Guilds', as they are called, are grudgingly accepted as sole providers of long-distance, safe and reliable travel. Besides the Navigators, only the Loremasters can traverse the world with ease, sailing through reefs and shoals with impunity, and riding the Flows of Essence where the land prohibits conventional travel. As part of their Code, the Navigators favor no one, instead charging all a high price for their services of guidance and Essence manipulation.

Obviously, all Navigators are masters of the Essence, for not only can they guide ships and caravans along the safest route, but they are able to *Teleport* groups, ships and large animals across vast distances by using nearby Essence Flows. Nearly all Navigators utilize some sort of device in their trade, although its nature and appearance can vary tremendously from Guild to Guild. It is important to note that one of the tenets of the Guild Code is that Navigators will not transport what they consider military personnel or items, either for the purpose of attack, espionage or sabotage, and they maintain the right to refuse any such assignment.

There are several ways to contact the Guilds, should one have the cash and the inclination to travel. Black stone obelisks, one foot square and twenty feet tall, are scattered across the lands of the world. They are unmarked, shiny black, and virtually indestructible. Simply place a hand on one and say, in any language, "I require a Navigator" and one will magically appear within minutes. He or she will then discuss terms and payment (almost invariably cash up front). Conventional transportation is never supplied by the Guild, and in fact the client must provide such for the Navigator. The Navigator, however, will advise the ignorant client as to the most appropriate mode of transport. It is occasionally possible to make much of a journey via direct *Jump* (as the Navigators refer to *Teleport*), but long Jumps are tricky and prohibitively expensive.

To calculate the cost of a Guild-directed trip, use as a standard unit of either one person or 50 lbs of cargo. Charge 1 gp. per mile per unit overland; 1 gp. per 10 miles per unit by sea. An additional flat rate of 100 gp. per unit per Jump — as deemed necessary by the Navigator — is charged, with a surcharge of 10 gp. per unit per mile of Jump travel over 50 miles. (Nearly all Jumps used at the Navigator's discretion to bypass barriers and perilous areas are less than 50 miles.) Safe arrival of the personnel/cargo to the destination is guaranteed, barring interference by raiders and occurrences unrelated to the journey, such as random spoilage of the cargo, or the death of a passenger due to assassination or illness. Weather on such guided journeys is never unpleasant enough to delay the trip or risk harm to those involved — the Navigators apparently exercise limited weather control in addition to their other powers.

The Guilds have divided the world into districts, each Guild having a defined jurisdiction. A single Navigator is invariably the guide for an entire assignment.

One of the more flamboyant (not to mention stuffy and condescending) Guilds is the group known as the *Guides of Vurn-Kye*. Their Navigators use a Compass which resembles a golden sextant with tiny jewelled fittings. A Navigator is never parted from his Compass, and when it is not in use he or she carries it in a fine black leather pouch slung from the belt. Navigators in this Guild wear a tunic and pants of black cloth trimmed with gold thread and gold fastenings, black leather boots and, unless the weather is very hot, black gloves. Their symbol, an abstracted sextant-compass, is embroidered in silver and gold thread and many tiny gems on the left breast. The Guides of Vurn-Kye comprise the Guild usually associated with travel to and from the Mur Fostisy.

### THE LOREMASTERS

The presence of Loremasters such as Elor, and the extent of their involvement in play is of course up to the GM, but he or she should take every care to remember that discretion and subtlety are traits common to all Loremasters. They will rarely interfere directly unless dire consequences to *all the Mur Fostisy* would result from their inaction. Dire consequences to the PCs do not count.

Never prominent personalities, yet so often to be found operating beneath the flashy veneer of many a realm's government, Loremasters are the great meddlers of the world. Lurking behind thrones and in boudoirs, they whisper a word here, overhear a rumor there. Information is their trade and the substance of their lives. Without them the world would most likely be a desolate planet with only small pockets of life under the cruel domination of creatures unspeakable, servants of the Unlife.

The Loremasters are in fact a fairly sophisticated organization, controlled by a council of twelve elder Loremasters charged with coordinating the actions of their agents around the world. Six members of the Council, all of whom are elected for life (or 100 years, whichever ends first) are Elves, the balance being saged mortals. Let it be noted that mortal lifespans in the World of Loremaster vary tremendously; in some cultures 300 years of life is the average. The Council rarely intervenes unless specifically asked by the Loremaster involved.



### 6.1 PLAYER CHARACTER BACKGROUNDS:

Several options exist for a Ky'taari player: he might be a trader, an agent sent by the King, or even a monk on a mission for one of the Ryaani or even the A-Ryaan. A monk away from his monastery is relatively rare, but not unheard-of, as they are occasionally sent as couriers or travel as bodyguards of their Ryaan.

A young Fustir might have left his people to seek his origins, or understand the interactions of the peoples of the Mur Fostisy. Alternatively, he might have encountered one of the Priests of the Iron Wind among his tribe, and somehow discovered that the Priest is evil. Unable to convince anyone else of this, he is forced to flee his tribe and to seek proof of the unscrupulous intentions of the Priests.

From among the Udahir are sent agents, those whose task is to explore the surrounding lands and judge whether the time has yet come for the Hidden People to reveal themselves. A PC might very well be one of those charged to travel the Mur Fostisy, contact the various peoples (without revealing his/her own exact origins) and "experience the world". An added purpose might be to recover an item somehow stolen from the vaults long ago, or to locate a long-lost sibling or cousin who had preceded the PC as an agent.

A PC might be a Syrkakar youth of the family of the Ninth (slain) Syrkakang. He is disenchanted with the current Syrkakang (perhaps even suspects that the Iron Wind is at work) and seeks to recover the *Twy Syrkakang* (see items section) unseat the unlawful Syrkakang and free his people. Needless to say, this is a very ambitious and long-term quest if taken to its conclusion, requiring help and cooperation from other PCs. However, it would be to the benefit of all the inhabitants of the Mur Fostisy for the Syrkakar to return to a more peaceful state.

There are, of course, many other background possibilities, including just about any other racial type, perhaps washed up on the chill shores of the Mur Fostisy after a shipwreck, somehow trying to get back to the mainland, or helping out the troubled inhabitants of the land.

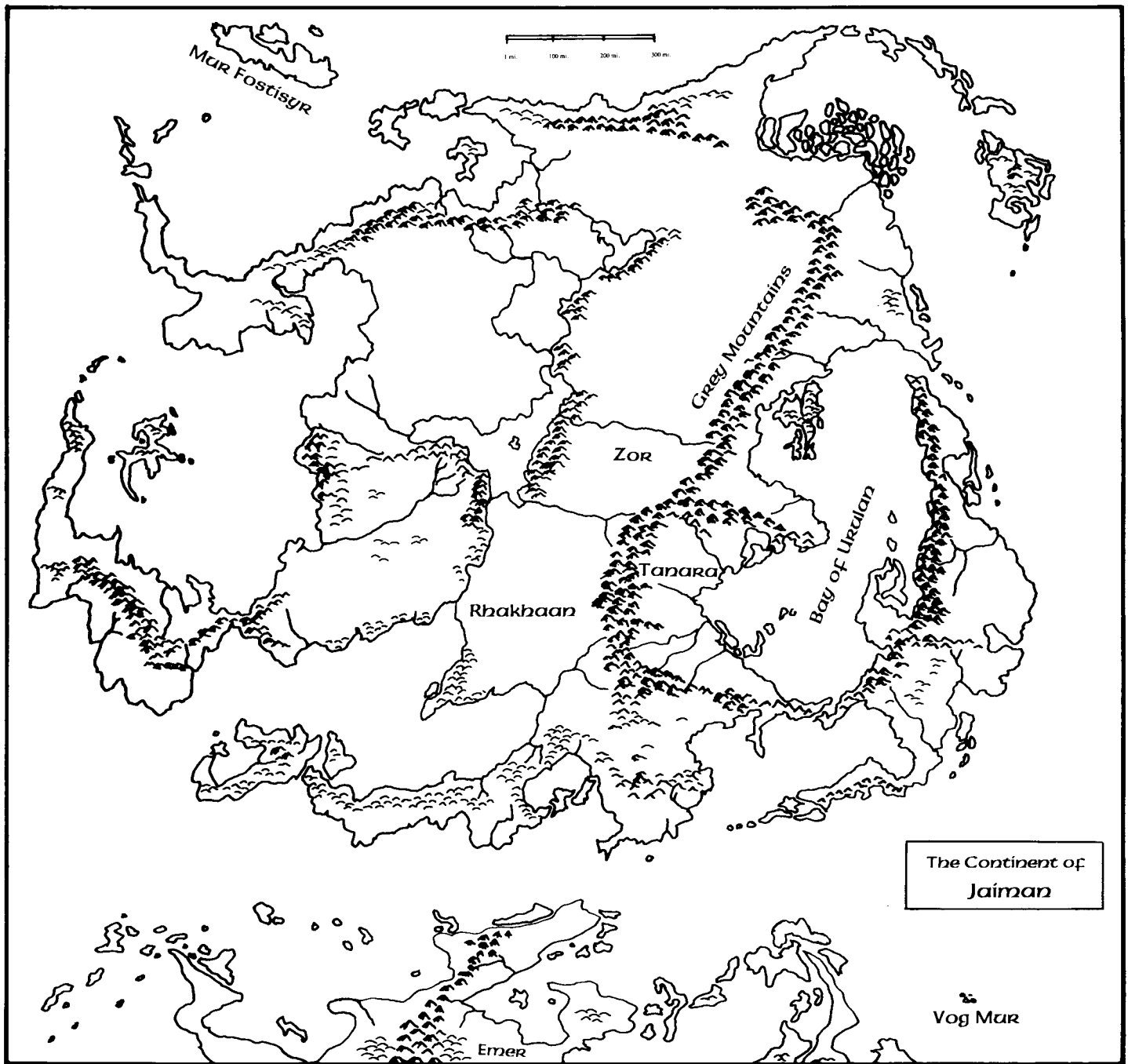

## 6.2 SCENARIOS

Below are listed several possible adventures for the PCs to undertake. They can be run as individual scenarios or woven into a unified quest for the PCs to perform.

Besides the suggestions below, there is the possibility of an encounter with a sea-drake if the adventurers are out on the water or ice, or if they are on land, they might run into any of a number of other creatures which inhabit the Mur Fostisyr.

### 6.21 FOR LOWER LEVEL CHARACTERS (1-5)

The adventurers could be travelling by ship along the Jaiman coast and shipwrecked on an isle of the Mur Fostisyr. Early encounters could include isolated Syrkakar or Fustir engagements.

City adventures are also a possibility. Syclax especially could be a very dangerous and exciting place to adventure. If the PCs get themselves in trouble with the wrong people they could find themselves being pursued by the Messengers of Syrkakang!

### 6.22 FOR MEDIUM LEVELS (6-10)

Var Ukaai might be appropriate for a group this level, perhaps needed to recover some family heirloom held in the Var Ukaak vault, or the company could have been sent as agents (by Elor? By the Ky'taari? by rebel Syrkakar?) to find out who the new Syrkakang *really* is.

Smart adventurers could successfully pull off a small raid on the Taurkytaal, if they do not alert the Lord Demon. He might prove difficult to defeat unless the group is large and/or well-equipped to deal with him.

### 6.23 FOR UPPER LEVELS (11-15)

A high-level group (not necessarily with any roots in the Mur Fostisyr) might be commissioned by (and transported here by) the Vurn-kye Guild, to recover Deniroik's *Compass*. The reward from the Guild would be quite handsome, and if the PCs happen to loot Deniroik's treasures while they are there, the Guild would probably look the other way.

Aalk Gaath is a fearsome place when the Dragonlord is home, for he is certainly an enemy to be feared. PCs below tenth might have trouble here, unless there are at least five in the group, and they are well-armed.

## 7.0 GLOSSARY

**Aalk Gaath:** (*"Citadel of the Dragon"*) Home of the Dragonlord Oran Jatar and headquarters of the Athimurl and Gaath divisions of the Priests of the Order Arnak.

**Adea Hu:** (*"Pillars of Black Ice"*) Second largest island in the Mur Fostisyr, controlled by the Syrkakar.

**Arduvaal of Vraniis:** (1391-4881 S.A.I.) Famed Sage and Loremaster, one of the foremost historians of the Age.

**Arianna:** Goddess of the sun, worshipped by the Ky'taari.

**A-Arnaar:** High temple of the Ky'taari, located above the capital city.

**Arnak:** Orders of Priests who serve the Iron Wind. Although their presence has only been documented on the Mur Fostisyr, it is suspected that they have spread their cruel order to the mainland. See sec. 3.21 for details of their powers.

**A-Ryaan:** Hereditary Title of the High Priestess of the Ky'taari.

**Athimurl:** One of the six orders Arnak, relating to the snow lion.

**Aztaur:** High Demon; master of the Taurkytaal.

**Barl Syrnak:** Original name of the Mur Fostisyr before the Syrkakar renamed it.

**Brya Sug:** (S. *"Door of Trees"*) Port city and main market of the Syrkakar. Many races gather here to trade.

**Chintakari:** Highest religious position among the Udahir, nearly always held by a woman Seer or Astrologer.

**Compass:** The name given to the device used by the Navigators in their profession.

**Dakuralani:** (K. *"Lights of the Night"*) Ky'taari name for the northern lights/aurora borealis.

**Dawnwater's Edge:** (*Kaldaraak-Vaar*) Most holy site of the Ky'taari, hidden in a high mountain lake.

**Deniroik:** Renegade Navigator now residing in a fortress in the Mur Fostisyr.

**Dragonlords:** (*Kugor*, pl. *Kugoran* in their own tongue) An ancient race of unclear origins, they are huge beasts which possess a high intelligence and cunning. Legend says that the highest lords among them are able to assume human form at will.

**Elor Once Dark:** A Loremaster. He is high in that august order, and yet one who chooses to wander the World rather than become involved in the bureaucratic hierarchy. He is considered by his peers as one of the wisest yet most unpredictable Loremasters. His title refers to when he allegedly fell to evil for a time. This tale is completely unsubstantiated, however. To some he is known as Elor Duo-deca Dark.

**Elves:** A race of rustic, immortal beings resembling Mannish peoples, but generally more slender and graceful. They are one with the earth, and many possess Animistic powers. Apparently those who fall to evil or become overly enamoured of Essence lose their immortality, as they become separated from the earth. Their exact origins are uncertain, although it is generally accepted that they predate most Mannish cultures and perhaps even the Lords of Essence.

**Eog:** An extremely hard metal. It is brittle in its natural state, but when combined with other elements can be used to make superior weapons and armor. Treat as enchanted. In addition, certain pure types of Eog have the power to inhibit the Flows of Essence: White Eog can limit the power of Dark (evil) Essence, while Black Eog, in sufficient quantities, can cancel out non-evil Essence. In appearance, the metal is dull in lustre.

**Fustir:** One of the four principal peoples of the Mur Fostisyr. See sec. 3.31.

**Haid:** A race of people on the northwestern coast of Jaiman; they were overrun by the Syrkakar.

**Ikasha:** Multibladed throwing weapon utilized by the Ky'taari.

**Iruaric:** Language of the Lords of Essence, essentially a 'dead' tongue now, known to very few.

**Jaiman:** Western continent of the World of Loremaster.

**Jaimani-Elves:** A specific Elven grouping in northwestern Jaiman, they were nearly annihilated by the Syrkakar.

**Kaldaraak-Vaar:** See "Dawnwater's Edge".

**Kugor:** Language of the Dragonlords. Not commonly spoken (or even known) by most other peoples.

**Kytaal:** (K. *"Ice-stone"*) Strong, translucent stone used as a primary building material by the Ky'taari.

**Ky'taari:** (K. *"People of the Ice"*) One of the peoples of the Mur Fostisyr. See sec. 3.33.

**Kyvinaar:** Land of the Ky'taari.

**Laen:** Extremely hard volcanic glass which can be forged into very keen-edged weapons. Can also be tinted during the forging process, and has been found in several naturally caused tints — though the tinted form is very rare. Treat as enchanted.

**Mur Fostisyr:** (S. *"Land of Blue Light"*) Island cluster northwest of the continent of Jaiman.

**Oran Jatar:** Dragonlord, master of the Aalk Gaath.

**Navigator:** Members of the of the elite Guilds who control long-distance travel across the world. The only possessors of Compasses, they can transport themselves, and their clients across vast distances quickly and safely. Alternatively, one of the individual Guilds refers to itself simply as "The Navigators."

**Ovir:** Huge white polar bears, subject of worship by the Udahir.

**Ryaan:** Title given to Priestesses of the Ky'taari.

**Susymog:** Ordainer, master of the Var Ukaak, the Syrkakang of Syclax.

**Syclax:** Military capital of Adea Hu.

**Syrkakang:** High lord of the Syrkakar.

**Syrkakar:** (S. *"Lords of the Blue Forest"*) One of the peoples of the Mur Fostisyr; see sec. 3.32 for details.

**Taiga:** A type of conifer which makes up the majority of the wooded areas in the Mur Fostisyr.

**Tanhuz:** Title of the King of the Udahir.

**Taurkytaal:** (K. *"Dark Ice-stone"*) Citadel of Aztaur, the chill demonlord.

**Thyfurriak:** Bird riders of the Udahir.

**Tonak:** Conifer found almost exclusively on the Mur Fostisyr, its wood is used by the Ky'taari to make their exceptional paper.

**Uda Tyygk:** City of the Udahir.

**Udahir:** One of the peoples of the Mur Fostisyr. See sec 3.34 for details.

**Ugus Fost:** Haidic lord who conquered the Fustir long ago and precipitated the move by the Haid to the Mur Fostisyr, thus altering their name to Syrkakar, *"Lords of the Blue Forest."*

**Unlife:** An evil force whose source is unknown. Acting always through minions and agents, it seeks the destruction of all life.

**Var Ukaak:** (S. *"Unseeing Eye"*) Citadel of Susymog.

**Valkir:** Name given by the Udahir to a mythical Ovir believed to have led them to their current home. Also the name of a constellation.

**Zjedrahir:** (Z. *"People of the Stars"*) Original name of the Udahir. The stone used as a primary building material by the Ky'taari.

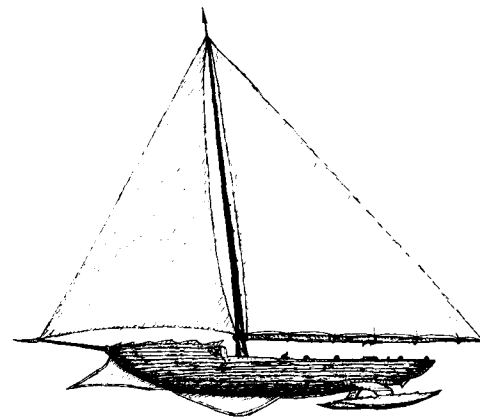

*Ky'faryn*



# IRON CROWN ENTERPRISES CATALOG

## MIDDLE-EARTH ROLE PLAYING

A COMPLETE SYSTEM FOR  
ADVENTURING IN MIDDLE-EARTH

MIDDLE-EARTH ROLE PLAYING (US) \$ 8.00  
MERP (BOXED EDITION) . . . . . (US) \$12.00

## MIDDLE-EARTH ADVENTURE MODULES

ADVENTURE-SIZE SUPPORT MODULES  
FOR MIDDLE-EARTH ROLEPLAYING  
THAT ARE ADAPTABLE TO MOST  
FANTASY ROLE PLAYING SYSTEMS.

BREE and the Barrow Downs . (US) \$ 6.00  
DAGORLAD . . . . . (US) \$ 6.00  
CIRITH UNGOL and  
SHELOB'S LAIR . . . . . (US) \$ 6.00  
HILLMEN OF THE TROLLSHAWS (US) \$ 6.00

## MIDDLE-EARTH CAMPAIGN MODULES

CAMPAIGN-SIZE MODULES  
FOR MIDDLE-EARTH ROLE PLAYING AND  
ADAPTABLE TO MOST FRP SYSTEMS.

POSTER / MAP (TUBED) . . . . . (US) \$ 5.00  
POSTER / MAP  
(FOLDED FACE-OUT) . . . . . (US) \$ 5.00  
GUIDEBOOK TO  
MIDDLE EARTH . . . . . (US) \$ 9.00  
ANGMAR . . . . . (US) \$10.00  
UMBAR . . . . . (US) \$10.00  
THE COURT OF ARDOR . . . . . (US) \$10.00  
NORTHERN MIRKWOOD . . . . . (US) \$10.00  
SOUTHERN MIRKWOOD . . . . . (US) \$12.00  
ISENGARD . . . . . (US) \$10.00  
MORIA I (Upcoming)

THESE PRODUCTS AVAILABLE AT  
BETTER RETAIL OUTLETS WORLDWIDE.  
DEALER INQUIRIES WELCOME.

## MIDDLE-EARTH BOARD GAMES

MULTI-PLAYER BOARD GAMES  
SET IN TOLKIEN'S WORLD.

THE FELLOWSHIP OF THE RING (US) \$25.00  
THE BATTLE OF FIVE ARMIES (Upcoming)  
LONELY MOUNTAIN (Upcoming)

## THE ROLEMASTER SERIES

THE ELITE FRP SYSTEM WITH GUIDELINES  
IN CHARACTER DEVELOPMENT, MAGIC,  
ARMS, AND COMBAT.

ARMS LAW / CLAW LAW . . . . . (US) \$12.00  
SPELL LAW . . . . . (US) \$14.00  
ROLEMASTER . . . . . (US) \$34.00  
CHARACTER LAW . . . . . (US) \$10.00  
CAMPAIGN LAW . . . . . (US) \$10.00  
ROLEMASTER BESTIARY (Upcoming)

## THE LOREMASTER SERIES

ADVENTURE AND CAMPAIGN-SIZE MODULES  
DETAILING A UNIQUE FANTASY WORLD  
CREATED BY I.C.E.

THE CLOUDLORDS OF TANARA (US) \$10.00  
THE WORLD OF VOG MUR . . . . (US) \$ 6.00  
THE SHADE OF THE  
SINKING PLAIN . . . . . (US) \$10.00  
THE IRON WIND . . . . . (US) \$ 8.00  
CYNOR, THE CURSED OASIS (Upcoming)  
THE GATES OF GEHAENNA (Upcoming)

THE MIDDLE-EARTH LINES WILL BEAR  
THE COPYRIGHT OF TOLKIEN ENTERPRISES,  
A DIVISION OF ELAN MERCHANDISING, INC.



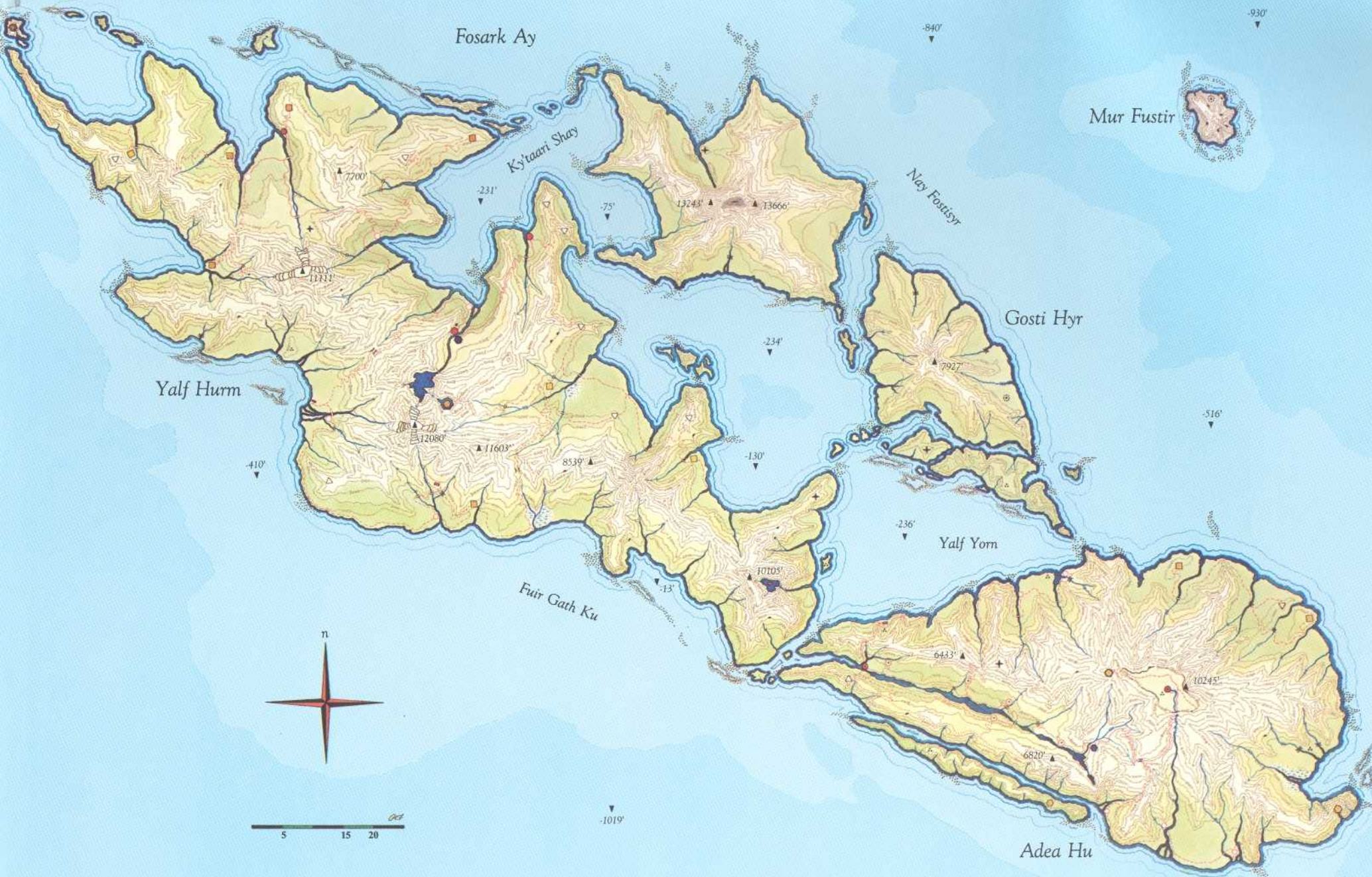



Yalg Syclax

Rouon (Dry-Moat)

Yon Syclax

-  Alley
-  Covered Alley
-  Dry Lake
-  Geyser-vent
-  Partially Covered Alley
-  Pulley-way Access
-  Ruin
-  Street
-  Underground Pulley-way
-  Var Huir
-  Wall
-  Watch-tower
-  Well
-  Cultivated Area
-  Cave Entry
-  Mud-pot (boiling)
-  Contour

Contours equal 50' increments.

Rouon (Dry-Moat)

Syclax ("Five Gates")

Yalg Syclax

100' 200' 400'





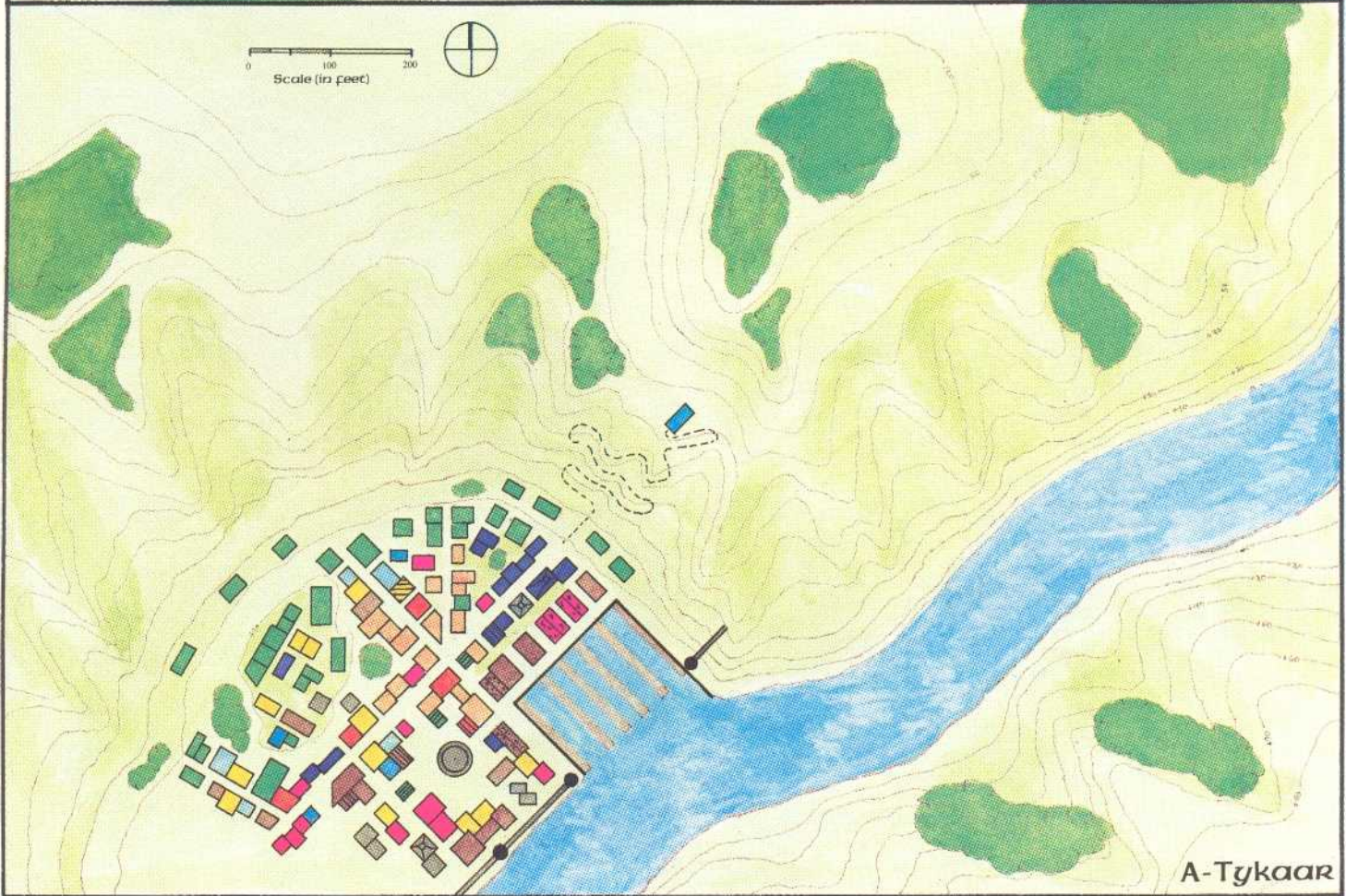
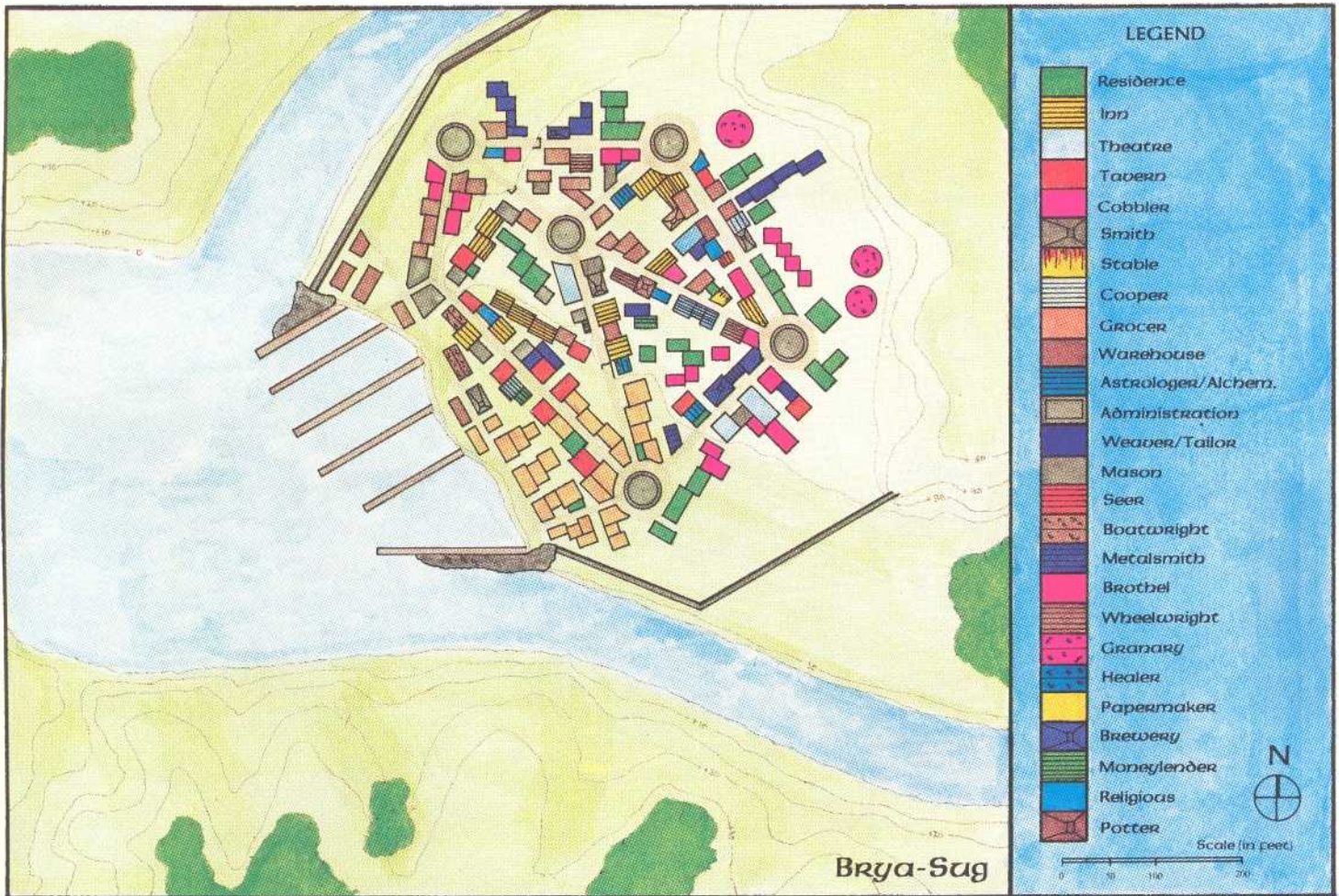



# THE DAWNING OF A NEW FANTASY WORLD...

## Enter the World of Loremaster!

The **IRON WIND** recounts the tale of Elor Once Dark, a famed Loremaster who traveled to the chill land of the Mur Fostisyr, snow-clad isles surrounded by cruel glaciers and treacherous icy waters. It is the home of the Iron Wind, an arm of the unlife threatening to subdue the valiant peoples of the isles. Demons, Supernatural assassins, Dragonlords and corrupt Elven priests all serve the dark purpose of the Iron Wind as they strive to further drive apart the already divided peoples. Against these terrifying minions stand the Elvish Ky'taari; the stout, hardy Fustir, the secretive, superhuman Udahir hidden in their subterranean metropolis; and the fierce, warlike Syrkakar — who are already falling under the cruel shadow of the Iron Wind.

This series of campaign and adventure modules are designed specifically for use with the **ROLEMASTER** fantasy role-playing game system. Other modules in the line include:

**VOG MUR:** A tropical island group teeming with adventure. Search for the secret of Ordye Throg, nestled in the slopes of Buir Dom, the once active volcano. Face the unspeakable terror that wanders the ancient Mausoleum of Gart.

**THE SHADE OF THE SINKING PLAIN:** In the distant Northern Kingdoms, the Undead Shade, trapped in the spirit world by her own dark Sorceries, terrorizes the sea lane aboard a huge enchanted ship of war in her ruthless search for a cure to her affliction.

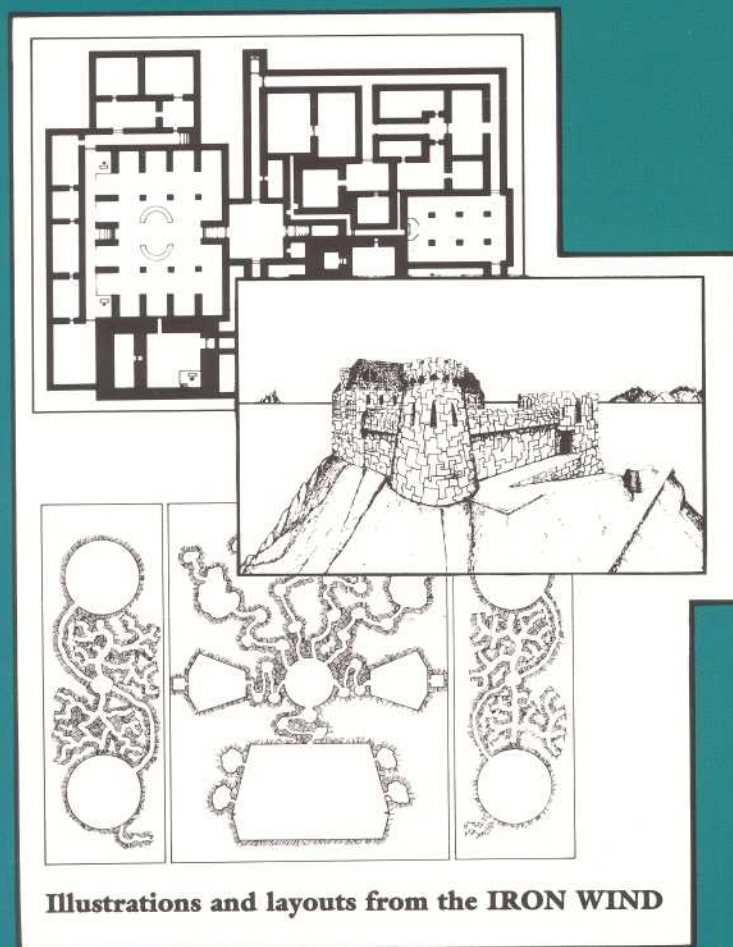

Illustrations and layouts from the **IRON WIND**



**THE CLOUDLORDS OF TANARA:** Cornerstone of the Series, this 64 page module contains general background information for the entire world, a color map of the continent of Jaiman, color layouts of cities and castles. The land of Tanara, torn by internal strife, is terrorized by false gods astride mighty flying steeds, and by the Implementor, an undead Sorcerer-warrior.

**Upcoming Modules:**  
Cynor: the Cursed Oasis  
The Gates of Geheanna

### The Loremaster Series:

Clusters of islands and small continents dot the surface of the world. Myriad cultures and peoples lie separated by sheer mountains, treacherous reefs, and the powerful but invisible Flows of Essence.

Churning like ocean tides under the Five Moons, the Essence ebbs and flows, its eddys and currents dictating unseen barriers and centers of power. Some have learned to tap into that power.

Travel across the world is perilous, though some have made it an art: the aloof Navigators will transport anyone anywhere — for a fee. And of course, there are the mysterious, saged Loremasters, keepers of the old knowledge and consummate wielders of the Essence. It is they who lead the ongoing fight against the Unlife and its twisted servants.

ISBN 9-915795-23-X