

Palladium Books® Presents:

ROBOTECH

THE

GENESIS PITS

SOURCEBOOK



ZELEZNIK
2012

By Irvin Jackson

SCANNED BY MOSPEADA

OCR BY MOSPEADA

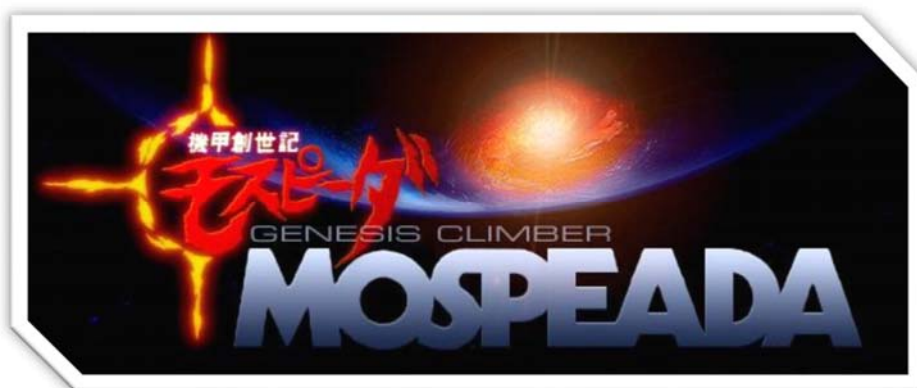

Warning!

Violence and the Otherworldly

The *fictional* world of **Robotech®** deals with war, alien invasion, betrayal and violence. It is an exotic realm of the future where alien invaders, robotic war machines, alien technology, space travel and alien worlds are commonplace.

Some parents may find the war, violence, aliens, and science fiction elements of the game inappropriate for young readers/players.

We suggest parental discretion.

Please note that none of us at Palladium Books® condone violence and war, nor encourage the belief in aliens or the fear of alien invasion. This is a fictional game, not real life.

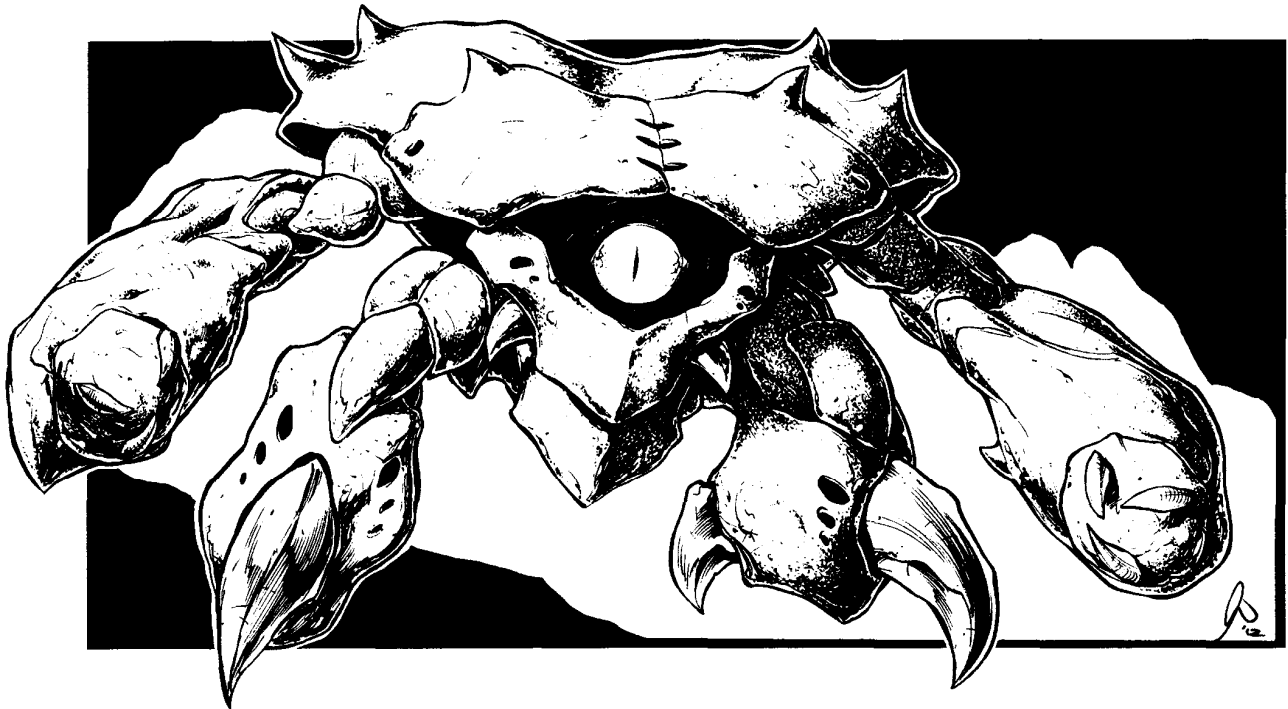

**Robotech® The Genesis Pits™ – an epic sourcebook
for the Robotech® The Shadow Chronicles® Role-Playing Game.**

Dedication

In memory of my grandfather, Dr. Joseph A. Pitts, Sr., **who taught me that science was at its best when it was used to help our fellow man.**

– Irvin Jackson, 2012

First Printing – November 2012

Robotech is copyright 1985-2012 Harmony Gold USA, Inc. All rights reserved. Visit www.robotech.com

Genesis Pits Sourcebook is copyright 2012 Palladium Books Inc. & Kevin Siembieda. All rights reserved, world wide. Visit www.palladiumbooks.com

All rights reserved, world wide, under the Universal Copyright Convention. No part of this book may be reproduced in part or whole, in any form or by any means, without permission from the publisher, except for the purpose of brief quotes for use in reviews. All incidents, situations, institutions, governments and people are fictional and any similarity, without satiric intent, of characters or persons living or dead, is strictly coincidental.

No part of this publication may be scanned, OCR'd, reproduced, sold or distributed in any way for electronic publication on the web/Internet or any other medium unless authorized in writing by Palladium Books Inc.

Robotech®, Shadow Chronicles®, Macross®, Southern Cross, New Generation and associated names, logos, and all related indicia are trademarks of Harmony Gold USA, Inc.

Palladium Books®, Megaverse®, Rifts®, and The Rifter® are registered trademarks owned and licensed by Kevin Siembieda and Palladium Books Inc. One game system – a Megaverse® of adventure, Mega-Damage, E-Clip, M.D., M.D.C., S.D.C., I.S.P., P.P.E., P.E., Horror Factor, Perception Roll, and other game terms, names, titles, and other game related words, system of play, and slogans are trademarks owned by Palladium Books Inc.

Palladium Online: www.palladiumbooks.com
Robotech Online: www.robotech.com



Robotech®: The Genesis Pits™ Sourcebook is published by Palladium Books® Inc., 39074 Webb Court, Westland, MI 48185. Printed in the USA.

Palladium Books® Presents:

ROBOTECH®

THE GENESIS PITS SOURCEBOOK

Written by: **Irvin Jackson**

Additional Writing, Game Rules & Ideas: **Kevin Siembieda**

Editors: **Alex Marciniszyn**
Wayne Smith
Kevin Siembieda

Proofreader: **Julius Rosenstein**

Harmony Gold Consultants:
Steve Yun
Tommy Yune

Cover by: **John Zeleznik**

Interior Artists:

Nick Bradshaw	Apollo Okamura
Kevin Long	Benjamin Rodriguez
Allen Manning	Mike Wilson
Brian Manning	Tommy Yune
Michael Mumah	

Art Direction and Layout Supervisor: **Kevin Siembieda**

Layout and Typography: **Wayne Smith**

Robotech® Logo Design: **Tommy Yune**

RPG rules, game design and
system of play created by **Kevin Siembieda**.

Palladium Books Online: www.palladiumbooks.com

Special Thanks to *Irvin Jackson* for revealing more secrets of the Invid and providing riveting source material for gamers of the Robotech saga. To *Doug Lamberson*, *David “Rabid Southern Cross Fan” Ferris*, and others for their input and suggestions. *Steve Yun*, *Tommy Yune*, *Douglas Wooten* and *Blake Cannon* for all of their help, input and contributions. The artists, *Apollo*, *Ben*, *Brian*, *Allen*, *Nick*, *Kevin* and *Mike* for bringing this book to life, and to the Palladium heroes of the UEEF: *Wayne Smith*, *Alex Marciniszyn*, *Julius Rosenstein*, and *Kathy Simmons* for their dedication and hard work.

– *Kevin Siembieda, November 2012*

Contents

How to use this book	7
The Genesis Pits	7
The first Genesis Pits on Optera	7
Then the Robotech Masters arrived	7
Earth has not been spared Genesis Pits	8
Earth Resistance and the Genesis Pits	8
The UEEF	9
The Inorganics	10
The Cougar	11
The Crann	12
Plasma Cannon	14
Handheld Laser Gun	14
The Odeon	15
The Scrim	17
Nerve Gas Bulbs	19
Typical Inorganic Formations	19
Genesis Pits: A Closer Look	20
All have a Command and Control Hive	20
Mutation Pits	20
Destroying a Genesis Pit	21
Minor Mutations	22
Minor Invid Mutations Table	22
Mutation Origin Chart	25
Pit Monster Creation Tables	26
Minds of Altered Sentient Victims	26
Genesis Pit Random Mutation Tables	27
A. Body Type	27
B. Intellect	28
C. Size	28
D. Speed and Agility	29
E. Diet	29
F. Locomotion	30
G. Natural Weapons and Defenses	31
H. Special Senses	33
I. Combat Abilities	34
Creatures from the Pits	34
Regger Whip	34
Star-Shelled Encephlavore	36
Fantoman Rukh	37
Dinosaurs	38
Ceratopids	38
Dimetrodon	40
Pteranodon	40
Raptors	41
Tyrannosaurus Rex	42
Florida Hell Gardens	42
The Miami Ruins	42
Super-Protoculture	44
Hell Gardens Genesis Pit	44
Giant Mutant Insects	45
Assassin Bugs	45
Giant Dragonflies	46
Adult Mammoth Hawker	46
Mammoth Hawker Larva	46
Giant Palmetto Bugs	47
Golden Orb-Weavers	47
Web Entanglement Attack	49
Killer Wasps	49
Gura-Invid & the Grand Cannon	51
The Grand Cannon Genesis Pit	51
Gura-Invid Mutants	53
Monster Invid	54
Monster Invid Hive Society	54
The Gura-Invid Vicereine	54
The Gura-Invid Viceroy	54
The Two Gura-Invid Hives	54
Gura-Invid Abilities	55
Gura-Invid Descriptions Start	56
Gura-Invid Scout	56
Gura-Invid Hunter	58
Gura-Invid Worker	60
Gura-Invid Warrior	62
The Vicereine	64
Siberia Genesis Pit	66
Secret Robotech Masters Base	66
The Siberian Genesis Pit	67
Denizens of the Genesis Pit	68
Dire Wolf	68
Saber-Tooth Tiger	69
Woolly Mammoth	69
Neanderthals	70
Off-World Genesis Pits	71
Janus – A Devastated Planet	71
Terminus Zone	72
Janus’ Day Side Genesis Pits	72
Black Bioroids	72
Janus’ Night Side	73
The Robotech Masters’ Forces	73
Terminus Zone	74
Harvester Bioroid Mutant	74
Bioroid Drum Weapon	76
Mutant Marauders	76
Ku’Urtz – The Zentraedi Lost Garrison	77
Zentraedi Mutant Outcasts	78
Garrison Zentraedi	79
Ku’Urtz Genesis Pit	79
Korek Tree Stalker	80
Quiet Walkers	81
Giant Spined Auroch	82
New O.C.C.s	83
UEEF Explorer Corps	83
Exploration Specialist O.C.C.	84
Exploration Specialist M.O.S. Descriptions	85
Invid Simulagent	86
Notable Ships and Mecha	87
VFH-RAU “Fury” (Frankenmecha)	87
SDF-4 Liberator	89
SDBC Shimakaze-Class Battlecruiser	93
Space Combat	95
Close Space Combat	98
New Weapons & Equipment	100
Invid Hand Blaster	100
M-2 Bayonet	101
M440 60mm Mortar	101
T-9 12.7mm Pump Pistol	102
Nanotube-Blade Chainsaw	102
Holographic Image Projector	102
Portable Prospector	103
Protoculture Bio-Emulator	103
UEEF All-Weather Thermal Poncho	103

Vehicles	103
ATT-40 All-Terrain Assault Jeep	103
ST-10 Sandstorm UTV	105
M99 Light Utility Jeep	105
Runaround Cargo Truck	105
Cityking 5-Ton Truck	106
Salvage Tables	106
UEDF Salvage Table	106
Zentraedi Salvage Table	107
Robotech Masters Salvage Table	107
Invid Salvage Table	108
Other Robotech® RPG Titles	110

Quick Find Table

Black Bioroids	72 & 74
Destroying a Genesis Pit	21
Dinosaur: Dimetrodon	40
Dinosaur: Pterodactyls & Pteranodons	40
Dinosaur: Raptors	41
Dinosaur: Triceratops	38
Dinosaur: Tyrannosaurus Rex	42
Everglades, The (see Hell Gardens)	44
Frankenmecha: VFH-RAU "Fury"	87
Genesis Pits: A Closer Look	20
Genesis Pits: Command and Control Hive	20
Genesis Pits: Concealment/Hidden	20
Genesis Pits: Contaminants	8
Genesis Pits: Destruction of	21
Genesis Pits: Earth	8, 20, 42, 51 & 66
Genesis Pits: First on Earth	51
Genesis Pits: First On Optera	7
Genesis Pits: Florida (Hell Gardens)	42
Genesis Pits: Giant Mutant Insects	45
Genesis Pits: Grand Cannon	51
Genesis Pits: Hell Gardens	44
Genesis Pits: Ice Age Mammals	68
Genesis Pits: Janus (alien planet)	72
Genesis Pits: Ku'Urtz (alien planet)	79
Genesis Pits: Minor Invid Mutations Table	22
Genesis Pits: Mutated, Extinct and Altered Beings	20
Genesis Pits: Mutation Pit	20
Genesis Pits: Neanderthals	70
Genesis Pits: Pit Monster Creation Tables	26
Genesis Pits: Random Mutation Tables (for Monsters)	27
Genesis Pits: Regess	7, 21 & 51
Genesis Pits: Regent	21
Genesis Pits: Resistance Fighters on Earth	8
Genesis Pits: Siberia	66
Genesis Pits: UEEF, The	9
Genesis Pits: Vary Greatly	20
Giant Mutant Insects	45
Giant Spider (see Golden Orb-Weaver)	47
Grand Cannon Genesis Pit	51
Grand Cannon Genesis Pit, Inside	52
Gura-Invid	51
Gura-Invid Abilities	55
Gura-Invid Hives	54
Gura-Invid Hive Society	54
Gura-Invid Hunter	58
Gura-Invid Mutants	53
Gura-Invid Scout	56

Gura-Invid Vicereine	64
Gura-Invid Viceroy (see Vicereine)	64
Gura-Invid Warrior	62
Gura-Invid Worker	60
Harvester Bioroid (aka Black Bioroid)	74
Ice Age Animals (see Siberia)	68
Inorganics, The	10
Inorganics, List of Types	11
Inorganics, Cougar, The	11
Inorganics, Crann, The	12
Inorganics, Formations	19
Inorganics, Laser Gun	14
Inorganics, Odeon, The	15
Inorganics, Scrim, The	17
Invid Mutants (see Gura-Invid)	51
Lisa Hayes (see Gura-Invid)	51 & 54
Killer Wasps	49
Mammoth Hawker (see Giant Dragonflies)	46
Mammoth, Woolly	69
Minor Invid Mutations Table	22
Monster Invid (see Gura-Invid)	53
Mutant Flower of Life (see Hell Gardens)	43
Mutant Invid (see Gura-Invid)	51
Mutation Origin Chart	25
Mutation: Pit Monster Tables	26
Neanderthals	70
New M.O.S. Skill Packages	85
Astro-Navigator M.O.S.	85
Extraterrestrial Reconnaissance M.O.S.	85
Xenoculture Expert M.O.S.	86
Xenotech Reclamation M.O.S.	86
New O.C.C.s	83
Pit Monster Combat Abilities	34
Pit Monster Creation Tables	26
Pit Monster, Ceratopids	38
Pit Monster, Dinosaurs	38
Pit Monster, Fantoman Rukh	37
Pit Monster, Giant Insects (see Hell Gardens)	42 & 45
Pit Monster, Giant Spined Auroch (Ku'Urtz)	82
Pit Monster, Korek Tree Stalker (Ku'Urtz)	80
Pit Monster Natural Weapons	31
Pit Monster, Regger Whip	34
Pit Monster Special Senses	33
Pit Monster, Star-Shelled Encephlavore	36
Prehistoric Mammals (see Siberia Genesis Pit)	68
Quiet Walkers (alien, see Ku'Urtz)	81
Regent & Genesis Pits	21 & 71
Regess	7, 21 & 51
Robotech Masters: Arrival on Optera	7
Robotech Masters: Mutant Bioroids	74
Robotech Masters: Genesis Pits and UEEF	9
Robotech Masters: Janus (a devastated planet)	71
Robotech Masters: Secret Base (see Siberia)	66
SDBC Shimakaze-Class Battlecruiser	93
SDF-4 Liberator	89
Siberia Genesis Pit & Secret Base	66
Space Combat	95
Super-Protoculture (see Hell Gardens)	44
Woolly Mammoth	69
Zentraedi (see Ku'Urtz)	77
Zentraedi Mutants	78

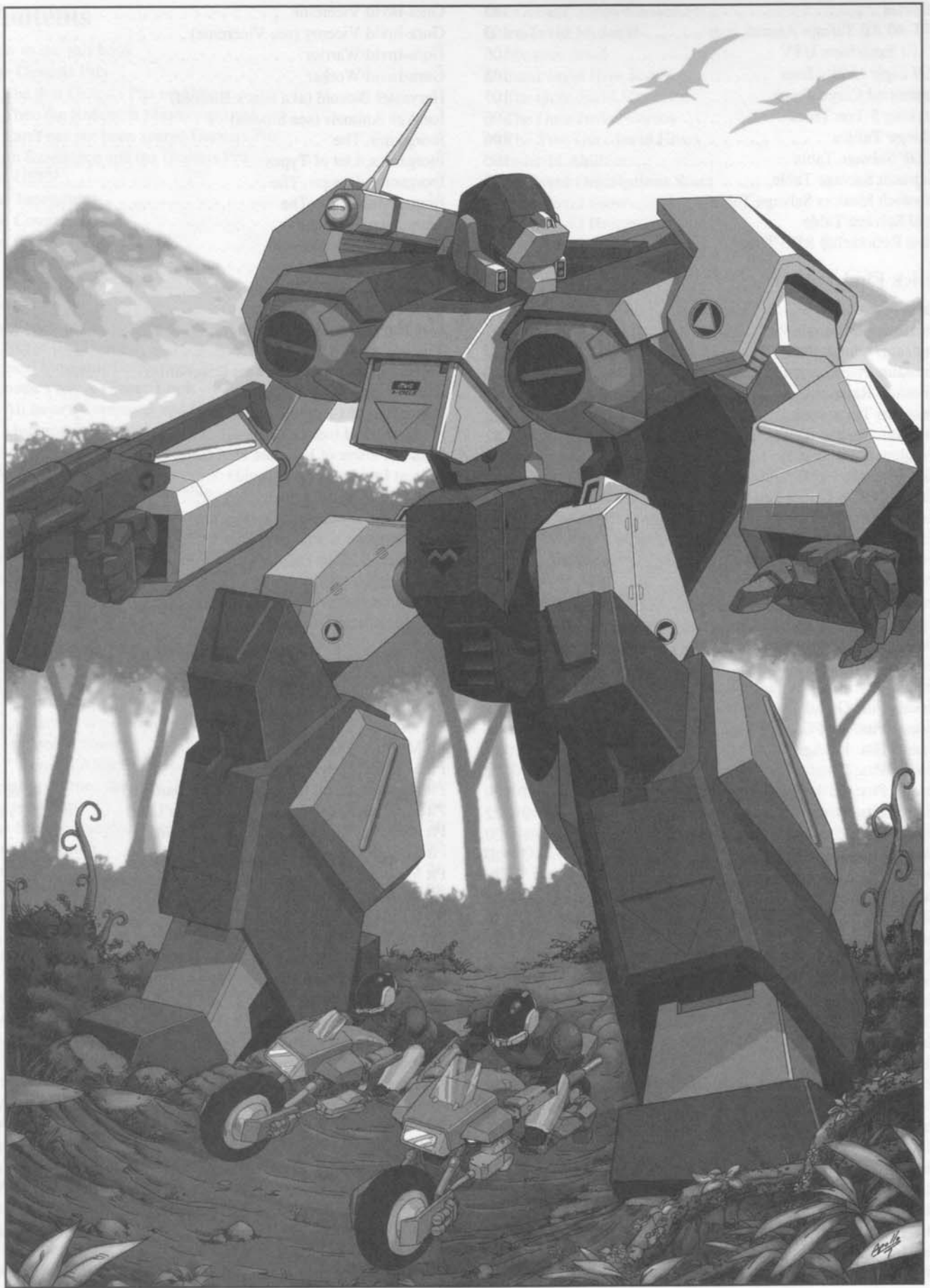

How to Use this Book

This Genesis Pits Sourcebook is a tool for creating adventures for the **Robotech® RPG** setting. It is most appropriate for the *New Generation* and *Shadow Chronicles* eras of the Robotech® Saga. It can be used in campaigns on Earth during the Invid occupation, or for Genesis Pits that are found on planets throughout space.

Genesis Pits can provide excellent adventure opportunities for UEEF campaigns, from the first breakout of hostilities between the Pioneer Expedition and the Invid, to the time when the UEEF battled the Regent and his Invid and Inorganic forces to liberate worlds occupied by the vengeful and tyrannical alien ruler. For campaigns set in the here and now, this can be a Shadow Chronicles setting while the UEEF deal with the

treacherous Haydonites or encounter hostile planets where one or more Genesis Pits have run amok, creating havoc, or are being used by enemy forces for nefarious purposes.

Whatever the time-line and setting, *Genesis Pits* are a wonderful mechanism for creating the unexpected and throwing a curve ball at a group of players who have been fighting nothing but Invid (or Masters or Haydonites) for a while. The Pits are also an excellent means to introduce unique villains, unexpected monsters and even entire environments that keep the distinctive feel of the Robotech® Saga, but enable the Game Master to take the adventure into new, uncharted territory to keep the game fresh and players on the edge of their seats.

- Irvin Jackson & Kevin Siembieda

The Genesis Pits

For eons, even before contact with the Robotech Masters or their Zentraedi warriors, the Invid have dabbled with the forces of evolution. Controlling natural selection has been a part of their species' culture for as long as the *Flower of Life* has been in their lives. Before the invaders from the stars who would eventually become known as the *Robotech Masters* decimated the Invid world and turned the Invid into a grief-stricken, homicidal scourge upon the galaxy, before the Regess ever heard the name Zor, the Invid used the special properties of the Flower of Life to alter themselves to suit their environment.

The first Genesis Pits on Optera were holy sites where Invid received the blessings of the Flower of Life's near-metaphysical properties. They were transmuted for the good of the hive into whatever form would help them best prosper as a race. The Pits were also used to alter the environment and to study and understand the history of evolution upon any given life form. The Pits were kept in harmony with the planet and, in some cases, used to heal the planet itself.

Then the Robotech Masters arrived with their seemingly unstoppable armada. Little more than galactic pirates covered in the trappings of civilization, the Masters defoliated Optera, destroying all plant life on the surface, but only after cramming starships full of the Invid Flower of Life, and all the Protoculture they could carry. When the Masters had taken all they could want, they ordered their army to sterilize the planet so that nothing would grow there ever again, and left the Invid to die.

That was a mistake which has cost not only the Robotech Masters and the people of Tirol, but the rest of the galaxy as well; including humanity.

The desperate Invid turned to their leaders, the Regent and Regess, to do something. Unless they acted quickly, billions would starve to death. **The Regess** led her people to the *Genesis Pits*. Driven by an insatiable thirst for vengeance as much as an indomitable will to survive against all odds, she enacted a mass transmutation that gave birth to the intergalactic horde we know today as the Invid. Once she was finished, **the Regent** took the reins of supreme commander of this new force. Subsisting on

hidden emergency supplies of the Flower of Life and whatever Robotech Master supply ships they could capture, the Invid reconfigured themselves into monsters of destruction and took their war to the stars.

They also took with them the secrets of the **Genesis Pits**. Sadly, no longer were the Pits holy sites or hallowed places of evolutionary reflection and learning. Instead, the Pits had become brutal genetic factories used to create unforgiving forces of organisms up or down the evolutionary paths, however unnatural, that the Invid desired.

At first, the Invid used the Pits to develop new bio-mechanical bodies to save themselves, and then to create mecha and warrior pilots like the *Invid Scouts*, *Troopers* and *Shock Troopers* to carry their vengeance to the hated Robotech Masters and their servants. Then the Regess, in her anger, used the Pits to torture any Robotech Masters they captured alive. "If the Robotech Masters want to treat other species like animals, then let them become animals," she declared. Her mate, the Regent, agreed, and took this philosophy farther than she ever intended. Over time, other species would share a similar fate.

Once the Invid were out among the stars, they discovered a wealth of *alien races* and creatures, all of whom had taken different evolutionary paths. Beings who had adapted to different environments and conditions, and whose bodies had different needs and different strengths and weaknesses. Every species the Invid have come into contact with have horror stories about *Genesis Pits*; especially if their planet had been occupied and its people enslaved by the vengeful aliens. In some cases, whole races disappeared down the dark gullets of these Pits and were never seen again... at least not in any form the rest of the galaxy recognized.

Eventually, when much of their ire had vented, the Regess grew weary of the senseless bloodshed, and she began to look toward a better fate for her people. This change of heart alienated her from the ever-bloodthirsty and self-destructive Regent, causing the Regess to gather all the collected knowledge of the many species in this sector of the galaxy and pool them in an effort to find the "ultimate life form." When the Flower of Life blossomed

on Earth, she took that knowledge, her people and her plans for the evolution of her race with her to invade humanity's home world.

The Regent, unable or unwilling to stop his genocidal war against everything not Invid, was ultimately destroyed in a climactic battle with *the UEEF*, the renegade human usurper *T. R. Edwards*, and the *Zentraedi High Lord Breetai* over the dead world of *Optera*.

In the aftermath of the Regent's death and the Regess's new mission, many Genesis Pits on worlds across the galaxy were simply *abandoned* without ever being "shut down." They were just left to continue to mutate, evolve and, in some cases, devolve countless species, often to the detriment of the war-torn population left to recover from the ravages of Invid occupation.

Earth has not been spared the horror of the Genesis Pits.

Once the Regess finally found a world where the *Flower of Life* could grow in abundance, she decided it would be the new home world of her species, its human natives be damned. That meant the Invid had to adapt and find the ultimate life form suited for their newly adopted (stolen) home. In a bit of galactic irony, the Invid would eventually decide that the *human form* was the one best suited to dominate Earth and to secure the Invid's future. Before the Regess reached that fateful decision, however, she had Genesis Pits built across the planet, as she had done many times, on many worlds across the stars.

During the war, some Earth Genesis Pits were controlled and patrolled by Invid who kept out "contaminants" of all kinds, including people. Others were allowed to develop unchecked, the monstrosities from within shambling out into the wastelands of war-ravaged Earth where they made new lives. Likewise, there are alien-looking forests and environments that have blossomed to life, born from the seeds and creatures created in a Genesis Pit and carried into the region not far from the Pit that originated them. Like the mythological Pandora's Box, all manner of danger have crept out of the Genesis Pits to spill across our planet.

In the depths of space, similar things are taking place on many planets known and unknown to the UEEF. To complicate matters, on some, the Regent's **Inorganics** still stalk the dark corners of once occupied worlds, hiding and defending genetic factories spewing out endless horrors to fight a war that is no more. It is estimated that the cleanup of Genesis Pits and the threats they represent will take decades and cost numerous lives of both humans and aliens. Although humanity did not know it at first, our world has joined an unwilling fraternity of planets haunted and terrorized by Invid evolutionary experiments that have crawled out from the depths of the Genesis Pits.

Earth Resistance and the Genesis Pits

Since the earliest days of the occupations, there have been rumors and stories of "monster pits" and "Invid bug holes" from groups around the globe. However, due to the decentralized and independent nature of Earth's resistance forces, very few people have put the pieces together, and virtually no one in the resistance understands what a Genesis Pit is or what use they are to the Invid. From the perspective of the average resistance leader, Genesis Pits are a "non-issue" or, at best, low priority. They are not weapons caches, not strategically located (in fact, they are usually built in the most remote locations possible), and have no clear and apparent value. On top of that, even if they were important, how do you destroy one? Fill it in?

In many cases, you have to fall into one or be thrown in by the Invid to ever encounter any of the dinosaurs, monsters or myster-

ies contained inside. And in the cases where the Genesis Pit creations are unleashed onto the surface (more often than people realize), word spreads quickly to avoid those areas. So most human resistance leaders mistakenly dismiss the importance and danger of the Genesis Pits. When one is found and identified, they simply place a big red X on the map and turn their attention to more immediate and important targets, like the nearest Protoculture storage facility, slave farm or sympathizer weapons depot.

This is a potentially deadly oversight. **First**, as the Invid experiments advance, more and more humans are being dumped into Genesis Pits for sinister evolution experiments by the Regess. **Second**, the Invid release far more creatures onto the surface than the resistance realizes. After all, what good is testing life forms for their suitability to life on Earth if they never actually experience life on Earth? **Third**, the Genesis Pits are a danger to the planet itself. Many of the life forms within, including plant life, are alien invaders into our ecosystem (like the Invid) and can out compete the natural ecosystem, animals, vegetation and human inhabitants. Left unaddressed, in time they could destroy or take over the already stressed balance of life on Earth. The Invid also pay little attention to the geology or stability of the landscape. They think nothing of building on an unstable fault line, causing earthquakes, sinkholes that swallow whole towns, and decimating the environment for miles around. Even after they leave, the Genesis Pits and the creatures they spew forth represent a danger to life on Earth that will last for generations.

At most, the average resistance fighter may have heard rumors of "pits filled with monsters" or "massive underground Invid hives" where they keep dinosaurs and weird creatures as pets, but those stories are often second-hand, very difficult to verify, and really hard for the average resistance fighter to swallow.

However, there are a few remaining scientists and resistance leaders who know the "stories" to be true, and have begun to worry. Some understand that these are evolution experiments and shudder to think what the end goal could be. Others do not have a clue what the Genesis Pits are for or what they do, but fear that something very important is being ignored. And there are some who recognize the threat these Pits represent to nearby communities and the environment, and wish to protect their fellow man and homeland. In any case, these forward-thinking individuals are seldom able to distract the resistance fighters from their war and goals of destroying Invid Hives, doing battle with the enemy, liberating Protoculture farms and gathering supplies to keep their fight going. Thus, they are likely to turn to independent, but well-meaning and well-armed groups (like the player characters) to investigate Genesis Pits, drive strange mutations out of friendly towns and deal with sightings of "monsters."

In the case of player characters, at most they may have heard there was some big hole somewhere with monsters or dinosaurs or Invid living underground. Even if they heard that much, they have no clue that the Invid are doing evolution experiments. Heck, most younger freedom fighters do not even know what evolution is! And most people on Earth who do know what evolution is do not believe the Invid have the power to force or manipulate a process that is supposed to take millions of years on animals (let alone people) and accelerate it to a matter of weeks or months. The only exceptions might be the *Invid Experiment* characters. If they have the ability to telepathically communicate with the Invid, they probably "heard" the term *Genesis Pits*, but do not grasp the full extent of what it meant. Similarly, the character may have actually been created/mutated

within a Genesis Pit, but may not realize it. However, as the product of an Invid experiment, the character is more likely to believe the aliens are capable of anything, and give much more weight to, and have concern about, stories about Genesis Pits. Almost no humans know the ultimate goal of the Genesis Pits or about the Invid's race to find a form that will let them dominate all life on the planet. Note: Even in the UEEF, the subject of Genesis Pits was rated *Above Top Secret*, and the early reclamation fleets who made it to Earth have never heard of one, except perhaps as an old barracks rumor or ghost story. What they've most likely heard is nothing at all.

The UEEF

The UEEF high command in the final Earth reclamation force has much more experience with the Invid and the sometimes miraculous workings of Protoculture. They have spent years attempting to free alien worlds and liberate entire civilizations from Invid tyranny on the other side of the galaxy. They have encountered *Genesis Pits* on a dozen worlds, but even after all that, they know very little about them or what purpose they serve.

The UEEF leadership and some special forces units are aware that they are a unique phenomenon and that they are somehow important to the Invid. They are also aware that the Pits can reshape life forms and can be used for the purpose of terraforming. However, they tend to believe that the Invid were using Genesis Pits to try to find ways to grow the Invid Flower of Life in alien environments. The Flower of Life has only been known to thrive in two places: *Optera*, the Invid home world, and *Earth* (and that is not discovered until much later in the Robotech Saga). So the UEEF leaders just assume the Invid are trying to find new ways to grow their "food source." This is, sometimes, quite true, but it is not the whole purpose of the Genesis Pits.

Before the conquest of Earth, the UEEF had fought Invid under the control of the Regent, not the Regess. The Regent was a male counterpart to the Regess, who seemed to embody the Invid species' military prowess, anger and vengeance. While the Regess turned toward the inner secrets of Protoculture and sought ways to rejuvenate *Optera* and grow the Flower of Life for the betterment of her people, the Regent used it to seek revenge and cause destruction. He hounded the Robotech Masters, and later the UEEF, until he was finally destroyed. His Genesis Pits were Frankenstein laboratories of monstrous creations and torture, used like production factories and hidden from view. The UEEF often fought the creations of those Genesis Pits, but rarely found the Pits themselves. But they did, on occasion, stumble across the Regess' Pits, which were almost always attempts to grow the Flower of Life.

Since the Earth was a veritable Flower of Life garden, and it was obvious the Invid planned to use it as their new home world, the UEEF leaders felt no need to pass on information about the Genesis Pits to the assault groups that attempted to liberate Earth. They did not expect them to encounter any Genesis Pits there.

If the Robotech Masters knew what the Genesis Pits were for, they did not share that information with anyone else, and took that secret (as well as many others) to their graves. It is very possible that much of their cloning and genetic knowledge came from what they learned from Invid Genesis Pits. Their surviving clones know nothing about the Genesis Pits, however, and the Zentraedi never cared enough to ask. The giant warriors think of Genesis Pits as places of torture and biological weapons

designed to create more, monstrous enemy forces, and/or to corrupt, consume and take over the planets where they are established. If a Zentraedi force gave a Genesis Pit any consideration, it was only to destroy it.

The end result is that almost nobody knows exactly what the Genesis Pits are or why the Invid build them. But they are a threat to any life that happens to live near them or dares to venture inside of one. As long as there are Genesis Pits hidden in dark, abandoned corners of the Earth, humanity's future is uncertain. The same can be said for any world out among the stars that harbors one or more of these horror factories. (Most worlds once occupied by the Regent have 2D4 Genesis Pits, sometimes many times more.)

In a UEEF Shadow Chronicles campaign that focuses on the search for the SDF-3 and the last supplies of Protoculture, Genesis Pits play a very different role than they do on an Earth-bound campaign. The UEEF is scouring the galaxy with its last Protoculture resources to find *Admiral Rick Hunter and his crew*, and the Protoculture Matrix his ship carries. Because of their limited fuel supplies, they cannot just search every star system throughout the galaxy. It would take centuries, and their stores of Protoculture would be depleted before they really started.

Instead, the UEEF is conserving its strength and investigating any strange anomalies, odd Protoculture emissions and unusual reports involving Protoculture or the Invid Flower of Life. In some cases, they may suspect the reports are references to sightings of the SDF-3 by alien races and by reconnaissance teams and listening posts left scattered throughout the galaxy. In other cases, they are hoping to find storehouses of Protoculture left behind by the Robotech Masters, Invid or Zentraedi that they can cannibalize to keep their forces and ships going. So instead of sending resource-gobbling fleets to investigate rumors of a Protoculture storage facility or mutant Flowers of Life, they will send lone ships and teams to investigate and report back. If they find something truly promising or advantageous to the UEEF, then they send in a substantial force to collect or study the find. In some cases, the reports of hidden, still-active Invid Hives, or high Protoculture-related energy readings, will lead these ships and teams to planets with Genesis Pits.

On planets with Genesis Pits, there are almost never any Invid guarding them (the entire species migrated to Earth and then to parts unknown). But some will be protected by Invid automatons known as *Inorganics*, created by the Invid Regent. Even if there are no Inorganics present, there may be old defenses, rogue Zentraedi, Robotech Master clones or the mutant or monstrous inhabitants of the Genesis Pits themselves with which to contend.

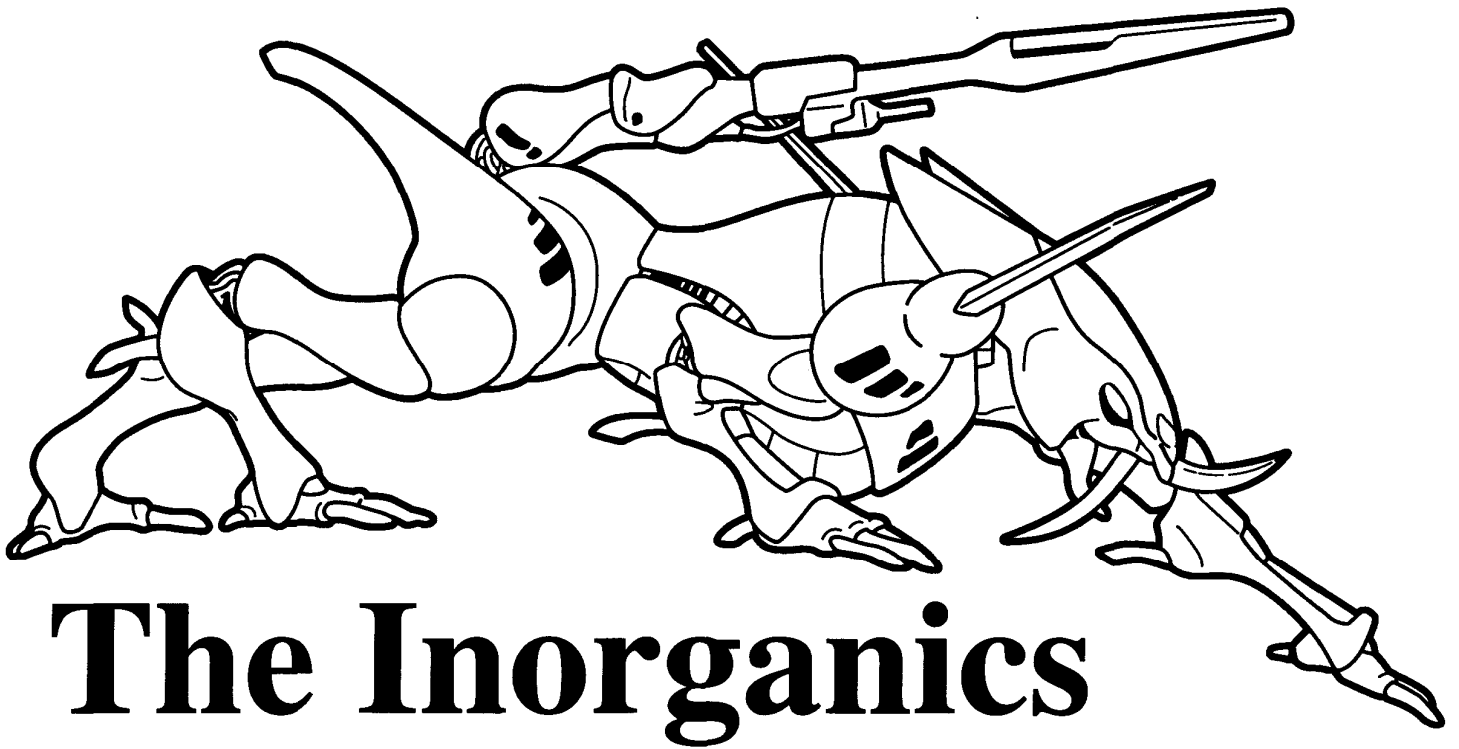

The Inorganics

When the United Earth Expeditionary Force (UEEF) battled the Invid on Tirol and numerous other worlds before the invasion of Earth, they often found an army of soulless, robotic war machines at the vanguard of the Invid army. These were the Inorganics, a creation of the war-crazed Regent.

The Regent relied heavily on these monstrous creations for several reasons. First, he was a paranoid control freak and the unwavering programming of the Inorganics, who have virtually no free will, makes even Invid Troopers look like radical free-thinkers. Second, whereas the Regess referred to her subjects as her children, the Regent treated them as a disposable resource, wasting lives in a way that appalled the Regess. Very early in their war against the Robotech Masters, she put her foot down on the massive assaults the Regent hurled against their armada. Third, the deployment of Inorganics allowed the Regent to exercise his twisted imagination, and they are the embodiment of the hate, loathing and spite that filled his heart to the exclusion of little else.

The Regent created a nearly countless horde of these automatons in special Genesis Pits that used the bio-mechanical technology created by the Regess, without the living pilots or wills that drove them. The Regess considered such things abominations of life, and would have no part of them. She sneered at these Inorganics he had created, using the word as an insult. The Regent let the name stick, hoping that the repulsion the Regess felt at their existence would be shared by his enemies. Such was the sad, strained relationship between the two leaders of the Invid race.

To describe the Inorganics as robots would be a mistake. They are not. The Regess was very specific in her name for them. When one is destroyed, it is revealed to be hollow and crumbles to dust. Some of the more literary and fanciful minded members of the UEEF have compared them to Earth legends of Golems and automatons from Earth's past. They are not quite alive as we define it, but they are not wholly machine either. There is no apparent software to be corrupted, no servos to disable or damage,

nor is there a living brain, nor a heart. However, they do appear to have emotions. Or at least one emotion: hatred combined with a desire to destroy all life forms that are not Invid. It is as if the very will and hatred that filled the Regent have been filtered down into these most favored creations.

At first glance, Inorganics appear to enter battle just like a robot would: Fearless, unyielding and regimented. But unlike some automated drones, they appear to be inquisitive, cunning, and spiteful. They show a disdain for all living things that are not Invid and seem to take pleasure in their destruction. When they charge into battle, it is not the steady onslaught of a mechanical army, but the unsheathed rage of a bio-mechanical horde.

Most thought that the threat of the Inorganics, which were the scourge of every world the Regent touched, would die when the Regent died in battle over Optera against Breetai. That was not to be, however, and they live on as machines of destruction. A lasting legacy of the Regent's malevolence. Since the Regess despises them, she has left them behind to continue on with their mission of destruction and war. Since they do not need the Regent to function, Inorganics have kept right on functioning. Some are under the control of hidden Invid Brains loyal to the Regent that still perform long-forgotten duties throughout the galaxy, others continue to wage war, protect long deserted Invid strongholds and Genesis Pits, while others appear to be in some autonomous standby mode, activated by the detection of active Protoculture or the presence of enemy life forms.

Active Inorganics are most often encountered in the Regent's Genesis Pits, where he used them as guards and to gather subjects for experimentation. They continue to be a major problem on Tirol, the former home world of the Robotech Masters, now occupied by the UEEF, as well as on Optera, the devastated home world of the Invid, and other strategic locations in the galaxy. And when we say "a major problem," we mean legions of the

abominations that continue to engage in surgical strikes, acts of aggression and sabotage, and launch periodic mass attacks and sieges. In some places, one would not know the Regent is dead or that the Invid have lost the war.

Types of Inorganics

There are four primary types of Inorganics which were *known* to be used by the Regent. The vicious *Crann* and *Scrim* are small shock troops deployed to decimate enemies in waves. *The Hellcats*, or *Cougars*, are catlike scouts, bristling with sensors more advanced than those of almost any other Invid unit and experts at stealth, tracking and surprise attacks. The most feared, largest and dangerous are the hulking *Odeon*, who served as the Regent's elite storm troopers.

The Cougar

Also known as the Hellcat

The Invid Cougar, or Hellcat, is a striking departure in design and function from the other Inorganics. Made to look like some kind of demonic feline, these automatons are the hunters, trackers and cavalry of the Inorganic legions.

The Cougars are the only non-bipedal inorganic. All of the others, including the Crann, Scrim and Odeon, have a shape that

is somewhat a caricature of a fully-evolved Invid. But the Cougar lopes into battle on four legs with a sleek body reminiscent of its namesake. It attacks with tooth and claw and appears to sniff out its prey with advanced olfactory and acoustical sensors. The mechanical monsters even growl and snarl when facing their prey.

Also unlike the other Inorganics, which seem to function in a cold, calculating manner, the Cougars are very animalistic and emotive. They are always high-strung, appear to be filled with rage and hatred for their foes, snap suddenly at threats, play cat and mouse games with cornered prey, and are known to roar victoriously upon the bodies of their fallen foes.

Some UEEF scientists have suggested that the Regent actually imprinted the behavior of some predatory hunting cat onto the Cougar Inorganics' personality matrix to make them more feline and deadly. This has led to some debate as to whether they were the first Inorganics, and the rest were perfected models that came later, or whether they are the most recent Inorganic design, showing the Regent moving toward a more life-like and aggressive programming. The victims of these hunter/killers really don't care.

These feline Inorganics are deployed either individually, in small packs of 3D4, or in massive columns. The smaller numbers are used to hunt down hidden prey, flush out resistance and stalk

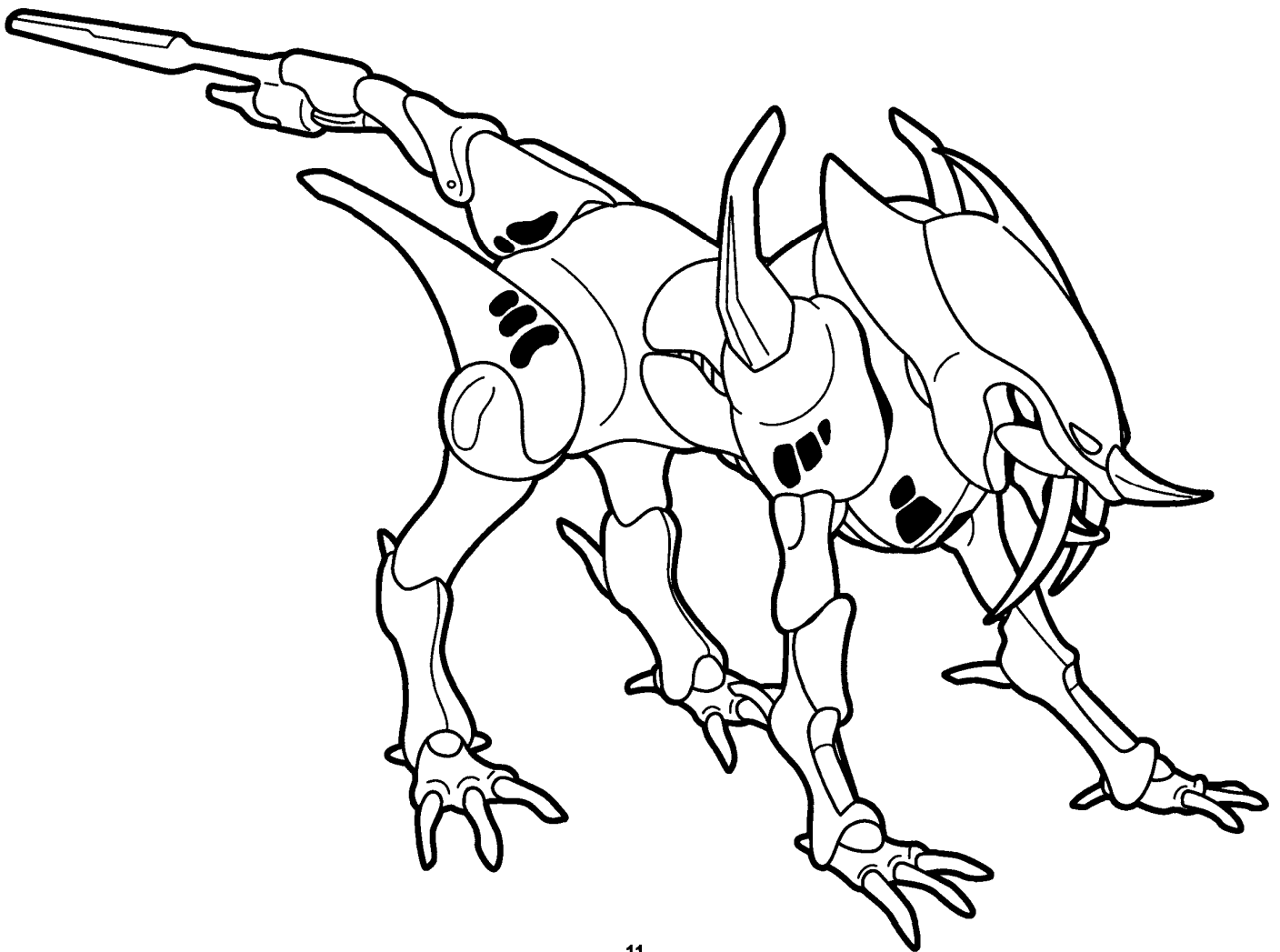

foes into small, confined places. When deployed en masse, Cougars are used like cavalry, flanking enemies, breaking up their formations and softening them for a follow-up assault from other Inorganics or Invid.

For the amount of fear they can generate within enemy ranks, they are fairly weak when compared to the other Inorganics. They have the lightest armor and their weaponry, claws and teeth, is all for close combat. However, they have an incomparable viciousness and an animal cunning mixed with a level of tactical intelligence. Fighting a group of these Inorganics is like fighting an armored wolf pack with claws that can rend steel, and who know to take out weapons and cockpits first, and how to wait in ambush and divide and conquer. Because they were sometimes deployed scattershot across occupied worlds, often working independently for long periods of time with no controlling Invid Brain, and have the strongest survival instincts, Cougars are the most common Inorganics still functioning in the aftermath of the Regent's death.

In some cases, it appears they have "gone feral" and truly emulate predatory cats, living in small, isolated packs, guarding their territory and hunting local prey - of which humanoids rank at the top of their list. Of course, being Inorganics, they do not need to eat, cannot reproduce and do not even need to sleep, so why they seem to "play act" these behaviors when on their own is a mystery and may be an artifact of their original personality programming. There are even rumors that some captured in the wild have been trained to serve as pets, guard robots and even war steeds by non-Invid.

Cougar Inorganic

Class: Inorganic Scout and Hunter/Killer.

M.D.C. by Location:

Legs (4) - 50 each

* Head - 60

Tail - 20

** Main Body - 75

* Destroying the head and sensor eye knocks out the Inorganic's sensors, leaving it effectively blind. It is likely (60% chance) to go berserk, lashing out at everything nearby, but loses all combat bonuses and is -10 to strike, parry, dodge and all other combat maneuvers.

** Depleting the M.D.C. of the main body destroys the Inorganic, causing it to shatter into bits or crumble into dust and flakes.

Speed:

Running: 120 mph (192 km).

Leaping: 60 feet (18.3 m) straight up or lengthwise, 120 feet (36.6 m) with a running start.

Flight: Not possible.

Statistical Data:

Height: 4 feet, 6 inches (1.4 m).

Length: 8 feet (2.4 m).

Width: 4 feet (1.2 m).

Weight: 1,500 pounds (675 kg).

Physical Strength: Robotic P.S. of 30.

Cargo: Not designed to carry any load, but they could theoretically be used as a robotic pack beast that could carry about 1.5 tons or pull twice that amount. Now, getting one to do that...

Skills & Abilities of Note: Climb 65%, Detect Ambush 60%, Detect Concealment 70%, Intelligence 40%, Land Navigation 95%, Math: Basic 98%, Tracking (humanoids) 70% and Prowl 65%.

Weapon Systems:

1. Hand to Hand Combat: The Cougar is a melee combat unit which prefers to slash and tear at enemies with its vicious claws and metal teeth.

Attacks per Melee: Five.

Hand to Hand Damage: *Claw Swipe:* 3D6 M.D. full strength or 6D6 M.D. from a power claw strike (counts as two melee attacks).

Leaping Claw Strike: Jumps onto an opponent with all of its claws, doing **1D6x10** M.D., plus **50%** chance of knock-down on anything less than 12 feet (**3.6** m) tall and weighing under five tons. Targets that are knocked down lose initiative and their next two melee attack/actions. Counts as three melee attacks. **Note:** The Cougar must have enough room (at least **30** feet/9.1 m) to perform this maneuver.

Tail Swat. 1D6 M.D. (only possible to targets directly behind the Cougar).

Body Block/Tackle: 2D4 M.D., plus victim is knocked down, losing initiative and their next attack/action.

Bonuses: +4 to initiative, +5 to strike, +4 to parry, +6 to automatic dodge (+8 if running at full speed; the act of auto-dodging does not use up a melee attack), +2 to disarm and +3 to roll with impact.

2. Sensors & Features of Note: Inorganics have Invid sensors and features 1-7 and 9 from the **Robotech®: The Shadow Chronicles® Role-Playing Game**. There is no pilot compartment (and no pilot), they are not killed by destroying the sensor eye, and only the Odeon have external speakers. Inorganics are far less reliant on Protoculture to identify their enemies because the Regent designed them to be weapons of terror unleashed on civilians and military targets alike. Therefore they have a Perception rating of 45% (same as the Invid Brain usually controlling them).

In addition, the Cougar Inorganic has olfactory sensors that can pick pheromones and chemical traces out of the air, giving it the ability to track by smell alone. Along with its normal sensors, this gives the creature the ability to hunt down prey where they hide and more easily detect ambushes. Track by smell: 60% and +2 to all smell and hearing based Perception Rolls.

The Crann

The Crann serves as both the ranged combat unit of the Inorganic force and as a reconnaissance unit. Unlike the Cougars, which are trackers and scouts and prefer stealth, the Crann has boosted sensors and can spy on the enemy from great distances. They are often used to coordinate massed Inorganic attacks, and quite frequently are directly taken over by an Invid Brain.

Only the Cougar Inorganic units are more independent than the Crann, which is designed for self-preservation because of its strategic importance. But the Crann is by far the most intelligent of the known Inorganics. A Crann will pull back from a losing

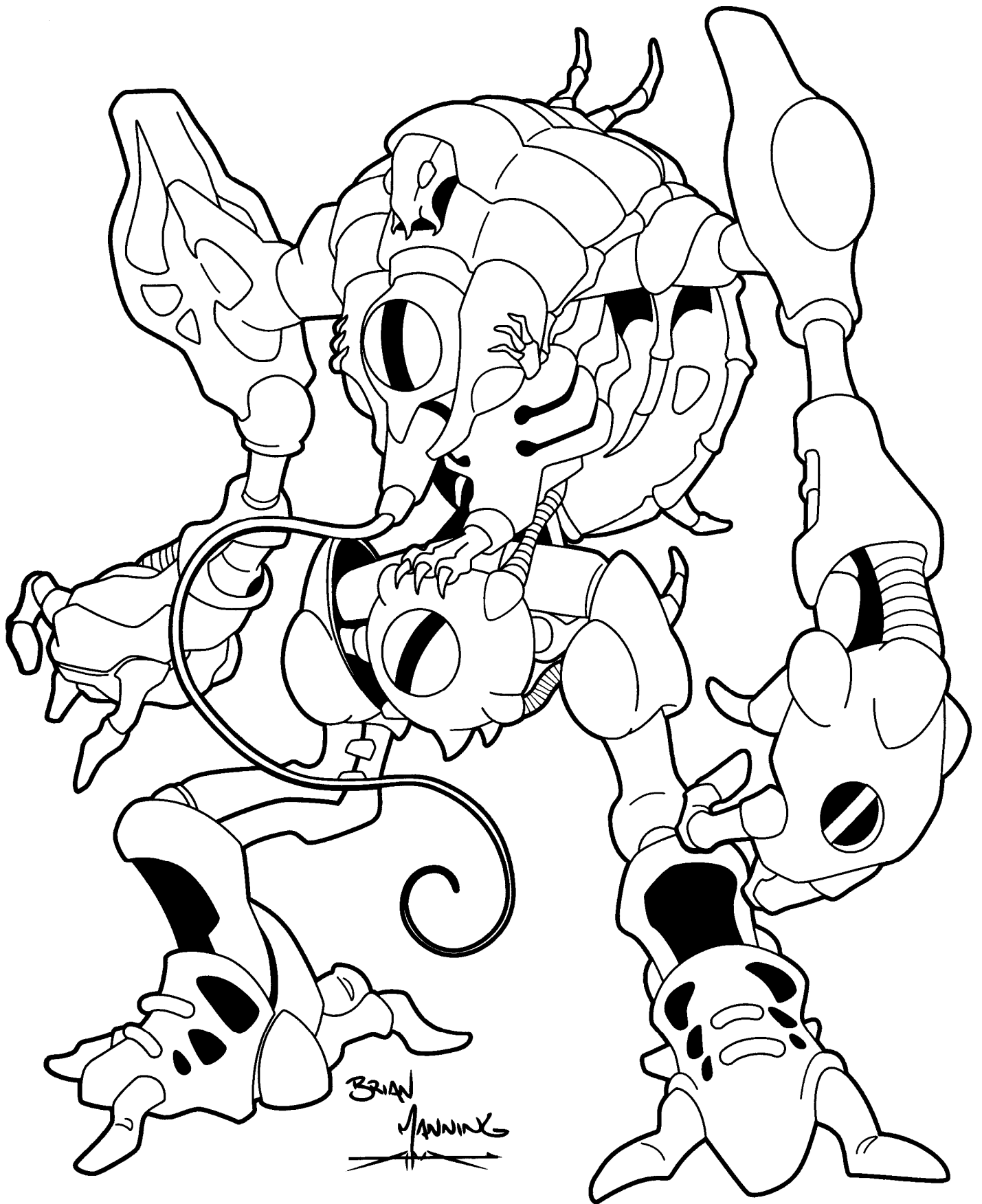

battle to transmit data to a controlling Invid Brain, will outflank enemies, and often commands other Inorganics when the Invid Brain is not directly involved or available.

A large number of Crann have survived the fall of the Regent and engage in ambushes and surprise attacks upon former Invid enemies. While the Inorganics seem not to have any true emotions, the Crann give many the impression that somehow the Regent's strongest emotion, hate, filtered into their lifeless metal bodies. This is because the Crann seem to take delight in acts of torture, terror, sabotage, surprise attacks, all-out sieges and the implementation of all manner of carnage. Furthermore, as the coordinator of onslaughts carried out by other Inorganics, the Crann gives the enemy no quarter nor mercy.

While not as fast and agile as some other Inorganics, Crann are maneuverable combat units in their own right, and their deadliness is enhanced by their intellect. In combat, they take cover, outflank enemies, and choose targets for most effect, probably better than most living Invid. They are armed with a head mounted plasma cannon, and often carry the same handheld blaster as the Odeon. They use advanced targeting sensors to target their enemies with uncanny accuracy, making them the best long-ranged combat fighters among the Inorganics. However, their armor is weak and they rarely engage in stand-up, head-to-head combat. That's the job of the monstrous Odeon and Cougar.

The Crann's multiple eyes, flailing, tongue-like whip, and its ability to detach its hand and send it crawling around like something out of a horror movie, make it not just dangerous, but downright creepy to fight in combat. While the Crann is typically most dangerous at long-range, the electrified, whip-like flagellum they use in melee combat can be deadly. Not only can it slice through most super alloys, but it can deliver a nasty shock that can disorient Cyclone riders in Battloid mode. Soldiers clad only in body armor are often rendered unconscious.

When an Invid Brain is using a Crann to directly observe and coordinate a battle, all Inorganics involved receive a +2 to initiative and fight much more intelligently. Instead of rigid formations marching into enemy fire, they attack major threats first, go doggedly after objectives key to the Invid victory, and overall fight like there was some intelligent general guiding them.

Most UEEF soldiers have been warned to destroy any Crann they encounter at first sight, even if it is hanging back and simply observing a battle or operation. Such "silent observers" are usually under the direct control of an Invid Brain, and what the Crann sees, the Brain knows. Destroying a Crann while linked to an Invid Brain disorients both the Brain and the Inorganic forces under its control, causing all Inorganics involved to lose their next two attacks/actions. It also temporarily blinds the Invid Brain to what is going on in the battle. Unfortunately, the Invid Brain can assume control of another Crann in 1D4 melee rounds (one minute or less). If there are no Crann involved in the battle, or if all of the Crann have been destroyed, the Brain must rely on transmitting psychic orders to the Inorganics without clear real-time information of what is occurring.

While Cougar Inorganics are capable of making catlike growls and roars, the Crann are the only Inorganics truly capable of speech. Most of the time when a Crann speaks it is to be the mouthpiece of the Invid Brain controlling all the nearby Inorganics, but they also used speech during the war to command prisoners of war and the enslaved populace of occupied enemy areas.

Crann Inorganic

Class: Inorganic Ranged Combat and Reconnaissance Unit.

M.D.C. by Location:

Plasma Cannon - 50

Energy Flagellum - 75

Handheld Laser Gun - 100

* Head/Sensor Eye - 80

* Lower Body Eye - 150

* Hands/Sensor Eyes (2) - 80 each

Arms (2) - 90 each

Legs (2) - 180 each

** Main Body - 200

* It is almost impossible to blind a Crann by destroying its sensor eyes. By the time an attacker destroyed them all, they could have destroyed the Inorganic a couple times over. But if an attacker can destroy all of the sensor eyes, it knocks out the Inorganic's sensors, leaving it effectively blind. It is likely (60% chance) to go berserk, lashing out at everything nearby, but loses all combat bonuses and is -10 to strike, parry and dodge. All four eyes must be destroyed for this to occur.

** Depleting the M.D.C. of the main body destroys the Inorganic, causing it to shatter into bits or crumble into dust and flakes.

Speed:

Running: 100 mph (161 km).

Leaping: 50 feet (15.2 m) straight up or 80 feet (24.4 m) lengthwise with a running start.

Flight: Not possible.

Statistical Data:

Height: 10 feet, 5 inches (3.2 m).

Length: 5 feet, 9 inches (1.8 m).

Width: 6 feet (1.8 m).

Weight: 1.25 tons.

Physical Strength: Robotic P.S. of 30.

Cargo: Can carry up to 1.5 tons or pull twice as much.

Skills and Abilities of Note: Climb 70%, Detect Ambush 60%, Detect Concealment 60%, Intelligence 75%, Land Navigation 90%, Math: Basic 98%, Prowl 50%, and Tracking (people) 60%.

Weapon Systems:

1. Plasma Cannon: This is the primary weapon of the Crann. It is mounted on the head and used for long-range assaults. The Crann's advanced sensors give it uncanny accuracy, particularly against enemies using Protoculture (which is pretty much what defines an enemy for its Invid masters; that, and being a non-Invid life form).

Primary Purpose: Assault.

Range: 6,000 feet (1,829 m).

Mega-Damage: A single shot from the plasma cannon does 6D6+5 M.D. Only fires single blasts.

Bonus: +2 to strike. This is in addition to any bonus from Protoculture Targeting (+4 when applicable, see sensor, below).

Rate of Fire: Each blast counts as one melee attack/action.

Payload: Effectively unlimited.

2. Handheld Laser Gun: This is a laser weapon that fits onto the Crann or Odeon's hand, with the fingers slipping into three holes built into the back of the weapon. Because it was made for the much larger Odeon, it tends to appear over-sized on the

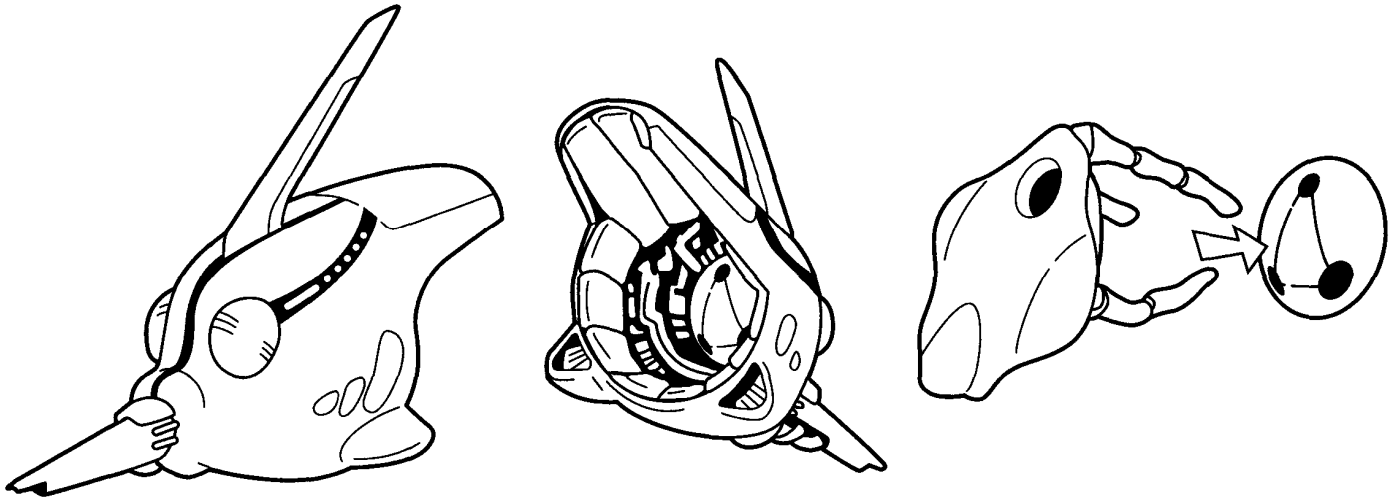

smaller Crann. Typically only carried by the Crann when it is expecting heavy combat. Always carried by the Odeon.

Primary Purpose: Assault and Anti-Armor.

Range: 2,000 feet (610 m).

Mega-Damage: 1D6x10 M.D. per blast.

Bonuses: Only those gained from Protoculture Sensors.

Rate of Fire: Each blast counts as one melee attack/action.

Payload: Effectively unlimited; draws power from the Inorganic.

3. Energy Flagellum: This is a close combat weapon that works like an energy whip. Not only can the super-alloy metal cable shred Mega-Damage materials, but it also delivers a powerful jolt of electricity that can stun living creatures, even through armor. The weapon is completely retractable and can extend to a surprising reach.

Primary Purpose: Anti-Personnel.

Range: 20 feet (6.1 m).

Mega-Damage: 5D6 M.D., and characters in body armor must make a save vs non-lethal poison (16 or better) or be stunned. A victim who is stunned is -8 to strike, parry and dodge, plus reduce the character's speed and number of attacks per melee round by half. Stun penalties last for 1D4 minutes. If the target fails another save while suffering penalties from a previous attack from this weapon, he or she is knocked unconscious for 2D4 melee rounds. A successful save means the penalties and their duration are halved, but the penalties are cumulative. Only effective on characters in body armor or in Cyclone Battloid armor (who get a +2 to save). Characters in heavier mecha, like the Silverback, ASC powered armor, AJAX and Alpha Fighter, or protected by a vehicle, are unaffected by the stun damage. Non-armored humans are almost always killed instantly by the initial attack.

Rate of Fire: Each strike counts as one melee attack.

Payload: Effectively unlimited.

4. Hand to Hand Combat: In addition to the whip, the Crann can use its clawed hands and feet to engage in combat.

Attacks per Melee: Five.

Hand to Hand Damage: *Punch/Strike:* 1D6 M.D. on a restrained punch, 3D6 M.D. on a full strength punch, and 6D6 M.D. on a power punch, but the latter counts as two melee attacks.

Tear/Pry with Claws: 2D6 M.D.

Kick: 2D6 M.D.

Hand to Hand Bonuses: +4 to strike and parry, +6 to dodge, +2 to disarm, +4 to entangle (+6 to entangle with flagellum), and +4 to roll with impact.

5. Sensors & Features of Note: Inorganics have Invid sensors and features 1-7 and 9 from the **Robotech®: The Shadow**

Chronicles® Role-Playing Game. There is no pilot compartment (and no pilot), they are not killed by destroying the sensor eyes, and only the Odeon have external speakers. Inorganics are far less reliant on Protoculture to identify their enemies because the Regent designed them to be weapons of terror unleashed on civilians and military targets alike. Therefore they have a Perception rating of 45% (same as the Invid Brain usually controlling them).

In addition, the Crann is much more intelligent, sneaky and dangerous. It is able to recognize and target leaders, strategic locations and equipment, and engage in acts of sabotage, surgical strikes, ambushes and traps; +2 to all Perception Rolls involving such things.

The Odeon

This hulking monstrosity is the most commonly deployed Inorganic. Unfortunately for its enemies, it is also the largest and toughest. Odeon are walking tanks, designed to soak up damage and crush enemies under the weight of their advance. They plod into enemy fire, oblivious to obstacles and the damage they are taking, firing away with handheld laser guns and smashing with metal feet and claws.

It is rare that the Odeon are used in any way that resembles conventional tactics. They are a blunt instrument of war, deployed as an irresistible force. On rare occasions, the Regent would send Odeon charging against an enemy that he intended to drive elsewhere, using them to flush targets out or to divide enemy forces. But such occasions were rare. He much preferred to have them smash everything in sight. The Odeon are also used to police captive populaces. Their large, hulking presence was usually enough to quell most resistance. Orders to the enslaved populace can be broadcast out of the two pipe-like speakers protruding from their backs.

Odeon are much less numerous after the destruction of the Regent, even though they were once the most mass-produced of the Inorganics. This is because near the end of his reign, the Regent

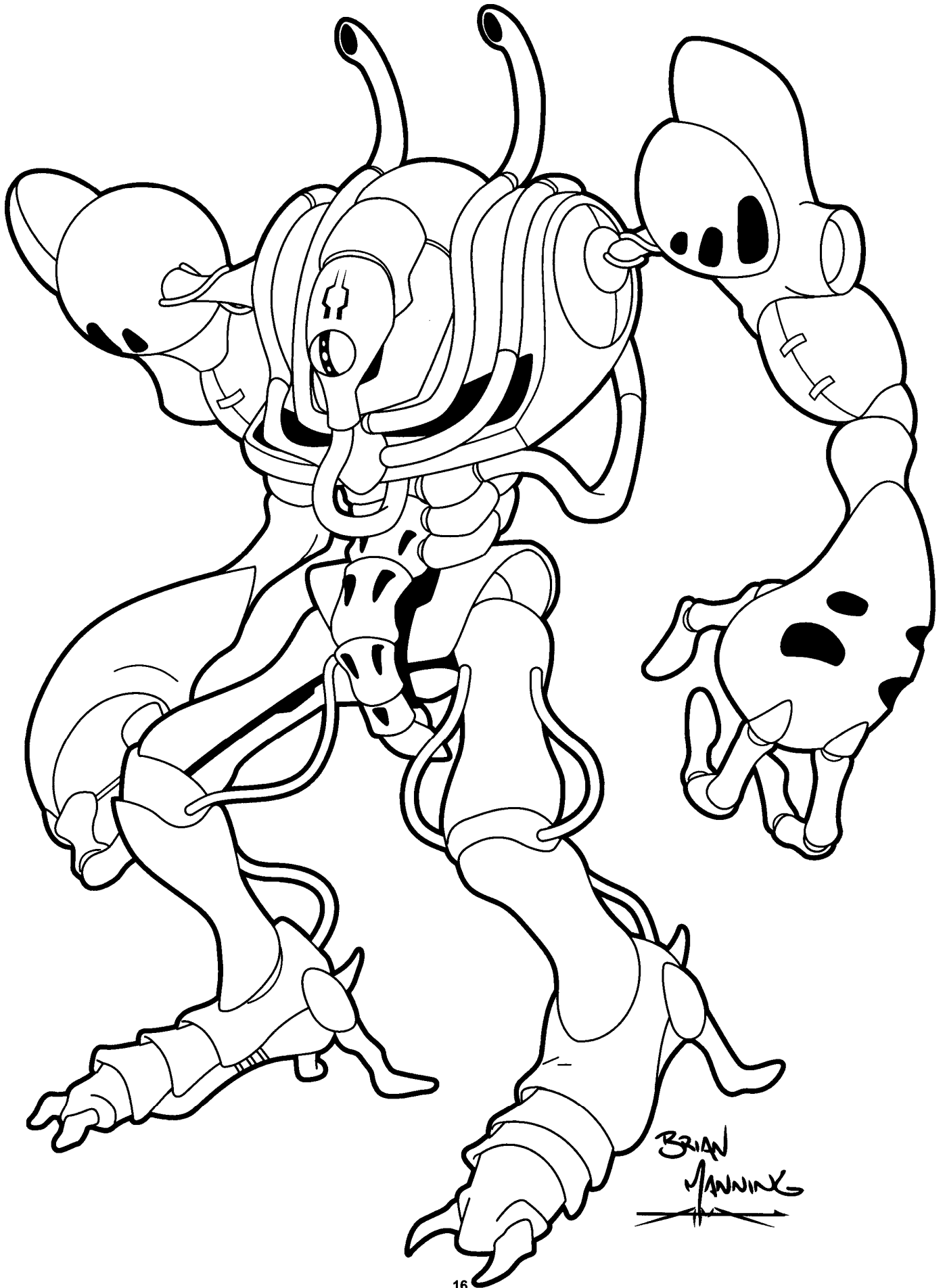

deployed them as a stopgap measure against the UEEF and the alien races who joined them in their war of liberation. He never thought twice about sending them to their destruction, and so vast legions of Odeon were destroyed. They also lack the speed, cunning and guile of other Inorganics, so they were less likely to survive after the war.

Most Odeon will be found protecting the Central Hives controlling Genesis Pits on alien worlds or deployed among other Inorganic forces. They care nothing about the abandoned projects running amuck at a Genesis Pit, unless the experiments try to get into the Hive itself or attack the Odeon. Unlike the other Inorganics, they are much less capable of identifying the enemy and have about the same ability to distinguish an inactive Alpha Fighter from a rock as an Invid scout does.

As long as one can flee their slow, methodical march, and as long as there is a means to escape their advance, the Odeon do not pose much of a threat to mecha with any speed. But in situations where there is nowhere to run or where they must be confronted, these giant metal monsters can be a true terror.

Odeon Inorganic

Class: Inorganic Heavy Assault Unit.

M.D.C. by Location:

Handheld Laser Gun - 100

* Head/Sensor Eye - 200

Hands (2) - 100 each

Arms (2) - 150 each

Legs (2) - 250 each

** Main Body - 500

* Destroying the head and sensor eye knocks out the Inorganic's sensors, leaving it effectively blind. It is likely (60% chance) to go berserk, lashing out at everything nearby, but loses all combat bonuses and is -10 to strike, parry, dodge and all other combat maneuvers.

** Depleting the M.D.C. of the main body destroys the Inorganic, causing it to shatter into bits or crumble into dust and flakes.

Speed:

Running: 40 mph (64 km).

Leaping: 20 feet (6.1 m) straight up or lengthwise.

Flight: Not possible.

Statistical Data:

Height: 21 feet (6.4 m).

Length: 5 feet, 6 inches (1.7 m).

Width: 9 feet (2.7 m).

Weight: 3 tons.

Physical Strength: Robotic P.S. of 40.

Cargo: Can carry up to 2.5 tons or pull twice as much.

Skills and Abilities of Note: Climb 50%, Detect Ambush 40%, Detect Concealment 40%, Intelligence 30%, Land Navigation 90%, and Math: Basic 98%.

Weapon Systems:

1. Handheld Laser Gun: This is a laser weapon that fits onto the Odeon or Crann's hand, with the fingers slipping into three holes built into the back of the weapon.

Primary Purpose: Assault and Anti-Armor.

Range: 2,000 feet (610 m).

Mega-Damage: 1D6x10 M.D. per blast.

Rate of Fire: Each blast counts as one melee attack/action.

Bonuses: Only those gained from Protoculture Sensors.

Payload: Effectively unlimited; draws power from the Inorganic.

2. Hand to Hand Combat: The Odeon is a physical powerhouse, able to bash its enemies into scrap.

Attacks per Melee: Five.

Hand to Hand Damage: *Punch/Strike:* 2D6 M.D. on a restrained punch, 4D6 M.D. on a full strength punch, and 1D6x10 M.D. on a power punch, but the latter counts as two melee attacks.

Tear/Pry with Claws: 4D6 M.D.

Kick/Stomp: 3D6 M.D.

Hand to Hand Bonuses: +4 to strike and parry, +2 to dodge, +1 to disarm, and +4 to roll with impact.

3. Sensors & Features of Note: Inorganics have Invid sensors and features 1-7 and 9 from the **Robotech®: The Shadow Chronicles® Role-Playing Game**. There is no pilot compartment (and no pilot), they are not killed by destroying the sensor eye, and only the Odeon have external speakers. Inorganics are far less reliant on Protoculture to identify their enemies because the Regent designed them to be weapons of terror unleashed on civilians and military targets alike. Therefore they have a Perception rating of 45% (same as the Invid Brain usually controlling them).

The Scrim

One of the most common front-line Invid Inorganics, the Scrim are deployed as close combat units and are most effective in urban environments, enclosed bases and in the hallways of starships, where they can press their foes in hand-to-hand combat. The Regent frequently used them as terror weapons, sending hundreds or thousands into civilian cities where they would wreak unimaginable carnage.

The Scrim are agile and relentless killers armed with a pair of long arms equipped with scythe-like blades that can slice through starship hulls, Battloids and flesh. They also have three arms mounted on the front of their bodies with claws designed to tear, pry and rend. To enhance their effectiveness as terror weapons, they also come equipped with two bulbous nerve gas dispensers, which release a deadly cloud that can incapacitate enemies and send a civilian populace into a blind panic. Quite often, the first sign that a horde of Scrim has been unleashed is the frightening, noxious cloud rising from the edge of a most-likely doomed metropolis.

When attacking larger enemies, or just enemies that can fight back (like those in environmental armor and mecha), the Scrim prefer to swarm their target, taking it down in a deadly wave of blades and claws. A mecha caught by a group of Scrim can literally be ripped to shreds until the horrors can get to the pilot; at which point they will go right for the kill. Fortunately, Scrim are not the most heavily armored of the Inorganics and are especially vulnerable to long-ranged attacks if caught out in the open.

Scrim Inorganic

Class: Inorganic Melee Combat Unit.

M.D.C. by Location:

Gas Bulbs (2) - 75 each

Scythe Arms (2) - 100 each

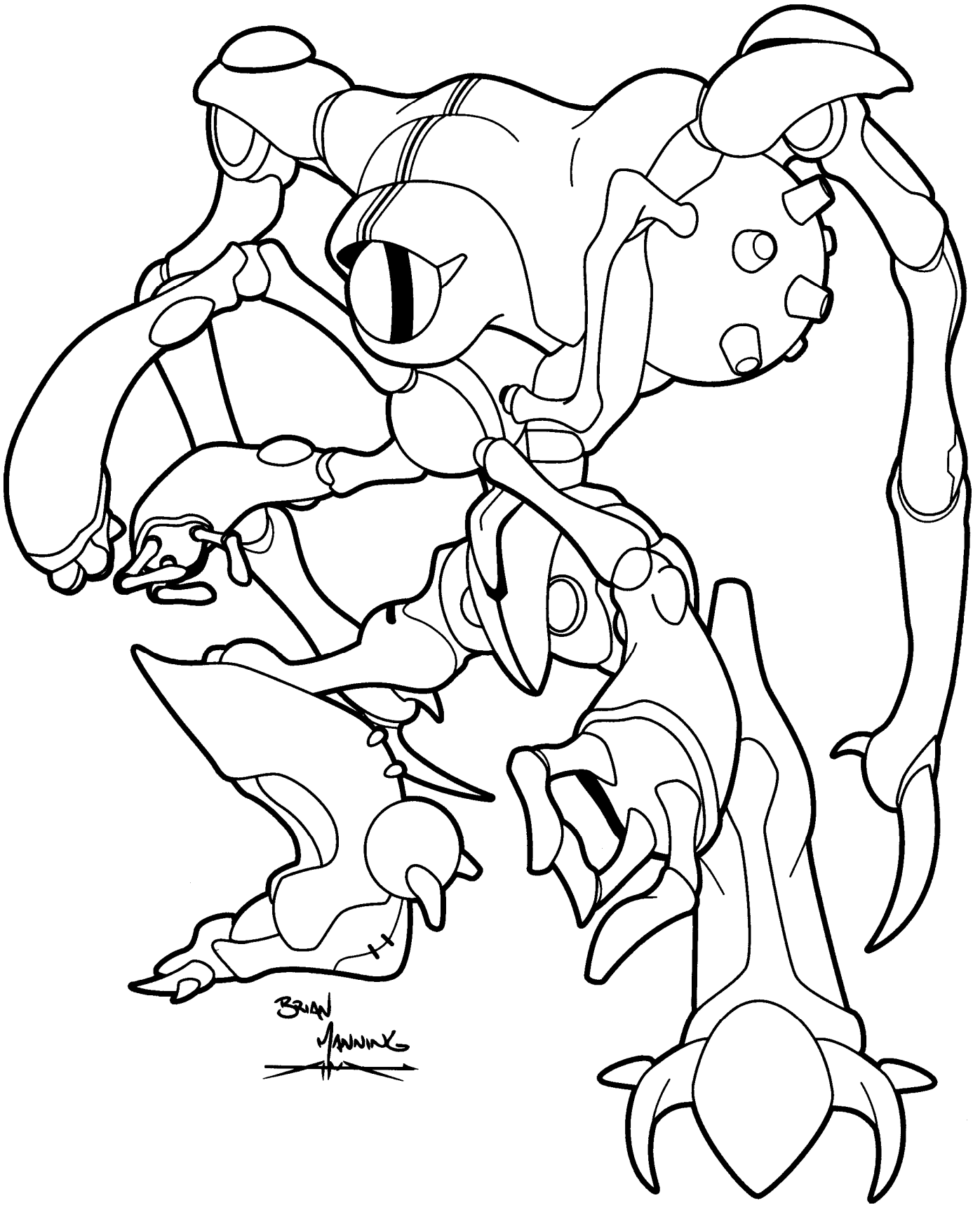

Claw Arms (3) - 125 each
Claw Hands (3) - 50 each
Legs (2) - 150 each
* Head - 150
** Main Body - 250

* Destroying the head and sensor eye knocks out the Inorganic's sensors, leaving it effectively blind. It is likely (60% chance) to go berserk, lashing out at everything nearby, but loses all combat bonuses and is -10 to strike, parry, dodge and all other combat maneuvers.

** Depleting the M.D.C. of the main body destroys the Inorganic, causing it to shatter into bits or crumble into dust and flakes. **Speed:**

Running: 80 mph (128 km).

Leaping: 50 feet (15.2 m) straight up or 80 feet (24.4 m) lengthwise with a running start.

Flight: Not possible.

Statistical Data:

Height: 10 feet, 6 inches (3.2 m).

Length: 6 feet (1.8 m).

Width: 7 feet (2.1 m).

Weight: 1.5 tons.

Physical Strength: Robotic P.S. of 30.

Cargo: Can carry up to 1.5 tons or pull twice as much.

Skills & Abilities of Note: Climb 70%, Detect Ambush 40%, Detect Concealment 40%, Intelligence 50%, Land Navigation 90%, Math: Basic 98%, Prowl 40%, Tracking (people) 40% and Paired Weapons.

Weapon Systems:

1. Nerve Gas Bulbs (2): There is a globular container under each armpit of the Scrim. These devices, resembling World War One underwater mines, can release a cloud of deadly nerve gas that can kill and incapacitate any living creature. They are typically used en masse, with dozens or hundreds of Scrim releasing their gas weapons at once and driving their enemies into a panic. Choked and poisoned by the gas, most victims are then easy prey for the Scrim's deadly blades and slashing claws.

Primary Purpose: Anti-Personnel.

Range: 100 foot (30.5 m) radius around the Inorganic. The area is usually much larger, however, because entire platoons of Scrim typically release their gas at one time.

Damage: 1D4x10 Hit Points/S.D.C. per melee round of exposure, quickly killing most who cannot escape the deadly cloud. If a save vs lethal poison of 14 or better is made, the individual only suffers 2D6 damage. Individuals in sealed structures, vehicles, power armor, spacesuits, gas masks, or those in full environmental body armor are not affected. **Note:** Most civilian vehicles and buildings are not environmentally sealed! A vehicle needs to be rated for nuclear, biological and chemical (NBC) warfare to keep the gas out. Fortunately, virtually all fully enclosed UEEF military vehicles, spacecraft and pre-fabricated buildings can be sealed to keep the gas out. Early encounters with the Scrim are a big reason for that.

Duration: The gas cloud lasts for 4D4 minutes and then dissipates; half that time in a strong wind.

Rate of Fire: Fortunately, the gas in each bulb can only be released once. To release the gas again, the Inorganic must return to its Hive and have the gas dispensers refilled.

Payload: One charge each, for a total of two. Must return to the Hive or base of operations to have the gas restocked. **Note About Armor Repair:** The same holds true of repairs of combat damage suffered by an Inorganic. In most cases, the Inorganic

must return to the base of operations, an Invid Hive or Genesis Pit, for any repairs to be made to its body/armor. Such repairs are automated and automatic unless the facility is only partially operational and there is no Invid Brain running it. Without a home base or Genesis Pit, repairs to Inorganics are impossible.

2. Hand to Hand Combat: The Scrim was specifically designed as a close quarters, melee combat war machine whose goal is to cut its enemies to shreds.

Attacks per Melee: Six.

Hand to Hand Damage: *Scythe Blade Slash:* 4D6 M.D.

Punch/Claw Strike: 1D6 M.D. on a restrained punch, 3D6 M.D. on a full strength punch, and 6D6 M.D. on a power punch, but the latter counts as two melee attacks.

Tear/Pry with Single Claw: 3D6 M.D. (counts as one melee attack).

Tear/Pry with Two Claws: 6D6 M.D. (counts as two melee attacks).

Tear/Pry with Three Claws: 1D4x10+8 M.D. (counts as three melee attacks).

Kick: 2D6 M.D.

Special Pin Attack: The Scrim can use two of its arms to attempt to pin an opponent, leaving it open for attacks from a third claw arm or its scythe blades. The pinning attack takes two melee attacks, but on a roll of 18, 19 or 20, the opponent is completely pinned and cannot dodge or parry attacks by the Scrim's other weapons until freed. While the opponent cannot use its arms or legs to attack the Scrim, some weapon systems, such as shoulder-mounted weapons, chest missile launchers or head guns, can still be used to target and damage the Scrim.

Note: The Scrim has the Paired Weapons skill, meaning it can perform parry/strike, dual strikes and other combat maneuvers available to those with the Paired Weapons skill, making it particularly dangerous in close quarters combat.

Hand to Hand Bonuses: +6 to strike and parry, +4 to dodge, +3 to disarm, +4 to entangle/pin, +4 to pull punch, and +3 to roll with impact.

3. Sensors & Features of Note: Inorganics have Invid sensors and features 1-7 and 9 from the **Robotech®: The Shadow Chronicles® Role-Playing Game**. There is no pilot compartment (and no pilot), they are not killed by destroying the sensor eye, and only the Odeon have external speakers. Inorganics are far less reliant on Protoculture to identify their enemies because the Regent designed them to be weapons of terror unleashed on civilians and military targets alike. Therefore they have a Perception rating of 45% (same as the Invid Brain usually controlling them).

Typical Inorganic Formations

Genesis Pit Patrol Squad

1 Crann
1D4+1 Cougars
1 Scrim
2 Odeon

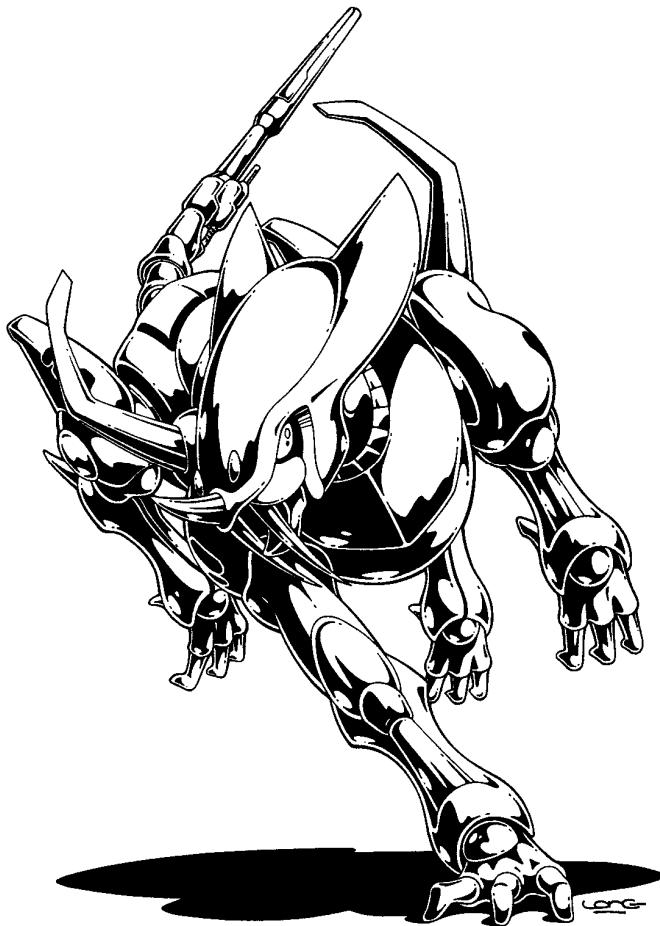

Cougar Pack

2D4+1 Cougars

Light Hunter/Killer Patrol

1 Crann 2D4 Cougars 1D4 Scrim
1D4 Odeon

Reconnaissance Squad

6 Cougars
3 Crann

Urban Pacification Patrol

1D4 Crann
2D6 Scrim
2D4
Odeon
3D4
Cougars

Heavy Hunter/Killer Patrol

1D4 Crann 4D4 Cougars 2D4
Scrim 2D6 Odeon

Heavy Combat Extermination Force

2D4 Crann 3D6 Scrim 1D4x10
Odeon 4D6 Cougars

Genesis Pits: A Closer Look

On Earth, all of the Genesis Pits were created by the Regess, and have a similar design. They are all buried deep underground, in massive enclosed caverns that keep in the specialized atmosphere, consist of one or several massive chambers and have a hidden Control Hive overseeing operations.

But the Genesis Pits on Earth represent the final Genesis Pit design, refined through centuries of trial and error, and are made specifically for Earth's unique situation. Genesis Pits found on other worlds can be constructed quite differently, especially those created by the Regent.

That being said, there are still commonalities that are shared by all Genesis Pits.

1. All Genesis Pits have a Command and Control Hive. This Hive is controlled by an *Invid Brain* whose job it is to see that the Genesis Pit serves its specified purpose, and is protected from enemy attacks and outside interference. The Command and Control Hive tends to employ a disproportionate number of *Invid Soldiers* and *Invid Troopers* for specimen collection, and to help the Invid Brain conduct its experiments. Units that focus on flight and attack, such as Invid Fighter Scouts, are less common here than in other Invid bases. In Genesis Pits constructed by the Regent, Crann and Scrim Inorganics are also heavily used for the same purposes.

2. Each Control Hive will have a "Mutation Pit" - also referred to as a Genesis Pit, or mini Genesis Pit. It is a seething cauldron of Protoculture-fueled mutagens that immediately attack the genetic structure of any creature that falls or is thrown into the pit. When a being is purposefully placed in the Mutation Pit as part of an experiment, the Invid Brain (or Regent or Regess) can control what mutations and alterations take place, directing the mutagens to unravel and reshape its victim on a genetic level beyond anything human science can achieve. But when the Mutation Pits are not controlled, either because the Invid Brain is unaware something has fallen into the Mutation Pit, or because the Genesis Pit itself has long been abandoned by its Invid staff, the results are completely random and there is no telling what will emerge after a creature falls into one.

3. Genesis Pits are filled with mutated, extinct or genetically re-engineered creatures. The entire purpose of a Genesis Pit is to create and evolve or devolve life. So unless a Pit is abandoned or has been shut down, it continues to create new and changing life forms. Thus, the name of "Genesis."

4. All Genesis Pits are hidden. They may not all be underground like those of Earth, but they are always placed in out-of-the-way locations that are not easy to find nor easy to reach. This is because they serve the same purpose as research and development facilities or, in some cases, production factories. All assets you want to keep away from the enemy because they are vital to the war effort and vulnerable to attack. And if they are well hidden, it takes fewer assets to protect them.

Beyond those similarities, Genesis Pits can vary greatly. The biggest differences come when comparing those made by

the Regess to those created by the Regent. **The Regess** was interested in evolution and experimentation that *bettered* her people and ensured their survival. While some involved cruel experimentation on unwilling test subjects, as well as the creation of freakish, sometimes dangerous, creatures, cruelty and terror were not the goals of the Regess. They may have been inadvertent by products, but that was never the reason the Regess ever created a Genesis Pit (making Earth fortunate in that regard).

The Regent, however, is a different story altogether. His Genesis Pits were almost never made for the betterment of the Invid species or anyone, unless you consider the annihilation, subjugation and terrorizing of anyone he perceived to be an enemy of the Invid to qualify as "betterment." Instead, the Regent's Pits focused on the torture and punishing mutation of enemies and the creation of terror weapons. Whether it was to take Robotech Master clones and Zentraedi and turn them into mockeries of their species and then unleash them as morale-breaking shock troops, or to create all new, horrific mutations to force a populace into submission via terror, the Regent's Pits are all about creating fear and destruction.

Identifying whether the Regess or Regent created a Genesis Pit is fairly simple - although by the time you notice the difference it is usually too late. First, the Regess' Pits are for scientific experimentation and evolution. They are giant laboratories with enclosed, painstakingly created (or recreated) habitats designed to both test and shelter their inhabitants in familiar surroundings. In contrast, the Regent's Genesis Pits are stark, often barren, or weird and alien. The creatures within are either pitted against each other like gladiators to see which is strongest, or kept contained, sometimes caged or otherwise imprisoned, like the creations of a giant laboratory or factory waiting to be unleashed. In other cases, the Regent's Genesis Pits are designed for nothing else than to devolve or torture the enemy (non-Invid), and are, again, ugly, brutal engines of terror and destruction.

Another major difference is the behavior of the Invid within the Genesis Pit. Quite often, the forces of the Regess hold back from attacking to see whether an intruder is valuable as a test subject or X-factor that may reveal new data. However, if they see an intruder as a "contaminant" or force of destruction who could harm the experiments taking place within, then that intruder is chased away or destroyed. In the Regent's Genesis Pits, all intruders are either destroyed without mercy or captured, questioned and then subjected to sadistic torture or cruel experimentation (genetic manipulation). Some are captured and thrown into the Mutation Pit without any type of interrogation. This is done either for experimental purposes or simply to torture those with the temerity to invade the Regent's domain or challenge his superiority.

Finally, the Regess' Genesis Pits are designed to keep the creations contained within, perhaps for life. Any successful experiment is usually noted, its genetic sequences copied and stored, and then it is likely to be destroyed or abandoned. The Regess uses the information gleaned from the experiment at a later time to transmute one of her own race into the life form of choice, so that she has control over it and can communicate with it.

The Regent's Genesis Pits are designed to create monsters and unleash them into the worlds he wishes to punish or subjugate. They have ramps built into cavern walls that lead to the surface, and are built at a very shallow depth (sometimes inside mountains or old volcanoes). When an experiment is successful as a weapon, tool or monster, he replicates it thousands of times over until the Genesis Pit is bursting at the seams with the chosen horror. Then those creatures are loosed upon the world to wreak

havoc. In some cases, they may even be transported to other worlds, where they are released to cause carnage in the Regent's name or to soften up the enemy before he attacks in earnest, or to prey upon survivors who flee into the wilderness in an attempt to escape his wrath.

Destroying a Genesis Pit

Obviously, these monster factories are a threat to all life wherever they are constructed. Who knows what could crawl out of a Mutation Pit's Protoculture-powered primordial ooze? One could easily give birth to a race of super beings that could take over the galaxy or monsters that might destroy it. Perhaps it has already happened, and those creations are just biding their time and building their numbers.

This begs the question: How do you stop a Genesis Pit?

The structures themselves are massive, often built deep in the ground and surrounded by bedrock. One of the few recorded Genesis Pit destructions occurred in Chile when an earthquake caused a segment of the Andes Mountains to fall on top of it. It was a stroke of luck that could hardly be engineered to happen on call.

One possibility considered by the Regess was orbital bombardment. The Invid have painful memories of the bombardment of Optera, an event that was virtually repeated on Earth with the assault of Dolza's armada. That is why most Genesis Pits are built so deep below ground. Even Zentraedi particle beam cannons can only penetrate so deep into the ground before their energy begins to radiate outward from the point of impact, following the path of least resistance.

Very few ships exist anymore that can generate the kind of firepower necessary to even destroy one Pit. The SDF-3 (missing) can do it, as can the SDF-4 Liberator. But the UEEF has restricted usage of the Liberator's Shadow Technology-based Synchro Cannon due to possible sabotage. Besides, folding the ship in to destroy a Genesis Pit on an alien world is out of the question because of the drain on resources, let alone the risk of reconnecting the weapon. Firing the Synchro Cannon at a site on Earth is equally a nonstarter. Who knows what the Haydonites have programmed it to do if the weapon were reconnected and activated?

Another possible, but rather expensive, option is to send in an armed force large enough to "sanitize" - kill everything within - the Genesis Pit, fight their way to the Command and Control Hive and then find a way to shut down the Mutation Pit. Alternately, if stopping the creation of new monsters is the goal, a strike team could make its way to the Control Hive and destroy it and the Mutation Pit, hopefully putting an end to the mutation of the life forms within. Either approach is risky and far from foolproof. Moreover, such a mass assault will cost UEEF lives, slaughter countless living creatures (not all of which are threats), including possible new, sentient life forms, and bum up vital resources. A small strike team has an even higher likelihood of failure and the operation could take months or years.

And once you get to the Mutation Pit, then what? You don't dare chuck a satchel charge in there and send Protoculture mutagen spraying all over God knows what or who. If you fill it in,

what happens when the earth worm(s) you didn't see fall into it? Nothing ruins a commando raid like the unexpected appearance of a giant, man-eating worm that spits acid.

The only real option is to seal off the Mutation Pit securely and guard it, possibly for generations, or at least until someone can figure out a way to deactivate the Protoculture mutagens. That means holding the Command and Control Hive against the creatures inhabiting the Pit, if you don't go ahead and kill them all first in a painful and costly campaign of annihilation.

Don't forget, even if there is nothing *inside* the Mutation Pit at the moment, it still gives off low levels of DNA-mutating radiation. That means your own guards could begin growing things they shouldn't be growing after a period of a few months or a few short weeks' time.

Genesis Pits are a deadly riddle that humanity and the other species will be trying to solve for quite some time.

Minor Mutations

The victims of full Invid experiments are not the only ones who have been altered by the Invid. There are a number of people across the planet who bear the marks of Earth's latest invaders. In some cases, they were just unfortunate enough to be bom near (or in) a Genesis Pit that leaked its genetic-altering radiation into the local environment. In other cases, they were the targets of minor Invid experimentation or were rescued before their captors could complete their gruesome work.

Unlike Invid Experiments, these beings almost always *look completely human*, but with some slight difference that is recognizable as being inhuman or "unnatural." To most humans, these characters look just like anyone else, but perhaps with some extra parts or abilities. They are more pitied than feared, although in some places, these minor mutants are just as shunned as full Invid Experiments and obvious mutants.

Any Earth-born human can choose ONE minor mutation during character creation for the cost of TWO O.C.C. Related Skills, subject to Game Master (G.M.) approval. Mutations are extremely rare, and there would probably never be more than one full Invid Experiment and one character with a minor mutation in a typical party. Invid Experiments can NOT receive a minor mutation from the chart below.

In addition to choosing a minor mutation from the following list, the character should also choose (or roll) on the chart below to determine how he or she acquired the initial mutation.

A player character may also get a minor mutation during game play, but this is obviously entirely under the control of the GM. In those cases, it's most likely that the character was captured and experimented on by the Invid briefly before being rescued, or was exposed to some intense burst of Invid mutagenic energy, like a Mutation Pit.

Minor Invid Mutations Table

Antennae
Bio-Regeneration
Cartilage Skeleton
Echo-Location
Evolved Brain
Exceptional
Hearing



Fine Manipulator
Tendrils
Forearm Spines
Heightened Empathy
Heightened Metabolism
Internal Gyroscope
Nocturnal
Overdeveloped Musculature
Prehensile Tail
Protoculture Sensor Eyes
Retractable Claws
Retractable Tentacles
Solar-Powered
Tough, Scaly Skin

Antennae: The character has two thin antennae that grow out of his or her head just like an insect's. They are 1-2 feet (0.3 to 0.6 m) in length and can be hidden by long hair or under a hat or a helmet. However, they must be extended and free to grant their bonuses. The antennae work as motion sensors, and give the character a +2 on Perception Rolls involving smells, +2 on initiative, +2 to parry and +3 to dodge. When in the dark, the character suffers only half the penalties of fighting in the dark/blind (-5 to strike, parry and other combat maneuvers) that most normal humans suffer. They also provide the character with the ability to **Track by Smell**. Base Skill: 36% +4% per level. The antennae will grow back in 1D4 days if cut off or broken.

Bio-Regeneration: This character heals at incredible speed, and is even able to regenerate lost limbs over time. The radiation from the Genesis Pits has kept this character's body creating stem cells into adulthood, which serve any purpose the body requires, including replacing damaged parts with new ones. The character heals 1D6 S.D.C. or Hit Points per minute and can regenerate lost arms and legs in 2D4 weeks. The mutant is also +3 to save vs disease and poison, and +10% to save vs coma/death. However, the character's skin looks, like it has the same elasticity and softness of a newborn and doesn't tan from sunlight. There are no blemishes, scars or wrinkles, making the character appear much younger than he really is. While this gives him a +1D4 to P.B., the character suffers a penalty of -2 to M.A. and even those who find the character attractive will be struck by the oddness of his or her skin, even if they cannot immediately figure out what looks out of place.

Cartilage Skeleton: This character does not have actual bones, but instead has flexible cartilage that bends easily, but is almost impossible to break. On the downside, it doesn't support nearly as much weight or muscle. The mutant receives a +4 to roll with impact, +2 to P.P. attribute, and takes half damage from falls and crashes. He also receives the Escape Artist skill at +10%. However, the mutant tends to have a small build: 4 feet, 9 inches to 5 feet, 6 inches (1.5 to 1.7 m) tall for men; 4 feet, 6 inches to 5 feet, one inch (1.4 to 1.5 m) tall for women on average; weight is reduced by one-third and Physical Strength is limited (roll only 2D6 for starting P.S.).

Echo-Location: This character has an ability almost like living sonar, similar to that of a bat. It provides the mutant with a sonic "map" of the environment around him, allowing him to "see" people and objects coming up behind him, completely negating penalties for fighting blind or in the dark (no penalty). He can also find hidden chambers or hidden Invid mecha buried underground, or invisible or hidden foes via sound imaging. The character also receives a +2 to all Perception Rolls.

On the downside, the character has a sounding chamber in his skull which gives the head an unnatural shape - either a protruding, rounded forehead like a dolphin, or the rear of the skull is slightly elongated; -3 to P.B. attribute. This also makes wearing a standard helmet impossible, plus wearing a helmet negates the echo location ability. A customized helmet is required to fix both problems. The character's echo location ability has a range of 300 feet (91.4 m), unless he is in a loud, noisy environment like a concert or pitched battle, at which point the range is reduced by one-third to 100 feet (30.5 m).

Evolved Brain: The character's brain has taken the next evolutionary step (or one possible step) that awaits human intellect, giving him or her increased intelligence and cognitive abilities. This is similar to some Zentraedi, like Exedore. The character

receives an additional 2D4 to I.Q. (minimum of 16) and receives a bonus of +5% to all Communication, Science and Technical skills in addition to the likely skill bonus from having a high I.Q. The character also receives a +2 to Perception Rolls. However, the character's head is misshapen and asymmetrical. This is usually passed off by other humans as a birth defect or possibly a sign of Zentraedi blood; -1D6 to P.B., -2 to M.A. and M.E. attributes.

Exceptional Hearing: This mutation gives the character hearing well beyond the sensitivity of normal humans. The mutant can easily distinguish a whisper 1,000 feet (305 m) away, and not only does his hearing have increased range, but it is also more accurate as well. This means the character is able to identify specific sounds that most people would fail to even hear. The mutant can identify mechanical devices by the hum of their engine, recognize familiar people by their footsteps and breathing, and tell the difference between two different types of Cyclones by the idle of their engines. **Recognize Familiar Sounds:** 45% +5% per level. **Identify Unfamiliar Sounds:** 27% +3% per level.

The character's ears are oddly shaped; either long and pointed or large and circular, like a parabolic dish. They can be hidden by a helmet, hat or other head covering or by growing hair very long and full. **Bonuses:** +4 to hearing-based Perception Rolls, +1 on initiative, and +3 to dodge. It should be virtually impossible to sneak up on this character and make a surprise attack. **Penalties:** -2 to P.B. attribute, and the individual is vulnerable to loud and high-pitched sounds (double penalties and duration of sound attacks).

Fine Manipulator Tendrils: The character has dozens of thin, filament-like tentacles that sprout from the fingertips, allowing him or her to better perform skills requiring a deft hand. The tendrils can retract under the fingernails and can be completely undetectable short of a medical scan. They provide the character with +5% to all skills requiring a fine touch, including all mechanical and electrical repairs, Medical skills, Pick Locks, Pick Pockets and Safe Cracking. Note that the bonus applies **ONLY** when the character is actually working on something *hands-on*, so the bonus would not apply if using Mechanical skills to design a new engine or Medical skills to diagnose a patient's illness. If severed, the tendrils heal and grow back at twice the rate of hair and fingernails.

Forearm Spines: The mutant has two chitinous spines growing out of each forearm. These are sharp enough to cut, but flexible enough to lay down against the skin when he wills it, allowing him or her to wear armor and clothing over them. The spines can be used as weapons, doing 2D6 S.D.C. damage, and provide the character with a +2 to parry as long as they are uncovered and available to parry. The spines also provide a +10% bonus to climbing walls, but not rappelling. The downside is that the character has four large spikes growing out of his arms and must always wear loose, long sleeve shirts or armor to hide them.

Heightened Empathy: This character has developed a psychic ability to read other beings' emotions. It works with humans, animals, and even Invid, Zentraedi and other aliens. However, the power is *always on*, cannot be turned off, and the character cannot block out strong emotions. Typically, the power is a general feeling of the mood of everyone around him or her, but the character can focus on a specific individual and sense that person's emotional state with amazing clarity. The ability does not give the mutant the power to read someone's mind, but

it can tell him whether the person is angry, hostile, depressed, lonely, happy, etc. The empathic mutant cannot be surprised by an attack by a living being except when the character has tuned out all but one person, at which point someone else could surprise him. Otherwise, the mutant will always feel the violent intent directed towards him seconds before the attack happens. If focused on one specific being, the empath receives a +1 on initiative and +1 to parry and dodge vs that individual. **Range:** 60 foot (18.3 m) radius when just receiving general emotional states from everyone, 120 foot (36.6 m) range when focused on just one person.

Unfortunately, the constant strain of trying to mentally filter all of the raw emotions around him makes the empath anxious and on edge much of the time, especially in large groups and crowds. He is also less mentally stable and more than a bit distracted. **Penalties:** -2 to save vs insanity and psionic attacks, -5% skill penalty whenever 2-10 people are around, -15% when there are a dozen or more within the psychic's sensing range, and -30% when the emotions are especially strong (hate, fear, panic, etc.) or there are dozens and dozens of people around. The empathic character also has trouble distinguishing what someone said from what they are actually feeling, and may make embarrassing, harmful or compromising statements about feelings people would rather keep hidden. ("Why do you hate your brother so much?" "You should try to control your attraction to Bill's wife, especially when he's standing right here.") When possible, the character tends to seek time away from other living beings so he can quiet the static in his head. Seclusion is the only time the empathic character feels calm and at peace.

Heightened Metabolism: This mutation sends the character's metabolic rate into overdrive. His body processes food and turns it into energy with startling efficiency. This makes the character fast, with excellent reaction speed and endurance, but also makes him a bit hyper, constantly hungry and a poor sleeper. Physically, this character is thin and wiry; almost unnaturally so. The mutant is always fidgeting and doing something, like munching on . . . just about any food or snack. Sitting still is almost impossible. The character receives the following bonuses: +2 to the P.P. attribute, +2 on initiative, and +1 attack per melee round. **Penalties:** However, the character is easily distracted and generally unfocused, -2 to any non-combat Perception Rolls and -5% to all Electrical, Mechanical, Medical, Science and Technical skills. The character also eats two to four times as much as a normal human and generally tries to in take at least 8,000 calories per day to be well-fed, but never gains weight.

Internal Gyroscope: This character has a small cavity in his head filled with extremely iron-rich blood that is magnetically sensitive. The character always knows which way magnetic north is located, even when underground. This enables him to know which direction he is headed in, what is right-side up, and gives him an excellent sense of balance and direction. The character receives the Land Navigation skill at +10% (or receives an additional +10% bonus if the skill is provided by his O.C.C.), Sense of Balance at 60% +2% per level, and +2 to roll with impact.

The mutant is uncomfortable in space and on other planets that do not have a magnetic field similar to Earth's. The character also suffers around powerful magnetic fields or electrical power sources (not Protoculture power sources, however) and during

electrical storms. In those instances, the character is -2 to initiative, -4 to Perception Rolls, -5% on skill performance, and loses one attack per melee focusing on keeping his or her bearings. If on most other planets or in space, the character loses all bonuses from the internal gyroscope unless there is a magnetic field similar to Earth's. The character feels out-of-place in these environments and typically wants to return to Earth whenever possible. If caught in zero-gravity, the character is completely disoriented, loses half his attacks, has no initiative and there is a 20% chance every melee round that he will suffer nausea and vomiting, incapacitating him for an entire melee round.

Nocturnal: This mutant is most active and productive at night time. Once the Sun is down, he enjoys a bonus of +2 to P.S. +2 to P.P., +1 attack per melee round and increase Spd by 25%. The character also has Night vision (200 foot/61 m range). Nocturnal mutants also have cat-like eyes that reflect light. Some people find the character's eyes to be exotic (+1 to P.B.), but some find them weird and frightening (they see the character as -2 P.B.).

When the Sun is up, the character is sluggish, out of sorts and sensitive to bright light; -2 to P.S. and P.P., -25% to Spd, -1 attack per melee round, -5% on skill performance, has poor day vision and must wear sunglasses or tinted visor to protect his eyes. The character is excessively pale and the skin has a slightly blue tint, as does the hair.

Overdeveloped Musculature: This character is the epitome of beefcake. Muscle mass is 1.5 times that of most normal humans, giving the mutant a muscle-bound, bodybuilder's physique and enhanced strength. While some may suspect the character is taking steroids, most people do not assume the character is a mutant unless he or she performs some freakish feat of strength. **Bonuses:** +10 to P.S. attribute (minimum of 18) which is considered Augmented, +2 to P.E., +2 to P.B. and +4D6 to S.D.C. Add one foot (0.3 m) to the character's height and 3D4x10 pounds (13.5 to 54 kg) to the character's weight, but it is all muscle. **Penalties:** -2 to I.Q., -1D4 to Spd attribute, and it may be hard to find clothing that fits and armor may need slight alteration to be wearable by the bulky character. (The Field Armorer and similar skills suffice in making such modifications to armor.) The character also eats at least twice as much as a normal human and generally tries to in take at least 6,000 calories per day to be well-fed.

Prehensile Tail: This mutation gives the character a long, flexible tail that is able to hold things, press buttons and even use rudimentary weapons. It improves the character's balance as well (+10%). To use the tail, it must be free to move about and not kept tucked under clothing or trapped inside armor. The character may have to cut holes in his equipment to allow the tail to poke out, but most prefer to keep their secret, and their tail, inside their pants. When freed, the tail gives the character +1 attack per melee round, can use melee weapons at -1 to strike and parry, and can use ranged weapons but all shots count as wild. The character loses these bonuses when the tail is hidden in clothing and armor. Some people find the character's tail to be exotic (+1 to P.B.), but some find it unnatural and frightening (they see the character as -2 P.B.).

Protoculture Sensor Eyes: The character's eyes work like biological versions of a Protoculture Sensor found in Invid mecha. They enable the individual to see Protoculture emanations from vehicles, mecha and power plants as well as the aura emanating from the Flower of Life and its seed. The character can see Protoculture power sources through walls and underground, but only when the power sources are active. This means the

character can see a Cyclone Rider hiding behind a tree or rock, or can see Invid Troopers lying in wait underground. This also means the character can tell when a weapon system or mecha powered by Protoculture is turned on or shut down, whether it has ceased to function and can roughly gauge the strength of the power supply, allowing him or her to tell if the source is large or small, or whether someone's Cyclone or Alpha is running low on Protoculture. However, the character tends to see everything in tints of red, making some colors (like blue and green) hard to distinguish. The character also has red-tinted pupils and irises, giving his eyes an unearthly look. This can be hidden by sunglasses, goggles, or contact lenses, but good luck trying to find contact lenses on Invid-occupied Earth. -1 to P.B. attribute. Range of Protoculture Vision: 2,000 feet (610 m), otherwise vision is the same as any other human.

Retractable Claws: The fingernails of this mutant extend 1D4 inches (2.5 to 10 cm) and are razor sharp, much like a cat's. The claws add an additional 2D4 S.D.C. damage and give the character a +10% to Climbing rolls. Even when retracted, the fingernails look unusual and sharp, and the fingers are slightly larger than normal.

Retractable Tentacles: This character has two tentacles that are 1D4+4 feet (1.5 to 2.4 m) in length. They extend from the back, just under the shoulders. Tentacles are prehensile and can press buttons, pull levers, open doors, entangle opponents and wield simple weapons, like swords, knives, staves, and guns with simple triggers. Except for two odd lumps on the back, the tentacles are unnoticeable when retracted. When extended, they provide the character with one additional attack per melee round, +2 to parry and +2 to entangle. They are -2 to strike when using firearms and -10% to perform skills requiring fine dexterity, such as picking someone's pocket or using any Medical or Mechanical skills.

Solar-Powered: This character thrives in the daytime and seems to get a substantial bit of his energy directly from the Sun. During the daytime, as long as he is in direct sunlight, he is +1 attack per melee round, +4 to P.S. and P.E., +5% on all skills and tends to have a positive, upbeat and infectious disposition (+2 to M.A.). However, at night, the mutant slows down significantly and appears de-energized and almost seems to wilt a bit. The bonuses from sunlight are gone and the character is -4 to P.S. and P.E., -2 to M.A., -5% to all skills, -1 attack per melee round and -2 on Perception Rolls. In addition, the character has a slightly green tint to his skin and the hair is also a shade of green. Indoors, out of direct light or on heavily cloudy days or overcast weather, the character receives no bonuses or penalties from the mutation.

Tough, Scaly Skin: The character's skin looks mostly human from a distance, but on closer inspection, it is rough and scaly, providing the mutant with additional protection from harm. This mutation is commonly found near Genesis Pits attempting to duplicate Earth's conditions during the Cretaceous period, the time of the dinosaurs. The character receives an additional 1D4x10+10 S.D.C. and has some resistance to high temperatures (heat and humidity have no negative impact up to 115 degrees Fahrenheit (46 C), at which point the character feels the negative effects of hot temps). He also takes half damage from S.D.C. fire and takes twice as long to be affected by heat-related health conditions such as heat stroke.

On the downside, the character's skin is very odd and unattractive (-5 to P.B. attribute). The face is the least affected area

and can pass as human, but he must wear full clothing covering arms and legs (and probably gloves as well) to hide his unusual skin from others. The mutant is also either bald or has sparse, thin and uneven hair.

Mutation Origin Chart

01-20% Minor Experiment: The Invid captured the character, did a few tests and gave the individual a minor mutation. Then they simply released him or her back out into the world. These "tag and release" victims often are not certain what to think of what happened, and may be haunted by nightmares and/or nagged by a sense of powerlessness because they were unable to prevent what happened to them. Many join the Resistance both to rid the world of these monsters and to regain a sense of control over their own destiny.

21-40% Protoculture Radiation Exposure: Radiation from Protoculture is usually a non-issue and it is the safest, cleanest power source ever discovered by mankind, with the possible exception of wind power. However, long-term exposure to unshielded Protoculture radiation can cause mutation in living beings. In this character's case, he may have lived too close to a damaged Protoculture power supply. Most likely, he lived in the hulk of an old Zentraedi starship with a busted reactor, or moved into a partially destroyed Southern Cross base whose reflex furnaces were not fully shut down after the invasion.

41-60% Raised in a Genesis Pit: The Pit was probably one of the first built here on Earth. There were several around the world that were essentially traps meant to bait humans and lure them inside with an illusion of shelter. The humans there were unknowingly exposed to Protoculture radiation and watched for mutations. These communities often had an unusually high number of missing persons, because the Invid would snatch some of the more "interesting subjects" either for dissection and examination or full experimentation. This character lucked out and left "home" before his or her turn came for "collection and study" by the Invid.

61-75% Raised Near a Genesis Pit: The character lived in a community that was near an Invid Genesis Pit, but more than likely did not know of its existence (01-75%) or if he knew, did not know what it was (76-00%). However, there were always stories and sightings of "monsters" in the wilderness nearby and a high rate of strange mutations among the people there.

76-85% Incidental Exposure: The character may never know when, where or how he was exposed to a Genesis Pit mutagen. Until the mutation manifested, the character thought he was an average, red-blooded Earthling. The mutation is just one more reason to hate the Invid (and/or the Masters) for what they've done to the Earth and humanity.

86-00% Rescued: The character was briefly captured by the Invid and was made the subject of experimentation. However, the character was rescued before the Invid could get too far in their experimentation. In many cases, these characters vow to never be captured by the Invid again, and fight to the death if necessary. They never want to give the Invid a chance to finish what they started. There's also the nagging worry in many of these victims that they were not rescued, but merely allowed to escape. Some even wonder whether they are being secretly followed and studied by the Invid to this day, or whether the Invid might come back someday to gather up their test subjects for further study.



Pit Monster Creation Tables

In most cases, creatures found in Genesis Pits are carefully reconstructed from genetic samples found by the Invid. They may take weeks, months or years to develop. While, on an evolutionary scale, that's lightning fast, there are special **Mutation Pits** found in the depths of some Genesis Pits or Command and Control Hives that speed up the process even faster. For the Regess, Regent or an Invid Brain, controlling the mutation effects of these powerful devices is simply a matter of will, but if there is nothing controlling it, anything that falls in is subject to random mutation. These mutations occur almost immediately (1D4 melees rounds!), and are irreversible, sometimes crippling and often horrific.

In Genesis Pits that have been damaged or abandoned, these Mutation Pits are an extreme danger to the surrounding territory. The monstrosities that can come out of them, born from insect, animal or humanoid victims, can be more deadly than the Invid themselves.

The tables that follow are a fun way for a Game Master to randomly create thousands of combinations of slobbering monsters from a Genesis Pit. Any and all can threaten the countryside, be intentionally released to terrorize freedom fighters and human communities, or, in some tragic cases, be the ultimate fate for once noble rebels captured by the Invid or innocent people or animals unwittingly transformed into living nightmares. Any attributes not mentioned during the course of creating a creature using this chart are at a default of 2D6+6, except for M.A., which should be 3D6 for sentient beings and 1D6 for unintelligent creatures. Hit Points (unless M.D.C.) are P.E. attribute number x2.

Minds of Altered Sentient Victims

In most cases, the mutated creature will have been an animal, but where an intelligent being is the victim of a Genesis Pit or Mutation Pit, roll percentile dice to see what happens to their intelligence and personality after transformation.

01-15% Memories and skills are wiped away. The individ-

ual retains only a vague recollection of friends, loved ones and his past humanity (may pause from eating a comrade-in-arms, go into a rage at the sight of a former enemy, suddenly lunge to the defense of a child or soldier, etc.). Otherwise, this mutant is almost mindless or animalistic, and has lost the ability to think or speak beyond the range of a predatory or pack animal such as a dog. I.Q. 1D4+3.

16-30% Alignment Reversal. Good and selfish alignments become evil; truly evil. On the other hand, beings who were once evil become Unprincipled or a good alignment. In either case, old memories, skills and abilities remain, but they are looked upon as a past life. A time before the character had an epiphany and wised up to his or her new alignment and superior view of life. Odds are the individual looks upon past choices (alignment) with regret, shame or disgust. The character's new alignment is the one that drives him or her now, be it wickedness and a life of villainy, or a life of evil turned toward redemption and goodness.

31-45% The bestial side has been unleashed. This character maintains a significant part of his or her memories, intelligence and skills, but a chunk are missing and only those best suited to combat, hunting and killing remain. This lost soul has devolved or mutated into an aggressive predator. Alignment is, at best, Unprincipled or Anarchist, and skills and abilities (new and old) are used to hunt, kill and fight. For these characters, might makes right and when enraged, frustrated or caged, a murderous fury that is difficult to contain sweeps over them. These individuals revel in combat and killing, and may even relish being powerful monsters that are less than human. Penalties: -1D4+1 to I.Q., only half of all skills remain and those skills that remain are predominantly combat, hunting and wilderness oriented. The mutated character can speak and read native language at only 35% proficiency (assuming he could read his in the first place).

46-65% Lucked Out or Curse? The intelligence and personality are unchanged, and all memories and skills remain intact. However, the character is mutated in other ways (see tables below) and this individual often finds it the hardest to accept his or her new, monstrous form.

66-80% Boosted Intellect. The character receives a +1D4+2 I.Q. bonus (minimum 17), and +1D4 to M.E. attribute. He or she understands much more about some aspect of the universe, but may be more confused about his/her own place in it. Select two new skills from the Science category at +10%, but is slow to act and is frequently lost in contemplation or distracted by the possibilities. -1 attack per melee, -1 on Perception Rolls and -2 on initiative rolls.

81-90% Protector of Justice. The transformed character retains his or her memories, skills and personality, and enjoys a +1 bonus to I.Q. and M.A., among other possible mutations. However, the mutant can never shake the feeling that he or she is a freak or even a monster. Certainly something less than human thanks to the Invid. Rather than becoming bitter and angry, such individuals take it upon themselves to become champions and protectors of humanity and all innocent people. Even if an Anarchist or evil alignment, the character values human life, hates the Invid, and despises those who mistreat people who are handicapped or different. The character tends to have violent feelings and outbursts against those responsible for the abuse of others, including bullying, torture and slavery. In fact, the character's hatred of the Invid and other enslavers, murderers and tyrants borders on the obsessive and grants bonuses of adrenaline and righteousness of +1 attack per melee, +1 on

initiative and +1 to strike when fighting them directly.

91-00% Alien Mind. This mutant only vaguely resembles the person he or she was before. Worse, the character feels detached and removed from humanity to the point he finds it difficult to care for “mortal beings” or relate to “mere humans.” The individual becomes quickly irritated and annoyed by those of normal or lower intelligence. The character tends to be arrogant, cold, aloof, and unsympathetic towards others and to the point. In many cases, particularly with evil characters, they lose their humanity altogether and see themselves as superior or even a god. I.Q. is 20+2D4, select a total of 1D4+2 additional skills at +20% from the Medical, Science or Technical skill categories and ignore any prerequisite skill requirements. All previous skills in those categories get a +10% bonus, but skills in the categories of Communication, Domestic, Physical, and Wilderness suffer a -10% penalty.

Alien Mind mutants are, at best, Anarchist or Aberrant, and have little concern for those around them, have little sympathy for consequences born out of stupidity or unchecked emotion, and do not think about how their own actions may hurt, injure, or endanger other people. This character is also likely to be condescending to anyone without an exceptional I.Q. and has an unhealthy fascination with the minds and sciences of the Invid, Robotech Masters, Haydonites and other intelligent alien beings.

Genesis Pit Random Mutation Tables

Roll under each category table from A to I to create a Genesis Pit monster or mutant.

A. Body Type

This defines the general shape and classification of the creature. Roll once.

01-10% Amphibian: The creature has soft, slick skin that is water resistant. It starts with 2D6+9 S.D.C., can swim at 80% proficiency, and can stay underwater for P.E. attribute number x3 minutes. Re-roll P.B. attribute: 2D4+1.

11-20% Arthropod: Covered with a strong, hard exoskeleton like that of a crustacean or insect, this monster is heavily armored and hard to kill. It starts with 3D4x10 M.D.C., and can fight at full combat capacity until reduced to its P.E. attribute number below zero in M.D.C. Re-roll P.B. attribute: 1D4+1.

21-30% Avian: This mutation is covered in feathers, hollow boned and sharp-eyed. This does not automatically give it the ability to fly, but reflexes are faster and the body is lighter. Hawklike vision gives the character the ability to read a stop sign two miles (3.2 km) away and a +2 to all visual Perception Rolls and initiative. Weight is 25% less than normal. Plumage may be considered beautiful. Starts with 2D6+14 S.D.C. Re-roll P.B. attribute: 2D6+4.

31-40% Bio-Mechanical: This creature does not look like a natural flesh and blood creature, but more like a machine, or half machine, half-living being, with some parts appearing to be metal and/or mechanical. Starts with 1D4x10+10 M.D.C. Re-roll P.B. attribute: 2D6.

41-50% Cephalopod: This mutation is a baggy mass of flesh that is incredibly strong and resilient like that of a squid or octopus. The Mutant is also highly intelligent; +1D4 to I.Q. attribute. Re-roll P.B. attribute: 1D6+2.

Cephalopods are often excellent chameleons and/or able to alter or mold their bodies. Some also have shells. Roll below:

01-50% Soft-Bodied Chameleons and Shape Shifters. Able to reduce body size to 20% normal and can squeeze between bars, cracks and other openings as narrow as 6 inches wide (15 cm) even if the mutant is gargantuan in size. Also able to change color to match the surrounding environment, giving the mutant a +20% bonus to the Prowl skill (or a natural Prowl ability of 45%). Starts with 1D4x10+10 S.D.C.

51-00% Shelled. These mutants have tough, shell-like structures, usually on their back, giving them the ability to absorb tremendous damage. They can pull all of their limbs and heads fully into these shells for protection. Starts with 1D4x100 S.D.C. (or 1D4x10+20 M.D.C.; Game Master's choice).

51-60% Mammalian: Warm-blooded, covered in skin and possibly fur, this creature can regulate its body temperature to survive in most climates. Suffers only half penalties from exposure, receives +1 to save vs diseases and poisons, and receives one additional roll on the natural weapons and defenses chart. Starts with 6D6 S.D.C. Re-roll P.B. attribute: 3D6.

61-70% Humanoid: The mutant has a general human/humanoid appearance, though some may, in the end, appear to be part human and part animal or a monstrous amalgamation of many things. If the creature started out as an animal, insect or plant, it now has a human shape, with two legs, two arms, hands, feet and a head.

71-75% Plant: This is not an animal at all, but actually a mobile plant. While it is likely carnivorous, it also derives some benefits from sunlight. Bonuses in Sunlight: +1 attack per melee, +2 to initiative, strike, parry and dodge. Penalties in Darkness/Night: -1 attack per melee, -2 on initiative, -2 to strike, parry and dodge, and reduce Spd by 10%. No bonuses or penalties during the day when not in direct sunlight (e.g. when it is overcast or the character is indoors). Starts with 1D6x10+8 S.D.C. Re-roll P.B. attribute: 2D6.

76-80% Radiata: An extremely unusual-looking creature with clear skin (leaving internal organs visible), the ability to generate a phosphorescent glow (sometimes encompassing the entire body, sometimes in specific patterns and colors), and a deadly touch. If these mutations touch the flesh of another living being, they can inject a powerful poison that causes intense agony. The victim must make a save vs lethal poison (14 or better to save) or be incapacitated by pain for one entire melee round and suffer 1D6 points of damage directly to Hit Points. A successful save means that the victim takes no damage, but is -1 to strike, parry and dodge, and reduce Spd by 5% for one melee round, but can continue to function. Multiple stings inflict cumulative damage and penalties. These monsters are slimy and alien-looking. Starts with 1D4x10 S.D.C. Re-roll P.B. attribute: 1D4. **Note:** The Radiata can have a humanoid form or be a creature that more resembles a jellyfish, even if it is a land-dwelling creature.

81-90% Saurian: Reptilian, dinosaur-like beings covered in scales, but warm-blooded (like a bird) and tough. +1D4 to save vs poisons and toxins, and +3 to roll with impact. Starts with 2D4x10 S.D.C. Re-roll P.B. attribute: 2D6.

91-00% Slug: Slimy, squishy, and often unpleasant to look at, these creatures generate mucus that is sticky and disgusting, have eyestalks that give them 360 degree vision, have vestigial shells, and can squeeze between bars, cracks and other openings as narrow as 12 inches wide (0.3 m) even if the mutant is very large. A slug mutant gets a +25% bonus to existing Climbing skills (or a

base Climbing of 60%) and is able to climb sheer surfaces, and is +3 to entangle and disarm (due to sticky residue). Cannot be surprised from behind and has a vestigial shell (meaning the shell is soft and flexible, allowing it to be squished or squeezed and pop back out to normal). Starts with 1D6x10 S.D.C. Re-roll P.B. attribute: 1D4. Re-roll Spd attribute: 1D6+2.

B. Intellect

Unless the creature was sentient when it was put into the pit, roll on the chart below. This not only affects raw intelligence, but general eating behavior as well. Roll once. **Note:** If the creature was sentient, roll on the **Minds of Altered Sentient Victims Table** toward the beginning of this section.

01-10% Mindless, Gibbering Garbage Disposal: This creature is so stupid it is dangerous to anything and everything. It has an insatiable appetite for food/prey and seeks to constantly shovel anything in reach into its ever-ravenous maw, be it human beings, Invid, garbage or a leather sofa. It eats so much that it can quickly devastate an ecosystem. When attacked, the monster fights to the death and does not stop until it is killed or incapacitated. In combat, it tends to focus on the first target or anything causing it pain.

I.Q. 1D4.

11-20% Territorial: This beastie has staked out a part of the region as its home range and hunting territory, and it won't generally leave. It is not usually overtly hostile, meaning unless it sees someone or something as food, it leaves people and animals alone. The exception is it may see humans and other large creatures (any adult-sized or larger being that isn't food) as a threat to it and its offspring or herd, and will chase them out of its territory and harry the creature(s) until they are out of sight. Threatened beings that refuse to be chased off will be attacked until they finally leave or are slain. Such efforts are preceded by bellowing, stomping about and other displays meant to scare away other creatures. Once the perceived threat is gone, the monster returns to whatever it was doing. The trick with these types of creatures is figuring out what they consider their territory or destroying them before they become too numerous and widespread. **Note:** A territorial monster may ignore or tolerate other large animals and even predators that it does not consider threats (i.e. do not compete with it directly), but humanoids are seen as dangerous invaders. I.Q. 1D6.

21-40% Pack Animal: This monster tends to gather with others of its own kind and travels in packs (like wolves), herds (like cattle) or flocks (like birds). The larger the group, the more aggressive the pack becomes to perceived threats and the more pack defenders (usually the males) there are to fight. I.Q. 1D6+1 (animal).

41-60% Ambush Predator: A monster that catches and feeds on other living beings, including humans. It seldom tries to chase prey over any significant distance. Instead, this predator prefers to lie in wait, strike quickly from a hiding place, make the kill and then eat in private, conserving its strength. Prey may be eaten where slain, or dragged off to a den, lair or other safe place depending on the nature of the monster. (For example, leopards like to drag their prey up into a tree to eat it, while lions and wolves tend to eat their kill where it falls.) This creature has a natural Prowl skill of 64% when motionless or moving very slowly. Running speed is tripled for one melee round at the beginning of any attack. I.Q. 1D4+5 (animal).

61-80 Predatory Hunter: These mutants actively stalk specific prey and are among the most intelligent of creatures. They go out, track down food and kill it. They may do this using speed, natural weapons or brute force, depending on their nature. Most predators, even monsters, typically retreat if the prey is too tough, attack at times of opportunity (like when their prey is sleeping), and target the weakest and easiest prey of a group. They receive the Tracking (people) and Track Animals skills at 70% each (+10% to follow a blood trail). I.Q. is 1D6+6 (animal).

81-00% Sentient: This creature is fully aware of himself, the world around him, his own abilities and monstrous birth or re-birth. This could even occur to a creature that did not possess human intelligence before it went into the Genesis Pit. **Note:** Humans and others who entered the Pit as a sentient being roll on the **Minds of Altered Sentient Victims Table** toward the beginning of this section.

Animals, insects and plant life mutated into human level I.Q. and awareness select one language at +15%, and four skills starting at the base skill level from each of the following categories: *Domestic*, *Physical* and *Wilderness*. I.Q. 3D6. Omnivorous, meaning they can eat meat or plants, just like humans. This does NOT mean they won't eat a human.

Awareness of previous existence:

01-50% Start their Sentient existence as a blank slate, meaning they have no recollection of their prior animal existence.

51-80% Remember their life as an animal only as a vague, half-remembered dream, and perhaps only in their dreams. They may believe they were something else in the past, and were changed somehow, but are not sure about any of the details (what, where, when, who, etc.). They accept and welcome their new sentient existence and make the best of their new life.

81-00% Remember their life as an animal, insect or plant clearly and hate having been turned into "something else" - "something awful." They probably have an affinity for nature and wildlife, dislike human and Invid civilization and science, and may dislike people in general. They consider themselves monsters or freaks, have trouble adapting to their new existence and may carry a chip on their shoulder that makes them belligerent people, villains or murderous monsters.

C. Size

The dimensions of a monster that crawls out of a Mutation Pit seem to have little connection to the size it was when it went into one. Some are no larger than a dog, others are the size of a bat-troid or a house. Roll once.

01-15% Small Build: About the size of medium to large dog, weighing 40-100 lbs (18-45 kg). Add 10% to Prowl, +1 to dodge, and reduce the S.D.C. or M.D.C. of creatures that started out human-size or larger by one third.

16-45% Man-Sized: Somewhere between 5-7 feet (1.5 to 2.1 m) tall, or long in the case of some creatures. No bonuses or penalties for size.

46-65% Large: Two times the size of an average human. Height or length is 10-13 feet (3 to 4 m), weighs between 350 and 1,000 lbs (157-450 kg). Add 2D4 to P.S. and make it the equivalent of Augmented Strength, double the original S.D.C. or M.D.C., -10% to Prowl, all clothing and armor must be custom-made and needs to eat 2-3 times more food than the average human.

66-85% Massive: This is a huge, hulking mutation the size of

many mecha. It looms 15-30 feet (4.6 to 9.1 m) tall, weighs 2D4 tons and all S.D.C. and Hit Points are doubled and converted to M.D.C. If the creature was already M.D.C, due to its body type, that M.D.C. is doubled. Add 2D6 to P.S., make it the equivalent of Robot Strength, and increase Spd attribute by 10%

86-00% Gargantuan: A towering mass of horror that is usually seen stumbling into skyscrapers and crashing through tangles of power lines. The creature is 30+1D6x10 feet (12.2 to 27.4 m) tall or long and weighs 2D4x10 tons. It has 2D4x100 M.D.C., in addition to any previous M.D.C. the creature had from body type. Base Strength is 20+4D6 and considered Supernatural. But the monster is -4 to dodge, Prowl is -50% and only possible in large, heavy cover, and the creature registers on Protoculture sensors as well as motion and seismic sensors.

D. Speed and Agility

Roll once on the chart below to determine how fast and agile the monster is. Remember, the two do not always go hand in hand.

01-10% Nearly Immobile: This creature is virtually rooted to the spot and moving takes a great effort. This is typically due to weight and/or morphology. Double the creature's weight, reduce Spd to a mere 1D4, reduce attacks per melee by half (maximum three), and re-roll P.P. attribute: 2D6.

On the plus side, it is hard to tell the creature is alive. It may look like some weird alien plant or statue and seldom moves. Odds are, it appears non-threatening or possibly dead. A Perception Roll of 12 or better is required to notice that it is actually breathing or moving. Receives a +10% to Prowl (hides in plain sight by standing absolutely still and slowly repositioning itself). However, when it moves, it is likely to move with deadly purpose and can be surprisingly deadly as an ambush predator.

11-30% Calculating: Overall speed and agility are average, but this creature knows just when to move for maximum effectiveness by carefully watching and gauging its opponents. Spd and P.P. are 1D4+9, but the mutant gets a +2 on initiative, +1 to strike, parry, and disarm, and +2 to pull punch and roll with impact.

31-50% Freight Train: The mutation is an incredibly fast runner, but stopping and turning are often problematic. Often rams into its foes, knocking them down or trampling them. Spd attribute is 2D4x10+20 and does a charging attack that takes two attacks but does the same damage as a power punch. A charging attack can knock over creatures and mecha up to twice the monster's size and weight. Victims of knockdown lose two attacks and initiative. But the critter is about as agile as a tree stump, with a P.P. of 1D4+4, -4 to dodge, and it has difficulty stopping.

When running at speeds greater than 15 mph (24 km or Spd of 22) without running into people, vehicles or objects, and it will usually still bump into them and inflict some damage (the same damage as a punch attack, but does not knock them down or trample them), and the creature must exert great effort and use up two melee attacks/actions. To stop without bumping into anyone or anything at all, the creature must use up four melee attacks/actions. And if it was running near or at top speed and tries to stop fast and without collision, it is difficult for it to stop; must use up 1D4+4 melee attacks.

51-70% Slippery: While not particularly fast on its feet, this mutation is nimble and hard to grab. P.P. is 2D6+11, plus all body flip/throws, entangle, disarm and pinning attacks directed at

the creature by opponents are -2 to strike. The creature also gets a +2 to roll with impact and bonuses to dodge apply to an automatic dodge in which the act of dodging does not use up a melee attack. These monsters are usually also slippery to the touch. They might be coated in slime, covered in a slick skin or natural armor that is highly polished, smooth and slippery. Spd attribute is 2D6.

71-90% Racer: Lightning fast and agile, this is a monster built to run. It can turn on a dime, elude pursuers or run down prey. It has one additional attack per melee round, +2 to roll with impact, and fatigues at half the usual rate of its species. Reroll the following attributes: P.P. 2D6+5, Spd 1D6x10+60 (48- 82 mph/77 to 131 km) and is +4 to dodge when running at or near full speed. Can navigate thick foliage and obstacles, change course at top speed with no problems, stop on a dime and can leap heights twice its own height and distances three times its height. However, the speed is limited based on the creature's endurance. Can only run at top speed for one minute per each P.E. attribute point before becoming winded and needing to rest for 1D4 minutes (speed and combat bonuses are half for the duration of the rest period); P.E. 12 means it can run 12 minutes at top speed. However, the creature can run at half its top speed for one hour per each P.E. attribute point. Must consume food equal to half its body weight every day.

91-00% Hair-Trigger: This creature is a whirlwind of motion and quick to take action. When on the move, it is constantly moving, fidgeting, leaping, jumping, playing and dashing about in frightening acrobatic displays. P.P. is 3D6+10, Spd is 0D4x10+22, +2 attacks per melee, +2 on initiative, +4 to automatic leap dodge (the act of dodging or leaping does not use up a melee attack), and has the Acrobatics skill (plus all applicable bonuses). On the downside, the creature can only maintain this frenetic pace for 8-10 hours a day. After which, the mutant feels exhausted. Reduce Spd, attacks per melee and all combat bonuses by half until it can get 12-14 hours of sleep. As a result, this mutant sleeps half the day away, and is prone to napping, dozing or otherwise not doing anything, when it is bored and there is nothing to do. When ready for sleep, the mutant prefers to sleep uninterrupted for at least 10 hours and finds a quiet, safe place to hide while sleeping.

E. Diet

What the creature eats can vary widely and is likely to depart from its original diet. Because of the link between predatory instincts and intelligence, most Invid evolutionary experiments are carnivorous or omnivorous at best.

01-10% Alloy Muncher: The beast has a diet of metal and alloys. It can bite through steel and gnaw through the armored hull of a Veritech or spaceship. Even if the creature cannot normally do Mega-Damage with its bites, its mouth is loaded with special enzymes that oxidize even rust-proof materials, causing them to become weak and crumbly, enabling the mutant to gnaw or scrape shavings and bits away for consumption. Each bite does 1D6 M.D. to metal, metallic alloys and most hardened, manufactured materials used in armor, building construction and Mega-Damage structures, even if they are not entirely made of metal. If the creature already does Mega-Damage with its bite, add 1D6 M.D. to that damage when biting metal or Mega-Damage alloys.

11-20% Blood Drinker: As the name indicates, this creature drinks the blood of other living creatures. It could do this by sucking the blood out through hollow fangs, with hypodermic

needle-like spines on the ends of tentacles, or by simply slashing or biting its prey and gulping down the blood that spurts out of the wound. It is +3 to save vs poisons, toxins and diseases itself, but is often a vector (carrier) for diseases picked up from other species. 75% chance of having an anticoagulant in its saliva that makes blood run more freely. Anyone bitten or attacked by the creature bleeds profusely, losing 1D4 Hit Points every melee round until a successful First Aid roll is made to stop the bleeding. Of course, the blood-sucking monster will have to be dealt with first.

21-30% Brain Feeder: This creature has a disgusting diet of brain matter. It prefers sentient brains, the smarter the better, and it is not picky about what species. It must eat the equivalent of one adult human brain per day. For 1D4 hours after feeding, the creature is actually more alert and intelligent, with an additional +1D6 to I.Q., +2 to Perception Rolls, +2 to initiative and +10% to all skills.

31-40% Carrion Eater: Like a vulture, this monster prefers to eat dead, rotting meat. It picks over the remains of the dead left by other predators. It also attacks the wounded/injured, the weak, and the elderly who seem sick or infirm. It may also target children and lame animals as well. When extremely hungry, a carrion eater sometimes attacks lone individuals it believes it can take. The monster knows the signs of battle and combat between modern war machinery mean there is likely to be food available and it might move in to feed on the dead or grab injured combatants while the battle still rages. The mutant is impervious to disease, can smell blood up to 1D20 miles (1.6 to 32 km) away (roll once during creation to determine its range), and can track by blood at 55%

41-50% Energy Leech: The mutation feeds on fire/heat, electricity, energy weapons, nuclear power, and Protoculture. It is impervious to energy attacks, including plasma, lasers, particle beams, ion weapons, and normal fire. Melee attacks with physical weapons, bullets, explosions and missiles do full damage.

51-60% Garbage Disposal: The ultimate omnivore, this creature eats any plant or animal matter it can find, including fruits, vegetables, grain, processed meat/foods, garbage, rotting food and dead bodies. It will clear out a farmer's field and then gnosh on the farmer too if he tries to stop it. Generally, these monsters are hunters of opportunity, meaning that they go for the easiest, fattest thing in range. These types of creatures eat constantly and indiscriminately. Though not a predator, they will attack, kill and feed on weak, injured, sick and lame animals and people, but only if there's not an easier food source available.

61-70% Invid Hunter: This mutation has some genetic link back to the Invid's home world of Optera, regardless of what its outer form looks like. In fact, this creature hunts and eats Invid, and makes them its primary diet. This monster uses its abilities to invade Invid Hives and eat Invid in stasis or, if possible, break open their mecha and eat the pilots inside. Even if they have Protoculture-based abilities, these monsters are *invisible* to Protoculture sensors and impervious to the effects of the Flower of Life spores as well. If not M.D.C. already, combine Hit Pints and S.D.C. and make the mutant an M.D.C. creature. +1D6 to P.S. attribute, P.S. is Augmented, and +1 on initiative and +1 to strike when fighting Invid.

71-80% Man-Eater: Not only is this a dedicated carnivore, but this creature specifically eats humans or humanoids (including Zentraedi, Tirolians and evolved, human-like Invid). If not

an accidental mutation, it was probably designed to help rid the Earth of its remaining human population or by the Regent to prey upon the Masters, Tirolians, Zentraedi, and other humanoids of rebellious planets. Zentraedi, Robotech Masters and their clones are definitely part of that menu. These would only attack a full-sized Zentraedi if they themselves are very large or very powerful, or hunt in packs that attack in numbers.

81-90% Meat Eater: Classic carnivore. This creature prefers raw meat from fresh kills. It has a simplified digestive system that quickly takes nutrients out of raw meat without making itself sick. The main prey of such a mutant is likely to be animals, but may include humanoids, especially if the monster is large. +1 to initiative, +2 to save vs poisons and toxins.

91-00% Protoculture Consumer: This creature subsists on Protoculture or the Invid Flower of Life, or both. It can eat the Flower's buds and leaves for energy and can also consume refined Protoculture as well. It is impervious to the spores of the Flower of Life but can be detected by Protoculture sensors. If powerful enough, the mutant will try to rip through both Invid and human mecha to get to the Protoculture inside.



F. Locomotion

This category is the primary method the mutant uses to get from Point A to Point B. It may have additional limbs via other tables, but this is how it moves. Roll once.

01-15% Quadruped: The mutant has four legs, like a dog or horse. Fast runner. Bonus: Double the Spd attribute number.

16-35% Biped: Walks on two legs and likely to have two arms and hands for manipulating objects. No bonus.

36-42% Arboreal Swinger: This creature relies primarily on two powerful arms and, to a lesser extent, two legs or a prehensile tail to move about by swinging through trees, abandoned skyscrapers and the like. The mutant moves at double speed when traveling through trees or through a dense urban area by swinging from one handhold to the next, but is at half speed when it has to run across the ground. 01-50% Two legged, no tail. 51-00% Prehensile tail used primarily for climbing, balance and swinging through trees, etc.; not suitable for using weapons or combat. Bonuses: +1D6 to P.S., +10 to Spd when swinging only, and gets the skills Sense of Balance, Climbing and Climb Rope at 88%.

43-50% Slitherer: The monster moves around either on its belly, like a snake, or on an undulating muscular foot running the length of its body, like a snail or slug. Bonuses: Due to its low body profile and the absence of “footsteps” when it moves, the creature receives the Prowl skill at 50% (or +10% Prowl bonus if it already has the skill) and is +1 to dodge. Slitherers are sensitive to ground vibrations like the footsteps of an approaching mecha or heavy vehicle, as well as seismic events up to 1D6 miles (1.6 to 9.6 km) away. No bonus or penalty to Spd attribute; Slitherers can be very fast or very slow depending on other factors. Their body size is measured by length instead of height.

51-60% Jumper: The mutant gets around by hopping from place to place. It can cover great distances quickly, but is less capable in confined spaces like caves or hallways. Bonuses: +1D4x10 to Spd attribute, and receives automatic leap dodge at +2. However, it can only dodge when it has room to jump twice its height. Any less headroom and it loses the ability to leap dodge and speed is half.

61-70% Floater: This mutation by which the creature gets around by hovering its entire body off the ground, and will immediately mark it as “not from around these parts” if on Earth. The monster does not use wings to hover but either floats due to gas-filled sacks or by tapping into the earth's electromagnetic field and repulsing itself off the ground. This is not a fast way to get around, but it is quiet and virtually impossible to track. Floating predators love to hide in dense overhead cover and drop down on their prey. Very few things, particularly humans, have a habit of looking up to check for danger. Bonuses: Spd is standard (same as running Spd), but those trying to track the mutant or to detect an ambush by it are -20% to do so. The creature has a maximum altitude of 500 feet (152 m), a Prowl skill of 70% (or +15% Prowl bonus if it already has the skill), and is +3 to roll with impact.

71-80% Flyer: This Genesis Pit monster has a pair of wings with which to fly like a bird or bat. This is its primary means of travel, and when it lands it rarely takes more than a few clumsy steps at a time. Bonuses: +1D6x10+50 to Spd attribute number when flying, but running speed is half, and +3 to dodge while in flight.

81-90% Multipede: This mutant has an unusual number of legs. Roll 3D10 for the number of PAIRS of legs the creature possesses (from 6 to 60 legs total). Bonuses: Triple Spd attribute number, receives the Wrestling skill and can perform entangle and body block/tackle attacks (+3 bonus applicable to both), is +2 to roll with impact, does not lose initiative or an attack from being knocked over and gets Sense of Balance at 92%. The size of these creatures should be based on length and not height.

91-00% Teleporter: This mutant gets around by making short-range, line of sight, space folds! This allows it to escape any physical trap as long as it can see somewhere else to teleport. The creature can teleport twice per melee round up to a range of 1,000 feet (305 m), but must be able to see its destination point. The monster often teleports in, snatches prey or strikes at an enemy, and then teleports to somewhere safe before it suffers retaliation. The monster's appearance and disappearance is accompanied by a crack or popping noise, as air rushes in to fill the vacuum created by its disappearance or is pushed outward by its arrival. Bonuses: This Genesis Pit creature automatically has a second means of locomotion, like flying or walking. Roll on the chart again and ignore any roll above 90%, but any bonuses from

the other form of locomotion are half. The monster is also +1 on initiative, +2 to dodge by teleportation and has the Land Navigation skill at 88% (+10% skill bonus if the character already had the skill).

G. Natural Weapons and Defenses

This is what the creature uses to kill its prey and protect itself. Roll twice.

01-05% Acidic Blood: Whether the creature is S.D.C. or M.D.C., it has molecular acid pumping through its veins that can melt through virtually any known substance. The blood is under high pressure and often squirts out at the slightest cut or puncture. Anytime the creature is stabbed, shot, or its skin otherwise broken, there is an acidic blood spurt that has a 01-60% chance of hitting everything in a radius equal to half the creature's height. So if a 10 foot (3 m) tall creature gets stabbed, everyone within 5 feet (1.5 m) has a 60% chance of being sprayed by acid. Damage: 3D6 M.D. per spray, but it continues to bum and do an additional 2D6 M.D. for 1D6 melee rounds. Anytime it depletes the M.D.C. of a structure before it is finished metabolizing, the acid falls onto the surface under it. This means that if acid splashes on someone's armored arm, they have to either take the arm armor off before it bums through or somehow stop the chemical reaction. Trying to wipe or rub it off never works, and only gets the acid onto a new surface to bum. Chemistry: Analytical roll is necessary to determine how to neutralize the acid, but that roll is at -20% if attempted on the spot (like while fighting the mutant) or if done without proper scientific equipment. The creature itself is immune to all forms of acid and blood-borne diseases.

06-10% Bestly Strength: This monster is strong and possesses a pronounced musculature (looks like it is on steroids). Bonuses: +2D4 to P.S., +1D4 to P.E., and its Strength and Endurance are both equal to Robotic.

11-15% Bio-Energy Cannon: The creature's body generates large amounts of energy that it can expel either through a natural biological cannon that grows somewhere out of its body (typically the head, shoulders or back), or it can expel the energy from out of its mouth like a breath attack. Damage: 3D6 M.D. with a range of 800 feet (244 m). It can use this attack twice per melee round. This ability can be rolled twice and the creature can have either two cannons or one large one that does 6D6 M.D. and fires four times per melee round!

16-20% Claws: An old Mother Nature standard. These are either retractable claws that are great for climbing (01-50%), or larger claws used for digging (51-00%). The claws add 2D4 to S.D.C. punch damage or 2D6 to M.D. punch damage, depending on the strength and nature of the creature. Retractable climbing claws give the monster the Climbing skill at 70% (or +10% bonus if it already had the skill). Digging claws allow the creature to burrow its own body length every melee round and it can use this ability to escape from enemies or, if it's smart enough (I.Q. of 7 or better), it can dig pit traps or sand traps for its prey. Attempts to climb out of such traps are at -25% to Climbing rolls, as they are designed to keep prey inside.

21-25% Corrosive Coating: This creature is covered in corrosive slime that damages anything it touches. The coating is thick and viscous, but fortunately, does not continue to bum once it is away from the creature's body. Damage: 2D6 to everything that makes contact with the creature, S.D.C. or M.D. depending on whether the creature is S.D.C. or M.D.C. Double damage to

anyone attempting to body block/tackle, body flip/throw or pin and incapacitate the monster. However, tracking the creature is at +10%, since its footsteps bump the very ground it walks upon.

26-30% Deafening Roar: This monster roars loudly. Very loudly. So loudly, in fact, that it has the chance to stun its prey, rendering it momentarily helpless, and likely turning it into a quick meal. Anyone within 50 feet (15.2 m) must make a save vs insanity of 14 or better or be stunned for an entire melee round (unable to attack, defend, move, speak or take any actions/use any skills). Characters in protective body armor or light mecha in Battloid mode like a Cyclone or Southern Cross powered armor, receive a +4 to save. Characters in fully sealed environmental vehicles are unaffected. This creature can make this attack once per melee round and it counts as two of the monster's combat attacks/actions.

31-35% Electric Shock: The mutant's body generates an electric charge, making it deadly to touch. It can also hurl electrical bolts at short ranges. Damage: 2D6 S.D.C. or M.D. per touch depending on whether the creature is an S.D.C. or M.D.C. being, and can fire an electric bolt for 4D6 damage once per melee round at a range of 600 feet (183 m) from its eyes or hands.

36-40% Engulfing Maw: This creature has a monstrous, gaping mouth that can stretch to twice the diameter of its head. It can attempt to swallow whole any creature half its size, so a 12 foot (3.6 m) tall monster could try to swallow a man. Anytime the creature makes a bite attack and rolls a Natural 18, 19 or 20, the victim is engulfed and pinned if he fails to parry or dodge the attack (include bonuses from both attacker and defender).

Opponents who are engulfed within the maw can hope to kill the creature by firing a weapon blindly (-6 to strike), otherwise they will have to rely on others to save them. A victim that is engulfed will be swallowed in two attacks and if not crushed by the damage will be smothered in two minutes inside the creature's gullet unless he is wearing armor with its own air supply. Damage from the creature's bite is equal to its punch damage. Victims engulfed take double damage every time the creature gets to make an attack or action until they are swallowed.

On the flip side, the mutant can do nothing but attempt to swallow its prey or try to run away and eat in private. It cannot attack others or parry incoming attacks, but it can dodge by running away. Any dodges made by the creature are at -2 while trying to swallow someone or something whole. If the creature is more than four times larger than its prey, the prey is swallowed in one gulp.

41-45% Exoskeleton: The Genesis Pit creature is covered in bony, hardened plates. Bonuses: 2D6x10 S.D.C. or M.D.C. depending on the nature of the creature. Creatures of massive size get an additional 3D6x10 S.D.C./M.D.C., but it also doubles the creature's weight.

46-50% Hypnotic Gaze: This monster's stare has a hypnotic effect that it can use to paralyze or mesmerize anyone it stares at eye to eye. Once the creature makes eye contact, the victim makes a save vs psionics of 15 or better, or else he is hypnotized. When hypnotized, the victim cannot speak, move, or defend himself. He is stuck staring into the beast's eyes. As long as eye contact is maintained and not interrupted, the creature can walk up to its victim and attack. Most creatures try to make that first attack a killing or crippling blow, because once the victim is attacked he is shaken out of the hypnotism and can again try to defend himself. Most creatures with this ability prefer to use it on isolated victims where others cannot interfere.

51-55% Invisibility: The monster has the ability to bend light around itself, making it functionally invisible. This gives the creature a Prowl ability of 88% when invisible (half when visible). It can only be spotted clearly through thermographic vision, sonar or radar. Its footprints can be seen as they are made, and although stealthy, it still makes noise. This power can be maintained as long as the mutant desires, and some never become visible until slain. Those fighting an invisible creature they cannot see are -9 to strike, parry and dodge. If not detected, the creature's first attack is a surprise attack; no chance at defending.

56-60% Poisonous Bite: The monster has fangs that inject a powerful neurotoxin or paralytic poison. Most creatures with a poisonous bite use that bite to disable prey for feeding. 01-50% Neurotoxin does 2D6 straight to Hit Points; save vs lethal poison for half damage. 51-00% Paralyzing poison renders the victim immobile within one melee round after one bite, or immediately after two. Paralysis lasts for 1D4 melee rounds per exposure to the poison. A successful save vs non lethal poison prevents paralysis, but the victim still loses half of his attacks per melee, he has no initiative and is -1 to strike, parry and dodge for 1D4 melee rounds. Obviously, characters in armor are unaffected, as long as the armor holds out against the attacking creature. The bite does damage equal to the creature's punch damage.

61-65% Power Bite: This monster has tremendous teeth and powerful jaws that savage its prey, ripping them to bloody shreds. Often the monster has numerous rows of teeth and replaces them extremely quickly. Damage from this bite is double that of a punch attack, and the creature can make a *power bite* for twice that damage, but such a bite counts as two attacks. +2 to strike when biting.

66-70% Regeneration: The damnable thing heals almost as fast as you can damage it! Every melee round, the creature regenerates 2D6 (S.D.C. or M.D.C. depending on its nature) and must be reduced to its P.E. attribute number below zero to kill it. The creature will often run away when hurt, heal up in private and then attack again at full strength. It can regenerate any limb except the head in a matter of 1D6+6 minutes.

71-75% Smothering/Crush: The mutant could be like a snake and wrap its prey in coils or could be a massive blob of flesh that slops itself over its victims until they stop moving (sometimes beginning to eat them in the process), or encircle its prey/opponent in its arms with a bear hug and crush. In any case, it is a pinning attack that not only renders victims unable to move any limbs that are caught in the vice grip, but also cuts off their air supply and slowly crushes them to death. The creature can only smother/ crush one victim at a time and is vulnerable to outside attacks from other people. It can attempt to parry when it has a victim in its clutches, but it cannot dodge unless it releases him. Damage is 4D6 (S.D.C. or M.D. depending on the nature of the creature) every attack/action the creature makes to crush/smother its captive foe. The smothering attack must be dodged, it cannot be parried.

76-80% Stinger: The monster is equipped with a stinger in either a tail, tentacle or other appendage. The stinger itself is a lancing weapon that can run a man through, but it also delivers a dose of poison that causes damage and intense pain. The jab of the stinger itself inflicts 2D6 damage (S.D.C. or M.D. depending on the creature), and the poison, if successfully injected into a living being, causes 4D6 damage (again, S.D.C. or M.D. depending on the nature of the monster) that causes the victim to writhe in agony for one melee round (no attacks or actions during that

time). A saving throw vs lethal poison means the victim takes half damage and is not in intense pain (can still fight or flee). The creature can attack with the stinger every action if so desired, but each strike attempt with it counts as one melee attack. The poison only works on living beings.

81-85% Tentacles: This Genesis Pit monster has 1D4 sets of tentacles in addition to its other limbs. These tentacles are prehensile, strong, fast and meant for combat. If the beast has 1 or 2 sets of tentacles, it receives one additional attack per melee round. If it has 3 or 4 sets of tentacles, it receives two additional attacks. The tentacles have the creature's normal Physical Strength and do punch damage on a strike. They can extend to up to twice the creature's body length and are +3 to entangle and disarm. They can pin/incapacitate on a Natural 19 or 20, which works the same as it does for the Wrestling skill.

86-90% Quills/Spines: The monstrosity is covered in numerous sharp barbs. These are both a defensive measure, preventing creatures from attacking it without taking damage themselves, and can be used as an offensive attack as well. Trying to grab or physically strike the creature results in 3D6 damage from the quills (S.D.C. for S.D.C. creatures, M.D. for M.D.C. creatures). The monster can also hurl the barbs up to 120 feet (36.6 m) to inflict 2D6 damage. The creature is +2 to parry all attacks.

91-95% Webbing: The monster is equipped with spinnerets on either its jaws, hands or abdomen that allow it to create webs, just like a spider. It can use these sticky tendrils to bind prey and wrap them in a cocoon on a successful entangle attack roll, or once a victim is incapacitated. The webs are extremely sticky and almost impossible to remove quickly. Only someone with the Escape Artist skill can get out of the webbing in one melee round. Most others just get themselves helplessly entangled even further. Web traps are cleverly hidden and require a Detect Ambush or Detect Concealment roll to detect. For specific details on webs and web traps, see the giant Golden Orb Weaver spider description in the Hell Gardens Genesis Pit section. **Note:** The monster cannot "shoot" webs at its victims.

96-00% Supernatural Strength: This monster is strong and possesses a pronounced musculature (looks like it is on steroids). **Bonuses:** +2D6 to P.S., +1D6 to P.E., and its Strength and Endurance are both equal to Supernatural.

H. Special Senses

All Genesis Pit mutants start with the five senses (hearing, sight, smell, taste and touch), but one sense is heightened by their mutation or their natural genetic heritage.

01-10% Antennae or Extra Sensory Organ: Just like an insect, the creature has a pair of long antennae, or feelers. They increase its sense of smell and provide limited motion sensing capabilities. Track by Smell: 60% +2% per level of experience. Identify Smells: 50% +2% per level of experience. Detect changes in wind direction and can smell smoke and strong odors from up to 2 miles (3.2 km) away; base skill is 50% +1% per level of experience. **Bonuses:** +1 to parry and dodge, +2 to Perception Rolls involving scents, and penalties from blindness are half.

11-20% Enhanced Vision: The monster has hawk-like vision able to read a stop sign from three miles (4.8 km) away. It is also keenly aware of direction based on the position of the sun, moon and stars. **Bonuses:** +2 to all Perception Rolls based on vision. Gets the skills Detect Concealment at 60% and Land Navigation at 75%. If the character already had the skills, he gets a +10%

and +15% bonus, respectively.

21-30% Extra-Sensory Perception: Danger Sense: This creature has what can only be described as a sort of *psychic premonition*. In this case, the individual seems to know when danger is imminent or when someone is about to attack, and is nearly impossible to surprise. **Bonuses:** +1 attack per melee, cannot be surprised from attacks from behind or ambushes, and seems to anticipate attacks before they happen, giving it a +3 on Perception Rolls involving danger, incoming attacks and avoiding attacks, +2 on initiative, +1 to strike and disarm, +2 to parry and +3 to dodge.

31-40% Heat Sensors: This ability manifests as pits near the nose or elsewhere on the body, or as thermographic vision. Either way, the creature has the ability to detect sources of heat such as warm engines and mecha, fire, and the warmth of living mammals and people. In darkness, the creature can see opponents via their body heat and can also see in the infrared spectrum of light; no penalty in darkness or being blinded.

41-50% Heightened Sense of Hearing: The monster has incredible hearing, able to clearly make out a whisper 1,000 feet (305 m) away. +2 to all hearing based Perception Rolls, +2 on initiative, and +1 to parry, dodge and roll with impact. Adversaries and prey attempting to Prowl and sneak past or sneak up on this being suffer a Prowl penalty of -30%.

51-60% Heightened Tactile Senses: The mutant's sense of touch is incredibly sensitive, giving it an increased awareness of everything with which it comes into physical contact. The creature gets a +10% bonus to all skills relying on touch, including most Mechanic, Physical and building skills.

61-70% Protoculture Sense: Like the Invid, this creature can see and sense Protoculture. The monster can detect inactive Protoculture and the Flowers of Life at 1,000 feet (305 m), and active Protoculture power sources at 2,000 feet (610 m). **Bonuses:** +2 to strike and dodge vs all Protoculture powered devices and beings.

71-80% Sonar: Like a dolphin or bat, this creature has some kind of natural sonar system. This could be echo-location or it could radiate sonar "pings" via some special organ not present on creatures from Earth. **Range:** 1,500 feet (457 m), doubled under water. The monster is very good at dealing with high-speed threats or targets, and gets a +1 to strike and +2 to dodge projectiles, including arrows, bullets and missiles.

81-90% Superior Sense of Smell: The mutant has highly developed olfactory senses that enable it to sniff out prey and danger. The creature can track by smell at 80% +1% per level of experience, identify smells at 75%, and is +3 to all scent-based Perception Rolls.

91-00% Roll Twice: This creature has two advanced senses. Ignore this result if rolled a second time.

I. Combat Abilities

The creature's basic fighting capabilities. Roll once or choose one.

01-20% Defensive: The creature is most concerned with defense, not getting hurt and escape. If it can run away or hide, rather than fight, it will. Even if a natural hunter, its first priority is to try to come out of a fight unscathed. Number of Attacks: Four per melee round. Bonuses: +4 to parry or dodge (pick one), +2 to disarm and +3 to roll with impact.

21-40% Capable: The monster is not necessarily aggressive, but when it feels threatened, angered or has to fight to defend itself or others, and when it hunts, it is ferocious, capable and deadly. Number of Attacks: Five per melee round. Bonuses: +2 on initiative, +3 to strike and parry, +2 to dodge, +2 to disarm and +3 to pull punch. Inflicts a Critical Strike (double damage) on a Natural 19 or 20.

41-60% Hyper-Aggressive: This is a natural bom killer and likes to practice on anything that threatens, annoys or angers it. In combat, it is a whirlwind of teeth, claws or whatever other appendages it may have. Number of attacks: Six per melee round. +3 to initiative, +4 to strike, +2 to parry, and inflicts a Critical Strike (double damage) on a Natural 18, 19 or 20.

61-80% Mild-Mannered: This creature is rather stoic and tolerant. It tends to ignore intruders who don't bother it, and would rather avoid fighting if possible. The beast engages in combat only when given no other choice. This is the kind of creature you might have to poke a few times with a stick to get it to respond. It will also fight when cornered and threatened, to protect its young or mate, and when blood is drawn. However, the monster stops fighting when its opponent turns tail to run away, plays dead or surrenders/stops being threatening. Number of Attacks: Four per melee round. Bonuses: No bonuses in combat, but +1D6 to P.E. attribute, increase S.D.C. or M.D.C. by 50% (round up), and +2 to roll with impact.

81-00% Skittish: This monster is nervous about engaging in combat and will try to get away and avoid it whenever possible. However, if threatened, cornered or protecting others, it is a decent fighter. Number of Attacks: Five per melee round. Bonuses: +1 to strike and parry, +4 to dodge, +2 to automatic dodge, and has the Detect Ambush skill at 50%.

Creatures from the Pits

The following are a few examples of creatures created by the Invid in Genesis Pits which have somehow spread to multiple worlds and which have successfully bred to sustainable populations. Thankfully, few of them are believed to have found their way to Earth.

Regger Whip

Believed by many to be the inspiration for the *Scrim Inorganic*, the Regger Whip is a vicious, nasty little predator that takes a bite out of anything that moves. Many believe the creature was specifically engineered by the Invid Regent as a terror weapon. What's more likely, however, is that they were designed to thin out the fauna of occupied planets to increase the chance of planting and successful growth of the Invid Flower of Life.

The Regger Whip is about 3 feet (0.9 m) long, dark grayish brown, with a hard cartilage shell covering most of its back and body. From out of that shell emerges eight tentacles armed with poisonous stingers. The creature slithers across the ground on a fleshy pseudopod at high speeds (outrunning them on foot is impossible for humans) and hurls itself at its targets with a chattering, gurgling noise. The stingers are like steak knives, not only poisoning prey, but hacking it up and shoveling the bits and chunks of flesh into the hidden maw in its shell even as it fights.

Described by some in the UEEF as rabid land squids, these creatures are insanely aggressive and always hungry. Avoiding the beasts is nearly impossible, as they have excellent vision and can also feel the vibrations of living things moving nearby.

Despite their small size, they are tougher than most humans, much faster, and utterly relentless. The monster uses no tactics beyond "see it, chase it, kill it, eat it." They attack the first living thing they see and keep at it until it is dead or they are.

They live in broods of 3D6, often nesting in shallow caves or small, abandoned buildings that have fallen into disrepair. Once the brood sees anything moving, they rush it, gibbering and slobbering, lashing out with stingers, running prey to ground and devouring it.

Fortunately, they are still vulnerable to even small side arms, cannot penetrate super alloy armor, and they are not too bright. Still, these creatures have been a pain in the UEEF's side on every Invid occupied world they have ever visited.

Regger Whips breed quickly and just keep eating and attacking everything in their path until they are put down. Whole platoons on Tirol and other worlds are dedicated to eradicating the creatures, which are a serious threat to civilian populations. Luckily, hiding is not on the Regger Whip's agenda. They charge right out and attack without any measure of stealth or cunning.

There are a few people who believe that the Invid intended to use the Scrim's poison nerve gas dispensers to clear out infestations of Regger Whips on conquered worlds once the nasty critters had served their purpose.

The little horrors infest **Tirol**, increasing the belief that there is a Genesis Pit located on the planet. The UEEF works hard to keep them out of the capital city, *Tiresia*, and they hope to clear the beasts out and reclaim some of the smaller cities that have



been abandoned due to Regger Whip infestations or the ravages of the Invid War.

Regger Whip

Nickname: Land Squid or Rabid Land Squid.

Alignment: Though not truly evil, this is a nasty, vicious predator that attacks and kills all living things it sees, and thus is considered Diabolic by most people.

Attributes: I.Q. 2D4, M.E. 3D6, M.A. 1D4, P.S. 3D6, P.P. 4D6, P.E. 3D6, P.B. 1D6, Spd 2D4x10+40 (42-80 mph/67 to 128 km).

Hit Points: 6D6

S.D.C.: 5D4x10

Size: 2-4 feet (0.6 to 1.2 m) long, with tentacles adding another 3-4 feet (0.9 to 1.2 m) in length when fully extended.

Weight: 2D4x10+20 pounds (18-45 kg).

Average Life Span: 10 years, but most get themselves killed long before then.

Natural Abilities: Hawk-like vision (can spot a mouse-sized prey from a mile away), detect motion and vibrations 1,000 feet (305 m), Detect Concealment 60%, Land Navigation 75%, and Prowl 60%.

Attacks per Melee: Five.

Bonuses: +2 to all Perception Rolls, +3 on initiative, +3 to strike, +2 to parry, +4 to dodge, +3 to roll with impact, +2 to disarm, Critical Strike on a Natural 19 or 20, and +2 to save vs poisons and toxins.

Damage: Stinger does 2D6 S.D.C./Hit Point damage for the initial stab or slash. If the stinger breaks the skin, victims must make a save vs non lethal poison of 16 or better or take 4D6 S.D.C./Hit Points damage. After one melee round, the victim

is completely paralyzed for 1D4 melee rounds. On a successful save, damage from the poison is only 1D6 and there are no paralytic effects. A strike with a tentacle without the stinger (virtually never happens) is 1D4 S.D.C.

Habitats: Earth-like planets (oxygen breathers), anywhere there is plenty of food/prey. Because they literally kill everything in sight, they tend to be migratory, clearing out an area of living beings (people and animals) and moving on. They nest in groups of 3D6 in partially enclosed habitats like shallow caves, under rock outcroppings, in bombed-out or abandoned buildings, in basements and tunnels and decaying, crashed spaceships.

Star-Shelled Encephlavore

These are huge, centipede-like monsters who feed upon an organic chemical called dopamine. The name Encephlavore literally means “brain eater,” because that is where dopamine is produced in most living beings. In humans, Robotech Masters, Zentraedi and most other sentient, humanoid species, dopamine is released in the brain as a sort of reward, to make us feel good for doing something the body wants us to do. This has led some to believe that the star-shelled Encephlavore is like a *drug addict*, eating the brains of other creatures to get that rush, with the nutritional value of the brains as an afterthought of evolution.

It is known that the “Brain Eaters,” as they are also known, were developed in Invid Genesis Pits, but for what reason is anybody’s guess. However, they do not attack Invid. This could be because the Invid brain is so different, so alien, that it works in an entirely different way chemically than humans and Robotech Masters (who many believe share some common ancestry).

Star-Shelled Encephlavores are large, weighing up to one ton and growing up to 15 feet (4.6 m) in length. They are propelled on a system of 50 armored legs and sport two lobster-like claws. They are covered in thick armor and get their name from the dark black-blue color and the scintillating little motes of fluorescent light that cover the shell. This adaptation is not just for looks, as the undulating motion of the star-like dots causes a hypnotic effect on many creatures, allowing the Encephlavore to simply walk right up, crack open the victim’s skull and begin feasting.

Their armor, as tough as M.D.C. body armor, can repel small arms fire and they can even survive hits from missiles, energy weapons and gun pods. Their claws are capable of tearing through light armor and in the right circumstances, they can even rip a pilot from his mecha.

The creature prefers to avoid an involved fight, usually only fighting to protect itself. Though they would rather take their prey unawares, alone and without a struggle, they are adequate combatants.

These monsters usually hunt alone or in pairs, and are scattered about the local star group. There have been some unconfirmed sightings on Earth. A Brain Eater requires one adult, human-sized brain per day. However, they have been known to go after full-sized Zentraedi, which they can hypnotize, kill, and prey upon for a week. The monster is a predator, but it is not a man-eating fiend. If it has eaten for the day, it is unlikely to attack unless provoked. They are smart enough, theoretically, to be trained as guard animals, though feeding them can be a bit tricky.

Star-Shelled Encephlavore

Nickname: Starpedes and Brain Eaters.

Alignment: Considered to be Anarchist by most, Miscreant by some.

Attributes: I.Q. 1D6+4 (high animal intelligence, equal to a smart dog), M.E. 1D6+9, M.A. 1D4, P.S. 3D6+10 (considered Augmented P.S.); P.P. 2D6+10, P.E. 2D6+4, P.B. 1D4, Spd 1D4x10+10.

M.D.C.: 4D6x10, can fight at full capacity until it is at its P.E. number below zero in M.D.C.

Size: 11+1D4 feet (3.7 to 4.6 m) in length.

Weight: 1,000 to 2,000 pounds (450-900 kg).

Average Life Span: 60-80 years.

Natural Abilities: Heightened sense of hearing, able to clearly hear a whisper from 2,000 feet (610 m) away, opponents are -30% to Prowl when trying to avoid one. Tracks by sound 70%, Climbing 65% and Land Navigation 50%. Due to its glittering shell and large size, Prowling is impossible and the monster cannot swim.

Hypnotic Attack (Special): The Star-Shelled Encephlavore chooses a target and begins undulating to cause the “stars” to dance (counts as one attack/action). Anyone looking at the creature finds the dancing, twinkling star field attractive and compelling. Each person must roll to make a save vs psionic attack. A 12 or better means they escaped being transfixed. A roll of 1-11 means they are hypnotized and transfixed by the moving star field. Hypnotized victims lose all awareness except for the beautiful colors and star pattern dancing on the monster’s shell. They cannot attack, defend themselves or take any action until they are attacked by the creature or let free of the trance. The Brain Eater picks a specific individual, moves toward him and takes action to crack open the skull and eat the brain. Such a victim stands motionless and allows the attack to happen, screaming only for an instant before the monster takes its first, killing bite of his brain. Hypnotized victims can be shaken out of the trance by someone else, knocked out of the way or jarred to awareness by a loud noise, explosion or the scream of the Brain Eater’s first victim. Even then, they lose initiative and two melee attacks for the rest of that melee round. **Note:** Remember, after the monster has eaten one brain, it almost always (01-90%) slithers off, ignoring any other potential prey. If still hungry, it will repeat the process described above, which works on animals as well as humanoids.

Attacks per Melee: Four.

Bonuses: +2 to all hearing-based Perception Rolls, +2 on initiative, +5 to parry, +3 to dodge, +2 to disarm, +10 to roll with impact and +6 to save vs Horror Factor. Enemies are -2 to strike with a body flip/throw, entangle, disarm or pinning attack leveled at the monstrosity.

Damage: Typically attacks with claws, doing 2D6 M.D. Can also perform knockdown attacks and attempt to pin its opponent under its massive body, provided its prey is smaller than it is. Body block/tackles do only 2D6 S.D.C., but the victim loses initiative and one melee attack. Prey is pinned on the roll of a Natural 19 or 20.

Habitat: Brain Eaters seem to prefer warm, humid climates and tend to avoid large cities and urban areas despite the target-rich environment. Most are encountered in the wilds of alien forests, swamps and caves. Solitary hunters, it is rare to en

counter more than one, and never more than three. The low population means the monster is low priority and most intelligent species tend to avoid them instead of hunting them down.

Reports of giant centipedes on Earth near the end of the Invid occupation may be attributed to Star-Shelled Encephlavores, or they could be sightings of insects from the Florida Hell Gardens or even some as yet undocumented horror from a Genesis Pit.

Fantoman Rukh

One of the largest known creatures, these beings are 100 feet (30 m) long, with a 200 foot (61 m) wing-span and a massive, gaping maw designed for eating large prey. They evolved naturally on the giant world of Fantoma, which has a number of large animals on its surface. Fantoma is also where the Zentraedi were first developed as miners, and the Fantoman Rukh quickly became known as the only living thing that saw the giant Zentraedi as prey.

Zentraedi responded by almost wiping the monsters out of existence. And the Fantoman Rukh would have slipped into extinction if the Invid Regent hadn't learned about them and grown them in his Genesis Pits. Something that hunted and frightened

the Zentraedi was extremely appealing to him. He grew them in Genesis Pits wherever he thought he might encounter the Zentraedi or the Masters and, of course, genetically tweaked them to be the largest, meanest versions he could engineer.

In hard-fought ground campaigns, he would release flocks of them to soften the enemy up, and would feed captured Zentraedi to his own personal Rukhs to amuse himself. As a result, these mutant Fantoman Rukhs can be found on just about any world where the Zentraedi and the Invid fought.

They have a bio-mechanical look similar to Invid mecha, and their wings are bat-like. Their most startling feature is their massive, oversized jaws. This gaping, tooth-filled maw can bite a Zentraedi in half, and the beast is strong enough to grab one of the giant warriors in its maw or claws and fly away with him to finish the kill and eat its prey away from the battlefield. They are fast, but not agile, and operate like dive bombers, ungracefully slamming into their prey, attacking and either devouring it on the spot or carrying it off. Most seem to like to carry their prey away where they can't be attacked by other creatures or have their food stolen by other Fantoman Rukhs. Not satisfied with its massive, ripping jaws, the Regent bred his version to have a bio-energy cannon growing from its chin, and boosted a part of the beast's brain to give it some psionic abilities to sense danger and prey. Fantoman Rukhs are territorial by nature, staking out a range that



can cover a 300 mile (480 km) area, and attack any large animal more than 15 feet (4.6 m) in size. They frequently mistake mecha for prey.

Small, human-sized beings are horrified by the appearance of a Fantoman Rukhs as the monster is just as happy to gobble up tiny humans, as if they were mice, as it is to attack Zentraedi warriors and other large prey, be it animal or humanoid. However, the beasts are likely to ignore tiny humans in favor of *any* larger prey, from cattle and horses, to Veritechs, fighter planes and Destroids, mistaking them for giant prey. Hiding indoors or underground is effective, as the monster is not smart enough to realize prey is inside even if the building is an S.D.C. structure it could easily smash open. Fantoman Rukhs are used to diving on prey out in the open.

Fantoman Rukh

Alignment: Animal predator considered to be Anarchist.

Attribute: I.Q. 1D6, M.E. 3D6, M.A. 1D6, P.S. 30+4D6 (equal to Robotic P.S.), P.P., 2D4, P.E. 4D6, P.B. 2D6, Spd 3D4x10+80 flying, only 4D6 walking on its two, bird-like legs and taloned feet.

M.D.C.: 2D4x100

Size: About 100 feet (30 m) in length, with a wing-span of about 200 feet (61 m).

Weight: 2D6+50 tons.

Average Life Span: 25 years.

Natural Abilities: The Fantoman Rukh is as dumb as a rock, and it is so large, and so much Protoculture is used in creating these creatures, that they register on Protoculture sensors. Invid can detect a Fantoman Rukh five miles (8 km) away, and are always warned to take cover by the Invid Brain or leader in charge when one or more are in their immediate area. However, after the fall of the Regent, there are no Invid active at most areas inhabited by the Fantoman Rukh. (Inorganics don't count, and are programmed to take no action against the giant predator even if they are attacked by it. Hard and untasty, most Fantoman Rukhs take a bite or two and spit the Inorganic out.) **Attacks per Melee:** Five.

Bonuses: +4 on initiative, +7 to strike with bite, +4 to strike with bio-energy cannon, +2 to strike with taloned feet or ram attack, +1 to parry, +3 to dodge in flight(-3 to dodge on the ground!), +2 to roll with impact, +9 to save vs Horror Factor, and its psychic sense makes it almost impossible to bait one into a trap or ambush, unless it ignores the danger. **Mega-Damage:** Bite does 6D6 M.D. and the creature can swallow whole anything 20 feet (6.1 m) tall or smaller. On a roll of a Natural 19 or 20, a target small enough is completely engulfed in the monster's maw and pinned, only able to attack at a -6 to strike. Claw attack does 3D6+3 M.D. and a flying body block/ram/crash attack does 5D6 M.D.

The Rukh bio-energy cannon grows from the bottom of the monster's chin/jaw and inflicts 3D6 M.D. per blast. Range is 800 feet (244 m). It can be fired only twice per melee round and each blast counts as one attack.

Psionic Danger Sense: The Fantoman Rukh can sense when another creature has hostile intentions and when an attack is about to be leveled at it. This psychic sense helps to provide the bonuses listed earlier, and enables the beast to dodge attacks it doesn't see and sidestep/dodge surprise attacks, ambushes and traps. This is an automatic ability that is "on" all the time. There is no trap that can fool this creature.

Habitat: The monster prefers large, spacious lands with large mountain ranges and plateaus, but was evolved and unleashed anywhere the Zentraedi or the Robotech Masters had a strong ground presence. The original Fantoman Rukh has long been extinct, was about 20% smaller, and had no psionic abilities or bio-energy cannon.

Dinosaurs

Earth dinosaurs and prehistoric animals are often found in Earth Genesis Pits. Likewise, dinosaur-like creatures are often found in Pits on other planets. This has to do with evolving and devolving life forms on the part of the Regess, and the desire to create marauding monsters on the part of the Regent.

Described below are a few notable dinosaurs that characters may expect to encounter inside a Genesis Pit. One, all, and/or mutant variations of the creatures described below may be encountered.

Ceratopids

The *Triceratops* is the most famous member of the ceratopid family of dinosaurs from Earth's past. However, there are a wide range of similar creatures. In most cases, other ceratopids have one large horn above the nose, like a rhinoceros, and all have a large protective shield of bone and spikes covering the neck and shoulders. The Triceratops, of course, has three wicked horns, the top two measuring 3-4 feet (0.9 to 1.2 m) long, while the one on the nose is a foot (0.3 m) or smaller. In all cases, the horns are used to fight off predators.

Ceratopids are herbivores that eat grass, weeds, pine cones, nuts, berries, ferns and other vegetation. They can be found in settings as varied as open plains and prairies to forests. Ceratopids gather in herds of 20-80 animals, and may be seen grazing with other herbivorous animals. They are preyed upon by large predators of all kinds as well as pack hunters like raptors and humans. As a result, the dinosaurs consider humans, Zentraedi, Invid and their mecha to be dangerous. That being said, they rarely fight unless panicked, backed into a corner, attacked, or defending their nest or young. As a rule, ceratopids ignore small, slow moving humanoids, and back away from danger whenever they can. However, they are not cowards and will stand their ground and fight to the death when necessary. An attacking ceratopid charges, head down and attacks using its horns like a rhinoceros or bull.

Triceratops Stats Alignment:

Considered Anarchist.

Attributes: I.Q. 1D4+3 (medium animal intelligence), M.E. 1D6+6, M.A. 2D6+6, P.S. 28+2D6 (Supernatural), P.P. 14+1D6, P.E. 18+1D6, P.B. 3D6, Spd 34+3D6; a minimum speed of 38 (26 mph/41.6 km), most have a speed of 40-44 (about 30 mph/48 km).

Mega-Damage by Location:

Head - 200



Tyrannosaurus Rex

- * Horns (3) - 60 each
- * Front Legs (2) - 100 each
- Hind Legs (2) - 150 each
- * Underbelly - 110
- Main Body - 100+1D4x100

* A single asterisk means a small or difficult target to hit and requires a Called Shot at -3 to strike.

Horror Factor: None.

Size: 6 feet (1.8 m) tall at the shoulders, 25-30 feet (7.6 to 9 m) long.

Weight: 4-5 tons.

Average Life Span: 40-50 years.

Natural Abilities: Excellent speed, can run without pause and without exhaustion for four hours, like to wade in water and can hold breath underwater for 1D4+1 minutes, and although constantly eating, can go without food or water for up to three months without noticeable effect. Equivalent skills of Identify Plants & Fruits 80%, Land Navigation 90% and Swim at 55%. **Attacks per Melee:** Three

Mega-Damage: Head Butt 1D6 M.D., jab with horns 2D6 M.D. (typically a warning), stab with horns 4D6 M.D., power stab 1D4x10+8 M.D., stomp 1D6 M.D., tail slash 2D4 M.D., and bite does 4D6 S.D.C.

A running head/horn ram ('counts as two melee attacks'): 2D4x10 M.D. and knocks human-sized opponents 4D4 yards/meters away. Such small opponents, including characters in M.D.C. body armor or power armor, are most vulnerable to such attacks, but even large mecha can be knocked down and damaged (20% chance for mecha up to 70 feet/21.3 m tall). A victim who is thrown or knocked down loses initiative and one melee attack as well as takes damage.

R.C.C. Bonuses: +1 on Perception Rolls to notice predators and threats, +1 on initiative, +3 to strike and parry, +2 to dodge, +3 to roll with impact, +2 to save vs disease and poison, and +4 to save vs Horror Factor. These are all in addition to any possible attribute bonuses.

Habitat: In or around a Genesis Pit.

Dimetrodon

The Dimetrodon is the most well known member of the sphenacodont family of dinosaurs. This beast resembles a giant monitor lizard with a large maw filled with long, sharp teeth and two large canines. Its most distinctive feature, however, is the impressive "sail-fin" on its back, measuring up to three feet (0.9 m) tall. The Dimetrodon ranges in size from 9-11 feet (2.7 to 3.3 m) long and is an aggressive and deadly predator. It feeds on other dinosaurs, smaller animals and humans. The monster finds humans to be easy prey and some become man-eaters. Thankfully, while Dimetrodon may gather in groups of 1D4x10, like alligators along a waterway, they are solitary hunters who travel away from the group to hunt prey. However, if prey falls under attack within such a gathering, 1D6 other Dimetrodon will try to steal the prey for themselves, which can amount to being attacked by more than one.

Dimetrodon prefer marshlands, swamps, and light forests, but are good swimmers and can make a home in most warm environments; cannot tolerate freezing temperatures.

Dimetrodon Stats

Alignment: Animal predator generally considered Anarchist or evil.

Attributes: I.Q. 1D6 (low animal intelligence), M.E. 2D4, M.A. 2D4, P.S. 20+2D6 (Supernatural), P.P. 1D4+16, P.E. 1D6+18, P.B. 1D4, Spd 2D6+6 on the ground with a minimum speed of 10 mph (16 km); double speed for short bursts lasting 1D4 melee rounds. In water, increase speed by 50%. Supernatural P.S. and P.E.

Mega-Damage by Location:

* Head - 110

* Legs (4) - 50 each

Sail Fin (1, large) - 90

Tail (1) - 60

Main Body - 2D6x10+35

* A single asterisk means a small or difficult target to hit and requires a Called Shot at -3 to strike.

Horror Factor:

Size: A total length of 9-11 feet (2.7 to 3.3 m) from snout to the tip of the tail; stands 2-3 feet (0.6 to 0.9 m) tall at the top of the head; sail fin adds three to three and a half feet (0.9 to 1 m) for a total height of around 5 feet (1.5 m).

Weight: 380 to 450 pounds (171 to 202.5 kg).

Average Life Span: 20-35 years.

Natural Abilities: Nightvision 200 feet (61 m), superb hearing, Land Navigation 70%, Prowl 50% (+10% in water), track by smell 70% (+15% to follow blood scent), and Swim at 85%.

Attacks per Melee: Four.

Mega-Damage: Nipping Bite attack 1D4 M.D., full strength bite 2D6 M.D., power bite (counts as two attacks) does 4D6 M.D., and tail swat or claw attack 1D6 M.D.

Bonuses: +2 on Perception Rolls involving hunting, prowling and attacks, +1 on initiative, +3 to strike, +1 to parry and dodge, +1 to roll with impact, +5 to save vs disease and poison, and +3 to save vs Horror Factor. These are all in addition to any possible attribute bonuses.

Habitat: In or around the forests, swamps and waterways of a Genesis Pit.

Pteranodon

The Pteranodon family of flying dinosaurs can be thought of as giant, leather-winged predatory birds that may see humanoids as prey or invaders. Pteranodon may range in size from the size of a condor with a wing-span of 10-12 feet (3-3.6 m) to the size of a Beta in Battloid mode, with a wing-span of up to 60 feet (18.3 m). The Pterodactyl is the most well-known by the average person, but many variations and mutations to be found in any given Genesis Pit.

Pteranodon of a Genesis Pit may be cliff-dwelling creatures or roost in the ruins of tall buildings, crashed spaceships or in tall, large trees. Prey for the largest and most aggressive of these dinosaurs includes humans, horses, cattle, deer, and smaller dinosaurs, as well as carrion. The winged behemoths typically swoop down from above to snatch up their earthbound prey in their taloned feet or large beak, lined with crooked teeth like a crocodile. Their arms are part of their gigantic wings, like a those of a bat, and like the bat, their fingers are quite articulated and used to climb, scale the walls of cliffs and buildings, and tear apart their prey. The dinosaurs vary in color, but most are shades of green, tan or grey. Like most predators, Pteranodon are territorial and have an established hunting ground that spans a 50 mile (80 km) radius.

Pterodactyls and Large Pteranodons Stats

Note About Small Pteranodon: Reduce M.D.C. by half or two-thirds for small species of Pteranodons, reduce P.S. attribute by one-third, Horror Factor by 3 points and most other stats remain unchanged.

Alignment: Animal predator generally considered Anarchist or evil.

Attributes: I.Q. 1D6 (low animal intelligence), M.E. 2D4, M.A. 3D4, P.S. 28+2D6 (Supernatural), P.P. 1D6+18, P.E. 1D6+17, P.B. 1D6, Spd 2D6+6 on the ground or when climbing, but 50+3D6 flying; a minimum speed of 55 (37.5 mph/60 km). Supernatural P.S. & P.E.

Mega-Damage by Location:

* Head/Beak - 100

* Wing Arms (2) - 120 each

* Hind Legs (2) - 90 each Wing

Membranes (2) - 110 each Main

Body - 4D6x10+45

* A single asterisk means a small or difficult target to hit and requires a Called Shot at -3 to strike.

Horror Factor: 14

Size: Stands 10-20 feet (2 to 6.1 m) from head to toe, with a reach of 15 feet (4.6 m) and a wing-span of 50-60 feet (15.2 to 18.3 m).

Weight: 1,000 pounds (450 kg).

Average Life Span: 20-40 years.

Natural Abilities: Good ground and flying speed, can fly without pause and without exhaustion for five hours, prowl (silent flight and dive attack) 70%, track by smell 70%, keen hawk like vision (can see a rabbit two miles/3.2 km away) and superb hearing.

Attacks per Melee: Three.

Mega-Damage: Talon strike with lower legs do 6D6 M.D., wing claws 3D6 M.D., wing slash 2D6 M.D., bite does 1D4x10 M.D., stomp 1D4 M.D., and a diving attack with talons (effectively a power strike that counts as all three melee attacks) 4D4x10 M.D.! It takes one full melee round of flying to set up another diving attack.

Bonuses: +2 on Perception Rolls involving hunting, +2 on initiative on the ground, +3 if flying, +1 to strike on the ground, +3 flying, +2 to dodge when flying, +1 to roll with impact or fall, +5 to save vs disease and poison, and +4 to save vs Horror Factor. These are all in addition to any possible attribute bonuses.

Habitat: In or around a Genesis Pit.

Raptors

The Raptor or more precisely, the Dromaeosauridae family of carnivorous dinosaurs are, generally, small, man-sized theropod carnivores that hunt alone, in pairs and in packs of 6-16. As is typical of this breed of animal, they have powerful hind legs designed for running and leaping, with small, clawed front arms for tearing apart the carcass of their prey. Although a single human clad in Cyclone armor and armed with an energy weapon is a match for one Raptor, he is in trouble and may be torn to shreds by a group as few as three or four. The cunning pack animals use group tactics, with 2-3 striking simultaneously from different sides, and/or taking turns attacking, tag team style, from the sides and from behind. Against large prey like Triceratops and

Duckbilled dinosaurs, 3-6 will leap on the back while one or two strike at the legs, throat and underbelly. A pack of 10-16 have been known to bring down large herbivore dinosaurs in less than two minutes, a buffalo or horse in seconds. A lone Cyclone rider is seen as easy pickings and a pack of Raptors will eye adventurer groups, giant Zentraedi and Invid as potential prey.

The predators typically track and observe their prey for as long as five hours, studying their formation (if a group or herd), picking out the easiest targets (typically the smallest, sick/injured and stragglers), waiting for the most advantageous place and moment to strike, and often testing the prey with mock runs to see how it or they react and make adjustments for real battle. They even use simple combat tactics like ambush, flanking, surprise and divide and conquer.

The larger the pack, the more daring and deadly the raptors become. For example, a pack of 4-6 are likely to back down to an equal number of humans in power armor or Cyclone mecha, but a pack of 8-10 will make aggressive gestures and runs at their human opponents to test their strength and willingness to fight. Any sign of weakness will incite a full on attack. Meanwhile, a pack of 12-16 are generally willing to take on any living creature, with Veritechs, giant Zentraedi and large Invid included. Groups of Raptors larger than this are extremely uncommon because there are too many challenges for leadership and the development of subgroups that challenge the dominant pack members. The leader and second in command of every pack are the two largest *females*. **Note:** Females are 20% larger than males and have 20 more M.D.C. than described below. They lay 2D4 eggs once a year.

Raptor Stats

Raptor Note: There are variety of Raptors, the *Velociraptor* is simply the one best known to people. It has a long snout, as do the *Sauromitholestes*, *Sauromithoides*, and others. There is also the *Dromaeosaurus* with a shorter and more rounded snout. Most are around the same size, so the stats below can apply to any of them. Only the *Deinonychus* is twice as big at **10-** 15 feet (3 to 4.6 m); increase M.D.C. by 40%, P.S. and Spd attributes by 20%, and it does an additional 1D6 M.D. in all of its attacks; all other stats are roughly the same).

Alignment: Considered Miscreant or Diabolic.

Attributes: I.Q. 1D4+6 (high animal intelligence), M.E. 1D6+10, M.A. 2D6+2, P.S. 19+1D6 (Supernatural), P.P. 1D6+17, P.E. 1D6+17, P.B. 2D6+4, Spd 44+2D6 for an average speed of 50 (35 mph/56 km).

Mega-Damage by Location:

Head - 50

Rear Legs (2) - 60 each

Front Arms and Claws - 20 each

Main Body - 6D6+30

Horror Factor: 9 for one, 12 for a pack of 4-8, and 14 for 10 or more Raptors in a pack.

Size: Approximately 4 feet (1.2 m) tall, 6-7 feet (1.8 to 2.1 m) long from snout to tail tip. Only the *Deinonychus* is known to stand 6 feet (1.8 m) tall and is 10-11 feet (3 to 3.3 m) long.

Weight: 70-120 pounds (31 to 54 kg).

Average Life Span: 30-45 years.

Natural Abilities: Excellent speed, can run without pause and without exhaustion for six hours, leap up to 15 feet (4.6 m)

high and 20 feet (6.1 m) across (increase by 30% when running at maximum speed). Can go without food or water for two weeks without ill effect; eats live prey and carrion and frequently takes the kills of other lone predators or small groups. Raptors can smell blood one mile (1.6 km) away, can track by scent 65% (+10% to follow blood scent), track animals and humanoids by scent and vision 65%, Prowl 86%, Land Navigation 80%, Detect Ambush 75%, and Climb 75%/25%.

Vulnerability: Cannot swim and tend to underestimate humanoid opponents.

Attacks per Melee: Four.

Mega-Damage: Bite does 2D6 M.D., clawed feet 2D6 M.D., tail slash 2D6 S.D.C. plus P.S. bonus, small fore-claws 4D6 S.D.C. plus P.S. bonus, and head butt 2D4 S.D.C.

Bonuses: +2 on Perception Rolls of all kinds, +4 on initiative, +3 to strike, +2 to parry and disarm, +3 to dodge, +2 to roll with impact, +6 to save vs Horror Factor - fearless in large packs. These are all in addition to any possible attribute bonuses.

Habitat: In or around a Genesis Pit, but can survive in most environments, from deserts and grasslands to forest, jungle and city ruins, provided there is prey to hunt. Dislike cold climates and mountainous terrain.

Tyrannosaurus Rex

The Tyrannosaurus Rex is perhaps the most famous of all the dinosaurs and has captured the imagination of people for centuries. That being the case, there isn't much to be said about this towering carnosaur. The T-Rex is both a hunter and a scavenger. Its favored prey are large animals that offer little or no danger to it, including other dinosaurs, horses, deer and cattle. Humans can be easy prey too except they often spit fire (energy weapons) and have tough shells (power armor and mecha).

Besides the gaping mouth filled with serrated teeth the length of daggers, characters must beware the beast's slashing tail and the claws of its massive hind legs.

Tyrannosaurus Rex Stats

Alignment: Considered Miscreant or Diabolic.

Attributes: I.Q. 1D4+4 (medium animal intelligence and predatory cunning), M.E. 1D6+6, M.A. 2D6, P.S. 50+2D6 (Supernatural), P.P. 14+1D6, P.E. 23+1D6, P.B. 3D6, Spd 34+3D6; a minimum speed of 38 (26 mph/41.6 km), but most have a speed of 40 to 44 (about 30 mph/48 km).

Mega-Damage by Location:

Head - 280

Forearms (2; useless) - 40

each Hind Legs (2) - 300 each

*Tail - 220

*Underbelly - 300

Main Body - 400+1D4x100

* A single asterisk means a small or difficult target to hit and requires a Called Shot at -3 to strike.

Horror Factor: 16

Size: 25-30 feet (7.6 to 9.1 m) tall and 40-50 feet (12.2 to 15.2 m) long.

Weight: 5-7 tons.

Average Life Span: 25 years.

Natural Abilities: Good speed but can only run at full speed for 15 minutes before becoming exhausted; typically moves along

at about half maximum speed (around 15 mph/24 km). Can go without food or water for up to two months without noticeable effect; lives off the fat stored in its tail. The Tyrannosaurus Rex has excellent hearing and an outstanding sense of smell, so it can smell blood and decaying flesh up to 1.5 miles (2.4 km) away, track by smell 80%, recognize scents 80% and is surprisingly fast and responsive for a creature its size.

Vulnerabilities: Soft underbelly, useless forearms, hates water and cannot swim.

Attacks per Melee: Four.

Mega-Damage: Head Butt 3D6 M.D., bite 2D4x10 M.D., claw attack with hind leg 1D6x10 M.D., kick 6D6 M.D. slashing tail 1D4x10 M.D.

Bonuses: +2 on Perception Rolls involving movement, hunting and danger, +3 on initiative, +2 to strike, +2 to roll with impact, +5 to save vs disease and poison, and +10 to save vs Horror Factor. These are all in addition to any possible attribute bonuses.

Habitat: In or around a Genesis Pit; prefers forest/jungle environments.

Carnosaur Note: Smaller Tryrannosaurids and Carnosaurs like the *Allosaurus*, *Ceratosaurus*, and others, are roughly half the size of the T-Rex. Accordingly, reduce P.S., P.E., M.D.C., and Mega-Damage inflicted from their attacks by half. Most other stats are fundamentally the same.

Florida Hell Gardens

The Miami Ruins

During Dolza's Rain of Death, Miami took two hits from Zentraedi particle beam cannons. One beam hammered into Liberty Square and the other came down just south of Miami Beach, clipping Fisher Island. The blast that landed in the city incinerated everything west of I-95 for dozens of blocks in all directions. The resulting blast flattened much of the city between the airport and the ocean, but left a significant portion of downtown relatively intact. Miami Beach, which is a long island parallel with the Atlantic coast, actually saved the city from a huge tsunami, breaking the massive wave before it could hit the mainland, but much of the city still floods on a regular basis. Such floods are always followed by a Giant Palmetto bug infestation.

Due to massive levels of devastation, it would be 15 years before humans moved back into the city. Most now live in the ruins of downtown between 1st Avenue and the ocean. There were plans for reconstruction, and a *Southern Cross naval base* was built at the Port of Miami, which was once the largest port for cruise liners in the world. One liner still sits partially submerged where it was taking on passengers when the Zentraedi attacked.

The Southern Cross also temporarily reclaimed Miami Airport, but the airfield was abandoned and fell into disrepair after the Second Robotech War. The ruins of hangars and rusting fighters and mecha litter the runways and tarmacs and are

occasionally home to Giant Palmetto Bugs.

The city is now run by a group of Invid sympathizers who struck a deal with the Invid to turn over rebels in return for an end to Invid slave raiding parties that took away a quarter of the population to work on regional Protoculture Farms and Plantation Island. Miami's biggest claim to power, and their primary duty, is the organization of gangs armed with flamethrowers who destroy any saplings from the Hell Gardens that take root east of the airport. This is an ongoing effort to keep the Hell Gardens from spreading into the city. Fortunately, at the early stages of growth, the insects that guard the Gardens are not angered by such actions taken in an area that is not an actual part of the Hell Gardens, and the people of Miami want to keep it that way. It is critical that new growth is detected and destroyed as early as possible.

The local militia, controlled by the city council, keeps order, roots out rebels and also destroys any insects attempting to nest in the city itself. The latter is easily the most dangerous of their duties, especially since they have to do so with small arms, as the Invid will not allow them to use mecha. Most members of the militia are armed with salvaged Southern Cross armor, rifles and side arms.

What the rulers and inhabitants do not know is that they are part of the Invid Hell Gardens experiment. The Invid are curious to see whether the giant insects and various mutant flora will overwhelm the human inhabitants and how these disparate life forms will adapt to living side by side with one another. Therefore, they are wary and aggressive towards obvious outsiders who may come in to ruin the experiment by tipping the scales in favor of humanity, especially if they bring in powerful mecha and weapons, which could also threaten them and the Genesis Pit as well.

The Hell Gardens

Located deep within the Florida Everglades is one of the few **Genesis Pits** whose effects are known to inhabitants for hundreds of miles around. People living in the region have begun calling the area the Hell Gardens. Filled with massive, mutated Invid Flowers of Life, it is a no-man's land due to the pervasive spores and Invid activity. But it isn't the giant, tree-like alien flowers that have people locking their doors at night and never taking their eyes off their children whenever they even come near the Hell Gardens. It is the giant insects that live in, and protect, the region that cause the most concern.

The Hell Gardens are centered on what used to be known as the *Otter Cave Trail* in *Shark Valley*, just west of the Miami ruins. The ground above is pockmarked with holes in the bedrock varying in size from a foot (0.3 m) across to the size of a large truck. Many of these holes go only a few feet deep, but the larger ones extend down hundreds of feet and several lead into a Genesis Pit ten miles (16 km) in diameter. Very few people have been down into the Pit itself, but you don't have to go into the Pit to experience its horrors. Many of its occupants have spread to the surface and dominate the surrounding landscape. The Invid do not seem to care what gets out, as long as the experiments underground are not disturbed.

Of course, most people don't really know that the Hell Gardens are the product of a Genesis Pit, or even what a Genesis Pit is. What they do know is that the region spawns giant, monstrous

insects and other weird creatures capable of overwhelming Veritech Fighters. Many, of course, believe the alien, Invid invaders are somehow responsible, but don't know how, and just try to avoid the sprawling "monster zone" of Florida.

The area is already known for rampant Flower of Life growth, but the first thing a traveler will notice is that all the flowers and vegetation here are larger. And the Flowers of Life that are present are the size of trees, grow even more wild and pervasive, and are *not* tended by the Invid. There are Invid in the area, primarily from a Hive and Invid Protoculture Farm on the gulf coast (on what used to be known as Plantation Island), but they do not harvest these tree-size Flowers of Life. Invid patrols that see humans destroying the tree-sized Flowers of Life will attack them and try to stop their destruction, but in most cases, the Invid do not have to defend the Hell Gardens. Giant insects do that for them.

Through means most people cannot even begin to fathom, insects large and small seem to know when the Hell Gardens are being damaged and attacked, and they rise up together to destroy those who threaten the flora. Bugs that would normally be the deadliest of enemies will work together to rip a Cyclone apart with mandible and claw if the pilot decides to begin blasting the Invid plants. And they are indiscriminate defenders. Once riled up, the insects attack everyone they see within a 1D4 mile (1.6 to 6.4 km) radius of where the attack on the forest/damage is taking place. Anybody within that zone of aggression is likely to be regarded as a "destroyer" and fall under attack. For this reason, humans living in the area often come to the forest's defense to stop outsiders from chopping down trees or causing damage to the Flowers of Life for the sake of their own safety. Thankfully, the insects are content with driving destructive interlopers away, though many invaders are so overwhelmed, they never get the chance to flee.

The mutant Flowers of Life growing on the surface of the Hell Gardens stand 100-200 feet (30.5 to 61 m) tall, and are sometimes confused for alien trees. Most other plant life in the area, including ordinary Earth vegetation and trees, also grow 20- 40% larger than normal. The spores from the Invid Flower fill the air, making face masks, respirators or fully environmental body armor mandatory for any travelers who do not wish to fall under the spores' hallucinogenic influence. Those who do fall under their influence tumble into a realm of delusion and fantasy and may end up wandering the Hell Gardens fighting or fleeing from danger that is not really there for days on end. Some lost souls become raving lunatics who have lived in the forest for years. People familiar with the Flower of Life will notice that many of the Flowers here appear to be hybrids that have somehow been crossed with plants common to Earth. The most common hybrids appear to be crossed with the large variety of ferns that inhabit the Everglades.

The giant Flowers, as amazing and dangerous as they can be, take a back seat to the insects. Deadly mutant dragonflies, Assassin Bugs, giant Wasps and giant spiders make the plants their home and appear to be well-adapted to the Invid spores. Unfortunately for the 50,000 humans living in the ruins of Miami, and other people who live or travel on the outskirts of the region, these monstrous bugs are not confined to Shark Valley, and frequently attempt to spread out into the surrounding area.

Freedom fighters are often called on to destroy new, giant wasp nests being constructed in the burned out husks of Miami skyscrapers, or to go into nearby woods and swamps to bum

giant spider egg sacs before they hatch and begin to prey upon livestock, pets and people. Even the Invid sympathizers who run Miami turn a blind eye to freedom fighters and their mecha if they have agreed to exterminate mutant insects causing them trouble, as long as they do not intend on staying long afterward and they agree not to do anything to antagonize the Invid in the region.

The Invid typically do not react to human attacks on giant insects in the area, and in some cases, have been seen observing the action. However, if the human combatants display a significant amount of firepower or numerous Protoculture powered mecha, the Invid wait until the battle is over and then attempt to slaughter the survivors. As a result, freedom fighters and other do-gooders are wise to make fights short and with minimal pyrotechnics, particularly if Invid have been seen nearby. Human fighters also have to worry about causing an insect uprising if they do too much damage to the Flowers of Life in the Hell Gardens while fighting the bugs.

The giant wasps are considered the deadliest, because without any natural checks and balances, their hives can dominate an area very quickly, and they are the most aggressive of all the insects. Wasps are also very organized and attack en masse, particularly when hungry or their nest has been disturbed. Giant insects have disrupted the ecology of the Everglades in that area, driving out most of the natural creatures that once lived there. That means when the predatory insects get hungry, they often turn their multifaceted eyes on humans and livestock.

The people of North America know that the Invid Flower of Life is linked to the creation of Protoculture, so they realize wherever the flowers are found, the Invid are likely to be nearby. In Florida, however, there are persistent rumors of "secret underground Invid bases" where the conquering aliens are said to be using *giant* Flowers of Life to create some sort of **Super-Protoculture**. For years, freedom fighters, bandits and others have braved the Hell Gardens to find this underground base and obtain this Holy Grail of Protoculture. If any such fuel exists, no one has been able to find it. It is always hearsay, rumors and dead ends. However, if - and that's a big if - it exists, the Hell Gardens seem to be the likely location.

Of course, there is an underground Invid base (the Genesis Pit and its Command and Control Hive) under the Hell Gardens, and enough adventurers have had close calls with the Pit to keep the rumors alive. Most experienced Invid fighters and former UEEF personnel scoff at rumors of Super-Protoculture. After all, even if the Invid did find a way of refining some sort of high-octane Protoculture, why would they process it for use in human vehicles? Common sense would dictate that they would use it for themselves, and the Protoculture the Invid use in their own mecha is unfit for use in human machinery. The Protoculture given to Invid sympathizers in the human-usable Protoculture cells is standard grade material meant to keep the populace docile by providing just enough power to get by and to give their sympathizers the perception of power and control.

Hell Gardens Genesis Pit

Most people think of the Hell Gardens as part of *the Everglades*, infested with tree-size Invid Flowers of Life and monster insects. What they do not realize is that the origin of these mutations is an enormous Genesis Pit hidden below the surface. Unlike most Genesis Pits, this one is shallow, with only a few

hundred feet between the surface of the Everglades and the top of the Genesis Pit. That barely matters, however, because there are large holes cut into the roof to let in sunlight and to let some of the largest, *mutant Flowers of Life* grow out of the Pit. It is also buried shallow and given such large openings to let the giant insects spawned inside the Pit out into the region above ground.

In many places, the floor of the Genesis Pit is a seething mass of giant insects of all kinds, living on a mulch of some kind (and each other) that has collected under a fallen carpet of massive leaves. The spores here are thicker than just about anywhere else on Earth, and at least a breathing mask is required for visitors to survive.

Traveling by air appears deceptively safer, but in truth, the spaces between the flowers are often crisscrossed with the webs of giant *Golden Orb-Weaver Spiders*. Flying higher than that invites attack by *giant wasps* and *dragonflies*. The wasps are the dominant species, however, with several large hives scattered throughout the forest wilderness.

The Invid Command and Control Hive is buried under a massive tangle of roots of the largest specimen of the Invid Flower of Life, which has grown an astounding 400 feet (122 m) tall, right out of the Pit. The Invid Hive almost looks like a natural part of these alien plants. There is only one large chamber to this Genesis Pit. It is ten miles (16 km) across, with the giant Flowers and the Invid Hive at the center. The roof forms a sort of dome, perforated with holes that are 20 feet (6 m) across on average; large enough for many mecha to fly through. The floor of the Pit slopes upward from the low-lying edges to form a tall hill in the center, dominated by the largest of the Flowers of Life, which push through the roof and send tendrils up into the Hell Gardens above. It is almost impossible to tell where the Pit ends and the Gardens begin.

The Hive itself is well hidden, given away only by a faint reddish-orange glow from between the massive roots. The occasional Invid Shock Trooper patrol can be seen coming and going, looking eerily like the wasps leaving one of their giant nests. Along the edges of the Pit are wetlands and grass-filled swamps. Deadly dragonfly nymphs hide under the water, lying in wait for a fresh meal and lashing out at anyone who ventures too close or enters the water.

It appears to be one of the easiest Genesis Pits to get into and out of, but that too is a deception. The giant wasps are quick to attack anything that flies or falls through the holes in the ceiling of the Pit, and several of those holes are covered with enormous spider webs. More than one Cyclone Rider, thinking he was home free, has thrustered through those holes and webs at top speed, only to be snatched out of midair by a spider or an Assassin Bug in hiding on the surface.

Giant Mutant Insects

- Assassin Bugs
- Giant Dragonflies/Mammoth Hawkers
- Giant Palmetto Bugs
- Golden Orb-Weavers
- Killer Wasps

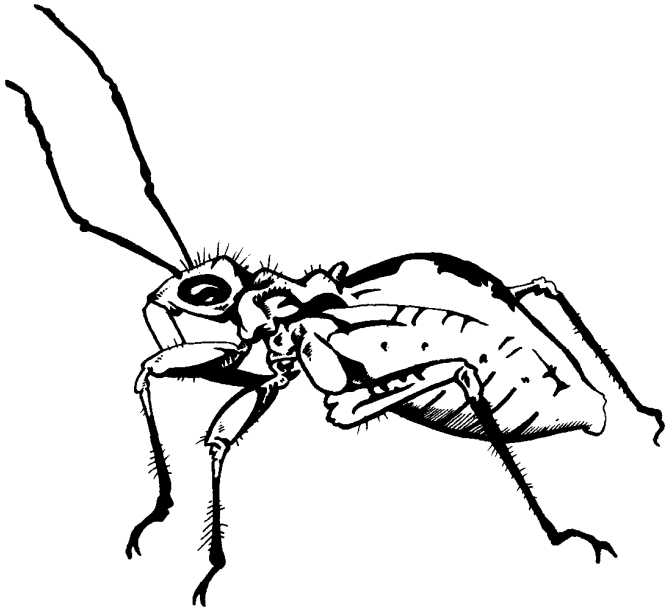

Assassin Bugs

This monstrosity was once considered beneficial to mankind when it was normal size. Now, this ninja of the insect world is a stealthy killer that creeps up on its prey or waits in ambush. When prey is spotted, the insect sneaks close and leaps out from hiding to stab it with a spear-like proboscis that injects lethal, acidic poison into its body. Most people considered that scary when the insect was the size of your thumbnail. At seven feet (2.1 m) long, they are downright terrifying.

It becomes immediately apparent when a Giant Assassin Bug is stalking the Miami ruins because the desiccated bodies of its victims are soon found with their insides dissolved and sucked out. Once a Giant Assassin Bug is located, ranged attacks work best to kill it or drive it off. Just do not let one get the drop on you or you may become its next meal. The trick is finding the insect before it finds you.

Being mutated to giant size seems to have made these lethal predators even more intelligent than before. They are known to have outmaneuvered militia hunting parties, often managing to pick off one or two of the would-be hunters for dinner before retreating back to their lair in the Hell Gardens. Like most predators, Assassin Bugs target easy prey, such as livestock, penned animals and people who are sleeping, sick or injured. Fortunately, their favorite meal is other giant insects, but more and more of them are developing a taste for human innards.

The primary weapon of the Assassin Bug is a long proboscis, which is kept folded under the body until it is whipped out with deadly efficiency. Like the classic stories of the Samurai's sword, it is often a one shot, one kill weapon, especially against a foe not protected by the armor of an M.D.C. mecha or body armor. The Giant Assassin Bug waits until just the right moment before flipping the beak out from under its body and jab it with deadly accuracy into its intended prey. The moment the proboscis penetrates the body of its prey, powerful acid is pumped into the victim. Acid that immediately begins dissolving its internal organs. When the prey collapses, the victorious Assassin Bug drinks the dissolving insides like a living juice pouch. Oh, and the monster is not polite enough to wait until the victim is dead. Once inca-

pacitated by the agonizing pain of the acid racing through the bloodstream, the insect beings draining its prey of precious life fluids and dissolving organs. The lucky ones are struck in the head or near the heart, killing them instantly.

If the Assassin Bug has a fight on its hands, it attempts to maneuver into position to strike with its rapier-like appendage, while using the spikes and spines on its body and legs to keep enemies at bay. It hits hard enough to damage and can eventually kill armored humans or light mecha, like the Cyclone, especially if it aims for the head (which it is smart enough to do). Thankfully, the odds are heavily in favor of the Cyclone. The same is true for anyone who can spot the insect before it spots them. If you see the Assassin Bug first, it is easy enough to avoid it or kill it before it gets close enough to engage its impaling proboscis in close combat. Likewise, if the potential meal proves to be too tough, or has too many allies willing to help fight, the Giant Assassin Bug slinks away to find easier prey.

There are two factors that keep this deadly bug from being an overwhelming horror. First, it is lightly armored in comparison to most insects and Earth mecha, meaning it can be killed or driven off with small arms fire. Second, humans are not its first dining choice. The Assassin Bug much prefers to prey upon other insects and large mammals such as alligators, horses and cattle, among others.

In actuality, without the Giant Assassin Bug, the giant insect problem would be much worse. Far more giant insects die at the sword of this six-legged Shinobi than humans.

The monster is a solitary hunter most likely to be encountered in the Hell Gardens, the Genesis Pit that spawned them or on the outskirts of this danger zone. The creatures prefer environments where they can hide and prowl among the foliage. They rarely go to places of human habitation, and only then if they are very hungry or in the process of defending the Hell Gardens from a perceived threat, in which case the insects fight alongside all the other giant bugs.

Assassin Bug

Alignment: Considered Diabolic by most, because of the gruesome way they eat their victims, and because they are stealthy, ruthless killers that strike without warning.

Attributes: I.Q. 1D6+2 (a cunning predator), M.E. 2D6, M.A. 1D4, P.S. 2D6+10 (considered Augmented), P.P. 2D6+10, P.E. 3D6+6, P.B. 1D4, Spd 2D4x10.

M.D.C.: 2D4x10 + P.E. attribute number.

Size: 7 feet (2.1 m) long.

Weight: 350-500 lbs (159-227 kg).

Average Life Span: Roughly five years.

Natural Abilities: Like most true insects, the Assassin Bug has a pair of sensitive antennae, or feelers, that enable it to detect slight changes in air currents and minute vibrations and provide a heightened sense of smell. The bug takes only half penalties when blind or fighting in total darkness, and can also Track by Scent: 45%; Prowl: 80%; Climb (including up sheer vertical surfaces and along ceilings): 75%.

Acid Spray: Can spray a jet of acid from its sword-like proboscis. This acid completely dissolves an unprotected human and can even melt the super alloys of Robotech mecha. Against M.D.C. alloys, the acid does 3D6 M.D. per melee round for 1D4 melee rounds, but can be stopped by washing it off with water. Range of Spray: 60 feet (18.3 m).

Note: The same acid is injected into the prey it impales with its proboscis.

Attacks per Melee: Three.

Bonuses (in addition to any attribute bonuses): +4 on initiative, +4 to strike (+6 with proboscis), +3 to parry and dodge, and +5 to roll with impact.

Mega-Damage: Proboscis Strike: 2D6 M.D., plus 3D6 M.D. from acid. Ram/Tackle: 1D4 M.D. due to body spike. Leaping stab attack (usually from behind or from hiding): 1D4x10 M.D. plus acid damage, plus the victim is knocked down, losing his next attack and initiative, but counts as two of the Assassin Bug's attacks. On a Natural 20, the victim is pinned by this attack.

Habitat: Both in the Genesis Pit itself and throughout the Hell Gardens, and sometimes in the less inhabited ruins of Miami and other Florida cities.

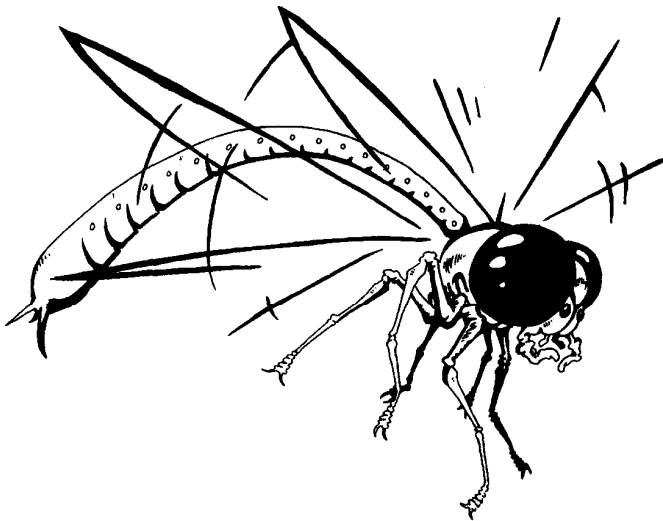

Giant Dragonflies

Also known as Mammoth Hawkers

What the natives of Florida call "Mammoth Hawkers" are actually giant mutant dragonflies. Although usually not interested in humans, the adults can be a danger for any flying mecha, because they instinctively attack fast-moving airborne targets, including the Invid!

These creatures are the largest of the giant insects and are often the first to detect someone causing damage to the Flowers of Life. They are fast, can be deadly to humans and can even damage an Alpha Fighter if allowed to get in close.

But it is the nymphs, which look almost nothing like a dragonfly, that are the real danger to humans on the ground. The immature nymphs are voracious eaters and tireless, merciless predators. Fortunately, they tend to stick to the swampy waters of the Everglades and do not venture out onto dry land. In many ways, young hawkers (an old name for dragonflies) have replaced the role of alligators and large snakes in the Hell Gardens portion of the Everglades. They lie in wait in shallow water, hidden by reeds, logs and undergrowth, and snap at prey that comes within striking range. When prey is snagged in the larva's mandibles, it is dragged under the water, where the nymphs bite and drown their victim at the same time.

Mammoth Hawkings can be seen buzzing and hovering over the Hell Gardens from a great distance, and they are usually the

first of the giant bugs a visitor to the area is likely to see.

Adult Mammoth Hawker

Also Known As: Giant Dragonfly.

Alignment: Considered Anarchist. Attacks flying targets if hungry, and will attack anyone or anything destroying a Flower of Life.

Attributes: I.Q. 1D6 (instinctual predator, poor problem solver), M.A. 1D4, M.E. 1D6+2, P.S. 4D6+12 (considered Robotic), P.P. 2D6+9, P.E. 2D6+9, P.B. 2D6, Spd Flying: 4D6+50 (36-50 mph/57.6 to 80 km), Walking: 2D6+7.

M.D.C.: 5D6x10

Size: 16+2D4 feet (5.5 to 7.3 m) in length.

Weight: 1,000 lbs (450 kg; incredibly light for their size).

Average Life Span: Unknown. Takes two years to reach adulthood. Live for at least 10 years, possibly longer.

Natural Abilities: Extraordinary sight, polarized vision (cannot be blinded by glare), able to see and recognize prey from 3 miles (4.8 km) away, and the placement of the eyes give it an almost 360-degree field of vision. Can only be surprised by attacks from underneath and directly behind. During flight, they can hover stationary and fly backwards and sideways.

Attacks per Melee: Five.

Bonuses (in addition to likely attribute bonuses): +2 to initiative, +3 to strike, +7 to automatic dodge in flight (the act of dodging does not use up a melee attack), and +4 to save vs Horror Factor.

Damage: Bite: 5D6 M.D. Flying Ram: 4D6 M.D. plus anyone flying must make a piloting roll or crash.

Habitat: Swampy areas and wetlands, usually above groves of the Invid Flower of Life. Seeing a large number hovering in one area is often a sign that the giant insects are attacking what they believe to be a threat to the Flowers or the Hell Gardens.

Mammoth Hawker Larva

Also Known As: Dragonfly Nymph.

Alignment: Considered Diabolic and will attack just about any living thing that strays within striking range.

Attributes: I.Q. 2D6 (cunning predator), M.A. 1D6, M.E. 3D6, P.S. 2D6+9 (considered Augmented), P.P. 2D6+7, P.E. 2D6+9, P.B. 1D4, Spd 1D4x10+22 slithering on land and through mud, 30% faster in water, and can swim in water as shallow as six inches (0.15 cm).

M.D.C.: 2D6x10

Size: 1D4+4 feet (1.5 to 2.4 m) in length.

Weight: 3D6x10+120 lbs (68-135 kg).

Average Life Span: 2 years before molting into an adult dragonfly.

Natural Abilities: Sense vibrations and movement up to 100 feet (30.5 m; double in water), Prowl on land 45% (+20% in water), Swim 98%, and is amphibious and able hold its breath underwater for one minute per P.E. attribute point.

Attacks per Melee: Four.

Bonuses (in addition to likely attribute bonuses): +4 on initiative, +5 to strike, +2 to dodge (double in water), +4 to roll with impact, +1 to disarm, +3 to entangle and +3 to save vs poisons and toxins.

Damage: Mandible Bite: 3D6 M.D. Tail Stinger: 3D6 M.D. Body Block/Tackle: 2D4 M.D. **Note:** The monster always

attempts to drag prey underwater to limit its movement and drown. Most people and animals drown in 2D4+1 melee rounds, if they are not bitten and stung to death first.

Habitat: Found throughout the swamps, marshland, ponds and river banks of the Everglades within and on the outskirts of the Hell Gardens.

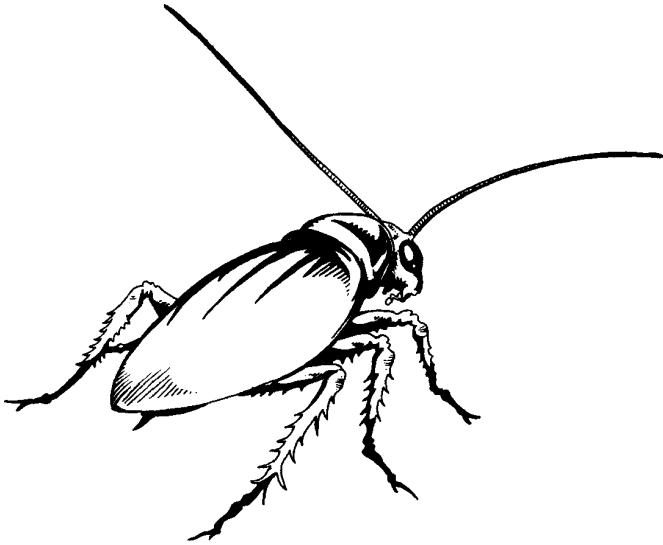

Giant Palmetto Bugs

Ask most Floridians and they'll tell you that normal Palmetto Bugs are large enough as it is. Now, most of us know these things as cockroaches. The only difference is that these cockroaches can fly. In fact, what Floridians call a Palmetto Bug isn't an actual Palmetto Bug, but the common cockroach. For reasons scientists have not figured out, once they go south they start to fly.

In the Hell Gardens, the Palmetto Bug has been grown to the size of an automobile. They are not aggressive or dangerous to mankind as a predator, but they are, indirectly, a serious problem. They eat everything, get into everything and can spread filth and disease. Their musky scent causes breathing problems for people with asthma and other respiratory issues, they defile and devour food supplies, damage crops, and are ugly as sin. They also attract giant predators, particularly the Golden Orb-Weaver spider and Giant Assassin Bugs, for whom the Palmetto Bugs are a favorite meal, as well as other large monsters.

Giant Palmetto Bugs have made the most aggressive incursions into human habitats, particularly the ruins, tunnels and old sewers of Miami. Since they rarely attack humans, they often go unnoticed or are ignored until there is enough of an infestation that something has to be done. Killing Giant Palmetto Bugs and destroying their nests and females carrying egg sacs is its own profession in the city of Miami. Exterminators for hire can make a good living just off the small bounties on these monsters' heads. It's relatively safe, unless someone gets in over their head trying to fight too many, or if they are caught by surprise by a predator who sees them as easier or tastier prey than their usual roach meal.

Giant Palmetto Bugs have little in the way of offensive abilities. At most, they can bite or perform a flying ram attack. They can also trample people in a stampede, but that's usually accidental.

Giant Palmetto Bug

Alignment: Anarchist.

Attributes: I.Q. 1D4, M.E. 1D6, M.A. 1D4, P.S. 3D6+10 (equal to Robotic), P.P. 2D6+3, P.B. 1D4, Spd 1D4x10+6 on the ground; 2D6x10 flying.

M.D.C.: 3D4x10

Size: 6+1D4 feet (2.1 to 3 m) long, and about three feet (0.9 m) at the shoulder.

Weight: 2D4x100 lbs (90-360 kg).

Average Lifespan: Four years.

Natural Abilities: Impervious to Disease, Nightvision 800 feet (244 m), Prowl 40%, Swim 50% and have a pair of well-developed feelers that enable them to smell food (including cooked food, garbage and dead animal, among other things) a half mile (0.8 km) away. Also, the feelers reduce penalties from being blind or fighting invisible foes by half (-5 on all combat rolls).

Attacks per Melee: Two.

Bonuses: +4 to parry, +4 to dodge, +10 to roll with punch, fall or impact, +4 to save vs poisons and toxins.

Mega-Damage: Bite does 6D6 S.D.C. A Power Bite inflicts 1D4 M.D. (counts as two attacks). A Flying Ram does 1D6 M.D., plus victim is knocked down, losing one attack and initiative. If the target of a ram is a moving vehicle or mecha, the pilot must make a control roll at -5% to stay on course and avoid crashing.

Habitat: In theory, anywhere there is a food source, be it grain storage, a market, slaughterhouse, garbage dump, or even places with large amounts of paper or wood, which they also eat. At the moment, the bug is found in greatest numbers in and around the Everglades, forests and Genesis Pit of the Hell Gardens. However, they are starting to spread into the ruins of other cities, farmlands and crashed spaceships throughout southern Florida. If left unchecked, it is only a matter of time before the creature spreads throughout North America.

Golden Orb-Weavers

The Golden Orb-Weavers are another deadly predator of the Hell Gardens. The giant spider stands 7-8 feet (2.1 to 2.4 m) tall and feeds on other giant insects, animals and humans alike. They weave massive, beautiful webs that glisten like gold in sunlight, thus their name. The webs can be dangerous and deadly traps, but they also have some beneficial uses as well.

Golden Orb-Weavers typically wait in their webs for someone or something to foolishly blunder into it. Despite the scintillating colors and strands as thick as steel cables, the webs are sometimes artfully hidden, with strands cutting across paths under carpets of leaves, or parts of the web just on the other side of dense bushes.

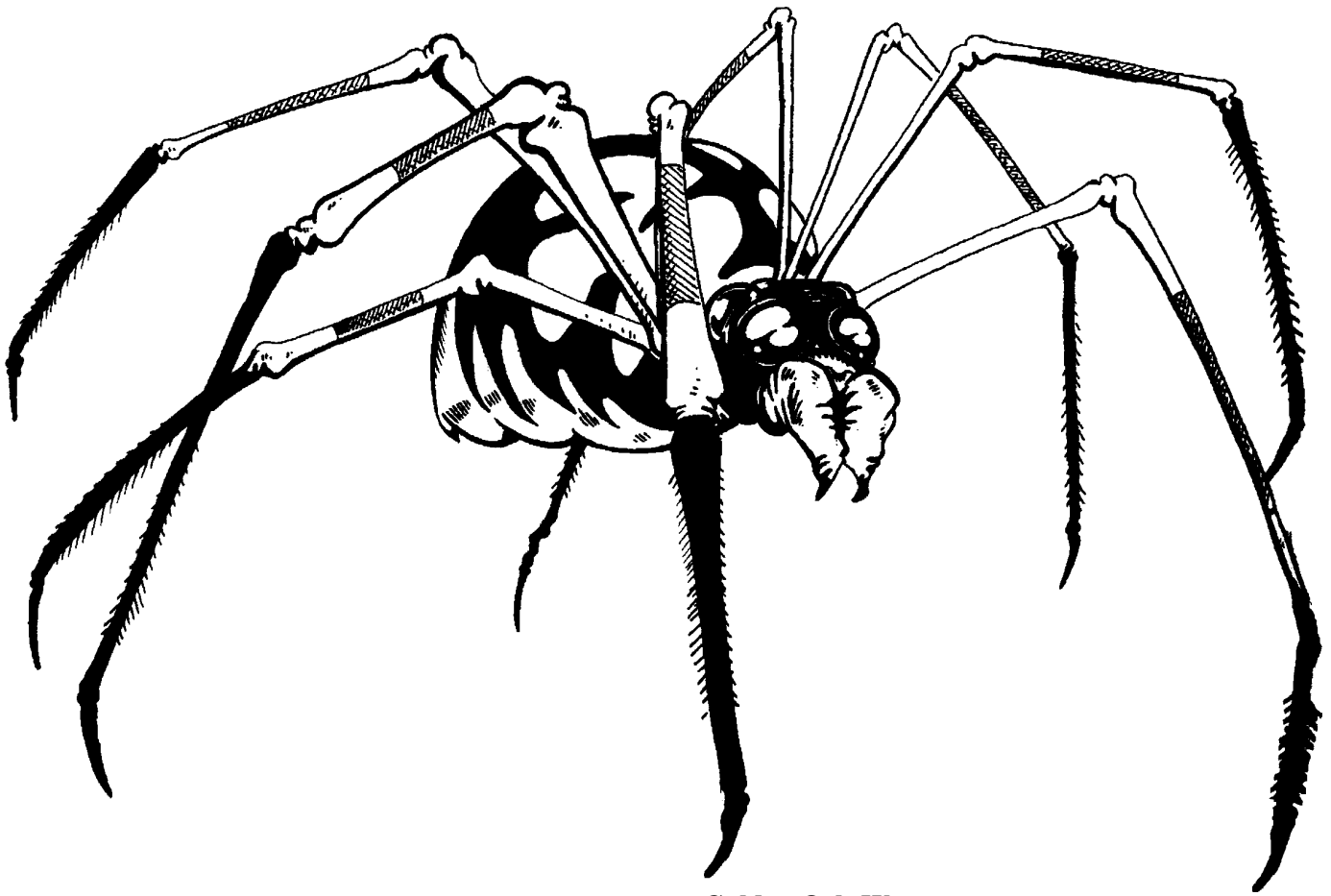

These webs are covered in a powerful adhesive and anyone who comes into physical contact is stuck fast, unless they can be cut loose. In most cases, struggling only makes things worse, as more strands get stuck to the victim and bind him further. The struggle sets the giant web vibrating, alerting the spider that dinner has been caught. The Golden Orb-Weaver will rush in, biting at the prey with a deadly neurotoxin and wrapping it up further in more webbing. Once the prey is fully trapped, it is either carted off to the center of the web to be eaten later, or killed and eaten on the spot. The Golden Orb-Weaver kills in a manner similar to the Assassin Bug, injecting powerful enzymes into its victim that break down the internal organs into soup that the monster then slurps out, leaving a desiccated husk.

The Golden Orb-Weaver is not always content to stay in its web and wait for its next meal. It will sometimes go hunting for prey, laying down hidden carpets of webs and then pouncing from cover when a meal gets stuck. Besides its vicious, poisonous bite and sticky web, the giant Golden Orb-Weaver has powerful legs, used to stomp, kick and help entangle prey.

In most cases, the females are the ones encountered. They are 10 times the size of the males and typically the ones who spin the intricate webs. Males tend to live on their webs and wait for the female to catch something, then rush in to eat when it's safe.

Golden Orb-Weavers lay hundreds of eggs at once, which are generally wrapped in a large bundle of silk and stuck to the side of a tree or building. Most humans who find one of these sacks will attempt to bum it before the spiderlings hatch. This is likely to incite an attack by the female, who is never far off.

Golden Orb-Weaver

Alignment: Anarchist, predatory creature that only attacks when hungry or to defend the Invid Flower of Life or its own young.

Attributes: I.Q. 2D4, M.A. 1D6, M.E. 2D6, P.S. 4D6+10 (considered Robotic), P.P. 5D6, P.E. 3D6+6, P.B. 2D4, Spd 6D6+10.

M.D.C.: 4D6x10

Size: Stands 7-8 feet (2.1 to 2.4 m) tall and the body is 8-10 feet (2.4 to 3 m) long with a leg-span of 20-30 feet (6.1 to 9.1 m).

Weight: One ton.

Natural Abilities: Nightvision 500 feet (152 m), see in the infrared light spectrum, sense vibrations 400 feet (122 m), set traps and snares 45%, and Prowl 50%.

Spin webs: The Golden Orb-Weaver is a prodigious web spinner, able to create a 180 foot (55 m) diameter web in one night. It can also quickly spin webs to help capture foes. Golden Orb-Weaver strands are six times stronger than steel and take up to 5 M.D. to cut through, meaning an S.D.C. blade is not sufficient. They can be burned through with normal fire (like a lighter), lasers and other energy weapons, or ripped apart by mecha. While M.D. energy weapons will cut through one strand per blast/attack, it takes a full melee round to bum through one strand with normal fire. However, the webs stick to everything they touch, so unless someone has the skill Escape Artist, they have only a 20% chance of actually tearing free in just one melee round; 1D4+1 is more typical because any efforts to cut or tear loose result in getting tangled in more strands. Roll at every attempt to break free.

First, roll 1D6 to determine how many strands the character is initially stuck to.

Next, roll on the following table to determine success:

01-10% The character has severed or destroyed a single strand without getting caught in more.

11-25% The character has severed or destroyed 1D4 strands without getting caught in more and may be free!

26-60% The character has ripped or destroyed 1D6 strands only to get caught in 1D4 more of them.

61-90% The character has severed or destroyed 1D6 strands only to get caught in 1D6+2 more, has become more entangled, and loses one melee attack, all combat maneuvers are -2 (with cumulative effect) and the victim could continue making things worse until he has no attacks left (completely entangled!) or the spider attacks. Unless distracted by multiple choices of prey, the Golden Orb-Weaver spider rushes out to pounce on its stuck prey in one melee round!

91-00% **Lucked out** and broke free of all strands and is able to drop to the ground or pull free of the web. There is only a 01-15% chance that the giant spider will attack prey that is free of its web and on the ground or hovering in the air. No likelihood of pursuing prey that has escaped if there is other prey trapped in the web.

Attacks per Melee: Four.

Bonuses (in addition to likely attribute bonuses): +3 to initiative, +2 to strike (+5 when victims are stuck in the web), +2 to parry and dodge, +4 to roll with impact, +4 to save vs poisons and toxins, Critical Strike from behind, and +3 to save vs Horror Factor. **Note:** Hates fire and it has a Horror Factor of 16 for the monster.

Mega-Damage: **Kick Attacks:** The Golden Orb-Weaver spider can kick and stomp with its front legs, doing 1D4 M.D. and kick harder with its back legs, doing 2D4 M.D.

Poisonous Bite: 4D6 M.D., plus living creatures must make a save vs lethal poison (14 or better) or the neurotoxin does 2D6 directly to Hit Points (or M.D.C. if applicable) and causes agonizing pain. Victims of the neurotoxin lose half their attacks per melee and reduce all combat bonuses by half. A successful save means the victim only takes 1D4 S.D.C. damage (not directly to Hit Points) and loses one melee attack; no other penalties.

Web Entanglement Attack: When the spider rolls a Natural 19 or 20, the Golden Orb-Weaver begins to wrap its prey in webbing. The victim must parry or dodge or be swept up and spun around over and over as he is wrapped with more webbing. Victims of web entanglement lose two melee attacks on the initial web entanglement and cannot run or fight until they break free of the webbing. Each subsequent web entanglement attack reduces the trapped victim's number of attacks by one, until he cannot move at all. Each spider web attack counts as two melee attacks/actions for it. The webbing is strong, sticky and difficult to break. It has a 2 M.D.C. per web entanglement attack and the more the prey is covered in webbing, the more M.D.C. the silk cocoon has. To tear free of a cocoon with only 1 M.D.C. requires a Robotic P.S. of 26 or greater, otherwise human victims may cut themselves lose with an M.D. blade or blast their way free, or hope that a teammate will come to their rescue before it is too late. **Note:** An additional 6 Robot P.S. points are required for each additional layer and 2 M.D.C. of webbing. "Prey" captured in a web cocoon are usually carried by the spider up into its web and kept to be eaten at a later

time (6D6 hours later). The webbing is porous, so people and animals not in environmental armor can breathe, they just cannot move, because the spider keeps webbing them up until they cannot move or attack.

Habitat: So far, the giant spiders are found in greatest numbers in and around the Everglades, forests and Genesis Pit of the Hell Gardens. However, they are also encountered in the ruins of other cities and crashed spaceships throughout southern Florida and can survive in any warm climate. It is only a matter of time before the creature spreads throughout the American South, Southwest and into Mexico. There are unconfirmed reports of the occasional giant spider reported as far west as Mississippi.



Killer Wasps

Believed to be mutated paper wasps, Killer Wasps grow to the size of a small pony and live in hives of 4D6x10 members. They can dominate a five mile (8 km) area around their hive and are a threat to all living things in their territory. And yet, they do not eat meat. At least the adults don't. They live on nectar, making them ideal pollinators even at giant size. Moreover, many live off the nectar of the Flower of Life. The threat to living creatures comes from the need to feed their larvae. They sting their prey, paralyzing it, and fly it back to the nest, where the unfortunate victim is eaten alive by dozens of blind, hungry wasp larvae. In return, the larvae create sweet secretions that the adult wasps eat.

Like most social insects, Killer Wasps live in hives, have a queen who founded the colony and lays the eggs, and work together to eat and survive. That includes fighting to protect the nest. Killer Wasps are territorial, which is where the problem for humans arises. The aggressive insects are quick to attack any creature they consider to be a threat to the hive. Moreover, they send out regular patrols and scouting expeditions, posting guards at hive entrances, and use tactics that include flanking maneuvers during battle. Wasps, like humans, are one of the few creatures on Earth that actually recognize individuals by facial features, so they cannot be fooled with scents or other ploys into thinking adventurers are allied. They recognize every member of the hive on sight.

Giant Killer Wasps are the most feared of monsters in the

Hell Gardens. Killer Wasps fear nothing and unlike bees, they can use their deadly stingers over and over, and also have powerful jaws capable of peeling open an armored vehicle like a tin can. They typically only bite defensively, however. Their stinger is their favorite weapon when on the attack. Even a lone individual is aggressive and may attack Invid and mecha. However, what makes them so deadly is that it is rare to encounter only one giant wasp at a time.

When a threat is detected away from the hive (beyond two miles/3.2 km from the nest out to about five miles/8 km), 1D4 of the monstrous insects study all outsiders in "their territory." If the intruder is assessed to be nonthreatening, the wasps fly away. If the intruder(s) seems like a potential threat, the Giant Killer Wasps will make a flyby pass to get a better look and to assess the danger level. While the wasps *might* attack, odds are they'll keep their distance, but shadow the intruder(s) and potential threat. When an intruder gets within two miles (3.2 km) of a nest, 1D4+1 additional Killer Wasps join the first set; alerted by both the sound of agitation in the first wasps' flight patterns and a danger scent that is exuded and detectable only by other Killer Wasps.

These wasps continue to watch the interlopers and there is a 01-60% chance 1D4 will buzz and even bump the intruder(s). Others hover right in the face of the unwanted visitors as if to say, "You don't belong here, turn around while you still can." Actually, that's exactly what such behavior means. Failure to heed such visual cues results in the wasps attacking. If all the attacking giant wasps are quickly slain (in three melee rounds/45 seconds), it will delay the inevitable onslaught of more Killer Wasps flying in to attack. However, the same conflict will play out again within 2D6 minutes as more wasps in the area take notice of the intruders. One quarter that time if the intruders are traveling fast and near, or heading toward, the nest. The next flyby is likely to have 2D4 Killer Wasps in the group. Killing these wasps or upon coming within one mile (1.6 km) of the nest, the intruders should expect 1D6 additional Killer Wasps to join the attack every 30 seconds (two melee rounds). If this results in obvious, loud or prolonged combat - and it usually does - or when the intruders get within a half mile (0.8 km) of the nest, 2D6 Killer Wasps join the battle every 15 seconds (one melee round).

It there is any good news in this onslaught, it is that Killer Wasps will settle for driving intruders/threats away from the nest, rather than demanding their destruction. However, away from the nest, especially after a confrontation, means at least three mile (4.8 km) away, and the nest will be on alert for the next 1D6+6 hours with increased patrols of at twice the usual number of wasps harboring even greater aggression toward intruders.

Attack the nest and expect 4D6 Killer Wasps to join the fray every 15 seconds (one melee round), and they fight with their last dying breath until the intruders are destroyed or driven at least 2D6+6 miles (12.8 to 28.8 km) away. Note: In all combat situations, Killer Wasps fight until destroyed or until the perceived "threat" is driven an acceptable distance away.

Killer Wasps are rampant in the *Hell Gardens Genesis Pit*, where two large nests are located. Anyone entering the Pit needs to keep out of sight or risk attack. The giant wasps will even attack and take down Invid Scouts, but the Invid seem to accept the rare loss for the sake of their ongoing experiment.

Killer Wasp nests are a major threat to the humans in the Mi-

ami ruins and the smaller villages on the edge of the Hell Gardens and throughout Florida as far north as Pensacola. Any resistance fighters or adventurers who are hired by the locals to hunt giant insects are probably being hired to specifically hunt Killer Wasps. The locals, even Invid sympathizers, would rather risk the lives of strangers than their own. If the mercenaries are successful, all the better. If they die in the attempt, it's no big loss, and the Killer Wasps often leave working mecha and weapons behind where their victims fell, which Invid sympathizers can claim for themselves.

If any of the creatures from the Hell Gardens could threaten the fragile ecological balance of the Earth, even after the Invid have left, it is the Giant Killer Wasps.

Killer Wasp

Alignment: Considered Diabolic at worst, Anarchist at best.

Attributes: I.Q. (individually, 1D6, but treat any group of 4 or more as having a collective animal intelligence of 1D6+5), M.E. 1D6+9, M.A. 1D6+5, P.S. 2D6+19 (considered Robotic), P.P. 2D6+15, P.E. 2D6+9, P.B. 1D6, Spd 1D4x10+44 flying (36-80 mph/58 to 128 km), 4D6 walking.

M.D.C. 4D6x10 (queens are about twice as large and have double the M.D.C., but never leave the hive).

Size: 5 feet (1.5 m) long, 11 foot (3.3 m) wing-span.

Weight: 1,000 lbs (450 kg).

Average Lifespan: Five years.

Natural Abilities: Antennae make penalties when blind or fighting in total darkness half, and track by scent 40% (+25% to follow warning/danger scent and the scent of the Flower of Life), plus Land Navigation 96% and Identify Fruits and Plants/Flowers 60%.

Attacks per Melee: Four.

Bonuses (in addition to likely attribute bonuses): +3 to initiative, +5 to strike with stinger, +1 to strike with all other attacks, +1 to parry, +2 to dodge, +6 to automatic dodge in flight (the act of dodging does not use up a melee attack), +2 to save vs poisons and toxins, and impervious to Horror Factor. **Mega-Damage:** **Bite:** 1D4 M.D.

Restrained Stinger: 4D6 S.D.C. or 1 M.D. against M.D.C. opponents. The Restrained Stinger attack is used to paralyze S.D.C. creatures (like humans) so that they can be transported back and fed to the young in the hive.

Full Strength Stinger: 2D6 M.D., plus poison causes pain and paralysis. Victims who fail a save vs non lethal poison (16 or better) are stricken with immediate agony, lose initiative, reduce Spd and their attacks per melee by half, and all combat maneuvers are -6 (to strike, parry, etc.). By the start of the next melee round, the victim becomes paralyzed for 1D4 rounds. The penalties linger for 1D6 minutes after the paralysis wears off. Those who save vs non-lethal poison are not paralyzed, and only lose one attack per melee for that first melee round. **Habitat:** The giants prefer warm, humid environments with lots of flowering plants and/or the Invid Flower of Life. At the present, the Killer Wasps are found in greatest numbers in and around the Everglades, forests and Genesis Pit of the Hell Gardens. However, they are starting to spread into all of Florida and neighboring Georgia and Alabama. If left unchecked, it is only a matter of time before the creature spreads throughout North America.

Gura-Invid & the Grand Cannon

At the time of the First Robotech War, the *Grand Cannon* was meant to be a marvel of Robotechnology. The pinnacle of achievement in the use of Protoculture and Reflex Weaponry. Built deep into the earth on the site of Eielson Air Force Base in Alaska, the Grand Cannon was a massive particle beam cannon built on the same design principles as the main gun on the *SDF-1*. The plan was to have several Grand Cannons around the world which would be able to protect the Earth no matter what direction invaders approached from. When the Zentraedi attacked the Earth, the Grand Cannon in Alaska was operational, but the others were still under construction. Still, the cannon inflicted significant damage on the enemy fleet when fired, even without the ability to aim with much accuracy.

The success of the Grand Cannon was short-lived. The cannon was knocked out by the Zentraedi retaliation and suffered a reactor meltdown that killed nearly its entire staff. *Commander Lisa Hayes* was one of the only survivors, and she may have perished as well if not rescued by ace pilot *Rick Hunter*. The two would eventually marry and lead the joint expeditionary force into Tirolian space in search of the Robotech Masters. It would be on Tirol that humanity would confront the Invid for the very first time.

For years, the site of the Grand Cannon has been rumored to still contain treasures of Robotechnology and secret Protoculture stores, but it was too far removed from the rest of civilization and too hot with radioactivity to settle or explore. A number of flyovers throughout the years by Veritechs and satellites returned images of a rusting, collapsed entrance and high radiation signatures lethal to human life.

Then the Invid came.

Attracted to the powerful Protoculture emissions at the Grand Cannon, the Invid scrubbed the radiation from the site to levels they believed were safe for them, and explored the ruins of the old military wreckage. Typical of Invid behavior, they walked right over completely intact *Destroids* and *Valkyries*, as well as weaponry and other pieces of technology from the First Robotech War because they were powered down and of no interest to them.

Impressed by the size and sturdiness of the underground military complex and tunnel housing for the massive cannon, the Regess turned the former Grand Cannon into Earth's first Genesis Pit.

Before she decided it would be best to alter the Invid to adapt to the Earth, the Regess originally had the idea of altering the Earth into a new version of *Optera*, and returning the Invid to their natural state. The Grand Cannon was the test bed for terraforming the planet to suit their natural form and reestablishing Opteran species of flora and fauna from the Invid home world in and around the Grand Cannon. Genesis Pits were often used for terraforming other planets, and this would be no different.

It was not to be.

The ambient radiation the Invid did not clean up, combined with the unearthly powers of the Genesis Pit and the Regess's unfamiliarity (at the time) with the Earth's biosphere, resulted in mutations even among the *Invid* and their *bio-mechanical mecha*. The Invid Brain in charge of operations at the Grand Cannon Invid Hive discovered a number of Invid had fused with their mecha and could not be removed from them. Later, their mecha began to mutate as well. The Brain reported its findings to the

Regess, who, after some consideration, allowed the mutations to continue.

Why? Only the Regess has that answer. Curiosity, more likely than not. It is likely the Regess saw the transformation as the workings of fate or a new possible path for the Invid, and she wanted to see what would become of these mutating specimens. When the mutated Invid grew in number and became less and less controllable and predictable, the Regess decided to remove her unaffected Invid troops from the Grand Cannon Hive, leaving only a few of her Scouts to observe the mutations in secret and from a distance, never staying long within the Genesis Pit, the Hive or the surrounding ruins of the military compound. The isolation of this Invid Hive and Pit located within the desolate Alaskan wilderness made it the perfect laboratory for this new and exciting Genesis Pit experiment.

With her psyche stretched across an entire species and constantly probing the cosmos for threats and new sources of Protoculture, the Regess is distracted and sometimes forgets about "side projects" like the one going on at the Grand Cannon Genesis Pit. Sometimes she leaves them without thought or consideration for decades, especially if they no longer fit with her current plans. So it is that the Grand Cannon Genesis Pit has been left to evolve on its own. The Invid there are continuing to change as they take a different evolutionary path. Someday, the Regess will return to see what has blossomed from this experiment, but when that might be is anybody's guess.

Unbeknownst to the Regess, something wholly unexpected has occurred: They have begun to breed and grow in numbers.

The Grand Cannon Genesis Pit

In its day, the Grand Cannon was a marvel of human achievement, made possible by Reflex weaponry and Earth's ever-growing understanding of Robotechnology. It was literally a giant cannon built right into the ground with a military compound built around it. The muzzle of the cannon is 9 miles (14.4 km) wide, and the barrel and power planet descend a total of six miles (9.6 km) into the Earth. The cannon also served as a military command base for the United Earth Government (UEG), doubling as a planetary command and control center and as a (theoretically) protective bunker against aerial and orbital bombardment.

Despite all that, the Grand Cannon was considered a boondoggle and useless showpiece by many of its detractors. They argued that the only way it could be effective was if an enemy accidentally stumbled into its very limited firing arc. The answer to this was to be a series of Grand Cannons which would have been able to defend the Earth from any angle, but technical difficulties and budget issues resulted in delay after delay, and the other cannons were never finished.

Of course, no one expected the sheer size of the Zentraedi fleet or the magnitude of their attack, which brought even this massive weapon into play. The cannon was fired just one time during the climactic assault on Earth by Commander Dolza's fleet of five million warships. Despite the gun's limited ability to aim, some reports estimate that the Grand Cannon destroyed more

than 700,000 Zentraedi starships. But after that one attack, even its hardened underground structure could not withstand the bombardment unleashed by the Zentraedi. The base was devastated, and nearly everyone in it was killed. The structure itself, stocked with Robotechnology, was too damaged and flooded with radiation for humans to use the ruins for any purpose. As a result, the contaminated ruins of the Grand Cannon were designated a hazard zone and abandoned. By the end of the Second Robotech War, it was all but forgotten, at least until the Invid found a use for it.

The base, like the cannon itself, was built around a Y-shaped, cylindrical shaft into the earth, much like a giant martini glass stuck in the ground. The muzzle, two miles (3.2 km) deep, is the top part of the Y. The focusing lenses and power plant are the bottom part of the Y. The upper section of the shaft housed machine shops, troop quarters, support staff, combat forces, supplies and mecha to operate and defend the base. The surface itself doubled as a large airfield and landing pad for the numerous shuttles, jets and helicopters that traveled to and from the base. The *communications nexus*, coordinating information from across the Earth and beyond, was, by necessity, placed close to the surface.

The *Command and Control Bunker* was located deep near the bottom of the shaft, close to the massive *Reflex Furnace*. This was to keep the top brass of the base safe from attack. In the end, however, it was their death sentence, as the overloaded Reflex Furnace blew up, wiping out the heads of the UEG military command structure.

When the Invid moved in, they built the core of the Genesis Pit on top of the ruined reactor, with the Mutation Pit and Invid Brain Control Room located in what was once the massive engineering control section at the very bottom. It has since become the Vicereine's Chamber within the Gura-Invid Hive. This lower central shaft is ringed by thousands of Gura-Invid eggs and larvae. The Gura-Invid under the command of a Gura-Invid Vicereine use the rest of the bottom and lower section of the shaft as housing for the Scouts, Hunters, Workers and Warriors. At the very bottom and center is the Mutation Pit where the Vicereine is usually located. She has, on occasion, thrown people or other living things into the Pit, and it is given a wide berth by the rest of the Gura-Invid. There's no telling what the radiation from the Pit is doing to them over time.

The Vicereine's male counterpart, *the Viceroy*, and his Gura-Invid legion, occupy the surface area that was once the airfield, and the upper portion of the Grand Cannon is where a second Gura-Invid Hive and Genesis Pit is located. It is nearly identical to the one at the bottom of the Grand Cannon in every way. The uppermost levels of the facility had served as hangars and took the heaviest damage during the Zentraedi attack. Much of it had caved in or partially melted, and then the nuclear winter came, choking the hallways with radioactive snow and rainwater, the weight of which caused more structural collapse.

The two Hive leaders and their Monster Invid tend to behave as if the other Hive does not exist; ignoring each other and going about their own business. Even when the members of one Hive come within inches of the other, they act as if they do not see each other and continue to go about their separate business as if the others were ghosts. This further suggests the two Gura-Invid Hive leaders may be twins that coexist in parallel Hives, separate and apart, but equal within Gura-Invid society. Mirror images of some twisted Invid experiment gone haywire. If the Grand Can-

non should be invaded or fall under attack, both forces would fight the enemy, with each force following the directives of its own Hive leader and only coordinating with their own troops. They never work together.

Both Gura-Invid Hives pay little attention to the technology that man left behind. While much of it has deteriorated, there are a number of mecha storage bays and weapon depots filled with *first generation Robotechnology mecha and gear* waiting for the brave (or foolish) who can get in and out with it successfully. The existence of such weapons and technology had been a moot point, as the radiation levels left them unusable. However, since the Invid scrubbed much of the radiation away, they are now viable for retrieval. Any humans who brave exploring the base and look carefully can find a small, partially collapsed service tunnel that is too small for the Gura-Invid to squeeze through, but is accessible by humans; even those wearing small, light mecha such as Cyclones, Southern Cross powered armor or body armor. As long as there are no active Protoculture power sources running, it is unlikely that the Gura-Invid would take any interest in service tunnels as they are insignificant to them and not actually inside the Grand Cannon's barrel/main shaft.

Inside the partially collapsed hangars and mecha bays of the upper levels are two dozen, intact first-generation *Valkyrie Fighters* (and the wreckage of another two dozen suitable for salvage as spare parts). There are also a couple dozen *Destroids* (including one *Mk. II Monster!*) and a small stockpile of short-range, medium-range and a few long-range missiles. There is also a fully stocked armory with weapons, uniforms, flight suits and other basic gear located a bit deeper into the compound, though half of it has collapsed. Located in the lower level of the base are several smaller weapon depots and another six *Valkyries* and a half dozen *Defenders*, *Phalanxes* and *Tomahawks*. The passage of time, the elements, decay and exposure to radiation for years until the Invid cleaned it up, have ruined all stored food, water and conventional fuel/gasoline. One third of all missiles and other equipment are also so decayed as to be unusable. With some quick maintenance of the mecha, however, they can be activated and piloted out of the base. Of course, activating any Valkyrie, Destroid or Protoculture powered device quickly alerts the Gura-Invid defenders at both Hives. The question then becomes, can a band of humans grab that mecha without a massive confrontation? Or if battle erupts, can they fight their way out with their hard-fought treasures. One or more Valkyries might be able to fight their way out and put considerable distance between themselves and the Monster Invid once they get above ground to escape. Destroids, on the other hand, would seem to have little hope of escape unless a transport vessel was available to haul them away. Even then, it seems likely that the Destroids and transport would be swarmed and destroyed by the Monster Invid before escape could be achieved. But where there is a will, there is a way. Of course, sneaking in to retrieve weapons and gear, and sneaking out has a much greater chance of success without a battle.

Located elsewhere in one of the hangars is a *Star Goose transatmospheric shuttle*. The shuttle is damaged beyond repair and will never fly again, but it is resting on an elevator shaft that goes from two-thirds of the way down the shaft of the Grand Cannon to the surface. Some repairs would be necessary, but with a successful Electrical Engineer or Jury-Rig skill roll and a power source, a group could get the elevator platform working. This could be a way to get a couple of working Destroids or a

truckload of equipment to the surface. The shuttle itself is good for parts and has a storage locker with two CHR-1 Hazardous Environment Armored Suits and two MP-84 Machine Pistols with six standard ammo clips for each. (All of these items and more can be found in the **Robotech® The Macross™ Saga Sourcebook.**)

Beyond these areas, the base is pretty much unrecognizable. Half of it is in ruin and the other half has been turned into an alien environment reminiscent of the Invid home world. Dominating the bottom and top are two Gura-Invid Hives, each with its own Genesis Pit.

Getting in and out of the Grand Cannon without a life and death battle may seem like an impossibility, but there is one more secret that could be a life saver for humans. There were several elevator shafts that were used by human personnel, one of which is still intact. The elevator car is long gone, destroyed at the surface and the shaft concealed by a mound of debris at the ground level. However, there are openings large enough for a human or Cyclone mecha to squeeze through at the second and third floor. The elevator shaft is much too small for the Gura-Invid to fit, but wide enough for a Cyclone to climb down each wall of the shaft. It goes from the surface, down the side of the barrel of the Grand Cannon, all the way to the bottom.

Nobody knows about this elevator shaft and it would have to be found through careful exploration or by accident by player characters. It is also possible that a set of Top Secret floor plans of the base could, by some miracle, be uncovered.

The elevator shaft could provide access directly from the surface to the Mutation Pit and Vicereine's Chamber. More importantly, it can provide a way out of the Grand Cannon. If, through some unfortunate series of events, the player characters find themselves trying to fight their way out of the Vicereine's Chamber, a Perception Roll of 12 or better will reveal a partially blocked off elevator door. 40 M.D. is necessary to blast away the Gura-Invid Hive resin to free the door enough to pry it open. There is no elevator, just a four mile (6.4 km) vertical climb to the top and another two mile (3.2 km) flight or four mile diagonal hike to get out.

Along the shaft there are the various levels of the base, each with an elevator door the Monster Invid might find, but the Gura-Invid cannot follow through the shaft itself, and do not know where it leads. (They don't understand that it was an elevator shaft which inherently means it would go up and down, a simple deduction for someone used to our technology, but not the Invid.)

Note: When the Regess and her Invid occupied Earth, the nearest known true Invid Hives were located far south in Kenai and Juneau and they had no contact with Gura-Invid. In fact, they stayed away from the Grand Cannon.

Gura-Invid Mutants

So far, few people have seen these strange "new" Invid. According to eyewitness reports, it is clear they are Invid hybrids of some sort. While they *resemble* the traditional Invid Scouts, Fighter Scouts, Troopers, Shock Troopers and the like, in their general shape and role within their hive society, their "mecha" appears to be organic like the shell of a crab or beetle, in which the shell or exoskeleton is a living part of them. It is an astute observation, because that is exactly what has happened. The Invid pilots of the Gura-Invid have permanently merged with their bio-mechanical mecha. The outer shell has become a living part

of their bodies (and some might suspect, always were in some ways).

The true form of the Invid is that of a bipedal plant eater with a soft body reminiscent to a humanoid slug. They do not even have teeth. It is certainly not a body made for the bloody mayhem of an interstellar war. When the Regess wanted to strike terror into the hearts of the enemy and find a form capable of inflicting the carnage and revenge her people cried for, she chose the crablike *Gura*, a natural, monstrous predator of Optera. The Gura in its natural animal incarnation most closely resembles the *Invid Trooper*, complete with its cyclopean single eye, hunched-over body, armored carapace, and oversized, clawed forearms. All these traits would become the signature of most Invid mecha.

The Gura, themselves perished on the Invid home world along with all other life forms except the Invid and some Flowers of Life, as the result of the Robotech Masters' deliberate devastation of Optera. However, the animal's genetic code was already part of the Regess's vast library of information stored within her mind.

The DNA of the monstrous Gura, infused with bio-mechanical elements, would give birth to the living Invid mecha known today. A bio-mechanical war machine that would give the Invid people the raw power, speed and abilities they needed to exact their revenge upon the Robotech Masters. This was something new for the gentle-minded Invid, but as always, they adapted. Their new form made them capable of war and destruction on a level they could never before have imagined. A fact the Robotech Masters and many other sentient beings would discover all too soon.

It would seem that the Protoculture radiation from the Grand Cannon awakened some part of the Gura within the mecha when it merged with the Invid pilots, who practically lived inside the armored mecha as it was. Exposed to the mutagen of the Grand Cannon Genesis Pit, Invid and mecha fused on a genetic level that would astound even the Regess. No longer can these Invid be removed from their mecha shells. Pilot and bio-mechanical mecha have become one mind and one physical construct.

This fusion of Invid with the reawakened Gura animal predator has created a true synthesis of both creatures. The animal never had the capability to fly, nor did it possess bio-mechanical energy blasters or the sentience and hive mind of the social Invid species. The Gura-Invid is a true hybrid that is much more *Invid* than animal. That having been said, there are several degrees of separation between the Gura-Invid and true Invid. The former is more primitive and displays obvious emotion, whereas the Invid legions function more like obedient and selfless servants of the Regess (and Regent while he was alive).

The Gura-Invid do function as a hive mind the same as the Invid, and they even have their own hive leaders, but they also exhibit a propensity for aggression and do not hesitate to fight and kill any creature that threatens them or their hive. This is the ferocity of the predator surfacing, but reined in, for now, by the sentience of the Invid mind. The Gura were carnivorous predators and solitary hunters who preyed upon other life forms. Had the animal dominated the Gura-Invid genes, they may have stalked humans as prey, but the Gura-Invid are omnivores who subsist mostly on vegetation, including the mutated Invid Flowers of Life that grow in abundance in the Alaskan wilderness (at least until the Regess abandons Earth for parts unknown). However, they can eat meat, animals, grains, processed food, and even garbage and the remains of humans if necessary.

For the Gura-Invid evolving down a different evolutionary path, Earth is the only home they know, and it is unclear whether they have any (or much) of the racial memories possessed by true Invid. Over time, and as the Gura-Invid continue to grow in numbers, they may become more aggressive and threaten humanity's dominance of the Earth.

While the true Invid occupy Earth, they avoid the area around the Grand Cannon, and ignore the mutants living there. In a way, it's because they can no longer see them. Or rather, they see them instinctually as non-threatening. The psychic emissions of the *Gura-Invid hybrids* are close enough to those of other Hives that the Invid avoid them the same way they do not cross into the patrol zones of other Invid Hives. The Invid never question whether that Hive should be there or not, nor do they question that the psychic signature of Gura-Invid seems to be a bit different and more feral. The Invid lack the individual initiative of a human soldier, who would immediately recognize and report to his superiors if he found a Neanderthal. And if an Invid patrol did report the presence of a Monster Invid, the Regess would instruct them to ignore it.

So far, human eyewitness reports tell of Gura-Invid - often referred to as **Monster Invid** - minding their own business and eating plants. Most people have never even heard of "Monster Invid" and only the lucky ones who have managed to escape a Gura-Invid know what happens when a human gets too close or seems too threatening to this strange, new breed of Invid. Those who don't manage to escape the monsters are torn apart, or captured and taken back to the Gura Hive for food. And if the rumors that speak of it are true, sometimes Monster Invid actually devour those they defeat in combat where their opponent falls.

Note: When the Regess gathers her people and leaves the Earth, the mutant Invid of the Grand Cannon Genesis Pit are left behind. Whether this is deliberate to let the natural evolution continue, or the Gura-Invid have mutated to such a point where she no longer holds sway over them, is unknown, but they remain Earthbound.

Monster Invid Hive Society

The Gura-Invid mutants are creatures of instinct. They have a society resembling an insect hive even more so than the true Invid.

The Gura-Invid Scouts and Hunters go out, find food sources, and identify threats.

The Gura-Invid Troopers/Workers do the majority of heavy work, harvesting and defending the Hive.

The Gura-Invid Shock Troopers/Warriors are the elite combat warriors that obliterate any threat to the Hive or their Vicereine.

The Gura-Invid Vicereine is the Hive leader. Like a mini-Regess, she leads her people and gives them direction. At the moment, that is to breed and expand the Hive. **Note:** In fact, there are more than one Vicereine, but the others have been driven from the Hive. If the Invid Regess knows about the Gura-Invid Vicereines, she simply ignores their existence. It seems likely that all Gura-Invid, including the Vicereines, would ultimately bend to the power and will of the deific Regess.

The Gura-Invid Viceroy. There are two Gura-Invid Hives. One is ruled by a Vicereine (similar to a queen, just as one would expect of an insect colony), but the other is ruled by a *Viceroy*. This might explain and mirror the origin of the Invid

Regess and Regent. More about the Viceroy elsewhere in this section.

There are two Gura-Invid Hives, both located in the sprawling, multi-level ruins of the old Grand Cannon military compound. Each also has its own Genesis Pit (presumably created by the Regess, so she is aware of what is taking shape here). The capabilities of the two Pits to accelerate different paths of evolution are under the control of the two Gura-Invid Hive Leaders. However, their knowledge of the Pits' capabilities is limited. For now, they both use the mysterious energy to transmute the newborn Gura-Invid into whatever caste is needed at their respective Hive. Thus, both serve as the literal mother and father of the two new Gura-Invid Hive communities. They also, in a way, seem to be following in the footsteps of the *Regess* (unknowingly or instinctually) and have taken a *human* appearance.

The form of the two Hive Leaders is based on the lone image displayed on a broken view screen at the base. The screen still retained partial power all these years and kept looping the last messages from a female communications officer who was calling for help as the last survivor after the Zentraedi onslaught. The recording played over and over for decades on a cracked, dirty screen in the depths of the Grand Cannon. The Vicereine, and the neophyte Vicereines that followed, cannot explain their attraction to this human or why they feel compelled to take her form, but it seems appropriate to do so. The copy is not completely accurate, however, due to the degraded state of the screen and the digital image. As a result, the image was in black and white, so all would-be Hive Vicereines have a grayish skin tone and their hair is black.

It is said that no human who lays eyes on the Vicereine lives to survive the encounter. But one survivor of the 10th Mars Division attack fleet lived long enough to recognize her, for the image on the screen is that of a young *Lisa Hayes*. The Vicereine has since developed an interest in humans and occasionally captures a few to talk to them. She tries to learn about human culture, asking questions for days or weeks, but after a while she gets bored or feels her captives have no more to contribute and she has them fed to the immature young who need protein to grow.

The other Gura Hive Leader's appearance is also based on the image on the screen, only this is a male representation. Like the Invid Regess and Regent, the initial Grand Cannon Genesis Pit seems to have created two distinct Gura-Invid leaders. One female and one male. The male is less curious about humans and more cruel and sadistic in his ruthless treatment of human life. How the *Vicereine* and *Viceroy* were created is unknown, even to them. It appears the initial Grand Cannon Genesis Pit, established by the Regess, has recreated a new Invid species along a different evolutionary path. Whether this was the Regess' intention is known only to her. Regardless whether the Gura-Invid were planned or an accident, the Regess has allowed them to exist. The fact that there is a male and female leader may reflect the Invid's own origins, and there may be something in their biological makeup that requires one female and one male to lead their people. After all, the *Invid Regess* and the *Regent* commanded two different armadas of Invid. Invid forces who followed one leader or the other with absolute loyalty. While the two leaders and their Invid legions shared goals and worked together at times, the two functioned separately and tackled the same problems from very different perspectives. The two even clashed

at times. And while many assumed the *Regess* and *Regent* were mated, they may have simply been two separate, but equally powerful beings born to protect and lead their species. It seems very likely that if this is a new breed of Invid, that the Invid species always starts out with two iconic, deific figures, one female and one male. The female seems to represent intellect and curiosity, the male representing aggression and violence.

Whatever the Gura-Invid are, they are different enough from true Invid that they have lost their link to the Regess. It is to the new Gura-Invid Vicereine and Viceroy that the denizens of the two Hives are linked. It is these leaders they acknowledge and obey. As a hive mind, they had to be created, for the Invid require someone to lead them and focus their hive identity and purpose.

The spontaneous "birth" of a queen occurs in many insect hive societies, and there are some animals that can change sex when there is the need. In the case of hive insect societies, when a queen dies, a new one rises from the ranks. In the case of the Gura-Invid, individuals within the hive are of low intelligence, and to humans may seem almost mindless and without personality, but they form a sort of collective intellect that gets smarter the larger the population grows. It could be that the Gura-Invid reached a point in hive intelligence where they purposefully or instinctually manifested the Vicereine and Viceroy to lead them. Considering the metaphysical nature of the Invid, this may have been an act of sheer will by the populace. More likely, somewhere buried in their racial memory and their biology is the means by which one of them would change spontaneously into a new leader (Vicereine and/or Viceroy) to lead them, just as a bee larva can be transformed into a new queen. If the Monster Invid are even consciously aware of the process, it is a secret kept from outsiders. If anyone can figure out how the Vicereine and Viceroy came into existence, they might also gain new and deeper insight into the development of the Regess herself.

Though there is only one male leader known to have been spawned for the Gura-Invid, the *Vicereine* is not the only noble female born in the Hive. There have been six others, all of whom appeared sometime after the Vicereine took command of her Monster-Invid Hive, and only inside her Hive. Upon physical maturity, which is only one year's time, three of the neophyte Vicereines were slaughtered, but three others escaped alive. All six had taken the appearance of human females that resemble *Lisa Hayes*, and the three survivors escaped destruction by fleeing into the Alaskan wilderness. Each is trying to figure out what to do with her life if it is not to lead her people.

One of the reasons the Vicereine and Viceroy coexist is that they both came into being at the same time, but went their separate ways before reaching full maturity, and each established their own hive at opposite ends of the Grand Cannon military base. Moreover, the Vicereine may be the Yin to the Viceroy's Yang. In short, they may need each other to grow both Monster-Invid Hives. Presumably, these other neophyte Vicereines would need a male Gura-Invid to mate with, but no such mate appears to exist. The Vicereine and Viceroy don't seem to need partners, or perhaps, they are destined for each other in some way.

While an ordinary human would perish in the harsh elements of the Alaskan wilderness, the extraordinary abilities of all Invid suggests the expelled neophytes would have a good chance of surviving. The question becomes, what happens to a young Gura-Invid Vicereine when she doesn't have a Hive of her own to command? Is she slowly driven insane? Does she adopt an even

more human appearance and blend in with human society, or does she live like a wild animal in the wilderness? Certainly if one of the neophyte Vicereines found her way to a human settlement, she would be treated as a refugee suffering from shock and nurtured to be healthy and useful. What might happen if a Neophyte Vicereine tries to find a mate among humans? Can they mate with a human and bear offspring? Would the offspring be human or Gura-Invid, or a hybrid of both? Is this the next step (or possible alternative step) in Invid evolution? Could they start a new Hive? If the Vicereine or Viceroy is slain, will one of the other Vicereines sense it and return to take command of that Hive? These are all questions yet to be answered when it comes to these enigmatic beings.

Gura-Invid Abilities

ALL Gura-Invid, also known as Monster Invid, have the following mutant abilities and vulnerabilities:

1. Sense Protoculture: The Gura-Invid have a sort of Protoculture radar that detects both the Flowers of Life and Protoculture powered vehicles as well as any creatures, including some Invid experiments that subsist on Protoculture. Unlike true Invid, this is not related to sight, but is a mutation of a Gura ability that once helped them hunt prey on Optera by being able to track anything that ate the Flower of Life. It works like a form of sonar, radiating in all directions, similar to how a shark finds prey in the water by sensing the electrical activity of the animal's nervous system. This provides the Gura-Invid with the ability to Track Protoculture (70% +1% per level of experience) at a range of five miles (8 km). This also provides all Monster Invid a bonus of +2 to strike with ranged weapons when targeting Protoculture powered devices and beings that subsist on Protoculture.

2. Superior Sight: All Gura-Invid have excellent vision, similar to a predatory bird, and could read a stop sign from two miles (3.2 km) away, assuming they could be taught to read. They also have nightvision with a 2,000 foot (610 m) range.

3. Electromagnetic Navigation: The Gura can sense the flow of magnetic fields in the earth and use them to flawlessly navigate back to their Hive from anywhere on Earth.

4. Psychic Recognition and Communication with fellow Gura-Invid: All Monster Invid are psychically linked to one another and are able to call for help and coordinate with other Gura-Invid from the *same Hive*. The range is an astounding 100 miles (160 km), and if they are within 100 miles (160 km) of the Hive, the Gura-Invid Vicereine can work as a psychic relay station, connecting the members of her entire Hive at once. Gura-Invid instantly recognize members of *their own Hive*, and also seem to recognize normal Invid on some level, as well as the Monster Invid of the other Gura Hive (though they do not acknowledge each other). This means they will not attack true Invid or Gura-Invid from the other Hive unless provoked or attacked. This is unlikely to happen, since the other Monster Invid of both Hives ignore each other completely, and their Invid creators see the Gura-Invid as subjects in a great experiment.

This psychic link shared by all members of each specific Gura-Invid Hive means that when one of the Monster Invid is attacked by human beings or other non-Invid, the members of its Hive know it. If the fight lasts longer than four melee rounds (one minute), more and more Monster Invid arrive on the scene until the enemy is overwhelmed, captured, destroyed or chased off. 2D4 Monster Invid join the fight every 1D4 minutes that the

battle rages and for 2D4 minutes after it has ended. If the fight is over by the time the first couple of Invid waves arrive, the Gura-Invid search the area for intruders with a hunger to exact bloody retribution for any murder of their kin or damage to the hive.

5. Psychic Death Scream: When destroyed, the Gura-Invid lets out a psychic death scream that is transmitted outward to the extent of its psychic range. This alerts EVERY Monster Invid in range, and often the Hive as well, that there are dangerous beings loose in the area. In most cases, 6D6+12 Gura-Invid swarm the area, searching for the killer. When they find the threat, they attempt to utterly destroy it and anyone or anything with it.

6. Gura Achilles' Heel: Like most Invid mecha, the Gura are instantly killed by a shot through the eye. Any shot that depletes the M.D.C. of the eye-piece pierces it and kills the Gura-Invid brain/pilot inside.

Strike Penalty: Shooting a Gura-Invid in the eye is just as difficult as targeting an Invid mecha's sensor eye. It is shielded from the top by an armored carapace that acts as a hood, meaning it can only be hit from straight on or below eye level (i.e., from the ground level looking up). Even then it is a difficult target to strike, and even more so if the Gura-Invid is up and moving, especially at high speeds. Consequently, to hit the eye, an attacker must make a "Called Shot" and suffers the following penalties: -4 to strike a stationary Gura-Invid target, -6 to strike a slow moving one (under 60 mph/96 km) and -11 to hit a fast moving and/or weaving/dodging Monster Invid.

7. Not Equipped for Space Travel: The less evolved Gura-Invid are incapable of traveling in space or through a vacuum. They die of suffocation, exposure or decompression like most other creatures when exposed to the environment of space.

8. Protectors of the Hive: Like ants, all Gura-Invid are fanatical about the protection of their Hive, and do not hesitate to die in their efforts to take down what they perceive to be an enemy or threat to the Hive or their Vicereine (or Viceroy).

Note: The stats of all Gura-Invid are presented like those of living beings rather than mecha, because they are NOT mecha, despite the physical resemblance.

Gura-Invid Scout

This is the Gura-Invid analog to the classic Invid Scout with some distinct differences. Its shell is a lighter, natural red color and is a thick, tough material that looks more like an organic insect exoskeleton than metal. The carapace is rough and uneven, and with swept-back spikes and spines of varying size along the edge of the forearm claws, shoulders and rim of the top shell. This gives the Gura-Invid a more demonic or monstrous look than its sleek, smooth, true Invid counterpart. Likewise, the feet of the Gura-Invid Scout are much more claw-like, similar to those of the Invid Trooper. There is no obvious mouth, as it is little more than a slit below the eye.

The Gura-Invid Scout is physically stronger and more aggressive than the true Invid, but flies much, much slower. This is because they do not have engines or thrusters. Instead, they have two pairs of powerful insect wings that are protected by armored shells, like that of a beetle, and the wing covers move out of the way when the creature takes flight. The wings flap at impressive speed and are capable of propelling the Monster Scout to speeds of several hundred miles per hour.

Gura-Invid Scouts operate in a similar manner to the scouts of

an ant hill: They leave the Hive and radiate out in all directions for about 100 miles (160 km), vigilant for potential threats and food, particularly groves of Invid Flowers of Life. Sometimes they make extended scouting forays of up to 300-400 miles (480-640 km), always leaving a couple other Gura-Scouts about 100 miles (160 km) behind so they make a psychic line of communication all the way back to the Hive. The other Monster Scouts in the back portions of the chain hunker down, hide from sight, and serve as living relay stations. If one of the links in the chain is broken - i.e. the Gura-Invid is killed - then the rest of the Scouts further away from the Hive are cut off. However, the creatures' psychic link informs those ahead and behind it that it has been slain, warning the others of danger. When that happens, the Gura-Scouts ahead of their slain brethren, and the one immediately behind it in the relay line, head to the location of their dead comrade as fast as their wings can carry them. They do so to determine the cause of death, not to fight, and once the cause has been identified (or not), they head back to the Hive with the information.

The Gura-Invid Scout is quick, tenacious and cunning in combat. It prefers to lead enemies into a place of ambush where the larger, more powerful Monster Invid or many more Monster Scouts lie in wait. Gura-Scouts are also excellent at hiding in thick brush, hovering quietly in dense tree canopies and using the snow and ice of the Alaskan wilderness as cover where it either hides and watches, or waits to launch an ambush attack. Gura-Invid Scouts prefer to slash and gouge at what they believe to be sensitive areas of an opponent with their claws and feet, or pick up smaller prey, carry them into the air and drop them from a great height, allowing gravity to do the killing for them. When they have the advantage of numbers, one or two are likely to grab hold and drive their prey into the ground. The battered enemy is then left on the ground for their sisters to move in upon and rip it to shreds.

Gura-Invid Scouts travel as lone individuals or in small groups of 1D4+2, although such patrols are often spread out over a large area and the true number of them may not be immediately apparent until combat begins. It is then that the presence of nearby Monster Scouts (seldom more than 1D4+1 melee rounds away), becomes deadly obvious.

Gura-Invid Scout

Also Known As: Monster Scout.

Alignment: Considered a predatory hunter of Anarchist alignment, except when it comes to members of its Hive.

Attributes of Note: I.Q. 1D4+5 (high level of animal-like cunning, little intellect otherwise), M.A. 1D6, M.E. 1D6+6, P.S. 2D4+20 (Robotic), P.P. 1D4+16, P.E. 1D4+11, P.B. 2D4, Spd: **Running:** 2D6+55 (on average 45 mph/72 km on the ground), **Flying:** 1D6x10+474 (on average 350 mph/560 km). Cannot operate in space.

M.D.C. by Location:

Claws (2) - 20 each
Forearms (2) - 100 each
Upper Arms (2) - 50 each

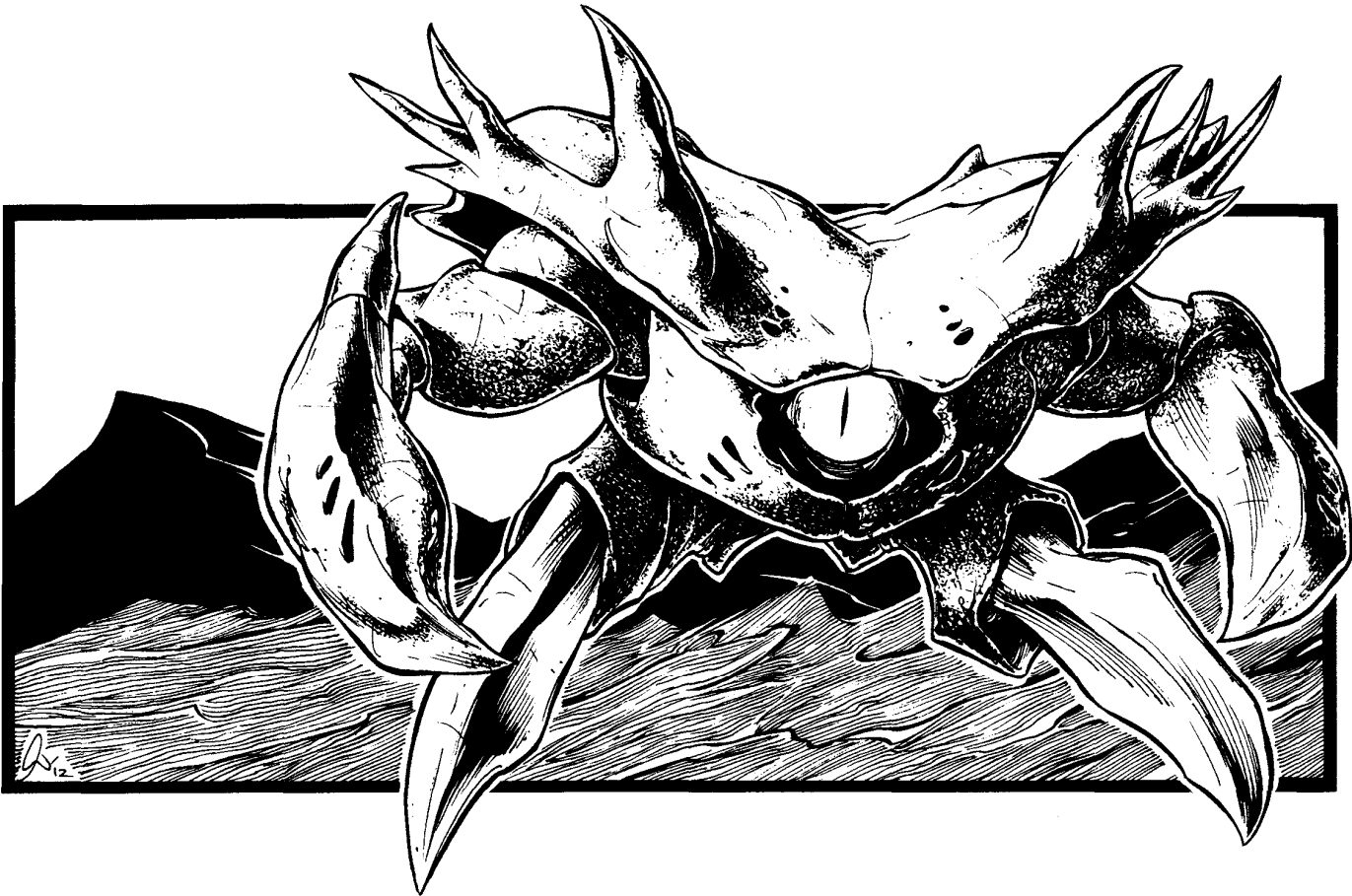

Wing Covers (2) - 50 each
 * Wings (4; two per each side) - 25 each
 Legs and Feet (2) - 80 each
 ** Eye (1) - 25
 *** Main Body - 90

* Destroying a wing reduces the creature's flight speed by 25%, destroying both wings on one side will render it unable to fly. The wings are difficult targets to hit, are protected by the wing covers and require an attacker to make a successful "Called Shot" with the following penalties: Shooting at a stationary target -3, moving target -5, and fast moving target -9 to strike.

** The eye is the most vulnerable place on the Monster Invid's body and its destruction kills the mutant immediately. The eye is a small target surrounded by heavy chitin armor and requires an attacker to make a successful "Called Shot" with the following penalties: Shooting at a stationary target -4, moving target -6, and fast moving target -11 to strike.

*** Depleting the M.D.C. of the main body kills the Gura-Invid, releasing a death pheromone alarm that can be detected by other members of its Hive from 10 miles (16 km) away.

Height: 9 feet (2.7 m).

Width/Breadth: 12 feet, 6 inches (3.8 m).

Length/Depth: 11 feet (3.3 m).

Weight: Three tons.

Flying Speed: See Spd attribute above.

Skills of Note: Camouflage (self only) **60%**, Detect Ambush 45%, Detect Concealment 35%, Dowsing **70%**, Identify Plants and Fruits 50%, Land Navigation 90%, Prowl 55%, Tracking

(People) 50%, and Wilderness Survival 80%.

Natural Abilities: See Gura-Invid Abilities, described earlier, plus regenerates 1D6 M.D. per hour.

Hand to Hand Combat: The Gura-Invid Scout is only capable of engaging in hand to hand combat.

Attacks per Melee: Four.

Hand to Hand Damage: Claw Strike: 4D6 M.D.

Kick or Stomp: 3D6 M.D.

Bite: 2D4 M.D. (rarely used as an attack. The mouth is a small set of mandibles located under the single eye and usually protected by a retractable chitin plate).

Flying Body Block/Ram: 1D6 M.D. per every 100 mph (160 km) of speed. Plus there is a cumulative 10% chance per 100 mph (160 km) of speed of knocking an opponent of equal size or up to 50% larger off its feet or an airborne enemy 1D6x100 feet (30.5 to 183 m) off course. In either case, the victim loses initiative and two melee attacks. This attack counts as two of the Gura-Invid Scout's melee attacks.

Bonuses (includes all attribute bonuses): +2 to initiative, +3 to strike, +2 to parry and dodge, +5 to dodge in flight, +2 to roll with impact, +5 to save vs Horror Factor and +6 to save vs poisons, diseases and gases. Remember, these are living creatures, not mecha, so they can occasionally be susceptible to poisons and other toxins.

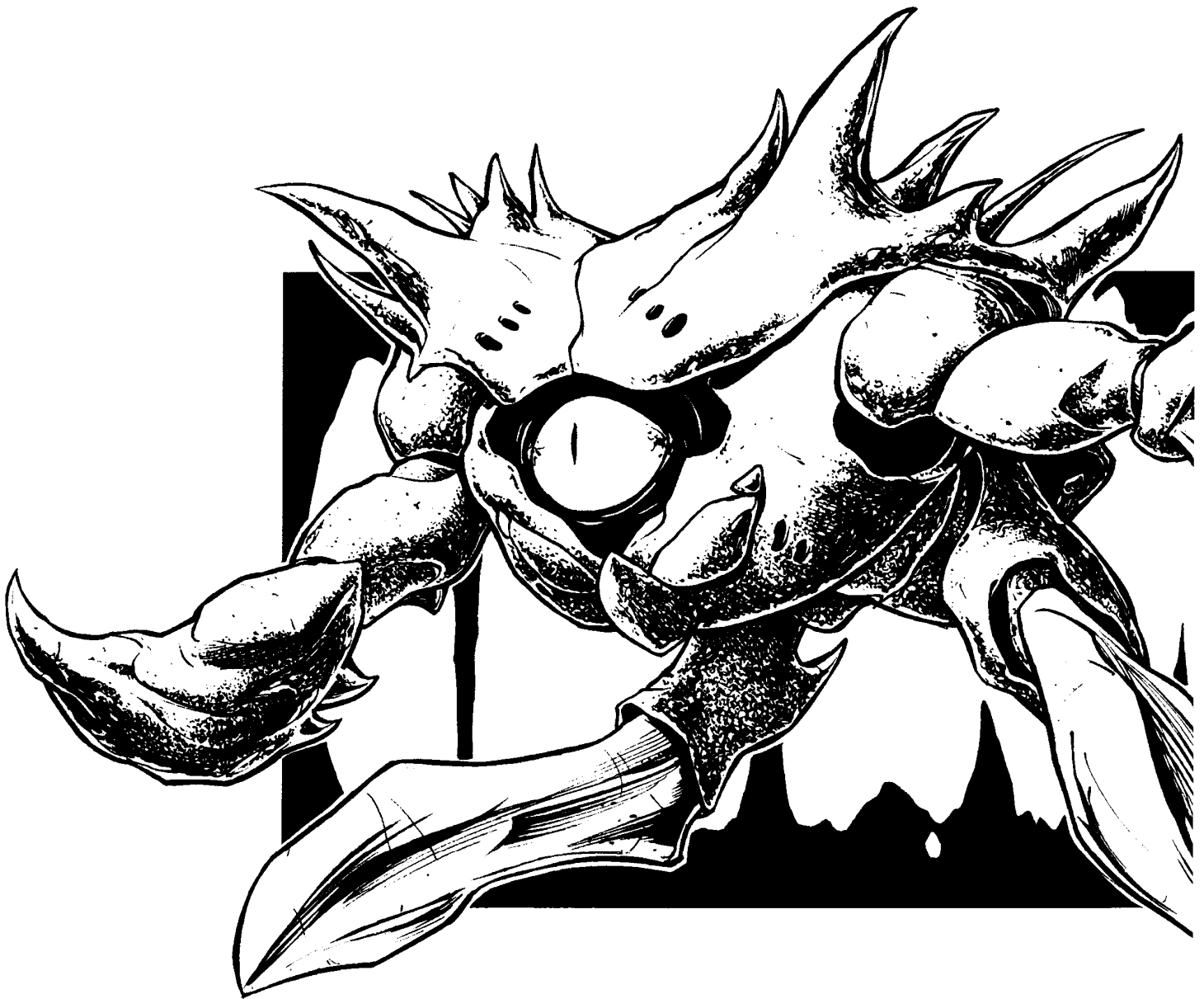

Gura-Invid Hunter

This is the most commonly encountered member of the Gura-Invid Hive as they are the first-line combatants and Hive defenders. Gura-Invid Hunters fight intruders, enemies and prey, thus the name. They are similar to the Gura-Invid Scout in appearance, except they are covered with more and larger spines on their carapace and forearms, and mandibles. The mouth is a small set of mandibles located under the single eye. The mouth can be protected and concealed by a retractable chitin plate that slides away to reveal the mandibles when it wants to use a bite attack. The Hunter has six wings hidden under armored coverings like a beetle, and has stronger wing muscles than the Scout, making it a faster flyer. They still cannot compare to mecha and most high-tech flying vehicles when it comes to speed, but what they lack in speed they make up in agility and ferocity. In addition to their claws, Gura-Invid Hunters possess *Bio-Electric Energy Cannons* that fire deadly M.D. blasts.

Tenacious and cunning, the Gura-Invid Hunters scout and patrol the hive territory to keep it safe, as well as hunt prey (humanoids and the Flower of Life). When patches of the Flower of Life are located in the wild, it is the Gura-Invid Hunter who patrols and protects the valuable food supply. In combat, Hunters prefer to overwhelm their targets with numbers, bait them into ambushes, and harry them with hit and run attacks from the air. They are also excellent trackers, keen observers and fast attack defenders of the Invid Hive. Gura-Invid Hunters often accompany Scouts and Workers to protect them or to ensure intruders or prey do not escape these slower Gura-Invid.

As a rule, Hunters tend to travel in patrols of three to six, and sometimes a single one accompanies a pair or small group of Gura-Invid Scouts or three Hunters will fly watch over a party of Gura-Invid Warriors or Workers. When the Hive is threatened, Hunters are the first to respond, gathering in a swarm of 6D6 be-



fore dispersing in small squads of 3-6 to attack a single opponent/intruder.

Gura-Invid Hunter

Also Known As: Hive Defender and Attack Gura.

Alignment: A predatory hunter, effectively Anarchist alignment, though humanoid opponents may consider them Miscreant and murderous.

Attributes of Note: I.Q. 1D4+6 (high level of animal-like cunning, little intellect otherwise), M.A. 1D6, M.E. 1D6+6, P.S. 2D4+24 (Supernatural), P.P. 1D6+19, P.E. 2D4+12, P.B. 2D4, Spd: Running: 2D6+55 (on average 45 mph/72 km on the ground), Flying: 2D6x10+550 (on average 410 mph/656 km). Cannot operate in space.

M.D.C. by Location:

Bio-Electric Cannons (2) - 25 each

Claws (2) - 20 each

Forearms (2) - 120 each Upper

Arms (2) - 60 each Wing

Covers (2) - 60 each

* Wings (6) - 30 each Legs

and Feet (2) - 90 each

** Eye (1) - 25

*** Main Body - 100

* Destroying a wing reduces the creature's flight speed by 20%, destroying all three wings on one side will render it unable to fly. The wings are difficult targets to hit, are protected by the wing covers and require an attacker to make a successful "Called Shot" with the following penalties: Shooting at a stationary target -3, moving target -5, and fast moving target -9 to strike.

** The eye is the most vulnerable place on the Monster Invid's body and its destruction kills the mutant immediately. The eye is a small target surrounded by heavy chitin armor

and requires an attacker to make a successful “Called Shot” with the following penalties: Shooting at a stationary target -4, moving target -6, and fast moving target -11 to strike.

*** Depleting the M.D.C. of the main body kills the Gura-Invid, releasing a death pheromone alarm that can be detected by other members of its Hive from 10 miles (16 km) away.

Height: 9 feet, six inches (2.9 m).

Width/Breadth: 13 feet, five inches (4 m).

Length/Depth: 11 feet (3.3 m).

Weight: 3.25 tons.

Flying Speed: See Spd attribute above.

Skills of Note: Camouflage (self only) 60%, Detect Ambush 45%, Detect Concealment 40%, Hunting 75%, Land Navigation 90%, Prowl 50%, and Tracking (People) 70%, and Track and Trap Animals 80%.

Natural Abilities: See Gura-Invid Abilities, described earlier, plus regenerates 1D6 M.D.C. per hour.

Combat: The Gura-Invid Hunter can attack with its bio-electric energy cannons or engage in hand-to-hand combat.

Bio-Electric Energy Cannons (2): These are knob-like protrusions on the top of the carapace, in front of the wing coverings. They harness the abundant bio-energy from the creatures and concentrate it into powerful electrical energy beams, like directed bolts of lightning.

Primary Purpose: Attack

Range: 2,000 feet (610 m).

Mega-Damage: 2D6 M.D. for one, single blast, 4D6 M.D. for a dual blast. Cannot fire bursts nor strafe like a true Invid Fighter Scout. Almost always fire dual blasts unless one cannon is destroyed. A dual blast counts as one melee attack.

Rate of Fire: Each single or dual blast counts as one melee attack.

Payload: Effectively unlimited.

Hand to Hand Combat: Instead of attacking with ranged weapons, the mutant can attack using its claws or bite with its mandibles.

Attacks per Melee: Five.

Hand to Hand Damage: Claw Strike: 4D6 M.D.

Kick or Stomp: 3D6 M.D.

Bite: 2D4 M.D., but rarely used as a method of attack unless right on top of its opponent. The mouth is a small set of mandibles located under the single eye and usually protected and concealed by a retractable chitin plate.

Flying Body Block/Ram: 1D6 M.D. per every 100 mph (160 km) of speed. Plus there is a cumulative 10% chance per 100 mph (160 km) of speed of knocking an opponent of equal size or up to 50% larger off its feet or an airborne enemy 1D6x100 feet (30.5 to 183 m) off course. In either case, the victim loses initiative and two melee attacks. This attack counts as two of the Gura-Invid Hunter’s melee attacks.

Bonuses (includes all attribute bonuses): +2 to initiative, +4 to strike, +3 to parry and dodge, +7 to dodge while in flight, +3 to roll with impact, +7 to save vs Horror Factor and +6 to save vs poisons, diseases and gases. Remember, these are living creatures, not mecha, so they can occasionally be susceptible to poisons and other toxins.

Gura-Invid Worker

This is the mainstay of the Gura-Invid Hive. The Worker was the inspiration for the entire family of Invid mecha. While somewhat analogous to the Invid Trooper, the Gura-Invid Worker has shorter legs and walks low to the ground, giving it better balance and more of a crab-like appearance. The Gura-Invid Worker is a deep, blotchy purple with a more rounded appearance and fewer spines sticking out than the other Gura-Invid. It has the big, shield-like forearms of an Invid Trooper, but rather than the massive claws, it has three segmented fingers that look more like insect legs arrayed in a sphere-like bulb like the hands of the *Invid Enforcer*, only the Worker's fingers are much longer than the little claws of the Enforcer. The Worker has stubby wings concealed under protective armored plates on its back, like a beetle, but they are only capable of very short flights and hovering, not long-range travel nor aerial acrobatics or flying combat maneuvers. This makes the behemoth appear slow and ponderous when it takes to the air, and reminds some people of a sluggish bumblebee. As a result, the Worker walks from one place to another.

One of the Gura-Invid Worker’s most important jobs is to gather and tend to gardens of the Flower of Life. Its long, articulated fingers come in handy for this task and other jobs that require hands with better articulation and manipulation than claws. However, those fingers still end in small, sharp claws that can rake and slice Earth mecha in close combat. In addition to tending to the Flower of Life and other food sources, the Gura-Invid Worker does most of the heavy labor for the Hive: digging, gardening, carrying, clearing debris, hauling cargo, building, guarding the eggs, tending to the eggs, tending to the Vicereine and performing most of the non-combat functions. Workers can fight, and will fight to the death to protect the Hive and the Vicereine (or Viceroy, as the case may be), but fighting and scouting is not their job. Unless the Hive is under direct attack or they are commanded to fight by their Vicereine, Workers busy themselves with the day to day routine of cleaning and maintaining the Hive. That also means, with rare exception, Workers seldom stray far from the Hive, the Genesis Pit or their gardens. They can be encountered in groups of 2D4 with a Hunter or Scout when working outside the Hive, such as when gathering the Invid Flowers of Life, and in groups of 2D6+4 inside the Hive itself. Of course, Workers represent half of the Gura-Invid in the Hive.

Gura-Invid Worker

Also Known As: Hive Monster Invid, Crab Gura-Invid and Gardener Invid.

Alignment: A predatory hunter, effectively Anarchist except when it comes to members of its Hive.

Attributes of Note: I.Q. 1D4+3 (high animal-level intelligence), M.A. 1D6, M.E. 1D6+2, P.S. 2D6+32 (Supernatural), P.P. 1D6+9, P.E. 2D6+20 (Supernatural), P.B. 1D6, Spd: Running: 2D6+70 (60 mph/96 km); Flying: 1D4x10+200 (on average 150 mph/240). Cannot operate in space.

M.D.C. by Location:

Fingers (3 total, 2 fingers and a somewhat smaller, thumb-like appendage) - 30 each

Forearms (2) - 150 each

Upper Arms (2) - 80 each

Wing Covers (2) - 90 each

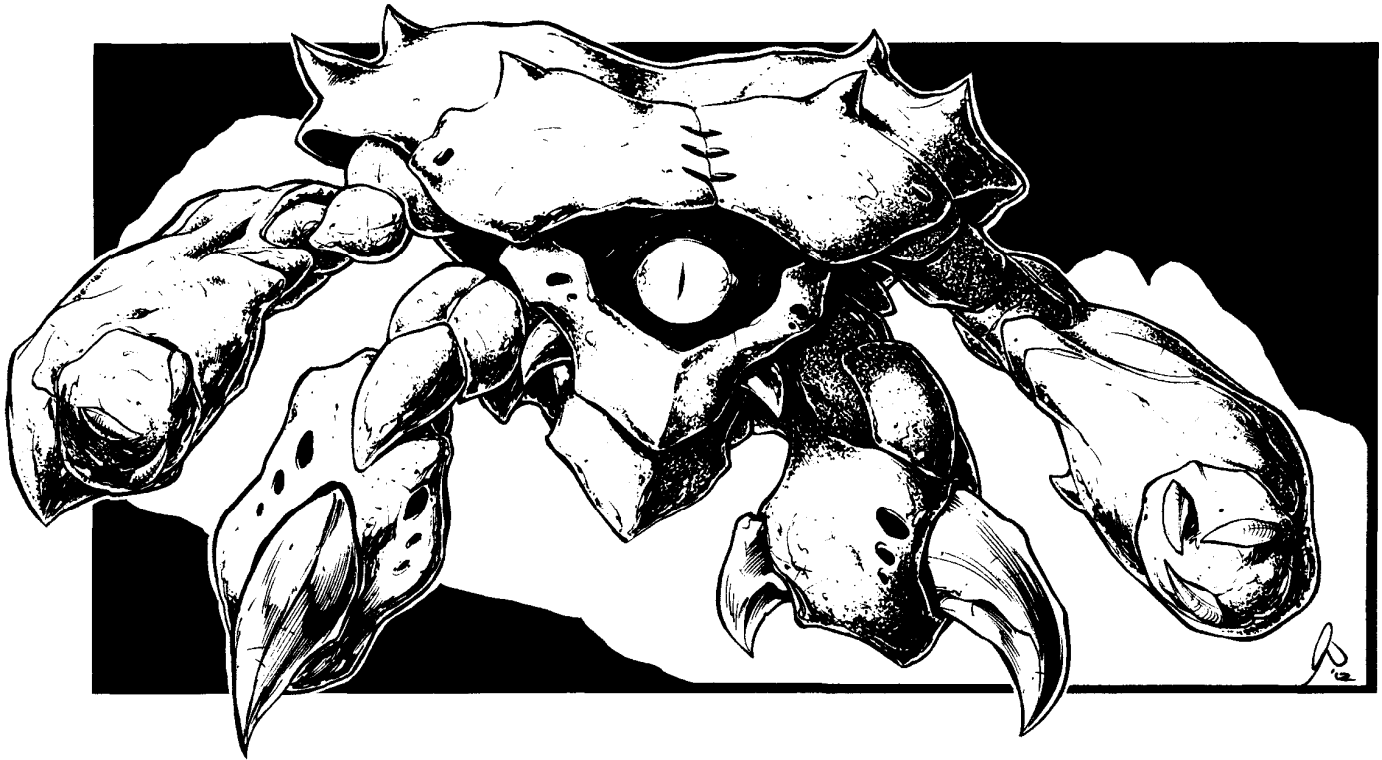

- * Wings (4) - 50 each
- Legs and Feet (2) - 150 each
- ** Eye (1) - 30
- *** Main Body - 150

* Destroying a wing reduces the creature's flight speed by 25%, destroying both wings on one side renders it unable to fly. The wings are difficult targets to hit, are protected by the wing covers and require an attacker to make a successful "Called Shot" with the following penalties: Shooting at a stationary target -3, moving target -4, and flying target -6 to strike (the Worker cannot fly fast).

** The eye is the most vulnerable place on the Monster Invid's body and its destruction kills the mutant immediately. The eye is a small target surrounded by heavy chitin armor and requires an attacker to make a successful "Called Shot" with the following penalties: Shooting at a stationary target -4, moving target -6, and fast-moving target -11 to strike.

*** Depleting the M.D.C. of the main body kills the Gura-Invid, releasing a death pheromone alarm that can be detected by other members of its Hive from 10 miles (16 km) away.

Height: 11 feet (3.3 m).

Width/Breadth: 15 feet, 6 inches (4.7 m).

Length/Depth: 11 feet, 3.3 m).

Weight: 4.5 tons.

Flying Speed: See Spd attribute above.

Skills of Note: Botany 85%, Camouflage 50%, Climbing 75%/65%, Gardening 90%, Housekeeping 80%, Identify Plants and Fruits 90%, Military Fortification 55%, Mathematics: Basic 88%, Preserve Food 90%, Recycle 70%, Tracking (People) 30%, and Wardrobe & Grooming 75%.

Natural Abilities: See Gura-Invid Abilities, described earlier, plus regenerates 1D6 M.D.C. per hour.

Combat: Though not a natural warrior, the Worker can fight.

Hand to Hand Combat: The Gura-Invid Worker can engage in

hand to hand combat using its claws or biting with its mandibles. In addition, its articulated hands/fingers enable it to use weapons, blunt objects, tools, and even large energy weapons, provided they are available to it (which as a rule, they are not). Attacks per Melee: Three.

Hand to Hand Damage: Clawed Finger Strike: 3D6 M.D.

Kick or Stomp: 4D6+4 M.D.

Bite: 2D4 M.D., but rarely used as a method of attack unless right on top of its opponent. The mouth is a small set of mandibles located under the single eye and usually protected and concealed by a retractable chitin plate.

Flying Body Block/Ram: 2D6 M.D. per every 70 mph (112 km) of speed. Plus there is a cumulative 25% chance per 70 mph (112 km) of speed of knocking an opponent of equal size or up to 50% larger off its feet, or an airborne enemy 1D6x100 feet (30.5 to 183 m) off course. In either case, the victim loses initiative and one melee attack. This attack counts as two of the Gura-Invid's melee attacks.

Bonuses (includes all attribute bonuses): +1 to initiative, +3 to strike, parry and dodge, +2 to dodge in flight, +3 to roll with impact. In addition, the creatures are impervious to Horror Factor (fearless) and +8 to save vs poisons, diseases and gases (remember, these are living creatures, not mecha, so they can occasionally be susceptible to poisons and other toxins).



Gura-Invid Warrior

The most powerful of the species besides the Vicereine, these large warriors are analogous to an Invid Shock Trooper and are the vanguard of the Gura-Invid Hive's fighting forces. The Warrior is significantly larger than any of the others; is even larger, stronger and more heavily armored than the Invid Shock Troopers deployed by the Regess and Regent. However, like the other Gura-Invid, the Warrior is slower and less adept at long-range attacks than the mecha version, but remains a force to be feared. Its mandibles are larger than the others and used without hesitation for biting and tearing at prey in close combat. Where the classic Invid Shock Trooper has plasma cannons, the Warrior has large bio-energy cannons, and it has the same type of heavily armored forearms and deadly claws for close combat. The only difference with the claws and forearms is they appear more organic and chitinous, with small spikes and barbs along the side and top of the forearm. Likewise, the legs and shell of its body are covered with spikes and spines that make the behemoth an ominous sight to behold.

The Gura-Invid Warriors almost always move in teams of three and work together to attempt to box a single enemy in between them to tear it apart. The cannons are used to blast enemies from a distance as well as to herd them where they want them to go and to soften up a target before they move in for the kill. They rarely kill with the cannons alone, preferring to deliver the death blow with their claws or mandibles.

With the exception of the Vicereine, Warriors are the most intelligent of the Gura-Invid, and appear to have rank over the others. Unlike traditional Shock Troopers, they have a significant amount of predator cunning that borders on independent behavior. Favorite tactics include surprise attacks and ambush from buried positions. In fact, the spines on their back function as seismic sensors when buried, letting the monsters know when anything weighing more than 100 pounds (45 kg) steps within 50 feet (15.2 m) of their buried position. They then spring up, swiping with claws in an attempt to hold onto prey while they deliver killing bites and blast at those who try to flee or take flight.

Gura-Invid Warriors are extremely aggressive and territorial, and are more likely to attack on sight than any of the other Gura-Invid, especially when intruders are within 10 miles (16 km) of the Hive. Warriors are surprisingly agile given their bulk, and their weaponry can dish out terrible damage, but have little experience or strategy and tactics for dealing with mechanized troops such as Earth mecha. As a result, they tend to fight mecha as they would a big animal.

Gura-Invid Warrior

Also Known As: Hive Defender and Monster Warrior.

Alignment: A predatory hunter, effectively Anarchist except when it comes to members of its hive.

Attributes of Note: **I.Q.** 1D4+8 (near human level intelligence), **M.A.** 1D6, **M.E.** 1D6+6, **P.S.** 2D6+34 (Supernatural), **P.P.** 1D6+12, **P.E.** 1D6+18 (Supernatural), **P.B.** 1D6, **Spd:** **Running:** 2D6+70 (60 mph/96 km); **Flying:** 1D6x10+474 (on average 350 mph/560 km). Cannot operate in space.

M.D.C. by Location:

Bio-Electric Cannons (2) - 120 each
Claws (3 per hand) - 40 each
Forearms (2) - 250 each
Mandibles (one pair) - 50

Upper Arms (2) - 130 each
Wing Covers (2) - 100 each
* Wings (4) - 60 each
* Legs and Feet (2) - 200 each
** Eye (1) - 35
*** Main Body - 250

* Destroying a wing reduces the creature's flight speed by 25%, destroying both wings on one side renders it unable to fly. The wings are difficult targets to hit, are protected by the wing covers and require an attacker to make a successful "Called Shot" with the following penalties: Shooting at a stationary target -3, moving target -5, and fast-moving target -9 to strike.

** The eye is the most vulnerable place on the Monster Invid's body and its destruction kills the mutant immediately. The eye is a small target surrounded by heavy chitin armor and requires an attacker to make a successful "Called Shot" with the following penalties: Shooting at a stationary target -4, moving target -6, and fast-moving target -11 to strike.

*** Depleting the M.D.C. of the main body kills the Gura-Invid, releasing a death pheromone alarm that can be detected by other members of its Hive from 10 miles (16 km) away.

Height: 17 feet, 3 inches (5.2 m) due to the bio-electric energy cannons.

Width/Breadth: 14 feet (4.3 m).

Length/Depth: 13 feet (3.9 m).

Weight: 13 tons.

Flying Speed: See Spd attribute above.

Skills of Note: Camouflage (self only) 60% +20% when buried, Climbing 65%/55%, Detect Ambush 60%, Detect Concealment 45%, Land Navigation 80%, Prowl 30%, Tracking (People) 50% and Wilderness Survival 80%.

Natural Abilities: See Gura-Invid Abilities, described earlier, plus regenerates 2D6 M.D.C. per hour.

Combat: The Gura-Invid Warrior can attack with its bio-electric energy cannons or engage in hand to hand combat.

Bio-Electric Energy Cannons (2): These are cannon-like protrusions on the top of the carapace, sitting inside and slightly forward of the wing coverings. They harness the abundant bio-energy from the creatures and concentrate it into powerful electrical energy beams, like directed bolts of lightning.

Primary Purpose: Assault.

Range: 4,000 feet (1,219 m).

Mega-Damage: 4D6 M.D. per single blast, 1D4x10 M.D. for a simultaneous dual blast at the same target. Cannot fire bursts or strafe like a true Invid Shock Trooper. Almost always fires dual blasts unless one cannon is destroyed.

Rate of Fire: Each single or dual blast counts as one of the Warrior's melee attacks.

Payload: Effectively unlimited.

Hand to Hand Combat: Instead of attacking with ranged weapons, the mutant can attack using its formidable claws and teeth. **Attacks per Melee:** Five.

Hand to Hand Damage: Claw Strike: 5D6 M.D.

Power Punch/Claw Strike: 1D6x10 M.D., but counts as two melee attacks.

Kick or Stomp: 4D6 M.D.

Bite: 5D6 M.D. Unlike the other Gura-Invid, the Warrior has prominent mandibles made for biting and tearing enemies apart.

Flying Body Block/Ram: 3D6 M.D. per every 100 mph

(160 km) of speed. Plus there is a cumulative 15% chance per 100 mph (160 km) of speed of knocking an opponent of equal size or up to 50% larger off its feet, or an airborne enemy 1D6x100 feet (30.5 to 183 m) off course. In either case, the victim loses initiative and two melee attacks. This attack counts as two of the Gura-Invid Warrior's melee attacks.

Bonuses (includes all attribute bonuses): +2 on Perceptions Rolls involving combat, +3 on initiative, +5 to strike, +4 to parry, dodge, and disarm, +4 to pull punch, +5 to dodge in flight, +5 to roll with impact, impervious to Horror Factor (fearless), and +8 to save vs poisons, diseases and gases. This is a living creature, not mecha, so it can be susceptible to poisons and other toxins.

The Vicereine And Other Gura-Invid Vicereines

Like the Invid themselves, the Gura-Invid are led by a queen. However, the Gura-Invid Vicereine is much more similar to the queens of Earth insect hives than the Regess and true Invid. Not only do they give birth to each and every member of the Hive, but there is only one Vicereine for each Hive and no over-arching species leader. Or at least, not at present, as there are only two Gura-Invid Hives, one with a Vicereine and one with the Viceroy.

All Gura-Invid Vicereines (and Viceroy) possess human level intelligence, but it is unclear whether that intellect improves over time to become genius level like the Regess. It seems unlikely. However, they are clever and cunning, and possess some level of instinct that automatically informs the Vicereine (and the Viceroy) and the neophyte Vicereines of their place and duty within the Gura-Invid hive society. Though the Vicereines (and Viceroy) look human, they are totally alien, which makes them dispassionate, cruel and unsympathetic toward humans and other sentient species. Thus, a Vicereine's (and Viceroy's) loyalty is to the people of her Hive.

The Vicereine's Entourage: A Hive Vicereine is almost always accompanied by a handful of drones, typically one Scout, one Hunter, two Workers, and a trio of Warriors, all of whom tend to her every need. Double or triple the number listed whenever she leaves the confines of the Hive.

Even *outcast neophytes* have an entourage. These are 1D4 Workers, and a trio of Warriors who tended to her as a hatchling and developed a psychic link in the process that was stronger than that of the Hive Vicereine. These loyal servants abandon the Hive to follow their outcast Vicereine to serve and protect her. For now, they are the only ones the outcast has a psychic connection with. This means if the outcast neophyte wishes to blend in among humans, she must keep her entourage a secret and hidden.

All Gura-Invid Vicereines (and Viceroy) take the form of a human female. In the case of the daughters of the Vicereine, they are variations of Lisa Hayes, with the first Vicereine looking the most like Lisa. They look to be in their early 20s and are unlikely to age as time goes by. The neophyte Vicereines tend to radiate a healthy glow and seem slightly more exotic than their mother, which could lend to the theory that they need to mate (but with whom? The Viceroy?) before starting their own Hive, and thus are naturally more attractive, giving off an aura of vitality. The outcast neophytes (daughters of the Vicereine) also begin to look

more human than their mother as they encounter humans away from the Hive where they were born. To lay eggs, all Vicereines must turn into their monstrous, insect-like form; see #2 below.

Special Abilities of the Hive Vicereine:

All Vicereines have the following abilities, but many of them are dormant in *outcast Gura-Invid Vicereines* until they are able to establish a Hive of their own. Exactly how that is done is unknown.

1. Mega-Damage Being. Despite their frail human looks, Gura-Invid Vicereines are as durable as any robot mecha, and possess Supernatural P.S. and P.E. and can engage in M.D. combat. Applicable to all Invid Vicereines (and Viceroy), including outcasts.

2. One Mind, Two Bodies. All Vicereines have two forms, a human form (the Vicereine closely resembles Lisa Hayes) that can be maintained indefinitely, even when rendered unconscious, and the Gura-Invid form that resembles a massive, bloated Gura-Invid Warrior, covered in large spines and quills, with a glowing cluster of 1D4+4 small sensor eyes around the one large eye. The Hive Vicereine's insect-like abdomen trails off in a massive, bloated, translucent egg sac over 60 feet (18.3 m) long. The Vicereine only appears to take Gura-Invid form for egg laying, a process no human has seen and lived to talk about.

3. Psionic Link to Hive Minions. An active, ruling, Hive Vicereine has a psychic connection to all of her "children," including any other Vicereines she may have spawned. This connection does NOT extend to other species nor to the brood of other Gura-Invid Vicereine Hives (of which there are currently none), only the members of that specific Hive. So while the Vicereine can communicate via telepathy, at any distance, with any of the neophytes she has spawned, she cannot communicate with, nor command, the offspring of one of those Vicereines should she ever be able to start her own Hive. Likewise, the Vicereine cannot communicate with or control the populace of the second Gura-Invid Hive under the control of the Viceroy. (And as far as anyone knows, there is no other "Viceroy," just the one.) Does not apply to outcast Vicereines until they have their own Hive.

4. Possess Hive Minions. An active, ruling Gura-Invid Vicereine can temporarily possess any Gura-Invid member of her own Hive. When this happens, the Vicereine sees and hears everything the Gura-Invid she possesses experiences, and has complete control over its body and actions. While possessed by the Vicereine, the body of the minion has its own abilities and M.D.C., but is also temporarily imbued with a fraction of her power. Increase the M.D.C. of the possessed body by 50% to all locations, P.S. is +10 and Supernatural, +2 additional attacks per melee, +1 to strike, parry and dodge, and long-range weapons (if any) do 50% greater damage. The Vicereine tends to do this primarily to Hunter Scouts and Warriors when there is a major threat to the Hive or when she is particularly curious about something her scouts have reported. The imbued power lasts for 1D4x10 minutes or until the Vicereine relinquishes control, whichever comes first. When the possession ends the minion has no recollection of what happened while it was a living vessel of the Vicereine. Does not apply to outcast Vicereines until they have their own Hive.

5. Psychic Force Bolts. The Gura-Invid Vicereine can fire a bolt of energy at a target with a thought and a glance or by pointing her hands. It does 1D6 M.D. per level of experience, 1,000 foot (305 m) range, and is +4 to strike, +5 to strike Protoculture-

powered mecha and beings that radiate Protoculture. It does not apply to outcast Vicereines until they have their own Hive.

6. Telekinetic Throw. A Hive Vicereine can lift and hurl heavy objects. It is likely this ability is crucial in building a new Hive, but it also serves them as a defensive and offensive capability.

She can pick up and throw 100 pounds (45 kg) per level of experience. Each 100 pounds (45 kg) thrown does 1D4 M.D. upon impact. This power can be used on inanimate objects, like rocks, or on living creatures, and she is +2 to strike. An unarmored human thrown by this force takes 6D6 S.D.C.; half damage if wearing riding leathers and a helmet or other crash protection gear. Those inside body armor suffer only 2D4 S.D.C. damage, but their armor takes the 1D4 M.D. per level of experience from the impact. Anyone thrown in this fashion loses initiative and one attack/action. A successful roll with impact reduces damage by half. This attack is invisible and cannot be dodged! However, targets can dodge when other objects are thrown at them. Range for Throwing Objects: 500 feet (152 m) +50 feet (15 m) per level of experience.

7. Learn and Speak Languages. All the Gura-Invid Vicereines can learn languages incredibly fast and can understand and speak any language at 50% proficiency after only 1D4+2 hours of hearing it spoken; +10% per each subsequent day exposed to the language till reaching a maximum mastery of 90%. There is no limit to the number of languages that can be learned. Psychic abilities no doubt play a role in this.

8. Food and Adaptability. One would think that the departure of the Regess and the loss of the Flower of Life on Earth would doom the species to starvation. Untrue. The Gura-Invid will revert to their more animalistic nature and become meat-eating predators, at which point humans are likely to be regarded as prey and rivals to be destroyed.

9. Behavioral Note (All Vicereines). The Gura-Invid are mutant hybrids of the intelligent Invid and the Gura, an animal predator driven by instinct and a desire to hunt, kill and feed. As a result, the mutants have some difficulty using higher reasoning thought processes or dealing with other sentient creatures. In most cases, if a neophyte Vicereine sees something she wants, she will simply walk up and take it, and kill anyone who tries to stop her. She will ask awkward and strange questions, utterly lack subtlety and may be coldly violent with no concern or remorse for the loss of non-Gura-Invid life. They are smart enough to learn and speak human languages, understand when they are overmatched (self-preservation is their most powerful instinct) and possess basic hunting, fighting and ambush instincts, as well as a strong sense of self-preservation. However, they will struggle with the concepts of personal expression and freedom, laws, rules, justice, art, entertainment and most aspects of human civilization and human emotion and logic. For the Gura-Invid, might makes right and in the animal food chain they are at the upper level, certainly above humans.

Gura-Invid Vicereine

Game Master Note: The Gura-Invid Vicereines are meant to be non-player characters (NPCs) only. Although one may join a player group and travel with them for a short time, it will become quickly apparent that something is “not quite right” about her.

Alignment: Anarchist. May develop into another alignment with enough contact with human beings.

Attributes of the Vicereine: I.Q. 14, M.A. 20, M.E. 18, P.S. 39 (Supernatural), P.P. 13, P.E. 21, P.B. 14, Spd 17. Strength and Endurance are considered to be Supernatural.

Attributes for a Neophyte Gura-Invid Vicereine: I.Q. 1D6+10, M.A. 2D6+10, M.E. 1D6+14, P.S. 2D6+32 (Supernatural), P.P. 2D6+8, P.E. 2D6+12 (Supernatural), P.B. 2D6+6 in human form 1D4+2 in monstrous Gura-Invid form, Spd 2D6+12 running; cannot fly under her own power, but can survive in space.

Attributes of the Viceroy: I.Q. 12, M.A. 19, M.E. 16, P.S. 42 (Supernatural), P.P. 17, P.E. 18, P.B. 15, Spd 18, Strength and Endurance are considered to be Supernatural.

M.D.C.: 710 for the Vicereine (680 for the Viceroy). P.E. attribute number $\times 10 + 1D6 \times 100$ M.D.C. for other Vicereines.

Size: Typical human size in human form. In egg-laying form, the Vicereine is 72 feet (22 m) long (including egg sac) and weighs about 15 tons.

Experience Level: 5th level, for the Vicereine and Viceroy.

Occupation: Supreme Hive Leader of one Gura-Invid Hive.

Disposition of the Vicereine: Curious, remorseless, heartless, but not intentionally cruel. Only concerned with the perpetuation of her race.

Disposition of the Viceroy: Curious, aggressive, ruthless, war-like, brutal and deliberately cruel. Enjoys fighting and war and conquest of lesser beings like humans. Concerned with conquests and the perpetuation of his species.

Natural Abilities: All Vicereines have the Gura-Invid Abilities #1-6, described at the beginning of this section, as well as Nightvision 1,000 feet (305 m; can see in total darkness) and Bio-Regenerate 2D6+4 M.D. per melee round. The Vicereines (and Viceroy) can also survive for one hour per P.E. attribute point in the vacuum of outer space, and though the Vicereine fights to defend the Hive and her people, it is she that all the lesser Gura-Invid serve and they will sacrifice their lives to protect their Vicereine. Remember, active Hive Vicereines (and the Viceroy) also possess the special abilities previously described.

Skills of Note: Vicereines have very few skills at first, relying mostly on their natural abilities and instinct. To start, they speak English 90%, and know Botany (+10%), Dowsing (+20%), Land Navigation (+24%), Prowl (+10%), and a total of four other skills of choice (+5%). However, when exposed to humans (and in the case of outcast neophytes, during their travels), the Vicereine can pick up eight additional skills from any category, as long as she has someone (such as a prisoner) to teach her and has met all the prerequisites. **Note:** The Viceroy starts with the skills listed, but his four other skills are Martial Arts, W.P. Blunt, W.P. Energy Pistol and W.P. Energy Rifle.

Attacks per Melee: Five. (The Viceroy has six.)

Bonuses (in addition to likely attribute and skill bonuses): +2 to all Perception Rolls, +3 on initiative, +2 to strike, parry and dodge, +2 to pull punch, +4 to roll with impact, +4 to save vs psionics and mind control of any kind, poisons and toxins do half damage for half duration, and the Hive Vicereine is +6 to save vs Horror Factor (the outcast neophytes are +2 to save vs H.F.).

Mega-Damage: As per Supernatural P.S., special powers, or weapons.

Weapons and Equipment of Note: An outcast Vicereine wears clothing to fit in when traveling, but other than that, only holds onto things she finds interesting or helpful, be it a weapon, an electronic device or shiny, colored piece of glass, etc. She is likely to leave it behind when her curiosity has been satiated. Other items and larger things may be carried by her entourage. Once a Vicereine has established a Hive, she rarely leaves it for any reason, unless it is destroyed.



Siberia Genesis Pit

In the frozen wastes of Siberia, far from what has been the traditional strongholds of humanity, the Invid have constructed the largest Genesis Pit on the planet. Utilizing the natural environment around it, dug a mile (1.6 km) deep into the permafrost in northern Siberia, this gigantic evolutionary laboratory has recreated Earth during the last ice age.

Why the Invid chose this time in history, of course, is a mystery, but it is a period that played a large role in shaping the planet Earth as we know it today. The creatures that emerged from that time period went on to evolve the human species that would eventually dominate the planet. Whatever the reason for the Regess, it is obviously an important project and covers a sprawling 10 mile (16 km) radius underground, not far from what used to be *Norilsk*, north of the Arctic Circle. As one would expect, the frozen, treeless tundra above hides a lost world of woolly mammoths, sabertooth tigers, dire wolves, giant ground sloths and many other animals from that era.

Secret Robotech Masters Base

The northern depth of Siberia hides another secret. It is a secret of which even the Invid are unaware. Hidden to the southwest of the Siberia Pit, near the ruins of *Nadym*, is the last, somewhat functional, **Robotech Master mother ship**.

The massive vessel set down in the area shortly after the last battle of the Second Robotech War. The Masters aboard knew they did not have the Protoculture needed to escape the solar system before the Invid arrived, and knew enough about the Flower of Life to choose an area where it was unlikely to grow. The hope was to covertly siphon off Protoculture from the remnants

of humanity (or the Invid) until they could make their escape. However, the Robotech Masters failed to anticipate the ferocity of the Invid attack. The Invid are always vicious, but they have never hit a world quite so hard as they hit Earth. This was mainly because the Robotech Masters fought the Invid when they were led into battle by the *Regent* (the Regess's now deceased mate). The Regent tried, in many ways, to fashion himself after the Robotech Masters, copied their tactics and often their strategies and goals, while at the same time proclaiming himself and the Invid to be superior. As a result, he saw himself as a conqueror of worlds and the enslaver of lesser beings. The Regent relished campaigns of terror and lording over his victims.

The Regess, by contrast, was all matter-of-fact business. She and her Invid hit the Earth like bio-mechanical locusts. They ripped to shreds any opposition in ferocious, unrelenting, all-out warfare that had little parallel in Earth history. Her goal was to wipe out Earth's defenders, crush human civilization and use whoever might survive as slave labor and pawns. With Earth's defenders neutralized, she would claim Earth as the Invid's new home world and continue her metaphysical experiments in evolution. Survivors who stayed out of the Invid's way were largely ignored, at least until they were then needed for labor or experimentation. Survivors enslaved by the invaders served a new, in-human master. Any resistance was quelled with lethal force. Her plan was as simple as that.

The Robotech Masters hiding in Siberia watched in horror, and then redoubled their efforts to stay hidden amidst the carnage of the invasion. Somehow, they have succeeded, and they and their crew have survived by never leading the Invid back to their doorstep, using humans and Earth equipment whenever possible to do their dirty work, and misleading the Invid to look for them elsewhere. The Masters on this mother ship have managed to syphon off a respectable amount of Protoculture from the Invid and crashed spacecraft from early, futile attempts by the UEEF to liberate the Earth. However, it is not anywhere near enough to get them back to Tirol or even to escape the Earth before the Invid would swarm to destroy them. And so the Robotech Masters continue to quietly steal and horde Protoculture, ever searching for ways to get enough energy to make good their escape.

When the Siberian Genesis Pit went online, Protoculture sensors aboard the mother ship spiked. The Masters were very excited, until they realized the power source was a Genesis Pit. They were familiar with the massive evolutionary laboratories, but had never figured out how they worked or why the Invid built them. Now they had one in their back yard, and its close proximity made it a threat to their very existence. If the Invid learned their presence on Earth and the location of the mother ship, they would stop at nothing to annihilate them. The Robotech Masters want the Pit gone, but they can't destroy it themselves. To take direct action against it with Bioroids and clones would be like sending the Regess an engraved invitation to their hideout in Siberia. Instead, the Masters have hatched a plot to trick humans into helping them execute a daring plan against the Invid.

To that end, they have begun the remarkable process of trading off excess Bioroids and equipment, in return for human-made mecha and machinery. They are extremely careful to do this in a way that does not lead the humans back to their ship and have hired other humans to work as middlemen. These middlemen pretend that the Bioroids are salvage from the last war and can

even show people how to rig them to accept standard Protoculture energy cells instead of the compressed Protoculture slugs they traditionally use. Bioroids and hover sleds are traded in return for Cyclones, Alphas, and other human-made mecha and, most importantly, Protoculture.

When the Masters have enough human mecha and Protoculture to pull it off, they plan to hit the Genesis Pit with a full offensive; first by instigating the Neanderthals in the Pit to rebel, then tricking human freedom fighters into attacking one end of the Pit, while they, concealed inside human mecha, launch an attack to capture the Invid Brain running the Pit and enough Protoculture to power the mother ship and blast off into space. If their human pawns do their job and the operation goes well, they'll be able to execute a space fold before the Regess realizes what's going on and sends enough Invid forces to destroy them.

Most humans do not understand the hatred that exists between the Invid and the Robotech Masters, especially if they were born on Earth. The moment the Invid catch sight of a Bioroid or even a functional Zentraedi Battle Pod, they go berserk and attack, sending out double the usual number of attackers. If more than three of these hated enemies are spotted at the same time, the local Invid Brain may empty out the Hive in an effort to destroy them and hunt down any others that may be in the area. Ultimately, this is what the Masters want. They want to get the Invid Brain in the Siberia Genesis Pit to get used to sending out its forces and winning against the surrogate Bioroid pilots. Then, at the right moment, when the Hive's forces are chasing down humans in Bioroid clothing, the Masters will launch a real attack on the Pit and execute their escape plan.

Some freedom fighters have realized the magnitude of the Invid's hatred of the Masters, and use salvaged or purchased Bioroids as diversions to draw Invid forces away from their real objective, such as rescuing slaves from an Invid Protoculture Farm or raiding a Protoculture storage facility to make off with Protoculture cells to power their own mecha.

It should be noted that it is always the weaker equipment, such as the basic blue Bioroid mecha, hover sleds and Terminator body armor that the Robotech Masters are secretly trading away. Mecha like the Invid Triumvirate Fighter and Command Bioroids are kept for the day the Robotech Masters anticipate they will have to fight their way free of Earth and space fold to freedom.

The Robotech Masters know that secrecy is their only means of survival, so any group of humans that discovers their existence will find themselves in danger. Not only will the Masters send agents to go after anyone who could reveal them to the Invid directly, but they strike out through the network of human pawns and mercenaries they have developed throughout Eurasia over the last several years. Players who ascertain that the Robotech Masters have a secret base on Earth are liable to find themselves attacked by vicious bandits and bounty hunters, often using Robotech Master weapons and equipment, and who seem quite bent on their destruction. If they successfully evade these unwitting minions, they are likely to find a more direct attack by clones pretending to be human survivors or fellow freedom fighters clad in scavenged UEEF or ASC mecha, uniforms and combat gear. Mercenaries, bandits and bounty hunters will be hired by third parties and cannot be traced back to the Masters. Bioroid pilots and clones, on the other hand, may suggest the existence of Robotech Masters, but they will die before revealing the location of the secret base/mother ship.

The Siberian Genesis Pit

The actual town of *Norilsk* has been abandoned for decades since the Zentraedi bombardment of Earth. Buildings, long vacant and decayed, still litter the surface, though half buried in years of unshoveled and unmelted ice and snow. Many have collapsed under the weight of snow and age. It is a ghost town with nothing of apparent value, except perhaps a bit of shelter for a night or two.

In the middle of this ghost town is a shaft leading straight down into the Invid's Siberian Genesis Pit. The entrance is concealed by ice and snow most of the year, but the Pit itself gives off enough heat that any thermographic sensors immediately detect the unusual vent of relatively warm air from below. Once you know where to look, and what to look for, the entrance to the Pit is easy to find.

The shaft leads to a mile (1.6 km) deep drop into the ground, opening up on a small ice shelf that looks out over the huge underground interior of this Genesis Pit. The landscape is mostly flat, with a large, central plain surrounded by forests that push against the outer walls of the Genesis Pit. At any given time, up to 60% of the Pit is covered in heavy fog. Patches of snow and ice are broken by stubborn grasses, coniferous trees such as pines and evergreens, and roaming herds of woolly mammoths, their smaller mastodon cousins, ground sloths and other creatures from Earth's Pleistocene Epoch; creatures that date as far back as 100,000 years, sometimes more. And if one looks closely, prowling through the brush are saber-toothed cats and packs of dire wolves. As wondrous as the animal life may be, they are not the most shocking inhabitants. The bigger surprise are the groups of small, furtive figures hunting down mastodons with spears: *prehistoric man*.

Even before Scott Bernard and his rebel group disrupted the Invid's plans on Earth and made the Regess consider the human form, she was already studying it. There are several reasons for this, the main one being that we look like Robotech Masters, but are clearly not. How did this happen? The Regess wondered. Are the humans of Earth a lost colony? Parallel evolution? The influence of the Flower of Life, which the Invid and some others think has its own awareness and agenda?

As a result, various species of prehistoric man, most notably Neanderthal and Cro-Magnon, are among the Siberia Genesis Pit's most unpredictable and dangerous inhabitants.

The Invid Hive that controls the entire Genesis Pit is well-hidden, located at the bottom of a large central lake that works as a watering hole for many of the inhabitants. Close observation and a knowledge of animals and/or how to track them should reveal that most of the creatures stay away from the northwest corner of the small lake. If one is patient and observant enough, an Invid Trooper or group of Invid Scouts will be seen emerging from and sliding back into the water, indicating the presence of an underwater Hive. Of course, the humanoid inhabitants know the "monsters" live in the lake, but communicating with our prehistoric cousins is a tricky matter.

The Siberian Genesis Pit has a fully staffed Hive, and the Invid Brain is dedicated to the continued and smooth operation of the ongoing evolutionary experiment. It will do anything to rid the Pit of modern interlopers, but tries to do so without too much stress and trauma inflicted upon the creatures within it.

The Hive underneath the water has an airlock-like main entrance that keeps the icy lake waters out. If something untoward were to happen to that portal, the waters of the lake would come flooding into the Invid Hive, damaging its power core and causing the entire structure to collapse. There are always four Shock Troopers submerged near the entrance to prevent that from happening and they are never sent away from their post for any reason. An attacker must deal with them to get to the airlock.

Inside the Hive is a massive Mutation Pit that has been used to create many of the Pit's inhabitants as well as to experiment on the prehistoric humans who live there. They are lab animals for the Invid, who are curious as to why so many of their attempts on human subjects fail to result in loyal subjects. Since prehistoric man is no better at explaining self-determination to the Invid than modern man, all the Invid have done is make more genetic mutations.

The Invid Brain is aware that there have been intrusions into the Pit by what it believes to be humans (really clones of the Masters trying to get the lay of the land, enemy strength and locate strategic targets). The Brain has attempted to capture and interrogate some of these interlopers, but they have always escaped or been killed in the process - sometimes by their own comrades. The Invid Brain has not figured out that these are actually Robotech Master Operatives.

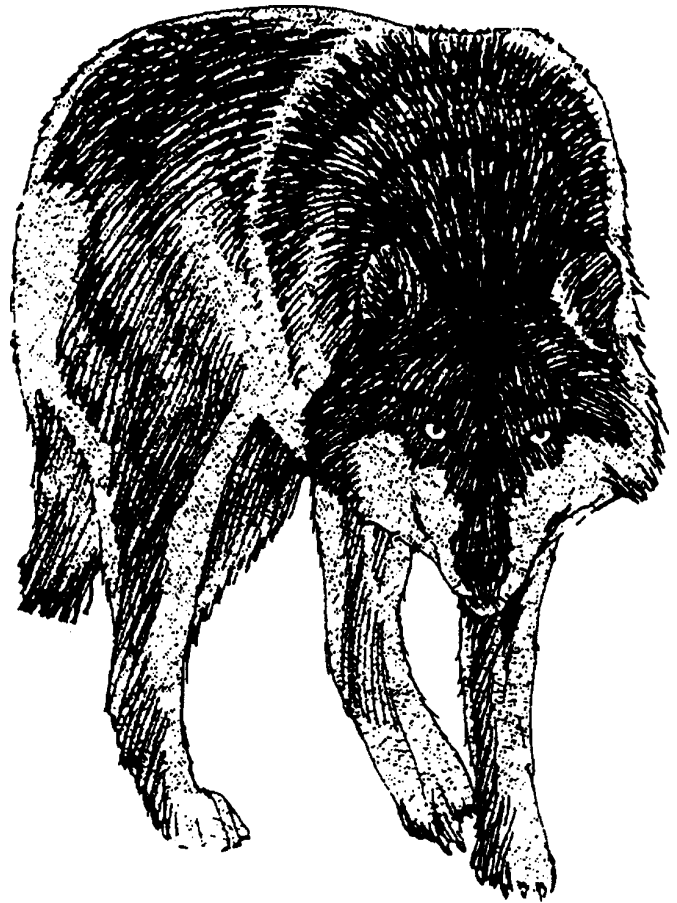

Denizens of the Genesis Pit

The creatures in the Siberian Pit come from the last glacial period, ranging from about 110,000 to 10,000 years ago, when sheets of ice three to four kilometers thick covered much of the northern hemisphere. Herds of woolly mammoths and mastodons wandered the cold tundra, stalked by large predators. Many large versions of animals we know today, what are referred to as "mega fauna," existed during this period. Many were wiped out by the end of the Ice Age, or evolved into smaller versions of themselves that require much less energy (food/oxygen), thus improving survival chances. This includes all sorts of fur-covered rhinos and elephants, as well as horses, bovines, canines, felines, bears, sloths and other animals. For humans, the height of technology was stone tools and there was no known written language or civilization.

These animals and human ancestors live once again in this Genesis Pit, and many could survive on the Siberian tundra should they manage to escape.

Several of the most significant creatures are detailed below.

A Few Notable Ice Age Animals (Quick Stats)

Note: In all cases, "animals" are generally considered to be of Anarchist alignment, though predators who prey upon humans or become man-eaters, predators that prefer to hunt humanoids, may be considered Miscreant or Diabolic evil.

Dire Wolves: This prehistoric animal was 40% larger than the Timber Wolf and had good speed and hunted in packs like modern wolves. **Attributes:** I.Q. 2D4 (animal predator), M.E. 1D6+8, M.A. 1D6+10, P.S. 1D6+14 (equal to Augmented Strength), P.P. 1D6+11, P.E. 2D6+14, P.B. 1D6+8, Spd 3D6+32 (30 mph/48 km on average), with bursts that increase running speed by 50% for 1D4+1 minutes. **Natural Abilities:** Adapted to

cold environments, Nightvision 500 feet (152 m), and the equivalent skills of Climbing 35%, Land Navigation 90%, and track by smell 88% (+8% to follow a blood scent). **Hit Points:** 1D6x10+6. **Attacks per Melee:** Three. **Damage:** Bite 3D6 S.D.C. damage and claws 1D4. **Bonuses:** +3 on initiative, +5 to strike, and +4 to dodge. **Note:** Pack hunter with 3D4 pack members in a pack; hunted in forests and plains.

Giant Bison/Buffalo and Elk: Large herbivores that mainly feed on grasses (elk and deer also feed on leaves and tree bark), these animals are easily 33-50% larger than their modern day counterparts. **Attributes:** I.Q. 1D4+2 (animal intelligence), M.E. 2D4, M.A. 2D6, P.S. 1D6+12 (equal to Augmented Strength), P.P. 1D6+6 (1D6+15 for Elk), P.E. 1D6+14, P.B. 2D6+4, Spd 2D6+36 (30 mph/48 km on average), with bursts that increase running speed by 30% for 1D4 minutes. **Natural Abilities:** Adapted to cold environments, Elk can leap 10 feet (3 m) high and 20 feet (6.1 m) across, Nightvision 200 feet (60 m), and the equivalent skills of Identify Plants and Fruit 75%, Land Navigation 65% and Swimming 70%. **Hit Points:** 2D4x10+12. **Attacks per Melee:** Two. **Damage:** Head butt or bite 1D6 S.D.C., gore with horns 2D6+2 S.D.C. plus targets weighing less than 300 lbs (135 kg) are knocked down or hurled 2D4 feet (0.6 to 2.4 m) through the air, losing one melee attack and initiative, stomp 2D4 S.D.C. and trample 3D6 S.D.C. and victim loses one melee attack and initiative. **Bonuses:** +1 on Perception Rolls, +2 to strike, +2 to dodge for bison, +5 to dodge for Elk/caribou/deer. **Food:** Grass and vegetation. **Note:** Bison and similar bovines are plains/tundra animals while Elk/caribou/deer are forest animals that may also live in, or travel across, plains. There are several species of each. Travel in herds. In the small expanse of the Genesis Pit, a typical herd is 3D6+10 animals.

Giant Cave Bear: This prehistoric animal towered five feet (1.5 m) at the shoulders on all fours and 10-14 feet (3 to 4.3 m)

tall standing upright on its hind legs. It is likely (01-65% chance) to see human-sized beings as potential prey or threat and attack. **Attributes:** I.Q. 2D4 (animal predator), M.E. 1D6+8, M.A. 1D6+10, P.S. 2D4+26 (equal to Augmented Strength), P.P. 1D6+9, P.E. 2D6+16, P.B. 1D6+8, Spd 2D6+24 (20 mph/32 km on average), with bursts that increase running speed by 30% for 1D4 minutes. **Natural Abilities:** Adapted to cold environments, Nightvision 50 feet (15.2 m), and the equivalent skills of Climbing 60%, Land Navigation 80%, Swimming 85% and track by smell 80% (+5% to follow a blood or decay scent). **M.D.C.:** 4D6 M.D.C. (4D6x100 Hit Points and can be hurt by S.D.C. weapons but it takes a lot of damage to kill it). **Attacks per Melee:** Three. **Damage:** Nip 2D6 S.D.C., bite 1D6 M.D., restrained claw strike 4D6 S.D.C., and full strength claw strike 2D4 M.D. **Bonuses:** +2 on initiative, +3 to strike and parry, and +3 to dodge. **Note:** Solitary hunter or mated pair. Females may hunt with young for up to three years; gives birth to two cubs. Hunts mainly in the forest and mountainous regions, preys upon deer, caribou, fish, and other animals, as well as carrion, but humanoids may be seen as easy prey, especially if injured.

Giant Tree Sloth: This lumbering prehistoric animal is 8-12 feet (2.4 to 3.6 m) long on all fours and when standing on its hind legs, and weighs 700-1,000 pounds (315-450 kg). Though menacing in size and appearance, this gentle behemoth is a plant eater that stands on its hind legs to feed on the leaves of trees. Giant sloths have three highly developed claws used to strip and eat, leaves, bark and to tear off branches. **Attributes:** I.Q. 1D4+2 (animal intelligence), M.E. 1D6+8, M.A. 2D4, P.S. 1D4+20 (equal to Augmented Strength), P.P. 1D6+9, P.E. 2D6+14, P.B. 1D6+3, Spd 1D6+12 (8 mph/12.8 km on average), with bursts that increase running speed by 20% for one minute. **Natural Abilities:** Adapted to cold environments, Nightvision 200 feet (60 m), the equivalent skills of Climbing 25%, Identify Plants and Fruit 85%, Land Navigation 60%, and Swimming 55%. **M.D.C.:** 2D6 M.D.C. (2D6x100 Hit Points and can be hurt by S.D.C. weapons but it takes a lot of damage to kill it). **Attacks per Melee:** Two. **Damage:** Nip 1D4 S.D.C., bite 1D4 S.D.C., restrained claw strike 1D6 S.D.C., full strength claw strike 4D6 S.D.C. **Bonuses:** +2 to strike, parry and dodge. **Note:** Solitary animal or mated pair. Females will travel with young for two years; gives birth to 1D4 cubs. Eats bark, nuts, berries, and fruit, but primarily leaves and twigs. A forest-dwelling animal.

Saber-Tooth Felines: The saber-tooth tiger and its cousins were solitary hunters of large prey and ate carrion as well. **Attributes:** I.Q. 1D4+6 (cunning animal predator), M.E. 1D6+7, M.A. 1D6+4, P.S. 1D6+18 (equal to Augmented Strength), P.P. 1D6+15, P.E. 1D6+15, P.B. 1D6+10, Spd 2D6+26 (20 mph/32 km on average), with bursts that increase running speed by 50% for one minute. **Natural Abilities:** Nightvision 1,000 feet (305 m), can leap 30 feet (9.1 m) high or across, and the equivalent skills of Climbing 50%, Land Navigation 85%, Prowl 60%, Swimming 60%, and track by smell or sight 70%. **Hit Points:** 3D4x10. **Attacks per Melee:** Four. **Damage:** Bite 4D6 S.D.C., claws 2D6+4 S.D.C., power claw strike one M.D. but counts as two of the animal's attacks. **Bonuses:** +1 to Perception Rolls, +2 to initiative, +4 to strike, and +3 to parry and dodge. **Note:** Hunts alone or in prides of 1D6+1

Woolly Mammoth: Covered in a mass of shaggy fur, with long, curving and deadly tusks, this ancestor to the elephant is perhaps the most famous Ice Age creature known by modern man. Whole actual woolly mammoths have been found frozen in

the ice with Siberia having once been a prime stomping ground (pardon the pun). Thus, it was one of the easiest creatures for the Invid to recreate.

They are most distinctive for their size, shaggy fur, short haunches, tall front legs, hunched back, and for their two massive tusks, sweeping forward and curling upward; some tusks reaching lengths of 12 feet (3.6 m) long. These make fearsome weapons, and a charging woolly mammoth can damage even the largest Earth mecha and Invid. They also use their agile trunks and sheer mass as weapons, able to hoist enemies into the air, tossing them, entangling and crushing foes with their trunks, or simply stomping them flat into the ground. Mammoths are plains animals that travel in herds of 4D6+6. All of the mature females are the guardians of the herds, protecting the young from predators. Males tend to be solitary creatures who travel away from the herd, except during mating season, although most herds have 1- 2 males who stay with them year-round. They are herbivores, which mean they eat plants, and are only truly dangerous when threatened or attacked. **Attributes:** I.Q. 1D6+6 (cunning animal intelligence), M.E. 1D6+8, M.A. 1D6+10, P.S. 2D6+24 (equal to Augmented Strength), P.P. 1D6+10, P.E. 1D6+12, P.B. 1D6+8, Spd 2D6+16 (15 mph/24 km on average), with bursts at double speed that can be maintained for one minute per P.E. attribute point. **Natural Abilities:** Impervious to the effects of exposure and cold weather. Surprisingly intelligent with well-developed long-term memory for an animal. Instinctively know the skills Dowsing 70%, Identify Plants and Fruit 75%, Land Navigation 85%, and Swimming at 80%. **M.D.C.:** 5D6 M.D.C. (5D6x100 Hit Points and can be hurt by S.D.C. weapons but it takes a lot of damage to kill it). **Attacks per Melee:** Three. **Damage:** Head butt or bite 1D4 M.D., gore with tusks 1D6 M.D. plus targets weighing less than 500 lbs (225 kg) are hurled through the air 2D6+3 feet (1.5 to 4.6 m), losing one melee attack and initiative, stomp does 1D4 M.D., trample 1D4 M.D. and victim loses one melee attack and initiative. **Bonuses:** +1 on Perception Rolls, +2 to strike, +2 to parry with trunk or tusks and +1 to dodge. **Food:** Grass and scrub plants found on the plains where they live. There are nine known species of woolly mammoth, which are smaller than the Imperial Mammoth and the woolly mammoth described here. Travel in herds of 4D6+6.

Woolly Imperial Mammoth: This is the largest of the woolly mammoth species, and though believed to have been indigenous to North America, can be found in the Siberian Genesis Pit. Male "bulls" reach up to 14 feet (4.3 m) tall, and their two massive tusks can reach lengths of 16 feet (4.9 m) long! Same fighting capabilities and habits as the woolly mammoth described above. **Attributes:** I.Q. 1D6+4 (cunning animal intelligence), M.E. 1D6+12, M.A. 1D6+6, P.S. 2D6+30 (equal to Augmented Strength), P.P. 1D6+10, P.E. 2D6+18, P.B. 1D6+8, Spd 2D6+14 (14 mph/22.4 km on average) with bursts at double speed for one minute per P.E. attribute point. **Natural Abilities:** Impervious to the effects of exposure and cold weather. Surprisingly intelligent with well-developed long-term memory for an animal. Instinctively know the skills Dowsing 75%, Identify Plants and Fruit 80%, Land Navigation 85%, and Swimming at 70%. **M.D.C.:** 1D4x10+6 M.D.C. (1D4x1,000+60 Hit Points and can be hurt by S.D.C. weapons but it takes a lot of damage to kill it). **Attacks per Melee:** Four. **Damage:** Head butt or bite 1D4 M.D.; jab or butt with tusks 1D4 M.D.; gore with tusks 2D4 M.D. plus targets weighing less than 500 lbs (225 kg) are hurled through the air

2D6+6 feet (2.4 to 5.5 m), losing two melee attacks and initiative; stomp 1D4 M.D.; trample 2D4 M.D. and victim loses one melee attack and initiative. **Bonuses:** +1 on Perception Rolls, +3 to strike, +4 to parry with trunk or tusks. **Food:** Grass and scrub plants found on the plains where they live.

Woolly Mastodon: The Mastodon is a woodland elephant that more resembles a modern Indian elephant in shape and size, just covered in short fur, and with long, slightly scooped tusks, though nowhere near as large as the woolly mammoth. **Attributes:** I.Q. 2D4+2 (cunning animal intelligence), M.E. 1D6+7, M.A. 1D6+9, P.S. 2D6+20 (equal to Augmented Strength), P.P. 1D6+10, P.E. 1D6+12, P.B. 1D6+8, Spd 2D6+19 (16 mph/25.6 km on average), with bursts at double speed that can be maintained for one minute per P.E. attribute point. **Natural Abilities:** Impervious to the effects of exposure and cold weather. Surprisingly intelligent, with a well-developed long-term memory for an animal. Instinctively know the skills Dowsing 70%, Identify Fruits and Plants 75%, Land Navigation 80%, and Swimming at 90%. **M.D.C.:** 5D6 M.D.C. (5D6x100 Hit Points and can be hurt by S.D.C. weapons but it takes a lot of damage to kill it). **Attacks per Melee:** Three. **Damage:** Head butt or bite 1D4 M.D., gore with tusks 1D4 M.D. plus targets weighing less than 500 lbs (225 kg) are hurled through the air 2D6+2 feet (1.2 to 3.3 m), losing one melee attack and initiative, stomp 1D4 M.D., trample 1D4 M.D. and victim loses one melee attack and initiative. **Bonuses:** +1 on Perception Rolls, +2 to strike, +2 to parry with trunk or tusks, +1 to dodge. **Food:** Leaves, twigs and bark from the forests when they live. **Note:** There are several species of Mastodons. Travel in herds of 6D6+8.

Neanderthals

Whether these are actual Neanderthals is unknown. They could be another classification of early man or some Genesis Pit mutant equivalent, but they do appear to be some kind of ancestor to humans. They are large, strong, hairy and primitive. Their level of intelligence and inventiveness is limited compared to modern humans, and they are oriented to a life of primitive hunting and gathering. They tend to be territorial, aggressive, and prone to violence in a world where life is short and danger abounds. Used to a life hunting woolly mammoths (a remarkable achievement given their weaponry), and fighting off packs of dire wolves, they are quick to adapt and learn, and far more dangerous than they appear.

While most appear to be directly derived from ancient man, there are a few, generally the leaders, who appear to have been mutated by the Invid. It could be that the Invid, having failed to convert many contemporary humans into willing drones through the use of their experiments, have resorted to trying to recreate and mutate our ancestors. While most are "normal" Neanderthals, about one in 20 are Invid Genetic Experiments (created as normal, see **Robotech: The New Generation Sourcebook**, page 27, except with the skills listed below).

The Robotech Masters and their clones, experienced for eons with first contact situations, have made inroads into primitive alliances with these throw-backs, by providing them weapons, food and tools. As they have with many primitive cultures the Masters have encountered, they are exploiting these proto-humans. Some they take for experimentation, others they use as scouts while in the Genesis Pits, and they are quietly attempting to turn the entire population against the Invid, knowing full well they will be

slaughtered. They plan to use the diversion to conduct a full-scale raid on the Invid Hive to capture the Brain and enough Protocol-culture to space fold away from Earth.

Neanderthals

Alignment: Most are Anarchist or Unprincipled, but can be any.

Attributes: I.Q. 2D6+2, M.E. 2D6+8, M.A. 2D6+2, P.S. 3D6+8, P.P. 2D6+4, P.E. 3D6+5, P.B. 2D6+2, Spd 4D6+4.

Hit Points: P.E. attribute number +6D6.

S.D.C.: 6D6+20

Size: Slightly shorter than today's humans, at an average of five feet to five feet, six inches (1.52 to 1.68 m) tall.

Weight: Between 105-180 lbs. (47-81 kg), mostly muscle.

Natural Abilities: Resistant to cold (takes half penalties from exposure and can resist it twice as long), and fatigue at half the normal rate of other humans. Also remember, one in 20 have been transformed into Invid Genetics Experiments, giving them bizarre alien forms and powers.

Attacks per Melee: Four.

Bonuses (not including possible bonuses from Attributes): +1 on Perception Rolls involving survival, hunting and combat, +3 to strike, +2 to parry, dodge and disarm, +3 to roll with impact, +3 to pull punch, and +2 to save vs poisons and toxins.

Common Hunting & Survival Skills: Climbing (+15%), Fishing (+20%), Hunting, Prowl (+10%), Identify Plants & Fruit (+20%), Skin & Prepare Animal Hides (+15%), Tracking (people; +10%), Track & Trap Animals (+15%), Wilderness Survival (+20%), W.P. Targeting, W.P. Blunt, W.P. Knife and W.P. Spear.

Experience Level: 1D6, or as the Game Master chooses for NPCs (Non-Player Characters).

Common Gear: Furs and skins for clothing, flint knives (1D6), war clubs (wood or wood and stone; 2D4), and spears (1D8). But some have been given powerful energy rifles and metal weapons as "gifts" by the Robotech Masters, especially if they seem pliable and gullible enough to be led against the Invid. A few highly intelligent "favorites" may be taken back to Tirol to have their genetic traits researched further if the Robotech Masters can make good on their escape.

Habitat: Can make a home virtually in any environment on the planet, but once they leave the Genesis Pit they will be at -4 to save vs all current Earth diseases. Live in villages of 2D4x10 individuals.

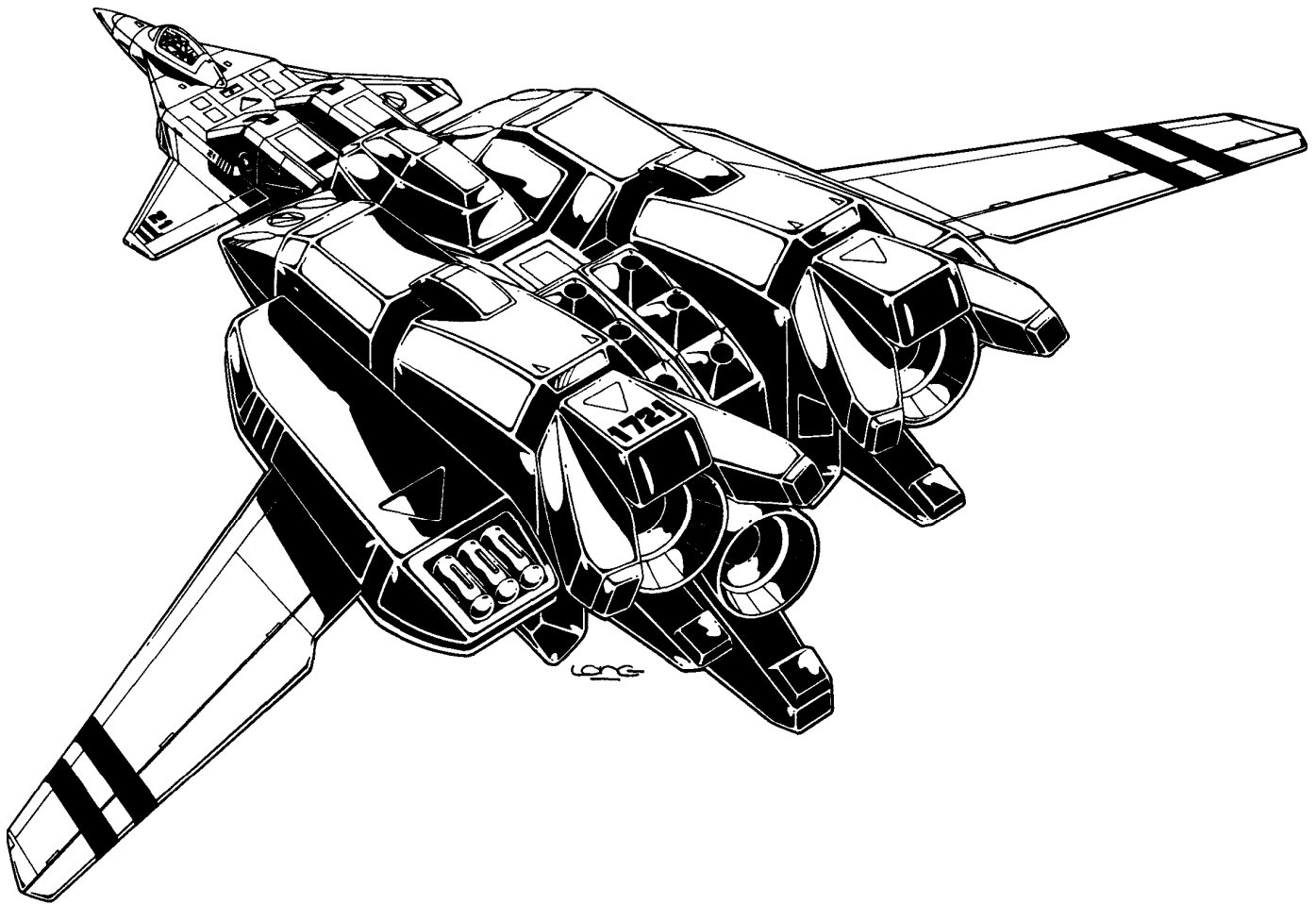

Off-World Genesis Pits

Janus

A Devastated Planet

Perhaps the most extreme example of the use of Genesis Pits in the known universe is the second world in the *Iolas System*. A former stronghold of the Robotech Masters, it was a center for trade, commerce, research and development before the Regent and his legions descended upon it. After a conflict that raged for hundreds of years, the world became a symbol of war, misery and destruction. Its original name has been all but forgotten, and it is now known simply as Janus.

Janus is a world that is almost literally torn in half. It is tidally locked with its sun, meaning it does not rotate, so half of the planet is always day and the other half is perpetual night. The day side is dominated by the remnants of the Regent's wrath: Inorganics and the fiendish creations from Genesis Pits. The night side is barely held by the last remnants of the planet's militia; clones long abandoned by the Robotech Masters, but who refuse to acknowledge it.

The day side is a hot, arid hell, pocked with dozens of Genesis Pits that are so large and so prevalent that they have permanently

damaged the planet's tectonic plates. The planet contains the largest force of known surviving Inorganics. Thousands are believed to inhabit the Genesis Pits, protecting the evolutionary chambers for a master long dead and for a species that has cast them aside. The day side is filled with myriad creatures, mostly former inhabitants of the planet's natural, now obliterated, ecosystem. These creatures have all been subjected to the brutal and often random evolutionary powers of the Genesis Pits. Monsters that hurl themselves at any living thing that does NOT carry the taint of the Pits.

Perhaps the day side's most frightening inhabitants are the Harvesters, former Robotech Master clone troopers who have been mutated into misshapen behemoths and fused with their Bioroids. They get their name from their primary goal: Grab untainted life forms and drag them back to the Mutation Pits to swell their ranks and the ranks of all the monstrous mutants over running the baked, devastated sunlit side of the planet.

The night side is comfortably cool, and scattered with the last, hollowed remnants of the once great Robotech Master society. Raided incessantly by Harvester Bioroid Mutants and Inorganics,

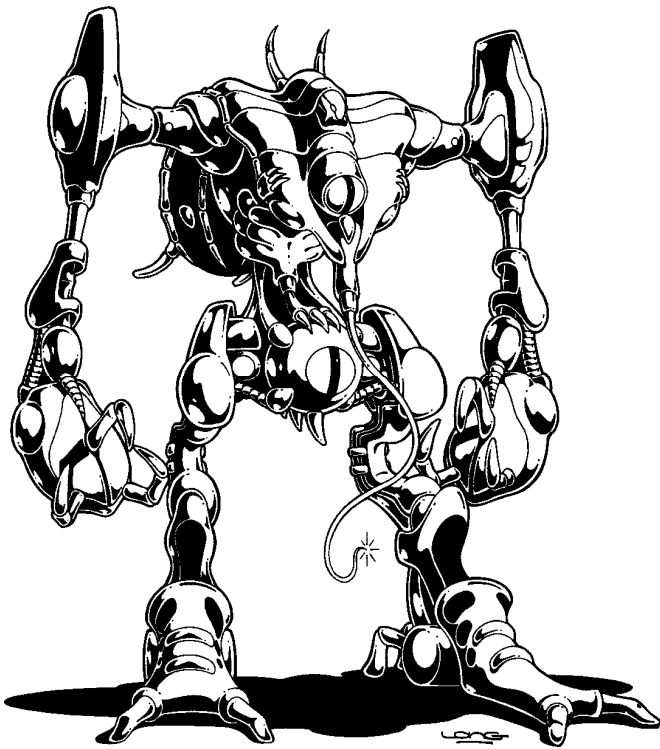

the last remaining *Free Clones* and *Clone Masters* fight to hold back the Invid abominations from taking the entire planet. Fighting with scraped together Bioroids, a decaying pool of endlessly recycled clones, and a dwindling supply of Protoculture, it is as if no one has yet told them that they are fighting against the inevitable, or that their side lost many years ago. Of course, if they were to accept these realities, they would die, so they continue to fight as the only rational option.

A ten degree ring around the planet, where day is stuck fading to night, is a battleground known as the **Terminus Zone**. This region of never-ending twilight, where day and night meet, is where the last forces of the Robotech Masters and the Regent's monstrous legions engage in constant combat. The more organized and rational clones rack up huge body counts among the Harvesters and Inorganics in these battles, but they are hopelessly outnumbered, and feel the loss of each soldier far more deeply than the mindless, heartless enemy ever could.

Janus was once a shining gem in the intergalactic crown of the Robotech Masters, with a population of more than 10 billion. Now, no one is sure how many clones remain. Certainly not more than a couple million, on a planet as large as Earth and with substantially more landmass and less water. Most sentient beings who know of this world shudder to think how many of those billions were tossed callously into the mutating liquids of the Genesis Pits and now shamble mindlessly on the surface with nothing but a dead Regent's bloodlust driving them onward to battle.

This planet, despite its horrors, or perhaps because of them, is likely to draw the attention of the UEEF.

First, the planet borders on legend, and many of the alien allies the humans made in their war against the Regent have spoken of it in both wonder and dread. It is known that the battles there rage on. Which raises the question of how the Robotech Masters' clones are still fighting. Surely, they must be sitting on a significant cache of Protoculture to keep their war machines functioning.

Second, the planet was a showcase of Robotech Master tech-

nology and military might. Who knows what treasures lie in the rubble? It was, at the very least, known to have a powerful early warning system that could track space folds across several parsecs, something which could be extremely valuable in the hunt for the SDF-3.

Unfortunately, going there will not be as simple as landing on the night side and recruiting the aid of the Robotech Master clones. First, the legendary planet must be located. Second, the Masters' forces are still under explicit orders to destroy all invaders, and the UEEF Marines certainly fit that bill. The clone forces on Janus still believe they fight for their Masters, and that belief appears to be completely independent of whether those Masters still live or care about their survival. They will not give up their Protoculture stores without a fight. They will battle to hold onto any technology in their possession, even if they offer to rescue them and/or have evidence showing the rule of the Robotech Masters is over. Securing some kind of agreement or even a cease-fire with the Clone Masters and their beleaguered clone warriors will take a herculean effort on behalf of anyone representing the UEEF.

Then, of course, there is the matter of the Inorganics and Genesis Pit mutations who will automatically attack any visitors to the planet, and fight to the death.

Janus' Day Side Genesis Pits

Instead of conquering the planet like the Regent had done so many times before, he had special plans for this world. He knew that it was the most modern and densely populated gem in the Masters' galactic holdings, and he wanted to do more than just take it away. He wanted to scar it and leave it in a perpetual state of hell.

His invasion started as a typical Invid attack, falling from the sky in the hundreds of thousands, targeting and swarming the defenses and establishing a beachhead position. But this time, things were different. Shortly after securing a significant portion of the day side of the planet, the Regent immediately began to erect massive Genesis Pits, the size and scope of which had never been seen. From these Pits the Regent created and unleashed a new enemy: The Robotech Masters' own soldiers turned into monsters! Captured clones and Bioroid pilots were brainwashed, mutated and transformed into mindless, rampaging drones under the control of the Regent. They still piloted Bioroid mecha and rode hover sleds, but they were now monsters consumed with raiding cities and dragging people back into the enemy's clutches where they too were transformed into fiends consumed with fighting, killing and wreaking destruction on their territory. Civilians were dragged away en masse and unleashed as more mutant combatants. The mutants seem to have no thoughts or desires of their own, other than a mindless need to kill combat forces and drag their fallen mecha away, along with civilian captives, so that they may be turned in the evil thralls of the Regent. These so-called **Black Bioroids** rained down destruction and added to the Regent's already formidable forces. Giving him a fighting force he could throw at the hated Masters without care or compassion.

At first the Robotech Masters were stunned. Then angry, and then extremely concerned. Up to that point, in his own way, the Regent was a predictable homicidal maniac. He swooped in, destroyed everything he could find and then pillaged the resources. Simple. Predictable. And completely understandable. This new,

malicious and wicked innovation scared the Masters. They never knew the Genesis Pits could be used to subjugate and so transform a non-Invid species. If the Regent could transform the Masters' own people, turning them into mindless killing machines, programmed to destroy their own civilization, the madman may have just become unstoppable.

How the Regent came upon this secret is a mystery that died with him some decades later. All the Masters knew was that they had to put an end to it then and there. Attempts to shake the Invid off of the planet using the Zentraedi and orbital bombardments failed. Orbital reconnaissance showed extensive construction and massive holes being ripped into the planet's crust. Out of those holes (massive Genesis Pits) were marching the captured citizens of the Robotech Masters' empire, transformed into mutants and monsters under the sway of the Invid Regent. The Invid King had created a self-generating army that constantly made his forces stronger and the enemy weaker. It was a battle the planet's defenders could never win.

However, the Robotech Masters understood the Regent's personality and barbaric temperament well enough to know that if they could make it look as if this new tactic was an utter failure, he would abandon it. Thus, though the day side half of Janus fell to the Regent's mutant army and the planet was ultimately doomed, the Robotech Masters won the war. They quickly gave up on saving the planet, instead turning their strategy to convincing the Regent that his new scheme was a failure and waste of tremendous resources. If they could do that, it would prevent him from adopting this new, devastating tactic on other worlds.

And it worked.

The Regent became frustrated that the new tactic did not net him an easy victory and break his enemy completely. Like a child with an expensive toy that somehow missed his expectations, the Regent lost interest in using Genesis Pits to transform enemy captives into soldiers fighting for him, and went back to his old combat tactics. What he never realized was that the Robotech Masters fought this growing army of monsters with everything they had. They poured in unprecedented resources, and suffered unfathomable and crippling losses to their military. However, they played down the herculean effort and publicly behaved as if the battle for Janus was of no significance and little consequence to them. They even laughed about it and made sure the Regent knew it. Convinced he was wasting his time and embarrassed by

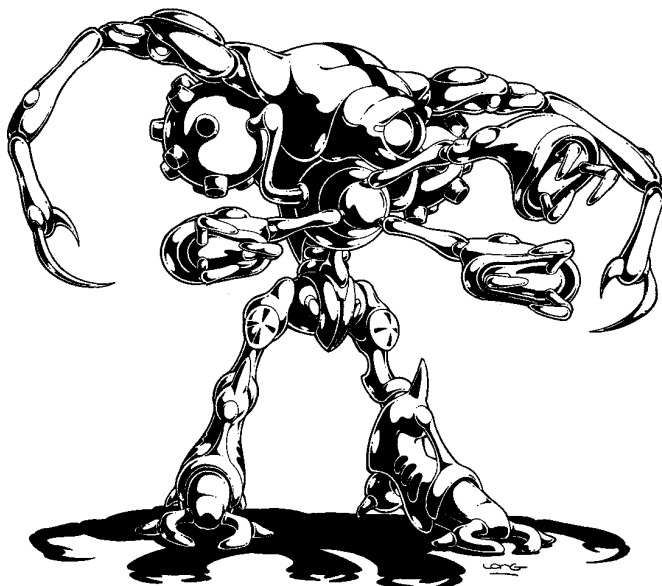

the failure of what should have been his greatest achievement, he gave up on it, left the planet in the throes of endless combat, and took his Invid troops to conquer other worlds as he had done many times before.

The Robotech Masters breathed a sigh of relief that the Regent never realized just how many resources they poured into the battle just to reach a draw. Those resources are the only reason the world stands today, but the battle there continues.

Today, more than two-thirds of the planet is a wasteland covered in craters and ruins. The day half of the planet is pockmarked with one Genesis Pit after another, seething with monsters and mutations whose sole purpose is to destroy anyone unlike the Invid or themselves. The Pits are so many, that in some cases, the walls between them have collapsed, blending several Pits into one. Earthquakes occur daily, causing more damage and chaos. Inorganic patrols stalk the surface and defend the Mutation Pits. Monsters of all shapes and sizes hunt through earthquake shattered landscapes, alien Genesis Pits and the burned out husks of cities that fell centuries ago. And mutant Bioroids continue to hunt for anything that is not already mutated to drag it back and toss it into a Mutation Pit to join them.

So why would anyone in their right minds try to find this planet, let alone go to the day side of Janus? First and foremost, the legendary *Hyperspace Fold Detection System* is said to be located somewhere on the day side in the old Capitol City. This is known to be functional because it is still transmitting data to a small satellite in orbit controlled by Robotech Master Clones still loyal to the fallen empire who coordinate with the remaining forces on the surface.

Second, a number of crashed vessels litter the surface on the day side, drawn there by an unknown force. Could the SDF-3 be one of them? Could the crashed ships hold stores of Protoculture or technology that the UEEF could use? Or secrets about the Haydonites the UEEF could use against them?

Third, one or more UEEF spaceships could space fold there by accident and investigate from orbit, or crash on the day side like many vessels before them. The latter would require the survivors to either hole up and try to last until a rescue operation comes for them, or try to make it to the night side and try to join forces with the Robotech Master clones. The player characters could be on the crashed ship, or could be assigned to the rescue mission.

Janus' Night Side

The Robotech Masters' forces. The night side is a collection of war-torn, mostly emptied out fortress cities connected by thousands of miles of highway and tunnel systems. Once they were beautiful examples of Tirolian architecture. Today, most have fallen into decay.

The only cities that are inhabited are a handful scattered throughout the night side and military posts along the *Terminus Zone*. The Clone Masters who have survived the centuries long conflict have, wisely, decided to put all their resources into preventing the Inorganics and Genesis Pit mutants from completely invading and dominating the night side of the planet. To this end, they have created a ring of defensive positions known as the **Terminus Zone**. Most of these positions are particle beam gun towers running on geothermal power, sitting behind massive kill

zones. When the enemy tries to cross the vast, emptied out territory of the kill zone, the towers open up, slaughtering them. This enables large stretches of territory to be defended by only a few men.

Despite the serene beauty and relative intact state of many of the cities, they provide little beyond basic shelter and clean water. Life never flourished on the night side without sunlight, leaving it cold and sterile and mostly unpopulated. What resources were there have all been scavenged and sent to the front lines at the Terminus Zone.

The people living in the night side cities, while much more civilized, are wary of aliens like the UEEF, and see most other life forms as inferior and potential trouble; or as fodder to be tricked and used against the enemy.

Many of the sprawling, empty cities are in various states of ruin. Some due to the passage of time and the elements, and others blasted and bombarded by Invid attacks before the Regent abandoned the planet. While these expansive ghost towns and ruins provide a lot of places for visiting off-worlders to hide and set up bases of operation, danger is ever present. Millions of mutations have snuck or battled their way into the night side. Though they are scattered across half a world, and are hunted by the remaining Bioroid pilots, encounters with the mutant Bioroids consumed with killing and Inorganics are an ever-present danger. Enemy forces are scattered across the night side, mostly in the vast, desolate and abandoned areas as lone warriors, pairs and small groups of 2D6+6. They are common enough that one should not sleep too lightly in the abandoned high-tech skyscrapers.

Elsewhere, mostly near the Terminus Zone, clones and Masters continue to fight and survive. Their culture has become one of daily conflict and battle. It's all they have known for centuries. These combatants have secured armories, laboratories, secret bases and enough Protoculture to keep the fight going. But unless someone can get through their loyalty conditioning, they will die before giving that information to strangers.

There is much here that the scientists of the UEEF would find interesting. Cloning chambers, Robotech Master Technology and history, a veritable xeno-archeological treasure trove if the Protoculture situation in the UEEF were not such a restriction on exploration. But even far behind the lines of the Terminus Zone, there is still a threat from Bioroid defenders who patrol the night side in search of nests of mutants, Inorganics and other dangers that could threaten them and their people. That would include "alien visitors" such as humans from the UEEF.

Harvester Bioroid Mutant

Also known as "Black Bioroid"

Besides the Inorganics (detailed elsewhere in this book), the Harvester Bioroids, also known as *Black Bioroids*, are the most feared inhabitants from the day side of Janus. They are an unwholesome fusion of clone pilots with the Bioroid mecha they once used as vehicles.

They are fierce and unrelenting combatants, with a hunger for destruction and killing. They are called Harvesters because after they have dealt with soldiers and defenders, they capture and

drag civilians, and fallen combatants who still live, back to the mutation chambers in the Genesis Pits on the day side. Victims placed in the Pit climb out of the glowing green sludge as either mindless savages or new Harvesters (aka Black Bioroids) consumed with destruction and bringing more unwilling conscripts for mutation to swell their ranks.

One of the most frightening aspects of the Harvesters is their shouting and shrieking in battle. Some speculate that their screams are from the anguish of the victims turned into monsters. Others think it is just a reaction from minds turned into animalistic, bloodthirsty combatants.

Harvester Bioroid Mutants appear to be the monstrous extrapolations of the Blue, Green and Red Bioroids. Each is 10-20% larger and bulkier than the original, and their color is much darker, almost black with blue, green or red highlights. They are also more organic looking with what looks like tree roots or thick veins running through their limbs and neck, and replacing the cable-like musculature of the traditional Bioroid mecha. The body of the pilot within the armor is a bloated cocoon-like mass that fills the pilot compartment with organic tendrils connecting him to his machine like the roots of a tree or a mass of vines. The fingers of the Bioroid mecha end in vicious claws and Black Bioroids possess tremendous strength.

In combat, they fight with the standard drum pods issued by the Masters to their troops, but they may also use pieces of M.D.C. pipe and debris as clubs, spears and staves. Harvester Bioroid Mutants appear to be powered by Protoculture, which means there must be one or more sources on the day side. This is encouraging for two reasons. First, a Protoculture storehouse could be robbed and pillaged. Second, the Protoculture will eventually run out, and without power, this war may one day grind to a halt.

Harvester Bioroid Mutant

Also Known As: Black Bioroids.

Vehicle Type: Mutated Bioroid Soldier and Specimen Collector.

Crew: One mutated clone.

M.D.C. by Location:

* Head - 90

Upper Arms (2) - 75 each

Left Forearm - 90

Right Forearm and Fused Drum Pod - 110

Claws (2) - 40 each

Upper Legs (2) - 100 each

Lower Legs (2) - 115 each

Feet (2) - 80 each

** Mutant Housing Cocoon - 40

*** Main Body - 175

* Destroying the head exposes the mutant housing cocoon, but does not blind or otherwise hinder the mutant, which appears to sense the world around it through the mutated clone within, perhaps via some sort of psychic perception ability. Targeting the head requires a "Called Shot" and even then the attacker is -2 to strike.

** The mutant housing cocoon stores the original mutated clone, which has now been fused to the cocoon and, through it, the Bioroid. Destroying the cocoon kills the mutant within and shuts down the Bioroid. The mecha's head must first be destroyed to expose the cocoon. Hitting the cocoon requires a "Called Shot" and even then the attacker is -3 to strike.

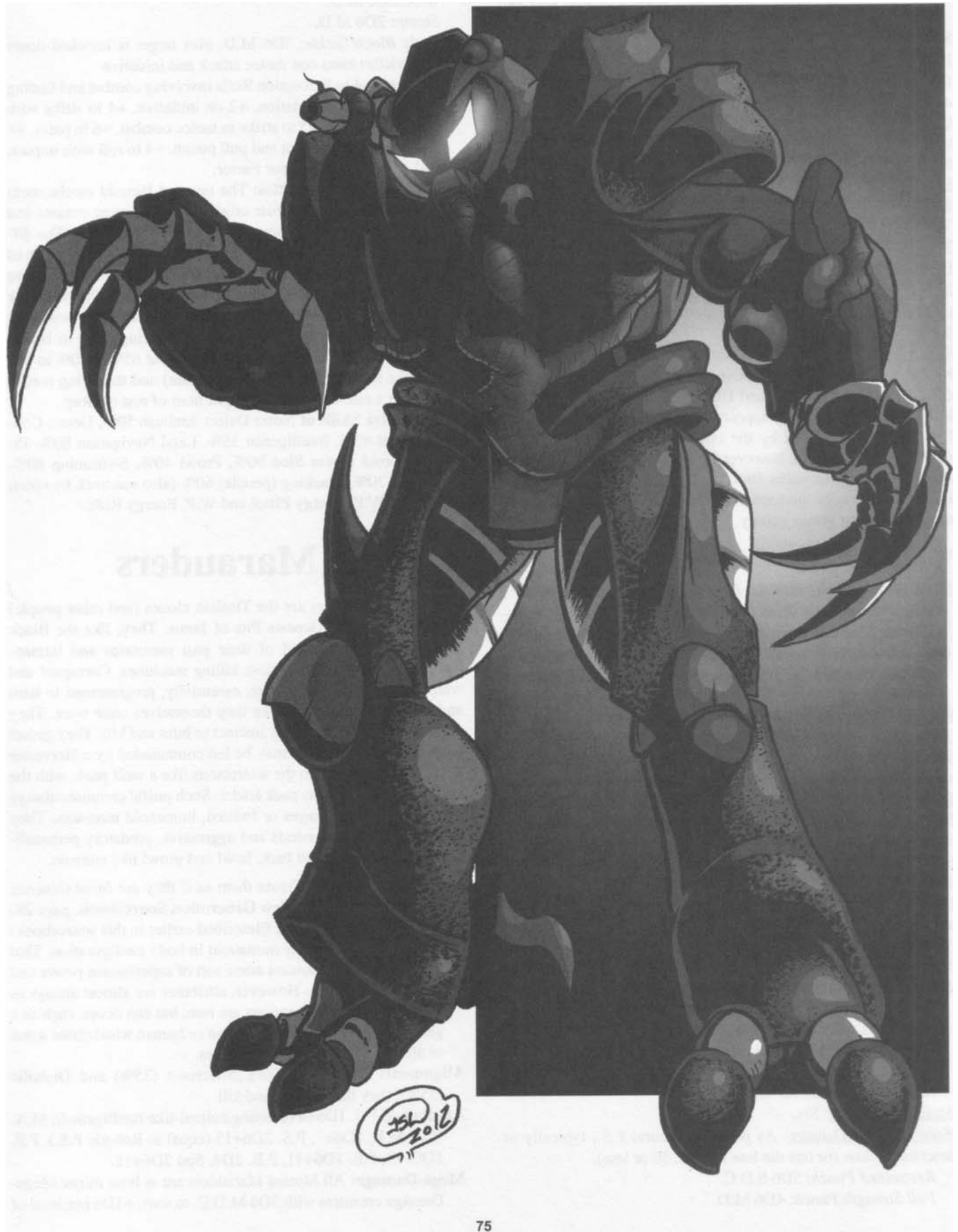

*** Destroying the main body causes the Bioroid mutant to shut down, rendering it inoperable. However, other Harvesters will attempt to retrieve the housing cocoon so that they can place the clone in another Bioroid body.

Speed:

Running: 100 mph (160 km).

Flying: Harvesters are incapable of flight and do not use the Hover Sleds flown by the original Bioroids.

Leaping: 45 feet (13.7 m) up or 120 feet (36.5 m) across. A running start will increase jump distance by 30 feet (9.1 m).

Statistical Data:

Height: 21 feet (6.4 m).

Length: 6.7 feet (2 m).

Width: 9.1 feet (2.8 m).

Weight: 12 tons.

Physical Strength: Supernatural P.S. of 1D6+28.

Experience Level: 1D4, never higher; too animalistic.

Cargo: None, except victims, weapons and gear carried in their hands.

Power System: A mutated Protoculture reactor made of both biological and mechanical parts. Even the Science Masters are mystified by how it functions, and UEEF scientists would be utterly lost. It is known that they appear to run on the same compressed Protoculture slugs used by the original Bioroids. Where these slugs are coming from, however, is unknown and there is some speculation that Harvester Bioroids can draw upon and channel Protoculture energy, perhaps even from the Flower of Life itself, to recharge their power supply.

Weapon Systems:

1. Standard Issue, Bioroid Drum Weapon - TPBGp-Mk I Pulse Beam Gun Pod (1): This awkward looking, drum shaped, 22mm Bioroid sidearm fires heavy ion bolts at an astounding 450 rounds per minute. The Mk.I gives the Bioroid a heavy punch and has very favorable penetration and stopping power.

Primary Purpose: Anti-Mecha & Assault.

Secondary Purpose: Anti-Personnel.

Weight: 200 pounds (90 kg); the weight is of no concern for the stronger mutants.

Range: 1,200 feet (366 m).

Mega-Damage: 2D6 M.D. for a single blast, 1D6x10 M.D. for a five round burst.

Rate of Fire: Single shots or five pulse bursts. Each shot or burst uses one attack.

Payload: 300 single blasts or 60 bursts in an internal, rechargeable Protoculture magazine.

Note: No penalty to strike when firing bursts, but bonus to strike counts only when making an Aimed Shot with a single blast.

2. Hand to Hand Combat: Harvesters possess Supernatural P.S. better designed for melee combat than the original bioroid. Its strength is fearsome, and the hands have been changed into claws often used to tear clones out of their pilot compartments or snatch them off defensive positions to be carried back to the Mutation Pits of Janus' day side.

Attacks per Melee: Six.

Hand to Hand Damage: As per Supernatural P.S., typically as described below (or one die less for P.S. 30 or less).

Restrained Punch: 5D6 S.D.C.

Full Strength Punch: 4D6 M.D.

Tear/Pry with Claws: 5D6 M.D.

Power Punch (counts as two melee attacks): 1D4x10 M.D.

Kick: 5D6 M.D.

Stomp: 2D6 M.D.

Body Block/Tackle: 3D6 M.D. plus target is knocked down and the victim loses one melee attack and initiative.

3. Bonuses: +4 to Perception Rolls involving combat and finding new victims for mutation, +2 on initiative, +4 to strike with ranged weapons, +5 to strike in melee combat, +6 to parry, +4 to dodge, +2 to disarm and pull punch, +4 to roll with impact, and +5 to save vs Horror Factor.

4. Sensors/Special Abilities: The mutated Bioroid mecha seem to have lost many of their original technological sensors and instead hunt by sight, sound and smell, like animals. The difference being that their senses are heightened beyond those of ordinary humanoids. Nightvision 600 feet (183 m) and can see in perfect darkness; vision in sunlight is hawk-like, allowing them to see small targets the size of a mailbox up to two miles (3.2 km) away; heightened sense of hearing, able to hear a whisper at 200 feet (61 m), track by scent 65% (+10% to follow the scent of blood or Protoculture) and the living mecha heals at a rate of 1D6 M.D.C. per hour of rest or sleep.

5. Instinctive Skills of Note: Detect Ambush 50%, Detect Concealment 45%, Intelligence 35%, Land Navigation 80%, Pilot Bioroid Hover Sled 90%, Prowl 40%, Swimming 80%, Tailing 70%, Tracking (people) 60% (also see track by scent, above), W.P. Energy Pistol and W.P. Energy Rifle.

Mutant Marauders

Mutant Marauders are the Tirolian clones (and other people) transformed in the Genesis Pits of Janus. They, like the Black Bioroids, emerge devoid of their past memories and humanity, transformed into relentless killing machines. Corrupted and warped by the Invid, they are, essentially, programmed to hunt and kill other humanoids like they themselves once were. They are now monsters driven by instinct to hunt and kill. They gather in groups of 1D6+8 and may be led/commanded by a Harvester Bioroid, but most roam the wastelands like a wolf pack, with the strongest and largest as pack leader. Such pitiful creatures always look like brutish savages or twisted, humanoid monsters. They have primitive, feral minds and aggressive, predatory personalities. Few can talk. Most bark, howl and growl like animals.

Marauder Creation: Create them as if they are *Invid Genetics Experiments* (see the **New Generation Sourcebook**, page 28) or *Genesis Pit Monsters* (described earlier in this sourcebook) that are predominantly humanoid in body configuration. That means many will possess some sort of superhuman power and nonhuman abilities. However, attributes are almost always as indicated below. Exceptions are rare, but can occur, such as a genetically altered clone, Tirolian or human who retains some or all of his intellect and memories.

Alignment: Anarchist (30%), Miscreant (35%) and Diabolic (35%); they like to fight and kill.

Attributes: I.Q. 1D6+4 (cunning animal-like intelligence), M.A. 1D4, M.E. 1D6+7, P.S. 2D6+15 (equal to Robotic P.S.), P.P. 1D6+13, P.E. 1D6+11, P.B. 2D4, Spd 2D6+11.

Mega-Damage: All Mutant Marauders are at least minor Mega-Damage creatures with 3D6 M.D.C. to start, +1D6 per level of experience. Some may have additional M.D.C. due to muta-

tions/powers as per *Genetics Experiment* or *Genesis Pit Monster*. Lost M.D.C. is recovered at a rate of 1D6 points per 24 hours of healing, unless it has a power that provides accelerated healing.

Disposition: Aggressive, savage and driven to fight and kill. Ruthless in combat and most fight to the death. They are living killing machines.

Level of Experience: 1D4, or as the G.M. deems appropriate, but never more than 6th level.

Skills (Optional): Marauders are driven by the instinct to hunt, capture and kill the enemy. And the enemy is the Masters, their clones, humans and pretty much any race that is not the Invid, Inorganics or their fellow mutants. If any specific skills are allowed, they should be limited to 1D4 Physical skills (excluding Hand to Hand Combat or high-tech skills), 1D4 Wilderness skills, 1D4 W.P. Ancient Weapons and maybe one Modern W.P., maybe. That's it.

Attacks per Melee: 1D4+1 as per handheld weapons, guns (still smart enough to use them, even if it's without a skill bonus) or via biting, claws and powers or abilities gained via their mutation.

Bonuses (these are in addition to possible attribute bonuses):
+1 to Perception Rolls involving stalking prey, combat and escape, +1 on initiative, +3 to strike, +2 to parry and dodge, +1 to disarm, and +3 to roll with impact.

Weapons & Gear: Basic items the Marauder Mutants salvage and find appealing or useful on a simple level.

G.M. Note: You can have armies, tribes and clans of mutants that are virtually identical in appearance and abilities of your own design using the *Invid Genetic Experiment* (see **New Generation Sourcebook**, page 28) or *Genesis Pit Monster* (in this sourcebook), or have dozens of different types, as you deem desirable or best for you campaign and style of gaming.

Ku'Urtz

The Zentraedi Lost Garrison

Due to the vagaries of space folding and its effect on perceived time, and because every planet and every species measures time differently, it is difficult to tell by Earth time just how long the Robotech Masters' empire straddled the stars. A year on the Robotech Masters' home world of Tirol, a moon orbiting the gas giant Fantoma, is nothing like a year on Earth. But it is a certainty that the Robotech Masters and their Zentraedi shock troops ruled a significant portion of the Milky Way Galaxy for centuries. During that time, Zentraedi forces were spread throughout the galaxy to enforce their Masters' will and to battle with the ferocious Invid and other enemies.

When the Robotech Masters' regime fell as it ran out of Protoculture, many of those Zentraedi, perhaps thousands of ships, were left stranded or wandering without orders or direction throughout the cosmos. Many still attempt to fulfill their last orders in aging starships that are slowly running out of power. In some cases, they have learned enough to know that they are on their own, and have turned pirate or mercenary, knowing no other way to live than by fighting. In some other cases, they search for a purpose or just a way to survive. One such example of this is

the **Ku'Urtz fortress**, garrisoned by Zentraedi to observe and contain, via combat, an Invid Hive that was established on the planet more than a century ago (by Earth time). The Robotech Masters wanted to know what the Invid were doing there, and whether they had found a new planet on which to grow the Flower of Life. Accompanying the Zentraedi detachment were a number of Robotech Master Scientists and their clone assistants.

It was inevitable that the Invid would discover the Robotech Masters and their Zentraedi soldiers, and the two groups brutalized each other for decades in guerilla warfare throughout the planet's dense, sprawling jungles. The Invid never attacked all-out because they were on the planet to try and do exactly what the Robotech Masters suspected, and cultivating the Flower of Life was much more important than defeating the Zentraedi. The Zentraedi, likewise, fought the Invid only enough to defend themselves and wait, just in case the Invid succeeded.

Over time and with the collapse of the Robotech Masters' empire due to the ravages of the Invid's unrelenting galactic war, the Masters quite simply forgot about the Ku'Urtz outpost. The Science Masters would send a report every few months detailing the lack of progress the Invid were making, and it would get filed away with billions of other reports and documents that disappointed the Robotech Masters. Then, at some point, the reports stopped reaching them entirely and the outpost was written off and forgotten.

Early on, the Zentraedi cruiser that brought the Ku'Urtz contingent to the planet was severely damaged and would never fly again, so they turned it into a ground-based fortress from which to watch the Invid and launch the occasional attack. When the annual supply ship stopped coming, and when a few years later, the Invid just left (presumably to invade Earth), the Zentraedi garrison found itself all alone with no orders and no enemy to fight. Even with strict rationing of their Protoculture supplies, they were doomed without help. The garrison's Science Masters and clones, not nearly as resilient as their Zentraedi bodyguards, all died, many at the hands of the Invid before they vacated the planet, and the rest from the planet's inhospitable environment.

Before their demise, they had determined that the Invid were constructing an evolutionary experiment known as a *Genesis Pit*, which the Robotech Masters had seen before, but knew almost nothing about. For years with little else to do, they decided to try to unravel the mystery of the Pit. The Zentraedi, trained for battle, did what little they could to help. And so they documented and learned what they could about the Genesis Pit from observation. After the Invid seemed to have left the planet and the Pit behind, the Zentraedi commander, a Warlord named *Volram*, took a desperate course of action and led his troops on a raid into the Invid Genesis Pit, which still gave life readings and signs of a Protoculture power supply. They found the Invid Hive deep in the Pit to be devoid of hostile forces, and far more hospitable than the jungle wilderness, so they chose to relocate there. The creatures living in the Pit also provided a good food source. As for the strange Protoculture emanations, there was no explanation for it.

The Zentraedi moved in, taking advantage of the strategic underground position of the Genesis Pit and the massive Invid Hive buried underneath it. While the few remaining Science Masters knew the Genesis Pit evolved and mutated many of the creatures inside the Pit, they incorrectly assumed that, a) those inside the Hive would be safe from the effect, and b) without the Invid present and in control, the mutation effects and accelerated

evolution should be inactive. Those Masters all perished before they could warn the Zentraedi of their mistake. What the giant warriors could not know was that the mysterious effects of the Pit would change them.

Due to the deliberate designs of their creators, the Robotech Masters, Zentraedi DNA is easy to alter and adjust. The Masters wanted to be able to go into Zentraedi DNA and easily change it for any environment they saw fit. This also means they are highly susceptible to the altering power of the Genesis Pits. As a result, every Zentraedi has experienced some kind of mutation. Most are minor, but others are extreme. In some cases, the effects have driven the Zentraedi soldiers mad, requiring the others to cast them out of the Genesis Pit and into the wild to fend for themselves, lest they become a threat to their fellow soldiers.

These insane, mutant outcasts have reverted to a more primal state of living, using their mutations to dominate the native life and survive.

The outpost fortress included a wing of female power armor pilots who were a special detachment to the Robotech Science Masters, and they have also done something unheard of among the Zentraedi: begun to breed.

This is seen by the more civilized and less mutated Zentraedi as a horrible abomination that they do not understand and, because the Zentraedi lack knowledge of biological reproduction among higher beings (they think it's only possible among lower animal life forms), this is seen as a sign of further mutation. *Warlord Volram*, who still leads the civilized Zentraedi who inhabit the Genesis Pit (unwittingly increasing the risks of more and extreme mutations), is desperate to find a way to get his men off the planet before it is too late. That means any interstellar ship that lands on Ku'Urth will be attacked. He has hoarded the last Protoculture supplies so that his Zentraedi have some functioning combat mecha when the opportunity comes. The last thing he has any intention of doing is giving those precious Protoculture supplies over to a bunch of Micronians, no matter how much they might resemble his former Masters.

Any UEEF forces who land to investigate are going to get a rude welcome both from the vicious and savage Zentraedi outcasts, as well as the more reasonable-seeming Zentraedi personnel living in the Pit. However, they later will want use any visitor's spacecraft to escape the planet, or force visitors into cannibalizing their spacecraft to repair the downed Zentraedi vessel to make it space-capable again.

Zentraedi Mutant Outcasts

The Zentraedi react to the Genesis Pit mutation effects far more quickly and dramatically than humans or most other humanoid species. Not only does it cause more mutations, more frequently, but it also decreases the Zentraedi's state of mind and mental stability, making them less reasonable, more aggressive and paranoid. When Zentraedi warriors become too "disturbed" and dangerous, or too monstrous and inhuman, *Warlord Volram* and his loyalists drive them out of the Genesis Pit to survive on their own in the towering jungles that cover most of the planet. They are still Zentraedi, and quite often, they have done nothing against the other Zentraedi around them, so *Volram* does not have them killed. In a way, he kind of admires them. They have,

in essence, become a more pure expression of the Zentraedi warrior: more powerful, ruthless and combative. However, it is most definitely admiration from afar. *Volram* does not look forward to becoming like them.

There are several independent tribes of outcasts surrounding the Genesis Pit within a 200 mile (320 km) radius, though virtually none venture closer than five miles (8 km) from the Genesis Pit that spawned them. Three of the largest tribes number close to 200 members and have several female Zentraedi among them, former Power Armor Pilots and Auxiliary Specialists who were specifically sent to aid the now-deceased Robotech Science Masters. One tribe, the most powerful, is led by such a female. They are all extremely hostile and dangerous, particularly to outsiders who have something, like weapons, food, Protoculture and mecha that they want.

One thing they have working to their advantage is that along with their strange, new powers and increased aggression, they have begun to do something no Zentraedi (except those who aligned with humanity) have ever done, have babies. And lots of them. Unfortunately, learning to raise and care for them, or even deciding whether they should, has been trial and error, with 50% not surviving the first year. But they are beginning to get the hang of it, which could spell doom for *Volram* and his garrison as the mutants grow in numbers and power over the next 15-20 years. After all, he and his warriors have no way to make new troops. None of these Zentraedi children have reached maturity yet, but when they do, they will be an entirely different kind of being who lacks the Robotech Masters' programming and training. They will know only what life in the hard and savage jungles of Ku'Urtz has taught them.

Another thing that the mutations and being forced to live as outcasts have taught these Zentraedi, is how to make improvised weaponry. They have very few energy weapons, and most of those are out of power, so they have had to create new weapons from what was left on the surface and what they were able to scavenge from the environment and the wreckage of their own mecha and the mecha of the Invid. These are usually blunt or bladed instruments that utilize the Zentraedi's incredible strength and endurance.

The Altered Form and Abilities of Outcasts:

1. Mutation: *The Outcasts*, as they are known, have extreme levels of mutation, equivalent to the mutations experienced by the *Invid Genetics Experiment O.C.C.* in the **Robotech®: The New Generation Sourcebook**. For each outcast, roll once on the Protoculture Mutation chart. Any S.D.C. bonuses are converted to M.D.C., and any M.D.C. given by the mutation is doubled. On the downside, reduce their I.Q. by 30% and they roll twice on the Invid Experiment side effects chart.

In the alternative, roll twice on the *G. Natural Weapons and Defenses* and *H. Special Senses* tables found in the **Pit Monster Creation Tables** of this sourcebook.

Otherwise, Outcasts are created in the same way as normal Zentraedi, except that they have half the usual O.C.C. Related Skills (forgotten and replaced by powerful emotions, aggression and strange powers). **The Zentraedi Warrior Elite** and **Auxiliary Specialists** seem able to retain greater intelligence (reduce I.Q. by only 10%), and *Volram* is the only Zentraedi Warlord on the planet; none of the higher castes are present.

2. Outcast Weapons: Only one in 10 Outcasts has an energy rifle or pistol with whatever finite energy reserve the weapon may

still contain. The rest do, however, have 1D4 melee weapons made from the surrounding area, and scraps of metal and armor, such as makeshift axes, swords, spears, knives, war clubs, staves and similar.

3. Average Experience Level: The typical Warrior Elite or Auxiliary Specialist Outcast has an average level of 1D6+2, while the average Warrior Infantry Outcast has a level of 1D4+1. **Note:** Because of their savagery, limited intelligence, and the fact that they are full-sized Zentraedi, they are not recommended as player characters.

Garrison Zentraedi

The Zentraedi forces who are still loyal and sane enough to serve under Volram are based inside the Invid Hive located in the Ku'Urth Genesis Pit. The abandoned Hive is a subterranean complex below the surface of the Pit. These troops are very much like the standard Zentraedi presented in the **Robotech® Macross Saga Sourcebook**, except that they have suffered minor mental degradation (reduce I.Q. and M.E. attributes by 10%; round down) and all have 1D4 minor mutations; roll on the **Minor Invid Mutations Table** presented earlier in this book. Those with the most mutations tend to be the most savage, and know they will be cast out if they don't control themselves.

Warlord Volram keeps the garrison personnel together through force of will, and the faint and fading hope that either the Robotech Masters or a Zentraedi fleet will remember that they are here and retrieve them, or accidentally stumble upon them and rescue them. If anyone else with working reflex weaponry or Robotechnology shows up, Volram will either attempt to take their ship or loot them for supplies. Failing all of that, there is a chance that he will swear the loyalty of his men in exchange for a lift off the planet, but whoever makes the offer will need to be a strong, forceful leader for the proud Zentraedi to sign on.

Although they use them extremely sparingly, these Zentraedi still have a number of working mecha and personal weapons. These include Battlepods, a few power armor, and a number of rifles and side arms.

The mecha at Volram's command include the following:

- 1 Glaug Officer's Battlepod (Volram's personal mecha).
- 4 Queadluun-Rau Female Powered Armor Units.
- 15 Nousjadeul-Ger Male Powered Armor Units.
- 19 Gluuhaug-Regult Light Artillery Battlepods (each is missing 2D4x10% of its missiles).
- 63 Regult Tactical Battlepods.

There is also one *Cyclops Reconnaissance Pod* that is actually flightworthy (-10% to pilot control rolls and speed due to lack of maintenance), which Volram is keeping as an ace-in-the-hole. He's not sure how it could be useful, but it seems like a good idea to have it as an option. It is hidden in the overgrowth on the surface of the Genesis Pit and Volram uses its sensors as a security system.

All of the mecha are in various states of disrepair and have not had maintenance since the last capable Robotech Science Master died some years ago. This means that each is missing 1D6x10% of its M.D.C. and is -1D4 to strike, parry and dodge. These penalties are halved for the female powered armors, which are better taken care of and seldom used, and Volram's Glaug has no damage or penalties.

Most of the soldiers are armed with nothing more than light or

heavy battle armor and homemade melee weapons fashioned from salvage and pieces of the Invid Hive. Of course, some may have mutant abilities that come in handy in combat. These improvised weapons (mostly knives, axes, spears, swords, war clubs and some bows and arrows) inflict 2D6 M.D. plus the Zentraedi's punch damage. One in four has a Z-PR particle assault rifle and two extra energy magazines.

There are approximately 800 Zentraedi among Volram's forces. It is not clear how many wild Zentraedi there are, but estimates put them at around 600, divided into several tribes and clans.

Game Note: Any abilities that provide additional S.D.C. should be converted to M.D.C. on a point for point basis. Those who undergo further mutation and serious mental instability are cast out into the wild to join one of the growing tribes of Outcasts. Of course, leaving the Genesis Pit stops the mutation. These Zentraedi can be reasoned with and want nothing more than to escape this cursed ball of mud and jungle. Abandoned by the Masters, and seeing other Zentraedi among the UEEF, many are likely to be willing to join the Marines.

G.M. Note: If the Game Master allows it, these mutant Zentraedi are eligible as player characters, but they are likely to be micronized after signing onto the UEEF. Micronized mutant Zentraedi retain their powers and mutant abilities, though further mutation stops as soon as they leave the Pit.

Ku'Urtz Genesis Pit

The Genesis Pit itself was, as the Robotech Masters guessed, built as a potential greenhouse for a hybrid breed of the Invid Flower of Life, but not exactly in the way that they thought. The Invid Flower of Life can take root in a variety of soils; deserts, swamps, plains and even in arctic tundra. But it only seems to want to flower and release its spores in exactly the right conditions. However, what those conditions are, even the Invid, who have studied the plant for millennia, can not quite quantify.

For the Invid, this was never an issue back on their home world, where the plant grew everywhere. They treated the Flower of Life as a living being with a will of its own, often repeating the ancient saying, "Flower Will as the Flower Wills." They never had to force it to grow before, and there is some speculation that the Flower shared a special bond with the planet itself. Once their home world had been defoliated and the Invid were at war and among the stars, they became desperate for the Flower that gave them power and kept them alive. They believed they had to find a way to *make* the Flower of Life grow on new worlds, and in vast quantities. The Robotech Masters felt much the same. Both failed.

One reason they failed was obvious to both the Robotech Masters and the Invid: The Flower wouldn't reproduce on its own. With no way for the spores to get from one plant to another, there were no new flowers, and the spores would only be released when the plant bloomed. And it seemed clear that the plant required some unknown ... something ... to bloom. Some genetic signal, some environmental change that no one knew.

In many cases in nature, a creature known as a *pollinator* gets plants to bloom and release their spores. On Earth, one of the best examples is the common bee. Many plant species rely on the bee to reproduce by spreading their spores from one to another as they go from flower to flower. So, both the Invid and the

Robotech Masters tried their hands at creating different pollinators to entice the Flower of Life to bloom, release its spores, and spread.

The planet Ku'Urtz, a lush, green world covered in rainforests and alive with insects and wildlife, was thought to be the ideal laboratory to unlock the mystery of the Flower of Life. The Invid landed and gathered a number of the planet's pollinators and put them in the Genesis Pit, hoping to alter one or more species enough that they would become pollinators for the Flower of Life.

While most are rather small (comparatively) and are not much of a threat to a 30-36 foot (9-11 m) tall Zentraedi, to humans from the UEEF, the Ku'Urtz Genesis Pit is a collection of pollinating insects that are some of the most strange and dangerous monsters humanity has ever faced.

The pit itself consists of a large, 10 mile (16 km) diameter cave 2,000 feet (610 m) below the surface of one of the most dense rainforests on the planet. The floor of the pit slopes upwards from waterlogged wetlands to a relatively dry plain. Half of the plains have been claimed by the Zentraedi under Warlord Volram's control. Their main camp surrounds a hidden passage down to the abandoned Invid Hive and its still-functioning Mutation Pit. After a few of the local animals wandered into the Mutation Pit from the surface and emerged as monsters, the Zentraedi covered it with an old, domed grate and have it under constant guard. Most of the mecha are parked on the surface for easy launch, but the barracks and vital supplies, including the remaining Protoculture, are stored in the deepest parts of the Invid Hive.

The Genesis Pit is covered with a variety of large flowers indigenous to Ku'Urtz. Among them, mutations of the Invid Flower of Life. Some of the ordinary plants have mutated to three or four times the size of trees on Earth, with blossoms that can be 10 feet (3 m) across. There are no true Flowers of Life, but there are several hybrid mutations, presumably left behind because they are failed experiments incapable of producing Protoculture despite the Invid's best efforts.

However, many of the attempts to create pollinating life forms survive on the many mutant flowers in the Genesis Pit. Those that have escaped the Pit have begun to breed and multiply in the jungle surrounding the Pit, as well as having spread several of the plant mutations. Slowly, they will reshape the face of Ku'Urtz.

Korek Tree Stalker

The Korek is a squat, 7-10 foot (2.1 to 3 m) long lizard that resembles an alligator with long, powerful, feline-like legs and claws with an opposable thumb. It is covered in cloying, sweet smelling slime that hisses when it drips to the ground or on the flesh of animals.

This nasty reptile was responsible for many deaths among the Robotech Masters and Tirolian people who were once part of the Ku'Urtz garrison, as the micronian-sized Masters and clones were no match for the stealthy predator. The Korek is an ambush predator that hides among flowers and vegetation (some species on this world have blossoms larger than 10 feet/3 m in diameter before being mutated). Its skin is covered in a corrosive mixture that emits the scent of sweet nectar, attracting insect and animal prey to it, hiding inside a large blossom or in a tree overlooking a field of them. When prey gets close, it leaps onto its prey, pummeling it to death with brute force, while the acidic coating

on its skin burns, injures and panics its victim and contributes to making the kill.

It is a pollinator because it rolls in the nectar of the plants where it hunts, getting both nectar and pollen all over it. Its acid has no effect on plant life.

The slimy coating works as both a weapon, burning its prey, and as a defense mechanism. The coating is extremely slimy and slippery, and few living creatures want to keep hold of a creature that is burns their flesh.

Korek Tree Stalker

Alignment: Considered Diabolic; a predator that ambushes its prey from a place of hiding and preys upon small humanoids such as Tirolians and humans.

Attributes: I.Q. 1D6+2 (cunning predator), M.E. 1D6+8, M.A. 1D4, P.S. 2D6+12 (considered Augmented), P.P. 2D6+14, P.E. 2D6+10, P.B. 2D6, Spd 1D6+10 on the ground, but x3 when leaping and traveling through the giant trees of Ku'Urtz. M.D.C.: 1D4x10+18; scaly M.D.C. hide.

Size: 6+1D4 feet in length (2.1 to 3 m).

Weight: 350-400 pounds (158-180 kg) of muscle and teeth.

Average Life Span: 2D6+20 years.

Natural Abilities: Bio-Regenerate 1D6 M.D.C. per melee round, Nightvision 200 feet (61 m), and equivalent skills of Acrobatics 75%, Climbing 90%, Camouflage (self and slain prey) 65%, Land Navigation 65%, Prowl 55% (+10% when hiding), Swimming 55% and Tailing to stalk prey 55%.

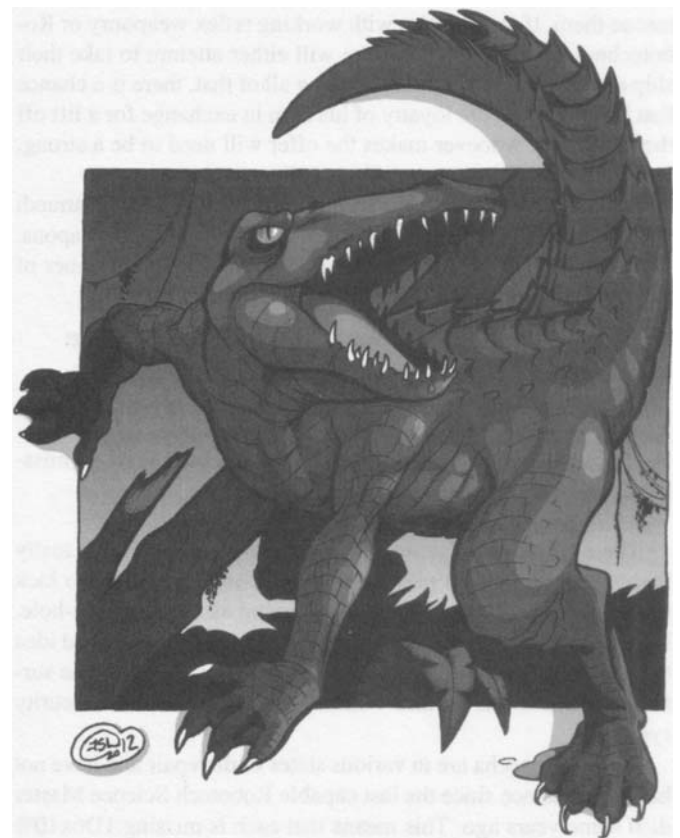

Acid Secretion (Special): The Tree Stalker's skin is coated in a thin, corrosive slime that works as a healing salve for the monster, pouring into every wound almost immediately, but as an acid that burns the flesh of other animals and people. Inflicts 2D6 M.D. to flesh, most fabrics and plastic, every time it makes physical contact with the creature, or when the Korek pounces on top of prey or swats them with claws; half damage to most M.D.C. alloys and materials used in armor. The slime also makes the creature slippery and body flip/throws, entanglement and pinning attacks are at -3 to strike. Furthermore, attackers using such combat maneuvers take damage from the acid. The acid neutralizes almost immediately after leaving the creature's body, meaning it does not continue to burn after first contact. The coating has a sweet, pleasant, flowery aroma, giving anyone familiar with it a +10% bonus to track the creature or realize it is nearby and may be stalking them.

Sonar: The Korek navigates by a form of sonar that helps it move quickly and swiftly through the trees and to sense approaching prey when it is completely hidden from view. The range is an astounding 1,500 feet (457.2 m).

Attacks per Melee: Four.

Bonuses (in addition to likely attribute bonuses): +1 on initiative, +3 to strike, +1 to parry, +2 to dodge, +5 to roll with impact, Critical Strike on a Natural 19 or 20, +6 to save vs poisons, toxins and acids.

Mega-Damage: Claw strike as per Augmented P.S. plus 2D6 M.D. to each hit due to the acid slime coating. Bite 1D4 M.D. Touching acid coated skin does 2D6 M.D.; no damage to plant-life, half damage to M.D.C. armour.

Habitat: Trees and plants with large flowers. Lone hunters that abandon mates and young immediately. Each stakes out its own small territory, usually a grove of trees or field of flowers. Considered a pest by the giant Zentraedi in the Genesis Pit because of the bad bums it can give to the unwary; deadly to humans.

The Quiet Walkers

Possibly the only sentient native species to the planet, the "Quiet Walkers" have no known name other than the descriptive one given to them by the Zentraedi. They are tall, humanoid beings with somewhat bird-like heads and covered in beautiful feathers. They resemble a mix between reptilian and avian, like the first feathered dinosaurs.

The Quiet Walkers appear to be intelligent, tribal, and get their name from the fact that they move silently, never appear to speak and can seemingly vanish at will. For many months after landing on Ku'Urth, the Zentraedi and Robotech Science Masters had trouble believing scouts who reported their presence. The Invid left them alone and eventually, so did everyone else.

The only conflicts with the Quiet Walkers have come following battles, as the humanoids are scavengers and carrion eaters who appear in the wake of a battle to strip the dead of their belongings and in many cases, to cart off as many of the dead as they can to eat. Early on, the Zentraedi thought this to be simply distasteful, but as their supplies began to run short and things got more desperate, the Quiet Walkers' scavenging was not taken well and the giants began to shoot the Quiet Walkers on sight. However, the aliens ability to simply disappear, combined with their stealth and determination to avoid direct conflict, has the

Zentraedi chasing shadows much of the time. How they know when someone is dying is a mystery to the Zentraedi and has given them an almost superstitious apprehension about the Quiet Walkers' true nature.

While overall peaceful, the Quiet Walkers can be a threat. They do not always wait until someone is dead to take them. Being seriously injured or knocked unconscious is enough for them to attempt to claim a body as food, and all the better if it has some simple to use technology, like a gun, knife or flashlight

When they need to fight and kill, Quiet Walkers do so with a stinger imbedded in a whip-like, reptilian tail or by using an electric field generated by their bodies. They can also hurl bolts of electricity that can kill a full-sized Zentraedi in just a few shots. They are nearly impossible to surprise, knowing every sound and movement of the jungle around them.

But their most impressive power is their ability to warp space, giving them a form of teleportation. This makes them nearly impossible to catch or track and explains why for so long their existence was in dispute. The Robotech Master scientists wondered if the creatures' ability had some ties to Protoculture, but they seem to be indifferent to the Flowers of Life and are immune to the spores.

There have only been a few reports of Quiet Walker villages, which are always temporary and can be packed up and moved at a moment's notice. These villages tend to consist of no more than 2D4x10 individuals who all disappear when strangers enter (presumably teleporting to some pre-arranged meeting location). There is almost nothing known about their culture, and their language is an indecipherable stream of chirps, whistles and purrs. Perhaps had the Robotech Science Masters survived, they would have tried to communicate with them, but the Zentraedi have no interest in doing so and are completely incurious about these beings. However, the Zentraedi know the aliens have taken a number of rifles and other small arms over the years, and will take any opportunity to get them back. It is a task easier said than done when dealing with a species who can vanish into thin air and have made the alien jungles of this world their home for countless centuries. The Quiet Walkers do not seem to like any Genesis Pit and have never been known to enter one.

Quiet Walker

Note: Not recommended as player characters, but can be used as such. Would most likely learn the Pathfinder O.C.C.

Alignment: Predominantly Anarchist (50%), but can be any.

Attributes: I.Q. 2D6+3, M.E. 2D6+3, M.A. 2D6+3, P.S. 2D6+9, P.P. 2D6+6, P.E. 2D6+9, P.B. 2D6+3, Spd 2D6+6. Strength counts as Augmented.

M.D.C.: 1D4x10+20

Size: 11 +1D4 feet (3.6 to 4.6 m).

Weight: 600-700 lbs (270-315 kg); tall and lanky builds.

Average Lifespan: Unknown, but at least 2D6+60 years.

Experience Level: 1D4+1 or as the G.M. desires.

Skills of Note: All speak their own language at 98%, Wilderness Survival (+15%), Prowl (+20% in jungle, +10% elsewhere), and four other Wilderness, Eomestic or Ancient W.P. skills of choice.

Natural Abilities: Hawk-like vision, allowing them to see mouse-sized creatures at a range of two miles (3.2 km), smell blood or decay at a range of 6 miles (9.6 km), track by scent is 35% (+35% to track scent of decay/rotting meat and blood),

and identify potentially lethal illness and injury (blood and skin infections, septic wounds, gangrene, rotting flesh, etc.) at 80%.

Teleportation (Special): This ability appears to be similar to space-folding. It enables the creature to warp space around it, fade from view and reappear elsewhere. The process is quick, quiet and has an impressive range of **2,000** feet (610 m) or line of sight, whichever is less or convenient. Remember that their incredible vision combines to make this ability extremely effective. It takes 3-5 seconds to complete a teleportation and it counts as two of the Quiet Walker's melee attacks.

Teleportation can be performed once per melee round (every 15 seconds). The character can only teleport himself and objects up to 500 pounds (225 kg) of weight within a four foot (1.2 m) radius of himself. They NEVER teleport away with another living person or animal, even if injured, but may do so with a corpse.

Generate Electricity (Special): During combat and when afraid, the Quiet Walker's body generates an electric energy field that does 2D6 M.D. when touched by an attacker as well as when fired as a bolt of electricity. A Quiet Walker can fire an energy blast once per melee round with a maximum range of 600 feet (183 m).

Stinger and Poison: Does 2D6 M.D. for the initial strike, and the poison burns and does an additional 1D6 M.D. for one melee round. Most unarmored humans are obviously killed by a single blow. Those who make a successful save vs lethal poison (14 or better) suffer 2D6 S.D.C. damage and feel a momentary, slight, burning sensation. Range: Melee combat.

Attacks per Melee: Four. Combat skill is equal to Hand to Hand: Basic.

Mega-Damage: Quiet Walkers always try to avoid combat. However, when injured, frightened or cornered, they may engage in physical combat (Augmented P.S.), strike with their stinger, or use their power of generating electricity (see *Natural Abilities*). The beings may also use any type of weapon available to them, but seldom do so.

Bonuses (in addition to possible attribute bonuses): +2 to all vision-based Perception Rolls, +2 to initiative to make good an escape, +2 to strike, +4 to parry, +2 to dodge (and dodging using their warping ability), +4 to roll with impact, and impervious to poisons, toxins and disease.

Habitat: Nomadic jungle dwellers living in small, nomadic tribes.

Notes: Roughly 10% will have a captured Zentraedi weapon often used like a bazooka or as a gun emplacement guarding a village, since they are too big to be used as side arms or rifles.

Giant Spined Auroch

Another genetic misfit created in the Genesis Pit, Giant Spined Aurochs are deadly and powerful enough to give a Zentraedi pause. It is a hulking, four-legged beast covered in shaggy fur and several lines of long, deadly spikes running along the length of its body, shoulders and top of its head. When running, the spines lay flat against the animal's body, but when angry or attacking, it raises its spines for additional protection

and damage capabilities. The Giant Spined Auroch can top 10 feet (3 m) at the shoulder with a body length of 25 feet (7.6 m), not including the shaggy 6 foot (1.8 m) long tail. A pair of antennae are located on the head, behind a pair of small, round ears. The sensory antennae supplement the animal's normal senses and enable it to hunt at night and sense movement nearby (within 100 feet/30.5 m).

Like many of the predators created by the Invid, the Giant Spined Auroch has some surprises in store for its enemies. Besides the obvious deadly spikes that can be raised for defense and fired like projectiles, it has the massive claws that can rend metal and three rows of dagger-like teeth to tear prey and opponents apart. Worse, the Giant Spined Auroch is unafraid of humanoids, even the giant Zentraedi, and will not hesitate to attack if it feels threatened or if the humanoid seems vulnerable. All humanoids smaller than 12 feet (3.6 m) tall are seen as prey.

If any creature should have filled the role of pollinator, it is the Auroch. It lives in groves of flowering trees and vegetation, including the Flower of Life, and enjoys rolling around in them, hunting and killing among them. In fact, the fur and spines of the animal are usually covered in spores of the Flower of Life. Yet, the Flowers did not multiply, the seeds do not develop and no new Flowers of Life have taken root. The Flowers found on Ku'Urth are those that the Invid left behind in the Genesis Pit, and many of them are not true Flowers of Life but mutant strains that failed to produce Protoculture. Of course, if left undisturbed, the Flower of Life appears to be immortal. Making sure they stayed undisturbed appears to have been another one of the roles of the Giant Spined Aurochs. The creatures are extremely territorial and ravenous meat eaters. This means they attack and eat any living thing that comes within "their" grove of Flowers of Life. There is little that escapes the animal's notice and as soon as something steps into the grove, the Aurochs that live there (typically a family pack of 2D4 animals) charge out to attack.

Surprisingly agile and as fast as many ground vehicles, Giant Spined Aurochs can reach bursts of speed of up to 120 mph (192 km). Outrunning them on foot is not an option unless inside mecha or a speedy vehicle, and the giant animals are so nimble that they can cut, dart and zip through the Flowers of Life without breaking a stalk. These creatures are one of the few things on the planet that can truly threaten even an armed and armored Zentraedi giant. Killing one is a mark of pride for both civilized and mutant Zentraedi living on the planet.

Giant Spined Auroch

Alignment: Considered Anarchist and even Diabolic.

Attributes: I.Q. 1D6+1 (not very cunning, but deadly), M.E. 1D6+4, M.A. 1D4. P.S. 2D6+18 (Supernatural), P.P. 2D6+14, P.E. 2D6+10, P.B. 2D6, Spd 1D6x10+60 (50-80 mph/80 to 128 km), with bursts of speed 50% greater for up to one melee round (15 seconds) per P.E. attribute point.

M.D.C.: P.E. attribute number x10.

Size: 1D6+19 feet (6.1 to 7.6 m) long, 1D4+7 feet (2.4-3.3 m) tall at the shoulder, plus a six foot (1.8 m) long tail.

Weight: 1D4+4tons.

Average Lifespan: 1D6+20 years.

Natural Abilities of Note: Climbing 45% (+20% to climb the Flower of Life), Land Navigation 65% (+25% to return "home" to its particular grove), identify smells 85%, track by

smell 75% (+15% to follow strong scents and blood scent), Swimming 45%, can leap 15 feet (4.6 m) high and 40 feet (12.2 m) lengthwise, and penalties for being blinded are half.

Feelers (Special): A pair of antennae on its head, behind a pair of small, round ears, function as prehensile feelers in the dark or when blind and augment the Auroch's sense of smell as well as the animal's ability to sense movement, hence its bonuses to dodge and take initiative. Antennae lost in combat regrow within 2D6+10 days. If both are lost, reduce the tracking and scent related capabilities by half.

Attacks per Melee: Five.

Mega-Damage: Paw swat does 1D6 M.D., full strength claw swipe does 4D6 M.D., bite does 5D6 M.D., power bite (counts as two attacks) does 1D6x10 M.D. and attempting to grab or physically strike the creature causes the attacker to suffer 2D6 M.D. from the quills covering its body, head and shoulders.

Bonuses (in addition to likely attribute bonuses): +2 on initiative, +3 to strike with claw strike, +5 to strike with bite attacks, +3 to parry, +4 to dodge, +1 to roll with impact, Critical Strike (double damage) on a roll of a Natural 19 or 20, and +4 to save vs poisons and diseases. Giant Spiny Aurochs are not afraid of much of anything, cannot be surprised with attacks from what should be its blind-side or from behind, unless it has lost its antennae.

Habitat: Forest, specifically groves of the Invid Flower of Life and other flowers and flowering trees.

Note: May stalk prey as a solitary hunter, in pairs or in small family packs of 2D4 animals.

New O.C.C.s

UEEF Explorer Corps

The galaxy is extraordinarily vast. Scouring it even for a ship as large as the *SDF-3* is nearly an impossible task. Even with good leads, powerful sensors and an idea of where it could be, it makes finding a needle in a haystack seem easy.

The UEEF realizes that what it needs are experts in exploring the galaxy, of which humans have fairly few. This is not the first time such experts have been needed. During the war with the Invid Regent, humanity explored numerous alien worlds the likes of which humankind had never imagined. It quickly became apparent that a new training program was needed for a new type of operative: a space explorer. One who could adapt to incredible situations and environments, and who could quickly assess and understand alien environments, cultures and technology. The UEEF needed people who not only were trained to go where angels feared to tread, but who could make sense of the universe for the high command.

And so the **Explorer Corps** was born. Its operatives a cross between scout, explorer, anthropologist, scientist and diplomat. During the liberation of Earth, these Exploration Specialists of the Corps were left behind on Tirol or aboard the *SDF-4*, as they were not considered essential combat personnel, and best used elsewhere. Now, with the *SDF-3* missing among the vastness of

space, they are leading the search to find the ship and its crew. It is the Explorer Corps who spearheads finding and chasing down leads and rumors about *Admiral Hunter* and the *SDF-3*'s possible whereabouts. The Explorer Corps is also pressed into service whenever new alien people are encountered, or the mysteries of alien worlds need to be unraveled. They are on the cutting edge of discovery, and in the thick of the most dangerous situations the UEEF is liable to face.

Exploration Specialists may operate as an independent agent or as a member of a team. They are trained to be creative, open-minded and to think outside the box. Part of the job is to stay flexible and calm in the face of the unimaginable. That means a well-trained Exploration Specialist does not flinch under pressure or when face to face with strange alien beings who may seem hostile and dangerous.

While Exploration Specialists are the heart of the Explorer Corps, the Corps contains personnel of all professions and skill sets, from those needed to crew spacecraft and maintain equipment, to combat troops and mecha pilots to escort and protect members of the Corps and innocent civilians, and fight monsters. However, it is the Exploration Specialists who first set foot on

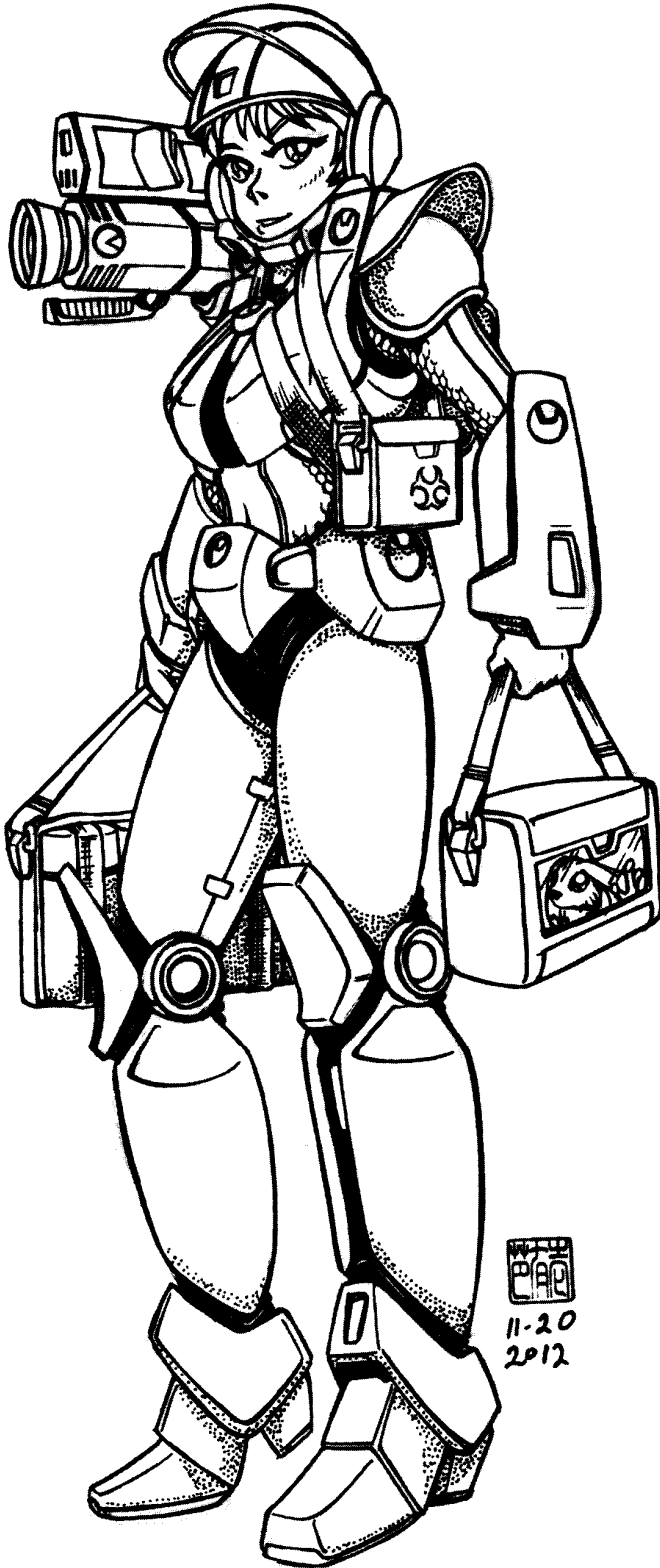

alien worlds, assess the situation, make recommendations on how best to proceed, make first contact with new civilizations and help to decipher the mysteries of the galaxy.

Exploration Specialist O.C.C.

Rank: Always an officer; Lieutenant and higher ranks.

Alignment: Any, but most are idealists who follow in the footsteps of generations of heroes starting with the First Robotech War. They tend to be Principled (30%), Scrupulous (30%), Unprincipled (20%) or Anarchist (15%) and champion the causes of freedom and justice.

Attribute Minimum Requirements: I.Q. 10, M.E. 12, P.E. 10.

An M.A. of 15 or higher is helpful and recommended, but is not required.

Common Skill Set: All start at the base skills.

Computer Operation (+5%)

Language: English

Literacy: English

Mathematics: Basic (+5%)

O.C.C. Skills: Basic training skills and skill bonuses common to the Exploration Specialist.

Climbing (+10%)

Forced March

Intelligence

(+10%)

Lore: One of choice (+10%).

Navigation (+10%)

Radio: Basic (+25%)

Running

Sensory Equipment (+15%)

Space Survival (+25%)

Swimming (+10%)

Wilderness Survival (+10%)

W.P. Energy Rifle

W.P.: One of choice

Zero Gravity Combat

Hand to Hand: Expert, which may be changed and improved by some M.O.S. The best Hand to Hand skill always applies.

M.O.S. (Military Operational Specialty): Each M.O.S. represents the character's area of special training within the Explorer Corps. Pick one of the following. A list of skills and bonuses appears under each M.O.S. description presented at the end of this O.C.C. Read them all and select the one you feel best fits your character's personality and goals. Astro-Navigator Extraterrestrial Reconnaissance Xenoculture Expert Xenotech Reclamation

O.C.C. Related Skills: These are additional skill choices related to the character's military occupation and background. Select four at level one, plus one additional skill at levels 3, 5, 7, 9, 11 and 13.

Communications: Any (+10%).

Domestic: Any.

Electrical: Basic Electronics and Computer Repair only (+5%).

Espionage: Any.

Mechanical: Basic and Automotive Mechanics only.

Medical: Any.

Military: Any (+5%).

Physical: Any.

Pilot: Any (+5%).

Pilot Related: Any.

Science: Any (+5%).

Technical: Any (+10%).

W.P. Any.

Wilderness: Any (+10%).

Secondary Skills: Select two skills from the Secondary Skills list in the **Robotech®: The Shadow Chronicles® RPG** at levels 1,3,6,10 and 14. These are additional areas of knowledge and do not get any bonuses, other than possible bonuses for having a high I.Q. All Secondary Skills start at the base skill level.

Standard Equipment: Mission specific vehicle or mecha, mission specific CBR-5 or CVR-3 body armor, Gallant H-90 side arm with all attachments, 6 extra H-90 Protoculture Energy

Clips, portable tool kit, canteen, dress uniform, flight suit, personal clothing and effects.

Equipment Available on Assignment: Depending on the character's skills, the Game Master and the campaign, characters can be assigned any Battloid, Veritech Fighter, or Ground Veritech, any mission specific land vehicles, aircraft or spacecraft, any firearms, weapon systems and ordnance, optical enhancements, and any and all mission specific special equipment, as well as access to computers and special facilities.

Monthly Wages: Well trained and well paid, Exploration Specialists make between 4,000 and 5,000 credits a month. Due to their high level of training and expertise, Exploration Specialists are all commissioned officers starting at 1st or 2nd Lieutenant (0-2).

Personal Savings: 2D4x 1,000 credits.

Note: Use the Military Specialist experience table in **Robotech®: The Shadow Chronicles® Role-Playing Game.**

Exploration Specialist M.O.S. Descriptions

Pick one M.O.S.

Astro-Navigator M.O.S.: This character's skills are the UEEF's equivalent of sea navigators of old. Not only do they understand star charts and how to helm a space vessel, but they also have an in-depth knowledge of astronomical phenomena and astrophysics. Those with this M.O.S. are almost always posted aboard ships entering unexplored space.

Astrophysics (+25%)

Mathematics: Advanced (+20%)

Navigation: Space (+20%)

Optic Systems (+10%)

Pilot: One Mecha of choice.

Pilot Spacecraft: Light and Medium (+20%)

Pilot Spacecraft: Heavy (+15%)

Pilot Spacecraft: Capital/Super-Capital (+10%)

Research (+10%)

Space Fold Operations (+15%)

W.P. Starship Energy Weapons W.P. Starship Artillery

M.O.S. Bonuses: +3D6 S.D.C., +1 to M.E. attribute, +1 to Perception Rolls involving the character's areas of specialty.

M.O.S. Special Gear: Access to the bridge, navigation systems, and computers of spacecraft, as well as restricted scientific data. They are tasked with knowing everything there is to know about unexplored areas of space where the UEEF is sending its forces.

Extraterrestrial Reconnaissance M.O.S.: These specialists are frequently the first soldiers to touch down on an alien world. Often working in small teams, pairs, or alone, they scout new planets, derelict spacecraft and other settings, and report back to command, providing vital intelligence on the environment, the native creatures, and threat level, if any. Sometimes their surveys can take weeks before an area of a planet is assessed for further and/or widespread exploration, with members of the Explorer Corps charged with investigation of the most dangerous areas and locations populated by sentient life forms.

Camouflage (+15%)

Detect Ambush (+10%)

First Aid (+10%)

Holistic Medicine (+15%)

Land Navigation (+16%)

Mecha: Pilot Ground Veritechs

Mecha Elite Combat Training: VR-030 Series Cyclones Prowl (+15%)

Tailing (+15%)

Tracking (people; +10%)

Wilderness Skills: Two of choice (+10%).

W.P.: One Ancient W.P. of choice.

W.P.: One Modern W.P. of choice.

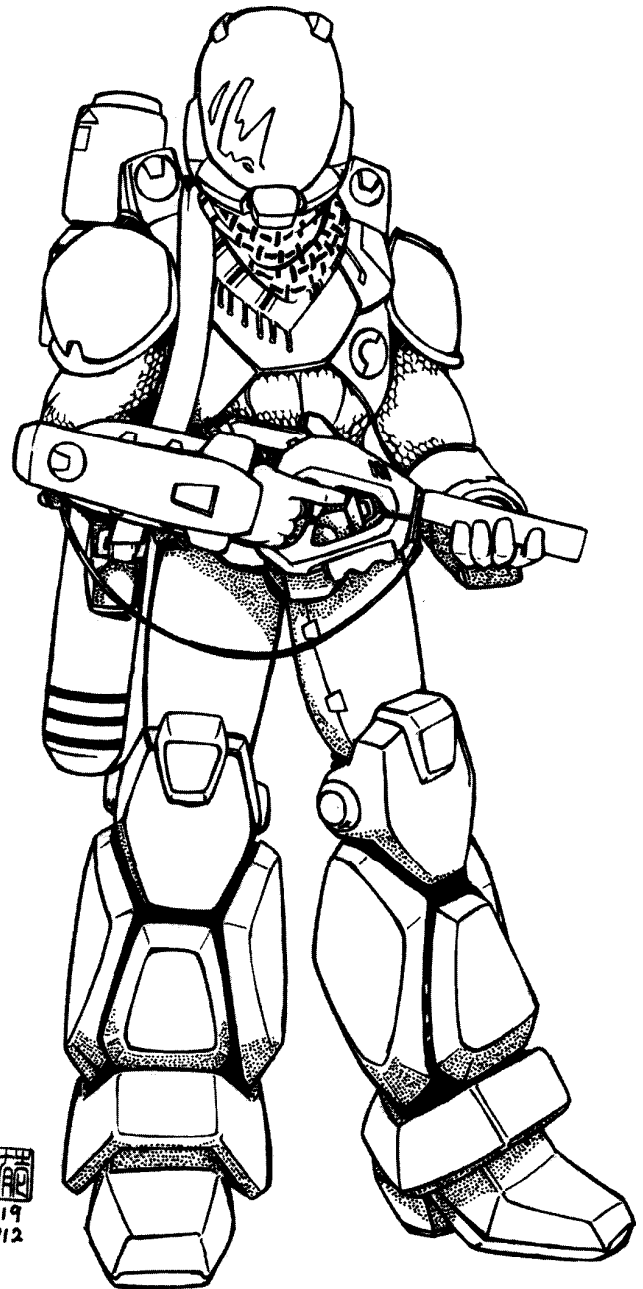

M.O.S. Bonuses: +5D6 to S.D.C., +2 to P.E. attribute, +1 on Perception Rolls involving the character's areas of specialty, and +1 on initiative.

M.O.S. Special Gear: CVR-3 Armor, VR-030 Series Cyclone and UEEF Military Survival Pack, and one additional weapon for each M.O.S. W.P. with four clips for any modern weapon.

Xenoculture Expert M.O.S.: Often referred to as alien specialists or "first contact" specialists, Xenoculture Experts are brought in to study and deal with newly discovered sentient beings and alien civilizations, as well as dealing with "difficult" known sentient life forms. They often work side-by-side with science officers, but take the lead whenever it becomes time to speak to or understand and assess an alien species.

Anthropology (+20%)
Barter (+20%)
Biology (+5%)
Chemistry (+5%)
Cryptography (+15%)
History: Earth (+15%)
Interrogation (+10%)
Languages: Tirolian and Zentraedi (+10%)
Literacy: Tirolian and Zentraedi (+15%)
Lore: One of choice (+15%).
Mecha: Pilot Ground
Veritechs Psychology (+10%)
Public Speaking (+20%)
Xenobiology (+15%)

M.O.S. Bonuses: +3D6+6 to S.D.C., +1D4 to M.A. attribute, +2 to Perception Rolls, an additional +5% to any Communication skills and +10% on the Intelligence skill.

M.O.S. Special Gear: Access to scientific facilities, classified data, mecha and vehicles as necessary for each mission. Often assigned an NCO or fellow Corps member as an assistant and bodyguard during negotiations with alien sentient beings.

Xenotech Reclamation M.O.S.: This character's job is to determine the purpose, function, threat level, strengths and weaknesses of alien technology, and if possible, figure out how best to use it for the benefit of the UEEF or how to counter, sabotage or turn it against the aliens if they prove to be hostile and aggressive. Archaeology (+20%)

Computer Programming (+5%)
Cryptography (+10%)
Electrical Engineer (+15%)
Excavation & Rescue (+15%)
Jury-Rig (+15%)
Mathematics: Advanced (+10%)
Mecha: Pilot Ground Veritechs or Battloids.
Mechanical Engineer (+10%)
Mechanical or Electrical skills: Two of choice (+15% each).
Pilot: One of choice; excluding spacecraft.
Salvage (+15%)

M.O.S. Bonuses: +4D6 S.D.C., +2 to P.S. attribute, +2 to Perception Rolls involving understanding alien technology, its function and its operation, and an additional +5% to all Mechanical skills.

M.O.S. Gear: Access to scientific facilities, laboratories, research and development databases, a vehicle matching the M.O.S. piloting skill, tools and other equipment as needed.

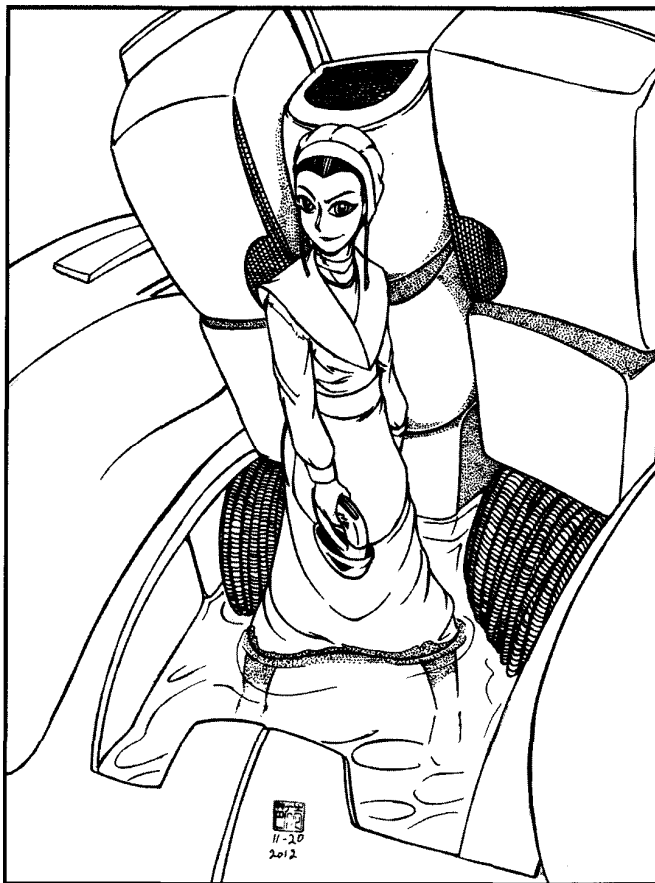

Invid Simulagent

Ariel (also known as Marlene) was not the first time, nor the last, that the Regess created a *Simulagent* to serve as a spy among her enemies. It is a tactic she has used repeatedly in the past, mostly against the Robotech Masters. These human-like constructs, which would later serve as the templates for the next step in Invid evolution, are crucial in collecting intelligence on her enemies.

They are initially created in a Genesis Pit, often using the DNA of a dead or captured enemy. Then, before they are finished developing, they are inserted into an enemy stronghold or a location where an enemy can find them. In the latter case, the Simulagent poses as a refugee or survivor of a battle. They then telepathically report back to the Regess all that they uncover about the enemy's position, plans, strengths and weaknesses.

This tactic was far more effective on the Robotech Masters than most realize. Imitating the programmed, predictable and emotionally stunted behaviors of a Robotech Master clone was child's play compared to trying to imitate a free-thinking and expressive human. A team of three Simulagents, appearing to be a triumvirate of clones, could pass easily among the teeming hordes of the Robotech Masters' minions if they were careful, and could gain access to vital information.

These agents were critical early in the war between the Invid and Robotech Masters, allowing the Regess to make calculated moves against her hated foes while her maniacal mate, the Regent, flailed about, destroying anything in his path and holding their attention.

On Earth, Ariel was not the only Simulagent placed among the humans. There were others. Those who were not damaged during insertion, like Ariel was, are aware of their mission and

capabilities, as well as their allegiances, unlike she was. Very few humans even suspect Simulagents are possible, let alone worry about one being among them. They often still don't even know about them even after they've been infiltrated by them. If discovered, such an agent is assumed to be a traitorous Invid sympathizer, and not a Genesis Pit evolved Invid made to look human.

While most Simulagents are loyal to their Invid people, the human body and mind are very different from an Invid or even a Master's clone. Humans feel and exhibit a much wider range of emotions, feelings and personality. The Regess did not compensate for this. She did not know how. This has led to some Simulagents, like Ariel, questioning their loyalties to the Invid, and all must deal with an array of emotions and feelings that are alien to them. While most will stay true to the Regess until the end of time, *some* will follow Ariel's path and come to appreciate, and then defend, the nobility and frailty of the human race.

Simulagent O.C.C.

Note: Human Simulagents can experience emotional conflict as described above, but this is not the case with Tirolian Simulagents. All other stats are identical for both human and Tirolian Simulagents.

Available Species: Invid Princes and Princesses only.

Alignment: All start out Aberrant, with their ultimate loyalties to the Regess. However, they could, over time, shift to any alignment.

Attribute Requirements: None. Each is individually created for the job.

Powers and Abilities: Same as all Invid Princes and Princesses. Remember that the teleportation abilities were not unlocked until the Battle of Reflex Point, so in campaigns that take place before that battle they should not be available.

O.C.C. Skills

Cryptography (+10%)

Detect Concealment (+15%)

Intelligence (+10%)

Languages: Two of choice (+15%).

Literacy: One of choice (+10%).

Lore: Invid (20%)

Mathematics: Advanced (+5%)

Prowl (+10%)

Surveillance (+5%)

Undercover Ops (+10%)

Wilderness Survival

W.P. Energy Pistol

W.P. One of choice.

Hand to Hand: Assassin

Note: Can pilot all types of Invid mecha.

O.C.C. Related Skills: These are additional skill choices related to the character's occupation and background. Select seven at level one, plus one additional skill at levels 3, 6, 8, 11 and 14. Communications: Any (+5%).

Domestic: None.

Electrical: Basic only.

Espionage: Any (+10%).

Mechanical: Basic only.

Medical: None.

Military: Any (+5%).

Physical: Any (+10% where applicable).

Pilot: Any (+5%), without restriction.

Pilot Related: Any.

Science: Any (+5%).

Technical: Any (+5%).

W.P. Any.

Wilderness: Any.

Secondary Skills: Select two skills from the Secondary Skills list in the **Robotech®: The Shadow Chronicles® RPG** at levels 2, 4, 8 and 12. These are additional areas of knowledge and do not get any bonuses, other than possible bonuses for having a high I.Q. All Secondary Skills start at the base skill level. **Level of Experience:** Player characters should start at level one experience. Use the Invid Prince/Princess experience table in the **Robotech®: The New Generation Sourcebook**, page 35.

NPCs (Non-Player Characters) are usually only first or second level, and seldom more than sixth level, but can be whatever level the Game Master desires.

Starting Equipment: Extremely limited, often dropped into a situation naked and carrying only what they were able to forage before linking up with the target human group. A set of clothing (worn, possibly ill-fitting), one energy pistol of choice, plus two additional magazines for that weapon, one weapon matching their other starting W.P., goggles or sunglasses, canteen, 2D4 days of rations.

Starting Vehicle: None when undercover, but can pilot all types of Invid mecha.

Starting Money: As a rule, starts with none when undercover. Most pose as a refugee or a homeless, penniless, survivor down on his or her luck.

Personal Savings: None.

Notable Ships and Mecha

VFH-RAU "Fury"

Valkyrie/Queadluun-Rau Frankenmecha

Many so-called "Frankenmecha" designs used during the war with the Invid were born out of necessity. There was no formal government or military, and rebel fighters had to scrounge and cobble together whatever they could salvage. As a result, they began to fuse aspects of one mecha with another, creating mechanical chimeras that may look unusual, but offered combat capabilities to help the cause of freedom. Such Frankenmecha are often the fusion of 2-3 different kinds of mecha, sometimes more - whatever it takes to create one working unit. In some cases, however, as with the Fury, the Freedom Fighters go out of their way to create a very particular weapon of war.

The Fury is an attempt to reintroduce the agility and raw power of the old Zentraedi female power armor into the fight against the invading Invid. The mecha was known for its maneuverability and its ability to engage multiple opponents at once. It not only had speed and effectiveness in open-air engagements, but was also designed to excel at close-quarters

combat. A good Queadluun Rau pilot could transition from a deep space engagement to the so-called “knife fight in a phone booth” of urban combat without losing her lethal effectiveness. In fact, the armor was designed centuries earlier as an anti-Invid mecha during the height of the war between the Robotech Masters and the Invid.

When the Invid first invaded, and the remnants of Earth’s Robotech defenders were driven into the wilds, the soldiers found a number of Zentraedi ships that had gone unaccounted for during the years since the destruction of Dolza’s fleet. These ships provided shelter and building materials and sometimes Protoculture cells, but in many cases, they housed dozens to hundreds of long lost *Zentraedi mecha* that were unusable to the diminutive human and micronized Zentraedi survivors. In one such find, freedom fighters discovered a cache of the notorious *Queadluun-Rau Zentraedi Female Power Armor*. For years they stripped them for parts and missiles and just left them dormant, because there was no way for a human to control machines meant for 30 foot (9.1 m) giants.

Then, a cadre of mechanics and Special Forces units, many with Zentraedi heritage, set out to find replacement cockpits that could be mated to the old power armor to allow human-sized pilots to control them. They specifically looked for old VF-1 Valkyrie cockpits because they could be most easily removed (they were ejection modules and designed to be removable) and mated to other mecha. Over a period of two years, they cannibalized cockpits and parts from more than two dozen severely damaged Valkyries to combine them with the Queadluun-Rau robotic armor. The final product looks like a wingless Valkyrie in *Guardian mode*, but with the arms, legs, thrusters and armaments of the Queadluun-Rau female power armor, and the nose/torso and head of a Valkyrie. It has no wings, but can leap, hover above the ground and has limited flight capabilities.

The non-transformable mecha is fast, agile, and devastating in combat but they are very rare and eat through missiles and Protoculture at a high rate. Most freedom fighter units who possess a few of these priceless hybrids train their pilots to use the missiles sparingly, and only deploy them in very important operations.

"Fury" Frankenmecha

Model Type: VFH-RAU Battloid (an unofficial designation).

Class: Single Seat, All-Environmental Air Cavalry Robot Vehicle.

Crew: One (two if the chassis and cockpit used was from the VF-1D or VEF-1).

M.D.C. by Location:

* Sensor Head - 100

Upper Arms (2) - 70

each Forearms (2) - 150

each Hands (2) - 35 each

Legs (2) - 100 each Feet

(2) - 75 each

** Main Queadluun-Rau Thrusters (2; back) - 100 each

Head Weapons: Laser (1A have one, 1J have two, 1R have 2, 1S have four) - 50 each

Rotary Particle Cannons (2; forearms) - 75 each

Queadluun-Rau Missile Launchers (4; behind shoulders and part of the thruster section) - 100 each

Reinforced Pilot Compartment - 175

*** Main Body - 350

* Destroying the sensor head knocks out most of the Fury's

sensors. Radar range is reduced to ten miles (16 km), long-range radio and laser communications are lost, and the laser targeting system is destroyed. All of this leaves the Battloid at -3 to strike, parry and dodge. Destroying the sensor head also destroys all point defense lasers.

** Destroying one thruster reduces speed and combat bonuses by half. Destroying both thrusters means the Fury cannot fly, hover or enjoy thruster assisted leaps. If the thrusters are destroyed while flying, the mecha crashes to the ground.

*** Depleting the M.D.C. of the main body destroys the mecha, rendering it totally useless.

Speed:

Running: 85 mph (136 km).

Leaping: 250 feet (76.2 m) up or across with thruster assistance, half that without.

Flight: 550 mph (880 km) in an atmosphere.

Space: 1,550 mph (2,480 km) or Mach 2.

Statistical Data:

Height: 43 feet (13 m).

Length: 36 feet (11 m).

Width: 40 feet (12 m).

Weight: 25.5 tons.

Physical Strength: Robotic P.S. of 44.

Cargo: There is a small space big enough for a survival pack and a sidearm.

Power System: One miniaturized Reflex Furnace powering two fusion pulse-detonation thrusters delivering thrust through vectored thrust nozzles and numerous vectored and vernier thrusters; converted to run on sixteen Protoculture cells.

Weapon Systems:

1. LLW-20 CIWS Lasers (1, 2 or 4): Each Fury carries a standard Valkyrie sensor head (located below the pilot’s compartment, like a Veritech in Guardian mode) with 1-4 20mm lasers depending on the type of Valkyrie’s head. These short-range, low yield lasers are designed to give the Fury point defense and anti-personnel capabilities. The number of lasers mounted varies by the model of the Valkyrie scavenged to create the Fury: VF-1A variants mount one laser, VF-1J, VF-1R, VEF-1 and VF-1D sensor heads mount two lasers, and the VF-1S variant mounts four lasers.

Primary Purpose: Air-to-Air/Air-to-Ground Combat and Dog Fighting.

Secondary Purpose: Anti-Missile and Self-Defense.

Weight: Not applicable, part of the airframe.

Range: 2,000 feet (610 m).

Mega-Damage: 2D4 M.D. per laser per single blast. Models with multiple lasers can fire a single shot or all of them simultaneously at the same target. Increase damage accordingly (two lasers do 4D4 M.D., three lasers do 6D4 M.D., four 8D4 M.D.). The lasers can also be used as a cutting beam to bum through bulkheads and slice through hulls. Damage for a cutting beam is 2D4 M.D. per laser, per melee attack spent burning or cutting.

Rate of Fire: Each blast uses one of the pilot’s melee attacks. The cutting beam uses as many attacks as the pilot is willing to dedicate.

Payload: Effectively unlimited.

2. Medium Particle Cannons (2): Mounted in each forearm is a three-barreled, medium particle cannon.

Primary Purpose: Anti-Mecha.

Secondary Purpose: Anti-Aircraft/Anti-Ship.

Weight: Not applicable, part of the Fury's hull.

Range: 4,000 feet (1,219 m).

Mega-Damage: 3D10M.D. for one cannon burst or 1D6x10M.D. when both are aimed and fired simultaneously at the same target.

Rate of Fire: Each single or double burst counts as one attack.

Payload: Effectively unlimited.

Note: The guns hit like a wrecking ball, and any mecha under 100 tons hit by a double blast has a chance of being knocked down. When hit, the pilot must make a roll on the appropriate mecha piloting skill to keep his footing. Invid mecha (which do not use piloting skill rolls) must make a roll with impact roll higher than the Fury pilot's roll to strike. Mecha that are knocked down lose initiative and one attack while they return to their feet.

3. 60mm Mini-Missile Launchers (4): Mounted on each hip and on the thruster engine mounts above the shoulders are four rapid-fire missile launchers refitted to fire standard UEEF 60mm mini-missiles. These missiles are used in both offensive and defensive capabilities, but unlike the Qeadluun-Rau pilots of years past, they are meant to be used sparingly, with the large payload giving the mecha longer battlefield endurance instead of overwhelming striking power. Remember that these missiles are often difficult to replace for freedom fighters.

Primary Purpose: Anti-Mecha and Anti-Aircraft.

Secondary Purpose: Anti-Missile.

Weight: Not applicable, part of the suit's hull.

Range: One mile (1.6 km).

Mega-Damage: Per type of mini-missile, but typically HEAP (High Explosive Armor Piercing) missiles which inflict 1D4x10 M.D. per missile.

Rate of Fire: One at a time or in volleys of 3,6 or 12. Each volley uses one attack.

Payload: 126 missiles total; 21 mini-missiles in each hip-mounted launcher, and 42 mini-missiles in each thruster-mounted launcher (21 at the ready, 21 in an armored magazine).

4. Hand to Hand Combat: The Fury is a powerfully strong melee fighter, able to tangle fist-to-claw in close with any Invid unit.

Hand to Hand Damage: *Restrained Punch/Forearm:* 1D6 M.D.

Full-Strength Punch: 3D6 M.D.

Power Punch: 1D6x10 M.D. (counts as two

attacks). *Tear/Pry/Crush with Hands:* 6D6 M.D.

Kick: 3D8 M.D.

Stomp: 3D6 M.D. against targets under 10 feet (3 m) tall.

Jump Kick: 5D8 M.D. Counts as two attacks.

Body Block/Ram: 2D8 M.D. per 20 mph (32 km) of running or flying speed. Uses two attacks and has a 60% chance of knockdown against targets up to 30% larger. Target loses initiative and two melee attacks. At any speed beyond 140 mph (224 km), the Fury takes one quarter damage from the impact.

Bonuses from Mecha Elite Combat Training: Because the cockpit and controls are those of a Valkyrie, the pilot must choose *MECT Valkyrie* and use those bonuses for elite combat training.

But because of the remarkable thruster system and design of the Qeadluun-Rau, add an additional +2 to dodge on the ground and +3 to auto-dodge while flying

5. Sensors: Has all the standard Valkyrie sensors and accompanying bonuses.

SDF-4 Liberator

Shadow Dimensional Fortress

Designed as the next generation of Super Dimensional Fortress, the SDF-4 is the first to be designated as a *Shadow Dimensional Fortress*, although whether it should maintain that designation is now in question. The newest in the SDF-series, the SDF-4 was made to lead the Earth Reclamation Force, thus its name. It was the first battle-fortress designed totally around Haydonite technology, including Shadow technology and the Synchro cannons, and is also the first successful, human-made dimensional fortress completely constructed from the ground up. The SDF-1 was a partial reconstruction of Zor's personal battle-fortress, and the SDF-3 was built into the frame of a Zentraedi cruiser. The SDF-2 was destroyed before construction could be completed.

The question of whether it should still be considered a "Shadow" Dimensional Fortress comes from the fact that the Shadow stealth system has been indefinitely deactivated to prevent Haydonite sabotage. It is only by extreme providence that the Liberator was not pitted directly against the Haydonites before their treachery was revealed.

The Liberator serves as the flagship of the remaining United Earth Expeditionary Forces, playing a triple role as a command and control vessel, as well as a supercarrier and mobile space dock. It was supposed to play a role as a battleship as well, but since the betrayal by the Haydonites was revealed, its main armaments and cloaking technology have all been deactivated, significantly degrading its ability to operate as a front-line combat vessel.

Quietly, this has come as a relief to some in the UEEF command echelon, who always thought it was unwise to put the flagship, chief supply vessel and mobile fuel depot front and center in combat as the biggest target on the battlefield. Others, particularly adherents to the Hunters' school of thinking, are pushing to have the ship refitted as a front-line combat vessel again, arguing that it is a rallying point and morale booster for forces in combat. Plus, the Hunters' supporters say, you don't keep your biggest gun in the holster during a fight.

The Liberator is the largest battle-fortress ever built. At four-fifths of a mile in length (1.3 km) it is twice the length of an *Ikazuchi-class Carrier* and several times the mass. It has a crew significantly larger than that of the SDF-3 Pioneer and is far more heavily armed. The ship is home base to more than 1,200 Veritech Fighters and thousands of Cyclones and other ground combat units.

Designed as a space control vessel, the Liberator is meant to fold in with an accompanying fleet and dominate the space battlefield by obliterating enemy assets, establishing orbital control over planets, deploying its fighters to achieve space and air superiority, serving as a mobile space station and port-of-call for allied forces and garrisoning occupied enemy territory. In the case

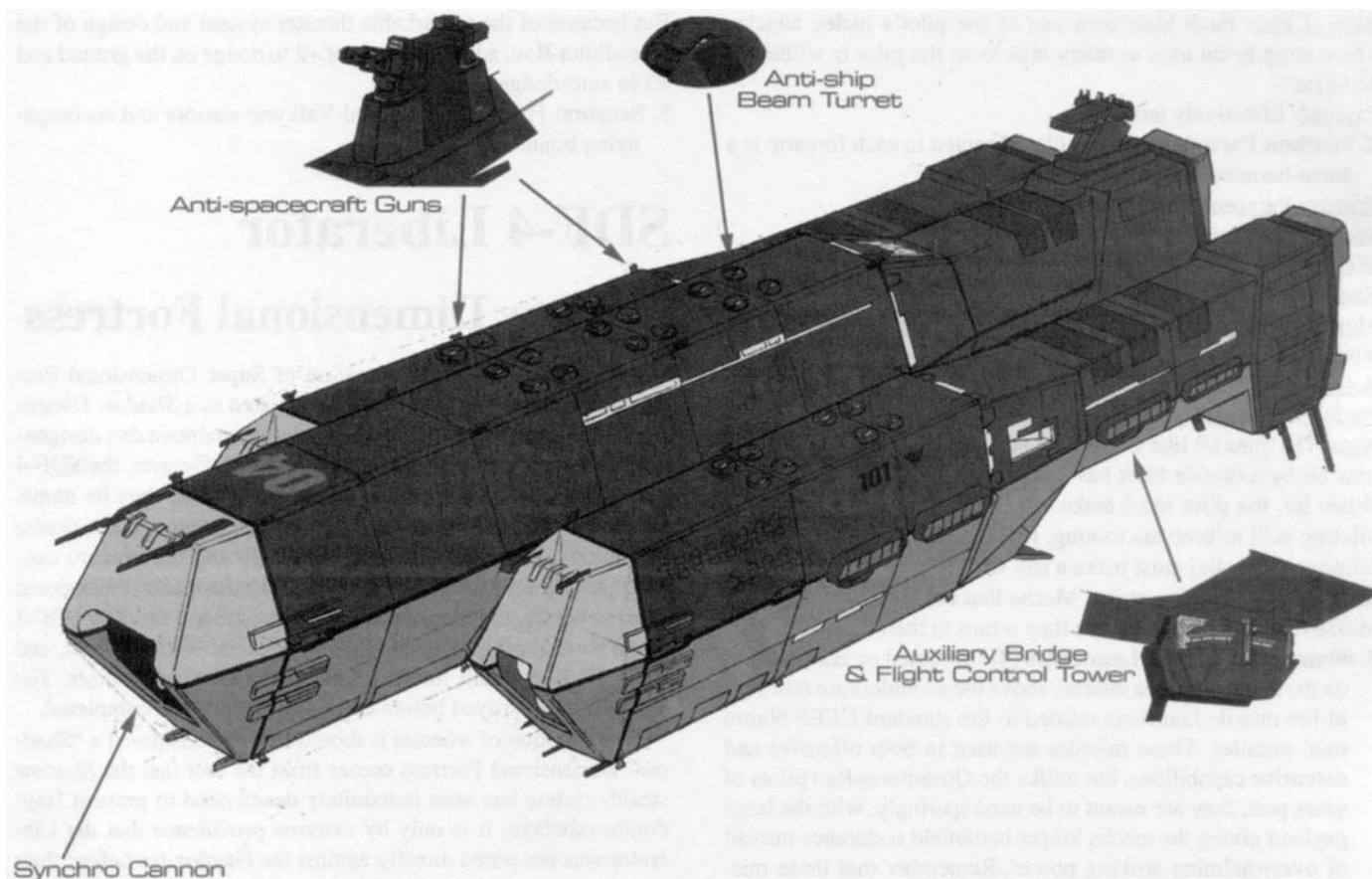

of Earth, it was meant to deliver a knock-out blow to Reflex Point from high orbit and then serve as the UEEF's base of operations in Earthspace while any mop-up actions took place. Nobody anticipated the sudden and total departure of the Invid, even in the best-case scenarios.

Once the liberation of Earth was complete, the Liberator was to have been stationed around Earth, supported by Space Station Liberty, while the Pioneer returned to Tirol orbit, creating a secured space fold trade route between what the UEEF sees as the two most important planets in the known galaxy. Earth could be rebuilt using technology from Tirol, and Tirol could be replenished using the raw resources of Earth, and the two cultures would be united.

It was a nice dream. Whether the Haydonites and the disappearance of the Pioneer have shattered that dream or just delayed it remains to be seen.

Whereas the Pioneer was designed, in part, to be both warship and exploration vessel, the Liberator is meant for pure combat. It has little in the way of research and development assets, and although it can carry more passengers than the Pioneer, its accommodations are designed much more along military standards, while the Pioneer carried a large scientific and diplomatic contingent, as well as the families of most of the fleet.

They say war is the harshest of teachers, and the Liberator was designed around the hard lessons learned through years of space warfare. It is utilitarian, inelegant and designed for pure functionality. It sports few of the fluid lines of a Shimakaze, none of the soft curves of a Garfish and none of the slender grace of a Horizon-T. Someone once described it as a massive slab of Robotechnology with engines. It's a fair description.

The primary hull is built around the largest Synchro Cannon ever constructed. When it was activated it out-ranged and out-powered even the famous "main guns" of the legendary *SDF-1*. Backing that

up are three super laser cannons, one located in each of the outrigger hangar sections. It also has numerous missile launchers, anti-ship beam turrets and point defense lasers.

Perhaps its most potent weapon, however, is its massive fleet of Veritech Fighters, totaling more than 1,200 fighting craft. It can deploy its fighters from eight rapid launch bays and two more traditional hangar bays (typically used for recovery and shuttle launches). The Veritechs are housed in the two massive flight deck outriggers on either side of the ship.

It also carries two regiments of UEEF Marines, including a mobile cavalry regiment of Cyclone and Silverback Riders for ground deployment, as well as four Horizon-T dropships to deliver them planetside. Most of the ground forces are stationed in the marine barracks section of the ship, attached to the ventral hull. The entire section can, if necessary, detach and land on a planet, providing a prefabricated garrison and command and control facility for the UEEF's ground forces.

What the role of the Liberator will be in the search for Admiral Hunter's flagship has yet to be determined. *General Gunther Reinhardt*, the current supreme commander of the UEEF in Admiral Rick Hunter's absence, is loath to place the ship in danger. After the events of *Robotech: The Shadow Chronicles the movie*, the vessel can be found in high orbit over the remains of Reflex Point, coordinating operations for the remains of the UEEF. There has been some debate about returning it to Tirol, but General Reinhardt did not come all this way just to turn around and go back, and without knowing what the Haydonites have planned, he intends to put most of his efforts into protecting the home world, which he believes is what Admiral Hunter would have wanted him to do.

SDF-4 Liberator

Model Type: Liberator-Class Shadow Dimensional Fortress.

Class: SDF (Shadow Dimensional Fortress)

Ship's Complement:

Ship's Crew: 6,839

Bridge Crew: Ship's Captain (1), Executive Officer (1), Officer of the deck (1), Junior Officer of the Deck (1), Conning Officer (1), Helm (2), Navigation (6), Communications/Sensors (6), Fold Ops (5), and Security (10 Security Corpsmen in CBR-5 armor and armed with M-25C Wolverine Carbines).

Combat Information Center: UEEFMC Lieutenant General (1, currently Lt. Gen. Gunther Reinhardt), UEEFMC Brigadier General (1, in charge of troop deployment, strategy and tactics), Colonel (4, acting as seconds to the Lt. General and the Brigadier General), Military Advisory Team (12), Commander Air Group (1, CAG, commander of the ship's air wing), Mechanized Infantry Commander (1, in charge of ground and boarding operations), Comms Team (15), Command Security (20 Marines in CVR-3 armor and armed with M-25C Carbines), and Ship's Weapons Crew (20).

Ship's Operations Crew: Administrative Support (950), Engineering (1,850), Medical Team (820), Science Team (180), Ship's Security (400 Security Corpsmen wearing CBR-5 and armed with M-25C Wolverine Carbines), General Enlisted (2,300), and Internal Communications (230)

Troops: 28,234

UEEF Naval/Marine Aviators: 1,224 combat ready pilots and 600 pilots in reserve.

UEEF Fleet Personnel: 14,844 (Various M.O.S. and O.C.C.s).

UEEF Marine Corps 3rd and 4th Regiment: 11,566 (Various M.O.S. and O.C.C.s).

Mecha Complement:

Veritech Fighters: 1,224 total.

802 VF/A-6 Alphas (X, I, H or Z variants)

422 VF-B-9 Betas (A or X variants)

Non-Variable Battloids: 288

240 ZBR-10 Mk.I Bioroid Interceptors

48 MBR-12 Mk.II Condors

Cyclones: 16,000

1,500 030 Series

1,000 040 Series

13,500 050 Series

Silverbacks: 3,000

300 VM-9Es

200 -9Hs

2,500 VM-9Ls

LCA-12T Horizon-T: 4, including full crews, mecha and armaments (not counted among the ship's stores above). Two are located on the bottom level of each carrier arm with their own dedicated drop bays.

M.D.C. by Location:

Forward Hull Section (1/3) - 50,000

Synchro Cannon - 15,000

Midships Hull Section (1/3) - 40,000

* Aft Hull Section (1/3) - 40,000

** Carrier Arms (2) - 60,000 each

*** External Garrison Base - 40,000

Secondary Super Laser Cannons (3) - 8,000 each

**** Hull per 40 feet (12.2 m) - 120

***** Command Tower - 7,500

Interior Bulkheads per 10 feet (3 m) - 50

Exterior Hatches - 100 each

Alpha Launch Bays (8) - 2,000 each

Launch Bay Doors (8) - 700 each

Auxiliary Bridge and Flight Control Towers (2) - 1,000 each

Midships Recovery/Landing Hangar Doors (2) - 2,000 each

Main Thruster Nozzles (26) - 2,000 each

Secondary Thruster Nozzles (6) - 1,200 each

Particle Cannons (56) - 300 each

Missile Bays (30) - 250 each

Point Defense Lasers (46) - 150 each

* Destroying the aft section of the hull destroys the engines, setting the ship adrift. The Command Deck is also destroyed, eliminating Primary Weapon Control. The ship can continue to fight from either Auxiliary Bridge, but at a -2 to strike for all weapon systems.

** Destroying both carrier arms leaves the ship without hangars for its fighters, and is likely to cause the destruction of most Veritech Fighters within the hangars when the arm(s) is destroyed. Only those already deployed in the field escape destruction.

*** The Garrison Base can be dropped through re-entry for a controlled landing on the surface of a planet. It can also lift off again and re-attach itself to the SDF-4 in low orbit. Destroying the Garrison Base destroys the 3rd Regiment, about half of the marines on the ship, unless they are already deployed.

**** Punching holes in the hull will cause the Damage Control Systems to automatically seal off whatever compartment has been exposed to vacuum. Ships are highly compartmentalized to prevent easy decompression of the whole ship.

***** Destroying the Command Tower destroys the Bridge. With the Bridge destroyed, the ship can still be commanded from the Auxiliary Bridge and Flight Control Tower or the Combat Information Center, but all weapon systems are -2 to strike and primary sensors will also be destroyed.

Speed:

Hover: The Liberator is not well-suited for atmospheric operations, and its atmospheric performance is pretty much limited to takeoff and landing.

Flying:

Space: Cruising Speed of 4,567 mph (7,307 km) or Mach 6. Maximum Speed of 9,134 mph (14,614 km) or Mach 12. Maximum interplanetary speed of approximately 1,863,000 mph (2,998,000 km or 1/360th the speed of light) can be attained within 10 days of sustained acceleration (without the use of Hyperspace Fold Drives).

Maximum Range: Limited only by supplies. The Reflex Furnaces can carry enough Protoculture for up to 15 years of standard operation, although shipboard expendable stores are only good for 24 months of constant deployment with a standard crew and troop complement. However, Protoculture fuel supplies can be quickly depleted through the use of Hyperspace Fold Drives. The drives generate a fold bubble up to 3.75 miles (6 km) across that can also carry non-fold capable ships within range of the sphere. The amount of Protoculture expended with each fold depends on the diameter of the fold bubble generated and the distance traveled, up to a limit of 500 parsecs in a single jump. Trips longer than that require multiple folds.

Statistical Data:

Length: 4,282 feet (1,305 m).

Beam: 2,710 feet (826 m).

Height: 1,712 feet (522 m).

Weight: 42,650,000 tons fueled and provisioned.

Power Source: 12 Reflex Furnaces powering 32 capital plasma thruster arrays and one Mk.X Capital Space Fold Generator.

Weapon Systems:

1. Type V Capital Class Synchro Cannon (deactivated): This is the largest Synchro Cannon ever known to have been built, and probably the last. Utilizing booby-trapped Haydonite technology, when this weapon was armed it was the largest, most destructive weapon ever mounted on a human starship. The only weapon ever built that was considered more powerful than this was the *Grand Cannon*. Capable of firing sustained beams and of directing that beam in swaths across the ship's forward firing arc, it was designed to destroy the swarms of Invid that typically make frontal massed assaults at UEEF fleets.

The cannon has been indefinitely deactivated and detached from all power supplies. Its primary arming components have been placed in storage and the firing aperture has been welded shut in order to ensure there is no way for the Haydonites to somehow remotely re-arm the cannon, which they could then use to detonate the entire battle-fortress in one blast.

Primary Purpose: Anti-Fleet.

Secondary Purpose: Planetary Bombardment.

Weight: Not applicable. Part of the ship's hull.

Range: 250,000 miles (400,000 km) in space, but only 150 miles (240 km) in an atmosphere.

Mega-Damage: Destroys EVERYTHING in its line of fire. A dodge and other evasive action is the only way to escape annihilation.

Rate of Fire: Once every two minutes.

Payload: Effectively unlimited.

Note: These weapons have difficulty hitting small, fast targets like mecha and aerospace fighter craft, and even ships as large as Horizon-class transports. Refer to the chart in the **Robotech®: The Shadow Chronicles® Role-Playing Game Hardcover Edition**, and reprinted in this sourcebook.

2. FESL-10 Super Laser Cannons (3): The secondary weapons of the SDF-4 have become the primary weapons since the Synchro Cannon was disabled. They are its three super lasers. One is mounted in the front of each carrier arm and a third is mounted in the prow of the garrison base. Each cannon is a cluster of very high-powered, free electron lasers that fire together to create a single, powerful beam. These weapons are used to destroy incoming Invid "Clam" Carriers before they unleash their deadly payload.

Primary Purpose: Anti-Capital Ship.

Secondary Purpose: Anti-Installation and Siege Fire.

Range: 120,000 miles (192,000 km) in space, 250 miles (400 km) in atmosphere.

Mega-Damage: 1D6x1,000 M.D. per super laser blast. Two can be fired for 2D6x1,000 M.D., or all three can be fired for 3D6x1,000 M.D. Multiple super lasers can only be fired at vessels at least 500 feet (152.4 m) in length across their broadest measurement.

Rate of Fire: Each super laser can fire once per minute.

Payload: Effectively unlimited.

Note: These weapons have difficulty hitting small, fast targets like mecha and aerospace fighter craft, and even ships as large

as Horizon-class transports. Refer to the charts in the *Space Combat* section of this book.

3. HPC-SC240 Triple-Barreled, 240mm Particle Cannon Turrets (56): Identical to the main weapons of the Ikazuchi-class carriers, these weapons are used primarily against sub-capital class ships, like cruisers, frigates and destroyers. They are mounted in armored turrets, with 12 on the dorsal hull of the main superstructure and eight on the dorsal hull of each carrier arm and an equal number on the ventral hulls. The turrets have a 360 degree rotation and 65 degree elevation.

Primary Purpose: Anti-Ship.

Secondary Purpose: Anti-Installation and Siege Fire.

Weight: Not applicable, part of the ship's hull.

Range: 30 miles (48 km) in atmosphere, 240 miles (384 km) in space.

Mega-Damage: 1D4x100 M.D. per single blast.

Rate of Fire: Twice per melee round (15 seconds).

Payload: Effectively unlimited.

Note: These weapons have difficulty hitting small, fast targets like mecha and aerospace fighter craft, and even ships as large as Horizon-class transports. Refer to the charts in the *Space Combat* section of this book.

4. HM-6 Heavy Missile Launchers (30): These missile launchers are scattered across the hull under concealed plates.

Primary Purpose: Anti-Ship.

Secondary Purpose: Anti-Installation and Siege Fire.

Weight: Not applicable, part of the ship's hull.

Range: Per long-range missile; typically 500 miles (800 km); see missile descriptions in the **Robotech®: The Shadow Chronicles RPG**.

Mega-Damage: Per warhead; varies with type.

Rate of Fire: Singly or in volleys of one, two, four or six.

Payload: Six in each of the 30 armored magazines, 180 total. The ship can carry another **120,000** missiles in its hold and has a munitions facility for the production of up to 400 per day with the proper supplies. Only Reflex warheads require Protoculture to create. All others can be constructed using conventional materials.

5. MLWS-40 Rapid-Fire 40mm Point Defense Lasers (46):

Mounted along the sides of the primary hull and carrier arms, as well as around the bridge tower, these weapon turrets are excellent anti-mecha weapons and do a reasonable job against the fast and nimble Invid Fighter Scouts.

Primary Purpose: Anti-Mecha, Anti-Space Fighter.

Secondary Purpose: General Defense.

Weight: Not applicable, part of the ship's hull.

Range: 4,500 feet (1,372 m).

Mega-Damage: 2D6x10 M.D. per single blast.

Rate of Fire: Each blast counts as one attack. Attacks per melee are equal to those of the "gunner" assigned to the weapon position, plus one (typically 4-6 attacks per melee round). Each laser is used to attack its own, independent target(s), and MLWS-40s seldom work in tandem with the other laser positions to fire upon

the same target, as each gunner is typically given a “zone” to defend that optimizes his or her turret's firing arc.

Bonus: +1 to strike opponents from man-sized mecha, fighters and shuttle craft. This is in addition to the Battle Fleet Bonus noted below.

Payload: Effectively unlimited.

Ship's Systems of Note: Tactical life support, escape pods for all crew, multiple robot and munitions factories, science laboratories, training facilities and could comfortably carry a maximum population of 180,000 in addition to the ship's crew. External, extendable docking collars allow for multiple ships to dock for any repairs just short of those that require dry dock.

6. Battle Fleet Bonus: The Advanced Command and Control Capabilities well exceed those of the Ikazuchi, allowing the battle-fortress to share sensor and tactical data instantly with every ship in the fleet. This grants *the fleet* a +4 to strike against anything directly engaged by the Liberator and supersedes any similar bonuses provided by smaller vessels.

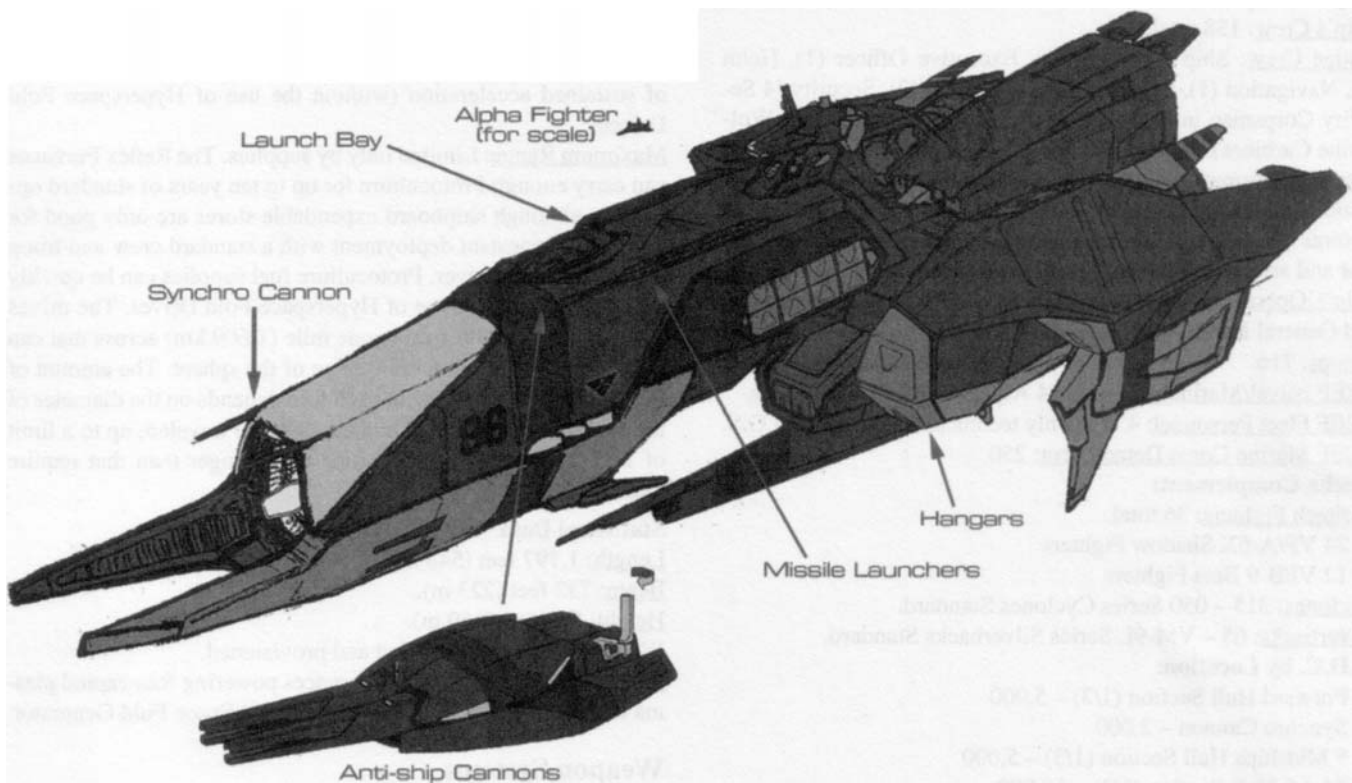

SDBC Shimakaze-Class Battlecruiser

One of the newest types of capital vessels fielded by the UEEF, the Shimakaze class is designed to be a hard-hitting cruiser that relies more on its guns than its complement of mecha; a significant strategic divergence from UEEF battle plans and tactics employed over the last generation. Shimakaze battlecruisers are intended to replace the venerable Tokugawa-class battleship as the fleet's ship-of-the-line. One Shimakaze, *the Icarus*, was the first UEEF vessel to mount a capital-scale Synchro Cannon. That ship was the flagship for the rogue *General T. R. Edwards* before being commandeered by *Captain Vince S. Grant*. Unfortunately, the remaining Shimakaze battlecruisers were refitted to carry Synchro Cannons as well in the

build-up to the liberation of Earth. Now the UEEF High Command is considering retrofitting those ships to their original configurations, by replacing the Synchro Cannon with bow-mounted super lasers, which would take them out of service for quite some time.

Even without its main gun, the Shimakaze is a powerful combatant, armed with a new type of heavy beam cannon, numerous missile tubes, point defenses and a squadron of Veritech's. But one can make the point that its most lethal weapon is its speed and maneuverability. The Shimakaze flies like a fighter, able to weave through combat, penetrate enemy defensive lines and deliver a knock-out punch directly to strategic enemy assets. This is another

departure from previous (and still prevailing) UEEF tactics which rely on rigid formations of vessels anchored by a carrier or battle-fortress that keep their distance while the Veritech squadrons move in for what the Synchro Cannons do not destroy at range.

The Shimakazes still carry a powerful turret-mounted, antiship particle beam cannon that was originally designed to be the ship's primary weapon. The cannon is incredibly efficient in its power usage, and has excellent range and a high firing rate for a weapon its size. The old point-defense lasers have also been replaced with more powerful pulse laser batteries with a much higher rate of fire, providing the ship with better anti-fighter and anti-mecha cover. Perhaps more importantly, they provide improved coverage for the rest of the fleet from mecha and fighter assaults.

Shimakaze Battlecruiser

Model Type: Shimakaze-Class Battlecruiser.

Class: SDBC (Super Dimensional Battlecruiser)

Ship's Complement:

Ship's Crew: 138 total.

Bridge Crew: Ship's Captain (1), Executive Officer (1), Helm (2), Navigation (1), Communication/Sensors (2), Security (4 Security Corpsmen in CBR-5 armor and armed with M-25C Wolverine Carbines).

Combat Information Center: Operations Commander (1), Commander's Aides (2), Military Advisors (4), Ship's Weapons (8), Comms (6), Security Team (6 Security Corpsmen in CBR-5 armor and armed with M-25C Wolverine Carbines).

Ship's Operations Crew: Engineering (20), Medical Team (15), and General Enlisted (65).

Troops: 716

UEEF Naval/Marine Aviators: 24 Alpha pilots, 12 Beta pilots.

UEEF Fleet Personnel: 430 mainly technical and support M.O.S.

UEEF Marine Corps Detachment: 250

Mecha Complement:

Veritech Fighters: 36 total.

24 VF/A-6X Shadow Fighters

12 VFB-9 Beta Fighters

Cyclones: 315 - 050 Series Cyclones Standard.

Silverbacks: 65 - VM-9L Series Silverbacks Standard.

M.D.C. by Location:

Forward Hull Section (1/3) - 5,000

Synchro Cannon - 2,000

* Midships Hull Section (1/3) - 5,000

** Aft Hull Section (1/3) - 10,000

*** Hull per 40 foot (12.2 m) area - 200

**** Bridge Tower - 2,000

Interior Bulkheads per 10 foot (3 m) section - 50

Interior Hatches - 50 each

Exterior Hatches - 125 each

Alpha Launch Bays (2) - 1,200 each

Launch Bay Doors (2) - 500 each

Midships Recovery/Landing Hangar Bays (2) - 1,600 each

Main Thrusters (4) - 850 each

Anti-Ship Particle Beam Turret - 900

Missile Launchers (30) - 250 each

Point Defense Turrets (4) - 200 each

* Destroying the midships hull section takes out the Command Deck and eliminates all weapons controls, rendering the ship flyable but unable to fight.

** Destroying the aft section of the hull destroys the engines, setting the ship adrift.

*** Punching holes in the hull will cause the Damage Control System to automatically seal off whatever compartment has been exposed to vacuum. Ships are highly compartmentalized to prevent easy decompression of the whole ship.

**** Destroying the Bridge Tower destroys the Bridge. With the Bridge gone, the ship can still be commanded from the Central Command Deck.

Speed:

Hover: The ship can hover in atmosphere and is capable of VTOL launches.

Flying:

Atmosphere: The Shimakaze is more capable in atmosphere than most UEEF space vessels. Maximum atmospheric cruising speed at any altitude is 1,340 mph (2,144 km) or Mach 2. It can reach a max of near Mach 13 to escape atmosphere.

Space: Cruising speed of 6,850 mph (10,960 km) or Mach 9. Maximum speed is 15,224 (24,358 km) or Mach 20. Maximum interplanetary speed of approximately 1,676,700 mph (2,682,720 km or 1/400th the speed of light) can be attained within 12 days of sustained acceleration (without the use of Hyperspace Fold Drives).

Maximum Range: Limited only by supplies. The Reflex Furnaces can carry enough Protoculture for up to ten years of standard operation, although shipboard expendable stores are only good for one year of constant deployment with a standard crew and troop complement. However, Protoculture fuel supplies can be quickly depleted through the use of Hyperspace Fold Drives. The drives generate a fold bubble up to one mile (1,609 km) across that can also carry other ships within range of the sphere. The amount of Protoculture expended with each fold depends on the diameter of the fold bubble generated and the distance traveled, up to a limit of 150 parsecs in a single jump. Trips longer than that require multiple folds.

Statistical Data:

Length: 1,797 feet (548 m).

Beam: 732 feet (223 m).

Height: 523 feet (159 m).

Weight: 750,000 tons fueled and provisioned.

Power Source: Three Reflex Furnaces powering four capital plasma thruster arrays and one Mk.IV Capital Space Fold Generator.

Weapon Systems

1. Type I Capital Class Synchro Cannon: This was the first Synchro Cannon ever installed onto a capital class UEEF starship, providing the ship incredible firepower and finally giving a UEEF ship-of-the-line the same punching power as a Zentraedi battlecruiser. While the weapon packed a nearly irresistible punch, both rate of fire and range suffered due to the drain on the ship's Reflex Furnaces. This was later improved in future capital class Synchro Cannons, but with the liberation of Earth requiring as large a battle-ready fleet as possible, the Shimakazes were never refit with a newer version of the cannon. Now that the weapons have been revealed to be a Haydonite trap, they have been deactivated fleet-wide.

Primary Purpose: Anti-Ship.

Secondary Purpose: Planetary Bombardment.

Weight: Not applicable. Part of the ship's hull.

Range: 75,000 miles (120,700 km) in space, but only 100 miles (160 km) in atmosphere.

Mega-Damage: Destroys EVERYTHING in its line of fire. A dodge and other evasive action is the only way to escape destruction.

Rate of Fire: Once every five minutes.

Payload: Effectively unlimited.

Note: These weapons have difficulty hitting small, fast targets like mecha and aerospace fighter craft, and even ships as large as Horizon class transports. Refer to the chart in the **Robotech®: The Shadow Chronicles® Role-Playing Game Hardcover Edition**, and reprinted in this sourcebook.

2. HPC-SC320 Twin-Barreled, 320mm Particle Cannon Turret: Before the ships were redesigned to house a Synchro Cannon, this weapon was intended to be the Shimakaze line's main gun. While the ship's offensive power was to rely heavily on missiles, much like the old, seagoing Ticonderoga-class missile cruisers of the late 20th Century, this weapon provided combat flexibility, and by mounting it in a turret allowed the ship to maximize the use of its maneuverability without relying on a limited, forward-facing weapon. Now that the Synchro Cannons have been deactivated, it is again the battlecruiser's main gun.

Primary Purpose: Anti-Ship and Assault.

Secondary Purpose: Anti-Installation and Defense.

Weight: Not applicable. Part of the ship's hull.

Range: 120 miles (192 km) in atmosphere, 960 miles (1,536 km) in space.

Mega-Damage: 2D6x100 M.D. per single blast, 4D6x100 M.D. per simultaneous double blast.

Rate of Fire: Twice per melee round (15 seconds).

Payload: Effectively unlimited.

Note: These weapons have difficulty hitting small, fast targets like mecha and aerospace fighter craft, and even ships as large as Horizon-class transports. Refer to the charts in the *Space Combat* section of this book.

3. HM-1 Heavy Missile Launchers (30): These missile launchers line the midsection of the ship.

Primary Purpose: Anti-Ship.

Secondary Purpose: Anti-Installation and Siege Fire.

Weight: Not applicable, part of the ship's hull.

Range: Per long-range missile; typically 500 miles (800 km); see missile descriptions in the **Robotech®: The Shadow Chronicles® Role-Playing Game**.

Mega-Damage: Per warhead; varies with type.

Rate of Fire: Each launch tube fires one missile at a time, but can fire combined volleys of up to 30 missiles.

Payload: Twelve in each of the 30 armored magazines, 360 total. The ship can carry another 360 missiles in its hold.

4. MLWS-60 Rapid-Fire, 60mm Point Defense Lasers (4):

An upgrade to the older MLWS-40s, four of these are mounted on either side of the bridge tower. These turrets are excellent anti-mecha weapons and do a reasonable job against the fast and nimble Invid Fighter Scouts.

Primary Purpose: Anti-Mecha, Anti-Space Fighter.

Secondary Purpose: General Defense.

Weight: Not applicable, part of the ship's hull.

Range: 6,000 feet (1,829 m).

Mega-Damage: 3D6x10 M.D. per single blast.

Rate of Fire: Each blast counts as one attack. Attacks per melee are equal to those of the "gunner" assigned to the weapon position, plus one (typically 4-6 attacks per melee round). Each laser is used to attack its own, independent target(s), and MLWS-60s seldom work in tandem with the other laser positions to fire upon the same target, as each gunner is typically given a "zone" to defend that optimizes his or her turret's firing arc.

Bonus: +2 to strike opponents from man-sized to mecha, fighters and shuttle craft.

Payload: Effectively unlimited.

5. Ship's Systems of Note: Advanced avionics suite, IFF computer, tactical life support, escape pods for all crew and troops.

Space Combat

Adventures in **Robotech®** are fun and far reaching. They can take place over a forty-some year span of time on Earth, on alien worlds and in *outer space*. In fact, *space battle* is a running theme through the **Robotech®** series. That means not just Veritech fighters against other mecha, but dogfights in space, boarding enemy spacecraft, and ship to ship combat.

Lines of Defense

Strategy & Tactics to Consider

Most spaceships, especially those designed for war, have **three imaginary perimeter lines** around the vessel.

The first is the outer perimeter, where long-range weapons and missiles are used to destroy or repel incoming attackers.

The second is the inner perimeter line, where careful targeting with the big guns is used and combat escorts, fighters and mecha are launched to engage and stop the enemy. When this line is penetrated by enemy attackers, the ship is in jeopardy of being hammered at close range and/or boarded by the enemy unless it takes evasive action (i.e. engage light speed or space fold away). Penetrating this second perimeter means the attackers can get in close to the spaceship to attempt to cripple it (destroy weapon systems, comm towers, sensory arrays, engines, etc.) or even to board and capture the vessel, or destroy it by inflicting multiple attacks from multiple attackers (i.e. other members of the combat wings attacking the ship). This is rather like a pack of wolves working together to take down a moose (or elephant), and though time consuming and dangerous, it can be done.

The third perimeter line is the walls of the ship itself and the space immediately around it. The cannons and weaponry of the ship may be used to shoot at fighters and mecha, but because these weapons are designed for long range, they suffer large penalties to strike such close, small, fast and agile targets. The vessel may have lighter, short-range weapons designed specifically for close space combat (within one mile/1.6 km and closer), but they are comparatively few, have less firepower (i.e. can't destroy an enemy fighter in one or two blasts), and usually require a gunner who won't panic and maintains his post. The vessel may also have held back some percentage of its own fighters and mecha which it can now deploy to engage the enemy in close combat right outside its hull. However, if the ship's Captain did not hold back any fighters, then he is at the mercy of the attackers unless he can recall fighters at the inner perimeter line or get help from nearby allied vessels or base.

Without help, the attackers may press the close combat to cripple, board or destroy the ship. If boarding is attempted, the ship's only defense is the armed troops or crew inside the ship. Surrender is advised. **Note:** From a game perspective, boarding returns to one on one combat between the player characters and Non-Player Character (NPC) defenders.

Mecha, Fighters & Small Spacecraft vs Capital Warships

Attacking any spaceship requires either destroying it first with one's own long-range, heavy weapons, or penetrating the perimeter lines and getting in close with fighters and mecha to cripple, board or destroy the enemy vessel. Fighters and mecha taking on small and medium-sized spacecraft requires teamwork and agility, but attacking a large warship or capital ship means a heck of a lot more firepower and time to bring down such a behemoth. Against a capital spacecraft, fighters and mecha are like a swarm of bees trying to take on a whale. That having been said, there are ways to do so.

First, fighters and mecha attacking a large or capital spaceship must get close to the vessel. In the case of large and capital ships, it may be possible to dodge heavy weapon fire and missile salvos.

It must be understood that the powerful, long-range weapons described under capital ships are specifically designed for mass destruction and heavy bombardment of giant targets, such as cities and military bases located on planets and moons, space stations, massive enemy warships, vast armadas of thousands of spacecraft, moons and even orbital bombardment. In short, these big, powerful weapons are designed for equally big targets like other capital vessels. Their big guns are NOT designed for combat with small, man-sized targets, mecha like Veritech Fighters, nor other small spacecraft. Trying to hit a small target like an Alpha or Beta with these big guns is like trying to swat a fly with a howitzer! It's almost impossible.

That means *small targets*, especially those the size of Veritech Fighters, are extremely difficult to hit with these *big guns*. These large, devastating energy blasts can be seen for miles and, even though the energy bolt strikes fast, they can be dodged because they are so easy to detect. This is not a design flaw on the part of the weapons, these "big guns" are designed to take out big targets: other capital ships, space stations, planetary bases, entire cities and sometimes, even the planet itself. Of course, any small vessels and clusters of small spacecraft caught in the blast are damaged (probably destroyed), but an alert and quick acting fighter pilot can usually get his speedy vehicle out of harm's way. Likewise, because small vessels are so fast, maneuverable, and well, *small*, these big guns suffer massive penalties to hit them.

Big Gun Bonuses & Penalties to Strike Based on the *Size* of the Target

Bonuses to strike apply when the intended target is especially large, 1,000 feet (305 m) or larger. Only W.P. Starship Artillery and W.P. Starship Energy Weapons give bonuses to strike every few levels. High P.P. attributes and other bonuses do not apply. Success (the roll of a 5 or higher to strike) is greatly affected by the size or land area of the target. The larger it is, the more likely the blast is to strike and inflict substantial damage.

Penalties to strike apply when the target is small, less than 1,000 feet (305 m). The big guns of capital space ships are not designed for use against small adversaries.

- +14 20,000 feet (6096 m) or larger.
- +10 19,999-10,000 feet (6096 to 3048 m).
- +6 9,999-5,000 feet (3047 to 1524 m).
- +4 4,999-2,000 feet (1524 to 610 m).

+1 1,999-1,000 feet (609 to 305 m).

-4 999-400 feet (304 to 122 m).

-8 399-150 feet (121 to 45.7 m).

-10 140 feet (42.6 m) or smaller; most Veritechs and space fighters are 45-80 feet (13.7 to 24.4 m) and extremely difficult to hit.

Note: All small spacecraft/mecha/vehicles (999 feet/304 m or smaller) get an *automatic dodge* against large energy blasts/volleys. An automatic dodge means the vessel dodges without using up any of its attacks.

Missile Attacks at Large and Capital Ships

Modified Dodge for Large & Capital Vessels. *Capital ships and other large vessels*, 10,000 feet (3048 m) or bigger, cannot dodge or move completely out of way of an incoming missile volley or barrage of energy weapons, but may be able to maneuver enough to avoid full impact.

The roll to dodge is unchanged. The defender must roll a 20-sided die (1D20) and match or better his attacker's roll to strike. A **failed roll** to dodge means the vessel takes full damage. A successful roll to dodge means, in this case, the large vessel is able to maneuver away enough to be struck by a glancing blow, taking only *one third* the normal damage from the entire volley. **Note:** This only applies to the volleys of medium- and long-range missiles, and capital ship sized weapons, fired from a range of over 40 miles (64 km). A large spacecraft cannot dodge missiles or weapons fired at closer range.

Intercepting Missile Volley Attacks. Most capital spaceships and battle cruisers have scores of energy weapons that can be used to try to blast incoming missile volleys, blowing them up before they hit the ship. Determining the strikes and damage for each individual energy blast is ludicrous, and would take an hour per melee. Instead, combine all the energy weapons trained on the incoming missile volley into one "volley" or simultaneous barrage. As long as the barrage of energy blasts is equal to at least 25% of the number of missiles in the volley, there is a good chance it will detonate several of the missiles and cause the entire missiles to explode before they hit.

As always, the attacker must roll to strike for the entire volley of missiles as if it were one unit. This means that the entire volley strikes and does multiple damage (roll M.D. for each missile in the volley) or the entire volley misses (or is destroyed), doing no damage at all.

To determine success, the defending capital ship rolls 1D20 and adds bonuses to strike and/or subtracts any applicable penalties.

If the roll is equal to or higher than the roll of the attacker, the *entire volley* of incoming missile volley is destroyed. No damage to the capital vessel.

If the defensive intercept roll is less than the attacker's roll, but above the *number 10*, half the missiles in the volley are destroyed and the other half hit and do damage.

If the defender's number is between 6-10, only 10% of the incoming missiles are destroyed, and the rest hit and do damage.

If the number is 5 or less, the barrage of energy blasts misses, falls short or is ineffective and the entire missile volley hits and does damage. A roll of 1-4 is an automatic miss.

Another alternative is to put a smaller ship in the missiles' path and sacrifice it to the missile volley. Even "smart" missiles are likely to be fooled (01-80% chance) and impact on the other vessel. This can also be done against some energy attacks, but

the most devastating weapons will destroy everything in their path.

Reminder: A *volley* is the simultaneous firing/launching of several energy blasts at the same, specific target. All the blasts in a volley, whether it be 3 or 33, are directed at that one target and can NOT be divided to strike several targets.

Damage from a Volley: If a target is hit by a volley, the attacker rolls the appropriate damage for each missile contained in the volley. Yes, I know this can lead to rolling handfuls of dice, or you can roll the damage for ONE missile and multiply it by the number of missiles in the volley for fast results. If it is *obvious* a vessel has been obliterated, then by all means the Game Master should proclaim it destroyed and avoid the time of needless dice rolling. The Game Master should be the one who recognizes and proclaims a vessel's destruction and foregoes the need of dice rolls.

Missile Attacks from Capital Ships

A capital warship may fire an individual missile or volleys of missiles at enemy targets. The usual missile volley rules apply. However, it should be noted that missiles launched from a capital ship are likely to be medium- and long-range missiles with heavier payloads, making damage considerable.

Random Missile Assault

Random bombardment can be performed when ten or more missiles are launched simultaneously, but they are NOT launched as a volley at any one specific target. Instead, *each* of the missiles speeds off in search of its own target. A variety of up to 20 different enemy targets can be stored in the missile's memory. When one of the programmed targets is identified, the missile(s) locks onto it and strikes.

The random seek and destroy program means more than one (1D4) missile is likely to home in on the same target, even if there are many other targets available. Missiles, even guided missiles and smart missiles, are relatively dumb, locking in on the *first* available adversary. Any number of missiles from a random bombardment can link up to form a volley against one target, but seldom more than four. Furthermore, the missiles are most likely to single out large and nearby targets.

The formula for determining the number of missiles that will randomly home in on a target is simple. 1D4 missiles per every 10 missiles launched. Roll at least once for each available target, beginning with the closest, until most of the missiles are accounted for. There are bound to be some that stray off, so don't worry about numbers under four.

Example:

20 missiles are launched in a random assault at five Veritech Fighters. The closest has 3 (out of 1D4) on his tail, his two nearest buddies have two each (out of a roll of 1D4 each). 1D4 is rolled again to see how many have homed in on the fourth Veritech. A one is rolled for a total of 8 missiles speeding toward targets. Had only ten missiles been fired, the fifth Veritech would be out of danger and the two remaining missiles considered to have strayed harmlessly away. However, since 20 missiles were fired, we roll 1D4 for the fifth fighter as well. Bad luck, a four is rolled. Total missiles accounted for are 12. That leaves eight stray missiles in search of other targets (other Veritech Fighter, spaceships, etc.)

If 30 missiles had been launched the outcome would have been the same with the exception that 18 missiles would have gone off in search of other prey.

If 40 or 50 missiles had been launched then each Veritech Fighter would be assailed by 2D4 missiles. 60 missiles would be 3D4, 80 would be 4D4 and so on.

Note: If only *one target* is available 50% of the missiles will automatically home in on it, the remainder stray off. The usual means of dealing with missiles, such as dodges, shooting them, outrunning and so on are applicable. Smart missiles are +5 to strike.

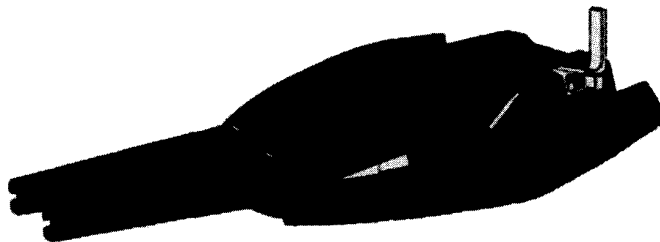

Bombardment from Ship Energy Weapons

As noted, many of the larger warships have numerous weapons that can be directed at numerous individual enemy targets, but can also be directed at one specified target, such as another capital ship or similarly large target. Again, to save time and reduce dice rolling, the G.M. may combine the energy blasts as a single "barrage" - similar to a volley - and roll 1D20 only once to determine if the entire barrage hit or missed. This makes space combat quicker and deadlier, with a greater element of luck. All weapons must have the range capacity to reach the target. The defender/target of the barrage always wins ties. And either the entire barrage hits or misses. Only small targets can try to dodge. Capital ships, space stations and ground bases are sitting ducks. **Note:** A simultaneous barrage uses the same bonuses and penalties to strike based on *size* as previously presented in this section.

Mecha & Fighters vs Spaceships

While most combat (80-90%) of the role-playing adventures will involve character versus character, mecha versus mecha, fighter versus fighter combat, there are times when a squad of individual characters in mecha, power armor, fighters and small spaceships may go up against one of the enemy's big warships. That may sound crazy, but there are some cases where this will happen and may even make sense. A squad of Veritech Fighters, UEEF mecha, Invid, and other one or two-manned vessels may certainly attack any spacecraft.

When going up against small and medium-sized spaceships, combat gets a little more dangerous and tricky, while attacking capital warships may be considered suicidal.

In all cases, the comparatively small fighters and mecha are going up against a large, even gigantic, heavily armed enemy spacecraft. A spacecraft that is likely to have as part of its offensive and defensive capabilities, 1) long-range beam weapons and cannons that have 2-10 times the range of a mecha or fighter, 2) long-range missiles and, 3) its own complement of fighters and mecha or similar escorts. This, in effect, creates a gauntlet of danger the erstwhile attackers must navigate to avoid damage and destruction even before they get into range to attack the enemy vessel.

It is important to note that **small spaceships** may range from 100-400 feet (30.5 to 122 m) long, **medium-sized spaceships** are the size of modern day naval battleships or carriers, up to 1,000

feet (305 m) long, and **large space vessels** up to 2,000 feet (610 m)! The giant **capital ships** and space stations measure a half-mile to several miles long.

Even **small and medium-sized spaceships** may pack the firepower of a battleship. That means the attacker must dodge heavy incoming fire and missiles as close to the vessel as a half-mile (0.8 km) away. Depending on the combat capabilities of the vessel, the long-range attack may start at 5-100 miles (8 to 160 km) away from the enemy vessel. These long-range attacks are probably from heavy beam weapons, cannons, rail guns and missiles that inflict anywhere from 1D6x10 to 1D6x100 M.D. per blast! Meaning the incoming fighters or mecha must dodge enemy fire or suffer heavy damage that could destroy them in one or a few blasts.

Small, one- and two-man fighters and mecha pilots shouldn't get cocky, as most capital space vessels have both *heavy, long-range* (easy for the small fighters to avoid) and *point defense weapons* (short-range precision weapons) to use against small, incoming enemy attackers, as well as their own wings of combat fighters and/or mecha for close combat, engaging in dogfights in space and repelling would-be landing parties.

Small and especially medium-sized spaceships built for war typically have two or more fighters to engage enemy attackers. Usually many more, such as one to several dozen space fighters and/or mecha as escorts or part of their own military offensive and defensive capabilities. Large and capital warships are likely to have entire wings or hundreds of fighters/mecha to defend them.

These escorts and fighters are likely to be released to engage enemy threats that are up to *5 miles (8 km)* away. If there is good news, the heavy fire from the big guns usually stops or reduces dramatically to avoid hitting their own fighters. Once fighters are launched, the spaceship will usually target other large enemy vessels and small fighters that are either away from their own fighters, or which seem to have scooted past the fighters and are coming in for an attack. Of course, additional (if available, and that's a big "if") fighters or mecha may be launched to engage attackers.

Escorts, Fighters & Other Defenders

Enemy fighters and small assault spacecraft that penetrate the capital ship's perimeter line of defense are swiftly dealt with by its smaller, shorter-ranged defense weapon batteries and the vessel's own close combat fighters. This combination of devastating long-range weaponry, short range defense weapons, and extremely fast and mobile fighters and close combat mecha, provides an extremely effective assault and defense force.

Large and capital warships are often *escorted* by other small and medium-sized vessels. At the outer perimeters, these escort ships fire upon, and try to intercept, small enemy spacecraft, fighters and mecha. However, they are NOT likely to fire upon even Horizon-sized targets within *five miles (8 km)* of a capital ship for fear of missing the target and hitting the big ship. These "capital ships" are big. Hmm, big is an understatement, huge - enormous - and in some cases, one to several miles long! But while they may not risk blasting their large command and support vessels with their own heavy and long-range weapons, they are likely to unleash smart missiles and fighters to engage the enemy before they can reach the big spaceship(s).

Engaging enemy fighters and mecha in space involves the same combat dice rolls and maneuvers you are already familiar with on the ground and in the air (initiative, strike, parry or dodge, etc.). This basically takes on the aspect of an *aerial dog-*

fight in space.

Close Space Combat

More than one way to skin (or cripple) a Capital Ship

Close combat in space for these capital ships - carriers, destroyers, battleship cruisers and dimensional fortresses - generally refers to combat and dogfights with fighters and mecha *outside* the hull of the spacecraft itself. When enemy fighters, mecha and small vessels get in *close* (typically a few miles/km to right outside the ship's hull), they attack the big ships with the intention of knocking out smaller targets such as sensor arrays, communication towers, weapon batteries, gun turrets, engines, and similar targets, as well as the fighters and mecha defending the enemy ship. This is done with the intention of harassing and crippling the capital vessel rather than actually destroying it. A capital warship can be destroyed by waves of attacking mecha and fighters, but such attacks require a vast number of attackers and a considerable amount of time. *Crippling it* is a much more effective way to take it out of the battle.

Targeted attacks against large vessels. Attackers can harass and cripple an enemy vessel by targeting weapon systems, sensor clusters, communication towers, radar arrays, hangar bays and hatches, maneuvering jets, main thrusters, life support, the Command Bridge, and similar aspects critical to the function, defense, combat and travel capabilities of the vessel. Like any other target, the attacking characters must repeatedly strike/blast the intended target until it is destroyed. This can be done by an individual or the combined firepower of a squad, or via the use of explosives brought along special to do the job.

Targeting and hitting these areas and structures on the surface of a spaceship is usually pretty easy as most are quite large, and even if shielded or recessed, player characters zooming in for a close-range attack inside a mecha or fighter should have an easy time of it. This is especially true if the attacking character can hover above, in front of or nearby the target and drop bombs or blast away at it, and then zip away; needs to roll a meager **5** or higher to strike a stationary target. *Point-blank range* should be treated as an automatic strike. If the target is relatively small, double man-sized or smaller, or if the attacker is moving or the target is moving, the attacker must roll to strike as usual, with anything above a roll of **10** hitting.

Hit and run tactics, bombing and strafing runs are the attacker's best options, because as soon as a specific target on the hull of the big ship comes under fire, the enemy knows the attacker's location and is likely to send defenders (troops, mecha, fighters) to that area to repel the attack and/or destroy the attacker(s). If the attacker remains on the move, close to the hull, hiding and taking evasive action, he should be difficult to locate by enemy fighters and defenders. Staying in one place too long (i.e. more than a minute or so) flirts with disaster, as retaliation will be swift and deadly.

Note: Player characters onboard a spaceship may find themselves serving as escorts/close combat defenders or manning a weapon station, gun turret or missile launcher, or even commanding the crew of a small, medium, or large ship.

Boarding Large & Capital Ships

Close combat against any ship, but especially large and capital warships, may also be done with the intention of boarding the enemy ship!

Once inside, the attackers may be able to inflict considerable damage to the less fortified *interior* of the ship, as well as unsuspecting and poorly armored crew members, and even gain access to vulnerable strategic areas of the ship such as the bridge, command deck, communications, life support, engine room, reactor containment, spacefold engines, etc., and shut them off, or damage or destroy these areas, further crippling the vessel's capabilities from within.

Of course, blasting one's way inside may be easier than getting out. Once inside, the boarding party must navigate unfamiliar hallways, find the strategic centers and deal with onboard defenders. Onboard defenders are likely to include enemy mecha, fighters, and power armor units, as well as armed troops, boobytraps, and possibly interior defenses and security systems. There is also the element of the unknown in regard to enemy response. Will the crew stand down if their captain/leader is taken captive? Some might, others won't. In some cases the threat will cause the enemy to surrender, in other cases the threat might inspire other officers and troops to retaliate with even greater determination to repel or destroy them. There is also the ever present danger of self-destruction rather than being taken captive. Game Masters, use your discretion.

Ship to Ship Combat

The only sure way to destroy a capital ship is to attack with an equally powerful spacecraft, two or more large ships or overwhelming numbers.

Even though the big warships have incredible amounts of M.D.C., and a dozen or more attacks per melee, combat can be resolved quickly. After all, if the weapons inflict equally devastating amounts of damage, the big ships can destroy each other in minutes. Unless one opponent or the other surrenders, combat lasts about six melee rounds and one perishes in flames.

The basic combat rules and rolls remain unchanged.

Step 1: Attacks per Melee

The description of specific weapon systems for each ship will indicate how often they can fire per melee.

Main gun. The most devastating weapon (main gun) may only be able to fire once or twice per melee round, or perhaps even only once or twice every few to several minutes.

Heavy secondary weapon systems can probably fire 2-6 times per melee round.

Smaller weapon systems, manned weapon turret stations, and similar can fire as per the number of attacks of their independent gunners (usually 4-7 times per melee round).

Missile stations can typically fire one or two missiles at a time, or as many as half to all of their payload in a missile volley.

Step 2: Initiative

Determining initiative is crucial because it will set the pace for that entire melee round, and with large and capital ships, the one who shoots first is most likely to be the victor.

Two players, or a player and the G.M., each represent one of the commanders of the two vessels. Typically the G.M. plays the role of the enemy. Each rolls 1D20 for the initiative as usual.

In game context, only player and player allies have a bonus of +2 added to their initiative roll and always win ties even if they are the attacker! If the player's vessel and/or their allies are outnumbered, they automatically have the initiative. No other bonuses apply, except in the case of surprise (unlikely), which provides a +1 initiative bonus. If there is no player character in command of the ship, the players should take turns rolling for

their allied warship.

As always, a twenty-sided die (1D20) is rolled. The highest roll wins and that ship fires its main gun, secondary guns, and smaller weapons (if in range) first (see Attacks above). When their attack is done, the other ship returns fire.

Step 3: How to Strike

The procedure is exactly the same as usual. Remember to roll for each weapon system available in an attack. Also, remember to add W.P. and weapon bonuses (when applicable) to strike. When firing the big guns from a starship, the bonus to strike does NOT include the pilot's or commander's attribute bonuses to strike, but only those from W.P. Starship Artillery and Starship Energy Weapons skills.

More than one weapon position may fire at the same target provided that the weapon position can be aimed at the target and fired in its direction. For example, a weapon fixed in a forward pointing position cannot shoot at a target off to the side or behind it, while turrets with the suitable angle of rotation could reposition, aim and fire.

A simplified Ship to Ship Combat exchange:

To make Ship to Ship Combat faster and simple, we suggest the following:

Main Gun: Let the main gun fire once that first melee and then as indicated in the description, but no more than once per melee round.

Each Secondary Weapon System: Can fire twice per melee round.

Missile Launchers: Can fire as often as twice per melee, but the missile volley can be one missile to its entire payload.

Medium- and Short-Range Weapon Systems: This pretty much includes all other weapon systems, such as weapon turrets, rail guns, auto-cannons, other energy weapons, etc. Each can shoot at a different target (fighters, escort ships, etc.) or coordinate their attacks to fire at the same target simultaneously in one massive bombardment (roll once for to strike and damage) of a single large target (e.g. a capital ship or space station), four times per melee round. Weapon systems manned by a gunner and engaged in defending against fighter or mecha attacks have the same number of attacks as its gunner. Gunners with *W.P. Starship Energy Weapons* and/or *W.P. Starship Artillery* get one extra attack per melee round when operating a ship's gunnery position.

The order in which a particular weapon system is fired is solely up to the player's (or G.M.'s) discretion, though in all-out combat, the first shot is usually with the big gun, followed by the next heaviest weapon, and so on in declining order.

The total number of attacks a warship has is equal to the total number of functioning, available weapon systems.

Any weapon system not engaged in ship to ship combat is presumed to be otherwise engaged (i.e. shooting at other enemy aggressors or targets), or not in position to attack.

Step 4: Dodge and Parry

Only small vessels, fighters and mecha can dodge the large beams of an attacking ship or try to parry and dodge the blasts, missiles and other attacks from all other opponents and spaceships. Remember, a *Natural Twenty* (unmodified by bonuses) always wins. Four or more, in a volley is impossible to dodge. Large and capital vessels can attempt to maneuver, so as to suffer a *glancing blow* and take less damage; described previously, roll the same as a dodge.

Other Combat Rules

Critical Strikes, close proximity/damage radius, Called Shots, damage from missile strikes, shooting missiles, and dodging guided missiles/smart bombs, are unchanged.

Swarming Attacks

Swarming attacks are possible since even the big ships and their massive weapons can only hit so many targets and inflict so much damage at once. Swarming attacks, while likely to suffer huge casualties (2D4x10% destroyed by the big guns and secondary weapon barrages), still make it possible for some of the fighters in the swarming attack to successfully penetrate perimeter lines and get close to the big ship. In the case of player characters, it is always presumed they are part of those who succeed. Once close to the ship, one on one combat and dogfights with smaller defender ships and fighters is likely to ensue. If not, or until it does, the surviving attackers in the swarm can begin independent (fire at will) or coordinated attacks (working in concert as a team) to target locations on the bigger ship to cripple, hurt and/or board the vessel.

Mass assaults and coordinated strafing runs where numerous small ships, fighters and/or mecha attack in tandem (as a group) may be handled *similarly to missile volley attacks*. Meaning, if seven fighters are on a strafing run or firing upon the same gun turret, roll once for the damage inflicted by the same (or equivalent) weapon and multiply by seven per melee attack. This makes combat quick and easy. Of course, all (or most) of the attacking fighters need to use the same type of weapon in the attack, be it gun pod, lasers or missile volleys.

Dispersing/chasing away small, swarming attack ships will stall (temporarily stop) their coordinated mass attack and cause them to scatter and regroup, which takes 1D4+1 melee rounds. However, the only way to eliminate them is to try to target them with close combat defensive weapons (limited and spread out on most big ships) or for the ship to send its own fighters and mecha out to engage and destroy them one on one. As a rule, other mecha, fighters and small attack ships are deployed to engage enemy fighters who get close enough to do damage.

New Weapons & Equipment

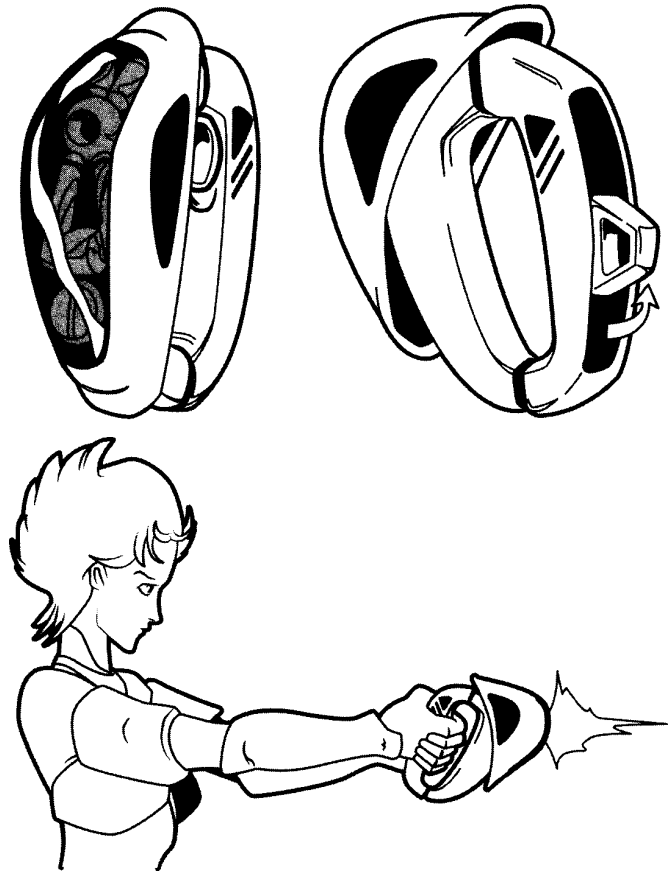

Invid Hand Blaster

This alien pistol appears to have been designed specifically for use by the Invid Princes, Princesses and Simulagents. It is a small laser pistol provided primarily as a means of self-defense for times when the human-like Invid leave the cockpits of their war machines or in case they are caught outside of their mecha during an attack on an Invid Hive. The weapons are essentially pistol versions of the forearm lasers of the Invid Soldier.

The Invid Hand Blasters are simple point and shoot weapons that just about anybody can use. They are lightweight, accurate and do *not* use a Protoculture fuel cell or energy clip, and instead are recharged off of the Invid user's mecha. They have limited usefulness to anyone who is not an Invid Prince or Princess or who does not have access to an Invid Commander or Invid Overlord mecha.

Weight: 2 pounds (0.9 kg).

Range: 500 feet (152 m).

Mega-Damage: 2D4 M.D. for a single blast. Only fires single blasts.

Rate of Fire: Each blast counts as one melee attack.

Payload: Can fire 30 laser blasts before recharging is required. However, recharging takes only half an hour, or one minute per

blast, once the weapon is in the Invid Commander or Invid Overlord mecha. The weapon does not appear to actually need to be plugged into anything, it just needs to be *inside* the pilot's compartment to recharge.

Bonus: +1 to strike.

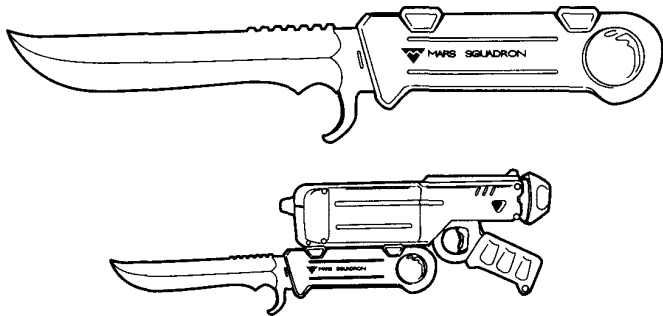

M-2 Bayonet

The M-2 is a standard issue bayonet originally designed to accompany the FAL-2 Pulse Laser Rifle (**Robotech®: The Shadow Chronicles® Hardcover**, page 127, or page 180 of the manga edition). When used with the FAL-2, the bayonet can link into the power supply and is surrounded by a high-frequency vibration field, allowing the bayonet to cut through super alloys. When unattached, it is simply a large, but sturdy and reliable, knife.

Weight: 8 ounces (0.2 kg).

Range: Melee combat only.

S.D.C. Damage: 1D8

Mega-Damage (only when attached to the FAL-2): 2D4 M.D.

Payload: Not applicable when unattached, but each melee round the bayonet is in use while attached to the FAL-2 drains the equivalent of a single M.D. blast.

M440 60mm Mortar

This is an indirect fire weapon that lobs 60mm shells one mile (1.6 km) away. While a staple of infantry for more than a century, this weapon proved to have little actual use in warfare utilizing Reflex Weaponry until the Invid invaded. Its mobility, ease of use and the fact that it does not rely on Protoculture make it an excellent weapon for the resistance, particularly when ambushing fixed targets, like Protoculture Farms or Invid checkpoints in controlled cities. The typical Invid appears to have some difficulty determining the source of indirect fire from non-Protoculture powered sources, giving mortar teams time to fire off several rounds before needing to move again.

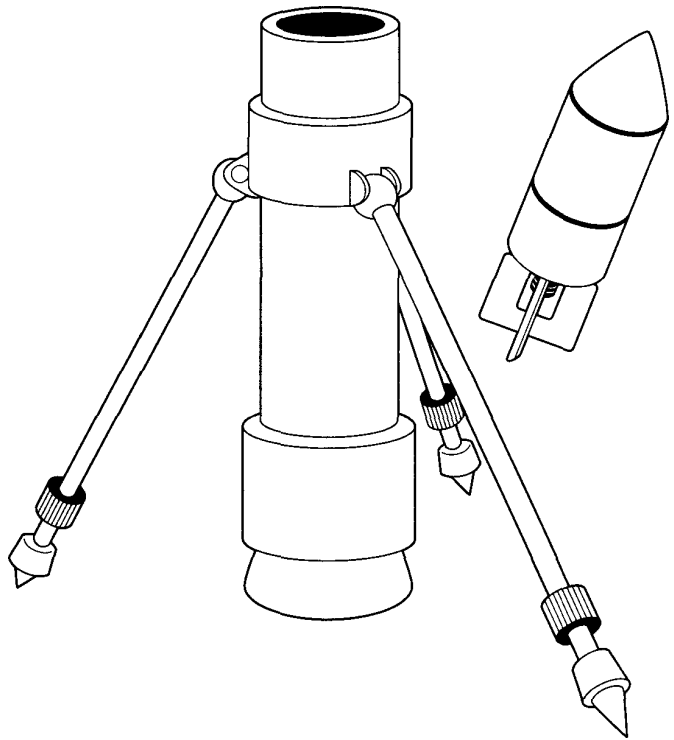

The M440 is unique for a mortar design in that it comes as one piece, with the tripod built into the sides of the cannon, nor does it require a base plate. This makes set up as quick as three actions (two to deploy and one to set the range), and breaking it down is as simple as picking it up off the ground and folding the legs back against the launch tube. While the M440 can be fired by one person, it is most effective when used by a two-man team. W.P. Heavy Military Weapons is required to operate this mortar with any accuracy. Characters without this W.P. skill are **-6** to strike. **Purpose:** Anti-Fortification and Anti-Personnel.

Weight: 15 pounds (6.8 kg).

Range: One mile (1.6 km).

M.D.C.: Varies by shell type. High Explosive (HE) shells: 1D6x10 M.D. to a 6 foot (1.8 m) blast radius; Plasma Gel (PG) shells do 4D6 M.D. to an 8 foot (2.4 m) blast radius on impact and continue to burn for 1D4+1 melee rounds, doing 2D6 M.D. each round; in addition, there are Smoke Cartridge shells used for screening, signaling or marking targets, Standard Illumination shells which launch powerful flares that light up a night battlefield, and Protoculture Illumination shells which launch *Protoculture flares* that can be used to distract and bait the Invid.

Rate of Fire: It takes a lone operator two melee attacks to fire each shell, however a two-man team can launch five shells per melee round.

Payload: Each shell is dropped into the mortar immediately before firing. The ammo-bearer can carry a backpack with up to 15 shells. The shells are also often stored in crates of 60, particularly when the mortar is fired from the back of a flatbed truck or other vehicle which can quickly drive away after firing several rounds.

Note: The M440 was designed to fire 60mm shells to capitalize on limited production capacity when the UEEF was being built. While it is not technically compatible with other 60mm rockets commonly used in the UEEF, a weapons engineer or field munitions expert can modify the rockets to work as mortar shells for the M440.

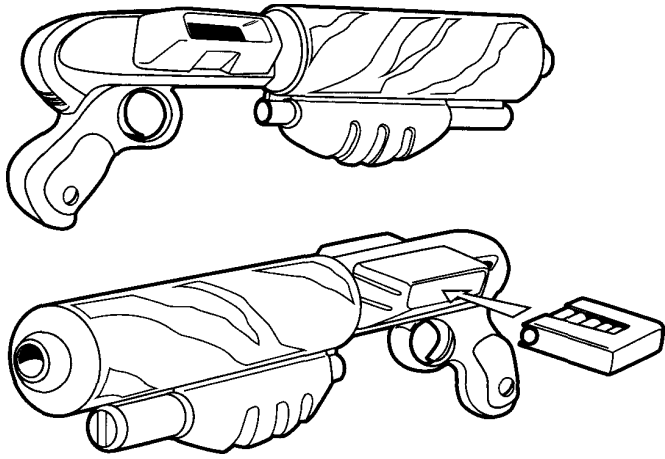

T-9 12.7mm Pump Pistol

The T-9 Pump Pistol is a powerful handgun originally designed for settlers who were repopulating the wastelands following the First Robotech War with the Zentraedi. They had to have a reliable, easy to use weapon that was effective against both human and rogue Zentraedi raiders. It had to be durable, utilitarian and have significant stopping power.

The T-9 uses large 12.7 mm slugs for smaller targets, and can fire explosive ammunition for larger or armored targets. Its pump action design keeps the weapon simple and easy to use, clean and repair. It has a side-loading, six-round magazine that virtually eliminates the possibility of jamming and can be fired comfortably one- or two-handed, although it has better balance when fired with both hands. It was originally sold with a survival knife (1D6 S.D.C. damage) that fit into the accompanying holster, but it is rare to find a complete set of gun, holster and knife after the Invid invasion.

Weight: 4.5 pounds (2 kg).

Range: 800 feet (244 m).

Mega-Damage: Standard 12.7 mm solid slugs do 5D6 S.D.C. damage, but explosive shells do 2D6 M.D.

Rate of Fire: Single shot only. Each shot uses one melee attack.

Payload: 6 rounds per clip.

Bonus: +1 to strike when fired with both hands; -1 to strike when fired one-handed, unless the character has a P.S. of 22 or greater.

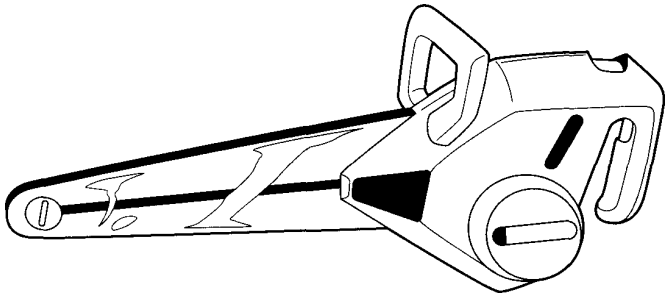

Nano-tube-Blade

Ultra-High-Speed Chainsaw

Originally designed for search and rescue and damage control aboard UEEF ships, this chainsaw has the option of being ethanol or gasoline driven or Protoculture powered with the flip of a switch. In its ethanol powered mode, it is useful for cutting down trees and through most normal S.D.C. materials. When switched to Protoculture, the speed of the superhard phase carbon nano-tube-tipped blades increases tenfold and it is capable of cutting through hull plating like cardboard. Its smooth action and balance make it much easier to control than traditional chainsaws,

however it was not designed to be a weapon, making it clumsy in combat.

Weight: 12 pounds (5.4 kg).

Range: Hand-to-hand melee combat only.

S.D.C. Damage: 1D4x10

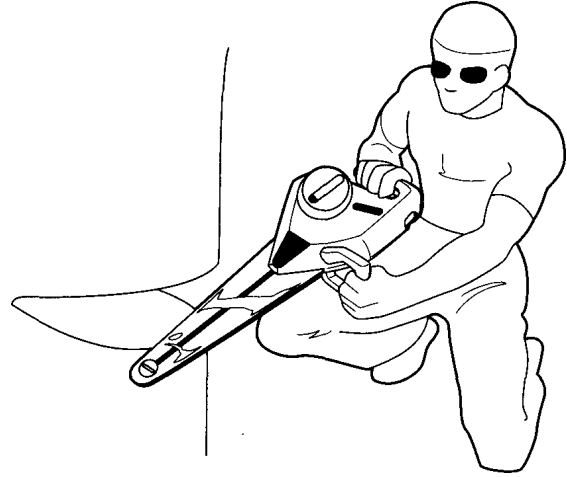

M.D.C. Damage: 3D6 M.D.

Payload: Can run for 10 continuous minutes on a one liter (0.26 gallon) fuel canister using virtually any type of ethanol or gasoline. A Protoculture fuel cell will power the chainsaw in S.D.C. mode continuously for a month, but only for about 15 minutes of continuous use in Mega-Damage mode. M.D. is only possible when using a Protoculture fuel cell, but then the device can be sensed by the Invid.

Penalties: -2 to strike when attempting to hit a moving target in combat.

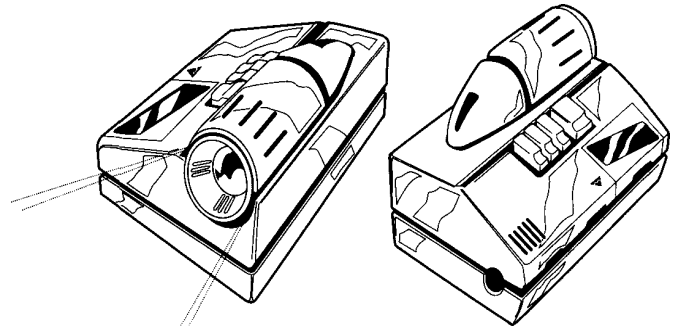

Holographic Image Projector

This device displays a three-dimensional projection in mid-air. It is useful in analyzing enemy fleet movements and formations (due to the three-dimensional nature of space warfare), briefing soldiers in the field and passing intelligence data between sources. The 3-D hologram allows viewers to analyze visual data from all angles and the built-in computer can extrapolate the likely shape of an object from 2-D or incomplete 3-D visual records. It runs on a standard lithium rechargeable battery.

Weight: 9 pounds (4 kg).

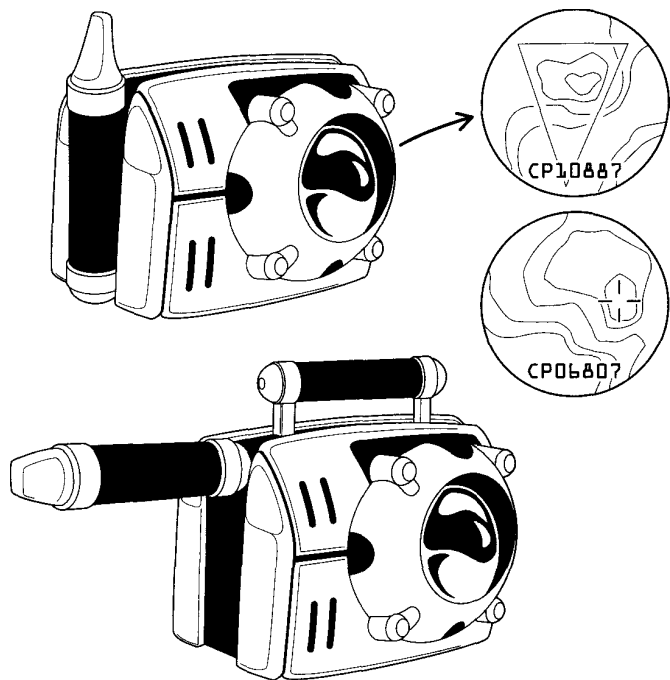

Portable Prospector

The Portable Prospector is a small but powerful sensor package that was used by surveyors during Reconstruction and by the UEEF during exploration of alien worlds. The device contains a battery of sensors, including ground-penetrating radar, a Geiger-counter (for detecting radiation levels), electromagnetic field detector, ultrasound, thermal-graphic imager, spectrometer and air sampler. All have a range of 2,000 feet (610 m). It runs on standard, non-Protoculture, rechargeable lithium batteries which can be recharged by most generators, and has an extendable solar panel on the back that can recharge the batteries when left in the sun for eight hours.

The Portable Prospector is useful in tracing heat sources, detecting hidden power sources, underground caverns, hidden compartments, dangerously radioactive areas and for detecting things which may not be visible to the human eye - including Invid that have buried themselves underground or snow. The *Sensory Equipment* skill is required to use this device.

Weight: 6 pounds (2.7 kg).

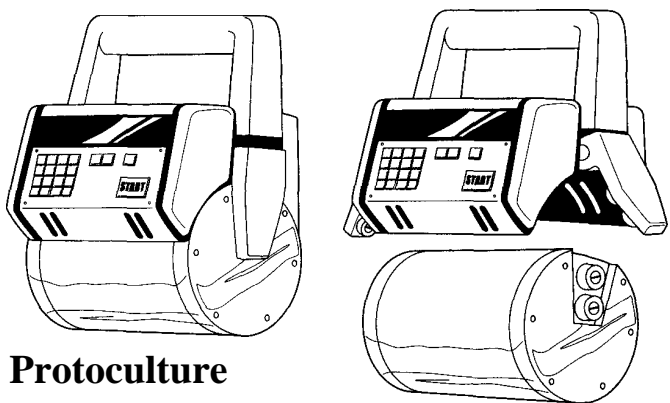

Protoculture Bio-Emulator

This device was brought to Earth by the UEEF Expeditionary Forces because it has proven successful in many previous campaigns against the Invid. It emits a powerful Protoculture energy signature that acts as a beacon/lure to any Invid with a Protoculture sensor. However, the pulse is steady and very mechanical,

unlike the variations in power of an actual machine. There is a cumulative 8% chance every minute that the Invid will recognize the emissions as abnormal and suspect a trap. In most cases, however, they continue to investigate the source of the power readings even when danger is suspected, in order to draw out resistance fighters, but the investigating Invid will call for support, first, to bolster their numbers.

The Protoculture emanations from the Bio-Emulator are so high and diffuse, and the device is so small, that it makes it difficult for the Invid to actually pinpoint the device's location. Invid have a 35% chance of pinpointing the device when it is active and only a 20% chance if the Bio-Emulator is well-concealed.

Primary Purpose: Invid Lure.

Range: Most Invid can detect the emissions from a mile (1.6 km) away, but Invid Fighters and Invid Scouts can detect the Protoculture signature from a distance of 2 miles (3.2 km).

Duration: The device can run for 10 hours on one Protoculture cell.



UEEF All-Weather Thermal Poncho

This is a simple poncho manufactured with advanced materials that provides adequate protection from the elements and exposure. In addition to its obvious use as a rain poncho, it has internal heating elements capable of protecting the wearer from temperatures as low as 10 degrees Fahrenheit (-12.2 C) and when folded up, is smaller than a deck of playing cards. The poncho offers no armor protection of any kind.

Vehicles

ATT-40 All-Terrain Assault Jeep

This is a six-wheel, armored version of the ATT-30 designed purely for combat purposes. It sacrifices all of its passenger space for the addition of extra armor, a rotary-barreled laser cannon mounted in what would usually be the passenger's seating area, and a 60mm multiple rocket launch system that takes up the entire rear bed.

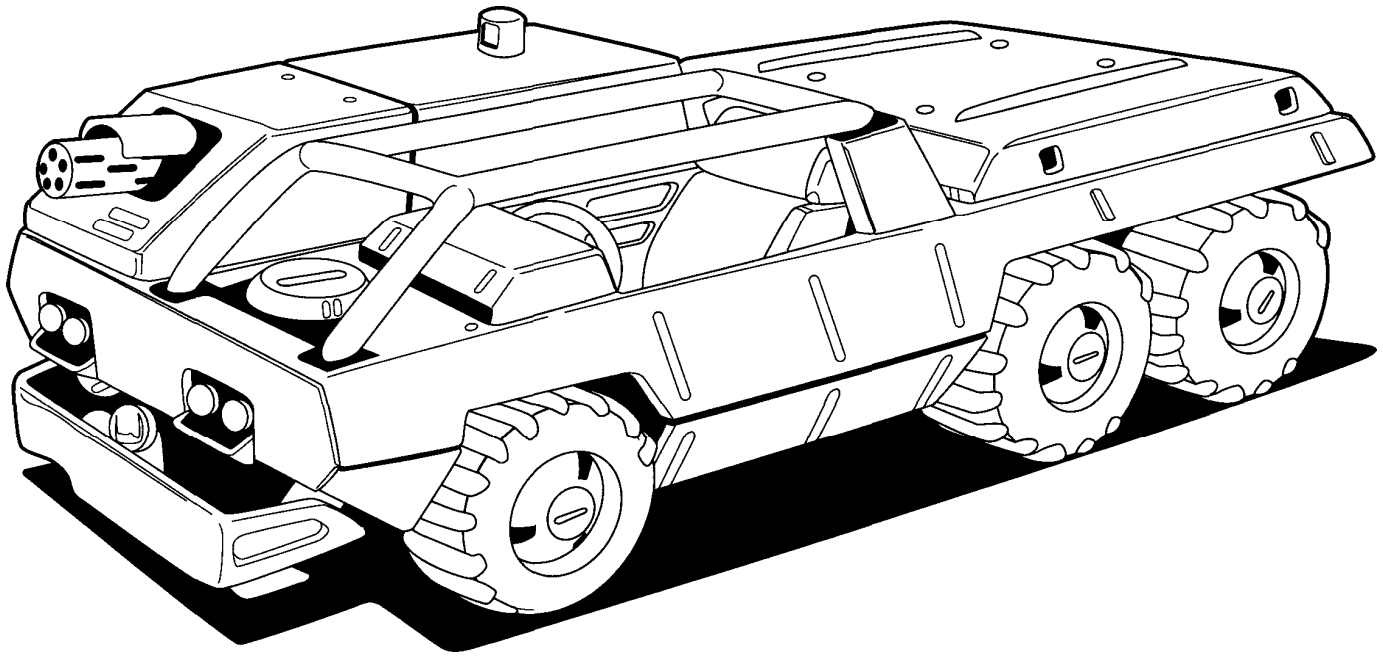

Originally meant to provide mobile infantry fire support, a number of these vehicles came to Earth during the first liberation attempt by the UEEF. However, they were meant to be used as part of a much larger military force, and their lack of cargo capacity and their reliance on Protoculture limits their use for the resistance. They are most often used as escort vehicles for supply caravans and as patrol vehicles by freedom fighters, but also by Invid sympathizers who do not have to worry about retribution from the Invid and who have significant resources at their command.

Vehicle Type: Truck.

Class: Military Ground Assault Vehicle.

Crew: One driver.

M.D.C. by Location:

Headlights (4) - 2 each

* Tires (6) - 15 each

Rotary Laser Cannon - 75

Rocket Launcher - 100

** Main Body - 250

* Destroying one tire reduces speed by 30% and inflicts a -10% piloting skill penalty. Losing two tires immobilizes the vehicle.

Note: The tires are shielded and very difficult to hit from the front. To shoot out a tire from a front position, the attacker must make a successful "Called Shot" with the following penalties: Shooting at a stationary target -6, moving target -8, and fast moving target -14 to strike; half those penalties when at the side or rear of the truck. These penalties also apply to targeting the driver or passengers, headlights and other small targets.

** Depleting the M.D.C. of the main body destroys the vehicle, rendering it useless. However, the missile launcher can still function independently.

Speed: 140 mph (224 km) empty. 80 mph (128 km) at maximum load.

Statistical Data:

Height: 5 feet (1.5 m).

Length: 13 feet, 6 inches (4.1 m).

Width: 6 feet (1.8 m).

Weight: 8 tons.

Cargo Capacity: None.

Power System: Protoculture-fired Rotary Engine that requires four Protoculture cells to operate.

Weapon Systems:

1. Rotary Laser Cannon: This is a multi-barreled laser cannon with low stopping power, but capable of putting out a voluminous amount of fire. It was designed to provide suppressing fire to cover the advance of infantry. The rotary barrel keeps the weapon from overheating. The entire assemblage can elevate to an angle of 30 degrees, but the gun must be in the lowered position to deploy the missile launcher.

Primary Purpose: Assault.

Range: 4,000 feet (1,219 m).

Mega-Damage: A single blast does 2D6 M.D., a six-round burst does 1D6x10 M.D. (counts as one attack). Typically fired in bursts.

Rate of Fire: Each blast or burst counts as one melee attack.

Payload: Effectively unlimited.

2. 60mm Multiple Rocket Launch System: This is a standard missile launcher used on a number of UEEF flatbed combat vehicles. On the ATT-40 it is built into the truck itself and cannot be removed.

Primary Purpose: Anti-Mecha/Anti-Aircraft.

Secondary Purpose: Anti-Personnel.

Range: One mile (1.6 km).

Mega-Damage: By mini-missile. Standard load is High Explosive Armor Piercing (HEAP) which deals 1D4x10 M.D. per missile.

Rate of Fire: Individually, in pairs, or in volleys of 4 or 6.

Payload: 18 mini-missiles.

3. Special Equipment of Note:

Built-In Radio: Short- and long-range directional radio. Range: 100 miles (160 km).

Mini-Radar: Capable of tracking airborne targets at a range of 20 miles (32 km) and land-based targets at a range of 5 miles (8 km).

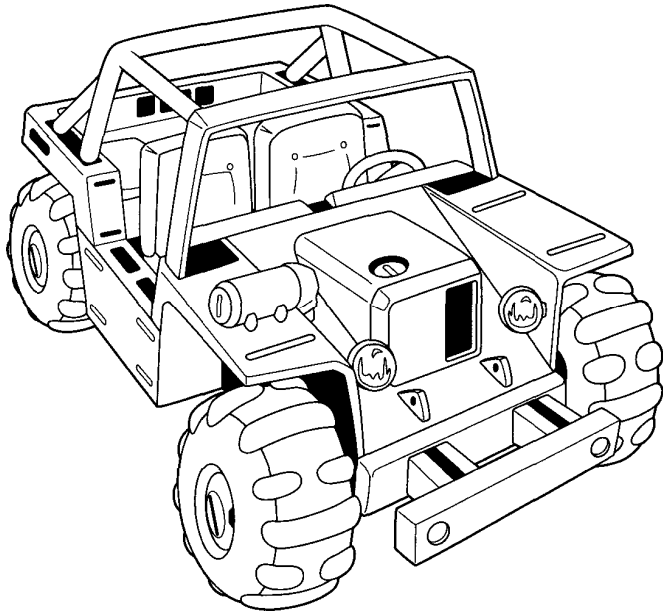

ST-10 Sandstorm UTV

The Sandstorm is a militarized, two-person, side-by-side, armored utility terrain vehicle that crosses a sport all-terrain vehicle with a dune buggy. It is rugged, fast, but unarmed and lightly armored. However, it has a flex fuel engine that gives it good range and allows operation near the Invid without fear of Protoculture emissions detection. Manufactured en masse by the United Earth Government (UEG) after the UEEF departed, it is a common vehicle and is used extensively on Earth throughout the Invid occupation.

Vehicle Type: Dune Buggy.

Class: Off-Road All-Terrain Vehicle.

Crew: One, but can carry one passenger.

M.D.C. by Location:

Wheels (4) - 2 each

Engine - 20

Main Body - 70

Speed: Max speed is 80 mph (128km).

Statistical Data:

Height: 5 feet, 2 inches (1.5 m).

Length: 9 feet, 6 inches (2.9 m).

Width: 4 feet, 7 inches (1.4 m).

Weight: 1,100 lbs (495 kg).

Cargo: The back bench can carry two UEEF Military Survival Packs or 30 pounds (13.5 kg) of gear.

Power System and Range: 660cc Single-Cylinder flex fuel engine with a continuously variable transmission (CVT) and an 8 gallon (30.2 liter) gas tank that gets 80 miles (128 km) per gallon.

Weapon Systems: None.

Bonuses: +5% to all vehicle piloting skill and control rolls on rough terrain.

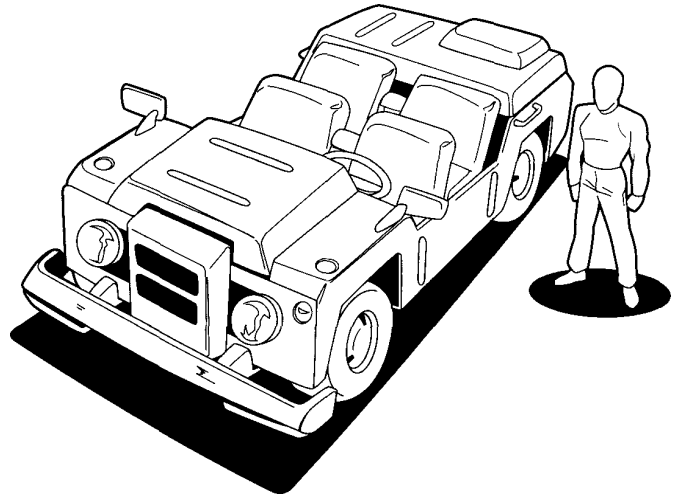

M99 Light Utility Jeep

A direct descendant of the classic Willys from the early 20th Century, the M99 is a light utility vehicle used primarily as a personnel carrier and reconnaissance vehicle. The design was used by both the Southern Cross and the UEEF, and in both cases, was most often used by officers. It saw extensive use by resistance forces and civilians alike during the Invid occupation.

Vehicle Type: Jeep.

Class: Light Utility Vehicle.

Crew: One, can carry up to four passengers (one in the passenger seat and up to three in the back seat).

M.D.C. by Location:

Tires (4) - 5 each

Windshield - 2

Main Body - 120

Speed: Max speed is 130 mph (208 km).

Statistical Data:

Height: 4 feet, 4 inches (1.3 m) with windshield down, 6 feet (1.8 m) with windshield raised.

Length: 12 feet, 6 inches (3.8 m).

Width: 5 feet, 2 inches (1.6 m).

Weight: 2,293 pounds (1,032 kg).

Cargo: Rear trunk can be converted to a small flatbed with a 1/4 ton (227 kg) carrying capacity.

Power System: Protoculture-fired Rotary Engine that requires two Protoculture cells to operate. Also has a backup, 14 gallon (53 liter) fuel tank that can accept almost any form of vehicle fuel.

Weapon Systems: None standard, but crew-served weapons can be mounted on the rear flatbed.

Special Equipment of Note:

Built-In Radio: Short- and long-range directional radio. Range: 200 miles (320 km).

Trailer Hitch: The rear bumper has a modular trailer hitch.

Runaround Cargo Truck

This is a ubiquitous light utility truck used as an urban cargo vehicle. It is easy to repair and find parts for, runs off an electric motor and anybody who can turn a steering wheel can drive one. However, they are slow, low-powered and not built for off-road use. They are also unarmored.

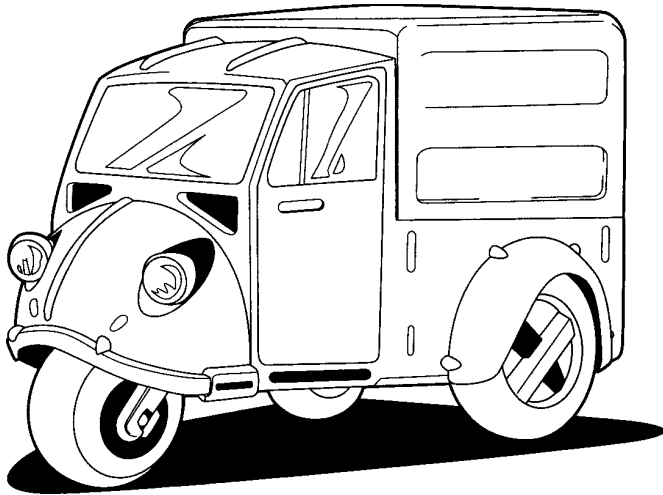

Vehicle Type: Truck.

Class: Civilian Cargo Vehicle.

Crew: One, plus one passenger.

S.D.C. by Location:

Wheels (3) - 25 each

Headlights (2) - 5 each

Cargo Bed - 300

Cab/Main Body - 200

Speed: Max Speed is 50 mph (80 km).

Statistical Data:

Height: 6 feet (1.8 m).

Length: 9 feet, 2 inches (2.8 m).

Width: 5 feet (1.5 m).

Weight: 655 pounds (295 kg).

Cargo: 4x3.5 foot (1.2x1 m) cargo bed capable of carrying 1,100 pounds (495 kg).

Power System and Range: 450 amp brushless electric motor powered by an electric battery with a 150 mile (240 km) range per charge.

Weapon Systems: None.

Penalties: -10% to pilot automobile whenever attempting to drive off a paved road.

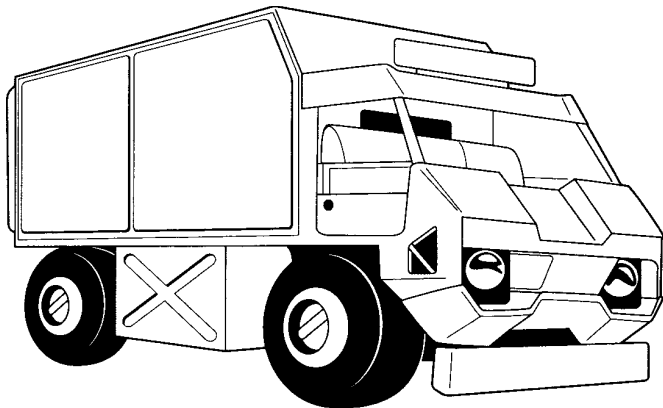

Cityking 5-Ton Truck

A light armored utility truck left over from the Second Robotech War, frequently used as a personnel carrier in urban environments and capable of light off-road duty (unpaved roads, even terrain, etc.). It is popular among law enforcement agencies in larger cities and among large caravans traveling through mostly secured territories. It can be converted from an enclosed cargo area to a flatbed truck.

Vehicle Type: Truck.

Class: Military Cargo Vehicle.

Crew: One driver, can seat one passenger. Can carry 10 armored soldiers and their gear in the cargo compartment.

M.D.C. by Location:

Tires (4) - 15 each

Headlights (2) - 5 each

Main Body - 120

Speed: Max speed is about 120 mph (193 km).

Statistical Data

Height: 9 feet, 6 inches (2.8 m).

Length: 25 feet (7.6 m).

Width: 7 feet, 10 inches (2.3 m).

Weight: 6 tons.

Cargo: 5 tons in 16x7 foot (4.8x2.1 m) cargo area.

Power System: Protoculture-fired supercharged rotary engine. Requires four Protoculture fuel cells to operate, but can also be run off a traditional gasoline engine with a 20 gallon (75.7 liter) capacity.

Weapon Systems: None.

Special Equipment of Note:

Built-in Radio: Short- and long-range directional radio.

Range: 200 miles (320 km).

Salvage Tables

While UEEF and Southern Cross salvage is the most commonly found on Earth, there are still hidden caches of supplies and ruins of military bases from the old days of the *United Earth Defense Force (UEDF)*, as well as salvageable materials in *Zentraedi* starships that crashed in remote locations, and the remnants of destroyed vessels that were part of the *Robotech Master* invasion. In many cases, these locations have been looted repeatedly over time and have been stripped to bare husks, but even at some of these locations there is something left behind or buried under debris waiting to be found. Furthermore, there are still crashed ships and hidden supply caches out there that are located in inaccessible locations, like mountain-tops, lakes and deserts, or at forgotten locations, where humans seldom travel. They can be stumbled upon by accident, discovered when investigating rumors and legends, or known to historians and military experts.

For the tables below, a successful Salvage skill roll is required to find ANYTHING of value. Only one roll per player with the skill, per wreck or abandoned base, is allowed. A failed roll means nothing was found. On a successful salvage skill check, roll on the corresponding chart. In the alternative, the Game Master may allow items (as he or she determines) to be discovered by blind luck. As always, Game Masters can ignore the table if they want the players to find something specific, but you might want to let them roll randomly in addition to any plot device finds as well. Likewise, G.M.s can adjust and add different items to what is discovered.

UEDF Salvage Table

UEDF bases were spread across the Earth. Significant efforts were made to salvage most of them, particularly before the launch of the Pioneer mission, but some were forgotten because they were small and insignificant, or could not be approached because they took a direct hit and the radiation was too high. In many cases, high-tech equipment will need significant repairs and finding a working mecha is almost unheard of, though it can happen. Salvage could also be recovered from old ARMD platforms that crashed to the surface following the Zentraedi

assault. Consult the **Robotech® Macross Saga Sourcebook** for information on the items found below.

01-05% A case of four M-21 Assault Rifles, 1D6x100 rounds of 5.56 SLAP ammunition, and 6D6 25mm grenades. In the alternative, a case of 8, fully charged, Protoculture fuel cells.

06-10% One CHR-1 Hazardous Environment Armored Suit (missing 2D6 M.D. from the Main Body).

11-15% One GU-11 Rotary Cannon (will require a Mechanical Engineering or Weapons Engineer roll to be functional) with a fully loaded magazine.

16-20% 4D6 High Explosive (Light) short-range missiles.

21-25% One KX1300P Kanagawa Patrol Cycle (needs gasoline and an overhaul with the Automotive Mechanics skill). Also could be converted to an electric engine from a contemporary motorcycle if there is a mechanic with the skills to do it.

26-30% One CT-20 Cargo Truck (needs gasoline). Could be converted to an electric engine or Protoculture engine from a contemporary truck if there is a mechanic with the skills to do it.

31-35% Two RL-1 light anti-armor weapons with a magazine of HEAP mini-missiles for each.

36-40% A storage crate with 100 fragmentation mini-missiles, but only 2D4x10 are functional. A Demolitions Disposal, Field Armorer and Munitions Expert, Recognize Weapon Quality or Weapons Engineer skill roll is required to determine which ones still function.

41-45% One Mk.17 Anti-Armor Missile Launcher (no ammunition).

46-50% One Spartan Shock Baton (fully functional, but battery must be recharged).

51-55% 2D6 plasma medium-range missiles.

56-60% Data cache leading to two small UEDF caches (each requires a Land Navigation or Navigation skill roll at +10% to find, roll no more than once on this chart to determine what is found there (yes, you could find another data cache).

61-65% One damaged Tomahawk Destroid with 3D6x10 M.D. damage, with no missiles or rockets. The gun cluster and .50 cal machine-gun are fully loaded with the exception of the flamethrower, whose ammunition has evaporated or broken down over time.

66-70% One damaged Defender Destroid with 2D4x10 M.D. damage, loaded with APDS but missing 1D4x100 rounds of ammunition from each arm.

71-75% One totaled AH-68 Comanchero Helicopter. It cannot be salvaged, but all of its weapon systems are functional and can be removed for use elsewhere or stripped of ammunition. The hard points have four fully-loaded MLOPs and two high explosive (heavy) medium-range missiles.

76-80% 2D6 long-range missiles armed with medium Reflex warheads. Fully functional!

81-85% One "Brownie" VF-1A Valkyrie Veritech Fighter with a fully loaded GU-11, but no missiles. One wing is detached and will require a mechanic with the proper skills to reattach before it can fly. However, it can operate in Battloid mode without problems. Also needs fuel (takes SLMH-V, but can be converted to run on Protoculture cells).

86-90% A storage crate of six GU-11s, unloaded, near a storage crate of 2D4x1,000 rounds of 55mm HEAP ammunition.

91-95% One pristine Spartan Destroid, but only the 25mm auto-cannon and the 180mm mortar have ammunition (both are fully loaded).

96-00% One VF-1J "Super Veritech" with minor damage

(missing 2D4x10 M.D. from the Main Body). Has a fully loaded GU-11 and 6D6 HEAP missiles in the FASTPack. No wing missiles are mounted. It is fully fueled. There is also the skeleton of a dead pilot in the cockpit from whom the helmet and flight suit can be salvaged.

Zentraedi Salvage Table

Even after all these years, Zentraedi wrecks are everywhere. Furthermore, there were numerous camps and bases constructed by malcontents across the wastelands, a few of which were never found. Remember, the size of these items means that many of them must be stripped for parts or used by a large mecha such as an Alpha, Beta or larger. Zentraedi derelicts are also to be found on the moon, adrift in space and crashed on alien worlds.

01-10% One Z-PR Mk.VIII Zentraedi Particle Assault Rifle with two empty energy magazines (can be recharged by a skilled mechanic).

11-20% 2D4x100 M.D.C. worth of automated hull patch plates (these were built into the hulls of the Zentraedi ships and automatically slid into place when a hull breach was detected).

21-30% Two 32mm Plasma Machine Pistols with two spare energy magazines each (for a total of six magazines).

31-40% One destroyed Light Artillery Battlepod. Beyond repair, but has 4D6 working medium-range plasma warhead missiles. The launchers can also be recovered and attached to another mecha or vehicle by an experienced engineer.

41-50% A small cache of Protoculture, equivalent to 3D4 canisters.

51-60% One fully functional Regult Tactical Battlepod with minor damage (6D6 M.D. to Main Body). Can only be driven effectively by a full-sized Zentraedi. Weapons and power plant could be stripped by a skilled engineer.

61-70% Two Z-TFG Flechette cannons with four tubular magazines (can be used by a human mecha like a giant shotgun).

71-80% 1D6x10+10 103mm mini-missiles (each does 1D4x10 M.D.).

81-90% Heavily damaged Female Powered Armor (missing 3D6x10 M.D.C. from Main Body). Requires significant repairs to be flightworthy, and can only be flown by a giant Zentraedi anyway. Good for parts and armor. Contains 2D4x10 103mm mini-missiles and a full load of grenades.

91-00% Slightly damaged Glaug Officer's Battlepod (missing 1D4x10 M.D.C. from Main Body), with a cockpit refitted for a micronized Zentraedi or human. The rail cannons and auto cannons are fully loaded, but there are no missiles.

Robotech Masters Salvage Table

The Invid savaged any remaining Robotech Master vessels that could not escape the solar system at the end of the Second Robotech War. Many of those hulks crashed to Earth (and a few on the moon). While most people think of the massive, diamond shaped mother ships, there were numerous smaller support ships as well, like the *Quiltra-Draenitzs Class transports* and the *Roil-Tiluvo Class assault dropships*. Players should remember that the Invid will be particularly tenacious if they believe they are fighting Robotech Master Forces.

01-05% Two Tr-ISG Mk.I Ion Blaster Guns with a single, rechargeable Protoculture clip each.

06-10% One Tr-LRL Mk.I Light Rocket Launcher with a full magazine of standard mini-missiles (5D6 M.D. each).

11-15% One set of undamaged Legionnaire Combat Armor (light).

16-20% 1D4 Tr-LLR Mk.I Legionnaire Assault Rifles, each with a fully loaded, rechargeable Protoculture magazine.

21-25% 1D4 Bioroid Drum Gun Pods (the internal magazines of each need to be recharged).

26-30% One Bioroid Disc Gun Pod (internal magazine needs to be recharged).

31-35% 1D6 completely undamaged Searchlight Drones.

36-40% A case of 3D4 Tr-LR-H Laser Assault Rifles and 5D6 Protoculture drum magazines.

41-45% A case of 1D6x10 plasma mini-missiles.

46-50% Three sets of Legionnaire Combat Armor (heavy) in good condition.

51-60% Protoculture fuel slug cache (enough to run one Bioroid for 1D6+1 months). A Patcher or someone skilled in Biomechanical Maintenance could adapt another Protoculture powered mecha to run off of these slugs, but would likely have to convert it back once the slugs were depleted.

61-66% Slightly damaged Bioroid Terminator Combat Armor (missing 3D6 M.D.C. to Main Body) and a fully loaded laser assault rifle. Armor can run for another 1D6+12 months before its generator needs refueling.

67-70% 1D4 working Bioroid Hover Sleds with minor damage (each is minus 6D6 M.D.C.). No fuel (a skilled engineer could modify it to run on fuel cells).

71-75% Lightly damaged Bioroid Scout (4D6 M.D.C. missing from Main Body), 1D6 weeks of fuel and an empty gun pod (can be recharged).

76-80% Upgraded Blue Bioroid with some damage (1D4x10 M.D.C. missing from Main Body), no Disc Gun Pod and no fuel. In the alternative, no mecha but 3D6 fully charged Protoculture cells.

81-84% The wreckage of three "Triumvirate" Bioroid Invid Fighters. Individually useless hulks, but could be salvaged to make one working Bioroid. This will take time and hard work, and there is the problem of transporting them to a place to strip down and rebuild. All three have fully loaded gun pods and a full charge of compressed Protoculture fuel slugs.

85-89% Heavily Damaged Green Bioroid with 1D6x10+10 M.D. damage and its moderately damaged Bioroid Hover Sled (subtract 6D6 M.D.C. from Main Body). Both are fully fueled, but the Bioroid is missing half the payload for its Pulse Beam Gun Pod (can be recharged).

90-92% Three "Triumvirate" Bioroid Invid Fighters in good working order and fully charged! All three have fully loaded gun pods and a full charge of compressed Protoculture fuel slugs. This is a huge find.

93-96% Pristine Red Bioroid Commander with a full month of fuel slugs, but no gun pod.

97-00% Upgraded Red Bioroid Commander in excellent condition, a full month of fuel slugs and a gun pod with a fully charged magazine.

Invid Salvage Table

The Invid use mecha that are bio-mechanical in nature, and so alien, that it is hard to imagine salvaging spare parts, but human ingenuity can work wonders. Even after the Regess takes all of her Invid and their mecha with her when she leaves the Earth following the Battle of Reflex Point, many sites of past Invid activity can still have usable salvage left behind, especially inside *Genesis Pits*. In fact, depending on the Pit, salvage from any of

the Salvage Tables might be found, especially the gear of soldiers and adventurers who fell victim to the Invid or to the mutants and monsters in the Pit.

Note: Much of Invid technology is operated via thought and mental command, and its alien nature and bio-mechanical aspects make salvage difficult. Moreover, the vast majority of these alien beings do not look or behave like humans. Most Invid practically live inside their mecha. Most do not wear clothes, use electronic devices or tools, nor own personal possessions.

01-05% One EP-37 60mm Pulse Beam Rifle dropped by a UEEF combatant; 50/50 chance the weapon is fully loaded or its energy is spent.

06-10% The shield and rifle of an Invid Soldier; both fully charged. -3 to strike when the rifle is used by humans, as it is large, heavy and unlike Earth weapons.

11-15% One H-90 Gallant without the rifle stock dropped by a UEEF combatant. There are also two fully charged energy clips for the weapon nearby. G.M. may substitute other, common weapons and gear from any era of the Robotech Wars.

16-20% 1D6+1 fully charged Protoculture canisters.

21-25% Protoculture farm. If this comes into play before the Regess takes her Invid off the planet, there will be supplies, farm tools, clothing and equipment used to keep the human slaves alive and working in the fields. That also means there will be fields of the Invid Flower of Life as well as a storage area with 1D6x100 Protoculture canisters waiting for transport to a storage facility or Invid Hive! If after the Invid have left the planet, there are still tools, equipment and supplies left at the abandoned farm site. There are no Flowers of Life, but there will be barracks, bams and places to find shelter, and there might even be one or more secret caches of supplies for the Invid sympathizers who once managed the farm or for Simulagents. See **#86-90%** for a likely range of supplies, or substitute one Invid Blaster and 36 full Protoculture canisters. There may even be a broken-down vehicle or two that can be repaired by someone with the right skills and made to run again.

26-30% 2D6+4 fully charged Protoculture canisters may be found anywhere the Invid had once established a Hive, Genesis Pit, Protoculture farm, warehouse or other facility. There is a 01-50% chance of also finding 1D4 Invid and/or UEEF weapons, and 1D6 other common items. The sites of battles are also likely to have weapons and gear that can be salvaged (double the amount of common combat gear that can be found).

31-40% The blasted remains of an Invid mecha. Invid Scouts, Fighter Scouts and Troopers are the most likely to be found left on the field of battle. The Invid mecha's Mega-Damage armor can be salvaged as building materials and scrap M.D.C. metal for patching armor. No single piece has more than 20 M.D.C., and the total amount that can be salvaged is the equivalent of 1D4x10% of the mecha's Main Body in M.D.C. material. Most else is fried and destroyed. There is a 01-50% chance that 1D4 parts from damaged/destroyed Invid mecha, like weapons, thrusters, sensors, etc., can also be salvaged.

41-45% Crashed Clam Ship! The wreckage of one of the famous Invid Carriers offers a wealth of scrap metal salvage (2D6 tons of M.D.C. composite metal that can be re-used as building materials), 1D6 Invid Blasters, 1D6 Invid Rifles and Shields of the Invid Soldier, 4D6 Protoculture canisters filled with fuel, and the wreckage of 1D4 Invid Scouts that didn't escape before the crash. The rest is mangled steel and burned up debris.

46-50% An Invid food vat containing 1D6x1000 gallons

(1D6x3,785 liters) of the green nutrient fluid found inside all Invid mecha. This is the stuff that the Invid eat.

51-55% One fully charged Invid Hand Blaster as typically used by Invid Princes, Princesses and Simulagents, and sometimes given to human sympathizers in the service of the Invid.

56-60% 1D4+1 fully charged Protoculture canisters.

61-65% Supplies and gear left by the Invid for a group of their human sympathizers. This can be almost anything the G.M. thinks is appropriate, from food and medical supplies to communication/radio equipment, fossil fuel, weapons and ammo, or even 1D4x10 Protoculture fuel canisters, or possibly even a basic vehicle like a jeep or small truck.

66-70% Remnants of destroyed human equipment from failed raids on Hives, etc. Again, this can be almost anything the G.M. thinks is appropriate (without going overboard), from food and medical supplies to a few weapons and ammo, to one or two functioning Earth mecha from ANY era of Robotech, and/or several damaged Earth mecha that can be salvaged for parts and Protoculture canisters that still have fuel.

71-75% A heavily damaged Bioroid Scout and hoversled. Both are missing half their M.D.C. There is also an empty Bioroid gun pod that can be recharged.

76-80% An abandoned Invid Hive! These Invid bases can be small, medium or large. When abandoned, the Invid seem to strip the Hive of most of its power core, technology, internal workings, weapon systems, mecha, Protoculture and gear. However, the facility can provide M.D.C. shelter, living space, storage and the foundation for a habitable space or fortification. A search is likely to turn up 2D4 Invid Blasters, 1D6 Rifles and Shields of the Invid Soldier, 1D6 UEEF energy weapons, 1D4x10 Protoculture canisters (fully charged), 1D4 Invid Food Vats, and other common items of Invid or human origin.

Beware if the lights are still on (rare), even if only in part of the Hive, because it means the Hive is NOT completely abandoned! It means the Hive is being used by either an Invid Simulagent or an Invid Brain (probably in a concealed room), and a skeleton crew of Invid have remained behind for an unknown purpose. The skeleton crew is likely to be composed of 2D6 fully equipped and armed Invid Soldiers (twice as many if this is one of the Regent's old Hives), 1D4 Invid Scouts, 2D4 Invid Fighter Scouts, 2D4 Troopers, and 1D4 Invid Shock troopers. There may also be an active Genesis Pit nearby. This force of covert operatives will try to avoid detection by humans, as their mission is likely to be the quiet observation of humans, Invid Experiments or other interests, like a Genesis Pit or mutants unleashed by one. The active Hive will have a small Protoculture power core to keep the Hive functioning on a basic level, a working food processing area and food vats, plus an additional reserve of 4D6x10 Protoculture canisters!

81-85% One damaged mecha left behind by a Simulagent. Roll again to determine type of mecha: 01-70% Invid Commander, 71-85% Invid Enforcer, 86-98% some kind of Earth mecha, probably UEEF, 99-00% a rare Invid Overlord! The Commander and Overlord can be piloted by humans trained in the operation of Battloids, Destroids or Veritech Fighters. The damaged mecha is missing 1D6x10% of its M.D.C., but is otherwise intact and fully powered.

86-90% Supply Jackpot! A supply cache left behind for a Simulagent or Invid royalty. It contains two Invid Blasters (hand-gun), two T-9 Pump Pistols (of human manufacture) and 144 rounds of ammo for it, two survival knives (1D6 S.D.C.), a first aid kit, two flashlights, two compasses, a digital sound recorder, 1D4 all-weather ponchos, two sets of human clothing (one for a

male and one for a female), two backpacks, two duffle bags, enough food rations to last one month for two people, two meal field kits, four canteens, four 5 gallon (18.9 liter) plastic drums of drinking water, and 24 fully charged, Protoculture fuel canisters.

91-95% Invid Mecha Jackpot! One brand new Invid Commander Battloid as used by Invid royalty and Simulagents and 60 fully charged, Protoculture fuel canisters.

96-00% Earth Mecha Jackpot! The Invid must have captured several UEEF soldiers and stripped them of their mecha. The fate of these poor souls is unknown, though they were probably subjected to Invid experimentation and mutation or torture and death. Their mecha were tossed aside in a storage room as junk and forgotten. The sacrifice of these courageous warriors is now available for a new generation of heroes.

Some of the mecha and gear may be in pieces and all are missing 1D6x10% of their M.D.C., but any characters familiar with UEEF mecha and gear can easily gather and put together the equipment. Each mecha has 2D4x10% of its Protoculture fuel supply, and weapons and ammo (missiles, energy supply, etc.) are reduced by half.

This jackpot of Earth mecha includes: One Alpha or Beta Fighter (G.M.'s choice), one VR-38 series Scout Cyclone, 1D4 VR-041H Series Saber Cyclones, 1D4+1 VR-052T series Assault Cyclones, 2D6 suits of CVR-3 body armor (with 70-80% of their M.D.C. intact), one VR-038L Anti-Armor rocket launcher, 1D6 EP-37 60mm Pulse Beam Rifles (1D6x10% of their payload is spent), and 1D6 EP-40 Ion Pulse Pistols. **Note:** As always, the G.M. may adjust the mecha and gear found.

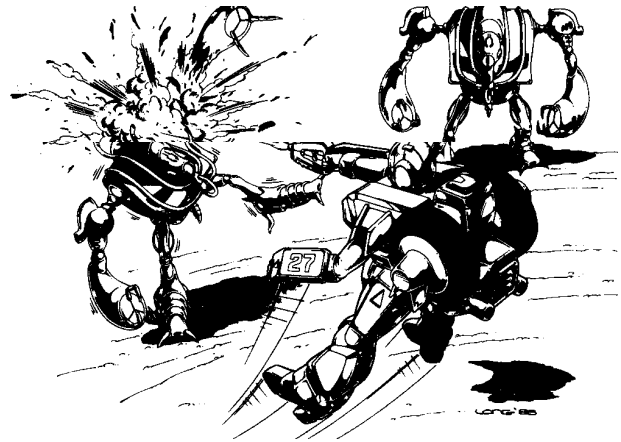

Other Robotech® RPG Titles

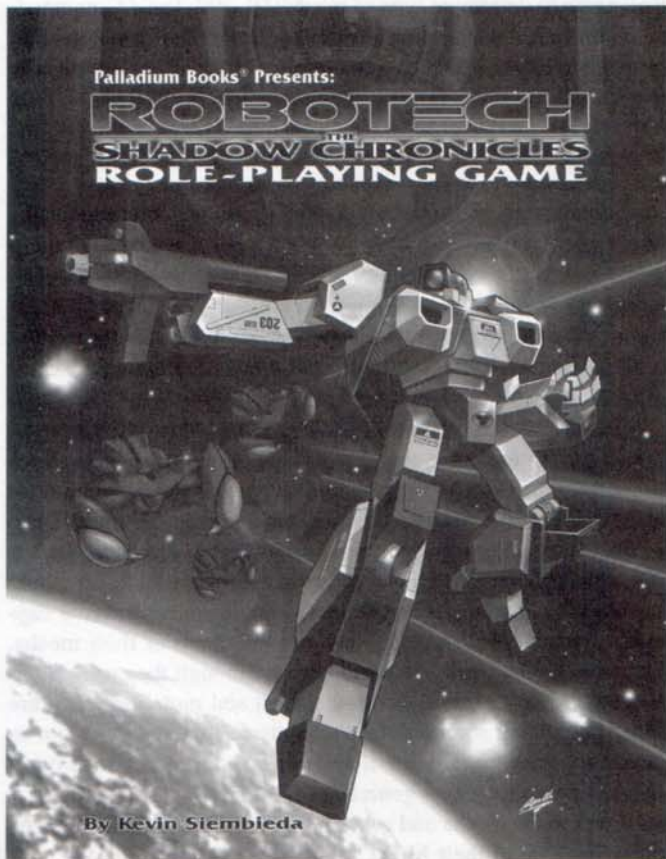

Robotech®: The Shadow Chronicles® RPG – 8½ x 11 Deluxe Hardcover Edition

An expanded hardcover “core rule book,” the Deluxe Hardcover Edition is filled with additional artwork throughout, offers superior reproduction of toned artwork, better paper stock, larger type-face, and some additional text, including two Haydonite spaceships, three UEEF ships, space combat rules and a handful of additional vehicles.

- Larger illustrations throughout.
- Some additional art and text.
- New Haydonite and UEEF spacecraft & spaceship combat rules.
- Veritech Fighters, Cyclones, and much more.
- O.C.C.s include the Battloid Ace, Veritech Fighter Pilot, Military Specialist, and others.
- 5 different UEEF character classes and more than 25 different Military Operational Specialties for dozens of combinations.
- Invid mecha and adventure ideas.
- Haydonites, the Wraith, Infiltrator and spaceships.
- Complete stand-alone RPG with skills, weapons, rules and guidelines for using other Palladium settings.

- 8½ x 11 full book size, hardcover, “core rules.” Available only in the USA and Canada.
- \$30.95 – 224 pages. Cat. No. 550HC – ISBN 1-57457-137-0.
- Manga edition for easy portability (5x7½ inches). Available only in the USA and Canada. \$16.95 – 336 pages. Cat. No. 550 – ISBN 1-57457-133-8.

Robotech®: The Macross® Saga Sourcebook

The Macross® sourcebook is a treasure chest packed with the mecha, vehicles, weapons and characters that made Robotech® famous. Valkyries, Destroids, ground vehicles, aircraft, spacecraft, weapons, Zentraedi soldiers, Zentraedi mecha, alien invaders, heroes, villains and more.

- Veritech Fighters & Destroids.
- 14 aircraft and aerospace vehicles.
- 13 ground vehicles, plus weapons and equipment.
- Zentraedi mecha & select spacecraft.
- Zentraedi warriors and their culture.
- Quick Roll Tables for Macross characters.
- Ordinary People O.C.C., new skills and more.
- Notable anime characters started out as NPCs.
- Written by Jason Marker & Kevin Siembieda.
- Manga size for easy portability (5x7½ inches). Available only in the USA and Canada.
- \$15.95 – 256 pages. Cat. No. 551 – ISBN 1-57457-138-9.

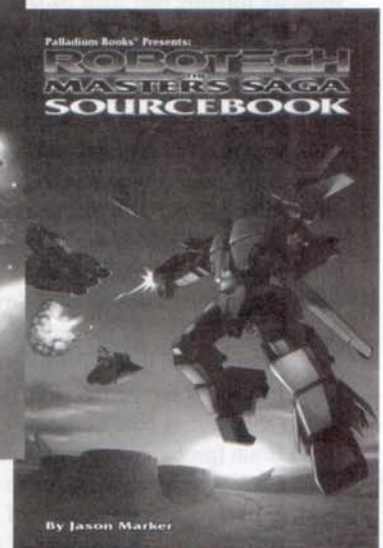
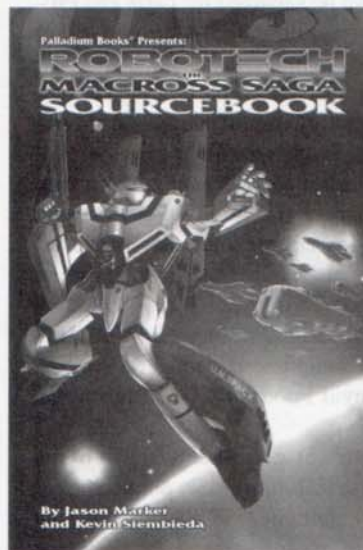

Robotech®: The Masters Saga™ Sourcebook

The Masters Saga™ captures the era of the Second Robotech War and brings the mecha and heroes of the Army of the Southern Cross (ASC) to life. Adventures can start in the jungles of South America, where the fledgling ASC and the UEDF battled Zentraedi Malcontents, UEG separatists, rebels and terrorists be-

fore the UEEF blasted into outer space. Or play during the years of global Reconstruction. Or start your game the day the Masters appeared and the Second Robotech War began. Or play the days between the Masters' defeat and the arrival of the Invid. Or role-play the battle against the invading Invid swarm when they first appeared, as well as the days that followed as your ASC heroes try to rescue survivors and establish resistance groups to battle the Invid until help can arrive from the UEEF!

- The Army of the Southern Cross™ – all 15 branches.
- Veritech Hover Tanks, AJAX, Logan and more.
- Four ASC battloids plus the Golem robot.
- Six suits of ASC power armor – never before seen.
- Vehicles, body armor, jump packs, weapons & equipment.
- The Robotech Masters, Tirolians, their spaceships & weapons.
- Seven Bioroids, Bioroid Hover Sled, weapons and more.
- Tirolian villains and player characters.
- History, background and world information.
- Quick Roll ASC Character Creation Tables.
- Infinite possibilities for adventure.
- Written by Jason Marker and Kevin Siembieda.
- Manga size for easy portability (5x7½ inches). Available only in the USA and Canada.
- \$16.95 – 256 pages. Cat. No. 552 – ISBN 1-57457-139-7.

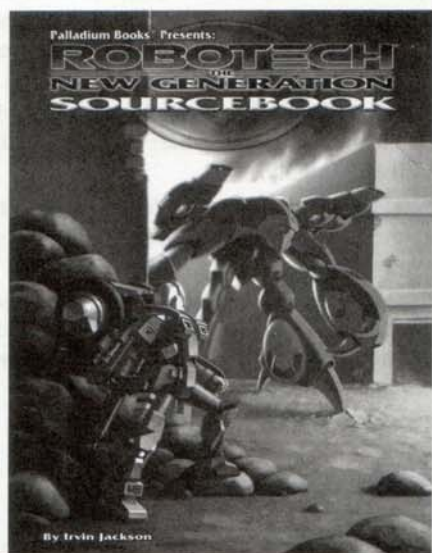

Robotech®: New Generation™ Sourcebook

The battle for the liberation of Earth starts here. For the first time in its history, the Earth has been invaded and occupied by alien invaders – the Invid. The Invid think they have won, but Freedom Fighters, UEEF soldiers and other heroes continue to fight. This is the first sourcebook to combine ALL generations of Robotech® into one epic setting.

- New weapons, vehicles and mecha.
- Battloids, Veritechs, power armor and tech from all eras of Robotech® come together.
- Kit-bashed mecha combining parts from different mecha.
- 7 new O.C.C.s: Freedom Fighter, Patcher, Urchin & more.
- Human Invid Protoculture Experiment player characters.
- The resistance and how it operates.
- Guidelines for survival and rules for exposure.

- Stats for Corg, Sera, Lunk, Annie, Rook and others.
- Invid Hives, world overview and adventure ideas.
- Written by Irvin Jackson – 8½ x 11 inch size (not manga). Available only in the USA and Canada.
- \$16.95 – 96 pages. Cat. No. 554 – ISBN 1-57457-178-3.

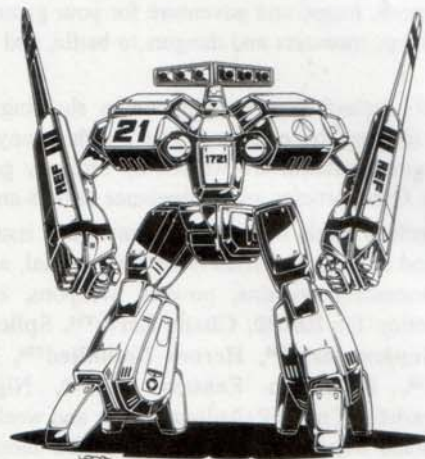

Coming 2013

Robotech®: UEEF Marines™ Sourcebooks One & Two

Explore new battle torn worlds, fight Invid and Inorganics, discover new alien people and civilizations and do it as the liberating heroes of the UEEF Marines.

- New weapons, mecha and vehicles.
- Alien worlds, people and more.
- Battles and adventure.
- Nuff said for now.
- Written by Irvin Jackson. 8½ x 11 inch book format. Available only in the USA and Canada.
- Size, price and release date not yet known. Coming 2013.

Robotech® RPG Tactics: Defense of Macross Island (Box Game)

Yes, you read that correctly. Palladium Books is preparing to release a tactical, mass combat game with 1/285th scale game pieces starting with the **Macross Saga**. To make this game and the game pieces everything Robotech® fans could want, Palladium will be working with a renowned group of developers and some of the top sculptors in the business. The game and accessory sets of Robotech mecha and spaceships are in development right now, and should see a debut release this summer.

We plan to do similar games and 1/285th scale game pieces for each era of Robotech® including **The Masters Saga**, **New Generation** and **Shadow Chronicles**. All to scale. All gorgeous.

We will NEED your support to make this expansion of the RPG line and game pieces the masterpieces we want them to be. Please, keep your eyes open for more details and how you can help in January, 2013.

The Rifter® Subscription

The Rifter® is your doorway to unlimited imagination and numerous Palladium role-playing worlds. It offers new heroes, powers, weapons, magic and adventure for your games. It presents new villains, monsters and dangers to battle, and new ideas to consider.

It helps you unlock your imagination by showing you what gamers, just like *you*, have created. That's right, many of the articles and source material are written by ordinary gamers and fans like *you*. Other articles are by freelance writers and staff.

The Rifter® is made for you, our fans. Each issue presents unofficial (and sometimes official) source material, adventures, characters, monsters, villains, powers, weapons, equipment, ideas and fiction for **Rifts®**, **Chaos Earth™**, **Splicers®**, **Beyond the Supernatural™**, **Heroes Unlimited™**, **Ninjas & Superspies™**, **Palladium Fantasy RPG®**, **Nightbane®**, and/or any variety of other Palladium games and world settings. It's also a place where we test new ideas, and showcase new games, like *Dead Reign* and the upcoming *Mechanoids® Space*.

It is also a way to get the latest news, coming attractions, and sneak previews of upcoming Palladium products, events and secret projects.

Sourcebook

As a **sourcebook**, each issue of **The Rifter®** presents optional and/or official source material for a variety of Palladium's role-playing settings – **Rifts®**, **Phase World®**, **Palladium Fantasy RPG®**, **Heroes Unlimited™**, **Nightbane®**, **Beyond the Supernatural™**, and other titles such as **After the Bomb®**, **Ninjas & Superspies™**, **Rifts® Chaos Earth™**, **Splicers®**, and others. Every issue includes material for 3-6 different Palladium RPG lines.

Magazine

As a **magazine**, each issue includes the latest news and goings on at Palladium Books, information on new product, our schedule of releases, convention appearances, special offers, and even sneak previews and extra "official" material for new Palladium games or sourcebooks.

Talent Show

The Rifter is unlike anything on the market because it is a way for *you*, the fan, the unpublished writer and hopeful young artist to get published and break into the industry.

No other game company does that, so take advantage of the opportunity to see *your* work and *your* name in print! You'll get a small payment (about \$10 per printed page of text), four free copies of the issue your work appears in, and bragging rights to all your friends. Best of all, you get to share your ideas with thousands of other Palladium gamers.

Think it can't happen to you? Think again. Many of Palladium's artists and writers got started in **The Rifter®**, including *Apollo Okamura*, *Brian Manning*, *Mike Mumah*, *Carl Gleba*, *Todd Yoho*, *Brandon Aten*, *Taylor White*, *Jason Richards*, and many others.

Palladium is always looking for written material for **Rifts®**, **Chaos Earth™**, **Beyond the Supernatural™**, **Nightbane®**, **Palladium Fantasy RPG®**, **Heroes Unlimited™**, **Ninjas & Superspies™**, **After the Bomb®**, and all our game lines. We'd also like to see cartoons and comic strips.

Send your "article/source material" (5-30 pages) or art samples (photocopies, never original art), to *The Rifter® Submissions Dept*, 39074 Webb Court, Westland, MI 48185.

Subscribe Today

Lock in the current price and discount

The price of **The Rifter®** is \$11.95 retail (a steal for 96 pages of RPG source material and adventures), but a subscription saves you even more money, and you have the convenience of delivery right to your door. All prices are in U.S. dollars.

- **\$39.80 – that's only \$9.95 each**, a savings of \$8, and Palladium picks up the shipping cost. **Note:** This rate is *limited* to subscribers in the USA only.
- **\$61.80 – Canada.** Our apologies, but Palladium Books can no longer cover the increased cost of postage to other countries. We hope you understand.
- **\$75.80 – Overseas:** Overseas subscriptions *are* charged an additional fee for overseas shipping costs. Sorry. We are only passing along the additional postage costs, but it is hefty. Our apologies.
- **Free Shipping anywhere in the USA.**
- **Great Savings.**
- **A Megaverse® of adventure and fun.**
- **How to order.** Send mail orders with a check or money order (for \$39.80 in the USA) to:

The Rifter® Subscription Dept.

39074 Webb Court

Westland, MI 48185

Credit Card Orders: Can be made on our web site (www.palladiumbooks.com) or by telephone 734-271-2903 (this is an order line *only*).

Check or Money Orders: Send them to the address above with a note indicating which issue number you want your subscription to start.

Please indicate what issue number you'd like your subscription to start (i.e., last issue, current issue, next issue, or when your current subscription ends).

This offer is good till October 31, 2013.

© Copyright 2012 Palladium Books Inc.

www.palladiumbooks.com

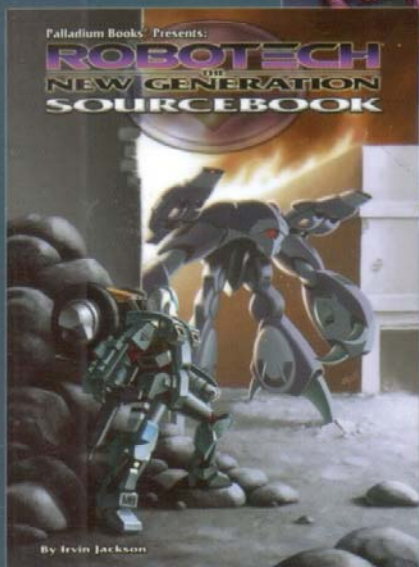
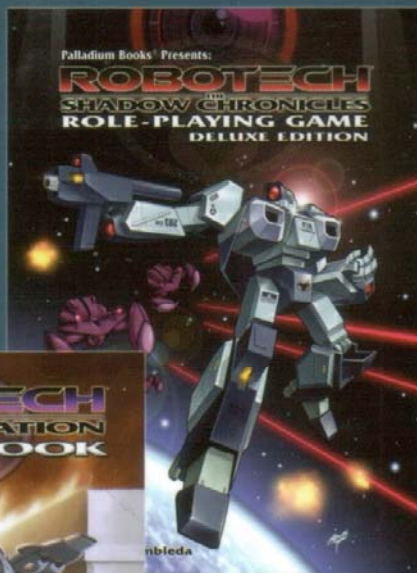
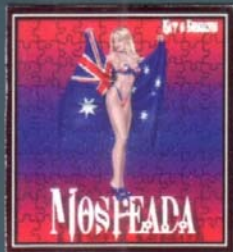

Also for Robotech®

Robotech® The Shadow Chronicles® RPG

- Play Veritech Pilots and Cyclone Riders.
- Battle the Invid and Haydonites.
- Fast playing & quick combat.
- A complete 200+ page role-playing game.
- Available as a manga size pocket edition.
- Also available as an 8½ x 11 inch hardcover edition.

Robotech® The Macross® Saga Sourcebook

- Destroids and Veritechs.
- Zentraedi & their mecha.
- Weapons, vehicles, spacecraft & more.
- A sourcebook for the Robotech® RPG series.
- Manga size, 256 pages.

Robotech® The Masters® Saga Sourcebook

- The 15 divisions of the Army of the Southern Cross.
- A new generation of transformable Veritech Fighters.
- Veritech Hover Tanks, Battloids and combat vehicles.
- Robotech Masters, Bioroid warriors and their weapons.
- New Character Classes & M.O.S. skill bundles.
- Manga size, 256 pages.

Robotech® New Generation™ Sourcebook

- Liberate Earth from the Invid! World overview.
- ALL eras of Robotech mecha are available to players.
- Frankenmecha – amalgamations of different Earth mecha.
- 7 new Occupational Character Classes (O.C.C.s).
- New Generation weapons, combat vehicles, gear and more.
- 8½ x 11 inch size, 96 pages.

ROBOTECH THE GENESIS PITS SOURCEBOOK

An in-depth look at the Invid Genesis Pits, their purpose, function, and the mutants and monsters they unleash. This sourcebook is jam-packed with never before seen game information on the Genesis Pits, mutations, mutation tables (so you can generate your own Genesis Pit monsters and characters), Invid Simulagents, new vehicles and equipment, and more.

- Inorganics - the war machines of the Regent.
- Gura-Invid – monstrous mutant Invid that do not leave Earth when the Regess and her Invid legions depart.
- Invid Simulagent character stats and information.
- New weapons, gear and vehicles of Earth's freedom fighters, including the SDF-4.
- Bioroid and Zentraedi mutants.
- Different Genesis Pits from across the galaxy.
- Creation Tables for Genesis Pit Mutants as player characters and NPC villains.
- Tables for creating Genesis Pit Monsters as player characters and NPC villains.
- New Character Classes, mutants, dinosaurs, and more.
- The *Robotech® The Shadow Chronicles® RPG* "rule book" is needed to play (Cat. No. 550 or 550HC).
- 112 pages. Written by Irvin Jackson.

Infinite possibilities, limited only by your imagination.™

\$16.95

Cat. No. 555

ISBN-10: 1-57457-179-6

ISBN-13: 978-1-57457-179-0

**Palladium
Books Inc.**
www.palladiumbooks.com

**Harmony
GOLD**
www.robotech.com

ISBN 978-1-57457-179-0



5 1695



9 781574 571790