

PALLADIUM BOOKS® PRESENTS
THE ROBOTECH® RPG BOOK FIVE:

INVID INVASION

BY KEVIN LEMBICIA

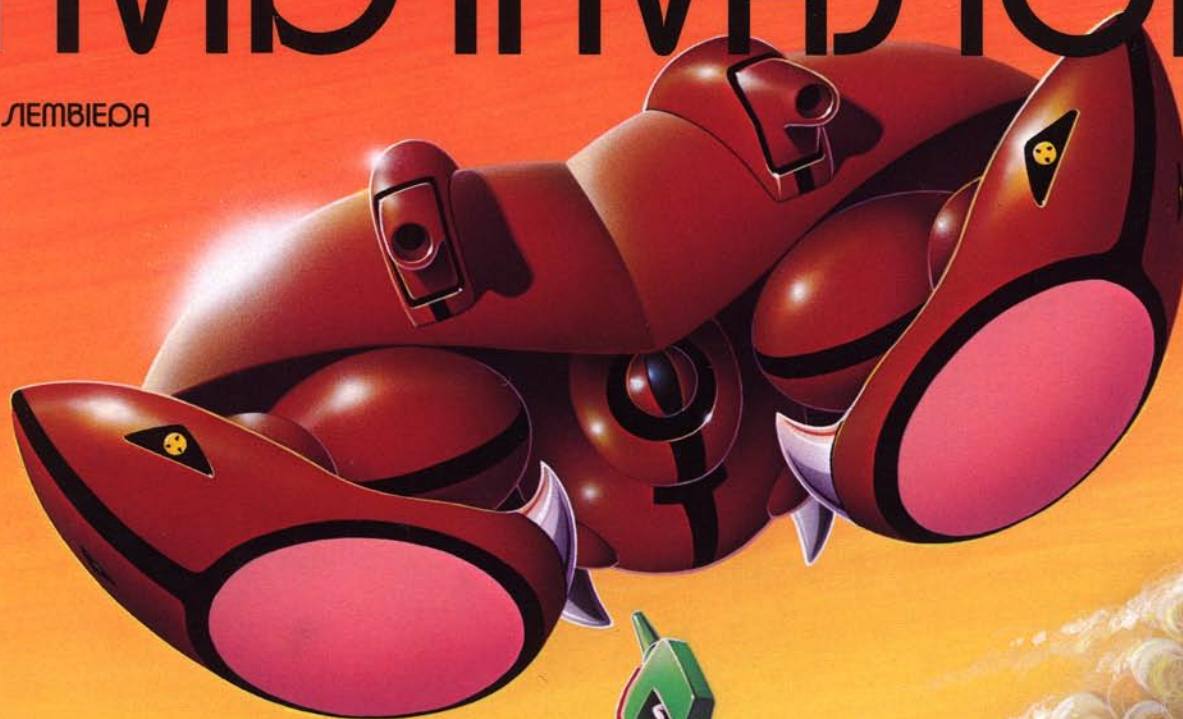

LONG

About this book

Originally published in 1988

This book was first printed in the mid-1980s. Before the Internet as we know it, and even before the term “anime” came to be known in the United States.

Accurate information about the original anime was difficult to find, and the people managing the *Robotech*® intellectual property in those days preferred to keep *their Robotech*® at arm’s length from the original three anime series – *Macross*, *Southern Cross* and *Genesis Climber Mospeada* – that inspired the unique and beloved creation that is **Robotech**®.

As a result, the details and stats behind some of the mecha, characters, vehicles, weapons and settings reflect a different era and mindset than the **Robotech**® we know today. The information and stats reflect that time period, the information available, and the wishes of the *Robotech*® series’ creator and the managers of the I.P. at that time. Palladium Books followed their wishes.

Please enjoy these **Robotech**® RPG books for what they are. Enjoy the nostalgia, and use or adapt the rules, stats, maps and data to the modern **Robotech**® books as you deem desirable. Though different, much of the material of these 1980s and 1990s books is easily modified and adapted to current **Robotech**® RPG titles and **Robotech**® RPG Tactics™.

An important note about the new *Robotech*® RPG titles: When we *relaunched* the **Robotech**® RPG series in the new millennium, we approached the games as if they were brand new to us. Stats and information are all updated and brought in line with the modern history, back story, and mecha, as well as featuring new artwork. That means new stats, deeper history, and new information and equipment. Some titles like **Robotech**®: **The Masters Saga**™ **Sourcebook** contain a wealth of new and exciting mecha, power armor, robots and weapons never before seen in the RPG series. Stats and information from the original books were NOT reprinted, and only a small amount of the past artwork has reappeared in the new *Robotech*® titles.

It is our pleasure to make the original *Robotech*® titles available, once more, with the permission of Harmony Gold, USA, Inc. Enjoy.

– Kevin Siembieda, Publisher & Game Designer, 2017

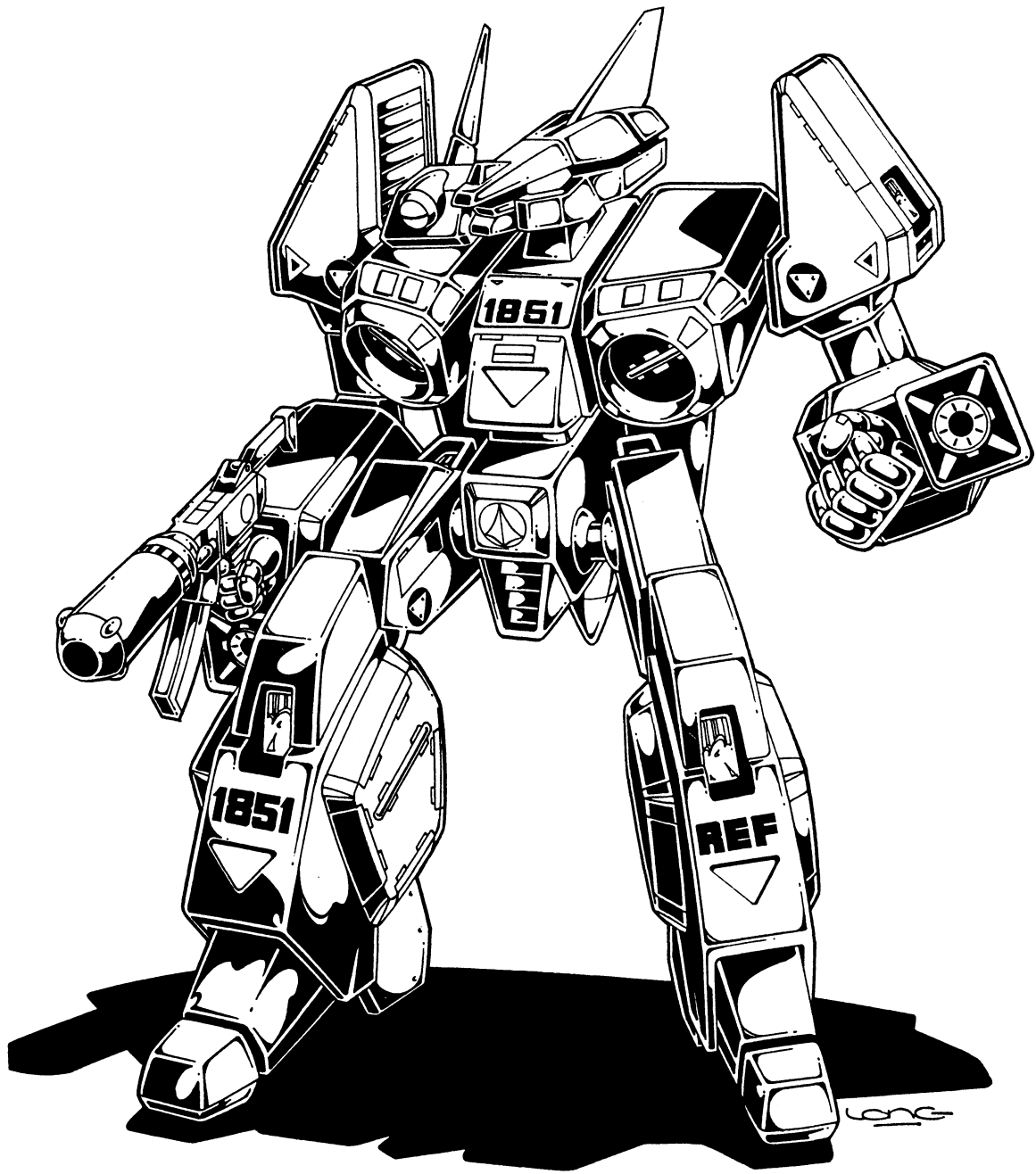

PALLADIUM BOOKS® PRESENTS

THE ROBOTECH® RPG BOOK FIVE:

INVID INVASION

This Book is Dedicated to Steve for his generosity and friendship. Keep on defiling

WARNING

This book contains new and original works of art that are **protected by Federal Copyright Law**. NO artwork may be printed or published in any form, for any reason, without *written permission* from the Publisher of Palladium Books®. The use of this artwork, in any product not produced by Palladium Books® is a Federal crime! ***Offenders will be pursued in Federal Court.***

PDF Edition – May 2017

Sixth Printing – November 1997

Copyright © 1983, 1984, 1985, 1986, 1987, 1988 Kevin Siembieda.

Characters copyright © 1985 by Harmony Gold U.S.A., Inc./Tatsunoko Production Co. Ltd. All rights Reserved.

Copyright © 1988 by Kevin Siembieda. All rights reserved under the Universal Copyright Convention. No part of this book may be reproduced in part or whole, in any form or by any means, without permission from the publisher, except for brief quotes for use in reviews. All incidents, situations, institutions, governments and people are fictional and any similarity, without satiric intent, of characters or persons living or dead is strictly coincidental.

ROBOTECH is a trademark owned and licensed by Harmony Gold U.S.A., Inc.

Palladium Books and **Megaverse** are registered trademarks owned and licensed by Kevin Siembieda. All other titles are trademarks owned by Kevin Siembieda/Palladium Books.

ROBOTECH® RPG Book Five: Invid Invasion is published by Palladium Books Inc., 39074 Webb Court, Westland, MI 48185.

Printed in the United States of America.

PALLADIUM BOOKS® PRESENTS
THE ROBOTECH® RPG BOOK FIVE:

INVID INVASION

Written By: Kevin Siembieda

Editors: Alex Marciniszyn
Randi Cartier

Technical Consultant: Richard Burke
Japanese Translator: Koichiro Tanaka

Cover Painting: Kevin Long

Interior Art: Kevin Siembieda

Additional Art By: Kevin Long

Typography: Maryann Siembieda
Keylining: Kevin Siembieda

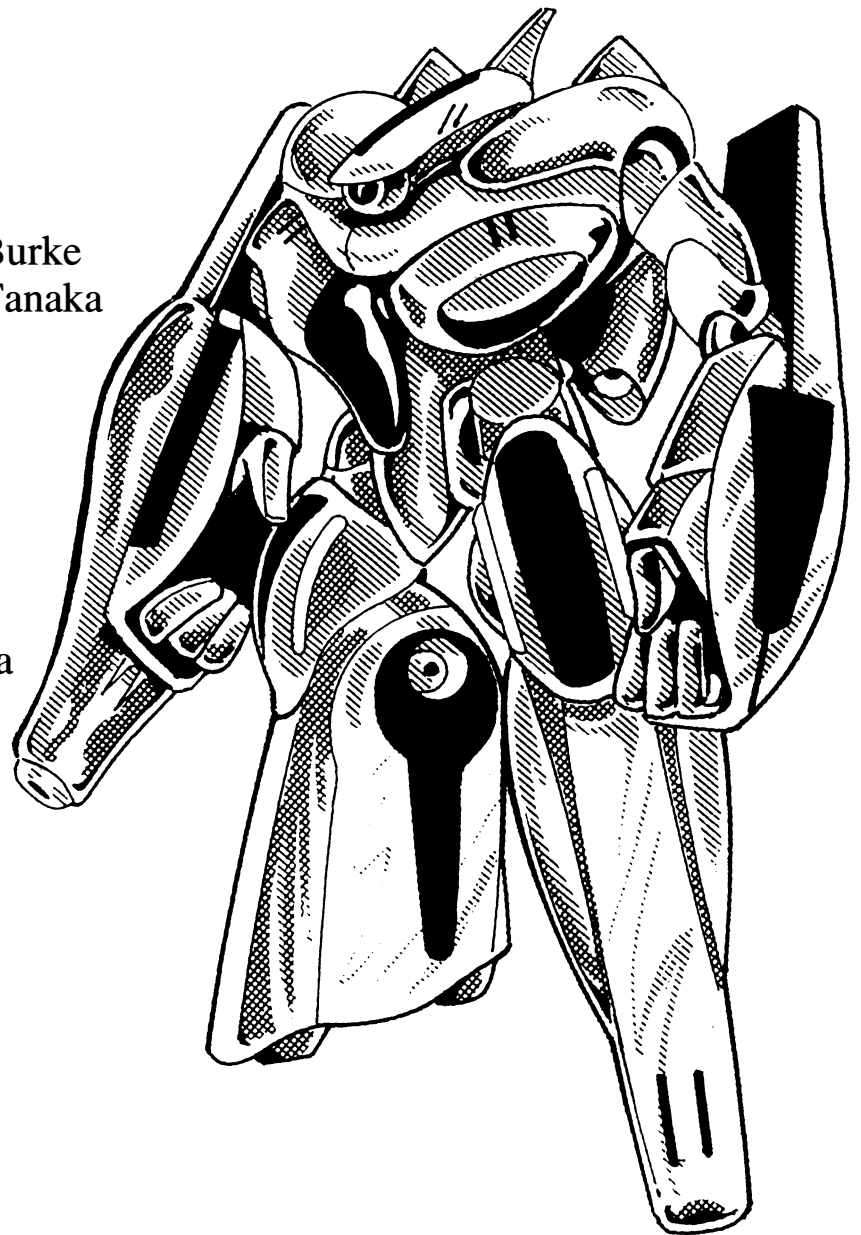

Special thanks to Mike Ebert, Animag; Owen Hannifen, Japanese Animation Archives; Vaunda Perry, Wyvern Web Graphics; Mike Pondsmith, R. Talsorian Games; David Riddick, Books Nippan; and Andrew P. Yanchus.

CONTENTS

	Page		Page
Playing the Invid Invasion	5	Invid (Origin Story)	67
Using Existing Characters	5	The Invid on Earth	71
Selecting an Occupational Character Class	6	Invid Pilots	72
Using Macross & Southern Cross O.C.C.s	6	Invid Mecha	76
REF Veritech Fighter Pilot O.C.C.	7	Sensors and Equipment	77
REF Cyclone Rider O.C.C.	9	Invid Scout	78
REF Military Specialist O.C.C.	10	Invid Armored Scout	79
REF Bio-Maintenance Engineer O.C.C.	11	Space Booster for Scouts	80
Nomad Scout O.C.C.	12	Invid Trooper/Worker	80
Freedom Fighter/Mercenary O.C.C.	13	Invid Shock Trooper	81
Non-Military Personnel O.C.C.	14	Invid Command Unit (Pincer)	82
Skills Listed by Category	15	Invid Royal Command Battloid	84
Skill Descriptions	16	Invid Enforcer	86
Combat	25	Other Invid Vehicles	88
Combat Terms	25	Invid Hives	89
S.D.C. for Characters	27	Robotech Characters	94
Hand to Hand Combat	27	The Earth Under Invid Domination	99
Modern Weapon Proficiencies	28	The Earth of the Invid	99
Mecha Combat	29	Adventure and Scenario Background Ideas Begin	99
Missile Chart	30	A Global Summary, Circa 2038	100
Mecha Hand to Hand Combat	31	The Invid Genesis Pits	101
Optional Rules or Round Out Your Character	35	Modified Humans	104
New Mecha Descriptions	36	Random Encounter Tables	105
Cyclone	36	Random Town Encounters	109
Cyclone VR-052 Battler	37	Character Sheets	111
Cyclone VR-041-Saber	39		
Cyclone VR-038-LT	41	Quick Find Table	
Cyclone Special Equipment	43	Using Macross and Southern Cross Characters	5
Alpha	45	Macross and Southern Cross O.C.C.s	6
Standard Alpha	47	Skill Modifications	6
Shadow Fighter Alpha	51	Skills Listed by Category	15
The Beta	52	Pilot Skills	21
The VF-1V Vindicator	57	Rogue Skills	23
Weapons	58	Wilderness Skills	24
Vehicles	61	S.D.C. for Characters	27
Optional Vehicle Combat Rules	64	Hand to Hand Combat	27
		Modern Weapon Proficiencies	28
		Missile Chart	30
		New Mecha Descriptions Begin	36
		Cyclone Body Armor	43
		EU-13 Destabilizer (Shadow Alpha)	51
		EU-12 Destabilizer (Vindicator)	58
		Gallant H-90	59
		Cobalt Limpet Mine	60
		Motorcycles	62
		Invid: How they Respond to Humans	71
		Invid Brain	74
		Invid Sensors and Equipment	76
		Invid Perception Factor (see NOTES)	71

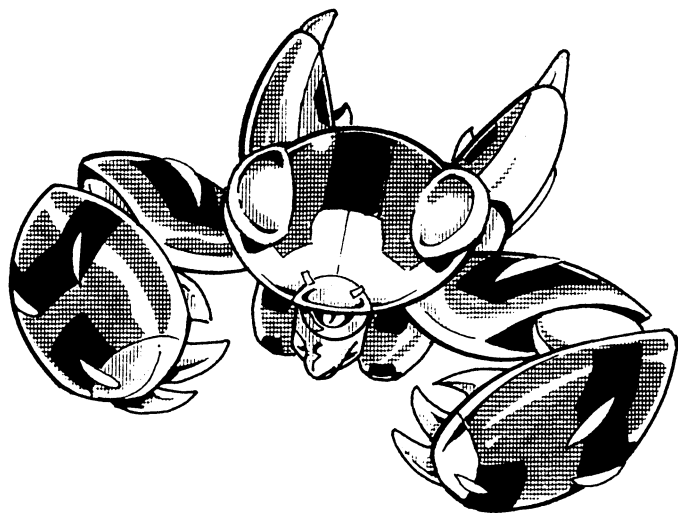

INTRODUCTION

The Invid Invasion is a supplement to the original **ROBOTECH**® RPG, *Book One: Macross*. It is NOT a complete game in itself!

The Invid Invasion is adapted directly from the T.V. series. ALL the mecha, weapons, vehicles and equipment found in this book can be seen in the T.V. series. Aided by Japanese translations of the original Mospeada cartoon, conversations with Carl Macek, examination of model sheets and frame by frame viewing of film sequences have all played a part in revealing the complete story of the **Invid Invasion** chapter of the Robotech trilogy. Small and obscure details have been restored and put into proper perspective.

In some cases, the mecha or data may have only appeared in one episode. For example, we don't see the *Alpha Shadow Fighters* till the very last episode. We see the giant *VF-IV Vindicator* and the powerful Destabilizer gun in episodes 84 and 85 (the last), but only get an indication of its size, compared to a squad of cyclone riders, in a five second action scene in #84. Using frame by frame viewing, the size was obvious, but in regular viewing we had all missed it the first half dozen times. Another example is the appearance of the cyborg, Dusty Ayres, the product of the invid's bionic experimentation on humans. In that same episode, "Hired Gun" (#81), we also see the missile launcher sidecar for the first and last time. I have tried to capture all of these items and events to re-create the full adventure of the T.V. series. With a little skill, a lot of research and a bit of luck, I will have succeeded. The Invid Invasion, its mecha and antagonists, creates the most exciting characters and adventures since Macross. Kick off your shoes, roll those dice and have a ripsnorting time. The fate of the Earth rests in your hands.

PLAYING THE INVID INVASION

The rules for character creation, attributes, hit points, damage, mega-damage, alignments, combat and all the rest are unchanged. Only the specific Occupational Character Classes (O.C.C.s) and skill selection process are different. A few new skills have also been added to accommodate the new O.C.C.s and environment.

USING EXISTING CHARACTERS

Players can keep their current *Macross* or *Southern Cross* characters rather than roll up new characters. To do this, the game master (G.M.) need only time warp them into the current time period. Obviously, the characters managed to survive the last war or two and are carrying on their fight for freedom against the new invid foe. Don't worry about playing out, or heavily developing, the intervening five or ten years. Just work up a logical outline of past events and get them to the present invid crisis. Of course, the characters will be several years older, but should *not* get any free, or automatic leaps in experience levels. It's best to assume they've seen minimal action or have lived relatively normal lives until the invid invaded. A possible solution without aging, could be that the characters got placed into stasis accidentally, as prisoners, or on purpose, on board a semifunctioning Zentraedi spaceship, or they were a part of a sleeper task force and have awakened now because the Zentraedi ruin has been attacked or its energy is depleted or a preprogrammed time has elapsed. Yeah, I know it sounds contrived, but it is possible.

Old RDF or Southern Cross characters should start off with their regular mecha, fully loaded and ready for combat. Finding additional ammunition, supplies and equipment will be difficult. Furthermore, the old RDF Destroyers may prove to be too large and slow to successfully combat the invid on a prolonged guerilla-type basis. However, RDF and Southern Cross characters *can* pilot the new Robotech Expeditionary Force (REF) mecha. Veritech pilots (Veritech Fighters, Logan or AJACS) will have little difficulty adapting to Alpha and Beta Veritech Fighters. Destroyer and Hover Tank pilots can easily learn to pilot Cyclones. **Veritech pilots** get the full benefits of Hand to Hand Bonuses From Alpha, Beta and Vindicator Combat Training. The use of a cyclone counts as Hand to Hand Cyclone Basic Training. **The Destroyer and Hover Tank pilots** get the full benefits of Hand to Hand Bonuses from Cyclone Training. The use of an Alpha or Beta is only possible if the character has some type of *pilot aircraft* skill and, even then, it counts as Hand to Hand Combat Bonuses from Alpha and/or Beta Basic Training, plus penalties of -10% on flying/pilot skill(s) and -1 on initiative. Note: Each mecha hand to hand training category applies only to that specific type of mecha. Do not combine one set of mecha hand to hand bonuses with another. Likewise, the character's old mecha combat training is applicable only to that specific mecha and is not added to the new mecha bonuses.

SELECTING THE TIME PERIOD

The players and GM really have two choices. You can re-create the T.V. series, beginning with the initial invasion of the invid, circa 2035, culminating with the battle at Reflex Point about three years later, or start anywhere before the Reflex Point episode.

The other choice is to start your campaign six months *after* the battle of Reflex Point, when a small force of invid, estimated to be about two million worldwide, return to Earth to cultivate the life-giving "Invid Flower of Life." This choice allows the players to play the same type of adventures they could in the first, meet or play Rand, Rook, Lancer, Lunk and Annie (Scott Bernard has left Earth), and leave the future outcome completely

open. As a campaign, the adventures could lead anywhere. With a smaller invad occupying force, the humans have a better chance of defeating their foes and reclaiming Earth (or will more invad show up?) The possibilities are yours to explore.

SELECTING AN O.C.C.

The world is radically different from previous Robotech books. Human life teeters on the brink of extinction. Civilization has been thrown into an upheaval and industry is gone. There are no big thriving cities, only ruins where humans try to reclaim what they can. There are no more factories, no manufacturing plants, no refineries, no television stations, radio or newspapers. Worse, there are no global or even regional governments. What remains are little pockets of humanity clinging to survival. Some cling to scavenged relics of the old world and old laws. Others have rebuilt little towns and hamlets, mostly farming communities like those of America during the 1800's. Still others have fallen into tribal societies, living like the indians of the Americas or jungle tribes. Some are ex-soldiers turned mercenaries, some wild gangs or criminals. But mostly, there is wilderness, wastelands and the *invad*.

In this world, the one global government, the RDF and Southern Cross are fading memories of a shattered past. Yet there are still men and women who will not give up the fight. The old soldiers of the RDF and Southern Cross, survivors of the REF assault waves to free Earth, and a whole new generation of people who will not succumb to alien domination. Resistance fighters who strike out at the invad enslavers. Individuals who fight alone, groups large and small, warriors who use the values and weapons of the RDF/REF and fight under that banner, or as the secret freedom fighters who fight as a network of teams and individuals across the world.

The O.C.C.s presented in this book reflect the war ravaged condition of the Earth and *combat orientation* of the characters. If the characters are not part of the freedom fighter's movement or aren't independent operators fighting against the invad, then they are wandering adventurers scavenging the ruins of the old world eking out a living the best they can. They could be thought of as being a future version of the Magnificent Seven or soldiers of fortune. Their motives may be altruistic, or self-serving, or a little bit of both.

O.C.C. REQUIREMENTS

The selection of a particular Occupational Character Class (O.C.C.) is limited by the minimum attribute(s) requirement needed to play. The eight attributes should have already been determined. *See the ROBOTECH® RPG, pgs 4-10, Creating a Player Character.*

O.C.C. SKILLS

Each O.C.C. has two skill categories: O.C.C. skills and "other" skills. **O.C.C. skills** are areas of training that are automatically taught to everyone in that chosen occupation. **The other skills** are other areas of training and knowledge possessed by the character and are generally reflective of his or her O.C.C. choice. These other skills may augment the occupational skills or reflect other interests.

Due to popular demand, I have added the accumulation of *additional* "other" skills as the characters increase in experience

levels. In this harsh world, where the characters must adapt to survive, it seemed logical that they would develop new skills as they grew in experience. All new skills begin at level one proficiency and progress to the next degree of skill as the character continues to mature. For Example: At third level, two new skills are selected as first level skills (after all, they are new to the character). When the hero attains fourth level, the skill proficiency of the two new skills increases along with the original skills. The original skills are all fourth level and the two new skills are at second level and so on.

Skill bonuses are indicated in parenthesis and are reflective of the degree and emphasis of training. The skill bonus is a one time bonus applicable immediately. Not all skills or skill categories will have a bonus. A bonus (+) after a skill category applies to all skills in that category unless otherwise stated. If the same skill is available in two different categories, only the highest bonus applies, not both. The same skill can not be selected more than once. Physical skill bonuses are accumulative.

A few words about Mecha Combat are needed to avoid confusion. The REF cyclone, alpha, beta and other mecha are less complex than their predecessors. Consequently, anybody with an I.Q. above 6 and a good instructor can be taught to pilot mecha. However, although other character O.C.C.s can pilot the mecha and select mecha combat, the Veritech Pilot O.C.C., Cyclone Rider O.C.C., Military Specialist O.C.C. (limited), and Destroid Pilot O.C.C. (found in Sentinels) have the very best training and best bonuses. All other O.C.C.s can only get *Basic* mecha combat training. **Characters without any mecha combat skills can not** pilot a mecha in battloid mode, use its weapons, nor engage the transformation sequence of a veritech. However, it is possible for a character to pilot some mecha like the Alpha, Beta and Cyclone when they are in their vehicle configuration. For Example: A character who has the pilot motorcycle skill can drive a cyclone as a motorcycle, but can *not* transform into battloid, nor operate its special weapon systems. Likewise, a person with the pilot jet skill can pilot the alpha or beta fighters when they are in jet mode, but can not change them into any of their other modes, nor operate any of the weapon systems.

MACROSS AND SOUTHERN CROSS O.C.C.s

Players can play their old Macross RDF and/or Southern Cross characters, complete with their old mecha, weapons and skills. These are old-timers from the previous Robotech wars. Consequently, they are not familiar with the new mecha and equipment of the Robotech Expeditionary Force (REF). Until they find or capture new equipment, they will be content with their old, familiar equipment and will most likely prefer it. **Note:** The word old is used figuratively rather than a measure of a great many years. Most "old" RDF or Southern Cross soldiers will only be 33 to 45 or so years old. Remember, its only been about 15 years since the REF blasted off from Earth.

SKILL MODIFICATIONS

The RDF VF series Veritech pilots can pilot the VF-1V Vindicator at full mecha combat skill and all other veritechs, like the alpha, beta, logan and AJACS, at a basic training level (the logan and AJACS are equal to the beta's basic training).

The Southern Cross logan and AJACS pilots can pilot the

VF series veritechs, vindicator, alphas and betas at a basic mecha combat level.

Destroid Pilots can pilot the new REF destroids (*see Sentinels*) and the hover tank. Southern Cross hover tank pilots can pilot old and new destroids, but are -1 on initiative. Over the years, a few new skills have been developed. Select three from the following categories. All new skills are at second level proficiency.

Communications: Radio: Basic and Radio: Scrambler.

Domestic: Any

Espionage: Wilderness Survival and Land Navigation only.

Mechanical: Automotive and Basic Mechanics only.

Medical: First Aid (+5%)

Physical: Swimming, Climbing, or Body Building only.

Pilot: Any (+5%)

Pilot Related: Any (+5%)

Rogue: Any

Science: None

Technical: None

W.P.: Any

Wilderness: Boat Building, Carpentry, Hunting, and Horsemanship only.

THE REF VERITECH FIGHTER PILOT O.C.C.

The Veritech Fighter pilot is still the very elite of the Robotech Defense Force (RDF) and the Robotech Expeditionary Force (REF). The smaller and more agile Alpha and Beta Fighters make these mecha pilots deadlier than ever.

As Robotechnology improves the trend is to make simpler and simpler mecha so that minimal training is necessary. But do not think this makes for a less capable veritech pilot. On the contrary, these men and women are the most skilled mecha pilots in the galaxy. The simpler operation of the mecha enables the veritech pilot to add a whole complement of mecha to his list of skills. Thus, the *REF veritech pilot* can fly the alpha fighter, beta fighter, shadow fighter (alpha), VF-1V vindicator, the old Macross VF series veritech and the Southern Cross logan and AJACS.

The veritech pilot of the REF is also trained in the use of the sensational cyclone, the all-purpose personal combat mecha.

The piloting of Destroids, old and new, is no longer an optional part of the veritech pilot's training. The emphasis of the veritech pilot's training is on the mastery of the many types of transformable "veritech" mecha. Destroid piloting is now a completely distinct and separate occupational character class (O.C.C.). The *new Destroids* of the REF can be found in **Robotech II: The Sentinels**.

The cyclone combat training is specifically limited to the VR-052 Cyclone Battler and the standard Battler weapon systems only.

In addition to the O.C.C. skills listed, with bonuses in parentheses, the player can select "other" skill areas. These additional skills are limited as stated.

Attribute Requirements: I.Q. 9, P.P. 9 or higher is preferred.

O.C.C. Skills:

Pilot Jet (+20%)

Pilot Veritech Fighters (all) (+20%)

Mecha Combat: Veritech Fighter (select two*)

Mecha Combat: Cyclone**

Weapon Systems (+20%)

Read Sensory Instruments (+15%)

Navigation (air, land, water) (+15%)

Hand to Hand: Expert***

*Select two specific types of Veritech mecha combat from Alpha, Beta, and Vindicator. ALL types of veritechs can be operated by the veritech fighter pilot, but at the basic training level. To increase one's skill, the character must select the specific mecha combat training. Use the Beta *Basic* training abilities if the veritech pilot has no formal mecha combat training in the Logan and/or AJACS Southern Cross mecha. The Macross and Southern Cross Veritech Fighter O.C.C.s can pilot the VF-1V Vindicator with the usual VF veritech bonuses, but all new mecha are piloted at the basic training level.

**Does not include the special bonuses for the VR-038-LT, nor the Cyclone Rider O.C.C. special strike bonus from the W.P. Cyclone Weapon System.

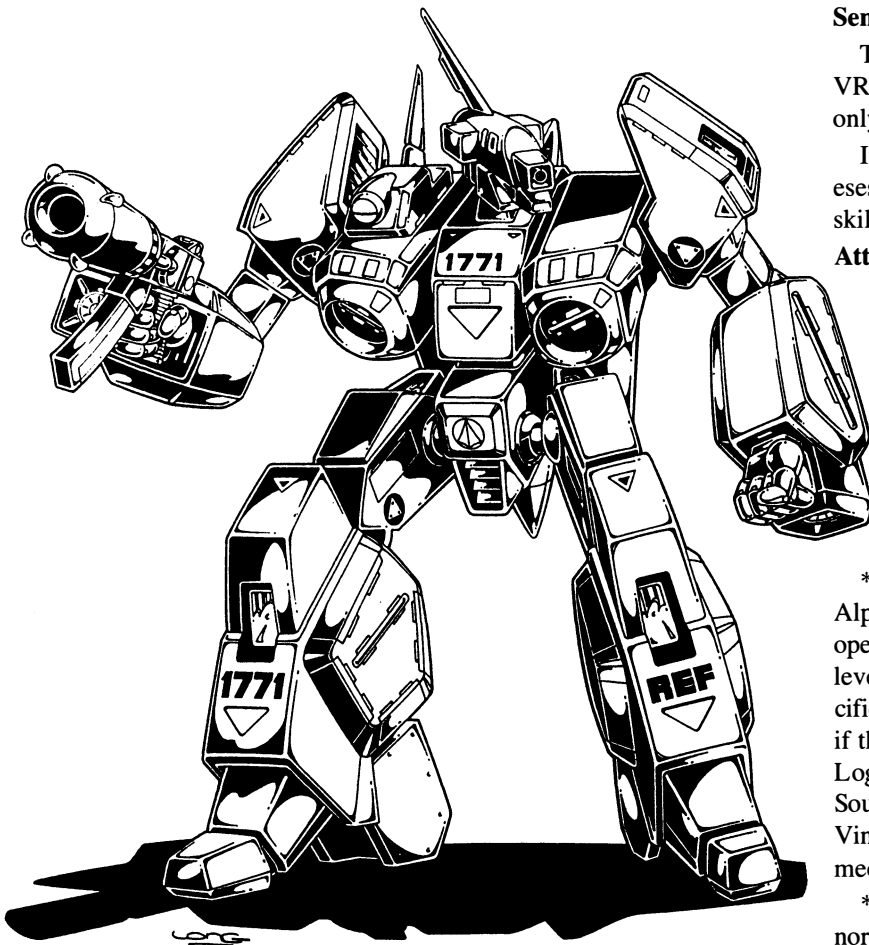

***Hand to Hand: Expert can be changed to Martial Arts, but costs one "other" skill.

Other Skills: Select 14 other skills. Plus one additional at level three, two at level six and one at level eleven. All new skills start at level one proficiency.

Communications: Any

Domestic: Any

Electrical: Basic Electronics only

Espionage: None

Mechanical: Basic, auto, aircraft and veritech mechanics only. (+ 5%)

Medical: First Aid only

Physical: Any

Pilot: Any except destroid. (+ 10% on all aircraft)

Pilot Related: Any (+ 10%)

Science: Math only

Technical: Any

Rogue: None

W.P.: Any, except Cyclone Weapon Systems.

Wilderness: None

Standard Equipment: Alpha (any except Shadow Fighter) or Beta Fighter; select one. Roll on the missile table that follows to determine how many missiles the fighter currently has. One VR-052 Cyclone Battler with a full complement of mini-missiles. The Gallant H-90 with an extra rifle stock, flash suppressor, and two energy clips. Cyclone body armor, four pint canteen, food rations for two weeks, first-aid kit, extra uniform, survival knife, binoculars and flashlight.

Alpha Missile Table (all short range)

- 01-11 4D6 missiles, all armor piercing.
- 12-23 2D6 armor piercing missiles, 2D6 plasma, and 2D6 high explosive (medium).
- 24-35 6D6 armor piercing and 1D6 high explosive (light).
- 36-46 4D4 high explosive (medium), 4D4 fragmentation, 2D4 smoke.
- 47-57 6D6 fragmentation, 1D6 armor piercing.
- 58-68 6D6 smoke, 2D6 high explosive (medium), 1D6 high explosive.
- 69-79 6D6 plasma and 1D6 fragmentation.
- 80-90 6D6 high explosive (light), 2D6 tear gas, 1D4 plasma.
- 91-00 6D6 high explosive (medium), 2D6 high explosive (light), 2D6 fragmentation, 1D6 plasma.

Alpha Additional Weapons

- 01-20 None
- 21-40 GU-11 Gun Pod
- 41-75 GU-XX Gun Pod
- 76-00 Gladiator's Mace

Beta Missile Table

- 01-11 4D6 short-range armor piercing missiles; 1D6 high explosive (heavy) medium range.
- 12-23 1D4 × 10 short-range high explosive (medium) and 1D6 plasma.
- 24-35 1D6 medium range multi-warhead, 2D6 short range fragmentation, 2D6 short-range high explosive (light), 2D6 short-range smoke.
- 36-47 6D6 + 6 short-range plasma missiles.
- 48-59 1D4 + 2 medium range plasma (heavy) missiles, 4D6

short-range armor piercing.

- 60-71 1D4 × 10 short-range armor piercing missiles and 1D6 short-range fragmentation.
- 72-82 1D4 × 10 short-range fragmentation missiles and 2D6 short-range armor piercing.
- 83-92 One long-range reflex missile (medium) and 4D6 short-range high explosive (medium).
- 93-00 Two long-range reflex multi-warhead missiles, 1D4 medium range high explosive (medium) and 3D6 short-range high explosive (light) missiles.

NOTE: The Beta comes automatically equipped with a built-in GU-XX (see Beta #5) with full payload.

Shadow Fighter or Vindicator VF-1V (Optional)

If the game master wishes, he can allow the player to select the shadow fighter or vindicator instead of an alpha or beta. Remember, the vindicators and shadow fighters are very uncommon and should not be available very often. Roll to see how many missiles are left.

Missile table for the SF-7 or VF-1V

- 01-12 1D4 × 10 short-range armor piercing missiles and destabilizer (EU-13) with full payload.
- 13-24 6D6 short-range high explosive (medium) missiles and 1D6 fragmentation.
- 25-37 1D4 × 10 short-range plasma missiles.
- 38-50 1D4 × 10 short-range high explosive (light) and 1D6 armor piercing.
- 51-62 1D4 × 10 short-range fragmentation missiles and 2D6 smoke.
- 63-73 1D4 × 10 short-range high explosive (medium) and 1D6 plasma.
- 74-84 1D6 × 10 short-range armor piercing missiles.
- 85-94 2D6 short-range plasma missiles, 1D6 armor piercing, 2D6 fragmentation and an EU-13 destabilizer with full payload.
- 95-00 3D6 short-range armor piercing missiles, EU-13 destabilizer and GU-XX (hand-held), both will full payload.

NOTE: If a vindicator, substitute the EU-13 for the EU-12.



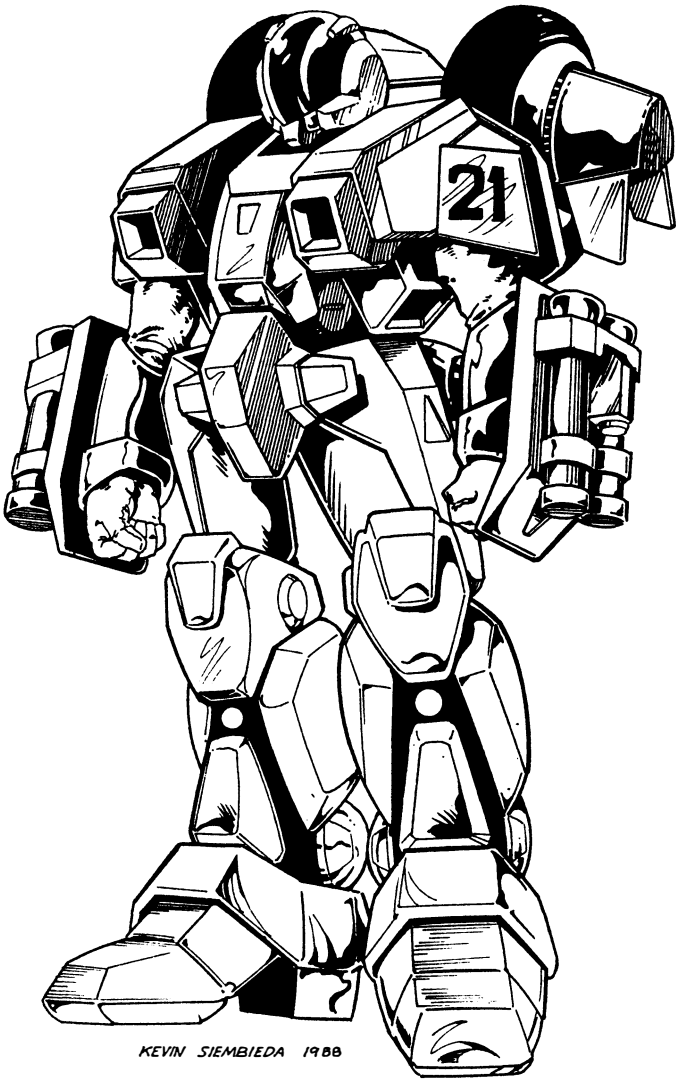

THE REF CYCLONE RIDER O.C.C.

The cyclone rider is a new breed of mecha warrior, a combination of destroid pilot and military specialist. The cyclone riders could be considered to be the elite *special forces* of the REF/RDF. It is the cyclone rider who is usually involved in covert operations, reconnaissance, rescue missions, demolition, and intelligence. Armed with the human-size power armor of the cyclone, its wearer becomes a pint size juggernaut, faster, stronger, capable of limited flight and armed with mini-missiles and energy weapons. The small size insures stealth and a mobility that no other mecha enjoys.

The cyclone rider is trained in the use of all three cyclone types and all cyclone weapon systems including the CADS-1 system of the VR-041 Saber cyclone. Each of the three cyclone models have their own unique characteristics.

The VR-052 Battler Cyclone is the heavy-duty combat unit and is the most common.

The VR-041 Saber Cyclone is a special unit designed for CADS-1 hand to hand combat and espionage.

The VR-038-LT Light Combat Cyclone is often thought of as being simply a lightweight model for female warriors. While it is true that the VR-038-LT was designed with women soldiers in mind, it has proven to be a superior unit for stealth and,

consequently, is used for clandestine operations. The light combat cyclone has an even quicker reaction time than its heavier predecessors and enjoys several combat bonuses the others do not. As a result, the light combat cyclone can be used by men and women, and is often the mecha of choice for clandestine operations where hand to hand combat and precision timing are required.

The cyclone rider can also learn to operate the new REF destroids (see *Sentinels*) and may request alpha fighter training, but must have the pilot jet skill and uses the mecha combat table Hand to Hand Bonuses from Alpha *Basic* Training. The basic training table means the character lacks the full skills and abilities of a veritech pilot whose O.C.C. has provided in depth and lengthy formal training.

In addition to the O.C.C. skills listed, with bonuses in parentheses, the player can select "other" skill areas. These additional skills are limited as stated.

Attribute Requirements: I.Q. 8, P.P. 8 or higher is preferred.

O.C.C. Skills:

Pilot Motorcycle (+20%)

Pilot Mecha: Cyclone (all) (+20%)

Mecha Combat: Cyclone (all types) W.P. Gallant

Weapon Systems (+15%) W.P. Heavy

W.P. Cyclone Weapon Systems* Hand to Hand: Expert**

*W.P. Cyclone Weapon Systems is *exclusive* to the cyclone rider and adds a bonus of +1 to strike when using the GR-97 forearm missile launcher, Gallant H-90, CADS-1 saber system, EP-40 pulse beam cannon, EP-37 60mm beam cannon, and RL-6 heavy rocket cannon.

**Upgrade to Martial Arts costs one extra "other" skill.

Other Skills: Select 14 other skills. Plus two additional at level three, one at level six and one at level eleven. All new skills start at level one proficiency.

Communication: Any (+5% on all radio)

Domestic: Any

Electrical: Basic electronics only

Espionage: Detect Ambush, Detect Concealment, Escape Artist, Intelligence, Land Navigation, and Wilderness Survival only (+5%).

Mechanical: Basic and Automotive (includes motorcycle) only (+10%).

Medical: First Aid only. Physical: Any

Pilot: Any (+10% on all ground vehicles/mecha. Must have pilot jet skill to select Alpha, Beta, or other flying mecha and, even then, hand to hand mecha combat is limited to "Basic" training). Pilot Related: Any +5%

Science: Math only.

Technical: Any (+10% on both demolition skills).

Rogue: Any (+15%)

W.P.: Any

Wilderness: None (May select any as a future additional skill).

Standard Equipment: Choice of cyclone model. Receives standard weapon systems for that model and has a full payload for each. The Gallant H-90, 1D4 extra energy clips for energy pistol mode, but no rifle extension. Choice of additional sidearm energy or S.D.C. weapon. Cyclone body armor, cyclone detachable storage boxes, flashlight, survival knife, binoculars, two canteens, food rations for two weeks, an extra set of clothes, 3 signal flares and 100ft (30m) of light nylon cord.

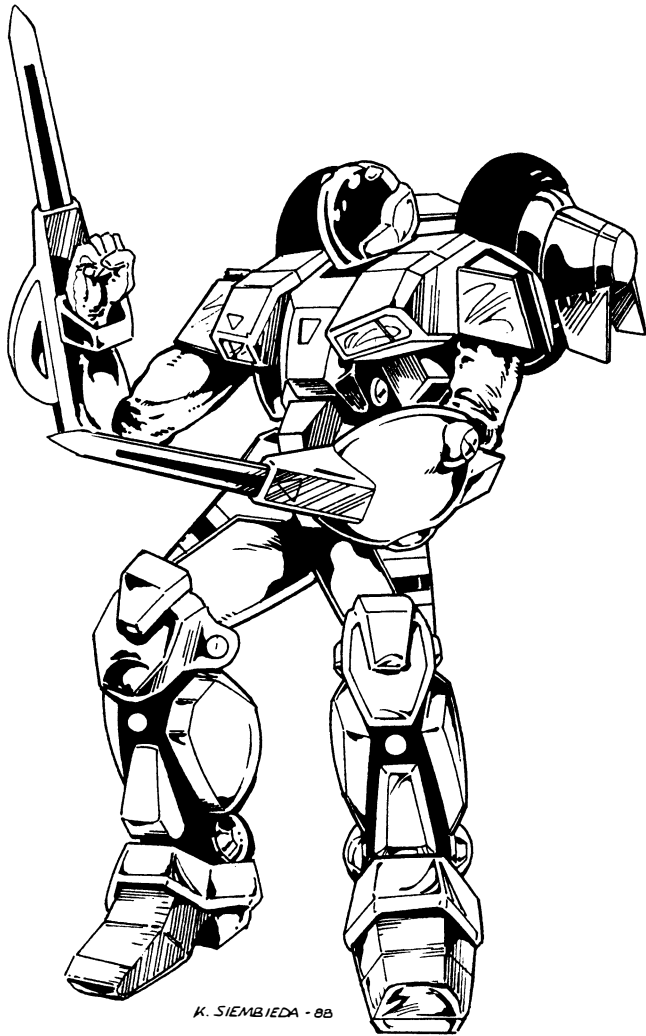

REF MILITARY SPECIALIST O.C.C.

The Robotech Expeditionary Force (REF) Military Specialist is a jack-of-all-trades. He or she is trained in the use of the VR-041 Saber Cyclone and is a fair Alpha pilot, but the main emphasis of training is on espionage. It is the military specialist who usually leads a group of cyclone riders on covert missions, for the REF military specialist is a master at information gathering and subterfuge.

One of the character's skills is the ability to establish an information network composed of loyal associates, spies, stoolies and sympathizers. This is an invaluable ability for the creation of underground networks of freedom and resistance fighters. There is a 25% + 5% per level of experience chance that a REF military specialist can *find* a freedom fighter ally or organization at any town or village within about a 1000 square miles of his/her usual operating territory. There is a 15% + 5% per level of the character's experience (reputation) that freedom fighter(s) will *know* the character as a fellow freedom fighter and offer what aid they can muster; GM's discretion. This is most likely to be protective housing, food, area map, information, rumors and an occasional ammo clip or missile.

Reduce the percentages in both categories by *half* when operating outside the character's usual territory. The better the charac-

ter's reputation and level of experience, the better the people will respond to him and his allies.

Cyclone combat training is specifically limited to the VR-041 Saber cyclone and the CADS-1 saber system.

The alpha assigned to a REF military specialist will usually be the VAF-6R reconnaissance alpha.

In addition to the O.C.C. skills listed, with bonuses indicated in parentheses, the player can select "other" skill areas. These additional skills are limited as stated.

Attribute Requirements: I.Q. 10, M.A. 10 or higher is preferred, as well as a high P.P., but neither is mandatory.

O.C.C. Skills:

Pilot Jet (+10%)

Pilot Cyclone (+10% to pilot the VR-041 Saber specifically, but can pilot any cyclone).

Mecha Combat: Cyclone (VR-041 only)*

Intelligence (+20%)

Interrogation (+15%)

Disguise (+15%)

W.P. Energy Rifle

W.P. Gallant

Hand to Hand: Martial Arts.

*Mecha Combat: Cyclone is specifically limited to the VR-041 Saber cyclone, with full bonuses. The pilot cyclone skill enables the character to pilot any of the three cyclones, but the VR-052 and VR-038-LT cannot be used at full proficiency; use Hand to Hand Combat Bonuses Basic Training.

The pilot jet skill allows the character to select a veritech piloting skill (alpha and beta are usually encouraged) and mecha combat skills, but will always be at the "Basic" training level.

Other Skills: Select 16 other skills, but at least two must be communications and two espionage. Plus two additional skills at level three, one at level six, one at level nine and one at level twelve. All new skills start at level one proficiency.

Communication: All at +10%; but Cryptography at +15%.

Domestic: Any

Electronics: Any

Espionage: Any (+15%)

Mechanical: Basic, Automotive, Aircraft, Computer Repair and Locksmith only (+5%)

Medical: Paramedic only (+5%)

Physical: Any (+10% when applicable)

Pilot: Any except destroids (+5% on motorcycle, alpha, beta, and all aircraft; all mecha combat is limited to "Basic").

Pilot Related: Any

Science: Any

Technical: Any (+5%; both demolition skills are +10%)

Rogue: Any (+10% on streetwise only).

W.P.: Any except cyclone weapon systems.

Wilderness: None (may select any as future additional skills).

Standard Equipment: VR-041 Saber Cyclone with a pair of CADS-1 and full missile payload. The Gallant H-90 with rifle stock and 1D4 rifle energy clips, plus 1D4 pistol energy clips. Choice of additional energy weapon plus one clip, and choice of additional S.D.C. weapon and 1D4 Cobalt Limpet Mines. Cyclone body armor, survival knife, binoculars, two canteens, food rations for two weeks, a set of extra clothes, gloves, 3 signal flares, and 200ft (61m) of light nylon cord and grappling hook. Note: Not likely to have a green reconnaissance alpha or beta as standard issue.

REF BIO-MAINTENANCE ENGINEER O.C.C.

A new breed of mechanic is the Bio-Maintenance Engineer, an expert in mecha and protoculture powered devices. It is the duty of the Bio-Maintenance Engineer (BME) to service, repair, modify and maintain mecha in perfect working order. The BME has an in depth knowledge of protoculture and can adapt the invid and zentraedi energy cells for human use. He or she can also recharge energy clips for weapons, repair conventional vehicles and may have a number of other mechanical and/or electrical skills.

Although the character can fix and maintain mecha with astounding skill, he/she can not pilot mecha. If he or she has the pilot motorcycle skill, he/she can pilot the cyclone only in motorcycle mode. Likewise, the alpha and beta can be piloted in jet mode if the character has the pilot jet skill. No mecha combat skills are available (not even the "basic" training category). This is not some odd oversight on the part of the military, but is intentional. It was feared that knowledge of mecha mechanics and protoculture combined with the knowledge of piloting mecha would make the Bio-Maintenance Engineer a security threat. A disgruntled BME soldier or spy could, theoretically, have easy access to mecha, steal one, and sell the mecha and his services on the black market. To help curb this, the RDF brass made the decision to prohibit a BME from learning mecha piloting and mecha combat skills.

In addition to the O.C.C. skills and "other" skills available, the Bio-Maintenance Engineer has a number of special skills.

SPECIAL SKILLS (Exclusive to the BME)

1. Repairing Mecha

Base Skill: 55% + 5% per level of experience.

This special skill enables the character to build, repair, custom modify and maintain all types of mecha. This means the bio-maintenance engineer can restore M.D.C. armor, replace damaged limbs, replace/repair damaged weapons and parts, replace energy cells and adapt alien protoculture energy cells to human mecha.

Repair Penalties

The following penalties apply whenever the character tries to build, repair or modify a mecha. The penalties generally reflect the complexity and difficulty of the job. *All penalties are accumulative.* For example: Working on replacing the arm of an alpha fighter, the character is -25% to replace the limb, but also -10% because he does not have the electrical engineer skill and then add a -5% aircraft construction penalty because the alpha is also an aircraft. Total penalty is -40%. Another -20% would apply if it were a rush job or -10% if improper tools were being used.

Mecha Repair Penalties

- 30% if the character does not have mecha electronics.
- 10% if the character does not have the electrical engineer skill. Electrical skill is important for all repairs.
- 25% replacing a limb (hand, arm, leg, etc.) A failed roll means a frozen, and non-transforming body part. An impaired leg will reduce running speed by half and -2

to dodge. An impaired arm means (minus) -1 melee attack and -1 to parry.

- 10% replacing or repairing sensory equipment like radar, optics, etc. A failed roll means the sensor is not working.
- 5% aircraft construction; any type of aircraft work other than maintenance.
- 20% V.T.O.L. capabilities; tricky work.
- 25% propulsion systems, hover jet(s), etc. A failed roll means a fault in the system; best speed and altitude are half normal. Also, -2 to dodge.
- 20% weapon systems repair, replacement or installation. A failed roll means the weapon does not function. No penalty if the person has the armorer skill.
- 5% electrical wiring. A failed roll means not connected properly.
- 5% adapting invid or zentraedi energy cells for human mecha. A failed roll means try again.
- 15% protoculture energy system repair or replacement. A failed roll means improper connection and mecha is without power. Try again.
- 20% adding M.D.C. by replacing or patching the armor. Difficult and time consuming work. Must have replacement armor available (salvaged from another mecha or factory material). A failed roll means the weight and design are awkward. Reduce maximum speed by 20% and -10% to all piloting rolls. You can tear it down and try again.
- 10% own original design modification.
- 20% rush job; takes half the usual time, but may be flawed (a failed roll).
- 10% for every 20 hours of continuous work without at least six hours of sleep.
- 10% improper tools. Takes twice as long as normal and quality may be inferior (a failed roll).

Time Restrictions

The amount of time needed to work on a mecha varies with the complexity of the task. The player and game master will have to work together on deciding how much time will be needed to do the work properly. Also the hours of work required may be interrupted with breaks for food, rest, sleep and combat. Precision work requires an alert mind and hand not dulled by fatigue. Some estimates for work time are:

1. Simple maintenance such as oil change, cleaning, lubrication, and changing protoculture cells will take 10 to 20 minutes, even in the middle of a forest.
2. Adapting alien protoculture storage cells for use in human mecha will take an hour or two.
3. Equipment repairs of separate units like radar, radio, targeting computer and so on can get complicated taking anywhere from one hour to six or eight hours. Use of RDF repair facilities will reduce the time by half.
4. Add on another 2D4 hours to completely replace the equipment mentioned in #3.
5. Major engine work; 8 to 48 hours.
6. Replacing or repairing a weapon system; 2 to 16 hours.
7. Replacing M.D.C. armor requires about two (2) hours for every 10 M.D.C. points restored. Replacement armor must be salvaged from other mecha. RDF and Southern Cross bases used to keep replacement armor at the base mecha maintenance and repair facility, but all such bases (and

factories) are believed to have been destroyed. Heavy equipment and mecha welding and bonding tools are required. Field repairs are difficult, even with the bonding equipment and at least one battloid to assist with the heavy work for the full duration takes three times longer (six hours per every 10 M.D.C.).

8. Replacing a mecha limb is also difficult and is best done at a mechanics facility. Under the best conditions, an entire appendage can be replaced in 10 or 12 hours. In the field, a battloid will be needed to assist in the heavy work (an alpha arm weighs nearly two tons) and will take twice as long.

2. RECOGNIZE MECHA QUALITY

Base Skill: 50% + 5% per each additional level of experience from the firsthand examination.

20% + 5% per each additional level when observing from a distance.

Bio-Maintenance Engineer is so adept at his/her trade that the character can size up the quality, condition and/or damage of any mecha, veritech or battloid, by looking at it (of course, first hand inspection is best). Their expert eye can estimate the vehicle's capabilities, approximate M.D.C., speed, maneuverability, weapons, etc.

Attribute Requirements: I.Q. 8, P.S. 10. A high P.P. is preferred too, but is not a prerequisite.

O.C.C. Skills:

Mechanical Engineer (+20%)

Veritech Mechanics (+20%)

Mecha Mechanics (+15%)

Mecha Electronics (+15%)

Weapon Systems (+10%)

Computer Operation (+10%)

W.P. Energy Pistol

W.P. Energy Rifle

Hand to Hand: Basic*

*Hand to Hand: Basic can be changed to Hand to Hand: Expert at the cost of one "other" skill or to Martial Arts at the cost of two "other" skills.

Other Skills: Select 16 other skills, but at least two must be selected from mechanical. Plus two additional skills at level three, one at level six and one at level eleven. All new skills start at level one proficiency.

Communications: Any

Domestic: Any

Electronics: Any (+5%)

Espionage: None

Mechanical: Any (+15%)

Medical: First Aid or Paramedic, but the latter counts as two skill choices.

Physical: Any

Pilot: Any, except Mecha and Mecha Combat (+10% on any ground vehicle skills, +5% aircraft).

Pilot Related: Any (+5% on all ground vehicles).

Science: Math only

Technical: Any

Rogue: None

W.P.: Any, except Cyclone Weapon Systems.

Wilderness: None

Standard Equipment: Choice of a non-combat vehicle (no tanks or armored recon vehicles); usually an RDF land rover, RV-B dune buggy, jeep, truck, van, or motorcycle (an occasional AAT-30 armored assault transport vehicle can be made available at the GM's discretion). Mini-tool pack, portable tool box, welding equipment, protective goggles, work jumpsuit, air filter, gloves, Geiger counter, utility belt, backpack, canteen, food rations for two weeks, flashlight and ID6 signal flares. Weapons include a survival knife, and choice of an energy pistol, energy rifle and conventional S.D.C. weapon (pistol, sub-machinegun, etc.) A suit of cyclone body armor and wrist radio (8 mile range) are also standard.

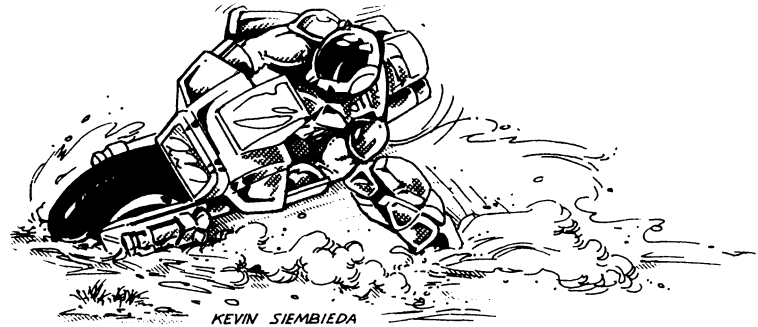

THE NOMAD SCOUT O.C.C.

The nomad scout is one of Earth's civilian survivors who has learned to live off the land. Like the rangers and mountain men of old, the nomad scout understands the lay of the land and is an expert in wilderness survival. The character can track animals, identify plants, locate water, hunt, fish and prowl through forests like a panther.

Nomad scouts are usually tough, self-reliant and independent. Their loyalty is with the human race, not the invad. They despise the notion of human beings becoming a slave race to the alien invaders and will often assist in acts of rebellion and sabotage. The nomad scout is a wanderer, but the character is different from the nomadic tribes that roam the wastelands. The scout does more than eke out a life by living off the land, he/she is an adventurer. An individual who craves the excitement and challenge of conflict. In another day, this character may have been a knight-errant in search of fame, glory and adventure.

An inventive and resourceful scavenger, the nomad scout will usually utilize a blend of ancient equipment and high technology. Thus, the character may wield a Gallant H-90 with the same ease as his bow and arrow or sword. He will know how to hunt and ride a horse, but will probably prefer a cyclone motorcycle mecha and will have learned how to transform it.

Although the nomad scout has no RDF bylaws, code of honor or orientation, most player characters will be of a good or anarchist alignment. Of course, there is always a few bad apples in every group, but, generally, most nomad scouts are gregarious, freewheeling spirits with a lust for adventure and a zeal for life.

Attribute Requirements: I.Q. 9. A high P.P. and P.E. are best, but not mandatory.

THE FREEDOM FIGHTER /MERCENARY O.C.C.

O.C.C. Skills:

Climbing (+20%)

Land Navigation (+15%)

Identify Plants and Fruits (+20%)

Hunting (W.P. Rifle) (+10%)

Prowl (+15%)

Track Animals (+20%)

W.P. Ancient Weapons: Select One

Wilderness Survival (+20%)

Hand to Hand: Basic

*Hand to Hand: Basic can be changed to Hand to Hand: Expert at the cost of one "other" skill or to Martial Arts at the cost of two "other" skills.

Other Skills: Select 18 other skills, but at least two must be piloting skills and another two must be wilderness skills. Plus two additional skills at level three, two at level six, one at level nine and one at level twelve. All new skills start at level one proficiency.

Communication: Any (+5% to radio: basic)

Domestic: Any (+10%)

Electronics: Basic Electronics only

Espionage: Detect Ambush, Detect Concealment, Escape Artist, Intelligence, Sniper, and Tracking only (+10%).

Mechanical: Basic Mechanics, Automotive, and Aircraft Mechanics only (minus -5% on aircraft mechanics).

Medical: First Aid or Paramedic (+10%), but the Paramedic skill counts as two skill selections.

Physical: Any (+5% when applicable)

Pilot: Any, except space and destroids. Mecha combat is always at the "basic" training level. (+10% on pilot cyclone mecha, motorcycle, truck and automobile.)

Pilot Related: Any (+5%)

Science: Basic Math only

Technical: Any

Rogue: Any (+5%)

W.P.: Any

Wilderness: Any (+15%)

Standard Equipment: 60 to 120ft of rope or lightweight cord, spikes and grappling hook; flashlight, butane lighter, 2D4 books of matches, several plastic bags (mostly to protect things from getting wet), extra set of clothes, soap, cap or hat (to protect head from the sun and elements), back-pack, military style utility belt, sleeping bag and canteen. 1D4 skinning knives, ancient weapon (of choice), one conventional rifle (usually bolt-action, especially if he has the sniper skill), one energy weapon (choose one). A vehicle of choice that is suitable for a rough and tumble outdoors environment, usually a motorcycle, jeep or pickup truck. Any type of cyclone (and cyclone body armor) can be the vehicle if the game master allows it (I suggest it), but only if the character has taken the cyclone or motorcycle pilot skill and Mecha: Basic Cyclone Combat skill. The game master may also allow a handful of other reasonable items.

The Freedom Fighter or Mercenary character is another *civilian* survivor who has taken up arms and learned guerilla tactics to combat the invading invid. Choosing the Freedom Fighter/Mercenary O.C.C. means that the character was never a member of the RDF, REF or Southern Cross and has no formal military experience. **Note:** A veritech pilot may be considered a freedom fighter or a mercenary, but the O.C.C. will always remain that of the veritech pilot O.C.C. The character with RDF, REF or Southern Cross training will always be that *military O.C.C.* and it can not be changed, even though the character may be part of the freedom movement or sell his services as a mercenary. The trained Robotech military personnel will always have their special military training to set them apart from the average warrior.

This is not to suggest that the freedom fighter/mercenary O.C.C. is any less capable than the other O.C.C.s. They are valiant men and wome committed to freeing humans from the heartless whims and enslavement of the invid. Many have been trained by old RDF or Southern Cross soldiers and have an excellent understanding of energy weapons, demolitions and, to a lesser extent, mecha.

Freedom Fighters are too few and too inadequately equipped to consider blatant sieges against the invid hordes. Instead, their tactics consist of subtle sabotage and hit and run guerilla techniques. For Example: They will cause a distraction elsewhere while a demolition team is setting explosives at a protoculture processing plant. They will help slaves escape from protoculture farms and work camps. They'll try to sneak into an invid hive to assassinate the invid brain or blow up the hive. They will ambush invid patrols and try to protect innocent people and towns. They are also on constant reconaissance gathering information about the enemy's movements, facilities, routines, plans, traps, and human sympathizers (allies).

The Freedom Fighters of North America are quite organized, with an elaborate network of resistance outposts, secret bases and loyal supporters. However, the world has been torn asunder, with tiny pockets of humanity scattered across the land. Only one in every 10 towns and villages is even aware that there are organized resistance fighters and a mere one in every 20 or 30 will be an active ally or member of the freedom fighters' network.

The favorite mecha of the resistance is the small, versatile cyclone, especially the VR-052 Battler. Alphas, Betas and the larger old veritechs destroids, and hover tanks are difficult to hide and much harder to learn to operate. **Note:** Despite its size and complex controls, the Southern Cross hover tank is another favorite mecha. The old RDF motorcycle and land rover, and Southern Cross hover cycle are among their favorite vehicles. The RDF commanhero assault helicopter is the favorite aircraft.

Field operatives and mercenaries will often own a cyclone and cyclone body armor. Those that do not almost always wear cyclone body armor or Southern Cross body armor (both provide 50 M.D.C.) and carry some form of heavy weapon, whether it be an energy rifle, Gallant H-90 or rocket launcher.

Attribute Requirements: An I.Q. of 8 or better and a high P.S. and P.P. are all preferred, but no minimum attributes are required, only loyalty and a warrior's heart.

O.C.C. Skills:

Pilot Motorcycle (+5%)

Radio: Basic (+10%)

Weapon Systems (+5%)

W.P. Knife

W.P. Heavy

W.P. Energy Rifle

W.P. Energy Pistol

Hand to Hand: Basic*

*Hand to Hand: Basic can be changed to Hand to Hand: Expert at the cost of one "other" skill, or to Martial Arts at the cost of two "other" skills.

Other Skills: Select 16 other skills. Plus two at third level, two at sixth level and two at tenth level.

Communication: Any (+5% to radio: scramblers, satellite, and surveillance).

Domestic: Any

Electrical: Basic Electronics only

Espionage: Sniper only

Mechanical: Basic, Automotive, Aircraft and Computer Repair only (+5%)

Medical: First Aid only

Physical: Any (+5% when applicable)

Pilot: Any except destroid, vindicator and VF series veritechs.

Mecha combat is limited to "basic" training. (+5% on all ground vehicles and cyclone pilot skill; +2% on pilot alpha).

Pilot Related: Any

Science: Math only

Technical: Any (+10%)

Rogue: Any (+10%)

W.P.: Any except cyclone weapon system

Wilderness: Archery, Boot building, Horsemanship and Hunting only.

Standard Equipment: Cyclone or Southern Cross body armor, extra set of clothes, back-pack, and traditional battle harness (combination of suspenders and belt designed to distribute the weight of ammopouches and accessories.) Survival knife (2; usually one in belt, the other in the boot), "wolverine" assault rifle with 2D4 grenades, sub-machinegun (player's choice of S.D.C. weapon) as a sidearm (can be exchanged for any kind of S.D.C. damage pistol if desired), and choice of energy weapon (a Fal-2 or Sal-9 or one of the more common Southern Cross relics) and 2D4 energy clips for it. Also 1D4 + 1 cobalt limpet mines and some type of RDF optical system (See *Robotech® RPG*, pg 80 for goggles & binoculars. Choose one.)

Roll to determine what type of vehicle the character has (or the G.M. may allow players to pick one. G.M.'s choice.)

01-18 Cyclone VR-052 Battler with 4D4 mini-missiles (player can choose missile selection). If the character does not have the cyclone mecha combat skill, he or she can use the machine only in motorcycle mode.

19-30 RDF Motorcycle (See *Robotech® RPG*, pgs 75-76).

31-48 AAT-30 Armored Assault Transport with 4D6 mini-missiles (player can choose types).

49-65 Souped-Up Motorcycle; a hog with medium armor (300 S.D.C. main body and 50 per each wheel) and all-terrain capabilities (+2% on rough terrain), Maximum speed: 108mph (173kmph).

66-82 VR-038-LT Light Combat Cyclone with a standard issue RL-6 rocket cannon, fully loaded, with 1D6 + 1 additional rockets. Used only as a motorcycle without cyclone mecha combat skill.

83-00 Southern Cross Hover Cycle (See *Southern Cross*, pgs 77 & 78).

Special Note: Like the military specialist, the freedom fighter fighters O.C.C. can find help from fellow freedom fighters, provided he/she can prove that he's a "real" member of the freedom fighter's resistance network. If the character is part of the resistance, he/she will know the identifying code word. However, the code word is changed every four to six months. It is also dangerous to say the code to the wrong person. Criminals and roving gangs are the second enemy of the freedom fighters and the criminal faction has no love for the goody-two-shoes freedom fighters, RDF, REF or Southern Cross. Identifying oneself as a freedom fighter or RDF/REF member is like issuing a challenge to some thugs, as they will rise to meet that challenge to see how tough the "soldier boy" really is.

The initial code is "Prometheous has risen."

NONMILITARY PERSONNEL O.C.C.

Not everyone who fights the invad is a trained warrior. Some are ordinary people who won't idly stand by and watch their race become the slaves of marauding aliens. These are characters like "Annie" who made up in spirit what she lacked in skill. (Editor's Note: Unlike Annie, your character can exercise some common sense and self-control. It is not mandatory to be obnoxious.)

Most nonmilitary personnel will never learn how to pilot mecha, but can use most other weapons and vehicles.

Attribute Requirements: None; just a desire to be free.

O.C.C. Skills: Special

The character has professional training in some areas. Select *three skills* and add a one time bonus of 15% to each of them. Players should exercise some logic by choosing appropriate skills. **For Example:** A character with an I.Q. of 4 is not likely to be a medical doctor or astrophysicist.

Automatic O.C.C. type Skills Include:

Pilot Automobile (+5%)

Cook (+5%)

Computer Operation (+5%)

Basic Mathematics (+5%)

Other Skills: Select 17 other skills. Plus two at third level, two at sixth level and one at tenth level. All new skills start at level one proficiency.

Communication: Any, except Laser and Cryptography.

Domestic: Any (+5%)

Electrical: Any except Mecha Electronics
 Espionage: None
 Mechanical: Any, except Mecha Mechanics and Veritech Mechanics.
 Medical: First Aid, or any other, but the others count as two skills each and Medical Doctor counts as four skill choices.
 Physical: Any, but Hand to Hand Expert, Boxing and Werestling count as two skills each, Martial Arts and Gymnastics count as three skills each.
 Pilot: Any conventional vehicles (+5%); excludes tank, jet-pack, spacecraft and all mecha skills.
 Pilot Related: Navigation and Read Sensory Instruments only.
 Rogue: Any (+2%)
 Science: Any

Technical: Any (+5%), excluding both Demolition skills.
 W.P.: Any, except Cyclone Weapon Systems.
 Wilderness: Any, except Track and Skin Animals, and Identify Plants and Fruits.

Standard Initial Equipment: An automobile, jeep, dune buggy or motorcycle. Extra clothes, cap or hat, gloves, 50ft of light rope, flashlight, hunting knife, hatchet (small axe), frying pan, hiking boots (optional), sunglasses, back-pack, canteen, and 2D6 pieces/bars of favorite candy (or substitute favorite beverage). Weapons are initially limited to S.D.C. weapons; select two (rifle, pistol and knife are most typical).

Energy weapons and heavy weapons can be attained and used through the course of adventures. Likewise, the vehicle can be upgraded at a later time.

SKILLS LISTED BY CATEGORY

Note: *New Skills are in Italic*

COMMUNICATIONS

Cryptography
 Laser
 Optic Systems
 Radio: Basic
 Radio: Scramblers
 Radio: Satellite
 Surveillance
 T.V./Video
Note: Read Sensory Instruments is found under Pilot Related Skills.

DOMESTIC

Cook
 Dance
 Fish
 Sew
 Sing

ELECTRICAL

Basic Electronics
 Electrical Engineer
Mecha Electronics: Same as RPG skill, but includes new mecha.

ESPIONAGE/MILITARY

Detect Ambush	Interrogation
Detect Concealment	Land Navigation
Disguise	Pick Locks
Escape Artist	Pick Pockets
Forgery	Sniper
Intelligence	Tracking
Impersonation	Wilderness Survival

MECHANICAL

Automotive Mechanics	Computer Repair
Aircraft Mechanics	Locksmith
<i>Armoror</i>	Mecha Mechanics
Basic Mechanics	Mechanical Engineer

Veritech Mechanics: The same skill, but it now includes the new Alpha, Beta, and Vindicator.

MEDICAL

Criminal Science/Forensics
 First Aid
 Medical Doctor
 Paramedic
 Pathology

PHYSICAL

Hand to Hand: Basic
 Hand to Hand: Expert
 Hand to Hand: Martial Arts
 Body Building
 Boxing
 Climbing
 Fencing
 Gymnastics
 Prowl
 Swimming
 Swimming: S.C.U.B.A.
 Wrestling

Note: Mecha Combat is found under Pilot Skills.

PILOT (Ground, Air, and Water)

Automobile
 Mecha Battloid (Southern Cross)
 Mecha: E.B.S.I.S. Battloid (Southern Cross)
Mecha: Cyclone
Mecha: Veritech
 Mecha: Combat
Mecha: Combat Basic
 Military Hover Cycle (Southern Cross)
 Military Hover Vehicles (Southern Cross)
 Motorcycle
 Jet Pack (Southern Cross)
Truck: Small
Truck: Large
 Tank
 Airplane; old style, single or twin engine
 Helicopter
 Jet
 Lancer Space Fighter
 Space Shuttle
 Boats: Sail Type
 Boats: Motor Type

PILOT RELATED SKILLS

Navigation (Air, Land, Water)
Navigation: Space
Read Sensory Instruments
Weapon Systems (missiles, lasers, etc.)

ROGUE SKILLS

Concealment
Palming
Pick Locks
Pick Pockets
Prowl
Safe-Cracking
Streetwise

SCIENCE

Astrophysics
Biology
Botany
Chemistry
Chemistry: Analytical
Mathematics: Basic
Mathematics: Advanced

Note: Computer is found under Technical.

TECHNICAL

Computer Operation
Computer Programming
Demolitions
Demolitions: Disposal
Photography

Note: Instrument Reading; see Pilot Related Skills.

WEAPON PROFICIENCIES (W.P.)

Ancient Weapons

W.P. Blunt
W.P. Chain
W.P. Knife
W.P. Sword
W.P. Staff

Also see Fencing under Physical Skills.

Modern Weapons:

W.P. Revolver
W.P. Automatic Pistol
W.P. Semi & Fully Automatic Rifle
W.P. Rifle
W.P. Sub-Machinegun
W.P. Heavy
W.P. Energy Pistol
W.P. Energy Rifle
W.P. Gallant H-90
W.P. Cyclone Weapon Systems

Note: Weapon Systems; see Pilot Related Skills.

WILDERNESS SKILLS

Archery
Boat Building
Carpentry
Identify Plants and Fruits
Horsemanship
Hunting
Skin & Prepare Animal Hides
Track Animals

SKILL DESCRIPTIONS

NOTE: For your convenience, we have reprinted the old skill descriptions with the new. This way you don't have to continually flip through TWO different books.

COMMUNICATIONS

Cryptography: Skill in recognizing, designing, and cracking secret codes and messages. After ten minutes of studying a code the character can attempt to decipher it, but at a -10% chance. Otherwise, the character must study for two hours before every additional roll. **Base Skill:** 30% + 5% per level of experience.

Laser: This skill provides the character with an in depth knowledge of laser communication systems. **Base Skill** is 40% + 5% per level of experience.

Optic Systems: Training covers a wide variety of optic systems, from video to optical enhancements devices, to laser optics. The character will understand the meaning of optical readings, recording, transmission, and use of special equipment like thermo-imagers, passive light intensifiers, infrared, ultraviolet, etc. **Base Skill:** 50% + 5% per level of experience.

Radio Communications: All these skills enable the character to effectively use various communications equipment and techniques.

Radio: Basic: This is the knowledge of the operation and maintenance of field radios and walkie-talkies, wire laying, installation, radio procedure, communication security and visual signs/communications, as well as knowing Morse code.

Base Skill: 50% + 5% per level of experience.

Radio: Scramblers: This is training in the use of electronic masking and scrambling (unscrambling) equipment, and codes, for increased security. **Base Skill:** 40% + 5% per level of experience.

Radio: Satellite Relay: This is an understanding of the methods and operation of satellite transmissions. **Base Skill:** 25% + 5% per level.

Surveillance Systems: This is the study and understanding of the operation, methods, and techniques involved in the use of surveillance systems. Includes motion detectors, simple alarm systems, complex alarm systems, video and camera equipment, amplified sound systems, miniature listening devices (bugs, telephone tapping), recording methods, and some optical enhancement systems (specifically as they relate to camera lenses). **Requires:** Electronics (basic) or electrical

engineering. Photography skills, prowl, and investigative skills may also be useful, but not required. **Base Skill:** 40% + 5% per level of experience.

Tailing, or following someone without their knowledge, is another form of surveillance. This also includes stake-out procedures. A failed surveillance roll indicates that the tail was spotted and the subject is aware of being observed/followed. A failed roll in the use of equipment indicates a ruined or garbled recording/film (not usable) or malfunction. Bugging equipment can be easily located or noticed during the course of casual activity if a character fails his surveillance roll while planting it.

T.V./Video: This is the understanding of the techniques involved in video and audio, filming, editing, special effects transmissions and equipment. **Base Skill:** 40% + 5% per level of experience. Spending two skills on this one skill area makes the character of professional film quality/abilities. A one time bonus of 10% applies in this case.

DOMESTIC

Cook: Skill in selecting, planning and preparing meals. A cooking roll failure means that the cooked food is either inedible (burnt!) or distasteful. **Base Skill:** 50% + 8% per level of experience. Spending two skill selections on this one skill area makes the character of professional quality. One time bonus of 10% applies in this case only.

Dance: A practiced skill in the art of dancing. **Base Skill:** 40% + 6% per level of experience. Spending two skills will produce professional quality dancing skill. One time bonus of 15% if this is the case.

Fish: These are the fundamental methods (and enjoyment) of the relaxing sport of fishing. Areas of knowledge include the use of lures, baits, poles, line, and the cleaning and preparation of fish for eating. **Base Skill:** 60% + 5% per level of experience.

Sew: The practiced skill with the needle and thread, to mend, layout, cut and sew simple patterns, and do minor alterations. This is not a tailoring ability unless the player spends two skills. **Base Skill:** 40% + 5% per level of experience.

Sing: The simple ability to read music and carry a pleasant tune. **Base Skill:** 40% + 5% per level of experience. The character's singing ability is nice, but not of professional quality, unless two skills are spent. Add 20% bonus if this is done. Minmei watch out!

ELECTRICAL

Basic Electronics: This is a rudimentary understanding of the principles of electricity, simple circuits, wiring, and so on. This person can do basic wiring, repair appliances and read schematics. **Base Skill:** 40% + 5% per level of experience.

Electrical Engineer: Knowledge of electricity. Characters can diagnose and locate electrical problems. It is also possible to put together electrical equipment. The character can attempt to bypass security systems and burglar alarms at a -25%; if Surveillance Systems is also taken, then there is a +10% bonus instead. **Base Skill:** 45% + 5% per level of experience. **Note:** Characters who are not electrical engineers must have Basic and Advanced Mathematics to select this skill.

Mecha Electronics: First hand knowledge of the electrical systems built into RDF and REF mecha. The character knows

exactly how they interact with protoculture and the intricacies of Robotechnology. Other skills in electrical systems do not apply to mecha, making this an invaluable skill for repairing the famous war machines. **Base Skill:** 35% + 5% per level of experience. **Note:** There is a -15% penalty when working on the old RDF destroids and the mecha of the Southern Cross due to a lack of experience with these more primitive and overly complicated protoculture and fusion generator systems.

ESPIONAGE/MILITARY

Detect Ambushes: Training which develops an eye for spotting locations and terrain suitable for ambushes and being ambushed. It also provides a rudimentary knowledge of guerrilla tactics used by the enemy. **Base Skill:** 50% + 5% per level of experience.

Detect Concealment: This is a skill which enables the individual to spot and recognize camouflage, tricks, concealed huts, buildings and vehicles, as well as the ability to construct unobtrusive shelters that blend into the environment. **Base Skill:** 40% + 5% per level of experience.

Disguise: The character knows how to apply make-up, wigs, skin putty, and other special effects, in order to alter his own appearance or the appearance of somebody else. **Base Skill:** 40% + 3% per level of experience.

Escape Artist: The character will know the methods, principles, and tricks of escape artists. By tensing and relaxing muscles, flexing and popping joints, the character can try slipping out of handcuffs, straightjackets, etc. Also includes a knowledge of knots and the ability to conceal small objects on the person. Picking Locks is a separate skill. **Base Skill:** 30% + 5% per level of experience.

Forgery: The techniques for making false copies of official documents, signatures, passports, I.D., and other printed material. The character must have an original or photocopy to work from in order to make an accurate copy. Skilled forgers can recognize other counterfeits at -6%. **Base Skill:** 30% + 5% per level of experience.

Intelligence: This is the specific training in the practices and principles of recognizing and analyzing sources of information about the enemy, observation techniques, counter intelligence measures and proper procedure. This includes the practical assessment of sights and sounds, estimation of ranges, what to report, handling prisoners of war, and handling captured documents and equipment (tagging, and reporting to group leader or proper authority).

This means the character will be able to accurately estimate ranges; the number of enemies/troops, direction, purpose; and assess the importance of specific information, documents and prisoners.

Further intelligence training includes a working knowledge of indigenous guerrilla warfare practices, concealment techniques, appearance, and current activities. This will enable the intelligence officer to recognize suspicious activity as guerrilla actions and identify guerrilla operatives. **For Example:** A particular booby trap, or weapon, or mode of operation, may be indicative of guerrilla activity in that area. It may be up to the character to confirm the existence of guerrillas, and their strengths and numbers in a particular area.

Another area of training made available to intelligence is

the identification of enemy troops, officers and foreign advisors. This means the person learns the many distinguishing ranks and marks that identify specific military units, special forces, and officers of the enemy. Such identification can pinpoint and confirm enemy operations, goals and movement, as well as confirm outside intervention/aid. **Note:** A failed roll in any of the intelligence skills means that evidence is inconclusive, or the character has incorrectly assessed the information/situation and is uncertain. A failed roll involving individual clues may mean the intel officer has dismissed it entirely as being meaningless. (GMs, use your discretion). **Base Skill:** 45% + 5% per level of experience.

Impersonation: This skill enables a person to impersonate another person or type of soldier (in general). This means the person must have a rudimentary (if not comprehensive) knowledge of the person or general type of personnel that he is impersonating. This is likely to include a knowledge of enemy/subject of impersonation, military procedure, dress, command, and rank, and will usually require speaking the language fluently. This means the character can convincingly impersonate a general type of person/soldier/advisor by accurate disguise, proper action, and language.

The **Base Skill** is 40% to impersonate general personnel and 20% to impersonate a specific individual (which may require weeks of study and special disguise), +4% per level of experience.

The success of one's impersonation/disguise can only be determined after exposing oneself to those whom you wish to trick. A successful impersonation requires the player to roll under his skill for each of his first THREE encounters. Afterward, the character must roll under his skill for *each* encounter with an officer. If interrogated/questioned, he must successfully roll for every other question or be revealed as an impostor. **A failed roll** means his impersonation has failed and he is recognized as an impostor and is in immediate danger.

Interrogation: This skill includes training in the questioning of prisoners, captives and informers, and the assessment of that information. **Base Skill:** 40% + 5% per level of experience.

Land Navigation: This skill allows the person to stay on course while traveling over land by means of observation. This includes mentally marking/recognizing geographic landmarks, estimating distance and movement, recognizing sounds, and other navigation tricks. Techniques include night travel. The player should roll once for approximately every three miles traveled. A failed roll means the character is drifting off course by 200-2000 yards (roll 2D10 × 100 yards). Do not roll again until the next three miles. A successful roll at that time will allow the character to recognize his error and correct it. Of course, errors mean lost time and traveling through unknown or potentially dangerous areas. A second (and third) failed roll means the character continues to travel 2D10 × 100 yards further off course. All failed rolls are cumulative unless corrected.

Note: A group of average men can cover approximately 5 miles an hour at a brisk, but relaxed pace, through grassland, along dirt roads or paved streets. Travel through dense forest or jungle at a cautious pace, with eyes open for danger, is

about one mile per hour. At this pace, one can easily watch for booby traps, snipers, ambushes, wild animals, tracks, and clues, make other observations, without fear of traveling too fast (and missing them). Only at a faster pace will one begin to miss details and court death. **Base Skill:** 45% + 5% per level of experience.

Picking Locks: The character knows the methods, techniques and tools for picking/opening, key, and basic, tumbler type locks.

It takes 1D6 melee rounds for each attempt to pick a lock. A failed roll means the lock holds; try again. **Base Skill:** 35% + 5% per level of experience.

Pick Pockets: An ability to remove items from a person without their being aware of it. If a pick pocket attempt fails, the item has NOT been removed and there is a 67% likelihood of the intended victim recognizing the intent of the action. **Base Skill:** 30% + 5% per level of experience.

Sniper: This skill represents special training in long-range rifle firing, and marksmanship. The character must first have a semiautomatic rifle or bolt-action rifle skill to which the sniper skill bonus of +2 to strike can be applied.

Tracking: Visual tracking consists of the identification of tracks, and following the paths of men or animals by the signs they leave on the ground and vegetation. Tracking is a precise art, requiring much practice. The skill includes the evaluation of tracks, which may indicate whether the person being tracked is loaded down with equipment, running, moving slowly (by measuring the space between steps), male, female, walking backwards, injured (staggered footprints), and so on. By these means, the tracker can estimate the person's rate of movement, apparent direction, the number of persons in the party, and whether the person knows he's being followed. Other methods of tracking require recognizing other telltale signs, such as blood and other stains, broken and displaced vegetation, overturned rocks; litter, such as cigarette butts, ration cans, candy wrappers, soiled bandages and remains of campfires, and even odors carried by the wind.

Tracking also includes the recognizing of dangerous animals by their tracks, habits and feces. Likewise, tire tracks of vehicles can reveal much, such as size and type of vehicle, weight of load, etc.

Counter-Tracking techniques are also known, such as covering one's trail; avoiding obvious pitfalls, such as littering, misdirection, parallel trails, and others.

A failed roll means that the signs are inconclusive, vague or misleading. Additional signs must be found to verify or clarify (roll again). Three consecutive failed rolls means the tracker has completely lost the trail. Roll once every 40 yards when FOLLOWING a trail. Persons attempting to follow a skilled tracker are -20% to follow his trail if he is deliberately trying to conceal that trail (however, his rate of travel is reduced by half). **Base Skill:** 35% + 5% per level of experience.

Wilderness Survival: Techniques for getting water, food, shelter, and help when stranded in wild forests, deserts or mountains. Characters without this skill will not be able to stay healthy for more than a few days out in a wilderness area. **Base Skill:** 40% + 5% per level of experience.

MECHANICAL

Automotive Mechanics: Ability to repair, rebuild, modify, and redesign conventional vehicles with internal combustion (gas) engines. Includes body work, turbine engines, and diesel truck engines. **Base Skill:** 50% + 5% per level of experience.

Aircraft Mechanics: The understanding, ability to repair, rebuild, modify and redesign conventional aircraft, including single and twin engine airplanes, fan-jets, jets, fighter jets, helicopters and shuttle craft. The Veritech Fighter is not a conventional aircraft and does *not* apply. **Base Skill:** 45% + 5% per level of experience.

Armorer (NEW): This is the military version of a weapon's engineer. The character can maintain, fix, modify, mount and figure out most military weapons. This ranges from repairing assault rifles and recharging energy clips to installing a MM-60 Multi-Missile system into an Alpha. **Base Skill:** 35% + 5% per level of experience.

Basic Mechanics (NEW): This is a rudimentary understanding of how machinery operates. This person can repair and maintain simple mechanisms and common motorcycles, automobiles and similar vehicles. Special modifications, souping-up vehicles, and working on aircraft and mecha are out of the question! **Base Skill:** 30% + 4% per level of experience.

Computer Repair: Knowledge of the internal electronics of computers and related devices (terminals, printers, etc. . . .). The character can attempt to repair, sabotage, or fix computers. Note that figuring out a repair problem requires one roll; the character must roll again to actually fix it. No computer operation or programming skills are included; many computer repair personnel don't even know how to turn the machines on! **Base Skill:** 40% + 5% per level of experience.

Locksmith: The practiced study of lock designs, and the ability to repair, build, modify and "open" locks. The methods, techniques, and tools of lock picking include the old-style key and tumbler, combination, and modern electronic locking systems. **Time Requirements:** 1-4 melees to open an antiquated key type lock; 1-6 minutes to open an elaborate tumbler type; 2-16 minutes to open a simple electronic lock (usually by patching in a bypass system); and 1-6 hours to break a complex, state-of-the-art electronic lock system, such as those used in high security and restricted areas.

If an unsuccessful skill roll is made, the lock is *not opened and the process must be repeated. If an attempt to open an electronic lock fails, roll to see if the lock has been irreparably damaged; 32% chance. If damaged, the lock CANNOT be opened.* **Base Skill:** 25% + 5% per level of experience. **Special Bonus:** Add a one time bonus of 5% if the Electronics Skill is also taken.

Mecha Mechanics: A comprehensive knowledge and ability to repair, build, and modify Mecha, including the *Logan*, *AJACS*, *Battloids* and the old and new destroids, alphas, betas, vindicators, cyclones, and Southern Cross mecha. A lack of familiarity with Southern Cross and Zentraedi mecha makes working on them more difficult, -10% penalty, but hardly impossible. **Base Skill:** 40% + 5% per level of experience.

Mechanical Engineer: A training, understanding and knowledge of how machinery is designed, operated, built, and maintained. Characters can attempt to redesign, modify, sabotage, repair, or construct mechanical devices. The first percentage is for how to operate/analyze/design machinery; the second is for how to repair, construct or sabotage. **Base Skill:** 45% + 5% per level of experience. **Special Bonus:** +5% to Locksmith skill and +5% to Surveillance Systems skill.

Veritech Mechanics: A very specialized skill dealing with the repair, building and maintenance of the *transformable* mecha. Without this skill, a character with mecha mechanics could effect structural repairs and limb replacement, but the delicate transformation system would be out of whack and prevent the veritech from changing into different configurations. This includes all veritech mecha, including the cyclones, alphas, betas, VF series veritechs and vindicator. The somewhat different Southern Cross mecha, logan, AJACS and hover tank, imposes a -5% penalty. **Base Skill:** 30% + 5% per level of experience.

MEDICAL

Criminal Sciences & Forensics: Basic knowledge of police skills. Includes simple criminal law, fingerprinting, ballistics (matching bullets to weapons and angles of impact), and general investigative techniques. Forensic medicine is also included, enabling the character to find evidence of time of death, cause of death, and other details when examining a corpse. **Note:** Biology, Chemistry, Chemistry: Analytical and some Mathematics are all required before taking Criminal Sciences & Forensics. **Base Skill:** 35% + 5% per level of experience.

First Aid: Rudimentary medical treatment which includes how to bandage wounds, stop bleeding, administer CPR/artificial respiration, and use antiseptics, and common anti-inflammatory drugs and painkillers. **Base Skill:** 50% + 6% per level of experience. A failed roll means the patient has not responded to treatment or that treatment was improperly applied.

Paramedic: An advanced form of emergency medical treatment which includes *all* first aid techniques, the setting of broken bones, suturing of wounds, use of oxygen and emergency equipment, use of drugs, knowledge of how to move a critically injured person, and other lifesaving techniques. **A failed roll** means the patient has not responded to treatment or that the treatment has been improperly administered. **Note:** For serious injury or coma, roll three times, consecutively, on percentile dice. A roll of two successful out of three means the wound has been properly treated or the patient's condition has been stabilized. Failure means the patient's condition is unchanged. Another character can immediately attempt to apply medical aid or the same player can try again, but only after he or she has spent six minutes for examination and/or concentration. **Base Skill:** 50% + 6% per level of experience.

Medical Doctor: The character has a Ph.D. (doctorate degree), with a Master's of Science, to be a practicing doctor.

Areas of training/study include: clinical skills, medical discipline, code of ethics, laboratory skills, techniques, methods of data collection, physiology (muscles, respiratory, blood, body fluids); fundamentals, principles and procedures of

pathology (diseases, their structure and function), rudimentary pharmacology (use, reaction, and interaction of drugs). The medical doctor (M.D.) is also trained in surgical procedures (he is a surgeon). **Note:** the first percentile number indicates the ability to diagnose a problem and the second is the ability to successfully treat it. **Base Skill:** 70/60% + 5% per level of experience.

Pathology: This is that branch of medicine that deals with the nature of diseases, their causes and symptoms, and the functional and structural changes caused by disease. Training includes anatomy, physiology, cell biology, manifestation of disease, tissue injury and repair, abnormal cell structure, metabolism, diagnosis of human disease, tissue culture methods and applications, analysis of drugs in biological samples and laboratory research, investigative methods, and use of the instruments tools and equipment. **Requirements:** Chemistry. **Base Skill:** 45% + 5% per level of experience.

PHYSICAL

Hand to Hand Combat: There are three major kinds of fighting techniques available to all characters:

Hand to Hand: Basic: This provides the fighting techniques taught in military basic training or in self-defense classes. Students learn elementary methods of attack and self-defense. Counts as one skill. *See the combat section for listing of specific abilities.*

Hand to Hand: Expert: An advanced form of self-defense and unarmed combat usually taught to commandos. Counts as two skills. *See the combat section for listing of specific abilities.*

Hand to Hand: Martial Arts: This is some form of oriental fighting skill (karate, kung-fu, etc.) that teaches advanced hand to hand combat. Counts as three skills (except for the Military Specialist and special conditions for upgrading Hand to Hand Combat). *See the combat section for listing of specific abilities.*

Body Building & Weight Lifting: By working out with weights and body building machines the character increases body strength and muscle.
+ 2 to P.S.
+ 10 on S.D.C.

Boxing: Classic art of fighting with fists. Training helps build the body and develop reflexes. Skilled boxers will *Automatically* Knockout opponents on a natural twenty for 1D6 melees rounds. Unlike normal Knockout/Stun, this does NOT have to be declared before the strike roll.
One additional attack per melee.
+ 1 to Parry/Dodge
+ 1 to Roll with Punch/Fall
+ 2 to P.S.
+ 3D6 on S.D.C.

Climbing: Knowledge of the tools and techniques for climbing up sheer surfaces. Players should roll once for every 20ft (6m) of a vertical climb. Every "skilled" climber gets a second roll to recover his/her hold. **Base Skill:** 50% + 8% per level of experience.

Rappelling is a specialized rope climbing skill used in descending from helicopters, scaling walls and cliff facings. For game purposes, rappelling will include ascending and

descending climbs. Minimum base effectiveness is 30% + 5% per level of experience. A failed roll means a slip or fumble; roll again to regain hold or fall.

Fencing: The ancient arts of Hand to Hand Weapons are learned from fencing teachers. This includes not only Olympic-style fencing with foil, epee or saber, but also Kendo (use of the Samurai sword) and other weapons. Adds a bonus of + 1 to strike and parry when combined with W.P. Sword. **Note:** Paired Weapons is a separate skill. See the W.P. Tables in the Combat Section for details.

Gymnastics: Learning to do falls, rolls, tumbles, cartwheels, and to work on rings and parallel bars. Characters with Gymnastics can leap 4ft up or 4ft across, with an additional 2ft per level. **Note:** Characters with Leap Attack can use these distances in a strike. Provides the following abilities:
60% + 5% per level Sense of Balance.
70% + 4% per level Climb Rope.
20% + 6% per level Climbing (or adds a bonus of + 10% to a climb skill).
70% + 8% per level Back Flip.
30% + 5% per level Prowl.
+ 1 to Roll with Punch/Fall.
+ 1 to P.S.
+ 1 to P.P.

Prowl: This skill helps the character to move with stealth; quietly, slowly and carefully. Techniques include balance and footing, short steps and pacing, rifle positioning, prone positions for low visibility, and crawling. A failed Prowl roll means that the character has been seen or heard. If the Prowl is successful, then the character is not seen and may make a Sneak Attack. **Base Skill:** 40% + 5% per level of experience.

Swimming: The rudimentary skill of keeping afloat, diving, lifesaving, and swimming techniques. **Base Skill:** 50% + 8% per level of experience. The percentile number indicates the overall quality of form as skill of execution. A special bonus of + 1 to parry and dodge while in water applies. **Note:** A character can swim a distance equal to $3 \times$ his P.S./Strength in yards/meters per melee. This pace can be maintained for a length of time equal to his P.E./Endurance in melees.

S.C.U.B.A.: The letters S.C.U.B.A. stand for Self-Contained Underwater Breathing Apparatus. Characters learn the methods of skin diving, and underwater swimming; and the use of oxygen tanks/apparatus, mask and flippers. **Base Skill:** 50% + 5% per level of experience and reflects the degree of skill and expertise at S.C.U.B.A. **Note:** A character can swim a distance equal to $2 \times$ his P.S./Strength in yards/meters per melee. This pace can be maintained for a length of time equal to the character's P.E./Physical Endurance in melees.

Wrestling: As taught in High Schools and Colleges, wrestling is more of a sport than a combat skill, but it does provide useful combat training.
Pin/Incapacitate on a roll of 18, 19 or 20.
Crush/Squeeze does 1D4 damage.
Body Block/Tackle does 1D4 damage and opponent must Dodge or Parry to avoid being knocked down.
+ 1 to Roll with Punch/Fall
+ 1 to P.S.
+ 1 to P.E. + 4D6 on S.D.C.

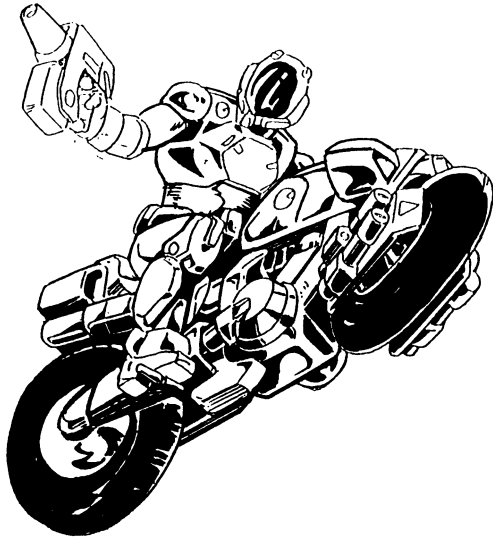

PILOT SKILLS (Ground, Air, Water)

Automobile: Manual & Automatic transmission, includes dune buggies and jeeps. **Base Skill:** 80% + 4% per level of experience.

Mecha (Battloid only): (NEW): Characters with this skill are taught the fundamentals of maneuvering giant Battloids. All Southern Cross battloids are designed very similarly, so a trained pilot can operate any of them. However, the E.B.S.I.S. battloids and the old Destroids operate differently and require separate training (each is a separate skill). The training program focuses on piloting, not combat. Thus, mecha combat for battloids must be taken, but it does include all Southern Cross non-transformable battloids. **Base Skill:** 60% + 5% per level of experience.

Mecha (E.B.S.I.S.) (NEW): This skill is identical to the one before it, but applies to Soviet Battloids only. **Base Skill:** 55% + 5% per level of experience.

Mecha Cyclone (NEW): This is a separate mecha pilot skill because of the many unique capabilities and the different “power armor” type operation of this man-sized mecha unit. Training focuses on transformation and piloting, not combat. Thus, *Mecha Combat: Cyclone* must be taken to enjoy the full combat bonuses available. **Base Skill:** 50% + 5% per level of experience.

Mecha Veritech (NEW): The piloting skills required to fly the big transformable mecha. Training focuses on the transformation process and the strengths and weaknesses of each mode of operation (jet, guardian and battloid). This skill is generally reserved for the Veritech Pilot O.C.C. exclusively. **Base Skill:** REF Veritechs: 50% + 5% per level of experience. RDF Veritechs (VF): 40% + 5% per level of experience. Southern Cross Veritechs: 35% + 5% per level of experience.

Mecha Combat: Each mecha, the alpha, beta, cyclone, vindicator and all the others, has a different weapon system, hand to hand aptitude, and personality quirks that make each specific mecha unique. Because each handles differently, the pilot must select a separate mecha combat skill for each specific mecha type (cyclone, alpha, beta, etc.) to enjoy its maximum combat effectiveness (bonuses).

The Hand to Hand Bonuses from Mecha Combat Training list the exact combat abilities, damage and bonuses for each

mecha. They are found at the end of this section. Mecha Combat is usually reserved for mecha pilots. Each specific mecha type, new and old, counts as a separate skill selection. **Note:** In addition to the specific mecha, the veritech pilot can operate all other aircraft style mecha, but only at the basic level. The cyclone rider can use all cyclones with equal skill.

Mecha Combat BASIC (NEW): Readers will also see a stat block for *basic* mecha combat. These abilities apply to general training in mecha combat available to many O.C.C.s. The basic combat training enables the character to use the mecha well, but not quite at peak efficiency.

Military Hover Cycle: The practiced skill of riding the speedy Southern Cross hover cycle. Surprisingly, the hover cycle is still fairly common on the war torn American continents.

Base Skill: 50% + 4% per level of experience.

Military Hover Vehicle: Include a variety of trucks and armored vehicles that were once the equipment of the Southern Cross. However, few of these vehicles seem to have survived the invid invasion. **Base Skill:** 54% + 4% per level of experience.

Jet Pack and Space Booster Pack: These are two special items that were used by the Armies of the Southern Cross. Both are fairly uncommon and require Southern Cross body armor to use. **Base Skill:** 45% + 5% per level of experience.

Motorcycle: The practiced skill of riding a motorcycle. **Base Skill:** 60% + 4% per level of experience.

Truck (Small) (NEW): Manual or automatic transmission; includes pickup trucks, small cargo trucks, vans and trailers. **Base Skill:** 60% + 4% per level of experience.

Truck (Large) (NEW): These are the manual transmission, eight to sixteen-wheeler transport trucks. The biggest of these trucks can easily haul mecha (weight capacity — 60 tons). **Base Skill:** 42% + 4% per level of experience.

Tank: The piloting of armored assault vehicles; includes armored all terrain vehicles, amphibious recon, and other armored heavy vehicles and construction vehicles.

SPECIAL NOTE: The following rules apply to all types of automobiles, trucks, vans, motorcycles and even armored vehicles/tanks.

Special Maneuvers: Conditions and Penalties: Evasive Action: Fleeing or dodging another vehicle, obstacle, missile or some other attack by moving out of the way. Evasive action often involves weaving, zigzagging and sudden turns at high speeds. A successful roll means the pilot has successfully dodged out of the way. **Skill Penalty:** -15%; pilot/driver can not attack, passengers are -6 to strike in an attack. **A failed roll** means an ineffective evasive maneuver which, in turn, means the vehicle has been struck, blasted, and/or the attacker is still hot on his tracks. **THREE CONSECUTIVE, successful evasion rolls** means the pilot has completely lost the pursuer.

Reverse Driving: This is simply driving in reverse/backward. **Skill Penalty:** -25% if driving over 65mph, and roll for each turn, swerve or evasive action. Pilot can not attack, but passengers are only -2 to strike. **A failed roll** means a minor collision.

Stunts: Includes sharp turns at high speeds, sudden on-the-dime-stops, sudden U-turns at high speeds, propelled leap (such as riding up over an incline or object, sailing 20ft in the air, land and keep on going) and similar maneuvers. **Skill Penalty:** -25%; lose all attacks that melee. **A failed roll** means the stunt is incomplete and serious difficulties encountered. Roll on the following table:

Loss of Control (Stunt and SideSwipe)

- 1-38 Minor collision; momentarily stopped. Reduce vehicle's S.D.C. by 1/3. Occupants shaken, but okay.
- 39-59 Stunt maneuver botched; reduce speed by half.
- 60-80 Engine or structural problems develop, requiring pilot to pull over and stop. Vehicle needs 2-12 hour's worth of repairs.
- 81-97 Collision. Vehicle is totaled; pilot and occupants receive 3D6 points of damage (subtract from hit points).
- 98-00 Collision/crash; all killed.

Sharp Curves: 90 degrees, high speed. **Skill Penalty:** -10%.

Sideswipe: This maneuver can be used against a stationary object, moving vehicle or person. The purpose of a sideswipe is to strike another vehicle, object or person with a glancing blow from the body of your vehicle. **To strike**, the swiping player rolls under his Pilot skill minus the 20% skill penalty in attempting this dangerous maneuver. **Note:** The target, if controlled by another person, can attempt to dodge via "evasive action" or "stunt" driving. **Skill Penalty:** -20%; no other attack possible. **A failed roll** to sideswipe means an automatic miss, and the player must roll under his Pilot skill, -20%, to maintain control of the vehicle. If control is lost, roll on the **Loss of Control Table** under stunts. **Damage** from a sideswipe is 2D6 for every 20 miles of speed. The sideswipe also damages the vehicle, which is equal to 1/3 the damage inflicted to the target. Thus, if the sideswipe inflicted 24 points of damage to the target, it would also do 8 points of damage to the vehicle. **Note:** The GM may substitute rules from *Road Hogs*, the TMNT supplement.

Airplane: Includes the old propeller, single and twin engine types. **Base Skill:** 70% + 4% per level of experience.

Helicopter: Includes the small, two-seater observation types; large transport and assault. **Base Skill:** 60% + 4% per level of experience.

Jet: Includes the fan-jet, commercial jet and jet fighter. **Base Skill:** 60% + 4% per level of experience.

Lancer Space Fighter: **Base Skill:** 60% + 4% per level of experience.

Space Shuttle: **Base Skill:** 60% + 4% per level of experience.

SPECIAL NOTE: *The following rules apply to ALL aircraft.* Roll under your pilot skill for each maneuver:

Special Maneuvers: Conditions and Penalties: Evasive Action: Fleeing or dodging another aircraft, obstacle, missile or other attack by moving out of the way. All attacks are lost while engaged in evasive action; unless something suddenly flies directly in front of the vehicle, and even then the pilot is -4 to strike. **Note:** This tactic will lose *any* attacker(s), meaning they cannot attack unless the attacker(s) engage in a "dog tail" chase. **Skill Penalty:** -12% (no attack possible) Maneuver consumes one full melee. **A failed roll** means an

ineffective evasive maneuver, attacker(s) still in strike position and/or have struck. The player's attacks are still forfeit even though the evasive action failed.

Tilt Dodge: This is a difficult maneuver in which the pilot attempts to avoid an attack by quickly tilting or jerking out of the way at the last minute. In this way, the pilot can stay on course and continue his own attacks (if any). **Skill Penalty:** -35%; -2 to strike. **A failed roll** means no dodge, aircraft is hit and takes full damage. A tilt dodge can be used to attempt to avoid each individual attack. A tilt dodge can *not* avoid more than one blast from a multiple/simultaneous assault; evasive action is necessary.

Stunts: These are sudden, severe or highly difficult maneuvers, including dives, sharp turns, dead-man's drops (nearly straight down, high speed drop), tumbles, summersaults and similar actions. **Skill Penalty:** -30%; lose all attacks that melee. **A failed roll** means the stunt is incomplete and serious difficulties encountered. Roll percentile dice on the following table:

- 1-40 Engine chokes; stalled out and descending. Must make an emergency landing unless the vehicle can be restarted (Pilot skill -25%; can try once every melee). All attacks are defensive only, -4 to strike.
- 41-70 Stunt maneuver botched; speed and altitude reduced by 1/3.
- 71-88 Engine difficulties; forced to make an emergency landing. Repairs will require 4-24 hours.
- 89-00 Engine and/or vehicle damaged beyond repair; crash inevitable. Character must parachute to safety. Optional: Can direct vehicle on a suicide crash into an immediate target. Pilot skill, -20%, to strike.

Emergency Landing: Executed when the vehicle or pilot is damaged and flight can not be maintained. **Skill Penalty:** -30%; loses all attacks. **A failed roll** will result in a crash landing. Roll on the following table for Crash Landing:

- 1-31 Pilot and/or passengers survive; minor injury.
- 32-57 Crash; pilot and passengers take 5D6 damage.
- 58-80 Pilot and passengers in critical condition/coma, require immediate, extensive medical treatment. Treat as surviving death and coma.
- 81-83 No survivors; vehicle exploded.
- 84-00 Passengers survive with minor injury, pilot dead. Optional: Pilot can opt to parachute to safety rather than attempting a landing.

Shadow: Is a maneuver in which the air vehicle pursues another vehicle without detection. This is usually done by flying above and behind the pursued, using clouds as cover. The pursuer will mimic the vehicle pursued in every way, so that they will be thought to be a radar shadow or aberration. **Skill Penalty:** -20%; no attacks possible without revealing true position and nature. While imitating the evasive actions, stunts, and so on of the craft being shadowed, roll for each maneuver being copied.

Dog Tail: This is an offensive maneuver in which the pilot closely pursues an enemy air vehicle while locked in combat. This is the only maneuver that can pursue a vehicle taking evasive action. By hanging on the enemy's tail, or "dog tailing," the attacker can usually strike with little or no fear of a counter-strike. **Skill Penalty:** -15%; no strike penalty.

A **failed roll** means the target has momentarily slipped out of the striking range/area. Roll once every other melee to maintain dog tail position, *or* for every evasive or stunt action.

Boats: Sail Type: Base Skill: 80% + 4% per level of experience.

Boats: Motor Type: Large and small (not ships). **Base Skill:** 70% + 4% per level of experience.

PILOT RELATED SKILLS

Navigation: Skills in map reading, star charts, course computation, following landmarks, and use of navigational equipment. Includes air, land and water navigation, as well as piloting by instruments alone. **Note:** Basic mathematics and read sensory equipment are required to navigate. **Base Skill:** 60% + 5% per level of experience. A failed roll means the pilot is off course. Roll 2D6 × 100 for aircraft, 4D6 × 100 for Veritech Fighters, and 1D6 × 100 for land vehicles to determine how many miles/kilometers they are off course by. Roll for every hour that one is off course.

Navigation – Space: Basically the same as normal navigation techniques. The only difference is the use of stars, and some of the sensory equipment. **Base Skill:** 60% + 5% per level of experience.

Read Sensory Instruments: Individuals with this training can maintain, understand, operate, and “read” or interpret sensory data from all types of conventional sensor devices. These devices include radar, sonar, motion detectors, surveillance equipment, optical enhancements, instrument panels and so on. **Base Skill:** 40% + 5% per level of experience. **Note:** Characters without a sensory skill cannot understand nor operate air vehicles, radar or detection/surveillance equipment.

Weapon Systems: This is the complete understanding of weapon units and systems incorporated in *vehicles* and *Mecha*. It includes the Battloids, and a vast variety of weapons, lasers, particle beams, auto cannons, missile launchers, and so on. **Special Bonus:** +2 to strike. This does not include hand-held weapons which require individual W.P. training. **Note:** Characters without the weapon systems skill will be able to operate them only if skilled in piloting that vehicle (like Pilot Mecha or Helicopter, etc.), but they will have no bonus to strike and never have the initiative. **Base Skill:** 70% + 5% per level of experience.

ROGUE SKILLS (NEW!)

Concealment: Is the practiced ability to hide something on one’s body or in hand, usually by continually moving it around from hand to hand or place to place unnoticed. Objects must be no larger than 14 inches in height and length and 6 inches in width, and weigh 10lbs or less. The smaller and/or lighter the item, such as a knife, gem, small sack, scroll, etc., the easier it is to conceal. Larger items such as a book, club, statue or other similarly larger and heavier objects are more difficult to conceal on one’s person for obvious reasons. A penalty of –5% applies to items over 7 inches (remember, 14 inches maximum) because they are of a more difficult size. Items larger than 14 inches are impossible to conceal. **Base Skill:** 20% + 5% per level of experience.

Palming: Simply the ability to pick up and seemingly make a small object such as a coin, key, playing card, knife, etc.,

disappear by concealing it in one’s hand. Adds a bonus of +5% to pick pockets skill. **Base Skill:** 25% + 5% per level of experience.

Pick Locks: The character knows the methods, techniques and tools for picking/opening key, and basic, tumbler type locks. It takes 1D6 melee rounds for each attempt to pick a lock. A failed roll means the lock holds; try again. **Base Skill:** 35% + 5% per level of experience.

Pick Pockets: An ability to remove items from a person without their being aware of it. If a pick pocket attempt fails, the item has NOT been removed and there is a 67% likelihood of the intended victim recognizing the intent of the action. **Base Skill:** 30% + 5% per level of experience.

Safe-Cracking: Knowledge of various safes, lock boxes and security rooms, along with the methods for illegal entry. The character knows the methods, techniques and tools for opening (‘cracking’) tumbler and combination type locks.

It takes one melee round to open a simple combination lock and five melee rounds for a complicated safe lock. To open a safe/complicated tumbler lock, the player must successfully make a skill roll (roll under) two out of three times. Failing the roll means that the lock holds, but this can be attempted again. **Base Skill:** 50% + 2% per level of experience.

Blowing a safe with explosives requires sophisticated knowledge, as well as the following tools: Electric drill, blowtorch, (or laser drill), plastic explosives, etc. . . . Roll just once. Failure means the safe has been blown shut and cannot be opened without heavy machinery. **Base Skill:** 60% + 3% per level of experience. **Note:** Must also roll under the Demolitions skill to successfully use and detonate the explosives.

Prowl: Same as the physical skill.

Streetwise (NEW): This skill instills an understanding of the darker side of city streets and the low-life who roam those streets. The character who is streetwise will be able to recognize gang members by their dress, symbols and mannerisms; guess at whether they are low level gang members or upper echelon, recognize a brawl situation (impending attack), and know some of the more typical gang rituals and codes of ethics, as well as likely hangouts.

Similarly, the streetwise skill will help the character to recognize and communicate with fences, criminal arms dealers, bandits and other criminal types. These skill abilities are used to avoid trouble and dangerous situations more than anything else. **Base Skill:** 30% + 5% per level of experience.

SCIENCE

Astrophysics: Knowledge of stellar astronomy and how it relates to nuclear physics, quantum mechanics, relativity, and other explanations for the creation of deep space phenomena, like quasars and black holes. **Note:** Basic and advanced Mathematics are required before taking Astrophysics. **Base Skill:** 30% + 5% per level of experience.

Biology: Basic understanding of cells, anatomy, physiology, evolution and genetics. The character will know the basic use of a microscope, how to cultivate bacteria and how to classify new organisms. **Base Skill:** 40% + 5% per level of experience.

Botany: Plants, their categories and functions, are studied extensively. Characters will know the basics of cross-fertilization, germinating and growing experimental plants. **Base Skill:** 40% + 5% per level of experience.

Chemistry: Basic understanding of chemical principles and formulae. Characters know enough chemical laboratory procedures for analyzing and synthesizing chemical compounds to be competent assistants. **Base Skill:** 60% + 5% per level of experience.

Chemistry – Analytical: Chemical engineering theory, useful in the analysis of compounds and their practical applications. Characters will be highly skilled in the use of laboratory equipment, and can analyze and synthesize chemicals. Note: Basic and advanced mathematics are prerequisites. **Base Skill:** 50% + 5% per level of experience.

Mathematics – Basic: Includes basic addition, subtraction, multiplication, division, fractions and algebra. **Base Skill:** 80% + 4% per level of experience.

Mathematics – Advanced: Includes geometry, trigonometry, calculus and techniques for advanced mathematics. **Base Skill:** 64% + 4% per level of experience.

TECHNICAL

Computer Operation: A knowledge of how computers work, along with the skills to operate peripherals like keyboards, printers and modems. Characters can follow computer directions, enter and retrieve information, and similar basic computer operations. However, this does NOT include programming. **Base Skill:** 60% + 5% per level of experience.

Computer Programming: Designing, programming, debugging, and testing computer programs/software. Note: Computer Operation is required before taking computer programming. **Base Skill:** 40% + 5% per level of experience.

Demolitions: Demolitions provides the person with an advanced knowledge in the use and workings of explosives and detonation devices for the purpose of blowing up bridges, buildings and sabotage. This includes *all* types of explosives, such as mines, dynamite, plastics, nitro, blasting caps, etc. It also includes a basic understanding of the strategic placement of mines and booby traps. This will increase a character's awareness of suspicious rope, string and wire. **Base Skill:** 60% + 5% per level of experience. A failed roll means a dud; no explosion.

Demolitions: Disposal (or Explosive Ordnance Disposal): This skill enables the character to safely defuse unexploded mines, bombs, explosive booby traps, dud artillery rounds, dud explosive charges, or any other explosive devices. **Base Skill:** 60% + 5% per level of experience. A failed roll means the item has exploded without warning.

Photography: Taking black and white or color still pictures. Characters will know how to load, develop and enlarge film. **Base Skill:** 50% + 5% per level of experience.

WEAPON PROFICIENCIES

There are two categories of weapon proficiencies (W.P.): Ancient and Modern.

Ancient Weapon Proficiencies: Each skill area provides combat training with a particular type of weapon. The result is hand to hand combat bonuses to strike and parry, but only

when that weapon is used. Each W.P. counts as one skill. The character may select several W.P.s **Note:** Characters without a W.P. CAN use any weapon, but without bonuses.

W.P. Blunt: A skill with any type of blunt weapon, including maces, hammers, cudgels, pipes, staffs and clubs. **Bonuses:** +1 to strike and parry at **level one**, add another +1 to strike and parry at **level four** and +1 to parry at **level eight**.

W.P. Chain: Includes ordinary lengths of chain, mace and chain, flail, nunchaku, etc. **Bonuses:** +1 to strike at **level one**, add another +1 to strike and parry at **level four**, and +1 to parry at **level eight**.

W.P. Knife: Combat skill with all types of knives. **Bonuses:** +1 to strike when thrown, **level one**; +1 to strike and parry at **level two**, +1 to parry at **level five**, +1 to strike at **level six** and again at **level nine**.

W.P. Sword: Combat skill with large and small swords. **Bonuses:** +1 to strike and parry at **level one**; an additional +1 to strike and parry at **level four**, and again at **level eight**.

Modern Weapon Proficiencies: These are areas of training and practiced skill with a particular type of modern weapon. Each W.P. counts as one skill. Characters may have several W.P.s Each provides a bonus to strike. See the Combat Section for details.

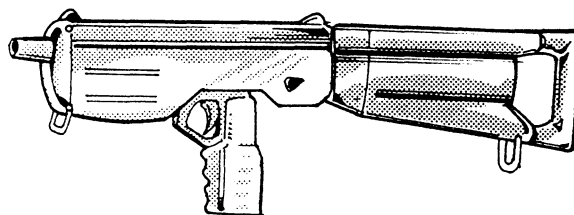

WILDERNESS SKILLS (NEW!)

Archery: The practiced use of the bow and arrow and crossbow. The archery skill is effectively a weapon proficiency with bow weapons. *Bonus to strike* with bow and arrow/crossbow: +1 at first level plus +1 to strike for each additional TWO levels of experience. *For Example:* Level one, +1; level three, +2; level five, +3 and so on.

Rate of Fire: Two at level one and ONE for each additional TWO levels of experience. *For example:* Level one, 2 shots per melee; level three, 3 shots; level five, 4 shots and so on.

<u>Bow Types and Ranges</u>	<u>S.D.C. Damage Per Arrow</u>
Short Bow — 420ft	1D6
Large Bow (longbow) — 700ft	1D8
Compound Bow — 800ft	2D6
Crossbow — 700ft	1D8

The skill also includes the ability to select the proper wood and make a quality bow. **Base Skill** to make a bow is 40% + 5% per level of experience. A *failed roll* means the bow is poorly crafted, is -1 to strike and has a 50% chance of cracking every time it is fired.

Boat Building: Is a great skill that enables the character to build a variety of rafts, small rowboats and large flatbed boats and even a canoe. A small raft can be made within 1D6 + 1 hours if the lumber or other suitable materials are available — a large raft within 4D6 hours. A canoe will take 2D6 days, rowboats — 4D4 days, large flatbed boat — 1D4 × 10 days. Time is doubled or even tripled if trees must be cut down and wood prepared. Of course, the amount of time can also

be reduced with several people working on the project. **Base Skill:** 25% + 5% per level of experience. A failed roll means the boat has leaks. Try patching it up for 4D4 hours and try again (this time, with a +10% bonus).

Carpentry: This is a fundamental knowledge of working with wood. The character can build chairs, tables, chests, stairs, repair wood items and so on. **Base Skill:** 30% + 5% per level of experience.

Identify Plants/Fruits: This is a skill to recognize the many different types of plants and fruits. This is a particularly handy skill when gathering herbs, edible mushrooms, and edible fruits and berries. **Base Skill:** 25% + 5% per level of experience.

Horsemanship: A familiarity with horses, how to ride them and take care of them.

Riding/care/feeding: A fundamental knowledge in the care and grooming of horses.

Recognize quality/breed: The percentile number indicates the success ratio of recognizing the quality (age, speed, health, etc.) and breed (race horse, way, riding, etc.) of horses in general.

Jump: The percentile number indicates the success ratio of NOT being thrown from the horse when jumping (or backing). Character must roll under the percentage to remain in the saddle and in control.

(+) **Plus to parry and dodge:** Applies to the rider, not horse. The rider gains a combat advantage from height and speed of being mounted.

Charge Attack: Adds +3 to damage with any ancient weapon, -2 to strike with guns or bow and arrow.

Horse Attack: Having the horse kick and rear. Two attacks per melee; front legs do 2D6 damage, rear do 4D6 damage (S.D.C.).

Bonuses: Attacking while mounted on a horse gives the character the advantages of height and speed. Plus +1 to parry and dodge, +2 to damage (S.D.C.).

Raise/Breeding Horses: This is a fundamental knowledge in the raising, training and breeding/mating horses.

Base Skill: 40% + 4% per level of experience. A failed roll means the character fails at what he was attempting. Make control rolls for difficult moves like charge attacks, leaps, and other sudden movements. A failed roll means the rider falls off his mount.

Hunting: A practiced skill at hunting, killing and preparing a variety of animals for food or sport. Includes a *W.P. Rifle* (bolt-action, not automatic) and a *skill bonus* of +2% for prowl, +5% for track animals, +5% to skin animals, and +5% to cook the catch. No base skill.

Skin and Prepare Animal Hides: This is the ability to carefully skin an animal, large and small, and be able to prepare/preserve/tan its hide for leather or fur. This ability also adds a +5% bonus to the sewing skill. **Base Skill:** 40% + 5% per level of experience.

Track Animals: This skill enables the character to identify an animal's tracks, scent, spore and likely habitat. The character can also follow the animal's tracks and other signs. This also means he/she can estimate how old the tracks are and what direction it headed.

Tracking humans with this skill is possible, but is done with a penalty of -20%. **Base Skill:** 30% + 5% per level of experience.

COMBAT

COMBAT TERMS

A.R.: This is a character's **Armor Rating**. The A.R. indicates what an attacker must roll in order to do damage to the character. Any roll of 5 or better will strike a character with no body armor. Characters with **Artificial Body Armor**, metal armor, bullet-proof vests, etc., can easily be successfully attacked by rolls falling under the artificial armor's A.R., doing damage to the S.D.C. of the *body armor*, but not to the S.D.C. of the defender. Or, by striking above the armor's A.R., damage the character's personal S.D.C. and/or hit points. **Example:** A defender has a natural A.R. of 5 and is wearing body armor with an A.R. of 8. If the attacker rolls 9 or better, then damage is done directly to the defender. A roll of 5, 6, 7, or 8, would only hurt the body armor, not the wearer. A roll of 1, 2, 3, or 4, would totally miss.

Damage Table (Basic)

Human Fist	1D4
Human Kick	1D6 or 1D8
Blackjack	1D6
Bull Whip	1D8
Thrown Small Objects	1D4
Falling	1D6 per 10ft
Collision	1D8 per 10mph
Smashing through Glass	1D4
Dropped or Thrown	
Large Objects	1D8 per 100lbs
	1D8 per 40ft, and 1D4 per 4mph

Death Blow: An automatic kill. The defender can try to roll with death blow by rolling over the attacker's strike. If the defender is not killed, then the current S.D.C. and hit points are reduced to half. This attack is available only under certain conditions.

Dodge: A character dodges by moving out of the way of the attack. Dodging always takes up one attack/action per melee round. To Dodge, the defender must roll higher than the attacker's strike roll on a twenty-sided die.

Entangle: A defender can attempt to trap the weapon or arm of an attacker. This is done instead of parrying or dodging, and takes up one attack per melee. An entangle is successful if the defender rolls above the attacker's strike roll. It takes one attack and a roll to entangle to keep an opponent's arm or weapon entangled every melee round. In order to get free, the entangled opponent must roll a dodge against the entangle roll.

Hand to Hand Combat: Fighting skills that provide the characters with attacks per melee, bonuses, and techniques. Characters without combat training have only one attack per melee and have *no* automatic chance to parry.

Hit Points: This is the number of points of damage a character can take before dying. Characters don't lose hit points until their S.D.C. is down to zero. A character's base hit points is the P.E. plus 1D6. Another 1D6 of hit points is gained every time the character advances an experience level. Lost hit points are not recovered without medical attention.

Initiative: Whoever gets to attack first is considered to have the Initiative. Initiative is automatic in sneak attacks and long range attacks. In most other cases, each opponent rolls a twenty-sided, highest roll gets the initiative. Rolling for initiative takes place at the beginning of each melee round of combat.

Kick Attack: This is a karate-style kick. It is a normal attack that does 1D4 damage for the untrained, or higher with hand to hand skills. Anyone trained in hand to hand combat can do a kick attack.

Knockout/Stun: Anyone hit by a knockout or stun attack will be temporarily incapacitated. The victim is not necessarily unconscious, just dazed.

Jump Kick: A Jump Kick is performed by leaping completely off the ground and attempting to land foot-first on an opponent. Jump Kick can be used only by those skilled in hand to hand martial arts. The advantage of a jump kick is that it works as a *critical strike* and doubles the normal damage inflicted. The disadvantage of a jump kick is that no other attack may be performed in that melee round (all attacks for that melee are used up in the kick). The jump kick must be the character's first attack of that melee round. For the rest of the melee round, the character can only parry, dodge or move into position.

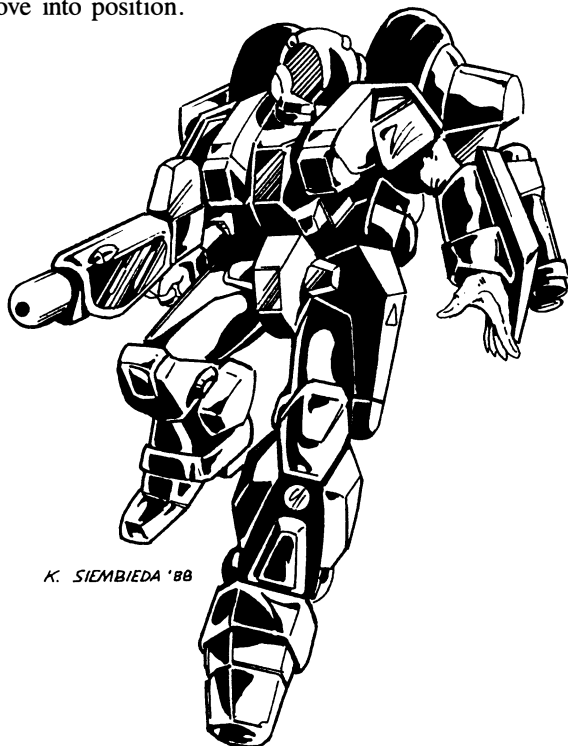

Leap Attack: An airborne assault where the weapons or fists are wielded in mid-leap. A leap attack must be made only at the beginning of a melee round and, like the jump kick, uses up *all* attacks for that melee. Usually, only a single strike can be made during a leap attack. However, if two opponents are close together, the attacker can leap between them and strike both of them at the same time; roll to strike for each character. After the leap, the character may not attack again until the next melee round, but can parry or dodge or move

into position. Automatic parries work in mid-leap, but dodges are impossible. A successful leap attack is a critical strike and does double damage.

Long-Range Attack: By using a long-range weapon from a distance, an attacker can perform an undetected *first strike*. Provided the attacker is not seen, the defender automatically loses initiative and may not dodge the first attack that melee round.

Melee or Melee Round: Exactly 15 seconds. The segment of time combatants have to strike, counter and/or return strike. Generally, playing characters have two or more attacks per melee.

Multiple Attackers: Takes place when an opponent is faced by more than one attacker. Characters with hand to hand combat skills can attempt to parry any attacks within their line of sight. The defender from multiple attackers can strike at only one target at a time (see leap attack for a rare exception).

Natural Twenty: This is the result of 20 when rolling a twenty-sided die. A strike with a natural twenty will always be a critical strike. If someone with a strike bonus of +2 rolls an 18, then they have an attack roll of 18 *plus* unnatural bonus modification; NOT a natural twenty, and it is not a critical strike. A natural twenty beats all other rolls and can only be parried or dodged by *another natural twenty*.

Paired Weapons: Certain kinds of weapons, such as Sais, Nunchaku, knives, clubs and swords, can be used as paired weapons. Users of paired weapons can strike and parry simultaneously, can do twin strikes against a single target or against a pair of targets, and can parry two different opponents at the same time. In other words, warriors skilled in paired weapons often can do two actions for every one of their melee attacks. BUT, every time they use twin actions they LOSE their automatic parry.

Parry: A defender can attempt to parry most physical attacks. This is done by blocking the attacker's blow with a weapon or hand. Characters trained in hand to hand combat can parry without losing melee attacks. Bullets and energy attacks *cannot* be parried!

Pull Punch: The ability to control the force of a hand to hand attack. Usually used to reduce the blow to less than killing force. The character can choose to half damage, quarter damage, a single point or no damage at all. A character must declare a pulled punch. The player must roll 11 or better on a twenty-sided die; failure means full damage is inflicted.

Roll with Punch/Fall: Hand to Hand combat fighters can reduce the damage from blows and falls by rolling. If the defender is successful, then only half damage is taken. Roll with punch/fall does not work against energy blasts, bullets, fire, bladed weapons, psionics or radiation. Victims must roll higher than the attacker's roll. *Falling* characters must roll a 14 or higher, on a twenty-sided die, to roll with the fall.

Saving Throws: Occasionally, characters must roll to save against exotic attacks like poison, gas, insanity, psionics, etc.

Lethal Poison	14 or better
Non-lethal Poison	16 or better
Harmful Drugs	15 or better
Acids	No save possible — Dodge!
Insanity	12 or better
Psionics	15 or better for non-psionics 10 or better for psionic

S.D.C.: This stands for *Structural Damage Capacity*, which is the amount of damage an object can absorb before breaking. Living creatures also have S.D.C.; it represents their physical resistance to damage. All the S.D.C. of a living thing must be reduced to zero before the hit points can be affected. Note: A cousin to S.D.C. is M.D.C. or Mega-Damage Capacity. M.D.C. applies to Mecha, and is explained in the Mecha Combat section which follows shortly.

S.D.C. Table (Basic)

Below are the S.D.C. values for a variety of objects. When an object's S.D.C. is reduced to zero, it is considered broken. Game masters should exercise common sense in applying these values. For example, a normal human cannot break through a vault door with bare fists, no matter how many times natural twenties are rolled.

The S.D.C. of different weapons is applied *only* if someone is actually attempting to break the weapon. A properly wielded sword can inflict or parry many times its S.D.C. On the other hand, using the sword to wedge open a door could easily snap it off.

It is also important to note that the S.D.C. applies to the entire object. A bullet can penetrate many objects with only a small fraction (about 2%) of S.D.C. loss. For example, if a bullet punching through an exterior brick wall hit a target, it would inflict normal damage minus the 4 points of S.D.C. it wasted getting through the wall.

Airplane, Single Engine	400 S.D.C.
Airplane, Jet Airliner	2000 S.D.C.
Boat, Canoe/Rowboat	40 S.D.C.
Boat, Cabin Cruiser	450 S.D.C.
Boat, Cargo Freighter	8000 S.D.C.
Box, Cardboard	2 S.D.C.
Box, Wood Shipping Crate	12 S.D.C.
Box, Metal Shipping Crate	48 S.D.C.
Car, Compact	250 S.D.C.
Car, Luxury	450 S.D.C.
Car, Door Only	150 S.D.C.
Car, Windshield Only	100 S.D.C.
Door, Interior Wood	100 S.D.C.
Door, Exterior Wood	170 S.D.C.
Door, Metal Grill	350 S.D.C.
Door, Solid Metal	600 S.D.C.
Door, Metal Safe	800 S.D.C.
Door, Bank Vault	5000 S.D.C.
Handcuffs, Regular	60 S.D.C.
Handcuffs, Heavy	120 S.D.C.
Lock, Common Latch	40 S.D.C.
Lock, Dead Bolt	100 S.D.C.
Lock, Heavy Padlock	75 S.D.C.
Motorcycle	100 S.D.C.
Truck, Medium Sized Pick-up	450 S.D.C.
Truck, Half-Ton Pick-up	550 S.D.C.
Truck, Freight Hauler	650 S.D.C.
Wall, Interior Plaster	120 S.D.C.
Wall, Exterior Wood	150 S.D.C.
Wall, Exterior Brick	200 S.D.C.
Wall, Cinder Block	300 S.D.C.
Wall, Reinforced Concrete	400 S.D.C.
Weapon, Hard Wood	40 S.D.C.
Weapon, Metal Sword	100 S.D.C.
Weapon, Small Pistol	35 S.D.C.
Weapon, Assault Rifle	75 S.D.C.

Simultaneous Attack: Instead of defending with a parry, dodge or entangle, a character can choose to do a simultaneous attack. In this case, the character does not defend ("Go ahead, hit me; I can take it!") and simply attacks in response. The advantage of a simultaneous attack is that *neither* opponent can parry, dodge or entangle. In all probability, both will take damage. *Exception:* An opponent with paired weapons can engage in simultaneous attack (with one weapon) AND parry (with the other), OR, both the paired weapons can be used to strike with NO parry.

Sneak Attack: An attacker may lie in wait (ambush), attack from behind, or sneak up (prowl) on an opponent. If the foe does not discover the attacker, then the sneak attack is successful. The sneak attacker always has initiative, and the defender is not able to parry or dodge the sneak attack.

Strike: Anyone attempting to hit an opponent must roll to strike. As with all combat rolls, a roll to strike is made with a twenty-sided die.

Throw: Simply, this means throwing a weapon. Rolling to throw is exactly the same as rolling to strike, except that there are different bonuses per weapon type. See Weapon Proficiency.

NOTE: A character may use ANY type of weapon, but gets no combat bonuses, such as strike or parry, unless he has a Weapon Proficiency (W.P.) in that particular weapon. This applies to modern and ancient weapons.

DETERMINING PHYSICAL S.D.C. FOR CHARACTERS

Each O.C.C. provides a base physical S.D.C. from training. They are as follows:

Veritech Pilot: 20

Cyclone Rider: 40

Military Specialist: 25

Bio-Maintenance Engineer: 20

Nomad Scout: 30

Freedom Fighter/Mercenary: 25

Nonmilitary Personnel (Typical Person): 10

Additional physical S.D.C. can be gained from physical skills such as Boxing. *All S.D.C. points are accumulative.*

HAND TO HAND: BASIC

- Level 1** Two attacks per melee; +2 to pull/roll with punch, fall or impact.
- +2 to parry and dodge.
 - Kick attack does 1D6 points damage.
 - One additional attack per melee.
 - +1 to strike.
 - Critical strike on an unmodified roll of 19 or 20.
 - +2 to damage.
 - Judo-style body throw/flip; does 1D6 damage, and victim loses initiative and one attack per melee.
 - One additional attack per melee.
 - An additional +2 to pull/roll with punch, fall or impact.
 - An additional +1 to parry and dodge.
 - An additional +1 to strike.
 - Critical strike or knockout from behind.
 - An additional +2 to damage.
 - An additional attack per melee.

HAND TO HAND: EXPERT

- Level 1** Two attacks per melee; +2 to pull/roll with punch, fall or impact.
- +3 to parry and dodge.
 - +2 to strike.
 - One additional attack per melee.
 - Kick attack does 1D6 damage.
 - Critical strike on an unmodified roll of 18, 19 or 20.
 - Paired weapons.
 - Judo-style body throw/flip; does 1D6 damage, and victim loses initiative and one attack.
 - One additional attack per melee.
 - +3 to damage.
 - Knockout/stun on an unmodified roll of 18, 19 or 20.
 - An additional +1 to parry and dodge.
 - Critical strike or knockout from behind (triple damage).
 - An additional attack per melee.
 - Death blow on a roll of natural 20.

HAND TO HAND: MARTIAL ARTS

- Level 1** Two attacks per melee; +3 to pull/roll with punch, fall or impact.
- +3 to parry and dodge; +2 to strike.
 - Karate-style kick does 1D8 damage.
 - One additional attack per melee.
 - Jump kick (critical strike).
 - Critical strike on an unmodified roll of 18, 19 or 20.
 - Paired weapons.
 - Leap attack (critical strike).
 - One additional attack per melee.
 - Judo-style body throw/flip; does 1D6 damage, victim loses initiative and one attack.
 - An additional +4 to damage.
 - An additional +2 to parry and dodge.
 - Knock-out/stun on an unmodified roll of 18, 19 or 20.
 - An additional attack per melee.
 - Death blow on a roll of a natural 20.

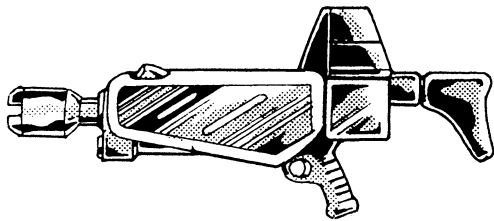

MODERN WEAPON PROFICIENCIES

The original system for modern weapons presented in **Heroes Unlimited** and **Teenage Mutant Ninja Turtles & Other Strangeness** consist of fairly accurate and effective rules. However, they tend to bog down the speed of play with numerous dice rolls for damage and time determining how many rounds fired actually strike. I've since developed a quick playing, alternative set of rules, which appears for the first time in a formal, large press publication. (The same rules saw print earlier this year in a special, promotional pamphlet). Game masters should

feel free to substitute these rules, if they prefer, with those from the previously mentioned game books or even those from the **Revised RECON**. All are modern weapon rules that would work just as well in **ROBOTECH**®.

Weapon Proficiencies (W.P.) are areas of training and practiced skill with a particular type of weapon, such as revolver or sub-machinegun. This skill provides special bonuses to strike when using that weapon. Do not add this strike bonus to your character's hand to hand or Mecha combat skill bonuses to strike.

Weapon Proficiencies provide the following bonuses:

Aimed: +3 to strike.

Burst: +1 to strike.

Wild: No bonus or penalty.

Training also enables the character to easily reload, disassemble, unjam, clean and otherwise maintain the weapon. **Recognizes weapon quality** — 30% at level one and +6% per each additional level of experience. **Add a bonus** of +1 to strike for every THREE levels of experience beyond level one. When firing a weapon, there are three main modes or categories of attack: *aimed, burst or wild*.

AIMED

An **aimed shot** means a person takes the time to carefully aim and squeeze off one well placed shot. Each individual shot takes one full attack. Thus, if a character has four attacks per melee he/she can shoot FOUR aimed shots. This applies to all weapons. Roll to strike for each shot.

Bonus to Strike is +4 with a revolver or +3 for all others.

BURST

A **burst** is the shooting of several rounds, one immediately after another. Aim is more hasty and the recoil moves the weapon with each shot, reducing the accuracy. Semiautomatic/automatic weapons, machineguns and sub-machineguns are designed for burst firing. The concept is that, while accuracy is reduced, the odds of hitting one's target with multiple rounds is increased because more shots are fired.

Bonus to Strike is +1 with all weapons.

Note: Roll to strike once to see if the entire burst hits. Do not roll for each individual bullet. If the burst misses its target, then all the rounds in that burst miss.

Short bursts fire 20% of the entire round magazine; i.e., 30 round magazine — 6 rounds/bullets are fired. Damage: Roll the normal damage dice for ONE round $\times 2$. Uses up one attack. Can be fired at only one target.

Long bursts fire 50% of the entire round magazine; i.e., 30 round magazine — 15 rounds/bullets are fired. Damage: Roll the normal damage dice for ONE round $\times 5$. Uses up one attack. Can be fired at only one target.

Entire magazine: Shooting off the entire clip/magazine within a melee round is possible. 100% of the rounds are fired. Damage: Roll the normal damage dice for ONE round $\times 10$. Uses up *two* attacks that melee. Can be fired at only one target. Machineguns are the only exception to this rule.

Spray: Shooting a burst at several targets at once is possible, but is the same as shooting wild. You must fire a *long burst or an entire magazine* in order to spray. See shooting wild.

SHOOTING WILD

Shooting wild occurs when a trained character shoots without taking time to aim. This usually applies when the person is blinded, angry, running, rolling, leaping, shooting from a moving vehicle, etc.

Bonus to Strike: With a W.P., there is no bonus or penalty; with no W.P., the person strikes at -6 . Long bursts or the entire magazine must be fired. Counts as two attacks. Can be fired at one target or in a spray. **Damage for shooting wild at one target:** Roll normal damage dice for ONE round $\times 2$. Roll once to strike with the wild burst. **Hitting an innocent bystander** is a real possibility when shooting wild; 20% chance. Roll for each wild burst fired. **Damage** is the normal damage from one round (a wild shot).

Spraying an area with bullets can be dangerous and is considered to be shooting wild. The object of a spray is to hit several targets simultaneously. **First**, roll once to determine if you strike the target area; 1D20; 5 or higher strikes as usual. Then roll 1D4 to determine how many individual targets are struck within the target area. However, each target gets a roll to dodge to avoid getting shot. **Damage** is the normal damage from one round. **Hitting an innocent bystander** is even more likely; 50% chance. **Damage** is from one round (a wild shot.)

Bursts or Sprays from a machinegun are different only in the number of rounds fired, targets struck, and chance of hitting a bystander. Machineguns have a much greater ammunition capacity, so they do not have to empty the same percentage of their entire clips.

Short burst/one target: 10% of rounds/magazine; inflicts normal round damage $\times 2$. Counts as one attack.

Short burst spray: 10% of rounds/magazine; inflicts normal damage from ONE round, hits 1D4 targets.

Long burst/one target: 30% of rounds/magazine; inflicts normal damage $\times 5$. Counts as one attack.

Long burst spray: 30% of rounds/magazine; inflicts normal damage from ONE round, hits 1D8 targets. Counts as one attack.

Empty the entire magazine/one target: All rounds fired; inflicts normal round damage $\times 20$. Counts as all melee attacks/one full melee.

Empty the entire magazine in a spray: All rounds fired; inflicts normal round damage $\times 2$, hits 2D8 targets. Counts as ALL melee attacks/one full melee. Chance of hitting innocent bystanders is 70%.

A Special Note About Shotguns:

Shotguns can fire once or twice per melee (double-barreled). It can fire both rounds simultaneously or one at a time. Buckshot scatters, and will strike the specific target plus 1D4 others within its blast area (approximately a 15ft/4.6m area).

Note: *Conventional Weapons* will do absolutely NO DAMAGE to Mecha or mega-structures (M.D.C.), even if the combined damage from a burst is over 100 S.D.C. Only weapons that inflict mega-damage (M.D.) can damage a mega-structure.

No Weapon Proficiency means the character shoots without bonuses to strike.

W.P. Gallant H-90: This is a separate weapon proficiency because of its unique multi-configurations, and damage capabilities. As always, anybody can try to use any weapon whether they have a W.P. in it or not (no bonuses to strike

if not). But in the case of the Gallant H-90, the person will not know about the increasing or decreasing of damage and range, or how and why to add its attachments.

W.P. Cyclone Weapon Systems: This skill is exclusive to the cyclone rider O.C.C. and gives the character a $+1$ bonus to strike when using any of the standard cyclone weapons. They include the CADS-1 Saber system, EP-37 60mm beam cannon, EP-40 rocket cannon, RL-6 rocket cannon, GR-97 forearm missile launcher, GR-103 mini-missile launcher and missile launcher sidecar.

W.P. Heavy: Includes the use of grenade launchers, rocket launchers, the RL-6 rocket cannon, and other bazooka-like weapons.

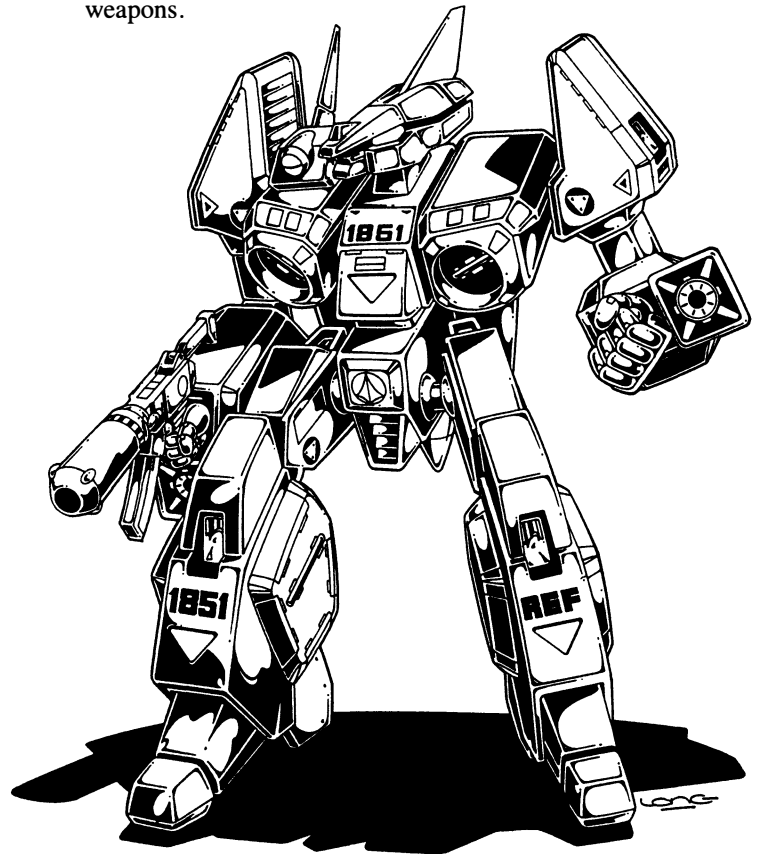

MECHA COMBAT

MINI-MISSILES

Mecha Combat is mostly unchanged; see *Robotech® RPG*, pgs 34-38.

The only real difference is the inclusion of **mini-missiles**. The cyclones and some special REF heavy weapons and vehicles utilize mini-missiles; small, powerful bazooka type rockets that inflict mega-damage. Range is generally half as great as the standard RDF short-range missiles, but the mega-damage is comparable.

Unlike its larger predecessors, the mini-missile is not self-guided and has no special bonuses to strike. **Strike bonuses** are the same as *modern weapon proficiencies*; **aimed** (firing no more than two missiles, $+3$), **bursts** (firing a volley of missiles in any quantity, 3 to 60) and **wild** (firing a missile or volley of missiles without taking time to stop and aim). A character can also add in any strike bonus from a high Physical Prowess (P.P.) attribute.

Mini Missiles for the Cyclone and Special Armaments

<u>Warhead</u>	<u>Mega-Damage</u>	<u>Speed</u>	<u>Maximum Range</u>	<u>Blast Radius</u>
High Explosive	5D6	500mph (804kmph)	1 mile (1.6km)	5ft (1.5m)
Fragmentation	5D6	500mph (804kmph)	½ mile (0.8km)	20ft (6.1m)
Armor Piercing	1D4 × 10	1400mph (2251kmph)	1 mile (1.6km)	3ft (0.9m)
*Plasma/Heat	1D6 × 10	1200mph (1929kmph)	1 mile (1.6km)	15ft (1.5m)
Smoke	None	500mph (804kmph)	20ft (6.1m)	

*Plasma/heat can only be used in the GR-97 forearm missile launcher of the Cyclone Battler.

Short Range Missiles

<u>Warhead</u>	<u>Mega-Damage</u>	<u>Speed</u>	<u>Maximum Range</u>	<u>Blast Radius</u>	<u>M.D.C.</u>
High Explosive (light)	1D4 × 10	500mph (804kmph)	3 miles (4.8km)	10ft (3m)	5
High Explosive (Med.)	1D6 × 10	500mph (804kmph)	2 miles (3.2km)	15ft (4.6m)	5
Fragmentation (light)	1D4 × 10	450mph (724kmph)	2 miles (3.2km)	20ft (6.1m)	5
Armor Piercing (Med.)	1D6 × 10	650mph (1045kmph)	5 miles (8km)	5ft (1.5m)	5
Plasma/Napalm (Med.)	1D6 × 10	500mph (804kmph)	3 miles (4.8m)	15ft (4.6m)	5
Tear Gas	None	200mph (321kmph)	½ mile (.8km)	10ft (3m)	5
Knock-Out Gas	None	200mph (321kmph)	½ mile (.8km)	10ft (3m)	5
Smoke (colors available)	None	300mph (482.7kmph)	1 mile (1.6km)	20ft (6.1m)	5
Fire Retardent	None	200mph (321kmph)	½ mile (.8km)	20ft (6.1m)	5

Medium Range Missiles

<u>Warhead</u>	<u>Mega-Damage</u>	<u>Speed</u>	<u>Maximum Range</u>	<u>Blast Radius</u>	<u>M.D.C.</u>
High Explosive (light)	1D6 × 10	1200mph (1929kmph)	50 miles (80.4km)	20ft (6.1m)	10
High Explosive (Med.)	2D4 × 10	1200mph (1929kmph)	40 miles (64.3km)	20ft (6.1m)	10
High Explosive (Heavy)	2D6 × 10	1200mph (1929kmph)	40 miles (64.3km)	30ft (9.1m)	10
Fragmentation (Med.)	2D4 × 10	1000mph (1608kmph)	40 miles (64.3km)	40ft (12.2m)	10
Armor Piercing (Med.)	2D4 × 10	1600mph (2571kmph)	60 miles (80.4km)	20ft (6.1m)	10
Plasma/Heat (Heavy)	2D6 × 10	1400mph (2251kmph)	40 miles (64.3km)	40ft (12.2m)	10
Multi-Warhead	2D4 × 10	1200mph (1929kmph)	80 miles (128.7km)	20ft (6.1m)	10
Smoke	None	1000mph (1608kmph)	40 miles (64.3km)	40ft (12.2m)	10

Long Range Missiles

<u>Warhead</u>	<u>Mega-Damage</u>	<u>Speed</u>	<u>Maximum Range</u>	<u>Blast Radius</u>	<u>M.D.C.</u>
High Explosive (Med.)	2D4 × 10	1600mph (2571kmph)	500 miles (804km)	30ft (9.1m)	20
High Explosives (Heavy)	3D4 × 10	1600mph (2571kmph)	500 miles (804km)	40ft (12.2m)	20
Fragmentation (Heavy)	3D4 × 10	1400mph (2251kmph)	400 miles (643km)	80ft (24.4m)	20
Armor Piercing (Med.)	2D4 × 10	2010mph (Mach 3)	800 miles (1286km)	30ft (9.1m)	20
Plasma/Heat (Med.)	2D6 × 10	1400mph (2251kmph)	500 miles (804km)	40ft (12.2m)	20
Plasma/Heat (Heavy)	3D6 × 10	1400mph (2251kmph)	500 miles (804km)	50ft (15.2m)	20
Proton Torpedo (Heavy)	4D6 × 10	2010mph (Mach 3)	1200 miles (1928km)	50ft (15.2m)	25
Reflex (Med.)	2D6 × 10	1800mph (2892kmph)	1000 miles (1608km)	40ft (12.2m)	20
Reflex (Heavy)	3D6 × 10	1800mph (2892kmph)	1000 miles (1608km)	50ft (15.2m)	20
Reflex Multi-Warhead	4D6 × 10	1800mph (2892km)	1800 miles (2893km)	50ft (15.2m)	25

HAND TO HAND BONUSES FROM CYCLONE COMBAT TRAINING

- 2 hand to hand attacks per melee (plus those of the pilot).
- Body flip/throw: 1D4 M.D. plus victim loses initiative and one attack that melee. Possible only in battloid mode.
- Body block/tackle/ram: 1D4 M.D. plus 70% chance of knocking opponent down (this will cause the victim to lose initiative and one attack that melee). Counts as TWO attacks.
- Kick attack.
- Leap kick; counts as two attacks.
- +1 to strike.
- +2 to parry.
- +3 to leap dodge. An automatic dodge just like the parry, with no loss of attacks per melee. The cyclone is so mobile that the pilot can leap, hop, and skip out of the way without penalty.
- +3 to dodge. This is the regular type of dodge, applicable when in motorcycle mode.
- +3 to roll with punch, fall or impact (explosion), reducing damage by half.
- Critical strike, same as pilot's hand to hand.
- One additional hand to hand attack at level five.
- One additional hand to hand attack at level ten.

Damage: **Punch** 1D4 M.D.

Kick 1D4 M.D.

Leap Kick 2D4 M.D.

Body Flip/Throw 1D4 M.D.

Body Block/Tackle 1D4 M.D.

The Cyclone also has a physical strength (P.S.) equal to a P.S. 40 (+25 S.D.C. damage bonus).

NOTE: The VR-038-LT (Light Combat) cyclone enjoys the following *additional bonuses*:

+1 to parry

+1 to leap dodge (automatic)

+1 to dodge in motorcycle mode

+1 to roll with punch, fall or impact

+1 on initiative.

P.S. of the VR-038-LT is equal to P.S. 30

Remember, these bonuses are in addition to the pilot's own hand to hand training and attribute bonuses, but apply **ONLY** when piloting a cyclone in battloid mode. These mecha combat bonuses do *not* apply to the pilot's physical abilities when outside the mecha. **Note:** Changing modes counts as one attack/action that melee round.

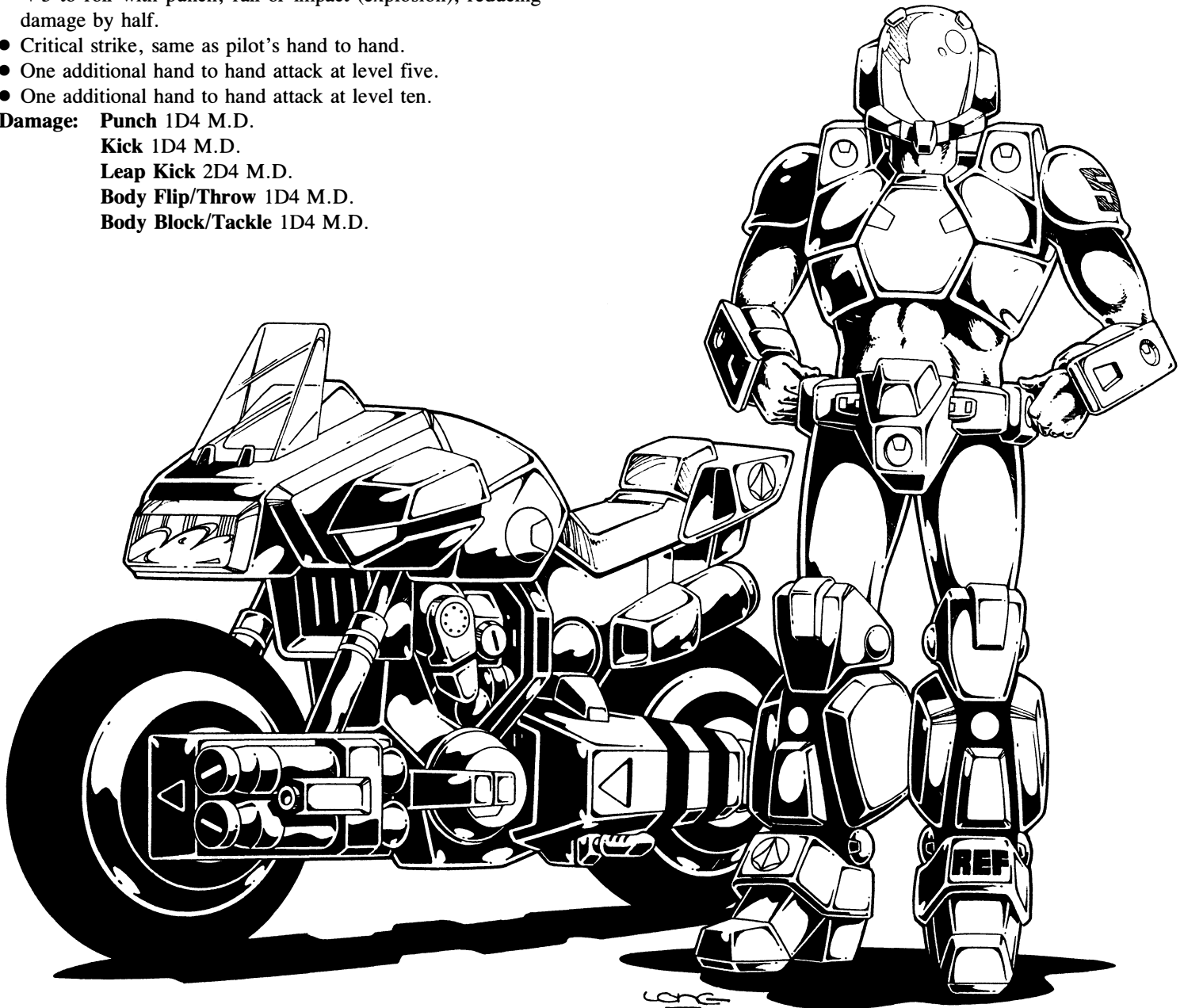

HAND TO HAND BONUSES FROM CYCLONE BASIC TRAINING

This category applies to all characters who were not officially trained by the RDF, Southern Cross or Expeditionary Force in mecha combat.

- One hand to hand attack per melee (plus those of the pilot).
- Body flip/throw: 1D4 M.D. plus victim loses initiative and one attack that melee. Possible in battloid mode only.
- Body block/tackle/ram: 1D4 M.D. plus a 60% chance of knocking opponent down (this will cause the victim to lose initiative and one attack that melee). Counts as TWO attacks.
- Kick attack.
- Leap attack; counts as two attacks.
- +1 to strike.
- +1 to parry.
- +1 to leap dodge. An automatic dodge just like the parry, with no loss of attacks per melee.
- +2 to dodge. This is the regular type of dodge applicable when in motorcycle mode.
- +2 to roll with punch, fall or impact (explosion), reducing damage by half.
- Critical strike same as pilot's hand to hand.
- One additional hand to hand attack at level six.
- One additional hand to hand attack at level eleven.

Damage: **Punch** 1D4 M.D.

Kick 1D4 M.D.

Leap Kick 2D4 M.D.

Body Flip/Throw 1D4 M.D.

Body Block/Tackle 1D4 M.D.

Remember, these bonuses are in addition to the pilot's own hand to hand training and attribute bonuses, and apply **ONLY** when piloting a cyclone in battloid mode. These mecha combat bonuses do *not* apply to the pilot's physical abilities when outside the mecha. **Note:** Changing modes counts as one attack/action that melee round.

HAND TO HAND BONUSES FROM ALPHA COMBAT TRAINING

- 3 hand to hand attacks per melee (plus those of the pilot).
- Body flip/throw: 1D4 M.D. plus victim loses initiative and one attack that melee. Possible only in battloid mode.
- Body block/tackle/ram: 1D6 M.D. plus a 70% chance of knocking opponent down (this will cause the victim to lose initiative and one attack that melee). Counts as TWO attacks.
- Kick attack.
- Leap kick; counts as two attacks.
- +2 to strike.
- +2 to parry.
- +3 to dodge in battloid & guardian modes; +5 to dodge in jet mode (this is a conventional dodge).
- +3 to roll with punch, fall or impact (explosion), reducing damage by half.
- Critical strike, same as pilot's hand to hand.
- One additional hand to hand attack at level six.
- One additional hand to hand attack at level eleven.

Damage: **Punch** 1D6 M.D. in battloid.

Punch 1D4 M.D. in guardian.

Kick 1D6 M.D. (possible only in battloid).

Leap Kick 2D6 M.D. (possible only in battloid).

Body Flip/Throw 1D6 M.D.

Body Block/Tackle 1D6 M.D.

Stomp 1D4 M.D. in Battloid

Remember, these bonuses are in addition to the pilot's own hand to hand training and attribute bonuses. These mecha combat bonuses do *not* apply to the pilot's physical abilities when outside the mecha.

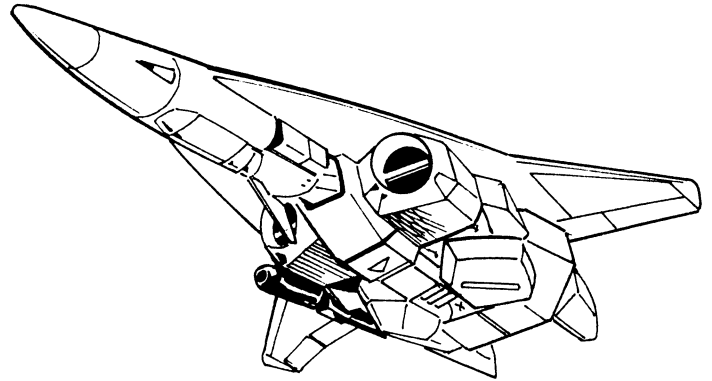

HAND TO HAND BONUSES FROM ALPHA BASIC TRAINING

This category applies to all characters who were not formally trained by the RDF, Southern Cross or Expeditionary Force in mecha combat.

- One hand to hand attack per melee (plus those of the pilot).
- Body flip/throw: 1D4 M.D. plus victim loses initiative and one attack that melee. Possible only in battloid mode.
- Body block/tackle/ram: 1D4 M.D. plus a 60% chance of knocking opponent down (this will cause the victim to lose initiative and one attack that melee.) Counts as TWO attacks.
- Kick attack.
- Leap attack; counts as two attacks.
- +1 to strike.
- +1 to parry.
- +1 to dodge in battloid and guardian modes, +3 to dodge in jet mode.
- +2 to roll with punch, fall, or impact (explosion), reducing damage by half.
- Critical strike, same as pilot's hand to hand.
- One additional hand to hand attack at level seven.
- One additional hand to hand attack at level twelve.

Damage: **Punch** 1D6 M.D. in battloid.

Punch 1D4 M.D. in guardian.

Kick 1D6 M.D. (possible only in battloid).

Leap Kick 2D6 M.D. (possible only in battloid).

Body Flip/Throw 1D6 M.D.

Body Block/Tackle 1D6 M.D.

Stomp 1D4 M.D. in battloid; effective only against small objects (12ft/3.6m tall or smaller).

Remember, these bonuses are in addition to the pilot's own hand to hand training and attribute bonuses. These mecha combat bonuses do *not* apply to the pilot's physical abilities when outside the mecha.

HAND TO HAND BONUSES FROM BETA COMBAT TRAINING

- 2 hand to hand attacks per melee (plus those of the pilot).
- Body flip/throw: 1D4 M.D. plus victim loses initiative and one attack that melee. Possible only in battloid mode.
- Body block/tackle/ram: 1D6 M.D. plus a 73% chance of knocking opponent down (this will cause the victim to lose initiative and one attack that melee). Counts as TWO attacks.
- Kick attack.
- +1 to strike.
- +3 to parry. Can use arm shield to block missile attacks.
- +2 to dodge in battloid & guardian modes; +4 to dodge in jet mode (this is a conventional dodge).
- +2 to roll with punch, fall or impact (explosion), reducing damage by half.
- Critical strike, same as pilot's hand to hand.
- One additional hand to hand attack at level seven.
- One additional hand to hand attack at level thirteen.

Damage: **Punch** 1D6 M.D. in battloid.

Punch is not possible in guardian (no arms).

Kick 1D6 M.D. (possible only in battloid).

Leap Kick is not possible.

Body Flip/Throw 1D6 M.D.

Body Block/Tackle 1D6 M.D.

Stomp 1D4 M.D. in Battloid

Remember, these bonuses are in addition to the pilot's own hand to hand training and attribute bonuses. These mecha combat bonuses do *not* apply to the pilot's physical abilities when outside the mecha.

HAND TO HAND BONUSES FROM BETA BASIC TRAINING

This category applies to all characters who were not formally trained by the RDF, Southern Cross or Expeditionary Force in mecha combat.

- One hand to hand attack per melee (plus those of the pilot).
- Body flip/throw: 1D4 M.D. plus victim loses initiative and one attack that melee. Possible only in battloid mode.
- Body block/tackle/ram: 1D4 M.D. plus a 60% chance of knocking opponent down (this will cause the victim to lose initiative and one attack that melee.) Counts as TWO attacks.
- Kick attack.
- +1 to strike.
- +2 to parry.
- +1 to dodge in battloid and guardian mode, +3 to dodge in jet mode.
- +1 to roll with punch, fall, or impact (explosion), reducing damage by half.
- Critical strike same as pilot's hand to hand.
- One additional hand to hand attack at level seven.
- One additional hand to hand attack at level thirteen.

Damage: **Punch** 1D6 M.D. in battloid.

Punch is not possible in guardian (no arms).

Kick 1D6 M.D. (possible only in battloid).

Leap Kick is not possible.

Body Flip/Throw 1D6 M.D.

Body Block/Tackle 1D6 M.D.

Stomp 1D4 in Battloid

HAND TO HAND BONUSES FROM VINDICATOR COMBAT TRAINING

- Two hand to hand attacks per melee (plus those of the pilot).
- Body flip/throw: 1D4 M.D. plus victim loses initiative and one attack that melee. Possible only in battloid mode.
- Body block/tackle/ram: 2D4 M.D. plus an 80% chance of knocking opponent down (this will cause the victim to lose initiative and one attack that melee.) Counts as TWO attacks.
- Kick attack.
- +1 to strike.
- +2 to parry.
- +2 to dodge in battloid mode.
- +4 to dodge in guardian mode.
- +6 to dodge in jet mode.
- +3 to roll with punch, fall, or impact (explosion), reducing damage by half.
- Critical strike same as pilot's hand to hand.
- One additional hand to hand attack at level six.
- One additional hand to hand attack at level eleven.

Damage: **Punch** 1D6 M.D. in battloid.

Punch 1D4 M.D. in guardian mode.

Kick 1D6 M.D. (possible only in battloid).

Leap Kick 1D6 M.D. (possible only in battloid).

Body Flip/Throw 1D6 M.D.

Body Block/Tackle 1D6 M.D.

Stomp 1D4 M.D.; effective only against small objects (12ft/3.6m tall or smaller).

Remember, these bonuses are in addition to the pilot's own hand to hand training and attribute bonuses. These mecha combat bonuses do *not* apply to the pilot's physical abilities when outside the mecha.

HAND TO HAND BONUSES FROM VINDICATOR BASIC COMBAT TRAINING

- One hand to hand attack per melee (plus those of the pilot).
- Body flip/throw: 1D4 M.D. plus victim loses initiative and one attack that melee. Possible only in battloid mode.
- Body block/tackle/ram: 2D4 M.D. plus an 80% chance of knocking opponent down (this will cause the victim to lose initiative and one attack that melee.) Counts as TWO attacks.
- Kick attack.
- No strike bonus.
- +1 to parry.
- +1 to dodge in battloid mode.
- +2 to dodge in guardian and jet modes.
- +2 to roll with punch, fall, or impact (explosion), reducing damage by half.
- Critical strike same as pilot's hand to hand.
- One additional hand to hand attack at level seven.
- One additional hand to hand attack at level thirteen.

Damage: **Punch** 1D6 M.D. in battloid.

Punch 1D4 M.D. in guardian mode.

Kick 1D6 M.D. (possible only in battloid).

Leap Kick 1D6 M.D. (possible only in battloid).

Body Flip/Throw 1D6 M.D.

Body Block/Tackle 1D6 M.D.

Stomp 1D4 M.D.; effective only against small objects (12ft/3.6m tall or smaller).

Remember, these bonuses are in addition to the pilot's own hand to hand training and attribute bonuses. These mecha combat bonuses do *not* apply to the pilot's physical abilities when outside the mecha.

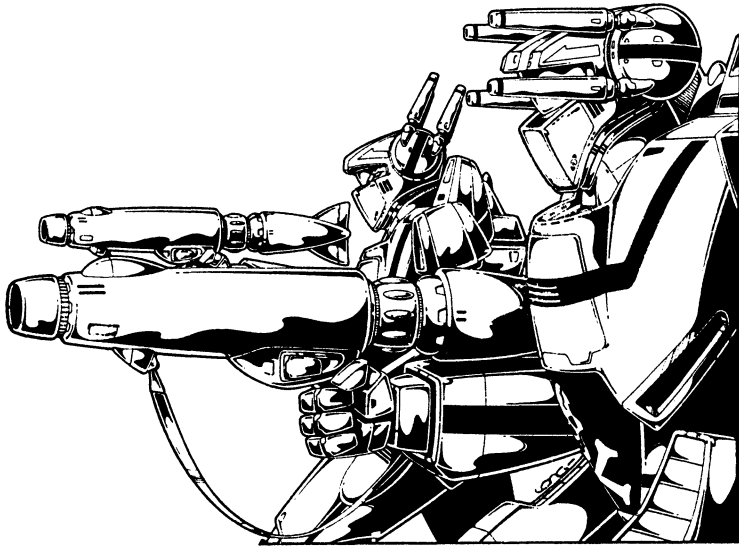

THE MECHA AND WEAPONS OF THE SOUTHERN CROSS, RDF AND ZENTRAEDI

The Southern Cross

The weapons, mecha and vehicles of the **Southern Cross** can still be found from time to time. However, most of the Southern Cross' bases (ruins) have already been excavated by human survivors. Thus, most salvageable equipment is in the possession of freedom fighters, gangs, bandits, mercenaries and towns.

Of the mecha, the Veritech Hover Tank is the most common and they are very few and far between. The Logan Fighter and AJACS Attack Copter are virtually nonexistent. Occasionally, a non-transformable battloid such as the G.M.P. Multi-Purpose Battloid, T.C. Recon Battloid and C.D.U. Battloids will turn up.

The most common remaining articles of the Southern Cross include the hover cycle, armored land rover, A.T.A.C. body armor, T.C. body armor, C.D.U. body armor, standard backpack, standard survival kit, standard utility belt, heavy and light combat shields, tri-laser, P-20 pulse laser, Lancer laser pistol (See *Southern Cross*, pg 89), and LR-20 laser rifle (See *Southern Cross*, pg 90), but energy clips are scarcer than the weapons.

The RDF

Its been about 15 years and two devastating global wars since the **RDF** once maintained peace on Earth. What little RDF mecha that was left behind by the Robotech Expeditionary Force (R.E.F.) was destroyed in the two global assaults. Still, an occasional old destroid, usually a gladiator or excaliber, or veritech fighter can be found from time to time.

Surprisingly, there are still a number of RDF vehicles and equipment in use today. They include non-protoculture powered L.V.T. Adventurer II, Falcon Jet Fighter (quite uncommon), Howard LH-2000 Helicopter, the Sea-Sergeant Helicopter, the Commanchero Assault Helicopter (the favorite weapon of the big towns and bandit groups, but becoming increasingly scarce), Land Rover, RDF Motorcycle and RV-B Dune Buggy. The old RDF body armor and laser rifles are very uncommon.

Conventional motor vehicles, military and commercial, are all desperately sought after. The biggest demand is for all terrain vehicles, jeeps, other four-wheel drive vehicles, motorcycles, and trucks. Helicopters and small aircraft are also desired, but few aircraft remain.

Mechanics who can repair, modify and build vehicles are generally treated like kings and desperately sought after. Their expertise is crucial in this devastated world where industry has been destroyed. Only they can fix and maintain the precious relics of the past.

The Zentraedi

Most Zentraedi rogues (98%) were eliminated during the Zentraedi uprisings of 2019 and 2020. All others were micronized and integrated into human society or became members of the REF. What few full size Zentraedi and mecha that currently exist can be found in the jungles of South America and Asia (old rogues and E.B.S.I.S. soldiers). The entire population of rogue Zentraedi *may* number as many as 1000 in South America, and 3000 scattered throughout Asia and Indonesia and Indo-China quadrants combined. Those in the E.B.S.I.S. were annihilated with the rest of Europe.

For the most part, Zentraedi rogues keep to themselves, carving out a life in the jungle. They avoid the invid and humans alike. However, some, especially those of South America are conducting their own guerilla type offensive against the invid. After all, the Zentraedi were created to destroy invid. The ex-E.B.S.I.S. soldiers are most likely to join forces with human freedom fighters.

The most common Zentraedi mecha include Tactical Battle Pods, Light Artillery Pods, Officer's Pods (much less common than the former two) and an *occasional* Fighter Pod, Female and Male power armor and Reentry Pods.

Any traces of the *Robotech Masters* have been completely atomized by the invid.

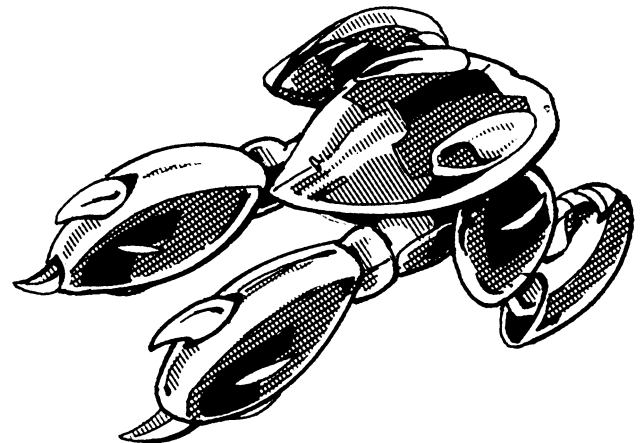

OPTIONAL RULES

Optional Ways to Round Out Your Character

I've found that many players like as much background and details about their characters as possible. Consequently, I've assembled a series of optional tables to satisfy those details. All tables require the roll of percentile dice.

Age

I think it's best to generally assume most characters are young; late teens to mid-twenties.

- 1-30 Late Teens (16, 17, 18 or 19)
- 31-60 Early Twenties (20-22)
- 61-80 Mid-Twenties (23-25)
- 81-00 Late Twenties (26-28)

Family Ties: Parents

- 1-10 Died in Zentraedi global assault.
- 11-20 One died in the Robotech Master's assault; 1-50 mother, 51-00 father.
- 21-35 Both died in the Invid assault.
- 36-45 One died in the Invid assault; 1-50 father, 51-00 mother.
- 46-50 Both are in space on board the SDF-3.
- 51-60 Both alive and well.
- 61-70 Both died in the Invid assault on Moon Base.
- 71-80 One killed by bandits or wild gang; 1-50 father, 51-00 mother.
- 81-90 Orphan; never knew your parents.
- 91-00 Taken by Invid and never seen again (both).

Relationship to the Other Characters (Roll for each character in the group)

- 1-5 Brother or sister.
- 6-20 No relationship developed yet.
- 21-30 Friends
- 31-50 No relationship developed yet.
- 51-60 Dislikes the other.
- 61-70 Friends
- 71-90 No relationship developed yet.
- 91-00 Both members of the REF/RDF.

Disposition

- 1-10 Hates invid and all aliens, very prejudiced, distrusts all aliens.
- 11-15 Shy, timid; tends to be a loner.
- 16-20 Gung-ho, guts and glory type who sees self as a hero. Likes combat.
- 21-25 Worrywart, nervous and cautious.
- 26-37 Hot-headed, quick-tempered, emotional, but basically nice.
- 38-45 Schemer, gambler who likes to take chances.
- 46-50 Blabber mouth; nice guy, but too talkative.
- 51-56 Wild man; cocky, overconfident, takes unnecessary risks.
- 57-66 Nice guy; friendly, courteous and hospitable.
- 67-76 Snob; arrogant, feels superior to others.
- 77-84 Tough guy; self-reliant, cocky, a lone wolf.
- 85-89 Paternal; overbearing, overprotective of others, especially young characters.
- 90-94 Complainer, constantly aggravated about something.
- 95-00 Paranoid, trusts no one.

Land of Origin

- 1-16 Europe
- 17-25 Jupiter Base
- 26-40 South America
- 41-55 North America
- 56-70 Mars Base
- 71-85 Moon Base
- 86-95 Robotech Factory in Space
- 96-00 SDF-3 in Space

Birth Order

- 1-30 First Born
- 31-60 Second Born
- 61-90 Last Born
- 91-00 Illegitimate

Weight

- 1-20 Skinny
- 21-40 Average
- 41-60 Husky
- 61-80 Potbelly
- 81-00 Obese

Note: Average weight:

- 150 to 180lbs, male
- 110 to 140lbs, female

Height

- 1-30 Short
- 31-70 Average
- 71-00 Tall

Note: Average height:
6ft, male
5ft 6in, female

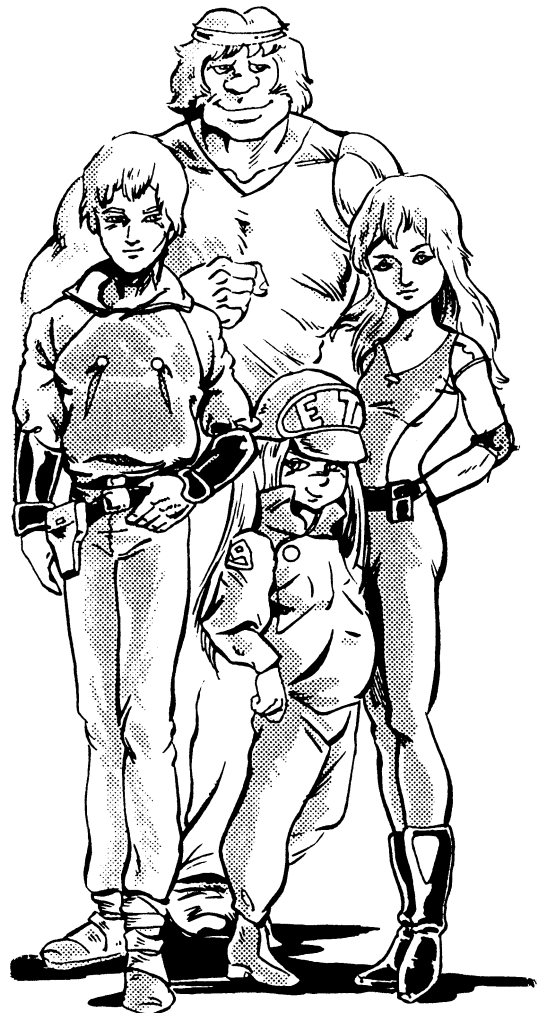

THE CYCLONE

Veritech Riding Armor

The Cyclone is the latest achievement in human robototechnology. The mecha unit is a light, but heavy-duty motorcycle that can transform into a battloid mecha that's almost as formidable as the old Veritech Fighter. The veritech riding armor is composed of new super alloys that are incredibly light, making the creation of a heavily armored, man-sized mecha possible. The mecha is so lightweight (200lbs/90kg) and compact that it can be folded down and placed inside a storage unit in an Alpha Fighter. Despite the fact that it is lightweight, the armor provides 200 M.D.C. protection, better than the Southern Cross' Logan and almost equal to the 40ft (12.2m) VF series Veritech.

The Cyclone is designed to be the ultimate land combat system for the RDF foot soldier. In **motorcycle mode**, the cyclone offers high mobility, maneuverability and speed. The motorcycle can travel over the worst terrain with minimal difficulty and is a much smaller target than a more conventional four-wheeled vehicle. This makes the cyclone ideal for clandestine operations, reconnaissance and one-man missions, as well as for massive troop movements.

In **battloid mode**, the cyclone becomes a suit of protective power armor. The seven foot (2.1m) mecha provides a variety of devastating weapon systems, easy conversion from M.D.C. weaponry to S.D.C. weapons, superhuman strength, superhuman speed and even limited flight. As power armor, the battloid is like a second skin that responds to the wearer's slightest movement. Combined with the unique bond between man and machine created by its protoculture power cells, the mecha can leap, roll and dodge with lightning speed. (*See Hand to Hand Bonuses from Cyclone Combat Training for specific bonuses in close combat.*)

To maximize the versatility of the Cyclone Veritech, the mecha can operate on both protoculture and gasoline. However, the limitations of liquid fuel prevents flight and inhibits its maximum speed and mobility. The liquid fuel is included as a back-up system to be used when the protoculture energy cells are running low or are, not available.

A **fully powered protoculture cell** will last about two months of constant combat and riding. Moderate use of the motorcycle mecha can stretch that by two or three times. Flying depletes the energy three as quickly. Cells not in use will stay at full power for decades.

There are three styles, or models, of Cyclone Veritech Riding Armor. The first and most common is the **VR-052 Battler Cyclone**. The Battler is designed to be a frontline combat unit with heavy assault capabilities. It comes standard with GR-103 front loaded mini-missiles and a pair of GR-97 forearm missile shields. The cyclone rider can use any variety of conventional or M.D.C. weapons as sidearms. Standard issue is the **Gallant H-90**, a multipurpose sidearm that can be used as an automatic pistol (S.D.C.), energy pistol (M.D.C.) or energy rifle (M.D.C. and long range). The Battler Cyclone has been included in the Alpha Fighter as a combat/survival mecha unit for downed pilots. It also gives the pilot the extra versatility to conduct air and ground combat maneuvers.

The **VR-041 Saber Cyclone** is identical to the Battler, with minor stylistic changes. The one significant difference is the replacement of the forearm mini-missile launcher system with the newly developed Close Assault and Defense System (C.A.D.S.), Model One. CADS-1 are a pair of disc-like arm shields that contain a retractable, high-frequency pair of mega-damage blades. The sabers can slice through M.D.C. structures as easily as a conventional sword cuts through S.D.C. structures. The original concept was to create a weapon system suitable for special forces assigned to clandestine operations. The silent, but deadly weapons are ideal for espionage. The only sound they make is a low hum. Approximately one in every 50 cyclones are fitted with CADS. Note: Other hand-held weapons can also be used by the pilot.

The third type of veritech riding armor is the **VR-038-LT (Light Combat Unit)**. The "38 Lite," as it is often called, is a lighter version of its predecessor (about 110lbs/50kg). It is designed specifically to accommodate the many valiant female soldiers in the RDF. The Light Combat Cyclone is less heavily armored (lower M.D.C. of 150) and does not come equipped with any type of missile system. However, the Light Combat Cyclone is even more maneuverable than the other cyclones. (*See Hand to Hand Combat Bonuses from Cyclone Combat Training special note.*) To compensate for its lack of built-in armaments, the 38-Lite comes equipped with the RL-6 Heavy Rocket Cannon, a sort of high-tech, multi-round bazooka. The weapon is hand-held and can be fired in the cyclone armor, or without the armor as a shoulder supported weapon like a LAW rocket launcher. Most cyclone designed weapon accessories are too heavy or awkward to be used without the cyclone armor.

CYCLONE

Model Types (3): VR-052 Battler (Scott Bernard type)
VR-041 Saber (Lancer type)
VR-038-LT (Light Combat; Rook type)

Class: Military Operation Soldier Protection Emergency Aviation Drive Auto.

Crew: One

M.D.C. by Location:

Headlight (front) — 2
Front Tire — 2
Rear Tire — 2
Storage Box (2) — 2
Rocket Thrusters (rear) — 50
*Main Body — 200

*Depleting the M.D.C. of the main body will shut the mecha down completely, making it useless.

M.D.C. by Location in Battloid Mode:

Tires (2, mounted behind shoulders) — 2 each
Rocket Thrusters (rear, lower back) — 50
**Forearm Shields (2) — 50 each
Legs (2) — 100 each
Head — 50
*Main Body — 200

*Depleting the M.D.C. of the main body will shut the mecha down completely, rendering it useless. An emergency release system allows the person inside to shed

the immobilized armor. Remember, the wearer of the cyclone armor is also wearing ride-armor underneath it for added protection. Note: The VR-038 Light Combat Cyclone has a Lower Main Body M.D.C. of 150.

**The forearm shields of the VR-052 cyclone mecha (Scott's) have a GR-97 short-range missile system (standard for the VR-052). They have still 50 M.D.C. each arm.

Speed: Motorcycle Mode: 210mph (336kmph) maximum. Typical cruising speed is around 80mph (128kmph). The mecha is equipped with heavy shock absorbers and reinforced M.D. body to easily handle rough terrain at high speeds. Turbo boost by the rear jet enables the motorcycle to make leaps of up to 40ft (12.2m) across or hurl itself 20ft into the air. Battloid Mode, Running: 60mph (96kmph) maximum. Battloid Mode, Flying: Hover stationary up to 30ft (9.1m) above the ground and fly up to 200ft (61.5m) high and at a maximum speed of 180mph (288kmph). However, flight uses up protocluture energy cells three times faster than normal. Flight is not possible without protocluture. Battloid Mode Leaping: The powerful legs of the cyclone mecha can leap up to 20ft (6.1m) high or across unassisted by the thruster. *A thruster assisted leap* can propel the mecha up to 100ft (30.5m) high or lengthwise.

Height: Battloid Mode: 7ft (2.1m)
Motorcycle Mode: 3.6ft (1.09m)

Width: Battloid Mode: 3.4ft (1.03m)
Motorcycle Mode: 1.6ft (0.5m)

Length: Battloid Mode: 3.10ft (0.94m)
Motorcycle Mode: 5ft

Weight: VR-052 Battler & VR-041 Saber — 200lbs (90kg)
VR-038 Light Combat — 110lbs (49kg)

Cargo: Has detachable cargo boxes (2) that can be connected to the rear of the bike like saddlebags. The size of each container is 18 inches tall by 20 inches wide by 18 inches deep (18×20×18). A passenger can also ride seated behind the driver. **Maximum cargo weight limit**, in addition to the rider is 250lbs (113kg). Reduce maximum speed by 20% for every additional 50lbs (22kg) and – 1 to dodge. **NOTE:** The storage boxes and passenger drop off the motorcycle when it changes into a cyclone battloid. Valuables in the storage box must be retrieved later or carried in one hand. *Storage box weight per pair:* 10lbs (4.5kg) empty. One storage box can hold 12 mini-missiles (weight — 24lbs).

WEAPON SYSTEMS

Weapon Systems by Model Type

The VR-052 Battler (Scott Bernard Type)

1. GR-103 Mini-Missile Launcher (2): This standard weapon is built into the VR-052 and VR-041 cyclones. In motorcycle mode, the two missile launchers are side by side in the nose of the cycle. In battloid mode, the missile launchers are divided, with one on each side of the chest/shoulder area. Both launchers hold six missiles (usually armor piercing).

Primary Purpose: Assault

Secondary Purpose: Anti-Aircraft (ground to air missiles)

Missile Type: *Mini-missiles* designed for cyclone mecha and a handful of special bazooka-like rifles. Any of the available types of missiles can be utilized, but *armor piercing* is standard issue for the VR-052 Battler.

Mega-Damage: Varies with type of missile.

Rate of Fire: One at a time or in volleys of 2, 4, 6 or all. The number of missile volleys which can be fired per melee is equal to the pilot's combined number of hand to hand attacks. Remember, each volley, even a volley of 4 or more missiles, counts as one attack.

Range: Varies with missile type, but always around one mile (1.6km).

Payload: Each missile launcher holds six (6) each, for a total of twelve (12).

2. GR-97 Forearm Missile Launcher: The VR-052 Battler comes automatically equipped with a pair of missile launchers built into the forearm shields of the cyclone. These appear as two cylinder shaped canisters that run the length of the arm shield. Each canister contains one mini-plasma missile. The missiles can be fired one at a time or in pairs. **NOTE:** When the cyclone is in motorcycle mode, the launchers are stored at the base of the front wheel.

Primary Purpose: Assault

Secondary Purpose: Anti-Aircraft (ground to air missiles)

Missile Type: Plasma mini-missiles only!

Mega-Damage: 1D6×10 M.D.

Rate of Fire: Individual or a volley of two (2) fired simultaneously.

Range: One mile (1.6km)

Payload: Four (4) total, but up to 12 additional missiles can be securely fitted in one cyclone storage box. Each missile weighs 2lbs (0.9kg).

Note: The GR-97 can be used by any of the other cyclone models as an *optional* weapon system in place of its standard weapon. Likewise, the VR-052 Battler Cyclone can discharge the GR-97 missile launcher and then use any of the other arm/shield weapon systems. ALL cyclone weapon systems are interchangeable.

3. Gallant H-90 Multi-Weapon System: The Gallant H-90 is a standard sidearm issued to all cyclone, alpha and beta pilots of the RDF Expeditionary Force. It is a versatile weapon that can be used as a S.D.C. automatic pistol, M.D.C. pistol, or M.D.C. high-powered rifle complete with attachable rifle stock. *See the Gallant description in the weapon section for more details.*

Primary Purpose: Assault

Range: Varies. S.D.C. semiautomatic — 200ft (61m); Pulse Energy Pistol — 500ft (152m); Pulse Energy Rifle — 1400ft (427m).

Mega-Damage: Varies. S.D.C. semiautomatic — 4D6 S.D.C. damage per shot. Although bursts of energy are fired on the semiautomatic setting, they do only S.D.C. damage, not M.D. Pulse Energy Pistol — 1D6 M.D. per blast. Pulse Energy Rifle — 4D6 M.D. per blast.

Rate of Fire: Aimed, burst or wild. *See Modern Weapon Proficiencies.*

Payload: *The S.D.C. damage pistol* draws so little energy as to be considered unlimited with a single energy clip (estimate 1000 blasts).

Pulse Energy Pistol: 20 blasts per energy clip. The Gallant can be switched from a S.D.C. pistol type weapon to an energy pistol with the flick of a switch. However, to convert it into an energy rifle, the rifle stock and "extra" rifle energy clip must be attached.

Pulse Energy Rifle: 30 blasts per rifle energy clip. An addi-

VR-052 Battler with GR-97 Forearm Missile Launcher
(Scott Bernard Type)

Battler with
EP-40 Pulse Beam Gun
(Rand Type)

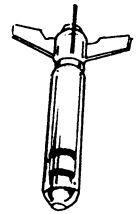
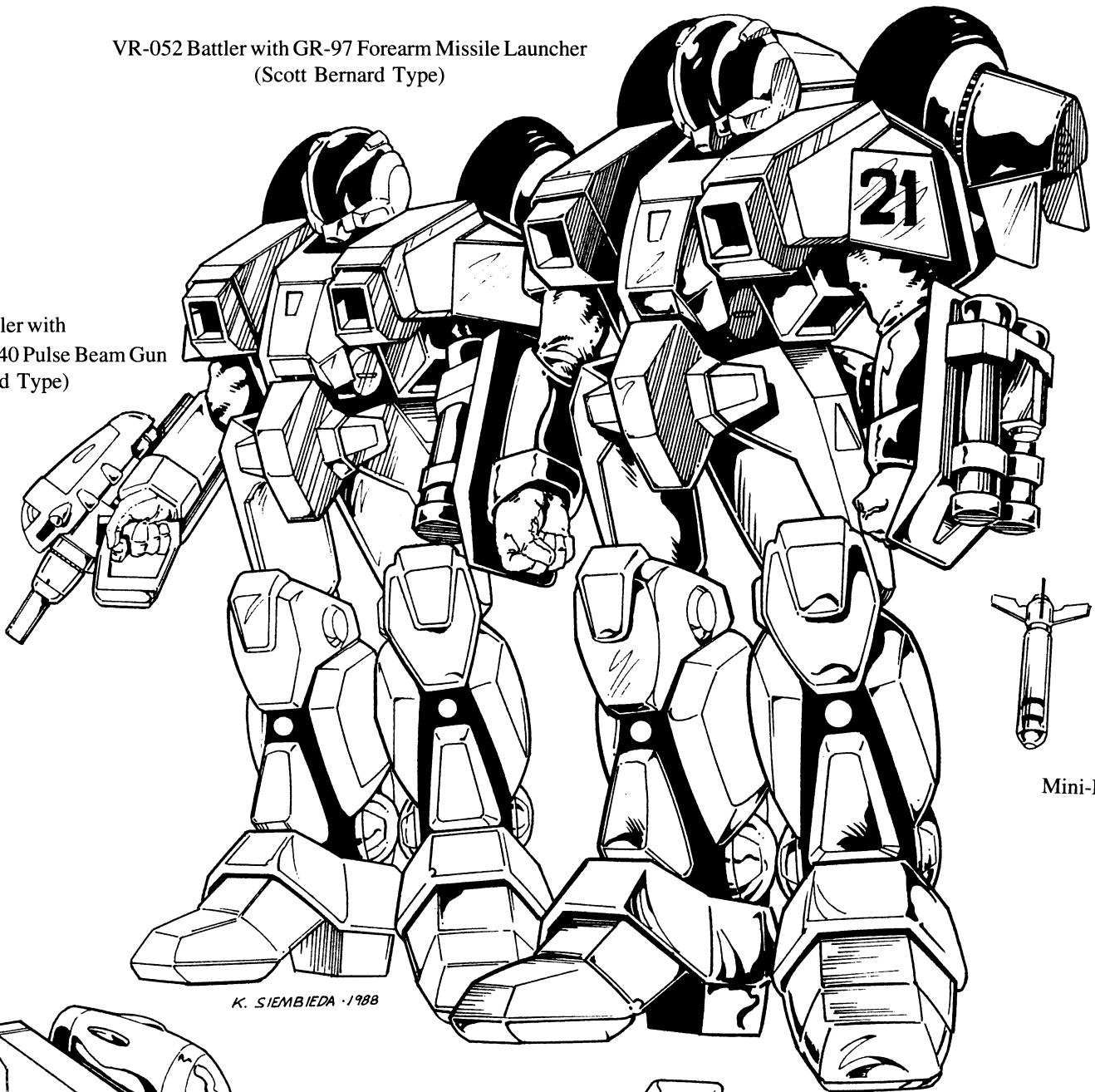

Mini-Missile

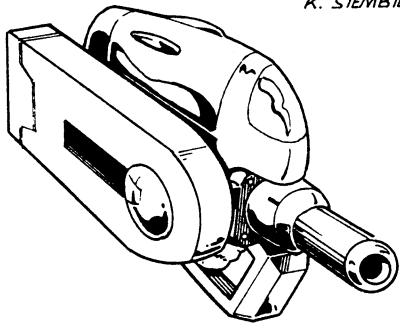

EP-40 Pulse Beam Gun

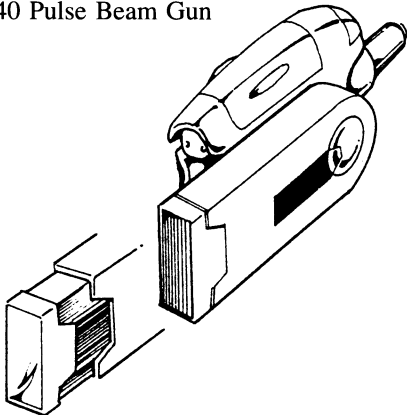

Battler in Motorcycle Mode

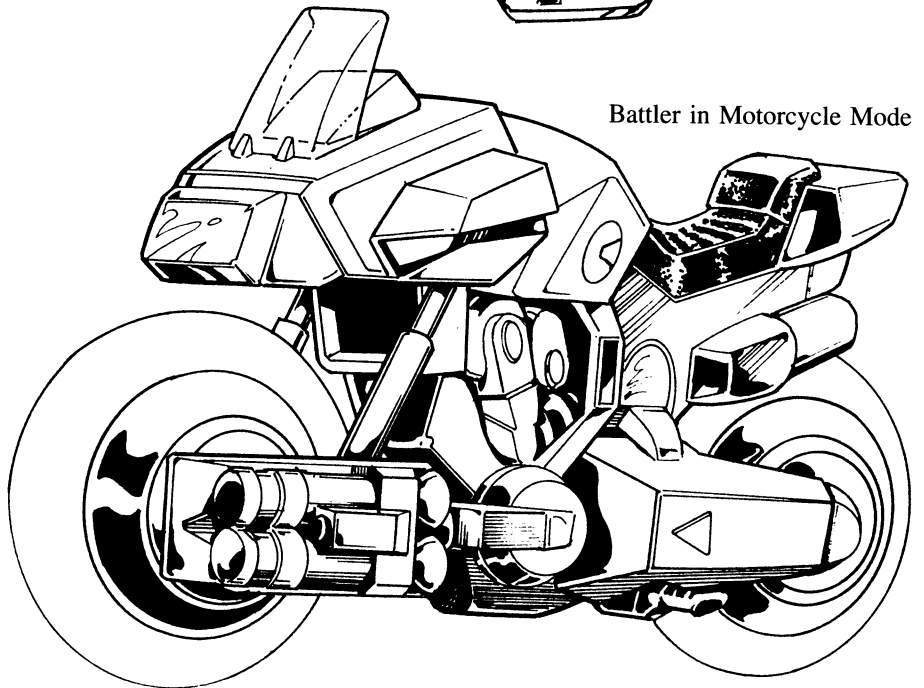

tional energy clip and rifle stock container must be attached to use as a rifle.

Note: The Gallant uses protoculture energy.

- 4. Hand to Hand Combat:** Rather than fire any weapons the cyclone can engage in hand to hand combat. Punch does 1D4 M.D., kick does 1D4 M.D. (VR-052 & VR-041 cyclone mecha have an equivalent strength of P.S. 40, the VR-038-LT has a P.S. 30). Leap kick — 2D4 M.D., body flip — 1D4 M.D., or body block — 1D4 M.D.

OPTIONAL WEAPON SYSTEMS

- 1. Missile Launcher Sidecar:** The sidecar can be attached to the cyclone in motorcycle mode only, or onto any type of larger, conventional motorcycle. The sidecar will automatically detach and drop away from the cyclone when it changes into battloid.

Primary Purpose: Assault

Secondary Purpose: Anti-Aircraft (ground to air missiles)

Missile Type: Any *mini-missiles* except plasma. Usually high explosive or fragmentation are used.

Mega-Damage: Varies with missile type.

Rate of Fire: One at a time or in volleys of 3, 6 or 9 (all). As always, a volley, regardless of the number of missiles, is counted as one attack.

Range: Varies with missile type, but always around one mile (1.6km).

Payload: Holds a total of nine (9) mini-missiles.

- 2. EP-37 60mm Beam Cannon:** A large energy rifle designed for the cyclone foot soldier as an additional weapon system. The weapon is stored on the right or left side next to the front wheel hub in motorcycle mode, but must be carried in battloid mode. It can be used by normal humans not in cyclone mecha like a rifle, but is heavy and awkward, and imposes a penalty of -3 to strike.

The EP-37 system comes complete with a built-in telescopic, passive, light amplifying (night sight) targeting system.

Primary Purpose: Assault

Range: 4000ft (1200m)

Mega-Damage: 1D4 × 10 M.D. per blast.

Rate of Fire: Aimed, burst or wild. *See Modern Weapon Proficiencies.*

Payload: 10 blasts per energy clip.

Weight: 14lbs (6.4kg). M.D.C. of Weapon: 5

- 3. EP-40 40mm Pulse Beam Gun** (Rand's cyclone weapon). Another energy weapon designed specifically for use with cyclone mecha. The weapon appears to be a large pistol that can be stored on either side of the front wheel hub in motorcycle mode and is mounted on the forearm shield, in place of a GR-97 missile launcher, for storage in battloid. The EP-40 must be held in hand to be fired while in battloid mode.

In motorcycle mode, the weapon can be rotated upward in a 45 degree angle and *fired* by pressing a trigger in the handle bars.

The EP-40 system comes complete with a built-in laser targeting system that provides a *bonus of +1 to strike*. Unfortunately, its weight and awkward design makes it almost impossible for it to be used by humans not in cyclone mecha. Strike penalty for humans is -10, and it can only be used

as a two-handed weapon.

Primary Purpose: Assault

Range: 2000ft (609m)

Mega-Damage: 4D6 M.D. per blast

Rate of Fire: Aimed, burst or wild. *See Modern Weapon Proficiencies.*

Payload: 30 blasts per energy clip.

Weight: 22lbs (10kg). M.D.C. of Weapon: 10.

Special Bonus: +1 to strike — thanks to the laser targeting system.

- 4. RL-6, Heavy Rocket Cannon** (*See VR-038-LT Cyclone*).
- 5. CADS-1** (*See VR-041 Saber Cyclone*), but not recommended.
- 6. Any type of hand-held weapon** can be fired while in cyclone mecha.

The VR-041 Saber (Lancer Type) Weapon Systems

- 1. Close Assault and Defense System (CADS-1)** is the most advanced hand to hand weapon system built for mecha. In place of the other types of forearm shield weapons available, the Saber Cyclone is fitted with large disc-like shields that contain the CADS-1 system. With the press of a manual stud control or by voice activation (a spoken 4 digit code), one or both of the retractable high-frequency sabers will spring out for instant use. The sabers are double-edged, sword-like weapons with a high-frequency energy field around them, creating a mega-damage blade weapon. Hence, the "Saber" part of this mecha's name.

The blades are powered by the cyclone's own power supply and can not be removed without tools. Frequent use of the blades will drain the protoculture cell twice as quickly.

Detached from the cyclone mecha, a CADS-1 is a worthless weapon, weighing far too much to wield even as a two-handed weapon and it no longer has mega-damage capability (does 2D6 S.D.C., but is -10 to strike and parry).

Primary Purpose: Hand to Hand Combat

Secondary Purpose: Clandestine operations (silent and deadly).

Range: Within reach

Mega-Damage: Slash — 2D6 M.D., Punch — 3D6 M.D., or Power Punch — 6D6 (counts as two attacks).

Number of Attacks Per Melee: Equal to combined hand to hand attacks.

Weight: 25lbs each (11.4kg)

M.D.C. Special: 50 when retracted, but a renewing force field provides the blades and forearms with unlimited M.D.C. when extended (this only protect the saber blades and forearms).

Special Bonus: Adds +2 to parry in hand to hand combat and even enables the character to attempt to *parry/block energy blasts*, but with absolutely no bonuses (natural, unmodified dice rolls only).

Note: The CADS system comes standard with the VR-041 Saber Cyclone (one for each arm). Opting for a different weapon system or split systems is not advised and uncommon. In motorcycle mode, the CADS are located on either side of the front wheel hub. Penalty: The inclusion of the CADS-1 system on the other two cyclones will reduce their maximum speeds by 20% per each unit.

VR-041 Saber
(Lancer Type)

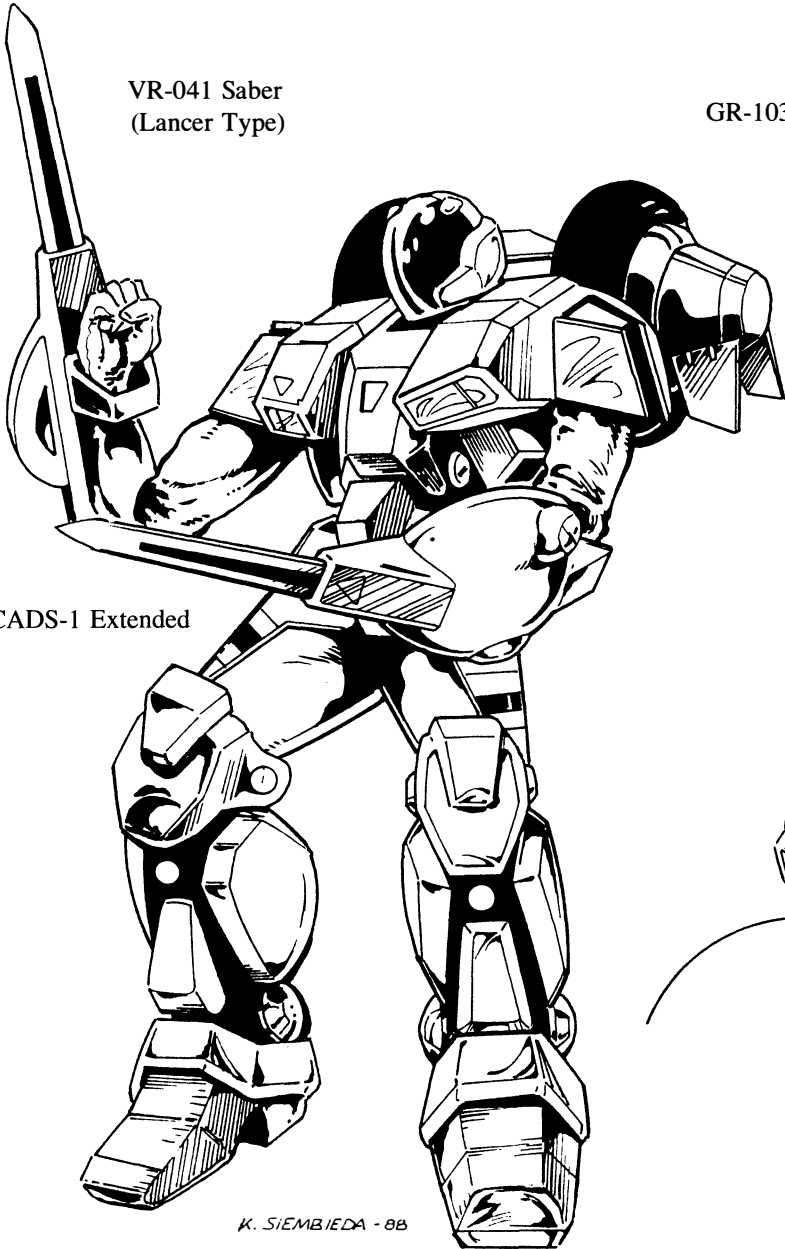

Mini-Missile

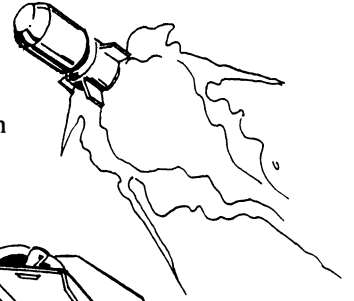

GR-103 Mini-Missiles Location
in Battloid Mode

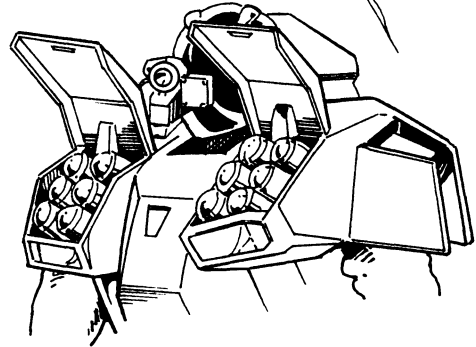

CADS-1 Extended

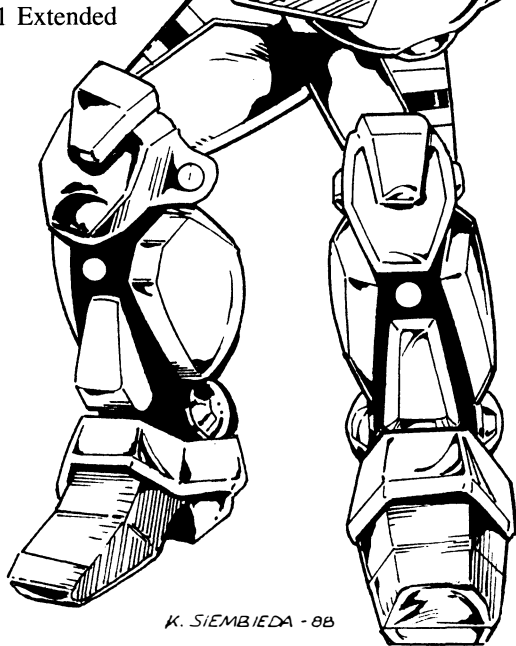

GR-103 Mini-Missiles Location
in Motorcycle Mode

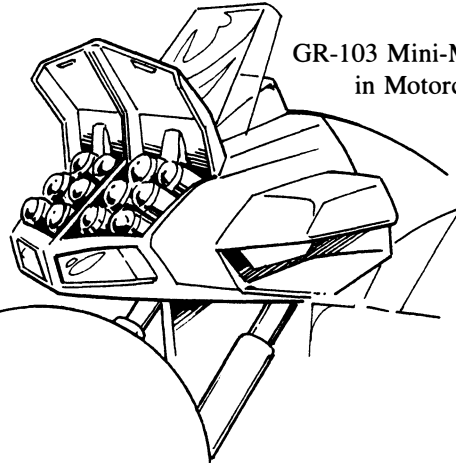

Rear View

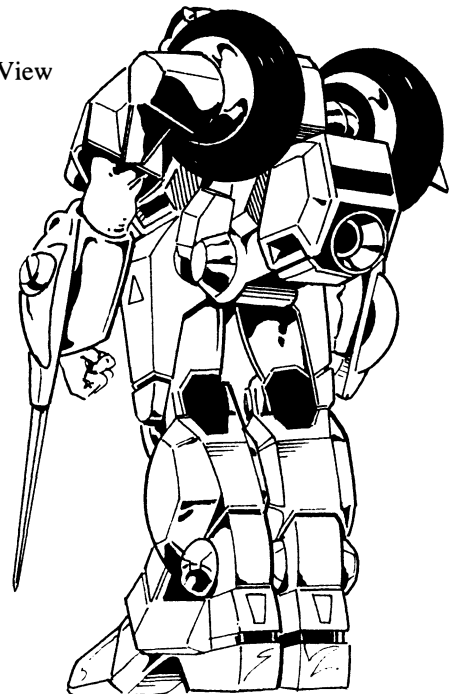

Motorcycle Mode

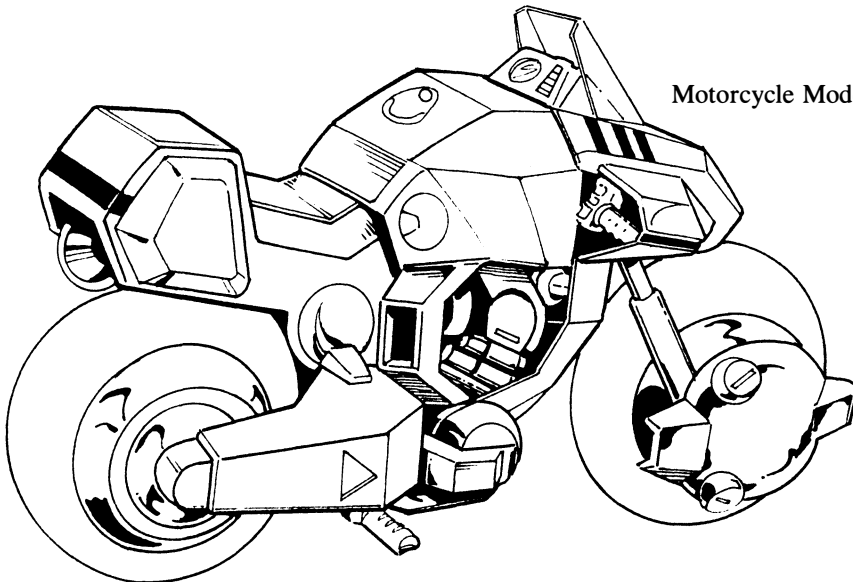

2. **GR-103 Mini-Missile Launcher (2):** This is identical to the VR-052 Battler Cyclone (#1).
3. **Gallant H-90 Multi-Weapon System** is issued as the sidearm. Identical to the VR-052 Battler Cyclone (#3).
4. **Hand to Hand Combat:** Same as the VR-052 Battler, or the CADS can be used in place of a punch. Blades can not be used in motorcycle mode.

OPTIONAL WEAPONS

- 1) **GR-97 Forearm Missile Launcher** is not recommended, but can be *substituted* for the CADS.
- 2) **Missile Launcher Sidecar.** See Battler.
- 3) **EP-37 60mm Beam Cannon.** See Battler.
- 4) **EP-40 40mm Pulse Beam Gun** is not recommended, but can be *substituted* for the CADS.
- 5) **RL-6 Rocket Cannon.** See VR-038-LT Cyclone.
- 6) **Any type of hand held weapon.**

Special Equipment: Same as VR-052 Battler Cyclone.

The VR-038 Light Combat Cyclone (Rook's Type) Weapon Systems

1. **RL-6 Heavy Rocket Cannon.** The RL-6 is standard issue with the Light Combat Cyclone. Unlike some of the other weapons, the RL-6 rocket cannon can be mounted on the cycle's undercarriage for storage or top mounted on the right or left side. In the top mounted position, the rocket cannon can be easily fired, but in a fixed forward position.

The mini-missile rockets are carried in a six (6) round box magazine. Reloading of all six missiles requires one full

melee. The RL-6 Rocket Cannon is a futuristic version of a recoilless rifle and *can* be used by normal humans wearing no mecha as a shoulder supported weapon.

Primary Purpose: Assault

Range: 4000ft (1200m)

Mega-Damage: Varies with mini-missile type, but usually uses armor piercing, high explosive or fragmentation. Can use any mini-missiles *except* plasma.

Rate of Fire: Up to all six can be fired in a single melee, but only one at a time.

Payload: Six (6) mini-missiles.

Weight: 16lbs (7.3kg) M.D.C. of Weapon: 3

2. **Gallant H-90 Multi-Weapon System** is issued as the sidearm to all RDF Cyclone riders. Identical to the description under VR-052 Battler Cyclone (#3).
 3. **Hand to Hand Combat:** Same as the VR-052 Battler, but with additional *bonuses* for mobility and light weight (See *Hand to Hand Bonuses for Cyclone Combat Training*).
- Note:** The GR-103 mini-missile launcher is NOT available to the light combat cyclone.

Female Body Armor

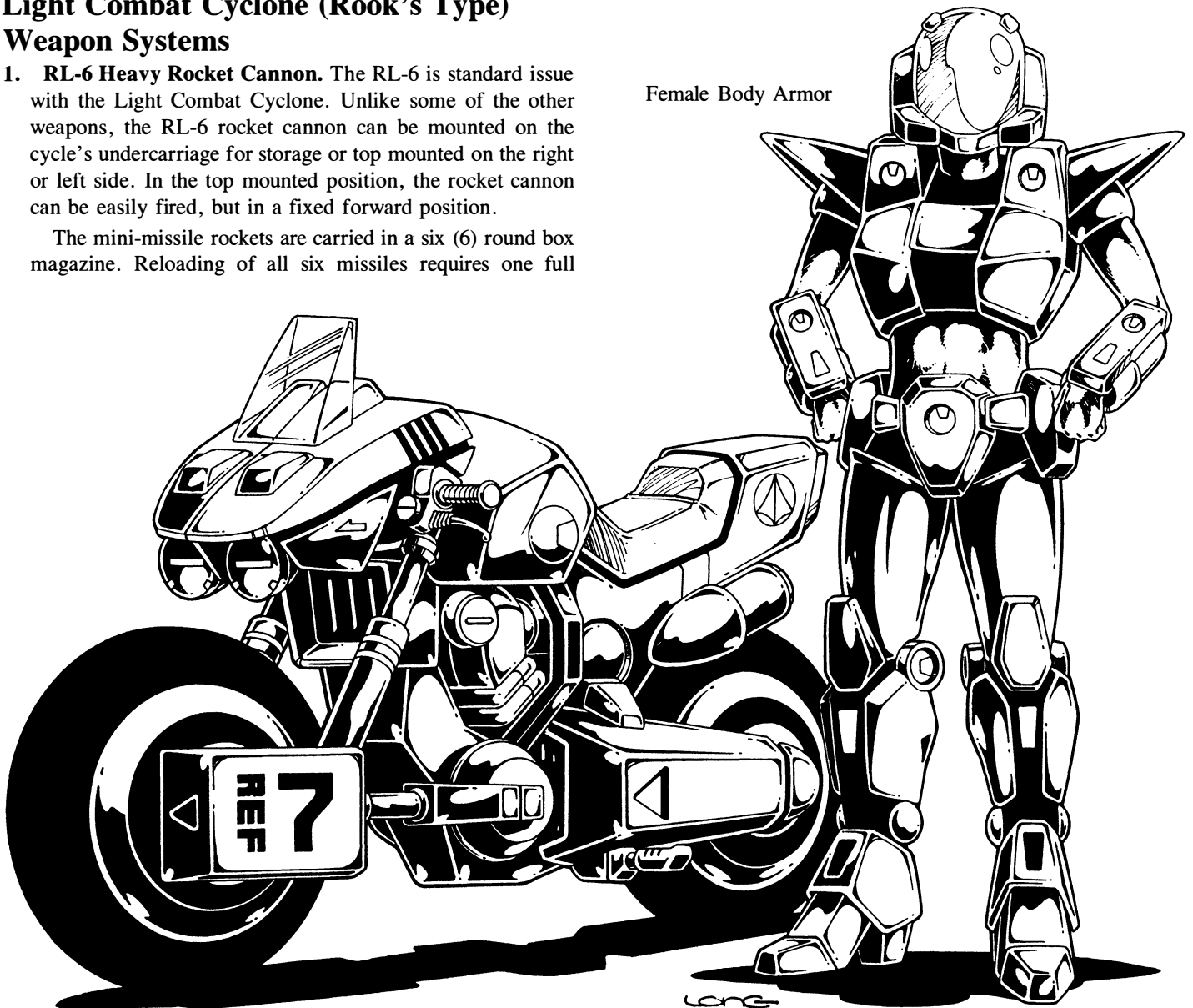

OPTIONAL WEAPONS

- 1) **GR-97 Forearm Missile Launcher.** See VR-052 Battler for description.
- 2) **Missile Launcher Sidecar.** See VR-052 Battler Cyclone for description.
- 3) **EP-37 60mm Beam Cannon.** See VR-052 Battler.
- 4) **EP-40 40mm Pulse Beam Cannon.** See VR-052 Battler.
- 5) **CADS.** See VR-041 Saber for description.
- 6) **Any type of hand-held weapons.**

Special Equipment: Same as VR-052 Battler Cyclone.

VR-038-LT Light Combat Cyclone
(Rook Type)

Motorcycle Mode

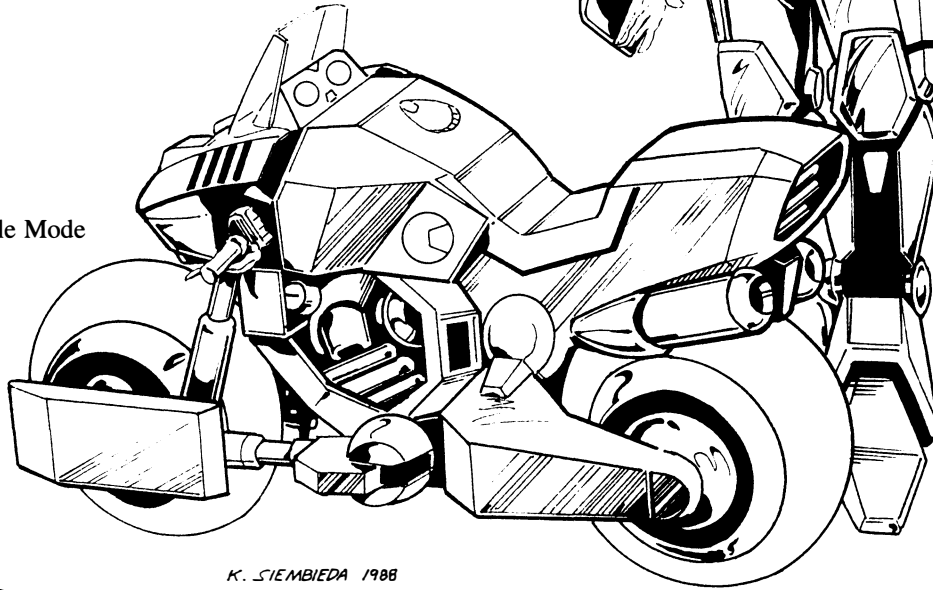

K. SIEMBIEDA 1988

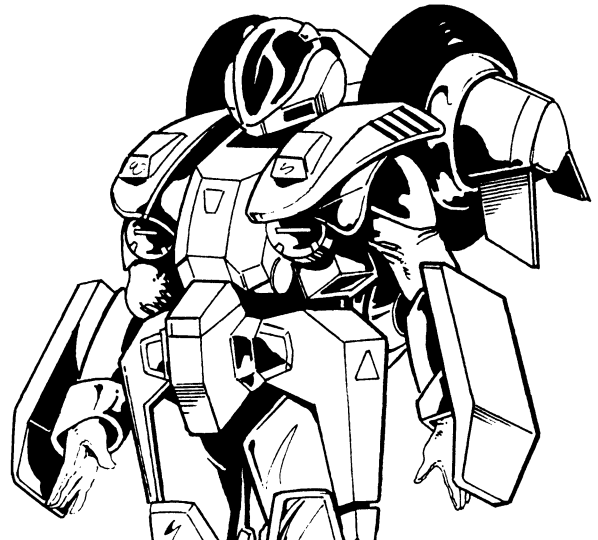

Battloid Mode

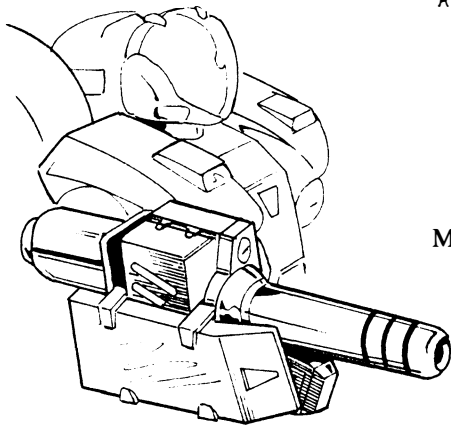

RL-6 Heavy Rocket Cannon
Mounted on the arm of a battloid

VR-038-LT in Battloid Mode
(Rear View)

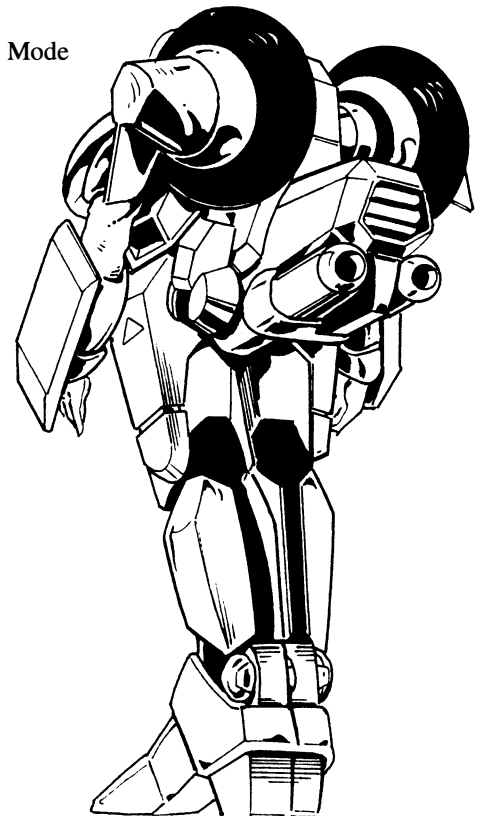
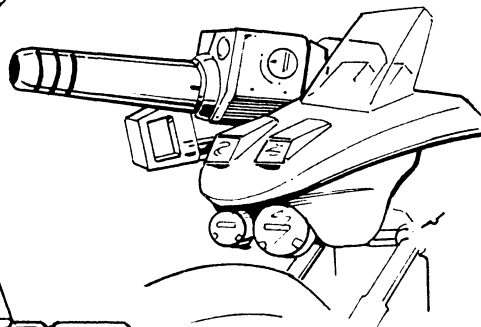

EP-37 60mm Beam Cannon

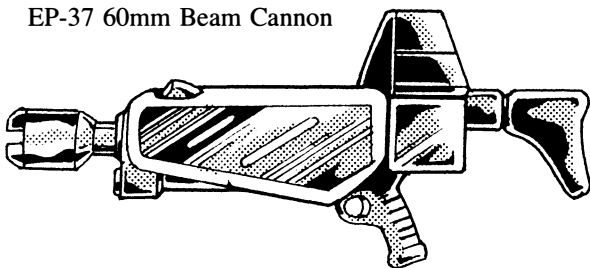

SPECIAL EQUIPMENT

Standard for ALL Cyclone Mecha

1) **Protoculture Engine:** All cyclones have a protoculture powered engine. One protoculture energy cell will keep a cyclone running for about **two months** before needing refueling. *Flying* and hovering will drain the protoculture cell very quickly (3 times as fast). But *occasional* bursts of flight, thruster assisted leaps will have minimal draining of energy. Game Masters use your own judgment in regard when the energy cell is running low. Be certain to give players advance warning so that their characters will have an opportunity to scrounge up extra protoculture cells to refuel. **Note:** The energy cells can not be detected by invad when motors are turned off/not running. The unusual energy can only be detected when a cyclone (or Gallant) is turned on. Turning an engine off will not necessarily make a character invisible to an invad; they do have vision after all. A cyclone can not be turned off unless it is in motorcycle mode.

2) **Conventional Fuel Conversion System:** All cyclones can use regular liquid fuel like a conventional motorcycle. This is provided as a back-up system. Fuel Capacity is four gallons. Estimated Range: 200 miles (321km) without refueling. Modifiers: Maximum speed: 150mph (240kmph). Hovering and flight are not possible.

3) **Short-Range Radar with Head-Up Display System** (displays radar screen inside the helmet). Can identify and track up to 20 different targets. Range: One mile (1.6km).

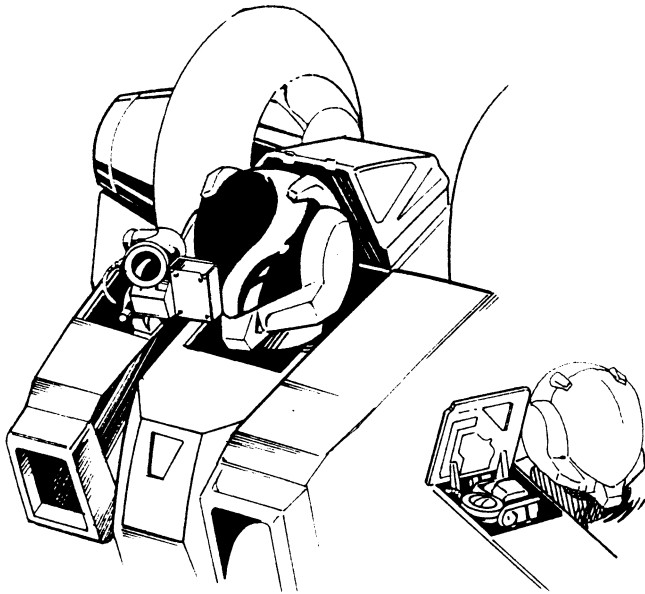

4) **Computer Targeting System** with infrared capabilities is located in the right shoulder of the cyclone in battloid mode. **Bonuses:** Adds +2 to strike with missiles, adds +1 to strike with other weapon systems (pistols, rifles, etc). Range: 4000ft (609m) by line of sight.

5) **Radio Communication System:** Wide band and directional, with voice command actuation (4 digit code). Earphones are built into the helmet. Range: Two miles (3.2km).

6) **Miscellaneous Indicators** for speed, height, fuel, time and date are standard for all models.

7) **Tinted Helmet Visor.**

8) **CVR-3 Cyclone Body Armor** is a durable, lightweight blend of metal alloys and ceramics. It is a standard item issued to all Cyclone Veritech riders and Alpha pilots. In addition to its mega-damage protection and self-contained environmental capabilities (it's just like a spacesuit when the helmet is sealed,) the body armor is an integral part of the cyclone veritech system. The body armor is designed with special connectors and braces where the cyclone attaches itself to its battloid operator. Without the body armor, the VR-motorcycle can *not* convert into battloid mode. That means a pilot with no CVR body armor can not use the battloid aspect of the mecha until he/she finds some CVR body armor. Southern Cross or old RDF armor can *not* be substituted. Until the CVR body armor is obtained, the character can only use the cyclone as a souped-up combat motorcycle.

Despite stylistic differences, all of the CVR-Body Armors have the same basic properties:

- M.D.C. 50 and laser resistant (lasers do 1/2 damage).
- Complete Environmental Battle Armor (E.B.A.) suitable for use in space and other hostile environments.
- Computer controlled life support system.
- Internal cooling and temperature control.
- Humidifier.
- Gas filtering and artificial circulation.
- Independent oxygen supply and purge system which automatically engages in low oxygen or polluted environments. Eight hour oxygen supply, maximum.
- Insulated, high temperature resistant weave of nylon, synthetic fibers, and metal mesh.
- Fire resistant up to 300 degrees centigrade. Normal fires do no damage, but plasma and nuclear fires have full effect.
- Radiation shielded.
- Helmet with removable face plate.
- Directional, short-range radio built into the helmet. Range is 4 miles (6.4km)
- Tinted, light sensitive visor.
- Utility belt/holster.

9) **Standard Survival Kit:** This is a small reinforced box about the size of a briefcase. The main compartment is locked with an individual, combination-type lock mechanism. The kit usually contains a first-aid kit, pocket knife, matches or lighter, flashlight, vitamins and two week's worth of freeze-dried foods. Approximate Weight: 10lbs (4.5kg) — fully loaded. S.D.C. of Kit: 12 S.D.C.

Tinted Visor

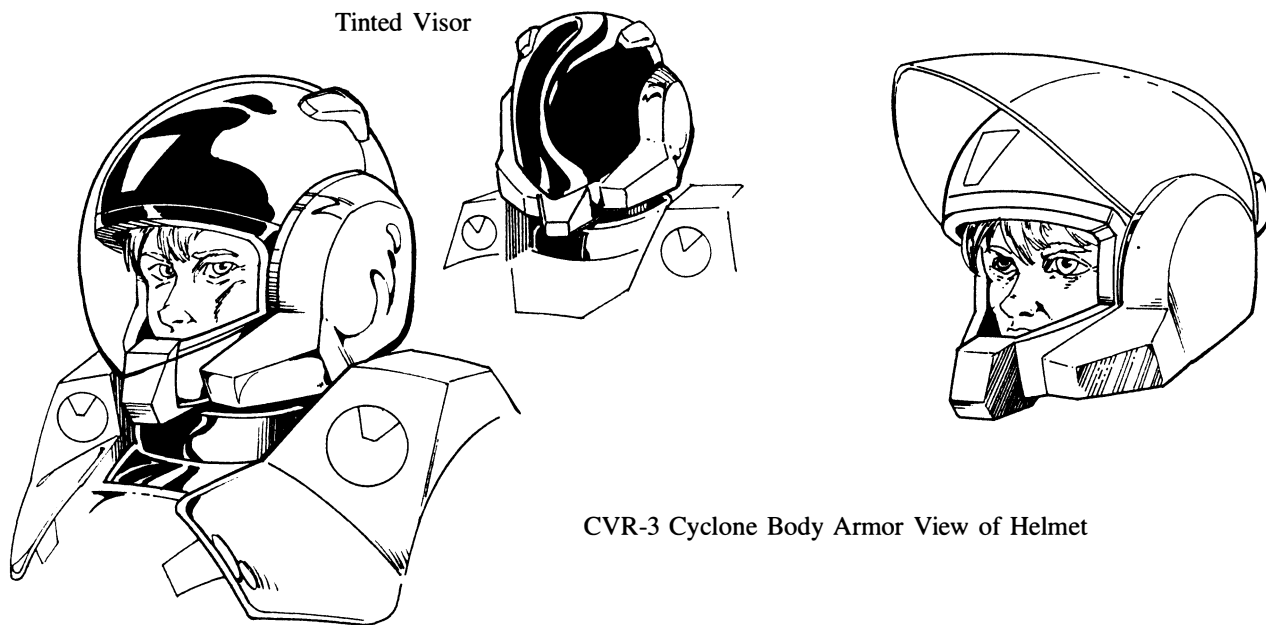

CVR-3 Cyclone Body Armor View of Helmet

Male Cyclone Body Armor
(Front View)

Male Cyclone Body Armor
(Rear View)

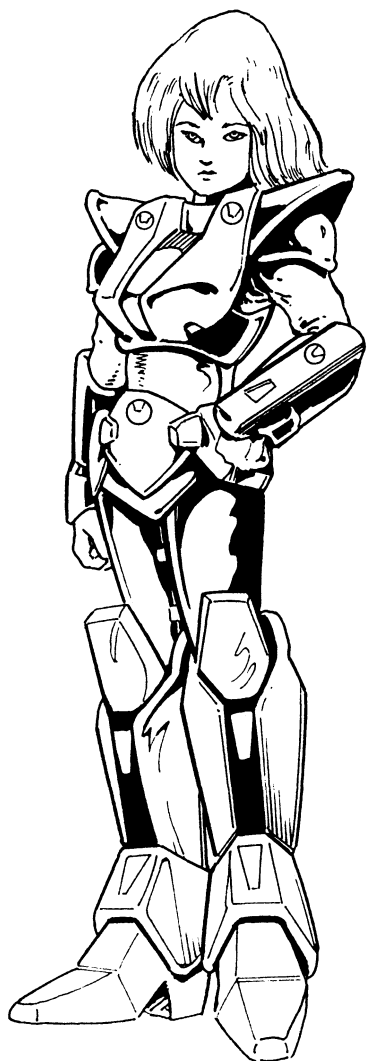

Female Cyclone Body Armor

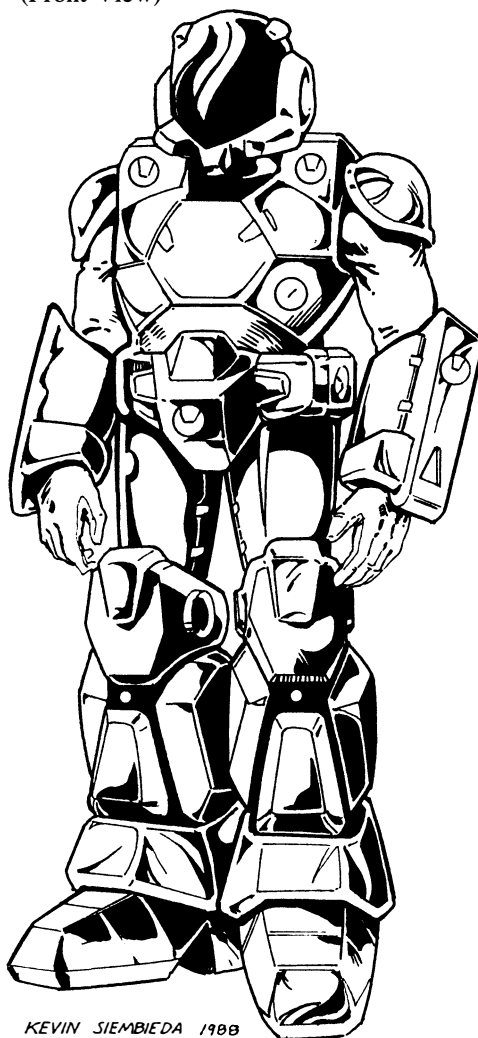

KEVIN SIEMBIEDA 1988

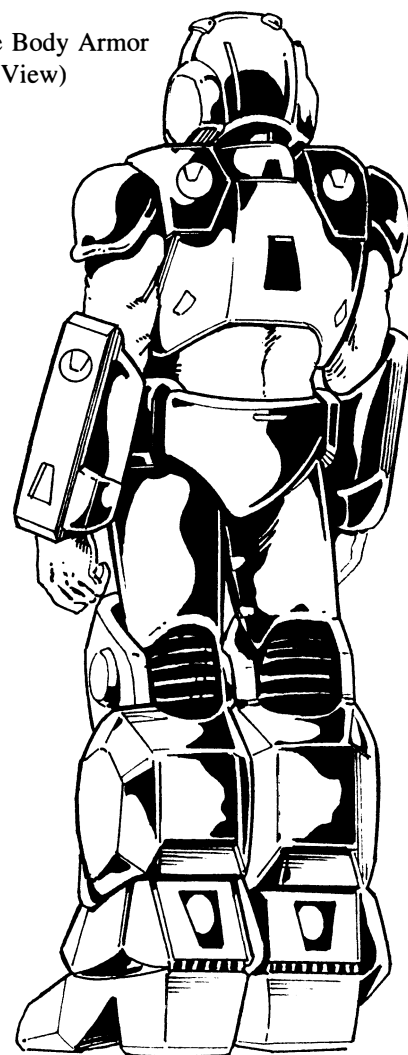

A Note About Ammunition and Protoculture Cells.

In the postwar, occupied Earth setting of the Invid Invasion, the availability of ammunition, mini-missiles, missiles, weapon energy clips, and protoculture cells, to power the mecha, are rare and all are often difficult to find. Characters must scavenge wrecked mecha, crashed spaceships and old military bases to find what they need. Fortunately, the invid do not understand human mechanics and will often ignore good (working) mecha and/or supplies, because they do not recognize them as such. This means the invid might leave an entire storage bay full of protoculture cells and cyclones, completely alone. Of course, human bandits aren't that stupid.

Other alternatives available to characters are much more dangerous. They can try to loot invid protoculture processing plants (the invid power cells are easy to modify for human use), highjack cells from the mecha of bandits or evil gangs, or sell their services as warriors to towns and villages in exchange for the protoculture or ammo. An occasional unscrupulous town or group of mercenaries or bandits will stock and sell protoculture cells, mecha, weapons and equipment. Money is no longer of value so all items must be obtained through trade. Some of the bigger outfits will provide credit for trade, using the old prewar credit system as a standard. The danger with this is that credit can be lost if the weapons traders move on, are destroyed, or a new leader takes over. So it is best that any trade credits be spent immediately on supplies.

The value of the items traded for depends on the specific location, needs and wants of the weapons traders, so prices will vary greatly from place to place or even from time to time. Characters can trade weapons, ammunition, mecha, protoculture cells, vehicles, gasoline, mecha or machine parts, clothes, food, information and services. The items can be traded for similar items or completely unrelated things. **Players**, do not be thrown by this barter system. It's just like a fantasy game where characters go on adventures and return to town to *trade* in their loot for gold (credits) or equipment (weapons and magic/ammunition and protoculture cells). It's basically the same, just different items and setting. The trade of services is just like wizards and warriors accepting a deal to guard somebody or to deliver a package, etc., in exchange for a magic sword, armor or gold. The only difference is that the characters will now be trading services for energy weapons or energy clips, mecha or body armor, or credits.

A grateful person or town may also offer the characters equipment or supplies out of gratitude. The smart player has his character pull the unused missiles, protoculture cell(s), and ammunition from a defeated opponent (conditional, based on alignment and circumstances).

The most difficult items to scavenge or trade for are Beta and Alpha mecha, good (working) Beta and Alpha parts, mecha missiles, cyclone mecha, protoculture cells, RDF weapons, Southern Cross weapons, energy clips, cyclone body armor, Southern Cross body armor, and old RDF, Southern Cross or Zentraedi mecha, assault vehicles, air vehicles and ground vehicles; in that order.

Many towns will not have a weapons trader or any kind of trade system. Some towns may have a small, secret trade organization, others, an obvious trade house. Some traders are honest,

some criminal, others are a trap to flush out freedom fighters for their invid masters. Game Masters, take time to plot out the possibilities.

Standard Sensors and Equipment for All Veritech Alpha and Beta Fighters

Fuel Capacity

The new veritechs have a smaller fuel capacity that utilizes micronized protoculture cells. 16 fully charged protoculture cells will give it an active combat life of about one year. The vehicles can function with half as many cells (8) for about 10 months, but the maximum speed is reduced by half and it is - 1 to strike, parry and dodge. **Note:** Invid protoculture cells attained from an invid protoculture processing plant can be easily adapted for use in Earth mecha.

Radar

Range: 10 miles (16km). Can identify and track up to 48 targets simultaneously.

Radio Communications

Wide band and directional radio and video telecast capabilities. Range is 600 miles (945km) or can be boosted indefinitely via satellite relay.

Laser Communications

Long-range, directional communication system. Effective range: 100,000 miles.

Combat Computer

Calculates, stores, and transmits data onto the cockpit computer screen or head up display (H.U.D.) of the pilot's helmet. Patches in with targeting computer.

Targeting Computer

Range: 100 miles (160km). Assists in the tracking of enemy targets and is partly responsible for the Alpha's high strike bonus.

Laser Targeting System

Range: 100 miles (160km). Assists in the striking of enemy targets and is partly responsible for the Alpha's high strike bonus.

Motion Detector & Collision Warning System

Close Range: 200ft (61m); sounds an alarm and red light warns pilot of impending collision and/or immediate target.

Telescopic Optical Enhancement

Range: 2000ft (609m). Field of vision: 20ft (6.1m)

Head Spotlights

Range: 600ft (182m)

Loudspeaker

Loudspeaker system that can amplify the pilot's voice up to 90 decibels.

Ejector Seat

In case of an emergency, the pilot can be instantly ejected. In battloid mode, the pilot is ejected out of the mecha's back.

Self-Destruct

A last ditch effort to prevent the capture of a Veritech unit (usually preceded by the pilot's ejection from the veritech) is self-destruction. Explosive damage is fairly contained. An Alpha or Beta without missiles (or few) does $1D6 \times 10$ M.D., but a veritech with all or most of its missiles (40 or more) will do $2D6 \times 100$ M.D. to a 50ft (15.2m) radius.

Smoke Screen System

The Alpha and Beta can emit a thick cloud of smoke from its rear to create immediate cover. The smoke screen system can discharge a maximum of 4 bursts before needing replacement (smoke missiles can be converted to function in the system). Each burst will cover a 60ft area (19.8m).

Heat and Radiation Shields

Special shielding prevents the penetration of life threatening heat and radiation.

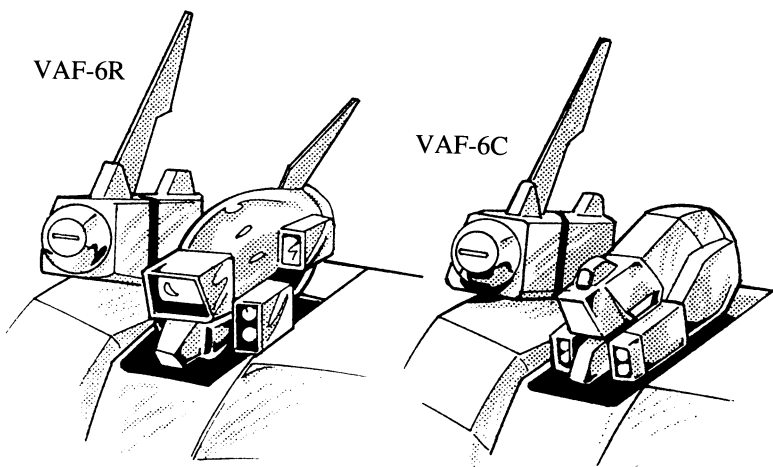

Special Surveillance Equipment for the VAF-6R Reconnaissance Alpha (Green Lancer Type)

Infrared Spotlight (head)

Range: 2000ft (609m). The infrared spotlight sits in the front of the sensor head like the giant, red eye of a cyclops. It emits an infrared light beam that is invisible to the normal eye (including invid). However, an enemy with infrared optics can easily see the beam of light and track it to the Alpha. Smoke impairs vision/beam.

Thermo-Imager (Head)

Range: 2000ft (609m). A special optical heat sensory unit that allows the infrared radiation of warm objects to be converted into a visible image. It also enables the pilot to see in darkness, shadows and through smoke.

Nightvision Optics (Head)

Range: 2000ft (609m). An image intensifier that is passive, meaning it emits no light of its own, but relies on ambient light which is electronically amplified to give a visible picture. Night-vision can *not* work in absolute darkness (but infrared can).

External Audio Pickup (Head)

Range: 300ft (91.5m). A sound amplification listening system that can pickup a whisper 300ft away.

External Video Surveillance System (Head)

Range: 600ft (183m). The box on the side of the head is a video camera system with telescopic capabilities: $6 \times$ magnification. The video images can be relayed to a cockpit monitor and stored on removable video disks. Maximum disk capacity is 24 hours. Disks can be erased and reused.

Special Cloaking Device Exclusive to the Alpha VAF-7A Shadow Fighter

Shadow Cloaking Device

The Shadow Fighters are equipped with Doctor Lang's and Robotech scientist Cabell's latest masterpiece, a cloaking device that makes the Alpha Fighter invisible to instrument detection. The cloaking device hides the veritech from enemy radar, invid protoclature sensors/targeting, and scrambles all other detection methods such as microwaves and lasers. Only conventional optical systems and the opponent's own vision can be used to see a Shadow Fighter. Consequently, the Alpha Shadow Fighters can zoom in on a target completely undetected by radar or other sensor. It is only when they come into visual range that they can be detected.

Bonuses: +3 on initiative, +1 to strike.

Note: There is a 50% chance that the shadow cloaking device will fail with every hit that is below half the main body's M.D.C. (below 150 points). Shadow Fighters are also very rare, and most were sent to Earth and destroyed during the Robotech Expeditionary Force's first wave attack against the invid (the REF underestimated the strength and number of invid opponents).

THE ALPHA Veritech Fighter

The Alpha and Beta Veritech Fighters are the latest developments of Doctor Lang and his Robotech research specialists. The initial idea was to create a smaller, transformable veritech fighter. Something very much like the old 45ft (13.7m) VF-Veritech series, but half the size for greater combat mobility. A smaller mecha could go places its larger predecessors could not. It would also make the vehicle a smaller target.

The Alpha is a small jet fighter that stands about 28ft tall in battloid; a full 16ft 5 inches shorter than the Super Veritech. Doctor Lang contends that he can reduce the size another eight feet (2.4m), but at the sacrifice of the formidable weapon systems.

Although the Alpha Fighter is slower than the VF series veritech, it is much more maneuverable and loaded with five times as many short range missiles (60 as compared to the VF's 12). Like the VF series veritech, the Alpha Fighter also has a standard GU style gun pod called the GU-XX. One GU-XX is standard issue, but two can be stowed on the Alpha in jet and guardian

VAF-6R ALPHA FIGHTER

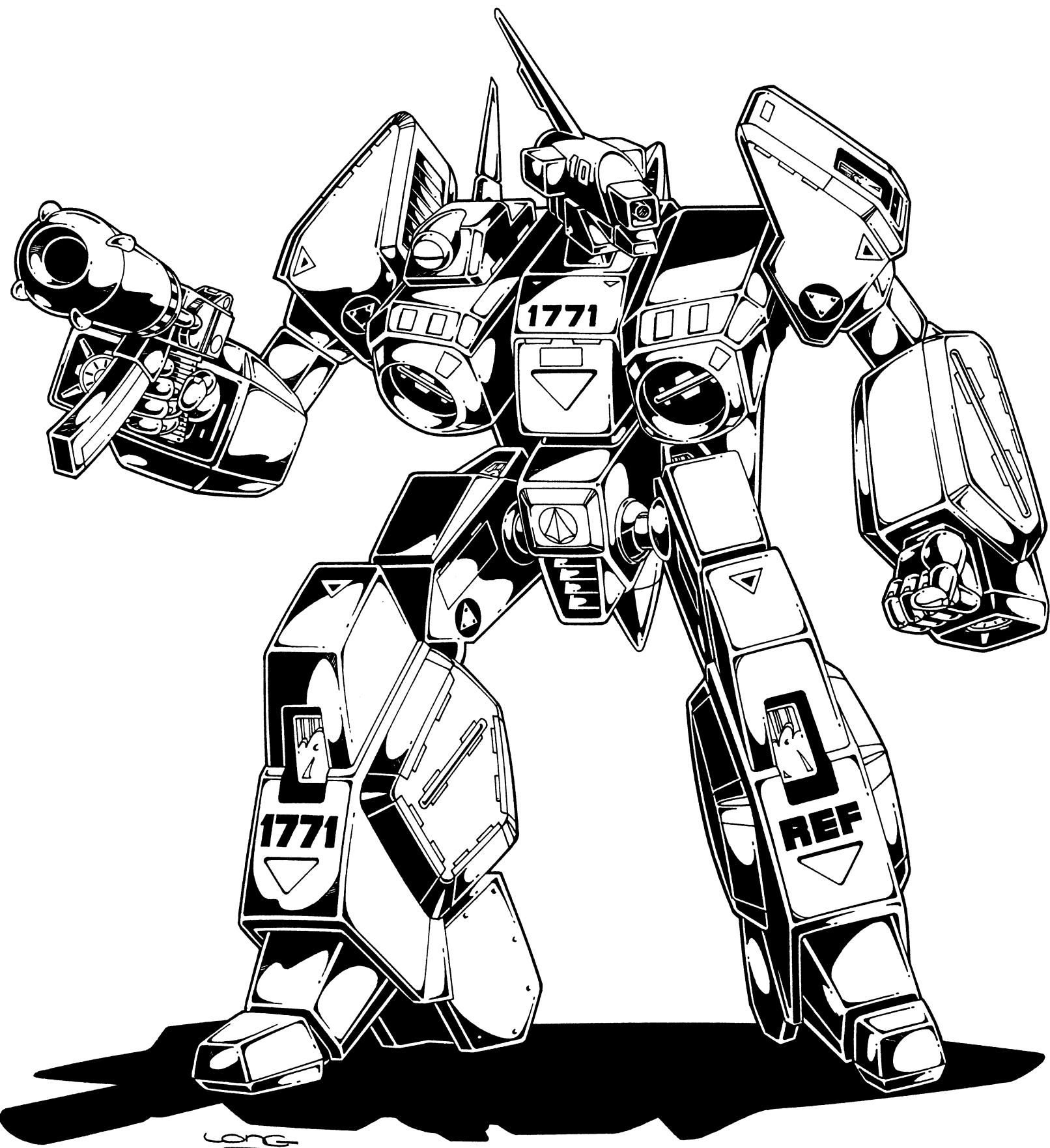

modes. Or one can be mounted on the top and one on the undercarriage. Unlike the old veritech, the GU-XX can be fired while in jet and guardian modes (used as a hand-held weapon in battloid mode only).

Perhaps the most outstanding aspect of its design is its compatibility with the Beta Fighter. The Alpha can attach itself to the larger Beta fighter, becoming a larger, faster, more formidable war machine. The Beta's powerful jet boosters can be used to blast the two veritechs, merged into one, into space. This transatmospheric aspect gives the Alpha total environmental flexibility. Even more impressive is that the Alpha can transform into battloid mode and remain attached to the Beta for the speed and maneuverability of a jet, but with the full combat potential of the battloid. The two vessels can separate from one another at any time. The effect is that one large aircraft can separate and become two separate and incredibly powerful fighting mecha. If escape is necessary, the two can speed off separately or attach back into one vehicle to blast off at Mach 8. At Mach 8, the Alpha and Beta can easily blast into outer space. Both veritechs can function on land, in air, in space or underwater. *See Beta Veritech Fighter for full data on it.*

ALPHA FIGHTER

Model Types (4): VAF-6C (Blue, Scott Bernard Type)

VAF-6J (Red, Rook Type)

VAF-6R (Green, Lancer Type)

VAF-7A Shadow Fighter (Dark Blue-Black, and Grey)

Class: *Veritech Fighters VAF Series*; VAF-6C Combat Alpha, VAF-6J Jupiter design and manufacture, VAF-6R Reconnaissance Alpha and VAF-7A Shadow Fighter (special invisid stealth fighter). The VAF-6C and VAF-6J are identical in every way except color and head stylization, and the fact that the 6J was manufactured by Jupiter Base.

Crew: One

M.D.C. by Location:

Head — 50

*Head Sensor Unit (1) — 30

Hands (2) — 30 each

Forearms/Missile Pods (2) — 40 each

Shoulders/Missile Pods (2) — 60 each

Legs, Upper (2) — 100 each

Lower Legs/Thrusters/Missile Pods (2) — 100 each

Wings (2) — 100 each

Tail (2 Fins) — 50 each

**Main Body — 300

Reinforced Pilot's Compartment — 150

GU-XX Gun Pod — 75

*Depleting the M.D.C. of the head sensor will impair the pilot's sensory and targeting equipment. *Long-range radar* is severely diminished, leaving an effective range of one mile (1.6m). *Radio and laser communications system* are lost. *Short-range radio back-up system* provides a 60 mile (96km) range. *Laser targeting* is destroyed; -1 to strike.

**Depleting the M.D.C. of the main body will shut the mecha down completely, rendering it useless.

Speed: Jet Mode: Mach 2.3 (1541mph/2465kmph) maximum. Altitude ceiling of 60 miles (96km).

Jet Cruising Speed: About Mach 1 (670mph)

Guardian Mode: Hover stationary to Mach 1 (670mph/1072kmph)

Battloid Mode Flying: Hover stationary to about 300mph (482kmph), with a maximum altitude of about 10,000ft (3048m), around 2 miles/3.2km.

Battloid Mode, Running: 120mph (160kmph)

Battloid Mode, Leaping: 100ft (30.5m) up or across without booster assistance. 300ft (91.5m) with booster jets' assistance.

Height: 28ft 7in (8.75m) in battloid mode.

15ft (4.6m) in jet mode including tail fins.

Width: 13ft (4.3m) in battloid mode.

22ft (6.7m) in jet and guardian modes.

Length: 34ft (10.3m) in jet and guardian modes.

Weight: 11 tons without missiles; 16.4 tons fully loaded.

Cargo: No available space for cargo unless the cyclone is removed from its storage compartment. The cyclone storage compartment can hold about 500lbs (226.8kg).

WEAPON SYSTEMS

1. **MM-60 Multi-Missile System:** The Alpha is bristling with short-range missiles, 60 in all.

Shoulders: 8 each

Forearms: 10 each (5 on both sides of the arm)

Lower Legs: 12 each (3 missile launchers on each leg).

Primary Purpose: Assault

Secondary Purpose: Anti-Aircraft

Missile Type: Standard RDF short-range missiles, usually high explosive, armor piercing, or plasma. A typical combat mix of missiles is 30 armor piercing, 20 high explosive or plasma, 8 fragmentation, 2 smoke.

Mega-Damage: Varies with missile type.

Rate of Fire: One at a time or in volleys of two, four, eight, sixteen, thirty or all. The number of volleys a character can fire per melee is equal to his/her combined hand to hand attacks. Remember, a volley, regardless of the number of missiles, counts as one melee attack.

Range: Varies with missile type; 1 to 5 miles.

Payload: A maximum capacity of 60 short-range missiles. Mini-missiles or medium and long range missiles can not be used.

Note: The war torn world makes the availability of missiles an extremely rare event. Players should be careful not to expend all their missiles because it may be a long time before more are found.

2. **GU-XX 35mm Tri-Barrel Gun Pod:** This is the standard armament issued to all Alphas except the Shadow Fighters. Normally, *one* GU-XX is provided, but two can be used and carried. The GU-XX can be mounted on top or on the undercarriage of the Alpha in jet or guardian mode. Unlike the old GU-11 gun pods, the GU-XX can be fired from its fixed mounted position(s) while in jet or guardian mode. The weapon(s) are hand-held in battloid mode.

Primary Purpose: Assault/Defense

Range: 4000ft (1200m)

Mega-Damage: Does 4D6 M.D. short burst, 1D4 × 10 medium burst, 2D4 × 10 M.D. full melee burst.

Rate of Fire: Short or medium bursts count as one attack. The pilot can fire as many bursts as his combined hand to hand attacks per melee. A full melee burst takes the place of all other attacks.

ALPHA IN JET MODE

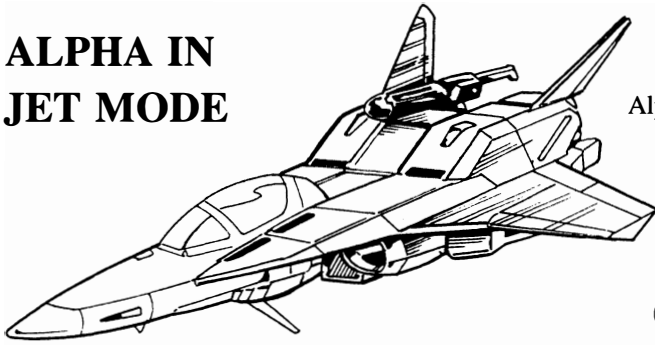

Alpha Fighter with top mounted GU-XX Gun Pod

MM-60 Multi-Missile System Shoulder Missiles
(top mounted in Jet Mode)

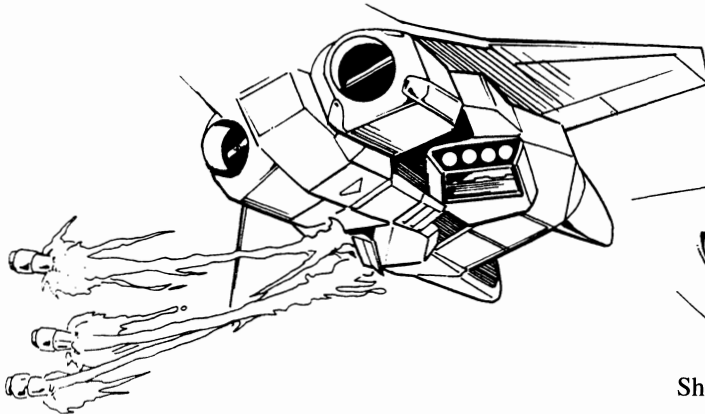
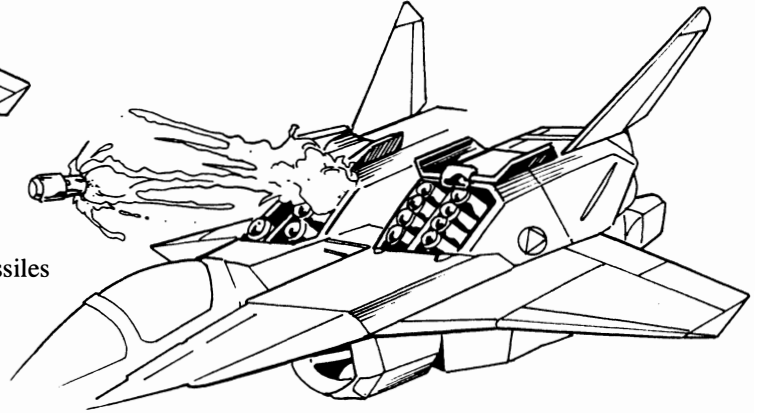

MM-60 Multi-Missile System Leg Missiles
(mounted on the underside in Jet Mode)

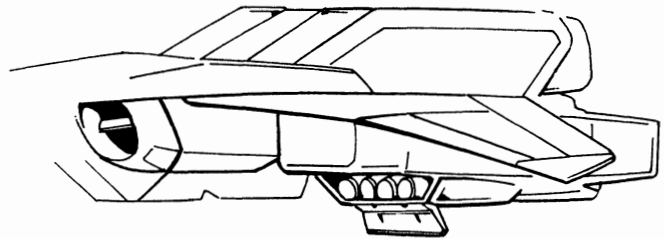

Shoulder Missiles

Single Bottom Mounted
GU-XX Gun Pod

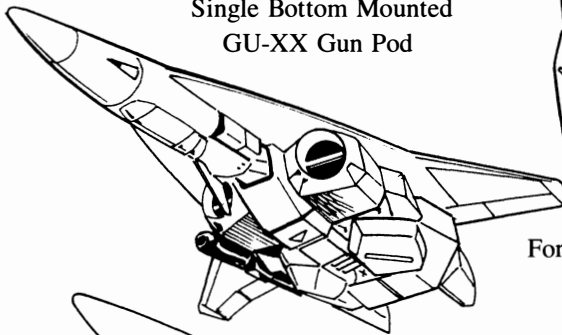

Forearm Missiles

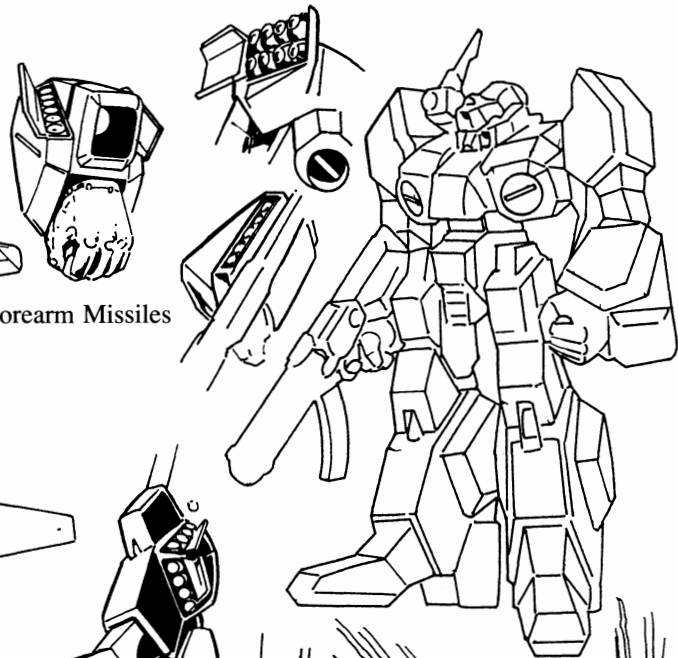

Dual Mounted
GU-XX Gun Pods

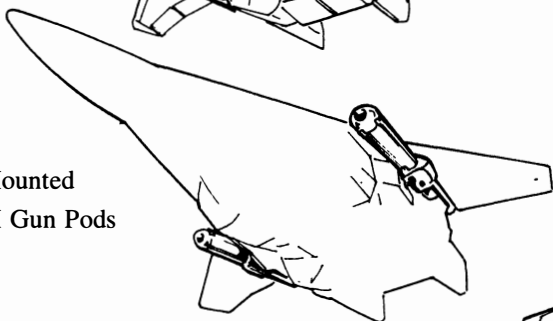

Leg Missiles

GU-XX 35mm Tri-Barrel Gun Pod

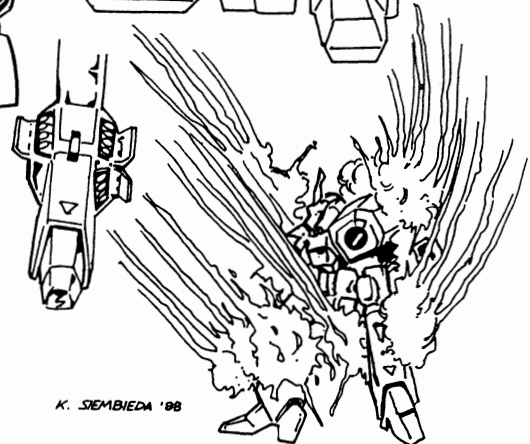
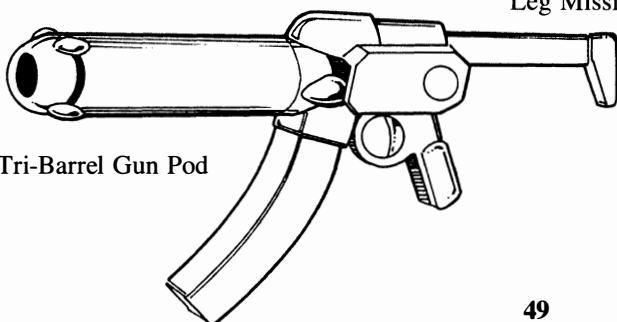

K. SIEMBIEDA '98

Payload: Can fire . . .
40 short bursts or . . .

20 medium bursts (equal to 2 short bursts) or . . .

10 full melee bursts (equal to 4 short bursts).

Note: TWO GU-XX ammo clips can be stored in the legs (one clip in each). It requires two melee actions/attacks to reload a clip.

3. Hand to Hand Combat (optional): Rather than fire any weapons, the Alpha can engage in hand to hand combat.

Punch does 1D6 M.D., Kick — 1D6 M.D., Leap Kick — 2D6 M.D., Body Flip — 1D6 M.D., or Body Block — 1D6 M.D.

- 4. Optional GU-11 Gun Pod.** See Robotech® RPG.
- 5. Optional E-20 Gun Pod.** See Southern Cross.
- 6. Optional EU-11 Gun Pod.** See Southern Cross.
- 7. Optional Gladiator Mace.** See Robotech® RPG. Can be used only in battloid mode.

VAF-6J ALPHA FIGHTER

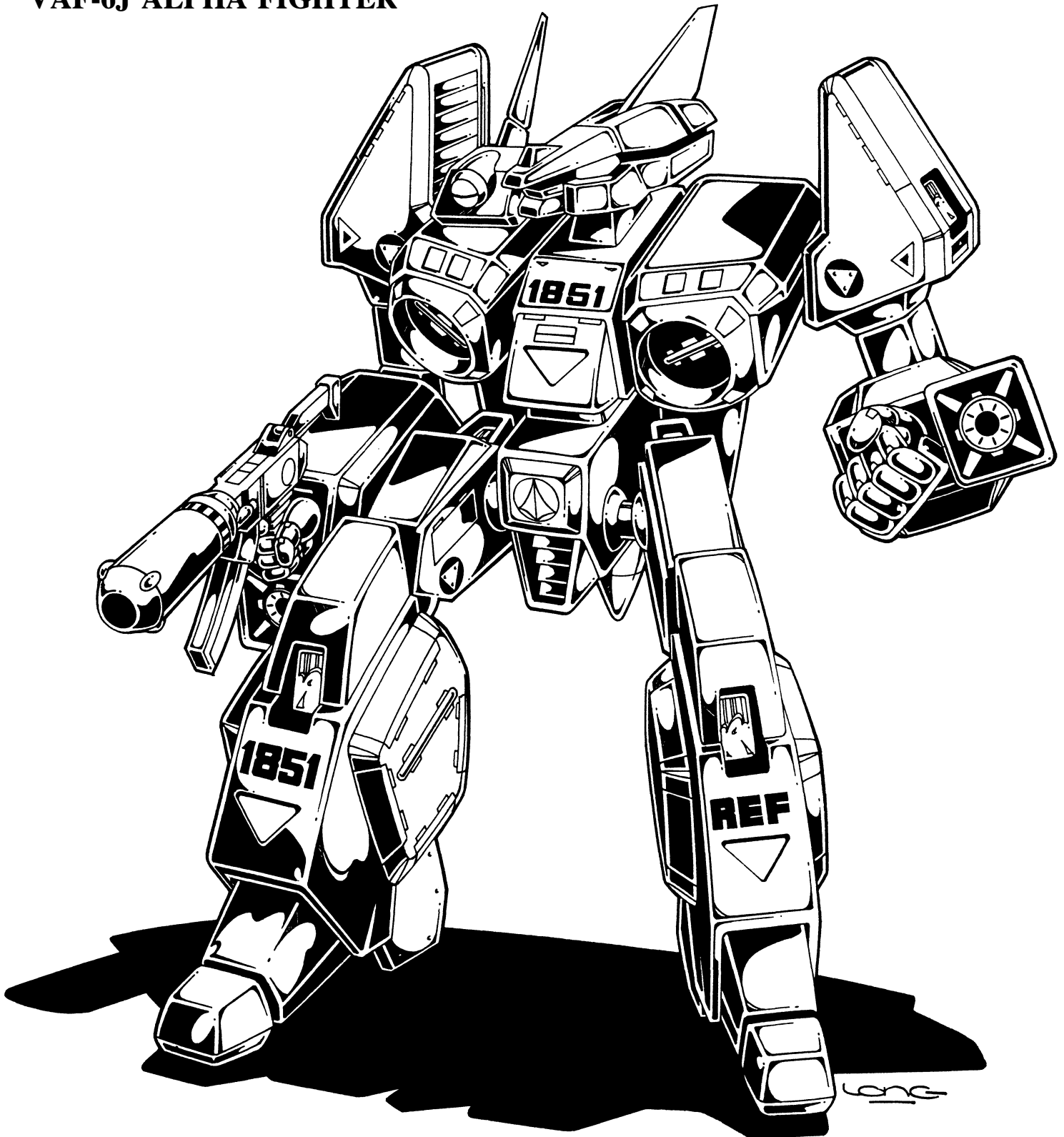

THE SHADOW FIGHTER

Veritech Alpha Fighter VAF-7A

The Shadow Fighter is like the other Alpha Fighters in general shape, design, speed, function and armaments. Other than stylistic and color differences, the SF-7," a nickname, is identical to its brothers. There are only three items that make it different and more lethal.

The Shadow Fighter derives its name from a newly developed cloaking device which obscures it from radar, sonar, and most sensors other than enhanced optics. This means the enemy will not see the SF-7 coming on radar or by use of conventional detection systems. Thus, one minute the sky is empty and peaceful, the next moment, a black and grey fighter jet is streaking into view (normal sight or telescopically enhanced) with weapons blazing. The opponent rarely has time to react let alone attack. It's like a sneak or prowl attack at Mach Two speeds. The opponent doesn't know what hit him until it's too late. NOTE: Unless somebody sees the Shadow Fighter coming, the SF-7 always has the initiative (strikes first) for the first melee round. After that, everybody rolls initiative (the Shadow is +3) for each melee of combat.

The "shadow cloaking device" was initially created to combat invid. It was discovered, after some initial encounters with the REF, that the invid did not have the same kind of sensors or optics that humans used. Instead, the invid had protoculture sensors that instantly and accurately alerted them to the presence of protoculture energy. To make matters worse, the invid mecha all possessed protoculture targeting systems that can lock in on the source of protoculture emanations like a heat seeking missile locks in on and homes in on a heat source. This made sneak attacks impossible and escape difficult. The Robotech Expeditionary Force (REF) suddenly found themselves betrayed by their own weapons. The solution was to find an alternative energy source, which was impossible considering the circumstances, or to find some way to cloak the energy. Fortunately, Doctor Lang and Cabell were able to do just that. Soon the Shadow Fighters were invisible to protoculture sensors of any kind, as well as conventional detection systems. This development would ultimately give the REF the edge they needed in their battles with the Invid Regent.

Another device that is exclusive to the Shadow Fighter Alpha and VF-1V Vindicator is a powerful energy weapon called a "Destabilizer." The destabilizer is another invention specifically designed to thwart the invid. Mounted on the shoulder and drawing on the additional energy of the veritech, it can unleash an energy bolt that will disrupt the invid's, otherwise invincible, force fields. The disruption punches a 10 + 2D6ft hole in a force field, allowing troops to enter. The weapon can also be used as a hand held weapon like the GU series gun pods, only more powerful.

The Shadow Fighter Alpha and the Vindicator became the REF's first strike assault force, with the other Alphas, Betas, and mecha following afterward. Because of the SF-7's combat capabilities as an Alpha and the added stealth provided by the cloaking device, Rick Hunter sent a fleet of them to protect the Earth from the invid threat. Sadly, Rick underestimated the

number of invid on Earth. All he knew was that the REF had lost contact with their homeworld and the last garbled message seemed to suggest the invid. So, despite their superiority, most of the Shadow Fighters were destroyed, falling victim to the sheer multitude of the enemy (they were outnumbered by about 1000 to 1). However, a few have survived from the first and last REF assault waves. G.M. NOTE: The Shadow Fighters are extremely rare. Even in the heyday of their production by the REF, only one in every 50 Alphas was a SF-7. On the war torn, invid occupied Earth, perhaps one in every 1000 mecha of any kind is a Shadow Fighter.

Vehicle Type: Special Assault

Class: Veritech Fighter. VAF Series Alpha, model VAF-7A.

M.D.C. by Location and all other data is identical to the Alpha Fighters previously discussed.

WEAPON SYSTEMS

1. **MM-60 Multi-Missile System:** See Alpha Fighter.
2. **GR-12 Shoulder Launch System:** Only the Alpha Shadow Fighter has an additional pair of missile launchers built into the upper chest area. The system is similar to those of the destroids and adds an extra 24 short- range missiles to its armaments.

Primary Purpose: Assault/Defense

Missile Type: Standard RDF short-range missiles, usually high explosive or fragmentation.

Mega-Damage: Varies with missile type.

Rate of Fire: One at a time or in volleys of two, four, six or twelve (all). One volley counts as one attack, regardless of the number of missiles launched in the volley. The number of volleys fired per melee is equal to the pilot's combined hand to hand melee attacks (usually five or six).

Payload: 12 in each shoulder launch unit, for a total of 24.

3. **EU-13 Destabilizer:** A powerful energy weapon that is standard issue for the Alpha Shadow Fighter. *One* Destabilizer can be mounted on the top of the Alpha when in jet and guardian modes. Or carried by hand in battloid or guardian modes. Like the GU-XX, the Destabilizer can be fired while in jet and guardian modes from its fixed mounted position.

Primary Purpose: Assault/Defense

Range: 4000ft (1200m)

Mega-Damage: Does 1D4 × 10 per each blast (bursts are not possible)

Rate of Fire: Equal to the pilot's combined hand to hand attacks per melee (usually four or five).

Payload: 40 blasts.

Note: Two EU-13 energy clips can be stored in the legs (one in each leg). It requires two melee actions/attacks to reload a clip. Only the big REF ships and facilities on the Moon and Mars bases can recharge an EU-13 energy clip.

4. **Optional GU-XX Gun Pod.** See Alpha Fighter.
5. **Optional EU-11 Gun Pod.** See Southern Cross.
6. **Optional GU-11 Gun Pod.** See Robotech® RPG.
7. **Optional Gladiator Mace.** See Robotech® RPG.
8. **Optional Hand to Hand Combat.** Same as Alpha Fighter.

Beta Note: The Shadow Alpha can connect with a Beta (usually painted in matching colors) just like a regular Alpha.

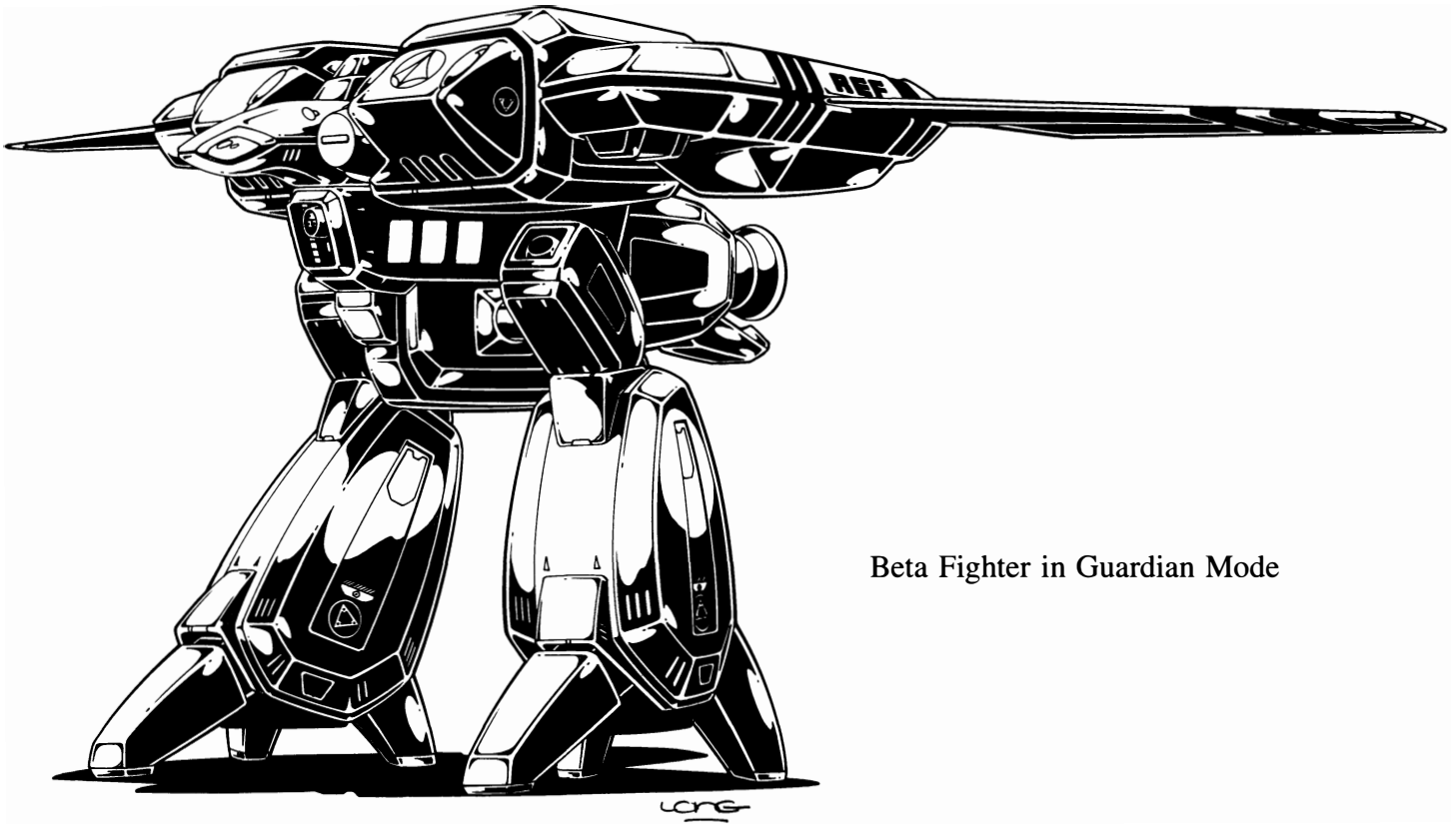

Beta Fighter in Guardian Mode

THE BETA Veritech Fighter

The Beta is part of the new modular veritech combat system. Like the Alpha, it is a separate and distinctive veritech fighter. However, it can connect to the Alpha, effectively becoming one large war machine. Together, the Beta adds greater speed, trans-atmospheric flight, and heavy missiles. The Alpha adds a barrage of short-range missiles and the flexibility of a battloid mode transformation while still attached to the Beta. When the situation demands it, the two veritechs can detach and fight as two completely independent combat units.

The Beta and Alpha combination is usually used when entering a planet's atmosphere from space (or exiting an atmosphere), first strike (then separate to engage in separate combat, effectively doubling the number of veritechs) and space combat.

The armaments of the Beta Fighter are similar to the Alpha's, but with greater range and destructive potential. A GU-XX is built into the center of the fuselage that can be fired in a fixed position only in jet and guardian modes. Its automatic feed gives it many times more rounds than the hand-held GU-XX of the Alpha. Short, medium and long-range missiles can be fired from several positions. Two heavy missiles from the front, six medium range missiles from the top mounted rack and eight short-range missiles (plus reloads) from each of its retractable top missile bays (chest in battloid mode). Plus, the Beta can drop bombs from its cargo/bomb bay while in jet mode and has an additional 20 short-range missiles in battloid mode (10 in each leg). **Note:** The hands and arms are designed in such a way that the Beta can not hold a GU or EU style gun pod. It must rely on missiles, hand to hand combat and speed (not maneuverability).

The Beta Fighter is designed specifically to be a heavy back-up or counterpart to the speedy Alpha. Consequently, the Beta is much larger and laden with explosives. Although its rocket boosters can attain a speed of Mach 8, maneuverability is minimal. The Mach 8 speed is provided as a means to escape gravitational forces (breach Earth's atmosphere), and make hasty retreats and attacks. The Mach 8 speed also matches the speed of some of the invad vessels which the Alpha and Beta were designed to combat. The best speed the Beta can muster without the rocket thrusters is just under Mach 2. The Beta is also less maneuverable than its half pint Alpha counterpart. As a team, the Beta provides the muscle and extra oomph, while the Alpha provides the speed and agility. **Note:** The only difference between all Betas is their color and distinguishing insignia. Even the Shadow Beta is the same except that it is blue-black and grey in color and has the "shadow cloaking device" which makes it invisible to protocol-ture sensors and radar. (See *Shadow Fighter Alpha and the shadow cloaking device.*)

BETA FIGHTER

Model Types (2): VBF-1A (Blue, Red or Green)
VBF-1S (Shadow Beta, blue-black and grey)

Class: Veritech Fighter, VBF series.

Crew: One pilot, but seat two others in cockpit. (Optional: One can operate the weapon systems, the other, communications and sensory equipment, while the pilot flies. Or the pilot can do it all). The cargo/bomb bay area can hold passengers instead of bombs. Up to six can fit comfortably, ten cramped.

BETA FIGHTER IN BATTLOID MODE

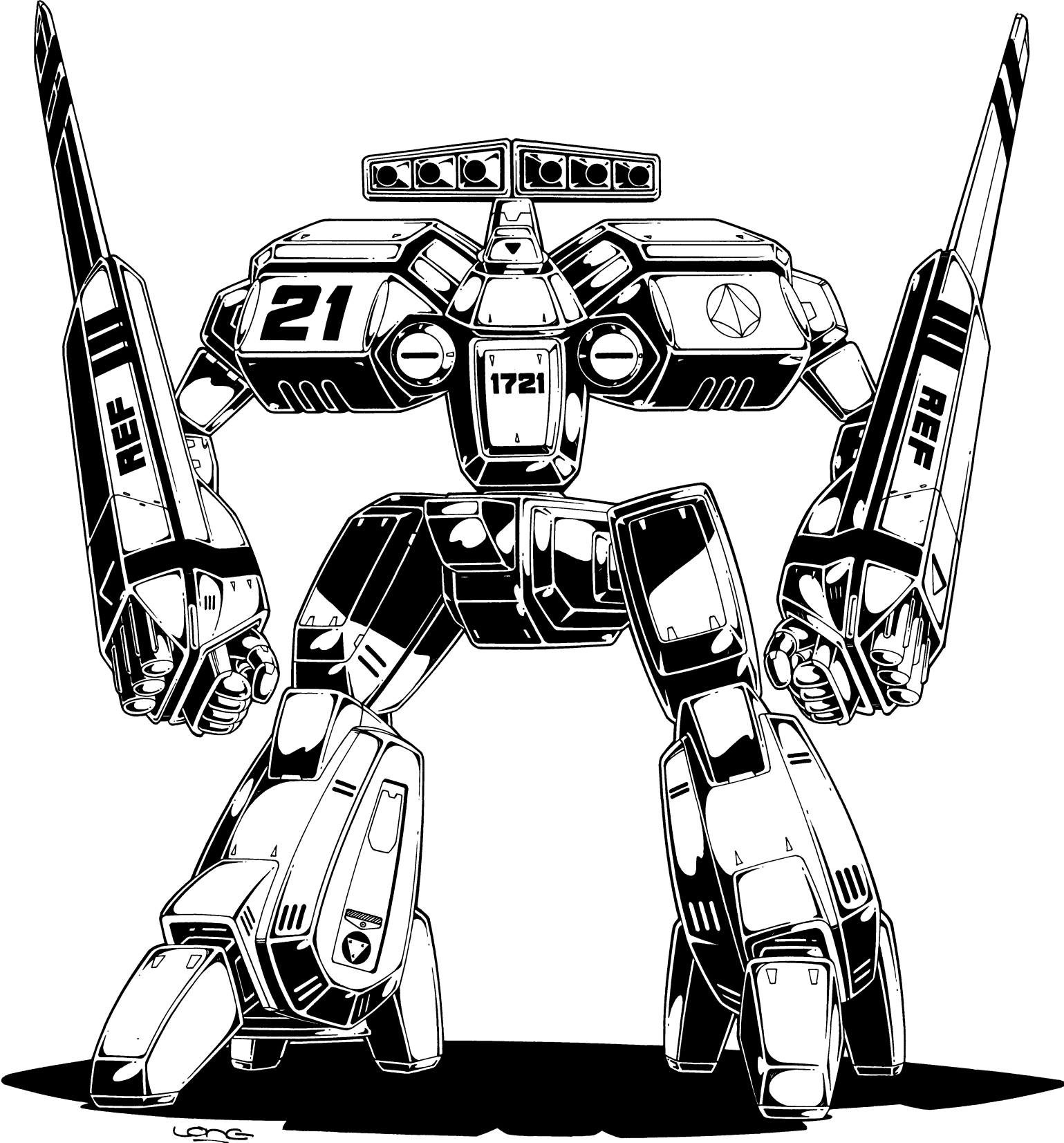

M.D.C. by Location:

*Sensor Head — 50
Hands (2) — 50 each
Shoulder/Chest Retractable Missile Bays (2) — 150 each
**Big Forearm Shields (2) — 300 each
Upper Arms (2) — 80 each
Top Missile Racks (2, side by side) — 50 each
Upper Leg Missile Bays (2) — 100 each
Lower Legs/Feet (2) — 150 each
Wings (2) — 100 each
Bomb Bay (Jet Mode only) — 200
Rear Jet Thrusters (Pair, side by side) — 60 each
Rocket Thrusters (3) — 150 each
***Main Body — 350
Reinforced Pilot's Compartment — 200
****GU-XX (Jet & Guardian Modes only) — 75

*Depleting the M.D.C. of the sensor head will knockout long-range communications (reduce to 60 miles/96km range), long-range radar (reduce to one mile) and laser targeting (-1 to strike).

**The forearm shields can be used to shield the main body or body parts from damage. The character can try to block incoming attacks of any kind, punches, blasts, and even missiles, by blocking with one or both arms (missiles require both arms). Roll a parry. If successful, only the arm shields take damage. NOTE: Depleting the arm shields to below their M.D.C. will destroy the wing connection joints and damage the wing(s), making transformation into jet or guardian modes *impossible!* Likewise, the loss of an arm is the loss of a wing and connection unit, making transformation impossible.

***Depleting the M.D.C. of the main body will completely shut the mecha down.

****The GU-XX of the Beta is built into it and protected by the main body. Because it is such a difficult target, attackers are -4 to strike it.

Speed: Jet Mode with Jet Thrusters: Mach 1.8 or 1206mph (1930kmp) maximum. Altitude ceiling is 50 miles (80km).

Jet Mode with Rocket Thrusters: Mach 8.3 (5561mph/8900kmp), making the Beta transatmospheric (able to blast into outer space under its own power.)

Jet Mode Cruising Speed: 600mph (960kmp)

Guardian Mode: Hover stationary to 600mph (960kmp)

Battloid Mode Flying: Hover stationary to about 300mph (482kmp), with a maximum altitude of 8,000ft (2440m), about a mile and a half (2.8km).

Battloid Mode, Running: 80mph (128kmp)

Battloid Mode, Leaping: 80ft (24.4m) up or across without booster assistance. 300ft (91.5m) with jet booster assistance.

Height: 35ft (10.7m) in battloid mode.

20ft (6.1m) in jet mode.

28ft (8.5m) in guardian mode.

Width: 28ft (8.5m) in battloid mode.

64ft (19.5m) in jet and guardian modes.

Length: 24ft (7.3m) in battloid mode.

32ft (9.7m) in jet & guardian modes.

Weight: 14 tons without missiles, 19.5 tons fully loaded (including missiles and bombs).

WEAPON SYSTEMS

1. MM-40S — Super Multi-Missile System: The Beta has two MM-40 systems built into each chest/shoulder area in battloid and accessible on the right and left of the cockpit in jet or guardian mode. The retractable systems raise their missile launchers from protective storage bays to fire volleys of short-range missiles. The two MM-40 systems can fire independently or simultaneously. The automatic reload system enables the pilot to fire his entire payload of 80 missiles in one melee (this is possible by firing both MM-40 systems simultaneously, launching 16 missiles, 8 each, each melee attack up to five times).

Note: Can be launched in all modes.

Primary Purpose: Assault

Secondary Purpose: Anti-Aircraft

Missile Type: Standard RDF short-range missiles, usually high explosive, armor piercing or plasma. Different types are rarely mixed, so all 40 missiles per launcher would be the same. Of course, missiles can be mixed if desired.

Mega-Damage: Varies with missile type.

Rate of Fire: One at a time or in volleys of two, four, six, eight (or sixteen if both launchers are fired simultaneously). One volley counts as one attack. The number of attacks per melee is equal to the pilot's combined hand to hand attacks per melee (usually 4 or 5).

Payload: 40 missiles per each launcher, for a total capacity of 80.

Note: The war torn world makes the availability of missiles an extremely rare event. Players should be careful not to expend all their character's missiles too soon, because it may be a long time before more are found.

2. Short-Range Leg Missiles: Each leg has a short-range missile launcher built into the thigh. These missiles can be launched only in battloid mode.

Primary Purpose: Assault/Defense

Secondary Purpose: Antipersonnel

Missile Type: Standard RDF short-range missiles, usually high explosive or fragmentation.

Mega-Damage: Varies with missile type.

Rate of Fire: One at a time or in volleys of two, four, six, eight or ten (all). One volley counts as one melee attack, regardless of the number of missiles in the volley. The number of attacks per melee is equal to the pilot's combined hand to hand attacks per melee (usually 4 or 5).

Payload: Ten in each leg, for a total of 20.

Note: Leg missiles can only be launched while in battloid mode. Remember, the availability of missiles is scarce.

3. Medium Range, Top Mounted Missiles: These are the missile racks seen on top of the Beta in battloid mode and recessed into the rear of the Beta in jet or guardian modes. The missiles can be launched while in any configuration.

Primary Purpose: Assault

Secondary Purpose: Anti-Mecha

Missile Type: Standard RDF medium range missiles, usually high explosive, plasma or armor piercing. Of course, any medium range missiles can be used.

Mega-Damage: Varies with missile type.

Rate of Fire: One at a time or in volleys of two or three.

Payload: Three missiles per each launcher (2), for a total of six.

Note: Medium range missiles are more scarce than short range.

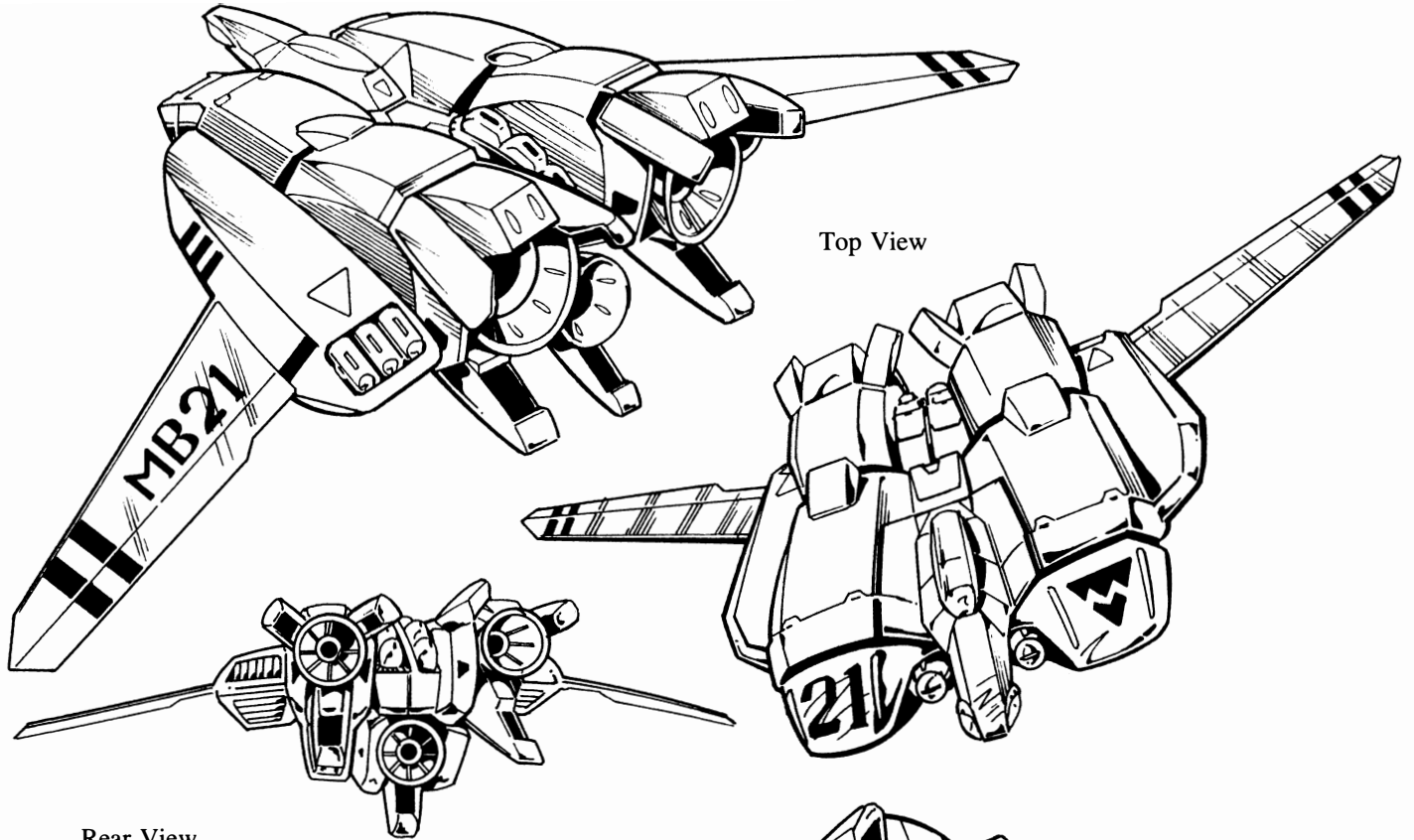

Top View

Rear View

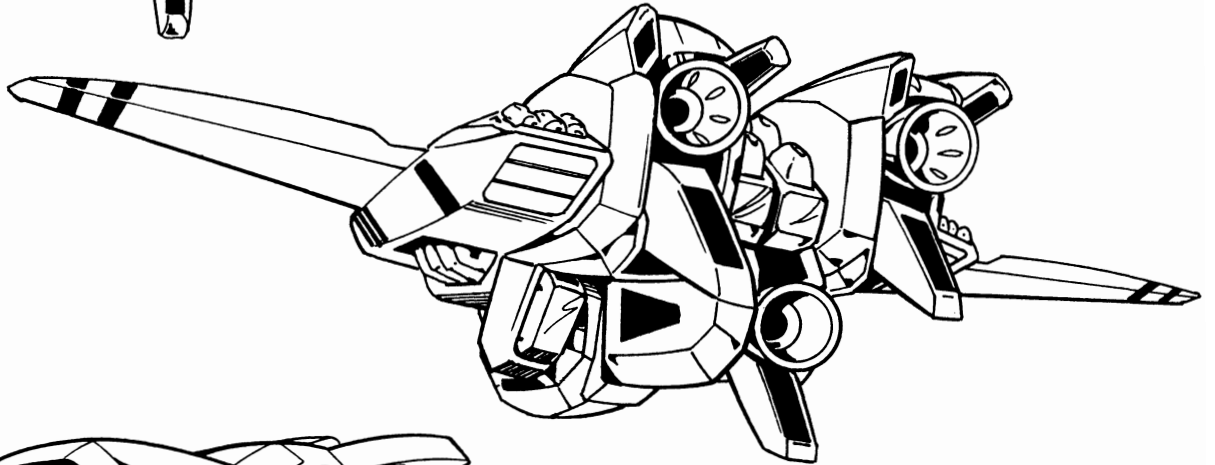

3/4 Side View

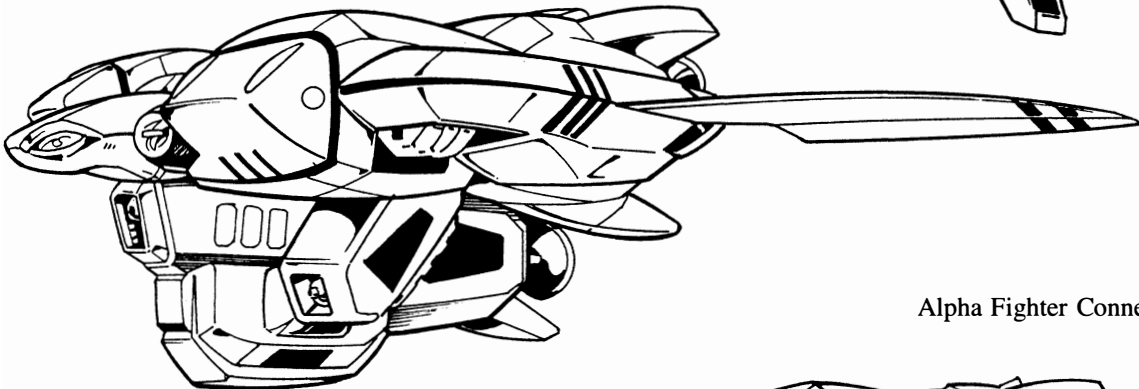

Alpha Fighter Connected to a Beta

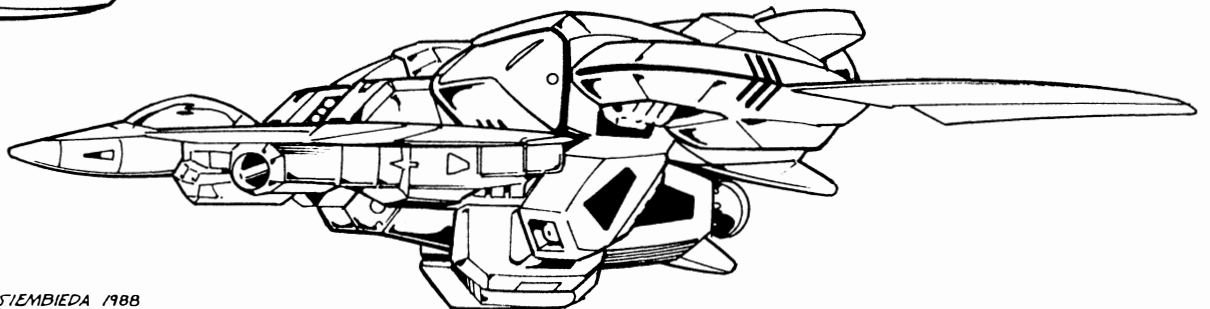

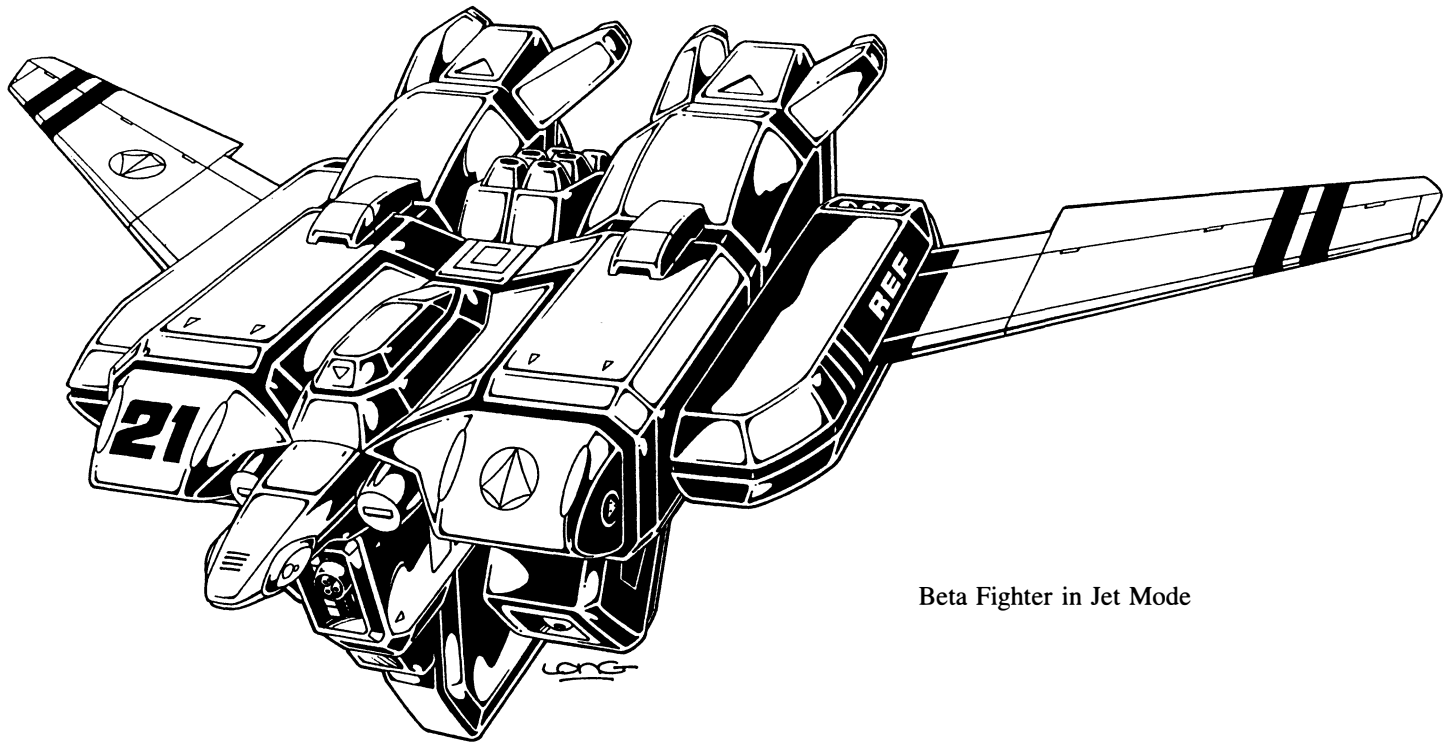

Beta Fighter in Jet Mode

4. Two Long-Range Missiles can be seen in the mid-chest area of the Beta in battloid or on either side of the cockpit in jet and guardian modes. These can be launched only from jet or guardian mode.

Primary Purpose: Heavy Assault

Secondary Purpose: Anti-Spacecraft

Missile Type: Standard RDF long-range missiles, usually proton, reflex heavy and reflex multi-warhead.

Mega-Damage: Varies with missile type.

Rate of Fire: One at a time.

Payload: Two

Note: Surprisingly, the long-range missiles are about as rare as the short-range missiles because there are few mecha that use them. All reflex and proton missiles are extremely rare.

5. The Beta Can also drop bombs.

Primary Purpose: Ground Assault

Missile Type: Bombs are equal to short or medium range missiles. Usually fragmentation or high explosive.

Mega-Damage: Varies with the type of bomb.

Rate of Fire: Volleys of 2, 4, 6, or 8.

Payload: The bomb bay can hold up to sixteen bombs.

Note: These are bombs not guided missiles. As such they are minus -4 to strike a stationary ground target, -6 to strike a moving target(s) and -10 to hit a small moving target like an invid scout or vehicles. Bombs are usually used against large stationary targets.

6. Beta GU-XX 35mm Tri-Barrel Gun Pod with auto-feed.

This weapon is exactly like the GU-XX handgun used by the Alpha Fighters. The difference is that it is built into the body of the Beta and has an automatic feed and a greater ammunition

payload. To reload the Beta GU-XX requires tools, a mechanic and 4D4 minutes. The person must crawl into the gun bay and undo the ammo compartment and reload. To modify the ammo from a conventional GU-XX gun pod requires an additional 1D4 hours per clip.

Primary Purpose: Assault/Defense

Range: 4000ft (1200m)

Mega-Damage: Does 4D6 M.D. per short burst, 1D4×10 M.D. for a medium burst and 2D4×10 for a full melee burst.

Rate of Fire: Short and medium bursts count as one attack (total attacks equal to the pilot's combined hand to hand attacks per melee). A full melee attack takes the place of all other attacks.

Payload: 160 shorts bursts, or 80 medium bursts (equal to 2 short bursts) or 40 full melee bursts (equal to 4 short bursts).

Note: Can *not* fire in battloid mode.

7. Hand to Hand Combat: In addition to Punch — 1D6 M.D., Kick — 1D6 M.D., Body Flip and Body Block — 1D4 M.D., the Beta can attempt to parry energy blasts and missiles with its giant shield arms. Roll to parry as usual (roll 1D20), plus bonuses. A successful parry of energy blasts, missiles and explosives means only the arm shields take damage. In mecha hand to hand combat, a parry will block the opponent's punch or kick without damaging the arm shields.

Depleting all the M.D.C. of the shield arm (300 points each) destroys the coupling mechanism for the wing, making it impossible to change out of battloid mode. Depleting the shields will also damage or destroy the wing(s) housed inside them.



THE VF-1V VINDICATOR

Veritech Fighter

The last of the VF series Veritech Fighters is the Vindicator. It is actually a cross between an Alpha and a VF veritech. The Vindicator has the size and mass of the old VF series veritech, but the basic shape, styling and armaments of the Alpha Fighter. Although it towers 46ft (14m), the REF added it to its active mecha as a first strike assault unit that fights alongside the Shadow Fighters. Doctor R. Burke, the mecha's co-designer, has coined the nickname "Zentraedi Buster" because it was originally intended to combat any Zentraedi warriors who may still serve the Robotech Masters.

The Vindicator also uses an earlier, larger version of the destabilizer energy weapon and has the "shadow cloaking device" built into it. In fact, at a quick glance, the Vindicator appears to be a larger version of the Shadow Fighter.

The VF-1V is super scarce on the war ravaged Earth. It was designed in space and never added to the RDF's or Southern Cross' mecha forces. Instead, it was kept exclusively part of the REF forces. Only a handful of Vindicators survived the REF's assault on Reflex Point.

VINDICATOR FIGHTER

Model Type: VF-1V, (blue-black and grey color, identical to the Alpha Shadow Fighter).

Class: Veritech Fighter, VF series;
Nickname: "Zentraedi Buster."

Crew: One pilot. A passenger can fit in the cockpit, but must sit in the pilot's lap.

Cargo: No available space unless cyclone storage bay is emptied. Can hold up to 1000lbs.

M.D.C. by Location:

- *Sensor Head — 70
- Hands (2) — 40 each
- Forearms/Missile Pods (2) — 60 each
- Shoulders/Missile Pods (2) — 100 each
- Upper Legs (2) — 100 each
- Lower Legs/Thrusters/Missile Pods — 150 each leg
- Wings (2) — 150 each
- Tail (2) — 50 each
- **Main Body — 400
- Reinforced Pilot's Compartment — 200
- Destabilizer (gun) — 100

*Depleting the M.D.C. of the head sensor will impair the pilot's sensory and targeting equipment. *Long-range radar* is greatly diminished, leaving an effective range of one mile (1.6km). *Radio and laser communication systems* are lost. *Short-range radio back-up system* provides a 60 mile (96km) range. *Laser targeting* is destroyed; -1 to strike.

**Depleting the M.D.C. of the main body will shut the mecha down completely, rendering it useless.

Speed: Jet Mode: Mach 3.3 (2211mph/3537.6kmph), with an altitude ceiling of 60 miles (96km).

Jet Cruising Speed: About Mach One (670mph/1072kmph).

Guardian Mode: Hover stationary to Mach One (670mph/1072kmph), with a maximum altitude of 30,000ft (9150m), or about 4 miles.

Battloid Mode Flying: Hover stationary to about 400mph (640km), with a maximum altitude of about 10,000ft (3048m).

Battloid Mode, Running: 80mph (128kmph).

Battloid Mode, Leaping: 100ft (30.5m) up or across without using jet boosters, 300ft (91.5m) with jet boosters.

Height: 46ft (14m) in battloid mode.
29.6ft (9m) in guardian mode.
22ft (6.7m) in jet mode.

Width: 20ft (6.1m) at shoulders in battloid.
46ft (14m), jet and guardian modes with wings fully swept.

Length: 47ft (14.3m) in jet and guardian modes.

Weight: 21 tons

WEAPON SYSTEMS

1. **MM-70 Multi-Missile System:** Same as the Alpha MM-60 except it can hold more missiles due to its size.

Shoulders: 10 each arm

Forearms: 12 each arm

Lower Legs: 13 each leg

Primary Purpose: Assault

Secondary Purpose: Anti-Aircraft

Missile Type: Standard RDF short range missiles, usually high explosive, armor piercing, or plasma. Of course, any short range missiles can be used.

Mega-Damage: Varies with missile type.

Rate of Fire: One at a time or in volleys of two, four, eight, sixteen, thirty-two or all (70). The number of volleys a character can fire is equal to the pilot's combined hand to hand attacks per melee. One volley counts as one attack regardless of the number of missiles in the volley.

2. **EU-12 Destabilizer:** A powerful energy weapon that is standard issue for the Vindicator. The EU-12 is a larger version (twice as big) of the Shadow Fighter's EU-13. One destabilizer can be mounted on the top of the Vindicator when in jet or guardian mode and can be fired from its fixed housing. In battloid mode, the weapon is hand-held.

When mounted on the shoulder, the EU-12 draws additional energy from the Vindicator and can fire a special burst of energy that will disrupt force fields. Against the invid hives' force fields, one blast has an 80% chance of creating a 6D6 foot hole in the field. The hole will last 4D6 minutes. One blast from an EU-12 destabilizer will obliterate the force field used to block exterior hive entrances for a duration of 4D6 + 20 minutes. It has identical effects against Zentraedi force fields.

Primary Purpose: Assault

Secondary Purpose: Force field disruption.

Mega-Damage: 1D6 × 10 per blast (bursts are not possible).

Rate of Fire: Equal to the pilot's combined hand to hand melee attacks (usually 4 or 5).

Payload: 40 blasts Range: 4000ft (1200m)

Note: Two EU-12 energy clips can be stored in the legs (one in each leg). It requires one full melee (15 seconds) to reload a clip. Only the biggest REF ships and facilities on the Moon and Mars bases can recharge an EU-12 energy clip.

3. **Hand to Hand Combat:** Punch — 1D6 M.D., Kick — 1D6 M.D., Leap Kick — 2D6 M.D., Body Flip and Body Block — 1D6 M.D. and Stomp — 1D4 M.D.

NOTE: Although the VF-1V may resemble an Alpha, it does not have a giant Beta counterpart.

Remember, only a handful of Vindicators exist on Earth. They are *extremely* rare.

WEAPONS

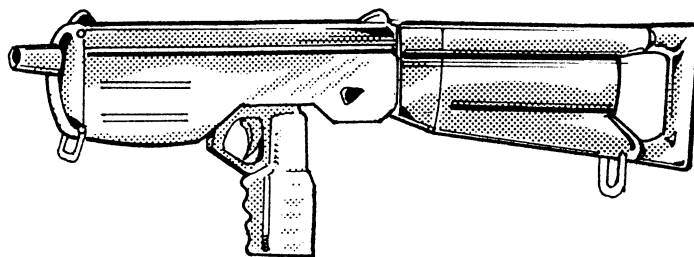

FAL-2 AUTOMATIC PULSE LASER RIFLE

The Fal-2 was designed as an infantry assault weapon and enjoyed widespread popularity worldwide before the invid invasion. The Soviet version, the Koskov 47, is virtually identical to the Fal-2 and became a favorite weapon of the black market throughout the South American Sector. The appeal of the Fal-2 is that it is exactly like a sub-machinegun, but does mega-damage.

Weight: 6lbs (2.7kg)

Mega-Damage: 2D6 M.D. per blast

Rate of Fire: Aimed, burst, wild. See modern weapon proficiencies. Can fire full clip in one melee.

Effective Range: 1200ft (366m)

Payload: 40 blasts per energy clip.

Note: The Fal-2 is still quite common. One reason for this is that it can be recharged with protoculture cells or at conventional RDF or Southern Cross energy clip recharging facilities (but none are known to exist). One protoculture cell is good for about 20 rechargings. To recharge an energy clip, the character must have the electrical engineer or mechanical engineer skill and a sufficient energy source.

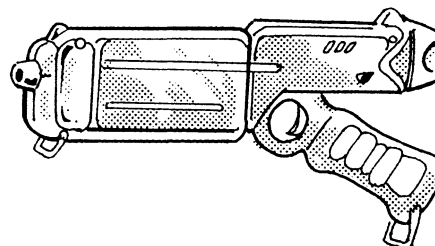

SAL-9 SINGLE SHOT LASER PISTOL

This is a simple laser pistol that functions much like a semiautomatic pistol. The person can squeeze off shots as quickly as he can move his trigger finger (9 maximum), unlike an automatic weapon that will continue to fire as long as the trigger is depressed. The Sal-9 is also very common and popular among nomads, rogues and gangs. It is considered to be a weapon of skill and often used like the Colt 45's of the old west for gunfights and duels.

Weight: 4lbs (1.8kg)

Mega-Damage: 1D6 M.D. per blast.

Rate of Fire: A maximum of 9 blasts per melee can be fired, but counts as shooting wild. See modern weapon proficiencies. Aimed, burst, wild.

Effective Range: 800ft (244m)

Payload: 45 per energy clip.

Note: Can be easily recharged using conventional generators, protoculture cells and/or RDF or Southern Cross facilities (if one can be found that is still working).

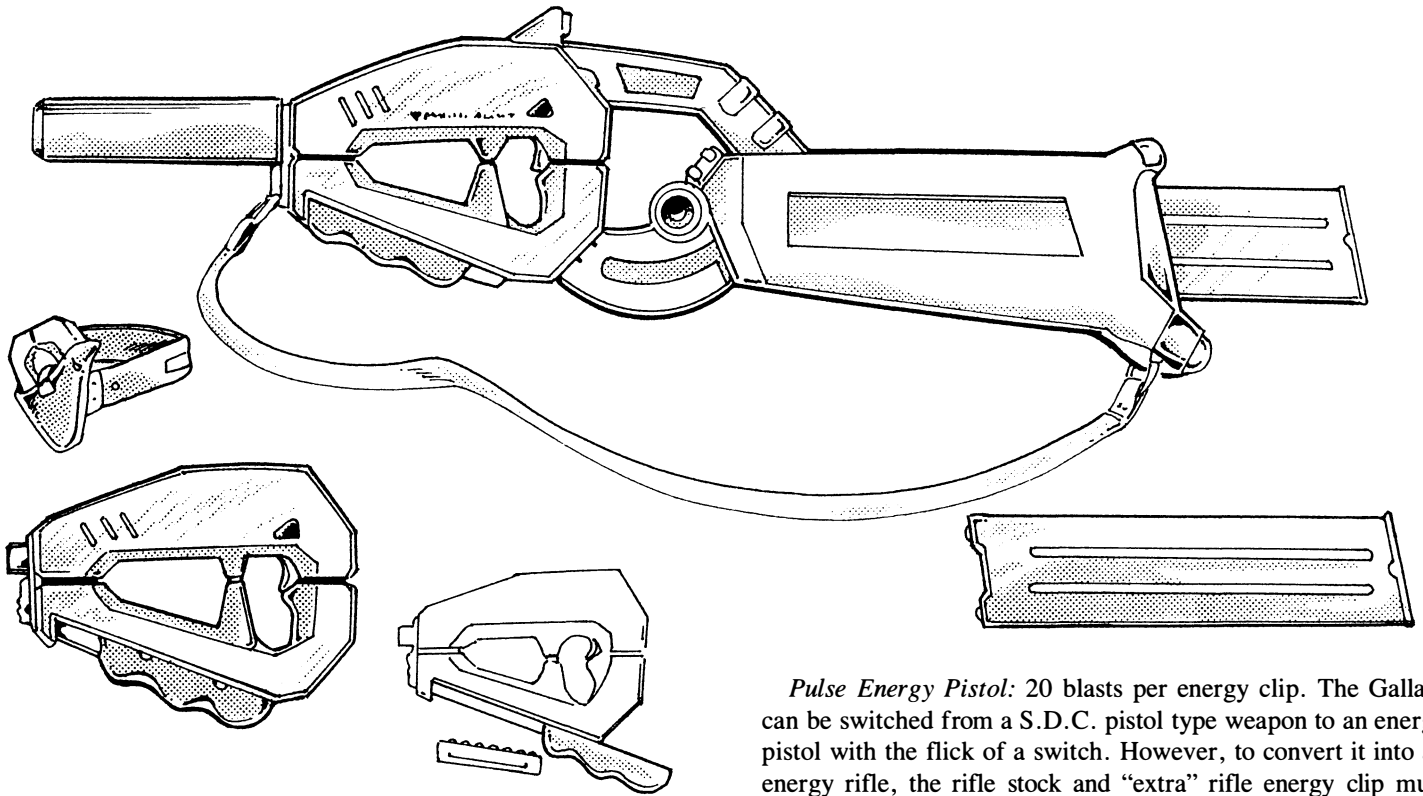

GALLANT H-90 MULTI-WEAPON SYSTEM

The Gallant H-90 is the *standard* all-purpose weapon of the Robotech Expeditionary Force (REF) and subsequently, the RDF as well. Its primary manufacturer was the Gallant Company located at Mars Base (RDF).

The weapon is unique because of its versatility and durability in the field. The durability is evident in that the weapon rarely jams, needs minimal maintenance, operates equally well in all climates (including sub-zero, humid and hot), and can even be submerged underwater for hours and still fire immediately thereafter.

The Gallant's amazing versatility lays in that it can be instantly transformed from a S.D.C. damage weapon into a Mega-Damage (M.D.) weapon with the flick of a switch. And then, the power and range of the M.D. weapon can be increased by adding a rifle stock containing a booster energy clip. Comes equipped with built-in sight and a detachable flash suppressor/cooling nozzle accessory.

Weight: 1½lbs (0.7kg) without stock, 7lbs (3.2kg) with stock.

Primary Purpose: Assault

Range: Varies. S.D.C. semiautomatic — 200ft (61m); Pulse Energy Pistol — 500ft (152m); Pulse Energy Rifle — 1400ft (427m).

Mega-Damage: Varies. S.D.C. semiautomatic — 4D6 S.D.C. damage per shot. Although bursts of energy are fired on the semiautomatic setting, they do only S.D.C. damage, not M.D. Pulse Energy Pistol — 1D6 M.D. per blast. Pulse Energy Rifle — 4D6 M.D. per blast.

Rate of Fire: Aimed, burst or wild. See *Modern Weapon Proficiencies*.

Payload: The S.D.C. damage pistol draws so little energy as to be considered unlimited with a single energy clip (estimate 1000 blasts).

Pulse Energy Pistol: 20 blasts per energy clip. The Gallant can be switched from a S.D.C. pistol type weapon to an energy pistol with the flick of a switch. However, to convert it into an energy rifle, the rifle stock and "extra" rifle energy clip must be attached.

Pulse Energy Rifle: 30 blasts per rifle energy clip. This additional energy clip and rifle stock container must be attached to use as a rifle.

Note: The Gallant uses protoculture energy.

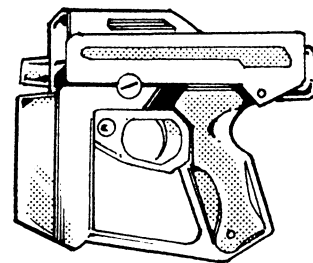

RDF 9mm "WOLF" AUTO-PISTOL

This is a light, conventional S.D.C. weapon in the RDF arsenal that is fairly common. The weapon became infamous as Col. Wolff's favorite weapon of choice and was renamed the "Wolf 9mm." Gangs often use the Wolf 9mm as a symbol of rank, with only the leader and upper ranking gang members being allowed to carry them. Ammunition is plentiful since it fires a standard 9mm cartridge.

Its most unusual feature is the double automatic feed that provides a bigger payload. Some argue that this feature makes the Wolf auto-pistol a sub-machinegun.

Weight: 3½lbs (1.6kg)

S.D.C. Damage: 2D6 S.D.C. (*not* M.D.) per round.

Rate of Fire: See modern weapon proficiencies. Aimed, burst, wild.

Effective Range: 800ft (244m)

Payload: 20 round magazine

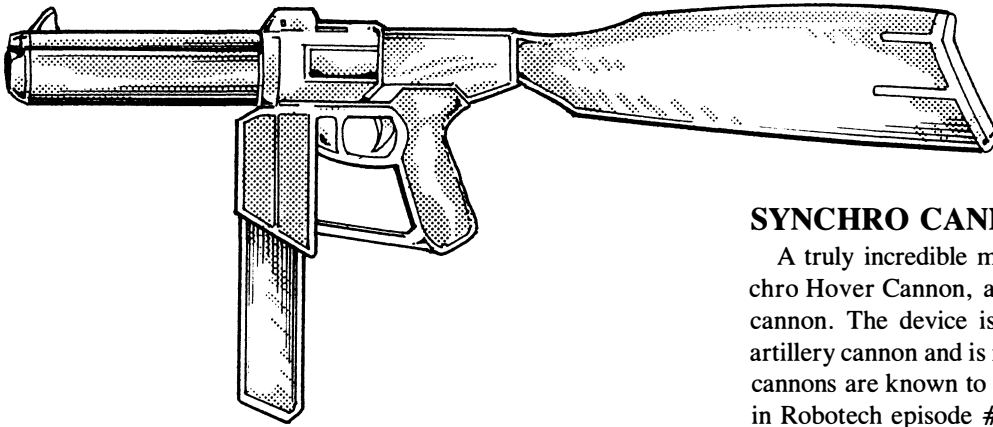

Infantry, M-35 “Wolverine” Assault Rifle

Type: Human Assault Rifle

Primary Purpose: Assault/Defense

Mega-Damage: 25mm Grenade Launcher does 2D6 M.D.; the 4.45mm ammo does no mega-damage (4D6 S.D.C.).

Range: 1150ft (350m)

Rate of Fire: Auto-grenade launcher — up to 4 per melee; the 4.45mm, caseless, 60 round ammo clip.

Payload: Auto-grenade launcher holds 4 grenades. The 4.45mm caseless has a clip of 60 rounds.

Weight: 19lbs (8.6kg)

The M-35 “Wolverine” has become the RDF’s main assault weapon. Developed by Doctor R. Burke, it can be set for single shot, semiautomatic or full automatic, and fires 4.45mm caseless rounds. The auto-firing grenade launcher can fire four 25mm high explosive grenades per melee before needing reloading. A 4.45mm ammo clip can be replaced in 5 seconds (one action), but the grenades will require one full melee (15 seconds). The weight and uniqueness imposes a penalty of -2 to strike without a Modern Weapons W.P. The M-35 comes equipped with a bipod and infrared telescopic sight.

WEAPON NOTES: In this postwar setting, the old weapons of the RDF and Southern Cross and conventional arms still exist, but the availability of ammunition and specific types varies greatly. Some places may have a lot of weapons, others none or few. Some may have a lot of ammunition, but no weapons to use it with. Game Masters should use their discretion when making RDF and Southern Cross items available. Mecha, tanks and military equipment of all kinds are scarce. The more common sidearms will be the most numerous.

Also see Cyclone Mecha for . . .

Missile Launching Sidecar (VR-052)

EP-37 60mm Beam Cannon (VR-052)

EP-40 40mm Pulse Beam Cannon (VR-052)

RL-6 Heavy Rocket Cannon (VR-038-LT)

Conventional Weapons: See Robotech RPG

Conventional Equipment, such as optical, sensors, etc.: See Robotech RPG.

Energy Rifles: See Southern Cross and/or Sentinels RPG for various available energy rifles.

SYNCHRO CANNON

A truly incredible mechanism of destruction is the REF Synchro Hover Cannon, a miniature version of the SDF-3’s reflex cannon. The device is about twice the size of an old 150mm artillery cannon and is mounted on a hover platform. No synchro cannons are known to exist on Earth (one is seen and destroyed in Robotech episode #83).

Primary Purpose: Assault

Weight: 10 tons

Mega-Damage: Obliterates EVERYTHING in its path of fire. Fires a destructive beam about 50ft wide (15.2m)

Rate of Fire: TWO times per melee

Effective Range: 10,000ft (3048m)

Payload: Effectively unlimited.

Speed: Slow. 30mph (48kmph), with a maximum altitude of 600ft (183m).

Note: Nicknamed “the Terminator.”

COBALT LIMPET MINE

The cobalt limpet mine is a marvel of micronization. The entire device is less than a foot long (0.3m) and weighs a mere 5lbs. The explosives, detonation device and timer, with digital readout, are all contained in a sturdy metal casing (20 S.D.C.). The timer can be set for up to 60 minutes and stopped up to 5 seconds before detonation.

Weight: 5lbs (2.3kg)

Mega-Damage: 1D4 \times 10

Blast Radius: 20ft (6.1m)

AM-1 Anti-Mecha Mine

Type: Explosive for RDF and Southern Cross

Primary Purpose: Anti-Mecha

Mega-Damage: 1D6 \times 10. Note: Considering this is a land mine, the G.M. may opt to subtract damage from the legs rather than the main body. I personally feel this is most appropriate; after all, the legs are taking the brunt of the damage.

Range: 40ft (12.2m) blast radius.

Rate of Fire: One time only.

Weight: 150lbs (68kg)

The AM-1 was developed by Doctor R. Burke and first used in the Arkansas Quadrant, Zentraedi conflict prior to the establishment of the Arkansas Protectorate. It has since been heavily used in the South American Sector and major trouble spots around the world. High-tech pirates and some independent nations have created their own versions (and use stolen AM-1s as well) which are usually twice as heavy and often nuclear (50%).

The mine is a high explosive encased in a sturdy, nonmetallic shell, or plates, making it difficult to detect. It is activated when a weight of 15 tons is placed on it. Note: The Zentraedi Male Power Armor weighs under 5 tons, and even with the foot soldier’s own weight of 6 to 8 tons, it is not likely to activate the mine. It is very effective in disabling mecha.

AM-2 “Watchdog” Anti-Mecha Mine

Type: Explosive for RDF and Southern Cross

Primary Purpose: Anti-Mecha

Mega-Damage: 1D6 × 10

Range: 20ft (6.1m) blast radius; 300ft (91.5m) strike range.

Note: Hits main body.

Rate of Fire: One time only.

Weight: 275lbs (129.2kg)

The AM-2’s recent introduction into the world’s defense forces has been met with enthusiasm. It is a smart bomb which can identify and attack specific targets. The process is . . . 1) The bomb lays dormant until its seismic sensors detect heavy movement. 2) When the source of the seismic disturbance is within 300ft (91.5m), an infrared/ultraviolet, passive, radar targeting sensor protrudes six inches above the earth and scans the area. 3) A small targeting computer identifies the potential target, whether it be Zentraedi foot soldiers, Battle Pods, Invid mecha, RDF mecha, tanks, or other heavy vehicles. 4) Attacks any *programmed* target by launching a high explosive guided missile (range: 300ft). Up to ten different targets can be placed into memory.

The AM-2 has been nicknamed *watchdog* because of its discriminating and friendly nature. Programmed to attack only pre-determined “enemies”, it will not attack so-called friendly mecha/targets even if stepped on or otherwise disturbed. Like a trained watch-dog, it waits for an intruder before it barks.

Note: The only defense against these mines is to stand perfectly motionless. The slightest movement, even opening a missile pod or rotating a weapon turret, will bring the next attack. In a field of AM-2s, the devices will attack individual targets, or fire on the same available target in rapid succession (one after the other), not simultaneously.

VEHICLES

RDF ARMORED ASSAULT TRANSPORT AAT-30

The Assault Transport vehicle is a cross between a jeep, a truck and dune buggy. It is a rugged, four-wheel drive vehicle designed specifically for traversing the wastelands. The front seat accommodates the driver and one passenger comfortably. The rear is a cargo bed like a pickup truck’s that can be easily modified to carry troops (seats 6 to 8 comfortably) or cargo (three ton limit).

Inside the cargo bed is an enclosed rectangular box that appears to be a storage bin, complete with a top opening access hatch. In reality, this is a concealed mini-missile launcher. What appears to be an access hatch raises up to reveal the retractable missile launcher. The missile launcher is fixed forward, at a 45 degree angle. The mini-missiles are the same type as those utilized by the cyclone.

The AAT-30 was originally used by RDF reconnaissance patrols and for supply runs in the wastelands. Since the invid invasion, the vehicle has become a favorite of bandits because of its harmless appearance and durability.

Vehicle Type: Military all-purpose transport.

Crew: One pilot and up to 10 passengers.

A.R.: Not Applicable

M.D.C. by Location:

*Main Body — 90

Missile Launcher — 30

Wheels (6) — 2 each

Headlights (2) — 1 each

*Depleting the M.D.C. of the main body destroys the vehicle.

Speed: 180mph (288kmph)

Range: 800 miles (1280km). Uses any type of gasoline.

Length: 24ft (7.3m)

Weight: 2.8 tons

Cargo: 3 tons can be hauled.

Special Equipment:

Radio: **Range: 50 miles (96km). Wide band & directional.**

High Intensity Headlights: **50ft beam (15.2m)**

Mini-Radar: **Range: One mile (1.6km), but only 75% accurate and easily obscured by hills, mountains and forest.**

WEAPON SYSTEMS

1. The GR-30-AAT Mini-Missile Launcher: A standard weapon for the AAT-30 that fires the small missiles originally developed for the cyclone.

Primary Purpose: Defense/Assault

Missile Type: Mini-missiles. Any can be used but fragmentation and high explosive are standard issue.

Mega-Damage: Varies with missile type.

Rate of Fire: One at a time or in volleys of 2, 3, or 5. Five is the maximum number in a volley. The automatic reload system replaces missiles as soon as they are fired. One volley counts as one attack.

Range: Varies with missile type, but about one mile (1.6km).

Payload: 30 total (up to 5 can be fired per volley).

CIVILIAN ALL TERRAIN HAULER (TRUCK)

A large, bulky vehicle that resembles a giant version of the RDF AAT-30. This vehicle was designed before the invid assault for traveling through wastelands and broken roads. The wide, oversize wheels provide additional traction and prevent roll overs (add +5% to pilot skill). A much sought after vehicle.

Vehicle Type: Truck

Crew: One driver and up to two passengers.

A.R.: 10 (not applicable against M.D. weapons).

S.D.C. by Location:

*Main Body — 2000 S.D.C. (equal to 20 M.D.C.)

Wheels (4) — 100 each (equal to 1 M.D.C.)

Headlights (2) — 25 each

*Depleting the S.D.C. of the main body destroys the vehicle.

Speed: 150mph (240kmph) empty, 110mph (176kmph) fully loaded.

Range: 200 miles (320km)

Length: 32ft (9.75m)

Weight: 6 tons

Cargo: Can carry up to 20 tons.

Weapons: None standard, although a variety of conventional

machineguns and energy weapons have been mounted on the front passenger side and rear (manned turret) by bandits and freedom fighters.

THE CIVILIAN “WOODY” TRUCK

The woody is a rebuilt truck made of wood, usually plywood, attached to an old truck frame. This type of truck is used by poor communities and nomads.

S.D.C. by Location:

*Front Engine Section of Main Body — 300 (equivalent to 3 M.D.C.)

Wood Cargo Bay Area — 300

Headlights (2) — 25 each

Wheels (4 to 8) — 40 each

*Depleting the S.D.C. of the main body (front) will destroy the vehicle.

Speed: 120mph (192kmph) empty, 90mph (144kmph) full.

Range: 180 miles (288kmph)

Length: 30 to 50ft (9 to 15.2m)

Weight: 6 to 12 tons

Cargo: Can carry 10 to 30 tons depending on size of truck.

Special Equipment: None, although some may have a towline or reinforced bumper for pushing.

Weapons: None standard, and *rarely* anything special like jerry-rigged turrets or mounted guns.

THE CIVILIAN TRACTOR HAULER

Farm communities and wasteland inhabitants have been known to modify and soup-up tractors for transportation and cargo hauling. These vehicles can be made surprisingly fast and are very well suited for rough terrains.

S.D.C. by Location (not M.D.C.):

*Main Body — 800 (equal to 8 M.D.C.)

Front Wheels (2) — 40 each

Large Rear Wheels (2) — 150 each

Spotlight or Headlights (2) — 10 each

*Depleting the S.D.C. of the main body destroys the vehicle.

Speed: 35mph (56kmph), regular
60mph (96kmph), souped-up

Range: 120 miles (192km), regular
80 miles (128km), souped-up

Length: 14 to 25ft (4.2 to 7.6m), tractor only. Cargo trailer (attached to the rear) is usually 10 to 20ft long (3 to 6.1m) and 6 to 12ft wide (1.8 to 3.6m).

Weight: 2.5 to 5 tons, tractor only.

Cargo: Can haul 6 to 12 tons.

Special Equipment: Towline and push bar bumper are pretty standard.

Weapons: None

MOTORCYCLES

Motorcycles have become one of the most popular forms of transportation partly because of their speed and mobility, but mostly because of their fuel efficiency. A vast variety of motor-

cycles, dirt bikes, and modified cycles exist.

DIRT BIKES are generally smaller and lighter than street bikes and designed for rough terrain.

S.D.C.: 80 main body, wheels (2) — 20 S.D.C. each.

Speed: 60mph (96kmph)

Range: About 400 miles (643km) per tank of gasoline.

Length: 4 or 5ft (1.5m)

Weight: About 80lbs (36kg) **A.R.:** 6

Crew: One driver, one passenger (optional).

Bonuses: +10% to pilot skill on rough terrain.

SCOOTERS are small, light, two-wheeled vehicles designed for city streets.

S.D.C.: 80 main body, wheels (2) — 10 S.D.C. each.

Speed: 60mph (96kmph)

Range: 400 miles (643km) per tank of gasoline.

Length: 4 or 5ft (1.5m)

Weight: About 80lbs (36kg) **A.R.:** 5

Crew: One driver, one passenger (optional).

Penalty: -10% on pilot skill for rough terrain.

SMALL MOTORCYCLES are smallish, lightweight vehicles designed for city streets, but are also fairly adaptable to dirt roads and grass.

S.D.C.: 100 main body, wheels (2) — 10 S.D.C. each.

Speed: 90mph (144kmph)

Range: 500 miles (804km) per tank of gasoline.

Length: 5 or 6ft (1.8m)

Weight: About 100 to 150lbs (45 to 67kg) **A.R.:** 6

Crew: One driver, one passenger (optional).

Penalty: -5% on rough terrain.

Bonus: +5% on paved streets.

MEDIUM-SIZED MOTORCYCLES are bigger, more powerful motorcycles. They are designed for paved roads, but adapt well to dirt roads and grass.

S.D.C.: 120 main body, wheels (2) — 20 each

Speed: 120mph (192kmph)

Range: 500 miles (804km) per tank of gasoline.

Length: 6ft (1.8m)

Weight: 200 to 300lbs (90 to 135kg) **A.R.:** 6

Crew: One driver, one passenger (optional). A sidecar can also be added.

Penalty: -10% on rough terrain.

Bonus: +10% on paved roads.

HOGS are the big muscle bikes with a lot of power behind them. They are best suited to paved city streets, but adapt well to dirt roads and grass.

S.D.C.: 180 main body, wheels (2) — 20 each

Speed: 150mph (241kmph)

Length: 6 to 7ft (2.1m)

Weight: 500 to 800lbs (225 to 360kg) **A.R.:** 7

Crew: One driver, one passenger (optional). A sidecar can also be added.

Penalty: -10% on rough terrain.

Bonus: +10% on paved roads.

THREE-WHEELED recreational vehicles resemble motorcycles and hold one person. They are excellent for sand and rough terrain.

S.D.C.: 140 main body, wheels (3) — 20 each

Speed: 90mph (144kmph)
Range: 400 miles (643km)
Length: 7ft (2.1m)
Weight: 800 to 1000lbs (360 to 450kg) **A.R.:** 6
Crew: One driver, one passenger (optional). A sidecar can not be added.
Penalty: None.
Bonus: +10% on rough terrain.

Modified motorcycles are common. Usually speed, rough terrain capabilities and armor constitute the modifications. An auto mechanic or mechanical engineer can make the following modifications, assuming he or she has the tools, parts and time.

Souped-Up Speed: Can increase the speed by 20%. Reduce range by 10%. Add a penalty of -5% to pilot skill on rough terrain and tight maneuvers. Time Required: 6D6 hours.

All-Terrain Modification: Larger wheels, heavy shocks and, possibly, body frame reinforcement. Reduce speed by 20%. No rough terrain penalty and add a +2% bonus. Time Required: 6D6 hours.

Armor Plating

Light Armor: Adds 60 S.D.C. to main body, 20 S.D.C. to wheels (protected), and 5 to A.R. Reduce speed by 10%.

Medium Armor: Adds 120 S.D.C. to main body, 30 S.D.C. to wheels, and 6 to A.R. Reduce speed by 10% and range by 10%.

Heavy Armor: Adds 240 S.D.C. to main body, 50 S.D.C. to wheels, and 8 to A.R. Reduce speed by 20%, range by 20%.

Time Required: 2D4 days for light and medium, 3D4 days for heavy.

GAME MASTER NOTE: It is possible to include the vehicle rules found in the post holocaust TMNT supplement **Road Hogs** (\$6.95). The inclusion of the *Road Hogs* rules is left up to the individual game master and is strictly optional. The *Road Hogs* rules are applicable only to S.D.C. vehicles; mecha and M.D.C. vehicles can not be modified.

The Southern Cross hover cycle can still be found and is a favorite vehicle of everybody as are most hover vehicles. The RDF motorcycle is also found from time to time. The hover cycle cannot be modified. See *Robotech® RPG* for typical conventional vehicles, including airplanes.

MBT-62 “Dark Knight” Tank

Vehicle Type: Tank
Crew: Two (pilot and weapons technician) plus up to 5 passengers.
Speed: 75mph on land (121kmph), 10mph in water (16km).
Max. Range: 600 miles (965.5km)
Weight: 45 tons
Length: 33ft
Width: 17ft (5m)
M.D.C. by Location

Tracks/Treads — 70 each side
Main Gun — 100
Missile Launcher — 75
Laser Turret — 25
Reinforced Crew Compartment — 75

*Main Body — 250

*Depleting the M.D.C. of the main body will shut the vehicle down completely.

WEAPON SYSTEMS

1) **The Main Gun** is an 120mm, air-cooled, auto-rocket cannon. The cannon can swivel 45 degrees from side to side and 90 degrees up and down. Laser targeting.

Primary Purpose: Assault

Mega-Damage: 4D6 per blast

Range: 4000ft (1200m)

Rate of Fire: Twice per melee.

Payload: 40 rounds.

2) **Dual MBT Rocket Launchers** are mounted on the top of the tank. Capable of 360 degree rotation, and 90 degree arc of firing.

Primary Purpose: Assault

Mega-Damage: 1D4 × 10.

Range: 3 miles (4.8km)

Rate of Fire: Twice per melee.

Payload: 6 light high explosive missiles

3) **Twin Barrel, ROV-8 Laser Turret** mounted on the top front of the tank. 90 degree side to side rotation, and 90 degree arc up and down.

Primary Purpose: Assault

Mega-Damage: 2D6 per blast

Range: 2000ft (610m)

Rate of Fire: Twice per melee

Payload: Unlimited

4) **Front Mounted, 7.62mm Light Machinegun.** This conventional weapon is the only weapon operated by the pilot. It does NOT inflict mega-damage.

Primary Purpose: Antipersonnel

Mega-Damage: None; inflicts 5D6 S.D.C. per round.

Range: 3000ft (915m)

Rate of Fire: 200 rounds per melee maximum

Payload: 2000 rounds

Equipment of Note

1. **Self-Contained Environment** with independent oxygen supply and circulatory system.
 2. **Long-range, wide band radio.** Range: 200 miles (321.8km).
 3. **Passive and active radars** can identify up to 40 miles (64km) and track two dozen targets within a 20 mile (32km) radius.
 4. **2 week food** and water supply.
 5. **Standard weapons:** M-16 and 60mm LAW (one each).
- Total Attacks Per Melee:** Six plus S.D.C. machinegun.

LCT-73 “Tornado” Combat Tank

Vehicle Type: Tank
Crew: Two (pilot and weapons technician) plus up to 3 passengers.
Speed: 90mph on land (144.8kmph), 10mph in water (16km).
Max. Range: 700 miles (1126.3km)
Weight: 16 tons
Length: 25ft (7.6m)
Width: 10ft (3m)

M.D.C. by Location

- Tracks/Treads — 50 each side
- Snub-Nosed 90mm — 50
- Main Gun — 50
- Laser Turret — 25
- Reinforced Crew Compartment — 50
- *Main Body — 120
- *Depleting the M.D.C. of the main body will shut the vehicle down completely.

Weapon Systems

1) Self-loading, 90mm Recoilless Rifle. 30 degree rotation.

Primary Purpose: Anti-Tank
Mega-Damage: 1D10 per blast
Range: 2000ft (610m)
Rate of Fire: Twice per melee.
Payload: 20 rounds.

2) Snub-nosed, 90mm Recoilless Rifle (operated by the pilot).

30 degree rotation and arc of fire.
Primary Purpose: Assault
Mega-Damage: 1D10 per blast
Range: 2000ft (610m)
Rate of Fire: Twice per melee.
Payload: 20 missiles

3) Twin Barrel, ROV-8 Laser Turret mounted on the top of the tank. 360 degree rotation and 180 degree arc of fire.

Primary Purpose: Anti-Air
Mega-Damage: 2D6 per blast
Range: 2000ft (610m)
Rate of Fire: Twice per melee
Payload: Unlimited

4) Front Mounted, 7.62mm Light Machinegun.

Primary Purpose: Antipersonnel
Mega-Damage: None; inflicts 5D6 S.D.C. per round.
Range: 3000ft (915m)
Rate of Fire: 200 rounds per melee maximum.
Payload: 2000 rounds

Equipment of Note

1. **Self-Contained Environment** with independent oxygen supply and circulatory system.
2. **Medium range, wide band radio** — 100 mile range (160.9km).
3. **Passive and active radars** — 20 mile range (32km).
4. **Laser targeting;** +1 to strike.
5. **Optical enhancement:** Infrared, thermo-imager, passive night sight, and telescopic. Range for all is 2000ft (610m).
6. **Spotlight** on left top side. 90 degree rotation.

Turbo Fan Jet

A commercial, one-man jet aircraft once used by many of the world's nations and industry (as well as high-tech bandits). Its design makes it capable of traveling at low altitudes at high speeds.

Vehicle Type: Jet Aircraft

Crew: One

M.D.C. by Location

- Fan Jet — 40
- Wings (2) — 40
- *Main Body — 75
- *The usual conditions apply.

Speed: 300mph cruising, 650mph (near Mach 1) with normal jets, and 870mph (Mach 1.4) with the turbojet engaged. The Mach 1.4 speed can only be maintained for about 20 minutes.

Range: 600 miles (960km)

Length: 22ft (6.3m)

Weight: 5 tons

Bonuses: +3 to dodge

Weapon Systems

None are standard; however, high caliber, armor piercing machineguns have been known to be built into the nose.

Mega-Damage: 1D6 per burst

Range: 4000ft (1200m)

Rate of Fire: 6 bursts per melee

Payload: Enough for 20 attacks; approximately 1300 rounds.

OPTIONAL RULES

Excerpted from Road Hogs by Erick Wujcik

© Copyright 1986 Palladium Books®

Control Rolls

Poor road conditions place drivers in constant danger of losing control of their vehicles. To avoid losing control, the characters must roll against their **Pilot skill**. *Control Rolls must be made for each of the following situations:*

Exceeding Cruising Speed: Any time a driver exceeds the Cruising Speed for the vehicle there's the danger of losing control. Every melee round of excessive speed requires a Control Roll. Cruising speed is about half the maximum speed.

Exceeding Road Speeds: Going too fast on back roads or trails is dangerous, no matter how well built the vehicle is. Any travel over 75mph on a back road or over 45mph on a trail requires a Control Roll. This is not the case with Highways; a vehicle can travel all the way up to Cruising Speed on a Highway without rolling for Control.

Exceeding Maneuver Speed: Every *turn, swerve* or *land change* that occurs while exceeding Cruise Speed or Road Speed *requires another Control Roll with a -12 penalty.*

Driving in Reverse: Attempting to drive in reverse at any speed over 25mph. Roll a Control Roll with a -30% penalty.

Poor Road Conditions: Requires a Control Roll. This can include anything from rain to steep inclines. -30% or optional. See Road Quality and Obstacle Table for specific penalties.

Avoiding Obstacle: Swerving around any object requires a Control Roll; no penalty. If the swerve or dodge involves leaving the road surface, then the penalty is -40%.

Avoiding Aerial Attacks: Every dodge is an evasive action. -30% penalty.

Loss of Control Table (Optional)

The game master or player should roll on the following table every time a character fails a Control Roll. Roll percentile dice.

01-10 Pothole! Vehicle slams into something and rebounds. Or, just as likely, the vehicle bottoms out, smashing the underside into broken pavement or a pothole. Vehicle

takes 4D6 points of damage to S.D.C. and Speed is reduced by 10%.

- 11-25 Out of Control!** The vehicle skids out of control. Ends up off the road, in a ditch or in some other embarrassing situation. Stuck 3D6 Melee Rounds.
- 26-44 Stall!** Forced to make a sudden stop; the vehicle stalls out. Getting it going again takes 2D6 Melee Rounds.
- 45-76 Skid!** Skid out of control and into an object. The vehicle takes half normal damage from this minor crash. Speed is reduced by 25%.
- 77-90 Crash!** Skid out of control and into an object. The vehicle takes full damage and occupants take half damage. Speed is reduced by 50%.
- 91-97 Totaled!** Vehicle crashes and is totally destroyed. Occupants take full damage.
- 98-00 Roll and Burn!** The vehicle goes completely out of control and rolls over 1D6 times. Vehicle takes double damage, occupants take normal damage. In 1D10 melee rounds the vehicle's fuel tank will explode; anyone remaining inside will be torched.

Vehicle Combat Tactics, Maneuvers & Techniques

The Ram

Ramming is a vehicle-to-vehicle attack where one vehicle attempts to bash into the rear of another. The speed of the ramming/attacking vehicle must exceed 10mph of the vehicle it is attacking. Speeds greater than 10mph above the defending vehicle's constitutes a crash. Likewise, head-on collisions/rams and ramming stationary objects at speeds over 10mph constitutes a normal crash, damaging all parties.

Ramming damage varies with the size of the attacking/ramming vehicle.

<u>Damage to Target Vehicle</u>	<u>Inflicts</u>
Motorcycle	4D6
Automobile, small truck, mini van	6D6
Full size truck or van	6D8
½ ton truck or bus	6D10
10 or 16 wheeler/semi-truck	10D10

Note: The attacking vehicle also suffers damage, but only ½ of that which it inflicts on its target. Only if the attacking vehicle has a ram-prow built onto it will the vehicle take no damage.

Control Rolls: Immediately after a successful ram, both vehicles must make control rolls. The attacker is -25 and the defender is -40.

The Sideswipe

When cars are neck-and-neck, they can attempt to shove each other off the road. Works exactly like the Ram except that damage is half those listed. **Control rolls** are the same as for Ramming.

The Cut-Off

The attacker pulls in front of the defender, cutting off the lane and forcing the defender to either hit/crash or swerve to avoid hitting. The attacker rolls to strike and must make a control roll. A failed strike means the maneuver is unsuccessful/incomplete and can be tried again. A failed control roll means a crash. If the attacker succeeds and the defender fails to dodge (either by

missing the roll or by not rolling), then there is a collision. **Control Rolls:** The attacker is -30, and the defender is -25.

The Block

Basically, this happens when the attacker wants to keep the defender in some position. A good example is when the cars are neck-and-neck and the right hand car sees an oncoming truck in the left lane and decides to force his opponent to stay in that lane. This same technique can be used to keep one's opponent from passing as well. If the attacker rolls a successful strike, and if the defender does not try to dodge or fails to dodge, then the defender is stuck in that lane until the next melee. Neither a *Sudden Brake* or a *Drag Race* is good against a Block. Executing a block may require high speeds and/or quick maneuvering, like switching lanes, swerving, etc. Control rolls should be made for each block/strike maneuver and dodge/evasive action. **Standard Control Rolls apply.**

The Sudden Brake

When two cars are side-by-side, preferably in different lanes, one of them can attempt to get behind the other by hitting the brakes. Whether or not the braking car actually pulls behind depends on a straight (twenty-sided die) initiative roll. Both cars roll; high roll wins. However, the braking car reduces speed by half for one melee. An unsuccessful Sudden Brake means the opposing car is still side-by-side. **Control Rolls** must be made with a -15 penalty. **Warning:** Don't attempt to brake with anyone immediately behind you unless you want a collision.

The Bootleg Turn

This is a special maneuver that lets the vehicle completely change direction. Basically, the driver turns, slams on the brakes and "fishtails" the car into the opposite direction. While in the Bootleg, the vehicle has *no chance to Dodge*. A **Control Roll** must be made with a -50 penalty.

Drag Racing

When two cars are neck-and-neck and trying to pull ahead of each other, that's a Drag Race. The same thing happens when one car is behind another and both decide to speed up. A lot depends on the Speed of the vehicle; the higher the better. However, there's a lot more to drag racing than engine performance. The driver's skill and reflexes, as well as raw luck, are just as important.

Rolls for Drag Racing are made on twenty-sided dice. The driver's P.P. bonus can be added.

If both cars were neck-and-neck, then the winner will be way out in front. When one car is trying to overtake another, then winning means catching up and losing means falling way behind. In case of a tie, the cars maintain their current position. A Natural Twenty is perfect luck, either leaving a pursuer in the dust or coming up neck-and-neck with a fleeing prey.

Note: There is a -5 penalty when driving any vehicle for the first time. In other words, if a character just stole a car and is trying to escape in it, he'll have a -5 penalty on the initiative rolls.

Road Quality & Obstacle Table (Optional)

On tended roads, roll every 20 miles. For *well traveled*, but poorly maintained roads, the roll should come every 10 miles. *Back Roads* and *Trails* call for a roll every 5 miles. During Vehicle-to-Vehicle combat, the GM may want to roll more often.

Remember, cruising speed is half the vehicle's maximum speed.

01-25 Excellent Conditions. No Problems.

26-30 Broken Pavement. Make Control Roll. Failure means the vehicle's alignment gets messed up; decrease Speed by 20%.

31-35 Car-Eating Potholes. Make Control Roll. Failure means the vehicle suffers 4D6 S.D.C. damage, and reduce Speed by 10%.

36-40 Stretch of Dirt Road. Reduce Speed or make Control Roll on "Trail" column of table.

41-45 Construction Area. Road reduced to one lane for both directions. 30% chance of worker directing traffic. Otherwise, vehicle takes its chances with oncoming traffic.

46-50 Bandit Ambush. From 3 to 12 (3D4) bandits vehicles are ready to come out of hiding. Victim takes 3 machinegun shots (no bonuses to hit, no Dodge possible) at once.

51-60 A Crater has obliterated the road and surrounding area. The crater is a rocky dust bowl that is 4D6 × 10 feet deep and 2D6 miles round; -15% on control rolls, -30% on control when traveling faster than cruising speed. Can go through the crater (down first) or around. Roll to determine the type of area around the crater:

01-25 Grassland; -5% penalty.

26-50 Dirt and rock; -15% penalty on control rolls.

51-75 Bumpy, grass & shrub covered earth; -10% penalty.

76-00 Light forest; -15% penalty.

61-70 Poor Visibility. Fog, rain, snow or other weather problem clouds the road for the next 30 minutes. After 30 minutes, roll again.

71-75 Road Disappears. The pavement is too broken up for 1D6 × 100 feet and ends. Roll to see what the terrain is like for the next 1D6 × 10 miles. At the end of the roadlessness roll again.

01-20 Marsh or mud for 1D4 miles, reduce maximum speed by 50%. 50% chance of getting stuck every half mile. Control rolls, -50%.

21-40 Grassland. Bumpy and dotted with shrubs; -5% penalty.

41-60 Dirt, rocky; lumpy, low hills. -10% penalty on control rolls.

61-80 Light Forest. -10% on control rolls over cruising speed.

81-00 Flat grassland; no penalties.

76-80 Roadblock. Rock slide, huge tree, blown up vehicles(s) or mecha wreckage completely block the road. Control rolls with -5% to avoid. Must *stop* and go around. G.M.'s Choice: This could also be a trap by bandits (who are lurking nearby) or invid (1D4 scouts, 1D4 armored scouts, one shock trooper or GM's own selection).

81-90 A Huge Crater has swallowed the road. The crater covers a 2D4 × 10 mile area and is 2D6 × 100 feet deep. *First roll for interior of crater:*

01-16 Filled with water (1D6 × 100ft deep). Must go around.

17-33 Mud Bowl. -60% on all control rolls, speed is reduced by 50%. 50% chance of getting stuck every half mile/km. Should go around.

34-49 Light Forest. -30% on control rolls if traveling faster than cruising speed.

50-65 Dust Bowl. Vehicles will kick up dust clouds. Poor visibility; -30% on all control rolls at speeds above 15mph.

66-81 Grassland. No penalty.

82-00 Rocky; grass and shrubs. -20% on control rolls when traveling faster than cruising speed.

Then roll for area around the crater should players go around rather than through the crater.

01-15 Dust Bowl, same as crater.

16-30 Grassland, same as crater.

31-45 Light forest, same as crater.

46-60 Rocky grassland, same as crater.

61-75 Dense Forest. -40% on control rolls when traveling faster than cruising speed.

76-90 Tall hills, almost mountainous, with light trees, tall grass, flowers and shrubs. -10% on all control rolls, -40% when traveling faster than cruising speed.

91-00 Desert. Reduce maximum speed by 25%. -30% on control rolls when traveling faster than cruising speed.

91-00 Gaping Hole. Control roll is -20% to avoid. The hole is 3D4ft wide, 3D6ft deep and covers the whole width of the road. Must go around. Riding into the hole (a failed control roll) does 4D6 S.D.C. damage and the vehicle will be stuck. Character(s) must figure out a way to get the vehicle out of the hole.

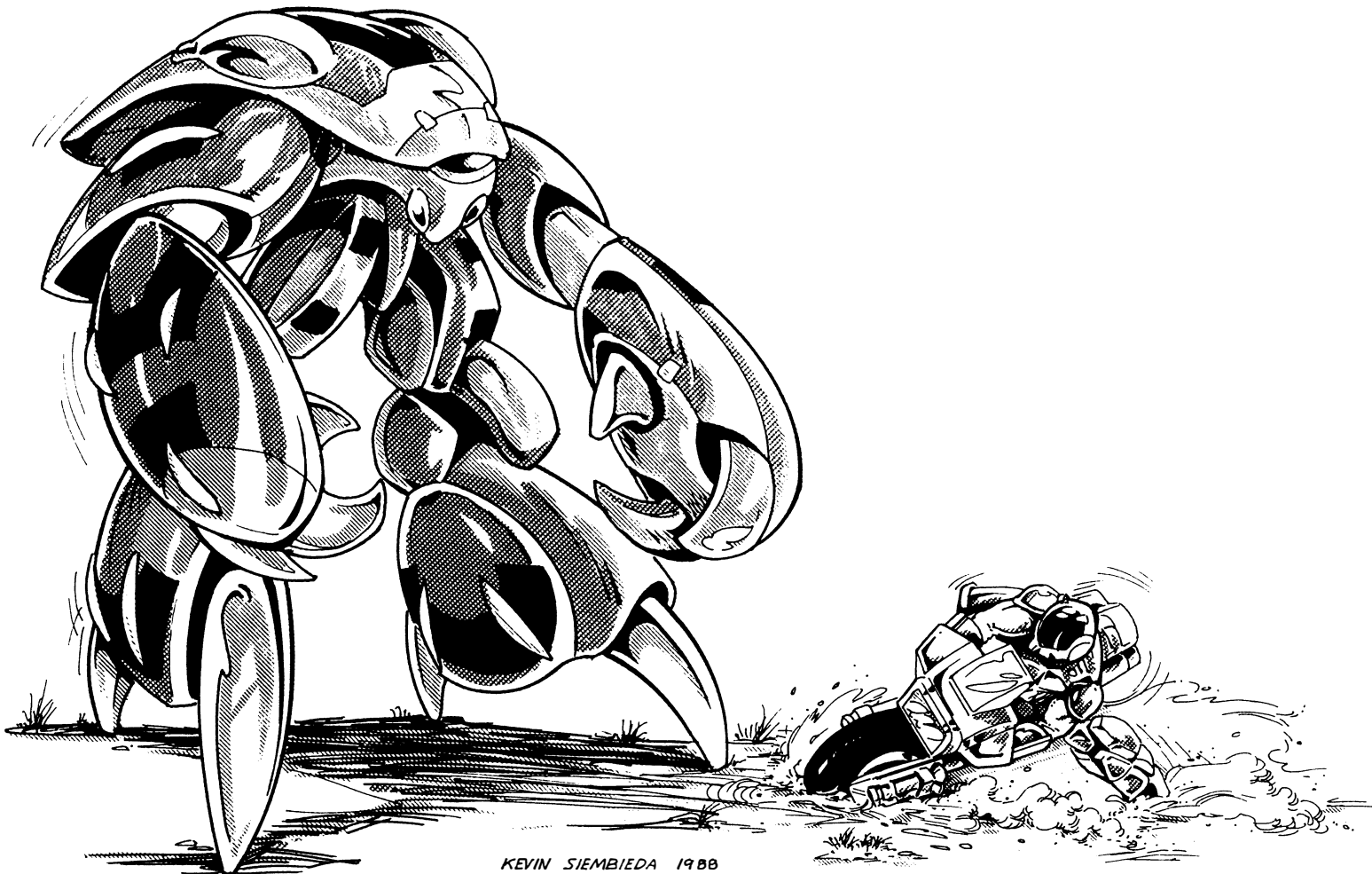

KEVIN SIEMBIEDA 1988

THE INVID

The story of Earth's involvement in the intergalactic wars over protoculture begins hundreds of years earlier on a world in a distant galaxy. This was the homeworld of the Invid.

To understand the Invid, one must understand protoculture; *The Invid Flower of Life*. The so-called "Flower of Life" is a mysterious flowering plant indigenous exclusively to the Invid's homeworld. It possesses several properties truly unique to any plant in the universe.

One of those properties is the generation of incredible amounts of *bio-energy*. As the Robotech Master, Zor would discover, a properly germinated seed placed under constant pressure generates more energy than a nuclear power plant. "Clean," natural, non-polluting energy. This process inhibits the plant's growth, which in turn causes it to generate even more energy. Locked in stasis, the seed will continue to produce energy for decades. A single seed can power a modern city of millions, for generations. But there's more.

The use of this energy with machines creates a paranormal link between man and machine. It is as if the bio-energy instills some essence of life into the machine. A quasi-life that requires a living, intelligent life-form to direct it. The psionic union between man and machine makes the mechanical device act more like an extension of the operator instead of a mere tool.

It is this unique phenomenon that makes the Veritech Fighters, Alphas and other mecha (human and alien) so incredibly agile. The giant machines react with almost human reflexes because they are effectively mechanical extensions of their pilots. Thus, the machines respond to the person's slightest movement.

Yet perhaps the most unusual aspect of the Invid Flower of Life is the psychic abilities it imparts to those who consume it. Consumption by humans creates *uncontrollable* hallucinations and occasional precognitive visions accompanied by headache and nausea. (**Note:** A half ounce of pollen or a quarter ounce of seed, less than 14 grams, will induce hallucinations in humans, with a 1-38% chance of an insightful or precognitive vision. During the hallucination the character is completely oblivious to the world around him and can not talk, walk, attack or defend himself. The stupor lasts 6D6 minutes. The side effects are a painful headache and nausea that *last 1D6 hours*, with **penalties** of -2 on initiative, -1 to strike, parry and dodge. There is also a chance the character will poison himself; roll to save vs poison *each time* the Flower of Life is consumed. A failed roll means 5D6 damage directly to hit points. Continued, regular use will cause insanity; 1-60% chance each time after eighth try. Roll on random insanity table once, phobia table once, and obsession table once. This character will be addicted to the flower.

The Invid, however, can consume the Flower of Life without ill effect. Centuries of use by the Invid had created a strange, passive race of creatures living in harmony with their planet.

They had no belching factories, no houses or industry per se. Instead, they lived as one race, one people, who were one with their planet. It is difficult to say if the Flower of Life molded the Invid into what they were/are. But it is certain that the psychic powers it imparted shaped the Invid society.

The Invid had long ago mastered the vast powers of the Flower of Life. With it, the Invid grew and changed. Like bees, the Invid's lives centered around the harvesting of the flowers. Never destroying, like humans who chop down forests or strip the earth of its minerals, but cultivating and sharing the wondrous plant. A symbiotic relationship that allowed both plant and Invid to prosper.

From the use of the flower, one central intelligence, one mind, came into existence. Like Earth bees or termites, the countless individual Invid were directed by *one controlling intelligence*, the queen bee. It was this one controlling intelligence that was telepathically and empathically linked to all her children. Her thoughts, feelings and visions could be instantly transmitted to all the Invid of the world. It was this one intelligence that controlled the myriad powers of the Flower of Life. Indeed, the other Invid were almost extensions of herself. So connected with her people that she feels each one's death, even hundreds of thousands of miles away. Each Invid death is painful. Each death syphons a little of her energy away.

Although no machines or civilization was immediately apparent, the Invid intelligence had developed a bizarre psychic bio-science that can only be equated to Earth's mythical alchemy. The intelligence could draw on the life-building energy to transmute (the power to transform one element into another) her surroundings and even her people. It was this power that she used to create the "hives" to shelter her minions. It was this same transmutation ability that enabled her to change her own physical body and those of the Invid. An instant mental "evolutionary" process as she saw it. In a similar way, the intelligence could create more of her people, almost at will, like a giant, alchemical, bio-engineering factory. The Robotech Masters would later unravel the secrets of this process to create the giant warrior-clones, Zentraedi, and give themselves near immortality (or so they thought) through accelerated cloning.

For eons the Invid lived in peaceful harmony. Their way of life simple, almost mindless. Then, on one fateful day, a race of beings known as the Robotech Masters came to the Invid world.

The Robotech Masters were a race of humanoids (they look just like humans and *may* be distant ancestors) who were infamous for their super-science. Unfortunately, the Robotech Masters used their great science to bully and enslave other worlds. They did this by offering their aid to less advanced civilizations and making them dependent upon their "secrets" of technology. Once dependent upon them, the Robotech Masters would extract payment in the form of allegiance, materials, minerals, production, and so on. Those who dared to refuse or reject them were beaten into submission or destroyed. In a way, the Robotech Masters were malicious mega-merchants who created an intergalactic monopoly and, therefore, an empire, crushing anyone who got in their way.

The discovery of the Invid homeworld was a disappointment, because its people *appeared* to be an indifferent race of simpletons. However, never to be ones not to explore and exploit all

possibilities, the Masters left a team of scientists to see if this world was of any value to them.

The scientific team was led by a brilliant and uncharacteristically compassionate Robotech scientist named Zor. In the months that followed, Zor discovered the unusual link between the slug-like humanoids and the Flower of Life. He would befriend the Invid ruling intelligence and share her many secrets.

Blinded by naivety and by the excitement of the wondrous plant, Zor developed a way in which the Robotech Masters could harness its energies. A shockingly simple process (to him) to create what he called "organic fusion." Zor also pioneered the mechanics of the Robotech Masters' bio-engineering through "protoculture," the refined and harnessed bio-energy of the Invid Flower of Life. The young scientist revelled in the euphoria of his discoveries. He thought to himself that he was about to bring a new age of greatness to the Robotech Masters and the universe. Zor's excitement was empathically transmitted to the Invid intelligence and she to felt his joy. Unknown to Zor, the Invid intelligence had discovered new feelings, new thoughts, and new visions through him. Feelings she had never known (one might call love). She soared along with his intense love of life, excitement and happiness.

Zor's superiors were equally ecstatic about his discoveries. Indeed, a new age had dawned. With this new power they could increase their empire a hundredfold. They could rule a thousand worlds and bring the universe to its knees.

As Zor's masters hatched their evil schemes, he continued his research, discovering more and more. When the Robotech Masters finally returned to the Invid homeworld they were greeted as friends, perhaps as demigods. Zor proudly gave lectures on his many theories and unveiled his second greatest invention, a new, super dimensional spacecraft prototype powered solely by protoculture (the SDF). The spectacular vessel held many of his new discoveries and theories. The masters marveled over the prototype spacecraft. Without a doubt, young Zor was the most brilliant mind of their race.

Amid the accolades, the Robotech Masters instructed Zor to gather up a vast supply of seeds for immediate use. As he did this, the Invid intelligence told him that others of his world were also collecting the life-giving seeds. She was suddenly wary and nervous, but Zor calmed and assured her that all was right and that such a treasure must be shared with the universe and not hoarded by any one race. The Invid one mind remained fearful, but deferred to Zor's wisdom and friendship.

With sufficient seeds collected (half of which were aboard Zor's new superfortress), the Robotech Masters made their move to insure their immortality and domination over the universe. (Ironically, it would seal their doom and create a new nightmare to ravage the cosmos.) They began the immediate and complete defoliation of the Invid homeworld. The Robotech Masters could not afford to let any other race, even these apparently harmless people, possess protoculture. Their first mistake was greed. Their second mistake was the defoliation of the planet, for the "**Flower of Life**" could grow nowhere else. A dilemma that the Masters would discover later. Their third mistake was rooted in their arrogance which blinded them to the awesome power of the Invid.

Zor and the Invid alike were horrified! Zor could not believe the Robotech Masters would do such a heinous act. His reclusive years as a scientist sheltered him from the cruelty of the Robotech

Masters. Now his eyes were opened, but too late. His pleas for them to stop were ignored. His impassioned speeches about sharing the wondrous discoveries (at no charge) were received with laughter. At that moment, Zor's world crumbled. His naivety had condemned an innocent people. He was helpless to stop the defoliation of the Invid world, but he was not entirely powerless. In a small way, he could help rectify the carnage he had inspired. Alone, aboard the prototype vessel, he furiously set to work.

Meanwhile, the Invid planet was wracked by a catastrophic change. The Robotech Masters' plan was especially monstrous. Their super-powerful defoliants would destroy *all* plant life. The method so deadly that no vegetation would grow there for 10,000 years. Yet the Invid people would be unharmed, just left to die of starvation. And so it would have been if the Invid were the helpless innocents the Robotech Masters believed them to be. Instead, another equally devastating change was taking place inside the many hives. The intelligence was transforming her people into a combat force to crush the hideous despoilers of a world. To the Robotech Masters' surprise, a lethal force of mechanized aliens suddenly appeared to savage their troops. The battle was fierce and terrible, but could not save the planet.

Then the hand of fate entered the fray and tragedy struck again. During the ensuing battle, Zor was mortally wounded, but not before he could implement his last desperate plan to make right this terrible wrong. His flagship, the new prototype (SDF), suddenly burst to life and vanished as it made its jump into hyperspace (the space fold process). With it, a vast reserve of precious protoculture; unprocessed seeds placed in suspended animation, hidden somewhere in its deepest recesses. ALL of Zor's notes, new theories, speculations, and plans for the prototype super fortress had been purged from all the other computers. Thus, most of Zor's knowledge of protoculture was forever destroyed. Whatever new secrets he had unearthed died with him. Still, the Robotech Masters knew enough to build their empire. They held the secret of *organic fusion* and the last *known* supply of protoculture seeds. They also had the power of protoculture *bio-engineering* (although far less sophisticated than what was possible, as evident from the Invid's power of transmutation). With that knowledge, they had already created the Zentraedi and would go forth to subjugate hundreds of worlds. Retreating from the Invid planet, they thought they had seen the last of the Invid. They were very wrong.

Perhaps the only reason the Robotech Masters were able to escape the clutches of the Invid was because of the torrent of emotions that wracked the directing intelligence. The trauma of the Robotech Masters' betrayal and treachery was confusing, compounded by the horror of the destruction of the "Flowers of Life." Too many thoughts raced through the intelligence's brain. Then the final blow. The death of Zor! It was far too much for her to handle all at once. The intelligence screamed and went numb. Without their leader to guide them, the newly created Invid warriors were no match for the Robotech Masters, who made a hasty getaway.

The battle was lost, but the war was far from over. When the intelligence regained consciousness, she found that she had undergone a metamorphosis of her own. There was now a second intelligence, a male counterpart to herself and one almost as powerful. The male entity was the embodiment of vengeance full of hate, aggression and anger. Together, they vowed that

the Robotech Masters would be destroyed. The Flower of Life belonged to the Invid alone; anyone who dared to use its essence (protoculture) would be destroyed.

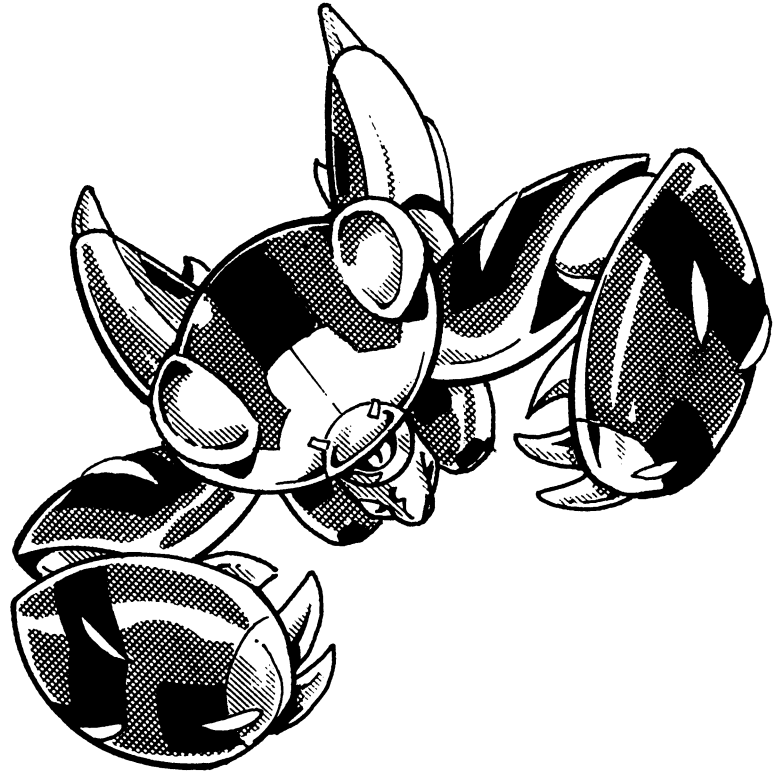

So began a war that would stretch across the centuries. Millions of Invid and Zentraedi (the Masters' warrior race) would perish. Along with them, entire worlds of innocents who were coerced into using protoculture provided by the heartless Robotech Masters. The Invid scouts scoured the universe, searching for the essence of the Flower of Life. Whenever "its" presence was found, the twin intelligences, known as the *Regis* and *Regent*, were alerted. A terrible swarm of scouts, armored scouts, shock troopers, pincers and, later, the dreaded inorganics would swarm over the world, collecting the protoculture and obliterating the population.

After a few centuries of war, the *Regis* grew tired of the constant battle. Instead, she suggested finding a new world on which protoculture would grow and they again could live in peace. However, the *Regent* was a being of passion who thrived on war. Bent on revenge, he would not accept anything but the destruction of the Robotech Masters. Already the *Regent* had enslaved several worlds. His goal, like the Robotech Masters', became one of intergalactic conquest and domination. So it was the Invid became divided; half ruled by the *Regis*, the other half ruled by the *Regent*. Over the decades, the rift between the two would cause a schism that will send them to two entirely different destinies. The *Regis* would pursue "enlightened evolution" and ultimately, follow Zor's trail (the SDF-1) to Earth and beyond. The *Regent* would finally find and ravage the Robotech Masters' homeworld. There, he would encounter the SDF-3, the indomitable Rick Hunter and the Sentinels.

For the moment, we will forget about the *Regent* (see *Sentinels RPG*) and follow the *Regis* and the Invid Invasion of Earth.

Zor, appalled by the unforgivable actions of his people, finally saw the Masters as the maleficent force they had always been.

Worse, he had given them the tool (protoculture) to fulfill their evil dreams. His only hope was to steal the precious seeds and give his knowledge to other people throughout the universe. Zor's first task was to erase all his new theories and discoveries from the Robotech Masters' main computers. That accomplishment meant that the secrets of protoculture were locked away in his head alone.

Sadly, Zor was mortally wounded before he could escape. Still, there was hope. A planet in a distant galaxy. A planet he had seen in a protoculture induced vision. A planet whose primitive people would grow to understand protoculture. A people who, although teetering themselves on the brink of self-destruction, had always opposed oppression. How he knew these things he did not truly understand, but time had limited his choices. In that instant, the fate of the Robotech Masters, the Invid, and humanity was placed on the shoulders of the human race; Earth.

Realizing that the humans of Earth needed time to advance in technology and grow as a people, Zor plotted a course that would lead the Robotech Masters, and their Zentraedi pawns, on a wild chase across space and time. With his last dying breath, he launched his mighty, new vessel on its fateful journey.

The ship's journey carried it across to the cosmos, only pausing long enough to attract its pursuers and then disappear in a space fold long before it could be captured.

As time went on, the capture of Zor's vessel became more and more imperative. The Robotech Masters' supply of protoculture was finite and becoming exhausted. Despite their super-science and best efforts, they could not get the Flower of Life to grow from seed. The best that could be achieved were a variety of mutant strains, all of which lacked the vital properties of protoculture. Without the supply of seeds aboard Zor's vessel, they were doomed!

The Invid, with their alchemy, would fare no better in growing the few seeds they had saved. Fortunately, they had stored a thousand lifetimes of the precious *energy* and remained comparatively strong.

Nearly 400 years after the vessel had been launched, Zor's flagship crash landed on Earth. Its arrival would unite the planet, yet nearly destroy it as well. Although some of the secrets of protoculture would be uncovered, making it possible to rebuild the vessel, now known as the SDF-1, as well as, create the Veritech Fighters and Destroids, the humans never learned of its secret cargo of seeds hidden, and in stasis, deep inside the ship. It would only be after the Robotech Masters' assault on Earth and their destruction above the wreckage of the SDF-1, that unleashed the blossoming seeds, into our world (*See the last few episodes of Southern Cross and, specifically, episode #60.*)

Surprisingly, the Flower of Life grows amazingly well on Earth (not that most humans know what it is, other than an alien form of plant life). In a few short years, the Flower of Life is everywhere, growing with the vitality of a weed. Did Zor know Earth could sustain the flower? Perhaps. But as Earth became a vast garden of protoculture flowers, it also signaled the coming of the Invid.

The Invid Regis sensed the existence of the Flowers of Life from a distant galaxy, gathered her people and came to Earth. Her goal: to cultivate the flowers and claim the Earth as the Invid's new homeworld. The fact that Earth was already popu-

lated by an indigenous, intelligent life-form was of little consequence. The Regis had grown indifferent toward other life. Her concern was only for her people. The destruction that followed was spawned from desperation and callousness. At last, she had found the only known world that could support the Flower of Life. A world she claimed for the Invid.

The Earth was again laid under siege. All major cities and populated areas were annihilated. The powerful E.B.S.I.S. obliterated before they knew what hit them. The sprawling anarchy of the Argentine Quadrant atomized. The millions of Scandinavians gone in an instant.

Quebec Quadrant was the first to actually see the invaders. The Flower of Life prospered in this region better than anywhere else, so the Invid dared not risk its destruction with area affect weapons. Out of the sky they came like angry hornets. The last of the organized Armies of the Southern Cross and RDF hurried to Quebec's aid, but to no avail. The pitifully tiny Earth forces had no chance against the millions of Invid. The battle for North America lasted an astonishing three days.

The last vestiges of humanity were broken and scattered. Some communities were converted into slave farms to harvest protoculture. Other small towns, tribes and villages were *allowed* to exist, as long as their people did not use protoculture or dare resist the Invid's rules.

Anarchy worse than the post-holocaust days of the first two Robotech Wars reigned. Rebel soldiers, gangs and madmen scrambled for a little piece of power. Others simply survived the best they could. These were the most difficult days in Earth's history. A time when the Earth was occupied by merciless aliens, with mankind, their slaves.

Despite the odds, brave resistance fighters dared to strike out at the inhuman Invid. Claiming what small victories they could, an organized network of freedom fighters grew. Among their ranks, old RDF soldiers, survivors of Rick Hunter's Expeditionary Force (three assault waves would meet defeat at the hands of the Invid), scavengers, and peasants. Anyone strong enough and brave enough to resist the Invid could find some place among the freedom fighters. Other independent groups of resistance fighters also existed, but, were mostly small units of rag-tag guerilla fighters who scavenged the land and tried to establish a sort of vigilante justice.

Invid hives dotted the globe. These were the aliens' bases of operations, the largest of which housed the Invid Regis. Through an unlikely series of events, culminating with the third assault wave of the Expeditionary Force (*See Robotech T.V. episodes #84 and 85*), the Regis decided that Earth was tainted by "the shadow of the Robotech Masters," destroys the Expeditionary Force and leaves Earth in a dazzling display of energy transmutation. She explains that this is an "evil planet," not suitable as the homeworld of the noble Invid. "We will continue our evolutionary development elsewhere." **Note:** *All seen in episode #85, Symphony of Light.*

Lancer (a.k.a. Yellow Dancer), a member of the infamous freedom fighters under the leadership of Scott Bernard, muses aloud; "I only wonder if we've really seen the last of them?" (*also the last episode, #85*). It seems the Invid have left the Earth, taking all available protoculture with them. At last, peace is restored. The Earth is free. Or so it seemed for the next several months.

Lancer's words seem almost prophetic, for the Invid do return. Not as a force of a hundred million to claim the Earth as the Invid's new homeworld, but as an occupying force sent to cultivate and harvest the precious Flower of Life. Like all the worlds in the past, except Earth, the Flower of Life will not grow on the planet sensed by the Regis (she speaks of a different planet that may be suitable as a new homeworld in episode #85). Having met with failure, the Regis and most of her Invid continue their search for a new home and continued "enlightened evolution." She refuses to return to Earth to reclaim it as a home for her people, but it is "the only *known* source of the Flower of Life" (also revealed in the last episode).

NOTE: The symbiotic bond between the Flower of Life and the Invid race is too strong to sever. Consequently, she has sent an occupying force of about two a million (humans don't know how many, but estimate about half a million to one million) to seize control of the areas richest in protoculture and force the humans to farm and process it for future needs.

These Invid are just as merciless and uncaring about human life as the previous occupying force, but this time things are a little different. There are far less Invid, with the main force light years away. The humans, as weak, scattered, and fragmented as they are, believe they have defeated the Invid once and can do it again. But most importantly, the brilliant controlling mind of the Regis is not present to direct them. Instead, these forces are directed by Invid brains and human-like commanders who generally lack experience as creatures with independent thought. Their tactics are still very basic, often lacking any real cunning or strategy. This makes them vulnerable even to the pitifully small forces of human freedom fighters.

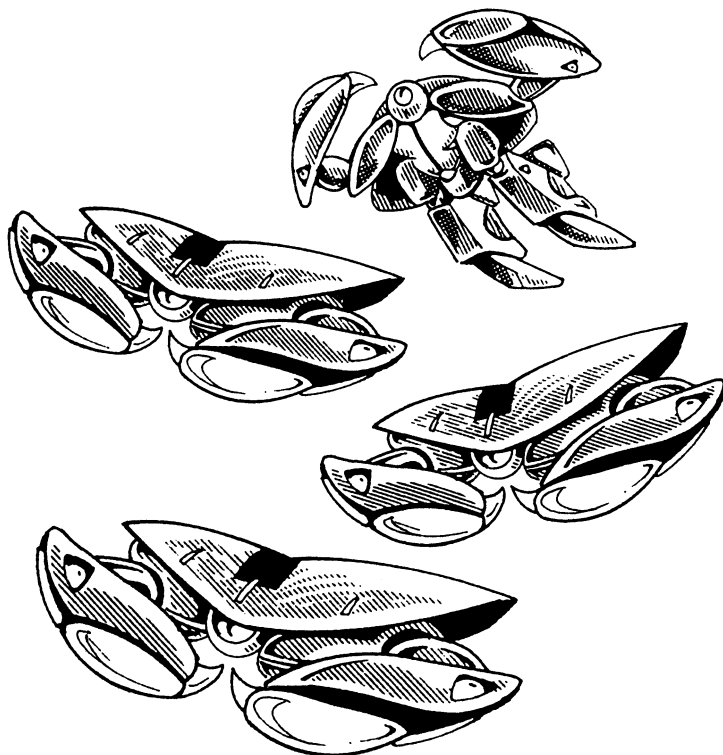

THE INVID: Aliens in an Alien Land

It is important to point out that the Regis and her Invid are not necessarily evil, just completely alien to the human animal and, therefore, dangerously indifferent. She does not direct her

forces to destroy and enslave the people of Earth out of spite or revenge, but out of callousness. Humans simply represent an obstacle to the achievement of her ultimate goal: to reestablish the Invid Flower of Life and to find a new homeworld for her children (the Invid). The destruction of humans was carried out with the same cold, unthinking indifference as when a human might go about the methodical extermination of mice in a building he wishes to occupy. The mice are not perceived to be the rightful inhabitants of the building, but seen as annoying pests that must be eliminated before the place can be completely refurbished and occupied. So it was with the Invid. It would be years later, through continued "enlightened evolution," that the Regis would become more human-like and perceive a certain kinship with humans.

It is this *lack* of human emotions, sensitivity and understanding that makes the Invid the heartless murderers they are. They *are* completely alien. Inhumans who understand nothing about human beings nor human technology. Although we both use protoculture and seem to have similar levels of technology, our sciences are utterly different. The Regis can alchemically alter the genetic structure of an Invid in a matter of minutes, create the hives out of thin air and erect the Genesis Pits, but can not comprehend the simple workings of a bicycle.

Her children, the Invid troops, understand even less. That is why a human can turn off his protoculture powered mecha and abandon it in full sight without fear of it being destroyed. The Invid Regis, herself, might not be fooled by such a blatant ploy, but her troops see only a chunk of meaningless metal. If no protoculture or signs of life exist, then it is as unimportant as the rock next to it. This is also why the Invid ignore crashed spaceships, and ancient abandoned military bases or buildings that contain mecha, ammunition and/or supplies. **First**, they don't recognize any of these inanimate objects as having any significance whatsoever. They are all worthless pieces of junk. **Second**, a particular place, building or spacecraft is just as meaningless. It has no perceived value, importance or danger. If it moves, including automated machines, make it stop moving! Non-movement means no life and no threat. If it has protoculture, destroy it! No creatures other than Invid may possess it. If life-forms or movement are hostile (attack or make threatening actions), destroy them. If hostile activity seems to be directed at the Invid, the Flower of Life or Invid slaves, destroy it. Any life-forms in the vicinity of a hostile action (usually about a 5 mile/8km area) are likely to be a threat and are to be exterminated without prejudice (that means without hesitation or other consideration). The enemy is *the enemy*. Destroy without mercy. This is the Invid credo.

The Invid scouts, troopers and pincers are all killing machines. They are mindless extensions of the hive and the will of the Regis. They function exactly like the worker and protector bees or termites of Earth insects. Without thought for their personal well-being, they fight till the death. Their sole purpose is to fight and die while protecting the queen (the Regis) or implementing her demands. There is no fear, no hate, no remorse, no sorrow, only instinctive, mindless duty. A deadly duty executed without mercy. To fight until you can fight no more. The Robotech Masters tried to match these super-soldiers, making the Zentraedi as equally unyielding. The clashes between these two warrior races has left carnage unparalleled in the annals of history.

THE INVID ORGANISMS

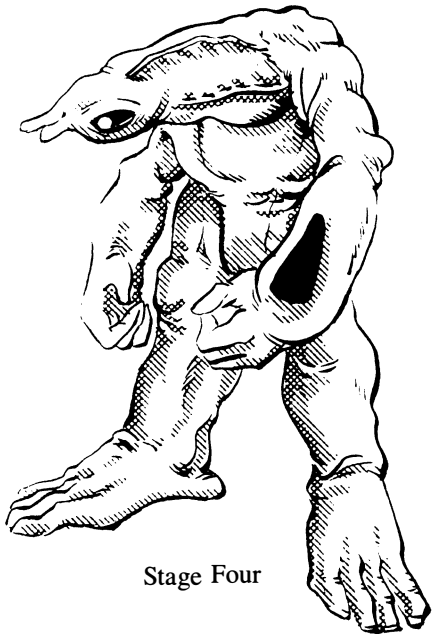

Stage Four



Stage Three



Stage Two

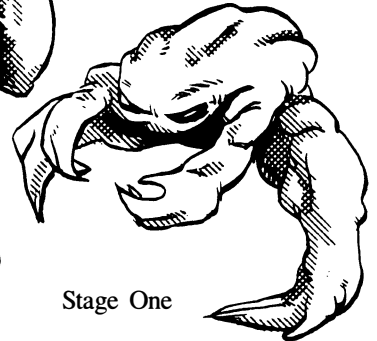

Stage One

INVID PILOTS

Although humans generally perceive the invid to be giant, mechanized, insect-like creatures, the invid are actually flesh and blood humanoids. The giant insect appearance is created by the *mecha* which is piloted by the invid organism inside.

Each of the various types of invid mecha are piloted by an invid at a different stage of genetic evolution. All invid pilots, except the stage five pilot, have virtually no emotions, therefore, they do not experience fear, hate, love, etc.

Stage One Invid Pilot

The stage one invid pilot is the most primitive, alien, and slug-like in appearance. It's a small creature with a thick, round, trunk, from which a pair of stubby arms and legs protrude. The limbs appear to resemble the chunky flippers of a walrus rather than human appendages and provide minimal movement. The hands are only partially articulated and walking is almost impossible.

The stage one pilot is one with its mecha, giving it high maneuverability and all of its limited attention. The stage one invid is incapable of independent thought and is the drone of the hive. The ugly little creature spends its entire life in its mecha and will die in a matter of minutes if it is ever plucked from the life support system of the mecha.

Pilots: Invid Scouts and Armored Scouts

Hit Points: 10 S.D.C.: 0

Attributes: Subhuman, I.Q. 3, M.A. 3, M.E. 10, P.S. 3, P.P. 3, P.E. 10, P.B. 3, Spd. 3

Attacks Per Melee (outside of mecha): None

Note: Can not live or function outside of invid mecha. Dies within 1D6 melees. Not capable of independent thought.

Stage Two Invid Pilot

The second stage invid pilot is larger, almost twice as big (about 4ft/1.2m tall), with greater upper torso development and humanoid appendages. At this stage, this invid looks just as gruesome as the former. However, the hands are much more

articulated, with an opposable thumb, and walking is possible.

This is the worker invid who doubles as a warrior. Like the stage one invid, it can not survive outside of its mecha, nor is it capable of independent thought.

Pilots: Trooper/Worker and Shock Trooper

Hit Points: 14 S.D.C.: 2

Attributes: Subhuman, I.Q. 5, M.A. 5, M.E. 10, P.S. 6, P.P. 6, P.E. 10, P.B. 3, Spd. 6.

Attacks Per Melee (outside of mecha): One, hand to hand ONLY.

Note: Cannot live or function for long outside of mecha. Dies within 2D6 melees. Incapable of independent thought.

Stage Three Invid Pilot

The third stage invid stands erect, with clearly defined arms, hands (fully articulated), legs and feet. Height is 5ft (1.5m). Although humanoid, this invid is still obviously an alien, with sagging, bulky musculature, brownish-grey skin and slug-like head.

Unlike its predecessors, the stage three pilot *is* capable of independent thought. This means it can make observations, analyze a situation, draw its own conclusions and take action. Of course, the stage three invid pilot always follows the directives of the Regis or Invid Brain. The thinking capabilities of the stage three invid qualify it to be the lieutenant of the invid troops. Thus, it is a stage three invid pilot, in its command mecha (pincer), that will *lead* a troop of scouts or shock troopers into combat or on a seek and destroy mission. It is also the stage three invid who is left to handle rebels and to lead defense forces at protoculture processing plants and farms, and hive perimeters.

Pilots: Invid Command Unit (a.k.a. Pincer)

Hit Points: 20 S.D.C.: 5

Attributes: I.Q. 8, M.A. 5, M.E. 10, P.S. 8, P.P. 8, P.E. 14, P.B. 6, Spd. 8

Attacks Per Melee (outside the mecha): Two, hand to hand ONLY. Damage is 1D6 from a punch or kick, no bonuses.

Note: Like its predecessor, the stage three pilot can not live or function long outside of its mecha and dies within 4D6 melees. Capable of independent thought.

Stage Four Invid Pilot

The fourth stage invid pilot is a completely humanoid being and represents the invid in their natural form. Although humanoid, this invid still looks alien, with a long, muscular neck, slug-like head, large bulbous eyes and saggy, grey-brown skin. The body is barrel chested, with thick, bulky limbs. Height is about 5 to 6ft (1.5 to 1.8m) at the shoulders/neck.

This is the captain and technician (in the loosest sense of the word) of the lesser invid. Its intellect is high and it is capable of independent thinking and reasoning similar to humans. This means it can assimilate information and act on it. Of course, the stage four invid is completely loyal and dedicated to the Regis and Invid Brain.

It is the stage four invid that operate as hive guards and technicians, in that they transport vessels, assist in biological experiments/operations on humans, assist in the genesis pits, and perform various skilled functions in the hive itself. Known as Enforcers, they maintain and service the hive and protect the Invid Brain or Regis from invaders who penetrate the hive. Their high intelligence also places them in charge of operations at protoculture farms and processing, storage and transportation facilities. A stage four invid may lead any of the lesser invid on any type of operation (under the direction of higher authority). They also pilot the clam-shaped invid transport.

Pilots: Enforcer (power armor) and Invid Transport.

Hit Points: 20 S.D.C.: 4D6

Attributes: I.Q. 12, M.A. 12, M.E. 12, P.S. 12, P.P. 12, P.E. 16, P.B. 9, Spd. 9

Attacks Per Melee (outside of mecha): Two, hand to hand or by weapon. Damage from punch or kick is 1D6.

Bonuses: +1 to strike, parry and dodge; +1 to save vs poisons/toxins. **Penalty:** -2 on initiative.

Skills (equivalent to Earth Skills): Radio: Basic — 60%, T.V./Video — 50%, Pilot Enforcer Mecha (power armor) — 90%, Pilot clam-shaped Transport Ship — 90%, Pilot Space Shuttle — 80%, Navigation (land, air, water) — 88%, Navigation: Space — 98%, W.P. Energy Pistol (+2 to strike), W.P. Energy Rifle (+1 to strike). The two energy weapon W.P.s apply only to hand held weapons that are not part of the Enforcer's power armor. Surgical and medical skills are telepathically transmitted from the Regis or an Invid Brain and are not a remembered skill ability. The Regis or Invid Brain basically takes control of the stage four pilot and uses him as an extension of itself.

Note: The stage four invid pilot can survive without mecha, but rarely does so. The Enforcer power armor is like a second skin, or natural exoskeleton, that it wears constantly. *See Invid Mecha: The Enforcer.*

Stage Five Invid Pilot

The stage five invid pilot is the result of the Regis's "enlightened evolution." The stage five invid looks exactly like a human, attractive, slender, and tall (about 6ft/1.8m). They have a light caucasian skin/complexion, and tend to have long hair (at least shoulder length).

This is the Regis's current view of the ideal life-form, perhaps subliminally patterned after her dear Zor. Like a human, the stage five pilot has a well developed intellect capable of independent thought, deductive reasoning, inventiveness and theory. Of all the invid pilots, the stage five pilot is the most like the Regis. Whether this will be the last step in the invid race's evolution is not known. However, it does seem to be what the Regis is leaning toward.

One problem with the human form and truly independent thought is the loss of the one mind. The stage five invid warrior-pilot can make his/her own decisions and, for the first time in invid history, defy the will of the Regis or Invid Brain. Which is exactly what happens with Marlene/Ariel and Sera in the T.V. series.

Another potential problem is the presence of emotions previously unknown to the lesser invid. The stage five invid pilot experiences the full range of human emotions, from anger and hatred to love and fear. Emotions are something that the Regis herself does not quite understand. Unfortunately, subjective thought is not possible without them.

These problems, and other considerations, have made the Regis hesitate and reconsider the next great evolutionary step. Currently, she is deploying the stage five pilots as commanders to lead and direct the lesser invid. Many have been sent back to Earth to see how well they will fare against the insurrection and cunning of the humans. A baptism of fire.

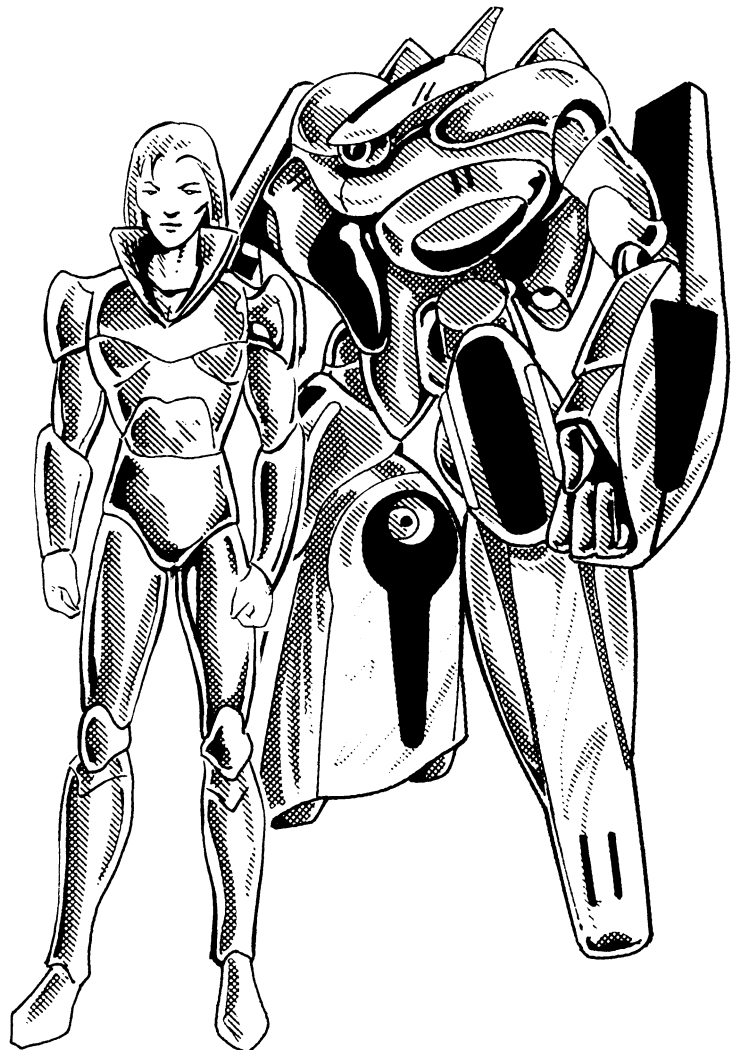

As always, the stage five invid are linked to the Regis in spirit and are able to receive her telepathic and empathic transmissions. At this point, most of the stage five invid are steadfastly loyal to the Regis and the invid cause. If anything, they are fanatics loyal and driven to accomplish her prime directives at all costs. They view humans as the evil shadows of the hated Robotech Masters (emotions which may have been accidentally implanted by the Regis empathically). Consequently, most of the stage five invid regard humans with suspicion, anger and disdain.

Pilots: Royal Command Battloid

Hit Points: 24 + 1D6 **S.D.C.:** 6D6

Alignments: Anarchist, Miscreant, or Aberrant

Attributes: I.Q. 9 + 1D6, M.A. 9 + 1D4, M.E. 6 + 1D6, P.S. 10 + 1D6, P.P. 10 + 1D6, P.E. 10 + 1D6, P.B. 10 + 1D6, Spd. 10 + 1D6. *Note:* Any attribute of 16 gets to roll another 1D6 and add it to that specific attribute score.

Attacks Per Melee: Three, hand to hand or by weapon. Damage from a punch or kick is 1D6.

Bonuses: +1 to strike, +3 to parry and dodge, +2 on initiative.

Skills (equivalent to Earth skills): Pilot Royal Command Battloid — 90%, Navigation (land, air, water) — 80%, Navigation: Space — 75%, Detect Ambush — 60%, Detect Concealment — 50%, W.P. Energy Pistol (+2 to strike), W.P. Energy Rifle (+1 to strike).

Special Abilities: Sense presence of other invid within a one mile area (1.6km). Are still linked to the Regis so they can receive telepathic commands and their death will be felt by the Regis.

Note: The stage five invid pilot looks exactly like a human and can survive outside its mecha indefinitely. *See Invid Mecha: The Royal Command Battloid.*

THE INVID BRAIN

Each hive complex serves as a command center and base of operations within a particular region. Inside are thousands of invid pilots and mecha locked in stasis, as well as hundreds, if not thousands, of active invid troops. The commander of hive operations is the Invid Brain.

The Invid Brain appears to be a protoplasmic mass of pink flesh. The organism is huge, measuring 20ft across (6.1m) and 12ft tall (3.6m). It is the brain, acting under the direction of the Regis, who delegates the many chores and responsibilities of the hive to the legion of invid under its command. The brain functions like a surrogate Regis, telepathically directing all operations in the area. For example, if the brain has been instructed to establish a protoculture farm and/or processing facility, it will spend all its efforts on establishing, maintaining and protecting that facility. If the prime directive is to suppress human insurrection, it will focus on the hunting down and neutralization of all humans who use protoculture or dare to oppose the invid. Likewise, it is the Invid Brain who coordinates genetic and biological experimentation on humans, supervises and protects Genesis Pits and all daily routines and maintenance of the hive.

Other than the Regis or a specially appointed stage five invid pilot (humanoid), only the Invid Brain has the authority to revive invid pilots from stasis and place them in their mecha as it deems necessary. Only the Invid Brain (and Regis) has any real knowledge or skills such as medical/surgical, biology, genetics,

mechanical and electrical. Like the Regis, the Invid Brain acts as the controlling intelligence of all other invid (only stage five invid can defy the brain's commands). As a result, the brain can completely control 2D4 invid pilots, usually type four, to perform delicate skills. Note that the Invid Brain can not control a stage five pilot.

Unlike most invid, the brain has some rudimentary emotions and is capable of independent thought and decision making abilities. However, the emotions are somewhat repressed and the thought processes linear. Observations and decisions are colored by its alien perspective, which can sometimes blind it to the obvious. *For Example:* It will have difficulty recognizing and determining the exact purpose and function of unusual human devices. Consequently, while it is likely to recognize a vehicle, weapon or clothing, it will find a blender or microwave oven, or a toy, a complete mystery.

The Invid Brain is always nestled away, deep within the *Hive's Center*. Nearby will be the Invid Stasis Chamber. A dozen or more (12 plus 2D6) Enforcers are *always* present to serve and protect the brain. An additional 1D6 Enforcers, 1D6 Troopers and 1D6 Armored Scouts are always nearby (will arrive in 4 melees/one minute). All will fight to the death to defend the brain. Intruders (any non-invid creatures) are automatically captured (to be interrogated by the brain), experimented on, or destroyed. Hostile forces are immediately destroyed or chased out of the hive. **G.M. NOTE:** The Invid Brain can instantly communicate with any and *all* of the invid under its command. Consequently, it can summon scores of invid to its aid in a matter of minutes. In a typical hive, the response would go something like this. **First Wave responds in 1D4 minutes:** 4D6 Invid Scouts, 4D6 Invid Armored Scouts, 4D6 Troopers, 4D6 Enforcers. **Second Wave responds 2D4 minutes later:** 1D4 × 10 Armored Scouts, 1D4 × 10 Scouts, 1D6 × 10 Troopers, 1D4 × 10 Shock Troopers, 4D6 Pincers, 4D6 Enforcers.

If the brain is destroyed, the hive will continue to function via automation. The invid forces of the hive will continue to act on the last few prime directives issued by the brain, but they will be unorganized and take no new initiatives on their own. The invid will function this way until a new brain is provided by the Regis (this will not happen in the case of the reoccupied Earth setting) or until a stage five invid pilot is appointed leader, or just assumes control without being sanctioned by the Regis. In either case, the invid will obey a type five humanoid as they would an Invid Brain.

Pilots: Controls the hive and directs the invid of that hive.

Hit Points: 600 **S.D.C.:** 200

Alignment: Aberrant; totally loyal to Regis and Invid life.

Attributes: I.Q. 17, M.A. 20, M.E. 20, no physical attributes.

Physical Attacks Per Melee: None, but can take two actions or make three commands per melee. **Special Attack:** In the last throes of death the Invid Brain can fling (via telekinesis) parts of its protoplasm essence on top of an opponent, covering him or her in glop. The gloppy covering will prevent movement and suffocate its victim. A person will pass out from lack of oxygen within six melees (1½ minutes) and *die* of suffocation within a total of 12 melees (3 minutes).

Psionic Attacks Per Melee: One per melee. *The Brain has the following psionic abilities: Telepathic Communication* (Invid Range: 300 miles/482km; human range: 300ft/91.5m), **Sense Protoculture Energy** (Range: 14 miles/22.5km), **Bio-Regeneration** (self; 2D4 × 10 hit points or 2D6 × 10 S.D.C. once every half-hour), **Levitation** (can lift itself or up to 4 tons straight up or down in the air, up to 300ft/91.5m high), **Telekinesis** (The ability to move objects with the mind. Can move weights of up to 100lbs/45kg. Range: 100ft/30.5m. Hurling objects between 1 to 20lbs do 1D6 damage, 25 to 50lbs do 4D6 damage, 55-100lbs do 1D4 × 10 damage. *All damage is S.D.C. damage.* Up to FOUR objects can be telekinetically controlled at one time), **mind block** (prevents the psychic probe of others) and **meditation**. **NOTE:** The telepathy and sense protoculture energy are automatic and natural. Thus, they do not count as one psionic action and can be done continuously throughout the melee. *Invid Telepathic Communication* is the ability to talk to another being in his head, sort of like a radio transmission. It does not include reading minds nor telepathic probes. *Sense Protoculture Energy* enables the Invid Brain to feel the presence of protoculture energy in use and pinpoint the exact number of protoculture devices in use and their general location (a 600ft/183m area). Protoculture energy does not radiate in detectable traces when the device/mecha is turned off. I.S.P. are not listed because the brain's power is effectively inexhaustible.

Skills (equivalent to Earth skills): Radio: Basic — 90%, T.V./Video — 90%, Basic Electronics — 90%, Basic Mechanics (very general) — 70%, Invid Mecha Mechanics — 80%, Medical Doctor (surgical) — 90%, Forensics — 70%, Pathology — 90%, Biology — 92%, Botany — 92%, Chemistry — 90%, Bionics (a special medical and biology skill) — 80%, Interrogation — 70%, Detect Ambush — 70%, Detect Concealment — 50%, Intelligence — 50%, Navigation (all) — 70%.

Note: We get an excellent portrayal of an Invid Brain in action and see the inside of a hive in episode #72, Fortress.

THE REGIS

The power and purpose of the Regis has been pretty extensively covered already. In short, she is the life-force and directing intelligence of her invid people.

The planet Earth is crucial to her because it is the only *known* planet where the precious Invid Flower of Life can grow. She has also come to recognize that humans are not insignificant life-forms, but that they are intelligent, potentially dangerous creatures. Humans are regarded with great suspicion, dislike (not hate), and a bit of fear because they seem to be somehow inexplicably connected to the loathsome, evil Robotech Masters. It is these sentiments and the possibility that the human form may be the final evolutionary form of the invid that convince the Regis that Earth is not appropriate as the new Invid Homeworld. She leaves Earth, taking most of her people with her, but sends back an occupying force to cultivate and harvest the Flower of Life.

Whether the Regis will ever try to reclaim the Earth as the Invid Homeworld is unknown (but not likely). She will probably continue her search for another planet that is not “in the shadow of the Robotech Masters,” even if it takes eons. Will the human

form be the last step in the Regis's search for “enlightened evolution?” Perhaps, perhaps not. If not, will that decision change her mind about exterminating humans completely and claim the Earth as the Invid homeworld after all? Who can say?

THE REGIS

Invid All-Mother

Characteristics in Humanoid Form

Hit Points: 100,000 (or 1000 M.D.C.)

Physical S.D.C.: 50,000 (or 500 M.D.C.)

Alignment: Aberrant

Attributes: I.Q. 20, M.E. 20, M.A. 30, P.S. 12, P.P. 12, P.E. 30, P.B. 12, Spd. 12

Age: unknown, presumably thousands of years (at least 10,000 years old).

Weight: 150lbs (78kg) **Height:** 6ft (1.8m)

Disposition: Cool-headed, cold-hearted, tough, self-reliant, confident, indomitable. Tends to be arrogant and indifferent toward other life-forms. Hates the Robotech Masters and will attack them at sight.

Insanity: Obsessed with “enlightened evolution;” reaching a higher, superior place on the evolutionary scale. Also obsessed with finding a suitable new homeworld for her people. A world that will support the Flower of Life.

Level of Experience: No appropriate category; the Regis is the supreme intelligence and power of her people.

Skills (equivalent to Earth skills): The complete understanding of the metaphysical powers of the Flower of Life/Protoculture — 98%, Protoculture Alchemy/Transmutation Powers — 98%, Radio: Basic — 90%, T.V./Video — 90%, Basic Electronics — 96%, Basic Mechanics (general) — 96%, Invid Mecha Mechanics — 98%, All Medical Sciences — 98% each, All Sciences at 98% each, Navigation (all) — 98%, Pilot Invid Mecha (all) — 98%, Interrogation — 75%, Intelligence — 75%, Detect Ambush — 75%, Detect Concealment — 70%, Tracking — 70%, and Bionics (a special medical/science skill) — 90%.

SPECIAL ABILITIES:

Transmutation of Invids: The bio-engineering ability to create clones and evolve them into any of the five invid pilots. This power can also be used to completely transform an invid into other life-forms as seen in the *Genesis Pits*. The transformation of an invid into a different stage requires a mere few minutes (1D4 minutes each). The radical transformations of the Genesis Pits require days each, sometimes longer, and can not be changed back into a regular invid again.

The transmutation power can also be used on herself, which explains her current humanoid appearance. **Note:** This power works only on invid.

Transmutation of Mecha: The alchemical ability to create the various invid mecha out of thin air (or so it seems). This power is also used to repair mecha instantly, almost magically. The Regis has created millions of mecha which are then placed in a stasis bubble to be perfectly preserved until needed. The process of creation requires days of mental preparation and protoculture, but once begun, an actual mecha can be created within minutes (1D4 minutes each).

Transmutation of Hives: The alchemical technology used to create the hives. The creation of a hive with its complete workings requires 1D4 days each.

Transmutation to Warp Speed: The knowledge of protoculture used to transform herself and all available invid into a form of living energy which can travel the cosmos at incredible speeds (space fold). The process has grown to be very familiar to the Regis and can be executed in minutes (6D6 minutes; add 1D6 minutes for every million invid she takes with her). This power can be thought of as a type of super-teleport. Range: Unlimited.

Stasis Bubble: The Regis can create a stasis bubble around something, preserving that object in a state of suspended animation indefinitely (approximate time limit: 400 years). The Regis or Invid Brain can take the item out of stasis at any time. Likewise, a stage five humanoid invid in command of a hive can use the hive's automated systems to take an item *out* of stasis. But only the Regis can place an item *into* stasis.

The stasis bubble actually appears more like an oval or "egg" shape that fits snugly around the item. The stasis field is semitransparent so the item it contains can be seen through it. The stasis field has 200 M.D.C. Disrupting the field by inflicting damage has a 90% chance of destroying the item inside. Size limit of an item (living or inanimate) is 60ft (18.3m).

Physical Attacks Per Melee: None, but can take 3 actions.

Psionic Attacks Per Melee: Two

Psionic Abilities:

Telepathic Communication: A mental ability by which the Regis can communicate with any or all of her *invid*. Range: indefinite; light years away. This power does not include reading minds or mental probes. Telepathy can be used to communicate with humans and other creatures, but the range is reduced to about 100 miles (160km) when dealing with non-invids.

Sense Protoculture Energy: The Regis can psychically feel the presence of protoculture energy being used anywhere near her (within a 100 mile/160km radius). This sense is so strong that it will also register the presence of living Flowers of Life within 500 miles (804km). The exact numbers and general location (within 600ft/183m) can also be determined.

Empathy: The ability to sense the emotions of any living creature. The Regis can read the emotions of up to 24 individuals or the general emotions of a large group. This power does not include empathic transfer. Range: 500ft (150m) for individuals, up to two miles for a group.

Levitation (self): Can lift and suspend herself up into the air. Limited to up and down movement only. Maximum height: 3000ft (900m).

Telekinesis: Same as the Invid Brain, but is +3 to strike and parry.

Mind Bolt: A bolt of electromagnetic force can be hurled at an enemy. The bolt can do as little as 1D6 S.D.C., 2D6 S.D.C., 4D6 S.D.C., 1D4 × 10 S.D.C. or as much as 2D6 M.D.C.!! The bolt can be fired as often as three times per melee (all three psionic melee attacks). *Range:* 1000ft (300m). *Bonus to Strike:* +5.

Force Field: A temporary force field can be erected around herself for one melee. The force field offers 50 M.D.C. protection. Each time the shield is created, it *counts as one*

psionic attack. The Regis can only erect one force field per melee.

Bio-Regeneration (self): The Regis can regenerate 2D6 × 10 hit points or 3D6 × 10 S.D.C. once every 15 minutes.

Bio-Transmutation (heal other invid): She can alchemically heal another invid, restoring 1D4 × 10 hit points or 1D4 × 10 S.D.C. once every minute. This power can be used on non-invids (humans) as well, but only restores 1D6 hit points or S.D.C.

Mind Block: A mental wall that prevents the penetration of telepathy, empathy and other mind probes.

Notes: I.S.P. for psionics is not included because the Regis' power is effectively unlimited.

THE REGIS IN ENERGY FORM

In energy form the Regis has all the same abilities, but her hit points and S.D.C. are increased 10 times (H.P.:1,000,000, S.D.C.: 500,000).

INVID MECHA

Standard Sensors, Equipment and Notes for All Invid Mecha

PROTOCOLTURE SENSOR

Range: One mile (1.6km). This is a powerful sensor that can register protoculture energy, indicate how many protoculture energy based targets there are (up to 40 individual targets) and their approximate location (within a 600ft/183m area). The sensor will also track each target, indicating general direction and approximate speed of travel.

At close range, 600ft (183m), the sensor can pinpoint the target's *exact location* and can track the energy behind walls, through buildings and even 100ft (30.5m) underground. The energy signal(s) is displayed on a radar-like screen, with each target indicated as a small yellow blip.

Although quite formidable, the sensor's Achilles' heel is that it can only register and track protoculture energy that is *in use* (even tiny amounts of protoculture, such as used in the Gallant handgun will register). This means if the protoculture device is *turned off* the signal disappears. The best the invid can do is fly over to the general location of the last reading and do a visual search. Since the invid do not understand human machinery (it all looks the same to them, except for size), a human could stop his cyclone mecha in the middle of a field, turn it off (stopping the protoculture signal) and run and hide in the woods to the side of the field. The invid may or may not notice the cyclone (probably not if it is camouflaged) and will have no idea where the human pilot may be hiding. If the cyclone is spotted, there is a chance the invid may recognize it and destroy it and/or do a more extensive search for the pilot. *See Perception Section under notes.*

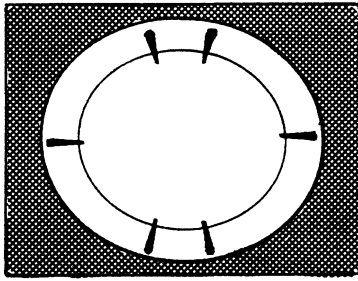

PROTOCOLTURE TARGETING SYSTEM

Short Range: 2000ft (609m); +3 to strike bonus.

Medium Range: 4000ft (1200m); +2 to strike bonus.

Long Range: 11,000ft (3350m or about 2 miles/3.2km); +1 to strike bonus.

The protoculture targeting system locks onto any target that is *actively using protoculture energy*. This would apply to the Alpha, Beta, Cyclone, Veritech Fighters (Macross VF series), Destroyers (Macross and Sentinels), and protoculture powered spacecraft, vehicles and weapons. **Note:** *Southern Cross* mecha can use protoculture or fusion turbines. In fact, all non-transformable battloids rely only on fusion reactors and about half the remaining Southern Cross transformable mecha are fusion powered. That means the protoculture targeting system can not be used on them (no strike bonus). The same is true of the conventional combat vehicles, such as the Commanchero assault helicopter, jets and tanks. **Remember**, the strike bonus from this targeting system is only applicable to *protoculture powered* devices and mecha.

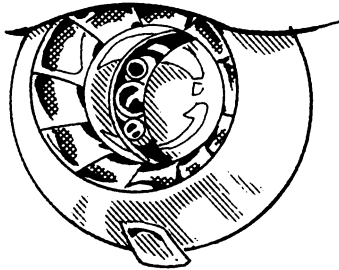

OPTICAL ENHANCEMENT SYSTEM

The invid have a fairly unimpressive optics system. **Normal vision** is roughly equal to a human's, with a limited **telescopic magnification** capability that increases the range to about 1600ft (488m) with a 20ft (6.1m) field of vision and a 4x magnification. **Nightvision** is another feature which amplifies ambient light to give a visible picture. Range: 300ft (91.5m).

The invid see everything through a red haze, as if looking through a ruby filter. This is not to be construed to be infrared vision. The invid do not have infrared, ultraviolet, nor thermo-imaging optics/sensors. Only the stage five invid pilot and Regis have full color vision like humans.

EXTERNAL AUDIO PICKUP

A sound amplification listening system. Range: 200ft (61m).

EXTERNAL SPEAKER SYSTEM

The Pincer, Enforcer and Royal Command Battloid have a loudspeaker system that amplifies and projects the pilot's voice from normal voice levels up to 90 decibels.

COMMUNICATION

The invid do not use radio waves. Instead, telepathic transmissions are used to communicate. All invid can communicate among themselves up to a range of about 2000ft (609m). Only the Invid Brain and Regis have a much greater range. **Note:** The stage one and two invid pilots have no vocal cords and can not speak.

INVID ENERGY PISTOL

The invid have a simple energy blaster that is used primarily by the stage four and stage five (humanoid) invid pilots.

Primary Purpose: Defense

Weight: 2lbs; considered an energy pistol.

Mega-Damage: 2D4 M.D. per blast.

Rate of Fire: A maximum of 10 blasts per melee can be fired, but counts as shooting wild. See modern weapon proficiencies; aimed, burst, wild.

Effective Range: 500ft (150m)

Payload: 40 blasts

Note: The invid handgun is found only in the invid hives and as the sidearm of stage five invid pilots.

NOTES

Invid Mecha do not have radar, infrared, thermo-imagers, motion detectors, or radio. Consequently, the invid lack the skill to use these devices.

Most invid spend their lives inside their mecha. The pilot's compartment is a life support system, complete with a life-giving *nutrient pool* in which the pilot sits completely immersed. The green nutrient fluid is derived from the processed husks of the Flower of Life. The only exceptions are the stage four invid pilots who can live in and out of the nutrient, and the type five invid humanoids who do not require the fluid. Of course, the Regis and Brain can function without need of the nutrient pool.

Perception Factor (P.F.): The ability to recognize the purpose of human machines. If recognized as a combat device, there is a 64% likelihood the invid will destroy it. (A roll of 65-00 means it just left it there, unharmed.)

Invid Scout & Armored Scout: P.F. 1-20%

Trooper/Worker & Shock Trooper: P.F. 1-24%

Pincer Command Unit: P.F. 1-32%

Enforcer: P.F. 1-40%

Royal Command Battloid: P.F. 1-50%

Invid Brain: P.F. 1-50%

Regis: P.F. 1-60%

INVID MECHA TYPES

Scout: Piloted by stage one invid.

Armored Scout: Piloted by stage one invid.

Trooper/Worker: Piloted by stage two invid.

Shock Trooper: Piloted by stage two invid.

Pincer Command Unit: Piloted by stage three invid.

Enforcer: Piloted by stage four invid.

Royal Command Battloid: Piloted by stage five invid.

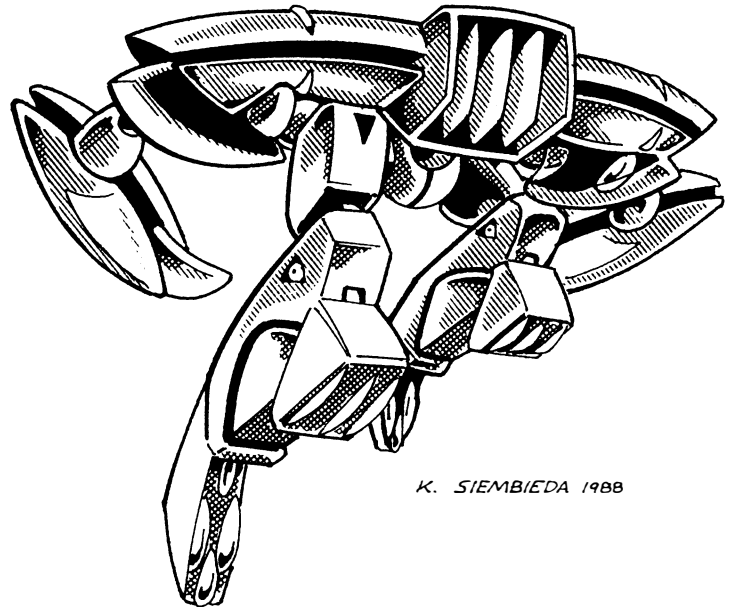
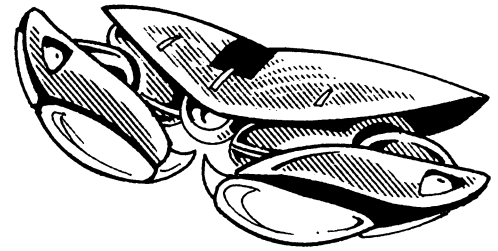
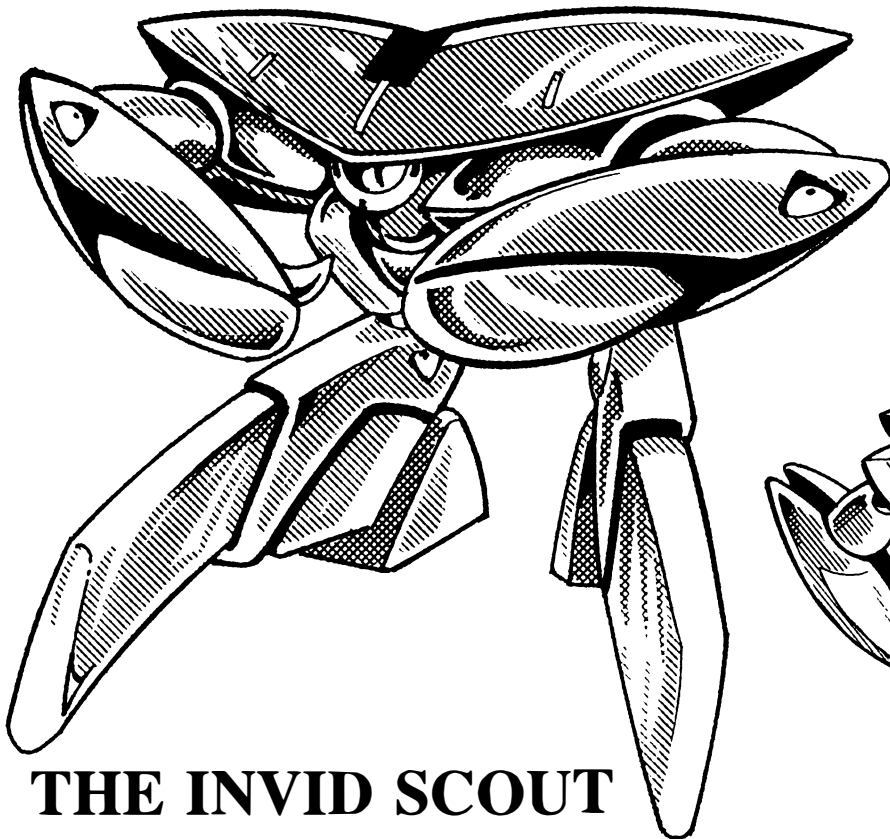

K. SIEMBIEDA 1988

THE INVID SCOUT

The most common Invid is the Invid Scout. Keeping with the analogy of bees, the Invid Scout is like the little worker bee, busily buzzing about in search of protoculture and enemies. Although the least capable in combat, the small red scout is astonishingly fast, maneuverable and fearless. The scout carries no long-range armaments, but its claws and forearm shield blades (the black design portion of the arms) can slice through an opponent with appalling ease.

The Invid Scouts randomly patrol the surface of the Earth, as well as sporadic patrols in space and around the moon. Whenever protoculture is found, the patrol zooms in to destroy it and its users. If strong resistance is encountered, one or two scouts will break away and speed off to get reinforcements. The remaining Invid Scouts will engage the enemy and fight to their last dying breath. Reinforcements will usually include a shock trooper or pincer with 2D4 armored scouts (or regular scouts or troopers).

Invid Scout (also known as "Iigaa")

Crew: One; stage one invid pilot.

M.D.C. by Location:

- Hand/Claw (2) — 5 each
- Forearms (shields) (2) — 50 each
- Upper Arms (2) — 20 each
- Legs & Feet (2) — 25 each
- Main Engine Thruster (rear) (1) — 25
- *Sensor Eye (1) — 10
- **Main Body — 50
- Reinforced Crew Compartment — 20

*The sensor eye is the most vulnerable place on the invid's mecha body. Destruction of the sensor eye will kill/destroy the mecha and pilot (goes right through crew compartment). However, it is a small target protected by surrounding shielding, thus, to hit it the player/character must make a "called" shot and is -3 to strike.

**Depleting the M.D.C. of the main body will shut the mecha completely down. Depleting the main body M.D.C.

and crew compartment M.D.C. will blow the invid into pieces.

Speed: Flight: Stationary hover to 2345mph (3772kmph), maximum (Mach 3.5) with a 50 mile ceiling.

Flight: Cruising speed for reconnaissance: 60 to 150mph (96 to 240kmph).

Ground, Running: 40mph (64kmph).

Ground, Jumping: 100ft (30.5m).

Height: 8.3ft (2.5m)

Width: 12.3ft (3.75m)

Length: 10.7ft (3.25m)

Weight: 4.5 tons

Cargo: Can carry up to one ton.

WEAPON SYSTEMS

Hand to Hand Only!

Attacks Per Melee: Four

Hand to Hand Bonuses: +2 to strike, +3 to parry, +2 to dodge on the ground, +4 to dodge in flight, +6 to dodge at maximum speed (Mach 3.5), to roll with impact +1.

Related Abilities: Prowl — 45%, Detect Ambush — 40%, Detect Concealment — 30%, Track — 30%.

Types of Attacks:

Punch/Claws do 1D6 Mega-Damage (M.D.)

Forearm Blade does 2D4 M.D. (the black design area is a special concealed blade).

Stomp does 1D4 M.D., but the target must be 7ft (2.1m) tall or smaller. Kick attacks are not possible.

Body Block/Ram does 2D6 M.D., but counts as two attacks.

Note: The scout can wear a booster rocket for greater speed. See *Space Booster*.

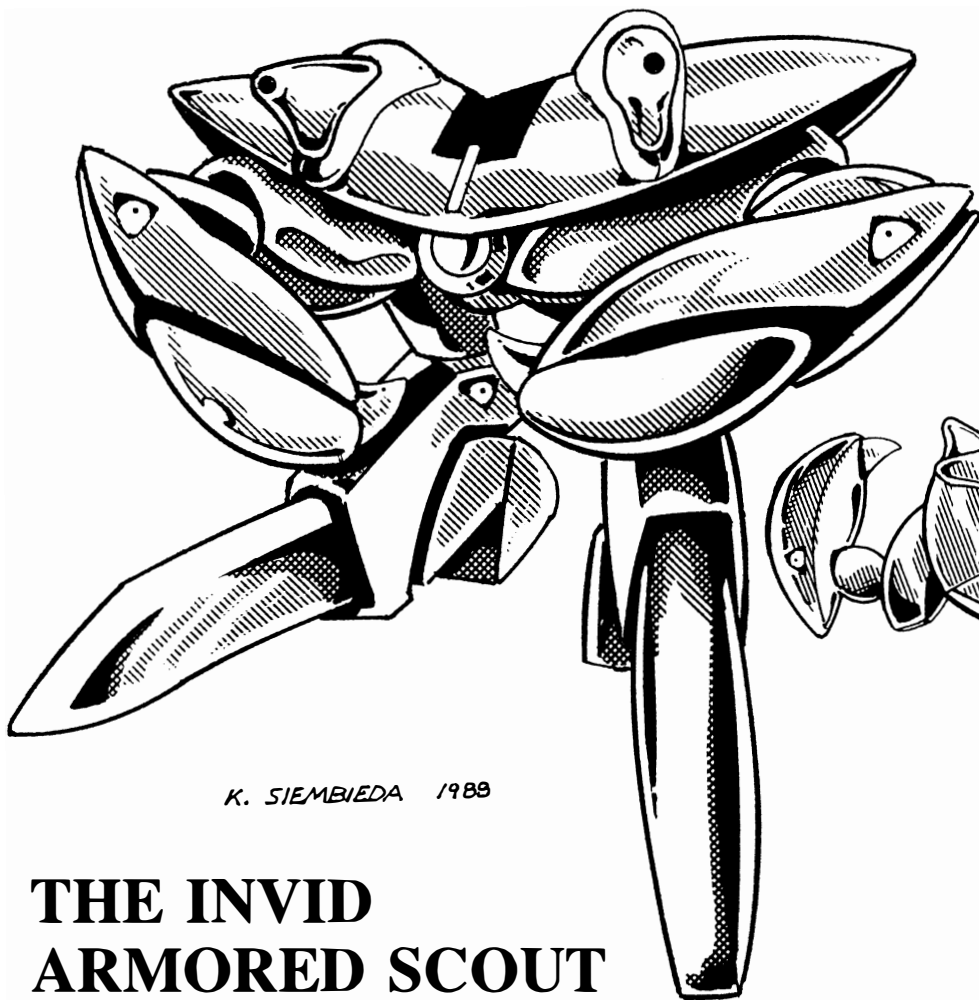

K. SIEMBIEDA 1989

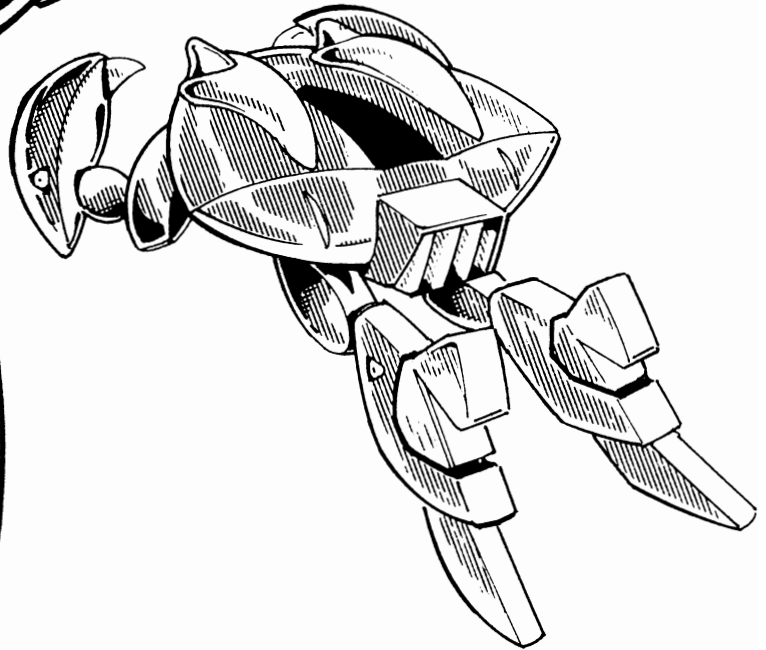
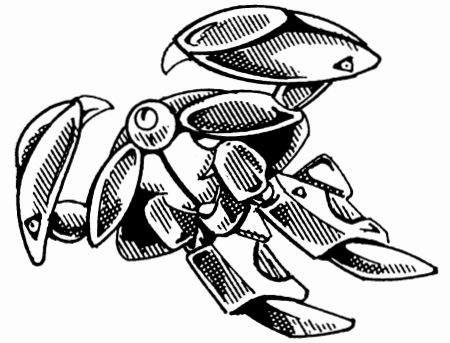

THE INVID ARMORED SCOUT

The Armored Scout enjoys the same popularity as the Invid Scout. Both are almost identical in every way, except that the armored scout is a little more durable and has a pair of plasma pulse blasters mounted on what appear to be shoulder plates. Otherwise, the two units, scout and armored scout, look identical.

The real difference is its combat capabilities. In addition to the hand to hand combat of the regular scout, the Armored Scout is equipped with plasma weapons, adding the versatility of distance attacks. Its body armor is somewhat heavier, making for a tougher combat unit, but without a loss of mobility. The design concept is to have a *small*, quick combat unit suitable for reconnaissance, defense and offense.

Invid Armored Scout (also known as "Iigau")

Vehicle Type: Combat and Reconnaissance

Crew: One; stage one invid pilot.

M.D.C. by Location:

Hand/Claw (2) — 5 each

Forearms (2) — 50 each

Upper Arms (2) — 25 each

Legs & Feet (2) — 25 each

Main Engine Thruster (rear) (1) — 30

Pulse Beam Cannon (2) — 30 each

*Sensor Eye (1) — 20

**Main Body — 70

Reinforced Crew Compartment — 20

*The sensor eye is the most vulnerable place on the invid's mecha body. Destruction of the sensor eye will kill/destroy the mecha and pilot (goes right through crew compart-

ment). However, it is a small target protected by surrounding shielding, thus, to hit it the player/character must make a "called" shot and is -3 to strike.

**Depleting the M.D.C. of the main body will shut the mecha completely down. Depleting the main body M.D.C. and crew compartment M.D.C. will blow the invid into pieces.

Speed: Flight: Stationary hover to 2345mph (Mach 3.5) maximum, with a 50 mile ceiling.

Flight: Cruising speed for reconnaissance is 60 to 150mph (96 to 240kmph).

Ground, Running: 40mph (64kmph).

Ground, Jumping: 100ft (30.5m) up or across.

Height: 9ft (2.7m)

Width: 12.3ft (3.75m)

Length: 10.7ft (3.25m)

Weight: 5 tons

Cargo: Can carry up to one ton.

WEAPON SYSTEMS

- Two Pulse Beam Cannons** (Plasma Energy) mounted on the top shoulder areas of the main body covering. Both plasma cannons are usually fired simultaneously as a dual system, but can be fired individually. Each cannon can move up and down in a 90 degree arc.

Primary Purpose: Assault

Range: 4000ft (1200m)

Mega-Damage: One single blast 1D6 M.D. (rarely fired in single blasts), dual blasts 2D6 M.D. (two simultaneous shots)

are standard) or burst 4D6 M.D. (approximately 4 to 6 pulse blasts fired in bursts is typical of the invid armored scout. There is no need to determine if the burst is 4 or 6 pulses as the both do 4D6 M.D. as a burst).

Rate of Fire: Four attacks per melee. Dual blasts and bursts count as ONE attack.

Payload: Unlimited

Bonuses to Strike with Beam Cannons: +1; hand to hand bonus does not apply.

2. Hand to Hand Combat

Attacks Per Melee: Four

Hand to Hand Bonuses: +2 to strike, +3 to parry, +2 to dodge on the ground, +4 to dodge in flight, +6 to dodge at maximum speed (Mach 3.5), to roll with impact +1.

Related Abilities: Prowl — 45%, Detect Ambush — 40%, Detect Concealment — 30%, Track — 30%.

SPACE BOOSTER (Optional)

Exclusively used by the Scout and Armored Scout

The Invid Scouts can attach themselves to a booster rocket sled for even greater speed. The use of the booster rocket attachment is reserved for high speed space combat, pursuit or interception, and to escape the gravitational pull of a planet. For example, the space booster enables the invid scouts to break free of Earth gravitation, becoming a transatmospheric vessel able to rocket into space and return like a space shuttle.

Space Booster

Vehicle Type: Optional rocket system.

Crew: None; controlled by the invid scout pilot.

M.D.C. by Location:

Small Thrusters (2; one on each side) — 30 each

Main Thruster — 100

*Main Body — 150

*Depleting the M.D.C. of the main body will destroy the booster sled.

Note: Destroying *both* small thrusters will reduce the maximum speed by 25% and -1 to dodge. Destruction of the main thruster will reduce speed by 75% and -3 to dodge.

Speed: Flight: Increases the scouts speed to a maximum of 4020mph (Mach 6) in an atmosphere and to Mach 8 in space.

Bonuses: +2 to dodge.

Height: 8ft (2.4m)

Width: 12.3ft (3.75m)

Length: 14.6ft (4.45m)

Weight: 3.5 tons

Cargo: None

Weapon Systems: None

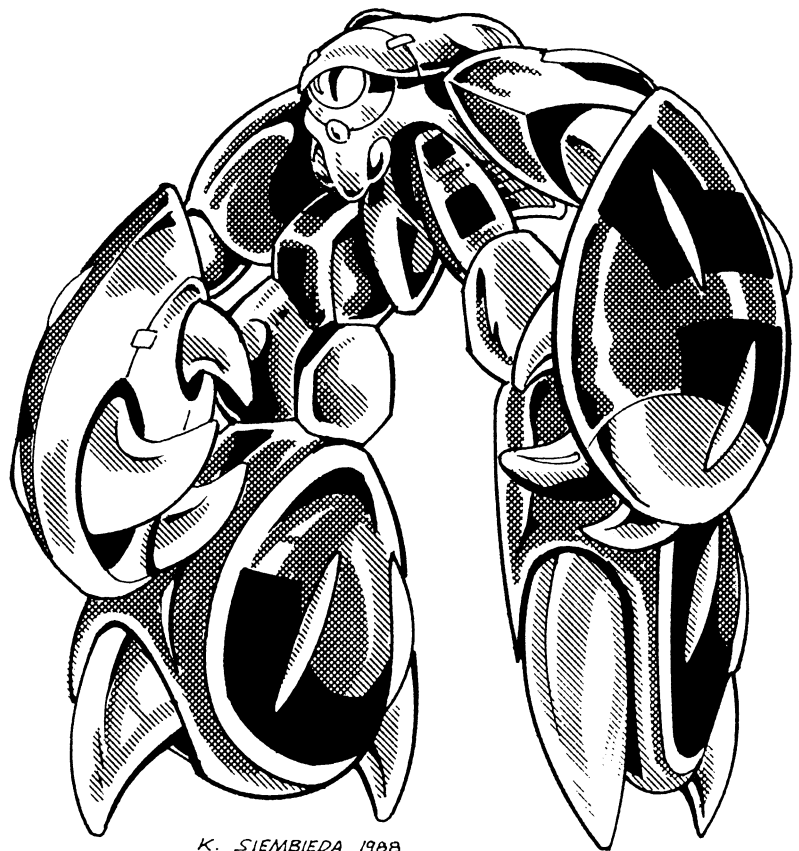

THE INVID TROOPER

The trooper is a big, 16 and a half foot tall, purple brute who doubles as warrior and drone worker. Like all invid, the trooper can hover and fly, but it is much slower than the invid scouts. However, the trooper is physically tougher and stronger than its little brothers. Its huge clawed hands can cut through mecha like a knife cuts butter.

The trooper is often used to *capture* human rebels for enslavement, experimentation or interrogation, and to police and monitor towns of humans who are invid sympathizers, as well as to guard and work at protoculture farms and processing plants, patrol hostile areas, heavy labor and engage in combat. As the lumbering foot soldier and strongman of the Invid army, the trooper and shock trooper are the next most common of the invid mecha.

Invid Trooper/Worker (also known as "Gurab")

Vehicle Type: Combat and labor

Crew: One; stage two invid pilot.

M.D.C. by Location:

Hand/Claw (2) — 50

Forearm (shields) (2) — 80 each

Upper arms (shielded) (2) — 80 each

Legs & Feet (2) — 80 each

Rear Thruster (1) — 30

*Sensor Eye (1) — 20

**Main Body — 80

Reinforced Pilot's Compartment — 40

*The sensor eye is the most vulnerable place on the invid's mecha body. Destruction of the sensor eye will kill/destroy the mecha and pilot (goes right through crew compartment). However, it is a small target protected by surrounding shielding, thus, to hit it, the player/character must

make a "called" shot and is -3 to strike.

**Depleting the M.D.C. of the main body will shut the mecha completely down. Depleting the main body M.D.C. and crew compartment M.D.C. will blow the invid into pieces.

Speed: Flight: Stationary hover to 300mph/(482kmph) maximum, with an altitude ceiling of about 10,000ft (3048m).

Ground, Running: 60mph (96kmph).

Ground, Jumping: 30ft (9.1m) up or across.

Height: 16.6ft (5m)

Width: 13ft (4m)

Length: 15ft (4.6m)

Weight: 10 tons

Cargo: Can carry up to three tons.

WEAPON SYSTEMS

Hand to Hand Only!

Attacks Per Melee: Four

Hand to Hand Bonuses: +1 to strike, +3 to parry, +1 to dodge on the ground and in flight, +1 to roll with punch, fall or impact.

Types of Attacks

Punch/Claw: 3D6 Mega-Damage (M.D.)

Crush with Hand: 1D6 M.D.

Body Block/Ram: 2D6 M.D., but counts as two attacks.

Stomp: 2D6 M.D., but the target must be 10ft (3m) tall or smaller.

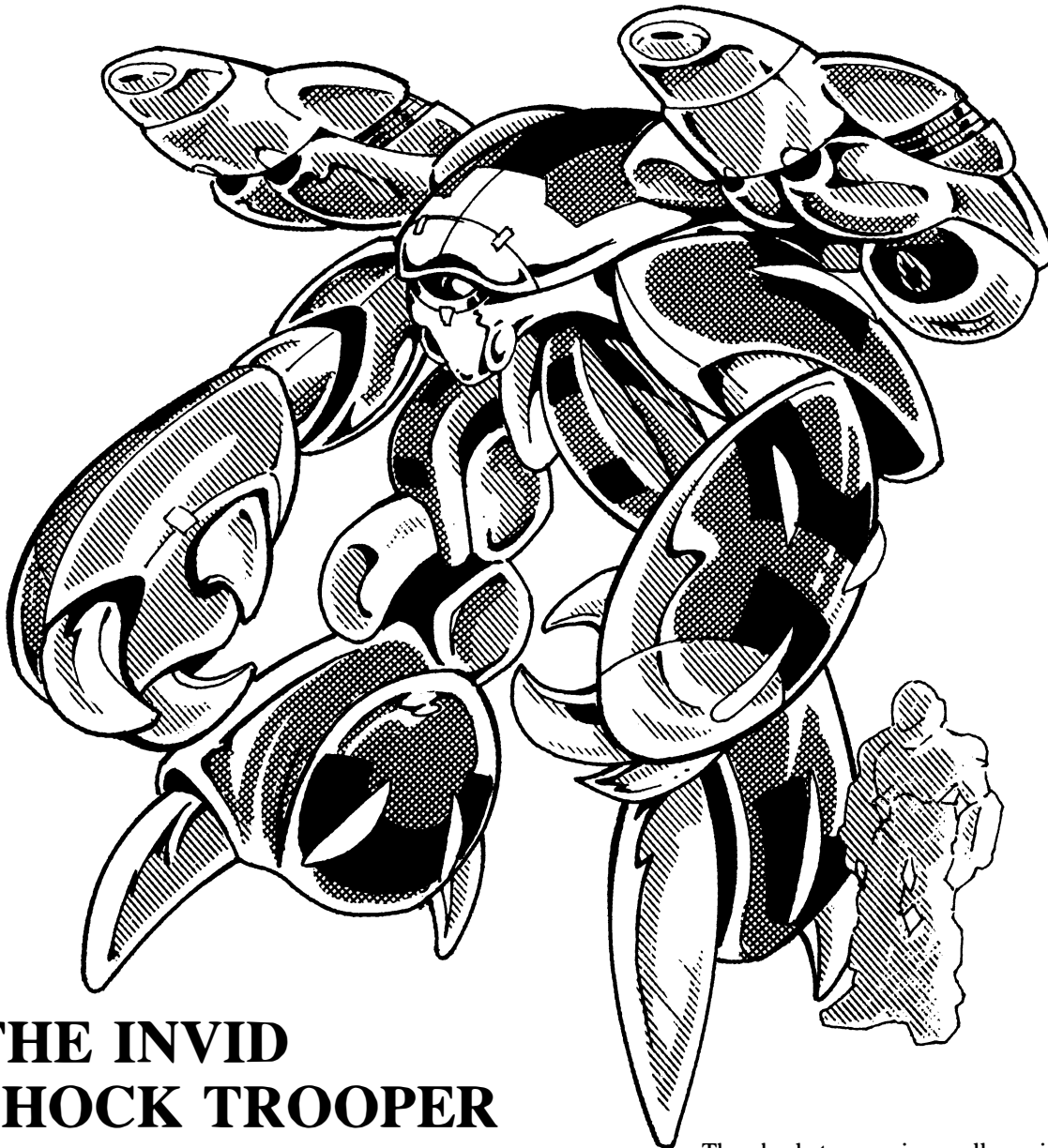

THE INVID SHOCK TROOPER

The shock trooper is a "trooper" outfitted with two powerful plasma cannons attached to the main body above the shoulders. The cannons can swivel up and down in a 90 degree position, making them effective against ground and air attacks. The body is identical to the trooper/worker in every way.

The shock trooper is usually assigned to similar duty as its unarmed brother, with an emphasis on combat. This is the invid foot soldier.

Invid Shock Trooper (also known as "Gurab")

Vehicle Type: Combat (labor, when necessary)

Crew: One; stage two invid pilot.

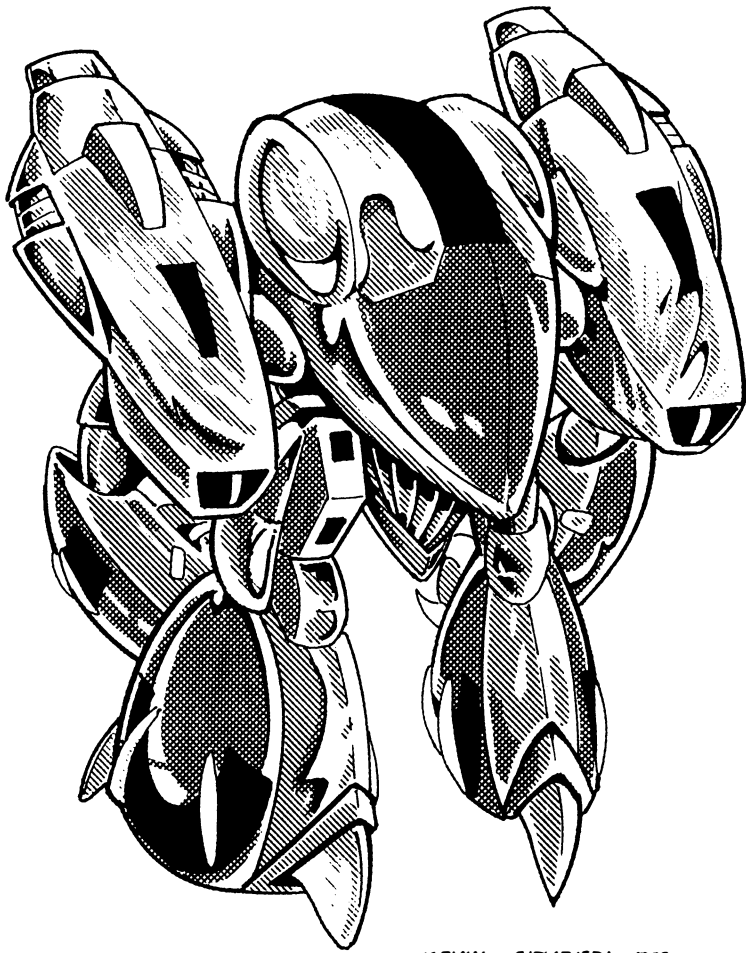

KEVIN SIEMBIEDA · 1988

M.D.C. by Location:

Plasma Cannons (2) — 80 each

Forearms (2) — 80 each

Upper Arms (2) — 80 each

Legs & Feet (2) — 80 each

Rear Thruster (1) — 30

*Sensor Eye (1) — 20

**Main Body — 80

Reinforced Pilot's Compartment — 40

*The sensor eye is the most vulnerable place on the invid's mecha body. Destruction of the sensor eye will kill/destroy the mecha and pilot (goes right through crew compartment). However, it is a small target protected by surrounding shielding, thus, to hit it, the player/character must make a "called" shot and is -3 to strike.

**Depleting the M.D.C. of the main body will shut the mecha completely down. Depleting the main body M.D.C. and crew compartment M.D.C. will blow the invid into pieces.

Speed: Flight: Stationary hover to 300mph/482kmph maximum, with an altitude ceiling of about 10,000ft (3048m).

Ground, Running: 60mph (96kmph).

Ground, Jumping: 30ft (9.1m) up or across.

Height: 19ft (5.8m)

Width: 15ft (4.6m)

Length: 15ft (4.6m)

Weight: 11.5 tons

Cargo: Can carry up to three tons.

WEAPON SYSTEMS

1. Twin Plasma Cannons exclusive to the Shock Trooper.

One is mounted over each shoulder and can fire independent of each other or simultaneously. The plasma is fired in energy bolts often referred to as "annihilation discs." The plasma cannons can be positioned to point up or down in a 90 degree arc.

Primary Purpose: Assault

Secondary Purpose: Anti-Aircraft

Range: 4000ft (1200m)

Mega-Damage: One single blast — 2D6 M.D., two simultaneous blasts — 4D6, simultaneous burst — 6D6 M.D., one continuous stream (lasts entire melee, trained on one target) — 1D6 × 10 M.D., strafing run (wild burst shooting) — 2D6 M.D.

Rate of Fire: Four attacks per melee (equal to hand to hand). Two simultaneous blasts and bursts count as ONE attack.

Payload: Unlimited

Bonus to Strike: Only *protoculture targeting system* bonuses are applicable against protoculture powered devices. Hand to hand bonuses do not apply to energy weapons.

Note: The mouths of the twin cannons always glow white just before they are about to shoot.

2. Hand to Hand Combat

Attacks Per Melee: Four

Hand to Hand Bonuses: +2 to strike, +3 to parry, +2 to dodge on the ground, +4 to dodge in flight, +6 to dodge at maximum speed (Mach 3.5), to roll with impact +1.

Related Abilities: Prowl — 45%, Detect Ambush — 40%, Detect Concealment — 30%, Track — 30%.

INVID COMMAND UNIT

The Pincer Command Unit is the equivalent of an invid lieutenant or captain leading and directing his troops of scouts, troopers and shock troopers. Unlike the invid under its command, the Pincer command unit is intelligent and is capable of assimilating data and decision making. This makes it far more clever and treacherous than its counterparts. To make matters worse, the Pincer is heavily armored maneuverable and possesses twin heat cannons of devastating power. The heat beam is so strong that it can melt down a cyclone in a matter of minutes.

The Pincer Command Unit is rarely encountered alone. It is usually found leading a patrol of scouts and shock troopers, directing shock troopers, overseeing work farms and slave camps, and protecting the hive. The command unit is answerable only to a Royal Command Battloid placed in command by an Invid Brain or the Regis, an Invid Brain or the Regis herself. **Note:** One in every 10 invid troopers or shock troopers is a Pincer Command Unit (or one in every 30 scouts).

Invid Command Unit (a.k.a. Pincer, P.C.U. and "Gamo")

Vehicle Type: Combat Squad Leader

Crew: One; stage four invid pilot.

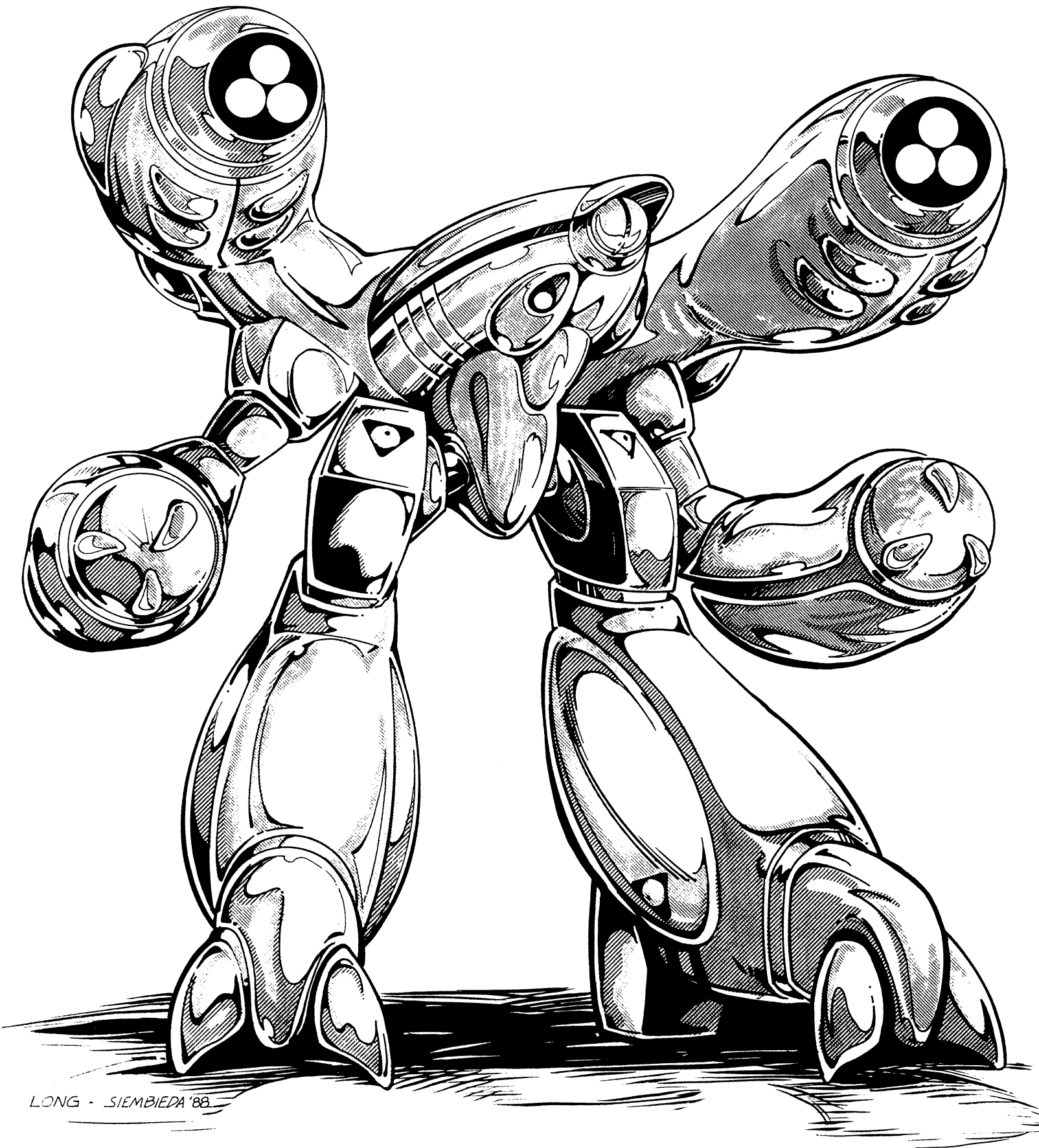

M.D.C. by Location:

Heat Cannons (2) — 100 each
Mini-Plasma Weapons (2) — 10 each
Claw “Pincer” Hands (2) — 30 each
Arms (2) — 80 each
Legs and Feet (2) — 150 each
Jet Thrusters (rear) (2) — 50 each
*Sensor Eye (1) — 20
**Main Body — 200
Reinforced Pilot’s Compartment — 80

*The sensor eye is the most vulnerable place on the invid’s mecha body. Destruction of the sensor eye will kill/destroy the mecha and pilot (goes right through crew compartment). However, it is a small target protected by surrounding shielding, thus, to hit it, the player/character must make a “called” shot and is -3 to strike.

**Depleting the M.D.C. of the main body will shut the mecha completely down. Depleting the main body M.D.C. and crew compartment M.D.C. will blow the invid into pieces.

Speed: Flight: Stationary hover to 722mph/1162kmph (Mach 1.1), with a maximum altitude of about 4 miles (6.4km).
Flight: Cruising speed for reconnaissance is 60 to 150mph (96 to 240kmph).
Ground, Running: 70mph (112kmph) maximum.
Ground, Jumping: 30ft (9.1m) without boosters, or 100ft (30.5m) up or across with boost from jet thrusters.

Height: 26ft (7.1m)

Width: 22ft (6.7m)

Length: 21ft (6.4m)

Weight: 22.5 tons

Cargo: Can carry up to three tons.

WEAPON SYSTEMS

1. **Twin Heat Cannons** are mounted on the main body, hanging over the shoulders like two giant caterpillars. Both always fire simultaneously in a directed beam of heat energy. If one cannon is destroyed, the other is rendered useless.

Although fixed in a forward position, the rotating inner nozzle of the cannon can adjust to about a 30 degree angle. To shoot in a different direction or greater angle, the invid must move its entire body. A favorite tactic is to fly several hundred feet (200 to 1000ft) above the ground and blast opposing ground units.

Primary Purpose: Assault

Range: 4000ft (1200m)

Mega-Damage: Single blast — 3D6 M.D., long blast (counts as two attacks) — 1D6 × 10 M.D., concentrated blast (same target all melee, with one continuous beam) — 2D6 × 10 M.D., continuous beam strafing run does 2D6 M.D. to everything it hits.

Rate of Fire: Equal to hand to hand attacks per melee (four single blasts).

Payload: Unlimited

Bonus to Strike: +2 to strike at all times against any target, protoculture powered or *not*. Don’t forget to add strike bonuses from *protoculture targeting system* against protoculture powered devices like the Alpha, Beta, Cyclone and Gallant.

Note: The mouths of the cannons always glow white just before they are about to shoot.

2. **Mini-Plasma Weapons (2)** are recessed into the front of the main body on either side of the sensor eye. These weapons can fire simultaneously or individually. Destroying one does not immobilize the other. To attempt to shoot out one of the mini-plasma guns, the attacker must make a “called shot” and is minus -3 to hit (they are quite small and on a moving, attacking target).

Primary Purpose: Assault

Range: 2000ft (609m)

Mega-Damage: A single blast does 2D6 M.D., a simultaneous blast (2 energy bolts) does 4D6 M.D. A simultaneous, double blast counts as ONE attack (hits the same target).

Rate of Fire: Equal to hand to hand attacks; 4 single or 4 double blasts.

Payload: Unlimited

Bonus to Strike: +1 to strike at all times against any target, protoculture powered or *not*. Add *protoculture targeting bonuses* only when attacking a device powered by protoculture.

3. Hand to Hand Combat

Attacks Per Melee: Four

Hand to Hand Bonuses: +2 to strike, +2 to parry, +2 to dodge on the ground, +3 automatic dodge when flying at any speed (an automatic dodge works like a parry and does not forfeit an attack), +2 to roll with punch, fall or impact.

Types of Attacks

Punch: 2D4 Mega-Damage (M.D.)

Crush with Pincer: 1D6 M.D.

Kick: 2D6 M.D.

Stomp: 2D6 M.D., but the target must be 15ft (4.6m) tall or smaller.

Body Block/Ram: 3D6 M.D., but counts as two attacks.

ROYAL COMMAND BATTLOID

The Royal Command Battloid is a new design developed by the Regis to accommodate the human-like invid pilots (stage 5). This is the biggest, most agile and versatile of the invid mecha and can be considered to be equal to Alpha and Beta, or any Veritech, in battloid mode.

As if its maneuverability and size were not intimidating enough, the Command Battloid is equipped with a plasma cannon arm shield and a payload of missiles similar to the Alpha’s. The missiles are fired from the back of the protruding jet thrusters.

The Royal Command Battloid is assigned to command troops, conduct sieges, go on search and destroy missions, direct operations at protoculture farms and processing plants, and can even be placed in charge of hive outposts. They might best be thought of as the generals of the invid army. They are deadly, merciless combatants who seem to excel at war. Unlike most of the invid mecha pilots, the Royal Command Battloid pilot is intelligent, observant and clever. They can assess information and act on their own volition. One in every 300 troopers or shock troopers will be a Royal Command Battloid.

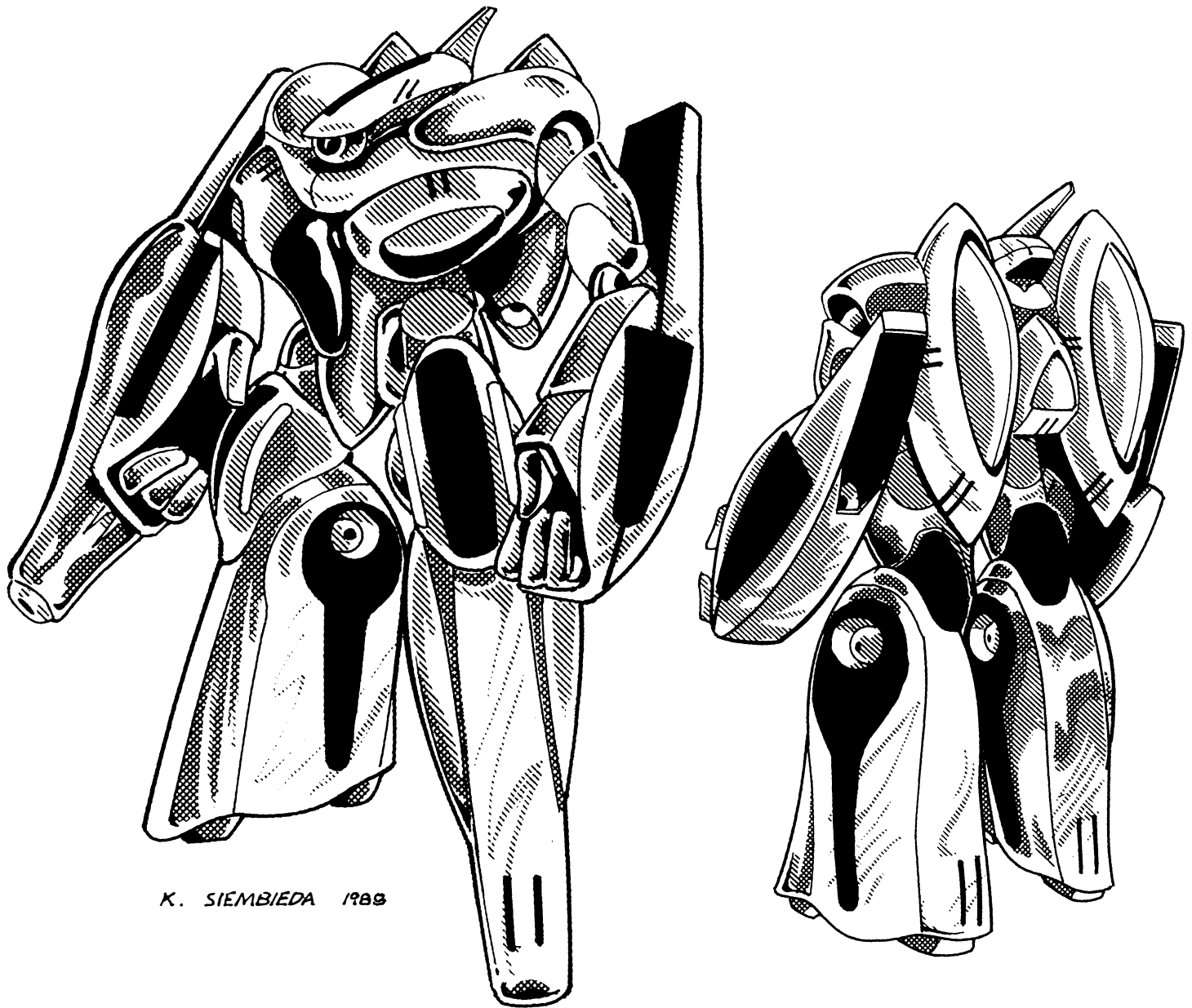

Invid Royal Command Battloid (a.k.a. Invid Battloid and R.C.B.)

Vehicle Type: All-purpose combat commander and director of operations.

Crew: One; stage five invid pilot.

M.D.C. by Location:

- Shielded Forearm (1) — 200
- Shielded Plasma Cannon Arm (1) — 200
- Upper Arm (2) — 100 each
- Hands (2) — 50 each
- Legs and Feet (2) — 200 each
- Jet Thrusters & Missile Pods (2) — 120 each
- *Head Sensor Unit — 50
- **Main Body — 300
- Reinforced Pilot's Compartment — 150

*This head sensor is not like the eye sensor. Its destruction will knockout all sensor systems, leaving the pilot to rely only on visuals. Its destruction will not destroy the mecha nor hurt the pilot.

**Depleting the M.D.C. of the main body will shut the mecha down completely.

Speed: Flight: Stationary hover to 1340mph (Mach 2), with an altitude ceiling of 50,000ft.

Flight: Cruising speed for reconnaissance is 60 to 150mph (96 to 240kmph).

Flight: Stationary hover and low speeds can be maintained at any altitude.

Ground, Running: 70mph (112kmph) maximum.

Ground, Jumping: 50ft (15.2m) up or across without jet boosters, 300ft (91.5m) with a boost from jet thrusters.

Height: 29ft (8.8m)

Width: 13ft (4m)

Length: 12ft (3.6m)

Weight: 23 tons

Cargo: Can carry up to 6 tons.

WEAPON SYSTEMS

1. **Shielded Plasma Cannon:** The forearm of the right arm is covered by a large shield with a plasma cannon built into it. This is a standard weapon carried by all Royal Command Battloids. When destroyed, the smoldering husk can be ejected, leaving the unarmored arm beneath it exposed (20 M.D.C.). Although fitted on the right arm, the plasma cannon

can be used on either. Tools, and 3D4 minutes are required to remove the weapon from one arm and place it on the other (the shield must be removed first).

Primary Purpose: Assault

Range: 4000ft (1200m)

Mega-Damage: Single shot does 4D6 M.D. or burst shot does 6D6 M.D. per attack, or strafing, continuous full melee pulse stream (shooting wild) does 2D6 M.D. to each item or area that is hit (counts as all attacks).

Rate of Fire: Equal to hand to hand attacks (5 single shots or 5 bursts).

Payload: Unlimited. Note that the plasma cannon is tied directly to the mecha and can not be removed and used by other mecha.

Bonus to Strike with Plasma Cannon: +3 to strike at all times against any target, protoculture powered or *not*. Don't forget to add the strike bonuses from the *protoculture targeting system* when up against protoculture powered devices and mecha.

Note: The mouth of the cannon always glows white just before it is about to shoot.

2. Two Missile Launchers are built into the back section that connects with the jet thrusters.

Primary Purpose: Assault

Secondary Purpose: Anti-Aircraft

Range: Varies with missile type, but all are short range, 2 to 5 miles (3.2 to 8km). Note that these are *not* mini-missiles, but regular short-range missiles (See *Robotech® RPG*, pg 39).

Mega-Damage: Varies with missile type, but almost always *Plasma* — 1D6 × 10 M.D.

Rate of Fire: One at a time or in volleys of 2, 4, 6, 12 or all (48). Remember, one volley counts as one attack regardless of the number of missiles.

Payload: 24 short-range missiles in each launcher pod for a total of 48. *All are +3 to strike.*

3. Hand to Hand Combat

Attacks Per Melee: Five (5)

Hand to Hand Bonuses: +4 to strike, +5 to parry, +2 to dodge on the ground, +4 automatic dodge when flying at any speed (an automatic dodge works like a parry and does not forfeit an attack), +4 to roll with a punch, fall or impact, +2 on initiative.

Types of Attacks

Punch: 2D6 Mega-Damage (M.D.)

Crush in Hand: 1D4 M.D.

Kick: 1D6 M.D.

Leap Kick: 2D6 M.D.

Body Flip: 1D4 M.D.

Body Block/Ram: 2D6 M.D., but counts as two attacks.

Stomp: 1D6 M.D., but the target must be 15ft (4.6m) tall or smaller.

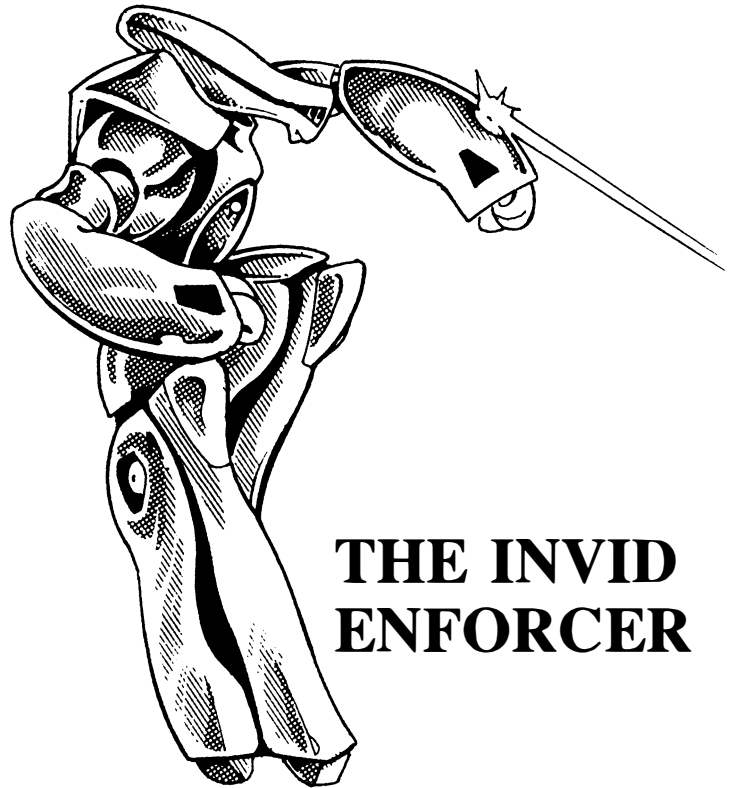

THE INVID ENFORCER

The Invid Enforcers are stage four invid pilots encased in a powerful exoskeleton of armor (power armor). Their main role is to “enforce” the will of the Regis. Unlike the lesser invid, the Enforcers are intelligent and capable of independent thought and decision making. They can command invid scouts, armored scouts, troopers, shock troopers and Pincer Command Units.

It is the Enforcers who serve and aid the Invid Brains and the Regis. Consequently, they are also known as “Royal Hive Units” or “Hive Guards.” However, their duties are not limited to the hive. An Enforcer may lead a reconnaissance patrol or assault team, or direct operations at a protoculture farm or slave camp. The Enforcers are also the invid’s interrogators, surgeons (experimenting on humans) and technicians, handling all the more delicate and precision tasks. They act as direct contacts with invid sympathizers and help coordinate traps to capture/kill freedom fighters. It is also the Enforcers who operate the Genesis Pits.

Perhaps the most unusual aspect of the Enforcers is that the Invid Brain (and Regis) can seize complete control over a handful, like possession, and use them as extensions of itself. This is the process used for carrying out biological experiments and other scientific or delicate procedures.

As warriors, they appear deceptively small (7ft/2.1m), sluggish, and vulnerable. This is a clever ploy, as they are armored and have a number of hidden weapons at their disposal. Both arms house a concealed laser, a rifle-like weapon is a deadly bazooka type item and the shield, mounted on the arm or back, generates a force field that can absorb great amounts of damage. A jet thruster is built into the back, adding flight capability to the unit.

Despite the Enforcer’s versatility, or perhaps because of it, they are found mostly in and around Invid Hives and Genesis Pits, and participants in special operations (usually as coordinators). One in every 1000 troopers or shock troopers will be an enforcer.

Invid Enforcer (also known as Hive Guards)

Vehicle Type: Power Armor

Crew: One; stage four invid pilot

M.D.C. by Location:

Hands (2) — 5 each

Forearms (laser concealed within) — 20 each

Upper Arms (2) — 20 each

Legs (2) — 30 each

Jet Thruster (rear) — 20

Energy Rifle (1) — 10

Energy Shield — 150

*Head & Sensor Eye — 20

**Main Body — 50

Note: No reinforced pilot's compartment.

*The sensor eye is the most vulnerable place on the invid's mecha body. Destruction of the sensor eye will kill/destroy the mecha and pilot (goes right through crew compartment). However, it is a small target protected by surrounding shielding, thus, to hit it, the player/character must make a "called" shot and is -3 to strike.

**Depleting the M.D.C. of the main body will shut the mecha completely down. Depleting the main body M.D.C. and crew compartment will blow the invid into pieces.

Speed: Flight: Stationary hover to 200mph/321kmph, with a maximum altitude of about 6000ft (1828.8m).

Ground, Running: 30mph (48kmph).

Ground, Jumping: 30ft (9.1m) without boosters, or 100ft (30.5m) up or across with a boost from jet thrusters.

Height: 7ft (2.1m)

Width: 4ft (1.2m)

Weight: 500lbs (226kg)

Length: 3ft (.9m)

Cargo: Can carry up to one ton.

WEAPON SYSTEMS

1. **Concealed lasers in forearms:** Two small lasers are built into the arms of the Enforcer power armor. Both are fixed in

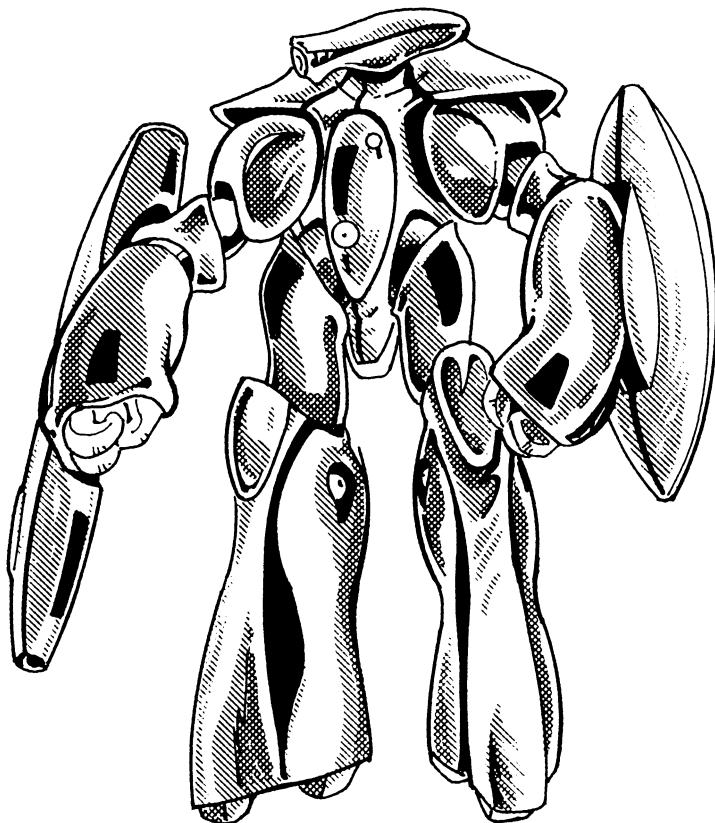

one position, able to shoot only in the direction the arm is pointed. Destruction of the forearm (20 M.D.) destroys the laser.

Primary Purpose: Defense

Range: 500ft (152m)

Mega-Damage: A single blast does 2D6 M.D. or a burst doing 3D6 M.D.

Rate of Fire: Equal to hand to hand melee attacks (three per melee). A burst is considered one attack, but is not as accurately fired as a single aimed shot. *See Modern Weapon Proficiencies.*

Payload: Unlimited

Bonus to Strike with the Concealed Lasers: +2 to strike at all times against any target, protoculture powered or *not*. Add the bonuses for the *protoculture targeting system* when up against protoculture powered enemies.

2. **Energy Rifle:** The Enforcer Energy Rifle is used exclusively by the Enforcers. The rifle is attached to the right arm where it can draw energy from the enforcer's power armor. When not in use, the rifle is attached to the back.

Primary Purpose: Assault/defense

Range: 2000ft (609m)

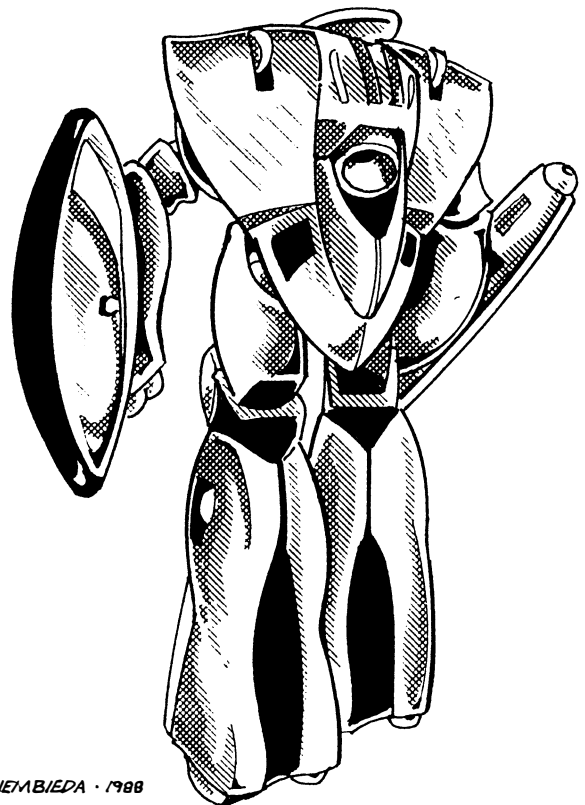

KEVIN SIEMBIEDA • 1988

Mega-Damage: 4D6 M.D. per blast or a burst doing 5D6 M.D.

Rate of Fire: Equal to hand to hand melee attacks (three per melee). A burst is considered one attack, but is not as accurately fired as a single aimed shot.

Payload: Unlimited

Bonuses to Strike with the Rifle: +2 to strike at all times against any target, protoculture powered or *not*. Add the bonuses for the *protoculture targeting system* when up against protoculture powered enemies.

3. **Energy Shield:** A large, round energy shield is standard issue for the Enforcers. It can be stowed on the back or held in hand (usually left hand).

Primary Purpose: Defense

Range: Self/hand to hand

Mega-Damage: Can be used to hit or ram an opponent. Damage is same as hand to hand.

Special Features: M.D.C. of shield is 150. Adds a bonus of +3 to parry and can be used to parry/block energy blasts and mini-missiles. Size: 4ft (1.2m) round. M.D.C. capability (150 M.D.C.) can be recharged at a rate of 20 M.D.C. per hour.

Note: The shield can not function unless attached to the body armor. The Enforcer armor can NOT be modified for human use.

4. Hand to Hand Combat

Attacks Per Melee: Three (3)

Hand to Hand Bonuses: +2 to strike, +2 to parry (+5 with shield), +2 to dodge on the ground, +4 to dodge in flight (both are normal dodges), +4 to roll with punch, fall or impact.

Types of Attacks

Punch: 1D4 Mega-Damage (M.D.)

Power Punch: 2D4 M.D. (counts as two attacks)

Kick: 1D4 M.D.

Leap Kick: 2D4 M.D.

Body Flip: 1D4 M.D.

Body Block/Ram: 1D4 M.D.

Hand Crush/Squeeze: 1 M.D. (100 S.D.C.)

OTHER INVID VEHICLES

INVID RETRIEVAL DRONE

The retrieval drone is a smallish, disc shaped object that resembles a flying saucer (seen in T.V. Episode #72). The hover vehicle is completely domed, with five triangular protrusions around its rim. These protrusions contain retractable arms for touching and grasping small items. The bottom of the disc is yellow, with a diamond mosaic pattern. This is the directional antigravity generator that creates a tractor beam for the retrieval of invid mecha and other items. Its main function is to retrieve invid mecha and invid pilots to be awakened from stasis. They are seldom seen outside the hive.

Invid Retrieval Drone (also known as "Aiga" or The Disc).

Vehicle Type: Labor and transport.

Crew: One; stage one invid pilot.

M.D.C. by Location:

Retractable Arms/Hands (5) — 5 each

Arm Housings (5) — 10 each

Tractor Beam (bottom) — 40

*Main Body (domed top) — 50

Reinforced Pilot's Compartment — 40

*Depleting the M.D.C. of the main body will completely shut down the vehicle. Destroying the antigravity tractor beam will cripple the vehicle, preventing flight or movement.

Speed: Flight: Stationary hover to 60mph (96km) maximum.

Altitude is limited to 300ft (91.5m) above any surface.

Ground movement other than hover/flight is impossible.

Height: 10ft (3m)

Width: 15ft (4.6m)

Length: 15ft (4.6m)

Weight: 4 tons

Cargo: Up to 30 tons can be held and carried in the tractor beam. To break out of the tractor beam, the vehicle/mecha must have a thrust of 300mph or greater (482km).

Weapon Systems: None

SPECIAL EQUIPMENT

1. **Antigravity Tractor Beam** is emitted from the bottom of the glowing yellow disc. The invisible tractor beam can pickup and carry up to 30 tons, with a size limit of about 80ft (24.4m). The beam is strong, but not so strong as to be inescapable if caught in it. Any vehicle that can travel at speeds of 300mph (482kmph) or faster can easily break free of the tractor beam within 1D4 melees of effort. It is important to note that the retrieval drone is rarely used to gather living or moving items. Furthermore, the stage one invid pilots are not capable of independent thought or reasoning. Thus, they will not react against an intruder or hostile force unless ordered to do so. This means that a retrieval drone will continue to perform its duty even with combat going on all around it. It will not sound an intruder alert unless it is attacked directly.

Primary Purpose: Mecha and pilot retrieval from stasis for activation.

Secondary Purpose: Cargo hauler.

Mega-Damage: None, no weapons.

2. **Five Retractable Arms** are located along the rim. The arms are used for grasping. They have no mega-damage strength and are not suitable for combat.

Actions Per Melee: Six

Length of Reach: 30ft (9.1m)

Damage Capabilities: (S.D.C.) Hit/Punch — 2D6 S.D.C., Crush/Squeeze — 6D6 S.D.C. Can lift and carry 500lbs (226kg) each.

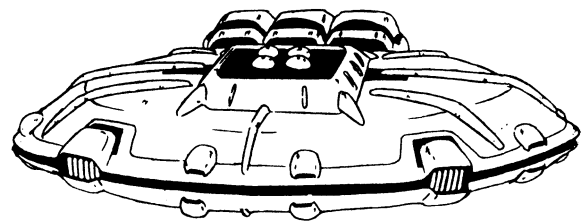

INVID TROOP CARRIER

The invid troop carrier is a large, clam shaped, flying saucer-like vehicle designed for flight in space, atmosphere and even underwater. Its three huge rear thrusters give it enough power and speed to easily breach Earth's atmosphere. An antigravity system controlled by the four domes seen on its top, provides maximum maneuverability and power. The bizarre transport vehicle opens like a clam to release its 200 plus troops.

Invid Troop Carrier (also known as the Clam Ship)

Vehicle Type: Troop transport.

Crew: Four stage four invid pilots in full enforcer armor. Only one pilot is needed, the other three are back-up.

M.D.C. by Location:

Maneuvering Jets (12 small) — 100 each

Maneuvering Jets (4 large) — 200 each

Main Thrusters (3 rear) — 500 each

Antigravity Domes (4) — 300 each

*Main Body — 2000

Note: No reinforced pilot's compartment.

*Depleting the M.D.C. of the main body will completely destroy the troop carrier. Destroying all 4 of the antigravity domes will reduce speed by 30% and allow for forward movement only. Destruction of the three main thrusters will reduce speed by 70%.

Speed: Flight: Stationary hover to Mach 10.

Has full trans-atmospheric capabilities.

Flight: Cruising speed is about Mach 1.

Height: 110ft (33.5m)

Width: 500ft (152.4m)

Length: 600ft (183m)

Weight: 140 tons

Cargo: 250 scouts or armored scouts, or . . .

200 troopers or shock troopers, or . . .

140 Pincers or Royal Command Battloids

Weapon Systems: None

Special Bonus: +6 to dodge (automatic like parry).

THE INVID HIVES

Invid hives serve as military outposts that house the director of operations (the Invid Brain), active troops and reserve troops (those in stasis). It is the communications and command center for a region that may cover 1000 miles. The largest may cover a five mile area (8km), while the smallest a quarter of a mile (about 1500ft/457m). However, most hives span about two miles (3.2km).

There are two styles of Invid Hives. The first is a spherical structure supported by four to six huge pillars that resemble snaking tree trunks constructed out of concrete. The pillars, like the outer walls, are extremely hard and fortified against mega-damage attacks. These "*stilt hives*" usually have predominately aerial type mecha such as the armored scout, scout and royal command battloid.

The other type of hive is the "*domed hive*." This hive appears as a huge domed structure with ten or eleven armored tendrils winding out of it at the base. The tendrils are the force field generators that create a protective energy dome whenever the hive is under attack by a large force. (The stilt hive does not have a force field.) The orientation of the domed hive is combat and ground operations. Consequently, it has less aerial mecha than the stilt hive and more shock troopers and pincer command units.

Although the ground hive appears to be a *dome*, it, like all invid hives, is really a sphere with half buried underground. Around the domed hive, the land is barren earth with only an occasional tuft of grass or weeds. The barren earth stretches for about 3000ft (914m) all around the dome. Troopers and shock troopers are *buried* under the ground at strategic locations around the perimeter of the hive and near each ground entrance. Strong ground vibrations or sensing protoculture (remember, the targeting system can see protoculture through several feet/meters of earth) will cause the buried troopers to spring up from underground to attack their startled opponent (always have the initiative). Mini-patrols fly around the *stilt hive* and hide in the surrounding vegetation. But 4D4 troops will be hidden, buried somewhere underneath the hive, with one or two others near each support pillar.

A TYPICAL HIVE

The following diagrams and corresponding data apply to a typical two mile (3.2km) Invid Hive. Reduce or increase the actual numbers and types of invid according to hive size, casualties and RPG campaign needs.

ALL hives are basically laid out the same, although the Game Master can make some modifications. Corridors are tubular. Entrances rarely have any kind of door that slides or swings open. If there is any type of barrier it will be a transparent energy force field. Most areas, such as stasis chambers, have no walls or barriers; instead, a fibrous, almost plant-like, weave of roots and vines (no leaves) block and separate areas like walls. Vertical tunnels, up and down, are large, completely cylindrical tubes with openings at other levels. There is no elevator platform, just the tube. Remember, all invid mecha can fly; thus, invid buzz around the hive like bees and need no elevators or confining walls.

Size: Two miles (3.2km)

Typical Number of Troops: 960

Note: A *Stilt Hive* will have mostly aerial units: 20% scouts, 30% armored scouts, 10% royal command battloids, 20% shock troopers, 20% others. A *Domed Hive* will have mostly ground troops: 10% scouts, 15% armored scouts, 10% pincer command units, 25% troopers, 35% shock troopers, 5% others.

Perimeter Defenses:

Stilt Hive: 1) Standard Reconnaissance Patrol consisting of three armored scouts and seven scouts patrolling an area 5 to 10 miles (8-16km) away from the hive. 2) Heavy Reconnaissance Patrol of one pincer, three shock troopers and six armored scouts that monitor an area about one or two miles (1.6-3.2km) away from the hive. 3) 4D4 troopers are buried in the ground, scattered underneath the hive. 4) One or two troopers or shock troopers are also buried near each support pillar. Protoculture energy or unusual ground movement will make the hidden invid spring to the surface to investigate/attack. The invid are buried about 5 to 10ft below the surface (1.5-3m). 5) All outer openings, entrances, have an energy field that can be turned on and off in an instant by the controlling Invid Brain. *Note:* Hives with no Invid Brain can not use their energy shields. 6) Optional: A mini-patrol of one armored scout and two scouts often circle directly overhead.

Domed Hive: 1) Standard Reconnaissance Patrol surveys a perimeter of about 5 to 10 miles (8 to 16km) away from the hive. 2) Wasteland Patrol consisting of one pincer command unit, four troopers and five shock troopers patrol an area of about one or two miles (1.6 to 3.2km) away from the hive. 3) 20 to 40 troopers are buried around the hive at strategic locations within 2000ft (609m) of the hive. 4) One shock trooper guards each of the ground level entrances (level four

is the ground level of a domed hive). **5)** Energy force field can be erected by the Invid Brain (or Regis) to completely cover the hive's dome. The force field is usually created only when a large force of attackers lay siege to the hive (400 or more) or if the attackers seem particularly dangerous (high-powered mecha). No amount of damage, short of a massive nuclear assault, will have any affect on the force field. However, Rick Hunter's Expeditionary Force has developed a mecha energy weapon called a "Destabilizer," which can disrupt the energy field and create an Alpha size hole in the force field. *See Alpha Shadow Fighters.*

M.D.C. by Location:

Pillar of Stilt Hive (4 to 6) — 20,000 each
Outer Wall (10ft area) — 400
Inner Wall (10ft area) — 200
Energy Barriers of Outer Portals (59) — 300 each
Energy Conduits of Dome Force Field (10 tendrils) — 3000 each
Dome Energy Force Field — 1,750,000
*Power Core (1) — 2000

*Depleting the M.D.C. of a central power core will cause an explosion that will destroy ALL of levels 2, 3, 4, 5 and everybody and everything on those levels. There is also a 44% chance of destroying the Invid Brain on level six. 20% of all other invids and mecha on levels one, six and seven present during the explosion will also be destroyed. The force field generator is automatically destroyed too.

The invid can try to salvage what they can, clear out debris and make some repairs, but the hive is without power. However, the invid and mecha in stasis will remain in stasis. The Invid Brain, if it still lives, can still take invid pilots and mecha out of stasis as part of its alchemical powers. Only the Regis can reconstruct a power core.

A TYPICAL HIVE FLOOR PLAN

Only general placement of areas and population have been provided. No exact measurements are listed because they will change with the size of the hive. Also, the exact numbers and types of invid will vary depending on whether it is a Stilt Hive or Domed Hive and on the combat history of the hive.

LEVEL ONE (TOP)

One A: An active invid bay. It will usually contain the following invid at any given time. An equal number are on patrol or on other assignments within a 1000 mile (1600km) radius.
2D6 × 10 — scouts
1D6 × 10 — troopers.

One B: Another active invid living area. It will usually contain the following invid at any given time. An equal number are on patrol (or other assignments within a 1000 mile (1600km) radius).
2D6 × 10 Armored Scouts
1D6 × 10 Troopers
1D6 × 10 Shock Troopers
1D4 × 10 Pincer Command Units
1D6 Royal Command Battloids

Note: Change 1D6 × 10 Troopers to 2D4 × 10 Armored Scouts and 1D6 R.C. Battloids to 3D6 R.C. Battloids for Stilt Hives.

One C: Hangar Bay alive with invid.

1D4 Clam Transport Ships
1D4 Royal Command Battloids
1D6 Enforcers
2D6 Pincers
1D6 × 10 Shock Troopers
1D6 × 10 Scouts
1D4 × 10 Armored Scouts

Note: Change 1D6 × 10 Shock Troopers to 2D4 × 10 Armored Scouts and add 1D4 R.C. Battloids if a Stilt Hive.

One D: Storage area that may be empty, contain human proticulture cells, prisoners for interrogation or almost anything. Larger hives may use it as an extension of the hangar bay.

LEVEL TWO

Two A: A large living area crawling with combat ready invid. It will usually contain the following invid at any given time. Twice that number are on patrol or on other assignments within a 1000 mile (1600km) radius.

1D6 × 10 Armored Scouts
1D6 × 10 Troopers
1D6 × 10 Shock Troopers
1D4 × 10 Pincers

Note: Change 1D6 × 10 Troopers to 1D6 × 10 Scouts for a Stilt Hive.

Two B: Another large living area for activated invid. This area is usually reserved for Invid Scouts and Armored Scouts, most of which, about 300, are on patrols or on other assignments somewhere within a 1000 mile radius of the hive.

2D4 × 10 Invid Scouts
2D6 Troopers
1D4 Shock Troopers

Two C: The huge open area around the hive's central power core. Two corridors connect this level to the power core. Two Shock Troopers are constantly posted at each opening. A standard reconnaissance patrol of three armored scouts and seven scouts is on patrol inside the open area. The open core area also connects level two with level three (level four has no entry portals). The central power core is a gigantic sphere suspended in the middle of the hive.

Two D: The Central Power Core.

LEVEL THREE

Three A: Stasis chamber for type three invid pilots.

Three B: Stasis chamber for type two invid pilots.

Three C: Stasis chamber for type one invid pilots.

Three D: Open area that connects to the central power core and three openings to the outside. A handful of mecha are always found in this area.

2D4 Armored Scouts
1D6 Troopers

A Pincer and two Shock Troopers guard the opening to the power core (H).

Three E: Mecha stasis chamber containing Scout mecha.

Three F: A living area for mecha. It will usually contain the following invid at any given time. Twice that number are on patrol or on other assignments within a 1000 mile (1600km) radius around the hive.

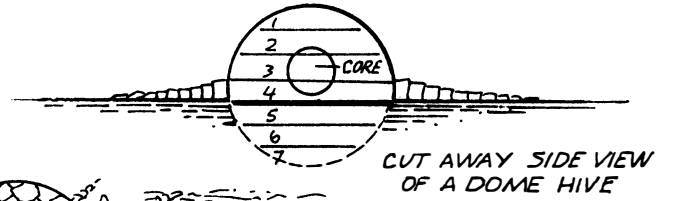
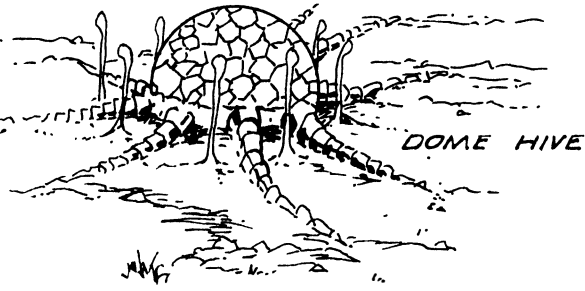
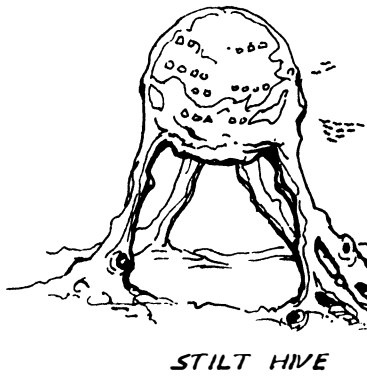

LEVEL ONE

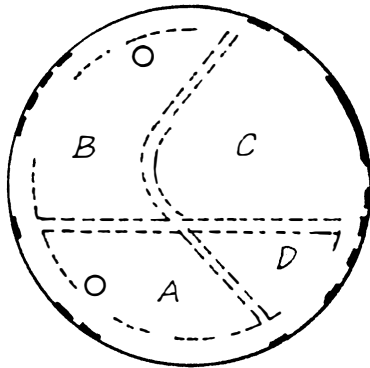

LEVEL TWO

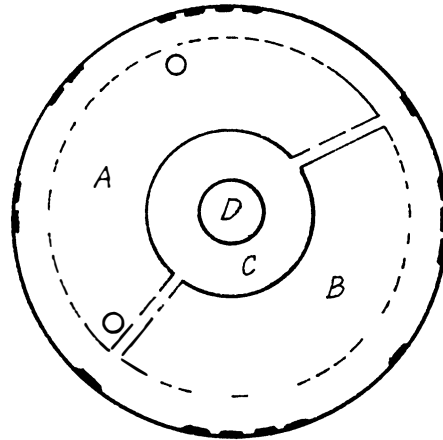

LEVEL THREE

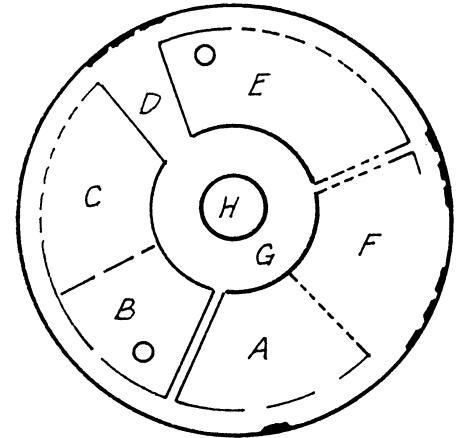

LEVEL FOUR

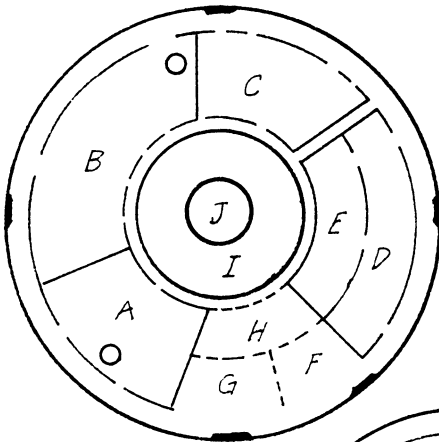

LEVEL FIVE

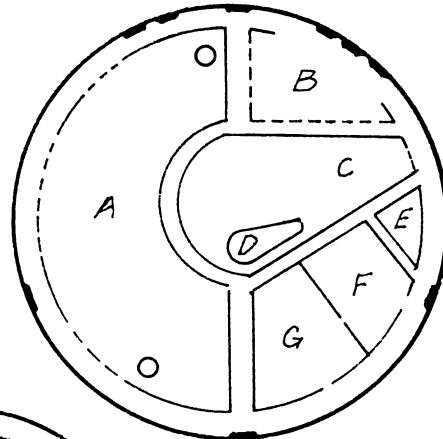

LEVEL SIX

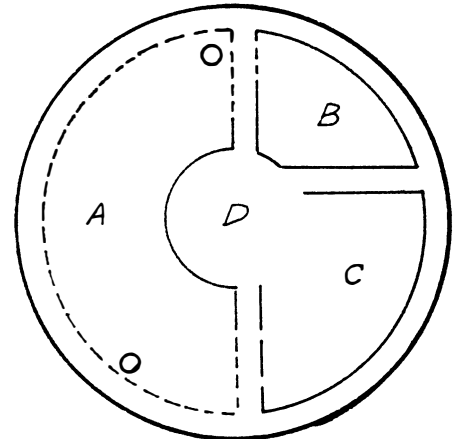

LEVEL SEVEN

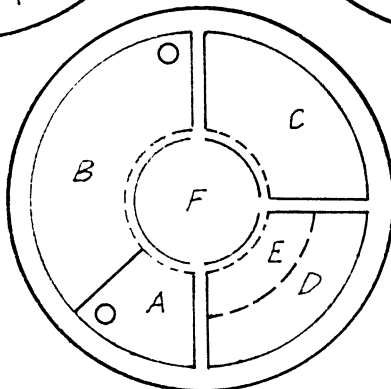

Map Code Key

- Fibrous wall with many openings.
- Solid wall.
- - - - - Opening
- ■ ■ ■ Outer access opening; can be sealed with a force field.
- Main vertical tunnels; connects all levels.

1D4 Enforcers
1D4 Pincers
6D6 Troopers
4D6 Shock Troopers
4D6 Scouts

Three G: The huge open area around the central power core. Three corridors connect this level to the core (including #D). Two shock troopers are stationed at the openings of the two small corridors. A standard reconnaissance patrol around the core ever alert for intruders. Intruders in this area are automatically destroyed, without questioning. The openings connects level three with level two (level four has no connecting openings).

Three H: The central power core.

LEVEL FOUR

Four A: Stasis chamber for type one pilots.

Four B: Mecha stasis chamber for Armored Scout mecha.

Four C: Mecha stasis chamber for Scout mecha.

Four D: Mecha stasis chamber for Pincer mecha.

Four E: Stasis chamber for type one invid pilots.

Four F: Storage area (66% chance of being empty).

Four G: Open area for active mecha. Contains:

1D4 Scouts
2D6 Troopers
1D6 Shock Troopers

Four H: Storage area (42% chance of being empty). Can contain anything.

Four I: Open area around the central power core. There is no access opening to the core on this level. Blowing a hole through the wall with explosives is the only way to get to the core on this level.

Four J: The central power core.

Note: Level four is the ground level for a Domed Invid Hive. Each of the FIVE access openings to the outer doors is guarded by one shock trooper. A **patrol** of one Pincer, 2D4 Shock Troopers and 2D4 Troopers make rounds through the corridors and stasis chambers to insure that no intruders have breached the hive. **Reinforcements** from the upper levels can arrive within 1D6 melees; most likely 2D6 Armored Scouts, followed in 1D6 melees, by 2D6 Scouts, 2D6 Armored Scouts, 2D6 Troopers, 1D6 Shock Troopers and 1D4 Pincers.

LEVEL FIVE

Five A: Mecha Stasis Chamber for trooper mecha. In a Stilt Hive, half of this chamber would contain scouts. Guarded by a patrol of 1D6 troopers.

Five B: Open living area for invid. It is likely to contain the following:

1D4 Armored Scouts
1D4 Scouts
2D6 Shock Troopers
3D6 Troopers
1D4 Pincers
1D4 Enforcers

Five C: Medical and research area for the invid. This is where the Enforcers interrogate human prisoners and conduct biolog-

ical and bionic experimentation on humans and other life-forms. It is also a living area for type four invid. At all times the following invid can be found here:

4D4 Enforcers
2D4 Stage four invid pilots (no mecha).
1D6 Troopers
1D6 Retrieval Drones
4D4 *Empty* Enforcer Power Armor

Five D: Inside Five C is a triangular chamber with metal sliding doors (M.D.C. 100). Inside the chamber is a pool of the invid's green nutrient fluid made from the pulp of the invid Flower of Life. In the pool are:

1D4 Trooper mecha standing guard
1D4 Enforcer mecha
5D6 Stage four invid pilots without mecha or weapons
1D6 Stage three invid pilots without mecha or weapons. They will try to protect the stage four invids.

Five E: Another solid wall chamber with metal sliding doors (2 with 100 M.D.C. each). This is a prisoner holding cell.

Five F: Storage area that is likely to contain human weapons, vehicles and devices for scientific study. Most items will be broken or partially disassembled. There is a 1-20% chance that it will contain a functioning Alpha Fighter (with 2D4 × 10 M.D.C. main body damage), a 50% likelihood of a perfect condition cyclone (any model; G.M.'s choice) and a 70% chance of having 1D4 × 10 mini-missiles (probably armor piercing). There's also a 50% chance of it containing a good, working condition, conventional vehicle.

Five G: Stasis chamber for type one and type two invid pilots.

LEVEL SIX (Hive Center)

Six A: Mecha stasis chamber for shock trooper mecha. In a Stilt Hive, half will be Armored Scouts. Guarded by a patrol of 1D6 Troopers.

Six B: Stasis chamber for a variety of invid pilots: 30% are type four, 40% are type three, 20% are type two, 10% are type one.

Six C: The transmutation chamber! This is the lair of the Invid Brain. The transmutation chamber is where it awakens the invid pilots and mecha from stasis and merges them. It is also the area where the Brain conducts its interrogation of prisoners, experiments and torture. It also repairs damaged mecha here.

The Invid Brain is always surrounded by protectors and servants.

1D4 Retrieval Drones
1D4 Shock Troopers
2D4 Troopers
3D4 Enforcers

Six D: The Invid Brain! The following mecha are always present:

12 + 2D6 Enforcers
1D4 Troopers
1D4 Retrieval Drones
Other mecha may be present.

The Invid Brain rests in the middle of a semicircular chamber. To destroy the brain is to destroy the directing force of the hive.

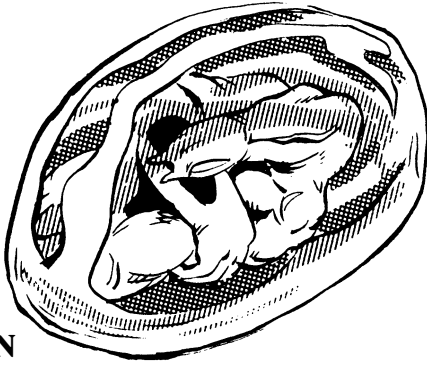

TYPICAL INVID FORMATIONS

Standard Reconnaissance Patrol

3 Armored Scouts
7 Scouts

Mini-Patrol

1 Armored Scout (lead)
2 Scouts

Heavy Reconnaissance Patrol

This patrol is sent out into hostile areas.

1 Pincer Command Unit
3 Shock Troopers
6 Armored Scouts or Scouts

Wasteland Patrol

1 Pincer Command Unit
4 Troopers
5 Shock Troopers

LEVEL SEVEN

Seven A: Stasis chamber for type three invid pilots.

Seven B: Stasis chamber for type two invid pilots. Guarded by 1D6 Troopers.

Seven C: Mecha stasis chamber for Enforcer (70%) and Pincer (30%) mecha.

Seven D: Stasis chamber for type four invid pilots. Guarded by 1D4+1 Enforcers, 2D4 Troopers.

Seven E: Invid living area. Contains the following:

4D4 Enforcers
4D4 Type four invid without power armor.
3D4 Pincer Command Units
2D4 Shock Troopers
1D4 Royal Command Battloids
1D4 Retrieval Drones

Notes: Change 2D4 Shock Troopers to 3D4 R.C. Battloids if a Stilt Hive.

Seven F: Large, circular nutrient pool for invid pilots to relax in. Contains:

2D4×10 type four invid without power armor or weapons.
1D6×10 type three invid without mecha or weapons.
1D4×10 type two invid without mecha or weapons.
1D4×10 type one invid without mecha or weapons.
2D4 Enforcers standing guard.
3D4 Troopers standing guard.
1D4 Pincers standing guard

Note: 3D4 Troopers, 1D4 Pincers and 1D4 Enforcers patrol level seven on a regular basis.

Hive Perimeter Patrol (when intruders are anticipated)

2 Pincers
10 Troopers
10 Shock Troopers

Plus 1D6 Mini-Patrols flying over the area and 4D4 Shock Troopers buried 3ft (0.9m) underground in strategic locations who spring out when an active protoculture device is sensed in the area or heavy ground movement is felt.

Hive Interior Patrol

4 Enforcers
4 Troopers
2 Scouts or Armored Scouts

City Patrol

1D4 Enforcers
1 Pincer or Royal Command Battloid
1D4+1 Troopers
1D4+1 Armored Scouts or Scouts

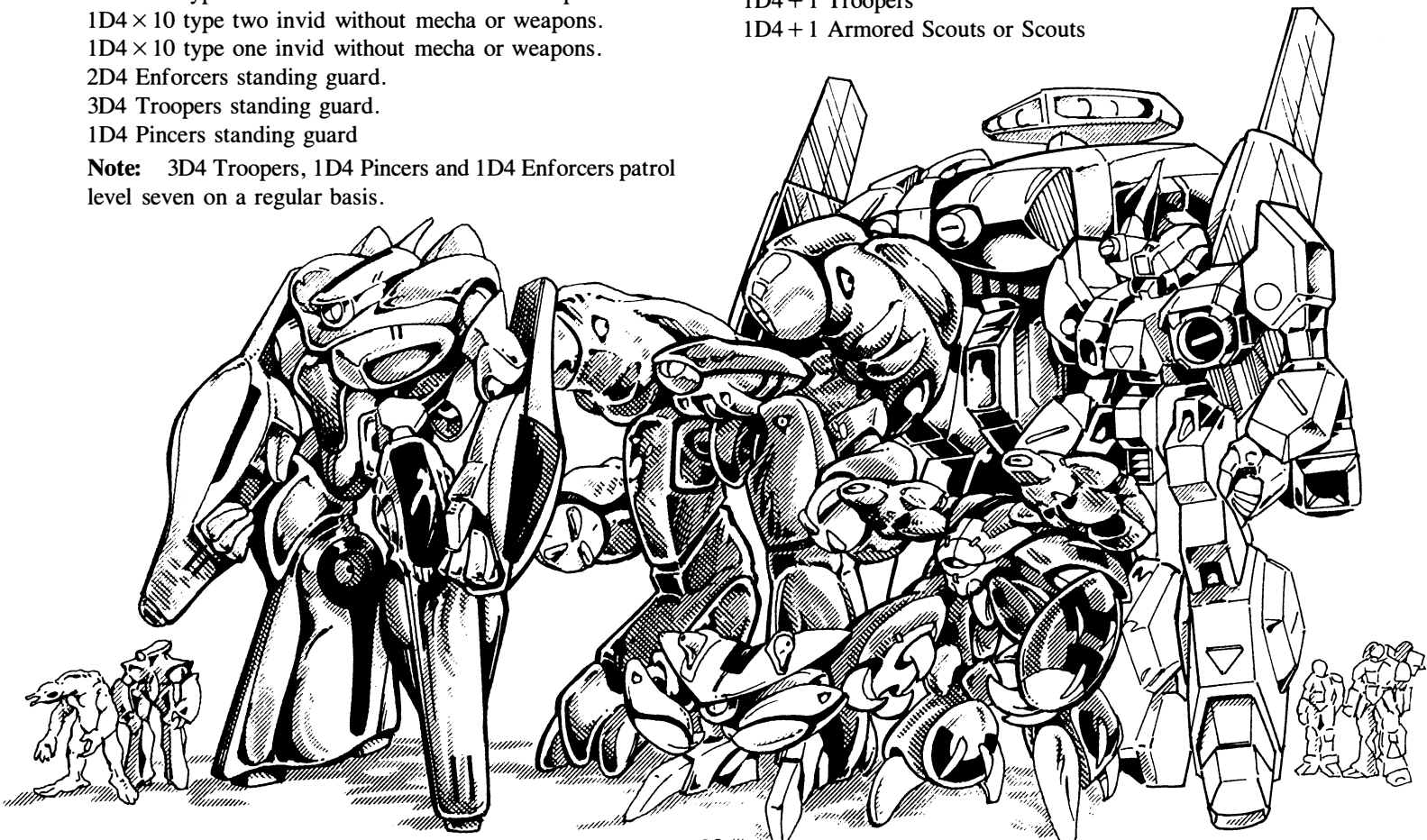

ROBOTECH CHARACTERS

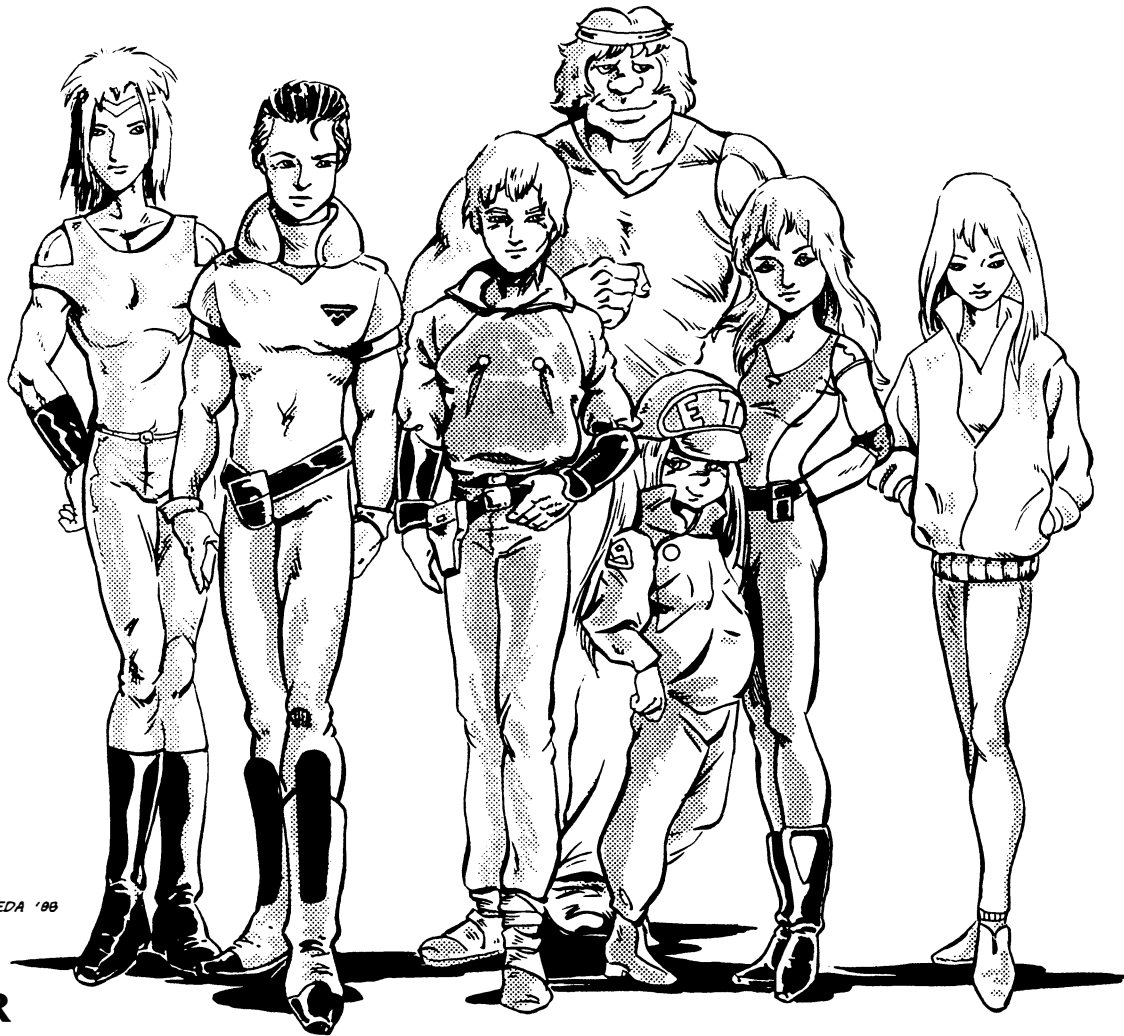

LANCER

(a.k.a. Yellow Dancer)

REF Military Specialist

Hit Points: 39 S.D.C.: 25

Alignment: Scrupulous

Attributes: I.Q. 15, M.E. 14, M.A. 17, P.S. 13, P.P. 20, P.E. 13, P.B. 19, Spd. 15

Age: 24 at the beginning of the series, 25 at its end.

Weight: 130lbs **Height:** 6ft

Disposition: Quiet, but strong and confident. Compassionate, gentle and somewhat effeminate, but an excellent fighter; always cool headed and quick thinking under fire. Very brave (almost fearless). Has exceptional reflexes. Good strategist.

Level of Experience: 5th level at series' end.

Rank: Was a lieutenant in the REF, but has joined the freedom fighters as an independent agent since the first REF assault wave failed two years earlier. Lancer was a survivor of that assault.

Skills: Pilot Motorcycle — 85%, Pilot Motorboats — 90%, Pilot Jet — 90%, Pilot Veritech — 80% (Alpha), Mecha Combat: Alpha, Mecha Combat: Cyclone, Intelligence — 90%, Interrogation — 80%, Land Navigation — 85%, Disguise — 70%, Detect Concealment — 80%, Radio: Basic — 85%, Radio: Scramblers — 75%, Dance (pro quality) — 85%, Sing (pro quality) — 85%, Cook (not pro quality) — 90%, Basic Mechanics — 55%, Hand to Hand: Martial Arts,

Prowl — 75%, Swimming — 85%, Demolitions — 98%, Demolitions: Disposal (3rd level) — 85%, W.P. Gallant H-90, W.P. Energy Rifle, W.P. Energy Pistol (3rd level).

Personal Profile: Lancer is a soldier from the REF's first assault attempt to liberate the Earth. The fleet crushed and Lancer alone, he settles down in a small town where he falls in love. But Lancer can not just sit back while the invid enslave mankind. Instead, he begins to apply his skills as a REF Military Specialist to gather intelligence and establish an underground resistance league. To his dismay, he discovers that the majority of the townspeople have succumbed to invid's domination and are active invid sympathizers. When they discover Lancer's covert operations to undermine their invid masters, the townspeople turn on him. The only way he can escape is by disguising himself as a woman (his girl friend's idea) and slips out of town. *See episode #65 for Lancer's/ Yellow Dancer's complete origin story.*

The disguise is so effective that it gives Lancer an idea for the perfect secret identity. Combining his uncanny ability to appear and act feminine with his natural talent as a singer (professional quality), Lancer is able to create a believable alter ego, that of the female singer called "Yellow Dancer." As a woman, he is not perceived to be a threat. As Yellow Dancer, the entertainer, he can travel from town to town without rousing suspicion and can gain access to places and individuals that only a celebrity could. The Yellow Dancer

persona is the perfect way to quietly gather intelligence and pass information along to members of the freedom fighters networks.

Eventually, Lancer joins forces with Scott Bernard and his group of freedom fighters. Together they reap mayhem among the invid, ambushing patrols, protecting towns, sabotaging a protoculture processing plant and destroying an invid hive. Along the way, Lancer encounters the invid princess, Sera and a strange bond develops between them. In the climactic battle at Reflex Point, Sera saves his life and proclaims that she is falling in love with Lancer. She joins the rebels and stays behind on Earth with her love, the enigmatic Lancer.

Note: Despite Lancer's female persona, he is a courageous and skilled warrior who seldom loses his cool. It is this calculated reserve and his sharp, analytical mind that make him a natural at covert operations. He can quickly size up a situation and take the most appropriate action. Although cunning, experienced and loyal, Lancer is best as an independent operative or a solid second in command. He is *not* the leader type.

SCOTT BERNARD

REF Veritech Pilot

Hit Points: 34 **S.D.C.:** 32

Alignment: Principled

Attributes: I.Q. 14, M.E. 12, M.A. 20, P.S. 14, P.P. 19, P.E. 14, P.B. 15, Spd. 14.

Age: 20 at the beginning of the series, 21 at its end.

Weight: 160lbs **Height:** 5ft 10 inches

Disposition: Strong, resolute, confident, brave and independent. A natural leader, although he doesn't seem to recognize that quality.

Level of Experience: 4th level at serie's end.

Rank: Lieutenant; from Mars Division.

Skills: Pilot Jet — 96%, Pilot Veritech Fighters (all): Alpha & Beta — 90%, Mecha Combat: Alpha, Mecha Combat: Beta, Mecha Combat: Cyclone (VR-052), Weapon Systems — 98%, Read Sensory Instruments — 76%, Navigation — 95%, Navigation: Space — 90%, Radio: Basic — 70%, Radio: Scramblers — 60%, Basic Electronics — 60% First Aid — 74%, Pilot Motorcycle — 76%, Pilot Automobile — 96%, Pilot Airplanes — 96%, Mecha Combat: Vindicator, Hand to Hand: Expert, Gymnastics, Climbing — 70/50%, Swimming — 70%, W.P. Gallant H-90, W.P. Energy Pistol, Demolitions — 70%, Demolitions: Disposal — 70% (the two demolitions skills are at 2nd level).

Personal Profile: Scott is one of the *new generation* of Robotech Defenders who was born in space. Until he crash landed on Earth, he had never seen the mother planet for which he would fight so valiantly. Mars, with its vast deserts, was the land of his childhood. Trees and grass were only found at parks inside the protective environments of Mars Base. Of course, he had seen books and videos, but they were nothing compared to the real wilderness of Earth. A wilderness in which he would be engulfed while he struggled to save Earth from the clutches of the Invid.

Young Scott, age 10, accompanied his parents on their journey with the Robotech Expeditionary Force. By seventeen, he had joined the REF/RDF Mars Division as a Veritech

pilot. In the next few years, Scott would prove himself a dozen times as a superb veritech pilot and strong leader. The Alpha and Beta were his favorite mecha and space, his favorite environment. Perhaps it was the emptiness of Mars and its distance from Earth, but Scott always felt most at home in space.

Lieutenant Scott Bernard was one of the thousands of REF defenders sent by Rick Hunter to chase the dreaded invid from Earth. Sadly, Rick Hunter did not realize that the Regis, herself, and millions of invid had claimed Earth as their new homeworld. Scott Bernard and the REF's second assault wave to liberate Earth met with the same fate as the first, obliteration. During the battle, Lt. Bernard's fiancée, Marlene, is killed and his Alpha crippled. He is fortunate to survive his crash landing in a Brazilian desert in the South American sector.

Scott forces himself not to think about the death of Marlene, turning his sorrow and anguish into revenge. Commander Rick Hunter's orders were that all survivors must head to Reflex Point, the invid's control hive, and destroy it. With firm resolve, Scott arms himself with his Cyclone and Gallant H-90 and begins his long trek to Reflex Point in the North.

Along the way, Scott encounters several charismatic individuals who have been waging their own one-man wars against the invid. It is to Scott's credit that he is able to unite the individuals under his subtle command and mold them into a devastatingly effective team of guerilla fighters. The group's members become more than soldiers, they become close friends, almost a family.

At the series' end (episodes #84 and 85), Scott and company battle at Reflex Point. After a few close calls combating the invid Corg (pilots a Royal Command Battloid), Scott, piloting a Beta, slays Corg, rescues Lancer and Sera, and lives to see the invid leave Earth. Although 85% of the Robotech Expeditionary Force is destroyed, there is much rejoicing.

A few months later, Scott leaves his friends and dear Marlene (the stage five invid who loves him) behind. The SDF-3 is missing and Scott, the eternal soldier, decides it's his duty to find the SDF-3 and its famous crew. One of the surviving REF Space Battle Cruisers will serve to carry Lt. Scott Bernard through the cosmos on his quest. With Scott as their leader, it is only a matter of time before they succeed.

Note: Scott was 10 years old when he left on the SDF-3; thus, 14 years have passed by 2036, which would make him 24. However, Scott is physically 20 years old due to time and space distortions caused by the space fold process.

RAND

Randolf O'Keefe

Nomad Scout

Hit Points: 30 **S.D.C.:** 30

Alignment: Scrupulous

Attributes: I.Q. 21, M.E. 14, M.A. 15, P.S. 14, P.P. 15, P.E. 12, P.B. 17, Spd. 14

Age: 18 at the series' start, 19 at its end.

Weight: 140lbs **Height:** 5ft 7 inches

Disposition: A friendly and gregarious Tom Sawyer of the future; clever, cunning, resourceful, imaginative, observant,

idealistic and brave. Sometimes a little too cocky for his own good.

Level of Experience: 3rd level at series' end.

Rank: None; nonmilitary status.

Skills: Climbing — 95/75%, Prowl — 70%, Track Animals — 65%, Hunting — 65%, Land Navigation — 65%, Identify Plants and Fruits — 60%, Wilderness Survival — 75%, Radio: Basic — 70%, Cook — 84%, Fishing — 85%, Sewing — 65%, Basic Electronics — 55%, Intelligence — 70%, Basic Mechanics — 42%, Automotive Mechanics — 65%, Paramedic — 85%, Pilot Motorcycle — 82%, Pilot Automobile — 92%, Pilot Airplane — 82%, Navigation — 80%, Sailing — 92%, Boat Building — 55%, Hand to Hand: Basic, W.P. Knife, W.P. Automatic Pistol, W.P. Gallant H-90, W.P. Energy Pistol, and Swimming — 70%. *New Skills* taught by Scott include: Pilot Cyclone and Mecha Combat: "Basic" Cyclone. (Both at 1st level proficiency.)

Personal Profile: Rand has spent most of his young life wandering the wastelands created by the first two Robotech Wars. He had learned, long ago, how to survive in the wilderness, so the carnage caused by the invad's invasion had little impact on him. What was different is that this time Earth's defenses failed and the Earth suddenly became an occupied war zone.

As a nomad, the gregarious Rand had no family ties nor allegiances to a community. The wide open spaces were his to explore. Life was one grand adventure, with the invad the dramatic antagonists of that adventure. Rand quickly made sport of teasing and outwitting invad. It was a game that the resourceful, young lone wolf excelled in.

Rand's devil-may-care, swashbuckling attitudes slowly changed while he road with the somber Scott Bernard and the others. In part, it was the bond of friendship that grew between them all. In part, it was the direction of Scott. But mostly, it was the realization that this was no game. That people needed him and that he *could* make a difference. The lone wolf had joined the pack.

Yet, even with his new outlook, Rand would retain his optimistic outlook, ideals and happy-go-lucky disposition. Fiercely loyal to his friends, there was nothing he would not do to help them. Surprisingly, the teen-ager's bravery and enthusiasm were tempered by a sharp mind that was always able to clearly assess a situation and select the best strategy. Rand was not one to attack a situation recklessly.

Note: By the T.V. series' end, Rand had confessed his love for *Rook Bartley* and the two rode off together. As non-player characters. Rand and Rook will be together. Both are too idealistic and courageous not to take up arms the moment they learn that the invad have returned. It is very possible that they lead or assist a small band of freedom fighters and are definitely active members of the resistance movement.

Both Rand and Rook are modern day knights errant. They live by a high code of ethics and ideals that would make King Arthur proud. Consequently, they will come to the immediate aid of other good characters in any kind of trouble. At the game master's discretion, Rand and Rook may join up with the player characters for a while or cross paths from time to time, but they are not likely to team up with them for any long duration.

Both characters are known to freedom fighters in old New York and what used to be Quebec Quadrant. *See Rook.*

LUNK

William "Lunk" Benovich

REF Bio-Maintenance Engineer

Hit Points: 35 **S.D.C.:** 28

Alignment: Unprincipled

Attributes: I.Q. 10, M.E. 9, M.A. 10, P.S. 23, P.P. 13, P.E. 19, P.B. 8, Spd. 10

Age: 25 at the T.V. series' beginning, 26 at its end.

Weight: 240lbs **Height:** 6ft 8in

Disposition: Gentle, caring, easygoing; a loyal friend and good soldier, but lacks confidence and self-esteem, something which his friendship with Scott and the others help to restore by the series' end.

Level of Experience: 4th level at series' end.

Rank: Sergeant

Skills: Mecha Repair Skill (special) — 75%, Recognize Mecha Quality — 70% close inspection/40% from a distance, Mechanical Engineer — 85%, Electrical Engineer — 70%, Veritech Mechanics — 70%, Mecha Mechanics — 80%, Mecha Electronics — 70%, Armorer — 70%, Weapon Systems — 90%, Computer Operations — 90%, Radio: Basic — 60%, Optic Systems — 70%, Computer Repair — 75%, Hand to Hand: Basic, Body Building, Wrestling, Swimming — 70%, W.P. Energy Rifle, W.P. Energy Pistol, W.P. Sub-Machinegun, W.P. Automatic Pistol, W.P. Heavy, W.P. Blunt (3rd level), Demolitions — 80%, Demolitions: Disposal — 80%, Pilot Automobile — 98%, Pilot Truck: Small — 90%, Pilot Truck: Large — 68%, Read Sensory Instruments — 60%.

Personal Profile: Lunk is an ex-REF Bio-Maintenance Engineer who is tormented by his hatred of war. At one point in his past, he freezes in combat and hides while his comrades are slaughtered. Any effort to save them would have been futile and would have only led to his death as well, but all Lunk feels is that he was a coward. Lunk's guilt turned him into a noncommittal person who avoided combat of any kind. Eventually, he is forced to take a stand, but still fears he is a coward and that, when push comes to shove, he will betray Scott and his new friends.

Lunk is far from being a coward, which he proves time and time again, until he himself comes to realize it. He is like most people caught in a war, afraid and confused. He hates the fighting, the destruction and the death. He'd rather be a farmer, but circumstances dictate otherwise.

Lunk is a warm, gentle giant of a man whose great strength saves his friends on many occasions. At the T.V. serie's end, he plans to finally start his farm and live a simple, quiet life. At least for the immediate time being. Annie and Marlene accompany him, mostly because they have nowhere else to go.

Note: As non-player characters, we can assume that Lunk, Annie and Marlene will not take the return of the invad laying down. It is almost certain that they would again join the resistance fighters and likely reunite with Rook and Rand and/or Lancer and Sera. However, the group did split up and it was several months afterward that the invad returned.

ANNIE

Annie "Mint" LaBelle

Nonmilitary Personnel

Hit Points: 16 S.D.C.: 15

Alignment: Anarchist

Attributes: I.Q. 8, M.E. 11, M.A. 8, P.S. 8, P.P. 12, P.E. 9, P.B. 9, Spd. 7

Age: 16 at the beginning of the series, 17 by its end.

Weight: 86lbs **Height:** 4ft 2 inches

Disposition: An irrepressible rascal who is talkative, hyperactive, melodramatic, passionately romantic and spunky. Her mouth gets her into more trouble than anything else. Gains a certain amount of self-control and confidence by the series' end.

Level of Experience: 2nd level by series' end.

Rank: None

Skills: *Pilot Automobile — 98%, *Pilot Small Trucks — 81%, *Computer Operation — 85%, Computer Programming — 50%, Pilot Motorcycle — 68%, Math: Basic — 88%, Cook — 79%, Dance — 57%, Sewing — 55%, Sing — 55%, Swimming — 60%, Climbing — 60/40%, Photography — 65%, W.P. Automatic Pistol. Annie's skills are limited, with seven selections still available, because she is still young, innocent and not completely skilled.

*Areas of professional training, with bonuses added in.

Personal Profile: Annie is a happy free spirit who has been swept up into the invid war. She tends to be hyperactive, talkative, impetuous and overzealous. Too often she acts on her feelings and not on her head, which gets her into trouble. Annie is an innocent who feels she must do her part to combat the invid, yet she is frustrated because she has no special skills nor the physical strength to do so. Still, she is feisty, courageous, and a survivor.

The group of freedom fighters lead by Scott become her new family. By the T.V. series' end, Annie has matured somewhat, learning to be more self-reliant and less childish. She stays with Lunk and Marlene to carve out a new life together.

Note: As a non-player character, Annie will be with or near Lunk. If she's not actively on the road with Lunk and the others, she will be using her gift of gab and enthusiasm to rally the small town she's moved into. She will stimulate moral and help the freedom fighter movement in every way she can.

Annie will offer player characters shelter, food, info, ammunition (if she has any) and advice. Of course, this will be done with much chatter and melodrama.

ROOK BARTLEY

Freedom Fighter

Hit Points: 28 S.D.C.: 49

Alignment: Unprincipled

Attributes: I.Q. 15, M.E. 18, M.A. 14, P.S. 13, P.P. 19, P.E. 12, P.B. 15, Spd. 13

Age: 18 at the beginning of the series, 19 at its end.

Weight: 110lbs **Height:** 5ft 7 inches

Disposition: Tough, self-reliant, brave and resourceful. Tends to be cool and standoffish, fearing to get close to anyone.

Was a lone wolf until she joined Scott and the others. Loves Rand.

Level of Experience: 3rd level by the series' end.

Rank: None; nonmilitary per se. (she's an independent rebel.)

Skills: Pilot Motorcycle — 77%, Pilot Automobile — 97%, Pilot Jet — 72%, Pilot Cyclone, Mecha Combat: Cyclone — 70%, Weapon Systems — 80%, W.P. Knife, W.P. Heavy, W.P. Energy Rifle, W.P. Energy Pistol, W.P. Sub-Machine-gun, W.P. Semi & Fully Automatic Rifle, W.P. Gallant H-90, Hand to Hand: Expert, Gymnastics, Body Building, Radio: Basic — 70%, Cook — 74%, Basic Electronics — 55%, Automotive Mechanics — 70%, First Aid — 68%, Prowl — 65%, Streetwise — 55%, Navigation — 80%, Read Sensory Instruments — 60%. *New Skills* taught by Scott include: Pilot Alpha and Mecha Combat: "Basic" Alpha.

Personal Profile: Rook is a tough, independent lone wolf who can take care of herself better than most men. She is the classic rebel, driven to prove herself.

Part of her toughness comes from an almost inborn skill for self-preservation. Orphaned from her parents in her early teens, Rook joined a gang where she learned to fight and ride a motorcycle. However, she found the anarchy and ruthlessness of gang life to be undesirable and left to follow her own vision.

Shortly after the invid's invasion, Rook found a VR-038-LT Light Combat Cyclone, mastered it herself, and became a mysterious, red garbed *freedom fighter* combating invid and righting injustice. Man's inhumanity to fellow man could be as heartless as the invid's, so Rook became the champion of all innocents everywhere.

Sadly, Rook's loss of her parents and family, the betrayal of a friend and the hard, often cruel, life in the savage world Earth had become had made her cold, bitter and hard. She had learned that if she did not open her heart she would not get hurt. Thus, she had no friends nor family, only a burning obsession to right injustices and to free humankind from the claws of the invid.

Meeting Scott Bernard, Rand and the others would dramatically change Rook. Once again she was a member of a team, friends . . . almost family. People who championed the same cause as she. Individuals who all suffered from the war, but who all refused to give up. Friends who truly cared and brought out the best in each other.

Despite Rook's best efforts, she began to feel and care about others again. Care about specific individuals, not just some faceless person or lofty ideal. And of those people, there was one very special person. The irrepressible, Rand. Their mutual attraction was instant, but Rook repressed her feelings and rebuked Rand's every kindness. Yet, in the end, she could not deny her feelings and finally let herself fall in love.

Note: As a non-playing character, Rook is still the tough, self-reliant person she has always been. Together with Rand, she has donned her red VR-038-LT Cyclone to fight the invid for a second time.

Rook, "The Red Warrior," as she is known, is a recognized freedom fighter in old New York, the Quebec Quadrant and in many small towns in the old Brazilia Quadrant where she used to conduct her one-woman war against injustice. *See Rand.*

MARLENE

No last name; stage five invid

Nonmilitary Personnel

Hit Points: 15 S.D.C.: 30

Alignment: Scrupulous

Attributes: I.Q. 13, M.E. 11, M.A. 14, P.S. 8, P.P. 9, P.E. 11, P.B. 20, Spd. 10.

Special Ability: Can sense the presence of any invid within 2000ft (609m), but the sensation causes chills and painful headaches.

Age: Less than one year old as a stage five invid.

Weight: 112lbs **Height:** 5ft 9 inches

Disposition: Clever, observant, but insecure and confused about her invid heritage and her place with her human friends. Loves Scott Bernard and is loyal to the other members of the group. Marlene has much to learn about herself.

Level of Experience: 1st level at the series' end.

Rank: None; was created by the Regis to be a double agent, spying on the humans.

Skills: Pilot Royal Command Battloid and Mecha Combat for same. *Note* that the skills are somewhat different than the usual human O.C.C.s. In addition to the skills listed, Marlene can select 10 skills from the following categories: Communications, Domestic, Pilot (any conventional vehicles), Rogue, Science, Technical, W.P. and Wilderness.

Personal Profile: Marlene is a stage five invid who appears human in every way. The Regis created her to spy on Scott Bernard's group of freedom fighters, but a mishap gave her amnesia. She is found helpless and nude, like an infant. She can barely talk and seems terrified by everything. Scott names her Marlene (real invid name is Ariel) and the group takes her in their company. Over the months that follow, Marlene becomes an integral part of the group as they fight the invid. This whole time she believes herself to be human. It is quite a shock to her and the others when it is discovered she is an invid (green blood).

In an act of bravery, Marlene confronts the Regis and tries to convince her that what the invid are doing is as wrong as what the Robotech Masters did to them. Together with Sera, she is able to cause the Regis enough doubt, that the Regis decides to leave this planet, for the shadow of the Robotech Masters is still present and adversely affecting her children.

Marlene stays on Earth because she feels more human than invid. Although she professes her love to Scott, he leaves her behind as he takes to the stars. She stays with Lunk and Annie to build a new life.

Note: As a non-player character, Marlene will be found with Lunk and/or Annie. She has no combat experience, although she will find that she can operate an invid Royal Command Battloid instinctively. She tends to be less combat oriented and more intellectual and spiritual. Marlene will spend her efforts helping the sick, the wounded, the hungry and the homeless, rather than take up arms against the invid. She will try to avoid battling against her own people, but can *not* condone what they are doing.

SERA

No last name; stage five invid

Invid Warrior (Equal to a Freedom Fighter)

Hit Points: 18 S.D.C.: 40

Alignment: Unprincipled

Attributes: I.Q. 12, M.E. 12, M.A. 11, P.S. 13, P.P. 15, P.E. 10, P.B. 11, Spd. 13

Age: Less than six months old as a humanoid, stage five invid at the series' end.

Weight: 125lbs **height:** 5ft 10 inches

Disposition: Capable, observant, analytical, and compassionate, but a little unsure of herself and confused by her feelings (budding love) for Lancer (and compassion for humans in general).

Level of Experience: 2nd level at the series' end.

Rank: Royal Invid Princess; operates the Invid Royal Command Battloid. A top invid rank.

Skills: Pilot Royal Command Battloid — 85% and Mecha Combat of RCB, Gymnastics, Prowl — 60%, Swim — 60%, Hand to Hand: Expert, W.P. Energy Pistol. *New Skills* taught to her by Lancer include: Radio: Basic — 60%, Pilot Automobile — 84%, Pilot Motorcycle — 64%, Pilot Cyclone — 55%, Mecha Combat: Cyclone (VR-041-Saber) on the "Basic" Level, W.P. Gallant H-90, Demolitions — 65%. Five more skills can be selected at third level, two at fourth level, two at sixth level and two at eighth; select from the Freedom Fighter O.C.C.

Personal Profile: Sera is a type five invid. Until Sera and Ariel rebelled, the Regis had considered the human form to be the ultimate life-form. Now she's not so sure.

Sera and Corg were created as the first of the superior invid beings, but the human form and the emotions that come with it makes Sera see too many similarities between humans and herself to stay enemies. Her emotions are further taxed when she becomes irrationally attracted to Lancer (it's love at first sight).

Ultimately, Sera argues against the invids tactics and pleads with the Regis to give up the war and try to live in harmony with humans. The argument is enough to make the Regis question her motives and is partly responsible for the invid's brief departure from Earth.

Note: As a non-player character, Sera is found in the company of her love, Lancer. Although she would rather reach a peaceful settlement with the invid, she is ready and willing to fight to protect her adopted planet and humankind.

Lancer has taught her how to operate Earth weapons and vehicles, but she is most adept with her Royal Command Battloid. She is familiar with hive layout, operation, and strategies. She is branded a traitor by the Regis and known to *all* the Earth's invid (empathically). She will not be able to command or bluff these invid troops.

The humans don't know quite what to think of her, except to view her with suspicion. It is only Lancer's reputation that makes the freedom fighters accept her at all.

CORG

No last name; stage five invid

Invid Warrior

Hit Points: 35 **S.D.C.:** 40

Alignment: Miscreant

Attributes: I.Q. 11, M.E. 10, M.A. 8, P.S. 14, P.P. 20, P.E. 15, P.B. 11, Spd. 16.

Age: Less than six months as a stage five invid. *Killed* by Scott Bernard in the last episode in a battle royal.

Weight: 180lbs **Height:** 6ft 2 inches

Disposition: Hates humans, loves combat. Aggressive loner, bent on murder. Fanatically loyal to the Regis.

Rank: Royal Invid Prince; pilot of the Invid Royal Command Battloid.

Skills: Pilot and Mecha Combat for the Royal Command Battloid — 90%, Hand to Hand: Expert, Gymnastics, Prowl — 60%, Swim — 60%, W.P. Energy Pistol.

Personal Profile: Corg is Sera's counterpart in every respect.

Both were created simultaneously as the elite children in the invid's enlightened evolution. Like Sera, Corg is confused by his new emotions, but unlike Sera, feels no sympathy for humans.

Corg uses his emotions to foster hate and revenge. He quickly comes to enjoy the thrill of combat, delighting in challenges. He excels at war and becomes an almost unstoppable killing machine. He is finally killed by the Beta Fighter piloted by *Scott Bernard*, but only after Corg had nearly killed him and trashed the Alpha in an early battle, immobilized Lancer, toyed with Rand and Rook (playing cat and mouse games, blowing Rand's Alpha apart, limb by limb) and destroyed dozens of other REF veritechs.

Note: Corg is definitely blown to smithereens in the final episode of the T.V. series, so there is no way he can return. Of course, players re-creating the episodes can utilize him. Otherwise, the G.M. will have to do with other stage five invid who become just as demented and ruthless.

THE EARTH OF THE INVIDS

Our planet Earth has been mercilessly battered by one alien race after another. To call it war torn is an understatement. No city remains intact. No army, no government, nor industry has survived. Indeed, humankind struggles against the jaws of extinction.

The first assault on Earth was at the hands of Zentraedi. The attack by these giant warriors was anticipated, but unavoidable. Their fleet of over four million warships decimated 70% of the planet. However, the legendary SDF-1 and the valiant Robotech Defense Force (RDF) were able to defeat the Zentraedi and help rebuild the Earth. With the RDF's direction and courage, the people of Earth rose from the ashes of destruction to rebuild its civilization. New cities and industry were established. Even the one united world government was able to linger long enough to provide people with the faith and tenacity to overcome the holocaust.

Then came the Robotech Masters. Ironically, the SDF-3 and Robotech Expeditionary Force (comprised of most of the RDF, its mecha, seasoned soldiers and loyal micronized Zentraedi, led by Rick Hunter) had left Earth in search of the Robotech Masters to avoid this very conflict. The fledgling *Armies of the Southern Cross* and its mecha forces were left to protect the Earth, but were barely equal to the task.

The second Robotech War lasted about one year. In the end, the Robotech Masters were defeated. Only a handful of cities were completely destroyed by the Masters. A comparatively minuscule 10% of the Earth suffered major destruction. However, the war completely exhausted the resources of the Armies of the Southern Cross. The Southern Cross lost 68% of its manpower, 83% of its mecha and 94% of its bases of operation, including its world headquarters and regional command posts. Without leadership, the soldiers disbanded. Most retired and took up civilian life, some tried to maintain defense outposts to protect humanity and to provide some semblance of order. Others used their military expertise, weapons and armor to create their own little kingdoms.

Three men clad in body armor (mega-damage capacity) and armed with hand-held energy weapons were twice as powerful as 20th century tanks. They were like supermen, nearly indestructible and as powerful as a conventional army of men. No ordinary force could oppose them.

Thus, with brute force, they claimed their lands and carved out their empires. Tiny little kingdoms sprang up everywhere, like feudal estates of the Middle Ages. Hundreds of independent states, each ruled by a different faction. Localized wars were constant. Society was shattered. Only a few, like the E.B.S.I.S. and Argentine Merchant Republic, resembled the nations of old. Those who controlled industry or farmland were the largest, most powerful cities/kingdoms. Although anarchy reigned, the human race lived on.

There was one more oddity. A never before recorded flowering plant was discovered to have spread across most of North America, parts of South America and the most fertile areas of the rest of the world. Most people didn't know where the hell it came from, nor did they care. The few who pondered its existence assumed it was a mutation of an Earth plant or an *alien* vegetation from the Second Robotech War. The plant seemed harmless, except that it grew like a weed and was lethal to consume. Absolutely nobody ever connected this flowering weed, the "Invid Flower of Life," to be the source of protoculture.

The Invid Regis sensed the existence of the all-important flower and came to Earth, bringing her legions of Invid warriors (millions and millions) with her. Without warning, she bombarded our planet. Over a three day siege period, 96% of the Earth's cities and 89% of all human life was obliterated. Civilization as we knew it was crushed.

A few years have passed since the coming of the Invid. Human beings, a resilient race, have tenaciously clung to survival. Tiny communities of people are scattered throughout the world. However, the cities and technology of the industrial age are gone. The world is a desolate place with great expanses of empty wastelands and wilderness. The nearest town, village or tribe is usually hundreds of miles away from each other.

A typical town will consist of 200 to 800 people. A big town, a couple of thousand and a *rare* city or very large town may have 10,000 to 20,000 people. Tribes and groups of nomads seldom number over 200 members.

The biggest communities often center around an old factory that still functions, the ruins of an old city, military base (RDF, Southern Cross or pre-1999 installation) or the husk of a crushed spaceship (Zentraedi or REF). These are usually communities that have some sort of limited industry, electrical power and/or remnants of salvaged technology, whether it be mecha and weapons or more conventional items. These semi-industrial communities frequently attract individuals with market-

able skills, such as mechanics, electricians, craftsmen and mercenaries. As such, most will have a comparatively substantial system of commerce, with mechanical repair services, armorers, merchants (barter system) and services available (bars, gambling, merc's for hire, etc.). The largest towns are the best places to find high-tech weapons, ammunition, vehicles, mecha parts, protoculture cells and even mecha (rare). Of course, they are also the most potentially dangerous, crawling with unscrupulous merchants, mercenaries, rogues, gangs, bandits and invid sympathizers.

Most small communities, three thousand people or less, are farmers or laborers. Technologically, they parallel the preindustrial revolution about equal to the 1700's Americas, or early 1800's. They are like the early pioneers who carved a place out of the land with a hatchet and a musket.

The analogy of the stereotypical early days of the old west comes to mind. The pre-civil war days of North America. It's an appropriate analogy, right down to the level of technology and lawlessness, except there is no federal marshal, no federal government and no cavalry. Only little towns governed by those people. Towns that have no electricity, no television, no, or minimal, radio communications and is pretty much cut off from the rest of the world. Most survive by growing crops and/or raising cattle. Some may offer goods and services to trade with other communities like lumber camps and carpentry, fishing and fish, mechanical skills/repairs, or military strength/protection.

Picture a combination of post-World War Three (after the nuclear holocaust), the old west, feudal Europe, the road warrior, Palladium Books'® *After the Bomb/Road Hogs* and the remnants of Robotechnology all rolled into one. That is the Invid Earth.

PLAYER BACKGROUND

The Player Character's Place in the World

It is said that the Third Robotech War lasted three days, but many human survivors have not admitted defeat, continuing the battle to free the people of Earth from alien oppression. In most Invid Invasion campaigns, your characters will be the *resistance fighters* who oppose the invid's tyranny, or wandering *adventurers/scavengers* who have been drawn into the conflict.

Rumor has it that the Invid were defeated by a returning REF fleet and freedom fighters less than a year ago. Although the stories vary, most conclude that the central command post of the invid, in the north-east portion of North America, was destroyed, and the invid fled. But then the invid learned that the liberators were, themselves, destroyed and so they have returned.

General Knowledge About the Invid

1. Most civilians/townspople have no idea why the invid came or what they want. The invid are simply viewed as maniacal alien invaders. The "Invid Flower of Life" is simply an insignificant weed.
2. Most people know nothing or little about protoculture, mecha or high technology.
3. Most people do not know the "alien weed" (the Invid Flower of Life) has anything to do with protoculture energy or robotechnology, or why the invid want it.
4. About 30% of the free people have come to realize that the invid seem to want this plant, but don't know why or that it is the plants that have attracted the invid to Earth. 90% of the people who live near an invid protoculture farm/Flowers of Life farm and/or invid protoculture processing factory realize that the "alien weed" has important significance to the invid, but only 50% know that it has some connection with protoculture energy. NONE know the full story behind the invid and the Flowers of Life.

5. Resistance fighters (playing characters) are generally much more informed and do know that the invid covet the "Flower of Life" for many reasons, although they may not know all the details. They also know that the Invid Flower of Life is somehow turned into protoculture energy. However, the exact process is a mystery.
6. Robotech Defense Force (REF) trained characters know that the Invid Flower of Life is needed for the creation of protoculture energy. They also know that the plant can be used as an addictive, and often deadly drug. Members of the REF further know that the invid have conquered Earth to protect, harvest, and control the source of protoculture. The planet Earth has, effectively, been turned into an Invid farm colony, with enslaved humans to work the farms and processing plants.
7. The invid kill anybody caught destroying or possessing the "alien weed."
8. The invid collect or destroy all sources of protoculture energy, as well as everyone who used or kept that energy or item(s) powered by protoculture.
9. The invid seem to be able to sense or track protoculture energy. For this reason, many towns have outlawed the use of protoculture and will hurry out strangers who utilize protoculture.
10. The invid crush resistance without mercy, destroying entire towns who assist or support subversive activity.
11. The invid, especially the smaller invid, seem quite simple minded. The largest seem to be the leaders.
12. The invid often ignore abandoned human vehicles, weapons and mecha. It's almost as if they do not recognize what they are or don't care. (REF trained characters know that they don't. Read the Invid Section for details).
13. The invid capture nomads and may raid an entire town of its people to work as slaves on protoculture farms and processing plants.
14. The invid treat all humans, men, women, children and the elderly, like work animals. Those that cannot work are released (1-50%) or destroyed (51-100%).
15. The invid have come to work with humans who have turned *traitor* against their fellow man. The reasons for this treachery can be almost anything, from greed and power to assurance of invid pacification and protection toward that particular human town or individual, or in exchange for support/survival of the town (the invid provide food, energy cells and perhaps protection in exchange for the humans alerting them to freedom fighters or even the active entrapment and/or execution of human rebels, or other acts of service and loyalty). These are usually the desperate, terrified or evil.
16. It is usually the Invid Enforcers who communicate directly with humans. The Pincer and Royal Command Battloid may also work with or command loyal humans.
17. The human sympathizers are allowed to keep and use any weapons and equipment they can salvage and may receive additional supplies and protoculture energy cells from the invid.
18. Human sympathizers are used to help operate the slave camps and to supervise and control the slave laborers. These privileged humans can be armed with REF or Southern Cross body armor (M.D.C. 50) and energy weapons, but mecha are not allowed at processing plants or on protoculture farms.
19. An invid sympathizer who double-crosses his invid masters is a marked man and killed on sight. There is no trial, no questions, only immediate termination.
20. Humans are never allowed in the hive except as the subjects of interrogation or experimentation.
21. Invid have difficulty recognizing one human as being different

from another. The stage four and stage five invid pilots are the only invid who can easily distinguish between specific individual humans.

22. Only the Pincer, Enforcer, Royal Command Battloid, stage four and stage five invid pilots, and Invid Brain (and Regis) can “speak” to humans. The Scout, Armored Scout, Trooper, Shock Trooper, Retrieval Drone and stage one to three invid pilots are incapable of human speech.

A GLOBAL SUMMARY CIRCA 2038

THE SECTORS

1. The North American Sector

This sector, which includes the old USA and Canada, is the focus of invid activity. The original seeds of the “Invid Flower of Life” grew within the wreckage of the SDF-1, located at the Montana/Calgary border. The Robotech Masters’ detonation of their mothership over the site released the seeds, which were carried across the country and eventually, the globe. Since this sector was the first continent to be exposed to the prolific plant, and was the most fertile, it is the most heavily seeded. Thus, the North American Sector is the primary farmland of the invid.

The North American Sector was also the least devastated by the invid’s initial siege for two reasons. One: the sector had been pretty thoroughly bombarded in the previous two Robotech Wars. That means that most of the country was wilderness with scattered pockets of civilization. Two: the invid did not wish to destroy the “Flower of Life,” which grew in great abundance in this sector. Consequently, the major cities and obvious military outposts were destroyed in the initial bombardment. Smaller cities, towns and feudal kingdoms were attacked by invid troops, further scattering the already minuscule population. *Remember*, North America was mostly wasteland and wilderness at this point. The new seat of civilization was the heavily populated Northern Euro Sector, the Far East Sector, Quebec Quadrant, Mexico Quadrant and the Argentine Quadrant.

2. The South American Sector

This sector is now mostly jungle and wasteland. The cities of the Argentine Quadrant have been leveled, as have the many RDF/Southern Cross military outposts. What’s left are city ruins, rubble, and small, insignificant towns and villages. The few rogue Zentraedi that still exist in the Amazon Jungles (the heart of the old Zentraedi Control Zone) have either dug themselves in deeper, losing themselves in the jungle, or have actually stepped out and joined the human resistance fighters. Nearly one thousand full size Zentraedi have joined the human freedom fighters. Approximately 2D4 × 100 Zentraedi rogues remain hidden in the jungles.

3. The Northern Euro Sector

This area includes the once heavily populated Scandinavian countries and the E.B.S.I.S.; today it is a barren wasteland, devoid of life. No city remains standing. This sector was the hardest hit by the invid’s initial bombardment; 97% of all life was destroyed.

4. The African Sector

After the Zentraedi uprisings of 2019-2020, the area was lightly populated and still is. Since the sector was already mostly wasteland and jungle, and because the invid Flower of Life does not grow well here, it has been largely ignored by the invid. A few cities were attacked by swarms of invid, but a handful of small towns were completely

untouched. This makes Africa the secret industrial nation of the world. Industrial and technological levels are roughly equivalent to the U.S. of 1950, complete with radio and video communication. Estimated population is 70,000.

The people of Africa believe themselves to be the only survivors of the invid invasion. They have not tried to contact the outside world for fear of attracting the invid. Although the Southern Cross base there was attacked by the invid, a couple hundred soldiers survived and have been able to salvage 60 Hover Tanks, 11 Logans, 16 GMP Battloids, 4 Recon Battloids, 3 VF-1J Veritechs, 3 Gladiators, 2 Excalibers, 1 Raider-X, 3 GMP Robots, 127 Hover Cycles, 12 Hover Land Rovers, 2 ATV Missile Launchers, over 300 suits of Body Armor, a full complement of standard energy weapons and missiles, a weapons recharge facility, and one shuttle craft and one AJACS. The underground complex of the Southern Cross base (75% in ruins) is the central base of operations for the “African Resistance League.”

The African Resistance League is currently considering sending a reconnaissance team or two to South America and/or North America in search of other survivors.

Note: The survivors in North America and the rest of the world know nothing about the people of Africa. Remember, global communications no longer exists.

5. Far East Sector

The islands of Japan have been laid to waste. There are no survivors; 100% fatalities.

6. The Eastern Sector

Includes India, China, Indonesia, and Australia. Noticeable places of civilization were laid to ruin by the invid, but small villages have been left alone. China and India have been the hardest hit because of their large populations and because the invid Flower of Life grows only moderately well there. Both areas have lost about 50% of their already reduced populations to the alien intruders.

THE MAJOR QUADRANTS AND HIGHLIGHTS

- Monument City** is a giant crater surrounded by grassy plains, light forest and fields of invid Flowers of Life. A large invid stilt hive is located about 100 miles (160km) from the site of the SDF-1.
- Quebec Quadrant** as one of the new independent nations, was a heavily populated and industrialized quadrant. Consequently, the invid annihilated it in their initial onslaught. No cities remain; fatalities were about 96%. Vegetation is just starting to reclaim the land. The invid Flower of Life also seems to grow *fairly well* here. A stilt hive is located at what was once a place called Inukjuak.
- The Arkansas Protectorate** is devoid of Zentraedi and is a major area for agriculture (so there are many human towns and villages), as well as a prime location for the growth of the invid Flower of Life.

The invid have a large stilt hive and two typical domed hives in this sector. They also have huge proticulture farms and proticulture processing plants near each hive (within 200 miles of the hive).

- Mexico Quadrant** was another heavily populated region that has been destroyed by the invid. 60% was atomized by the invid’s initial assault, and the remaining cities and towns were besieged by invid troops. Approximately 88% of all life was killed. Mostly nomads, tribes, and wild gangs roam the wastelands. An occasional town populated by farmers or goat herders is all that remains of civilization.
- Venezuela Quadrant**, predominantly farmland, has an abundance of invid Flowers of Life. Thus, the land was spared from the initial bombardment. Major towns and cities were smashed into ruins, with

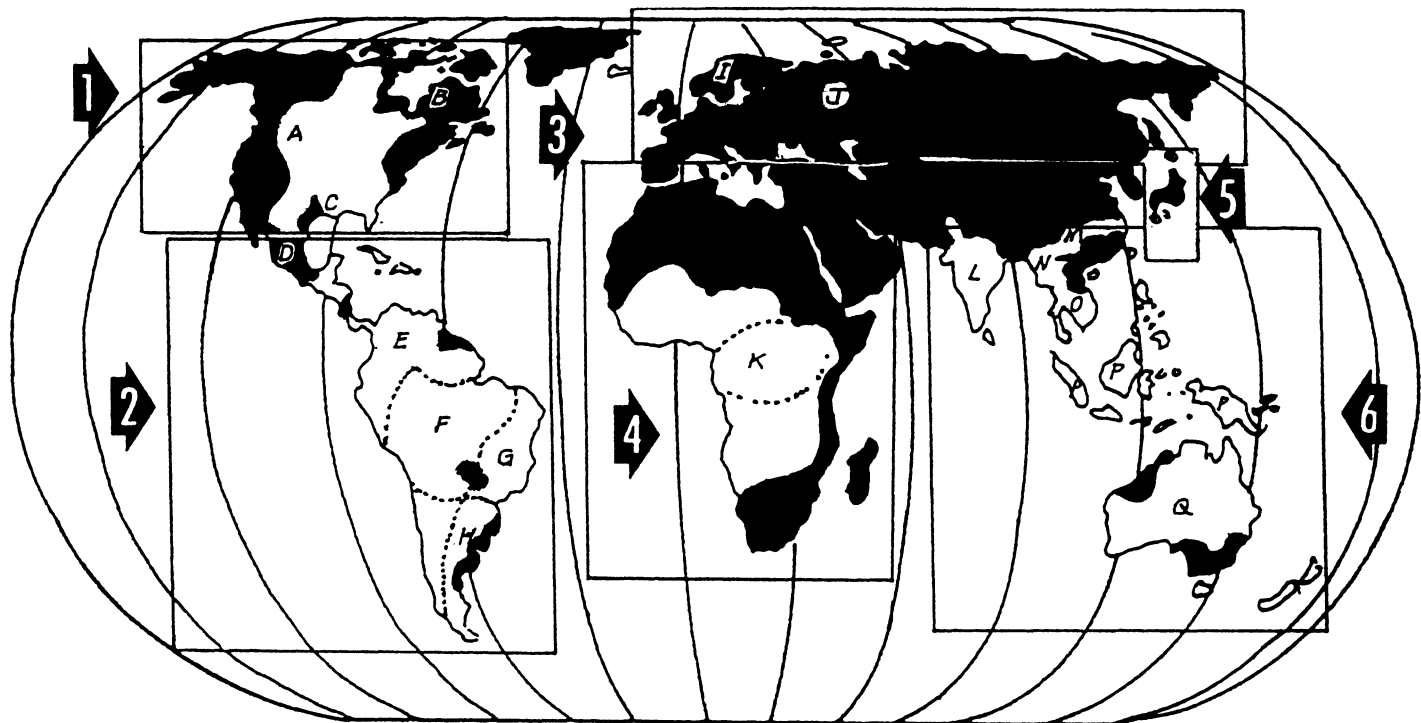

a 36% fatality rate. Survivors were enslaved to become workers for the many protoculture farms in this quadrant. Four protoculture processing factories are known to exist. The Venezuela Quadrant is also known for its many small villages of invid sympathizers who rely on the invid to survive. Some of these towns are completely designed to lure and trap freedom fighters.

F. Zone-Z (The Old Zentraedi Control Zone) is a dense jungle area following the Amazon River. Under a thousand full size Zentraedi still live hidden in the jungle. These rogues care nothing about the Earth, humans or invid. However, another 800+ have joined the human freedom fighters to combat their most hated foe, the invid. These invid stomping Zentraedi usually operate as small, independent strike forces of six to twenty-four warriors using guerrilla tactics. Some have teamed up with human allies or work in conjunction with human resistance forces. Although most of these Zentraedi operate in the jungles of South America, some have moved as far north as Mexico Quadrant and may continue upward.

Almost all the Zentraedi are clad in Zentraedi mecha: 50% Tactical Battle Pods, 20% Officer's Pods, 15% Female Power Armor, 5% Male Power Armor, 5% Fighter Pods, 5% others. **Note:** Although they are working with humans to destroy a common foe, the Zentraedi still dislike humans and are usually arrogant and rude toward their tiny allies. No micronization chambers are known to exist.

G. The Brazilia Quadrant, a lightly populated area with some major industrial facilities and military bases, has been conquered by the invid. The factories, cities, towns and bases have been obliterated. All that remains are scattered farms, cattle ranches, and tiny villages. The invid Flower of Life grows fairly well in parts of Brazilia. There is at least one protoculture slave farm and dome hive in this quadrant.

H. Most of the Argentine Quadrant has been reduced to rubble. The invid hit this densely populated new nation (the home of the high-tech bandits and E.B.S.I.S. base) with the same destructive power they threw against Europe and Quebec. The major cities and inhabited areas were obliterated, destroying 99% of all life. The smaller towns and villages were attacked by invid troops, wrecking them and killing 37% of the population.

Currently, the quadrant is half wasteland and half forest. The human population is small and scattered.

The northern portion of the quadrant, where Brazilia and the Z-Zone all connect, is a fertile land where the invid Flower of Life

grows in abundance. Several slave farms, processing factories and hive(s) are believed to operate at that junction. No human reconnaissance patrol has ever returned from that region.

I. The Scandinavia Quadrant, including Norway, Sweden, Finland, and Denmark, has been atomized. No survivors! The land is dotted with the jutting remnants of cities, melted buildings and hundreds of craters. The land has been transformed into a dead-zone that only grass and shrubs live on.

J. The E.B.S.I.S., which includes Germany, Poland and the U.S.S.R., is a continuation of the devastation. The invid pounded the E.B.S.I.S. territories into pulp; 98% fatalities. A tiny refugee population has survived have left helpless refugees to wander the barren wastelands of Europe.

The invid randomly patrol the continent, but it has no value to them.

K. Congo Quadrant: Mostly jungle with scattered towns and secret human outposts (see the Africa Sector). The invid are only remotely interested in this area because the flower can be found growing here and there. However, with the vast farmlands of the Americas, the invid need not cultivate this land. They are mainly here to protect it from falling into non-invid hands.

L. India Quadrant is a land of sorrow and death. The invid troops have slain 50% of the people and enslaved many others to harvest the invid Flower of Life. The damnable flower grows fairly well in India, although nowhere near as well as in the Americas. Drought, famine and disease will claim the lives of half the human survivors.

M. Manchurian Quadrant, with its feudal kingdoms, has suffered under the invid's rule. Cities have been beaten into ruin, but the people still fight on. Some E.B.S.I.S. mecha and low-tech (20th century) weapons and vehicles are used in this struggle. The Chinese are faring adequately against the invaders because of the low numbers of invid currently present in their country. The invid Flower of Life does not grow too well in this quadrant, but can be grown.

N. China Quadrant: This is a shattered and devastated land with a dwindling population. Resistance is scattered, using conventional arms, which are mostly useless against the invid. There is at least one large invid dome hive and several protoculture farms (located near it) in operation.



● **The Black dots**
indicate known Invid hives.

O. Indochina Quadrant includes Burma, Thailand, Laos, Cambodia, Vietnam and Malaya. Mostly jungle, it has long been believed to be the last refuge of the rogue Zentraedi. What was not known is that a Robotech Masters' mothership crash landed near Burma. Thus, Robotech Masters have intermingled with Zentraedi and the local human populace to combat the loathsome Invid. The Masters have taken great pains to keep their presence a secret. If the Invid discover them, they will swarm over the quadrant to search out and destroy their most hated enemy. Several underground complexes have been constructed and the dense jungle provides excellent cover. Without the power of the Regis, the Invid troops will have great difficulty routing the Robotech Masters and their forces.

The secret Robotech Masters forces consist of approximately 600 Tactical Battle Pods, 100 Officer's Pods, 100 Artillery Pods (light & heavy), 70 Recon Pods, 3 Theatre Scouts, 2 Reentry Pods, 249 Zentraedi foot soldiers without mecha, 200 standard Blue Bioroids, 100 Green Bioroids, 60 Red Bioroids, 20 sets of Invid Fighters (3 per set), 500 Bioroid Hover Craft, 8 Robotech Assault Carriers, 200 Bioroid Terminators, 21 "Robotech Masters," 51 Clone Masters, 47 Science Masters and 111 Tirolian citizens. Plus, a human force of about 40,000 guerrillas scattered throughout the quadrant. The guerrillas are armed mostly with conventional 20th century armaments, with an occasional RDF, Southern Cross, or REF piece of equipment. 15% are armed with the Bioroid Terminator heavy laser assault rifle (See *Southern Cross*, pg 102). See *Southern Cross* for data on the Robotech Masters and their mecha.

Note: 1) The rest of the world does not know about the Masters or what is going on in that quadrant. 2) The Science Masters are about to complete a protoculture processing unit that will turn Invid Flower seeds into protoculture energy. If successful, they will be able to completely reenergize their mothership (See *Southern Cross*, pg 103). This will then enable them to repair the vessel and to also begin to manufacturing of bioroids and other war vehicles. Humans can be transformed into bioroid pilots and used as an army of warrior slaves. 3) The Robotech masters are *considering* creating an army and taking over the Earth themselves. The alternative will be to gather up as many protoculture seeds as possible and then blasting off into space to rebuild their empire.

P. Indonesia Quadrant has Invid Flowers of Life growing here and there. All traces of civilization have been turned to ash, forcing all surviving humans to retreat into the jungles.

Q. Australia Quadrant was decimated by the Invid's initial bombardment. No cities remain intact. It is in a similar state as North America, but with much fewer Invid. The Invid Flower does not grow well in Australia.

Note: Wastelands created by the Invid assault are generally crater filled lands of mixed terrain that will consist of either large grasslands, dust bowls, deserts, dead forests and/or ruins of cities.

The wastelands of North America are mostly the result of the first Robotech War of almost 20 years ago. Although great portions remain lifeless deserts and dust bowls, much of the rest has grown into a wilderness of light forests, or rolling plains of tall grass and shrubs, or vast plains of the Invid Flower of Life.

THE FLOWER OF LIFE

The Invid Flower of Life can be found scattered throughout the American continents and most of the world in varying quantities. However, it is North and South America where the alien plant thrives.

The following map illustrates where the Invid Flower of Life and consequently, the Invid are most common.

/// **Solid lines** indicate a great abundance of Invid Flowers. Vast plains of the plant, with Invid protoculture farms are numerous. The flowers seem to grow everywhere, even in the wastelands.

/// **Broken lines** indicate areas where the Invid Flower of Life grows with some difficulty. The plants tend to be smaller, less healthy and far less numerous, but do exist in a great enough quantity as to be significant.

■ **Black** indicates wastelands. The European, Asian and African wastelands have no Invid Flowers, nor little life of any kind.

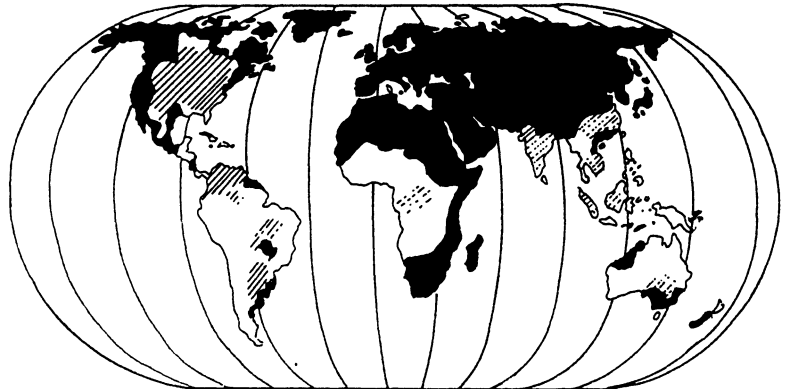

GAME MASTER NOTES

Some quick, two-bit advice. 1) Unless you have some specific ideas, throw the group of player characters together at the beginning of the game. Give them a quick background, like "You two REF characters have been traveling together for a while now; along the way you ran into this Nomad Scout. He seems to be a likable fellow who wants to drive the Invid from the Earth. The other two guys are Freedom Fighters (or whatever) who are riding with you, at least for the time being, in search of . . . (whatever; adventure, revenge, to save mankind, protoculture cells, etc.). You are all first level, and know little about each other." This gets everyone together immediately.

2) Next, set up the environment. Where in the world are they (sector, quadrant and specific setting)? What is their goal (liberate a town, find/buy supplies, find fellow freedom fighters, find mercenary work, find and attack invid, sabotage a protoculture factory, etc.)? Place them near their goal, or on the road to it, and build your adventure from there.

3) Remember that invid are pretty simple minded (except for the pilots of the Pincer, Enforcer, Invid Brain and Royal Command Battloid). That means that in combat the invid will always be attracted to protoculture energy and active mecha. They will zero in on active mecha first (targeting on their protoculture emanations), on other sources of protoculture next, like energy weapons, and human antagonists with no protoculture last. Furthermore, the invid *may* completely ignore a human who has no protoculture and is not obviously hostile. Unless they have been ordered to locate and kill all humans encountered, or sent to destroy a town, or to capture human slaves, an invid or invid patrol *will* ignore even large groups of humans, including nomad tribes and towns. They will simply note their location and move on. However, invids will always attack any humans within two miles of a hive and chase away or destroy anybody within eight or ten miles (12 or 16km).

4) **Because they do not recognize human machinery, it is usually safe for a character to turn off his mecha and leave it tucked away in the underbrush or behind a building. Even if the invid find it, they will probably leave it alone.** (See the invid perception factor on

page 77). This enables the character to move around, prowl, investigate, etc., without fear of being targeted by an invid protoculture sensor. GMs, let your players know about this. REF characters should know about this from training and experience. the non-REF O.C.C. characters may not know this at first, but should be able to realize it after a few encounters with the invid. This knowledge gives the characters great flexibility and the opportunity to use their skills.

5) Adventures should not be just "blow-up them-there invid." This is a world full of adventure, and dangers. The invid should be the main villains, but not necessarily the focus of every adventure. You can have human sympathizers who try to trap and kill or capture freedom fighters; you can play an unscrupulous human(s) who has tried to build his own little empire, and who may or may not work with the invid, but is a tyrant nonetheless. There can be rescue missions, sieges against protoculture factories, or attacks on invid hives, or liberating towns, or helping escaped slaves reach a safe haven, or getting food or medicine for a town, or . . . anything. It is probably best to think of the setting as a post-nuclear war setting with the invid as the despotic new order of life that oppresses the human survivors. If you can, try to see some episodes of the Harmony Gold T.V. Series about the Invid Invasion. That will give you a strong idea about the setting and how the invid and REF mecha work in the invid setting; explore them. Generally, any type of adventure that you can play in a fantasy campaign, or science fiction post-holocaust campaign can be played in invid.

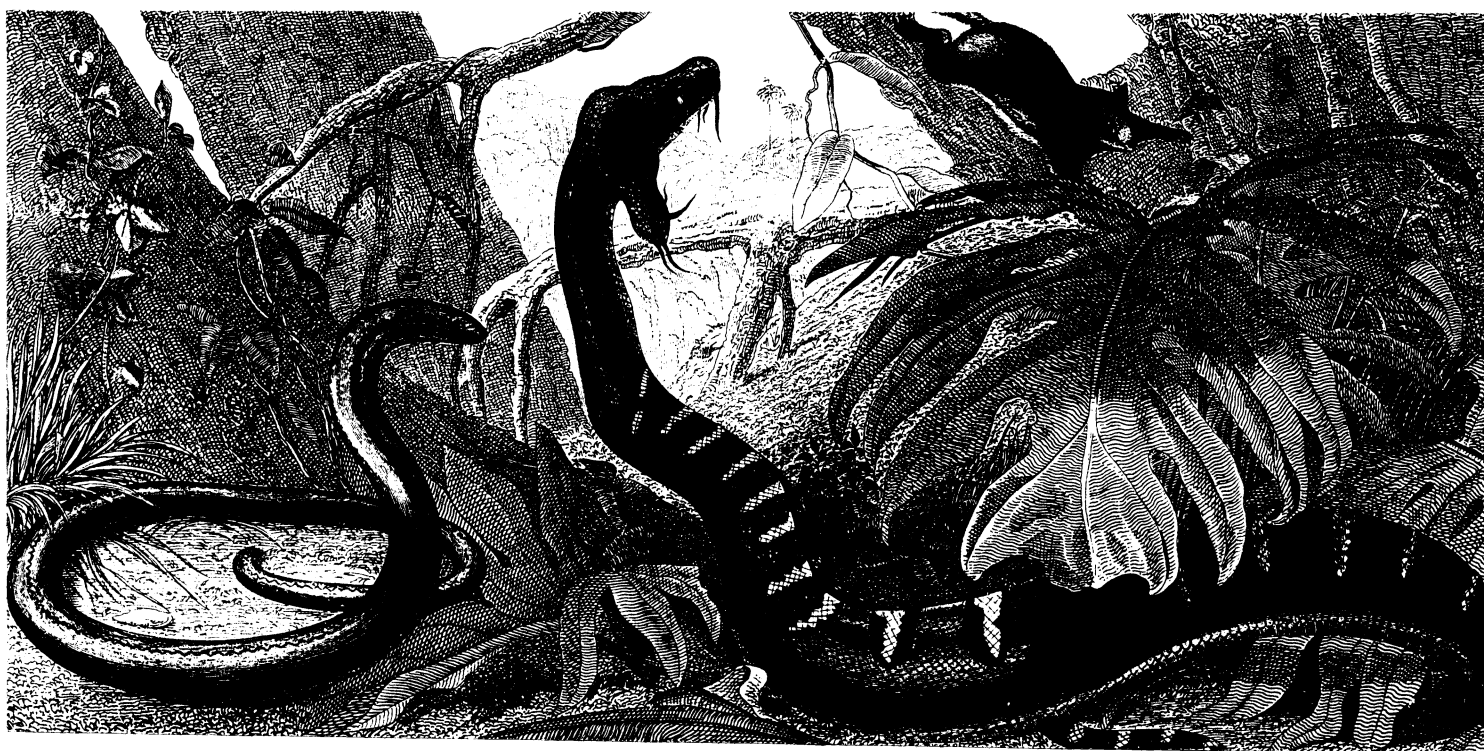

THE INVID GENESIS PITS

The Genesis Pits are bizarre underground complexes designed for experiments in biological mutation and evolution. It is at the pits that invid transform ordinary life-forms into any number of genetic variations. Likewise, the invid sometimes re-create extinct life-forms such as dinosaurs, and prehistoric mammals.

The experimental creations are observed in a natural, but controlled environment. Through the wonders of the invid's alchemical technology, the environment is easily maintained. The seasons can be accelerated to three times the normal rate to better simulate the passage of

time and the subject animal's reaction to change. Often the invid will introduce a random or unnatural element to study the subject's reactions. Human beings are often that random element.

A genesis pit is always underground and will typically cover a 10 to 30 mile area (16 to 48km). Different environments and subject creatures may coexist within the same pit, separated only by an invisible boundary line or a physical force field.

The Research Hive can be located anywhere within the pit and is usually concealed. It is always a domed hive, but is half the size of a typical hive, sometimes even smaller. Inside, the basic floor plan is mostly unchanged, but the numbers and types of invid are much different. *Two Brains* direct the operation of the genesis pit. Usually, one can be found on level three, the other on level six; both have twice as

many attendants. Level three is identical to level five, but the mecha stasis chamber (#5-A) is a giant research facility.

The following invid can be found at a genesis pit research hive (these are the total number).

2D6 × 10 *Scouts

3D6 × 10 *Armored Scouts

1D4 × 100 *Troopers/Workers

1D4 × 10 *Shock Troopers

2D4 × 10 Pincer Command Units

1D4 Royal Command Battloids

1D4 × 2100 Enforcers

2D4 × 100 Stage Four Invid Pilots (active)

Two Invid Brains

*An equal number are in stasis.

Other differences . . . Level Two: 2-A is a giant storage area; 2-B is a stasis chamber for storing experimental subjects.

Above ground, the land looks natural and undisturbed. To look at it, one would never suspect that a genesis pit existed a thousand feet (300m) below. Access to a genesis pit is possible only through a handful of tunnels. The access tunnel is a large cylindrical shaft that goes straight down 1000ft (300m). At the bottom of the shaft is a light force field that will slow the descent of the falling objects. Another 500ft (150m) beneath the shaft is the floor of the genesis pit.

Finding an access tunnel to a pit is extremely difficult, as they are very well concealed. Only a thorough search will uncover the shaft (usually requires 3D6 × 10 minutes of intense searching in a suspected area). There are almost always (80%) 1D4 invid troopers and one shock trooper near the access tunnel (within 4000ft/1200m).

The invid patrol the surface above a genesis pit with pairs of troopers dispersed throughout the area and 1D4 standard reconnaissance patrols flying overhead.

GAME MASTER NOTES

In the T.V. series we see a massive genesis pit with hundreds of different dinosaurs from every time period. You can do the same or fill the pit with other strange creatures, real, mutant, or alien. The following are some quick creation rules for dinosaurs. Remember, only carnivorous will be aggressive hunters. Herbivores are likely to run away, and will attack mecha only if scared or trapped, regardless of how big they are or how mean they look. Herbivores may bite or chase a human size opponent, because the small size does not scare it.

CARNOSAURS

(Allosaurus, Ceratosaurus, Dilophosaurus)

Height: 10 to 20ft (3-6m)

Length: 20 to 40ft (6-12m)

Hit Points: 2D6 × 1000; remember, 100 hit points is equal to about one M.D.C. point.

Armor Rating: 10 (applies to S.D.C. weapons)

Attacks Per Melee: Two; bite does 1D4 M.D.C. (1D4 × 100 S.D.C.), tail does 1D4 × 10 S.D.C. damage only, but will knock cyclones in battloid mode 3D6 feet away and down. Victim of a knockdown tail attack loses one melee attack. Tiny claws do 4D6 S.D.C. damage, feet claws do 1D4 × 10 S.D.C. damage. Both claw attacks only scrape mecha.

Natural Abilities: Track by smell of blood — 70%, running speed — 40mph.

TYRANNOSAURIDS

(Tyrannosaurus, Albertosaurus, Daspletosaurus)

Height and Length: 4D4ft bigger than Carnosaurs.

Hit Points: 4D6 × 1000

Armor Rating: 13

Attacks per Melee: Everything is double the Carnosaurs'.

Natural Abilities: Same as Carnosaurs'.

HADROSAURIDS, IGUANODONTIDS & HYSILOPHODONTIDS

Note: Each of these classes of dinosaurs are herbivores that vaguely resemble the Carnosaurs in shape. The main difference is they have more developed forearms for grabbing the plants they eat. They will not be intimidated by human size intruders and may attack, but only to chase away the intruder. They may (70% chance) fight to the death if wounded.

Height: 4D6 + 4ft **Length:** 4D6 + 8ft

Hit Points: 2D4 × 1000

Armor Rating: 10 + 1D4

Attacks Per Melee: Two; bite does 2D4 × 10 S.D.C., tail does 1D4 × 10 S.D.C., claws do 4D6 + 10 S.D.C., trample does 1D6 × 10 S.D.C.

Speed Running: 4D6mph

THE BIG HERBIVORES

(Stegosaurids, Ceratopids and Sauropods)

These big fellows attack only when scared, hurt or if attacked. All are bigger than 20ft (6m) long; most are 40ft (12m) or longer.

Hit Points: 4D6 × 1000

Armor Rating: 14

Attacks Per Melee: Two; stomp inflicts 1D4 M.D.C. (1D4 × 100 S.D.C.), trample does 3D4 M.D.C. (3D4 × 100 S.D.C.), head butt or tail slap does 2D4 × 10 S.D.C.

MODIFIED HUMANS THROUGH INVID EXPERIMENTATION

The invid Enforcers and Brains occasionally capture humans for strange biological experiments. These experiments are conducted out of curiosity, or in the name of biological evolution, or out of just plain cruelty.

The experiments are always painful, and degrading. They may involve surgery and/or alchemical transformations. Evolutionary, alchemical transmutations are usually conducted at genesis pits.

Roll on the following tables to determine the results of the experiments. A game master may opt to make selections rather than random rolls.

TABLE ONE: TYPE OF EXPERIMENT

1-35 Bionic

36-70 Biological

71-00 Evolutionary

BIONIC EXPERIMENTS

These experiments involve the in depth study of human physiology: muscles, skin tissue, nervous system and pain threshold. Some involve psychological responses of the victim.

Roll on the following table:

- 01-20 Limb Replacement:** Replaced both legs and feet with artificial ones. The mechanical limbs seem completely fused to the human body. They respond like normal flesh and blood legs in every way. Special Abilities: Running Speed — 50mph (80kmph), with minimal exhaustion. Leaps up to 20ft (6.1m) up or across. M.D.C. of 60 per leg. Kick attack does 3D6 S.D.C. damage.
- 21-40 Limb Replacement:** Replaced both hands and arms with artificial ones. Work perfectly except there is only a minimal sense of touch (reduce all technical, mechanical, electrical, medical, pick locks, pick pockets, and concealment skills by -5% each). Special Abilities: Add 12 points to P.S. attribute; add +5% to climbing and swimming. Also add a bonus of +1 to parry. M.D.C. of each arm is 50.
- 41-60 Limb Replacement:** All. Both legs, arms, hands and feet are replaced with invid mechanical units. Includes upper body reinforcement too. Subtract 1D4 points from P.B., 1D4 from P.E., and one point from M.E. in addition to any attribute penalties rolled later. All penalties are permanent. Special Abilities: All those gained from both leg and arm replacement, plus a natural Armor Rating (A.R.) of 16. The armor rating means *conventional* S.D.C. weapons only inflict physical damage (S.D.C. and hit points) when the attacker rolls a 17 or higher to strike. M.D.C. weapons still do full damage (A.R. not applicable).
- 61-80 Sensor Implants:** The character can sense protoculture just like the invid. The individual can “feel” the presence of protoculture energy within 200ft (61m). Has a protoculture targeting system *similar* to the invid’s standard protoculture targeting system. Adds a +2 bonus to strike at close range (200ft/61m) and +1 bonus to strike at long-range (within 2000ft/609m) targets that are actively using protoculture energy. The sensor is automatic and cannot be controlled. Every time it activates, the character will suffer a dull, throbbing, headache and is -1 on initiative.
- 81-00 Main Body Replacement:** The entire trunk of the body is replaced, with the head and limbs remaining flesh and blood. All internal organs have been replaced. Special Abilities: Main body M.D.C. 100. Drugs, chemicals, poisons, and gases have minimal effect; they last only 1/3 as long and the character is +5 to save against the drug/toxin. Unfortunately, the saving throw bonus applies to all chemicals, including medicines, painkillers and alcohol. Remember, although the body has a M.D.C. of 100, only the invid can repair it and they have no obligation to effect such repairs (they might — 1-40, or they might not — 41-00). Humans lack the technology (alchemy) to repair or replace invid bionic parts.

BIOLOGICAL EXPERIMENTS

These experiments involve the in depth study of human biology; how and why the human body functions. Experimentation includes the effects of adverse conditions, chemicals and pain has on the human body.

Roll on the following table:

- 01-12 Mental Stimulation:** Telepathic communication; same as Invid Brain (*see pg 75*).
- 13-24 Mental Stimulation:** Levitation; same as Invid Brain (*see pg 75*).
- 25-36 Hormone and Chemical Change:** Triples the character’s natural speed attribute; also adds +1 to initiative, parry and dodge, and +5% to climbing and swimming skills. Unfortunately, the character is hyperactive and has difficulty sleeping. Also there is a 1-50% chance of losing all body hair (-1D4 on P.B.) or 51-00% becoming five times as hairy as normal (-1D4 P.B.).
- 37-51 Hormone and Chemical Change:** Toughens the character, adding 4D4 + 20 physical S.D.C. and 1D6 to P.E., and makes him/her resistant to the affects of pain and exhaustion. However, it has reduced his/her speed by half and has made the person 40lbs heavier.

- 52-64 Enhanced Healing:** A stimulated nervous system. The character can regenerate hit points at a rate of 2D6 per day and 4D6 S.D.C. per day (24 hour period). However, the character must eat twice as much as usual or become fatigued and sluggish (speed is half, -2 on initiative; -1 to strike, parry or dodge; all skills -5% when fatigued).
- 65-78 Enhanced Vision:** Perfect 20/20 vision, plus can see 200ft (61m) in the dark (works just like nightsight optics). However, eyes are sensitive to bright lights (needs sunglasses).
- 79-89 Heat and Fire Resistant:** Is not tired by heat and fire does half damage. However, suffers from cold. Temperature of 50 degrees Fahrenheit feels like freezing.
- 90-00 Enhanced Sense of Smell and Hearing:** Double that of normal humans’.

EVOLUTIONARY EXPERIMENTS

These alien transmutations completely change the human body. The process can create a mutant being that simulates a possible path of biological evolution on the planet Earth. All transmutations create a humanoid being, but that is often the victim’s only link to his previous life-form. Evolutionary experiments almost always occur at a genesis pit.

- 01-20 Reptilian:** Appears to resemble a lizard with large round eyes, small nose, tiny ears, long face, small pointed teeth, no body hair, long tapered fingers, long fingernails, scaly skin, and 1-50% have a tail (1D6ft long). Bonuses: Add 4D4 to speed, 1D6 to P.S., 1D4 to P.E. and 20 to the character’s physical S.D.C.
- 21-40 Ape-Man:** Appears as a small, fur covered humanoid with ape-like features, long arms, and short, bowed legs. Reduce the character’s height by 4D4 inches and speed attribute by half. Bonuses: Add 1D4 + 2 to P.S., one to P.E. The character is ambidextrous, which means he/she can use either hand with equal skill. The person is also double-jointed, which means he or she has a 50% chance of slipping out of any bond, including handcuffs and straightjackets. Skill bonuses include +15% to escape artist and +10% to pick pockets, palming, and climbing.
- 41-60 Ape-Brute:** Looks like the legendary big-foot. Increase height by 4D4 inches. Bonuses: Add 4D6 + 20 to physical S.D.C., 1D6 + 1 to P.S., 2D4 to speed, 1D4 to P.E., and add 40lbs to the person’s weight.
- 61-80 Evolved Human (?):** Resembles a Steven Spielberg alien, has a larger head, large eyes, thin mouth and lips, pale skin color, sixth finger, longer thumb, thin body. Add 1D6 inches to height. Bonuses: Increase I.Q. by 1D4, and M.E. by 1D4. Can levitate self and up to 150lbs (67kg) to a height of 200ft (61m), and has mind block. Add +2% to all skills (this is in addition to other possible I.Q. bonuses).
- 81-00 Humanoid Mutant (Miscellaneous):** Roll three times to determine three different mutations.
- | | |
|-------|----------------------------------------------------------------------------------------------------------------------------------|
| 01-10 | Odd Skin Color: |
| 01-20 | Yellow |
| 21-40 | Green |
| 41-60 | Grey |
| 61-80 | Black (as in coal black) |
| 81-00 | Red |
| 11-14 | Cat-like eyes, large and green. Nightvision 40ft (12m). |
| 15-24 | Tough, lumpy skin. Adds 25 to S.D.C. |
| 25-32 | Stocky, exceptionally broad or husky person about twice as broad as a normal human. Add 60lbs (27kg); also add 4D6 + 2 to S.D.C. |
| 33-41 | Tall: Add 2D4 inches to height, 1D6 to S.D.C. |
| 42-50 | No body hair. |
| 51-56 | Short fur covers most of the body except face, underbelly and palms of hands. |

- 57-61 Long body hair, about twice as much as normal and three times as long.
- 62-70 Fangs; inflicts 1D4 S.D.C. damage from bite.
- 71-79 Retractable Claws; inflict 1D6 S.D.C. damage.
- 80-88 Huge hands, twice as big as normal.
- 89-00 Scaly skin with 12 S.D.C.

- 3. Experimental subjects are fairly rare. Typically, the G.M. should not allow for more than one or two of such augmented characters.

TABLE TWO: PENALTIES FROM EXPERIMENTATION

Note: All penalties are permanent. All victims of an invid experiment must roll on this table.

- 01-25 Constant aches and pains:** -1D4 P.E., -1 P.B., -1 on initiative.
- 26-50 Spasms of terrible pain.** 1-50% chance of this occurring under intense pressure or during heavy activity (including more than 5 minutes of physical combat). The spasm lasts only one melee, but the character cannot attack or walk and is -4 to parry, dodge and roll. Also -2 to P.B.
- 51-75 Horribly scarred:** Reduce physical beauty to a P.B. 4; -1 to P.E., -1 to M.A.
- 76-00 Mentally unbalanced:** Roll again to determine the nature of the insanity.
 - 01-13 Obsessed with revenge: Bent on the destruction of the invid and their human sympathizers, especially those who are responsible for his/her condition. The obsession makes the character a little reckless, but not suicidal.
 - 14-26 Phobia. Invid Enforcer, Brain, Regis and stage four invid (without armor). The character is terrified of these specific invid and will fall into a whimpering stupor, unable to attack or run away (can not attack) whenever confronted by even one. These invid types were involved in the experiment (the Regis is ultimately responsible).
 - 27-38 Nervous frenzy whenever the invid seem to be overpowering (winning a battle, outnumbering the group/him by more than two to one, and similar). The nervousness and fear imposes these penalties: -15% on all skills, -2 to strike, -3 on initiative against invid.
 - 39-51 Dominated by Invid: 1-60% chance of obeying/surrendering to an Invid Enforcer, Brain, Regis, Royal Command Battloid, or stage four and stage five invid pilots. If commanded to betray or harm a fellow human, the character will be confused and hesitate for 2D4 melees. The poor soul is also -2 on initiative when engaged against these types of invid.
 - 52-63 Phobia: Darkness, same as usual.
 - 64-76 Phobia: Insects; specifically slugs, leeches and worms (they remind him/her of invid).
 - 77-88 Alcoholic: Can be cured, but takes twice as long. Very insecure and scared.
 - 89-00 Chronic Nightmares: 70% chance of having a nightmare, reliving the horror, every time the character falls asleep. 50% chance of waking up screaming for 1D4 melees (15 to 60 seconds). Tends to be a night owl, sleeping less than 6 hours a day.

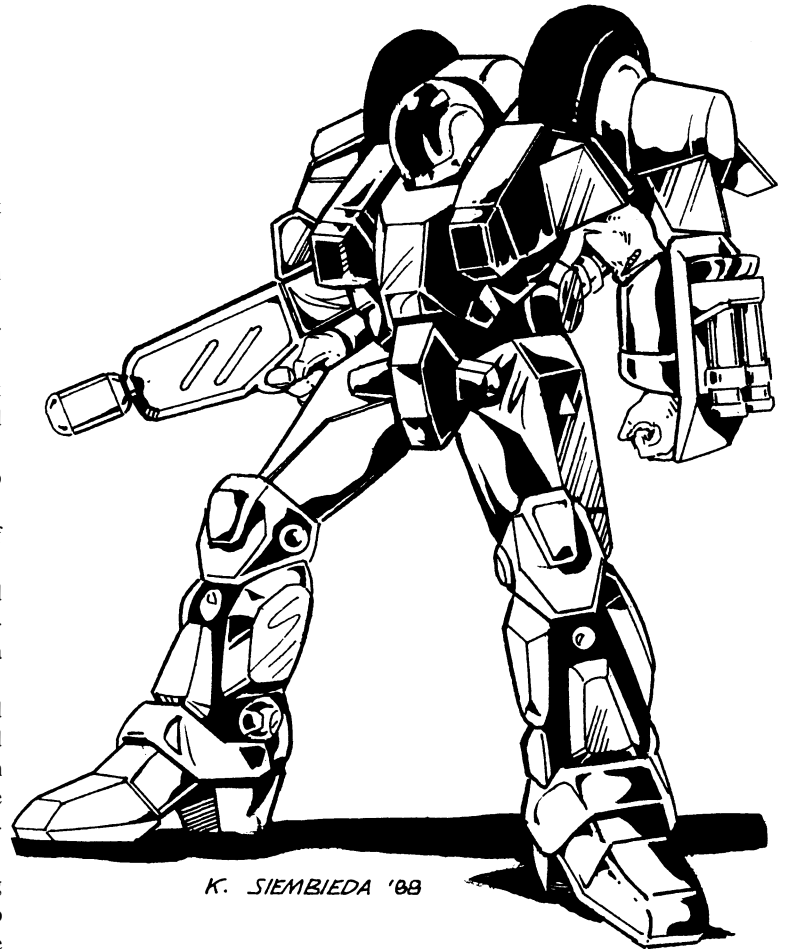

RANDOM ENCOUNTER TABLES

NORTH AMERICAN WASTELANDS (Roll Once for Every 6 Hours, or as needed)

- 01-08 Invid Mini-Patrol:** One armored scout, two scouts. Will attack and fight to the death with anyone they see, even if outnumbered. One of the scouts will fly off to get reinforcements and will return with a "Wasteland Invid Patrol" of one Pincer, 4 Troopers, and 5 Shock Troopers within 4D6 minutes. All will fight to the death.
- 09-11 Wild Dog Pack** of 4D4 animals will attack groups of three or less humans or other animals (horses, etc.).
- 12-18 Dead Forest:** 3D6 miles of gnarled trees reach their dead, blackened, leafless, moss encrusted fingers to a cloudless sky. Grass, weeds, moss and poison mushrooms compose the only living vegetation. Game animals such as rabbits, possums, pigeons and pheasants are common, along with less tasty rodents and birds. Roll for Chance Encounters:
 - 01-32 3D6 Nomads will run and hide; they know little.
 - 33-59 1D4 Invid Troopers and 1D4 Shock Troopers.
 - 60-80 One scout flying overhead. It will pickup protoculture energy and fly off to get reinforcements, an Invid Wasteland Patrol, unless it is destroyed. Reinforcements arrive within 2D6 minutes.
 - 81-00 4D6 human bandits will attack the characters if they outnumber them. Otherwise, they will try to mooch food and equipment and steal anything they can lay their hands on. All have

NOTES

- 1. All invid bionics are powered by protoculture. The protoculture energy will last approximately 1½ years. Only a REF bio-maintenance engineer or the invid can recharge the energy cell.
- 2. The victim of the experiment is invisibly tagged like an experimental animal. All invid can see the tag and know that this is an experimental animal. Consequently, they will try to avoid killing it (subduing or ignoring the person), unless absolutely unavoidable.

S.D.C. automatic weapons, except the leader who has a FAL-2 pulse laser (no mecha).

19-23 Little village of about 1D4 hundred people. The people are very friendly and helpful, although they have no valuable information, ammunition or equipment, just food, water and shelter. They are really invid sympathizers who will direct the player characters into an invid patrol, and lull them into a false sense of security while somebody goes to get/signal the invid. 1D4 scouts, 1D4 armored scouts, and 1D4 shock troopers will arrive to fight resistance fighter.

24-28 Little village of about 1D4 hundred people. The people are very friendly and hospitable, but have little of value. These are good people who really do hate the invid. If most of the player characters are kind or helpful, the leader will offer them one of the following possibilities:

- 01-25 1D6 Cobalt Limpet Mines
- 26-50 1D6 Gallant Energy Clips
- 51-75 1D4 Protoculture Energy Cells
- 76-00 Battered Cyclone Body Armor (36 M.D.C.)

29-34 Field of Invid Flowers of Life that stretches across 2D4 mile area. Roll again: 1-40 means no invid; 41-70 means 2D4 armored scouts and 1D4 scouts flying overhead on patrol; 71-00 means 1D4 troopers, 1D4 + 1 shock troopers and a pincer. All invid fight to the death.

35-39 Town on fire!The invid have attacked a town to gather slaves. Half the town is ablaze. 1D4 + 1 armored scouts strafe those fleeing in vehicles, while 1D4 + 2 shock troopers suppress any resistance. Six scouts have gathered 1D6 × 10 people at the edge of town to be carried off as slaves. 2D4 other scouts and 2D4 troopers rummage through the town, grabbing fleeing people. One pincer commands this horror (R.C.B. or enforcer can be substituted).

40-45 Human Gang looking for trouble. 1D4 have cyclone body armor and VR-052 Battler Cyclones. However, only the leader has 20 high explosive mini-missiles and EP-40 Pulse Gun, the others have a meager 1D6 fragmentation mini-missiles and conventional automatic weapons. The second in command is wearing Southern Cross body armor with 3D6 + 20 M.D.C. left and has a Gallant H-90 with a full power rifle stock and two extra energy clips. 3D6 others and the second in command ride souped-up all-terrain motorcycles. Another 1D4 ride cars and another 2D4 ride in a truck. Every third gang member has a M.D.C. energy weapon and all have additional conventional weapons. They will attack the group as long as they think they can overpower them. They will flee if the leader commands it or if the leader is defeated/killed. GMs, embellish this encounter as much as you like. This same group of thugs probably terrorizes a small town in the area (250 mile radius).

46-51 1D4 + 1 Royal Command Battloids (RCB) looking to prove their superiority over humans. Will fight until they've lost 75% of their main body M.D.C., then they'll retreat, but will come back within 2D4 hours with new RCBs and 1D4 + 1 shock troopers (add six more shock troopers and a pincer if fighting more than one alpha).

52-56 A Crashed REF Spacecraft, but invid are inside and out, smashing everything to bits. 1D4 + 1 troopers are pounding the outside while two armored scouts fly overhead. Characters can not see what's inside. Inside is a pincer, 1D4 scouts and a shock trooper wrecking everything it sees. If the invid are destroyed, the characters will be able to salvage the following: 3D6 Gallant H-90 Energy Clips, 1D4 Gallant H-90 Pistols, 1D4 FAL-2 with 2D6 Energy Clips, 1D6 salvageable protoculture cells, extra uniforms, boots and some food. Plus roll percentile to find: 01-11 — Old Minmei records, 12-20 — one VR-052 Battler Cyclone with full armaments, 21-40 — 20 high explosive and 2D6 plasma mini-missiles, 41-60 — 1D4 wolverine assault rifles, a box of ammunition (24 ammo clips) and a box of grenades (36 grenades), 61-75 — 24 Cobalt Limpet Mines, 76-90 — One RL-6 rocket cannon, plus 6D6 extra fragmentation mini-missiles, 91-00 — one cyclone body armor and a mecha mini tool kit.

57-59 Human oil refinery with 1D6 oil derricks pumping away. Has produced 26,000 gallons of gasoline of gasoline and oil. Operated by evil opportunists who see this as a means to build an empire. Cooperate completely with invid to lure and destroy resistance fighters (rob them first if possible. Invid allow the traitors to use a fully loaded RDF Gladiator and energy weapons. 1D4 invid enforcers stay hidden among the 100 human workers. An invid wasteland patrol is only two minutes away.

60-68 An invid patrol of 2D4 armored scouts, 1D6 shock troopers and a royal command battloid looking for human mecha and users of protoculture.

69-73 Screams from a small house (in the middle of nowhere or in a town or ruins). An enforcer is about to make an on the spot dissection (or interrogation) of a family. The husband and teenager have been beaten unconscious; it is the mother and two little children screaming. A second enforcer guards the door with full armaments.

74-78 High-Tech Bandits looking for valuables. Will not kill their victims unless necessary. This is a tough group, with 1D4 RDF AAT-30s (see pg 61), 2D4 civilian all-terrain haulers, a dozen motorcycle men armed with automatic weapons, one dark knight tank (see pg 63), 1D4 heavy CDU battloids (see *Southern Cross*, pg 69 or can substitute gladiators with no missiles), 1D4 commanhero assault helicopters (turbo fan-jets or Southern Cross logans can be substituted), plus 2D4 × 10 men in trucks. 80% have Southern Cross body armor (50 M.D.C.), 50% have mega-damage weapons. Will retreat if they begin to take casualties. Affiliation with the invid: 1-50 none hate them, 51-00 work with them.

79-83 Four Pincer Command Units hunting human freedom fighters. Will fight to the death.

84-86 1D6 Hungry Carnosaurs escaped or released from a genesis pit. May be attacking a town or a vehicle.

87-94 Invid Patrol: 1D4 + 1 troopers, 1D6 + 1 shock troopers and a pincer looking for users of protoculture. Will attack only if protoculture energy is being used.

95-00 Invid Patrol: 2D6 invid scouts, 2D4 armored scouts and a pincer looking for human opposition and protoculture users.

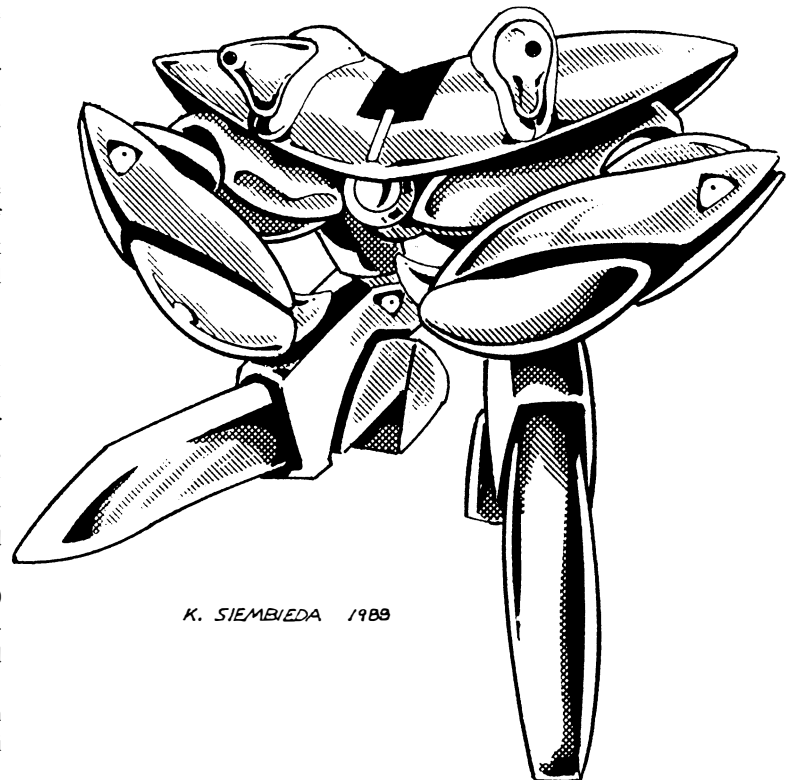

RANDOM TOWN ENCOUNTER TABLE

STEP ONE: TYPE OF TOWN

- 01-35 Agricultural** (Farmers); low technology.
- 36-50 Livestock** and some farming; low technology.
- 51-70 Scavengers.** Live in the ruins of an old city, survive by hunting, scavenging for supplies, barter with travelers and looting the dead. Mixed technology (low). Gangs and bandits are likely (40%).
- 70-80 Military;** self-sufficient. Roll again:
- 01-20 Conventional weapons and equipment.
 - 21-39 Mix of conventional and high-tech, (RDF, Southern Cross and/or REF) but no mecha.
 - 40-59 Mix of conventional and high-tech Southern Cross and/or RDF weapons, equipment and mecha.
 - 60-80 Mix of conventional and high-tech Southern Cross, RDF, and REF (as much as 30% can be REF).
 - 81-90 High-tech, with Southern Cross and RDF mecha and equipment.
 - 91-00 High-tech, with mostly REF mecha and equipment (up to 70%).
- 81-90 Industrial, low-tech,** equal to about 1925. Will also have *some* high-tech items like energy weapons and vehicles from the RDF or Southern Cross.
- 91-00 Industrial, high-tech,** equal to about 1999. Will also have conventional type RDF and Southern Cross vehicles, equipment and energy weapons. Any mecha will have been scavenged (most likely to be old RDF or Southern Cross items rebuilt).

STEP TWO: SIZE

- 01-10** 1D6 × 100 people
- 11-20** 2D4 × 100 people
- 21-40** 4D6 × 100 people
- 41-60** 2D4 × 1000 people
- 61-70** 3D4 × 1000 people
- 71-80** 4D4 × 1000 people
- 81-90** 4D6 × 1000 people
- 91-00** 6D6 × 1000 people

STEP THREE: KNOWN BY THE INVID?

- 01-30 Known by the invid, but ignored.** A patrol flies by 1D6 times a month.
- 31-55 Known by the invid, and occasionally investigated** by 2D6 enforcers or one enforcer accompanied by 1D4 troopers, 1D4 + 1 shock troopers. A mini-reconnaissance patrol also flies by randomly 1D6 times per week. Every once in a while a towns-person will be seized by an invid for interrogations (1-50 chance of being returned in one piece, 51-00 chance of never being seen again), experimentation or slave labor.
- 56-85 Known by the invid and monitored heavily.** The invid raid the town, smashing buildings and killing a handful of people, whenever they try to use protoculture powered devices, use mecha, help freedom fighters, take hostile actions toward invid or act suspicious. 3% of the townspeople are secret invid sympathizers working with the invid. Recon patrols fly by 2D6 times per week and ground troops wander by often, once every 2D6 + 20 hours. **Typical Ground Troops:** 01-20 — 1D4 + 1 trooper, 21-40 — 1D6 shock troopers, 41-60 — 1D4 pincers, 61-80 — 1D4 enforcers and one shock trooper, 81-00 — one pincer and 2D4 shock troopers.
- 86-00 Not known!** Somehow the community has remained undiscovered and unmolested by the invid. **Do not roll step four.**

STEP FOUR: AFFILIATION WITH THE INVID

- 01-30 NONE!** Hate invid and will try to help fugitives and proven Freedom Fighters in any way possible. 20% chance of a small Freedom Fighter resistance force being present.
- 31-40 NONE!** But are afraid. Prefer to be indifferent. Will not help nor hurt Freedom Fighters. 33% chance that they can be rallied to help fellow humans. 30% chance they can be terrorized by invid into betraying fellow humans.
- 41-50 NONE!** But super selfish. Care only about the safety of the town. They will not help resistance fighters at all and will encourage strangers to leave town as soon as possible. Protoculture weapons and mecha are not wanted in town. If the presence of strangers are seen to jeopardize the town, the people may try to drive the strangers away or kill them. These towns usually have a secret militia or mercs with mega-damage energy weapons, explosives or other means of attack (possibly even an old RDF or Southern Cross mecha or cyclone). There is an 88% likelihood that the town will betray a stranger and a 60% chance that it will betray a fellow townsman to the invid if it means protecting the majority. Tends to be a paranoid, nervous and unfriendly community.
- 51-60 Invid Slave Community (town, farm or factory):** Humans forced to obey the invid or be killed. The people will usually be rude and inhospitable to get strangers to leave quickly, before the invid find out that they are there. There is a 55% chance somebody will warn a stranger to leave before the invid come. However, once the invid learn of the stranger's presence, the slaves will offer no help and may be ordered to help capture or kill the intruder(s). There is a 35% chance that one or two of the slaves will try to help a fellow human escape/avoid the clutches of the invid. The fate of the discovered stranger(s) is . . . (roll percentile):

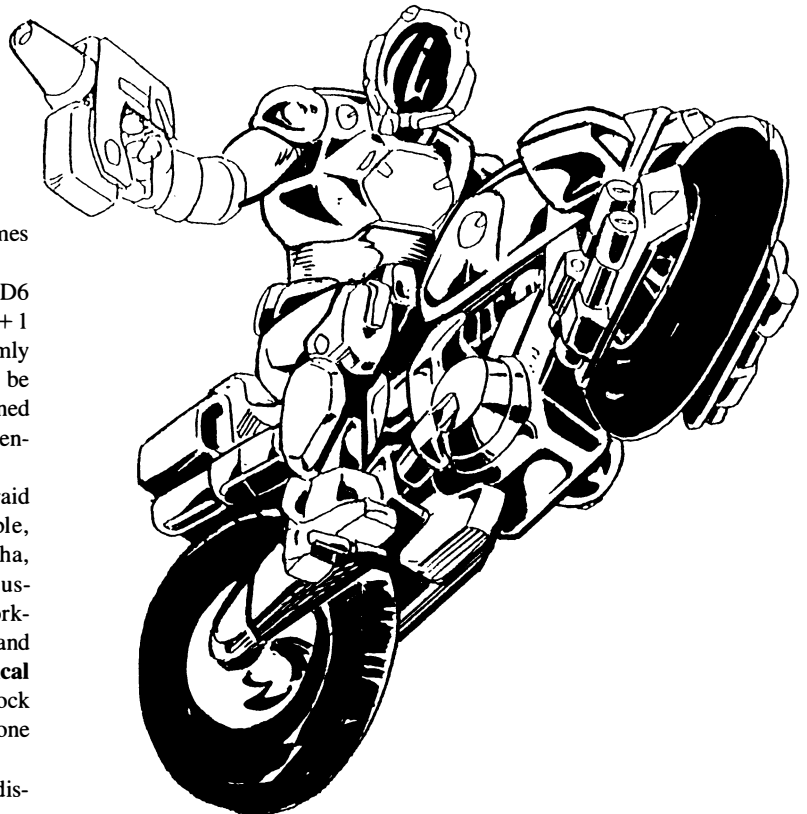

- 01-20 Hunted by invid for immediate termination. The invid expect the slaves to help locate and capture the strangers.
- 21-40 Invid try to capture for interrogation followed by termination.
- 41-60 Invid hope to capture for experimentation.
- 61-80 Invid try to capture for interrogation and then send to pro-culture slave farm or factory. Slaves must help.
- 81-00 Invid try to capture for slave labor. Other slaves are expected to assist in the capture.

Note: 1D4 scouts, 2D6 armored scouts, 1D6 troopers, 1D6 shock troopers and 1D4 pincers will be on patrol within a five mile (8km) area of the slave community.

61-85 Sympathizers: Town, village or city that works with the invid. This community will do whatever the invid ask of them. Their response toward strangers is usually a false friendliness to get information from them. Nomads are usually left alone, but freedom fighters, mercenaries, and REF characters will be betrayed to the invid. The betrayal may be alerting the invid to their presence, telling of their plans or other harmful info, stealing their weapons or mecha, capturing them, or even murder.

In return, the invid help support the community and protect it. 10% of the population will not like what goes on here, and will try to warn or help strangers whenever they can.

86-00 Freedom Fighter Trap: The community works for the invid by capturing freedom fighters, or anybody who speaks badly of the invid. In return, the people enjoy an uncommon prosperity. The

- fate of the captives is . . .
- 01-10 People attempt to kill them.
- 11-20 Interrogated and robbed by the people, then turned over to the invid for further interrogation.
- 21-40 Invid called upon to destroy them (the people don't soil their hands with blood).
- 41-50 Stripped of mecha and all valuables, beaten, then released by townspeople.
- 51-60 Invid try to capture them for slave labor.
- 61-70 Invid capture for interrogation and then send to slave farm or factory.
- 71-80 Invid try to capture for interrogation followed by termination.
- 81-90 Invid capture for experimentation.
- 91-00 Townspeople trick freedom fighters into going into a trap where invid wait to murder them.

IMPORTANT NOTE

Due to space limitations, the new *REF spacecraft* and *Japanimation Side Notes* can be found in **SENTINELS**

EXPERIENCE LEVELS FOR REF O.C.C.

	<u>Veritech Pilot</u>
1	0,000-2,100
2	2,101-4,200
3	4,201-8,400
4	8,401-17,200
5	17,201-25,400
6	25,401-35,800
7	35,801-51,000
8	51,001-71,200
9	71,201-96,400
10	96,401-131,600
11	131,601-181,800
12	181,801-232,000
13	232,001-282,200
14	282,201-342,400
15	342,401-402,600

	<u>Cyclone Rider</u>
1	0,000-2,000
2	2,001-4,000
3	4,001-8,200
4	8,201-16,400
5	16,401-24,500
6	24,501-34,600
7	34,601-49,700
8	49,701-69,800
9	69,801-94,900
10	94,901-129,000
11	129,001-179,100
12	179,101-229,200
13	229,201-279,300
14	279,301-329,400
15	329,401-389,500

	<u>Freedom Fighter & Nomad Scout</u>
1	0,000-1,900
2	1,901-3,800
3	3,801-7,300
4	7,301-14,300
5	14,301-21,000
6	21,001-30,000
7	30,001-40,000
8	40,001-53,000
9	53,001-73,000
10	73,001-103,000
11	103,001-138,000
12	138,001-188,000
13	188,001-238,000
14	238,001-288,000
15	288,001-328,000

	<u>Bio-Maintenance Engineer Communications</u>
1	0,000-1,925
2	1,926-3,850
3	3,851-7,450
4	7,451-14,900
5	14,901-21,000
6	21,001-31,000
7	31,001-41,600
8	41,601-53,000
9	53,001-73,000
10	73,001-103,500
11	103,501-139,000
12	139,001-189,000
13	189,001-239,000
14	239,001-289,000
15	289,001-339,000

	<u>Military Specialist</u>
1	0,000-2,120
2	2,121-4,240
3	4,241-8,480
4	8,481-16,960
5	16,961-24,960
6	24,961-34,960
7	34,961-49,960
8	49,961-69,960
9	69,961-94,960
10	94,961-129,960
11	129,961-179,960
12	179,961-229,960
13	229,961-279,960
14	279,961-329,960
15	329,961-389,961

	<u>Non-Military</u>
1	0,000-1,875
2	1,876-3,750
3	3,751-7,250
4	7,251-14,100
5	14,101-21,200
6	21,201-31,200
7	31,201-41,200
8	41,201-51,200
9	51,201-71,200
10	71,201-101,500
11	101,501-136,500
12	136,501-186,500
13	186,501-236,500
14	236,501-286,500
15	286,501-326,500

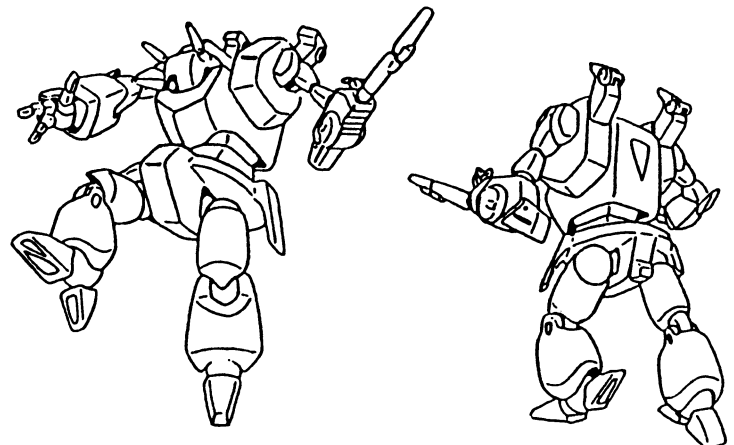

ROBOTECH® RPG CHARACTER SHEET

Name: _____

Rank: _____

Alignment: _____

Hit Points: _____ S.D.C. (Physical): _____

Experience Level: _____

O.C.C.: _____

Savings: _____

I.Q.: _____ Age: _____

M.E.: _____ Sex: _____

M.A.: _____ Weight: _____

P.S.: _____ Height: _____

P.P.: _____ Land of Origin: _____

P.E.: _____ Birth Order: _____

P.B.: _____ Disposition: _____

Spd.: _____

O.C.C. Skills:

Other Skills:

Weapon Proficiencies:

Primary Mecha: _____

Secondary Mecha: _____

Combat: *See Mecha Log*

Body Armor: _____ M.D.C.: _____

WEAPONS

Weapon: _____ Damage: _____ Range: _____

Weapon: _____ Damage: _____ Range: _____

Weapon: _____ Damage: _____ Range: _____

Weapon: _____ Damage: _____ Range: _____

Others: _____

Vehicle Type: _____

Notes: _____

MECHA COMBAT LOG

COMBAT SKILLS

Pilot's Hand to Hand	Mecha Combat	Mecha Combat	Mecha Combat	Mecha Combat
Type: _____	Type: _____	Type: _____	Type: _____	Type: _____
No. of Attacks: _____	No. of Attacks: _____	No. of Attacks: _____	No. of Attacks: _____	No. of Attacks: _____
Damage: + _____	Strike: + _____	Strike: + _____	Strike: + _____	Strike: + _____
Strike: + _____	Parry: + _____	Parry: + _____	Parry: + _____	Parry: + _____
Parry: + _____	Dodge - Vehicle: _____	Dodge - Vehicle: _____	Dodge - Vehicle: _____	Dodge - Vehicle: _____
Dodge: + _____	Dodge - Guardian: _____	Dodge - Guardian: _____	Dodge - Guardian: _____	Dodge - Guardian: _____
Roll: + _____	Dodge - Battloid: _____	Dodge - Battloid: _____	Dodge - Battloid: _____	Dodge - Battloid: _____
Kick: _____	Auto Dodge (Spec.): _____	Auto Dodge (Spec.): _____	Auto Dodge (Spec.): _____	Auto Dodge (Spec.): _____
Jump Kick: _____	Roll: _____	Roll: _____	Roll: _____	Roll: _____
Flip: _____	Initiative: + _____	Initiative: + _____	Initiative: + _____	Initiative: + _____
Knock Out: _____	Damage	Damage	Damage	Damage
Critical Strike: _____	Punch: _____	Punch: _____	Punch: _____	Punch: _____
Death Blow: _____	Punch: _____	Punch: _____	Punch: _____	Punch: _____
Prowl: _____	Kick: _____	Kick: _____	Kick: _____	Kick: _____
Climb: _____	Leap Kick: _____	Leap Kick: _____	Leap Kick: _____	Leap Kick: _____
Palm: _____	Stomp: _____	Stomp: _____	Stomp: _____	Stomp: _____
Pick Pockets: _____	Flip: _____	Flip: _____	Flip: _____	Flip: _____
Pick Locks: _____	Tackle: _____	Tackle: _____	Tackle: _____	Tackle: _____
Streetwise: _____	Speed	Speed	Speed	Speed
Hit Points: _____	Flying: _____	Flying: _____	Flying: _____	Flying: _____
S.D.C.: _____	Guardian: _____	Guardian: _____	Guardian: _____	Guardian: _____
Notes: _____	Running: _____	Running: _____	Running: _____	Running: _____
_____	M.D.C.	M.D.C.	M.D.C.	M.D.C.
_____	Main Body: _____	Main Body: _____	Main Body: _____	Main Body: _____
_____	Head: _____	Head: _____	Head: _____	Head: _____
_____	Legs: _____	Legs: _____	Legs: _____	Legs: _____
_____	Arms: _____	Arms: _____	Arms: _____	Arms: _____

WEAPONS & MISSILE LOG

Check off missiles as they are used

CYCLONE Mini-Missiles

Chest: Left Side || 1 || 2 || 3 || 4 || 5 || 6 ||

Chest: Right Side || 1 || 2 || 3 || 4 || 5 || 6 ||

GR-103 Missile Types: _____

GR-97 Forearm Missiles

Left Arm || 1 || 2 ||

Right Arm || 1 || 2 ||

Notes: _____

Other Weapon Systems

Type: _____

Range: _____

Damage: _____

Payload: _____

Notes: _____

ALPHA FIGHTERS

MM-60 Multi-Missile System (Short Range)

Left Shoulder: || 1 || 2 || 3 || 4 || 5 || 6 || 7 || 8 ||

Right Shoulder: || 1 || 2 || 3 || 4 || 5 || 6 || 7 || 8 ||

Left Arm: || 1 || 2 || 3 || 4 || 5 || 6 || 7 || 8 || 9 || 10 ||

Right Arm: || 1 || 2 || 3 || 4 || 5 || 6 || 7 || 8 || 9 || 10 ||

Left Leg: || 1 || 2 || 3 || 4 || 5 || 6 || 7 || 8 || 9 || 10 || 11 || 12 ||

Right Leg: || 1 || 2 || 3 || 4 || 5 || 6 || 7 || 8 || 9 || 10 || 11 || 12 ||

Shadow Fighter GR-12 Missiles (Extra)

Left Chest: || 1 || 2 || 3 || 4 || 5 || 6 || 7 || 8 || 9 || 10 || 11 || 12 ||

Right Chest: || 1 || 2 || 3 || 4 || 5 || 6 || 7 || 8 || 9 || 10 || 11 || 12 ||

Gun Pod Type: _____

Range: _____

Damage: _____

Payload: _____

Notes: _____

OTHER: _____

Range: _____

Damage: _____

Payload: _____

NOTES: _____

BETA FIGHTERS

MM-40s Multi-Missiles (Short Range)

Left Shoulder: || 1 || 2 || 3 || 4 || 5 || 6 || 7 || 8 || 9 || 10 ||

|| 11 || 12 || 13 || 14 || 15 || 16 || 17 || 18 || 19 || 20 ||

Right Shoulder: || 1 || 2 || 3 || 4 || 5 || 6 || 7 || 8 || 9 || 10 ||

|| 11 || 12 || 13 || 14 || 15 || 16 || 17 || 18 || 19 || 20 ||

Leg Missiles (Short Range)

Left Leg: || 1 || 2 || 3 || 4 || 5 || 6 || 7 || 8 || 9 || 10 ||

Right Leg: || 1 || 2 || 3 || 4 || 5 || 6 || 7 || 8 || 9 || 10 ||

Top Mounted (Medium Range)

Top: || 1 || 2 || 3 || 4 || 5 || 6 ||

Long Range (Fired in Jet or Guardian Mode)

Left Shoulder: || 1 || 2 ||

Gun Pod Type: _____

Range: _____

Damage: _____

Payload: _____

Robotech® RPG

Based on the animated TV series that has thrilled generations

The Robotech® RPG and sourcebooks in this series are ALL completely new and rewritten. They are NOT reprints of the Robotech® titles from the 1980s and 1990s. Each contains new rules, stats, descriptions, characters, and a wealth of new information!

Based on the fan-favorite television show, the Robotech® RPG enables players to experience adventures in any or all eras and generations of the Robotech® saga. Fast character creation and anime action.

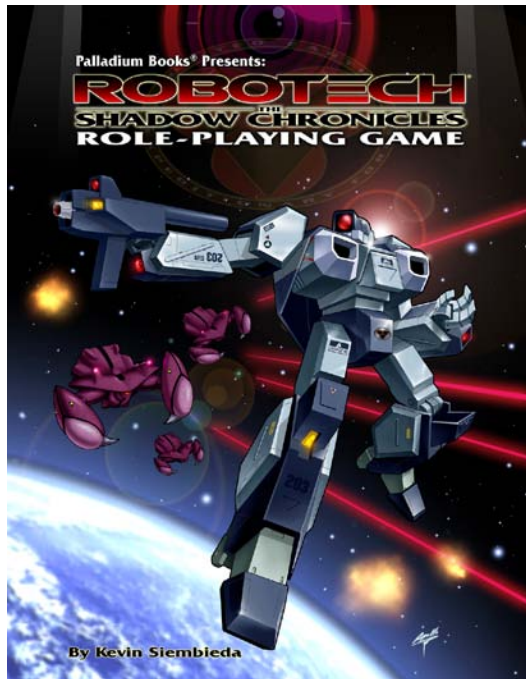

Robotech®: The Shadow Chronicles® Hardcover RPG

The core rule book, it contains everything you need to play except imagination, dice and friends. Newcomers to the Robotech® saga will be able to quickly understand and play the game without ever having seen the television series.

The Shadow Chronicles® RPG presents the forces of the United Earth Expeditionary Force (UEEF) and its combat mecha, including Veritech Fighters, Alphas, Betas, Cyclones, and more. The enemy is the Invid and the traitorous Haydonites. Based on the popular Robotech® television series. Illustrated throughout.

- Core rule book, Invid and Shadow Chronicles space setting.
- Haydonites, the Wraith, Infiltrator and spaceships.
- 8 Invid mecha, plus the Invid Carrier.
- 16 UEEF mecha, including the Bioroid Interceptor, Condor, Alphas, Betas, Super Cyclone, Silverback, and more.
- UEEF weapons, Synchro Cannon, vehicles, spaceships and gear.
- Space combat rules, missiles and more.

- O.C.C.s include the Battloid Ace, Veritech Fighter Pilot, Military Specialist, and others. Five core UEEF character classes and 25 MOS skill packages for a wide range of diversity.
- Character creation takes 15 minutes or less with Quick Roll tables.
- A complete Role-Playing Game. 8½ x 11 hardcover, “core rules.” Compatible with other Palladium Books Mega-Damage settings like Rifts®.
- \$30.95 – 224 pages. Cat. No. 550HC.



Robotech®: The Shadow Chronicles® RPG – Pocket-Sized Manga Edition

The same Robotech® RPG core rules as above (minus space combat rules and Haydonite spacecraft) in a smaller, “Manga Edition” size; 336 pages, 5 x 7½ inch portable book.

- Fast playing RPG rules. Mega-Damage setting.
- Complete stand-alone RPG.
- Manga size – 5 x 7½ inches – for easy portability.
- \$16.95 – 336 pages. Cat. No. 550.

Robotech®: The Macross® Saga Sourcebook

All your favorite iconic mecha and world setting. The Macross® Saga Sourcebook is a treasure trove of the mecha, Valkyries, Destroids, ground vehicles, aircraft, spacecraft, weapons, Zentraedi aliens, Zentraedi mecha, heroes, villains, action and story that made Robotech® famous.

The story of Macross is one of courage and survival against impossible odds, when an alien invader threatens the survival of all life on Earth. However, Earth’s defenders are far more ready for the Zentraedi alien invaders than they know. Epic adventure. Giant transformable robots. Sacrifice and heroics.

- The famous Valkyrie Veritech Fighters.
- Destroids – giant combat robots that are walking tanks.
- 14 aircraft and aerospace vehicles.
- 13 ground vehicles, plus weapons and equipment.
- 7 Zentraedi mecha, plus Fighter Pod, Recovery Pod, Soldiers, Shuttle and select spacecraft.

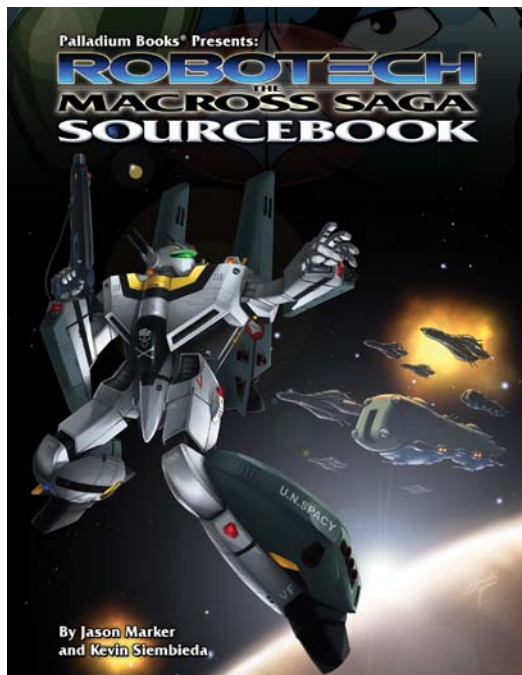

- The Zentraedi: Giant clone warriors and their culture.
- Quick Roll Tables for Macross characters.
- Ordinary People O.C.C., new skills and more.
- Notable anime characters statted out as NPCs.
- \$16.95 – 128 pages. Cat. No. 551. 8½ x 11 inch size.

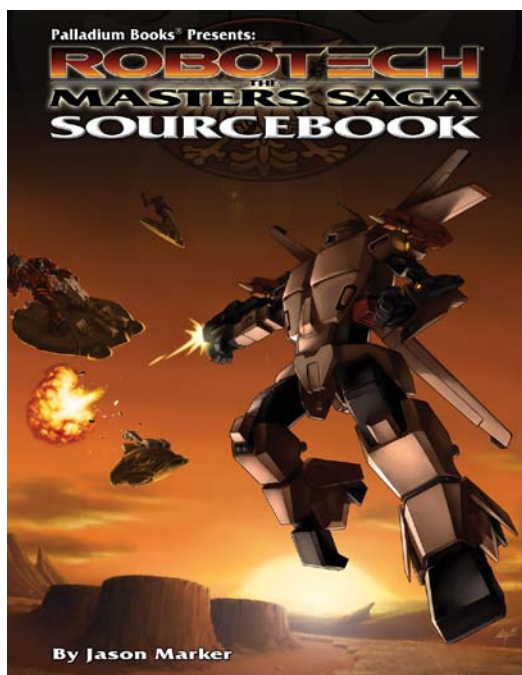

Robotech®: The Masters Saga™ Sourcebook

Never before revealed mecha, power armor, robots, gear and information, all statted out and described. **The Masters Saga™** captures the *Second Robotech War* with never before seen comprehensive details about the mecha, armor, weapons and gear of the 15 divisions of the Army of the Southern Cross (ASC), who battle the new alien threat of the *Robotech Masters*.

The Masters are the visionaries behind Robotechnology and Protoculture. Creators of the giant Zentraedi warriors and the

masters of a crumbling galactic empire won through war and conquest.

Adventures can start in the jungles of South America, where the fledgling ASC and the UEDF battled Zentraedi Malcontents, UEG separatists, rebels and terrorists before the UEEF blasted into outer space; or play during the years of Global Reconstruction. Or start your game the day the Robotech Masters appear and the Second Robotech War begins. Or even play the days between the Masters' defeat and the arrival of the Invid, as well as the years of Invid occupation as your ASC heroes try to rescue survivors and establish resistance groups to battle the Invid until the UEEF fleets return!

- The Army of the Southern Cross™ – all 15 branches.
- Veritech Hover Tanks, AJAX, Logan and more.
- 4 ASC Battlroids plus the Golem robot.
- 6 suits of ASC Powered Armor – never before seen.
- Many vehicles, body armor, jump packs and weapons.
- 7 different Bioroids, Bioroid Hover Sled & weapons.
- Robotech Masters, Tirolians, and their spaceships.
- Tirolian villains and player characters.
- History, background and world information.
- Quick Roll, 15 minute character creation tables.
- Infinite possibilities for adventure.
- \$20.95 – 160 pages. Cat. No. 552. 8½ x 11 inch size.

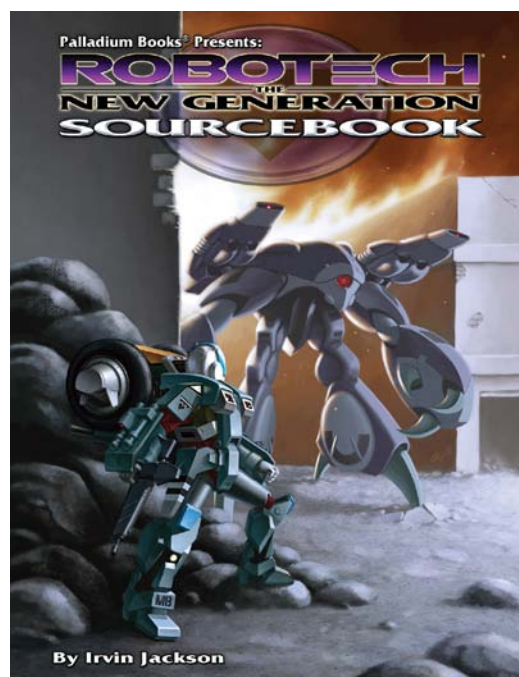

Robotech®: The New Generation™ Sourcebook

The Third Robotech War erupts on Earth. The planet has fallen to the Invid invasion force. You play resistance fighters, a new generation of bold heroes who dare to oppose the frightening alien overlords known as the Invid. Defend the human race against the Invid invaders and rescue the innocent from the alien tyrants.

Best of all, play characters, mecha and weapons from ALL four eras of Robotech® – from Macross and the Masters Saga to New Generation and the Shadow Chronicles®. Or build a Frankenmecha. Epic adventure.

- New and variant mecha, vehicles and weapons.
- Resistance Fighter O.C.C.s & Organization creation rules.
- *ALL eras of Robotech mecha* are available to players, from the giant Valkyries and Destroids, to Hover Tanks and AJAX, to the small, sleek Alpha Fighters and Cyclones of the UEEF.
- *Frankenmecha* – improvised mecha – amalgamations of different eras of mecha cobbled together into something new and deadly.
- 7 new Occupational Character Classes (O.C.C.s).
- Notable weapons, combat vehicles, and resistance fighters.
- The Regis, Simulagents, Invid Brain, Prince and Princess.
- Global overview under Invid domination and Invid mutations.
- Invid Hives, Protoculture Farms and adventure.
- \$16.95 – 96 pages. Cat. No. 554. 8½ x 11 inch size.

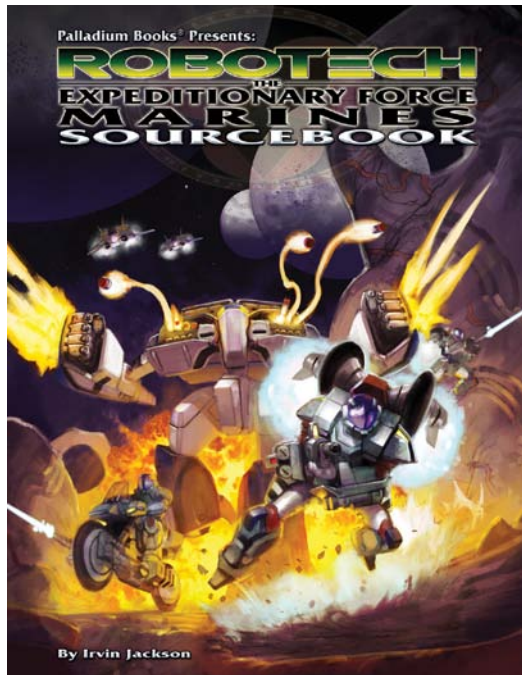

Robotech®: Expeditionary Force Marines™

Expeditionary Force Marines™ is a riveting **Robotech®** sourcebook that carries you to alien worlds. Your characters can pilot the early Cyclones and next generation of Destroids, meet aliens, liberate alien worlds and combat the merciless Invid Regent, his Inorganic shock troopers and Invid swarms. Epic, planet-hopping adventure awaits.

The Robotech®: Expeditionary Force Marines Sourcebook is set in space with the UEEF (United Earth Expeditionary Force) led by Admiral Rick Hunter, Lisa Hayes, Breetai and Exedore. This valiant force of mecha-clad heroes travel across the galaxy liberating planets from the bondage of the Invid Regent, the Robotech Masters and other tyrants and monsters. New alien people are introduced and become part of the Expeditionary Force Marines. In between their ongoing war with the Regent and his Invid and Inorganics, they explore planets, battle space pirates and face treachery on many fronts.

- 5 new Marine O.C.C.s, 22 M.O.S. skill packages, and some new skills.

- 8 new Destroids, two of them Zentraedi, plus a Battloid or two.
- 6 new Cyclones, including Space Cyclones, the Spider Hover Cyclone, the Walker and more.
- CVR-1 and CVR-2 body armor and notable Expeditionary Force (and alien) weapons, gear and vehicles.
- 6 alien races and brief overviews of their planets.
- 34 Perytonian Energy Wizard Magic spells.
- The Regent's war machine: Invid Scientist R.C.C., Invid Assault Trooper (new), Invid Fury (new), Invid Ogre (new), Invid Ranger (new), Garn Inorganic (new), the Regent statted out, and more.
- Quick Roll Creation Tables for UEEF Marines as player characters.
- Time-line for the Expeditionary Force and related events on Earth.
- The *Robotech® The Shadow Chronicles® RPG* "rule book" is needed to play (Cat. No. 550 or 550HC).
- Written by Irvin Jackson and Kevin Siembieda.
- \$20.95 – 160 pages. Cat. No. 553. 8½ x 11 inch size.

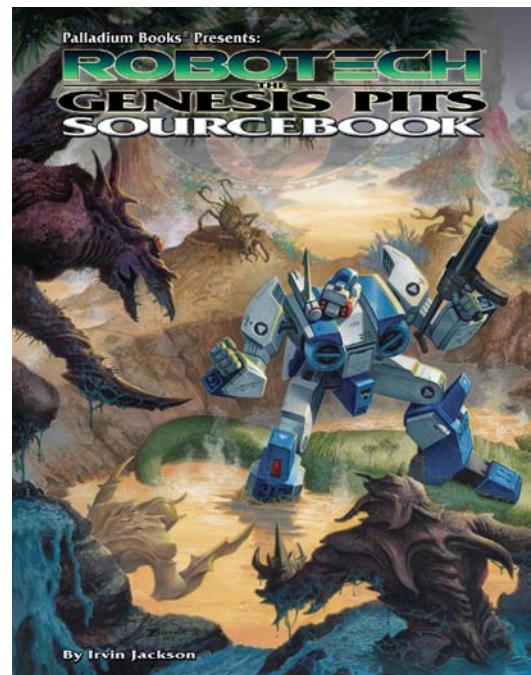

Robotech®: Genesis Pits Sourcebook

An in-depth look at the horror and wonder of the Invid Genesis Pits, their purpose, function and the creatures they create. Rules and tables for creating monsters, stats for different types of dinosaurs, insects and animals, new Frankenmecha, and more.

- **Secrets of the Invid.** Notable Genesis Pits of Earth.
- **Genesis Pit mutations, monsters and mutants.**
- **Different types of Genesis Pits from across the galaxy.**
- **Genesis Pit Monster creation tables and rules.**
- **Mutant Invid and other monsters described and statted.**
- **The Inorganics and other war machines of the Invid Regent.**
- **Ways to destroy a Genesis Pit. New weapons and gear.**
- **Simulagents, Bioroid and Zentraedi mutants, and more.**
- \$16.95 – 96 pages. Cat. No. 555. 8½ x 11 inch size.



ROBOTECH

RPG TACTICS™

Main Boxed Game – Cat. No. 55100 – Available Now!

A fast-paced, strategy battle game that captures the speed and action of Robotech®. Play Earth defenders or Zentraedi invaders.

- Scalable from small squad skirmishes to mass battles.
- Turn-based system of play and uses D6. Two or more players.
- 34 highly detailed game pieces. 6mm scale.
- 112 page color rule book with paint guide and index.
- 53 laminated, color game cards.
- 24 custom dice, two decal sheets and more.
- Assembly and painting required. Glue not included.
- \$99.95 retail – Cat. No. 55100 – shipping now!
- Available in North and South America, the EU, Australia & New Zealand.

Note: Each product contains plastic game pieces requiring assembly and painting. Glue not included. This is not a toy. Small parts, not suitable for children under the age of 13. Adult supervision advised. Images shown here are not to scale.



UEDF Valkyrie Wing™ – Cat. No. 55201

Build your fleet of Earth defenders with the Valkyrie Veritech Fighter; six game pieces total. **\$36.95 retail.**

- 2 Valkyries in Fighter mode.
- 2 Valkyries in Guardian mode.
- 2 Valkyries in Battloid mode.
- Multiple heads for making the VF-1A, VF-1J, VF-1R & VF-1S.



UEDF Tomahawk/Defender Destroids™ – Cat. No. 55202

Expand your Destroid squad with these formidable walking tanks; four game pieces total. **\$32.95 retail.**

- 2 Tomahawk Destroids – the main battle tank of Destroids, brimming with powerful particle beam cannons for arms, and wielding a battery of missiles and an array of other weapons.
- 2 Defender Destroids – a long-range, anti-aircraft juggernaut capable of shooting down incoming Zentraedi Battlepods and Gnerl Fighters.



UEDF Spartan/Phalanx Destroids™ – Cat. No. 55203

Add some long-range power and up-close punch to your army with these valuable Destroids; four game pieces total. **\$32.95 retail.**

- 2 Spartan Destroids – civil defense, riot control and deadly in hand to hand combat.
- 2 Phalanx Destroids – a walking, long-range missile artillery unit.



Zentraedi Regult Battlepods™ – Cat. No. 55401

Expand your Zentraedi forces with their main infantry battle mecha; six game pieces total. **\$36.95 retail.**

- 6 Regult Tactical Battlepods – the lightning quick Regults, armed with a pair of particle cannons and auto-cannons, attack in wave after wave.



Zentraedi Artillery Battlepods™ – Cat. No. 55402

Give your Zentraedi legion greater firepower with these artillery and support Battlepods; four game pieces total. **\$36.95 retail.**

- 4 Zentraedi Support Battlepods, each of which can be made into:
 - Gluuhaug-Regult – Light Artillery Battlepod
 - Serauhaug-Regult – Heavy Artillery Battlepod
 - Telnesta-Regult – Experimental Particle Beam Battlepod
- Four game pieces total.**



Zentraedi Glaug Command™ – Cat. No. 55403

This diverse pack provides your Zentraedi forces with greater tactical capabilities; three game pieces total. **\$36.95 retail.**

- 1 Glaug Officer's Battlepod – the fast and deadly mecha of Zentraedi field leaders.
- 1 Quel-Regult Scout Battlepod – the stealthy eyes and ears of your Zentraedi battle force; electronic warfare capabilities.
- 1 Quel-Gulnau Recovery Pod – enhances the Glaug's ability to bring in Battlepod reinforcements. **Note:** This figure has NEVER before been offered by any company.





RIFTS®

- Imagine Earth transformed into an alien landscape.
- Humans exist – barely. And we are not alone.
- Aliens and monsters emerge from the Rifts – holes torn in the fabric of space and time, connected to countless worlds and realities.
- Ancient gods, demons and magic have returned.
- Magic and technology clash.
- Hundreds of character classes, many inhuman.
- *Rifts® Ultimate Edition* is the core RPG rule book.
- Expansive world setting with 90+ sourcebooks to draw upon.
- Rifts®, your portal to endless adventure.
- Limited only by your imagination.

www.palladiumbooks.com

© 2014 Palladium Books. Rifts®, Megaverse®, Nightbane® and other titles, slogans and likenesses are trademarks of Palladium Books, Inc. Palladium Books - 39074 Webb Court, Westland, MI 48185 USA - 734-271-2903 order line.

Other RPG Worlds from Palladium Books®:

- *Rifts®* – the ultimate role-playing experience.
- *Rifts® Chaos Earth®* – Play the apocalypse as it happens.
- *Splicers®* – Weird science. Bio-tech battles insane robot legions.
- *Robotech® RPG* – All eras of the TV show brought to life.
- *Dead Reign® RPG* – Can you survive the Zombie Apocalypse?
- *Palladium Fantasy RPG®* – Unique world, monsters as player characters, magic and more.
- *Heroes Unlimited™ RPG* – Play any hero; mutants, aliens, cyborgs, superhumans, mages, immortals and more.
- *Nightbane® RPG* – Conspiracy, magic, horror and monsters.
- *Beyond the Supernatural™ RPG* – Modern horror and suspense.
- *Ninjas and Superspies™*, and more.

Can YOU survive the Zombie Apocalypse?



The Dead Reign® RPG series

Dead Reign® RPG – “Core Rules.” It is the aftermath of the *zombie apocalypse*. The dead reign and the living fight against impossible odds. Can you survive? Find out with this fast-paced horror game. Easy to learn. Fast character creation and combat.

- **Zombie combat and survival rules, vehicles and equipment.**
- **6 iconic Character Classes plus Ordinary People (40+ occupations).**
- **7 types of zombies, plus the Half-Living.**
- **101 Random Scenarios, Encounters, Settings and other tables.**
- **\$22.95 retail – 224 pages – Cat. No. 230. Available now.**

Civilization Gone™ Sourcebook

Civilization has crumbled to nothing. There is no army. No government. No help coming. What now?

- **Madmen, Psychopaths, villains, heroes and protectors.**
- **House, home and survivor camp tables, resources & encounters.**
- **\$12.92 retail – 64 pages – Cat. No. 231. Available now.**

Dark Places™ Sourcebook

Travel the rails and urban underground to move about undetected by zombies.

- **Worm Meat, Bug Boy, Sewer Crawler & Impersonator Zombies.**
- **Traveling the rails, sewers and other dark places.**
- **Random encounter tables, boxcar content tables, and much more.**
- **\$12.92 retail – 64 pages – Cat. No. 232. Available now.**

Endless Dead™ Sourcebook

The zombies grow in number and strangeness. Can humankind survive?

- **Zombie amalgamations, tables and encounters.**
- **New player characters & timetables for your campaign.**
- **Weaponizing vehicles, vehicle combat rules, and military bases.**
- **Creating survivor caravans, hideouts, Safe Havens & more.**
- **\$16.95 retail – 96 pages – Cat. No. 233. Available now.**

Other horror titles from Palladium Books®

Beyond the Supernatural™ RPG **Nightbane® RPG**

Fear the Reaper™ Sourcebook

Heroes who, like knights of old, travel the highways fighting zombies and helping survivors.

- **Comprehensive background on the Road Reapers.**
- **Their code, missions, weapons, strategies and tactics.**
- **The Terror Zombie and more.**
- **\$12.95 retail – 48 pages – Cat. No. 234. Available now.**

Graveyard Earth™ Sourcebook

The Zombie Apocalypse across the globe; provides a world overview and many adventure ideas.

- **Many tables for settings, encounters and adventure hooks.**
- **Random Safe Havens by region, and Survivor Leaders.**
- **How to get home from abroad, zombie threat levels & more.**
- **\$12.95 retail – 64 pages – Cat. No. 235. Available now.**

Hell Followed™ Sourcebook

This big, 160 page sourcebook begins to redefine the zombie genre. It broadens the field of possibilities and expands upon the modern zombie mythos. It is full of twists and surprises you will not expect.

- **11 new types of terrifying zombies.**
- **7 player characters, plus Masked Lunatics – heroes or madmen?**
- **21 disasters to complicate survival, and urban survival.**
- **Government enclaves, conspiracy theories and more.**
- **\$20.95 retail – 160 pages – Cat. No. 236. Available now.**



Palladium Books® Check List & Order Form

Dept. P-16, 39074 Webb Court, Westland, MI 48185

Name: _____ Address: _____

City: _____ State: _____ Zip/Postal Code: _____ Country: _____

Credit Card Number: _____ Expiration Date: _____ Visa MasterCard

Telephone Number: _____ Signature: _____ AMEX Other

The Rifter® Series

- ___ 173 The Rifter® #73 – \$13.95
- ___ 174 The Rifter® #74 – \$13.95
- ___ 175 The Rifter® #75 – \$13.95
- ___ 176 The Rifter® #76 – \$13.95
- ___ 177 The Rifter® #77 – \$13.95
- ___ 178 The Rifter® #78 – \$13.95 (Spring)

Splicers® Note: Sourcebooks coming soon.

- ___ 200 Splicers® RPG – \$23.95

Dead Reign®

- ___ 230 Dead Reign® RPG – \$22.95
- ___ 231 SB 1: Civilization Gone™ – \$12.95
- ___ 232 SB 2: Dark Places™ – \$12.95
- ___ 233 SB 3: Endless Dead™ – \$16.95
- ___ 234 SB 4: Fear the Reaper™ – \$12.95
- ___ 235 SB 5: Graveyard Earth™ – \$12.95
- ___ 236 SB 6: Hell Followed™ – \$20.95

Rifts® Novels

- ___ 301 Sonic Boom™ – \$9.95
- ___ 302 Deception's Web™ – \$9.95
- ___ 303 Treacherous Awakenings™ – \$9.95
- ___ 304 Tales of the Chi-Town 'Burbs™ – \$12.95
- ___ 305 Rifts® Path of the Storm™ – \$12.95

Weapons Books

- ___ 401 Weapons and Armor™ – \$8.95
- ___ 402 Weapons and Castles™ – \$8.95
- ___ 403 Weapons and Assassins™ – \$9.95
- ___ 404 Weapons & Castles of the Orient™ – \$9.95
- ___ 409 Exotic Weapons™ – \$9.95
- ___ 410 European Castles™ – \$9.95

Palladium Fantasy RPG®

- ___ 450 The Palladium Fantasy RPG® – \$26.95
- ___ 4500HC Palladium Fantasy RPG® 30th Anniversary Hardcover – \$50.00
- ___ 451 Dragons & Gods™ – \$24.95
- ___ 453 Old Ones™ 2nd Ed. – \$24.95
- ___ 454 Monsters & Animals™ 2nd Ed. – \$24.95
- ___ 455 Adventures on the High Seas™ – \$24.95
- ___ 458 Island at the Edge of the World™ – \$20.95
- ___ 459 Yin-Sloth Jungles™ – \$20.95
- ___ 462 Western Empire™ – \$24.95
- ___ 463 Baalgor Wastelands™ – \$24.95
- ___ 464 Mount Nimro™ – \$20.95
- ___ 465 Eastern Territory™ – \$24.95
- ___ 466 Library of Bletherad™ – \$20.95
- ___ 467 Northern Hinterlands™ – \$24.95
- ___ 468 Land/Damned 1: Chaos Lands™ – \$24.95
- ___ 469 LoD 2: Eternal Torment™ – \$24.95
- ___ 470 LoD 3: The Citadel – \$24.95 (coming)
- ___ 471 Wolfen Empire™ – \$20.95
- ___ 472 Mysteries of Magic™ One: Heart of Magic – \$16.95
- ___ 474 Bizantium/Northern Islands™ – \$20.95
- ___ 475 Garden of the Gods™ – \$16.95 (coming)

Heroes Unlimited™ / After the Bomb®

- ___ 500-2 Heroes Unlimited™, 2nd Ed. – \$26.95
- ___ 5000HC Heroes Unlimited™ 30th Anniversary Hardcover – \$50.00
- ___ 501 Villains Unlimited™ Revised – \$24.95
- ___ 503 After the Bomb® RPG – \$24.95
- ___ 505 Road Hogs™ (After the Bomb® II) – \$9.95
- ___ 507 Mutants Down Under™ (AB III) – \$9.95
- ___ 511 Mutants of the Yucatan™ (AB IV) – \$9.95
- ___ 513 Mutants in Avalon™ (AB V) – \$16.95
- ___ 514 Mutants in Orbit™ (AB VI) – \$16.95
- ___ 515 Aliens Unlimited™ – \$24.95
- ___ 516 Heroes Unlimited™ G.M.'s Guide – \$24.95
- ___ 517 Century Station™ – \$24.95
- ___ 518 Gramercy Island™ – \$24.95
- ___ 519 Aliens Unlimited Galaxy Guide™ – \$24.95
- ___ 520 Mutant Underground™ – \$16.95
- ___ 521 Powers Unlimited® One – \$16.95
- ___ 522 Powers Unlimited® Two – \$16.95
- ___ 523 Powers Unlimited® Three – \$16.95
- ___ 525 Revised Ninjas & Superspies™ – \$20.95
- ___ 526 Mystic China™ – \$24.95
- ___ 527 Armageddon Unlimited™ – \$20.95

Robotech® RPG

- ___ 550 Robotech® The Shadow Chronicles® RPG (manga size) – \$16.95
- ___ 550HC Robotech® The Shadow Chronicles® Deluxe Hardcover RPG – \$30.95
- ___ 5500HC Robotech® The Shadow Chronicles® Gold Ed. Hardcover RPG – \$70.00
- ___ 551 Robotech® Macross® Saga Sourcebook – \$16.95
- ___ 552 Robotech® The Masters Saga™ Sourcebook (NEW in 8½ x 11) – \$20.95
- ___ 553 Robotech®: Expeditionary Force Marines Sourcebook – \$20.95
- ___ 554 Robotech® The New Generation™ Sourcebook – \$16.95
- ___ 555 Robotech® Genesis Pits Sourcebook – \$16.95

Robotech® RPG Tactics™ (New!)

- ___ 55100 Robotech® RPG Tactics™ – \$99.95
- ___ 55105 Robotech® RPG Tactics™ Rulebook – \$20.00
- ___ 55101 UEDF Dice Pack – \$12.00
- ___ 55102 Zentraedi Dice Pack – \$12.00
- ___ 55201 UEDF Valkyrie Wing – \$36.95
- ___ 55202 UEDF Destroid Pack – \$32.95
- ___ 55203 UEDF Spartan Pack – \$32.95
- ___ 55401 Zentraedi Regult Battlepods – \$36.95
- ___ 55402 Zentraedi Artillery Battlepods – \$36.95
- ___ 55403 Zentraedi Glaug Command – \$36.95

Rifts® Chaos Earth®

- ___ 660 Rifts® Chaos Earth® RPG – \$20.95
- ___ 661 Rifts® CE Creatures of Chaos™ – \$12.95
- ___ 662 Rifts® CE The Rise of Magic™ – \$12.95
- ___ 665 Rifts® Chaos Earth® First Responders™ – \$16.95 (coming)
- ___ 666 Rifts® Chaos Earth® Resurrection™ – \$20.95

Beyond the Supernatural™

- ___ 700 Beyond the Supernatural™, 2nd Ed. – \$24.95
- ___ 702 Tome Grotesque™ – \$20.95 (coming)
- ___ 703 Beyond Arcanum™ – \$24.95 (coming)

Nightbane®

- ___ 730 Nightbane® RPG – \$24.95
- ___ 731 Nightbane®: Between the Shadows™ – \$20.95
- ___ 732 Nightbane®: Nightlands™ – \$20.95
- ___ 733 Nightbane®: Through the Glass Darkly™ – \$20.95
- ___ 735 Nightbane® Survival Guide™ – \$20.95

Rifts®

- ___ 800HC Rifts® RPG Ultimate Edition – \$39.95
- ___ 801 Rifts® Sourcebook One Revised – \$20.95
- ___ 802-E Rifts® World Book 1: Vampire Kingdoms™, Revised – \$24.95
- ___ 803 Rifts® Conversion Book One™ – \$24.95
- ___ 804 Rifts® WB 2: Atlantis™ – \$20.95
- ___ 805 Rifts® Sourcebook 2: Mechanoids™ – \$16.95
- ___ 807 Rifts® WB 3: England™ – \$20.95
- ___ 808 Rifts® WB 4: Africa™ – \$20.95
- ___ 809 Rifts® Dimension Book 1: Wormwood™ – \$20.95
- ___ 810 Rifts® WB 5: Triax™ – \$24.95
- ___ 811 Rifts® Pantheons of the Megaverse® – \$24.95
- ___ 812 Rifts® Sourcebook 3: Mindwerks™ – \$16.95
- ___ 813 Rifts® Mercenaries™ – \$20.95
- ___ 814 Rifts® WB 6: South America – \$20.95
- ___ 815 Rifts® WB 7: Underseas™ – \$24.95
- ___ 816 Rifts® DB 2: Phase World® – \$24.95
- ___ 817 Rifts® DB 3: Phase World® Sourcebook – \$16.95
- ___ 818 Rifts® WB 8: Rifts® Japan™ – \$24.95
- ___ 819 Rifts® WB 9: South America Two™ – \$24.95
- ___ 820 Rifts® WB 10: Juicer Uprising™ – \$20.95
- ___ 821 Rifts® WB 11: Coalition War Campaign™ – \$24.95
- ___ 822 Rifts® WB 12: Pyscape™ – \$20.95
- ___ 825 Rifts® WB 13: Lone Star™ – \$20.95

- ___ 826 Rifts® WB 14: New West™ – \$24.95
 ___ 827 Rifts® WB 15: Spirit West™ – \$24.95
 ___ 828 Rifts® Sourcebook 4: Coalition Navy™ – \$16.95
 ___ 829 Rifts® WB 16: Federation of Magic™ – \$20.95
 ___ 830 Rifts® DB 4: Skraypers™ – \$20.95
 ___ 831 Rifts® Index Volume Two™ – \$16.95
 ___ 832 Rifts® WB 17: Warlords of Russia™ – \$24.95
 ___ 833 Rifts® WB 18: Mystic Russia™ – \$20.95
 ___ 834 Rifts® WB 19: Australia 1 – \$24.95
 ___ 835 Rifts® WB 20: Canada™ – \$24.95
 ___ 836 Rifts® WB 21: Splynn Dimensional Market™ – \$24.95
 ___ 837 Rifts® WB 22: Free Quebec™ – \$24.95
 ___ 838 Rifts® WB 23: Xiticix Invasion™ – \$20.95
 ___ 839 Rifts® Coalition Wars®: Sedition™ – \$20.95
 ___ 840 Rifts® Coalition Wars®: Coalition Overkill™ – \$16.95
 ___ 841 Rifts® Coalition Wars®: Sorcerers' Revenge™ – \$16.95
 ___ 842 Rifts® Coalition Wars®: Cyber-Knights™ – \$16.95
 ___ 843 Rifts® Coalition Wars®: Shadows of Evil™ – \$16.95
 ___ 844 Rifts® Coalition Wars®: Final Siege™ – \$24.95
 ___ 845 Rifts® Game Master Guide™ – \$26.95
 ___ 846 Rifts® Aftermath™ – \$24.95
 ___ 847 Rifts® DB5: Anvil Galaxy™ – \$20.95
 ___ 848 Rifts® Book of Magic™ – \$26.95
 ___ 849 Rifts® Adventure Guide™ – \$24.95
 ___ 850 Rifts® Bionics Sourcebook™ – \$16.95
 ___ 851 Rifts® DB 6: Three Galaxies™ – \$20.95
 ___ 852 Rifts® Dark Conversions™ – \$24.95
 ___ 853 Rifts® Chi-Town 'Burbs™ – \$9.95
 ___ 854 Rifts® The Tolkeen Crisis™ – \$12.95
 ___ 855 Rifts® The Black Vault™ – \$9.95
 ___ 856 Rifts® The Vanguard™ – \$9.95
 ___ 857 Rifts® WB 24: China One™ – \$20.95
 ___ 858 Rifts® WB 25: China Two™ – \$20.95
 ___ 859 Rifts® DB 7: Megaverse Builder™ – \$16.95
 ___ 860 Rifts® DB 8: Naruni Wave Two™ – \$16.95
 ___ 862 Rifts® WB 26: Dinosaur Swamp™ – \$20.95
 ___ 863 Rifts® MercTown™ – \$20.95
 ___ 865 Rifts® Merc Ops™ – \$20.95
 ___ 866 Rifts® WB 27: Adventures in Dinosaur Swamp™ – \$20.95
 ___ 867 Rifts® Mercenary Adventure Sourcebook – \$12.95
 ___ 868 Rifts® WB 28: Arzno™ – \$20.95
 ___ 869 Rifts® WB 29: Madhaven™ – \$16.95
 ___ 870 Rifts® John Zeleznik Coloring Book – \$5.95
 ___ 871 Rifts® Machinations of Doom™ – \$18.95
 ___ 872 Rifts® DB 10: Hades™ – \$24.95
 ___ 873 Rifts® DB 11: Dyval™ – \$24.95
 ___ 874 Rifts® WB 30: D-Bees of North America™ – \$24.95
 ___ 875 Rifts® DB12: Dimensional Outbreak – \$24.95
 ___ 876 Rifts® Megaverse® in Flames™ – \$24.95
 ___ 876HC Rifts® Megaverse® in Flames™ Gold Hardcover Edition – \$50.00
 ___ 877 Rifts® Heroes of the Megaverse® – \$16.95
 ___ 878 Rifts® Sourcebook: Shemarrian Nation™ – \$16.95
 ___ 880 Phase World®: Fleets of the Three Galaxies™ – \$16.95
 ___ 881 Rifts® WB 31: Triax™ Two – \$24.95
 ___ 883 Rifts® DB 14: Thundercloud Galaxy™ – \$20.95
 ___ 884 Rifts® Vampires Sourcebook™ – \$20.95
 ___ 885 Rifts® WB 32: Lemuria™ – \$24.95
 ___ 886 Rifts® Black Market™ – \$24.95
 ___ 886HC Rifts® Black Market™ Hardcover Gold Edition – \$60.00
 ___ 887 Rifts® WB 33: Northern Gun™ One – \$24.95
 ___ 888 Rifts® WB 34: Northern Gun™ Two – \$26.95
 ___ 889 Rifts® Sourcebook: Coalition States, Heroes of Humanity™ – \$20.95
 ___ 890 Rifts® World Book: Secrets of the Atlanteans™ – \$24.95 (coming)
 ___ 891 Rifts® World Book: Sovietski™ – \$24.95 (coming)
 ___ 892 Rifts® Sourcebook: The Disavowed™ – \$16.95 (coming)
 ___ 893 Rifts® CS: Heroes of Humanity™ Arsenal Sourcebook – \$16.95 (coming)
 ___ 894 Rifts® Haunted Tech™ – \$16.95 (coming)
 ___ 2510 Rifts® & The Megaverse® Art Book – \$22.95
 ___ 2510-HC Rifts® & The Megaverse® Art Book, Hardcover – \$50.00
 ___ 2510-CML Rifts® & The Megaverse® Art Book, Collector's Masterwork Edition – \$125.00
- Miscellaneous Products**
 ___ 600 Deluxe Revised RECON® RPG – \$22.95
 ___ 2537 Gamer Coffee Mug – \$10.00
 ___ 2539 Rifts® Dice Bag – Black – \$8.00
 ___ 2545 Dead Reign™ Coffee Mug – \$10.00
 ___ 2554 Palladium Bookmarks, Set One – \$5.00
 ___ 2555 Palladium Bookmarks, Set Two – \$5.00
 ___ 2561 Property of Chi-Town Library Pencil – \$0.50 each
 ___ 2562 Future Visions™ – The Artistry of Charles Walton II – \$13.95
 ___ 2566 Glitter Boy Mouse Pad – \$9.95
 ___ 2567 Old Ones Mouse Pad – \$9.95
 ___ 2568 Zombie Graveyard Mouse Pad – \$9.95
 ___ 2575 Rifts Poker Cards 1 (full color) – \$11.99
 ___ 2576 Rifts Poker Cards 2 (line art) – \$11.99
- Note:** T-shirts and other products can be found online: www.palladiumbooks.com
- Rifts® Miniatures**
 ___ MI8002 Xiticix Pack – \$18.00
 ___ MI8004 Coalition Dog Pack – \$18.00
 ___ MI8005 Men of Magic Pack #1 – \$18.00
 ___ MI8006 Cyborgs Pack #1 – \$18.00
 ___ MI8007 Simvan & Ostrosaurus Pack – \$18.00
 ___ MI8008 Coalition Skelebots Pack #1 – \$18.00
 ___ MI8009 Coalition SAMAS Pack #1 – \$22.00
 ___ MI8010 Coalition Sky Cycle Pack – \$22.00
 ___ MI8011 Coalition Dog Pack #2 – \$18.00
 ___ MI8015 Damaged Skelebots Pack #1 – \$12.00
 ___ MI8016 Cyber-Adventurers Pack – \$18.00
 ___ MI8017 Rogues & Scout Pack #1 – \$18.00
 ___ MI8018 Brodkil & Witchling Pack – \$18.00
 ___ MI8019 Damaged Skelebots Pack #2 – \$18.00
 ___ MI8020 Psi-Stalkers & Scouts Pack #1 – \$18.00
 ___ MI8021 Shadow Beast – \$12.00
 ___ MI8022 Mystic Knight – \$6.00
 ___ MI8023 Lord Magus – \$6.00
 ___ MI8024 High Magus – \$6.00
 ___ MI8025 Coalition Psi-Stalker – \$6.00
 ___ MI8026 Coalition Dog Boy in DPM-D1 Armor – \$6.00
 ___ MI8027 Coalition Dog Boy #2 – \$6.00
 ___ MI8028 Coalition Dog Boy #3 – \$6.00
 ___ MI8029 Coalition Dog Boy #4 – \$6.00
 ___ MI8030 Coalition Dog Boy #5 – \$6.00
 ___ MI8031 Glitter Boy – \$20.00
 ___ MI8032 Glitter Boy Pilot – \$6.00
 ___ MI8033 Kydian Overlord – \$20.00
 ___ MI8034 Dragonsaurus – \$10.00
 ___ MI8035 Slaver and Slave (Atlantis) Set – \$10.00
 ___ MI8036 Crazy – \$6.00
 ___ MI8037 Juicer #1 – \$6.00
 ___ MI8038 Juicer #2 – \$6.00
 ___ MI8039 Cyborg #1 – \$12.00
 ___ MI8040 Cyborg #2 – \$12.00
 ___ MI8041 Cyborg #3 – \$6.00
 ___ MI8042 Coalition Officer – \$6.00
 ___ MI8043 Coalition Grunt #1 – \$6.00
 ___ MI8044 Coalition Grunt #2 – \$6.00
 ___ MI8045 Coalition Grunt #3 – \$6.00
- When placing an order by mail, please add money for shipping and handling.** Add \$5.00 for orders totaling \$1-\$50, \$10.00 for orders totaling \$51-\$95, and for orders totaling \$96-\$200 please add \$15.00 US. Double the amount for Canada, and *quadruple* it for overseas orders. For more shipping options, order online at www.palladiumbooks.com. Allow 2-4 weeks for delivery. Make checks and money orders payable to: *Palladium Books*
- Check release dates for new products.** If the book you order has not been released yet, your order will be held as a backorder until the product is available. Please note that prices are subject to change without notice.
- Orders can also be placed by phone,** at (734) 721-2903 (order line only). Please have your credit card information when you call.

www.palladiumbooks.com

PALLADIUM BOOKS® PRESENTS
THE ROBOTECH® RPG BOOK FIVE: A ROBOTECH® RPG SOURCEBOOK.



\$20.95

Cat. No. ROBO56

ISBN-10: 0-916211-28-2

ISBN-13: 978-0-916211-28-8