

PALLADIUM BOOKS® PRESENTS . . .

ROBOTECH®

THE ROLE-PLAYING GAME

BY KEVIN SIEMBIEDA



LONG

About this book

Originally published in 1986

This book was first printed in the mid-1980s. Before the Internet as we know it, and even before the term “anime” came to be known in the United States.

Accurate information about the original anime was difficult to find, and the people managing the *Robotech*® intellectual property in those days preferred to keep *their Robotech*® at arm’s length from the original three anime series – *Macross*, *Southern Cross* and *Genesis Climber Mospeada* – that inspired the unique and beloved creation that is **Robotech**®.

As a result, the details and stats behind some of the mecha, characters, vehicles, weapons and settings reflect a different era and mindset than the **Robotech**® we know today. The information and stats reflect that time period, the information available, and the wishes of the *Robotech*® series’ creator and the managers of the I.P. at that time. Palladium Books followed their wishes.

Please enjoy these **Robotech**® RPG books for what they are. Enjoy the nostalgia, and use or adapt the rules, stats, maps and data to the modern **Robotech**® books as you deem desirable. Though different, much of the material of these 1980s and 1990s books is easily modified and adapted to current **Robotech**® RPG titles and **Robotech**® RPG Tactics™.

An important note about the new *Robotech*® RPG titles: When we *relaunched* the **Robotech**® RPG series in the new millennium, we approached the games as if they were brand new to us. Stats and information are all updated and brought in line with the modern history, back story, and mecha, as well as featuring new artwork. That means new stats, deeper history, and new information and equipment. Some titles like **Robotech**®: **The Masters Saga**™ **Sourcebook** contain a wealth of new and exciting mecha, power armor, robots and weapons never before seen in the RPG series. Stats and information from the original books were NOT reprinted, and only a small amount of the past artwork has reappeared in the new *Robotech*® titles.

It is our pleasure to make the original *Robotech*® titles available, once more, with the permission of Harmony Gold, USA, Inc. Enjoy.

– Kevin Siembieda, Publisher & Game Designer, 2017

PALLADIUM BOOKS® PRESENTS . . .

ROBOTTECH®

The Role-Playing Game

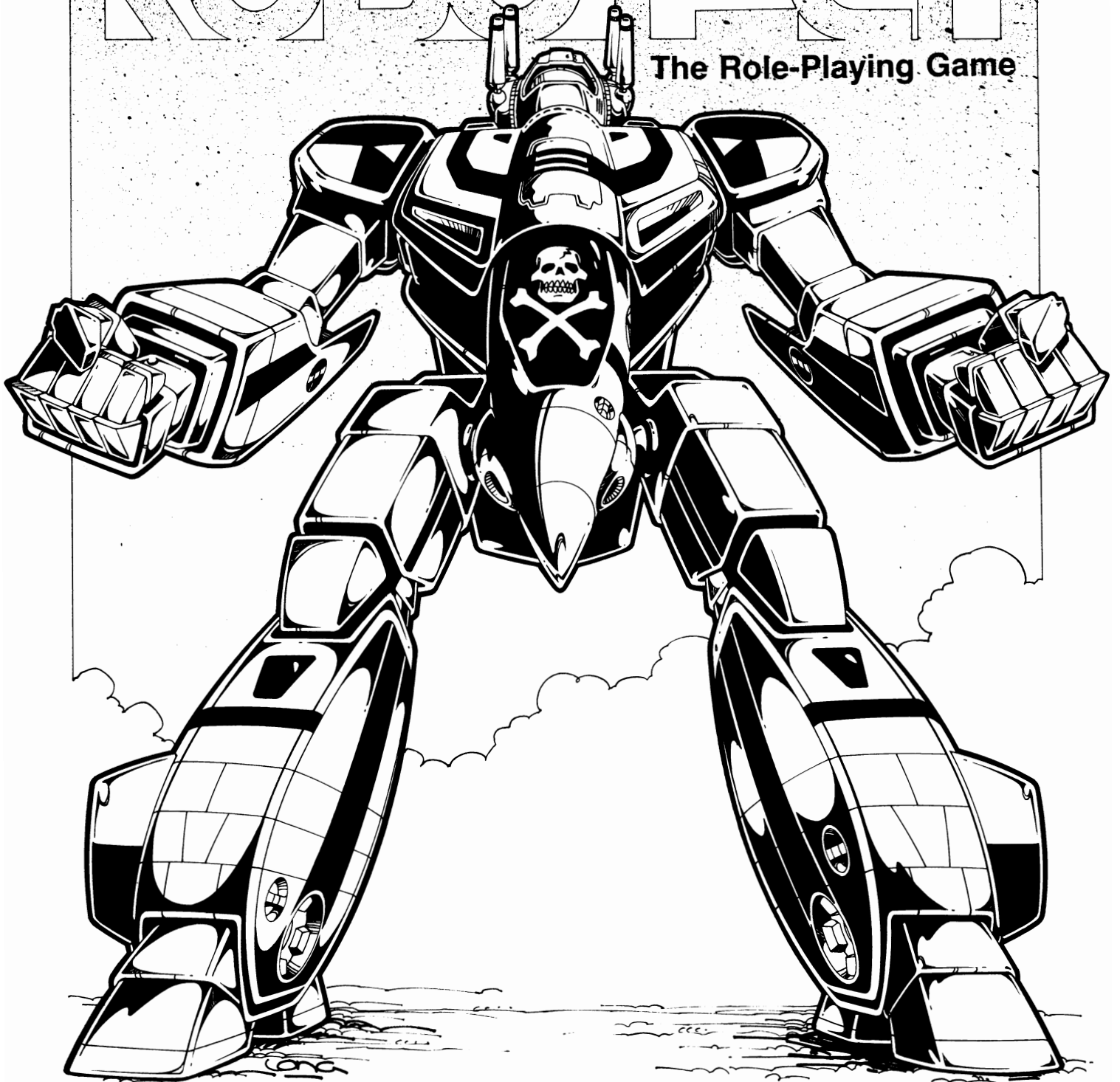

BOOK ONE: MACROSS®

Dedicated to my love, Maryann.

WARNING

This book contains new and original works of art that are **protected by Federal Copyright Law**. NO artwork may be printed or published in any form, for any reason, without *written permission* from the Publisher of Palladium Books®. The use of this artwork, in any product not produced by Palladium Books® is a Federal crime! ***Offenders will be pursued in Federal Court.***

PDF Edition – April 2017

Twelfth Printing – January 1998

Copyright © 1983, 1984, 1985, 1986 Kevin Siembieda.

Characters copyright © 1985 Harmony Gold U.S.A., Inc./Tatsunoko Production Co. Ltd. All rights Reserved.

Copyright © 1986 by Kevin Siembieda. All rights reserved under the Universal Copyright Convention. No part of this book may be reproduced in part or whole, in any form or by any means, without permission from the publisher, except for brief quotes for use in reviews. All incidents, situations, institutions, governments and people are fictional and any similarity, without satiric intent, of characters or persons living or dead is strictly coincidental.

"ROBOTECH" is a trademark owned and licensed by Harmony Gold U.S.A., Inc.

Palladium Books and Megaverse are registered trademarks owned and licensed by Kevin Siembieda.

Mega-damage, M.D.C. and S.D.C. are trademarks owned and licensed by Kevin Siembieda.

ROBOTECH: The Role-Playing Game is published by Palladium Books Inc., 39074 Webb Court, Westland, MI 48185. Printed in the United States of America.

PALLADIUM BOOKS® PRESENTS . . .

ROBOTECH®

THE ROLE-PLAYING GAME

Written By: Kevin Siembieda

Editors: Alex Marciniszyn
Florence Siembieda

Technical Consultant: Richard Burke
Japanese Translator: Akira Kushida

Chief Artist: Kevin Long
Additional Art: Aubrey Bradford
Art Direction: Kevin Siembieda

Cover Artist: Kevin Long

Typography: Maryann Siembieda
Keylining: Matthew Balent



Special thanks to Erick Wujcik, Larry Jordan, Carl Macek, Mark Freedman, Caryl Mann, Gabriela Aranda, Books Nippan, Karl Heisterman of TCI, Harmony Gold, U.S.A. Inc, my play-testers and my family.

TABLE OF CONTENTS

	Page
Introduction	3
Glossary	3
How to Play	3
Creating a Character:	
Step One: The 8 Attributes	4
Step Two: Hit Points & S.D.C.	5
Optional Damage Rules	5
S.D.C., M.D.C. & Mega-Damage	6
Step Three: Selecting an Occupation & Skills	7
Step Four: Equipment & Money	8
Step Five: Rounding Out One's Character	8
Alignments	8
Experience	10
Insanity	11
Optional Rules	14
Occupational Character Classes (O.C.C.)	15
Destroid Pilot O.C.C.	16
Veritech Fighter Pilot O.C.C.	17
Communications Engineer O.C.C.	18
Electrical Engineer O.C.C.	19
Field Scientist O.C.C.	19
Mechanical Engineer O.C.C.	20
Military Specialist O.C.C.	21
O.C.C. Experience Levels	22
Skills	23
Weapon Proficiencies	30
Hand to Hand Combat	31
Hand to Hand Combat Tables	33
Mecha Combat	34
Volleys and Bursts	35
Missiles	37
Missile Chart	39
Optional Damage Tables	40
Mecha Hand to Hand Combat	41
Earth Mecha	
The Veritech Fighter	43
History	44
Standard Equipment	46
Individual Descriptions Begin	47
The Super Veritech	52
The Armored Veritech	54
Disposable Rocket Sled	55
The Destroids	56
The Excaliber MK VI	56
The Gladiator	58
The M.A.C. II	60
The Raider X	63
The Spartan	65
Vehicles	
Space Vehicles	66
Fighter Jets	71
Other Aircraft	72
Land Vehicles	74
Conventional Vehicles	76
Modern Conventional Weapons	77
Ancient Weapons	79
Equipment (Sensory and Other)	79
The Zentraedi	82
Zentraedi Mecha	84
Zentraedi Quick Roll Villain	95
Playing a Zentraedi Character	96
Zentraedi Mecha Combat	97
The History of the Reconstruction	98
The Western Hemisphere	98
Adventure Scenarios (Random Table)	100
On the Defensive (adventure)	101
Glossary of ROBOTECH® Terms	102
Japanimation Side Notes	102
Robotech Characters	104
The SDF-1	108

INTRODUCTION

Welcome to the world of **ROBOTECH**®. In the proceeding pages you will find the television series accurately and loyally recreated. Long time fans of the Japanese version of the series, **Macross**, will find that we have retained much of the wonderful, original data from the **ROBOTECH**®/**Macross** saga. Long hours spent accurately translating such classic, Japanese books as *Memory Perfect*, *the Macross Guide Books* and others, have provided us with a wealth of information never before published in the English language. Carl Macek's valuable insight and direction has enabled us to produce not only an exciting game, but what we believe to be "the" definitive, English language, **ROBOTECH**® source book.

The **ROBOTECH**® RPG series will go beyond simply emulating the T. V. show. Thanks to Carl Macek and the people at Harmony Gold U.S.A., Inc., we will have the unique opportunity to build onto the existing series. We will be able to create the intervening NINE years between the destruction of the SDF-1 and 2 and the launching of the SDF-3. Future supplements will elaborate on the Zentraedi, Moon and Mars bases, the civil wars and the turbulence that wracks the Earth as humanity valiantly struggles to rebuild its world. Mr. Macek has provided us with a time-line that will take us up to the beginning of his upcoming **ROBOTECH**® — sequel **The Sentinels**. We will follow up that time-line with the Earth-bound sagas of *Southern Cross* and *Mospeada*.

The advantage of role-playing games is that the fabrics of space and time are yours to mold. You, the players, are NOT stuck with any one scenario, setting or time-line. Begin your campaign with the struggle of a new Earth after the decimation by the Zentraedi and the destruction of the SDF-1 and 2. That's the newest and most exciting for us right now, so that's the one we suggest. It will place characters in a pretty freewheeling situation with a lot of obvious adventure possibilities in this post-holocaust world. On the other hand, you may start a few years earlier with the maniacal Khyron, still alive and at large. Or perhaps go back to the fateful day that the SDF-1 was launched with its inexperienced crew to combat a relentless foe. Or still yet, you could be patrolling the moon or Mars base or the asteroid belt, ever vigilant for renegade Zentraedi or Invid scouts. The world of **ROBOTECH**® is laid out for your playing pleasure. Extrapolate, create; the possibilities are limited only by your imagination.

HOW TO PLAY A ROLE-PLAYING GAME

Role-playing games are really just an advanced form of regular board games. In fact, they are so advanced that they no longer use a board. Some of the elements are still the same; you still need paper and pencil, dice and players, but the main thing you need to play a role-playing game is **IMAGINATION**.

Let's Take It A Step At A Time.

Imagine The Scene

Picture a waiting room; there is a desk, 10 comfortable chairs, and a large video screen on the front wall. If you face the screen, you will see a door on the right-hand wall and four, large windows on the left wall. There is also a large clock that tells you it is 3 o'clock, a glance out the dark window lets you know that it is the middle of the night.

Can you picture this scene? Try to keep the mental image in your head. Don't worry if you forget the details; one of the great things about role-playing is the way your memory is improved with practice. Now you are ready for the next step . . .

Imagine The Setting

At the front of the room there is a mad-looking figure. A micronized Zentraedi, he looks around suspiciously. At his feet, there are two, very frightened people, both in stained, blue, work clothing. The Zentraedi points a large pistol at the people and screams in a hoarse voice, "Where is the money?"

Obviously, there is some kind of crime taking place here and, judging from the state of the criminal, his victims are in dire danger. The next step is to find out how YOU fit into all this.

Imagine The Character

Now here comes the tricky part. YOU are not in the room, but there is somebody in the room whose eyes you see through. This person is your *Character*, an imaginary individual that is your *Playing Piece* in this game.

Normally, you will spend an hour or more developing a new player character. Once the character has been created, you will probably continue playing that character for many weeks, perhaps years.

In our example, let us assume that you are playing **Rick Hunter**, the young lieutenant and commander of the Skull Squadron. Just picture yourself (as Rick) standing at the far end of the room.

Imagine Action

Actually, you need one, important, extra ingredient to make a role-playing game work, the **Game Master**. The game master (GM) is another player (a real person!) who controls all the characters in the game, *except* the different player's characters. In this case, *You* are the only player and I am acting as the game master (GM).

"The Zentraedi has not yet noticed Rick standing quietly in the back of the room," the GM informs you, "but he looks like he is about to shoot one of the janitors". What are YOU going to do?

As Rick, YOU have an important decision to make. Should you leap at the Zentraedi? Attempt to throw a knife through the alien's weapon hand? Shoot with your weapon? How can you best protect the innocent janitors and capture the renegade Zentraedi?

In a role-playing game there are no simple answers. There are also almost no limits to what you can do. The only restrictions are that you cannot go beyond the physical, mental and emotional limits of your character.

What You Need To Play

Other than imagination, players, and a game master, you will also need the following:

1. **Dice:** 2 four-sided, 4 six-sided, 2 eight-sided, 2 ten-sided, and 2 twenty-sided.
2. Plenty of **Pencils** and **Paper**.
3. Game Master and players (at least a total of 2 plus the GM).

Glossary OF ROLE-PLAYING GAME TERMS

Attributes: These are numbers used to evaluate the strengths and weaknesses of your character. For example: P.P. means Physical Prowess; how smooth, agile and quick a character is in combat. A P.P. of 4 would indicate that the character is pretty clumsy. A P.P. of 10 would be an average, fairly coordinated human being. While a P.P. of 16 or more would belong only to characters with exceptional speed and reflexes. Attributes are also called Statistics or Stats.

Campaign: A word used to describe an ongoing game. If you play the same characters with the same game master on a regular basis, then you are in a *Campaign*.

Character: Every player (except the GM) has a character that serves as an imaginary playing piece; also called *Playing Character*.

Death: Just as in real life, characters can die. The death of heroes in comic books, or in games, is a fairly rare event. The amount of death in a campaign usually depends on the individual game master. Players should take a character's death calmly. Remember, it's **ONLY** a game. GM's should allow players to roll up a "NEW" character and include it in the game as soon as is appropriate for the ongoing game. However, characters should not be a dime a dozen.

Dice: There are a variety of different dice used in role-playing games. First of all, there are the standard, six-sided dice; the kind you use for most board games. We call them “D6”. Often we let you know how many dice to roll with an expression like, “roll 3D6”. This means: “roll three six-sided dice and add the results together”. Dice are also available with four-sides (D4), eight-sides (D8), ten-sides (D10), and even twenty-sides (D20). They are available at most hobby stores.

Game Master: (GM) This is the person who controls the game “world”. All the non-player characters, innocent bystanders, police and politicians, even the weather, is controlled by the GM.

Player: A player is a person who plays a character in a role-playing game.

Role-Playing Game: Sometimes called a role-playing game (RPG), or fantasy role-playing (FRP), these are games with game masters and imaginary characters.

Roll a Twenty-Sided: Simply roll a twenty-sided die for a number.

Roll Percentile: Take two, ten-sided dice of different colors. Let’s say we have one green and one red. First, you declare which die will be high (“I call red high”). Next you roll the dice. First, you read the *High* die and then, the *Low* die; just put the numbers together and you have a percentile. For example: “Red is 4 and green is 8, so I have a 48%”.

Run: This is just a term gamers use to describe playing a game. Example: “He runs an excellent campaign,” “I ran in Kevin’s game last week”.

Saving Throw: This is a roll (usually on a twenty-sided die) to avoid some unpleasant event. For example: A character might have to roll a saving throw to avoid being overcome by tear gas.

Scenario: This is a specific adventure that confronts the characters in a role-playing game. A scenario is usually a story with a beginning (hearing about the criminal), a middle (tracking down the criminal’s hide-out), and an end (defeating the criminal). Most campaigns are developed around a number of scenarios.

CREATING A CHARACTER

The creation of a character is relatively simple, requiring five, main steps:

- Step 1: The Eight Attributes (and bonuses)
- Step 2: Hit Points and S.D.C.
- Step 3: Occupational Character Class
- Step 4: Equipment and Money
- Step 5: Alignments

STEP 1: THE EIGHT ATTRIBUTES and ATTRIBUTE BONUSSES

The first step in creating a character is to roll-up the eight attributes: I.Q., M.E., P.S., P.P., P.E., P.B., and Spd.

Three, six-sided dice are rolled to determine each attribute. The higher the number, the greater the ability. If an attribute is “exceptional”, 16, 17 or 18, then an additional six-sided die is rolled and added to the total for that attribute.

Intelligence Quotient (I.Q.): Indicates the intelligence of the character. The exact I.Q. is equal to the I.Q. attribute multiplied times ten. Characters with an I.Q. of 17 or better, will receive a one-time bonus added to all the character’s skill percentages.

Mental Endurance (M.E.): Measures the amount of mental and emotional stress the character can withstand.

Mental Affinity (M.A.): Shows the character’s personal charm and charisma. Natural leaders, with an M.A. of 17 or higher, have a bonus to invoke trust or intimidation in others.

Physical Strength (P.S.): This is the raw physical power of a character. The P.S. times 10 indicates how heavy an object (in pounds) the character can carry. A character can lift 30 times the P.S. Exceptionally strong characters, having a P.S. of 15-19, can carry 20 times their P.S. and lift 40 times their P.S. Someone with a P.S.

of 20-23 can carry 30 times their P.S. and lift 60 times their P.S. Anyone with a P.S. of 24 or higher, can carry 50 times their P.S. and lift 100 times their P.S. Any character with a P.S. of 17 or better, receives a bonus to damage in hand to hand combat.

Physical Prowess (P.P.): Shows the degree of dexterity and agility of the character. A P.P. of 17 or higher is rewarded with bonuses to dodge, parry and strike.

Physical Endurance (P.E.): Demonstrates the character’s stamina and durability. The amount of physical punishment, and resistance to fatigue and disease, are determined by P.E. A character can carry the maximum weight load (see P.S.) for the P.E. times 4 minutes. Carrying the maximum weight while running or fighting can only be done for the P.E. times 2 minutes. If a character lifts the maximum weight (see P.S.), then it can only be held for as many melee rounds (15 seconds each) as the character has points of P.E. A character can run at maximum speed for one minute for each point of P.E. Character’s with a P.E. of 17 or better receive bonuses to save vs. coma, death and toxins.

Physical Beauty (P.B.): Is an indication of the physical attractiveness of the character. A P.B. of 17 or better will be rewarded with a bonus to charm or impress.

Speed (Spd): Specifically, this is the character’s maximum running speed. The Spd. times 20 is the number of yards or meters that the character can run in one minute.

ATTRIBUTE BONUS CHART

	17	18	19	20	21	22	23	24	25	26	27	28	29	30
I.Q. add to all skills. One time bonus.	+3%	+4%	+5%	+6%	+7%	+8%	+9%	+10%	+11%	+12%	+13%	+14%	+15%	+16%
M.E. save vs. psionic attack/insanity	+1	+2	+2	+3	+3	+4	+4	+5	+5	+6	+6	+7	+7	+8
M.A. trust/intimidate	45%	50%	55%	60%	65%	70%	75%	80%	84%	88%	92%	94%	96%	97%
P.S. Hand to Hand Combat: Damage	+2	+3	+4	+5	+6	+7	+8	+9	+10	+11	+12	+13	+14	+15
P.P. parry, dodge and strike bonus	+1	+2	+2	+3	+3	+4	+4	+5	+5	+6	+6	+7	+7	+8
P.E. save vs. coma/death	+5%	+6%	+8%	+10%	+12%	+14%	+16%	+18%	+20%	+22%	+24%	+26%	+28%	+30%
save vs. poison	+1	+2	+2	+3	+3	+4	+4	+5	+5	+6	+6	+7	+7	+8
P.B. chamr/impress	35%	40%	45%	50%	55%	60%	65%	70%	75%	80%	83%	86%	90%	92%
Spd: No special bonuses other than the raw, natural ability to run.														

STEP 2: HIT POINTS & S.D.C.

HIT POINTS

Hit points might best be thought of as life points because they indicate how much physical damage (cuts, bruises, etc.) a character can withstand before he/she dies. These are the points that are observed during a battle (or melee) to determine how much damage is inflicted on friend or foe. Each time a character is struck by a weapon he takes physical damage. The individual players keep score of how many hit points their character has by subtracting the damage from his/her character's hit points each time that character is hit by a weapon. Likewise, the game master keeps score of how much damage the player inflicts upon his opponent. When a character has zero hit points, he is in a coma and will soon die unless extensive medical aid is applied. When a character's hit points have been knocked far below zero, he is dead and beyond saving.

DETERMINING HIT POINTS

Now that you have some idea of what hit points are about, let us get into the technical aspects of their determination and use.

1. Base Hit Points: Having rolled up your 8 attributes, you will recall that one is **physical endurance** (P.E.). The physical endurance score indicates your character's base/starting amount of hit points. This number means that he/she can lose that many hit points before dying.

Some of you will have a character with many hit points . . . don't get too cocky, a laser in the right hands can whittle you down to size in one melee round. Others will find themselves with a character who has only a handful of hit points (as little as 3), . . . don't despair or feel cheated, you'll just have to use cleverness and cunning in avoiding direct confrontations until you've built up your hit points.

2. Building Hit Points: After determining your base hit points, pick up one six-sided die, roll it and add the number rolled to your hit point base. Only roll one six-sided die one time.

As your character grows in knowledge and experience he will gain more skill and expertise in his chosen profession (see: Occupational Character Classes). At the same time he will also mature physically, increasing his hit points. Thus, each time a character attains a new experience level, roll one six-sided die and add it to the existing hit points.

RECOVERY OF HIT POINTS

After a battle, characters who have sustained physical damage must tend to their wounds. The attending of wounds can be administered by fellow characters, trained medical personnel or by oneself, if the character has first aid skills and is not physically impaired.

First aid-type skills include basic and immediate medical treatment, such as bandaging and cleaning of wounds, stopping of bleeding and so on, until the character can receive better medical care.

Recovery: Non-professional treatment. This is basic, first aid-type treatment by oneself, or non-medically trained people. This type of treatment may be used if the character is not able to seek professional treatment immediately. It is not necessarily inferior treatment, especially for not too serious of an ailment, but just lacks the full facilities and experience of a major medical institution. **Rate of Recovery:** Two hit points per day (24 hours).

Recovery: Professional treatment. This is medical treatment from a doctor, clinic or hospital. **Rate of Recovery:** Two hit points per day for the first two days, and four hit points per day for each following day, until the character has regained all his/her original hit points.

SURVIVING COMA AND DEATH

When a character's hit points are reduced to zero (or less), he/she collapses; lapsing into a coma. This character is near death, and will die in a matter of hours unless he/she receives immediate medical

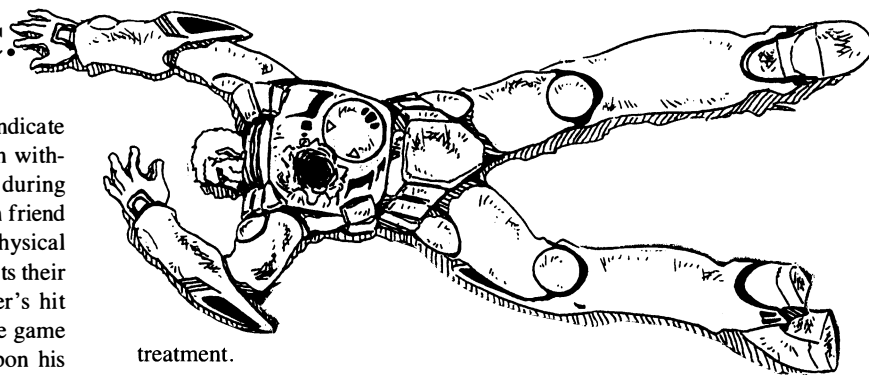

treatment.

How much damage below zero a character can undergo is indicated by the physical endurance (P.E.) attribute. A character can take one point of damage below zero (negative 1, -2, -3, etc.) for each P.E. point. **Example:** A character with a P.E. of 9 will lapse into a coma at zero hit points, but still lives up to a negative 9. However, if the character receives more damage (which is very possible) than the P.E., he is dead with no hope of recovery. Thus, if a character with a P.E. of 9 takes 10 points or more, below zero, exceeding his P.E., he is beyond medical help and dies.

Coma Length

The length of time a character in a coma will survive without treatment, is again indicated by the P.E. Add one hour for each P.E. point. **Example:** P.E. 9 = 9 hours; P.E. 10 = 10 hours, and so on.

Recovery From a Coma

Whether a character survives the coma and is stabilized (brought back to, at least, one hit point above zero) is determined by the roll of percentile dice. If the player rolls two, successful recovery rolls out of three tries, the character breaks out of the coma and is no longer in danger of dying. This also means that he is brought up to one hit point above zero. Recovery of hit points from that time on are standard; see Recovery of Hit Points. **Note:** This can be attempted every hour.

Recovery Ratio (roll 2 out of 3)

- Treatment from non-professional, medical individual, but with medical skills: 1-18%.
- Treatment from an intern or nurse (R.N.): 1-32%
- Treatment from a doctor without proper facilities: 1-46%.
- Treatment from a doctor at a clinic (fair facilities): 1-56%
- Treatment from a hospital: 1-66%.
- Treatment from a major, large hospital: 1-70%.

Optional Recovery Side-Effects from Severe Damage/Near Death (Hit Points)

Roll on this table when a character has lost all of his/her hit points and has been near death (coma). **Impairment is permanent** as a result of the grave physical damage. **NOTE:** This is not a mandatory table, but is left up to the game master's discretion.

- 1-10 No permanent damage.
- 11-20 Major stiffness in joints; reduce P.P. by 2.
- 21-39 Minor stiffness in joints; reduce P.P. by 1.
- 40-55 Legs impaired; walk with a limp reduce Spd by 2.
- 56-70 Major scarring; reduce P.B. by 2.
- 71-82 Chronic pain; reduce P.E. by 1.
- 83-92 Minor brain damage; reduce I.Q. by 1.
- 93-00 Major brain damage; reduce I.Q. by 2 and M.E. by 1.

OPTIONAL DAMAGE RULES

A character receives serious physical damage when he loses a great amount of hit points. The following is a list of side effects from physical damage. The effects of the damage are generally temporary and cumulative. Thus, if a character suffers the loss of a great deal of hit points within a short time he will suffer the multiple affects of physical damage.

Roll each time severe damage is endured.

Roll Percentile	Damage	Minuses
1-14	Minor bruises and lacerations.	Spd - 2 - 1 to dodge
15-29	Severely bruised and battered muscles	P.P. - 1 Spd - 3
30-44	Damaged (sprain, pulled, cut, etc.) arm or shoulder.	P.P. - 3
45-59	Damaged leg or hip.	Spd is 1/2 - 2 to dodge
60-74	Damaged hand and/or wrist	P.P. - 1 P.S. - 2
75-89	Head Injury	- 5% on all skills; Spd - 2
90-00	Damaged back or pelvis.	P.E. - 1 P.P. - 2 Spd - 3

NOTE: None of these effects are permanent nor life threatening. Minuses apply to that one limb. Speed minuses affect the whole body. Remember effects are cumulative; roll each time the character is badly hurt.

Side-Effects from Physical Damage (Hit Points) (Optional)

Roll on this table when 75% to 99% (almost all) hit points are depleted. Impairment is temporary, lasting 1-4 weeks (roll one four-sided die).

Roll Percentile	Damage	Minuses
1-10	Severely battered and bruised	Spd - 2 - 3 to dodge
11-20	Torn arm muscle	P.P. - 3 P.S. - 2
21-29	Torn leg muscle	Spd is 1/2 - 2 to dodge
30-39	Fractured bone: arm	P.P. - 2 P.S. - 3
40-49	Fractured bone: leg	Spd is 1/2 - 4 to dodge
50-59	Fractured bone: ribs or pelvis	P.E. - 2 Spd is 1/2
60-69	Broken bone: arm	P.P. is 1/2 P.S. is 1/2
70-79	Broken bone: leg	Spd is 1/3 - 6 to dodge
80-89	Broken bone: ribs	P.E. - 3 P.P. - 1 Spd - 3
90-00	Severe Concussion	- 8 on all skills, Spd - 3

NOTE: None of these effects are permanent nor life threatening, although painful and debilitating. Minuses apply to that one particular limb. Speed minuses affect the whole body. Remember, effects are cumulative.

About blood loss. When a character is severely hurt, down to only 15% of his hit points and is bleeding; he will soon die of blood loss unless he or she receives immediate medical attention. Even a basic first aid and no or little movement can bind wounds and prevent further blood loss/damage. Without medical aid the person will continue to lose blood and take **one point (hit point) of damage every minute/4 melee rounds.**

STRUCTURAL DAMAGE CAPACITY, MEGA-STRUCTURES AND MEGA-DAMAGE

In this game there are three types of physical measures of damage or endurance.

Hit Point
S.D.C.
M.D.C.

HIT POINTS

Hit points might best be thought of as life points, because they indicate how much physical damage (cuts, bruises, wounds, etc.) a character can withstand before he or she dies. ALL living creatures have hit points. *Also see creating a character: Step 2 for details.*

S.D.C. or STRUCTURAL DAMAGE CAPACITY

There are two types of S.D.C. The first applies to living creatures and is a sort of supplement to hit points. The second applies to inanimate, non-living structures such as chairs, locks, doors, buildings, vehicles and so on.

Structural Damage Capacity (S.D.C.) points are similar to hit points, but represent physical toughness or endurance rather than life. Most living creatures, including Humans and Zentraedi, have S.D.C. points. S.D.C. in people is a sort of reserve stamina that enables them to suffer physical abuse, strain or pain, but keep on going. A perfect example is a boxer. A boxer has built up his body, toughening muscles and increasing his body's resistance to fatigue and pain through intense physical training. Now, if YOU (yes, you the reader) and this boxer engaged in hand to hand combat, you could deliver several punches to the boxer and he would barely feel it. One or two counter punches from the boxer will knock you to the ground. The point of this example is that the boxer has a much greater S.D.C. than a normal person. Consequently, he can take much greater physical punishment before he will begin to suffer from it.

Determining physical S.D.C. is simple. Each O.C.C. provides a base S.D.C. from training: 30 for Military Specialist; 25 for Destroid and Veritech Pilots; and 20 for all other O.C.C.'s. Additional physical S.D.C. are gained from physical skills, such as boxing. *All S.D.C. points are accumulative.*

Inanimate objects, such as buildings, vehicles, furniture and so on, also have S.D.C. In this case, the S.D.C. indicates the total amount of damage that the object can withstand. These S.D.C. function exactly like hit point except that they apply to non-living things. Any damage sustained is subtracted from the S.D.C. When the S.D.C. is reduced to zero it is broken or smashed beyond repair. **A NOTE TO THE GAMEMASTER:** The S.D.C. system just described is a standard rule in most Palladium Books® games. From time to time I hear the complaint, for example, how can somebody be bashing or shooting into a door and the door is in perfect condition until all its S.D.C. is depleted? My answer is; it's not in perfect condition. Using the example of the door, the G.M. should explain exactly what's happening. "You bash into the door with your shoulder. Its a very solid door and you inflict minimal damage (give S.D.C. damage). You realize that it will take quite a while to gain entry this way and you may hurt yourself." Or "You can feel the door give a little under your great strength (give S.D.C. damage). Another bash and the door frame cracks and moans, but it still holds (give S.D.C. damage). It will take another couple of attempts (as the door's S.D.C. dwindles), but it's definitely giving." Or "Your submachine gun riddles the wood door with a dozen holes (something the player can look through), but the door is still locked and holding strong." Obviously, attacks on normal objects will scrape, dent, crack, splinter, crumble and so on, even if the object is not destroyed. To smash or destroy something may require multiple attacks

and in some cases, like being locked behind an iron door or bulkhead without a weapon or proper tools, it will be impossible to damage the item at all.

Artificial armor, such as bulletproof vests and bionic or robotic armor, also has an armor rating (A.R.) and S.D.C. The armor rating indicates exactly how much protection is afforded by the armor and how easily it is penetrated. The higher the A.R. the better. If an attack roll to strike is less than the A.R. of the armor, the armor absorbs the attack; subtract the damage from the armor's S.D.C. When the armor's S.D.C. is depleted, it no longer affords protection and is useless.

If an attack roll to strike is higher than the armor's A.R. it penetrates the armor, inflicting damage to the physical body's S.D.C. (not the armor's S.D.C.) and/or hit points.

Note: A.R. only applies to S.D.C. and conventional vehicles, weapons and structures. A.R. does not apply to Mecha or Mega-Structures. See M.D.C. and Meg-Damage.

M.D.C. or MEGA-STRUCTURES and MEGA-DAMAGE

Mega-Damage Capacity (M.D.C.) is a damage system that will be new to most of you. It is a structural damage capacity that reflects staggering advancements in science and technology. A technology that has created new super-tough alloys, micronized energy sources, galaxy spanning vehicles, and weapons with more power, precision and range than any 20th century weapon.

In effect, M.D.C. is a *super-structural damage capacity* that far outstrips the normal S.D.C. **In the context of this specific book, M.D.C. applies to . . .**

- ALL Earth Mecha, such as the Veritech and Gladiator.
- ALL Alien Mecha, such as the Battle Pods.
- ALL Alien spacecraft.
- ALL Human spacecraft.
- Most vehicles and objects for war.

All of those listed are built to withstand incredible punishment . . . *mega-damage*. As such, they are in a class of their own.

M.D.C. vs S.D.C.

- 1) Generally, 100 S.D.C. (or hit points) equals about ONE M.D.C. point.
- 2) This also means that One Mega-Damage point does approximately 100 S.D.C of damage.
- 3) Most conventional weapons do absolutely no damage to a mega-structure, even when combined.
- 4) **Example:** The *Gladiator* defense mecha engages a group of *thirty rebel bandits*. The bandits are armed with conventional arms of submachine guns, grenades, and flamethrowers. Suppose they stay to fight this *one* mecha and ALL begin to shoot at him. The *Gladiator*, being 37ft (11.3 meters) tall, is an easy target, so everybody hits at least three times. The combined damage inflicted is 400 S.D.C., but the *Gladiator* walks out of the hail of bullets and explosives with only a few scratches and smudges on its paint job. **It took NO damage.**

The pilot sees ½ dozen bandits running toward a car to make a getaway. There's no need for excessive gun play, so the *Gladiator* fires one laser blast from its gun cluster (1D4 M.D.); it strikes (the roll to strike is 16) and does a mere 3, mega-damage points (M.D.). The car is blown in half because the 3 M.D. is equal to about 300 S.D.C., the FULL S.D.C. of the vehicle.

A full size *Zentraedi* steps out from behind a building firing a standard alien gun pod (it does mega-damage). The alien has initiative and fires four shots. Two miss entirely. Two are solid hits, doing full damage to the *Gladiator*; 1D6 mega-damage per each hit. In this case the damage rolled is low, 7 M.D. is inflicted (that's about 700 S.D.C.). A mere scratch to the *Gladiator*. Combat continues.

Mega-Damage (M.D.) and Mega-Structural Capacity (M.S.C.) Summary

1. One Mega-Damage Point (M.D. point) is about equal to 100 S.D.C. Always round S.D.C. down when assessing damage; for example, an object that has 219 S.D.C. is hit by 2 M.D. points of damage, the item is totaled (all 219 S.D.C.)
2. One Mega-Damage Point is also equal to 100 hit points.
3. Conventional weapons, normal grenades, automatic weapons, flamethrowers, even rams from an automobile, DO NOT harm mega-structures, such as Veritech Fighters, Starships, and all Human and Alien mecha.

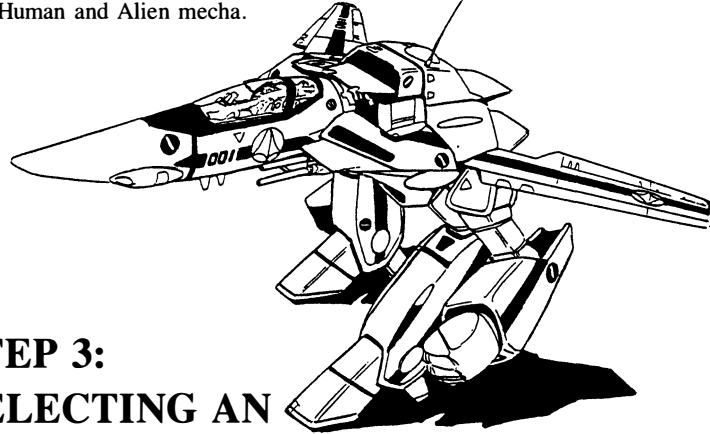

STEP 3: SELECTING AN OCCUPATION & SKILLS

For the sake of simplicity, each player chooses ONE Occupational Character Class (O.C.C.), with its small selection of O.C.C. skills, and additional training/ skills. Each O.C.C. indicates a major area of study and knowledge as is pertinent to the character's occupation. Unlike **Heroes Unlimited** or the **Palladium Role-Playing Game**, the skill selection is very limited and does not include secondary skills. However, players will find their characters to be capable, as well as different, from every other O.C.C. This quick character generation system will enable players to build characters quickly and completely. The scope of the establishing scenario setting is, in itself, limiting, so playing characters have been designed to fit snugly into that environment with maximum playability.

Each O.C.C. has skills or skill bonuses in areas not available to the other O.C.C.'s. Consequently, players may want to consider what O.C.C. their fellow players are selecting, in order to build a well rounded team or group of characters. Of course, this does not mean that every player should select a different O.C.C.; it simply means to consider the desired scope and versatility of your *team* when selecting an O.C.C. The same is true when selecting individual skills. The team with the most versatility and combined strengths is most likely to persevere (and this *is* a team oriented game). The cast of characters and their respective O.C.C.'s will depend on the number of players and personal preferences. I would recommend that players go with what they feel most comfortable playing and their instincts above all else.

O.C.C. REQUIREMENTS

The selection of an O.C.C. is limited only by the minimum attribute(s) requirement needed to play. The eight attributes should have already been determined by the roll of three, six-sided dice (see *Creating a Character: Step 1*). Generally, a player will be able to choose from two or three possibilities.

O.C.C. SKILLS

Each O.C.C. has two skill categories: O.C.C. Skills and Other Skills. O.C.C. skills are skills that everyone in that chosen occupation have trained in. They are basic and crucial skills to that occupation. **The Other Skills** are other areas of training and knowledge possessed by the character. They may augment the occupational skills or simply reflect other interests.

SKILL BONUSES

The base proficiency or skill level is denoted in each skill *description*. However, you'll notice that many of the skills, under every O.C.C., will have a skill bonus indicated. The skill bonus will be shown as a plus (+) symbol followed by a number. All skill bonuses are a one time bonus, applicable immediately. As the character grows in experience (via experience levels), the skill proficiency also grows. **NOTE: Maximum skill ability is 98% because there is always some margin of error.**

If NO skill bonus is indicated then this means there is no bonus available from that O.C.C. ONLY the unmodified, base skill proficiency is used.

See skill descriptions for specific explanations and proficiencies.

MULTIPLE O.C.C.'s

Considering the war torn conditions, it's unlikely that a character would really get an opportunity to study more than one area of expertise. Consequently, a multiple O.C.C. could be more of a hindrance than a help. However, for those of you who still desire a split character class, here are the rules and conditions.

1. The character must meet the physical and/or mental **attribute requirements**.
2. **Must first reach third level** or higher in his or her original O.C.C.
3. **Begins the New O.C.C.** at zero experience and at "field training level", which means the usual O.C.C. skills are selected, but NO BONUSES APPLY.
4. **Players must score 2000** experience points before attaining first level. At first level, all the usual bonus points are added to each skill and regular experience point accumulation begins at zero.
5. The previous/original O.C.C. skill knowledge and proficiency, and experience points, are permanently **frozen** at the point when the new O.C.C. was selected. This means that, while the character retains his previous O.C.C.'s skill knowledge and abilities, those skills are NOT increasing because he/she spends the bulk of the time in perfecting the new O.C.C. skills.

However, if the same skill is chosen in both O.C.C.'s, that skill will continue to improve, but ONLY beginning after it has reached the previous skill level. **Example:** If the skill is frozen at level three, it remains so until the skill level of the new O.C.C. reaches level three. At that point, the experience points/level can again apply to that skill and the character's skill proficiency in that particular area will continue to increase at the same level as his/her current O.C.C.

STEP 4: EQUIPMENT AND MONEY

All characters are issued a set of **standard equipment**, as well as equipment available in the field or under special conditions. Also assume each character has a number of "common", personal items, such as a modest wardrobe, stereo, video/TV, artwork, knickknacks, booze, and so on. Each character also has his own small, one bedroom, studio-type apartment. Characters can spend their income on a larger apartment, wardrobe, weapons, special items, and so on.

Money is referred to as credits. Each specific Occupational Character Class (O.C.C.) indicates the monthly salary in credits and the formula for determining the character's available savings in credits. Players may use their character's saving/credits as deemed appropriate.

STEP 5: ROUNDING OUT ONE'S CHARACTER

ALIGNMENTS

Good: Principled and Scrupulous
Selfish: Unprincipled and Anarchist
Evil: Miscreant, Aberrant and Diabolic

Alignments are an important factor in developing a character, his/her attitudes and moral principles. ALL players *must* choose an alignment for their character.

NEUTRAL

First of all, there is *no* such thing as an absolute or true neutral. All people tend toward good, evil or self-gratification. An absolute true neutral could not make a decision, go on an adventure, kill, or take any action of any kind without leaning toward good, evil or self-gratification. It is humanly impossible and is, therefore, eliminated in the context of this game. (I realize that some of the philosophers out there may disagree with this, but that's a topic for philosophical debate and not a factor of this game. Sorry, no neutrals).

GOOD ALIGNMENTS

Principled, Scrupulous

Because a character is of a good alignment, it does not make him/her a saint. Good characters can be just as irritating, obnoxious, arrogant, even prejudiced and full of quirks. However, life and freedom are of the highest priority. Such a person can always be trusted in a life and death situation. Ben Dixon is a good example of a lovable, but irritating, good guy.

Principled (Good)

Principled characters are, generally, the strong, moral character. Rick Hunter and Lisa Hayes are of a principled alignment, with the highest regard for other's lives and well-being, truth and honor.

Principled characters will . . .

1. Always keep his word.
2. Avoid lies.
3. Never kill or attack an unarmed foe.
4. Never harm an innocent.
5. Never torture for any reason.
6. Never kill for pleasure.
7. Always help others.
8. Work well in a group.
9. Respect authority, law, self-discipline and honor.
10. Never betrays a friend.
11. Never break the law unless conditions are desperate. This means no breaking and entry, theft, torture, unprovoked assaults, etc.

Scrupulous (Good)

Scrupulous characters value life and freedom above all else, and despise those who would deprive others of them. This type of hero is typically portrayed in many Clint Eastwood and Charles Bronson films; the person who is forced to work beyond the law, yet for the law, and the greater good of the people. They are not vicious or vindictive men, but are men driven to right injustice. I must point out that these characters will always *attempt* to work with or within the law whenever possible. Roy Fokker would fall into this alignment.

Scrupulous Characters Will . . .

1. Keep his word to any other good person.
2. Lie only to people of selfish or evil alignments.
3. Never attack or kill an unarmed foe.
4. Never harm an innocent.
5. Never torture for pleasure, but may use muscle to extract information from criminals or evil characters.
6. Never kill for pleasure; will always *attempt* to bring the villain to justice alive no-matter how vile he may be.
7. Always help others.
8. Attempt to work within the law whenever possible.
9. Bend and, occasionally, break the law when deemed necessary. This means they may use strong arm techniques, harass, break and enter, theft, and so on.
10. Distrust authority.

11. Work with groups, but dislike confining laws and bureaucracy (red tape).
12. Never betrays a friend.

SELFISH ALIGNMENTS (But Not Necessarily Evil)

Unprincipled (Selfish)

This, *basically*, good person tends to be selfish, greedy, and holds his/her personal freedom and welfare above almost everything else. He/she dislikes confining laws, self-discipline and distrusts authority. This is the Han Solo, Star Wars, character. The guy who is always looking for the best deal, associates with good and evil characters, is continually tempted to lie and cheat, and hates himself for being loyal and helping others. The beautiful, but self-absorbed, Lynn Minmei would be unprincipled.

Unprincipled Characters Will . . .

1. Have a high regard for life and freedom.
2. Keep his word of honor.
3. Lie and cheat if necessary (especially to those of anarchist and evil alignments).
4. Will not kill an unarmed foe (but will take advantage of one).
5. Help those in need.
6. Not use torture unless absolutely necessary.
7. Work with a group, especially if profitable.
8. Never harm an innocent.
9. Never kill for pleasure.
10. Dislike authority.
11. Never betray a friend.

Anarchist (Selfish)

This type of character likes to indulge himself in everything. He is the insurgent, con-man, gambler and high roller; the uncommitted freebooter seeking nothing more than self-gratification. This character will, at least consider, doing anything if the price is right. These people are intrigued by power, glory and wealth. Life has meaning, but his has the greatest meaning. Laws and rules infringe on personal freedom and were meant to be broken. An anarchist aligned person is always looking for the best deal, and will work with good, selfish or evil to get it; as long as he comes out of the situation on top. The anarchist is continually teetering between good and evil, rebelling, and bending the law to fit his needs.

Anarchist Characters Will . . .

1. May keep his word.
2. Lie and cheat if he feels it necessary.
3. Not likely to kill an unarmed foe, but, certainly, knockout, attack, or beat up an unarmed foe.
4. Never kill an innocent (but may harm or kidnap).
5. Not likely to help someone without some ulterior motive (even if it's only to show off).
6. Seldom kill for pleasure.
7. Use torture to extract information (not **likely** to torture for pleasure).
8. Not work well in a group (this is the cocky, loudmouth who is likely to do as he damn well pleases).
9. Have little respect for self-discipline or authority.
10. May betray a friend.

EVIL ALIGNMENTS

Miscreant

Aberrant

Diabolic

All evil characters are not bent on universal genocide or domination over all living creatures. They are not maniacal people actively seeking to harm innocent people. Nor are all evil characters sadistic and untrustworthy. Many evil characters may actually seem kind or likable.

There is nothing wrong with playing an evil character, although he may not survive too long if he betrays or harms too many people. This is fantasy role-playing, not reality. You can play any type of character

you desire, just continue to play in character.

Evil alignments are a step beyond the self-gratification of the selfish alignments. Evil characters are ruthless individuals who are willing to say or do anything to achieve their goal. Human life has little meaning to them, and friends tend to be (but not always) people to use and discard when they are no longer of value. Evil aligned people do not automatically slay any good aligned person because of different ethics and philosophy. All the better to use good to achieve their own goals, for the end always justifies the means.

Miscreant (Evil)

This self-serving, unscrupulous character is out only for himself. Power, glory, wealth, position, and anything that will make his life more comfortable is his goal. It matters not who gets caught in the middle, as long as he comes out smelling like a rose. This person will lie, cheat and kill anyone to attain his personal goals. Khyron is a perfect example of miscreant.

Miscreant Characters Will . . .

1. Not necessarily keep his word to anyone.
2. Lie and cheat anyone; good or evil.
3. Most definitely attack an unarmed foe (those are the best kind).
4. Use or harm an innocent.
5. Use torture for extracting information and pleasure.
6. May kill for sheer pleasure.
7. Feels no compulsion to help without some sort of tangible reward.
8. Work with others if it will help him attain his personal goal.
9. Kill an unarmed foe as readily as he would a potential threat or competitor.
10. Has no deference to laws or authority, but will work within the law if he must.
11. Will betray a friend if it serves his needs.

Aberrant (Evil)

The cliché that there is "No honor among thieves" is false when dealing with the aberrant character. This is a person who is driven to attain his goals through force, power, and intimidation. Yet the aberrant person stands apart from the norm with his own, personal, code of ethics (although twisted ethics by the standards of good). He expects loyalty from his minions, punishing disloyalty and treachery with a swift, merciful death. An aberrant person will always keep his word of honor and uphold any bargains. He will define his terms and live by them, whether anyone else likes it or not. Breetai and Exedore fit this category.

Aberrant Characters Will . . .

1. Always keep his word of honor (he is honorable).
2. Lie to and cheat those not worthy of his respect.
3. May or may not kill an unarmed foe.
4. Not kill (may harm, kidnap) an innocent, particularly a child.
5. Never kills for pleasure.
6. Not resort to inhumane treatment of prisoners, but torture, although distasteful, is a necessary means of extracting information.
7. Never torture for pleasure.
8. May or may not help someone in need.
9. Work with others to attain his goals.
10. Respect honor and self-discipline.
11. Never betray a friend.

Diabolic (Evil)

This is the category where the megalomaniacs, violent, and most despicable characters fall. This is the cruel, brutal killer who trusts no one and has no value for anyone or anything that gets in his way. Aberrant aligned characters find these unhonorable people just as revolting as a good aligned character. General Dolza fits this description.

Diabolic Characters Will . . .

1. Rarely keep his word (and have no honor).
2. Lie to and cheat anyone.
3. Most certainly attack and kill an unarmed foe.

4. Use, hurt and kill an innocent without a second thought or for pleasure.
5. Use torture for pleasure and information.
6. Kill for sheer pleasure.
7. Likely to help someone only to kill or rob him.
8. Not work well within a group (consistently disregarding orders to do as he pleases).
9. Despise honor, authority, and self-discipline.
10. Associate mostly, with other evil alignments.
11. Betray friends (after all, you can always find friends).

EXPERIENCE

An Experience Level System is used for two reasons: 1) to fit in with the other, Palladium Books, games and 2) because I've found it to be a fun and realistic system. After all, nothing can substitute for real experience, especially in a combat situation.

Readers will also notice that each Occupational Character Class (O.C.C.) has its own experience level tables. The varying levels of experience needed for each O.C.C. reflects the difficulty of certain skills or areas of study, as well as game balance.

EXPERIENCE POINTS

Except in specially devised scenarios and tournaments, there is no winner in a role-playing game. The accumulation of heroic deeds, friends, prestige, weapons, equipment, knowledge and skills, can be construed to be the results of winning. If a character survives and meets with success in his endeavors, that is winning. However, there are rewards besides the acquisition of material goods and reputations, and that's developing your character's skills, knowledge and abilities. This is accomplished through the gathering of experience points.

Why An Experience Point System?

The reason I use an experience point system is because I find them extremely realistic and practical. Training is useful, but there is no substitute for experience. I don't know how many times I've read a comic book with the main character thinking to himself; something like — "Only my years of experience enabled me to beat him.," or, "He's good, but lacked the years of experience and training to handle the situation". Practical experience in the field is an important and real factor in the development of a character.

The experience system is specifically designed so that characters will mature fairly rapidly, tapering off as they reach higher levels of experience (around fifth or sixth level).

Why do the experience levels only go to level 15? Because characters are not likely to ever reach that level, even after years of regular play. In my original, **Palladium Role-Playing Game**, play-test campaign; after two years of weekly, long (average 9 hours), playing sessions; the characters averaged 7th to 9th level and progressing, ever so slowly, toward tenth level. Realistically, a high level character is not, necessarily, all that fun to play, unless the campaign maintains a high level of challenge and adventure.

Experience Points and Their Application

It's difficult to devise a point system by which a game master can judge and reward his players fairly. The ultimate purpose of experience points and experience levels is to provide a means in which the player's character can grow and develop. Many fantasy role-playing games have their own unique system, charts, equations and computations for distributing experience points. You may want to adopt one of these systems to this game if that's what you're comfortable with.

On the other hand, I use a very subjective method of observation and logic. I feel that any twit can chop or blast a creature that has just pounced out from around the corner. Most experience points concentrate on the "kill factor", but what about the thought process? What about the decisions, plans, or motives for a particular action? Doesn't clever-

ness and a cool head count? Aren't these the true ingredients of good role-playing? It seems unfair to me that the person who devises a clever plan should get much less experience points than the players who carry out the plan because they are better skilled to do so. And what about role-playing? Shouldn't the brilliant medical student playing a character with an I.Q. of 3 (and staying firmly in character, saying and doing things as the character, even though he realizes the stupidity as a player) get experience for playing in character? Hell yes! Considering how flexible and subjective most of the other role-playing conditions and rules are, I don't see the logic in having a strict, limited, experience point system. So, here is my chaotic, subjective, experience system.

Each player's character, involved in a given situation/confrontation, should receive the appropriate experience points. The game master (GM) should make a list of his players at the beginning of the game and jot down each player's experience points as they gather them throughout the course of the game. At the end of the game, the GM totals each player's points and gives them each totals, so that they can keep track of their growing experience and skills.

The difficulty with this system of determining experience points is the subjectivity. The GM must utilize the preceding experience outline with some thought. **Example:** Eight, third level characters, armed to the teeth and in heavy armor, kill an average opponent. The eight players should receive experience points for killing a minor menace. After all, the creature didn't have a chance and presented no real threat to the characters. However, if one or two, first or second level characters killed or subdued the same opponent, they should receive experience points for killing a major or even a great menace, because the threat and the ingenuity involved is much greater.

I've found this method stimulates imaginative playing instead of promoting slash and kill. GM's, don't be Santa Claus, heaping wonderful amounts of experience points; be fair and tolerant. Let your players truly earn their experience points, growing in skill and knowledge. If you have a group of players rising rapidly in experience levels, you will know it's because they are clever and imaginative players. And that's what this game is all about.

Character (O.C.C.) Experience Levels

Each Occupational Character Class (O.C.C.) has a listing for Levels of Experience. A character involved in an adventure gains experience points for his thoughts, actions and deeds. As these experience points accumulate, the character will reach new plateaus, indicating his continual growth, development and mastery of his chosen O.C.C.; and the skills, knowledge and abilities involved. Each time a player's character accumulates enough experience in a particular O.C.C., his skills increase accordingly. This is why the skills are listed by levels.

A clever plan, a quick attack all earn experience points. The more experience a character receives, the higher the level he attains in that occupation; the greater the skills. **Players:** Be certain to keep a careful record of the experience given to you at the end of each game. When a character attains a new level, be certain to tell the GM so that your skills and hit points can be increased accordingly.

Experience and Hit Points

Each time a character reaches a new level of experience, the player gets to roll **one**, six-sided die and add the number rolled to the character's hit points. This indicates the physical development and maturity of the character as he develops.

Per Level of Experience

Per level of experience, or per each level of experience, or per level of the (and O.C.C.), indicates that the person can perform a skill, or ability at his highest level of experience. This often indicates the amount of damage that can be inflicted or a duration.

<u>Point</u>	<u>The Action</u>
25	Successfully performing a skill at a crucial time.
25	Clever, but futile idea.
100	Clever, useful idea or action.
100	Quick thinking idea or action.
200	A critical plan or action that saves the character's life and/or a few comrades.
400-1000	A critical plan or action that saves the entire group or many people.
100-300	Endangering the character's own life to help others.
500-700	Self-sacrifice (or potential self-sacrifice) in a life and death situation (like leaping in front of a blast, meant for someone else, to save that person, even though likely to die; or offering own life to save the group or another).
100	Avoiding unnecessary violence.
100-200	Deductive reasoning and/or insight.
50	Good judgment.
50	Playing in character bonus.
50-100	Daring (clever or not).
25-50	Killing or subduing a minor menace.
75-100	Killing or subduing a major menace.
150-300	Killing or subduing a great menace.

INSANITY

In the context of this game, we will assume that all our heroes are mentally and emotionally sound. Any insanities, developed from this point on, will be the result of trauma or, occasionally, physical damage to the head and/or brain.

Trauma

I've found that having a character roll on the insanity tables after a terrible trauma is very appropriate, realistic and fun; adding a new element to the game. What constitutes a traumatic experience is, in part, up to the game master and the actual situation.

The following is a guide to some traumatic situations requiring a roll on the Random Insanity Tables.

Long period of physical and/or mental torture.

Two to eight weeks: Roll once on the Insanity Table. Nine weeks to months: Roll once on the Insanity Table and once on the Neurosis Table.

Drug Induced Hallucinations that were particularly terrifying, hideous, or realistic.

Roll once on the Phobia Table. If extremely traumatic, lengthy, or reoccurring hallucinations: roll on the Random Insanity Table. A real life encounter with the subject of the traumatic hallucination is likely to cause more trauma. 70% chance of developing another insanity; roll on the Random Insanity Table.

Witnessing or experiencing a shockingly grotesque atrocity.

Roll on the Phobia Table.

Terrible, frightening or unusual brush with death.

Roll on the Random Insanity Table.

Witnessing the terrible or shocking death of a deeply loved one.

Roll on the Psychosis Table.

Severe physical disability

60% chance of alcoholism or drug addiction.

The cause (accidental) of several innocent people's death.

(applies to characters of a good alignment).

Roll on the Random Insanity Table.

INSANITY TABLES

RANDOM INSANITY TABLE

(Resulting from Trauma) Roll percentile dice.

- 1-10 **Reborn**; Alignment reversal; good becomes evil, evil becomes good (selfish becomes principled or scrupulous).
 - 11-20 **Neurosis**; Roll on the table that follows.
 - 21-25 **Compulsive Liar**; even if of a good alignment.
 - 26-30 **Kleptomaniac**; a compulsion to steal, even if of a good alignment.
 - 31-40 **Obsession**; roll on the table that follows.
 - 41-50 **Phobia**; roll on the table that follows.
 - 51-60 **Psychosis**; roll on the table that follows.
 - 61-70 **Fear of Animals**; see neurosis.
 - 71-80 **Recluse**; prefers to be alone, quiet, unobtrusive.
 - 81-90 **Affective Disorder**; roll on the table that follows.
 - 91-00 **Fear of the Dark**; see neurosis.
- Note:** More than one phobia, obsession, psychosis, and affective disorder is possible. If the same one is rolled, ignore it and roll again.

RANDOM INSANITY TABLE (Optional)

- 1-19 Affective Disorders
- 20-45 Neurosis
- 46-65 Phobia
- 66-85 Obsession
- 86-00 Psychosis

AFFECTIVE DISORDERS

- 1-19 **Frightened** by loud noises to the point of cowering and wetting self.
- 20-35 **Disgusted** by anything sticky, and will go to *any* length to avoid touching it.
- 36-54 **Obsessed** with cleanliness, and must clean up any area he/she is at for more than a few minutes.
- 55-75 **Outraged** by acts of violence, becoming violent himself; 72% chance of going berserk and attacking the perpetrator of the violent act without regard for self. Bonuses: +1 to strike, +2 to damage.
- 76-88 **Hates** music and musicians, and will try to destroy or stop the source of those terrible noises.
- 89-00 **Intimidated** by spoken language; cannot speak meaningful sentences, and must use sign language or written communication.

NEUROSIS

- 1-18 **Fear of the Dark** (spent much time locked in closets) to the point of gibbering and total collapse while in the dark.
- 19-34 **Fear of Animals** (chewed on by the family pet while a nipper) to the point of running away when confronted by small, furry things.
- 35-49 **Cannot tell the Truth**; compulsive liar, even if of a good alignment.
- 50-64 **Invasion of the Body Snatchers**: Acute paranoia toward all aliens, those of alien heritage and even humans born off of Earth. ("They're out to get ya! They could be anybody!! even . . . you!?!").
- 65-85 **Fear of Heights** (Uncle Goober used to dangle the character, by one foot, out of windows) to the point of being frozen above the second story; character is fine as long as ground is not visible.
- 86-00 **Fear of Success** (mom always said you weren't any good): character will sabotage self at critical moments. The following minuses apply during critical, or high pressure moments (battle, danger, watched by others, etc.): -15% to all skills, -3 to hit, dodge, parry and damage.

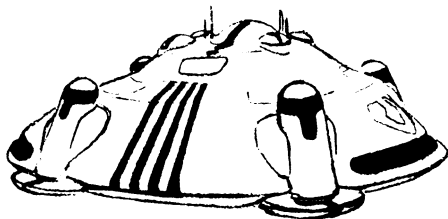

PSYCHOSIS

- 1-15 **Hysterical Blindness** when under pressure, 1-89% likelihood of happening — roll for each situation.
- 16-28 **Paranoid type**; everyone is out to get you/trusts no one.
- 29-49 **Manic depressive**; alternate severe depression one week (suicidal, nobody loves you — -5% on all skills) with manic episodes the next week (everything is great and I'm the best that there ever was! — +5% on all skills). 30% chance of alcoholism.
- 50-73 **Schizophrenia**; you are passive and easily frightened; jumpy. You hear voices telling you that all the angels are dead; worry about what angels are. 50% chance of alcoholism or drug addiction.
- 74-85 **Mindless aggression**; roll percentile:
- 1-94 Semi-functional: when frustrated, angry, or upset, there is a 72% likelihood of going berserk and lashing out at anyone/everyone around until killed or confined; will take 3-18 minutes of confinement to regain composure.
 - 95-00 Non-functional/homicidal: Continually going berserk until confined or killed; have one lucid day a week and try to talk your way out of confinement.
- 86-00 **Become a psychiatrist** and try to cure everyone around (they're all sick, even if only you have the perspicacity to tell); be sure to demand stiff fees.

PHOBIAS (A deep, overriding fear)

- 1-5 Insects
- 6-10 Reptiles
- 11-15 Boats
- 16-18 Opposite Sex
- 19-20 Dogs
- 21-25 Darkness
- 26-30 Confining Enclosures
- 31-35 Warehouses/Abandoned Buildings
- 36-40 Contamination
- 41-45 Zentraedi (especially micronized)
- 46-50 Heights
- 51-55 Space Fold (teleporting)
- 56-60 Aliens
- 61-65 Water
- 66-70 Drugs
- 71-75 Robots (not necessarily mecha)
- 76-80 Flying
- 81-85 Police
- 86-90 Computers
- 91-92 Strangers
- 93-95 Cats
- 96-00 Open Spaces

Note: If the same phobia is rolled, the player must re-roll.

OBSESSIONS

Obsessions are either an intense, irrational love/desire of something, or an intense hatred/loathing. The former is likely to cause the obsessed person to obtain his desire, while the latter is likely to cause the obsessed person to avoid or destroy the object of his obsession. *The game master*

can decide which is most appropriate under the circumstances or roll once on the following table . . .

Focus of the Obsession

- 1-50 Love/Desire
- 51-00 Hate/Destroy

Obsessions

- 1-5 Timeliness (either a fanatic about being punctual or always late).
- 6-12 High technology (either loves to acquire/use or loathes it).
- 13-20 Women (or men, if a woman character)
- 21-27 Wealth
- 28-35 Secrecy (either prizes his secrecy above all else, or abhors even the thought of keeping secrets).
- 36-43 Specific individual.
- 44-50 Specific object/item or animal.
- 51-55 Appearance (fashion plate or slob).
- 56-63 Danger (either loves the thrill of danger, which usually means throwing caution to the wind, the more deadly the better; or, despises danger, overly cautious, worry wart, jumpy).
- 64-70 Food (covets only the finest foods and drink, or would, just as readily, eat worms and stale food as anything else; a slob).
- 71-78 Alcohol (either a heavy drinker with a keen taste for the finest liquor, or a fanatical, anti-alcohol prude).
- 79-86 Gambling (will bet it all, or an anti-gambling fanatic).
- 87-92 Solitude (either loves quiet and being alone to the point of growing irrationally angry and frustrated if continually bothered or interrupted; or can't stand the thought of being left alone for even short periods of time).
- 93-00 Gods and/or clergy (feelings may be directed at a specific deity(s), clergy-member, or religion, church or sect).

Note: This insanity may drive a character to incredible, even outrageous lengths, to satisfy his or her obsession.

CURES FOR INSANITY

Affective Disorder or Neurosis: Therapy and counseling, and/or the use of hypnosis. Requires a minimum of three months of therapy, with the following results:

- 1-29 No effect; requires another three months of therapy.
- 30-69 Half cured; person feels occasional return of old neurosis or disorder when under stress, 48% chance.
- 70-00 Total cure.

Psychosis: Therapy and possible use of hypnosis and drugs to control the moods and tension/stress. Requires a minimum of six months of therapy with the following results:

- 1-33 No effect; requires another six months of therapy.
- 34-68 Psychosis replaced by phobia.
- 69-00 Total cure.

Phobia: There is no cure for phobias, but prolonged or repeated exposure to the object of the fear will lessen the intensity of the fear. Requires a minimum of three months of therapy with the following results:

- 1-39 No effect; requires more therapy.
- 40-88 Fear is lessened, so that the person can function normally, but he/she still doesn't like the phobia object — ugh!
- 89-00 Fear is intensified, so that there is a 50% likelihood that the person will become completely paralyzed until the source of the fear is removed, or the person is physically removed.

Therapy sessions generally cost 75 credits each, with two sessions per week (this includes treatment for each category of insanity). Similar therapy can help obsessions.

AFFECTS OF ALCOHOLISM

(Roll for effects and disposition while intoxicated)

- 1-10 Mean, hostile, strong; +2 to damage.
- 11-20 Quick temper, argumentative; +1 on initiative, -1 to parry or dodge.
- 21-30 Impulsive, takes risks; +2 on initiative.
- 31-40 Quiet, withdrawn; -2% on all skills.
- 41-50 Paranoid, trusts no one, agitated; +1 on initiative.
- 51-60 Moody, sad; -5% on all skills.
- 61-70 Secure/self-assured only while intoxicated; -2% on all skills when sober.
- 71-80 Depressed, pessimistic; -5% on all skills.
- 81-90 Hyper, agitated, always moving, distracted; -2 on initiative.
- 91-00 Super syndrome; believes he/she is best when intoxicated. +5% on all skills when intoxicated, -10% when sober.

Totally Drunk (staggering)

The alcoholic is in a totally, drunken state, 25% of the time (intoxicated as often as possible — 80% of the time), and tends to drink even more during a crisis — 50% of the time.

When totally drunk, the following penalties apply:

- -4 on initiative.
- -2 to strike, parry and dodge.
- Reduce speed by half.
- Reduce *all* skills by 12%

Alcoholism can be cured, and requires willingness to seek aid, abstinence from all alcohol, therapy and support of friends.

Withdrawal Symptoms:

First Week: -5% on all skills, -2 on initiative, strike, parry and dodge. Very sick, shaky, insecure. 40% chance will go back to drinking.

Second Week: -2% on all skills, -2 on initiative; -1 to strike, parry and dodge. Still shaky, insecure, craves alcohol. 20% chance will fall back to drinking. Roll for both weeks.

Third through Sixth Week: -2 on initiative. Still shaky, insecure, but feeling more confident. 13% chance will fall back to drinking. Roll for each week.

The next six months: Now it's a battle to stay dry; 15% chance the character will return to alcohol under extreme pressure. Roll for each pressure situation, such as near death (of self or friend), major failure, crucial situation relying heavily or entirely on the person, etc.

After those six months: There is still a possibility of returning to drink when under extreme pressure, as explained above; 5% in a crisis. If the ex-alcoholic should ever drink alcohol again, there is a 43% likelihood of becoming addicted again. Roll for each *drink*. Note: A character can attempt to fight alcoholism repeatedly, regardless of numerous failures.

THE AFFECTS OF DRUG ADDICTION

Drug addiction is generally more severe in its effects and initial withdrawal symptoms. However, once detoxified/dry, the person is less likely to return to drugs than an alcoholic. Most references to drug addiction refers to hard drugs, such as L.S.D., heroin, P.C.P., barbiturates (downers), amphetamines (speed), cocaine derivatives, and mood altering drugs.

Roll for effects and disposition while intoxicated

- 1-10 Quick temper, argumentative; +1 on initiative.
- 11-20 Totally passive, will *not* attack, confused, wants to be left alone. -5 to parry, dodge, and roll with punch or fall.
- 21-30 Extremely paranoid. Trusts no one, not even friends; +1 on initiative.
- 31-40 Disoriented. Has difficulty following movement; -4 to parry and dodge, -2 to strike.
- 41-50 Hallucinations. Totally oblivious to reality; -4 to parry and

dodge, 50% chance of not recognizing friend or foe, or attacking a friend (thinking him an enemy), or not recognizing danger, or cringe in terror of battle phantoms.

- 51-60 Withdrawn, quiet; -6% on all skills
- 61-70 Secure/self-assured only while high; -4% on all skills when not on drugs.
- 71-80 Depressed, pessimistic; -8% on all skills.
- 81-85 Reoccurring hallucinations when under severe pressure/combat. 43% chance of reoccurrence/flash-back, same as hallucination listed previously.
- 86-91 Hyper, agitated, always moving, distracted; -2 on initiative, -2% on all skills.
- 92-00 Super syndrome; believes his abilities are heightened by drugs; +1 to strike, parry and dodge; +6% on all skills when high. -1 to strike, parry and dodge; -12% on all skills when straight (not on a drug-high).

General notes concerning drugs:

- Takes 15 to 20 minutes to take effect.
- Affects last 45 minutes to two hours.
- Remains in system, even after the high is gone, for 48 hours.
- Addicts *need* a continual supply, taken at least once or twice a day (or more often, depending on the drug and desired effects).

Drug addiction can be cured, and requires a willingness to seek treatment and being slowly weaned off its dependency by gradual substitutes. Total withdrawal, or going "cold turkey", is the sudden abstinence from any drugs.

Withdrawal Symptoms (cold turkey)

First Week: -35% on all skills, -8 on all combat skills, violently ill; nausea, vomiting, cramps, etc. Requires regular observation and facilities. 75% likelihood of taking the drug if it's available.

Second Week: -20% on all skills, -4 on all combat skills, very weak, shaky, nauseous. 50% chance of taking the drug if it's available.

Third Week: -10% on all skills, -2 to strike, parry and dodge. Weak and insecure, but feeling considerably better. 28% chance of taking the drug if available.

Fourth Week: Completely detoxified, only psychological addiction remains. 14% chance of taking the drug if made available. Suggest continued therapy/counseling.

The next six months: This is the battle to stay dry. 10% chance will return to drugs if under extreme pressure.

After those six months: There is little chance of turning to drugs, even under pressure; 3% chance.

Note: A character can attempt to fight addiction repeatedly, despite numerous failures to do so.

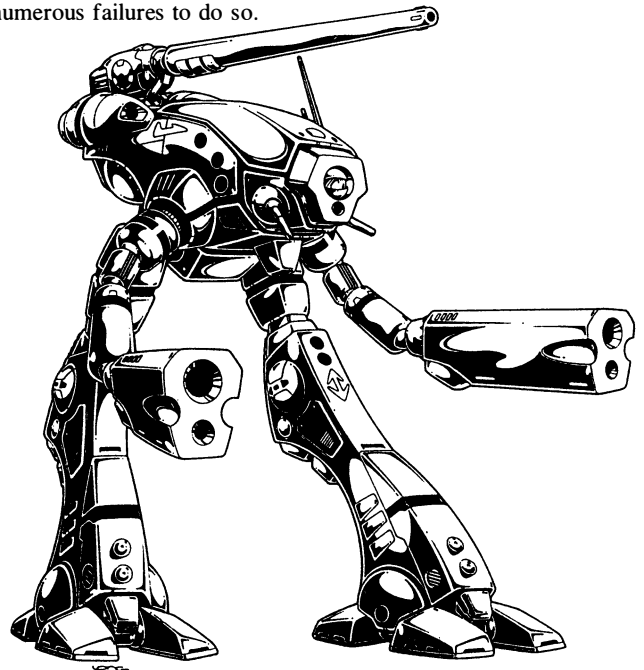

OPTIONAL RULES

Optional Ways to Round Out Your Character

I've found that many players like as much background and details about their characters as possible. Consequently, I've assembled a series of optional tables to satisfy those details. All tables require the roll of percentile dice.

Age

I think it's best to generally assume most characters are young; late teens to mid-twenties.

- 1-30 Late Teens (16, 17, 18 or 19)
- 31-60 Early Twenties (20-22)
- 61-80 Mid-Twenties (23-25)
- 81-00 Late Twenties (26-28)

Weight

- 1-20 Skinny
- 21-40 Average
- 41-60 Husky
- 61-80 Potbelly
- 81-00 Obese

Note: Average weight:
150 to 180lbs, male
110 to 140lbs, female

Height

- 1-30 Short
- 31-70 Average
- 71-00 Tall

Note: Average height:
6ft, male
5ft 6in, female

Land of Origin

- 1-18 Asia
- 19-37 Europe
- 38-60 North America
- 61-75 South America
- 76-89 Mars Base
- 90-00 Moon Base

Relationship to the Other Characters

(Roll for each character in the group)

- 1-15 Brother or sister.
- 16-25 No relationship developed yet.
- 26-42 Friends.
- 43-50 Finds him or her irritating, but basically okay.
- 51-60 Old classmates (school or military).
- 61-70 No relationship yet developed.
- 71-85 Dislikes the other.
- 86-96 Cousins
- 97-00 Friends

Family Ties: Parents

- 1-25 Died in civil war.
- 26-40 Both alive and well.
- 41-80 Both died in the Zentraedi global assault.
- 81-90 Only one still alive; 1-50 father, 51-00 mother.
- 91-00 Orphan, never knew your parents.

Birth Order

- 1-30 First Born
- 31-60 Second Born
- 61-90 Last Born
- 91-00 Illegitimate

Disposition

- 1-10 Hate Zentraedi, very prejudiced, distrust all aliens.
- 11-15 Shy, timid, tends to be a loner.
- 16-20 Gung-ho, guts and glory type who sees self as a hero. Likes combat.
- 21-25 Worrywart, nervous and cautious.
- 26-37 Hot-head, quick-tempered, emotional, but basically nice.
- 38-45 Schemer, gambler who likes to take chances.
- 46-50 Blabber mouth, nice guy, but too talkative.
- 51-56 Wild man, cocky, overconfident, takes unnecessary risks.
- 57-66 Nice guy, friendly, courteous and hospitable.
- 67-76 Snob, arrogant, feels superior to others.
- 77-84 Tough guy, self-reliant, cocky, a lone wolf.
- 85-89 Paternal, overbearing, overprotective of others, especially young characters.
- 90-94 Complainer, constantly aggravated about something.
- 95-00 Paranoid, trusts no one.

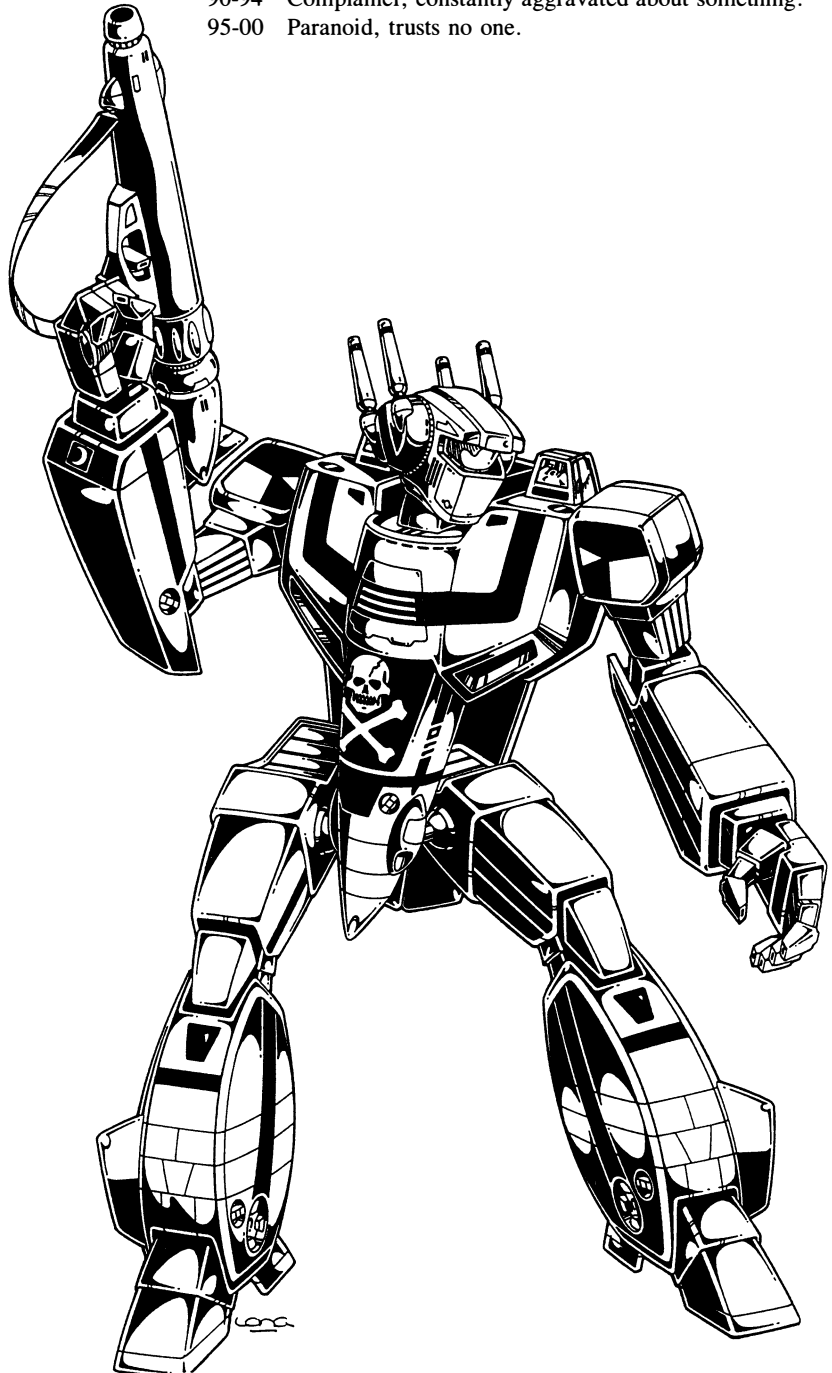

OCCUPATIONAL CHARACTER CLASSES (O.C.C.)

Human O.C.C.

Destroid Pilot
Veritech Fighter Pilot
Communications
Electrical Engineer
Field Scientist
Mechanical Engineer
Military Specialist

Requirements

I.Q. 6
I.Q. 8, P.P. 9
I.Q. 10
I.Q. 7
I.Q. 12
I.Q. 7
I.Q. 10, P.P. 10

Note: All O.C.C.'s can select skills which enable the character to pilot Destroids, although not quite as proficiently as the Destroid O.C.C. Considering the war torn nature, the ROBOTECH® world, it's probably wise that all players select the Mecha piloting skill, but this is *not* mandatory. Only the Veritech Fighter Pilot O.C.C. skill offers the use and training of the transformable Veritech Fighter. The term "*Other Skills*" refers to other areas of training the character can select. These are broken into 12 categories. Each category contains a number of skills. In some cases the category contains several skills, in other, only a few, while still others will be offered only a limited number of skills to a particular O.C.C. or totally off limits.

SELECTING AN O.C.C.

When selecting an O.C.C. it is important to bear in mind the type of ROBOTECH® scenarios or campaign your game master intends to run. Is it recapturing the basic Macross T.V. saga? Space adventures? Predominately combat? Exploration? These are important things to know before selecting an O.C.C. and building a character any further.

Generally, I think most players will be playing in the post-destruction of Earth period which picks up where the Macross Saga ends (with the destruction of the SDF-1 and 2) and prior to Sentinels and Southern Cross. This is a period of great civil unrest with local, new and old governments vying for power; continual Zentraedi uprisings and assaults; human and alien rebels, bandits, mercenaries, rogues, and cutthroats of all kinds eager to take advantage of this grim circumstance. It is a desperate world beset by famine, broken communication and the threat of alien invasion. It is a world that has been pushed to the edge of oblivion and is struggling to climb out of the abyss. It is your job to protect and aid the strong, yet desperate people who struggle to rebuild their shattered lives in a world gone mad.

As members of the Robotech Defense Force, you represent the last bastions of hope, civilization, law and order. Only you and your fellow RDF volunteers can help snatch the Earth and honest people out of the greedy hands of those who would feed on the innocent and helpless. Like the Texas Rangers of old, you are a few men and women trying to keep peace in a vast, troubled world.

Most of civilization has been destroyed. Except for a few major cities, humanity is scattered in little pockets among great desolation. In many cases, your RDF unit of a dozen or less Veritech Fighters and/or Destroids, represent the only law within 10,000 miles. More likely than not, your characters will be assigned to remote and hostile areas to enforce law and order, protect the people, hunt down fugitives, stop smugglers, investigate rumors, locate Zentraedi forces, suppress Zentraedi and rebel assaults, and generally assist the civilian populace.

When selecting your O.C.C. you should definitely remember the environment you will be active in. Try to select skills that will help you and your teammates to survive. Remember, this is ultimately a war story, so all characters should probably have at least a couple of combat type skills, such as weapon proficiencies (W.P.), hand to hand combat, pilot Mecha, pilot some other type of vehicle, and so on. It is wise to have a character that is not completely helpless or without practical skills when he or she is outside of a Veritech Fighter or

Destroid. Not all the adventures will be duking it out in a giant battle armor. The character in a well balanced campaign will have to step down out of his Mecha and function in the real world and in combat situations. There are also other deadly, fast and versatile vehicles like the assault helicopter and RDF motorcycle, so don't limit your options to just Mecha. The choices are yours; enjoy!

GAME MASTER'S NOTE

Let the players select their O.C.C. as well as desired type of Destroid (with the possible exception of the M.A.C. II), unless it will ruin the continuity of your campaign. If everyone wants to play Veritech Fighter pilots or the same type of Destroid, it's okay. If they want to play all different O.C.C.'s and Destroids, that's okay too.

Veritech Pilots will always start off piloting the VF-1A model. After a while, if the character proves himself to be an ace or becomes a low ranking officer, he will be assigned his own VF-1J and allowed to customize it to his or her own taste (these are only cosmetic changes). Squadron leaders and second in commands are assigned the VF-1S, but only after they have proven themselves.

Destroids are automatically assigned to the Destroid pilot. Although the pilot will usually be assigned one, specific type and specific Destroid as his/hers, the pilot is trained to pilot any of the five, non-transformable battloids. Thus, the pilot may be assigned or able to select, different types of Destroids from time to time, depending on the situation or special assignment. Even the remote Robotech Defense Force outposts and bases will usually have a half dozen to a dozen back up units; commonly the Gladiator, Excaliber and Raidar X; the Spartan may also be available. The M.A.C. II is never a back up unit, but one may be assigned, with pilot, to the base, and may be available for temporary loan (50% chance of the regular pilot staying with the M.A.C. II, even on loan).

Even O.C.C.'s other than the Destroid pilot can learn to operate a Destroid, but rarely with the skill and versatility of the pilot O.C.C. The GM should allow the O.C.C.'s access to the Destroids, although you may want to limit availability to two or three specific types and only for specific missions. If the group of characters are on constant patrol in remote areas don't be skimpy, let anyone who can pilot one have one; the group's likely to need the muscle.

About the hand to hand combat skills. In many instances the player can upgrade the character's hand to hand at the cost of one of the "other" skills. This refers to trading in one of the, so called, "other" skills to get a better hand to hand. This is an option left solely up to the player, but you should remind Mecha pilots that the better the hand to hand, the better their Mecha combat abilities.

Check the skill descriptions because, in many cases, very specialized skills like Mecha Combat and Pilot Mecha, have limitations or additional skill costs.

Equipment, other than those provided in the O.C.C. section, can be assigned or purchased. Each character draws a salary and has some sort of personal savings. If enlisted in the Robotech Defense Force, a modest apartment will be furnished. In remote areas, a RDF base will be established in or near a town or small city. Here additional equipment and supplies will be available upon assignment (especially weapons, missiles, repairs, etc.) or available for purchase in town. The base and/or town may or may not have laboratory or medical facilities. The remotest areas have minimal facilities.

Destroid Pilot O.C.C.

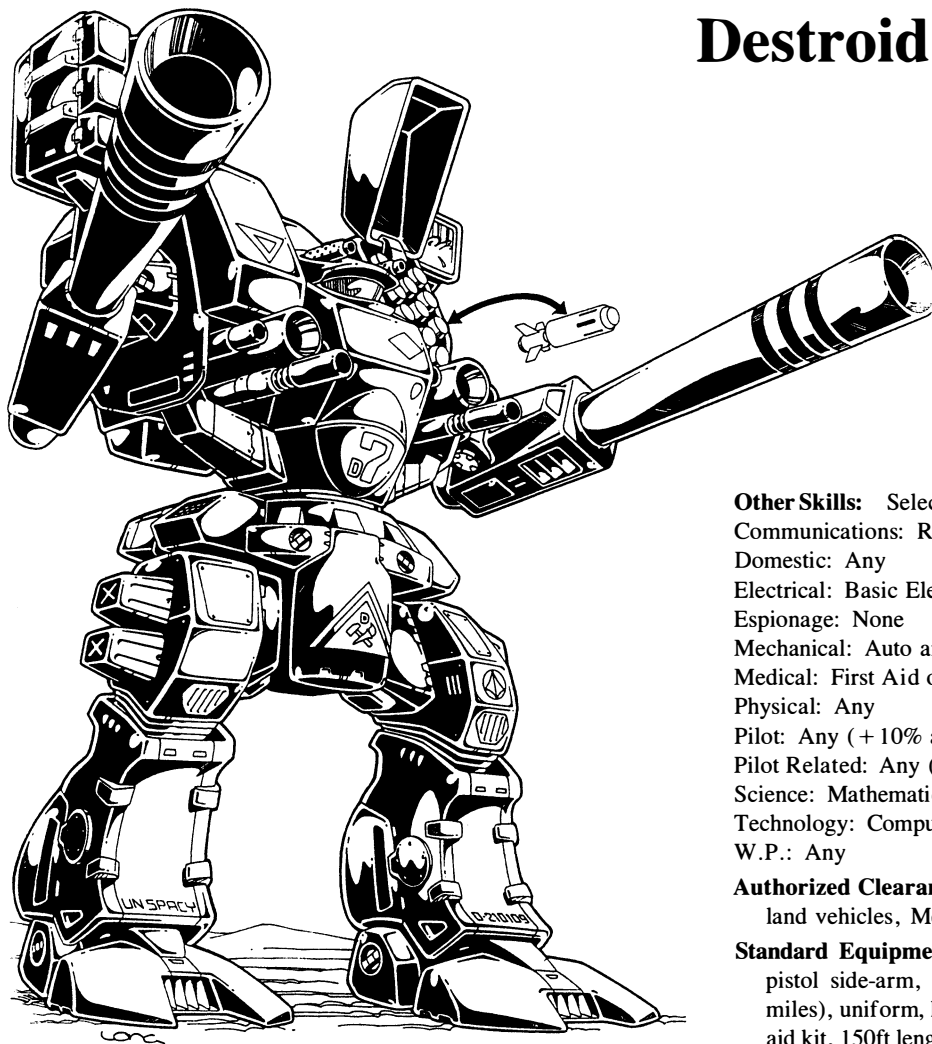

Other Skills: Select 14 other skills; 2 must be additional Pilot skills.

Communications: Radio skills only

Domestic: Any

Electrical: Basic Electronics only

Espionage: None

Mechanical: Auto and Mecha mechanics only (+5%)

Medical: First Aid only

Physical: Any

Pilot: Any (+10% aircraft/+15% land vehicles)

Pilot Related: Any (+20%)

Science: Mathematics; basic only

Technology: Computers skills only

W.P.: Any

Authorized Clearance Upon Assignment: Laser pistol, laser rifle, land vehicles, Mecha and spacesuit.

Standard Equipment: One, regularly assigned Destroid; automatic pistol side-arm, semi-automatic rifle, wrist radio (short range, 8 miles), uniform, helmet, binoculars, food rations (two weeks), first-aid kit, 150ft length of nylon cord, 3 signal flares, canteen, 2 gallons of water stored and cooled in the Mecha, sleeping bag, flashlight and combat body armor.

Monthly Wages: 2000 credits per month for enlisted men at levels 1-4; 5th level and higher — 2500 credits per month, while officers make 3000 to 4000 credits per month.

Personal Savings: 4D6 × 100.

The Destroid pilot is the elite grunt of the Robotech Defense Force. This character is trained in the operation of the most formidable, frontline, assault and defense mechanism ever devised by mankind; the Destroid. These 50ft metal giants are non-transformable Battloids, packing more firepower than ten tanks. *See Destroid descriptions.*

The Destroid pilot is the only O.C.C. that formally trains the character to pilot all non-transformable Mecha. After the initial training, the character receives *Mecha combat* training in two, specific types of Destroids (choose two). This training provides the pilot with maximum combat abilities. Additional Mecha combat can be selected without limit. Thus, a character may be adept in the piloting of all five Destroids. Each additional Mecha combat skill counts as one skill.

In addition to the O.C.C. skills listed with their bonuses, the player can select "Other" skill areas. These additional skills are limited only as stated.

Attribute Requirements: I.Q. 6; high P.P. is preferred, but not a prerequisite.

O.C.C. Skills:

Pilot Automobile (+10%)

Pilot Mecha (all Destroids) (+20%)

*Mecha Combat (choose two)

Weapon Systems (+15%)

**Hand to Hand Basic

W.P. Semi & Fully Automatic Rifle

* Additional Mecha combat can be selected with the "other" skills available.

** Hand to hand basic can be upgraded to Expert at the cost of one skill.

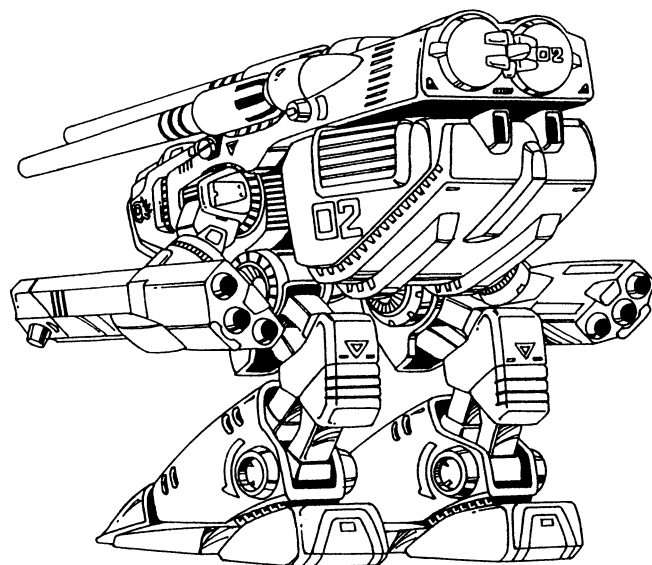

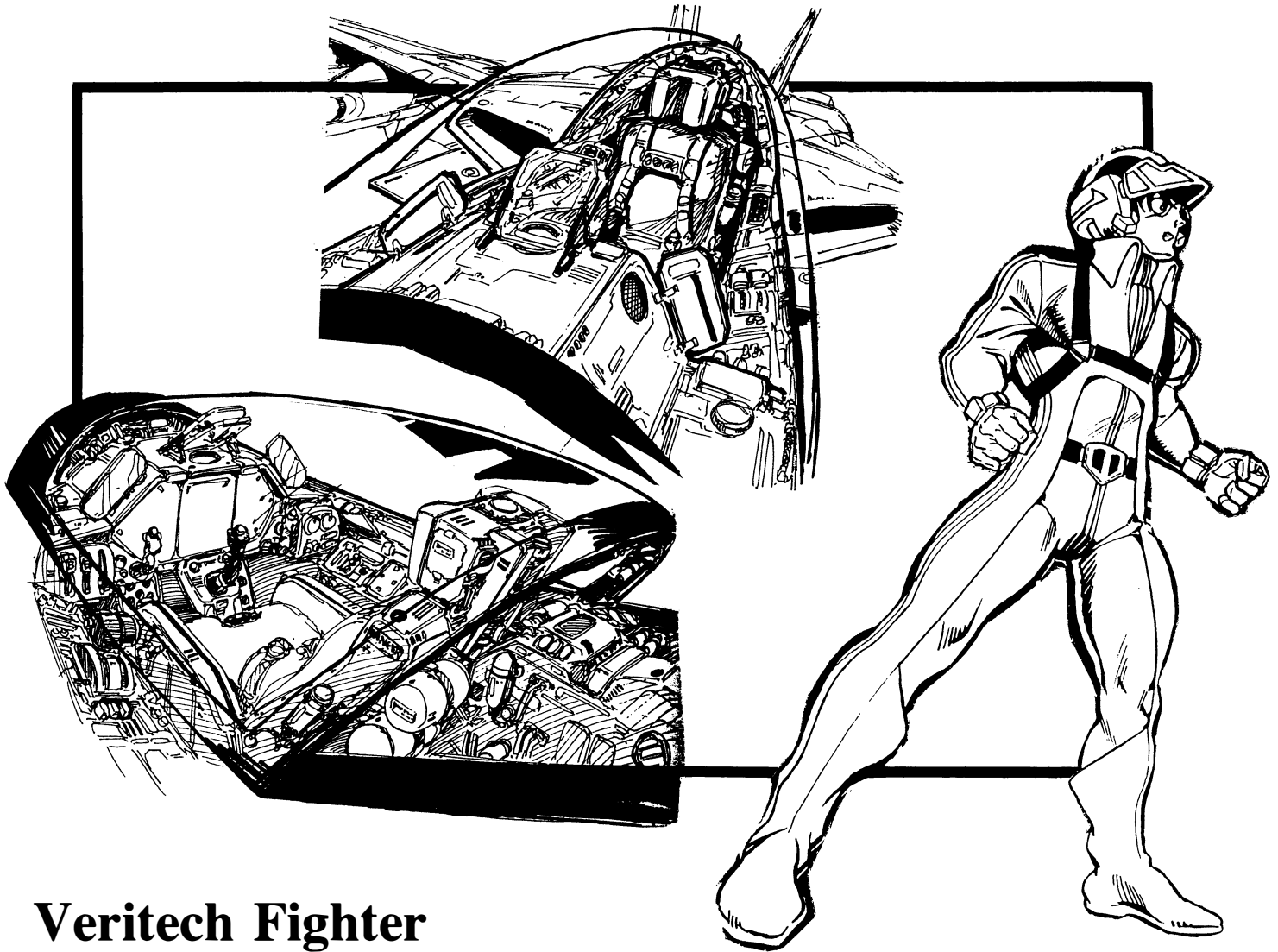

Veritech Fighter Pilot O.C.C.

The Veritech Fighter pilot is the very elite of the Robotech Defense Force. These characters are the only people trained to pilot the transformable Veritech Fighter. The Veritech Fighter is the most versatile and mobile of all the Mecha and the backbone of the Robotech Defense Force. *See Veritech Fighter descriptions.*

The Veritech pilot is taught every aspect of his machine under the most difficult combat conditions on land, in the air, and space. Although a Veritech Fighter pilot *can* learn to pilot Destroids, it is not part of the formal training and must be selected as one of the character's *other* skills. Each additional Mecha combat skill counts as one skill.

In addition to the O.C.C. skills listed, with bonuses in parenthesis, the player can select "other" skill areas. These additional skills are limited only as stated.

Attribute Requirements: I.Q. 8; P.P. 9 or higher is preferred.

O.C.C. Skills:

Pilot Jet (+20%)

Pilot Veritech Fighter 70% + 3% per level of experience

Mecha Combat: Veritech Fighter only

Weapon Systems (+20%)

Read Sensory Instruments (+15%)

Navigation (+15%)

*Hand to Hand Expert

*Hand to Hand Expert can be changed to martial arts, but costs one skill.

Other Skills: Select 14 other skills. One must be an additional, aircraft pilot skill.

Communications: Radio skills only.

Domestic: Any

Electrical: Basic electronics only.

Espionage: None

Mechanical: Auto, aircraft, Veritech and Mecha mechanics only (+5%)

Medical: First aid only.

Physical: Any

Pilot: Any (+10% on all aircraft)

Pilot Related: Any (+10%)

Science: Mathematics basic only.

Technology: Computer and photo skills only.

W.P.: Any

Authorized Clearance Upon Assignment: Laser pistol, laser rifle, land vehicle, aircraft, combat body armor and Mecha. The body armor is clunky and *rarely* used by the Veritech Fighter pilot.

Standard Equipment: One, regularly assigned Veritech Fighter (VF-1A for enlisted men; VF-1J for aces and low ranking officers), automatic pistol side-arm, semi or fully automatic rifle, wrist radio (short range – 8 miles), uniform, spacesuit, helmet, binoculars, food rations for two weeks, first aid kit, 150ft length of nylon cord, 3 signal flares, canteen and flashlight.

Monthly Wages: 2400 credits per month for enlisted men at levels 1-5, 6th level and higher — 3000 credits per month, while officers make 3400 to 4400 credits per month.

Personal Savings: 4D6 × 100.

Communications Engineer O.C.C.

The communications engineer is the high-tech wizard who can link an entire world with sight and sound. This character has an indepth knowledge of state of the art communication systems. This includes laser and satellite transmission, sensory equipment and weapon systems. Training includes combat orientation, enabling the communications engineer to coordinate Destroid and Fighter pilots, interpret sensory data, and relay that information correctly and quickly to combat personnel. This character can be a field operator as part of a recon or security unit or a deck officer on the bridge of the SDF-1, A.R.M.D. Space Platform or battleship.

Training does not include piloting Mecha, but it is an available skill. The communication engineer can learn to pilot any Destroid by selecting Mecha skills among the *other* skills available. Considering the combat nature of their work, it may be wise to be able to pilot Mecha if needed. The communication engineer can operate the weapons system of the Commachero assault helicopter, and assist with the weapons and targeting of most others.

In addition to the O.C.C. skills listed with bonuses, the player selects "other" skill areas. These additional skills are only limited as stated. Players should try to select skills that reflect the character's O.C.C. and combat conditions.

Attribute Requirements: I.Q. 10

O.C.C. Skills:

Laser communications (+15%)
Radio: Basic (+30%)
Radio: Scramblers (+15%)
Radio: Satellite Relay (+30%)
Surveillance Systems (+10%)
Read Sensory Instruments (+10%)
Weapon Systems (+10%)
Computer Operation (+15%)

Other Skills: Select 16 other skills from those available. **Note:** Hand to hand basic counts as one skill, hand to hand expert counts as two, and martial arts counts as three skills.

Communications: Any (+10%)
Domestic: Any
Electrical: Basic Electronics only (+5%)
Espionage: None
Mechanical: Automotive, aircraft and computer repair only
Medical: First Aid only
Physical: Any
Pilot: Any
Pilot Related: Any (+10%)
Science: Mathematics basic, and Advanced Technical: Computer and photo only (+5%)
W.P.: Any

Authorized Clearance Upon Assignment: Additional sensory scanning equipment, surveillance equipment, optical enhancements, video and photography equipment, weapons, land vehicle, aircraft, spacesuit, combat body armor and Mecha (if warranted).

Standard Equipment: Mini-tool pack, wrist radio (short range – 8 miles), uniform, helmet, protective goggles, binoculars, flashlight and utility belt.

Note: All O.C.C.'s are allowed to carry and use additional personal items, such as vehicles, side-arms, clothing and equipment.

Monthly Wages: 2000 credits per month for enlisted men at levels 1-5; 6th level and higher — 2400 per month. Officers make as much as 3000 to 4000 credits per month. Freelance agents (mercenaries) make only slightly more than the enlisted man; about 2400 credits per month.

Personal Savings: 4D6 × 100.



Electrical Engineer

The electrical engineer is a character skilled in electronics. In the high-tech world of ROBOTECH®, this skill and knowledge is greatly needed, and coveted to repair and maintain the Mecha and machinery. So coveted by the technologically ignorant Zentraedi, that electrical engineers are often abducted to service the alien war machine. Unscrupulous mercenaries, skilled in electrical engineering, can make a fortune aiding the Zentraedi and rebel governments. However, these traitors of humanity are considered to be the foulest fugitives. Being caught conspiring against the United Earth Forces and humanity will lead to imprisonment or death.

The electrical engineer is not formally trained to pilot Mecha, but can select Mecha skills among the “other” skills available.

In addition to the O.C.C. skills provided, with bonuses indicated in parenthesis, the player can select “other” skill areas. These additional skills are limited only as stated.

Attribute Requirements: I.Q. 7; high P.P. is preferred, but not mandatory.

O.C.C. Skills:

Computer Operations (+10%)

Computer Repair (+15%)

Electrical Engineering (+15%)

Mecha Electronics (+20%)

Read Sensory Instruments (+5%)

Basic and Advanced Mathematics (+10%)

Other Skills: Select 16 other skills.

Communications: Any (+5%)

Domestic: Any

Electrical: Any (+10%)

Espionage: None

Mechanical: Any (+5%)

Physical: Any

Pilot: Any

Pilot Related: Any (+5%)

Science: None

Technical: Computer and Photo only (+10%)

W.P.: Any

Authorized Clearance Upon Assignment: Any land vehicle, aircraft or Destroid (if the character has the piloting skills required); additional tools, access to a garage and/or laboratory, superior equipment, spacesuit, combat body armor and weapons.

Standard Equipment: Mini-tool pack, portable tool box and tools, flashlight, 3 signal flares, binoculars, protective goggles, air filter, Gieger counter, utility belt, wrist radio (short range – 8 miles), uniform and work clothes.

Monthly Wages: 2000 credits per month for enlisted men at levels 1-5; 6th level and higher — 2600 credits per month. Officers and specialists (I.Q. bonus or 12th level and up) — 3400 to 4800 per month. Freelance agents can net anywhere from 2000-5000 credits per month depending on skill level and need. Zentraedi and human rebels often need electrical engineers and may buy their services in barter for gold, gems, weapons, or other goods or favors usually worth two and three times the freelance rate. Only the mechanical engineer is valued more.

Personal Savings: 5D6 × 100.

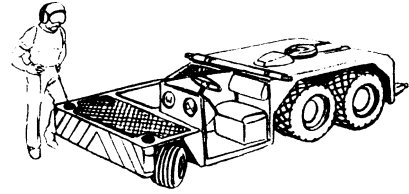

Field Scientist O.C.C.

The field scientist is a “Jack-of-all-trades”, using his or her varied knowledge to form rudimentary hypotheses, and for analysis, interpretation, cataloging and investigation. A field scientist is often a standard member of most recon teams and security outposts. Skills include Mecha repair, demolitions, and a variety of sciences.

The field scientist’s training does not include Mecha skills, but, can be acquired as part of the “other” skills selected. Considering the combat nature of assignments, it may be wise to select, at least, the Mecha piloting skill.

In addition to the O.C.C. skills listed with bonuses, the player can select “other” skill areas. These additional skills are limited only as stated. Players should try to select skills that reflect the character’s O.C.C. and combat conditions.

Attribute Requirements: I.Q. 12; high M.E. is helpful, but not a prerequisite.

O.C.C. Skills:

Computer Operation (+15%)

Computer Programming (+10%)

*Medical Paramedic (+10%)

Mathematics Basic (+10%)

Mathematics Advanced (+10%)

* Medical Paramedic can be upgraded to Medical Doctor, but M.D. counts as two skill selections.

Other Skills: Select 18 other skills from those available. At least 4 should be selected from the science, medical and technical categories combined.

Communications: Radio, Optic Systems and T.V./Video only (+5%)

Domestic: Any

Electrical: Any (+5%)

Espionage: Wilderness Survival and Land Navigation only

Mechanical: Any (+5%)

Medical: Any (+10%)

Physical: Any

Pilot: Any

Pilot Related: Any

Science: Any (+15%)

Technical: Any (+10%)

W.P.: Any

Authorized Clearance Upon Assignment: Sensory, scanning equipment, surveillance equipment, optical enhancements, video and photography equipment, portable laboratory, tools, land vehicle, aircraft, spacesuit, Mecha, access to laboratory facilities and combat battle armor.

Standard Equipment: Mini-tool pack, specimen pack, surgical scalpels, first-aid kit, uniform, helmet, protective goggles, disposable surgical gloves, oxygen mask, portable computer, portable microscope.

Note: All O.C.C.’s are allowed to carry and use additional personal items, such as vehicles, side-arms, clothing and equipment.

Monthly Wages: 2200 credits per month for enlisted men at levels 1-5; 6th level and higher — 2800 per month. Officers make 3200 to 4400 credits per month, while freelance agents make about 3000 to 4000 credits per month depending on skill level.

Personal Savings: 4D6 × 100.

Mechanical Engineer O.C.C.

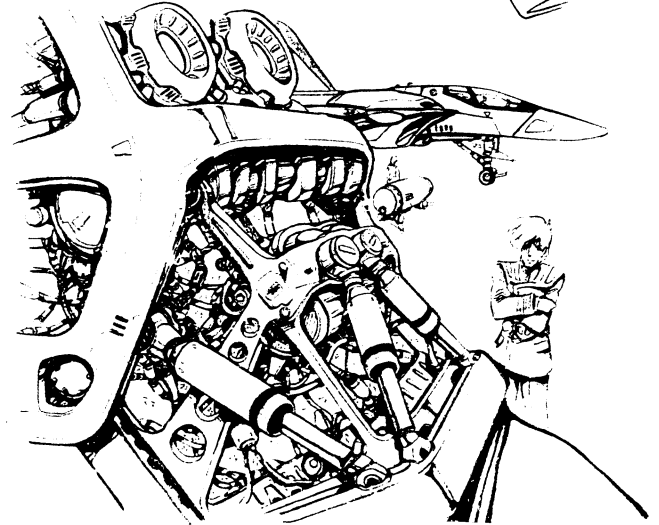
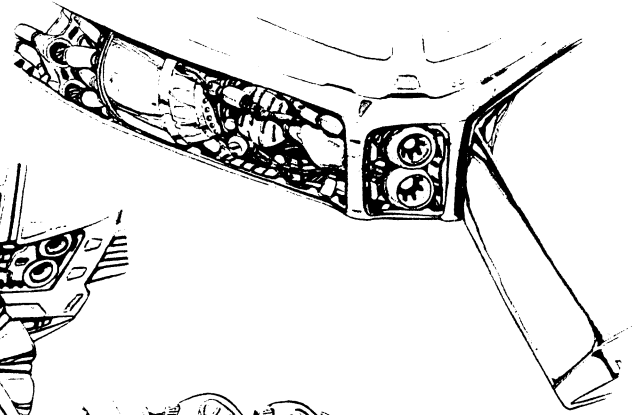
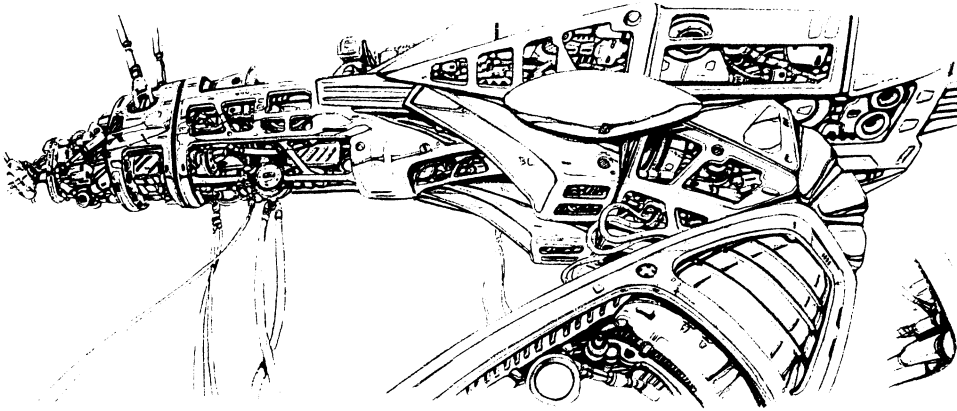

This character is a mechanical genius, able to effect repairs, modify design and operate machinery. While usually the unsung hero behind the scene, the Mechanical Engineer is often a crucial member of Mecha recon teams and security units. In remote areas these men and women are as revered and needed as doctors. Since Zentraedi can not fix their own machines, they sometimes kidnap mechanical engineer, or enlist the aid of unscrupulous free agents (mercenaries) to repair their aging and combat damaged Mecha. Mechanical Engineer mercenaries, who sell their talents to Zentraedi, are considered to be among the worst traitors to humanity.

The mechanical engineer is not formally trained as Mecha pilots, but can select Mecha skills among the "other" skills available. Their mechanical familiarity with Mecha provide them with +10% to pilot Destroids.

In addition to the O.C.C. skills listed, with bonuses in parenthesis, the player can select "other" skill areas. These additional skills are limited only as stated.

Attribute Requirements: I.Q. 7; high P.P. is preferred, but not a prerequisite.

O.C.C. Skills:

Mechanical Engineering (+20%)

Mecha Mechanic (+20%)

Weapon Systems (+10%)

Pilot Automobile (+10%)

Computer Operation

Other Skills: Select 16 other skills; at least 2 must be mechanical.

Communications: Any

Domestic: Any (+5%)

Electrical: Any (+5%)

Espionage: None

Mechanical: Any (+15%)

Medical: First Aid or Paramedic (counts as 2 skills)

Physical: Any

Pilot: Any (+10%, ground vehicle; +5%, aircraft)

Pilot Related: Any

Science: Mathematics Basic and Advanced only

Technical: Computer and Photo only (+5%)

W.P.: Any

Authorized Clearance Upon Assignment: Any land vehicle, aircraft or Destroid (if the character has the piloting skills); additional tools, access to a garage and superior equipment, spacesuit, combat body armor and weapons.

Standard Equipment: Mini-tool pack, portable tool box, flashlight, 3 signal flares, binoculars, protective goggles, air filter, Geiger counter, utility belt, wrist radio (short range – 8 miles), uniform and work clothes.

Monthly Wages: 2000 credits per month for enlisted men at levels 1-5; 6th level and higher — 2600 credits. Officers and specialists (I.Q. bonus or 12th level and up) — 3400-4800 credits per month. Freelance agents can net anywhere from 2200-6000 credits per month depending on skill level and need. Zentraedi and human rebels often barter in gold, gems, weapons, or other goods worth three and four times that.

Personal Savings: 6D6 × 100

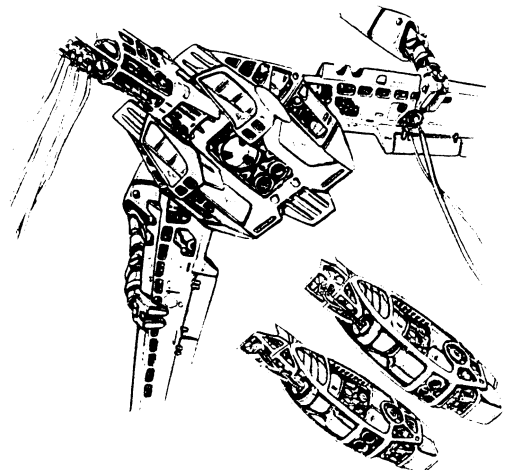

Military Specialist O.C.C.

The military specialist is highly trained in combat and espionage. Their specialized background may include demolitions, sniper, espionage, weapons and piloting (such as assault helicopters, etc). They are the brave men and women assigned to reconnaissance, intelligence gathering, tracking fugitives, infiltrating enemy strongholds and clandestine operations.

The military specialist's training does not include Mecha. However, the character can learn to pilot any Destroid by selecting Mecha skills among the *other* skills available. Most will avoid the larger, artillery type Mecha, sticking with the more versatile Destroids, like the Gladiator and Excaliber. Veritech Fighter skills are NOT available, even to the specialist.

In addition to the O.C.C. skills listed with bonuses, the player can select "other" skill areas. These additional skills are limited only as stated.

Attribute Requirements: I.Q. 10, P.P. 10

O.C.C. Skills:

Intelligence (+20%)

Interrogation (+10%)

Pilot Automobile

W.P. Revolver

W.P. Semi and Fully Automatic Rifle

Hand to Hand Expert or Martial Arts (choose one)

Other Skills: Select 18 other skills; at least 4 must be espionage, 2 physical, and 2 additional W.P.

Communications: Any

Domestic: Any

Electrical: Basic Electronics only

Espionage: Any (+15%)

Mechanical: Auto or Aircraft Mechanics only

Medical: First Aid or Paramedic only (+5%)

Physical: Any (+10% on any skill percentages, like prowl)

Pilot: Any

Pilot Related: Any

Science: Mathematics basic

Technology: Any; including demolitions, +15% on Demo

W.P.: Any

Authorized Clearance Upon Assignment: Energy weapons, land vehicles, aircraft, Mecha, explosives, heavy weapons, surveillance equipment; personal and special equipment, such as lock picking tools, camera, optics, etc.

Standard Equipment: Personal vehicle (car or motorcycle), revolver (high caliber) for side-arm, semi or fully automatic rifle, wrist radio (short range – 8 miles), uniform, helmet, binoculars, flashlight, knife and combat body armor.

Monthly Wages: 2000 credits per month for enlisted men at levels 1-5; 6th level and higher — 2500 credits per month. Officers make as much as 3000-4000 credits per month. Experts and expert free agents can make outrageous amounts of money, 6000-36,000 per job, depending on the dangers, area of expertise and circumstances. Freelance agents are generally of anarchist, unprincipled or evil alignments. Such mercenaries are usually looked upon with disdain.

Personal Savings: 4D6 × 100.

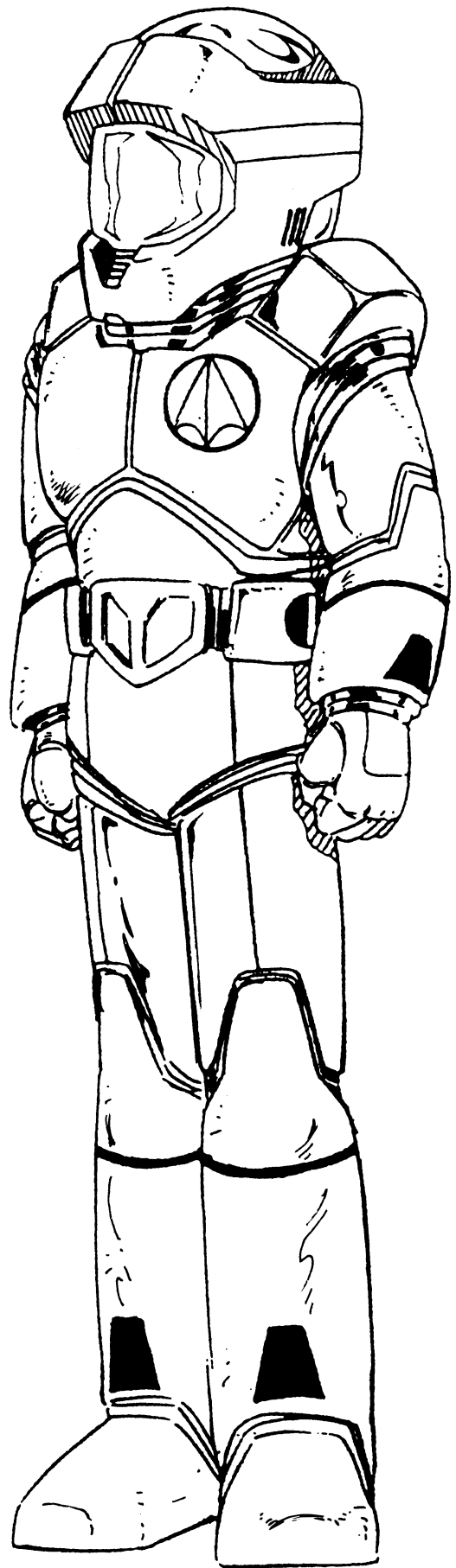

EXPERIENCE LEVELS PER O.C.C.

Military Specialist

<u>Level</u>	
1	0000-1925
2	1926-3850
3	3851-7450
4	7451-14,900
5	14,901-21,000
6	21,001-31,000
7	31,001-41,600
8	41,601-53,000
9	53,001-73,000
10	73,001-103,500
11	103,501-139,000
12	139,001-189,000
13	189,001-239,000
14	239,001-289,000
15	289,001-339,000

Electrical Engineer & Field Scientist

<u>Level</u>	
1	0000-1900
2	1901-3800
3	3801-7300
4	7301-14,300
5	14,301-21,000
6	21,001-30,000
7	30,001-40,000
8	40,001-53,000
9	53,001-73,000
10	73,001-103,000
11	103,001-138,000
12	138,001-188,000
13	188,001-238,000
14	238,001-288,000
15	288,001-328,000

Mechanical Engineer & Communications Engineer

<u>Level</u>	
1	0000-1750
2	1751-3500
3	3501-7000
4	7001-14,000
5	14,001-20,000
6	20,001-29,500
7	29,501-40,000
8	40,001-52,000
9	52,001-72,000
10	72,001-102,000
11	102,001-137,000
12	137,001-187,000
13	187,001-237,000
14	237,001-287,000
15	287,001-327,000

Destroid Pilot

<u>Level</u>	
1	0000-1875
2	1876-3750
3	3751-7250
4	7251-14,100
5	14,101-21,200
6	21,201-31,200
7	31,201-41,200
8	41,201-51,200
9	51,201-71,200
10	71,201-101,500
11	101,501-136,500
12	136,501-186,500
13	186,501-236,500
14	236,501-286,500
15	286,501-326,500

Veritech Pilot

<u>Level</u>	
1	0000-1860
2	1861-3700
3	3701-7300
4	7301-14,200
5	14,201-21,400
6	21,401-31,600
7	31,601-41,800
8	41,801-52,000
9	52,001-72,000
10	72,001-102,000
11	102,001-136,500
12	136,501-187,000
13	187,001-238,000
14	238,001-288,000
15	288,001-328,000

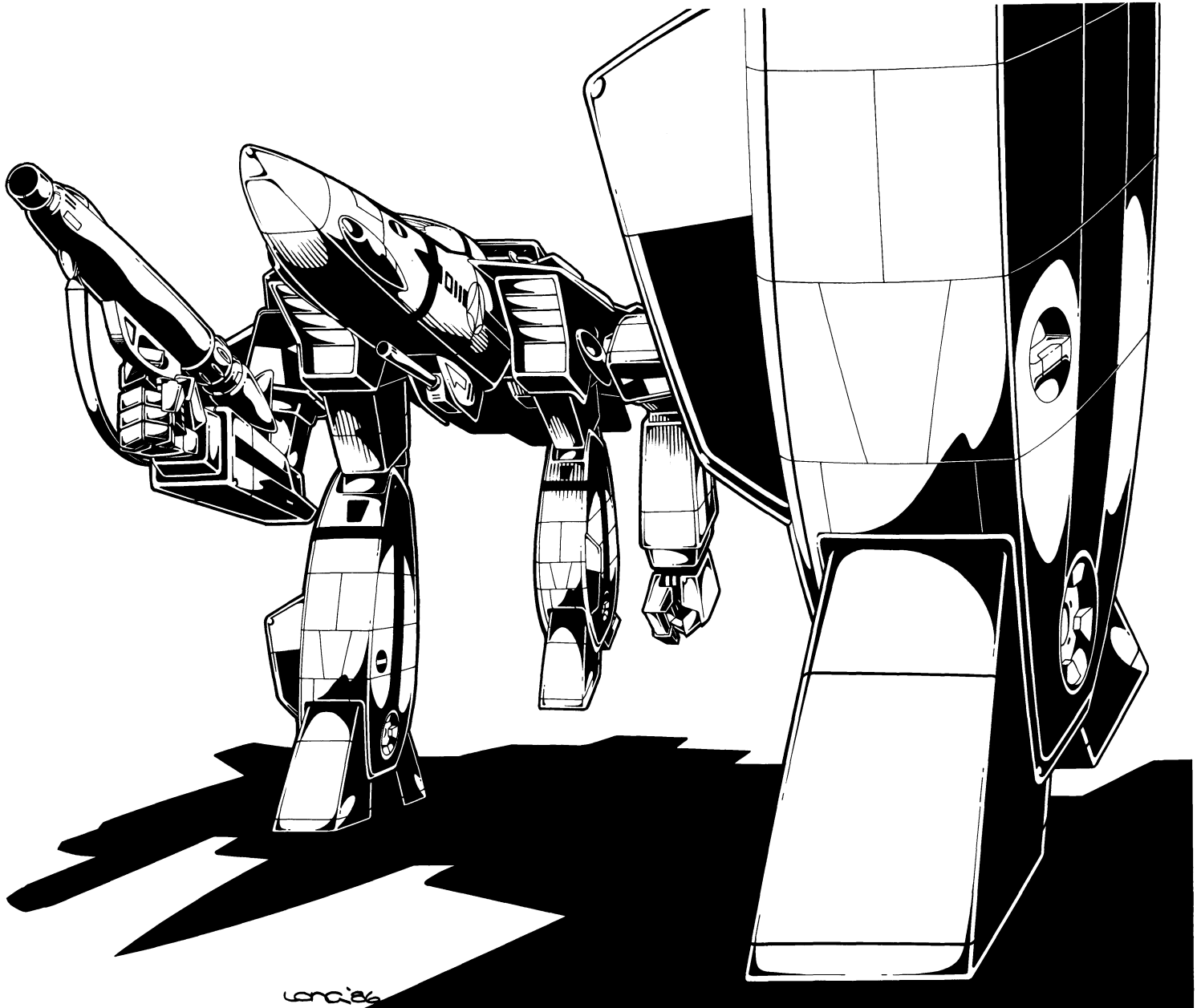

EDUCATION and SKILLS

The characters in this game are all highly educated or specially trained. Each Occupational Character Class (O.C.C.) will indicate how many total skills can be selected and if any restrictions apply to skill categories.

SKILLS LISTED BY CATEGORY

COMMUNICATIONS

- Cryptography
- Laser
- Optic Systems
- Radio: Basic
- Radio: Scrambler
- Radio: Satellite
- Surveillance
- T.V./Video

Note: Read Sensory Instruments is found under Pilot related skills.

DOMESTIC

- Cook
- Dance
- Fish
- Sew
- Sing

ELECTRICAL

- Basic Electronics
- Electrical Engineer
- Mecha Electronics

ESPIONAGE/MILITARY

- Detect Ambush
- Detect Concealment
- Disguise
- Escape Artist
- Forgery
- Intelligence
- Impersonation
- Interrogation
- Land Navigation
- Pick Locks
- Pick Pockets
- Sniper
- Tracking
- Wilderness Survival

MECHANICAL

- Automotive Mechanics
- Aircraft Mechanics
- Computer Repair
- Locksmith
- Mecha Mechanics
- Mechanical Engineering
- Veritech Mechanics

MEDICAL

- Criminal Science/Forensics
- First Aid
- Medical Doctor
- Paramedic
- Pathology

PHYSICAL

- Hand to Hand Basic
- Hand to Hand Expert
- Hand to Hand Martial Arts
- Body Building

- Boxing
- Climbing
- Fencing
- Gymnastics
- Prowl
- Swimming
- Swimming S.C.U.B.A.
- Wrestling

Note: Mecha combat is found under Pilot Skills.

PILOT (Ground, Air and Water)

- Automobile
- Mecha (Destroid only)
- Mecha Combat
- Motorcycle
- Truck
- Tank
- Airplane; old style, single or twin engine.
- Helicopter
- Jet

- Lancer Space Fighter
- Space Shuttle

Note: Veritech Fighter is a special O.C.C. skill, it is available only to Veritech Fighter Pilots.

- Boats: Sail
- Boats: Motor

PILOT RELATED SKILLS

- Navigation (Air, Land, Water)
- Navigation: Space
- Read Sensory Instruments
- Weapon Systems (missiles, lasers, etc.)

SCIENCE

- Astrophysics
- Biology
- Botany
- Chemistry
- Chemistry: Analytical
- Mathematics: Basic
- Mathematics: Advanced

Note: Computer is found under Technical.

TECHNICAL

- Computer Operation
- Computer Programming
- Demolitions
- Demolitions: Disposal
- Photography

Note: Instrument Reading; see Pilot Related Skills.

WEAPON PROFICIENCIES (W.P.)

- Ancient Weapons*
- W.P. Blunt
- W.P. Chain
- W.P. Knife
- W.P. Sword
- W.P. Staff
- Also see Fencing under Physical Skills.
- Modern Weapons*
- W.P. Revolver
- W.P. Automatic Pistol
- W.P. Semi & Fully Automatic Rifle
- W.P. Rifle
- W.P. Sub-Machinegun
- W.P. Heavy
- W.P. Energy Pistol
- W.P. Energy Rifle

Note: Weapon Systems; see Pilot Related Skills.

SKILL DESCRIPTIONS

COMMUNICATIONS

Cryptography: Skill in recognizing, designing, and cracking secret codes and messages. After ten minutes of studying a code the character can attempt to decipher it, but at a -10% chance. Otherwise, the character must study for two hours before every additional roll. **Base Skill:** $30\% + 5\%$ per level of experience.

Laser: This skill provides the character with an in depth knowledge of laser communication systems. **Base Skill** is $40\% + 5\%$ per level of experience.

Optic Systems: Training covers a wide variety of optic systems, from video to optical enhancements devices, to Laser Optics. The character will understand the operation of optical readings, recording, transmission, and use of special equipment like thermo-imagers, passive light intensifiers, infrared, ultraviolet, etc. **Base Skill:** $50\% + 5\%$ per level of experience.

Radio Communications: All these skills enable the character to effectively use various communications equipment and techniques.

Radio: Basic Communications: This is the knowledge of the operation and maintenance of field radios and walkie-talkies, wire laying, installation, radio procedure, communication security and visual signs/communications, as well as knowing Morse code. **Base Skill:** $50\% + 5\%$ per level of experience.

Radio: Scramblers: This is training in the use of electronic masking and scrambling (unscrambling) equipment, and codes, for increased security. **Base Skill:** $40\% + 5\%$ per level of experience.

Radio: Satellite Relay: This is an understanding in the methods and operations of satellite transmissions. **Base Skill:** $25\% + 5\%$.

Surveillance Systems: This is the study and understanding of the operation, methods, and techniques in the use of surveillance systems. Includes motion detectors, simple alarm systems, complex alarm systems, video and camera equipment, amplified sound systems, miniature listening devices (bugs, telephone tapping), recording methods, and some optical enhancement systems (specifically as they relate to camera lenses). **Requires:** Electronics (basic) or electrical engineering. Photography skills, prowl, and investigative skills may also be useful, but not required. **Base Skill:** $40\% + 5\%$ per level of experience.

Tailing, or following someone without their knowledge, is another form of surveillance. This also includes stake-out procedures. A failed surveillance roll indicates that the tail was spotted and the subject is aware of being observed/followed. A failed roll in the use of equipment indicates ruined or garbled recording/film (not usable) or malfunction. Bugging equipment can be easily located or noticed through the course of casual activity if a character fails his surveillance roll while planting it.

T.V./Video: Techniques and understanding of video and audio, filming, editing, special effects transmissions and equipment. **Base Skill:** $40\% + 5\%$ per level of experience. Spending two skills on this one skill area makes the character of professional film quality/abilities. A one time bonus of 10% applies in this case.

DOMESTIC

Cook: Skill in selecting, planning and preparing meals. A cooking roll failure means that the cooked food is either inedible (burnt!) or distasteful. **Base Skill:** $50\% + 8\%$ per level of experience. Spending two skill selections on this one skill area makes the character of professional quality. One time bonus of 10% applies in this case only.

Dance: A practiced skill in the art of dancing. **Base Skill:** $40\% + 6\%$ per level of experience. Spending two skills will produce professional quality dancing skill. One time bonus of 15% if this is the case.

Fishing: These is the fundamental methods and enjoyment of the

relaxing sport of fishing. Areas of knowledge include the use of lures, baits, poles, line, and the cleaning and preparation of fish for eating. **Base Skill:** $60\% + 5\%$ per level of experience.

Sewing: The practiced skill with the needle and thread, to mend, layout, cut and sew simple patterns, and do minor alterations. This is not a tailoring ability, unless the player spends two skills. **Base Skill:** $40\% + 5\%$ per level of experience.

Sing: The simple ability to read music and carry a pleasant tune. **Base Skill:** $40\% + 5\%$ per level of experience. The character's singing ability is nice, but not of professional quality, unless two skills are spent. Add 20% bonus if this is done. Minmei watch out!

ELECTRICAL

Basic Electronics: This is a rudimentary understanding of the principles of electricity, simple circuits, wiring, and so on. This person can do basic wiring, repair appliances and read schematics. **Base Skill:** $40\% + 5\%$ per level of experience.

Electrical Engineer: Knowledge of electricity. Characters can diagnose and locate electrical problems. It is also possible to put together electrical equipment. The character can attempt to bypass security systems and burglar alarms at a -25% ; if Surveillance Systems is also taken, then there is a $+10\%$ bonus instead. **Base Skill:** $45\% + 5\%$ per level of experience. **Note:** Characters who are not electrical engineers must have Basic and Advanced Mathematics to select this skill.

Mecha Electronics: This is firsthand knowledge of the electrical systems built into the Destroids and Veritech Fighters, and how they interact with protoculture and the fundamentals of Robotechnology. Other areas of electrical expertise do not apply to Mecha, making this an invaluable skill to repair the giant war machines. **Base Skill:** $35\% + 5\%$ per level of experience.

ESPIONAGE/MILITARY

Detect Ambushes: Training which develops an eye for spotting locations and terrain suitable for ambushes and being ambushed. It also provides a rudimentary knowledge of guerrilla tactics used by the enemy. **Base Skill:** $50\% + 5\%$ per level of experience.

Detect Concealment: This is a skill which enables the individual to spot and recognize camouflage, tricks, concealed huts, buildings and vehicles, as well as the ability to construct unobtrusive shelters that blend into the environment. **Base Skill:** $40\% + 5\%$ per level of experience.

Disguise: The character knows how to apply make-up, wigs, skin putty, and other special effects, in order to alter his own appearance or those of somebody else. **Base Skill:** $50\% + 5\%$ per level of experience.

Escape Artist: The character will know the methods, principles, and tricks of escape artists. By tensing and relaxing muscles, flexing and popping joints; the character can try slipping out of handcuffs, straightjackets, etc. Also includes a knowledge of knots and the ability to conceal small objects on the person. Picking Locks is a separate skill. **Base Skill:** $30\% + 5\%$ per level of experience.

Forgery: The techniques of making false copies of official documents, signatures, passports, I.D., and other printed material. The character must have an original or photocopy to work from, in order to make an accurate copy. Skilled forgers can recognize other counterfeits at -6% . **Base Skill:** $30\% + 5\%$ per level of experience.

Intelligence: This is the specific training in the practices and principles of recognizing and analyzing sources of information about the enemy, observation techniques, counterintelligence measures and proper procedure. This includes the practical assessment of sights, and sounds; estimation of ranges, what to report, handling prisoners of war, and handling captured documents and equipment (tagging, and reporting to group leader or proper authority).

This means the character will be able to accurately estimate ranges; the number of enemies/troops, direction, purpose; and assess the importance of specific information, documents and prisoners.

Further intelligence training includes a working knowledge of indigenous guerrilla warfare, practices, concealment techniques, appearance, and current activities. This will enable the intelligence officer to recognize suspicious activity as guerrilla actions and identify guerrilla operatives. **For Example:** A particular booby trap, or weapon, or mode of operation, may be indicative of guerrilla activity in that area. It may be up to the character to confirm the existence of guerrillas, and their strengths and numbers in a particular area.

Another area of training, made available to intelligence, is the identification of enemy troops, officers and foreign advisors. This means the person learns the many distinguishing ranks and marks that identify specific military units, special forces, and officers of the enemy. Such identification can pinpoint and confirm enemy operations, goals and movement, as well as confirm outside intervention/aid. **Note:** A failed roll in any of the intelligence skills means that evidence is inconclusive, or the character has incorrectly assessed the information/situation and is uncertain. A failed roll involving individual clues may mean the intel officer has dismissed it entirely as being meaningless. (GM's, use your discretion). **Base Skill:** 45% + 5% per level of experience.

Impersonation: This skill enables a person to impersonate another person or type of soldier (in general). This means the person must have a rudimentary (if not comprehensive) knowledge of the person or general type of personnel that he is impersonating. This is likely to include a knowledge of enemy/subject of impersonation military procedure, dress, command, rank, and will usually require speaking the language fluently. This means the character can convincingly impersonate a general type of person/soldier/advisor by accurate disguise, proper action, and language.

The **Base Skill** is 40% to impersonate general personnel and 20% to impersonate a specific individual (which may require weeks of study and special disguise), +4% per level of experience.

The success of one's impersonation/disguise can only be determined after exposing oneself to those whom you wish to trick. A successful impersonation requires the player to roll under his skill for each of his first, THREE encounters. Afterward, the character must roll under his skill for *each* encounter with an officer. If interrogated/questioned, he must successfully roll for every other question or be revealed as an imposter. **A failed roll** means his impersonation has failed and is recognized as an imposter and is in immediate danger.

Interrogation: This skill includes training in the questioning of prisoners, captives and informers, and the assessment of that information. **Base Skill:** 40% + 5% per level of experience.

Land Navigation: This skill allows the person to stay on course, while traveling over land, by means of observation. This includes mentally marking/recognizing geographic landmarks, estimating distance and movement, recognizing sounds and other navigation tricks. Techniques include night travel. The player should roll once for approximately every three miles traveled. A failed roll means the group is drifting off course by 200-2000 yards (roll 2D10×100 yards). Do not roll again until the next three miles. A successful roll at that time will allow the character to recognize his error and correct it. Of course, errors mean lost time and traveling through unknown or potentially dangerous areas. A second (and third), failed roll means the team continues to travel 2D10×100 yards further off course. All failed rolls are cumulative unless corrected.

Note: A group of average men can cover approximately 5 miles an hour at a brisk, but relaxed pace, through grassland, along dirt roads or paved streets. Travel through dense forest or jungle at a cautious pace, with eyes open for danger, is about one mile per hour. At this pace, one can easily watch for booby traps, snipers,

ambushes, wild animals, tracks, clues and other observations, without fear of traveling too fast (and missing them). Only at a faster pace will one begin to miss details and court death. **Base Skill:** 45% + 5% per level of experience.

Picking Locks: The character knows the methods, techniques and tools for picking/opening, key, and basic, tumbler type locks.

It takes 1D6 melee rounds for each attempt to pick a lock. A failed roll means the lock holds; try again. **Base Skill:** 35% + 5% per level of experience.

Pick Pockets: An ability to remove items from a person without their being aware of it. If a pick pocket attempt fails, the item has NOT been removed and there is a 67% likelihood of the intended victim recognizing the intent of the action. **Base Skill:** 30% + 5% per level of experience.

Sniper: This skill represents special training in long-range rifle firing, and marksmanship. The character must first have a semi-automatic rifle or bolt-action rifle skill, to which the sniper skill bonus of +2 to strike can be applied.

Tracking: Visual tracking is the identification of tracks, and following the path of men or animals by the signs they leave on the ground and vegetation. Tracking is a precise art, requiring much practice. The skill includes the evaluation of tracks, indicating whether the person being tracked is loaded down with equipment, running, moving slowly (by measuring the space between steps), male, female, walking backwards, injured (staggered footprints), and so on. By this means, the tracker can estimate the person's rate of movement, apparent direction, the number of persons in the party, and whether the person knows he's being followed. Other methods of tracking require recognizing other, telltale signs, such as blood and other strains, broken and displaced vegetation, overturned rocks; litter, such as cigarette butts, ration cans, candy wrappers, soiled bandages and remains of camp fires, and even odors carried by the wind.

Tracking also includes the recognizing of dangerous animals by their tracks, habits and feces. Likewise, tire tracks of vehicles can reveal much, such as size and type of vehicle, weight of load, etc.

Counter-Tracking techniques are also known, such as covering one's trail; avoiding obvious pitfalls, such as littering, misdirection, parallel trails, and others.

A failed roll means that the signs are inconclusive, vague or misleading. Additional signs must be found to verify or clarify (roll again). Three, consecutive, failed rolls means the tracker has completely lost the trail. Roll once every 40 yards when FOLLOWING a trail. Persons attempting to follow a skilled tracker are -20% in following his trail, if he is deliberately trying to conceal that trail (however, his rate of travel is reduced by half). **Base Skill:** 35% + 5% per level of experience.

Wilderness Survival: Techniques for getting water, food, shelter, and help, when stranded in wild forests, deserts or mountains. Characters without this skill will not be able to stay healthy for more than a day out in the wilderness area. **Base Skill:** 40% + 5% per level of experience.

MECHANICAL

Automotive Mechanics: Ability to repair, rebuild, modify, and redesign conventional vehicles with internal combustion (gas) engines. Body work, turbine engines, and diesel truck engines, each require separate skills. **Base Skill:** 50% + 5% per level of experience.

Aircraft Mechanics: The understanding, ability to repair, rebuild, modify and redesign conventional aircraft; including single and twin engine airplanes, fan jets, jets, fighter jets, helicopters and shuttle craft. The Veritech Fighter is not a conventional aircraft and does *not* apply. **Base Skill:** 45% + 5% per level of experience.

Computer Repair: Knowledge of the internal electronics of computers and related devices (terminals, printers, etc. . . .). The charac-

ter can attempt to repair, sabotage, or fix computers. Note that figuring out a repair problem requires one roll: the character must roll again before actually fixing it. No computer operation or programming skills are included; many computer repair personnel don't even know how to turn the machines on! **Base Skill:** 40% + 5% per level of experience.

Locksmith: The practiced study of lock designs, and ability to repair, build, modify and "open" locks. The methods, techniques, and tools of lock picking include the old-style key and tumbler, combination, and modern electronic locking systems. **Time Requirements:** 1-4 melees to open an antiquated, key type lock; 1-6 minutes to open an elaborate tumbler type; 2-16 minutes to open a simple electronic lock (usually by patching in a bypass system); and 1-6 hours to break a complex, state-of-the-art electronic lock system, such as those used in high security and restricted areas.

If an unsuccessful skill roll is made, the lock is *not opened and the process must be repeated. If an attempt to open an electronic lock fails, roll to see if the lock has been irreparably damaged; 32% chance. If damaged, the lock CANNOT be opened.* **Base Skill:** 25% + 5% per level of experience. **Special Bonus:** Add a one time bonus of 5% if the Electronics Skill is also taken.

Mecha Mechanics: A comprehensive knowledge and ability to repair, build, and modify Mecha, including Destroids and Zentraedi battle pods and power armor. Veritech Fighters are *not* included; their transformable nature calls for additional training (see Veritech Mechanics). **Base Skill:** 40% + 5% per level of experience.

Mechanical Engineer: A training, understanding and knowledge of how machinery is designed, operated, built, and maintained. Characters can attempt to redesign, modify, sabotage, repair, or construct mechanical devices. The first percentage is how to operate/analyze/design machinery; the second is how to repair, construct or sabotage. **Base Skill:** 45% + 5% per level of experience. **Special Bonus:** + 5% to Locksmith skill and 5% to Surveillance Systems skill.

Veritech Mechanics: A very specialized skill, dealing with the repair, building and modification of the unique, transformable Mecha. **Basic Skill:** 30% + 5% per level of experience.

MEDICAL

Criminal Sciences & Forensics: Basic knowledge of police skills. Includes simple criminal law, fingerprinting, ballistics (matching bullets to weapons and angles of impact), and general investigative techniques. Forensic medicine is also included, allowing the character to find evidence of time of death, cause of death, and other details when examining a corpse. **Note:** Biology, Chemistry, Chemistry-Analytical and some Mathematics, are all required before taking Criminal Sciences & Forensics. **Base Skill:** 35% + 5% per level of experience.

First Aid: Rudimentary medical treatment which includes how to bandage wounds, stop bleeding, administer CPR/artificial respiration, and use antiseptics, and common anti-inflammatory drugs and pain killers. **Base Skill:** 50% + 6% per level of experience. A failed roll means the patient has not responded to treatment or that treatment was improperly applied.

Paramedic: An advanced form of medical emergency treatment which includes *all* first aid techniques, the setting of broken bones, suturing of wounds, use of oxygen and emergency equipment, use of drugs, knowledge of how to move a critically injured, person and other lifesaving techniques. A **failed roll** means the patient has not responded to treatment or that the treatment has been improperly administered. **Note:** For serious injury or coma, roll three times, consecutively, on percentile dice. A roll of two successful out of three, means the wound has been properly treated or the patient's condition is stabilized. Failure means the patient's condition is unchanged. Another character can immediately attempt to apply medical aid or the same player can try again, but only after he or she

has spent six minutes of examination and/or concentration. **Base Skill:** 50% + 5% per level of experience. Counts as 2 skills.

Medical Doctor: The character has a Ph D (doctorate degree), with Master's of Science, to be a practicing doctor.

Areas of training/study include: clinical skills, medical discipline, code of ethics, laboratory skills, techniques, methods of data collection, physiology (muscles, respiratory, blood, body fluids); fundamentals, principles and procedures of pathology (diseases, their structure and function), rudimentary pharmacology (use, reaction, and interaction of drugs). The medical doctor (M.D.) is also trained in surgical procedures (he is a surgeon). **Note:** the first percentile number indicates the ability to diagnose a problem and the second is the ability to successfully treat it. **Base Skill:** 70/60% + 5% per level of experience. Counts as 3 skills unless stated otherwise.

Pathology: This is that branch of medicine that deals with the nature of diseases, their causes and symptoms, and the functional and structural changes caused by disease. Training includes anatomy, physiology, cell biology, manifestation of disease, tissue injury and repair, abnormal cell structure, metabolism, diagnosis of human disease, tissue culture methods and applications, analysis of drugs in biological samples and laboratory research, investigative methods, and use of instruments tools and equipment. **Requirements:** Chemistry. **Base Skill:** 45% + 5% per level of experience.

PHYSICAL

Hand to Hand Combat: There are three major kinds of fighting techniques available to all characters:

Hand to Hand Basic: This provides the fighting techniques taught in military basic training or in self-defense classes. Students learn elementary methods of attack and self-defense. Counts as one skill. *See the combat section for listing of specific abilities.*

Hand to Hand Expert: An advanced form of self-defense and unarmed combat usually taught to commandos. Counts as two skills. *See the combat section for listing of specific abilities.*

Hand to Hand Martial Arts: This is some form of oriental fighting skill (karate, kung-fu, etc.) that teaches advanced hand to hand combat. Counts as three skills (except for the Military Specialist and special conditions for upgrading Hand to Hand Combat). *See the combat section for listing of specific abilities.*

Body Building & Weight Lifting: By working out with weights and body building machines the character increases body strength and muscle.
+ 2 to P.S.
+ 10 on S.D.C.

Boxing: Classic art of fighting with fists. Training helps build the body and reflexes. Skilled boxers will *Automatically* Knockout opponents on a natural twenty, for 1D6 melees rounds. Unlike normal Knockout/Stun, this does NOT have to be declared before the strike roll.

One additional attack per melee.

+ 1 to Parry/Dodge
+ 1 to Roll with Punch/Fall
+ 2 to P.S.
+ 3D6 on S.D.C.

Climbing: Knowledge of the tools and techniques for climbing up sheer surfaces. Players should roll once for every 20ft (6m) of a vertical climb. Every "skilled" climber gets a second roll to recover his/her hold. **Base Skill:** 50% + 5% per level of experience.

Rappelling is a specialized, rope climbing skill used in descending from helicopters, scaling walls and cliff facings. For game purposes, rappelling will include ascending and descending climbs. Minimum base effectiveness is 30% + 5% per level of experience. A failed roll means a slip or fumble; roll again to regain hold or fall.

Fencing: The ancient arts of Hand to Hand Weapons are learned from fencing teachers. This includes not only olympic-style fencing with foil, epee or saber, but also Kendo (use of the Samurai sword) and other weapons. Adds a bonus of +1 to strike and parry when combined with W.P. Sword. **Note:** Paired Weapons is a separate skill. See the W.P. Tables in the Combat Section for details.

Gymnastics: Learning to do falls, rolls, tumbles, cartwheels, and to work on rings and parallel bars. Characters with Gymnastics can leap 4ft up or 4ft across, with an additional, 2ft per level. **Note:** Characters with Leap Attack can use these distances in a strike. Provides the following abilities:

60% + 5% per level Sense of Balance.

70% + 4% per level Climb Rope.

20% + 6% per level Climbing (or adds a bonus of +10% to a climb skill).

70% + 8% per level Back Flip.

30% + 5% per level Prowl.

+1 to Roll with Punch/Fall.

+1 to P.S.

+1 to P.P., plus add 3D6 to S.D.C.

Prowl: This skill helps the character to move with stealth; quietly, slowly and carefully. Techniques include balance and footing, short steps and pacing, rifle positioning, prone positions for low visibility, and crawling. A failed Prowl roll means that the character has been seen or heard. If the Prowl is successful, then the character is not seen and may make a Sneak Attack. **Base Skill:** 40% + 5% per level of experience.

Swimming: The rudimentary skill of keeping afloat, dives, lifesaving, and swimming techniques. **Base Skill:** 50% + 8% per level of experience. The percentile number indicates the overall quality of form as skill of execution. A special bonus of +1 to parry and dodge while in water applies. **Note:** A character can swim a distance equal to $3 \times$ his P.S./Strength in yards/meters per melee. This pace can be maintained for a total of melees equal to his P.E./Endurance.

S.C.U.B.A.: The letters S.C.U.B.A. stand for Self-Contained Underwater Breathing Apparatus. Characters learn the methods of skin diving, and underwater swimming; and use of oxygen tanks/apparatus, mask and flippers. **Base Skill:** 50% + 5% per level of experience and reflects the degree of skill and expertise at S.C.U.B.A. **Note:** A character can swim a distance equal to $2 \times$ his P.S./Strength in yards/meters per melee. This pace can be maintained for a length of time equal to the character's P.E./Physical Endurance in melees.

Wrestling: As taught in High Schools and Colleges, wrestling is more of a sport than a combat skill, but it does provide useful combat training.

Pin/Incapacitate on a roll of 18, 19 or 20.

Crush/Squeeze does 1D4 damage.

Body Block/Tackle does 1D4 damage and opponent must Dodge or Parry to avoid being knocked down.

+1 to Roll with Punch/Fall.

+1 to P.S.

+1 to P.E.

+4-24 on S.D.C. (roll 4D6).

PILOT SKILLS (Ground, Air, Water)

Automobile: Manual & Automatic transmission includes dune buggies and jeeps. **Base Skill:** 80% + 4% per level of experience.

Mecha (Destroid only): Players selecting this skill must choose one specific Mecha in which he or she is taught the fundamentals of maneuvering the giant Battloid. Despite striking similarities, each Mecha unit is different and requires special instruction. This means that a player may choose this skill repeatedly in order to pilot more than one type of Mecha. **For Example:** A player selects the pilot

Mecha once to pilot the Destroid known as the Gladiator, that's one skill. He then selects the Mecha pilot skill again to operate an Excaliber and, yet again, to pilot a Spartan. That's a total of three Destroids, so that's three skills. Only the Destroid Pilot O.C.C. teaches the operation of All Destroids.

Note: This training concentrates on piloting, not combat. The number of attacks per melee, bonuses to strike, dodge, parry, etc., are identical to those of the pilot. To maximize one's combat abilities, *Mecha Combat* must also be selected for each. **Base Skill:** 60% + 5% per level of experience.

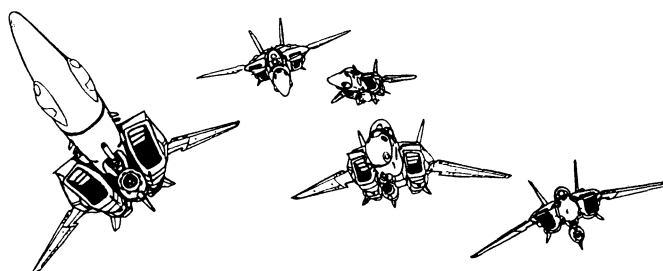

Mecha Combat: Each Destroid has a different weapon system and hand to hand capability. To take full advantage of these astounding machines, the character should have Mecha combat. This training enables the pilot to complete the symbiotic link with the Destroid, nearly doubling the number of attacks and agility.

Like the Pilot Mecha skill, the player must select Mecha combat for each Destroid to function at maximum efficiency. **Using the previous example:** The player might decide that he needs only the two Destroids he'll use most often at full capability. Thus, he chooses Mecha combat for the Gladiator and Excaliber. *That's TWO, Mecha Combat Skills.* He can still pilot and use the weapon systems of the Spartan, but at about half of what the others are now capable of. *See the Combat Section for listing of specific abilities and bonuses.*

Motorcycle: The practiced skill of riding a motorcycle. **Base Skill:** 60% + 4% per level of experience.

Truck: Manual or automatic transmission; includes vans and trailers. **Base Skill:** 66% + 4% per level of experience.

Tank: The piloting of armored assault vehicles; includes armored all-terrain vehicles, amphibious recon, and other, armored heavy vehicles and construction vehicles. **Base Skill:** 50% + 5% per level of experience.

SPECIAL NOTE: The following rules apply to all types of automobiles, trucks, vans, motorcycles and even armored vehicles/tanks.

Special Maneuvers: Conditions and Penalties: Evasive Action: Fleeing or dodging another vehicle, obstacle, missile or some other attack, by moving out of the way. Evasive action often involves weaving, zigzagging and sudden turns at high speeds. A successful roll means the pilot has successfully dodged out of the way. **Skill Penalty:** -15%; pilot/driver can not attack, passengers are -6 to strike in an attack. **A failed roll** means an ineffective evasive maneuver which, in turn, means the vehicle has been struck, blasted, and/or the attacker is still hot on his tracks. **THREE, CONSECUTIVE,** successful evasion rolls means the pilot has completely lost the pursuer.

Reverse Driving: This is simply driving in reverse/backward. **Skill Penalty:** -25% if driving over 65mph, and roll for each turn, swerve or evasive action. Pilot can not attack, but passengers are only -2 to strike. **A failed roll** means a minor collision.

Stunts: Include sharp turns at high speeds, sudden-on-the-dime-stops, sudden U-turns at high speeds, propelled leap (such as riding up over an incline or object, sailing 20ft in the air, land and keep on going) and similar maneuvers. **Skill Penalty:** -25%; lose all attacks that melee. **A failed roll** means the stunt is incomplete and serious difficulties encountered. Roll on the following table:

Loss of Control (Stunt and SideSwipe)

- 1-38 Minor collision; momentarily stopped; reduce vehicle's S.D.C. by 1/3; occupants shaken, but okay.
- 39-59 Stunt maneuver botched; reduce speed by half.
- 60-80 Engine or structural problems develop, requiring pilot to pull over and stop. Vehicle needs 2-12 hours of repairs.
- 81-97 Collision; vehicle is totalled; pilot and occupants receive 3D6 points of damage (subtract from hit points).
- 98-00 Collision/crash; all killed.

Sharp Curves: 90 degrees, high speed. **Skill Penalty:** -10%.

Sideswipe: This maneuver can be used against a stationary object, moving vehicle or person. The purpose of a sideswipe is to strike another vehicle, object or person, a glancing blow with the body of your vehicle. **To strike**, the swiping player rolls under his Pilot skill minus the 20% skill penalty in attempting this dangerous maneuver. **Note:** The target, if controlled by another person, can attempt to dodge via "evasive action" or "stunt" driving. **Skill Penalty:** -20%; no other attack possible. **A failed roll** to sideswipe means an automatic miss, and the player must roll under his Pilot skill, -20%, to maintain control of the vehicle. If control is lost, roll on the **Loss of Control Table** under stunts. **Damage** from a sideswipe does 2D6 for every 20 miles of speed. The sideswipe also damages the vehicle, which is equal to 1/3 the damage inflicted to the target. Thus, if the sideswipe inflicted 24 points of damage to the target, it would also do 8 points of damage to the vehicle. **Note:** The GM may substitute rules from *Road Hogs*, the TMNT supplement.

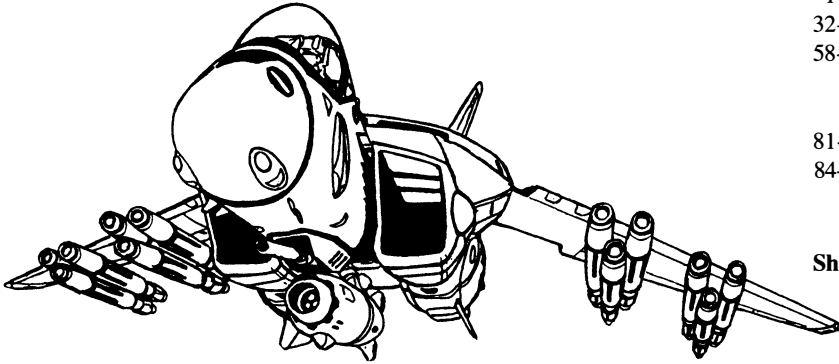

Airplane: Includes the old propeller, single and twin engine types. **Base Skill:** 70% + 4% per level of experience.

Helicopter: Includes the small, two seater, observation types; large transport and assault. **Base Skill:** 60% + 4% per level of experience.

Jet: Includes the fan jet, commercial jet and jet fighter. **Base Skill:** 60% + 4% per level of experience.

Lancer Space Fighter: **Base Skill:** 60% + 4% per level of experience.

Space Shuttle: **Base Skill:** 60% + 4% per level of experience.

SPECIAL NOTE: *The following rules apply to ALL aircraft.* Roll under your pilot skill for each maneuver:

Special Maneuvers: Conditions and Penalties: Evasive Action: Fleeing or dodging another aircraft, obstacle, missile or other attack by moving out of the way. All attacks are lost while engaged in evasive action; unless something suddenly flies directly in front of the vehicle, even then the pilot is -4 to strike. **Note:** This tactic will lose *any* attacker(s), meaning they cannot attack unless the attacker(s) engage in a "dog tail" chase. **Skill Penalty:** -12% (no attack possible) Maneuver consumes one full melee. **A failed roll** means an ineffective evasive maneuver, attacker(s) still in strike position and/or have struck. The player's attacks are still forfeit from a failed evasive action.

Tilt Dodge: This is a difficult maneuver, in which the pilot attempts to avoid an attack by quickly tilting or jerking out of the way at the last minute. In this way, the pilot can stay on course and continue his own attacks (if any). **Skill Penalty:** -35%; -2 to strike. **A**

failed roll means no dodge, aircraft is hit and takes full damage. A tilt dodge can be used to attempt to avoid each, individual attack. A tilt dodge can *not* avoid more than one blast from a multiple/simultaneous assault; evasive action is necessary.

Stunts: These are sudden, severe or highly difficult maneuvers, including dives, sharp turns, dead man's drop (nearly straight down, high speed drop), tumble, summersault and similar actions. **Skill Penalty:** -30%; lose attacks that melee. **A failed roll** means the stunt is incomplete and serious difficulties encountered. Roll percentile dice on the following table:

- 1-40 Engine chokes, stalled out and descending; must make an emergency landing unless the vehicle can be restarted (Pilot skill -25%; can try once every melee). All attacks are defensive only, -4 to strike.
- 41-70 Stunt maneuver botched, speed and altitude reduced by 1/3.
- 71-88 Engine difficulties; forced to make an emergency landing. Repairs will require 4-24 hours.
- 89-00 Engine and/or vehicle damaged beyond repair, crash inevitable. Character must parachute to safety. Optional: Can direct vehicle on a suicide crash into an immediate target; Pilot skill, -20%, to strike.

Emergency Landing: Executed when the vehicle or pilot is damaged and flight can not be maintained. **Skill Penalty:** -30%; loses all attacks. **A failed roll** will result in a crash landing. Roll on the following table for Crash Landing:

- 1-31 Pilot and/or passengers survive, minor injury.
- 32-57 Crash; pilot and passengers take 5D6 damage.
- 58-80 Pilot and passengers in critical condition/coma, require immediate, extensive medical treatment. Treat as surviving death and coma.
- 81-83 No survivors; vehicle exploded.
- 84-00 Passengers survive with minor injury, pilot dead. Optional: Pilot can opt to parachute to safety rather than attempting a landing.

Shadow: Is a maneuver in which the air vehicle pursues another vehicle without detection. This is usually done by flying above and behind the pursued, using clouds as cover. The pursuer will mimic the vehicle pursued in every way, so that they will be thought to be a radar shadow or aberration. **Skill Penalty:** -20%; no attacks possible without revealing true position and nature. While imitating the evasive actions, stunts, and so on of the craft being shadowed, roll for each maneuver being copied.

Dog Tail: This is an offensive maneuver in which the pilot closely pursues an enemy air vehicle while locked in combat. This is the only maneuver that can pursue a vehicle taking evasive action. By hanging on the enemy's tail or "dog tailing", the attacker can usually strike with little or no fear of counter-strike. **Skill Penalty:** -15%; no strike penalty. **A failed roll** means the target has momentarily slipped out of the striking range/area. Roll once every other melee to maintain dog tail position, *or* for every evasive or stunt action.

Boats: Sail Type: **Base Skill:** 80% + 4% per level of experience.

Boats: Motor Type: Large and small (not ships). **Base Skill:** 70% + 4% per level of experience.

PILOT RELATED SKILLS

Navigation: Skills in map reading, star charts, course computation, following landmarks, and use of navigational equipment. Includes air, land and water navigation, as well as piloting by instruments alone. **Note:** Basic mathematics and read sensory equipment are required to the navigate. **Base Skill:** 60% + 5% per level of experience. A failed roll means the pilot is off course. Roll 2D6 x 100 for aircraft, 4D6 x 100 for Veritech Fighters, and 1D6 x 100 for land vehicles, to determine how many miles/kilometers they are off course by. Roll for every hour that one is off course.

Navigation – Space: Basically the same as normal navigation techniques. The only difference is the use of stars, and some of the sensory equipment. **Base Skill:** 60% + 5% per level of experience.

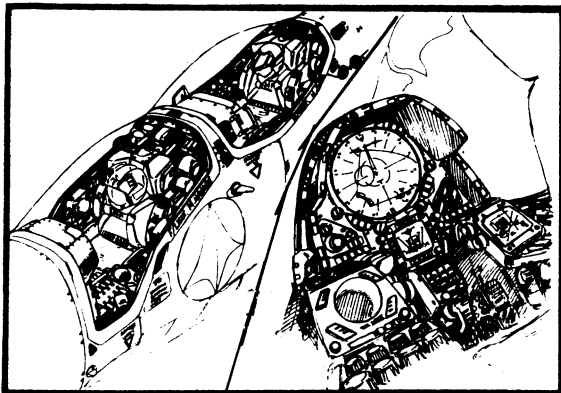

Read Sensory Equipment: Individuals with this training can maintain, understand, operate and “read” or interpret sensory data from all types of conventional sensor devices. These devices include radar, sonar, motion detectors, surveillance equipment, optical enhancement instrument panels and so on. **Base Skill:** 40% + 5% per level of experience. **Note:** Characters without a sensory skill cannot understand nor operate air vehicles, radar or detection/surveillance equipment.

Weapon Systems: This is the complete understanding of weapon units and systems incorporated in *vehicles* and *Mecha*. It includes the Destroids, vast variety of weapons, lasers, particle beams, auto cannons, missile launchers, and so on. **Special Bonus:** +2 to strike. This does not include hand-held weapons which require individual, W.P. training. **Note:** Characters without weapon systems skill will be able to operate them only if skilled in piloting that vehicle (like Pilot Mecha or Helicopter, etc.), but has no bonus to strike and never have the initiative. **Base Skill:** 60% + 5% per level of experience, and represents the overall comprehension and ability of the character.

SCIENCE

Astrophysics: Knowledge of stellar astronomy and how it relates to nuclear physics, quantum mechanics, relativity, and other explanations for the creation of deep space phenomena, like quasars and black holes. **Note:** Basic and advanced Mathematics is required before taking Astrophysics. **Base Skill:** 30% + 5% per level of experience.

Biology: Basic understanding of cells, anatomy, physiology, evolution and genetics. The character will know the basic use of a microscope, cultivating bacteria and how to classify new organisms. **Base Skill:** 40% + 5% per level of experience.

Botany: Plants, their categories and functions, are studied extensively. Characters will know the basics of cross-fertilization, germinating and growing experimental plants. **Base Skill:** 40% + 5% per level of experience.

Chemistry: Basic understanding of chemical principles and formulae. Characters know enough chemical laboratory procedures for analyzing and synthesizing chemical compounds in order to be competent assistants. **Base Skill:** 60% + 5% per level of experience.

Chemistry – Analytical: Chemical engineering theory, useful in the analysis of compounds and their practical applications. Characters will be highly skilled in the use of laboratory equipment, and can analyze and synthesize chemicals. **Note:** Basic and advanced Mathematics are prerequisites. **Base Skill:** 50% + 5% per level of experience.

Mathematics – Basic: Includes basic addition, subtraction, multiplication, division, fractions and algebra. **Base Skill:** 80% + 4% per

level of experience.

Mathematics – Advanced: Includes geometry, trigonometry, calculus and techniques for advanced mathematics. **Base Skill:** 64% + 4% per level of experience.

TECHNICAL

Computer Operation: A knowledge of how computers work, along with the skills to operate peripherals like keyboards, printers and modems. Characters can follow computer directions, enter and retrieve information, and similar, basic, computer operations. However, this does NOT include programming. **Base Skill:** 60% + 5% per level of experience.

Computer Programming: Designing, programming, debugging, and testing computer programs/software. **Note:** Computer Operation is required before taking computer programming. **Base Skill:** 40% + 5% per level of experience.

Demolitions: Demolitions provides the person with an advanced knowledge in the use and workings of explosives and detonation devices, for the purpose of blowing up bridges, buildings and sabotage. This includes *all* types of explosives, such as mines, dynamite, plastics, nitro, blasting caps, etc. It also includes a basic understanding of the strategic placement of mines and booby traps. This will increase a character’s awareness of suspicious rope, string and wire. **Base Skill:** 60% + 5% per level of experience. A failed roll means a dud; no explosion.

Demolitions Disposal (or Explosive Ordnance Disposal): This skill enables the character to safely defuse unexploded mines, bombs, explosive booby traps, dud artillery rounds, dud explosive charges, or any other explosive device. **Base Skill:** 60% + 5% per level of experience. A failed roll means the item has exploded without warning.

Photography: Taking black and white or color, still pictures. Characters will know how to load, develop and enlarge film. **Base Skill:** 50% + 5% per level of experience.

WEAPON PROFICIENCIES

There are two categories of weapon proficiencies (W.P.): Ancient and modern.

Ancient Weapon Proficiencies: Each skill area provides combat training with a particular type of weapon. The result is hand to hand combat bonuses to strike and parry, but only when that weapon is used. Each W.P. counts as one skill. The character may select several W.P. **Note:** Characters without a W.P. CAN use any weapon, but without bonuses.

W.P. Blunt: A skill with any type of blunt weapon including mace, hammers, cudgels, pipe, staff and clubs. **Bonuses:** +1 to strike and parry at **level one**, add another +1 to strike and parry at **level four** and +1 to parry at **level eight**.

W.P. Chain: Includes ordinary lengths of chain, mace and chain, flail, nunchaku, etc. **Bonuses:** +1 to strike at **level one**, add another +1 to strike and parry at **level four** and +1 to parry at **level eight**.

W.P. Knife: Combat skill with all types of knives. **Bonuses:** +1 to strike when thrown, **level one**; +1 to strike and parry at **level two**, +1 to parry at **level five**, +1 to strike at **level six** and again at **level nine**.

W.P. Sword: Combat skill with large and small swords. **Bonuses:** +1 to strike and parry at **level one**; an additional +1 to strike and parry at **level four**, and again at **level eight**.

Modern Weapon Proficiencies: These are areas of training and practiced skills with a particular type of modern weapon. Each W.P. counts as one skill. Characters may have several W.P. Each provides a bonus to strike.

MODERN

WEAPON PROFICIENCIES

The system for modern weapons presented in **Heroes Unlimited** and **Teenage Mutant Ninja Turtles & Other Strangeness** are fairly accurate and effective rules. However, they tend to bog down the speed of play with numerous dice rolls for damage and time determining how many rounds fired actually strike. I've since developed a quick playing, alternative set of rules, which appears for the first time in a formal, large press publication. (The same rules saw print earlier this year in a special, promotional pamphlet). Game masters should feel free to substitute these rules if they prefer, with those from, the previously mentioned game books or even those from the **Revised RECON**. All are modern weapon rules that would work just as well in **ROBOTECH™**.

Weapon Proficiencies (W.P.) are areas of training and practiced skill with a particular type of weapon, such as revolver or sub-machinegun. This skill provides special bonuses to strike when using that weapon. Do not add this strike bonus to your character's hand to hand or Mecha combat skill bonuses to strike.

Weapon Proficiencies provide the following bonuses:

Aimed: +3 to strike.

Burst: +1 to strike.

Wild: No bonus or penalty.

Training also enables the character to easily reload, disassemble, unjam, clean and otherwise maintain the weapon. **Recognizes weapon quality** — 30% at level one and +6% per each additional level of experience. **Add a bonus** of +1 to strike for every THREE levels of experience beyond level one. When firing a weapon, there are three main modes or categories of attack; *aimed, burst or wild*.

AIMED

An **aimed shot** means a person takes the time to carefully aim and squeeze off one, well placed shot. Each individual shot takes one full attack. Thus, if a character has four attacks per melee he/she can shoot FOUR aimed shots. This applies to all weapons. Roll to strike for each shot.

Bonus to Strike is +4 with a revolver or +3 for all others.

BURST

A **burst** is the shooting of several rounds, immediately one after another. Aim is more hasty and the recoil moves the weapon with each shot, reducing the accuracy. Semiautomatic/automatic weapons, machineguns and sub-machineguns, are designed for burst firing. The concept is that, while accuracy is reduced, the odds of hitting one's target with multiple rounds is increased because more shots are fired. **Bonus to Strike** is +1 with all weapons.

Note: Roll to strike once to see if the entire burst hits. Do not roll for each individual bullet. If the burst misses its target, then all the rounds in that burst miss.

Short bursts fire 20% of the entire round magazine; i.e., 30 round magazine — 6 rounds/bullets are fired. **Damage:** Roll the normal damage dice for ONE round $\times 2$. Uses up one attack. Can be fired at only one target.

Long burst fires 50% of the entire round magazine; i.e., 30 round magazine — 15 rounds/bullets are fired. **Damage:** Roll the normal damage dice for ONE round $\times 5$. Uses up one attack. Can be fired at only one target.

Entire magazine: Shooting off the entire clip/magazine within a melee round is possible. 100% of the rounds are fired. **Damage:** Roll the normal damage dice for ONE round $\times 10$. Uses up *two* attacks that melee. Can be fired at only one target. Machineguns are the only exception to this rule.

Spray: Shooting a burst at several targets at once is possible, but the same as shooting wild. You must fire a *long burst* or an *entire magazine* in order to spray. See shooting wild.

SHOOTING WILD

Shooting wild occurs when a trained character shoots without taking time to aim. This usually applies when the person is blinded, angry, running, rolling, leaping, shooting from a moving vehicle, etc.

Bonus to Strike: With W.P. there is no bonus or penalty; with no W.P. the person strikes at -6 . Long bursts or the entire magazine must be fired. Counts as two attacks. Can be fired at one target or in a spray. **Damage for shooting wild at one target:** Roll normal damage dice for ONE round $\times 2$. Roll once to strike with the wild burst. **Hitting an innocent bystander** is a real possibility when shooting wild; 20% chance. Roll for each wild burst fired. **Damage** is the normal damage from one round (a wild shot).

Spray an area with bullets can be dangerous and is considered to be shooting wild. The object of a spray is to hit several targets simultaneously. **First**, roll once to determine if you strike the target area; 1D20; 5 or higher strikes as usual. Then roll 1D4 to determine how many individual targets are struck within the target area. However, each target gets a roll to dodge to avoid getting shot. **Damage** is the normal damage from one round. **Hitting an innocent bystander** is even more likely; 50% chance. Damage is from one round, wild shot.

Bursts or Sprays from a machinegun is different only in the number of rounds fired, targets struck, and chance of hitting a bystander. Machineguns have a much greater ammunition capacity, so it does not have to empty the same percentage of its entire clip.

Short burst/one target: 10% of rounds magazine; inflicts normal round damage $\times 2$. Counts as one attack.

Short burst spray: 10% of rounds magazine; inflicts normal damage from ONE round, hits 1D4 targets.

Long burst/one target: 30% of rounds magazine; inflicts normal damage $\times 5$. Counts as one attack.

Long burst spray: 30% of rounds magazine; inflicts normal damage from ONE round, hits 1D8 targets. Counts as one attack.

Empty the entire magazine/one target: All rounds fired; inflicts normal round damage $\times 20$. Counts as all melee attacks/one full melee.

Empty the entire magazine in a spray: All rounds fired; inflicts normal round damage $\times 2$, hits 2D8 targets. Counts as ALL melee attacks/one full melee. Chance of hitting innocent bystanders is 70%.

A Special Note About Shotguns:

Shotguns can fire once or twice per melee (double-barrel). It can fire both rounds simultaneously or one at a time. Buckshot scatters, and will strike the specific target plus 1D4 others within its blast area (approximately a 15ft/4.6m area).

Note: *Conventional Weapons* will do absolutely NO DAMAGE to Mecha or mega-structures (M.D.C.), even if the combined damage from a burst is over 100 S.D.C. Only weapons that inflict mega-damage (M.D.) can damage a mega-structure.

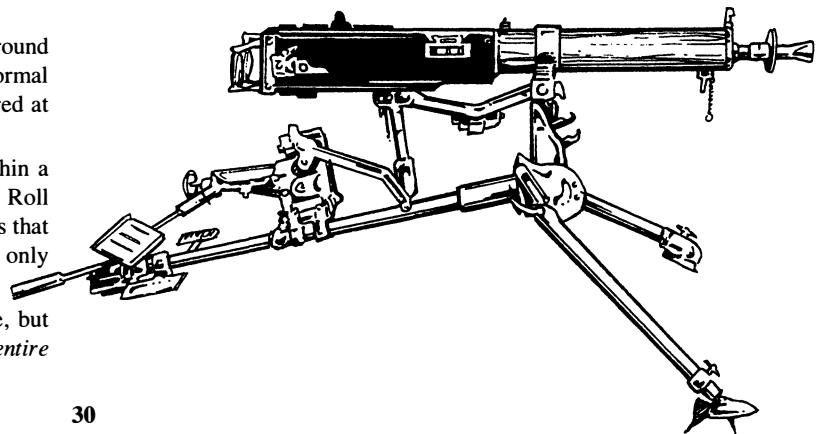



HAND TO HAND COMBAT

The combat system of **ROBOTECH™** is really just an adaption of that in *Heroes Unlimited* and *T.M.N.T.* It is designed to be fast moving and easy to understand. All combat strikes, parries and dodges, are resolved by rolling **twenty-sided dice**.

Players will notice that combat has been divided into two categories: **Hand to Hand Combat**, and **Mecha Combat**. This is actually much more simple than one might first believe. Both combat categories operate on the same basic principles, require the same dice, and work to achieve fast paced action. *Just remember that Mecha Combat ONLY applies when piloting or combatting Mecha.*

Resolving Combat: A Step-By-Step Introduction

In any fantasy role-playing game, especially one based on T.V. and comic book characters, there has to be a way of dealing with combat. In other words, when the hero tangles with the villain, you've got to be able to figure out the winner.

STEP 1: Determine Initiative

Any time opponents square off for battle, the game master must determine who has the initiative. In other words, who will attack first. Successful *Sneak Attack* or *Long Range Attack* will always have initiative for that melee. Otherwise, whoever *rolls highest* on a twenty-sided die will attack first. In the case of a tie, reroll. Initiative is rolled only once per melee. That roll will determine the pace for that entire melee.

STEP 2: Attacker Rolls Strike

The next step is for the first attacker to **roll a twenty-sided die**. If the result is a four or less (counting bonuses), then the attacker misses. *Any roll above a four (4) hits the opponent*. But, if the roll is a five (5) or better, *and less than the opponent's Armor Rating (A.R.)*, then damage may be done only to the S.D.C. of the opponent's armor (see Body Armor and Natural Body Armor). A roll

over the opponent's A.R. does direct damage to the character's S.D.C. and Hit Points. Note that special attacks like Knockout/Stun or Death Blow must be declared **BEFORE** rolling to strike. Note: A.R. and S.D.C. do not apply to Mecha.

STEP 3: Defender May Parry, Dodge or Entangle

Any time an attacker rolls a successful hit, the defender can choose to parry, dodge, or entangle. *Parrying* can be done automatically by anyone trained in any form of Hand to Hand combat. That means that the parry can be performed without wasting a melee attack. *Non-combat trained characters will lose their next melee attack every time they parry.*

NOTE: Bullets and energy attacks cannot be parried, but **CAN** be *dodged*. Defending by dodging or entangling means automatically giving up the next melee attack.

Entangle means the character actually pins or snares an opponent's weapons or arm.

The defender can only defend against attacks within his line of vision. Attacks from the rear cannot be parried, dodged or entangled.

STEP 4: Attacker Rolls Damage

If a successful strike is not parried, dodged or entangled, the attacker rolls for the amount of damage inflicted and adds any damage bonuses. Critical strikes do *double damage*. Combined critical strikes, like a natural twenty and a jump attack, do triple damage. Add the damage bonus to the roll before doubling or tripling. A natural, unmodified, 20 is always a critical strike.

STEP 5: Defender May Attempt To Roll With Punch

If the attack is a blunt, physical attack (fist, foot, club, staff, etc.), then the defender can attempt to Roll With The Punch. In order to roll with punch, the defender must match or better the attacker's roll to strike. Successfully rolling with a punch means the character takes *half* damage. Successfully rolling with a knockout punch means the character takes double damage, but is **NOT** unconscious or stunned. Rolling with a death punch results in loss of half of all remaining S.D.C. and hit points. Failing to roll with punch means taking full damage off of the defender's S.D.C. and/or hit points.

Continuing The Combat

Once the above is completed, the process is repeated for whoever lost the initiative. So long as the opponents have melee attacks left, the combat continues back and forth. When *all* the attacks or actions per melee round of all opponents are finished, it's time to start a new melee round. Initiative is redetermined at the *beginning* of every melee round. That is to say, that if a character has four attacks per melee, when *all* attacks are used, a new melee round begins.

COMBAT TERMS

A.R.: This is a character's **Armor Rating**. The A.R. indicates what an attacker must roll in order to do damage to the character. Any roll of 5 or better, will strike a character with no body armor. Characters with **Artificial Body Armor**, metal armor, bulletproof vests, etc., can easily be successfully attacked by rolls falling under the artificial armor's A.R.; doing damage to the S.D.C. of the *body armor*, but not to the S.D.C. of the defender. Or, by striking above the armor's A.R., damaging the character's personal S.D.C. and/or hit points. **Example:** A defender has a natural A.R. of 5 and is wearing body armor with an A.R. of 8. If the attacker rolls 9 or better, then damage is done directly to the defender. A roll of 5, 6, 7, or 8, would only hurt the body armor, not the wearer. A roll of 1, 2, 3, or 4, would totally miss.

Damage Table (Basic)

Human Fist	1D4
Human Kick	1D6 or 1D8
Black Jack	1D6
Bull Whip	1D8
Thrown Small Objects	1D4
Falling	1D6 per 10ft
Collision	1D8 per 10mph
Smashing through Glass	1D4
Dropped or Thrown	
Large Objects	1D8 per 100lbs 1D8 per 40ft, and 1D4 per 4mph

Death Blow: An automatic kill. The defender can try to roll with death blow by rolling over the attacker's strike. If the defender is not killed, then the current S.D.C. and hit points are reduced to half. This attack is available only under certain conditions.

Dodge: A character dodges by moving out of the way of the attack. Dodging always takes up one attack/action per melee round. To Dodge, the defender must roll higher than the attacker's strike roll on a twenty-sided die.

Entangle: A defender can attempt to trap the weapon or arm of an attacker. This is done instead of parrying or dodging, and takes up one attack per melee. An entangle is successful if the defender rolls above the attacker's strike roll. It takes one attack and a roll to entangle to keep an opponent's arm or weapon entangled every melee round. In order to get free, the entangled opponent must roll a dodge against the entangle roll.

Hand to Hand Combat: Fighting skills that provide the characters with attacks per melee, bonuses, and techniques. Characters without combat training have only one attack per melee and have *no* automatic chance to parry.

Hit Points: This is the number of points of damage a character can take before dying. Characters don't lose hit points until their S.D.C. is down to zero. A character's base hit points is the P.E. plus 1D6. Another 1D6 of hit points is gained every time the character advances an experience level. Lost hit points are not recovered without medical attention.

Initiative: Whoever gets to attack first is considered to have the Initiative. Initiative is automatic in sneak attacks and long range attacks. In most other cases, each opponent rolls a twenty-sided, highest roll gets the initiative. Rolling for initiative takes place at the beginning of each melee round of combat.

Kick Attack: This is a karate-style kick. It is a normal attack that does 1D4 damage for the untrained, or higher with hand to hand skills. Anyone trained in hand to hand combat can do a kick attack.

Knockout/Stun: Anyone hit by a knockout or stun attack will be temporarily incapacitated. The victim is not necessarily unconscious, just dazed.

Jump Kick: A Jump Kick is performed by leaping completely off the ground and attempting to land foot-first on an opponent. Jump Kick can be used only by those skilled in hand to hand martial arts. The advantage of a jump kick is that it works as a *critical strike* and doubles the normal damage inflicted. The disadvantage of a jump kick is that no other attack may be performed in that melee round (all attacks for that melee are used up in the kick). The jump kick must be the character's first attack of that melee round. For the rest of the melee round, the character can only parry, dodge or move into position.

Leap Attack: An airborne assault where the weapons and fists are wielded in mid-leap. A leap attack must be made only at the beginning of a melee round and, like the jump kick, uses up *all* attacks for that melee. Usually, only a single strike can be made during a leap attack. However, if two opponents are close together, the attacker can leap between them and strike both of them at the same

time; roll to strike for each character. After the leap, the character may not attack again until the next melee round, but can parry or dodge or move into position. Automatic parries work in mid-leap, but dodges are impossible. A successful leap attack is a critical strike and does double damage.

Long-Range Attack: By using a long-range weapon from a distance, an attacker can perform an undetected, *first strike*. Provided the attacker is not seen, the defender automatically loses initiative and may not dodge the first attack that melee round.

Melee or Melee Round: Exactly 15 seconds. The segment of time combatants have to strike, counter and/or return strike. Generally, playing characters have two or more attacks per melee.

Multiple Attackers: Takes place when an opponent is faced by more than one attacker. Characters with hand to hand combat skills can attempt to parry any attacks within their line of sight. The defender from multiple attackers can strike at only one target at a time (see leap attack for a rare exception).

Natural Twenty: This is the result of 20 when rolling a twenty-sided die. A strike with a natural twenty will always be a critical strike. If someone with a strike bonus of +2 rolls an 18, then they have an attack roll of 18 *plus* unnatural, bonus modification; NOT a natural twenty, and is not a critical strike. A natural twenty beats all other rolls and can only be parried or dodged by *another natural twenty*.

Paired Weapons: Certain kinds of weapons, such as Sais, Nunchaku, knives, clubs and swords, can be used as paired weapons. Users of paired weapons can strike and parry simultaneously, can do twin strikes against a single target or against a pair of targets, and can parry two, different opponents at the same time. In other words, warriors skilled in paired weapons often can do two actions for every one of their melee attacks. BUT, every time they use twin actions they LOSE their automatic parry.

Parry: A defender can attempt to parry most physical attacks. This is done by blocking the attacker's blow with a weapon or hand. Characters trained in hand to hand combat can parry without losing melee attacks. Bullets and energy attacks *cannot* be parried!

Pull Punch: The ability to control the force of a hand to hand attack. Usually used to reduce the blow to less than killing force. The character can choose to half damage, quarter damage, a single point or no damage at all. A character must declare a pulled punch, the player must roll 11 or better on a twenty-sided die; failure means full damage is inflicted.

Roll with Punch/Fall: Hand to Hand combat fighters can reduce the damage from blows and falls by rolling. If the defender is successful, then only half damage is taken. Roll with punch/fall does not work against energy blasts, bullets, fire, bladed weapons, psionics or radiation. Victims must roll higher than the attacker's roll. *Falling* characters must roll a 14 or higher, on a twenty-sided die, to roll with the fall.

Saving Throws: Occasionally, characters must roll to save against exotic attacks like poison, gas, insanity, psionics, etc.

Lethal Poison	14 or better
Non-lethal Poison	16 or better
Harmful Drugs	15 or better
Acids	No save possible — Dodge!
Insanity	12 or better
Psionics	15 or better for non-psionics 10 or better for psionic

S.D.C.: This stands for *Structural Damage Capacity*, which is the amount of damage an object can absorb before breaking. Living creatures also have S.D.C.; it represents their physical resistance to damage. All the S.D.C. of a living thing must be reduced to zero before the hit points can be affected. Note: A cousin to S.D.C. is M.D.C. or Mega-Damage Capacity. M.D.C. applies to Mecha, and

is explained in the Mecha Combat section which follows shortly.

S.D.C. Table (Basic)

Below are the S.D.C. values for a variety of objects. When an object's S.D.C. is reduced to zero, it is considered broken. Game masters should exercise common sense in applying these values. For example, a normal human cannot break through a vault door with bare fists, no matter how many times natural twenties are rolled.

The S.D.C. of different weapons is applied *only* if someone is actually attempting to break the weapon. A properly wielded sword can inflict or parry many times its S.D.C. On the other hand, using the sword to wedge open a door could easily snap it off.

It is also important to note that the S.D.C. applies to the entire object. A bullet can penetrate many objects with only a small fraction (about 2%) of S.D.C. loss. For example, if a bullet punching through an exterior brick wall hit a target, it would inflict normal damage minus the 4 points of S.D.C. it wasted getting through the wall.

Airplane, Single Engine	400 S.D.C.
Airplane, Jet Airliner	2000 S.D.C.
Box, Metal Shipping Crate	48 S.D.C.
Car, Compact	250 S.D.C.
Car, Luxury	450 S.D.C.
Car, Door Only	150 S.D.C.
Car, Windshield Only	100 S.D.C.
Door, Interior Wood	100 S.D.C.
Door, Exterior Wood	170 S.D.C.
Door, Metal Grill	350 S.D.C.
Door, Solid Metal	600 S.D.C.
Door, Metal Safe	800 S.D.C.
Door, Bank Vault	5000 S.D.C.
Handcuffs, Regular	60 S.D.C.
Handcuffs, Heavy	120 S.D.C.
Lock, Common Latch	40 S.D.C.
Lock, Dead Bolt	100 S.D.C.
Lock, Heavy Padlock	75 S.D.C.
Motorcycle	100 S.D.C.
Truck, Medium Sized Pick-up	450 S.D.C.
Truck, Half-Ton Pick-up	550 S.D.C.
Truck, Freight Hauler	650 S.D.C.
Wall, Interior Plaster	120 S.D.C.
Wall, Exterior Wood	150 S.D.C.
Wall, Exterior Brick	200 S.D.C.
Wall, Cinder Block	300 S.D.C.
Wall, Reinforced Concrete	400 S.D.C.
Weapon, Artillery Piece	1500 S.D.C.
Window, Ordinary Glass	20 S.D.C.
Window, Plexiglass	35 S.D.C.

Simultaneous Attack: Instead of defending with a parry, dodge or entangle, a character can choose to do a simultaneous attack. In this case, the character does not defend ("Go ahead, hit me; I can take it!") and simply attacks in response. The advantage of a simultaneous attack is that *neither* opponent can parry, dodge or entangle. In all probability, both will take damage. *Exception:* An opponent with paired weapons can engage in simultaneous attack (with one weapon) AND parry (with the other), OR, both the paired weapons can be used to strike with NO parry.

Sneak Attack: An attacker may lie in wait (ambush), attack from behind, or sneak up (prowl) on an opponent. If the foe does not discover the attacker, then the sneak attack is successful. The sneak attacker always has initiative, and the defender is not able to parry or dodge the sneak attack.

Strike: Anyone attempting to hit an opponent must roll to strike. As with all combat rolls, a roll to strike is made with twenty-sided dice.

Throw: Simply, this means throwing a weapon. Rolling to throw is exactly the same as rolling to strike, except that there are different

bonuses per weapon type. See Weapon Proficiency.

NOTE: A character may use ANY type of weapon, but gets no combat bonuses, such as strike or parry, unless he has a Weapon Proficiency (W.P.) in that particular weapon. This applies to modern and ancient weapons.

HAND TO HAND: BASIC

- Level 1** Two attacks per melee; +2 to pull/roll with punch, fall or impact.
- +2 to parry and dodge.
 - Kick attack does 1D6 points damage.
 - One additional attack per melee.
 - +1 to strike.
 - Critical strike on an unmodified roll of 19 or 20.
 - +2 to damage.
 - Judo-style body throw/flip; does 1D6 damage, and victim loses initiative and one attack per melee.
 - One additional attack per melee.
 - An additional +2 to pull/roll with punch, fall or impact.
 - An additional +1 to parry and dodge.
 - An additional +1 to strike.
 - Critical strike or knockout from behind.
 - An additional +2 to damage.
 - An additional attack per melee.

HAND TO HAND: EXPERT

- Level 1** Two attacks per melee; +2 to pull/roll with punch, fall or impact.
- +3 to parry and dodge.
 - +2 to strike.
 - One additional attack per melee.
 - Kick attack does 1D6 damage.
 - Critical strike on an unmodified roll of 18, 19 or 20.
 - Paired weapons.
 - Judo-style body throw/flip; does 1D6 damage, and victim loses initiative and one attack.
 - One additional attack per melee.
 - +3 to damage.
 - Knockout/stun on an unmodified roll of 18, 19 or 20.
 - An additional +1 to parry and dodge.
 - Critical strike or knockout from behind (triple damage).
 - An additional attack per melee.
 - Death blow on a roll of natural 20.

HAND TO HAND: MARTIAL ARTS

- Level 1** Two attacks per melee; +3 to pull/roll with punch, fall or impact.
- +3 to parry and dodge; +2 to strike.
 - Karate-style kick does 1D8 damage.
 - One additional attack per melee.
 - Jump kick (critical strike).
 - Critical strike on an unmodified roll of 18, 19 or 20.
 - Paired weapons.
 - Leap attack (critical strike).
 - One additional attack per melee.
 - Judo-style body throw/flip; does 1D6 damage, victim loses initiative and one attack.
 - An additional +4 to damage.
 - An additional +2 to parry and dodge.
 - Knock-out/stun on an unmodified roll of 18, 19 or 20.
 - An additional attack per melee.
 - Death blow on a roll of a natural 20.

MECHA COMBAT RULES

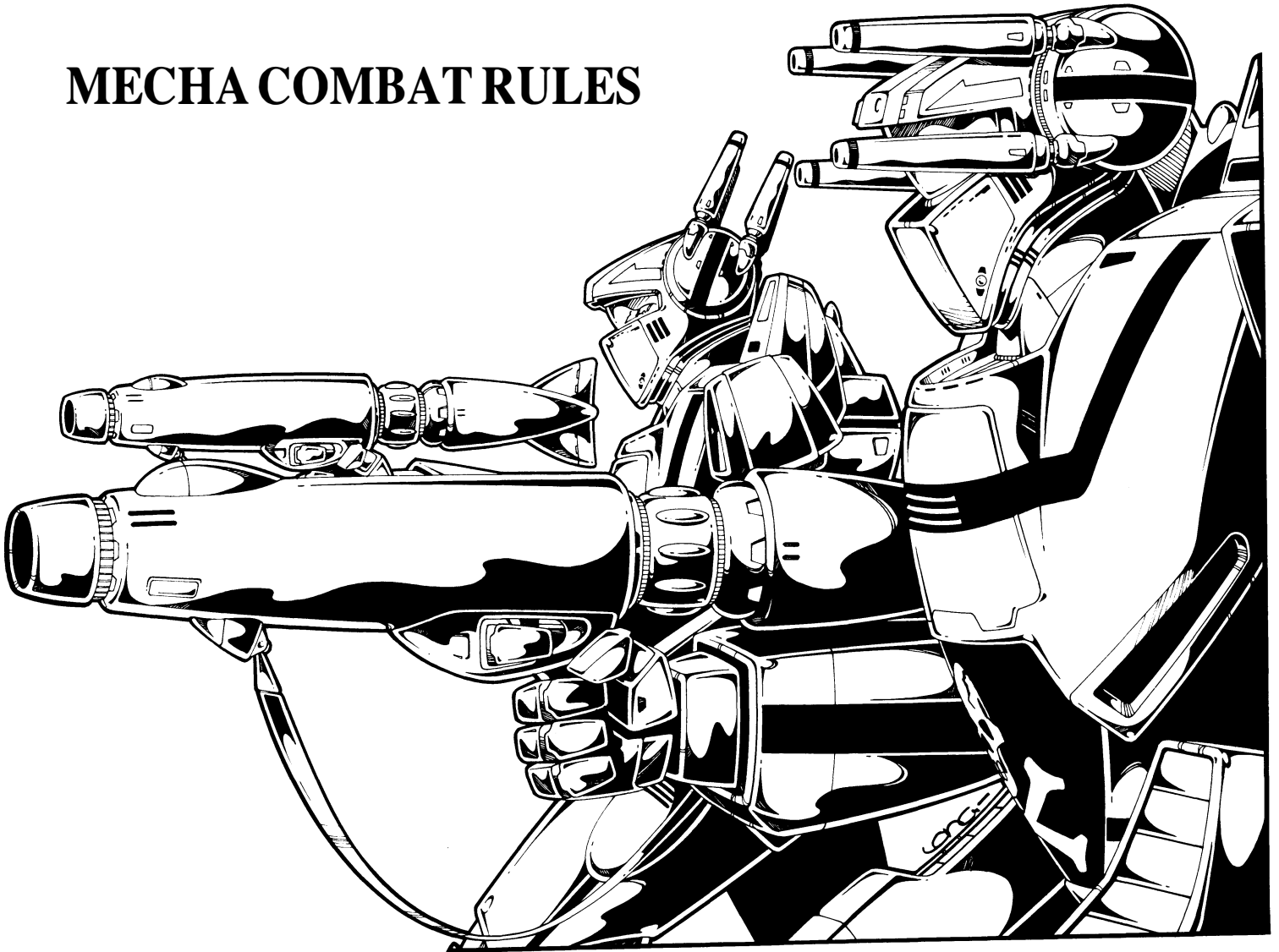

The following are the rules that are used when playing mecha. You will find that the basic rules are only minor modifications of the standard, **Palladium Books'** combat rules just described. The use of giant war machines requires some special considerations, modifications and clarification.

WHAT IS MECHA?

Mecha is the term used to describe the giant, robot, battle armor, and machines used by the humans and Zentraedi aliens. Generally, Mecha are giant, robot-like constructions or armored battle suits, that respond to the pilot's every movement as if the construction was an extension of his or her own body. Weapon systems, such as lasers, auto cannons and missile launchers, are built directly into the Mecha, providing the pilot with more firepower than a dozen tanks.

Examples of Mecha include: The Veritech Fighter, which can transform; Destroids/Battloid,s and Zentraedi Battle Pods and Power Armor. For game purposes, the giant sized Zentraedi, 40 to 60 feet tall, will be regarded the same as Mecha in combat.

RESOLVING COMBAT

The basic steps of resolving combat are essentially unchanged. Players must still determine initiative, roll to strike, defender may parry or dodge, damage is determined, defender may attempt to roll with the punch or impact. These are always the basic combat actions. See the previous combat descriptions for details. What follows are modifications, additional details, and conditions as they apply to Mecha.

MEGA-DAMAGE, S.D.C. & M.D.C.

It is crucial that players clearly understand the concept of Mega-Damage and Mega-Damage Capacity (M.D.C.). Basically, M.D.C. indicates a super tough armor or physical structure. A structure so tough, that normal weapons will not damage it. To damage Mega-Damage Capacity (M.D.C.) structure you must use something that inflicts Mega-Damage (M.D.).

Consider this example with a contemporary M.D.C. structure we all recognize, a tank. There you are, sitting inside a tank; a powerful, heavily armored (M.D.C.) weapon. A kid walks up to your tank and begins to bounce a hard rubber ball against the hull of the tank. He can do this all day long without damaging the tank in the tiniest way. The kid picks up a rock and throws it, hard, against the tank. Again, no damage is done other than a tiny nick in the paint. Now, pounding with all his might against the hull with a baseball bat, the kid is scuffing the daylights out of the paint job, but still does *no* damage. Yet, all of these items could affect and damage most items with a normal Structural Damage Capacity (S.D.C.).

You're still sitting in your tank when somebody waltzes up and lets go with a .357 Magnum at point-blank range. The bullets bounce off the tank's armored hull, leaving only large gouges in the paint and scratched armor. No damage is done. His two buddies whip out an Uzi sub-machinegun and an M-16 assault rifle, and spray the tank with a hail of bullets. The combined attack must number into the *hundreds* of

S.D.C. damage. But the tank's hull is undamaged because it is super tough . . . M.D.C.! Normal weapons, even when combined, can not damage a mega-structure. Only a weapon that inflicts mega-damage (M.D.) can harm the tank.

A car skreeches to a halt 60ft away. Two men with a heavy duty bazooka take cover behind their compact car. *Now the tank is in trouble!* Why? Because the bazooka is a mega-damage weapon. You think: "Who are all these lunatics in this example and why are they beating on my tank?!" COMBAT: Player of the tank pilot rolls a twenty-sided die (1D20), the player of the bazooka team does likewise, to determine *initiative*. The high roll goes to the bazooka team; they have initiative, which means they strike first. Again, a 1D20 is rolled, this time to *strike*. A seven is rolled. Since the tank is too large and too slow to *dodge* the bazooka team shoots and successfully strike and do damage. If the tank is lucky, it will take minimal damage (a low damage roll). If unlucky, the shell will inflict severe damage (a high roll of damage).

The tank is damaged, but can still operate because the total M.D.C. has not been depleted. As the bazooka team gets ready to fire another shell, it's the tank's turn to strike/counterattack. It aims, and the cannon is fired at the compact car the two men are hiding behind. The car has a Structural Damage Capacity (S.D.C.) of 300 and an Armor Rating (A.R.) of 6. However, the tank's cannon inflicts mega-damage, so the Armor Rating does not apply. A successful roll to strike is quickly followed by a damage roll. The roll is low. A measly 4 M.D. points. The car is a burning mass of twisted metal. Why? Because the 4 M.D. points of damage are equal to 400 S.D.C. The car is destroyed.

Quick Mega-Damage and M.D.C. Reference Chart

- 1 M.D. Point equals approximately 100 S.D.C. points.
- 1 M.D. Point equals 100 Hit Points.
- Armor Ratings do *not* apply when up against a weapon that inflicts mega-damage. This is always true!
- Normal weapons do absolutely no damage to mega-structures (M.D.C.), even if the total damage is over 100 S.D.C.
- Only weapons that do M.D. can damage M.D.C.

Also See *Mega-Damage and M.D.C. explanation in the beginning of the book.*

ARMOR RATING

Armor Ratings do not apply to Mecha or Mega-Damage Capacity (M.D.C.). Either you strike and do damage, or you miss.

Armor Ratings apply only to conventional combat and S.D.C. Armor ratings do *not* apply when struck/attacked by a weapon that inflicts mega-damage. Of course, one can always attempt to dodge or roll with an attack to avoid or minimize damage.

DETERMINING THE NUMBER OF ATTACKS PER MELEE AND COMBAT BONUSES

All Mecha possess a design element, protoculture, which creates a symbiotic link between the pilot and the machine. This symbiotic relationship enables the Mecha to respond with almost human reflexes, agility, dexterity and mobility. No, the Mecha does not have an I.Q. or will of its own, but the pilot's physical abilities to strike, parry, dodge, roll and attack, *do* combine with the Mecha which can effectively double all hand to hand combat abilities.

This is how it works. Players will find two skills that exclusively determine the Mecha's number of attacks: 1) The pilot's normal, hand to hand combat skill, and 2) The pilot's Mecha Combat skill. Simply combine the number of attacks gained from each skill. The total number indicates the total attacks per melee possible. Most first level pilots, with both skills, will have a total of FOUR attacks per melee.

The same is done to determine the pilot's Mecha combat bonuses to strike, parry, dodge, etc. This means, if the pilot has a +2 bonus to dodge in Hand to Hand Combat and a +1 bonus to dodge in Mecha Combat, the two are added together for a total of +3 to dodge. Note: Attribute bonuses are also applicable and are added to the total bonus to strike, parry or dodge.

The combining of number of attacks and combat bonuses apply ONLY when piloting Mecha! When outside of the massive battle armor, the pilot must rely *exclusively* on his or her Hand to Hand skills and *not* the combined abilities of the two skills. Why? Because the Mecha Combat skill is not a physical training, but a mechanical proficiency which relies on eye/hand coordination, reflex and dexterity as they relate directly to the Mecha. The Mecha Combat skill does not build physical strength, endurance or combat techniques.

Unskilled Characters and Mecha

If the pilot has only the normal, hand to hand combat skill, those are the exact abilities that apply to the Mecha in combat. There are NO additional bonuses added. A first level character will usually have two attacks per melee.

If the pilot does not have normal hand to hand combat, but *does* have Mecha combat, then he/she possess all of those combat skills and bonuses. Nothing more. A first level character will usually have two attacks per melee.

If the pilot does not have hand to hand combat training nor Mecha combat, he or she is limited to one attack per melee and no special bonuses. **Note:** If the character has any physical attribute bonuses they *are* transferred to the Mecha.

WEAPON SELECTION

The Mecha pilot usually has several modes of attack available to him. These may include lasers, machineguns, grenade launchers, missiles and hand to hand combat. Weapons or modes of attack, can be used in any combination. You are limited only by the number of attacks per melee and possible, payload and rate of fire restrictions. **For example:** a character piloting a *Gladiator* has five attacks per melee. The character fires a volley of four missiles (attack #1), fires its top laser turret (attack #2), fires a long burst from its auto cannon (attack #3), followed by another long burst from its auto cannon (attack #4), and punches the Zentraedi Battle Pod which has just lunged out from around the corner (attack #5). All this in one melee round or 15 seconds.

Wait a minute, you say. This character has FIVE attacks, but, in the example he fires a volley of four missiles and then continues to attack four more times. Isn't that EIGHT attacks. No; and here's why.

VOLLEYS & BURSTS

One volley or one burst *counts as one attack*, even if a dozen, yes 12, missiles are launched. How? Because it requires only one attack/action to fire several missiles or rounds, *simultaneously*, at *one* specific target. Roll to strike and dodge as usual.

Disadvantages

1. **The entire volley or burst must be directed at ONE specific target.** The character can *not* divide a volley or burst between several targets. To attack more than one target the pilot must take time to aim and fire at each, which means each is a separate attack that melee. **For Example:** A Veritech Fighter is up against four Zentraedi Battle Pods. The pilot decides to launch four of his 12 missiles at *one* Battle Pod. That's one attack, leaving three more that melee. He can *not* fire the four missiles simultaneously at all four of the Pods. To strike all four Pods, the pilot must fire at *each*, individual Pod separately. However, this will take up all four of the pilot's attacks that melee.
2. **Must roll to strike for the entire volley or burst, as if it were**

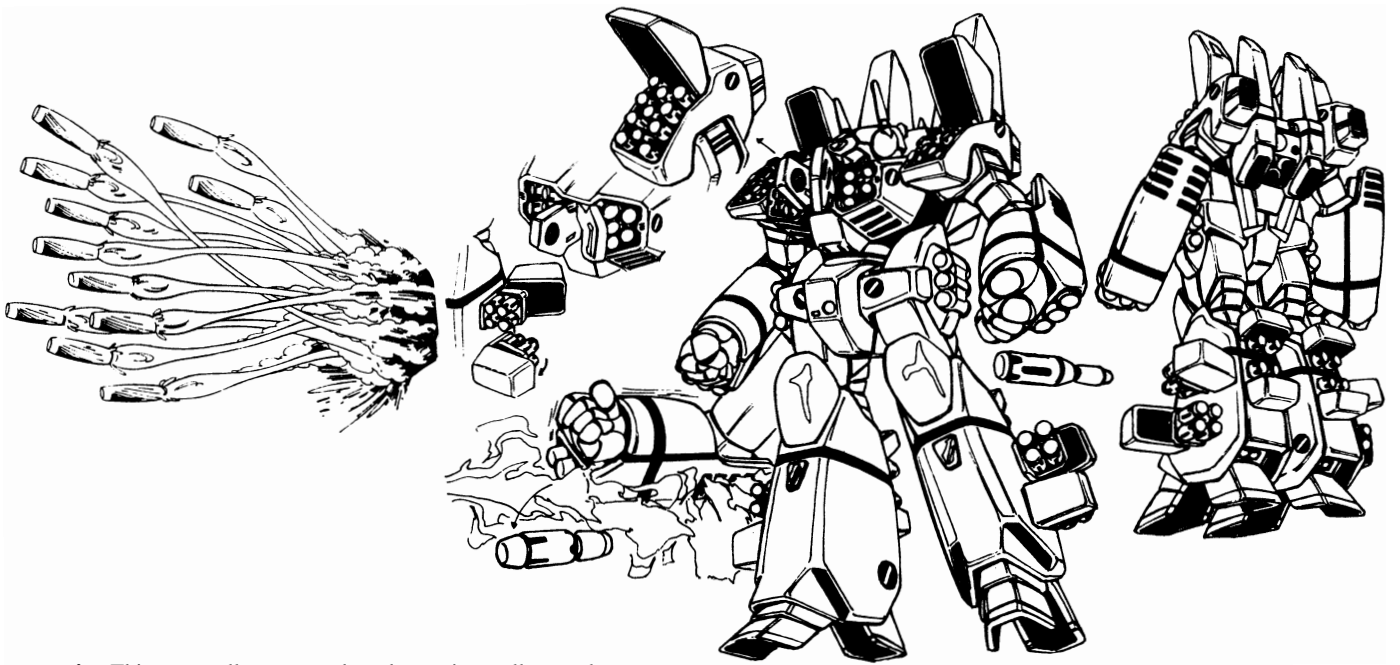

one unit. This generally means that the entire volley or burst, either strikes and does multiple damage (roll for each missile in the volley) or the entire volley misses, doing no damage at all. Do *not* roll to strike for each, individual missile or round. Also see Missiles for related combat data.

3. **Continuous fire of bursts** can often be maintained for the entire melee. While the full melee burst counts as one attack and does significant damage, that particular weapon can not be used against any other targets for that full melee.
4. **Payload:** Volleys and bursts usually deplete a limited number of missiles or rounds quickly. Once the payload is expended, the weapon is temporarily useless.

Note: Unless limited by volleys, bursts or other, listed restrictions, the same weapon can be fired repeatedly in the same melee or in tandem with others.

HOW TO STRIKE

The procedure for ascertaining a strike is unchanged. The attacker rolls a 20 sided die (1D20). A roll of 1, 2, 3, or 4, is an automatic miss. A roll of 5 or higher is a strike/hit. Damage always comes off the Mecha's *main body* unless it is a called shot (specific target).

The only way a target can avoid being struck is by dodging out of the way or parrying the attack, if possible.

Remember, Armor Ratings (A.R.) do not apply to Mecha, or when up against weapons that inflict mega-damage (M.D.).

STRIKE BONUSES

Bonuses to strike can be gained by skills, such as hand to hand combat and/or Mecha combat and/or from a high Physical Prowess (P.P.) attribute. All bonuses are accumulative. Remember, bonuses from Mecha combat apply only when Mecha is being piloted. This bonus does not apply to missile related combat.

CRITICAL STRIKE

A critical strike occurs when a player with hand to hand combat skill makes an extremely high die roll to strike without the aid of bonus modifiers. An unmodified "natural" 20 is always a critical hit, regardless of hand to hand training.

Critical strikes do double damage. Optional damage tables have been provided for additional side effects from critical strikes. Their inclusion in the game is up to the GM and/or players.

CLOSE PROXIMITY STRIKE BONUSES

Technological advances have made war a long- range affair, with soldiers firing missiles at opponents 20 miles away, who appear, as tiny blips on a radar screen. However, the creation of battle armor, such as the Veritech Fighter, Destroids and Battle Pods, has restored the strength of the infantry, making close range combat possible. Thus, if opponents are within close proximity of one another (within 500ft/152m), they gain a bonus of +1 to strike. This bonus applies to all combatants, skilled and unskilled, using weaponry or hand to hand combat with Mecha. It does not apply to normal hand to hand combat among humans.

CALLED SHOTS

A character may attempt to shoot a specific target or area. This is done by clearly stating what the exact target is before the roll to strike is made. Once the shot is "called", the player rolls the usual 1D20 to strike. A successful roll, above a 12, hits exactly whatever the intended target was, unless the opponent dodges.

Called shots can be an important strategy enabling characters to *disable* Mecha rather than destroy the whole unit. This means a character can destroy specific targets on Mecha and vehicles, such as radar antennas, weapon barrels, sensors, mechanical legs, arms, etc.

Note: Any shot which is not called will strike what is identified as the *main body* of the Mecha or vehicle. The main body is the largest, bulkiest part of the target and most likely to be hit. If a player calls his shot, but misses by rolling under 12, but above 4, he/she still strikes, but hits the *main body* instead of the specific, "called" target.

I avoid random hit location tables because I feel the randomness is too fluke and unrealistic.

TO ROLL WITH A PUNCH, FALL, OR IMPACT

This is a saving throw of sorts, or a second dodge, to minimize damage. Players of Heroes Unlimited will already be familiar with this rule. It is much like the hand to hand combat rule. In this case, if the player fails his dodge to roll and is about to be hit by a missile(s), he has a sort of second dodge or saving throw, where the character tries not to resist the explosive impact and rolls *with* it. A successful roll

with impact works like a dodge. The player must roll 1D20 and match or better the roll to strike. A success means the character suffers only half damage. A failed roll means a direct hit doing full damage. In **ROBOTECH™**, a character can roll with the impact from explosive missiles, punches, body blocks, falls, and similar impact damage.

You can *not* roll with the impact of attacks from auto cannons, machineguns, energy weapons, or plasma/napalm missiles.

THE DODGE

The dodge for Mecha is identical to its hand to hand counterpart. The defender must roll a twenty-sided die (1D20), and match or better his attacker's roll to strike. A successful roll means he has moved out of the way and takes no damage. A failed roll means the dodge was not a success and the character is hit, taking full damage.

As Mecha pilots, there are some new situations that effect one's ability to dodge. They are as follows:

DODGING THE BIG GUNS

Pilots of fast moving vehicles, like jets, and Mecha, like Veritech Fighters and Zentraedi Battle Pods, can dodge the massive energy beams and cannon blasts from starships. Since these weapons are designed to strike and destroy large targets, such as massive starships, space stations, and even planets; small, mobile vehicles can avoid them with relative ease.

Veritech Fighters, Jets and Zentraedi Pods are +6.

All other Mecha and Helicopters are +2 to dodge.

MISSILES

In translating Japanese text about the **Macross T.V. Series**, we unearthed a wealth of specific names and numbers for missiles, like the GH-30 or GA-95. It seems the Japanese love to name everything. Unfortunately, hard data regarding range and type of warhead was limited to short, medium, long, and nuclear or "many". Meanwhile, the producers of the English language, **ROBOTECH™ T.V. series** (adapted from the Japanese **Macross**), have added specific labels to the missiles, such as reflex, proton torpedo, plasma torpedo, and so on. To avoid mass confusion, I have broken the missiles into basic, generic types and ranges. This method maintains the integrity of both versions of the animated series and satisfies all game requirements.

The descriptions of war machines in this game, such as the Veritech Fighters, Destroids, Zentraedi Pods and war vehicles, will specifically state if they can launch missiles. It will also denote the type of missile as *short, medium, or long range*. In some cases, a Mecha or vehicle can fire two types of missiles, such as medium *and* long range. Under each range category you will find a selection of specific types of warheads, such as high explosive, fragmentation, plasma, reflex, and so on. Not all missile warheads are of a destructive nature and can be smoke, tear gas or chemical (i.e. fire retardant, and knockout gas). Mecha and vehicles can fire one warhead type, or any combination of missile types, as long as they are listed under the appropriate range category.

STRIKES: GUIDED MISSILES

Missiles do not enjoy the pilot's combined bonuses to strike. Since they are all self-guided, missiles are launched as separate units with their own bonus of +3 to strike. Reflex missiles, which are smart bombs, are +5 to strike.

Rolls to strike are made on the usual, twenty-sided die. Missiles can be launched one at a time (roll to strike for each), or in volleys of two or more (roll once to determine whether the entire volley strikes its target).

It is possible to dodge one, two, or even three missiles. However, it is impossible to dodge a volley of four or more missiles. It is also possible to shoot a missile(s) down before it hits you. *See Volleys and Bursts, and Dodging Missiles for more details about missile combat.*

DAMAGE FROM MISSILE STRIKES

Direct hits do full damage. A volley of missiles inflicts full damage from each and every missile in the volley.

Near misses do half damage. There are two ways one can take damage from a near miss. **The First** is by being within the blast radius of the target struck by a direct hit. **For example:** Your companion, standing 10ft away, is hit by a high explosive missile with a 30ft blast area. He takes full damage from a direct hit, but you are also caught in the blast because you were standing too close together. Fortunately, your character takes half damage since he was not caught directly in the blast. Damage can be reduced by half again if the player makes a successful die roll to "roll with punch, fall or impact".

The Second way one takes half damage from a near miss is by successfully "rolling with the punch, fall or impact" of the attack. In this case, the player fails his dodge roll and is about to be hit by a missile(s). However, he has a sort of second dodge or saving throw, where the character tries not to resist the explosive impact and rolls with the impact. A successful roll with impact works just like a dodge. The player must roll 1D20 and match or better the roll to strike. A successful roll means the character suffers half damage. A failed roll means a direct hit doing full damage.

SHOOTING MISSILES

Shooting and depleting the M.D.C. of a missile can detonate and destroy it. However, there are restrictions.

1. The character must have an attack(s) available to him/her that melee

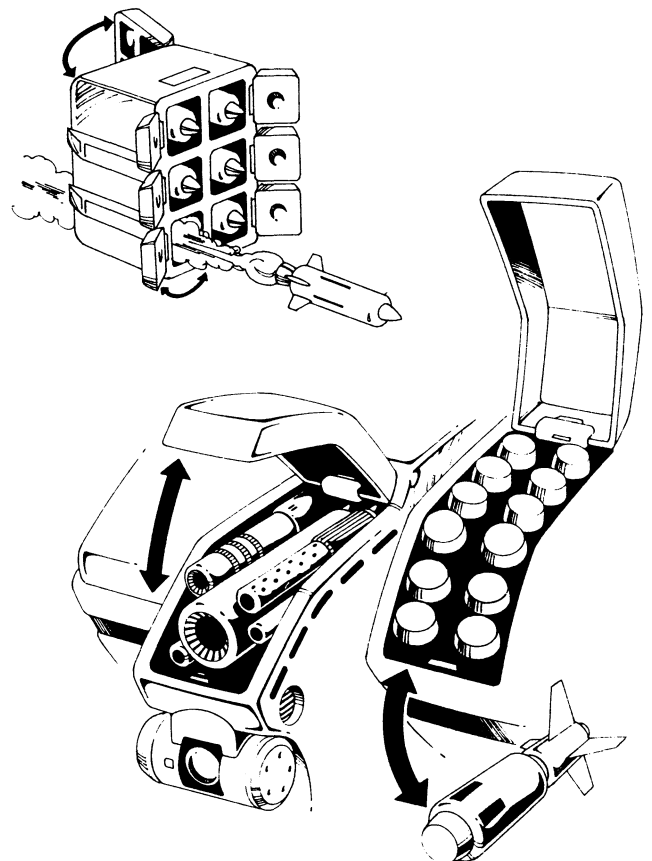

to assail the missile. If all the attacks for that melee have already been used up, the character can not shoot at the missile(s).

2. Can only shoot at *one* missile, within the volley, at a time. A volley of six missiles would require six attacks, which is impossible at the speed missiles travel. This means the player has only one or two attacks (GM's discretion) to shoot at one or two missiles within the volley. However, if one missile is detonated, there is a 45% chance (1-45%) that its explosion will detonate the other missiles in the entire volley.

The player can also use his own missiles, if available, to shoot down a missile volley. Under this circumstance, there is a 75% (1-75%) likelihood of detonating the entire volley of missiles.

3. If the M.D.C. of the missile is not completely depleted, it is damaged, but does not detonate and will still strike its target, inflicting full damage.
4. Attacks on a missile count as a normal attack.

SPECIAL MISSILE DEFENSE TACTICS

If a missile can not be dodged, the Mecha can sacrifice its arms by covering its main body with them, thus allowing the arms to take the damage instead of the body. The disadvantage of this tactic is that the arms are likely to be blown to smithereens. If the arms are not destroyed, I strongly suggest the GM, or player, rolls on the *Optional Critical Damage Tables* under "arms", to determine specific damage and side effects.

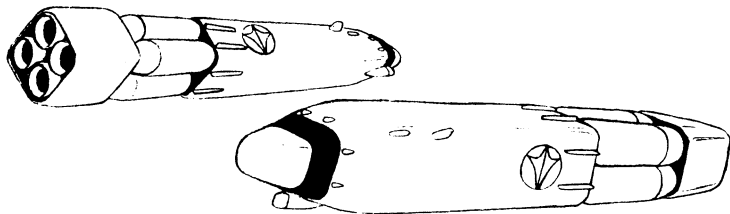

DODGING GUIDED MISSILES

ALL the missiles used by the Zentraedi Mecha, and most other military forces, are self-guided missiles. Generally, most are preprogrammed to respond to specific images (video camera/sensor mounted in the nose of the warhead), or specific heat or radiation levels which clearly identify the enemy.

Reflex Warheads are smart bombs that can identify the enemy and chase it down. Reflex missiles will keep going until they find a target, or are destroyed. They can actually dodge attacks directed at them, and turn around to attempt to hit a target if it misses, or if the target dodges the first attack.

Conventional Guided Missiles: +3 to strike.

Reflex Missiles: +5 to strike, +4 to dodge; Two attacks per melee (until it hits). All missiles always strike the *main body*.

Contrary to what one might think, you *can* dodge one, two and even three, guided missiles. It happens in the T.V. series all the time. The dodge rules are the same as always. However, it is impossible to dodge a volley of four or more missiles launched simultaneously. A volley of four or more missiles will strike every time, with each and every missile in the volley hitting and inflicting damage. The character has two options to avoid or minimize the damage of a massive missile volley; try to roll with the impact, taking half the normal damage; or shoot the missiles down before they strike.

MISSILE NOTES

1. **The terms**, light, med. or medium and heavy, found in parenthesis after the warhead type, refers to the destructive force of the warhead.
2. **All missiles** are self-guided; +3 to strike.
3. **Reflex missiles** are self-guided smart bombs which can be programmed to seek out and attack a specific target. It can change course, adjust speed to conserve fuel, dodge attacks aimed at it, and turn around to try to strike a target again if it misses the first time. +5 to strike (instead of +3), +4 to dodge; 2 attacks per melee. Radar 100 mile range.
4. **Multi-warhead missiles** are usually a cluster of medium range missiles housed inside the casing of a large, long range missile. When the body casing runs out of fuel or reaches its target, it fires the four medium range missiles.
5. **Plasma** is a new, concentrated, liquid heat, ten times hotter than normal napalm.
6. **Fragmentation** missiles are missiles that send out fragments, or shards of metal, upon impact, affecting a larger area.
7. **Fire Retardant missiles** explode, releasing a chemical foam that puts out fires.
8. **Smoke** missiles release large, billowing clouds of smoke, filling the blast radius. They are used to provide cover or to mark an area.
9. **A Proton Torpedo** is a longer range, more powerful, explosive, energy missile.
10. **The maximum** range is the maximum effective range of the missile.
11. Missiles have been assigned a **M.D.C.**; depletion of the M.D.C. from attack will detonate the missile.
12. **The speed** is provided to give players an idea of how fast the missiles travel.
13. **The blast radius** is the full area damaged by the missile impact. The specific target of the missile takes **FULL DAMAGE**, while all else in the blast radius takes half damage.

OTHER COMBAT TERMS

Payload: Indicates the finite number of missiles or rounds. Energy weapons are generally considered to have unlimited payload.

Range: The maximum effective range or distance a weapon can fire, or a missile or vehicle can travel.

Rate of Fire: This will indicate any limitations as to how many times a weapon can be fired pre melee, and/or the number of rounds or missiles in a burst or volley.

Generally, a weapon, especially energy weapons, can be fired repeatedly, equal to the pilot's combined, hand to hand and Mecha combat skills. Any combination of weapons can be used per melee.

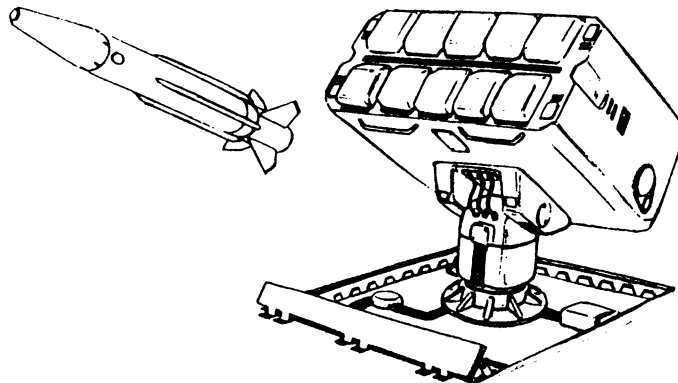

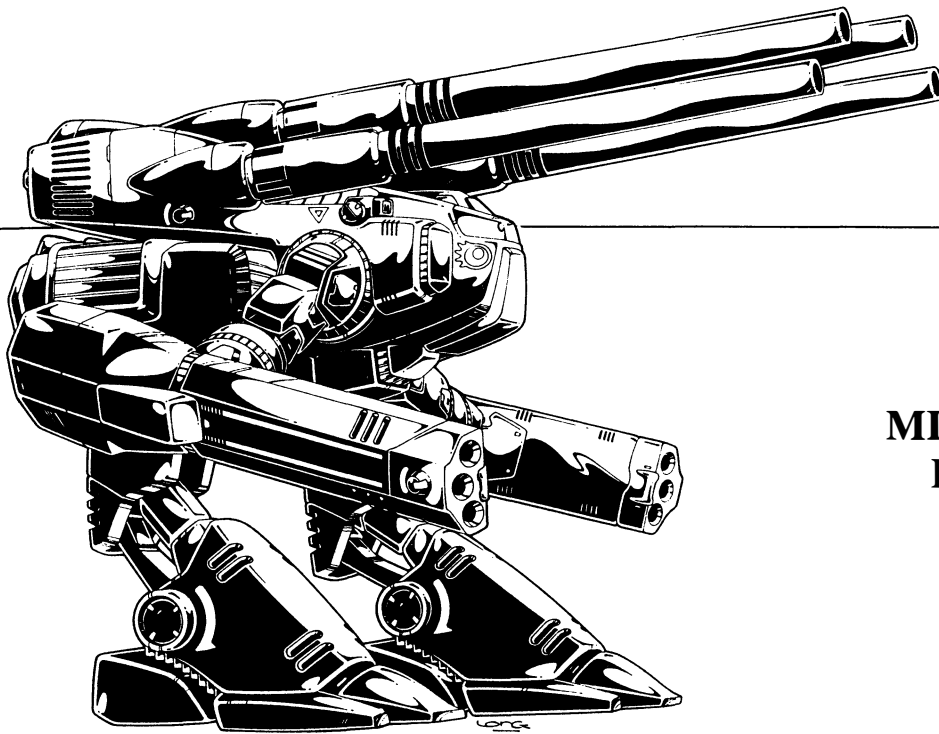

MISSILES RANGES WARHEADS DAMAGE

Short Range Missiles

<u>Warhead</u>	<u>Mega-Damage</u>	<u>Speed</u>	<u>Maximum Range</u>	<u>Blast Radius</u>	<u>M.D.C.</u>
High Explosive (light)	1D4 × 10	500mph (804kmph)	3 miles (4.8km)	10ft (3m)	5
High Explosive (Med.)	1D6 × 10	500mph (804kmph)	2 miles (3.2km)	15ft (4.6m)	5
Fragmentation (light)	1D4 × 10	450mph (724kmph)	2 miles (3.2km)	20ft (6.1m)	5
Armor Piercing (Med.)	1D6 × 10	650mph (1045kmph)	5 miles (8km)	5ft (1.5m)	5
Plasma/Napalm (Med.)	1D6 × 10	500mph (804kmph)	3 miles (4.8m)	15ft (4.6m)	5
Tear Gas	None	200mph (321kmph)	½ mile (.8km)	10ft (3m)	5
Knock-Out Gas	None	200mph (321kmph)	½ mile (.8km)	10ft (3m)	5
Smoke (colors available)	None	300mph (482.7kmph)	1 mile (1.6km)	20ft (6.1m)	5
Fire Retardent	None	200mph (321kmph)	½ mile (.8km)	20ft (6.1m)	5

Medium Range Missiles

<u>Warhead</u>	<u>Mega-Damage</u>	<u>Speed</u>	<u>Maximum Range</u>	<u>Blast Radius</u>	<u>M.D.C.</u>
High Explosive (light)	1D6 × 10	1200mph (1929kmph)	50 miles (80.4km)	20ft (6.1m)	10
High Explosive (Med.)	2D4 × 10	1200mph (1929kmph)	40 miles (64.3km)	20ft (6.1m)	10
High Explosive (Heavy)	2D6 × 10	1200mph (1929kmph)	40 miles (64.3km)	30ft (9.1m)	10
Fragmentation (Med.)	2D4 × 10	1000mph (1608kmph)	40 miles (64.3km)	40ft (12.2m)	10
Armor Piercing (Med.)	2D4 × 10	1600mph (2571kmph)	60 miles (80.4km)	20ft (6.1m)	10
Plasma/Heat (Heavy)	2D6 × 10	1400mph (2251kmph)	40 miles (64.3km)	40ft (12.2m)	10
Multi-Warhead	2D4 × 10	1200mph (1929kmph)	80 miles (128.7km)	20ft (6.1m)	10
Smoke	None	1000mph (1608kmph)	40 miles (64.3km)	40ft (12.2m)	10

Long Range Missiles

<u>Warhead</u>	<u>Mega-Damage</u>	<u>Speed</u>	<u>Maximum Range</u>	<u>Blast Radius</u>	<u>M.D.C.</u>
High Explosive (Med.)	2D4 × 10	1600mph (2571kmph)	500 miles (804km)	30ft (9.1m)	20
High Explosives (Heavy)	3D4 × 10	1600mph (2571kmph)	500 miles (804km)	40ft (12.2m)	20
Fragmentation (Heavy)	3D4 × 10	1400mph (2251kmph)	400 miles (643km)	80ft (24.4m)	20
Armor Piercing (Med.)	2D4 × 10	2010mph (Mach 3)	800 miles (1286km)	30ft (9.1m)	20
Plasma/Heat (Med.)	2D6 × 10	1400mph (2251kmph)	500 miles (804km)	40ft (12.2m)	20
Plasma/Heat (Heavy)	3D6 × 10	1400mph (2251kmph)	500 miles (804km)	50ft (15.2m)	20
Proton Torpedo (Heavy)	4D6 × 10	2010mph (Mach 3)	1200 miles (1928km)	50ft (15.2m)	25
Reflex (Med.)	2D6 × 10	1800mph (2892kmph)	1000 miles (1608km)	40ft (12.2m)	20
Reflex (Heavy)	3D6 × 10	1800mph (2892kmph)	1000 miles (1608km)	50ft (15.2m)	20
Reflex Multi-Warhead	4D6 × 10	1800mph (2892kmph)	1800 miles (2893km)	50ft (15.2m)	25

OPTIONAL CRITICAL DAMAGE TABLES

Damage is determined by hit location. Use these tables when mecha is struck a *critical* blow (double damage still applies in addition to the side effects listed under each appropriate table). A critical hit is always one of the following: **1)** A natural, unmodified roll of 20 to strike on a 20 sided die. **2)** Hand to Hand critical strike bonus; usually an unmodified roll of 18, 19, or 20. **3)** Mecha Hand to Hand critical strike bonus (same as normal hand to hand).

G.M.'s Note: Remember, these are optional tables and *not* hard and fast rules. Use them if you like or discard them entirely.

Random Critical Hit Damage Tables (Roll Percentile Dice for each table)

Arm

- 1-20** Arm immobilized; still intact, but will not respond to controls. Lose one attack per melee in hand to hand combat.
- 21-40** Arm damaged, but functions; does half damage in hand to hand combat, cannot lift or carry more than 200lbs.
- 41-59** Arm suffers triple (not double) damage.
- 60-85** Sluggish response; -2 to strike and parry in hand to hand combat.
- 86-00** Arm blown clean off! Lose one attack per melee.

Leg

- 1-25** Suffers triple damage.
- 26-46** Mobility slightly impaired, stiff; -2 to dodge.
- 47-69** Mobility greatly impaired; walks with a noticeable limp; reduce walking/running speed by half. -4 to dodge.
- 70-89** Immobilized leg; will NOT respond at all, stiff, but can be dragged along like a leg in a cast. Reduce walking/running speed by 80%.
- 90-00** Leg blown off at the knee. Roll percentile dice again. **1-50:** Falls over, losing all attacks for one melee until mecha can prop itself up. Then stuck in that one place, unable to move. -1 to strike, -4 to parry, -8 to dodge. **51-00:** Falls to one knee, loses two attacks that melee. Can still crawl along at a speed of 1D4 miles per hour. **Exceptions:** *The M.A.C. II* suffers quadruple damage instead of leg being shot off. Zentraedi battle pods topple over because of their leg construction. All penalties are the same as those described in 1-50.

Main Body

- 1-10** Massive engine and systems damage, overheating; *all* systems will shut down in 4D4 melees.
- 11-20** Lose targeting computer; weapons -2 to strike.
- 21-30** Lose *all* communications and exterior audio systems; effectively deaf.
- 31-40** Lose radar/sonar; pilots visuals only.
- 41-45** Lose video monitors, pilots visuals only.
- 46-56** Severe internal damage; reduce speed by half, -1 attack per melee, -2 to parry and dodge.
- 57-65** Pilot stunned for 1D4 melees; helpless.
- 66-74** Knocked off feet; lose two attacks that melee.
- 75-82** Electrical system damage; control panel catches fire, control cabin filled with smoke. -4 to strike, parry and dodge until fire is put out.
- 83-88** Weapons system damage; lose 1D4 weapons, or if a Veritech Fighter, all weapons knocked out except for 1D4 missiles and GU-11 gun pod.
- 89-94** Power failure; everything temporarily dead for one full melee.
- 95-00** Severe damage; Veritech cannot change modes/transform. All other mecha takes triple damage instead of double.

ANOTHER SET OF OPTIONAL DAMAGE ROLLS

The following tables can be rolled on when a specific hit location has suffered major damage (a loss of 70% of its M.D.C.).

Hands

- 1-30** Immobilized; cannot flex fingers.
- 31-69** 1D4 fingers shot off; cannot do articulated work, grasp, pick up or hold items well.
- 70-00** Hand is shot off; gone.

Arms

- 1-25** **Immobilized;** still intact, but cannot operate.
- 26-49** **Sluggish Response;** lose one hand to hand attack.
- 50-74** **Structurally Weakened;** cannot lift, carry or hold more than 200lbs. Does half damage in hand to hand attacks.
- 75-00** Joints Lock, temporarily immobilizing the arm. Roll percentile dice once every melee. 1-55 means that the joints lock that melee. Loses half of hand to hand attacks each melee the joints are locked.

Legs

- 1-25** **Immobilized;** leg will not respond, but can be dragged along. Reduce speed by 80%
- 26-49** **Stiff Joints;** catch and tremble, unsteady. Reduce speed by 1/3, -2 to dodge.
- 50-74** **Structurally Weakened;** cannot continually support the weight of the mecha, gives out periodically. Roll percentile dice once every six melees. 1-40 means the leg gives out and the mecha stumbles, losing two attacks that melee.
- 75-00** Mobility impaired, -4 to dodge.

Main Body

Special: One of the following is lost for every additional 20 M.D.C. points of damage. All damage is accumulative.

1. Radar and Sonar lost.
2. Targeting system lost; -2 to strike with weapons.
3. Spotlights/Head lights lost.
4. Optics (binocular, telescopic, video) lost; pilot's visuals only.
5. Communications lost.
6. Internal lights lost; operates by control board lights and touch. -1 to strike, parry and dodge.
7. Sensors all lost; -6 on initiative.
8. Lose one secondary weapon system.
9. Speed reduced by half.
10. Lose one secondary weapon system.
11. Pilot stunned, 1D4 melees.
12. Severely damaged, poor mobility; lose one attack per melee. -2 to parry and dodge.
13. Speed reduced again by half.
14. Lose main weapon system; looks bad.

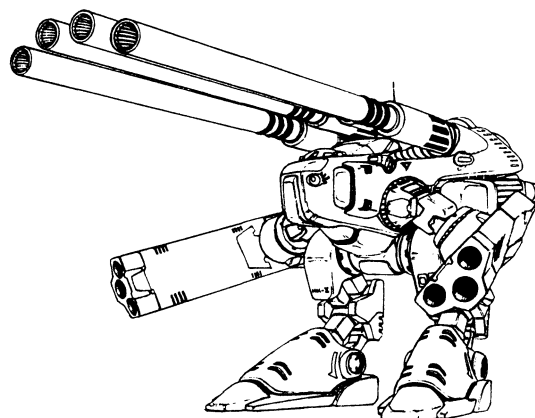

HAND TO HAND BONUSES FROM EXCALIBER COMBAT TRAINING

- Two hand to hand attacks per melee (plus those of the pilot).
- +1 to roll with punch, fall or impact (explosion), reducing damage by half.
- Body block/tackle/ram (roll to strike as normal)
- +1 to strike.
- +1 to parry and dodge.
- Critical strikes same as pilot's hand to hand.
- One additional hand to hand attack at level six.
- One additional hand to hand attack at level eleven.

Damage: **Punch** 1D6 mega-damage (M.D.)
Body Block 1D4 M.D.
Stomp 1D4 M.D.

Remember, these bonuses are in addition to the pilot's own hand to hand training and attribute bonuses. They do *not* apply to the pilot's physical abilities outside the mecha.

HAND TO HAND BONUSES FROM GLADIATOR COMBAT TRAINING

- 3 hand to hand attacks per melee (plus those of the pilot).
- +1 to strike and parry.
- +2 to roll with a punch, fall or impact (explosion), reducing damage by half.
- Body block/tackle (roll to strike as normal).
- Power punch; +4 mega-damage (M.D.)
- Triple damage on a natural 20.
- Mace bonuses: +1 to strike, +2 to parry. These are in addition to all other hand to hand bonuses, but apply *only* when the battle mace is used.
- Critical strikes same as the pilot's hand to hand.
- One additional attack at level five.
- One additional attack at level ten.

Damage: **Restrained Punch/Slap** 1D4 mega-damage (M.D.)
Full Strength Punch 2D6 M.D.
Power Punch 2D6 +4 M.D.
Mace adds 1D6 M.D. to normal punch.
Body Block/Tackle 2D4 M.D.
Stomp 1D4 M.D.
Tear or Pry with hands 1D4 M.D.

Remember, these bonuses are in addition to the pilot's own hand to hand training and attribute bonuses. The mecha bonuses do *not* apply to the pilot's physical abilities outside the mecha.

HAND TO HAND BONUSES FROM M.A.C. II COMBAT TRAINING

- Two hand to hand attacks per melee (plus those of the pilot).
- Can *not* roll with punch, fall or impact.
- +1 to strike.
- +1 to parry (no dodge bonus).
- Critical strikes same as the *main* pilot's.
- One additional hand to hand attack at level five.
- One additional hand to hand attack at level ten.

Damage: **Punch** 2D6 mega-damage (M.D.)
Stomp 3D4 M.D.*

* Because of the M.A.C. II's incredible size and weight it can step on/stomp objects up to 24 feet tall.

Remember, these bonuses are in addition to the pilot's own hand to hand training and attribute bonuses. They do *not* apply to the pilot's physical abilities outside the giant machine.

HAND TO HAND BONUSES FROM RAIDAR X COMBAT TRAINING

- Two hand to hand attacks per melee (plus those of the pilot).
- +1 to roll with punch, fall or impact (explosion), reducing damage by half.
- Body block/tackle/ram (roll to strike as normal)
- +1 to strike.
- +2 to parry and dodge.
- Critical strikes same as pilot's hand to hand.
- One additional hand to hand attack at level six.
- One additional hand to hand attack at level eleven.

Damage: **Punch** 1D4 mega-damage (M.D.)
Body Block 1D4 M.D.
Stomp 1D4 M.D.

Remember, these bonuses are in addition to the pilot's own hand to hand training and attribute bonuses. They do *not* apply to the pilot's physical abilities outside the giant machine.

HAND TO HAND BONUSES FROM SPARTAN COMBAT TRAINING

- One hand to hand attack per melee (plus those of the pilot).
- +1 to roll with punch, fall or impact (explosion), reducing damage by half.
- Body Block/Tackle/Ram (roll to strike as normal).
- +1 to strike.
- +1 to parry and dodge.
- Critical strikes the same as pilot's hand to hand.
- One additional hand to hand attack at level five.
- One additional hand to hand attack at level ten.

Damage: **Swatting Blow** 1D4 mega-damage (M.D.)
Body Block 1D6 M.D.
Stomp 1D6 M.D.

Remember, these bonuses are in addition to the pilot's own hand to hand training and attribute bonuses. They do *not* apply to the pilot's physical abilities outside of the mecha.

HAND TO HAND BONUSES FROM VERITECH COMBAT TRAINING

- 2 hand to hand attacks per melee (plus those of the pilot).
- +3 to roll with punch, fall or impact (explosion), reducing damage by half.
- Body flip/throw; 1D4 damage plus victim loses initiative and one attack that melee. Possible only in Battloid mode.
- Kick attack.
- +1 to strike.
- +2 to parry and dodge*
- Critical strikes same as pilot's hand to hand.
- One additional hand to hand attack at level six.
- One additional hand to hand attack at level eleven.

Damage: **Punch** 1D6 mega-damage (M.D. in *Battloid mode*).
Punch 1D4 M.D. in *Guardian mode*.
Body Flip/Throw 1D4 M.D.
Kick 1D6 M.D.
Stomp 1D4 M.D.**

* +4 to dodge in Guardian mode; +6 to dodge as Jet Fighter.

** Effective only against small objects (12ft or smaller),

Remember, these bonuses are in addition to the pilot's own hand to hand training and attributes, but apply *ONLY* when piloting a Veritech Fighter. These bonuses do *not* apply to the pilot's physical abilities when outside the Mecha. **Note:** Can change modes at will without losing any attacks per melee.

EARTH MECHA

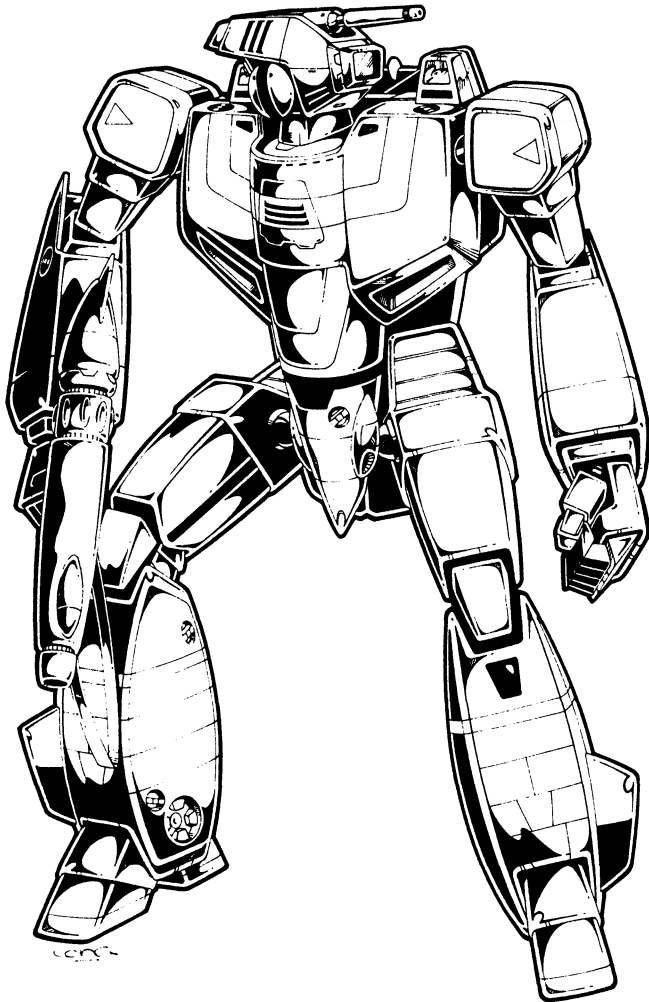

VERITECH FIGHTERS

Type VF-1A: Standard; one laser head mount.

Type VT-1D: Trainer; seats two, two laser head mounts.

Type VF-1J: Officer (low ranking); two laser head mounts.

Type VF-1S: Squadron leader & second in command; four laser head mounts. Only a limited number of this model are available.

Super Veritech: Body styles VF-1A, J, and S; additional armor, missile capacity, and self orbital. Specifically designed for space patrols in orbit around Earth and moon base.

Note: *Armored Veritech* refers to additional blow-away armor that can fit on any VF-1A, J or S model Veritechs. Adds additional M.D.C. and A.R. protection, but can only be used in Battloid mode. The armor must be ejected/removed in order to change into Guardian or jet fighter modes. See specific details under the Veritech section.

DESTROIDS

Excaliber: Defense/assault; multiple weapon system includes: particle beam guns, short and long range missiles. Massive destructive potential.

Gladiator: Defense/assault; also used for riot control and reconnaissance. Superior hand to hand capabilities; short range missiles and lasers.

M.A.C. II: Defense/assault; basically a giant, walking artillery unit with 4 auto cannons and particle beam guns.

Raidar X: Defense/assault/antiaircraft; two, double barrel auto cannons.

Spartan: Defense/assault, also used in demolitions; massive, heavy, long range missile capabilities.

NOTE: ALL destroids are *non-transformable* battloid mecha.

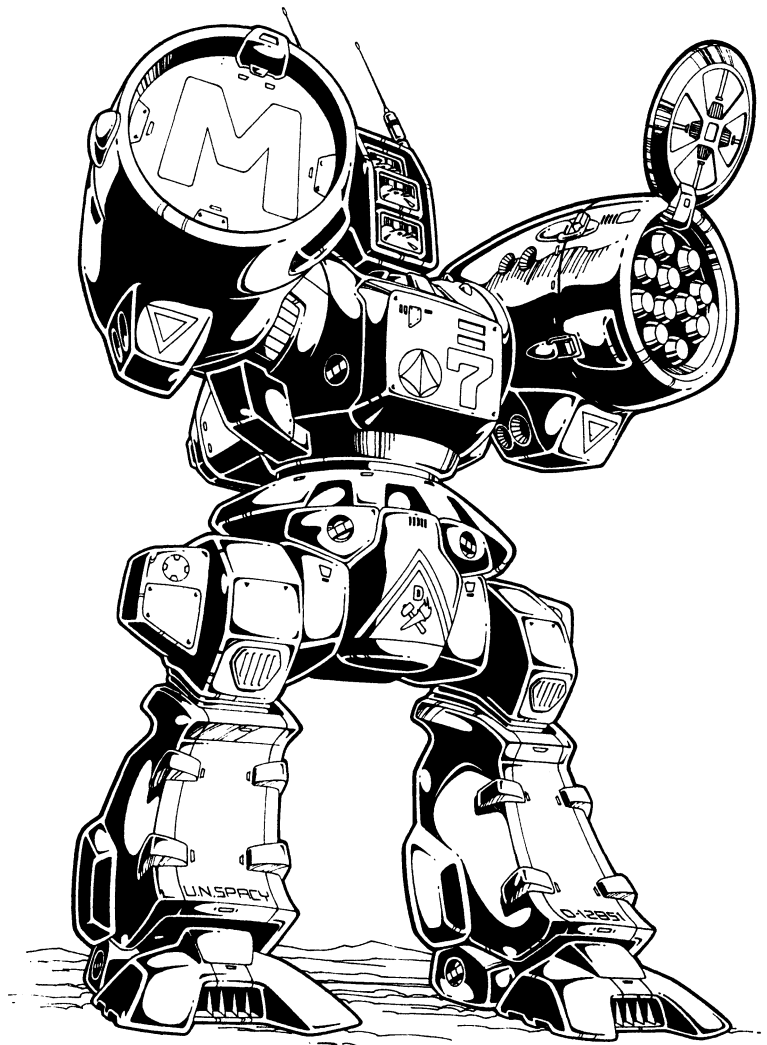

THE VERITECH FIGHTERS

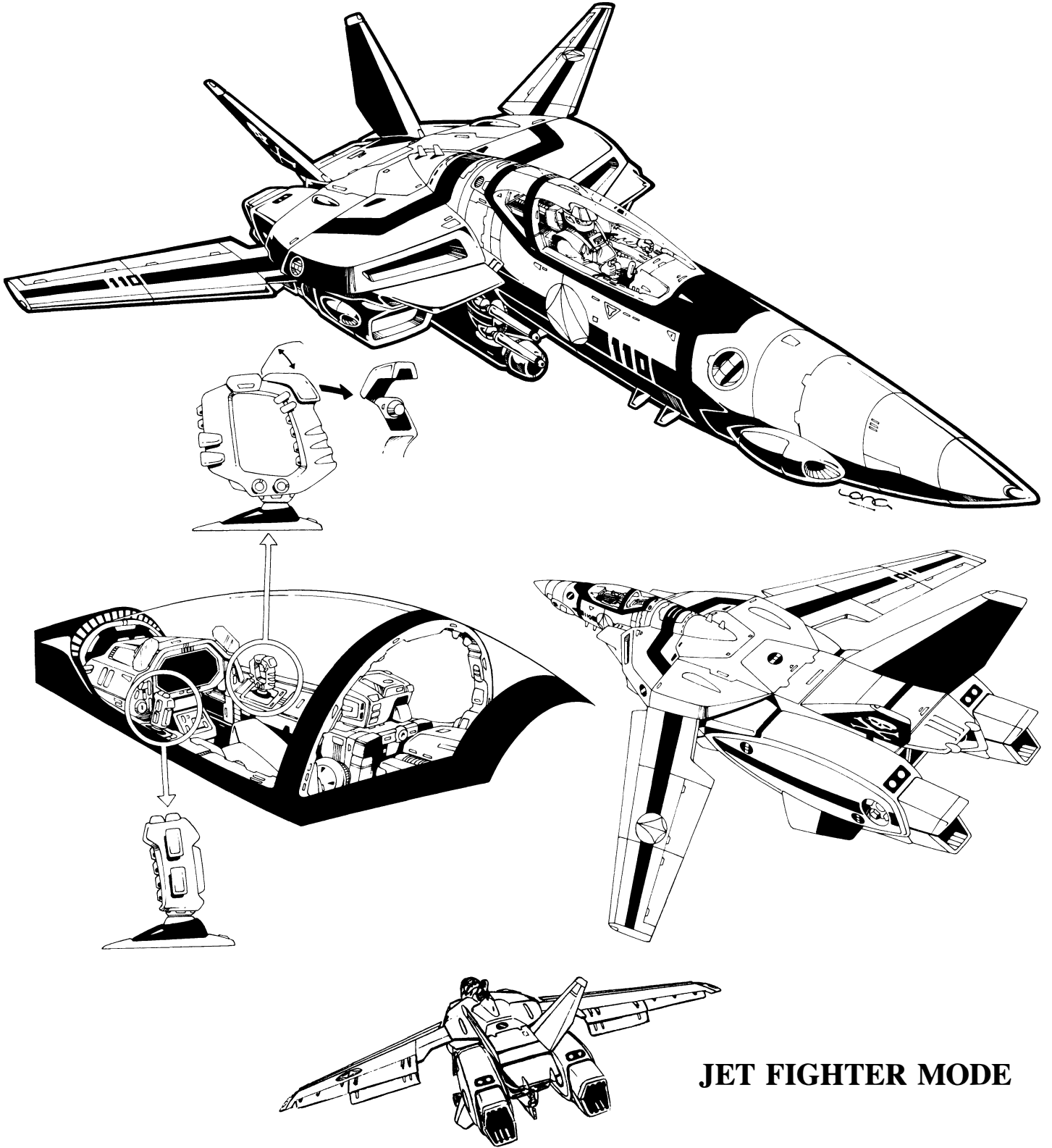

JET FIGHTER MODE

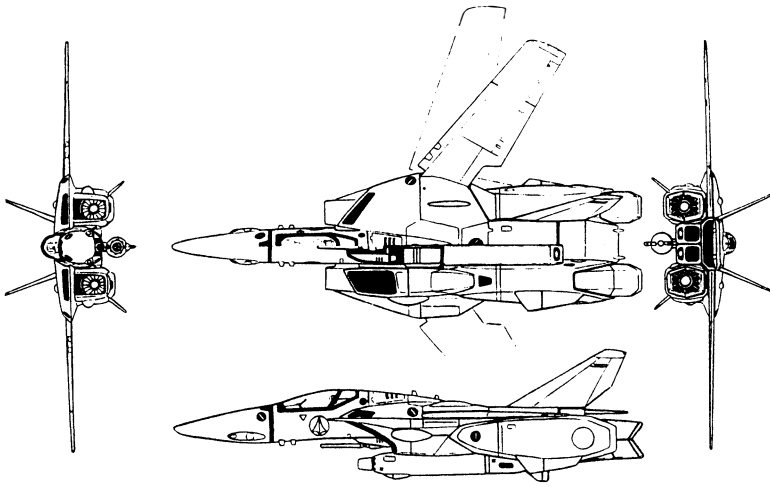

HISTORY OF THE VERITECH TRANSFORMABLE FIGHTER

The discovery of the SDF-1 provided mankind with great, new, technological theories, science and advancement. It also established that man was not alone in the universe. Under the potential threat of invasion by giant aliens, the new, united world government began to develop war machines, utilizing the new technology, to combat any extraterrestrial threats. The obvious combat nature of the fallen SDF-1 implied that it was created by a race of giants well versed in the ways of war. Should they ever come to Earth to retrieve the spacecraft, mankind must be ready to repel a potentially hostile invader from a distant star. Thus, the Veritech and Destroyers were developed.

The Veritech was the Robotech design team's unique solution to satisfy two, essential, combat conditions: *aerial combat* and *ground combat*. Rather than developing a machine that was little more than a wheeled airplane, they came up with a machine that could actually transform to accommodate both required operations.

The basic combat pattern of the *Veritech* was conceived to, **first**, be in aerial combat mode (Jet Fighter) and to raid by missiles and machine guns; **second**, it would change its form into a more appropriate ground combat mode, that of the soldier or Battloid mode, a humanoid configuration. In this mode it could carry out a severe mop-up operation. The Guardian mode, three modes in all, was not part of the initial design.

The immediate problem was the execution of a quick, metamorphic process that would never place the vehicle in a vulnerable stage, even while changing. The secondary problem was to incorporate high mobility and vertical take-off and landing (VTOL) capabilities.

The folding torso system was applied in the VTOL system, which was necessary in order to land while it changed. During this intermediate stage, the Veritech assumes the Guardian mode, slowing to a hover as the VTOL system is engaged.

Originally, the *Guardian mode* of the Veritech's conversion was to be used only for landing. However, it was soon discovered that the Guardian mode provided extreme mobility, using the vertical take-off system to hover and move about at great speed. While not as fast or airmobile as the Jet Fighter mode, nor quite as suitable to rough terrain and hand to hand combat as the Battloid mode, the Guardian transition provides the pilot with a wonderful blend of the two. In the Guardian mode, the Veritech can hover, jet about at speeds of up to 670mph, have the advantage of legs for walking/standing and landing in small areas and rugged terrain, and the flexibility of arms/hands; the use of the GU-11 gun pod and limited hand to hand combat.

The final transition is the *Battloid mode*, which is a 42 foot, humanoid robot or soldier. In this mode the Veritech can run, climb, leap, kick, roll and engage in hand to hand combat. When all three modes are used in tandem it creates a device of incredible versatility.

The Veritech Fighters are hybrid machines which incorporates traditional technology and power systems with small protoculture-based engines salvaged from alien mecha discovered in the wreckage of the SDF-1. Although the humans do *not* fully understand the principles of Robotechnology or protoculture, they are able to successfully utilize it. In essence the humans are able to tap into an energy source (protoculture) that they do not understand the hows or whys of, but that can be easily adapted into existing technology. Future studies and contact with the Zentraedi would ultimately lead to a more complete understanding and development of the protoculture-based science of Robotechnology. However, the true secrets of Robotechnology would elude mankind for many generations.

One of the truly unique aspects of Robotechnology is that man and machine share a symbiotic relationship, linking pilot with mecha. It is a bond that provides the mecha's immediate response to commands/controls, mobility, and almost human agility. Rather than the pilot operating a mere machine, a tool, both complement and supplement each other's abilities with astonishing ease. It is this same aspect which allows for the smooth, technologically engineered, transformations of the Veritech.

The differences between the four major types or models, VF-1A, J, S and VT-1D, are relatively small. Much of the obvious differences are purely stylistic, cosmetic variations, while the unit itself is basically unchanged.

The VF-1A is the standard Veritech Fighter. Its most distinguishing feature, other than markings, is that it has *one* laser mounted on its head. **G.M. Note:** The VF-1A is the model that players will normally begin with. The other models are reserved for officers and aces.

The VF-1J has a twin laser unit mounted on its head and is the standard model consigned to proven aces and low ranking officers (up to lieutenant).

The VF-1S is exclusive to squadron leaders, commanders and squadron captains (second in command).

The VT-1D is the Veritech Trainer. It is primarily used for the flight training of new recruits. The VT-1D is the only Veritech Fighter that seats two pilots; the trainee in the front and the instructor in back. The two head mounted lasers operate independently, with one controlled by the trainee and the other by the instructor.

A sort of a *fifth style* or model is the **Super Veritech**. It is basically a souped-up version of the standard VF-1A, J and S models, made to more easily withstand the rigors of space and space combat. Additional armor plates on legs, chest and forearms; booster rocket pack to attain orbit from ground launches, additional multi-missile capability, and enhanced speed, mark the major modifications. The Super Veritech is generally used for space patrols and heavy combat situations.

A *variation available* to all Veritech Fighters, except the Super Veritech, is the addition of special armor and short range armaments. See the Armored Veritech description for details. *Another supplemental item*, available to all Veritech Fighters, is a disposable rocket sled or booster pack which enables it to reach deep space orbit.

Some Technical Notes About the Veritech

There are a total of 57 controls involved in the various modes of the Veritech. Legs are controlled by foot pedals, accurately simulating walking. The "G" lever initiates the Guardian mode. The "F" lever initiates the Fighter mode. The "B" lever initiates the Battloid mode. The "C" lever engages a sudden reverse thruster maneuver when in Guardian mode only. The Veritech *can* change modes while in motion/flight.

The nose or pilot's compartment/jet nose can be detached when the overall Veritech has suffered debilitating damage. In many cases this allows the pilot to be safely retrieved from the wreckage of his Veritech. **Note:** All Veritech Fighters are spaceworthy.

GUARDIAN MODE

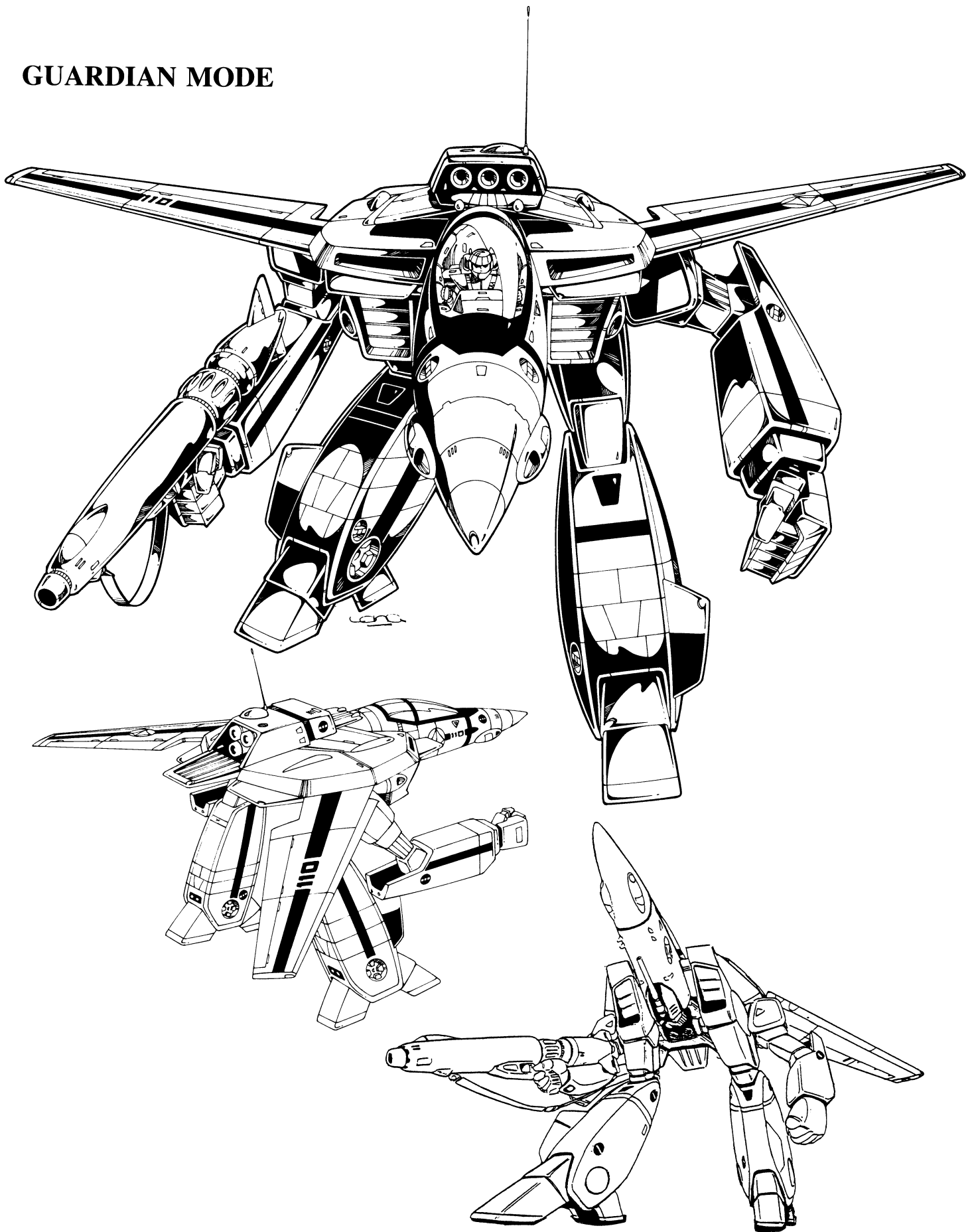

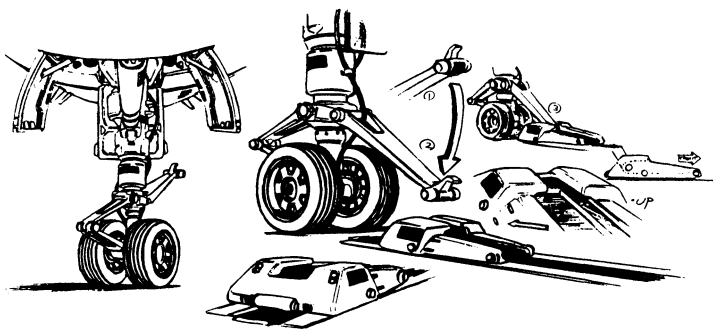

STANDARD SENSORS AND EQUIPMENT FOR ALL VERITECH MECHA

FUEL CAPACITY

The Veritech Fighters are extremely durable. The use of protoculture, micronized reactors and the science of Robotechnology, gives the Veritech an average, useful life span of 12 years before needing a new energy system. With constant use, the life span is cut by half.

RADAR

Range 200 miles (321.80km); can track up to 48 targets simultaneously.

MOTION DETECTOR & COLLISION WARNING SYSTEM

Close range: 200ft (61m); sounds alarm and red light warns pilot of impending collision and/or immediate target.

RADIO/VIDEO COMMUNICATIONS

Wide band and directional, radio and video telecast capabilities. Range is 600 miles (965.4km) or can be boosted indefinitely via satellite relay.

LASER COMMUNICATIONS

Long range, directional, communication system. Effective Range: 150,000 miles.

LASER TARGETING SYSTEM

Range: 200 miles

COMBAT COMPUTER

Calculates, stores and transmits data onto the cockpit computer screen or Head Up Display (H.U.D.). Patches in with targeting computer.

EXTERNAL AUDIO PICKUP

Sound amplification listening system. Range: 300ft (91.5m)

LOUDSPEAKER

Loudspeaker system that can amplify the pilot's voice up to 90 decibels.

EXTERNAL VIDEO SURVEILLANCE SYSTEM

A video camera relays images to a cockpit monitor. 360 degree rotation. Range: 300ft (91.5m). Telescopic capabilities: 6x magnification.

TELESCOPIC OPTICAL ENHANCEMENT

Range: 1600ft (488m). Field of vision: 20ft (6.1m)

SHOULDER HEADLIGHTS/SPOTLIGHTS

Range: 300ft (91.5m)

HYDRAULIC PILOT CHAIR

Can rise out of the Veritech 10ft (3.0m) and retract back inside.

EJECTOR SEAT

In case of emergencies the pilot seat can be instantly ejected.

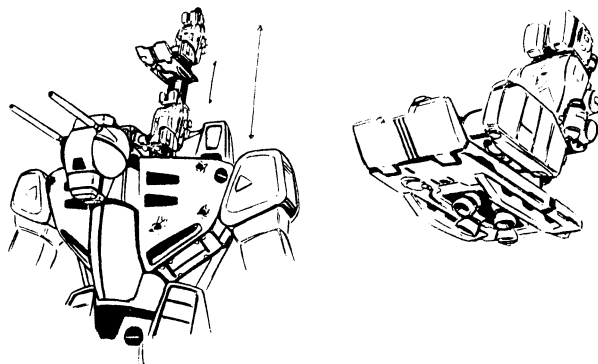

UTILITY ARMS

This is a set of small, retractable arms housed in the right forearm, to perform delicate work and to effect repairs. Each of the three arms has an A.R. of 6 and 3 M.D.C.

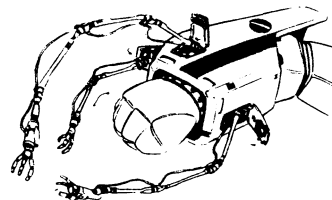

SELF-DESTRUCT

A last ditch effort to prevent capture of the Veritech unit (usually preceded by the pilot's ejecting from the Veritech). Explosive damage is fairly contained — 10ft radius (3m); does 2D4x10 M.D.

HEAT AND RADIATION SHIELDS

INDEPENDENT OXYGEN AND CIRCULATORY SYSTEM

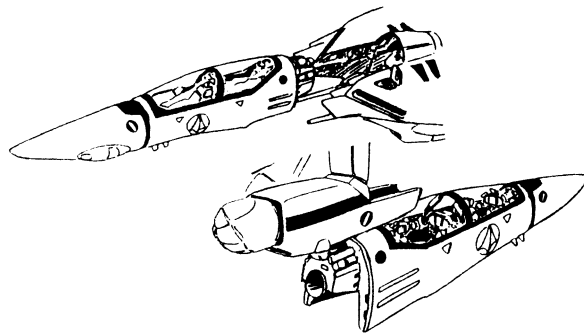

DETACHABLE PILOT'S COMPARTMENT

This is the reinforced pilot's compartment (jet's nose) which can be detached and mounted onto another Veritech's arm for ease of carrying (or carried by any Destroid).

THE VERITECH FIGHTERS

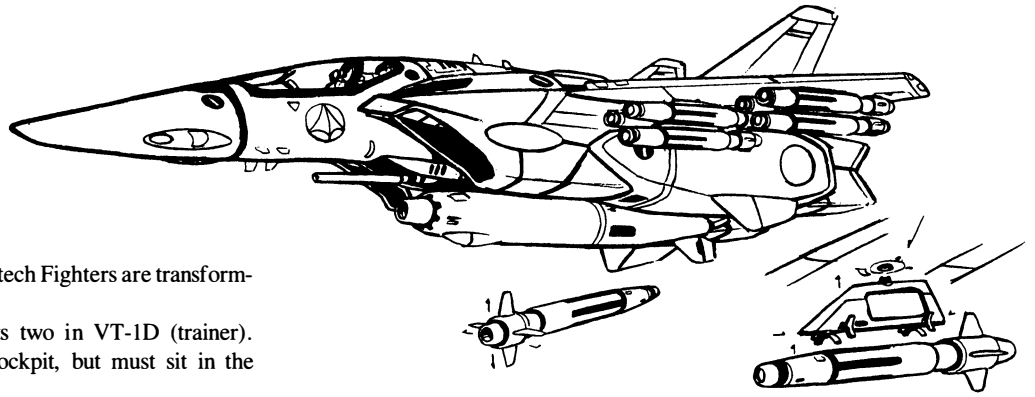

Vehicle Type: VT-1D, VF-1A, J and S Veritech Fighters are transformable battloids.

Crew: One in types VF-1A, J and S; seats two in VT-1D (trainer).

Note: A passenger can also fit in the cockpit, but must sit in the pilot's lap.

M.D.C. By Location:

Head Laser Mounts — 24 each

Head — 75

Arms — 75 Hands — 30 each

Legs/Engine Thrusters — 150

*Main Body — 250

Reinforced Pilot Compartment — 200

Retractable Utility Arms — 3 each

Wings — 100 each

Tail — 50 each

GU-11 Gun Pod — 100

*Depleting M.D.C. of main body shuts the unit completely down.

Speed: 2676mph (Mach 4) with a 60 mile ceiling in **Jet Fighter mode**.

670mph/Mach 1 (1078kmph) maximum, and as slow as a complete hover in **Guardian mode**. 60mph (96.5kmph) maximum in battloid mode running; flying in space — 120mph.

Height: 42.6ft (13m) in Battloid mode.

22.3ft (6.79m) in Guardian mode.

16ft (4.87m) in Jet Fighter mode.

Width: 16ft (4.87m) at shoulders in Battloid mode.

25.3ft (7.7m) wing span in Jet and Guardian modes.

Weight: 18.5 tons

Main Engine: FF-2001 fusion turbine in each leg.

Range: Effectively unlimited. The reactor style power source provides enough energy to operate for about five years of *continual* use. Average life span of power system is 12 years before requiring replenishment of protoculture.

Weapon Systems

1) Jet Fighter High Powered Lasers: A pair of lasers are built into the nose of the Veritech Fighter for aerial dog fighters and assault. They can *only* be fired when in Jet fighter mode and are limited to a straight ahead line of fire.

Primary Purpose: Assault

Secondary Purpose: Anti-Missile

Range: 4000ft (1200m)

Mega-Damage: 6D6 M.D. per twin blast. Can only fire short bursts.

Payload: Unlimited

2) Laser(s): Mounted on the head when in Battloid mode, but located on the underbelly when in Guardian and Jet Fighter mode. 360 degree rotation. All models have *two attacks per melee* or one extended blast.

Primary Purpose: Assault/Defense Weapon.

Secondary Purpose: Tool for cutting.

Range: 2000ft (609m)

Mega-Damage: VF-1A: 1D4 M.D., VF-1J and VT-1D: 2D4 M.D., VF-1S: 4D4 M.D. One, long, extended blast lasts on full melee and does double damage; counts as two attacks that melee and can not be used against fast moving/dodging opponents.

Payload: Unlimited

3) Heavy Missiles: These include proton torpedoes, plasma missiles and reflex missiles. THREE of these large missiles can be mounted on each wing for a total of six. Torpedoes can be all the same or a combination. These are always guided missiles of long range capacity.

Primary Purpose: Assault/defense.

Mega-Damage: Varies with individual missile type. See missile descriptions elsewhere.

Payload: 3 on each wing for a total of 6.

Rate of Fire: Any number up to full payload.

4) Light or Medium Short Range Missiles may be *substituted* for the long range missiles, but can *not* be mixed with the long range types. This means the Veritech Fighter can either carry 6 long range missiles or 12 short range missile, not both (no medium range missiles). Warheads vary. See missile descriptions elsewhere for mega-damage, warheads and range. Rate of Fire: 1, 2, 3, 4, 6, or all.

Total number of missiles: 6 on each wing for a total of 12.

5) GU-11, 55mm, three barrel gun pod. A standard issue armament for ALL Veritech's!

Primary Purpose: Assault/defense

Mega-Damage: Does 3D6 short burst, 6D6 long burst or 1D6 × 10 damage for full melee burst.

Range: 4000ft (1200m).

Payload: 200 rounds per clip equals 20 short bursts or 10 long bursts or 5 full melee bursts or any combination thereof. Additional ammo clips can be engaged, but requires ½ a melee, meaning that the player loses half his attacks that melee.

6) Optional Hand to Hand: Punch does 1D6 mega-damage (M.D.) in Battloid mode, 1D4 M.D. in Guardian mode, kick does 1D6 M.D. Stomp does 1D4 M.D., but is limited to targets no more than 12 feet tall. Body flip does 1D4 M.D.

WEAPON COMBAT SUMMARY

Attacks Per Melee: Equal to the combined hand to hand skills of the pilot. Usually 4 attacks at first level.

High Powered Lasers: Available only in Jet Mode; 3D6 M.D., Range: 4000ft (1200m).

Lasers Mounted on Head: 1D4 or 2D4 or 4D4 M.D.; Range: 2000ft (609m).

Short or Long Range Missiles: M.D. and Range vary.

GU-11 Gun Pod: 3D6, 6D6 or 1D6 × 10 M.D.; Range: 4000ft (1200m).

Alternate Mode of Attack: Hand to hand punch, kick, stomp or body block.

Note: The Veritech Fighter in Battloid Mode is more agile than its human pilot and can execute any hand to hand combat move, such as jump kick, leap attack, rolls, etc. that the pilot can.

THE VF-1A VERITECH FIGHTER

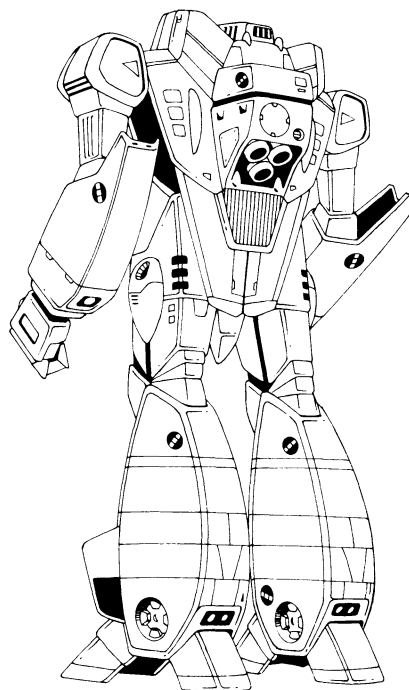
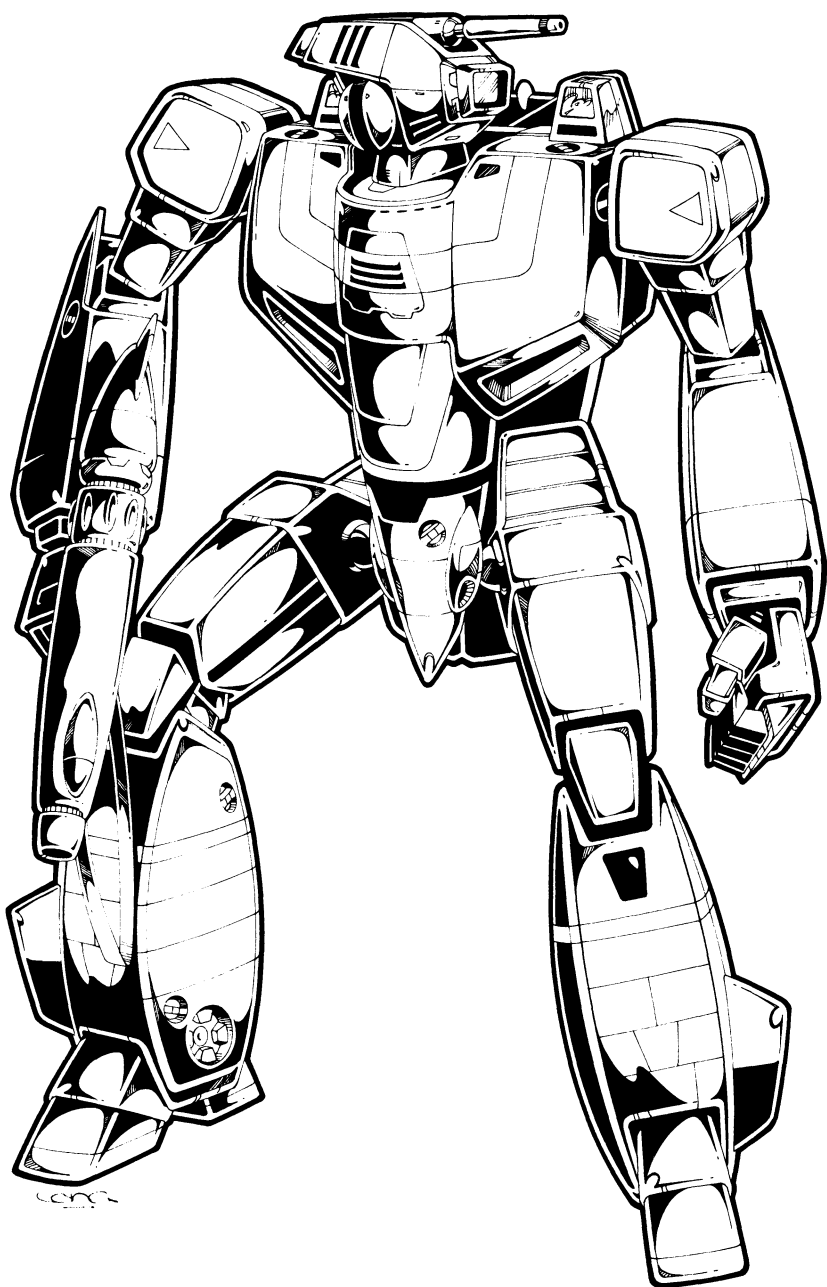
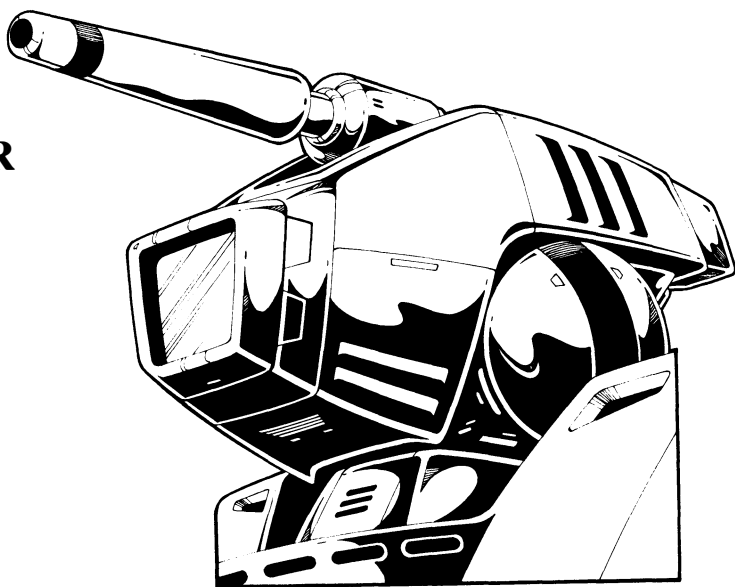

THE VT-1D VERITECH FIGHTER (Trainer)

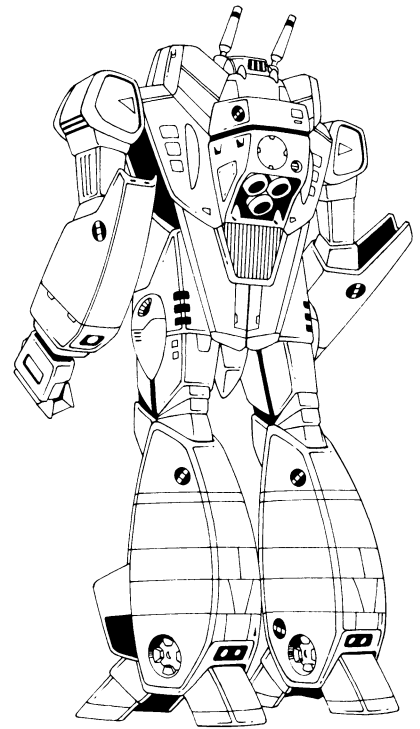
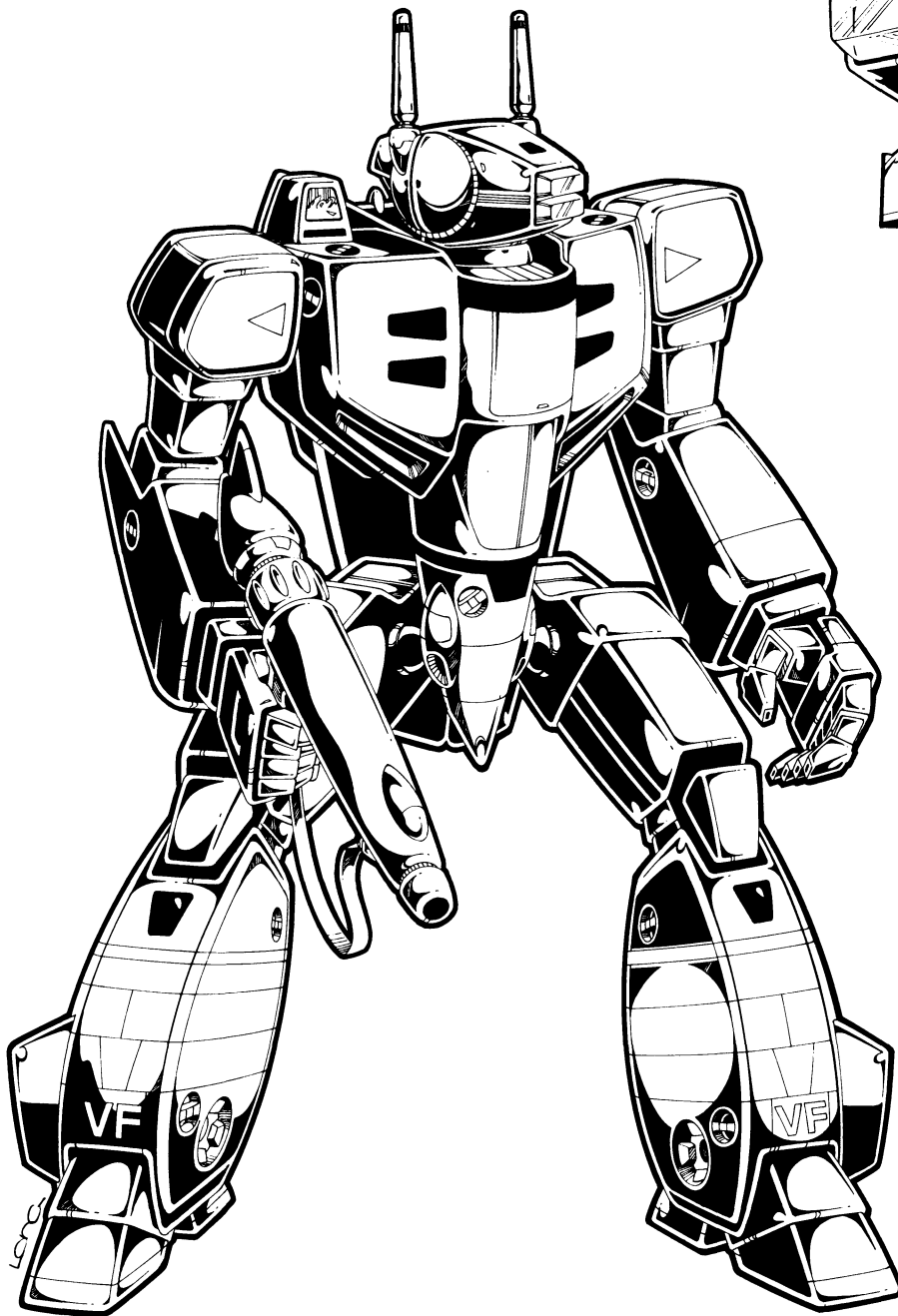
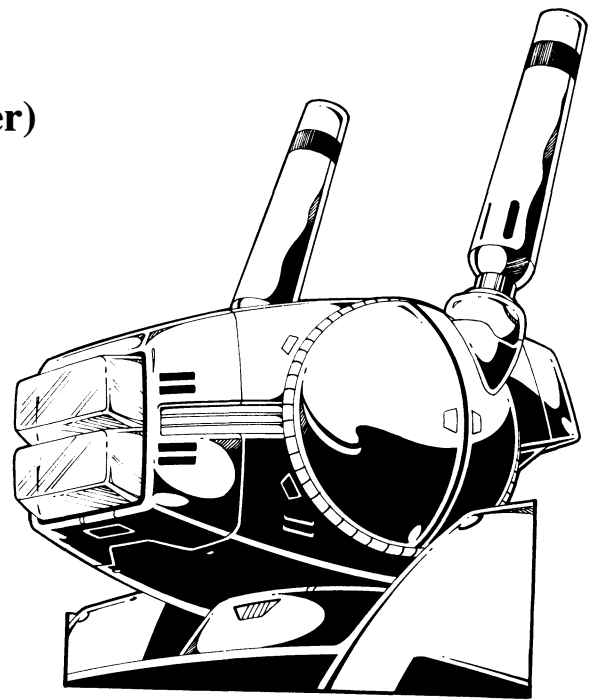

THE VF-1J VERITECH FIGHTER

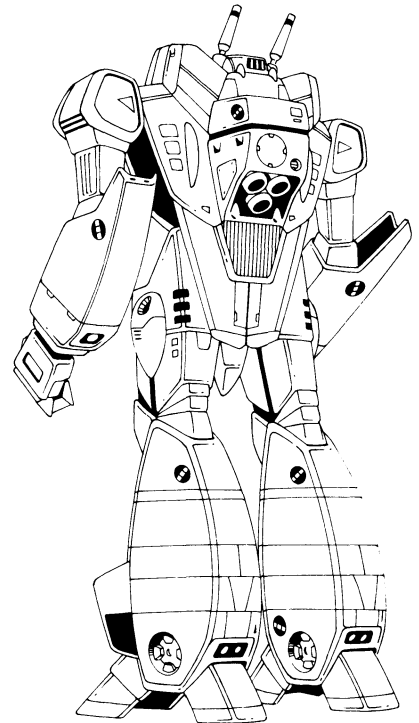
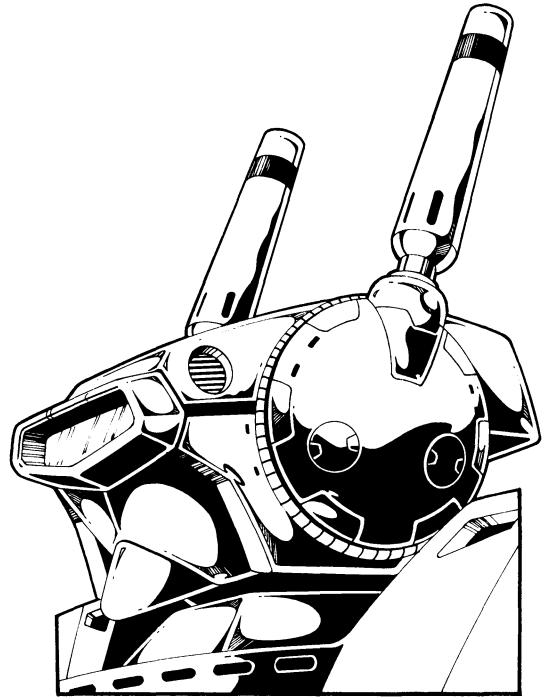
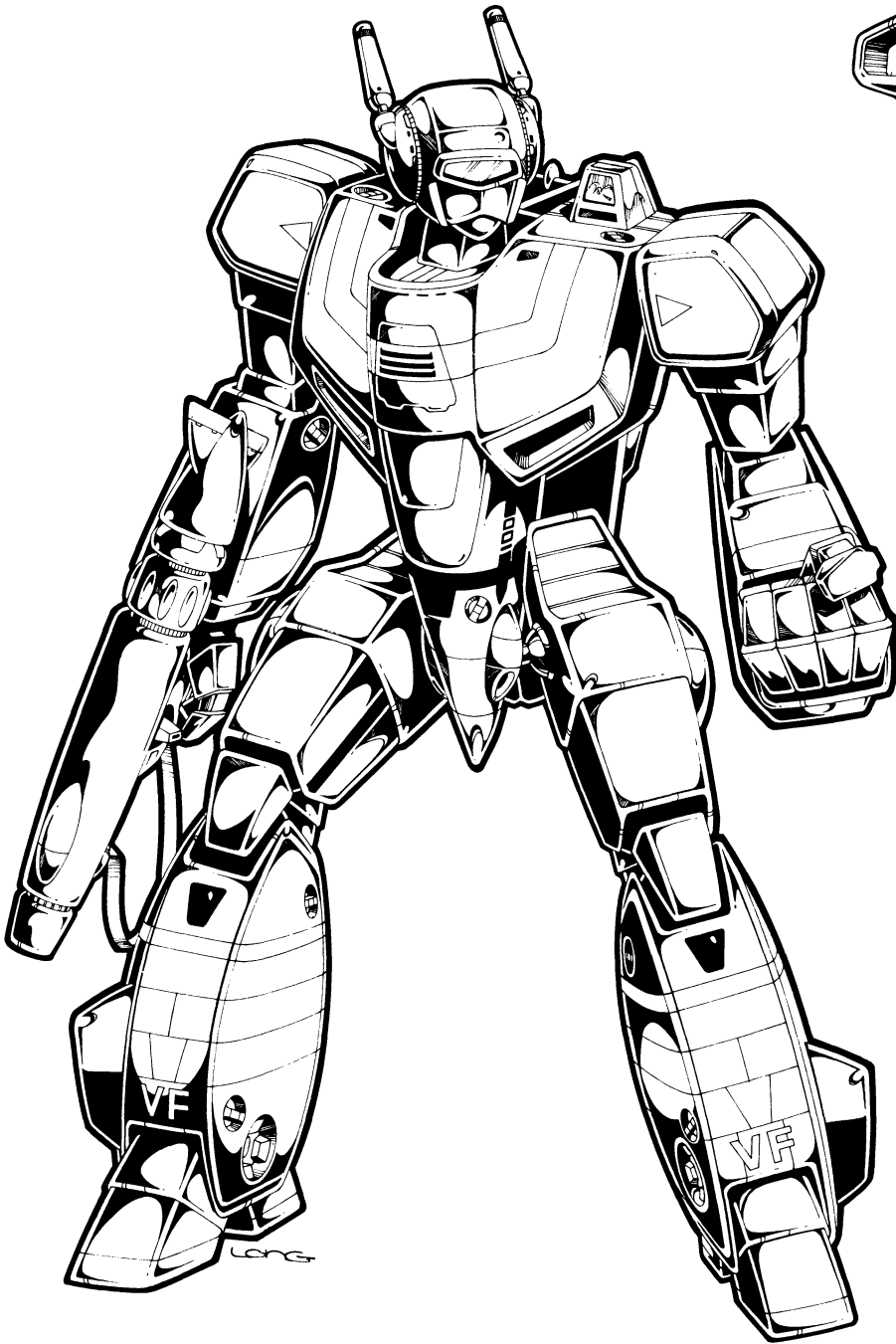

THE VF-1S VERITECH FIGHTER

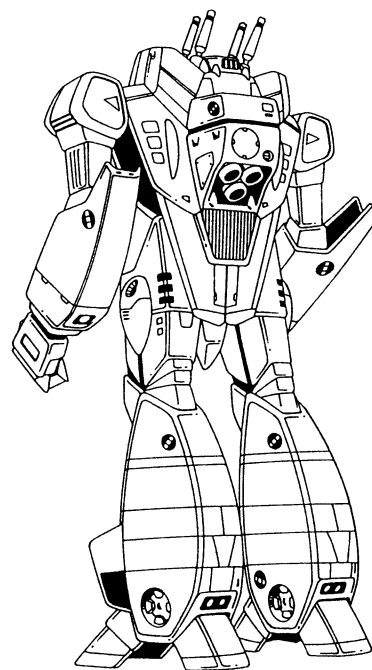
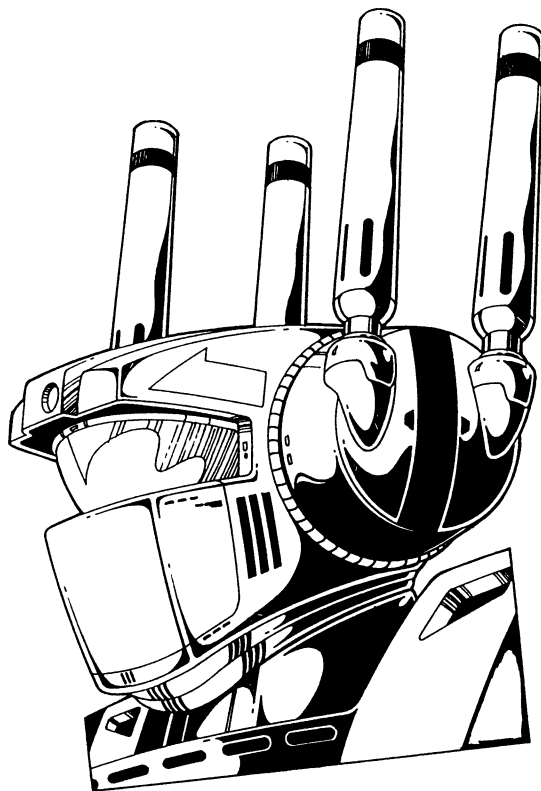

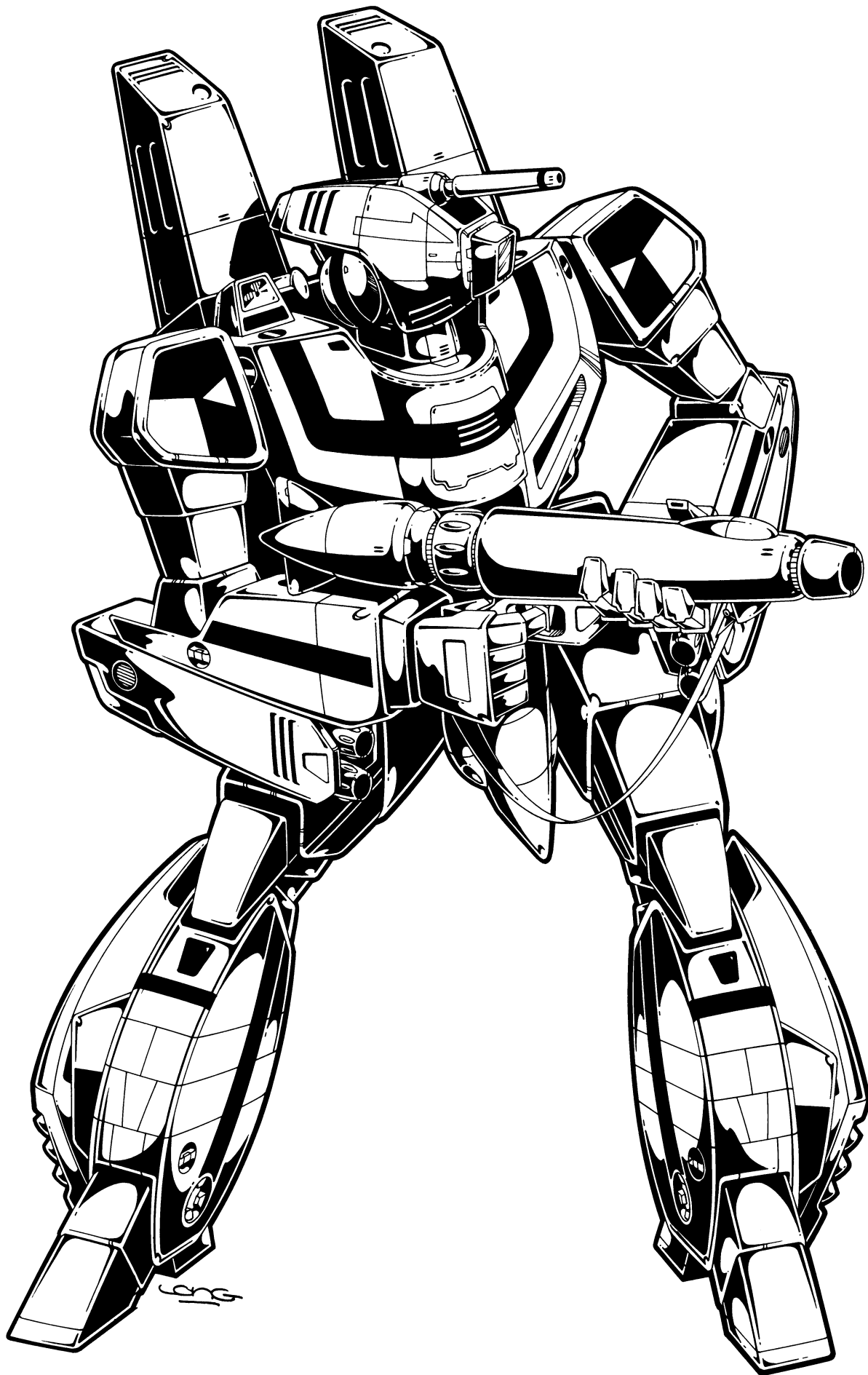

THE SUPER VERITECH

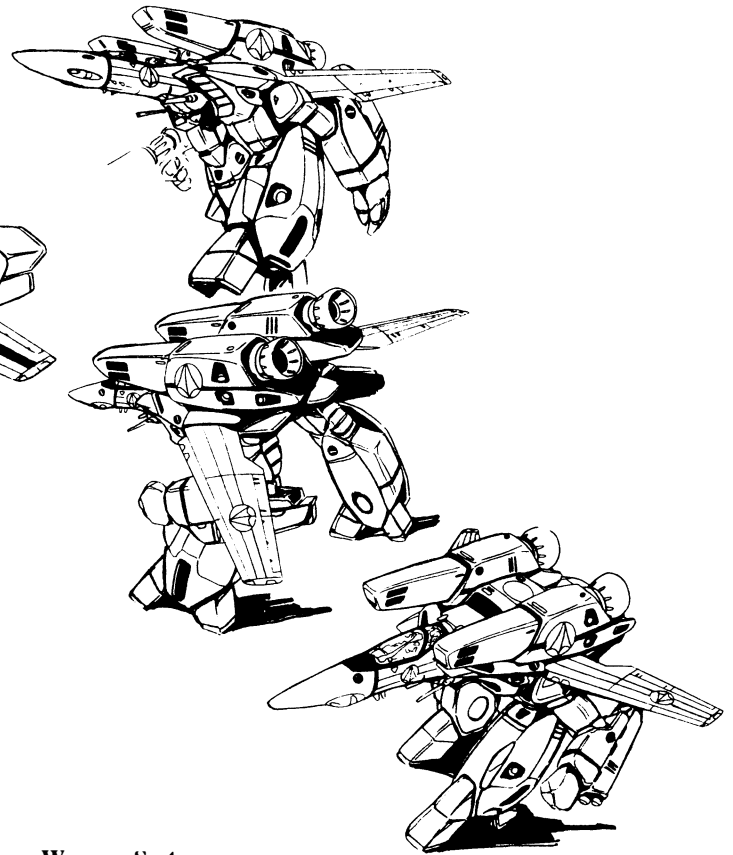
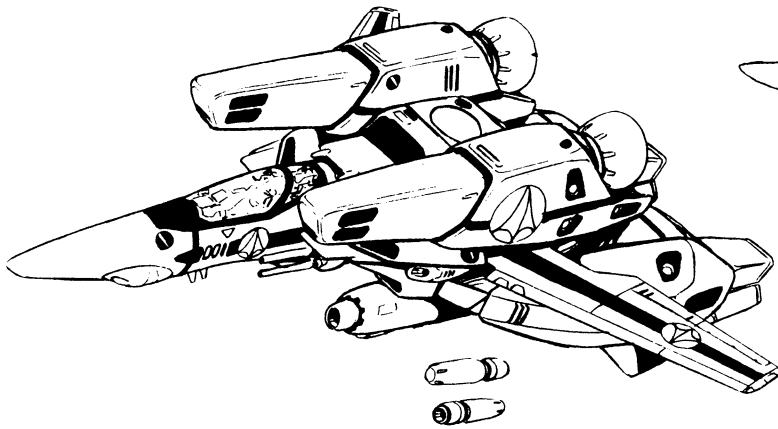

THE SUPER VERITECH

The *Super Veritech* is the state of the art design for Veritech Fighters. In appearance it looks very much like an ordinary VF-1A, J or S model with the usual variation of head mounted lasers denoting rank. However, closer inspection reveals that it is slightly taller (almost 46ft compared to the 42.6ft of the regular VF), more heavily armored, and mounted with twin booster jets which enables it to reach nearly Mach 5 to breach Earth's orbit and provide greater mobility in space. Additional weapons include twin missile launchers built into the booster jet unit. Other improvements include better acceleration and mobility.

Vehicle Type: VF-1A, J and S Veritech Fighters (transformable Battloids).

Crew: One

M.D.C. By Location:

- Head Mounted Laser(s) — 30 each
- Head — 100
- Hands — 50
- Arms — 100
- Legs and Thrusters — 200
- *Main Body — 300
- Reinforced Pilot Compartment — 200
- Retractable Utility Arms — 3 each
- Booster Jets & Missile Launchers (2) — 200 each
- Wings — 150 each Tail — 50 each
- GU-11 Gun Pod — 100
- *Depleting M.D.C. of the main body shuts the unit completely down.

Speed: 2950mph (Mach 4.3) with a suborbital ceiling of 100 miles in normal **Jet Fighter mode**. *With boosters* 3216mph (Mach 4.8) which can achieve full orbit. 670mph/Mach 1 (1078kmph) maximum in **Guardian mode** and 60mph (96kmph) in **Battloid mode** running, or 150mph in battloid mode flying in space.

Height: 45.9ft (14m) in Battloid mode
29.6ft (9m) in Guardian mode
22.3ft (6.79m) in Jet Fighter mode

Width: 20ft (6.1m) at shoulders in Battloid mode.
48ft (14.7m) with wings fully swept

Weight: 21.5 tons

Main Engine: FF-2001 Fusion Turbine in each leg.

Secondary Engine: Auxiliary, rocket booster pack for attaining orbit and extra speed.

Weapon Systems

NOTE: The Super Veritech possesses ALL the usual armaments plus the following:

- 1) **Two Short Range, Medium Warhead Missiles** in each forearm for a total of four missiles.

Mega-Damage: Varies with the type of warhead used, as does range.

Rate of Fire: One or two at a time.

- 2) **Missile Launching Pods** (2) mounted on the back of the Veritech along with the twin rocket boosters. Each missile launcher carries a payload of 20, medium range, medium warhead missiles for a total of 40 missiles.

Mega-Damage: Varies with the type of missiles used, as does range.

Rate of Fire: Volleys of 2, 4, or 8 missiles. One volley constitutes one melee attack, even if a total of 8 missiles were launched.

Notes: The auxiliary twin booster rocket jets and missile launcher pods can be jettisoned. Reentry into Earth's atmosphere requires the launcher unit to be jettisoned to avoid air drag. Maneuver ports in the lower leg add to the Super Veritech's maneuvering abilities.

Special Bonuses: +1 to dodge and parry.
+1 extra attack per melee.

These bonuses are in addition to those gained from hand to hand combat.

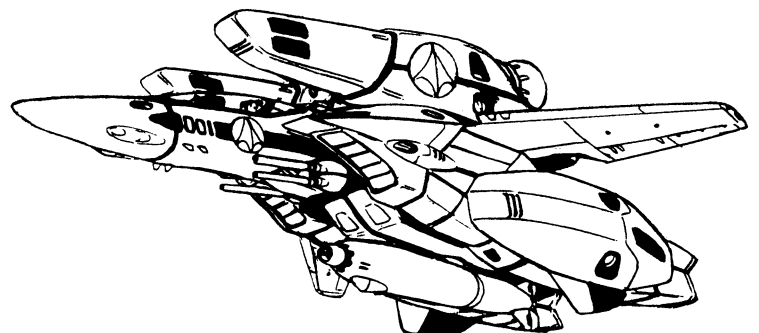

THE ARMORED VERITECH

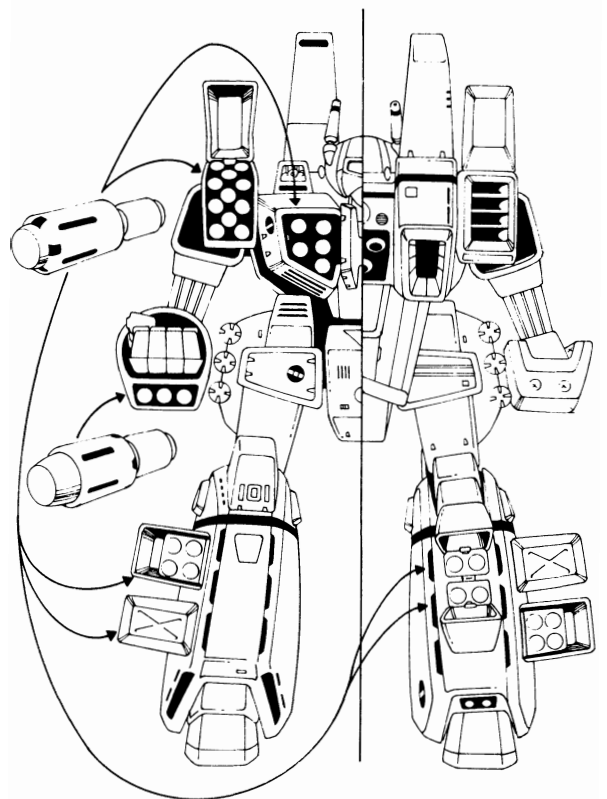
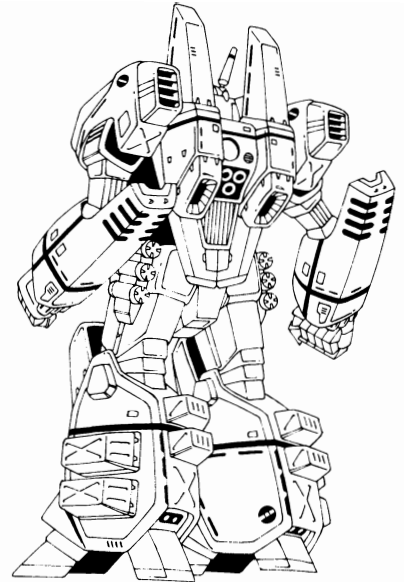
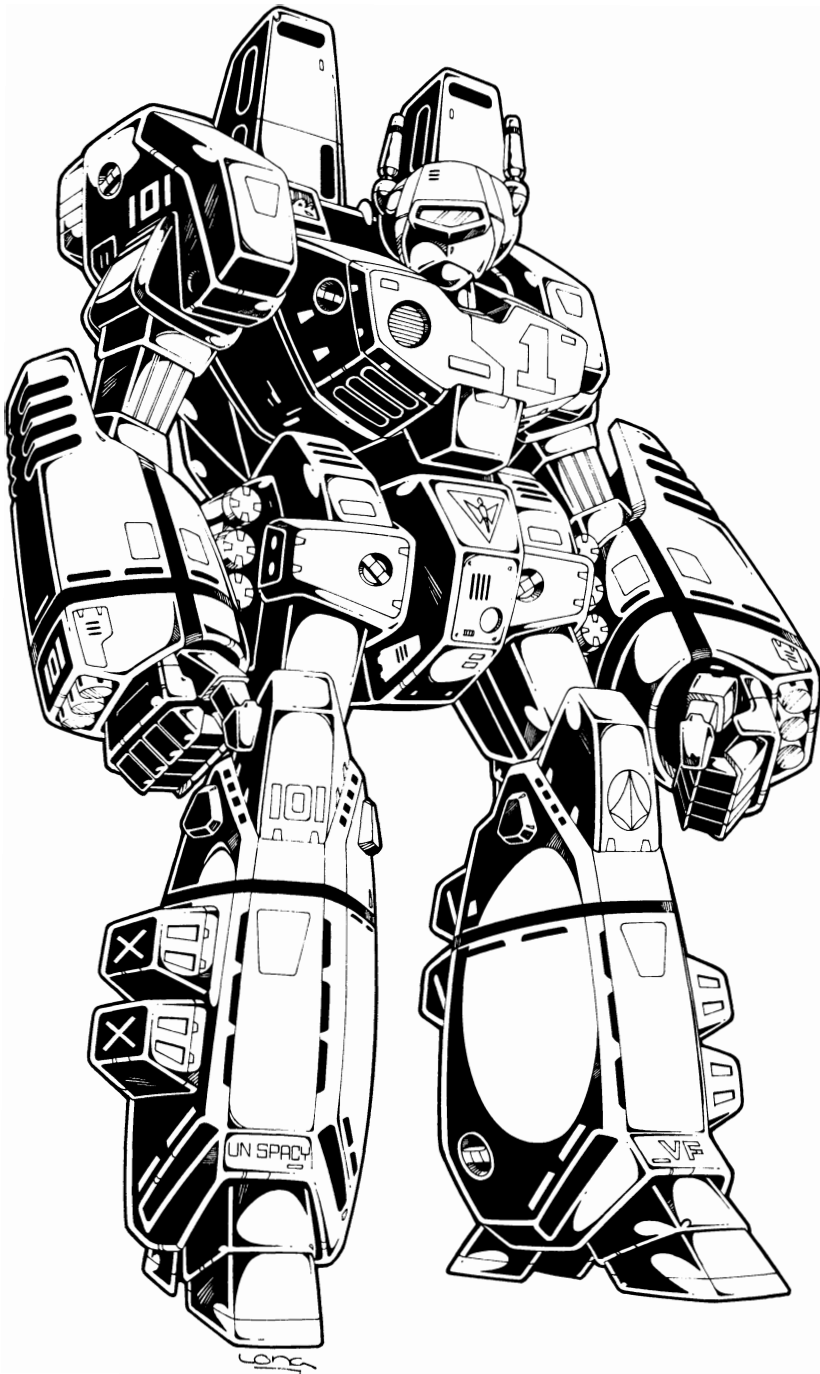

Special Armor and Weapon Systems: The Armored Veritech

The Veritech Fighter, in Battloid mode, can be outfitted with 16.2 tons of additional armor and missile systems. Any of the Veritech types can become an *Armored Veritech*, except for the Super Veritech.

The armor can provide any Veritech with almost double its normal M.D.C. and firepower. On the down side, the armor can only be applied to the Veritech in Battloid mode and reduces speed and mobility. However, the supplemental armor and armaments are of a break-away design that can be instantly jettisoned, enabling the Veritech to utilize its full range of abilities and normal transformation. It *cannot* transform into other modes unless the armor is jettisoned. Likewise, the armor must be jettisoned to gain reentry into the atmosphere when in space. Of course, the armor can be worn in the atmosphere and on ground, but the additional bulk causes significant drag when reentering the atmosphere from space.

The following statistics are modifications to the standard Veritechs. All damage is first subtracted from the additional armor (which can be jettisoned when severely or completely damaged).

The following are the additions and modifications which apply to an Armored Veritech.

- **Limited to Battloid mode;** armor must be jettisoned to change modes.
- Additional, twin, **supplemental booster pack** to help overcome the extra weight of the armor and impaired speed.

Adds one additional attack per melee.

M.D.C. of supplemental armor (in addition to normal)

Arms add 75.

Legs/Engine Thrusters add 100.

Leg Missile Pods add 75.

Main Body adds 100.

Missile Shoulder Mounts add 300 each.

Note: The laser head mount, head, hands, pilot compartment, utility arms, wings, tail and GU-11 gun pod remain, unchanged.

Speed: 40mph (64.36kmph) maximum running or booster pods. All other speed is reduced by 30%.

Additional Weapon Systems

- 1) **Short Range, Guided Missile Launchers** are mounted on each shoulder. The missile compartments/launchers are heavily armored to protect the missiles from detonation by enemy fire. Also protects shoulder joints.

Primary Purpose: Assault/defense. Missile type can vary from explosive to chemical. *See missile descriptions elsewhere.*

Range: Varies; see individual missile types and descriptions elsewhere.

Damage: Varies; see individual missile types and descriptions.

Rate of Fire: Volleys of two with a total of 12 fired simultaneously (one big volley) or one at a time.

Note: This missile launching unit is identical to those mounted on the Gladiator and Excaliber Battloids. *See Destroids*

- 2) **Arm Missiles** fire three, short range missiles per each arm.

Primary Purpose: Assault/defense.

Missile Type varies; see individual descriptions.

Range: Varies; see short range missile descriptions.

Damage: Varies with type.

Rate of Fire: 1, 2, or all 3 simultaneously launched per arm.

- 3) **Hip Missiles** fire up to three, short range missiles from each hip (total six) with medium warheads that are more usually destructive than shoulder and arm launched missiles.

Primary Purpose: Assault/defense.

Range: Varies; see short range missile descriptions.

Damage: Varies with missile type; see missile descriptions.

Rate of Fire: 1 or 2 or all 3, simultaneously per each hip.

- 4) **Leg Mounted Missiles** fire short range, medium warhead missiles.

Two missile pods are mounted on the side and back of each leg.

Three missiles are housed in each for a total of 12 per each leg.

Primary Purpose: Assault/defense

Damage: Varies with missile type.

Rate of Fire: Volleys of three.

Range: Varies; see missile descriptions.

Note: All missiles inflict mega-damage.

- 5) **Chest Mounted Missiles:** 5 in each breast; fires one at a time or volleys of 2 or 5. All else same as #4.

THE DISPOSABLE ROCKET SLED

Another piece of additional equipment for the Veritech Fighter is the *disposable rocket sled* or booster pack. The rocket sled is a four engine thruster unit which attaches to the rear of the Veritech. This quartet of powerful boosters with liquid fuel can launch the Veritech Fighter into orbit like a shuttle-craft. Once in orbit, the pilot disengages the rocket sled and can fly about freely. The rocket sled will fit ALL Veritech models except the Super Veritech, which has its own booster jets.

Weight: 18.2 tons

Speed: 3660mph (Mach 4.8)

Fuel Capacity: One time. Enough to achieve full orbit once.

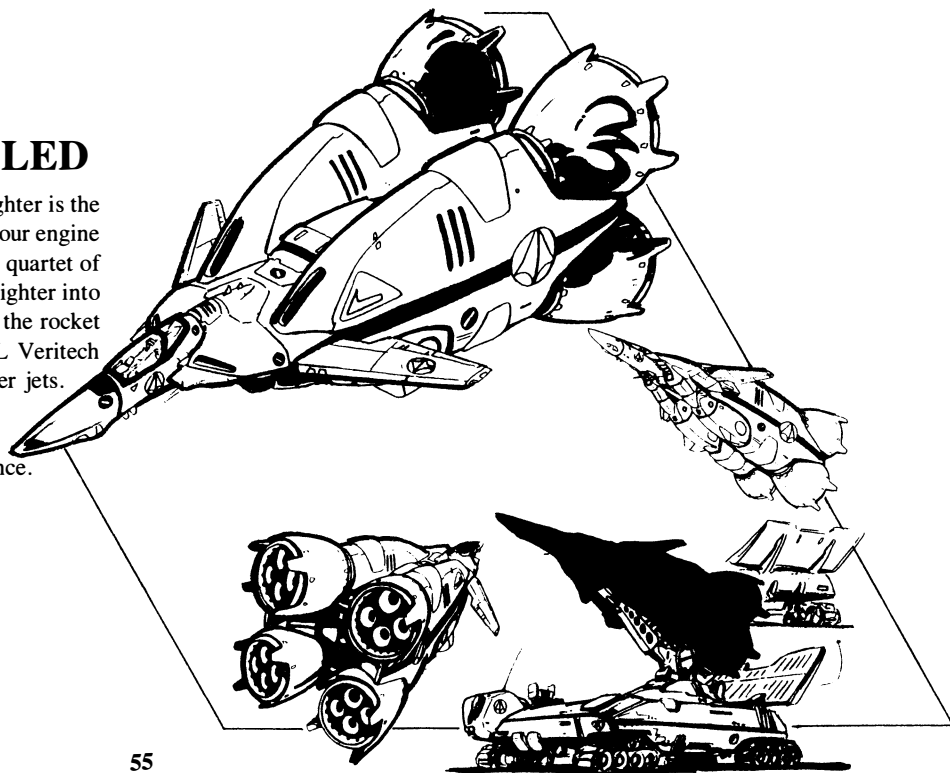

THE DESTROIDS

THE DESTROIDS

Destroids are non-transformable ground mecha used for assault, defense, riot control, and reconnaissance. They are generally lumbering giants which resemble the Veritech Fighter in *Battloid* mode. Most are armed with a variety of missiles, auto cannons and energy weapons. They might best be thought of as walking artillery units.

The Destroids, like the Veritech Fighters, combines traditional technology and power systems with small protoculture-based engines and robototechnology. Also like the Veritech pilots, the Destroid pilots share a symbiotic relationship with the device he/she operates. This endows the massive mecha with surprising agility and mobility. However, the Destroid's design sacrifices the astonishing speed, agility and overall versatility of the Veritech Fighters in favor of much more raw firepower. Instead, they are a walking armory, heavily armored and capable of massive destruction. Like Earth's artillery or tank divisions of old, these all terrain vehicles are a main line ground defense or assault force of amazing power.

SENSORS AND EQUIPMENT

STANDARD FOR ALL DESTROIDS (Non-Transformable Battloid Mech)

RADAR

Range: 30 miles (48.2km). Conventional operation.

RADIO/VIDEO COMMUNICATIONS

Wide band, directional radio and video telecast capabilities. Range: 600 miles (965.4km) or can be boosted indefinitely via satellite.

LASER TARGETING SYSTEM

Close Range: Two miles (3.2km)

COMBAT COMPUTER

Calculates, stores and monitors data on the control panel computer screen or head up display.

EXTERNAL AUDIO PICK-UP

Sound amplification and sound listening system. Range: 300ft (91.5m).

LOUDSPEAKER

Loudspeaker system that amplifies and projects the pilot's voice up to 90 decibels.

THERMO-IMAGER

A special, optical, *heat* sensory unit that allows the *infrared* radiation of warm objects to be converted into a visible image. Enables the pilot to see in darkness, shadows and through smoke. Range: 1600ft (487m).

NIGHT VISION OPTICS

An image intensifier which is passive, meaning it emits no light of its own, but relies on ambient light which is electronically amplified to give a visible picture. Range: 1600ft (487m).

REINFORCED PILOT'S COMPARTMENT

This is the specially armored and padded pilot compartment, designed for maximum protection of the mecha pilot even if the vehicle is totally destroyed. Can be retrieved and carried by Veritech Fighters or Gladiator.

HEAT AND RADIATION SHIELDS

INDEPENDENT OXYGEN AND CIRCULATORY SYSTEM

FUEL CAPACITY

The use of protoculture, through Robototechnology, gives the **Destroids** and *all* Mecha a long life span. These giant machines can operate at full capacity for an average life span of 22 years before requiring re-energizing. Constant use will reduce that time by about half.

180 DEGREE ROTATION

All Destroids, except the M.A.C. II, can rotate their torso 180 degrees.

THE EXCALIBER MK VI

The **Excaliber** is a *non-transformable mecha* used as an assault and defense, heavy weapons system aboard the SDF-1 and on Earth. In many respects the Excaliber is a combination of a heavy artillery support unit and a frontline combat unit, with both long range and short range armaments. Without a doubt, this mecha's array of weapons outstrips any of its kind. It is often deployed as a companion to the M.A.C. II to protect it from close range assaults. Armed with two gun clusters identical to the one built into the Gladiator, machineguns, two particle beam cannons and a battery of missiles, the Excaliber might be best thought of as a walking dreadnought.

It's main disadvantage is that it lacks any hands, making grasping, holding or any articulated work impossible. The absence of hands also limits its effectiveness in hand to hand combat. Another drawback is the Excaliber's slow speed.

Since the Zentraedi assault on Earth, the Excaliber MK VI has become a major tool in the peace keeping efforts while society tries to rebuild itself. It is an ideal unit in suppressing major uprising, renegade Zentraedi attacks, law enforcement, reconnaissance and patrols in desolate areas.

The Excaliber MK VI: also known as the Tomahawk MBR-04-VI

Vehicle Type: Destroid

Crew: One or two

M.D.C. by Location:

Searchlight — 20

Upper Arm — 100 each

P-Beam Forearms — 100 each

Legs — 200 each

*Main Body — 300

Reinforced Crew Compartment — 200

Missile Pods Mounted on Shoulders — 150 each

Missile Pod Above Right Shoulder — 50

Middle Pods on each Leg — 50 each

Gun Cluster — 75

Top Mounted, Twin Machinegun Unit — 25

Note: No Head Unit

*Depleting the M.D.C. of the main body shuts the mecha completely down.

Speed: 50mph (88kph)

Height: 36.10ft (11.27m)

Width: 25.9ft (7.9m) at shoulders

Length: 16ft (5.1m)

Weight: 31 tons

Main Engine: MT 828 Fusion Reactor; Output=2800 SHP

THE EXCALIBUR

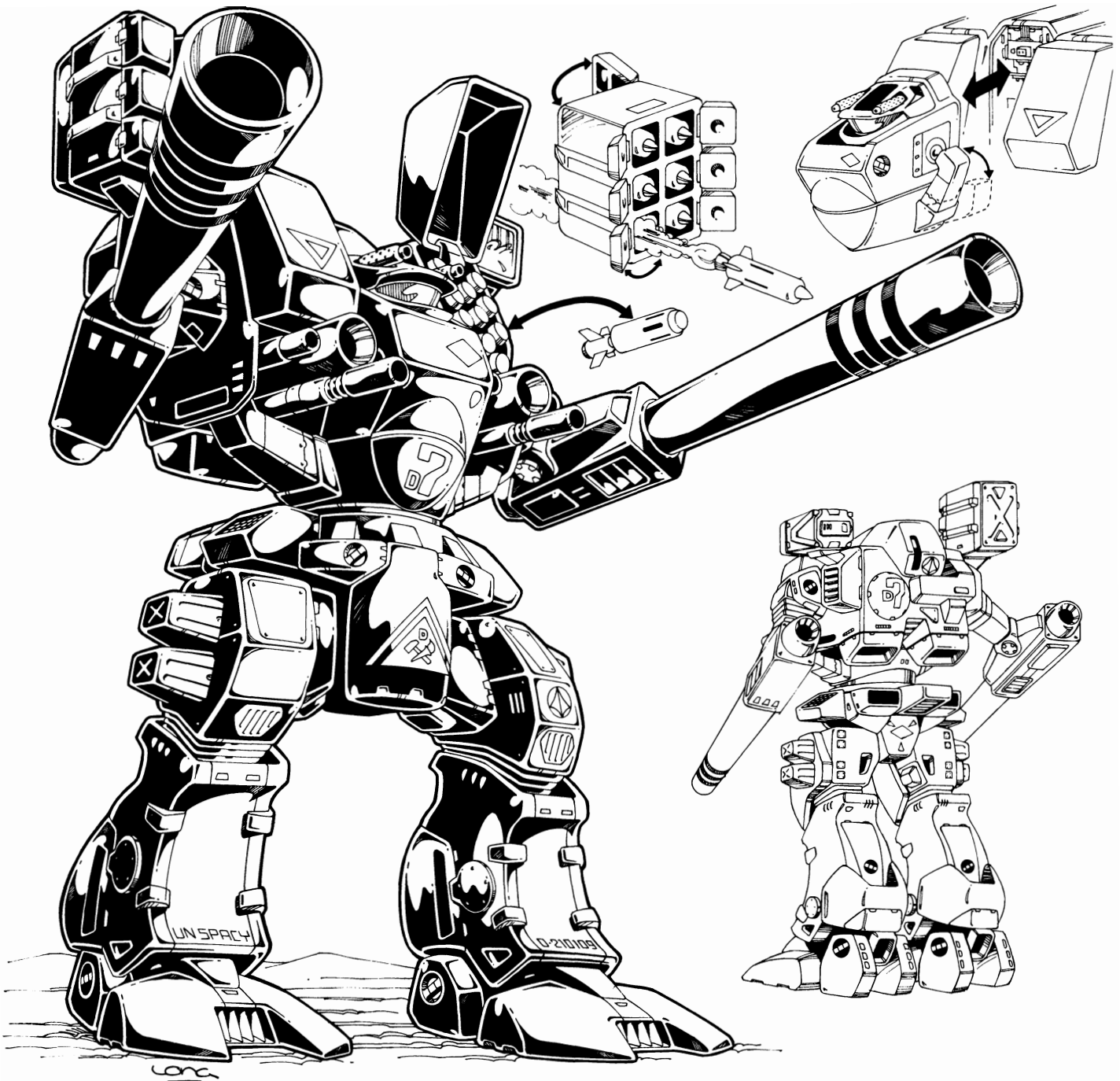

WEAPONS COMBAT SUMMARY

Attacks Per Melee: Equal to combined hand to hand skills.

Twin Barrel, M-89, Machinegun: 2D4 M.D., 4D4 M.D. of 1D4 × 10 M.D.; Range: 2000ft (600m)

Two Gun Clusters (each has the following)

Short Range Laser: 2D6 M.D., Range 2000ft (600m)

32mm auto cannon: 2D6, 4D6, or 6D6 M.D., Range 4000ft

180mm grenade launcher: 4D6 M.D., Range 4000ft. R.F.: One

Flamethrower: 5D10 normal damage, Range 200ft

Particle Beam Arms: 5D10 + 25 damage, Range 2 miles.

Missile Shoulder Pods: Damage and Range vary with missile type; payload 24.

Medium Range Missile Pod: Damage and Range vary; payload: 6 missiles.

Leg Missile Pods: Damage and Range vary; payload: 3 per each of the four pods — total of 12 missiles.

Alternate Mode of Attack: Hand to Hand; punch, stomp or body block.

Weapon Systems

- 1) **Top mounted, twin barrel, M-89, 12.7mm machinegun.** Located recessed between the shoulders and appears almost head-like. The angle of fire is limited to a 45 degree arc up and down and straight ahead.

Primary Purpose: Antipersonnel

Mega-Damage: 2D4 M.D. for short burst, 4D4 M.D. for long burst or 1D4 × 10 M.D. for one full melee of continuous fire (each burst is considered to be one attack regardless of the length).

Payload: 1000 rounds (one short burst uses 10 rounds), long burst 20 and full burst 40. Range: 2000ft (600m)

- 2) **TZ IV Gun Clusters (2):** Placed on each side of the chest, just under the shoulder missile pods. Each of the two gun clusters contain the following.

Weapons: (1) laser, (1) 32mm auto cannon, (1) 180mm grenade launcher and (1) flamethrower.

Laser does 2D6 mega-damage (M.D.). Range 2000ft (609.6m). Rate of fire equal to the pilot's hand to hand attacks per melee. Payload unlimited.

32mm Auto Cannon does 2D6 M.D. short burst, 4D6 M.D. long burst, 6D6 M.D. for one full melee of continuous fire (each is considered to be one attack regardless of the size of the burst). Range is 4000ft (1200m). Payload is limited to 240 rounds. 24 shells are fired per melee on a full melee burst, 12 in a long burst and 6 in a short burst.

180mm Grenade Launcher does 4D6 M.D.. Range is 4000ft (1310m). Rate of fire is once per melee. Payload is a total of 50 rounds.

Flamethrower does 5D10 Normal damage (not M.D.; ineffectual against any mecha). Range is 200ft, rate of fire is two per melee with a total of 50 blasts. Note: Flames will ignite all combustible material; 40% chance of igniting gasoline tanks.

- 3) **Missile Launcher Pods** mounted on each shoulder. The missile compartments/launchers are heavily armored, protecting the missiles from detonation by enemy fire. The missile pods also serve to protect the shoulder joints.

Primary Purpose: Assault/defense

Secondary Purpose: Riot Control/Civil Rescue

Missile Type: Short range, guided missiles. Specific warheads vary with the situation and can include explosive, gas and chemical. A *common missile mix for civil defense* is 12 explosive, 4 tear gas, 4 knockout gas, and 4, fire retardent, chemical foam. A *common mix for straight combat* conditions is all explosive, or a combination of 2 plasma/napalm, 2 smoke, 2 knockout gas and the remainder explosive.

Mega-Damage: Varies with specific warheads. *See missile descriptions elsewhere.*

Rate of Fire: One at a time or volleys of two with a total of 12 volleys.

Note: Each missile pod holds a *payload* of 12 missiles each for a total of 24 (two fired simultaneously counts as one attack). Volleys can be fired equal to the total hand to hand abilities of the pilot per melee.

- 4) **Heavy Missile Pods** mounted above the right shoulder. The unit launches a total of six, medium range, medium warhead missiles. The missiles can be launched one at a time or in volleys of two.

Each volley counts as one attack.

Primary Purpose: Assault/defense

Missile Types: Medium range, guided missiles. Specific warheads vary.

Mega-Damage: Varies with specific warheads, as does range.

Rate of Fire: Individually or in volleys of two.

Payload: Six missiles total. Manual reload, from somebody outside, requires the proper equipment and takes 6 melees.

- 5) **Twin, Leg Missile Pods** mounted on the leg. Each pod (4) contains three, small, short range missiles.

Primary Purpose: Defense

Secondary Purpose: Assault

Mega-Damage: Varies with missile type.

Range: Varies with missile type, but are always short range.

Rate of Fire: Individually or in volleys of two.

Payload: 3 per each pod for a total of 12. Two pods are mounted on each leg.

- 6) **Particle Beam Cannons, PBC-11,** compose each arm. It is these two, powerful weapons that give the Excaliber MK VI its deadly long range capabilities.

Primary Purpose: Assault/defense

Mega-Damage: 5D10 + 25 per blast

Range: 10,000ft (nearly two miles)

Payload: Unlimited

Rate of Fire: Four maximum per melee.

- 7) **Optional hand to hand combat** is very limited and awkward for the Excaliber, although its heavy, particle beam cannon arms can cause a fair amount of damage when used as bludgeons.

Mega-Damage: Punch 1D6 M.D.

Body Block 1D4 M.D.

*Stomp 1D4 M.D.

*The stomp with the foot is effective only against small objects of 12ft (3.6m) or smaller.

Note: The Excaliber can *not* jump, leap, kick, or climb. It can not pickup or carry objects unless they are huge and can be balanced on the PBC arms. Maximum weight: 8 tons.

Number of Attacks is equal to the hand to hand abilities of the pilot.

Special Equipment: *Searchlights* mounted above the left shoulder. Visible light and infrared. Range is 600ft (360m); capable of 180 degree rotation and an arc of 90 degrees up and down.

THE GLADIATOR

The Gladiator is a *non-transformable mecha* used as a defensive weapon system in deep space, aboard the SDF-1, and the by Earth Defense Force. Unlike its fellow Destroids (like the Excaliber) which are basically heavy artillery support units, the Gladiator is a frontline combat unit designed with an excellent balance of mobility, weaponry and hand to hand combat capabilities. Of all the Destroids, the Gladiator is the most versatile in overall mobility, agility and means of attack. It is the only Destroid that can engage in *full hand to hand* combat. So powerful are its slashing hands that they have been known to punch through the armor of Zentraedi assault pods. Its combat capabilities are augmented with an impressive combination of weapon systems.

The main disadvantage to the Gladiator is that it lacks any sort of long range weapon system. Another drawback, shared by all ground mecha, is that it is much slower than most of the enemy mecha it must face.

Since the Zentraedi assault on Earth, the Gladiator has become a major tool in the peace-keeping efforts during the difficult reconstruction of cities and society. It is the ideal unit for law enforcement, riot control, civil defense, reconnaissance, and patrols in remote areas.

The Gladiator is also known as the Spartan MBR-07-MK II

Vehicle Type: Destroid

Crew: One or two

M.D.C. By Location:

Hands — 100 each

Arms — 150 each

Legs — 250 each

*Main Body — 250

Reinforced Crew Compartment — 250

Missile Pods Mounted on Shoulder — 150 each

Gun Cluster — 75

Top Laser Turret — 25

Battle Mace — 50

GU-11 Gun Pod (optional) — 100

Note: No Head Unit

*Depleting the M.D.C. of the main body shuts the mecha completely down.

THE GLADIATOR

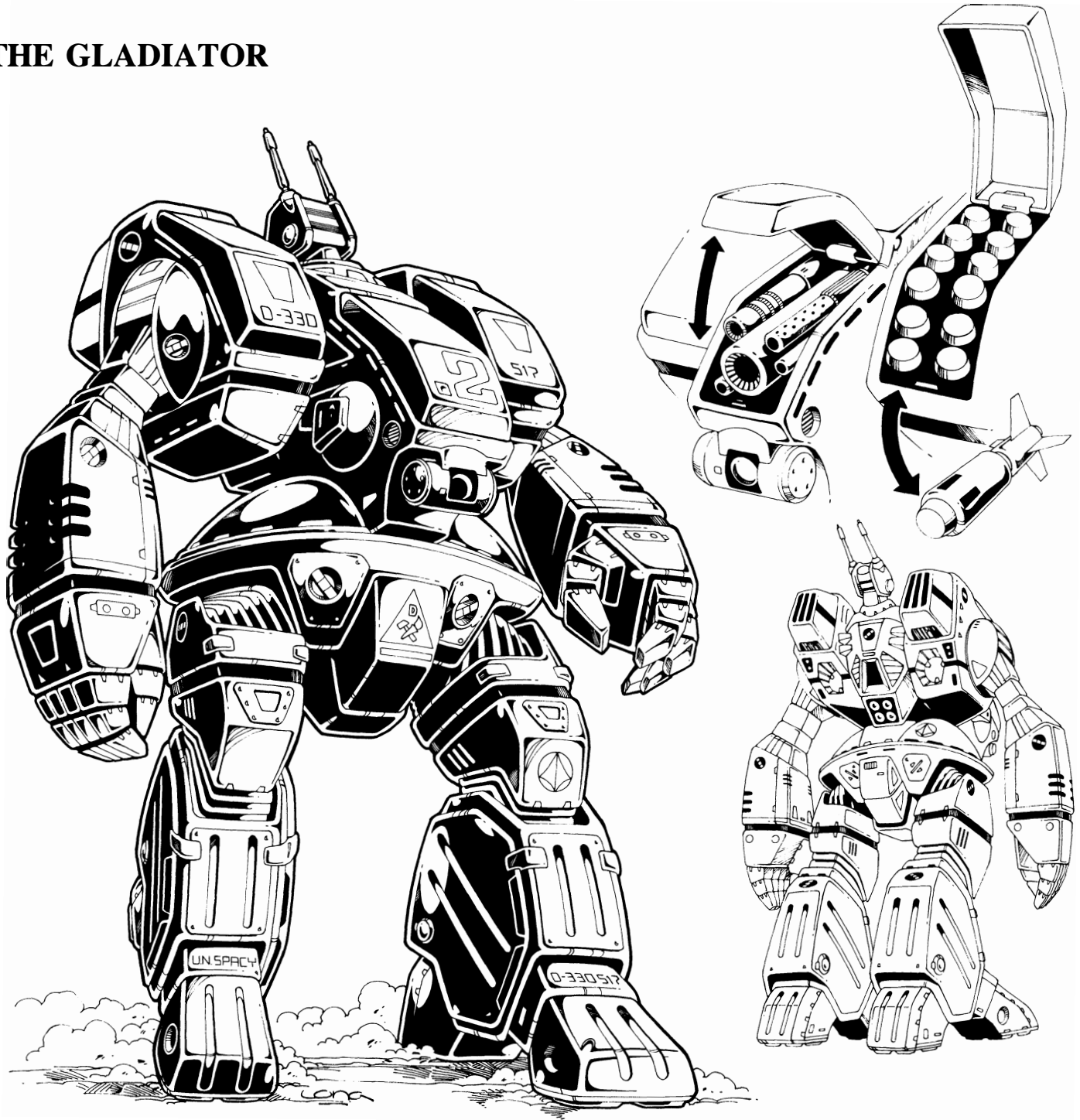

WEAPONS COMBAT SUMMARY

Attacks Per Melee: Equal to combined Hand to Hand skills

Laser Turret: 4D6 M.D., Range: 4000ft (1200m)

Gun Clusters

Short Range Laser: 2D6 M.D., Range: 2000ft (609.6m)

32mm Auto Cannon: 2D6, 4D6 or 6D6 M.D.; Range: 4000ft

180mm Grenade Launcher: 4D6 M.D.; Range: 4000ft, R.F. One

Flamethrower: 5D10 normal damage; Range: 200ft

Missile Launcher Pods: Damage and Range vary with missile type. Payload 24.

Alternative Modes of Attack

Hand to hand with mace adds 1D6 M.D. to normal punch.

Hand to hand: punch, stomp or body block

GU-11 gun pod; hand held; see Veritech Fighters.

Speed: 65mph (104kmph) maximum

Height: 37ft (11.3m)

Width: 27ft (8.3m)

Length: 20ft (6.1m)

Weight: 27.4 tons

Main Engine: DT-2004 Fusion Reactor; Output = 3200 SHP

Weapon Systems

1) **Twin Barrel, ROV-10, Laser Turret:** Mounted on top of the main body between the shoulders like a tiny head. 360 degree rotation.

Primary Purpose: Anti-Aircraft Weapon.

Secondary Purpose: Protection of the Flank

Mega-Damage: 4D6 per blast

Range: 4000ft (1200m)

2) **Missile Launcher Pods:** Mounted on each shoulder. The missile compartments/launchers are heavily armored, protecting the missiles from detonation by enemy fire. The missile pods also serve to protect the shoulder joints.

Primary Purpose: Assault/defense

Secondary Purpose: Riot Control/Civil Rescue

Missile Type: Short range, guided missiles. Specific warheads vary with the situation and can include explosive, gas and chemical. A *common missile mix for civil defense* is 12 explosive, 4 tear gas, 4 knockout gas and 4, fire retardent, chemical foam. A *common mix for straight combat* conditions is all explosive, or a combination of 2 plasma/napalm, 2 smoke, 2 knockout gas and the remainder explosive.

Mega-Damage: Varies with specific warheads. *See missile descriptions elsewhere.*

Rate of Fire: One at a time or volleys of two or four, with a total of 12 volleys. Note: Each missile pod holds a *payload* of 12 missiles each for a total of 24 (two can be fired simultaneously and count as one attack). Volleys can be fired equal to the hand to hand abilities of the pilot per melee.

3) **Main Armament: TZ-IV Gun Cluster** located in the heavily armored midsection of the body.

Weapons include: (1) laser, (1) 32mm auto-cannon, (1) 180mm grenade launcher and (1) flamethrower.

Laser does 2D6 mega-damage (M.D.). Range 2000ft (609.6m). Rate of fire is equal to the pilot's combined hand to hand attacks. Payload: unlimited.

32mm Auto Cannon: Does 2D6 M.D. short burst, 4D6 M.D. long burst, 6D6 M.D. for one full melee of continuous fire (each is considered to be one attack regardless of the size of burst). Range: 4000ft (1310m). Payload is limited to 240 rounds. 24 shells are fired per melee on a full melee burst, 12 in a long and 6 in a short burst.

180mm Grenade Launcher does 4D6 M.D.. Range: 4000ft (1310m). Rate of Fire: Once per melee. Payload: A total of 50 rounds.

Flamethrower: Does 5D10 NORMAL damage (not M.D.; ineffectual against any mecha). Range: 200ft. Rate of Fire: Two per melee with a total of 50 blasts. Note: Flames will ignite all combustible material; 40% chance of igniting gasoline tanks.

4) **Optional Use of the GU-11 Gun Pod.** This is the identical weapon used by the Veritech Fighters; does 3D6 short burst, 6D6 long burst or 1D6 x 10 mega-damage for one full melee burst.

Range: 4000ft (1310m)

Rate of Fire: Number of short bursts and long bursts are equal to the pilot's combined number of hand to hand attacks. *See Veritech Fighter for details.*

5) **Optional Hand to Hand with a Battle-Mace:** This is a large, 12 foot (3.6m), reinforced, metal alloy mace or club. Well balanced; specifically designed for the Gladiator.

Primary Purpose: Riot Control/Hand to Hand Combat

Mega-Damage: 1D6 M.D. is added to the normal 2D6 M.D. of a Gladiator's punch.

Number of Attacks Per Melee: Equal to Hand to Hand.

Special Note: The mace can be thrown. Range: 200ft (61m). Inflicts 2D6 M.D.

6) **Optional Hand to Hand Combat:** Rather than fire any weapons, the Gladiator can engage in hand to hand combat by delivering a series of powerful punches.

Mega-Damage: Restrained Punch/Slap — 1D4 M.D.

Full Strength Punch — 2D6 M.D.

Power Punch — 2D6 + 4 M.D.

*Stomp with Foot — 1D4 M.D.

Body Block/Tackle — 2D4 M.D.

Tear or Pry with Hands — 1D4 M.D.

Note: The Gladiator can *not* jump, leap or kick. It can climb if the structure can support its weight, and can pickup and carry up to 15 tons. *Also see Hand to Hand Mecha skill.*

*Stomp is effective only against small objects of 12ft or smaller.

Number of Attacks: Is equal to the hand to hand abilities. Physical hand to hand attacks can be used in combination with weapon attacks.

THE M.A.C. II

The M.A.C. II is the largest, non-transformable, ground cruising mecha ever operated by mankind. It was developed, using the mobile systems of the Destroids, to be a moving fortress. Its design enables it to blast enemy ground troops and repel air assaults as well.

The M.A.C. II's destructive force is tremendous, perhaps equalled only by the Spartan and its array of heavy missiles. However, the practicality of this massive machine in actual combat is questionable. It suffers from poor mobility, the lowest speed of all Destroids, lack of any short range weaponry, lacks hands for articulated work, and its great mass makes it unsuitable for terrains with soft earth, wetlands, or mountainous regions. Only its incredible armor plating saves it from being totally vulnerable to enemy assaults. Consequently, the M.A.C. II is often accompanied by the Excaliber and/or Gladiator to help protect it from close range onslaughts.

Since the Zentraedi assault on the Earth, the M.A.C. II has been restricted to use as an artillery support system. However, they are also used to suppress major Zentraedi and rebel uprisings, and for law enforcement and defense in remote areas.

The M.A.C. II: also known as the Monster; HWR-00-MK II

Vehicle Type: Destroid

Crew: Two or three, but can hold up to 8 additional passengers.

M.D.C. By Location:

Four Main Cannons — 100 per each barrel

Upper Arms — 100

Forearms/Tri-Cannons — 300

Legs — 300

*Main Body — 400

Reinforced Crew Compartment — 250

*Depleting the M.D.C. of the main body will shut the mecha completely down.

Speed: 20mph (32.18kph)

Height: 73.7ft (22.46m)

Width: 31.10ft (9.75m)

Length: 42.7ft (13m)

Weight: 186.3 tons/285.5 tons loaded with missiles and full ammo.

Main Engine: WT-1001 Fusion Reactor, Output = 11500 SHP

Secondary Engine: CT-8P Fusion Reactor, Output = 890 SHP

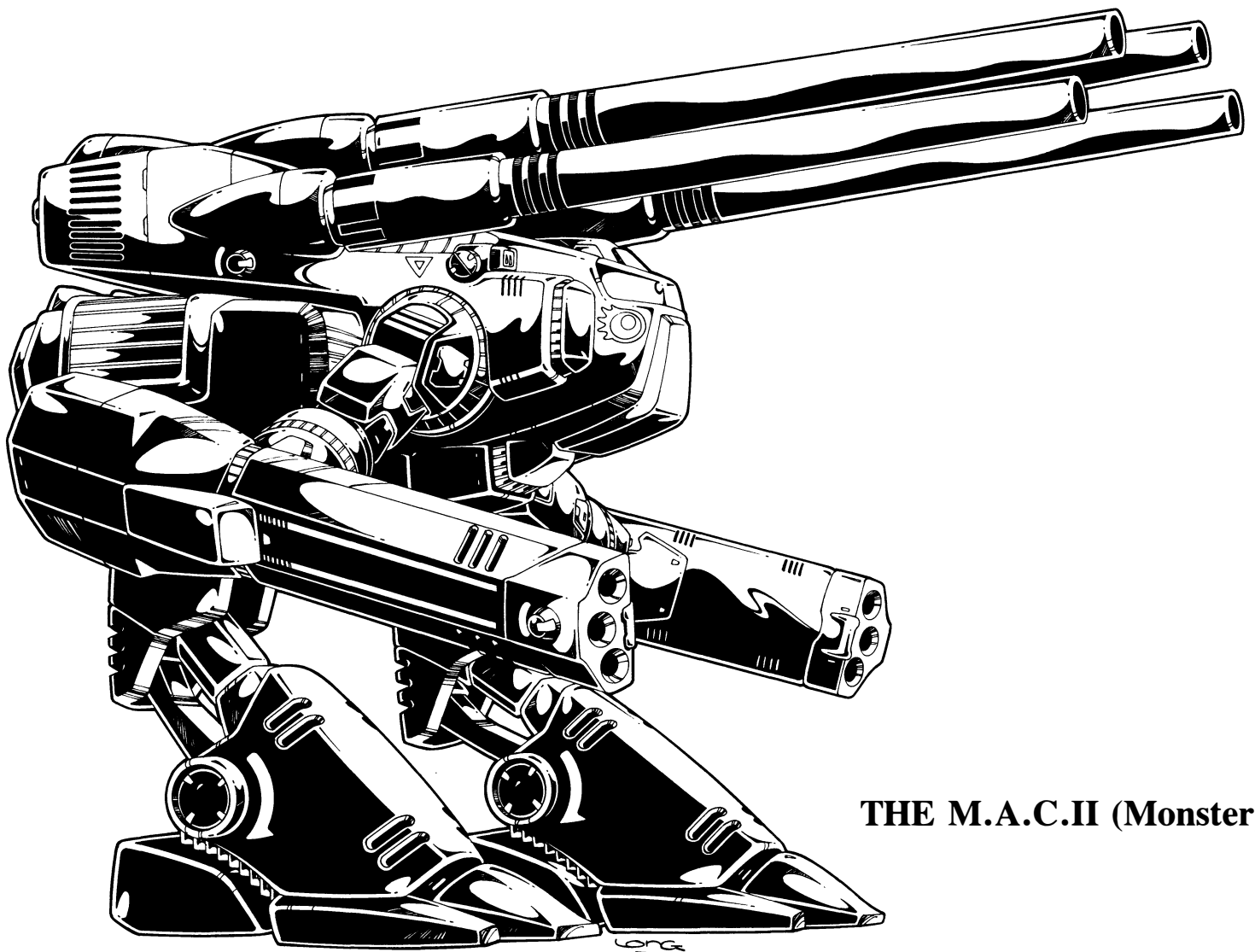

THE M.A.C.II (Monster)

Weapon Systems

1) Four, 40cm, Automatic Cannons are its main armament. The cannons are mounted on top of the mecha's main body.

Primary Purpose: Assault/defense

Secondary Purpose: Anti-Aircraft

Mega-Damage: 2D6 × 10 M.D. per individual round; blast radius: 20ft (6.1m). Can also fire volleys of 2 or 4 rounds simultaneously (multiply the number of dice rolled appropriately).

Range: 12 miles (19km) minimum effective range 600ft (183m).

Rate of Fire: Is equal to the total hand to hand skills of the pilot (usually 4 at first level). It must be stressed that one volley, which can be *two* or *four* rounds doing as much as 2400 points of M.D. damage, is considered to be only one of the total attacks per that melee. See the volley description under Mecha Combat.

Payload: Each of the FOUR guns can fire TEN rounds each for a total of 40 rounds. The big guns can be reloaded, but proper equipment and training is required. To fully reload takes 10 minutes (40 melees) per each gun.

Note: The four cannons can be raised up and down in a 60 degree arc. They are not capable of independent movement, which means all four must be positioned simultaneously.

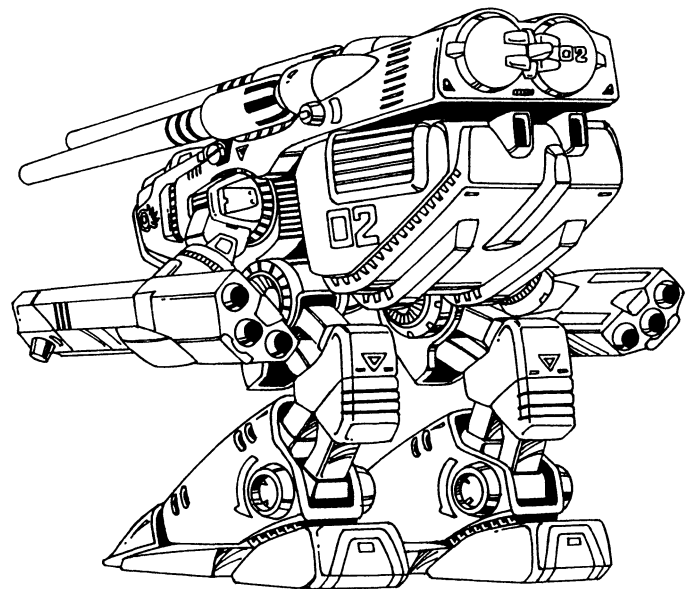

2) **Tri-Laser Cannons** comprise both arms. These weapons provide the M.A.C. II with a barrage of long range assaults against enemy aircraft and ground troops alike.

Primary Purpose: Anti-Aircraft

Secondary Purpose: Assault and defense

Mega-Damage: Fires in volleys of *THREE*, doing $3D4 \times 10$ M.D. per each volley.

Range: 10 miles (16km)

Rate of Fire: Is equal to the total hand to hand skills of the pilot (usually 4 at first level).

Payload: Unlimited

3) **Optional, Triple-Barrel, Anti-Ground Missile Launchers.** The original design of the M.A.C. II had the laser arms fitted with missile launchers. Advancements in technology enabled scientists to replace the missile launcher arms with the less limited lasers. However, the M.A.C. II's modular design allows for it to be fitted with either type of arms.

Primary Purpose: Assault/Antipersonnel

Secondary Purpose: Defense

Mega-Damage: Varies with the specific type of short, medium or long range missiles fired.

Range: Varies with missile type.

Rate of Fire: Individually, in pairs, or three fired simultaneously (one attack).

Payload: 12 per each arm for a total of 24. Can be reloaded with proper equipment, but takes five minutes (20 melees).

4) **Optional Hand to Hand Combat:** Although limited by its size, weight and design, the M.A.C. II can be as deadly in close combat as any of its fellow Destroids.

Mega-Damage: Punch — 2D6

*Stomp — 3D4

*The M.A.C. II's incredible size makes it able to stomp/step on objects up to 24ft (7.3m) tall. Its weight provides for its significant damage by stomp and punch.

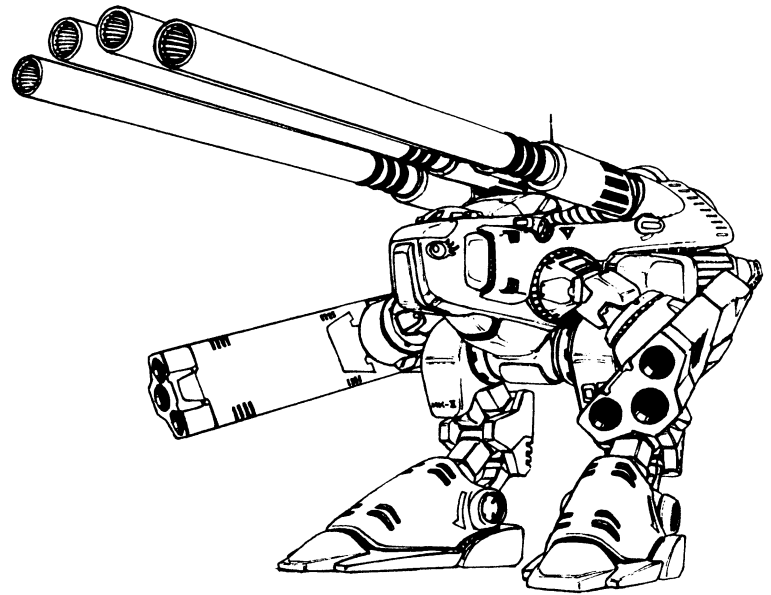

WEAPONS COMBAT SUMMARY

Attacks Per Melee: Equal to the combined hand to hand skills (mecha and normal hand to hand) of the pilot.

Four, 40cm Auto-Cannon: $2D6 \times 10$ M.D.; Range: 12 miles (19km).

Tri-Laser Cannons: $3D4 \times 10$ M.D.; Range: 10 miles

Alternative Modes of Attack

Triple barrel missile launcher: Damage and Range varies with missile type; payload 24.

Hand to Hand: Punch or Stomp.

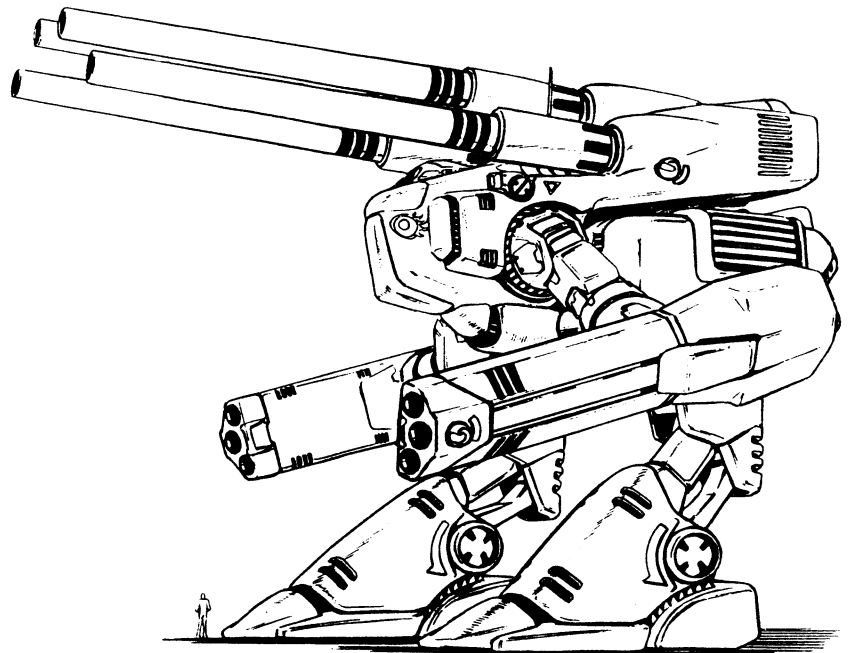
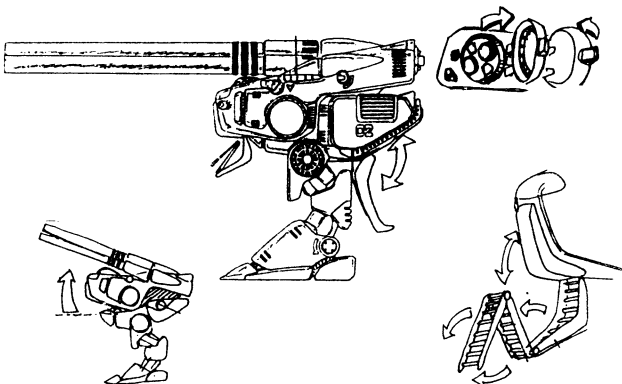
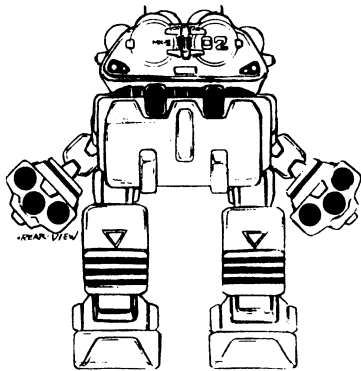

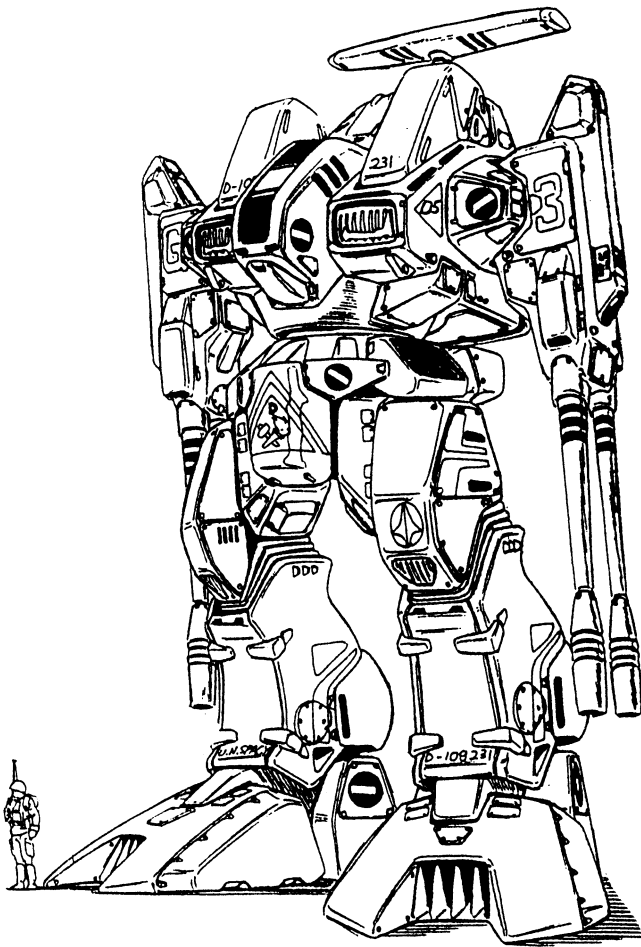

RAIDAR X

The Raidar X is a non-transformable mecha used as an anti-aircraft unit aboard the SDF-1, by the U.N. SPACY and local Earth governments. Raidar X is lighter weight and faster than the other Destroids, but relies only on one weapon type — its multi-action, laser armament system. However, the lasers provide multiple, long range attack capabilities unequalled by any other mecha, except for the M.A.C. II.

Despite the Raidar X's superior range it suffers from several disadvantages. It is the lightest and, therefore, least heavily armored, relies on one weapon system, lacks any short range secondary weapons (although the lasers can be used at close range), and lacks hands; so it can not grasp, hold or perform any articulated work. Even its enhanced speed falls short against the speed of the Zentraedi Battle Pods.

Since the Zentraedi invasion, the Raidar X is used primarily for defense in air assaults and as a peace keeping tool, especially in remote regions and lowlands where its speed and power can be used to full advantage.

Raidar X: Also known as the Defender ADR-04-MKX

Vehicle Type: Destroid

Crew: One or two

M.D.C. By Location:

Radar/Sensor Unit — 50

Searchlights (2) — 15 each

Upper Arm — 100 each

Laser Forearms — 75 per each barrel

*Main Body — 250

Reinforced Crew Compartment — 250

Legs — 200 each

Note: No Head Unit

*Depleting the M.D.C. of the main body shuts the mecha completely down.

Speed: 80mph (128.72kmph)

Height: 35.3ft (10.75m)

Width: 24.6ft (7.5m)

Length: 16.7ft (5.1m)

Weight: 21.7 tons

Main Engine: MT 828 Fusion Reactor; Output = 2800 SHP

Weapon Systems

- 1) **Pair of wide angle, rapid fire, double barrel Laser Cannons** controlled by an advanced targeting/radar system. This elaborate targeting/radar system increases the Raidar X's accuracy.

Bonus of +2 to strike only while the radar sensory unit mounted atop the mecha is functional. This bonus is in addition to any other bonuses the pilot might have.

Primary Purpose: Anti-Aircraft

Secondary Purpose: Assault

Mega-Damage: 2D10 short burst, 4D10 heavy burst, 6D10 maximum burst, per arm.

Range: 8 miles (12.7km)

Rate of Fire: 8 short, 4 heavy, or 4 maximum bursts blasts per melee, per pair of laser arms (total bursts per melee: 16 short or 8 heavy or 8 maximum bursts). This is the only mecha that has more energy/weapon attacks than its hand to hand capabilities.

Payload: Unlimited

- 2) **Optional Hand to Hand Combat:** Is extremely awkward because of the lack of hands and normal arms. However, the Raidar X can get by in a pinch.

Mega-Damage: Punch — 1D4

Body Block — 1D4

*Stomp — 1D4

*The Stomp with the foot is effective only against small objects of 12ft (3.6m) or smaller.

Note: The Raidar X can *not* jump, leap, kick or climb. Nor can it pick up or carry objects unless they are large and can be balanced or cradled by the laser barrel arms. Maximum carrying weight is 6 tons.

Number of Attacks is equal to the hand to hand skills of the pilot.

- 3) **Optional: Replace laser arms with dual type, 966-PFG, air-cooled auto cannons.** The auto cannons were used on earlier models, but replaced by the more formidable lasers.

Mega-Damage: 2D10 short volley, 3D10 long volley and 4D10 for a maximum volley, per arm.

Range: 8 miles (12.7km)

Rate of Fire: 6 short volleys or 4 long or 2 maximum volleys per each pair of cannons (total of 12, 8 or 4 blasts per melee).

Payload: 200 rounds per arm. (4 rounds are fired at max.)

SPECIAL EQUIPMENT

- 1) **Advanced Radar and Sensory Unit** mounted on the top of the Raidar X mecha's main body housing. Radar Range: 200 miles and can track 77 targets simultaneously.

Other Sensors . . .

Heat: Can pickup and pinpoint heat emanations. Excellent for tracking and night fighting. Range: 600ft (180m).

Motion: Detects and registers movement within a 600ft (180m) area. Can pinpoint up to 100 targets.

Radiation: Detects and registers levels of radiation, pinpointing areas of specific concentration. Range: 2700ft (822.96m).

Infrared and Ultraviolet optical/video scan system. Range: 2700ft (822.96m).

Combat Computer: Calculates and transmits data onto a control panel monitor or head up display on the pilot's helmet.

- 2) **On board computer system** to record and analyze data.
- 3) **Long range laser communications** system. Range: 1200 miles; with satellite relay indefinitely.
- 4) **Infrared and visible light searchlights.** Range: 600ft (180m).

THE RAIDAR X

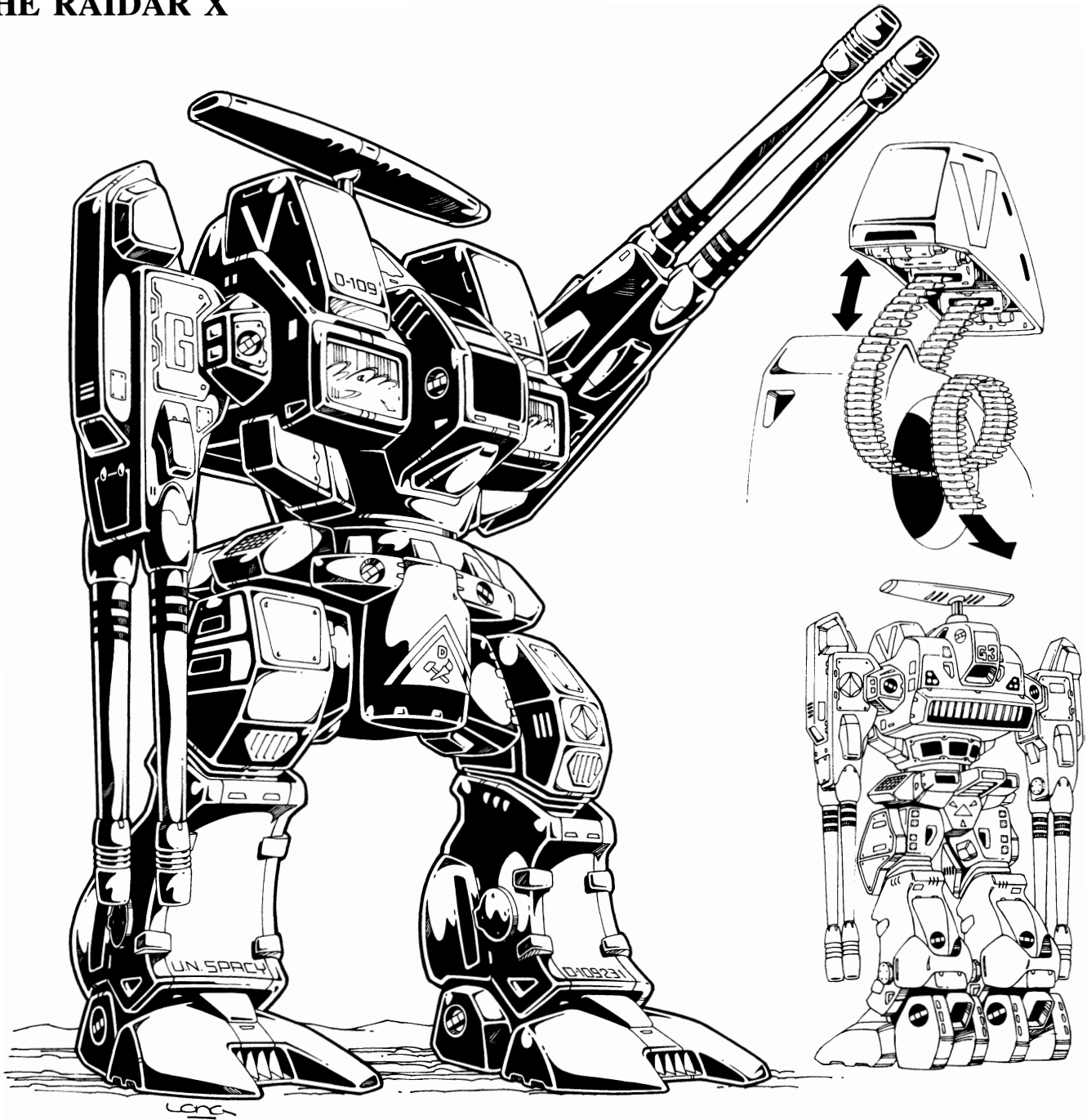

WEAPONS COMBAT SUMMARY

Attacks Per Melee: *SPECIAL*; 16 short bursts, or 8 long burst attacks per melee with double barrel laser arms (8 or 4 blasts per each individual arm). OR hand to hand, close combat, equal to the pilot's total hand to hand skills (usually four at first level).

Double Barrel Laser: 2D10, 4D10 or 6D10 M.D.; Range: 8 miles (12.7km).

Alternative Modes of Attack

Auto Cannons: 2D10, 3D10, or 4D10 M.D. Range: 8 miles

Hand to Hand: Punch, body block or stomp.

THE SPARTAN

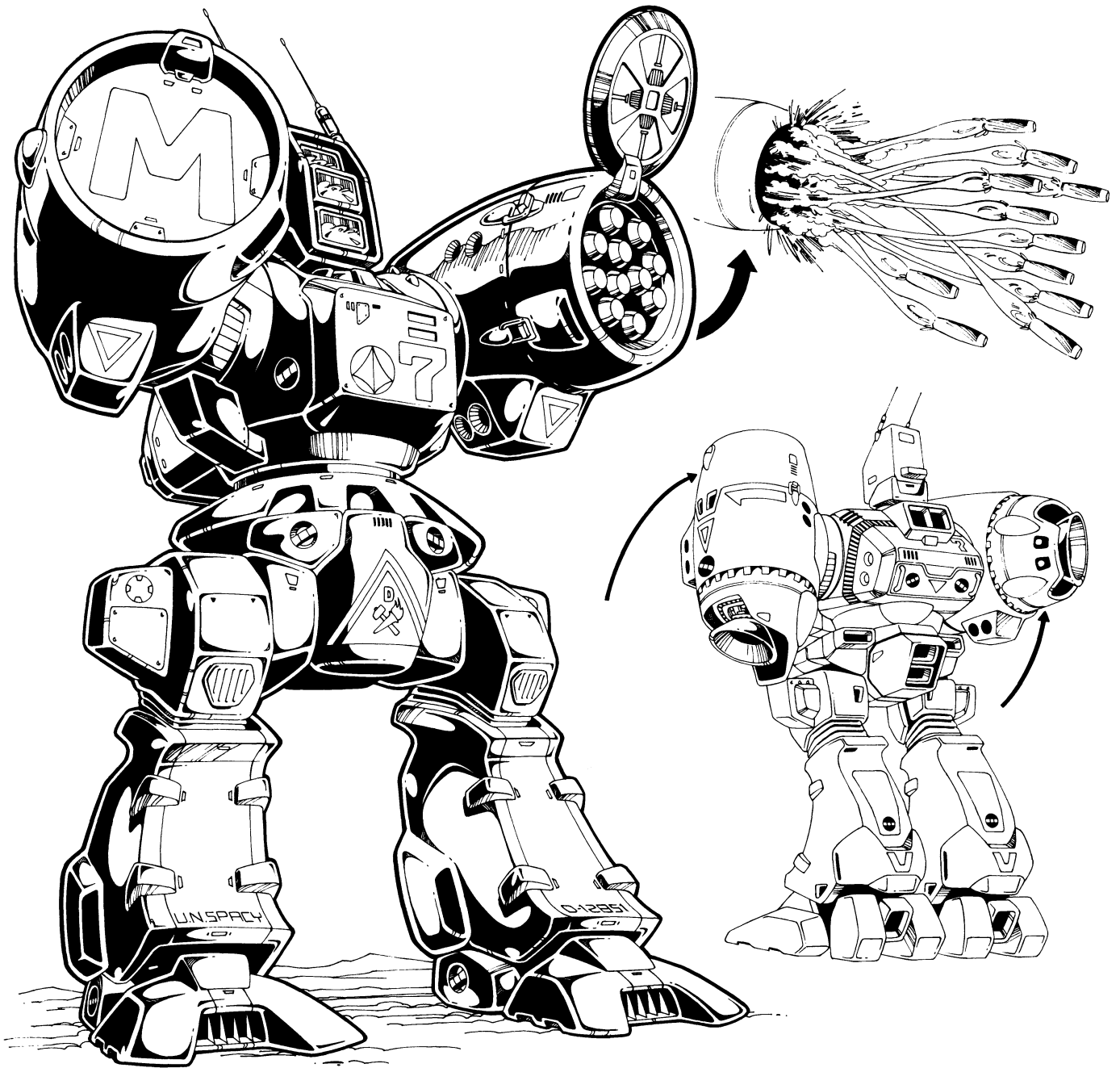

WEAPONS COMBAT SUMMARY

Attacks Per Melee: Equal to the pilot's, total, hand to hand skills (mecha and normal).

Missile Launchers Damage and Range vary.

Hand to Hand: Punch, body block, stomp.

THE SPARTAN

The Spartan is a non-transformable mecha used for long range attacks and defense. It can be thought of as a walking missile launcher. This mecha's greatest advantage is that it has the most destructive, long range capabilities of any other destroid. It was a major force on the SDF-1, and on Earth against the Zentraedi.

As an artillery support unit, the Spartan is unsurpassed, however, it is perhaps the least versatile of all the mecha. It is the second slowest, has no short range defense or secondary weapons system, and not only lacks hands, but also lacks any type of humanoid arm construction or movement, making it extremely awkward in hand to hand combat.

Since the Zentraedi invasion, it has been used primarily as a defensive weapon, but can also function as non-combat workers for construction, hauling heavy loads and demolitions.

The Spartan: Also known as the Phalanx SDR-04-MK XII

Vehicle Type: Destroid

Crew: Two or Three

A.R.: 13

M.D.C. By Location:

Tri-Searchlight — 30

Shoulder Joints — 100

Missile Pods (2) — 150 each

*Main Body — 200

Reinforced Crew Compartment — 250

Legs — 200 each

Note: No Head Unit

*Depleting the M.D.C. of the main body will shut the mecha completely down.

Speed: 45mph (72.3kmph)

Height: 39.5ft (12.05m)

Width: 24.6ft (7.5m)

Length: 16ft (5m)

Weight: 47.2 tons

Main Engine: MT 828 Fusion Reactor; Output = 2800 SHP

Weapon Systems

1) The Spartan only has one weapon system — missile launchers mounted on each arm. However, the type of missiles carried can provide a variety of attacks, damage and range. All the missiles are self-guided, long or medium range types.

Primary Purpose: Assault and defense

Secondary Purpose: Anti-Aircraft and construction

Mega-Damage: Varies with type of missile(s). See missile descriptions elsewhere for details on damage and range.

Range: Long and medium range missiles.

Rate of Fire: Can fire volleys of missiles one at a time or in increments of threes, i.e.: 3, 6, 9, or 11, per arm. One volley, regardless of the number of missiles fired in that volley, is equal to one hand to hand attack.

Payload: 22 missiles per each arm for an attack of 44. The missile pod arms can be reloaded with special vehicles and equipment, but requires a full 5 minutes or 20 melees.

Note: The missile pods are capable of 360 degree rotation, can move independently of each other and can fire straight up, if necessary. The Spartan can fire any of the heavy, long range missiles. Usually a mix or variety of missiles will be carried to accommodate a number of circumstances.

2) **Optional hand to hand combat** is very limited for the Spartan without true arms and hands, but it is not helpless.

Mega-Damage: Swatting Blow — 1D4 M.D.

Body Block — 1D6 M.D.

*Stomp — 1D6 M.D.

*The Stomp with the foot is effective only against small objects of 12ft (3.6m) or smaller.

Note: The Spartan can *not* jump, leap, kick or climb. Nor can it pick up or carry objects unless they are huge and can be balanced or cradled by the missile pod arms. Maximum carrying weight is 6 tons.

Number of attacks is equal to the total, combined, hand to hand combat skills of the pilot.

Special Equipment: Tri-Level searchlight with visible light and infrared capabilities. Range: 600ft (180m).

VEHICLES

SPACE VEHICLES

The A.R.M.D. Space Platform

Lancer I Space Fighter

Lancer II Space Cannon

The Searcher SFV

The Cat's-Eye Recon

Space Shuttle

FIGHTER PLANES & JETS

The L.V.T. Adventurer II

The Falcon Fighter Jet

QF-3000 E Ghost

OTHER JET AIRCRAFT

The Titanic VC-27 Tunny-VTOL

Fan Jet

HELICOPTERS

Howard LH-2000

The Sea-Sergeant

The Commanchero

LAND VEHICLES

AAR-Recon II

The Land Rover

RDF Motorcycle

RV-B Dune Buggy

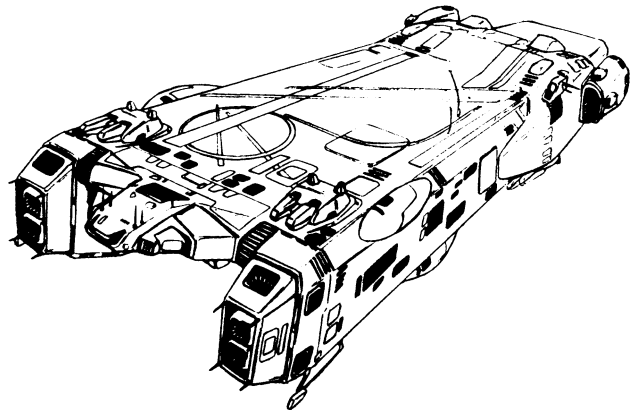

THE ARMOR/A.R.M.D. SERIES SPACE PLATFORM

The A.R.M.D. (seen on the T.V. series, in the first episode or two, as the Armor 1 and the Armor 2) Space Platform or "Carrier Space Ships" were originally designed to be a sort of flying dock or space rig for space fighter planes and Veritech Fighters. However, the design was modified, adding an array of weapon systems to the platform and converting it into an aircraft carrier in space. The A.R.M.D. platform quickly became a major component in the Earth Defense Force's strategic system.

Utilizing the secrets of Robotechnology unearthed from the SDF-1, the A.R.M.D. space platforms were built, and placed into orbit around the Earth. However, despite the overall achievements of this structure, the A.R.M.D. fleet of five would prove ineffective against the overwhelming Zentraedi fleet. Only two would survive the ultimate conflict; left to circle the earth as ever watchful guardians of the Robotech Defense Force.

The greatest disadvantage of the A.R.M.D. space platform is its low speed and lack of overall mobility. Another strike against the platforms is that they are not really capable of deep space travel, limited to Earth orbit and/or short trips to orbit the moon.

The A.R.M.D. Space Platform

Vehicle Type: Space Aircraft Carrier

Crew: 160 officers, approx. 2900 enlisted men, 600 men assigned to air attack units (jet fighters and Veritech Fighters). Total: 3600, plus, it can accommodate another 1200, special assignment personnel.

M.D.C. by Location:

- Main Laser Cannons (5) — 300 each
 - Main Anti-Warship Missile Launchers (2) — 400 each
 - Medium Anti-Warship Missile Launchers (6) — 200 each
 - Anti-Aircraft Guns (48) — 100 each
 - *Main Communications Deck — 600
 - Foredeck — 600
 - **Main Body — 2000
 - Flight Deck — 400
- *Depleting the main communications and sensor deck will cause great confusion in collecting data and organizing battle formations.
- **Depleting the main body means the flight deck is a shambles, 60% of *all* weapons are shut down, flight/movement of the A.R.M.D. is impossible; the platform is severely damaged and in dire condition. Followed by the destruction of the foredeck *all* weapon and life support systems will shut down. The space platform is a mutilated derelict adrift in space. Another 500 points of mega-damage destroys/blows up the entire platform. Chance of any crew survival is 1%.

Speed: 250mph (402.25kmph)

Dimensions in Feet: 1410.8 × 763 × 210

Flight Deck Width: 380ft (115.8m)

Weight: 474,000 tons

Main Engine: OTMN-3T Reflex Engines (2)

Secondary Engine: Numerous thruster ports for stabilization, direction and mobility.

Weapon Systems

1. Main Laser Cannons (5)
2. Main Anti-Warship Missile Launchers (2)
3. Medium Anti-Aircraft Missile Launchers (6)
4. Anti-Aircraft Guns (48)
5. Aircraft:
 - Manned Lancer I Space Fighter (96)
 - QF-3000E Ghost Fighters (Unmanned) (270)
 - Space Cannon SPC-II (Unmanned) (200)

Note: Can also accommodate Veritech Fighters, although not a standard compliment.

1) **Five, Main Laser Cannons** are located on the giant space platform. Two are located near the foredeck, on the top of the deck surface, two in similar locations on the underside and one at the rear of the vessel. All are capable of 360 degree rotation and can fire in an arc of 180 degrees.

Primary Purpose: Assault/defense.

Secondary Purpose: Anti-Aircraft/Anti-Missile

Mega-Damage: 4D6 × 10 per each blast.

Range: 100 miles (160.90km)

Rate of Fire: Two per each cannon, per melee for a total of ten.

Payload: Unlimited

Note: +2 to strike

2) **The Two, Main, Anti-Warship Missile Launchers** fire deadly volleys of reflex and nuclear, heavy warhead missiles. These are the very large, I.C.B.M.-type missiles.

Primary Purpose: Anti-Warship (spaceship)

Secondary Purpose: Defense/Assault

Mega-Damage: 1D6 × 200 per missile or 2D6 × 200 per volley. Note that one volley, 2 missiles is considered to be one attack.

Range: 800 miles (1286km), travelling at 2690mph.

Rate of Fire: Two volleys per melee for a total of 4 or 8 missiles; fires in volleys of two or one at a time.

Payload: 40 per each missile launcher for a total of 80.

Note: Reflex warheads make these smart bombs; +5 to strike and +4 to dodge attacks.

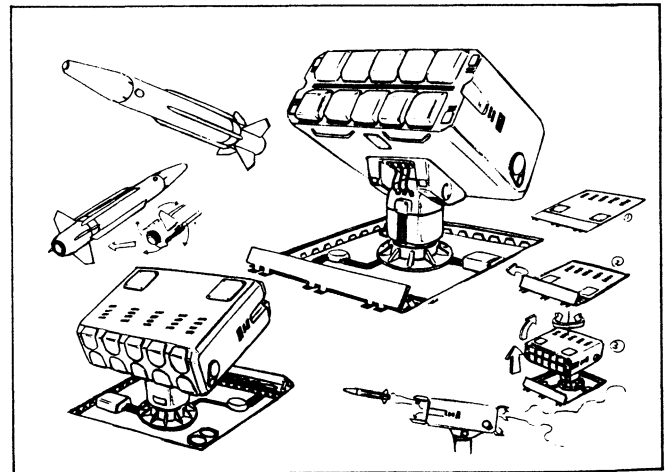

3) **Medium, Anti-Warship Missile Launchers** fire large reflex, nuclear and multiple warhead missiles. Six are spread across the main deck/body.

Primary Purpose: Anti-Warship

Secondary Purpose: Assault/defense.

Mega-Damage: 1D6 × 100 for reflex and nuclear
2D6 × 100 for multiple warhead

Range: 400 miles for reflex and nuclear.

600 miles for multiple reflex warhead.

Rate of Fire: Two volleys of one or two missiles per melee from EACH of the six missile launchers for a total of 12 or 24 missiles fired per melee.

Payload: 40 per each missile launcher for a total of 240 missiles.

4) **Anti-Aircraft Laser Guns** are scattered on the top and underside of the A.R.M.D. (24 each on top and bottom).

Primary Purpose: Anti-Aircraft

Secondary Purpose: Defense

Range: 25 miles

Mega-Damage: Per each individual gun — 1D10 × 5 short burst, 3D4 × 10 long burst, 3D8 × 10 for continual firing the entire melee round.

Rate of Fire: Six short bursts or 3 long bursts or one, long, continual burst. This is per each individual unit, of which there are 48.

Bonuses: +2 to Strike

Payload: Unlimited

5) **Aircraft:** See the individual descriptions for details on each. A typical A.R.M.D. Space Platform will contain:
270 QF-3000E Ghost Fighters (Unmanned)
200 SPC-II Space Cannons (Unmanned)
96 SF-3A Lancer I Fighters (Manned)
24 Veritech Fighters (Optional; not standard)

Notes: The lowest orbit around Earth is 110 miles. Any lower than that and the space platform may slip into Earth's atmosphere, lose orbit and burn up on reentry.

Bonuses: A.R.M.D. is +1 to dodge.

Communications Network is superior, with laser, radio and video telecast capabilities.

Sensors: Radar (300 mile range); heat, motion, radiation and light detection.

WEAPONS COMBAT SUMMARY

Attacks Per Melee: 74 plus aircraft*

5, Main Laser Cannons: 2 attacks each, 1D6 × 100 M.D.

2, Main, Anti-Warship Missile Launchers: 2 attacks each, 1D6 × 100 M.D. per missile.

6, Medium, Anti-Aircraft Missile Launchers: 2 attacks each, 1D4 × 100 or 1D6 × 100.

48 Anti-Aircraft Guns: 6, 3 or one attack per melee doing 1D4 × 5 or 1D4 × 10 or 3D4 × 10

Aircraft: Manned and Unmanned.

*See G.M.'s note for condensing the number of attacks to 23 (plus aircraft).

Game Master's Note: It's not likely that an encounter with the A.R.M.D. Space Platform will ever occur. On the other hand, the game master certainly has enough options open to him that the players may share an adventure with a space platform. Combat with the A.R.M.D. Platform can be handled in several ways. One is to let each player or pair of players be in charge of directing an area of the A.R.M.D.'s armaments. **For Example:** One could be in charge of the two, main, anti-warship, missile launchers. It would be his or her responsibility to select a target, decide on how many volleys of missiles to fire and then to launch them (timing could be crucial). Another could be in charge of the five, main, laser cannons. Somebody else, in charge of the six medium launchers. A fourth person or pair could be in charge of the 48 anti-aircraft guns, while yet another directs some of the space cannons or Ghost Fighters and so on. In this way, everybody will have a key place in the over-all combat of the space platform.

Another alternative would be fighting in the smaller picture of a larger battle, with the A.R.M.D. played by the G.M. in the background while players played their usual mecha, locked in close, personal combat.

Then there is that scenario in which the players may find themselves, for whatever reason, renegades who must flee from or fight the A.R.M.D. Space Platform. The G.M. would then send aspects of the platform's might against the players.

Quick rolls may be required or desired when using the multiple armaments of the A.R.M.D. Space Platform. The G.M. may come up with his own means of combining multiple attacks into a lesser number of attack, and damage rolls, or consider the following.

The 48 Anti-Aircraft Guns: Only *six* guns can be trained on any one target which could reduce the 48 individual weapons into EIGHT groups of six. Damage rolls could be 6D10 × 5 for short bursts, 6D4 × 20 for long bursts and 3D8 × 100 for continual fire all melee.

The 6, Medium, Anti-Warship Missile Launchers can be divided and combined in the same way, assuming that two missile launchers are shooting at the same target. This turns the six into THREE. Damage rolls would be 2D6 × 100, if only one missile was launched from both launchers; or 4D6 × 100, if a volley of two missiles was launched from each.

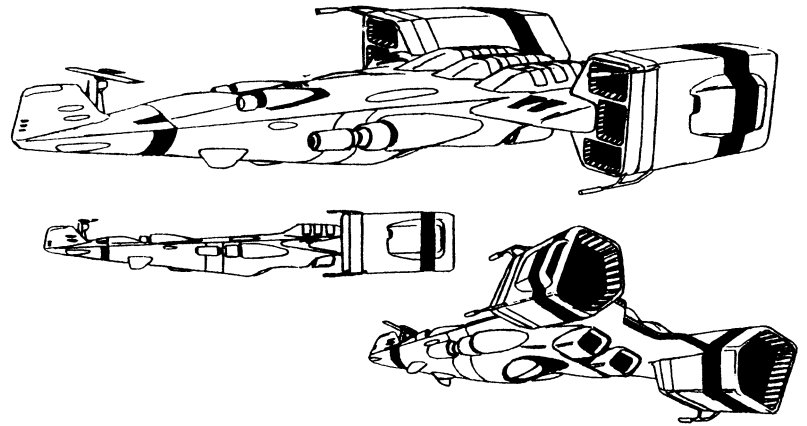

LANCER I SPACE FIGHTER

This deadly space fighter is a manned companion to the unmanned, Lancer II Space Cannon. The Lancer I is a heavy-duty armament system built into a twin jet rocket chassis. Its strengths are high mobility and multiple attack capabilities. It is used exclusively in space by the A.R.M.D. Space Platforms and moon bases.

Lancer I Space Fighter

Vehicle Type: Space

Crew: One

M.D.C. by Location:

Laser Cannon (4) — 30 each

Radar Sensor — 25

Engine Thrusters (2) — 75 each

*Main Body — 150

Reinforced pilot's compartment — 100

*Depleting the M.D.C. of the main body will shut the vehicle down completely. Destruction of an engine thruster will make movement impossible.

Speed: 2007mph (Mach 3) maximum, or hover. Note that this is a spacecraft and CANNOT fly in an atmosphere.

Range: 6000 miles

Length: 32.6ft (9.9m)

Weight: 10 tons

Weapon Systems

1) The main weapon system are four small, but powerful, **laser cannons**.

Primary Purpose: Assault

Mega-Damage: 1D6 for short burst or 2D6 for long burst.

Range: 5 miles (8km)

Rate of Fire: The lasers can be fired individually (one at a time) or all four simultaneously, *four times per melee*.

Payload: Unlimited

2) **Eighteen, medium range missiles** can be launched.

Primary Purpose: Assault

Mega-Damage: Varies with specific missile type. See missile descriptions elsewhere. Any of the medium range missiles can be used.

Range: Varies with specific missiles.

Rate of Fire: 1, 2, 3, or 6.

Payload: Eighteen maximum.

Notes: 1) Hand to Hand combat is not possible with this non-transformable vehicle. 2) Radar: Range: 60 miles (96.5km), can track up to 24 targets simultaneously. 3) Targeting computer enhances accuracy in assault. 4) Wide band and directional, radio and video telecast capabilities. Range: 600 miles. 5) The pilot is seated in a small, one man, windowless cockpit. Consequently, the pilot must rely entirely on computer targeting, optics and radar. 6) Bonuses: +1 to strike, +3 to dodge.

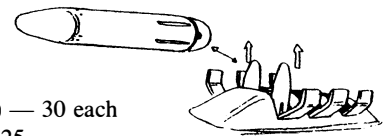

LANCER II SPACE CANNON

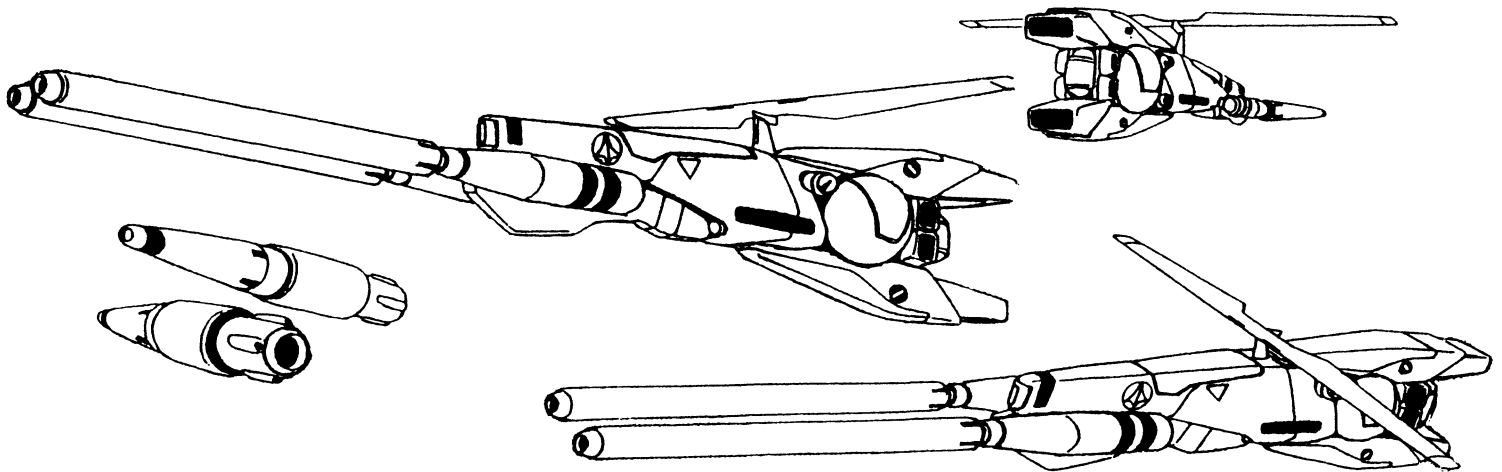

The Space Cannon is a fully automated, unmanned attack vehicle which operates on reflex power and weapon systems. This means that the Lancer is directed by an artificial intelligence that can actually search out its target, identify and destroy (attack). If the target is beyond its strike range, it will wait until a programmed target comes into range.

The Space Cannon is fairly mobile, able to take evasive action and even plot rudimentary strategies. It was used exclusively on the A.R.M.D. orbital defense station.

Lancer II Space Cannon

Vehicle Type: Space, unmanned; reflex, drone

Crew: None

M.D.C. by Location:

Cannons (2) — 100 each

Radar/Sensor Unit — 75

*Main Body — 100

**Engine Thrusters (2) — 50 each

*Depleting the M.D.C. of the main body will shut the vehicle down completely.

**Destroying one of the main thrusters reduces speed and mobility (bonuses to dodge) by half. Destruction of both thrusters will immobilize the vehicle, preventing direction, movement or evasive action. -2 to strike; can *not* dodge.

Main Engine: Reflex Reactors

Speed: 1450mph (Mach 2.2)

Range: 2000 miles (3218km)

Length: 25ft (7.6m)

Weight: 9.3 tons

Weapon Systems

The Space Cannon has only one weapon system; the twin, long range auto cannons mounted in its nose. The shells fired are plasma-type warheads that resemble small missiles.

The weapon system is tied into a reflex and advanced targeting system, somewhat reminiscent to that of the Veritech Fighter.

Radar range is 200 miles and can track 48, individual targets.

Bonuses: +5 to strike, +4 to dodge.

Twin Auto Cannons

Primary Purpose: Assault/defense.

Mega-Damage: 1D6 × 10

Range: 10 miles (16km)

Rate of Fire: 4 blasts per melee.

Payload: 120 rounds

Notes: Hand to Hand combat is impossible; this is a non-transformable vehicle.

SPACE SHUTTLE

The space shuttle was commonly used for transporting cargo and passengers between Earth, the moon base, the orbiting SDF-1 and A.R.M.D. Space Platforms.

Vehicle Type: Space

Crew: 4, but can carry up to 40 passengers.

M.D.C. by Location:

Wings — 50

Pilot's Cockpit — 75

*Main Body — 150

*The same conditions apply as those noted under the Cat's-Eye Recon.

Speed: 350mph (563.15kmph) cruising speed, 1450mph (Mach 2.2) normal speed and Mach 5 with booster jets to achieve orbit or for special maneuvers.

Range: 20,000 miles

Length: 152ft (46.3m)

Weight: 90 tons

Bonuses: +3 to dodge

Notes: Has radar with a 200 mile (321.6km) range and standard, long range, audio/video, laser communications.

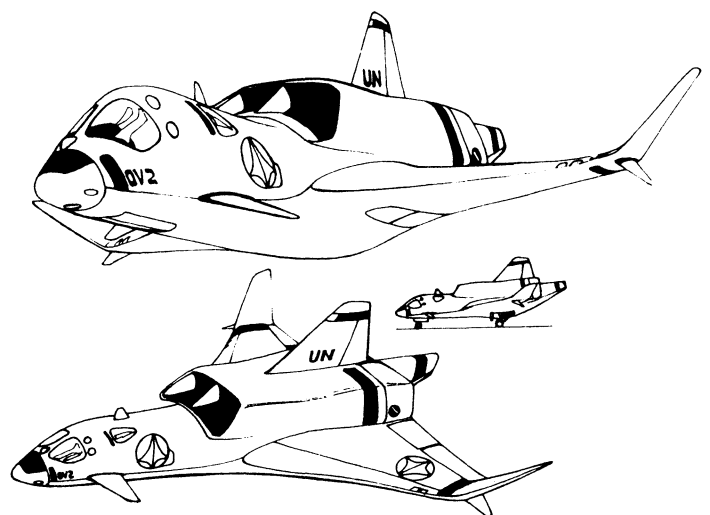

THE SEARCHER SFV

A one man space vehicle used for repairs and investigations in outer space. It has five manipulator arms, but they are almost useless in combat and have no weapons.

Vehicle Type: Space

Crew: One

M.D.C. by Location:

Four Manipulator Arms — 25 each

5th, Heavy Arm — 40

Sensor Unit — 20

Spotlights (4) — 1 each

Thruster — 25

*Main Body — 75

*Depleting the main body M.D.C. will destroy the spacecraft.

The pilot must eject before the vessel is destroyed or die.

Speed: 80mph (128.72kmph); also capable of hovering.

Range: 300 miles (482km)

Length: 20ft (32.1m)

Weight: 8.4 tons

Weapon Systems

None per se, however, the Searcher does have some limited *hand to hand abilities*.

Attacks Per Melee: Four

Mega-Damage: One M.D. point from a swat or jab from one of the 4 manipulator arms. 1D4 M.D. from the 5th, heavy arm.

Bonuses: +1 to strike and dodge, +2 to parry.

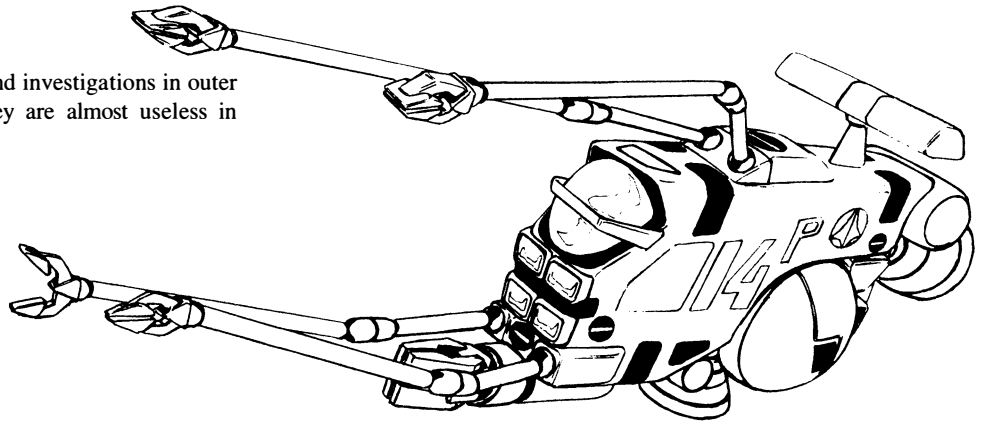

Notes: The four manipulator arms can pickup and carry up to 1000lbs (450kg) each or 2 tons combined. The heavy duty, retractable, fifth arm can pickup and carry up to one ton by itself. The arms are fairly agile.

The sensor mounted on top of the vehicle contains a limited range *radar*, 20 miles (32.1km), *radiation detectors* which can measure, identify and pinpoint radiation, *heat sensors* which can do the same in regards to heat and a thermo-imager. The latter three have a 600ft (180m) range. An onboard, diagnostic computer records and analyzes all data.

The four front mounted headlights/spotlights use visible light and infrared. Range: 300ft (91m).

THE CAT'S-EYE RECON

Vehicle Type: Space/Air/Jet

Crew: 4, but can accommodate another 6.

M.D.C. by Location:

Tactical Sensor — 50

Wing & Engine (2) — 50 each

*Main Body — 150

Cockpit — 75

*As always, depleting the M.D.C. of the body means the vehicle is destroyed. If a wing is destroyed the vehicle will crash. Obviously, if the wing is destroyed in space, the vehicle is crippled and adrift, but will not crash.

Speed: 375mph (601.76kmph)

Range: 1900 miles (3057.1km)

Length: 65ft (19.8m)

Weight: 10.4 tons

Bonuses: None

Weapon Systems: None

Notes: The Cat's-Eye Recon is suitable for space and atmosphere flight. However, it does not have trans-atmosphere flight capacities, meaning that it can not attain orbit. Ceiling height in earth's atmosphere is 50,000 feet.

The radar sensory unit is able to collect information on all moving targets within a range of 400 miles. It can accurately track 600 targets at once and interpret up to 300.

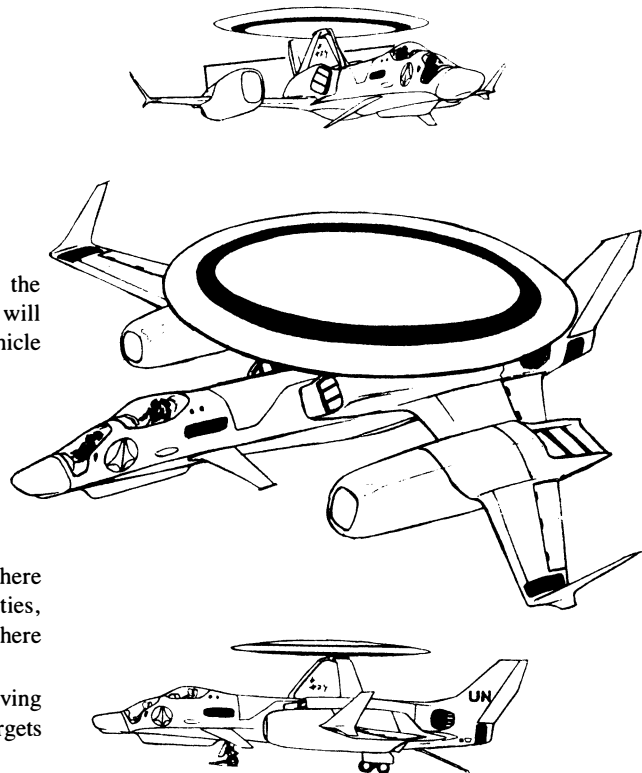

FIGHTER PLANES and JETS

THE L.V.T. ADVENTURER II

A Light, Vertical Take-off, jet fighter used by the Robotech Defense Force and local governments. This fighter was commonly used on aircraft carriers as anti-aircraft weapons. They are light, fast, highly mobile and capable of vertical take-off, making them ideal for rugged terrain and reconnaissance.

Since the Zentraedi invasion, the Adventurer aircraft has become more popular. Its excellent economy on fuel, speed and L.V.T. capabilities, make it ideal for patrolling remote areas. It is also becoming a common weapon, used by local governments to combat growing civil unrest.

Its main disadvantage is that its armaments are limited to short range missiles and, is no match against the Veritech Fighters or some of the heavier jets.

Vehicle Type: Jet Fighter

Crew: One (can accommodate 1 or 2 passengers)

M.D.C. by Location:

Wings — 40 each

Tail — 40

*Main Body — 75

*Depleting the main body M.D.C. will totally destroy the aircraft. The pilot's only hope for survival is to parachute to safety. Destroying a wing or the tail will send the stricken aircraft into a dive to its doom. However, the pilot and passengers, if any, will have ample time to parachute to safety unless flying low.

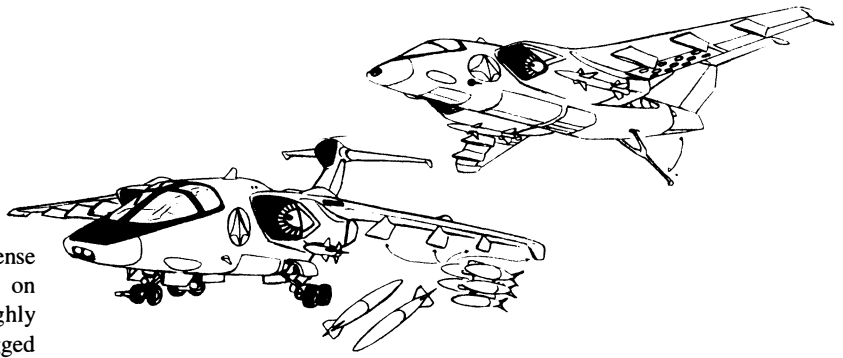

Speed: 722mph (1162kmph) maximum, 350mph is cruising speed. 55,000ft (16,765m) is the service ceiling with a 100ft (30m) bottom ceiling.

Range: 1800 miles (2896.2km)

Length: 35ft (10.66m)

Weight: 5.5 tons fully loaded, 3.9 tons empty

Bonuses: +3 to dodge.

Weapon Systems

1) **Limited to short range guided missiles.** All the usual missiles listed elsewhere are able to be launched by the Adventurer II. Three missile clusters of 5 missiles each can be loaded onto each wing for a total of 30 missiles. All are self-guided and +2 to strike.

Mega-Damage: Varies with individual missile warheads. *See short range missile description elsewhere.*

Range: Varies, but, generally, about 2 miles (3.2km)

Rate of Fire: Can launch missiles one at a time or in volleys of 2, 3, 4 or 5 (the entire cluster). One volley, regardless of the number of missiles launched, constitutes one attack.

Number of Attacks: Four

Payload: 30 total missiles, 15 per wing.

Note: Can be reloaded by landing and use of simple equipment, taking about three minutes.

THE FALCON FIGHTER JET

This is an interceptor and ground attack fighter used by the Earth Defense Force and some local governments. It is a fast, highly mobile aircraft armed with missiles.

Vehicle Type: Air/Jet Fighter

Crew: One

M.D.C. by Location:

Twin Engines (2) — 75 each

Wings (2) — 75 each

Pilot's Cockpit — 75

*Main Body — 120

*Depleting the main body M.D.C. means the jet is destroyed. The pilot's only hope for survival is to eject and parachute to safety. Destroying a wing or engine will cripple the aircraft.

Speed: 1850mph (Mach 2.7). Service ceiling is over 50,000ft (15,240m)

Range: 800 miles (1287.2km)

Length: 53ft (8.2m)

Weight: 7.4 tons

Bonuses: +2 to strike, +4 to dodge

Weapon Systems

1. **Three Medium Range Missiles** mounted on each wing for a total of six.

Mega-Damage: Varies with the type of missile, but usually carries the heavy warheads, such as Plasma and High Explosives.

Rate of Fire: Can fire missiles one at a time or in volleys of 2, 4, or 6.

Range: Varies with the missile type, but usually about 50 miles.

Payload: 6 missiles

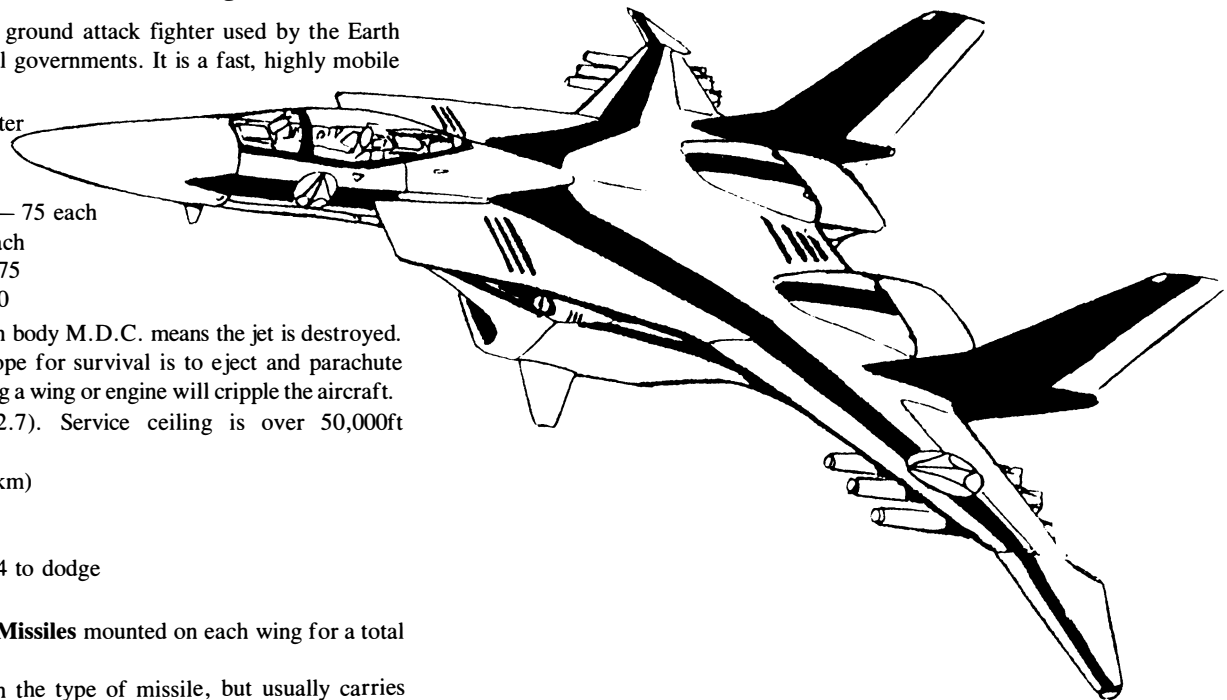

Special Equipment

- 1) Radar can identify and track up to 30 targets within a 100 mile range.
- 2) Targeting Computer.
- 3) Emergency Oxygen Unit.

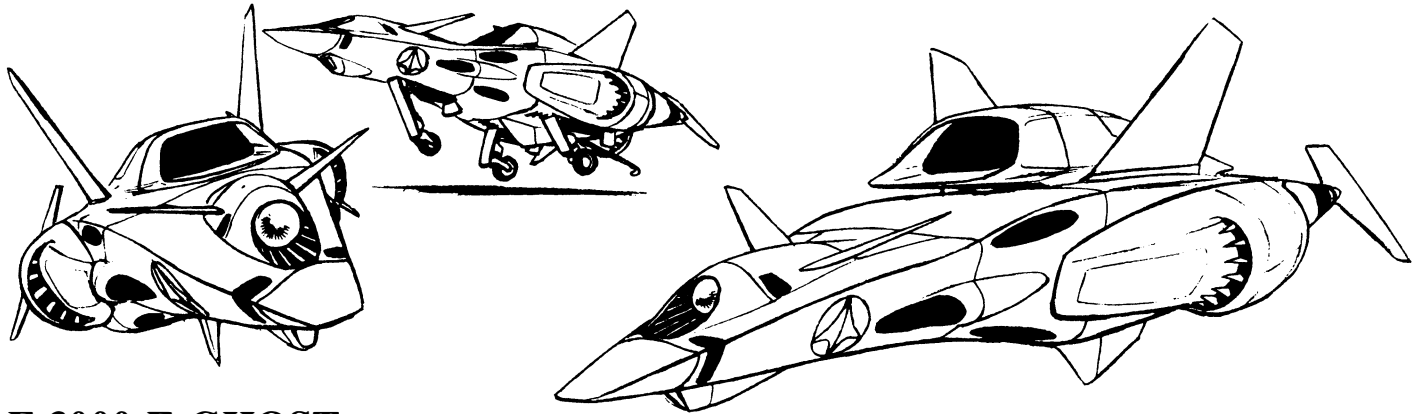

QF-3000 E GHOST

A trans-atmosphere, unmanned, fighter jet called “the Ghost” because it has no pilot. This all condition fighter utilizes reflex weaponry and power systems like the Space Lancer II. Consequently, it is a robot fighter that can identify, pursue, evade and attack enemy aircraft and missiles. Being trans-atmosphere means that it can operate equally well in space or atmosphere. It can take-off from the ground and, with the aid of special booster jets, achieve low orbit at about 100 miles above the Earth. Likewise, it can be launched from space and pursue an enemy into the Earth’s atmosphere without burning up upon reentry.

The Ghost was primarily used by the Robotech Defense Force on the A.R.M.D. Space Platform and on some aircraft carriers. Since the Zentraedi’s devastating attack on Earth, the QF-3000 E Ghost has been mostly limited to the remaining A.R.M.D. Space Platforms and space patrols.

QF-3000 E Ghost

Vehicle Type: Jet Fighter
Crew: None, Unmanned
A.R.: 12

M.D.C. by Location:

Right & Left Thrusters — 75 each
 *Main Body — 100

*Depleting the M.D.C. of the main body destroys the craft.

Speed: 722mph (1162kmph) cruising, 1450mph (Mach 2.2) normal, and close to Mach 5 with booster jets to achieve low orbit or special, evasive maneuvers.

Range: 4000 miles

Length: 53ft (16m)

Weight: 8.3 tons

Bonuses: +1 to strike, +2 to dodge.

Weapon Systems

1) **Three Auto Cannons** on either side of the fighter for a total of six. All three fire simultaneously.

Mega-Damage: 6D6 for short burst, 2D6 × 10 for long burst.

Rate of Fire: 24 in a long burst and 12 in a short burst. Can fire 4 short bursts or 2 long, per each set of cannons.

Number of Attacks: 8 short or 4 long.

Range: 4000ft (1200m)

Payload: 480 rounds per side for a total of 960.

OTHER JET AIRCRAFT

THE TITANIC VC-27 TUNNY-VTOL

The Titanic VC-27 Tunny is the largest, Vertical Take Off and Landing aircraft ever designed. It is a huge transport vehicle, able to carry up to 300 men. It can also transport one Destroid by carrying it suspended by a cable. It is currently being used by the crumbling United World Government, as well as local governments.

Vehicle Type: Air/Jet

Crew: 4

M.D.C. by Location:

4 Main Thruster Jets — 50 each

Pilot’s Cockpit — 75

Main Body — 200

Note: As always, depleting the M.D.C. of the main body means that the aircraft has been destroyed. However, in this case, the cockpit and engine thrusters are more likely targets. If the cockpit is destroyed the aircraft will plummet out of control to its doom, but to strike the cockpit (or the thrusters), the attacker must successfully make a called shot. The VC-27 Tunny can fly with one engine completely dead on each wing (reduce speed by 30%). If two thrusters are destroyed on the same wing, or 3 or 4 engine thrusters destroyed the giant vehicle can attempt a crash landing. Success Ratio: 4% on land, 20% on water.

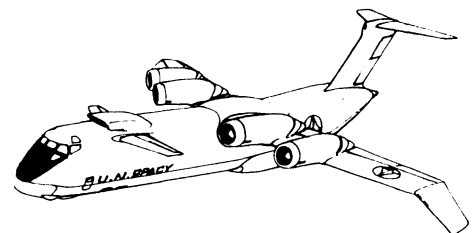
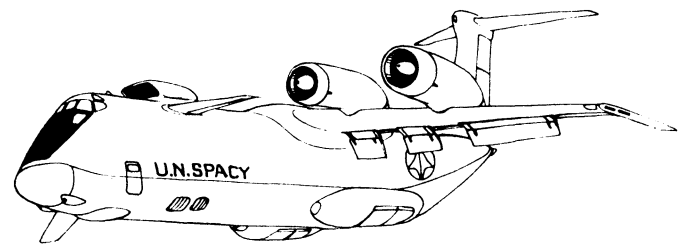

Speed: 525mph (844.68kmph)

Range: 6550 miles (10,458.50km)

Length: 180ft (54.86m)

Weight: 150 tons

Bonuses: +1 to dodge.

Payload of Weight: Troops or equipment: 46 tons.

Weapons System: None

FAN JET

This is a common, two passenger mini-jet like the one used by Rick Hunter. They are generally recreational aircraft used for private transportation and racing.

Vehicle Type: Air/Jet

Crew: One plus passenger

A.R.: 8

M.D.C. by Location:

Fan Jet — 35

Wings — 35 each

*Main Body — 75

*The usual conditions apply.

Speed: 250mph cruising, 400mph (643.60kmph) maximum and 700mph (1126kmph) with booster jet engaged. The latter speed can only be maintained for about 15 minutes.

Range: 600 miles (960km)

Length: 20ft (6.1m)

Weight: 3 tons

Bonuses: +1 to dodge

Weapons Systems: None

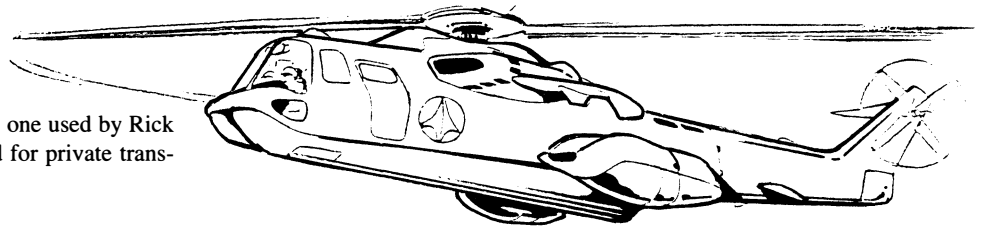
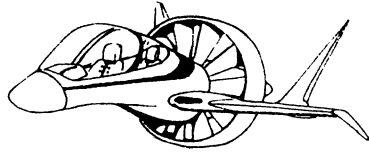

M.D.C. by Location:

Main Propeller — 2

Tail — 2

*Main Body — 10

*Depletion of the M.D.C. of the main body means the aircraft is destroyed.

Speed: 150mph (240kmph) cruising, 300mph (482kmph) maximum.

Range: 500 miles (804km)

Length: 57ft (17m)

Weight: 4900lbs (2205kg)

Bonuses: +1 to dodge.

Weapon Systems

1) **Four, anti-sub, air to water torpedoes.** Can be used against Zentraedi, underwater/sea assaults.

Primary Purpose: Assault/defense.

Mega-Damage: 1D6 × 10

Range: 3 miles (4.8km)

Rate of Fire: Individually or full volley (4).

Payload: 4

Note: Self-guided; +2 to strike.

2) **Twin, M-89, 12.7mm, air cooled, machineguns** located in the nose of the helicopter.

Mega-Damage: 2D4 M.D. short burst, 4D4 M.D. long burst or 6D4 full melee burst.

Range: 2000ft (600m)

Rate of Fire: 4 short bursts, 2 long bursts, 1 full melee.

Payload: 200 rounds; full burst equals 20 rounds.

Note: The Sea Sergeant can land in the water.

WEAPONS COMBAT SUMMARY

Attacks Per Melee: 1, 2, 3 or 4 torpedo, and 4 of 2 by machineguns.

Torpedo: 4D6 M.E. each. **Range:** 3 miles (4.8km)

Machinegun: 1D4 M.D. short, 2D4 long or 4D4 full melee. **Range:** 2000ft (600m).

HELICOPTERS



HOWARD LH-2000

A light helicopter used by the military for observation and reconnaissance patrols.

Vehicle Type: Helicopter

Crew: Pilot plus 1-3 passengers.

A.R.: 8

M.D.C. by Location:

Main Propeller Blade — 2

Tail — 2

*Main Body — 5

*Depleting the M.D.C. of the main body means the vehicle is obliterated. The other two locations will send the vehicle crashing, out of control.

Speed: 175mph (278kmph) cruising; 325mph (522kmph) maximum.

Range: 600 miles (964km)

Length: 30ft (9m)

Weight: 1,160lbs (519kg)

Weapon Systems: None

Bonuses: +2 to dodge.

THE SEA-SERGEANT

A military helicopter used as a troop carrier, scout and limited assault vehicle. It can also carry a Destroid suspended by cables, but the helicopters speed and range is reduced to 1/3.

Vehicle Type: Helicopter

Crew: Two plus up to 24 troops.

A.R.: 8

THE COMMANCHERO

A military assault helicopter used by the Earth Defense Force and local governments. The Commanchero is outfitted with short range missiles, machinegun, and booster jets for speed and mobility. It has two cockpits; one for piloting the helicopter and one for the operation of the main weapon system. The helicopter is state of the art technology with reinforced body armor and cockpits. The standard crew is pilot and copilot in the one cockpit, and one weapon's technician in the other. The technician can be a military specialist, field scientist, communications engineer or any mecha pilot. The only weapon not controlled by the weapon tech is the forward, triple barrel machinegun. The Commanchero is often used for suppressing riots, combat reconnaissance, and policing and defending remote areas.

The Commanchero

Vehicle Type: Helicopter, assault

Crew: Three (can accommodate up to six passengers)

A.R.: 12

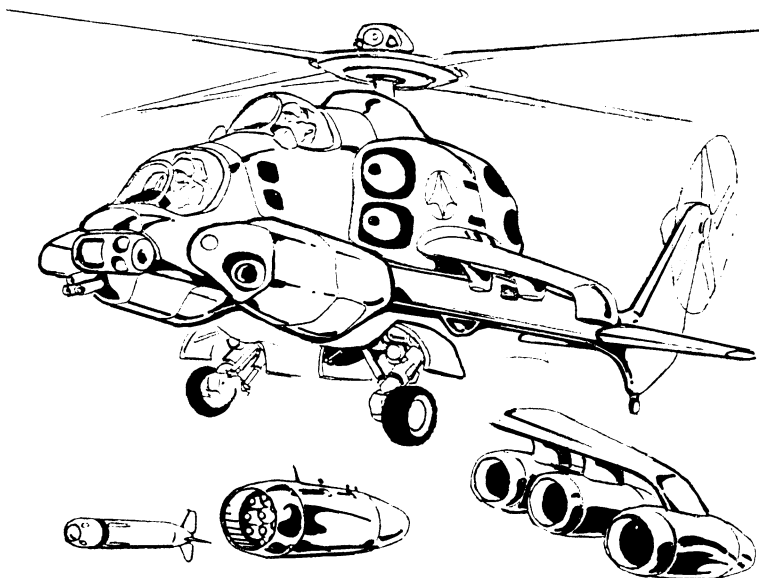

M.D.C. by Location:

- Main Propeller — 30
- Tail — 30
- Booster Jets (on side of body) — 50 each
- *Main Body — 100
- Missile rack on wing (2) — 50 each
- Side mount auto cannon (2) — 50 each
- Forward Machinegun — 20
- Reinforced Cockpits — 50 each

*Depleting the M.D.C. of the main body means the vehicle is destroyed and crashing down in a fiery wreck. Destruction of the propeller or tail will send the craft out of control/crashing, but provides time for the crew to eject and parachute to safety. Passengers don't have that luxury.

Speed: 150mph (240kmph) cruising, 300mph (482kmph) maximum for helicopter, 500mph (804kmph) with booster jets.

Range: 600 miles (964km)

Length: 58ft (17m)

Weight: 8404lbs (3780kg)

Bonuses: +2 to strike with all weapons; +2 to dodge normal, +3 to dodge with booster jets engaged.

Weapon Systems

- 1) **Forward, triple barrel, M-89, 12.7mm, air-cooled machinegun** located in the lower nose of the helicopter. *This is the ONLY weapon operated by the pilot or copilot.*

Primary Purpose: Assault/defense.

Mega-Damage: 3D4 for short burst, 6D4 for long burst or 6D6 for full melee burst.

Rate of Fire: 6 short bursts or 3 long bursts or 1 full melee.

Range: 2000ft (600m)

Payload: 400 rounds; full burst equals 40 rounds, a long burst is 20 rounds and a short burst is 10 rounds.

Note: Can fire in an 180 degree arc up and down, and with a 30 degree rotation of the barrels.

- 2) **Side mounted, 32mm auto cannon;** one mounted on each side. Operated by the weapon's technician.

Primary Purpose: Assault/defense.

Mega-Damage: Does 2D6 short burst, 4D6 for long burst or 6D6 M.D. for one full melee of continuous fire.

Rate of Fire: 4 short bursts or 2 long bursts or 1 full melee burst.

Note: This is per each of the two auto cannons.

Range: 4000ft (1200m)

Payload: 240 rounds each; 24 shells are fired per melee on a full burst, 16 on a long burst, 8 on a short burst.

Note: Can fire in a 30 degree rotation/angle.

- 3) **Wing rack missile pods.** Three, removable, missile pods are attached to each, small wing for a total of six pods. Each pod contains nine, short range missiles, for a total of 27 missiles per each wing (54 in all). The missiles can be of any of the variety listed under that category. This means the missiles can be high explosive, tear gas, smoke, etc., or any combination. *See missile descriptions elsewhere.*

Primary Purpose: Assault/defense.

Mega-Damage: Varies with the specific type. Select any short range missiles.

Rate of Fire: One at a time or volleys of 2, 3 or 9.

Range: Varies with specific missile; usually about 2 miles.

Payload: 54, total, short range missiles; nine in each missile pod.

Note: Preloaded missile pods can be attached to a Commanchero within a mere 3 minutes (12 melees), but the chopper must land at the loading/arming zone.

Special Equipment

- 1) **Radar:** 60 mile (96.5km), can track 30 targets simultaneously.
- 2) **Laser Targeting:** Provides for the aforelisted bonuses to strike.
- 3) **Thermo-Imager:** Special optics and heat sensors allow the infrared radiation of warm objects to be converted into a visible image. Sees in darkness, shadows and through smoke. Used by ALL crew members. Range: 600ft (180m).
- 4) **Loudspeaker:** Amplifies voice 90 decibels.
- 5) **Standard Radio Communicator.**
- 6) Crew has emergency **oxygen** units.
- 7) **Radiation Sensors;** 600ft range.
- 8) **Searchlight** can be attached to undercarriage of the vehicle. Range: 600ft (180m). Not standard issue.
- 9) **Ejector Seats** and parachutes for crew.

WEAPONS COMBAT SUMMARY

Attacks Per Melee: *Pilots* by machinegun only: 6, 3, or 1. *Weapons Technician:* 4, any combination of weapons.

Pilot's Forward Machinegun: 3D4, 6D4 or 6D6 M.D. Range: 2000ft (600m).

32mm Auto Cannon: 1D6, 2D6 or 4D6 M.D., Range: 4000ft (1200m)

Missile Launcher Pods: Damage and range vary with missile type. Payload: 24.

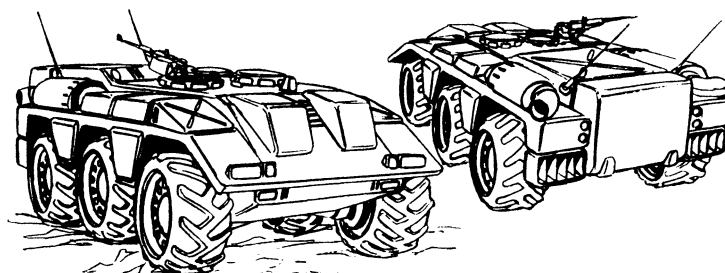

AAR-RECON II ARMORED AMPHIBIOUS RECONNAISSANCE VEHICLE

The all welded steel hull provides the crew with protection from small arms fire and shell splinters. The hull and frontal area are specially reinforced to protect engine and crew. The AAR-Recon is fully amphibious, being propelled in the water by steerable propellers at the rear of the hull. Before entering the water, a trim vane is hydraulically erected at the front of the hull and the bilge pumps are switched on. An oxygen/air circulatory and purge system enables all hatches to be sealed airtight for up to 3 hours.

It is commonly deployed by the local governments in reconnaissance and combat.

Vehicle Type: Military, all terrain recon.

Crew: Pilot and weapons pilot; plus up to six passengers.

A.R.: 12 (S.D.C)

M.D.C. by Location:

*Main Body — 10 M.D.C./1000 S.D.C.

Hatches (2) — 2 M.D.C./200 S.D.C.

Machinegun — 2 M.D.C./200 S.D.C.

Wheels (6) — 75 S.D.C. each

Headlights (4 sets) — 10 S.D.C. each

*As always, depleting the M.D.C./S.D.C. of the main body will totally shut down/destroy the vehicle. Further damage will strike crew members. Destroying three or more wheels will immobilize the vehicle.

Speed: 60mph (96kmph) maximum on land, 10mph (16kmph) in water.

Range: 800 miles (1287.2km)

Length: 25ft (7.6m)

Weight: 6.2 tons

Special Equipment

Radio: Range: 300 miles (482.7km)

Radar: Range: 30 miles

Combat Computer: With head-up display.

Thermo-imager: An optical heat sensor that allows the infrared radiation of warm objects to be converted into a visible image. Enables the pilot to see in darkness, shadows and through smoke. Range: 1600ft (487m).

Radiation Shielding

Weapon Systems

1) **Top mounted, single barrel, M-89 12.7mm machinegun.** This weapon can be manned and operated manually or by remote control. Somebody other than the pilot must operate the gun. 360 degree rotation with an 180 degree arc up and down.

Mega-Damage: 1D4 points for a short burst, 2D4 M.D. for a long burst or 4D4 M.D. for one full melee of continuous fire.

Range: 2000ft (600m)

Payload: 1000 rounds; one short burst uses 5 rounds, one long burst 10 rounds, or 20 rounds for a full burst. Note: This is a single barrel version of the double barreled machinegun found on the Excaliber. Consequently, the two do different damage.

Additional ammo feed canisters can replace expended ones, but the person changing them must expose himself to do so. Requires one full melee. Each canister contains 1000 rounds; 10 canisters are usually carried inside.

THE LAND ROVER

The Land Rover is a lightly armored reconnaissance vehicle suitable for rough terrain. It is a sturdy, open-air vehicle commonly used by all military branches of the world governments.

Vehicle Type: Military utility truck.

Crew: One pilot and up to five passengers (3 comfortably).

A.R.: 10 (S.D.C.)

M.D.C. and S.D.C by Location:

*Main Body — 6 M.D.C./600 S.D.C.

Wheels — 50 S.D.C.

Headlights — 10 S.D.C.

*If all M.D.C./S.D.C. of the main body is depleted, the vehicle is destroyed.

Speed: 120mph (193kmph)

Range: 500 miles (804.50km)

Length: 24ft (7.3m)

Weight: 3.8 tons

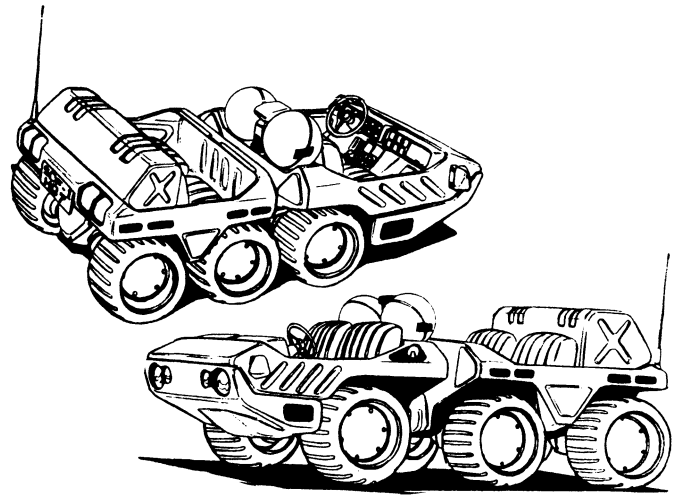

Bonuses: None

Special Equipment

Radio: Range: 50 miles (96.5km)

High Intensity Headlights: 50ft beam (15.2m).

Loudspeaker: Amplifies voice by 90 decibels.

Mini-Radar: Range: 4 miles (6.4km), but only 75% accurate and easily obscured by hills, mountains and forest.

Weapon Systems: None

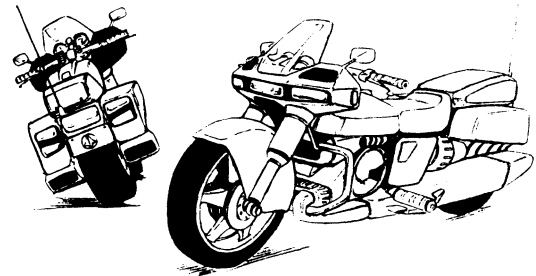

RDF MOTORCYCLE

The Robotech Defense Force security department has modified a standard motorcycle, making it tougher and faster. Modifications include a lightweight, reinforced frame and fenders, heavy-duty shocks, extra wide wheels for better traction, bulletproof windshield, and more powerful engine. The RDF Motorcycle has been adopted by local government and law enforcement agencies. It is an ideal vehicle for scouting and transportation in remote areas.

Note: Like most conventional vehicles, machinery and items, a Mega-Damage Capacity (M.D.C.) is not appropriate. Instead, regular S.D.C. or Structural Damage Capacity applies. This may sound more confusing than it really is. The bottom line is that, if conventional vehicles, structures or items are struck by something that does mega-damage, it is destroyed. PERIOD. There is no debate. Conventional structures can *not* survive against mega-damage (M.D.). However, conventional vehicles, and such, do have a certain resistance or endurance against conventional weapons, hence the S.D.C. rating. Furthermore, just because a conventional item is frighteningly vulnerable to mega-damage, it does not make that item useless or undesirable. There is still a real need and use for conventional weaponry, vehicles, etc. *Also see the sections on M.D.C., S.D.C., and combat, for insight and details.*

Vehicle Type: Motorcycle

Crew: One; sidecar optional (1)

A.R.: 6 (S.D.C.)

M.D.C.: Not Applicable

S.D.C. by Location:

*Headlights — 5 each

Main Body — 150 (1 M.D.C. point)

*Wheels — 25 each

Bulletproof Windshield — 50

*Opponents shooting at the wheels are — 2 to strike; headlights — 4.

Speed: 150mph (240kmph) maximum

Range: Approximately 600 miles (968.5km)

Length: 6ft (1.8m)

Weight: 900lbs (405kg)

Bonuses: +2 to dodge

Special Equipment

Radio: Range: 50 miles (96.5km)

High Intensity Headlights: 50ft beam (15.2m)

Loudspeaker: Amplifies voice by 90 decibels.

Mini-Radar: Range: 4 miles (6.4km), but only 75% accurate and easily obscured by hills, mountains and forest.

Weapon Systems: None

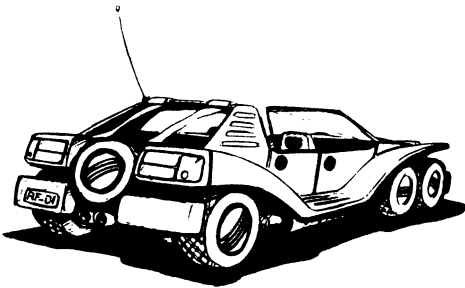

RV-B DUNE BUGGY

A common, military and recreational vehicle which enjoys renewed popularity in the devastated lands of Earth. It is a tough, well designed vehicle, well suited to the extensive, parched lands, broken and mangled roads and rough terrain. Although its maximum speed is limited, it can ride through the rugged, rocky and rolling wilderness without sacrificing that speed or mobility.

Vehicle Type: Utility Vehicle

Crew: One pilot and up to 5 passengers (3 comfortably)

A.R.: 8 (S.D.C.)

M.D.C. and S.D.C. by Location:

*Main Body — 4 M.D.C./400 S.D.C.

Wheels (6) — 50 S.D.C.

Headlights (2) — 10 S.D.C. each

*If the M.D.C./S.D.C. of the main body is depleted, the vehicle is destroyed. This vehicle can function even if it loses one front wheel on each side.

Speed: 110mph (176.9kmph)

Range: 500 miles (804.5km)

Length: 11ft (3.3m)

Weight: 2.8 tons

Bonuses: +1 to dodge; does not need to reduce speed greatly on rough terrain (reduce only by 25%; all other vehicles, reduce by 60%).

Special Equipment

Spare Tire: Mounted in the rear.

Optional: Radio, same as Land Rover.

Weapon Systems: None

CONVENTIONAL VEHICLES

The Robotech world is approximately 30 years from today, thus it contains many vehicles like those we have today. The only differences are body style, moderately better handling and superior fuel consumption (about twice as good as today, with an average of around 50 miles per gallon.)

The following are some basic vehicles and statistics:

A Typical Tank

Weight: 43 tons

Length: 21ft (6.2m)

Speed: 55mph on land, 5mph in water

Crew: 2, plus up to 3 passengers.

Max. Range: 580 miles (932km)

M.D.C. by Location:

Treads — 25 each side

Main Cannon — 30

Laser Gun — 20

Turret — 50

Main Body — 200

Weapon Systems

1. **Twin Barrel ROV-10 Laser** mounted on top of the turret in place of the traditional machinegun.

Mega-Damage: 2D4 per blast.

Range: 4000ft (1200m)

Rate of Fire: 4 per melee

2. **An Air Cooled Auto Cannon** is the big gun built into the turret.

Mega-Damage: 2D8 per blast

Range: 6000ft (1600m)

Rate of Fire: 4 per melee

Note: Both the cannon and laser can be fired 4 times per melee (8).

Automobiles

Combat: Light armor; A.R.: 8; 3 M.D.C./350 S.D.C. Speed: 110mph (176.9kmph). Range: 500 miles (804.5km).

Jeep: A.R.: 5; 4 M.D.C./400 S.D.C. Speed: 120mph (193kmph). Range: 500 miles (804.5km).

Small Truck: A.R.: 5; 4 M.D.C./400 S.D.C. Speed: 120mph (193kmph). Range: 500 miles.

Semi-Truck: A.R.: 6; 6 M.D.C./600 S.D.C. Speed: 130mph (206kmph). Range: 350 miles (533.15km).

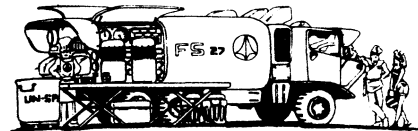

Consumer Motorcycle: A.R.: 4; 1 M.D.C./100 S.D.C. Speed: 100mph (160kmph). Range: 500 miles (804.5km).

Consumer Auto – Full Size: A.R.: 5; 4 M.D.C./400 S.D.C. Speed: 120mph (193kmph). Range: 350 miles (562km).

Consumer Auto – Luxury: A.R.: 5; 4 M.D.C./450 S.D.C. Speed: 110mph (176.9kmph). Range: 300 (482.7km).

Consumer Auto – Mid-Size: A.R.: 5; 3 M.D.C./350 S.D.C. Speed: 110mph (176.9kmph). Range: 350 miles (562km).

Consumer Auto – Compact: A.R.: 4; 3 M.D.C./300 S.D.C. Speed: 110mph (176.9kmph). Range: 350 miles (562km).

Consumer Auto – Racer: A.R.: 4; 3 M.D.C./300 S.D.C. Speed: 200mph (321.8kmph). Range: 350 miles (562km).

Consumer Van: A.R.: 5; 4 M.D.C./400 S.D.C. Speed: 110mph (176.9kmph). Range: 300 miles (482.7km).

Airplanes

Single Engine: A.R.: 4; 4 M.D.C./400 S.D.C. Speed: 300mph (482kmph). Range: 680 miles (1040km).

Twin Engine: A.R.: 5; 5 M.D.C./550 S.D.C. Speed: 420mph (670kmph). Range: 600 miles (964km).

Small Jet: A.R.: 5; 8 M.D.C./850 S.D.C. Speed: 600mph (960kmph). Range: 1370 miles (2205km).

NOTES ON MODERN CONVENTIONAL WEAPONS

Explosives: Most hand grenades should be treated as thrown weapons. Grenade launchers are used as Weapon Proficiency – Rifle. See equipment section for more information.

Reloading: Almost all modern weapons come equipped with easy-to-load clips (magazines). There are even quick loaders for revolvers. This means that attackers can fire a full clip every melee. However, older weapons (bolt action, muzzle-loaders, hand loaded revolvers) and most shotguns will require a full melee round (or more) to reload. Note that it will take much longer to reload while in the thick of hand to hand combat.

Effective Range: This is the longest distance that the weapon can be fired without losing accuracy or damage. Guns can be fired beyond their effective range, but with no W.P. Skill Bonus and with a –4 to strike for every 25 feet beyond the effective range.

Moving Targets: It is a lot harder to hit someone while they are moving. –3 to strike at moving, running or leaping targets. –6 to strike anything speeding 40mph or more.

Strike Bonus: Physical Prowess (P.P.), Physical Training and other strike bonuses *Do Not Apply* to modern weapons. When using a gun, only the W.P. Skill bonuses with that weapon can be used. For example, a character with +5 to strike in hand to hand combat and level 1 skill in revolver would have a +3 *Bonus to Strike* for an aimed shot.

Shotguns: This weapon is usually limited to a maximum of *two* shots. One round can be fired, or two rounds can be fired simultaneously. Can be an aimed shot or wild. Reloading takes one full melee.

The list below is not meant to be comprehensive. It does, however, cover all the typical weapons found in the hands of common citizens, police, criminals, terrorists and military forces the world over. For more detailed information on a variety of modern weapons consult **Heroes Unlimited** or, better yet, **The Palladium Book of Contemporary Weapons**. All costs are in credits, most are illegal, black market prices.

REVOLVERS

.22 or .25 Revolver

Made by a variety of manufacturers, this is the kind of “Saturday Night Special” most commonly sold in the U.S. Commonly used for protection or for committing crimes. Generally, they have 6 or 8 shots, are lightweight (roughly 1lb), and have a limited effective range. **Cost:** From 50 to 500 credits. **Damage:** 1D6 per round.

.38 Service-Six Ruger Revolver

A standard, police officer’s side-arm. Roughly the same as all .38 specials. **Cartridge:** .38 special. **Feed:** 6 chamber, side loading cylinder. **Weight:** Just under 2lbs. **Effective Range:** 150ft. **Cost:** 250. **Damage:** 2D6 per round; there is also a .38+ power round that does 3D6 per round.

Barracuda FN Revolver – .357 Magnum

Used by some police officers, government agents and heavily armed

criminals. **Cartridge:** .357 magnum. **Feed:** 6 round cylinder. **Weight:** Slightly over 2lbs. **Effective Range:** 150ft. **Cost:** 500. **Damage:** 4D6 per round.

AUTOMATIC PISTOLS

7.65mm PP Walther – 7.65 Automatic

This is typical of the kind of small automatic pistol used for protection and criminal activities. Consider the Walther as top-of-the-line. **Cartridge:** 7.65mm short. **Feed:** 8 round, detachable magazine. **Weight:** 1½lbs. **Effective Range:** 120ft. **Cost:** 600. **Damage:** 2D6 per round.

Browning GP 35 – 9mm Automatic

Used as a side-arm by many military force’s personnel, terrorists and well equipped criminals. **Cartridge:** 9mm. **Feed:** 13 round magazine. **Weight:** Just under 2lbs. **Effective Range:** 120ft. **Cost:** 600. **Damage:** 2D6 per round.

.45 Model 15 General Officers – .45 Automatic

Formerly the standard side-arm of the U.S. military, now found commonly throughout the world. This is the ideal weapon for trench warfare, where accuracy is not as important as knock-down power. **Cartridge:** .45 ACP. **Feed:** 7 round magazine. **Weight:** Just over 2lbs. **Effective Range:** 135ft. **Cost:** 400. **Damage:** 4D6 per round.

SUB MACHINEGUNS

7.65mm Model 61 Skorpion – 7.65mm Sub-Machinegun

This is the kind of high rate of fire, easy to hide weapon favored by terrorists. **Cartridge:** 7.65mm or .32 ACP. **Feed:** 10 or 20 round magazine. **Weight:** 3½lbs. **Effective Range:** 150ft. **Cost:** 900. **Damage:** 1D8 per round.

Ingram Model 10 – .45 Sub-Machinegun

A particularly high-powered sub-machinegun. Used by the U.S. government security agencies. **Cartridge:** .45 ACP. **Feed:** 30 round magazine. **Weight:** 6¼lbs. **Effective Range:** 600ft. **Cost:** 700. **Damage:** 4D6 per round.

9mm Uzi – 9mm Sub-Machinegun

Almost all international sub-machineguns have the same attributes as the Uzi. Very common with foreign police forces, government security forces and terrorists. **Cartridge:** 9mm. **Feed:** 25 or 30 round magazine. **Weight:** 7½lbs. **Effective Range:** 600ft. **Cost:** 900. **Damage:** 2D6 per round.

The RDF Sub-Machine Pistol – 9mm

The Robotech Defense Force, (RDF) standard field weapon is the high-powered, 9mm machine pistol. **Cartridge:** 9mm. **Feed:** 30 round magazine. **Weight:** 5½ pounds. **Effective Range:** 500ft. **Cost:** 800 credits on the black market (not made for use by the general public). **Damage:** 2D6 per round.

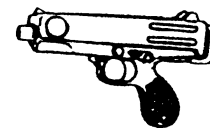

RIFLES

30-06 Hunting Rifles

There are dozens of different models of hunting rifles. Most have optional, telescopic sights and multiple-shot clip magazines. Weight and range varies. **Cost** depends on quality; anywhere from 200 credits on up. **Damage:** 5D6 per round.

5.56mm M16A1 – 5.56 Assault Rifle

This is typical of the new, lighter-weight, more reliable rifle being issued to all modern armies. **Cartridge:** 5.56mm. **Feed:** 20 or 30 round magazine. **Weight:** 6½lbs. **Effective Range:** 1200ft. **Cost:** 700. **Damage:** 4D6 per round.

7.62mm AK-47 – Russian Assault Rifle

The AK-47 can be found in virtually any, terrorist or revolutionary camp anywhere in the world. **Cartridge:** 7.62mm. **Feed:** 30 round magazine. **Weight:** 9½lbs. **Effective Range:** 900ft. **Cost:** 900 credits. **Damage:** 4D6 per round.

MACHINEGUNS

.30, 5.62mm and 7.62mm Calibre Light Machineguns

These are the most common kind of light machineguns found in military forces the world over. **Cartridge:** .30, 5.62mm and 7.62mm in 100, 200 and 250 round belts. **Weight:** 15 to 25lbs. **Effective Range:** 3000ft. **Rate of Fire:** Can empty the weapon in two melee rounds. **Cost:** 2000 credits and up (mostly illegal). **Damage:** 5D6 per round.

.50 and 14.5mm Heavy Machineguns

These are commonly found mounted on armored military vehicles. As with their lighter cousins, the heavy machineguns are usually found only in military units. Accuracy is poor because they are meant for use against large vehicles or massed soldiers. On the other hand, they will punch right through armor or engine blocks. **Cartridge:** .50 and 14.5mm belts of varying sizes. **Weight:** 30 to 100lbs. **Effective Range:** 3000ft. **Cost:** 5000 and up (highly illegal). **Damage:** 7D6 per round.

SHOTGUNS

Model 3000 Police Smith & Wesson Shotgun

This is fairly typical of pump action shotguns used by police for riot control. **Calibre:** 12 gauge. **Feed:** Single shot (pump action). **Weight:** Under 7lbs. **Cost:** 900; prices for lower priced models could be as little as 300. **Damage:** Buckshot does 4D6 per round. Solid slug does 5D6 per round.

HEAVY WEAPONS

Rocket Launcher

Called the “Super Bazooka”, it was designed as an antitank weapon, but was sometimes used against bunkers. **Weight:** 12lbs (5.4kg), front and rear tubes; 9lbs, rocket. **Length:** 61 inches (1549mm). **Effective Range:** 3600ft (1200m). **Damage:** 1D4 M.D. or 1D4 × 100 S.D.C. **Cost:** 900 credits (mostly illegal). **Blast Radius:** 50ft (15m).

66mm Light Antitank Weapon (LAW)

Light and disposable, this was a favorite weapon for taking out “hardened” positions where the enemy had metal or concrete protection. Against tanks it’s not quite as effective, actually killing only about 10% of the time. **Weight:** 5.2lbs (2.6kg). **Size:** 35 inches (889mm), extended. **Rate of Fire:** Single shot and discard. **Effective Range:** 1000ft (325m). **Blast Radius:** 50ft (15m). **Damage:** 1D6 M.D. or 1D6 × 100 S.D.C. **Cost:** 1000 credits (mostly illegal).

90mm Recoilless Rifle

This weapon looks like a bazooka or rocket launcher (see antitank weapons). Fires a single, antitank round. **Weight:** 35lbs (16kg), unloaded. **Feed:** Breech. **Rate of Fire:** (rapid) 10 rounds per minute (max. of 5 rounds) – sustained rate of 1 round per minute. When firing at the rapid rate, a 15 minute cooling period must be observed after every 5 rounds. **Effective Range:** 1200ft (400m). **Blast Radius:** 80ft (24m). **Damage:** 1D10 M.D. or 1D10 × 100 S.D.C. **Cost:** 1600 (highly illegal).

40mm Grenade Launcher Mounted on Rifle

This was basically a M-79 installed under the barrel on a M-16 Assault Rifle. **Weight:** 11lbs (5kg). **Length:** 15.6 inches (361mm). **Feed:** Single shot. **Rate of Fire:** 3-5 rounds per minute. **Effective**

Range: 1150ft (350m). **Damage:** 1D4 M.D. of 1D4 × 100 S.D.C. **Cost:** 900 credits (highly illegal).

SPECIAL GUNS

Tranquilizer Rifle

This is a rifle designed to fire a tranquilizer dart. Its effective range is about half that of a normal rifle and must be hand loaded, with a maximum capacity of two (both can be fired per melee and require the following melee as a reload time). Saving throw vs. toxin. **Range:** 800ft (240m). **Rate of Fire:** 2 per melee. **Bonus to Strike:** Must have W.P. Rifle. **Damage:** Tranquilizer will render its victim unconscious within 1D4 melees. **Duration:** Effects last 4D4 minutes. **Cost (rifle):** 1000 credits. **Cost (darts):** 10 credits.

Dart Gun

Range: 110ft (33.5m). **Rate of Fire:** 2 per melee. **Bonus to Strike:** Must have a W.P. with Pistol or Revolver. **Damage:** Tranquilizer renders victim unconscious. **Duration:** 4D4 minutes. **Cost (pistol):** 500 credits. **Cost (darts):** 10 credits each. Saving throw vs. toxin.

Gas Gun (pistol)

The gas gun is a long, wide, tubular barreled handgun that fires a gas canister. **Types of gases:** Tear Gas, Tranquilizer (knockout), Nerve Gas, and Smoke Gas/Screen. **Cost (gun):** 200. **Cost of Tear Gas and Tranquilizer Gas Canisters:** 50 credits. **Cost of Nerve Gas:** 75 credits. **Cost of Smoke:** 25 credits. **Range:** 160ft (48.8m). **Rate of Fire:** 1 per melee. **Bonus to Strike:** Must have a W.P. with Pistol. **Damage:** Varies with the type of gas used.

Stun Gun (blaster)

This pistol fires an energy charge that short circuits the nervous system. Victims are dazed, – 10 to strike, parry and dodge, for 2D4 melees.

A successful **saving throw** means that the person has successfully fought off the effect and is unimpaired. Roll to save against each blast that strikes. **Range:** 100ft (30.5m). **Rate of Fire:** 5 per melee. **Bonus to Strike:** Must have a W.P. with Energy Pistol. **Damage:** Special. **Saving Throw:** Save vs toxins. **Energy Capacity:** 10 charges. **Cost (gun):** 4000 credits. **Cost (energy clips):** 1000 credits.

GASES: GRENADES & BOMBS

Tear Gas

This extremely potent irritant temporarily impairs vision and respiration, causing eyes to burn and water profusely, skin to burn (a sensation not in actuality), and making breathing very difficult. **Victims** are – 6 to strike, parry, dodge and lose any chance for initiative. Effects are immediate. **Saving Throw:** None (gas masks counter the gas effectively). **Cost:** 40 credits each.

Knockout Gas

These are tranquilizers; anesthesia-type mists that will induce drowsiness within 1D4 melees and sleep within 1D4 minutes. **Saving Throw:** If a character makes a successful saving throw vs toxins, his body has successfully fought off the effects of the gas and is unimpaired. However, the player must roll once for every minute (four melees) that the character is exposed to the gas (gas masks counter the gas effectively). **Cost:** 60 credits each.

Nerve Gas (paralysis)

This is a gas that attacks the person’s nervous system, in this case, causing paralysis. Takes effect within 2D4 melees (two minutes). **Saving Throw:** If a character makes a successful saving throw vs toxins, his body will have luckily fought off the effects of the gas (and should get out quick). Roll a saving throw for each minute (four melees) exposed to the gas. Gas masks are useless against most nerve agents, however, Atropine Injectors, an anti-

nerve gas agent, will negate the gas' effects. **Cost of Injectors:** 400 credits per dosage. One injector is needed for every ten minutes of exposure and must be administered immediately. **Cost of Gas:** 120 credits each.

Explosive Grenade

Weight: 10 ounces (283 grams). **Effective Casualty Radius:** 20ft. **Effective Range:** 100ft (30m). **Damage:** 1D4 × 10 S.D.C.

INCENDIARY WEAPONS

The use of fire has always been popular in U.S. wars. Clearing enemy bunkers with flamethrowers or incendiary grenades is very effective. **Only 1 shot per Combat Round with incendiaries.**

M-2A1-7 Portable Flamethrower

With a solid stream of fire, a soldier could clear out an entire enemy machinegun nest. In confined spaces (inside a bunker, foxhole or building), everyone in the target area is affected equally. **Damage:** 5D10, plus ignition of all combustible material. **Weight:** 42.5lbs (19kg). **Feed:** Manual. **Effective Range:** 70ft (20m), un-thickened; 150ft (45m), thickened. **Cost:** 400 (mostly illegal).

AN-M14 TH3 Incendiary Hand Grenade

This is one of the most dangerous weapons and not just for the enemy. It is difficult or impossible to throw it far enough to avoid getting hit with fragments. **Damage:** up to 12ft from impact – 1D100 + 20 S.D.C. or 1 M.D.C.; 12-24ft away – 5D10; 24-36ft away – 3D10; 36-120ft away – 1D10. Burns for 10 melee rounds. **Weight:** 24 ounces (.9kg). **Time Delay Fuse:** 4-5 seconds. **Effective Casualty Radius:** Lethal up to 60ft (18m), dangerous to 120ft (36m). **Cost:** 30 credits.

ENERGY WEAPONS

Energy hand-held weaponry is still extremely limited. All energy weapons are powered by an energy clip, also known as E-Clip, or a portable generator. An E-clip can only be recharged at a Robotech Defense Force base, or by jury-rigging certain power sources found on the Zentraedi spaceships and SDF-1. Rate of fire is the operator's choice, taking aimed shots or firing bursts (see conventional weapon combat).

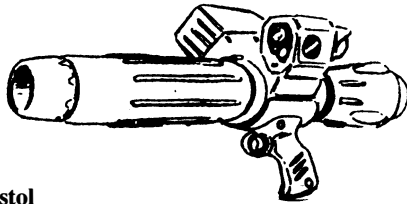

Laser Pistol

A handgun available to RDF elite. **Feed:** 10 shot E-clip. **Weight:** 1½lbs (.7kg). **Effective Range:** 200ft (60m). **Damage:** 4D6 per blast. Does *not* inflict Mega-Damage.

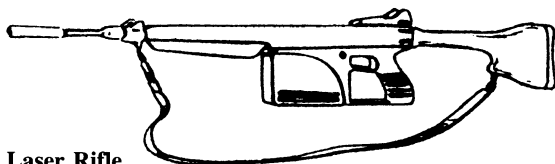

Light Laser Rifle

A lightweight rifle often provided to Veritech Fighter and Destroid pilots. **Feed:** 20 shot E-clip. **Weight:** 7lbs (3.2kg). **Effective Range:** 2000ft (600m), **Damage:** 5D6 per blast. Does *not* inflict Mega-Damage.

Heavy Laser Rifle

This is a much more powerful weapon, but requires the use of a heavy, back-pack generator (16lbs) and, limited range. However, it *does* inflict mega-damage. **Feed:** 20 shots. **Weight:** 9lbs (4.1kg), rifle; and 16lbs (7.3kg), generator. **Effective Range:** 900ft (270m).

Damage: 1D6 mega-damage (M.D.) per blast (that's 1D6 × 100 S.D.C.). Note: Restricted to special and dangerous assignments, usually in remote areas. Capable of single shot or burst firing. Same rules as conventional weapon combat.

Ancient Weapons

Type	2-Handed	Length	Weight	Damage	Cost*
Axe, Battle	no	2.75ft	4.6lbs	2-12	150
Axe, Throwing	no	1.25ft	1.25ft	3lbs	1-4

POLE ARMS

Glaive	yes	7.5ft	6lbs	2-12	200
Halberd	yes	7.25ft	5lbs	3-18	400
Sabre Halberd	yes	8ft	7lbs	3-18	400

SPEARS

Short Spear	no	4-6ft	4lbs	1-6	100
Long Spear	yes	7-10ft	6.5lbs	1-8	150
Javelin	no	7ft	4lbs	1-6	50
Trident	yes	5ft	4lbs	1-8	100

SHORT SWORDS

Short Sword	no	2.5ft	3lbs	1-6	125
Falchion	no	2.75ft	4lbs	1-8	150

LARGE SWORDS

Bastard	yes	3.75ft	4.5lbs	1-8 + 2	250
Broadsword	no	3ft	3.5lbs	1-8	200
Claymore	yes	4ft	6.5lbs	2-12	300

BALL and CHAIN

Ball and Chain	no	3ft	4.5lbs	1-8	175
Flail	yes	5.25ft	5.5lbs	2-12	250
Gouppillon Flail	yes	2ft	4.5lbs	3-18	360
Mace and Chain	no	3ft	4.5lbs	2-12	200
Nunchaku	yes	2.75ft	2.5lbs	1-8	30

BLUNT WEAPONS

Mace	no	2.5ft	4.5lbs	1-8	120
Cudgel	no	2.75ft	2.5lbs	1-8	75
Club/Stick/Pipe	no	2.75ft	3lbs	1-6	10

STAVES

Short	no	4-6ft	3lbs	1-6	75
Long	yes	7-9ft	5lbs	1-8	80
Bo Staff	yes	9.5ft	3lbs	1-8	120
Quarterstaff	yes	6ft	3.5lbs	1-8	100
Iron Staff	yes	6-7ft	7lbs	1-8 + 2	100

*All weapon costs are in credits.

EQUIPMENT

SENSORY EQUIPMENT

Heat: Special sensors pickup and measure heat emanations. Can monitor temperature, or made directional to pinpoint a specific heat point/target. **Range:** 250ft (76m); field of detection is 25ft (7.6m). Portable/hand held. **Weight:** 8lbs (3.6kg). **Cost:** 1200 credits.

Dosimeter: Picks up and measures radiation levels. **Range:** 20ft (6.1m). Hand-held; **Weight:** 1lb (.5kg). **Cost:** 200 credits. Wide availability.

Motion: Detects movement and pinpoints location. Requires sensor placement and monitor screen. **Range:** 60ft (27.4m). Portable; **Total Weight:** 15lbs (6.8kg). **Cost:** 400 credits. Fair availability.

Motion Detector Signaler: This device is virtually identical in purpose and use as the ultraviolet signaler except that it does not emit any vibrations in the air. **Cost:** 900 credits; poor availability.

Mini-Radar/Sonar: Requires radar signal unit and monitor. Trained operators (sensory equipment skill) can positively identify readings/objects, pinpoint location and estimate rate of travel and direction at 65% proficiency. **Range:** 5 miles (8km). Portable; **Total Weight:** 18lbs (8.2kg). **Cost:** 2500 credits. Fair availability.

Standard Radar/Sonar Unit (large): **Range:** 100 miles (160km). **Weight:** 260lbs (117kg). **Cost:** 16,000 credits.

Radar Detector (portable): Indicates the use/presence of radar in the area. **Range of Detection:** 1 mile (1.6km). **Cost:** 200 credits. Poor availability.

Ground Sensor System: Uses seismic and laser sensors to detect vehicles/men, their direction and their numbers. A good communications engineer can make such projections with 75% accuracy. The control unit with digital display, computer mount and monitor, is the center of this sensor web or fence. Up to 22, transmitter/receiver, sensor units can be linked to the control unit. Range between transmitters is 800ft (240m) and can register activity up to 10 miles (16km) away. **Cost:** 18,500 credits. Poor availability; generally limited to the military and scientific research.

Microwave Fence: Transmitter and receiver sensor posts emit an invisible, microwave curtain or fence that will light up and send a signal to the control unit when an intruder breaches its curtain. Range between transmitter posts is 500ft (150m). Posts are 7ft (2m) high. Can effectively cover a 14 mile (22km) area. **Cost:** 20,000 credits. Poor availability; primarily used for military purposes.

OPTICS

GOGGLES AND BINOCULARS

Infrared Distancing Binoculars: A high-powered optical enhancement device with infrared adjustments, cross hair indicator lines, and digital readout of estimated distance and rate of travel. **Range:** 2 miles (3km). The I.D. binoculars enjoy extreme popularity among the populace, being used for field work, exploration, recreation, and are standard issue for the military. **Cost:** 1200 credits; wide availability.

Multi-Optics Helmet (M.O.H.): The multi-optics helmet is a special optical enhancement system built into a protective helmet. It includes the following features:

1. **Targeting Sight:** 1600ft (480m)
2. **Infrared Optics System:** 1600ft (480m)
3. **Telescopic Monocular Lens:** Range: 2 miles (3km)
4. **Thermo-imager:** Range: 1600ft (480m)

Special Bonus: +1 to strike when the optics and targeting sight are engaged. Note that the thermo imager is a special, optical, heat sensory unit that allows the infrared radiation of warm objects to be converted into a visible image. Enables the pilot to see in darkness, shadows and through smoke. **Cost:** 2900 credits. Good availability.

Optics Band: The optics band is a headband type optical system most often used in research, micro-repairs and scientific study. Its range is limited as it is designed for close work, not long-distance or combat surveillance. Features include:

1. **Infrared and Ultraviolet Optic System:** **Range:** 200ft (90m) maximum.
 2. **Magnification Lens (to the 400th power):** **Range:** 7ft (2m)
 3. **Night Sight:** **Range:** 200ft (90m)
 4. **Adjustable Color Filters.**
- Cost:** 800 credits.

Infrared Optic System: **Range:** 1200ft (360m). This type of optical enhancement device relies on a source of infrared light, usually a pencil thin beam of light projected from the goggle or binoculars to

illuminate its targets. The narrowness of the beam severely limits the scope of one's view to a small area of about two square meters (7ft). This can make surveying a large area a problem. Another drawback is that the infrared light beam is clearly visible to another infrared optic system, giving away the operator's position. These drawbacks are inherent to ALL infrared systems. **Cost:** about 1000 credits; fair availability.

Thermo-Imager: **Range:** 1600ft (480m). Basically an optical heat sensor, it converts the infrared radiation of warm objects into a visible image. These devices allow its operator to see in darkness, shadows and through smoke. Battery powered and electrically cooled. A typical running life is 16 hours. **Cost:** about 1400 credits; poor availability.

Ultraviolet Systems: **Range:** 400ft (120m). Enables its wearer to see into the ultraviolet range of light radiation. It's usually integrated into a larger optics package rather than used alone. **Cost:** 500 credits.

Night Sight: **Range:** 1600ft (480m). A night vision optics system is an image intensifier, meaning that it is a passive system that does not emit any light of its own, but electronically amplifies existing ambient light to provide a visible picture. **Cost:** 1400 credits; poor availability.

Pocket Night Viewer: **Range:** 800ft (240m). This is a mini-night sight, usually a monocular style, easily concealed and portable. **Cost:** 800 credits; poor availability.

Conventional Binoculars: **Range:** 1 mile (1.6km). Magnification through a series of lenses. **Cost:** 700 credits; fair availability.

SURVEILLANCE EQUIPMENT

Keyhole or Tube Microphones: A microphone (mic.) with a long, hollow tube which can be flexible or stiff, allowing it to be placed in cracks, mounted in walls or placed in similar, small, "keyhole"-type crevices. Picks up sounds up to 34ft (10m) away and transmits up to 1000ft (300m). **Cost:** 150 credits; fair availability.

Video Wall Mount: This small, remote video camera is only about the size of a man's palm (5 inches in diameter), thus it is easily concealed. The camera is backed with a powerful suction device that will adhere to any smooth surface, whether it be a wall, table, appliance, vehicle and so on. The video wall mount can broadcast continually for 72 hours, or by remote or preprogrammed, regulated intervals. The lens has limited mobility, able to rotate in about a 90 degree radius. It's audio capacity has twice the duration of its video transmission and, able to pickup sounds up to twenty feet (6m) away with crystal clarity. The monitor can be the mini-hand held screen or any variety of larger or multi-unit monitors. **Cost:** 200 credits; fair availability through the conventional market, but a hot commodity at 300 credits on the black market. Hand held monitor costs 150 credits.

Contact Microphone: Translates vibrations into sound, but requires a sounding board such as a wall, windows, large object, etc. Can be as small as a tie tack. Picks up sounds up to 10 meters away, and transmits up to 1000ft (300m). **Cost:** 170 credits; fair availability.

Wireless Microphone: This compact mic. is about the size and thickness of a box of matches. It can pickup sounds up to 14ft (4m) away and broadcast up to 300ft (90m) away. **Cost:** 250 credits; poor availability.

Tracer Bug: This is a tiny device about the size of a checker which has a sticky or magnetic side that can be attached to a vehicle or slipped into a person's pocket, back pack, briefcase, etc. It can transmit a signal that can be followed up to 8 miles (12km) away. Battery powered it has a limited life of 72 hours of constant transmission. **Cost:** 140 credits; fair availability.

Pocket Scrambler: The scrambler will distort or "scramble" outgoing radio signals, preventing interception and interpretation by the enemy. **Cost:** 300 credits; good availability. **Note:** Other, more

conventional video systems, cameras, lenses and optics, are also effective tools for surveillance.

Ultraviolet Signaler: The signaler is a small strip of ultraviolet sensors and another transmitter strip that can be adhered to a doorway, walls and so on, to create a beam of invisible light blocking that area. When the beam is broken by an intruder or vehicle, etc., it will send a silent signal to a monitoring device and/or trigger a video unit. **Cost:** 900 credits; fair availability.

Communications Equipment: Communications equipment is fairly basic in regards to character's use and needs. Various surveillance and video systems might be added on, depending on the circumstances and the players' ingenuity.

Field Radio: A back-pack-style radio transmitter and receiver with wide band, long-range capabilities, frequency equalizer, field strength detector and scrambler. **Range:** 60 miles (96km). **Weight:** 16lbs (7kg). **Cost:** 600 credits; good availability.

Hand Held Communicator: Basically an enhanced walkie-talkie, it is a basic instrument issued to all military personnel and field operatives. Was also used by the public in recreation. **Cost:** Per single unit – 150 credits; excellent availability (common). **Weight:** 6 ounces (170 grams). **Range:** 3 miles (4.8km).

SPECIAL EQUIPMENT

Portable Laboratory: This is another impressive portable unit that can perform several functions.

1. **Microscope** in a specially padded housing.
2. **One dozen specimen slides** and another dozen specimen trays for storage and transportation of item(s) for further analysis. A variety of vials, jars and test tubes.
3. **An incubation chamber** that is about the size of a VCR (1½ft × 1ft × 8in. deep).
4. **Four burners.**
5. **Instrument tray** with a variety of common tools such as scalpels, tweezers, pins, tape, needles, calculator, etc.
6. **A refrigeration chamber** which is about half the size of the incubation chamber.
7. **An insolation chamber.** A special, airtight, sealable compartment about the size of the incubation chamber.
8. **A chemical cabinet** which holds several dozen chemicals commonly needed in the analysis of chemical structures.
9. **Centrifuge Device.**
10. **Dosimeter.**
11. **Tape recorder.**
12. **Mini-computer.**
13. **Mini-still camera**, 35mm, 32 photo capacity.
14. **Toxic analyzer**, identical to the one used in the "portable bio-scan". **Cost:** 12,000 credits; poor availability. **Weight** of the whole unit is 58lbs (26kg).

Portable Scan Dihilator: The portable scan dihilator is a uniquely comprehensive sensory device with FULL scanning capabilities.

1. **Radar/Sonar:** **Range:** limited to a 5 mile area. A trained operator (sensory equipment skill) can positively identify readings as specific objects or vehicles, pinpoint location, and estimate rate of travel and direction at 65% proficiency.
2. **Sensors** include dosimeter, radar detector, heat, infrared, ultraviolet, microwave, and energy sensitive instruments; all of which identify, locate source, and record.
3. **Long range wide band radio** with scrambler. **Range:** 40 mile radius.
4. **Detachable short range (hand-held) communicator.** **Range:** 3 miles.
5. **Video camera** (mini) with both wide and narrow angle lenses. Audio-visual recorder using metal discs with digital meter; lens filters, telescopic lens (480m) and tripod included. Capable of radio telemetry when boosted by long range radio.

Cost is about 4200 credits. Fair availability.

BODY ARMOR

Limited to the infantry, combat armor is available to all O.C.C.'s on assignment and is NOT available on the commercial market. Such armor, purchased on the black market is illegal, leading to the confiscation of the armor and a 5000 credit fine. **Black Market Cost** is 1000 credits.

The infantry combat armor is a full suit of reinforced procelain and polycarbonate body plates and helmet. Insulated, fire resistant up to 245°C. Radiation shielded, tinted, light sensitive visor, gas filtering and artificial circulation, and independent oxygen supply and purge system (3 hour capacity). **A.R.:** 14; **S.D.C.:** 200 (M.D.C. 2); **Weight:** 13kg.

MISCELLANEOUS EQUIPMENT

<u>Field</u>	<u>Cost</u>
Sunglasses	15 credits (cr)
Tinted protective goggles	25cr
Gloves	10cr
Flashlight	25cr
Handcuffs	25cr
Night Stick (1D6 damage)	10cr
Leather jacket	200cr
Utility belt	20cr
Back-pack (small)	30cr
Back-pack (large)	50cr
Hiking boots	50cr
Coveralls	20cr
Small knife (1D4 damage)	20cr
Hat – baseball type	10cr
Hard hat	40cr
Canteen (1qt.)	15cr
Compass	30cr
Wristwatch	50cr

Electro-Adhesive Pad: This is a hand-held device that will adhere strongly to any metal surface by means of passing a small current through two, metal electrodes. These pads are commonly used by astronauts and can be used in astronauts shoes, but the hand-held pads are much more flexible and generally preferred. **Cost of the Electro-Adhesive Pads (2) and generator (hip or back-pack):** 30,000 credits. **In shoe form:** 40,000 credits. Can hold up to 1000lbs; works *only* on metal.

Hand Cuffs (novelty item): 10 credits; S.D.C. 40

Hand Cuffs (police): **Cost:** 20 credits; S.D.C. 80

Slap Glove: Six ounces of powdered lead is built into each glove just above the knuckles padding the wearer and adding weight and strength to the force of one blow. +2 to damage. Available from most security guard suppliers. **Cost:** 30 credits.

Fibreglass Nightstick: **Cost:** 10 credits, 1D4 damage.

Steel Rod Encased Nightstick: **Cost:** 20 credits; 1D6 damage.

Automatic Lock Pick; Release Gun: This item is only sold to law enforcement agencies at a cost of about 40 credits. Throws all pins into position at one time and never damages or harms the lock mechanism. Opens all types of locks (tumbler, spool, regular or mushroom). **Cost** on the street (only 19% chance it is even attainable): 600 credits minimum; may cost as much as 200% more depending on the seller and circumstance.

Lock Pick: The pick can be almost any style or size, but is always a small, thin, steel tool which ends in a slight, upward curve or special tip configuration. It is used to raise the pins of the lock so that it will open. A good range of pick thickness is .025-.035. These are available through locksmiths, and locksmith suppliers, and some establishments that specialize in rare, hot and illegal items. **Cost** is usually high. 20 credits per pick, with at least a dozen needed for a proper range. **Note:** Smiths and suppliers will not sell these tools to anyone off the street and may investigate or report the inquiry.

THE ZENTRAEDI



The Zentraedi history is a story of cruelty and manipulation at the hands of beings who had grown alien to their own humanity. Eons past, a race known as the Robotech Masters needed an inexpensive labor force to excavate planets with heavy gravity and environments far too harsh for ordinary human life. Using their own body cells and unsurpassed knowledge of genetics and cloning, they created the Zentraedi. However, the Robotech Masters soon found a more daring use for their artificial race of giants. With the alien, Invid, threat becoming ever more annoying, they decided to turn the Zentraedi into a warrior race. Warriors who would devote their lives to defending them against

the Invid and conquer new worlds to add to their empire.

Through the mastery of genetics and cloning, the Zentraedi were grown from human cells. These clones were slightly modified; adjusting body and bone structure to support their great size and mass. To add a new wrinkle, the Robotech Masters found a way to encode the Zentraedi DNA so that they could be micronized, or shrunk down, to normal human size and then restored to giant size at a later time. This provided the giants with even greater versatility. As giants, they were formidable soldiers. When combined with the secrets of Robotechnology, they would become almost invincible.

The problem now was how to keep the servant from usurping the master? The solution was easy for a race grown cold and unsympathetic to the human condition: psychologically impair the servant. A challenge the Robotech Masters welcomed with enthusiasm, for it was a new *game* to occupy their time for at least little while.

The conditioning of the Zentraedi must be complete, so it begins at the very conception of their artificial birth. The rudimentary blocks of learning are implanted as the beings gestate within their clone chambers. When they awake, a few short years after conception, the slumbering giants are fully grown, adult specimens, at the peak of physical maturity. Already they possess a full comprehension of languages, basic syntax, images, motor responses, and a false sense of history and purpose. The clone is quickly absorbed into society, eager to learn and prove itself.

Sadly, it's indoctrination is into a twisted mockery of society which breeds aggression, mind control, and complete and utter dependence on the Robotech Masters.

Male and female are segregated always. Never cohabiting, never communicating, never interacting, except for fleeting moments on the battlefield, combating a common foe. Male and female exist in separate fleets, miles apart. The natural biological attractions are squashed, and replaced with underlying feelings of suspicion and arrogant disdain toward each other's gender. The Zentraedi men and women are so far removed emotionally and physically that they actually think of each other as being similar, but alien beings. All sense of history and identity are lost. The Zentraedi do not even realize that a man and woman can bond and create new life. They have no understanding of biology or science. They have no parents, no racial memories. They are born in a sterile clone chamber and nurtured by trials of combat. The *Robotech Masters* are *the* creators. It is they who give life, and then give that life purpose. War.

To insure the Zentraedi's total loyalty, they are made to be completely dependent upon their masters. The giants are taught no sciences, no mathematics, no theology, nor art. Self-expression, creativity and individuality are systematically crushed where ever it may surface. Only the fine arts of combat are learned, to the exclusion of all else. So purposely ignorant are the Zentraedi that they can not repair their own weapons, vehicles, machinery, or even clothes. The Robotech Masters provide for EVERYTHING!! Food, clothing, shelter, power and life purpose. Thus, the Robotech Masters hold all the power while the Zentraedi are little more than the vessels with which that power is served.

The average Zentraedi soldier is *three years old*, emotionally retarded, and thrives on aggression. But not mindless aggression. No, the Robotech Masters have trained their subjects well. They follow the orders of their superior officers, do not fight amongst themselves, and strive to fulfill their destiny; to conquer. Seeing the Robotech Masters as almost legendary, god-like beings, the Zentraedi serve them without question. Sadly, the Robotech Masters view their creations as inexpensive, mass produced, flesh and blood robots. Human in origin and design, because it is far easier to manufacture Zentraedi than robots of metal. Because even the best robot is not as effective as a properly developed and programmed, biological unit such as the warrior giants. They are more versatile, intuitive, resilient, driven, and infinitely more aggressive than any robot could ever be. In the final analysis, it is the human factor that makes the Zentraedi the deadliest war machines possible.

The Zentraedi soldier is the ideal warrior. Bred to war, they are conditioned to obey orders without question. They fight to the death against overwhelming odds without fear, hesitation or regret. A Zentraedi does not mourn when a fellow dies in combat, for it is the fate of all Zentraedi. Love and friendship are replaced by cool aloofness and fierce sense of purpose; to fight and be victorious as a whole, as a race, not just as an individual. The thrill of combat is like sweet nectar to these giants. To dance with death and prove victorious, an unparalleled high. It is their life purpose, their destiny, to seek and destroy. Victory means destruction. Death and annihilation are viewed

with cold indifference, not out of cruelty or callousness, but because they are simply the anticipated by-products of war. In war there is always death. Death in combat is fulfillment. Death by combat is inevitable. This is the proud achievement of the Robotech Masters.

However, the Zentraedi war machine suffers several flaws inherent within their emotional make-up and artificial society. Though powerful and fearless, they lack compassion or insight. To win is to destroy. There is no growth. No change. No assimilation of other cultures or ideas. Indeed, mercy and compassion are seen as weaknesses. Concepts contrary to the Zentraedi way of life are viewed as contamination, and often, irrevocably deadly. This is as the Robotech Masters want things. Yet, it is also what subverts their loyal instruments of destruction. Although clever and cunning, the Zentraedi lack true inventiveness; a trait discouraged except among the elite officers, and even then it must be directed toward strategy and tactics. All Zentraedi warriors are instilled with arrogance and disdain for all other life. A trait that, while lending itself to heroic bravado and self-sacrifice, also leads to the underestimation of one's enemy. This same arrogance, coupled with the overwhelming need to win and total obedience to authority, can lead to senseless bloodshed and lemming-like destruction.

Only the officers reach any great age and wisdom. They are encouraged and nurtured to develop an intellect and imagination for combat. Yet, like the ordinary Zentraedi soldier, the officers have no true, individual identity. They are simply bigger cogs in the same machine. It is their responsibility to direct and keep the smaller cogs moving smoothly and efficiently. Only the top ranking officers possess rudimentary skills in reading and mathematics. Only they have a, specifically tailored, sense of history. And even among the oldest and greatest officers, only a tiny handful have ever actually met their makers, the Robotech Masters.

Surprisingly, the Zentraedi are not all doomed to be social miscreants, forever devoid of knowledge or compassion. These are not a stupid people, nor aliens. They are human beings who have fallen victim to a maniacal plot by the decadent and, perhaps, insane Robotech Masters. With proper stimulation and cultivation, they too can learn the value of friendship, caring, creativity and self-expression. This is clearly evident by Breetai and his soldier's changes as their world view grows and alters through their prolonged contact with the humans of the SDF-1. Mental and emotional changes that happen rapidly, for the Zentraedi are as clever as any Earth-born human. New concepts, once viewed with terror or disgust soon became acceptable, even pleasurable. Once free in an open society, the Zentraedi discovered a bold new world before them. However, ages of conditioning and false history make these changes difficult and, for many, repugnant.

ZENTRAEDI REBELS AND ROGUES

Properly conditioned soldiers, Breeti's fleet followed their commander into battle against their own people without question. After a successful siege they found themselves lost on a world they did not understand and commanded to lay down their arms and join Earth's society. For many, it is a world they can not comprehend, with customs both frightening and deplorable. Others perceive themselves to be the vanquished; alive, and forced to live among their conquerors. A shame that is unbearable. Still others have tried to change, but find these Earthmen to be weak, confusing and decadent. They find themselves second class citizens, unskilled, alone, confused and feared. For these Zentraedi, it is a transition that is impossible. A fate far worse than death. They are warriors! Without war they are useless, without purpose. They crave the excitement of battle more than any obscure promise of enlightenment. Thus, it is these lost souls who rebel and lash out against the very people who offer them liberty. They have no recourse, they are soldiers, and must fight. They know they can not win. They know that they will die. But till death claims them, they will fight the good fight and welcome a glorious death. A warrior's death.

These are the Zentraedi villains, rebels and rouges who still plague

the battered Earth as its people struggle to rebuild their planet. Some are micronized, others full size, towering among the newly built skyscrapers. Some are wandering bandits, others, marauders, bent on wholesale destruction of the micronean, human enemy. Some are maniacally evil, while others are frustrated or running scared. Some have joined up with human scum; rebels, bandits and exploiters of human misery. Others have linked up with political factions that see the opportunity to garner land, or power, or to destroy an old enemy. Still others simply struggle to survive the only way they know how.

The Earth has been decimated. Life clings desperately on. It is a new, wild and savage world that tests the strongest and most virtuous of mankind. It is a world in which giant warriors hate, and freely roam.

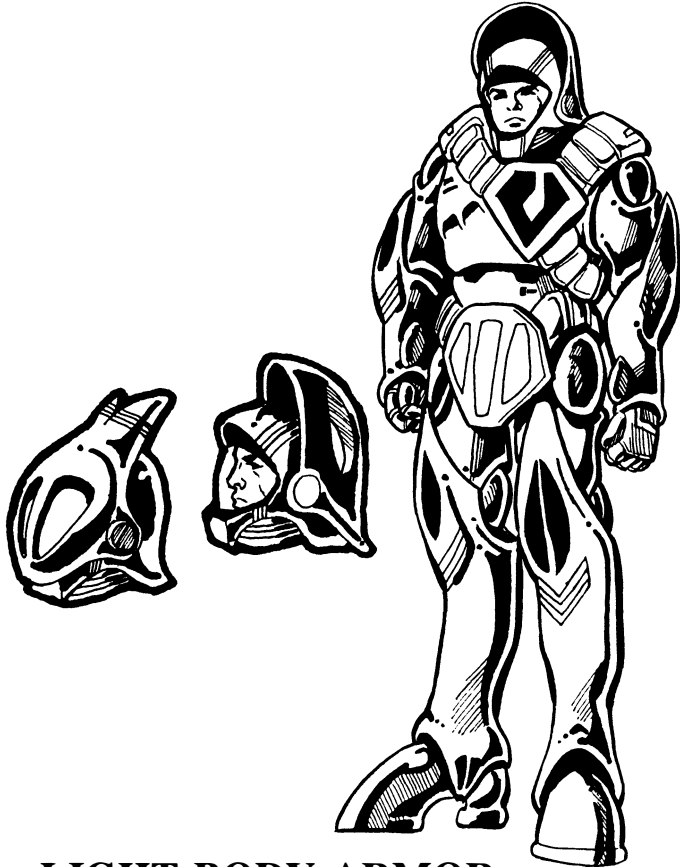

LIGHT BODY ARMOR

This is the standard outfit for the Zentraedi foot soldier and other troops. It is a light, poly-carbonate armor with oxygen back-pack, and helmet with tinted visor. It can also be worn with a space helmet. Being light armor, it affords only minor protection — **M.D.C. 25**. *This protective body armor must not be confused with the two types of Power Armor.*

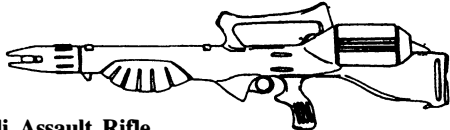

The Zentraedi Assault Rifle

The Zentraedi use an assault rifle, or gun pod, which is very similar to the GU-11 gun pod used by the Veritech Fighter.

Mega-Damage: 1D6 short burst, 2D6 long or 4D6 for a full melee burst.
Range: 4000ft (1200m)

Payload: 200 rounds

Rate of Fire: 4 short bursts, 2 long or one full melee of continuous fire.

Zentraedi Laser Pistol

This weapon is most often used by foot soldiers not in Battle Pods, and by soldiers clad in Power Armor.

Mega-Damage: 1D6 per shot

Range: 300ft (90m)

Payload: Unlimited



ZENTRAEDI MECHA

Tactical Battle Pod

Light Artillery Battle Pod

Heavy Artillery Battle Pod

Recon Scout Pod

Officer's Battle Pod

Power Armor (male)

Power Armor (female)

SENSORS AND EQUIPMENT

STANDARD FOR ALL BATTLE PODS

RADAR

Range: 30 miles (48.2km). Conventional operation.

RADIO/VIDEO COMMUNICATIONS

Wide band directional radio, and video telecast capabilities. **Range:** 600 miles (965.4km) or can be boosted indefinitely via satellite.

LASER TARGETING SYSTEM

Close range; two miles (3.2km).

COMBAT COMPUTER

Calculates, stores and monitors data on the control panel computer screen or head-up display.

LOUDSPEAKER

Loudspeaker system that amplifies and projects the pilot's voice, up to 90 decibels.

NIGHT VISION OPTICS

An image intensifier which is passive; meaning it emits no light of its own, but relies on ambient light which is electronically amplified to give a visible picture. **Range:** 1600ft (487m)

HEAT AND RADIATION SHIELDS

INDEPENDENT OXYGEN AND CIRCULATORY SYSTEM

THE TACTICAL BATTLE POD

The Tactical Battle Pod is the most common of all the Zentraedi war machines. It is a highly dependable, non-transformable, Mecha assault system that is issued to *every* infantry soldier. Although not equipped for hand to hand combat, the Battle Pod is designed for exceptional balance, speed, and a variety of short and long-range weapon capabilities.

The construction and operation of the Tactical Battle Pod is extremely simple. The pilot sits cradled inside the bulbous body of the pod with immediate access to all controls. The legs are controlled by foot pedals which respond to the pilot's manipulation. Weapon systems are operated by hand. Rear thrusters, mounted on the sides, and mini-thrusters in the legs; provide for mobility in space, while the massive, ostrich-like legs gives the pilot exceptional stability, balance and speed on land. The legs are so powerful that the battle pod can actually leap, bound, and kick without losing balance. Even after a fall, the pod can get on its feet quickly to rejoin the battle.

This impressive mobility is largely the result of the symbiotic relationship between man and machine via protoculture. Protoculture is the mysterious energy source of the Robotech Masters, which instills an almost alive quality to the machine. As a result the machine responds

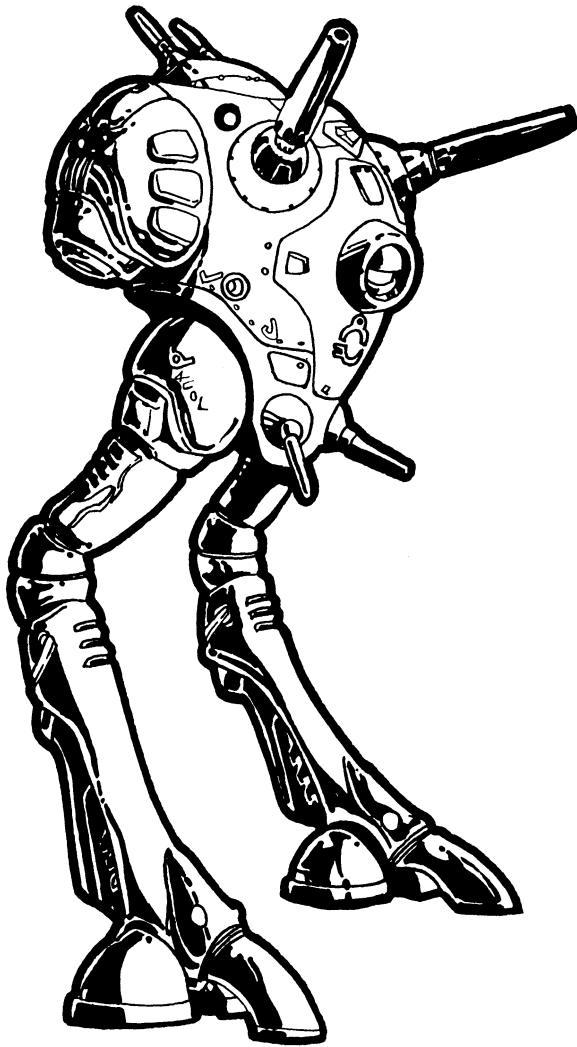

to physical manipulation as if it were an extension of the pilot. Of course, the Zentraedi have no real understanding of how the Mecha works, the use of protoculture, or even how to repair damaged Mecha. From a practical viewpoint, the principles are identical to the Earth Defense Force's own Mecha.

In contrast to the human Mecha, with roomy and reinforced pilot compartments, the Zentraedi pilot literally fills the pod's body cavity, is cramped, and has no additional protection beyond the light armor of the pod itself. This makes the pilot extremely vulnerable to attacks.

Zentraedi soldiers are often forced to discard extremely damaged Mecha, but the pods are very inexpensive, and mass produced — on a mind boggling scale — at fully automated weapons plants scattered throughout the universe (and under the control of the Robotech Masters).

It is important to note that, while there are four, different types or styles of the Battle Pod, they are almost identical in body operation and movement. Only weapon systems change (this does not include the Officer's Pod). Like the human Destroids and Veritech, the pod's energy source has a life span of about 8 years when used constantly (20 years is normal, average.)

THE TACTICAL BATTLE POD

Also known as the Regult Combat Pod.

Vehicle Type: Zentraedi Mecha

Crew: One

M.D.C. by Location:

- Particle Beam Cannon (2) — 25 each
- Laser Guns (top) (2) — 10 each
- Auto Cannon (2) — 25 each

- Legs (2) — 25 each
- Engine Thrusters (2) — 25 each
- *Main Body — 50

*Depleting the M.D.C. of the main body means the pod is completely destroyed and useless. The pilot is likely to be slain.

Speed: 175mph (281.5kmph), running; 650mph (1045.85kmph) flying in space.

Height: 50ft (15.2m)

Width: 26.2ft (8m)

Length: 27.2ft (8.3m)

Weight: 37 tons

Main Engine: Reactor; output: 1.3 GGv

Weapon Systems

1. **Dual Mounted Particle Beam Cannons** are mounted in the front, toward the top of the main body. Each cannon can move independent of the other. Both are capable of 360 degree rotation, with an 180 degree arc, up and down, and side to side.

Primary Purpose: Assault

Secondary Purpose: Defense

Mega-Damage: 4D10 per blast

Range: 4000ft (1200m)

Rate of Fire: Individual blasts, or volleys of two fired from both P-beam Cannons simultaneously (8D10 M.D.). One volley is equal to one attack. Total number of attacks are equal to the number of hand to hand attacks of the pilot; usually, 4 or 5 per melee.

Payload: Unlimited

2. **Top Mounted Laser Guns** located directly in the top center of the body. Capable of 180 degree rotation and arc.

Primary Purpose: Anti-Aircraft

Secondary Purpose: Assault/defense

Mega-Damage: 2D6 per blast (1D6 individually)

Range: 4000ft (1200m)

Rate of Fire: Equal to the pilots hand to hand.

Payload: Unlimited

3. **Auto Cannons** located in the lower front of the battle pod. 360 degree rotation, with an 180 degree arc up, down, and side to side.

Primary Purpose: Assault/anti-personnel

Secondary Purpose: Defense

Mega-Damage: 1D6 short burst, 2D6 long burst, and 4D6 for one full melee of continuous fire. Each burst is considered to be one attack, regardless of the damage inflicted. Damage is per one cannon.

Range: 2000ft (609m)

Payload: Is limited to 480 rounds per gun. 24 rounds are expended on a full melee burst, 12 for a long burst and 6 for a short burst.

4. **Optional Hand to Hand Combat** is limited to kick attacks, body blocks and stomps.

Mega-Damage: Kick 1D6 M.D.

Body Block 1D6 M.D.

*Stomp with Foot 1D4 M.D.

*The stomp is effective only against small objects of 12 ft or smaller.

Number of Attacks: Equal to the hand to hand abilities of the pilot for both weapons and physical combat.

WEAPON COMBAT SUMMARY

Attacks Per Melee: Equal to combined hand to hand skills.

Particle Beam Cannon: 4D10 M.D.; Range: 4000ft (1200m)

Laser Guns: 2D6 M.D.; Range: 4000ft (1200m)

Auto-Cannon: 1D6, 2D6 or 4D6 M.D.; Range: 2000ft (600m)

Alternate Modes of Attack: Hand to hand, kick, stomp or body block.

Special Note: *All Battle Pods can leap and bound.* **Range:** Leap horizontal: 80ft (24.4m), Leap vertical: 25ft (7.6m) high. Battle Pods, including the Officer's Pod, can *not* fly in an atmosphere, but can fly in space.

LIGHT ARTILLERY BATTLE POD

This is basically the standard Tactical Battle Pod, with twin missile launchers mounted on top instead of the anti-aircraft lasers. The additional weight and awkwardness of the missile launchers slows the maximum speed of the Battle Pod by about 50%. Generally, one out of every dozen Tactical Battle Pods is a light artillery unit. Of course, exact numbers vary with each combat situation.

The Light Artillery Battle Pod

Also known as the Regult Light, Artillery Combat Pod

Vehicle Type: Zentraedi Mecha

Crew: One

M.D.C. by Location:

Particle Beam Cannons (2) — 25 each

Auto Cannons (2) — 25 each

Missile Launchers (2) — 50 each

**Missile Launcher Pivot — 30

Legs (2) — 25 each

*Main Body — 50

*Depleting the M.D.C. of the main body means the pod is completely destroyed and useless. The pilot is likely to be slain.

**The missile launcher pivot is the thin, but tough, connecting unit that holds and turns the missile launcher pods. Attackers are -2 to strike the pivot, even on a called shot.

Speed: 90mph (144.8kmph), fully loaded, 120mph (193kmph) with missiles expended.

Height: 62.7ft (19.12m)

Width: 32.3ft (9.86m)

Length: 27.2ft (8.3m)

Weight: 39.6 tons

Main Engine: Reactor type; output: 1.3 GGV

Weapon Systems

1. **Dual Mounted Particle Beam Cannons** are mounted in the front, toward the top of the main body. Each cannon can move and fire independently, or in tandem. Both are capable of 360 degree rotation, with 180 degree arc, up, down and side to side.

Primary Purpose: Assault

Secondary Purpose: Defense

Mega-Damage: 4D10 per blast

Range: 4000ft (1200m)

Rate of Fire: Individual blasts or simultaneous volleys (2 blasts, one from each cannon; 8D10 M.D.).

Payload: Unlimited

2. **Auto Cannons** mounted in the lower front of the battle pod. 360 degree rotation with an 180 degree arc, up, down and side to side.

Primary Purpose: Assault/antipersonnel

Secondary Purpose: Defense

Mega-Damage: 1D6 short burst, 2D6 long burst or 4D6 for an extended, full melee of continuous fire. Each burst is considered to be one attack, regardless of the damage inflicted.

Range: 2000ft (600m)

Payload: Limited to 400 rounds per gun. 24 rounds are expended in a full melee burst, 12 in a long burst and 6 for a short burst. A typical combination of bursts will provide for about 30 melees of continuous fire.

3. **Light Missile Launchers** can fire any type of *short range* missile. Since the Zentraedi are concerned only with victory/destruction, usually high explosive, plasma and other destructive type, are used. The missile pods are mounted on a pivot that can rotate side to side, or up and down, within an 180 degree arc.

Primary Purpose: Assault

Secondary Purpose: Anti-Aircraft

Mega-Damage: Varies with specific missile type.

Range: Varies; short range, usually, about 2 or 3 miles.

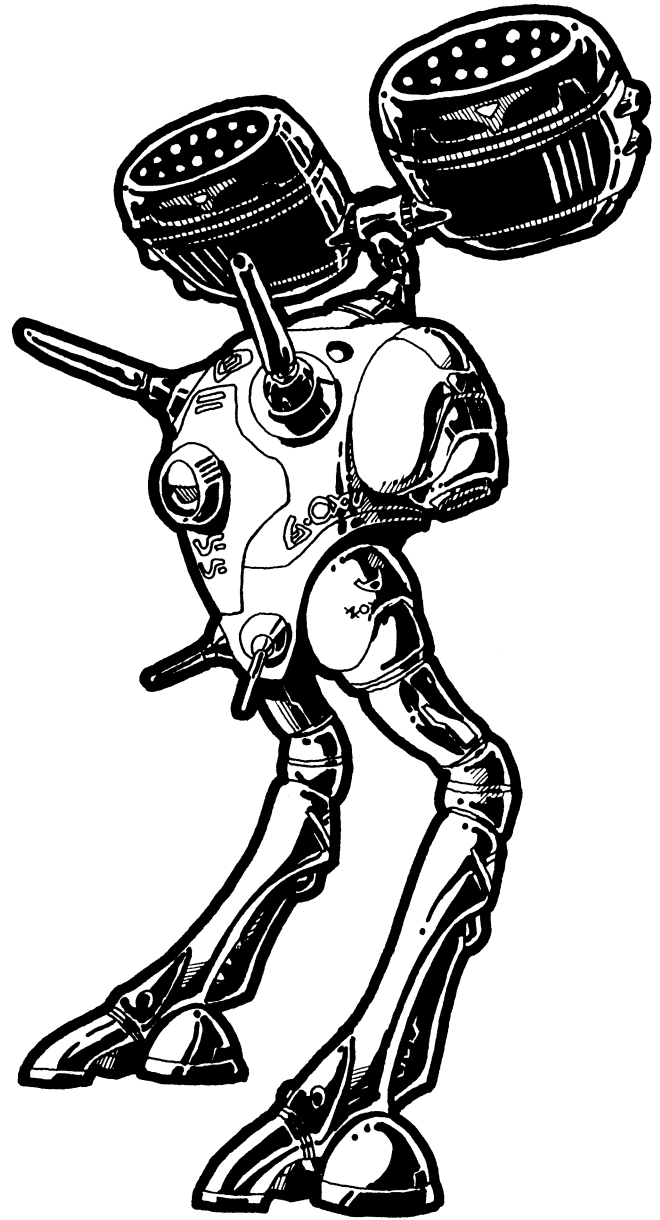

Rate of Fire: One at a time or in volleys of 2, 4 or 6, per each missile pod (2).

Payload: 12 short range missiles, per each missile pod, for a total of 24.

4. **Optional Hand to Hand** combat is limited to kicks, body blocks and stomps.

Mega-Damage: Kick 1D6 M.D.

Body Block 1D6 M.D.

*Stomp with foot 1D4 M.D.

*The stomp is effective only against small targets of 12ft or smaller.

Number of Attacks: Equal to the combined hand to hand of the pilot.

WEAPON COMBAT SUMMARY

Attacks Per Melee: Equal to the combined hand to hand of the pilot.

Particle Beam Cannon: 4D10 M.D.; Range: 4000ft (1200m)

Auto-Cannon: 1D6, 2D6 or 4D6 M.D.; Range: 2000ft (600m)

Missile Launcher: Damage and range vary.

Optional Hand to Hand: Kick, stomp or body block.

HEAVY ARTILLERY BATTLE POD

This combat pod is identical to the Light Artillery Battle Pod, except that it can launch heavy, longer range missiles. Like its Light Artillery kin, the missile launchers additional weight and awkwardness slows the maximum speed of the Battle Pod by about half. Generally, one out of every 24 or 30 Tactical Battle Pods is a Heavy Artillery unit. Exact numbers vary with specific situations.

The Heavy Artillery Battle Pod

Also known as the Regult, Heavy Artillery Combat Pod

Vehicle Type: Zentraedi Mecha

Crew: One

M.D.C. by Location:

Particle Beam Cannons (2) — 25 each

Auto-Cannons (2) — 25 each

Missile Launcher (2) — 50 each

**Missile Launcher Pivot — 30

*Main Body — 50

*Depleting the M.D.C. of the main body means the pod is completely destroyed and useless. The pilot is likely to be slain.

**The missile launcher pivot is the thin, but tough, connecting unit that holds and turns the missile launcher pods. Attackers are -2 to strike the pivot, even on a called shot.

Speed: 80mph (128.7kmph), fully loaded; 100mph (160.9kmph) with missiles expended, or 600mph (945.4kmph), flying in space.

Height: 62.7ft (19.1m)

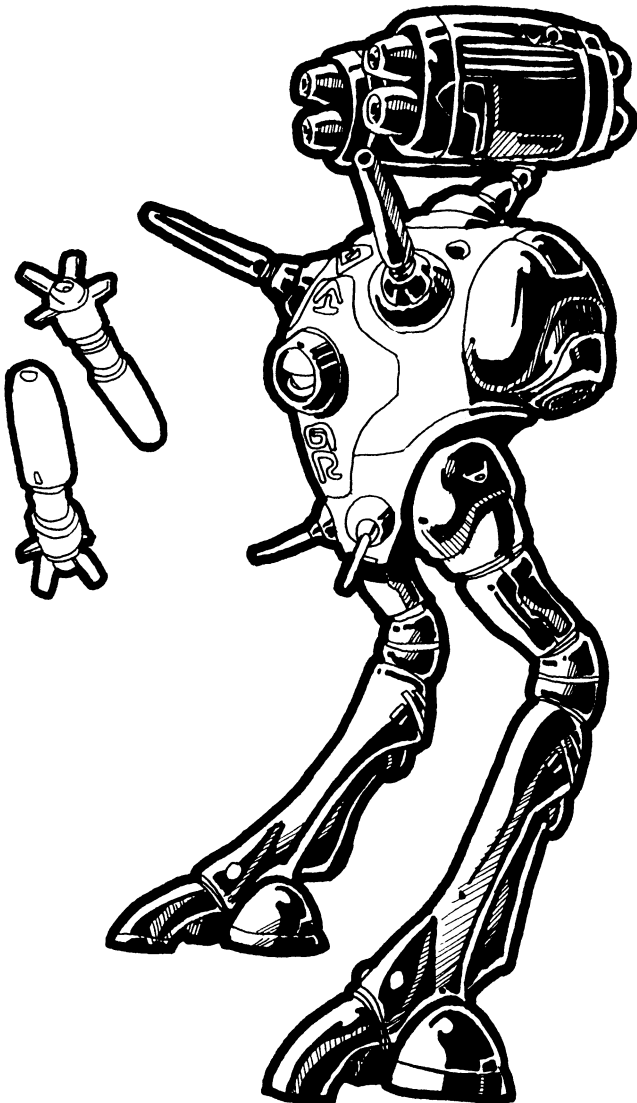

Width: 26.6ft (8m)

Length: 27.2ft (8.3m)

Weight: 41 tons

Main Engine: Reactor type; output 1.3 GGV

Weapon Systems

Note: The weapon systems are identical to the Light Artillery Battle Pod. The only difference is the type of missiles launched.

The heavy missile launcher can fire any type of medium range missile. Missile type is usually limited to the most destructive warheads. The missile pods are mounted on a pivot that can rotate, side to side or up and down within an 180 degree arc.

Primary Purpose: Assault

Secondary Purpose: Anti-Aircraft

Mega-Damage: Varies with specific missile type.

Range: Varies, but, usually, about 50 miles.

Rate of Fire: One at a time, or in volleys of two.

Payload: 4, medium range missiles.

WEAPON COMBAT SUMMARY

Attacks Per Melee: Equal to the combined hand to hand of the pilot.

Particle Beam Cannon: 4D10 M.D.; Range: 4000ft (1200m)

Auto-Cannon: 1D6, 2D6 or 4D6 M.D.; Range: 2000ft (600m)

Missile Launcher: Damage and range varies.

Optional Hand to Hand: Kick, stomp or body block.

RECON SCOUT POD

The Recon Scout Pod is a standard battle pod with ALL its weapon systems replaced with sensors and communication systems. The Scout is often deployed to investigate unknown regions, and to relay reliable data to the other units and scout ships. Their duty is to act as the "eyes" and "ears" for the combat troops. They are usually accompanied by two Tactical Battle Pods for support.

Recon Scout Pod

Also known as the Regult Tactical Scout

Vehicle Type: Zentraedi Mecha

Crew: One

M.D.C. by Location:

Radar/Sensor Unit — 20

Legs (2) — 25 each

*Main Body — 50

Note: A Searchlight is part of the main body and the first thing to be incapacitated (10 MD).

*Depleting the M.D.C. of the main body means the pod is completely destroyed and useless. The pilot is likely to be slain.

Speed: 120mph (173kmph), running; 600mph (965.4kmph), flying in space.

Height: 60ft (18.2m)

Width: 41ft (12.6m)

Length: 23.6ft (7.2m)

Weight: 39.8 tons

Main Engine: Reactor type; output: 1.3 GGV

Weapon Systems: None

SPECIAL EQUIPMENT & SENSORS

- 1. Directional Radar:** **Range:** 200 miles (321.8km). Can track up to 48 targets simultaneously.
- 2. Radio Monitor:** Can pickup, transmit, or record radio transmissions. **Range:** 50 miles (80.45km).
- 3. Laser Communications:** Long-range, directional communication system. **Effective Range:** about 90,000 miles.
- 4. Radiation Detection:** Can identify and pinpoint radiation.
- 5. Searchlight:** Located at the center of the scout like a giant, unblinking eye. Can use visible, infrared and ultraviolet light. **Range**

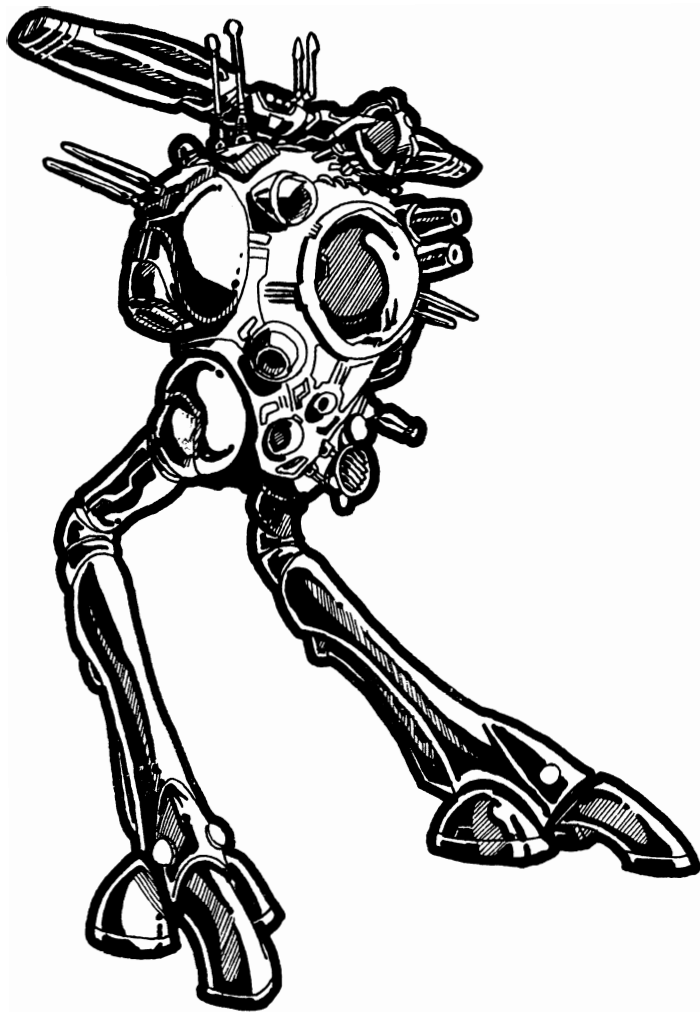

of light beam is 400ft (120m).

6. **Optical Sensors** allow the pilot to see in the infrared and ultraviolet spectrum.
7. **Laser Targeting Computer:** Enables the pilot to accurately measure the distance of a target. **Range:** 9000ft (2745m).
8. **Video Relay Camera** with telescopic lenses. Used to transmit pictures of terrain or target(s) to a recon scout ship.

THE OFFICER'S BATTLE POD

The Officer's Battle Pod is a standard, combat Mecha issued to all in the elite officer class of the Zentraedi army. Its basic design, construction and operation is similar to the standard Tactical Battle Pod. The legs are controlled by foot pedals, arms and weapons by the physical manipulation of the pilot, and superior movement and response is possible through the symbiotic relationship between man and machine via proticulture. The pod performs equally well on land as it does in space. Rear thrusters provide propulsion, while smaller thrusters mounted in the legs and body, maneuverability.

The Officer's Battle Pod addresses the problems of the standard, tactical Mecha. It is less cramped, heavily armored, and even possesses hand to hand capabilities by using its arm-like weapon appendages. Additional improvements include greater speed and firepower. Although the Officer's Pod can fit itself into a special armored unit with trans-atmospheric capabilities, the pod itself can *not* transform. Approximately one in every 100 Battle Pods is an Officer's Pod.

The Tactical Officer's Pod

Also known as the Glaug Combat System

Vehicle Type: Zentraedi Mecha

Crew: One

M.D.C. by Location:

Large Particle Beam Cannon — 50

Front Auto Cannons (2) — 25 each

Weapon Arms (2) — 50

Sensor Eye (1) — 25

Legs (2) — 50 each

Engine Thrusters (2) — 25 each

*Main Body — 100

*Depleting the M.D.C. of the main body means the pod is completely destroyed and useless. The pilot is likely to be slain.

Speed: 300mph (482.7kmph), running; 670mph, (1078.2kmph) flying

Height: 54ft (16.55m)

Width: 26.2ft (8m)

Length: 27.2ft (8.3m)

Weight: 41.2 tons

Main Engine: Reactor type; output: 3.9 GGV

Weapon Systems

1. **Large Particle Beam Cannon** mounted on the topmost part of the main body. The cannon has limited movement, with only a 60 degree maximum angle, up and down and a 45 degree rotation, side to side.

Primary Purpose: Assault

Secondary Purpose: Anti-Aircraft

Mega-Damage: 5D10 + 25 per blast

Range: 10,000ft (nearly 2 miles/3.2km)

Rate of Fire: A maximum of *two* per melee.

Payload: Unlimited

2. **Auto Cannons** mounted in the lower, chest-like area of the main body. Each can move independent of the other, with a 360 degree rotation, and an 180 degree arc, up, down, and side to side.

Primary Purpose: Assault/antipersonnel

Secondary Purpose: Defense

Mega-Damage: 1D6 for short burst, 2D6 for long burst, or 4D6 for a full melee of continuous fire.

Range: 4000ft (1200m)

Payload: Limited to 240 rounds per each gun. 24 rounds are expended in a full melee burst, 12 in a long burst and 6 in a short burst.

3. **Weapon Arms or Appendages:** Each arm has two weapons built into them; a *particle beam cannon* and a *small impact cannon*.

Weapon Arms – Particle Beam Cannon

Primary Purpose: Assault

Secondary Purpose: Anti-Aircraft

Mega-Damage: 4D10 per blast

Range: 4000ft (1200m)

Rate of Fire: Individual blasts at a rate equal to the pilot's combined, hand to hand combat skill.

Payload: Unlimited

Weapon Arms – Small Impact Cannon

Primary Purpose: Assault

Secondary Purpose: Defense

Mega-Damage: 1D8 for short burst or 2D8 for long. Continuous fire is not possible.

Range: 4000ft (1200m)

Rate of Fire: Equal to the pilot's combined, hand to hand skills.

Payload: Limited to 240 rounds per each weapon arm. Fires 6 rounds in a short burst, 12 in a long burst.

4. **The Officer's Pod can also fire short range missiles.**

Primary Purpose: Assault

Secondary Purpose: Defense

Mega-Damage: Varies with specific missile.

Range: Varies, any short range missiles.

Rate of Fire: One or volleys of two.

THE OFFICER'S BATTLE POD

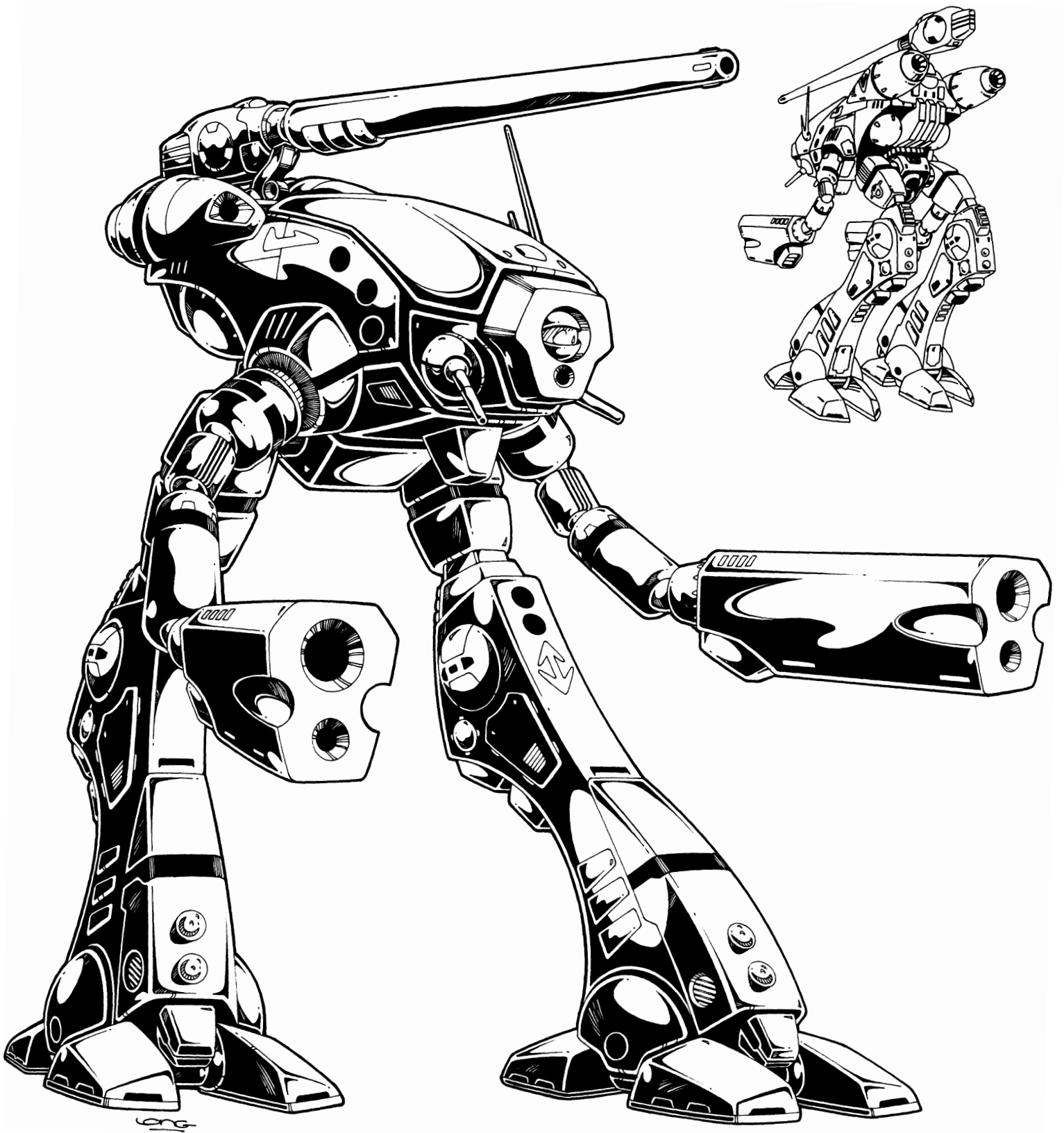

Payload: Six

5. Optional Hand to Hand Combat is possible.

Mega-Damage: Punch 1D4

Kick 1D6

*Stomp 1D4

Body Block 1D4

*The stomp with the foot is effective only against small objects of 12ft or smaller.

Number of Attacks: Equal to the hand to hand abilities of the pilot for both weapons and physical combat.

Note: The Officer's Pod can leap up to 80ft (24.4m) horizontally, or 25ft (7.6m) high.

WEAPON COMBAT SUMMARY

Attacks Per Melee: Equal to the combined hand to hand of the pilot; usually, 4 or 5 attacks.

Particle Beam Cannon: 5D10 + 25 M.D.; Range: 10,000ft (3.2km)

Auto-Cannons: 1D6, 2D6 or 4D6 M.D.; Range: 4000ft (1200m)

Arms – Particle Beam: 4D10 M.D.; Range: 4000ft (1200m)

Arms – Impact Cannon: 1D8 or 2D8 M.D.; Range: 4000ft (1200m)

Optional Hand to Hand: Punch, kick, stomp or body block.

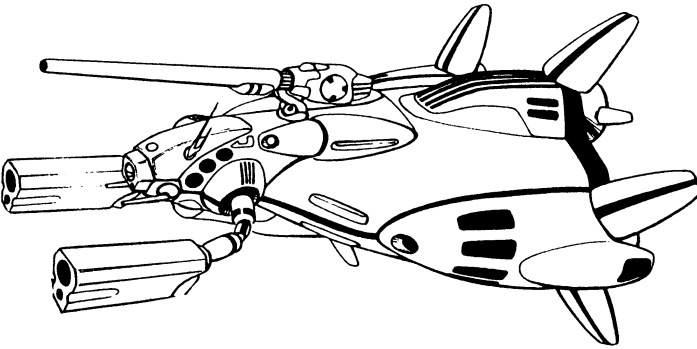

THE OFFICER'S POD ARMORED VEHICLE

The Officer's Battle Pod can be fitted into a sort of booster sled which provides the pod with trans-atmospheric capability, increased mobility and additional protection from a force field. The force field is a variation of the pin-point barrier system on board the SDF-1.

The addition of the Armored Vehicle turns the Officer's Pod into a small, space-worthy vehicle that could exist for months in space. The three booster jets makes it almost as fast as the Veritech Fighter. Only the Officer's Pod can be fitted into the Armored Vehicle.

The Tactical Officer's Pod Armored Vehicle

Vehicle Type: Zentraedi Transatmospheric Fighter

Crew: None; the pilot of the Pod controls the vehicle.

M.D.C. by Location:

Thrust Engines (3) — 50 each

Laser Ports (2) — 25 each

*Main Body — 75

** Energy Shield — 100

PLUS: The usual targets on an Officer's Pod, except the legs which are tucked inside the Armored Vehicle.

*Depleting the M.D.C. of the main body will destroy the sled or so called "Armored Vehicle". However, the Officer's Pod will be undamaged, and able to disengage itself from the wreckage of its booster vehicle and continue to attack under its own power.

**Energy shields are built into a handful of Zentraedi vehicles.

It can be adjusted to protect specific areas of the pod and vehicle, from front to top to bottom. It can not cover the entire vehicle at one time. Its other limitation is that weapons (front) can not be fired while the shield is engaged to protect

the front, which is the pod section. To fire, the shield must be moved to the top or bottom of the vehicle. On the plus side, the energy shield can be moved, disengaged, and re-engaged instantaneously.

Speed: 2280mph (Mach 3.4), or up to 3660mph (Mach 4.8), for short periods, to achieve orbit.

Armored Vehicle's Weapon Systems

1. Multi-Laser Blasters are recessed into the two, side thruster engines. Can shoot straight ahead only.

Primary Purpose: Assault

Secondary Purpose: Anti-Missile

Mega-Damage: 4D10 per blast, per each side (3). Fires in bursts, releasing a dozen pencil thick beams of light.

Range: 4000ft (1200m)

Rate of Fire: Maximum is equal to the number of attacks of the pilot (usually 4 or 5 per melee).

Payload: Unlimited

POWER ARMOR (Male)

Power Armor or Nousjadeul-Ger, general usage powered suit, as the Zentraedi call it, is a combination of many things. It is an armored spacesuit with self-propulsion, an exoskeleton with enhanced strength for manual labor, and a combat armor with interchangeable armaments. Its back thrusters, mounted near the shoulders, provides fair mobility in space, but it can *not* fly in an atmosphere. Although any Zentraedi, male and female, can use this power armor, it is usually reserved for use by males.

The armor's production is limited because it is not as suited for combat as the Battle Pods. Power Armor lacks the high speed and mobility necessary for combat. It is also much more costly to manufacture. However, it is a valuable part of the Zentraedi armaments because it is the only combat armor that has full, manual articulation. One or two Zentraedi in Power Armor are often included in exploration and reconnaissance teams.

The total number of male Power Armor is approximately equal to one in every 200 Battle Pods.

Power Armor (Male)

Also known as Nousjadeul-Ger

Vehicle Type: Mecha Combat Suit

Crew: One

M.D.C. by Location:

Shoulder Cannon (1) — 50

Laser Pistol — 30

Front Mounted Impact Cannon — 30

*Main Body — 100

**Arms — 30 each

**Legs — 50 each

Head/Helmet — 75

*Depleting the M.D.C. of the main body will effectively wreck and shut down the Power Armor. This means the Impact Cannon and large cannon will not fire, special optical enhancements and radar go out, and increased strength and speed go back to normal. Future attacks will hit the pilot inflicting S.D.C. and hit point damage.

**Arms and legs will be wounded and temporarily paralyzed when the M.D.C. of the armor is depleted and some S.D.C./hit point damage inflicted. Limbs will remain useless until medical treatment is received.

Speed: A character's running speed is tripled; average speed is about 40mph (64.3kmph); flying speed is 70mph (112.6kmph)

Height: Approximately 55ft (16.8m)

Weight: 4 tons (does not include the weight of the Zentraedi inside)

Main Engine: Reactor type; output: 2.4 GGv

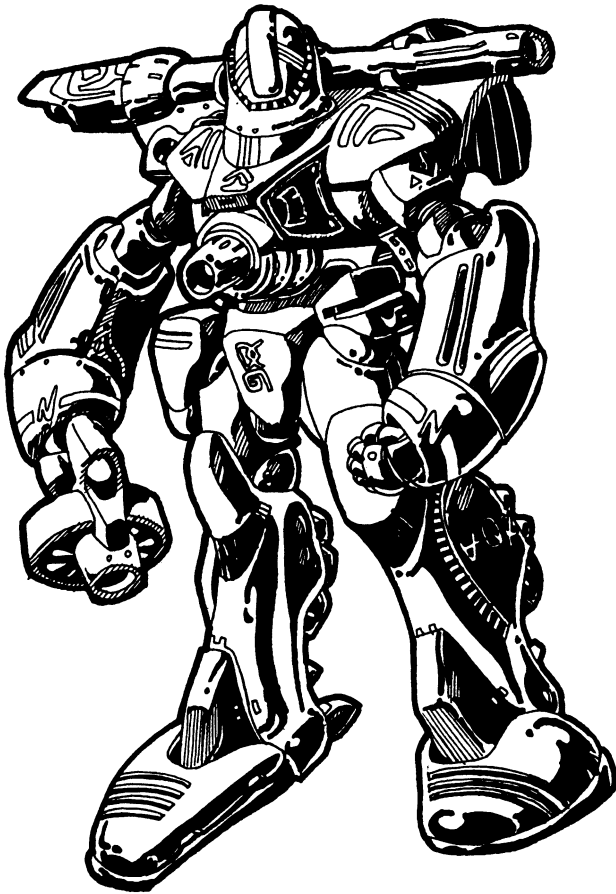

4. **Optional Laser Pistol**, side-arm.

Mega-Damage: 1D6

Range: 300ft (90m)

Payload: Unlimited

5. **Optional Hand to Hand Combat:** Rather than fire any weapon, the warrior can engage in hand to hand combat, delivering a series of powerful punches.

Mega-Damage: Punch 1D8 M.D.

Body Flip/Throw 1D4 M.D.

Body Block 1D4 M.D.

Kick 1D6 M.D.

*Stomp 1D4 M.D.

*The stomp attack is effective against small objects of 12ft or smaller.

Number of Attacks: Equal to the combined hand to hand attacks, per melee, of the pilot.

Strength and Weight: The increased strength of the Power Suit enables the Zentraedi to lift up to 20 tons and carry up to 14 tons.

WEAPON COMBAT SUMMARY

Attacks Per Melee: Equal to the combined hand to hand skills of the pilot.

Impact Cannon: 2D8 M.D.; Range: 4000ft (1200m)

Particle Beam: 4D10 M.D.; Range: 4000ft (1200m)

Alternate Modes of Attack:

Plasma Cannon: 3D8 M.D.; Range: 4300ft (1290m)

Laser Pistol Side-Arm: 1D6 M.D.; Range: 300ft (90m)

Hand to Hand: Punch, stomp, kick, flip or body block.

Weapon Systems

Note: The armaments are interchangeable, which means they might vary in type, or may not be used at all. Interchangeable armaments are denoted as *optional*.

A standard, *combat ready* Power Armor will always utilize a shoulder cannon.

1. **Impact Cannon** mounted in the front and center of the torso. This is the only weapon built into the Power Armor as a standard item.

Primary Purpose: Assault

Mega-Damage: 2D8 per blast

Range: 4000ft (1200m)

Rate of Fire: Equal to the pilot's combined attacks per melee (usually 4).

Payload: 40 rounds

2. **Shoulder Mounted Particle Beam Cannon.** *OPTIONAL.*

Primary Purpose: Assault

Mega-Damage: 4D10 per blast

Range: 4000ft (1200m)

Rate of Fire: Equal to the combined attacks of the pilot.

Payload: Unlimited

3. **Shoulder Mounted Plasma Cannon** can be used *instead* of the Particle Beam Cannon. *OPTIONAL*

Primary Purpose: Assault

Mega-Damage: 3D8 per blast

Range: 4300ft (1300m)

Rate of Fire: Equal to the pilot's combined attacks per melee (usually 4).

Payload: Unlimited

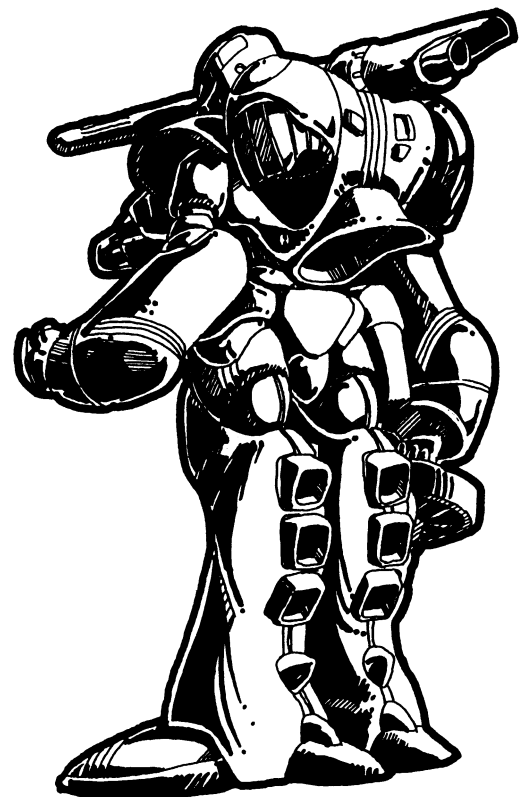

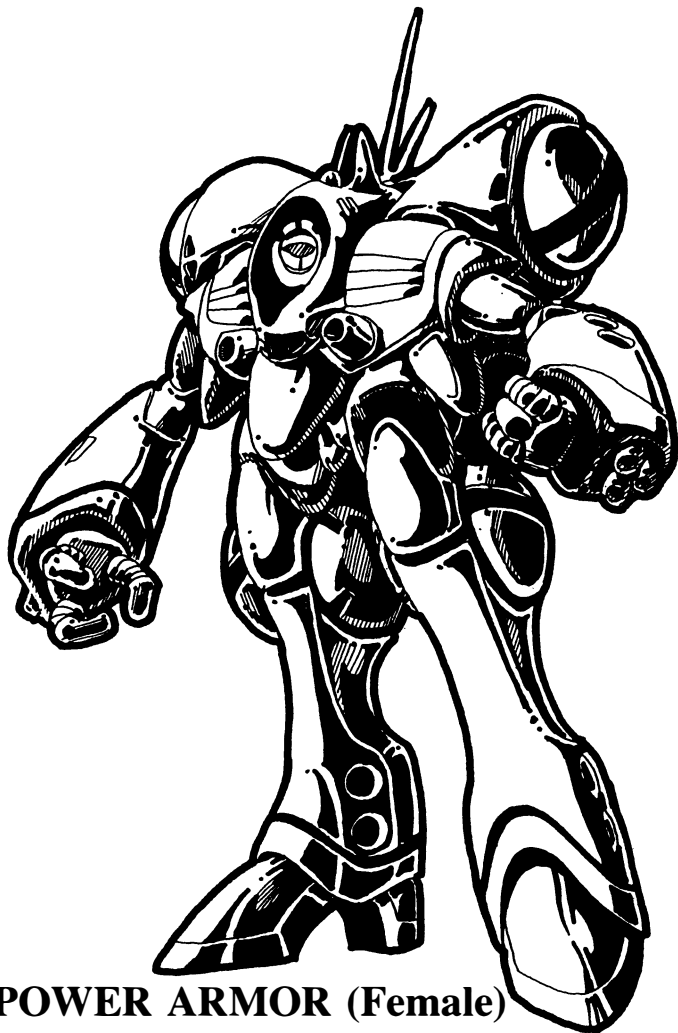

POWER ARMOR (Female)

This is a highly mobile, power boosting, battle suit which was specially developed for the ultra-efficient female officers. The female battle suit is, without doubt, the best Mecha unit in the Zentraedi army. Its unique design incorporates what the Zentraedi call an *Inertia-Vector Control System*, which compensates for problems related to acceleration and propellant/fuel. Another special feature, exclusive to the female Power Armor, is a *high speed focussing sight* built into the face plate. The Power Armor is designed for the rigors of space and atmosphere. Its aerial combat design, light armor and great flight mobility, make it a superior weapon.

The Power Armor is the most expensive battle suit to manufacture, largely because of the Inertia-Vector Control System which provides its unparalleled mobility. Consequently, they are restricted (and specially designed for), the elite, *female*, Zentraedi Air Combat troops, officers and aces.

The total number of female Power Armor is approximately equal to one in every 1000 Battle Pods. A typical, air combat unit will contain 12 to 24 battle suits, with a commanding officer and, at least, one ace.

Power Armor (Female)

Also known as *Queadlunn-Rau Battle Suit*

Vehicle Type: Mecha Combat Suit

Crew: One

M.D.C. by Location:

- **Communication Antenna — 5
- **Face Plate/Sight System — 30
- **Dual Auto Cannons — 20 each
- **Forearm Guns (2) — 20
- Missile Launchers (4) — 50 each
- Engine (2) — 50 each
- Arms (2) — 30 each
- Legs (2) — 50 each
- *Main Body — 150

*Depleting the M.D.C. of the main body will shut down the entire unit, immobilizing it completely. The pilot is now vulnerable to all attacks.

**The very small size and/or location of these items make them difficult targets to strike. Attackers are — 6 to strike on a called shot.

Note: The woman's smaller stature, and seating inside the Power Armor, places the pilot completely in the main body, with arms extended only into the shoulders. The Mecha's arms and legs are mechanically operated.

Speed: Running speed is 110mph (176kmph), flying speed is 2600mph or almost Mach 4.

Height: 55ft (16.8m)

Width: 26ft (8m)

Length: 27ft (8.3m)

Weight: 32.5 tons, fully loaded

Main Engine: Reactor style; output: 2.1 GGV

Weapon Systems

1. **Dual Auto Cannons** mounted in the chest. Both fire simultaneously, unless one is damaged and unable to shoot (reduce damage by half).

Primary Purpose: Assault

Secondary Purpose: Defense/anti-aircraft

Mega-Damage: 4D8 per double blast (each of the two cannons firing).

Range: 4000ft (1200m)

Rate of Fire: Equal to the combined hand to hand of the pilot.

Payload: 80

2. **High Speed, Triple Barreled Pulse Lasers** built into the forearms.

Primary Purpose: Assault

Mega-Damage: 3D6 per blast

Rate of Fire: Equal to the combined hand to hand of the pilot.

Range: 2000ft (600m)

Payload: Unlimited

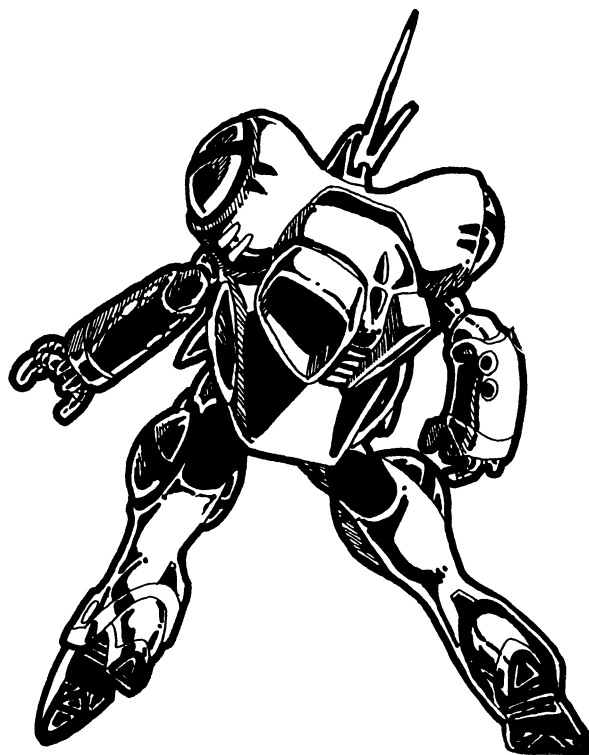

3. Short Range Missile Launchers: two top mounted, near the engine thrusters, and two mounted in the hip.

Primary Purpose: Assault

Secondary Purpose: Defense/anti-missile

Mega-Damage: Varies with missile type. Can select any of the High Explosive, or Armor Piercing, *short range missiles*..

Range: Short range; about 2 or 3 miles (4km).

Payload: Hip launchers: 21 each, for a total of 42; top launchers have 21 each, plus one set of reloads, for a total of 84. Total payload is 126, short range missiles.

Rate of Fire: One at a time, or in volleys of 2, 4, 8 or 12. Remember, one volley counts as one attack, even if 12 missiles are launched.

4. Optional Laser Pistol as a side-arm.

Mega-Damage: 1D6

Range: 300ft (90m)

Payload: Unlimited

5. Optional Hand to Hand Combat. Rather than use any of its vast arsenal of weapons, the female Power Armor can engage in physical combat. It can deliver a series of powerful punches, kicks and blocks.

Mega-Damage: Punch 1D8 M.D.

Body Flip/Throw 1D4 M.D.

Body Block 1D4 M.D.

Kick 1D6 M.D.

*Stomp 1D4 M.D.

*The stomp attack is effective against small objects of 12ft or smaller.

Number of Attacks: Equal to the combined hand to hand attacks, per melee, of the pilot.

Strength and Weight: The increased strength of the Power Armor enables the Zentraedi to lift up to 16 tons and carry up to 10 tons.

WEAPON COMBAT SUMMARY

Attacks Per Melee: Equal to the combined hand to hand skills of the pilot.

Dual Auto Cannons: 4D8 M.D.; Range: 4000ft (1200m)

Pulse Laser: 3D8 M.D.; Range: 2000ft (600m)

Missiles: Damage and range varies.

Alternate Modes of Attack:

Laser Pistol Side-Arm: 1D6 M.D.; Range: 300ft (90m)

Hand to Hand: Punch, stomp, kick, flip or body block.

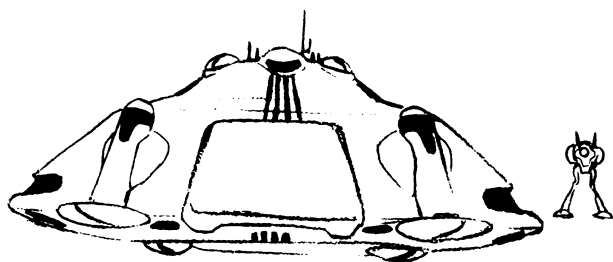

THE REENTRY POD

The Reentry Pod is a military transport vessel which is used to carry Battle Pods to specific locations or to a planet's surface (the Battle Pods can not fly in an atmosphere). These lightly armored troop carriers can transport about 24 Battle Pods or 48 foot soldiers. The Reentry Pods can function in space, air and under water.

Vehicle Type: Transport ATV

Crew: Three

Transports: 480 Battle Pods or 960 foot soldiers; total weight: 1000 tons.

M.D.C. by Location:

Release Hatch — 100

Landing Feet — 20

*Main Body — 600

*Depleting the M.D.C. of the main body will destroy the Pod.

Speed: 1340mph or Mach 2 (2156kmph), cruising, and up to about Mach 5 to enter space. Note that the Pods can not maintain the maximum speed for any great length of time.

Length & Width: Are about 756ft (230m)

Weight: 140 tons

Weapon Systems: None

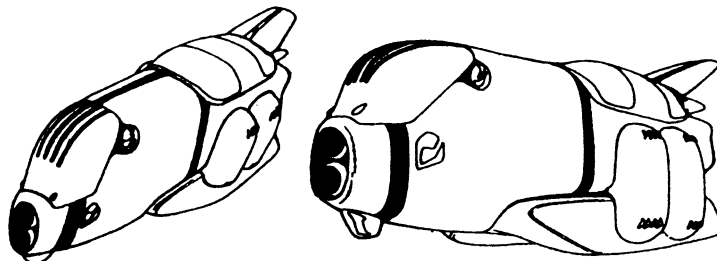

ZENTRAEDI SHUTTLE-CRAFT

The Zentraedi use a small shuttle-craft or life-boat to transport officers and limited personnel from one battle cruiser to another.

Vehicle Type: Transport/Space

Crew: One (pilot)

Transports: Up to 16 Zentraedi

M.D.C. by Location:

Pilot Cockpit — 100

*Main Body — 200

*Depleting the M.D.C. of the main body destroys the shuttle. Destruction of the cockpit immobilizes it.

Speed: 670mph or Mach 1 (1078kmph)

Length: 200ft (60m)

Weight: 80 tons

Weapon Systems: None

FIGHTER PODS

Single seated, trans-atmospheric Fighter Pods used by the Zentraedi in aerial and space assaults. They are fast, respond quickly, are heavily armed and very small targets. The large jets can maintain speeds of about Mach 2, and achieve Mach 5 long enough to escape Earth's gravity. Their numbers are about equal to 4 out of every 100 Battle Pods.

Vehicle Type: Fighter/Space

Crew: One

M.D.C. by Location:

Particle Beam Gun Cluster — 25

Engine Thrusters — 30 each

*Main Body — 50

Force Field — 100

*Depleting the M.D.C. of the main body destroys the Fighter Pod and its pilot.

Speed: 1340mph or Mach 2 (2156kmph), and up to Mach 5 for dodging, maneuvering and achieving orbit.

Length: 57ft (17.37m)

Bonuses: +2 to dodge normal, or +5 to dodge at Mach 5. +1 to strike with Particle Beam.

Main Engine: Reactor Type

Weapon Systems

1. Particle Beam Cannon Cluster mounted in the nose of the Fighter Pod.

Primary Purpose: Assault

Secondary Purpose: Defense/anti-missile

Mega-Damage: Cluster can fire one cannon doing 1D4 × 10, or all three simultaneously doing 3D4 × 10.

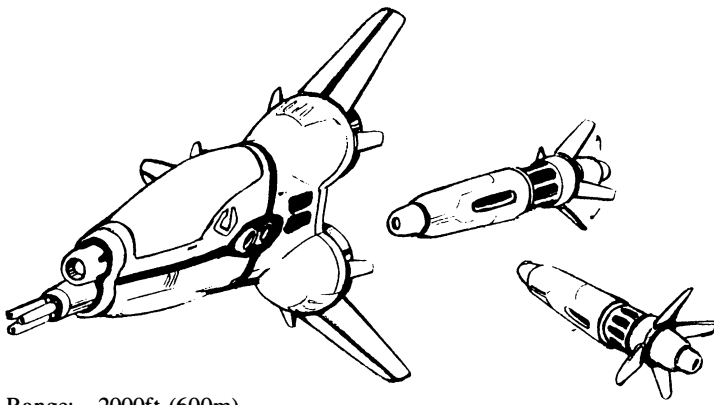

Range: 2000ft (600m)

Rate of Fire: 2 per melee, plus missile attack.

Payload: Unlimited

2. Medium Range Missile Launcher built into the top, sides, and bottom of the Fighter Pod.

Primary Purpose: Assault

Mega-Damage: Varies with the type of missile. Select *any* of the medium range missiles listed under missiles.

Range: Varies with the type of missile.

Rate of Fire: One at a time, or volleys of 2 or 4. One volley is one attack. Can fire a missile or missile volley only TWICE per melee, plus two, particle beam attacks.

Payload: 16 missiles total.

3. Special Force Field operates very much like the one on the Officer's Armored Vehicle. The force field can be moved to protect the front, but then the weapons can not be fired, or moved to top or bottom or rear. It is a light energy shield which affords limited protection.

THEATRE SCOUT RECONNAISSANCE POD

The Theatre Scout Recon Pod is an all terrain *vehicle* with superior radar and sensory capabilities. It is most often deployed by Zentraedi fleets or battle cruisers as an advance scout to investigate derelict spacecraft, asteroids, planets, moons, unexplored areas and military targets. Its four, tripod-like legs enable it to operate in rugged terrain.

An unique addition, for a Zentraedi vehicle, is the inclusion of an escape capsule. This is a small, shuttle-craft type vehicle that can carry the four crew men to safety if the Theatre Scout is severely damaged. Unlike the Recon Battle Pod, the Theatre Scout is equipped with four, rapid fire guns. Between the front mounted guns is the vehicle's giant, optical sensor eye, which has earned it the nickname "Bug-Eye" among the humans.

Despite its armaments and multi-terrain capabilities, the Theatre Scout is far too slow and clumsy to make it a worthy combat unit. Its weapons are solely for defense. There is about one Theatre Scout for every 200 Battle Pods.

Vehicle Type: Space/recon

Crew: Four (pilot, copilot, and two soldiers to monitor sensory equipment).

Escape Capsule: Speed: 1340mph or Mach 2 maximum.

M.D.C.: 100 main body. Weapons: None.

Note: Length: 100ft (30m), seats 4. Sensory equipment range is reduced by 60% (see *Pod Stat*). Bonuses: +2 to dodge.

M.D.C. by Location:

Dual Barrelled Gun Turrets (2) — 50 each

Sensor Eye — 100

Legs (4) — 75 each

*Main Body — 600

*Depleting the M.D.C. of the main body will shut down the entire vehicle. Only the escape capsule is fully operable.

Note: *The Escape Capsule has an M.D.C. of 200.*

Speed: Walking/running, 80mph (128.7kmph); flying, 1005mph or

Mach 1.5 (1616kmph); underwater, 100mph (160kmph) max. or 50mph (80.45kmph) walking under water.

Length: 400ft (120m)

Height of Body: 110ft (33m)

Height with legs fully extended: 200ft (60m) from the ground to the belly of the Theatre Scout.

Weight: 340 tons, fully loaded

Weight of the Escape Capsule: 68 tons

Main Engine: Reactor type.

Weapon Systems

1. Front Mounted Rapid Fire Particle Beam Cannons Each pair of dual turrets is operated by one of the four crew members (usually not the pilot).

Primary Purpose: Defense/anti-missile

Secondary Purpose: Assault

Mega-Damage: 1D4 × 10 per individual blast, or one, full melee burst does 5D4 × 10 per each turret.

Range: 2000ft (600m)

Rate of Fire: 6 per each gun turret.

Payload: Unlimited

2. Medium Range Missiles which fire from the sides of the Theatre Scout.

Primary Purpose: Defense

Secondary Purpose: Assault

Mega-Damage: Varies with the type of missiles. Select any of the medium range missiles listed on page 39 of the ROBOTECH™ RPG.

Range: Varies with the type of missile.

Rate of Fire: Volleys of 2 or 4. One volley is one attack. Can fire a missile volley only ONCE per melee, plus particle beam attacks.

Payload: 24 missiles total.

ESCAPE CAPSULE

Crew: 1 to 4

M.D.C.: 100 — Main Body

Speed is flying only 1340mph or Mach 2 maximum.

Height: 60ft (18.3m)

Width: 40ft (13.7m)

Length: 100ft (30.5m)

Weight: 68 tons

Weapons: None

Bonus: +2 to dodge

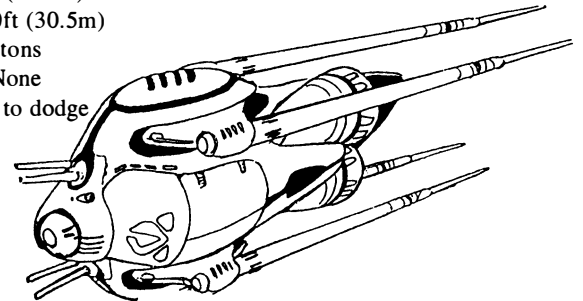
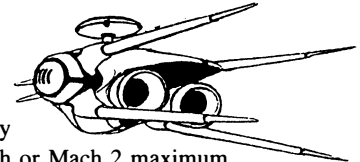

SENSORY EQUIPMENT

Radar: Range: 200 miles (321.8km); can identify and track 60 targets.

Sonar: Identical to radar.

Radio and Video Receiver and Recorder.

Radiation: Detects, measures and identifies radiation. Range: 1000ft (300m)

Motion: Detects movement and pinpoints location. Range: 1000ft (300m)

Heat: Pickup and measures heat emanations. Range: 1200ft (400m)

Ground Sensor System: Uses seismic and laser sensors to detect vehicles or major troop movement, as well as natural and unnatural seismic activity. Range: 10 miles (16km).

Optics Include: Thermo-Imager Ultraviolet

Night-sight Telescopic

Infrared Range for all is 2000ft (600m)

Radio and Laser Communications are of the standard variety.

Photography: Video and still, plus telephoto capabilities.

THE ZENTRAEDI, QUICK ROLL, VILLAIN

Gender

- 1-75 Male (roll on Rank)
76-00 Female (always officer)

Level of Experience

- 1-25 First
26-55 Second
56-80 Third
81-00 Fourth

Hit Points

- 1-25 1000 (10 M.D.C.)
26-50 1400 (14 M.D.C.)
51-75 1600 (16 M.D.C.)
76-00 2200 (22 M.D.C.)

Add 1D6 × 100 for each level of experience above level one.

Rank

- 1-25 Officer
26-00 Soldier

Alignment

- 1-25 Diabolic
26-50 Anarchist
51-75 Miscreant
76-00 Aberrant

Age in Years (soldier)

- 1-20 One
21-40 Two
41-60 Three
61-80 Four
81-00 Five

Age in Years (officer)

- 1-20 Ten
21-40 Fifteen
41-60 Twenty
61-80 Twenty-Two
81-00 Twenty-Five

Weapons and Equipment (soldier)

- 1-10 No armor or modern weapon; may have a club or spear.
11-24 Foot soldier; body armor (25 M.D.C.), assault rifle and laser pistol.
25-45 Tactical Battle Pod in perfect condition.
46-55 Light Artillery Battle Pod with only half its missiles.
56-66 Recon Scout; pilot has body armor and laser pistol.
67-77 Heavy Artillery Battle Pod with half its missiles.
78-88 Tactical Battle Pod with minor damage (− 10 M.D.C.).
89-00 General use Power Armor in perfect condition and fully loaded with weapons, including laser pistol.

Weapons and Equipment (officer)

- 1-15 Officer in body armor (M.D.C. 25) with Zentraedi Assault Rifle.
16-25 Officer in Tactical Battle Pod in perfect condition; also clad in body armor and armed with standard assault rifle (male or female).
26-55 Officer's Pod in perfect condition (Power Armor, if female).
56-66 Power Armor; fully loaded and in good condition (select the appropriate model for male or female).
67-82 Officer's Pod; damaged, − 50 M.D.C., and no Particle Beam Cannon (male or female).
83-90 Fighter Pod in good condition, except the force field is gone, but still has Particle Beam Cannon Cluster and 4 missiles.
91-00 Theatre Scout in good condition, piloted by one officer and a foot soldier; both armed with the Zentraedi assault rifle and have body armor. The Theatre Scout has both gun turrets fully operable.



O.C.C and Skills

Soldier

- Pilot Mecha (Pods) + 20%
Mecha Combat (Pods)
Weapon Systems (Pods) + 20%
Read Sensory Instruments
Hand to Hand Combat: Basic
Radio: Basic
W.P. Energy Pistol
W.P. Energy Rifle

Plus choose . . .

- 2 Physical Skills
2 W.P. Skills

Officer

- Pilot Mecha (Pods) + 20%
Mecha Combat (Pods)
Weapons Systems (Pods) + 20%
Read Sensory Instruments + 10%
Hand to Hand: Expert
Radio: Basic + 10%
W.P. Energy Pistol
W.P. Energy Rifle
Computer Operation + 5%

Plus choose . . .

- 4 Espionage
4 from any of the following: communications, technical, physical, pilot related or W.P.

PLAYING A ZENTRAEDI CHARACTER

Players can play a micronized Zentraedi or, if the game master allows it, a full size Zentraedi. Presumably, these are loyal Zentraedi who have joined the Robotech Defense Force (RDF), or are friendly mercenaries hired by a local government or private organization (the latter may be illegal).

The use of equipment will be based upon the character's history. Characters who are not clearly loyal, or have acted against humans, will NOT be given access to Mecha or any war machines, and will not be allowed in the RDF. **Note:** The Army of the Southern Cross does not allow Zentraedi to join, except for occasional officers.

Loyal Zentraedi can learn new skills including pilot Mecha, Mecha Combat and human weapon systems. However, they are NEVER taught Mecha mechanics, Veritech mechanics or Mecha electronics. Skills such as mechanical are still too complicated for the Zentraedi to learn at this point in history. Only those in the RDF or mercenaries can learn Mecha skills.

DETERMINING ATTRIBUTES

The determination of attributes is identical to normal humans with the following exceptions:

Male Soldiers:

- I.Q. roll 2D6 + 3
- P.S. roll 3D6 + 4 (genetically designed for greater strength).
- All others are the normal roll of 3D6.

Male Officers:

- I.Q. 3D6 + 4 (genetically designed for higher I.Q.)
- P.S. 3D6 + 4
- All others are the normal roll of 3D6.

Female Officers:

- I.Q. 3D6 + 4
- P.P. 3D6 + 4
- All others are the normal roll of 3D6.
- The usual bonuses apply.

This is a Micronized Zentraedi.

FULL-SIZED ZENTRAEDI

To become a full-sized Zentraedi, roll-up the attributes as just explained and adjust them with the formula that follows. If micronized again, the attributes revert back to normal.

Mental attributes are unchanged. This includes I.Q., M.A. and M.E. **Physical attributes are multiplied by 100**, except for P.B. and P.P., which stay the same. **Speed** is multiplied by 10.

Weight: $\times 100$ **Height:** $\times 10$

For Example:

Physical Strength: P.S. 15 becomes P.S. 1500. Damage is now translated into Mega-Damage, inflicting one M.D. for each 400 P.S. points. Always round down. Thus, P.S. 1500 does 3 M.D. points of damage; that's 300 S.D.C.

Physical Endurance: P.E. 9 becomes 900. That's 900 hit points! or 9 M.D.C.

Physical S.D.C. points are gained from physical skill/working out. They too are multiplied by 100. Thus, an S.D.C. of 22 would be 2200 or 22 M.D.C. Damage is always subtracted from S.D.C. first.

Physical Speed: Speed is increased by 10 times. This means a speed of 11 becomes 110. Every 10 points of speed is equal to 200 yards or meters (that's 600ft). The speed of 110 is equal to 2200 yards/meters or a little more than one mile. This is the maximum speed running and can be maintained for a time, in minutes, equal to the unadjusted P.E. In our example that was a P.E. of 9 (900 adjusted). Thus, the character can run a total of 24,400 yards (72,600ft or about 14 miles) in a total of 9 minutes.

ALIGNMENTS

The character can be any alignment; good, selfish or evil.

O.C.C. and Skills

The Zentraedi's formal training is very stilted by the Robotech Masters. Consequently, there are only two Occupational Character Classes (O.C.C.). The skills reflect the needs of the warrior and very little else. However, loyal Zentraedis who have joined the human race in friendship, can learn new skills that are not exclusive to war.

ZENTRAEDI BATTLE POD PILOT (Soldier)

Note: This is *without* human influence or skills.

Attribute Requirements: I.Q. 4

O.C.C. Skills

*Pilot Mecha (All Pods)
Mecha Combat (All Pods)
Weapon Systems +15%
Read Sensory Instruments +10%
Hand to Hand: Basic

*Same as Destroid skill, except that it's Zentraedi Mecha.

Other Skills: Select 8 other skills; two must be Physical and two must be W.P.

Communications: Radio: Basic and T.V./Video only

Domestic: None

Electrical: None

Espionage: Any, except Intelligence, Impersonation, Forgery, and Disguise; +10%

Mechanical: None

Medical: None

Physical: Any

Pilot: Mecha, space-shuttle, jet-type vehicles only; +10%

Pilot Related: Any

Science: None, except Basic Math

Technical: Any, except computer programming

W.P.: Any

Zentraedi under human tutelage can select additional skills as follows:

2 Domestic, and a mix of 5 skills from any of these categories: Communications, Domestic, Electrical (basic electronics only), Mechanical (automotive and aircraft only), Medical (first aid or paramedic only), Pilot, Science (basic and advanced math only), Technical (any).

Standard Zentraedi Equipment Issued to all Pod Pilots: Tactical Battle Pod, assault rifle, uniforms, body armor and helmet.

Authorized Clearance Upon Assignment: Laser pistol, Recon Scout Pod or Light or Heavy Artillery Pod, Male Power Armor, Fighter Pod or other vehicle.

Wages: From humans their pay would be equal to that of similar human O.C.C.'s.

Experience Levels are the same as the Destroid Pilot O.C.C.

ZENTRAEDI OFFICERS (Military Specialist)

Note: All females are officers. This training is *without* human influence.

Attribute Requirements: I.Q. 12

O.C.C. Skills:

Pilot Mecha (All Pods)
Mecha Combat (All Pods)
Weapon Systems +20%
Read Sensory Instruments +20%
Radio: Basic +10%
Hand to Hand: Expert

Other Skills: Select 10 other skills; three must be Espionage and two from W.P.

Communications: Any

Domestic: None

Electrical: None

Espionage: Any +20%

Mechanical: None

Medical: Paramedic only (counts as one skill)

Physical: Any

Pilot: Mecha, space-shuttle, jet-type vehicles only; +10%

Pilot Related: Any +15%

Science: Basic and advanced math only

Technical: Any

W.P.: Any

Zentraedi under human tutelage can select additional skills as follows: 2 Domestic, and a mix of 6 skills from any of these categories: Domestic, Electrical (basic electronics only), Mechanical (any, except Mecha and Veritech mechanics, and mechanical engineer), Medical.

Standard Equipment Issued to All Officers: Officer's Pod for male or female, or Power Armor (females only), assault rifle, laser pistol, uniform, body armor and helmet.

Authorized Clearance for ANY Mecha or small spacecraft.

Experience levels same as Military Specialist O.C.C.

ZENTRAEDI MECHA COMBAT

HAND TO HAND BONUSES FROM BATTLE POD COMBAT TRAINING

- One hand to hand attack per melee (plus those of the pilot).
- +1 to roll with punch, fall or impact (explosion), reducing damage by half.
- +1 to strike.
- +1 to dodge (no parry is possible).
- Critical strikes are the same as pilot's hand to hand.
- One additional hand to hand attack at level six.

Note: Applies to all Battle Pods except the Officer's.

Damage: **Kick** 1D6 Mega-Damage (M.D.)

Body Block 1D6 M.D.

Stomp 1D4 M.D.

Remember, these bonuses are in addition to the pilot's own hand to hand training and attribute bonuses. They do *not* apply to the pilot's physical abilities outside the Mecha.

HAND TO HAND BONUSES FROM OFFICER'S POD COMBAT TRAINING

- Two hand to hand attacks per melee (plus those of the pilot).
- +2 to roll with punch, fall or impact (explosion), reducing damage by half.
- +1 to strike.
- +2 to parry and dodge.
- One additional hand to hand attack at level six and again at level eleven.

Damage: **Punch** 1D4 Mega-Damage (M.D.)

Kick 1D6 M.D.

Body Block 1D6 M.D.

Stomp 1D4 M.D.

Remember, these bonuses are in addition to the pilot's own hand to hand training and attribute bonuses. They do *not* apply to the pilot's physical abilities outside the Mecha.

HAND TO HAND BONUSES FROM POWER ARMOR COMBAT TRAINING

- Two hand to hand attacks per melee (plus those of the pilot).
- +3 to roll with punch, fall or impact (explosion), reducing damage by half, (+4 for the female).
- Body flip/throw: damage, plus victim loses initiative and one attack that melee.
- Kick attack
- +1 to strike (+2 for female).
- +2 to parry and dodge (+3 for female).
- Critical strikes are the same as the pilot's hand to hand.
- One additional hand to hand attack at level six and again at level twelve.

Damage: **Punch** 1D8 Mega-Damage (M.D.)

Body Flip/Throw 1D4 M.D.

Body Block 1D4 M.D.

Kick 1D6 M.D.

Stomp 1D4 M.D.

Remember, these bonuses are in addition to the pilot's own hand to hand training and attribute bonuses. They do *not* apply to the pilot's physical abilities outside the Mecha.

SPECIAL NOTE

Due to space limitations, we were forced to leave out more material than we wanted to, such as the big Zentraedi battle cruisers. The good news is that we will be publishing a *source book* that has it all, called **THE ZENTRAEDI!** Followed immediately afterwards with at least two additional books in the **ROBOTECH™** saga. All will be out before the summer of 1987. So watch for them!

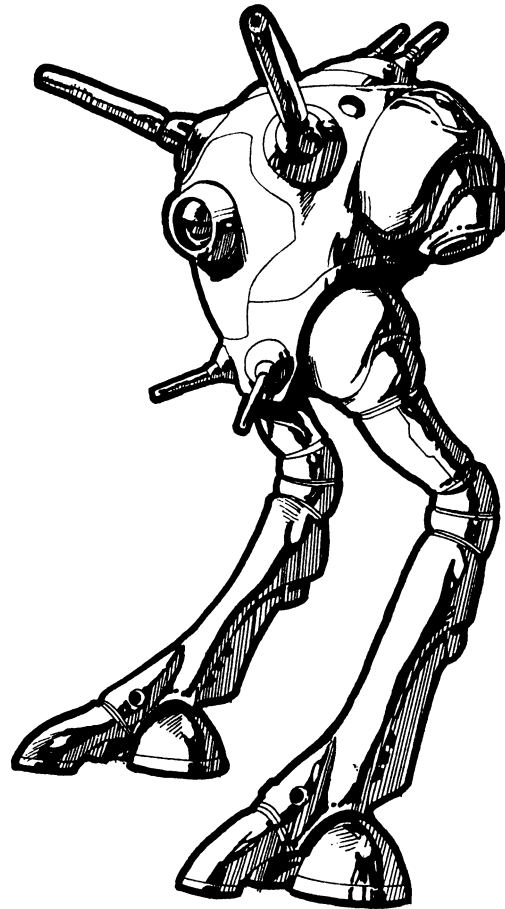

THE HISTORY OF THE RECONSTRUCTION

Based on concepts provided by Carl Macek

Following the cataclysmic battle in the vicinity of **New Macross City** (near the Canada/Montana border) which destroyed the *SDF-1*, *SDF-2* and *Khyron's Zentraedi Battle Cruiser*, the citizens of Earth began a full-fledged period of Reconstruction geared to restore their planet to its former glory. Nearly seventy percent of the Earth had been destroyed in this "First Robotech War". New population centers grew out of the ashes. Various geographic sectors became the hubs of commerce, military defense and scientific research. The Earth was soon divided into a series of city-states which attempted to bring back a sense of normalcy to the planet.

The survivors of this final battle feared the consequences of potential radioactive fallout or other deadly contamination from the destruction of the three mighty vessels. Since the two, *Earth battle fortresses* did contain nuclear reactors and devices, and little was known about Khyron's ship, the threat of contamination was very real. Consequently, the decision was made to bury the remains of the three vessels and commemorate the battle sight as a historic landmark.

A new city would be built in the shadow of this great monument. Here, in the North American Sector, the business of building an adequate defense force, capable of protecting the Earth against any further alien attacks, was placed in the hands of **Major General Rick Hunter**. Together with *Field Marshall Leonard* and the newly formed *Army of the Southern Cross*, the next decade would be spent realizing that goal.

While Rick Hunter was busy rebuilding the *Robotech Defense Force*, several of the other survivors of the "First" Robotech War were busy with projects of their own. Zentraedi allies, *Breetai* and *Exedore*, were hard at work in the Robotech Factory, learning as much as possible so that they could repair the damaged Mecha and vehicles salvaged after the war. Their goal was to rebuild and restore as many spacecraft, Mecha, vehicles and ordnance as possible, in the event of further retaliation from their ex-leaders, the so-called **Robotech Masters**.

During the period of reconstruction a new *Mars Base* was established, as well as several, orbiting space stations and a lunar base. Many Earthborn scientists and technicians would opt to live on board the *Robotech Factory*, and various off-world bases, in order to mine the necessary ores and maintain constant vigilance over their vulnerable homeworld.

Max and **Miriya Sterling** would be placed in command of the famous *Skull Squadron*. Their job; to ferret out all traces of hostile Zentraedi warriors. Through the course of their work, they would team up with a young, flamboyant officer named *Johnathan Wolfe*. A fighter pilot who would soon distinguish himself as a fine leader and excellent combat pilot. Most of the *Skull Squadron's* activities would take place in and around the vicinity of *Brazilia* near the heartland of the Amazonian rain forest. The *Veritech Fighter* and combat Mecha base, established in the South American Sector, would become the training ground for many of the new recruits to the *Robotech Defense Force*.

Doctor Emile Lang would travel to the Far East Sector where he would establish the *Robotech Research Center*. Under the ash and shattered remains of Tokyo, the *Robotech Research Center* would grow to become the technological center of the world. It is here that Dr. Lang perfects the *Enhanced Video Emulator*: the device that created the illusion of night, day and sky aboard the *SDF-1*. A unique device built into the original *SDF-1's* technology, presumably to create a pleasant environment for the occupants' long voyages in deep space. Dr. Lang would spend most of his time trying to discover the secrets of Robotechnology locked in the memory matrix of the gigantic "mother" computer found hidden in and removed from the guts of the *SDF-1*. Indeed, the very creation of the *Robotech Research Center* is to unlock whatever secrets are sealed within the alien computer.

Rear Admiral Lisa Hayes coordinates the top secret construction of the *SDF-3*. It is part of the promise she made to Admiral Gloval, prior to his death, to rebuild the Earth and keep her safe. Work takes place on the orbiting *Robotech Factory*, assisted by *Breetai* and *Exedore*. The plan is to build a new, *SDF* class battle fortress in the exact likeness of *Zor's* original ship. The interstellar ship will then be used to travel to *Tirol*, the moon of *Fantoma*, *homeworld to the Robotech Masters*. There, a plea for a peaceful solution to the problems which prompted the first war, without further bloodshed, will be presented. In the event that diplomacy fails, the *SDF-3* will be prepared for war. Unlike the *SDF-1* and *SDF-2*, the *SDF-3* will not have provisions for a civilian population. It is a warship, filled with combat Mecha and ready to take its fight for freedom to the stars.

The Army of the Southern Cross is so named, due to the fact that *Fantoma*, the home planet of the *Robotech Masters*, is located in the constellation known as "The Southern Cross". It is this newly formed army's responsibility to build an army to repel any future alien attack. The *Southern Cross* works with the *Robotech Defense Force* to protect civilians from enemy Zentraedi and human rebels. *Field Marshall Leonard* holds command of the *Southern Cross* forces.

The Robotech Defense Force is still the major defense force on the planet, and has been assigned the difficult task of policing the vast, devastated wastelands and scattered areas of population. Combat veterans, from the first war, are looked upon for training and support. In the desperate years of reconstruction and turmoil to follow, the almost legendary *Robotech Defense Force* would represent law, order, nobility, and most of all, symbolize the ability to triumph against seemingly insurmountable odds. Units of as few as a half dozen, brave men and women would be asked to patrol and protect thousands of miles of hostile territory against deadly and unpredictable foes. Often armed with only their Mecha, wits and courage, they would live up to their legendary status.

Note: This post-holocaust world picks up where *Macross* leaves off and prior to *Southern Cross*.

THE WESTERN HEMISPHERE AFTER THE ZENTRAEDI ASSAULT

North American Sector

Population: 40,000,000 Humans and
50,000 Zentraedi (95% micronized)

By far the strongest manufacturing, economic and military force in the Americas. The North American Sector is centered around *Macross City* in the Alaska region. While *Macross City* is the western anchor of the sector; *New Detroit* is its eastern stronghold, with *Southern Cross* as its military base of operation, virtually all the Zentraedi who remain in this area have been micronized and integrated peacefully into the population.

Quebec Sector

Population: 6,000,000 Humans and
8,000 Zentraedi (70% micronized)

Taking advantage of the feudal breakdown in the world. The french-speaking population of Quebec formed their own Francophobe government. They are relatively pacifistic compared to most governments of the Western Hemisphere. In Quebec, the civilian government has appointed Zentraedi as co-commanders of the armed forces and maintains over 5,000 Zentraedi Battle Pods as part of their military machinery.

York

Population: 18,000,000 Humans and
1,400 Zentraedi (100% micronized)

York, although completely controlled by humans, is not part of the unification movement. They have extensive manufacturing and Robotechnology facilities, but they use these largely for self-defense. The area is ruled by a strong, anti-Zentraedi government that advocates killing all Zentraedi on sight. Those Zentraedi that remain in York must do so secretly.

Arkansas Protectorate

Population: 5,700,000 Humans and
22,000 Zentraedi (micronizing varies)

Something of a paradox, the Arkansas Protectorate is ruled and organized by Zentraedi who are not part of the union, but who also stand against the Zentraedi Control Zone. The situation here came about after the Zentraedi succeeded in conquering the area and then discovered that the humans were willing to accept Zentraedi rule, so long as they were kept safe from other invasions. (*See scenarios for more details*).

Zentraedi Control Zone

Population: 9,000,000 Humans and
145,000 Zentraedi (about 65% micronized)

Although Khyron is long gone, his legacy lives on in this huge, rugged area of South America. Rebellious and criminal Zentraedi from every corner of the world, still trickle in. Earlier, just after the bombardment of Earth, dozens of partially functional Zentraedi Cruisers were collected in the mountains and jungles of the Western Amazon. The weapons and supplies provided by these ships continue to supply the Zentraedi years later, fueling their continuous warfare. In addition, the remaining cannon, of the broken Cruisers remain an incredible defense against attacking aircraft. Even satellites and ships, orbiting far above South American Sector, are not safe from these weapons.

Another major addition to the strength of the Zentraedi Control Zone came when they captured the incomplete Brazilian Grand Cannon. Even though the mighty weapon was incomplete, it contained huge amounts of protoculture; enough to fuel the Zentraedi war machine for decades.

The Zentraedi Control Zone is also changing. In the first few years, the humans of the area were virtual slaves of the Zentraedi. Gradually, when the Zentraedi came to realize that human technicians could actually repair damaged Mecha, the Zentraedi started integrating useful humans into their bases. This process speeded up as the Zentraedi became more and more decadent and began developing tastes for human cooking, comforts and companionship.

Eventually, however, the Zentraedi Control Zone is doomed. In every battle they lose another few, irreplaceable, Battle Pods or power armor. Although the fighting can continue to go on for years, the grim reality is that, while the attacking human forces continue to build fighting Mecha, the defenders are gradually running out of Mecha.

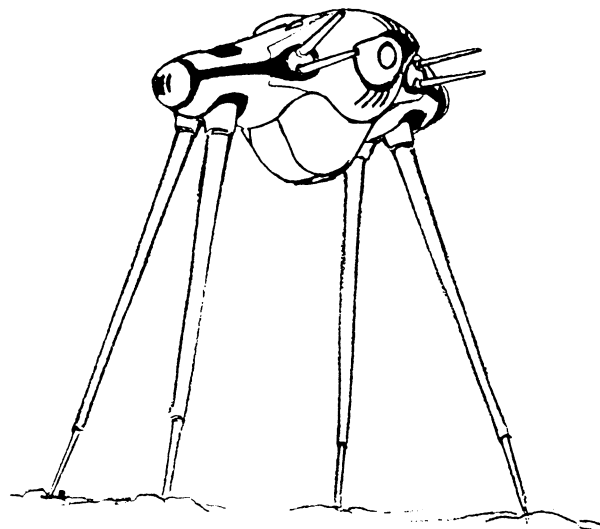

Argentine Sector

Population: 24,000,000 Humans and
220,000 Zentraedi (85% micronized)

This nation would not exist but for the constant support and assistance of the North American Sector. Although it does serve as a manufacturing and military base, it is also wracked with Anti-Unification demonstrations and terrorist acts. Military equipment and personnel from all around the world come to the Argentine Sector to participate in the major assault against the Zentraedi Control Zone.

Most contributions to the assault are for purely selfish reasons. As long as the Zentraedi continue to be attacked, they continue to defend their control zone. Every time there's a pause of a month or more in the fighting, the Zentraedi get restless and send out a major strike force. These strikes can hit anywhere in the world, inflicting monstrous damage on manufacturing and population centers. Simply put, it's cheaper for the world's nations to support Argentine's attack than to risk a surprise attack from bored Zentraedi.

Ironically, the Argentine Sector contains even more Zentraedi than the Zentraedi Control Zone that's under attack. Even among the Zentraedi who adopt the micronized life-style, there is still the old urge to battle. This is the one place in the world where the war never ends. . . .

Zentraedi Infiltration Bases

In remote locations throughout the world, the Zentraedi operate mobile, supply and reconnaissance bases. Most are allied with the Zentraedi Control Zone, but a significant number are their deadly enemies. The bases are moved every few weeks to avoid any chance of detection. Usually the bases consist of from 2,000 to 12,000 Zentraedi (about 50% micronized). One or two, operational cruisers (capable of short-range travel, but not capable of taking off from Earth), a handful of reentry and fighter pods, and one Battle Pod for every two Zentraedi.

Surveillance and Assault Bases

Surrounding the Zentraedi Control Zone is a network of surveillance stations. These continuously monitor the area for any sign of a Zentraedi breakthrough. Each base is equipped with eight M.A.C. II's ("Monsters"), four Spartans, and two Raidar X's for self-defense. In addition, each base has landing fields, and hangers and barracks for a full squad of Veritech Fighters. Unfortunately, there aren't enough Veritech squads to fill every Surveillance Base; only enough for one out of every three.

ADVENTURE SCENARIOS . . .

Random Combat Encounters

Note: This table is for the Reconstruction time-line and can apply to any period after the near destruction of Earth. *Zentraedi are full-size, unless stated otherwise.*

- 1-10 **Reentry Pod** waiting for 3D4 Tactical Battle Pods, and one Recon Scout Pod 4D6 miles away. Is guarded by one Tactical Battle Pod; crew: four foot soldiers in body armor with laser pistols.
- 11-13 **One, lone Tactical Battle Pod**, will hide or retreat if outnumbered.
- 14-18 **2D4, Zentraedi foot soldiers**; in battle armor with assault rifles.
- 19-26 **1D6 Tactical Battle Pods** with an Officer's Pod; extremely hostile.
- 27-32 **Two Zentraedi officers in Power Armor (FEMALE)**. Fully armed and extremely dangerous; will fight to the death.
- 33-42 **Micronized Zentraedi and 2D4 human bandits**, armed with automatic weapons, and two grenade launchers attached to the rifles. Also have two dune buggies and one hijacked, very battered, Gladiator Destroid. The Gladiator has only 3, short range, high explosive missiles, but a fully operating gun cluster. M.D.C. is half normal. (*GM Note:* To avoid repetition, you can substitute an Excaliber, Raidar X, or Veritech stuck in Battloid mode. Cripple the armaments in such a way as to give the players a real chance to win, or at least survive. If your group can handle it, the Mecha could be close to fully functional, and you could add a couple of Battle Pods or another Destroid. Don't get too carried away with giving out illegal or battle salvaged, human Mecha.)
- 43-47 **Recon Scout Pod** will summon 2D4 Tactical Battle Pods unless it is destroyed within 1 melee.
- 48-50 **Two Tactical Battle Pods** and one Light Artillery Battle Pod; fully armed and hostile.
- 51-57 **Human and Zentraedi, high-tech bandits**; this is a big operation, perhaps sponsored by a local government or industry. They are illegally salvaging Zentraedi and human Mecha for unknown purposes. *One* (or *two*, if the playing group is powerful enough) **Commanchero Assault Helicopter**, *one Howard 2000 Recon Helicopter*; one, large transport helicopter (about the size of the Sea-Sergeant). The latter two choppers are unarmed. Ground units include *two Land Rovers*, *one dune buggy* with a recoilless rifle mounted on it, 6-12 men and *two*, (or more, if the group can handle it) **Zentraedi Tactical Battle Pods**. *This is a standard, high-tech, bandit's or looter's salvage unit. They are usually a mix of the worst Zentraedi and human mercenaries. They can either work as independents, selling to the black market or criminal organizations, or, more often, hired by an unscrupulous government or organization. This activity is highly illegal and considered an act of traitors.*
- 58-60 **3D4, Zentraedi foot soldiers** armed with assault rifles. They are hungry, tired and desperate; will flee or fight to the death. They are responsible for the plundering of local towns and outposts.
- 61-64 **Zentraedi Trap:** 2D4, full-size, Zentraedi foot soldiers in battle armor, and unarmed (really have laser pistols tucked away), are menacing a van and some other vehicle. The passengers are screaming in terror. (1-65% likelihood that passengers are micronized Zentraedi pretending, 66-00% that they are real hostages). 1D4 Fighter Pods, with no missiles, await the signal to attack, as does a Heavy Artillery Battle Pod with half its missiles. The Fighter Pod(s) is 40,000 feet in the air, and the Heavy Artillery Battle Pod is 25 miles away (GM can include 1D4 Tactical Battle Pods too, if feasible).

- 65-70 **Recon Scout Pod** with one Tactical Battle Pod; will summon 1D6 more Battle Pods unless destroyed within 3 melees.
- 71-75 **An Officer's Pod and 1D4 Tactical Battle Pods**; can summon another 1D4 Battle Pods within 10 melees. Extremely hostile; 1-60: Flee if out-powered; 61-00: Will fight until the death.
- 76-80 **Zentraedi on the prowl:** These seasoned troops include: 3D4 foot soldiers with body armor and assault rifles, two Tactical Battle Pods, one Officer's Pod, one Light Artillery Battle Pod, and one, Male Power Armor combat suit. All fully loaded and spoiling for a fight.
- 81-85 **Anti-Unification Rebels** will attack any members of the Robotech Defense Force or Army of the Southern Cross. *Troops Include:* Three, hijacked RDF motorcycles, whose drivers are armed with laser pistols. Two land rovers fitted with recoilless rifles; each one holds four rebels. Two are armed with normal assault rifles, one has a L.A.W., and the fourth is the driver. One Commanchero Assault Helicopter, fully armed and two Howard 2000 Scout Helicopters. Lastly, one canvas covered, military-type truck with food, ammunition, explosives, three flame throwers, and 3D4 other rebels armed with automatic rifles. *These are terrorists who travel the country terrifying towns, sabotaging RDF patrols and outposts, and other acts of terrorism.*
- 86-88 **Large Patrol:** 2D4 Tactical Battle Pods, 1D4 Light Artillery Battle Pod, one Officer's Pod, one Recon Scout Pod, one Heavy Artillery Pod and 4D4 foot soldiers. Hostile.
- 89-91 **Patrol of 1D4 + 1 Fighter Pods**; fully armed and looking for trouble. Will flee if things begin to go badly.
- 92-96 **One Theatre Scout**; fully operational. Will attack only if attacked first. It can also call 1D4 Fighter Pods and 2D6 Tactical Battle Pods if it is under siege. The reinforcements show up in the following order. Fighter Pods can arrive within 10 melees; the Battle Pods can arrive within 10 minutes (40 melees).
- 97-00 **One Reentry Pod** in flight; will ignore any humans unless it is attacked and can not escape. If attacked, it will release 3D4 officers in FEMALE Power Armor. If it lands, it can release an additional 4D4 females in Tactical Battle Pods and 1D4 Heavy Artillery Battle Pods.

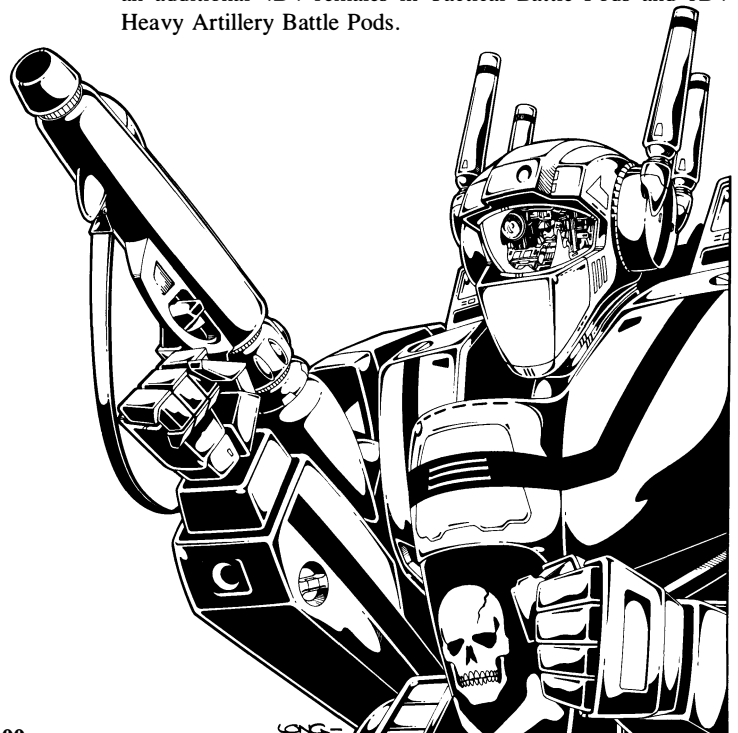

ROBOTECH: ON THE DEFENSIVE

Note: This is an introductory level situation that can be completed in a single game session. Suitable as a “shake-down” mission for beginning role-players. Characters can be any mix of O.C.C. and Mecha.

PLAYER BACKGROUND . . .

Read the following to the players:

“You are on a routine patrol when you receive a frantic cry for help on the emergency channel. A nearby human mining town just detected two Zentraedi Battle Pods and a dozen or so, full-size Zentraedi approaching. They are requesting immediate assistance. What are you doing?”

Only minutes away, the player characters will soon arrive on the scene to witness the following:

“As you get into view, you see that the town is under attack. None of the attackers are airborne, but you see a number of giant attackers, at least 20. While this force seems to be attacking the town at the moment, another 20 or 30 seem to be moving to surround the town; half are Battle Pods. What are you doing?”

Combat begins immediately. Anyone who spends more time inspecting the battlefield should realize the following:

It seems that the Zentraedi have a plan that is working fairly well. By staying close to the ground and buildings, they make it difficult for the town’s Raidar X anti-aircraft weapons to hit them without also hitting buildings, and jeopardizing civilians. Any other Mecha weapons that are made for airborne or heavy assaults are also useless since they would endanger the civilian populace. This has to be a close combat situation using light lasers, machineguns, maybe light auto-cannons, and hand to hand combat. A situation ideal for Veritech Fighters, the Gladiator and, to a lesser extent, the Excaliber. Other Mecha will be extremely limited.

The players should be informed that their main base is about 20 minutes flight time away from their current battle site. They should also know that they are the only patrol in the immediate area.

GAME MASTER INFORMATION

This scenario is designed to fit into any campaign. It provides a good blend of restrained combat, and tension over the safety of the 600 townspeople.

Even a small group of Veritech Fighters and/or Destroids should be able to drive back the attacking Zentraedi. The real challenge will be doing so without destroying the entire town, or at the cost of many civilian lives.

The other challenge for the players will be to avoid being suckered by the Zentraedi into calling for reinforcements. The first time the players call for reinforcements read the following:

“This is Veritech Base. There seems to be a general Zentraedi offensive. Only two Veritech Squads remain on stand-by. Are you sure you need help?”

This is the only warning the players will receive. They *can* call for one or both of the remaining Veritech Squads. Of course, within ten minutes the “reinforcements” will be forced to return to the main base when news of the *real* Zentraedi assault comes through. This is just a ploy to spread out and weaken the Robotech Defense Force to insure the success of the assault on the real target a few thousand miles away.

NPC CHARACTERS

The town is equipped with:

- One Spartan
- Two Raidar X’s

These units will not leave the town, instead, they’ll stay put and fire at any targets that come into range. The Zentraedi are moving slowly and trying to stay under cover. Their real purpose is to look more menacing than they actually are to draw out more Mecha reinforcements.

Consequently, they have not provided the three, human Mecha with easy targets.

Telerdai, a Zentraedi commander, has been assigned the task of drawing away as many defenders as possible from the human’s main base in the area. To do this, he plans on attacking the town and tiny, RDF outpost with what seems to be a major attack force.

He has ordered the Battle Pods to stay back while a small unit of Zentraedi in Power Armor have positioned themselves in a cross-fire, so that any Veritech Fighters will have to expose themselves to their firepower if they want to attack the Battle Pods.

ZENTRAEDI FORCES INCLUDE:

- (1) **Officer Battle Pod** (Telerdai)
- (5) **Standard Tactical Battle Pods in town:** All five are in excellent condition.
- (20) **Battle Pods surrounding town:** Note: These are unarmed scout pods or severely damaged units which have been fitted with fake guns, so that they will appear, at first glance, to be Tactical Battle Pods. Close range inspection (within 800 feet) will reveal that there is something wrong.
- (22) **Zentraedi foot soldiers in town, with clubs.** Only one in 3 has an energy weapon.
- (28) **Zentraedi foot soldiers** hanging back near their commander’s pod. *All* are armed with standard, Zentraedi weapons.
- (3) **Reentry Pods** to make a hasty retreat. The big pods are guarded by FOUR Tactical Battle Pods. They are hidden among cover (trees or rocks) about 4 miles from town.
- (5) **Zentraedi in Power Armor** with particle beam, shoulder mounted guns. Positioned to ambush Veritech Fighters and other aircraft.

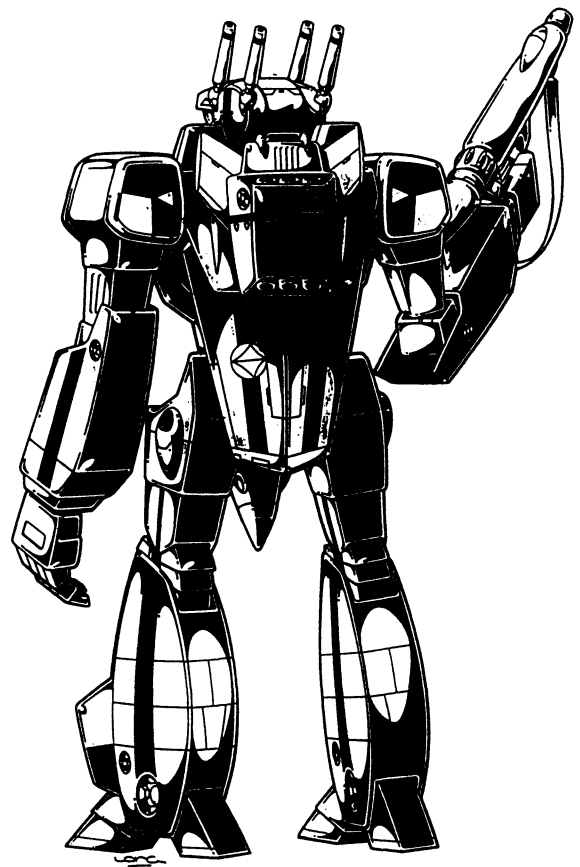

GLOSSARY OF ROBOTECH® TERMS

Destroid: A non-transformable battloid developed from Earth's limited understanding of protoculture and Robotechnology. The Destroids are giant, 45 to 80ft tall, robot suits, and vital to the Robotech Defense Force.

Hyperspace: A dimension between the standard dimensions of time and space. It is a zone which can be used to travel light-years without feeling the effects of time. The *Space Fold* process is the traveling through hyperspace. Navigation in hyperspace is not always accurate and is most hazardous when traveling great distances.

Invid: These enigmatic, protoplasmic creatures are the natives to the planet which originated protoculture. Protoculture is derived from the sacred plant, "The Flower of Life", which once grew exclusively on the Invid homeworld until it was discovered by the Robotech Masters, taken, and cultivated elsewhere. The Invid are obsessed with gathering all the Flowers of Life and returning them and any protoculture, to their homeworld. In the **Mospeda** episodes of the T.V. series, (and in the future **Palladium Books**, role-playing games), the Invid discover Earth's role with protoculture/the Flower of Life. *Also see Protoculture.*

Mecha: A term that refers to all mechanisms which utilize Robotechnology and protoculture. It is most commonly thought of in the context of the Destroids, Veritech Fighters and Zentraedi Battle Pods.

Protoculture: A source of unique bio-energy derived from the *Invid Flower of Life*, discovered by the great Robotech Master, Zor. In its unrefined form, the Invid use protoculture for nourishment and metaphysical enlightenment. Zor found that the plant produced a source of energy, during gestation, unlike anything in the known universe. Through field studies, Zor learned that if he applied constant pressure to the properly germinated seed, he could control the energy of protoculture. This also prevents the plant's growth, which causes it to generate even more of its complex energy field. Trapped in stasis, the seed will continue to generate power for decades.

This led to the conceptualization of *organic fusion* which became the basis for Robotechnology and the creation of Mecha. A Mecha derives its energy from protoculture as well as instilling it with a symbiotic link between man and machine.

The RDF/Robotech Defense Force: A part of the United Nation's World Government defense force. The RDF is specifically charged with the use and development of Robotechnology and Mecha for combat/defense. It is the military force which Rick Hunter and our cast of characters belongs to or are allied with.

Reflex Power: The term "reflex" can be applied to weapons, engines and machinery. It is simply a system which works intrinsically, or responds to certain conditions as a "reflex" reaction. It is a form of passive artificial intelligence.

Robotechnology: The discoverer of protoculture, Zor, is the father of Robotechnology. He learned that the other Robotech Masters intended to keep the secrets of Robotechnology, protoculture and Mecha to themselves, for their own foul reasons. This prompted Zor to hide an almost inexhaustible supply of protoculture on board his newly designed spacecraft, the SDF-1, along with the necessary data to unlock the mysteries of protoculture. The ship was then sent to Earth; an act that would brand Zor as a traitor and cost him his life. For the next decade, the Zentraedi would be sent out throughout the universe to locate the SDF-1 for the retrieval of the needed protoculture and the new, lost, advances Zor had secretly perfected (transformable Mecha).

Unfortunately, the SDF-1's crash landing, and alien nature, would make it difficult for humans to unravel all the secrets locked within her. Although they would be able to create a variety of Mecha, the full understanding of protoculture would be lost for decades. Likewise, the protoculture hidden on board the SDF-1 would remain hidden.

Robotech Masters: The decadent race of technological geniuses and creators of Robotechnology. They have ruled the known universe for so long, that they have become arrogant and unsympathetic to humanity. They are cunning and ruthless, viewing all aspects of life as merely parts of a game. It is their decadence and loss of humanity that is bringing their once noble race to the edge of Armageddon.

SDF-1 & 2: The Super Dimensional Fortress based on the original designs of the Robotech Master, Zor. The SDF-1 becomes the pivotal focus and salvation of Earth in its battle with the Zentraedi. The SDF-1 and SDF-2 are destroyed in Khyron's final assault. The *SDF-3* is based as close as possible to Zor's original design. It will be used to take the war to the Robotech Masters. Watch for "*The Sentinels*" T.V. series for this exciting, new chapter in the **Robotech®** saga.

Space Fold: The method used by the *SDF-1*, *Zentraedi* and *Robotech Masters*, by which vehicles travel through hyperspace. The actual mechanisms for accomplishing a space fold are unstable and rather destructive, so it is not a common means of travel.

Veritech Fighter: Transformable combat Mecha vital to the RDF.

Zentraedi: A race of warrior clones designed by the Robotech Masters.

Zor: The deceased creator of Robotechnology. Cabell, a scientist who has inherited Zor's place in the Robotech Master's hierarchy, continues secret experiments to create an exact clone of Zor. The purpose is to extract the secrets of Robotechnology from the clone. Thus far, all attempts have been a failure.

JAPANIMATION SIDE NOTES

What follows are bits and pieces of information uncovered from our translations of various Japanese books about the original **Macross** T.V. show plus data gleaned from other sources. So, Japanimation fans this section is for you.

Destroids

This is the original term for the non-transformable Mecha. Harmony Gold U.S.A., Inc. prefers the term "non-transformable Battloid", although there is one time, in the American version, where they are called *Destroids*.

The Excaliber/Tomahawk

1) The original Japanese name for the Excaliber was the Tomahawk MBR-04-MK VI. 2) Main engine manufactured by Clance McFay. 3) Has a secondary engines an EM9G Fuel Dynamo, Output = 450kw. Manufactured by G.E. 4) Particle beam manufacturer — MAULA. 5) Air-cooled, machine gun top mount produced by Laminton Co. 6) TZ-IV gun clusters are actually TZ-III gun clusters with laser weapon, flamethrower, 25mm auto cannon and 180mm grenade launcher — manufactured by ASTRA. I made it a TZ-IV, identical to the Gladiator, to keep the game less complicated. As you can see, except for the auto cannon, they are identical. 7) Leg missiles by Biforze. 8) Tomahawk used by the U.N. SPACY and local Earth governments.

Gladiator/Spartan

1) The original Japanese name for the Gladiator was the Spartan MBR-07-MK II. 2) The TZ-IV gun cluster is manufactured by ASTRA. 3) The hands are called crow hands (crowbar hands?).

The M.A.C. II/Monster

1) The original Japanese name for the M.A.C. II was the Monster HWR-00-MK II (HWR=howitzer?). 2) The main engine was a Galland (?) WT 1001 Thermonuclear Reactor; output = 11,500 SHP. 3) Secondary engine was a heavy industrial CT8P Thermonuclear Reactor; output = 890 SHP. Manufactured by Shin-Nakasu. 4) The four guns are 40cm, air-cooled, liquid fueled cannons. 5) The arm weapons were LSSN-20N Triple-Barrel, anti-ground missile launchers. 6) *History:* Began designing in December 2000 A.D.; construction of research model began October 2005 A.D.; with the first working model September 2008 A.D. At the time of the SDF-1's launching, only two working Monsters had been built. 7) The MK-1 prototype did not have the missile launcher arms, but these were added after combat tests.

Raidar X/Defender

1) The original Japanese name for the Raidar X was the Defender ADR-04-MK X. 2) Main engine manufactured by Clance Fay. 3) Has a secondary engine, an EM-10T Fuel Dynamo; output = 510kw. Manufactured by G.E. 4) Only weapon system were two pair of rapid fire, 78mm, air-cooled auto cannons called Dual Type 966-PFG; manufactured by Contrabess. 5) There is actually little about the radar of sensor antenna other than "radar system." 6) Used by the U.N. SPACY and local Earth governments such as the USA and Canada. 7) The upper half of the Defender/Spartan was seen mounted at the waste as gun turrets on the SDF-1.

Spartan/Phalanx

1) The original Japanese name for the Spartan was the Phalanx SDR-04-MK XII. 2) Main engine manufactured by Clance McFay. 3) Has a secondary engine; a CT-03 Fuel Dynamo, Output = 970 kw. 4) Appears to hold only one pilot.

MISCELLANEOUS EARTH SPACECRAFT

The Lancer I

There is very little actual data on this particular space vehicle, which is seen in fleeting glances in one episode of the animated series. What is known is 1) It is a space vehicle. 2) It launches 18 missiles. 3) It fires some sort of energy weapon. 4) We have presumed that this is the Lancer I because there is definite mention of a "manned" Lancer vehicle being part of the A.R.M.D. Space Platform's assault fleet.

The Lancer II

We were unable to find much data, even through translations of Japanese text, about this vehicle. The following is definite: 1) Unmanned drone. 2) Equipped with "large-sized, twin machine (auto) cannon and targeting radar." 3) Used solely in outer space. 4) Part of the A.R.M.D.-01-2 Space Platforms' defense, assault system. 5) Presumably, about one dozen of these drone space cannons were housed in each of the Armor (A.R.M.D.) Space Platforms.

The A.R.M.D. Space Platform

Our translations provided interesting fragments of data, but lacked real hard data for such things as size, dimensions, speed and exact weapon systems. The following data was unearthed and incorporated in the preceding text. 1) A.R.M.D.-01 (specifically) carrier spaceship. 2) 174,000 tons, operating inertial mass. 3) Gravitational Control System of Robotech/protoculture nature. 4) Motive power system; Robotech, advanced heat-pile system. 5) Rocket propelling system; Robotech "main nozzle cluster OTMN-3T" (2) with Vernea Thrusters (many). 6) Robotech, "guided converging beam cannon system" (5). 7) *Many* small sized anti-aircraft guns, six medium sized, self guided, anti-warship, missile launchers; and two anti-planetary, anti-warship missile launchers. 8) Specific aircraft listed were the seventy-eight SF-3A Lancer II and two hundred seventy "all condition, unmanned fighter QF-3000E Ghost". 9) What I call the Space Cannon SPC-II is an unmanned drone fighter that appears to have been used exclusively by the A.R.M.D. carrier. Exact numbers could not be found. 10) A.R.M.D. Carrier Spaceship was developed by the United Space Forces, Space Weapons Plant.

SDF-2

1) Began construction at the underground plant of the United World, Apollo Lunar Base in the year 2003 A.D. 2) Completion goal date: 2013 A.D. Expected to go into service in 2014 A.D. 3) "Considerably larger than the SDF-1." 4) Engine: "Over Technology (Robotech), Macross Heat Pile System" (identical to the engine on the SDF-1). 5) "Fold System Cluster", Gravitational Control Systems, Super Periodic Flight System and thrusters; all use the new, alien "Over Technology" (Robotech). 6) Included: "many new systems." 7) Built on the moon to take advantage of the much weaker gravitational forces. 8) Totally self-sufficient. 9) Name . . . Megalode (?) or Megalord (?).

SDF-1

Most of the data in the SDF-1 section is accurate. As with most of the Japanese source material there is an absence of hard, complete details.

THE ZENTRAEDI

The Zentraedi Race/History

1) The Zentraedi are apparently a warrior race, genetically designed and cloned for war. By whom is not clear. Perhaps they clone themselves. 2) They are apparently part of "the Galactic Empire." 3) Most of the Battle Cruisers, Battle Pods and Power Suits (combat armor) were developed for, and during, the *Divisive War*. 4) Most of these instruments of war are ancient, with no further improvements since "500,000 periods ago." 5) It seems the *Divisive War* of the Galactic Empire ended about 500,000 periods ago. 6) There were hundreds of millions of fully automated manufacturing plants scattered throughout the universe, so that they could not all be destroyed in a few attacks. 7) "The *Glaug* (Officer's Battle Pod), *Automated Production System* had been destroyed 280,000 periods ago during the full-scale attack on the *Roycommi Weapons Plant of the Inspection Forces*. From then on the *Glaug* slowly decreased in number and is presently (2009 A.D., Earth time) relatively uncommon. **Kamjin** (*Khyron*) privately owns three, almost brand new *Glaug/Officer's Pods* that were found in a weapon's shelter and taken out only 3700 periods ago. 8) There is mention of, "The Inter-Planetary Republic breaks up. War begins between the Inspection Group and Zentraedi Group." 9) There is no mention of the Robotech Masters which is an element in the American version.

The Zentraedi Tactical Battle Pod

1) Japanese name for pod is the *Regult*. 2) Engine is of Esbelliben manufacture and is a Thermonuclear Reactor; output = 1.3 GGv. 3) Developed and produced by Esbelliben, Number 4432369, Zentraedi Fully Automated Weapons Plant. 4) There are about 300 million other automated weapons plants which mass produce the *Regult*. This makes it impossible to stop the flow of *Regults* to the battle front by destroying the factories. 5) Each infantry soldier is equipped with one. 6) Easy to operate, but working the legs is tiring; worse than walking. 7) The *Regult Tactical Battle Pod* is a standard Zentraedi weapon.

The Zentraedi Recon Scout Pod

1) Japanese name for the Pod is the *Regult Tactical Scout*. 2) Esbelliben thermonuclear reactor for engine. 3) Developed and remodeled at Ectromeria, Number 979972010, Zentraedi Fully Automated Weapons Plant. 4) Design based on the combat *Regults* 5) In addition to radar, it utilizes a detection device referred to as the "Visible Ray Sensing System." Unfortunately, no data is provided. 6) Sensing capabilities can *not* be considered superb. 7) Unarmed; requires the escort of the combat *Regult*. 8) All-directional radar system is the main detection system. 9) Also mentions a "standard", long-range laser sensor.

The Zentraedi Officer's Battle Pod

1) Japanese name for the Pod is the *Glaug* combat pod for officers. 2) Engine: Roycommi thermonuclear reactor; output = 3.9 GGv. 3) Developed and produced by Roycommi, Number 330048902, Automated Weapons Plant. 4) Battle tested and proven. 5) *Khyron* personally had three Officer Pods.

Protoculture

The only mention of protoculture we could find in our rather limited translations, comes from the time-line originally published in *Memory Perfect*. 1) 500,000 B.C. begins the first year of the protoculture calendar. 2) First colonization of protoculture beings in space (could this refer to the Robotech Masters or Invids?); 2400 P.C. (protoculture calendar). 3) Second colonization of protoculture beings in space. Use of Fold Flight System in their ships, in the year 2700 P.C. (about 400,000 B.C.). 4) Establishment of the Interplanetary Republic; 2800 P.C. 5) Investigation ship of the protoculture beings visit Earth (Robotech Masters or Invid? I presume the former) in the year 3000 P.C. 6) In the year 25,000 P.C. (about 380,000 B.C.), 22,000 P.C. years after the war between the Inspections Group and the Zentraedi begins, the translation states: "Extinction of the protocultures." This is the last mention of protoculture in the rather lengthy time-line that continues. Does this refer to the so-called "protoculture beings" or protoculture itself? **Remember**, it appears that protoculture was *never* defined in the Japanese series and is *not* as important an aspect to that series as it is in the American version. Protoculture has been elaborated and extrapolated upon by Carl Macek, which makes it a pivotal catalyst in the English language version. The theme of protoculture and the Robotech Masters is cleverly developed and interwoven to tie together the other two series, Southern Cross and Mospeada, as well as, the thrust for the new series, Sentinels, currently in production.

Robotechology

The term and concepts of Robotechology which utilizes protoculture, a sort of bio-energy, is the development of Carl Macek. The original Japanese story has nothing of the sort. The crashing of the SDF-1 does introduce technological advancements, and there are many references to the new, alien or "Over" Technology, but it is clearly *not* protoculture or Robotechology. The numerous translations of Mecha and vehicles, all refer to conventional types of nuclear reactors, engines and weapons. *For example*, the *Regult* and other Battle Pods are powered by a thermonuclear reactor.

Robotech Masters

There is *no* mention of the Robotech Masters. The concept and development of the Robotech Masters, and their relationships with humans, Invids and Zentraedi, are of American origin, created, in part, to tie together the three, *unrelated* animated series: **Macross**, **Southern Cross**, and **Mospeada**. The other reason was to create an epic Science Fiction story, the likes of which has never been attempted on American television. Many fans of the **original Macross** series do not seem to realize that the show was, basically, a war story set in the future with emphasis on the personal trials and tribulations of our heroes. It was the original **Macross** series that started the transformable robot craze. However, much of the science fiction subplots and overtones have been added for American T.V.

A Note About The Macross Movie: The gorgeous, **Macross the Movie**, made in Japan (not the American release, which is entirely different, *Megazone 23*), has very little to do with the original T.V. series. Briefly, the T.V. series, **Macross**, was a phenomenon in Japan that created a wave of imitators in Japan and abroad. To capitalize on the demand of fans, a group of Japanese businessmen produced the movie version. Unfortunately, they were more concerned with the unique visuals of the Mecha, and series in general, than in continuity or story. The result is a beautifully animated movie that recounts a twisted version of the original T.V. show. It is not the so-called "real" version. Despite reports to the contrary, the American T.V. series is an edited, somewhat rewritten version of the Japanese T.V. show, and has *not* been redrawn or has new film added to it.

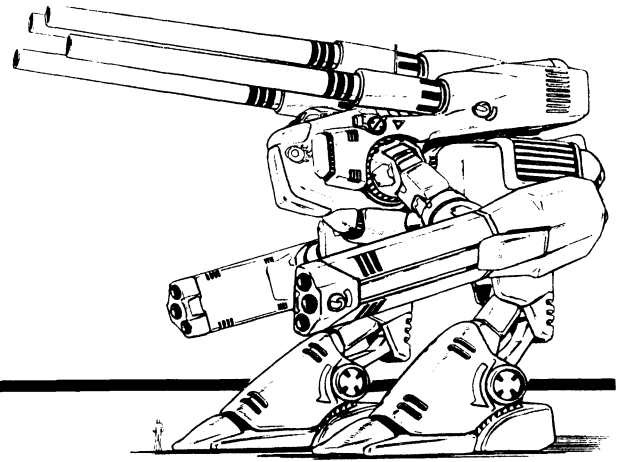

THE ROBOTECH™ CHARACTERS

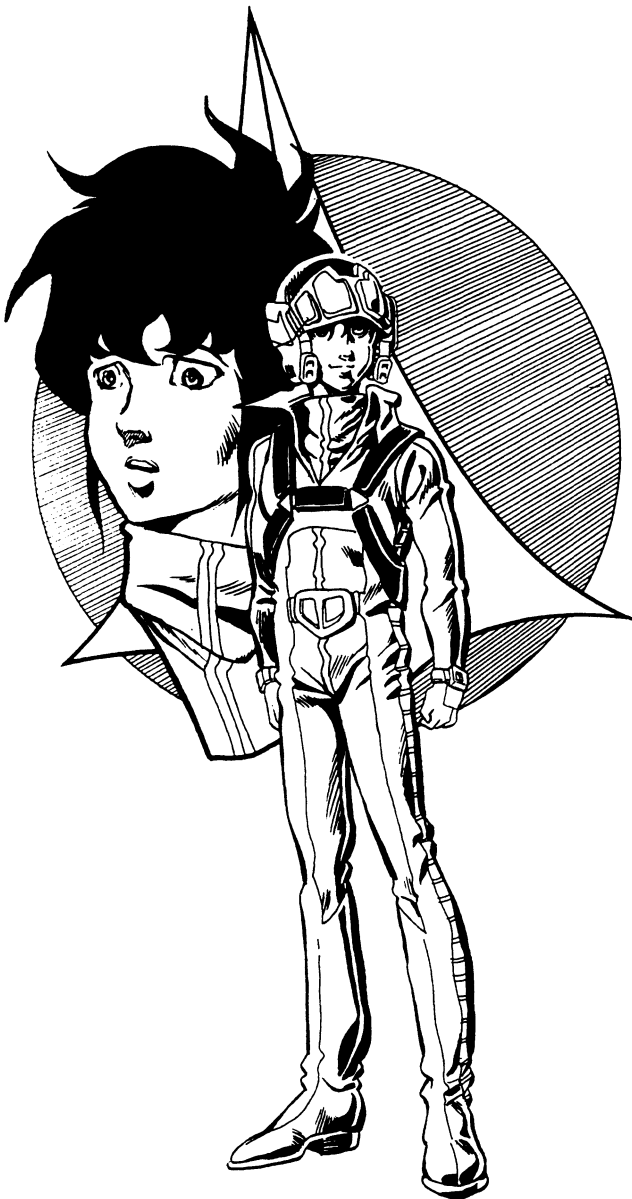

Rick Hunter — Veritech Pilot

Pilots a VF-1S

Hit Points: 49 **S.D.C.:** 20

Alignment: Scrupulous

Attributes: I.Q. 12, M.E. 15, M.A. 13, P.S. 15, P.P. 18, P.E. 14, P.B. 16, Spd 14

Age: 19 at the beginning of *Macross*; 23 at its end.

Weight: 140 **Height:** 5ft 6 inches

Disposition: Honest, caring, responsible, courageous, dedicated.

Level of Experience: Seventh Level Veritech Pilot at series end.

Skills: Mecha Combat (Veritech Fighter), Mecha Combat (Gladiator), Weapon Systems 95%, Read Sensory Instruments 90%, Navigation 98%, Pilot Veritech Fighter 98%, Pilot Jet 98%, Pilot Airplane 98%, Pilot Automobile 98%, Hand to Hand: Expert, Swimming 98%, Prowl 75%, W.P. Sub-Machinegun, W.P. Automatic Rifle, Radio: Basic 85%, Aircraft Mechanics 85%, Mecha Mechanics 80%, Navigation: Space 98%, Computer Operation 98%.

Rank: Lieutenant Commander and squadron leader of the Veritech Skull Squadron by the end of the series. *Currently Major General.*

Personal Profile: Rick's love for flying begins as a child. He is encouraged by his father, uncle and best friend, Roy Fokker, and the other members of "*The Hunter Brother's Aerial Circus.*" After Roy leaves the aerial show to join the military, Rick takes his place and becomes an excellent amateur pilot, winning trophies seven years in a row. The two friends are reunited when Roy Fokker, now a member of the Robotech Defense Force, invites Rick to the trial launching of the SDF-1. That festive occasion turns into a nightmare as Rick and all the people of Macross City, and the world, are sucked into intergalactic war with the giant, Zentraedi aliens.

Throughout the conflict, Rick struggles with his inner feelings in regard to his role in the war. Over the next few, war-torn years, Rick grows as a skilled Veritech pilot as well as a person. The sobering experiences of war, death of loved ones and consequences of one's actions, mold Rick Hunter into a courageous and strong leader. A role he reluctantly accepts. At the series' end, Rick and his love, Lisa, stand before the ruin of the SDF-1 and vow to see an end to this war. Ah, but our story does not end there.

Rick is now *Major General* Rick Hunter, charged with the rebuilding and revitalization of the Robotech Defense Force (RDF). In addition, the RDF must suppress Zentraedi rebels and keep peace in a war struggling to survive. His wife, Rear Admiral Lisa Hayes (Hunter), oversees the top secret construction of the SDF-3. A project that will ultimately send Rick and Lisa on an epic adventure among the stars.

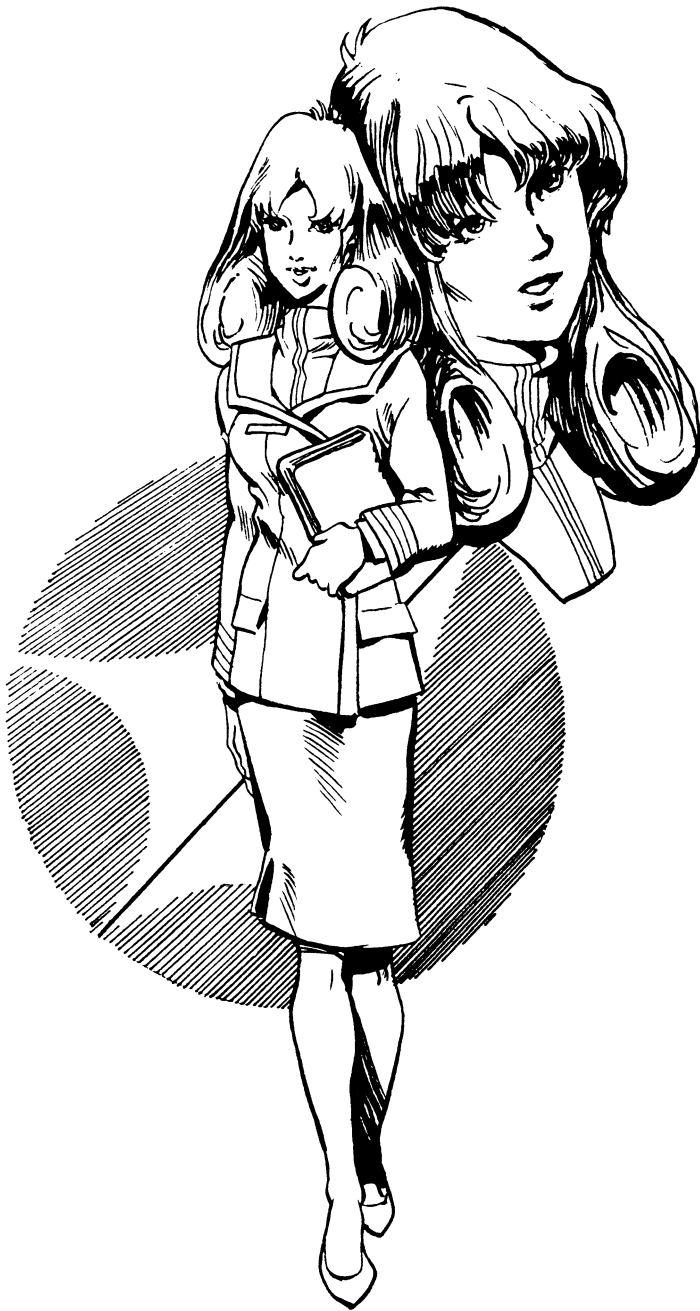

Lisa Hayes — Communications Officer

First Officer aboard the SDF-1

Hit Points: 60 **S.D.C.:** 15

Alignment: Principled

Attributes: I.Q. 14, M.E. 17, M.A. 9, P.S. 10, P.P. 12, P.E. 12, P.B. 12, Spd 10

Age: 24 at the beginning of Macross; 28 at its end.

Weight: 115 **Height:** 5ft 9 inches

Disposition: Cool, self-reliant, dedicated, courageous, somewhat withdrawn, a loner.

Level of Experience: Tenth Level at series end.

Skills: Radio: Basic 98%, Radio: Scramblers 98%, Radio: Satellite Relay 98%, Laser Communications 98%, Surveillance Systems 98%, Computer Operation 98%, Optic Systems 98%, Weapon Systems 98%, Cook 98%, Dance 98%, Basic Electronics 95%, Computer Programming 95%, Navigation 98%, Navigation: Space 98%, Math: Basic and Math: Advanced 98%, Pilot Jet 98%, Pilot Airplane 98%, Pilot Automobile 98%, Pilot Truck 98%, First Aid 98%, Swimming 98%.

Rank: Lieutenant Commander during the series. *Currently Rear Admiral Hayes.*

Personal Profile: The daughter of Admiral Hayes, Lisa grew up a navy brat. She joined the Space Corps in hope of being stationed on Mars Base with her fiancé, Karl Riber. Instead, Lisa was assigned to the SDF-1 as first officer, in charge of all ship's operations including communications and defense pattern of the Veritech Fighter Squadrons. Tragically, her fiancé died when the Zentraedi annihilated Mars Base Sara.

Eventually, Lisa falls in love with Rick Hunter. It is a romance filled with endless complications and missed opportunities. Finally, in the last episode of the Macross series, Rick realizes he loves Lisa and not his lovely friend, Lynn Minmei.

Rick and Lisa marry, and together continue their struggle to bring lasting peace to the war-torn planet Earth. Now a Rear Admiral, it is Lisa's job to help construct the top secret SDF-3. She is aided in this endeavor by Zentraedi Commander Breetai and his Minister of Affairs, Exedor. It is a project that will send Lisa, Rick, Breetai and others, on a space odyssey of epic proportions.

Lynn Minmei — Professional Singer

Civilian

Hit Points: 22 **S.D.C.:** None

Alignment: Unprincipled

Attributes: I.Q. 11, M.E. 12, M.A. 24, P.S. 8, P.P. 10, P.E. 10, P.B. 18, Spd 9

Age: Almost 16 at the beginning of the series, nearly 20 at its end.

Weight: 96 **Height:** 5ft 2 inches

Disposition: Immature, perceptive, cheerful, somewhat self-absorbed; a loyal friend.

Level of Experience: Civilian/Professional Singer, Fifth Level.

Skills: Cook (professional quality) 98%, Dance 70%, Sing (professional quality) 98%, First Aid 80%, Pilot Automobile 98%, Basic Math 98%.

Personal Profile: Lynn Minmei becomes the darling of the crew and refugees living aboard the SDF-1. Her natural good looks, girlish charm, and charisma, combined with her excellent singing voice, turn her into a major celebrity on the battle fortress. Ironically, her singing has an overwhelming influence on the Zentraedi who have never heard singing and actually becomes part of the strategy which defeats them.

Minmei is part of the romantic triangle with Rick Hunter and Lisa Hayes. While her innocent flirtations and immaturity are a constant frustration to Rick, the two become good friends who care deeply for one another.

After the final battle with Khyron, Minmei spends her time as an ambassador of good will, boosting morale as she always has. On a trip to the Far East Sector, she meets Janice Voss, an acquaintance of Dr. Emil Lang. A friendship grows quickly between the two entertainers and a partnership is formed. Minmei hopes to bury, once and for all, any feelings of love she may have had for Rick Hunter.

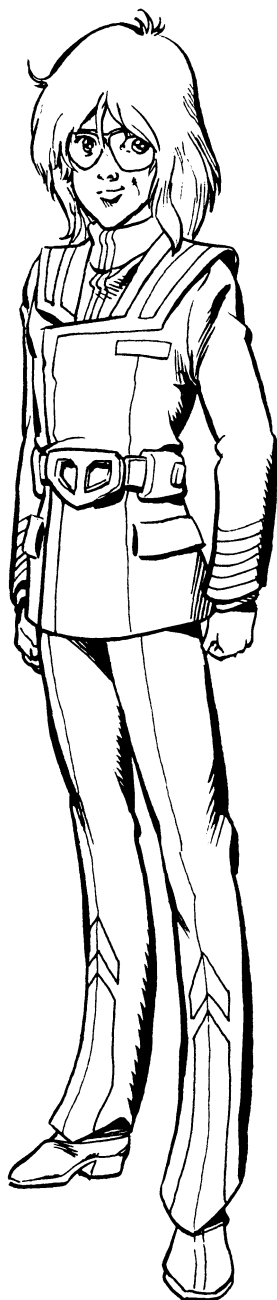

Max Sterling — Veritech Pilot Ace

Pilots a VF-1J

Hit Points: 36 **S.D.C.:** 20

Alignment: Scrupulous

Attributes: I.Q. 14, M.E. 18, M.A. 11, P.S. 12, P.P. 22, P.E. 13, P.B. 9, Spd 13

Age: 19 at the beginning of Macross; 22 at its end.

Weight: 150 **Height:** 5ft 10 inches

Disposition: Confident, bold, daring, fearless, loyal and trustworthy; very sharp, aware and clever.

Level of Experience: Sixth Level Veritech Pilot at series end.

Skills: Mecha Combat (Veritech Fighter), Weapon Systems 95%, Read Sensory Instruments 85%, Navigation 98%, Pilot Veritech Fighter 98%, Pilot Jet 94%, Pilot Helicopter 94%, Pilot Automobile 98%, Hand to Hand: Expert, Swimming 98%, W.P. Automatic Pistol, W.P. Energy Rifle, Radio: Basic 80%, Dance 64%, Basic Electronics 70%, Mecha Mechanics 75%, Veritech Mechanics 60%, First Aid 96%, Basic Math 98%, Advanced Math 84%, Navigation: Space 98%.

Rank: Lieutenant and Ace of the Skull Squadron by the end of the series.

Personal Profile: Max Sterling is one of the many young men from Macross City to enlist in the RDF. Max is a natural! His technique is pure perfection when it comes to flying and fighting in the Veritech Fighter. Skilled in electronics and mechanics, Max personally sees to it that his Veritech is at peak efficiency. He's also made some "special" adjustments which makes his Veritech Fighter a little more versatile and maneuverable (+1 to parry, dodge and roll). As is customary with aces in the RDF, he is allowed to customize (cosmetic changes) his VF-1J. All of these special additions has caused his Veritech to be dubbed "The Max Type".

Max falls in love with a micronized Zentraedi ace, and their marriage becomes the first Human/Zentraedi marriage in space; a widely publicized event. Max, Miriya and their first child, are among the survivors of the first Robotech Wars and Khyron's final battle.

Shortly after the destruction of the SDF-1 and SDF-2, Max is promoted to Commander of the *Skull Squadron*, with Miriya becoming Lt. Commander. Both are charged with the grim task of suppressing or destroying all hostile Zentraedi and are assigned to the South American Sector, a hotbed of Zentraedi aggression. The new base of operations for the famous Skull Squadron is in South America near Argentina.

Miriya Sterling — Veritech Pilot Ace

Micronized Zentraedi Female Officer

Pilots a VF-1J (currently is second in command of the Skull Squadron).

Hit Points: 54 **S.D.C.:** 37

Alignment: Scrupulous

Attributes: I.Q. 15, M.E. 11, M.A. 14, P.S.:45, P.P. 21, P.E. 14, P.B. 15, Spd 11

Age: 27

Weight: 130 **Height:** 5ft 10 inches

Disposition: Tough, capable, cool and clever. Completely loyal to the RDF, Max and her friends.

Level of Experience: Seventh Level Military Specialist and equal to a Fifth Level Veritech Pilot

Skills: Pilot All Battle Pods and Power Armor (female), Mecha Combat with All Pods, Mecha Combat Power Armor, Weapons Systems (Zentraedi) 98%, Read Sensory Instruments 98%, Radio: Basic 98%, Hand to Hand: Expert, Interrogation 98%, Detect Ambush 98%, Climbing 98/70%, Body Building, Operate Computer 98%, W.P. Energy Pistol, W.P. Energy Rifle, Basic Math 98%, Pilot Shuttle 98%

Human Skills Include (all are at fifth level) Dance 70%, Sew 65%, Pilot Mecha (Veritech), Mecha Combat (Veritech) 85%, Weapon Systems (Earth), Pilot Jet 80%, W.P. Knife, W.P. Revolver.

Rank: Zentraedi Captain; RDF Lt. Commander.

Personal Profile: Miriya was the ace pilot of the Zentraedi flotilla commanded by Azonia. It is the assault of Power Armor (female) units lead by Miriya that is responsible for the death of Roy Fokker. During this same assault, Miriya engages in close combat with Max Sterling. The contest is, at best, a draw. Obsessed with beating the human's ace (Max), she subjects herself to the micronization process to seek Max out and kill him. Instead, the two fall madly in love and marry.

Miriya has rejected her Zentraedi heritage, joined the RDF and is among the most loyal of the Zentraedi defectors. She will gladly die fighting, to protect her friends, family and new found world from any evil that threatens.

Miriya has been assigned to the Skull Squadron as Max's second in command to ferret out all traces of hostile Zentraedi warriors. This has placed them in the dangerous South American Sector, also known as the Zentraedi Control Zone.



Khyron — Zentraedi Officer

Zentraedi Male Officer

Hit Points: 2900 or 29 M.D.C. **Physical S.D.C.:** 4000 or 40 M.D.C.

Alignment: Miscreant

Attributes: I.Q. 14, M.E. 9, M.A. 8, P.S. 20 (2000, can inflict 5 M.D. points with fists), P.P. 19, P.E. 14 (1400 hit points/14 M.D.C.), P.B. 17, Spd 12 (120).

Note: The numbers in parenthesis are the Zentraedi statistics. Khyron NEVER allowed himself to be micronized.

Age: 15 (since emergence from the clone chambers)

Weight: 16,000 pounds (8 tons) **Height:** 54ft

Disposition: Cocky, arrogant, vindictive, treacherous; megalomaniac.

Insanity: Obsessed with the destruction of the SDF-1. Also loathes humans in general.

Level of Experience: Fourth Level Military Specialist.

Skills: Pilot Mecha (all Battle Pods), Mecha Combat (all Battle Pods), Mecha Combat (Officer's Pod), Weapons Systems 98%, Read Sensory Instruments 80%, Hand to Hand: Expert, W.P. Energy Pistol, W.P. Energy Rifle, W.P. Blunt, Radio: Basic 80%, Radio: Scramblers 60%, Paramedic 70%, Pilot Jet 76%, Body Building, Wrestling, Computer Operation 80%.

Rank: Zentraedi Warlord.

Personal Profile: Khyron and Azonia die in a suicide run into the helpless SDF-1 (the last Macross episode). I have included Khyron for those of you who intend to recreate the original Macross saga.

Khyron is the most insidious warlord in the entire fleet. He is a glory-hungry, opportunist who will stop at nothing to achieve his goals. Self-centered and supremely arrogant, he expresses only contempt for his superiors and views the quest for the SDF-1 as a waste of time. Repeatedly thwarted and embarrassed by the SDF-1, Khyron grows to hate the "micronians" and becomes obsessed with the destruction of the SDF-1.

He is extremely rash, making him unpredictable. Hot headed and cold hearted, Khyron is a deadly foe.

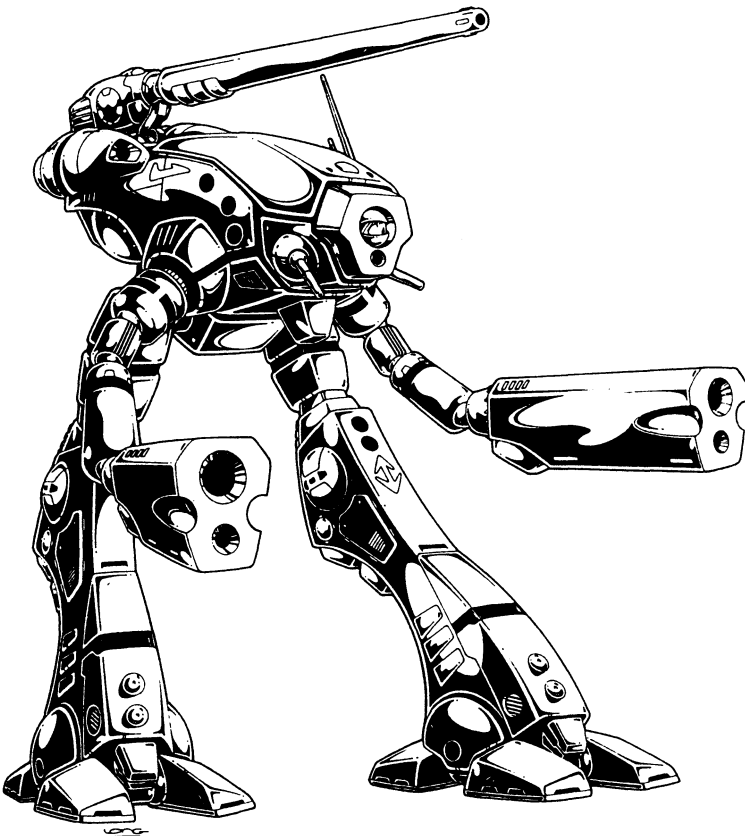

THE SDF-1/SUPER DIMENSIONAL FORTRESS

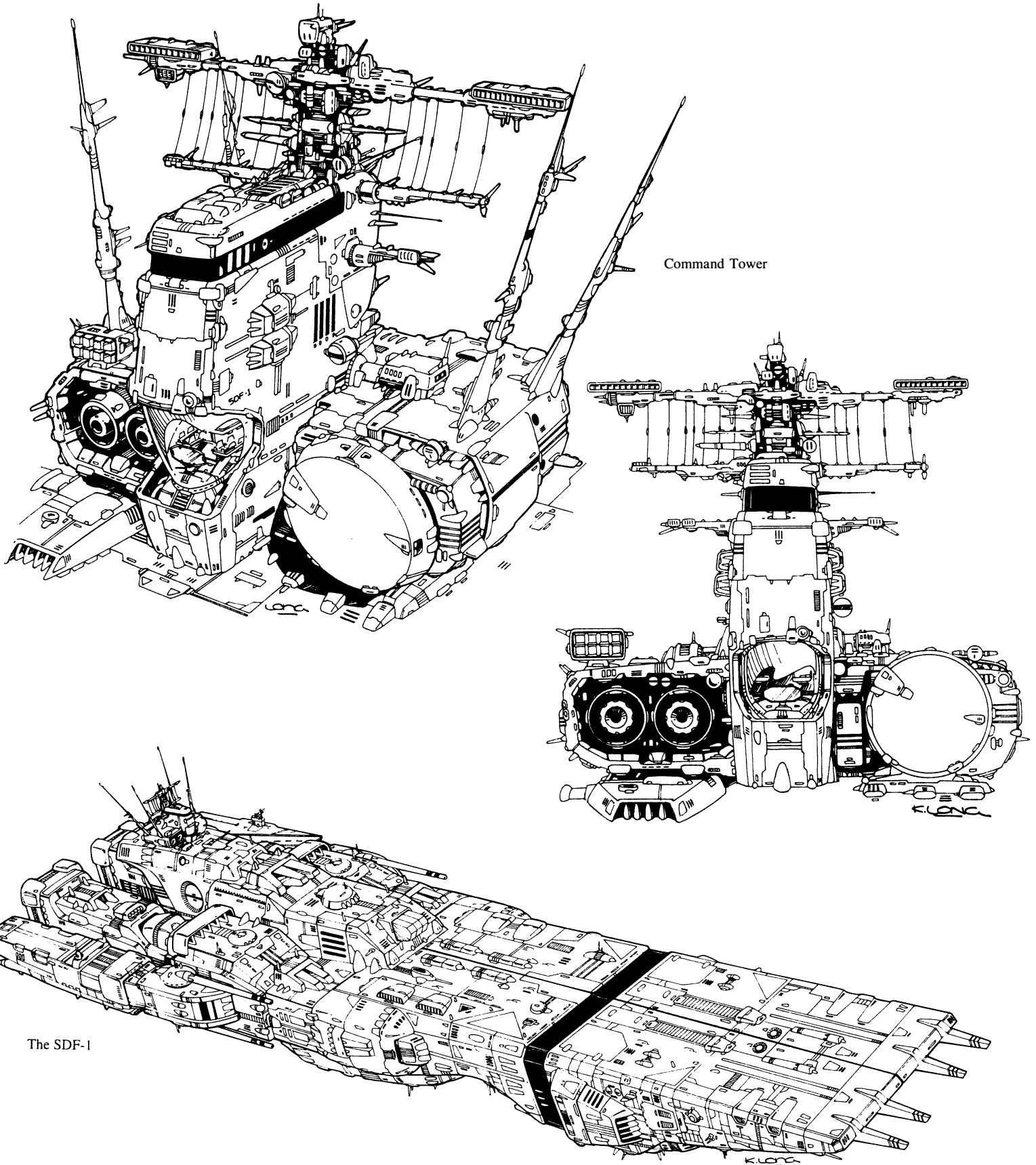

Even though the SDF-1 and SDF-2 are destroyed by the obsessed Khyron and Azonia, I have included it for those who wish to recreate the original Macross saga or extrapolate the SDF-3 for their own series of space adventures. The information presented is as accurate as possible.

The SDF-1 is the reconstructed spacecraft of Zor, the creator of Robotechnology. In the shattered hulk of the alien vessel, the humans were able to gather enough information to achieve great technological advancements. The Destroids and Veritech Fighters were the first triumphs of this new "Robotechnology". The crowning achievement was the complete reconstruction of the spaceship itself, the SDF-1.

The SDF-1 retained the rudimentaries of its original design, but many changes and modifications were made. Some were made out of necessity, like the additions of the two battleships, Daedalus and Prometheus, as the arm-like appendages. Likewise, the inclusion of the civilian populace of Macross Island was an unplanned modification. Other modifications were added as new discoveries were made. The Pinpoint Barrier System was one that was later developed into a full force-field that could encircle the entire battle fortress. Its most unique feature was the Modular Transformation, which would allow it to conform to the most appropriate form needed for the combat situation.

The Battle Fortress also has Destroid, Veritech, and other complete manufacturing facilities on board. Thus, Mecha can be repaired and constructed on the SDF-1.

Vehicle Type: Space/Battle Fortress

Crew: 800, plus 1200 military personnel; 70,000 civilians were also added to the complement on the SDF-1.

M.D.C. by Location:

- Main Rocket Thrusters (2) — 6000 each
- Command Tower — 6000
- Prometheus (arm) — 3000
- Daedalus (arm) — 3000
- Leg-Like Sections (2) — 6000 each
- Small Guidance Thrusters (36) — 400 each
- Sensory Tuner (top of command tower) — 1000
- Main Body (center) — 12,000

Main Armaments:

- The Main Gun Reflex Cannon (1) — 6000
- Reflex Beam Cannons (8) — 600 each
- Rail Cannons (4) — 1500 each

Secondary Armaments:

- Long Range Missile Launchers (12) — 500 each
- Medium Range Missile Launchers (48) — 200 each
- Dual Barrel Auto Cannons (48) — 150 each
- High Powered Laser Cannons (48) — 150 each

Additional Combat Systems:

- Destroids: Excaliber (36)
- Gladiator (24)
- Raidar X (72)
- Spartan (56)
- M.A.C. II (24)
- Veritechs: VF-1A (200)
- VF-1J (50)
- VF-1S (40)
- Armored (6)
- VT-1D (12)

Note: The original complement of Veritech Fighters were: 120 VF-1A, 30 VF-1J, 20 VF-1S, and 12 VT-1D trainers.

Length: 3600ft (1200m)

Weight: 18,000,000 tons

Main Engines: Reflex, heat pile system cluster.

Rocket Propelling System: 3 thruster cluster.

Gravitational Control System (failed when first engaged).

Fold System (disappeared after its first use).

Weapon Systems

Anti-Space Cruiser Weapons

1. The Main Gun/Reflex Cannon. This is part of the original Robotech Master weapon restored. It does devastating amounts of damage, but draws so much energy that it can only fire once every ten minutes. The original SDF-1 design was slightly flawed, which meant that many times the gun could not fire at all, or fired once and only once. When the Pinpoint Barrier

or force field is engaged, the main gun can *not* fire. Also, because of irreparable damage from the disappearance of the fold system, the reflex cannon can only fire in the Battloid-like mode.

Primary Purpose: Assault

Secondary Purpose: Anti-Warship

Mega-Damage: Absolutely destroys *EVERYTHING* in its path of fire. That's an energy beam approximately two miles (3.2km) wide and 60,000 miles long.

Range: 60,000 miles (96,480km)

Rate of Fire: Once every two minutes. After the first shot, roll on the following table for *each* shot to follow.

- 1-25 Energized and ready to fire.
- 26-50 Requires an additional ten minutes to recharge.
- 51-75 Requires an additional twenty minutes to recharge.
- 76-00 Will not fire; needs 24 hours to recharge.

Payload: Unlimited

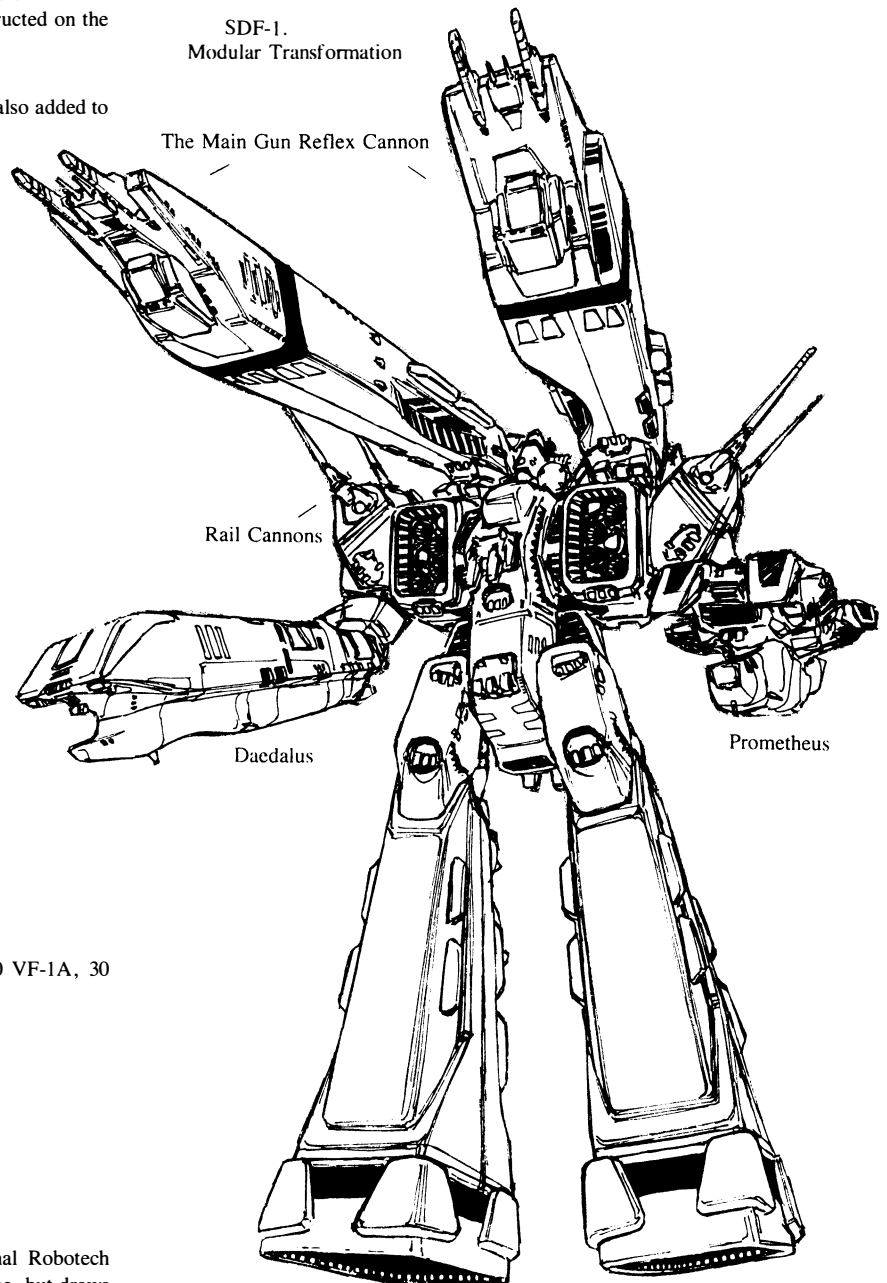

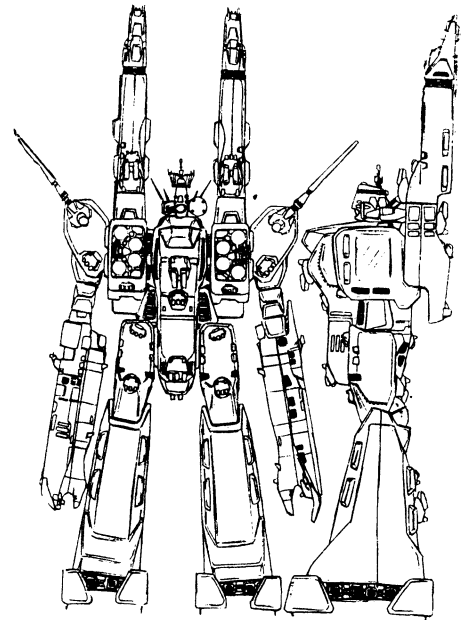
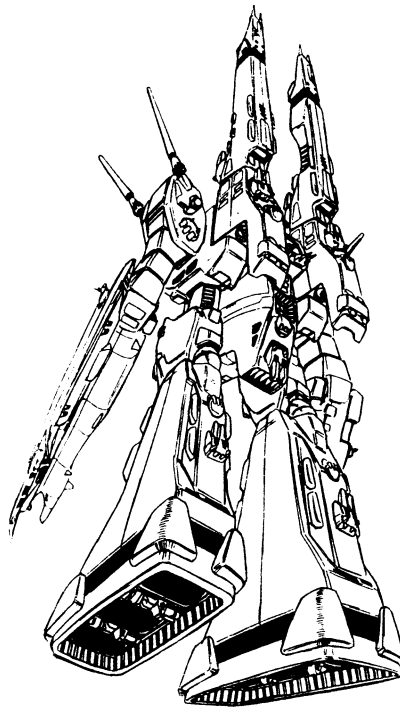
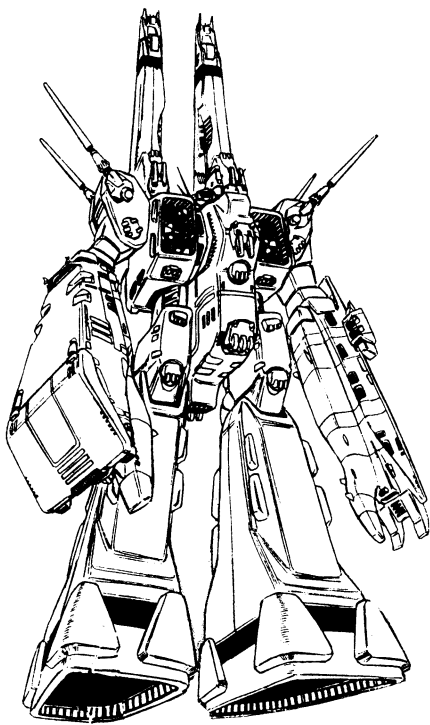

2. Reflex (Robotechology), Guided Converging Beam Cannons are scattered across the SDF-1. These *eight cannons* are similar to the big guns of the Zentraedi battle cruisers.

Primary Purpose: Assault
Secondary Purpose: Defense/anti-warship
Mega-Damage: 1D4 × 1000 M.D. per blast
Range: 16 miles (25km)
Rate of Fire: Each of the eight cannons can fire FOUR times per melee.
Payload: Unlimited

3. Reflex, Ultrahigh Speed Electromagnetic Rail Cannons are mounted on what appears to be the shoulders of the SDF-1.

Primary Purpose: Assault
Secondary Purpose: Defense/anti-warship
Mega-Damage: 3D4 × 100 per blast
Range: 16 miles (25km)
Rate of Fire: There are *FOUR* Rail Cannons, *each* can fire 8 times per melee.
Payload: Unlimited

SECONDARY ARMAMENTS

1. Long Range Rocket Launcher: A *dozen* of these large missile launchers are scattered across the ship.

Primary Purpose: Defense
Secondary Purpose: Anti-Warship/anti-missile
Mega-Damage: Varies with missile type, but these missiles are always armed with the most lethal warheads, including: *Reflex, Multi-Warhead, Proton Torpedoes, Reflex Heavy, and Plasma* (usually in that order of preference).
Range: Varies; usually about 1000 miles.
Rate of Fire: Each of the twelve fire volleys of 2, 4, 6 or 8. Requires 2 melees to reload.
Payload: Unlimited

2. Medium Range Missile Launchers: *Four dozen* of these are scattered across the ship.

Primary Purpose: Defense
Secondary Purpose: Anti-Aircraft/anti-missile
Mega-Damage: Varies with the missile type, but usually the deadliest are deployed. That's likely to include High Explosive, Plasma, and Multi-Warhead.
Range: Varies, but usually about 40 miles (64.3km)
Rate of Fire: Volleys of 2, 4, 6 or 8. Requires 2 melees to reload.
Payload: Unlimited

3. Dual Barrel, 40cm, Auto Cannons, similar to those mounted on the M.A.C. II Destroid, are placed strategically over the SDF-1. *Approximately 48 in all.*

Primary Purpose: Defense/anti-aircraft

Mega-Damage: Volleys of two (one round fired from each barrel), doing 2D4 × 10 M.D.

Range: 12 miles (19.3km)

Rate of Fire: Four volleys per each cannon. Requires 2 melees to reload.

Payload: Unlimited

4. High-Powered Laser Cannons placed across the entire vessel. *Approximately 48 in all.*

Primary Purpose: Defense/anti-aircraft

Secondary Purpose: Anti-Personnel

Mega-Damage: 1D4 × 10 per blast

Range: 4000ft (1200m)

Rate of Fire: Four times per each Laser Cannon.

WEAPONS COMBAT SUMMARY

Total Attacks Per Melee number nearly 1000 with all systems engaged.

Main Gun/Reflex Cannon: Total destruction; Range: 60,000 miles

Reflex Beam Cannons (8): 1D4 × 1000 M.D.; Range: 16 miles (25km)

Rail Cannons (4): 3D4 × 100 M.D.; Range: 16 miles (25km)

Long Range Missile Launchers (12): Damage and Ranges vary.

Medium Range Missile Launchers (48): Damage and Ranges vary.

Dual Auto Cannons (48): 2D4 × 10 M.D.; Range: 12 miles (19.3km)

Laser Cannons (48): 1D4 × 10; Range: 4000ft (1200m)

Additional Weapons:

Destroids and Veritech Fighters.

If the GM should engage in battleship to ship combat (no such rules are provided here, but *may* appear in the *Zentraedi supplement*), he/she should probably lump the weapon systems' total attacks per melee as one. Reducing rolls significantly. Even this is a poor alternative. The GM would do best to engage in one on one combat.

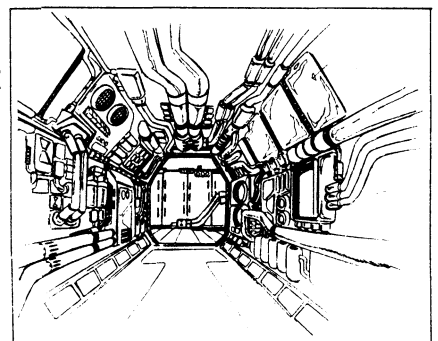
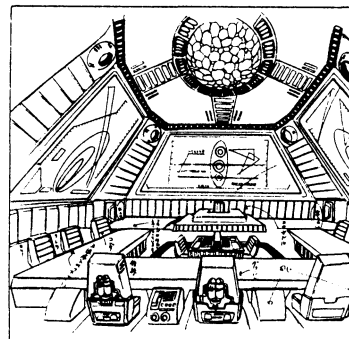

Robotech® RPG

Based on the animated TV series that has thrilled generations

The Robotech® RPG and sourcebooks in this series are ALL completely new and rewritten. They are NOT reprints of the Robotech® titles from the 1980s and 1990s. Each contains new rules, stats, descriptions, characters, and a wealth of new information!

Based on the fan-favorite television show, the Robotech® RPG enables players to experience adventures in any or all eras and generations of the Robotech® saga. Fast character creation and anime action.

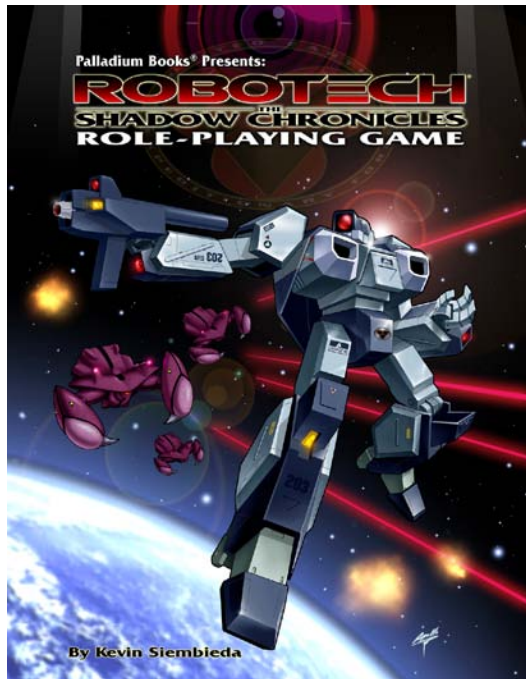

Robotech®: The Shadow Chronicles® Hardcover RPG

The core rule book, it contains everything you need to play except imagination, dice and friends. Newcomers to the Robotech® saga will be able to quickly understand and play the game without ever having seen the television series.

The Shadow Chronicles® RPG presents the forces of the United Earth Expeditionary Force (UEEF) and its combat mecha, including Veritech Fighters, Alphas, Betas, Cyclones, and more. The enemy is the Invid and the traitorous Haydonites. Based on the popular Robotech® television series. Illustrated throughout.

- Core rule book, Invid and Shadow Chronicles space setting.
- Haydonites, the Wraith, Infiltrator and spaceships.
- 8 Invid mecha, plus the Invid Carrier.
- 16 UEEF mecha, including the Bioroid Interceptor, Condor, Alphas, Betas, Super Cyclone, Silverback, and more.
- UEEF weapons, Synchro Cannon, vehicles, spaceships and gear.
- Space combat rules, missiles and more.

- O.C.C.s include the Battloid Ace, Veritech Fighter Pilot, Military Specialist, and others. Five core UEEF character classes and 25 MOS skill packages for a wide range of diversity.
- Character creation takes 15 minutes or less with Quick Roll tables.
- A complete Role-Playing Game. 8½ x 11 hardcover, “core rules.” Compatible with other Palladium Books Mega-Damage settings like Rifts®.
- \$30.95 – 224 pages. Cat. No. 550HC.



Robotech®: The Shadow Chronicles® RPG – Pocket-Sized Manga Edition

The same Robotech® RPG core rules as above (minus space combat rules and Haydonite spacecraft) in a smaller, “Manga Edition” size; 336 pages, 5 x 7½ inch portable book.

- Fast playing RPG rules. Mega-Damage setting.
- Complete stand-alone RPG.
- Manga size – 5 x 7½ inches – for easy portability.
- \$16.95 – 336 pages. Cat. No. 550.

Robotech®: The Macross® Saga Sourcebook

All your favorite iconic mecha and world setting. The Macross® Saga Sourcebook is a treasure trove of the mecha, Valkyries, Destroids, ground vehicles, aircraft, spacecraft, weapons, Zentraedi aliens, Zentraedi mecha, heroes, villains, action and story that made Robotech® famous.

The story of Macross is one of courage and survival against impossible odds, when an alien invader threatens the survival of all life on Earth. However, Earth’s defenders are far more ready for the Zentraedi alien invaders than they know. Epic adventure. Giant transformable robots. Sacrifice and heroics.

- The famous Valkyrie Veritech Fighters.
- Destroids – giant combat robots that are walking tanks.
- 14 aircraft and aerospace vehicles.
- 13 ground vehicles, plus weapons and equipment.
- 7 Zentraedi mecha, plus Fighter Pod, Recovery Pod, Soldiers, Shuttle and select spacecraft.

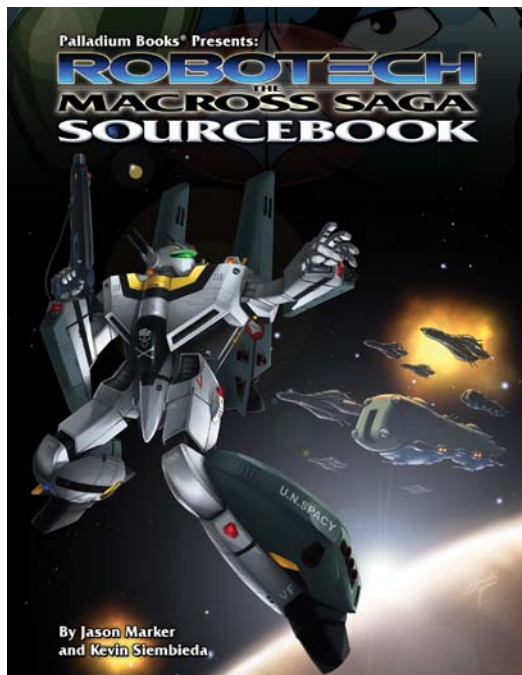

- The Zentraedi: Giant clone warriors and their culture.
- Quick Roll Tables for Macross characters.
- Ordinary People O.C.C., new skills and more.
- Notable anime characters statted out as NPCs.
- \$16.95 – 128 pages. Cat. No. 551. 8½ x 11 inch size.

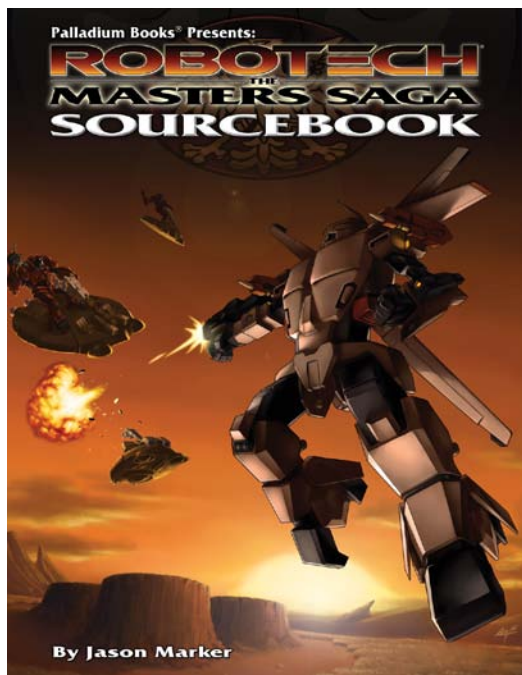

Robotech®: The Masters Saga™ Sourcebook

Never before revealed mecha, power armor, robots, gear and information, all statted out and described. **The Masters Saga™** captures the *Second Robotech War* with never before seen comprehensive details about the mecha, armor, weapons and gear of the 15 divisions of the Army of the Southern Cross (ASC), who battle the new alien threat of the *Robotech Masters*.

The Masters are the visionaries behind Robotechnology and Protoculture. Creators of the giant Zentraedi warriors and the

masters of a crumbling galactic empire won through war and conquest.

Adventures can start in the jungles of South America, where the fledgling ASC and the UEDF battled Zentraedi Malcontents, UEG separatists, rebels and terrorists before the UEEF blasted into outer space; or play during the years of Global Reconstruction. Or start your game the day the Robotech Masters appear and the Second Robotech War begins. Or even play the days between the Masters' defeat and the arrival of the Invid, as well as the years of Invid occupation as your ASC heroes try to rescue survivors and establish resistance groups to battle the Invid until the UEEF fleets return!

- The Army of the Southern Cross™ – all 15 branches.
- Veritech Hover Tanks, AJAX, Logan and more.
- 4 ASC Battloids plus the Golem robot.
- 6 suits of ASC Powered Armor – never before seen.
- Many vehicles, body armor, jump packs and weapons.
- 7 different Bioroids, Bioroid Hover Sled & weapons.
- Robotech Masters, Tirolians, and their spaceships.
- Tirolian villains and player characters.
- History, background and world information.
- Quick Roll, 15 minute character creation tables.
- Infinite possibilities for adventure.
- \$20.95 – 160 pages. Cat. No. 552. 8½ x 11 inch size.

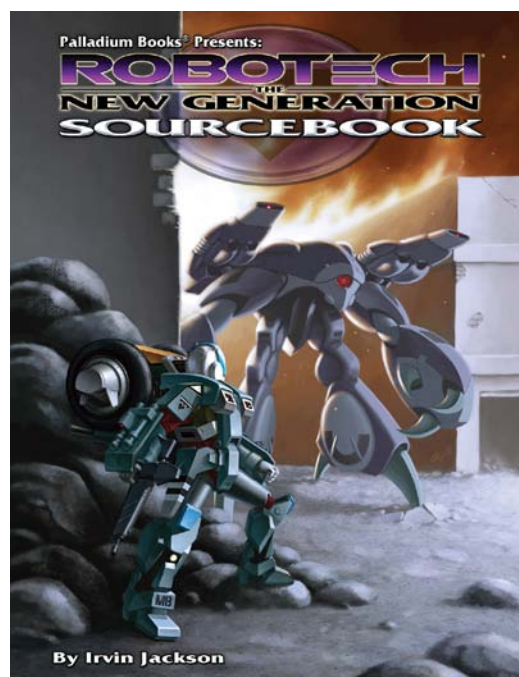

Robotech®: The New Generation™ Sourcebook

The Third Robotech War erupts on Earth. The planet has fallen to the Invid invasion force. You play resistance fighters, a new generation of bold heroes who dare to oppose the frightening alien overlords known as the Invid. Defend the human race against the Invid invaders and rescue the innocent from the alien tyrants.

Best of all, play characters, mecha and weapons from ALL four eras of Robotech® – from Macross and the Masters Saga to New Generation and the Shadow Chronicles®. Or build a Frankenmecha. Epic adventure.

- New and variant mecha, vehicles and weapons.
- Resistance Fighter O.C.C.s & Organization creation rules.
- *ALL eras of Robotech mecha* are available to players, from the giant Valkyries and Destroids, to Hover Tanks and AJAX, to the small, sleek Alpha Fighters and Cyclones of the UEEF.
- *Frankenmecha* – improvised mecha – amalgamations of different eras of mecha cobbled together into something new and deadly.
- 7 new Occupational Character Classes (O.C.C.s).
- Notable weapons, combat vehicles, and resistance fighters.
- The Regis, Simulagents, Invid Brain, Prince and Princess.
- Global overview under Invid domination and Invid mutations.
- Invid Hives, Protoculture Farms and adventure.
- \$16.95 – 96 pages. Cat. No. 554. 8½ x 11 inch size.

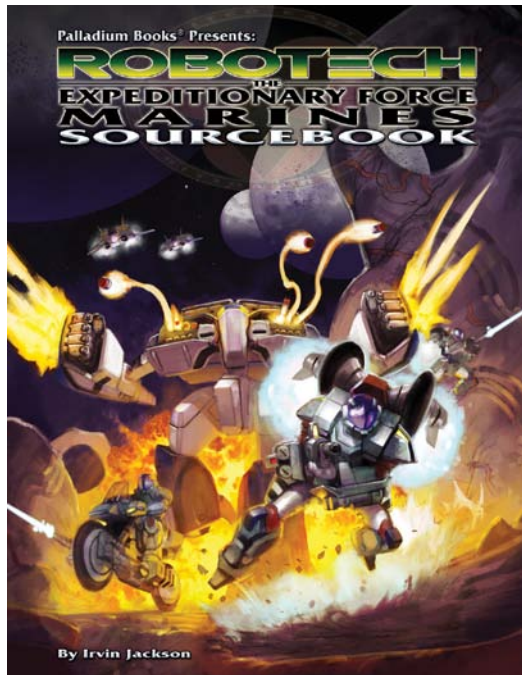

Robotech®: Expeditionary Force Marines™

Expeditionary Force Marines™ is a riveting **Robotech®** sourcebook that carries you to alien worlds. Your characters can pilot the early Cyclones and next generation of Destroids, meet aliens, liberate alien worlds and combat the merciless Invid Regent, his Inorganic shock troopers and Invid swarms. Epic, planet-hopping adventure awaits.

The Robotech®: Expeditionary Force Marines Sourcebook is set in space with the UEEF (United Earth Expeditionary Force) led by Admiral Rick Hunter, Lisa Hayes, Breetai and Exedore. This valiant force of mecha-clad heroes travel across the galaxy liberating planets from the bondage of the Invid Regent, the Robotech Masters and other tyrants and monsters. New alien people are introduced and become part of the Expeditionary Force Marines. In between their ongoing war with the Regent and his Invid and Inorganics, they explore planets, battle space pirates and face treachery on many fronts.

- 5 new Marine O.C.C.s, 22 M.O.S. skill packages, and some new skills.

- 8 new Destroids, two of them Zentraedi, plus a Battloid or two.
- 6 new Cyclones, including Space Cyclones, the Spider Hover Cyclone, the Walker and more.
- CVR-1 and CVR-2 body armor and notable Expeditionary Force (and alien) weapons, gear and vehicles.
- 6 alien races and brief overviews of their planets.
- 34 Perytonian Energy Wizard Magic spells.
- The Regent's war machine: Invid Scientist R.C.C., Invid Assault Trooper (new), Invid Fury (new), Invid Ogre (new), Invid Ranger (new), Garn Inorganic (new), the Regent statted out, and more.
- Quick Roll Creation Tables for UEEF Marines as player characters.
- Time-line for the Expeditionary Force and related events on Earth.
- The *Robotech® The Shadow Chronicles® RPG* "rule book" is needed to play (Cat. No. 550 or 550HC).
- Written by Irvin Jackson and Kevin Siembieda.
- \$20.95 – 160 pages. Cat. No. 553. 8½ x 11 inch size.

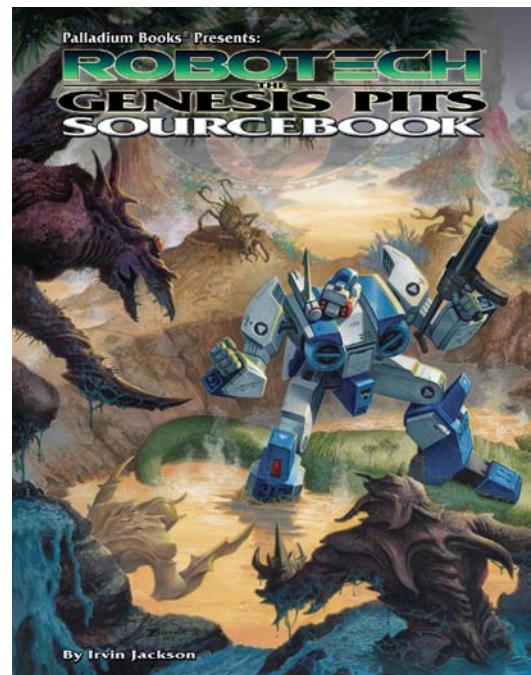

Robotech®: Genesis Pits Sourcebook

An in-depth look at the horror and wonder of the Invid Genesis Pits, their purpose, function and the creatures they create. Rules and tables for creating monsters, stats for different types of dinosaurs, insects and animals, new Frankenmecha, and more.

- **Secrets of the Invid.** Notable Genesis Pits of Earth.
- **Genesis Pit mutations, monsters and mutants.**
- **Different types of Genesis Pits from across the galaxy.**
- **Genesis Pit Monster creation tables and rules.**
- **Mutant Invid and other monsters described and statted.**
- **The Inorganics and other war machines of the Invid Regent.**
- **Ways to destroy a Genesis Pit. New weapons and gear.**
- **Simulagents, Bioroid and Zentraedi mutants, and more.**
- \$16.95 – 96 pages. Cat. No. 555. 8½ x 11 inch size.



ROBOTECH

RPG TACTICS™

Main Boxed Game – Cat. No. 55100 – Available Now!

A fast-paced, strategy battle game that captures the speed and action of Robotech®. Play Earth defenders or Zentraedi invaders.

- Scalable from small squad skirmishes to mass battles.
- Turn-based system of play and uses D6. Two or more players.
- 34 highly detailed game pieces. 6mm scale.
- 112 page color rule book with paint guide and index.
- 53 laminated, color game cards.
- 24 custom dice, two decal sheets and more.
- Assembly and painting required. Glue not included.
- \$99.95 retail – Cat. No. 55100 – shipping now!
- Available in North and South America, the EU, Australia & New Zealand.

Note: Each product contains plastic game pieces requiring assembly and painting. Glue not included. This is not a toy. Small parts, not suitable for children under the age of 13. Adult supervision advised. Images shown here are not to scale.



UEDF Valkyrie Wing™ – Cat. No. 55201

Build your fleet of Earth defenders with the Valkyrie Veritech Fighter; six game pieces total. **\$36.95 retail.**

- 2 Valkyries in Fighter mode.
- 2 Valkyries in Guardian mode.
- 2 Valkyries in Battloid mode.
- Multiple heads for making the VF-1A, VF-1J, VF-1R & VF-1S.



UEDF Tomahawk/Defender Destroids™ – Cat. No. 55202

Expand your Destroid squad with these formidable walking tanks; four game pieces total. **\$32.95 retail.**

- 2 Tomahawk Destroids – the main battle tank of Destroids, brimming with powerful particle beam cannons for arms, and wielding a battery of missiles and an array of other weapons.
- 2 Defender Destroids – a long-range, anti-aircraft juggernaut capable of shooting down incoming Zentraedi Battlepods and Gnerl Fighters.



UEDF Spartan/Phalanx Destroids™ – Cat. No. 55203

Add some long-range power and up-close punch to your army with these valuable Destroids; four game pieces total. **\$32.95 retail.**

- 2 Spartan Destroids – civil defense, riot control and deadly in hand to hand combat.
- 2 Phalanx Destroids – a walking, long-range missile artillery unit.



Zentraedi Regult Battlepods™ – Cat. No. 55401

Expand your Zentraedi forces with their main infantry battle mecha; six game pieces total. **\$36.95 retail.**

- 6 Regult Tactical Battlepods – the lightning quick Regults, armed with a pair of particle cannons and auto-cannons, attack in wave after wave.



Zentraedi Artillery Battlepods™ – Cat. No. 55402

Give your Zentraedi legion greater firepower with these artillery and support Battlepods; four game pieces total. **\$36.95 retail.**

- 4 Zentraedi Support Battlepods, each of which can be made into:
 - Gluuhaug-Regult – Light Artillery Battlepod
 - Serauhaug-Regult – Heavy Artillery Battlepod
 - Telnesta-Regult – Experimental Particle Beam Battlepod
- Four game pieces total.**



Zentraedi Glaug Command™ – Cat. No. 55403

This diverse pack provides your Zentraedi forces with greater tactical capabilities; three game pieces total. **\$36.95 retail.**

- 1 Glaug Officer's Battlepod – the fast and deadly mecha of Zentraedi field leaders.
- 1 Quel-Regult Scout Battlepod – the stealthy eyes and ears of your Zentraedi battle force; electronic warfare capabilities.
- 1 Quel-Gulnau Recovery Pod – enhances the Glaug's ability to bring in Battlepod reinforcements. **Note:** This figure has NEVER before been offered by any company.



RIFTS®

- Imagine Earth transformed into an alien landscape.
- Humans exist – barely. And we are not alone.
- Aliens and monsters emerge from the Rifts – holes torn in the fabric of space and time, connected to countless worlds and realities.
- Ancient gods, demons and magic have returned.
- Magic and technology clash.
- Hundreds of character classes, many inhuman.
- *Rifts® Ultimate Edition* is the core RPG rule book.
- Expansive world setting with 90+ sourcebooks to draw upon.
- Rifts®, your portal to endless adventure.
- Limited only by your imagination.

www.palladiumbooks.com

© 2014 Palladium Books. Rifts®, Megaverse®, Nightbane® and other titles, slogans and likenesses are trademarks of Palladium Books, Inc. Palladium Books - 39074 Webb Court, Westland, MI 48185 USA - 734-271-2903 order line.

Other RPG Worlds from Palladium Books®:

- *Rifts®* – the ultimate role-playing experience.
- *Rifts® Chaos Earth®* – Play the apocalypse as it happens.
- *Splicers®* – Weird science. Bio-tech battles insane robot legions.
- *Robotech® RPG* – All eras of the TV show brought to life.
- *Dead Reign® RPG* – Can you survive the Zombie Apocalypse?
- *Palladium Fantasy RPG®* – Unique world, monsters as player characters, magic and more.
- *Heroes Unlimited™ RPG* – Play any hero; mutants, aliens, cyborgs, superhumans, mages, immortals and more.
- *Nightbane® RPG* – Conspiracy, magic, horror and monsters.
- *Beyond the Supernatural™ RPG* – Modern horror and suspense.
- *Ninjas and Superspies™*, and more.

Can YOU survive the Zombie Apocalypse?



The Dead Reign® RPG series

Dead Reign® RPG – “Core Rules.” It is the aftermath of the *zombie apocalypse*. The dead reign and the living fight against impossible odds. Can you survive? Find out with this fast-paced horror game. Easy to learn. Fast character creation and combat.

- **Zombie combat and survival rules, vehicles and equipment.**
- **6 iconic Character Classes plus Ordinary People (40+ occupations).**
- **7 types of zombies, plus the Half-Living.**
- **101 Random Scenarios, Encounters, Settings and other tables.**
- **\$22.95 retail – 224 pages – Cat. No. 230. Available now.**

Civilization Gone™ Sourcebook

Civilization has crumbled to nothing. There is no army. No government. No help coming. What now?

- **Madmen, Psychopaths, villains, heroes and protectors.**
- **House, home and survivor camp tables, resources & encounters.**
- **\$12.92 retail – 64 pages – Cat. No. 231. Available now.**

Dark Places™ Sourcebook

Travel the rails and urban underground to move about undetected by zombies.

- **Worm Meat, Bug Boy, Sewer Crawler & Impersonator Zombies.**
- **Traveling the rails, sewers and other dark places.**
- **Random encounter tables, boxcar content tables, and much more.**
- **\$12.92 retail – 64 pages – Cat. No. 232. Available now.**

Endless Dead™ Sourcebook

The zombies grow in number and strangeness. Can humankind survive?

- **Zombie amalgamations, tables and encounters.**
- **New player characters & timetables for your campaign.**
- **Weaponizing vehicles, vehicle combat rules, and military bases.**
- **Creating survivor caravans, hideouts, Safe Havens & more.**
- **\$16.95 retail – 96 pages – Cat. No. 233. Available now.**

Other horror titles from Palladium Books®

Beyond the Supernatural™ RPG **Nightbane® RPG**

Fear the Reaper™ Sourcebook

Heroes who, like knights of old, travel the highways fighting zombies and helping survivors.

- **Comprehensive background on the Road Reapers.**
- **Their code, missions, weapons, strategies and tactics.**
- **The Terror Zombie and more.**
- **\$12.95 retail – 48 pages – Cat. No. 234. Available now.**

Graveyard Earth™ Sourcebook

The Zombie Apocalypse across the globe; provides a world overview and many adventure ideas.

- **Many tables for settings, encounters and adventure hooks.**
- **Random Safe Havens by region, and Survivor Leaders.**
- **How to get home from abroad, zombie threat levels & more.**
- **\$12.95 retail – 64 pages – Cat. No. 235. Available now.**

Hell Followed™ Sourcebook

This big, 160 page sourcebook begins to redefine the zombie genre. It broadens the field of possibilities and expands upon the modern zombie mythos. It is full of twists and surprises you will not expect.

- **11 new types of terrifying zombies.**
- **7 player characters, plus Masked Lunatics – heroes or madmen?**
- **21 disasters to complicate survival, and urban survival.**
- **Government enclaves, conspiracy theories and more.**
- **\$20.95 retail – 160 pages – Cat. No. 236. Available now.**



Palladium Books® Check List & Order Form

Dept. P-16, 39074 Webb Court, Westland, MI 48185

Name: _____ Address: _____

City: _____ State: _____ Zip/Postal Code: _____ Country: _____

Credit Card Number: _____ Expiration Date: _____ Visa MasterCard

Telephone Number: _____ Signature: _____ AMEX Other

The Rifter® Series

- ___ 173 The Rifter® #73 – \$13.95
- ___ 174 The Rifter® #74 – \$13.95
- ___ 175 The Rifter® #75 – \$13.95
- ___ 176 The Rifter® #76 – \$13.95
- ___ 177 The Rifter® #77 – \$13.95
- ___ 178 The Rifter® #78 – \$13.95 (Spring)

Splicers® Note: Sourcebooks coming soon.

- ___ 200 Splicers® RPG – \$23.95

Dead Reign®

- ___ 230 Dead Reign® RPG – \$22.95
- ___ 231 SB 1: Civilization Gone™ – \$12.95
- ___ 232 SB 2: Dark Places™ – \$12.95
- ___ 233 SB 3: Endless Dead™ – \$16.95
- ___ 234 SB 4: Fear the Reaper™ – \$12.95
- ___ 235 SB 5: Graveyard Earth™ – \$12.95
- ___ 236 SB 6: Hell Followed™ – \$20.95

Rifts® Novels

- ___ 301 Sonic Boom™ – \$9.95
- ___ 302 Deception's Web™ – \$9.95
- ___ 303 Treacherous Awakenings™ – \$9.95
- ___ 304 Tales of the Chi-Town 'Burbs™ – \$12.95
- ___ 305 Rifts® Path of the Storm™ – \$12.95

Weapons Books

- ___ 401 Weapons and Armor™ – \$8.95
- ___ 402 Weapons and Castles™ – \$8.95
- ___ 403 Weapons and Assassins™ – \$9.95
- ___ 404 Weapons & Castles of the Orient™ – \$9.95
- ___ 409 Exotic Weapons™ – \$9.95
- ___ 410 European Castles™ – \$9.95

Palladium Fantasy RPG®

- ___ 450 The Palladium Fantasy RPG® – \$26.95
- ___ 4500HC Palladium Fantasy RPG® 30th Anniversary Hardcover – \$50.00
- ___ 451 Dragons & Gods™ – \$24.95
- ___ 453 Old Ones™ 2nd Ed. – \$24.95
- ___ 454 Monsters & Animals™ 2nd Ed. – \$24.95
- ___ 455 Adventures on the High Seas™ – \$24.95
- ___ 458 Island at the Edge of the World™ – \$20.95
- ___ 459 Yin-Sloth Jungles™ – \$20.95
- ___ 462 Western Empire™ – \$24.95
- ___ 463 Baalgor Wastelands™ – \$24.95
- ___ 464 Mount Nimro™ – \$20.95
- ___ 465 Eastern Territory™ – \$24.95
- ___ 466 Library of Bletherad™ – \$20.95
- ___ 467 Northern Hinterlands™ – \$24.95
- ___ 468 Land/Damned 1: Chaos Lands™ – \$24.95
- ___ 469 LoD 2: Eternal Torment™ – \$24.95
- ___ 470 LoD 3: The Citadel – \$24.95 (coming)
- ___ 471 Wolfen Empire™ – \$20.95
- ___ 472 Mysteries of Magic™ One: Heart of Magic – \$16.95
- ___ 474 Bizantium/Northern Islands™ – \$20.95
- ___ 475 Garden of the Gods™ – \$16.95 (coming)

Heroes Unlimited™ / After the Bomb®

- ___ 500-2 Heroes Unlimited™, 2nd Ed. – \$26.95
- ___ 5000HC Heroes Unlimited™ 30th Anniversary Hardcover – \$50.00
- ___ 501 Villains Unlimited™ Revised – \$24.95
- ___ 503 After the Bomb® RPG – \$24.95
- ___ 505 Road Hogs™ (After the Bomb® II) – \$9.95
- ___ 507 Mutants Down Under™ (AB III) – \$9.95
- ___ 511 Mutants of the Yucatan™ (AB IV) – \$9.95
- ___ 513 Mutants in Avalon™ (AB V) – \$16.95
- ___ 514 Mutants in Orbit™ (AB VI) – \$16.95
- ___ 515 Aliens Unlimited™ – \$24.95
- ___ 516 Heroes Unlimited™ G.M.'s Guide – \$24.95
- ___ 517 Century Station™ – \$24.95
- ___ 518 Gramercy Island™ – \$24.95
- ___ 519 Aliens Unlimited Galaxy Guide™ – \$24.95
- ___ 520 Mutant Underground™ – \$16.95
- ___ 521 Powers Unlimited® One – \$16.95
- ___ 522 Powers Unlimited® Two – \$16.95
- ___ 523 Powers Unlimited® Three – \$16.95
- ___ 525 Revised Ninjas & Superspies™ – \$20.95
- ___ 526 Mystic China™ – \$24.95
- ___ 527 Armageddon Unlimited™ – \$20.95

Robotech® RPG

- ___ 550 Robotech® The Shadow Chronicles® RPG (manga size) – \$16.95
- ___ 550HC Robotech® The Shadow Chronicles® Deluxe Hardcover RPG – \$30.95
- ___ 5500HC Robotech® The Shadow Chronicles® Gold Ed. Hardcover RPG – \$70.00
- ___ 551 Robotech® Macross® Saga Sourcebook – \$16.95
- ___ 552 Robotech® The Masters Saga™ Sourcebook (NEW in 8½ x 11) – \$20.95
- ___ 553 Robotech®: Expeditionary Force Marines Sourcebook – \$20.95
- ___ 554 Robotech® The New Generation™ Sourcebook – \$16.95
- ___ 555 Robotech® Genesis Pits Sourcebook – \$16.95

Robotech® RPG Tactics™ (New!)

- ___ 55100 Robotech® RPG Tactics™ – \$99.95
- ___ 55105 Robotech® RPG Tactics™ Rulebook – \$20.00
- ___ 55101 UEDF Dice Pack – \$12.00
- ___ 55102 Zentraedi Dice Pack – \$12.00
- ___ 55201 UEDF Valkyrie Wing – \$36.95
- ___ 55202 UEDF Destroid Pack – \$32.95
- ___ 55203 UEDF Spartan Pack – \$32.95
- ___ 55401 Zentraedi Regult Battlepods – \$36.95
- ___ 55402 Zentraedi Artillery Battlepods – \$36.95
- ___ 55403 Zentraedi Glaug Command – \$36.95

Rifts® Chaos Earth®

- ___ 660 Rifts® Chaos Earth® RPG – \$20.95
- ___ 661 Rifts® CE Creatures of Chaos™ – \$12.95
- ___ 662 Rifts® CE The Rise of Magic™ – \$12.95
- ___ 665 Rifts® Chaos Earth® First Responders™ – \$16.95 (coming)
- ___ 666 Rifts® Chaos Earth® Resurrection™ – \$20.95

Beyond the Supernatural™

- ___ 700 Beyond the Supernatural™, 2nd Ed. – \$24.95
- ___ 702 Tome Grotesque™ – \$20.95 (coming)
- ___ 703 Beyond Arcanum™ – \$24.95 (coming)

Nightbane®

- ___ 730 Nightbane® RPG – \$24.95
- ___ 731 Nightbane®: Between the Shadows™ – \$20.95
- ___ 732 Nightbane®: Nighlands™ – \$20.95
- ___ 733 Nightbane®: Through the Glass Darkly™ – \$20.95
- ___ 735 Nightbane® Survival Guide™ – \$20.95

Rifts®

- ___ 800HC Rifts® RPG Ultimate Edition – \$39.95
- ___ 801 Rifts® Sourcebook One Revised – \$20.95
- ___ 802-E Rifts® World Book 1: Vampire Kingdoms™, Revised – \$24.95
- ___ 803 Rifts® Conversion Book One™ – \$24.95
- ___ 804 Rifts® WB 2: Atlantis™ – \$20.95
- ___ 805 Rifts® Sourcebook 2: Mechanoids™ – \$16.95
- ___ 807 Rifts® WB 3: England™ – \$20.95
- ___ 808 Rifts® WB 4: Africa™ – \$20.95
- ___ 809 Rifts® Dimension Book 1: Wormwood™ – \$20.95
- ___ 810 Rifts® WB 5: Triax™ – \$24.95
- ___ 811 Rifts® Pantheons of the Megaverse® – \$24.95
- ___ 812 Rifts® Sourcebook 3: Mindwerks™ – \$16.95
- ___ 813 Rifts® Mercenaries™ – \$20.95
- ___ 814 Rifts® WB 6: South America™ – \$20.95
- ___ 815 Rifts® WB 7: Underseas™ – \$24.95
- ___ 816 Rifts® DB 2: Phase World® – \$24.95
- ___ 817 Rifts® DB 3: Phase World® Sourcebook – \$16.95
- ___ 818 Rifts® WB 8: Rifts® Japan™ – \$24.95
- ___ 819 Rifts® WB 9: South America Two™ – \$24.95
- ___ 820 Rifts® WB 10: Juicer Uprising™ – \$20.95
- ___ 821 Rifts® WB 11: Coalition War Campaign™ – \$24.95

- ___ 822 Rifts® WB 12: Psyscape™ – \$20.95
 ___ 825 Rifts® WB 13: Lone Star™ – \$20.95
 ___ 826 Rifts® WB 14: New West™ – \$24.95
 ___ 827 Rifts® WB 15: Spirit West™ – \$24.95
 ___ 828 Rifts® Sourcebook 4: Coalition Navy™ – \$16.95
 ___ 829 Rifts® WB 16: Federation of Magic™ – \$20.95
 ___ 830 Rifts® DB 4: Skraypers™ – \$20.95
 ___ 831 Rifts® Index Volume Two™ – \$16.95
 ___ 832 Rifts® WB 17: Warlords of Russia™ – \$24.95
 ___ 833 Rifts® WB 18: Mystic Russia™ – \$20.95
 ___ 834 Rifts® WB 19: Australia 1 – \$24.95
 ___ 835 Rifts® WB 20: Canada™ – \$24.95
 ___ 836 Rifts® WB 21: Splynn Dimensional Market™ – \$24.95
 ___ 837 Rifts® WB 22: Free Quebec™ – \$24.95
 ___ 838 Rifts® WB 23: Xiticix Invasion™ – \$20.95
 ___ 839 Rifts® Coalition Wars®: Sedition™ – \$20.95
 ___ 840 Rifts® Coalition Wars®: Coalition Overkill™ – \$16.95
 ___ 841 Rifts® Coalition Wars®: Sorcerers' Revenge™ – \$16.95
 ___ 842 Rifts® Coalition Wars®: Cyber-Knights™ – \$16.95
 ___ 843 Rifts® Coalition Wars®: Shadows of Evil™ – \$16.95
 ___ 844 Rifts® Coalition Wars®: Final Siege™ – \$24.95
 ___ 845 Rifts® Game Master Guide™ – \$26.95
 ___ 846 Rifts® Aftermath™ – \$24.95
 ___ 847 Rifts® DB5: Anvil Galaxy™ – \$20.95
 ___ 848 Rifts® Book of Magic™ – \$26.95
 ___ 849 Rifts® Adventure Guide™ – \$24.95
 ___ 850 Rifts® Bionics Sourcebook™ – \$16.95
 ___ 851 Rifts® DB 6: Three Galaxies™ – \$20.95
 ___ 852 Rifts® Dark Conversions™ – \$24.95
 ___ 853 Rifts® Chi-Town 'Burbs™ – \$9.95
 ___ 854 Rifts® The Tolkien Crisis™ – \$12.95
 ___ 855 Rifts® The Black Vault™ – \$9.95
 ___ 856 Rifts® The Vanguard™ – \$9.95
 ___ 857 Rifts® WB 24: China One™ – \$20.95
 ___ 858 Rifts® WB 25: China Two™ – \$20.95
 ___ 859 Rifts® DB 7: Megaverse Builder™ – \$16.95
 ___ 860 Rifts® DB 8: Naruni Wave Two™ – \$16.95
 ___ 862 Rifts® WB 26: Dinosaur Swamp™ – \$20.95
 ___ 863 Rifts® MercTown™ – \$20.95
 ___ 865 Rifts® Merc Ops™ – \$20.95
 ___ 866 Rifts® WB 27: Adventures in Dinosaur Swamp™ – \$20.95
 ___ 867 Rifts® Mercenary Adventure Sourcebook – \$12.95
 ___ 868 Rifts® WB 28: Arzno™ – \$20.95
 ___ 869 Rifts® WB 29: Madhaven™ – \$16.95
 ___ 870 Rifts® John Zeleznik Coloring Book – \$5.95
 ___ 871 Rifts® Machinations of Doom™ – \$18.95
 ___ 872 Rifts® DB 10: Hades™ – \$24.95
 ___ 873 Rifts® DB 11: Dyval™ – \$24.95
 ___ 874 Rifts® WB 30: D-Bees of North America™ – \$24.95
 ___ 875 Rifts® DB12: Dimensional Outbreak – \$24.95
 ___ 876 Rifts® Megaverse® in Flames™ – \$24.95
 ___ 876HC Rifts® Megaverse® in Flames™ Gold Hardcover Edition – \$50.00
 ___ 877 Rifts® Heroes of the Megaverse® – \$16.95
 ___ 878 Rifts® Sourcebook: Shemarrian Nation™ – \$16.95
 ___ 880 Phase World®: Fleets of the Three Galaxies™ – \$16.95
 ___ 881 Rifts® WB 31: Triax™ Two – \$24.95
 ___ 883 Rifts® DB 14: Thundercloud Galaxy™ – \$20.95
 ___ 884 Rifts® Vampires Sourcebook™ – \$20.95
 ___ 885 Rifts® WB 32: Lemuria™ – \$24.95
 ___ 886 Rifts® Black Market™ – \$24.95
 ___ 886HC Rifts® Black Market™ Hardcover Gold Edition – \$60.00
 ___ 887 Rifts® WB 33: Northern Gun™ One – \$24.95
 ___ 888 Rifts® WB 34: Northern Gun™ Two – \$26.95
 ___ 889 Rifts® Sourcebook: Coalition States, Heroes of Humanity™ – \$20.95
 ___ 890 Rifts® World Book: Secrets of the Atlanteans™ – \$24.95 (coming)
 ___ 891 Rifts® World Book: Sovietski™ – \$24.95 (coming)
 ___ 892 Rifts® Sourcebook: The Disavowed™ – \$16.95 (coming)
 ___ 893 Rifts® CS: Heroes of Humanity™ Arsenal Sourcebook – \$16.95 (coming)
 ___ 894 Rifts® Haunted Tech™ – \$16.95 (coming)
 ___ 2510 Rifts® & The Megaverse® Art Book – \$22.95
 ___ 2510-HC Rifts® & The Megaverse® Art Book, Hardcover – \$50.00
 ___ 2510-CML Rifts® & The Megaverse® Art Book, Collector's Masterwork Edition – \$125.00
- Miscellaneous Products**
 ___ 600 Deluxe Revised RECON® RPG – \$22.95
 ___ 2537 Gamer Coffee Mug – \$10.00
 ___ 2539 Rifts® Dice Bag – Black – \$8.00
 ___ 2545 Dead Reign™ Coffee Mug – \$10.00
 ___ 2554 Palladium Bookmarks, Set One – \$5.00
 ___ 2555 Palladium Bookmarks, Set Two – \$5.00
 ___ 2561 Property of Chi-Town Library Pencil – \$0.50 each
 ___ 2562 Future Visions™ – The Artistry of Charles Walton II – \$13.95
 ___ 2566 Glitter Boy Mouse Pad – \$9.95
 ___ 2567 Old Ones Mouse Pad – \$9.95
 ___ 2568 Zombie Graveyard Mouse Pad – \$9.95
- Note:** T-shirts and other products can be found online: www.palladiumbooks.com
- Rifts® Miniatures**
 ___ MI8002 Xiticix Pack – \$18.00
 ___ MI8004 Coalition Dog Pack – \$18.00
 ___ MI8005 Men of Magic Pack #1 – \$18.00
 ___ MI8006 Cyborgs Pack #1 – \$18.00
 ___ MI8007 Simvan & Ostrosaurus Pack – \$18.00
 ___ MI8008 Coalition Skelebots Pack #1 – \$18.00
 ___ MI8009 Coalition SAMAS Pack #1 – \$22.00
 ___ MI8010 Coalition Sky Cycle Pack – \$22.00
 ___ MI8011 Coalition Dog Pack #2 – \$18.00
 ___ MI8015 Damaged Skelebots Pack #1 – \$12.00
 ___ MI8016 Cyber-Adventurers Pack – \$18.00
 ___ MI8017 Rogues & Scout Pack #1 – \$18.00
 ___ MI8018 Brodkil & Witchling Pack – \$18.00
 ___ MI8019 Damaged Skelebots Pack #2 – \$18.00
 ___ MI8020 Psi-Stalkers & Scouts Pack #1 – \$18.00
 ___ MI8021 Shadow Beast – \$12.00
 ___ MI8022 Mystic Knight – \$6.00
 ___ MI8023 Lord Magus – \$6.00
 ___ MI8024 High Magus – \$6.00
 ___ MI8025 Coalition Psi-Stalker – \$6.00
 ___ MI8026 Coalition Dog Boy in DPM-D1 Armor – \$6.00
 ___ MI8027 Coalition Dog Boy #2 – \$6.00
 ___ MI8028 Coalition Dog Boy #3 – \$6.00
 ___ MI8029 Coalition Dog Boy #4 – \$6.00
 ___ MI8030 Coalition Dog Boy #5 – \$6.00
 ___ MI8031 Glitter Boy – \$20.00
 ___ MI8032 Glitter Boy Pilot – \$6.00
 ___ MI8033 Kydian Overlord – \$20.00
 ___ MI8034 Dragonsaurus – \$10.00
 ___ MI8035 Slaver and Slave (Atlantis) Set – \$10.00
 ___ MI8036 Crazy – \$6.00
 ___ MI8037 Juicer #1 – \$6.00
 ___ MI8038 Juicer #2 – \$6.00
 ___ MI8039 Cyborg #1 – \$12.00
 ___ MI8040 Cyborg #2 – \$12.00
 ___ MI8041 Cyborg #3 – \$6.00
 ___ MI8042 Coalition Officer – \$6.00
 ___ MI8043 Coalition Grunt #1 – \$6.00
 ___ MI8044 Coalition Grunt #2 – \$6.00
 ___ MI8045 Coalition Grunt #3 – \$6.00
- When placing an order by mail, please add money for shipping and handling.** Add \$5.00 for orders totaling \$1-\$50, \$10.00 for orders totaling \$51-\$95, and for orders totaling \$96-\$200 please add \$15.00 US. Double the amount for Canada, and *quadruple* it for overseas orders. For more shipping options, order online at www.palladiumbooks.com. Allow 2-4 weeks for delivery. Make checks and money orders payable to: *Palladium Books*
- Check release dates for new products.** If the book you order has not been released yet, your order will be held as a backorder until the product is available. Please note that prices are subject to change without notice.
- Orders can also be placed by phone,** at (734) 721-2903 (order line only). Please have your credit card information when you call.
- www.palladiumbooks.com**

BOOK ONE: MACROSS®

\$20.95

Cat. No. ROBO50

ISBN-10: 0-916211-21-5

ISBN-13: 978-0-916211-21-9

