

PALLADIUM BOOKS® PRESENTS:

RIFTS® WORLD BOOK 31:

# TRIAx™ 2

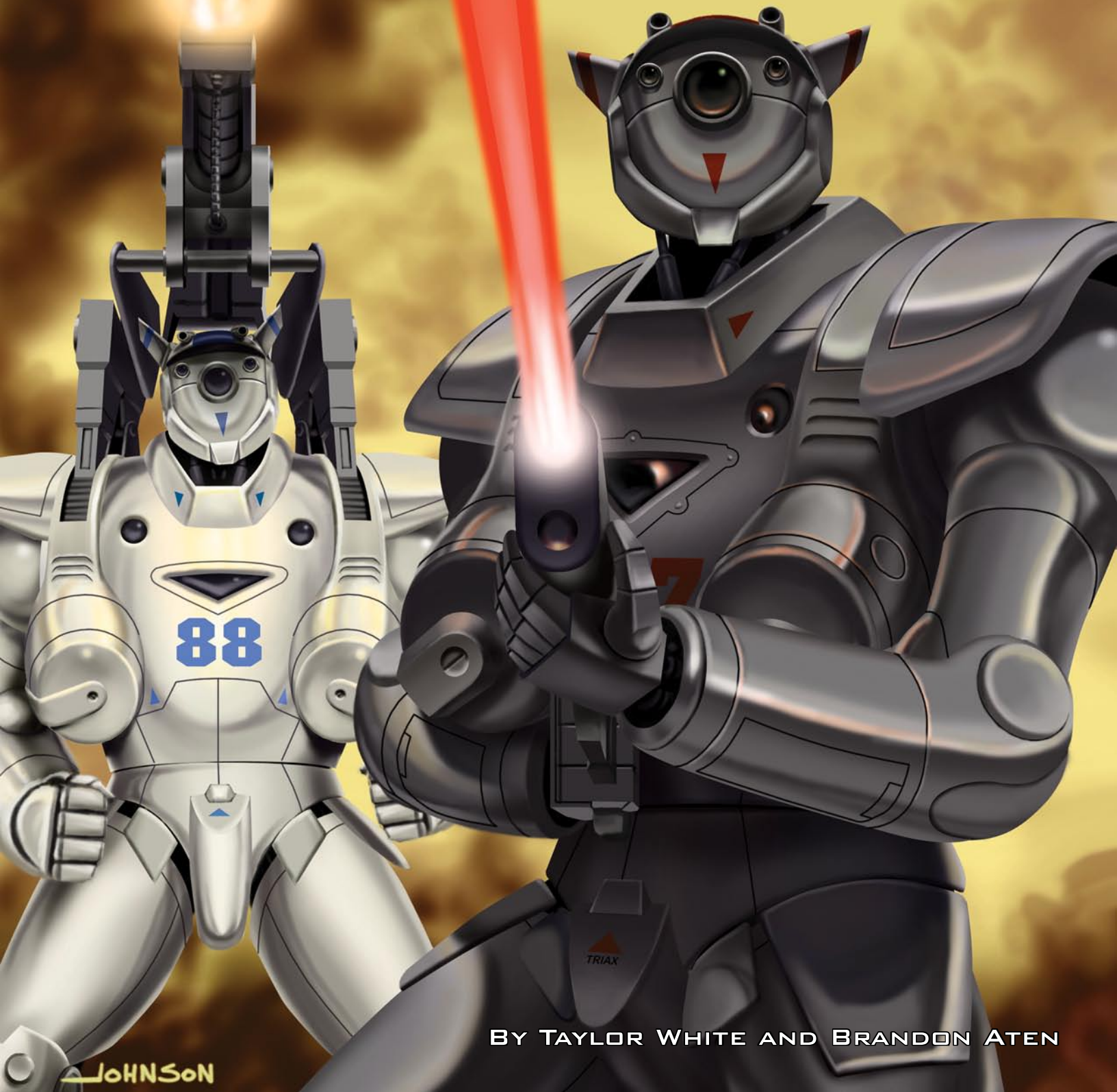

BY TAYLOR WHITE AND BRANDON ATEN

JOHNSON

# Warning!

## Violence, War, Magic & the Supernatural

The fictional worlds of *Rifts*® are violent, deadly and filled with aliens, war and supernatural monsters. Other-dimensional beings often referred to as “demons,” torment, stalk and prey on humans. Alien life forms, monsters, vampires, ghosts, ancient gods and demigods, as well as magic, insanity, psychic powers and combat are all elements in this book. *All of it is fiction.*

Some parents may find the violence, magic and supernatural elements of the game inappropriate for young readers/players. We suggest parental discretion.

Please note that none of us at Palladium Books® condone or encourage the occult, the practice of magic, the use of drugs, or violence.

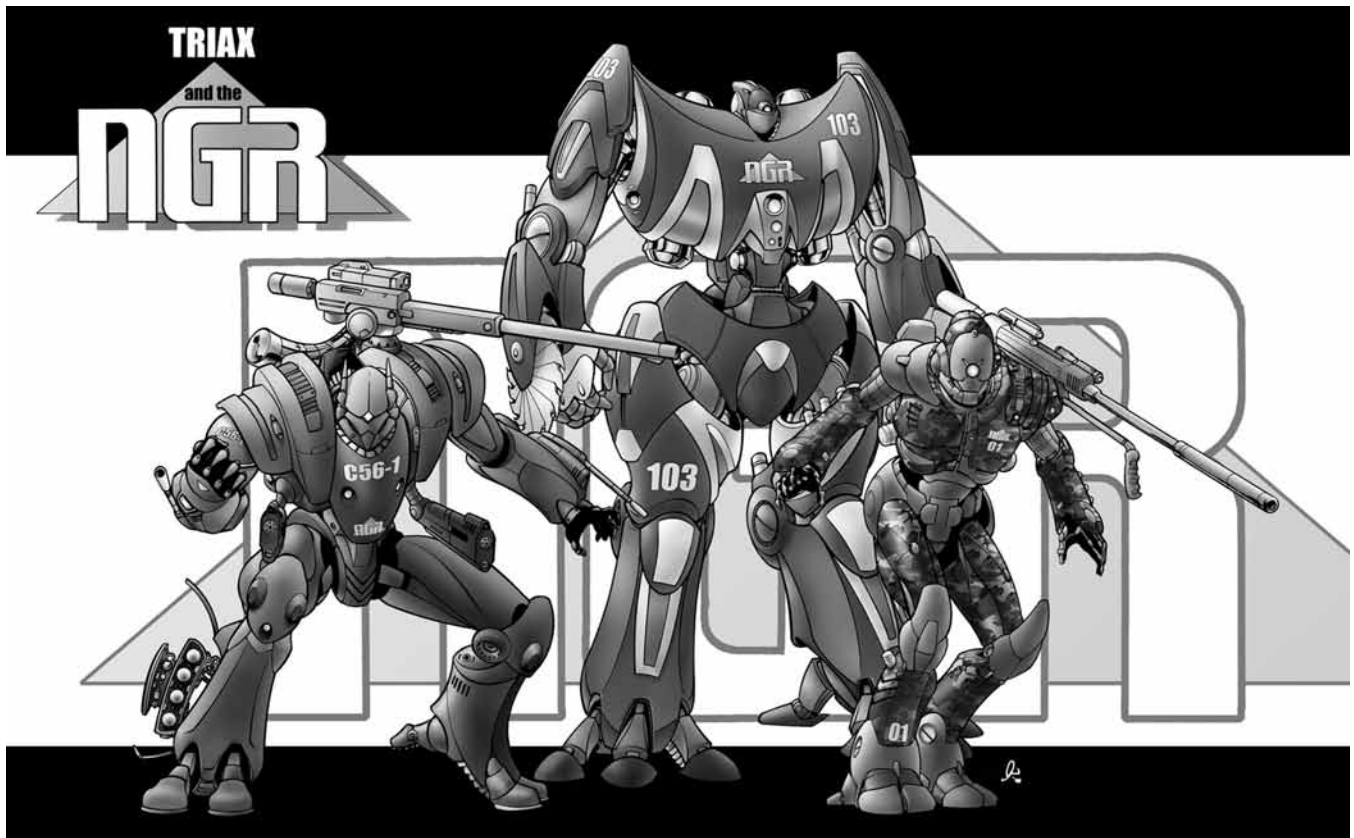

An epic sourcebook for the *Rifts*® series.

Compatible with the entire Palladium Books® Megaverse®

## Dedications and Special Thanks:

To Alma, the girl who inspired much of my writing in this book. “Ona je najlijepija Dyevoyka.”

To Andreas, our friend from Manheim who helped propel the 704 to international fame.

And finally to Frau Rice, my high school German teacher for three years, who didn't mind if I read *Rifts® World Book 5: Triax and the NGR* in class.

- Taylor White

To Sarah for always being there. To Taylor White for always being persistent and helping me move forward even when I didn't think I could. To Tom Nelson for being the ever present thorn in our sides. To Pepe. I wish we could have gotten this to you sooner. To Phalanx and Sir Tenzan for knowing entirely way too much about aircraft. And finally to Kevin Siembieda, thanks for giving us chance and letting our imaginations run free with this.

- Brandon K. Aten

To Taylor and Brandon for building upon the world I created and inspiring me to explore new possibilities. To Thomas Bartold whose German and European adventures made us laugh and wince, and because he's one heck of a friend.

- Kevin Siembieda

**The cover**, by *Scott Johnson*, depicts a pair of Jaegers blasting away at the enemy. We thought this simple, dynamic image said it all.

## PDF Edition – October 2016

No part of this publication may be scanned, OCR'd, reproduced or distributed in any way for electronic publication on the web/internet or any other medium.

Copyright 2010 Palladium Books Inc. & Kevin Siembieda

All rights reserved, worldwide, under the Universal Copyright Convention. No part of this book may be reproduced in part or whole, in any form or by any means, without permission from the publisher, except for brief quotes for use in reviews. All incidents, situations, institutions, governments and people are fictional and any similarity, without satiric intent, of characters or persons living or dead, is strictly coincidental.

Rifts®, The Rifter®, Phase World®, Megaverse®, The Mechanoids®, The Mechanoid Invasion®, Splicers®, Coalition Wars®, After the Bomb®, RECON®, Nightbane®, and Palladium Books® are registered trademarks owned and licensed by Palladium Books Inc. and Kevin Siembieda.

Altara, Angel of Death, Angel of Vengeance, Archie Three, Bio-Wizard, Black Faerie, Body Fixer, Blind Warrior Women, Blood Druids, 'Bot, 'Borg, 'Burb, Brodkil, Captain Nemo-2, Chaos Earth, Chi-Town, Chromium Guardsman, City Rat, Coalition States, CS, Combat Cyborg, Coming of the Rifts, Crazy, Cyber-Doc, Cyber-Knight, D'norr Devil Man, Dinosaur Swamp, Dyna-Bot, E-Clip, Emperor Prosek, Erin Tarn, Federation of Magic, Flooper, Free Quebec, Gargoyle Empire, General Rasheen, Glitter Boy, Grackle Tooth, Great Cataclysm, Headhunter, Horune Pirates, Jinna Gir Song, Juicer, Lazlo, Ley Line Walker, Longstrike, Lord Dunscon, Lord Splynnecryth, Madhaven, Magic Zone, Manistique Imperium, Mind Melter, Mindwerks, Mystic Knights, Naruni, Naruni Enterprises, NGR, New German Republic, New Navy, New West, Northern Gun, Phoenix Empire, Psi-Stalker, Psyscape, Rifts Earth, Shemarrian, Shifter, Skelebot, Song Warriors, Spinne, Splynn Dimensional Market, Splugorth, Minions of Splugorth, Splugorth Slavers, Stormspire, Tattooed Man, Techno-Wizard, Titan Robotics, Tolkeen, Triax, Triax Industries, True Atlantean, Ulti-Max, Undead Slayer, Vampire Kingdoms, Rifts® Game Master Guide, Rifts® Book of Magic, Rifts® Dark Conversions, Rifts® Atlantis, WaffenTek, War Eagle, Warlords of Russia, Wilk's, Witchling, Xiticix, Mega-Damage, M.D.C., S.D.C., I.S.P., P.P.E., and other names, titles, initials, characters, character likenesses and slogans are trademarks owned and licensed by Kevin Siembieda and Palladium Books Inc.

Palladium Online: [www.palladiumbooks.com](http://www.palladiumbooks.com)

**Rifts® World Book 31: Triax™ 2** is published by Palladium Books Inc., 39074 Webb Court, Westland, MI 48185-7606. Printed in the USA.

**Palladium Books® Presents:**

**Rifts® World Book 31:**

# **Triax 2™**

Written by: **Taylor White, Brandon Aten and Kevin Siembieda**

Editors: **Alex Marciniszyn**

**Wayne Smith**

**Kevin Siembieda**

Proofreader: **Julius Rosenstein**

Cover Painting: **Scott Johnson**

Primary Artist: **Michael Wilson**

Contributing Artists:

**Amy L. Ashbaugh**

**Kent Burles**

**Mark Dudley**

**Kevin Long**

**Allen Manning**

**Brian Manning**

**Nicholas Maradin**

Maps: **Taylor White**

Art Direction: **Kevin Siembieda**

Typography and Layout: **Wayne Smith**

Based on the RPG rules, text, characters, settings, concepts and Megaverse® created by **Kevin Siembieda**.

**Special Thanks to** *Brandon Aten*, who has the soul of a poet, and *Taylor White*, who has the vision of a film-maker, for coming up with the idea for making this epic book and coming up with cool new background, history, characters, technological wonders and fun ideas. To *Mike Wilson*, who did an amazing job designing and illustrating the vast majority of NGR war machines. To *Kent Burles* and *all my artists* whose imaginations and talent breathes power into our words. And to the best staff (and friends) a person could ever hope for: Alex, Wayne, Kathy and Julius. May we win all the battles yet to come.

– *Kevin Siembieda, 2010*

# Contents

A few words from one author . . . . .	8
<b>The New German Republic . . . . .</b>	<b>8</b>
Time Line . . . . .	10
<b>The War Against the Gargoyles . . . . .</b>	<b>11</b>
Notable Major Events by Year . . . . .	12
<b>104 P.A. . . . .</b>	<b>12</b>
Full Militarization . . . . .	12
Battle of Zurich . . . . .	13
<b>105 P.A. . . . .</b>	<b>14</b>
New Scientific Findings about Gargoyles . . . . .	14
Tiny Extermination Robots . . . . .	14
Uranium Rounds . . . . .	15
Locating Aviaries . . . . .	15
Typical Military Strike on Aviary . . . . .	16
Jinna Gir Song and the Atlanteans . . . . .	17
Song Warriors . . . . .	18
<b>106 P.A. . . . .</b>	<b>18</b>
The Destruction of Wroclaw . . . . .	18
A short history . . . . .	18
Statistics of Wroclaw . . . . .	20
The Gargoyle Attack . . . . .	20
Wroclaw Assessment and Aftermath . . . . .	21
Gargoyles vs Brodkil . . . . .	21
<b>107 P.A. . . . .</b>	<b>22</b>
Triax Industries . . . . .	23
NGR President – Assassinated . . . . .	23
A New Leader . . . . .	24
Aftermath . . . . .	24
A Call to Arms . . . . .	25
The Coalition Army . . . . .	25
Triax Secret Project . . . . .	25
Operation Sea Storm . . . . .	26
<b>108 P.A. . . . .</b>	<b>27</b>
The Battle Continues . . . . .	27
An Empire Divided . . . . .	27
<b>Summer to Present . . . . .</b>	<b>28</b>
Gargoyles’ Shattered Empire . . . . .	28
Zerstrun’s Gargoyle Empire . . . . .	28
Map of Rifts Europe 109 P.A. . . . .	29
Phoenix Empire . . . . .	30
A New Player Enters . . . . .	30
Struwelpeter Stats . . . . .	31
<b>The NGR Military . . . . .</b>	<b>33</b>
Navy . . . . .	33
Air Force/New Luftwaffe . . . . .	34
Military Cental Command . . . . .	34
New Weapons and Tactics . . . . .	35
Hired Guns . . . . .	35
Current Bounties for Monsters . . . . .	36
Other Freelance Work . . . . .	37
German Black Market . . . . .	38
The operations of the VGN . . . . .	38
<b>The NGR Government . . . . .</b>	<b>39</b>
NGR Foreign Relations – 109 P.A. . . . .	40
<b>Major NGR Cities . . . . .</b>	<b>42</b>
Dusseldorf/Ruhr . . . . .	42
Map of The New German Republic . . . . .	43
Some notable Crime Figures . . . . .	44
Frankfurt am Main . . . . .	44
Koln . . . . .	45
Munich . . . . .	46
Victor Lazlo: 109 P.A. Update . . . . .	46
Berlin . . . . .	47
Denmark . . . . .	48
<b>The Autobahn . . . . .</b>	<b>48</b>
Autobahn Random Table . . . . .	50
NGR RailBahn . . . . .	51
Airports . . . . .	52
<b>The Typical NGR Citizen . . . . .</b>	<b>53</b>
Cultural Attitudes of the Citizens . . . . .	54
The NGR & Magic . . . . .	55
Psychics & Mutants . . . . .	56
The Matter of Refugees . . . . .	57
NGR Food and Drink . . . . .	57
German Beer . . . . .	58
Beers around the World . . . . .	59
<b>NGR &amp; D-Bees . . . . .</b>	<b>59</b>
Mandatory Deportation . . . . .	59
D-Bees in the Military . . . . .	60
D-Bee Industrial Service Program . . . . .	60
D-Bee Border Militias . . . . .	61
Civil Rights & D-Bees . . . . .	62
Work Release Program . . . . .	63
D-Bee Equal Rights Movement . . . . .	64
General Rasheen . . . . .	65
Quick Stats for General Rasheen . . . . .	68
<b>Triax Industries . . . . .</b>	<b>69</b>
A Short History of Triax Industries . . . . .	69
Triax Business Report . . . . .	70
Corporate Espionage . . . . .	72
Triax Commercial Products . . . . .	73
Triax Instant Meal Paste . . . . .	73
Triax Energy Supplements . . . . .	73
Triax Cosmetics & Beauty Products . . . . .	76
<b>Triax Ground Vehicles . . . . .</b>	<b>76</b>
Commercial S.D.C. Automobiles . . . . .	77
Motorcycle . . . . .	78
Pickup Truck . . . . .	78
Armored Security Vehicle . . . . .	79
Triax S.D.C. Hover Vehicles . . . . .	80
Hovercycle . . . . .	80

A-Type Hover Car . . . . .	81
Triax WR Wilderness Class M.D.C. Vehicles . . . . .	82
<b>Other (Vehicle) Manufacturers . . . . .</b>	<b>83</b>
RRK Korporation . . . . .	83
RRK Oberteil Armored Hovercar . . . . .	83
WaffenTeck Vehicles . . . . .	84
Available Features for Vehicles . . . . .	85
Gimmick Vehicular Weapons Systems . . . . .	88
Common Weapons System for Vehicles . . . . .	89
<b>Triax Domestic Robots . . . . .</b>	<b>89</b>
Triax V-100 Housekeeper . . . . .	90
Triax V-500 Robot Pets . . . . .	95
<b>Triax Weapons . . . . .</b>	<b>96</b>
New Triax Pistols . . . . .	96
New Triax Rifles . . . . .	97
Robot & Power Armor Weapons . . . . .	102
TX-H Series Weapons . . . . .	103
<b>WaffenTek Energy Weapons . . . . .</b>	<b>106</b>
<b>New Triax Body Armor . . . . .</b>	<b>107</b>
T-25 “Uber” Super-Exoskeleton . . . . .	108
<b>New Triax Power Armor . . . . .</b>	<b>110</b>
X-11 Predator II . . . . .	110
X-21 War Eagle . . . . .	113
X-80 Butterfly . . . . .	115
X-700 Fat Boy . . . . .	117
X-710 Hell Angel . . . . .	121
X-1001 Ulti-Max II . . . . .	123
New Jaeger Weapon Systems . . . . .	125
<b>NGR (Military) Robot Drones . . . . .</b>	<b>126</b>
DV-39 Wolf . . . . .	126
DVO-1 Aerial Spy Drone . . . . .	128
EIR-60 Extermination Robot . . . . .	129
EIR-70 Spy Robots . . . . .	130
<b>New Triax Robot Vehicles . . . . .</b>	<b>132</b>
X-1471 Wolfhound . . . . .	132
X-2010 Longstrike . . . . .	139
X-2020 Rainmaker . . . . .	136
X-2525 Faust . . . . .	138
X-2730 Griffon . . . . .	141
X-2750 Talon . . . . .	143
X-4500 Gunman . . . . .	145
X-4600 Sharpshooter . . . . .	148
X-5050 Black Death . . . . .	150
X-5001 Devastator Mk II . . . . .	153
<b>NGR Combat Vehicles . . . . .</b>	<b>157</b>
XM-350 Rhino . . . . .	157
<b>New NGR Aircraft . . . . .</b>	<b>159</b>
Standards Systems on all NGR Aircraft . . . . .	159
XM-279 Earth Lifter . . . . .	161
XM-199 Phoenix . . . . .	163
<b>XML-Series Cybernetic Airframes . . . . .</b>	<b>165</b>

Luftwaffe Cyborg Combat Pilot O.C.C. . . . .	165
Luftwaffe Cyborg Combat Pilot Bionics . . . . .	167
Luftwaffe Cyborg Combat Pilot Stats . . . . .	168
XML-280 Black Eagle . . . . .	169
XML-283 Wraith . . . . .	170
XML-285 Ghost . . . . .	172
XLH-Hardpoint Weapon Pods . . . . .	174
<b>NGR Mobile Bases . . . . .</b>	<b>177</b>
NGR Drop Forts & Deployment Pods . . . . .	177
Some Specific Deployment Pods . . . . .	177
Fortification Pod . . . . .	178
<b>Harbingers of War . . . . .</b>	<b>179</b>
NGR Undertow . . . . .	181
TX-MISB Mobile Infantry Strike Base . . . . .	183
Forward Section . . . . .	183
Command Center & Main Troop Carrier . . . . .	186
Rear Section . . . . .	188
TX-MSIB IA-30 Infantry APC . . . . .	189
AA-50 Alternative Artillery APC . . . . .	190

## Quick Find

Atlantean Warriors (see Jinna Gir Song) . . . . .	17
Autobahn, The . . . . .	48
Autobahn Random Encounters . . . . .	50
Black Market . . . . .	38
Brodkil Empire . . . . .	30
Brodkil vs Gargoyles . . . . .	21
Captain Nemo-2 . . . . .	13 & 25
Coalition Army . . . . .	25 & 41
Cyborg Combat Pilot . . . . .	165
D-Bees in the NGR . . . . .	59
D-Bees: Border Militias . . . . .	61
D-Bees: Civil Rights . . . . .	62
D-Bees: Industrial Service Program . . . . .	60
D-Bees: Mandatory Deportation . . . . .	59
D-Bees: NGR Military . . . . .	60
Dream Peter (see a New Player Enters) . . . . .	30
EIDs: Enemy Infiltration Drones . . . . .	11
EIDs: Extermination Robots . . . . .	14 & 129
Full Militarization . . . . .	12
Gargoyles: Aviary Location . . . . .	15
Gargoyles: Bounties . . . . .	36
Gargoyles: Empire Divided . . . . .	27
Gargoyles: Emperor Zerstrun . . . . .	28
Gargoyles: Extermination Raids . . . . .	15 & 16
Gargoyles: Nests & Eggs . . . . .	14
Gargoyles: Uranium Rounds . . . . .	15 & 71
Gargoyles vs Brodkil . . . . .	21
General Rasheen . . . . .	65
History of the War (starts) . . . . .	11
Hover Vehicles, M.D.C. . . . .	82

Hover Vehicles, M.D.C. (RRK) . . . . .	83
Hover Vehicles, M.D.C. (WaffenTek) . . . . .	84
Hover Vehicles, S.D.C. (Triax) . . . . .	80
Hover Vehicles, Special Vehicle Features . . . . .	85
Jinna Gir Song . . . . .	17
Map of Rifts Europe 109 P.A. . . . .	29
Map of The New German Republic . . . . .	43
Mercenaries (see Hired Guns) . . . . .	35
Mercenaries: Freelance Jobs . . . . .	37
NGR: Beer . . . . .	58
NGR: Black Market . . . . .	38
NGR: Capital, Berlin . . . . .	47
NGR: Citizens . . . . .	53
NGR: Cities of Note . . . . .	42
NGR: Council of Gargoyle Reproduction . . . . .	14 & 17
NGR: D-Bees . . . . .	59
NGR: Government, The . . . . .	39
NGR: Luftwaffe, Cyborg Combat Pilot . . . . .	165
NGR: Luftwaffe, New . . . . .	34 & 159
NGR: Magic . . . . .	55
NGR: Mercenaries (see Hired Guns) . . . . .	35
NGR: Military . . . . .	33
NGR: Military Cental Command . . . . .	34
NGR: Navy . . . . .	33
NGR: New President Viktoria Sperling . . . . .	24
NGR: Secret Project Undertow . . . . .	25 & 180
NGR: Typical Military Strike on Aviaris . . . . .	16
O.C.C.: Cyborg Combat Pilot . . . . .	165
Operation Sea Storm: Delayed . . . . .	13
Operation Sea Storm: . . . . .	26
Phoenix Empire . . . . .	30
RRK Korporation (Hover Vehicles) . . . . .	83
S.D.C. Automobiles . . . . .	77
S.D.C. Hover Vehicles . . . . .	80
Song Warriors (see Jinna Gir Song) . . . . .	17 & 28
Song Warriors, NGR Relations . . . . .	41
Spy'Bots: Infiltrate Gargoyle Nests . . . . .	11
Struwwelper (see a New Player Enters) . . . . .	30
Time Line of Important Dates . . . . .	10
Triax Industries (description & History) . . . . .	69
Triax: Business Report . . . . .	70
Triax: Cars & Trucks (starts) . . . . .	76
Triax: Energy Supplements (legal drugs) . . . . .	73
Triax: Instant Meal Paste . . . . .	73
Undertow . . . . .	181
Uranium Rounds . . . . .	15 & 71
Vehicle Features . . . . .	85
Victor Lazlo . . . . .	46
Viktoria Sperling, NGR President . . . . .	24
VGN, German Black Market . . . . .	38
War 104-109 P.A. . . . .	12

Wroclaw, history and destruction . . . . .	18
Zerstrun . . . . .	28
Zerstrun's Gargoyle Empire . . . . .	28
Zurich, Battle of . . . . .	13

### **Triax Body Armor**

Cyclops Booster, T-1011-X2 . . . . .	107
Infiltrator Espionage Armor, T-E02 . . . . .	109
Juicer EBA, TX-J50 . . . . .	108
Sea Cyclops Dive Armor, TD-10 . . . . .	110
"Uber" Super-Exoskeleton, T-25 . . . . .	108

### **Triax Power Armor**

Butterfly, X-80 . . . . .	115
Fat Boy (Glitter Boy), X-700 . . . . .	117
Hell Angel (Flying Glitter Boy), X-710 . . . . .	121
Jaeger Weapon Systems, New . . . . .	125
Predator II, X-11 . . . . .	110
Ulti-Max II, X-1001 . . . . .	123
War Eagle, X-21 . . . . .	113

### **Triax Robot Drones/A.I.s**

Aerial Spy Drone, DVO-1 . . . . .	128
Chauffeur, V-200 . . . . .	91
Extermination Robot, EIR-60 . . . . .	129
Housekeeper, V-100 . . . . .	90
Landscaper/Farm Worker, V-250 . . . . .	92
Personal Assistant-Bot, V-1000 . . . . .	93
Pets, V-500 . . . . .	95
Spy Robots, EIR-70 . . . . .	130
Wolf, DV-39 . . . . .	

### **Triax Robots, Military**

Black Death, X-5050 . . . . .	150
Devastator Mk II, X-5001 . . . . .	153
Faust, X-2525 . . . . .	138
Gunman, X-4500 . . . . .	145
Griffon, X-2730 . . . . .	141
Longstrike, X-2010 . . . . .	139
Rainmaker, X-2020 . . . . .	136
Sharpshooter, X-4600 . . . . .	148
Talon, X-2750 . . . . .	143
Wolfhound, X-1471 . . . . .	132

### **Triax Weapons**

Assault Rifle, TX-17 . . . . .	100
Briefcase Shotgun, TX-A1 . . . . .	100
Briefcase Submachine-Gun, TA-A2 . . . . .	101
Ion Pistol, TX-25 . . . . .	96
Grenade Launcher Rifle, TX-75 . . . . .	98
Laser Assault Pistol, TX-23 . . . . .	96
Laser Sharpshooter Laser Rifle, TX-SL12 . . . . .	97
Laser Ultra Sniper Rifle, TX-SL13 . . . . .	97

Particle Beam Pistol, TX-27	97
Particle Beam Rifle, TX-46	99
Revolver (M.D.C.), TX-6	96
Shotgun, Exterminator, TX-SS01	99
Sonic Stun Projector, VS-101	101

**Triax Weapons: Giant Size Melee Weapons**

Blast Hammer, TX-H3	104
Defensive Shield, TX-001	105
Electro-Mace, TX-H1	103
Heavy Weapon Shield, TX-002	106
Plasma Whip, TX-H5	104
Vibro-Axe, TX-H2	104

**Triax Weapons: Giant Weapons for Robots**

Laser Pulse Rifle, TX-222	102
Particle Beam Rifle, TX-249	103
Rail Gun, TX-252	103

**WaffenTek Weapons**

Laser Pistol, WT-10 (M.D.C.)	106
Laser Rifle, WT-20 (M.D.C.)	106
S.D.C. Pistol, VolksPistole VP-01	106
S.D.C. Laser Rifle, Hell-Fighter VP-2	107



## A few words from one author

**Rifts® World Book 5: Triax & the NGR™** told the story of the New German Republic (NGR) and their struggle against the Gargoyle Empire. **Rifts® Sourcebook 3: Mindwerks™** expanded the setting to talk about Mindwerks, the Brodkil Empire, and the nations of Poland. **World Book 7: Rifts® Underseas** gave us the NGR Navy. These books set the stage in Europe for what was yet to come: The campaign to destroy the two demonic empires and make Germany and Poland safe from these monsters once and for all. **The Siege on Tolkeen™** series and **Rifts® Aftermath** propelled the world of Rifts several years into the future, to 109 P.A.

This book, **Triax™ Two**, is the next act in the *ongoing saga* of the New German Republic. It brings the story up to date with descriptions of what has been transpiring between Triax, the NGR, and the Gargoyle and Brodkil Empires. And it's exciting stuff, let me tell you. The battle lines change and shift. Nations lose some ground, while their enemies gain some. Tragedies occur. New villains are introduced. Heroes emerge. Technology plays an even bigger role in hitting the monsters where it hurts them the most. Triax Industries™ has been hard at work creating new and more efficient weapons, robots, and vehicles to use against the monsters.

**Triax™ Two** is also about the people, culture, and society of the New German Republic. World Book 5 gave us the military. This book provides more about civilian life. It can be thought of as a sort of travel guide as your characters make their journey across the NGR, whether they were born there, are stopping by to shoot some monsters, looking for work as mercenaries, making a mess of things, or settling down in a foreign land. This book should give you enough information (along with previously printed material) to make a fully playable campaign in the NGR as soldiers, mercenaries, adventurers, Gypsies, City Rats, civilians, or whatever you should choose.

Speaking of campaign choices, this book is a must-have for technology-based campaigns, even if your characters spend their time in North America. Here you'll find information on Triax Industries, how it functions, how it got its start, a handful of its fine products (both military and civilian), and background on some of its more clandestine operations. And, of course, it is jam-packed with weapons, vehicles, power armor, robots, and other technological gadgets and wonders.

In writing this book, we have learned what an incredible country Germany is. I do hope that one day I can make that huge leap across the Atlantic and become more intimately familiar with a country I have only read about. In the meantime, I'll just have to have my characters travel there instead. *Viel Spass!*

– Taylor White, Co-Author, 2010

# The New German Republic

When the Great Cataclysm rocked the planet and obliterated most lands, Germany, Austria and southwestern Poland were somehow spared the full extent of the devastation suffered elsewhere around the world. They were hammered by forces loosed by *the Coming of the Rifts*, and millions of people perished, but approximately half the cities remained standing. More importantly, the German government, technology, manufacturing capabilities and a number of entire cities remained mostly intact. This was a miracle considering the rest of the planet saw 80-90% devastation and loss of life. Only a few other places survived the initial carnage of the Great Cataclysm with comparatively light damage. A frightening thought.

On one hand, this was a blessing. On the other hand, Germany was alone. Every other nation around them was all but wiped from the face of the Earth, or so they thought at first. Communication networks were down – permanently. Weird phenomena rippled around them, and reconnaissance into the shattered world revealed to the survivors of Germany that the rest of humanity seemed to have been largely obliterated. The people of Germany from civilian to soldier, to government official were in shock. It took a while for it all to sink in. Then there were millions of questions. What happened? How did it happen? Who was responsible? Why were they spared? What should they do next? And on and on.

Very quickly they realized the world they knew was gone, replaced by madness and chaos. Strange lines of energy radiated from the ground, some human survivors seemed to possess strange powers, and alien beings and monsters – honest to God monsters – were on the loose. As time went by, the aliens, monsters and supernatural horrors seemed to increase in number.

The German government wisely focused its energy on establishing stronghold cities and relocated survivors from the outskirts, rural areas and severely damaged cities to the strongholds. They then made a massive effort to fortify and protect these havens of civilization. Again fate played an important role here, as Germany, Austria and southwestern Poland were *not* immediately attacked and overwhelmed by monsters like many other places around the globe. This gave the German people and their leaders decades to build defenses, to build an army, and adjust to a planet Earth that had been reconfigured into a bizarre and alien world. With industrial giant Triax Industries involved with defense, advanced technology and robotics were utilized. By the end of the first century of what was a New Dark Age for the rest of the world, the foundation of the **New German Republic (NGR)** had been laid. By the time the Gargoyles and Brodkil started to stream into the region, the NGR was already a strong and formidable high-tech nation. Of course, the German people had to adapt, make hard choices and painful sac-



rifices over the centuries, but they have managed to survive and prosper.

Sadly, the Fates that seemed to have shined on them in the early days, began to turn against the New German Republic, and in the last century, the nation and its neighbors have been surrounded by vast swarms of hostile Gargoyles and Brodkil sub-demons. Some estimates put these monstrous enemies numbering into the millions.

For decades, the NGR has held its own against the invading monsters. Triax Industries plays a huge role in the nation's survival and defense, but the question remains: Can the NGR maintain its freedom, or will the nation finally fall to a superhuman enemy? The NGR insists the answer is the former. Outsiders wonder.

## Time Line

### Important Dates in the New German Republic

**2021** – Triax Industries is founded in Frankfurt through the consolidation of three German industrial companies (specializing respectively in steel manufacturing, robotics, and advanced computers). The company comes onto the world scene when it develops a way to create Mega-Damage steel through molecular bonding; a form of nanotechnology.

**2030** – Hovercraft technology is perfected and made available to the mass market by a German automobile company.

**Summer, 2064** – Triax Industries unveils lightweight Mega-Damage armor and the *Uni-Max X-003 exoskeleton suit* at the World's Fair in Flushing Meadows, Queens, New York.

**December 22nd, 2098** – The Great Cataclysm begins.

**May, 2150** – Brodkil gangs break through the former Czech Republic and invade Berlin.

**October, 2245** – The NGR (New German Republic) eradicates the Brodkil invaders and reclaims Berlin. The capitol of the NGR is moved to Berlin. The reigning President makes it the mission of the NGR to liberate all of Europe from the monsters.

**2262** – Gargoyles invade and destroy Zurich. They remain nestled among the crumbling ruins.

**January 2286 (Zero P.A.)** – The Post-Apocalyptic Calendar is started by the Coalition States in North America.

**2289 (3 P.A.)** – The NGR Army begins the Bloody Campaign, where they mount a massive show of force to push Gargoyles and other monsters far to the south of the Alps, killing hundreds of thousands of them in the process.

**2294 (8 P.A.)** – The Bloody Campaign ends and is declared a success.

**2300 (14 P.A.)** – Brief outbreak of violence in Poland; vampires are blamed.

**2306 (20 P.A.)** – The NGR first hears about a “Gargoyle Empire” far to the south.

**2312 (26 P.A.)** – Construction begins on the Passau Research Komplex. It is finished two years later.

**2315 (29 P.A.)** – Brodkil gangs attack the city of Passau in order to destroy the new Triax Komplex and are driven back by NGR troops.

**February, 2324 (38 P.A.)** – Gargoyles, in an apparent act of retribution for the Bloody Campaign, mount an offensive that carries them across Western Europe. Millions of humans are displaced or killed.

**2326 (40 P.A.)** – Construction begins on a resurrected Autobahn system.

**2331 (45 P.A.)** – The Mandatory Deportation law is signed. D-Bees are forced to abandon their homes, businesses, and most of their property, and are banished to ghettos and border towns around the New German Republic.

**2346 (60 P.A.)** – The NGR first makes contact with the Coalition States (CS) in North America.

**2349 (63 P.A.)** – Triax makes the last attempt by anyone on the planet to breach Earth orbit. The attempt is a colossal failure.

**2370 (84 P.A.)** – The main offices for Triax Industries are moved from Frankfurt to the newly-finished Triax Tower in Berlin.

**2374 (88 P.A.)** – The Passau Triax Production Factory is completed. Also, the NGR Federal Department of Defense gives the military the green light to conduct their campaign to destroy the increasing presence of Gargoyles in and around Germany, Austria and Poland.

**2379 (93 P.A.)** – The first *Alliance Pact* is formed between the New German Republic and the Coalition States.

**2380 (94 P.A.)** – *Victor Lazlo*, the famous pre-Rifts parapsychologist, reappears near the NGR border after having been gone for nearly four hundred years.

**Fall, 2389 (103 P.A.)** – *Erin Tarn* visits the NGR and meets Victor Lazlo for the first time.

The Gargoyles proclaim themselves to be an autonomous empire and declare war on the New German Republic. In truth, the war between the NGR and the Gargoyle invaders has been going on for decades, but now the Gargoyles seem more organized and bent on the NGR's destruction than ever.

Following the Gargoyles' lead, the Brodkil in Poland claim all of Poland as the Brodkil Empire. They vow to enslave all humans and D-Bees, and destroy all who stand in their way.

**Spring, 2390 (104 P.A.)** – The NGR Army begins Full Militarization.

**November, 2390 (104 P.A.)** – Zurich is reclaimed from the Gargoyle Empire and made the staging point for an invasion of southern France. *Operation Sea Storm* is delayed due to unforeseen technical errors.

**2391 (105 P.A.)** – The attack on Zurich leads to some new scientific discoveries on Gargoyle procreative habits. The NGR military forms the *Council of Gargoyle Reproduction* to apply this knowledge against the monsters.

**June, 2392 (106 P.A.)** – The Gargoyle Empire, aided by the Brodkil, invade and destroy the city of *Wroclaw* in Poland.

**February, 2393 (107 P.A.)** – Due to an insult by the Gargoyles, 10,000 Brodkil demons, led by the *Angel of Vengeance*, eradicate the Gargoyle presence in Wroclaw, claiming the city for themselves.

**March, 2393 (107 P.A.)** – Tens of thousand Gargoyles splinter from the Gargoyle Empire and form their own autonomous factions.

**April 14, 2393 (107 P.A.)** – Helmut Mayer, the President of the NGR, is assassinated. Viktoria Sperling, the current CEO of Triax Industries, is inaugurated a short time thereafter.

**November, 2393 (107 P.A.)** – Unknown to the most of the country, the NGR’s secret offensive against the Gargoyle Empire takes it’s first step with the launch of the *Undertow Submersible Super-Carrier*. It is loaded with troop and heads for the south of France.

**December, 2393 (107 P.A.)** – After years of setbacks, Operation Sea Storm is carried out. It proves to be incredibly successful. The Gargoyle Empire is split in half and fragments into hundreds of disorganized armies. Dissension and chaos among the monsters reaches new heights.

**July 6th, 2394 (108 P.A.)** – *The Devastator Mk II* is revealed in a huge media event.

**Spring, 2395 (109 P.A.)** – The NGR and Coalition States sign a strengthened *Alliance Pact*. The Coalition triples their normal aid; Free Quebec and the NGR also strengthen their alliance.

**Summer, 2395 (109 P.A.)** – Current date.

# The War Against the Gargoyles

circa 104-109 P.A.

*“The People must be the ones to win, not the war. War has nothing to do with humanity. War is something inhuman.”*

– Zlata Filipovic

For the last five years, the war between the Gargoyle Empire and the New German Republic has grown more and more intense. Both sides are completely dedicated to the obliteration of the other. If there was ever a time for negotiation and diplomacy, it has long passed. The only thing that will satisfy either nation is the total eradication of their hated enemy.

Both the Gargoyles and the NGR (and to a lesser degree, the Brodkil) have suffered considerable losses. The Gargoyles started out with superior numbers, and though their losses have been great, they reproduce and reach physical maturity much more quickly than humans. So even though the Gargoyles have lost hundreds of thousands of troops, more are quickly spawned to fill in the gaps. Without the constant culling by the NGR military, the Gargoyles might have overpopulated Europe decades ago.

The NGR military’s main advantage is their advanced technology and the development of incredible new weapons to fight the Gargoyles. Humans learn, adapt, and evolve. They make and use tools and devices to tame their environment and survive. The German people, especially, have been renowned for their ingenuity in science and technology. Their collective aptitude for innovation has led them to create marvelous war machines capable of leveling the playing field against the monster hordes that surround them. Technology alone, designed, developed, manufactured and implemented almost singly by Triax Indus-



tries, has allowed the NGR to stand defiant against a foe that is superhuman, giant and outnumbers them. Every year, new technology is developed and new insights into the monsters are discovered that enable the NGR to gain even greater effectiveness at battling them.

Triax Industries is the force that drives the NGR’s army and the survival of its people. Three seldom recognized inventions of Triax have proven to especially useful in gathering intelligence on the enemy. They are the tiny Spy Robots made to look like insects and mice, the *Enemy Infiltration Drones (EIDs)* and *EICs Robots and Infiltration Combat Cyborgs (EICs)*. The small spy robots get in, video-record data, and get out without even being noticed. Both the Robot and Infiltration Cyborgs are designed to look like flesh and blood Gurgoyles and Gargoyles. The robot drones are controlled by an artificial intelligence (A.I.) and computer programs to behave like Gargoyles/Gurgoyles. The cyborgs are wonders of bionic engineering with a human brain and soul inside an artificial Gargoyle body made to seem like one of the living creatures. The Infiltration Robots and Cyborgs have given Triax Research Scientists an unprecedented look at the true nature of Gargoyles, enabling humans to observe and interact with the Gargoyles as if they were one of them. This has helped the NGR to understand Gargoyle society, positions of rank and their bestial nature, and most importantly, the ICCs have been able to locate, target, access and map enemy military bases, roosts (communities), and aviaries (nesting grounds and hatcheries) as well as identify and locate key figures in the Imperial Gargoyle hierarchy. Armed with this knowledge, surgical strikes can be made against the enemy.

Over time, the Gargoyles have come to realize *Triax* is the backbone of the NGR military. Destroy or cripple it, and the NGR war machine grinds to a halt. The Gargoyles remain at a loss as to how to do that, exactly, but the monsters have begun to plot and find ways to strike deep into the heart of the NGR. The enemy has proven to be relentless. Though the Army of the New German Republic is mighty, it has been unable to stop all the aggression leveled at it by its monstrous arch-enemy, the Gargoyles. Attacks, some devastating, keep coming. Though the NGR dislikes it, they have come to the conclusion that the Gargoyle Empire must be utterly destroyed and the Gargoyles swept from their land. It is a daunting task and a grim prospect.

Though the Gargoyle Empire seems to be rapidly deteriorating and fragmenting, it remains a clear, present and unpredictable danger. In the meantime, other dark forces have entered the stage.

## Notable Major Events by Year



### 104 P.A. Full Militarization

The New German Republic's Military High Command had wanted to launch a full-force strike at the Gargoyle Empire for decades. They claimed that the teeter-totter fighting between the NGR and the Gargoyles had done little to hamper the advancement of the monsters in Europe. What was really needed, they said, was an incredible display of force to cut down the popula-

tion of the enemy and intimidate the rest of the Gargoyles into leaving Europe forever. To "show the monsters who was boss," as it were.

In 88 P.A., the NGR Federal Department of Defense (*Verteidigungsministerium* or *Bundeswehr* are used interchangeably) gave the military the green light to conduct their campaign to destroy the Gargoyles. For the next fifteen years, the military Central Command worked to plan and carry out a strategy to do just that. Deals were made with *Triax* to design weapons, armor, vehicles, and other technology that could bring the Gargoyles to their knees. Much of the weapons and armor in this book have been developed just for this purpose, as the latest advancements in the NGR's ongoing campaign to eradicate the Gargoyle threat. A few new robots and machines of war would start to be unveiled by the end of 105 P.A., but most (including the Devastator Mk II, the "Fat Boy" Glitter Boy, the Sonic Stun Device, and a few other technologies) have not been available to the military in large quantities until 108 and 109 P.A. Now that they are being added to the already formidable NGR military, things are really heating up.

Plans for the new, massive assault on the Gargoyle Empire have been a huge national affair. *Triax* increased their military-oriented productivity by 200%, bringing in thousands of new employees. The military itself called for more recruits and had large and successful re-enlistment drives. Huge marketing campaigns excited young people about joining the military and they were happy to start their mandatory five year military service period; many signed up for 8-10 year terms right off the bat. Similarly, a new law required refugees coming into the NGR to serve no less than eight years before they would be granted citizenship. Even the possibility of recruiting D-Bees had been considered, but only as shock troops and front-line defensive squads.

It seemed the whole nation was becoming bolstered under a single banner: The eradication of the Gargoyle threat. The focus of the national mentality shifted from a long standing defensive position to an aggressive, militant one. The media labeled this phenomenon "Full Militarization" (or as it is known in Euro, "Vollständig Militarisierung"). The NGR government and military adopted the term, and it has stuck. "Full Militarization" became the slogan for the NGR, a call-to-arms where everyone pitched in to make the enormous operation a success.

This process of building up the military was in full force until November of 104 P.A. The military had everything it needed to launch its campaign of destruction. All it had to do was throw the first punch. That would take place in Zurich, 30 miles (48 km) from the NGR's southern border.

In the year 2262, twenty-four years before the beginning of the Post-Apocalyptic calendar, Gargoyles flew into Zurich, a pleasant and thriving community, and utterly destroyed it. The residents were slaughtered, only 20% of the population managed to escape alive. The Gargoyles ravaged the city and used its bones of steel and concrete to create lofts and perches for themselves to roost. By the time the NGR military staged a counter-attack, the Gargoyles were too firmly entrenched. Time and time again, the Gargoyles held the ruins of Zurich and chased off soldiers, mercenaries, and monster hunters. The city was theirs to inhabit. Even Germany's Bloody Campaign, occurring

between 3 P.A. and 8 P.A., failed to evict the Gargoyle invaders from the city. Eventually, the NGR gave up on retaking Zurich, and let the monsters have it.

The Gargoyles have sat firmly entrenched in Zurich for over a century, amassing more monsters, chasing off or killing intruders and the curious, and making the occasional attack on the Black Forest Border Towns. Which is exactly why the NGR Military High Command saw this as the perfect target for the first strike: it would make a profound and lasting impression on the German people, fulfill their demands for revenge, and send a powerful message to the Gargoyle Empire that it was time for them to move on or die. The psychological element was crucial. The military needed to shock the Gargoyle Empire with a quick and decisive victory on a target they considered to belong to them. By the same token, the NGR military wanted the battle to have a domino effect on the soldiers and citizens of their nation, and send morale so high they could ride it all the way through France, wiping out the Gargoyles every step of the way. The NGR government wanted to take back Zurich as a symbol to the average citizen that Full Militarization could work and they didn't have to be afraid any longer. Lastly, the military wanted to use Zurich as a staging point for their planned invasion of France to wipe out the Gargoyle Empire once and for all.

This attack would work in tandem with *Operation Sea Storm*, scheduled for a month after the attack on Zurich. The NGR planned to use both operations as a "pincer attack," to hit the Gargoyles hard and force them to flee Switzerland and head further west, where Operation Sea Storm would hit them again, without warning, from the southern coast of France with a massive naval strike. The idea was to cut the Gargoyle Empire into two sections, which could then be dealt with more easily.

Early in the morning of November 4, 104 P.A. the NGR Army launched their first strike on Zurich. It started when Commandos, slipping in under the cover of darkness, tagged several points with laser guidance systems. Then, a full barrage of long- and medium-range missiles completely obliterated the targets chosen by the Commandos. The Gargoyles were startled into action, and took wing in confusion as more missiles and long-range weapons were unleashed upon them. The (then, brand new) Longstrike and Jaegers using new interchangeable weapon systems, and other power armor troops, moved in to conduct the brunt of the assault. They were supported by heavily-armed infantry squads and Heavy Combat Cyborgs armed with Depleted-Uranium weaponry, and Luftwaffe fighters. The Gargoyles tried their best to mount an effective defense, but the initial shock, combined with the sheer ferocity of NGR soldiers using new and unfamiliar technology, was overwhelming.

The Gargoyles weren't the only ones surprised during the battle. The NGR was shocked to learn Zurich held Gargoyle *nesting grounds* among the twisted stone and steel structures of the city ruins. When it became apparent that the Gargoyles were going to lose the city, a mass exodus occurred. The Gargoyles fought most ferociously to evacuate their young and unhatched eggs to escape into the wilderness. The most brutal and ruthless fighting occurred within these "nests" or "hatcheries," where thousands of the monsters battled to protect their young. The "Sonic Stun Device," seeing its first real combat use, gave the

advantage to the NGR forces. The Gargoyles that remained in their roosts were unable to cope with the machine, and were wiped out by NGR soldiers.

The Battle of Zurich lasted nearly thirty-six hours, with no break in the fighting. The last five were particularly brutal, and were involved when the NGR soldiers suffered the most casualties. Even so, the NGR lost only about 12% of the troops, mostly infantry. The Gargoyles, however, suffered an incredible 93% casualty rate. Only those who fled were able to escape the onslaught. Zurich was undisputedly back in the hands of the NGR.

In the weeks that followed the battle, Gargoyle forces from the east made several attempts to reclaim Zurich and exact revenge for the destruction of a nesting place. All met with utter failure. As NGR armored troops spread across the mountain lowlands, the Gargoyles fled Switzerland almost entirely, either heading further west into France, or further up into the Swiss Alps. Here too the Longstrike assault robot, Jaegers, Ulti-Max and other power armor troops led the way.

Back home among the civilian population was total media frenzy, and a week-long celebration. No one expected such a quick and definitive victory. The country was ecstatic. Watching the Gargoyles fleeing in terror had exactly the effect the government had hoped for. Morale and confidence in the NGR military had been restored.

Operation Sea Storm, the massive coastal strike on the south of France, was slated to happen in December of 104 P.A. However, critical design flaws discovered at the last minute prevented the key, underwater attack vessel from being finished. Unexpected complications in its design and manufacture delayed Operation Sea Storm, not months, but years. It would ultimately require bringing in a new management team to get the super-carrier critical to the operation launched by Winter 108 P.A. and the combat operation in place and ready to go by December that same year.

The public didn't know it, but Operation Sea Storm was the critical follow-up punch needed to truly rout the Gargoyles and shatter their Empire. Without it, the Gargoyles were pushed out of western Switzerland and deeper into France and other regions where they could continue to regroup and launch new attacks against the NGR. That changed the war plan to decimate the Gargoyle Empire and prolonged the war. Military leaders had to scramble and come up with new strategies and tactics to hold the Gargoyles at bay and strike at them in other ways. That meant defending and holding onto Zurich and the territory along the NGR's southwestern border in order to keep the Gargoyles centralized in France until Operation Sea Storm could get underway.

Speaking of the NGR Navy, contact with **Captain Nemo-2 and the New Navy** was made late in 104 P.A., and an informal pact made, mainly to share naval intelligence, and a "You watch my back, and I'll watch yours" policy. Ironically, the delay of Operation Sea Storm, would give the military time to expand and ready the rest of its naval forces. All of whom would be chomping at the bit and hungry to make the operation a success when it could finally get underway.

# 105 P.A.

## New Scientific Findings about Gargoyles

The attack on Zurich revealed things about Gargoyle nesting and reproductive habits previously unknown. Numerous photographs, video accounts, and physical evidence of the Gargoyle nesting place, hatcheries and roosts were sent to the *Passau Research Komplex* for further study and speculation. Research teams followed that by going into the wild to find and study other Gargoyle nests. One was located in Austria. Using tiny observation robots disguised as insects (cockroaches, beetles, spiders, etc.), developed just for this purpose, the research teams were able to observe Gargoyles mating and nesting in their natural habitat, undisturbed by humans. They watched the Gargoyles for months, and witnessed the full nesting and reproductive process. They documented everything. Excitement ran high.

In September of 105 P.A., the scientists at Passau published their findings to an eagerly awaiting military. What follows is part of the summary report.

*Gargoyle aviaries are usually located in caves and cliffs, high up in the mountains (the site in Zurich was an unusual divergence). All species of Gargoyles, including the wingless Gurgoyles, lay eggs like birds. The eggs are kept in clutches scattered throughout caves a bit lower in the mountains. These aviaries are communal sites where hundreds to thousands of Gargoyle females come to roost every eight years or so. Anywhere from one to seven melon-sized eggs are in a typical clutch.*

*The female remains until the eggs hatch, which takes almost two months. Males may "visit" for the first month or two and bring food, but they mostly leave the female alone. The females may leave the nest for hours at a time to hunt, leaving the eggs vulnerable to attack. However, this being a communal arrangement, other male and female Gargoyles join forces to attack and chase away (not necessarily kill) intruders, which include animals, humanoids, and other non-Gargoyle supernatural creatures. The community works together to protect and support the nests, eggs, young, and the aviary itself.*

*Females care for the young until they can climb and fly on their own, approximately four weeks after birth. Gargoyles reach a near adult appearance and physical build within 11-16 months, but do not reach sexual maturity for 10 years. After the first year or so with the female, the male takes over the training of the young, and teaches them the basics of hunting and fighting. This training period last for a year to a year and a half. At the end of that period, the young Gargoyles appear to be adults and are left to fend for themselves. This process is fundamentally the same for the wingless Gurgoyles. The impish Gargoylites were not observed.*

**(Game Master Note:** In game terms, each clutch of eggs has 1D6+1 eggs, and each egg has 1D6+2 M.D.C. The eggs take 3D6+44 days to hatch. Mothers fight to the death to defend their young and are +1 attack per melee, +1 on initiative, and +2 to strike when defending their nests/young or in a murderous rage of revenge against those who might have killed their offspring. Juvenile Gargoyles can fly 3D6+16 days after birth, and they stay with the mother for 1D6+10 months before the father takes over their education/training for another 1D6+10 months.)

A special Council of Gargoyle Reproduction called the **Beratung auf Gargoyle Fortpflanzung (BGF)** was founded under the Army Intelligence Division and staffed with the brightest scientists and military strategists on Gargoyle matters. The data has been scrutinized, hypotheses were formed, computer models made and virtual tests conducted. Deep in the secret halls of the Triax Passau Research Komplex, captured Gargoyles were experimented on, dissected, and analyzed. Robots were dispatched to known Gargoyle aviaries to record additional information. Infiltration Cyborgs and Robots, disguised as Gurgoyles and Gargoyles, were sent in to the enemy's nesting grounds and hatcheries to learn more.

Their findings were a boon to the military. The equivalent to discovering the secret weakness of the Gargoyles or the password to their secret military manufacturing base. In a sense, the NGR now has access to one of the Gargoyle Empire's greatest secrets, their means of fast replenishment of their troops. As the German military learned, Gargoyles reproduce and physically mature much faster than humans do. A typical NGR family has one (or two) child at a time, and that child will not be combat-ready (with training and weaponry) for at least 17-18 years. Gargoyles, on the other hand, produce six times as many young, which reach full physical maturity in only 10 years, and even the young sub-demons are several times more powerful than a human, and capable of combat after only about four years of age! The juvenile Gargoyles may not be as fast and powerful as an adult, but they are still giants, possess Supernatural Strength and are the rough equivalent of a teenage human by age four. This explains why the enemy always seems to be reinvigorated and its troops restored every few years. Just by the numbers alone, the implications are staggering, and a testament that the NGR military has been able to keep the Gargoyle forces in check for so many decades. Current estimates suggest the NGR has consistently killed 15-20 Gargoyles for every one human.

The new data acquired by the military is proof that knowledge is power. Armed with information, the NGR Army can develop new strategies to seek out, target and destroy aviaries, disrupt mating patterns and prevent the monstrous Gargoyles from replenishing their troops with new blood at such a staggering pace. By the end of 105 P.A., the Council of Gargoyle Reproduction (a not-so-clever euphemism, but what would you expect from the military?) had put into place several new tactics to fight Gargoyles where it would hurt them the most: their ability to continue their species.

The first, and most obvious tactic was to infiltrate the aviaries and destroy as many Gargoyle eggs as possible. There were many ways to accomplish this, from the use of missiles and explosives, to collapsing the cave on the eggs and females, to charging in and blasting away. However, all of those methods put human forces in jeopardy, required fierce and heavy combat, and earned the vengeance of the surviving Gargoyle forces. Instead, the BGF came up with a much more subtle and insidious method of extermination: miniaturized robot assassins.

**Tiny Extermination Robots**, similar to the ones equipped with cameras to spy on the monsters, only this time the robots carried a small, but powerful explosive charge. Enough so that, when nestled under an egg, the charge would blow a hole in the egg and let the yoke ooze out, killing the undeveloped monster inside of it. These robots, made to look like insects such as

cockroaches, large beetles and mice, would not hold up under any intense scrutiny, but who pays much attention to an insect the size of a poker chip or a mouse; especially when you're a 20 foot (6.1 m) tall Gargoyle? Furthermore, the disposable robot assassins could be made of cheap S.D.C. material, and the explosive charge only had to deliver 1D4 M.D. to punch a small hole in the egg and ruin it. After a year or so, the Gargoyles figured out what was going on, but by then tens of thousands of eggs had been destroyed, and 55% of the tiny robots, dispatched in small batches of 50-100 at a time, still managed to make it to their mark and destroy the eggs.

**Commando Squads** are used against the Gargoyles on many different levels, from surgical strikes to infiltration and rescue. They are skilled at sneaking inside aviaries and setting explosive charges at weak spots to collapse exits and ceilings, cause underground rivers and lakes to flood aviaries, and similar acts of destruction that can wreck the breeding ground and possibly kill a number of the roosting females as well as destroy most of the eggs. Of course, the problem with this method is that it forces the Gargoyles to find a new nesting ground, and that means the NGR has to go searching for it as well. Commando Squads may also set laser designators or radio transmitters as a homing beacon for long-range missile strikes, and may be dispatched to "acquire" new specimens (eggs or infants) for further testing.

Once the Gargoyles figured out what was going on, the monsters started to keep human prisoners – captured soldiers and innocent civilians – in the aviaries to dissuade the NGR from using attacks to bomb and destroy the entire nesting place. Thus, Commando Squads and Infiltration Cyborgs are often sent to infiltrate Gargoyle aviaries and rescue human captives before an all-out raid or missile attack is launched. NGR Commandos and Infiltration Cyborgs include some of the most talented and highly-trained soldiers in the Army. Only the best of the best are given these missions, which are considered a high honor.

**Mercenaries are not hired for attacks on Gargoyle aviaries** because they are not trusted to get the job done. This kind of operation simply cannot be trusted to freelancers, who may lack the training and mental discipline required to get the job done. Furthermore, NGR Military Intelligence is hesitant to give outsiders valuable strategic information such as the location of a Gargoyle aviary.

That having been said, adventurers and mercs may find nests and hatcheries and sell the information to the NGR, or engage in their own extermination campaigns so they may collect the bounty the NGR has placed on the carcasses of the slain monsters. The bounties are not large, but a well equipped company of mercenaries can make a decent living hunting Gargoyles. Furthermore, the aviaries and other Gargoyle communities sometimes have weapons, gear, magic items and valuable goods stashed away. Items the mercs can use themselves or trade on the open market. Practitioners of magic among mercenary forces may also have the advantage of using magic to infiltrate a Gargoyle nest to gather intelligence, set explosives or traps, or attack and kill the monsters. Metamorphosis into a Gargoyle Lord is always an easy way to gain access to Gargoyle encampments, prisoners and resources. When you stop to consider all that spell casters can do, the possibilities are limitless.

**Biological and Chemical** weapons are something the NGR considered during the early days of the war, but early tests were

inconclusive, and the military ended up going in other directions. After all, Gargoyles (and Brodkil) are lesser supernatural beings, and their physiology is not only alien, but supernatural in nature. Recently, these programs have been opened back up by the Council for Gargoyle Reproduction with the purpose of using biological or chemical agents to halt the reproductive process in Gargoyles; emphasis on chemical agents. There has been little progress made in either arena. These areas are way outside Triax's area of expertise, and there are no other European companies doing this kind of work. Nevertheless, the Council decided to give the researchers another five or six years before re-evaluating their financial viability.

**Uranium Rounds**, which have classically been used to keep supernatural creatures from Bio-Regenerating, are found to have another, extremely useful purpose. If damaged by a significant amount of Uranium Rounds (not DU), and if the rounds are left to fester in the Gargoyles during a mating cycle, it can make males temporarily sterile and prevent pregnancy in females. The NGR is exploring the possibility of exposing Gargoyle aviaries to high amounts of radiation (far beyond those tolerable for humans and most other life forms).

**Locating Aviaries.** An important part of taking out Gargoyle hatcheries is finding where these places are located. They are almost always permanent structures built into a mountain cave, decrepit skyscraper in a ruined city, or some other elevated, hidden place. On occasion, an aviary is found underground, but Gargoyles and Gurgoyles prefer places high-up, making mountain caves the number one location, and the ruins of tall M.D.C. buildings their next favorite place. Thus, aviaries are usually located in mountainous regions. This also helps to explain why the majority of the Gargoyle population is located in the Alps Mountain Range.

The NGR military has long-range reconnaissance squads in nearly all of Europe, trained to look for Gargoyle aviaries and other enemy encampments. These reconnaissance teams incorporate an indispensable resource in this effort: the native wilderness people of Europe, especially *Psi-Stalkers*. Psi-Stalkers have been living in the wilds of Europe ever since the Two Hundred Years Dark Age, hunting and surviving well under the radar of the Gargoyle Empire. Since Psi-Stalkers instinctively prey upon supernatural beings, and Gargoyles are so numerous in this part of the continent, they are natural enemies. Psi-Stalkers hate Gargoyles and delight in tracking them down and killing them, especially the flightless Gurgoyles and the weaker Gargoylites. As mutant humans and people who live in the wild, Psi-Stalkers are very good at avoiding, tailing and tracking Gargoyles. This also means they know where they are camped, and if the Psi-Stalkers don't know where a Gargoyle or Gurgoyles base or hatchery is located, they can certainly, over time, track one down. The trick is getting the Psi-Stalkers to help.

Although Psi-Stalkers are not D-Bees, the NGR has not embraced them as brethren either. Thus, there is a certain amount of suspicion and distrust between both parties. Still, most Psi-Stalkers are usually willing to tell NGR soldiers and adventurers about Gargoyle troop movements and the location of campsites and aviaries. The NGR military has taken advantage of their extensive knowledge and even have deals going with a few select tribes, setting them up with Triax dealers for weapons, armor, medicine, vehicles, and other equipment for their



help in hunting and exterminating Gargoyles. NGR patrols even sometimes use one or more Psi-Stalker “native guides” in their patrols, rescue missions, and searches for Gargoyle lairs. Due to the nature and relationship between the military and Psi-Stalkers, the human mutants are not regarded as “mercenaries” nor as true citizens of the NGR, but they are seen as indigenous people helping to defend their country.

### **A typical military strike on a Gargoyle Aviary**

When the NGR does want to take down a Gargoyle nest via military force, the attack goes something like this: Commandos, Psi-Stalker scouts, and/or Infiltration Cyborgs that look like Gurgoyles, sneak into (or on top of, or within sight) of an aviary, usually under the cover of darkness, to lay targeting devices and take laser readings. That information is transmitted back to a *Mobile Infantry Strike Base*, which is always present during these engagements, or if close enough to the NGR border, a standing military base. Commando teams, assisted by Luftwaffe Intelligence high altitude flyovers, also perform reconnaissance of the aviary and the surrounding area, noting terrain features and any nearby settlements.

Using the real time intelligence, the strike leaders at the mobile command center assemble troops, power armor, robots, jet fighters, and in some instances, heavy bombers to lay siege to the aviary. Taking out a Gargoyle breeding ground is a huge deal, and essential to the war effort, so there is rarely any shortage of troops or military resources. Sometimes the attacks are planned weeks or months in advance.

Infantry troops are transported via air (or on foot) to a staging point near the aviary. They are equipped with heavy weaponry and extra ammo. There is one Jaeger or other power armor unit, or Heavy Cyborg, for every ten infantry men. Jaegers and power armor units are outfitted with close-quarters, hard-hitting weapons designed to initiate ground fights and cause maximum damage to the enemy.

The attack begins with a long-range barrage of missiles using the laser designations and sensor data gathered by the infiltration team. This initial assault is designed NOT to take out the aviary from long-range, as it is usually much too deep inside the mountain to take out with missiles or bombs. If the opening is sealed off, the Gargoyles eventually dig out. Instead, the missile strike is designed to shock, confuse, kill and scatter enemy forces *outside* and around the nest, as well as get those inside the aviary to panic and begin to evacuate the site, carrying the eggs and young outside. The missile barrage also prevents enemy troops from setting up a line of defense or regrouping to retaliate.

This tactic works very well, as most Gargoyles at aviaries are not concerned with combat as much as they are with evacuating the eggs and young to a new, safe location. Resistance, however, is always intense as the mothers and defenders are willing to fight to the death to protect the next generation. That’s where ground troops and low flying aircraft and aerial power armor troops come into play. It is their job to, a) stop the Gargoyle forces trying to ferry the eggs and young out of harm’s way, and b) enter the aviary and take down as many defenders, nursemaids, mothers and young as they can. This task is more difficult when the aviary is part of a larger base of operation or

roost, or if there are Gargoyle roosts nearby and the warriors swarm to defend the aviary under siege.

After the missile barrage, the Gargoyles and Gurgoyles are likely to flitter and run about in a frenzy of confusion and terror as they rush to protect the eggs and the young. Gargoyle Penalties: -3 on initiative, -1 to strike, parry, and dodge, and -15% to skill performance for the first 1D4 melee rounds after the barrage.

While the Gargoyles are disoriented, the NGR assault force rush to the scene to continue the attack. The infantry forces advancing to go into the aviary are largely power armor troops, heavy Combat Cyborgs, and light robots supported by aircraft and medium to heavy robot combat forces and transport vehicles that hold back at a distance. The heavy robot troops are there to handle incoming Gargoyle forces that may deploy from neighboring Gargoyle camps to protect the nest, and to keep paths of retreat open for the infantry to retreat when they are done wiping out the nest.

All known entrances and exits to the aviary should have been noted and “painted” (marked) by targeting lasers and radio transmitters, enabling NGR ground and air troops to quickly find them and advance upon them. The advancing military forces use mini-missiles, rail guns loaded with uranium rounds and heavy weapons to make precise strikes on all monsters as they try to flee. A certain number of infantry, power armor troops and robots remain outside to engage defenders, take down enemies trying to escape, and keep the entrances/exits to the caves that access the nest open. The rest of the troops, mostly cyborgs and power armor, but at least 25% are a combined force of infantry soldiers and Commandos, lay siege to the nest deep inside the mountain.

Combat inside the aviary is the most vicious and unforgiving. The females, defenders and young fight for their lives. The human troops battle to take their lives, destroy the clutches of eggs, and decimate the nest. It is a horrendous, last-man-standing scenario. Once the NGR troops feel that they have destroyed 50-60% of the demonic adults, young and eggs, they hold off any defenders while demolitions experts (often Commandos) set charges to collapse ceilings and pillars to finish the job.

The Gargoyles rely heavily on their ability to fly, and Gurgoyles their ability to climb and leap, so the sub-demons typically have the advantage of terrain, as aviaries are usually located at elevated positions inside the ruins of large, tall buildings or inside mountain cave networks and other elevated tunnel networks. Such elevated and uneven terrain is more difficult for human ground forces to access and fight in, even if they are clad in advanced power armor, exoskeletons or robot assault vehicles. Aerial NGR forces try to engage enemy fliers, but again, depending on the terrain and circumstances, their effectiveness may be limited. Gargoyles are clever, and they know to fly low to the ground, between buildings or mountain peaks, and take similar evasive action to keep aircraft at a disadvantage. The monsters are also able to stay off radar by flying low and between buildings and rocky outcroppings. The air force must also be careful not to put the ground force in danger from friendly fire or collateral damage that may include falling debris and slain or injured Gargoyles dropping out of the sky! Aircraft are most effective providing cover fire when the ground troops retreat from the combat zone for extraction. When their troops are

out of the combat zone, the aircraft can cut loose and hammer the ground and airspace occupied by the enemy.

Naturally, the goal of such strikes is to destroy the aviary, and every single egg, young Gargoyle and female possible. However, the strike leaders at the mobile command center are satisfied to chase off the majority of the adults, as long as they wipe out the majority of the eggs and young; everything after that is frosting on the cake. It is here that the monstrous nature of the enemy works as a psychological advantage for the human troops. It would be difficult to charge in and slaughter human-like women and children, but in the case of the Gargoyle species, females look very much like the males, the young look like small adults or females, even the very young stand 7-10 feet (2.1 to 3 m) tall, and the eggs are just faceless objects to be destroyed. As a result, the soldiers do *not* feel they are fighting women and children, but monsters, which they are. Most Gargoyle species are supernatural and demonic beings. All are giant-sized, and all possess Supernatural Strength that can kill an unarmored man with a single punch and tear the limbs from a robot or peel a soldier out of his power armor with their bare claws.

After a successful extermination raid, a swarm of tiny explosive robots are left behind for continued attacks on eggs and injured Gargoyles, as well as similar small spy robots for continued observation. Other cameras, motion detectors, and planted camouflaged spy devices with advanced sensors may be left behind to watch for returning Gargoyles and to make sure the breeding ground isn't rebuilt and re-inhabited. If the monsters try to rebuild the aviary, the NGR is alerted and can take appropriate action.

**Note:** The Council of Gargoyle Reproduction is still a very new program, and it is unknown how effective its efforts will be to help end the conflict more quickly. However, computer projections suggest these raids on breeding grounds will have a tremendous impact on the Gargoyle population. If the pressure on these sites is maintained, the Gargoyle population could be reduced by as much as 25-33% in only 6-8 years! And that percentage will only go up. At least for now, the NGR has one up on the Gargoyle Empire as far as long-term strategy is concerned. The NGR is fully prepared to make this a war of attrition if they have to.

The Council is always looking for new ideas on slowing down or halting Gargoyle reproduction. It is also important to note that as the war drags on and more and more aviaries are destroyed, the Gargoyle Empire will begin to increase the defenses at these locations, and may even start using them as traps to lure combat forces into their clutches. Aviaries in France and Belgium are always defended by Gargoyle Mages, Gargoyle power armor and robots, and the farther they are from the border of the New German Republic, the more dangerous it is for human forces to make it deep into enemy territory, to make these surgical strikes. Long-range missile strikes have limited effect as the hatcheries are usually deep underground and even bunker busting missiles inflict minimal damage. Furthermore, the NGR's strategy for slowing down Gargoyle reproduction have minimal effect on the overall population at this stage of the war. The effects, however, have been greater than anticipated. The attacks have worked the monsters into a rage, angering them to the point of making suicide attacks against major NGR installations

out of revenge, scattering their forces and forcing them to relocate aviaries at greater distances away from the NGR border. Furthermore, the attacks have had a tremendous and immediate impact on a psychological level and the morale of the enemy. The attacks on the aviaries and breeding grounds have sent the Gargoyles' morale crashing, caused considerable dissension among their ranks, divided forces and caused Gargoyle troops to become reckless, desperate and engage in suicidal last stands, particularly at aviaries, that have decimated their fighting forces. All these things are benefits the NGR leaders had not expected, but they are taking full advantage of it all. In the short-term, this has made the enemy even more aggressive and violent, but they the NGR forces continue to hold and Gargoyle casualties continue to climb.

## Jinna Gir Song and the Atlanteans

### Expanded from *Rifts® World Book 3: England* (page 48)

Unknown to the NGR, they have been receiving assistance in the war from a very unlikely source, a band of resistance fighters made up of humans, D-Bees, and even some True Atlanteans. Their leader is a woman named Jinna Gir Song, a veteran at fighting Gargoyles. What might confound and concern the NGR even more than the fact that a group with D-Bees is quietly working on the sidelines helping them, is that Jinna Gir Song is actually an adult Chiang-Ku Dragon of considerable power. She has been battling the Splugorth for centuries, and they frequently use Gargoyles as troops. She is also a master of Tattoo Magic (it is rumored her ancestors were among the original creators of the craft), and has decked her followers with Magic Tattoos, including some rare and forgotten tattoos.

Jinna and her fighters became embroiled with the Gargoyle War back in 38 P.A., after witnessing the horrible vengeance of thousands of Gargoyles sweeping across Europe in retribution for the NGR's Bloody Campaign thirty-five years prior. Instead of directly approaching the human nation – which had become sorely human-supremacist by 38 P.A. – she decided it would be best to aid the NGR from the shadows. As a result, Jinna and the Atlanteans function as a guerilla unit, staying in the wilderness, infiltrating enemy camps, gathering information, and covertly disseminating it to the NGR military.

Jinna and her Atlanteans regularly tangle with Gargoyles and the Minions of Splugorth. They have been working hard at cutting the supplies from Atlantis to the Gargoyle Empire and preventing shipments of weapons and power armor from making it into their hands. Jinna has fought alongside General Rasheen on a number of occasions, though not since he took public office with the NGR, and she tends to avoid involving herself in the politics of other people. However, her hatred of Gargoyles and the Splugorth makes this fight personal.

In August 105 P.A., the existence of Jinna and her Atlantean fighters was discovered by the NGR military. Scouts and spies in the south of France picked up on her trail and it was confirmed by the Gargoyles complaining about her efforts against them and her support of the NGR.

Jinna suspected that she had been discovered by the humans, but was confident that her efforts were appreciated. Jinna and her Atlantean teammates spent their time between 104 P.A. and the Summer of 107 P.A. battling the Minions of Splugorth and

helping the locals. In 107 P.A., Jinna played a pivotal role in *Operation Sea Storm*.

## Quick Stats for Jinna Gir Song

**Alignment:** Scrupulous.

**Attributes:** I.Q. 22, M.E. 24, M.A. 24, P.S. 25 (Supernatural), P.P. 17, P.E. 16, P.B. 17, Spd 22.

**M.D.C.:** 1,000, +1,000 more when in her natural dragon form.

**Level of Experience:** 11th level Chiang Ku Dragon R.C.C. (See *Rifts®*: England for details on the Chiang Ku Dragon.)

**Note:** Jinna Gir Song is also decorated with many magical tattoos, some super-rare, and a few that have not been seen on Earth for millennia. She has been known to award magical tattoos to warriors of exceptional bravery and skill, as well as magic items and technological weapons. She and her crew have supply caches and weapon depots hidden throughout Italy, France, Switzerland, Austria and Germany.

## Jinna's Resistance Fighters – The Song Warriors

Jinna Gir Song's fighters are recruited from across the Megaverse by invitation only. Anyone who hates the Splugorth, Gargoyles, and Demons, and who possesses a strong, noble, warrior spirit *may* be considered to join her team. She is also happy to join forces with other bands of heroes who oppose the Splugorth or the Gargoyle Empire, or lend a helping hand from time to time. Jinna currently has around 1,500 fighters recruited to her cause.

Racial Breakdown:

50% True Atlanteans.

20% Humans (mostly Europeans, but some from other continents and even other dimensions).

5% Dragons of various types (Jinna is the only Chiang-Ku).

10% Elves and Dwarves.

5% Ogres, Trolls, and various other monster races of good alignment.

5% Psi-Stalkers and Simvan.

5% Various others.

Typical O.C.C.s Include: Atlantean Undead Slayers, Atlantean Tattooed Masters, Mercenary Soldiers, Atlantean Monster Hunters (See *Rifts® South America* for details), Combat Cyborgs (North American, Euro and Russian), Juicers (German/European versions), Crazies (mostly from Poland), Ley Line Walkers, Shifters, Druids (from England), Wilderness Scouts, Operators, Body Fixers, and various ex-NGR military O.C.C.s with appropriate power armor, robots and gear salvaged from the battlefields of Germany and France. Around 20% of the fighters are escaped slaves from Atlantis, unskilled and equal to the Vagabond O.C.C., and ones and twos of many other O.C.C.s across the board. All are paragons of heroism and dedication to Jinna and the cause.

Weapons, Armor and Vehicles: Jinna's fighters use a great deal of magical weapons and equipment. Some rely entirely on magic or on other natural abilities. The humans among them trade with Triax directly, mercenaries, adventurers or wilderness people (never the Black Market) for energy weapons, ammunition and explosives. They also salvage weapons from Splugorth

Slavers, Gargoyles, Kittani Warriors and gear left on the field of battle.

Power armor and vehicles are in very short supply, and tend to be light and fast types such as the Triax Terrain Hopper and Predator models, as well as the newer styles. Hover vehicles and off-road vehicles are also scarce.

Main Areas of Operation: Members of the fighters have dubbed themselves the **Song Warriors** and are divided into cells of 100-200 troops operating throughout France, Switzerland, Austria, Germany, and Northwestern Italy. Occasionally they move into Belgium, Spain, and England.

## 106 P.A.

For the first half of the year, the war seemed to increase in intensity, especially around the Black Forest region. The Gargoyle Empire sent more troops from Belgium into France to attack the NGR forces making a push there.

Elsewhere, Gargoyles made a small, though concentrated attempt to break through the southern border, just south of Munich. The entire eastern border was particularly quiet during these months. Gypsies and psychics in Poland began to liken it to the calm before a storm.

## The Destruction of Wroclaw, 106 P.A.

**A Short History of Wroclaw:** Little has changed for the Polish city of Wroclaw since the coming of the Rifts. Wroclaw was a center for industry ever since the end of the Second World War. The city was quick to receive and adapt to every new technology that came into being, and attracted companies from all across Europe to establish factories and businesses there.

At the height of the Golden Age before the Coming of the Rifts, Wroclaw was an industrial giant. It managed to stay on the forefront of bringing the new technologies of the day into Poland, which in turn brought in billions of credits in tax revenue, and created thousands of jobs for its inhabitants.

Wroclaw suffered during the Great Cataclysm, but like Germany, it survived with much of its infrastructure and manufacturing capabilities intact well into the Dark Age. Unfortunately, most of Wroclaw's infrastructure was built on money from outside sources. With the destruction of those companies, the city struggled to support itself. It depended heavily on the *Poznan Collective* and *Tarnow* for supplies and defense. For decades, the great factories sat silent, unused. It was only with the resurgence of mankind in Europe, sparked mainly by the formation of the New German Republic, that Wroclaw began to dust itself off. Indeed, German manufacturers and entrepreneurs came to Wroclaw and began to adapt the factories to the service of the Army of the New German Republic.

As of 105 P.A., Triax leased 45% of Wroclaw's industrial capabilities for their military manufacturing needs. With Triax's aid, Wroclaw rebuilt itself into a powerful industrial city-state. The people once again had jobs and money flowing into the local economy.

Steadily, however, a dark cloud grew on the horizon. Economically, Wroclaw was in a good position. When it came to matters of war, however, Wroclaw's close proximity to the



Brodkil Empire and vital importance to Triax made it a target for the NGR's enemies as well as the marauding Brodkil.

## Statistics of Wroclaw – 106 P.A.

**Total Population:** Approximately 540,000 residents, with another 120,000 in surrounding villages. Wroclaw also had an average transient population of 2D4x1,000 people. Despite being heavily based in industry, the city-state had a thriving arts and cultural community, with an emphasis on theater and opera. Those who could afford to take the dangerous journey across the *Monster Zones* found the trip well worth the risk to catch one of the city's amazing shows.

**Population Breakdown:** Wroclaw, like most of Poland, was very prejudiced against non-humans, even more so than the NGR. D-Bees and non-humans had no rights and were frequently beaten or jailed for no reason. If D-Bees could find a job, it was usually the worst kind of slave labor imaginable, and the pay barely enough to live on. Humans had an overwhelming majority at 80%, with the next most common races being Ogres, Orcs, and Trolls, making up another 17% percent. The rest were a mixture of miscellaneous D-Bee races.

### Employment Breakdown:

Industrial: 35% (mostly Triax)

Industrial Related (Repairs, Installation and Maintenance): 15%

Construction: 10%

Entertainment: 5%

Service (Hotels, Restaurants, Bars, Nightclubs, etc.): 5%

Financial Services: 5%

Military and Law Enforcement: 3%

Other: 10%

Unemployed (also counts mercenaries and adventurers; roughly 90% of the D-Bees counted among the population are unemployed): 12%

**The darkening storm.** For years, the Gargoyles and Brodkil searched for a way to cripple the New German Republic (NGR) by attacking Triax Industries. The problem wasn't easily solved. Most major Triax installations are deep within the NGR in heavily-defended cities. The Gargoyles did what they could to hurt Triax, including attacking field teams, research operations, merchants and supply caravans outside the NGR, but their efforts did little to hurt the mega-corporation.

With the NGR's Full Militarization in 104 P.A., the fight rapidly heated to the boiling point. The Gargoyles started taking bigger risks to get to Triax, sending more troops to hit harder targets. They began to take second looks at cities, military bases, and fortifications previously believed to be impenetrable or too risky to attack. *The city of Wroclaw* was one such target. It quickly rose to the top of the "hot targets" list for two main reasons. One, it was close enough to the Brodkil Empire that the Gargoyles could launch a major offensive very quickly, without giving the NGR army time to mobilize a defense. By the time a sufficient counterattack was launched, the city would be in ruins. Two, destroying the enormous Triax manufacturing plant in the city would finally make Triax bleed. Not realizing the extent of Triax Industries' holdings, the monsters came to believe if

they took down the Triax manufacturing compound at Wroclaw, they'd cripple the company, making it their primary target.

**The Gargoyles attack.** Early one summer morning in 106 P.A., the monsters made their move against Wroclaw. Thousands of Gargoyles and Gurgoyles led hundreds of thousands of Brodkil through the forests and farmland of southern Poland and punched through the city's flimsy defensive perimeter like it was paper and slingshots. The swarming monsters filled the streets like a flood, killing every person they saw; human, D-Bee, man, woman and child. Those who they did not slaughter outright were gathered up and taken to the city center.

A large contingent of flying Gargoyles made their way directly to the Triax manufacturing plant where they met with the greatest resistance. The monsters attacked the plant, full-force, with Gargoyles tearing apart the buildings and Brodkil showing up minutes later to round up the work force and obliterate them. What the monsters did not tear apart with their bare hands, they blew to smithereens with explosives. They had somehow managed to get their hands on a large shipment of *fusion blocks* and other explosive ordnance (the Brodkil said they were a gift from the "Angel of Death"), which they used to strategically blow the factories into rubble. Weapons, armor, and explosives salvaged from the carnage were sent back into the *Monster Zones*.

It was not long before the NGR army mobilized a counter-strike. Supersonic transport jets, filled with infantry soldiers, power armor, and heavy combat robots, took off from the NGR interior for Wroclaw as fast they could mobilize. By the time they arrived, large sections of the city were in flames and blood flowed into the streets in rivers. NGR robots and power armor suits led the assault, followed by heavy cyborg troopers and infantry soldiers. Rescue teams desperately tried to find and evacuate as many civilians as they could. The fighting was intense, with the majority of the attack occurring at the city center. The monsters had the upper hand, and used thousands of captured civilians as bullet shields. The NGR soldiers concentrated on driving the monsters away, inflicting as little collateral damage to the civilians as possible.

Hours passed, and it seemed Wroclaw was doomed. The NGR briefly gained the upper hand, but then Brodkil raiding parties came up from the southern forests in droves to provide reinforcements. Shortly thereafter, Gargoyle troops in power armor attacked. It was clear to the NGR that the monsters would not give up until Wroclaw laid in ashes. It was decided by High Command to recover as many civilians as possible and abandon the city to the monsters. The focus changed from defending the city and pushing the invading demonic hordes out, to a frantic rescue mission and battle to get all the NGR troops out before they were completely overrun. When this became apparent to the monsters, they too changed tactics. They started focusing on butchering the civilians and taunting the soldiers with the loss. It became a race between the two armies, one trying to annihilate the people, and the other desperately trying to save as many as they could.

Twenty-nine hours after the battle had begun, Wroclaw was nearly wiped off the map. A full third of the populace had been killed in the initial assault, with thousands more dead at the end of the battle. The monsters had sustained heavy losses, especially compared to the NGR army. Nevertheless, the day and the

city belonged to the monsters. Wroclaw was in flames, and the Triax plant was no more.

## Wroclaw Assessment and Aftermath

The Battle of Wroclaw was the NGR's first major loss in years. The Gargoyles had slowly been encroaching on unclaimed territory in Northern France, Belgium, and the Netherlands for years, but there had been only small villages and farming towns there, which were protected, but unclaimed by the NGR military. Wroclaw was a major population center, with important industrial resources. It was an important part of Triax's manufacturing network, and its loss, though not crippling, was deeply felt. Moreover, the loss of so many civilian lives, not to mention a city of culture and art that had survived the Great Cataclysm and the new Dark Age, made the people of the New German Republic mourn as they had not mourned in generations. It also made them feel their own mortality. As for the military, it was a stinging and tragic loss, but also a wake-up call. They had become complacent and overconfident. Wroclaw should have had more protection, and the loss of such a valued ally due to their own negligence was hard to swallow. The Gargoyles had destroyed everything. Every theater, every museum, every school and university, every cathedral and church, every factory, mall, pub, and park. They wanted the NGR to never try to take the city back, so they destroyed everything. Any surviving humans or D-Bees were either killed and eaten, or sent off to slave camps.

Wroclaw's destruction sent shock waves of grief and terror across the NGR and Poland. People clamored for vengeance and wept in sorrow and fear. "What city will be the next to fall?" they cried.

The around the clock media coverage of the battle and its aftermath brought images of the destruction flowing across the television and computer monitor screens of every home in the NGR. The country's internet added to the sensationalization of the event with rumors, unofficial reports, speculation and outright misrepresentations. Waves of refugees poured into the NGR, overwhelming the already strained integration programs and putting more pressure on charitable groups. Political and military pundits argued and debated for hours about what, if anything, could be done. The big question of the day was, "Is Full Militarization a mistake?" as blame was placed on the military for botching the defense and counter-attack at Wroclaw. The military, in turn, placed blame on the NGR government, who in turn blamed the governments of Warsaw, Tarnow, and nearby Warlord Seriyev for not doing enough to protect such a valuable community, and for not doing a darn thing during the invasion. Those governments fired back with their own accusations and excuses to avoid blame. The arguments and debates raged on for weeks after the city was decimated, with little being done. In truth, EVERYONE held some blame for the tragedy, and everyone looked upon the Gargoyle and Brodkil Empires with greatly increased concern and fear. The monsters had just escalated the war, and nobody was safe.

Meanwhile, the monsters fortified their new positions and planned their next attack. They saw what was happening to the NGR, and were thrilled beyond belief. Their next strike, they swore, would make Wroclaw seem like a street brawl.

## Success Divides the Enemy

It may sound counterintuitive, but the victory over Wroclaw created *division* among the monster hordes. The nature of demons and sub-demons like Gargoyles and Brodkil is intense aggression, violence and rivalry. While one might have expected the easy decimation of Wroclaw and the routing of the famous armored troops of the New German Republic at the combined hands of the Gargoyle and Brodkil Empires would have united the monsters, it did just the opposite.

First, both sides claimed to be the fighting force that spelled victory in the attack. This led to immediate fighting, derision and ultimately, a huge schism between the two monster nations. Wroclaw would be the first and last time the two Empires would fight together. To further complicate matters, their heady success had made the monsters overconfident and drove many of them to take major risks and launch foolish attacks against the NGR and defenders of Poland they could not win. Meanwhile, warlords within the Gargoyle Empire began to believe they knew better than their supreme leader, *Emperor Zerstrun*, which caused many to challenge the Emperor in battles for his throne that only led to their deaths and the Empire's loss of several competent leaders. This caused warriors loyal to their slain leaders to splinter off from Zerstrun's Empire and go their own way. The growing chaos and spontaneous rebellion spread and caused many Gargoyles in the Empire to slip out of their nationalistic mind-set and start acting against orders. This resulted in much dissension in the ranks, and more infighting between Gargoyle forces. Some even went so far as to start staking territory for themselves, and chasing off or killing any other Gargoyle, Brodkil, or mortals who dared challenge their claim or trespass on their land. Similar problems and schisms also took place in the Brodkil Empire, though the Angel of Death and her lieutenants were able to hold their Empire together a bit better for a while longer than Emperor Zerstrun.

## Gargoyle vs Brodkil

Throughout the latter half of 106 P.A., and on into 107 P.A., Wroclaw's destruction gave the Gargoyles and the Brodkil great cause for celebration. They may have lost Zurich, but in return they had dealt their enemy a harsh blow. To them, it was sweet revenge, and a message to the humans that their efforts were useless. As an added insult, the monsters were keeping Wroclaw. The Gargoyles planned to build grand structures out of the ruins of the city for them to perch and roost on. However, the Brodkil wanted the iconic symbol of victory for themselves. They had helped take the city and felt it was their forces that won the day. That meant the ruined city belonged to them and would be used to expand the borders of the Brodkil's territory. Besides, Wroclaw was inside the Brodkil Empire and the monsters had no desire to see the Gargoyles get a foothold inside their Empire. Neither of the Empires was willing to back down as both had played an equal role in its destruction. All that was needed to propel this bickering into violence was a little push in the right direction. That push came from one of the Brodkil gods known as the *Angel of Vengeance*.

When the Gargoyles first approached the Brodkil with the plan to invade Wroclaw, they brought it before the *Angels of*

*Death and Vengeance* in the secret Mindwerks laboratory. The Angels decreed that this was a plot most beneficial to their goals. Destroying the Triax production facility in Wroclaw would give them the opportunity to not only steal weapons and materials for their Brodkil “children,” but to steal Triax’s design and production files. They could get weapon plans and schematics, and cybernetic and bionic designs, to help “inspire” them to make even more twisted devices of their own.

When the occupying Gargoyles interfered with this plan, the Angels of Death and Vengeance sent a legion of Brodkil demons outfitted with heavy weaponry, advanced bionics, and Psynetic augmentation to help resolve the matter. When the Brodkil reinforcements arrived and the Gargoyles still refused to relinquish their claim to Wroclaw, battle erupted. An army of 10,000 Brodkil, led by the *Angel of Vengeance* herself, marched upon the Gargoyles. What followed was an epic slaughter. Almost five thousand Gargoyles were slain. Thousands more fled. Those who went north into southern Poland were met by NGR and Polish forces. Military Intelligence had been watching the situation in Wroclaw with great interest. Anticipating a conflict between the rival monster Empires, the NGR and Polish defenders had increased their military presence throughout southern Poland. When the Gargoyles scattered into that part of the country, the human forces were waiting for them. Their reception of the monsters was merciless.

Retreating Gargoyles who headed south were met by angry Brodkil who had been ordered to seal off the borders of their Empire and destroy any Gargoyle they encountered. While a number of Gargoyle warriors broke through the lines, two-thirds met a terrible fate.

One thousand Gargoyle traitors (most of which were actually the wingless Gurgoyles) were taken captive by the Brodkil, and allowed to live, with two conditions. One, they had to get on their knees and scream to the heavens that Brodkil are their superiors and that the twin Angels of Death and Vengeance were, indeed, “gods.” And two, they had to swear allegiance to their new gods and denounce Emperor Zerstrun as a fool and a failure. Of course this drama was filmed and widely distributed across Europe. It was a show that played across the television sets and computer monitors of the NGR for months. It also had the desired effect of embarrassing Emperor Zerstrun and causing even greater dissent within the ranks of the Gargoyle Empire.

With the Gargoyles publicly humiliated and evicted from Wroclaw, the Brodkil began to salvage weapons, armor, and other technology from the ruins of the Triax facility, adding to their terrible strength in the coming years.

This event marks a drastic shift in the politics between the Gargoyle and Brodkil Empires. From Emperor Zerstrun’s perspective, this catastrophe was born out of jealousy and contempt, nothing else. He had never been anything but amicable with the Brodkil and their leader, and at least pretended to treat the mad women as equals. This unprovoked attack on his people served as proof that the Angel of Death and her right hand, the Angel of Vengeance were, indeed, insane and agents of chaos. A hundred plans for their destruction and his own revenge upon the Brodkil raced through Zerstrun’s mind. In the final analysis, the Gargoyle Emperor has chosen to stay his hand. At least for now. He is a cunning military strategist, and realizes that con-

fronting the Brodkil Emperor now would only divide and weaken his own Empire and give the humans the opening they’ve been waiting for to destroy both Empires of monsters. Thus, Emperor Zerstrun has publicly admonished the “bitches” and their Brodkil whelps, but has taken no action against them. Privately, the Gargoyle Emperor seethes. His plan to set a combined force attack of Gargoyles and Brodkil upon the NGR has been ruined. He has been publicly embarrassed, and if he had his way, he’d be eating the “Goddesses of the Brodkil” for lunch and picking his teeth with their bionic claws. Instead, his carefully laid plans are a shambles, and he must regroup and find a new way to destroy the humans. This is greatly frustrating for him, because after years of planning and maneuvering, victory was within his grasp, only to have the unpredictable Brodkil leaders ruin things. His troubles don’t end there. The entire affair has made Emperor Zerstrun look the fool. And weak. The perception of weakness sends more ripples of rebellion and dissent through his fragmenting and disillusioned followers.

Most of the Gargoyles in the Empire demand immediate retribution. Gargoyles have always known they were superiors to the Brodkil and to be handed this defeat . . . it is too much to accept. The Brodkil had no right to take Wroclaw for their own, and the killing of thousands of the Gargoyle flock was beyond an insult. To many it is a declaration of *war* and they demand satisfaction. Emperor Zerstrun knows war with the Brodkil is pure folly and tries to dull his warriors’ anger with new plans to destroy the hated New German Republic, and a promise to gut the backstabbing Brodkil after the humans have been dealt with. His words and empty promise do little to quell the outrage of his people. Gargoyles scattered across the Empire call out against Zerstrun’s befuddled inaction. Some even demand his removal as Emperor. The Gargoyle Empire splinters as it has never seen before. Suddenly, Emperor Zerstrun sees his Empire falling apart, and his dream of a Gargoyle kingdom free and independent from the Lords of Hades slipping from his grasp.

Between February and April of 107 P.A., a few tiny factions of Gargoyles, Gurgoyles, and Gargoylites, under the leadership of a Gargoyle Lord or Mage, go “rogue.” That is, they break away from the Gargoyle Empire and establish their own political entities. These factions are separate, located in isolated pockets around Europe, but mostly occurring in Austria. Although they are isolated, their goals are the same: the eradication of the Brodkil Empire! These monsters initially represent less than 5% of the entire Gargoyle Empire, but their numbers continue to rise. By the year’s end, a full 25% of the Gargoyles have gone “rogue,” and the rest are disgruntled and unhappy.

## 107 P.A.

The year 107 P.A. will prove to be one of the darkest in decades. No one is untouched by the horrors of war in this year. The people of the NGR, Poland, France, the Gargoyle and Brodkil Empires; all are affected in one way or another. Within the span of just a few months, everything starts to come unraveled.

The destruction of Wroclaw the year before had wounded the psyche of the NGR and the nation of Poland deeply. For the first time in centuries, the NGR was left feeling vulnerable and afraid. If their enemies could cause the kind of destruction wit-

nessed in Wroclaw in little more than a day, what else were the monsters capable of? Who else would fall? Where would the monsters strike next? How vulnerable were their own defenses? How badly had they underestimated the enemy? When would the fiends target another human city? Which would it be?

**An aura of fear** and uncertainty pervaded the national mentality of the NGR. Everyone was lost to sorrow and fear. Everyone was on edge, awaiting the next attack and wondering if they would be next.

**Triax Industries** experiences a record drop in stock values and profits in 107 P.A. Losing the Production Facility in Wroclaw is a shock to the corporation. All the projected output of the destroyed facility is declared an irretrievable loss, an amount that totals into the billions of credits. That is compounded by a terrified nation of consumers who, almost overnight, abandon retail shopping and huddle in their homes. Sales plummet and company executives brace for a rough period.

Triax is held together only by its reigning *CEO Viktoria Sperling*. She sees no reason to panic and quickly redirect the production quota from the Wroclaw Facility to every other Triax production facility, splitting the work up evenly among them all and then increasing production despite the sales downturn. She shocks the executive board and District Production Managers by hiring more workers to handle the increased workload; 40% are refugees displaced from Wroclaw and 60% are D-Bees living in ghettos and border towns, praying for a chance to work for Triax and obtain citizenship. The CEO correctly anticipates what combat units and gear the NGR Military will need to retaliate against the Gargoyle Empire and got the refugees and D-Bees into the factories and gets working on them immediately. When the call to arms and increased demand arrive a few months later, Triax already has a stockpile ready to go.

Viktoria Sperling's pro-D-Bee political stance is well known throughout the NGR. She contributes money to independent D-Bee and refugee relief funds, and has done more through Triax to help the disenfranchised nonhumans than any previous leader in the country. D-Bees working for Triax have a better chance than others of becoming full citizens of the Republic and of working their way up inside the company to make a decent living for themselves. Sperling's political critics (of which there are many, including the Coalition States) claims she is opening the doors to "the enemy" by allowing any kind of "inhuman creature" into the nation. The most venomous of her critics call her a traitor to her race and warn the inhuman D-Bee laborers will one day rise up to bring down their proud nation.

## **NGR President – Assassinated!**

On the heels of the loss of Wroclaw, the unthinkable happens. On the morning of April 14, 107 P.A., the President of the NGR, Helmut Mayer, is killed by Gargoyle assassins during a dedication ceremony in the small western city of *Saarbrucken*.

Ground had just been broken on a massive new Triax stockyard and shipping center. When it was completed, the Saarbrucken commercial transportation center would have its own magnetic rail system and international airport with flights to Chi-Town, Free Quebec, Poland and the Sovietski.

President Mayer was giving an uplifting speech about rising from the tragedy of Wroclaw and carrying on into the future.

Six hundred people had turned out for the ceremonial media event. Although the event was important politically, and to Triax of course, it was actually rather commonplace for the President to give these kinds of speeches, so to the average citizen this was not major news.

Most people had just started their workday when the attack began. Television cameras captured the entire event as it happened. Gargoyles emerged, flying overhead from what appeared to be the city proper of Saarbrucken itself. It was hard to count them at first, but there were twenty-three of the monsters. They swooped in quickly, the two leaders using magic spells to confound the President's security team, and made a beeline for President Mayer. The President's security force, made up of NGR Commandos, two full-conversion 'Borgs, and fast-moving Predator Power Armor, engaged the Gargoyles while a quartet of Combat Cyborgs tried to get the President to safety. The sounds of battle drowned out the news correspondents as they tried to explain what was transpiring before them.

Mere seconds after the attack started, pictures and video were fed onto the NGR internet by eyewitnesses. Local short-range and wide-band radio frequencies were clogged with people calling for emergency services and contacting friends and loved ones. On secure channels, the military called for immediate assistance in the form of fast-moving X-2700 Dragonwings, X-2750 Talons, and XM-270 Mosquito Airships. Around the country, radio and television stations were switched on to the major news programs. Everyone stopped working and watched, full of dreadful anticipation. On the streets, people crammed





themselves into electronics stores and giant Triax retail outlets, to huddle around the enormous screens. People stopped their cars in the middle of the streets, causing massive gridlock for miles around as they turned up their radios and clicked on mobile computers to get the live report.

The Gargoyles would not allow themselves to be stopped. By the time they reached the event site, a quarter of them had been crippled or killed. The rest completely ignored their injuries and wasted no time in tossing the NGR soldiers and local *Polizei* forces aside, not to kill them, but only to get them out of their way. It was clear to everyone present that the monsters were there with the singular purpose to kill President Mayer.

If there had been more time between when the Gargoyles were spotted and when they reached the dedication ceremony, the President might have gotten away. His security forces were prepared for an attack from just about anything. In the end, only three Gargoyles survived long enough to get to the President inside his armored hover limousine speeding away to safety. One grabbed the limo and tore it open like it was made out of aluminum foil. Gunfire and mini-missiles from the cyborg defenders inside the vehicle blew the head of the monster off its shoulders as another snatched the limo from the dead creature's hands. News cameras kept focus on the attack, but as the second Gargoyle reached into the vehicle through a hail of gunfire, and pulled its hand back out with President Mayer in its grasp, the stations cut away to the anchor people at their desks. Stunned beyond words, the anchors stuttered about the President being killed. Bloody footage of the President being torn in half made it onto the NGR internet only seconds after it happened. Television and radio stations kept broadcasting, giving a horrendous account of the murder of the nation's leader. A minute later, security had slain the last two Gargoyles, and air support rocketed by overhead, but it was too late. President Mayer was dead.

For the rest of the day and the week that followed, the civilian nation of the NGR stopped dead in its tracks. A State of Emergency was declared. Planes en route to the NGR were closely monitored by Central Command and escorted by XM-280 Fighter Jets. Those that could turn back were ordered to do so. Trains outside the NGR were ordered to return to their station of origin. All internal transportation services were suspended. *The AutoBahnPolizei* set up roadblocks every ten miles (16 km) on every major highway. The military, however, exploded into action. All on-leave personnel were recalled. All close-range reconnaissance and patrol teams were ordered back to base. The nation closed all of its borders, hunkered down, and prepared for an all out invasion by the Gargoyle Empire. A state of terror gripped the nation.

The Gargoyle invasion never happened, but the damage had been done. Not only to the government, but to the psyche of the people. For the first time in a century, citizens no longer felt safe and protected. The war against the Gargoyle Empire had been brought to their doorstep.

## A New Leader

Miles away from Saarbrücken, sitting inside of Triax Towers in Berlin, *Viktoria Sperling* watched helplessly as the Gargoyles murdered President Mayer on live television. Only minutes after the President was confirmed dead, her phone rang. She was in-

formed that with the President's untimely demise, the responsibility of leadership of the nation fell on her shoulders.

According to law in the NGR Electoral System (and it's actually a hold-over from Germany's pre-Rifts days), the CEO of Triax holds Vice Presidential powers, and in the event the current President cannot fulfill his duties, the Vice President takes over immediately. Eight minutes after President Mayer's death, *Viktoria Sperling* was sworn in as the new acting President of the NGR. As the leader of both the Republic and Triax Industries, *Sperling* holds immense administrative power, at least until the next election cycle when a new President will be elected. She used that power to shake the nation out of shock and horror, to mobilize the NGR's greatest military operation ever. The first thing she did was to create a special investigative body within the government with authority over the military and local police, with the express order to uncover hidden dangers in the NGR interior (such as hiding Gargoyles), and specifically to unravel the mystery of why there were Gargoyles waiting for President Mayer at Saarbrücken. This investigative body, which was to remain Top Secret (*Vertrauenssache*), was made up of Triax Espionage Agents, Triax Security Agents, NGR military commandos, and leaders of the special task force, all of them the top in their field.

## Aftermath

It had been less than a year since the Gargoyle Empire and their Brodkił allies had completely decimated the city of Wrocław in Poland. In many ways, the NGR was still reeling from that attack. The murder of President Mayer was the sum of all the NGR's fears, realized. Somehow, Gargoyle assassins had planted themselves inside the NGR's borders and laid in wait for President Mayer. The investigation revealed the monsters had spent days holed up in a large condemned building, barely large enough to contain them. They had gained access to the building without being seen through the use of magic, but how did they know to come there? There had to have been a spy within the government's own ranks. The fact the monsters had gained entry into the NGR was shocking and terrifying enough to the citizens of the Republic. If the monsters did it once, they could do it again. Any place. At any time. For all they knew, there could be hundreds, or thousands of Gargoyles hiding, waiting to strike at any moment.

On television, the talking heads of the media bombarded each other relentlessly with questions. Political pundits let the accusations fly at nearly everyone: Monsters, D-Bees, foreigners, Gypsies, even the Coalition States. People tuned in and listened because they were scared and they wanted answers. The big question was, who helped the assassins? Who was the "inside man?" Fingers pointed everywhere.

Indeed, the military investigation determined how the Gargoyles had managed to get so deep into the nation. The attack had been orchestrated by a band of rogue Gargoyles and made possible via suicidal courage, perfect timing, the use of magic, dumb luck and a little help. The source of that help sent more shock waves through the NGR. Members of a D-Bee anti-NGR terrorist group had helped the Gargoyles get into NGR territory and hidden them. The D-Bees believed to be responsible were quickly arrested, tried, and executed for the crime.

The national consciousness shifted after the attack on the President. Though justice had been served, people clamored for revenge and new measures to improve national security. Enlistment in the military shot up 40%. Violent crimes against D-Bees skyrocketed. Suspicion was contagious. People started eyeing D-Bees, psychics, and foreigners with icy glares. Human supremacist groups and movements found new members and support. The NGR was becoming a paranoid and unfriendly place.

**In Poland**, a week-long grieving service was held in mourning for the terrible loss of President Mayer. The Kingdom of Tarnow started building up its own borders and began doing surgical strikes against known Brodkil hideouts. *King Peter Wojtyla* refused to respond to media outlets in either Poland or the NGR regarding the attack on Wroclaw, but he offered his most sincere condolences to President Mayer's family and the families of all those who lost their lives that day.

**To the majority of the Gargoyle Empire**, this was one of their greatest triumphs. They had been working and fighting for decades for something like this. A chance to really hit the humans where it hurts the most, and a chance to drive fear into their hearts. The Gargoyles rejoiced. Best of all, the Gargoyles were able to shove this in the face of the Brodkil, as if to say, "Look what we have accomplished, on our own!" The Gargoyles knew, more than ever, that they didn't need the Brodkil, and they didn't need Emperor Zerstrun. After all, it was a group of rogue Gargoyles, acting against orders, who managed to take down the NGR President.

The problem with sub-demons, such as Gargoyles and Brodkil, is that they rarely have the wisdom and insight to see the "big picture" of any particular thing. They are very straightforward creatures, operating on base instincts and emotions to carry them through. For instance, while the Gargoyle Empire celebrated "their" attack, and the Brodkil muttered about why they hadn't thought of it first, their enemy, the New German Republic was preparing its counter-assault. Unlike most others of his kind, Emperor Zerstrun realized this. He knew their greatest battle was yet to come. He also knew that unless the Gargoyle Empire stayed united they were doomed. Try as he could, the majority of the Gargoyles refused to hear him. They now saw his careful plans and strategies as weakness and cowardice to take bold action. More independent acts of violence and attacks against the NGR were unleashed by the growing number of uncontrolled rabble and malcontents of the Empire. None of their actions met with any significant success nor had any real impact on the NGR except to keep the humans focused on revenge. In time, Emperor Zerstrun knew they would all see how wrong they were. He only hoped there would be enough of his Empire left standing to pull it back together and survive. Until then, he pulled back the Gargoyle forces still loyal to him and retreated to a sanctuary in the French Alps and waited. Waited for the NGR's terrible revenge that he knew would come like a raging storm.

## A Call to Arms

In order to cover every possible contingency, President Sperling reaches out to other outside sources to work with the NGR. To scout the seas, she talks to **Captain Nemo-2** and his **New Navy**. She pleads her case, personally, in the office of the

*U.S.S. Ticonderoga* where she appeals to Captain Nemo-2's humanity and sense of history. At one time, his nation and Germany were close allies, both strong in military and economic matters. She says that a great alliance can happen between them again. She insists that if initial NGR intelligence reports are correct, now is the time to crush the Gargoyle Empire, while its demonic troops are drunk with power and its leadership is broken and fragmented. Captain Nemo-2 agrees. He commits to doing additional reconnaissance along the coast of France as well as acting as the NGR's personal guide through the hostile waters. He also pledges a sizable fighting force to help them take their fight to southern France, but warns them that mysterious forces from across the Mediterranean Sea have been seen in flying machines, going to and from the Gargoyle Empire. What this could mean, he does not yet know.



**The Coalition Army.** Though the Coalition States are embroiled in their own war against an inhuman and magic wielding enemy, Emperor Prosek commits to sending 30,000 Coalition Army troops across the Atlantic Ocean to join in the NGR's massive offensive against the Gargoyle Empire. This a more impressive and gutsy move on the part of the Coalition than it may sound. Not only are CS military resources committed back at home, but the CS intends to "fly" its troops across the Atlantic Ocean in a caravan of Death's Head Transports to join the battle in France! The NGR has provided the coordinates of what they think is a safe route across a notoriously hostile and deadly sea. The information has been secretly provided by freedom fighter Jinna Gir Song, who knows the Splugorth and Horune Pirate trade routes well, and should circumvent any encounters with their forces or dimensional anomalies. However, one can never be certain of such things, and the trek is a brave and risky move.

**Triax and the Secret Project.** President Sperling, now able to act with almost total authority over the military and Triax, takes a long, hard look at *Operation Sea Storm*, which has been floundering in administrative limbo for years. The enormous battle plan to hit the Gargoyles with a two-pronged attack from the borders of Germany and from behind along the shores of the south of France had been scheduled to happen almost three years prior. It never got off the ground "due to unresolved design flaws" with Top Secret *Project Undertow* – the creation of a gargantuan submersible troop carrier.

To get part of the NGR Army to the south of France unseen, a giant underwater troop carrier had been designed. In theory, it could deploy enough soldiers and armor on the shores of France to attack the Gargoyles from their unguarded rear. This second army must be able to operate independent of the rest of the NGR forces and be large enough and capable enough to hammer the

enemy where and when they least expect it. For many years, Triax and the military had been designing and constructing the gargantuan undersea transport. It is supposed to be able to house thousands of military personnel, robots, power armor, and combat vehicles and be able to remain underwater for weeks, even months, at a time as it travels through the world's oceans. This incredible transport has been under secret construction at the NGR's shipyards in the North Sea for nearly a decade. Its deployment has been delayed by an endless stream of incompetence, politics and concerns over design elements.

The delays end now.

President Sperling sacks the lead team managers and installs her own, handpicked team of administrators, engineers and troubleshooters to take over. They have five months to get the *Undertow Submersible Carrier* ready to launch for service in *Operation Sea Storm*. Further delays are not acceptable. Her team is told to do whatever it takes to get the job done. President Sperling, still acting CEO of Triax Industries, sets the construction and deployment of this mobile underwater military base as the company's top priority. She brings thousands of human and D-Bee laborers to Triax's *NordSee Shipyards*, where they, along with workers from the **New Scandinavian Alliance**, work in shifts around the clock to find the ongoing design flaws and get the vessel seaworthy in less than five months, or else. For every worker on the submersible transport before, there are now five. As President, she promises the people of the NGR that every citizen, refugee, and D-Bee who wants work, and wants a hand in constructing a secret weapon that will lead to the utter destruction of the Gargoyle Empire, shall have it. However, they will be away from home and work in total isolation, unable to contact the outside world for at least six months. People flock to the opportunity.

All other aspects of the battle plan are put into action as the NGR military prepares to engage in its largest and most complicated, coordinated offensive ever.

A cadre of concerned and frightened politicians convene a frantic meeting with the President. They insist it is impossible to launch *Operation Sea Storm* in that short a period of time, and madness to involve the Americans in this battle. They protest, saying all the NGR needs is more time to prepare. A year or two, perhaps. The President will not hear it.

If the country's military leaders share the politicians' concern, they do not voice it. They reassess their military strategies and tactics, and press their forces to be ready for combat in five months. The military's stout support of the plan wins the President a slim majority of support from the rest of the NGR government.

In early November, 107 P.A., the **Triax Undertow Submersible Carrier and Launching Base** is completed. The megalithic warship is nearly three times as wide as the Poseidon, the NGR's largest (at the time) submersible. The main structure is in a half-sphere shape, lending some to give it the nickname "Diving Bell." The Undertow functions as the jumping-off point for troops assigned to *Operation Sea Storm*. Thirty-five thousand troops, their power armor, robots, weapons and gear shall be carried to France below the waves. An additional 28,000+ troops are to be transported by other watercraft such as Poseidon submersible carriers (see **World Book 7:**

**Rifts® Underseas**), and join forces with the 30,000 Coalition infantry troops. The Undertow and *Operation Sea Storm* are closely guarded secrets. The vessel is known to the public only as a "secret weapon" that shall be deployed sometime in the future, with estimates placing its completion a year from now.

## Operation Sea Storm

Six weeks later, the Undertow reaches its target destination, a small bay near the ruins of the pre-Rifts city of Marseille, on the southern coast of France. Marseille was destroyed during the Great Cataclysm, washed away into the ocean. The Gargoyles have established a small coastal enclave in the mountains southeast of Marseille. This enclave also contains a large Gargoyle aviary. This location is the first target of *Operation Sea Storm*.

The Undertow has its bugs and issues, but does the job it is designed to do, and delivers its payload of anxious NGR troops to France. Coalition troops have not fared as well and are nowhere to be found. They are late, and with radio silence in place, there is no way of knowing their fate. The NGR force waits 24 hours before they decide they must move forward without their CS allies.

The Gargoyles in Marseille are caught completely unaware and are absolutely decimated by the assault. Landing craft hit the ruins of Marseille, deploying thousands of ground troops who fight their way to the aviary as flight capable troops zoom ahead to engage the enemy. The aviary is destroyed and thousands of Gargoyles slain. Gargoyles that try to fly away are mowed down by barrages of missiles and aerial NGR power armored troops and aircraft launched from the Poseidon warships. Ground infantry arrive to finish the job. No prisoners are taken.

The NGR troops are surprised the battle at the aviary goes down so fast and easy. Human casualties are minimal. Intel had suggested they'd be met with much greater resistance and that reinforcements would come from two major Gargoyle colonies to the northeast. As if on cue, NGR intelligence reports combat in that region, and flashes from missile and energy weapons can be seen in the distance. The Coalition Army has arrived. They were a little off course and delayed due to a surprise storm that ended as unexpectedly as it had begun. When the Coalition forces realized the battle at the aviary was already underway, they went to intercept the Gargoyle reinforcements coming from the two communal roosts. NGR forces quickly join the battle and the slaughter continues. CS casualties are higher than the NGR's because they faced a larger enemy force, but their casualties are still below 4%. It is an auspicious start that will make the fabled Bloody Campaigns of both nations pale by comparison.

The NGR/Coalition forces establish a permanent beachhead in Marseille. The Gargoyle presence this far south is minimal, compared to the demonic hordes in the north of France and in and around Germany. They want to press their advantage and the element of surprise and charge into the depths of France, cutting a swath of destruction wherever the enemy is encountered. The two well disciplined military forces work surprisingly well together. For the CS, there is a sense of immediate camaraderie in meeting their European counterparts and a euphoric high as their combined forces shatter the enemy.

# 108 P.A.

## The Battle Continues

The NGR and CS forces are both in unfamiliar territory and proceed with caution, sending long-range reconnaissance squads to scout ahead. One such squad meets with Jinna Gir Song, who is by now known to NGR operatives in the region. She and her Song Warriors are known enemies of the Gargoyle Empire and a de facto ally to the NGR. Jinna already knows about the taking of Marseille and she offers her forces to become the eyes, ears and guides through enemy territory throughout France. The CS forces are opposed to allying themselves with a small, well equipped army of mercenaries that obviously include D-Bees and sorcerers. However, these are desperate times, and the Coalition leaders defer to the NGR, who seem to know these “resistance fighters.” Jinna meets with Brigadier General Hans Rauchmann, the commander of all forces involved with Operation Sea Storm, and with Captain Nemo-2 of the New Navy. They accept Jinna’s assistance with forming their battle plans in France, and promise that she will be rewarded. A noble dragon, Jinna Gir Song insists that no compensation is necessary. Protecting humans from Gargoyles and the Minions of Splugorth is reward enough for her. (Of course, she appears in human form and keeps the dragon thing a secret.)

The Song Warriors lead the way throughout France, giving the combat force unparalleled insight into Gargoyle movements, strategic targets and enemy activity. The plan is to go north beyond Marseille, through the ruins of Avignon, Valence, Lyon, up into Mulhouse, keeping just beyond the western edge of the Alps. It is in the mountains where the Gargoyles are the most numerous and have the greatest advantage. Together they travel from the south of France to Lyon, and take a terrible toll on the Gargoyles. Enemy resistance is fierce at times, but as intelligence had suggested, enemy forces are fragmented and there is no one leader calling the shots, or an overall plan. Each Gargoyle horde, whether they number in the hundreds or the thousands, is operating as an independent combat unit and is no match for the combined NGR/CS/Song Warriors forces.

By the end of January, 108 P.A., NGR and CS troops make it into Lyon, where they establish temporary, entrenched fortifications and heavily-defended encampments, complete with advanced sensory equipment, long-range artillery, power armor, and robots. They create a wedge at this weak point in the Gargoyle Empire. No enemy of the NGR is able to get past this wedge. To travel from one side of the Empire to the other means having to move through a fast-closing gap.

At the same time all this is going in France, NGR forces are pushing into the Gargoyle Empire from Germany. When they reach Zurich, the bloodiest battle of the campaign is fought. When the Gargoyle held city ruin is won by the NGR, the army spreads out to take the western half of Switzerland, including Bern, Lausanne, and Geneva. By mid-February of 108 P.A., NGR soldiers from Geneva meet up with their comrades in Lyon. A celebration takes place as a great victory has just been won for the NGR. Operation Sea Storm, coupled with the first strike in Zurich, and a combined military operation with the Coalition Army has proved immensely successful.

The Gargoyle Empire is more or less geographically split in half. Major enemy bases, aviaries and communities have fallen along the way. Several hundred thousand (some estimates puts the number over one million) Gargoyles have been destroyed, and the Gargoyle Army is shattered into a thousand fragmented and panicked pieces. Hot with the flush of a resounding victory, the combined human forces proceed to exterminate Gargoyles around Germany and along the dividing line from Zurich to Marseille. The Gargoyles’ losses are the greatest they have ever seen in the last 100 years, plus most of the “Empire” is fragmented and in tatters. An estimated 20% have been destroyed (with more to follow). An estimated 40% of the aviaries in France and around Germany are destroyed. An estimated 75% of the survivors have abandoned Emperor Zerstrun and have splintered into a thousand smaller groups, each with their own leader. None of these splinter groups are willing to work together and all have their own plans for revenge against the NGR and/or the treacherous Brodkil Empire. Though their efforts will cause some additional loss of life and property, and keep tensions high, they ultimately result in additional staggering losses to the Gargoyle forces.



## An Empire Divided

Without Emperor Zerstrun’s leadership and a unified Gargoyle Army, and with a general failure to communicate, the Gargoyles are unable to mount a united defense. One by one, every Gargoyle city and encampment in the region falls. Those

Gargoyle camps that had already split from Zerstrun's Empire find their limited resources rapidly dwindling away. It is the Gargoyles who come out the losers of this mad free-for-all as the human forces methodically march them down and exterminate every Gargoyle and inhuman ally of the monsters they encounter. Rogue or Zerstrun loyalist, the NGR destroys them all without mercy.

Had the Gargoyle Empire been united, they would have stood a chance against the encroachment of the NGR into their territory, and might have been able to stop or limit the success of Operation Sea Storm. However, they are only sub-demons, after all, and cannot be expected to maintain solidarity without a Demon Lord, or someone like Emperor Zerstrun, to lead them. It was a miracle that Zerstrun was able to keep them united for the decades that he did, because it is against their nature. The squabbling, rivalry and lack of unity currently taking place in half of the Gargoyle Empire is more typical of these sub-demons. Still, the fragmented Gargoyle bands continue to strike back and fight as best they can, but fall time and time again. Those who try to cross the NGR line drawn by Operation Sea Storm are pushed back or destroyed. Not one Gargoyle is able to cross from one half of the Empire to the other.

From his hidden stronghold in the French Alps, **Emperor Zerstrun** puts forth a proclamation to the part of the Gargoyle Empire that has remained mostly loyal to him and can still receive his orders (the northwestern half being cut off, naturally). He tells them the Empire will make a stand against the NGR, and they will do so as a unified force. He is formulating a strategy to crush Triax factories in Köln and the entire industrial Ruhr region. At first, the Gargoyles shrug Zerstrun off. They are tired of his convoluted plots. They want action *now*! In a fit of demonic rage, Emperor Zerstrun kills five naysayer warlords with his own hands. Then he has their retinue slain and orders his personal guard to execute ANY Gargoyle who speaks out against him from that point on. Ironically, this brutal display of primal power is just what the Gargoyles in his part of the Empire need to fall back in line under Zerstrun's sway. Defectors and splinter groups in much of the Empire reunite with their tails between their legs. Only a few groups of rabble-rousers refuse. Out of fear for their lives, they go into hiding, or leave the borders of Zerstrun's Gargoyle Empire, heading south into Italy and east into the Balkans.

Emperor Zerstrun promises destruction for any who try to take the reins of either half of "his" Gargoyle Empire. For the moment, he is busy reuniting his half of his Empire. Next, he'll turn his attention to revenge upon the NGR. He is starting to fear that his dream of a Gargoyle Empire is impossible. However, in true Gargoyle fashion, he has decided that if his nation cannot exist, then the New German Republic must die with his dream. The plans for revenge are already starting to form in Zerstrun's mind.

## Summer to Present

**The Coalition States** assault force has returned home, all except for a group of "advisors" and a "support team." The former are Intelligence Officers and Commandos. Their job includes getting a feel for the NGR, their trustworthiness, culture, and the threat level against the nation, as much as working with the NGR and offering military advice, strategies and tactics. The latter is a mixed group of 1,244 CS Special Forces, Juicers, Rangers, Combat Cyborgs, Field Scientists, Psychics, Dog Boys, and RPA Pilots to assist the NGR in the war against the Gargoyles and Brodkil. So far, all reports are overwhelmingly positive. The alliance between the CS and NGR is a good fit for both parties. It would seem the CS and NGR alliance will only get friendlier and stronger over time. More coordinated, joint military assaults against the Gargoyles are being planned, as well as an increased exchange of technology, military hardware, personnel and trade. In the Spring of 109 P.A., the NGR and Coalition States sign an "official" long-term Alliance Pact.

**The Song Warriors** have gone back to battling the Gargoyles and Splugorth in their own way. The group's involvement in Operation Sea Storm, and subsequent battles for six months afterward, are part of the "Top Secret" files in the government. The group's involvement is not made known to the public. Jinna and her warriors understand and are just happy they could break the spine of the Gargoyle Empire and contribute to its continued deterioration.

**The Gargoyles' Shattered Empire.** The parts of the Gargoyle Empire splintered into small Gargoyle camps split their time between harassing the NGR and the Brodkil Empire. Against the NGR, they send hit and run raids against NGR patrols, bases and forces in the wilderness. Though they try, few of the Gargoyle assault groups get close enough to hit civilian targets. Many of the camps in the east have also started fighting the Brodkil. Again, most of the Gargoyle attacks on the Brodkil are unorganized and sloppy, but so are most of the Brodkil. In between, the rival Gargoyle clans fight amongst themselves.

The NGR does enough to keep this rabble on their toes and away from the NGR border, but for now, are less worried about them than they are about Emperor Zerstrun.

**Zerstrun's Gargoyle Empire.** In much of the southeastern half of the divided Gargoyle Empire, Zerstrun has not only managed to keep his Gargoyle Empire from disintegrating, but is successfully galvanizing them back into a fighting force. There is still much dissension among his Gargoyle Lords, Mages and warlords, but for now, he is back in control. Unfortunately, Emperor Zerstrun has lost more than half of his Empire and nearly two-thirds of his forces (the splinter groups in the northwestern half and in the easternmost parts, and those destroyed by the NGR). He is working on a plot to once again cripple Triax and seize a large chunk of the NGR for the Gargoyles. If successful, he hopes the rest of the Gargoyles will rejoin him. Failing that, he is developing a few suicide runs that would destroy him and his followers, but tear down the NGR in the process. The Emperor still has mixed feelings about this line of thought, and hasn't decided if this is what he should do or not.

The NGR considers Zerstrun their greatest threat. He is a capable leader and a decent strategist and tactician. Moreover, he

# RIFTS EUROPE

## 109 P.A.



has enough Gargoyle warriors (estimated at 850,000-1.3 million) to do some serious damage should they launch an all-out attack or several fierce assaults. As a result, the NGR Army continues to put pressure on the southern parts of the Gargoyle Empire, hitting Gargoyle roosts and military camps, and continuing their campaign of total extermination. The NGR has also started laying plans for permanent fortifications and rail lines to run from Germany to the southern coast of France. They need to hold the lands won by Operation Sea Storm in order to keep the Empire divided, weak and vulnerable to future military operations.

**The Brodkil Empire.** The Angel of Death has been watching the events unfold around Emperor Zerstrun. This, she decides, is the perfect time to decimate the Gargoyle Empire and put the lowly sub-demons in their place. She has started preparing a massive army of Brodkil, most of them outfitted with bionics and Psynetic implants. She could have as many as four million Brodkil march against the easternmost part of the Gargoyle Empire in all-out war by year's end. There remain an estimated 1.5 million Gargoyle warriors in splintered bands in that part of the country, and without one strong commander to lead them, they are probably doomed. With the Gargoyle Empire split in half and Zerstrun drawing plans of his own against the NGR, he is unaware of the Angels' intentions. If the Brodkil does make a move against the Gargoyles, it is difficult to say if Emperor Zerstrun will have his forces join the fight. If this confrontation occurs, it will be bloody and horrendous.

**Pharaoh Rama-Set of the Phoenix Empire** has been supplying the Gargoyle Empire for years. He is watching the Angels of Death and Vengeance very carefully. Although he would prefer to conquer the NGR with the Gargoyles as his puppets, he is not willing to invest in them any longer if he feels they are going to lose to the humans or the damn Brodkil.

## A New Player Enters

From behind the scenes, somewhere deep in the Black Forest of Germany, a strange and evil supernatural being has existed, possibly for centuries, even millennia. He has been known by several different names and has taken many forms, but his penchant for causing the tragic deaths of mortals has been constant. The Germans know him as **Struwwelpeter**. A creature that exists in both the mortal, physical world, and a realm of dreams and the imagination. It is in this ethereal world of dreams where he is most powerful, floating from one dreamer or idle mind to another, like moving through the Astral Plane. There, he causes horrible nightmares, plants suggestions to cause chaos and suffering, or inspires artists and musicians to create images of horror and death in order to frighten others and drive the artists into madness.

From where Struwwelpeter originates is a mystery. In pre-Rifts times, he was believed to be nothing more than a fairy tale. With the Great Cataclysm and the coming of the Rifts, Struwwelpeter has found an entrance to the physical realm. No longer limited to one world or the other, the monster can travel freely from one to the other, and can even straddle the physical world and the dream world simultaneously, at least for a time. During the Great Cataclysm and the chaos that followed,

Struwwelpeter roamed the Black Forest, picking off survivors as they huddled together, desperately trying to find refuge from the unrelenting chaos. Struwwelpeter got into their heads, gleefully turning father against son, brother against brother, and soldiers against each other.

As the chaos subsided and the ley lines began to settle, Struwwelpeter retreated into the darkest recesses of the Black Forest, where he moved into the role of observer. He watched and listened to the people of Germany as they worked to rebuild their civilization, and he watched as new creatures from other world entered the realm of Earth. He enjoyed watching the humans of Europe succumb to despair and misery during the new Dark Age, and savored their terror and suffering. Struwwelpeter swam through these dark emotions like a warm bath and reveled in their intensity.

Slowly, as civilization crawled up from the darkness, Struwwelpeter awoke with it. People moved back into the Black Forest region. Humans came and rebuilt from the wreckage of the villages and cities that had fallen to the Cataclysm or had been reclaimed and overrun by nature. D-Bees settled in the Black Forest as well, bringing with them their own dreams, fears and hopes. New and delectable experiences for Struwwelpeter to enjoy. Supernatural creatures, monsters and demons emerged from the Tree of Darkness in the Black Forest. Many became pawns and scapegoats for Struwwelpeter, who had learned to cause suffering and take lives through others so that he could remain unnoticed.

Struwwelpeter became something of a horror legend in the Black Forest. To those who believed in his existence, he was spoken of only in whispers. To those who did not believe, he is folklore or a children's bedtime story. When people in the villages died of weird reasons, it was blamed on D-Bees, or Gypsies, or creatures from the Rifts. When travelers spoke of a tall, lanky man with wild hair and razors for fingers prancing through the forest in the dead of night, singing songs of madness and death, they were laughed off as drunks, or victims of Faerie trickery. No one believed in the danger because Struwwelpeter did not want them to.

The NGR has no official policy regarding Struwwelpeter. In fact, the military and police have no official evidence of his existence let alone any trouble he may have caused. Only roughly 20% of the soldiers and Polizei who regularly patrol the Black Forest believe that Struwwelpeter is real, to everyone else, he is dismissed as a local legend. A fairy tale that has no bearing on "real" events. This could prove to be disastrous in the future, as Struwwelpeter grows in power and his influence among the Gargoyles becomes more widespread. It was Struwwelpeter who gave an ambitious Gargoyle named Zerstrun the dream to build an Empire for his people. It was Struwwelpeter who inspired resentful D-Bees to become terrorists and kill the President of the NGR. It is Struwwelpeter who encouraged rival Gargoyle leaders to challenge the rule of their Emperor and break from the Empire to build their own petty kingdoms. And it was Struwwelpeter who whispered in the ears of the Brodkil and told them to dream big, for they were the conquerors of Wroclaw and better than the arrogant Gargoyles.

In the future, this creature of chaos could manipulate the Gargoyles (or Brodkil, or D-Bees, or human supremacists) to take disastrous actions against the people of the NGR. Ever since the Gargoyle Empire made its move to sweep across Europe in 38 P.A., Struwwelpeter became fascinated with them. Gargoyles were more intelligent than most of the monsters residing in the Black Forest. They had a society, a hierarchy, and a civilization of sorts. They had been beaten and downtrodden for millennia by demonic masters and dreamed of finding a way to become the masters of their own fate. That desire was delicious and malleable to a being such as Struwwelpeter, and he used it to create war and misery. The Gargoyles were more like animals than men, and Struwwelpeter liked their passion and simplicity. They lacked the reasoning power of humans and were susceptible to his influence. Over time, Struwwelpeter dreamed up a new game, with the Gargoyles as his playing pieces and the humans his unwitting opponents.

Now, with the Gargoyle Empire divided in two halves, the game took a new surprising twist. In the southeastern half, he'd leave Emperor Zerstrun to take charge and do as he deemed fit against the NGR. With the other half, Struwwelpeter would take a more active hand. The Gargoyles there had already started to dissolve into thousands of tiny Gargoyle camps, each led by a powerful Gargoyle Lord or Mage, and each with its own idea of what to do about the NGR. Struwwelpeter is slowly creeping into the dreams and idle thoughts of these leaders and playing on their fears, prejudices, ambitions and desires. He introduces new ideas into their heads, ideas of usurping leadership and joining together under a new name. Struwwelpeter inserts his own face and name into their dreams, promising them victory against the people of the NGR. He fills their heads with promises of an exalted Gargoyle Kingdom on Earth. A place where they are the masters of all of Europe and dominate the pitiful humans and back-stabbing Brodkil.

The Gargoyles share these dreams with each other, and soon thoughts turn to action. Struwwelpeter's influence takes hold easily among the Gargoyles. Though only a few thousand Gargoyles around the Black Forest region are totally under Struwwelpeter's thrall, they are a dedicated lot. More are being added to their ranks every day, and they are ready to fight and die for "the dream."

Struwwelpeter has many forms, though his favorite is that of a very tall, thin, lanky young man with wild, long, unkempt hair, and foot (0.3 m) long fingernails (which are actually claws capable of Mega-Damage attacks). His face is unusual and disarming, appearing as a young man, about 13-15 years of age, with a crooked smile, long hooked nose, and eyes that sparkle with mischief and madness. When moving through the forest, he usually turns invisible, unless he suspects someone is watching, in which case he dances and twirls among the trees to a whimsical musical tune only he seems to hear. If he is stalking a victim, he brings his clawed hands up near his chin, letting his long fingernails dangle, hunching over, and making overly dramatic steps through the woods or village streets. His absurd movements only add to his terrifying presence.

## Struwwelpeter

**Note:** Pronounced STRU-vel-PAY-ter.

**Also Known as:** Shock-Haired Peter, Shaggy Peter, and Dream Peter.

**Species:** An unknown Greater Supernatural Being, possibly a unique creature unto himself or an ancient, archaic Chaos Demon Lord.

**Alignment:** Diabolic.

**Attributes (Supernatural):** I.Q. 14, M.E. 21, M.A. 24, P.S. 20 (Supernatural), P.P. 22, P.E. 18, P.B. 8, Spd 25.

**Mega-Damage:** 160 (60 Hit Points, 28 S.D.C. and A.R. 10 in S.D.C. environments.)

**P.P.E.:** 600. **I.S.P.:** 160.

**Age:** Unknown; presumed to be immortal.

**Size:** 11 feet, 3 inches (3.4 m), 250 lbs (112.5 kg). Also see Natural Powers and Abilities.

**Awe/Horror Factor/Reputation:** 15 to those living in the Black Forest, 12 elsewhere. His Awe Factor in dreams can range from 8-15, and in nightmares from 12-15, depending on how he presents himself and what's going on in the dream.

**Disposition:** Struwwelpeter is very dramatic and theatrical. He makes sweeping gestures with his hands, shows a wide range of emotions on his face and may speak in metaphors, limericks and rhymes. He prefers to kill his victims with a flourish, often letting them live long enough to make it dramatic, sometimes finishing them off with a quick poem or moral message about the behavior which led them into his clutches in the first place. This flare for the dramatic also means the creature often overstays his welcome, leaves prisoners alive too long and open for rescue, and takes foolish risks. He is also supremely confident and tends to vastly underestimate his opponents and the victims he uses as his pawns and chess pieces in his little games.

**Experience Level:** Equal to a 12th level Assassin and Mystic.

**Skills of Note:** Creative Writing 80%, Performance 85%, Sing 80%, Cook 60%, Dance 98%, Play Musical Instruments: Piano, Violin, Fiddle, Flute, Guitar, Accordion, all at 80%, Sewing 90%, Impersonation 90%, Tracking 90%, Juggling 70%, Prowl 70%, Imitate Voices and Sounds 60%, Tailing 90%, Art 95%, W.P. Knife, Sword, Paired Weapons, at 12th level.

**Natural Powers & Abilities:** Can magically speak and read all languages, Nightvision 200 feet (61 m), keen normal vision, see the invisible, turn invisible at will (must turn visible to attack), and Bio-Regenerate 1D6 M.D.C. per melee round. Also see *Magic* and *Psionics*.

**Limited Metamorphosis of His Claws (special):** Can make his claw-like fingernails as short as two inches (5 cm) or as long as two feet (0.6 m). Short or long, they inflict M.D. He can also meld them together and form one long, wide blade, like a scythe. He may use these finger blades, like daggers or short swords, or in a scissor motion to sever an opponent's appendages. When used for torture, he starts with the thumbs,



then moves on to the fingers, toes, ears, nose, tongue, genitals, and so on. Damage for these is listed below.

**Metamorphosis (special):** Shaggy Peter can turn into an impish teenage boy (14-16), an old man with a crooked back, a proper gentleman (complete with suit or tuxedo), or a large, shaggy dog.

As a dog, Struwwelpeter has a Spd of 45 (30 mph/48 km), and his bite inflicts 4D6 S.D.C. damage (or 2D4 M.D. against Mega-Damage opponents) and the victim must roll to *save vs disease* or immediately fall ill with fever: Reduce attacks per melee by half, P.E. is reduced by 70%, -4 to all combat actions, no initiative, and skills suffer a -25% penalty. The person is very weak, disoriented, and uncomfortable for 1D6 days.

**Limited Dimensional Teleport (special):** Struwwelpeter can Dimensional Teleport at 80%, body and all, but only to one place, the plane of dreams. However, from there, he can find his way to the worlds of mortals. In this strange plane, he can float among the minds of beings who are sleeping, daydreaming, or lost in creative thought. He can also enter the dreams of sub-demons just as easily, but creatures of magic and lesser supernatural beings are +4 to save, Greater Demons and greater supernatural beings are +7 to save, and Demon Lords and deities are +12 to save. To reach these supernatural beings, they must be in the realm of mortals. While in the dream world, Struwwelpeter has only two attacks per melee, and can only use his own words, cunning, charisma and psionic powers to influence people (normal rules apply). In the dream world he cannot directly affect the physical world, nor does he know what's going on in the outside world, except for what he gleans from dreams.

**Limited Resurrection (special):** If killed in the physical world of mortals, Struwwelpeter is banished to the dream world for a time, where he is in a state of unconsciousness, floating around the dream world blissfully dreaming of his past deeds. He awakens and can return to the realm of humans in 2D6 years.

**Vulnerabilities:** 1. Vulnerable to magic and psionics; both have full effect and do full damage.

2. Like Faerie Folk, Dream Peter cannot step over or across salt. Thus, a circle of salt will trap him and a line of salt holds him at bay. Likewise, sleeping in a bed which is outlined in salt prevents the impish being from entering one's dreams. In all cases, the line of salt must be unbroken. If there is a break in the line or the salt is brushed or washed away at any location, Dream Peter may enter (or exit). However, "he" cannot remove the salt himself, someone must do it for him.

3. Struwwelpeter gets bored very easily, and he finds it impossible to concentrate on more than one or two tasks or schemes at a time.

4. People who refuse to engage in any of his schemes or games confound and frustrate him. However, he doesn't kill or injure such a person, instead he tries to secretly manipulate and involve him in one of his schemes or keeps trying to convince him to join in one.

5. Lastly, characters with strong moral fiber (*Principled alignment*) are left alone. Dream Peter regards them as just

no fun at all. He won't involve those folks unless they do something to invoke his ire.

**Attacks per Melee:** Six.

**Bonuses (attribute bonuses included):** +4 to strike or parry, +11 to strike or parry with *finger nail claws/blades*, +7 to dodge, +1 to disarm, +4 to pull punch, +4 to roll with impact, +6% save vs coma/death, +2 save vs magic, +3 save vs psionic attacks, and Critical Strike on a 19 or 20.

**Mega-Damage:** Shaggy Peter possesses Supernatural P.S. so his attacks inflict M.D. to his opponents. He may also use magic or psionics. Is not known to ever use a weapon or device of any kind; relies on his own innate abilities.

Restrained Slap/Claw Strike: 6D6 S.D.C.

Full Strength Claw Swipe: 3D6 M.D.

Power Claw Slash: 6D6 M.D., but takes two actions.

Fingernail Scratch: 2D4 S.D.C.

Scissor Cut: 1D6x10 M.D., but takes two actions.

Kick: 2D6 M.D.

**Magic:** 600 P.P.E.; equal to a 12th level Mystic. Spell knowledge limited to the following: Apparition, Armor Bizarre, Befuddle, Charismatic Aura, Charm, Compulsion, Distant Voice, Fear, Fly as the Eagle, Fool's Gold, Heavy Breathing, Horror, Impervious to Energy, Locate, Luck Curse, Magic Net, Mask of Deceit, Multiple Image, Reduce Self, Shadow Meld, Speed of the Snail, Wall of the Weird, Wisps of Confusion, and World Bizarre.

**Psionics:** 160 I.S.P.; a Master Psionic, equal to a 12th level Mystic. Powers are limited to the following: Alter Aura, Astral Projection, Deaden Senses, Empathy, Empathic Transmission, Hypnotic Suggestion, Induce Sleep, Object Read, Mentally Possess Others, Mind Block, Mind Bond, Psychic Omni-Sight, Radiate Horror Factor, Remote Viewing, See Aura, Sixth Sense, and Telepathy.

**Allies:** Struwwelpeter has no one he considers a true ally. All living beings, be they mortals, creatures of magic, or supernatural beings, are toys for his demented games, and that may include Demon Lords and deities. He does, however, get along very well with evil, ugly Faerie Folk, who find him wickedly entertaining and fun. Thus, they may willingly help or protect him, trade with him and party with Dream Peter. Currently, he is manipulating and using the Gargoyles in one of his demented games. Where this may all be heading is anyone's guess, but it seems that he's trying to create a rival Gargoyle Empire to challenge Zerstrun's group and to mess with the Brodkil as well as humans. He enjoys manipulating Gargoyles and has developed a certain fondness for them, in a puppet master kind of way.

**Enemies:** Emperor Zerstrun is seen as the rival in his new game. Has no regard for any living beings other than as playthings. Dislikes the people and D-Bees of the Black Forest, and living, intelligent beings in general.

**Weapons:** None, relies entirely on his own abilities.

**Cybernetics:** None; as a supernatural being his body rejects them.

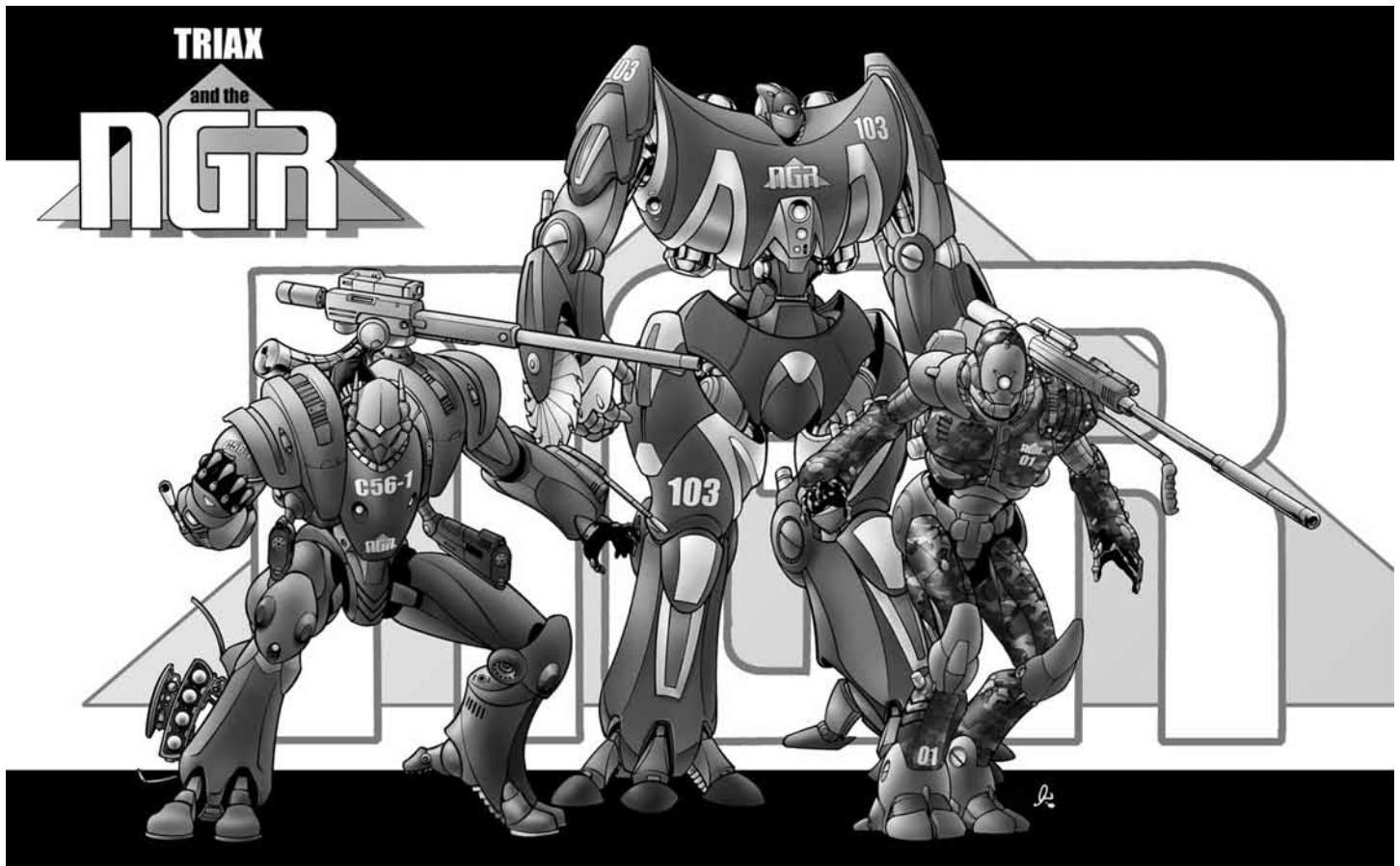

# The NGR Military

The military of the New German Republic is broken up into three branches: The Army (Heer), the Navy/Marines (Kriegsmarine), and the Air Force (Luftwaffe).

**The Army (Heer)** is primarily responsible for the integrity of the Nation's borders, and fighting the majority of the battles that the NGR military fights constantly. It is no surprise then, that they are the largest and most active branch of the German military machine.

The Army is a modern infantry ground force able to provide support, transport, artillery, armor, power armor troops, and robot troops as well as over a million (yes, a million) DV-series *robot drones* to assist them in battle. The sheer amount of destructive force that the NGR Army can produce is mind boggling. A single soldier in power armor is the equivalent of a squad of 20th Century soldiers, maybe even the equal to an entire platoon (40 troops); a walking tank. The same is true for Combat Cyborgs. Likewise, a single, giant combat robot is equal to an entire company of (140) soldiers or a 20th Century tank squad. Against creatures such as the Gargoyles and Brodkil, Triax power armor and robot combat vehicles are the great equalizers – turning an ordinary human soldier into a mechanical juggernaut as powerful or more powerful than any one or two (maybe even a dozen) of the enemy. If the NGR had not been locked in a struggle with the Gargoyle Empire for the better part of a century, the nation might very well have claimed and rebuilt a sizeable portion of Europe for humanity. On the other hand, some suggest that without the ongoing struggle with

the Gargoyles, there would have been no motivation to innovate as Triax has, and there would have been no need for the massive NGR military. Perhaps, but that was not the case. Thus, the constant battle against a supernatural foe has made the NGR a militarized society where the Army is glorified as national heroes and saviors of the nation.

**The Navy/Marines (Kriegsmarine)**, as described in **Rifts@: Underseas™**, is a relatively small naval force when compared to the *New Navy* or the naval powers of the 20th and 21st Centuries. The NGR has only recently begun developing a navy with the assistance of the *Free Scandinavian Alliance*. The fledgling city-states to the north have a few, but very high quality ships which Triax was allowed to study in order to develop their own ocean vessels. Until the proposal and execution of *Operation Sea Storm*, the NGR had little interest in a navy. However, with that bold battle plan in place and meetings with the people behind the New Navy (descendants and ships of the Pre-Rifts American Navy), the value of a navy became increasingly important. Awareness of naval combat forces like the New Navy, the Republic of Japan, and the Horune Pirates, and threats like the Lord of the Deep, and rumors of aquatic civilizations under the waves, convinced the NGR government it was time to build a navy. Allies such as the Coalition States in North America and the Sovietski in Russia shared information they had on such subjects, and both have also started to build their own, fledgling navies.

**The Air Force (Luftwaffe)** is a small and elite group of very specialized aerial combatants and robot pilots used for surgical strikes on enemies outside of the NGR's borders, air reconnaissance, fast-response, and troop support. They are an elite air force which serves to augment and enhance, but not replace, the aviators of the army who use flying power armor, robots and hover craft in combat. The NGR Air Force goes beyond convention, by using cyborg pilots who physically and mentally interface with their aircraft to become one. The NGR's unique *military cybernetic airframes* function as a literal extension of the pilots' own cybernetic bodies that "plug into" the aircraft. This neural interface with the cyborg pilot turns the aircraft into his body and enables the pilot to perform aerial combat feats never before seen from a human operator. This is something very new and borderline experimental. They are a new key factor in taking the war to the Gargoyle Empire and the Gargoyles out of their natural element: The skies.

**The New Luftwaffe** is a more recent development of the New German Republic and has existed as a separate military branch for only 40 years, and has really only come into its own in the last 15. Under the authority of Central Command, the organization is broken up into smaller operational groups. There are three air combat divisions in the New German Republic, located at strategic locations so they can be deployed anywhere in the Republic quickly. Each of these locations contains all of the equipment needed to maintain, equip, arm, and house every plane in the division. Pilots, combat troops, and support personnel are on site in shifts, 24 hours a day.

Each of the three divisions is further broken down into two air wings, which are each divided into three air groups containing a squadron of 24 aircraft. Each of these squadrons can be divided into smaller groups depending on the mission or sortie to which they are assigned. **Note:** A small group of 3-8 aircraft is likely to be the size of a group in which the player characters would find themselves.

The wings of the air divisions are named for pilots who have played an important and heroic role in German military aviation. More than half of them are named after pre-Cataclysm pilots, dating back to World War I. The Luftwaffe leadership felt that it was important to hold onto historical ties to their past for several reasons.

**The 1st Air Division**, stationed outside of Koln, contains the Fighter Wing **Seidt**, named for a fighter ace during the earliest encounters with the Gargoyle Empire. Seidt was credited with more than 300 confirmed Gargoyle kills, including 23 Gargoyle Lords and 27 Gargoyle Mages. Fighter-Bomber Wing **Stieglitz** is named for the General of the Luftwaffe during the Great Cataclysm, who was descended from a long line of German military aviators.

**The 2nd Air Division**, stationed outside of Munich, consists of the Fighter-Bomber Wing **Boelcke**, which, like the rest of the 2nd and 3rd Air Division names, is a holdover from the pre-Cataclysm Luftwaffe wing names. Boelcke was one of Germany's first fighter pilots and is credited with creating many of the tactics still used in air combat against the Gargoyles. The other wing in the 2nd Air Division is the Fighter Wing **Steinhoff**, named after a World War II fighter ace who later went on to become a leader in the pre-Cataclysm Luftwaffe and NATO.

**The 3rd Air Division**, stationed in Berlin, contains the Tactical Reconnaissance Wing **Immelmann**, named for one of Germany's first fighter pilots during World War One, and who later went on to be one of Germany's most decorated heroes. The 3rd Division also includes the **Richthofen** Fighter Wing, named for the infamous "Red Baron" of World War One. The Richthofen Wing is the most highly skilled and decorated of all the New Luftwaffe units and one of the most feared by the Gargoyles. Like their namesake, the Richthofen Wing usually has bright red wing markings or nose cones, with some aces even going so far as to paint or use their optical camouflage system to change the color of their aircraft entirely crimson to strike fear into the hearts of their enemies.

## Military Central Command

All of the branches of the NGR Armed Service are coordinated through Military Central Command in Berlin. Small scale operations such as regional patrols, garrison duties, and defensive reinforcement are generally handled by regional military leaders at local bases and outposts. Major offensive, multi-force operations, national defense, and military planning, strategies and tactics are handled by Central Command. Operation Sea Storm and all military operations against the Gargoyle and Brodkil Empires are planned and executed by Central Command.

Central Command is a fortified complex of massive dome-like bunkers, one for each of the three military branches, a fourth for communications and research, and a fifth central dome that is the largest of the quintet for administrative offices and operations. Each also has many subterranean layers and a tunnel network that connects them all together, though there are junctions where the tunnels can be completely sealed in case of an enemy breach. A large, military airfield, infantry base, hospital, barracks, parade grounds and outdoor stadium are all part of the Central Command complex.

The military compound is centrally located in Berlin, and is one of the most heavily fortified places within the NGR. Hundreds of automated defenses, robot drones, and power armor troops maintain constant guard over the complex, and anyone without the proper security clearance is escorted to the perimeter, may be held for questioning, and issued a citation of up to 10,000 credits. Those with the proper clearance are allowed access to the compound and to their respective areas. Many people within Central Command actually have multiple security clearances, giving them the ability to move freely within the base and its many secret, subterranean levels below.

**At the Communications Dome as well as the Central Dome**, there is a large operations and logistics hub where military and civilian communications, video, holographic battlefield layouts, and other data are all processed and displayed so that military leaders and analysts can monitor the progress of a battle, friendly and enemy troop movement, and other tactical aspects of military operations. Each military base, outpost, mobile command center, and military operation has its communications routed through Central Command. Other sources of intelligence, communications and research are also fed to Central Command for data analysis, review, comparative studies, defense, military application, and archival recordation. This keeps Central Command connected to all military operations with collateral and

supplemental data and information that might provide additional information and real time data.

Another unique aspect of Central Command is that all coordination of civilian resources, including contractors, industrial support, mercenaries, and civilian administration, takes place here. If the military is a well-oiled machine, then all of these civilians are the oil. They assist the military in tasks that range from weapon design and testing, supplying food to the troops, and maintaining civilian robots around military installations to payroll and cleaning services, medical and cybernetic services, information technology needs, and procurement.

## New Weapons and Tactics to Address the Gargoyle Problem

The NGR is constantly upgrading and experimenting with new weapons, but in recent years, they've moved away from general all-purpose war machines, to focus on weapons of destruction that are designed specifically to address the Gargoyle problem. In November of 104 P.A., the NGR military launched what was referred to as **Full Militarization** (or as it is known in Euro, "*Vollständig Militarisierung*"), an endeavor meant to expand the Army and take the war to the Gargoyles rather than continue the defensive war the NGR had been fighting. This meant the scientific arms of the military and Triax would develop strategies, tactics and weapons specifically designed to counter and destroy Gargoyles. Things that would negate the monsters' natural and biological advantages. If the monsters can fly, then develop armor and combat vehicles that can fly and fly better, faster, and carry a weapon load to enable a single NGR combatant to obliterate a dozen Gargoyles.

This also meant attacking the enemy with not just bullets and force, but with radiation and countermeasures. The NGR resolved not to only attack just the monstrous warriors – but to destroy all Gargoyles and take the fight to their roosts and nests. New scientific data was used to develop new plans, strategies, tactics and weapons to exterminate the Gargoyle infestation, destroy the hatcheries and wipe the relentless monsters from the face of the Earth. Some of the new technologies in the war against the Gargoyle Empire lack the versatility of previous Triax weapons, but they are devastating against Gargoyles and Brodkil. This has led to the development of many more flying units, miniature spy robots, miniature robots to destroy eggs still in the nests, the use of radiation and other developments.

## Hired Guns

Without a doubt, North America has the largest percentage of mercenaries and soldiers of fortune on Rifts Earth. The many different nations, gangs, feudal kingdoms, and individuals vying to carve out a home or power base provide plenty of work for such guns for hire. Things are different in Europe. For one thing, there aren't as many different nations trying to overrun or conquer each other. There are dozens of tiny feudal city-states that dot the landscape, as do rural villages, farms, monasteries and other small communities, but few are in strife with each other, and most have little need for mercenaries or lack the finances to hire them. The Monster Zones and wilderness take up a huge portion of Europe, but they tend to be no man zones. They attract explorers and adventurers, not mercenaries. Conse-



quently, one is more likely to encounter bands of heroes, explorers, healers, refugees, Gypsies, other wandering nomads, and bandits than any armed forces or mercenaries.

Until the Full Militarization in 104 P.A., mercenaries and adventurers in Germany often found it difficult to secure regular work. A mercenary or adventurer in Europe must be prepared to engage in many different activities, not just battlefield combat. They would need to be prepared to hunt and live off the land, or be willing to do physical labor to feed themselves during slow periods. Trapping and selling furs and mechanical repairs were other areas an adventurer or mercenary could fall back on. Otherwise, "heroes" might be able to get a few free meals and/or room and board for a while, by ridding a village or town of bandits, a troublesome monster or similar danger. However, once the threat was dealt with and the heroes' kindness repaid with food and lodging, they'd be expected to leave. The same is true of wandering mages, healers, psychics, and fortune tellers.

A popular choice for European mercenaries and adventurers is "Monster Hunter." Every community in Europe has a problem with Gargoyles, Brodkil, dragons, and other monsters from time to time, and when they do, they need a Monster Hunter. Again, depending on the prosperity of the community, payment for such a service is typically room and board, and perhaps some livestock, basic supplies, new clothes (probably handmade), healing, or similar trade. Weapons, armor, magic, credits or gold and gems for payment are very much the exception.

The logical move for a mercenary or adventurer looking for work would be to go to the New German Republic and other big or war-torn nations like the Kingdoms of Poland and the

Sovietski. The problem was, while the NGR could afford to hire mercenaries, they didn't need them. They have the most powerful army in Europe, and one of the most powerful on Earth. In addition, their enemies are limited to the Gargoyle and Brodkil Empires. No one else can stand against the might of the NGR war machines. From time to time, the NGR Army would make use of freelance warriors, but mainly as scouts, specialists and consultants. The NGR still knows very little about the applications and theories of magic, for example, and sometimes needs to seek outside help to deal with threats that involve magic and the supernatural.

It is important to note that mercenary companies in Europe tend to be much smaller than those in North America. Groups as large and as well-organized as Larsen's Brigade are completely unheard of. Instead, European mercs and adventurer groups rarely exceed twenty members. They are also a little more free-wheeling, swashbuckling and unprofessional. Most have no formal military training or experience and are just loosely thrown together bands of adventurers and guys good at fighting. For this reason, they tend to fly under the radar of the NGR Army and are not recognized officially by the government. They have no special rights or privileges, and engaging in illegal or terrorist activity will bring the law down on them the same as anyone else.

**Allowing mercenaries and adventurers in the New German Republic is another one of the new initiatives of Full Militarization.** In the past, the NGR actually tried to discourage "freelance" military operations, and the Army seldom hired mercenaries. However, with the initiative against the Gargoyle Empire, the NGR is, at last allowing mercs and other freelancers (i.e. adventurers, Bounty Hunters, etc.) to operate outside NGR borders, but within the Gargoyle and Brodkil Empires.

The NGR has started to offer bounties for the heads of Gargoyles. There are a few stipulations, however. First, no "monster hunting" is to take place within the borders of the NGR. Hunters must go into the Gargoyle or Brodkil Empires to hunt their prey.

Second, bounties are paid only for confirmed kills. The mercenary must literally bring back the head of each slain monster to collect his bounty, and the skulls must be fresh, not weeks old and decaying. Even this is tricky, and bounties being collected near the site of a recent Army battle may be denied for fear the Gargoyles were slain by the NGR Army and opportunists just cut off the heads of some of the fallen enemy. Eyewitness accounts and video are considered corroborating evidence, but not enough to confirm the kill in and of itself, unless an NGR military officer, ranked Captain or higher, signs an affidavit to confirm the number of kills and who should be paid.

Third, the monster hunting must never interfere with NGR military troops or operations. If a soldier tells a group of bounty hunters to back off or hunt someplace else, the adventurers or mercs are expected to comply (most do). The NGR Army can ill afford to have a bunch of crazy soldiers of fortune ruining their perfectly laid military plans. However, freelancers *may* be invited to "assist" in military operations, and get paid 100 credits a day, plus food and basic military provisions. Such invitations require the Commanding Officer signing a document authorizing their assistance, otherwise the freelancers cannot get paid.

Fourth, the NGR can, at its sole discretion, decline payment if they think the claimant is suspicious and pulling a scam.

The bounties are low. Good enough to be worthwhile, but low enough to require monster hunters to kill plenty of the monsters to make a decent living. Despite the low bounty, restrictions and dangers, the region has seen a considerable increase of people looking to capitalize on the situation and make some money. Some are refugees, peasants and D-Bees just trying to survive. Others are professional Bounty Hunters, Mercenaries, Wilderness Scouts and other adventurer and combat types looking for adventure and money. As word has spread, and with the Gargoyle Empire seemingly in a shambles, the bounty has even attracted fighters and adventurers from North America. Many of these heroes, mercs and adventurers from the Americas come to help the NGR, and get to explore a new part of the world and make some money at the same time. The bounty incentive plan seems to be working.



## Current Bounties for Monsters

**Gurgoyles and Gargoylites:** 500 credits each.

**Gargoyles:** 1,000 credits each.

**Gargoyle Lords and Gargoyle Mages:** 10,000 credits each (ten times as much if the Gargoyle Lord was highly regarded or very powerful).

**Brodkil:** 200 credits each.

**Enhanced Brodkil (those outfitted with bionics, M.O.M. implants, or other 'strange' Brodkil that have been popping up in recent years):** Varies, from 1,000 to 7,000 credits depending on the specimen.

**Human Criminals or Terrorists:** Must be brought in “alive.” No payment for slain “suspects.” Bounty varies from 500 to 20,000 credits depending on the individual. Only 100 credits each for no name bandits; 5,000-8,000 credits each for hijackers of military ordnance. Humans and notorious nonhumans are usually wanted alive, since the government wants to put them on trial.

**D-Bee or supernatural criminals, dissidents, or terrorists:** Varies as above for wanted humans, however, the bounties may be less and 30% of the time, bringing the criminals in “dead” is acceptable, provided the identity can be confirmed. The bounty may be many times higher for a fugitive that is a powerful mage, dragon, or Greater Demon.

## Other Freelance Work

For professional and experienced teams familiar with military procedures and protocol, the NGR Army sometimes hires freelancers for special operations, reconnaissance deep into enemy territory, and other risky and extremely dangerous missions. This is especially true when the mercenaries have skills and expertise in matters the NGR soldiers do not possess, such as dealing with magic threats.

### Missions may include any of the following:

**Long-Range Reconnaissance Spy Missions:** deep into enemy territory and “hot zones.” This is desirable when the NGR does not want the enemy to know they are on to them and can’t send soldiers. Instead they send mercs or adventurers with no obvious affiliation with the NGR.

**Exploratory Intelligence Missions:** The NGR has an interest in understanding other people, kingdoms and lands for reasons of strategic military importance or potential trade alliances. Sending outsiders rather than military troops or a even civilian team has its obvious advantages. Mercenaries and adventurers on this assignment may end up in such faraway places as Russia, China, Africa, Atlantis, Japan and the Americas. They leave, sometimes for months or years, sending back messages or coming back to make a full report. Mercenaries and adventurers who are originally from a foreign land are especially desirable for this kind of work since it means they will not be suspected of working for the NGR. And in some cases, the mercs may be natives of or familiar with the region, language, customs, and common dangers of the foreign land.

In the alternative, foreign-born mercenaries can be hired on as escorts to diplomats and ambassadors. Coalition-born adventurers are commonly used in this line of work as the NGR and CS seek to strengthen their ties.

**Specialists in Magic:** The NGR Army knows next to nothing of magic. Magic is the tool of monsters, D-Bees, foreigners, and Gypsies. While not illegal to practice, it is highly undesirable and suspicious. When the military or police encounters an enemy or danger that is based in, or relies heavily on, powerful magic, they often need to bring in “special operatives” to deal with the matter. That means (ideally trusted) mercenaries, adventurers or heroes from outside the NGR. These outside consultants are hired to provide insight into the specific dangers and issues, and, if necessary, to neutralize the threat. In extreme cases, the NGR may use “fire to fight fire,” and hire psychics,

Mystics and even practitioners of magic to deal with their magic-based enemy or threat.

Likewise, such “specialists” may be hired to deal with supernatural threats and other matters involving the supernatural, magic, psionics, and aliens.

**Special Ops:** Outside heroes, mercs and adventurers may be hired for any number of Special Operations, or to assist in such operations. Again, outsiders are ideal for missions where it is best if the NGR does not have a direct hand, or in matters like magic, where the NGR is ill-equipped to handle the situation. Special Ops missions may include assassination, surgical strikes, seek and destroy, sabotage, rescue missions, and others.

**Strategic Excavation Missions:** The excavation of European cities is another opportunity for mercenaries and outsiders. This always involves ruins and locations outside the borders of the NGR itself. Mercs may be hired as escorts and protectors of the excavation team or to engage in the excavation itself. “Excavation” is a rather broad term that may include digging through ruins of pre-Rifts cities and alien realms for specific artifacts, information or intelligence. However, it may also include intelligence gathering on the area itself and what dangers exist there, exploring and mapping ruins and subterranean tunnel networks, locating a specific building/location (i.e., military base, weapons cache, factory, science lab, research facility, etc.), and so on. There remain the ruins of hundreds of cities and towns that have been untouched by human hands for centuries. The Gargoyles, Brodkil and other monsters who claim a large chunk of Europe have no interest in digging up the treasures of the past. They may inhabit the ruins of pre-Rifts human cities, but care nothing about knowledge and resources they may yet contain. The monsters pretty much leave the old cities the way they find them. Nothing is recovered and, as a rule, little is destroyed beyond what was already destroyed by the Great Cataclysm and the passage of time over the last three centuries. Consequently, there are many wonderful pre-Rifts artifacts buried in the ruins of once great cities, just waiting to be reclaimed. Of course, one must contend with Gargoyles and other creatures that inhabit the territory and have no love for humanoids or regard them as prey.

Even more important than digging up the remnants of a fallen civilization, is the recovery of ancient technology. Triax and the NGR, Chi-Town and the Coalition States, the Sovietski and many other modern powers are built on the bones of the pre-Rifts world. It was only by rediscovering the wonders of the Golden Age that mankind has been able to pull itself out of the Two Hundred Years Dark Age. This process of rediscovery and relearning the secrets of the past continues to this day. Many technologies, some only experimental, lay buried in the ruins of toppled and buried cities. For the betterment of all mankind, some adventurers, scholars and scientists make it their goal to search for clues to the past and things that can be used anew.

**Industrial Espionage:** Industrial espionage is big business in technological nations all over Earth. Not only do governments watch what their neighbors are up to and determine what they are capable of, but they sometimes try to “acquire” certain techniques and technologies for themselves.

In the case of the NGR and Triax, they are often the targets and victims of industrial espionage. To avoid political consequences, the country or the corporation may hire outside mercs to recover stolen secrets, prototypes, documents and so forth, or

get evidence of who was responsible so legal/political action may be taken. Mercs may also be hired to track down and capture or kill industrial spies, sabotage their ill-gotten secrets, or destroy the stolen secrets or even destroy the facility or company who stole the secrets. Likewise, some private corporations may hire mercs to do any of the above, or to steal a rival's secrets for them!

Many of the larger corporations have their own specialists for this sort of thing, but many smaller companies need to hire outside help. Besides, there are times when even the largest and most capable company may want to distance themselves by hiring outsiders. To this end, they bring in spies, hackers, psychics who specialize in technology, and even assassins and saboteurs to steal secrets or undermine their competition. On the flip-side, the company may hire "outside agents" to protect their secrets, improve their internal security, guard key personnel and/or locations, safely deliver design documents or a prototype to a new facility, make problems disappear, and so on.

Industrial espionage is mostly a very discreet activity. No one wants to admit that it exists, but it does, and nearly every company engages in it on some level. Make no mistake, this is the realm of quick-thinking, highly intelligent characters, not those who are only interested in blowing things up. While the action is not always as intense as a stand-up laser fight, the rewards are numerous as the effort of the industrial espionage agent can drastically alter the future of the company he works for.

Governments like the NGR that are not interested in stealing secrets, still find it useful to have clear and complete knowledge about the capabilities of their enemies as well as friendly and rival nations. Spies and mercs without formal ties to the NGR are best for the job.

## German Black Market

### The Verbrecher-GeschäftsNetz (VGN)

Triax and the NGR do not sell their weapons on the open market. They are for government use only and are rarely even traded and sold to other ally nations. However, such items may be available on the *Black Market*. Of course, military ordnance on the Black Market is always stolen, hijacked or salvaged from the battlefield and sold illegally.

Even salvaged items are illegal to sell. According to the law, military hardware is NOT to be salvaged by anyone but the NGR Army. Anyone who does otherwise is engaging in a criminal act. Regrettably, the salvage of military hardware is common practice by Gypsies, bandits, mercenaries, and adventurers, many of whom are not citizens of the NGR. They are foreigners who follow military actions, raid battlefields, grab whatever they can and flee beyond the borders of the NGR, where they sell their ill-gotten gain. D-Bees and refugees in and around the NGR are also known to make extra money necessary to feed their families or support themselves by stealing NGR military hardware and looting the dead. Such "goods" are inevitably sold to the Black Market.

**The Verbrecher-Geschäftsnetz (VGN)** – the German Black Market – is a network of criminal gangs and smugglers who operate throughout the NGR, Poland, Russia, and most of Europe. They also have ties to other criminal groups and organizations

as clients who purchase their military goods, including the Black Market in North America.

Wherever there is an opportunity for dirty money to be made, there will be people there to make it. The VGN operate in every major city of the NGR and Poland and are willing to buy or trade goods with almost anyone, including D-Bees, wilderness people, Brodkil, Gargoyles, Minions of Splugorth, the Phoenix Empire and other monstrous beings and criminals. Smugglers of the VGN have an elaborate network of trade routes, and connections with other criminal groups, including all Russian Warlords, many Russian gangs, and the American Black Market. There is an irony in the fact that the VGN has established profitable ties to criminal groups in Russia and America. While the governments of the NGR, the CS, Free Quebec, Sovietski, and the Warlords of Russia have squabbled amongst each other for years trying to negotiate trade agreements, the criminal underworld has been trading Triax and other German goods for years. The Black Markets, however, use dimensional Rifts to travel long distances across Europe and to North America and back again. Once the goods are "acquired" they can have a shipment of stolen weapons from Germany to Chi-Town in minutes. By contrast, the CS and NGR, who refuse to use magic and Rifts to travel, need weeks to make deliveries and must travel across hostile environments. Obviously, traveling through Rifts has its own perils, such as ending up in other worlds with no way home, or attracting powerful monsters, but the gain far outweighs the risks to the Black Market.

**The operations of the VGN** are very similar to those of the North American Black Market, except it is not one or two massive, sprawling criminal organizations, but dozens of smaller criminal outfits that trade and sometimes work together. Unlike the American Black Market, which is a large, encompassing, structured organization, the VGN is made up of several dozen small gangs, each numbering around 3D6x100 members, and each with its own hierarchy and methods of operation. Although the VGN gangs consider each other friendly competitors, feuds, deadly rivalries and wars between them are common.

**The VGN's specialty is military and technological "commodities."** The VGN is a completely different and independent criminal organization from the American Black Market, but the latter is eager to trade with the VGN to get Triax military hardware. The VGN gets a lot of its Triax military weapons and vehicles by paying good prices for them; 30-40% of the market price, because the VGN can turn around and sell them to American buyers for double. The VGN has a no questions asked policy and is willing to buy from absolutely anyone.

**Salvaged Military Hardware.** The vast majority of Triax military hardware, from gear, guns and ammo to power armor and combat vehicles, is salvaged from the battlefields. After a battle, scavengers descend upon the fallen soldiers and Gargoyles to strip the dead and grab dropped weapons, ammunition, E-Clips, combat gear, spare parts and anything of value that is not tied down. Many go so far as to strip those still alive but unconscious or too injured to resist. They also break into disabled combat vehicles to steal what's inside and/or to tear them down for parts. The most organized and best equipped Gypsies, mercs, bandits and scavengers cart off entire vehicles, either by hot wiring and driving them away or pulling them onto a flatbed truck and hauling them away. Items that are damaged or broken are

# The NGR Government

repaired and resold to the German Black Market. The VGN then resells them through its illegal Black Market channels. Such “re-furbished and rebuilt” items typically have 1D4x10% less M.D.C. and may be missing one or two weapon systems or special combat features. Even with that being the case, old and new Triax military ordnance is in such high demand around the world, especially in North America, that the Black Market gets 2-4 times what the NGR pays to have the weapon, armor, robot or vehicle manufactured.

**Stolen Military Hardware.** An estimated 15-20% of the Triax military hardware sold by the VGN is stolen from the NGR military. Hijackers and raiders are known to loot any supply truck, depot or weapons cache left unguarded, and some are known to ambush and hijack cargo hauled by truck and train, and even the occasional factory warehouse. Some brazen or desperate brigands even ambush and rob troops, but only if they outnumber them by at least three to one or have a couple practitioners of magic or other superhumanly powerful beings to intimidate or waylay the troops as necessary. Robbing actual NGR troops is a rarity. More likely, bandits target D-Bee militia, supply depots at distant military outposts, and supply trucks as well as bands of mercenaries and adventurers who may have Triax and other military hardware that is easier pickings.

**Foreign Markets.** The VGN also illegally imports military hardware *from* North America, Africa (Phoenix Empire) and Atlantis (usually by way of Horune Pirates) into Europe, as well as sells Triax hardware and other contraband to them. Weapons and armor from the CS, Free Quebec, Northern Gun, Wellington Industries, Wilk’s, and other manufacturers can be found on the streets and villages of the NGR and the European wilderness. Most are “used” and the prices are usually a little more expensive (5-10%) than what they sell for in the American Black Market, but they are at least half to three times less than the price of Triax goods or new weapons by other manufacturers, which makes them very popular among Gypsies, bandits, raiders, D-Bees, adventurers and others in need of good, but comparatively inexpensive weapons.

**Cybernetics** is a huge market in the NGR and Sovietski, and illegal augmentation rakes in enormous amounts of money for the VGN. That includes cybernetics for D-Bees, which is verboten (forbidden). The VGN is also the only organization within the NGR that traffics in *M.O.M. technology* (the making of Cra-zies), which is highly illegal in Germany. Of course, the VGN deals in the traditional areas of organized crime, which include selling forged I.D.s and travel documents, gambling, prostitution, extortion, fencing stolen goods, racketeering, and even a bit of nonhuman slave trafficking.

**There are a few things the VGN does not sell.** Magic items and Techno-Wizard devices are dangerous to deal in, and not many average people have the money or interest in such things. The people of the NGR prefer technology over magic, and simply are not interested in magic items. D-Bees from magic-rich worlds are only a small secondary market because they lack the financial resources to buy magic. Ancient books and pre-Rifts artifacts are perfectly legal in the NGR, so the VGN doesn’t offer them. Drugs are perfectly legal in the NGR. Their use is discouraged, but not criminalized, so drug smuggling by the VGN is a small side business, mainly selling German and European drugs and herbs to other markets like North America.

The government of the New German Republic (NGR) is strikingly similar to the one that was in place before the Great Cataclysm. The German government is effectively a representational democracy where the people elect representatives to make decisions on their behalf. There are three branches of government in the NGR: the *Executive*, *Legislative* and *Judicial*. The *judicial branch* is independent of the other two. It enforces the laws passed by the government and passes judgment with impartiality, which is then enforced by the military police force. Each one of these branches of the German government has multiple components that act as a system of checks and balances for one another.

**The executive branch** consists of the President and the Vice President. The Labor party has held the position of the President for the past 20 years, and thanks to the long history of benevolence by *Triax Industries*, the CEO of Triax always holds the position of Vice President. This arrangement has worked well on all fronts, politically, domestically and diplomatically with the citizens of Germany, and other nations and groups wanting to trade with the prosperous nation. It works because the CEOs of Triax are dedicated patriots loved by the citizens of the NGR, and functions as a sign of national gratitude to the corporation without which the New German Republic would not exist.

The recent assassination of the President put the NGR in a completely unprecedented position, because no Triax Vice President had ever been elevated to the office of the President. Now, for the first time in NGR history, the Triax CEO is also President. After this dramatic situation came to the forefront, the government changed the constitution of the NGR to keep the Presidency an appointed or succeeded position and made the Vice Presidency a position of appointment with legislative approval.

Unlike most democratic governments, the presidency of the NGR is not truly elected by the people, but rather the President is appointed to a five year term by the legislative branch. Usually the person selected has no need to lobby or attempt to garner support for his or her appointment, since the legislative officials nominate based on current positions of leadership and past service to the country. Of course, this is not a corruption free system, and many backroom deals and promises are made in order for some candidates to secure their nomination from members of their own party and others.

**The role of the President in the NGR** is vastly different from the position in many other countries. Once in office, the President typically distances himself from his party and tries to remain impartial when it comes to partisan politics. Often, the President takes no stance on most issues so as not to influence the other legislators and their decision making. Some believe this makes the President a simple figurehead position with little real power behind it, but in actuality, it grants the President a vast amount of power and can make the President an influential



unifying presence. When the President does take a position on an issue, often important moral issues, or an issue that directly affects the security, safety and well-being of the German people, his opinion can be assured to generate a lot of attention and carry great political weight.

New President, *Viktoria Sperling* has used this to her advantage more than any other President in the history of the NGR. The perilous and tumultuous period for her people and the situation that led to her ascension to the Head of State has driven her to unite the German people under the banner of Nationalism to bring the Gargoyles' reign of terror to an end. She has used her powers of the Presidency to guide the people of the NGR, cut deals with outside allies, bring about startling military victories, and is slowly but surely reshaping the overall political and moral climate of the entire Republic. Her stance on bringing D-Bees back into German society is her most criticized Presidential position. It has earned her a lot of criticism and enemies, but has also been important in bringing many current and potential allies to the negotiating table.

**The Legislative Branch.** The branch that some would call the most powerful, and functions as the actual "face" of the NGR government, is the **Council of Governors**. The NGR is divided into 16 regions, each with its own body or form of government. This could be a single leader such as a district ruler or mayor, a group of leaders like a ruling council, or a combination of the two. Additionally, the region elects a Governor who is representative of the region's populace and voices their concerns on a national level to the Council of Governors.

These 16 representatives make up the most powerful decision making body within the NGR. Each member of the Council of Governors gets to vote when new laws and legislation are brought to the table. Every member is given an opportunity to voice their position for or against that legislation. It is here that most of the issues are either championed or quashed, with many of the most popular issues of the day gaining vast amounts of publicity in the media. It is also within the Council that many of the political figures of the NGR gain the most amount of publicity. Many legislators have made or destroyed their political future by supporting and speaking up for dozens, if not hundreds, of political and social issues important to the average citizen. Some are loved for their concern over the welfare of the German people, while others are scoffed at and scorned for trying to saturate the media with their image and presence. The media machine and attention and the favoritism of the populace combine to form a truly fickle monster more dangerous to an aspiring politician than any creature from the Rifts.

The Council of Governors appoints a *Head of Council* from within its ranks. One of the 16 Governors is selected by the others to be the Speaker of the Council. Generally this is a highly respected individual who has either served on the Council for a long period of time or who hails from a very influential region. Sometimes, as is currently the case, a simple nod of approval or support from the President or other high ranking official is enough to sway the Council.

While the Council of Governors is the face of each region, Parliament would be its heart. Each state from within the Republic elects five Representatives to the Parliament, with the D-Bee region allowed to elect only three. These 78 Parliamentarians make up the other half of the legislative branch. Much

like the Council of Governors, they select a leader from within their ranks to serve as Head of Parliament. He or she leads sessions and mediates discussions and debates between the Representatives and other sections of the government.

When a proposal for law is passed in the Council of Governors, it is effectively approved as a passable law for the majority of the regions, or one that is considered to be acceptable for the entire Republic. It is then sent to the Parliament, where it is further discussed, critiqued and modified. If any modifications are made, the proposal gets passed back to the Council of Governors for further review. If no changes are made in Parliament (very uncommon), then it is voted upon. If passed, it becomes law, and is out of the legislative branch's hands. Amendments to the constitution are handled in this manner, though they start in Parliament and are passed to the Council of Governors for approval. Proposals for laws and constitutional amendments can also come down from the President and are given to the appropriate branch of government for approval. Both the *Parliament* and the *Council of Governors* have to approve Presidential nominations for Vice President and Chancellor.

**The Chancellor** is the Head of Government in Germany, while the President is the Head of State. To clarify, *the Chancellor* takes care of the daily matters and oversees both the Parliament and the Council of Governors. *The President* is responsible for overseeing the Chancellor and meeting with other Heads of State in order to negotiate trade treaties, military alliances and the like. While the President has the Cabinet, the Chancellor deals directly with the Head of Governors and the Head of Parliament. When disagreements occur between the two sides of the legislature, *the Chancellor* is called in to mediate. If an agreement cannot be reached, the Chancellor makes the final decision to either further negotiate between the two sides or to scrap whatever piece of legislation is causing the dispute.

## NGR Foreign Relations – 109 P.A.

**Atlantis:** No diplomatic relations. The New German Republic does not trade with or make alliances with "monsters." The NGR keeps a nervous eye on the continent of Atlantis, and is happy that the nation of monsters has not seemed to have taken sides in their conflict with the Gargoyles. However, it has not gone unnoticed that there is a large population of Gargoyles there (different clans than the ones in Europe).

Lord Splynncryth and his minions have been watching the action in Europe for the last few decades with great amusement. While the NGR, Brodkil and Gargoyles have been exchanging hard blows in bids to undermine and destroy each other, all of Atlantis has been thoroughly entertained. With the Siege on Tolkeen raging in America and the NGR's Full Militarization in Germany, the Minions of Splugorth have been on the edge of their proverbial seats watching these stories unfold, taking bets on the outcome of battles, and enjoying the drama and chaos of the wars. Lord Splynncryth has no plans to alter his level of involvement. He has provided only the slightest of aid to the Gargoyles to keep the "show" interesting. He has, however, started sending Minions to France to capture the Chiang-Ku Dragon, *Jinna Gir Song*, leader of the band of heroes known as Song Warriors. There is history between these two, and Lord Splynncryth would like to make her a lovely slave for his personal amusement.

**Australia:** No diplomatic relations. The NGR has heard stories about civilizations in Australia from the New Navy and has sent a small military squad on a long-range reconnaissance mission there to find out what they can. It is likely that any meeting with government leaders will not take place for another 10-15 years, if ever.

**Coalition States:** Strong diplomatic relations. Relations couldn't be better. The CS lived up to its promise of providing hard-hitting Coalition troops to help in Operation Sea Storm, and has become an increasingly important trade partner. By Spring 109 P.A., the CS and the NGR sign an official, long term Alliance Pact. The CS immediately triples their normal supplies and aid. The CS is unable to maintain a large military presence in the NGR, which is okay by the German government, but has promised to provide up to 50,000 troops in case of a short term emergency. Problems at home with issues stemming from the Siege on Tolkeen have taken their toll. The CS needs every soldier they have to defend their borders and protect their own citizens from a number of threats. (See **Rifts® Aftermath**, page 175 for more details, and new threats stemming from the Minion War in **Rifts® Megaverse® in Flames**.)

**China:** No diplomatic relations. The NGR knows that China is completely overrun by demons. They don't know anything about the Geofront and want nothing to do with China.

**England:** No diplomatic relations with the British Isles. The NGR has heard there is a nation of humans, but that the isles are swarming with ley lines, sorcerers, Faerie Folk, monsters and creatures of magic. Thus, it has been given a wide berth. (See **Rifts® World Book 3: England**, for more details on this part of the world.)

**Free Quebec:** Growing diplomatic relations. Free Quebec has broken away from the CS to become an independent kingdom. It is expanding trade with the NGR, entering into a mutual public technology exchange. Quebec expects to learn a lot from NGR research, and hopes to copy some of their techniques, especially in battling the alien menace on their own soil, the Xiticix. Although both nations say they are opening all the doors to technology exchange, they are still keeping quite a few secrets from each other. (See **Rifts® Aftermath**, page 175 for more details.)

**Free Scandinavian Alliance:** Good diplomatic relations. This is a very small group of city states to the north that is currently engaged in an ongoing battle with the Lycanthrope tribes of the north. The predominantly human nation has shared its knowledge of naval engineering with the NGR in exchange for limited technology and weapons. This sharing of information assisted in the development of the Triax Navy, and while the leadership of the NGR is grateful for the assistance the Alliance provided, and is in constant communication with them, they understand that both nations have problems of their own and only limited aid can be provided.

**Kingdom of Tarnow, Poland:** Poor diplomatic relations. Nothing has really changed. Tarnow is as reclusive and arrogant as ever. King Peter Wojtyla refuses to share in the blame for the loss of Wroclaw, and the incident has strained relations.

**New Navy:** Strong "unofficial" diplomatic relations. The legendary Captain Nemo-2 and his New Navy are unofficial allies of the NGR. They were instrumental in helping the NGR Navy

execute Operation Sea Storm. They also provided reconnaissance and helped relay communications for NGR forces, as well as engaged the enemy in more than a few battles with airborne Gargoyle forces and a few monsters from the Phoenix Empire, who are secretly supporting the Gargoyle Empire. The NGR plans to strengthen ties with Nemo as they seek to cut supply lines from the Phoenix Empire to the Gargoyles.

**Phoenix Empire, Africa:** No diplomatic relations. Thanks to intelligence reports from the New Navy and the Song Warriors, the NGR learned, and has since confirmed, that the Phoenix Empire has been trading with the Gargoyle Empire. Not quite a diplomatic alliance, the Phoenix Empire has no love for humanity and is a sinister force to keep an eye on. (See **Rifts® World Book 4: Africa** for more details on this evil empire.)

**Poznan Collective, Poland:** Good diplomatic relations. After Wroclaw was destroyed in 106 P.A., the NGR sent more troops to help defend the tiny grouping of Poznan city-states. Triax Industries is in talks with the Poznan Collective to determine if the area could house new industrial complexes to replace the ones lost at Wroclaw. While the Collective has managed to hold its own, they are outmatched by the Brodkil and would probably fall to a large scale attack. Their future seems tenuous even with support from the NGR and other Polish kingdoms.

**Republic of Columbia:** No diplomatic relations. Minimal contact. Nothing has changed in the last several years.

**Republic of Japan:** No diplomatic relations, yet. The two nations have established mutual *radio contact* through the NGR Navy. The government is working on setting up a diplomatic mission to Japan. Leaders from the two nations should meet sometime in 111 or 112 P.A. Any formal pact that might result will not include military assistance (except perhaps from the NGR Navy), and only limited trade. They are simply too far away from each other to offer anything substantial, but the knowledge of another human civilization is welcome information in this shattered and alien world that Earth has become since the Great Cataclysm.

**Song Warriors:** This band of legendary heroes and freedom fighters are sworn enemies of the Gargolye Empire, the Phoenix Empire and the Splugorth of Atlantis. The band of heroes counts humans from around the globe, D-Bees, practitioners of magic, dragons and other nonhumans and questionable rogue elements among them. This makes them unacceptable to the NGR government. However, since they are such heroes of renown and beloved by the wilderness people in the German countryside and surrounding territories, the NGR and its military turn a blind eye to their activities and have no "official" communications or relations with the group. In secret, however, the military has made use of the group's intelligence and even allowed them to fight at their side during Operation Sea Storm. Off the record, both sides have helped each other on numerous occasions in the war against the Gargoyles before and since Operation Sea Storm, and share a mutual respect for one another.

**Sovietski:** Fair diplomatic relations. The NGR and the Sovietski have had increased contact over the last several years as the Sovietski eases up on their isolationist policies. There is minor trade of older technologies from both the Sovietski and the NGR, including limited bionics, cybernetics, and rail gun technology from the Sovietski, and energy weapon technology

from Triax. The NGR currently serves as a moderator between the Sovietski and the nations of Poland, but none of the Warlords have taken the NGR up on their offer to serve as a moderator between them in their own rivalries and conflicts.

The NGR is aware of the situation between Seriyev, the Sovietski, the nations of Poland, and the Brodkil surrounding, and laying claim to the same parts of Eastern Europe. The Sovietski have an entire field army in the fortress city of *Kaliningrad*, while the Brodkil, Warlord Seriyev, and the Polish nations all claim the area to its south and west. The situation could come to a head soon, and the NGR wants to make sure that the Polish nations and the Sovietski don't fall to the Brodkil's superior numbers. The NGR military hopes a formal alliance between them and these foreign kingdoms will add additional human forces against the Brodkil Empire. Triax Industries has sent a few of their own spies to learn what they can about the situation and to get a better handle on Sovietski technology and military capabilities. Triax has also tried, so far unsuccessfully, to infiltrate Warlord camps to learn more about (some would say "steal") the designs of the unique Russian Cyborgs. (See **Rifts® World Book 17: Warlords of Russia** for more details about this part of the world.)

## Major NGR Cities

The six largest cities/urban areas in the New German Republic, described below, account for about 25 million people. The NGR has a permanent human population of around 90 million. The NGR's population has seen tremendous growth over the last sixty years. From 90 P.A. to 104 P.A., **human refugees** from other lands seeking haven in Germany has accounted for the largest area of population growth. This has slowed to a trickle in the last three years, though people are still arriving every day.

In addition, there are around 2.4 million **D-Bees** living within the borders of the NGR. These numbers have not changed much in the last five years. Many D-Bees have died in attacks by Gargoyles, but are replenished by others coming in from other parts of Europe. (**Note:** For more regional information on the NGR, see **Rifts® World Book 5: Triax & the NGR**, pages 7-13 and 21-24, and **Rifts® Sourcebook 3: Mindwerks**, pages 76-79.)

### Dusseldorf/Ruhr

Dusseldorf/Ruhr encompasses a large, industrialized region north of Köln. *Dusseldorf* is the largest city in the area, and the unofficial "capital" of the Ruhr. The Ruhr also contains the cities of *Essen*, *Hagen*, and *Dortmund*, and numerous towns and villages. The population has exploded here in the last 40 years, and shows little sign of slowing down. Dusseldorf/Ruhr has the highest population of refugees, homeless people, and working poor in all of the NGR. The local government has built sprawling suburbs to house all of these people. A great number of these are little better than the 'Burbs of Chi-Town. Many are outright slums. Public transportation is very popular here. The Ruhr has an impressive train and bus system, and a few taxi companies as well. The inter-city Autobahn crisscrosses the area, similar to in Köln, linking all of these cities together in a huge, albeit congested, network.

The big difference between Köln and the Ruhr cities is the huge disparity between the rich and the poor. *Dusseldorf*, *Essen*, *Hagen*, and *Dortmund* are all cities built (or re-built) on *Black Market* money. In the Ruhr, the German Black Market focuses exclusively on two areas: real estate and entertainment. Historians could draw a sharp comparison between Dusseldorf and the pre-Rifts cities of Las Vegas and Hollywood. Dusseldorf is a glittering city of casinos, movie and television studios, theaters, nightclubs, dance halls, brothels, fashion designers, and celebrity tabloids. Anything that is trendy and popular in the New German Republic starts and ends in Dusseldorf. Essen, Hagen, and Dortmund are like little brothers, constantly hanging on to Dusseldorf to see what cool thing it's going to do next and imitating it. From those cities, trends spill out into the rest of the NGR, except in *Munich*, where trends are largely ignored in place of "real culture," and contributing to the stereotype of the "backwards" Bavarians.

The shiny, pop-culture of Dusseldorf belies the dark underbelly of the hundreds of thousands of poor and disparaged in the Ruhr. One doesn't have to venture very far from the million dollar apartment buildings and office towers to find swarming, hungry masses. Refugees from all across Europe have been deposited here, many recent arrivals of the last fifty years. Most work in the huge factories that cover much of the Western lands and get paid 30-35% less than NGR born citizens. D-Bees on work release programs can also be found, huddled together in dismal ghettos and factory towns. Many D-Bees are in the Ruhr illegally, squatting in the wilderness or hiding out among the rest of the population. Those employed usually work "under the table" and get paid 50-60% less than NGR born citizens.

**The Verbrecher-Geschaftsnetz** – German Black Market – owns many operations in Dusseldorf and the Ruhr region. They control quite a bit of real estate, mostly acquired illegally through extortion and other untoward measures. They make promises to refugees and D-Bees to help them gain entry into the NGR and become citizens, only to turn them into little more than slaves. Those who resist, protest too loudly or try to escape are handed over to corrupt Police (of which there are many in Dusseldorf, all in the pockets of the Black Market), or made to disappear.

### Statistics of Dusseldorf/Ruhr – 109 P.A.:

**Total Population:** Dusseldorf: 4 million, Essen: 1.3 million, Hagen: 1.5 million, Dortmund: 1.2 million.

In addition, there are around 1.8 million people in villages and suburban areas (40% are first- and second-generation refugees). Unaccounted for are a couple hundred thousand D-Bees, Gypsies, and immigrants living in the region illegally and in hiding. The Ruhr has such a large transient population it is impossible to know exactly how many there really are.

All in all, the Ruhr region has around 10 million people living in it. Although the Ruhr is a very large chunk of land, the cheap and automobile based city designs make it seem much more cramped than it really is.

**Points of Interest (Dusseldorf):** On the banks of the Rhine River is the towering *Rheinturm* telecommunications building. It was originally built in the late 20th Century, but collapsed during the Dark Age. It was rebuilt during Dusseldorf's reconstruc-



tion project. At the base is the Rheinturm Casino, named after as the tower. It is the largest in Dusseldorf and owned by the German Black Market. Near the top of the building is a five-star restaurant and lounge, but one must have the proper connections to gain entrance.

**Königsallee** is a street lined with the hottest fashion boutiques, restaurants and nightclubs. The famous and beautiful people fill the streets, trying to avoid photographers and tourists while checking out the new trends.

Every year, starting on November 11th, at 11:11 am, Dusseldorf holds a massive **“Karneval”** featuring parties and parades through the streets. Karneval is equal to the pre-Rifts phenomenon of Mardi Gras in scope and popularity. Karneval is

celebrated by everyone, both the rich and poor, the famous and the nobodys, humans and D-Bees alike. It is an ancient tradition that has fortunately survived the Coming of the Rifts.

**VGN Notes:** Many of the bosses of the Verbrecher-Geschäftsnetz (German Black Market) have their main bases of operation in the Ruhr. Although the German Black Market has no central leadership and is largely unstructured, a number of “gang leaders” are semi-public figures in Dusseldorf/Ruhr. They regularly dine with models, actors, and the heads of NGR super-corporations. They use smaller companies as fronts, and have all the right Polizei and government people in their pockets.

## Some Notable Crime Figures:

**Jurgen Nemcova:** 12th level Smuggler, Anarchist alignment, I.Q. 19, M.A. 25, P.B. 17. He is a charming and handsome playboy who operates one of the largest weapons trafficking rings in Europe. When he is not partying in Dusseldorf's hottest clubs, he is taking his private jet to Poland, Russia, and Merctown in North America to negotiate illegal million-credit deals. He also trades in Coalition and Triax military hardware. The CS has a 750,000 credit bounty on him if he can be taken alive.

**Monica Greely:** 11th level City Rat and Forger, Diabolic alignment, I.Q. 20, P.P. 21, P.B. 24. She sells refugee and D-Bee workers to companies, often with false documents claiming that they are in work release programs or actual NGR citizens. She is both cunning and beautiful, having built her reputation on betrayal, seduction, and lies. Cold-hearted in the extreme, Monica cares nothing for the people's lives she trades, nor the companies she destroys when they are raided by the Polizei for harboring "illegal" D-Bees. She "harvests" many of her victims from Eastern Europe, promising them safe harbor from Gargoyles, Brodkil, vampires, and other strange things in the former Balkan States.

**Leon von Vorpommern:** 8th level NGR Cyborg Soldier, Miscreant alignment, Robotic P.S. 40. He is the most violent and dangerous of all the Black Market Bosses in the NGR. Leon has his metal hands into nearly everything, from guns to cybernetics, to smuggling people, to extortion and racketeering, to gambling and real estate. No crime is too big or too small for this very dangerous full-conversion cyborg.

## Frankfurt am Main

Before the Great Cataclysm, Frankfurt was once the financial capital of all of Europe, and most of the developed world did business with it. The European Central Bank was located here, which developed and distributed a form of currency known as the "Euro" in the 20th and 21st Centuries. As more countries sought to join the European Union, globalization became more prevalent and other nations copied what was happening in Europe. Similar organizations sprung up in the Americas (North American Alliance), Africa, and Asia. This rampant "globalization" demanded a banking system that could work for all national groups. Thus, the *Universal Credit* was designed by a joint effort between the European Central Bank and the New York Federal Reserve. The headquarters for most of the banks of the nations that participated in the Universal Credit were located in Frankfurt. To this day, Frankfurt is still the banking and financial capital of the New German Republic. The *Central Bank* and the *NGR Börse* (stock exchange) are located in the 40 story *Eurotower*. The *NGR Bundesbank* hopes to eventually integrate the banks of the Coalition States, Free Quebec, the nations of Poland and the Sovietski to make the Credit once again, truly "universal."

Frankfurt is an ultra-modern metropolis in every sense. Enormous skyscrapers jut into the sky, and other areas of the city go just as deep underground where they are, in theory, safer from enemy attack. The hotels and restaurants are top-notch, the shopping is fabulous, streets and public rail system clean and efficient and the city is alive with throngs of people. Frankfurt is

one of the NGR's most heavily populated German cities and has the largest train station and commercial airports in the country. At the same time, there are plenty of public parks, places to walk and ride a bicycle.

The city has very few D-Bees, as the cost of living is very high in Frankfurt and most non-humans could never afford to live there. Most residents like it that way, even if it means things are expensive for everyone. Food, lodging, retail items, entertainment, damn near everything costs 5-20% more than anywhere else in the NGR, and still people with the resources flock to this elite city.

## Statistics of Frankfurt am Main – 109 P.A.:

**Total Population:** Approximately 4.8 million residents, with another 200,000 in surrounding villages. Frankfurt also has a high transient population of 4D6x2,000 people at any given time.

**Population Breakdown:** 95% human. There are very few D-Bees living in Frankfurt. Those who do are relegated to a small, gated suburban community in the northern part of the city. These D-Bees usually hold pretty good jobs as business administrators or managers. Regardless of their earnings, they must keep to their own community or face public harassment and persecution.

**Points of Interest:** Frankfurt is where Triax Industries was created and where its headquarters was located up until the year 2370 (84 P.A.), when they were moved to Berlin. Frankfurt is home to the first and largest Triax industrial complex in the country, a sprawling facility with numerous, fully automated factories, research and development laboratories, office buildings, design houses, and testing grounds that practically make it a small city in and of itself. During the Dark Ages, one section of the "Old Part" of the facility was converted into a defensible, M.D.C. housing facility. Today, the "Old Part" is a museum dedicated to the struggle of Triax and the NGR through the Dark Age. Naturally, Triax remains the premiere business of the city and continues to outshine every other manufacturer in almost every field, from military hardware to medicine, to cookware.

In addition to high finance and high society, Frankfurt is also a center for NGR transportation. The *Frankfurt Hauptbahnhof* (train station) is the largest and busiest in the NGR. Business people and visitors visit from around the country.

Near the train station is Frankfurt's "Red Light District," 16 square blocks of erotic movie houses, brothels, and strip clubs. This area, and around the train station, can get a little rough after dark and travelers need to be wary. Gang members, Gypsies, and Black Marketeers hang out in this section of town. Frankfurt also has one of the few commercial airports in the NGR. It has flights to Berlin and Poland, as well as to select NGR military camps in Germany and France, and even the occasional special flight to locations in North America (namely Free Quebec, Iron Heart and Chi-Town).

Northwest of the Hauptbahnhof is the *Messe Frankfurt fairgrounds*, where enormous trade festivals and fairs are held in the spring and summer months.

The Frankfurt museums are not as impressive as those in Berlin or Munich, but they have quite a number of them all in a row along the south bank of the Main River, near the Eurotower.

The largest and nicest museum explores Triax Industries from its earliest days before the Great Cataclysm to present. Frankfurt also has a museum and large memorial dedicated to the Gargoyle War and the soldiers who have fought and died in it.

The Frankfurt City Hall is located in an interconnected series of buildings known as the *Römer*, which was rebuilt after the Great Cataclysm. It is the center of the *Altstadt* (Old Town), famous for its authentic historic architectural recreations.

Nearby **Aschaffenburg** is a dismal factory town with a high D-Bee population. Many of the D-Bees work in factories here, or commute by train to the Main Triax Production Facility in Frankfurt.

To the west, **Wiesbaden** is a popular getaway. They have excellent hot springs, a lively arts center, and some of the finest gambling halls and casinos in the NGR. Most are legitimately owned, and fair in their operation, and totally free of Black Market influence.

## Köln (Cologne)

Köln, also known as “Cologne,” is a huge city situated in the center of the NGR’s industrial region. Köln and its neighboring cities, including **Dusseldorf** and the **Ruhr region**, provide a full third of Triax’s military production and 60% of manufacturing by other corporations. Köln is a sprawling city, split nearly in half by the *Rein River* (also called “the Rhine”).

The city was absolutely devastated during the Great Cataclysm by earthquakes, flooding, and freak Ley Line Storms. Köln sits among numerous ley lines which feed directly into the dreaded *Black Forest* region. When Köln was being rebuilt, factory planners at Triax Industries proposed that the center of the city house residences, entertainment facilities and shopping centers, and that the city be surrounded by a network of factory complexes and industrial parks linked to neighboring cities by rail and highways. This accomplished two things. First, it provided ample real estate for Triax and other corporations to set up their manufacturing complexes. Second, it made it easy for workers to commute from the cluster of cities and towns in the region to the factories of Köln. Likewise, raw materials and mechanical components could be shipped in quickly and easily. This insight by Triax allowed the Rein Industrial Region to grow at a very expeditious rate.

Far from the noise, pollution, and bleak surroundings of the “FabrikNetz” (a term describing the factory network in the Rein region), is the interior of Köln. The city is not the most aesthetically pleasing and has a definite “industrial” look and feel to it. Buildings are designed to be practical, not pretty. There is little of the beautiful European architecture so characteristic of the NGR. The roads are designed for driving and foot traffic is minimal. The streets are filled with cars and buses, and three rings of elevated highways surround and cut the city into sections. These highways link up with the Autobahn, and form a larger ring connecting Köln to all of the surrounding towns.

Köln also has a problem with organized crime. The German Black Market (known as the *Verbrecher-Geschaeftsnetz*, or VGN for short) has a strong influence in the city. They deal primarily with corrupt middle managers and industrial spies at local factories producing weapons, cybernetics, and robotics. Some more brazen members of the Black Market are known to

use the oftentimes confusing highway system to their advantage, hi-jacking shipments using custom-rigged vehicles like modern-day pirates. By whatever means their goods are “acquired,” the German Black Market takes their shipments far from the Rein region, through the western border and into the *Monster Zones*, or south to the *Black Forest region*, where they are Rifted to the Americas and other locations, or stored at hidden locations for redistribution in and around the NGR.

The High Command of the NGR Military have been watching the movements of the Gargoyle Empire very carefully. Over the last decade, they have watched as the monsters have expanded their territory through France, Belgium, and the Netherlands. With an increasing number of skirmishes along the NGR’s western border and the destruction of Wroclaw, they fear the Gargoyles’ next target may be the Rein region and the city of Köln. This has resulted in the deployment of newly-developed war machines around Köln into the western *Monster Zones*. New and better forts and military bases are also being constructed all along the border to counter any enemy incursions.

### Statistics of Köln:

**Total Population:** Approximately 3.7 million residents, with another 700,000 in surrounding villages. Köln also has an average transient population of 2D4x1000 people.

**Population Breakdown:** 84% Human. Unemployment is very low, around 6%, and even the majority of D-Bees in the region have decent jobs, working in one of the many factories in the Rein River region. The majority of people living in and around Köln work in manufacturing, communications, technology and hauling freight. Köln has the second largest Triax manufacturing complex in the nation (the largest is in Frankfurt, and Triax’s main office and fourth largest production center is located in Berlin). The majority of Triax’s weapons research and development gets done in Köln, and factories crank out guns, missiles, munitions, robots, vehicles, armor, and bionics and ship them by rail, truck and air to military bases all over the country.

**Points of Interest:** The most famous and unmistakable landmark in Köln is the *Cathedral*. It sits downtown, only a few streets west of the river front. Construction of the Cathedral began in the year 1248 A.D., and due to a few interruptions, was not completed until over six hundred years later. The Cathedral was one of the few buildings in Köln not totally destroyed during the Great Cataclysm, and it is the oldest. The Cathedral has survived World Wars, riots, bombings, invading foreign armies, demons, Gargoyles, fires, countless storms, and the passage of time. It undergoes renovations every five or ten years, but is mostly intact from its original construction. Psychic Sensitives and those who are attuned to the supernatural “feel” that there is something unusual about the Cathedral. The presence of psychic or magical energy can be felt, but it is impossible to determine from where it comes or what purpose the energy might serve. Whatever it is, it is very likely that it is one of the forces that has helped keep the Cathedral standing for centuries.

**Downtown Köln** was partially rebuilt to match its pre-Rifts architecture style. Unfortunately, all of the ancient Roman-constructed walls, archways, tunnels, and buildings were demolished during the Great Cataclysm. When the city was re-

built, great care was taken to restore the downtown area and the ancient constructs to the way they were. Since then, however, many of those aging and substandard edifices have been torn down to make way for office buildings and shopping centers. Many residents of Köln, especially those who live close to downtown, are in an uproar as their historic city center is being replaced by cold, drab architecture. The people here are attached to the image of their city the way it was in ancient times.

Across the Rein River is the other half of Köln. The smaller, less historic half. To the locals, it is also known as the *Schäl Sick*, or “wrong side.” The *Köln StadtMuseum*, a large museum dedicated to the history of the city, is found in this part of town. It traces the story of Köln from its original construction by the Romans all the way up to the present day. Outside the museum, visitors can stand on the waterfront and look out over the city’s skyline, with the Cathedral being the most beautiful and impressive structure in view.

## Munich

Munich, also known as München to the locals, is the largest and most culturally significant city in the southern region of the New German Republic. Also known as **Bavaria** (or Bayern), it is one of the most picturesque areas in the NGR. Breathtaking countryside is framed against mountains. Small towns dot the landscape, many playing host to lakes for swimming or mountain trails for hiking and skiing. To the south are the *Alps Mountain Range*, and beyond that, the lands once known as *Switzerland* and *Austria*, both inhabited by Gargoyles (although Switzerland less so since Full Militarization began in 104 P.A.). The NGR Army maintains a large number of bases, watchtowers, security outposts and patrols along the southern border and along the highest ridges of the Alps. The closest military base is only ten miles (16 km) north of the city.

Most Germans don’t really care much for Bavaria. They see the inhabitants as unsophisticated and unrefined. Bavarians, especially during festivals, tend to reinforce German stereotypes of overweight, drunken hedonists clad in lederhosen. While it is true that Munich has some of the largest and gaudiest festivals and street parties (Oktoberfest and Mardi Gras are still highly celebrated times of year), there are no larger number of people fitting old stereotypes here than anywhere else. Regardless of these stereotypes – or maybe even because of them – Munich is *the* place to be if one is looking for a good time. And as a bit of turn-around, some Bavarians complain that the rest of Germany is too stiff, uptight and don’t know how to party.

(For more on Munich, read **World Book 5: Triax and the NGR**, pages 11-12.)

### Statistics of Munich:

**Total Population:** Approximately 4 million residents, with another 400,000 in surrounding villages. Munich also has an average transient population of 4D6x1000 people, but this number almost quadruples during the fall and winter months, when the festivals are most popular and the skiing in the Bavarian Alps is at its best.

**Population Breakdown:** 80% Human. Munich has a substantial D-Bee population, at least when compared to the rest of the NGR. D-Bees are more open and obvious here, as the

mind-set of the people is more accepting of them. Few are the occasions when a D-Bee is assaulted in public, or faces severe discrimination. Nevertheless, a large part of the D-Bee population live in squalid ghettos on the southern edge of the city, or take the train into the city to work. Legally, they have no better rights than in any other part of the NGR.

Unemployment is at around 10%. Most jobs are service or military oriented. Unfortunately, that translates to high unemployment for D-Bees, at around 25%. The NGR military has a strong presence in Munich and stages assaults into Gargoyle occupied Switzerland from the area. The NGR’s third largest Triax industrial complex is located in Munich, so a large amount of the population also works there.

Mercenaries, adventurers, and monster-hunters are also popular in Munich. They use the city as a stepping off point to take them on travels through the Gargoyle Empire and the rest of Europe. Many have permanent residences or bases in or near the city, where they return to relax and party before their next jaunt.

**Points of Interest:** Munich is the cultural center for all of the NGR, and some would say, all of Europe. *Bier Gardens* and enormous *Bier Halls* are found all over the city; few are the smaller pubs and bars. These places constantly espouse a festival atmosphere, and everyone is welcome to sit at any table, including D-Bees, start a conversation with any stranger, and dance with anyone who is willing.

**Central Marienplatz**, in the center of the city, is packed with retail stores, entertainment venues and people year round. Marienplatz also holds the *Munich Rathaus* (town hall). In the tower of the Rathaus is the *Glockenspiel*, which entertains visitors with its mechanical dancing figures. Around the Rathaus are towering skyscrapers, built during the Golden Age and renovated many times over since the Great Cataclysm.

The **Munich Triax Industrial Complex** is the home of *Triax Motorwerks*, and a large museum detailing the history of the company and the German Automobile industry in general is also located near the automotive giant.

Southeast of Munich are the ruins of famous **Neuschwanstein Castle**. During the opening minutes of the Great Cataclysm, the Alps rumbled, and the historic castle collapsed when part of the mountain it rested on fell away in an avalanche. It lies mostly in ruins now, and most people stay away, claiming that it is haunted.

## Victor Lazlo: 109 P.A. Update

Victor Lazlo, the famed 20th Century parapsychologist, lives in Munich. His organization has grown rapidly in the last six years, almost tripling its membership and funding. Smaller satellite groups have been started in *Passau*, *Berlin*, and *the Black Forest* (Schwarzwald). Victor has gained a bit of mainstream credibility, due mainly to his association with *Erin Tarn*, whom the NGR people still idolize. Victor has capitalized brilliantly on this small modicum of fame, using talk show appearances and other speaking engagements to speak out more vocally on the plight of D-Bees and the injustices they face from the government.

In the last two or three years, things have really begun to pick up for Victor Lazlo and his name is becoming ingrained in the public’s mind. In a recent interview with *Volkstimme magazine*,

Victor was asked how he felt about his goals in creating equal rights for non-humans in the face of overwhelming adversity from the popular consensus. His response:

*"I have spent my entire life trying to convince people of things they don't want to hear about. Where I'm from, no one wanted to believe in magic, or aliens, Gargoyles or demons, and look where that got us. I fear that ignorance and stubbornness have taken hold of the people of this nation, but this time it is not a refusal to believe that otherworldly things exist, it is a refusal to believe that otherworldly beings are people too. That their lives have value."*

Victor Lazlo has written a best-selling book, detailing the Germany that he left behind in 1984. In the book, he draws some pretty wide parallels between a Germany split by the Cold War and the Berlin Wall, and the situation the NGR faces with the D-Bee population. He also speculates that the nation's rise as a world superpower in the 21st Century was due to the fall of communism and the reunification of East and West Germany in the latter part of the 20th Century, and that there is always great strength in unity.

His experience of the world of the late 20th Century has many Germans fascinated, and people are willing to listen to his recollections of the world before the Great Cataclysm and his views on history for hours. After all, he is a relic from the past, himself, making his words and first hand experiences of the past carry great weight.

Victor Lazlo's critics call him divisive and hyperbolic. They claim he is trying to take public attention, and thus, public funds away from the Gargoyle War, and turn it instead into support for D-Bees, who have always been unwanted and unwelcome in the NGR. Those critics claim conditions are not nearly as bad for D-Bees as he and other activists claim. They point out D-Bees are lucky to even be allowed to live in the ghettos and work with humans. They also cast doubts on Lazlo's authenticity as a person from the past who Rifted through space and time from before the Great Cataclysm (his incredible knowledge of history notwithstanding) and into modern times. His critics try to paint him as a loon, a charlatan, and a foreigner with an agenda to undermine their great society, and perhaps even the integrity and safety of the NGR.

Despite his critics, Victor Lazlo is only gaining more popularity, and is a huge hit with the younger crowd, many of whom are clamoring for him to run for public office. With a humble smile and a dismissive wave, Victor says he has no such ambitions. But if there is one thing that Victor Lazlo has learned, it's that the future is always changing and unpredictable.

## Berlin

(Sometimes referred to as "Frei" Berlin)

There is a common misconception among peoples living outside the NGR, and that is that Berlin is either occupied by monsters, or lies in ruin. This is especially the case in North America, even among those who know about the New German Republic, as many speak of the "great tragedy that is Berlin, once the seat of the German government and a center of unity and multiculturalism, now a desolate ruin and full of monsters and ghosts." As it sometimes is with rumors, these stories are fallacies with a basis rooted in truth.

There was a time when the city of Berlin did belong to monsters, and it was in ruins. Berlin suffered badly during the Great Cataclysm. Historians blame the corrupt local government, bloated and bureaucratic, for the destruction of the city. Although the Cataclysm itself was no more damaging to the city than any other part of Germany, the police and national security forces were so bogged down with red tape and plagued by cowardly and ineffectual leadership, that soon the scared, hungry, and cold citizenry began to panic. Their panic incited riots and anarchy throughout the city. The useless mayor took his staff and fled in his private helicopter to his estate in the country, leaving the residents and remaining city authorities to fend for themselves.

Berlin burned for weeks. Try as they might to curtail the hysteria and rioting, most of the police and national security forces were eventually forced to abandon the city and were reassigned by the national government to other areas where they could make a difference. Berlin was all but written off as a disaster area when demons and strange monsters started appearing, adding to the chaos, and killing and enslaving the humans who had remained in the ruins of the city. Street gangs fought back against the invaders as best they could, but it was a lost cause.

Berlin remained a no-man's land during the Dark Age, even as the New German Republic came into being and other cities were rebuilt. Preliminary excursions into the burned remains of the city revealed that little was left to salvage. It was such a dangerous place devoid of human life and inhabited by D-Bees and savage monsters, that the NGR Army formed a perimeter around the city and quarantined it. The NGR prioritized Berlin as last on their list of cities to rebuild; it was simply too far gone and there was too much work to be done elsewhere. Decades later, after a legion of Brodkiel tried to inhabit the ruins and caused much grief for people in the area, the NGR finally purged the ruins of monsters and began a massive reconstruction project.

Today, Berlin is the most modern city in the Republic and the seat of the NGR government – a symbolic gesture to unify the people of Germany and a defiant gesture to the hostile monster armies all around the NGR. When the city's reopening and official christening took place, the Chancellor promised that one day, "All of Europe would be as free and proud as Berlin." As an act of solidarity and confidence, Triax Industries relocated its headquarters to Berlin and built a new factory complex.

Through it all, Berlin retains its own unique character, some would say, soul. And that it cannot be broken or taken away by monsters. A popular phrase in Berlin goes, "*Berlin bleibt doch Berlin.*" Translated, it means "Berlin always remains Berlin."

### Statistics of Berlin:

**Total Population:** Approximately 2.4 million residents, with another 500,000 in surrounding villages. Berlin is a popular spot for visitors from outside the NGR, most of whom can not believe the city even exists, and sometimes stay for weeks or months, watching the never-ending construction going on as the city's reconstruction continues. Berlin has an average transient population of 3D6x1,000 people.

**Population Breakdown:** 97% human, the rest being D-Bees in work release programs (some working illegally). Unemployment is low, at around 5%. That statistic includes mercenaries



and adventurers, neither of which are considered to be employed.

**Points of Interest:** Berlin suffered immeasurable damage during the Great Cataclysm and Dark Age that followed. Veritably none of the original city remains. The city planners wanted to restore Berlin to its former glory, and set about recreating much of it in the style of its pre-Rifts appearance, but other than its “look,” the city is completely rebuilt from the ground up. What few of the old monuments and artifacts could be recovered have been placed in museums. The most famous of these museums is located at the *Museumsinsel* and the rebuilt *Deutsches Historisches Museum*, where German history is on display for all to see.

Miraculously, the *Brandenburg Gate* is still standing. The Quadriga statue that stood atop the gate had been removed by invading Brodakil during their occupation, but was found in one piece buried nearby. The Brandenburg Gate stands as a symbol of victory for the German people. Victory over the Great Cataclysm, the Brodakil demons who held the city for so long, and for the victory over the Gargoyle Empire that every citizen dreams of for the future. Every New Year’s Eve, there is a huge celebration at the Gate, with hundreds of thousands of people counting down the minutes to the new year. “Frohes Neues Jahr! Dieses Jahr,” they cheer. A proclamation that this year will be the year that the monsters are expelled from Europe.

*The Kurfürstendamm* (also known as the “Ku’damm”) is the place to see and be seen. It has the trendiest shops, the hippest cafes, and the most exclusive clubs and restaurants. Visiting dignitaries, business people and tourists to Berlin are guided here, where they drop serious credits on clothes, shoes, electronics, books, and even pre-Rifts artifacts. Native Berliners sit at many of the outdoor cafes and watch the tourists go by, sometimes gawking at their “backwards” nature (especially the Polish, Americans, Russians and Bavarians).

Sitting almost in the center of downtown is the massive **Triax Tower**. The building stands 150 stories, is the headquarters for Triax Industries and is currently the tallest building in Germany, and possibly the world; at least the tallest built by humans. The top thirty floors house the main offices of Triax Industries, with the offices of numerous parts suppliers, associates and other companies and organizations in the floors below them. The Triax Tower was constructed only about 30 years ago, and is part of the grand plan of rebuilding Berlin into the *capital* of the New German Republic. A new Triax factory complex has also been built and is located on the outskirts of the city.

Just east of downtown are the newly-constructed *Political Embassies* for visiting foreign dignitaries. There is one each for the Coalition States, Free Quebec, Tarnow, Wroclaw, Warsaw, and a few smaller nations. Foreign Ambassadors are surprised to learn that they will be staying in Berlin, a city many still think was destroyed and is a haunted ruin. Nearby is the *Bundestag*, the seat of government for Berlin and the whole NGR.

Outside the city is a beautiful countryside with a number of villages. *Zehlendorf*, *Potsdam*, *Zennigsdorf*, and *Falkensee* are all experiencing almost as much growth as Berlin. Southeast of Berlin is the *Köpenick Forest*, the *Grosser Müggelsee*, and the *Müggelberg Hills* (and the town of *Müggelheim*). Most of the D-Bees who work in Berlin live in a small ghetto in *Potsdam* and are forced to commute to the city.

Far to the south of Berlin is the **Erzgebirge Mountain Range**, which helps form a natural barrier between the NGR and the Brodakil demons inhabiting the Old Czech Republic.

## Denmark

Denmark deserves special mention. It is claimed by the New German Republic, but it is mostly off-limits (*verboten!*) to everyone except special federal departments. The entire country, and a great deal of Germany’s Baltic Coast, suffered unimaginable damage during the Great Cataclysm and the years afterwards. The reappearance of Atlantis drowned Denmark and it was totally underwater for about 20 years. After the waters receded, it became a playground for demons and other strange dimensional creatures. These creatures fought amongst each other in small wars, using weapons and magical powers that corrupted and polluted the land beyond repair.

Eventually, the demons and monsters inhabiting Denmark were wiped out by the NGR Military, and the country was claimed for Germany. Unfortunately, the NGR found that they had conquered a wasteland that was of little value to them. Today, Denmark is used as a *proving grounds* for NGR military weapons and maneuvers. The land is uninhabitable in the long term, except for a few small pockets. Most of these tiny pockets, the largest of which being only about twenty square miles (51.8 sq. km), reserved for military bases and three maximum-security prisons. **The NGR Navy** controls all of Germany and Denmark’s *Baltic Coast*, which they use for training exercises and the construction and storage of large naval vessels.

Non-military personnel are restricted from entering Denmark. Massive Mega-Damage walls, electrified fences, and armed guards help keep intruders out. There are no D-Bees, Gypsies, or civilians other than the prison population (roughly 700,000), and very few monsters. What few ruins of pre-Rifts cities remain are haunted by Entities, ghosts, and wandering undead creatures. The soil is mostly dead earth, that becomes sandy and rocky by the sea. The weather in Denmark is almost perpetually cold and cloudy, with only a short warm span of three weeks in July.

## The Autobahn

### Getting Around the New German Republic

The Autobahn was the name of a large network of super-highways that crisscrossed pre-Rifts Germany. Construction began in the 1930s, and continued up until the Great Cataclysm in 2098. With Germany being at the geographic center of Europe, and dependence on the automobile only increasing throughout the 21st Century, the highways were forced to handle a massive amount of traffic every day. As a result, the roads were constantly being maintained, and new roads were being added all the time.

The Autobahn had a reputation throughout the world as a system of roads that offered the “complete driving experience,” especially when combined with German automobiles. The roads were brilliantly designed to interact with the landscape to not only offer excellent views of the countryside, but to conform with the land to make a comfortable driving experience. Gas sta-

tions and rest stops were frequent and conveniently placed. The roads were mostly straightaways. They bent and pitched very little, and curves were generally very broad. Bridges and tunnels were placed to keep things nice and flat. This allowed people to drive very fast. There was something of a misconception about the Autobahn that it was a lawless, massive twenty-lane highway where one could drive along at whatever speed they wished. In fact, there were many places that did have speed limits, and there were some that did not. In truth, it was not really any different than most other highway systems, aside from the superior engineering in its design.

The Great Cataclysm completely shut down the Autobahn. Large sections were torn up by freak storms or swallowed by earthquakes and mudslides. Once things started to get *really* bad and people started to evacuate the cities, they found the super-highway impassible. Abandoned vehicles filled the roads and littered the surrounding fields and forests. Eventually, with the passage of time, those vehicles and most of the asphalt underneath them rotted away and were grown over by vegetation.

It took quite a long time for the NGR to attempt to rebuild the Autobahn. At first, there was little desire to resurrect the old highway system. People were living in large, sprawling cities, the countryside was dangerous, and most people had no reason to travel outside their home town. The new *RailBahn* was already in place at this time, so citizens who needed to leave the city could do so with the speed and convenience rail had to offer. The areas outside the cities were still considered dangerous wilderness, and were not yet under the level of control there is today. Simply put, no one wanted to drive on large stretches of open road.

**By the year 2326 (40 P.A.),** two things became apparent. First, the wilderness of the NGR interior was much less dangerous than it had been. Compared to the rest of the world, it never was that bad. Germany had its share of disasters and monster invasions, to be sure, but once the dust settled and the military started bringing the situation under control, it was found to be largely safe outside the cities. Second, the Gargoyle attacks from two years previous displaced millions of people all over Europe. Most of them poured right into the NGR. The already sprawling cities swelled even more. Small towns and villages became suburbs almost overnight. In those years, D-Bees were kicked out of the NGR, so they started forming shanty towns in the countryside and along the nation's borders. Public transportation was simply unable to compensate for the massive influx of people and exodus of non-humans. Triax, seeing a golden opportunity, ramped up its automobile division, and started rolling cars, trucks, and motorcycles off the assembly line, all economically priced for even the most destitute refugee or D-Bee, and, the government started to rebuild the Autobahn.

**By 109 P.A.,** the Autobahn still has not caught up to its pre-Rifts grandeur. There are many places in the NGR untouched and inaccessible by car, and many more that are only accessible by dirt or gravel roads. Rebuilding the Autobahn has been a slow process, mainly due to lack of funds. Public funds are used only to build highways around and in between major cities. Triax Industries provided many grants and loans to get the roads back in shape, but only to help sell their automotive line. The government has stepped in to build some sections of the Autobahn around population centers and is funding a strip

that runs from Berlin to Frankfurt, but that's about the extent of their endeavor. It will simply take a very long time for it to be completely rebuilt.

Traveling on the Autobahn is much riskier than it used to be. There are much fewer places to stop for gasoline (known as *Benzin*) or supplies, fewer emergency telephones on the side of the road, much less traffic, and a light presence of the authorities. The freeway is mostly lawless now. There are few areas with speed limits (usually between 60 and 120 kilometers per hour), and those limits tend to be ignored. However, the whole experience is much more exciting. Wealthy auto enthusiasts, sometimes with modified and tricked-out rides, take small vacations on the Autobahn tearing through the countryside. They go to show off their cars to other motorists and to get a rush by testing the dangers of the wilderness. Drag races and chases (sometimes violent) are common among these weekend drivers. They can become very aggressive and hostile to other motorists, especially to those who are blocking the lanes or not driving as fast as they are.

There are other things to be wary of on the Autobahn. Monsters wandering in from the forests or mountains, or from a Rift, may block the road or attack motorists. Although few monsters can match speeds with modern automobiles, they can cause trouble or get to drivers who have pulled onto the side of the road for a fill-up or during an emergency. To a lesser extent, motorized bandits and Gypsies are another danger. They are far more aggressive than monsters, but more easily tracked and dealt with by the authorities. Small bandit gangs, who are highly mobile, hide along the road until someone comes by, then they spring forth and give chase. They are usually content to simply rob a motorist of his credits and valuables, siphon off a share of his gas (leaving only enough to let him get to a *Tankstelle* or gas station), and send him on his way. Likewise, smugglers and Black Market operatives use the Autobahn and an encounter with them may lead to trouble, especially if an innocent motorist just happens across a hijacking in progress. There are also a few brutal gangs on the roads who engage in wanton acts of piracy, vehicle theft, rape, and murder.

**The NGR Federal Transport Ministry** (Bundesministerium für Verkehr) makes sure drivers are aware of these dangers before allowing anyone to drive on the Autobahn. For safety and convenience, digital signs are posted above the road, alerting motorists to dangers from weather, monsters, and bandits, and offering alternate routes (or sometimes simply informing drivers that they need to turn around or find a hotel for the night). These signs are updated every hour. Constant updates are also available by police band radio, CB radio, and wireless broadband internet.

**The AutobahnPolizei** (highway police) are a highly-trained and effective force for safety and regulation on the highway. They are far more mobile than any monster, bandit gang, or civilian motorist, and can be encountered at any location on the Autobahn in a matter of minutes; they are actually timed and graded on how quickly they respond to emergency calls. The Polizei patrol the highway with Mega-Damage armored vehicles, sometimes hover vehicles and power armor such as the Flanker, Ulti-Max and Predator. In the event of a crash, accident, or motorist attack, they are called out to assess and defuse the situation. They can call for tow-trucks and ambulances if

needed, and heavier firepower is available in the form of fast-moving aircraft and armored attack vehicles from the military, especially in the case of Gargoyle or Brodkil incursions. The typical highway officer uses the *Police O.C.C.* with an emphasis on Combat Driving, Pilot skills, Roadwise, and Wilderness Survival. They are excellent drivers and pilots, though tend to show-off more than they should.

**The NGR Military** uses the Autobahn to move troops and supplies in convoys. However, the largest transports of troops and supplies tend to be via aircraft or train. The military has more authority on the highway than the *Polizei*, but are under no obligation to aid motorists, except in the case of attacks by monsters or bandits, in which case the military has jurisdiction to open fire to eliminate the threat.

The Autobahn covers the interior of the NGR, but does not reach beyond its borders. In fact, there are no paved roads leading out of the NGR at all anymore. There are dirt roads leading off to the west, to villages and towns, and narrow mountain passes leading to Poland and through the Alps and Black Forest region in the south. Crumbling, ancient highways can still be found throughout Europe, though they can only be traversed by vehicles equipped for very rough terrain. Although private citizens are allowed to drive beyond the borders of the NGR, the government and military highly suggest against it, and will not guarantee the safety of anyone who leaves the country.

## Autobahn Random Table

### Random Encounters/

### Road Conditions on the Autobahn

For extra fun, roll on the following table every 10-20 miles (16-32 km).

**01-05% A Smooth Ride:** The drive is smooth. Traffic is non-existent.

**06-10% Light Traffic:** The characters have to reduce their speed to about 50 mph (80 km), or make 1D4 Piloting skill rolls to weave through the traffic and zoom on by. -5% penalty to Piloting skill rolls while in Light Traffic, plus an additional penalty of -10% in light or medium rain, and -20% in heavy rain, snow or fog (or if being pursued and shot at).

**11-15% Heavy Traffic:** Reduce speed to 25 mph (40 km), or make 1D4+3 Piloting skill rolls at -15% to weave through the other vehicles; plus an additional penalty of -10% in light or medium rain, and -30% in heavy rain, snow or fog (or if being pursued and shot at).

**16-20% Gridlock:** Traffic comes to a dead stop, usually because something bad is going on a few miles up ahead (accident, monster blocking the road, a monster attack, bandits, mudslide, etc). Weaving through is impossible, though the characters can leave the road if they wish. Doing so imposes a -30% penalty to all Piloting skill rolls. Not to mention it is illegal to leave the road, and the characters may be pursued and ticketed by any *Police* nearby.

**21-25% Closed Exit/Detour:** As luck would have it, either the exit the characters need to take is closed, or the road is closed and detours onto a small local highway, heading off in a different direction. In either case, the characters are 1D6x10 miles (16-96 km) off course. A Land Navigation skill roll or two

gets them back on track. Otherwise they'll have to ask for directions.

**26-30% Abandoned Vehicle:** Either a truck, auto, or motorcycle is parked on the side of the road, with no owner in sight. Is someone in trouble? Is it a trap? Is there anything to loot? Players may investigate if they choose. G.M.s may send whatever trouble they might want to unleash their way.

**31-35% Idiot Motorist:** Some goofball isn't paying attention to the road and nearly sideswipes the characters' vehicle. Roll on Piloting skill to avoid a collision. No penalty.

**36-37% Enraged Motorist:** This guy is really steamed about something. He is driving 50% faster than the characters, and almost rear-ends them! Perception Roll to notice him as he quickly closes the gap. If the Perception Roll succeeds, make a Control Roll at -10% or the characters' vehicle is hit and the motorist keeps going.

**38-40% Broken-Down Motorist:** His vehicle broke down, and is belching steam, smoke, or flames. A mechanic in the group could help, otherwise he asks for a ride to the nearest service station.



**41-45% Gargoyle Skirmish!** 1D6+1 Gargoyles (or Gurgoyles or Brodkil) rush onto the Autobahn. They are locked in combat with an equal number of NGR troops. If the drivers on the Autobahn aren't careful, they could become collateral damage. Dodging around the conflict and through friendly fire requires a roll on the Piloting skill at -30% for each obstacle (Gargoyle and NGR) to be avoided. If the NGR forces, for the moment, lose the skirmish, reinforcements arrive within 1D6+2

melee rounds, but the monsters *may* try to grab one or more motorists to use as human shields or hostages.

**46-50% Distress Call for Help!:** Somebody calls over the characters' radio, pleading for assistance. They could be at a nearby town, in another vehicle stranded on the side of the road, at a service station, or off in the wilderness close by. They need help because (roll percentile dice again or G.M. pick one or use something of your own): 01-10% trouble with bandits, 11-20% trouble with a lone Gargoyle or Gurgoyles, 21-30% trouble with two Brodkil, 31-40% trouble with 1D4 monsters of some other kind, 41-50% medical emergency, 51-60% a child has gone missing (Lost? Taken?), 61-70% has vital information that must get to the authorities/government but thinks he's being followed, 71-80% dangerous criminal, 81-90% wife (or wife and child) has been kidnaped by D-Bee terrorists, or 91-00% under attack or being pursued by a band (1D4+2) of Gargoyles or (2D4+2) D-Bee terrorists. If the characters don't have a radio, then someone on the side of the road flags them down or stands out in the middle of the highway in desperate need of help.

**51-52% Erratic Driver (or a drunk):** You can honk the horn all you want, but the car isn't going to speed up and it weaves all over the road. The driver swerves to block the characters' vehicle. Riding behind this person increases travel time by 20%; -15% penalty to Piloting skill roll to go around this erratic driver, but the car swerves as if trying to deliberately (he's not) hit the player characters vehicle(s). Roll to avoid collision with the above penalty to Piloting skill.

**53-55% Erratic Drivers:** Same as #51-52% above, except this time there are two such slow and erratic drivers and they are slowing traffic deliberately. They are members of a criminal operation and are slowing traffic so the car(s) behind them can be ambushed a little ways up ahead, or because some crime is happening a few miles up ahead (cargo hijacking, car-jacking, gas station robbery, etc.). Riding behind these people increases travel time by 20%; -25% penalty to Piloting skill roll to go around these two erratic drivers and the cars will swerve to block or to deliberately hit the player characters' vehicle(s). Roll to avoid collision with the above penalty to Piloting skill.

**56-57% Show-Off Motorist:** Some guy drives up next to the characters and challenges the driver to a drag race.

**58-60% Harmless Motorcycle Gang:** 4D6 bikers are tearing down the highway. They look tough, but as long as no one messes with them, they leave the characters alone. They spend a lot of time on the road, so they may even have some useful advice, information or rumors.

**61-65% Gargoyles or Gurgoyles (1D6+2):** They are not out for blood, they're just causing a disturbance and damage by blocking the road, forcing vehicles to crash or go off-road, kicking and flipping cars over, and creating havoc. Drivers may get hurt, but the monsters are just having cruel fun and flee when half of them lose 50% of their M.D.C. or as soon as NGR troops are seen coming in the distance. They melt back into the woods, where a Gargoyle Mage turns them invisible or uses a Chameleon magic spell to conceal them all.

**66-70% Gypsies:** Riding in a small caravan (2D4 vehicles) of rusted-out RVs, trucks, vans, or robot horses. They may (40% chance) try to rob or swindle anyone who comes too close or pulls off the road to talk with them. On the other hand, the

Gypsies may have helpful information or be willing to trade goods (30% chance).

**71-75% A Beast on Road:** This could be anything from a Eurotorpid dinosaur (see **Rifts® Sourcebook 3: Mindwerks™**), a small herd of cows and sheep or other farm animals on the loose, one or two Brodkil or Gurgoyles, or Gargoylites, or some other dumb animal or monster, or even a demon or Deevil! Whatever it is, it blocks the road. Monsters are likely to be hostile and attack any vehicle that comes too close or tries to go around it/them; -20% penalty to Piloting skill roll to go around and dodge incoming attacks.

**76-80% Road Damaged:** For the next 1D4 miles, this stretch of highway counts as Rough Terrain. Drivers need to slow down to 30 mph (48 km) or slower if their vehicle isn't equipped to handle it. Going faster requires a roll on one's Piloting skill with a penalty of -10% for every five mph (8 km) above 30 mph (48 km) the vehicle is going. A failed roll means the vehicle gets stuck or hung up on debris, or crashes off to the side of the road.

**81-85% Road Collapse:** A hunk of road is completely gone, leaving a crater where the road was; 2D6x10 yards/meters of damage. The highway has completely collapsed due to flooding, blown away from an explosive attack or literally ripped up and thrown away or left as giant, jagged chunks from a monster attack. Travelers must find an alternate route.

**86-90% Bandit Attack!:** Bandits on fast-moving hover vehicles (one or two bandits for each player character) emerge from over a hill or behind some trees. They either try to block the road and force vehicles to stop or drive next to them threatening to blow them to pieces unless they pull over and be robbed. These guys are crooks looking to steal weapons, ammo and valuables. They aren't killers but will fight and kill if they encounter resistance. The bandits leave if more than half of them are killed.

**91-95% Monster Ambush!:** A small group of monsters (1D4+2) charge vehicles on the road. The creatures are in a killing frenzy and fight to the death. The monsters also get the drop on the characters (have initiative and first strike), unless a player character makes a Detect Ambush skill roll or Perception Roll of 15 or higher.

**96-00% Roadblock:** The Autobahn Polizei have set up a roadblock and are stopping traffic to check identification. They are probably looking for a criminal or terrorist. Um, could that include the player characters? There is a 20% chance the authorities search the player characters' vehicle for contraband. Increase that to a 60% chance if one or more of the characters make wisecracks, behave in a nervous or suspicious manner, or are uncooperative.

## NGR RailBahn

The RailBahn is the name given to the modern system of trains and monorails that exist in the NGR. It encompasses Germany's old Deutsche Bahn and the larger EuroRail networks. The NGR RailBahn is a highly-efficient, ultra-modern means of travel, even if it can get a little expensive. The newer trains are brilliantly designed by Triax Industries and run very smoothly, quietly and quickly. Running at around 330 kilometers per hour

(over 200 mph), these trains can reach speeds that come close to some flying power armor. Going from Munich to Hamburg can be accomplished in under six hours. Going from Cologne to Frankfurt takes only 45 minutes.

The RailBahn carries commuters who go from one city to another all over the NGR interior, and even to a few places outside its borders, like Poland. The major line ends at the *Poznan Collective*, and local connecting trains take travelers to Warsaw and Wroclaw. At one time, there were also lines going to towns in the Netherlands and Belgium, but those have been permanently cut by the advancing Gargoyle Empire. For the same reasons, plans to build rail lines through the Bavarian Alps have also been scrapped. Since *Operation Sea Storm* and the occupation of Southern France, plans have been laid out to spread the RailBahn to military outposts there.

### Long Distance Travel:

Travel on the RailBahn can be quite pricey. Tickets fluctuate depending on holidays and peak holiday seasons when they are highest to slow seasons when the prices are lower. The RailBahn is very expensive to maintain. Building new railcars, laying new track, and repairing existing tracks costs millions of credits every year. Taxes and grants help defer the cost a bit, but not enough.

**Passengers in First Class** get a private room with roomy seating for eight (ideal for meetings), television and computer and printer office system, fold-away table, mini-refrigerator, dresser, closet, private lavatory and two sleeping bunks (two more can be added), as well as three free meals and snacks per day of travel, unlimited non-alcoholic beverages, and access to other cars for private dining, entertainment, gambling, and a private bar/lounge area. Of course, First Class customers pay for this luxury to the tune of 3,000 to 7,000 credits for the First Class room and 1,000 credits per person (4 maximum). Price varies with the destination.

**Second Class/Business seating** costs 500 to 1,200 credits per person to go from one city to the next, with destinations such as Berlin or Poland costing double. Second Class gets semi-private seating (four people per compartment), two free meals, a snack and three free non-alcoholic beverages, a sleeping bunk, as well as access to the other amenities on the train except those reserved for First Class.

**Coach/Third Class seating** is how most people travel. Third class gets one free meal, no access to amenities other than a public restroom, and must share a compartment with 1D6+4 other individuals. The seating is comfortable and roomy, with overhead and under the seat storage, but there is no sleeping bunk, and water, beverages, or additional food items must be purchased at an additional cost. This economy fare runs from 200-500 credits depending on the destination, 650-800 for the farthest destinations.

**Discounts.** Members of the Polizei, government and military (including foreign allies like the CS) enjoy a 30% discount on tickets, meals, and drinks. Students and ex-military get a 15% discount.

**D-Bees.** Nonhumans are allowed to ride the RailBahn, but they must stay in cars designated for D-Bees only, and located at the back of the train. Only Coach/Third Class seating is available and it comes with no discount, no free meal, and no special

amenities. Furthermore, the standard Coach compartment usually sees an extra couple of D-Bees squeezed into it (1D6+6), making seating a bit more cramped, but not terribly uncomfortable. Food and drinks in containers that can be sealed may be taken on the train.

### Local Train Travel:

**Taking one of the intra-city trains is much cheaper**, equal to any public transportation service. Five credits will get you on a train that runs all over the city all day, and transfers are free. These lines are owned and operated by the same companies that own the RailBahn lines, so they are also (mostly) clean, safe, and very efficient. D-Bees with work release programs, low-income individuals, and City Rats are the most common passengers on these trains.

**Security.** The RailBahn has its own private security force, made up of ex-soldiers and ex-police. They guard the cargo areas and engine car at all times, while others patrol the other cars, keeping the riff-raff in line, checking tickets, and offering help to anyone who needs it. It is suggested that passengers lock their rooms at night, and keep any valuables close, especially in Third Class where Gypsies (“thieves and robbers, all of them”) are common. *Weapons are not allowed* in the passenger area, they will have to be stowed with the rest of the cargo. The security team is adamant about this.

Bandit and monster attacks are few, especially within the NGR itself. The trains are much too fast to be caught by all but a few monsters and most motorized bandit gangs (unless they have flying power armor or modified hover vehicles). The most common danger is Brodkil attacks in Poland, and even they are still pretty rare. NGR military squads are assigned to patrol the areas around the rail lines and deter any Brodkil or other monsters and threats from getting within five miles (8 km) of the rail line. In Poland, the Brodkil consider it a personal challenge, almost a game, to derail a passenger train and cause the deaths of everyone aboard. More impressive if they can do it by actually boarding the engine and running the train off the track. Speaking of the Brodkil, they have significantly hampered any efforts to expand the rail system in Poland, leaving Tarnow cut off by that avenue.

**Note:** Triax trains are heavily armored, with 1,000 M.D.C. per car. The doors have around 100 M.D.C. and the windows have 20 M.D.C. each. Special armored cars for transporting military hardware and VIP passengers have 1,400 M.D.C. and no windows. Trains built by other companies (Rüstung-An-Der-Rhein Korporation and Golden Age Weaponsmiths, for example) typically have 35% less M.D.C. and are 10% slower/less efficient. All trains are nuclear powered and have a 20 year life span.

## Airports

There are currently only two commercial airports for travel for private citizens. One is in *Frankfurt am Main* and the other is the recently opened airport in *Berlin*. Both offer travel to Poland, New Moscow, Kaliningrad, the Coalition State of Chi-Town, and Free Quebec. Tickets are extremely expensive, 2,000 credits from Frankfurt to Berlin (and vice versa), 5,000-10,000 for European destinations, and 20,000 credits per

passenger for flights overseas, which are long and uncomfortable. The airline takes no responsibility if the aircraft does not reach its destination or there is loss of life or it goes missing with all passengers aboard. Such is the danger of air travel on Rifts Earth. By contrast, the military has many small airfields scattered throughout and around the NGR, about 20 in all. **Note:** It is illegal in the NGR for D-Bees, non-military psychics, mutants and practitioners of magic to fly on commercial aircraft.

## The Typical NGR Citizen

The average citizen of the New German Republic is educated, cultured, hard working and dedicated to the continued survival and prosperity of the Republic. German citizens tend to be a very pragmatic and efficient people, who may work hard, but also enjoy life and personal freedom. Their technologically advanced society offers most human citizens every modern convenience one could want, including local television and internet, computers and electronics, books, movies and entertainment, and all the rest. Compared to the rest of the world, especially chaotic places like China, non-Sovietski Russia, South America, and most of North America, citizens of the NGR enjoy a life of comfort and security. Unless they've served in the military, most have not seen combat, have never held a weapon, and may never be in direct danger from magic, monsters or the supernatural. Walking around some cities and towns, a visitor could never tell that there ever was a Great Cataclysm, or that the nation is locked in war against giant, supernatural monsters, some only a few hundred miles away. The German People and the New German Republic are very secure.

### Education of the Average Human Citizen

#### – Updated from World Book 5

Ninety percent of the human population in the NGR is literate and skilled. The average citizen has the equivalent of a high school education, while those in the areas of education, medicine, communications, computers, and technology are college educated. This is a striking contrast to most of the Coalition States, where illiteracy among the masses is promoted and Rogue Scholars and Scientists are hunted criminals. It is this level of education and the degree of personal freedom which concerns the Coalition States.

#### Skills & Abilities of the Average NGR Citizen:

- Basic Math (+15%)
- Computer Operation (+15%)
- Language: Euro (native)
- Language, Other: Pre-Rifts German (+20%)
- Literacy: Euro (native)
- Literacy, Other: Pre-Rifts German (+10%)

**Citizens without military experience** have two attacks/actions per melee round and select three skills from one skill category reflecting a profession (all +10%), two other skills (+5%) and four Secondary Skills.

The following skill categories are *not* available: Cowboy, Espionage, Military, Rogue, Wilderness and Weapon Proficiencies. Additionally, the average citizen cannot select skills that are military related, such as Hand to Hand: Commando,

Combat Driving, and Piloting of Military vehicles (including Robots and Power Armor). Nor is the “average” citizen particularly athletic, and those without military training have no weapon skills. For Secondary Skills, use the list in **Rifts® Ultimate Edition**.

**Citizens with military experience**, about 80% of the males over the age of 18, and 45% of adult females, have the following additional skills from having done at least a five year stint in the NGR Army. These are in addition to the skills above.

- Climbing (+5%)
- Pilot Truck (+10%)
- Radio: Basic (+5%)
- Running
- Swimming (+5%)
- Hand to Hand: Basic
- W.P. Rifles
- W.P. Energy Rifle

**Note:** Since Full Militarization in 104 P.A., the number of citizens enlisting in the military has increased sharply, even beyond the five year mandatory military service period. Skill bonuses listed above may be lower than the actual military O.C.C. due to lack of practice or interest.

### Education of the Average NGR D-Bee

Only 6% of the D-Bees living in the NGR are actually “citizens” and this minority is likely to have a better education and more (1D4+2) skills. Generally speaking, D-Bees are much less educated (2D4 years of grade school), unskilled and used primarily for low paying jobs, service jobs, menial labor and work that is hazardous and unpleasant, such as farming/picking crops, waste services, construction, building, cargo hauling, etc.

#### Skills & Abilities of the Average NGR D-Bee:

- Barter (+12%)
- Basic Math (+5%)
- Domestic: Four of choice (+20%) or two Mechanical (+15%).
- Computer Operation (+5%)
- Language: Euro (native)
- Language Other: One of choice (+10%).
- Literacy Other: Euro (+15%) or one Technical Skill of choice (+10%).
- Physical Labor

**D-Bees without military experience** (which is most) have three attacks per melee (or as per Hand to Hand Combat), and have a *total* of four skills selected from the following categories: Domestic, Electrical (no more than one), Physical, Rogue, Technical or Wilderness, with each getting a +5% skill bonus. Skills probably represent ways for the D-Bee to make a living or survive. Also select three Secondary Skills, from the list in **Rifts® Ultimate Edition**.

**D-Bees with military experience (probably not with the NGR)**, about 20% of the males over the age of 18 and 5% of the adult females, have the following additional skills. These are in addition to the skills above.

Climbing

Pilot: One of choice (+5%).

Radio: Basic (+5%)

Running or Swimming (+5%)

Hand to Hand: Basic

W.P. Ancient: Two of choice.

W.P. Energy Rifle

## Cultural Attitudes of the Citizens

The people of the NGR are fiercely nationalistic. They consider themselves Germans first and humans second. They speak of the glory of the New German Republic and how their nation will be the saviors of all of Europe. Non-German Europeans (including the Polish) are viewed as “little brothers” to be protected, watched over, rescued when they need it, and occasionally, put in their place. They don’t mean to be demeaning toward their human neighbors, the new German culture simply has a slight air of arrogance surrounding it. After all, they have been holding back the might of the Gargoyle Empire for more than a century, and have scored many big victories against the monster hordes. Thus, they tend to see themselves as highly educated, technologically advanced and cultured compared to most other nations in the post-apocalyptic world – which they are.

Unfortunately, this also means they tend to think they are smarter and better than most surviving people and nations in the world, and this is especially true when it comes to other refugees, Gypsies, D-Bees, civilizations in Asia, the Americas and other parts of the world, including other European countries. They view visiting *Americans and most outsiders* with a touch of curiosity and slight suspicion, especially if the visitors are there for business; the German people don’t like the idea of foreigners conducting business in their country. *Foreign mercenaries and adventurers* are looked upon with even greater suspicion and a touch of disdain, because there’s not telling what their agenda may really be, or where their loyalties may lie, especially if these individuals might have an effect on the war against the Gargoyles. *Foreign tourists*, on the other hand, are happily welcomed as long as they bring plenty of credits to spend.

Outsiders shouldn’t feel too slighted, as the people of the NGR who live in cities (which is the majority) look down on NGR farmers, country people, Psi-Stalkers, Poles, Russians and refugees as “inferior” and “simple folk.” *Gypsies and D-Bees* are generally regarded as lowlifes and thieves. Meanwhile, *D-Bees* and even some human refugees who live off the land as farmers, hunters and scavengers are viewed as primitive people and even barbarians. *Practitioners of magic* are non-existent in the NGR so they are an unknown, but the stories they’ve heard lead most Germans to consider them to be dangerous and untrustworthy.

The people of the NGR are understandably paranoid of dimension-hopping travelers and spell casters, and sometimes go out of their way to make them feel unwelcome. In small towns and some of the cities, the Polizei are called when dimensional travelers appear, especially if they are inhuman or demonic in appearance.

Other than Coalition soldiers, and CS ambassadors and dignitaries, the NGR doesn’t get very many visitors from North America, or anywhere else for that matter. Of those who do come over, most are wealthy businessmen either looking for a little vacation or perhaps to expand their business.

From the point of view of many German citizens, the one downside to the resounding success of Operation Sea Storm and the NGR’s continuing military success to destroy the Gargoyle Empire, is that it has opened up the Republic’s borders and is attracting mercenaries and adventurers from across Europe and as far away as North America. The government’s verdict is still out on whether this is good or bad, but the average citizen does not like it. This is due, in part, to the very fact that the NGR has been so very isolated for so long. Now that outsiders are filtering in, the people feel a little less secure and feel rather like they are being bothered by uninvited house guests. Indeed, as the Gargoyle Empire continues to crumble and the NGR becomes more renowned, refugees from other countries come seeking refuge from hostile lands, while mercs and opportunists are looking at the NGR as a realm to explore and profit from.

American mercenaries and adventurers (such as the player characters) are making their way to the NGR to see if the government wants to hire them as “freelancers,” or plan on hunting Gargoyles and collecting on bounties. Other mercs and adventurers see this as an opportunity to scavenge battle sites and Gargoyle strongholds to acquire Triax weapons, power armor and vehicles which are still rare in North America, repair and refurbish them, and sell them back home at a huge mark-up. The NGR does not allow this, and “scavengers” are supposed to return property of the NGR Army for a tiny reward. Instead, mercenaries, scavengers and smugglers across Europe and North America are keeping military items, getting them market worthy, and selling them on the Black Market, and especially to foreign markets in Russian and North America. Top dollar can be had in the Americas, but getting the goods across the Atlantic Ocean can be tricky at best, and deadly at worst. Still, more and more NGR military contraband is making it to the shores of North America, including the latest weapons, power armor, robots, and even combat vehicles. The government isn’t happy about it, but stopping it has proven impossible, especially since the scavenged items are usually taken out of the country and refurbished and shipped from outside the NGR.

When mercenaries and adventurers come to the cities of the NGR, as long as they are human, reasonably respectful, and don’t go around brandishing weapons, magic powers, or contraband NGR military gear, they are left alone. Some taverns and retailers overcharge such undesirables by 10-35%, but will usually refund money if confronted with the swindle. However, if most visitors notice, they ignore it and do not confront the local business people. If visitors take the time to learn the language (either Euro or pre-Rifts German; NGR citizens can speak both equally well), and perhaps even a few local customs, the locals are much quicker to embrace and welcome them.

## NGR Citizens & the Coalition States

The typical German is slightly paranoid about the Coalition States, its soldiers, citizens and technology. The Coalition’s image of black armor, death’s head transports, motifs and insignias designed to strike fear in the hearts of their enemies, also un-

nerves friends and allies. As a result, the German people find the CS and their military more than a little intimidating. Although there has never been any open hostility towards Coalition soldiers, they tend to make people nervous and uncomfortable. The NGR government says the CS is a trusted ally, and the people know they helped make the epic Operation Sea Storm campaign against the Gargoyles a resounding success. In fact, many are the tales of CS courage and commitment to that campaign. Consequently, government officials and citizens show very public support and respect to the Coalition States and their soldiers. Privately, however, there are some pretty heavy, informal debates going on about the wisdom of becoming allied to a such a violent and rather sinister looking nation as the Coalition States. In pubs and across dinner tables, some people wonder if the CS can be trusted, and whether they might have some ulterior motive in dealing with the NGR. The most paranoid citizens fear the Coalition may someday try to invade and conquer the NGR, while others are absolutely sure the CS wants to steal their technology. And some versed in history cannot help noticing some frightening parallels between the CS and a dark time in Germany's own past that they never want to repeat.

From the German point of view, Coalition soldiers are lacking in social graces and communication skills. The majority seem to have little to talk about except their experiences battling demons and sorcerers, and their strong love for Emperor Prosek and the Coalition States. Furthermore, they are outspoken, gruff, don't read, have little understanding about the rest of the world, and aren't, as a rule, interested in philosophy or politics (discussion of such things is highly suspicious among soldiers in the CS). Frankly, they are hard to get along with, and most Germans would prefer not to have them around. This is in contrast to the official government position, that the CS is their greatest ally and a most welcomed partner.

## Thoughts on the War

The war against the Gargoyle Empire has been going on for a very long time. Although every citizen of the NGR knows and realizes the very real danger they are in, they have grown accustomed to living *under siege*. The NGR infrastructure and defense network are incredibly strong, keeping the majority of the monsters beyond the borders of the nation. The occasional creature that does slip through, sometimes through random Rifts or from troublemaking spell casters, is dealt with swiftly and harshly. Most citizens live very comfortably, and have little to fear from the monsters beyond their borders. When they return to civilian life, those who have served in the military, which is the majority of all males and a good percentage of females, try to forget what they experienced in combat and immerse themselves in the illusion of normalcy.

The NGR government reminds the citizenry of its situation and sees that no one grows too complacent. Graphic photos and news reports of battles with Gargoyles and Brodkil make their way into the media on a regular basis, and are plastered all over the internet, newspapers, and magazines. Soldiers, especially those who have experienced injury or taken part in a climactic battle, are interviewed on late-night talk shows to give their accounts of the war and to remind everyone of the price being paid for the survival of the nation.

Every couple of years, the *War Tax* goes up, riling up the people and making them grumble and curse the dreaded monsters. It seems, to the average person, that whenever the War Tax goes up, the NGR stock market goes down (except for Triax, of course), making prices for everything from gasoline to sausages to climb.

Triax Industries has capitalized on the war in every way it can. Aside from providing the NGR military with every possible technological marvel at their disposal, and constantly striving to develop new ones, they market consumer goods to the general public and use part of their profits to help fund the war. Triax also sells T-shirts, hats, bumper stickers, magnets, etc., depicting slogans supporting the NGR military in the war. Triax has its own television news network with charismatic personalities discussing the monsters and the best way to defeat them, in between hawking their wares on air.

All this adds up to the average citizen existing between a state of fear and optimism as they rally together. There is also a mild detachment from the reality of the war, as the government has managed to keep the actual fighting and terror of it all at arm's length from its citizens. It is easy to forget about the war or think about in an abstract way when one lives in an ultra-modern, high-tech society. The people are knowledgeable about the Gargoyles and the war, and support it when they are expected to, but most of the time the average person goes about their day as normal. They wake up in the morning, try to get to work on time, meet friends at the pub later, try to get married, have children, enjoy life, and grow old. Underlying all of this is the dream that one day, the war will end and peace and prosperity will reign.

## The NGR & Magic

It's strange, but the New German Republic has had very little experience with magic and its practitioners. Consequently, they do not have strong feelings about its use one way or the other. Since Germany retained its scientific and technological infrastructure, and they, as a people and a culture, were so tech-oriented, they never stopped to consider magic as a viable option. Instead, they immersed themselves in science and wrapped themselves in technology. Without the need for, or influence of magic, the NGR has remained a bastion of technology. Meanwhile, for more than a century, the NGR has had its hands full fighting for their lives against supernatural monsters. Again, leaving no time for pursuing magic, and pushing them to continually focus on science and technology, robotics and bionics to fight the enemy and keep them safe.

German scientists are aware of magic and regard it as a little understood, alien science that relies more on the metaphysical than the laws of nature. Again, with the unending battle for survival over the generations, scientists have had little time to think about magic. While Gargoyles wield some magic and use magic weapons, the NGR's exposure to magic is, for the most part, very limited and mostly a non-issue. Gypsies and other people, human and inhuman, are known to use magic, but they, too, are mostly found in faraway lands and have never represented a serious threat to the NGR.

The decades of war with the Gargoyle Empire have kept the people of the NGR isolated from the outside world and new ideas, the use of magic among them. The practice of magic is al-



most entirely unknown to the citizens of the NGR's great cities. Quite literally, 99.5 percent of its citizens know magic exists, but have no desire to learn or use it. This is due to the fact that technology satisfies all of their needs, and it is all they know, understand and embrace.

Magic is unknown and scary. The enemy – Gargoyles, Brodkil, other demons, monsters and nonhumans – are known to use magic, so the mystic arts seem unsavory, dangerous and undesirable. All good reasons to avoid its practice. Thus, the industrialized urban dwellers of the NGR, which is the vast majority of the population (80%), have no interest in magic and want nothing to do with it.

By contrast, rural and wilderness people in the NGR have at least witnessed magic and are, generally, less resistant or opposed to its use. In fact, half see magic as a potentially useful tool. However, even among these NGR citizens, less than one percent actually practice any form of magic. They too rely on technology. It is among the D-Bee population where magic is more openly accepted and you are much more likely to find its practitioners. However, because German society is so technologically oriented, D-Bees, refugees and wilderness people who hope to one day be allowed to join German society, also reject magic in favor of technology. This choice has nothing to do with thinking of magic as dangerous or bad, and everything to do with being accepted by the society they want to join. For human supremacists, the fact that “nonhumans” are more inclined to use magic is evidence of magic's unsavory nature and another reason to reject it and be wary of D-Bees.

While the government of the New German Republic does not endorse or encourage the practice of magic, they have not outlawed its practice, nor do they hunt down or persecute those who use it. Unlike the Coalition States of North America, magic has not been a threat for the NGR, so its leaders are rather ambivalent toward it. Like their scientists, magic is seen as an enigma, and the government has many more pressing issues to deal with than worrying about the moral ambiguities of magic. Moreover, since its citizenry don't use or want magic, it is a non-issue. The government acknowledges there are practitioners of magic living and operating in the German wilderness regions and in countries around the NGR, but they have yet to be a threat to the Republic. Furthermore, the government acknowledges that many human and D-Bee practitioners of magic, and even magical beings such as dragons, wage their own fight against the Gargoyle and Brodkil Empires and have done things to defend, help and protect the NGR and its soldiers. Thus, when NGR soldiers or citizens are approached by a mage, they are *not* regarded with terror or hatred, but accepted as a foreign visitor passing through, or as a peculiar resident of the German countryside; a potential ally rather than an enemy.

It is only because of the constant lobbying, warnings and haranguing from their Coalition States allies, that the NGR government is even considering instituting formal laws and policies against the practice of magic. The thought being, if it helps strengthen and improve relations with the CS, why not outlaw something that nobody in Germany cares about? On the other hand, the government is resistant to having a foreign power dictate terms to them, even if they have the best of intentions. Furthermore, the forbidden fruit is always more desirable, and the government doesn't want to attract people to magic simply be-

cause it has been made illegal. It's a tricky situation for the NGR, who wants Coalition support and their troops to help them crush the Gargoyle Empire.

## Psychics & Mutants

Psychics, Mystics and mutants are all born with their abilities. In the cities, such individuals are usually raised by their families to repress their inborn powers and “act normal.” Regular folk view these characters with more pity than fear, as they are regarded as unfortunate and less than human. As long as the psychic or mutant treats his powers as an unwelcome burden, a cross to bear, then others are likely to treat him better. There are some, as there always are, who hate, fear, and distrust those who are different, but psychics, mutants and Mystics have been part of NGR society, and are born of humans, so such bigots are in the minority. Of course, these “gifted people” have it rough growing up, and are targets of ridicule and humiliation.

The government requires such gifted citizens be registered with the government, and hospitals, doctors, teachers and police are all required, by law, to report such individuals when they are uncovered. Because the stigma is truly minimal, most parents report their child being “gifted” with little concern about repercussions. In fact, the government has special programs to help the “gifted” understand, accept and control their power for their own peace of mind as much as the safety of those around them.

Psychics, Mystics and mutants are often recruited at an early age by the military, government agencies and Triax to use their powers for the greater benefit of their country. Many of the “gifted” can work their way into high positions within the military and Triax Industries. Those who have trouble accepting who they are may feel like freaks and misanthropes, have trouble adjusting to society and take a dark path. Street gangs in the poorer areas and D-Bee ghettos, as well as mercenaries, adventurers, criminal organizations, the Black Market and terrorists, like to recruit the gifted for their own nefarious purposes. On the street and in the criminal underworld, the gifted can rise quickly through their ranks and even attain positions of command and leadership. The Polizei have no sympathy or mercy for the gifted who go bad, and because of their powers, regard them as armed and dangerous, and can use lethal force as a result.

All matters involving magic and the supernatural, including dragons, demons, monsters from the Rifts, foreigners who are mages, etc., are best left to the Polizei, the military, and private security specialists (who are usually themselves among the gifted). It is uncommon for sorcerers and dangerous supernatural creatures to be encountered in the urban areas of the NGR interior, but it does happen. Random monsters and demonic creatures are contained and destroyed by armored troops. An investigation is always conducted to determine where the creature originated, whether it was just some dumb beast that wandered into town, or if it had a sinister agenda or was part of an a larger group or enemy force. If it is believed that the monster or mage was summoned or acting in conjunction with a secret group or enemy, investigators track down the source and bring him/them to justice. Less aggressive, but frightening or mischievous creatures of magic and supernatural beings such as Entities, Spirits, Faerie Folk, etc., are handed over to “specialists” in the military, police force or private security experts skilled in dealing with such matters. Unless the creature is particularly evil or danger-

ous, it is usually enough to chase them off. Gypsies are sometimes hired for this kind of work, especially in the countryside.

## Religion in the NGR

All of Europe is steeped in religious history, and Germany is no exception. Entire religions have been founded, restructured, and squashed over the course of German history. As the nature of the developed world turned more towards technology and science in the 20th and 21st Centuries, religion became less prominent. After the Great Cataclysm many people and communities rediscovered religion.

Officially, the NGR government has no stance on matters of religious faith. People are free to believe and practice whatever they choose, as long as it does not harm anyone or preach anarchy.



## The Matter of Refugees

The escalation of war and the movement of Gargoyles into human-occupied territories, especially with the destruction of Wroclaw in Poland, has brought a steady flow of refugees seeking asylum from the NGR. These are mainly simple peasant folk: farmers, hunters, traders and Gypsies. As the Gargoyles and Brodkil stretch their muscles, more and more human villages and towns are trampled. Those who manage to survive the carnage are displaced. Suddenly without a home, food, basic supplies, and surrounded by monsters, they seek a place where they can be safe, and there is no place in Europe that is perceived to be safer than the New German Republic.

The lucky ones survive the trek to the borders of the NGR, only to find themselves crammed into tiny apartments and filthy camps with thousands of other refugees. The conditions in many of these places are deplorable. Disease and crime are rampant. Medicine, food, clean water, and basic comforts are in short supply. The NGR government can ill afford to care for the growing refugee population. There are just too many people and not enough resources.

These camps hold thousands of people, locked in tightly together, with barely enough room to breathe, and with *nothing to do*. Boredom seems like it would be the least of their worries, but these are people who are used to working very hard to eke out a living. Being in a position that makes them feel useless creates tension and frustration. They hate feeling helpless and want to do something. This leads some to leave and take their chances in the wilderness on either side of the NGR border. It's sad to say, but the NGR is happy when they choose to leave and go somewhere else. This is not joy born of malice, but it helps alleviate a serious problem they don't have the capacity to fix. Better they make a life elsewhere than suffer in limbo.

Others start to complain loudly and brawls and even riots are commonplace. Compound that with rampant crime, roving gangs and sickness, and it is easy to see how volatile things can get in the refugee camps. NGR police officers, equipped with riot gear and piloting *Triax X-60 Flanker Urban Defender* power armor, are frequently called in to deal with the problem. This creates even more tension as the rioters are simply beaten down or arrested, then forced to return to the environment that led to trouble in the first place.

There are a few organizations that help refugees integrate into NGR society, but they too are overworked and overwhelmed by the sheer number of refugees.

In an attempt to help matter, the NGR government formed the Refugee and Dimensional Being Integration Program (R.D.B.I.P.). The R.D.B.I.P. is a government-sanctioned organization designed to teach immigrants how to cope with high technology and the society of the NGR. They are taught how to read and write Euro (and speak it if they cannot), basic mathematics and computer skills. From there, each refugee spends 18 months in a special school designed to find where they can fit best in society, and train them for this purpose. All of this has proven very effective at educating and integrating human refugees into the NGR. Thousands of lives have been saved, and the workforce of the NGR has grown stronger. This bolsters the economy, which in turn leads to a better life for the newcomers. However, only 25-33% of the refugees, starting with humans, get such integration and training.

## NGR Food and Drink

When one thinks of German food, some images immediately come to mind. Sausages, pretzels, sauerkraut, wiener schnitzel, beef dishes, a wide variety of decadent cakes and pastries, among others. All of these things are common, but they are by no means representative of the wide array of food available. The Germans had their own recipes for soups, pastas, potatoes, chicken dishes, and more.



Throughout the 21st Century, and especially during the Golden Age of Man, globalization made the world smaller and brought people closer together. Germany was at the forefront of European prosperity and development. People from all over the world immigrated to Germany to be a part of the massive opportunities available. Naturally, they brought their own cultures with them, and a big part of that is always their food. As a result, pre-Rifts Germany was a melting pot of delicious foods. On the same street in any major city, you could find the cuisine of Germany, Poland, the Netherlands, the Middle East, India, England, America, Mexico, and American fast food franchises.

The modern New German Republic has integrated these foods seamlessly. The same way the people of the NGR speak an amalgamation of languages known simply as “Euro,” their food and drink has been affected the same way. The food is typically rich and hearty, with generous portions, especially when prepared at home. There is a growing movement towards cheaper, faster meals, however, and many more young professionals are working longer and longer hours and have less time to cook for themselves. Instant meals, frozen dinners, and even nutrition “pastes” are replacing traditional meals for some people.

The D-Bees of the NGR don’t eat as well as their human neighbors. Most D-Bees live well below the poverty line, and cannot afford the freshest of ingredients or to eat in the finest restaurants. Some are lucky if they get a can of beans and a loaf of bread for a meal. There are government institutions in place to help provide D-Bees with some basic foods, but these are only basic staples. D-Bees who are recent transplants, either

from another dimension or rural parts of Europe, may eat the strangest combinations of things and may consider rodents and house pets potential food. Many are at quite a loss when they sample traditional “human” dishes. Even though a D-Bee may be a master of the culinary arts back home, the poor soul frequently finds that crucial ingredients to their recipes are nowhere to be found on Rifts Earth. This problem is all too common and the aliens must make due with whatever they can substitute. It’s all a part of the culture shock D-Bees suffer when torn from their native dimension. It takes a lot of adjusting, but these immigrant D-Bees eventually find foods that are pleasing to their obscure palates, or at the very least, something they can live on.

## German Beer (or Bier)

Of all the things throughout history that the German people have created for the world, nothing is considered as iconic as German beer. Every ancient civilization on Earth, from the Babylonians and Phoenicians, to the Atlanteans had their own recipes and techniques for brewing beer. It was the Germans, however, who took the idea and refined it, crafting it to what some people consider to be perfection. For many hundreds of years, German brewers have arguably been the masters of this craft the world over. This has not changed in the post-Rifts world.

Among the technologies, sciences and achievements lost because of the Great Cataclysm, were brewing techniques and formulas for many kinds of alcohol. With civilization in shambles, the focus of those alive became basic survival, not things like art, music, culture or brewing. Thus many of the secrets of brewing around the world have been lost and forgotten. However, in Germany, such secrets survived and the old secrets of science and standards for German brewers also survived.

The main ingredients for beer – barley mash, hops, and yeast – are native to Earth and extremely rare anywhere else in the Megaverse. Thus, beer is a commodity almost exclusive to Earth. Certainly D-Bees and dimensional travelers have taken the process with them to share on other worlds, but their numbers are small and their operations are obscure. And on the opposite spectrum, many similar alcoholic drinks are available from other worlds, but these drinks are considered inferior to authentic German brews by the people of the NGR.

There are several small operations within the German Black Market which pirate beer and other small-scale, locally-produced commodities for resale on other worlds. These organizations have grown so successful, and security measures at major breweries grown so complex and efficient as a result of constant piracy, that some of these criminals have started their own underground breweries. These breweries operate illegally, using stolen formulas and second-rate equipment to “fill out” their shipments of authentic beer. (**Note:** Sales of this illegal beer constitute a small percentage of the Black Market’s activities.)

Beer is a staple of life to the people of the NGR. They drink it with nearly every meal, and have hundreds of varieties to choose from. There are different brews for every season, every region, and every occasion. Lighter beers are consumed during the summer months and darker, stronger beers are more popular

when the weather turns cold. And there are special beers for Christmas and Oktoberfest, both of which are still celebrated in the NGR.

There is no legal drinking age in the NGR, though typically most parents refrain from serving their children alcohol until age fifteen. The potential for abuse is still high, and moderation is very important to the German people. **Note:** Beers typically cost between 2-5 credits each. Some more rare or obscure drinks can cost up to ten times as much. Beers imported by the Black Market typically go for three to five times as much. Alcoholism for D-Bees is three times greater than among humans.

## Some popular beers found in the NGR

Schnellenberg: Brewed in Dusseldorf, this is a popular *weizenbier*, made from wheat. The marketing campaign is directed mainly at young urban professionals and cutting edge, high-energy lifestyles. It has a light, spicy flavor to it, and is sometimes served with a slice of lemon or orange.

Triax Siegfiearn: The only beer brewed by Triax Industries, its name and labeling refers to victory over the monster hordes and the great celebration that will follow. Siegfiearn is a Pilsner, with a pale gold coloration and relatively low alcoholic content.

Dunk: Short for “Dunkel,” or dark, is a traditional German beer targeted at beer aficionados and people who really care about what they drink (or beer snobs). It is brewed far to the north, east of Hamburg. It has a very strong, almost harsh, flavor to it, and a very high alcoholic content (12% alcohol per volume).

Moshgrout: Named after an old Dwarven word for “avalanche” or “rockslide,” this thick, flavorful, mostly headless beer is brewed by Dwarves living in a small community in the Bavarian Alps. Their beer is sold all throughout the NGR, Poland, Russia, and most recently, North America, as well as on alien worlds. In exchange for the land and business license, the Moshgrout Dwarves pay a great deal in taxes, and are forced to tolerate a small garrison of soldiers who watch for Gargoyle activity near their mountain brewery and distribution warehouse.

A. Graf: This NGR brewery is located in the town of Mannheim (halfway between Frankfurt and Stuttgart). A. Graf sells a whole line of bottled beers, available in every supermarket and bar in the NGR and Poland, and even a few places in North America. They brew a very delicious Pilsner, an English-Style Brown Ale, a Pale Ale (which most serious beer snobs find to be lacking), a pretty decent Porter, and a DoppleBock that is simply amazing. The beer is named after Andreas Graf, who started the brewery to help the town of Mannheim regain an economic base after the Great Cataclysm.

## Beers from around the world

In North America, there are dozens of tiny breweries dotted across the map. Beer is not as popular there as it is in Europe. Bourbon, whiskey, pure grain alcohol, and other distilled spirits are far more common and popular, but beer drinks are a good part of the market. Likewise, in Russia, vodka is still the most popular alcoholic drink, and sake (rice wine) remains the traditional favorite drink enjoyed throughout Japan, though they have their beer drinkers as well. In China, drinks of all kinds are found, including whiskey, wine, and beer. Even the Demons of

China have their own recipes for alcoholic drinks, though many are distilled from all manner of horrid and disgusting things.

Northern Gun Draught: “Draught” is a fancy word that means little more than “served from a tap or keg.” Brewers at Northern Gun assure everyone that their “draught” tastes better than other bottled beer since it uses small carbon dioxide tablets to emulate being served from a tap. The effect is all psychological and there really is little difference. NG Draught is cheap, popular, and found nearly everywhere in North America.

Coalition Beer: This beer, produced and designed entirely by the Coalition government, is available mainly in CS cities. Its flavor is unimpressive, and the beer is prone to cause intense hangovers if consumed in large quantities. It is bottled with Karl Prosek’s stern face on every label. It was originally brewed and bottled in CS Missouri. All that being said, when you live your whole life inside the confines of a fortress mega-city, and there’s nothing else available, you don’t know what you’re missing.

Bastards Brew: Possibly one of the best beers, or at least one of the most respected by the Germans, coming out of North America is Bastards Brew. It is made at a small brewery somewhere within the American eastern wilds recently claimed as the *Shemarrian Nation*. It is a malty amber ale full of flavor that has hints of a variety of different grains which gives it a very strong character.

The Atlantean Original: The ancient Atlanteans held the secrets to many wonderful things, and one is a tasty beer beverage. This knowledge was taken with the Atlanteans when their continent disappeared, but they spread to the corners of the Earth to share their secrets with the indigenous people they encountered. Over the centuries, this original formula has sprouted off into literally hundreds of thousands of different recipes.

The original formulas for Atlantean beer are still handed down to this day. It is quite rare, and any Atlantean brewers guard the secret with force, if need be. Those who have sampled the original formula for Atlantean beer claim it is one of the finest in the Megaverse.

Tolkeen Dragon Breath Beer: Dragon Breath was brewed in Tolkeen, and it had a limited area of sale and little marketing campaign beyond word of mouth. With the obliteration of Tolkeen, Dragon Breath has become very high in demand among beer aficionados and other fans. The brewery was wiped out, and the brewers either killed or imprisoned by the Coalition Army during the Siege, making this super-rare beer a symbol of defiance against the Coalition. Every bottle that remains is regarded as a collector’s item. If a character can actually find a single bottle, he can expect to sell it for upwards of 1,000 credits. This price will only increase as the beer becomes rarer over time.

# NGR & D-Bees

## Mandatory Deportation

Simply put, the NGR government (and most regular citizens) don’t want D-Bees living alongside humans. They don’t want D-Bees in the NGR, Europe, or on Earth at all. Unfortunately, the population of D-Bees doesn’t seem to be going anywhere

anytime soon, and is actually increasing in some areas. Unlike their CS allies, the NGR cannot abide by a policy of genocide against nonhumans. Instead, the NGR simply deports D-Bees into shanty towns along its borders. It has been this way since the year 45 P.A. Prior to that time, there was much social prejudice against D-Bees, but the government hesitated to address the issue. *The Mandatory Deportation Law* changed that.

D-Bees can not become full citizens. At best, they are *second-class citizens* who have only a fraction of the rights and privileges of regular “human” citizens. Those who wish to live in the NGR urban areas have to accept this injustice, at least for the time being. A great many D-Bees live in the NGR illegally, but find it better than living in a hostile wilderness or monster zone.

The Polizei are very good at recognizing nonhumans, even shape-changers and those who are very similar to humans (the police know the skill *Lore: D-Bee* as an O.C.C. Related Skill). D-Bees found living in the NGR illegally are jailed, stripped of all possessions and assets, and eventually deported. Those who resist are beaten in the street like dogs and permanently banished, and not even allowed to live in border towns or ghettos. A banished D-Bee must remain 50 miles (80 km) from any NGR national border or military base. The most dangerous nonhumans, including career criminals, those responsible for murder, and terrorists, are quietly put on trial, judged, sentenced and executed.

Though few D-Bees earn the right to become an NGR citizen, it is possible for D-Bees to secure a place to live in an NGR city provided they have regular employment through a **D-Bee Work Release Program**. Most D-Bees who live and work in the NGR are participants in this program.

## D-Bees in the NGR Military

Voluntary Military Service for 10 years circumvents deportation. In an effort to raise the number of combat troops for the war effort, the NGR government has authorized military service for D-Bees. Those who serve in the military and get an honorable discharge are automatically approved for the D-Bee Work Release Program and become candidates for citizenship. This tactic has worked amazingly well. Many D-Bees honestly want the chance to both serve the NGR and make “their” adopted homeland safe from Gargoyle incursion. They also hope they can prove their worth by serving as dedicated and capable soldiers.

Most D-Bees in the NGR Military usually serve in *all D-Bee Regiments*, or in special units alongside human mutants, cyborgs, and other “unique” individuals. These special units are always led by a human officer, and may include one or more Commandos/Special Forces human soldiers to keep the rest of the inhuman rabble in line.

As a general rule, D-Bees who are human or almost human in appearance, ability and temperament, get the best work and treatment. The most inhuman and monstrous are mistreated and get the most unpleasant and dangerous assignments. D-Bees who have a natural affinity for one subject are almost always placed where their natural talents can be best utilized. For example, those who are mechanically inclined are assigned to repair and maintain weapons, armor, vehicles, etc.

**Military O.C.C.s available to D-Bees:** Infantry Soldier, Communications Officer, Field Mechanic, and Police Enforcement (Polizei). **Note:** D-Bees who are extremely ugly and inhuman, and/or who lack any useful abilities, are relegated to front-line infantry troops and grunt work. Others are used as garrison troops in remote locations that are either very dangerous or very boring.

D-Bees who more closely resemble humans or are attractive and have proven themselves to be intelligent, capable and loyal, are sometimes allowed the following O.C.C.s: *Intelligence Officer* (rare), *Power Armor Commando* (rare), *Robot Combat Pilot* (rare), and *Intelligence Commando* (rarest).

During the D-Bee’s service, he and his family may reside in specially designated housing inside or nearby NGR cities or military bases. These places are shabby ghettos or segregated housing.

**At the end of ten years of service**, the D-Bee can or sign on for another ten years of military service, or get his D-Bee Work Release Program papers and find work and housing in the NGR for as long as he wishes, provided he keeps residence in the D-Bee assigned areas and keeps his nose clean.

Military service for a D-Bee can work out nicely for many, as the NGR government really does get them work papers, help the vets find a job, and because most humans look upon D-Bee ex-soldiers as loyal to the country, ex-military personnel usually get a better level of work, especially those with skills other than manual labor and soldiering. Seeing D-Bees in action has also given some human soldiers a more humane outlook upon nonhumans. However, since D-Bees are usually assigned to all D-Bee units, they and humans remain segregated and apart.

## D-Bee Industrial Service Program

Military service isn’t for everybody, D-Bee or human. So there is another option for D-Bees who wish to live and work in the NGR. Triax Industrial Service of 15 years prevents deportation and allows on the job training. Triax established this program to reach out to a potential market for workers and consumers. Triax knows that if D-Bees don’t have any money, and aren’t near civilization, then they won’t be able to buy anything. The Executive Board is split down the middle on how to approach the “D-Bee Question.” Half don’t want or need the money that D-Bees have, and the others see a gold mine of potential. *The D-Bee Industrial Service Program* is an experiment of sorts (only started in the last twenty years) to see how profitable it can be. So far, it has proved reasonably successful. D-Bees vying for citizenship welcome work in a factory, but since they are paid 30% less than human workers, usually hold the lowest-paid jobs, and support large families (or more than one family), they are not buying commercial goods on the level Triax had hoped for. Most are put to work in factories, warehouses, shipping and receiving, janitorial services or product testing. Human-looking D-Bees can sometimes get work in Triax retail stores and showrooms, and those with the skills and a little luck may get work in engineering or research and development. Most of the time, the public does not seem to care or notice.

D-Bees have a harder time advancing in Triax Industries than in the military. Theoretically, a D-Bee can hold any position a

human can, except for the Executive Board. However, it is difficult to find a D-Bee in a more highly-paid and prestigious position at Triax. Most lack the education and knowledge of the business world, having grown up in the wilderness, ghettos and border towns. Still, it can happen. Since nonhumans in the workforce are so uncommon in the NGR, many humans are not used to working with them and do not like having to do so. Especially if a nonhuman is in management or a position of leadership.

## D-Bee Border Militias

There are a surprising number of cases in which an entire D-Bee community, living along the hostile borders of the NGR, wishes to join the military or get military support and sanction to carry arms and help fight the Gargoyles. At least 75% of border towns are predominantly inhabited by D-Bees. These rural communities are largely agriculture oriented. These villages and towns are run by their inhabitants, and most operate under NGR democratic style local governments. A good majority of these D-Bees have been on Earth and in Germany for generations and they consider it their home and country too, and are willing to fight and die for it.

When a border town wants to militarize to fight Gargoyles, the residents approach the NGR military with a statement that the entire community wants to lend their hand in the war. Believe it or not, this kind of thing happens so often that the military had to form a committee and come up with a standard protocol for it. At first, the NGR laughed it off, and only let the strongest among the border town D-Bees join the military. They soon realized, however, that they were missing a golden opportunity to take some of the burden off the regular Army troops. And if a whole D-Bee village got wiped out by angry Gargoyles in the process, many felt it would not be a horrible tragedy.

Here's the deal: In exchange for their loyalty and service as a sanctioned NGR border militia, they receive special benefits not available to other border towns. This includes basic infantry weapons and gear, special defense considerations (microwave fences, sensor tower, radar, etc.), and special combat assistance should they fall under attack (i.e. the NGR military will send armored forces to help engage the enemy within 1D4+4 minutes). These militia towns also get better and easier access to medicine, training and education (still minimal, but better), and select members of the town who have distinguished themselves in the line of duty can become citizens. As a citizen, the individual can travel anywhere in the NGR and, if so desired, move to the city.

**The responsibility of the Border Militia Town** is to act as a small military outpost. They must regularly patrol a designated and authorized perimeter delegated to them by the NGR Military, run reconnaissance patrols deep into the Monster Zones, and assist Army troops in the area. They are to report any strange occurrences, enemy troop movement and activities, and provide warnings in case of an impending attack. They must also stop and question foreigners, Gypsies, refugees, travelers, adventurers, mercenaries, and any other outsiders who enter their area of jurisdiction. A report is made on everyone questioned, and suspicious behavior is to be reported immediately. The army may also ask the militia force to detain suspicious characters or to follow from a distance and observe where they go and what they do. Regular citizens and NGR soldiers are not

to be bothered, questioned or detained, and if they ask for assistance, it is to be provided.

Border militias may engage enemy interlopers within the NGR border that is the town jurisdiction, but they are encouraged to notify the military first, and request military backup. Likewise, the Border Militia Town may actively engage, without authorization, any enemy forces they encounter within the Monster Zones – which are basically no-man zones where Gargoyles and other monstrous enemies frequently gather and make incursions into the NGR. However, if they get themselves into trouble, they are on their own. There will be no assistance from the NGR Army, unless there is a strategic advantage for the army to do so.

In the event of an attack on the NGR, the border towns serve as a *first line of defense*. The D-Bee militia is to hold the enemy as best they can while NGR Army reinforcements are sent out to join the battle. This can result in many D-Bee militia troops falling to the enemy, but their sacrifice never goes in vain. They bravely defend the border, softening up or delaying the enemy, and the army returns the favor by charging in like the proverbial cavalry to obliterate the enemy and avenge the fallen. In some circles, these D-Bees are the unsung heroes of the Gargoyle War, and the majority of NGR soldiers who have fought along side of them respect their courage and loyalty to their country.

The above notwithstanding, even though these loyal D-Bees are given special considerations, they are still D-Bees: unwelcome foreigners intruding on human soil. They have no special rights in NGR cities, their heroics go largely unrecognized and uncelebrated by the government, media and the citizenry, and they can still expect to be treated poorly by the general public.

Border towns who do not participate in this program are considered “on their own.” They get little help from the military, unless they are overrun by the enemy.

**Limited NGR Military Aid to Border Militia Towns.** The first step is to get the D-Bees the things they need to fight the Gargoyles. This includes, but is not limited to, basic combat training, weapons, armor, light combat vehicles, communications equipment (including both military and civilian gear), the construction of permanent defensive structures, medicine and other basic supplies. Weapons are limited to basic and older infantry models and the Triax Wilderness Rifles. Vehicles are basic trucks, jeeps and hovercycles, though the D-Bees may use whatever they have or can acquire themselves, including riding animals. The border town usually has a small fleet (3D4) of lightly-armored hover vehicles (120 M.D.C. or less, may or may not have a mounted weapon) or one or two Terror Mini-Tanks. Power armor is even rarer. Most towns are completely without power armor. Only 30% have 1D6 suits; typically a mix of Terrain Hopper, old-style Predator, and Super Trooper. Border Militia Towns also get monthly shipments of E-Clips, mini-missiles, grenades, and other supplies. D-Bees are expected to repair and maintain their own equipment, and they receive proper training in order to do so. These militias are also supplemented with additional food, medicine, blankets, clothing and other basic supplies on an as needed basis.

**Basic combat training** means these D-Bees can take NGR military O.C.C.s, though, as the result of an inferior and rushed training process, they only get half the *O.C.C. Related Skills* and half the usual amount from skill bonuses. D-Bee militia mem-

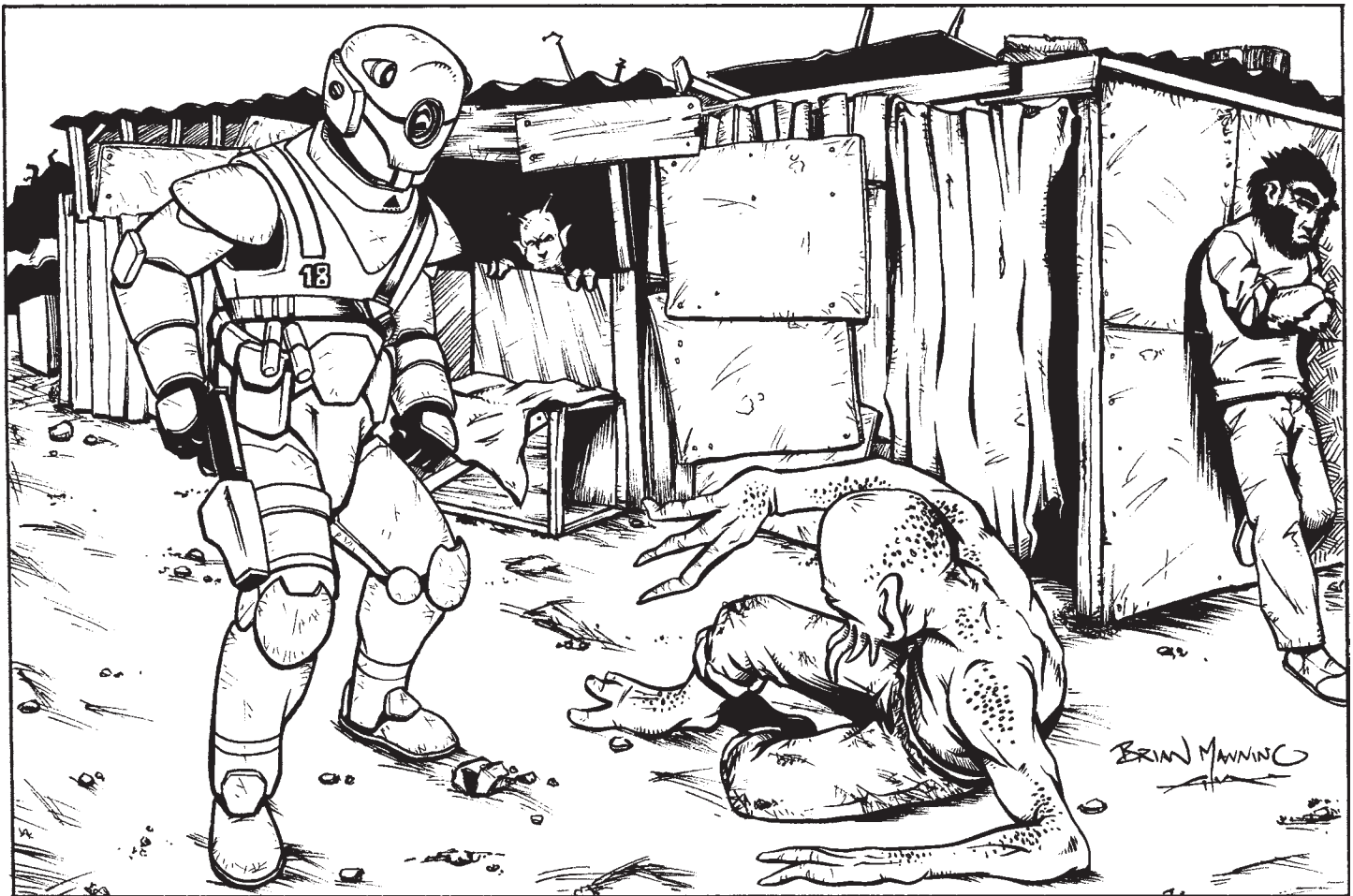

bers are limited to the following O.C.C.s: *Infantry Soldier*, *Communications Officer*, and *Field Mechanic*.

## Civil Rights & D-Bees

As stated previously, D-Bees in the NGR enjoy very few basic civil rights. Critics of the NGR's system of handling D-Bees claim that it falls under the definition of *Apartheid* – an unethical repression of a specified minority. The minority in this case is, of course, “dimensional beings,” aka D-Bees, but also includes (to some degree) human mutants and other beings. The NGR's treatment of D-Bees is fully sanctioned and supported by the law and government of the NGR. A major part of this treatment is *Mandatory Deportation*, explained above. Most laws governing D-Bees fall under the headline of Mandatory Deportation (called *Mindeststrafe aus Deportation* in the letter of the law).

**Property Rights:** D-Bees cannot own a home, a building or land. In most cases, their place of residence is either rented from an individual or commercial business, or leased from the federal government. They have little rights under this lease. The government can come in and do pretty much whatever they want with the property. They can renovate it, sell it off, even demolish it. Under the Mandatory Deportation laws, the government doesn't even need to give notice of any action. The *Polizei* simply show up one day and evict the D-Bee tenants living in federal housing projects. Those who resist are arrested, beaten, or worse. In practice, this is rarely done, and when it is enacted, it is seldom cruelly executed. D-Bees in federal leased properties

are almost always given a written notice that they are to be moved out by a certain date.

Most D-Bee ghettos found throughout the NGR are owned and operated by the Federal Office of D-Bee Affairs. The majority of D-Bees inside the NGR live in one of these segregated, D-Bee only communities. While some are decent and well maintained, most are older, poorly kept and often shabby homes and apartments comparable to the 'Burbs surrounding Coalition cities, though much smaller.

A small number of D-Bees have good incomes and are able to secure the proper papers to live in better quarters. However, even these lucky few may have trouble finding housing at a fair and reasonable price (D-Bees are typically charged double the amount to live in a nice “human” neighborhood or apartment building), and may find themselves living in a tiny apartment for an exorbitant price, or in a bad neighborhood at a reasonable price. These areas are privately owned, thus the D-Bee residents must frequently deal with unscrupulous landlords and prejudice from their neighbors. Not to mention the *Polizei*, who may stop and harass any nonhuman they see walking around outside the ghettos. Anyone they stop had better have his proper papers on him, and had better not give them any attitude.

D-Bees who rent from a commercial business (i.e. a house, condo, apartment building) have all the usual rights of a renter and laws of eviction, however, they are often expected to adhere to the letter of the law, and one missed or late payment can result in an expedited eviction of 10 days instead of 30, after proper papers have been served. Only the most ardent human

supremacists show up to evict without proper notice. Slum lords, however, take advantage of the nonhumans low status and often rent them substandard housing.

**D-Bees are allowed to own and operate their own businesses**, though these businesses require a massive amount of paperwork and wrangling with bureaucratic red tape to be approved. Even then, only the smallest business models have any hope of being approved. D-Bees tend to own vegetable and food stands, flower shops, custodial services, waste disposal, lawn and gardening services, repair shops, and similar businesses. These places are heavily taxed and frequented by the Polizei to make sure that everything is clean and legal. Any hint of Black Market or criminal activity gets the place shut down and the owners (and sometimes, all of the employees) arrested.

Some D-Bees have learned how to fool the Polizei. They use their business as a front for illicit activities, such as drug production and trafficking, weapon sales, smuggling refugees (typically nonhumans), forging identity papers and travel documents for D-Bees, fencing stolen goods, gambling, prostitution and other activities. Sometimes all the Polizei need is a nice fat bribe to look the other way (typically 2D6x1,000 credits a month). Other times it only requires a little cleverness. Many D-Bee businesses are designed to appeal only to other D-Bees, such as places that offer exotic foods, and services that humans may not need, like horn-sharpening or tentacle-cleaning. The Polizei only do routine stops at places like that, as they find such establishments too weird to hang around for very long. They stop in, ask a few questions, take a cursory glance around the place, and head out as soon as possible. The same is true of any simple, obvious business or service that has only or mostly D-Bees for employees and clients, such as a mechanic's garage.

Although nonhumans can own and operate a business, they cannot own the building or land where the business is located. Thus, D-Bee business owners are likely to pay an outrageous rent for a basic or substandard facility. D-Bee activists are quick to point out this keeps nonhumans oppressed and unable to compete on a level playing field.

**Voting Rights:** As it used to stand, nonhumans, mutants, and psychics were not allowed to vote. Since taking office in 107 P.A., Viktoria Sperling, with General Rasheen, has worked hard to change those laws. President Sperling's critics claim that this is a move that is only intended to garner her more votes in future elections, an accusation that is false and she resents.

Since the law was changed, human mutants and psychics are given full voting rights equal to any "normal" citizen (the popular theory when that law was written was that mutants and psychics were "abnormal" and thusly, not competent enough or trusted in an election). D-Bees are not afforded this right entirely. The thought goes that if nonhumans are willing to take the initiative and work for the NGR, then the NGR pays them back by allowing them to help shape the nation's future. What this means is that only D-Bees who are actual citizens (a tiny minority), and those registered with the government as enlisted in the NGR military or employed by Triax Industries, have the right to vote. Even then, a D-Bee's vote is only counted as *half* that of a human citizen. Furthermore, D-Bees are only allowed to vote in local and council elections, not presidential elections.

The D-Bees themselves are split on this issue. The majority see it as a boon and much-welcomed recognition they deserve for their loyalty and contributions. Some see it as the first step to getting *full rights* as NGR citizens, and dream of the day when a D-Bee presides as leader of the NGR. Others see it as an insult and a joke that only perpetuates the injustice of an unfair and prejudiced system. Any human candidate who supports D-Bee equality is sure to lose any election, anyway. Sadly, the NGR is a human supremacist nation. Any politician, from a lowly city alderman, all the way up to the presidency itself, is more than likely going to lose if they appear soft on D-Bees or support D-Bee civil rights. NGR citizens who are old enough to remember when the Mandatory Deportation laws went on the books will tell you endlessly about how much better the nation was without "those filthy aliens." It is likely to take many years, and much work, before this mentality can be changed.

**Employment:** It is possible for D-Bees to gain employment inside the NGR. Those seeking to do so must work their way through the forms and papers to secure a Work Release Paper. This inserts the D-Bee into a database of Foreign Nationals (also includes humans from other countries and Gypsies) who are either working or seeking work in the NGR. For D-Bees, there is an enormous waiting list, and the jobs are few (unless one wishes to work for Triax Industries under a long-term contract). *The Refugee and Dimensional Being Integration Program*, instigated by the Federal Office of D-Bee Affairs, is responsible for handling the cases of nonhumans seeking work in the NGR.

The **Work Release Program** has many requirements to it:

1. The applicant must be able to have at least a rudimentary understanding of either the Euro or German language (at least 50% skill percentage).
2. Most jobs require literacy (at least 50% skill percentage).
3. The job applicant must not have a prior criminal conviction.
4. Must either have been born on Earth or have lived on Earth for no less than five years.
5. Must be able to display some sort of marketable skill set or trade (physical and combat skills do NOT count; on the contrary, combat training is highly suspicious).
6. D-Bees must not be of a predisposition to cause harm to humans, whether voluntarily or involuntarily (the D-Bee can't be composed of hot lava or need to consume the blood of intelligent beings; that sort of thing).

The Work Release Papers are only valid for up to 12 months at a time. At the end of this 12 month period, the D-Bee must secure new papers. He must show that he is currently employed, and make monthly appearances at the Office of D-Bee Affairs for a quick review. A case worker lets the D-Bee know when he needs to apply for new papers. As long as the D-Bee can show proof of employment, getting the work papers renewed is not usually a problem.

Most D-Bees who are fortunate enough to work in the NGR are relegated to blue collar positions and manual labor. The majority of them end up in one of the NGR's numerous factories, or in custodial work, mopping floors and emptying trash. A large number also enter into construction, especially for companies who cannot afford robots. They work long hours for only



half or a third of the pay of their human counterparts, frequently in abhorrent conditions.

D-Bees working in the NGR tend to look out for each other. Even if they are of entirely different species, a D-Bee who owns his own business is more likely to hire nonhumans than humans. This is not out of spite or revenge, but out of empathy for their fellow D-Bees. They seek to help one another and stick together.

D-Bees are not entirely restricted from mercenary work inside the borders of the NGR, but the regulations are strict, and they MUST work in a human-operated company. Just like any other employer, the owner of the mercenary company must take full responsibility for his inhuman employee. If the D-Bee screws up, they both take the fall. Under no circumstances are D-Bees allowed to own or operate a mercenary company. Those who do are considered to be running terrorist organizations and are accused of cooperating with enemy forces (Gargoyles, Blood Druids, etc). Of course, mercenary outfits that work outside the NGR are under no such restrictions, they just cannot enter the borders of the NGR without getting arrested. This requires having a human broker who is willing to collect bounties from the NGR and trade/fence scavenged weapons, equipment, magic items and valuables the D-Bee mercs have acquired. The broker's cut is usually 25-40% and the D-Bees never know if an unscrupulous broker may really be taking a bigger cut or not.

There are no laws prohibiting the presence of D-Bees in political positions, but it is incredibly rare. D-Bees working for the government tend to be garbage collectors and sewer workers, not politicians. Typically, the D-Bee must be highly educated and be in with some very powerful people already in the government. In the alternative, as it was with *General Rasheen*, if a D-Bee is seen as a national hero (which is virtually unheard of, General Rasheen is the only publicly accepted, even loved, D-Bee in living memory), he can be elected into office by the voting public.

Not surprising, General Rasheen is a much-adored hero among the NGR's D-Bee populace. Simply put, they love him because he is one of them. He is a living symbol of everything they are trying to achieve. He is strong, charismatic, and utterly fearless. General Rasheen is bold in his words and actions. He is the foremost government figure working for the betterment of D-Bees and other Foreign Nationals. He is equally adept at facing down a flock of Gargoyles as he is the ruthless assault on his proposals on the Senate floor.

## The D-Bee Equal Rights Movement

D-Bees in the NGR have it pretty hard. They are forced to live in ghettos and don't have equal rights. Most are not even recognized as citizens of the NGR, but regarded as squatters and undesirables. Many stores, restaurants, malls, theaters, and bars, among other places, refuse to serve D-Bees. Nonhumans are frequently taunted in the streets and viewed as highly suspicious when outside the ghettos. Those who are foolish enough to taunt back, or try to fight, are quickly arrested (sometimes beaten first), interrogated, and placed on parole. One more infraction, and the individual runs the risk of banishment or imprisonment.

D-Bees are given the worst jobs, and are paid a fraction of that of their human colleagues. They are not allowed to form or join a union, and are allotted almost no rights against their employer by the law. They can be mistreated, overworked, underpaid, and finally kicked into the street with no legal recourse at all. Most nonhumans have come to accept this, and go about their jobs as quietly as possible.

Since human refugees started pouring into the NGR from the outside territories, the large D-Bee population has started to suffer from lack of attention and resources. The NGR's main goal is the protection of mankind, its own people. The flow of displaced humans into their borders means money, food, water, medicine, education, and other resources are being diverted to those humans first. What is left is trickled down to D-Bees, which isn't much. D-Bees often find themselves unable to buy fresh food or find even menial jobs. In another ten or twenty years, the NGR may be able to catch up to this level of unprecedented population growth, but for now the crowds are too dense, and the lines are too long. The result is, D-Bees are forced to suffer.

Many D-Bees, already unsatisfied with the NGR's treatment of non-humans, are being pushed to their stress limits. They are being evicted from their homes, losing their jobs, forced into the street and pushed to the side. The government simply does not care, and what small outreach programs exist are unable to contend with the sheer volume of D-Bees in need. This has made many D-Bees, even those who were complacent or understanding of the government's position on nonhumans, very angry. They are being pushed against a wall and many feel it is time to start pushing back. What's more, the feeling is spreading.

Throughout the ghettos and tenements, all the way to wilderness border towns, a movement is slowly gaining steam. Many nonhumans feel that things need to change. They are tired of offering their support to the NGR and getting nothing in return. They work, they farm, they toil, they sweat, some fight and die, all to further the greatness of the Republic. And still they are spat upon. It's been that way for decades, but many are calling for it to stop now. They are calling for a revolution.

Not a revolution in the sense of bringing down the NGR government, or even creating a separate, but equal D-Bee nation. The D-Bees of Germany want citizenship and equal rights. They want to be valued members of the NGR. They want the same inalienable rights of any "human" citizen. They want jobs and they want equal pay. They want the opportunity for education. They want their children to never know the hardships they have suffered.

To this end, a small handful of D-Bees have started to speak out. They are the voice of the downtrodden and disenfranchised. They are illuminating the nation to the mistreatment of their kind, and putting a face to their plight. The speakers have been arrested, beaten, and threatened. Yet they stay strong because they know their cause is just. They hold rallies, print up flyers, and create newsreels and video documentaries. They are the leaders of what could become a unified D-Bee civil rights movement. Slowly, their message is spreading, and they are gaining more support. Not just among nonhumans, but among some humans as well.

So far, most of the actions of the D-Bee civil rights speakers have been peaceful and perfectly legal. None are willing to use violence to gain support. They know the importance of distancing themselves from street gangs, fanatics, and terrorist groups, and know violence is seldom the right means to an end. D-Bee subversives are nothing new to the NGR, but this new movement is using peace, words, and knowledge to achieve their goals. Violent acts, such as looting, murder, terrorist acts, and bringing about anarchy will do nothing to change the minds of the German people about D-Bees. In fact, it may only push them farther down the road of hatred. No, this movement must be about justice, equality, unity and peace.

Within the NGR government itself, *President Viktoria Sperling* and *General Rasheen* have done a lot to try to improve conditions for D-Bees, and plan to do more. Anti-D-Bee lobbyists are far better funded than the civil rights speakers, and are using all of their power to keep D-Bees in their place as second-class citizens. Many politicians agree. The minority who want equality for D-Bees are doing what they can, but until the cultural mind set of the average NGR citizen is changed, no progress will be made.

The formal alliance with the fascist *Coalition States* and their extreme views about nonhumans has many of those who want reform all the more concerned. For the President of the NGR it is like walking a tightrope. On one hand, the NGR needs the CS as an ally and trade partner. On the other, the CS promotes the genocide of the nonhuman "alien invaders." To the CS, the only difference between D-Bees and Gargoyles is that D-Bees are easier to kill.

## General Rasheen

**An interview with beloved and respected General Rasheen in *Volkstimme Magazine*:**

In the history of the New German Republic, there has never been a nonhuman to experience such a meteoric rise through government service as General Rasheen. Seemingly warrior-borne and destined for greatness, General Rasheen has led a life filled with conflict. He says that it seems he is meant to go from one battle to the next.

General Rasheen's current battle may be his most challenging yet. As the foremost supporter of D-Bee rights on the Council of Governors, General Rasheen faces incredible opposition from nearly every other policy-maker in the nation. It should come as no surprise that General Rasheen is, himself, a D-Bee. He belongs to a race of giants from another world. In his culture, they extol virtues such as bravery, fighting prowess and strength of body and of character.

I met with General Rasheen at RatHausPlatz Park near City Hall in Berlin. A person of his incredible size seemed somewhat out of place in the park. At an impressive 16 feet (4.8 m) tall, he could have crushed me into jelly between those massive arms or under his foot. Yet I felt welcomed and relaxed as we spoke. It was hard for me to imagine this 'gentle giant' as one of the greatest warriors in history, and yet, until very recently, he was tearing Gargoyles apart with his bare hands in the Eastern Wilderness.

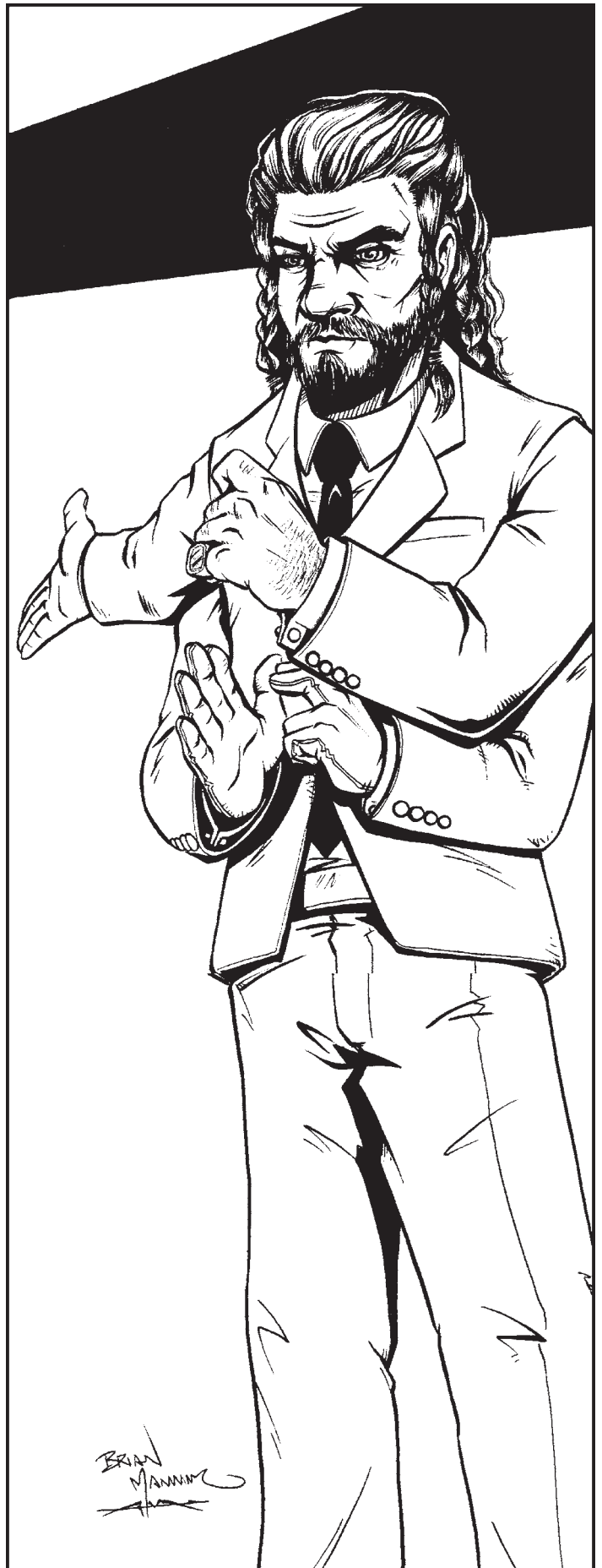

**Thank you for meeting with me, General Rasheen.**

My pleasure. I truly mean that. I had to get out of the office today. I like to come to the park to center my thoughts.

**Could you tell us where you're from, originally? Why you left there, why you came back, and what was it like returning home for you?**

Well, to go in order, I am originally from Amsterdam. If you mean my people, the giants, I really don't know. My tribe came to Europe generations ago. I'm afraid I'm not acquainted with my people's land of origin. I left Amsterdam because I was young and bold. I wanted to see the world. I felt my destiny was elsewhere, if that makes sense. I was probably just full of spit and vinegar. [Laughter] My species live for a very long time. Much longer than humans. So I always knew that if I survived, I would be back to this part of the world. Coming to Germany just felt right. It became my new home. I've never left her side.

**You've traveled to so many places, but most readers seem fascinated with your time in America. People are dying to know what the Cyber-Knights are really like. Care to share?**

[Laughs] Cyber-Knights, eh? Let me say that once I met some actual Cyber-Knights, I really began to understand people's fascination with them. They personify the cliché "larger than life" hero. They really do. They're just these ordinary people who have decided to make the world a better place. They strive to be noble and kind. Good and caring. They stand up to evil and injustice and help those in need. I hope this doesn't sound like bragging, because I'm a Cyber-Knight myself, but I found them to be inspirational. A culture of heroes for heroic people who are out there fighting every kind of evil imaginable just to make this world safer for ordinary people. I was truly humbled in meeting with them. I enjoyed training with them and becoming one of them. It also makes me more appreciative of our own heroes in the NGR Armed Forces. Men and women in a very similar position, standing up and defending what is right and true against seemingly impossible odds and an unrelenting enemy.

**So did you feel you found your destiny with them?**

Partly. Becoming a Cyber-Knight helped me find my purpose. My destiny? That was waiting for me here, in the New German Republic.

**What made you take up the fight against the Gargoyles by yourself?**

Oh, I don't know. I think mostly I was channeling my anger. I was furious at the Gargoyles for what they did to my childhood homeland. I was frustrated with myself. It was a stupid thing to do, to run around the Monster Zones and take on every Gargoyle I encountered, but I did.

**Yes, but you inspired others to join the fight.**

As crazy as it may sound, yes, I did. I'd like to think my actions saved lives and did good, but at the time, I think I was really just venting my anger. It was later, when others turned to me for leadership, that I took control and served the greater good.

**The D-Bees of the NGR see you as a hero in war and politics. What do you have to say about that?**

I think it's a wonderful thing that my fellow nonhuman sentients recognize and appreciate my contributions to the Gargoyle

War and efforts to keep all people of this great nation safe. I'm glad I inspire them and give them hope, but it is not enough. All of us must realize that we are a community of diverse and equal people. That the word 'humanity' does not apply only to human beings, but extends to all people. That's the message I hope to spread. That's why I've entered the political arena. As a Cyber-Knight, I am compelled to right injustice and speak for those who don't have a voice for themselves. For the time being, at least, I am the voice of the D-Bees of the NGR.

**What do you say to your detractors when they say D-Bees don't belong in government?**

I don't know. Maybe they are right. Sometimes I think to myself, "I really don't belong here." This isn't my homeland. These aren't my species. But I don't know where my 'homeworld' is. I was born here, on Earth. This, the NGR, is my home. You and everyone living in the Republic are my people. My family. Human and nonhuman. I don't stop and think, "Why am I fighting for these humans?" Nor do I fight for humans. I fight for all people. We all have value. We all have equal rights. We, human and nonhuman, are the New German Republic. And if that's the case, then we should all have an equal voice. I dare say the people who don't think D-Bees belong in government also believe we D-Bees don't belong in their neighborhoods, schools, workplaces or country either. Yet here we are, working, living, and dying just like everyone else. We're as much Germans or Europeans, or Earthlings, or whatever you want to call us, as anyone else.

**In recent years, we have seen a growing number of disillusioned and angry D-Bees resorting to violence to get their message across. How do you feel about them?**

Disappointed and concerned. I understand their anger and frustration, but violence is always destructive and hurtful. It never builds a healthy relationship or understanding. Hurting innocent people and screaming at them won't change anything. We need a healthy and open discussion. We need to reach an understanding. We can't let our fears and anger drive us apart.

**So what do you say to these militant people?**

I say be strong, speak out, but do so in a constructive manner. For 'D-Bees' to strike out at 'humans' only perpetuates the belief that we are different and makes one another the enemy. I've had enough of enemies. We – all of us – are the people of the NGR. What nonhumans need to realize is that many people, especially those living in the cities, don't know anything about us. We're different and, silly as it may seem to some of us, that makes some people fear us. Afraid because they don't know us, because they haven't had the opportunity to see beneath our four arms, scales, horns or other uniquely nonhuman features. When they get to know us they won't see us as different and frightening, they'll see us as their next-door neighbor or their friend in the workplace.

Mr. Baum, let me ask you a question. Are you afraid of me?

**No, Sir, of course not.**

Of course not? Why not?

**Um, because you're General Rasheen, hero of the NGR.**

But am I not many times larger than you?

**Yes, but . . .**

Don't I have four arms when you only have two?

**Yeah, so?**

So, aren't I different from you? Very different?

**Yes.**

Isn't that reason to hate me?

**I see what you're saying.**

Good. Now, if you would please answer the question. Why don't you hate me or fear me when I'm many times larger and more ferocious than most 'D-Bees'? I could strike you dead before you even knew what hit you.

**Because I know you would never do anything to hurt me.**

And you know that how? Because you know me. You know who I am. You know what I stand for. And that's what I want other people to understand. I am a so-called 'D-Bee.' An inhuman creature from another world. Yet because you know me. Because you know I care about and fight for all of you, the people of the NGR, you embrace me and trust me. But I am not any different from a million other D-Bees. We don't see ourselves as monsters or invaders, you know. We don't see ourselves that way, because we aren't either of those things. We see ourselves as Germans, and we see you and all people of the NGR as our brothers and sisters. If only everyone could see us the same way.

**I think that should give our readers plenty of food for thought. Thank you for your time, General.**

Thank you for letting me share my thoughts with you and your audience.

— Interview by Gerfried Baum,  
Staff Writer for *Volkstimme Magazine*.

General Rasheen was born in a D-Bee village near the rebuilt, human dominated city-state of **Amsterdam**, around 120 years ago. As is customary for his race, Rasheen was trained as a warrior and a defender of the people. For decades, he helped fight off monsters, wizards, and bandits who threatened the people of Amsterdam.

Around 25 P.A., Amsterdam and the New German Republic fostered an alliance. Swarms of Gargoyles, which had been a problem for decades, seemed to swell in numbers and become more organized. The monsters invaded Switzerland, Austria and Italy. They proclaimed themselves the "Gargoyle Empire" and announced their intention to conquer Germany and the surrounding region next. The leaders of the NGR sought Amsterdam as an ally. Even though the country had little in the way of weapons and technology, they were a predominately human nation of three million people, and were willing to volunteer their own citizens for NGR military recruitment.

Over the next ten years, Amsterdam prospered with NGR support. The city and the surrounding villages were much safer than they had been for years. Rasheen, along with a small group of D-Bee and human comrades, left Amsterdam to seek adventure and excitement in North America. They found plenty of what they sought as freelance mercenary warriors and operated in the area around Lazlo and New Lazlo, sometimes venturing into the Magic Zone, and far up into Canada. On these jaunts, Rasheen would battle supernatural creatures, pirates, nomadic raiders, insectoid monsters known as the Xiticix (Z-eye-tick-icks), and on a few occasions, Coalition soldiers. Rasheen went easy on the Coalition, sparing the lives of soldiers whenever he could. He learned a lot about their politics and the nation's pro-

paganda machine while in Lazlo. He sympathized with the Coalition States, and saw their people as noble and strong, only misguided and brainwashed by their misogynist leadership.

In one CS clash, Coalition soldiers had tracked a fugitive to a village of D-Bees in Northern Pennsylvania. The villagers insisted they did not know this person, but the soldiers threatened to destroy the entire village if the fugitive was not handed over to them. Rasheen happened to be there, simply passing through. When he approached the CS troops to try to find a diplomatic solution, they opened fire on him, fearing that the village's leader or defender was coming to crush them all. Rasheen fought the soldiers, without killing or seriously injuring any of them, and even managed to capture the fugitive, who had been flushed out of hiding during the firefight, and turned him over to them. The CS officer who was in charge of the manhunt quietly thanked Rasheen for his mercy and his cooperation, and in return, ordered his troops out of the area without any further violence.

Word of his actions spread, and it wasn't long before Rasheen was approached by a representative from the *Order of Cyber-Knights*. They had heard many stories of his actions around the Great Lakes region, and wanted to take him into their fold. Rasheen happily accepted.

In the years that followed, *Sir Rasheen* became something of a legend among Cyber-Knights. His strength and combat prowess were matched only by his courage and valor. He was a living embodiment of everything the Cyber-Knights stood for.

Many years later, around 70 P.A., word reached Sir Rasheen that things in his homeland had changed, and not for the better. He learned of the *Gargoyle Retribution of 38 P.A.*, in which the Gargoyle Empire swarmed across Europe, laying waste to everyone they could find. Amsterdam, though aided by NGR soldiers, had fallen. Millions of refugees poured into the NGR. In response, the NGR government enacted the *Mandatory Deportation Act*, which forcefully removed D-Bees from within the NGR's borders to make room for the huge wave of humans who needed homes and jobs. That, coupled with the NGR and the CS making a small alliance pact, caused a wave of anti-D-Bee sentiment to sweep across the NGR.

Immediately, Sir Rasheen returned to Europe, where he found monstrous Gargoyles inhabiting his old home of Amsterdam. They had destroyed everything he had known and loved. Sir Rasheen went wild with anger and grief, tracking down Gargoyles by the hundreds, demanded they leave, and when they refused and attacked him, he ended their lives. As word spread about the "Giant Avenger," resistance fighters, mercenaries and heroes found Sir Rasheen and joined him in his fight against the Gargoyles. Sir Rasheen soon found he had another talent, he was a natural leader and had a head for strategy and tactics. D-Bees and humans rallied around the giant and followed him wherever he led. They engaged in one battle after another, and as his army grew, so did the swath of destruction leveled against the Gargoyle Empire. Sir Rasheen and his followers did not win every battle. More often than not, discretion and retreat was the better part of valor, but he and his warriors sent a loud and clear message to the Gargoyles.

For many years, Sir Rasheen continued to battle the Gargoyles all throughout Europe, doing so with no direct support of the NGR military. And although his name did become known in

the NGR as a powerful destroyer of monsters, and leader of humans and D-Bees, the military and government refused to sanction or condone his actions.

After years of battling with the Gargoyles and Brodkil, the heroics of Sir Rasheen – who had come to be known as “General” Rasheen – could not be ignored. Furthermore, thousands of humans who either fought under his command or were rescued by the giant sung his praises. NGR intelligence learned that 60% of his fighting forces were human, and the exploits of the General had made him a folk hero even among the citizens of the NGR. Somehow, General Rasheen’s integrity and sincerity transcended the race barrier and he was embraced and loved by all people. In fact, it was the nonstop inquiries of the “human” citizens of the Republic, as to why the NGR military had not enlisted such a great hero to join and lead part of their very own army, that finally made the NGR government do just that. At first, the Army of the NGR enlisted the General to help them defend the NGR border and the many D-Bee border towns along it. General Rasheen was hesitant, but he saw a desperate need and innocent people in danger, so he agreed. Over time, the leaders of the NGR military also embraced General Rasheen and made him a true officer of the NGR Army and leader of soldiers – all soldiers, human and otherwise.

Today, General Rasheen is a beloved, decorated hero and one of the trusted leaders of the NGR Army. He is loved and respected by humans and D-Bees alike, but to the D-Bees of the NGR, he is the greatest hero in history.

Recently, the General has engaged in a new battle: the battle of equality for D-Bees, and it is proving to be the most difficult battle of his career. There is considerable resistance to the idea of equal rights for nonhumans, but those opposed to it are in trouble when they debate General Rasheen. All of their usual arguments that D-Bees are inhuman monsters that cannot be trusted, fall apart against General Rasheen. When issues of trust, loyalty, lack of intelligence, laziness and similar issues are raised, the General need only spread open his four gigantic arms and ask, “Am I lazy? Am I untrustworthy? Do you question my loyalty?” When the inevitable answer of “no” is given, the General then asks, “Am I not a D-Bee?” It is a difficult question to answer or refute.

Many opponents of equal rights for D-Bees try to claim the General is, a) an exception, and b) exceptional. However, he counters with the fact that the armies he has led, especially prior to joining the NGR, have always included a large percentage (40-60%) of D-Bees. Nonhumans who have bled and died to protect the NGR. Nonhumans who have shown valor and courage and loyalty equal to his own. D-Bees who battle for *all people* of Germany, 80% of which are human. D-Bees who cannot find a job, or if they do, are paid 30-50% less than a human who holds the same position, and who have to pay 25-50% more for housing, and who are treated like work animals rather than human beings.

Then comes the clincher. In war he, General Rasheen, legendary hero of the New German Republic, is trusted to formulate strategies and tactics against the enemies of the NGR. Strategies and war plans that could affect the entire country. He

commands armies and holds the fate of tens of thousands of human lives in his hands every day. Nobody questions those decisions. They trust him completely, and he has earned the privilege of citizenship in the NGR. Yet, as a D-Bee, he cannot vote for the President, and on the issues he can vote upon, his vote is counted as half. General Rasheen’s vote has half the value of the lowliest and least educated human citizen in the country. “How?” he asks. “How is that right?”

It isn’t.

General Rasheen is not a politician, but he is well spoken and articulate. His honest, sincere voice is difficult to refute and is making people stop and think. Whether it will make a difference is yet to be seen.

Some friends and advisors have told General Rasheen to be silent and that his support of the D-Bee civil rights movement could hurt his standing in the military, the government and among the people of the NGR. So far, it has not. He remains the most respected and beloved war hero in the history of the NGR, and that’s among both humans and nonhumans.

Lately, tension has been mounting between D-Bees and humans in the NGR. Many D-Bees are tired of their treatment, and are ready to start openly fighting back. General Rasheen tries his best to quiet the discontent and put their frustrations at ease, but he himself is growing frustrated with the stubbornness of the Council of Governors. Most of all, General Rasheen worries he has given the D-Bees of the NGR false hope. He is afraid they have put all of their faith in someone who cannot, no matter how hard he tries, change the status quo. Then again, he has faced impossible odds many times and usually triumphed. He hopes this is just another battle to be hard fought before victory.

## Quick Stats for General Rasheen

**Race:** A four-armed giant from another world.

**Alignment:** Principled.

**Attributes:** I.Q. 11, M.E. 14, M.A. 14, P.S. 30 (Supernatural), P.P. 14, P.E. 18, P.B. 14, Spd 15.

**M.D.C.:** 268

**Level of Experience:** 10th level Cyber-Knight.

**Skills of Note:** Speaks and is literate in the following languages: Euro, American, Dragonese/Elven, Gobblely, Spanish, and pre-Rifts German and French at 80%, Public Speaking 60%, Creative Writing 45%, Law (NGR-specific) 55%, Philosophy 75%, Research 50%, Military Etiquette 95%, Horsemanship: Cyber-Knight 98%/80%, Paired Weapons, and the following Weapon Proficiencies, all at 10th level: W.P. Sword, Energy Rifle, Energy Pistol, Heavy M.D. Weapons, Archery, Targeting, Spear, Axe, and Blunt.

**Cybernetics and Bionics:** One Bionic replacement arm (Robotic P.S. of 30, replaces his lower left arm) with a Particle Beam Cannon in the palm. Cyber-Knight Cyber-Armor (98 M.D.C., A.R. of 17).



# TRIAX INDUSTRIES

## A Short History of Triax Industries

Triax Industries was formed in the year 2021 by the merging of three independent German companies. Their names are forgotten to history, though it is known that one company specialized in steel manufacturing, another in robotics, and the third in computers (both software and hardware). The merger was masterminded by a young venture capitalist named *Alexander Gottschalk*. As the story goes, the name “Triax” was an amalgamation of the words “Triad” (as in, the three companies that merged) and “Alex.” Whether this part of the story is true or not is anyone’s guess, though it is a widely accepted legend.

Alexander Gottschalk started Triax with the intention of developing new technology that could be used in every facet of modern industry. His original idea was to combine the three sciences of metallurgy, robotics, and computers with new technology to form one giant, cutting edge technological empire. He wanted to create robots built from the strongest and most durable materials, running the smartest software. He had a vision of a future where super-intelligent, super-strong robots did the most dangerous work and most mundane of tasks, freeing humankind to be thinkers instead of laborers. His vision would put robot drones under the ocean to chart the depths and in space to explore Mars. His nano-robots would journey inside the human body to collect information and fight diseases such as AIDS and cancer head-on. They would help deal with dangerous construction, demolitions and natural disasters.

Alexander sunk his entire fortune into Triax Industries. If it failed, he would be penniless. For years, Triax Industries hemorrhaged money. The company lost 40% of the customers who dealt with the original three separate companies before the merger. Many of the old customers had their doubts about this ambitious new conglomerate and pulled out while their money was still good. Triax had trouble luring in new developers because the company’s goals seemed too ambitious. Lofty ideals were one thing, but to tackle so much, so quickly, seemed im-

prudent. It didn’t help that other technological companies of the time were already working on many of the same things. Cybernetics and bionics, for instance, hit big only a few years earlier. Triax had a cybernetics division that was doing reasonably well in Europe, but couldn’t find a foothold in the world market.

It seemed no one wanted to take a chance on the fledgling company. The media predicted the company would fail by the end of the decade. They were almost right. The energy crisis of the early 21st Century prompted a re-invention of personal conveyance. People were looking for innovations and cost savings in automobiles. Triax set out to create an alternative. Alexander Gottschalk, ever the dreamer, looked to science fiction of the past and created a division to construct a “Luftauto” – a flying car.

Development on “Luftauto” went well until 2030, when a rival automobile company based in Munich released a fully-realized hovercraft. The hover-car was about the size and shape of a modern sedan and flew on a cushion of air. It could reach speeds unheard of by ground vehicles, and was powered by a new type of electric engine. The vehicle was clean, eco-friendly, efficient, easy to operate (no more difficult than a regular auto), surprisingly affordable and best of all, fun. A new driving experience.

The spirit behind Triax was crushed, but they went ahead with the Luftauto project anyway. The first Triax Luftauto rolled (or floated) off the assembly line in 2036 with little fanfare. The company made a small profit from the Luftauto, though nowhere near what Triax investors had hoped for. In 2046, The Luftauto was discontinued due to lack of public interest.

Triax was almost bankrupt. None of its projects were being developed quickly enough. The race to the “Golden Age of Humankind” was in full swing, and Triax was being left behind. They simply were not producing the kind of revenues they needed to support so many of Alexander’s visions. They were behind in nearly every aspect of technological research. The Americans and Japanese (and in a few years, the Russians) were dominating the cybernetic and bionic markets. New medical technology, something Alexander had to scrap to keep other projects going, had exploded onto the world market and was huge. Suddenly, diseases thought incurable were being controlled and conquered. Triax had a small hand in medicine with nano-robots that could disinfect and suture wounds, fight disease, and even administer medication to patients based on an internal clock (this technology would later be found in RMK and IRMSS kits). The robotics program was moving along well, but it consumed much more of the company’s resources.

In 2050, Triax was at the breaking point. The executive board was fed up with Alexander Gottschalk, and the man was nearly broke. He sunk into a deep depression. It was thirty years since he had launched Triax and he’d been treading water most of that time. Alexander was now in his mid-fifties, his company was on the verge of going under, he felt too worn out to even think about another career, and things had never looked darker.

Then it happened. Triax metallurgy researchers had been working on a new super-alloy for almost 30 years. A metal composite material that was supposed to be 20 times tougher and more durable than steel and half the weight. Building upon ideas developed during the creation of medical nano-bots, scientists

had developed a way to bond and compress metal at the atomic level. At first, they only succeeded in creating ultra-thick and ultra-durable metal that was also ultra-heavy (a cubic foot of the stuff weighed nearly three tons!), and therefore was mostly useless. However, by bonding the metal at the atomic level with synthetic, lightweight metals and ceramics, they could create a metallic-like substance that was incredibly durable *and* lightweight! That was the plan, but it's not what they produced.

The end result was even more amazing: A process that made a steel-like super-alloy that was 100 times stronger than the best steel on the market. The material was one quarter the weight of steel, and the molecular nano-process could be applied to other metals, ceramics and plastic materials with the same results – lightweight plastic stronger than steel. Triax and its new invention was the biggest thing in the industrial world. It revolutionized everything. Triax began selling the super-alloy across the globe. Clients were lining up to get their hands on this new material.

Triax had been pulled from the very brink of total financial collapse to emerge on the world scene as the original creator of synthetic Mega-Damage material. Little did Triax know that it had created the technology that would one day pull humanity from the edge of extinction. The company made an untold fortune with this new technology, and Alexander Gottschalk was hailed as a business and scientific genius the likes of which the world had never seen. Finally, Triax had the resources it needed to pursue Alexander's dreams.

Next Triax incorporated the new metal into their line of industrial robots. These new robots were tested on assembly lines all over the world, and garnered critical acclaim from their customers. Triax robots were not only nigh indestructible, but ran like a top, were much more efficient, required less maintenance, and almost never broke down. Sales skyrocketed.

**In the summer of 2064**, long hailed by historians as the first year of the Golden Age of Humankind, Triax attended the World's Fair in Flushing Meadows, Queens with the full force of its new technology behind it. For the first time ever, the world was witness to lightweight, full-environmental, Mega-Damage body armor and the basis for what would become Triax Industries' entire line of robot vehicles and power armor, the Uni-Max X-003 Exoskeleton Suit.

**The Uni-Max** was originally designed as a robot shell. It was large, at over 14 feet (4.3 m) tall, and nearly 20 feet (6.1 m) wide with its arms outstretched. The original plan was to have one mechanical body to which Triax Research Scientists could easily "plug in" a modular robot brain. The reasoning was purely economic, and it never really worked. The Uni-Max was instead redesigned as a one-man driveable exoskeleton. In this respect, it worked phenomenally well. It was easy to operate, and gave its user near-human movement and agility. The suit was perfect for use in shipping and receiving, construction and manufacturing sectors. It was incredibly strong, and made of durable Mega-Damage Steel.

The 2064 World's Fair gave Triax the chance it needed to show the world what it could do. It also gave them a chance to see what everyone else was up to. The Germans were amazed at what had been done with Mega-Damage Steel in such a short time. The Russians were showcasing their own advanced, heavily armored bionic systems. The KLS Corporation had

taken Mega-Damage Steel and bonded it with highly reflective chrome, creating a laser resistant, perpetually shining armor. Wonders from all over the world were on display for everyone to see, and Triax was the number one attraction. Orders and contracts came pouring in before the World's Fair was even over.

Alexander Gottschalk, who stood as Chief Executive Officer of Triax Industries since its inception, died in the year 2080 of congestive heart failure. He was 86 years old. The company was inherited by his only grandson, who continued to run Triax after the Great Cataclysm and into the Two Hundred Years Dark Age. Triax became a vital partner in the survival of the German people and continued to develop new technology, weapons, robots and high-tech wonders. It was only by this company's amazing technology that the people of Germany were able to survive the challenges that came after the Great Cataclysm.

Today, Alexander Gottschalk is a highly revered historical figure to the people of the New German Republic, and especially to Triax Industries. Books are written and movies are made about his life, some historically accurate, and some portraying him as a larger-than-life business prodigy and trillionaire maverick playboy. A day in late summer has been set aside as a holiday remembering Gottschalk's achievements, and to pay homage to his genius. He is remembered as George Washington, Abraham Lincoln, Charlemagne, or Otto von Bismarck were in the time before the Great Cataclysm.

## **Triax Business Report, Summer 109 P.A.**

Triax Industries, as a direct result of being the sole supplier to the NGR military, has seen a sales boom during this tumultuous time of war and full scale militarization. The profits coming in from the government have helped Triax fulfill a record number of contracts providing the military with old, recent and new designs for body armor, weapons, power armor, robots and combat vehicles. At the same time, Triax had made its commercial products much more available to the private sector. Scaled down versions of older equipment such as the original Ulti-Max, Flanker, and Jaeger power armor suits have been sold in large quantities to private security forces and state approved militias. All these commercial units are sold with half of the M.D.C. of military grade units and lack heavy weapons. The commercial grade Ulti-Max doesn't come with a force field either. These adjustments keep the famous armored units formidable and capable, but much inferior to the military units still in service. The lighter armor and weapons also keep the price of these units at a point where even the farm communities and small businesses can afford them (roughly half price). Triax is also considering selling the reduced units to allied nations and foreign markets.

Over the past three years, the Coalition States have had their diplomats in talks with the NGR government in order to halt the import of Triax weaponry to the North American continent. Certain members of the CS elite have seen this as a means of aiding and supplying the enemies of the powerful CS, especially during the Siege on Tolkeen. While the NGR government said that it would try to pressure Triax into halting the export of military goods overseas, the real powerhouse and decision maker in this matter is Triax Industries itself. As a matter of diplomacy, for the last three years, Triax agreed to suspend the *direct export* of

product to North America, except to the CS itself, and Free Quebec. In the last year it has sent a hundred sales representatives to North America with the purpose of making contacts and negotiating sales with the Coalition States as well as some of the largest independent kingdoms. In the latter case, it is hoped that Triax can orchestrate the delivery of its goods to a neutral location, to a third party broker or to settlements and independent kingdoms that do not raise concern for the Coalition States. The potential CS market is large enough that Triax may be willing to forego outside markets in favor of an exclusive export/import deal with the CS and Free Quebec alone. Quebec has already agreed and the Coalition States is considering the arrangement.

Triax does recognize that North America is a volatile environment and it does not want to undermine an NGR ally and valuable customer such as the Coalition States. Thus, the company has been selective with whom it is selling armaments. The last thing Triax or the NGR wants is to become a destabilizing force in the region by selling weapons to enemies of the CS. However, they would like to increase their market share within the Coalition States itself, even if it is selling commercial wares instead of armaments. The halt of exportation to North America has had little effect on Triax aside from getting them to rethink and reorganize their business model for North America.

Despite Triax stopping its direct sales to North America, more of its goods are making it to the shores of America. This is usually via the Black Market and mercenaries bringing Triax military hardware to a market that can't get enough of it. These sales have increased dramatically since the Full Militarization campaign of 104 P.A. The CS isn't too happy about it, but understands and accepts the situation (for now). The CS also suspects that powers within the Federation of Magic and possibly agents of Tolkeen and even the Splugorth may be working to get Triax wares to the continent to further undermine the CS and encourage other third parties to take a stand against the Coalition. The Coalition leadership refuses to accept that their siege on Tolkeen has escalated tensions throughout North America.

When compared to *Wellington Industries* and *Northern Gun*, Triax North American sales increases seem almost diminutive. While sales from both of these companies has increased by 41% and projections show a 250% increase due to various military and civilian sales, Triax Industries believes that their careful and discreet business deals will earn them even greater revenues long-term. Conversely, Triax sales have recovered from the initial shock of the abrupt halt of weapons and armaments to North America, and have since made a modest 12% gain in the market. A position which is holding steady. With increased sales of commercial goods and some military goods to the CS and Free Quebec, Triax's position in the American marketplace seems secure.

Aside from a new, promising North American market and the incredible surge from the full militarization of the NGR, Triax sales throughout Europe are on the increase. A well negotiated deal with the Sovietski netted Triax a sales increase of 53% in that country. Not only was this a great stride for Triax (it's difficult breaking into the Russian market), but it also ensures that the people of Russia have a reliable and affordable means to protect themselves from monsters and bandits from that part of the world. Sales to the villages, towns, cities, and kingdoms throughout the rest of Europe have also increased. Due to their

rugged durability and reliability, the WR-10 Ion Pistol, WR-15 Laser Rifle, and the WR-17 Wilderness "Double" Rifle are hugely popular among many small communities. Police forces and small militias have also been snatching up the TX-43 Light Laser Assault Rifle by the crate and the TX-30 Ion Pulse Rifle is also a huge seller. Many small communities have passed on purchasing the TX-16 Pump Rifle and the TX-5 Pump Pistol solely because the cost of the ammunition would prove to be too great. All of these older weapons have sterling reputations and are incredibly affordable thanks to years of wartime mass production; the going prices are half what they once were for factory new weapons, and "used" models sell in Europe for as little as 30% of their original cost. (These same weapons still sell for full price on the American market. Of course, the trick is getting them to the North American market and finding a buyer without being intercepted and having products confiscated by the CS.)

Though they do make up a large portion of all export sales, weapon sales are not solely restricted to small arms or light power armor. Sales of combat vehicles, robot drones, and even prefabricated cyborg bodies and parts, such as the infamous VX-500 Manhunter or "Red Type Cyborg," have been a part of this surge in sales. Many items that used to be difficult to find or were only available on a restricted basis in Europe have become much easier to procure since Triax (and the Black Market) has released *used army surplus* and *commercial versions* of selected weapons and power armor (as noted earlier).

Triax has always taken its role as the sole military developer for the NGR quite seriously, and works diligently at fine tuning and perfecting all manner of new weapons technologies. While maintaining their increased manufacturing schedule, Triax has also continued with their ambitious research and development at such facilities as the *Passau Industrial Komplex* which explores new weapon technologies and works toward improving upon older combat systems. For years, Triax has sought out new and innovative ways to combat the Gargoyle menace, and many new technologies, such as the U- and DU-rounds, are the result of that research. With **Uranium** and **Depleted Uranium rounds** (a.k.a. U-rounds and DU-rounds) becoming an ever more popular piece of hardware in the Army's arsenal, production of the rounds has increased 500%. In recent years, the scientists at Triax Industries have been revisiting some of the older technologies in an effort to revamp and upgrade them to be even more formidable. New lasers, ion weapons and other Triax energy weapons have even greater punch or range, or both, and there have been strides in energy efficiency which accounts for greater payloads than some of the older models. As usual, Triax sets the standard for military technology, leaving everyone else trying to catch up. Though many of the Triax weapons systems are tried and true, the new push to utterly destroy the Gargoyle Empire has led to some new variants, improvements and whole new concepts for fighter aircraft, miniature infiltration and attack robots, power armor and armaments. The versatility and range of innovation has been most impressive, and the NGR top brass has been thrilled with the initial performance of the new weapon systems.

While being a staple of the NGR troops for the majority of the country's existence, laser and ion weapons have seen the most overhauling of any of the technologies. Triax plans to begin phasing out the designs for many of its older weaponry, a



process that is expected to take between five and ten years, starting in 110 P.A. The NGR military is still sitting on a massive stockpile of guns, rifles, rail guns, explosives, and T-10 Environmental Body Armor. Most of that stock will be recycled by Triax or sold to foreign markets.

## Back to the Drawing Board

### Failed Experiments and Useless Technology

Triax is a very large corporation with many, many different departments. Their military and research arms are obviously the most profitable and well-known, but they produce a variety of products for modern consumers of all walks of life.

For every success that Triax has had with their products, whether it be a new cybernetic implant, robot vehicle, artificially intelligent dishwasher, or ion pulse rifle, there have been a hundred failures, non-functional prototypes, and outright disasters. Some of these failures become learning opportunities. Others lead to something unexpected which may have as of yet unrealized potential. Research Scientists learn why a particular technology does not work, and that can sometimes lead to innovation or new technology.

Triax keeps records of all of its failures, successes and technology, new and outdated, as both hard copies and digital backups. They are locked away, separated from any network or computer database. Its military projects are the most secure, usually stored at NGR military installations. Triax's more mundane product records are kept by the individual department that initiated the designs. It is nearly impossible for any spy or saboteur to gain access to these records; Triax tends to guard its failures even more closely than its successes, since it doesn't want anyone to improve on a wild idea they may have never gotten off the ground. It is all a matter of corporate, as well as national, security.

## Corporate Espionage

Espionage between corporations is nothing new. Long before the Coming of the Rifts, even during the days of the East Indian Trading Company, there were companies trying to steal information from each other through lies, deceit, theft and occasionally, violence. Having the right information at the right time can mean the difference between a company scoring a major contract and falling into bankruptcy. Being out of the public eye, most people are completely unaware just how much industrial espionage takes place.

The greatest weapon in a spy's inventory is the mentality that companies believe it will never happen to them. No matter how small, inconspicuous, or well-defended, every company is vulnerable on some level. The job of the professional corporate spy is to discover and exploit those vulnerabilities.

During the Golden Age of Humankind, industrial spying was its own industry. Espionage was rampant among the corporations of the day. New technology was constantly under development and new secrets were being uncovered at an unprecedented rate. Shortly before the Great Cataclysm, the world was on a slippery slope heading into a new Cold War that was threatening to envelop every developed nation on Earth. Espionage became more common, more blatant, and more dangerous. There were

battalions of super soldiers and super spies, outfitted with the latest high-tech gear, chemical augmentation, genetic tinkering, and other wonders of the Golden Age. In order to facilitate the growing resentment among nations and secure the defense of their employers, these new spies were not above conducting flashy raids, destroying millions in property, and even kidnaping or killing to get the information they needed. Companies hired or created their own private security forces, equipped with power armor and Mega-Damage weaponry to counteract the new breed of corporate spies. When the Great Cataclysm hit, the corporations were smashed, and their precious information, that they would do anything for, was buried under the rubble of a fallen civilization.

It took a couple hundred years, but corporations began to re-surface. When the old technology was rediscovered, companies were formed to handle the restoration of the secrets of the past, and build upon them. Guarding those secret created nations (the CS, Free Quebec, NGR and Geofront, to name a few) and new industrial giants like Triax and Northern Gun. And with them the role of the industrial spy again flourished.

In the past, espionage between companies was not as exciting as one might think. It often involved paying off an employee on the inside to copy and pass on secrets, or getting an angry partner to do likewise. Even when a mole was inserted into a company or there was a "break-in," the real work of theft and sabotage is usually done with photography, scanners and computers. That continues on Rifts Earth, however, modern corporations in 109 P.A. tend to be aggressive and unrelenting in their acquisition of competitive technology. In addition, the fledgling nations spy on their industrial rivals and neighbors because information is power, and honestly, who can stop them? The Coalition States, for example, want to know what *everyone* is researching, constructing, and planning. For national security reasons, of course.

**Counter-Intelligence.** Every major corporation has some methods of counter-intelligence in place. Even something as simple as a background check can be used to weed out a potential spy. For employees entering into more important and secretive work, such as weapon design, multiple background checks are used, as well as cryptographers trained to spot false identification papers and workplace records. Some companies even use "truth serums," polygraph machines, and even Psychic Sensitives (powers such as Empathy, Telepathy, and See Aura reveal more about a potential employee than he is willing to say) as a way to prevent spies from getting into their organization or disgruntled employees made to turn against them. For dealing with nonhuman shape-changers, periodic DNA tests are sometimes administered.

Technology plays a big role in the security of the corporation. Cameras are placed in offices and vulnerable places in factories and research centers. Computer firewalls are in place and data files secured. Computer hackers are further deterred by the difficulty in gaining access to a company's physical network, and by IT professionals who watch the company's electronic network for unauthorized intruders. Triax is also working on Artificially Intelligent programs that can seek out network intruders and cut their signal from the inside. One of the greatest assets a company has to root out spies is its own employees. A

content and appreciative employee will not easily turn on his employer, and loyal employees will quickly report on suspicious activity. It is also wise to make sure they are vigilant in their conversations with other co-workers not to give out too much information. Employees who are high up in the corporation, especially weapons, cybernetics and bionics engineers, and those involved with new sciences, can pretty much assume that wherever they go and whoever they are with, someone, someplace, is listening in.

Triax and the NGR have been isolated from the outside world for centuries and have not had to contend with much in the way of industrial espionage. On top of that, most of their workers and citizens are super-patriots and would never think of compromising their nation or their favorite manufacturer. However, as the NGR's borders begin to open up, espionage and sabotage may become a more serious issue. The government and Triax have all the appropriate security measures in place, but they may still be caught off guard if they are not careful.

## Triax Commercial Products

The influence of Triax Industries on NGR society is inescapable. Most famous for their military arm, it is often overlooked that Triax also manufactures many other products. They have entire lines of commercial vehicles, adventuring gear, cybernetics and bionics and household products. As an NGR citizen, at least two-thirds of the electronic, computer and high-tech products a person owns are designed, produced, and sold by Triax Industries. Triax has its own outlet malls, mail order catalogs, and internet sites. The car you drive, the television you watch, your computer, your kitchen appliances, your home security system, your robot servant, and maybe even the toothpaste you use are all likely to be manufactured by Triax Industries. Never, in all of human history, has a society been so dependant on one company for its citizens' way of life.

The majority of products created for consumers are pedestrian household goods. However, there are some products created by Triax and not currently available outside the NGR that are worth mentioning. The items presented below were designed with the affluent and wealthy citizens of the NGR and Poland in mind. Player characters may want to procure some of them to make their travels a little more comfortable, or to resell in North America (the products are made by Triax, and will command top dollar), or to modify for their own personal use.

As for more mundane items, assume that anything produced by Triax is going to be at least 30% more efficient than competing products, whether that can be measured by Mega-Damage Capacity, miles per gallon, speed, tastiness, cleaning ability, effectiveness, etc.

All of these products are available at every NGR city, small towns, and sometimes other places in Europe, especially in Poland and Russia. For the more expensive products, financing is available at reasonable interests rates; 4-6%.

## Triax Instant Meal Paste Maker

This appliance is the size and shape of a large cappuccino machine. It is used by busy young professionals who lack the skill or the time to cook a proper meal for themselves. Inside the device are a variety of pellets that contain base dehydrated ingredients, such as fish, bread, sausages, honey baked ham, and spices. Using a small keypad, the person selects a meal from a pre-programmed list, and the IMPM device combines the ingredient pellets with hot water to form a thick paste. The paste dispenses into a bowl under the appliance, similar to a soft-serve ice cream machine. Original meals can even be programmed into the Instant Meal Paste Maker, allowing users to have their sauerkraut paste with more or less salt and pepper, or even something more obscure like cumin, paprika, or chili powder. Thick fruit smoothies, energy drinks and nutritional supplement drinks can also be made with the IMPM.

The idea of a paste meal may sound unappetizing, but the end result is surprisingly tasty. For outsiders, the whole idea takes some getting used to, but for many young executives, it is an easy way to make a quick, healthy breakfast, lunch or dinner for the person on the go. The Instant Meal Paste Maker creates a meal in under forty seconds, takes up only a small amount of space and can even be fitted into a vehicle – having an IMPM and a refreshment dispenser inside your car or truck is a current trend in the NGR.

The IMPM is widely available anywhere in the NGR and Poland, and can be found from time to time in the rest of Europe and North America, especially in Coalition cities.

**Cost:** 175 credits for the appliance, refilling the ingredients costs 100 credits. Typically can prepare 30+1D10 meals before needing refilling, which makes the cost per meal around three credits each.

## Energy Supplements

Energy drinks and dietary supplements are huge in the NGR, especially among young people under the age of 35. Most of them are simply soft drinks with vitamin supplements and the caffeine and sugar content jacked way up. The drinks are given impressive or fun sounding American names (popular among the people of Europe), and even some of the ingredients sound exotic, such as Taurine and Guarana Extract.

These energy supplement drinks have zero nutritional value, but do provide a lift. Drink enough of them and you can get a good buzz. The drinks don't have alcohol or dangerous lasting effects like Psi-Cola in North America, but each does have its own effects and side effects. Breaking an addiction to energy drinks is much easier than with hard drugs (unless otherwise noted). If an individual stops drinking them for a few weeks, he loses his urge for them and suffers no permanent addiction issues or health problems. And unlike hard drugs, the person feels very little temptation to drink them again; no more than having a taste for regular soft drinks. Used with moderation, the drinks are safe.

Consuming one energy supplement helps gives the user energy and keeps him awake and alert for hours. To get the addi-

tional effects and bonuses listed below, a character must gulp down two or three of the same drink.

In North America, Triax energy supplement drinks are becoming popular among City Rats and Wannabee Juicers. The Black Market imports them and charges five times what the drink sells for in Europe. They are readily available in most NGR grocery stores, rest stops, and gas stations.

**Some notable energy supplements follow:**

### Atomix Powder

Atomix Powder comes in a box the size and shape of baking soda. It can be ingested in a variety of ways. You can mix it with water, cook it into rock candy, or take it as a powder (by spoon or lick it off your fingers). The powder has a sweet-tart taste that provides an instant sensation in the mouth. The effects are the same, whichever way you take it: The user is infused with a rush of strength and energy, feeling confident and powerful. It also has a mild hallucinogenic side effect, causing everything the user sees to take on hues of yellow and green tone.

**Cost:** 40 credits a box. Each box contains approximately 20 doses.

**Bonuses:** Taking two doses makes the user +1 on initiative and +1 to P.S., plus the individual feels stronger, good looking, more confident and capable.

**Duration of bonuses & effects from consuming two (or more) doses within one hour:** 1D4 hours.

**Level of addictiveness:** Minimal even in large quantities.

**Penalties:** Reduced awareness results in -2 on Perception Rolls, -5% to skill performance, -20% to save vs Seduction, -2 to save vs mind control magic or psionics that plays to the individual's inflated sense of self high on this product. Most penalties are the result of feeling blissfully positive about oneself and looking at the strange colors. **Note:** Most popular among males.

### Cataclysm

Cataclysm is a drink that is *not* produced by Triax. Triax's name is on the label, but it is a bootleg product. Nobody can seem to track down the person or group responsible for its availability at underground dance clubs and disreputable venues. It is not available in stores, and is actually illegal to own, buy or sell.

Cataclysm is a delicious drink and high in vitamins and minerals, making it nutritious. However, the side effects from even one can are terrible and potentially life-threatening! Cataclysm has a number of chemicals that, when consumed by humans, create a total hallucinogenic fantasy realm that is a twisted version of the real world. The user sees a vision straight out of the *Great Cataclysm*: buildings toppling, people running and screaming, or people turning into demons, ley lines tearing through the ground, dimensional Rifts exploding in the sky, and similar hallucinations. The user sees himself as a powerful god-like being who can repel the demons and calm the chaos simply by waving his arms and speaking words of great power. Of course, as soon as he turns around, there are more demons to face, and more chaos to wade through. The hallucinating individual is a danger to himself and those around him because he is walking around and interacting with his hallucination in the real world. That means someone high on Cataclysm sees some people as demons and D-Bees, other people as terrified survivors in



need of his help, cars as alien spacecraft, and himself as the hero who can help. As a result, he says and does things out of context with the real world, underestimates or misinterprets real danger around him, may see innocent play and laughter as dangerous or threatening, may wander into traffic or onto a train track, open a window and crawl out on a ledge, kidnap a child or innocent person (to save them, of course), and a host of other crazy things out of whack with the real world. For this reason, the label advises that Cataclysm be taken at a safe, secure place with doors locked until the user(s) returns to normal.

**Cost:** 50 credits a can. Available only on the German Black Market, from drug dealers and places of ill-repute. The drink can be difficult to find at times.

**Bonuses:** Drinking one can is enough for a full blown hallucinatory experience that starts minutes after the drink is downed. Once the illusion starts, the person is unable to properly interact with the real world. He retains use of his combat abilities, but forsakes weapons for fisticuffs and his own, *imaginary*, magical or supernatural powers (all part of the delusion). The euphoria of the experience and being a (imaginary) super-hero is all consuming.

While under the influence of Cataclysm, the individual is +2 to save vs magic and psionic attacks, +6 to save vs drugs and stun attacks, and is impervious to Horror Factor, Seduction and possession!

**Duration of bonuses & effects of hallucination from drinking one can:** 1D6x10 minutes. Continuing to drink Cataclysm as the hallucination starts to wind down keeps the effect going with an accumulative effect of 2D6x10 additional minutes per subsequent can of the drink.

**Level of addictiveness:** High. The drink tastes wonderful and the sense of euphoria of being a great hero is unbeatable, even if it's not real. Most people actually enjoy the hallucinations, and the rush of experiences, adrenaline and sensations. It is an exciting escape from the drudgery of the real world.

**Penalties:** Every time a user drinks a can of Cataclysm, there is a 1% chance the “hallucinatory trip” doesn’t end. The 1% chance is cumulative, so drinking a second can makes that chance 2%, a third 3% and so on, even if the last time the person tripped on Cataclysm was years ago. The chance of never coming out of the hallucination stops at 50%, so every subsequent use of Cataclysm has a 50/50 chance of a permanent delusion.

Most partyers and casual users don’t go on a “Cataclysmic ride” more than 1-4 times in their entire life, so the odds that no permanent damage occurs is very much in their favor. However, it is still a risk.

Frequent users are at much greater risk: One “Cataclysmic ride” too many (and god only knows when that will be) and the following occurs (roll percentile dice): **01-33%** Half the time the character is okay and grounded in the real world, the other half of the time he lives in the Great Cataclysm as described above. **34-66%** The character is okay most of the time, but if attacked, threatened, hurt or placed under frightening or stressful conditions, there is a 01-85% likelihood he retreats to the hallucinatory Great Cataclysm where he is a hero and nothing can hurt him. Each hallucinatory spell lasts 4D6 hours. **67-00%** The victim is permanently lost in the hallucination and never snaps out of it.

## Metal

Metal comes in a tall black can. The name of the product is in big, red and silver, evil-looking letters. Cartoon demons, flying skulls, and electric guitars also adorn the can, enticing the buyer into a world of jacked-up, caffeine-induced Black Death frenzy.

The experience of drinking Metal is roughly equivalent to chewing on a handful of nails, which is actually a tag-line used by Triax to help sell it to their target demographic of young males. Metal is basically like any other energy drink, with an added secret bonus: a secret mixture of serotonin, adrenaline, testosterone, and other chemicals cultivated from select alien creatures from beyond the Rifts. Triax scientists have done extensive testing to make sure the drink is safe to consume for humans.

**Cost:** 5 credits per can.

**Bonuses:** Humans: +1 on initiative, +2 to damage in physical combat, and hyperactive. The user feels strong, powerful, aggressive and ready for action. D-Bees: Double the bonuses and the sense of power.

**Duration of bonuses & effects from consuming two or more doses:** One hour for humans, 1D4 hours for D-Bees.

**Level of addictiveness:** Minimal for humans, who would have to drink six or more cans of Metal every day to become addicted. However, D-Bees are very susceptible. If a D-Bee drinks more than 4-5 cans a week, it makes him an addict who craves 2-6 cans a day.

**Penalties:** -2 on Perception Rolls, -1 to parry and dodge, -3 to pull punch or roll with impact (just stands and takes the punch), -5% to skill performance, and the hyperactivity and aggression makes the user loud, bossy, pushy, and quick to fight when teased, laughed at, challenged or otherwise provoked. People on Metal are quick to get into brawls or take foolish risks showing off. Brawls can quickly get out of hand and cause property damage and personal injury. Addicts are irritable, short-tempered,

hyper and aggressive all the time. They like the ‘revved-up, hardcore’ feeling the drink gives them and they want it all the time. **Note:** Most popular among young males.

## Pick-Up

Pick-Up is a pill, billed as a “natural enhancer.” It is advertised as being a more adult alternative to Triax’s other energy drinks, which are mainly targeted at the younger crowd. It has a much smoother high that plateaus and falls off more slowly.

**Cost:** 50 credits per pack of 10 pills.

**Bonuses:** Improves alertness and clarity, +1 on Perception Rolls, +1 on initiative, +5% to skill performance and skills are done at a fast pace, plus the character does not feel the effects of fatigue, instead he feels energized.

**Duration of bonuses & effects from consuming one dose:** Pick-Up has no effect for the first 45 minutes after it is taken, but when it kicks in, it lasts 1D10+2 hours, after which there is an hour-long ‘cool-down’ period where the user returns to normal.

**Level of addictiveness:** Very high. After about a month of using Pick-Up, the character feels like he can only function well under the influence. Without it, he feels he is ponderous and stupid. Most people who drink Pick-Up do so before they go to work so they can become more efficient. Without it, they feel like their work is not as good, and they need Pick-Up to get back to that level of efficiency.

**Penalties:** When the high is over, the user feels exhausted: -2 on Perception Rolls, -2 on initiative, -10% to skill performance and skills take twice as long as normal to complete, plus the individual can barely keep his eyes open and needs to get 1D6+7 hours of sleep to feel like he’s back to normal. Penalties remain in place until the user of Pick-Up can get that sleep.

## Rat

“Rat” is a drink marketed primarily to inner-city dwellers. It is aimed at the self-styled “street tough” city dwellers, City Rats, punk rockers, Ghetto D-Bees, and street gangs, which means it is appealing to suburban wannabes as well. It is inexpensive and easy to find. Triax salesmen, dressed in the appropriate attire, set up booths at many local underground music spots, bars and nightclubs to sell and promote Rat. Those involved in this subculture are torn between whether or not they should like Rat. One half thinks it’s a tasty drink that identifies them with their culture and lifestyle. The other half thinks those who drink Rat are selling out and turning their lifestyle into pop-culture pablum. They would hate to admit it but they’d have to agree that it is a tasty drink, so it can’t be all that bad.

**Cost:** 10 credits per six-pack. One can is good enough for a hit.

**Bonuses:** Drinking two cans provides humans or D-Bees a nice “buzz” and mellow feeling. Drinking more has a similar effect as drinking beer or wine, reducing the individual’s inhibitions and making him feel more at ease and friendly. At the same time the drink is able to shrug off the effects of fatigue and lack of sleep for hours. Does not have the hangover effect of alcohol.

**Duration of bonuses & effects from drinking two or more cans within one hour:** Two hours for humans, half the duration for D-Bees.

**Level of addictiveness:** Roughly the same as drinking alcohol.

**Penalties:** When “buzzed” (2-3 cans an hour) the drinker is -1 on initiative, -2 on Perception Rolls, -1 on all combat moves and -10% on skill performance. Double penalties if the character is “blitzed” (has drunken 4+ cans an hour). The thing is, most people drunk on Rat don’t realize they are impaired.

## Zoom

Zoom comes in a tall can that looks like a can of spray-paint with a screw-off top. It is Triax’s highest grossing and most popular energy drink. Many humans say it tastes like battery acid with a cup of sugar added to it, but it is very popular among D-Bees. There has been some concern about Zoom since it was released as Triax’s flagship energy drink in 101 P.A., as it is the most difficult to give up drinking.

**Cost:** Three credits per can.

**Bonuses:** Drinking three cans provides +1 attack/action per melee round, +1 on initiative, and the ability to shrug off the effects of fatigue and lack of sleep for hours.

**Duration of bonuses & effects from drinking three or more cans within one hour:** 1D4+2 hours for D-Bees (half the duration for humans).

**Level of addictiveness:** Minimal unless consumed in large quantities of 3+ cans most days of the week for three weeks or more in a row.

**Penalties:** Those who become addicted to Zoom feel sluggish and lethargic: -2 attacks/actions per melee round and -15% on skill performance, except when drinking Zoom. After drinking one can, the individual feels normal for 1D4 hours (no penalties), but then sluggishness returns, so another can is desired. When something exciting or important is going on (school exam, party, dancing, etc.), the “zoom effect” is desired and three or four cans are drunk within one hour to get the bonuses above. Those addicted to Zoom drink at least three a day and need only four hours of sleep a day. However, this is an illusion and most are suffering from exhaustion without realizing it. Without Zoom for a day to keep them going, the users sleep for 2D6+10 hours straight and penalties are double for 1D6 days, before their metabolisms adjust and return to normal. Double the duration of penalties for humans.

## Cosmetics and Beauty Products

**More amazing than you might think.**

Triax makes everything from eyeliner and lipstick to moisturizers and body lotions. Being Triax that’s only the beginning, they go way beyond the norm.

### Cosmetic Perfection System

Triax has created a makeup application system that is guaranteed to be perfect every time. The user applies her makeup the way she likes it. Her face is then digitally scanned and programmed into one thousand tiny nano-bots. From that point forward, the ‘Bots can be released to apply the makeup exactly the same every time. This is done by placing a moist, electronically heated and soothing facial moisturizing towel over the face, and

lying back to enjoy the comfort of a warm face massage. There is a light but pleasant tingling sensation. 3-5 minutes later a lyrical buzzer sounds, the massage and moisturizing ends, and the towel is removed to reveal all the makeup perfectly applied to the person’s face. Variation in lipstick, eyeshadow and such can be adjusted by entering them into a pocket-sized Perfection Calibration Computer. The nano-bots do all the work in a fraction of the time and provide a comforting facial massage at the same time. The nano-bots are stored inside the application towel. The makeup never runs or smears, and is totally safe. There are 1,600 variations available via the Perfection Calibration Computer, and every woman can find her own personal and individual “look.” **Cost:** 650 credits for the complete system. Specific cosmetic items range from 2-150 credits depending on the tastes of the individual. Nano-bots need to be replaced and upgraded every three years at a cost of 300 credits. Each item has about five uses. **Bonus:** +1 to P.B. attribute for twelve hours.

### Ultimate Perfection Skin Care System

This system has nano-bots surgically implanted into the upper layers of the epidermis of the face and neck. When needed, the user simply programs into a small transmitter what she wants, and the nano-bots release chemicals into the skin to simulate the effects of make-up. They naturally color hair, smooth wrinkles, and lift skin. Wrinkles, lines, and age spots are diminished by 60% and make the person appear to be a natural-looking beauty at least 10 years younger than she is. The nano-bots actually stimulate skin cells to help retard the aging process and are programmed to find and eliminate skin cancer and alert users of any other skin diseases at their earliest onset. While the idea of having microscopic nano-robots under your skin might sound creepy to outsiders, the women (and 18% of the men) love it, insisting you don’t even know the nano-bots are there. Look young and your vibrant best 24/7. **Cost:** 5,500 credits for the initial installation of the Ultimate Perfection System. The person must return to a certified Triax Beauty Perfection Clinic for a recharge every 12+1D4 months, at a cost of 950 credits. **Bonus:** +2 to P.B. attribute and looks 3D4+7 years younger. **Note:** No additional cosmetics or CPS nano-bots are necessary, and the two nano-bot systems are not compatible. Select one or the other.

# Triax Ground Vehicles

What follows are commercial, civilian ground vehicles, presented by basic type. Almost all of these vehicles can be purchased with three different types of engines: gasoline drive, electric power and nuclear. The last is the least common as it is prohibitively expensive. Electric engines generally have a lower range per full charge, but to charge a battery costs one quarter the price of gasoline and can be done wherever electricity is available. All vehicles are made of S.D.C. materials. See **Triax WR Wilderness Class M.D.C. Vehicles** at the end of this section for Mega-Damage Capacity equivalent vehicles.

## Commercial S.D.C. Automobiles

The typical civilian automobile has changed very little since its inception at the beginning of the 20th Century. Cosmetic changes, such as more streamlined bodies, sexier colors, and trendy decorations are constantly introduced. They are cheap to own, and available to anyone with a proper license.

### S.D.C. by Location:

- Tires (4) – 20 each
- Windshield (2; front and back) – 80 each
- Door Windows (4) – 25 each
- Doors (2) – 50 each
- Main Body – 1,500 (equivalent to 15 M.D.C.)

**Speed:** 120 mph (192 km) maximum.

**Range:** Standard gasoline engine is 500 miles (800 km) per tank of fuel, 350 miles (560 km) per electric charge, unlimited for nuclear.

**Size:** 9-12 feet (2.7 to 3.6 m) long, 5 feet (1.5 m) tall, and 6 feet (1.8 m) wide. Weighs 800-1,000 lbs (360 to 450 kg).

**Crew:** One driver and three additional passengers can sit comfortably. If necessary, 2 more passengers can be squeezed in, but conditions are cramped and uncomfortable.

**Cargo Space:** There is a glove compartment in the dashboard the size of a lunch box, and 3x2x5 feet (0.9 x 0.6 x 1.5 m) of trunk space in the back.

**Cost:** 10,000-14,000 credits for a gasoline engine. 14,000-18,000 for electric, and 60,000 for nuclear.

## Luxury S.D.C. Sedan

The luxury sedan is a larger vehicle that can seat five people comfortably and is produced with higher-quality materials, and comes with many special features. The higher-ups of Triax Industries, celebrities, and some government officials drive around the NGR in these posh automobiles.

### S.D.C. by Location

- Tires (4) – 25 each
- Windshields (2) – 100 each
- Doors (4) – 65 each
- Door Windows (4) – 25 each
- Main Body – 2,000 (equal to 20 M.D.C.)

**Speed:** 130 mph (208 km) maximum.

**Range:** Standard gasoline engine is 350 miles (560 km) per tank of fuel, 250 miles (400 km) per electric charge, unlimited for nuclear.

**Size:** Typically 12-20 feet (3.6 to 6.1 m) long, 5 feet (1.5 m) tall, and 6 feet (1.8 m) wide. Weighs from 1,200 to 1,800 lbs (540 to 810 kg), depending on the size.

**Crew:** One driver, and can seat four additional passengers comfortably. Two other people can squeeze in, but conditions are cramped. Luxury limousines can seat one driver and 4-10 passengers comfortably but cost twice as much, weigh 50% more and get 30% less fuel efficiency/range.

**Cargo Space:** There is a glove compartment in the dashboard the size of a lunch box, and 3x2x5 feet (0.9 x 0.6 x 1.5 m) of

trunk space in the back. Additional compartments can be added for the cost of 2,000-8,000 credits.

**Cost:** 15,000-25,000 credits for gasoline, 20,000-30,000 for electric, and 70,000 for nuclear; double cost for a luxury limousine. Triple the price for double the S.D.C./M.D.C.

## Sports Car

Sports cars are very popular in the NGR among the wealthy and middle-class businessmen. There is an abundance of highway space to really enjoy the fast speeds and incredible handling of these prestigious cars. They are also popular in the Republic of Japan, where City Rats, Cyberoids, and Yakuza members regularly engage in high-speed street races after hours, which are highly illegal. Sports cars are less attractive among the people of the Geofront, who see them as gaudy symbols of excess. In North America, sports cars are rare, even among the rich. Many of the cities are walled in and tightly compacted, with little room to speed through, and there are few new or old pre-Rifts highways to enjoy. The few highways that do exist are patrolled by dangerous bandits and CS soldiers.

### S.D.C. by Location:

- Tires (4) – 30 each
- Windshields (2) – 90 each
- Door Windows (2) – 25 each
- Doors (2) – 55 each
- Main Body – 1,500 (equal to 15 M.D.C.)

**Speed:** 200 mph (320 km) maximum.

**Range:** Standard gasoline engine is 220 miles (352 km) per tank of fuel, 150 miles (240 km) per electric charge, and unlimited for nuclear.

**Size:** Typically 9-12 feet (2.7 to 3.6 m) long, 4 feet (1.2 m) tall, and 6-7 feet (1.8 to 2.1 m) wide. Weighs from 1,000-1,500 lbs (450 to 675 kg), depending on the size.

**Crew:** One driver, and seats one passenger comfortably. Sports cars are almost always two-seaters.

**Cargo Space:** There is a glove compartment in the dashboard the size of a lunch box, and 3x2x5 feet (0.9 x 0.6 x 1.5 m) of trunk space in the back.

**Cost:** 30,000-55,000 credits for gasoline, 40,000-65,000 electric, and 85,000-100,000 for nuclear.

## Compact Car

Currently, only European and Japanese automakers manufacture compact cars. They are all the rage among young, hip urbanites living in the cities. They are very economically priced, get excellent mileage, and can fit just about anywhere. They are not as popular in the Americas, where they are deemed “too Euro” and too little. Triax Motorwerks makes the most popular compact car in the world, a boxy, silly little thing named the “Tiny.”

### S.D.C. by Location

- Tires (4) – 15 each
- Windshields (2) – 60 each
- Door Windows (2) – 20 each

Doors (2)– 45 each

Main Body – 1,200 (equal to 12 M.D.C.)

**Speed:** 120 mph (192 km) maximum.

**Range:** Standard gasoline engine is 300 miles (480 km) per small tank of fuel, 200 miles (320 km) per electric charge, unlimited for nuclear.

**Size:** Typically 7-8 feet (2.1 to 2.4 m) long, 4 feet (1.2 m) tall, and 5 feet (1.5 m) wide. Weighs from 700-900 lbs (315 to 405 kg), depending on the size.

**Crew:** One driver, and can seat one additional passenger comfortably. These are tiny cars. A very large passenger will feel a bit cramped.

**Cargo Space:** There is a glove compartment in the dashboard the size of a lunch box, and 2x1x2 feet (0.6 x 0.3 x 0.6 m) of trunk space in the back.

**Cost:** 6,000-10,000 credits for gasoline, 11,000-15,000 for electric, and 50,000 for nuclear (rare).

## Motorcycle

Motorcycles come in a variety of shapes, sizes, and styles. In North America, a “chopper” style is more popular, especially in the Pecos Badlands. In Europe and Asia, they prefer a sleeker, more streamlined “bike.”

### S.D.C. by Location:

Tires (2) – 30 each

Main Body – 600-800 (equal to 6-8 M.D.C.)

**Speed:** 200 mph (320 km) maximum.

**Range:** Small gasoline engine is 300 miles (480 km) per tank of fuel, 200 miles (320 km) per electric charge, or unlimited for nuclear (very rare).

**Size:** Typically 5-8 feet (1.5 to 2.4 m) long, 3 feet (0.9 m) tall, and 2 feet (0.6 m) wide. Weighs from 200-600 lbs (90 to 270 kg), depending on the size.

**Crew:** One driver, some models can seat one additional passenger. A sidecar can be attached for an extra 1,000 credits that will allow one more passenger or cargo space (the sidecar typically has 200 S.D.C.).

**Cargo Space:** Small compartments, about the size of a lunchbox, can be attached to the motorcycle. Bags and sacks can also be strapped on.

**Cost:** 3,000-4,000 credits for gasoline, 7,000-10,000 for electric, and 45,000 for nuclear (very rare). Triple the price for double the S.D.C./M.D.C.

## Motor Scooter

Scooters are smaller, light motor-bikes designed primarily for urban driving and are found everywhere in the NGR and across Europe.

### S.D.C. by Location:

Tires (2) – 20 each

Main Body – 400-500 (equal to 4-5 M.D.C.)

**Speed:** 90 mph (144 km) maximum.

**Range:** Small gasoline engine is 200 miles (320 km) per small tank of fuel, 150 miles (240 km) per electric charge. Nuclear engines are not available for this vehicle.

**Size:** Typically 4-5 feet (1.2 to 1.5 m) long, 3 feet (0.9 m) tall, and 2 feet (0.6 m) wide. Weighs from 100-200 lbs (45 to 90 kg), depending on the size.

**Crew:** One driver, most models can seat one additional passenger that holds on to the driver.

**Cargo Space:** Small compartments, about the size of a lunch box, can be attached to the scooter, and so can travel bags and sacks. Some models have a lunch box sized compartment under the seat cushion.

**Cost:** 1,200-2,500 credits for gasoline or 4,000-6,000 for electric. Nuclear not available. Triple the price for double the S.D.C./M.D.C.

## Pickup Truck

The typical pickup is a utility vehicle made for hauling and pulling heavy loads. They are larger than an automobile and have a flatbed in the rear of the truck. Triax models come with an electric winch.

### S.D.C. by Location:

Tires (4) – 30 each

Windshields (2) – 100 each

Door Windows (2) – 30 each

Doors (2) – 60 each

Main Body – 2,500 (equal to 25 M.D.C.)

**Speed:** 120 mph (192 km).

**Range:** Gasoline engine is 250 miles (400 km) per tank of fuel, 180 miles (288 km) per electric charge, or unlimited for nuclear.

**Size:** Typically 14-18 feet (4.3 to 5.4 m) long, 7-9 feet (2.1 to 2.7 m) tall, and 6 feet (1.8 m) wide. Weighs from 2,000-3,000 lbs (900 to 1,350 kg), depending on the size.

**Crew:** One driver, and can seat one additional passenger in front with the driver. Some of the larger models have space behind the driver and passenger for 2-3 more passengers, but add 3,000 credits to the overall cost.

**Cargo Space:** There is a small compartment under the dashboard that can hold a few small items, and a flatbed in the back which is usually 7 feet (2.1 m) long, by 5 feet (1.5 m) wide and 2 feet (0.6 m) tall. Can carry loads as heavy as 3,500 lbs (1,575 kg) and pull up to six tons.

**Cost:** 12,000-15,000 credits for gasoline, 15,000-20,000 electric, and 60,000 for nuclear.

## Jeeps & SUVs

Jeeps and SUV style vehicles are designed for travel across rugged terrain and broken roads. In the NGR they are not very popular as most city dwellers stick to the city or well manicured parks. The countryside and wilderness areas even within the NGR’s borders are dangerous and best avoided. In North America however, these vehicles (especially those made of M.D.C. materials – main body 100-125 M.D.C.) are much more popular, at least among those who can’t afford a hover vehicle.

### S.D.C. by Location:

Tires (4) – 30 each

Windshields (2) – 100 each

Door Windows (2) – 30 each

Doors (4) – 65 each  
Rear Hatch (1) – 70  
Main Body – 3,200 (equal to 32 M.D.C.)

**Speed:** 120 mph (192 km).

**Range:** Gasoline engine is 250 miles (400 km) per tank of fuel, 180 miles (288 km) per electric charge, or unlimited for nuclear.

**Size:** 12-16 feet (3.6 to 4.9 m) long, 6-7 feet (1.8 to 2.1 m) tall, and 6 feet (1.8 m) wide. Weighs from 2,000-4,000 lbs (900 to 1,800 kg), depending on the size.

**Crew:** One driver, and can seat one additional passenger in front with the driver. Three other passengers can sit in the back, where there is either an open or hatchback cargo area, but add 3,000 credits to the overall cost.

**Cargo Space:** There is a glove compartment in the dashboard the size of a lunch box, and a small flatbed in the back which is usually 3 feet (0.9 m) long, by 5 feet (1.5 m) wide.

**Cost:** 15,000-20,000 credits for gasoline, 20,000-30,000 electric, and 65,000 for nuclear.

## Cargo Van

Cargo vans and small, paneled trucks are typically owned and operated by courier services, traveling merchants, and mail and cargo delivery services. They can haul many types of goods. The largest can even carry power armor suits. Similar stats can also be used for ambulances.

### S.D.C. by Location:

Tires (4) – 30 each  
Windshield (1, front) – 100  
Door Windows (2) – 25 each  
Door (2, front) – 60 each  
Door (1, sliding side door) – 200  
Door (2, rear) – 200 each  
Main Body – 3,500 (or 35 M.D.C.)

**Speed:** 100 mph (160 km) maximum.

**Range:** Gasoline engine is 250 miles (400 km) per tank of fuel, 180 miles (288 km) per electric charge, or unlimited for nuclear.

**Size:** 15-20 feet (4.6 to 6.1 m) long, 8-10 feet (2.4 to 3 m) tall, and 7 feet (2.1 m) wide. Weighs from 3,000 to 4,500 lbs (1350 to 2025 kg), depending on the size.

**Crew:** One driver, and sits one additional passenger comfortably.

**Cargo Space:** There is a glove compartment in the dashboard the size of a lunch box. The rear 80% of the van is cargo space. Can carry loads as heavy as 6,000 lbs (2700 kg) or pull a comparable weight.

**Cost:** 14,000-20,000 credits for gasoline, 19,000-30,000 for electric, and 60,000 for nuclear.

## Commercial Bus

A bus is a transport vehicle that may be used for public transportation by public transit systems, schools, churches, community groups, tour companies, and private industry. Public bus services are government run operations that charge passengers a nominal fee (a credit or two) to help pay for fuel and maintenance.

Most public systems use electric engines. They make wonderful transports for commuters, workers, soldiers, slaves, prisoners or very large families. In a pinch, they can also carry supplies and other goods.

### S.D.C. by Location:

Tires (6) – 32 each  
Windshield (1, front) – 110  
Passenger Windows (30) – 25 each  
Doors (3, one front, one side, one rear emergency) – 90 each  
Main Body – 7,000 (or 70 M.D.C.)

**Speed:** 100 mph (160 km) maximum.

**Range:** Standard gasoline engine is 300 miles (480 km) per tank of fuel, 200 miles (320 km) per electric charge, and unlimited for nuclear.

**Size:** 30-35 feet (9.1 to 10.7 m) long, 10-12 feet (3 to 3.6 m) tall, and 8 feet (2.4 m) wide. Weighs 5,000 to 6,000 lbs (2,250 to 2,700 kg).

**Crew:** One driver, and comfortably seats 40-50 passengers depending on the design and size of the vehicle. Another 20-25 passengers can be squeezed in under cramped conditions.

**Cargo Space:** There is typically space under the seats and overhead racks for small packages and carry-on baggage, and some buses have a large storage compartment in the undercarriage of the vehicle that can stow up to 2.5 tons of suitcases and packages. The latter is only in buses made for long distance travel.

**Cost:** 30,000-45,000 credits for gasoline, 40,000-55,000 for electric, and 85,000-90,000 for nuclear.

## Armored Security Vehicle

Armored cars are the only vehicles that can have their armor legally upgraded (except in the CS, where additional armor is still illegal) to Mega-Damage alloys. The vehicle is used to transport money, gold, gemstones, valuable documents, stocks and bonds, computer data files, rare and valuable artifacts, magic items, works of art, and sometimes munitions, weapons, hazardous materials, and even important people or prisoners.

### M.D.C. by Location:

Tires (6) – 30 M.D.C. each  
Windshield (1, front) – 50 M.D.C.  
Door Windows (2, small) – 26 M.D.C. each  
Driver & Passenger Doors (2, total) – 95 each  
Rear Double-Doors (2 doors) – 120 each  
\* Main Body – 200 M.D.C.  
\* Military armored security vehicle has 300 M.D.C.

**Speed:** 100 mph (160 km) maximum.

**Range:** Standard gasoline engine is 220 miles (352 km) per tank of fuel, 150 miles (240 km) per electric charge, and unlimited for nuclear.

**Size:** Typically 20 feet (6.1 m) long, 10 feet (3 m) tall, and 7 feet (2.1 m) wide. Weighs about five tons.

**Crew:** One driver and one additional passenger in the front. The passenger is typically a guard riding shotgun.

**Cargo Space:** There is a glove compartment in the dashboard the size of a lunch box. The rear 80% of the truck is cargo



space. Some are outfitted with folding shelves and tie-straps for cargo. Only armored cars specially designed to transport important personnel or prisoners have seats. Can carry loads as heavy as 10 tons.

**Cost:** 200,000 for gasoline, 230,000 for electric, and 260,000 for nuclear; add 30% to the cost of military grade vehicles.

**Note:** An *economy version* with half the M.D.C. across the board costs half as much in all categories.

## 16-Wheel Cargo Truck & Trailer

These enormous trucks look pretty much as they did in pre-Rifts days only the cabs are a bit more sleek and stylized. They are able to carry massive amounts of cargo across hundreds of miles. They are very popular in the NGR, Poland and Russia (as well as North America, particularly in the New West and along the Arzno Great Trade Road).

### S.D.C. by Location:

Tires (16) – 45 each

Windshield (1, front) – 120

Door Windows (2) – 30 each

Doors (2, truck) – 90 each

Truck/Cab (front) – 8,000 (equal to 80 M.D.C.)

Trailer – 5,000 (or 50 M.D.C.)

**Speed:** 100 mph (160 km).

**Range:** Standard gasoline engine is 400 miles (640 km) per full tank of fuel, 300 miles (480 km) per electric charge, and unlimited for nuclear.

**Size:** Trailer is roughly the size of a pickup truck only taller. The trailer can range from 26-40 feet (7.9 to 12.2 m) long, 15 feet (4.6 m) tall, and 7-9 feet (2.1 to 2.7 m) wide. The truck and trailer weigh 10-12 tons empty and can carry loads ranging from 65,000 to 90,000 lbs (29,250 to 40,500 kg).

**Crew:** One driver and one passenger in the front of the truck. Some come with a bigger cab for additional passengers (2-3) to sit, most come with a sleeping compartment with two bunks.

**Cargo Space:** There is a glove compartment in the dashboard the size of a lunch box. Behind the seats there is a sleeping area just big enough for two people and some extra storage. The trailer can range in size up to 40 feet (12.2 m) long. Can carry loads ranging from 65,000 to 90,000 lbs (29,250 to 40,500 kg).

**Cost (Truck and Trailer):** 90,000-120,000 for gasoline, 140,000-150,000 for electric, and 190,000-220,000 for nuclear.

## Triax Hover Vehicles

Hover vehicles move on a cushion of air. The originating technology dates back to the mid-20th Century, although the hover-systems were archaic and primitive compared to what was available in the Golden Age of Man and the modern post-Rifts era. Hovercraft technology, as it is known today, was developed around 2035 by a German automobile company that was eventually bought out and absorbed by Triax. Triax tried, unsuccessfully, to secure a dedicated patent on the technology, but the technology became available to all manufacturers. Soon hover cars and vehicles filled the roads.

It is important to point out that hover vehicles are *NOT* flying cars, but ground vehicles that ride along the ground on a cushion of air 1-3 feet (0.3 to 0.9 m) above the ground. In an emergency or when doing stunts, the vehicle can go a bit higher, 4-6 feet (1.2 to 1.8 m), but that's it. The advantage to hover vehicles is less wear and tear on the roads, and the vehicles can go off road and handle any terrain. They can glide across dirt, sand and gravel, broken pavement, mud, chunks of debris, and over a rock slide. The vehicles can even go over shallow bodies of water (no deeper than six feet/1.8 m). Adventurers and mercenaries love them, because there are so few roads out in the wilderness. Highways have disappeared and bridges have long collapsed. Hover vehicles can cut down a trip from a full day to only a few hours.

Although every technological-based nation on Rifts Earth has the capability to produce hover vehicles, the Northern Gun and Triax models are arguably the most popular among civilians and adventurers alike. What follows below are some common, commercial Triax hover vehicles in the NGR. These are not combat models and are unfit for combat use.

Other than the fact they can hover on jets of air, hover vehicles are not too different from normal cars in basic form and functionality. They do handle very differently, and anyone who can drive a car can *not* just fly a hover car or hovercycle; -40% skill penalty to piloting/driving skill, and -60% to perform stunts and control rolls.

The cost of hover vehicles is high as the demands on the vehicle require a considerable amount of energy. A gasoline based hover engine would barely get six miles (9.6 km) to a gallon of petrol/gasoline, limiting a 10 gallon tank to a short 60 mile (96 km) range. Electric energy systems with several batteries were selected as the alternative, providing a four battery system a range of 160 miles (256 km) before needing to recharge; 40 miles (64 km) per battery. Which is perfect for the average citizen of the NGR. Nuclear power systems are superior and offer effectively unlimited travel over the 15-20 year life of the power supply. However, the nuclear system costs 40,000 credits before the rest of the vehicle is even factored in.

To avoid kamikaze or demolition derby behavior from drivers, the NGR requires all commercial hover vehicles to be made of S.D.C. materials. Only military grade vehicles and WR Wilderness Class vehicles (not allowed within the borders of the NGR) are made of M.D.C. materials. **Note:** See **Triax WR Wilderness Class M.D.C. Vehicles** at the end of this section for Mega-Damage Capacity equivalent vehicles.

## Triax Hovercycle

You might think of a hovercycle as a motorcycle on steroids. It is a fast, sweet ride that has quick response, superior mobility and stops on a dime. As hover vehicles go, they are inexpensive.

### S.D.C. by Location:

Hover Jets (2 or 3) – 60 each

Maneuvering Jets (4-6) – 12 each

Windshield (1) – 16

Main Body – 800 (or 8 M.D.C.)

**Speed:** 200 mph (320 km).

**Range:** Electric power system and engine is 200 miles (320 km) per electric charge, or unlimited for nuclear.

**Size:** 6-9 feet (1.8 to 2.7 m) long, 3 feet (0.9 m) tall, and 2 feet (0.6 m) wide. Weighs from 500-700 lbs (225 to 315 kg), depending on the size.

**Crew:** One driver, one additional passenger can sit snugly behind and must hold onto the driver. Sidecar not available.

**Cargo Space:** Small compartments, about the size of a lunch box or saddlebags, can be attached to the hovercycle.

**Cost:** 20,000-25,000 credits for electric, and 55,000-65,000 credits for nuclear. Triple the price for double the S.D.C./M.D.C.

## Triax A-Type Hover Car

These vehicles make up 51% of Triax's auto sales. They are aimed at the average consumer with literally dozens of different models and body styles. If all you need is something inexpensive (for a hover car) and dependable to get you back and forth to work, this is the vehicle for you. A-Types are easily modified by any authorized Triax Motorwerks dealer. Any modification costs 25% less when added to an A-Type. Triax does this to keep the customer coming back for more.

### S.D.C. by Location:

Hover Jets (4, main) – 70 each

Maneuvering Jets (6) – 15 each

Windshields (2) – 100 each

Door Windows (2) – 20 each

Doors (2) – 70 each

Main Body – 1,600 (equal to 16 M.D.C.)

**Speed:** 130 mph (208 km).

**Range:** Electric power system and engine is 160 miles (256 km) per electric charge, unlimited for nuclear.

**Size:** 10-14 feet (3 to 4.2 m) long, 5 feet (1.5 m) tall, and 6 feet (1.8 m) wide. Weighs 1,000-1,200 lbs (450 to 540 kg).

**Crew:** One driver and three additional passengers can be seated comfortably. If necessary, 1-2 more passengers can be squeezed in under cramped conditions.

**Cargo Space:** There is a glove compartment in the dashboard the size of a lunch box and a small 2x2x3 foot (0.6 x 0.6 x 0.9 m) trunk space in the back.

**Special Features:** A-Types come standard with the following features: Anti-theft alarm and siren, voice activated locks and ignition, calendar and clock, digital gyro-compass, two disc CD player and digital radio stereo system.

**Cost:** 60,000-70,000 for electric, and 90,000-120,000 for nuclear.

## Triax Z-Type Luxury Hover Sedan

If you're a young, rich executive or a pop culture icon, or even if you just want to drive like the wealthy and famous, then you need a Z-Type. Triax gave these cars a designation far removed from their other vehicle lines to let drivers know that the Z-Type is something special. Faster, sexier, and more fun than any other vehicle Triax manufactures, the Z-Type is the "it" car that everyone dreams of. It handles incredibly well, even at high speeds, and comes standard with a large helping of fancy fea-

tures designed to give the buyer the ultimate comfortable driving experience. If you want to ride in style, you want to ride in a Triax Z-Type.

### S.D.C. by Location:

Hover Jets (4, main) – 100 each

Maneuvering Jets (10) – 20 each

Windshields (2) – 100 each

Door Windows (4) – 20 each

Doors (4) – 80 each

Main Body – 2,200 (equal to 22 M.D.C.)

**Speed:** 170 mph (272 km) maximum.

**Range:** Standard four battery electric power system and engine is 160 miles (256 km) per electric charge, unlimited for nuclear. A six battery system is available for 25,000 additional credits (240 mile/384 km range before needing to recharge).

**Size:** 12-18 feet (3.6 to 5.5 m) long, 5 feet (1.5 m) tall, and 6 feet (1.8 m) wide. Weighs from 1,300-1,800 lbs (585 to 810 kg), depending on the size.

**Crew:** One driver, and can seat four passengers comfortably, six under cramped conditions. Limousines can seat 4-10 passengers depending on the size and range from 16-20 feet (4.9 to 6.1 m).

**Cargo Space:** There is a glove compartment in the dashboard the size of a lunch box and 3x3x5 feet (0.9 x 0.9 x 1.5 m) of trunk space in the back.

**Special Features:** Z-Types come standard with the following features: Anti-theft alarm and siren, voice activated locks and ignition, dashboard computer (with high-speed broadband internet access from anywhere in the NGR), calendar and clock, digital gyro-compass, 10 disc CD player, digital radio stereo system, and an advanced active hover suspension system that provides +5% to Piloting skill rolls. It also has a complete environmental seal with computerized atmospheric compensation (the car automatically cools or heats the interior to a pleasant 72 degrees Fahrenheit or setting of choice), sound proofing, and independent air filter and oxygen supply (good for 6 hours of breathable air). Limousines come standard with bar, retractable onboard computers and printers, a deluxe sound system, digital recorder and player, spotlight and sunroof.

**Cost:** 85,000-110,000 for electric, and 140,000-160,000 for nuclear.

## Triax S-Type Hover Sports Car

If you're a young, rich executive or a pop culture icon and don't want the Z-Type Sedan, then you probably want the S-Type Sports Car. Sleek, hot and faster than a bat out of Hell. It handles incredibly well, even at high speeds, and comes standard with a large helping of fancy features.

### S.D.C. by Location:

Hover Jets (6, main) – 100 each

Maneuvering Jets (8) – 20 each

Windshields (2) – 100 each

Door Windows (2) – 20 each

Doors (2) – 80 each

Main Body – 1,800 (equal to 18 M.D.C.)

**Speed:** 230 mph (368 km) maximum.

**Range:** Standard four battery electric power system and engine is 160 miles (256 km) per electric charge, unlimited for nuclear. A six battery system is available for 25,000 additional credits (240 mile/384 km range before needing to recharge).

**Size:** 9-13 feet (2.7 to 3.9 m) long, 5 feet (1.5 m) tall, and 6 feet (1.8 m) wide. Weighs from 1,100-1,400 lbs (495 to 630 kg), depending on the size.

**Crew:** One driver and one passenger.

**Cargo Space:** There is a glove compartment in the dashboard the size of a lunch box and a small 2x2x3 foot (0.6 x 0.6 x 0.9 foot) trunk space in the back.

**Special Features:** S-Types come standard with the following features: Anti-theft alarm and siren, voice activated locks and ignition, dashboard computer (with high-speed broadband internet access from anywhere in the NGR), calendar and clock, digital gyro-compass, 5 disc CD player, digital radio stereo system and an advanced active hover suspension system that provides +5% to Piloting skill rolls. It also has a complete environmental seal with computerized atmospheric compensation (the car automatically cools or heats the interior to a pleasant 72 degrees Fahrenheit or setting of choice), and independent air filter and oxygen supply (good for 6 hours of breathable air).

**Cost:** 75,000-100,000 for electric, and 130,000-150,000 for nuclear.

## Triax B-Type Hover Work Vehicles

The B-Type series are a variety of work vehicles for hauling cargo and other utilitarian purposes. Examples of B-Type vehicles include full-size cargo vans, small trucks and hover pickup trucks with a large bed for hauling.

### S.D.C. by Location:

Hover Jets (5, main) – 100 each

Maneuvering Jets (6) – 25 each

Windshields (2) – 100 each

Door Windows (2) – 20 each

Doors (2) – 80 each

Main Body – 3,200 (equal to 32 M.D.C.)

**Speed:** 130 mph (208 km) maximum.

**Range:** Standard four battery electric power system and engine is 120 miles (192 km) per electric charge, unlimited for nuclear. A six battery system is available for 25,000 additional credits (180 mile/288 km range before needing to recharge). **Note:** More energy is expended to carry heavy loads.

**Size:** 18-26 feet (5.5 to 7.9 m) long, 7-12 feet (2.1 to 3.6 m) tall, and 7-8 feet (2.1 to 2.4 m) wide. Weighs 2-3 tons depending on the size.

**Crew:** One driver and one passenger is standard, with space for a third to slide in under cramped conditions.

**Cargo Space:** There is a glove compartment in the dashboard the size of a lunch box. The rear 80% of the truck is cargo space. Some are outfitted with folding shelves and tie-straps for securing cargo. Can carry loads as heavy as 8-12 tons depending on the size of the vehicle.

**Special Features:** Comes standard with anti-theft alarm and siren, voice activated locks and ignition, dashboard computer (with high-speed broadband internet access from anywhere in

the NGR), calendar and clock, digital gyro-compass, five disc CD player, digital radio stereo system and an advanced active hover suspension system that provides +5% to Piloting skill rolls.

**Cost:** 290,000-320,000 credits for electric and 370,000-450,000 for nuclear.

## Triax WR Wilderness Class – M.D.C. Vehicles

Vehicles with the “WR” classification are light combat vehicles designed for use outside the borders of the NGR. They can be purchased in the NGR but delivery must take place outside the country’s borders and the M.D.C. vehicles are illegal in the NGR except for military use and limited use by Triax (i.e. test runs and delivery outside the country). WR Class vehicles are very popular with mercenaries, adventurers, explorers, traveling merchants and Gypsies. The German Black Market has tried to start selling WR vehicles as a Triax brand in North America, but many don’t know and don’t believe WR vehicles are made by Triax, and WR brand sales are light. It is only the famous Triax weapons and vehicles “officially” used by the Army of the NGR that rate top interest and big bucks. In addition, Northern Gun and other American manufactured vehicles are much more popular.

A few WR Class vehicles appear in **Rifts® World Book Five: Triax and the NGR™**, pages 138-140. **Note:** Although the Wilderness Crusader has the designation “MZ-10,” it is officially considered a part of the WR class of vehicles.

**M.D.C. Vehicle Note:** M.D.C. equivalents for *all vehicles* described in the previous pages are available as WR Class vehicles. The cost is the price listed plus 2,000 credits for every one M.D.C. point assigned to the main body, with a minimum of 50 M.D.C. and a maximum M.D.C. limit of 220 M.D.C. for hovercycles and cars; 320 M.D.C. for trucks bigger than a pickup. Weapon systems cost extra, typically 35,000-100,000 credits each (the greater the damage, the higher the price).

## WR-3030 “Bear” All-Terrain Vehicle

A fast, rugged, motorcycle-sized quad-wheeled vehicle which is highly popular with all sorts of wilderness folk, small bandit gangs, Gypsies, and young people living in small villages and rural areas. It can handle forest trails, muddy ground, and mountain passes as well as it can handle pavement.

**German Name:** Der Bär

**Vehicle Type:** Automobile/Motorcycle.

**Class:** Civilian.

**Crew:** One pilot; can seat one additional passenger.

**M.D.C. by Location:**

Forward Headlight – 5

Tires (4) – 5 each

Main Body – 60

**Maximum Speed:** 150 mph (240 km).

**Length:** 8 feet (2.4 m).

**Weight:** 1,200 lbs (540 kg).

**Cargo:** None.

**Power System:** Gasoline or electric (nuclear costs an additional 1.4 million credits).

**Range:** Standard gasoline engine is 500 miles (800 km) per tank of fuel, 350 miles (560 km) per electric charge, unlimited for nuclear.

**Weapons and Sensor System:** Optional, though it is very uncommon for weapons to be attached.

**Additional Main Body Armor:** 25,000 credits per 10 M.D.C.; a total of 50 M.D.C. can be added.

**Market Cost:** 135,000 credits for a gasoline engine. 145,000 for electric, and 196,000 for nuclear.

## Other Manufacturers

Triax isn't the only manufacturer in Europe. There are hundreds of smaller corporations, producing anything and everything that is available in the modern New German Republic. Even among high-tech goods, there are dozens of companies competing with Triax for lucrative government and mercenary contracts, and the favor of the fickle NGR consumers.

Presented below are two such companies, both based in the NGR, selling mainly to customers in Germany, Poland, Russia and mercenaries, adventurers and outlaws around these places. The companies are too small to export anywhere else. The influence of the German Black Market is such, however, that the products of these smaller manufacturers can be found, albeit in smaller quantities, in other regions, and even in North America. Sometimes, to help unload them faster and at an inflated price, the Black Market makes the *false claim* that weapons and vehicles built by a smaller company are actually made by Triax, in order to use the name to boost sales. Triax weapons, armor, and vehicles, are famous for being the best around, and are highly coveted by mercenary companies, as well as kingdoms afraid of the Coalition States or any number of nefarious groups that are a danger to innocent people.

## RRK Korporation

### Rüstung-An-Der-Rhein Korporation

Abbreviated to simply RRK, this company got their name from the Rhein river which flows through the city of Köln, where the company was founded. RRK was originally started by German weapon smugglers who, for reasons unknown, left the Verbrecher-Geschäftsnetz (VNG) in order to go into legitimate business.

RRK is Europe's leading manufacturer of commercial armored vehicles available on the *open market*. RRK has recognized this as an opportunity, and are working to corner the civilian market. They also do custom alterations, weapon additions, hover conversions and add armor to all brands of vehicles, not just their own.

RRK also manufactures and markets a small selection of environmental body armor and power armor, but all of them are knock-offs of Northern Gun. Ishpeming, through very discreet investigation, has learned that the armor was simply copied and modified from existing NG products. They are extremely upset

about the blatant theft of their designs without any royalties or compensation, and are appealing to the NGR government for action. If the NGR chooses not to intervene (which is likely the case), Northern Gun has other methods for dealing with unscrupulous "thieves."

RRK environmental body armor has been modified so that it only slightly resembles NG armor, but the differences are mainly cosmetic, i.e. different colors and paint stylizations, helmet, fins and frills. However, these knock-offs are not as good in quality as NG products and this has compromised the design. As a result, RRK armor products have 20% less M.D.C. and 30% less speed and bonuses (as applicable) than the NG equivalent models they copy. Still, some German adventurers prefer RRK armor to NG because RRK armor can be bought directly from the company and costs 30% less than Black Market Northern Gun products.

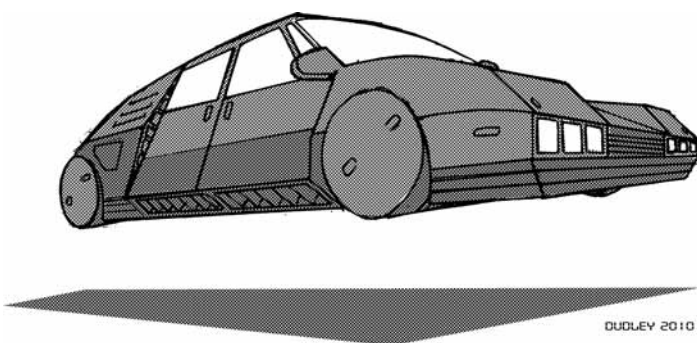

## RRK Oberteil Armored Hovercar

The Oberteil sedan is an M.D.C. armored hover car. The vehicle is reliable and offers good protection. It is sold without weapons, but weapons and other customized features can be added for additional costs. Like WaffenTek, Oberteil is happy to customize the vehicle to the customer's needs.

The Oberteil is illegal within the borders of the NGR without a special permit from the government (rare). Thus, like most M.D.C. vehicles, it is sold to other countries, mercenaries and adventurers outside the NGR. RRK also sells to the Black Market, who functions as their distributor to "specialty markets" like North America. Since Triax's sales to the North American market look they it will be limited to the Coalition States and Free Quebec, RRK and its Black Market partner hopes to sell its M.D.C. vehicles to the rivals and enemies of the CS. Again, breaking into the already competitive American market when Northern Gun and others have a stranglehold seems like an upward battle.

### M.D.C. by Location:

Hover Jets (4, undercarriage) – 50 each

Maneuvering Jets (6) – 15 each

Windshield (1, front) – 50

Door Windows (4) – 15 each

Doors (4) – 90 each

Main Body – 220

**Speed:** 150 mph (240 km).

**Range:** Electric power system and engine is 160 miles (256 km) per electric charge, unlimited for nuclear.

**Size:** 14 feet (4.3 m) long, 5 feet (1.5 m) tall, and 6 feet (1.8 m) wide. Weighs two tons.

**Crew:** One driver and 4 passengers comfortably, six squeezed in tight.

**Cargo Space:** There is a glove compartment in the dashboard the size of a lunch box and a 3x2x5 foot (0.9 x 0.6 x 1.5 m) trunk space in the back.

**Standard Features:** Anti-theft alarm and siren, key locks and ignition, calendar and clock, digital gyro-compass, and digital radio stereo system. Up to three weapon systems and six non-weapon features can be custom added to the vehicle.

**Cost:** 410,000 for electric, and 475,000 for nuclear.

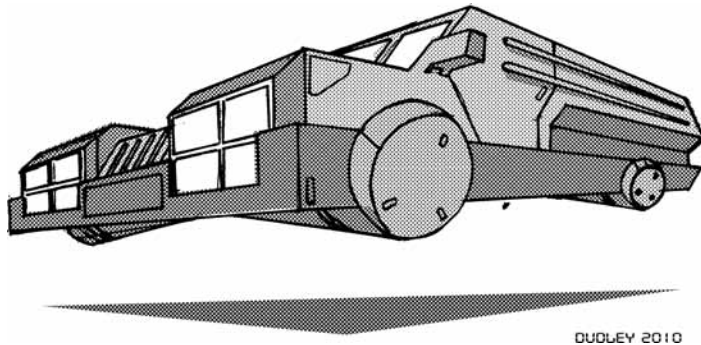

## RRK Super-Armored Hover Truck

The RRK Super-Armored Hover Truck has as much armor built into it as some tanks. The potential for abuse with such a heavy-armored vehicle is high. Regardless, it is very popular among security companies, banks, collectors of art and pre-Rifts artifacts, wilderness merchants, adventurers, mercenaries and Gypsies. It is illegal within the borders of the NGR.

### M.D.C. by Location:

Headlights (2 sets) – 10 each

Hover Jets (4, undercarriage) – 90 each

Maneuvering Jets (6) – 20 each

Windshield (1, front) – 50

Door Windows (4, slits) – 15 each

Doors (4) – 120 each

Main Body – 525

**Speed:** 100 mph (160 km).

**Range:** Electric power system and engine is 120 miles (192 km) per electric charge due to the weight, unlimited for nuclear.

**Size:** 25 feet (7.6 m) long, 10 feet (3 m) tall, and 8 feet (2.4 m) wide. Weighs 10 tons.

**Crew:** One driver and one passenger comfortably, unless it has an expanded passenger compartment (add 25,000 credits to the cost and reduce the cargo space by 15%), in which case it can hold three additional passengers comfortably, four cramped.

**Cargo Space:** There is a glove compartment in the dashboard the size of a lunch box and 80% of the truck is cargo space.

**Standard Features:** Comes with an independently controlled environmental cargo room, voice-activated electronic locks, anti-theft alarm and siren, and a remote controlled lockdown feature that allows the driver of the vehicle to disable the engine

in case the truck is stolen. Up to five weapon systems and eight non-weapon features can be custom added to the vehicle.

**Cost:** 2 million credits for electric, and 2.3 million for nuclear.

## WaffenTek Vehicles

The majority of WaffenTek's revenue comes from their vehicles, the most notable of which is described below. They have turned some of this money around and invested in the small arms market. They sell their weapons to mercenaries on a budget, adventurers, and Gypsies. Their profits from vehicles allow them to keep the prices low on their energy weapons, which makes them very attractive. They can be found throughout Europe; even the poorest and most rural village may have one or two WaffenTek items laying around.

Unfortunately, there is a mentality of "you get what you pay for" among some critics of WaffenTek. Some believe that their inexpensive weapons are poorly designed and cheaply manufactured. Neither is really true. It is unfair to compare WaffenTek to manufacturing giant Triax, but it is unavoidable. Still, all things considered, WaffenTek has its share of customers who seem very satisfied with their purchases.

WaffenTek vehicles are designed with speed, maneuverability, and light construction in mind. They are produced in direct competition with the Triax WR Wilderness brand as well as Northern Gun and their assortment of hovercycles and the famous Sky King. WaffenTek's famous slogan in their advertising campaign are, "Speed is Life" and "Fast is Fun." Flying down the highway at breakneck speed is exciting, gets the blood flowing, and keeps you young. Or so their marketing department would have you believe. Since these are M.D.C. vehicles, they are not legal within the borders of the NGR and are marketed to wilderness people, mercenaries, adventurers and the people of Poland and other nearby countries.

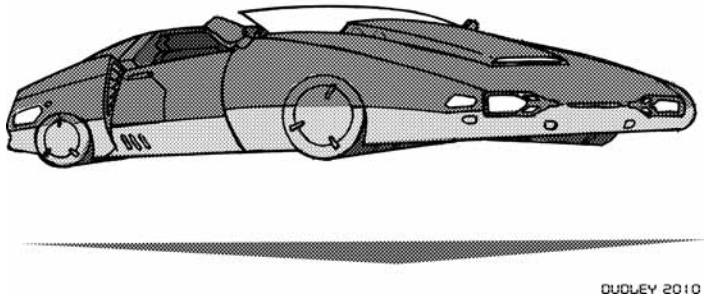

## WaffenTek BlitzSchnell

The WaffenTek BlitzSchnell (or "lightning fast") is one of the fastest hover cars available. It was designed with pure speed and acceleration in mind and is nearly as fast as some military vehicles, and in direct competition with Triax's WR 2020 Shark Bullet Bike. To some, it is considered WaffenTek's flagship vehicle, and still manages to generate more profits than any other vehicle in their catalogue. It has a sexy, compact design, and comes in a variety of colors.

### M.D.C. by Location:

Rocket Jets (2, rear) – 60 each

Hover Jets (4, undercarriage) – 40 each

Maneuvering Jets (8) – 10 each  
Windshields (2) – 40 each  
Door Windows (2) – 10 each  
Doors (2) – 70 each  
Main Body – 160

**Speed:** 275 mph (440 km).

**Range:** Electric power system and engine is 160 miles (256 km) per electric charge when driving under 200 mph (320 km), but 120 miles (192 km) when going faster due to the increased energy drain for very high speeds; unlimited for nuclear.

**Size:** 11 feet (3.3 m) long, 4 feet (1.4 m) tall, and 7 feet (2.1 m) wide. Weighs 1,000-1,200 lbs (450 to 540 kg).

**Crew:** One driver and one passenger only.

**Cargo Space:** There is a glove compartment in the dashboard the size of a lunch box and a 2x2x4 foot (0.6 x 0.6 x 1.2 m) trunk space in the back.

**Standard Features:** Anti-theft alarm and siren, voice activated locks and ignition, calendar and clock, digital gyro-compass, two disc CD player and digital radio stereo system. Up to two weapon systems and five non-weapon features can be custom added to the vehicle.

**Special Bonus:** The BlitzSchnell is so well-designed and responsive that it confers a bonus of +5% to Piloting skill rolls.

**Cost:** 379,000 for electric, and 435,000 for nuclear.

## Available Features for Vehicles

The following features can be added to any vehicle by an authorized dealer or specialist in vehicular customization, including RRK and WaffenTek. Having the dealer do the work is frequently cheaper and faster as private specialists charge 20-30% more than the prices listed. However, private specialists are usually willing to keep their clients' names confidential and are happy to install illegal weapons and other systems.

Adding weapons, heavy armor, force fields, and some other packages are illegal in some places (such as the NGR and CS), and frowned upon in most other civilized cities. In the NGR, being caught with an illegal modification results in the vehicle being confiscated and the owner being fined 2D6x1,000 credits for each illegal modification. Especially dangerous vehicles can land the offending individual in prison for 1D6+1 years, and if linked to a criminal or terrorist organization/group or used to murder, the prison sentence is 1D6x10+10 years in prison. If the tricked out vehicle is used in the commission of any non-violent crime the prison sentence is 2D6+2 years. In places like Russia and the Coalition States, the offenders are probably shot.

The prices below are just for the system, characters will still have to pay for installation. Authorized Triax, RRK, and WaffenTek dealerships can do most modifications for 30-40 credits an hour, with small jobs taking 1D4 days and larger jobs taking 4D6+6 days; double the hourly fee for rush jobs in half the time. Triax employees usually have an eight hour workday. Private specialists tend to charge 50-60 credits an hour for labor, and Black Market Operators charge 80-100 credits an hour, and put in 10-12 hour workdays.

The modifications can be made to S.D.C. and M.D.C. vehicles.

**Anti-Theft Alarm and Siren.** Alternates between six different loud, blaring noises that can be heard up to one mile (1.6 km) away. Can be deactivated with a small remote control. Cost: 800 credits.

**Atlas Computer Program.** Displays city maps, roadways and trails. Can also give directions from one point to another. The general atlas program shows the entire European continent, general geographic features (mountains, forests, rivers, etc.), the locations of major nations, major cities, and major trouble spots. Some places will have more detail than others. Inhabited and well mapped areas like the NGR and Poland will have much more information and details than the Gargoyle Empire and wilderness areas. This information can be presented in a variety of formats, including basic maps, and 3D-rendered virtual landscapes. Specific discs are available for the roads and streets of major cities, including each NGR, Polish and Russian city/city-state and other major communities. The other technological nations of Rifts Earth each have their own software and maps which are mostly compatible with each other (except for the Geofront, who intentionally strike their cities from maps and atlas programs). Of course, the environment and communities are constantly changing so the information is only 75% accurate and updates are issued regularly. An atlas more than a year old will only be 50% accurate and places like the wilderness areas, border towns and mercenary operations change constantly so they are NOT included at all. Cost: 300 credits of the basic program, specific places cost 100 credits each.

**Backup Fuel Source.** The vehicle is equipped with an additional electrical or gasoline energy source for emergencies. Cost: 8,000 credits for an extra full size gas tank (400 mile/640 km range for a typical car), 2,000 for an extra "mini-gas tank" (20 mile/32 km range). 14,000 credits for an extra battery (60 miles/96 km) tied into an existing electric power system and engine. Four battery car systems can take a maximum of three additional electric batteries, a six battery system can only take one extra.

**Boost Jump System.** This is a common knock-off of the Jump Jet system belonging to some American combat bikes. It can launch a vehicle a length equal to five feet (1.5 m) for every mile (1.6 km) per hour being traveled. The height of the launch is equal in inches to double the vehicle's speed in miles per hour. For example, a car going 100 mph would jump 500 feet (152 m) across and 200 inches, or around 17 feet (5 m), high. Included in the cost are special shocks that keep the vehicle from bouncing itself to pieces upon landing. The boost fuel tank has enough juice for five jumps, after which it must be refueled. Cost: 40,000 credits for the Boost Jump System, refueling the tank costs 500 credits.

**Calendar and Clock.** Keeps accurate date and time on a digital display. Cost: 100 credits.

**Custom Paint Job/Decals.** Cost: 100 credits each for simple, basic work. 200-1,500 depending on how fancy the buyer wishes to get. 2,000-12,000 credits for custom, airbrush painted work or to completely repaint the vehicle.

**Computer and Monitor built into the dashboard.** Fitted with wireless broadband internet access. Will not work more than five miles (8 km) away from cities with internet. Cities of the NGR, Poland, Geofront, and the Republic of Japan have

broadband wireless internet access. This is usually not the case in North American cities and most other places. Cost: 5,000 credits.

**D-Bee Pilot Modification (illegal).** Illegal in the CS and frowned upon in the NGR. It's a simple fact that humans design, build, and operate the majority of vehicles on the planet. Naturally, their vehicles are designed to accommodate the human body type and similar humanoids. But what if you have four arms? What if your head is twice the size of your body? What if your body is a giant eyeball with a mass of tentacles growing out of it? Driving a vehicle intended for humans is going to be near-impossible, or at the very least, quite uncomfortable. Customizing a vehicle for an alien physiology is an expensive procedure, especially for the pilot's compartment to be completely refitted to accommodate a non-humanoid body shape. This will give the pilot +5% to all control rolls, though creatures of a different body type (including humanoids) will be at -20% to all control rolls. Cost: 2,000-8,000 credits to modify and compensate for most humanoid D-Bees, 20,000-40,000 credits to compensate for massive size and non-humanoid life forms.

**Digital Gyro-Compass.** Cost: 100 credits.

**Digital Radio and Audio Disc Player.** Every vehicle comes standard with an AM/FM/HD radio with a range of about 100 miles (160 km). Most cities and kingdoms have radio stations that play anything and everything that was available from before the Great Cataclysm. Local stations (like the CS) may flood these open channels with propaganda or warnings to outsiders, D-Bees and monsters. For those with a bit more discriminating tastes, they can listen to whatever they want with this fancy system, as it can also play digital audio files in three different formats. Cost: 2,500 credits.

**Digital Video Disc and Holodisc Player.** A digital disc player and one display screen/monitor for the playing of recorded films, TV shows, archival and video data/research films, and similar recordings. Can be tied to an onboard computer or connected to a portable computer, cyborg or other data containment system and plugged into with a Universal Jack/Data Plug. Cost: 5,000 credits. A second monitor/view screen to watch the same data costs an additional 500 credits.

**Ejection Seat (illegal).** In case of an emergency, the pilot and any passengers can be instantly ejected (about 1,000 feet/3,048 m) into the air and parachute to safety. Cost: 1,500 credits per seat.

**Engine Diagnostic Readout, Advanced.** The instrument panel is modified to include a tachometer, temperature and oil pressure gauges, fuel mix indicator, and battery's charge on a digital readout. As an advanced diagnostic system, there is also a small screen that runs a constant stream of data that can be read at a quick glance indicating more complex issues and concerns about the engine, fuel leaks, damage to the vehicle, loss of sensors and wheels, the reason for overheating and other engine problems, and similar. Bonus: Diagnosis is equal to Automotive, Aircraft or Robot Mechanics skill, depending on what the vehicle is, at 80% proficiency, but only as it applies to *identifying the problem*. It is *no* good at making repairs and cannot talk someone through doing repairs. Cost: 12,000 credits. For an additional 5,000 credits a calm male or female voice will speak to inform the pilot of engine and vehicle performance issues.

**Environmental Pilot's Compartment (illegal).** The cab/driver's area has 40 M.D.C. and is airtight, with an independent oxygen supply, air-conditioning, and heating system, air purification and circulatory system (good for up to 24 hours). Cost: 50,000 credits, double cost to include the passenger area as well.

**External Audio Pickup.** A sound amplification listening system that can pick up a whisper 300 feet (91.5 m) away. Cost: 5,000 credits.

**Homing Beacon/Tracking Device.** The vehicle sends out a radio message that is just a series of beeps. The owner of the vehicle can locate the general direction and distance of the vehicle with a device about the size of a cell phone that bounces the signal back and forth at regular intervals. Cost: 10,000 credits, has a 40 mile (64 km) range. For 50,000 credits, the range is extended to 300 miles (480 km).

**Hover Vehicle Conversion.** A very costly process, this requires completely replacing tires, gas tank, and engine and installing a hover propulsion system. In many instances, the engine has to be replaced and there is a lot of body work. Cost: Prices vary, but are typically three to six times the vehicle's original cost. Maximum speed is limited to 120 mph (192 km) and cannot be increased. Dealers are unable or unwilling to perform this conversion.

**Improved Aerial Maneuverability.** Available only to hover vehicles. The vehicle is outfitted with electro-magnetic stabilizers and 2-6 extra maneuvering jets which help compensate for sudden changes in velocity and air conditions. Bonus: +5% to Piloting skill and reduces the penalty for performing stunts and maneuvers. Cost: 75,000 credits. 300,000 credits for M.D.C. and military grade hover vehicles.

**Keypad Locks.** Requires a code to be entered on a keypad to open the doors to the vehicle. Cost: 1,000 credits per lock. Can also be applied to ignition for the same cost of 1,000 credits.

**Laser Targeting System (illegal).** Assists in the selection and focusing of specific targets and adds a bonus of +1 to strike with linked weapon systems. Has a range of one mile (1.6 m). Cost: 50,000 credits.

**Mini-Microwave Oven (for larger vehicles).** Yep, you can drive and heat up your coffee or cook a meal while driving. Ideal for trucks. Cost: 300 credits.

**"Monster Truck" Tires (illegal).** These enormous wheels, measuring 10 feet (3 m) in diameter and 4 feet (1.2 m) wide (and sometimes bigger!), are excellent for driving over rough terrain and adverse weather conditions. **Note**: Illegal in the NGR and most cities. Bonus: Reduces Piloting penalty by two-thirds (66%) and the vehicle can drive over debris and through mud and shallow water no deeper than four feet (1.2 m). Each wheel has 60 M.D.C. and running over something does 3D6 M.D. to it. Can ride over objects/people under 8 feet (2.4 m) tall. Cost: 120,000 credits.

**Off-Road Modification.** Roads and highways are difficult to build and maintain outside major cities. Bandits, monsters, battles between Mega-Damage combatants, freak storms, and dimensional anomalies can render roadways impassable. The land between city-states and feudal kingdoms is typically unclaimed or uncontrollable wilderness. There are few nations with an infrastructure stable enough to maintain their own highway sys-

tem and open countryside. Even the NGR can't do it consistently. Thus, for those making long commutes from one city to another or engaged in adventuring and exploration, it may be desirable to outfit ground vehicles with off-road capabilities.

This modification includes bigger, stronger tires with superior traction on grass, dirt, mud and sand. The undercarriage of the vehicle is lifted up (at least six inches/0.15 m), fitted to spew the ground out behind the vehicle and not up into vital components. The axles, engine, and drive shaft are covered with light Mega-Damage metal for extra protection (8 M.D.C.). **Bonus:** Reduces Piloting penalty by half when dealing with off-road conditions, but no bonus applies when driving on paved roads. **Cost:** 28,000 credits. Not compatible with Vehicle Active Suspension (can only have one or the other). For military and M.D.C. vehicles the price is 200,000 credits.

**Radar System.** A radar system is built into the vehicle (front or back) for the purpose of tracking aircraft, missiles and flyers; can identify and track up to 48 targets simultaneously at a range of 30 miles (48 km). Flying close to the ground or among tree-tops or building level makes the target impossible to track. Best for flying targets 1,000 feet (305 m) above the ground or higher. **Cost:** 3,000 credits.

**Radio Communicator, Short-Range (4 miles/6.4 km range).** **Cost:** 200 credits.

**Radio, Long-Range, Broadband (300 miles/480 km range).** A field radio built into the car and using the body and frame as an antenna. Also has CB and Police scanning capabilities and can transmit and receive on all frequencies. **Cost:** 1,200 credits.

**Refreshment Dispenser.** A built-in unit that delivers hot coffee, tea, hot chocolate, or hot soup (pick one) from one spout and a cold drink like milk, ice water, soda or juice (pick one) from another. Must be recharged every few days. Ideal for trucks. **Cost:** 1,200 credits.

**Rims.** Factory hubcaps are for losers. Custom-designed rims are what the real players are rocking. There are literally thousands of different designs. **Cost:** 200 credits for nice but common rims, or 600 for the really nice and less common rims. Specialty models, such as spinners and flashing lights, cost 800-1,200 credits. *Combat Rims*, which have spikes or spinning blades meant to tear up other vehicles' tires, cost 4,800 credits for a set of 4. They do 1D6 M.D. when the vehicle is in motion, and have 15 M.D.C. themselves (and are illegal inside the NGR).

**Robot Control Device:** Basically a robotic "brain" drives the vehicle, doing all the piloting work automatically. The brain is tied to a variety of sensors that inform it on engine performance, velocity, and aerodynamics as well as cameras and sensors that inform it about road, weather and traffic conditions. It automatically stops at red lights and stop signs, and can react fast enough to avoid hitting another vehicle or move out of the way of dangerous obstacles or pedestrians. The driver simply asks the computer to take him to a particular destination, either an address, or the driver can say "home," "work," "pub" or other common, programmed destination, and the vehicle does all the work of driving there for him.

In regard to traffic, the robot brain can estimate with 95% accuracy the movements of all drivers around it, and can adjust accordingly. The robot brain always follows the posted speed limit and drives defensively. If it is forced into a situation it cannot understand or is ill-equipped to handle, it pulls over, turns on its hazard lights, shuts off the engine and asks for assistance. The robot brain is not suitable for racing, high speed chases, evasive action, or combat, and cannot be reprogrammed for them. Equal to a Piloting skill (for that type of vehicle) of 95%. **Cost:** 165,000 credits.

**Roll Cage.** Roll Cage is the commonly used term for a vehicle with added supports to prevent the cab or driver's compartment from being crushed in the event of a rollover crash. The result is a much safer vehicle. Comes with reinforced safety restraints for the driver and passengers. If the vehicle rolls over, it takes only half damage and the roof of the vehicle does not crush. The driver and occupants inside take only one third normal damage. **Cost:** 10,000 credits.

**Searchlight:** Turns 180 degrees and has a 45 degree up and down arc. 1,000 foot (305 m) range. **Cost:** 300 credits.

**Secret Compartments:** Hollow compartments can be built into the floor, seats, or walls of the vehicle. The largest possible is approximately 18 inches long (45.7 cm) and four to six inches (10 to 15 cm) deep. The smallest are about the size of a pack of cigarettes and medium-sized the equivalent of a lunch box. The larger compartments are ideal for storing supplies, tools, hand-size equipment, hand grenades, blade weapons and small handguns. Game Masters and players should use common sense regarding the number of compartments. **Cost:** 1,000 credits for each small, 2,500 for each medium, and 4,000 for each large.

**Self-Destruction Device (illegal).** The vehicle is rigged with explosives that can be activated to explode via encoded radio signal or digital code. Once activated, the driver and passengers have 30, 60 or 120 seconds to get to a safe distance. Safety features include a double confirmation sequence and a quick shut off verbal command or digital code sequence. The self-destruct mechanism is also designed to destroy the vehicle and all data contained in its systems, NOT to inflict damage to a wide area. Consequently, one is safe at a distance of only 15 feet (4.6 m) and collateral damage is 1D6 M.D. to a five foot (1.5 m) radius around the vehicle. The vehicle itself is completely destroyed, leaving nothing for salvage or restoration. It's a big block of partially melted metal and plastic. Anyone/thing inside the vehicle suffers 1D4x100 M.D. **Cost:** 80,000 credits.

**Speed Upgrades.** 2,000 credits (10,000 for hover vehicles) to boost the maximum speed by one mph (1.6 km). The typical engine can only be upgraded another 10% by the factory. Further upgrades have to be done after purchase, either by the buyer, an Operator/skilled mechanic, or the Black Market. Typically, a vehicle can only have its speed upgraded to 25% beyond its original maximum. Anything faster requires a whole new engine.

**Speed Boost (illegal).** By an injection of Nitrous Oxide, the vehicle can gain a momentary boost of speed. **Cost:** 10,000 credits gets one tank of boosting material which can be used 10+1D4 times before needing recharging. Any one vehicle can be outfitted with as many as six of these tanks. The Speed Boost takes the vehicle to an extra 50% beyond its normal maximum



speed for 2D6 minutes. **Note:** Not available for electrical and nuclear engines.

**Spoiler.** Doesn't do anything, but some people think they look cool. A common joke among City Rats is the bigger the spoiler the faster the vehicle. Cost: 200 credits.

**Targeting and Combat Computer (illegal).** Calculates, stores, and transmits data onto either a dashboard screen or a heads-up display (HUD) in the pilot's helmet. Can identify over 32,000 unique targets; must be linked to a radar and sensor array. All weapon systems linked to the Targeting and Combat Computer get a +1 bonus to strike. Cost: 500,000 credits.

**Vehicle Active Suspension.** The vehicle is equipped with a computer-controlled, hydraulic suspension system. Essentially, this gives the vehicle something of a reactive "brain" for dealing with changing position and terrain. On any car, truck, or van, the computer can lift up a wheel rather than just tilting when hitting a curb or rock. Bonus: +5% to all Piloting skill rolls and reduce penalties for stunts and special maneuvers by half. Cost: 50,000 credits. Not available for hover vehicles. For military and M.D.C. vehicles the price is 200,000 credits.

**Video Camera (mounted inside or outside).** Cost: 120 credits (10 S.D.C.) or 8,000 credits (5 M.D.C.).

**Voice-Activated Locks and Ignition.** Cost: 12,000 credits.

**Water Dispenser:** A refrigerated dispenser that holds and cools drinking water. Cost: 400 credits.

**Winch & Cable.** Mounted on the front or rear of the vehicle is an electric winch; basically a motor connected to a cable and a hook. The cable is 100 feet (30.5 m) long and can pull up to ten tons (and has 5 M.D.C.). Cost: 2,000 credits.

**Window Tinting.** Prevents anyone from seeing into the vehicle. Also doubles as polarized light protection. Cost: 50 credits per window.

## Gimmick Vehicular Weapon Systems

**Note:** All are illegal within the borders of the NGR and most civilized communities.

**Weapon: Anti-Missile Chaff.** When triggered, it sends out a canister designed to decoy enemy missiles. The canister heats up, attracting the missile's heat sensors, gives off a fake radio signal, and sends out streamers of aluminum designed to fool radar-guided units. Cost: 7,000 credits for a launcher that can fit five such canisters. Replacement canisters cost 800 credits each.

**Weapon: Deployable Piston Launcher.** These platforms are about the size of a large welcome mat (3x2 feet/0.9 x 0.6 m) and are heavy (60 lbs/27 kg). The launch plate is mounted on a spring-loaded piston and the device is shoved or dropped from the back of the vehicle. When another vehicle drives over the platform (it has sensors in it that know when a vehicle is on top of it), the piston fires, hitting the undercarriage of the target vehicle, and pushing it off the ground, usually flipping it over; roll for crash damage. The driver of the vehicle being struck by the piston *must roll under his Piloting skill* with a penalty of -40% in order to keep the vehicle from flipping.

Failure to maintain control of the vehicle means: 01-60% The vehicle flips over on its roof and suffers 4D6 M.D., plus is taken out of commission until the vehicle can be flipped back over, which is likely to be hours. 61-00% Crashes at full speed; roll for crash damage. These are complicated devices, and as such, a

little pricey. Cost: 16,000 credits for the mechanism. Each platform, which can be reused if recovered, costs 5,000 credits. **Note:** The Piston Launcher only works on vehicles weighing less than three tons. Heavier vehicles get a jolt and a startling loud bang (everyone inside loses initiative), but nothing else. If the pursuer sees the plate (about the size of a welcome mat) he can try to avoid it by swerving around it, -20% penalty to Piloting skill and -4 to dodge.

**Weapon: Drop Mine Explosive.** These small platforms are dropped from the back of the vehicle (10% chance of going off if "dropped" too roughly or at speeds greater than 70 mph/112 km). When another vehicle drives over the mine (it has sensors in it that know when a vehicle is on top of it), it explodes, doing 1D6x10 M.D. and the driver must roll under his Piloting skill at a -50% penalty to keep control of the vehicle (reduce penalty by half if the vehicle weighs more than three tons).

If control is lost, roll for explosive damage followed by crash damage. If control is kept, the vehicle suffers explosive damage and the act of keeping the vehicle under control requires vehicular speed is reduced by half and the driver and passengers lose all attacks for 1D4 melee rounds as the vehicle swerves wildly. If driving speed is not reduced, the vehicle crashes. **Note:** If the pursuer sees the mine (about the size of a lunch box) he can try to avoid it by swerving around it, -10% penalty to Piloting skill and -2 to dodge. Cost: 25,000 credits. The mechanism is destroyed in the explosion.

**Weapon: Oil Slick.** The pilot can release oil from a tank mounted on the underside of the vehicle. Contains enough oil for three oil slicks. A vehicle driving through the oil must make a control roll at -20%. Cost: 2,400 credits for the release mechanism and 200 credits for an oil refill.

**Weapon: Road Spikes.** These large spikes, also called vehicle caltrops, fall out of the back of a vehicle and cover the road, meant to bar the way for vehicles which roll on tires. They do no damage to military or treaded vehicles, and naturally, hover vehicles fly right over them. Roll under Piloting skill with a -20% penalty to avoid the layer of spikes, otherwise the vehicle drives right into them. Each tire or wheel takes 1D4+10 M.D., and the driver must make another Piloting skill roll to maintain control, taking a -5% penalty for each tire destroyed, for every 10 mph (16 km) that the vehicle is traveling. Failure means (roll percentile dice): 01-50% the vehicle spins out and comes to a halt. The vehicle is immobilized until the damaged tires are replaced (taking 1D6 minutes per tire to change), but more than one spare tire is not likely to be immediately available. 51-00% Vehicle speed is reduced by half before it crashes; roll for crash damage. Also useful for blocking the path of large monsters, sticking into their feet. Penalties until the spike is removed from the foot: Reduce Spd by 90%, reduce number of attacks by two, combat bonuses are reduced by half, and skill performance is -20%. Cost: 1,200 credits for the launch mechanism. 500 credits for each non-reusable container.

**Weapon: Smoke Screen.** Dispenses a cloud of dense, black smoke that covers the road. Can either be used to conceal a motionless vehicle, or to block the view of the road. The size of the cloud is roughly 40 feet (12.2 m) thick in all directions, less on a particularly windy day. Cost: 2,400 credits. 200 credits for a refill.

## Common Weapon Systems for Vehicles

Weapons are typically fixed forward in the front of the vehicle, or as a mounted gun that needs to be manned (in the back in place of the trunk or on the roof). Missile launchers are always built into the trunk or a cargo bay.

**Ion Blaster: Standard:** Mega-Damage: 3D6 M.D. Rate of Fire: Each blast counts as one melee attack/action. Range: 1,200 feet (366 m). Payload: 20 blasts per E-Clip. Unlimited if tied to a nuclear power supply. Cost: 38,000 credits.

**Light Laser:** Mega-Damage: 2D6 M.D. Rate of Fire: Each blast counts as one melee attack/action. Range: 2,000 feet (609 m). Payload: 20 blasts per E-Clip. Unlimited if tied to a nuclear power supply. Weapon Cost: 45,000 credits.

**Medium Laser:** Mega-Damage: 3D6 M.D. Rate of Fire: Each blast counts as one melee attack/action. Range: 2,000 feet (609 m). Payload: 15 blasts per E-Clip. Unlimited if tied to a nuclear power supply. Weapon Cost: 62,000 credits.

**Heavy Laser:** Mega-Damage: 4D6 M.D. Rate of Fire: Each blast counts as one melee attack/action. Range: 1,800 feet (548.6 m). Payload: 12 blasts per E-Clip. Unlimited if tied to a nuclear power supply. Weapon Cost: 88,000 credits.

**Rapid-Fire Pulse Laser:** Mega-Damage: 3D6 M.D. per single blast, 6D6 M.D. per rapid-fire triple pulse blast. Rate of Fire: Each blast counts as one melee attack/action. Range: 1,800 feet (548.6 m). Payload: 15 single blasts or 8 pulse blasts per E-Clip. Unlimited if tied to a nuclear power supply. Weapon Cost: 128,000 credits.

**Light Machine-Gun:** Can fire S.D.C. or M.D. rounds. S.D.C./H.P. Damage: 1D6x10 S.D.C./Hit Points per 10 round burst. Mega-Damage: 2D4 M.D. per 10 round burst. One M.D. for a single round. Rate of Fire: Each burst counts as one melee attack. Range: 3,000 feet (914 m). Payload: 600 round belt fed in a drum housing; 60 bursts. Note: Typically a manned gun on the roof of the vehicle or trunk area. The low cost, S.D.C. to M.D. versatility, and good S.D.C. and M.D. capacity makes it a popular weapon. Cost: 26,000 credits, 110,000 if built into an armored turret with 40 M.D.C. 600 round ammo-drum costs 1,800 credits.

**Mini-Missile Box Launcher:** Mega-Damage: 1D4x10 M.D. Rate of Fire: one at a time or in volleys of 2 or 4. Range: One mile (1.6 km). Payload: 16 total mini-missiles. Typically mounted in the trunk area or on the roof. A carrying case that holds 12 mini-missiles can be stowed in the car and the missiles removed for manual reloading into the launcher(s). Reloading takes about five seconds per each missile from a trained individual, or one melee round (15 seconds) per missile for those untrained in handling munitions. Missile carrying case has 20 M.D., weighs 10 pounds (4.5 kg) empty. Each missile weighs 4 pounds (1.8 kg). Cost: 140,000 credits for launch system and 6,000 per each missile.

**Mini-Missile Tube Launcher:** Mega-Damage: 1D4x10 M.D. Rate of Fire: One or two at a time. Range: One mile (1.6 km). Payload: Two. This is a simple tube launcher that contains a pair of mini-missiles. These small, low profile tube launchers can be mounted on the roof or side (front or rear) of the vehicle. Reloading takes about five seconds per each missile from a trained individual, or one melee round (15 seconds) per missile for those untrained in handling munitions. Missile carrying case

has 20 M.D.C, weighs 10 pounds (4.5 kg) empty. Each missile weighs 4 pounds (1.8 kg). Cost: 40,000 per dual launcher and 6,000 per each missile.

**Plasma Ejector:** Mega-Damage: 4D6+2 M.D. per single blast. Rate of Fire: Each blast counts as one melee attack/action. Range: 1,400 feet (426.7 m). Payload: 10 blasts per E-Clip. Unlimited if tied to a nuclear power supply. Cost: 150,000 credits.

**Particle Beam Gun:** Mega-Damage: 6D6+6 M.D. Rate of Fire: Each blast counts as one melee attack/action. Range: 1,200 feet (366 m). Payload: 8 blasts per E-Clip. Unlimited if tied to a nuclear power supply. Cost: 260,000 credits.

## Triax Domestic Robots

The dream of Triax's Domestic Robot Division is to put a Triax robot drone in every home. The DRD constantly strives to improve the physical designs, upgrade software and make drones more affordable. Domestic robot drones have very limited programming, and are made of high-impact S.D.C. metals instead of M.D.C. composite material in order to keep costs down and, in the event of sabotage, to prevent a Mega-Damage robot from inflicting grievous damage. It is illegal to add additional armor or weapons to any of these robots (though it is not unheard of). Despite Triax's best efforts, robots are never cheap. They are extremely sophisticated pieces of machinery and computer technology. They are as inexpensive as they are only because of the money spent on advanced robots for military applications. Without the needs of the military and mass production for the Army, the development and manufacturing costs of domestic robots would likely be 3-5 times greater. However, Triax has been able to put many of the basic elements of the military grade robots into their light, domestic designs.

One major way in which Triax is attempting to keep the price for these robots low is to offer a special recharging service. The power systems for robots are arguably the most expensive component, and buyers who want a robot that will last them for decades need to invest in an expensive, miniaturized nuclear power supply. Triax has designed a special battery that holds a charge for 60-80 hours of continual use. That's roughly one week of common household and business use, two weeks for light levels of use. When the battery is close to going dead, a red indicator light shines through, plus the robot itself will advise its owner that it is time for it to be recharged. This message starts when the energy level is down to two hours and repeats every 15 minutes until the robot is placed into a recharge outlet. Any Triax dealer can recharge the robot for a fee of 100 credits. It takes one hour to get the robot fully charged. That's very inexpensive compared to what one would pay in wages for a living person to function as a babysitter/nursemaid, housekeeper, helper, or assistant who is likely to get paid 70-100 credits for a single eight hour day's work. Of course, a living person may have a better range of skills, experience and personality than a robot, but the price can't be beat.

As far as automated domestic robots go, the idea is certainly not a new one, as primitive robot pets and "intelligent" appliances have been helping out around the house ever since the 21st Century. As computer technology became more advanced, nearly every appliance in the house became "smart." Although

these appliances were touted as robots, they were little more than machines with computers. The most advanced, like an oven that knew how to cook and could uplink with your food processor, sink, and refrigerator in order to prepare a meal, were impressive, but not true robots. The people of the NGR, and to a lesser degree other parts of the world, prefer their robots to look and act like people. Some might argue that humanoid robots would lose a degree, of functionality, but the current trend in robotics is to sacrifice a little bit of practicality for aesthetics. As a result, the majority of robots in high-tech societies have humanoid shapes, and walk, move, and behave similar to a human.

All Triax robots are considered “off the shelf” – meaning they have very little room for customization or non-warranty upgrades. Triax is able to provide consumers with custom robots and special orders, but they are much more expensive. (For custom robots, use the rules in **Rifts® Sourcebook One: Revised & Expanded.**) The prices listed for each robot under “Available Modifications and Upgrades” are Triax prices for that particular feature and modification. Any upgrade is available to any Triax domestic robot (aside from weapon upgrades; only the Black Market will deal in that), though the upgrade may not fall under the robot’s warranty.

**Note:** Unless stated otherwise, domestic robots do not have combat or weapon capabilities/skills and have *four actions* per melee round.

## Triax V-100 Housekeeper

This robot is programmed to fulfill domestic duties and is the equivalent of a housemaid or butler. The robot cooks, cleans, organizes, washes dishes, cleans windows, polishes furniture, mends clothes, and greets and announces guests. The typical body style of this robot is a rather clunky-looking mechanical person with “servant clothes” painted on. Many robot owners actually dress their ‘Bots in real clothing to make them seem more like a real person. Buyers can choose between either a male butler or female housemaid model.

**Model Type:** V-100M (for male) or V-100F (for female).

**Class:** Fully-Automated Self-Sufficient Domestic Robot.

**Crew:** None, a simple artificial intelligence.

**S.D.C.:** 90 for main body, 30 head, 30 per each limb, 15 per each hand and foot.

**A.R.:** 14

**Speed:**

**Running:** 15 mph (24 km) maximum. Note that running does NOT tire the robot and speed can be maintained indefinitely, however, running is considered heavy use and wears down the battery more quickly.

**Leaping:** Not possible.

**Flying:** Not possible.

**Range:** Electric battery provides 60-80 hours of use. The robot can be shut down when not in use to conserve energy, and automatically goes into a low energy “sleep mode” when its services are not needed.

**Statistical Data:**

**Height:** 5 feet, 8 inches (1.7 m).

**Width:** 2 feet (0.6 m).

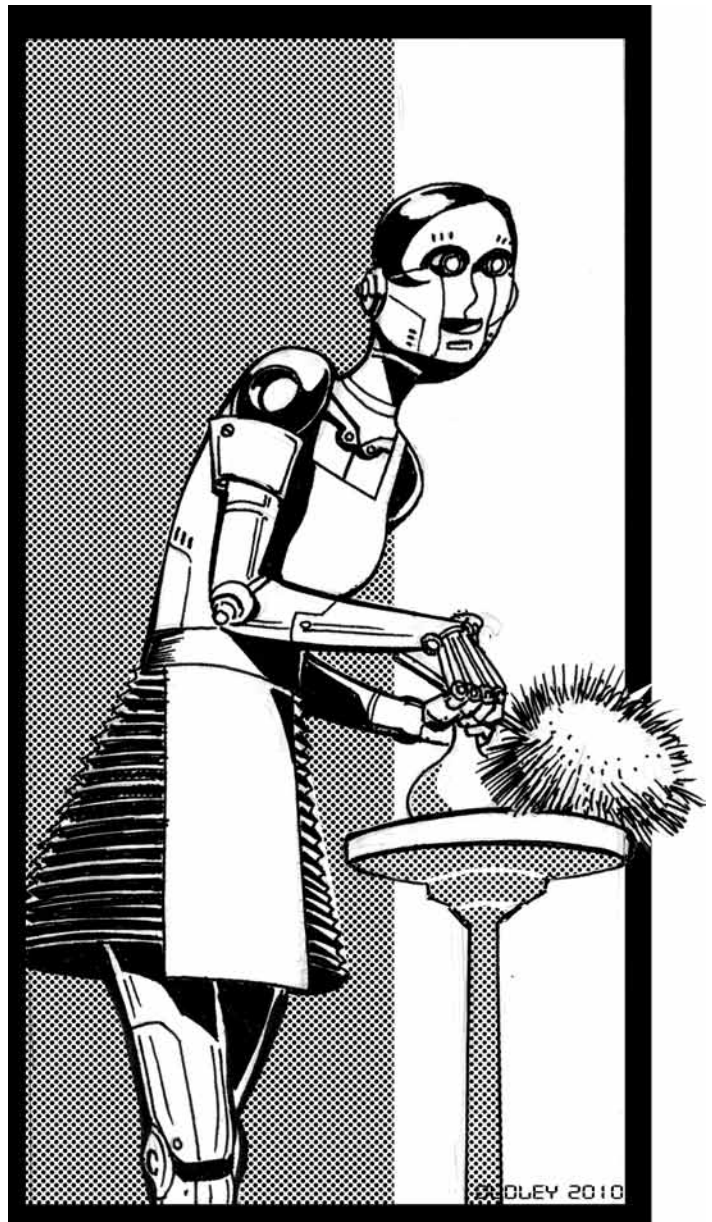

**Length:** 2 feet (0.6 m).

**Weight:** 250 lbs (112.5 kg).

**Physical Strength:** Robotic P.S. 15.

**Other Notable Attributes:** I.Q. 10, P.P. 12, P.B. 7, Spd 22.

**Cargo:** Has a number of small hooks, pegs, and rings to hold bottles of spray cleaner, mop buckets, feather dusters, and various other housecleaning items, or may wear clothes.

**Power System:** Proprietary Electrical Battery.

**Cost:** 350,000 credits new, but can be found for as little as 150,000 credits used. The German Black Market sells “refurbished” robots (and often stolen ‘Bots with their serial numbers removed) for as low as 90,000 credits, but it will be a model that is 1D4+4 years old and not in the greatest condition (-20% to S.D.C. and -10% to all skill programs).

**Standard Housekeeping Skill Program:**

**Domestic Services:** First Aid 90%, Housekeeping 90%, Language: Euro 90%, Literacy: Euro 88%, Preserve Food 90%, Radio: Basic 90%, Recycling 92%, Sewing 92%, Wardrobe & Grooming (includes cleaning of all kinds) 92%. (**Cost:** 30,000 credits as an add-on program.)

**Standard Sensor Systems:** Basic hearing system, human voice synthesizer (the butler has a sophisticated-sounding male voice, the maid a pleasant female voice), basic robot optic system (20/20 vision up to one mile (1.6 km), passive nightvision 1,000 feet/305 m for emergencies), molecular analyzer, monitor jack/connector plug, optical reader (for reading computer screens, newspapers, books, notes, etc.) and smoke detector.

**Available Upgrades and Add-On Programs:**

Domestic: Bartender Program: Brewing 90%, Brewing: Medicinal 90%, Performance 90%. Can make and prepare one thousand different drinks from different types of juices, teas, and coffees to alcoholic and exotic party beverages. Cost: 25,000 credits.

Domestic: Culinary Program: Cook 88%, Preserve Food 90%, I.D. Plants and Fruits 90%. The robot can be programmed to prepare one thousand different recipes. The 'Bot lacks the ingenuity to come up with original recipes or variations on existing ones, but the food follows the recipe and is of good quality. Cost: 35,000 credits.

Domestic: Language Program: Can speak traditional German and five other languages of choice at 90%. Cost: 3,000 credits.

Domestic: Entertainment Program: Dance 88%, Play Musical Instrument (two of choice) 85%, and Sing 85%. Cost: 10,000 credits.

**Available Modifications and Upgrades:**

Advanced Audio System – 10,000 credits.

Built-In Language Translator – 30,000 credits.

Human Personality Emulation Skill Program – 200,000 credits.

Juke Box – 5,000 credits and can play (sound comes from the mouth) two thousand different songs and tunes.

## V-200 Robot Chauffeur

The V-200 Robot Chauffeur is a popular model with those who have to travel a lot, as well as with the ultra-rich as a status symbol of sorts. Not only does the Robot Chauffeur drive, but it can perform vehicle repairs, and keeps the vehicles in its care clean and shiny.

There are even a few taxi and limousine companies that exclusively use the V-200 in their service. They are also used by shipping and construction companies, and courier services (especially if they must pass through dangerous territories).

The V-200 is programmed for safe, comfortable driving. It cannot be ordered to perform stunts or engage in vehicle combat, or any other action that might endanger its vehicle, itself, or its human passengers.

**Model Type:** V-200 Driver.

**Class:** Fully-Automated Self-Sufficient Domestic Robot.

**Crew:** None, a simple artificial intelligence.

**S.D.C.:** 90 for main body, 30 head, 30 per each limb, 15 per each hand and foot.

**A.R.:** 14

**Speed:**

Running: 15 mph (24 km) maximum. Note that running does NOT tire the robot and speed can be maintained indefinitely, however, running is considered heavy use and wears down the battery more quickly.

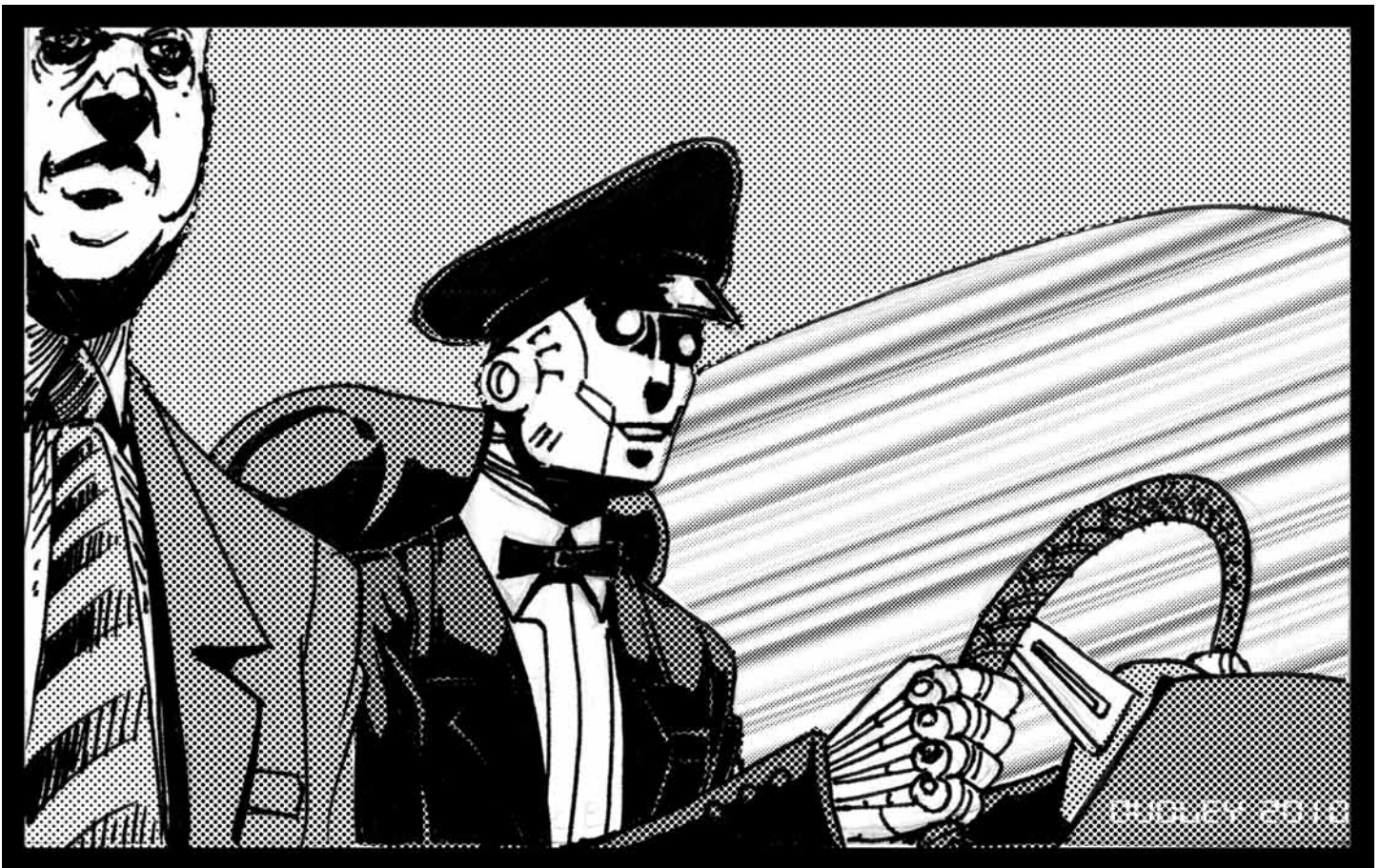

Leaping: Not possible.

Flying: Not possible.

Range: Electric battery provides 60-80 hours of use. The robot can be shut down when not in use to conserve energy, and automatically goes into a low energy “sleep mode” when its services are not needed.

**Statistical Data:**

Height: 5 feet, 8 inches (1.7 m).

Width: 2 feet (0.6 m).

Length: 2 feet (0.6 m).

Weight: 250 lbs (112.5 kg).

Physical Strength: Robotic P.S. 15.

Other Notable Attributes: I.Q. 12, P.P. 15, P.B. 7, Spd 22.

Cargo: None; only what can be carried.

Power System: Proprietary Electrical Battery.

Cost: 450,000 credits new, but can be found for as little as 199,000 credits used. The German Black Market sells “refurbished” robots (and often stolen ‘Bots with their serial numbers removed) for as low as 140,000 credits, but it will be a model that is 1D4+4 years old and not in the greatest condition (-20% to S.D.C. and -10% to all skill programs).

**Standard Skill Programs**: Both come standard.

Specialization Piloting: Basic Ground Vehicles. Language: Euro 90%, Literacy: Euro 88%, Pilot: Automobile 96%, Pilot Hovercraft 90%, Pilot: Motorcycle 90%, and Pilot: Truck 80%. (Cost: 30,000 credits as an add-on program.)

Computerized Atlas Program: This program allows the robot to know the exact layout of streets in any major NGR city. It automatically selects the best route to a given location, taking into account traffic, number of traffic lights as well as accounting for and adjusting to weather, road construction, recent accidents or other roadside hazards (available online and transmitted by radio on open police bands). The Atlas Program must be updated every year for best results. Upgrades cost 200 credits. Currently, the Atlas only includes the Autobahn and the cities of the NGR and Poland. (Cost: 5,000 credits as an add-on program.)

**Available Upgrades and Add-On Programs:**

Specialization Labor: Aircraft Mechanics: Aircraft Mechanics 75%, Basic Electronics 85%, Basic Mechanics 90%, Computer Operation 90%, and General Repair and Maintenance 90%. Cost: 55,000 credits.

Specialization Piloting: Speciality Aircraft. Pilot: Airplane 92% and Pilot: Jet Aircraft 88%. Cost: 40,000 credits.

Specialization Labor: Auto Mechanics: Automotive Mechanics 85%, Basic Electronics 85%, Basic Mechanics 90%, Computer Operation 90%, and General Repair and Maintenance 90%. Cost: 25,000 credits.

Specialization Piloting: Speciality Craft. Pilot Boat: Motor, Race & Hydrofoil 88% and Pilot Boat: Sail Types 88%, Pilot: Hovercycle 88%, Pilot: Tracked and Construction Vehicles 88%, and Pilot: Truck 90%. Cost: 35,000 credits.

**Standard Sensor Systems**: Basic hearing system, human voice synthesizer (sounds human), basic robot optic system (20/20 vision up to one mile (1.6 km), passive nightvision 1,000 feet/305 m for emergencies), wide band radio receiver and transmitter,

optical reader, optical scanner, gyro-compass, motion detector and warning system, monitor jack/connector plug.

## V-250 Landscaper/Farm Worker

The V-250 Landscaper/Farm Worker ‘Bot was originally designed for agricultural service. The farmers of Europe and North America needed a robot (or better yet, a large quantity of them) to tend to their crops. The V-250 could plant seeds, plow fields, pick fruit, combat pests and parasites, and harvest the crops. It never needs to sleep or take a break and can work at any hour, for any length of time, with no complaints.

The first run of these robots were snatched up almost as soon as they hit the showroom and immediately set to work in fields and farms across Europe. Triax inevitably followed them up with a copious amount of attachments and gratuitous gadgets aimed at making the robot even more efficient. They released amazing new farm tools and vehicles aimed at maximizing the robot’s effectiveness. People bought the new attachments because the Triax marketing machine declared that they simply could not live without a shiny new wheat thresher with datalink headjack plugs, remote control relay, and Vibro-Blades that never dull or rust. It wasn’t long before the bubble burst on the V-250, and all of its wonderful toys stopped selling once consumers realized how superfluous they were.

Since then, the V-250 has found new fame as a domestic gardening robot. It is still in service all over Europe. Even places that would otherwise seem barbaric or primitive may have an aging V-250 tending to the crops. Its main customers these days are wealthy landowners who keep two or three around to maintain the prestigious looks of their grand estates. They are also found around corporate parks, city parks, and university campuses.

**Model Type**: V-250

**Class**: Fully-Automated Self-Sufficient Domestic Robot.

**Crew**: None, a simple artificial intelligence.

**S.D.C.**: 120 for main body, 35 head, 30 per each limb, 15 per each hand and foot.

**A.R.**: 14

**Speed**:

Running: 15 mph (24 km) maximum. Note that running does NOT tire the robot and speed can be maintained indefinitely, however, running is considered heavy use and wears down the battery more quickly.

Leaping: Not possible.

Flying: Not possible.

Range: Electric battery provides 60-80 hours of use. The robot can be shut down when not in use to conserve energy, and automatically goes into a low energy “sleep mode” when its services are not needed.

**Statistical Data:**

Height: 6 feet (1.8 m).

Width: 2 feet (0.6 m).

Length: 2 feet (0.6 m).

Weight: 300 lbs (135 kg).

Physical Strength: Robotic P.S. 15.

Other Notable Attributes: I.Q. 10, P.P. 12, P.B. 7, Spd 22.

Cargo: None; only what can be carried.

Power System: Proprietary Electrical Battery.

Cost: This high demand 'Bot sells for 430,000 credits new for a basic model. Can be found for as little as 200,000 credits used. The German Black Market sells "refurbished" robots (and often stolen 'Bots with their serial numbers removed) for as low as 145,000 credits, but it will be a model that is 1D4+4 years old and not in the greatest condition (-20% to S.D.C. and -10% to all skill programs).

**Standard Skill Programs**: Pick A or B. If both are desired, the other must be purchased separately.

**A. Standard Landscaping Program**: Proprietary Gardening Program: Art (as it pertains to grooming and shaping trees, shrubbery, and plants for the purpose of beauty and decorative display) 80%, Climbing 88%, Floral Arrangement 88%, Gardening 90%, Language: Euro 90%, Literacy: Euro 88%, Masonry 88% and Rope Works 90%. (Cost: As an additional program is 22,000 credits.)

**B. Standard Farm Labor Program**: Specialized Labor: Farm Work: Animal Husbandry 80%, Botany 85%, Branding 88%, Climbing 90%, Herding Cattle 80%, Identify Plants and Fruits 92%, Language: Euro 90%, Literacy: Euro 88%, Lore: Cattle and Animals 92%, Pilot: Truck 92%, Preserve Food 92%, Recycling 92%, Skin & Prepare animal Hides 92%. (Cost: As an additional program is 67,000 credits.)

**Standard Sensor Systems**: Basic hearing system, biometric scanner, chemical spray (used to deliver pesticides and fertilizer), mechanical voice synthesizer, basic robot optic system (20/20 vision up to one mile (1.6 km), passive nightvision 1,000 feet/305 m for emergencies), macro eye (special), molecular analyzer, optical reader, molecular analyzer, and monitor jack/connector plug.

#### **Available Upgrades and Add-On Programs:**

Domestic: Bartender Program: Brewing 90%, Brewing: Medicinal 90%, Performance 90%. Can make and prepare one thousand different drinks from different types of juices, teas, and coffees to alcoholic and exotic party beverages. Cost: 25,000 credits.

Domestic: Culinary Program: Cook 88%, Preserve Food 90%, I.D. Plants and Fruits 90%. The robot can be programmed to prepare one thousand different recipes. The 'Bot lacks the ingenuity to come up with original recipes or variations on existing ones, but the food follows the recipe and is of good quality. Cost: 35,000 credits.

#### **Available Modular Robotics Modifications and Upgrades:**

1. Additional Pair of Hands and Arms (Robotic P.S. 15). Cost: 375,000 credits for one additional pair (4 total arms).

2. Modular Tool Arms – Replaces the pre-existing hand with a tool fitting. The following are available:

Basket (net basket with a large hoop opening, for holding picked fruits and vegetables): Costs 600 credits.

Blade (straight or hooked like a scythe): Costs 1,000 credits.

Blower (replaces hand): Costs 2,500 credits.

Branding Iron (has its own heating element for brand): Costs 4,000 credits.

Chain Saw: Does 3D6+10 S.D.C. damage and costs 3,500 credits.

Circular Saw: Does 2D6+10 S.D.C. damage and costs 3,500 credits.

Drill: Does 1D6+4 S.D.C. damage and costs 3,500 credits.

Fence Post Digger (replace hand with large scoop-drill to pull out wide plugs of dirt the size of a fence post; also suitable for planting): Costs 4,500 credits.

Hedge Trimmer/Large Shears: Costs 1,500 credits.

Hydraulic Extendable Hands & Forearm (extends reach up to 5 feet/1.5 m as needed): Cost: 98,000 credits.

Hydraulic Extendable Legs (extends height by up to 6 feet/1.8 m additional as needed): Cost: 120,000 credits.

Laser (for cutting and trimming): Does 2D6+10 S.D.C. damage, maximum range 60 feet (18.3 m) and costs 18,000 credits.

Scissor Fingers (thumb and first two forefingers are normal, bottom two fingers are replaced by small, precision scissors for snipping fruit from the vine and delicate trimming; super sharp blades do 1D4 S.D.C. damage): Costs 2,300 credits.

Spray Gun (replaces hand for applying chemicals and fertilizer, 40 feet/12.2 m maximum range): Costs 3,000 credits.

Thresher (replaces both hands): Cost: 12,000 credits.

## **V-1000 Personal Assistant-Bot**

The V-1000 is an all-purpose personal assistant robot. It has the greatest variety of skill programs available to it of any domestic robot. Whereas most domestic robots can get four additional skill programs, the V-1000 can get as many as *eight* total programs, including those available to other domestic robots. Unlike human personal assistants, the V-1000 doesn't need a paycheck (other than the one going to Triax Industries and weekly recharging), health benefits, or days off, and it never talks back, mouths off, or complains. Those who have bought one absolutely love it, exclaiming that they can't believe they ever got around without it.

**Model Type**: V-1000 All-Purpose Assistant.

**Class**: Fully-Automated Self-Sufficient Domestic Robot.

**Crew**: None, a simple artificial intelligence.

**S.D.C.**: 120 for main body, 35 head, 30 per each limb, 15 per each hand and foot.

**A.R.**: 14

**Speed**:

Running: 31 mph (49.6 km) maximum. Note that running does NOT tire the robot and speed can be maintained indefinitely, however, running is considered heavy use and wears down the battery more quickly.

Leaping: Not possible.

Flying: Not possible.

Range: Electric battery provides 60-80 hours of use. The robot can be shut down when not in use to conserve energy, and automatically goes into a low energy "sleep mode" when its services are not needed.

**Statistical Data**:



Height: 6 feet (1.8 m).

Width: 2 feet (0.6 m).

Length: 2 feet (0.6 m).

Weight: 250 lbs (112.5 kg).

Physical Strength: Robotic P.S. 15.

Other Notable Attributes: I.Q. 15, P.P. 12, P.B. 7, Spd 31.

Cargo: None, only what can be carried.

Power System: Proprietary Electrical Battery.

Cost: 600,000 credits new, but can be found for as little as 320,000 credits used. The German Black Market sells “refurbished” robots (and often stolen ‘Bots with their serial numbers removed) for as low as 225,000 credits, but it will be a model that is 1D4+4 years old and not in the greatest condition (-20% to S.D.C. and -10% to all skill programs).

**Standard Skill Programs:** The assistant gets both of these programs and has room of six additional, but each is sold separately.

General Knowledge. Basic Electronics 90%, Basic Mechanics 90%, Computer Operation 95%, General Repair and Maintenance 90%, Language: Euro and one of choice 90%, Literacy: Euro and one of choice 90%, Pilot: Automobile 90%, Pilot: Truck or Hovercycle 90%, and Recycle 90%. (Cost: 20,000 credits as an add-on program.)

Specialization Tutorial. Art 80%, Calligraphy 90%, History: Pre-Rifts (German & General) 80%, History: Post Rifts 90%, Law (General) 70%, Language: Other: American and two of choice 90%, Literacy: Other Two of choice 90%, Lore: Three of choice 88% each, Math: Basic 98%, and Philosophy 88%. (Cost: 50,000 credits as an add-on program.)

**Available Upgrades and Add-On Programs:**

Specialization: Adventuring. Anthropology 88%, Archeology 88%, Climb 88%, Cook 70%, First Aid 88%, Land Navigation 80%, Pilot: Hover Vehicle 88%, Salvage 88%, Tailing 70%, and Wilderness Survival 88%. Cost: 45,000 credits.

Specialization: Commerce. Appraise Goods 88%, Barter 65%, Gemology 88%, Math: Advanced 98%, Recognize Weapon Quality 80%, and Salvage 90%. Cost: 40,000 credits.

Specialization: Computers. Artificial Intelligence 50%, Computer Hacking 70%, Computer Programming 88%, Computer Repair 88%, Optic Systems 80%, Radio: Basic 90%, Research 80%, and Sensory Equipment 88%. Cost: 98,000 credits.

Specialization: Medical Assistant. Biology 90%, Brewing: Medicinal 80%, Chemistry 90%, Field Surgery 70%, Math: Advanced 98%, Paramedic 88%, Sensory Equipment 90%, Sewing 90%, and Xenology 60%. Cost: 100,000 credits.

Specialization: Physical Trainer. Aerobic Athletics, Biology (basic), Body Building, Climbing, Fencing, Juggling, Outdoorsmanship, Swimming, SCUBA, and Wrestling; can perform and teach skills at 80% proficiency. Bonus: +2 attacks/actions per melee round for the robot. Cost: 86,000 credits.

Specialization: Science. Biology 88%, Chemistry 98%, Chemistry: Analytical 95%, Math: Advanced 98%, Navigation 95%, and Sensory Equipment 95%. Cost: 120,000 credits.

Specialization: Security. Cryptography 80%, Electronic Countermeasures 88%, I.D. Undercover Agent 80%, Intelligence 80%, Locksmith 88%, Optic Systems 88%, Photography 88%, Streetwise 50%, Surveillance 88%, TV/Video 88%, and Wrestling. Cost: 95,000 credits.

Specialization: Technical. Excavation 85%, Firefighting 88%, Jury-Rig 75%, Recycling 90%, and Salvage 90%. Cost: 80,000 credits.

**Other:** Any of the programs listed under the previous domestic robots – Bartender, Culinary, Driving/Piloting, Farming, Gardening, Housekeeping, Repair, etc. If the price is not given

for one of these add-on programs, it is 1D4x10,000+15,000 credits.

**Standard Sensor Systems:** Basic hearing system, human voice synthesizer (sounds human), basic robot optic system (20/20 vision up to one mile (1.6 km), passive nightvision 1,000 feet/305 m for emergencies), biometric scanner, wide band radio receiver and transmitter, optical reader, optical scanner, gyro-compass, motion detector and warning system, monitor jack/connector plug.

**Available Modifications and Upgrades:**

- Built-In Language Translator – 30,000 credits.
- Human Personality Emulation Skill Program – 400,000 credits.
- Built-In Radio Receiver and Transmitter – 19,000.
- Bio-Scan Medical Survey Unit – 300,000 credits.
- Cosmetic Enhancements (any) – 25% less than listed price.
- Customized Paint Job – 500 credits.

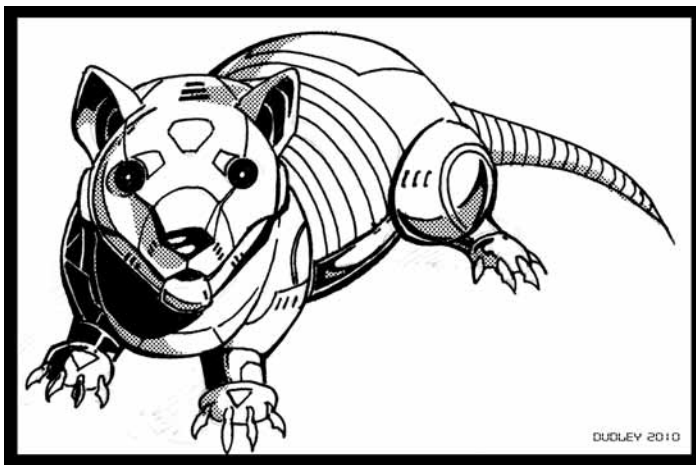

## Triax V-500 Robot Pets

Triax produces a variety of robot house pets. They use sophisticated micro-processors that can detect, read, and appropriately respond to human emotions. They respond to love, fear, sadness, and joy just like a real pet would do. They are perfect for those who cannot care for a real animal pet, don't want the hassle of caring for a real animal, or can't stand to see a live animal get old, sick and die. They also make excellent security systems, sounding an alarm by barking loudly when an intruder is detected or a disturbing noise is heard.

All of the robot pets have around the same physical capabilities and limitations. They come as cats, dogs, ferrets, pigs, large lizards, monkeys, cockatoos, parrots and other medium to large birds, but the birds cannot actually fly. The robot pets come standard looking like *mechanical versions* of the chosen animal, but for a little extra, Triax will cover the robot in fake skin and fur. The 'response voice' of each animal is very lifelike and realistic, and is upgradeable to give the pet actual speech capabilities.

**Model Type:** V-500 Animal Pet.

**Class:** Fully-Automated Self-Sufficient Domestic Robot.

**Crew:** None; simple artificial intelligence.

**S.D.C.** 35 main body, 15 head, 15 per animal limb.

**A.R.:** 15

**Speed:**

**Running:** 20 mph (32 km) maximum. Note that running does NOT tire the robot and speed can be maintained indefinitely.

**Leaping:** 3 feet (0.9 m) up or across, double with a running start.

**Flying:** Not possible.

**Range:** Electric battery provides 60-80 hours of use. The robot can be shut down when not in use to conserve energy, and automatically goes into a low energy "sleep mode" when its services are not needed.

**Statistical Data:**

**Height:** Up to 3 feet (0.9 m) tall.

**Width:** Up to one foot (0.3 m).

**Length:** Up to 3 feet (0.9 m) long.

**Weight:** Up to 60 lbs (27 kg).

**Physical Strength:** Robotic P.S. 8 for small to medium sized pets, P.S. 12 for large ones like dogs and monkeys.

**Other Attributes:** I.Q. 10, P.P. 14, P.B. 10, Spd 30.

**Cargo:** None, only what can be carried in the mouth.

**Power System:** Proprietary Electrical Battery.

**Cost:** Small to medium-sized pets: 20,000-35,000 credits new. Large pets: 45,000-55,000 new. Half to one third for a used or "refurbished" model (but it will be a model that is 1D4+4 years old and not in perfect condition; -20% to S.D.C. and -10% to all skill programs). Lifelike fur or feathers, warmth to the touch, costs extra.

**Standard Skill Program:**

**V-500 Pet Simulation Program.** The Robot Pet is programmed to behave exactly as the real animal would. Of course, each "pet" is programmed to have a friendly and gentle disposition. They do not have tracking capabilities unless it is purchased. The 'Bot also has the Human Personality Emulation Program, which allows the robot to respond human emotions and the needs of its owner like a real pet.

**Standard Sensor Systems:** Basic hearing system, animal voice synthesizer (sounds like the genuine animal), basic robot optic system (20/20 vision up to one mile (1.6 km), passive nightvision 400 feet/122 m for emergencies), clock/calendar, gyro-compass, molecular analyzer, and smoke detector.

**Available Upgrades and Add-On Programs:**

**Animal Hunter/Tracker Program:** I.D. Plants and Animals 88%, Land Navigation 80%, Running (adds 10 mph/16 km to Spd), Track Animals 80%, and Wilderness Survival 80%. **Cost:** 15,000 credits.

**Animal Medical Helper Program:** This program and related sensors enable the robot to function as a seeing eye animal, engage in medical alert procedures, radio for help in case of medical emergencies and assist its owner by reminding him to take his medicine, when to take which medicine and reading medicine bottles, etc. It can also talk in a calm, gentle human voice (male or female) and has the following additional sensor systems: wide band radio receiver and transmitter for medical alerts and calling for help, optical reader, and monitor jack/connector plug. **Cost:** 75,000 credits.



Animal Police Dog: Detect Ambush 60%, Demolitions Disposal 90% (has the data and knowledge and can talk a technician or police officer through the procedure), Detect Concealment 60%, Land Navigation 90%, Tailing 85%, Tracking People 88%, and Sniff Out Explosives (special; exactly what it sounds like) 88%; includes installation of an enhanced chemical sniffer sensor system. Cost: 250,000 credits.

#### **Available Additional Features, Sensor, Modifications and Upgrades:**

Bio-Scan Medical Survey Unit. Cost: 300,000 credits.

Cosmetic Enhancements: Fur/Skin/Feathers. The animal seems completely alive, seems to breathe, feels warm to the touch, purrs, pants or nuzzles when petted, and its fur feels nice to pet. Cost: 18,000 credits, half for small to medium-sized animals.

Cosmetic Enhancements: Realistic Eyes. Cost: 6,000 credits, half for small to medium-sized animals.

Human Voice Synthesizer. Cost: 4,000 credits.

Motion Detector and Warning System. Cost: 40,000 credits.

Wide Band Radio Receiver and Transmitter. Cost: 20,000 credits.

# Triax Weapons

The emphasis of the *new weapon designs* is greater stopping power/damage, extended effective range, and E-Clips with larger energy capacity for a larger payload (more shots). Most of the new weapons presented in these pages have one, two or all of these things going for them. In the battle against giant, supernatural beings like the Gargoyles and the armored Brodkil, both of whom use swarming tactics, stopping power and payload have become increasingly important, even more so than long range.

## New Triax Pistols

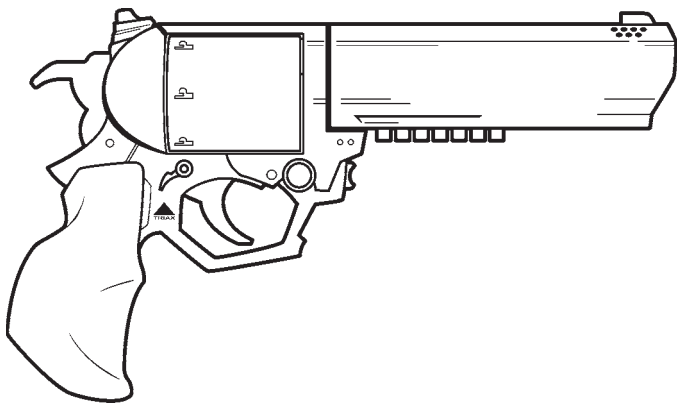

### TX-6 Revolver

The TX-6 Revolver uses the same rounds as the TX-5 Pump Pistol, TX-16 Pump Rifle, and the TX-17 Assault Rifle. The revolver is designed with a long, thick barrel similar to the big bore revolver, but with a more high-tech look. The TX-6 is quickly becoming a favorite side arm among infantry soldiers

and mercenaries. It has only recently been released on the German market with fair availability yet some have already found their way into the hands of eager gunslingers in the New West.

Weight: 5 pounds (2.25 kg).

Range: 800 feet (244 m).

Mega-Damage: 4D6 M.D.

Rate of Fire: Single shots only. Each blast counts as one melee attack.

Payload: Six. The weapon can be reloaded one round per melee action, or all six rounds can be reloaded in a single action using a speed loader.

Cost: 12,000 credits.

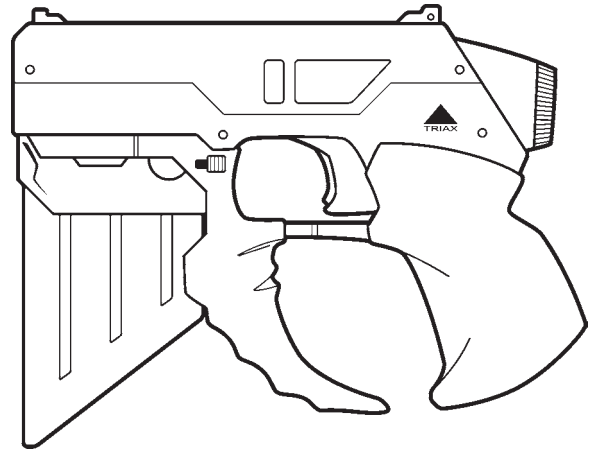

### TX-23 Laser Assault Pistol

Some members of the Triax Security Forces requested a small and easily concealed laser pistol capable of burst fire, like a sub-machine pistol, in order to put out a larger punch from a smaller package. The TX-23 is what Triax delivered. Eliminating the forward sliding E-Clip used in earlier designs, the pistol has a downward facing E-Clip in front of the trigger guard. The outward edge of the E-Clip port is flush with the barrel above, so the Assault Pistol appears rather blocky. Some soldiers and members of the Security Forces use Long E-Clips for a bigger payload; the weapon can accept both.

Weight: 5 pounds (2.25 kg).

Range: 800 feet (244 m).

Mega-Damage: 2D6 M.D. per single shot. 5D6 M.D. per three shot pulse.

Rate of Fire: Each single shot or three shot burst counts as one melee attack.

Payload: 20 shots per standard E-Clip or 50 shots from a Long E-Clip. Bursts use up three shots.

Cost: 20,000 credits.

### TX-25 Ion Pistol

The TX-25 is effectively the NGR designation for the *Q1-02 "Stopper" Ion Pistol* used by the forces of *Free Quebec*. This weapon was co-developed with Free Quebec and is considered one of the best energy pistols on the market.

Weight: 4.3 pounds (1.9 kg).

Range: 200 feet (61 m).

Mega-Damage: 4D6+4 M.D. per blast.

Rate of Fire: Single shots only, each shot counts as one melee attack.

Payload: 12 shots per standard E-Clip or 24 shots per Long E-Clip.

Cost: 18,000 credits.

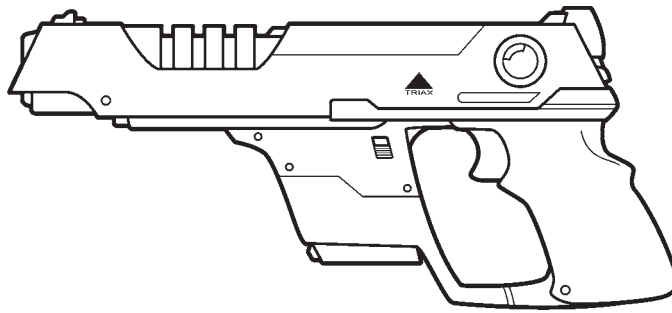

## TX-27 Particle Beam Pistol

The T-27 Particle Beam Pistol is a direct development from earlier Triax versions and boasts greater damage output and range. Off the battlefield, there is little use for a weapon that packs this much of a punch unless it is to kill.

Weight: 6.6 pounds (2.9 kg).

Range: 500 feet (152 m).

Mega-Damage: 5D6+5 M.D. per blast and a Critical Strike (double damage) on the roll of a Natural 19 or 20.

Rate of Fire: Single shots only. Each blast counts as one melee attack.

Payload: 10 shots per E-Clip.

Cost: 45,000 credits.

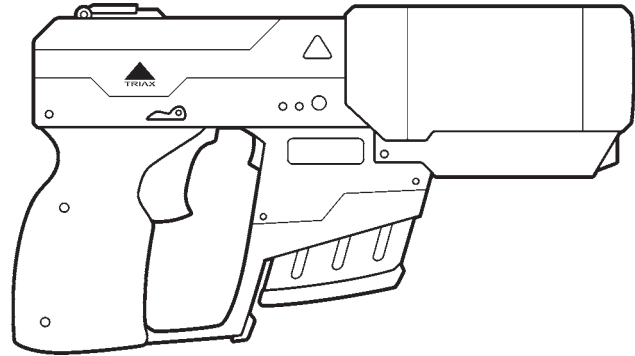

## New Triax Rifles

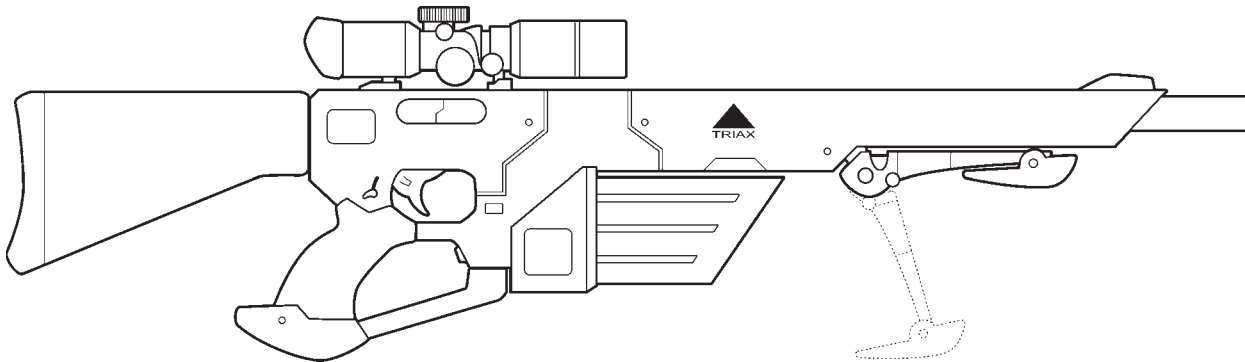

### TX-SL12 Sharpshooter Laser Rifle

One of the most advanced sniper rifles developed by Triax, the TX-SL12 was the predecessor to the TX-SL13 sniper rifle used by power armor troops and combat 'Borgs. The platform of the TX-SL12 has been combat tested over the past four years and has proved itself to be one of the most stable and reliable sniper rifles that Triax has ever designed, making it a favorite of scouts, assassins, snipers and bounty hunters. It was the test platform for the new standard Triax laser targeting system and was the last Triax weapon produced with the front sliding E-Clip, which gave it superior handling and balance over other comparable sniper weapons. Its powerful energy delivery system and superior range are better than almost anything put out by Triax's competitors, but its limited payload and the fact that each shot requires careful calibration combine to make it a very poor assault rifle.

Primary Purpose: Sniping.

Weight: 5 pounds (2.3 kg).

Range: 3,500 feet (1067 m).

Mega-Damage: 4D6 M.D.

Rate of Fire: Single shots only. Each blast counts as one melee attack.

Payload: 15 shots per forward sliding E-Clip.

Targeting Bonus: +2 to strike from laser targeting and superior balance.

Cost: 47,000 credits.

### TX-SL13 Ultra Sniper Rifle

The TX-SL13 Ultra Sniper Rifle or simply the "Ultra," as it is often referred, is a large, heavy, single shot, man portable rifle designed to enable ordinary infantry soldiers to shoot Gargoyles out of the sky.

The TX-SL13 uses a standard E-Clip plus the new innovation of a miniaturized nuclear power capacitor giving the TX-SL13 a massive energy delivering capability for a man-portable weapon. The capacitor of the weapon boosts the energy drawn from the E-Clip to give the blast the power of a heavy, single barreled laser one might find on an armored vehicle. It also enables the weapon to fire twice per thirty minutes *without* an E-Clip. The nuclear power cell automatically recharges in this

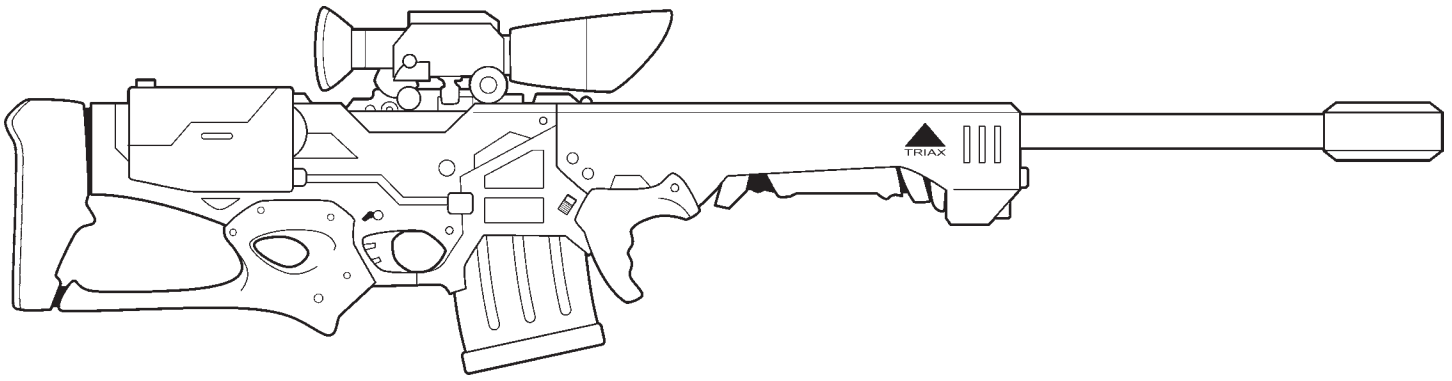

fashion and is good for one year with constant use. The Ultra can also be tied to a larger nuclear power source, like that of a cyborg, power armor or vehicle, via an external power cable, to circumvent the need for an E-Clip.

The Ultra is seldom given to heavy armored troops, because it is an infantry, heavy Gargoyle sniper rifle, and makes a poor assault weapon. It is only single shot, and the energy releases when fired has such a kick the weapon must be braced against something heavy or fired from a prone position to be accurate. It may also be mounted to a vehicle on a swivel gun turret like a rail gun. It cannot be fired accurately from the hip, while moving or from a standing position even by cyborgs and power armor. Ordinary soldiers suffer a penalty of -9 to strike, and cyborgs and power armor are -4 to strike unless the weapon is braced against a fixed surface for additional support (the hood of a car, the trunk of a fallen tree, a boulder, etc.). The release of energy has quite a kick and the size and weight of the rifle contributes to its unwieldiness.

The large rifle comes standard with a heavy-duty bipod to support the weapon barrel and to assist in firing stability. The targeting sight of the weapon can be hooked directly into the optics system of the user's helmet through a standard data port or headjack of a cyborg. The rifle itself is able to be broken down into 2 parts, the barrel and the body, for easier transportation,

usually by a two-man team (the sniper and the spotter). It can be stored in two pieces in matching heavy duty carrying cases that have wheels like a wheeled suitcase.

Primary Purpose: Long-Range Gargoyle Sniping.

Weight: 55 pounds (24.7 kg) total.

Range: 5,000 feet (1524 m).

Mega-Damage: 1D4x10 M.D. per shot.

Rate of Fire: Single shots only. Each blast counts as one melee attack.

Payload: 8 shots per standard E-Clip, 16 with a Long E-Clip. Plus two from the nuclear power cell every 30 minutes even if the E-Clip is empty. The power cell recharges at a rate of two shots per half hour.

Bonuses: +1 on a carefully Aimed/Called Shot when the weapon is properly braced.

Penalties: -9 for normal humanoids, -4 for cyborgs, power armor and those with Robotic or Augmented Strength, and -1 for those with Supernatural P.S. when the weapon is *not* braced. -1 to strike with a quick shot even if braced. Incapable of burst firing.

Cost: 90,000 credits for the weapon and an additional 10,000 for the dual, heavy duty cases (each has 20 M.D.C.). This weapon is in low production, restricted to NGR military use, and currently unavailable on the Black Market.

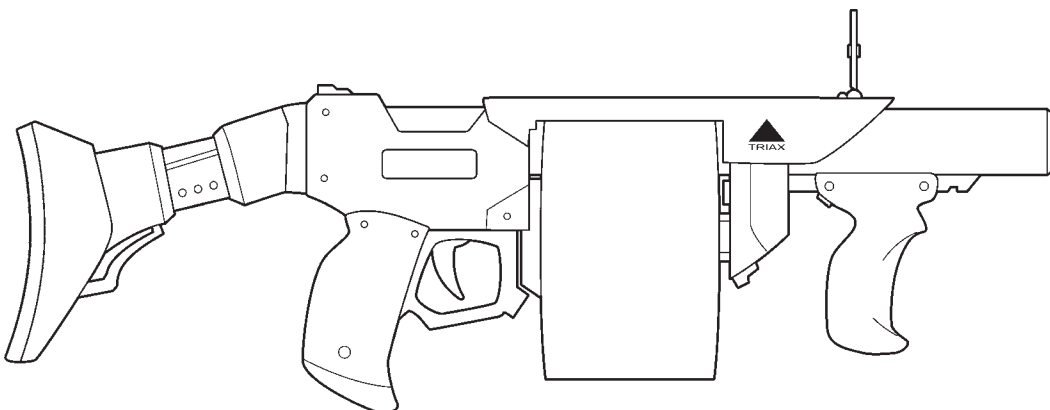

## TX-75 Grenade Launcher

This grenade launcher uses rocket propelled grenades reminiscent of the Wellington Industries ramjet rounds to propel the armor busting rounds farther than standard rifle grenades. The rounds were designed specifically with Gargoyles and heavily armored Brodkil in mind. Thus, the rounds have a Depleted Uranium casing which fragments upon impact. A human P.S. of

20 or higher is required to fire the grenades without suffering a penalty of -2 to strike.

Primary Purpose: Anti-Gargoyle/Anti-Armor.

Weight: 20 pounds (9 kg).

Range: 2,000 feet (610 meters).

Mega-Damage: 5D6 M.D. from grenades using Depleted Uranium to a three foot (0.9 m) impact radius. Fragmentation does 2D6+2 M.D. to a 12 foot (3.6 m) radius. Conventional explosive rounds, smoke, tear gas, and stun grenades may also be fired from this weapon.

Rate of Fire: Single shots only. Each blast counts as one melee attack.

Payload: 30 round drum. An ammo backpack carries two additional ammo drums for 60 additional grenades.

Targeting Bonus: +1 to strike from laser targeting when time is taken to carefully aim.

Cost: 55,000 credits for the TX-75. Grenades cost 1,200 per standard issue DU fragmentation round (800 credits per conventional fragmentation grenade, 1,000 per armor piercing).

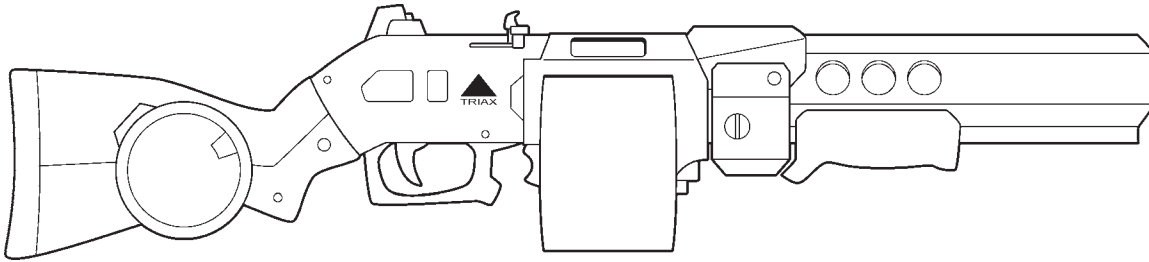

## TX-SS01 Exterminator Shotgun

The TX-SS01 was developed by the Triax weapons engineers to fill a request by cyborgs and troopers who wanted another heavy weapon that could be used for fighting in close quarters such as Gargoyle nests and hatcheries, as well as urban environments. It has a big payload and can fire a variety of rounds from its large bore barrel. The two most popular rounds are the solid slug, mainly for anti-Gargoyle operations, and buckshot for anti-personnel and destroying nests of eggs. Smoke, illuminating flare, tear gas and other chemical rounds are also available. A human P.S. of 22 or Augmented P.S. of 16 is required to use this weapon. Any user with a lower P.S. can fire the weapon, but is -2 to strike, is knocked back and loses initiative and one melee attack.

Primary Purpose: Anti-Gargoyle and Anti-Eggs.

Secondary Purpose: Anti-Personnel.

Weight: 15 pounds (6.75 kg), plus 8 pounds (3.6 kg) with ammo drum (20 pounds/9 kg).

Range: 600 feet (183 m).

Mega-Damage: Buckshot round does 2D6 M.D. to everything in a six foot (1.8 m) radius.

Solid slug does 4D6 M.D. to a single target. Man-sized to 16 feet (1.2 to 4.9 m) tall, armored troops, cyborgs, light to medium power armor, Gurgoyles and Brodkil must roll 12 or higher on 1D20 to *save vs knockdown* from the powerful impact from the solid slug. A failed roll to save means the victim is *knocked off his feet* and on his backside, suffering the loss of initiative and one melee attack. A successful save vs knockdown means the victim of the blast remains on his feet but takes an additional 1D6 M.D.

Rate of Fire: Single shots only. Each blast counts as one melee attack.

Payload: 8 rounds. Single rounds can be hand loaded.

Cost: 40,000 credits. Buckshot rounds are 400 credits each. Solid Slug rounds are 550 credits each.

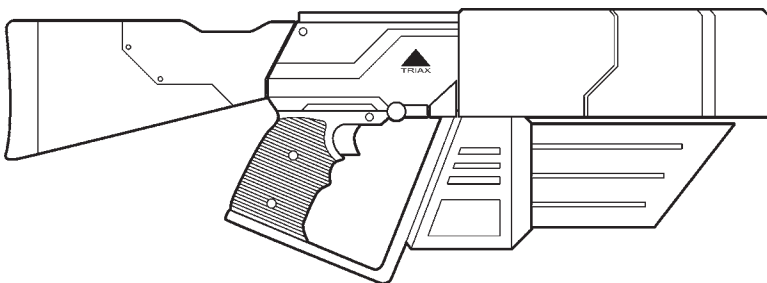

## TX-46 Particle Beam Rifle

In the search for weapons that deliver exceptional damage – important when dealing with beings that are giant-sized and fast healing like Gargoyles – a new particle beam rifle was developed. It has slightly better range and does more damage than its predecessor. The TX-46 has a larger barrel, an independent laser targeting sight, full stock, and still takes advantage of the FSE-Clip. Fans of the original TX-45 Particle Beam Rifle have purchased a number of these weapons and have been very complimentary about their performance in the field.

Primary Purpose: Assault.

Weight: 11 lbs (5 kg).

Range: 1,400 feet (426.7 m).

Mega-Damage: 1D4x10+8 M.D. and is a Critical Strike (double damage) on the roll of a Natural 19 or 20.

Rate of Fire: Single shots only. Each blast counts as one melee attack.

Payload: 24 shots.

Bonus: +1 to strike from laser targeting on Aimed shots.

Cost: 76,000 credits. This weapon is unavailable on the Black Market.

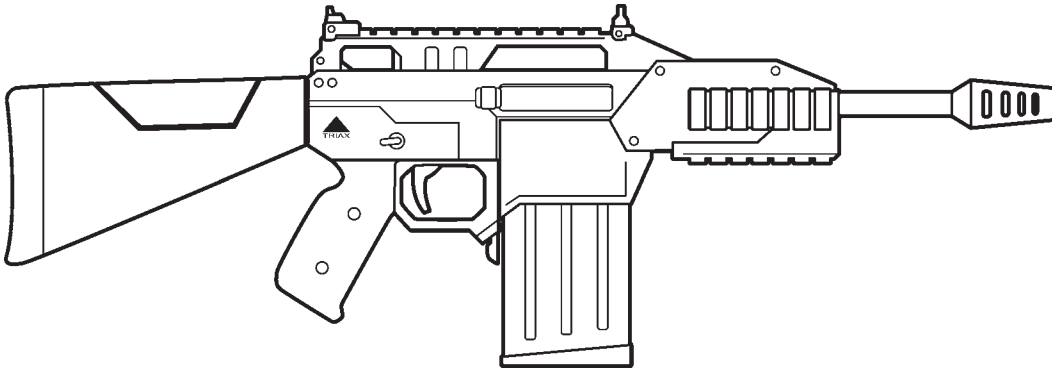

## TX-17 Assault Rifle

The traditional assault rifle was reborn in the labs of Triax, redesigned to handle the larger shells used in the pump series of weapons. The TX-17 Assault Rifle has a straight magazine directly in front of the trigger guard and can accept a variety of different sized ammo clips. An ammo drum can be used, but it makes the weapon more awkward to handle by human troops, but fine for cyborgs and power armor troops. The TX-17 comes standard with brackets for optical scopes and under-barrel accessories such as laser targeting sights and grenade launchers. A strength of 20 is required to use the TX-17 when an ammo drum is attached (-2 to strike if P.S. is less), but anyone can use the weapon with smaller clips.

Primary Purpose: Assault.

Weight: 15 pounds (6.75 kg), plus 5-7 pounds (2.3 to 3 kg) for ammo clip; 20 pounds (9 kg) with an ammo drum.

Range: 1,200 feet (366 m).

Mega-Damage: 4D6 M.D. per single round or 1D4x10+4 per three round burst. The weapon has a selector switch to go from single shot to three round burst.

Rate of Fire: Each single shot or three round burst counts as one melee attack.

Payload: 30 round and 45 round magazines, or a 105 round ammo drum. If the ammo drum is used a P.S. of 20 or greater is required.

Cost: 50,000 credits.

## Briefcase (Aktenkoffer) Guns

The Triax briefcase weapons come in two styles: the TX-A1 Combat Shotgun and the TX-A2 light submachine-gun. Both can fire S.D.C. and M.D. ammunition at the flip of a switch. At the first sign of danger, the Triax operative can press a concealed button in the handle or side of the briefcase to transform it into a weapon.

For the shotgun design, the lower half of the briefcase drops down and slides back to reveal the handle and stock, while also allowing access to the pump action slide. The submachine-gun design actually folds the lower section up to create the stock of the design, while exposing the handle. The ammunition is stored in the bottom half of the weapon which becomes the stock, maximizing

space and eliminating the need for an external magazine.

Briefcase weapons have a hard M.D.C. external housing that is made of Mega-Damage plastic harder than steel and able to pass through metal detectors. Triax scientists have even found a way for the casing to emit a false x-ray signature of the internal components to appear as files, papers, and other common items, not the inner workings of a gun. The case comes in metallic silver, matte grey, matte brown, or matte black, and can be covered in black or brown leather at a slight additional cost. These weapons have become instant favorites of Triax spies, assassins, and bodyguards.

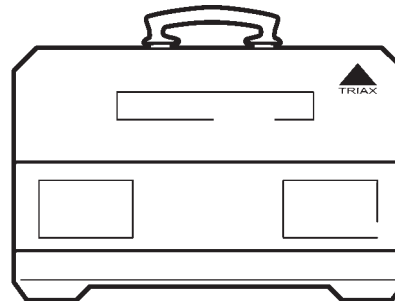
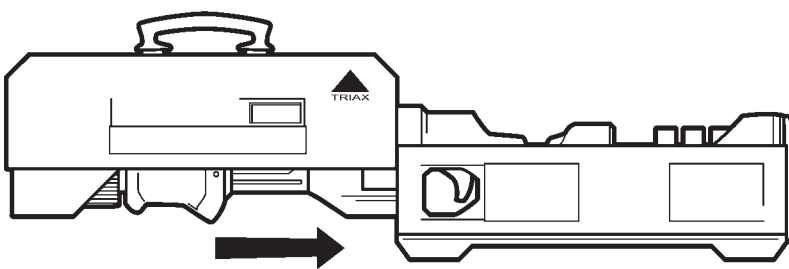

### TX-A1 Concealed Shotgun

Weight: 12 pounds (5.4 kg).

Range: S.D.C. shotgun shell or solid slug: 300 feet (91.5 m).  
Explosive rounds and armor piercing: 500 feet (152 m).

Damage: Varies with ammo type.

S.D.C. Shotgun Shell: 4D6 S.D.C. to a four foot (1.2 m) radius.

Solid Slug: 5D6 S.D.C.

M.D. Explosive Shell (Fragmentary): 2D6 M.D. to a six foot (1.8 m) radius.

M.D. Explosive Shell (Plasma): 3D6 M.D. to a three foot (0.9 m) radius.

M.D. Armor Piercing Round: 2D6+2 M.D.

Rate of Fire: Single shots only. Each blast counts as one melee attack.

Payload: Eight S.D.C. rounds and 8 M.D.C. rounds.

Cost: 25,000 credits.

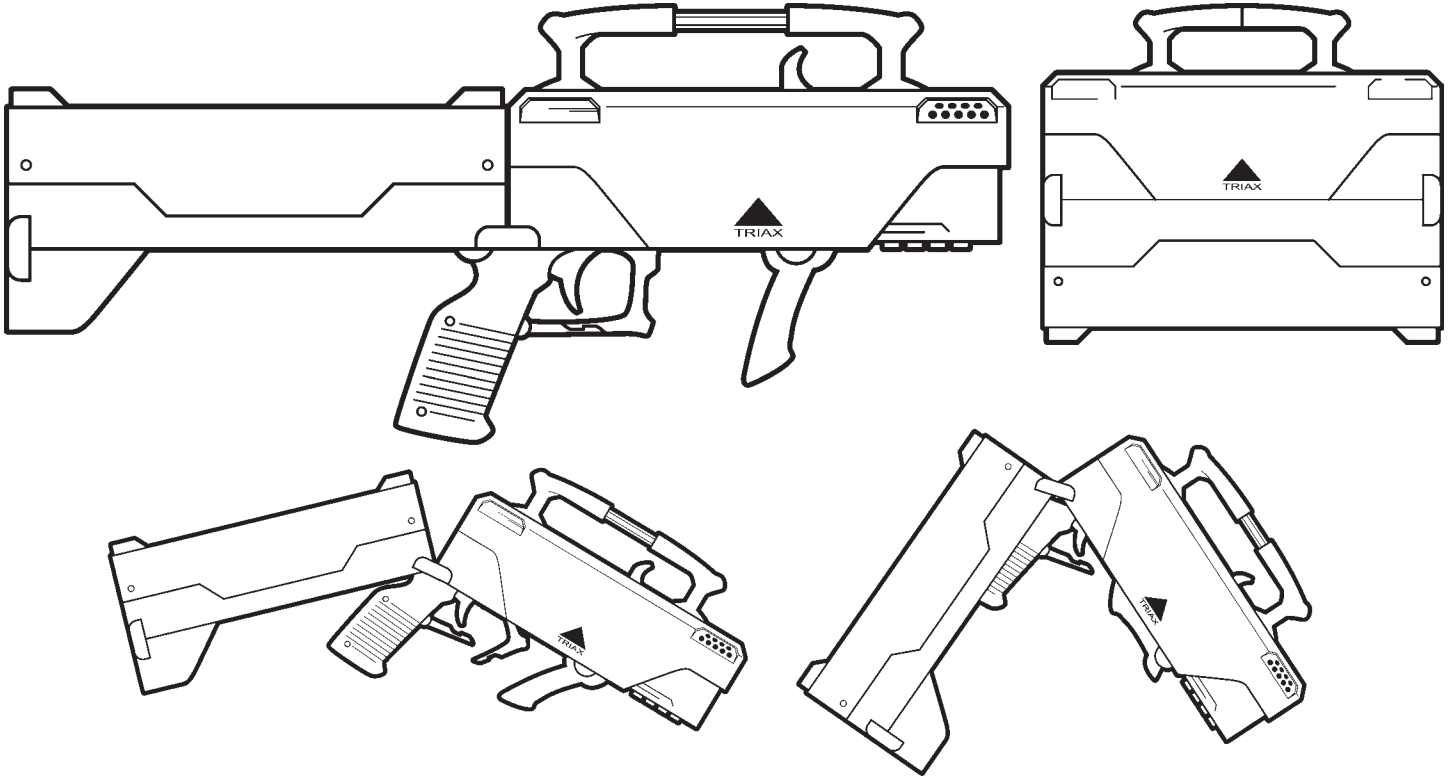

### **TX-A2 Concealed Submachine-Gun**

Weight: 12 pounds (5.4 kg).

Range: 800 feet (244 m).

Damage: 1D6x10 S.D.C. per burst or 2D6 M.D. per burst with M.D. ammunition.

Rate of Fire: Burst fire only. Each burst counts as one melee attack.

Payload: 30 S.D.C. bursts, and 30 M.D. bursts.

Cost: 30,000 credits.

### **VS-101 Sonic Stun Projector**

In keeping with the NGR's strategy of gaining air superiority over the Gargoyles, the scientists at the *Passau Research Komplex* created a Sonic Stun Projector to disorient Gargoyles. It is a large machine, about the size of a small car, which emits pulse-pounding sonic waves over medium to long distances. These sonic waves, audible only to Gargoyles, dogs, and a few other creatures, assault the inner ear organs, inducing vertigo and severe dizziness.

The Sonic Stun Device requires only one man to operate. Its operating parameters are simple and an operator can be taught its controls in under ten minutes (requires Literacy and Computer Operation). The control panel is hidden among other panels, and the keypad is designed to be too small for Gargoyles or Brodkil to operate. For optimum performance, the projector

should be located at an elevated position such as a rooftop or tower.

Some military units are built on hover platforms for mobility. These hover platforms can rise and hover 100-300 feet (30.5 to 91.5 m) in the air and are protected by a force field, as sound waves are not hampered by the field. An electronic key pad and remote control raises and lowers the machine as needed. The projector works resting on the ground, but range is reduced by half from surrounding trees, buildings or other large structures; works fine on an open plain. VS-101s that are not special mobile units on a hover platform can be transported by truck, power armor, robot, etc. Those used for civil defense are typically mounted on the roof of a building.

Engineers at Passau labored for years and went through hundreds of test subjects in order to create this device. So far, the device has seen limited use in border skirmishes, with very positive results. Though used in assaults on roosts and nests, most NGR military leaders see the VS-101 as ideal for defense against Gargoyle attacks. The NGR plans to have a few of these devices installed on towers in every major city, most border towns and permanent military bases, as well as strategic positions. Triax already has them installed on the roofs of every one of their factories and office buildings. Possible negative or long term effects of the weapon on humans and different species of D-Bees have not been thoroughly tested, but initial studies show

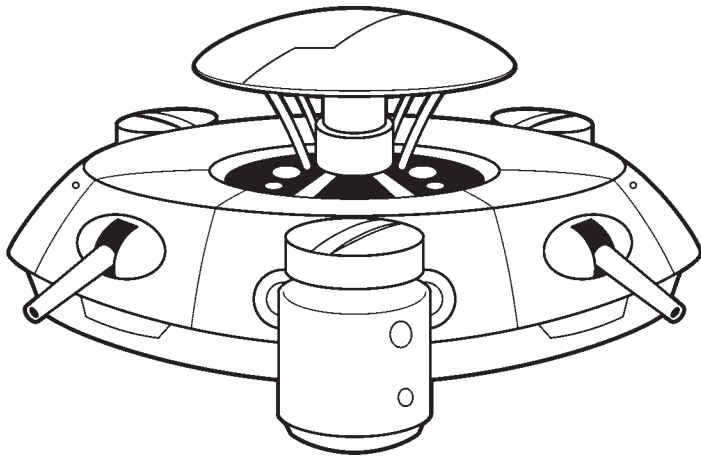

no harm whatsoever to humans or two dozen types of D-Bees. The Gargoyles absolutely despise this machine, and make it their primary target whenever it is encountered.

**Crew:** One trained operator or robot drone.

**M.D.C. by Location (Basic Unit):**

Control Panel (1) – 20

\*Main Body – 120

**Note:** This basic unit is used by the military and NGR government for defense against Gargoyles. Most do not have the force field or hover platform features, though most have wheels for repositioning.

**M.D.C. by Location (Mobile Military Unit):**

Hover Platform (1) – 100

Platform Hover Jets (3) 40 each

Control Panel (1) – 20

Force Field (does not block the sound waves) – 200

\*Main Body – 170

\* If the M.D.C. of the main body is reduced to zero, the unit is destroyed.

**Maximum Ground Speed:** Per means of transportation – truck, robot, aircraft, etc. Hover platforms can fly 80 mph (128 km) and can be piloted by a soldier on the unit itself or by remote control (line of sight required).

**Length:** 12 feet (3.6 m).

**Width:** 5 feet (1.5 m).

**Height:** 4 feet (1.2 m).

**Weight:** One ton, but the wheels of most units roll smoothly across smooth surfaces (floor, wood surfaces, concrete, rooftops, etc.), so that four men can move it as necessary. Triple the weight and increase the size by 40% for units built on a hover platform.

**Cargo:** Not applicable.

**Power System:** Electrical or nuclear. Electric power units are likely to be plugged into the power lines of the building and/or have a backup battery or generator. Most military units have a nuclear power supply.

**Cost:** Basic civil defense unit: 345,000 credits; 1.5 million with force field. Basic military defense unit: 430,000 credits; 1.6 million with force field; typically transported by vehicle. Military combat VS-101 on hover platform and force field: 2 million credits. Not yet available on the Black Market.

**Weapon Systems:**

**1. Anti-Gargoyle Sonic Stun, Pulse Emitter (1):** The Sonic Stun Projector emits sound waves that are inaudible to humans, but disorienting to Gargoyles and their kin. These sound waves travel in all directions and affect all species of Gargoyles, including Gargoyle Lords, Gargoyle Mages, Gurgoyles, and Gargoylites. Regrettably, they also affect canine races such as CS Dog Boys and other animals and races with sensitive hearing, including dogs and bats, but penalties are half. Brodkil are *not* affected. (**Note:** A general rule is any creature with advanced hearing, whether by magic, cybernetic hearing augmentation, or by natural ability, is affected by this machine.)

**Primary Purpose:** Disorientation of Gargoyles and similar creatures.

**Secondary Purpose:** Defense.

**Range:** 2,500 feet (762 m). The sound waves can be heard by Gargoyles for miles around, but they only have full effect and penalties at a comparatively close range. Beyond that range the creatures suffer no penalties.

**Disorientation Penalties:** All Gargoyles within range must roll to save vs disorientation. A roll of 14 or greater saves, no attribute bonuses apply.

**Failing to save:** Reduce the number of melee attacks/actions by half, no initiative (last to attack in the combat sequence), no Perception Roll bonuses apply, all combat bonuses are reduced by half, Reduce Spd (on foot and flying) by 70%, -50% on the performance of all skills, and the Gargoyles' ears ring and whistle with noise and their heads hurt and throb. Flying creatures find it difficult to maintain flight and have trouble dodging (no bonuses!) incoming attacks while airborne. Penalties persist for as long as the VS-101 is activated and the monster remains within range. Most will try to distance themselves.

**A successful save** means the victim suffers only half the penalties this device usually inflicts. A new saving throw must be made every two melee rounds.

**2. Other:** None are built into the VS-101. The unit is usually protected by troops, power armor or additional supporting defenses, all at an extra cost.

# Robot & Power Armor Weapons

## TX-222 Pulse Laser (Giant Size)

The TX-222 is powerful, giant-sized, burst firing pulse laser used as an assault weapon by some Power Armor Commandos and heavy Combat Cyborgs, and is standard issue to the Ulti-Max II as its main handheld weapon. Based on the TX-41 pulse rifle, the TX-222 is a more compact version of the weapon, but with a higher energy output for greater damage. Used mainly by giant robots and power armor that are 10-20 feet (3 to 6.1 m) tall.

**Primary Purpose:** Assault.

**Weight:** 135 pounds (60.7 kg).

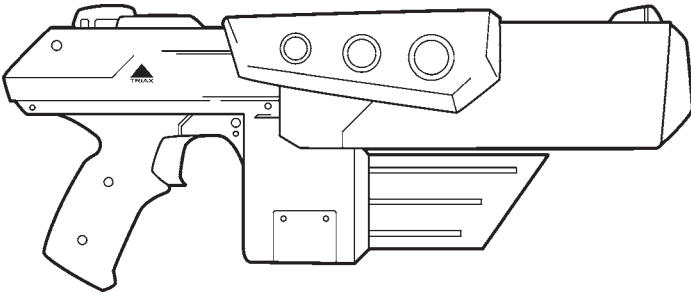

Range: 3,000 feet (914 m).

Mega-Damage: 1D6x10 M.D. per quadruple pulse burst.

Rate of Fire: Burst firing only, but the burst is less accurate and can not be used to make a Called Shot. Each burst counts as one melee attack.

Payload: 40 bursts from the internal power supply. When connected to a robot or power armor, the internal power supply automatically recharges at a rate of one burst every 10 minutes. A giant, front sliding E-Clip can also be used; it holds 40 bursts. Effectively unlimited when hooked to the power supply of the robot or power armor suit.

Cost: 160,000+ credits on the Black Market. This weapon is exclusive to the NGR Army, and rare on the secondary market.

## TX-252 Rail Gun (Giant Size)

The TX-252 is a larger, heavier, stockier version of the TX-500 'Borg rail gun, only it is designed for power armor and robots as a handheld assault weapon. Heavy cyborgs can use the weapon as well, but must do so as a two-handed weapon and are -2 to strike due to the awkward size and vibration when fired. It is standard issue to the Predator II and can be seen depicted in the illustration of that power armor (see page 110). It has a shorter range than most Triax rail guns, but packs a bigger wallop.

Primary Purpose: Assault/Anti-Gargoyle and Anti-Armor.

Secondary Purpose: Defense and Anti-Personnel.

Weight: Gun: 225 pounds (101 kg). One TX-252 ammo drum is an additional 250 pounds (112.5 kg). The ammo drum can hook to the back or hip of the power armor.

Range: 4,600 feet (1402 m).

Mega-Damage: 1D6x10 M.D. for a 30 round burst.

Rate of Fire: Each burst counts as one melee attack.

Payload: 3,000 round drum, capable of firing 100 full bursts.

Cost: 150,000+ credits on the Black Market. This weapon is exclusive to the NGR Army and hard to find on the secondary market.

## TX-249 Particle Beam Rifle (Giant Size)

This is a giant-sized particle beam rifle designed for use by the Ulti-Max II and other heavy power armor and giant robots (10-20 feet/3 to 6.1 m tall). The weapon is usually tied to the power armor or robot's nuclear power supply for effectively unlimited use, though it does reduce the life of the power supply by 30-50%. The weapon is tied to the robot's nuclear power supply, not by a cable that could get cut, disconnected, or tan-

gled, but via a special connection point in the hands of the power armor. That having been said, conventional "cabling" can be done and the TX-249 is designed to be able to take a standard giant-sized E-Clip in the event that the weapon needs an independent power source.

This is the first giant-sized particle beam rifle designed for power armor and robot troops. It has good range and a high damage yield. This weapon is often used in conjunction with a tripod by light power armor and heavy Combat Cyborgs because it is so large and unwieldy. A Robotic P.S. of 26 is needed to fire the weapon from a standing position without penalties.

Primary Purpose: Anti-Gargoyles & Anti-Armor.

Secondary Purpose: Assault and Defense.

Weight: 297 pounds (133.6 kg).

Range: 2,000 feet (610 m).

Mega-Damage: 1D6x10+10 M.D., Critical Strike (double damage) on a D20 roll of a Natural 19 or 20.

Rate of Fire: Each blast counts as one melee attack.

Payload: 33 blasts from the oversized E-Clip, 66 from the larger power pack from the back or the hip and cabled to the rifle, or effectively unlimited when tied to the power supply of the armor or robot.

Cost: 190,000+ credits on the Black Market. This weapon is exclusive to the NGR Army and hard to find on the secondary market.

## TX-H Series & Special Weapons

### For Robots and Power Armor

The TX-H (for "hand to hand" melee weapon) series was developed following the long success of the X-2500 Black Knight and requests by other robot and power armor units requesting hand to hand weapons for combat against Gargoyles and Brodkil.

When the development started, the minds at Triax decided to develop a range of weapons that include a mace, hammer, Vibro-Axe, energy sword and energy whip. Other weapons may follow. The new and redeveloped Electro-Mace and other hand weapons are sold outside the NGR and have proven to be extremely good sellers. The visceral nature of the weapons is part of their appeal. The fact that they can be hung from the waist and used as a backup weapon or side arm is also appealing. Since Gargoyles and other demonic beings tend to favor old style weapons, the Triax creations are handy for engaging the enemy up close and personal. Triax is considering expanding the variety of weapons offered in the line.

### TX-H1 Electro-Mace

The Electro-Mace has long been a favorite of robot crews and it was requested that the weapon be upgraded for use with the new Triax robots and power armor.

The TX-H1 is a revamped and restyled Electro-Mace for use in *smaller* power armors and robots (under 25 feet/7.6 m). The cowl that protects the hand and forearm has been removed



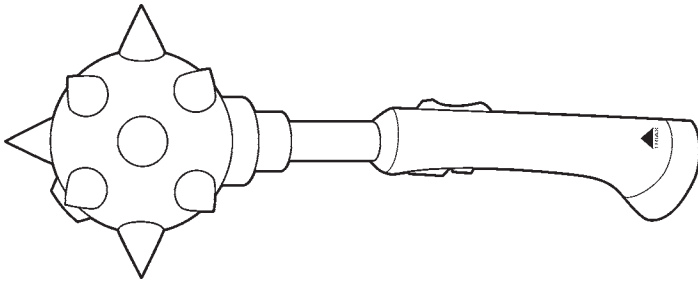

and the weapon is held by a handle, like a regular mace, but still allows the user to point and fire the electrical discharge. The TX-H1 still has its own independent power supply and does not require cables or special connections to the robot or power armor using it.

There are two styles of Electro-Mace available: The TX-H1-M for the “mace,” which is a heavy ball at the end of a handle, and the TX-H1-S for “morning stars” which is a mace covered in spikes for additional damage. **Note:** The old-style Electro-Mace is still available for larger robots and power armor.

Primary Purpose: Anti-Personnel & Riot Control.

Range: Hand to hand combat or 1,000 feet (305 m) via electrical blast.

Mega-Damage: *TX-H1-M Mace* is a blunt, pounding weapon that inflicts 2D6 M.D. per strike, +1D6 when the mace is electrically charged for extra damage every time it hits. The electrical blast does 3D6 M.D.

*TX-H1-S Morning Star* is a spiked, blunt, pounding weapon that inflicts 3D6 M.D. per strike, +1D6 when the mace is electrically charged for extra damage every time it hits. The electrical blast does 4D6+8 M.D.

Rate of Fire: The mace can fire three long-range blasts per melee.

Payload: Effectively unlimited.

Cost: Mace: 35,000 credits. Morning Star: 45,000 credits. 70,000 credits for the older, truly giant-sized Electro-Mace suitable for ‘Bots 27 feet (8.2 m) and larger.

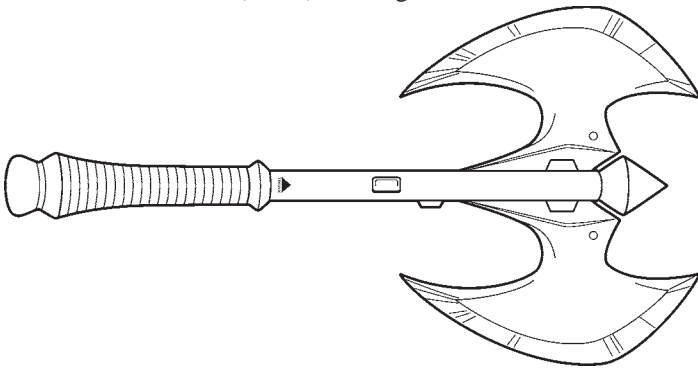

## TX-H2 Vibro-Axe

This is a large, double-bladed Vibro-Axe which can be used by larger robots and power armor. The TX-H2 is the least innovative weapon in the TX-H line of weapons, but Triax decided to include it since it has long been one of the most requested melee weapons and the price point is more affordable for many buyers.

Primary Purpose: Anti-Personnel, Close Combat and Firefighting.

Range: Hand to hand combat.

Mega-Damage: 3D6 M.D.

Payload: Effectively unlimited.

Cost: 22,000 credits.

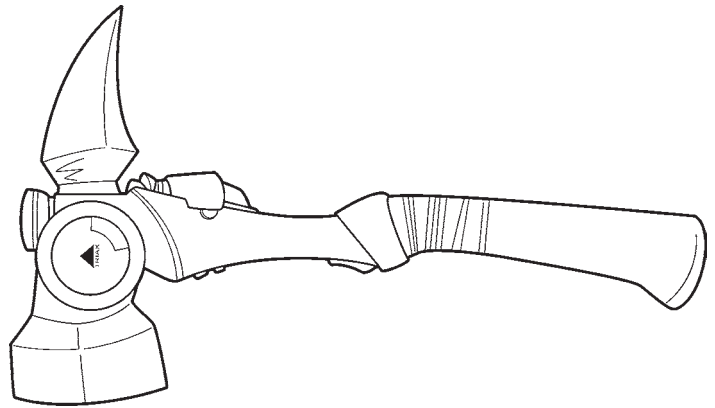

## TX-H3 Blast Hammer

The TX-H3 Blast Hammer is one of the newest melee weapons offered by Triax. The weapon resembles an old style *war hammer* with a blunt surface side on the weapon’s head and a large spike on the other.

When activated, the weapon collects kinetic energy through even subtle movements of the user, and when it is swung. Upon impact, the stored energy is released in a blast that not only makes the hammer more damaging, but can also knock a victim off of its feet. The thundering strike that echoes over the battlefield is often a sign that the battle is going well for the NGR troops.

Primary Purpose: Anti-Personnel and Close Combat.

Mega-Damage: Hammer: 2D6 M.D. from the blunt attack and 2D6+2 M.D. from the spiked part of the hammer when the “blast” feature is not activated. When activated, the concussive blast adds 2D6 M.D. and an 80% likelihood of knocking down opponents under 13 feet (3.9 m) tall and a 40% chance to knock down larger opponents. Roll percentile dice to determine a successful knockdown. Victims of a knockdown lose initiative and one melee attack/action.

Payload: The hammer can store enough kinetic energy for 10 blasts. Movement will restore the blasts at a rate of one per hour under normal use, while rapid movement like running or combat restores one blast every 20 minutes.

Cost: 40,000 credits.

## TX-H5 Plasma Whip

Deactivated, the weapon appears as a handle with a spike at one end (for parrying) and a long, semi-transparent, flexible filament connected to the other end. When activated, heated plasma streams across the long, thick, wire-like filament to create an energy whip.

When used to attack, the plasma whip strikes with Mega-Damage heat, burning its target, but entangling an opponent’s weapon, hand, leg, etc., inflicts even more damage. The entangled item or part takes continuous damage until the whip is shaken to release or the victim can pry it off. Thus, a plasma whip can be used to target and destroy a specific weapon and even a hand or limb. It can also be used to disarm an opponent with the lash of hot energy, causing him to drop his weapon or

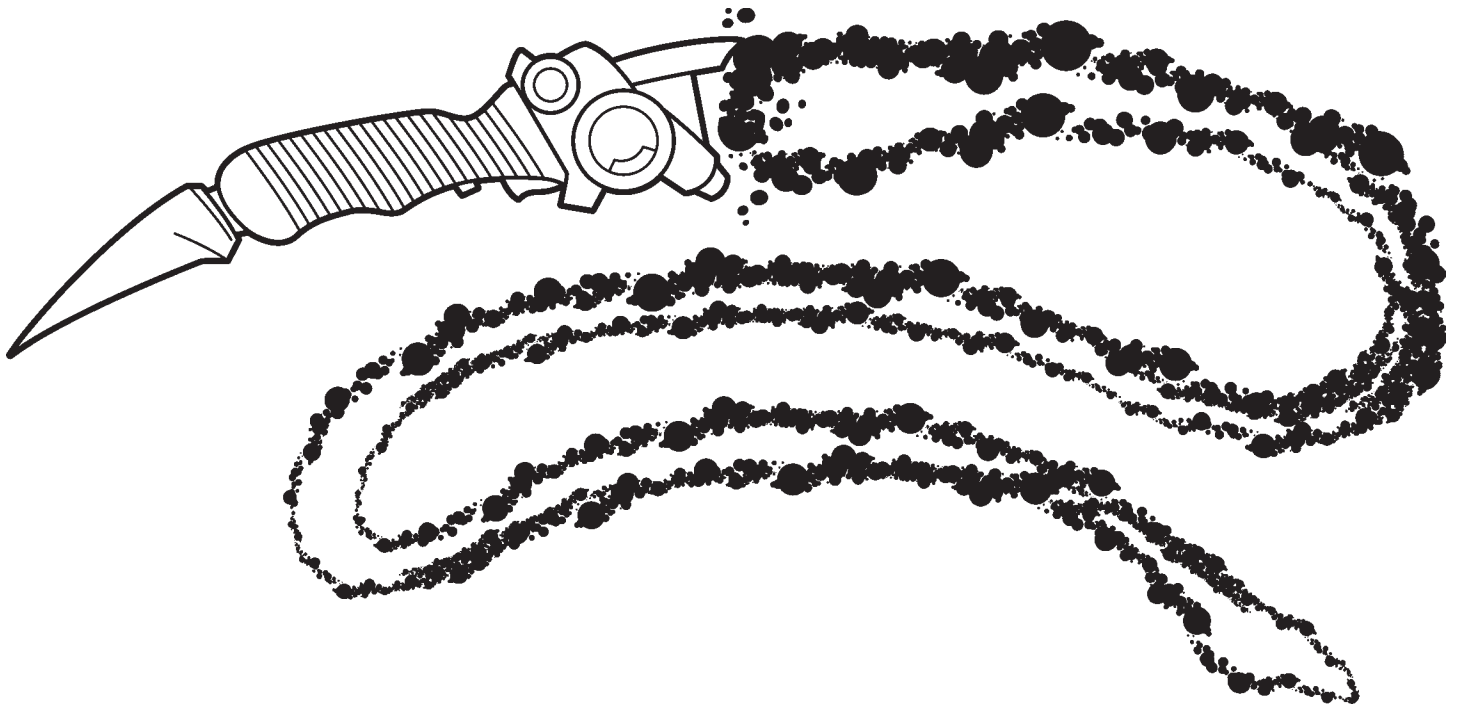

let go of an entangled weapon. The plasma whip can also fire a plasma blast, but the range is short.

Brodkil both fear and covet this weapon for its ability to quickly dismember or incapacitate an enemy, and many see it as a sign of strength to have survived its attacks and defeated the wielder in order to take it for oneself.

Primary Purpose: Anti-Personnel and Close Combat.

Range: 7 feet (2.1 m) as a whip. Energy discharge/blast has a range of 200 feet (61 m).

Mega-Damage: 2D6+2 M.D. for being struck/lashed by the charged energy filament or shot with an energy discharge. 6D6+3 M.D. every *melee round* a weapon, item or limb is entangled by the whip. Of course, the whip cannot be used to strike or disarm while it has something entangled. Trying to pry or pull/loosen the hold of the entangled whip does 2D6 M.D. to the hands or item being used to pry the whip loose. The whip-line can be cut, but requires 20 M.D. to cut through the line.

The spike end does 1D6 *S.D.C.* as a weapon, but can be used to parry incoming M.D. melee weapons or claw attacks from monsters.

Deactivated, the whip-line does 2D4 *S.D.C.* damage per whip attack.

Rate of Fire: Each whip strike or energy blast counts as one attack.

Payload: 9 energy strikes and/or blasts per internal power supply when used as a stand-alone weapon. Must be recharged at a military base or by the manufacturer.

Effectively unlimited when hooked to the power supply of a robot or power armor, which is how most use the weapon. Like the TX-249 and other new Triax robot weapons, the whip is usually tied to the robot's nuclear power supply via a special connection point in the hands of the power armor or 'Bot and the handle of the whip. A cable connection is dangerous with a whip as it is likely to get entangled and cut.

Bonuses: +2 to disarm and +2 to entangle.

Cost: 110,000 credits. Limited to poor availability on the secondary market.

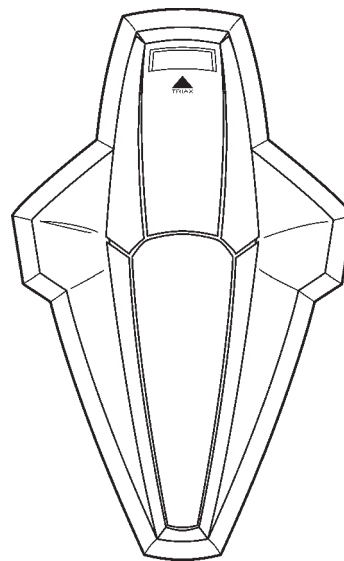

## TX-001 Defense Shield

A large shield used to provide additional armor protection for robots, power armor, and heavy combat 'Borgs. The shield is 7 feet (2.1 m) tall and three and a half feet (1.07 m) wide.

Primary Purpose: Defense and Riot Control.

Weight: 100 pounds (45 kg).

M.D.C. of the Shield: 160 points.

Range: Close combat.

Mega-Damage: 1D6 M.D. plus punch M.D. as per Robotic P.S.

Cost: 200,000 credits. Good availability. The cost is due to the high amount of Mega-Damage material.

Bonus: +1 to parry with the shield.

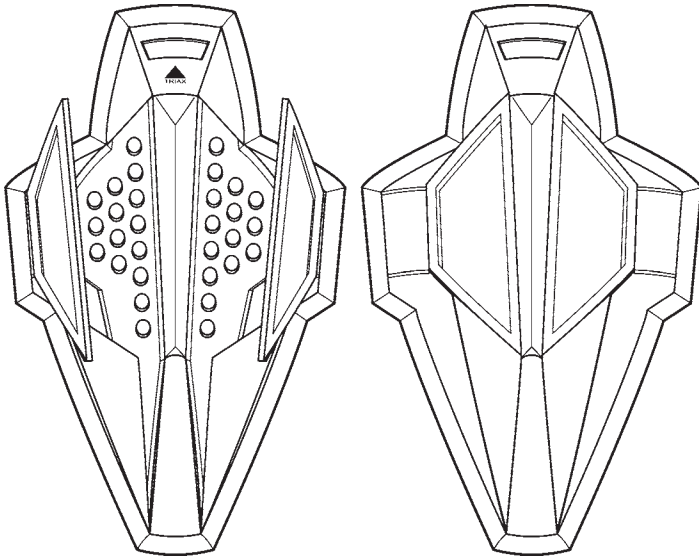

## TX-002 Heavy Weapon Shield

The TX-001 Heavy Weapon Shield not only provides additional armored protection, but conceals a battery of

mini-missiles. The missiles are hidden behind the armored plating that flips open to fire them.

Primary Purpose: Defense and Riot Control.

Secondary Purpose: Assault and Anti-Armor.

Weight: 200 pounds (90 kg) plus the weight of the missiles.

M.D.C. of the Shield: 160

Range: Close combat with the shield as a melee weapon, one mile (1.6 km) for mini-missiles.

Mega-Damage: Shield as a blunt weapon: 1D6 M.D. plus Punch M.D. as per Robotic P.S. Mini-Missiles: Varies with missile type. Any type can be used, but tends to be high explosive, inflicting 1D4x10 M.D. each.

Rate of Fire: Missiles can be fired one at a time or in volleys of 2, 4, 8 or all 30 at once.

Payload: 30 total missiles.

Cost: 400,000 credits for the cost of the shield plus the cost of the mini-missiles.

Bonus: +1 to parry with shield.

## WaffenTek Energy Weapons

Many WaffenTek energy weapons are derived from pre-Rifts designs the company found sixty years ago in Munich. The original designer of these weapons was a small company that was swallowed and bought out by Triax back when energy weapons were first available during the Golden Age. Triax took the original designs and absorbed them into their own. WaffenTek has unearthed and refined some of these “ancient” weapon designs and market them as their own.

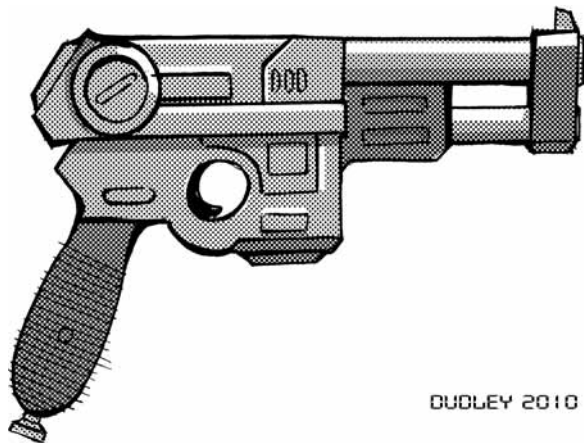

### WaffenTek WT-10 “Pre-Rifts” Laser Pistol

This simple laser pistol is based on designs in the early days leading up to the Golden Age of Mankind. It is cheap and easy to produce, and very popular. When more expensive Triax weapons can't be found, or cost too much to buy, the WT-10 is always available.

Weight: 2 lbs (0.9 kg).

Range: 600 feet (183 m).

Mega-Damage: 2D4 M.D.

Payload: 25 shots per standard E-Clip.

Cost: 6,500 credits. Excellent availability.

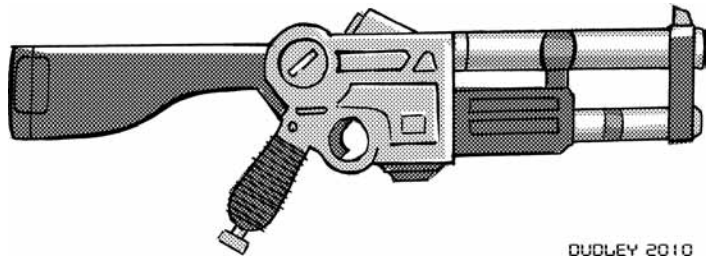

### WaffenTek WT-20 “Pre-Rifts” Laser Rifle

The WT-20 is an economical choice for sport hunters, wilderness scouts, competition shooters and home defense along the border or in communities outside the NGR.

Weight: 5 lbs (2.25 kg).

Range: 1,400 feet (427 m).

Mega-Damage: 3D4 M.D.

Payload: 21 shots per standard E-Clip.

Cost: 10,000 credits.

### WaffenTek “VolksPistole” VP-01

A controversial weapon to be sure, it seems like a step backwards in technology, but considered by most to be a leap forward in personal safety. The VP-01 VolksPistole, or “People’s Gun,” is an energy weapon designed to protect the average citizen. The average person has no need for a weapon that can blow

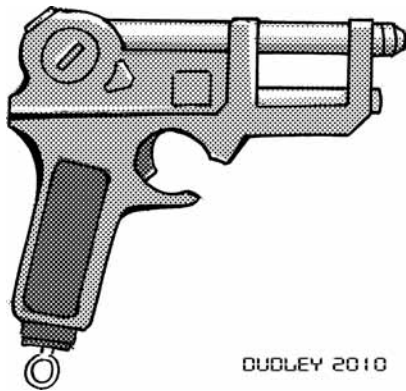

DUDLEY 2010

apart vehicles, burn down buildings, and disintegrate limbs. Although ballistic S.D.C. weapons are readily available and legal to own, energy weapons are seen as more “futuristic” and therefore more attractive by the public. The result is an energy pistol that fires S.D.C. laser beams. The VolksPistole has proven to be wildly popular and profitable, convincing WaffenTek to expand their line of S.D.C. energy weapons.

Weight: 1.6 lbs (0.7 m).

Range: 500 feet (152 m).

Damage: 4D6 S.D.C. damage. This pistol cannot be turned into an M.D. weapon and does not hurt M.D.C. targets.

Payload: 140 shots per standard E-Clip. The low level of damage means a much higher payload.

Cost: 3,000 credits.

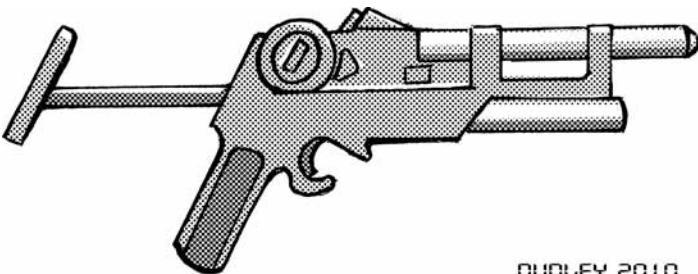

DUDLEY 2010

## WaffenTek “Hell-Fighter” VP-02 S.D.C. Laser Rifle

The Hell-Fighter is a light, easy to use S.D.C. laser rifle that uses the same technology as the VolksPistole and is very popular on the open market. Security teams and police officers sometimes use WaffenTek S.D.C. laser rifles, in civilian settings and situations where Mega-Damage weapons are overkill. The weapon is also popular among wilderness people, hunters, bandits, criminals, mercenaries and adventurers.

Weight: 6 lbs (2.7 m).

Range: 1,800 feet (548.6 m).

Damage: Three settings: 5D6 S.D.C., 1D4x10 S.D.C. and 2D4x10 S.D.C. This rifle cannot be turned into an M.D. weapon.

Payload: 120 shots at the low setting, 60 shots at the two higher settings.

Cost: 5,000 credits.

Bonus: +1 to strike on an Aimed shot from standard optic system and superior balance.

# New Triax Body Armor

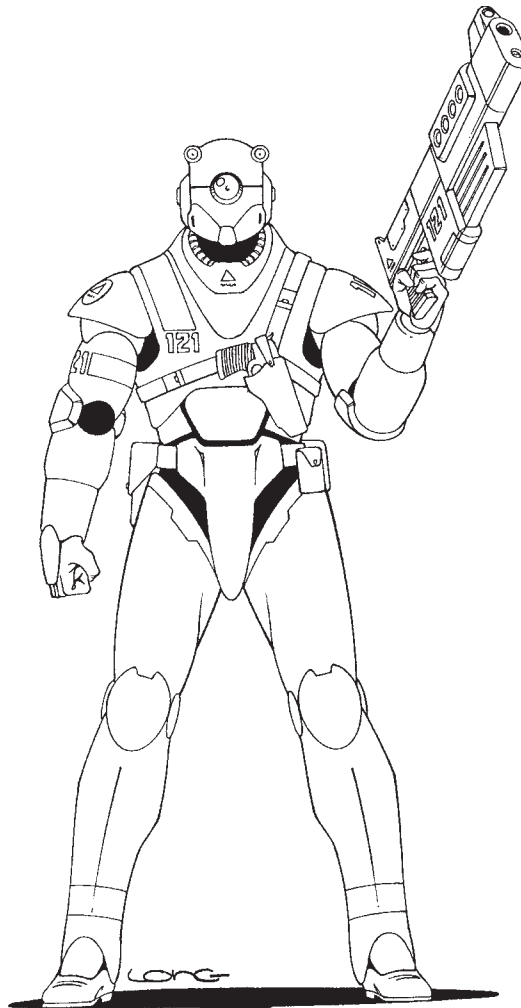

## T-1011-X2 “Cyclops Booster”

The Cyclops Booster is a light exoskeleton augmentation system that is built into existing suits of *T-10 Cyclops* and the *T-11 Enhanced* infantry body armor. This light booster system fits right into the existing armor and takes only two hours to re-fit by a certified Triax technician or Army Operator. The T-1011-X2 *supplements* the original armor to give the soldier a boost in strength, speed, and reflex action. The augmentation also helps reduce fatigue.

Currently, 40% of NGR troops have seen the upgrade, starting with officers, special forces, commando units, infantry companies assigned to raid and destroy Gargoyle roosts and nests, followed by regular infantry troops. Field Mechanics and Medics will be among the last to be upgraded, and the NGR Air Force is not designated to get the “boost” at all.

**Class:** T-10 and T-11 upgrade and augmentation.

**Size:** Human equivalent combat armor.

**Weight:** Adds 5 pounds (2.2 kg) to the weight of the original armor.

**Mobility:** No change.

**Upgrade and Boosted Features:** The booster system provides the following bonuses and augmentation to the existing T-10 and T-11 body armor: +6 to P.S. (human strength), +6 to Spd

(of the wearer), adds 4 feet (1.2 m) to leaps across or upwards, reduce rate of fatigue by 20%, enhanced reflexes provide a bonus of +1 to parry and dodge, and +1 to roll with impact.

**Cost:** 70,000 credits plus the cost of the suit.

## T-25 “Uber” Super-Exoskeleton Armor

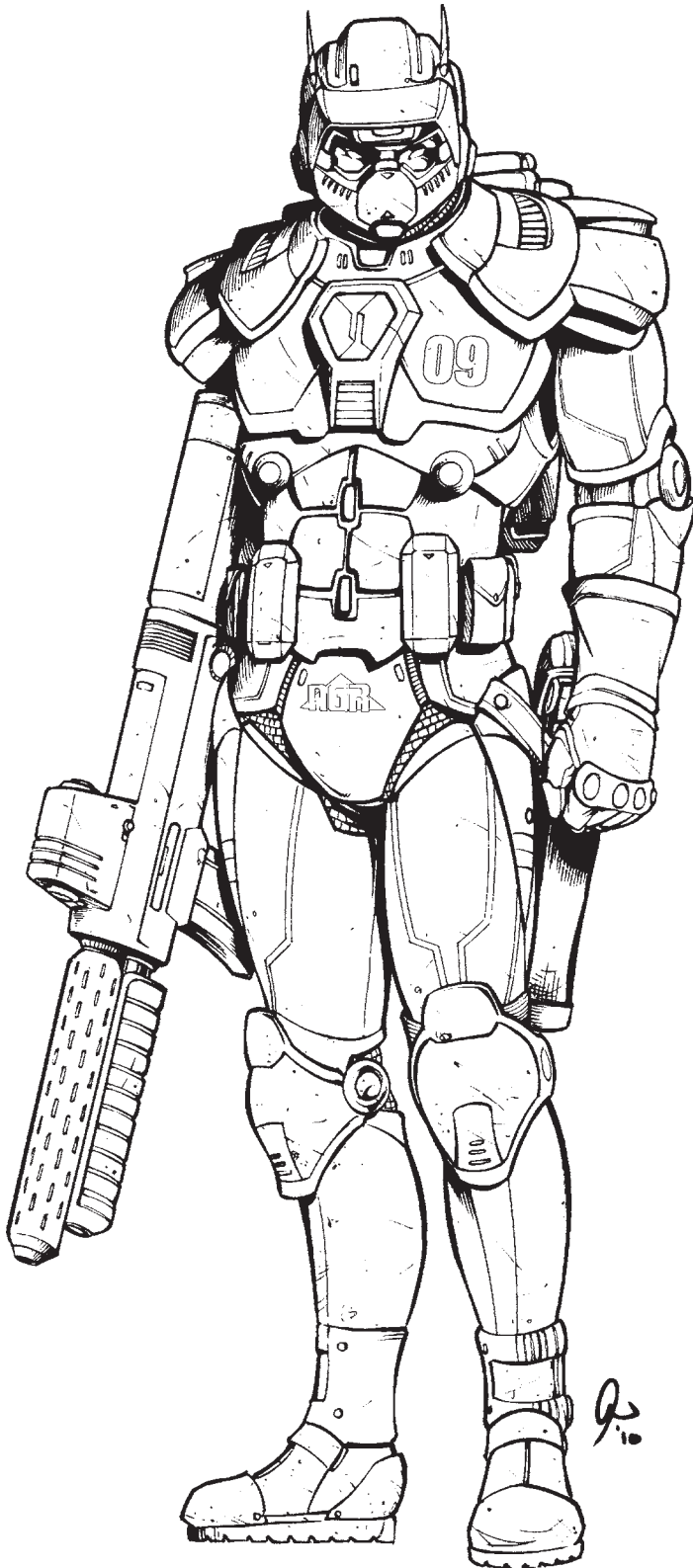

The T-25 uses the latest in M.D.C. compounds to create a heavy infantry armor that is comparatively light, has good mobility and verges on the brink of being power armor. It provides its ordinary human soldier with Robotic P.S., reduces fatigue and puts the wearer closer to the level of a cyborg trooper. The TX-50 Rail Gun is standard issue and can be used as an assault rifle and even fired one-handed. The T-25 augmented soldier may also be authorized, as per assignment, to use a variety of heavy weapons as a two-handed weapon that are normally restricted to cyborgs and true power armor troops. The T-25 is never assigned for work duty, but rather is given to heavy weapons specialists, front line assault troops, commando units, and infantry companies assigned to raid and destroy Gargoyle roosts and nests.

**Class:** T-25 Full Environmental Heavy Exoskeleton.

**Size:** 7 to 7.5 feet (2.1 to 2.3 m); varies with the size of the wearer.

**Weight:** 50 pounds (22.5 kg).

**Mobility:** Fair to good: -12% to Prowl, Swim, Acrobatics, and other Physical skills requiring high level of movement and dexterity.

### M.D.C. by Location:

\* Head/Helmet – 90

Arms – 80 each

Legs – 90 each

Main Body – 200

\*A single asterisk indicates a small or difficult target to hit. They can only be hit when the attacker makes a Called Shot, and even then the shooter is -3 to strike.

### Special TX-25 Features:

1. All standard NGR Cyclops Sensors and Features. See page 34 of **Rifts® World Book Five**.

#### 2. Exoskeleton Augmentation:

- Robot P.S. of 20 – does 2D6 S.D.C. on a restrained punch, one M.D. on a full strength punch, and 1D6 M.D. on a power punch (counts as two attacks).
- Reduces the rate of fatigue by 50%.
- Can leap 18 feet (5.5 m) across or upwards.

**Combat Bonuses:** +1 attack per melee, +1 on initiative, +1 to parry and dodge, +1 to disarm, and +3 to pull punch and roll with impact.

3. TX-50 Rail Gun: Standard issue. With the increased P.S. of this body armor, “human” infantry troops can handle heavy weapons normally designed for use by cyborgs. See page 146 of **Rifts® World Book Five**.

4. Energy Pistol Side Arm: Any old or new energy pistol may be selected as a side arm.

5. TX-H series weapons may be used with this armor.

**Cost:** 750,000 but can often go for twice that amount on the Black Market (rarely available).

## TX-J50 Juicer EBA

The Juicer TX-J50 is a full suit of Environmental Battle Armor (EBA) in a flexible suit that does not impair mobility and offers maximum armor protection. This is due in part to the advanced technology used to make light M.D.C. alloys and a fab-

ric-like M.D.C. armored mesh at the waist, neck and joints similar to the *T-E02 Infiltrator* (below). The standard face plate has simplistic smooth features, but can be replaced with a custom face plate that looks robotic or demonic, a feature that appeals to many Juicers. The top of the helmet has a modular clamp connector where a Juicer can crown himself with his trademark mohawk, spiked hair or ponytail.

**Class:** JEBA-TX-J50 heavy (Juicer) Environmental Battle Armor.

**Size:** Human Equivalent.

**Weight:** 30 pounds (13.5 kg).

**Mobility:** Very good to excellent for Juicers and Crazies. -5% to Climb, Prowl, Swim, Acrobatics and similar Physical skills. (-15% for non-augmented people.)

**M.D.C. by Location:**

Head/Helmet – 70

Arms – 40 each

Legs – 55 each

Main Body – 100

**Cost:** 225,000 but can often go for twice that amount on the Black Market.

## T-E02 “Infiltrator” Espionage Armor

The T-E02 is designed for special ops missions of sabotage and espionage. The armor has excellent mobility while providing maximum armor protection due, in part, to the advanced technology used to make light M.D.C. alloys and a fabric-like M.D.C. armored mesh at the waist, neck and joints. The soles of the shoes are a rubbery, impact resistant material that cushions the feet and muffles the sound of footsteps.

The T-E02 is equipped with an experimental camouflage system which some believe is a spin-off of the Naruni Enterprises Chameleon Armor. In actuality, Triax has long been experimenting with light bending technology and this feature of the T-E02 is from a pre-Rifts design.

**Class:** T-E02 Full Environmental Light Infiltration Armor.

**Size:** Human Equivalent.

**Weight:** 20 pounds (9 kg).

**Mobility:** Excellent, no penalties.

Head/Helmet – 50

Arms – 34 each

Legs – 45 each

Main Body – 90

**Special Features:**

1. Camouflage System: The armor literally changes color to match the predominant color of its surroundings. This includes streaks and mottled patterns of dark green, gray, brown, and black to create a camouflage pattern outdoors in a woodland setting and similar light/color patterns to help conceal the wearer. The suit also masks infrared and thermal emissions to make the suit invisible to thermal optics and sensors.

2. Utility Belt: Comes standard with a utility belt that has several pouches for carrying any number of supplies.

3. Dual Holster: Espionage missions usually entail getting in and out of buildings and other urban settings where combat is

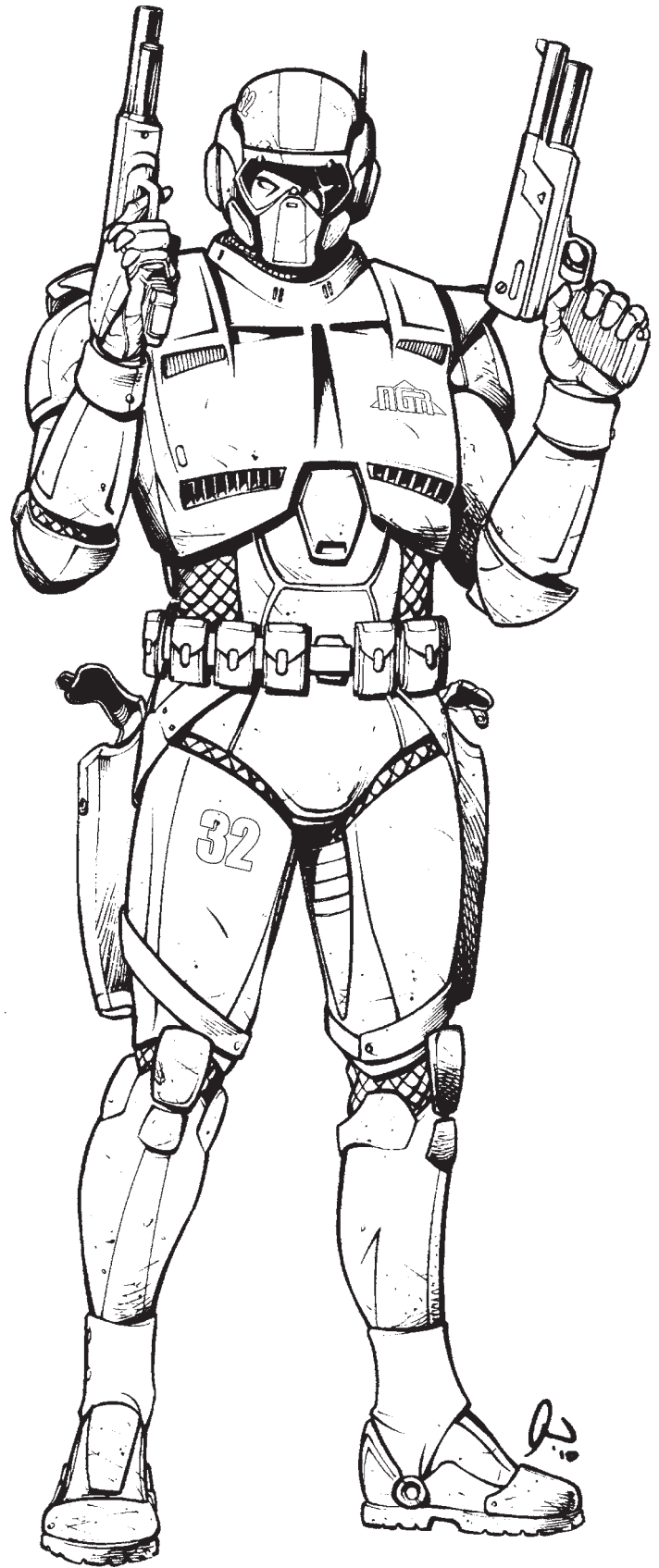

likely to be close combat. Consequently, a dual weapon holster comes standard.

4. Vibro-Blade: One Vibro-Knife in boot. 1D6 M.D.

5. Jump-Pack: Built into the armor is a light thruster system for assisted leap and jumps. When activated the wearer can leap 30 feet (9.1 m) upward and 40 feet (12.2 m) lengthwise, in-

crease by 30% with a running start. The jump pack can also be used to slow moment from a fall or a drop down from heights up to 700 feet (213 m); +3 to roll with impact and suffers only 10% of the usual damage. It also provides a bonus of +1 to dodge. The controls to are verbal commands or a small hand controller.

**Bonus:** +5% bonus to Prowl rolls.

**Cost:** 730,000 credits, but can often go for twice that amount on the Black Market.

## TD-10 “Sea Cyclops” Dive Armor

With the plans for *Operation Sea Storm* looming on the horizon and the expansion of the NGR navy, the military specialists of the NGR saw an immediate need for a suit of underwater body armor for their troops.

**Class:** TD-10 SCUBA Armor.

**Size:** Human equivalent.

**Weight:** 20 pounds (9 kg).

**Mobility:** Very Good. -5% to Climb, Prowl, Swim, Acrobatics and similar Physical skills.

### M.D.C. by Location:

Head/Helmet – 70

Arms – 35 each

Legs – 50 each

Main Body – 100

### Standard “Sea Cyclops” Weapon Systems & Features:

**Depth Gauge and Gyro-System:** Computer controlled depth and pressure gauge built into the armor and transmitted via the Heads-Up Display to provide the Marine with a constant indication of depth and general direction (i.e. pointed up, down, or sideways). An alarm sounds when the character sinks towards dangerous depths – to go deeper is to suffer the bends from the water pressure. Also, boots designed for easy attachment of modular swimming fins.

**Maximum Depth:** Suit depth tolerance of up to 1,000 feet (305 m).

**Modular Backpack System:** Allows for the attachment of additional oxygen tanks (4 hours per tank; two tanks maximum), or an underwater jet pack, flying jet pack, or an air and watertight storage container. However, most stealth operations preclude the use of conventional air tanks and propulsion systems.

**Special Ops Breathing Tank (standard):** A backpack style oxygen tank and rebreather designed to fit securely with mountings on the back of the armor suit. When the rebreather is engaged, it provides breathable air for up to 10 hours (which includes the suit’s standard 5 hour supply), does not leave bubbles and is totally silent! The pack has 40 M.D.C.

**Maneuvering Jets:** A dozen tiny maneuvering jets can be activated to give the diver better control and speed while in the armor, making the swimming penalty only -10%.

**Multi-Optic Band:** The helmet is equipped with an multi-optic system that enables the diver to see the infrared and ultraviolet spectrums of light and thermo-imaging, as well as telescopic sight and targeting.

**Cost:** 350,000 credits. Not usually available on the Black Market.

# New Triax Power Armor X-11 Predator II

The Triax X-11 Predator II is a new design of the long used workhorse of the NGR military, the X-10A Predator. The original Predator was a heavily armored exoskeleton used mainly to fight Gargoyles, flying monsters, and other airborne enemies. A task at which it excelled. The heavy armor of the Predator allowed it to take considerable damage and still maintain a dominant presence as an aerial adversary. Though it was slower than most flying power armor of other nations, its good mobility combined with a decent weapons package made it an instant favorite of NGR troops and mercenary units both at home and abroad.

When the NGR moved to Full Militarization, one of the biggest pushes was to add more units with flight capability to bring the fight to the Gargoyles. The first thing the engineers at Triax decided to do was improve upon the already reliable and beloved Predator. To make it what one lead designer called a “flying tank” – more durable, faster, and more deadly.

Indeed, the X-11 Predator II is effectively a flying tank capable of taking out flying monsters and armored opponents with improved versions of the X-10 43A Pulse Laser Cannon, mini-missiles, and forearm Vibro-Swords. Like the Coalition States *Super SAMAS*, the flight system is removable in the case of an emergency to give downed pilots the ability to remain mobile and not slowed down by the weight of the wings and propulsion system. A departure from the original design, the X-11 has wings mounted in the back at shoulder level rather than suspended above the main body on a pylon. While this design feature has very little effect on the flight performance of the Predator, some pilots say they feel like they have better control. The X-11 comes in light grey, black, crimson, blue, medium green, camouflage, and alpine white. **Note:** The original X-10A remains in use, but is being phased out and sold at two-thirds its original price to foreign markets.

## X-11 Predator II Power Armor

**German Name:** Der Raubtier Zwei

**Model Type:** X-11

**Class:** Strategic Armor Military Assault Suit.

**Crew:** One.

### M.D.C. by Location:

Wings (2) – 140 each

\* Head – 100

Main Rear Jets (3) – 100 each

Maneuvering Jets (3) – 75

Air Intakes (2, above shoulders) – 65 each

Hands (2) – 35 each

Arms (2) – 100 each

Legs (2) – 150 each

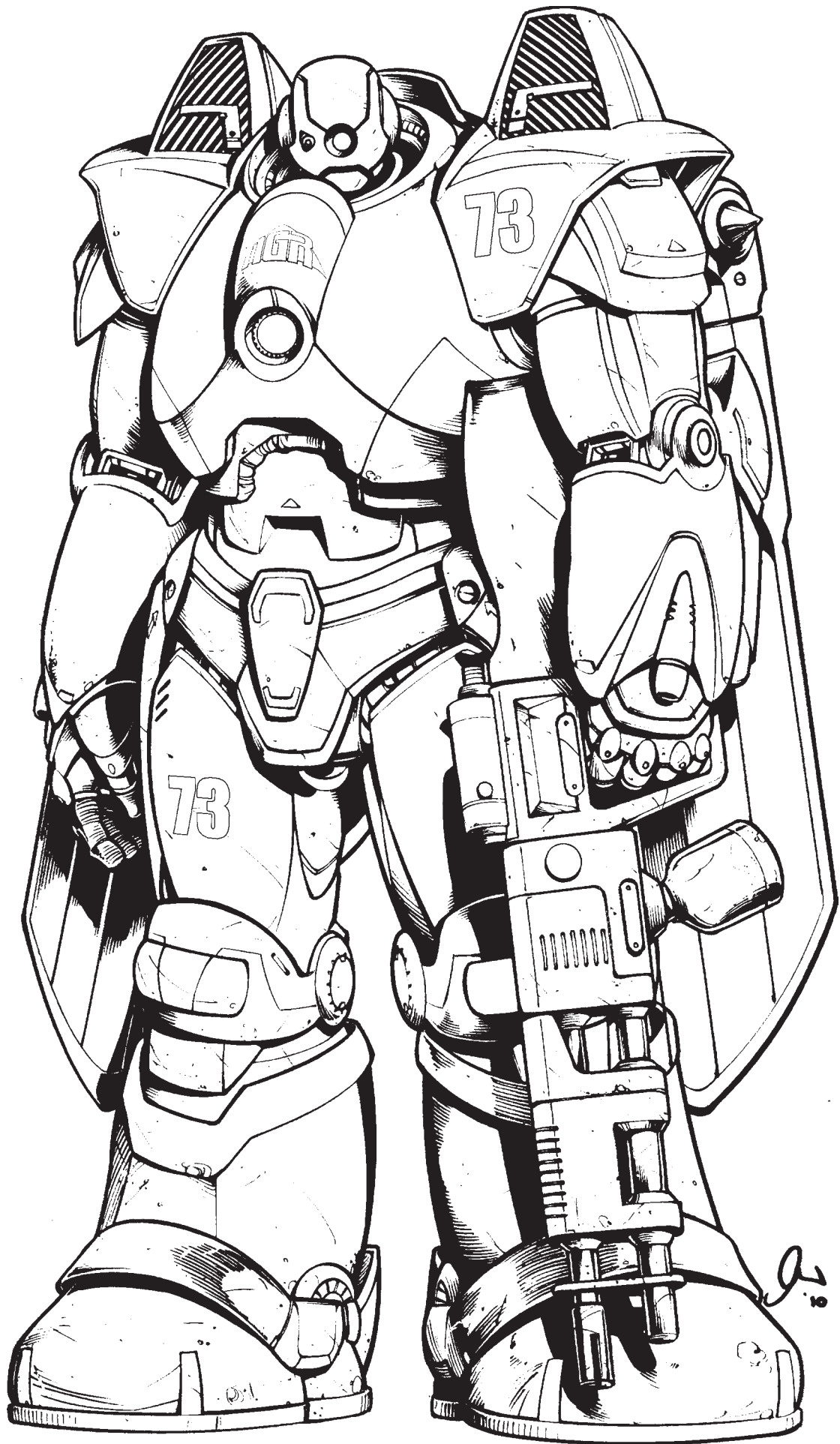



Feet (2) – 80 each

Chest Searchlight (1) – 5

\* Forearm Pulse Lasers (2) – 12 each

\* Vibro-Blades (2) – 40 each

\*\* Main Body – 480

\* A single asterisk indicates a small or difficult target to hit. They can only be struck when the attacker makes a Called Shot, and even then the shooter is -3 to strike. Destroying the head/helmet eliminates all forms of optical and sensory enhancement and the pilot must rely on his own human senses without any of the bonuses granted to him by the Robot Combat skill.

\*\* Depleting the M.D.C. of the Main Body shuts the power armor down completely, rendering it useless.

### Speed:

Running: 60 mph (96 km) maximum. The act of running tires out its operator, but at 20% of the usual fatigue rate.

Leaping: The robot legs can leap 20 feet (6.1 m) high or across. Add 15 feet (4.6 m) with a running start, and increase by ten-fold with a thruster assisted boost without actually attaining flight.

Flying: The flight system of the X-11 enables the Predator II to hover stationary in mid-air or fly at a maximum speed of 300 mph (480 km). Cruising speed is considered to be 150 mph (240 km). Maximum altitude of the suit is 20,000 feet (6,096 m), but the Predator II is considered a low altitude power armor meant to hug the ground to slip under enemy radar, as well as fly along treetops, above rooftops, around buildings and in mountains.

Underwater Capabilities: The unit can swim/rocket through water at a speed of 30 mph (48 km or 26 knots) and can walk along the bottom of the body of water at 25% of its running speed. Maximum depth is one mile (1.6 km).

### Statistical Data:

Height: 11 feet (3.35 m) from the top of the intakes to the toes of the unit.

Width: 5 feet (1.5 m) with wings down.

Length: 4 feet, 10 inches (1.45 m).

Wingspan: 19 feet (5.8 m) with wings fully extended.

Weight: 1,600 pounds (720 kg).

Physical Strength: Robot P.S. of 30.

Cargo: None.

Power System: Nuclear, average energy life is 20 years.

Black Market Cost: 4.9 million credits, but uncommon on the Black Market. Exclusive to the NGR Army. Not currently sold on the open market.

### Weapon Systems:

**1. X-11 453E Pulse Lasers (2):** The pulse lasers built into the forearms of the X-11 Predator II are direct descendants of the X-10 43A pulse cannon of the original Predator. The weapon can alternate from single shot to rapid-fire pulse blasts as the pilot desires.

Primary Purpose: Anti-Aircraft and Anti-Gargoyle.

Secondary Purpose: Defense.

Range: 4,000 feet (1219 m).

Mega-Damage: 2D6 M.D. per single shot or 1D6x10 M.D. per quadruple pulse blast. 2D6x10 M.D. when both arms are pointed at the same target and fired simultaneously.

Rate of Fire: Each single shot or pulse blast at the same target counts as one melee attack. If both arms are pointed at a different target, each blast counts as a separate attack.

Payload: Effectively unlimited; tied into the power supply of the armor.

**2. TX-252 Rail Gun (1, handheld):** The TX-252 is standard issue to the Predator II. It is a larger, stockier version of the TX-500 'Borg rail gun, only it is designed for power armor and robots as a handheld assault weapon. It has a shorter range than most Triax rail guns, but packs a bigger wallop. May be substituted with other handheld weapons designed for use by power armor and robots.

Primary Purpose: Assault/Anti-Gargoyle and Anti-Armor.

Secondary Purpose: Defense and Anti-Personnel.

Weight: Gun: 225 pounds (101 kg). One TX-252 ammo drum is an additional 250 pounds (112.5 kg) hooked to the hip or waist under the jet thrusters in the back.

Range: 4,600 feet (1,402 m).

Mega-Damage: 1D6x10 M.D. for a 30 round burst.

Rate of Fire: Each burst counts as one melee attack.

Payload: 3,000 round drum, capable of firing 100 full bursts.

**3. Wing Missile Launchers (Optional):** The heavier, lower mounted wings can accommodate more or heavier missiles. Each wing has three hard points that can hold three short- or medium-range missiles per wing, or three mini-missile cluster launchers (three mini-missiles per cluster for a total of nine mini-missiles per wing).

Primary Purpose: Anti-Gargoyle and Anti-Armor.

Secondary Purpose: Anti-Missile and Defense.

Range: Varies with missile type.

Mega-Damage: Varies with missile type, but most pilots favor armor piercing (1D4x10 M.D.) or fragmentation (5D6 M.D., 20 foot/6.1 m radius) mini-missiles. This gives them a larger payload when they anticipate engaging Gargoyles in dogfights and going up against swarms of the monsters.

Rate of Fire: One at a time or in volleys of 2, 4 or 6.

Payload: A total of six short- or medium-range missiles or 18 mini-missiles divided evenly between both wings.

**4. Forearm Vibro-Blades (2):** Each arm has a concealed, extendible and retractable Vibro-Sword for close combat.

Primary Purpose: Melee Combat and Defense.

Mega-Damage: 3D6 M.D.

**5. TX-H Series:** Any of the TX-H series hand to hand weapons can be used.

**6. Hand to Hand Combat:** Rather than use a weapon the pilot can engage in Mega-Damage hand to hand combat. See *Flying Power Armor Training* on page 352 of **Rifts® Ultimate Edition**.

**7. Sensor System Note:** Telescopic, passive nightvision and polarizing lens in addition to all other features common to NGR power armor.

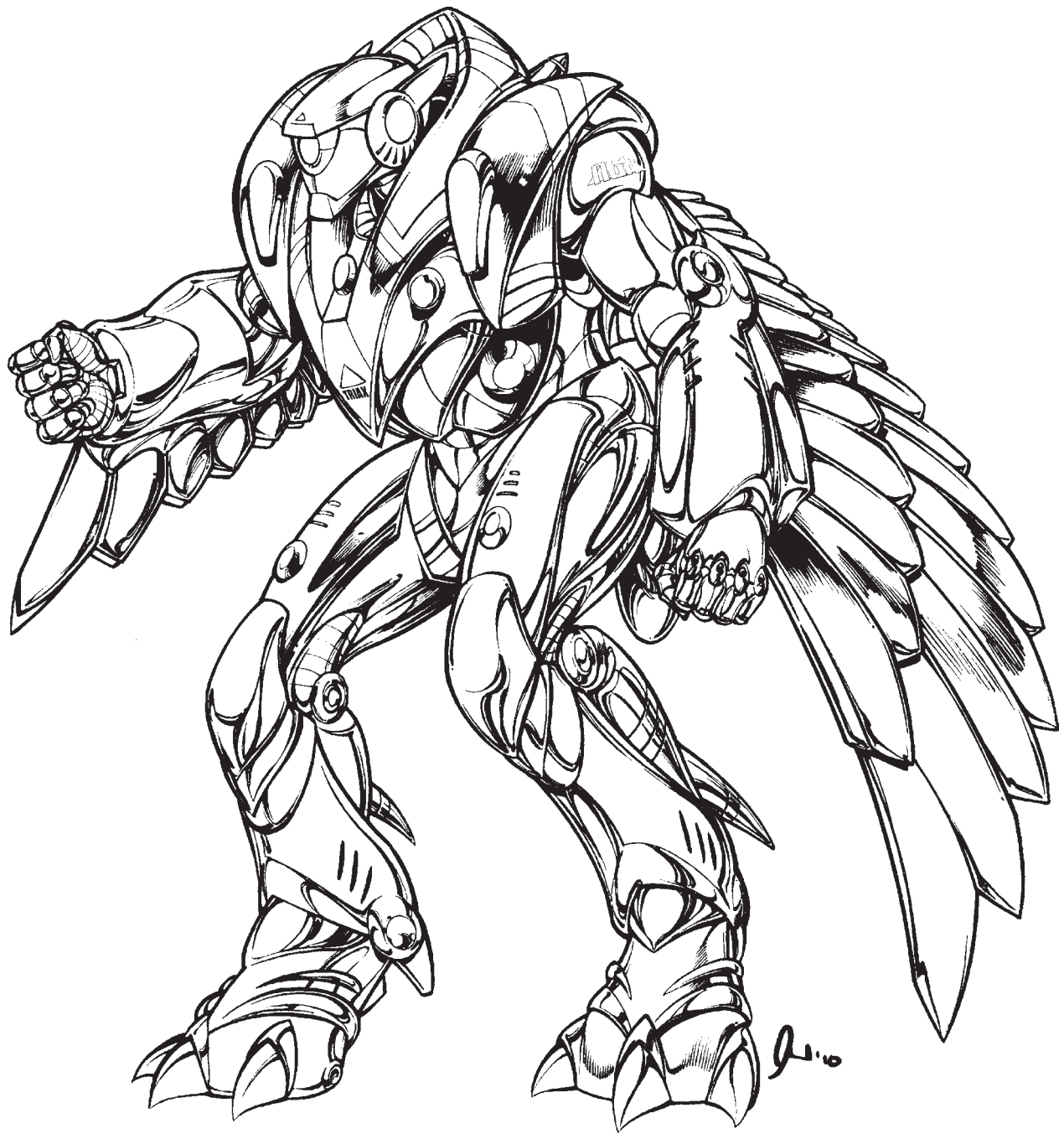

## X-21 War Eagle

The X-21 War Eagle is a new power armor suit developed by Triax Industries using a combination of old and experimental technologies. The War Eagle is a light, quiet, low altitude flying power armor capable of silent gliding to swoop down on enemy troops or into Gargoyle roosts and nests before the enemy realizes they are under attack. The wings are made of a light, flexible M.D.C. polymer and feathered similar to a real bird. The large feather-like wings are capable of folding in upon themselves where they are out of the pilot's way when on the ground. The helmet has one round sensor eye in the middle of its head, and closely resembles that of the Jaeger.

The wings are attached to the arms, giving the pilot absolute control over his movement. This also means the power armor flies in a prone position (like Superman). Depending on their

position, the War Eagle can fly, hover, glide or dive. A jet thruster on the back provides the main thrust and flight capabilities, while a series of stabilizing thrusters concealed all over the body help to stabilize and maintain flight patterns. The thruster system is designed to be silent, which means it sacrifices speed and power for stealth. Likewise, the clawed feet, which can be used in aerial combat with Gargoyles, are padded for silent movement on the ground as well. When silence is an absolute must, the system is shut down and the War Eagle swoops or dives down in silence.

As a prone flyer, a pair of pulse lasers similar to the X-11E Predator II are built into the shoulder housings. The shoulder weapon housings shift up and forward when flying. A panel slides down to reveal the gun barrels and the War Eagle can fire away at whatever is in front of it. The arms also contain lasers, but they are for aimed attacks and may not be available during

flight. There is no room for missiles and carrying an energy rifle is awkward, throwing off flying and gliding, and hampering aerodynamics (-10% penalty to Piloting skill).

The X-21 War Eagle is used for covert operations, scouting missions, and surgical strikes. Able to fly silently behind enemy lines, the War Eagle can function in the role of long-range reconnaissance scout, forward observer radioing in enemy coordinates and troop movement, commando style rescue operations, first strike in raids on nests or roosts, sabotage (fly in silently, place demolition charges and fly out), and destroying hardened strategic positions generally before the enemy even knows they have come and gone. The X-21 War Eagle has met with great success and is becoming popular with Military Specialists, Commandos and flyers. It comes in light grey, black, crimson, blue, medium green, camouflage, and alpine white.

## **Triax X-21 War Eagle Power Armor**

**Exclusive to the NGR Military and Triax Security Forces**

**German Name:** Der Kriegs-Adler

**Model Type:** X-21

**Class:** Strategic Armor Military Assault Suit.

**Crew:** One.

**M.D.C. by Location:**

\* Head – 90

Arms (2) – 100 each

\* Forearm Weapon Housings (2) – 50 each

Forearm Vibro-Swords (2) – 50 each

\* Shoulder Lasers (2) – 50 each

\* Chest Searchlights (2) – 5 each

\* Leg Searchlights (2) – 2 each

Legs (2) – 110 each

Clawed Feet (2) – 75 each

Wings (2) – 90 each

\*\* Main Body – 280

\*A single asterisk indicates a small or difficult target to hit. They can only be struck when the attacker makes a Called Shot, and even then the attacker is -4 to strike. Destroying the head/helmet eliminates all forms of optical and sensory enhancement, leaving the pilot to rely on his own human senses without any of the bonuses granted to him by the Robot Combat skill.

\*\* Depleting the M.D.C. of the main body shuts the power armor down completely, rendering it useless. Destroying all or most of the feathers of one wing reduces flying speed by half, makes dive attacks impossible and inflicts a -30% flying and aerial acrobatics penalty. If both wings are destroyed, flight is impossible.

**Speed:**

**Running:** 50 mph (80 km) maximum. Note that the act of running does tire out its operator, but at 20% of the usual fatigue rate.

**Leaping:** 20 feet (6.1 m) high or lengthwise from a stationary position, 40 feet (12.2 m) high or 55 feet (16.7 m) with a running start and increase by ten-fold with a thruster assisted boost without actually attaining flight.

**Flying:** The War Eagle sacrifices speed for stealth. Can hover stationary in mid-air or fly to a maximum flying speed of 100 mph (160 km), but cruising speed is considered to be 50 mph (80 km). Silent gliding is typically at cruising speed or less but is completely silent. Unless an enemy looks up he is not likely to notice the War Eagle. Power dive doubles the War Eagle's current speed and is always a sharp, downward angled dive. Maximum altitude of the suit is 6,000 feet (1,828 m), but it is considered a low altitude power armor meant to hug the ground and slip under enemy radar.

**Underwater Capabilities:** The unit can swim/rocket through water at a speed of 20 mph (32 km or 17 knots) and can walk along the bottom of the body of water at 25% of its running speed. Maximum depth is 800 feet (244 m).

**Statistical Data:**

**Height:** 9 feet (2.7 m).

**Width:** 4 feet (1.2 m) from shoulder to shoulder.

**Length:** 3 feet, 4 inches (1 m).

**Wingspan:** 14 feet (4.3 m) with wings/feathers fully extended.

**Weight:** 800 pounds (360 kg).

**Physical Strength:** Robot P.S. of 25.

**Cargo:** None, though belts, bags and other carrying cases can be strapped onto, or carried by, the War Eagle.

**Power System:** Nuclear, average energy life is 20 years.

**Black Market Cost:** 4.5 million credits, but uncommon on the Black Market. Exclusive to the NGR Army, and, in fact, is not known to most outsiders.

## **Weapon Systems:**

**1. X-11 453E Pulse Lasers (2):** A pulse laser is built into each shoulder of the War Eagle for the purpose of aerial combat and defense. The lasers are the same as the X-11 Predator II, except they are concealed in the shoulder area. A protective panel slides down so the guns can fire. The shoulder housing points forward when flying in a prone position and the guns have a 40 degree arc of fire up and down.

**Primary Purpose:** Anti-Aircraft and Anti-Gargoyles.

**Secondary Purpose:** Defense.

**Range:** 4,000 feet (1,219 m).

**Mega-Damage:** 2D6 M.D. per single shot or 1D6x10 M.D. per quadruple pulse blast. 2D6x10 M.D. when both pulse lasers are fired simultaneously.

**Rate of Fire:** Each single shot, pulse or dual pulse blasts at the same target counts as one melee attack.

**Payload:** Effectively unlimited; tied into the power supply of the armor.

**2. Forearm Laser Blaster (2):** Each forearm has a laser pulse weapon used for precision attacks and assault.

**Primary Purpose:** Targeted Strike.

**Secondary Purpose:** Defense.

**Range:** 3,000 feet (914 m).

**Mega-Damage:** 3D6 M.D. per single blast. 6D6 M.D. when both arms are pointed at the same target and fired simultaneously.

**Rate of Fire:** Each single or double shot at the same target counts as one melee attack. If both arms are pointed at a different target, each blast counts as a separate attack.

Payload: Effectively unlimited; tied into the power supply of the armor.

**3. Forearm Vibro-Blades (2):** Also contained in the forearm weapon housing is a Vibro-Sword for close combat and sabotage.

Primary Purpose: Melee Combat and Defense.

Secondary Purpose: Sabotage and Cutting Tool.

Mega-Damage: 3D6 M.D. each.

**4. Clawed Feet (2):** The feet of the War Eagle have three short, talon-like toes. These can help to scale the walls of buildings and the sides of mountains where Gargoyles roost. In combat, they can be activated as Vibro-Claws and used to kick and claw Gargoyles.

Primary Purpose: Melee Combat and Defense.

Secondary Purpose: Climbing.

Mega-Damage: 5D6 M.D. per foot/kick strike.

**5. Side Arms (1 or 2; Optional):** One or two pistols can be strapped to the waist and secured to each leg for additional firepower. Likewise, a utility belt with pockets or satchels containing explosives can be hooked around the waist.

**6. TX-H Series:** Any of the TX-H series hand to hand weapons can be used.

**7. Hand to Hand Combat:** Rather than use a weapon the pilot can engage in Mega-Damage hand to hand combat. See *Flying Power Armor Training* on page 352 of **Rifts® Ultimate Edition**.

**8. Sensor Systems & Features of Note:** The X-21 War Eagle has full telescopic optic system, passive nightvision, polarization filters and two small, high-powered searchlights built into the chest (1,200 feet/366 m range, and can angle in a 30 degree arc) and two smaller searchlights in its upper legs (same stats as chest lights). These are in addition to all other features common to NGR power armor.

## X-80 Butterfly

The Butterfly is another heavily armored power armor suit imagined when designers sought ways to bombard Gargoyle roosts, nests and hatcheries. Basically, the NGR Army wanted a man-portable missile array that could accompany other power armor units and troops on siege missions and blow the snot out of their roosts and nests quickly. Entering any Gargoyle lair is always dangerous, so it is best if troops can get in and get out fast. The X-80 Butterfly is what the minds at Triax conceived – a walking artillery unit not much larger than a Predator I or II.

Butterfly power armor has the familiar cyclopean helmet and reinforced body made to take punishment under heavy enemy fire. Despite its name, the X-80 Butterfly cannot fly. In place of wings is a butterfly-shaped missile launch system that can fire short-range missiles, as well as mini-missiles from the lower legs. In addition, the Butterfly has the same rapid-fire pulse laser as the Predator II built into its forearms and can carry any of the large, power armor/robot sized rifles for additional firepower.

The two tapering tubes below the heavy missile launchers are a pair of jump jets to give the Butterfly greater mobility. A

heavy thruster in the back between the missile launchers, plus an array of tiny stabilization thrusters help provide balance and forward movement when climbing (which the Butterfly can do quickly) and for jet powered leaps up to 200 feet (61 m) upward or across. Furthermore, if the Butterfly is knocked off the roof of a building or a mountain cliff, the jump system can be engaged to push it back to the wall where the power armor can grab a handhold, or slow its descent to reduce damage from falling at a great height (suffers only 10% normal damage).

### X-80 Butterfly Power Armor

**German Name:** Schmetterling

**Model Type:** X-80

**Class:** Strategic Armor Military Assault Suit.

**Crew:** One.

**M.D.C. by Location:**

Butterfly Missile Launchers (2) – 220 each

\* Mini-Missile Launcher Pods (2, lower legs) – 35 each

\* Head – 120

\* Jump Jets (2, behind) – 100 each

\* Back Thruster (1) – 55

\* Small Stabilization Thrusters (10, concealed) – 6 each

\* Hands (2) – 25 each

Arms (2) – 100 each

Legs (2) – 160 each

Feet (2) – 100 each

\* Forearm Pulse Lasers (2) – 12 each

\* Vibro-Blades (2) – 40 each

\*\* Main Body – 400

\* A single asterisk indicates a small or difficult target to hit. They can only be struck when the attacker makes a Called Shot, and even then the shooter is -3 to strike. Destroying the head/helmet eliminates all forms of optical and sensory enhancement and the pilot must rely on his own human senses without any of the bonuses granted to him by the Robot Combat skill.

\*\* Depleting the M.D.C. of the Main Body shuts the power armor down completely, rendering it useless.

**Speed:**

Running: 40 mph (64 km) maximum with the butterfly missile pack, 70 mph (112 km) without it. The act of running tires out its operator, but at 20% of the usual fatigue rate.

Leaping: The robot legs can leap 12 feet (3.6 m) high or across with the missile pack, add 10 feet (3 m) with a running start. 200 feet (61 m) upward and/or across with the jump jets engaged.

Flying: Not possible.

Underwater Capabilities: The unit can walk along the bottom of the body of water at half its running speed. Maximum depth is one mile (1.6 km).

**Statistical Data:**

Height: 14 feet (4.3 m) total height with missile launcher. Ten feet (3 m) from head to toe of the power armor, but the butterfly launch pack adds to the overall height.

Width: 6 feet (1.8 m) with missile launcher. 4 feet (1.2 m) from shoulder to shoulder.

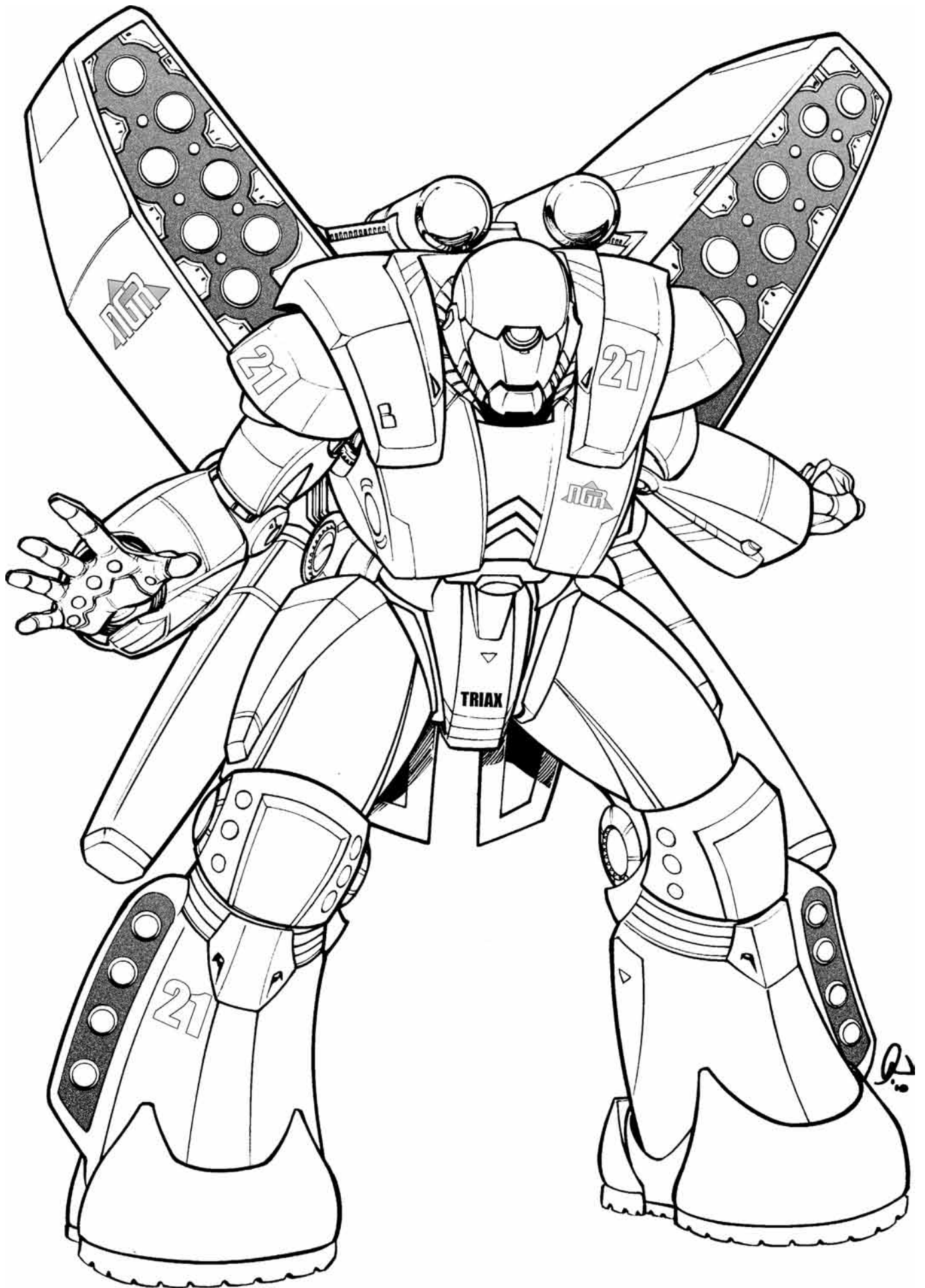

Length: 7 feet (2.1 m) of the power armor itself.

Weight: 3 tons with missile pack, 1.8 tons without it.

Physical Strength: Robot P.S. of 32.

Cargo: None.

Power System: Nuclear, average energy life is 20 years.

Black Market Cost: 3.4 million credits, cost of missiles extra.

Uncommon on the Black Market. Exclusive to the NGR Army. Not currently sold on the open market.

## Weapon Systems:

**1. Butterfly Missile Launch Pack:** The Butterfly style launcher fires short-range missiles. The entire launcher, jump jets and back thruster are all part of the same modular unit and can be, in an emergency, jettisoned from the X-80 power armor. The “butterfly” wings of the launcher can fold open and closed at a 45 degree angle as required.

Primary Purpose: Anti-Gargoyle and Anti-Armor.

Secondary Purpose: Anti-Fortification/Nest and Troop Support.

Range: Varies with missile type, but typically 500 miles (800 km).

Mega-Damage: Varies with missile type, but most pilots favor high explosive (2D6x10 M.D., 15 ft/4.6 m radius) or fragmentation (2D6x10 M.D., 20 ft/6.1 m radius) short-range missiles.

Rate of Fire: One at a time or in volleys of 2, 4, 7 or 14.

Payload: 28 total short-range missiles; fourteen locked, loaded and ready to fire, and a reload of seven in each firing wing that has to cycle into the firing chambers.

**2. Mini-Missile Leg Launchers (2):** Each lower leg has a mini-missile launcher.

Primary Purpose: Anti-Personnel.

Secondary Purpose: Anti-Missile and Defense.

Range: One mile (1.6 km).

Mega-Damage: Varies with missile type, but when facing Gargoyles, most pilots favor fragmentation which inflict 5D6 M.D. to a 20 foot (6.1 m) radius.

Rate of Fire: One at a time or in volleys of 2, 4, 6 or 8.

Payload: 8 total mini-missiles.

**3. X-11 453E Pulse Lasers (2):** The pulse lasers built into the forearms of the X-80 Butterfly can alternate from single shot to rapid-fire pulse blasts as the pilot desires.

Primary Purpose: Anti-Aircraft and Anti-Gargoyle.

Secondary Purpose: Defense.

Range: 4,000 feet (1219 m).

Mega-Damage: 2D6 M.D. per single shot or 1D6x10 M.D. per quadruple pulse blast. 2D6x10 M.D. when both arms are pointed at the same target and fired simultaneously.

Rate of Fire: Each single shot or pulse blast at the same target counts as one melee attack. If both arms are pointed at a different target, each blast counts as a separate attack.

Payload: Effectively Unlimited; tied into the power supply of the armor.

**4. Forearm Vibro-Blades (2):** Each arm has a concealed, extendible and retractable Vibro-Sword for close combat.

Primary Purpose: Melee Combat and defense.

Mega-Damage: 3D6 M.D.

**5. TX-252 Rail Gun (1, handheld):** The TX-252 is standard issue to the Butterfly. It is a larger, stockier version of the TX-500 ‘Borg rail gun, only it is designed for power armor and robots as a handheld assault weapon. It has a shorter range than most Triax rail guns, but packs a bigger wallop. May be substituted with other handheld weapons designed for use by power armor and robots.

Primary Purpose: Assault/Anti-Gargoyle and Anti-Armor.

Secondary Purpose: Defense and Anti-Personnel.

Weight: Gun: 225 pounds (101 kg). One TX-252 ammo drum is an additional 250 pounds (112.5 kg) hooked to the hip or waist under the jet thrusters in the back.

Range: 4,600 feet (1,402 m).

Mega-Damage: 1D6x10 M.D. for a 30 round burst.

Rate of Fire: Each burst counts as one melee attack.

Payload: 3,000 round drum, capable of firing 100 full bursts.

**6. TX-H Series:** Any of the TX-H series hand to hand weapons can be used.

**7. Hand to Hand Combat:** Rather than use a weapon the pilot can engage in Mega-Damage hand to hand combat. See *Ground-Based Power Armor Training* on page 352 of **Rifts® Ultimate Edition**.

**8. Sensor System Note:** Telescopic, passive nightvision and polarizing lens in addition to all other features common to NGR power armor.

# X-700 Fat Boy

## New NGR Glitter Boy

When The NGR brokered a trade between the distant North American nation of Free Quebec and Triax Industries in 105 P.A., the design of the *USA G-10 Glitter Boy power armor suit* was a key element of the deal. Free Quebec needed Glitter Boys and Triax could help increase their own stockpile, fast. The military leaders of the NGR had long admired the power and toughness of the USA G-10, and with this deal, the NGR now had the ability to integrate the units into their own forces.

Shortly after the acquisition of the design specifications to the USA-G10, Triax developed their own design called the *T-550 Cyclops*. The T-550 was slightly smaller and less armored, but included mini-missiles, Vibro-Swords, and a light laser to supplement the powerful Boom Gun which Triax also redesigned. The Boom Gun on the T-550 was smaller, lighter, and capable of independent targeting and tracking, effectively doubling the attacks of the pilot. The pilot could set the unit to fire while he operated the mini-missiles and other weapons at the power armor’s disposal. Triax was the first, and so far ONLY, company known to reproduce the famous *Boom Gun*, let alone modify it. Triax has since used this technological knowledge to develop more NGR power armor inspired by the traditional Glitter Boy.

Currently, there are two new models of Glitter Boy power armor in the field, but others are being considered. The T-550 Cyclops has been joined by the **X-700 Fat Boy** and **X-710 Hell Angel**. These power armors were considered to be quite experimental when they first rolled off the assembly line, but have

performed admirably in the field of battle and in their respective roles as a heavy assault and aerial assault power armor.

Unlike in Free Quebec, the NGR Glitter Boys look very different from the original USA-10 and they don't have their own special Glitter Boy legions. Instead, they are part of the regular army and fill all roles required of them. The NGR prefers mixed squads, platoons and companies of power armor and robots, so it is rare to see more than two Glitter Boys in the same power armor squad or more than 20% of any one type of armor or robot in a larger unit. Only special units may be comprised of armor that is all the same type, and even that is uncommon.

**The X-700 "Fat Boy" Glitter Boy** is a rotund, almost comical looking suit of power armor. Comical, perhaps, until it goes into action. The Fat Boy has a thick, heavy, laser chromium hide that can take considerable amounts of damage. Its big gun serves as heavy artillery support and anti-Gargoyle/anti-aircraft cannons. Its "egg shape" and short, thick, feet and legs provide it a lower center of gravity to help compensate for the power of its dual Boom Gun. The legs and hips have locking joints and the feet have the Glitter Boy stabilization rods that fire into the ground to anchor the armor when it fires the Boom Gun. This additional stabilization is not necessary when one blast is fired from the Boom Gun, but is required when both barrels are fired simultaneously.

## X-700 "Fat Boy" Glitter Boy

**Model Type:** X-700

**Class:** Laser Resistant Infantry Personnel Assault Suit.

**Crew:** One.

### M.D.C. by Location:

- Boom Gun (1, right shoulder) – 220
- Arms (2) – 300 each
- \* Shoulder Mini-Missile Launchers (2) – 130 each
- Hands (2) – 100 each
- \* Pop-Up Forearm Ion Blaster (1, right arm) – 35
- \* Pop-Up Forearm Laser (1, left arm) – 40
- Hands (2) – 120 each
- \* Head (low profile) – 260
- Legs (2) – 520 each
- Feet (2) – 280 each
- \*\* Main Body – 980

\*A single asterisk indicates a small or difficult target to hit. They can only be struck when the attacker makes a Called Shot, and even then the shooter is -2 to strike (the low profile head is -4 to strike). Destroying the head eliminates all forms of optical and sensory enhancement, and the pilot must rely on his own human senses without any of the bonuses granted to him by the Robot Combat skill.

\*\* Depleting the M.D.C. of the main body shuts the power armor down completely, rendering it useless. **Note:** As a Glitter Boy suit, the X-700 takes *half damage* from laser fire.

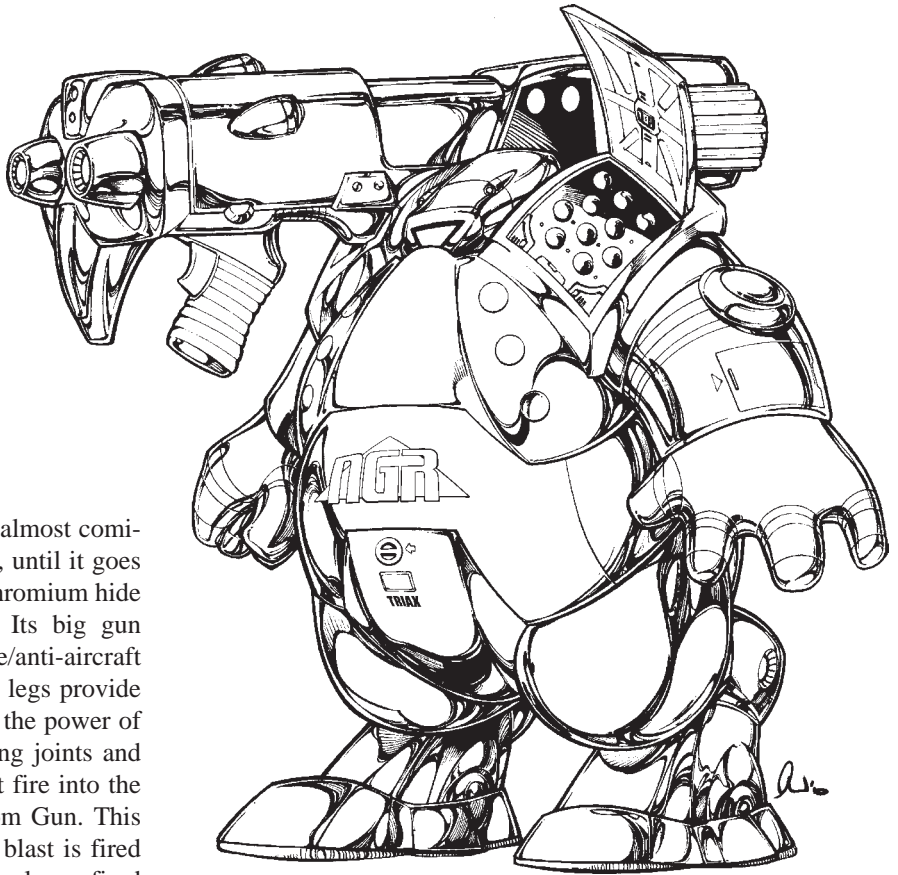

### Speed:

**Running:** 40 mph (64 km) maximum. Note that running does tire out its operator, but at 20% of the usual fatigue rate.

**Leaping:** Six feet (1.8 m) high or across.

**Flying:** Not possible.

**Underwater Capabilities:** The X-700 cannot swim, but can walk along the bottom of a lake or sea at a speed of 15 mph (24 km or 13 knots). Maximum depth is 1 mile (1.6 km).

### Statistical Data:

**Height:** 11 feet (3.3 m).

**Width:** 7 feet (2.1 m).

**Length:** 6.5 feet (2 m).

**Weight:** 4.2 tons. Add another half a ton when fully loaded with missiles and Boom Gun payloads.

**Physical Strength:** Robot P.S. of 38.

**Cargo:** Minimal. A one cubic foot compartment for personal items, and additional storage space for a rifle, handgun, survival knife, and first aid kit.

**Power System:** Nuclear, average energy life is 20 years.

**Black Market Cost:** 65+ million, but super-rare on the Black Market. Not available outside the NGR Army, except Free Quebec where it has yet to be revealed to the public.

### Weapon Systems:

**1. Dual Coaxial Boom Gun (1):** This weapon is an exclusive design for the X-700 Fat Boy. It combines two high-powered Boom Guns into one, huge, coaxial firing unit. The dual Boom Gun cannon is one of the NGR's most ambitious weapons devised by the developers of the Triax Glitter Boy

program. One might think this would have been a logical step in the evolution of the weapon, but the massive amount of force unleashed by simultaneous blasts is too much for the standard rocket recoil suppression system and Glitter Boy design. Hence the “Fat Boy” body design, thick legs, feet, arms and overall construction. Even then, the Fat Boy has recoil suppression jets built into its back and behind the shoulders.

Primary Purpose: Anti-Gargoyle and Anti-Armor.

Secondary Purpose: Assault and Anti-Fortifications.

Mega-Damage: 3D6x10 M.D. per single shot or 6D6x10 M.D. per double shot.

Any personnel within a 200 foot (61 m) radius of the Glitter Boy without a sound filtration system/ear protection are rendered temporarily deaf for 2D4 minutes and are -8 on initiative, -3 to parry and dodge; this includes Gargoyles and most other monsters. (**Note:** Troops clad in other NGR power armor and inside giant robots are deafened for half that time and suffer half the penalties due to sound dampeners built into ALL NGR power armor and ‘Bots. Troops, including infantry troops, with Glitter Boys assigned to them are equipped with sound dampening filters to protect their ears, and suffer no penalties.)

The sonic boom shatters conventional windows and shakes buildings and vehicles within a 300 foot (91.5 m) radius. Double the radius when both barrels are fired simultaneously.

Range: 11,000 feet (roughly two miles/3.2 km).

Rate of Fire: Each single or double blast counts as one melee attack.

Payload: 800 rounds capable of 400 double shots. 200 rounds are contained inside the boom gun with the rest contained in an internal feed mechanism housed within the massive body of the Fat Boy.

Special Feature: Like the T-550 Glitter Boy, the Boom Gun of the X-700 can fire independent of the pilot. The weapon tracks the nearest enemy target and fires until the target is destroyed or down, and moves on to acquire a new enemy target. If no enemy target can be found, the weapon remains in firing position and waits for a new target to come into view or for the pilot to take over manual firing. When the Boom Gun is set to computer targeted firing it has five attacks per melee (single or dual blasts), but cannot make Called Shots, attacks are directed at the main body. Only manual firing by the pilot can zero-in on a smaller specified target.

**2. Shoulder Mounted Mini-Missile Launcher (2):** Housed in each shoulder is a concealed mini-missile launcher. The protective cover flips up to fire.

Primary Purpose: Anti-Aircraft and Anti-Gargoyle.

Secondary Purpose: Anti-Missile and Anti-Armor.

Range: Usually one mile (1.6 km).

Mega-Damage: Varies with mini-missile type, but standard issue is armor piercing which does 1D4x10 M.D. per missile.

Rate of Fire: One at a time or in volleys of 2, 4, 6 or 8.

Payload: 40 total mini-missiles, 20 in each shoulder.

**3. Pop-Up Forearm Ion Blaster (1, right arm):** The weapon “pops up” from a concealed housing in the forearm to fire. Point and shoot.

Primary Purpose: Anti-Personnel and Close Combat.

Secondary Purpose: Defense.

Range: 800 feet (244 m).

Mega-Damage: 4D6 M.D.

Rate of Fire: Each blast counts as one melee attack.

Payload: Effectively unlimited; tied to the power armor’s power supply.

**4. Pop-Up Forearm Laser (1, left arm):** The weapon “pops up” from a concealed housing in the forearm to fire. Point and shoot.

Primary Purpose: Anti-Personnel and Anti-Gargoyle.

Secondary Purpose: Defense.

Range: 2,000 feet (610 m).

Mega-Damage: 3D6 M.D.

Rate of Fire: Each blast counts as one melee attack.

Payload: Effectively unlimited; tied to the power armor’s power supply.

**5. Special Systems of Note:** The X-700 “Fat Boy” has full optical systems including telescopic, passive nightvision, and, and polarization in addition to all standard features of NGR power armor (see page 48 of **Rifts® World Book 5: Triax and the NGR™**).

Self-Destruct Mechanism: Self-destruct mechanism to prevent the armor and its technology from falling into enemy hands. It turns the X-700 in to a pile of slag and does 1D6x10 M.D. to everything within a five foot (15 m) radius.

**6. Hand to Hand Combat Elite: Glitter Boy:** Rather than use a weapon, the pilot can engage in Mega-Damage hand to hand combat. The size and design of the Fat Boy gives it modifiers that are different from most Glitter Boys.

+1 extra attack/action per melee round, in addition to those of the pilot at level one; +1 additional attack at levels 4, 8 and 12.

Critical Strike is the same as the pilot’s.

+2 on initiative.

+2 to strike when shooting the Boom Gun and other rail guns and cannons, in addition to any W.P. Heavy M.D. Weapons skill bonuses.

+1 to strike in hand to hand combat.

+1 to parry in hand to hand combat. No dodge bonus.

+2 to pull punch and roll with impact.

Punch Damage: 1D4 M.D. on a restrained punch, 2D6 M.D. on a full strength punch.

Power Punch: 4D4 M.D., but counts as two melee attacks.

Kick and Stomp Attacks: Not possible.

Tear or Pry with Hands (Special): 2D6 M.D.

Body Block/Ram: 2D6 M.D.

Full Speed Running Ram: 3D6 M.D., but this attack uses up three melee actions.

Pylon Impalement: 1D6 M.D., not very useful in most combat situations.



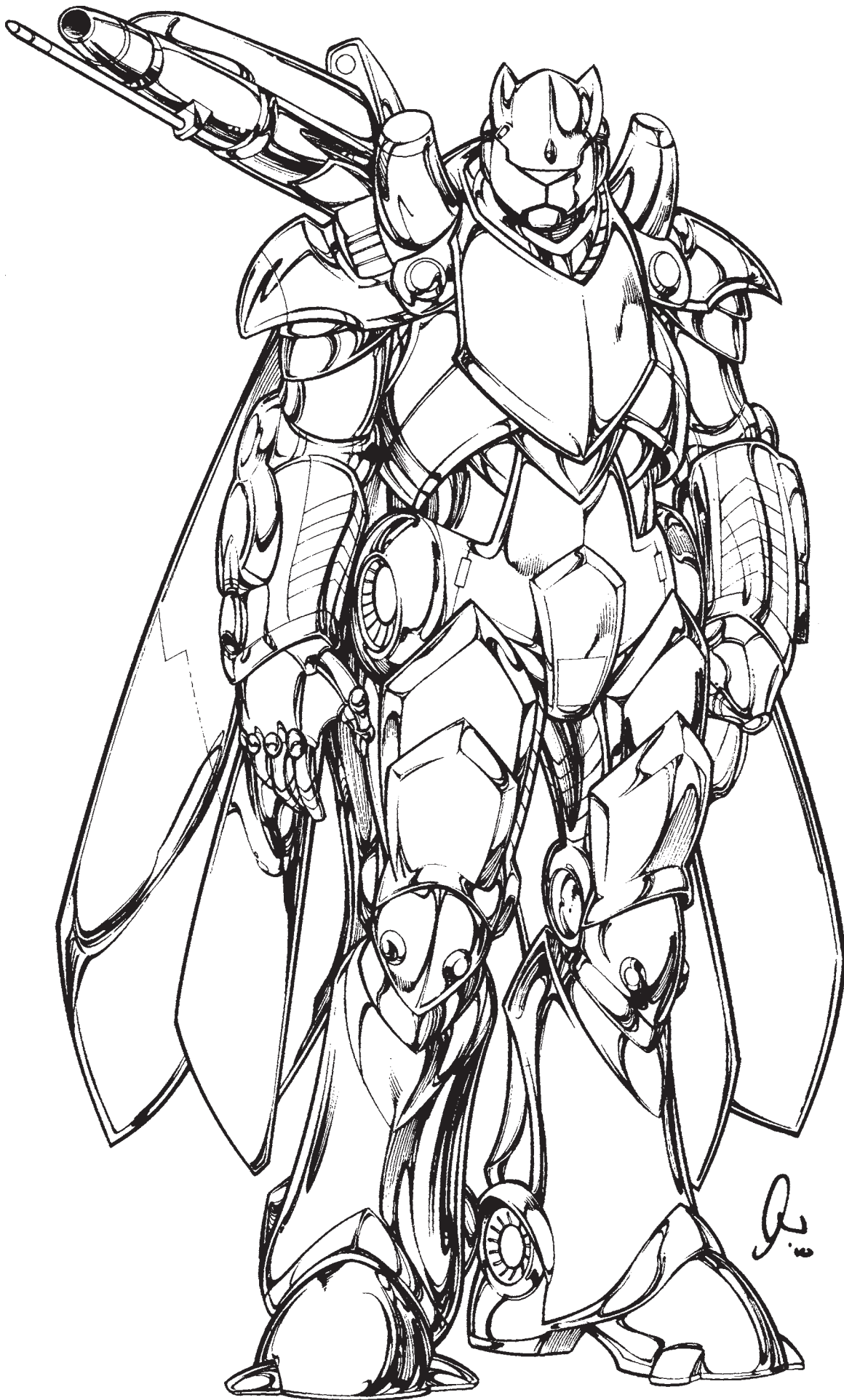

# Triax X-710 Hell Angel

## New NGR Flying Glitter Boy

Triax Industries had been working on new aerial power armor (and robot) designs for a long time. If the NGR wanted to take the war against the Gargoyles into a new direction by taking control of their skies, Triax was ready. The TX-710 Hell Angel uses Glitter Boy laser resistant armor and the standard TX-550 Boom Gun, but does so flying. Triax R&D are proud to make the first aerial version of the most infamous power armor suit ever created by humankind.

The TX-710 is a flying suit of power armor that contains some design elements of the X-21 War Eagle and the older X-10A Predator. It is fast and maneuverable for its size. Of course, with a flying unit, the recoil of the boom gun is an issue, as each blast would knock the power armor backward or into a spin. This was compensated for with additional stabilizing hover rockets and booster jets, as well as wings that are independent of the arms. The wings are computer programmed to instantly reposition and adjust to maintain stability and position in the air. Furthermore, unlike a traditional fighter aircraft and some other robot designs, the X-710 Hell Angel does not fly in a prone position nor fire straight ahead. Instead, the Hell Angel flies like the Predator or the Coalition's SAMAS, with wings titled out and above the shoulders and the body in an erect, standing position even in flight. The Boom Gun tilts over the right shoulder, same as the T-550. To fire, the pilot slows down to under 50 mph (80 km) or comes to a complete stop, hovers, and fires the Boom Gun. An integrated computer system knows the gun is about to fire and the instant it does, the back mounted rocket thrusters and stabilizing thrusters all kick in to hold the Hell Angel in place. Likewise the wings adjust to keep the power armor steady. From this stable position, the Hell Angel can continue to fire at enemy targets, turn and tilt to fire upon other aerial targets, and quickly fly out of the way of incoming attacks or drop down or rocket higher to engage the enemy.

Against other, faster flying enemy power armor, aircraft or flyers, the X-710 is in jeopardy of being outmaneuvered and vulnerable to being shot out of the sky, but against the slow flying Gargoyles it is devastating. Furthermore, this design is perfect for maneuvering and engaging enemies in urban, woodland and mountain settings, attacking Gargoyle roosts and nests, handling the Gargoyles' style of swarming attacks and taking down ground troops from an elevated position. The versatility of the Hell Angel also enables it to fight on the ground with equal ability. To fire its Boom Gun, the X-710 hovers a few to several feet above the ground and blasts away, with wings and jets kicking in as usual to hold its position. The X-710 does not have the feet pylons and cannot fire the Boom Gun when standing on solid ground.

In addition to the NGR Boom Gun, the Hell Angel has a battery of other weapons, including mini-missiles and forearm blasters which were seen as a necessity to deal with hardened targets and swarms of flying enemies, but the suit owes its name to the new plasma weapon system integrated into its forearms.

## X-710 "Hell Angel" Glitter Boy Unit

**Model Type:** X-710

**Class:** Laser Resistant Strategic Armor Military Assault Suit.

**Crew:** One.

## M.D.C. by Location:

\* Head – 190

\* Hands (2) – 75 each

Arms (2) – 200

\* Forearm Weapons (2, low profile) – 30 each

Shoulder Mounted Boom Gun – 100

Legs (2) – 320 each

\* Feet (2, each contains thrusters) – 100 each

Wings (2) – 200 each

\*\* Main Body – 600

\* A single asterisk indicates a small or difficult target to hit. They can only be struck when the attacker makes a Called Shot, and even then the shooter is -3 to strike. Destroying the head/helmet eliminates all forms of optical and sensory enhancement and the pilot must rely on his own human senses without any of the bonuses granted to him by the Robot Combat skill.

\*\* Depleting the M.D.C. of the Main Body shuts the power armor down completely, rendering it useless. **Note:** As a Glitter Boy suit, the X-710 takes *half damage* from laser fire.

## Speed:

**Running:** 60 mph (96 km) maximum. The act of running tires out its operator, but at 20% of the usual fatigue rate.

**Leaping:** The robot legs can leap 15 feet (4.6 m) high or across. Add 10 feet (3 m) with a running start, increase by ten-fold with a thruster assisted boost.

**Flying:** 260 mph (416 km) maximum, but cruising speed is 100 mph (160 km).

**Underwater Capabilities:** The unit can swim/rocket through water at a speed of 15 mph (24 km or 13 knots) and can walk along the bottom of the body of water at 25% of its running speed. Maximum depth is one mile (1.6 km).

## Statistical Data:

**Height:** 10 feet (3 m).

**Width:** 5 feet, 6 inches (1.7 m) at the shoulders.

**Length:** 5 feet (1.5 m) including back mounted thrusters and rail gun ammo drum.

**Wingspan:** 22 feet (6.7 m) with wings fully extended.

**Weight:** 1.5 tons.

**Physical Strength:** Equal to a P.S. of 30.

**Cargo:** A one cubic foot compartment for personal items, and additional storage space for a handgun, survival knife, and first aid kit.

**Power System:** Nuclear, average energy life is 20 years.

**Black Market Cost:** 90+ million credits, but super-rare on the Black Market. Exclusive to the NGR Army (even Free Quebec doesn't have these).

## Weapon Systems:

**1. TX-550 Boom Gun/Rail Gun (1):** This Triax version of the Boom Gun, like its predecessor, fires flechette style rounds at a speed of Mach 4.5 (slightly slower than the Mach 5 of the original) and actually creates a sonic boom when fired. The Triax design departs significantly from the original, combining laser targeting, an independent computer radar tracking

system and precision automated targeting calibration. When the gun is activated, the computer tracking and targeting system takes over, instantly seeking out the nearest target, or a specific target designated by the pilot. It then tracks that target, automatically adjusting the angle of the gun. The Boom Gun can be set to fire automatically the instant the enemy is targeted, or to target and wait for the pilot's signal. The Glitter Boy pilot can also take manual control of the gun and targeting and shooting via voice command. Either way, the pilot never needs to physically touch the Boom Gun on his shoulder. This leaves both hands free to operate other weapons and equipment.

The Boom Gun of the X-710 Hell Angel can angle itself forward and upward and at a downward angle in a 90 degree arc of fire, but it cannot pivot from side to side. To strike a target off to the side, the entire power armor must be turned to face that direction. An easy feat for the aerial Hell Angel. Again, the radar-targeting computer helps direct the pilot to achieve the proper alignment. When not in use the gun barrel rotates to an upward position behind the shoulder and locks into place. Yes, it can fire in the upward position.

The blast from the big gun is so powerful that without the automatic stabilization and recoil suppression system the Hell Angel would be knocked backwards 1D6x100 yards/meters and possibly (01-50% chance) into a tumbling spin. Synchronized jet and stabilizing thrusters, as described previously, engage to hold the power armor in place. The pylons automatically retract and the small thrusters disengage when the T-710 needs to move or reposition itself.

Primary Purpose: Anti-Armor and Anti-Gargoyle/Aircraft.

Secondary Purpose: Troop Support and Defense.

Weight: 700 lbs (315 kg), but built into the power armor.

Range: 11,000 feet (roughly two miles/3.2 km).

Mega-Damage: One Boom Gun Flechette round holds 200 slugs that inflict 3D6x10 M.D.

Effects of the Sonic Boom: Standard. See the X-700 Fat Boy for details.

Rate of Fire: Each Boom Gun blast counts as one melee attack.

Payload: 100 rounds. Unlike some power armor suits, the X-710 Hell Angel can be reloaded by hand, one round at a time, by the pilot (takes about 15 minutes) or an assistant. Alternately, the empty ammo drum can be removed and a new drum canister replaced by a field mechanic in a forklift or by a robot or cyborg (takes about 3 minutes).

**2. TX-249 Particle Beam Rifle (1):** This giant-sized particle beam rifle is designed for use with the Ulti-Max II and other heavy power armor, so the Hell Angel must use it as a two-handed weapon. It has good range and a high damage yield. Other heavy weapons and oversized power armor weapons may be used in place of the TX-249, but it is standard issue for its heavy damage capabilities.

Primary Purpose: Anti-Gargoyles & Anti-Armor.

Secondary Purpose: Assault and Defense.

Weight: 297 pounds (133.6 kg).

Range: 2,000 feet (610 m).

Mega-Damage: 1D6x10+10 M.D., Critical Strike (double damage) on a D20 roll of a Natural 19 or 20.

Rate of Fire: Each blast counts as one melee attack.

Payload: 33 blasts from the oversized E-Clip, 66 from the larger power pack cable hung from the back or the hip and cabled to the rifle. Effectively unlimited when tied to the power supply of the power armor.

Cost: 190,000+ credits on the Black Market. This weapon is exclusive to the NGR Army and hard to find on the secondary market.

**3. Forearm Plasma Weapon Systems (2):** Mounted on each forearm is a low profile plasma ejector. It is another weapon system designed to inflict heavy damage against Brodkil. Point and shoot.

Primary Purpose: Anti-Brodkil and Anti-Personnel.

Secondary Purpose: Defense.

Range: 1,000 feet (305 m).

Mega-Damage: 6D6 M.D. per single plasma blast, or 1D6x10 M.D. when both arms are pointed at the same target and fired simultaneously.

Rate of Fire: Each single or dual blast at the same target counts as one melee attack. If both arms are pointed at a different target, each blast counts as a separate attack.

Payload: Effectively unlimited; tied into the power supply of the armor.

**4. TX-H Series:** Any of the TX-H series hand to hand weapons can be used.

**5. Features and Sensor System of Note:** The X-710 "Hell Angel" has all the standard features and systems of NGR power armor plus telescopic optics, passive nightvision, and polarization.

Self-Destruct Mechanism: Self-destruct mechanism to prevent the armor and its technology from falling into enemy hands. It turns the X-710 in to a pile of slag and does 1D6x10 M.D. to everything within a five foot (15 m) radius.

**6. Hand to Hand Combat Elite: Glitter Boy.** Rather than use a weapon the pilot can engage in Mega-Damage hand to hand combat. The design and aerial nature of the Hell Angel gives it modifiers that are a bit different from the Glitter Boy ground units. Available only to those who take *Power Armor Combat Elite: Glitter Boy* (automatic to the Glitter Boy O.C.C.). **Note:** All bonuses are in addition to the pilot's own hand to hand combat training and attribute bonuses. They do *not* apply to the pilot's physical abilities when the character is outside his power armor.

+2 extra attacks/actions per melee round, in addition to those of the pilot at level one; +1 additional attack at levels 3, 7 and 11.

Critical Strike is the same as the pilot's.

+2 on initiative.

+2 to strike when shooting the Boom Gun and other rail guns and cannons, in addition to any W.P. Heavy M.D. Weapons skill bonuses.

+2 to strike in hand to hand combat.

+2 to parry in hand to hand combat.

+3 to dodge hovering in the air.

+5 to dodge when leaping or flying.

+1 to disarm.

+4 to pull punch.

+3 to roll with impact.

Punch Damage: 1D4 M.D. on a restrained punch, 1D6 M.D. on a full strength punch.

Power Punch: 2D6 M.D., but counts as two melee attacks.

Kick Damage: 2D4 M.D., Power Kick is not possible.

Running Leap Kick: 4D6 M.D., but counts as three attacks.

Tear or Pry with Hands (Special): 1D6 M.D.

Body Block/Ram: 2D4 M.D.

Full Speed Running Ram: 3D6 M.D., but this attack uses up three melee actions.

Stomp: 1D6 M.D.; effective only against objects smaller than three feet (0.9 m) tall.

Pylon Impalement: Not applicable.

Shoulders (2, mini-missile launchers) – 170 each

Legs (2) – 240 each

Rear Exhaust Tubes (3) – 50 each

\* Main Rear Booster Jet (1) – 30

\* Rear Directional Jets (2) – 60 each

Forearm Vibro-Swords (2, forearms) – 50 each

Mini-Missile Launchers (2, chest) – 150 each

Leg Mini-Missile Launchers (2, lower legs) – 60 each

\* Shoulder Spotlights (2) – 15 each

\* Head Sensors (1; top) – 100

Reinforced Pilot Compartment – 80

\*\* Main Body – 450

\*\*\* Force Field – 150

\* A single asterisk indicates a small or difficult target to hit. They can only be struck when the attacker makes a Called Shot, and even then the attacker is -3 to strike.

Destroying the head sensors eliminates all forms of optical and sensory enhancement. The pilot must rely on his own human senses without any of the bonuses granted to him by the Robot Combat skill.

\*\* Depleting the M.D.C. of the Main Body shuts the power armor down, rendering it useless.

\*\*\* Depleting the M.D.C. of the Force Field shuts the field system down completely. All subsequent damage is to be taken from the Main Body. It takes six hours to fully regenerate the force field. Force field is shut down if the Uma II loses more than two thirds of its Main Body M.D.C.

### Speed:

Running: 50 mph (80 km) maximum. Note that the act of running does not tire out its operator.

Leaping: 15 feet (4.6 m) high or lengthwise from a stationary position; 20 feet (6.1 m) with a running start, and 40 feet (12.2 m) with assistance from the rocket system.

Flying: Not possible.

Underwater Capabilities: The unit can swim at a speed of 15 mph (24 km or 13 knots) and can walk along the bottom of the body of water at 20% of its running speed.

### Statistical Data:

Height: 16 feet (4.9 m).

Width: 9 feet (2.7).

Length: 7 feet (2.1 m).

Weight: 4.5 tons.

Physical Strength: Robot P.S. of 40.

Cargo: Small area for the pilot's personal items, as well as a weapon bin that has room for one rifle, one pistol, light body armor, canteen and food rations (4 week supply). A two gallon water cooler is built into the unit.

Power System: Nuclear, average energy life is 20 years.

Black Market Cost: 30+ million credits, but super-rare on the Black Market. Exclusive to the NGR Army.

### Weapon Systems:

**1. TX-222 Pulse Laser Rifle (1, Handheld)**: The TX-222 is powerful, giant-sized, handheld, burst firing laser rifle used

## X-1001 Ulti-Max II

When the original X-1000 was designed and test marketed overseas it became an instant favorite for many mercenary companies, small and large alike. While the unit performed incredibly well, there were some aspects of the initial robot vehicle that were somewhat disappointing. The lack of mobility was one thing that troubled the technical and development teams, causing some to push for a more mobile and responsive unit. There were others who believed the role of the Ulti-Max was too limited in its scope and it could only be used effectively as a field infantry unit.

The Ulti-Max II bears little resemblance to its predecessor. The **Uma II**, as it has been nicknamed, has a more humanoid looking body, with rounded limbs and components and a variety of weapon systems. It is more mobile, capable of rocket assisted leaps, climbing the sides of mountains, and added balance for kick attacks. The mini-missile payload been increased, and it has a large Vibro-Blade for close combat. The Uma II can use any of the rail guns or oversized weapons designed for use by power armor and robots.

Visually, the X-1001 looks like a synthesis of the X-1000 Ulti-Max, X-10 Predator and X-2000 Dyna-Max with broad shoulders, cyclopean head sensors, and semi-hunched back posture. Like the Ulti-Max it straddles the line between power armor and light robot vehicle, as the pilot does not "wear" the armor, but sits in a pilot's compartment and manipulates foot pedals and other controls to make the power armor move. Thus, many consider the Ulti-Max II to be a manned robot combat vehicle, not true power armor.

### X-1001 Ulti-Max II Power Armor

**German Name**: Das Ulti-Max Zwei. Nickname "Uma II" or just "Uma."

**Model Type**: X-1001

**Class**: Ground Infantry Assault Unit.

**Crew**: One.

**M.D.C. by Location**:

Forearms (2) – 150 each

Upper Arms (2) – 135 each

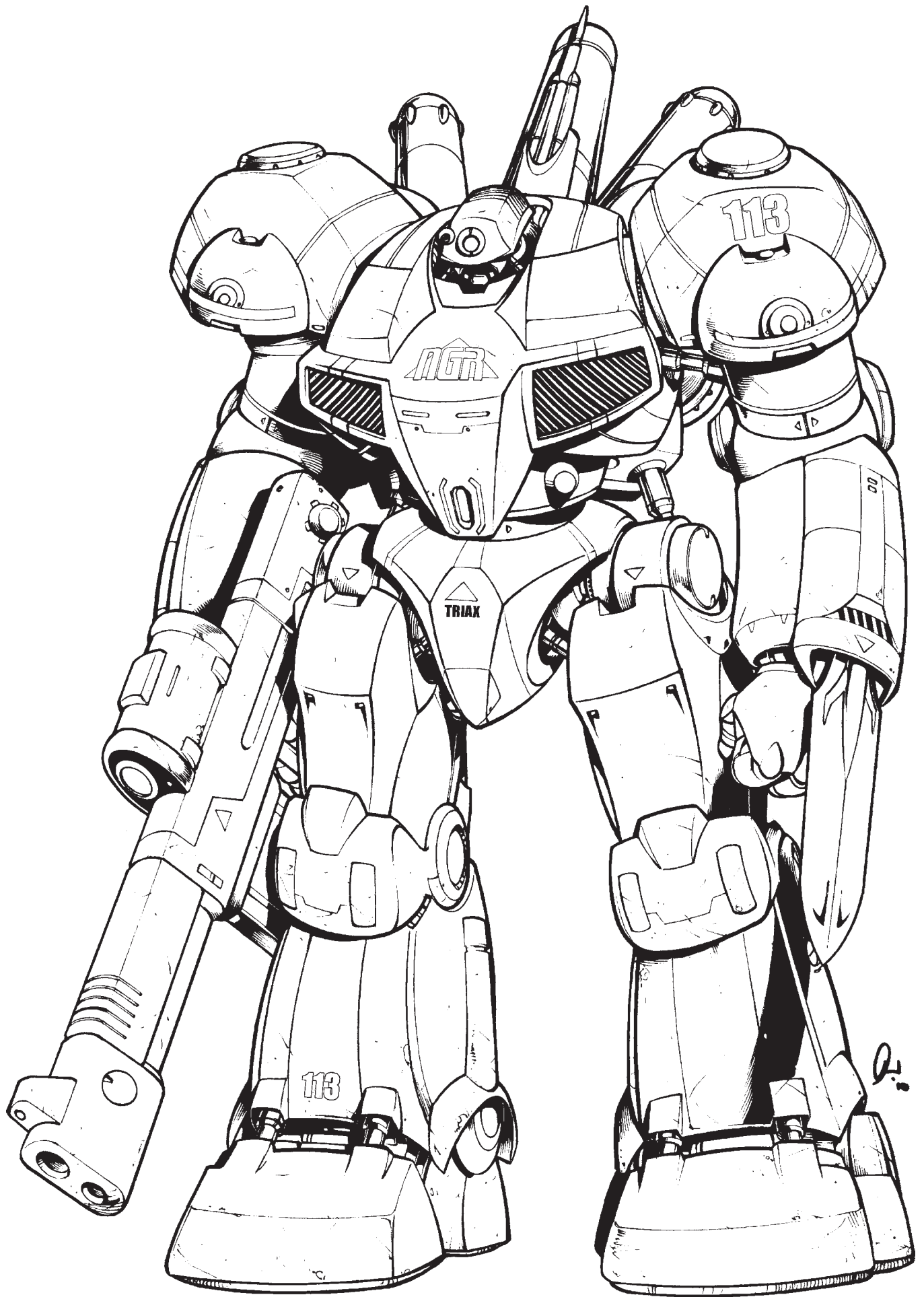

as an assault weapon. It is standard issue to the Ulti-Max II, but other giant, handheld rifles may be substituted. The weapon is usually tied to the Ulti-Max II's nuclear power supply, but not with a cable that could get cut or disconnected, but via a special connection point in the hands of the power armor. When not in use the weapon magnetically clamps to the thigh of the unit.

Primary Purpose: Assault.

Weight: 135 pounds (60.7 kg).

Range: 3,000 feet (914 m).

Mega-Damage: 1D6x10 M.D. per quadruple pulse burst.

Rate of Fire: Burst firing only, but the bursts are less accurate and can not be used to make a Called Shot. Each burst counts as one melee attack.

Payload: 40 bursts from the internal power supply. When held in the hand or stored on the thigh of the power armor, the internal power supply automatically recharges at a rate of one burst every 10 minutes. A giant, front sliding E-Clip can also be used; it holds 40 bursts. Usually hooked to Uma's power supply via hand connector link.

**2. Shoulder Mini-Missile Launchers (2):** Each shoulder has a mini-missile launcher on the top. The hatch flips open, missiles are launched, and the hatch closes to protect the remaining missiles.

Primary Purpose: Anti-Aircraft/Gargoyles.

Secondary Purpose: Anti-Armor and Anti-Missile.

Range: One mile (1.6 km).

Mega-Damage: Varies with mini-missile type, but armor piercing (1D4x10 M.D.) or fragmentation (5D6 M.D.) are typical.

Rate of Fire: One at a time or in volleys of 2, 3 or 4.

Payload: 40 mini-missiles total; 20 per shoulder launcher.

**3. Chest Mini-Missile Launchers (2):** Concealed within the chest of the unit, on either side of the sensor head, is a mini-missile launcher. The hatch flips open to fire the mini-missiles and then closes to protect the remaining missiles.

Primary Purpose: Anti-Aircraft/Gargoyles.

Secondary Purpose: Anti-Armor and Anti-Missiles.

Range: One mile (1.6 km).

Mega-Damage: Varies with mini-missile type, but armor piercing (1D4x10 M.D.) or fragmentation (5D6 M.D.) are favored.

Rate of Fire: One at a time or in volleys of 2, 4, 6, 8 all 10.

Payload: 20 mini-missiles total; 20 per chest launcher.

**4. Leg Mini-Missile Launchers (2):** Concealed in each lower leg is a mini-missile launcher. The panel opens, missiles fire, and the panel closes.

Primary Purpose: Anti-Aircraft/Gargoyles.

Secondary Purpose: Anti-Armor and Anti-Missile.

Range: One mile (1.6 km).

Mega-Damage: Varies with mini-missile type, but armor piercing (1D4x10 M.D.) or fragmentation (5D6 M.D.) are typical.

Rate of Fire: One at a time or in volleys of 2, 4 or 6.

Payload: 12 mini-missiles total, six in each leg launcher.

**5. Forearm Vibro-Blades (2):** Mounted in special forearm housings are retractable Vibro-Blades.

Primary Purpose: Melee Combat.

Secondary Purpose: Defense.

Mega-Damage: 3D6+3 M.D.

**6. TX-H Series:** Any of the TX-H series hand to hand weapons can be used.

**7. Sensor System Note:** The X-710 "Hell Angel" has all the standard features and systems of NGR power armor plus telescopic optics, passive nightvision, and polarization.

**8. Hand to Hand Combat:** Rather than use a weapon the pilot can engage in Mega-Damage hand to hand combat. See *Light Ground Robot Training* on page 352 of **Rifts® Ultimate Edition**. All abilities are the same except as follows: The Ulti-max II is capable of Kick Attack: 3D8 M.D. and Leap Kick Attack: 5D8 M.D.

## New Jaeger Weapon Systems

### New Triax X-535 Interchangeable Devices

After witnessing the superior versatility of the Glitter Boy legions of Free Quebec, the top military minds of the NGR wanted to make the X-535 Jaeger an even more all-purpose and well rounded power armor unit. The program received much support from the top brass who already saw the Jaeger as one of its best. Colonel Eisenfaust, the project's staunchest supporter, supervised the creation of the designs firsthand. Overall, the program has been deemed a success by the military top brass and the power armor commandos as well.

**Note:** All of the interchangeable weapons and devices for the X-535 Hunter/Jaeger have independent power supplies. Only one of these items (or older weapon system) may be mounted on the shoulders of the Jaeger at a time.

### TX-917FF Jaeger Force Field

The Jaeger Force Field is a modified version of the force field generator from the X-1000 Ulti-Max. It forms a force field dome over the unit that has a 30 foot (9.1 m) radius which can be used to provide protection to infantry troops and civilians. In simulations and trials there was generally one Jaeger unit with the TX-917FF per squad. The force field has 150 M.D.C. If the M.D.C. of the force field is depleted, the field generator shuts down and the Hunter is left without additional protection. Lost force field protection can only be regenerated if the generator is shut down, restoring 50 M.D.C. per hour. The force field must be turned off for the Hunter to fire its own built-in and handheld weaponry at enemies outside the protective force field bubble. The force field generator weighs two tons and has 160 M.D.C.

### TX-411R Jaeger Sensor Dome

The weapons developers at Passau combined some of the most advanced sensory systems into one large unit that grants the Jaeger a wide range of sensory capabilities. A Hunter with a TX-411R is assigned to perimeter patrols, recon squads or seek and destroy squads as well as remote outposts. The Sensor Dome weighs two tons and has 170 M.D.C. All systems are in addition to the standard equipment for all Triax robots and power armor.

## Special Equipment

**1. Advanced Radar:** Extended radar range of 200 miles (320 km). Can track 144 aerial enemy targets simultaneously.

**2. Long-Range Laser Communications:** Range: 1,000 miles (1,600 km) and can be used as a relay station. Range may be half in the mountains or in an area with several ley lines and/or dimensional disturbances.

**3. Radio/Radar Scrambling Unit:** Can scramble enemy radar and radio communications within a 10 mile (16 km) radius. Victims of the scrambling attack must make a skill roll under Radio: Countermeasures *and* Sensory Equipment skills with a -40% penalty to circumvent the scrambling signal and unscramble and reestablish communications; roll once every 10 minutes until successful.

**4. Laser Targeting:** This is primarily used to “tag” a reinforced position for an air strike or mortar strike. The infrared laser has a range of one mile (1,600 km) and is invisible unless an observer has enhanced optics to see in the infrared spectrum. If the unit with the TX-411R keeps the target tagged, the roll to strike for the attacker (the mortar team, artillery unit, or aircraft) is made at +10.

**5. All other sensor features** common to NGR power armor at double the usual range.

## TX-897G Rapid Fire Grenade Launcher

Designed for heavy fire support, the TX-897G is a rotary grenade launcher loaded with heavy fragmentary rounds. The weapon is slightly different from other Jaeger modifications since the weapon is not centered over the head of the Jaeger, but slightly offset over the right shoulder with the ammunition drum and sensor dome over the left shoulder. Against large formations of enemies, like groups of Gurgoyles, Gargoylites, and Brodkil, the grenade launcher can lay down either suppressive fire or direct attacks that can tear mobs to shreds. May also be used for riot control (smoke and tear gas grenades replacing explosive ordnance).

Primary Purpose: Anti-Personnel and Troop Support.

Secondary Purpose: Defense and Riot Control.

Range: 1,500 feet (457 m).

Mega-Damage: 3D6 M.D. to a 12 foot (3.6 m) radius per single round, or 1D6x10 M.D. to a 30 foot (9.1 m) radius per six round burst.

Rate of Fire: Single shots or bursts only.

Payload: 360 grenades.

## TX-111 Holographic Projector

The TX-111 Holographic Projector is used by power armor troops mainly at forward outposts to give the appearance of greater troop capacity and to confuse the enemy. The projector can create the illusion of as many as 10 of any of the power armor troops or one giant robot or combat vehicle fielded by the NGR within 300 feet (91.5 m) of the Jaeger. The illusion can be any mixture of troops or robots, all of which move and react independently to make the illusion even more believable.

Weight: One ton.

Primary Purpose: Psychological Warfare and Deception.

M.D.C.: 200 M.D.C.

Range: 300 feet (91.5 m) around the projector.

Payload: Effectively unlimited.

## VS-101 Sonic Stun Projector

A sonic projector mounted on top of the Jaeger as a mobile Gargoyle disruption device. See page 101 in the Weapons section of this book for complete stats and details.

# NGR Robot Drones

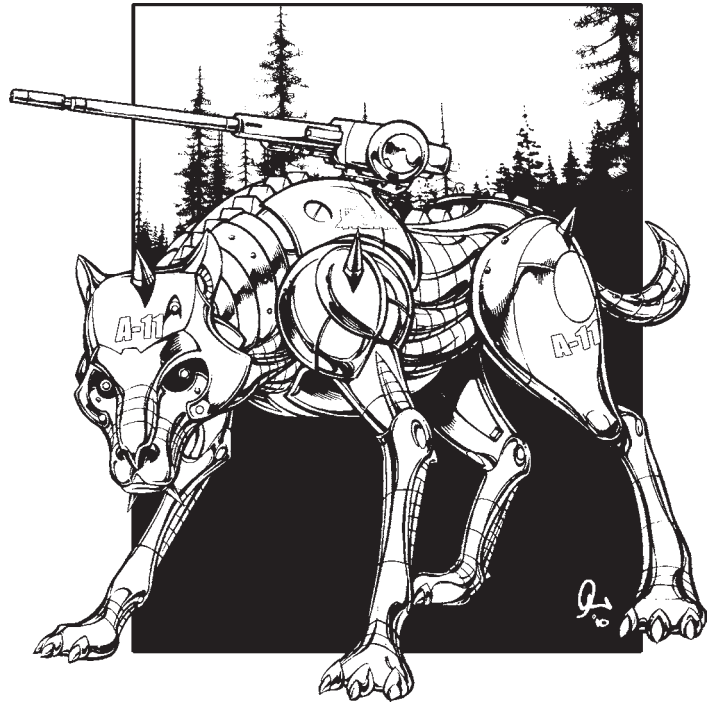

## DV-39 Wolf

The DV-39 Wolf is a robot designed to resemble a large, albeit mechanical, wolf. It has an artificial intelligence programmed with basic military operations, tactics, scouting, tracking, navigation, and melee combat. The Wolf robot can also speak to the soldier(s) it is assigned to serve, as well as communicate via radio and transmit video and sensor data. The DV-39 can be used as an individual unit, in pairs or packs, as companions to the *X-1471 Wolfhound robot*. The latter can link to as many as four DV-39s with its specialized combat computer system and control them like attack animals or trackers/scouts. The pilot of the X-1471 can tap into the drone(s) to take temporary control of them and coordinate their attacks, all from the security of his own animal-like robot vehicle.

The term “faithful companion” doesn’t even begin to describe the capabilities of the DV-39 Wolf robot drone. This robot is often assigned to a reconnaissance squad as a forward scout. Infantry soldiers have reported back to Triax with rave reviews. To give the robot some extra punch or enhance spying capabilities, a number of modular combat weapon and sensor systems have been designed to mount on its back.

## DV-39 Wolf Pack Robot Drone

**Exclusive to the NGR Military**

**Model Type:** DV-39

**Class:** Coordinated Reconnaissance and Strike Robot Drone.

**Crew:** None, Robot Drone.

**M.D.C. by Location:**

\* Head – 90

\* Back Mounted System – 60

Vibro-Claws (4) – 50 each

Legs (4) – 95 each

\*\* Main Body – 200

\* A single asterisk indicates a small or difficult target to hit. They can only be struck when the attacker makes a Called Shot, and even then the attacker is -3 to strike. Destroying the head eliminates all forms of optical and sensory enhancement.

\*\*Depleting the M.D.C. of the Main Body destroys the robot and any data it may have collected is destroyed along with it.

**Speed:**

Running: 120 mph (192 km) maximum.

Leaping: 20 feet (6.1 m) high, or 30 feet (9.1 m) lengthwise. A running start of 60 miles (96 km) per hour or greater increases the height and/or distance by 50%.

Flying: Not possible.

Underwater Capabilities: Swim across the surface of water at 20% its running speed.

**Statistical Data:**

Height: 3 feet, 6 inches (1 m).

Width: 2 feet (0.6 m).

Length: 5 feet, 6 inches (1.7 m).

Weight: 350 pounds (157.5 kg).

Physical Strength: Robot P.S. of 30.

Other Notable Attributes: I.Q. 14, P.P. 18, P.B. 10.

Attacks per Melee: Six.

Cargo: None.

Power System: Nuclear, average energy life is 20 years.

Black Market Cost: 1.2 million credits, but rarely available on the Black Market. Exclusive to the NGR Army. Not currently sold on the open market.

**Standard Wolf Robot Sensor Systems:** All the usual features and sensors common to NGR robots. Plus the following.

Optics: The DV-39 has advanced robot optics (basic 20/20 vision up to two miles/3.2 m away) with infrared, ultraviolet, polarization, and passive nightvision, all with a range of 4,000 feet (1,219 m), plus telescopic vision with a range of two miles (3.2 km), and an optical reader.

Motion Detector: Increased range: 500 feet (152 m), adds to the ability to respond quickly, parry and dodge.

Molecular Analyzer: Identical to the cybernetic lung implant of cyborgs.

Vibration Detectors: Located in the feet, these sensors enable the drone to detect ground movement by troops and vehicles, and estimate their speed, direction of travel and location at a base percentage of 70%.

Speech: A synthesized voice system and loudspeaker are standard, enabling the 'Bot to speak to NGR soldiers, but the voice is mechanical sounding. This is to prevent soldiers from starting to think of the robot as a "living" animal and becoming too attached to the robot.

**Standard DV-39 Wolf Computer Programs:**

Military General Programming: Demolitions Disposal 90% (has the data and knowledge, and can talk a technician or soldier through the procedure; includes a "chemical sniffer" sensor system), Languages include Euro, American, German, Techno-can, and Gobblely at 96%, Lore: Demons and Monsters 70% (+15% when it comes to Gargoyles and Brodkil), Mathematics: Basic 96%, Military Etiquette 96%, Radio: Basic 96% and and Sniff Out Explosives (special; exactly what it sounds like) 88%.

Military Reconnaissance & Intelligence Program: Climbing 85%/15%, Detect Ambush 60%, Detect Concealment 60%, I.D. Plants and Animals 88%, Intelligence 80% (+10% when dealing with Gargoyles and Brodkil), Land Navigation 88%, Mine/Trap Detection 68%, Prowl 70%, Tailing (people or vehicles) 85%, Track Animals 88%, Tracking People 88%, and Wilderness Survival 80%.

**Special Combat Systems:**

### 1. Optional Back-Mounted Combat System or Weapon:

Most DV-39 Wolf drones are deployed with a weapon or special features pack (Sensor or Video) on its back. The following are the options available, only one may be mounted at a time.

**A. Optional Back-Mounted Mini-Missile Launcher:** A light missile launcher.

Primary Purpose: Anti-Fortification/Anti-Armor.

Secondary Purpose: Anti-Personnel.

Mega-Damage: Varies depending on type of missile used, but armor piercing (1D4x10 M.D.) or plasma (1D6x10 M.D.) are typical.

Range: One mile (1.6 km).

Rate of Fire: One at time or in a volley of 2 or 4.

Payload: Six mini-missiles total.

**B. Optional Back-Mounted Laser:** A medium laser is mounted on the robot's back. This laser weapon or the ion cannon are favored by military specialists and pilots of the X-1471 Wolfhound robot.

Primary Purpose: Assault.

Secondary Purpose: Anti-Personnel.

Range: 4,000 feet (1,219 m).

Mega-Damage: 3D6 M.D. per single shot.

Rate of Fire: Each shots counts as one melee attack.

Payload: Effectively unlimited.

**C. Optional Back-Mounted Ion Cannon:** A heavy anti-personnel weapon that does greater damage but has a shorter range.

Primary Purpose: Assault.

Secondary Purpose: Anti-Personnel.

Mega-Damage: 5D6 M.D. per blast.

Range: 2,000 feet (610 m).

Rate of Fire: Each single blast counts as one melee attack.



Payload: Effectively unlimited.

**D. Optional Back-Mounted Video Communications Array:**

This device is exactly what it looks like: a video camera, radio dish, and a couple sensor pods and antennas. The video camera has a wide angle and zoom lens, and everything it films is stored inside the Wolf robot as well as transmitted to its handler or nearby base. This array gives the DV-39 Wolf long-range (500 miles/800 km) radio scanning and radio and video transmitting and relay capabilities. Great for scouting and video surveillance. This attachment hooks directly into the drone itself, and transmits everything the robot sees and hears.

**E. Optional Back-Mounted Sensor Array:** This package is similar to D, above, except that it adds a superior radar (double the range and capabilities of the standard robot system), has a laser distancer (1 mile/1.6 km), a larger array of thermal sensors, and it boosts the drone's own sensors by 50% and transmits the data back to base or the robot's handler.

**2. Hand to Hand Combat:** Instead of using a weapon, the DV-39 can engage in limited melee combat. The drone has six attacks per melee round.

Bite – 2D4 M.D.

Power Bite – 4D4 M.D.

Head Butt - 1D4 M.D.

Full Strength Paw Strike – 1D6 M.D.

Jumping/Pouncing Attack – 1D4 M.D. plus has a 01-90% likelihood of knocking down humans and D-Bees, as well as troops in body armor and exoskeletons. The victim of a knockdown attack loses initiative and one melee attack, plus the Wolf can be right on top of him to continue its attack, or move in to disarm or pin its opponent.

Critical Strike on the roll of a Natural 19 or 20.

Combat Bonuses: +4 on initiative, +2 to strike with ranged weapons, +4 to strike in melee combat, +6 to dodge (including attacks from behind), +5 to disarm, +3 to pin/incapacitate and entangle, +4 to roll with impact, and +6 to pull punch/bite/attack.

# DVO-1 Aerial Spy Drone

Aerial Observation and Survey Drone

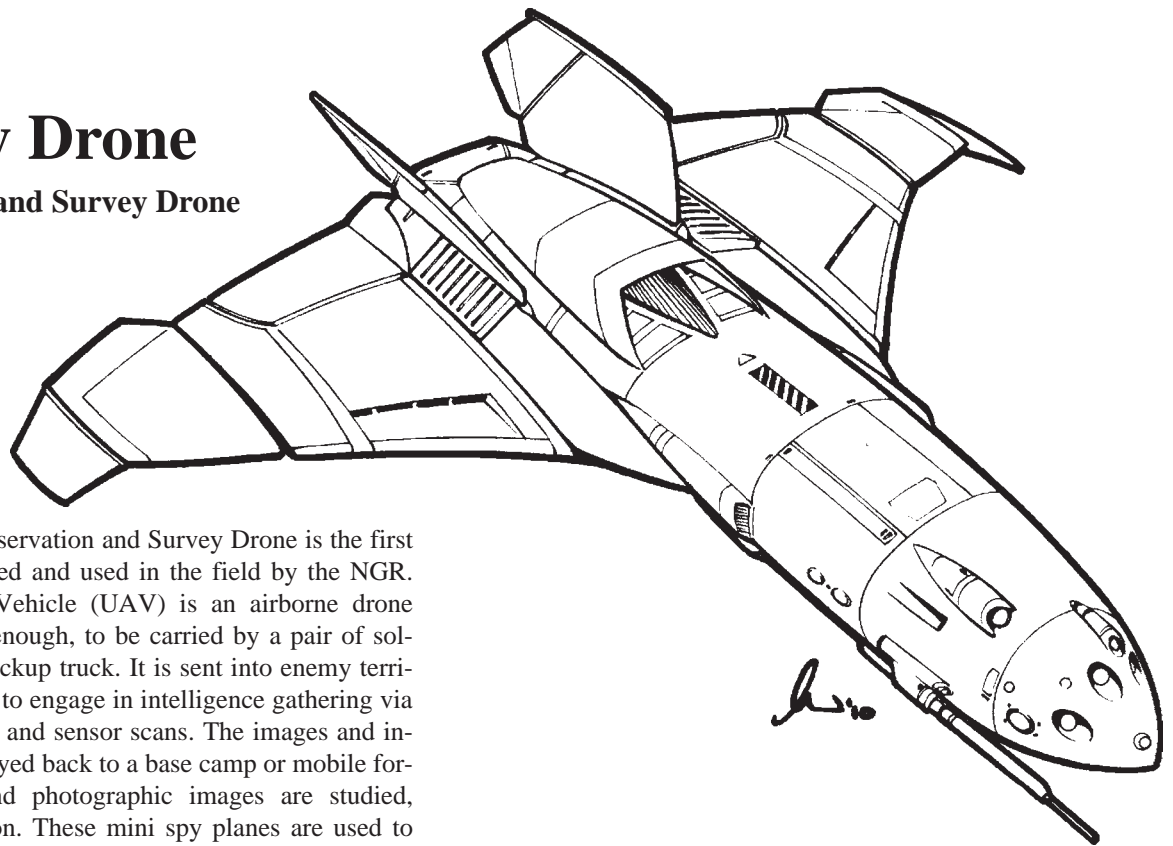

The DVO-1 Aerial Observation and Survey Drone is the first of its kind to be developed and used in the field by the NGR. This Unmanned Aerial Vehicle (UAV) is an airborne drone small enough, and light enough, to be carried by a pair of soldiers or in the bed of a pickup truck. It is sent into enemy territory, flying up in the sky, to engage in intelligence gathering via aerial photography, video and sensor scans. The images and information gathered is relayed back to a base camp or mobile fortress where the data and photographic images are studied, interpreted and acted upon. These mini spy planes are used to monitor, in real-time, the action taking place on the battlefield so the commanders and generals can get the full picture and adjust their own troop movements and strategies as necessary, but the main purpose is to find and observe the enemy. To this end, the DVO-1 flies into uncharted territory with the specific purpose of identifying and locating enemy troops, enemy encampments, fixed positions, Gargoyle roots, nests and lairs, troop movement, and other strategic data, and transmit “what it sees” in three-dimensional and topographical images to its command post. When enemy troops or a stronghold, bunker, nest or other strategically important feature or movement is identified, the drone's telescopic lens can zoom in for a closer look. Further-

more, the drone can engage in aerial surveillance, tailing and observing enemy movement, troop build-up, travel routes and activity from a safe distance, tens of thousands of feet in the sky, where the enemy are not likely to even know the drone is watching them. The DVO-1 can also paint a target with a laser marker for directed missile strikes. With the loss of orbiting satellites after the Great Cataclysm hundreds of years ago, this type of aerial intelligence gathering was thought to be gone, but the DVO-1 Spy Drone is Triax's solution to aerial spying. In the case of Gargoyles, the little spy plane can fly higher and faster than they can, easily avoiding detection, and when spotted, it easily escapes capture. The drone doesn't always work from a

great distance. Its small size and mobility enables it to engage in treetop and rooftop level surveillance as well as fly through city streets, around, and even inside, the ruins of buildings for a close look and plenty of details.

## DVO-1 Aerial Observation and Survey Drone

**Exclusive to the NGR Military**

**Model Type:** DVO-1

**Class:** Coordinated Strike Robot Drone.

**Crew:** None, Robot Drone.

**M.D.C. by Location:**

- \* Sensor Array – 30
- \* Secondary Sensor Array – 30
- \* Jet Engine – 30
- \* Stabilizer Thrusters (6) – 5 each
- \* Laser Turret – 20
- \*\* Main Body – 80
- \* A single asterisk indicates a small or difficult target to hit.

They can only be struck when the attacker makes a Called Shot, and even then the attacker is -3 to strike.

Destroying the sensor array and the secondary sensor array eliminates all forms of optical and sensory surveillance and the drone must return to base for repairs.

\*\* Depleting the M.D.C. of the Main Body destroys the robot drone and all the data it has collected.

**Speed:**

Running: Not possible.

Leaping: Not possible.

Flying: 250 mph (400 km) to an altitude of 35,000 feet (10,668 km).

**Statistical Data:**

Height: 3 feet (0.9 m) to the top of the tail fin.

Width: 5 feet (1.5 m) from wingtip to wingtip.

Length: 5 feet (1.5 m).

Weight: 200 pounds (90 kg).

Physical Strength: Not applicable.

Attacks per Melee: Five actions per round.

Cargo: None.

Power System: Nuclear, average energy life is 20 years.

Black Market Cost: 600,000 credits. Exclusive to the NGR Army and unavailable from any other source.

**Standard DVO-1 Computer Programs:** Designed to seek out, identify, determine location, observe, gather military intelligence, follow and film enemy troop movement and transmit the data and images to a specified base camp.

**Weapon Systems:** None.

**Standard DVO-1 Drone Observation and Intelligence**

**Gathering Systems:** All the usual features and sensors common to NGR robots. Plus the following:

1. Spy Camera Array: This is the DVO-1's primary purpose, to locate and take photographs and video of enemy troop movement and bases of operation, including camps, travel routes, nests and roosts. The camera array is equipped with several different cameras and lenses for both wide angle and zoom

close-ups; it can film up to 48 hours of video and shoot tens of thousands of still photo images. Unless programmed to do otherwise, the drone transmits a live video feed to its base of operations as well as stores it in a digital format.

2. Advanced Mapping: The DVO-1 can coordinate with other drones to generate a three-dimensional, topological map of a particular battlefield or region using visual, infrared, and ultraviolet imaging layers. For a comprehensive map, one DVO-1 is required for each 5 square miles (13 sq. km).

3. Long-Range Laser Communications: Receive and transmit radio and video. Range 1,000 miles (1,600 km).

4. Advanced Radar: Extended radar range of 200 miles (320 km) and can track 120 targets simultaneously.

5. Laser Targeting: This is used to "tag" an enemy position for an air strike or missile strike. The infrared laser has a range of two miles (3.2 km) and is invisible unless an observer has enhanced optics which allows them to see in the infrared spectrum. If the drone keeps the target tagged, the roll to strike with missiles gets an additional +5 (for a total of +8 to +10 for most missiles; if the missile had no bonus of its own, then the bonus is only +5).

6. Radio & Radar Scrambling Signal (special): Can scramble enemy radar units and radio communications to all units within 10 miles (16 km). Victims must roll on the Radio: Countermeasures and Sensory Equipment skills with a -40% penalty in place. Both skills must be a success or their systems remain knocked out. Victims roll once every 10 minutes. A success on both skills restores their systems. **Note:** To keep jamming the enemy's systems the DVO-1 must fly in a tight circle and remain within 10 miles (16 km) of the enemy it is scrambling. If it flies outside this range, the enemy's systems automatically return to normal.

## EIR-60

### Extermination Robot

EIR-60 robots resemble small spheres the size of a golf ball, walking around on six mechanical legs, like a spider (Yes, we know spiders have eight legs). The bottoms of the legs are designed to enable them to grab surfaces and climb.

Created for the sole purpose of destroying Gargoyle aviaries, the EIR-60 is little more than a glorified demolitions charge with legs, guided by a simple artificial intelligence (A.I.). When a Gargoyle nest has been located, an army of these little robots (hundreds to thousands) are set loose 1-4 miles (1.6 to 6.4 km) away. The little 'Bots scurry away to the designated coordinates. As they get close, the robots pause and enter the aviary one at a time so as not to be noticed. The A.I. adjusts to "search and acquire" mode once it gets within range of the nest/aviary and seeks out the actual nests and targets one egg. Once the nest is found, the EIR-60s are programmed to spread out, each selecting one Gargoyle egg to nestle up to or crawl under and wait. When the majority of the EIR-60s are in position (the drones are in radio contact with each other), they detonate. The explosion is small, just enough to punch a hole into the egg and let the yolk spill out, killing the undeveloped monster inside of it.



In addition to the basic EIR-60, there are other types of these robots, made to look like large cockroaches, beetles and mice to fool the Gargoyles. However, such subterfuge has been abandoned because the giant 16-20 foot (4.9 to 6.1 m) Gargoyles seldom pay attention to small scurrying creatures – including the spider-like EIR-60 Extermination Robots.

The EIR-60 and its variant Extermination Robots are all *disposable* one use devices made from cheap S.D.C. materials. The explosive charge only has to deliver 1D4 M.D. to punch a small hole in the egg and ruin it.

When a nest is suspected to be in an area, or when the Gargoyles are known to be looking for the Extermination Robots, the EIR-60s are deployed a few dozen at a time. Whereas vigilant Gargoyles might check eggs and notice hundreds of the Extermination Robots, a spot check is not likely to uncover 10-60 of them scattered throughout an entire aviary. Though this means the number of eggs destroyed may be smaller, the Gargoyle menace is still being terminated, and EIR-60s can be sent in every few days without being noticed.

## Triax EIR-60

### Exclusive to the NGR Military

**Nickname:** Affectionately called the “Egg Popper” and “Surprise Package” by the soldiers who oversee their deployment or raid Gargoyle nests.

**Model Type:** EIR-60

**Class:** Radio-Operated Stealth Demolitions Robot.

**Crew:** None, artificial intelligence.

### S.D.C. by Location:

Legs (6) – 5 each

Sensor Eyes (4) – 2 each

\*Main Body – 10

\*Depleting the S.D.C. of the robot destroys it and there is a 01-30% chance of the ‘Bot exploding.

### Speed:

**Running:** 10 mph (16 km) and are good at climbing but cannot climb sheer vertical walls or climb across ceilings like real in-

sects. The act of running does NOT tire the robot and speed can be maintained indefinitely.

**Leaping:** Six inches (15 cm).

**Flight:** Not possible.

**Range:** The robot’s internal battery allows it to run continuously for 96 hours, more than enough time to find a target and detonate its explosive package.

### Statistical Data:

**Size:** The body is two inches (5 cm) in diameter.

**Width:** Including legs, the robot is six inches (15 cm) wide.

**Color:** Typically painted black, brown or grey.

**Weight:** 1.4 pounds (0.6 kg).

**Physical Strength:** P.S. 6 (not Robotic P.S.).

**Cargo:** None.

**Power System:** Electrical, good for 96 hours.

**Black Market Cost:** Not available; exclusive to the NGR Army and unknown to the Black Market and the outside world. Estimated value is at 3,000 credits each.

**Standard Computer Programs:** Basic A.I. designed to seek out and identify Gargoyle nests and eggs, gain access to the egg, position itself right under or next to the egg and detonate.

**Weapon System: Demolitions Package (1):** The robot’s primary function is to deliver an explosive blast at a specific point to rupture a Gargoyle egg and destroy it.

**Primary Purpose:** Extermination/Destroy Gargoyle Egg.

**Mega-Damage:** 1D4 M.D.

**Payload:** One explosive charge. Robot Exterminators are one use items and the ‘Bot is completely atomized in the blast, leaving no obvious evidence (especially to Gargoyles) that it was ever there. Forensic examination would find trace evidence to identify the cause.



## EIR-70 Spy Robots

The first robot spy to look like an insects was a cockroach created by the Japanese in the 21st Century. Technology has improved considerably since, and Triax has been always on the cutting edge of robotics.

Tiny Spy Robots are wonderful for infiltration, tailing, surveillance, observation and intelligence gathering. For the most part, they go unnoticed, and if seen, nobody suspects the ‘Bot is

anything more than a bug or rodent passing through. To maintain the illusion, the Spy 'Bots are programmed to move and behave like the creatures that they replicate, and know to *run* and *hide* when someone comes at them with a broom or rolled up magazine. Being so tiny, the robot can only record and store about 72 hours of film and 1,000 still images, which is why most transmit a constant stream of information, sound and images that are recorded off-site at a mobile or nearby base. This allows the "handlers" assigned to the Spy Robot to see and hear what it sees and hears live, in real-time, as well as go back to study and analyze recorded data at a later time.

Spy Robots were originally created to infiltrate and spy on the Gargoyle enemy. Unlike the EIR-60 Extermination 'Bot, those designed for spying are typically made to look like the real animal or insect, complete with fur, whiskers or antennae. Even at a close look, the robot spy should look like the real animal, just like the commercially sold robot pets. However, the creatures feel hard to the touch and careful, close examination or dissection reveals their true, mechanical nature.

The applications and use of Spy 'Bots have been expanded beyond the study of Gargoyles and they are now used to infiltrate, follow and observe suspected criminals, smugglers, spies, mercenaries, terrorists, terrorist groups, D-Bees and even internal personnel. Though illegal for civilian use, Triax has used the Spy 'Bots to monitor workers and office personnel suspected of theft, misconduct and wrongdoing. Their applications in the area of industrial espionage and all forms of surveillance and spying are mind-boggling.

The NGR (and Triax) consider the tiny robots to be expendable, and make the drones out of S.D.C. material. This keeps cost down, plus you want your "spy" to be easy to break/destroyed so that the 'Bot, and any data it may contain, can be kept out of the wrong hands. Thus, a Spy Robot that is about to be captured can leap out a window or dive under the tire of an oncoming car or even bicycle to be crushed and destroyed.

## **EIR-70 Robot Spy Drone**

### **Exclusive to the NGR Military**

**Model Type:** Covert Animal Surveillance Robot.

**Class:** Coordinated Reconnaissance Robot Drone.

**Crew:** None, robot with an artificial intelligence (A.I.).

### **S.D.C. by Location:**

Head – 8

Legs (4-6) – 3 each

\* Main Body – 8-12 depending on the size of the 'Bot.

\* The entire creature is small, ranging from the size of a poker chip to that of a pack of cigarettes/mouse, making the entire construct/main body a small and difficult target to hit. The main body of the tiny 'Bot can only be struck when the attacker makes a Called Shot, and even then he is -5 to strike. The head, legs and tail (when applicable) cannot be targeted from a distance, only when the 'Bot is immobilized or held in one's hand can the appendages be removed or destroyed.

Depleting the S.D.C. of the Main Body completely destroys the robot drone and all data and video stored inside of it.

### **Speed:**

Running: 15 mph (24 km) maximum.

Leaping: One foot (0.3 m) high or lengthwise.

Flying: Not possible.

Underwater Capabilities: Swim across the surface of water at 30% its running speed.

### **Statistical Data:**

Size: Varies with the body type and animal being simulated. Stats are listed for the mouse Spy 'Bot. Large beetles are roughly equivalent, smaller insects are roughly half. Nothing larger than a mouse has been put into the field.

Height: Mouse: 2 inches (5 cm).

Width: Mouse: 2 inches (5 cm).

Length: Mouse: 4 inches (10 cm), plus tail: 8 inches (20 cm).

Color: Typically painted black, brown or grey.

Weight: 1.6 pounds (0.7 kg).

Physical Strength: Human equivalent P.S. of 10.

Other Notable Attributes: I.Q. 14, P.P. 18, P.B. 7.

Attacks/Actions per Melee: Six.

Cargo: None.

Power System: High capacity battery system with an average energy life of five months.

Black Market Cost: Not available; exclusive to the NGR Army and unknown to the Black Market and the outside world. Estimated value is at 3,000 credits each.

**Standard Drone Sensor Systems:** Wide-band radio receiver and transmitter, optical reader, optical scanner, gyro-compass, motion detector and warning system, molecular analyzer, and monitor jack/connector plug (may be in the tail, foot, or an antenna).

Radio Communication: Medium-range, wide-band directional radio. Range: 50 miles (80 km). The signal transmitted is encrypted, and requires knowledge of Electronic Countermeasures to retrieve and unscramble it; prevents being intercepted or hacked.

Optics: The Spy 'Bot has two small, wide-angle cameras and one telescopic zoom lens. It has advanced robot optics (basic 20/20 vision up to two miles/3.2 m away) with infrared, ultraviolet, polarization, passive nightvision, all with a range of 4,000 feet (1,219 m), plus telescopic vision with a range of two miles (3.2 km), and an optical reader.

Motion Detector: Increased range: 100 feet (30.5 m), adds to the ability to respond quickly and dodge.

Enhanced Audio Pickup System: High-quality microphones and listening array, able to hear sounds as quiet as 20 decibels as far away as 500 feet (152 m).

### **Standard EIR-70 Computer Programs:**

Military General Programming: Computer Operation 95%, Languages include Euro, American, German, Techno-can, and Gobblely at 96%, Lore: Demons and Monsters 70% (+10% when it comes to Gargoyles and Brodkil), Mathematics: Basic 96%, Military Etiquette 96%, and Radio: Basic 96%.

Military Reconnaissance & Intelligence Program: Climbing 85%/65%, Detect Ambush 60%, Detect Concealment 60%, I.D. Plants and Animals 88%, Intelligence 80% (+10% when dealing with Gargoyles and Brodkil), Land Navigation 88%, Prowl 85%, Tailing (people or vehicles) 95%, Tracking People 88%, Wilderness Survival 80%.

**Weapon Systems:** None.

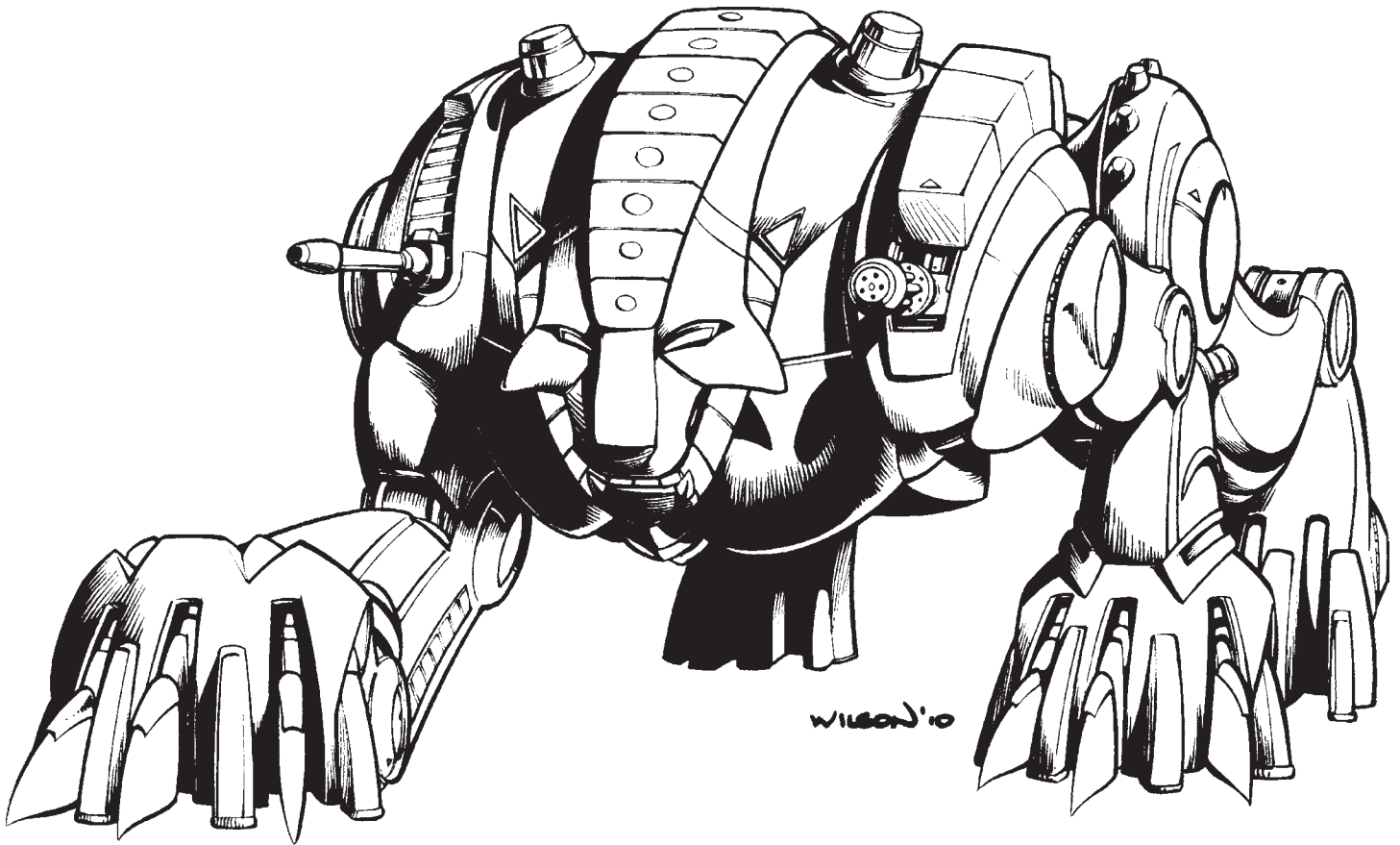

# New Triax Robot Vehicles

## X-1471 Wolfhound

The Wolfhound combat robot is a new development by Triax Industries in which it is trying out animal robot configurations. The X-471 Wolfhound resembles a large, robotic, wolf-like vehicle. Built into each shoulder is a different kind of forward weapon. Each has a 45 degree arc of fire to deal with low flying Gargoyles as well as Gurgoyles and other ground assault troops. Built into each of the large robot's feet are Vibro-Blades for claws, plus a mini-missile launcher is mounted on the left shoulder. For a touch of fun, a smoke maker is built into the mouth to make it seem as if Wolfhound growls and releases smoke when angry or ready for combat. Surprisingly, this makes a strong impression on the enemy and intimidates bandits and outsiders. The X-1471 Wolfhound is not as heavily armored as some of the infantry robots, but it has a low profile, excellent speed and good mobility. It can handle most terrains, and easily leaps or climbs over destroyed vehicles, piles of rocks or debris and can crawl through the mountains and handle urban environments.

The most unique function of the X-1471 Wolfhound is the ability to connect to, control and coordinate the smaller, DV-39 Wolf robot drones. The pilot of the Wolfhound can link up to as many as four of the Wolf scout 'Bots and see and hear everything they do. He or one of his crew members can also take over the DV-39's controls or simply monitor the actions of the robot

under its own independent A.I. This makes the DV-39 Wolf and X-1471 robot vehicle ideal for reconnaissance, advance scouting, border patrols and rescue missions. Field commanders and pilots of the Wolfhound love the robot's versatility, especially when used in tandem with the DV-39 Wolf scout.

### Wolfhound X-1471 Robot

**German Name:** Der Wolfhund (pronounced "wolfhuhnt").

**Model Type:** X-1471

**Class:** Ground Infantry Assault & Reconnaissance Robot.

**Crew:** Two, a pilot and a gunner, but the robot has seating for two passengers and typically includes one or two communications officers to monitor and coordinate 2-4 DV-39 Wolf drones attached to the Wolfhound.

#### M.D.C. by Location:

- \* Shoulder Laser Cannon (1; right shoulder) – 80
- \* Shoulder Rail Gun (1; left shoulder) – 80
- \* Mini-Missile Launcher (1, left shoulder) – 150
- \* Head (low profile) – 150
- \* Primary Sensor Clusters (2; between the shoulders) – 50 each
- Feet with Vibro-Blade Claws (4) – 130 each
- Hind Legs (2) – 160 each
- Front Legs (2) – 130 each
- Reinforced Pilot Compartment – 100
- \*\* Main Body – 350

\* A single asterisk indicates a small or difficult target to hit. They can only be struck when the attacker makes a Called Shot, and even then he is -3 to strike. Destroying the head sensors and

the secondary sensor cluster eliminates all forms of optical and sensory enhancement and the pilot must rely on his own human senses without any of the bonuses granted to him by the Robot Combat skill. The pilot of the X-1471 can also get sensory data from any of his Wolf drones if any are available, but combat bonuses are half.

\*\* Depleting the M.D.C. of the Main Body shuts the robot down completely rendering it useless.

### **Speed:**

Running: 120 mph (192 km). The act of running does not tire out its operator.

Leaping: The legs of the robot are designed for running and jumping. The robot can jump 30 feet (9 m) high and 40 feet (12.1 m) across; increase by 50% with a running start, and double at speeds in excess of 60 mph (96 km).

Flying: Not possible.

Underwater Capabilities: The robot can walk along the bottom of a body of water at one third its running speed. Maximum depth is one mile (1.6 km).

### **Statistical Data:**

Height: 11 feet (3.3 m) at the shoulder.

Width: 9 feet (2.7 m) wide.

Length: 18 feet (5.4 m).

Weight: 6 tons.

Physical Strength: Robot P.S. of 40.

Cargo: Two storage compartments, one on each side. Each is about four (1.2 m) feet long and one foot (0.3 m) deep.

Power System: Nuclear, average energy life is 20 years.

Black Market Cost: 34.9 million credits, but uncommon on the Black Market. Exclusive to the NGR Army. Not currently sold on the open market.

### **Weapon Systems:**

**1. Shoulder Laser Cannon (1):** On the right shoulder of the X-1471 Wolf is a high-powered laser cannon which acts as the main weapon of the unit. The weapon is capable of both single and double fire and has a 90 degree arc of fire.

Primary Purpose: Anti-Aircraft/Gargoyles and Assault.

Secondary Purpose: Anti-Personnel and Defense.

Range: 4,000 feet (1,219 m).

Mega-Damage: 1D4x10 M.D. per single blast.

Rate of Fire: Equal to the number of hand to hand attacks of the pilot.

Payload: Effectively unlimited.

**2. Shoulder Rail Gun (1):** On the left shoulder is a gatling-style rail gun. The weapon is capable of firing any rail gun ammunition but standard issue is DU rounds.

Primary Purpose: Anti-Armor/Gargoyles and Assault.

Secondary Purpose: Anti-Personnel and Defense.

Range: 4,000 feet (1219 m).

Mega-Damage: 6D6 M.D. per 15 round short burst or 1D6x10 M.D. per 30 round long burst of DU- or U-rounds. This weapon can only fire bursts.

Rate of Fire: Each short or long burst counts as one melee attack.

Payload: 3,900 rounds for a total of 130 long bursts.

**3. Mini-Missile Launchers (3):** A long, segmented box over the left shoulder contains three mini-missile box launchers, but looks like one long unit over the left shoulder. The lid(s) flips open to fire and closes immediately after.

Primary Purpose: Anti-Gargoyle and Anti-Armor.

Secondary Purpose: Anti-Missile and Anti-Personnel.

Range: Varies with missile type, but fragmentation is the standard payload with a half a mile (0.8 km) range.

Mega-Damage: Varies with missile type, but fragmentation (5D6 M.D. to everything in a 20 foot/6.1 m radius) is the standard load.

Rate of Fire: One at a time or in volleys of 2, 4, 6 or 12.

Payload: 48 total mini-missiles, 16 in each of the three shoulder launchers.

**4. Eye Lasers (2):** Each of the eyes contains a light laser which serves as an anti-personnel and defensive weapon. They are modeled after the weapons of the EIR Gargoyle Drone.

Primary Purpose: Anti-Personnel.

Secondary Purpose: Defense.

Range: 1,600 feet (488 m).

Mega-Damage: 2D6 M.D. per single blast or 4D6 M.D. per double blast.

Rate of Fire: Each single or dual simultaneous blast at the same target counts as one melee attack.

Payload: Effectively unlimited.

**5. Claw Vibro-Blades (4):** The large claws of the Wolf are deadly Vibro-Blade weapons capable of slicing through infantry soldiers and tearing into Gargoyles and other giant enemies. The claws also give the Wolfhound excellent traction running and help it climb.

Primary Purpose: Anti-Personnel and Melee Combat.

Secondary Purpose: Defense.

Range: Hand to hand combat.

Mega-Damage: 4D6+8 M.D. per claw strike (factors in Robot P.S.).

**6. Hand to Hand Combat:** Rather than use a weapon the pilot can engage in Mega-Damage hand to hand combat. See *Light Ground Robot Training* on page 353 of **Rifts® Ultimate Edition**. All abilities are the same except as follows: *Leap Attack (counts as three attacks)* does 4D6+6 M.D. (double damage if running at a speed greater than 50 mph/80 km) and has a 1-70% chance of knocking down giant opponents (15-30 feet/4.6 to 9.1 m); 01-90% against opponents smaller than 12 feet/3.6 m). Victims of knockdown leap attack lose initiative and two melee attacks.

**7. Sensor System Note:** The X-1471 Wolf has full optical systems including laser targeting, telescopic, passive night vision, thermo-imaging, infrared, and polarization. These are in addition to all other features common to NGR robots.

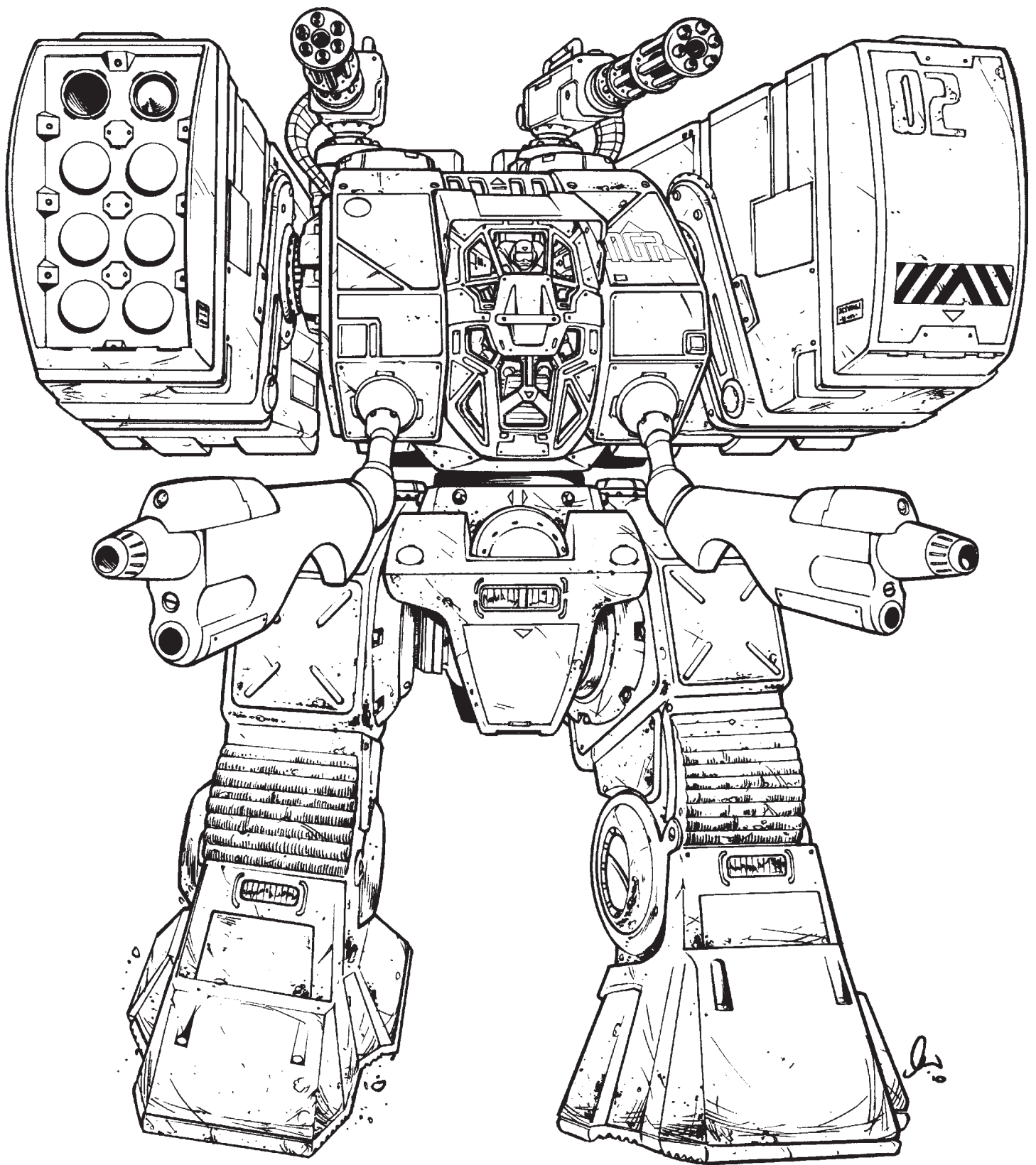

## X-2010 “Longstrike”

### Missile Carrier

To prepare for the Full Militarization effort, many of the military advisors of the NGR recommended there be a wider range of robots, including those developed for long-range assault, artillery barrages, and fire support. The **Langenstreik** (“Longstrike”) was the first of these units to walk off the assem-

bly line in 104 P.A. There was not a lot of hoopla around this bulky behemoth of a robot, because it is a “retool” of an existing industrial cargo robot modified and refitted for combat, but since its first deployment it has become a favorite of the NGR infantry.

The chassis of the X-2010 Langenstreik is an industrial robot used for loading and unloading heavy freight containers at airports, rail depots, freight lines and shipyards throughout the NGR. The large, bulky unit was selected because it was already

in operation, well known for its power and durability, and it could be hurried into production with minimal modification. As a cargo hauler, the original robot had a built-in retractable crane on top of the pilot compartment and the in place of arms was a modular system that could mount either two huge cargo containers or two cranes that could carry or move boxcars, skids and containers and carry them where they needed to go. The development team at Triax simply replaced the crane/cargo arms with large, box, long-range missile launchers and the top crane with dual rail gun turrets. The modular design of the box launchers also means they can be easily removed and reloaded with fresh missile launchers when the first ones are emptied of their missile payload. In a pinch, the launchers can still use the original container pods or crane arms to transport cargo and equipment or to move the wreckage of fallen giant robots, combat vehicles and the bodies of Gargoyles.

As an older design made for transporting heavy cargo, the Langenstriek is big, boxy, and has large feet and heavy legs to support the weight of the missile launchers. That also makes it an imposing sight. Realizing that a heavy industrial robot turned into a walking artillery unit would make a very enticing target to any enemy, the designers loaded the robot up with as much armor as they could bolt on. The missile pods are also designed for maximum protection of its payload. A couple of weapons were added to the 'Bot to provide additional combat capabilities and a means of self-defense. These include a pair of gatling rail guns that fire Depleted Uranium (DU) rounds and a pair of energy weapon arms, the same as the Dragonwings to handle enemy ground and air assaults.

The Longstrike may not be one of Triax's most innovative creations, but the robot vehicle has proven to be easy to mass produce, and in the field it is easy to operate, durable, and reliable. It requires minimal maintenance and repair, and can take a beating and keep on going, making it a workhorse popular among both robot pilots and the troops it supports. The Longstrike regularly hammers Gargoyle and Brodkil encampments from miles away to soften up enemy troops and fortifications before NGR troops attack, as well as provide cover fire for retreating troops and defense of entrenched military positions.

## **X-2010 Longstrike Missile Carrier**

**German Name:** Langenstreik

**Model Type:** X-2010

**Class:** Ground Artillery Missile Carrier Robot.

**Crew:** Three, one pilot, one gunner/missileer, and one communications officer, and a seat for one passenger (or an additional copilot or gunner).

**M.D.C. by Location:**

Lower Legs (2) – 300 each

Upper Legs (2) – 250 each

Missile Launcher Pods (2) – 400 each

\* Gatling-Style Rail Gun Turrets (2, top) – 100 each

Forward Weapon Arms (2) – 200 each

\* Floodlights (4, lower body and legs) – 12 each

\* Headlights (2, lower body) – 6 each

\* Sensor Cluster (1, rear) – 90

Optional Cargo Pods (replace missile launchers) – 200 each

Optional Heavy Loading Cranes (2, replace missile launchers) – 120 each.

Optional Light Loading Crane (replaces rail guns) – 80

\* Reinforced Pilot Compartment – 125

\*\* Force Field – 200

\*\*\* Main Body – 588

\* A single asterisk indicates a small or difficult target to hit. They can only be struck when the attacker makes a Called Shot, and even then he is -3 to strike. Destroying the sensor cluster eliminates all forms of optical and sensory enhancement and the pilot must rely on his own human senses without any of the bonuses granted to him by the Robot Combat skill.

\*\* Depleting the M.D.C. of the force field shuts it down and all subsequent damage is taken off the main body. It takes six hours to fully regenerate the force field (33 M.D.C. per hour). The force field is used between attacks to offer additional protection, and when the robot is out of ammunition and has only its weapon arms to fight with.

\*\*\* Depleting the M.D.C. of the main body shuts the robot down completely, rendering it useless.

### **Speed:**

Running: 30 mph (48 km) maximum.

Leaping: Not possible.

Flying: Not possible.

Underwater Capabilities: The robot can walk along the bottom of a body of water at one third its running speed. Maximum depth is two miles (3.2 km).

### **Statistical Data:**

Height: 40 feet (12.2 m).

Width: 28 feet (8.5 m).

Length: 18 feet (5.5 m).

Weight: 20 tons, fully loaded.

Physical Strength: Robot P.S. of 55.

Cargo: Five storage lockers, one for each crew member plus one for other storage. Four contain an energy rifle, energy pistol, and a suit of T-10 body armor, a gallon of drinking water and food rations for a week. The fifth locker contains medical supplies and other gear or emergency food rations. There is also an internal water cooler with 50 gallons (189.3 liters) of water.

Power System: Nuclear, average energy life is 20 years.

Black Market Cost: 29 million credits. Exclusive to the NGR Army. Not currently sold on the open market and uncommon on the Black Market.

## **Weapon Systems:**

**1. Modular, Quick-Replacement, Long-Range Missile Pods (2):** The main armament of the X-2010 Longstrike are its two interchangeable missile pods that fire a large number of long-range ordnance. The missile pods are large box launchers in place of robot arms (or cranes). Each can rotate in a 180 degree arc of fire, and they are heavily armored. With the proper heavy equipment, a spent box launcher can be removed and a new, fully loaded one "popped" into place in less than four minutes. This is ideal for defending military bases, bunkers and entrenched positions. In the field, missiles are generally used sparingly, often fired at very specific, stra-



tegic targets in volleys of 2-4 missiles. However, the missiles can also be fired en masse to wipe out a large area, breach heavy fortifications, level a Gargoyle roost, or to destroy a serious threat quickly. This tactic, while devastating to the enemy, leaves the robot without long-range missile attacks and reliant upon its short-range weapon systems.

Primary Purpose: Long-Range Artillery Barrage, Anti-Fortifications and Anti-Armor.

Secondary Purpose: Anti-Aircraft and Anti-Gargoyle.

Range: Varies with missile type, 500-1,800 miles (800 to 2,880 km).

Mega-Damage: Varies with missile type, and any long-range missile can be used. The *standard payload* is as follows:

80% of the missiles are Heavy High Explosive (4D6x10 M.D. to everything in a 40 foot/12.2 m blast radius, 500 mile/800 km range).

10% are Nuclear Multi-Warhead missiles (2D4x100 M.D. to a 50 foot/15.2 blast radius, 1,800 mile/2,880 km range).

10% are Plasma (5D6x10 M.D. to everything in a 50 foot/15.2 m blast radius, 500 mile/800 km range, for use against non-Gargoyle enemies).

All are smart missiles and +5 to strike.

**Note:** Gargoyles are impervious to fire and heat (as are most demons of Hades), so plasma weapons are not effective against Gargoyles or most demons. Brodkil take full damage from M.D. plasma.

Rate of Fire: One at a time or in volleys of 2, 4, 6, 8, 12, 16, 20, or all 48 (24 per missile launcher).

Payload: 48 long-range missiles total, 24 per launcher. Launcher can be reloaded (with proper gear common to most bases and fortified positions) within 1D4+5 minutes. Long-range missiles can be substituted with medium-range missiles (same number).

**2. Gatling-Style Rail Guns (2):** A pair of large, gatling-style rail gun turrets are mounted on the top of the Longstrike and fire from above the missile launchers. They are intended to deal with enemy infantry troops, light power armor, Gargoyles, and low flying Gargoyles. The turrets can rotate 360 degrees.

Primary Purpose: Anti-Gargoyles & Anti-Personnel.

Secondary Purpose: Defense.

Range: 4,000 feet (1,219 m).

Mega-Damage: 6D6+3 M.D. per 15 round short burst or 1D6x10+10 M.D. per 30 round long burst of DU- or U-Rounds. This weapon can only fire bursts.

Rate of Fire: Each burst, short or long, counts as one melee attack. When the gunner is busy launching missiles, the pilot fires these weapons. However, the gunner may take control of the rail guns to free up the pilot to engage in other maneuvers.

Payload: 6,000 rounds per each gun for a total of 200 long bursts.

**3. Dragonwing Weapon Arms (2):** Mounted in what would be the rib cage area under the chest plates of the robot are a pair of weapon arms the same as the *Dragon Wing*. It is a dual weapon with the top barrel being a laser cannon and the bottom an ion cannon. **Note:** These weapons are always fired by

the pilot and can also be used to strike and parry in melee combat.

Primary Purpose: Anti-Gargoyle/Aircraft.

Secondary Purpose: Anti-Infantry and Defense.

Range: Laser: 6,000 feet (1,829 m). Ion Cannon: 2,000 feet (610 m).

Mega-Damage: *Laser:* 1D4x10 M.D. per single blast or 2D4x10 M.D. when both weapon arms fire simultaneously at the same target.

*Ion Cannon:* 1D4x10 M.D. per single blast or 2D4x10 M.D. when both weapon arms fire simultaneously at the same target.

Rate of Fire: Each single or simultaneous dual blast counts as one melee attack.

Payload: Effectively unlimited.

**4. Hand to Hand Combat:** Rather than use a weapon the pilot can engage in Mega-Damage hand to hand combat. See *Heavy Ground Robot Training* on page 352 of **Rifts® Ultimate Edition**. All abilities are the same except as follows:

Reduce the strike and dodge bonuses for hand to hand combat by half, +1 to strike (additional bonus) to long-range attacks.

Incapable of running ram and kick attacks.

Stomp attacks do 3D6 M.D.

**5. Sensor System Note:** Telescopic, passive nightvision and polarizing lens in addition to all other features common to NGR robots. Plus the following additional sensors:

Advanced Radar: Extended radar range of 200 miles (320 km) and can track 144 enemy targets simultaneously.

Long-Range Laser Communications: Range 1,000 miles (1,600 km).

## X-2020 Rainmaker

The X-2020 “Regenmacher” (Rainmaker) was developed to be an Anti-Gargoyle/Anti-Aircraft robot that uses an animal-like quadruped body style for additional stability and all terrain capabilities. Armed with a special targeting system, two large anti-aircraft auto-cannons controlled by an A.I. and missiles, the Rainmaker is a dangerous foe against aircraft, Gargoyles and other flyers. The artificial intelligence (A.I.) and targeting system are able to better track low flying Gargoyles as well as higher flying aircraft. Clouds of black flak fill the sky with shrapnel. Gargoyles and other ground troops are targeted by mini-missiles or a high-powered rail gun mounted under the pilots compartment. The X-2020 is often deployed in mountain regions, city ruins and other places where Gargoyles roost, as well as at military bases, cities, villages and along borders to protect them from aerial raids.

### X-2020 Rainmaker

**Model Type:** X-2020 Regenmacher.

**Class:** Anti-Aircraft Platform, All-Terrain Assault Robot.

**Crew:** Four: Pilot, co-pilot, a dedicated gunner and a communications officer. Two passengers can also fit inside the Rainmaker.

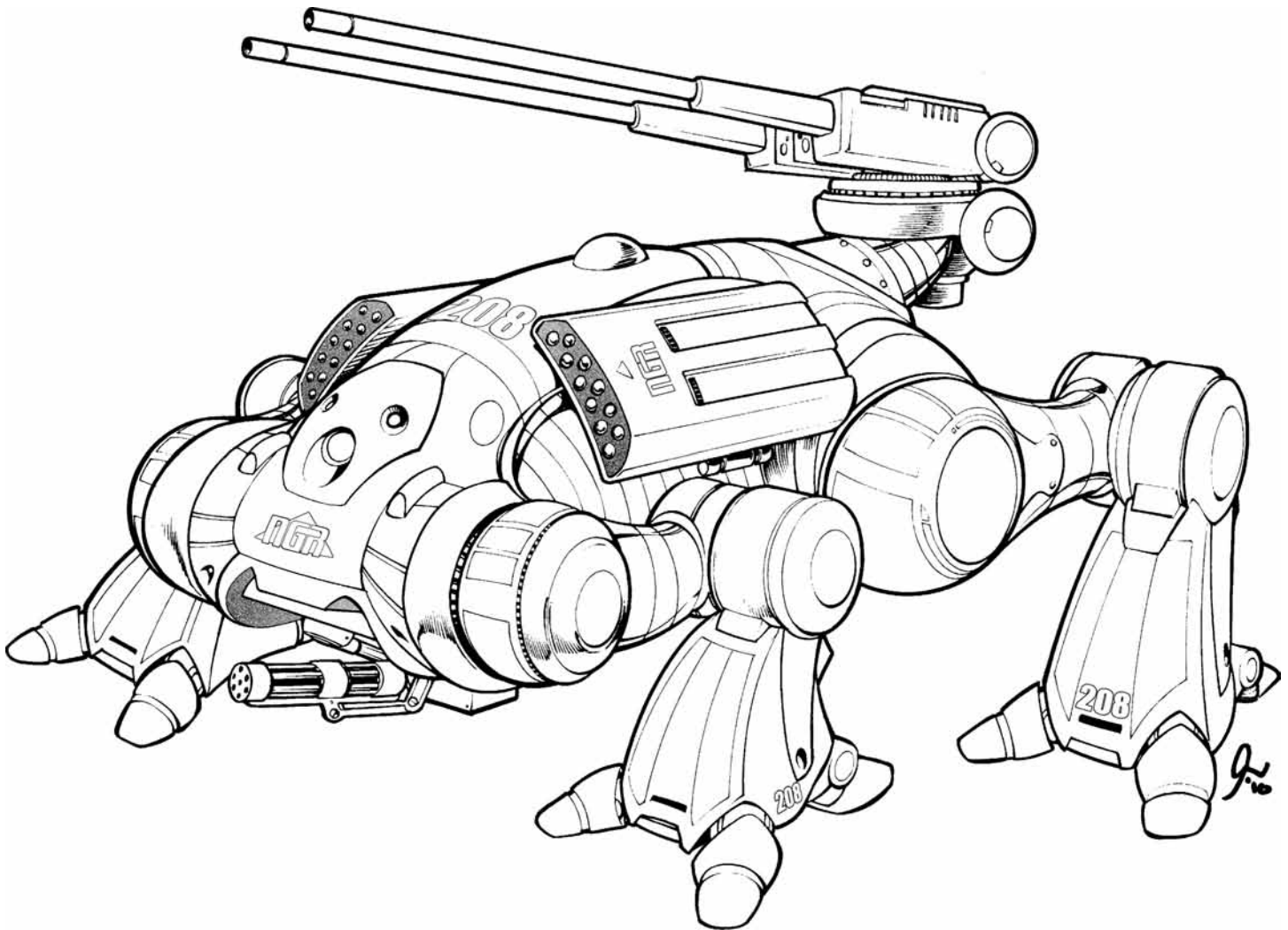

#### M.D.C. by Location:

- Anti-Aircraft Auto-Cannon Turret (1) – 250
- Medium-Range Missile Launchers (2) – 200 each
- \* Forward Rail Gun (1, undercarriage) – 100
- \* Ammo Drum (1, underbelly) – 80
- Upper Legs (4) – 150 each
- Lower Legs (4, contain Mini-Missile Launchers) – 200 each
- \* Sensor Cluster (1, top mid-section) – 80
- \* Secondary Sensor Cluster (1, rear) – 30
- \* Searchlight (1, front) – 12
- Reinforced Pilot Compartment – 200
- \*\* Force Field – 200
- \*\*\* Main Body – 570

\* A single asterisk indicates a small or difficult target to hit. They can only be struck when the attacker makes a Called Shot, and even then he is -3 to strike. Destroying the sensor units eliminates all forms of optical and sensory enhancement, and the pilot must rely on his own human senses without any of the bonuses granted to him by the Robot Combat skill.

\*\* Depleting the M.D.C. of the force field shuts it down and all subsequent damage is taken off the main body. It takes six hours to fully regenerate (33 M.D.C. per hour). **Note:** The force field is used when the robot is not engaged in combat and when

out of ammunition or extra protection between shooting. The weapons cannot fire when the force field is up.

\*\*\* Depleting the M.D.C. of the main body shuts the robot down rendering it useless.

#### Speed:

Running: 60 mph (96 km) maximum running speed. The robot is well suited for most terrain and can climb over piles and walls of rocks and debris unhindered as long as the slope is not greater than 60 degrees.

Leaping: Not possible.

Flying: Not possible.

Underwater Capabilities: Can walk along the bottom of a lake or sea at one third its maximum running speed. Maximum depth is one mile (1.6 km).

#### Statistical Data:

Height: 18 feet (5.5 m).

Width: 13 feet (3.9 m).

Length: 25 feet (7.6 m).

Weight: 14 tons fully loaded.

Physical Strength: Robot P.S. of 45.

Cargo: There are four storage lockers with an energy rifle, side-arm, and suit of T-10 body armor plus a gallon of water and one weeks food rations.

Power System: Nuclear, average energy life is 20 years.

Black Market Cost: 56 million credits. Exclusive to the NGR Army. Not currently sold on the open market and is not known to have ever been available on the Black Market.

## Weapon Systems:

**1. Recoilless Anti-Aircraft Auto-Cannon (1):** A big double-barreled anti-aircraft cannon is in a top-mounted turret at the back of the robot. The turret can rotate 360 degrees and has a 120 degree up and down arc of fire. **Note:** Always operated by an independent gunner.

Primary Purpose: Anti-Gargoyle/Aircraft.

Secondary Purpose: Anti-Missile.

Range: 20,000 feet (6,096 m).

Mega-Damage: A dual, two round simultaneous shot does 1D4x10 M.D., a four round burst does 1D6x10 M.D., or a rapid-fire burst of eight rounds does 2D6x10+12 M.D. A dual shot has a 5 foot (1.5 m) blast radius, a burst has a 15 foot (4.6 m) blast radius (everything in the radius takes damage).

Rate of Fire: Each dual shot or burst counts as one of the gunner's melee attacks.

Payload: 3,200 rounds total; 800 four round bursts or 400 eight round bursts.

Special Feature: When not operated by the gunner, the cannons can be placed on automatic fire. The guns can be set to fire two round shots or four round bursts at the nearest enemy target, or they can be set to only intercept fast, incoming targets (usually missiles). The guns are +2 to strike and have 6 attacks per melee in this mode.

**2. Medium-Range Missile Launcher (2):** On each side of this quadruped robot is medium-range missile launcher. Each can rotate from a forward position, 180 degrees to point up at angle, straight up, or behind the robot. These missiles are primarily used against Gargoyles and aircraft, or hardened, fortified positions and mountain lairs. The missile batteries are controlled by the co-pilot or the gunner.

Primary Purpose: Anti-Gargoyles/Aircraft.

Secondary Purpose: Anti-Missile and Assault.

Range: Varies with type of missile used, but typically 40 miles (64 km).

Mega-Damage: Varies with missile type, but typically high explosive (3D6x10 M.D. to a 30 foot/9.1 m radius) or fragmentation (2D6x10 M.D. to a 40 foot/12.2 m radius).

Rate of Fire: Fired in volleys of 2, 4, 6, 10 or 12. Each volley regardless of the number of missiles counts as one melee attack.

Payload: 44 total medium-range missiles, 22 in each launcher.

**3. Mini-Missile Launcher (4):** In each of the lower legs is a concealed mini-missile launcher. An armored panel slides open to fire and then slides closed.

Primary Purpose: Assault and Anti-Missile.

Secondary Purpose: Anti-Personnel.

Range: Varies with type of missile used, half mile (0.8 km) for fragmentation missiles, one mile for armor piercing.

Mega-Damage: Varies with type of missile used, but half the load is typically fragmentation (5D6 M.D. to everything within a 20 foot/6.1 m radius) and the other half armor piercing (5D6 M.D. to a 3 foot/0.9 m radius).

Rate of Fire: One at a time or in volleys of 2, 4 or 8.

Payload: 64 total, 16 mini-missiles in each leg launcher.

**4. Forward Rail Gun Turret (1):** Under the forward cockpit is a gatling-style rail gun used primarily against ground troops.

Primary Purpose: Anti-Personnel.

Secondary Purpose: Defense.

Range: 6,000 feet (1,829 m).

Mega-Damage: 6D6+3 M.D. for a 15 round short burst or 1D6x10+10 M.D. per 30 round long burst.

Rate of Fire: Each burst counts as one of the pilot or co-pilot's melee attacks.

Payload: 3,000 rounds per weapon, enough for 100 long bursts.

**5. Hand to Hand Combat:** Rather than use a weapon the pilot can engage in Mega-Damage hand to hand combat. See *Heavy Vehicular Style Robots* on page 352 of **Rifts® Ultimate Edition**. All abilities are the same except as follows:

The X-2020 is not able to punch, kick or leap, kick and a stomp attack does 3D6 M.D.

**6. Sensor System Notes:** Telescopic, passive nightvision and polarizing lens in addition to all other features common to NGR robots. Plus the following additional sensors:

Advanced Radar: Extended radar range of 100 miles (160 km) and can track 120 enemy targets simultaneously.

Sensor Bonuses: +2 to strike when using the *Recoilless Anti-Aircraft Flak Cannon* in addition to any likely skill bonuses. Not applicable to hand to hand combat.

## X-2525 Faust

The Faust has quickly become a favorite of those NGR robot pilots who love to get into the nitty-gritty business of melee combat with the minions of the Gargoyle Empire. Some have said that it takes a "special" kind of person to charge into combat in a robot with very few ranged weapons, someone who likes to mix it up close and personal. Despite the robot's size, it is surprisingly agile and well suited to combat. The head is actually a sensor array, with the pilot compartment in the chest. The arms can fold straight out and to the side, and rotate 360 degrees to slash at enemies that might come up behind it. The legs are designed for running and jumping, and a pair of rocket thrusters on the back enable the Faust to stop itself in midair and hover to the ground when knocked from a great height. The rockets also enable the Faust to make jet boosted leaps up to 500 feet (152 m) and rocket full bore to a height of 1,200 feet (366 m) to reach the roof of a skyscraper or a mountain peak to engage the enemy.

The Faust's primary weapons are a set of jagged circular blades that slide forward from their forearm housings and into position over the hands. Pilots of the Faust have been known to systematically dismember supernatural enemies on the field of battle, which has led many people to believe that this endless war is taking its toll on the NGR troops and making them as brutal as their enemy.

The robot is equipped with the infamous Slammer concussion missiles and a battery of mini-missiles as well. These give the robot a few ranged weapons at its disposal. The robot can

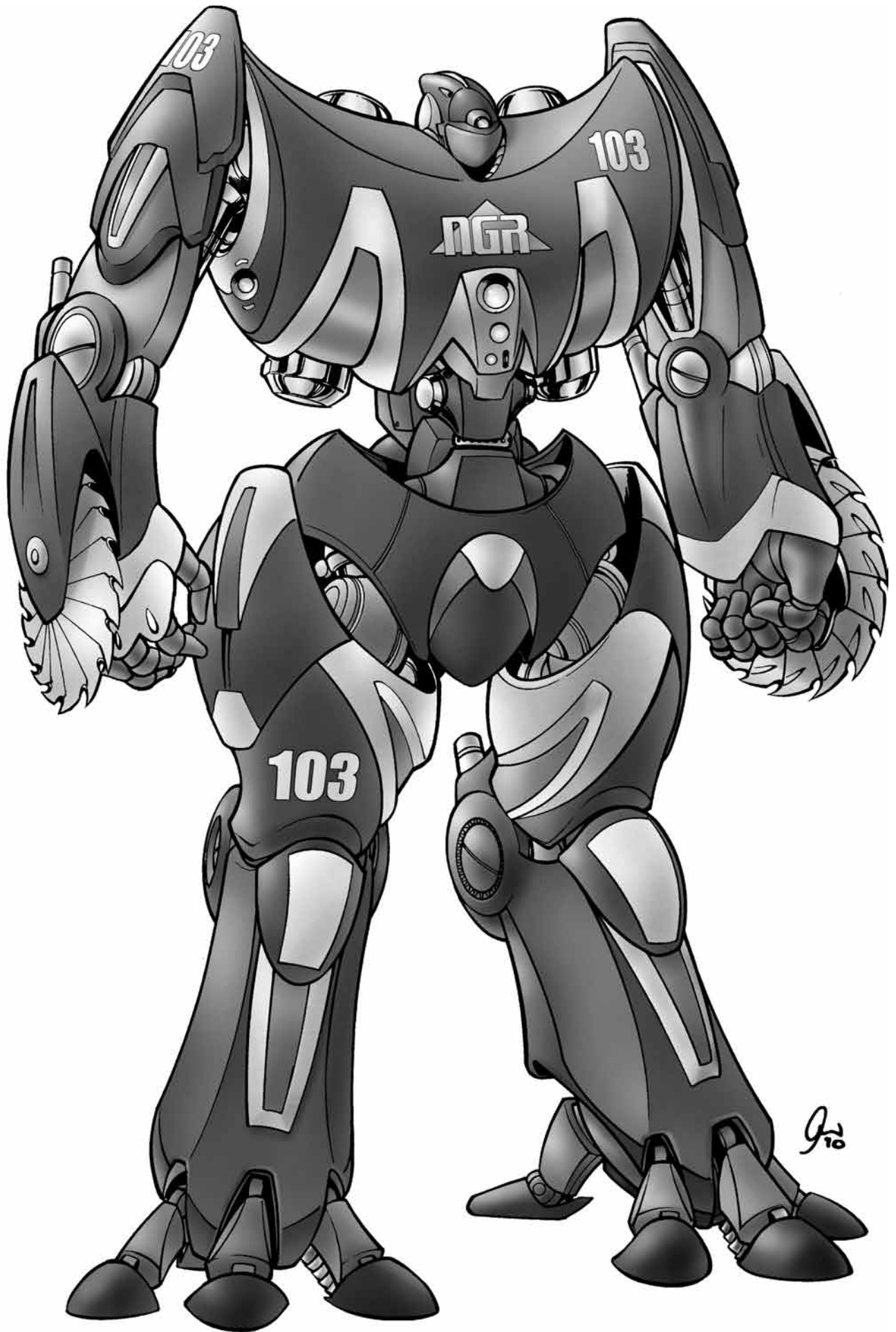

also charge its fists, like the TX-H1 Electro-Mace, to do additional damage or to fire a ranged electrical discharge from the hands. Faustus are made in limited numbers and are used primarily in raids on Gargoyle roosts and nests where it may be dangerous to engage in heavy weapons combat, or where hand to hand combat may be a better choice.

## **X-2525 Faust – Exclusive to the NGR Military**

**Model Type:** X-2525 Faust.

**Class:** Specialized Melee Combat Assault Robot.

**Crew:** Three, a pilot, a co-pilot and a communications officer.

### **M.D.C. by Location:**

Forearms (2) – 240 each

Upper Arms (2) – 260 each

\* Hands (2) – 130

Buzz Saws (2) – 120 each

\* Slammer Missile Launcher (1, chest) – 90

Upper Legs (2) – 240 each

Lower Legs (2, contain mini-missile launchers) – 240 each

Jet Thrusters (2, back) – 250 each

\* Chest Spotlight (1) – 5

\* Head/Sensor Cluster (1, top) – 190

\*\* Main Body – 900

Reinforced Pilot Compartment – 100

\* A single asterisk indicates a small or difficult target to hit. They can only be struck when the attacker makes a Called Shot, and even then he is -3 to strike. Destroying the head/sensor cluster eliminates all forms of optical and sensory enhancement, and the pilot must rely on his own human senses without any of the bonuses granted to him by the Robot Combat skill.

\*\* Depleting the M.D.C. of the main body shuts the robot down, rendering it useless.

### **Speed:**

**Running:** 70 mph (112 km) maximum. Cruising speed is around 40 mph (64 km).

**Leaping:** 30 feet (9.1 m) high or 50 feet (15.2 m) lengthwise from a standing position, increase by 50% with a running start. The jet thrusters on the Faust's back enable the robot to make jet-boasted leaps up to 500 feet (152 m) and rocket full bore to a height of 1,200 feet (366 m) to reach the roof of a skyscraper or a mountain peak to engage the enemy. The rocket thrusters also engage to break falls from great heights and land the robot softly on its feet.

**Flying:** Not possible.

**Underwater Capabilities:** Faust can rocket on the surface of water, skimming along on its belly at a speed of 100 mph (160 km/89 knots) or underwater at half that speed. The robot can also walk along the bottom of a body of water at one third its running speed. Maximum depth is two miles (3.2 km).

### **Statistical Data:**

**Height:** 27 feet (8.2 m).

**Width:** 15 feet (4.6 m).

**Length:** 8 feet (2.4 m).

**Weight:** 24 tons fully loaded.

**Physical Strength:** Robot P.S. of 55.

**Cargo:** There are three storage lockers, each with an energy rifle, sidearm, and suit of T-10 body armor plus a gallon of water and one week's food rations.

**Power System:** Nuclear, average energy life is 20 years

**Black Market Cost:** 90 million credits. Exclusive to the NGR Army. Not currently sold on the open market.

## **Weapon Systems:**

**1. Forearm Buzz Saws (2):** Housed in each upper forearm of the robot is a large circular saw blade used to slash and cut enemy armor and opponents to ribbons. When activated, the blades slide down the forearm and lock into place above the hands. The blades are capable of slicing through Mega-Damage armor and inflicting grievous wounds to Gargoyles and other supernatural opponents.

**Primary Purpose:** Melee Combat and Anti-Personnel.

**Secondary Purpose:** Defense.

**Range:** Melee combat.

**Mega-Damage:** The spinning buzz saw blades do 1D6x10+6 M.D., and even when turned off, they do 1D6 M.D. plus punch damage from punches and slashing attacks.

**Payload:** Effectively unlimited.

**2. Energy Fists (2):** The hands of the Faust can be charged with electricity like the TX-H1 Electro-Mace, adding damage to melee attacks and enabling it to fire short-range electrical arcs.

**Primary Purpose:** Melee Combat and Anti-Personnel.

**Secondary Purpose:** Self-Defense.

**Range:** Melee combat or electrical discharge 400 feet (122 m).

**Mega-Damage:** +10 M.D. to punch damage (6D6 M.D. on a full strength punch) from electrically charged fists. Electric discharge does 5D6 M.D.

**Payload:** Effectively unlimited.

**3. "Slammer" Concussion Missile Launcher (1, chest):** The large circular impression in the chest is a single shot Slammer missile launcher.

**Primary Purpose:** Anti-Gargoyles.

**Secondary Purpose:** Anti-Personnel.

**Range:** 6,000 feet (1,829 m).

**Mega-Damage:** 2D4x10 M.D. from a direct hit by the missile. More importantly, the concussion effect has a blast radius of 45 feet (13.7 m). All within the blast radius suffer 1D4x10 M.D. and those caught in that radius take 1D4x10 M.D. and are likely (01-88%) to be knocked off of their feet and stunned (01-65%).

If only knocked down, the victim of this attack has ringing ears and a headache, but only loses one melee attack and initiative. A victim of a direct hit is always knocked off of his feet.

If stunned, the victim is dazed: -10 to strike, parry and dodge, roll with impact or pull punch, is the last to attack, and loses half of his attacks per melee for 1D4 melee rounds! Speed is also reduced by half.

**Rate of Fire:** One at a time.

**Payload:** 12 total. As soon as one is fired, another cycles into the launch chamber.

**4. Leg Mounted Mini-Missiles:** A panel on the outer side of the lower leg slides open to fire mini-missiles.

Primary Purpose: Anti-Gargoyle and Anti-Armor.

Secondary Purpose: Anti-Personnel and Defense.

Range: Varies with missile type, but fragmentation is the standard payload with a half a mile (0.8 km) range.

Mega-Damage: Varies with missile type, but fragmentation (5D6 M.D. to everything in a 20 foot/6.1 m radius) is the standard load.

Rate of Fire: One at a time or in volleys of 2, 4, 6, 8, 10 or all 30.

Payload: 30 total; 15 mini-missiles in each launcher.

**5. TX-H Series:** Any of the TX-H series hand to hand weapons can be used.

**6. Hand to Hand Combat:** Rather than use a weapon the pilot can engage in Mega-Damage hand to hand combat. See *Heavy Ground Robot Training* on page 352 of **Rifts® Ultimate Edition**. All abilities are the same except as follows:

The Faust is fully capable of delivering Kick and Leap Kick attacks. Damage is 6D8 M.D. for a Kick and 2D6x10 M.D. for a Leap Kick.

**7. Sensor System Notes:** Telescopic, passive nightvision and polarizing lens in addition to all other features common to NGR robots.

## X-2730 Griffon

When the NGR decided to take the battle to the Gargoyle Empire, it wanted robots and combat vehicles that could engage the monsters in their natural environment: the air. Unlike other new flying units with a variety of aerial combat capabilities suitable for most combat situations, the X-2730 was designed with the specific intent of engaging and grappling with Gargoyles one on one in mid-air combat. It can also land to take on the wingless Gargoyles or enemy robots. Consequently, the flight capabilities of the Griffon more resemble those of a bumblebee or hummingbird, zipping from one opponent to another and then hovering in front of him and pounding it out. For melee combat the Griffon has long, hooked Vibro-Blades for claws and a spiked beak-like point at the front of its head for jabbing and head butt style attacks. The upside-down triangle is a powerful short-range ion cannon to blast its foes, and the roll back shielding behind the head opens to fire mini-missiles. When not in flight, the wings fold up and tuck behind its main jet thrusters, with a smaller pair of thrusters underneath the wings. For flight, the wings unfold out to the sides but in a “V” shape. On the battlefield the Griffon hops and leaps around like a fighting rooster, leaping back or to the side to dodge an enemy attack, then leaping back in to strike back, as well as rocketing up and hovering before zipping back down or to a new opponent. Though inspired by the gryphon of myth, with the body of a lion and the head and wings of an eagle, the X-2730 robot is bipedal, but its chicken-like legs and hunched over body sometimes make it look as if it’s on all fours. The hunched forward stance is deliberate, enabling the Griffon to rear up to deliver a head butt and to rocket head down like a bull into the belly of its Gargoyle or

Gargoyle opponent. A common tactic is to hit an opponent hard in the gut, rear up as he’s doubling over to headbutt him in the chin, and then blast with the ion nose cannon and/or strike with Vibro-Blade claws.

### X-2730 Griffon Robot

**German Name:** Der Griffon.

**Model Type:** X-2730

**Class:** Air and Ground Infantry Assault Robot.

**Crew:** Two, a pilot and a co-pilot/gunner.

**M.D.C. by Location:**

Head (1, front/beak area; low profile) – 250

\* Nose Gun (1, nose) – 60

\* Roll Back Mini-Missile Launcher (1, back) – 130

\* Sensor Clusters (2; between the thrusters) – 45 each

Arms (2) – 180 each

Vibro-Blades (3 per hand) – 90 each

Hind Legs (2) – 260 each

\* Folding Wings (2) – 140 each (hard to hit when folded back)

Main thrusters (2, top back) – 200 each

\* Secondary Thrusters (2, bottom rear) – 100 each

\* Hover Jets (6, undercarriage) – 25 each

Reinforced Pilot Compartment – 100

\*\* Main Body – 420

\* A single asterisk indicates a small or difficult target to hit. They can only be struck when the attacker makes a Called Shot, and even then he is -3 to strike. Destroying the sensor clusters eliminates all forms of optical and sensory enhancement and the pilot must rely on his own human senses without any of the bonuses granted to him by the Robot Combat skill.

Destroying one wing makes true flight impossible but thruster-assisted leaps and hovering are still doable.

\*\* Depleting the M.D.C. of the Main Body shuts the robot down completely rendering it useless.

**Speed:**

Running: 30 mph (48 km), but the Griffon doesn’t run, it hops, leaps, hovers and flies from one enemy to another like a bee from one flower to the next. The act of running does not tire out its operator.

Leaping: The legs of the Griffon are designed for jumping, dodging, kicking and clawing. The robot can jump 40 feet (12.2 m) high and across from a stationary position, 300 feet (91.5 m) with jet thruster-assisted leaps.

Flying: Hovering and fly are this robot’s natural state – think bumblebee or hummingbird for the type of movement when engaging the enemy. Maximum speed with rockets at full throttle is 300 mph (480 km), but cruising speed is more like 80 mph (128 km), and combat speed runs the whole gamut, including rocket speed head butt/ram attacks. Maximum altitude is 10,000 feet (3,048 m), but the Griffon typically operates at treetop and rooftop level.

Underwater Capabilities: The robot can skim across the surface of water at speeds of 100 mph (160 km/89 knots) or underwater

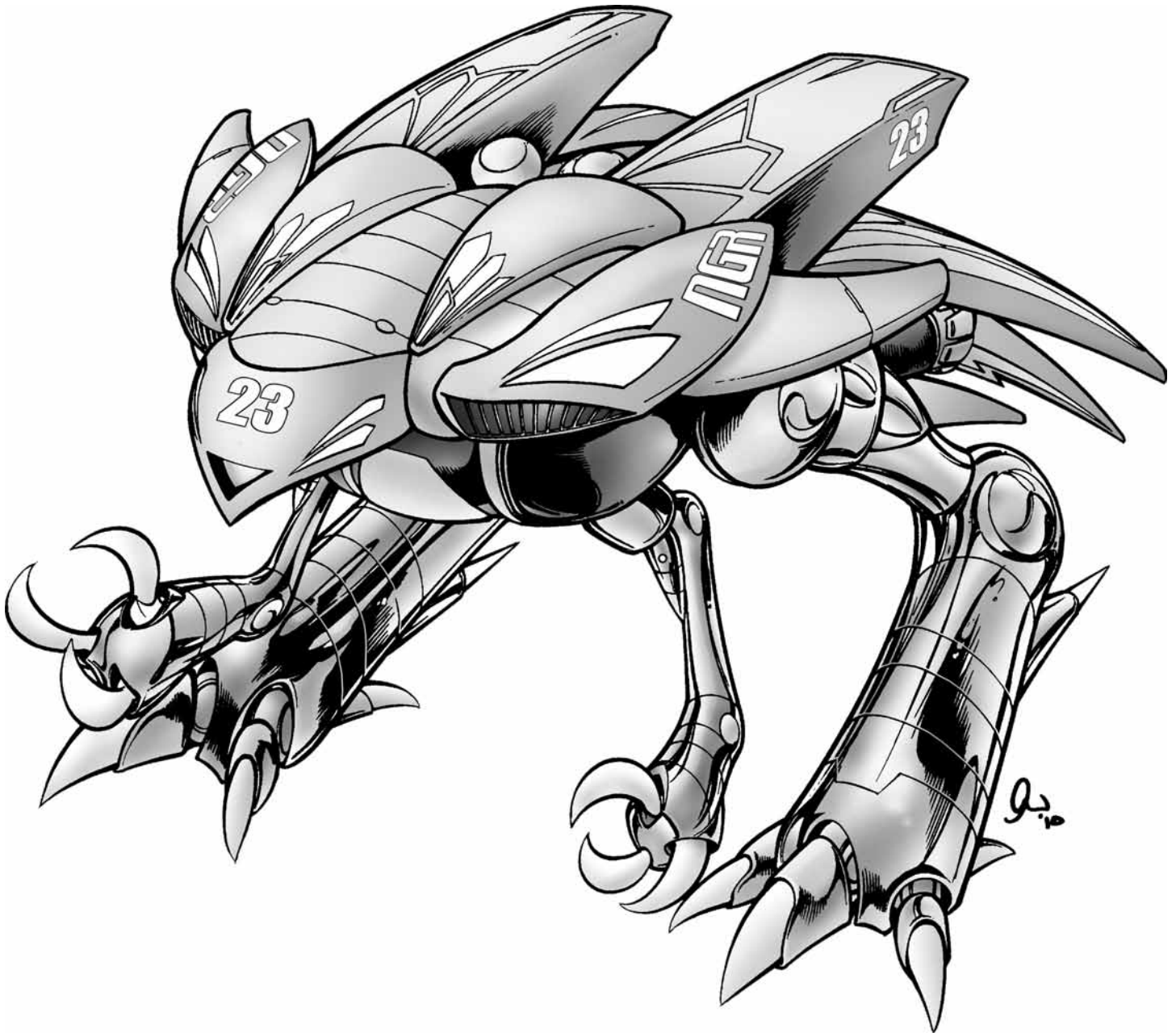

at half that speed. It can also walk along the bottom of a body of water at one third its running speed. Maximum depth is two miles (3.2 km).

**Statistical Data:**

Height: 11 feet (3.3 m) in its crouching combat stance, but can rear up to 20 feet (6.1 m) tall.

Width: 9 feet (2.7 m) wide.

Length: 12 feet (3.6 m).

Weight: 6 tons.

Physical Strength: Robot P.S. of 40.

Cargo: Two storage compartments, one on each side. Each is about four (1.2 m) feet long and one foot (0.3 m) deep.

Power System: Nuclear, average energy life is 20 years.

Black Market Cost: 42.5 million credits. Exclusive to the NGR Army. Not currently sold on the open market and rare on the Black Market.

**Weapon Systems:**

**1. Ion Cannon Nose Gun (1):** The upside-down triangle is a high-powered, short-range ion blaster. It shoots wherever the nose points.

Primary Purpose: Anti-Gargoyles and Assault.

Secondary Purpose: Anti-Personnel and Defense.

Range: 1,000 feet (305 m).

Mega-Damage: 1D4x10 M.D. per single blast.

Rate of Fire: Each blast counts as one of the pilot's melee attacks.

Payload: Effectively unlimited.

**2. Roll-Back Mini-Missile Launchers (1, back):** Behind the head is a series of panels that roll back to reveal a mini-missile launcher.

Primary Purpose: Anti-Gargoyle and Anti-Armor.

Secondary Purpose: Anti-Missile and Anti-Personnel.

Range: Varies with missile type, but fragmentation is the standard payload with a half a mile (0.8 km) range.

Mega-Damage: Varies with missile type, but fragmentation (5D6 M.D. to everything in a 20 foot/6.1 m radius) is the standard load.

Rate of Fire: One at a time or in volleys of 2, 4 or 6.

Payload: 48 total mini-missiles.

**3. Forearm Vibro-Blade Claws (3 per hand):** Each hand has three hooked Vibro-Blades for hacking and slashing Gargoyles in close combat or shredding enemy armored units. The claws can also be used to pry/tear and help the Griffon to climb.

Primary Purpose: Anti-Personnel and Melee Combat.

Secondary Purpose: Defense.

Range: Hand to hand combat.

Mega-Damage: 3D6+10 M.D. per claw strike (factors in Robot P.S.).

**4. Feet Vibro-Blade Claws (3 per foot):** Each foot has three large Vibro-Blades for hacking and slashing Gargoyles in close combat, usually from a leap attack or hover position. The claws also help the Griffon to climb.

Primary Purpose: Anti-Personnel and Melee Combat.

Secondary Purpose: Defense.

Range: Hand to hand combat.

Mega-Damage: 4D6 M.D. + Kick or Leap Kick damage when applicable.

**5. Sensor System Notes:** The robot has full optical systems including laser targeting, telescopic, passive nightvision, thermal-imaging, infrared, and polarization. These are in addition to all other features common to NGR robots.

**6. Hand to Hand Combat:** Rather than use a weapon the pilot can engage in Mega-Damage hand to hand combat. Although the Griffon is a giant robot combat vehicle, it has good speed and impressive agility, making it on par with flying power armor.

## Light Flying Robots

**Types:** Fast, agile and/or maneuverable robots that are under 22 feet (6.7 m) tall and have flight capabilities.

**Robot Combat Elite Bonuses:** Or as listed under individual robot descriptions.

+1 extra attack/action per melee round, *plus* those of the pilot at level one, +1 additional attack at levels 3, 6, 9 and 12.

Critical Strike is the same as the pilot's.

+3 on initiative.

+2 to strike with energy and long-range weapons.

+3 to strike in hand to hand combat.

+2 to parry.

+2 to dodge on the ground.

+5 to dodge when hovering, flying or leaping.

+2 to disarm.

+3 to pull punch.

+3 to roll with impact.

Punch Damage: As per Robot P.S.

Power Punch: Double damage, but counts as two melee attacks.

Tear or Pry with Hands: As per Robot P.S. plus Vibro-Blade damage from claws if applicable.

Head Butt, Elbow Strike or Beak Jab same as punch damage as per Robot P.S.

Kick Damage: As per Robot P.S.

Body Block/Ram: Equal to the Robot P.S. punch damage.

Fast Speed Flying Ram or Flying Leap Kick (100 mph/160 km or greater): Double the damage of Robot P.S. Leap Kick and a 01-80% likelihood of knocking an opponent off his feet if the opponent is the same size or smaller (reduce by half if twice as big). Victim takes M.D. and is knocked off his feet, losing initiative and two melee attacks/actions. The attacking flying robot automatically gains the initiative.

## X-2750 Talon

The X-2750 is another giant robot that is part of the NGR's move to gain air superiority over the winged Gargoyles. The X-2750 Talon is a large, winged humanoid-shaped robot reminiscent of the new Hell Angel power armor, only bigger and faster. It stands just over 20 feet (6.1 m) tall and has an overall wingspan of 36 feet (10.9 m). They have something of a Y shape and provide excellent lift and aerodynamics. They are independent of the arms, so the robot can carry an additional weapon, bombs, or cargo in its arms.

While the Talon does not have the capability to hit nearly as hard as the X-2700 Dragonwing, it has some tricks of its own. The two small weapon arms in the rib cage area are loaded with U-rounds to hinder the healing ability of the supernatural enemy, and a pair of twin, samurai sword style Vibro-Blades extend from each forearm to give the robot its name. For heavy weapons, the X-2750 is limited to Slammer concussion missiles and mini-missiles, in addition to whatever handheld weapon it may carry into combat. Many pilots are fine with taking the fight in the air right to the Gargoyles in close combat like the Griffon. However, the Talon is much faster and more versatile than the Griffon.

In flight, the Talon flies in a prone position, like Superman. Rocket thrusters on the back give it good speed and mobility, while the large wings provide excellent maneuverability. The Talon is used for aerial reconnaissance and raids on Gargoyle roosts and nests in the mountains. As a flyer, it can gain easy access to high altitude mountain fortresses and lairs, and engage Gargoyles in the air and on the ground. With the ability to fly up to speeds of Mach one, the Talon can easily outmaneuver Gargoyles.

### X-2750 Talon

**Exclusive to the NGR Military and Triax Security Forces**

**Model Type:** X-2750

**Class:** Light Air Infantry Combat Robot

**Crew:** Two, a pilot and a co-pilot/gunner.

**M.D.C. by Location:**

\* Head – 120



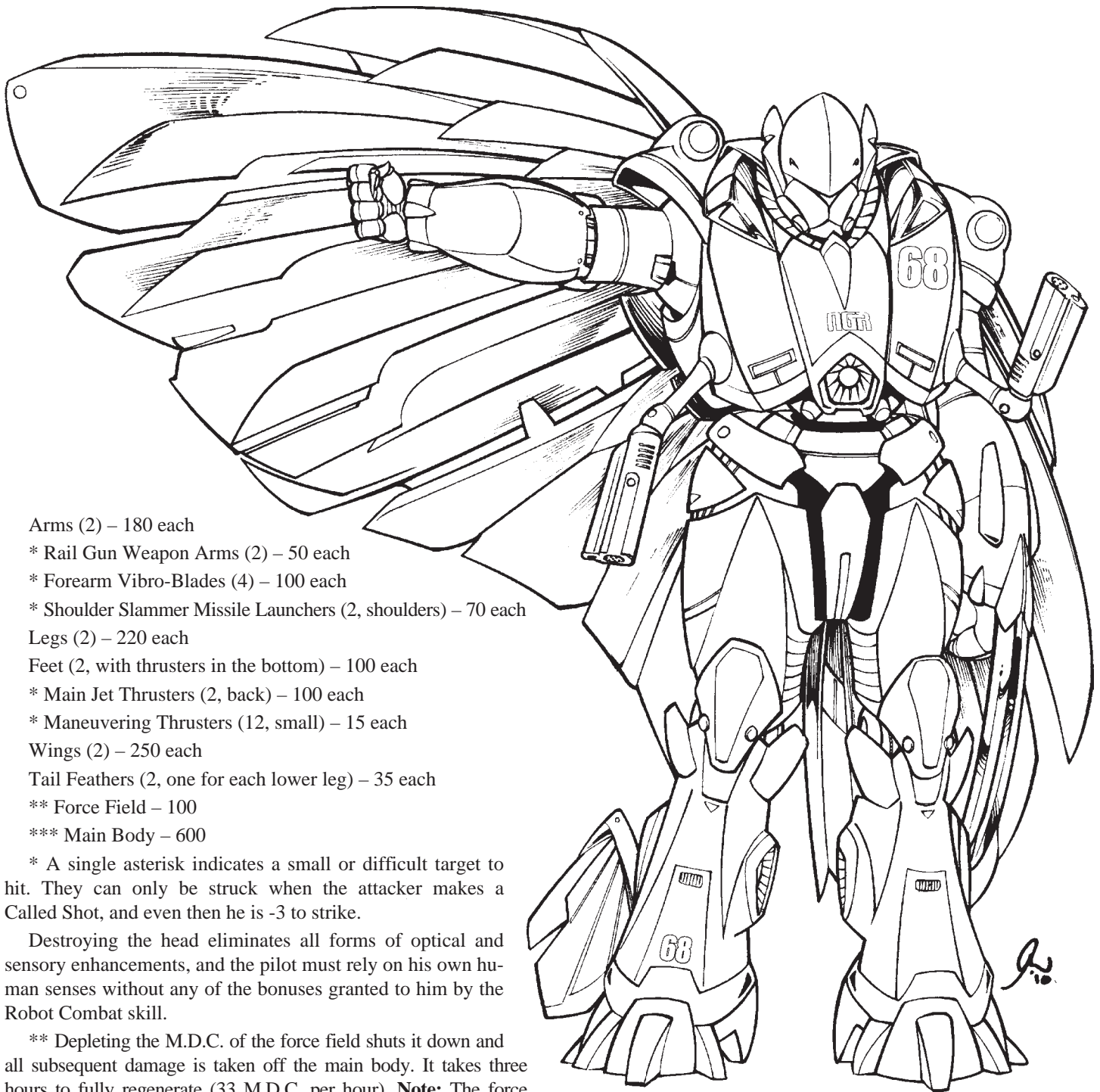

Arms (2) – 180 each

\* Rail Gun Weapon Arms (2) – 50 each

\* Forearm Vibro-Blades (4) – 100 each

\* Shoulder Slammer Missile Launchers (2, shoulders) – 70 each

Legs (2) – 220 each

Feet (2, with thrusters in the bottom) – 100 each

\* Main Jet Thrusters (2, back) – 100 each

\* Maneuvering Thrusters (12, small) – 15 each

Wings (2) – 250 each

Tail Feathers (2, one for each lower leg) – 35 each

\*\* Force Field – 100

\*\*\* Main Body – 600

\* A single asterisk indicates a small or difficult target to hit. They can only be struck when the attacker makes a Called Shot, and even then he is -3 to strike.

Destroying the head eliminates all forms of optical and sensory enhancements, and the pilot must rely on his own human senses without any of the bonuses granted to him by the Robot Combat skill.

\*\* Depleting the M.D.C. of the force field shuts it down and all subsequent damage is taken off the main body. It takes three hours to fully regenerate (33 M.D.C. per hour). **Note:** The force field cannot be raised when the Talon is on the attack, but can be used as a defensive measure when flying in and out of combat zones. The robot's weapons cannot fire when the force field is up.

\*\*\* Depleting the M.D.C. of the Main Body shuts the robot unit down completely, rendering it useless.

#### **Speed:**

Running: 50 mph (80 km) maximum.

Leaping: 30 feet (9.1 m) high or lengthwise from a standing position, double with a running start and wings extended, up to 1,000 feet (305 m) with thruster assistance without actually taking flight.

Flying: Hover stationary, glide (silent), and up to Mach 1 or 670 mph (1,072 km), double that speed for high altitude dive attacks.

Cruising speed is considered to be 200 mph (320 km). Maximum altitude is 45,000 feet (13,716 m).

Underwater Capabilities: The robot can skim across the surface of water at a speed of 100 mph (160 km/89 knots), float, with wings fully extended, or can walk along the bottom of a body of water at one third its running speed. Maximum depth is two miles (3.2 km).

#### **Statistical Data:**

Height: 21 feet (6.4 m).

Width: 9 feet (2.7 m) at the shoulders.

Length: 7 feet (2.1 m).

Wingspan: 36 feet (11 m) with the wings fully extended.

Weight: 20 tons fully loaded.

Physical Strength: Robot P.S. of 50.

Cargo: Storage locker containing two rifles, two suits of T-25 Uber body armor, first aid kit, a week's worth of food rations, a gallon (3.8 liters) of water and personal effects.

Power System: Nuclear, average energy life is 20 years.

Black Market Cost: 72 million credits. Exclusive to the NGR Army. Not currently sold on the open market and uncommon on the Black Market.

## Weapon Systems:

**1. Chest "Slammer" Concussion Missile Launchers (2):** Concealed within the chest of the unit, on either side of the pilot compartment, are two "Slammer" missile launchers. The covers to the launchers flip open to reveal the missiles, allow them to fire, and then close to protect the remaining missile payload.

Primary Purpose: Anti-Gurgoyles/Gargoyles.

Secondary Purpose: Anti-Personnel.

Range: 6,000 feet (1,829 m).

Mega-Damage: 2D4x10 M.D. from a direct hit by the missile. More importantly, the concussion effect has a blast radius of 45 feet (13.7 m). All within the blast radius suffer 1D4x10 M.D. and those caught in that radius take 1D4x10 M.D. and are likely (01-88%) to be knocked off of their feet and stunned (01-65%).

If only knocked down, the victim of this attack has ringing ears and a headache, but only loses one melee attack and initiative. A victim of a direct hit is always knocked off of his feet.

If stunned, the victim is dazed: -10 to strike, parry and dodge, roll with impact or pull punch, is the last to attack, and loses half of his attacks per melee for 1D4 melee rounds! Speed is also reduced by half.

Rate of Fire: One at a time.

Payload: 20 total, 10 per launcher. As soon as one is fired, another cycles into the launch chamber.

**2. Rail Gun Weapon Arms:** Located in the rib cage area of the Talon are a pair of small rail guns. Each fires U-rounds when going up against Gargoyles.

Primary Purpose: Anti-Gargoyle and Anti-Aircraft.

Secondary Purpose: Anti-Personnel.

Range: 4,000 feet (1,219 m).

Mega-Damage: 5D6 M.D. per 15 round short burst 1D4x10 M.D. per 30 round burst of U-Rounds, or 2D4x10 M.D. if both weapons are fired at the same target simultaneously. Gargoyles cannot be healed by bio-regeneration for 1D6 hours from U-Rounds.

Rate of Fire: Each bursts counts as one of the pilot or co-pilot's melee attacks.

Payload: 3,000 rounds per weapon, enough for 100 long bursts each.

**3. Forearm Vibro-Blade Swords (4):** Each forearm has two, long, extendible and retractable Vibro-Swords for close combat.

Primary Purpose: Melee Combat.

Secondary Purpose: Anti-Personnel and Defense.

Range: 12 foot (3.6 m) reach with the giant swords.

Mega-Damage: 1D4x10+8 M.D. per double blade attack (factors in Robot P.S. damage).

**4. Concealed Mini-Missile Launchers (2):** Concealed in each lower leg is a mini-missile launcher.

Primary Purpose: Anti-Gargoyles and Anti-Armor

Secondary Purpose: Anti-Personnel and Defense.

Range: Varies with missile type, but fragmentation is the standard payload with a half a mile (0.8 km) range.

Mega-Damage: Varies with missile type, but fragmentation (5D6 M.D. to everything in a 20 foot/6.1 m radius) is the standard load.

Rate of Fire: One at a time or in volleys of 2, 4, 6, 8, 12 or 24.

Payload: 24 total, 12 mini-missiles in each launcher.

**5. Giant M.D. Rifle or TX-H Series Weapon:** Any of the giant handheld weapons may be carried into combat, and one usually is. The TX-H series melee weapons can also be used, but with the Vibro-Swords of the robot, they are seldom necessary. The Talon may also carry *bombs* to be dropped on the enemy from above (equivalent damage as short-range missiles; no bonus to strike). In some cases, the Talon is used to fly in and position *VS-101 Sonic Stun Projectors* around a Gargoyle nest, roost or stronghold to disorient and confuse the enemy.

**6. Hand to Hand Combat:** Rather than use a weapon the pilot can engage in Mega-Damage hand to hand combat. See *Light Flying Robot Training* under the X-2730 Griffon for details.

**7. Sensor System Notes:** The robot has full optical systems including laser targeting, telescopic, passive nightvision, thermal-imaging, infrared, and polarization. These are in addition to all other features common to NGR robots.

## X-4500 Gunman

The "Schutze" is an agile, walking weapon platform developed to be a large infantry robot. It may be part of a combined arms force of other large robots, or a single unit providing heavy support to an infantry squad or platoon. The X-4500 Gunman is quick, agile, and carries variety of armaments so as to be useful in almost any combat situation. Its big gun is a laser cannon mounted on its left shoulder. On the right shoulder is a missile launcher loaded with the innovative "Slammer" concussion missiles; the launcher slides along a track behind the shoulder and locks into place there when it is not needed. A pair of rail gun weapon arms extend from the rib cage area and built into the lower legs are concealed mini-missile launchers. Each forearm sports a laser and the Gunman has a force field generator to provide additional protection when under assault. Of course, the 'Bot must lower the force field to fire its guns.

While the Gunman was not specifically designed for hand to hand combat, the robot holds its own reasonably well against Gurgoyles, Gargoyles, and other large creatures. Fast and mobile, the Gunman can use one or two H-series melee weapons or carry a giant size energy rifle for additional fire power. Special connectors in the robot's hands (like the Ulti-Max II) allow the handheld gun or melee weapons to link to its internal power supply for an unlimited payload. Still, the X-4500 is best suited for ranged combat and troop support.

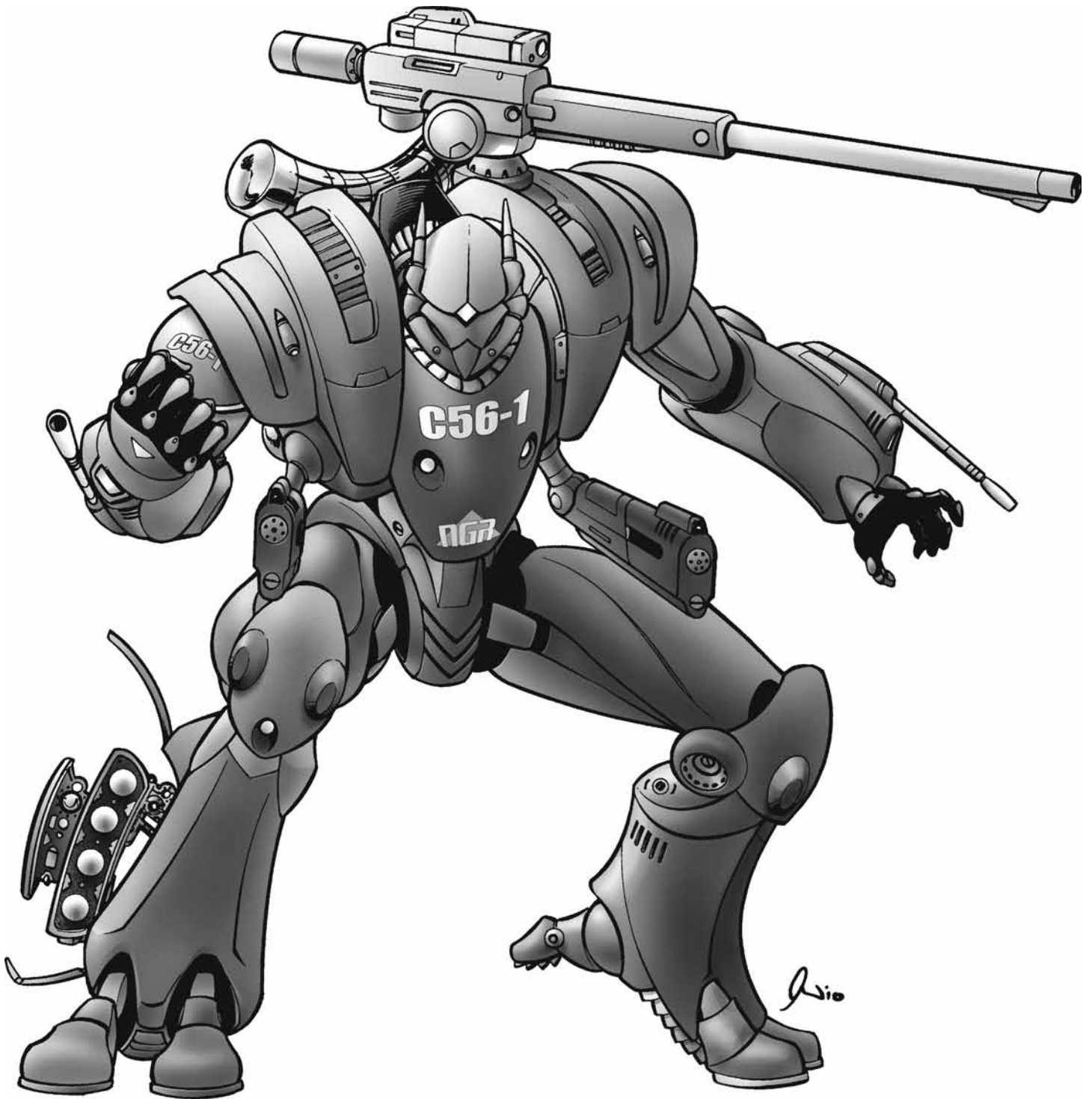

### **X-4500 Gunman – Exclusive to the NGR Military**

**Model Type:** X-4500

**Class:** Ground Infantry Assault Robot.

**Crew:** Two. One pilot and one gunner (he operates the two shoulder weapons).

**M.D.C. by Location:**

- Slammer Missile Launcher (1, right shoulder) – 90
- Laser Cannon (1, left shoulder) – 120
- \* Forearm Pulse Lasers (2, forearms) – 25 each
- \* Leg Mini-Missile Launchers (2, lower legs) – 35 each
- Rail Gun Weapon Arms (2, lower torso) – 50 each

- Shoulder Weapon Mounts (2) – 150 each
- \* Head/Sensor Cluster – 150
- Arms (2) – 255 each
- Legs (2) – 340 each
- Main Rear Booster Jet (1) – 70
- \* Spotlights (2, chest) – 5 each
- Reinforced Pilot Compartment – 100
- \*\* Force Field – 100
- \*\*\* Main Body – 610

\* A single asterisk indicates a small or difficult target to hit. They can only be struck when the attacker makes a Called Shot, and even then he is -3 to strike.

Destroying the head eliminates all forms of optical and sensory enhancements, and the pilot must rely on his own human senses without any of the bonuses granted to him by the Robot Combat skill.

\*\* Depleting the M.D.C. of the force field shuts it down and all subsequent damage is taken off the main body. It takes three hours to fully regenerate (33 M.D.C. per hour). **Note:** The force field cannot be raised when the Gunman is on the attack, but can be used as a defensive measure to weather an enemy barrage, while on patrol or on the retreat. The robot's weapons cannot fire when the force field is up.

\*\*\* Depleting the M.D.C. of the Main Body shuts the robot unit down completely, rendering it useless.

### **Speed:**

Running: 70 mph (112 km). 130 mph (208 km) when assisted by the rocket propulsion system.

Leaping: 15 feet (4.6 m) high or lengthwise, 25 feet (7.6 m) with a running start and 60 feet (18.3 m) when assisted by the rocket propulsion system. The thruster is designed to help the Gunman leap over piles of debris and wreckage and climb the sides of buildings and mountains where Gargoyles roost.

Flying: Full flight not possible. See Leaping.

Underwater Capabilities: The robot can walk along the bottom of a body of water at one third its running speed. Maximum depth is one mile (1.6 km).

### **Statistical Data:**

Height: 21 feet, 3 inches (6.5 m).

Width: 9 feet, 7 inches (3 m).

Length: 6 feet, 8 inches (2 m).

Weight: 12.4 to 13.2 tons depending on the load out.

Physical Strength: Robot P.S. of 45.

Cargo: Storage locker containing two rifles, two suits of body armor, and personal effects.

Power System: Nuclear, average energy life is 20 years.

Black Market Cost: 48 million credits, but uncommon on the Black Market. Exclusive to the NGR Army. Not currently sold on the open market.

### **Weapon Systems:**

**1. TX-4501 Shoulder-Mounted, High-Intensity Laser Cannon (1):** This high intensity laser is the main gun. It is mounted on the special shoulder track system of the Gunman so the weapon can be tilted backward and forwards. It also has its own mini-turret enabling cannon to rotate 360 degrees and has a 90 degree up and down arc of fire. Its long-range capabilities means it can snipe at the enemy and take on a flock of Gargoyles or horde of Gurgolyes as they rush forward long before they get within the combat range of most other infantry troops. The cannon is also good at close ranges and there is no recoil because it is a laser weapon.

Primary Purpose: Anti-Armor.

Secondary Purpose: Anti-Aircraft/Gargoyles.

Range: 8,000 feet (2,438 m).

Mega-Damage: 1D4x10 M.D. per blast.

Rate of Fire: Single shots only, each blast counts as one melee attack.

Payload: Effectively unlimited.

Bonus to Strike: +1 to strike on an Aimed or Called Shot.

**2. "Slammer" Concussion Missile Launcher (1):** A "Slammer" missile launcher is mounted over the right shoulder. It rides along the shoulder track and hangs from the back when not in use. It can also be ejected if the pilot of the Gunman thinks a launcher emptied of its missiles is weighing it down. However, most keep it to provide additional M.D.C. protection from the back and to save the army some money.

Primary Purpose: Anti-Gurgoyles/Gargoyles.

Secondary Purpose: Anti-Personnel.

Range: 6,000 feet (1,828 m).

Mega-Damage: 2D4x10 M.D. from a direct hit by the missile. More importantly, the concussion effect has a blast radius of 45 feet (13.7 m) in diameter. All within the blast radius suffer 1D4x10 M.D. and are likely (01-88%) to be knocked off of their feet and stunned (01-65%).

If only knocked down, the victim of this attack has ringing ears and a headache, but only loses one melee attack and initiative. A victim of a direct hit is always knocked off of his feet.

If stunned, the victim is dazed: -10 to strike, parry and dodge, roll with impact or pull punch, is the last to attack, and loses half of his attacks per melee for 1D4 melee rounds! Speed is also reduced by half.

Rate of Fire: One at a time.

Payload: 10 total.

**3. Forearm-Mounted Pulse Lasers (2):** Each forearm has a laser weapon housing mounted to it. The weapons are primarily anti-personnel weapons. By being mounted to the forearms, the Gunman's hands remain free to wield a giant rifle, handguns or melee weapons.

Primary Purpose: Assault and Anti-Personnel.

Secondary Purpose: Defense.

Range: 4,000 feet (1,219 m).

Mega-Damage: 3D6 M.D. per single shot or 1D4x10 M.D. per triple pulse blast. Both weapons can *not* be fired simultaneously at the same target.

Rate of Fire: Each single shot or pulse counts as one melee attack.

Payload: Effectively unlimited.

**4. Rail Gun Weapon Arms:** Located in the rib cage area of the Gunman are a pair of small rail guns. Each fires U-rounds when going up against Gargoyle forces.

Primary Purpose: Anti-Gargoyle and Anti-Aircraft.

Secondary Purpose: Anti-Personnel.

Range: 4,000 feet (1,219 m).

Mega-Damage: 5D6 M.D. per 15 round short burst, 1D4x10 M.D. per 30 round burst of U-rounds, or 2D4x10 M.D. if both weapons are fired at the same target simultaneously. Gargoyles cannot be healed by bio-regeneration for 1D6 hours from U-rounds.

Rate of Fire: Each burst counts as one melee attack.

Payload: 3,000 rounds per weapon, enough for 100 long bursts each.

**5. Leg-Mounted Mini-Missiles:** Concealed in each of the lower legs is a mini-missile launcher. It extends to fire and retracts back into its leg housing.

Primary Purpose: Anti-Gargoyles and Anti-Armor.

Secondary Purpose: Anti-Personnel and Defense.

Range: Varies with missile type, but fragmentation is the standard payload with a half a mile (0.8 km) range.

Mega-Damage: Varies with missile type, but fragmentation (5D6 M.D. to everything in a 20 foot/6.1 m radius) is the standard load.

Rate of Fire: One at a time or in volleys of 2 or 4.

Payload: 16 total, eight in each leg launcher.

**6. Optional Shoulder Weapon Systems (1):** Instead of the standard Slammer missile launcher or the laser cannon, the Gunman can elect to have one or both replaced with a number of other weapon systems. Most do more damage but have significantly less range.

**Optional: TX-4502 Shoulder-Mounted, Supercharged Ion Cannon:**

This cannon is sometimes used when the Gunman expects to need heavy firepower.

Primary Purpose: Anti-Robot and Anti-Armor.

Secondary Purpose: Assault and Troop Support.

Range: 4,000 feet (1219 m).

Mega-Damage: 2D4x10 M.D. per blast.

Rate of Fire: Each shot counts as one melee attack..

Payload: Effectively unlimited.

**Optional: TX-4503 Shoulder Mounted Particle Beam:**

This cannon is sometimes used when the Gunman expects to need truly heavy firepower. It is primarily used for assaults against hardened targets and is often requested for front-line troops to punch through fortified positions.

Primary Purpose: Assault.

Secondary Purpose: Anti-Armor/Anti-Gargoyle.

Range: 3,000 feet (914 m).

Mega-Damage: 2D4x10+10 M.D. per blast. Double damage on a roll to strike that is an unmodified Natural 19 or 20.

Rate of Fire: Single shots only.

Payload: Effectively unlimited.

**Optional: TX-4504 Shoulder-Mounted Rapid-Fire Grenade Launcher.** It is capable of laying down tremendous fields of shrapnel that tear anyone, human or Gargoyle, to pieces.

Primary Purpose: Anti-Personnel.

Secondary Purpose: Defense.

Range: 1,400 feet (427 m).

Mega-Damage: 4D6 M.D. to a 10 foot (3 m) radius, or 2D4x10 M.D. to everything in a 25 foot (7.6 m) radius per four round burst.

Rate of Fire: Each single shot or burst counts as one melee attack.

Payload: 200 grenades, enough for 50 bursts.

**7. TX-H Series:** One or two M.D. melee weapons can be selected from the TX-H series. When not in use they snap onto a clip on the side of the robot's hip.

**8. Hand to Hand Combat:** Rather than use a weapon the pilot can engage in Mega-Damage hand to hand combat. See *Light Ground Robot Training* on page 353 of **Rifts® Ultimate Edition**. The only difference is that the Gunman is fully capable of Kick Attacks (5D8 M.D.) and Leap Kicks (1D8x10 M.D., but counts as two attacks); damage is as per Robot P.S.

**9. Sensor System Notes:** The robot has full optical systems including laser targeting, telescopic, passive nightvision, thermo-imaging, infrared, and polarization. These are in addition to all other features common to NGR robots.

## Triax X-4600 Sharpshooter

The Scharfschutzen (Sharpshooter) is designed to function as a forward scout and designated sniper in fire teams, mixed squads and platoons sent into hostile enemy territory and border patrols. As such it is a bit smaller, sleeker and more humanoid-shaped than some of the other giant robots, even the Gunman. It is intended to sneak in behind enemy lines and send back coordinates for missile and artillery strikes, as well as function as a sniper to harass the enemy, take down strategic enemy personnel and other targets such as communications and sensor arrays, radar towers, etc.

Engineers designed the robot to have superior, human-like mobility, and excellent speed and agility for climbing, running, and hand to hand combat. To help the Sharpshooter move quickly from one firing spot to another, and to gain high ground positions for sniping, the robot has a pair of rocket boost jets in its back and six directional jets for stability. This enables the sniper unit to scale towers, climb up the sides of buildings and up cliff walls quickly, as well as leap over battlefield wreckage, debris and walls that are no taller than 75 feet (22.9 m).

Once in place, the Sharpshooter can activate its unique *active camouflage system*, allowing it to blend into the surroundings and wait for the perfect shot (sometimes for days on end). That means the Scharfschutzen usually takes position away from the rest of its squad and picks off enemies as they advance on his teammates' position, or as first strike in a coordinated attack. The Sharpshooter's cloaking device and additional sensors also make it ideal for scouting, search and destroy missions, rescue missions and commando-style prisoner rescue/retrieval operations.

The main weapon of the Scharfschutzen is a 14 foot (4.2 m) long, high-powered rail cannon known as the TX-4601 Long Rifle. It too is a sleek looking weapon with a long barrel designed for long-range precision targeting. The Sharpshooter is also excellent in hand to hand combat and always has two H series weapons hanging from its hips or behind its lower legs.

### X-4600 Sharpshooter

**Exclusive to the NGR Military**

**Model Type:** X-4600

**Class:** Ground Infantry Assault and Sniper Robot.

**Crew:** Two, one pilot and one communications officer.

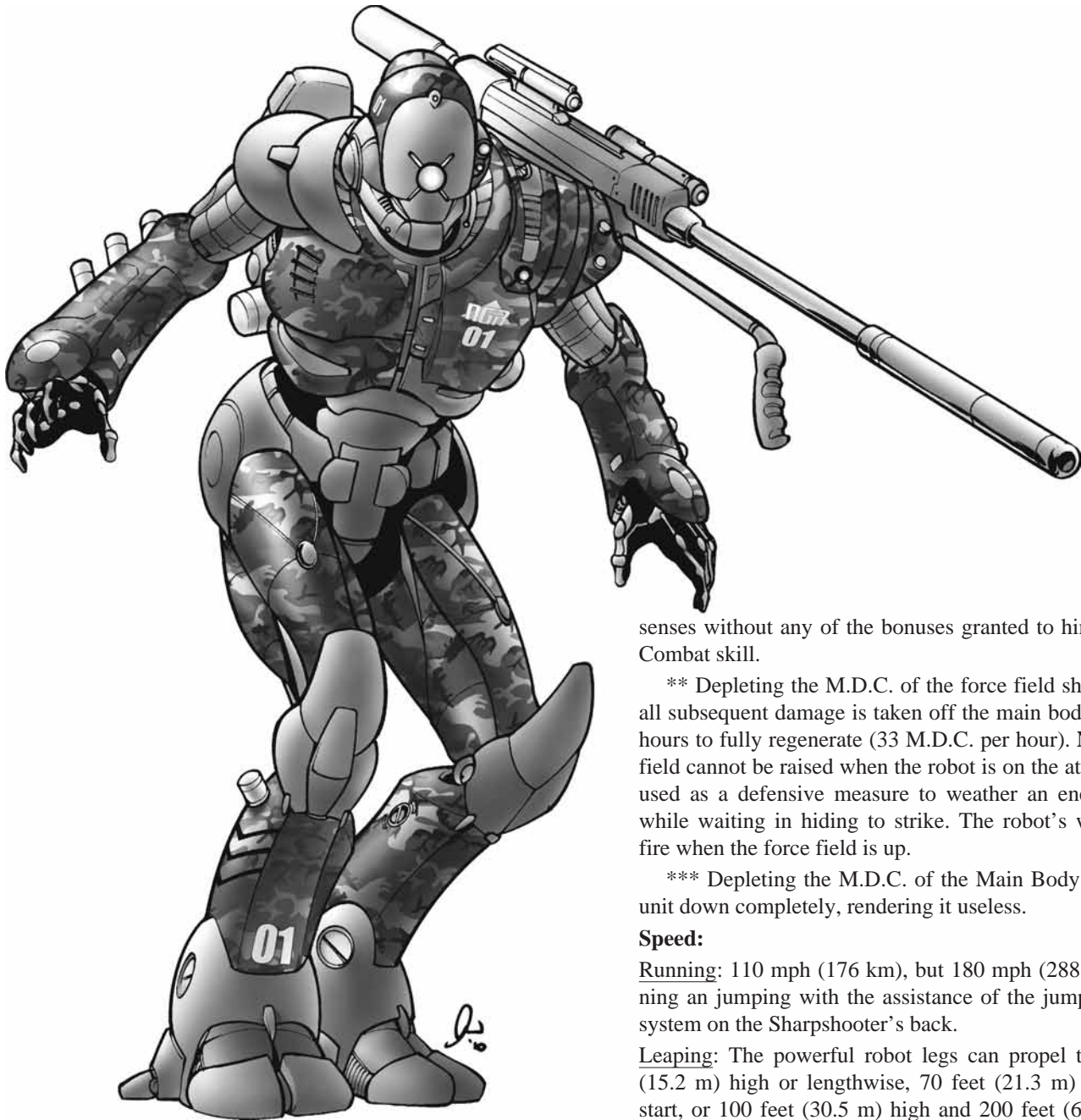

#### M.D.C. by Location:

- \* Head/Sensor Cluster – 112
- Arms (2) – 145 each
- Legs (2) – 240 each
- \* TX-4601 Long Rifle – 100
- \* Forearm Mini-Missile Launch Tubes (6) – 15 each
- Jet Thruster/Jump Jets (2, back) – 100 each
- \* Directional Jets (6, concealed) – 20 each
- \*\* Force Field – 100
- Reinforced Pilot Compartment – 100
- \*\*\* Main Body – 430

\* A single asterisk indicates a small or difficult target to hit. They can only be struck when the attacker makes a Called Shot, and even then he is -3 to strike.

Destroying the head eliminates all forms of optical and sensory enhancements, and the pilot must rely on his own human

senses without any of the bonuses granted to him by the Robot Combat skill.

\*\* Depleting the M.D.C. of the force field shuts it down and all subsequent damage is taken off the main body. It takes three hours to fully regenerate (33 M.D.C. per hour). **Note:** The force field cannot be raised when the robot is on the attack, but can be used as a defensive measure to weather an enemy barrage or while waiting in hiding to strike. The robot's weapons cannot fire when the force field is up.

\*\*\* Depleting the M.D.C. of the Main Body shuts the robot unit down completely, rendering it useless.

#### Speed:

Running: 110 mph (176 km), but 180 mph (288 km) when running and jumping with the assistance of the jump jet propulsion system on the Sharpshooter's back.

Leaping: The powerful robot legs can propel the unit 50 feet (15.2 m) high or lengthwise, 70 feet (21.3 m) with a running start, or 100 feet (30.5 m) high and 200 feet (61 m) lengthwise when assisted by the booster jet system.

Flying: Flight and hovering are not possible, see Leaping and jet boosters.

Underwater Capabilities: The robot can walk along the bottom of a body of water at one third its running speed. Maximum depth is one mile (1.6 km).

#### Statistical Data:

Height: 18 feet (5.5 m).

Width: 8 feet, 4 inches (2.5 m).

Length: 6 feet, 3 inches (1.9 m).

Weight: 8.5 tons.

Physical Strength: Robot P.S. of 40.

Cargo: Small area for the pilot's personal items, as well as a weapon locker that has room for one rifle, a sidearm, a suit of light body armor, canteen, 4 week supply of food rations. A two gallon (38 liter) water cooler is built into the unit.

Power System: Nuclear, average energy life is 20 years.

Black Market Cost: 42 million credits. Exclusive to the NGR Army. Not currently sold on the open market and uncommon on the Black Market.

## Weapon Systems:

**1. TX-4601 Long Rifle (Rail Gun):** The special ammunition for this weapon is a projectile that is launched with a small powder charge first, like a regular rifle round, and then accelerated down the barrel at increasingly faster speed by electromagnetic coils. Once shot out of the barrel and on the way to its target, the projectile activates a *ramjet*, increasing its speed even more.

Primary Purpose: Long-Range Precision Sniper Strikes.

Secondary Purpose: Anti-Personnel.

Range: 10,000 feet (3,048 m; close to two miles/3.2 km).

Mega-Damage: 2D4x10 M.D. per single round.

Rate of Fire: Each shot counts as one of the shooter's melee attacks. Single shot only.

Payload: 60 round, auto-feed.

Special Bonus: +2 on an Aimed or Called Shot in addition to any other applicable bonuses. The Long Rifle scores a Critical Hit on the roll of an unmodified Natural 18, 19 or 20.

**2. Forearm Mini-Missile Launch Tubes (6 total):** Each of the forearms has three mini-missile launch tubes containing two mini-missiles in each.

Primary Purpose: Anti-Gargoyles and Anti-Armor.

Secondary Purpose: Anti-Personnel and Defense.

Range: Varies with missile type, but fragmentation is the standard payload with a half a mile (0.8 km) range.

Mega-Damage: Varies with missile type, but fragmentation (5D6 M.D. to everything in a 20 foot/6.1 m radius) is the standard load.

Rate of Fire: One at a time or in volleys of 2 or 4.

Payload: 12 total, two in each launcher.

**3. Optional: Handheld Rifle.** May carry a robot-sized handheld weapon like the TX-222, though most do not. See the Weapons section of this book for details, page 102.

**4. TX-H Series:** Any of the TX-H series hand to hand weapons can be used, and often are. Many Sharpshooter pilots like to have a pair of Vibro-Blades or other M.D. melee weapon tucked away on the back of the robot's lower leg or hip for close combat. See page 103.

**5. Hand to Hand Combat:** Rather than use a weapon the pilot can engage in Mega-Damage hand to hand combat. See *Light Ground Robot Training* on page 353 of **Rifts® Ultimate Edition**. The only differences are that the Sharpshooter gets an additional +1 to disarm and dodge at level one, and is fully capable of Kick Attacks (3D8 M.D.) and Leap Kicks (5D8 M.D., but counts as two attacks); damage is as per Robot P.S.

**6. Sensor System Notes:** Telescopic, passive nightvision and polarizing lens in addition to all other features common to NGR robots, plus the following:

Active Camouflage: Holographic image adaptor projects the color and patterns of the surrounding environment to cloak

the Sharpshooter from the enemy. The armor also has heat signature dampening features to reduce and disguise its heat signature. The enemy is -4 on Perception Rolls to notice the robot when this cloaking system is engaged and anyone actively trying to search for the Sharpshooter suffers a penalty of -25% on their Detect Concealment and Sensory Equipment skill rolls.

Advanced Radar: Extended radar range of 200 miles (320 km). Can track 120 targets simultaneously.

Laser Target Painting: A laser system used to "tag" or "paint" a specific enemy target or position for an air strike, missile bombardment or artillery strike. The infrared laser has a range of one mile (1.6 km) and is invisible unless an observer has enhanced optics which allows them to see in the infrared spectrum. If the Sharpshooter keeps the target tagged, the roll to strike for the incoming missiles or air strike is +4 (in addition to any other possible bonuses the missiles or attackers might have to strike).

Long-Range Laser Communications: Range: 1,000 miles (1,600 km); half that range in the mountains and underground.

## X-5050 Black Death

Of all the new designs coming from the weapons engineers at Triax Industries, the X-5050 Black Death is one of the strangest and arguably least successful. When it was realized that the XM-279 Earth Lifter could not function as a troop and cargo transport into Gargoyle held territories, because it gets swarmed and destroyed, a new transport was requested. The idea was to create not only a troop transport, but a mobile artillery unit and mini-mobile base. It was a good idea, but the Black Death falls short.

The six-legged behemoth has considerable damage potential and good long-range strike capabilities, but it is extremely slow and ponderous compared to the much faster and mobile robots and power armor of the NGR Army, not to mention the enemy. The slow speed leaves the Black Death vulnerable to Gurgoyles and Gargoyle swarming attacks, which makes it no better than the Earth Lifter as a transport. The robot's extremely high development and production costs have also contributed to the brass's disappointment in the robot.

Despite the Black Death's firepower, smaller, faster enemy forces can usually rush the X-5050, disable its weapons and tear it to pieces in a relatively short time. In fact, it earned its nickname, "Black Death," because the behemoth would cut down scores, even hundreds, of Gurgoyles and Gargoyles or Brodkil troops, but the monsters keep coming until they can disable and destroy it. Without intervention from aircraft or power armor troops, the Black Death is a sitting duck in enemy occupied territory. This is not the case when the Black Death is part of a large, mobile offensive or troop formation where infantry troops, power armor forces, giant robots and other combat vehicles can keep the Gargoyle hordes away and help protect it. The vehicle also performs well as a mobile artillery support unit at military base camps, border operations and in areas where enemy forces are light.

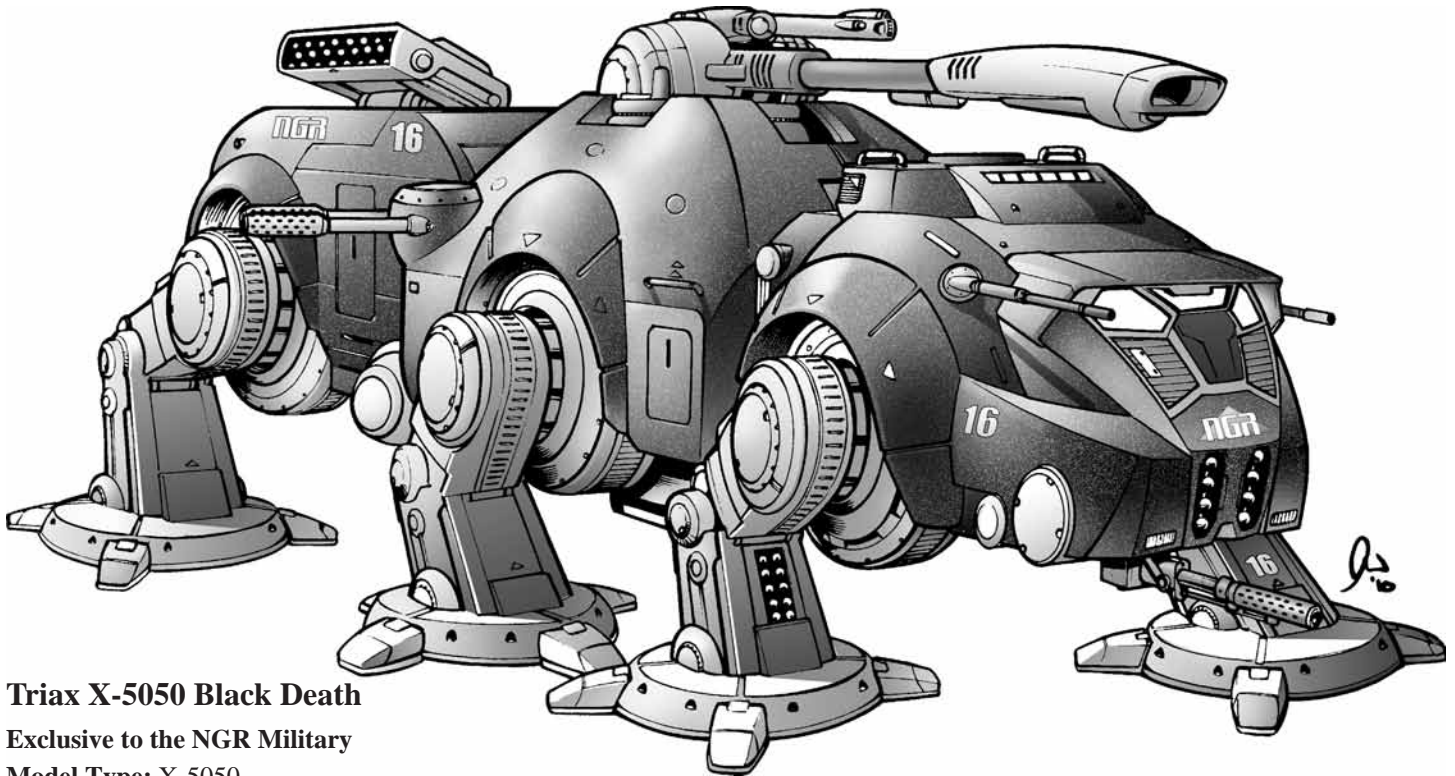

## Triax X-5050 Black Death

**Exclusive to the NGR Military**

**Model Type:** X-5050

**Class:** Mobile Artillery, All-Terrain Field Support Unit.

**Crew:** 12, one pilot, one co-pilot, five gunners, one artillery gunner, two communications officers, one technical officers and one unit commander.

**Troop Capacity:** 48-72 infantry soldiers, 8-16 flying power armor troops, and 3-6 light giant robots is the standard mix, but any similar combination of troops works.

**Cargo Capacity:** Instead of transporting troops the robot can haul up to 89,000 tons of cargo.

### M.D.C. by Location:

Main Particle Beam Gun – 270

Main Turret and Secondary Laser – 300

Rail Gun Turrets (3, sides and rear) – 150 each

\* Forward Rail Gun (1, nose) – 200

\* Forward Lasers (2) – 100 each

\* Forward Leg Mini-Missile Launchers (2) – 100 each

\* Forward Short-Range Missile Launcher (1, nose) – 150

Medium-Range Missile Launcher (1) – 300

\* Sensor Cluster (2, front sides) – 50 each

\* Forward Searchlights (2, nose) – 15 each

Legs (6) – 350 each

\* Cargo Bay Doors (4) – 180 each

Rear Cargo Bay Double Doors (1) – 250

\* Rear Cargo Bay Ramp (1) – 100

\*\* Main Body: Rear Section/Cargo Bay – 800

\*\* Main Body: Mid-Section/Cargo Bay – 1,200

\*\* Main Body: Forward Section/Head/Cockpit – 1,000

Reinforced Pilot Compartment – 150

\* A single asterisk indicates a small or difficult target to hit. They can only be struck when the attacker makes a Called Shot, and even then he is -3 to strike.

Destroying both sensor clusters (the circular items on the side of the head) eliminates all forms of optical and sensory enhancement. The pilot and gunners must rely on their own senses without any of the bonuses granted to them by the Robot Combat or Weapons Systems skills.

\*\* Depleting the M.D.C. of the main body of the front and mid-sections shuts the robot down completely, rendering it useless.

Destroying the two front or rear legs reduces speed by 50%. Destroying the two center legs reduces speed by 20%.

### Speed:

Running: 45 mph (72 km) maximum.

Leaping: Not possible.

Flying: Not possible.

Underwater: The Black Death is fully amphibious in that it can walk along the sea floor at a speed of 20 mph (32 km) to a depth of 3.5 miles (5.6 km).

### Statistical Data:

Height: 30 feet (9.1 m) from toe to top of the main gun turret. The head/forward section is raised 10 feet (3 m) above the ground.

Width: 34 feet (10.4 m).

Length: 83 feet (25.3 m).

Weight: 102 tons fully loaded, plus troops and/or cargo.

Physical Strength: Robot P.S. of 60.

Cargo: See Troop Capacity. Plus the crew has a small storage bay about the size of a pantry or large walk-in closet.

Power System: Nuclear, average energy life is 20 years.

Colors: Black and dark grey.

Black Market Cost: 182 million credits. Exclusive to the NGR Army. Not currently sold on the open market, nor have any appeared on the Black Market.



## Weapon Systems:

**1. Super PBA Main Cannon Turret:** The main weapon of the X-5050 Black Death is a smaller version of the still experimental Super PBA Cannon from the prototype Mobile Infantry Strike Base (see **Rifts® Sourcebook 3: Mindwerks™**). It is built into an armored turret, can rotate 360 degrees, and has a 45 degree up and down arc of fire. The turret has a dedicated gunner.

### **Particle Beam Cannon (Main Gun):**

Primary Purpose: Anti-Fortification/Anti-Armor.

Secondary Purpose: Assault.

Range: 8,000 feet (2438 m).

Mega-Damage: 1D6x100 M.D. per single blast. Critical strike (double damage on an unmodified roll of a Natural 19 or 20).

Rate of Fire: Each shot counts as one of the gunner's melee attacks.

Payload: Effectively unlimited.

Special Feature: Independent coordinated targeting system provides a +1 strike bonus in addition to any other bonuses the dedicated gunner may have.

**Heavy Laser (Secondary Weapon):** A single barrel, heavy laser is also built into the turret just above the Super PBA turret. It is used as an alternative or backup weapon should the big gun get destroyed and can be used for precision targeting.

Primary Purpose: Anti-Armor and Anti-Aircraft/Gargoyles.

Secondary Purpose: Assault and Defense.

Range: 6,000 feet (1,829 m).

Mega-Damage: 6D6 M.D. per blast.

Rate of Fire: Single shots only, each blast counts as one of the gunner's melee attacks.

Payload: Effectively unlimited.

Bonus to Strike: +1 to strike on an Aimed or Called Shot. The turret gunner fires both the particle beam cannon and the laser. Both can not be fired simultaneously.

**2. Single-Barrel Heavy Rail Gun Turret (1):** A single barrel rail gun turret is built into the nose of the Black Death. It can rotate 360 degrees (can fire forward or behind) and has a 30 degree arc of fire. Operated by a dedicated gunner. Does not use DU- or U-rounds.

Primary Purpose: Assault and Anti-Personnel.

Secondary Purpose: Defense.

Range: 6,000 feet (1,829 m).

Mega-Damage: 1D4x10 M.D. per 20 round short burst or 1D6x10 M.D. per 40 round long burst; fires standard ammo (not DU- or U-rounds). This weapon can only fire bursts.

Rate of Fire: Each short or long burst counts as one melee attack of the gunner.

Payload: 10,000 rounds each for 250 long bursts.

**3. Heavy Double-Barrel Rail Gun Turrets (3):** A double-barreled rail gun turret is located in back and another one is located in the mid-section on each side of the Black Death. Each turret can rotate 180 degrees and has a 45 degree arc of

fire. Operated by a dedicated gunner. Does not use DU- or U-rounds.

Primary Purpose: Assault.

Secondary Purpose: Defense.

Range: 6,000 feet (1,829 m).

Mega-Damage: 1D6x10 M.D. per 40 round single barrel burst or 2D6x10 M.D. double barrel burst; fires standard ammo (not DU or U rounds). This weapon can only fire bursts.

Rate of Fire: Each single or dual barrel burst counts as one melee attack of the gunner.

Payload: 12,000 rounds each for 150 dual barrel bursts.

**4. Laser Cannons (2):** These powerful weapons are located on either side of the pilot compartment and mainly used for assault and defense. Each has a dedicated gunner.

Primary Purpose: Anti-Armor and Anti-Aircraft/Gargoyles.

Secondary Purpose: Assault and Defense.

Range: 4,000 feet (1,219 m).

Mega-Damage: 5D6 M.D. per single blast.

Rate of Fire: Single shots only, each blast counts as one melee attack of the dedicated gunner.

Payload: Effectively unlimited.

Bonus to Strike: +1 to strike on an Aimed or Called Shot.

**5. Forward Short-Range Missile Launcher (1):** Built into the nose of the beast is a missile launcher.

Primary Purpose: Anti-Aircraft/Gargoyles and Assault.

Secondary Purpose: Defense.

Range: Varies with type of missile used, but high-explosive is five miles (8 km) and fragmentation is three miles (4.8 km).

Mega-Damage: Varies with type of missile used. Typically high-explosive (2D6x10 M.D. to everything in a 15 foot/4.6 m radius) or fragmentation (2D4x10 M.D., 20 foot/6.1 m damage radius).

Rate of Fire: One at a time or in volleys of 2, 4 or 8.

Payload: 48 total missiles.

**6. Front Leg Mini-Missile Launchers (2):** Each of the front legs contains a mini-missile launcher. To fire, a panel slides open, the missile volley is launched and the panel slides shut.

Primary Purpose: Anti-Gargoyles and Anti-Armor.

Secondary Purpose: Anti-Personnel and Defense.

Range: Varies with missile type, but fragmentation is the standard payload with a half a mile (0.8 km) range.

Mega-Damage: Varies with missile type, but fragmentation (5D6 M.D. to everything in a 20 foot/6.1 m radius) is the standard load.

Rate of Fire: One at a time or in volleys of 2 or 4.

Payload: 60 total, 30 in each front leg launcher.

**7. Medium-Range Missile Launcher Turret (1):** A large, medium-range missile launcher is located near the tail end of the Black Death. The turret can rotate 360 degrees and has a 45 degree arc of fire. It is used to attack aerial targets and Gargoyles.

Primary Purpose: Anti-Fortified positions and Anti-Armor.

Secondary Purpose: Anti-Gargoyles and Assault.

Range: Varies with type of missile used, but typically 40 miles (64 km).

Mega-Damage: Varies with missile type, but typically high-explosive (3D6x10 M.D. to everything in a 30 foot/9.1 m radius) or Multi-Warhead (5D6x10 M.D. to a 20 foot/6.1 m radius – this is a smart bomb). Often the payload is half and half.

Rate of Fire: Fired one at a time or in volleys of 2, 4, 6 or 8.

Payload: 42 total medium-range missiles.

**8. Hand to Hand Combat:** Rather than use a weapon the pilot can engage in Mega-Damage hand to hand combat. See *Heavy Vehicular Style Robots* on page 352 of **Rifts® Ultimate Edition**. All abilities are the same except as follows: Black Death is *not* able to parry, punch, kick or leap kick. However, a stomp attack does 6D6 M.D., but can only be used against targets smaller than 10 feet (3 m).

**9. Sensor System Notes:** Telescopic, passive nightvision and polarizing lens in addition to all other features common to NGR robots plus the following:

Advanced Radar: Extended radar range of 200 miles (320 km). Can track 120 targets simultaneously.

## X-5001 Devastator Mk II

The Triax *X-5000 Devastator* has long been one of the most iconic robot vehicles for the troops of the NGR. With the large arsenal of heavy weapons that it commands, it has served as the symbolic cornerstone of large assault forces. Many times the X-5000 has valiantly stood its ground against seemingly insurmountable odds to emerge victorious over the Gargoyle hordes. Sadly, there have been many times when the Devastator stayed behind to cover the retreat of infantry troops, only to fall to a vicious onslaught of Gurgoyles and their machines of war. It is these instances that made the top brass of the NGR Army request an upgraded Devastator. One that remains a heavy weapons platform, but with more armor and combat capabilities to give it a better chance against the relentless waves of close combat assailants.

Since the Full Militarization of the NGR towards the end of 104 P.A., the Triax Research and Development teams have been working almost constantly developing new weapon technologies for the Devastator to better fight the Gargoyle Empire. Because of major advances in weapon micronization and energy weapon technologies, the weapons engineers of Triax have been able to make the Devastator Mk II much more deadly than its predecessor both in long-range artillery bombardments and in close combat fighting. While the Mk II is still a heavy weapons platform similar to the original Devastator, it has been outfitted with many smaller short-range weapon systems and anti-personnel weapons to better support infantry and robot troops.

The first *X-5001 Devastator Mk II* walked off of the Passau assembly line on July 6th, 108 P.A., in what was a huge spectacle of an event. The unveiling ceremony was televised throughout the entire NGR, touting this new robotic unit as one to lead the human defenders of the NGR to victory over the Gargoyles and Brodkil. Public support for the program soared after the ceremony, and the Devastator Mk II became a new symbol of national pride. NGR military leaders were pleased with the

product Triax delivered, and despite the cost of the robot, they tripled the project's funding with orders for two Devastator Mk IIs to be delivered to each mechanized unit, three to the defense force in Munich, and three to New Berlin.

### X-5001 Devastator Mk II

**Exclusive to the NGR Military**

**German Name:** die Verwuestung Zwei

**Model Type:** X-5001

**Crew:** Eight, one pilot, one co-pilot, four gunners, one communications officer, and one intelligence officer/Military Specialist, but can be operated at nearly full capability with a crew half that size. The giant robot can accommodate as many as four additional human-sized passengers comfortably, and seven in cramped conditions.

**M.D.C. By Location:**

Super-Laser Cannon (1; handheld) – 250

\* Super-Ion Cannon (1; back) – 350

Long-Range Missile Launcher (1, chest) – 400

Medium-Range Missile Launchers (2, back) – 200 each

\* Mini-Missile Launchers (2, rib cage) – 100 each

Slammer Missile Launchers (2, lower legs) – 120 each

\* Belly Gun – 100

Shoulders (2) – 350 each

Upper Arms (2) – 250 each

Forearms (2) – 300 each

\* Forearm Weapon Housing (2, one per arm) – 200 each

\* Vibro-Swords (2, forearms) – 100 each

\* Hands (2) – 150 each

Legs (2) – 500 each

Feet (2) – 300 each

\* Leg Searchlights (2) – 25 each

\* Leg Spotlights (2) – 5 each

\* Head Searchlight – 10

Medium Cooling Pylons (2) – 250 each

Small Cooling Pylons (2, shoulder) – 120 each

Main Hatch (1; lower back) – 200

\* Emergency Escape Hatches (2) – 125 each

Head/Sensor Array – 400

Reinforced Pilot Compartment – 200

\*\* Force Field – 200

\*\*\* Main Body – 2,150

\* A single asterisk indicates a small or difficult target to hit. They can only be struck when the attacker makes a Called Shot, and even then he is -3 to strike.

Destroying the head eliminates all forms of optical and sensory enhancements, and the pilot must rely on his own human senses without any of the bonuses granted to him by the Robot Combat skill.

\*\* Depleting the M.D.C. of the force field shuts it down and all subsequent damage is taken off the main body. It takes six hours to fully regenerate (33 M.D.C. per hour). **Note:** The force field cannot be raised when the robot is on the attack, but can be

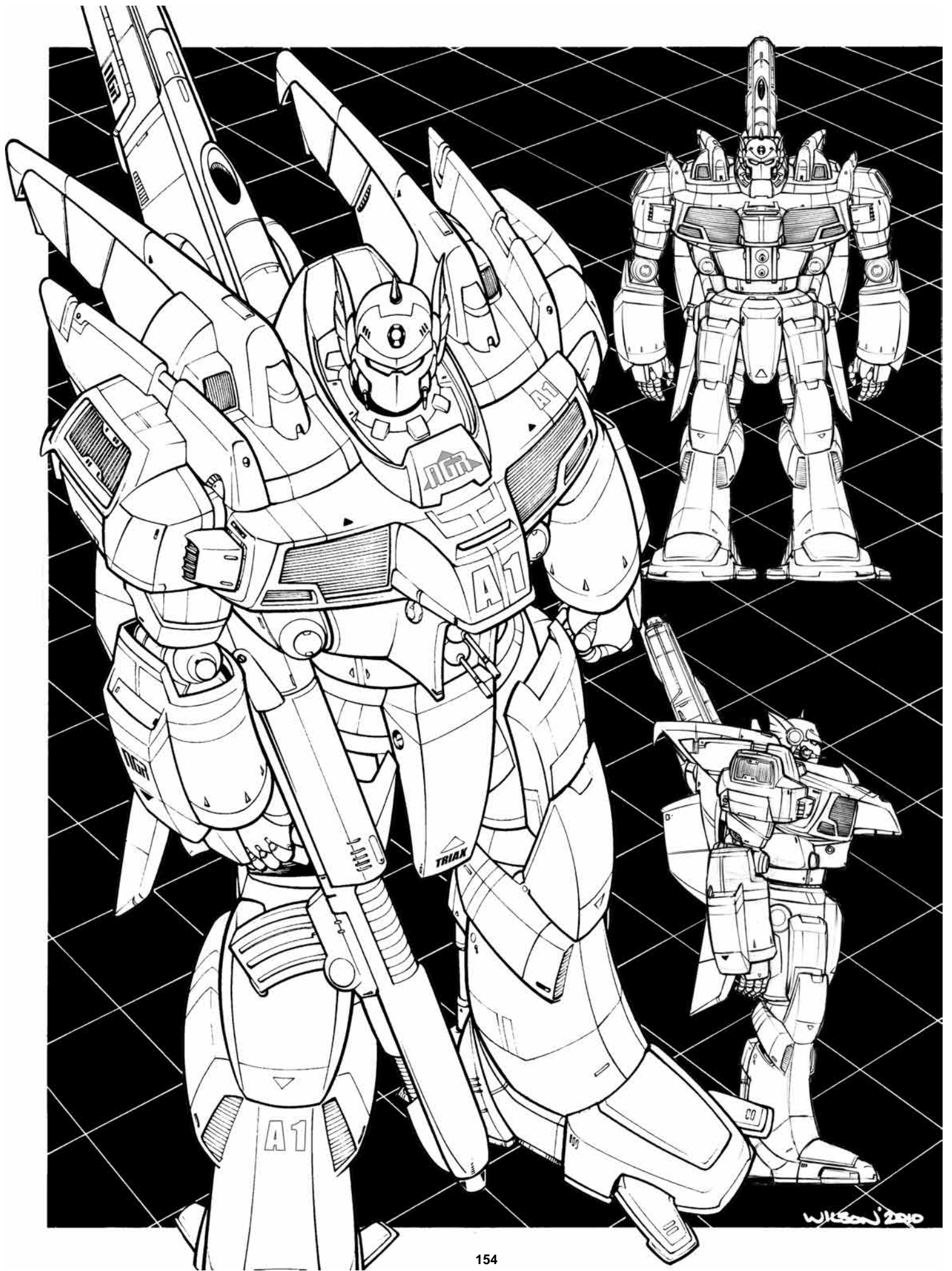

used as a defensive measure to weather an enemy barrage or while making a tactical retreat. The robot's weapons cannot fire when the force field is up.

\*\*\* Depleting the M.D.C. of the main body shuts the robot unit down completely, rendering it useless.

### **Speed:**

Running: 40 mph (64 km) maximum. Cruising speed is usually 20 mph (32 km).

Leaping: Not possible.

Flying: Not possible.

Underwater Capabilities: The robot can walk along the bottom of a body of water at one third its running speed. Maximum depth is two miles (3.2 km).

### **Statistical Data:**

Height: 58 feet (17.7 m).

Width: 25 feet (7.6 m) shoulder to shoulder

Length: 16 feet (4.8 m).

Weight: 160 tons).

Physical Strength: Robot P.S. of 60.

Cargo: Lockers for each crew member, plus power armor storage bay with 4 power armor suits; typically the T-31 Super Trooper, X-11 Predator II, or basic X-535 Jaeger, and an 8x6x6 foot (2.4 x 1.8 x 1.8 m) storage bay.

Power System: Nuclear, average energy life is 20 years.

Black Market Cost: 172 million credits. Exclusive to the NGR Army. Not currently sold on the open market, nor have any appeared on the Black Market.

### **Weapon Systems:**

Much like its predecessor, the power of the Devastator Mk II rests in its super-destructive armaments, massive payloads of missiles, and thick protective armor.

**1. TX-5050 Super-Laser Cannon (1, Rifle):** Based on the huge rifle-like weapon of the original Devastator, over the past 6 years, the weapons engineers at Triax have made advancements in energy weapon technologies. The end result is a truly massive energy weapon capable of dealing out very high-powered energy blasts. Typically manned by the co-pilot or a dedicated gunner.

Primary Purpose: Anti-Armor/Anti-Aircraft/Gargoyles.

Secondary Purpose: Assault.

Range: 8,000 feet (2,438 m).

Mega-Damage: 1D6x10 M.D. per low power blast or 2D6x10 M.D. per single full power blast. Does 50% more damage on a Critical Strike from a roll of an unmodified, Natural 18, 19 or 20.

Rate of Fire: Each blast, low or full power, counts as one of the gunner or co-pilot's melee attacks.

Payload: Effectively unlimited.

Special Feature: +1 to strike in addition to other targeting bonuses.

**2. TX-5051 Super-Ion Cannon (1):** This weapon is also modeled after its predecessor and benefits from the same advances in energy weapons technology. The Super-Ion Cannon is the big gun mounted on the back. It shifts to the

side and swings down over the right shoulder to fire forward facing enemies, but can fire in any position, even the when locked and stowed on back. It is one of the most destructive weapons in the NGR's arsenal. It is manned by a dedicated gunner.

Primary Purpose: Anti-Fortifications and Anti-Armor and Aircraft.

Secondary Purpose: Assault.

Range: 6,000 feet (1,829 m).

Mega-Damage: 4D6x10 M.D. per single full power blast.

Rate of Fire: Each blast counts as one of the gunner's melee attacks.

Payload: Effectively unlimited.

Special Feature: +1 to strike from coordinated targeting system.

**3. Long-Range Missile Launcher (1):** Housed in the center of the chest is a long-range missile launcher. The double doors open, the missiles fire, and the doors close again. Fired by a dedicated gunner.

Primary Purpose: Anti-Armor and Fortified Positions.

Secondary Purpose: Anti-Aircraft and Assault.

Range: Varies with missile type, but typical mix: 12 heavy high explosive (500 mile/800 km range), 4 plasma (500 mile/800 km range) and 4 nuclear (heavy, 1,000 mile/1,600 km range).

Mega-Damage: Varies with missile type, but standard issue is 12 heavy high explosive (4D6x10 M.D. to everything in a 40 foot/12.2 m blast radius), 2 plasma (5D6x10 M.D. to everything in a 50 foot/15.2 m blast radius) and 2 nuclear (heavy, 1D6x100 M.D. to everything in a 50 foot/15.2 m blast radius).

Rate of Fire: One at a time or in volleys of 2, 4 or 6.

Payload: 16 total long-range missiles.

**4. Medium-Range Missile Launchers (2):** On the back, mounted on either side of the Super-Ion Cannon is a concealed medium-range missile launcher. Typically fired by the co-pilot.

Primary Purpose: Anti-Fortified Positions and Anti-Armor.

Secondary Purpose: Anti-Gargoyles and Assault.

Range: Varies with type of missile used, but typically 40 miles (64 km).

Mega-Damage: Varies with missile type, but typically high-explosive (3D6x10 M.D. to everything in a 30 foot/9.1 m radius) or Multi-Warhead (5D6x10 M.D. to a 20 foot/6.1 m radius – this is a smart missile). Often the payload is half and half.

Rate of Fire: Fired one at a time or in volleys of 2, 4, 6, or 8.

Payload: 24 total medium-range missiles, 12 per launcher.

**5. Mini-Missile Launchers (2):** A tubular mini-missile launcher is located on each side of the rib cage area of the Devastator II. The covering folds down to fire missiles and then closes. The onslaught that can be unleashed by this weapon system is terrible and entire waves of Gargoyles can be wiped out by this destructive barrage. Typically operated by the pilot or co-pilot.

Primary Purpose: Anti-Personnel.

Secondary Purpose: Assault and Defense.

Range: Varies with missile type, but fragmentation is the standard payload with a half a mile (0.8 km) range.

Mega-Damage: Varies with missile type, but fragmentation (5D6 M.D. to everything in a 20 foot/6.1 m radius) is the standard load.

Rate of Fire: One at a time or in volleys of 2, 4, 6, 8, 12 or 24.

Payload: 96 total, 48 per mini-missile launcher.

**6. Slammer Concussion Missile Launchers (2):** Concealed in the lower legs of the robot are launchers for Slammer concussion missiles made famous by the Triax Dyna-Max. Typically fired by the same gunner who mans the Belly Gun.

Primary Purpose: Anti-Gurgoyles/Gargoyles.

Secondary Purpose: Anti-Personnel.

Range: 6,000 feet (1,828 m).

Mega-Damage: 2D4x10 M.D. from a direct hit by the missile. More importantly, the concussion effect has a blast radius of 45 feet (13.7 m). All within the blast radius suffer 1D4x10 M.D. and are likely (01-88%) to be knocked off of their feet and stunned (01-65%).

If only knocked down, the victim of this attack has ringing ears and a headache, but only loses one melee attack and initiative. A victim of a direct hit is always knocked off of his feet.

If stunned, the victim is dazed: -10 to strike, parry and dodge, roll with impact or pull punch, is the last to attack, and loses half of his attacks per melee for 1D4 melee rounds! Speed is also reduced by half.

Rate of Fire: One at a time.

Payload: 24 total, 12 per launcher.

**7. Ion Belly Gun Turret (1):** The ion belly turret is designed to counter ground troops and can rotate up and down 90 degrees and rotate left and right 45 degrees. The turret can fire one barrel or both simultaneously. Manned by a dedicated gunner.

Primary Purpose: Anti-Personnel.

Secondary Purpose: Defense.

Range: 4,000 feet (1,219 m).

Mega-Damage: 4D6 M.D. per single blast or 1D4x10 M.D. per dual simultaneous blast.

Rate of Fire: Each single or dual blast counts as one of the gunner's melee attacks.

Payload: Effectively unlimited.

**8. Dual Forearm Weapon Housing: Boom Gun and Vibro-Blade (2):** Mounted on each forearm is a special dual weapon housing that contains a Boom Gun and a retractable Vibro-Sword under the gun.

**Forearm Vibro-Swords (2):** Useful against Gargoyles, Gurgoyles and the large Gargoyle 'Bots in melee combat.

Primary Purpose: Melee Combat.

Secondary Purpose: Defense.

Mega-Damage: 1D6x10 M.D. including damage from Robot P.S. of 60.

Bonuses: +1 to parry and disarm.

**Forearm Mounted Boom Gun (2):** Located in the same forearm housings are one of the infamous Boom Guns. Since the Devastator Mk II weighs so much, there is no need for the recoil suppression system of the Glitter Boy. This weapon is usually used as a last resort since it has a

limited payload and may have detrimental effects on the surrounding troops. Controlled by the pilot.

Primary Purpose: Anti-Armor and Anti-Gargoyle.

Secondary Purpose: Assault and Defense.

Range: 11,000 feet (3,353 m).

Mega-Damage: 3D6x10 M.D. per blast.

Any personnel within a 200 foot (61 m) radius of the Boom Gun without a sound filtration system/ear protection are rendered temporarily deaf for 2D4 minutes and are -8 on initiative, -3 to parry and dodge; this includes Gargoyles and most other monsters. (**Note:** Troops clad in other NGR power armor and inside giant robots are deafened for half that time and suffer half the penalties due to sound dampeners built into ALL NGR power armor and 'Bots.

The sonic boom shatters conventional windows and shakes buildings and vehicles within a 300 foot (91.5 m) radius. Double the radius when both barrels are fired simultaneously.

Rate of Fire: Each blast counts as one melee attack.

Payload: 600 rounds total, 300 rounds per Boom Gun.

**9. The "Shocker" Electric Field Generator:** One of the innovative weapon systems of the Devastator Mk II is the "Shocker Field," which super-charges the metallic alloy plates covering the hulking body with M.D. electricity, shocking and injuring anyone touching the Devastator. This is ideal when the giant robot is being swarmed by Gurgoyles and/or Gargoyles to get them to let go and jump off. If there is a downside, it's that missiles cannot be launched while the Shocker Field is up.

Primary Purpose: Defense.

Range: The outer hull of the robot.

Mega-Damage: 2D6 M.D. every 4 seconds (equal to four attacks per melee round/15 seconds) to everything touching the exterior surface of the Devastator Mk II. Body armor, power armor and anything touching the Devastator takes damage. Thankfully damage is inflicted to the armor, not the soldier inside the armor, at least as long as the M.D.C. holds out. There is a 01-66% chance the surprise of the initial electrical charge makes anyone holding, hitting or climbing on the Devastator II let go and jump off. If that happens the attacker loses initiative and one melee attack. If the character hangs on or keeps hitting, the damage is cumulative and inflicted every four seconds.

Rate of Fire: Four shocks and 2D6 M.D. each time per melee round.

Payload: The electrical field can be maintained for up to two minutes (8 melee rounds) at a time, before automatically shutting off. Can be turned back on after 30 seconds (two melee rounds) or as desired by the pilot or co-pilot. Effectively unlimited.

**10. Sensor Systems Note:** The X-5001 has ALL the most advanced optic, sensory and radio equipment, plus all the features common to most NGR robots.

**11. Hand to Hand Combat:** Rather than use a weapon, the pilot can engage in Mega-Damage hand to hand combat.

**Bonuses & Damage from Elite Robot Combat Training: X-5001 Devastator Mk II.** Bonuses do not apply to gunners, only a trained pilot and co-pilot. Pilots skilled in Heavy

Ground Robots can substitute in a pinch but get half the bonuses listed below.

+1 extra attack/action per melee, plus those of the *pilot* (or co-pilot) at levels 2, 5, 8, 11 and 15.

+1 to strike with ranged weapons.

+2 to strike and parry in hand to hand combat.

+2 to disarm.

+2 to pull punch.

No bonuses to dodge. Must rely on the skill of the pilot.

No bonuses to roll with impact. Must rely on the skill of the pilot.

Damage (Robotic P.S. 60):

Restrained Punch – 4D6 M.D.

Full Strength Punch – 1D6x10 M.D.

Power Punch – 2D6x10 M.D.

Crush, Pry, Tear – 1D6x10 M.D.

Kick – 1D6x10 M.D.

Body Flip/Throw – 4D6 M.D.

Body Block/Ram – 1D6x10 M.D.

Stomp – 6D6 M.D. against targets 15 feet (4.6 m) tall or smaller.

Leap Kick is not possible.

# NGR Combat Vehicles

## XM-350 Rhino

### Heavy Hover Tank

When the Coalition States started developing new machines of war with the assistance of Triax Industries and the NGR, a variety of designs impressed the leaders of the NGR to request further weapons development in certain fields. For years, the NGR has fielded what many considered the best main battle tank in the civilized world, the *XM-330 Phantom Hover Tank*. When the Coalition deployed the CS Linebacker Heavy Hover Tank, development of a new NGR heavy hover tank began immediately.

The *XM-350 Rhino* or “Nashorn” is a low profile hover tank that provides its crew tremendous armor protection. Its main gun is a powerful, double-barrel particle beam cannon built into a turret that can rotate 360 degrees and has a 45 degree up and down arc of fire. When fired in tandem, the particle beam cannon is massively destructive. The Rhino is also equipped with three smaller laser pulse cannon; one in the front and one on each side of the tank. Each can rotate side to side 90 degrees and has a 25 degree up and down arc of fire. A mini-missile box launcher is located just above the sensor and communications turret in the back of the vehicle.

The most upgraded system on the XM-350 is based on the propulsion system that gave the Phantom its name. The hover system allows the XM-350 to move almost silently as it moves

into position around enemy encampments or into a prime firing position.

### Triax XM-350 Heavy Hover Tank

**Exclusive to the NGR Military and Triax Security Forces**

**Model Type:** XM-350 Nashorn.

**Class:** Heavy Hover Tank.

**Crew:** Six: One tank commander, one pilot, one co-pilot/communications officer, and three laser turret gunners.

#### **M.D.C. by Location:**

Main Particle Beam Cannon (1) – 230

Main Turret (top) – 270

Laser Turrets (3) – 130 each

Mini-Missile Launcher (1, back) – 60

\* Sensor Turret (1, back) – 125

\* Top Access Hatch – 100

\* Hover Jets (8, undercarriage) – 20 each

Reinforced Pilot Compartment – 100

\*\* Force Field – 200

\*\*\* Main Body – 800

\* A single asterisk indicates a small or difficult target to hit. They can only be struck when the attacker makes a Called Shot, and even then the attacker is -3 to strike.

Destroying the Sensor Turret located in the rear of the tank knocks out long-range communications and destroys all forms of optical and sensory enhancement. The pilot must rely on his own human senses without any of the bonuses granted to him by the Piloting skill and Special Features.

\*\* Depleting the M.D.C. of the force field shuts it down and all subsequent damage is taken off the main body. It takes six hours to fully regenerate the force field (33 M.D.C. per hour). The force field is used when traveling, on patrol, and between attacks to offer additional protection, and when the tank’s weapons are out of commission. The weapons cannot fire when the force field is up.

\*\*\* Depleting the M.D.C. of the main body shuts the vehicle down completely, rendering it useless.

#### **Speed:**

Land: 70 mph (112 km) maximum. The hover tank can ride on a cushion of air as low as two feet (0.6 m) off the ground or as high as six feet (1.8 m).

Water: Rides on the surface of water at a speed of 20 mph (32 km). No underwater capabilities.

Air: Not possible. The vehicle cannot fly.

#### **Statistical Data:**

Height: 10 feet (3 m).

Width: 22 feet (6.7 m).

Length: 40 feet (12.2 m).

Weight: 60 tons fully loaded.

Cargo: A storage locker with space for one rifle, side arm, and suit of T-10 body armor for each crew member.

Power System: Nuclear, average energy life is 20 years.

Black Market Cost: Not available outside of the NGR.

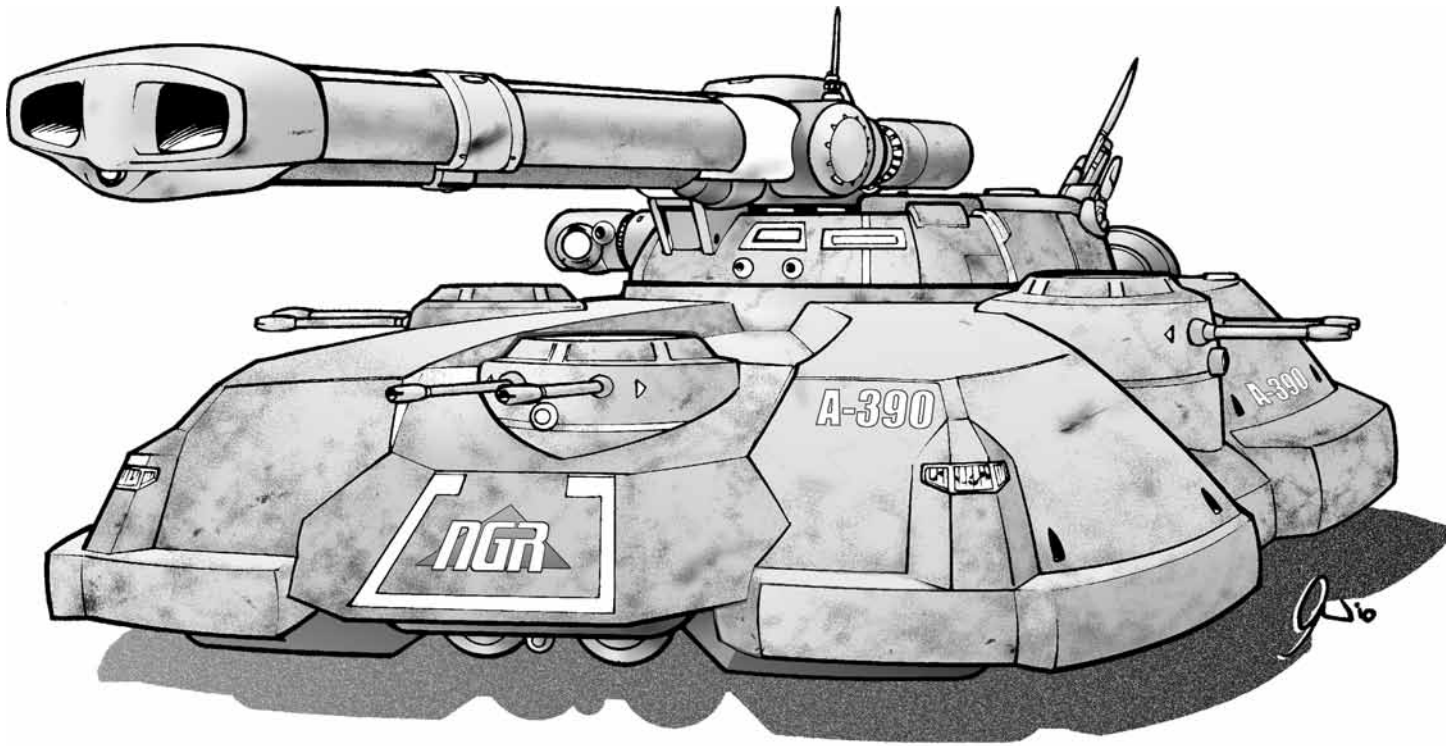

Black Market Cost: 58 million credits. Exclusive to the NGR Army. Not currently sold on the open market and uncommon on the Black Market.

## Weapon Systems:

**1. Main Turret: Heavy, Dual Particle Beam (1):** The main turret of the XM-350 houses one massive cannon that is a double-barreled particle beam. The weapon system can fire one individual blast or a simultaneous dual blast. The gun turret can rotate 360 degrees. The cannon is fired by the pilot or co-pilot. Range is short for a tank's main cannon, but damage yield is high and it is devastatingly effective against swarms of Gargoyles, Gurgoyles and Brodkil.

Primary Purpose: Anti-Armor and Anti-Fortifications.

Secondary Purpose: Anti-Gargoyles and Assault.

Range: 3,000 feet (914 m).

Mega-Damage: 2D4x10+4 M.D. per single blast, 4D4x10+8 M.D. when both barrels are fired in tandem. Critical Strike (double damage) occurs on a roll of a Natural 19 or 20 to strike.

Rate of Fire: Each single or dual blast counts as one melee attack.

Payload: Effectively unlimited.

**2. Pulse Laser Turrets (3):** The XM-350 has three pulse laser turrets, one in the front and one on each side (the rear, fourth turret is the armored sensor array). They can rotate side to side 90 degrees and have a 25 degree up and down arc of fire.

Primary Purpose: Defense.

Secondary Purpose: Anti-Personnel.

Range: 4,000 feet (1,219 m).

Mega-Damage: 3D6+3 M.D. per single shot or 1D6x10 M.D. per triple pulse blast.

Rate of Fire: Each single shot or triple blast counts as one attack.

Payload: Effectively unlimited.

**3. Mini-Missile Launchers (1):** A box launcher is located in the back of the tank, just above the sensor turret.

Primary Purpose: Anti-Aircraft.

Secondary Purpose: Anti-Personnel.

Range: One mile (1.6 km) for high-explosive and a half a mile for fragmentation (0.8 m).

Mega-Damage: Varies depending on type of missile used, but most common is high-explosive (1D4x10 M.D.) or fragmentation (5D6 M.D., 20 foot/6.1 m radius).

Rate of Fire: One at a time or in volleys of 2, 4 or 6.

Payload: 12 explosive mini-missiles total, plus two smoke missiles.

## 4. Special Features:

**A. Sensor Turret:** Communications, radar, optics and tracking same as all NGR robot vehicles, plus the following:

Long-Range Radio and Laser Communications: Receive and transmit radio and video. Range: 1,000 miles (1,600 km).

Advanced Radar: Extended radar range of 100 miles (160 km) and can track 120 enemy targets simultaneously.

Motion Detector: Increased range: 500 feet (152 m), adds to the ability to respond quickly, parry and dodge.

Molecular Analyzer: Identical to the cybernetic lung implant of cyborgs.

**B. Silenced Engine and Propulsion System:** The XM-350 has an improved version of the propulsion system on the XM-330 Phantom. It has an effective Prowl skill of 40% during the day and 70% at night.

**C. 360 Degree Arc of Fire:** The entire main turret can rotate 360 degrees. A full 180 degree rotation only takes one melee action of the pilot, co-pilot, or tank commander.

**C. Spotlight (1, top):** 2,000 foot (610 m) range.

**D. Design Bonuses:** +1 extra attack per melee round is added to the number of attacks of each turret gunner.

+1 to strike with the big gun, in addition to the gunner's bonuses.

+2 to strike with the laser pulse turrets, in addition to the gunner's bonuses.

+1 to dodge.

+5% to Pilot Tank skill due to its mobility and ease of operation.

## New NGR Aircraft

The Full Militarization of the NGR marked a new strategy in the war against the Gargoyle Empire. For generations, the NGR had been satisfied with holding the monsters at bay. While there were pushes and campaigns to hurt and deplete the enemy's forces, the war, for the most part, was a holding action. Now, for the first time, the NGR had decided to take the offensive and be the aggressor. Their goal, to crush and scatter the invaders who, for more than a century, have made it clear they will not stop until the NGR is destroyed and its millions of people slaughtered or enslaved. To make this goal a reality, the NGR and Triax have created an array of new power armor, robots and aircraft to take the battle to the air.

The obvious strategy would be to create a massive air force and blast the sub-demons back to Hell. Fast, high altitude aircraft could decimate the Gargoyle forces in short order and ground troops could come in to mop up. The problem is, aircraft require large airfields for storage, landings and take-offs. While the NGR aircraft outmatch and overpower the Gargoyles in the air, the aircraft are vulnerable on the ground. The larger the air force, the more vulnerable it becomes. Gargoyles are smart enough to realize the danger aircraft represent, and attack aircraft and airfields en masse. They even attack airfields before they are built or finished. The two civilian German airfields are small and the Gargoyles realize they are non-military. Still the monsters randomly attack the airports and random commercial flights. Gargoyles are most likely to attack an aircraft when it is coming in for a landing, taking off to go somewhere or taxiing on the tarmac. This is when the aircraft is at its lowest altitude and slowest speed. Gargoyles (and Brodkil) know all the tricks of bringing an aircraft down. For example, they don't bother with attacking the main body, but destroy one wing to cause it to crash and finish it off and its crew on the ground. Their next target is the engines for a similar result, or the sensor array to blind the pilot. Swarming with dozens of Gargoyles piling onto the aircraft, especially at low altitudes and slow speeds, is also a way to bring down a jet.

The NGR tried establishing airfields outside the NGR, but the Gargoyles followed them (or got reliable intelligence reports) and attacked until the operation to build the airfield was abandoned. Likewise, aircraft and airfields are so large and traffic is so obvious they become targets of Brodkil, dragons, and other monsters. In the current world environment, aircraft are no longer a safe option. This is why the NGR has focused on ground units, giant robots and comparatively small and humanoid-shaped power armor units as its ground to air flying forces. True air superiority is something that has eluded the NGR and all other global powers. Even the very limited commercial air

flights within the NGR are fraught with danger and most people avoid flying as a means of travel even if they can afford it. Heck, most people inside and outside the NGR think commercial flight is insane and a tragedy waiting to happen.

VTOL aircraft are one solution, and the NGR military maintains a few small airstrips, but they are under constant attack. In fact, aircraft and airfields have become red flags that send Gargoyles into a killer rage. Many of the monsters fight to the death to destroy aircraft and tear up airfields. Furthermore, Gargoyle Mages and Gargoylites are known to hire (or coerce) practitioners of magic (often D-Bees or other monsters) to use ley lines and Rifts as a means of magical transportation to get Gargoyle troops close to strategic targets like airfields, landed aircraft and the factories that make them, to overrun them in surprise attacks and destroy or damage aircraft, slaughter personnel, and rip up the airfield. This constant harassment has worked to force the NGR to keep its air force small and its aircraft very specialized.

While the NGR has a few jet fighters, their numbers are small and the vehicles and their pilots are at great risk. Even flyers such as the XM-180 Dragonfly, the XM-199 Phoenix and XM-279 Earth Lifter, which does not look like a conventional aircraft, are besieged by Gargoyles every chance the enemy gets. This has reduced the value and effectiveness of aircraft, at least against the Gargoyle Empire, and Brodkil aren't much more tolerant of them. Still, the wiz-kids at Triax come up with new aircraft designs, as well as new flying power armor and robots, to take the fight against the Gargoyles into the air. Persistence may pay off in the long run, especially with flying power armor and robots which do not garner the same amount of attention, venom and suicidal assaults that aircraft receive, and can be more easily concealed and protected. Still, the new flying power armor and robots are the most hated and attacked in greater numbers, and with more ferocity, than other types of power armor and combat robots.

The bottom line for the NGR is simple: They cannot field a large or versatile air force. They are limited to a small air force, restricted to specialized aircraft. All of this means the job of *fighter pilots* is absolutely the most deadly in the NGR. That's why the new *Luftwaffe Cyborg Pilots* are taking over the flying of most aircraft. The idea being that these cyborg pilots have a better chance of surviving Gargoyle attacks and crashes.

It bears mentioning that the persistent rumor that Triax has successfully reverse engineered an alien *anti-gravity engine* is completely false. Neither the NGR nor Triax has ever recovered an anti-gravity device, and even if they do so someday, and even if they could figure out the technology, it would take several decades (if ever!) to do so. Odds are, such an alien and advanced technology is beyond Triax, the CS, Archie Three or any Earth technological power.

The aircraft described in the pages that follow are either experimental and made in very small quantities, or like the *Wraith*, are built with Gargoyles in mind and have design elements specific to combating the monsters.

### Standard Systems on all NGR Aircraft

(Special thanks to Justin Kugler and Edward A. May, who served as technical consultants.)

In addition to the usual features common to Robots and Armored Vehicles (see **Rifts® World Book Five**, page 48 for de-



tails), the new aircraft have an expanded array of enhanced sensors and equipment to make them more effective. Likewise, the older NGR fighters like the XM-275 have been updated with these advanced systems (described below). **Note:** Likewise, except for transport aircraft, half of the *old aircraft* in the NGR Army, and all older models given to the New Luftwaffe, have been retooled to be flown by a single Cyborg Pilot.

**Combat and Targeting Computer:** These systems are essentially identical to those fitted to standard types of Triax Robot Vehicles, but are configured to allow the aircraft to use the exceptional range of its computer in combat. In addition to these common features, the advanced targeting computer will attempt to aid in targeting, providing a bonus of +1 to strike by graphically indicating on the HUD angles of deflection, energy states of enemy aircraft, and similar pertinent details.

**High-Bandwidth Communication Antennas:** Secure communication with up to 32 other aircraft within range of 200 miles (320 km).

**Hindsight Radar System:** This separate radar system is contained at the rear of modified aircraft. It essentially allows a pilot to see targets approaching from the rear and to lock forward-facing missiles onto targets *behind* the aircraft. This separate radar system has a 30 mile (48 km) range and can see in a 60 degree cone of sky immediately behind the aircraft. This system is slaved to the tracking computer previously described. **Note:** This feature is superseded by the more powerful radar systems on the Military Cybernetic Airframes.

**I.F.F. Transponder:** This is a sophisticated system that utilizes encrypted radar pulses to determine friendly from unfriendly aircraft. This system sends an interrogation signal to any unknown aircraft within 225 miles (360 km), which is automatically detected by their transponder system. Their transponder then sends an automated reply if it is coded to understand the interrogation signal. Triax transponders indicate the pilot/aircrew names and ranks, unit, mission, aircraft type, course, speed and altitude to compatible I.F.F. devices. These coded signals are very difficult to crack, and are changed periodically to keep such sensitive material out of the hands of enemies. This system is instrumental in helping to prevent midair accidents, mistaken identity, friendly fire incidents, and to further aid coordination on the battlefield.

**Imaging Radar and Tracking Computer:** This system is a sophisticated and powerful radar and tracking computer designed to detect *and* image objects at extreme ranges. The radar is so sensitive, up to a range of 200 miles (320 km) in a 180 degree arc in front of the craft, that it can literally create an image of the radar return and surmise a visual of the object that it is viewing. The tracking computer linked to the radar is capable of tracking 144 objects. The radar screen also acts as a touch pad, so if the pilot (or other crew member) wants to view what is on the radar screen, all he does is push the icon of the tracked object. This brings up a pop-up image next to the icon displaying what the radar return is revealing. Also included are terrain-following capabilities to aid piloting nap of the earth maneuvers and for detecting targets amid ground clutter.

**Inertial Navigation Computer:** This system charts the movement of the aircraft along with prerecorded sector charts

and maps to aid the aircrew in identifying their position, and navigating to wherever they need to be. The imaging radar also provides an accurate, up to the moment view of the terrain in front of the aircraft, allowing the pilot to locate landmarks amidst the landscape. This system provides a +20% bonus to the operator's Navigation skill.

**Laser Communications Array:** A small receiver panel fixed on the tail surfaces and a retractable turreted laser transmission device somewhere on the dorsal spine of the fuselage comprise the main components to this system. This system is used for making jamming and interception free communications between fighter units and airbases, without breaking radio silence. The range is generally limited to about 10 miles (16 km), but can be double on exceptionally clear days.

**Laser Targeting:** This system is essentially identical to that fitted to common Triax vehicles, but with a longer range of 10 miles (16 km). Unlike common North American types, this not only aids in targeting during short-range engagements, but aids in long-range engagements, and can also be used to direct laser-guided munitions to their targets (+5 to strike as the target is "painted" by the laser).

**Magnetic Anomaly Detection System:** A small, retractable probe in the nose or tail of the aircraft may be extended to search for large masses of metal such as hidden armored vehicles, robot vehicles, artillery pieces, and even submarines. It can see up to one mile (1.6 km) underwater, in a one mile (1.6 km) radius, from an altitude of 6,000 feet (1,829 m). Over land, it can see buried or hidden metal objects up to 10 feet (3 m) underground, in a one mile (1.6 km) radius, from the same altitude. Devices that use electromagnets, such as rail guns and electromagnetic drives, also trigger this device when in this mode of searching, at double the usual range (2 miles/3.2 km).

**Radar Detector:** This system detects when the aircraft has been scanned by radar waves, and analyzes them to determine their intent, and direction to the microwave transmitter. Furthermore, this system is programmed to memorize specific radar frequencies and strengths to indicate what type of radar set is being used to scan the aircraft. An example of this system in action is that of a ground-based Black Knight robot vehicle scanning the sky with its radar and picking up the aircraft. The radar detector in turn indicates to the pilot and crew the type of radar wave as an active scan, the direction from which it was detected, and is likely able to indicate that it is from a friendly radar set (or at least one manufactured by Triax).

**Anti-Missile Radar/Radio Jamming System (R/RJS):** This is an active though minor electronic countermeasures system intended to thwart the radar guidance portion of modern missiles and nearby communications, though it does little to impede the optical imprint portion of the guidance systems commonly used in most *missiles*. The system attempts to jam any missile painting the aircraft with its radar within a 15 mile (24 km) radius, with a 01-45% success rate. Up to two dozen radio frequencies may be jammed simultaneously, as per the command of the pilot or aircrew if trained in Electronic Countermeasures or Advanced Electronic Warfare. If the radar unit that is actively scanning the fighter is friendly, the pilot/aircrew may opt to override the R/RJS.

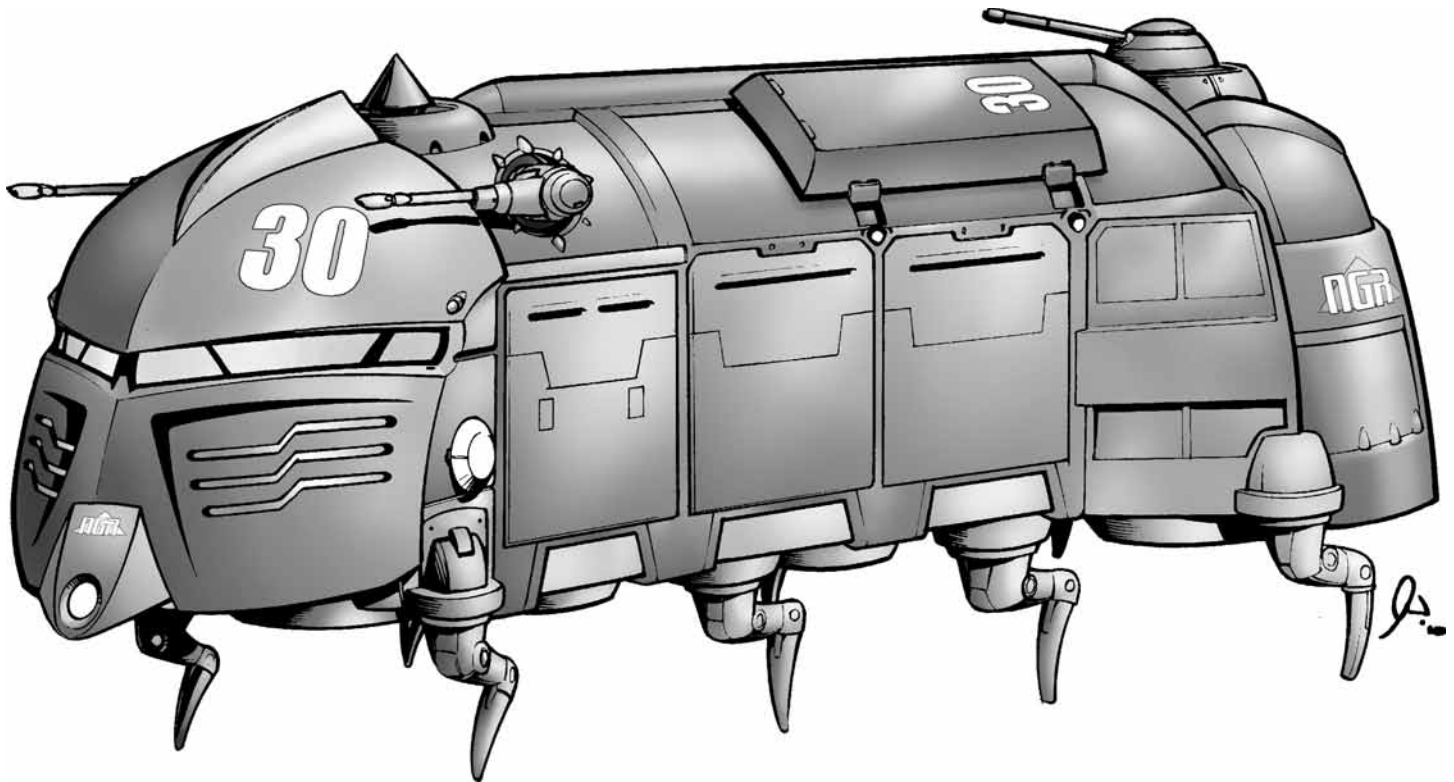

## XM-279 Earth Lifter

### Armored Transport

The XM-279 Earth Lifter is the NGR's answer to the *Coalition Death's Head Transports*. At 300 feet (91.4 m) long, the transport is capable of carrying almost any combination of NGR troops and can take them anywhere in the NGR in a matter of hours. The flying troop carrier is armed with particle beams, rail guns, and a battery of missiles to protect it and its valuable cargo until it reaches its destination, and may also be escorted by power armor troops or flying robots. Whereas this vehicle has formidable combat capabilities, it is rarely used in an offensive capacity, except to clear a landing zone before departure of its troop complement or deployment of cargo.

The XM-279 Earth Lifter has VTOL capabilities so it does not need an airstrip and can land on any firm terrain, even if the ground is a little rough or bumpy. To land, four legs unfold from each side. The six bay doors lower down to serve as the loading ramps, and troops and cargo disembark. The thrusters in the undercarriage are powerful enough to lift the craft off of the ground with a full load in about seven seconds (half a melee round), and off it goes. The Earth Lifter carries infantry troops and power armor units, but can also haul small vehicles and tons of cargo.

The original notion was that since this armored transport does not look like an aircraft, it would not be aggressively targeted by Gargoyle forces for annihilation. That notion proved to be incorrect, thus the use of the Earth Lifter is often limited to hauling troops to locations within the borders of the NGR, Poland and other locations not dominated by Gargoyles. This has also kept the transport's production low.

Apparently, Gargoyles hate anything that flies, and they recognize the purpose of the Earth Lifter as a troop transport and

the danger it represents. As a result, the hovering behemoth is set upon by swarms of the enemy wherever it appears, and whether it is coming or going; retreat does not stop the attack. The enemy is happy to fight to the death or until the vessel is destroyed. Even a crippled, downed Earth Lifter (or any aircraft) is tracked down and besieged until it is a smoking wreck. Clever in many ways, the Gargoyles have learned that the NGR usually sends in recovery teams to rescue any downed pilots and personnel, or to retrieve salvage from the downed craft. In response, the Gargoyles first rip the aircraft apart and grab any weapons and equipment their fighting forces can use, trade or sell. Second, they destroy gear they can't themselves use or easily sell. Third, the enemy usually sets up 1-6 patrols around the crash site as well as an ambush at the crash site to take down NGR troops.

### XM-279 Earth Lifter Armored Transport

#### Exclusive to the NGR Military and Triax Security Forces

**Model Type:** XM-279

**Class:** Military VTOL Transport.

**Crew:** Ten: One pilot, one co-pilot, three gunners, two communications engineers, two technical officers, and one crew chief.

**Troop Transport Capabilities:** 500 infantry soldiers (no power armor or giant robots). However a common mixed troop complement is 96-144 infantry soldiers, 72-96 power armor troops, and 12-20 robot vehicles.

**Cargo:** In the alternative to troops and war machines, as much as 190,000 tons of supplies and gear can be transported.

#### **M.D.C. by Location:**

Forward Windows (2, long) – 90 each

\* Forward Searchlight (1, front) – 10

\* Forward Sensor Cluster (1, top) – 100

- \* Undercarriage Landing Lights (10) – 3 each
- \* Forward Particle Beam Cannons (2) – 100 each
- \* Rear Laser Turret (1) – 150
- \* Concealed Rail Gun Turrets (4, two front, two back) – 50 each
- \* Side-Mounted Short-Range Missile Launchers (2, top) – 170 each
- VTOL Thrusters (10, undercarriage) – 140 each
- Rear Jet Thrusters (4) – 200 each
- Landing Legs (8) – 100 each
- Side Deployment Doors/Ramps (6) – 350 each
- Reinforced Crew Compartment – 200
- Force Field Generators (back section) – 600
- \*\* Force Field – 400
- \*\*\* Main Body – 1,800

\* A single asterisk indicates a small or difficult target to hit. They can only be hit when the attacker makes a Called Shot, and even then the character is -3 to strike.

\*\* Depleting the M.D.C. of the force field shuts it down and all subsequent damage is taken off the main body. It takes 12 hours to fully regenerate the force field (33 M.D.C. per hour). The force field is used when traveling, landing and takeoff, and while standing idle in the field. The weapons cannot fire and troops cannot disembark when the force field is up. The back section between the last bay door and the jet thruster housing (very back section where the laser turret is mounted) houses the force field generators. If that section is depleted of M.D.C., the force field is down completely.

\*\*\* Depleting the M.D.C. of the Main Body shuts the hover transport down completely, rendering it useless, and causing it to crash if in flight.

### Speed:

Running: Not possible.

Leaping: Not possible.

Flying: Hover stationary, hover above ground and slow movement for repositioning, and a maximum flying speed of 600 mph (960 km). Cruising speed is considered to be about 300 mph (480 km). Maximum altitude is 40,000 feet (12,192 m).

Water: Can hover above water, but has no ability to travel on or under water; sinks like a stone.

### Statistical Data:

Height: 80 feet (24.4 m).

Width: 90 feet (27.4 m).

Length: 300 feet (91.5 m).

Weight: Approximately 1,700 tons for the aircraft itself.

Storage Area for Crew & Internal Use: Two storage closets for crew weapons, gear and T-25 body armor, plus 20 first aid kits complete with RMK and IRMSS kits, and food and water for the crew for two weeks.

Power System: Nuclear, average energy life is 20 years.

Black Market Cost: 380 million credits. Fewer than a dozen are in service and they are exclusive to the NGR Army. Not sold on the open market and not available on the Black Market.

## Weapon Systems:

**1. Forward Particle Beams (2):** In the forward section, behind the crew compartment, are a pair of particle beam cannons. They point forward but can rotate 360 degrees to fire up, down and behind, but only a 20 degree outward (away from the body of the vehicle) arc of fire. They are used to clear out landing zones and defend against incoming attackers. Each is manned by a dedicated gunner.

Primary Purpose: Defense.

Secondary Purpose: Anti-Gargoyle/Aircraft and Assault.

Range: 4,000 feet (1,219 m).

Mega-Damage: 1D6x10+10 M.D. per single blast; Critical Strike (double damage) on a roll of a Natural 19 or 20 to strike. Because the two weapons are spread wide apart they can only be fired simultaneously at the same target (2D6x10+10 M.D.) if that target is at least 100 feet (27.4 m) wide.

Rate of Fire: Each single or dual blast counts as one of the gunner's melee attacks.

Payload: Effectively unlimited.

**2. Short-Range Missile Launchers (2):** Two large, short-range missile launchers are located on the top and off to the sides of the transport. They are used to blast incoming threats, or to attack ground targets called in by ground units. Fired by one of the gunners or the co-pilot.

Primary Purpose: Defense.

Secondary Purpose: Anti-Aircraft/Gargoyles and Assault.

Range: Varies with type of missile; high-explosive is five miles (8 km) and fragmentation is three miles (4.8 km).

Mega-Damage: Varies with type of missile used. Most common are high-explosive (2D6x10 M.D. to a 15 foot/4.6 m radius) or fragmentation (2D4x10 M.D. to a 20 foot/6.1 m radius).

Rate of Fire: One at a time or in volleys of 2, 4, 8 or 16.

Payload: 96 total missiles, 48 in each launcher.

**3. Rear Laser Turret (1):** A laser turret is located in the rear section of the transport above the jet thrusters. The turret can rotate 360 degrees and has a 220 degree arc of fire up and down. It is used against incoming aerial attackers from the rear and is manned by a dedicated gunner.

Primary Purpose: Defense.

Secondary Purpose: Anti-Gargoyle/Aircraft and Assault.

Mega-Damage: 6D6 M.D. per single blast.

Range: 6,000 feet (1,829 m).

Rate of Fire: Each blast counts as one of the gunner's melee attacks.

Payload: Effectively unlimited.

**4. Concealed Rail Gun Turrets (2):** Two rail gun turrets extend from the undercarriage in the nose/forward section. Both can rotate 360 degrees and have a 180 degree arc of fire from the bottom of the Earth Lifter to the ground and to behind the transport. They are used primarily against enemy ground forces and for defense and manned by the pilot or co-pilot.

Primary Purpose: Assault.

Secondary Purpose: Defense.

Range: 6,000 feet (1829 m).

**Mega-Damage:** 6D6 M.D. per 30 round short burst or 1D6x10 M.D. per 60 round long burst; fires standard ammo (not DU- or U-rounds). This weapon can only fire bursts.

**Rate of Fire:** Each short or long burst counts as one melee attack of the pilot or co-pilot.

**Payload:** 12,000 rounds each for 200 long bursts. Reloading each weapon takes about an hour and a skilled gunner or technician.

**5. Escorts (Optional):** As a rule, the Earth Lifter is accompanied by flying power armor, flying robots or combat aircraft for additional protection.

**6. Sensor Systems of Note:** The standard sensors and features common to all NGR aircraft, plus the following:

**A. Thermal Imager:** Converts heat radiation into a visible image. Enables the pilot to see in the dark, through shadows and smoke. Range 2,000 feet (610 m).

**B. Infrared and Ultraviolet Optics:** This optical system projects a beam of infrared light that is invisible to the naked eye. The infrared beam allows the pilot to see in the dark and to see other infrared beams. The ultraviolet system allows the pilot to see in the ultraviolet spectrum of light and is mostly used to detect the light beams of ultraviolet detection systems and sensors. **Note:** The infrared light beam can be seen by anybody who also has infrared optics, and the beam can be traced back to its source. Smoke impairs the infrared beam, making it impossible to see.

**C. Enhanced Radar:** Identifies and simultaneously tracks up to 192 different targets. Range: 200 miles (320 km).

**D. Special Bonuses:** +2 to dodge when flying at cruising speeds, and +3 to dodge when flying over 300 miles per hour (480 km). Trained NGR pilots receive a +10% bonus to their Piloting skill to fly the XM-279 transport.

**E. Force Field:** Described under M.D.C. by Location.

## XM-199 Phoenix

### Transport Aircraft and Troop Drop Ship

The XM-199 is a bigger, heavier version of the XM-180 Dragonfly. Both are designed to carry power armor troops, robots, and cargo pods to drop supplies and troops into enemy territory. The pilot compartment of the Phoenix looks very similar to the Dragonfly, but instead of having one short carrying pylon to hold power armor or cargo, it has three. Furthermore, the Phoenix is larger and longer, so it can carry much more than the Dragonfly, and it has VTOL (Vertical Take-Off and Landing) capabilities so it doesn't need an airfield, can be *hidden* from the enemy in ordinary warehouses and under tents and tarps, rather than out in the open on an airfield or in a hangar, and can get in and out of landing zones without an airstrip. Actually, like the Dragonfly (see **Rifts® World Book Five**), the Phoenix seldom *lands* in enemy territory. It flies overhead, usually at a fairly high altitude to avoid detection by the enemy, and "drops" its cargo and lets them fall to the ground below. (**Note:** See Deployment Pods in the *Mobile Base* section later in this book.)

The Phoenix is armed with lasers, rail guns and missiles, as well as provided additional protection by a force field. The

XM-199 has superior survivability for deploying and supporting forward positions, outposts and troop movement, which is good, because they, like all aircraft, are hated and targeted for destruction by the Gargoyle forces. One third sent into the combat theater never return.

### XM-199 Phoenix Mobile Fortification Transport

**Exclusive to the NGR Military and Triax Security Forces**

**Model Type:** XM-199

**Class:** Combat Supply and Troop Transport.

**Crew:** Five: One pilot, one co-pilot, one communications officer, and two gunners.

**Troop Transport Capacity:** The Phoenix can carry 22 Jaeger-sized units, 16 Ulti-Max II or Gunman-sized units, or 44 human troops/parachuters.

**Cargo Payload:** Rather than carry troops, the Phoenix can carry cargo in special "cargo drop pods" or what is often referred to as deployment pods. There are 22 transportation slots (with 44 carrying clamps) to carry up to 22 cargo pods. Human troops can double up on these holders which is why 44 troops can be carried versus 22 Hunter power armors or 22 cargo pods.

**M.D.C. by Location:**

\* Nose Gun (Double-Barreled Laser Turret) – 80

\* Rear Rail Gun Turret – 120

\* Medium-Range Missiles (2, wingtips) – 25 each

\* Sensor Domes (2, mid-section, top) – 60 each

\* Carrying Clamps (up to 44) – 10 each

\* Wings (2) – 200 each

Tail Section (1) – 160 each

Main VTOL Fan Thrusters (3) – 225 each

Main Thrusters (2, forward section) – 200 each

\* Secondary Thrusters (2, tail) – 80 each

Carrying Pylons (3) – 220 each

Reinforced Pilot Compartment – 150

\*\* Force Field – 200

\*\*\* Main Body – 400

\* A single asterisk indicates a small or difficult target to hit. They can only be struck when the attacker makes a Called Shot, and even then he is -3 to strike.

Destroying both Sensor Domes eliminates all forms of optical and sensory enhancement and the pilot must rely on his own human senses without any of the bonuses granted to him by the Piloting skill.

\*\* Depleting the M.D.C. of the force field shuts it down and all subsequent damage is taken off the main body. It takes six hours to fully regenerate the force field (33 M.D.C. per hour). The force field is used when traveling, landing and takeoff, and while standing idle in the field. The weapons cannot fire and troops cannot disembark when the force field is up.

\*\*\* Depleting the M.D.C. of the main body shuts the vehicle down completely, rendering it useless, and if in flight, the aircraft crashes. Thanks to its VTOL system, destroying one wing or the tail section does not cause the Phoenix to crash, but reduces speed and altitude by half. Destroying both wings or one wing and the tail section causes the aircraft to fall out of the sky.

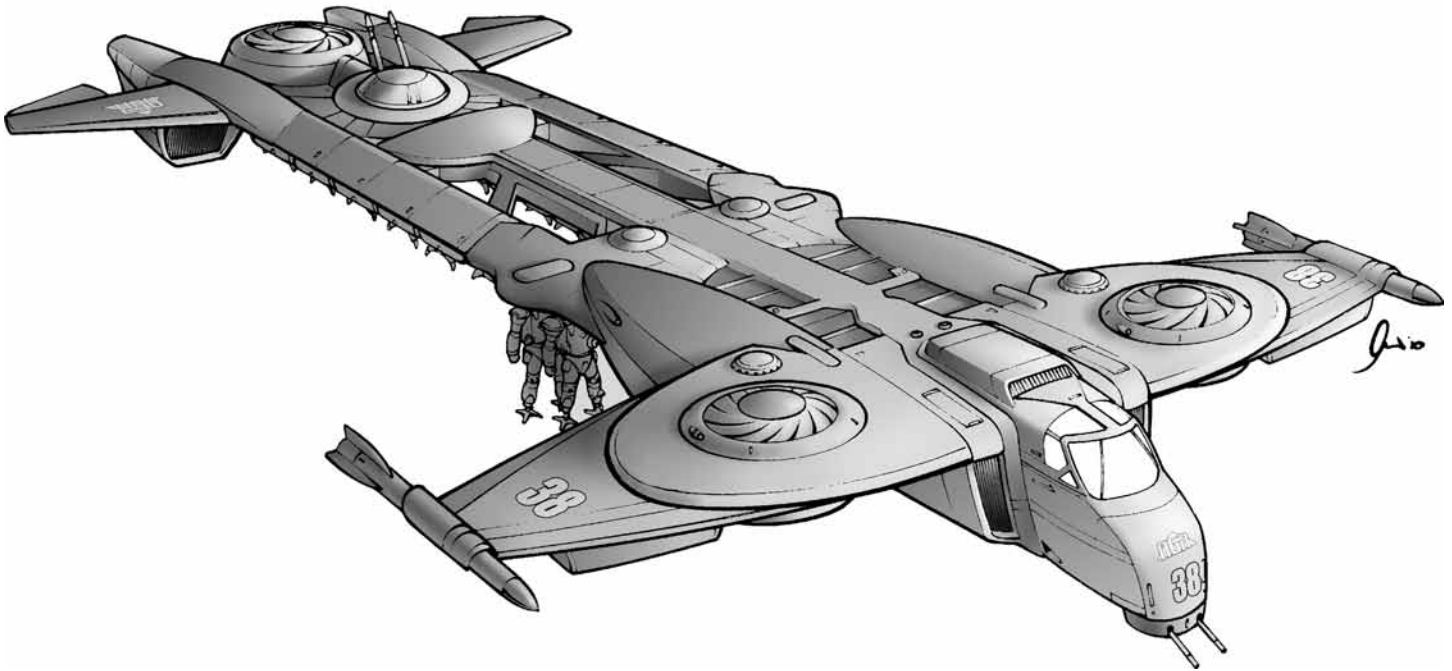

### **Speed:**

Driving on Ground: 10 mph (16 km).

Flying: 670 mph (1,072 km) maximum; cruising speed is 300 mph (480 km). Maximum altitude is 50,000 feet (15,240 m).

Flying Range: Effectively unlimited.

### **Statistical Data:**

Height: 22 feet (6.7 m).

Width/Wingspan: 55 feet (16.8 m), but the wings fold up, making the unit only 30 feet (9.1 m) wide for storage/housing.

Length: 100 feet (30.5 m)

Weight: 30 tons unloaded.

Cargo: Storage space for each member of the crew, enough for a rifle, side arm, and light suit of body armor.

Power System: Nuclear, average energy life is 20 years.

Black Market Cost: 34 million credits. Exclusive to the NGR Army. Not currently sold on the open market or available on the Black Market.

### **Weapon Systems:**

**1. Main Gun/Laser Turret (1):** A double barreled laser turret is built into the nose of the aircraft. It can rotate 360 degrees and has a 220 degree up and down arc of fire. Operated by a dedicated gunner.

Primary Purpose: Assault.

Secondary Purpose: Anti-Armor.

Range: 4,000 feet (1,219 m).

Mega-Damage: 2D4x10 M.D. per single blast.

Rate of Fire: Each blast counts as one of the gunner's attacks.

Payload: Effectively unlimited.

**2. Rail Gun Turret (1, rear):** A double-barreled rail gun turret is built into the tail section of the aircraft. It can rotate 360 degrees and has a 180 degree arc of fire. Operated by a dedicated gunner. Does not use DU- or U-rounds.

Primary Purpose: Assault.

Secondary Purpose: Defense.

Range: 4,000 feet (1,219 m).

Mega-Damage: 6D6 M.D. per 30 round short burst or 1D6x10 M.D. per 60 round long burst; fires standard ammo (not DU- or U-Rounds). This weapon can only fire bursts.

Rate of Fire: Each short or long burst counts as one melee attack of the gunner.

Payload: 6,000 rounds each for 100 long bursts.

**3. Short-Range Missiles (2):** Mounted under each wing is a box launcher containing short-range missiles. These are typically operated by the co-pilot or pilot.

Primary Purpose: Defense.

Secondary Purpose: Anti-Aircraft/Gargoyles and Assault.

Range: Varies with type of missile used, but high explosive is five miles (8 km) and fragmentation is three miles (4.8 km).

Mega-Damage: Varies with type of missile used. Typically high-explosive (2D6x10 M.D. to everything in a 15 foot/4.6 m radius) or fragmentation (2D4x10 M.D., 20 foot/6.1 m damage radius), or a combination of the two.

Rate of Fire: One at a time or in volleys of 2, 4, 8, 16 or 32.

Payload: 32 total missiles; 16 in each launcher.

**4. Medium-Range Missile Launcher (2):** Each wing has a single medium-range missile. Typically operated by the pilot.

Primary Purpose: Anti-Aircraft/Gargoyles.

Secondary Purpose: Defense.

Range: Varies with type of missile used, but both high explosive and fragmentation missiles have a range of 40 miles (64 km) and are the standard payload.

Mega-Damage: Varies with type of missile used. Typically high-explosive (3D6x10 M.D. to everything in a 30 foot/9.1 m blast radius) or fragmentation (2D6x10 M.D., 40 foot/12.2 m damage radius).

Rate of Fire: One at a time or both at once.

Payload: Two.

**5. Anti-Missile Chaff Dispenser (1):** Located in the tail end of the vehicle is a chaff dispenser. When trailed by missiles, a cloud of chaff, flares and other obtrusive particles can be released to confuse or detonate the enemy's attack.

Primary Purpose: Anti-Missile.

Mega-Damage: None, but roll percentile dice to determine the result:

**01-50%:** Enemy missile or missile volley detonates in chaff cloud. The threat is over.

**51-75%:** Enemy missile or missile volley loses track of real target and veers away in the wrong direction (may lock onto nearby aircraft).

**76-00%:** No effect. Missiles still on target.

Also note the chaff cloud will temporarily blind Gargoyles and other creatures flying through the cloud. The victims suffer the following penalties: Reduce melee attacks/actions, combat bonuses, and speed by half for 1D4 melee rounds. However, after that period the creature recovers and can renew his attack.

Payload: 16

**6. Sensors of Note:** The standard sensors and features common to all NGR aircraft.

# XML Series Cybernetic Airframes

## Militärischer Kybernetischer Flugzeugrahmen

The XML series of fighters are, in effect, cybernetic body extensions for the pilots of the New Luftwaffe. XML Cyborg Pilots are all unique cyber-humanoids whose bodies are designed to integrate into the aircraft and become one with it and take complete control over it.

## Luftwaffe Cyborg Combat Pilot O.C.C.

By Kevin Siembieda

Inspired by ideas and text by Taylor White and Brandon Aten.

The combat pilots of the New Luftwaffe are a new breed of warrior. All start as aviators in the NGR Army. Those who have distinguished themselves as especially brave and cool under fire may be invited to join the Luftwaffe. Accepting the invitation takes the pilots to the Luftwaffe airbase at *Birkenfeld*, where they undergo a battery of examinations that test their skills in basic and advanced aerial combat techniques, Gargoyle combat tactics, and aviation history, among other topics. They also undergo secret (i.e. the candidates are not aware of it) psychiatric evaluation and tests of their loyalty to the NGR. Becoming a Luftwaffe Aviator is not something to be taken lightly and it will change the candidate's life forever.

Fewer than 30% of the candidates are accepted into the New Luftwaffe. The rest go back to the Army to continue to serve as airmen piloting transports and other aircraft. Those who do meet the expectations of the Luftwaffe are told about the extensive *cybernetic reconstruction* their position requires. About half decline the invitation and go back to their previous positions in the Army.

**Those who accept** undergo a bionic transformation that turns them into a specialized Full Conversion Cyborg. The extensive bionic conversion enables the Luftwaffe Cyborg Combat Pilots to completely interface with their aircraft and perform aerial feats that are impossible for normal human pilots. After full conversion is accomplished, the new pilots undergo two months of grueling combat training in their new cyborg bodies and then another two months of combat training inside their cybernetic airframes. This is a new cybernetic process developed by Triax in which the Cyborg Combat Pilot becomes one with his aircraft.

A new, specialized, cybernetic neural interface system enables the XML Cyborg Combat Pilot to completely merge with the airframe of his combat vehicle. The aircraft becomes an extension of his own body. This can be a surreal experience the first dozen times the interface occurs. Inexperienced pilots typically lose a sense of time, space, purpose and even *self*, as all the elements of the aircraft become their own. The body of the aircraft and all its systems become a full functioning part of the Cyborg Combat Pilot. The wings, landing gear, sensor array, gun pods, and instrument panels are now physical and mental extensions of himself. The pilot *feels* and *knows* things about his airframe body instantly as information comes in, damage is taken, and weapons are fired. He can feel the energy of the nuclear power supply burning inside his belly. He feels the missiles leaving as if he had just thrown a weapon from his hand. He feels the wind and air caressing his frame as he flies, and he knows – just knows – his speed, altitude and air pressure as it changes. Likewise, the Cyborg Combat Pilot feels the heat of a plasma missile across his side, or the impact of rail gun rounds as they tear through his arms/wings, or the sting of a Gargoyle's claw as it slashes across his back or belly. It's all really damage to the aircraft, but the Cyborg Combat Pilot feels it as if it were his own body – because it is his body. That's how complete the connection and immersion with the cybernetic airframe is for the pilot. There is no (or little) actual physical pain, but the sensation is still there. Likewise, the pilot can feel it when electronic systems start to fail or sensors are knocked off-line. It is all something that takes a considerable amount of experience and practice to take it all in without feeling like *you* are going blind or numb or being shredded to pieces.

**Why put the pilot through all this?** Because the ones who can handle it are amazing and able to do things in their fighters that no flesh and blood pilot could ever do.

The response time and reflex action of Cyborg Combat Pilots interfaced with their fighters are, on average, nine times faster than a human pilot. They can dodge, take evasive action, and attack in the blink of an eye. They have a very keen awareness of what their aircraft bodies can do, and it enables them to push the vehicles to their limits. This results in aerial acrobats and maneuvers at unimaginable speeds without system failure, human

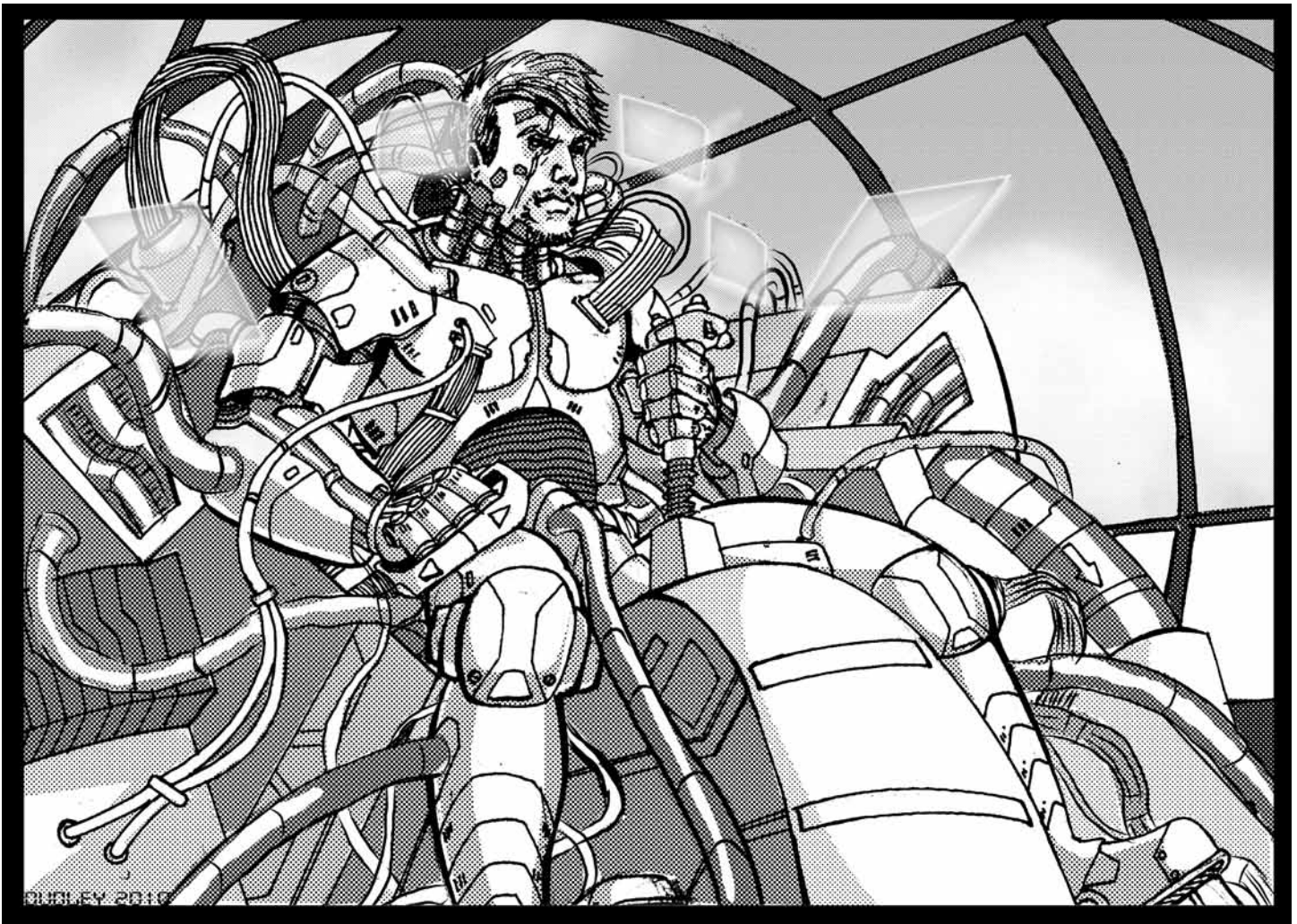

error or crashing. The Cyborg Combat Pilot can push the speed barrier and whip around buildings in a city, city ruins or the peaks of a mountain without tumbling out of the air or crashing. They can skirt the ground or rooftops with only a foot (0.3 m) between aircraft and surface, and pull up, swerve, dodge, and break off an attack with absolute precision. This makes them more than a match for the slow-moving Gargoyles, and capable of engaging, outmaneuvering and outgunning most known aircraft.

Once they get used to it, most Cyborg Combat Pilots love the visceral sensations of flying their combat aircraft. They love the feel of flying, the power of the engines burning, the high speed maneuvers, the climbs, the dives and the aerial acrobatics. Combat, for most, is the greatest thrill of all. Many Cyborg Combat Pilots actually report feeling the wind through their hair (which isn't there), power surging through their muscles (which they don't have), and the rush of adrenaline (which doesn't exist) when they are on a mission. All of which is impossible, yet they claim they actually *feel* it. Feel it and love it. The sensations are in their minds, but it all feels so real.

**On the down side**, it makes Cyborg Combat Pilots adrenaline junkies and thrill seekers. Even in combat, some take what seem to be unnecessary and crazy risks and chances. According to the pilots' reports later, they usually say they were in complete control and did not see any risk. When not flying or, better yet, engaged in combat, the Cyborg Combat Pilots either feel

bored out of their skulls, or on edge and anxious. To counter this, the NGR has discovered that having the pilots engage in any physical or mental activity keeps their minds preoccupied. Mental activity such as playing videogames, word games, watching action movies or comedies, and solving puzzles also keeps the Cyborg Combat Pilot from going stir crazy and helps him to stay calm, sharp and even tempered. Surprisingly, most Cyborg Combat Pilots are cheerful, friendly, considerate and even playful. So far, they have not shown any of the psychological issues, particularly depression, anxiety and disassociation, that other Full Conversion Cyborgs exhibit. This is due, in large part, to the fact that they feel "alive" – even hyper-alive – when interfaced with their cyber-airframes and engaged in flying missions (any) or combat. Of course, if there wasn't enough to do, and if they couldn't fly all the time, that might change. Furthermore, the Luftwaffe Cyborg program is only a few years old and there is no telling what or how bad the long-term effects might be.

As cyborgs, the flyers only need 3-4 hours of sleep/rest per day. Keeping a Cyborg Combat Pilot occupied for 20-21 hours a day that doesn't involve flying and combat can be problematic. The military has found one solution for that: Let them fly missions for 14-16 hours a day, with four hours down time and four hours of sleep. It is a pace they seem to be able to handle, and it's not like the NGR's borders don't need patrolling around the clock, or there aren't millions of Gargoyles, Brodkiil and other

monsters to track, observe and fight, so let them do it. Triax has found another solution: A neural transmitter sleeping berth that puts the cyborgs into a meditative state that is calming and relaxing for up to 8 hours at a time. This is especially useful in calming down and helping combat pilots who seem unusually agitated, aggressive or anxious. Actually, if necessary, the sleeping berths could put the flyers in a peaceful trance for up to 48 hours without any negative physical or mental side effects.

## Luftwaffe Cyborg Combat Pilot Bionics

**1. Bionic Humanoid Body:** The primary body of the Luftwaffe pilot is a light bionic frame left as a metallic body, except for a completely human face/head (usually their own, original face, though sometimes, at the pilot's request, improved to look more dashing and heroic). The Cyborg Combat Pilots are required to wear clothing when not inside their aircraft, as they are, in effect, Top Secret, and the Luftwaffe wants to hide the fact that its pilots are anything more than human. If the Coalition States, Sovietski or other "friendly" countries found out about their super-cyborg pilots and the advantages they have over human pilots, coupled with the NGR's unwillingness to share this technology — god only knows how they would respond, but it's a fair bet that it wouldn't be good.

The New Luftwaffe is the only military force in the world to use this kind of technology, with nobody else even close. Not even the insane Angel of Death at Mindwerks has dreamed up anything like this. The illustration shows the cyborg in a standard flight simulator in one of the early training stages to get the pilot used to his new body and abilities. However, in actuality, the Cyborg Combat Pilot is slipped into a special housing inside the aircraft, in a prone position, where myriad connectors plug into his body, all the data flashes directly into his mind and he sees what the camera systems and sensors of the aircraft tell him. The aircraft becomes his cybernetic body and responds to his commands at the speed of thought, like any other cybernetic body would.

**Size & Shape:** Human equivalent, able to wear standard issue infantry body armor.

**Physical Attributes of the Cyborg Body:** Robot P.S. 22, P.P. 20 (has no correlation to flying ability), P.E. Not applicable, P.B. 1D6+12 (as per face), Spd 66 (45 mph/72 km).

**Height:** 5 feet, 8 inches to 6 feet (1.7 to 1.8 m). Anything more ruins the illusion of being human.

**Weight:** 250-300 pounds (112.5 to 135 kg); varies in size based on the pilot's original body and basic standards for linkage to the cybernetic airframe.

### M.D.C. by Location:

Hands (2) – 25 M.D.C. each

Forearms (2) – 30 M.D.C. each

Upper Arms (2) – 40 M.D.C. each

Feet (2) – 12 M.D.C. each

Legs (2) – 50 M.D.C. each

Head – 60 M.D.C.

Main Body – 150

**Attacks per Melee:** Five attacks or actions.

**Standard Cybernetic Features:** Bionic Lung with Gas Filter and Oxygen Storage Cell (2 hours), Built-In Loudspeaker, Built-In Radio Receiver & Transmitter Headjack, Climb Cord, Clock/Calendar, Cyber-Nano-Robot Repair System, Depth Gauge & Alarm, Fingerjack, Headjack, human equivalent eyesight and hearing, Gyro-Compass, Language Translator, Radiation Sensor, Sound Filtration System, and the XML cybernetic airframe interface system.

**Bionic Weapon Systems:** The cybernetic airframe is the Cyborg Combat Pilot's "weapon system." None outside the aircraft.

**2. Military Cybernetic Airframe:** XML series aircraft and older model aircraft converted to XML systems; excludes transport and non-combat airframes.

**3. Elite Aerial Combat Skill: XML Series:** These are the bonuses and abilities the Cyborg Combat Pilot gets when he "interfaces" with an XML series military cybernetic airframe, the way a robot pilot gets bonuses to piloting a particular style of robot. However, the integration is so complete that the bonuses are superhuman, and enable the pilot to engage in fast moving, aerial acrobatics and dogfights zipping between Gargoyles in a dense flock without hitting them, and engaging the enemy in combat that more resembles an aerial ballet than a traditional dogfight. NGR Army pilots who observe Luftwaffe Cyborg Combat Pilots in battle are astounded at the accuracy of their attacks and maneuverability, leading some to start hushed rumors that there may be something more than meets the eye with the New Luftwaffe.

**Note:** The Elite Aerial Combat skill and bonuses below apply only when the character is flying *XML Series cybernetic airframes*. Piloting any other type of aircraft, the character only has his normal bionic body abilities and combat training, +1 one attack per melee round.

+12% to the skill Pilot: Jet Fighters.

+2 extra attacks/actions per melee round *added* to those of the Cyborg Combat Pilot (5) for a total of seven at level one, +1 additional attack/action at levels 3, 5, 7, 9 and 15.

+4 non-combat actions per melee round. These are actions that do no damage and involve maneuvering to dodge, swerve, fly up, down or around, take evasive action, etc.

+4 on Perception Rolls.

+1 on initiative at levels 1, 2, 3, 5, 7, 9, 11 and 13.

+2 to strike with rail guns and energy weapons of the cybernetic airframe being piloted at levels 1, 2, 4, 6, 9 and 12.

+2 to strike with missiles, even unguided missiles.

+4 to roll with impact.

**Automatic Dodge:** The act of dodging does NOT use up a melee attack/action, regardless of speed (slow or at full throttle). +2 to auto-dodge at levels 1, 2, 4, 7, 11 and 15.

**Critical Strike** (double damage) on an unmodified Natural 18-20.

*Can goose the airframe for +10% greater speed and altitude than is believed statistically possible based on the design specifications (i.e. numbers listed in the aircraft's description).*

*Can goose the airframe for last gasp performance by +10% based on main body M.D.C. Normally, if the main body of an*



aircraft is reduced to zero, all systems shut down and the aircraft crashes. HOWEVER, the Cyborg Combat Pilot can, through force of will, hold the airframe together for a while longer, despite the tremendous damage it has suffered. In game terms, it is as if the fighter has an extra, emergency 10% more M.D.C. This is enough for the pilot to get in that one last attack (then the aircraft is dead and he must eject or crash) or to make one last evasive maneuver and retreat to head back to base. Upon landing the torn up aircraft safely, all systems shut down and it actually falls apart seconds after touchdown! If the cybernetic airframe loses that extra 10% M.D.C. before a safe landing, the aircraft falls to pieces in mid-air and the Cyborg Combat Pilot falls to his doom (50% chance for a successful ejection).

*Surviving a fall.* Being a light Combat Cyborg there is a *chance* the pilot survives a fall (or crash) from high altitude. Roll percentile dice and reduce his odds of survival (starting at 100%) -20% for every 10,000 feet (3,048 km) of altitude. So if he was at 10,000 feet (3,048 km) he has a 01-80% chance of survival. At 20,000 feet (6,096 m) he has a 01-60% chance of survival. At 30,000 feet (9,144 m) he has only a 01-40% chance, and at 40,000 feet (12,192 m) only a 01-20% chance. He also suffers 1D6x10 M.D. damage for every 10,000 feet (3,048 m) he falls.

## Cyborg Combat Pilot O.C.C. Stats

**Alignment:** Any.

**Attributes Requirements:** I.Q. and M.E. 12 or higher, all others not applicable, it's the XML cybernetic airframe interface system and Luftwaffe special training program that matters.

**Racial Requirements:** The NGR Luftwaffe only use human pilots.

### O.C.C. Skills:

- Computer Operation (+10%)
- History: Aviation/Luftwaffe (+20%)
- Literacy: Euro (+30%)
- Language: Euro (+30%)
- Language: One of choice (+15%).
- Laser Communications (+10%)
- Math: Basic (+20%)
- Military Etiquette (+20%)
- Navigation (+25%)
- Pilot: Airplane (+20%)
- Radio: Basic (+10%)
- Sensory Equipment (+20%)
- Weapon Systems (+20%)
- W.P. Energy Pistol
- W.P. Energy Rifle
- Hand to Hand: Expert (Can be upgraded to Martial Arts at the cost of one O.C.C. Related Skill.)

### Combat Pilot M.O.S.

- Combat Flying
- Pilot: Hover Craft or Hovercycles (+30%)
- Pilot: Jet Fighters (+30%)

Pilot: Jet Aircraft (+24%)

Pilot: One of choice (+20%).

Pilot: Elite Aerial Combat: XML Series (Special, see above).

**O.C.C. Related Skills:** Select one other skill at levels 1, 2, 4, 7, 10 and 13. All new skills start at level one proficiency.

Communication: Any (+10%).

Cowboy: None.

Domestic: Any.

Electrical: Any (+5%).

Espionage: Any.

Horsemanship: None.

Mechanical: Basic and Aircraft Mechanics only (+10%).

Medical: First Aid and Paramedic only (the latter counts as two skills).

Military: Any (+10%).

Physical: Any, except Acrobatics or Wrestling.

Pilot: Any (+15%).

Pilot Related: Any (+15%).

Rogue: None.

Science: None.

Technical: Any.

W.P.: Any.

Wilderness: None.

**Secondary Skills:** Select three skills from the Secondary Skills List on page 300 of **Rifts® Ultimate Edition**, plus one additional Secondary Skill at levels 4, 8 and 12. These are additional areas of knowledge that do not get any bonuses, other than any possible bonus for having a high I.Q. All Secondary Skills start at the base skill level.

**Standard Equipment:** T-10 Cyclops armor for use when in their cyber-humanoid body, a flight suit, uniform, dress uniform, fine leather gloves, tinted goggles, handheld computer, pocket flashlight, portable tool kit, survival knife, one energy rifle of choice, one energy pistol of choice, 4 E-Clips for each, backpack, utility belt, canteen, and hovercycle or hover vehicle for personal use.

**Equipment Available Upon Assignment:** Military Cybernetic Airframe: Any, but typically starts with an XML-280 Black Eagle or XML-283 Wraith. Additional weapon pods may be added to the airframe as described at the end of this section. Most Luftwaffe Cyborg Combat Pilots have mid-level to top security clearance.

**Money:** The pilot gets a roof over his head, food, clothing, bionic maintenance and all other basic needs provided free as part of his pay. The character also receives a monthly salary of 2,500 credits (the savings of a first level character is 2D4x1000 credits). High ranking officers (8th level and higher) get 4,000 to 5,000 credits a month. Combat pilots get a private apartment. Starts as a Lieutenant after being accepted into the Luftwaffe.

**Cybernetics:** Previously described.

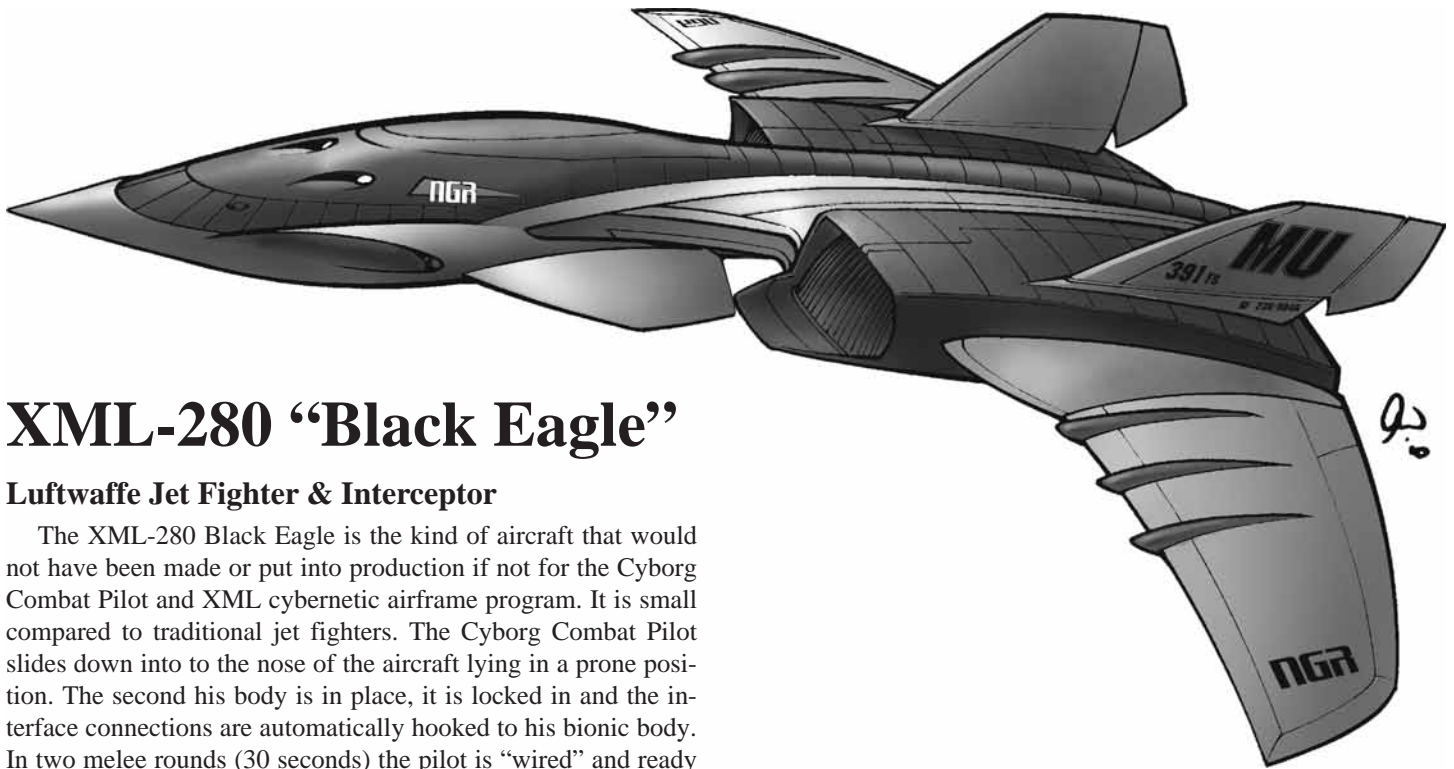

## XML-280 “Black Eagle”

### Luftwaffe Jet Fighter & Interceptor

The XML-280 Black Eagle is the kind of aircraft that would not have been made or put into production if not for the Cyborg Combat Pilot and XML cybernetic airframe program. It is small compared to traditional jet fighters. The Cyborg Combat Pilot slides down into to the nose of the aircraft lying in a prone position. The second his body is in place, it is locked in and the interface connections are automatically hooked to his bionic body. In two melee rounds (30 seconds) the pilot is “wired” and ready to take off. The aircraft is designed to fly right into a Gargoyle flock or roost and engage in dogfight-style combat with winged Gargoyles or flying Brodkil cyborgs. It may also engage in strafing runs against Gurgoyles, enemy robots and other enemy ground forces. In the hands of the Cyborg Combat Pilot, the Black Eagle can fly through streets, whip around corners, soar through mountain peaks and canyons, and engage the enemy wherever he may be found outdoors. They have become famous for rocketing into massive flocks of Gargoyles as they descend from the sky on infantry troops, bases and civilian cities and border towns to break the flock up and give the attacking monsters second thoughts about continuing their attack. Likewise, fast flying Black Eagle squadrons may zoom in low to the ground (a few hundred yards/meters to one or two yards/meters), guns blazing, to take on charging Gurgoyles or to save a fallen infantry soldier from one about to deliver a death blow.

On the battlefield and fighting above Gargoyle roosts and lairs, the XML-280 Black Eagle engages the enemy at speeds as slow as 130 mph (208 km) up to 350 mph (560 km), but it is still a supersonic fighter capable of sudden acceleration and sustained speeds of Mach 2. It may also carry a variety of ordnance load-outs attached to hardpoints (two on each wing), including missiles, free-falling bombs, lasers and other weapon pods. These are in addition to the nose laser guns the Cyborg Combat Pilots love to dogfight and strafe with.

### XML-280 “Black Eagle”

**Exclusive to the NGR Luftwaffe**

**Model Type:** XML-280

**Class:** XML Cybernetic Airframe Multi-Role Fighter

**Crew:** One specially-modified Cyborg Combat Pilot.

**M.D.C. by Location:**

- \* Recessed Nose Lasers (3, top) – 30 each
- \* Recessed Mini-Missile Launcher (2, sides) – 50 each

- \* Hardpoints (4, two per wing) – 15 each
- Jet Thrusters (2) – 200 each
- Wings (2) – 160 each
- Tail Fins (2) – 50 each
- \* Landing Gear (3) – 20 each
- Reinforced Pilot Compartment – 100
- \*\* Main Body – 380

\* A single asterisk indicates a small or difficult target to hit. They can only be struck when the attacker makes a Called Shot, and even then he is -4 to strike (-10 when the aircraft is going Mach 1 or faster).

Destroying one wing causes the airframe to become dynamically unstable and the pilot must immediately return to base (RTB); speed is reduced by half and serious maneuvers are made at -50% to Piloting skill rolls even for the cyborg (a fighter jet piloted by an ordinary pilot would have crashed already). If the Cyborg Combat Pilot fails his Piloting skill roll, he must eject immediately because the fighter is crashing. Destroying both wings causes the fighter jet to crash.

\*\* Depleting the M.D.C. of the main body completely destroys the vehicle and it will crash. HOWEVER, the Cyborg Combat Pilot *may* be able to still land the aircraft by holding it together through sheer force of will and an extra (temporary) 10% M.D.C.; see **Elite Aerial Combat Skill: XML Series** for details. When the fighter is destroyed in the air, the automatic ejection and recovery system immediately engages to save the pilot.

#### **Speed:**

**Flying:** Mach 2 (approximately 1,340 mph/2,144 km) is the maximum speed, but the Black Eagle can engage the enemy at speeds as slow as 130 mph (208 km).

**Flying Range:** Effectively unlimited.

**Maximum Altitude:** 65,000 feet (19,812 m).

### Statistical Data:

Height: 13 feet (3.9 m) tall from the belly of the craft to the tip of the tail fins.

Width/Wingspan: 34 feet (10.3 m).

Length: 48 feet (14.6 m).

Weight: 19 tons fully loaded.

Cargo: None.

Color: Black or dark grey.

Power System: Nuclear, average energy life is 20 years.

Black Market Cost: 158 million credits. Exclusive to the NGR Luftwaffe. Not sold on the open market and unavailable on the Black Market.

### Weapon Systems:

**1. Nose Lasers (3):** The nose section of the fighter has three recessed, high-powered, fixed forward lasers. They are used in aerial dogfights and strafing runs. NGR Cyborg Combat Pilots love to engage in dogfights and close combat in the air, over rooftops, mountain peaks, and low to the ground.

Primary Purpose: Anti-Aircraft/Anti-Gargoyle.

Secondary Purpose: Defense and Assault.

Range: 4,000 feet (1,219 m).

Mega-Damage: 3D6 M.D. per single blast, 6D6 per double blast and 1D4x10+8 M.D. per triple blast.

Rate of Fire: Each single, dual or triple blast fired simultaneously at the same target counts as one of the pilot's melee attacks.

Payload: Effectively unlimited.

**2. Nose Mini-Missile Launchers (2):** On each side of the nose is another recessed weapon system that is difficult to see with the dark coloring. These are mini-missile launchers.

Primary Purpose: Anti-Aircraft/Anti-Gargoyle.

Secondary Purpose: Defense and Assault.

Range: A half mile (0.8 km) for standard issue fragmentation.

Mega-Damage: Varies with missile, but fragmentation is standard issue (5D6 M.D. to everything in a 20 foot/6.1 m radius).

Rate of Fire: 1, 2 or 4.

Payload: Eight total, four per each of the nose mini-missile launchers.

**3. Wing Hardpoints (4):** There are two hardpoints on each wing on the Black Eagle, allowing for more munitions, weapons, and mission specific equipment to be mounted and tied into the cybernetic airframe. The hardpoints are mountings that hold weapon pods for more firepower. Any of the XLH series weapons can be used.

Primary Purpose: Varies with type of weapon used.

Secondary Purpose: Varies with type of weapon used.

Range: Varies with type of weapon used.

Mega-Damage: Varies with type of weapon used.

Rate of Fire: Varies with type of weapon used.

Payload: Varies with type of weapon used.

**4. Anti-Missile Chaff Dispenser (1):** Located in the tail end of the vehicle is a chaff dispenser. When trailed by missiles, a

cloud of chaff, flares and other obtrusive particles can be released to confuse or detonate the enemy's attack.

Primary Purpose: Anti-Missile.

Mega-Damage: None, but roll percentile dice to determine the result:

**01-50%** Enemy missile or missile volley detonates in chaff cloud. The threat is over.

**51-75%** Enemy missile or missile volley loses track of real target and veers away in the wrong direction (may lock onto nearby aircraft).

**76-00%** No effect. Missiles still on target.

Also note the chaff cloud will temporarily blind Gargoyles and other creatures flying through the cloud. The victims suffer the following penalties: Reduce melee attacks/actions, combat bonuses, and speed by half for 1D4 melee rounds. However, after that period the creature recovers and can renew his attack.

Payload: Four.

**5. Sensors of Note:** Standard as described earlier in this section.

## XML-283 "Wraith"

### Low Altitude Jet Fighter

The XML-283 Wraith is actually a highly advanced and revolutionary aerial fighter. It is comparatively tiny – smaller than most robots(!) – low profile and for the most part, a flying wing with guns. The XML-283 is shaped like an arrowhead with a plot compartment, two jet thrusters, a dozen tiny maneuvering jets and some recessed lasers. It has a radar signature that is easy to confuse with power armor, and can fly low to the ground to completely circumvent radar detection. It is capable of full flight vectoring, making it extremely maneuverable and agile.

The Cyborg Combat Pilot slides down into to the pilot's housing in the back of the aircraft lying in a prone position. The second his body is in place, it is locked in and the interface connections automatically hook to his bionic body. In two melee rounds (30 seconds) he is "wired" and ready for takeoff. Like the Black Eagle, the Wraith is designed to fly right into the thick of Gargoyle forces and engage in dogfight-style combat and strafing runs. Being smaller and even more maneuverable than the Black Eagle, in the hands of a Cyborg Combat Pilot, the Wraith can not only fly through streets, whip around corners, soar through mountain peaks and canyons, and engage the enemy wherever he is found, but the arrow-shaped fighter can fly sideways through narrow alleyways and even into Gargoyle roosts and nests. Power armor troops frequently raid skyscrapers turned Gargoyle roost, but they usually fly in, go so far, stop and make a standing, pitched battle before retreating or clearing the place of their inhuman enemy. Wraith pilots also fly inside buildings Gargoyles have turned into a roost, but they rocket down the hallways and large, open areas where Gargoyles and Gurgoyles live, blasting away and zooming around them, to come out the other side of the building, whip around, and make another run. The Wraiths do these strafing runs at speeds of 200-300 mph (320 to 480 km), and create so much confusion that they send the entire Gargoyle stronghold into an uproar in a matter of seconds. Wraiths may also plunge into the inner sanc-

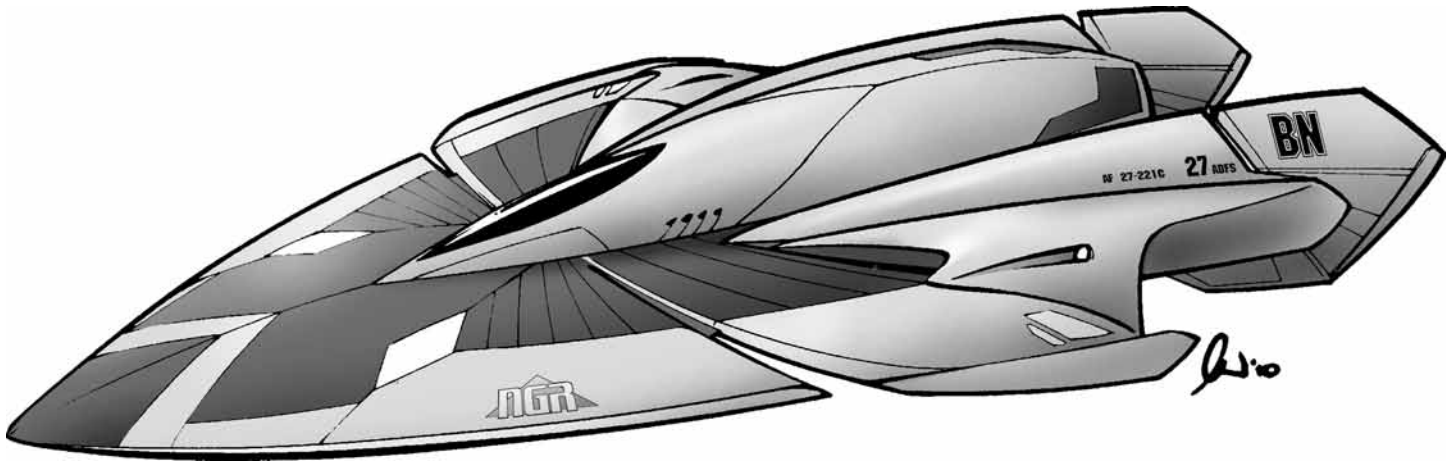

tums of the Gargoyles to punch a way in or out for power armor and infantry troops, or rescue troops that are trapped or pinned down. The Wraith can even enter Gargoyle aviaries, where they blast nests into scrambled eggs and gun down the defenders.

Pilots of the Wraith often work in conjunction with Black Eagles and power armor troops. Despite their amazing abilities and daring maneuvers when wired into their cybernetic airframes, Cyborg Combat Pilots are team players whose first concern is the other soldiers they are backing up. As a result, the pilots never do anything to put their comrades in harm's way, and do everything to aid and protect them.

To preserve the Wraith's aerodynamics and speed, it has no hardpoints and never adds other weapons to the airframe. The pilot relies entirely on the four rapid-fire lasers (one recessed in each wing near the thrusters and two in the underbelly), and its six mini-missiles that drop from a housing in the belly of the aircraft. After that, it's all speed and skill.

## XML-283 "Wraith"

### Exclusive to the NGR Luftwaffe

**Model Type:** XML-283

**Class:** XML Cybernetic Airframe Fighter.

**Crew:** One specially, modified Cyborg Combat Pilot.

### M.D.C. by Location:

- \* Recessed Wing Lasers (4, two top, two bottom) – 20 each
- \* Recessed Mini-Missile Launcher (1, belly) – 35
- \* Jet Thrusters (2, rear) – 170 each
- Wings (2) – 145 each
- \* Landing Gear (3) – 20 each
- \* Reinforced pilot Compartment – 100
- \*\* Main Body – 300

\* A single asterisk indicates a small or difficult target to hit. They can only be struck when the attacker makes a Called Shot, and even then he is -5 to strike (-11 when the aircraft is going 400 mph/640 km or faster).

With the Wraith it is difficult to tell where one wing ends and the other begins. Furthermore, the wings can take a fair amount of damage without causing the aircraft to crash. Destroying one wing causes the airframe to become less stable. The pilot can still fly, but speed is reduced by 30% and serious maneuvers are made at -20% to all Piloting skill rolls. When two-thirds (66%)

of the wings are gone, speed is reduced by half, the Piloting skill penalty is -50% for any maneuver other than basic flying, the cyborg needs to return to base or make an emergency landing. If the pilot fails his Piloting skill roll at any time, he must eject immediately because the aircraft is crashing. Destroying both wings causes the fighter to crash.

\*\* Depleting the M.D.C. of the main body completely destroys the vehicle and it will crash. HOWEVER, the Cyborg Combat Pilot *may* be able to still land the aircraft by holding it together through sheer force of will and an extra (temporary) 10% M.D.C.; see **Elite Aerial Combat Skill: XML Series** for details. When the fighter is destroyed in the air, the automatic ejection and recovery system immediately engages to save the pilot.

### Speed:

Flying: 560 mph (896 km) is the maximum speed, but cruising speed is 330 mph (528 km) and the Wraith can slow down to a dead stop and hover in mid-air if necessary. Can fly sideways, upside down and fly through narrow spaces with ease and at high speed.

Flying Range: Effectively unlimited.

Maximum Altitude: 45,000 feet (13,716 m) but tends to do most of its fighting at 10 feet (3 m) to 10,000 feet (3,048 m) above the surface.

### Statistical Data:

Height: 6 feet (1.8 m) tall from the belly of the craft to the top of the pilot compartment.

Width/Wingspan: 16 feet (4.9 m).

Length: 22 feet (6.7 m).

Weight: 9 tons fully loaded.

Cargo: None.

Color: Silver and royal blue.

Power System: Nuclear, average energy life is 20 years.

Black Market Cost: 125 million credits. Exclusive to the NGR Luftwaffe. Not sold on the open market and unavailable on the Black Market.

### Weapon Systems:

1. **Wing Lasers (4):** One forward fixed laser is located on the underside of each wing near the nose of the pilot compartment and one on top of each wing near the thrusters. They

are for aerial dogfights and strafing runs. NGR Cyborg Combat Pilots love to engage in dogfights and close combat in the air, over rooftops, mountain peaks, low to the ground and inside large buildings and Gargoyle cave nests.

Primary Purpose: Anti-Aircraft/Anti-Gargoyle.

Secondary Purpose: Defense and Assault.

Range: 4,000 feet (1,219 m).

Mega-Damage: 3D6 M.D. per single blast, 6D6 per double blast, 1D4x10+8 M.D. per triple blast and 1D6x10+6 per quadruple blast.

Rate of Fire: Each single, dual, triple or quadruple blast fired simultaneously at the same target counts as one of the pilot's melee attacks.

Payload: Effectively unlimited.

**2. Belly Mini-Missile Launcher (1):** A door slides open in the belly of the airframe to release mini-missiles that drop from a housing inside the pilot compartment section of the aircraft and take off at the target.

Primary Purpose: Anti-Aircraft/Anti-Gargoyle.

Secondary Purpose: Defense and Assault.

Range: A half mile (0.8 km) for standard issue fragmentation.

Mega-Damage: Varies with missile, but fragmentation is standard issue (5D6 M.D. to everything in a 20 foot/6.1 m radius).

Rate of Fire: 1, 2 or 4.

Payload: Six total.

**3. Sensors of Note:** Standard as described earlier in this section.

## XML-285 “Ghost”

### Air-Superiority Stealth Fighter

The XML-285 Ghost is the newest fighter of the Luftwaffe. It is a stealth fighter that brings an impressive array of capabilities to the battlefield. A variety of weapons and sensors allow it to dominate the sky and coordinate attacks from other members of its air wing.

Originally, the weapons loadout of this stealth fighter only included a light pulse laser and air to air missiles, but throughout the course of its development, more features were seen as crucial in order for it to be a true dominant force against a wide range of enemies, not just the Gargoyle Empire. It is manufactured in Poland and kept at a small, secret airfield in Poland that, so far, has remained undetected by Gargoyles and Brodkil.

The XML-285 is a stealth aircraft with a much reduced radar cross section with features such as radar absorbing materials and structural design to negate electronic means of detection. It has trapezoidal wings reminiscent of many pre-Rifts fighter designs like the F-22 or YF-2. Against the low-tech Gargoyles, this feature doesn't mean much unless they are supported by robots and power armor with radar detecting capabilities, but against technological opponents, the aircraft is a “ghost.” The designers took the Gargoyles' low-tech nature and obsessive hatred for aircraft into account and added an electronic variable visual camouflage to the external surfaces of the fighter, making it extremely difficult to spot with the naked eye.

When a part of a larger force, the XML-285 Ghost and its communications and coordination capabilities assist in monitor-

ing troop movement, target designation and battlefield management. Combined with its speed, thrust vectoring maneuverability, VTOL hover capabilities and weapons loadout, the Ghost is a capable fighter.

The Cyborg Combat Pilot is slotted into the pilot's compartment in a prone position and he handles all aspects of the aircraft. However, there is a second cockpit that can hold three crewmen, typically communications officers for handling independent and/or additional communications, sensor systems and electronic attacks against the enemy.

### XML-285 “Ghost” Air-Superiority Fighter

**Exclusive to the NGR Luftwaffe**

**Model Type:** XML-285

**Class:** XML Cybernetic Airframe Stealth Capable Fighter

**Crew:** One specially modified Cyborg Combat Pilot, plus up to three communications officers, depending on the mission.

**M.D.C. by Location:**

\* Concealed Nose Lasers (4) – 50 each

Thrusters (2) – 200 each

\* Landing Gear (3) – 75 each

\* Canard Wings (2) – 75 each

\* Tail Section – 210

Reinforced Pilot Compartment (under section with windows) – 100

Reinforced Crew Compartment (section with windows) – 100

\* Wings (2) – 270 each

\*\* Main Body – 440

\* A single asterisk indicates a small or difficult target to hit. They can only be struck when the attacker makes a Called Shot, and even then he is -4 to strike (-10 when the aircraft is going Mach 1 or faster).

Destroying one wing causes the airframe to become dynamically unstable and the pilot must immediately return to base (RTB); speed is reduced by half and serious maneuvers are made at -50% to Piloting skill rolls even for the cyborg (a fighter jet piloted by an ordinary pilot would have crashed already). If the Cyborg Combat Pilot fails his Piloting skill roll, he must eject immediately because the fighter is crashing. Destroying both wings causes the fighter jet to crash.

\*\* Depleting the M.D.C. of the main body completely destroys the vehicle and it will crash. HOWEVER, the Cyborg Combat Pilot *may* be able to still land the aircraft by holding it together through sheer force of will and an extra (temporary) 10% M.D.C.; see **Elite Aerial Combat skill: XML Series** for details.

**Speed:**

Flying: Mach 3.5 (approximately 2,665 mph/4,264 km). The XML-285 is VTOL capable due to a series of low profile hover jets built into the undercarriage.

Flying Range: Effectively unlimited.

Maximum Altitude: 65,000 feet (19,812 m).

**Statistical Data:**

Height: 13 feet (4 m),

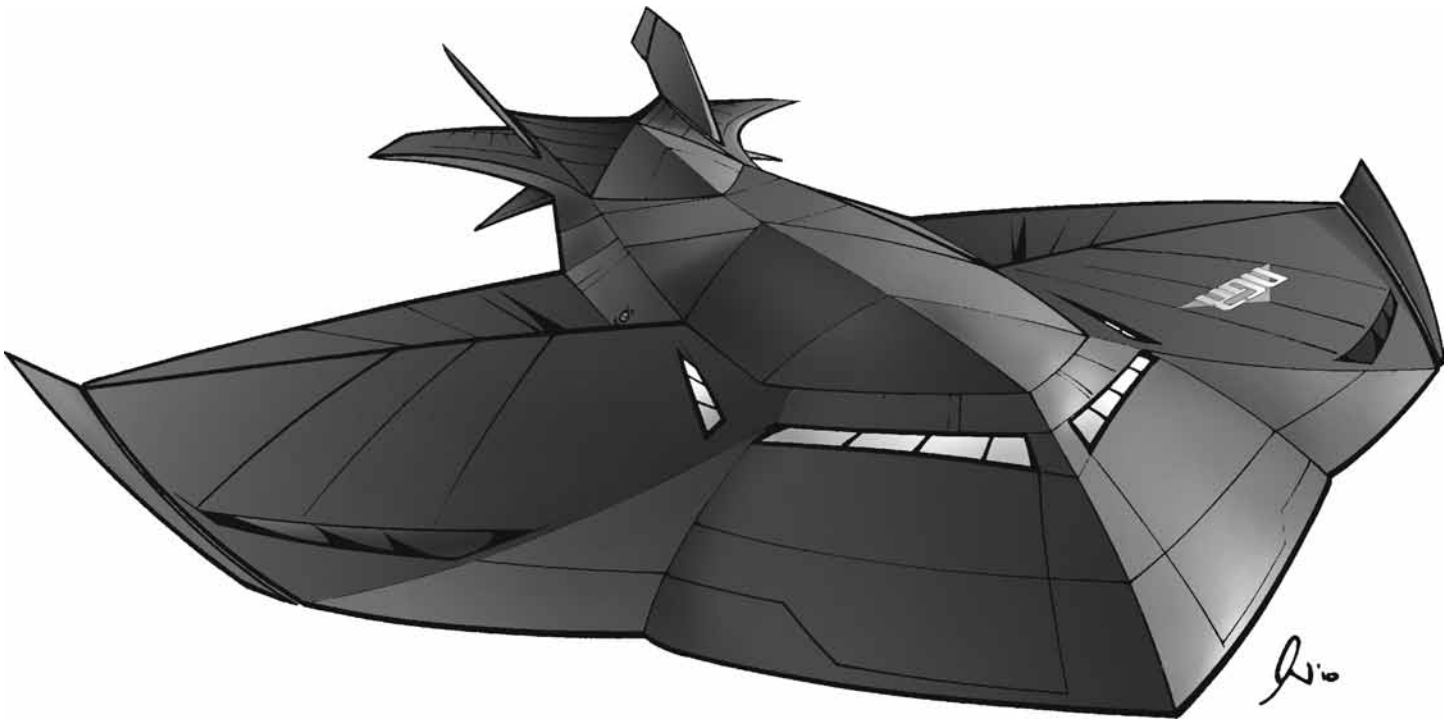

Width: 48 feet (14.6 m).

Length: 64 feet (19.5 m).

Weight: 30 tons fully loaded.

Cargo: None.

Color: Variable. The pilot is able to change the color of the craft based on the mission parameters. This chameleon type of visual camouflage is activated with a thought, but it can take up to 15 seconds for the craft to fully complete the change of colors. There are 10 patterns pre-programmed, including crimson, light blue, dark blue, light grey, dark grey, black, and four different camouflage patterns. Enemies are -4 on Perception Rolls to spot the aircraft visually when this system is activated.

Power System: Nuclear, average energy life is 20 years.

Black Market Cost: 190 million credits. Exclusive to the NGR Luftwaffe. Not currently sold on the open market and unavailable on the Black Market.

## Weapon Systems:

**1. Forward Pulse Lasers (4):** Concealed in the nose of the fighter are four lasers used to quickly dispatch enemy fighters, Gargoyles, robots, and other threats. They are linked to the nuclear power source of the aircraft, giving them a limitless payload. The use of energy weapons means there is no space taken up by heavy ammo magazines in the hull of the craft, allowing for maximum performance and agility.

Primary Purpose: Anti-Aircraft/Anti-Gargoyle.

Secondary Purpose: Defense and Assault.

Range: 4,000 feet (1,219 m).

Mega-Damage: 3D6 M.D. per single blast, 6D6 per double blast, 1D4x10+8 M.D. per triple blast and 1D6x10+6 per quadruple blast.

Rate of Fire: Each single, dual, triple or quadruple blast fired simultaneously at the same target counts as one of the pilot's melee attacks.

Payload: Effectively unlimited.

**2. Ventral Internal Weapons Bay #1, Mini-Missiles:** The Ghost houses the majority of its missiles in its main body. The primary bay is along the underside of the fuselage. The weapons bay doors open for a split second and eject the missiles and then shut closed again in order to maintain the lowest possible radar cross-section. Usually the bay carries heavy high-explosive missiles, but can carry any type of medium-range missiles.

Primary Purpose: Anti-Aircraft/Gargoyle.

Secondary Purpose: Assault.

Range: Varies with type of medium-range missile used, usually 40-60 miles (64-96 km), HE missile range is 40 miles (64 km).

Mega-Damage: Varies with type of medium-range missile used, but heavy, high-explosive (HE) missiles are standard issue (3D6x10 M.D. to everything in a 30 foot/9.1 m radius).

Rate of Fire: Fired one at a time or in volleys of 2, 4, 8, 12 or all 16.

Payload: 16 missiles.

Bonus: Missiles have a +3 bonus to strike with their guidance system. Laser designators override this bonus with their higher bonuses.

**3. Internal Weapons Bays #2 & 3:** On the outer sides of the air intakes are concealed weapons bays similar in fashion to the ventral weapons bay of the aircraft. The difference is they can hold and release gravity bombs, fire mini-missiles or drop deployment pods, depending on the mission parameters. Most Ghosts sent out on combat runs typically have one bay with bombs and one bay with mini-missiles.

**Mini-Missile Launcher:** A door slides open to release mini-missiles that drop from a housing and take off at the target.

Primary Purpose: Anti-Aircraft/Anti-Gargoyle.

Secondary Purpose: Defense and Assault.

Range: A half mile (0.8 km) for standard issue fragmentation.

Mega-Damage: Varies with missile, but fragmentation is standard issue (5D6 M.D. to everything in a 20 foot/6.1 m radius).

Rate of Fire: 1, 2, 4 or 6 at a time.

Payload: 16 total mini-missiles.

**Free Fall or Gravity Bombs:** Open the bay door and release in clusters.

Primary Purpose: Anti-Installation/Anti-Fortification.

Secondary Purpose: Anti-Armor.

Range: Dropped from the air down upon a target on the ground.

Mega-Damage: Varies with bomb type; same types and damage as medium-range missiles but inflict damage to double the blast radius.

Rate of Fire: Clusters of 2, 4 or 8.

Payload: 8 bombs are carried in a single bay.

- 4. Wing Hardpoints (4):** There are two hardpoints on each wing on the XML-285, allowing for more munitions, weapons, and mission specific equipment to be mounted on the wings. The hardpoints are close to the main body of the aircraft, keeping them closer to the center of gravity. Any of the XLH series weapons can be attached.

Primary Purpose: Varies with type of weapon used.

Secondary Purpose: Varies with type of weapon used.

Range: Varies with type of weapon used.

Mega-Damage: Varies with type of weapon used.

Rate of Fire: Varies with type of weapon used.

Payload: Varies with type of weapon used.

- 5. Anti-Missile Chaff Dispenser (1):** Located in the tail end of the vehicle is a chaff dispenser. When trailed by missiles, a cloud of chaff, flares and other obtrusive particles can be released to confuse or detonate the enemy's attack.

Primary Purpose: Anti-Missile.

Mega-Damage: None, but roll percentile dice to determine the result:

**01-50%** Enemy missile or missile volley detonates in chaff cloud. The threat is over.

**51-75%** Enemy missile or missile volley loses track of real target and veers away in the wrong direction (may lock onto nearby aircraft).

**76-00%** No effect. Missiles still on target.

Also note the chaff cloud will temporarily blind Gargoyles and other creatures flying through the cloud. The victims suffer the following penalties: Reduce melee attacks/actions, combat bonuses, and speed by half for 1D4 melee rounds. However, after that period the creature recovers and can renew his attack.

Payload: Four.

- 6. Sensors and Features of Note:** Long-range communication, radar, and radar same as all NGR aircraft vehicles, plus the following:

AESA Radar: Range: 600 miles (960 km). The radar system can identify and track up to 64 targets simultaneously and is also capable of Terrain Following for low altitude flight.

Chameleon Camouflage System: The enemy is -4 on Perception Rolls to notice the aircraft when this cloaking system is engaged. See the stat block under "Color" above for details.

High-Bandwidth Comm Antennas: Secure communications with up to 32 other aircraft within range of the AESA Radar.

Jam Enemy Communications and Radar: The Ghost has equipment that can scramble enemy radar units and radio communications to all units within 10 miles (16 km) of it. Victims must roll on the Radio: Countermeasures and Sensory Equipment skills with a -40% penalty in place. Both skills must be a success or their systems remains knocked out. Victims roll once every 10 minutes. A success on both skills restores their systems. **Note:** To keep jamming the enemy's systems the Ghost must fly in a tight circle and remain within 10 miles (16 km) of the enemy it is scrambling. If it flies outside this range, the enemy's systems automatically return to normal.

LIDAR: Laser Detection and Ranging. Allows the Ghost to detect and map physical features, weather phenomena, and enemy targets at high resolution and in three dimensions without radar. Range of 200 miles (320 km).

Surveillance Optic Systems, Advanced: Built into the belly of the Ghost are three small, wide-angle cameras and one telescopic zoom lens with a range of 6 miles (9.6 km). It can also see, photograph and video in infrared, ultraviolet, and passive nightvision (green hues).

Radar Warning Receiver: Passively detects other radars being operated within 690 miles (1,104 km), including radar sources from robots and power armor.

Radio & Laser Communications, Advanced: Long-range, wide-band directional radio. Range: 1,000 miles (1600 km). The signal transmitted is encrypted, and requires knowledge of Electronic Countermeasures to retrieve and unscramble it; prevents being intercepted or hacked.

Stealth Features: Imposes a -75% penalty to any attempts to detect the fighter via radar. The special shape of its intakes and exhaust also means that the plane is -55% to detect using infrared (IR) sensors. All infrared-guided missiles are -3 to strike. Opening one ordnance bay greatly increases the aircraft's radar signature from the underside of the aircraft and reduces the detection penalty to -36%. Opening two, or all three bays at the same time, negates radar stealth and the Ghost is visible to radar and visual detection until they are closed. Likewise, using any type of Active Jamming Equipment makes the Ghost visible.

## XLH Series Hardpoint Weapon Pods

The XLH Hardpoint Weapon Pods are mounted on fuselage or wing "hardpoints" (modular mounting brackets for weapon systems) to increase the weapon payloads of the aircraft. Hardpoint weapon pods are assigned in pairs, one on each side of the vehicle to balance the aircraft.

**Penalty:** Per each pair of pods, speed of the aircraft is reduced by 5% and the vehicle is -1 to dodge. For stealthy aircraft

like the XML-285, external hardpoints reduce the stealth capabilities completely, unless stealth pods are used. All pods are designed to be ejected and discarded when empty, at the discretion of the pilot, to be either left in the field or recovered at a later time.

## Rocket/Mini-Missile Pod

This pod contains a number of rapid-fire mini-missiles used mainly to attack ground targets and close aerial targets.

Primary Purpose: Anti-Personnel.

Secondary Purpose: Anti-Aircraft and Anti-Missiles.

Range: Varies with missile type; one mile (1.6 km) for armor piercing.

Mega-Damage: Varies with missile. Any mini-missile can be used, but armor piercing is standard issue: 1D4x10 M.D.

Rate of Fire: 1, 2, 4, 6 or all 12. Can be fire linked with other pods of the same type, meaning they can fire in tandem with other weapon pods.

Payload: 12 mini-missiles in each pod.

Note: The use of these weapon pods negates any stealth capabilities of the aircraft.

## Short-Range/Medium-Range Missile Pod

These pods carry larger missiles, primarily for attacking aircraft or assaulting fortifications.

Primary Purpose: Anti-Aircraft.

Secondary Purpose: Anti-Fortification/Anti-Installation.

Range: Varies with missile type. Any short- or medium-range missile can be used.

Mega-Damage: Varies with missile type.

Rate of Fire: 1, 2, 4 or 6 for short-range missiles, 1, 2 or 4 for medium-range missiles. Can be fire linked with other pods of the same type.

Payload: Six short-range or four medium-range missiles per pod.

Note: The use of these weapon pods negates any stealth capabilities of the aircraft.

## Free-Fall Bomb Ejector Rack

These racks carry a variety of free-fall bombs to be dropped on stationary or slow-moving targets.

Primary Purpose: Anti-Installation/Anti-Fortification.

Secondary Purpose: Anti-Armor.

Range: Dropped from the air down upon a target on the ground.

Mega-Damage: Varies with bomb type; same types and damage as medium-range missiles, but double the blast radius.

Rate of Fire: 1, 2, 3 or all 4. Can be fire linked with other ejector racks to saturate an area.

Payload: Four bombs per rack.

Note: The use of this weapon system negates any stealth capability of the aircraft.

## Pulse Laser Pod

External pulse lasers which can be fire linked with each other and with the weapon systems of the XML-280 or the XML-285.

Primary Purpose: Anti-Aircraft/Gargoyle.

Secondary Purpose: Defense.

Range: 6,000 feet (1,829 m).

Mega-Damage: 6D6 M.D. per pulse.

Rate of Fire: Each pulse blast uses one attack.

Payload: Effectively unlimited. Linked to the power source of the vehicle.

Note: The use of the pulse laser pods negates any stealth capability of the aircraft.

## Rail Gun Pods

External rail guns loaded with uranium rounds to be used against Gargoyles and other supernatural enemies. Ammunition is housed in independent internal magazines within the weapon pods.

Primary Purpose: Anti-Aircraft/Gargoyle.

Secondary Purpose: Assault.

Range: 6,000 feet (1,829 m).

Mega-Damage: 6D6 M.D. for a 15 round short burst or 1D6x10 M.D. per 30 round long burst with U-Rounds or DU-Rounds.

Rate of Fire: Each burst uses one melee attack.

Payload: Each pod contains 600 rounds, enough for 20 long bursts. Can be fire linked with other pods of the same type to fire in tandem.

Note: The use of the rail gun pods negates any stealth capability of the aircraft.

## Stealth Missile Pods

Similar to other external missile pods, these short- and medium-range missile launchers are made from the same radar absorbent materials and angular construction as some Luftwaffe planes. These weapon pods have significantly less of a negative impact on the radar cross-section of the aircraft on which they are used.

Primary Purpose: Anti-Gargoyle.

Secondary Purpose: Anti-Aircraft.

Range: Varies with missile type.

Mega-Damage: Varies with missile. Any short- or medium-range missile can be used.

Rate of Fire: One at a time, or in volleys of 1, 3 or 5 for short-range missiles, or 1, 2 or 3 for medium-range missiles. Can be fire linked with other pods of the same type.

Payload: Five short-range or three medium-range missiles per pod.

Note: The use of these weapon pods will only give a -5% penalty per pair to the stealth capabilities of the aircraft.





# NGR Mobile Bases

## NGR Drop Forts and Deployment Pods

Early on in its conflict with the Gargoyles, the NGR military recognized the brute strength, resourcefulness and adaptability of their inhuman foes. It was often the case that NGR soldiers found themselves under attack by superior numbers far from the resources of their country or the nearest military base.

To give their soldiers more support and a fighting chance way from home, the New German Republic had Triax Industries design a few mobile bases, but also a number of fortifications and supply containers that could be *airdropped* by an XM-180 Dragonfly or XM-199 Phoenix to military bases and operations in remote locations.

Triax developed something the Army calls Deployment Pods. Everything from weapons, ammunition, robot drones to food and medical supplies can be put in the various pods, meaning that with a single airdrop a company of soldiers can have the firepower and protection of a small outpost at their disposal.

A standard Deployment Pod is a ceramic M.D.C. container about half the size of a boxcar. There are larger ones and smaller ones (about the size of an office desk), but as a modular system, most are one size. Inside, are places for straps to secure cargo. On the bottom of the pod are five hover jet thrusters and a laser distancing and sensor system. What happens is the Deployment Pod is dropped at a high altitude (30,000-50,000 feet/9,144 to 15,240 m), at a specified drop point near an active base, outpost or troop operation. A radio signal device or any radio or laser marking system can be used to pinpoint the exact drop location. The cargo is released and the pod drops to earth. At a particular point the bottom hover jets kick in to slow the rate of descent and make sure the pod is on target. Four smaller stabilizing and positional thrusters on the top of the Deployment Pod keep the falling container from tumbling and help to shift it back on target as needed. The hover system is not strong enough to fly or even hover in mid-air, but it is strong enough to make the pod have a “soft” landing. In this case, “soft” is a hard thud, and if the pod lands on someone it does 1D4x10 M.D.

Punch in a simple code and one of the walls folds down to allow access to the cargo inside. After the cargo is removed, another code entered detaches the walls from their housing, making them loose fitting. This allows the soldiers to remove the walls (roof first) to either fold up to store, hide or send back on a ground transport vehicle (or even carried by a giant robot), or to be used as building materials to make walls, building for a base camp, etc. Deployment Pods are all-purpose units designed to be more than just containers. The only part that shouldn't be

used for building materials is the floor panel with the hover jets. It should be sent back and reused.

### Standard “cargo” Deployment Pod

The cargo pod generally takes up two transportation slots and can be used to carry a vast range of cargo such as weapons and ammo, body armor, food, medical supplies, building materials, basic gear, clothing, cots and bedding, digging/excavation equipment, generators, spare parts, and anything else the encampment or staging area might need. These units are effectively the flying boxcars that deliver the tools, supplies and equipment the army troops need. The cargo inside may be all the same, one or two items, or mix cargo of many different items.

The cargo pod, itself, can be used as a temporary shelter, bunkhouse, trash bin, etc., or taken apart and its walls used as building materials and fortification.

**Class:** Cargo Containment High Altitude Deployment Pod. Also known as “drop pods” and “DPs.”

#### M.D.C. by Location:

Wall (4) – 45 M.D.C. each

Roof/Ceiling (1) – 45

Floor (1, reinforced) – 80

Hover Jets (5, underside of floor) – 10 each

Stabilizing Thrusters (4, small, edge of roof) – 3 each

#### Statistical Data for Standard Drop Pod:

Height: 10 feet (3.5 m).

Width: 8 feet (2.4 m).

Length: 14 feet (4.3 m).

Weight: 400 pounds (180 kg), empty.

Cargo: This standard DP can hold up to 38 tons.

Power System: Two rechargeable electrical batteries like those used in electric engines for commercial cars. The batteries can be recharged repeatedly and reused, or cannibalized in the field and used in vehicles and other items.

Availability: Excellent.

Transport Slot Occupation: Takes up two transport slots.

## Some Specific Combat Items Delivered in Deployment Pods

### Battle Gear Supply Pod

18 T-10 Cyclops Body Armor

10 T-25 T-25 Uber Body Armor

2 T-12 Field Medic Body Armor

2 T-13 Field Mechanic Body Armor

2 T-E02 Infiltrator Body Armor

1 Portable E-Clip Charger

6 Ammo Drums for Rail Guns (800 rounds).

12 Smoke Grenades

12 Fragmentation Grenades

12 Signal Flares

24 Long E-Clips

72 Standard E-Clips

- 96 Weeks of Food Rations
- 24 Blankets
- 24 Bedrolls
- 6 Vibro-Knives (1D6 M.D.)
- 6 Backpacks
- 6 Utility Belts
- 6 Flashlights
- 6 Infrared Distancing Bionoculars
- 4 First-Aid Kits with RAU, RMK, RSU and IRMSS Robot Systems
- 2 Tool Kits
- 2 Triax Instant Meal Paste Makers (with food pellets)
- 4 50 Gallon drums of Drinking Water
- 1 Field Radio
- 1 Portable Computer
- 1 Language Translator
- 1 Case of Socks (most common fit all size, 72 pair)
- 1 Case of Underwear (most common fit all size, 72 pair)
- 1 Case of Chewing Gum (144 packs of gum)
- 1 Case of Energy Food Bars (96 bars)
- 1 Case of Disinfecting Soap (96 bars)
- 1 Case of Towels (48)

Transport Slot Occupation: Two.

### **Bunker Deployment Pod**

This DP contains everything a platoon needs to build a basic bunker, complete with M.D.C. framework, M.D.C. concrete, all other necessary building materials and components, and the tools to get the job done. Ten soldiers should be able to complete the construction in 12-16 hours time. The bunker is 15 feet (4.6 m) in diameter, four feet (1.2 m) tall, if half of it is underground (standard), 8-10 feet (2.4 to 3 m) tall if not. Comes with a small generator and two electric batteries. More structures or larger structures can be built using more than one Bunker DP. Every 15 square feet (1.4 square m) has 80 M.D.C.

Transport Slot Occupation: Two.

### **Force Field Generator**

The Force Field Generator System (new and experimental) is a modified version of the force field generator that first debuted in the *X-1000 Ulti-Max*. It forms a force field dome that covers a 15 foot (4.6 m) radius (18 foot/5.5 m ceiling) to provide some basic protection to infantry troops. The force field has 100 M.D.C. and protects from weather, insects, wild animals and surprise attacks. If the M.D.C. of the force field is depleted, the field shuts down. If the force field generator (nuclear powered; 20 M.D.C.) and eight perimeter field relay posts (5 M.D.C. each) are not destroyed, the force field regenerates in three hours (33 M.D.C. per hour).

Transport Slot Occupation: One slot in a half-sized Deployment Pod or packed in a standard two slot DP as part of a larger load in a standard Drop Pod.

### **Infantry Weapon Deployment Pod**

- 48 TX-30 Ion Pulse Rifles

- 24 TX-43 Light Assault Laser Rifles
- 12 TX-16 Pump Rifles with 300 rounds.
- 12 TX-46 Particle Beam Rifles
- 6 TX-75 Grenade Launchers with 200 grenades.
- 12 TX-SS01 Exterminator Shotguns with 400 rounds.
- 12 TX-50 Rail Gun and 36 light (600 rounds) and 12 heavy (2000 rounds) ammo drums for it.
- 12 Vibro-Knives
- 1 Portable E-Clip Charger
- 1 Generator
- 10 Cases of Standard E-Clips (72 to a case; fully charged)
- 1 Case of Fragmentation Hand Grenades (96 per case).
- 1 Case of Smoke Grenades (96 case).

Transport Slot Occupation: Two.

### **Power Armor Deployment Pod**

4-6 suits of power armor with standard weapon systems (commonly T-21 Terrain Hopper, X-60 Flanker, X-10A Predator One or X-11 Predator II, X-535 Hunter/Jaegers, unless something else specific was requested and approved).

- 4 T-25 Uber Cyclops Body Armor.

- 3 TX-250 Rail Guns with 36 Light (holds 600 rounds) and 12 Heavy Ammo Drums (holds 2,000 round each).

- 3 TX-500 'Borg Rail Guns with 24 Heavy Ammo Drums (holds 1,170 rounds each).

Transport Slot Occupation: Two.

### **Sensor System Deployment Pod**

The cargo in this DP is dedicated to sensor and communication systems. The Sensor Pod has the field equipment equivalents of all of the standard sensor features available to Triax robots and power armor, in addition to the following. Most are described in **Rifts® Ultimate Edition**.

1. Advanced Military Radar Unit: Extended radar range of 200 miles (320 km); half in mountains, valleys and urban settings. Can track 300 targets unit simultaneously.

2. Radar Detector.

3. Long-Range Laser Communications: Range: 1,000 miles (1,600 km).

4. Four Long-Range Military Field Radios: 500 mile range (800 km).

5. Four Portable Field Unit Computers.

6. Two Portable Scan Dihilators.

7. Portable Bio-Scan & Bio-Lab.

8. Motion Detector.

9. Electrical Generator and Four Rechargeable Electric Batteries: To power it all.

Transport Slot Occupation: Two.

### **Fortification Pod (Special)**

This is a departure from the standard Drop Pods containing cargo. It works on the same principle at the Deployment Pods in that it is dropped from an aircraft and has the same hover "touch down" system. Other than that, the similarity ends. This is a

modular heavy M.D.C. fortification that functions as a self-contained mini-command module.

### **Mobile Fortifications – Exclusive to the NGR Military**

**Model Type:** XMF-1

**Class:** Aerial Deployed Mobile Fortification. Also known as a “Drop Fort.”

**Crew:** Troop support

#### **M.D.C. by Location:**

- Optional Weapon Turret (1, side) – 150
- Short-Range Missile Launcher (1) – 100
- Mini-Missile Launchers (2) – 50
- Main Hatch (1, front) – 200
- Escape Hatch (1, back) – 200
- \* Retractable/Extendible Top – 380
- \*\* Main Body – 1,000

\* The top of the Drop Fort rises to allow troops to fire from a reinforced fortified position. It can also be raised for mass evacuation. A ramp that winds around the top of the structure provides a place for man-sized troops to stand.

\*\* If the M.D.C. of the Main Body is reduced to zero, the unit is destroyed.

**Speed:** None. The mini-fort cannot move of its own accord.

#### **Statistical Data:**

**Height:** 20 feet (6.1 m) to where the “roof” can be made to rise. The roof cap is another 5 feet (1.5 m) for a total height of 25 feet (7.6 m) from the bottom to the crown of the roof cap.

**Width/Length:** 20 feet (6.1 m) in diameter.

**Weight:** 8.8 tons.

**Cargo:** None.

**Power System:** Nuclear, average energy life is 20 years.

**Transport Slot Occupation:** Six.

**Black Market Cost:** Not available outside of the NGR.

### **Weapon Systems:**

**1. Short-Range Missile Launcher (1):** Mounted on the side of the roof is a short-range missile launcher. It can rotate 360 degrees.

**Primary Purpose:** Anti-Aircraft/Gargoyles and Assault.

**Secondary Purpose:** Defense.

**Range:** Varies with type of missile used, but high-explosive is five miles (8 km) and fragmentation is three miles (4.8 km).

**Mega-Damage:** Varies with type of missile used. Typically high-explosive (2D6x10 M.D. to everything in a 15 foot/4.6 m radius) or fragmentation (2D4x10 M.D., 20 foot/6.1 m damage radius).

**Rate of Fire:** One at a time or in volleys of 2 or 4.

**Payload:** Launcher holds four total missiles, but the fort comes with two reloads; robot or power armor required to reload by hand.

**2. Mini-Missile Launchers (2):** These launchers lower out of the ceiling when the roof is raised. One points forward, the other backward, both can rotate 180 degrees and have 20 degree arc of fire.

**Primary Purpose:** Anti-Gargoyle and Anti-Armor.

**Secondary Purpose:** Anti-Missile and Anti-Personnel.

**Range:** Varies with missile type, but fragmentation is the standard payload with a half a mile (0.8 km) range.

**Mega-Damage:** Varies with missile type, but fragmentation (5D6 M.D. to everything in a 20 foot/6.1 m radius) is the standard load.

**Rate of Fire:** One at a time or in volleys of 2, 4 or 6.

**Payload:** 24 total mini-missiles 12 in each launcher, but the fort comes with one reload for each (24 more missiles) to be reloaded by hand.

**3. Optional Weapon Turret (1):** A laser weapon turret is typically mounted on the side of the roof opposite of the short-range missile launcher.

**Primary Purpose:** Anti-Armor and Anti-Aircraft/Gargoyles.

**Secondary Purpose:** Assault and Defense.

**Range:** 4,000 feet (1,219 m).

**Mega-Damage:** 5D6 M.D. per single blast.

**Rate of Fire:** Single shots only, each blast counts as one melee attack of the dedicated gunner.

**Payload:** Effectively unlimited.

**4. Sensor System Notes:** All sensors and features common to NGR robots plus: Advanced Radar: Extended radar range of 200 miles (320 km; can track 120 targets simultaneously) and long-range communications (500 miles/800 km).

# Harbingers of War

The largest and most powerful pieces of military hardware ever produced by Triax Industries are referred to as the “Harbingers of War,” or “Wonder Weapons” (Wunderwaffe) by the media. Their development and production serve as an indication of the full level of the dedication to *Full Militarization* the people of the NGR have agreed upon. They know that these massive weapons of destruction will be instrumental in freeing their homeland from demonic bondage, and once free, they hope to liberate the rest of Europe from the hands of monstrous and demonic occupiers.

With the exception of the Undertow, production of these *superstructures* was not kept secret, as the military used their creation as a tool to boost morale and keep the war machine going. Photos of these vehicles in production and videos of them in action, even if it was field trials, were often displayed on news broadcasts and on the NGR internet. Each MISB that was rolled off of the assembly line was greeted with celebration. While the creation and deployment of the Undertow was top secret, a limited number of PR photos have been released since Operation Sea Storm’s success.

Currently, there are only the five full production model **Mobile Infantry Strike Bases** and one **NGR Undertow Submersible Carrier and Launching Base** in the field. More *may* be constructed as time, need and resources dictate.



# NGR Undertow

## Submersible Carrier & Launching Base

The NGR's Undertow was the vanguard for *Operation Sea Storm*, and the largest and most powerful undersea vehicle ever known to have been created by humans. It was designed and constructed out of necessity. When the NGR military was planning and conceiving Operation Sea Storm, they knew that they would need a way to transport thousands of soldiers over a very long distance, and they would need to do it without being detected by their enemies. Not only that, but this carrier vehicle would need to be completely self-sufficient, able to stay at sea for months at a time. The soldiers would have to rely only on what the carrier could take with it.

To fulfill the needs of Operation Sea Storm, Triax designed the **Undertow Submersible Carrier and Launching Base**. A marvel of naval design and construction, the Undertow is less a submarine or troop carrier and more of a mobile *underwater city*. Every amenity that a soldier or any other military personnel would need is provided. The Undertow has plenty of living space (dormitories for troops; officers and medical personnel get their own rooms), a state-of-the-art hospital that can provide any service available in the NGR cities, movie theaters and Virtual Reality (VR) entertainment centers, gymnasiums and large areas for competitive sports, restaurants, a few pubs, officers clubs, indoor gardens/nature centers, and even a shopping area.

The Undertow moves through the water by the way of intake valves, which move water through massive turbines, and eject it through the rear of the carrier. The turbines also help provide power to the carrier so as not to tax the nuclear engines and hopefully prolong the expected life of the vessel. These intake valves are located in a ring around the top of the lower section/main body. They can provide thrust in any direction, and provide incredible mobility for a vehicle of such massive size.

The Undertow is lacking in major built-in weapon systems, as it is designed mostly as a troop and armor carrier and has thousands of troops to defend her. Installing weapons would have taken up too much space better reserved for living quarters and storage. Nevertheless, it does have a series of medium-range and long-range missile batteries, and always keeps a reserve of aerial and underwater power armor troops for defense. The missile batteries are used in tandem with ground troops, flying armor and/or jet fighters.

**Model Type:** NGRS-1001 Series.

**Class:** Submersible Air/Sea/Land Carrier.

**Note:** Only one of these giants is in service and as of 109 P.A. there are no plans to manufacture more. This *may* change as the NGR becomes more embroiled in the affairs of the Phoenix Empire.

**Crew:** 6,000 total.

**Troop Capacity:** 35,000 total, which is over six full army divisions.

**Division of Elite Combat Troops (12,480 soldiers):**

Six Mechanized Infantry Companies: 48 X-4600 Sharpshooter, 96 X-4500 Gunman, 180 X-2730 Griffon, 240 IX-622 Bug, 240 X-821 Landcrab, 240 XM-350 Leopard III, 240

XM-330 Phantom Hover Tanks, 72 MZ-10 Wilderness Crusaders.

Power Armor Cavalry Companies: 72 X-700 Fat Boy Glitter Boy, 72 X-710 Hell Angel (flying Glitter Boys), 360 T-31 Super Trooper, 960 X-535 Hunter, 360 X-545 Super Hunter, 360 X-1001 Ulti-Max II, 360 X-2000 Dyna-Max, 36 X-2500 Black Knights and 1360 TXD-100 Ultra All-Environment Power Armor (see **World Book 7: Rifts® Underseas** for stats and descriptions).

Air Battalion: 660 X-2700 Dragonwings, 240 X-11 Predator II, 72 X-21 War Eagle, 180 X-710 Hell Angel (flying Glitter Boys), 360 X-2730 Griffon, 132 X-2750 Talon, 360 XM-140 Weapon Platforms, 96 XM-180 Dragonflies, 48 XM-199 Phoenix, 40 XM-270 Mosquitoes, 60 Lightning Combat Jets, 144 XML-280 Black Eagle Fighters, 576 XML-283 Wraith Low Altitude Fighters, 32 XM-280 Fighter Jets, and 3,840 troops.

Medical Companies: 600 doctors, 420 XM-50 Medic Ambulance Pods, 12 XM-250 Medical Hover Stations, plus medical support personnel (2,880 troops).

Other Vehicles Include: 240 Sea Mites, 240 Sea Bats, 360 X-6000 Transformable Subs, (see **World Book 7: Rifts® Underseas** for stats and descriptions) and lifeboats.

**Plus** 5,000 underwater sea sleds, diving equipment, wet suits, life rafts, sick bay/hospital with advanced medical facilities, quarantine area, marine biology laboratory, recreation and VR areas, combat simulation rooms (to keep combat skills sharp), a brig (prison area), complete environmental system, emergency power and life support, emergency lighting, external spotlights/searchlights (200 scattered around the ship, each with one M.D.C. and a 600 foot/183 m range), sectioned with watertight and airtight sealable compartments, and has repair and maintenance stations in the hangar sections.

### M.D.C. by Location of the NGRS-1001:

Top Sensor Array – 10,000

Bottom Sensor Array – 6,000

Large Hatch Doors (6) – 2,500 each

Small Hatch Doors (4) – 1,200 each

Power Armor Release Hatches (15) – 1,000 each

Surface Hangar Doors (15) – 1,000 each

Missile Bays (10) – 1,000 each

Thrust Valve (12, bottom) – 2,000 each

\* Bridge (topmost structure) – 20,000

Secondary Flight Deck and Communications (upper dish) – 30,000

\*\*Lower Section/Loading Dock (outer part of lower dish) – 50,000

\*\*\*Mid-Section/Main Body – 110,000

\* Destroying the Bridge means the ship must be operated from the Secondary Flight Deck and Communications section, without penalty, or from the engine room, in which case there is a –20% penalty to Piloting rolls and all weapon systems are disabled until a technician can jury-rig a set of controls (takes 1D6 hours; half that time if a successful Weapons Engineer skill roll is made at –20%).

\*\* Destroying the Lower Section/Loading Dock means that none of the submersible vehicles will have a place to dock to,

limiting the Undertow's ability to deploy troops. Troops will only be able to be launched from the Power Armor Release Hatches and Surface Hangar Doors.

\*\*\* Depleting the M.D.C. of the Main Body destroys the ship's structural integrity, causing it to sink. If the vessel sinks below 2.5 miles (4 km), the pressure will crush it, killing everyone inside – no survivors!

#### **Speed:**

Driving on the Ground: Not possible.

Flying: Not possible.

Water Surface: 30 mph (48 km).

Underwater: 40 mph (64 km).

#### **Statistical Data:**

Height: 6,400 feet (1,951 m).

Width: 4,800 feet (1,463 m).

Length: 4,800 feet (1,463 m).

Weight: 1,140,000 tons fully loaded.

Cargo: In addition to the standard complement of armor, aircraft and vehicles, the submersible can carry an additional 190,000 tons of extraneous cargo. Crew members and passengers have their own quarters with closets and such to keep personal effects.

Power System: Nuclear with a hydro-electric backup; expected life of 12 years.

Market Cost: Top secret! Not available, but cost 90 billion credits to build with all the standard features, weapons, and troops.

#### **Weapon Systems:**

**1. Medium-Range Missile Launchers (5):** These silo-style launchers are located in a ring around the upper third of the carrier and face up toward the sky. Used to engage enemy aircraft, ships, and ground targets.

Primary Purpose: Anti-Ship and Anti-Aircraft.

Secondary Purpose: Anti-Armor and Installation.

Range: 80 miles (128 km).

Mega-Damage: 5D6x10 M.D. for medium multi-warhead missiles.

Rate of Fire: One at a time or volleys of 2, 3, 4 or all five.

Payload: 432 in launch system, with an additional 216 in storage.

**2. Long-Range Missile Launchers (5):** Identical to the medium-range launchers above, but in an alternating ring, and about 150 feet (45.7 m) higher on the carrier.

Primary Purpose: Tactical Ground-Based Strikes/Anti-Fortification.

Secondary Purpose: Anti-Ship and Anti-Aircraft.

Range: 500 miles (800 km) for high-explosive, 1,000-1,800 miles (1,600-2,880 km) for nuclear.

Mega-Damage: 4D6x10 M.D. for high-explosive (heavy), 1D4x100 M.D. for nuclear (medium) or 2D4x100 M.D. for nuclear multi-warhead missiles.

Rate of Fire: One at a time or volleys of 2, 3, 4 or all five.

Payload: 432 in launch system, with an additional 216 in storage.

**3. Vehicles, Robots & Power Armor:** Don't forget that the Undertow carries an enormous amount of combat vehicles: attack ships, X-6000 Transformable Subs, up to six Poseidon submarines, tanks, troop transports, jet fighters, helicopters, and power armor (see troop capacity listing described earlier in the stat block).

#### **4. Notable Sensors & Other Systems:**

Long-Range Communications: Range is 500 miles (800 km); wide-band and directional, plus coordinated multi-com system.

Short-Range Communications: Range is 50 miles (80 km); wide-band and directional, plus coordinated multi-com system.

Communications and Sensor System: A complex communications network of radios, sensors, and computers that receives, collates, interprets and distributes/sends sensor, communications, targeting and combat data to the appropriate officers, ships, fighters, and navigational and combat stations as quickly as possible; in many cases, instantaneously to hundreds of recipients. Part of the job of the communications network is to handle long-range, short-range, person-to-person, internal ship communications and coordinated communications related to combat, as well as information recording, storage and retrieval.

If the main communications and sensor tower is destroyed, all operations are less effective, delays and errors are more likely, and some long-range systems *may* be lost. There is also a 01-50% chance that there will be a 1D4 melee round (15-60 second) period when all but internal communications are *down* and the secondary tower takes over.

External Audio Pickup: Range is one mile (1.6 km) underwater, 1,300 feet (396 m) when surfaced. A sound amplification system that can pick up and listen to sounds outside and around the vessel.

Long-Range Sonar (80 miles/128 km) that can simultaneously track 300 separate targets and identify 9,000 different targets including underwater structures/bases, sea vessels, aquatic animals, monsters, and mutants. Both long-range and short-range sonar also function as a means of motion detection.

Short-Range Sonar (10 miles/16 km) that can track 60 specific targets and identify 2,000 different vessels and key monsters.

Echolocation Sound System: (4 miles/6.4 km range/depths, with a narrow echo scanning field of about half a mile (2,600 foot/792.5 m radius) used to aid in navigation, accurately gauge depth, and locate and identify underwater terrain and formations, underwater vessels, robots, armor, wreckage, structures and sea animals.

Long-Range Radar: Range is 100 miles (160 km). Radar can track up to 200 aerial targets simultaneously and can identify 8000 different targets, including aircraft (pre- and post-Rifts), spaceships, dragons, and flying creatures.

Short-Range Radar: Range is 30 miles (48 km) and can track 100 specific targets simultaneously and identify 2,400 different aircraft and key flying monsters.

Targeting Computer & Bonuses: Calculates, stores and transmits data to all on-board weapon systems, combat stations and communications/sensor towers. Operators of *all* ship weapon systems are +1 on initiative and +1 to strike. Tied to laser, radar and sonar sensor systems.

Tactical Combat Network: Part of the communications and sensor network, whose job is to coordinate and distribute combat and sensory data, strategies, tactics and communications to away-teams and combat troops in the field (armored troops, power armor, subs and ships).

Thermal Imager: Range is 2 miles (3.2 km). An optical heat sensor that allows the infrared radiation of warm objects and beings to be converted to visible light. The operator can see in complete darkness, shadows, and through smoke.

Telescopic System: Range is one mile (1.6 km). 1-100x magnification with a 50 to 100 foot (15.2 to 30.5 m) field of vision. A telescopic optical system that is linked to view screens, has a nightvision/passive light amplification system and is usually (80% of the time) tied to a video recording system for making permanent records for later study and analysis. These are located in the system clusters at the top and bottom of the vessel.

# TX-MISB

## Mobile Infantry

### Strike Base

#### Final Production Model

Before the Full Militarization and the development of the NGR Undertow, the NGR Mobile Infantry Strike Base was the largest and most expensive military machine ever designed and constructed by Triax. Three prototypes of this massive mobile fortress were developed and deployed for field operations and performed extremely well despite many detractors predicting the hulking beast would be too much of an easy target and would be destroyed before actually seeing battle (see **Rifts® Mindwerks™**, page 81, for more information).

Throughout the early course of the military buildup and the first assaults on the aviaries, the MISBs or “Misfits” performed well. Serving as a forward base of operation from which to coordinate the massive deployment of troops necessary to destroy an aviary or Gurgoyles or Gargoyle Army. The MISBs were able to use their large complements of missiles and artillery to devastating efficiency. Of the three original prototypes, only one was destroyed, though the others suffered their share of damage.

After looking over the collected data regarding the multiple encounters in which the Misfits participated, the top researchers in charge of development for the MISB Project decided that particular modifications needed to be made in order to increase their survivability out in the field. The central troop carrier was made into one massive section in order to transport more troops into the field, a force field was added, modifications were made to the main cannon, a variety of anti-aircraft weapons were

added and the forward section was turned into a massively armored engine of destruction with a giant ram prow the size of an office building able to plow through enemy lines. These changes, in conjunction with a general vehicle overhaul, weapon upgrades, armor, and unique troop delivery methods, resulted in the TX-MISB full production model.

As of 109 P.A., there are five MISB Mobile Infantry Strike Bases in the field where they function as mobile command centers. They are typically deployed where mass troop mobilization is taking place to support troops holding strategic positions or making major offensives. Of the original three MISB prototypes, only one is still in service (see **Rifts® Mindwerks™**, page 81, for more information).

#### NGR Mobile Infantry Strike Base

Overall Height: 90 feet (27.4 m) at its highest point.

Overall Width: 112 feet (34 m) with both APCs attached.

Overall Length: 180 feet (54.8 m).

Overall Weight: Varies, but around 116,000 tons with all components.

Overall Speed: 40 mph (64 km) when pulled by all five component vehicles of the MISB. 23 mph (36.8 km) when pulled only by the rear or forward sections.

Power System: Nuclear with an operational life of 20 years. Each individual component of the MISB has its own independent nuclear power supply.

#### TX-MISB Forward Section

##### NGR Mobile Infantry Strike Base

The forward section of the TX-MISB is an engine of destruction containing a battery of powerful weapons. It's heavy, super-reinforced ram prow protects its nose and most of the forward section, and it is the thickest, densest Mega-Damage construct ever created by the NGR.

**Model Type:** TX-MISB-P1 Components A.

**Class:** Armored Infantry Assault & Troop Transport.

**Crew:** 16: Two pilots, two co-pilots, three communications officers, three technical officers, and six gunners.

**Troops:** Carries 60 infantry soldiers in T-25 Uber body armor, 18 power armor troops (any).

##### M.D.C. by Location:

Main Gun: Particle Beam Cannon (1) – 600

Laser Cannon (1; right side of the main gun) – 300

Ion Cannon (1; left side of the main gun) – 300

Long-Range Missile Launchers (2) – 300 each

Ion Tube Cannons (2, sides of the ram prow) – 400 each

Laser Turrets (2, top near missile launcher) – 120 each

\* Pop-Up Mini-Missile Launchers (6) – 30 each

\* Mini-Laser Turrets (6, back, A.I. controlled) – 40 each

\* Sensor Cluster (1, front, recessed) – 100

\* Secondary Sensor Array (1, concealed till needed) – 70

\* Giant Wheels (16) – 50 each

Ram Prow (1) – 4,300

Pilot's Compartment – 200





\*\*Main Body – 2,600

\* A single asterisk indicates a small or difficult target to hit. They can only be struck when an attacker makes a Called Shot and even then the character is -3 to strike. Destroying both Sensor Arrays (located under the big cannons on the sides of the forward section, above the ram prow) eliminates all long-range sensors and radar, but information can be re-routed from any of the other APC sections.

\*\* Depleting the M.D.C. of the Main Body shuts the vehicle down completely, making it useless.

### **TX-MISB Forward Section Speed:**

Driving: 60 mph (96 km) maximum when separated from the rest of the mobile base

### **Forward Section Statistical Data:**

Height: 80 feet (24.4 m) from the top of the side mounted long-range missile launcher. 70 feet (21.3 m) to be level with the main cannon.

Width: 60 feet (18.3 m).

Length: 54 feet (16.4 m).

Weight: 34,000 tons.

Power System: Nuclear with an operational life of 20 years. Each of the main guns have their own independent nuclear power supply.

## **Weapon Systems of the Forward Section:**

**1. Main Super-Particle Beam Acceleration Cannon (1):** This huge cannon is an accelerated particle beam weapon of unprecedented range and power. The Triax masterminds have spent the last six years tweaking and modifying this weapon (using the three prototype canons as test platforms), making it truly the most powerful and long-range energy weapon known to have been developed by post-Rifts technology. The housing underneath it is an independent sensor, radar and targeting array. The cannon can only point forward but can fire up and down in a 90 degree arc. The weapon has a dedicated gunner.

Primary Purpose: Anti-Fortification and Anti-Armor.

Secondary Purpose: Assault.

Range: 12,000 feet (3657.6 m); a little more than 2 miles/3.2 km.

Mega-Damage: 3D6x100 M.D. per single full powered blast. Critical Strike (in this case 1D8x100 M.D. additional damage) on a roll of an unmodified 19 or 20.

Rate of Fire: Once per melee round (needs about 10 seconds to recycle).

Payload: Effectively unlimited.

Special Feature: Independent coordinated targeting, +3 to strike.

Note: After 10 shots the weapon must be allowed to cool for five minutes. If not, roll for a system failure (01-50% chance) for each subsequent shot. A system failure means the gun cannot fire for 1D4 melee rounds.

**2. Super-Laser Cannon (1):** This powerful weapon is to the right of the main gun. It is an extremely effective weapon, especially when paired with the accompanying ion cannon. Like the main cannon, this weapon points forward, but can

fire up and down in a 90 degree arc. The weapon has a dedicated gunner.

Primary Purpose: Anti-Armor and Anti-Aircraft & Gargoyles.

Secondary Purpose: Assault and Defense.

Range: 10,000 feet (3,048 m).

Mega-Damage: 1D6x10 M.D. per single blast or 4D4x10 M.D. per triple pulse blast.

Rate of Fire: Each shot counts as one of the gunner's melee attacks.

Payload: Effectively unlimited.

Special Feature: Coordinated targeting system. Adds a bonus of +3 to strike. Uses the same targeting system as the main gun.

**3. Super-Ion Cannon (1):** This massive energy weapon is located to the left of the main cannon. Like the main cannon, this weapon points forward, but can fire up and down in a 90 degree arc. The weapon has a dedicated gunner.

Primary Purpose: Anti-Armor and Anti-Aircraft & Gargoyles.

Secondary Purpose: Assault and Defense.

Range: 6,000 feet (1829 m).

Mega-Damage: 2D6x10 M.D. per single blast.

Rate of Fire: Single shot only. Each blast counts as one of the gunner's melee attacks.

Payload: Effectively unlimited.

Special Feature: Coordinated targeting system. Adds a bonus of +3 to strike. Uses the same targeting system as the main gun.

Note: The Super Laser Cannon and the Super Ion Cannon can be fire-linked to shoot in tandem at the same target.

**4. Long-Range Missile Launcher (2):** On both sides of the main cannon is a triangular shaped housing that holds a number of long-range missiles. To fire the missiles, the launcher raises up and turns forward to shoot. When the launcher returns to its "stowed" position, empty launch tubes are automatically reloaded. Fired by a dedicated a gunner.

Primary Purpose: Anti-Armor and Fortified Positions.

Secondary Purpose: Anti-Aircraft and Assault.

Range: Varies with missile type, but typical mix: 12 heavy high explosive (500 mile/800 km range), 4 plasma (500 mile/800 km range) and 4 nuclear (heavy, 1,000 mile/1,600 km range).

Mega-Damage: Varies with missile type, but standard issue is 12 heavy high explosive (4D6x10 M.D. to everything in a 40 foot/12.2 m blast radius), 2 plasma (5D6x10 M.D. to everything in a 50 foot/15.2 m blast radius) and 2 nuclear (heavy, 1D6x100 M.D. to everything in a 50 foot/15.2 m blast radius).

Rate of Fire: One at a time or in volleys of 2, 4 or 6.

Payload: 96. 48 missiles per launcher.

**5. Forward Double-Barreled Laser Turrets (2):** Located on top of the forward section, near each of the long-range missile launchers is a double-barreled laser turret. They are mainly used for countering ground troops and Gurgoyles. Both turrets can fire independently of each other and have their own independent gunner. Each has a 220 degree arc of fire from the front of the vehicle to the side and toward the back, and 90 degree up and down arc of fire.

Primary Purpose: Anti-Personnel and Assault.

Secondary Purpose: Defense.

Range: 4,000 feet (1,219 m).

Mega-Damage: 5D6 M.D. per single blast or 1D6x10 M.D. per dual blast.

Rate of Fire: Each single or dual blast counts as one of the gunner's attacks per melee round.

Payload: Effectively unlimited.

**6. Forward Ion Tube Cannons (2):** Located on each side of the ram prow, 20 feet (6.1 m) above the ground, is a long tube. The tip of the tube opens up to reveal a double barreled ion cannon. The weapon points forward, but has a 30 degree arc of fire capable of damaging oncoming 'Bots, power armor, and ground troops. Somewhat limited in its firing range, the turrets' weapons are mainly used for defense.

Primary Purpose: Defense.

Secondary Purpose: Anti-Personnel.

Range: 4,000 feet (1219 m).

Mega-Damage: 1D4x10 M.D. per single blast or 2D4x10 M.D. per dual simultaneous blast.

Rate of Fire: Each single or dual blast uses one attack.

Payload: Effectively unlimited.

**7. Concealed Pop-Up Mini-Missile Launchers (6):** Scattered throughout the outer hull of the forward section are six concealed mini-missile launchers capable of raining down explosive fury all over the battlefield on all sides.

Primary Purpose: Anti-Aircraft/Gargoyle and Assault.

Secondary Purpose: Anti-Personnel and Defense.

Range: Varies with missile type, but fragmentation is the standard payload with a half a mile (0.8 km) range.

Mega-Damage: Varies with missile type, but fragmentation (5D6 M.D. to everything in a 20 foot/6.1 m radius) is the standard load.

Rate of Fire: One at a time or in volleys of 2, 4, 6, 8, 10 or 12. Each launcher can fire up to 12 mini-missiles in a single volley.

Payload: 96 mini-missiles per launcher for a total of 576 mini-missiles! Automatically reloaded every time the empty launcher retracts back into its concealed housing. It takes one melee round to reload.

**8. Forward Ram Prow.** Two thirds of the forward section is encased in a heavily armored ram prow designed to take incredible punishment from enemy attackers as well as being designed to plow right into the groups of Gurgoyles and mow them down.

Primary Purpose: Anti-Aircraft/Gargoyle and Assault.

Secondary Purpose: Anti-Personnel and Defense.

Mega-Damage: 2D4x10 M.D. at speeds of 50 mph (80 km) or greater. 1D4x10 M.D. at slower speeds. In addition, there is a 01-90% likelihood that giants and robots under 60 feet (18.3 m) tall are knocked down and off their feet. Victims of knockdown by this juggernaut lose initiative and two melee attacks/actions.

**9. Double-Barreled Laser Turrets (6, rear):** These weapons are only visible and able to fire when the forward section detaches from the rest of the MISB. They are on the back of the forward section behind the main gun and ram prow. Each turret is small, about half the sized of normal, manned gunnery station, and can rotate 360 degrees and fire in a 90 degree arc. Unlike the turrets in the prototype MISB, these turrets

are fully automated and under the control of a combat A.I. similar to the Dyna-Bot and do not need a live gunner. The A.I. can recognize 3,000 enemies and 450 hostile actions, and responds by firing upon them.

Primary Purpose: Defense.

Secondary Purpose: Assault.

Range: 4,000 feet (1219 m).

Mega-Damage: 3D6 M.D. per single blast or 6D6 M.D. per simultaneous double blast.

Rate of Fire: The combat A.I. can fire each turret six times per melee round.

Payload: Effectively unlimited.

**10. Troops:** There are numerous handholds and hand grips in the exterior walls of the forward section where infantry soldiers, power armor and even giant robots under 30 feet (9.1 m) tall can stand and fire at the enemy. The forward section can transport 96 infantry soldiers and 16 power armor troops.

**11. Sensor Systems Note:** The most advanced optic, sensory, and radio systems, plus all other features common to all Triax robots and military vehicles. The primary sensor cluster is located under the big cannons on the sides of the forward section, above the ram prow. A secondary sensor array is located to the right of the three guns in a concealed compartment. It is raised out of its containment pod only if the primary sensor array is destroyed. The secondary sensor array has 70 M.D.C. and is a difficult target to hit.

## MISB Command Center and Main Troop Carrier

**Model Type:** TX-MISB-P1 Component B.

**Class:** Armored Infantry Assault & Troop Transport.

**Crew:** 18: Two pilots, two co-pilots, three communications officers, three technical officers, and eight gunners.

**Troops in the APC Section:** 120 infantry soldiers in body armor, and 60 power armor troops such as the T-550 Glitter Boy, the new X-11 Predator II, and the X-21 War Eagle, 4 X-1001 Ulti-Max II, 12 DV-39 Wolf Drones, 1 DVO-1 Aerial Spy Drones, 12 XML Wraith Fighters and 3-6 giant robots under 25 feet (7.6 m) tall.

**Command Center Crew:** 96: A commander, a second-in-command, 12 communications officers, 8 technical officers, 16 field mechanics, 12 gunners, 8 military specialists, 10 power armor commandos, 6 Combat Cyborgs, 6 intelligence officers, 12 soldiers, and 4 reserve pilots.

**M.D.C. by Location of the Main Troop Carrier & Command Center:**

Side Pulse Laser Turrets (4, two on each side) – 150 each

\* Pop-Up Mini-Missile Launchers (10, lower section) – 30 each

\* Side Hatches (2, lower section) – 120 each

\* Top Hatches (4, lower section) – 120 each

\* Rear Hatches (2, lower section) – 150 each

Long- & Medium-Range Missile Launcher (1, left) – 400

Communication Tower & Sensor Array (rear of Command Deck) – 300

Reinforced Pilot Compartment (Command Deck) – 150

\* Giant Wheels (24) – 50 each

\*\* Main Body: Command Deck (top section) – 1,450

\*\* Main Body: APC Deck (lower section) – 1,640

\*\*\* Force Field (for lower section) – 200

\* A single asterisk indicates a small or difficult target to hit. They can only be struck when an attacker makes a Called Shot and even then the character is -3 to strike.

\*\* Depleting the M.D.C. of the main body of the APC deck shuts the vehicle down immobilizing it, but Central Command, with its own independent nuclear power source and weapon battery, remains fully functioning. Deplete all the M.D.C. for the main body of Central Command and all sensors and communications are lost and the crew many be injured or killed.

\*\*\* Depleting the M.D.C. of the force field shuts the system down completely. All subsequent damage is to be taken from the main body. It will take six hours to fully regenerate (33 M.D.C. per hour). **Note:** The force field is used to protect the lower portion of the troop transport section, not Central Command.

### Speed:

Driving: 12 mph (19.2 km) maximum when separated from the other 5 units. 40 mph (64 km) when pulled by all five unit vehicles. 23 mph (36.8 km) when pulled by the rear units as is most often the case.

### Statistical Data:

Height: 90 feet (27.4 m).

Width: 30 feet (9.1 m).

Length: 90 feet (27.4 m).

Weight: 35,000 tons.

Power System: Nuclear with an operational life of 20 years.

Black Market Cost: Not available. Specifically contracted by the NGR military.

## Weapon Systems MISB Command and Main APC:

**1. Dual Particle Beam Turret (1):** On the very top of the Command Center is a low profile turret for two particle beam cannons. The turret can rotate 360 degrees and the guns have a 70 degree arc of fire. The guns can fire independent of one another or in tandem. The turret has an independent gunner.

Primary Purpose: Defense.

Secondary Purpose: Assault and Anti-Gargoyle/Anti-Aircraft.

Range: 2,000 feet (610 m).

Mega-Damage: 1D6x10+10 M.D. per single blast or 2D6x10+20 M.D. per simultaneous dual blast. A Critical Strike (double damage) on a roll to strike that is an unmodified Natural 19 or 20.

Rate of Fire: Each single or dual blast counts as one of the dedicated gunner's attacks per melee.

Payload: Effectively unlimited.

**2. Double-Barreled Laser Turret (2):** Located on each side of the Command Center is one heavy, double-barreled laser turret. The turrets can rotate 360 degrees and have a 90 degree up and down arc of fire.

Primary Purpose: Assault.

Secondary Purpose: Defense.

Range: 6,000 feet (1,829 m).

Mega-Damage: 1D4x10 M.D. per single blast or 2D4x10 M.D. per simultaneous double blast.

Rate of Fire: Each single or dual blast counts as one of the dedicated gunner's melee attacks .

Payload: Effectively unlimited.

**3. Side Laser Turrets (4):** Located on each side of the Command Center are two double-barreled laser turrets. The turrets can rotate 360 degrees and have a 70 degree up and down arc of fire.

Primary Purpose: Defense.

Secondary Purpose: Anti-Personnel.

Range: 4,000 feet (1219 m).

Mega-Damage: 4D6 M.D. per single blast or 1D4x10+8 M.D. per simultaneous double blast.

Rate of Fire: Each single or dual blast counts as one of the dedicated gunner's melee attacks .

Payload: Effectively unlimited.

## 4. Multi-System Medium- and Long-Range Missile

**Launcher (1):** Located on the left side of the Command Center is a large structure that is a side-firing missile launcher. Both medium-ranged missiles and long-range missiles can be fired. Has two dedicated gunners and a communications officer.

Primary Purpose: Anti-Armor and Fortified Positions.

Secondary Purpose: Anti-Aircraft and Assault.

Range: Varies with missile type.

40 miles (64 km) is the typical range of medium-range missiles.

A typical mix of long-range missiles is heavy high-explosive (500 mile/800 km range) and 2 nuclear (heavy, 1,000 mile/1,600 km range).

Medium-Range Missiles Mega-Damage: Varies with missile type, but typical mix is half high-explosive (3D6x10 M.D. to everything in a 30 foot/9.1 m radius) and half Multi-Warhead (5D6x10 M.D. to a 20 foot/6.1 m radius – this is a smart missile).

Long-Range Missiles Mega-Damage: Varies with missile type, but a typical mix is six high-explosive (3D6x10 M.D. to everything in a 30 foot/9.1 m radius) and two Multi-Warhead (5D6x10 M.D. to a 20 foot/6.1 m radius – this is a smart missile). Often the payload is half and half.

Rate of Fire: One at a time or in volleys of 2, 4 or 6.

Payload: Medium-Range Missiles: 12 total. Long-Range Missiles: 8.

**5. Concealed Pop-Up Mini-Missile Launchers (10):** Scattered throughout the outer hull of the troop carrying mid-section are ten concealed mini-missile launchers (five on each side) that pop-up to fire and then retract back into their concealed housing.

Primary Purpose: Anti-Aircraft/Gargoyle and Assault.

Secondary Purpose: Anti-Personnel and Defense.

Range: Varies with missile type, but fragmentation is the standard payload with a half a mile (0.8 km) range.

Mega-Damage: Varies with missile type, but fragmentation (5D6 M.D. to everything in a 20 foot/6.1 m radius) is the standard load.

Rate of Fire: One at a time or in volleys of 2, 4, 6, 8, 10 or 12. Each launcher can fire up to 12 mini-missiles in a single volley.

Payload: 96 mini-missiles per launcher for a total of 960 mini-missiles! Automatically reloaded every time the empty launcher retracts back into its concealed housing. It takes one melee round to reload.

**6. Side-Mounted APCs (2).** There are two sided-mounted APCs that are attached to the massive Mobile Infantry Strike Base (MISB) that provide additional firepower, troops and protection. Either type of APC may be used, but the Infantry APC is standard because it carries more troops. The Armored Artillery APC is used to replace the Infantry APC when more long-range artillery support is anticipated. Both APCs are produced and deployed independent of the MISB.

**7. Command Center Sensor Systems Note:** The most advanced optic, sensory, and communications/radio systems, plus all other features common to all Triax robots and military vehicles. It is contained in the communications and sensor tower toward the back of the mid-section atop the Command Center.

## TX-MISB Rear Section

The back section is the smallest of the three-part central vehicle (A-B-C). It carries troops, but is also a mobile hospital and has a battery of weapon systems to guard the rear.

**Model Type:** TX-MISB-P1 Component C.

**Class:** Armored Infantry Assault & Troop Transport.

**Crew:** 16: Two pilots, two co-pilots, three communications officers, three technical officers, and six gunners.

**Mobile Hospital Wing (Second Floor):** 18 doctors, 3 Cyber-Docs, 24 nurses, 12 soldiers to help and protect; can accommodate 48 injured.

**Troops:** Carries 60 infantry soldiers in T-25 Uber body armor, and 18 power armor troops.

### M.D.C. by Location:

Flak Cannon Turret (1, top) – 500

Double Barrel Laser Turrets (2, back) – 300 each

Single Barrel Laser Turrets (4) – 200 each

\* Pop-Up Mini-Missile Launchers (6) – 30 each

Side Hatches (2, one on each side) – 200 each

Rear Hatch (1) – 200

Large Bay Door (1, in the rear) – 300

\* Giant Wheels (16) – 50 each

Ram Prow (1) – 4,300

Pilot's Compartment – 200

\*\* Force Field (Second Floor Hospital level) – 200

\*\*\* Main Body – 1,600

\* A single asterisk indicates a small or difficult target to hit. They can only be struck when an attacker makes a Called Shot and even then the character is -3 to strike. Gets sensor and targeting data from the Command Center.

\*\* Depleting the M.D.C. of the force field shuts the system down completely. All subsequent damage is to be taken from the main body. It takes 6 hours to fully regenerate (33 M.D.C. per hour). Weapons can be fired while the field is up, because it only protects the second floor hospital wing.

\*\*\* Depleting the M.D.C. of the main body shuts the vehicle down completely, making it useless, but the hospital has 1D4+2 hours of auxiliary power for evacuation.

### TX-MISB Back Section Speed:

Driving: 12 mph (19.2 km) maximum when separated from the other 5 units.

### Back Section Statistical Data:

Height: 80 feet (24.4 m) to the top of the anti-aircraft cannons.

Width: 60 feet (18.3 m).

Length: 56 feet (17 m).

Weight: 23,000 tons.

Power System: Nuclear with an operational life of 20 years. Each of the main guns have their own independent nuclear power supply.

## Weapon Systems of the MISB Rear Section:

**1. Recoiless Anti-Aircraft Flak Cannon (1):** A pair of flak cannons and mini-missile launcher are contained in this massive weapon turret. It rotates 360 degrees and has a 90 degree arc of fire, and has two dedicated gunners and a communications officer.

Primary Purpose: Anti-Aircraft/Gargoyle.

Secondary Purpose: Anti-Missile and Assault.

Range: Flak Cannon: 10,000 feet (3,048 m). Mini-Missiles: One mile (1.6 m).

Mega-Damage: Flak Cannon: Single round does 5D6 M.D., a double blast does 1D6x10 M.D., a rapid-fire burst (six rounds) does 2D6x10 M.D. to a five foot (1.5 m) blast radius.

Mini-Missiles: Armor piercing are standard issue and do 1D4x10 M.D. to a 3 foot (0.9 m) blast radius.

Rate of Fire: Each single shot or burst counts as one melee attack of the gunner.

Payload: Flak Cannon: 1,600 total rounds, 266 bursts of six rounds or 800 two round bursts. Mini-Missiles: 96.

**2. Double-Barreled Laser Turrets (2):** Located on each side of the back section is one heavy, double-barreled laser turret. The turrets can rotate 360 degrees and have a 90 degree up and down arc of fire.

Primary Purpose: Assault.

Secondary Purpose: Defense.

Range: 6,000 feet (1,829 m).

Mega-Damage: 1D4x10 M.D. per single blast or 2D4x10 M.D. per simultaneous double blast.

Rate of Fire: Each single or dual blast counts as one of the dedicated gunner's melee attacks.

Payload: Effectively unlimited.

**3. Single Barrel Laser Turrets (4):** One is located on each side of the back section and two in the back on either side of the bay cargo door. The turrets can rotate 360 degrees and have a 90 degree up and down arc of fire.

Primary Purpose: Defense.

Secondary Purpose: Anti-Personnel.

Range: 4,000 feet (1,219 m).

Mega-Damage: 4D6 M.D. per single blast or 1D4x10+4 M.D. per simultaneous double blast when fire-linked.

Rate of Fire: Each single or dual blast counts as one of the dedicated gunner's melee attacks.

Payload: Effectively unlimited.

**4. Concealed Pop-Up Mini-Missile Launchers (6):** Scattered throughout the outer hull of the forward section are six concealed mini-missile launchers capable of raining down explosive fury all over the battlefield on all sides.

Primary Purpose: Anti-Aircraft/Gargoyle and Assault.

Secondary Purpose: Anti-Personnel and Defense.

Range: Varies with missile type, but fragmentation is the standard payload with a half a mile (0.8 km) range.

Mega-Damage: Varies with missile type, but fragmentation (5D6 M.D. to everything in a 20 foot/6.1 m radius) is the standard load.

Rate of Fire: One at a time or in volleys of 2, 4, 6, 8, 10 or 12. Each launcher can fire up to 12 mini-missiles in a single volley.

Payload: 96 mini-missiles per launcher for a total of 576 mini-missiles! Automatically reloaded every time the empty launcher retracts back into its concealed housing. It takes one melee round to reload.

**5. Troops & Hospital:** Troops are carried on the lower level, and fully equipped field hospital is on the upper floor.

## TX-MSIB IA-30 Infantry APCs

On each side of the Command Center and Main Troop Carrier is a detachable Armored Personnel Carrier (APC). Both are identical in every way. They break off from the central MSIB to deploy troops at different locations or to engage the enemy as separate units.

**Model Type:** TX-MISB-P1 Components D & E.

**Class:** Armored Infantry Assault & Troop Transport.

**Crew:** 11: Pilot, copilot, three communications officers, four gunners, and two reserve gunners.

**Troops:** Each APC can carry one full company of 120 soldiers in body armor, or two platoons (60 troops) of power armor troops such as the new X-11 Predator II, X-21 War Eagle, Hell Angel, Glitter Boys and others of a similar size.

### M.D.C. by Location:

Laser Turrets (2, front sides) – 150 each

Ion Turrets (2, rear sides) – 90 each

\* Mini-Missile Launchers (2, side tube) – 100 each

\* Front Mini-Missile Launcher (1) – 200

\* Side Hatches (4) – 120 each

Rear Bay Hatch (1) – 200

Reinforced Pilot Compartment – 100

\*\*\* Force Field – 200

\*\* Main Body – 800

\* A single asterisk indicates a small or difficult target to hit. They can only be struck when an attacker makes a Called Shot, and even then he is -3 to strike.

\*\* Depleting the M.D.C. of the main body shuts the vehicle down completely, making it useless.

\*\*\* Depleting the M.D.C. of the force field will shut the system down completely. All subsequent damage is to be taken from the main body. It will take six hours to fully regenerate (33 M.D.C. per hour). Weapons cannot fire when the force field is up.

### Speed of the MISB APCs:

Driving: 70 mph (112 km) maximum when separated from the Command Center.

### Statistical Data of the MISB APCs:

Height: 30 feet (9.1 m).

Width: 20 feet (6.1 m).

Length: 70 feet (21.4 m).

Weight: 11,000 tons.

Power System: Nuclear with an operational life of 20 years,

Black Market Cost: Not available. Specifically contracted by the NGR military.

### Weapon Systems of the MISB Infantry APCs:

**1. Double-Barreled Laser Turret (2):** Located on the sides of the vehicle, toward the front, is a double-barrel laser turret. It can rotate 360 degrees and has a 90 degree arc of fire. Each has a dedicated gunner. The two turrets cannot fire-link.

Primary Purpose: Assault.

Secondary Purpose: Defense.

Range: 4,000 feet (1,219 m).

Mega-Damage: 1D4x10 per single blast or 2D4x10 M.D. per simultaneous double blast.

Rate of Fire: Each single or dual blast uses one attack.

Bonus: +1 to strike.

Payload: Effectively unlimited.

**2. Ion Turrets (2):** Located on the sides in the back of the APC is a double-barrel ion turret. It can rotate 360 degrees and has a 90 degree arc of fire. Each has a dedicated gunner. The two turrets cannot fire-link.

Primary Purpose: Assault.

Secondary Purpose: Defense.

Range: 2,000 feet (610 m).

Mega-Damage: 4D6 M.D. per single blast or 1D4x10 M.D. per dual simultaneous blast.

Rate of Fire: Each single or dual blast counts as one of the gunner's melee attacks.

Payload: Effectively unlimited.

**3. Front Mini-Missile Launcher (1):** The nose of the APC has a box style mini-missile launcher to attack troop formations and enemy fortified positions. Fired by the pilot or co-pilot.

Primary Purpose: Anti-Personnel and Assault.

Secondary Purpose: Anti-Armor and Defense.

Range: Varies with missile type, but fragmentation is the standard payload with a half a mile (0.8 km) range.

Mega-Damage: Varies with missile type, but fragmentation (5D6 M.D. to everything in a 20 foot/6.1 m radius) is the standard load.

Rate of Fire: One at a time or in volleys of 2, 4, 6, 10 or all 24.

Payload: 24 mini-missiles.

**4. Side Mini-Missile Tube Launchers (2)**: Each side of the APC has tube mini-missile launchers. Fired by the pilot or co-pilot.

Primary Purpose: Anti-Gargoyle and Anti-Armor.

Secondary Purpose: Anti-Missile and Anti-Personnel.

Range: Varies with missile type, but fragmentation is the standard payload with a half a mile (0.8 km) range.

Mega-Damage: Varies with missile type, but fragmentation (5D6 M.D. to everything in a 20 foot/6.1 m radius) is the standard load.

Rate of Fire: One at a time or in volleys of 2, 4, 6 or 12.

Payload: 96 mini-missiles per launcher, for a total of 192 mini-missiles.

**5. Sensor Systems Note**: All of the most advanced optic, sensory, and radio equipment plus all features common to all Triax robots.

**6. Troops**: Each APC can carry one full company of 120 soldiers in body armor, or two platoons (60 troops) of power armor troops such as the new X-11 Predator II, X-21 War Eagle, Hell Angel and others of a similar size.

**Note**: Maybe substituted with the AA-50 APC described below.

## AA-50 APC (Alternative APC) Armored Artillery Troop Carrier

**Note**: May replace the Infantry APC.

**Model Type**: "Alternative" TX-MISB-P1 Components D & E.

**Class**: Armored Infantry Assault & Troop Transport.

**Crew**: 10: Pilot, copilot, two communications officers, and six gunners.

**Troops**: 60 infantry soldiers in body armor and 12 power armor troops.

### M.D.C. by Location of the AA-50:

Main Gun (1) – 250

Forward Turrets (2) – 150 each

Side Ion Turrets (2, rear) – 120 each

Multi-Missile and Laser Turret (1) – 500

Medium-Range Missile Launcher (1, rear) – 120

Short-Range Missile Launcher (1, rear) – 150

Pop-Up Mini-Missile Launchers (4) – 30 each

Side Hatches (2, one on each side) – 200 each

Rear Hatch (1) – 200

\*\* Main Body – 1,200

Reinforced Pilot Compartment – 150

\* A single asterisk indicates a small or difficult target to hit. They can only be struck when an attacker makes a Called Shot, and even then he is -3 to strike.

\*\* Depleting the M.D.C. of the main body shuts the vehicle down completely, making it useless.

### Speed the MISB AA-50:

Driving: 50 mph (80 km) maximum when separated from the Command Center.

### Statistical Data of the AA-50:

Height: 30 feet (9.1 m) from bottom to tip of sensor antenna. 16 feet to the base of the main gun.

Width: 20 feet (6.1 m).

Length: 62 feet (18.9 m).

Weight: 15,000 tons.

Power System: Nuclear with an operational life of 20 years.

Black Market Cost: Not available. Specifically contracted by the NGR military.

### Weapon Systems of the AA-50:

**1. Main Gun (1)**: The main gun is a high-powered particle beam cannon. It is fixed forward but can move up and down in a 90 degree arc of fire.

Primary Purpose: Assault and Anti-Armor.

Secondary Purpose: Defense and Anti-Fortifications.

Range: 4,000 feet (1,219 m).

Mega-Damage: 2D4x10+8 M.D. per single blast. A Critical Strike (double damage) on a roll to strike that is an unmodified Natural 19 or 20.

Rate of Fire: Each shot counts as one melee attack for the dedicated gunner.

Bonus: +1 to strike.

Payload: Effectively unlimited.

**2. Laser & Ion Turrets (2)**: The forward weapon turrets have one laser (the large barrel) and two ion cannons. Each can be fired separately or in tandem for a triple blast as the same target. The turrets can rotate 360 degrees and have a 20% up and down arc of fire. Both turrets fire independent of each other and cannot be fire-linked. Each has a dedicated gunner.

Primary Purpose: Assault and Anti-Armor.

Secondary Purpose: Defense.

Range: Laser: 4,000 feet (1,219 m). Ion: 2,000 feet (610 m).

Mega-Damage: Laser: 5D6 M.D. per single blast. Ion: 4D6 M.D. per single blast or 1D4x10 M.D. per dual simultaneous ion blast. 1D6x10+6 M.D. when both ion guns and the laser are fired simultaneously at the same target.

Bonus: +1 to strike with laser.

Rate of Fire: Each single, dual or triple simultaneous blast counts as one of the dedicated gunner's melee attacks.

Payload: Effectively unlimited.

**3. Ion Turrets (2)**: Located on the sides in the back of the APC is a double-barrel ion turret. It can rotate 360 degrees and has a 90 degree arc of fire. Each has a dedicated gunner. The two turrets cannot fire-link.

Primary Purpose: Assault.

Secondary Purpose: Defense.

Range: 2,000 feet (610 m).

Mega-Damage: 4D6 M.D. per single blast or 1D4x10 M.D. per dual simultaneous blast.





Rate of Fire: Each single or dual blast counts as one of the gunner's melee attacks.

Payload: Effectively unlimited.

**4. Medium-Range Missile Launcher:** Right side, rear. These missiles are primarily used against Gargoyles and aircraft, or hardened, fortified positions and mountain lairs. The missile launcher is controlled by a dedicated gunner.

Primary Purpose: Anti-Gargoyles/Aircraft.

Secondary Purpose: Anti-Missile and Assault.

Range: Varies with type of missile used, but typically 40 miles (64 km).

Mega-Damage: Varies with missile type, but typically high-explosive (3D6x10 M.D. to a 30 foot/9.1 m radius) or fragmentation (2D6x10 M.D. to a 40 foot/12.2 m radius).

Rate of Fire: Fired in volleys of 2 or 3. Each volley regardless of the number of missiles counts as one melee attack.

Payload: 24 total medium-range missiles.

**5. Short-Range Missile Launcher:** Left side, rear. The missile launcher is controlled by a dedicated gunner.

Primary Purpose: Anti-Aircraft/Gargoyles and Assault.

Secondary Purpose: Defense.

Range: Varies with type of missile used, but high-explosive is five miles (8 km) and fragmentation is three miles (4.8 km).

Mega-Damage: Varies with type of missile used. Typically high-explosive (2D6x10 M.D. to everything in a 15 foot/4.6 m

radius) or fragmentation (2D4x10 M.D., 20 foot/6.1 m damage radius).

Rate of Fire: One at a time or in volleys of 2 or 3.

Payload: 32 total missiles.

**6. Concealed Pop-Up Mini-Missile Launchers (4):** Between the main gun and the forward turrets are four concealed mini-missile launchers that pop-up to fire and then retract back into their concealed housing.

Primary Purpose: Anti-Aircraft/Gargoyle and Assault.

Secondary Purpose: Anti-Personnel and Defense.

Range: Varies with missile type, but fragmentation is the standard payload with a half a mile (0.8 km) range.

Mega-Damage: Varies with missile type, but fragmentation (5D6 M.D. to everything in a 20 foot/6.1 m radius) is the standard load.

Rate of Fire: One at a time or in volleys of 2, 4 or 6. Each launcher can fire up to six mini-missiles in a single volley.

Payload: 32 mini-missiles per launcher for a total of 128 mini-missiles. Automatically reloaded every time the empty launcher retracts back into its concealed housing. It takes one melee round to reload.

**7. Sensor Systems Note:** All of the most advanced optic, sensory, and radio equipment plus all features common to all Triax robots.

**8. Troops:** Each AA-50 has a complement of troops who can join in battle.





# RIFTS®

- Imagine Earth transformed into an alien landscape.
- Humans exist – barely. And we are not alone.
- Aliens and monsters emerge from the Rifts – holes torn in the fabric of space and time, connected to countless worlds and realities.
- Ancient gods, demons and magic have returned.
- Magic and technology clash.
- Hundreds of character classes, many inhuman.
- *Rifts® Ultimate Edition* is the core RPG rule book.
- Expansive world setting with 90+ sourcebooks to draw upon.
- Rifts®, your portal to endless adventure.
- Limited only by your imagination.

[www.palladiumbooks.com](http://www.palladiumbooks.com)

© 2014 Palladium Books. Rifts®, Megaverse®, Nightbane® and other titles, slogans and likenesses are trademarks of Palladium Books, Inc. Palladium Books - 39074 Webb Court, Westland, MI 48185 USA - 734-271-2903 order line.

## Other RPG Worlds from Palladium Books®:

- *Rifts®* – the ultimate role-playing experience.
- *Rifts® Chaos Earth®* – Play the apocalypse as it happens.
- *Splicers®* – Weird science. Bio-tech battles insane robot legions.
- *Robotech® RPG* – All eras of the TV show brought to life.
- *Dead Reign™ RPG* – Can you survive the Zombie Apocalypse?
- *Palladium Fantasy RPG®* – Unique world, monsters as player characters, magic and more.
- *Heroes Unlimited™ RPG* – Play any hero; mutants, aliens, cyborgs, superhumans, mages, immortals and more.
- *Nightbane® RPG* – Conspiracy, magic, horror and monsters.
- *Beyond the Supernatural™ RPG* – Modern horror and suspense.
- *Ninjas and Superspies™*, and more.

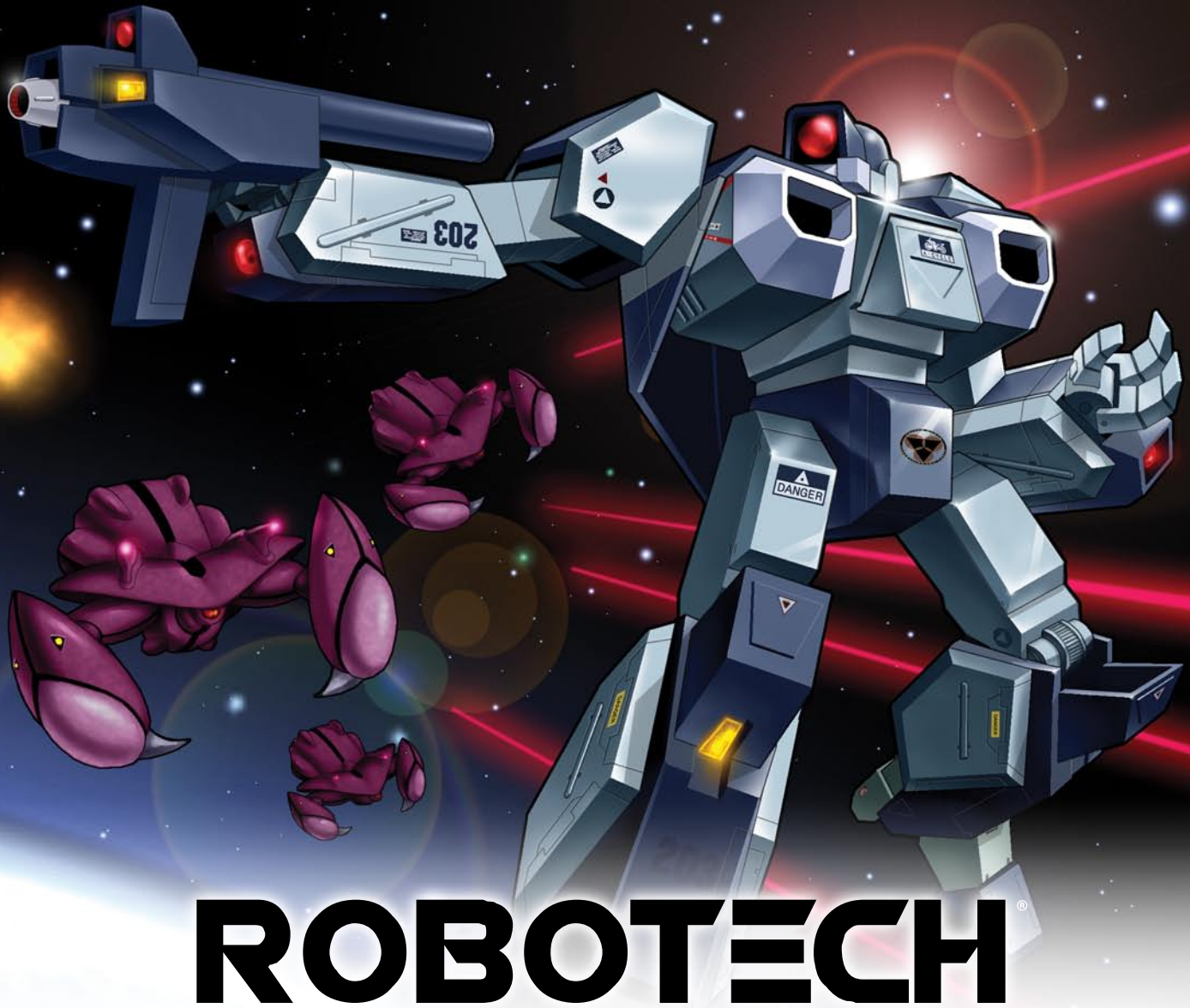

# ROBOTECH®

## Role-Playing Game and Sourcebooks

- **Four generations of heroes and mecha** • **Giant transformable robots** • **Alien invaders** • **Battle for control of the Earth** • **Combat takes to the stars** • **All presented in a core rule book and dynamic set of epic sourcebooks** • **Easy to learn** • **Fun to play** • **Quick character generation** • **Fast combat** • **Captures the action and adventure of the anime TV series** • **Isn't it time you joined the adventure?**

### Robotech® "Core Rules" – Shadow Chronicles® RPG Hardcover

All the rules and information a player needs to start a Robotech® role-playing campaign with Admiral Rick Hunter and the United Earth Expeditionary Force trekking across the galaxy.

- Human mecha: Alphas, Betas, Cyclones & much more.
- Five character classes. 25 different Military Specialties.
- Invid mecha, Haydonites, and alien enemies.
- Quick roll character tables. Make a character in 15 minutes.
- A complete, stand-alone RPG.
- 224 pages. Cat. No. 550HC. 8½ x 11 size, hardcover.

### Robotech®: The Macross® Saga Sourcebook – Cat. No. 551

A treasure chest packed with the iconic mecha, vehicles, weapons and characters that made Robotech® famous. Valkyries, Destroyers, ground vehicles, aircraft, spacecraft, weapons, Zentraedi soldiers, Zentraedi mecha, alien invaders, heroes, villains, and more.

- All the iconic Macross mecha, vehicles, weapons & characters.

[www.palladiumbooks.com](http://www.palladiumbooks.com)

### Robotech®: The Masters Saga™ Sourcebook – Cat. No. 552

Tons of never before seen stats and descriptions for the many weapons, armor, mecha and robots of the Army of the Southern Cross.

- The Army of the Southern Cross™ – all 15 branches and their mecha!

### Robotech®: New Generation™ Sourcebook – Cat. No. 554

The battle for the liberation of Earth starts here.

- Kit-bashed mecha combining parts from different mecha.
- Invid Hives, world overview, key characters and adventure ideas.

### Robotech®: Genesis Pits™ Sourcebook – Cat. No. 555

The Invid Genesis Pits, their purpose, function.

- Inorganics and other war machines of the Invid Regent.
- Genesis Pit mutations and monsters.

### Robotech®: Expeditionary Marines Sourcebook – Cat. No. 553

Join the UEEF (United Earth Expeditionary Force) led by Admiral Rick Hunter as they travel across the galaxy liberating planets from the bondage of the Invid Regent, the Robotech Masters and other tyrants.

- New mecha, weapons, and character classes of the UEEF Marines.
- New alien species and allies. Planet hopping and more.



# ROBOTECH

R P G T A C T I C S

## Main Boxed Game – Cat. No. 55100 – Available Now!

A fast-paced, strategy battle game that captures the speed and action of Robotech®. Play Earth defenders or Zentraedi invaders.

- Scalable from small squad skirmishes to mass battles.
- Turn-based system of play and uses D6. Two or more players.
- 34 highly detailed game pieces. 6mm scale.
- 112 page color rule book with paint guide and index.
- 53 laminated, color game cards.
- 24 custom dice, two decal sheets and more.
- Assembly and painting required. Glue not included.
- \$99.95 retail – Cat. No. 55100 – shipping now!
- Available in North and South America, the EU, Australia & New Zealand.

**Note:** Each product contains plastic game pieces requiring assembly and painting. Glue not included. This is not a toy. Small parts, not suitable for children under the age of 13. Adult supervision advised. Images shown here are not to scale.



### UEDF Valkyrie Wing™ – Cat. No. 55201

Build your fleet of Earth defenders with the Valkyrie Veritech Fighter; six game pieces total. **\$36.95 retail.**

- 2 Valkyries in Fighter mode.
- 2 Valkyries in Guardian mode.
- 2 Valkyries in Battloid mode.
- Multiple heads for making the VF-1A, VF-1J, VF-1R & VF-1S.



### UEDF Tomahawk/Defender Destroids™ – Cat. No. 55202

Expand your Destroid squad with these formidable walking tanks; four game pieces total. **\$32.95 retail.**

- 2 Tomahawk Destroids – the main battle tank of Destroids, brimming with powerful particle beam cannons for arms, and wielding a battery of missiles and an array of other weapons.
- 2 Defender Destroids – a long-range, anti-aircraft juggernaut capable of shooting down incoming Zentraedi Battlepods and Gnerl Fighters.



### UEDF Spartan/Phalanx Destroids™ – Cat. No. 55203

Add some long-range power and up-close punch to your army with these valuable Destroids; four game pieces total. **\$32.95 retail.**

- 2 Spartan Destroids – civil defense, riot control and deadly in hand to hand combat.
- 2 Phalanx Destroids – a walking, long-range missile artillery unit.



### Zentraedi Regult Battlepods™ – Cat. No. 55401

Expand your Zentraedi forces with their main infantry battle mecha; six game pieces total. **\$36.95 retail.**

- 6 Regult Tactical Battlepods – the lightning quick Regults, armed with a pair of particle cannons and auto-cannons, attack in wave after wave.



### Zentraedi Artillery Battlepods™ – Cat. No. 55402

Give your Zentraedi legion greater firepower with these artillery and support Battlepods; four game pieces total. **\$36.95 retail.**

- 4 Zentraedi Support Battlepods, each of which can be made into:
    - Gluuhaug-Regult – Light Artillery Battlepod
    - Serauhaug-Regult – Heavy Artillery Battlepod
    - Telnesta-Regult – Experimental Particle Beam Battlepod
- Four game pieces total.**



### Zentraedi Glaug Command™ – Cat. No. 55403

This diverse pack provides your Zentraedi forces with greater tactical capabilities; three game pieces total. **\$36.95 retail.**

- 1 Glaug Officer's Battlepod – the fast and deadly mecha of Zentraedi field leaders.
- 1 Quel-Regult Scout Battlepod – the stealthy eyes and ears of your Zentraedi battle force; electronic warfare capabilities.
- 1 Quel-Gulnau Recovery Pod – enhances the Glaug's ability to bring in Battlepod reinforcements. **Note:** This figure has NEVER before been offered by any company.



# Can YOU survive the Zombie Apocalypse?



## Dead Reign™ RPG

It is the aftermath of the *zombie apocalypse*. Civilization is gone, the dead reign, and the living fight to survive against impossible odds. Tales of zombies, human survival and horror as a fast-paced, easy to learn game and sourcebooks.

- **Zombie combat rules, vehicles and equipment.**
- **Six iconic Apocalyptic Character Classes and Ordinary People with 40+ occupations to choose from.**
- **Seven types of zombies plus the Half-Living.**
- **Secrets of the Dead and tips on fighting zombies.**
- **Death Cults, their Priests, power over zombies and goals.**
- **101 Random Scenarios, Encounters and Settings.**
- **100 Random Corpse Searches and other tables.**
- **Quick Roll Character Creation tables (10 minutes).**
- **A complete role-playing game by Siembieda and others.**
- **\$22.95 retail – 224 pages – Cat. No. 230. Available now.**

## Civilization Gone™

### Dead Reign™ Sourcebook One

It has been months since the dead rose to attack the living. Civilization has crumbled. There is no army, no government, no help coming. You are on your own and things are only getting worse.

- **Madmen and Psychopaths including the *Zombie Master, Ghost Walker, Backstabber, Messianic Leader, Zombie Lover, Deathbringer* and others.**
- **Bandits and Raiders who prey upon other survivors.**
- **Street Gang Protectors and their mission to save lives.**
- **Phobia and Obsession tables. Many adventure ideas.**
- **House and home resource and encounter tables.**
- **Random encounter and survivor camp creation tables.**
- **Additional world information and survival advice.**
- **\$12.92 retail – 64 pages – Cat. No. 231. Available now.**

## Dark Places™

### Dead Reign™ Sourcebook Two

Secrets of survival, including using railroad tracks and the urban underground to travel unseen and undetected by zombies.

- **Worm Meat, Bug Boy, Sewer Crawler and Impersonator Zombies.**
- **“Live Bait” zombie lures with human beings as bait.**
- **Traveling the rails and boxcar encounter tables.**
- **Traveling sewer tunnels, steam tunnels & other dark places.**
- **The pitfalls and dangers of the urban underground.**
- **Diseases, infection and additional world information.**
- **Random encounter tables, boxcar content tables, and more.**
- **\$12.92 retail – 64 pages – Cat. No. 232. Available now.**

## Endless Dead™

### Dead Reign™ Sourcebook Three

The zombie hordes grow in number and strangeness. Can humankind survive? Where is the military?

- **New types of zombies like Fused Zombies and Walking Mass Grave.**
- **New O.C.C.s including Wheelman and Zombie Hunter.**
- **Info & tables for weaponizing vehicles and vehicle combat rules.**
- **Random encounter tables for military bases, police stations, gun stores, buildings, suburbs, industrial parks, small towns, farmland and wilderness.**
- **Tables to make Survivor caravans, hideouts, Safe Havens & more.**
- **Timetable for setting zombie campaigns & many adventure ideas.**
- **\$16.95 retail – 96 pages – Cat. No. 233. Available now.**



## Other horror titles from Palladium Books®

Fear the Reaper™

Graveyard Earth™

Beyond the Supernatural™ RPG

Nightbane® RPG series

© Copyright 2012 Palladium Books Inc. All rights reserved. Rifts®, Palladium Books®, Megaverse®, Nightbane®, Heroes Unlimited, Dead Reign and other published book titles, names, slogans and likenesses are trademarks of Palladium Books Inc.

[www.palladiumbooks.com](http://www.palladiumbooks.com)

# Palladium Books® Check List & Order Form

Dept. P-16, 39074 Webb Court, Westland, MI 48185

Name: \_\_\_\_\_ Address: \_\_\_\_\_

City: \_\_\_\_\_ State: \_\_\_\_\_ Zip/Postal Code: \_\_\_\_\_ Country: \_\_\_\_\_

Credit Card Number: \_\_\_\_\_ Expiration Date: \_\_\_\_\_  Visa  MasterCard

Telephone Number: \_\_\_\_\_ Signature: \_\_\_\_\_  AMEX  Other

## The Rifter® Series

- \_\_\_ 170 The Rifter® #70 – \$13.95
- \_\_\_ 171-172 The Rifter® #71 & 72 – \$24.95
- \_\_\_ 173 The Rifter® #73 – \$13.95
- \_\_\_ 174 The Rifter® #74 – \$13.95
- \_\_\_ 175 The Rifter® #75 – \$13.95
- \_\_\_ 176 The Rifter® #76 – \$13.95 (Fall)

## Splicers®

- \_\_\_ 200 Splicers® RPG – \$23.95
- Note: Sourcebooks coming soon.

## Dead Reign®

- \_\_\_ 230 Dead Reign® RPG – \$22.95
- \_\_\_ 231 SB 1: Civilization Gone™ – \$12.95
- \_\_\_ 232 SB 2: Dark Places™ – \$12.95
- \_\_\_ 233 SB 3: Endless Dead™ – \$16.95
- \_\_\_ 234 SB 4: Fear the Reaper™ – \$12.95
- \_\_\_ 235 SB 5: Graveyard Earth™ – \$12.95
- \_\_\_ 236 SB 6: Hell Followed™ – \$20.95 (coming)

## Rifts® Novels

- \_\_\_ 301 Sonic Boom™ – \$9.95
- \_\_\_ 302 Deception's Web™ – \$9.95
- \_\_\_ 303 Treacherous Awakenings™ – \$9.95
- \_\_\_ 304 Tales of the Chi-Town 'Burbs™ – \$12.95
- \_\_\_ 305 Rifts® Path of the Storm™ – Screen-play & Sourcebook – \$12.95

## Weapons Books

- \_\_\_ 401 Weapons and Armor™ – \$8.95
- \_\_\_ 402 Weapons and Castles™ – \$8.95
- \_\_\_ 403 Weapons and Assassins™ – \$8.95
- \_\_\_ 404 Weapons & Castles of the Orient™ – \$8.95

## Palladium Fantasy RPG®

- \_\_\_ 450 The Palladium Fantasy RPG® – \$26.95
- \_\_\_ 4500HC Palladium Fantasy RPG® 30th Anniversary Hardcover – \$50.00
- \_\_\_ 451 Dragons & Gods™ – \$24.95
- \_\_\_ 453 Old Ones™ 2nd Ed. – \$24.95
- \_\_\_ 454 Monsters & Animals™ 2nd Ed. – \$24.95
- \_\_\_ 455 Adventures on the High Seas™ – \$24.95
- \_\_\_ 458 Island at the Edge of the World™ – \$20.95
- \_\_\_ 459 Yin-Sloth Jungles™ – \$20.95
- \_\_\_ 462 Western Empire™ – \$24.95
- \_\_\_ 463 Baalgor Wastelands™ – \$24.95
- \_\_\_ 464 Mount Nimro™ – \$20.95
- \_\_\_ 465 Eastern Territory™ – \$24.95
- \_\_\_ 466 Library of Bletherad™ – \$20.95
- \_\_\_ 467 Northern Hinterlands™ – \$24.95
- \_\_\_ 468 Land/Damned 1: Chaos Lands™ – \$24.95
- \_\_\_ 469 LoD 2: Eternal Torment™ – \$24.95
- \_\_\_ 470 LoD 3: The Citadel – \$24.95 (coming)
- \_\_\_ 471 Wolfen Empire™ – \$20.95
- \_\_\_ 472 Mysteries of Magic™ One: Heart of Magic – \$16.95
- \_\_\_ 474 Bizantium/Northern Islands™ – \$20.95
- \_\_\_ 475 Garden of the Gods™ – \$12.95 (coming)

## Heroes Unlimited™ / After the Bomb®

- \_\_\_ 500-2 Heroes Unlimited™, 2nd Ed. – \$26.95
- \_\_\_ 5000HC Heroes Unlimited™ 30th Anniversary Hardcover – \$50.00
- \_\_\_ 501 Villains Unlimited™ Revised – \$24.95
- \_\_\_ 503 After the Bomb® RPG – \$24.95
- \_\_\_ 505 Road Hogs™ (After the Bomb® II) – \$9.95
- \_\_\_ 507 Mutants Down Under™ (AB III) – \$9.95
- \_\_\_ 511 Mutants of the Yucatan™ (AB IV) – \$9.95
- \_\_\_ 513 Mutants in Avalon™ (AB V) – \$16.95
- \_\_\_ 514 Mutants in Orbit™ (AB VI) – \$16.95
- \_\_\_ 515 Aliens Unlimited™ – \$24.95
- \_\_\_ 516 Heroes Unlimited™ G.M.'s Guide – \$24.95
- \_\_\_ 517 Century Station™ – \$24.95
- \_\_\_ 518 Gramercy Island™ – \$24.95
- \_\_\_ 519 Aliens Unlimited Galaxy Guide™ – \$24.95
- \_\_\_ 520 Mutant Underground™ – \$16.95
- \_\_\_ 521 Powers Unlimited® One – \$16.95
- \_\_\_ 522 Powers Unlimited® Two – \$16.95
- \_\_\_ 523 Powers Unlimited® Three – \$16.95
- \_\_\_ 525 Revised Ninjas & Superspies™ – \$20.95
- \_\_\_ 526 Mystic China™ – \$24.95
- \_\_\_ 527 Armageddon Unlimited™ – \$20.95

## Robotech® RPG

- \_\_\_ 550 Robotech® The Shadow Chronicles® RPG (manga size) – \$16.95
- \_\_\_ 550HC Robotech® The Shadow Chronicles® Deluxe Hardcover RPG – \$30.95
- \_\_\_ 5500HC Robotech® The Shadow Chronicles® Gold Ed. Hardcover RPG – \$70.00
- \_\_\_ 551 Robotech® Macross® Saga Sourcebook – \$16.95
- \_\_\_ 552 Robotech® The Masters Saga™ Sourcebook (NEW in 8½ x 11) – \$20.95
- \_\_\_ 553 Robotech®: Expeditionary Force Marines Sourcebook – \$20.95
- \_\_\_ 554 Robotech® The New Generation™ Sourcebook – \$16.95
- \_\_\_ 555 Robotech® Genesis Pits Sourcebook – \$16.95

## Robotech® RPG Tactics™ (New!)

- \_\_\_ 55100 Robotech® RPG Tactics™ – \$99.95
- \_\_\_ 55105 Robotech® RPG Tactics™ Rulebook – \$20.00
- \_\_\_ 55101 UEDF Dice Pack – \$12.00
- \_\_\_ 55102 Zentraedi Dice Pack – \$12.00
- \_\_\_ 55201 UEDF Valkyrie Wing – \$36.95
- \_\_\_ 55202 UEDF Destroid Pack – \$32.95
- \_\_\_ 55203 UEDF Spartan Pack – \$32.95
- \_\_\_ 55401 Zentraedi Regult Battlepods – \$36.95
- \_\_\_ 55402 Zentraedi Artillery Battlepods – \$36.95
- \_\_\_ 55403 Zentraedi Glaug Command – \$36.95

## Rifts® Chaos Earth®

- \_\_\_ 660 Rifts® Chaos Earth® RPG – \$20.95
- \_\_\_ 661 Rifts® CE Creatures of Chaos™ – \$12.95
- \_\_\_ 662 Rifts® CE The Rise of Magic™ – \$12.95
- \_\_\_ 665 Rifts® Chaos Earth® First Responders™ – \$16.95 (coming)
- \_\_\_ 666 Rifts® Chaos Earth® Resurrection™ – \$20.95

## Beyond the Supernatural™

- \_\_\_ 700 Beyond the Supernatural™, 2nd Ed. – \$24.95
- \_\_\_ 702 Tome Grotesque™ – \$20.95 (coming)
- \_\_\_ 703 Beyond Arcanum™ – \$24.95 (coming)

## Nightbane®

- \_\_\_ 730 Nightbane® RPG – \$24.95
- \_\_\_ 731 Nightbane®: Between the Shadows™ – \$20.95
- \_\_\_ 732 Nightbane®: Nighlands™ – \$20.95
- \_\_\_ 733 Nightbane®: Through the Glass Darkly™ – \$20.95
- \_\_\_ 735 Nightbane® Survival Guide™ – \$20.95

## Rifts®

- \_\_\_ 800HC Rifts® RPG Ultimate Edition – \$39.95
- \_\_\_ 801 Rifts® Sourcebook One Revised – \$20.95
- \_\_\_ 802-E Rifts® World Book 1: Vampire Kingdoms™, Revised – \$24.95
- \_\_\_ 803 Rifts® Conversion Book One™ – \$24.95
- \_\_\_ 804 Rifts® WB 2: Atlantis™ – \$20.95
- \_\_\_ 805 Rifts® Sourcebook 2: Mechanoids™ – \$16.95
- \_\_\_ 807 Rifts® WB 3: England™ – \$20.95
- \_\_\_ 808 Rifts® WB 4: Africa™ – \$20.95
- \_\_\_ 809 Rifts® Dimension Book 1: Wormwood™ – \$20.95
- \_\_\_ 810 Rifts® WB 5: Triax™ – \$24.95
- \_\_\_ 811 Rifts® Pantheons of the Megaverse® – \$24.95
- \_\_\_ 812 Rifts® Sourcebook 3: Mindwerks™ – \$16.95
- \_\_\_ 813 Rifts® Mercenaries™ – \$20.95
- \_\_\_ 814 Rifts® WB 6: South America™ – \$20.95
- \_\_\_ 815 Rifts® WB 7: Underseas™ – \$24.95
- \_\_\_ 816 Rifts® DB 2: Phase World® – \$24.95
- \_\_\_ 817 Rifts® DB 3: Phase World® Sourcebook – \$16.95
- \_\_\_ 818 Rifts® WB 8: Rifts® Japan™ – \$24.95
- \_\_\_ 819 Rifts® WB 9: South America Two™ – \$24.95
- \_\_\_ 820 Rifts® WB 10: Juicer Uprising™ – \$20.95
- \_\_\_ 821 Rifts® WB 11: Coalition War Campaign™ – \$24.95

\_\_\_ 822 Rifts® WB 12: Psyscape™ – \$20.95  
 \_\_\_ 825 Rifts® WB 13: Lone Star™ – \$20.95  
 \_\_\_ 826 Rifts® WB 14: New West™ – \$24.95  
 \_\_\_ 827 Rifts® WB 15: Spirit West™ – \$24.95  
 \_\_\_ 828 Rifts® Sourcebook 4: Coalition Navy™ – \$16.95  
 \_\_\_ 829 Rifts® WB 16: Federation of Magic™ – \$20.95  
 \_\_\_ 830 Rifts® DB 4: Skraypers™ – \$20.95  
 \_\_\_ 831 Rifts® Index Volume Two™ – \$16.95  
 \_\_\_ 832 Rifts® WB 17: Warlords of Russia™ – \$24.95  
 \_\_\_ 833 Rifts® WB 18: Mystic Russia™ – \$20.95  
 \_\_\_ 834 Rifts® WB 19: Australia 1 – \$24.95  
 \_\_\_ 835 Rifts® WB 20: Canada™ – \$24.95  
 \_\_\_ 836 Rifts® WB 21: Splynn Dimensional Market™ – \$24.95  
 \_\_\_ 837 Rifts® WB 22: Free Quebec™ – \$24.95  
 \_\_\_ 838 Rifts® WB 23: Xiticix Invasion™ – \$20.95  
 \_\_\_ 839 Rifts® Coalition Wars®: Sedition™ – \$20.95  
 \_\_\_ 840 Rifts® Coalition Wars®: Coalition Overkill™ – \$16.95  
 \_\_\_ 841 Rifts® Coalition Wars®: Sorcerers' Revenge™ – \$16.95  
 \_\_\_ 842 Rifts® Coalition Wars®: Cyber-Knights™ – \$16.95  
 \_\_\_ 843 Rifts® Coalition Wars®: Shadows of Evil™ – \$16.95  
 \_\_\_ 844 Rifts® Coalition Wars®: Final Siege™ – \$24.95  
 \_\_\_ 845 Rifts® Game Master Guide™ – \$26.95  
 \_\_\_ 846 Rifts® Aftermath™ – \$24.95  
 \_\_\_ 847 Rifts® DB5: Anvil Galaxy™ – \$20.95  
 \_\_\_ 848 Rifts® Book of Magic™ – \$26.95  
 \_\_\_ 849 Rifts® Adventure Guide™ – \$24.95  
 \_\_\_ 850 Rifts® Bionics Sourcebook™ – \$16.95  
 \_\_\_ 851 Rifts® DB 6: Three Galaxies™ – \$20.95  
 \_\_\_ 852 Rifts® Dark Conversions™ – \$24.95  
 \_\_\_ 853 Rifts® Chi-Town 'Burbs™ – \$9.95  
 \_\_\_ 854 Rifts® The Tolkien Crisis™ – \$12.95  
 \_\_\_ 855 Rifts® The Black Vault™ – \$9.95  
 \_\_\_ 856 Rifts® The Vanguard™ – \$9.95  
 \_\_\_ 857 Rifts® WB 24: China One™ – \$20.95  
 \_\_\_ 858 Rifts® WB 25: China Two™ – \$20.95  
 \_\_\_ 859 Rifts® DB 7: Megaverse Builder™ – \$16.95  
 \_\_\_ 860 Rifts® DB 8: Naruni Wave Two™ – \$16.95  
 \_\_\_ 862 Rifts® WB 26: Dinosaur Swamp™ – \$20.95  
 \_\_\_ 863 Rifts® MercTown™ – \$20.95  
 \_\_\_ 865 Rifts® Merc Ops™ – \$20.95  
 \_\_\_ 866 Rifts® WB 27: Adventures in Dinosaur Swamp™ – \$20.95  
 \_\_\_ 867 Rifts® Mercenary Adventure Sourcebook – \$12.95  
 \_\_\_ 868 Rifts® WB 28: Arzno™ – \$20.95  
 \_\_\_ 869 Rifts® WB 29: Madhaven™ – \$16.95  
 \_\_\_ 870 Rifts® John Zeleznik Coloring Book – \$5.95  
 \_\_\_ 871 Rifts® Machinations of Doom™ – \$18.95  
 \_\_\_ 872 Rifts® DB 10: Hades™ – \$24.95  
 \_\_\_ 873 Rifts® DB 11: Dyval™ – \$24.95

\_\_\_ 874 Rifts® WB 30: D-Bees of North America™ – \$24.95  
 \_\_\_ 875 Rifts® DB12: Dimensional Outbreak – \$24.95  
 \_\_\_ 876 Rifts® Megaverse® in Flames™ – \$24.95  
 \_\_\_ 876HC Rifts® Megaverse® in Flames™ Gold Hardcover Edition – \$50.00  
 \_\_\_ 877 Rifts® Heroes of the Megaverse® – \$16.95  
 \_\_\_ 878 Rifts® Sourcebook: Shemarrian Nation™ – \$16.95  
 \_\_\_ 880 Phase World®: Fleets of the Three Galaxies™ – \$16.95  
 \_\_\_ 881 Rifts® WB 31: Triax™ Two – \$24.95  
 \_\_\_ 883 Rifts® DB 14: Thundercloud Galaxy™ – \$20.95  
 \_\_\_ 884 Rifts® Vampires Sourcebook™ – \$20.95  
 \_\_\_ 885 Rifts® WB 32: Lemuria™ – \$24.95  
 \_\_\_ 886 Rifts® Black Market™ – \$24.95  
 \_\_\_ 886HC Rifts® Black Market™ Hardcover Gold Edition – \$60.00  
 \_\_\_ 887 Rifts® WB 33: Northern Gun™ One – \$24.95  
 \_\_\_ 888 Rifts® WB 34: Northern Gun™ Two – \$26.95  
 \_\_\_ 889 Rifts® Sourcebook: Coalition States, Heroes of Humanity™ – \$20.95  
 \_\_\_ 890 Rifts® World Book: Secrets of the Atlanteans™ – \$24.95 (coming)  
 \_\_\_ 891 Rifts® World Book: Sovietski™ – \$24.95 (coming)  
 \_\_\_ 892 Rifts® Sourcebook: The Disavowed™ – \$16.95 (coming)  
 \_\_\_ 893 Rifts® CS: Heroes of Humanity™ Arsenal Sourcebook – \$16.95 (coming)  
 \_\_\_ 894 Rifts® Haunted Tech™ – \$16.95 (coming)  
 \_\_\_ 2510 Rifts® & The Megaverse® Art Book – \$22.95  
 \_\_\_ 2510-HC Rifts® & The Megaverse® Art Book, Hardcover – \$50.00  
 \_\_\_ 2510-CML Rifts® & The Megaverse® Art Book, Collector's Masterwork Edition – \$125.00

### Miscellaneous Products

\_\_\_ 600 Deluxe Revised RECON® RPG – \$22.95  
 \_\_\_ 2537 Gamer Coffee Mug – \$10.00  
 \_\_\_ 2539 Rifts® Dice Bag – Black – \$8.00  
 \_\_\_ 2545 Dead Reign™ Coffee Mug – \$10.00  
 \_\_\_ 2554 Palladium Bookmarks, Set One – \$5.00  
 \_\_\_ 2555 Palladium Bookmarks, Set Two – \$5.00  
 \_\_\_ 2561 Property of Chi-Town Library Pencil – \$0.50 each  
 \_\_\_ 2562 Future Visions™ – The Artistry of Charles Walton II – \$13.95  
 \_\_\_ 2566 Glitter Boy Mouse Pad – \$9.95  
 \_\_\_ 2567 Old Ones Mouse Pad – \$9.95  
 \_\_\_ 2568 Zombie Graveyard Mouse Pad – \$9.95

**Note:** T-shirts and other products can be found online: [www.palladiumbooks.com](http://www.palladiumbooks.com)

### Rifts® Miniatures

\_\_\_ MI8002 Xiticix Pack – \$18.00  
 \_\_\_ MI8004 Coalition Dog Pack – \$18.00  
 \_\_\_ MI8005 Men of Magic Pack #1 – \$18.00

\_\_\_ MI8006 Cyborgs Pack #1 – \$18.00  
 \_\_\_ MI8007 Simvan & Ostrosaurus Pack – \$18.00  
 \_\_\_ MI8008 Coalition Skelebots Pack #1 – \$18.00  
 \_\_\_ MI8009 Coalition SAMAS Pack #1 – \$22.00  
 \_\_\_ MI8010 Coalition Sky Cycle Pack – \$22.00  
 \_\_\_ MI8011 Coalition Dog Pack #2 – \$18.00  
 \_\_\_ MI8015 Damaged Skelebots Pack #1 – \$12.00  
 \_\_\_ MI8016 Cyber-Adventurers Pack – \$18.00  
 \_\_\_ MI8017 Rogues & Scout Pack #1 – \$18.00  
 \_\_\_ MI8018 Brodkil & Witchling Pack – \$18.00  
 \_\_\_ MI8019 Damaged Skelebots Pack #2 – \$18.00  
 \_\_\_ MI8020 Psi-Stalkers & Scouts Pack #1 – \$18.00  
 \_\_\_ MI8021 Shadow Beast – \$12.00  
 \_\_\_ MI8022 Mystic Knight – \$6.00  
 \_\_\_ MI8023 Lord Magus – \$6.00  
 \_\_\_ MI8024 High Magus – \$6.00  
 \_\_\_ MI8025 Coalition Psi-Stalker – \$6.00  
 \_\_\_ MI8026 Coalition Dog Boy in DPM-D1 Armor – \$6.00  
 \_\_\_ MI8027 Coalition Dog Boy #2 – \$6.00  
 \_\_\_ MI8028 Coalition Dog Boy #3 – \$6.00  
 \_\_\_ MI8029 Coalition Dog Boy #4 – \$6.00  
 \_\_\_ MI8030 Coalition Dog Boy #5 – \$6.00  
 \_\_\_ MI8031 Glitter Boy – \$20.00  
 \_\_\_ MI8032 Glitter Boy Pilot – \$6.00  
 \_\_\_ MI8033 Kydian Overlord – \$20.00  
 \_\_\_ MI8034 Dragonsaurus – \$10.00  
 \_\_\_ MI8035 Slaver and Slave (Atlantis) Set – \$10.00  
 \_\_\_ MI8036 Crazy – \$6.00  
 \_\_\_ MI8037 Juicer #1 – \$6.00  
 \_\_\_ MI8038 Juicer #2 – \$6.00  
 \_\_\_ MI8039 Cyborg #1 – \$12.00  
 \_\_\_ MI8040 Cyborg #2 – \$12.00  
 \_\_\_ MI8041 Cyborg #3 – \$6.00  
 \_\_\_ MI8042 Coalition Officer – \$6.00  
 \_\_\_ MI8043 Coalition Grunt #1 – \$6.00  
 \_\_\_ MI8044 Coalition Grunt #2 – \$6.00  
 \_\_\_ MI8045 Coalition Grunt #3 – \$6.00

**When placing an order by mail, please add money for shipping and handling.** Add \$5.00 for orders totaling \$1-\$50, \$10.00 for orders totaling \$51-\$95, and for orders totaling \$96-\$200 please add \$15.00 US. Double the amount for Canada, and *quadruple* it for overseas orders. For more shipping options, order online at [www.palladiumbooks.com](http://www.palladiumbooks.com).

Allow 2-4 weeks for delivery.

Make checks and money orders payable to: *Palladium Books*

**Check release dates for new products.** If the book you order has not been released yet, your order will be held as a backorder until the product is available. Please note that prices are subject to change without notice.

**Orders can also be placed by phone,** at (734) 721-2903 (order line only). Please have your credit card information when you call.

**[www.palladiumbooks.com](http://www.palladiumbooks.com)**



At stores  
everywhere



## Also from Palladium Books®

### Rifts® World Book 5: Triax™ & the NGR™

- The first epic book to explore Triax and the NGR.
- Background on the Gargoyle War and the NGR.
- Triax weapons, robots, cyborgs & power armor.
- Gargoyle forces, stats, weapons & equipment.
- Art by Kevin Long. Written by Kevin Siembieda

### Armageddon Unlimited™

(Heroes Unlimited™ crossover)

- Demons and Deevils vs superheroes.
- Can the heroes stop Armageddon?
- New Power Categories: Heroic Hellion, Demon Bestowed & others.
- Magic weapons, new super abilities and more. Summer 2010.

### Rifts® World Book:

### Megaverse® in Flames™

- Conflict and trouble across the globe.
- Soulmancy, Blood Magic and demon plagues.
- Rifts Calgary, Ciudad Diabolo and other places.
- Dimension Stormers, Deevils, Lord Doom, and much more.
- The Coalition's response and adventure ideas galore. Summer 2010.

### Minion War™ Titles

- **Dimension Book 10: Hades** (Demon Hell described)
- **Dimension Book 11: Dyval™** (Deevil Hell described)
- **Dimension Book 12: Dimensional Outbreak™** (Phase World®)
- **Heroes of the Megaverse®** (all settings)

Coming soon . . .

- **Armageddon Unlimited™** (Heroes Unlimited™ crossover)
- **Rifts® Megaverse® in Flames™** (Minion War™ for Rifts®)

### Rifts® World Book 31:

## Triax™ Two

The war between the people of the New German Republic and the Gargoyle Empire rages on. Only now the heroes of the NGR *seem* to be getting the upper hand. See where things stand in the year 109 P.A. and get a closer look at the NGR Army, government, society and people. This World Book also presents the latest weapons, combat vehicles, power armor and robots of the NGR as well as commercial vehicles, robot helpers, and more.

- 27 new Triax weapons plus new body armor and additional gear.
- 10 new Triax giant robots including the Talon and Devastator Mk II.
- 10 cars and commercial vehicles plus more than 50 special features.
- 9 new robot drones including robot assistants, pets and Spy 'Bots.
- 6 new Triax power armor suits, including the Predator II, Ulti-Max II, War Eagle, Fat Boy, and a flying Glitter Boy.
- 5 new aircraft and other combat vehicles.
- Mobile NGR forts and bases, cyborgs and more.
- Information about the New German Republic and its society.
- Details about the NGR military.
- The latest on the Gargoyle War and Gargoyle Empire.
- Mercenaries, adventurers, outsiders and surprises.
- Ideas for adventure, combat and much, much more.
- 192 pages by Taylor White, Brandon Aten and Kevin Siembieda.

Unleash your imagination!™

\$24.95

Cat. No. 881

ISBN-10: 1-57457-181-8

ISBN-13: 978-1-57457-181-3

**Palladium  
Books Inc.**  
www.palladiumbooks.com