

Palladium Books® Presents:

Rifts® Dimension Book Three™

PhaseWorld™

By C.J. Carella

Sourcebook

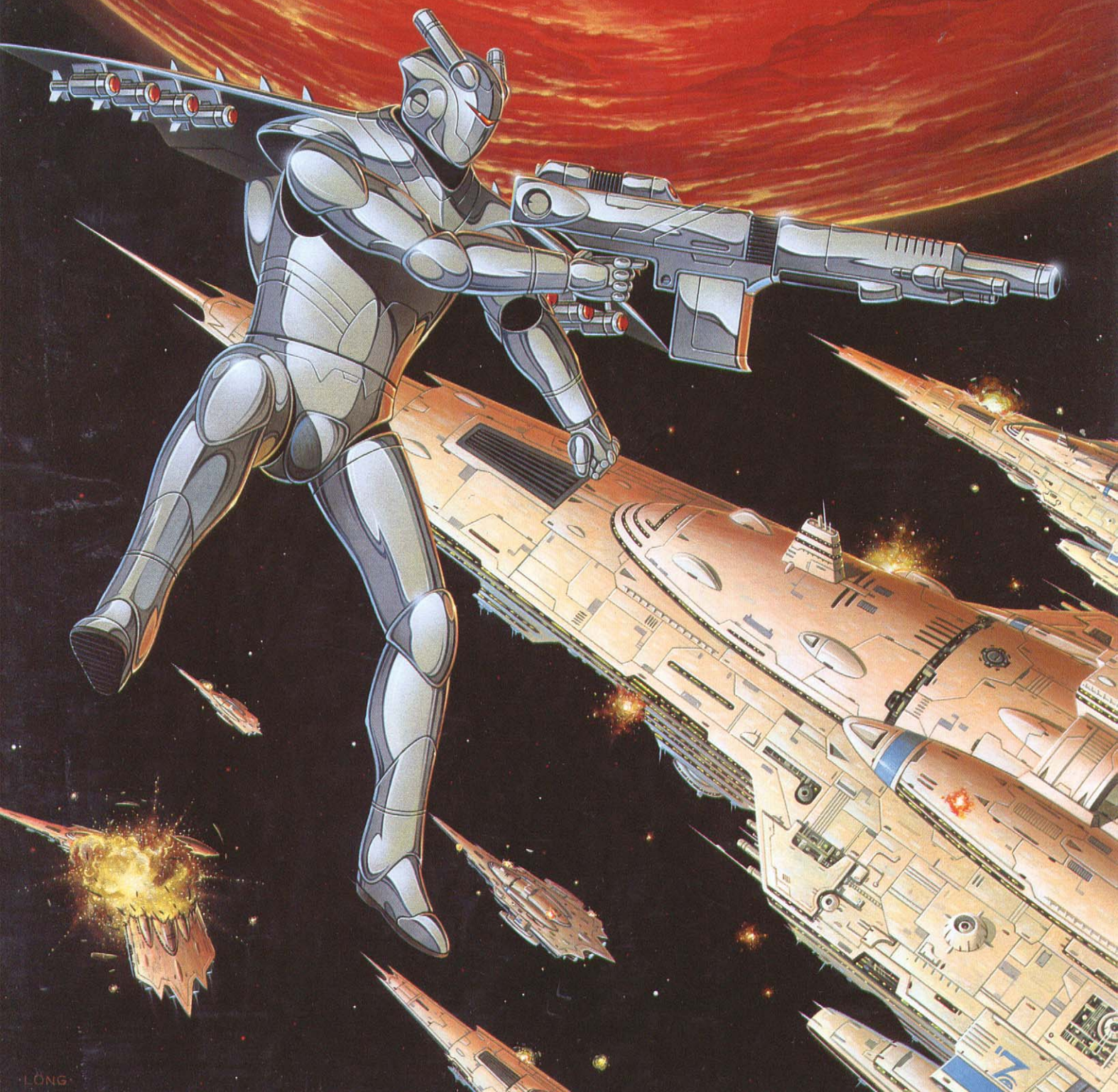

Warning!

Violence and the Supernatural

This book may be inappropriate for young readers.

The fictional World of Rifts is violent, deadly and filled with supernatural monsters. Other dimensional beings, often referred to as "demons," torment, stalk and prey on humans. Other alien life forms, monsters, gods and demigod, as well as magic, insanity, and war are all elements in this book.

Some parents may find the violence and supernatural elements of the game inappropriate for young readers/players. We suggest parental discretion.

Please note that none of us at Palladium Books condone nor encourage the occult, the practice of magic, the use of drugs, or violence.

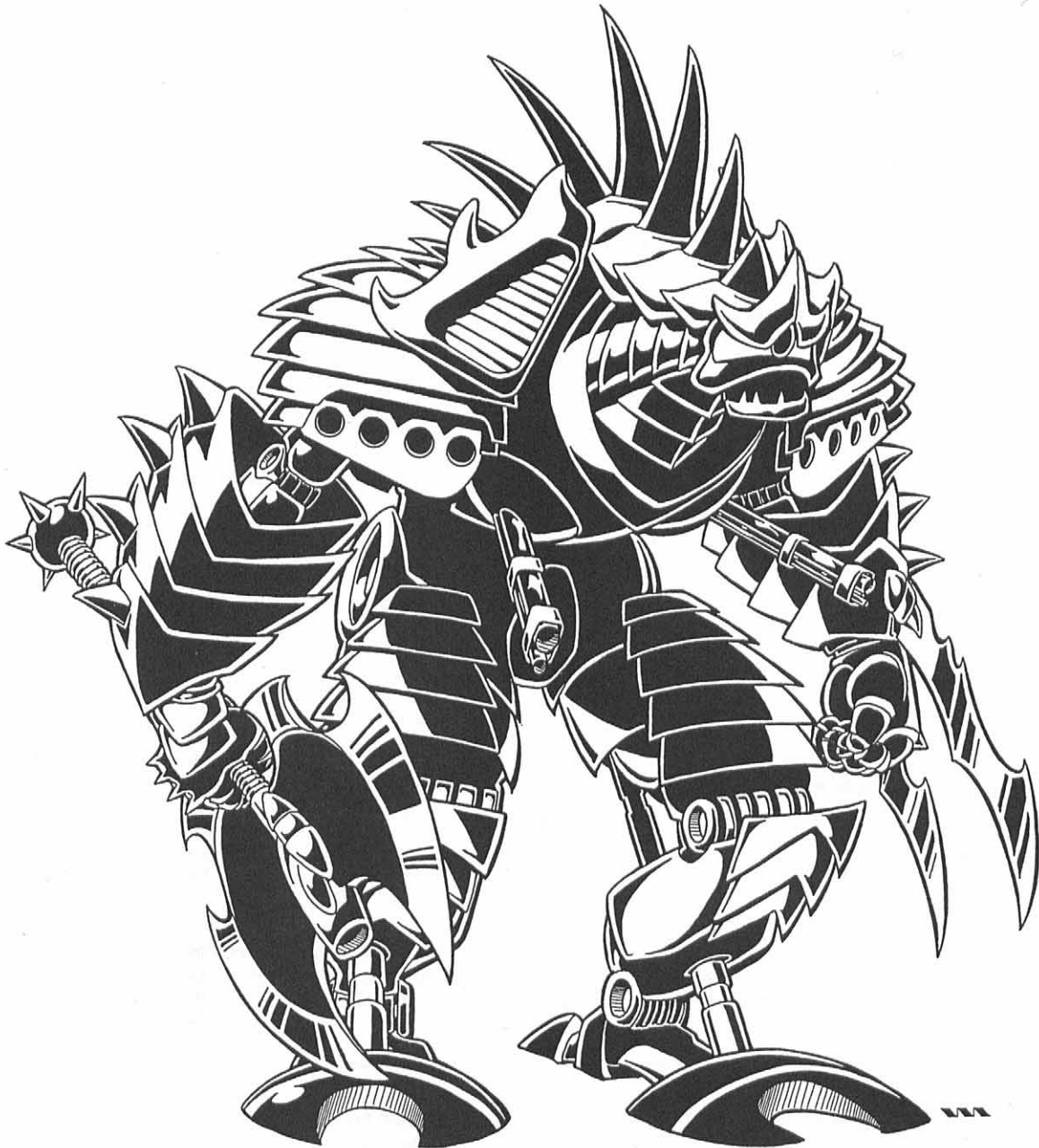

A supplement for the Rifts[®] RPG and Phase World[™].
Compatible with the entire Palladium Books[®] Megaverse[®]!

Rifts® Dimension Book™ Three: Phase World™ Sourcebook

Written By: **Carlos J. Martijena-Carella**

Additional Text & Concepts: **Kevin Siembieda**

Senior Editor: **Kevin Siembieda**

Editors: **Alex Marciniszyn**
James A. Osten
Kevin Kirsten
Julius Rosenstein

Cover Painting: **Kevin Long**

Interior Artists:
Vince Martin
Wayne Breaux Jr.
Scott Johnson
Kevin Long

Art Direction & Keylining: **Kevin Siembieda**

Typography: **Maryann Siembieda**
Michael O'Connor

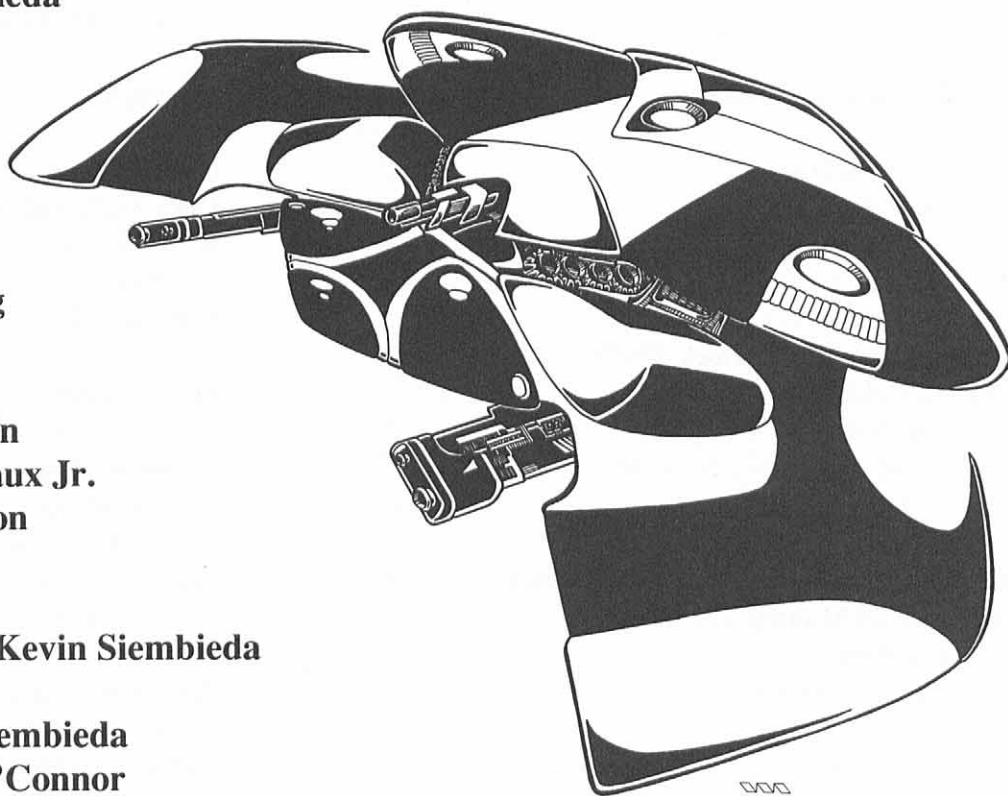

Special Thanks to C.J. Carella for more insight into the fabulous and mysterious universe of Phase World. To Vince Martin and Wayne Breaux for more incredible designs and artwork. Kevin Long for a dynamic cover depicting the CAF Silver Hawk power armor and friends. Scott Johnson for pitching in when we needed him and to Maryann, Kev K, Steve, Alex, Julius and the usual gang of Palladium techno-wizards for another exciting Rifts dimension book.

Kevin Siembieda

Contents

The Three Galaxies	6	Other Weapons & Weapon Manufacturers	58
Consortium of Civilized Worlds (CCW)	7	“Slicer” GR-Gun	58
CCW Law and Citizenship	8	“Death Disk” Weapon System	58
Crime & Punishment Chart	9	Web Gun	59
Independent Defense Force (IDF)	10	Daisho-10 Multiweapon	61
 		HW-19 Stun Pistol	62
CCW Planets of Note	11	T’Zee Piranha Gun	63
In’Val	11	 	
Bushi Federation	11	Power Armor	64
Malthus’ World (Dellian-4)	11	Warlock Combat Armor (UWW)	65
Robo-Jockeys R.C.C.	12	Enforcer Power Armor (NE)	67
In’Valian Exoskeletons	13	A-1 “Avenger” Power Armor	70
Oni R.C.C.	15	War Beast Combat Armor	72
Cyberai O.C.C.	16	 	
Oni Ninja R.C.C.	19	Robot Vehicles	73
Oni Ninja Techniques	21	Ovoid Combat Robot (NE)	73
T’Zee R.C.C.	24	Imperator Assault Robot (TE)	75
Gun Brother O.C.C.	25	Greataxe IFV Tank (UWW)	77
The Transgalactic Empire	27	Starships	79
Ghostworld	28	 	
Dweller Beneath NPC	29	Fighter Ships	79
Kreeghor Witch NPC	31	Black Eagle Fighter (CAF)	79
Invisible Guardsman O.C.C.	32	Katana Fighter (CAF)	81
Monro R.C.C.	34	Fire Eater (NE)	83
 		Spinnerette Interceptor	84
United Worlds of Warlock (UWW)	35	 	
Inglis the Mad	36	Star Frigates	86
Warlock Marine O.C.C.	37	Hunter Destroyer (CAF)	86
Warlock Marine Magic Specialist	39	Arcane Mark II Patrol Ship (UWW)	88
Turbo-Jockey O.C.C.	41	UFO Attack Ship	90
 		Warshield Cruiser (CAF)	91
Organizations Within the Three Galaxies	42	Smasher Cruiser (TE)	94
Tri-Galactice Military	42	Dwarven Iron Ship (UWW)	96
Life as a Merc	43	 	
Supernatural Division	44	Battleships, Carriers & Dreadnoughts	98
 		Protector Battleship (CAF)	98
The Intruders	45	Packmaster Carriership (CAF)	100
The Reaction	46	Ship Scale	101
Some Theories	47	Doombringer Dreadnought (TE)	102
The Beast	47	 	
The Mind Creatures	49	Space Combat (optional rules)	104
Using Aliens Unlimited in Phase World	50	Missile Combat	106
 		Random Damage Table (optional)	108
Technology & Weapons	52	 	
Plasma Cartridge Revolver	52	Experience Point Tables	110
K-Hex Explosive	55		

Quick Find Table

O.C.C.s & R.C.C.s

Cyberai (cyborg) O.C.C.	16
Dweller NPC Alien Intelligence	29
Gun Brother O.C.C.	25
Intruder Type One: The Beast Optional R.C.C. ...	47
Intruder Type Two: Mind Creatures Optional R.C.C. 49	
In'Valian Robo-Jockey R.C.C.	12
Invincible Guardsmen O.C.C.	32
Kreeghor Witch NPC	31
Monro R.C.C.	34
Oni Ninja R.C.C.	19
Oni Ninja Techinques & Powers	21
Turbo-Jockey O.C.C.	41
T'zee R.C.C.	24
Warlock Marine O.C.C.	37
Warlock Magic Specialist O.C.C.	39

Planets & Federations

Alexandria (UWW; True Atlanteans)	35
Aliens Unlimited (worlds of)	50
Asteroid Eaters (UWW)	36
Axis-5 (The Battlefield)	27
Battlefield, The (Axis-5)	27
CCW: Consortium of Civilized Worlds	7
Bushi Federation (Oni)	11
Dellian-4 (In'Val)	11
Ghostworld	28
Glory (TMS)	42
IDF: Independent Defense Force	10
In'Val (Dellian-4)	11
Intruders, The	45
Kreeghor Empire/Transgalactic Empire	27
Malthus' World	11
Malthus' World: T'Zee	24
Monro-Tet	28
Monro-Tet: Monro R.C.C.	34
Norrelgo-5 (TMS)	43
Naruni Enterprises (weapons)	52
TMS: Transgalactic Military Services	42
UWW: True Atlanteans: Alexandria	35
UWW: United Worlds of Warlock	35
UWW: Marine Armor (top of page)	38
UWW: Marine Armor Description	65
New Consortium O.C.C.s & R.C.C.s	12

Weapon Systems of Note

AML-11 Autoloading Missile Launcher (Warlock; #7) 67	
Black Eagle Fighter	79
Black Eagle: Cruise Missiles (#3)	81
Bottled Demon Missiles (Greataxe Tank; #2)	78
Daisho-10 Multiweapon	61
Death Cloud Cannon (Arcane; #1)	89
Death Disk	58
Energy Fang (Imperator; #4)	76
Energy Lance (Smasher; #1)	95
Energy Sword (Imperator; #3)	76
Flame Cannon (Dwarven; #2)	97
Foam Dispenser (Enforcer; #1)	69
Force Field Rules (Optional)	107
GC-55 G-Cannon (Warlock; #6)	66
Gravity Auto-Cannon (#1)	76
Intruder Body Armor (energy)	72
Intruder: Spinnerette Interceptor	84
Intruder: UFO Attack Ship	90
Katana Ship Modular Weapon Pods	82
K-Hex Explosives (Naruni)	55
Lightning Rods (Arcane; #4)	89
Plasma Cartridge (Naruni)	52
Volcano Rifle (Warlock; #1)	65
Weapon Limbs (Enforcer; #2)	69
Web Gun	59

Introduction

This second installment of **Phase World** deals with the Three Galaxies; its cultures, its technology, and new enemies that may threaten it in the near future. Much of the material that for diverse reasons did not make it to the first world book is also here. Does this book cover every base? Not by a long shot.

Trying to describe an entire game universe can be a daunting task. Rifts Earth, of course, is far from being “covered” after over a dozen worldbooks and sourcebooks (rapidly approaching twenty!). My hope is that **Phase World** and its strange denizens will become popular enough to warrant just as many books. But in the meanwhile, this book should answer more questions about the major planetary civilizations of the Three Galaxies. More weapons and equipment from the Consortium, the Empire, and the nefarious Naruni Enterprises are also included in these pages, as well as rules on large-scale space combat.

What next? Perhaps more detailed planetary information, or revelations about the Cosmic Forge, the First Race, and the cosmo-knights. My goal has been to create a science-fantasy setting where any possible type of space campaign can find a place. I'll continue working towards achieving it.

Enjoy!

—C.J. Carella

The Three Galaxies

Phase World is part of a large community of spacefaring races and civilizations known as the Three Galaxies. The events and conditions of the Three Galaxies are bound to have a major influence in **Phase World's** multi-dimensional starport, and through it they might reach everywhere in the Megaverse.

Star Travel in the Three Galaxies

In the **Consortium of Civilized Worlds (CCW)**, the Three Galaxies are divided into *sectors*. Each sector is a square, two-dimensional area 500 by 500 light years. Two-dimensional representations are practical because 85% of all habitable worlds in the Three Galaxies can be found in the *Galactic Biosphere*, a region about 10 light years thick, located at the edges and corners of the galaxies. The **Transgalactic Empire (TE)** divides its territory into *Dominions*, which vary in size from a minimum of 100×100 light years to many times that size. The *Kreeghor Dominion* is the foundation of the Empire and the largest section, a bit over 1,000 by 100 light years in area.

Faster Than Light (FTL) propulsion systems are described in **Rifts Phase World**, page 152. Most ships have an average speed of 1-5 light years an hour and are able to cover 20-100 light years a day. Rift-jump drives can cross great distances instantly, but their effective range is usually 5-20 light years per jump, with no more than six or seven jumps per day possible, which makes them roughly equivalent to standard FTL systems.



It has been determined that travel between galaxies is a lot faster than travel within a galaxy. It appears that the lack of massive objects in the “emptier” space between the galaxies reduces “gravity drag” and allows FTL systems to operate at 500% efficiency. An average ship can cover between 100 and 500 light years per day when traveling *between* galaxies.

Traveling to a distant star is not something that people do lightly. A trip from one end of the Corkscrew galaxy to the next (90,000 light years) would take 1D6 months for most ships. The fastest CG-ship (top speed of 240 light years a day) would need almost two years to travel from one end of the Three Galaxies to the other. In some ways, this situation is comparable to sea travel during Earth’s pre-industrial days, when a trip could take months or years, and was not something people did unless they had a good reason. Most inhabitants of the Three Galaxies will never get onto a starship, and live out their lives on the same world that they were born on.

Even most spacers spend most of their lives going back and forth through a relatively small area. Typically, 70% of all trade and travel between stars occurs in an area not exceeding 1,000 light years, roughly a week to ten day trip each way. Planets must by necessity be nearly self-sufficient, because imports may take weeks to arrive. Most planets have a fleet (or at least one or two ships) of merchant vessels to conduct trade with nearby worlds. Long-range trader ships that stop on dozens or hundreds of worlds, selling a little of their cargo to each of them, are less common, but do exist and play an important role in the economy. Advanced medicines and medical equipment, spare parts for machinery, and weapons are among the most common imports. Food is sometimes carried to densely populated worlds that cannot spare the room for cultivation. This is done by super-freighters carrying millions of tons of grain or pre-processed foodstuffs. If a world cannot manufacture something, it often becomes a luxury item that only the wealthy (or the government) can afford. Energy weapons are very expensive in primitive backwater worlds, although they are often purchased, at great expense, for self-defense.

The spaceways are fraught with danger. In addition to natural disasters, cosmic anomalies, and accidents, there are space pirates, mercenary raiders, aggressive and enemy worlds/armies and alien menaces. Since the nearest help from raiders, pirates and trouble may be hours or days away, each planet (and space vessel) must be prepared to defend itself. Most planetary collectives, including the Consortium of Civilized Worlds (CCW) and Transgalactic Empire, have a military detachment on every inhabited member or associated world. The detachment can be as small as a five to ten man squad on the ground, or as large as a 10 to 20 ship fleet and a ring of defensive satellites in orbit and a full division of troops on the ground.

Space patrols with law officers are a rarity, especially in deep space. The “law” and other protectors are most likely to be found in orbit around planets, moons, and space stations, or skimming known space-lanes. Consequently, the owners of cargo ships who can afford it and large convoys may have an escort of defending warships, or a strike force of robot, cyborg or superhuman protectors as part of its crew. Of course, cosmoknights and many spacefaring vessels will come to the rescue of those in distress, but the universe is a big place and the odds of them being close enough to offer immediate help in an emergency is slim.

Communications in the Three Galaxies

The most efficient communication systems depend on phase and contragravity technology. Messages are sent via laser or microwave transmitters combined with a phase or contra-gravity field to prevent their energies from being slowed down by gravity. These transmitters are able to cross space at a speed of 100 light years per hour, roughly ten times faster than the fastest starships. In the “empty” space between galaxies, this speed is multiplied by 5. Even so, a message sent from the farthest corner of the Three Galaxies will take 1300 hours (roughly 54 days, almost two months) to reach the other end; 170,000 light years away (considering that the 50,000 light year distance between the galaxies is crossed at a much greater speed).

Communications within a galaxy range from a few hours to a couple of weeks. Again, this means that a message for help will probably not be received for hours to several days. Furthermore, it typically takes days for a ship or fleet to respond to trouble, so each planet must be self-reliant and able to defend itself for at least that long. Likewise, spaceships must have suitable defenses to protect themselves from attackers, and/or life rafts and rations to survive if they are crippled and set adrift.

Consortium of Civilized Worlds

The CCW is the largest, most civilized and most successful planetary collective in the Three Galaxies. Outlined below is some more information about daily life, law, and the planets of this confederation.

Daily Life in the CCW

Technology dominates the lives of the denizens of the Consortium. Without it, survival would be impossible for the teeming billions who work, party and dwell in the enormous cities, space stations and new colonies scattered across the galaxies. Technology and the benign government of the Consortium have brought about the highest standard of living in the Three Galaxies; the average citizen of the Consortium enjoys luxuries and comforts undreamed of on Rifts Earth.

Over 80% of the CCW’s population lives in cities or suburbs. The average city has a population in excess of one million people, and several of them have as many as 100 million people! The remaining 20% of the population is divided between spacers, farmers and colonists of new or inhospitable worlds. Most city dwellers work in the service sector, anything from restaurants and entertainment services to communication networks,

stores and professions in law or medicine. Factories are largely automated and require very few workers. The Consortium has a large middle class, about 70% of the total population. The wealthy comprise about 10% of the total; the rest have incomes below the poverty line, and live in the slums that exist in almost every city. Even the poor have better lives than many citizens of other worlds, thanks to extensive social services provided by most CCW planets.

Information networks are everywhere. All but the poorest households have a “terminal,” a combination computer, telephone, TV and answering machine that is plugged into a huge information network. Through the “terminal,” the household members can order movies, holograms and virtual reality shows, communicate via video and audio anywhere on the planet and stations in orbit, plus they can access video libraries and databases, all without leaving the house. Magazines and movies can be purchased and printed out or stored on CDs for easy access.

A sizable percentage of the population (30%) works out of their homes, using their “terminals” to send their work to their employers, saving companies the expense of office space. This has led to a number of problems, including the “shut-in” phenomenon: people who rarely leave their house and who often develop mild agoraphobia (a fear of open spaces). These shut-ins prefer to live in their holographic or virtual reality world, where they can be in complete control. Shut-ins are common on densely populated worlds where as many as 15% of the population may suffer, to varying degrees, from the malady. However, it is almost unheard of on fringe, or recently colonized planets (less than 0.5%).

Law and Citizenship

The Consortium’s laws are very complex, due to the fact that it is a loose federation of worlds rather than a monolithic entity like the Transgalactic Empire. Since there are hundreds of “sub-governments” in the CCW with often contradictory laws, the Consortium has to separate local and galactic laws, and decide which laws apply in each case. To deal with this, all sentient beings in the CCW are granted dual citizenship, which makes them citizens of both the Consortium and one planet or planetary collective. Some people (including almost all spacers) have single citizenship, making them members of the Consortium but not of any other worlds or nations within its vast territory.

Taxes are always more favorable for local citizens than for Consortium citizens, so most people who reside and work on one planet will usually become citizens of that planet. Foreigners (those without CCW citizenship) are still subject to Consortium laws within CCW space. CAF personnel (Consortium Armed Forces), regardless of their original citizenship, are bound by CCW laws only.

Dual citizens are subject to the laws of both their “home planet” and the Consortium. While on the citizen’s homeworld, local laws have precedence; everywhere else, the person is subject to Consortium laws. For example, the planet *Motherhome* (see **Rifts Phase World**, page 56) has very harsh environmental laws. Starting a campfire without a license has a stiff fine (5,000 credits) and up to one year of community service as a penalty. This law applies only to *Motherhome* citizens. A CCW citizen would pay the lower fines dictated by Consortium law.

Local laws change a great deal from world to world. The only constants are those defined by the **Civilization Compact** with edicts that insist slavery is outlawed and trial by jury is required for all criminal matters; beyond that pretty much anything goes. Most planets have laws that are close copies of the Consortium’s codices. Others keep the laws of their original culture and civilization. About 70% of all Consortium planets, for instance, prescribe the death penalty for a number of crimes, from first-degree murder (80%) to grand larceny (5%)! Consortium law has the death penalty for the most severe crimes, like engaging in genocide, large-scale slavery, and mass murder.

Outlined below are some common crimes and their penalties under both Consortium law and the local laws of several planets and planetary collectives that belong to the CCW:

Crimes & Punishment

Crime Description

Concealed Weapon: This includes both hidden weapons (which require a permit in CCW space) and illegal weapons; on many planets, anything more lethal than a stunner is illegal; on others, only military-grade weapons are proscribed. In the *Bushi Federation*, carrying weapons (concealed or not) is never a crime (n/c).

Weapons Trafficking: Selling, smuggling or possession with intent to sell, of any illegal weapons. Illegal weapons vary from place to place. In the Consortium, anything heavier than an energy pistol requires a license to sell.

Smuggling: Transporting goods across national or planetary borders without paying the tariffs or taxes prescribed by law. This crime may be cumulative with drug or weapons trafficking. All penalties, if found guilty, are added together.

Drug Possession: Use or possession of an illegal substance or any product of an addictive or dangerous nature. Under the Consortium law, drug addicts are diseased, not criminals, and as such, they are rarely imprisoned.

Drug Trafficking: Selling, smuggling, or possession with intent to sell, of any illegal, addictive or potentially toxic substance.

Grand Larceny: Robbery of articles or property worth 5,000 credits or more.

Rape: Sexual assault.

Manslaughter: In CCW law, this covers wrongful or negligent deaths, as well as unintentional killings or murders with special circumstances (sometimes includes certain crimes of passion).

Murder 2nd: Murder in the second degree, unpremeditated murder.

Murder 1st: First degree murder, premeditated or “cold-blooded” murder.

Slavery: Kidnapping people to sell into slavery, or transporting slaves through a nation or planet’s space. This crime is not considered to be smuggling because people under Consortium law cannot be considered property.

Genocide: Deliberately causing the death of at least 1% of the known population of a sentient species, race, ethnic group, or planetary population (in the last instance, the planet must have a

minimum population of 100,000; otherwise, the crime is mass murder, not genocide). This is considered to be the most heinous crime in the Three Galaxies and the penalty is always death.

Penalty Description

The numbers before each word describe years of either imprisonment or rehabilitation testing period. A Consortium Standard Year is 360, 24-hour days. The number listed in the chart is the *average* sentence. Depending on the circumstances, the period can be as much as five times longer or one-fifth shorter.

Imprisonment: The condemned is sent to a prison and held there until the end of the sentence. Prison conditions vary widely. The prisons of the *Noro Federation* are among the most merciful and comfortable. Wolfen prisons are notoriously harsh, where inmates often kill each other, and quarters tend to be cramped, and dangerous places.

Rehabilitation Testing Period: "Rehab" for short. During rehab, the condemned lives either at a half-way house or on his/her own, but must check in with a rehabilitation officer once a week, and must wear an ankle, arm or limb bracelet that lets the authorities track him anywhere he goes. Rehab is designed to test whether the prisoner has changed his ways. The weekly interviews include psychological and even psionic tests to determine if the person is still thinking or behaving in a criminal way. Failing rehab means imprisonment. Imprisonment will be a year or the original prison sentence, whichever is longer, after which rehab starts over. It is possible for a person to spend the rest of his life going back from rehab to prison; multiple failures often lead to life imprisonment or even the death penalty.

The typical rehab bracelet has 50 M.D.C. and has a 500 mile (800 km) range. Some civilizations (including the CCW) may include micro-cameras and microphones that are monitored to ensure no criminal activities are being committed by the person.

This is usually the case when the person in rehab was found guilty of a serious crime, or is a repeat offender.

Rehab is not as foolproof or effective as CCW propaganda claims. Although it is a lot harder to avoid than 20th Century Earth methods, cunning or resourceful criminals can and do find ways of getting around rehab, or even escaping it.

Death: At the Consortium and most CCW member worlds, the death penalty is administered via lethal injection (most species can be affected by poisons) or by a firing squad (for the ones who cannot be poisoned). Some cultures have their own methods. The seljuk and the oni favor beheading, and the t'zee use the electric chair.

Crime In the CCW

"Crime is the price a free society must pay," is one common saying in the Consortium. Since the government is not constantly watching its citizens, opportunities for crime exist, and are exploited by the greedy, selfish, desperate, power hungry, and insane. Most criminal activity occurs in the poorest sections of cities and planets. Furthermore, the poorest 10% of the Consortium's society is 50 times more likely to be the victims of violent crime than the wealthiest 10%. The large majority of planets in the Consortium (70%) have criminal rates as low as those of Japan's during the late 20th Century. Piracy, smuggling and slavery tend to occur in frontier and isolated planets.

Despite the best efforts of both local and galactic authorities, however, criminal networks have developed on several worlds, sometimes with links that stretch between planets or even galaxies. Some of these crime rings are suspected of being fronts for the Transgalactic Empire, the Splugorth and Naruni Enterprises. The largest of these criminal organizations are the Linchpins, Gun Brothers, and the Merchants of Freedom.



Crimes & Punishment

	CCW	H. All.	W. Rep.	N. Fed.	B. Fed.	M. World
Con. Wp.	1-rehab	1-rehab	1-rehab	1-rehab	n/c	10,000 cred
Wp Traf.	5-prison +5-rehab	10-prison +2 rehab	15-prison	5-prison +5 rehab	15-prison	Death
Smuggling	1-rehab	2-rehab	1-prison	1-rehab	5-prison	Death
Drug Poss.	2-rehab	2-rehab	3-rehab	4-rehab	2-rehab	Death
Drug Traf.	5-prison +5-rehab	5-prison +2 rehab	15-prison	5-prison +5 rehab	15-prison	Death
Grand Larceny	1-rehab	1-rehab	2-rehab (5,000 credit fine)	Probation	1-prison	Death
Rape	5-prison +5-rehab	10-prison +5 rehab	15-prison	2-prison +10 rehab	Death	Death
Man-Sl.	5-prison +5-rehab	5-prison +5 rehab	10-prison	2-prison +10 rehab	10-prison	Death
Murder 2	10-prison +5 rehab	10-prison +5 rehab	15-prison +5-rehab	10-prison +5-rehab	Death	Death
Murder 1	15-prison +10 rehab	Death +10 rehab	Death	15-prison +10 rehab	Death	Death
Kidnap	15-prison +10 rehab	Death +10 rehab	Death	15-prison +10 rehab	15-prison	Death
Slavery	20-prison +10 rehab	Death	Death	15-prison +10 rehab	Death	Death
Genocide	Death	Death	Death	Death	Death	Death

The Linchpins are very similar to the Sicilian Mafia of 20th Century Earth. They consist of five extended “families” who have joined their forces to maximize their profit. They have interests in a number of criminal activities, including protection rackets, loan-sharking, and the sale of controlled substances, as well as prostitution and gambling on those planets where they are illegal. Most Linchpin “soldiers” are somehow related (if only by marriage) to one of the five families, which tends to minimize betrayals. The organization has a strict code of silence, which it enforces ruthlessly. In addition to their criminal activities, the Linchpins have enormous holdings in legal corporations and businesses, which are often used as fronts for criminal activities and money-laundering.

The Gun Brothers are a mystical secret society somewhat similar to the Earth’s tongs and triads of Asia. The Brothers are assassins and spies for hire who sell their services to the highest bidder. They are brutally efficient and rarely fail in their assignments. Their services are extremely expensive: a typical assassination costs a minimum of a million credits! In the history of the Consortium, only a handful of gun brothers have been apprehended and most of those committed suicide or were rescued before any useful information could be gained from them.

Gun brothers are recruited from the worst slums of the CCW. Usually the recruits are children, purchased or kidnapped. The youngsters are indoctrinated in the martial arts and combat techniques. Furthermore, acolytes are augmented with bio-wizardry enhancements and magical tattoos! Bio-wizardry is the exclusive province of the *Splugorth*, which marks the Gun Brothers as pawns of these monstrous dimensional monsters. Although the CCW has figured out the *Splugorth* connection, the identity of the *Splugorth* entity responsible remains a secret. It could be any of the five *Splugorth* intelligences operating in the Three Galaxies, or a sixth one working from another dimension.

The Merchants of Freedom (also known as the MOF) claim that their purpose in life is to circumvent “unfair trade barriers” presented by the Consortium and other governments. What this means is that for the right price, the MOF will sell anybody anything, be it legal or illegal. Members of the MOF have been implicated in gun-running, slave selling, kidnapping, and drug-trafficking. The authorities’ task is complicated by the fact that many MOF members are respected traders and businessmen who secretly work for the organization. The Merchants of Freedom often do business with the Linchpins and other criminal organizations, supplying them with military-grade weapons and communication equipment. They also hire many *independent runners* to transport their goods, although they are rumored to have a large fleet of transports (and even warships) at their disposal.

Consortium authorities are sure that the MOF are a front for *Naruni Enterprises*, but if this is true, the wily dimensional

The Independent Defense Forces (IDF)

Although the Consortium Armed Forces (CAF) keep garrisons on or near most member planets of the CCW, the organization simply does not have the manpower and funds to fully protect every planet. Most member planets prefer to have a relatively small CAF detachment that can deal with major threats but which isn’t large or powerful enough to become a law unto itself. For local protection, most member planets and planetary collectives have *Independent Defense Forces*, the Consortium’s equivalent of a militia or National Guard. The IDFs are accountable to the government that funds them, and not to the CAF, although in an emergency, the CCW Congress can “draft” any and all IDFs into the regular armed forces. The mission of the IDF is to defend planets from outside threats. They do not have police or patrol powers and cannot operate beyond a planet’s star system, except when “deputized” by a CAF officer.

IDFs have their own uniforms, weapons and equipment. Some imitate CAF designs, often purchasing surplus uniforms and vehicles and then altering them slightly to distinguish them. Others prefer to make their troops stand out, and have completely different gear. At the “core worlds” of the CCW, where raids and other threats are almost unheard of, the IDFs are little more than a paramilitary club in which storekeepers, students and young professionals get to play soldier a few times a year in return for tax credits or scholarship opportunities. On frontier planets where the danger of violence is very real, the IDFs are as well-trained and equipped as the planet can afford. *Naruni Enterprises* often supplies IDFs within the Consortium. However, most CCW members distrust the transdimensional weapon dealers, so many of them make do with obsolete CAF ships and weapons purchased at very low prices and with generous credit terms granted by the government.

A few planets use the IDF as a private army with which to twist or avoid the clauses of the *Civilization Compact* (see **Rifts Phase World**, page 53). On a few occasions, rivalries or disputes between two worlds have ended violently when the IDFs of one or both planets involved decided to take matters into their own hands. There have even been some incidents when an IDF fired upon CAF ships or personnel! These have been isolated cases, however. Since the largest IDF in the Consortium is only a fraction of the size of the CAF, no planetary defense force could hope to successfully defy the army in the field of battle.

Veterans of an IDF often move on to service in the CAF and vice versa. There is some degree of animosity between the two military forces, however. Many CAF officers distrust IDFs, seeing them as armies that are loyal to their local interests first and

CCW Planets of Note

In'Val

In'Val is the fourth planet around a sun-type star. Its weather and atmosphere are very similar to Earth's, making it an ideal world for 90% of the Three Galaxies' sapient races. It is a land of mystery. Once the homeworld of an advanced race (see the In'Valian "Robo-Jockeys" described below), the planet is now nearly empty. Although In'Val is a healthy and fertile world, well-situated in the Corkscrew Galaxy (and only 300 light years from Phase World), few people want to settle there. Several decades ago, In'Valian scientists accidentally opened a giant Rift and made contact with a god-like entity that cursed their entire race. Fear that the entity might return one day has kept most immigrants away. The CCW keeps a research station and a large military base on the planet. A number of cultists that believe the In'Valians made contact with a member of the First Race have also set up shop on the planet. Half a dozen competing cults have their headquarters there. Disputes between them are common, and they often turn violent.

The Bushi Federation

This small planetary collective joined the Consortium of Civilized Worlds thirty years ago. The Bushi Federation consisted of five planets in four star systems, all within 20 light years of each other and all located in the *Thundercloud Galaxy*. The five worlds are populated by the oni race, a species of tall red-skinned humanoids. To the amazement of human anthropologists, the oni culture seems to be based on medieval Japan! Each planet is controlled by a *daimyo* (warlord), subject to the power of the *shogun* of the Celestial Homeworld of the oni. There is even an oni emperor, but he remains a religious figurehead without political power. The Bushi armies are made up of cybernetically-augmented "cyberai" backed by conventional space forces. Both the uniforms and armor manufactured in the Bushi federation are designed to copy or resemble the medieval Japanese body armor of Earth. The social system of the federation mimics ancient Japan's, with a rigid caste system that puts the warrior class above all others.

Before being accepted by the Consortium, the Bushi Federation had to change a number of their laws, including the right of warriors to behead any commoners who were not respectful enough. The rulers of Bushi accepted the changes because they feared the Transgalactic Empire would try to absorb them. Rather than submit to "foreign devils," the oni culture decided to change their ways a little, while still retaining much of their culture.

The Bushi Federation has made several major advances in the field of cybernetics, computers, and weapon designs, including several power armor and energy blades. Several *daimyo* have become the heads of mega-corporations (*zaibatsu*) that sell Bushi products to the Three Galaxies. The Bushi's most impressive coup was a CAF contract to manufacture *Katana-class fighter ships* for service in the Consortium's fleets.

Malthus' World (Dellian-4)

Critics of the CCW point to Malthus' World as proof of the hypocrisy of the Civilization Compact. Malthus' World is named after an ancient economist who declared that population

growth almost always outstrips resources, resulting in scarcity and famine. The inhabitants of Dellian-4, the t'zee, are living examples of Malthus' theories. When CCW exploration ships reached Dellian-4 (located in the depths of the Corkscrew Galaxy), they saw a planet where every square inch of land and most of the ocean floors was built-on, cultivated, or otherwise being used by the 50 billion people crammed on a planet a bit smaller than Earth (0.9 of Earth's diameter, with 0.75 its land mass). The t'zee are one of the most fertile species in the Three Galaxies. Their population was kept in check by a devastating cycle of famines and plagues that killed billions and temporarily restored the balance. The t'zee had developed crude space travel techniques, and had terraformed two of the planets of their star system, but even those measures were not enough to stem overpopulation. Dellian-4 was a giant slum, with spiraling skyscrapers and teeming multitudes taking up all available space. No wildlife remained; every forest and jungle had been razed and built over long ago.

When the Consortium made contact, they discovered that the t'zee had very advanced medical techniques, far ahead of CCW technology. The t'zee culture had also developed nanotechnology, the science of building microscopic machines. When the government of Dellian-4 asked for permission to join the Consortium, supporters of the idea said that the t'zee contribution in those fields would be invaluable.

Not everyone wanted the t'zee to join, however. First of all, their culture was merciless and cruel. Overpopulation had developed a civilization with little regard for life or civil rights. The t'zee were fierce capitalists without room for pity; those who could not afford to buy food or medical care simply starved or died of disease. Food riots were put down savagely by the army, and the government was (and still is) a military dictatorship ruled by a Generals Council (also known as a Junta). The military is little more than a dupe of the Captains of Industry, wealthy heads of corporations who control most of the economy of the planet. Members of the Consortium Congress listed 127 violations of the Civilization Compact that were part of daily life on "Malthus' World." A number of congress people also pointed out that the t'zee, left unchecked, might overpopulate the rest of the Three Galaxies in a few centuries.

Despite these objections, the t'zee were granted "probationary" membership to the CCW, with the understanding that all violations of the Compact would be corrected over the next fifty years. That was over a century ago, and many, if not most, violations of the Compact continue to exist on both Malthus' world and the half-dozen colonies the t'zee have established since joining the CCW. Their corporations have become influential players in galactic politics and their lobbyists keep derailing any attempts of the CCW Congress to censure or expel the t'zee from the Consortium.

Over the last few decades, Malthus' World has developed a reputation as a notorious smugglers' port. Despite the best efforts of a CAF detachment on the planet and on space stations around it, there is so much traffic going back and forth that runners have an easy time buying, loading or selling illegal cargoes. The TVIA (see **Rifts Phase World**, page 54) has recently uncovered evidence suggesting that some of the t'zee Captains of Industry are conspiring to take over the entire Consortium! Their investigation continues and is revealing more disturbing information.

New Consortium

O.C.C.s & R.C.C.s

Described below are some more alien races and occupational character classes appropriate to the Consortium of Civilized Worlds.



In'Valian "Robo-Jockeys"

The In'Valians are masters in the science of prosthetics and robotics. The reason for it is simple: the entire species has been permanently crippled by a freak event that remains unexplained to this day. Once, the In'Valians were humanoids with a bluish tint to their skins, slightly taller and stronger than humans. The race evolved on a terrestrial planet, and developed a high level of technology (including crude faster-than-light ships). Like most species in the Three Galaxies, their culture did not develop magic, relying instead on science. Soon after making contact with other civilizations, the planet In'Val requested and was granted membership in the Consortium of Civilized worlds. A century later, tragedy struck.

A research team on In'Val was experimenting with transdimensional portals. The scientists wanted to come up with a technological way to open dimensional Rifts, rather than relying on magic. Their experiment, conducted on an orbiting space station, opened a massive Rift (over ten miles wide/16 km.) in the stratosphere of the planet. Through it slipped a gigantic creature, over 500 feet (152 m) tall, that resembled a gelatinous, tentacled mass. The Planetary Defense Forces reacted swiftly. No attempts to communicate with the creature were made. In a panic, it was destroyed by a concentrated barrage of cruise missiles and heavy lasers. The scientists tried desperately to close the Rift, but their machines seemed unable to do so. All efforts stopped and the planet was thrown into chaos and mass hysteria.

Through the 10 mile-long (16 km) Rift peeked an eye! An eye that filled the entire dimensional opening and was visible from the ground. The being looking down at the planet must have been several miles long. It is believed that this entity may have been the parent of the "little" creature the planetary defense forces destroyed. When it saw the slaughtered body of the "baby," the colossal entity gave a psychic bellow of anger and pain that was sensed for several light years and which instantly killed or drove insane most In'Valian psychics. Then the Rift closed.

All experimentation into Rift technology was immediately suspended. The officer who gave the order to fire on the alien creature was court-martialed and sentenced to life in prison. The In'Valians considered the case closed and the people thought their ordeal was over ... but then the Wasting Disease struck.

The general consensus is that the Wasting Disease was a magic curse of unimaginable magnitude. No known medical or magical treatment was able to counteract its effects. Efforts to isolate the sickness by quarantining those afflicted did not stop it. No viral or chemical agent could be found to cause the disease. The In'Valians, who as a culture worshipped their bodies and health, saw their bodies atrophy steadily. Those afflicted by the disease suffered from weaker and shrinking muscle tissue, brittle bones, and loss of height and weight. The victims also suffered total hair loss and their skin acquired an unhealthy pink coloration. The Wasting Disease spread steadily throughout the In'Valians. Most alarming of all, the Wasting Disease affected even those In'Valians who were born and bred on other planets, hundreds of light years away! The worst blow came when children were born with the mysterious plague.

The Wasting Disease did not kill; the afflicted lived on, but within a year were permanently disabled, unable to perform any heavy physical activity. Scientists calculated that at the current rate of spread, the entire species would be affected in less than ten years. The entity had cursed the In'Valian race unto the last generation. In'Valian and CCW doctors did their best, to no avail. Sorcerers from the United Worlds of Warlock and Phase

World were brought in, but they also failed. Brain transplants into healthy bodies were attempted, but removing the brain from a diseased body invariably killed the patient. Cybernetic implants and limbs were rejected by the twisted bodies. The only alternative was to build robotic exoskeletons to act as vehicles and tools for the victims.

Today, only a few million In'Valians survive. The race has dwindled after all of its members became affected by the entity's curse. These survivors cling to hopes that one day a cure will be found. Still, the average In'Valian is an angry, bitter individual. As a race, they are extremely wealthy, as each survivor acquired a share of the almost-empty planet, and was able to sell it for millions of credits. This hasn't prevented many from turning to crime or insane acts of violence.

In'Valians are greeted with a mixture of pity and fear, because nobody knows what they may do. Although they are physically crippled, they live most of their lives inside sophisticated exoskeletons. Many customize these exoskeletons, adding heavy armor and weapons and making them the equal of a suit of power armor. Many become obsessed with their mechanical suits, and refuse to leave them, refitting them so they act as walking homes where they can sleep and dwell almost indefinitely.

Alignment: Any, but lean towards anarchist and evil; most In'Valians feel that they got a raw deal from the universe.

Attributes: I.Q. 3D6+4, M.E. 3D6, M.A. 3D6, P.S. 1D4, P.P. 1D6, P.E. 2D4, P.B. 2D6+2, Spd. 1D4

Size: 2 to 4 feet (0.6 to 1.2 m) tall.

Weight: 40 to 80 lb. (18 to 36 kg)

M.D.C.: By armor only. See In'Valian exoskeletons, below.

S.D.C./Hit Points: 1D6+6 S.D.C.; Hit Points: P.E. plus 1D4 per level.

Horror Factor: None

P.P.E.: 2D4

Average Life Span: Perversely, the In'Valians' life spans have been enhanced by the Wasting Disease. The typical life span is 300 standard years, however many commit suicide before then.

Natural Abilities: None

Experience Level: Varies; typically 1D6+1.

Psionic Powers: None

Magic Powers: None

Combat: Can select a hand to hand combat skill, but it only applies while wearing an exoskeleton. Outside the exoskeleton, they have only one attack/action per melee.

Bonuses: These bonuses only apply while they are wearing an exoskeleton. +1 on initiative, +2 to strike, parry and dodge, +3 to roll/pull punch. Without the exoskeleton, they are at -4 to strike, parry and dodge and cannot lift or carry more than 15 pounds (6.8 kg).

Vulnerabilities/Penalties: In'Valians have a -30% penalty to all physical skills. Also, most physical skills are impossible for them, including athletics, acrobatics, gymnastics, body building, boxing and wrestling. Even engineering, computer and other skills that require manual dexterity and the pushing of buttons and levers are tiring and have a penalty of -10%.

Insanities: Many In'Valians develop an obsession towards their exoskeletons. Typically, they prefer to wear their augmenting suits at all times and only feel "normal" while relying on them.

O.C.C.s: In'Valians can be any non-magical or non-psionic O.C.C. open to humans or wolfen. A number of these creatures serve in the Consortium Armed Forces (CAF).

Alliances and Allies: The In'Valians are members of the CCW, although their standing has decreased steadily since their downfall.

Weapons: Varies. They favor built-in weapons for their exoskeletons, particularly energy weapons.

Body Armor: See the In'Valian exoskeleton, below.

In'Valian Exoskeletons

As a last ditch measure to deal with the Wasting Disease, In'Valian scientists developed advanced exoskeleton suits that could augment strength and speed, allowing members of the race to lead relatively normal lives. Although the exoskeletons have done little to raise the In'Valians' self-esteem and morale, they have managed to act as an equalizer for the entire species. From their birth, In'Valians are trained in the use of their personal exoskeletons. Many become extremely attached to them, giving their suits pet names and even talking to them as if they were alive. Many suits have artificial intelligence programs with full vocal capabilities, so they can talk back to their owners.

Most exoskeletons are shaped like a humanoid and are 6 to 7 feet tall (1.8 to 2.1 m). The In'Valian is in a cockpit in the torso. Most (70%) exoskeletons have open cockpits (the In'Valian is clearly visible as the pilot). Armored or space-walking versions have sealed cockpits of either glassteel (a transparent M.D.C. alloy) or enclosed metal, just like a robot vehicle. The In'Valians have developed Neural Circuitry (also used in many fighter ships and power armor) which reads nerve impulses and transmits them to the vehicle; this allows them to "pilot" their exoskeletons without moving levers or pushing buttons, which are fatiguing to the weak creatures.

Described below are some typical In'Valian Exoskeletons:

Light Exoskeleton

M.D.C. by location:

Arms (2) — 15 each

Legs (2) — 20 each

** Main Body — 60

** Depleting the M.D.C. of the main body destroys the exoskeleton, rendering it useless.

Other Features: The In'Valian is in an open cockpit. The neural controls are usually in a helmet. Using the helmet, the In'Valian can have the exoskeleton pick him up and place him in the cockpit. The exoskeleton can run at up to 40 mph (64 km); the artificial legs do all the running (no fatigue for the pilot). The robotic structure has a *human-equivalent P.S. of 22* (Restrained punch one S.D.C., full strength punch 1D6+7 S.D.C., and power punch 2D6+7 S.D.C./counts as two attacks) and the exoskeleton can wield any humanoid-sized weapon.

Power System: Nuclear; average energy life 5 years.

Cost: 100,000 credits.

Armored Exoskeleton

As above, but with an armored shell. The cockpit is covered by a transparent glassteel dome.

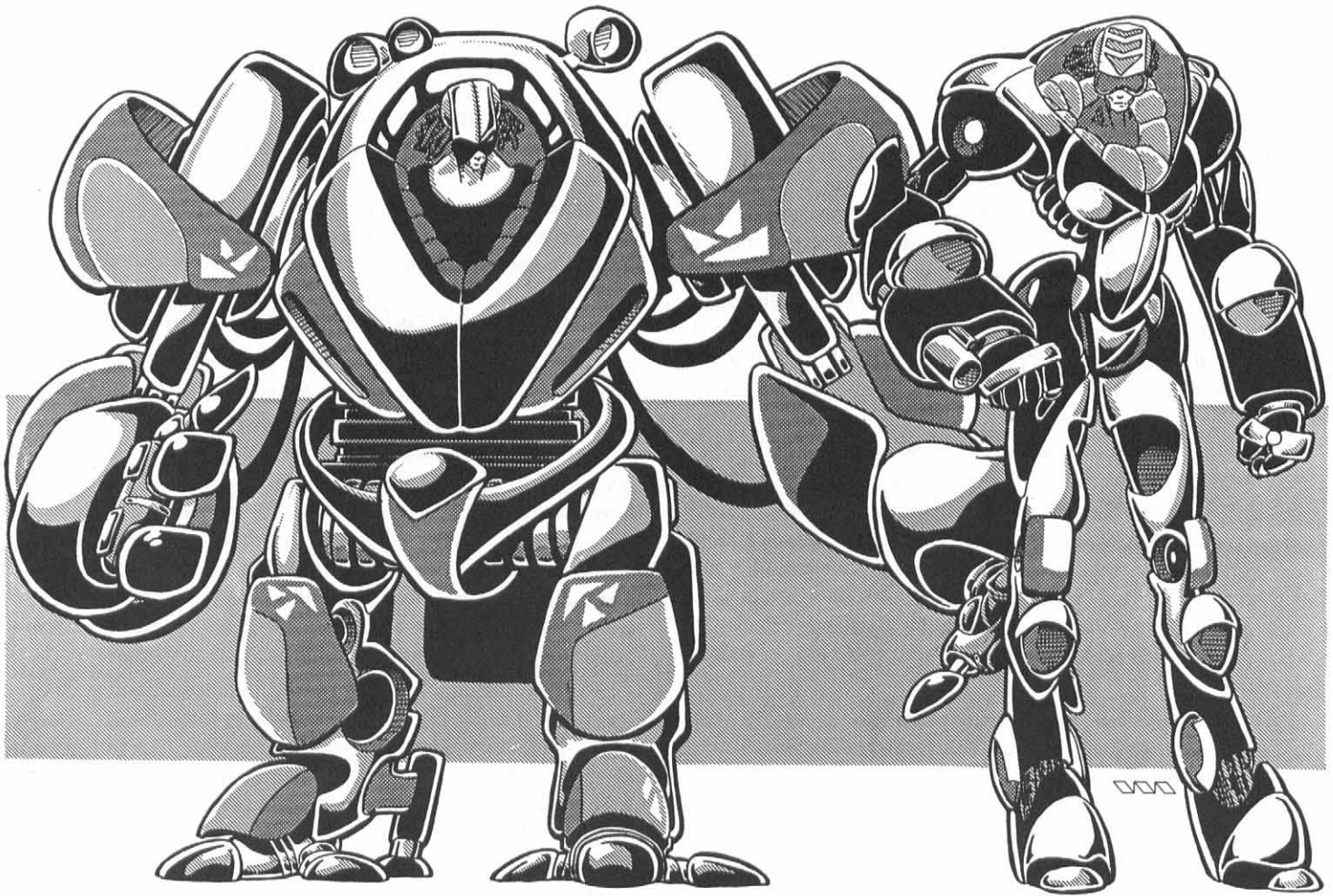

M.D.C. by location:

Arms (2) — 30 each

Legs (2) — 40 each

** Main Body — 120

* Glassteel Cockpit — 75

* Destroying the glassteel cover exposes the pilot to direct fire. Hitting the cockpit (and the pilot afterwards) requires a called shot at -2 to strike.

** Depleting the M.D.C. of the main body destroys the exoskeleton, rendering it useless.

Other Features: The exoskeleton's hands can wield any humanoid-sized weapon, but it has no weapon systems. The heavier frame has a *robot P.S. of 26* (Restrained punch 1D4 M.D., full strength punch 1D6 M.D., and power punch 2D6 M.D./counts as two attacks). One medium range and one short-range energy weapon or vibro-blade can be built into each arm at an additional cost of about 50,000 each (linked to the power supply for effectively unlimited payload).

Power System: Anti-matter; average energy life 40 years.

Cost: 1 million credits.

Combat Exoskeleton

A military version used by In'Valian soldiers or by travelers in dangerous areas of the Three Galaxies (like Phase World). In every way, the equal of a suit of power armor.

M.D.C. by Location:

Arms (2) — 100 each

Legs (2) — 120 each

Main Body — 300

Glassteel cockpit — 200

* Destroying the glassteel cover exposes the pilot to direct fire. Hitting the cockpit (and the pilot afterwards) requires a called shot at -2 to strike.

** Depleting the M.D.C. of the main body destroys the exoskeleton, rendering it useless.

Other Features: Typically this exoskeleton has one or more built-in energy weapons (each adds to the basic cost). One heavy, long-range weapon can be built into each arm (equivalent to any energy rifle, with unlimited payload) plus one or two short-range energy weapons (equal to most energy pistols, projectile sub-machineguns) or a vibro-sword. One mini-missile launcher (2 to 6 missile capacity for each unit), and an additional energy weapon or sensor system can be built into or mounted on each shoulder.

The power armor has a *robot P.S. of 32* (1D4 M.D. restrained punch, full strength punch 2D4 M.D., power punch 3D6 M.D./counts as two attacks). The cockpit has a built-in radio communicator and computer and pilot bio-system monitor. Additional power armor systems, like radar and laser targeting, can be installed at extra cost. The exoskeleton can carry and use any hand weapons suitable for humanoids, cyborgs or power armor.

Power System: Anti-matter; average energy life 40 years.

Cost: 8 million credits for a basic unit with one long- and short-range energy weapon. 12 million for a fully loaded combat model with a long- and short-range weapon in each arm, one laser finger tool (equal to a laser scalpel), one vibro-blade in one arm, and a pair of mini-missile launchers on both shoulders (4 to 6 missiles in each).

Size: Typically a bit larger than non-combat versions, 8 to 12 feet tall (2.1 to 3.6 m).

Oni R.C.C.

The oni name themselves after the giant goblins of Japanese mythology. They are large humanoids with straight black hair and light red skins. They have overmuscled builds, with wide shoulders and relatively narrow waists. Their eyes are large and black, with epicanthic folds. Although bigger and stronger than humans and wolfen, the oni are not supernatural creatures and can be hurt or killed by S.D.C. weapons. They are, however, exceptionally quick and graceful for their bulk.

Oni culture seems to be patterned after medieval Japanese civilization (see the Bushi Federation, above). Nobody is sure where the species acquired their knowledge, or why they adopted it as their own. The oldest oni stories refer to the ancient goddess Ameratsu, who guided them to their new home, uncounted millennia ago. Oni historical records claim that the goddess remained among them until less than 1,000 years ago; at which time she taught her people the secrets of technology and left. The debate over whether these stories are mythological accounts or historical fact still continues. Many occultists believe that the goddess did indeed bring the oni to their planet, probably through a dimensional Rift. Despite their mythical origins, the oni civilization is overwhelmingly technological. The race is capable of using magic, but only 0.001% of the population ever learns or practices it, and magic is relegated to legends and myths, with no impact on their daily life.

Although they do not know much magic, the oni have a long tradition of martial arts abilities. A select few have developed the power to channel their wills to perform superhuman feats. The best known of these lethal martial artists are the *oni ninja*, who have developed physical psionic powers that make them the match of both magicians and cyborgs.

Oni culture is very concerned with the concept of honor and duty. "Losing face" (shaming oneself or one's family or clan) is a terrible thing. Most oni will die rather than lose face, or commit suicide if they do. Obedience is so deeply ingrained in most oni that orders are obeyed at all costs, even when they are stupid or dangerous. Warriors follow the samurai code of obedience to one's lord, to the death if necessary. This sense of honor and duty has prompted many Oninese warriors to sacrifice their humanity and become *cyberai*, incredible cyborgs as powerful and feared as the Wolfen Quatoria or the Naruni Repo-Bots (see **Rifts Phase World**, page 66 and 46 respectively). Since the Bushi Federation joined the CCW, a large number of oni have joined the CAF, where they have distinguished themselves in combat and espionage.

The other side of the oni's code of honor is a strong sense of racial superiority. They consider themselves to be above all other species of the Three Galaxies. Humans, wolfen, noro and similar species are considered to be worthy allies, but not quite as "civilized" or honorable as the oni. As a result, many Oninese businessmen and criminals feel free to lie, cheat and steal from non-oni races. The majority of the population, however, continues to deal honorably with all races, provided that their good will is reciprocated.

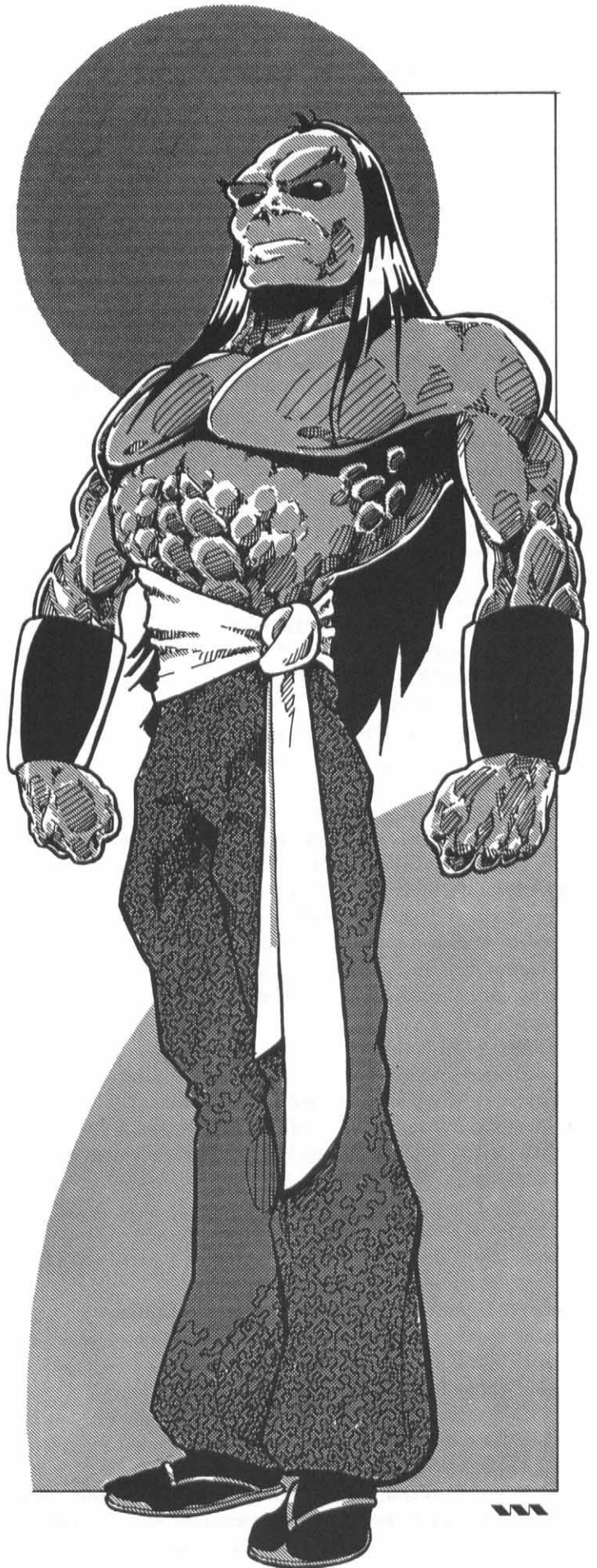

Besides their martial spirit, these people are best known for their mega-corporations (zaibatsu), which approach business with the same single-minded dedication their warriors reserve for combat. The most famous oni-run zaibatsu is **Bushido Industries**, which controls over a dozen corporations dealing with metallurgy, advanced computers, computer circuitry, starships, and weapon systems. Bushido Industries is well on its way to becoming a major player in the weapons business, which has led to friction with other CCW corporations and, more importantly, Naruni Enterprises. Bushido Industries is not above using "corporate ninja" in espionage, sabotage and even murder against their business rivals. Since Naruni Enterprises is also famous for its use of underhanded tactics, it is believed that a secret war between the two corporations is brewing and may explode at any time. A rumor that Bushido Industries is exploring the possibility of doing business with other dimensions (through Phase World) may be the spark that ignites the war.

Alignment: Any, but usually principled or aberrant. Very few (20%) are anarchist, miscreant or diabolic. Aberrant oni usually feel little or no obligation to respect the lives, property and rights of non-oni, unless they have proved themselves worthy of consideration.

Attributes: I.Q. 3D6, M.E. 3D6, M.A. 3D6, P.S. 4D6+10, P.P. 3D6+10, P.E. 4D6+10, P.B. 3D4, Spd. 4D6

Size: 7 to 9 feet (2.1 to 2.7 m) tall.

Weight: 300-450 lb. (136 to 204 kg)

M.D.C.: By body armor or bionics only.

S.D.C./Hit Points: 3D6x10 S.D.C. in addition to O.C.C. and skill bonuses. Hit points: P.E. x3 plus 2D6 hit points per level of experience.

Horror Factor: None most of the time, 8 for people seeing them for the first time or when facing oni ninja or Cyberai.

P.P.E.: 3D6 unless a magic O.C.C.

Average Life Span: 200 years with modern medical facilities available; 100 years normally.

Natural Abilities: Developed sense of smell (twice as sharp as a human's), acute hearing, and nightvision 200 feet (61 m).

Experience Level: NPCs can range from 1st to 15th level; average is 1D4+2.

Psionics: Most oni are not powerful psionics, but can be minor or major psionics, just like humans. A sizable percentage, however (5%) have the potential to channel their psionic power into superhuman abilities, usually through the study of the martial arts. See the Oni Ninja, below, or **Ninjas and Superspies** or **Mystic China** for ideas on martial arts super abilities, and the **Rifts Conversion Book One** for ways to convert martial arts powers to the Rifts universe.

Magic: Only if a magic O.C.C.; less than 1 in 10,000 Oni practices magic, including priests.

Hand to Hand Combat: Typically expert or martial arts.

Damage: Punch does 2D6 S.D.C. plus P.S. bonus, kick inflicts 2D8 plus P.S. bonus. A power punch or leap kick can inflict 1 M.D. point but counts as two melee attacks.

R.C.C. Bonuses: +1 on initiative (acute hearing), +1 to strike, parry and dodge, +2 to roll with impact and to pull punch. All these are in addition to skill or attribute bonuses.

Vulnerabilities/Penalties: The oni homeworld is slightly colder than the galactic average; in temperatures above 80 degrees Fahrenheit, the oni are uncomfortable (lose all R.C.C. combat bonuses and one melee attack/action).

O.C.C.s: Any CCW O.C.C. (CAF fleet officer, trooper, or scientist, TVIA inspector, etc.), as well as cyberai and oni ninja (both described below). A small percentage become spacers, runners, mercenaries and other independent operators. An even smaller percentage (0.001%) practice magic: of those, they are usually divided between priests of Ameratsu (30%; see **Rifts Conversion Book Two: Pantheons of the Megaverse** for the priest O.C.C.); ley line walkers (20%); mystics (15%); temporal wizards and warriors (20%); and all others (15%).

Alliances and Allies: Both the wolfen and the seljuk races have acquired a great deal of respect for the solemn, dedicated oni. Friendships between the three races are fairly common. Some humans, particularly those of Japanese ancestry, are also fascinated by these beings and wish to learn more about their origins.

Weapons and Equipment: Varies with O.C.C. Very likely to prefer Oninese equipment and weapons over all other brands; rarely use Naruni items for any reason.

Cyberai O.C.C.

Cyborg Warriors

The cyberai are oni warriors who voluntarily subject themselves to massive bionic reconstruction to better perform their duties. For two hundred years, these powerful cyborgs have served the daimyos, shoguns and emperors of the Bushi Federation. Since the oni joined the CCW, the cyberai can be found in several walks of life. **The corporate cyberai** work as part of the security detail at large corporations. Their loyalty is pledged to the corporation in the same way they used to swear allegiance to their feudal lords. **Military cyberai** enlist in the CAF or serve in the Bushi Federation's Independent Defense Forces (see the IDF section above). Although the CCW dislikes cyborgs in general, the CAF realizes that the cyberai are extraordinary warriors and as such, can be invaluable. Most cyberai in the CAF serve in special forces teams, due to their unique needs and abilities. Finally, there are **ronin** who serve nobody, having lost or forsaken their masters by choice or circumstances. Most ronin do not live in the Bushi Federation because they are often considered outsiders and dangerous, shiftless vagabonds there. Instead, they travel through the Three Galaxies, or to other parts of the Megaverse via Phase World, where they work as mercenaries, paladins, adventurers or outlaws.

The bionics used for cyberai are tougher and stronger than equivalent human systems. This is due in part to the oni race's large bodies, which allows for more powerful bionic frames, but mostly to the oni's advances in the field of cybernetics and nano-technology. The cyberai bionic frame is not only extremely fast and powerful, but it has a built-in force field and uses nano-technology to repair damage. But the most unique trait of the cyberai is their ability to reshape one or both hands to become mega-damage, mono-molecular blades, able to slice through the toughest alloys.

Even more so than the typical oni, most cyberai are extremely honorable and inflexible when it comes to questions of honor and duty. They follow the traditional way of the oni warrior, and are expected to die before failing to do their duty. Sometimes a

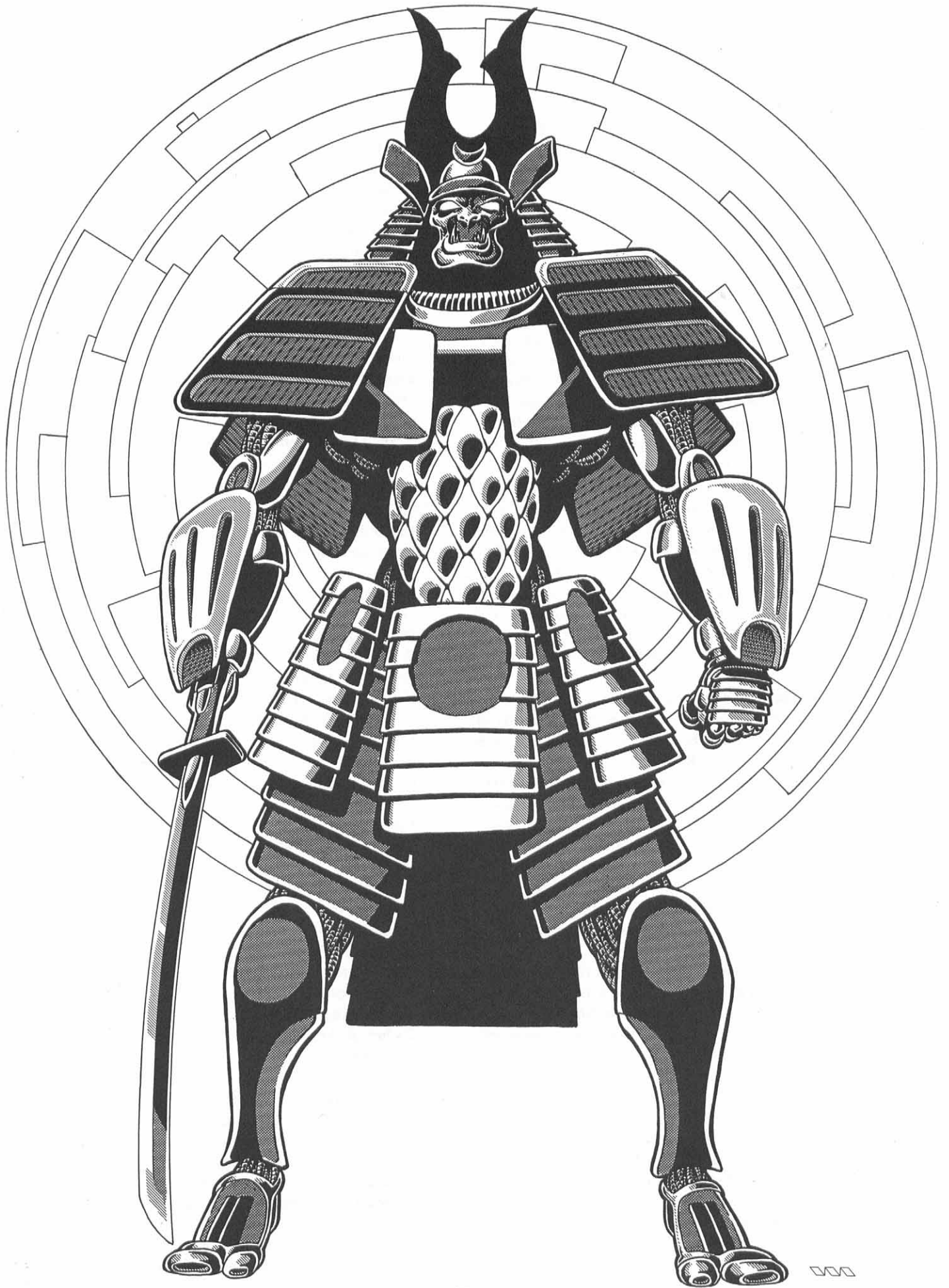

cyberai will take insane risks to pursue what he considers to be the honorable path. If he dishonors himself, the cyborg warrior is expected to commit ritual suicide, performed by turning off his cybernetic life support system. A handful may elect to become ronin mercenaries and live with the shame of dishonor (most of these rogues are villains with anarchist or miscreant alignments).

Attribute Requirements: M.E. 14 or higher. Physical attributes are altered by advanced bionic and cybernetic systems.

Alignment: Usually principled or aberrant. A few (20%) are of other alignments; most of those are Ronin.

O.C.C. Abilities and Bonuses:

1. Bionic Conversion: The cyberai are full cyborgs, their entire bodies having been replaced by bionic systems. Only the brain and portions of the oni's spinal cord remain. All other organs are replaced by metal, ceramic, plastic and composite materials. A cyberai without his body armor looks like a huge robot or 'borg, 9 to 10 feet (2.7 to 3.0 m) tall. Wearing his stylized samurai body armor, he resembles a giant Japanese statue or suit of armor. The bionic body has P.S. 50 (robot), P.P. 22, and Spd 88 (60 mph/96 km), P.E. not applicable. Roll mental attributes as normal.

2. Face Masks: The faces of the Cyberai are replaced by "face masks," metallic constructs that are somewhat expressive but which often look like monstrous beings to intimidate enemies. The typical cyberai face mask has a horror factor of 9; the most hideous will have an H.F. of 12 (8+1D4)!

3. M.D.C.: The cyberai is a mega-damage cyborg, larger and tougher than most 'borgs. The basic body has 420 M.D.C., hands: 30 M.D.C. each, arms: 100 M.D.C. each, legs: 130 M.D.C. each, head: 100 M.D.C., plus see body armor, below.

4. Body Armor: In addition to their bionic structure, cyberai wear a suit of samurai-style armor, with a main body of 480 M.D.C. This armor can be replaced or substituted with other cyborg armor (see **Rifts RPG**, page 243).

5. Nano-Machine Regeneration: Stored in a special compartment deep inside the cyborg is a nano-machine repair kit. Millions of virus-sized robots are released to repair the damage on the components of the cyberai! These repairs restore 2D6 M.D.C. per hour to ALL damaged parts throughout the body. The nano-machines can only work for 8 hours before requiring 16 hours of recharge time. The bionic components of the cyberai can also be repaired through conventional cyber-mechanics.

6. Nano-machine Katana (Special): The right hand of the cyborg uses nano-technology to become a mono-molecular katana (a Japanese sword) at the will of the cyberai! The edge is thin enough (about the width of a molecule) to penetrate most material, and the alloy is tough enough to cut into mega-damage materials! The act of creating the sword counts as one melee attack/action. The right hand elongates and sharpens, while the wrist narrows enough to act as a grip for the left hand to allow a two-handed attack. **Damage Note:** The mono-molecular katana has 120 M.D.C. (can only be attacked if targeted in combat), and it inflicts 5D6 M.D. from a single hand attack, 1D4×10 M.D. from a two-handed sword strike, and 1D6×10 M.D. from a two-handed power strike (stab, chop or slash; a power strike counts as two melee attacks).

7. Damage: The advanced bionic system and large size of the Cyberai allow him to inflict mega-damage with his bare hands and feet!

Restrained Punch — 2D6+35 S.D.C.

Full Strength Punch — 3D6 M.D.

Kick — 4D6 M.D.

Power Punch — 6D6 M.D. (counts as two melee attacks)

Leap Kick — 1D4×10 M.D. (counts as two melee attacks)

Judo Style Throw/Flip — 1D6 M.D.

Also see Katana damage in number six.

8. Combat Bonuses: +2 to initiative, +6 to strike, +4 to parry and dodge, +2 to pull punch, +2 to roll with impact, +4 to save vs horror factor and one additional attack per melee. These bonuses include bionic attributes, but do NOT include combat skill bonuses.

9. Sensory Systems: The cyberai has an advanced sensory suite. These include standard multi-optic eyes, ultra-ear, sound filtration system, and built-in radar (5 mile range/8 km, 75% chance of identifying targets, location and speed/direction of travel).

10. Other Bionic Features: Bionic lung with gas filter and oxygen storage cell, language translator, built-in loudspeaker and radio receiver and transmitter.

O.C.C. Skills:

Radio: Basic (+10%)

Language: Oni (98%; automatically gains Japanese at 50% at first level; +3% per level of experience).

Language: Two of choice (typically Galactic Trade Tongues) (+15%)

Detect Ambush (+15%)

W.P.: Sword

W.P.: Two of choice

Hand to Hand: Martial Arts (or Assassin if evil)

O.C.C. Related Skills: Select 8 other skills, plus select one at level four, two at level seven and one at levels eleven and thirteen. All new skills start at level one proficiency.

Communications: Any (+5%)

Domestic: Any

Electrical: Any

Espionage: Any (+5%)

Mechanical: Any

Medical: First aid only.

Military: Any

Physical: Any

Pilot: Any (+5%)

Pilot Related: Any (+5%)

Rogue: Prowl and streetwise only.

Science: Any

Technical: Any (+5%)

W.P.: Any

Wilderness: Any

Secondary Skills: The character also gets to select five secondary skills. Those are additional areas of knowledge that do not get the advantage of the bonus listed in parentheses. All secondary skills start at the base skill level. Also, skills are limited (any, only, none) as previously indicated in the list.

Standard Equipment: Varies with current allegiance. Corporate cyberai start out with three energy weapons of choice, a personal vehicle (anything smaller than a spaceship), plus a luxurious apartment with all the comforts a cyborg can enjoy.

Military cyberai receive standard issue weapons and equipment. Ronin start with one energy weapon of choice, a pair of Japanese-style swords (wakizashi and katana), hand computer, and a backpack with personal effects. All cyberai start out with personalized samurai armor; high-tech cyborg body armor with 480 M.D.C. and a back attachment for a jet pack.

Money: Corporate: 4D6×1000 credits. Military: 3D6×100 credits. Ronin: 2D6×100 credits.

Cybernetics: Can have an additional 1D4 cybernetic systems.

Oni Ninja R.C.C.

A small percentage of oni exhibit superhuman psionic powers, usually expressed in incredible physical attributes (considered to be supernatural). These super-powered martial artists are often found in monasteries, schools, and remote locations, where they dedicate themselves to honing their physical and mental skills. The most (in)famous of these Oninese martial artists are rarely, if ever, seen in public. These are the Oninese Ninja Clans, secretive organizations that specialize in subterfuge, assassination and espionage. The Ninja are removed from normal Oninese society and are typically hated and feared by most law-abiding citizens. Ninja sell their services to the rich and powerful. The Bushi government occasionally uses them for delicate missions that cannot be revealed to the public. Oni mega-corporations rely on these shadow assassins to do their dirty work. It is rumored that Bushido Industries, the largest, most powerful and most ruthless zaibatsu of the Bushi Federation, has an entire ninja clan on retainer!

Of late, the oni ninja have started selling their services to any customer in the Three Galaxies. They have expanded their network and now people with the right connections can hire the assassins throughout the Consortium, as well as on Phase World and several independent planets. On at least two occasions, members of the Kreeghor royal family have hired oni ninja; once to kill a relative during a succession dispute, and the other to murder an important leader of the Free Worlds Council. The ninja were successful in both cases.

Making contact with and hiring oni ninja clans is not easy. Oni zaibatsu (mega-corporations) have centuries-old contact procedures with these mysterious assassins. Beyond the Bushi Federation, streetwise skill rolls and asking the right questions in the seedier parts of starports and large cities have a chance of finding somebody who knows somebody else who *might* be able to arrange a meeting. Most communications with ninjas are done through phone, radio or computer networks. Payment is usually left in a drop zone to be picked up later, to minimize direct contact between the client and the assassins. The minimum fee for an act of sabotage or espionage is 100,000 credits (very valuable or difficult jobs can cost millions of credits). Murders cost at least 250,000 credits, and typically go for 2 to 10 million.

Life in the ninja clans is harsh and demanding. Members are trained in the ways of combat since they are old enough to walk. Babies with potential psychic powers are often kidnapped from hospitals or homes and brought to the clans. The ninja spend their lives hiding in plain sight, often pretending to lead normal lives while they hone their arts right under the noses of friends and neighbors. The fear of discovery always hangs over all clan members, which leads to paranoia and a life of deception. Young

ninja are raised by the clan as a whole, and are taught to love and obey the clan, and only the clan. All other people are considered to be outsiders, strangers, potential enemies, or prey to be hunted down, not equals to be friends or lovers. This includes members of their own race!

The few ninja who break the rules and forge a relationship with outsiders are branded traitors and persecuted. There have been a few instances where ninja have abandoned their clans and gone out on their own to perform good or ill. Very few of these renegades have survived, because the clans go to any lengths to preserve their secrets, including hunting down and eliminating all who dare abandon them. **Note:** The Game Master should keep this in mind if he allows a renegade or heroic oni ninja player character to work as a free agent with the player group. A renegade ninja will be in constant danger of discovery and attacked by his former clansmen. Although the ninja clan should not appear in every adventure (there aren't that many of them, after all, and the Three Galaxies are a big place — the Megaverse is even bigger), they could make a good recurring nemesis.

Thanks to their physical psionic powers, ninja become the equivalent of supernatural creatures, able to inflict mega-damage with their bare hands and to withstand M.D. weapons without armor. They are also masters of illusion and invisibility, able to outdo the wildest tales ever told about Earth's Ninja. The most powerful masters are said to be god-like beings, able to stand up to whole armies, or to kill someone without having to see him!

There are rumors that some ninja clans have started teaching their secrets to non-oni. No evidence has been shown of this practice, but it might be possible that master psionics of other races could learn the martial arts techniques that give the ninja their supernatural powers. (**Note:** Whether or not these rumors are true is, of course, up to the Game Master. Non-oni ninja (if allowed) use the same experience point table as oni ninja. Use the base attributes of the character's race and then add all bonuses and powers).

Despite their superhuman powers and abilities, the oni ninja are not invincible. Many times, the assassins have run afoul of the CAF, cosmo-knights, phase adepts, the wolfen Quatoria, and many other heroes and law-enforcers. The ninja's main enemies are the **Gun Brothers**, a transgalactic assassin organization. Secret wars between the two organizations are common. Phase World is currently the site of a three-way war between the *Gun Brothers*, the *Oni Ninja*, and the *Society of the Knife* (see **Rifts Phase World**, page 23).

The oni ninja and the cyberai hate each other with a passion. To the cyberai, the ninja are dishonorable, backstabbing lowlifes, while the ninja see the super-cyborgs as cumbersome monstrosities too stupid to use cunning tactics in combat. Even ronin and renegade ninja will rarely work together and never fully trust the other at first.

Attribute Requirements: M.E., P.S., and P.P. 15 or higher. Also see attribute bonuses, below.

Typical Alignment: Aberrant; loyalty to the clans requires some sort of twisted ethics. Renegades tend to be anarchist or unprincipled. A handful of ninja become principled, and scrupulous and abandon the ways of their clans. An equally small portion are miscreant or diabolic.



O.C.C. Abilities and Bonuses:

1. Psionic Transformation (physical psionic powers):

By channeling their powerful psionic powers inward, Oni Ninja become supernatural creatures. Also see M.D.C. and attribute bonuses. The character's hand to hand attacks inflict mega-damage (See **Rifts Conversion Book One**, page 22, for supernatural P.S. damage).

2. Attribute bonuses: +6 to P.S., P.E., and Spd, and +3 to P.P.; these are in addition to physical skill bonuses.

3. M.D.C.: The Ninja become M.D.C. creatures. Base M.D.C.: P.E. x5. They also gain additional M.D.C. from their special martial arts (described elsewhere in this section). S.D.C. points gained from physical skills are also added on as extra M.D.C. The ninja gains an additional 1D6 M.D.C. per level of experience.

4. Ninja Techniques: At level one, the character can select three Oni Ninja Techniques (described elsewhere in this section). Keep in mind that some techniques have as a prerequisite, another (lesser) technique. Every level starting at level three the ninja can select one additional technique.

5. Psionic Powers: The oni ninja are all master psionics, but most of their powers are focused on their martial arts and on their physical bodies, which makes them supernatural, mega-damage beings. Still, they possess a few psionic powers. At first level, the ninja can select three powers from the sensitive power category only. At levels three, seven and ten, select another two powers from that category.

6. I.S.P.: As master psionics, oni ninja become living batteries of psychic energy. Roll 3D6x10 plus the M.E. attribute. Add 12 I.S.P. per additional level of experience.

7. Psionic Healing: By spending 15 I.S.P. and meditating for one minute (4 melee rounds; cannot fight during this time), the character can heal 1D6x10 M.D.C. This healing power can be used once every hour.

O.C.C. Skills:

Language: Oninese (very similar to Earth's Japanese) 98%

Language: Three of choice (+20%)

Detect Ambush (+10%)

Detect Concealment (+10%)

Prowl (+15%)

Disguise (+15%)

W.P.: Three of choice.

Hand to Hand: Assassin

O.C.C. Related Skills: Select seven additional skills, plus select an additional skill at levels three, six, nine and twelve. All new skills start at level one proficiency.

Communications: Any

Domestic: Any (+5%)

Electrical: Any

Espionage: Any (+10%)

Mechanical: Any

Medical: Forensics (includes use of poisons, must learn prerequisite skills), paramedic and first aid only.

Military: Any (+10%)

Physical: Any (+5% where applicable)

Pilot: Any (+5%)

Pilot Related: Any (+5%)

Rogue: Any (+5%)

Science: Any

Technical: Any (+5%)

W.P.: Any

Wilderness: Any (+5%)

Secondary Skills: The character also gets to elect five secondary skills from the previous list. These are additional areas of knowledge that do not get the advantage of the bonus listed in parentheses. All secondary skills start at the base skill level. Also, skills are limited (any, only, none) as previously indicated in the list.

Standard Equipment: Ninja armored jumpsuit: black, easily worn under everyday clothes, with small shoulder pocket for hood and 65 M.D.C.; no prowl or movement penalties.

Money: 1D4x1000 credits.

Cybernetics: None; avoid them.

Oni Ninja Techniques

These powers are partially psionic in nature. Oni practitioners refer to I.S.P. energy as "Ki," or "breath." Ki is roughly equivalent to the Chi energy described in **Ninjas and Superspies** and **Mystic China**. In fact, Game Masters could integrate martial artist characters and super-abilities from these books into the **Rifts** and **Phase World** settings. Some of the abilities from those books (and from the Monk O.C.C. in **Rifts Dimension Book One: Wormwood**) could be adapted to any number of races including the oni. However, the oni ninja is not likely to have any or many of the abilities from those books. Their training and subsequent powers are very specific and unique to them.

Note: Some oni ninja powers cost I.S.P. with every use, while others require a PERMANENT expenditure of I.S.P. which is "burned off" when the ability is initially learned/mastered. Prerequisites, if any, are listed under each entry. These powers can only be used by the ninja. Abilities like force field and vanishing cannot be made to include/protect/conceal other characters.

List of Abilities

Automatic Dodge (5 I.S.P. lost permanently)

Art of Defense (5 I.S.P.)

Art of Offense (5 I.S.P.)

Art of Stealth (5 I.S.P.)

Aura of Defense (10 I.S.P. lost permanently)

Body Hardening (15 I.S.P. lost permanently)

Combat: Death Strike (All I.S.P.)

Combat: Dragon Fist (5 I.S.P.)

Combat: Dragon Kick (8 I.S.P.)

Combat: Dragon Leap Kick (10 I.S.P.)

Combat: Fast Hands (10 I.S.P.)

Combat: Spirit Fist (10 I.S.P.)

Face of a Friend (20 I.S.P.)

Inner Strength (5 I.S.P.)

Unnoticed Walker (10 I.S.P.)

Vanishing Act (15 I.S.P.)

Automatic Dodge

An automatic dodge means the character can dodge instead of parry without losing an attack/melee action.

I.S.P. Cost: 5 I.S.P. are permanently lost when this ability is gained.

Prerequisite: None

Art of Defense

These are techniques that allow for incredible defensive moves; lightning-fast parries, dodges, and defensive leaps. These powers require an expenditure of I.S.P. every round they are used. Activating the power is done automatically (does not use a melee attack/action). During that round, the character is +4 to parry, dodge, and roll with impact. During the same period, however, the character is so concentrated on defending, that he is at -1 on initiative, -2 to strike and all skills are at -10%.

I.S.P. Cost: 5 I.S.P. per melee round (15 seconds).

Prerequisite: None.

Limitations: While the art of defense is activated, the art of Offense cannot be used.

Art of Offense

By channeling his inner strength into a powerful attack stance, the ninja can launch incredibly accurate and devastating punches, kicks and other attacks. These powers require an expenditure of I.S.P. every round they are used. Activating the power is done automatically (does not use a melee attack/action). During that round, the character is +3 to initiative, +2 to strike, +2 to pull punch, acquires an additional melee attack, and strikes inflict +1D6 damage (M.D. or S.D.C., character's choice). However, the concentration on attacking reduces the character's defensive abilities: -2 to parry, dodge and roll with damage.

I.S.P. Cost: 5 I.S.P. per melee round.

Prerequisite: None.

Limitations: While the art of offense is activated, the art of defense (see above) cannot be used.

Art of Stealth

The ninja trains himself to walk, breathe and act silently, becoming uncannily quiet. Some of the silence around him is psionically generated, muting all "emissions" coming from the character, up to and including his infra-red (heat) signature! While the technique has been activated, the character is at +25% to prowling rolls and even thermal sensors are 50% less likely to sense him.

I.S.P. Cost: 5 I.S.P. per minute (four melee rounds/60 seconds).

Prerequisite: None

Aura of Defense

The ninja uses his I.S.P. to create a skin-tight force field around his body. This barrier has 50 M.D.C., plus 10 M.D.C. per level of experience! The aura can be maintained for one minute (4 melees), but can be reactivated at the beginning of each new melee round for the cost of 10 I.S.P.

I.S.P. Cost: 10 I.S.P. are PERMANENTLY lost when this technique is initially learned, plus it costs 10 I.S.P. per minute.

Prerequisite: Inner Strength

Limitations: Self

Body Hardening

I.S.P. is permanently spent to harden the body to the point that it becomes like iron. +2D4×10 M.D.C., impervious to normal fire and cold, and resistant to mega-damage fire and cold (half damage). It also gives the ninja a damage bonus of 1D4 M.D. from his punches and 1D6 M.D. to kicks; in addition to supernatural P.S. damage and other possible bonuses.

I.S.P. Cost: 15 points of I.S.P. are sacrificed permanently to acquire this technique; the effects are permanent.

Prerequisite: Art of Defense

Combat: Death Strike

This ultimate hand to hand attack is only attempted by experienced masters against very powerful opponents, because using it may mean the death of the ninja as well as that of his opponent. The use of this power is potentially deadly for the ninja because its use saps him of his strength and fighting abilities for several minutes, making him an easy and terribly vulnerable target.

The ninja can summon all of his physical and spiritual energy (uses up ALL I.S.P. points, and must have at least 30 I.S.P. points left) to inflict a terrible death blow. The attack must be made with the bare hands or feet and always strikes. It inflicts 2D4×100 M.D. to mega-damage creatures or 2D4×100 S.D.C./hit points to mortal S.D.C. beings. If the target of the death strike still survives the attack, he is temporarily paralyzed and knocked senseless for 2D4 minutes, leaving him open to further attack. If given the chance to recover, the victim remains somewhat disoriented and weakened: reduce speed, combat bonuses and the number of melee attacks by half for 1D4×10 minutes.

I.S.P. Cost: ALL I.S.P. is spent in this attack, plus the ninja must have a minimum of 30 I.S.P. Additionally, no other Oni Ninja Techniques may be used for 12 hours! The Ninja will be completely exhausted, unable to fight, concentrate, or talk for 1D4 minutes. For the ten minutes after that, he remains extremely weak and can barely move; one melee action per round, speed is reduced by 80%, all bonuses are gone, skills are impossible to perform and he cannot attack. After this period the character regains more strength and can function at half his normal ability level. The number of melee actions/attacks, all bonuses, skill proficiencies and speed are half of normal for the next six hours. The character's Ninja techniques return after 12 hours.

Prerequisites: Dragon Leap Kick and Aura of Defense

Combat: Dragon Fist

A punch, jab or open hand strike that inflicts an additional 1D4×10 M.D. (in addition to normal hand to hand damage) to supernatural beings, demons, elementals, and creatures of magic, including dragons and, incidentally, other oni ninja! This attack costs I.S.P. and counts as two melee attacks/actions and can be combined with a power punch.

I.S.P. Cost: 5 I.S.P. per strike.

Prerequisite: Art of Offense

Combat: Dragon Kick

The ninja learns to channel his I.S.P. into a powerful kick that does 1D6×10 M.D. (in addition to normal hand to hand damage) to supernatural beings, demons, elementals and creatures of magic, including dragons and other oni ninja. The attack counts as two melee attacks/actions and can be combined with a power punch kick.

I.S.P. Cost: 8 I.S.P. per attack

Prerequisite: Dragon Fist and Art of Offense.

Combat: Dragon Leap Kick

A powerful leap kick that inflicts 3D6×10 M.D. to supernatural beings, elementals and creatures of magic, including dragons. This must be the character's first and only attack for that melee (the leap concentration and focus uses up all other attacks). All the character can do after the kick is defend himself.

I.S.P. Cost: 10 I.S.P. per kick.

Prerequisite: Dragon Kick and Art of Offense.

Combat: Fast Hands

The Ninja can move his hands so quickly that he can block/parry every attack leveled at him simultaneously from multiple attacks without using up a melee attack/action.

I.S.P. Cost: 10 I.S.P. per melee round.

Prerequisite: Automatic Dodge and Art of Defense.

Combat: Spirit Fist

A punch, jab or open hand strike that unleashes a powerful telekinetic force that inflicts the equivalent of the character's normal M.D. punch. Range: five feet (1.5 m) per level of experience. Counts as a normal melee action/attack. Cannot be used as a power punch or dragon fist.

I.S.P. Cost: 10 I.S.P. per strike.

Prerequisite: Art of Offense

Face of a Friend

This extremely useful ability leads a person (usually the target of an assassination or victim of espionage) to believe the ninja is someone he trusts. The power is telepathic in nature and plucks an image from the victim's mind and uses it to mask the true appearance of the ninja. The victim gets a normal save versus psionics (a successful save means he sees the ninja as a stranger). Also, characters with mind block will be unaffected by this psychic illusion.

I.S.P. Cost: 20 I.S.P. per minute.

Prerequisite: None

Inner Strength

The Ninja does not fatigue, P.S. and speed attributes are temporarily increased by six points, +4 to save vs poison, drugs or disease, +10% to save vs coma, +2 to save vs mind control, and +1 to save vs magic. I.S.P. must be spent every melee the power is "on." Activating it counts as one melee attack/action.

I.S.P. Cost: 5 I.S.P. per melee round (15 seconds).

Prerequisite: Art of Defense

Unnoticed Walker

This power uses psionics to hide the presence of the ninja. As long as the character does not call attention to himself and stays out of the way of others, nobody will notice him. This power does not fool electronic or artificial sensors, but will affect both sentient beings and animals. The character can even be in plain view, but people will not seem to notice him. Attacking, failing a prowl roll or making noise will ruin the effect.

Furthermore, the character is "psionically muffled" meaning that psychic sensitive abilities such as empathy, telepathy, presence sense, sense evil, sense magic, see aura, detect psionics,

and psychic diagnosis do not pick-up a clear image/sense about the ninja and he is +1 to save against them all even if a save is not normally possible!

I.S.P. Cost: 10 I.S.P. per minute (4 melee rounds).

Prerequisite: Art of Stealth and the prowl skill.

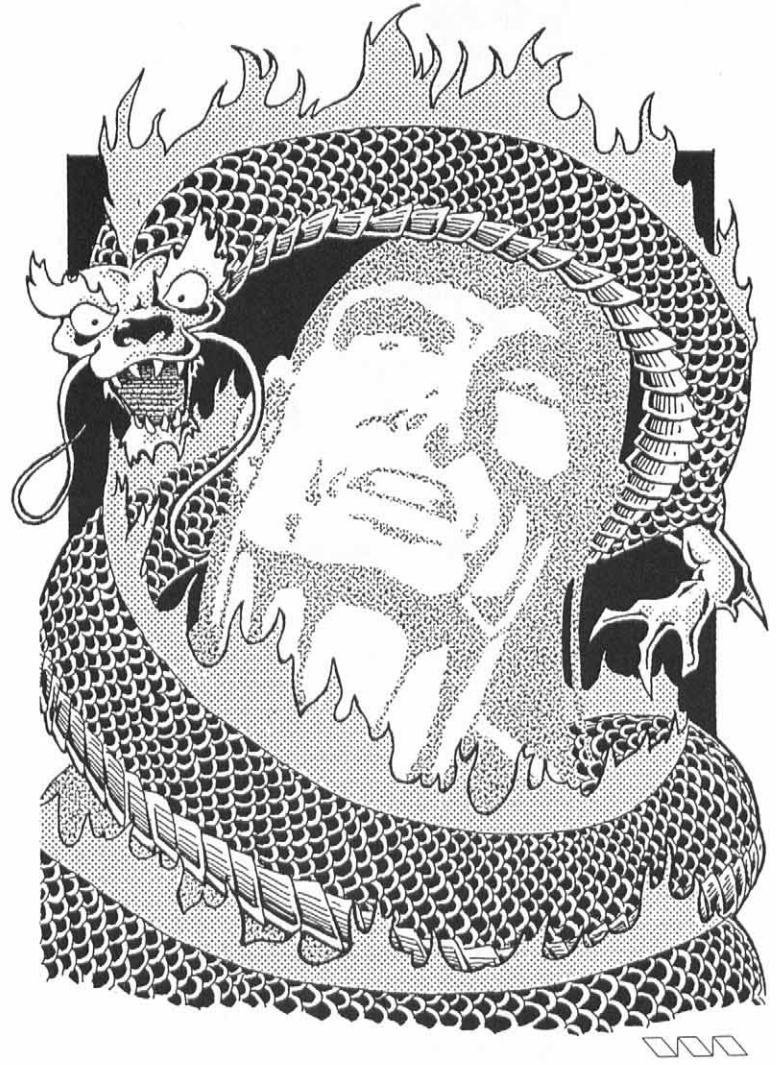

Vanishing Act

The ninja creates an illusory flash of light and smoke around him; when the smoke dissipates, observers will no longer be able to see him. All the people in the area get to make a save versus psionics to resist the effects of this power. If the save is made, they can see the ninja normally, but are -1 on initiative. After a successful disappearance, the ninja must use the unnoticed walker power to move around without detection.

I.S.P. Cost: 15 I.S.P. for the vanishing flash. The character can remain unnoticed for one minute per every 15 I.S.P. expended initially or added while vanished. Moving around will dispel the vanishing act, making him visible unless he activates the unnoticed walker ability (10 I.S.P. per minute/4 melees).

Prerequisite: Face of a Friend and Unnoticed Walker.



T'Zee R.C.C.

Very few people like or trust the t'zee. For one, they are one of the least attractive species of the Three Galaxies; short, furry creatures with a rounded torso and thin, scrawny arms and legs. Also, they have developed a reputation for being selfish and completely amoral, concerned only with survival at all costs. Given their origins, their attitude is somewhat understandable, but not acceptable.

The t'zee are native to Dellian-4, a planet commonly known as *Malthus' World*. They evolved from a small breed of marsupial tree-dwellers and have retained their ancestor's high breeding rate. After a short (three to four Earth months) gestation period, t'zee females give birth to a litter of at least four and as many as sixteen babies (4D4)! The fierce competition for survival starts from birth, as the babies have to fight to be fed and cared for. The dominant t'zee cultures are individualistic and pragmatic. Collaboration and cooperation are considered necessary for survival, but feelings of loyalty and "team spirit" are largely unheard of. The typical t'zee "knows" that today's ally will become tomorrow's competition. Thus, backstabbing and treachery are commonplace. To get ahead or make a profit, most t'zee will cheat, rob and murder their own relatives, let alone perfect strangers or aliens from other planets!

As the t'zee developed technology and medicine, the high mortality rates among the young decreased even as their overall life spans grew. The planet, which had relatively small land masses, soon became dangerously overpopulated. Pollution and deforestation completely obliterated the planet's ecology, and the t'zee had to develop technologies to deal with the ecological catastrophes that followed. None shed a tear for the countless animal and plant species that disappeared; from their viewpoint,

they were obviously not fit to survive. Microscopic robots (nanotechnology) were used to take the place of the extinct animal and plant life. Nanomachines now restore oxygen to the atmosphere (there aren't enough plants to do this anymore), recycle garbage and perform all kinds of miracles.

This nanotechnology and great advances in medical technology, have made the some of t'zee wealthy and powerful. Most natives live in sprawling slums where life is cheap and everything else is expensive. Malthus' World is the only CCW member planet where people literally starve to death on a regular basis. On Malthus' World, the death penalty applies for most crimes. Crimes against property (theft and vandalism) are considered to be as heinous as crimes against people (like murder or assault). The wealthy can usually pay their way out of any crime, however, and it is the poor who feel the full weight of the law. The only two groups that are well off are the military, which administer the overpopulated planet with an iron fist, and the wealthy factory and research and development owners that produce most of the valuable commodities on the planet. The latter group, known as the *Captains of Industry*, are among the wealthiest people in the Three Galaxies. Some Captains of Industry have joined Naruni Enterprises, both as stockholders and employees. Their finely honed survival instincts have allowed them to do well even against the Uteni and the True Naruni, and two t'zee currently sit on the Naruni Board of Directors.

The TVIA (Treaty Violation Investigation Agency) is constantly investigating the t'zee, documenting the constant CCW Compact violations committed by that race. Some agents have also discovered that a number of Captains of Industry may be involved in a plot to take control of the CCW! The evidence is still scanty and largely circumstantial, but the truth is beyond even the TVIA's paranoid imagination. A large number of t'zee are part of the **Survival Society**, a group that believes that the t'zee race must secure "living space" at all costs. Given their reproduction rate, the only way to do this is to take over most of the Three Galaxies and make sure no other species remain alive to compete for vital resources. The Survival Society's long-term goals include galactic conquest and genocide. Fortunately, their resources are nowhere near enough to fulfill those goals.

T'Zee can be encountered in the Three Galaxies as traders (many working for Naruni Enterprises), spacers, pirates, and spies. They make good villains for an adventuring party. Many have left their homeworld, disgusted by their merciless culture, seeking to build a better life elsewhere. However, they find it difficult to overcome their races reputation as merciless exploiters who are not to be trusted. Some t'zee have enlisted in the CAF, and a few have even distinguished themselves in the field.

Alignment: Any, but typically anarchist or evil.

Attributes: I.Q. 3D6, M.E. 3D6, M.A. 2D6, P.S. 3D6, P.P. 3D6+6, P.E. 4D6, P.B. 2D4, Spd. 3D6

Size: 4 to 6 feet (1.2 to 1.8 m) **Weight:** 120 to 200 lb. (54 to 91 kg).

M.D.C.: By armor only.

S.D.C./Hit Points: 1D6×10 S.D.C. plus skill and O.C.C. bonuses. Hit Points: P.E. plus 2D4 per level of experience.

Horror Factor: None

P.P.E.: 3D6

Average Life Span: 85 years.

Natural Abilities: None

Psionic Powers: 20% are minor psionics, 15% are major psionics, and 5% are master psionics (mind melters mostly). The rest have no psi-powers.

Magic Powers: None. The t'zee are capable of learning magic, but only a handful have ever done so.

Combat: By skill and training.

Damage: Bite does 2D6 S.D.C.

Bonuses: +4 save vs poison and disease.

Vulnerabilities/Penalties: None

O.C.C.s: Can be any CAF O.C.C., TVIA inspector, spacer, space pirate, runner, or any rogue, warrior or scientist O.C.C. Psionic O.C.C.s are also possible. Very few t'zee ever learn magic.

Alliances and Allies: Many T'Zee work with Naruni Enterprises (others compete head to head against them and the Splugorth).

Weapons and Equipment: Varies with O.C.C. The T'Zee favor a murderous weapon known as the "Piranha" gun, which fires metal and flesh-eating nanomachines (see the *Weapons and Equipment* section).



Gun Brother O.C.C.

The main competitors of the oni ninja in the field of assassination and espionage are the infamous Gun Brothers. These criminals use bio-wizardry and magical tattoos (see **Rifts Atlantis**) to enhance their bodies, becoming living weapons-for-hire. Unknown to most of their customers, the true purpose of the Gun Brothers is to spy on and sabotage the CCW and other planetary collectives of the Three Galaxies. The sponsor of the

organization is a Splugorth intelligence from another dimension, **Lord Norrek**. Norrek wants to set up shop in the Three Galaxies, by taking over the Consortium, which would put the largest and most powerful collective in the area under his control. The Gun Brothers are the tools he is using to that end.

The typical Gun Brother knows nothing of this diabolic plan. Most of them grew up in poor areas of the CCW or other worlds, and see the brotherhood as their rescuers. They are grateful for being transformed into super-beings and for being accepted and (they think) loved. This deception accounts for the fanaticism

these assassins show in the field, which often leads to suicide to avoid capture. The Splugorth minions in charge of the Gun Brothers have no scruples about using them as cannon fodder or sending them on suicide missions.

Some Gun Brothers have discovered that their masters are merely using them, and they have turned against them. Of those, many have become sworn enemies of the organization and have joined forces with heroes and law-enforcers to hunt down the Splugorth minions behind the brotherhood. Others have decided to go into business on their own, becoming mercenaries or private assassins. And a third group is wandering the Three Galaxies, looking for a place they can call their own.

All Gun Brothers cover their arms and torsos with colorful tattoos. A few of them wear magic tattoos, but for the most part the tattoos are decorative and used as a recognition badge among the members of the brotherhood. The brothers come from all races of the Three Galaxies and all have bio-wizard augmentation. They often work alongside *Sunaj Assassins* and other Splugorth minions (see **Rifts Atlantis**).

Note: At the Game Master's discretion, renegade Gun Brothers can be accepted as player characters. They will often have to deal with the enmity of the brotherhood and the distrust of the authorities (or even other player characters) who may not be convinced the character has abandoned his evil ways.

Typical Alignment: Aberrant (35%), miscreant (30%), diabolic (20%), anarchist (10%) and other (5%). However, even the miscreant, diabolic and most anarchist are fanatically loyal to the brotherhood.

Attribute Requirements: None, although high physical attributes are desirable.

O.C.C. Abilities and Bonuses:

1. Bio-Borg Conversion: The Typical Gun Brother is transformed into an M.D.C. being with 75 M.D.C., or gains an extra +50 M.D.C. if he already was an M.D.C. creature. Additionally, their P.S. becomes supernatural and get bonuses of +6 to P.S., +2 to P.P. and +30 to speed (average spd is 44; 30 mph/48 km).

2. Other Bio-Wizard Gifts: Some (20%) of all Gun Brothers receive 1D4 additional bio-borg appendages, powers and weapons. Another 20% get 3 to 6 (1D4+2) magic tattoos, 10% are given a symbiotic organism (see **Rifts Atlantis** for more information on bio-wizardry, magic tattoos and symbiotic organisms) and 6% undergo genetic reconstruction via arrangements with gene-slicers (see **Rifts Mindwerks**), Kreegor bio-engineering, or genetic experimentation which creates *mutants* who may grow wings, additional appendages, natural body armor or gain super abilities (see **Heroes Unlimited**, **Aliens Unlimited** and/or **Rifts Conversion Book One** for mutants and super powers).

3. Bonuses: +1 to initiative, +1 to parry and dodge, +2 to roll with impact, +1 to save vs psionics, +3 to save vs horror factor. All are in addition to attribute and skill bonuses.

O.C.C. Skills:

- Language: Native (98%)
- Language: Choice of Two (+20%)
- Prowl (+15%)
- Detect Ambush (+10%)
- W.P.: Energy Pistol
- W.P. Energy Rifle

W.P.: Two of choice

Hand to Hand: Expert

Hand to Hand: Expert can be changed to Martial Arts or Assassin at the cost of one "other" skill.

O.C.C. Related Skills: Select eight other skills. Plus select two additional skills at level three, two at level six, one at level nine, and one at level twelve. All new skills start at level one proficiency.

Communications: Any (+5%)

Domestic: Any

Electrical: Any

Espionage: Any (+5%)

Mechanical: Any

Medical: First aid only.

Military: Any

Physical: Any

Pilot: Any

Pilot Related: Any (+5%)

Rogue: Any (+5%)

Science: Any

Technical: Any

W.P.: Any

Wilderness: Any

Secondary Skills: The character also gets to select six secondary skills from the previous list. These are additional areas of knowledge that do not get the advantage of the bonuses listed in parentheses. All secondary skills start at the base skill level. Also, skills are limited (any, only, none) as previously indicated in the list.

Standard Equipment: Set of medium body armor (M.D.C. 60+), energy weapon (often of Kittani manufacture), hand computer/radio set, and vibro-sword.

Money: 2D4×1000 credits.

Cybernetics: None. See bio-wizardry implants, above.

Note: This is another character where the Game Master may *consider* using some of the martial arts combat skills and mystic abilities presented in **Ninjas & Superspies** and/or **Mystic China**.

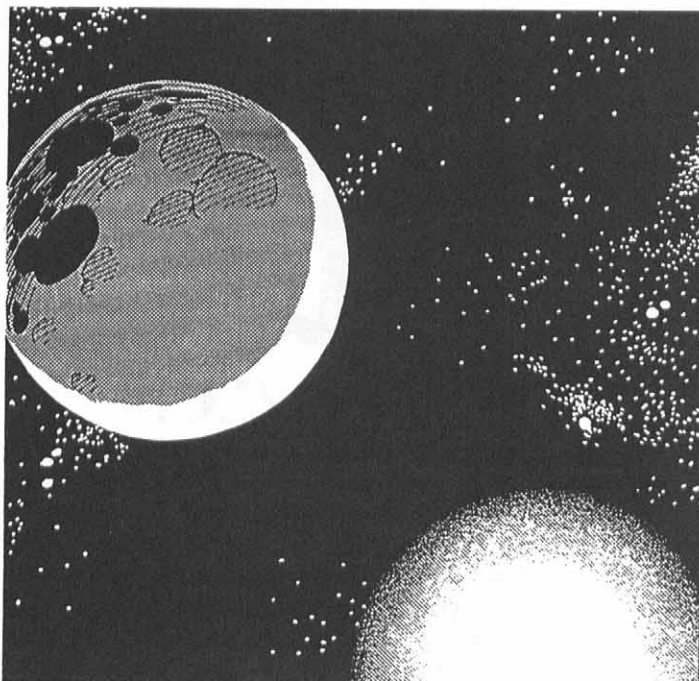

The Transgalactic Empire

Sprawled across the Three Galaxies, the kreeghor-controlled Transgalactic Empire continues to grow, overcoming the reversals inflicted by the Consortium and the Free World Council. The laws, customs and dark secrets of the Empire are described in this section.

Laws and Crime

Unlike the Consortium, the Transgalactic Empire has only one legal system in force throughout its territories. Kreeghor law is brutally simple (although "efficient" is how the kreeghor refer to it). The accused are assumed guilty until proven innocent, and money and power talks. Most sentences range from lengthy prison sentences to slavery and death. Prison is spent on the **Hellworlds**, and is considered to be a worse punishment than death. Imperial propaganda makes a big deal out of the fact that the law is never "easy" on criminals, and criticizes the CCW for "coddling murderers and hooligans."

Despite the harshness of the laws, crime is at least as common in the Empire as it is in the Consortium. Since most people are afraid of the cops, very few step forward and press charges or act as witnesses against criminals. As a result, a lot of petty thieves, murderers, and racketeers often get away with a lot, as long as they are careful not to step on the toes of the Royal Family and their lackeys. Criminal gangs dominate the slums and poor neighborhoods of most cities in the Empire. The kreeghor only sweep them up when they are suspected of collaborating with either the Splugorth or the Free World Council. The **Gun Brothers** have a few teams operating in the Empire, but they are being constantly hunted down by the authorities, who execute them without mercy (usually on the spot).

Smuggling is a common offense. Imperial tariffs are extremely high, in an attempt to try to protect the kreeghor monopoly on most manufactured goods. As a result, spacers willing to take risks can make an enormous profit running the Imperial blockades and selling products from other civilizations. Weapon smuggling, especially to the Free World Council, is also extremely profitable. The freedom fighters will pay any price for good quality military equipment, and they have the funds (typically loot from the Imperial treasure houses) to pay for it. They are especially eager to purchase Naruni and oni weapons.

There is no police force in the Empire. Instead, the Imperial Army acts both as the military and law-enforcement agency.

The Imperial Legions

The true symbol of the Transgalactic Empire is the marching legionnaire in full combat armor. Kreeghor, human, wolfen or alien, the Imperial soldiers are well-trained, armed to the teeth and for the most part, ready to kill in the name of the Empire. Although the Army also acts as the police, most of the soldiers' training is military, and criminology is kept to a minimum. That means that the army troopers are very inefficient law-enforcers, who usually react with deadly force and military tactics to most challenges or threats. This results in the deaths of many innocent bystanders as well as the evildoers. The army is feared and hated

by everyone, even supporters of the Empire. Still, many people join it, because of the privileges and power enjoyed by soldiers.

Military personnel are exempt from civilian laws and answer only to military courts. Disputes between legionnaires and civilians are usually decided in favor of the soldiers, and enlisted men can often get away with murder, as long as the victims are not wealthy or powerful. Imperial propaganda portrays soldiers as heroes and role models. The legionnaires' great deeds are often immortalized in movies and songs (usually of terrible quality), and they are not only well-paid, but enjoy generous retirement and injury pensions. The Empire knows its welfare depends on its armed forces and does its best to keep them happy.

A special branch of the Imperial Army, the **Invincible Guard**, is even more vicious, pampered and glorified. Members of the Invincible Guard are granted super-powers through bio-engineering. They act as enforcers and living symbols of the power of the Empire. All guardsmen are given a minimum rank of lieutenant in the army and many of them rise to higher ranks, all the way up to general. Many, if not most guardsmen, are extremely arrogant, cocky, and fanatically dedicated to upholding the empire. Since their authority comes directly from the Emperor, they are feared even by members of the Royal Family.

Imperial Planets of Note

Axis-5 (The Battlefield)

Axis-5 is the oldest ongoing battle in the known history of the Three Galaxies. For the last 75 years, this world, which is located right in the middle between the Transgalactic Empire and the Free World Council, has been a battlefield. Both the Empire and the freedom fighters want to conquer the planet. For the Empire, this would be an ideal staging area for an invasion force assembling against the rest of the Free Worlds. For the rebels, the planet and the star system can act as a shield against such an invasion. The Empire has been able to send larger forces to that planet, but the freedom fighters have more bases nearby, and are able to resupply their forces there. The Emperor does not dare send a huge armada to the planet, because he fears the commander might try to overthrow him. The result is a bloody stalemate.

The planet has changed sides nine times over the last seven decades. Peace has never lasted more than a few weeks before the losing side mounts a counterattack or at least a raid. Axis-5 is the place where young new commanders go to try and prove themselves, and perhaps win a lasting victory for their side. The planet, which once hosted a small human colony, is now a devastated wasteland. Above its orbit, enemy fleets batter each other. Down on the ground, armies clash, and the loser retreats to the hills and jungles to wage guerrilla warfare until reinforcements arrive.

Besides the contending armies, a third group frequents Axis-5: scavengers. Daring runners and pirates make quick raids on



the sites of recent battles, trying to scrounge damaged or abandoned equipment, and even sometimes attacking small ships or isolated army units. Valuable military equipment fetches a nice price on the black market, so many feel the risk is worth taking. On at least two occasions, fighters from both the Empire and the Free Worlds joined forces to battle independent raiders — and then turned once again at each other.

Monro-Tet

Monro-tet, the second planet of a star in the Anvil galaxy, is the homeworld of the monro race. The monro are ugly amphibians who have become an important part of Imperial affairs. Their planet's largest landmass is located mostly on the planet's equator and is covered by steaming jungles and stinking swamps. The monro thrive in such an environment, but most other species find it unattractive and unhealthy. A large number of visitors come to the planet, only because the jungles hide a number of ancient ruins rumored to be the creation of the mythical First Race.

The ruins are imposing and ancient. Carbon dating makes them at least one million years old, and despite the high humidity and heat of the jungle, they are in remarkably good shape. Several archaeologists are studying the ruins. So far, indications are that a race of long-limbed bipeds built and lived in the buildings until they mysteriously disappeared hundreds of thousands of years ago. Occasionally, a researcher finds a working artifact. Some of these ancient artifacts have been extremely powerful weapons, coveted by both the Imperial authorities (who rigorously supervise all archeological digs) and private collectors and museums (not to mention the Oni, Naruni and Splugorth). Some of these institutions have gone so far as to hire runners or adventurers who try to steal those artifacts from kreeghor scientists.

Ghostworld

A seemingly unremarkable planet in the Corkscrew galaxy, Ghostworld (originally named Beta-3) happens to disappear from time to time. Nine hundred years ago, the planet was colonized by kreeghor warriors when it became yet another colony of the budding empire. Then, ten years later, all communication ceased with the planet. A kreeghor ship was dispatched to investigate and found the planet was gone! Gravity sensors could still detect the planet's gravitonic pull, but the world was nowhere to be seen. The ship spent two days scanning the area to discover how an entire planet could disappear. On the third day, the planet reappeared in a giant flash of blue light that nearly overloaded the ship's sensors. The planet was back, as were all the buildings and installations on the planet. However, the three million inhabitants were gone without a trace!

The Empire dispatched a scientific and military task force, accompanied by magically-skilled Royal Kreeghor, to investigate. Years passed without any results. On the tenth year, the planet disappeared again. Observation satellites recorded the event: A flash of light swallowed the planet and then it was gone. Yet, the satellites continued to orbit around the empty space where the planet had been. When the planet reappeared three days later, the research teams on the surface were nowhere to be found. Every ten years since then, the planet disappears and reappears three days later. Despite centuries of study and observation since, no data can be offered to explain the bizarre phenomenon.

Always brutally practical, the kreeghor have taken up the practice of leaving condemned prisoners on the surface and letting them disappear to wherever the planet goes. From time to time, refugees and criminals also use the planet as a temporary hideout or base of operations. However, they are at the mercy of condemned kreeghor criminals desperate to get off the planet, psychic vampires, entities, and the unexplained anomaly of the planet. Anybody who can come and go, and values their life, never stays long on Ghostworld. Of course, a number of psychics, mystics, mages and scientists from throughout the Three Galaxies continue to study the planet — but if they are present at the moment of vanishing, they too are forever lost.

The seemingly ordinary planet is also identified with *ghosts* because it attracts banshees and a variety of entities, especially poltergeists and haunting entities who thrive on the psychic impressions left on the planet; mainly those of the condemned and the victims they murder or brutalize. Many of those condemned on the planet go insane from the stress and tension waiting for their uncertain fate. As the time of the vanishing approaches, anarchy reigns as many of the inmates engage in savage crimes and murder (attractive, powerful and tasty emanations for entities and psychic vampires). However, the entities seem to sense the coming of the time of vanishing and flee 72 hours before Ghostworld disappears.

Note to the Game Master: For now, we leave the strange occurrence, the planet's destination, what happens to the people, and the solution of the mystery to the Game Master's imagination. Maybe the players get captured by the kreeghor and are sentenced to "disappear" on Ghostworld. What awaits them at the other end of the journey is up to you. Or you may want to leave it a mystery that may one day be explained (maybe even as a *Rifts Dimension Book*, but not any time soon).

The Dweller Beneath The Dark Secret of the Empire

The rumors about the Kreeghor Emperor and the Royal Kreeghor are true; they are the creation of an alien intelligence of unimaginable power, a devourer of souls that saw the kreeghor race as a very useful tool. Hidden below the Kreeghor Imperial Palace is the *true* ruler of the Transgalactic Empire: The Dweller Beneath. Unknown to everybody but the Emperor(s) and the mysterious kreeghor witch, it has secretly manipulated the course of the Empire. It was through the intervention of the Dweller's agents and its supernatural powers that the kreeghor were able to throw off their Splugorth overlords. After helping the kreeghor race attain their "independence," it has helped to mastermind the building of their Transgalactic Empire. In return, the Dweller has fed on the suffering of the billions of sentient beings oppressed by the brutal Empire.

Every time a new Emperor is chosen, the candidate journeys to the sealed catacombs beneath the palace. At the end of the tunnel, the unsuspecting kreeghor is confronted with a huge nightmarish being, bigger than the entire palace overhead. The Dweller grants a fraction of its power to the Emperor in return for an oath of loyalty. Although the Dweller could replace the Emperor's mind with its own, it prefers to grant its pawn a limited degree of free will, both because he may be more useful if he can think on his own, and also because it enjoys the unpredictability of a free agent.

The Dweller realizes that the Consortium of Civilized Worlds is still too powerful for the Empire to conquer. This lesson was learned after a four year war that ended twenty years ago. The Consortium, with the help from the Free World Council, was not only able to resist all kreeghor attacks, but to actually capture several planets in a devastating counteroffensive. Although the current Emperor wishes to launch a massive, all-out attack, the Dweller senses that even if their efforts were victorious, the Empire would be severely weakened, and soon collapse as more worlds rebelled against it. The previous Emperor died under mysterious circumstances and the new ruler managed to hammer out a favorable peace treaty; one that effectively isolated the Free World Council from direct aid from the Consortium. For the time being, the Dweller and the Transgalactic Empire will leave the CCW alone, as long as the Consortium leaves them alone. When the Empire grows powerful enough to attack, then things will change dramatically.

The *Free World Council* is the one thing that the Dweller did not count on. This small but growing pocket of resistance has defied both brute force and the darker powers of the Empire. The Dweller suspects that the Free World Council may be the pawn of a god or alien intelligence, and attributes their success to that secret master. The creature cannot believe that simple mortals, no matter how heroic, could outmaneuver him.

The Dweller

Alien Intelligence NPC Villain

This creature has two forms. Its true shape is the thing living beneath the palace: a towering creature that looks like a pillar of moldy flesh, with a single huge eye at the top and greenish "hair" growing out of the upper end. It inhabits an enormous underground chamber it built for itself using stone magic. The Dweller can also send out fragments of its essence, which have their own body and a small degree of self-awareness. These fragments usually take the shape of Royal Kreeghor, but can assume any form, including that of a human and most of the other races found in the Three Galaxies. It currently has four essences strategically placed throughout the Three Galaxies. One is trying to infiltrate the Free World Council. So far, this creature has only managed to become a low-ranking freedom fighter, but this may change as the trooper performs more "heroic" deeds.

Alignment: Diabolic

Note: The attributes and other numbers in parentheses are for the essence fragments.

Attributes (supernatural): I.Q. 25 (20), M.E. 27 (25), M.A. 24 (20), P.S. 70 (40), P.P. 24 (22), P.E. 30 (25), P.B. 2 (varies), Spd. 44 (35).

M.D.C.: 120,000 for the entity (1D4×1000 for each fragment).

Horror Factor: 16 (11 for the life essences when they reveal their nature).

P.P.E.: 10,000 (1D6×100 for fragments)

Disposition: Compared to the Dweller, the Splugorth are humane, easy-going guys! The Dweller is a thoroughly alien being whose true goal is to devour (both physically and psychically) the entire Megaverse! Everything it does is a part of this insane plan, a plan it has spent a million years developing and which won't be finished for at least another million



years. One step of its master plan is to discover and absorb the mythical Cosmic Forge, which it believes will happen when the kreeghor have conquered the entire Three Galaxies.

Level of Experience: Equal to a 12th level ley line walker, stone master, and necromancer (the fragments are 4th level in all those areas of magic).

Natural Abilities: Immune to heat and fire — even mega-damage and magical fire, impervious to all known diseases, resistant to poison (half damage), regenerates 3D6×10 M.D.C. per minute, nightvision 1000 feet (305 m), keen hawk-like color vision, create 1D6 fragments of its life essence (currently has 4), and can telepathically communicate with its fragmented essences and the Kreeghor Emperor, even at galactic distances of 100,000+ light years!

The Dweller needs to feed on the suffering of sentient beings. It is a P.P.E. vampire and is kept fed through sacrifices performed by kreeghor witches and also by any crime and abuse committed in the name of the Empire. If that P.P.E. flow was somehow shut off, the creature would be reduced to a “mere” 20,000 M.D.C. and would lose 1D4×10 M.D.C. per day until it was destroyed.

The Natural Abilities of Fragmented Life Essences: By human standards, the essence fragments are a little more comprehensible than the Dweller. Their main goal is to serve their creator/greater self, but they also crave power for their own sake. Many of them will want to become independent, although such a feat is nearly impossible. Their feelings towards all lesser beings is utter contempt, and they love to inflict pain and suffering on the innocent, just for the sake of it. Their sadism was instilled on them by their creator, be-

cause the Dweller feeds on it through the telepathic link it shares with them.

Abilities include: Shape change at will into any creature up to 20 feet (6.1 m) tall or long (indefinite duration, takes one melee round to change its shape), regenerate 1D4×10 M.D.C. per minute, sense magic, sense magic/ley line and psionic energy up to a 200 foot (61 m) radius, nightvision 100 feet (30.5 m), and communicate telepathically with its creator/greater self. Also see psionics and magic.

Psionic Powers: Knows ALL psionic powers from all four categories, equal to a 12th level psionic (fragmented essences are 4th level).

I.S.P.: 3,000 (800 for fragmented essences)

Magical Knowledge: Knows all spells from levels 1-12 plus close rift, dimensional portal and teleport: superior. 12th level proficiency (4th level for fragments of its essence).

Combat abilities: Supernatural

Attacks Per Melee Round: Seven hand to hand or psionic attacks, or three by magic.

The essence fragments have five hand to hand or psionic attacks, or two by magic.

Damage: Based on their supernatural P.S.

Bonuses (includes attribute bonuses and natural abilities): +1 on initiative, +9 to strike and parry, +6 to dodge, -1 to roll/pull punch, +8 to save vs magic, +7 save vs psionics, +10 to save vs horror factor and 80% likelihood of evoking trust or intimidation.

The essence fragments are +2 on initiative, +7 to strike, parry and dodge, +4 to roll/pull punch, +5 to save vs magic and psionics, and +10 to save vs horror factor. Skill bonuses are not applicable to the Dweller or its fragments except for P.S. damage bonuses.

Damage: The Dweller will usually use magic or psionic powers to attack an opponent, however its snaking body is quite agile and it can engage in physical attacks that involve body slams and butts.

Restrained Body Butt/Bump — 2D6 M.D.

Body Butt/Bump — 1D4×10 M.D.

Body Slam — 2D4×10 M.D.

Power Body Slam — 3D6×10 M.D.

Damage from Fragmented Essences:

Restrained Punch — 6D6 S.D.C.

Full Strength Punch — 5D6 M.D.

Kick — 6D6 M.D.

Power Punch — 1D6×10

Vulnerabilities/Penalties: Both the Dweller and its fragments take double damage from Millennium Tree staves and wands, and all rune weapons.

Skills of Note: The Dweller has very little use for normal skills. It magically knows all languages, basic math, and lore: demon and monster at 98%. It and its essences also possess the skills land navigation, astronomy, and streetwise at 65%. The essences can learn three additional skills from any category at a 50% proficiency (does not advance).

Alliances and Allies: None. No entities in the Megaverse would knowingly ally themselves to the Dweller, with the possible exception of the Old Ones or some of the most malignant beings in the Megaverse. So far, however, no such alliances have taken places.

Minions: The kreeghor witch is the direct servant of the Dweller. The Kreeghor Emperor and, to some degree, the entire Empire, can be considered minions of this horrible intelligence!



Kreeghor Witch

NPC Villain

The Dweller occasionally selects a member of the kreeghor race or the Royal Kreeghor subspecies to serve him directly. The entity offers its servant enormous power in return for lifelong servitude. The kreeghor who accept such a deal are usually misfits or outsiders, warriors who feel betrayed or neglected by their superiors, or those who have been branded cowards or traitors (justifiably or not). The Dweller reshapes these outcasts into fanatical followers who do its bidding at all costs.

The kreeghor witches work in complete secret; neither the Imperial Authorities nor the Emperor himself know exactly what they do, although they rarely, if ever, interfere with them. The witches usually appropriate sections of laboratories, prisons and factories, to conduct their unholy rituals, often sacrificing innocent victims to satisfy the Dweller's hunger. Other witches travel beyond the Empire's borders, acting as spies and saboteurs, or starting cults that worship the Dweller. These traveling witches often try to hide or disguise their species, and even when discovered, are considered to be renegade kreeghor and not servants of the Empire. Kreeghor witches are active in the United Worlds of Warlock, Phase World and some frontier worlds in the Consor-

tium. Many seemingly senseless terrorist attacks, murders and catastrophes are actually the result of their handiwork.

Note: Kreeghor witches are not meant to be player characters. They are evil beings who have surrendered their free will to satisfy their craving for power. They make great enemies and obstacles for heroic parties. The witch is always a kreeghor; other races may be enlisted as devotees, but never become a witch.

Alignment: Diabolic or aberrant.

Attributes: Roll attributes normally for either the kreeghor or Royal Kreeghor R.C.C.s, but add +10 to P.S., +2 to P.P., +4 to P.E., and +12 to Spd.

Size: Standard for the species.

M.D.C.: Add 200 M.D.C. to the normal M.D.C. of the species.

Horror Factor: 9 or 14 (see Kreeghor R.C.C.s) and +2 if the witch's true nature is revealed.

P.P.E.: Add $2D6 \times 10$ to their total, plus 11 per level of experience.

Natural Abilities: In addition to the kreeghor's natural abilities, witches have the power to see the invisible and sense magic, plus increased magical and psionic powers (see below).

Psionic Powers: The witch gains three powers from the sensitive, physical or healing categories, plus one from the super category. I.S.P.: $3D6 \times 10$ plus M.E. attribute and gain $2D6$ I.S.P. per level. Every level after the first, the witch can select one additional sensitive power or physical power. **Note:** In the case of Royal Kreeghor, both the powers gained and the I.S.P. are cumulative with their natural powers.

Magic Powers: At first level, the witch gains six spells selected from levels 1-4. After the first level, they gain an additional spell per level of experience. In the case of the Royal Kreeghor, the witch learns a total of TEN spells at first level, and gains two spells per level of experience!

Combat: Normal for the kreeghor race.

Bonuses: +1 to parry and dodge, +3 save vs magic, +6 to save vs horror factor. These are in addition to attribute and skill bonuses.

Vulnerabilities/Penalties: Kreeghor witches take triple damage from holy weapons, and double damage from millennium tree and rune weapons.

O.C.C. Skills: Use the skills of the kreeghor R.C.C., plus add Lore: Demon and Monster (+25%).

Alliances and Allies: Kreeghor witches often work with cultists from other races, as well as kreeghor soldiers.

Weapons: Have access to any weapons and equipment from the Transgalactic Empire.



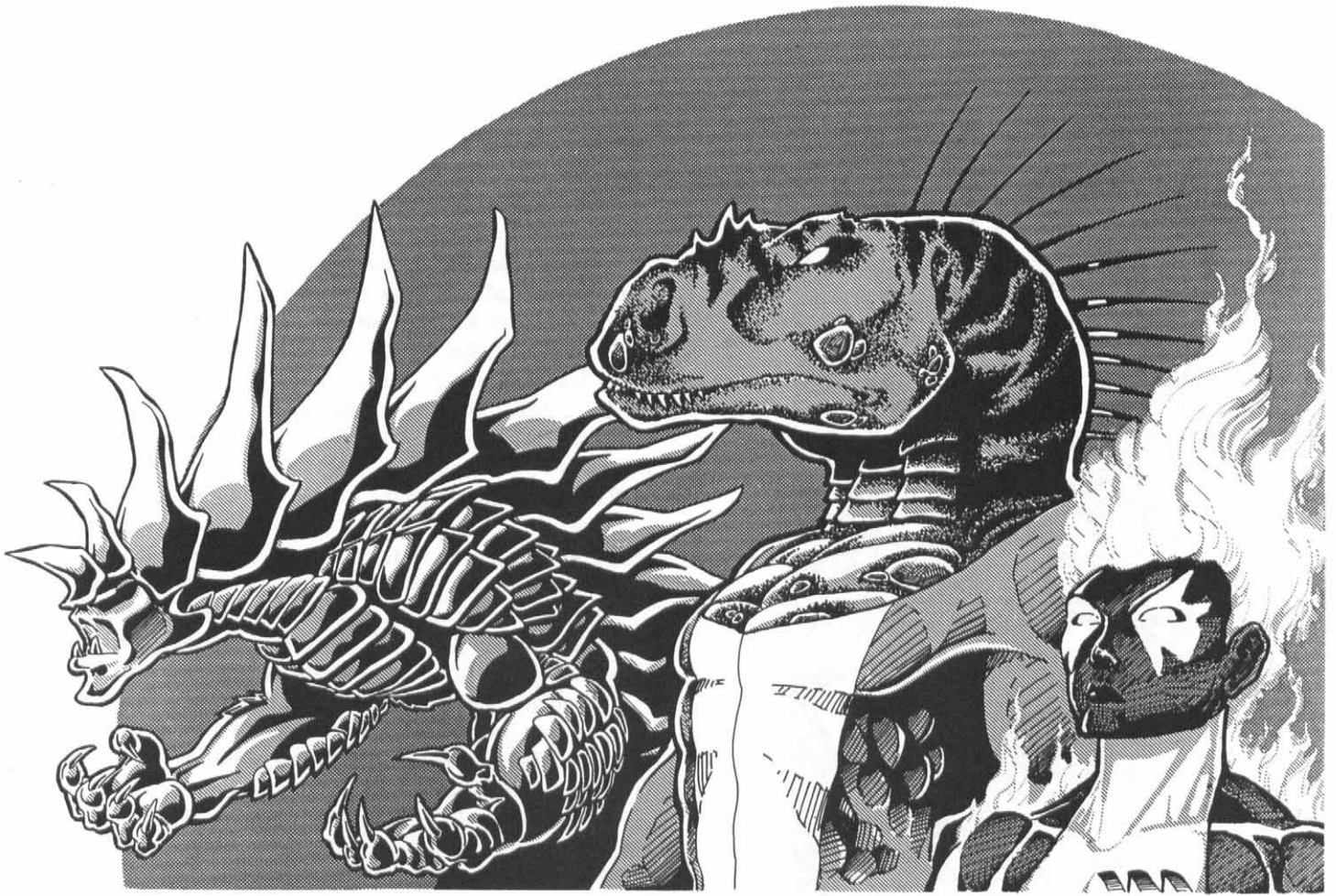

Invincible Guardsmen O.C.C.

One of the things the kreeghor learned to admire from the Splugorth was bio-wizardry, the ability to use magic and technology to create superhuman warriors. Although the kreeghor were unable to master bio-wizardry, they tried to imitate it with bio-engineering, mutating warriors of different races and transforming them into powerful killing machines. Half of the experiments end in failure and volunteers end up horribly deformed or suffer agonizing deaths. The rest came out transformed for the better, although often in unexpected ways.

Most guardsmen are utterly loyal to the Empire. 50% of them are kreeghor (normal kreeghor only; Royal Kreeghor cannot be modified), 20% are human, 20% wolfen, and the remaining 10% are members of assorted races. All guardsmen are volunteers chosen for their proven worth and dedication to the Imperial Army. They are showered with glory and luxuries, and they have power and influence over all parts of the Empire. As the personal guards of the Emperor, they answer only to him, and are often used to investigate members of the Royal Family who are accused of treason. The Royal Kreeghor, who are usually above all laws, fear and hate the guardsmen, and clashes between the super-powered warriors and the gifted Kreeghor are common and bloody.

Guardsmen are used as elite soldiers fighting alongside assault troops in the most difficult battles, or deployed against the

cosmo-knights and other super-powered enemies. They are also sent on special investigations or to command troops. Sometimes the sight of a colorfully costumed guardsman is enough to raise the morale of beleaguered Imperial troops.

A few guardsmen have witnessed gross acts of abuse and bloodshed that manage to undermine even their staunch loyalty, causing them to abandon the Empire. Others become so arrogant they feel they are above the laws and regulations of the Empire, and decide to strike out on their own. These renegades often make their way out of T.E. dominated space (where they are wanted criminals) and search for a new life in other galaxies, planets, and even in other dimensions. Only a handful of guardsmen have even joined the Free World Council! However, most of these elite, mutant soldiers are hated or feared by the freedom fighters and are always under suspicion of being Imperial agents trying to infiltrate the rebellion. Only the most dedicated renegades have managed to convince the rebels of their loyalty to them.

Attribute Requirements: P.S. 11, P.P. 9, P.E. 10 or higher.

O.C.C. Abilities and Bonuses:

1. M.D.C. Transformation: All Imperial guardsmen have their genetic structure permanently altered. Their flesh and skin become denser and diamond-hard, turning even members of "normal" races into M.D.C. beings. Base M.D.C.: Normal S.D.C. creatures gain P.E. M.D.C. plus 1D6 M.D.C. per level of experience. Members of M.D.C. races gain an additional 40 M.D.C.

2. Supernatural Attributes: The character's P.S. and P.E. become supernatural, making them able to inflict mega-damage with punches and kicks. The character heals 2D6 M.D.C. per minute (4 melee rounds); this may change due to special powers.

3. Super Abilities: In addition to the powers described above, the altered members of the Invincible Guardsmen get two super powers. Roll or choose once from each list below. All benefits are cumulative with both racial and power bonuses. For ideas on more powers, consult **Heroes Unlimited**, **Villains Unlimited**, or **Aliens Unlimited**. Note that the powers described here do not correspond exactly to the abilities in those books. Game masters may wish to change them to suit the needs of his or her campaign.

Major Super Power (Roll or choose once):

01-15% Metal Form: The guardsman's flesh becomes solid metal, becoming a near-invincible juggernaut. Add 500 M.D.C., +10 to P.S., and regenerates 1D4×10 M.D.C. per minute. The character gains an additional 600 lbs. (272 kg) to weight and 6 inches (0.15 m) in height. Speed is reduced by half.

16-30% Electricity Form: The guardsman becomes a being of pure electricity, able to control electrical energy, fire energy bolts inflicting up to 3D6 M.D. plus 1D6 M.D. per level of experience (range: 2000 feet/610 m). While in electrical form, the character gains an additional 100 M.D.C. and regenerates 4D6 M.D.C. per minute (4 melees). Electrical attacks do no damage to the character, while fire and energy attacks do half damage. The character can fly at up to 300 mph (480 km; minimum speed cannot be below 200 mph/320 km).

31-45% Stone Form: The character becomes living stone. Add 350 M.D.C., +8 P.S., and regenerates 1D4×10 M.D.C. per minute. The guardsman gains an additional 600 pounds (272 kg.) to weight and 6 inches (0.15 m) in height. Speed is reduced by half.

46-60% Flame Form: The guardsman can transform into a being of pure fire in the blink of an eye. Add 120 M.D.C. and regenerates 4D6 M.D.C. per minute. The character can fire energy blasts inflicting 2D6 M.D. plus 1D6 M.D. per level of experience (range: 2000 feet/610 m). The flame being can fly at up to 50 mph (80 km); add 10 mph (16 km) per level of experience.

61-75% Light Form: The transformed soldier can transform into a being of pure photonic energy (light energy), able to fire laser beams and fly! Add 100 M.D.C. and regenerates 4D6 M.D.C. per minute, or 1D6×10 M.D.C. if exposed to full sunlight (not the light of distant stars). The character can fire laser blasts inflicting 2D6 M.D. plus 1D6 per level of experience (range: 2000 feet/610 m). In light form, the character can fly at 600 mph (960 km). In space, the guardsman can fly at the speed of light for short periods of time (1 minute/4 melee rounds per level of experience).

76-90% Earth Form: The character becomes a quasi-elemental being, able to create and throw stone missiles, as well as being extremely tough and strong. Add 250 M.D.C. and regenerates 5D6 M.D.C. per minute. Add +6 to P.S. The guardsman can generate and hurl stones, inflicting 1D6 M.D. plus 1D6 per level of experience (range: 500 feet/152 m).

91-00% Crystal Form: The warrior becomes a being of living crystal, able to fire razor-sharp shards of crystal. Add 150 to

M.D.C., +2 to P.S., and takes half damage from laser attacks. The crystal shards do 2D6 M.D. plus 1D6 M.D. per level (range: 1000 feet/305 m).

Minor Super Power (Roll or choose once):

01-10% Enhanced Senses: Can see the invisible, sense magic, and sense heat emissions, plus X-ray vision: can see through most substances, except lead and radiation-proof alloys (most starship hulls and giant robots are radiation-proof).

11-20% Healing Factor: Add 1D6×10 M.D.C. to the character's physical body and regenerates an additional 1D6×10 M.D.C. every minute (4 melee rounds).

21-30% Enhanced Strength: Add 2D4+10 to P.S. and 1D4×10 M.D.C.

31-40% Enhanced Physical Prowess: Add +10 to P.P., +2 on initiative and +2 to pull punch and roll with impact.

41-50% Enhanced Physical Endurance: Add +10 to P.E., impervious to most diseases, fatigues at half the normal rate, and +1D6×10 M.D.C.

51-60% Flight: Can Fly at 50 mph (80 km), or double existing flight speed. Add 10 M.D.C.

61-70% Enhanced Speed: Add 1D6×10 to Spd and +1 on initiative.

71-80% Energy Resistance: The character takes no damage from the first 30 M.D. points of energy attacks in each melee round. The person is also invulnerable to stun-type energy weapons.

81-90% Psionic Powers: The character selects 2 powers from each of the physical, healing and sensitive categories and one from the super category. Select one additional power from any category at every level of experience. I.S.P.: 3D6×10 plus M.E. attribute. Gains an additional 10 I.S.P. per level.

91-00% Invulnerable to Psionics: The character cannot be affected in any way (positive or negative) from psionic attacks, mind control or magic charms. Plus the character is +4 to save vs horror factor.

O.C.C. Skills:

Radio: Basic (+10%)

Pilot: pick two (+10%)

Power Armor Combat: Basic

Read Sensory Equipment (+10%)

Weapon Systems (+10%)

Movement: Zero Gravity (+10%)

W.P. Energy Pistol

W.P. Energy Rifle

W.P. Heavy

Hand to Hand: Expert

Hand to Hand: Expert can be changed to hand to hand: martial arts or assassin at the cost of one "other" skill.

O.C.C. Related Skills: Select 8 other skills. Plus select two additional skills at level three, two at level six, one at level nine, and one at level twelve. All new skills start at level one proficiency.

Communications: Any (+5%)

Domestic: Any

Electrical: Basic Electronics only.

Espionage: None.

Mechanical: None.

Medical: First Aid only.
 Military: Any (+15%)
 Physical: Any except acrobatics.
 Pilot: Any (+5%)
 Pilot Related: Any (+5%)
 Rogue: Any
 Science: Math only.
 Technical: Any
 W.P.: Any
 Wilderness: Any

Secondary Skills: The character also gets to select six secondary skills. These are additional areas of knowledge that do not get the advantage of the bonus listed in parentheses. All secondary skills start at the base skill level. Also, skills are limited (any, only, none) as previously indicated in the list.

Standard Equipment: Imperial Guardsman armor (M.D.C. 120), energy pulse rifle, mess kit, hand communicator, four grenades, survival knife, utility belt, and dress uniform.

Money: 2D6×1000 credits to start. A salary will depend on whom the character is working for and the kind of work he is involved in.

Cybernetics: None.



Monro R.C.C.

The monro are non-humanoid amphibians who evolved in the swamp-covered world of Monro-Tet. The creatures are repulsive by most galactic standards: they have four-legs, with four writhing tentacles located on top sides of their massive torsos. The basic body shape is reminiscent of a cow or pig with hands and tentacles. The head is a grotesque horror: one huge central eye framing a thin mouth filled with sharp little teeth. The monro are

minor supernatural creatures, and many xenologists believe they are the abandoned minions of an alien intelligence. Other scientists disagree, claiming that the high magic environment of Monro-Tet is responsible for their supernatural abilities.

Despite the magical energies present on the planet, the monro never developed a magic-using culture. In fact, they have an instinctive fear and dislike for all things magical. The race as a whole prefers technology and has made great technological advances. Early monro FTL ships were exploring the galaxy when they encountered the kreeghor. After a short and hopeless war, the monro were absorbed into the Transgalactic Empire. Through the centuries, the race has become a valuable partner in the Empire. The mis-shaped creatures are respected administrators, scientists, and technicians. Some of the best mechanics of both the Imperial Navy and the Free World Council are monro techies. Many have also distinguished themselves as warriors.

The monro remain afraid of magic. Some stories claim that those who try to pursue the study of magic are suddenly transformed into a demonic monster, bound into service to an alien intelligence of incredible power. It might be possible (Game Master's choice) that the monro were once beholden to the Dweller Beneath, and that one day the intelligence may reclaim the entire species!

Alignment: Any

Attributes: I.Q. 4D6, M.E. 3D6, M.A. 2D6, P.S. 3D6+6, P.P. 3D6, P.E. 4D6, P.B. 2D4, Spd. 4D6. Supernatural strength and endurance.

Size: 4-5 feet (1.2-1.5 m) at the shoulder, and 5-7 feet (1.5 to 2.1 m) long.

Weight: 200 to 500 lb. (91 to 227 kg)

M.D.C.: P.E. plus 2D6×10. Add 1D6 M.D.C. per level of experience.

Horror Factor: 9 (appearance).

P.P.E.: 2D6×10

Average Life Span: 250 years.

Natural Abilities: See the invisible, see the infrared spectrum of light, sense heat emissions, bio-regenerate 1D4×10 M.D.C. per minute, and take half damage from heat and fire attacks.

Psionic Powers: None.

Magic Powers: None, currently.

Combat: Standard, but add two hand to hand attacks per melee round due to the tentacles. Note that the monro can use their front arms/legs and hands with good dexterity and their tentacles are extremely nimble and articulated.

Damage: Supernatural P.S.

Bonuses: +3 to save vs psionics, +4 to save vs horror factor.

Vulnerabilities/Penalties: Monro take double damage from holy weapons, rune weapons and those made from the Millennium Tree.

O.C.C.s: Monro can select most types of military and technical O.C.C.s. Many are spacers, runners, imperial legionnaires, freedom fighters, mechanics and rogue scholars.

Alliances and Allies: Most monro are loyal subjects of the Transgalactic Empire and work alongside the kreeghor, imperial human and wolfen, silhouette and machine people.

Weapons and Equipment: Varies with O.C.C.

United Worlds of Warlock

The UWW (also commonly known as the United Worlds) is a very loose federation, with more diverse laws and cultures than even the Consortium. The lack of centralization means that member planets are able to have any type of government, from enlightened democracies to savage dictatorships. A comprehensive overview of each world would fill a bigger book than this (and maybe it will be written one day), so only a few glimpses of this complex alliance are presented here.

Law and Crime

There is no galactic body of law in the United Worlds. Each planet or planetary collective formulates its own laws. The Parliament of Worlds (see **Rifts Phase World**, page 85) only has jurisdiction in interplanetary affairs, and even then only when a planet requests aid. This means that the only time the United Worlds' government and armed forces will intervene is in case of a major emergency or disaster. Two member planets can even declare war on each other, and unless one of them asks for help, the Warlock Navy will only stand by!

There are only two main guidelines that all members agree to obey: 1) No member planet or collective can declare war or attack an outsider planet or collective; doing so might drag the entire United Worlds into a war. If a planet does this anyway, it forsakes its membership and the UWW will not help it in the conflict. 2) The other rule enforced throughout the United Worlds is against the worship or service of "supernatural intelligences." To the eyes of the UWW, this category refers to any entity that feeds on the life energies of sentient beings. This includes vampires and vampire intelligences, demon and devil lords, and most supernatural monsters. "Gods" who desire wor-

ship but do not harm

supernatural intelligence. It has been successful most of the time.

The Dark Covens

Not all the organizations and governments of the United Worlds are benevolent. Chief among the would-be despoilers of Warlock are the evil cults collectively known as the Dark Covens. Many members of the covens are witches, evil shifters, and the priests of evil gods. Others include vampires, supernatural creatures like the Sowki, and minor demons masquerading as humans or elves. These groups are the common scourge of magic-using societies, and they are all too common in the United Worlds.

Despite their name, however, the Dark Covens are not a unified group. In fact, many fight against each other, because they serve different (and antagonistic) entities. Vampires in particular are often at odds with demon worshippers and witches. Still, each separate group is often a formidable force in its own right. Many covens have infiltrated entire planetary governments, influencing whole worlds through a number of converted or mind-controlled puppets.

United Warlock Worlds of Note: Alexandria — True Atlantean Colony

Alexandria is an important member planet of the UWW. The planet has one of the largest concentrations of True Atlanteans in the Megaverse — over 50,000 members of this ancient and wise species (for more information on the True Atlanteans and their place in the Megaverse, refer to **Rifts Atlantis**). The Atlantean colony in Alexandria is dominated by Clan Acherean, (no-

major pyramid, and transdimensional trade flourished. When the ships of the United Warlock Worlds arrived to Alexandria, the planet was already a prosperous and advanced world.

Clan Acherean was glad to relinquish power and allowed UWW administrators and officials to set up shop in their cities. The Atlanteans concentrated on managing the pyramids and then on venturing into the rest of the Three Galaxies to right wrongs and protect the innocent. Many Atlantean undead slayers, sorcerers and champions have come from Alexandria.

The Asteroid Eaters

These are not real planets, but huge artificial planetoids that orbit near asteroid fields. Each Asteroid Eater is a self-contained mining and manufacturing colony. Asteroids, planetoids, moons and even small planets are stripped of all useful minerals, which are then processed to build ships, weapons, computers and other materials. Most of the crews/inhabitants of the Asteroid Eaters are dwarves. Many are born, live out their lives, and die in their huge habitats, never having set foot on a real planet. The largest Asteroid Eaters can hold a population of five million; the smallest are little more than oversized ships that hold 5,000+ inhabitants.

Most Asteroid Eaters are considered to be installations belonging to a planet or corporation. A few of the largest ones, however, have declared their independence and are treated as full members of the UWW, with their own representatives and laws. One of these artificial planets, Ironring, is ruled by the demonic *Inglix the Mad*.

Inglix the Mad

NPC Patron or Villain

An occasional denizen of the Three Galaxies, Inglix the Mad is known and feared in several dozen dimensions, and throughout the United Worlds. This mysterious dwarf is ancient beyond belief, older than most dragons and even some of the so-called gods. Inglix is believed to have started out as an earth warlock in a primitive dimension, similar to the Palladium World. In fact, some rumors place him at the side of the mysterious ex-dungeon crawler, "Thraxus (see **Rifts Phase World**, page 20). Unlike Thraxus, who was concerned primarily with wealth, Inglix cared only for learning and sorcerous power. The dwarf managed to become a master of elemental magic and one of the most powerful warlocks on his world. Not content with that, he learned summoning and dimension-traveling magic, and stepped out into the Megaverse. His travels gave him even more knowledge and skills. When Inglix reached the Three Galaxies, he already was over a thousand years old, and an expert in all matters arcane.

Inglix was a founding member of the **Dwarven Guildmasters**, one of the three factions that founded the UWW. His bouts of insanity made him unfit to be a leader, however, and most of his influence lay in the development of new technologies and magical devices. Inglix was behind the design of the *Bottled Demon missile system*, the *Death Cloud Cannon* (see the Arcane Patrol ship, in the starship section), and many other strange creations. Despite his great contributions to the United Worlds, Inglix is not loved or greatly respected. This is due to his maniacal

and cruel disposition. He is known to dabble in the darker side of magic, including necromancy, and is suspected of having performed all kinds of atrocities in the Megaverse. Many members of the UWW believe he should be captured and executed for many of his crimes. Inglix's home is in **Ironring**, an Asteroid Eater planetoid that is considered to be an independent world with its own laws — and its laws specifically exempt Inglix from criminal prosecution!

In recent years, the dwarf seems to care only about creating new and more dangerous toys, than about gaining more knowledge. He hires adventurers throughout the Megaverse and sends them on dangerous quests for unique artifacts, ancient books of magic, and other secrets. Inglix can be used as an occasional patron for a party of player characters (or the player characters can have competitions and run-ins with other hirelings). Inglix learned the secrets of rune magic a couple of centuries back, but his knowledge is rudimentary and he wishes to learn more. Some of his current obsessions include learning Splugorth bio-wizardry (he pays top dollar for any bio-wizard symbiote or item brought before him), tattoo magic (he wishes to learn how to make magic tattoos), and the secrets of phase technology. He is also moderately interested in the Cosmic Forge, but believes it is a thing of legend and imagination.

Alignment: Aberrant

Attributes: I.Q. 22, M.E. 19, M.A. 12, P.S. 25, P.P. 17, P.E. 19, P.B. 8, Spd. 29; supernatural attributes.

M.D.C.: 400

Horror Factor: 11

P.P.E.: 1,546



Species: Originally a normal dwarf, now altered through centuries of magical use and manipulation. May have been an Asgardian dwarf (see *Rifts Conversion Book Two: Pantheons of the Megaverse*).

Level of Experience: 15th level earth warlock, 14th level techno-wizard, 12th level shifter, 10th level necromancer and alchemist, and 6th level rune smith!

Natural Abilities: Nightvision 300 ft (91.5 m; can see in total darkness), bio-regenerates 4D6 M.D. per hour. Has all the special abilities of a necromancer (see **Rifts Africa**), a techno-wizard, a shifter (**Rifts RPG**) and a warlock (see **Rifts Conversion Book One**).

Disposition: Inglix's nickname is not an exaggeration. He is quite insane, and his mood swings can turn darkly amusing, savagely murderous, or calm and collected at a moment's notice. He is left alone most of the time; only a few servants stay by his side. Many servants have quit, run away, or have disappeared.

Most communications with Inglix are done via vid-phones or magical messaging. Despite his savagery, the dwarf never seems to do anything that would directly hurt him or his interests, which has led many to believe that his madness is a ploy, or simply something Inglix enjoys doing for fun — which would still qualify him as being insane.

Insanities: Obsession: the acquisition of power and magic at all costs. He is also paranoid, sadistic and a manic-depressive.

Psionic Powers: Minor psionic with empathy and mind block.

I.S.P.: 87

Magical Knowledge: Knows all spells levels 1-13 plus impenetrable wall of force, restoration, dimensional portal and teleport: superior. Plus he knows all earth elemental magic and necromantic spells!

Combat abilities: Hand to Hand: Expert

Attacks Per Melee Round: Six hand to hand attacks, or two by magic.

Bonuses: +3 to strike, +7 to parry and dodge, +6 to roll with impact, +6 to pull punch, +6 save vs magic, +6 to save vs psionics, and +6 to save vs horror factor.

O.C.C. Skills of Note: Knows all electrical, mechanical and scientific skills at 98%, and knows over 16 languages and Lore: demon and monster, all at 98%.

Alliances and Allies: Inglix was Thraxus' companion during their "dungeon crawling" years. The dwarf and the mysterious trillionaire occasionally get together to reminisce about the old times, and they might come to each other's aid in case of need. Also, many dwarven guildmasters owe a great deal to Inglix, and although they dislike him they may feel indebted to help and protect him.

Minions: Inglix's personal bodyguards include several golems, robots and androids he has created himself. The inhabitants of Ironring, his personal Asteroid Eater, can be assembled into an army at a moment's notice, giving him over 200,000 soldiers out of a population of three million.

Transportation: Besides the Asteroid Eater, Inglix owns a small fleet of ships of all sizes, from fighters to cruisers.

Weapons: Inglix bears several magical weapons, including two lesser rune weapons (both of them axes). Any conceivable techno-wizard device could be found in his personal armory or on his person.

Body Armor: When facing combat, Inglix wears a suit of enchanted metal plate that offers 1,000 M.D.C. of protection and repairs itself at the rate of 1D6×10 M.D.C. per minute. Normally, he wears no armor save a bracelet enchanted with Armor of Ithan (140 M.D.C.).

Money: Inglix is extremely wealthy, with a personal fortune of 50 billion credits in cash and several times as much in property and other assets.

Warlock Marine O.C.C.

The Warlock Marines are elite soldiers used by the UWW to defend its borders from pirates, alien invaders, and the possible threat of invasion from the Transgalactic Empire. They are best known for their techno-wizard Warlock Combat Armor, a combination of high-technology and magic that is the pinnacle of centuries of development (**Note:** The Warlock Combat Armor is described in the Weapons and Technology Section). But beneath the hardware is a long tradition of heroism and camaraderie that goes beyond the normal esprit-de-corps of most military units. These Marines hold themselves above and apart from other soldiers and the rest of the universe. Every Warlock Marine will see combat many times before his or her ten year long tour of duty is over. Most reenlist and serve their entire lives in the Corps. Veterans of the corps can usually count for help and assistance from other veterans and members of the Corps; the only exceptions are Marines who show cowardice or gross stupidity in the face of the enemy — they are expelled from the Corps (the ones that survive, that is), and their names are stricken from all official records and personnel rolls.

Entrance to the Marine Corps is open to any citizen of the United Warlock Worlds. The racial breakdown among marines is roughly the same as for the UWW as a whole (see **Rifts Phase World**, page 84). Humans, elves and dwarves tend to dominate the make-up of the marines, but members of several other races, including seljuk, minotaurs, giants and even a few dragons, True Atlanteans and supernatural beings, all serve in the Corps. Females have been serving in the Corps for over 500 years and there is no longer any gender discrimination (women of all races represent 33% of the Corps' strength). Several female marines have risen to the High Command over the years.

Enrollment in the Warlock Marine Corps is strictly voluntary. Candidates have to meet very rigorous physical standards, far above their races' physical average. The recruits then undergo an entire year of training, designed to weed out unsuitable candidates and to harden the rest into efficient fighting machines. This year of training is commonly known as "The Hades Twelve" (for the twelve savage months of training and tests) and is often more dangerous than real combat. Among other things, would-be Marines practice combat maneuvers in a number of planetary environments, from airless moons to star-hugging hellworlds. Besides training, Marines are also given technological, and magical drugs and potions to enhance their physical abilities (see O.C.C. bonuses). At the end of the year, 70% of all candidates drop out, to be assigned to the *Warlock Military Support Corps* where they work in non-combat duties. Of the rest, 5% die or are severely injured in training accidents and hazards. The remaining 25% become Marines. About 1% have magical talents and

are assigned to the *Magic Division of the Corps* (see Warlock Marine Magic Specialist O.C.C.).

The graduation ceremony is a lot more than a formality. The new marines are assigned their combat armor suits. Each graduate steps into the armor while a team of techno-wizards conduct a powerful ritual. The armor molds itself perfectly around the soldier and the mind and soul of the warrior is linked to the armor. Many scientists and magicians speculate that the suit might be alive in some way as a result of this mystical union. Most marines develop a strong emotional attachment for their armor, giving them pet names and even talking to them. The history of the corps is full of stories in which a suit of combat armor performed some unexpected feat (like shooting an enemy before the marine even sees it) to protect its wearer. **Note:** At the Game Master's discretion, if a Warlock Marine character role-plays his/her affection for the suit to the hilt, the suit might actually respond in some interesting and useful way, at least from time to time.

New soldiers are assigned to one of the diverse postings given to Warlock Marine units. The Warlock Marines are shock troops first and foremost, and their units are fast and maneuverable. They are the first to draw combat duty in any conflict. Typical missions include assaulting pirate lairs, containing and destroying supernatural monsters, and patrolling the spaceways as the armed complement of military vessels.

Their only standard-issue vehicle is the *Greataxe IFV* (see the Weapons and Equipment section), a troop carrier/tank designed to shatter enemy defenses. The Marine Corps also has an Aerospace Arm, which relies mostly on fighter vessels like the *Shadow Bolt* (see **Rifts Phase World Book**, page 164). Most Marines see combat close and personal, or at least as close and personal as ultra-tech combat gets.

Marines are commonly divided into squads of four to six soldiers, platoons of 12 to 20, companies of 40 to 100, battalions 200 to 400, brigades of 1000 and divisions of 4,000 troopers. Most Navy ships carry a squad or platoon of marines. Embassies are assigned a platoon or company, depending on the size of the embassy and the potential dangers in the area. Combat missions (the most common assignment) vary, from a squad for a surgical strike to several divisions for a major operation (there are 20 active marine divisions in the United Warlock Worlds).

After their term of service is over, Marines are given the option to reenlist. About 60% do so. The rest usually end up working as mercenary (many ex-Marines have founded famous mercenaries companies), bodyguards, or military officers in other armies or police forces. Others become runners, pirates or adventurers, and only a few end up in non-violent "civilian" jobs. When they are discharged, Warlock Marines can elect to keep their personal armor, or receive a cash compensation of 150,000 credits instead. If they decide to keep the armor (90% do), the Marine has to swear a magically enforced oath never to act against the United Worlds of Warlock. Should the Ex-Marine try to use his Warlock Armor against his nation, the suit will explode, killing him instantly!

Attribute Requirements: Minimum P.S., P.E. and P.P. 13 or higher, and M.E. and I.Q. 10 or higher. Also see bonuses, below.

O.C.C. Abilities and Bonuses:

1. Attribute Bonuses: Due to their intense training and the use of advanced metabolic drugs and hormonal treat-

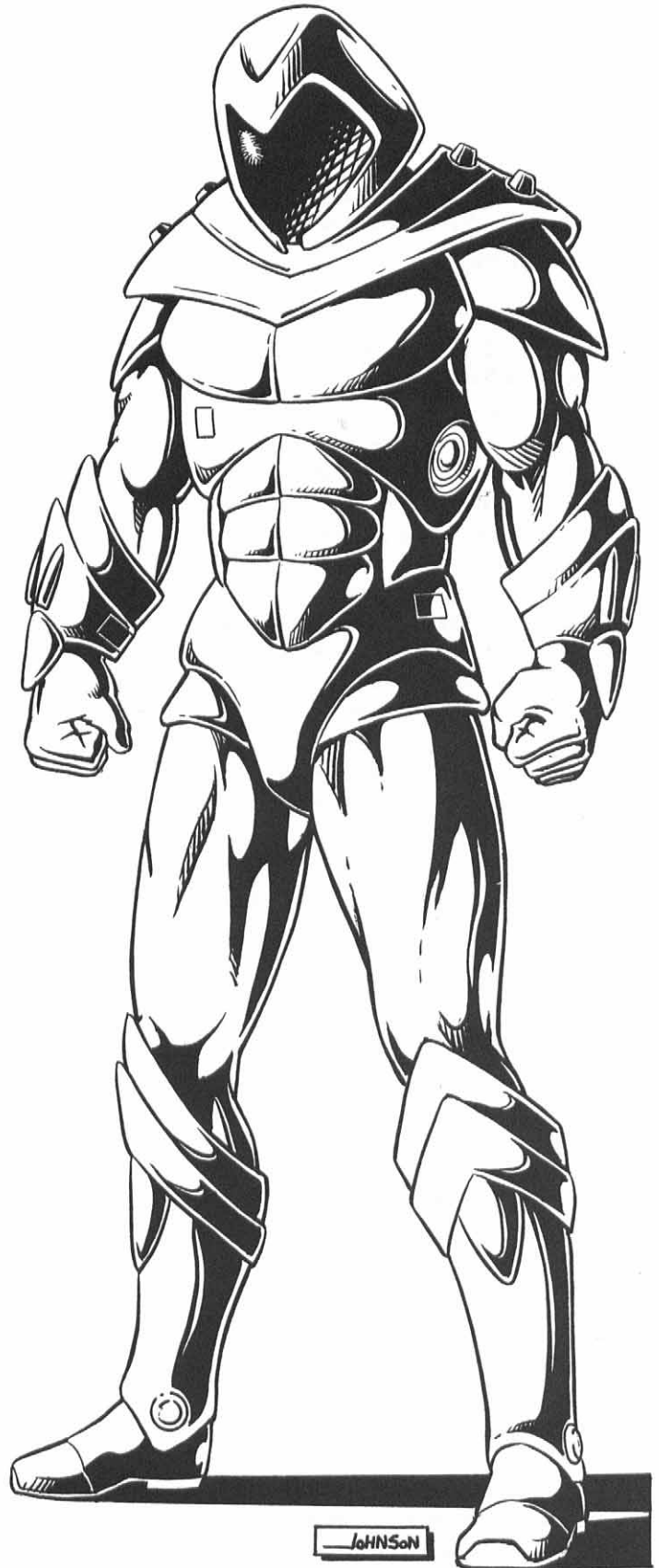

ments, Warlock Marines get +2D4 to P.S., +1D6 to P.P., +1D4 to P.E., and +2D6 to Spd. They also get a bonus of +1D6x10 to S.D.C. (or +4D6 M.D.C. for M.D.C. races). All these are in addition to skill bonuses.

2. Combat Bonuses: +2 to initiative, +1 to strike, parry and dodge, +1 to roll with impact, and +2 to pull punch. All these are in addition to attribute and skill bonuses.

Warlock Marine

Magic Specialist O.C.C.

3. Resistance Bonuses: Due to a combination of drugs, potions and training, Warlock Marines can resist magical and psionic attacks, as well as toxic substances: +3 to save vs magic of any kind, +3 to save vs mind controlling psionics or drugs, +2 to save vs poisons, toxins and disease. A side effect of this is the ability to drink enormous quantities of alcohol without ill effect — Warlock Marines are famous for being able to drink any sapient under a table.

O.C.C. Skills:

Radio: Basic (+10%)
Language/Literacy: Trade One (+10%)
Computer Operation (+5%)
Detect Ambush (+15%)
Detect Concealment (+10%)
Pilot: Robots and Power Armor
Pilot: Power Armor Elite
Pilot Tank (+10%)
Weapon Systems (+15%)
Read Sensory Equipment (+10%)
Boxing
Body Building
Climbing
W.P. Energy Pistol
W.P. Energy Rifle
Hand to Hand: Expert
Hand to Hand: Expert can be changed to Martial Arts at the cost of one “other” skill (or assassin if an evil alignment).

O.C.C. Related Skills: Select six other skills. Plus select two additional skills at level three, two at level six, one at level nine, and one at level twelve.

Communications: Any (+5%)
Domestic: Any
Electrical: Any
Espionage: Any (+5%)
Mechanical: Any (+5%)
Medical: First Aid or Paramedic only (+5%)
Military: Any (+10%)
Physical: Any
Pilot: Any (+10%)
Pilot Related: Any
Rogue: Any
Science: Math and chemistry only
Technical: Any
W.P.: Any
Wilderness: Any

Secondary Skills: Select six secondary skills from the previous list. These are additional areas of knowledge that do not get the advantage of the bonus listed in parentheses. All secondary skills start at the base skill level. Also, skills are limited (any, only, none) as previously indicated in the list.

Standard Equipment: Warlock Combat Armor (see Weapons and Equipment section), standard issue non-powered armor (M.D.C. 85, 16 pounds/7.2 kg, -10% prowl and physical skills penalty), EB-85 Blaster Rifle.

Money: 1D6×1000 in savings. Standard salary is 4000 credits per month. Mercenaries can make more or less money depending on the job and the employer.

Cybernetics: None to start with. Most cultures in the Three Galaxies view cybernetics and bionic replacements with distaste and avoid them if possible.

Marine candidates who have passed the grueling admission tests to the Corps are routinely tested for magical talent. The few who test positive are assigned to the Magic Division, a special branch of the Corps that uses magicians in combat. These marines are trained in both combat techniques and magic, and are able to combine them both with devastating effects. Since they have to divide their time pursuing both careers, however, Magic Specialists are not as competent in either field as a dedicated soldier or magician would be. Still, a power-armor marine that can use spells remains a dangerous and terrifying threat.

The techno-wizard Warlock Armor allows the wearer to cast spells through it (but normal range is reduced by half)! The result is a heavily-armored magician who can fall back on his mundane weapons should his magic fail. Magic Specialists are usually attached to platoons or larger units. Typically 1D4 magic specialists are assigned to each platoon. They act as magical defenders, healers, and anti-supernatural troubleshooters.

Attribute Requirements: Minimum P.S. and P.P. 13 or higher, P.E. 14 or higher, and M.E. and I.Q. 13 or higher. Also see bonuses, below.

O.C.C. Abilities and Bonuses:

1. Attribute Bonuses: Due to their intense training, and the use of advanced metabolic drugs and hormonal treatments, Specialists get +1D4 to P.S., +1 to P.P., +1 to P.E., and +1D4 to Spd. They also get a bonus of +1D4×10 to S.D.C. (or +4D6 M.D.C. for M.D.C. races). All these are in addition to skill bonuses. Their bonuses are less than those of standard marines because their training is split between physical and magical learning.

2. Combat Bonuses: +1 to initiative, +1 to parry and dodge, +1 to roll with impact, +1 to pull punch. All these are in addition to attribute and skill bonuses.

3. Resistance Bonuses: Due to a combination of drugs, potions and training, Marines can resist magical and psionic attacks, as well as toxic substances: +4 to save vs magic of any kind, +3 to save vs mind controlling psionics or drugs, +1 to save vs poisons and toxins. A side-effect of this is the ability to drink enormous quantities of alcohol without ill effect — Warlock Marines are famous for being able to drink any sapient under a table.

4. Magical Abilities: At first level, Magic Specialists learn the following spells:

Globe of Daylight
See the Invisible
Sense Evil
Chameleon
Detect Concealment
Armor of Ithan
Invisibility: Simple
Magic Net

At every level after the first, the character is taught one new spell equal to his own level of experience. Most spells taught have military, healing or sensory applications.



O.C.C. Skills:

- Radio: Basic (+10%)
- Language\Literacy: Trade One (+10%)
- Computer Operation (+5%)
- Detect Ambush (+10%)
- Detect Concealment (+10%)
- Lore: Demon and Monster (+10%)
- Pilot: Robots and Power Armor
- Pilot: Power Armor Elite
- Pilot Tank (+5%)
- Weapon Systems (+10%)
- Read Sensory Equipment (+10%)

- Boxing
- Body Building
- Climbing
- W.P. Energy Pistol
- W.P. Energy Rifle
- Hand to Hand: Expert

Hand to Hand: Expert can be changed to Martial Arts at the cost of one "other" skill (or assassin if an evil alignment).

O.C.C. Related Skills: Select five other skills. Plus select two additional skills at level three, two at level six, one at level nine, and one at level twelve.

- Communications: Any (+5%)
- Domestic: Any
- Electrical: Any
- Espionage: Any (+5%)
- Mechanical: Any (+5%)
- Medical: First Aid or Paramedic only (+5%)
- Military: Any (+5%)
- Physical: Any
- Pilot: Any
- Pilot Related: Any
- Rogue: Any
- Science: Math and chemistry only
- Technical: Any
- W.P.: Any
- Wilderness: Any

Secondary Skills: Select six secondary skills from the previous list. These are additional areas of knowledge that do not get the advantage of the bonus listed in parentheses. All secondary skills start at the base skill level. Also, skills are limited (any, only, none) as previously indicated in the list.

Standard Equipment: Warlock Combat Armor (see Weapons and Equipment section), standard issue non-powered armor (M.D.C. 85, 16 pounds/7.2 kg, -10% prowl and physical skill penalty), and EB-85 Blaster Rifle.

Money: 1D6×1000 in savings. Standard salary is 4000 credits per month.

Cybernetics: None to start with. Most cultures in the Three Galaxies view cybernetics and bionic replacements with distaste and avoid them if possible.

Turbo-Jockey O.C.C.



The Turbo-jockeys are naturals at piloting. They are hotshot pilots with the “right stuff,” possessed of incredible reflexes, reaction time, and spatial perception (the ability to sense one’s facing and direction). They are a small, highly respected elite group found among several races, including humans, oni, noro and wolfen. Some are sports racers, using their skills on land, air or sea vehicles. Others become fighter pilots: the military forces usually pamper these super-pilots, to the discontent of “normal” spacers and pilots. Many of these talented mavericks end up among mercenaries and outlaws, because they often have little patience for military discipline. Speed freaks, the turbo-jockeys are as likely to be found behind the wheel of a race car as in a fighter’s cockpit. They love speed, the feeling of pushing a vehicle to its limits and beyond, and taking insane risks.

Turbo-jockeys are born, not made. They are usually discovered at an early age, probably because of their desire (or obsession) to drive or fly, which usually manifests itself among them at an early stage of life. The lucky ones soon get the training they require to become pilots. They pick up piloting with an uncanny quickness and exceptional ability. Most of them live short, glorious lives, until the day they take one risk too many, or have a stroke of bad luck that ends it all.

Turbo-jockeys are very common in loosely-organized armed forces on independent planets. The Consortium Armed Forces (CAF) are fairly tolerant towards talented pilots, so there is a fair number of these hotshots among their ranks. The Transgalactic Empire only tolerates turbo-jockeys of the kreeghor race, and there are very few of those. On the other hand, the Free World Council has many of these elite pilots, which may account for several victories against overwhelming odds.

Attribute Requirements: P.P. and I.Q. of 12 or higher; also see attribute bonuses.

O.C.C. Abilities and Bonuses:

1. Attribute Bonuses: Turbo-jockeys have +1D4 to P.P. and +2D6 to their natural speed.

2. Combat Bonuses: +2 to initiative in all circumstances; +3 to initiative while operating a flying vehicle, +2 to strike and dodge in a flying vehicle, in addition to Fighter Combat bonuses (see **Rifts Phase World**, page 151).

3. Piloting Instincts: “If it flies, I can pilot it,” is not an idle boast among turbo-jockeys. These pilots can manage to operate almost any air or aerospace vehicle even if they haven’t had any formal training with it!

When faced with an unfamiliar vehicle, the turbo-jockey has a base percentage of 40% plus 1% per level of experience and I.Q. bonuses, if any. If the vehicle is very alien and difficult to fly (a phase ship or an intruder ship), the percentage drops to 25% plus 1% per level of experience and applicable I.Q. bonuses. Note that this ability does not allow the pilot to operate strange ship systems (like a phase ship’s special powers or alien weapon systems), just to pilot the vessel. The Game Master may rule that some ships designed for totally alien races, or requiring psionic or cybernetic connections, cannot be piloted by the turbo-jockeys until they receive the appropriate training or equipment.

O.C.C. Skills:

Basic Math (+15%)

Radio: Basic (+15%)

Read Sensory Equipment (+15%)

Pilot: One of choice (+25%)

Pilot: Two of choice (+15%)
Pilot: Fighter Combat: Elite
Weapon Systems (+10%)
Navigation — Space (+10%)
Computer Operation (+10%)
EVA (+5%)
Zero Gravity Movement and Combat
W.P.: One of choice
Hand to Hand: Basic
Hand to Hand: Basic can be changed to Hand to Hand: Expert at the cost of one “other” skill, or to Martial Arts (or Assassin if an evil alignment) at the cost of two other skills.

O.C.C. Related Skills: Select 10 other skills. Plus select two additional skills at level three, two at level six, one at level nine, and one at level twelve.

Communications: Any (+10%)
Domestic: Any
Electrical: Any (+5%)
Espionage: Intelligence only
Mechanical: Aircraft and automotive only (+5%)
Medical: First Aid only
Military: Any
Physical: Any

Pilot: Any (+10%)
Pilot Related: Any (+10%)
Rogue: Any
Science: Astronomy, Astrophysics and Xenology only (+5%)
Technical: Any
W.P.: Any
Wilderness: Any

Secondary Skills: The character also gets to select six secondary skills from the previous list. These are additional areas of knowledge that do not get the advantage of the bonus listed in parentheses. All secondary skills start at the base skill level. Also, skills are limited (any, only, none) as previously indicated in the list.

Standard Equipment: A pilot’s jumpsuit and personalized body armor, light sidearm (pistol), a set of clothing and personal items. Depending on his affiliation/assignment, he may own or be issued a personal fighter or light spaceship, and other equipment.

Money: The character starts off with 3D6×1000 credits.

Cybernetics: May or may not have a few (1D4) implants. Other than a universal headjack, many civilizations of the Three Galaxies frown on cybernetics and bionics except for prosthetics.

Organizations Within the Three Galaxies

Tri-galactic Military Services (TMS)

Company Breakdown: This information uses the Mercenary Company Design Rules found in **Rifts Mercenaries**, page 9.

A. Sponsorship: None
B. Outfits: Unlimited Clothing
C. Equipment: Unlimited Equipment
D. Vehicles: Unlimited Vehicles
E. Weapons: Maximum Firepower
F. Communications: Superior Communications
G. Internal Security: Paranoid
H. Permanent Bases: Company City
I. Intelligence Resources: Infiltration Network
J. Special Budget: Mega-Bucks
K. General Alignment of personnel: Anarchist
L. Criminal Activity: None.
M. Reputation and Credentials: Famous
N. Salary: Outrageous
Total Points Spent: 552

Size and Orientation: Large Mercenary Army

Transgalactic Military Services is the largest mercenary company in the Three Galaxies. An army in every sense of the word, TMS can field over 500,000 line soldiers, tens of thousands of vehicles and space fighters, and over a thousand military space-

ships. This organization is funded by the government of **Glory**, a fairly wealthy planet located in the Anvil galaxy. It sells its services to any buyer. Usually, TMS has dozens or even hundreds of small contracts for forces as small as a platoon or as big as a division. Most contracts involve less than one thousand soldiers, however.

The company recruits experienced soldiers from all parts of the Three Galaxies, and a sizable number from other dimensions. They also have recruiting offices on Phase World, where they hire transdimensional warriors as well. Their Supernatural Division consists of over 5,000 magicians, super-powered beings, dragons and other powerhouses.

Equipment is purchased from Naruni Enterprises and other independent weapons dealers. Their space fleet includes over a hundred of the famous Star Ghost fighters, possibly the deadliest craft of its class.

Origins

Like many mercenary organizations, Tri-galactic Military Services came to be at the end of a war. The last violent conflict between the budding Consortium of Civilized Worlds and the Kreeghor (now Transgalactic) Empire was a nasty war that lasted for four years. Millions of Consortium citizens were recruited and joined the war effort. At the end of the conflict, the CCW had fought the kreeghor to a standstill, but it was left with an oversized army; one it could no longer afford to maintain, especially after the danger from the kreeghor was (temporarily)

over. Thousands of veterans were discharged. These soldiers returned to their homes only to discover that jobs were scarce, or that their homeworlds had been ravaged by the invaders.

This fact did not go unnoticed. Some people became fearful that the veterans might turn to crime to make a living. Some Consortium Congressmen actually presented legislation calling for the creation of *Veteran Re-Education Centers*, which were little more than glorified concentration camps — not exactly the reward the heroes of the Transgalactic War had expected. The proposed law was defeated handily in Congress, but thousands of soldiers realized that their presence was no longer necessary, or welcomed.

Things might have ended up in a tragedy if not for an enterprising veteran of the war, retired *CAF General, Agnus Try-Ell*. He was a noro with an uncharacteristic streak of martial spirit, who had risen high in the ranks during the war. General Try-Ell came from a wealthy noro family, but his pacifistic relatives had all but disowned him, leaving him only a line of credit as his family legacy. Try-Ell used that line of credit, plus a number of personal loans from some contacts with weapon manufacturers he had met during the war, and started hiring veterans. The budding mercenary company set up shop on *Norrelgo-5*, a barely habitable world with a struggling, isolated human colony. *Norrelgo-5* was an ideal training ground for a force of mercenaries. More importantly, the world was independent, although fairly close to the CCW, but comfortably far from the Transgalactic Empire. The human colonists welcomed the presence of an armed force and gladly accepted the mercenaries' offer of protection in return for lease rights to a barren, desert-like continent.

Thousands of veterans flocked to General Try-Ell's side. The ex-CAF general set up an office on Phase World, and managed to wrangle a number of lucrative contracts. His troops performed beyond normal expectations, winning battles and skirmishes against far more numerous foes in a number of planetary civil wars. Like Try-Ell himself said, "Having nowhere else to go can be a powerful motivation." In a few years, the company grew by leaps and bounds. Now *Norrelgo-5* has three large cities and an orbiting starport, and the struggling colonists are now all millionaires.

All that happened over twenty years ago. The core of the TMS is made up of the veterans and their descendants, who have developed a warrior's philosophy and a sense of contempt for "civilians" who tend to teach their young to kill and then throw them away when they are no longer needed. General Try-Ell is still the commander of the force, thanks to the most advanced anti-aging treatments money can buy. He is still in great physical and mental shape despite being on his way to old age.

Contracts and Policies

Tri-galactic Military Services (TMS) works mostly with independent planets and lesser planetary federations in the Three Galaxies. The typical contract involves the hire of a body of troops that can range from a force the size of a platoon to a full division. They are usually hired to participate in a conflict or anticipated conflict against ground troops. Besides all-out war, however, a sizable percentage of TMS contracts involve training, escort, and defense missions. Training missions place a small team of officers in charge of teaching the arts of war to a local militia or army. Defensive missions or garrison duty, in-

volves protecting the client against raiders, rivals, pirates or invaders. On occasion, planetary governments within the Consortium have hired TMS for similar purposes. The CCW frowns on this, but as long as the mercenaries don't violate the Civilization Compact, there is nothing they can do about it. In fact, General Try-Ell will not allow his troopers to break the Civilization Compact, at least while operating in Consortium Space. On the few occasions when employers thought the mercenaries would do anything for money and tried to have them massacre primitive aliens or commit other Compact violations, the mercenaries have turned them in to CCW authorities.

Like most independent military organization, TMS deals with *Naruni Enterprises*. General Try-Ell is a wily negotiator and always keeps the upper hand in all commercial dealings. *Naruni Enterprises* is always paid on time and their association with the mercenaries has been very lucrative. This amicable liaison has prompted NE to try to acquire an interest in the mercenaries, but all attempts by the weapons dealers to exert influence on TMS have failed miserably. The mercenary company remains fiercely independent.

Life as a Merc

TMS mercenaries live harsh lives. When not on a paid mission, training takes up most of their time. War games, combat exercises, and qualification try-outs are conducted constantly. Soldiers are encouraged to cross-train and pick up more than one specialty. Leave is usually granted every two weeks or so, during which the mercs leave their Spartan training camps and head out to one of the three bustling cities on *Norrelgo-5*.

The cities, called N-1, 2 and 3 respectively, are nearly identical. The running joke is that a hung-over merc waking up in the morning will never know which city he's in. The "three N's" are brimming with bars, vice dens, and other places where the soldiers can find entertainment. Since the cities depend almost exclusively on the mercenary trade, the warriors pretty much do what they please, although all-out violence is stomped on by the Military Police, whose members are drawn from among the mercenaries themselves. The accepted wisdom is that the MPs don't cut the mercs any slack because they are angry at being on police duty while their comrades are out having fun.

While on campaign, discipline is strict. Under most circumstances, the mercenaries are expected not to fraternize with the local population. Crimes and abuse of the "locals" are not tolerated and the mercs try not to involve innocent parties in any unnecessary conflicts. When fraternization is forbidden (for a number of reasons, including avoiding spies and infiltrators, or getting too emotionally attached to locals), those who ignore such orders are severely punished. Penalties include: half pay, demotion in rank/authority, getting assigned to the foulest missions, removal from the TMS, and even the firing squad (a rare extreme).

TMS soldiers are paid a weekly salary, with bonuses given for high skill, heroism and hazardous duty. Base pay is 1200 credits a week for line soldiers, 1800 credits for noncommissioned officers, 2000 to 3,000 for medium grade officers, and 6,000 to 12,000 a week for superior officers. Additionally, all living expenses are taken care of while on training or combat duty. Bonuses for hazardous duties range from 1,000 to 5,000 credits, depending on the situation. Specialists (such as power

armor and fighter pilots) get paid 20 to 30% more than average, as do members of the Supernatural Division.

Soldiers can draw all of their salary in cash, or may invest some of it in a number of financial programs set up by the company. Over 80% of the mercenaries invest part or even most of their salaries. Investment programs include stock options (which entitle mercenaries to participate in the profits made by the company), retirement accounts that pay a handsome interest, and a number of health plans that cover the mercenaries' family members. Those mercenaries who participate in the investment programs are usually able to retire after 10 to 15 years of service with a sizable fortune in their pockets.

Personnel & Equipment

The TMS has between 450,000 and 500,000 troops divided into divisions of 4,500 to 10,000 soldiers each.

The unit breakdown is as follows (note: this assumes a unit at full strength; after a battle or a campaign, a unit may have 30% to 60% in casualties!):

Division: Each division has 3 to 5 brigades, totaling 4,500 to 10,000 troops.

Brigades: 1,500 to 2,000 soldiers, broken down into 3 to 5 battalions.

Battalions: 400 to 666 troops, divided into 2 to 4 companies.

Companies: 100 to 333 soldiers each, consisting of 2 to 5 platoons.

Platoon: 20 to 66 troops, divided into 2 to 4 squads.

Squads: 5 to 16 soldiers.

The smallest sizes are usually reserved for elite special operations troops like the Supernatural Squad and power armor units. Each battalion-sized or larger unit will also have attached medical, engineer and supply units, which will add an additional 40 to 1,000 personnel (these units are roughly 20% the size of the combat troops).

Vehicle units are broken down differently:

Armored Division: Three Brigades (300 to 1,500 vehicles/robots/power armor total).

Armored Brigade: Three Battalions (100 to 500 vehicles in each).

Armored Battalion: Four Companies (32 to 128 vehicles total).

Armored Company: Two to four platoons (totaling 4-16 heavy vehicles and 4-16 light vehicles in each).

Armored Platoon: Two to four tanks or giant robots, plus one to four light reconnaissance vehicles, armored personnel carriers, or power armor troopers in each.

In addition to the fighting vehicles, armored units will have attached supply, mechanic and medical units, usually at battalion level and up. These vehicles are lightly armed and armored, and can comprise as much as an additional 50% of the troops.

Finally, the space and air forces of the TMS are divided into wings of 2 to 8 air vehicles and squadrons of 3 to 5 wings. Most TMS ships are carriers, shuttles and fighters, but the company has a good-sized war fleet with about 200 frigates, 120 cruisers and 20 battleships, in addition to the carrier ships and small fighters.

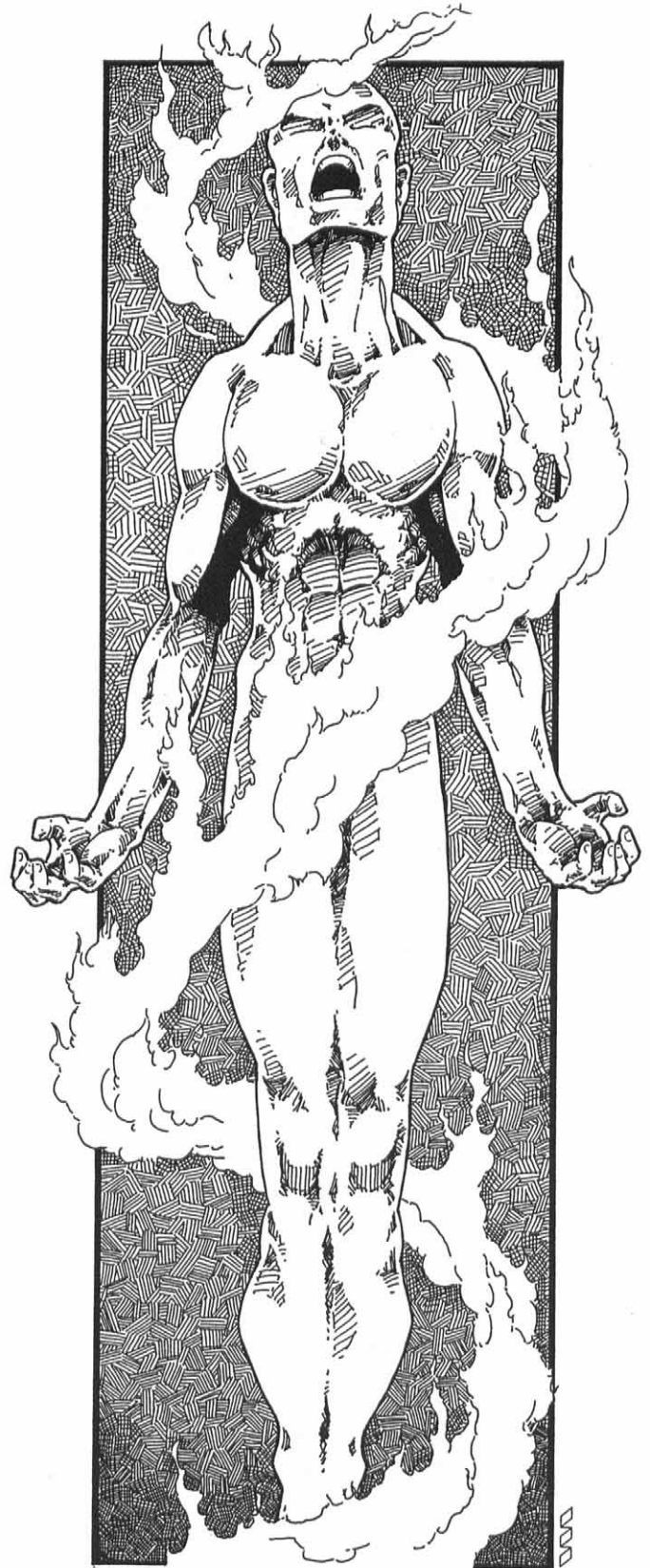

Some Well-Known Units

3rd Light Infantry Division: Also known as the *Supernatural Division*, this unit is made up completely of beings with super-powers, magic abilities, and psionics. In addition to magicians and mind melters, any number of M.D.C. beings, fallen knights, hatchling dragons, transdimensional creatures, full-conversion cyborgs, and exotic aliens are included in the division.

The unit is classified as “light infantry” because it is issued minimal weapons and equipment. Standard issue weapons and armor are given on a case by case basis; some troopers are given super-heavy weapons normally mounted on robots and power armor, while others are simply given a sidearm to supplement their formidable magic, psionic or special powers. The division is rarely deployed in its entirety, instead elements of the unit are assigned to other divisions to engage in special or covert operations, or to support armored attacks. The 3rd Light Infantry is one of the most elite formations both in the TMS and the Three Galaxies, and its members know it! Many “regular” soldiers resent “the braggarts from the 3rd;” brawls and practical jokes often break out between the 3rd and other units.

5th Armored Division: Popularly known as “The Golden Horde,” this division is made up of Glitter Boy suits — 900 to 1,200 USA-G10 suits! This is the largest concentration of Glitter Boys in the Three Galaxies and probably in the Megaverse! Where they come from remains a mystery, although it is likely that these suits are replicas manufactured in the Three Galaxies. The 5th Armored is used for frontal assault missions, where their firepower is enough to shatter most enemy formations. On one occasion, the soldiers of the 5th literally blasted down a mountain stronghold, reducing a solid granite formation to rubble after 10 hours of bombardment.

The Intruders

It all started with a number of seemingly unrelated incidents in the Corkscrew Galaxy (see **Rifts Phase World**, page 50). A merchant ship disappeared and a space station blew up; there were no survivors. Shortly thereafter, a private pleasure yacht limped into a spaceport, its owner screaming that strange ships had attacked it without warning. More ships disappeared, both in CCW and Imperial space. Both governments hurled accusations against each other, and patrol activity was stepped up along the galactic frontiers. Then a CCW frigate joined the growing list of missing vessels.

About a year after the incidents began, a Consortium-licensed planetary colony on the planet Marvel-II was attacked. The human and wolfen colonists of Marvel-II were a tough and resourceful lot, and their supplies included a number of mining robots that could easily double as combat machines in an emergency. Instead of an easy massacre, the attackers found themselves with a serious battle on their hands. A battle that attracted the attention of a CAF battle group a few light years away. The CAF fleet of six frigates, three cruisers and one Packmaster mothership came to the rescue of the beleaguered colonists. They expected to encounter pirates, Splugorth raiders, or perhaps kreeghor starships.

Instead, they ran into a new breed of enemies: strange ships that flashed bright colors, and looked like flying diamonds or jewels, even stranger than Phase World’s Space Ghosts. The dozen or so unidentified ships were trapped between the CAF fleet and the planet they were attacking. Even hopelessly outnumbered, they put up a fierce fight. The little spinning ships seemed to regenerate damage almost as fast as it was inflicted! After sustaining heavy losses, the CAF battle group was able to

destroy (but not capture) every one of the ships. Analysis of the few remains (the destroyed ships seemed to vanish, leaving only the remnants of the pilots’ bodies) confirmed that the vessels and their crews, belonged to a new species and civilization. Six months later, a fleet from the Transgalactic Empire had also documented an encounter with the same aliens.

So far, any attempts to communicate with the Intruders (as they became known) have failed. Humans who remembered legends from Earth’s past referred to the Intruders’ ships as “UFOs,” a name that stuck since the ships are almost impossible to detect or analyze. On a few occasions, the bodies of two types of aliens have been discovered, neither of whom have been previously reported in galactic records. It is believed that the two “races” are actually variants of the same species.

The Threat

So far, the Intruders have only conducted small-scale raids. The frequency of these attacks has not been enough to cause panic or serious disruptions in either the CCW or the Transgalactic Empire. The public only knows that some aliens, possibly from another galaxy, are raiding isolated outposts or firing on small ships. Compared to other dangers, like the Star Hives or the Splugorth, the Intruders seem to fade into insignificance. At the highest levels of the galactic governments, however, the threat seems both real and urgent.

First of all, the alien invaders are believed to come from another galaxy; one of the half a dozen or so which “face” the Corkscrew. If so, they have the means to quickly cover the 300,000+ light years separating the Three Galaxies from all other bodies of stars. Conventional FTL drives could cover that distance in one to three years (and this is for the closest stars in the closest galaxy), even accounting for the fact that g-drives can travel faster in the empty space between galaxies. Raids and invasions would not be cost-effective if traveling took that long. That suggests that the Intruders have a more advanced FTL system, perhaps something that has nothing to do with either gravity waves, phase technology or magical Rifts.

Even more importantly, the Intruders have demonstrated technological advances far ahead of anything produced by the Three Galaxies. At the cost of hundreds of lives, the governments of the Three Galaxies have discovered that the vehicles of the Intruders seem to be made of ultra-dense, rechargeable force fields. The term “solid energy” has been coined to explain these semi-transparent walls and armor plates, which seem to be created by power generators. “Solid energy” has all the properties of metals and ceramics, except it is almost weightless, and any damage sustained by it can be regenerated through the expenditure of more energy. Unlike conventional force fields, which are not stable enough to replace ship hulls or vehicle skins, “solid energy” seems to be the main “material” used in building the ships and power armor of the Intruders. Not only that, the vehicles do not need weapon systems; they fire energy beams that are simple extensions of their structures!

The energy vessels are faster, more maneuverable and harder to destroy than almost anything in the Three Galaxies’ arsenal. The only place where local technology is ahead of the aliens is in Phase-Tech. Phase beams are unimpeded by “solid energy,” and the Intruders seem utterly baffled by the abilities of phase ships. The aliens also seem to have no knowledge of magic, al-

though their technology seems to be quite resistant to magical and psionic attacks. But the fact remains that something is out there, something that is far more technologically advanced — and utterly hostile. Which leads to the second question that agonizes many government officials, especially in the Consortium (the Transgalactic Empire only cares about destroying or conquering these interlopers), why? Why are these aliens attacking, seemingly without provocation? Most attacks seem to concentrate on destroying and killing rather than in collecting loot or slaves. Every time the Intruders strike successfully, they leave no survivors and seem to take a perverse pleasure in obliterating any buildings, vehicles or structures they find. Only recently have they started trying to capture and steal phase-tech equipment, presumably to study and imitate.

There are a few theories as to the motives of the Intruders. They may simply be a genocidal civilization that wants to wipe out all possible competitors in a mad dash towards expansion and conquest. They may be the victims of a misunderstanding, perhaps unable to communicate with other species and are reacting violently because of it. Or maybe a galactic civilization has willingly or unwittingly committed some crime against the Intruders, and their attacks have been in retaliation for it.

The Reaction

Each government or group in the Three Galaxies has reacted differently to the appearance of the Intruders. Most incidents have occurred in the Corkscrew Galaxy, but rumors and unexplained events in the other two galaxies have been linked to the Intruders as well. The fear of a multi-galactic war is growing.

The CCW: The Consortium is trying to find a way to communicate with the Intruders in the hope that some sort of diplomatic solution can be reached. Given the technology of the aliens, a large-scale war could prove devastating for the CCW, even if it won the conflict. If diplomacy fails, the CCW may have to forge an alliance with the Transgalactic Empire, an alliance that could be as dangerous as the Intruders themselves.

The Transgalactic Empire: The Empire has suffered more from the Intruders' attacks than the CCW or any other galactic civilizations. The aliens seem to be more active in kreeghor space than anywhere else. Whether this is caused by proximity (perhaps the Empire is closest to the Intruders' home galaxy) or because the Empire is to blame for the Intruders' hostility is unknown. Imperial policy calls for the utter extermination of the invaders, and if possible, the capture of their wondrous equipment and technology.

Imperial ambassadors to the CCW and other planetary collectives have started making noises about a "concerted response against the Intruder threat." The Empire is particularly concerned with the Consortium's attempts at communicating with the aliens; the kreeghor fear that if the Consortium manages to get access to the Invaders' technology, they will immediately use it against the Empire (that's what the kreeghor would do in their place).

A number of unconfirmed reports mention Intruder ships and warriors fighting side by side with the freedom fighters of the Free World Council. The Emperor is now afraid that the rebels have somehow forged an alliance with the aliens. A number of spies and intelligence officers have been sent into the Council's territory to discover the truth behind those rumors.

The Free World Council: The leaders of the Free World Council are aware of the rumors regarding the Intruders aiding them against the Empire. They don't know whether or not they are true, because the purported incidents occurred in remote areas that have little contact with the freedom fighter's high command. To many rebels, anything that hurts the Empire is good for the FWC. Others view the coming of the Intruders with more caution, afraid that the Free Worlds may be next on the list of senseless attacks.

The United Worlds of Warlock: So far, no Intruder raids have occurred in United Worlds' space. The UWW is officially not interested in this conflict.

The Splugorth: The Splugorth of the Three Galaxies are both alarmed and mystified by these strangers. Consultations throughout the Megaverse have produced no reports of previous sightings or encounters elsewhere. They are something new and unknown. The Splugorth hate surprises more than anything else. They prefer to be on the giving side, not the receiving end of nasty surprises. The seemingly unreasoning violence of the alien invaders also bears some uncomfortable resemblance to the *Mechanoids*, although these beings appear to be organic. The Splugorth intelligences are concerned that the Intruders may be the minions of some unknown supernatural being.

So far, raids on Splugorth holdings have been minimal, although on one unfortunate occasion, a Splugorth slaver fleet and an Intruder raiding party both happened to attack an independent planet at the same time. When the dust settled, the two fleets had suffered heavy losses and withdrew, while the bewildered planetary defense forces watched on! The planet was unharmed.

Phase World: The main consequence of the Intruder threat has been higher sales in phase weapons and vehicles, as the governments of the Three Galaxies decide to exploit the only technological advantage they have on the aliens. Regrettably, demand has quickly outraced supply, raising prices as the Promethean engineers try to step up production. According to some Prometheans, the appearance of the Intruders has managed to concern the Elder first-stagers. If this is true, the Intruders are a more serious danger than anybody imagines, because Promethean elders are only concerned with cosmic threats that could affect the entire galaxy or even the Megaverse!

The Cosmo-Knights: Three cosmo-knights have confronted the Intruders so far. One is dead; the other two report that the Intruders' energy weapons are capable of overcoming the cosmo-knights' near-invulnerability to energy! This makes them a danger not only to the Three Galaxies but to the defenders of the Cosmic Forge. A few knights suspect that the Intruders may be the agents of some supernatural entity even worse than the Splugorth. **GM's Note:** The damage done by Intruder energy weapons is divided by ten, instead of a hundred (see **Rifts Phase World One**, page 101) when used against a cosmo-knight.

Naruni Enterprises: The Naruni Board of Directors held an emergency meeting when the news about the Intruders was first reported. Naruni contacts have been able to find out everything the CCW and Transgalactic Empire knows about the mysterious invaders. For Naruni Enterprises, the Intruders represent both a threat and an opportunity. The threat lies both in the Intruders' savagery (they are as likely to destroy Naruni property as much as anybody else's) and the fact that their technology is more advanced than the Naruni's, which has always prided itself with

being on the cutting edge of weapons tech. The opportunity is also twofold. First, scared governments are likely to step up military spending, and Naruni Enterprises will be happy to sell its wares to prepare the Three Galaxies for an upcoming galactic war. Secondly, if Naruni is able to capture and reproduce the effects of "solid energy" technology, they will have a monopoly on a new weapon technology, giving them a property what could increase sales by a factor of ten. Naruni is contracting teams of mercenaries to capture as many Intruder ships and crew members as possible. The Naruni Research and Development department can hardly wait to examine them.

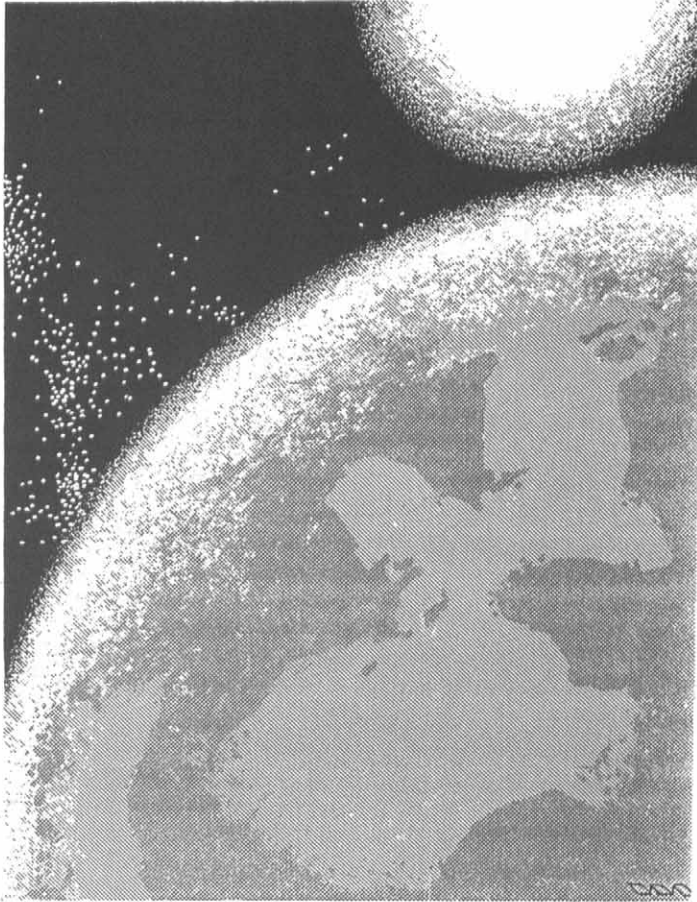

Some Theories Game Master Plot Suggestions

The Intruders can be used in any number of ways by the game master. They can be a "faceless menace" to throw at the party, or they can become the focus of an entire campaign as the Intruder threat grows and becomes more common. Depending on which possibility/theory the game master uses for his campaigns, Intruders could be allowed as player characters, or they could be unrelenting NPC villains. Some of these theories are currently believed by people in the Three Galaxies; others are unconfirmed rumors or wild speculation.

Game Masters should keep in mind that if the Intruders can be reasoned with, eventually solid energy technology may be made available to the Three Galaxies. This will have enormous impact on the lives of all galactic denizens.

1. The Intruders are the minions of an alien intelligence of unimaginable power. The monster thrives on death and destruction, and has granted its servants ancient knowledge and tech-

nologies so they can better perform their tasks. In that case, the Intruders' master will see the power behind the Transgalactic Empire, as well as the Splugorth, as its main rivals and will try to crush or gain dominance over them first.

2. The Intruders are an alien civilization from another galaxy. They believe only they have the right to exist in the universe. All other intelligent species must be exterminated (some may be enslaved) before they become a threat. Perhaps a few Intruders (less than 1%) disagree with this policy and may become deserters. It has been a few of these renegade groups who helped the Freedom Council against both the Transgalactic Empire and their own evil culture.

3. Same scenario as number two, but there are two opposing groups of Intruders locked in a civil war that spans the galaxies. The second group wishes to cooperate with other cultures. Unfortunately, the genocidal killers reached the Three Galaxies first, and the dissidents' attempts to make contact ended in violence when they were attacked on sight.

4. The Transgalactic Empire is to blame! An imperial exploration fleet reached the Intruders' homeworld in another galaxy, and attacked it without provocation. The kreeghor slaughtered millions of innocent people. The Intruders destroyed the TE fleet before it ever sent word back to the Empire. The aliens are convinced that the Three Galaxies are a haven for sadistic monsters. They see themselves as crusaders destroying a civilization of evildoers.

More recently, the Intruders have realized that not all denizens of the Three Galaxies are like the Empire, and they may eventually see reason. If the rumors about Intruders helping the Free World Council are true, maybe they have already recognized that not all the inhabitants of this sector of space are evil (they even have made an alliance with a galactic civilization).

5. They are invaders from another dimension, no better than the Splugorth or kreeghor. With their superior weapons and technology, they intend to invade and conquer the Three Galaxies and other worlds.

6. Just as the cosmo-knights feared, the Intruders are the agents of some supernatural entity or other dimensional power even worse than the Splugorth. They intend to find and capture/enslave the Cosmic Forge and use it for their own dark purposes.

Intruder Type One: "The Beast"

The so-called beasts seem to be the most common Intruder. Many corpses have been recovered from skirmishes with the mysterious aliens, and they have been dissected and studied by scientists of several nations from the Three Galaxies. Their nickname fits their appearance. They are tall and broad-shouldered beings, covered by a layer of fine fur, usually white, beige or reddish-brown with white stripes. Their faces are quite unusual, with one huge central eye and two smaller middle eyes, a large mouth, and a single walrus-like tusk coming down from its mouth, framed by two smaller fangs on its sides. The beasts' hands have only three fingers, including an underdeveloped "thumb." All three fingers end in sharp claws able to rend mega-damage alloys! Given the limited development of their hands, as well as their heavy musculature, it is unlikely these creatures

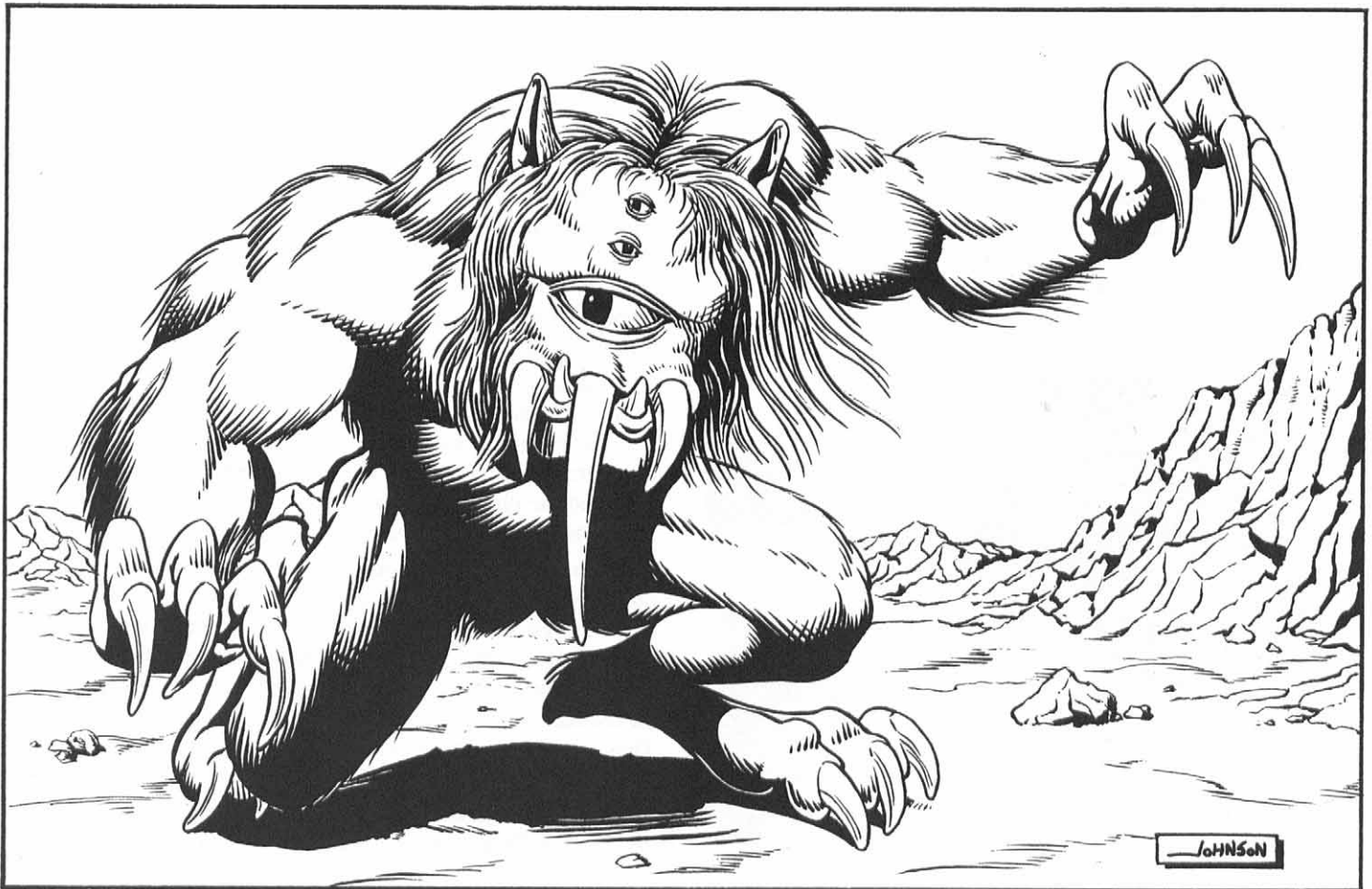

would have evolved into intelligent beings under normal circumstances. Some scientists think that the beasts may be trained animals, while others speculate that their masters (possibly the so-called mind creatures), are members of the same species as the beasts, but have been bio-engineered differently.

Alignment: Depends on the option chosen by the Game Master, but probably lean towards selfish and evil.

Attributes: I.Q. 2D6+2, M.E. 3D6, M.A. 3D6, P.S. 4D6+10, P.P. 3D6+10, P.E. 3D6+12, P.B. 1D6, Spd. 5D6. Supernatural strength and endurance.

Size: 7 to 9 feet tall (2.1 to 2.7 m).

Weight: 500 lb. (225 kg)

M.D.C.: P.E.+1D6×10. Add 1D6 per level of experience. Minor mega-damage creatures.

Horror Factor: 12

P.P.E.: 1D4×10

Average Life Span: Unknown. Probably close to human average (oldest corpse dissected was believed to be 50 years of age).

Natural Abilities: Nightvision (2000 feet/610 m), can see the invisible, and see into the infrared range. Enhanced healing: they recover 1D6 M.D.C. every hour.

Average Experience Level: Typically 1D4+2.

Psionic Powers: Natural mind block auto-defense only.

Magic Powers: None.

Combat: Equal to hand to hand: assassin.

Damage: Claws add 1D6 M.D. to supernatural P.S. damage (see **Rifts Conversion Book One**, page 22).

Bonuses: +2 on initiative, +2 to strike, parry and dodge, +2 to roll/pull punch, +4 save vs magic, +4 to save vs psionics, +6 to save vs horror factor. All in addition to attribute and skill bonuses.

Vulnerabilities/Penalties: Take double damage from rune and Millennium Tree weapons (proof of supernatural nature?).

R.C.C. Skills:

Radio: Basic (+20%)

Pilot: Intruder Ships (+20%)

Read Sensory Equipment (+10%)

Weapon Systems (+15%)

Power Armor Combat: Intruder Systems (Elite)

Fighter Combat: Elite

Hand to Hand: Expert

Hand to Hand: Expert can be changed to Martial Arts or Assassin at the cost of one "other" skill.

R.C.C. Related Skills: Select five other skills. Plus select two other skills at level three, two at level six, and one at levels eight, ten and twelve.

Communications: Any (+5%)

Domestic: Any

Electrical: Any (+5%)

Espionage: None.

Mechanical: Any (+5%)

Medical: First Aid only.

Military: Any (+10%)

Physical: Any

Pilot: Any (+10%)

Pilot Related: Any (+10%)

Rogue: Any
Science: Any
Technical: Any
W.P.: Any
Wilderness: Any

Secondary Skills: The character also gets to select five secondary skills. These are additional areas of knowledge that do not get the advantage of the bonus listed in parentheses. All secondary skills start at the base skill level. Also, all skills are limited (any, only, none) as previously indicated in the list.

Alliances and Allies: None, although there are rumors that the Free World Council may be about to forge an alliance with the Intruders (Game Master's call).

Weapons and Armor: Suit of War Beast armor (400 M.D.C.); uses built-in weapon systems.

Intruder Type Two:

“The Mind Creatures”

The mind creatures have the same facial features of the War Beasts, namely a single eye framed by two smaller ones, and a large central tusk protruding from the mouth. However, their size and body shape is completely different. The mind creatures have oversized heads (fully 40% of their total body height is in their enormous heads!), short and weak arms and legs, and a small, fur-covered body. Obviously not designed to be fighters, mind creatures are occasionally found piloting fighter ships or more often commanding large vessels and crews (most of the time). They seem to be master tacticians and coordinators who use telepathy as a means to communicate with and supervise large bodies of troops.

The similarities and differences between the two types of Intruders have got xenologists arguing. Are they of the same race, bred or mutated to fill different functions, or are they two separate species native to the same planet? The first theory seems more likely, but it is hard to be sure. So far no mind creature has been captured alive. During one incident, one such creature was killed by its beast subordinates when their ship was boarded by Imperial Legionnaires, suggesting the lesser creatures may be slaves of a lower (and resentful) caste.

Alignment: Game Master's option, but probably anarchistic or evil.

Attributes: I.Q. 4D6+6, M.E. 3D6+12, M.A. 3D6+4, P.S. 2D6, P.P. 3D6, P.E. 3D6, P.B. 2D6, Spd. 3D6. Supernatural strength and endurance.

Size: 3 to 5 feet (0.9 to 1.5 m).

Weight: 70-100 lb.(32 to 45 kg).

M.D.C.: P.E. +1D4×10 M.D.C. Add 1D4 M.D.C. per level. Minor mega-damage creatures.

Horror Factor: 9

P.P.E.: 4D6

Average Life Span: Unknown. Probably close to human average, but might be longer (or shorter) lived.

Natural Abilities: Nightvision (2000 feet/610 m), can see the invisible, see into the infra-red range, and have enhanced healing. They also recover 1D6 M.D.C. every hour. Also see psionic powers.

Experience Level: Average 1D4+4

Psionic Powers: All sensitive powers, plus mind block auto-defense, empathic transmission and group mind block. Special: The mind creatures have a form of super-telepathy that allows them to keep in communication with their war beasts at a distance of up to one light year per level! This communication only costs 2 I.S.P. per activation, and lasts one minute per level. The telepathy only works between mind creatures or between a mind creature and one or more beasts. Considered a master psionic. I.S.P.: 4D6×10 plus M.E. attribute; add 12 I.S.P. per level.

Magic Powers: None

Combat: As per skill.

Damage: Supernatural P.S. inflicts mega-damage on punches and kicks.



Bonuses: +4 to save vs magic, +3 to save vs psionics, and +4 to save vs horror factor.

R.C.C. Skills:

Radio: Basic (+15%)

Pilot: Intruder Ships (+10%)

Read Sensory Equipment (+15%)

Weapon Systems (+10%)
Lore: Demon and Monster (+15%)
Navigation: Space (+15%)
Fighter Combat: Elite
Hand to Hand: Basic

Hand to Hand: Basic can be changed to Expert at the cost of one "other" skill, or to Martial Arts or Assassin at the cost of two "other" skills.

R.C.C. Related Skills: Select eight other skills. Plus select two at level four, two at level seven, and one at levels ten and twelve.

Communications: Any (+10%)
Domestic: Any
Electrical: Any (+10%)
Espionage: Any
Mechanical: Any (+15%)
Medical: Any
Military: Any (+5%)
Physical: Any
Pilot: Any (+5%)

Pilot Related: Any (+10%)
Rogue: Any
Science: Any (+10%)
Technical: Any (+10%)
W.P.: Any
Wilderness: Any

Secondary Skills: The character also gets to select five secondary skills. These are additional areas of knowledge that do not get the advantage of the bonus listed in parentheses. All secondary skills start at the base skill level. Also, all skills are limited to (any, only, none) as previously indicated in the list.

Alliances and Allies: Other than the beasts, there is no evidence that the mind creatures have any contact or treaties with any other species or culture.

Weapons and Armor: Set of personal "solid energy" armor: M.D.C. 150 and regenerates damage at the rate of 3D6 per minute (every four melee rounds. The suit can also fire energy blasts that inflict 1D4×10 M.D.; range 1200 feet (366 m).



Using Aliens Unlimited in Phase World

Breaux and Siembieda's excellent supplement *Aliens Unlimited* can be extremely useful to Phase World Game Masters and players. With over a hundred alien races, the book is an ideal source of new races to people the Three Galaxies, Phase World and Megaverse. Of course, the **Aliens Unlimited** setting is *not* the **Phase World** universe; it is mostly located in the Milky Way Galaxy and involves different governments, intrigues and organizations. Game Masters may wish to make a few changes and modifications to *adapt* individual alien races or even whole organizations into a **Phase World** campaign (a number of suggestions follow).

Another alternative is to make these races and organizations visitors (or invaders) from another dimension. Their galaxies, homeworlds and technologies don't even exist in the Phase World (or Rifts) universe — but are from an entirely different dimension with only certain areas of similarity or parallel development. These people from another dimension may be tiny groups of adventurers, scientists, transdimensional explorers, scouts, pilgrims with dreams of colonization, refugees looking for a new home, transdimensional merchants like the Naruni or Splugorth, or dimensional raiders, a mercenary army or an entire invasion fleet. Game Master's choice.

Outlined below are some OPTIONAL guidelines and suggestions. Game masters are the final arbiters as to what races/O.C.C.s/powers and elements are appropriate to their game "universe." This section deals with making a place for some of the alien species described in **Aliens Unlimited** for use in the Three Galaxies. That book already has the stat and equipment conversion notes.

The Atorian Empire in Phase World

In the *Aliens Unlimited* universe, the most powerful organization in the Milky Way galaxy is the *Atorian Empire*, a ruthless, expansionist organization run by the Atorian race (see **Aliens Unlimited**, page 102). The role the Atorians play in the Three Galaxies will influence most other organizations and races described in the *Aliens Unlimited* universe. Two possible ways to adapt the Atorians, and the dozen plus associated and slave races of their empire, are developed here.

Option #1: The Rising Empire

This option makes the Atorian Empire an independent fourth "player" in galactic politics. The Atorians would be a relatively new power in the Three Galaxies, a mere three hundred years old. The Atorians, a major clan of the Fehran species (now commonly known as the Atorians) are natives to the Thundercloud Galaxy. The Atorians developed space travel technologies, expanded and became a budding star empire. Their wave of expansion took them into conflict with both the CCW and the Transgalactic Empire. A number of skirmishes and one major space battle between the Consortium and the Atorians ended in a treaty in which the Atorians promised never to attack or invade CCW member worlds.

The war with the Transgalactic Empire lasted much longer, and was beginning to turn against the Atorians when the Free World Council (see **Rifts Phase World**, page 72) first appeared, right in the Thundercloud galaxy. The Atorians took advantage of the rebellion; as the kreeghor hesitated, Atorian vessels struck at several key points, decimating the kreeghor fleets and severely damaging their war efforts in that galaxy. At this point, the Atorian Empire and the Free World Council maintain an uneasy non-aggression treaty, and the Transgalactic Empire is at war with both of them.

In this situation, the Atorians are an up-and-coming force in the Three Galaxies, with about ten allied or subservient races and half a dozen slave races at their service. This makes them the dominant force in the Thundercloud Galaxy, and they are planning to eventually take it over entirely and start expanding into the Corkscrew. Intrigue, espionage, raids and outright battles between the Atorians, their minions and the other forces of the galaxies are commonplace and may soon escalate.

In this situation, most of the events, racial histories and political status of the diverse races described in **Aliens Unlimited** remain basically unchanged, with the exceptions noted below.

Other Organizations

These groups and their races are more fully described in **Aliens Unlimited**.

In the **Phase World** setting, **The Federation of Alien Races (FAR)** is a weak collective of independent worlds in the Thundercloud Galaxy, formed to defend its members from both the Atorian and Transgalactic Empires. Although many members wish to join the Consortium of Civilized Worlds, the majority is still trying to preserve their independence. The increasing pres-

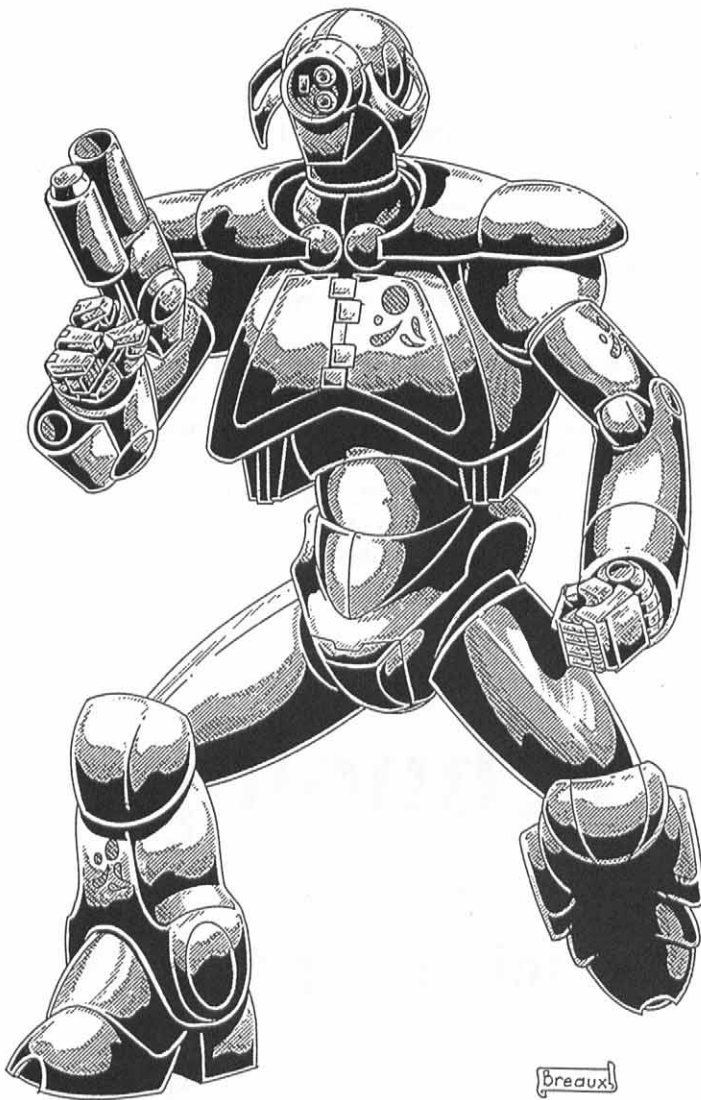

sure from the two contending empires is likely to drive the FAR into the Consortium's arms, where they will be safer, most likely happier, and more prosperous. Both the Atorians and the kreeghor will do their utmost to prevent such a union, launching propaganda wars to discredit the Consortium and the FAR, and sending spies, assassins and saboteurs to wreck negotiations.

In the **Phase World** setting, **The Niamese Coalition (NC)** is roughly the equivalent of the Free Worlds Council (FWC), but it is aimed against the Atorian Empire. Unlike the Free Worlds, the NC controls little or no territory. The bitter irony is that the kreeghor are covertly helping the Niamese Coalition, while the Atorians are giving some aid (or at least neutrality) to the FWC. The two organizations have made contact with each other, but their situation is delicate. An alliance between the two might lead to war with an additional empire; so far, the value of such a union does not outweigh the risk.

The Tagonglomerate (TGE) is a megacorporation based in the Thundercloud galaxy. It is a serious competitor to Naruni Enterprises and other manufacturers of the Three Galaxies, and competition between these companies is never pretty.

The Thissera-Micean Cooperative (TMC) is a law-enforcement organization that operates in the Thundercloud and Corkscrew galaxies, with jurisdiction over several independent planets (i.e., worlds not aligned to either the Consortium, the Empires or other large collectives). A number of cosmo-knights and other champions of good are likely to join the TMC.

Option #2: Atorians as Kreeghor Vassals

In this option, the Atorians originate from the Corkscrew Galaxy and become a fairly powerful empire, but it is overwhelmed and crushed by the budding Kreeghor Empire. The conquest of the Atorians occurred shortly before the war that destroyed the Wolfen Empire (see **Rifts Phase World**, page 52). Since then, the Atorians have been an important part of the Kreeghor Empire, ruling their former planets with an iron hand in the name of their monstrous overlords. Most Atorians have chosen to serve the Empire willingly and have carved an important place for their race. Concealed in this blanket of apparent loyalty, however, lies an ancient conspiracy for the Atorians to one day replace their kreeghor masters as the leaders of the Transgalactic Empire (more chances for intrigue, espionage and double-dealings).

Using this option requires making some changes in both the **Phase World** and **Aliens Unlimited** information. The Atorians should make up a sizable percentage of the Empire's population. A modified population breakdown *might* read like this:

Kreeghor 25%	Silhouette 5%
Atorians 10%	Monros 5%
Machine People 5%	Noro 5%
Wolfen 5%	
Humans 5%	
Mantella 5% (see Aliens Unlimited , page 95)	

Others 30% (including felias, kissent, pantherans, photins, danaus, dergins, innensi, and other races, none of which makes up more than 1% of the total population). Most of the races and organizations' dealings with the Atorian Empire might have happened before the kreeghor conquest, or may be the work of Atorians working for the Empire.

Other Organizations

The Federation of Allied Races (FAR) could be completely replaced by the Consortium. All races could be members of the CCW.

The Niamese Coalition could be a part of the Free Worlds Council or a possible ally. Collaboration between the two groups would be common, as their enemy is one and the same.

All other organizations remain virtually unchanged.

Technology & Weapons

Naruni Enterprises Weaponry

In addition to the weapons described in **Rifts Phase World** and **Rifts Mercenaries**, Naruni Enterprises has a large selection of hand weapons. Availability on Rifts Earth is subject to the Game Masters's approval; at this point, Earth is still a "soft" market, so only a few lines of weapons are being exported in any quantities. However, all of these weapons can be purchased on Phase World and at any of Naruni Enterprises dealerships, scattered through the Three Galaxies.

NE-6 "Magnum"

Plasma Cartridge Revolver

The NE-6 uses a revolver cylinder instead of a magazine for this popular plasma cartridge weapon. The revolver action is easier to maintain and fix, so the "magnum" is popular among colonists, spacers, runners, outlaws and pirates. These guns also appeal to some romantic humans who still remember the legends of the "Old West" from a time when humans still dwelt on the mythical planet Earth.

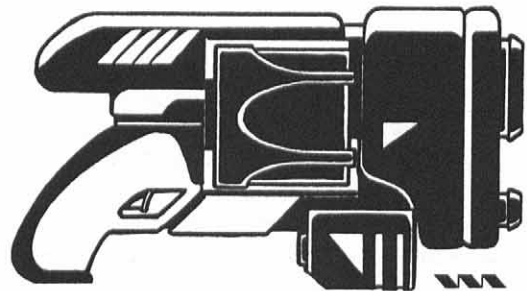

Weight: 6 lbs. (2.7 kg)

Mega-Damage: 1D4×10 M.D. per each plasma round.

Rate of Fire: Standard; each shot counts as one melee attack.

Maximum Effective Range: 500 feet (152 m)

Payload: 6 shot cylinder. Reloading the weapon takes one melee action per cartridge, or one melee action to load all six if a speed loader (200 credits) is used.

Cost: 15,000 credits. Each round costs 20 credits.

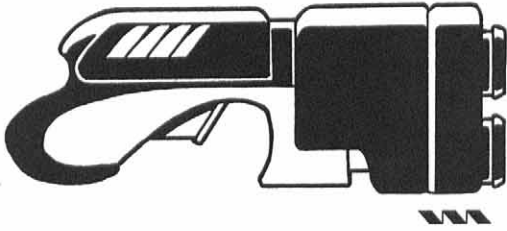

NE-H10 Plasma Derringer

This pistol is small enough to be hidden in a pocket or even up a sleeve (a sleeve holster, complete with a spring system that “shoots” the gun into the owner’s hand costs an additional 1000 credits). It has two miniature plasma cartridges that do less damage than a normal Naruni revolver but still packs more energy than a conventional laser. The only problem with this weapon is that its short barrel is uncomfortably close to the wearer’s hand. Each time the gun is shot, there is a 10% chance that the shooter’s hand will take 5D6 S.D.C. of heat damage from residual heat (no damage if wearing M.D.C. armor or insulated gloves).

Weight: Less than one pound (0.45 kg.)

Mega-Damage: 5D6 M.D.

Rate of Fire: Up to two shots.

Maximum Effective Range: 200 feet (61 m)

Payload: 2 plasma cartridges. Reloading the weapon takes one melee action per cartridge, or one melee action if a speed loader (200 credits) is used.

Cost: 10,000 credits. Each cartridge costs 15 credits.

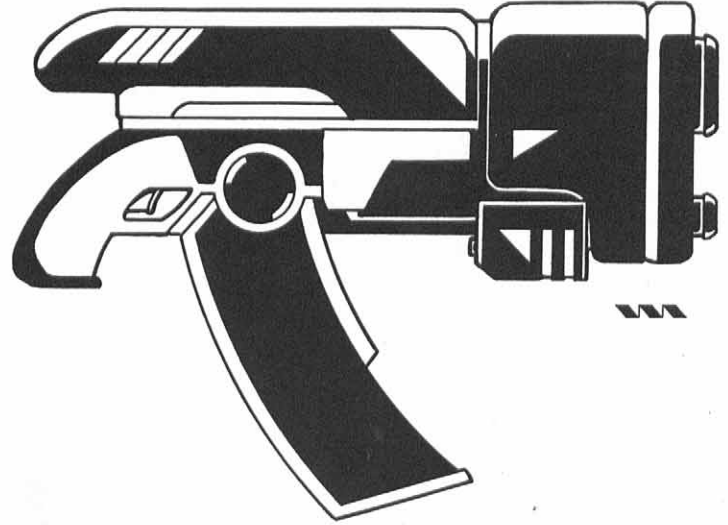

NE-300 “Stutterer”

The “Stutterer” is a plasma cartridge sub-machinegun, somewhat similar to a Thompson SMG from Earth, but much heavier. It uses a lighter cartridge than the standard Naruni weapons (the same cartridge as the NE-H10 and the NE-2L, previously described) to allow for a larger magazine capacity and automatic firing capability. The weapon’s short range makes it unsuitable for many military operations, but is ideal for house to house, urban combat, for boarding starships and any “close quarters” combat. Pirates and police forces prefer this weapon to assault rifles.

Weight: 20 lbs. (9 kg) with drum magazine, or 15 lbs. (6.8 kg.) with short clip.

Mega-Damage: A single shot does 5D6 M.D.; a 10 shot burst does 1D6×10+10 M.D.

Rate of Fire: A single shot or a burst counts as one melee attack.

Maximum Effective Range: 600 ft (183 m)

Payload: 50 shot drum magazine or 30 shot “banana” magazine.

Cost: 20,000 credits. Each cartridge costs 15 credits.

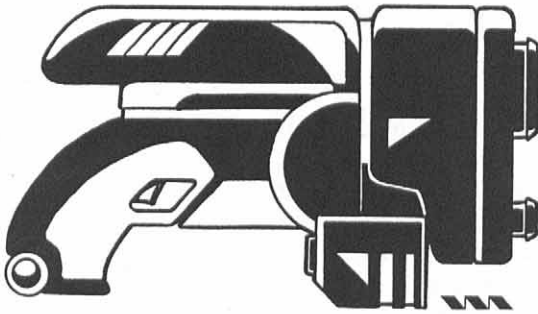

NE-2L Plasma Cartridge Autopistol

A “light” version of the NE-4 pistol that fires the same small cartridges used by the NE-H10. The NE-2L has more penetration and stopping power than most handguns on the market, and its magazine is built into the handle of the pistol rather than in front, making it less cumbersome than its heavier “cousin.” Several police and military units of the Three Galaxies have adopted the NE-2L as their standard sidearm. In some circles the weapon is dismissed as a “sissy gun,” although it is only slightly less powerful than the NE-4.

Weight: 4 lbs. (1.8 kg)

Mega-Damage: 5D6 M.D. per shot.

Rate of Fire: Standard for automatic pistols.

Maximum Effective Range: 500 feet (152 m).

Payload: 9 shot magazine.

Cost: 10,000 credits. Each cartridge costs 15 credits.

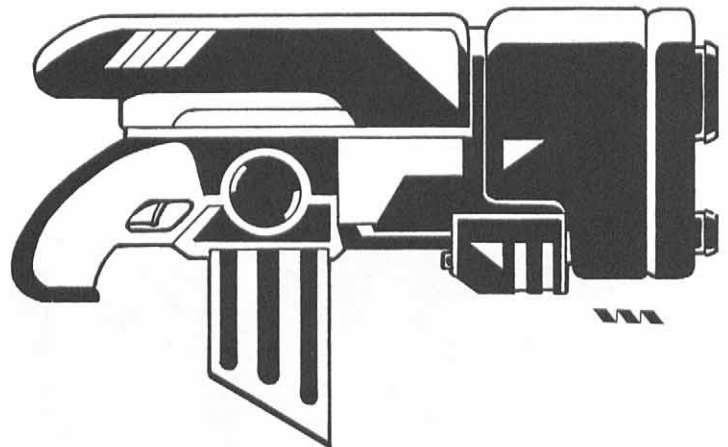

NE-600 Pulse Laser

Designed to be compatible with standard E-Clips, the NE-600 is built on the NE-300 frame (see above); the main outward difference between the two guns is the absence of a drum magazine in the NE-600. Like the plasma cartridge “Stutterer,” the NE-600 is a fast-firing weapon designed to shoot bursts. The laser

does more damage because the beam is “wider” than normal, affecting a larger area. For the same reason, it has a surprisingly short range for a laser, because the beam loses cohesion more quickly.

Weight: 14 lbs. (6.3 kg).

Mega-Damage: 4D6 per single shot or 1D6×10+10 per multiple pulse burst (three simultaneous shots).

Rate of Fire: Standard.

Maximum Effective Range: 600 feet (183 m).

Payload: 20 shots.

Cost: 30,000 credits.

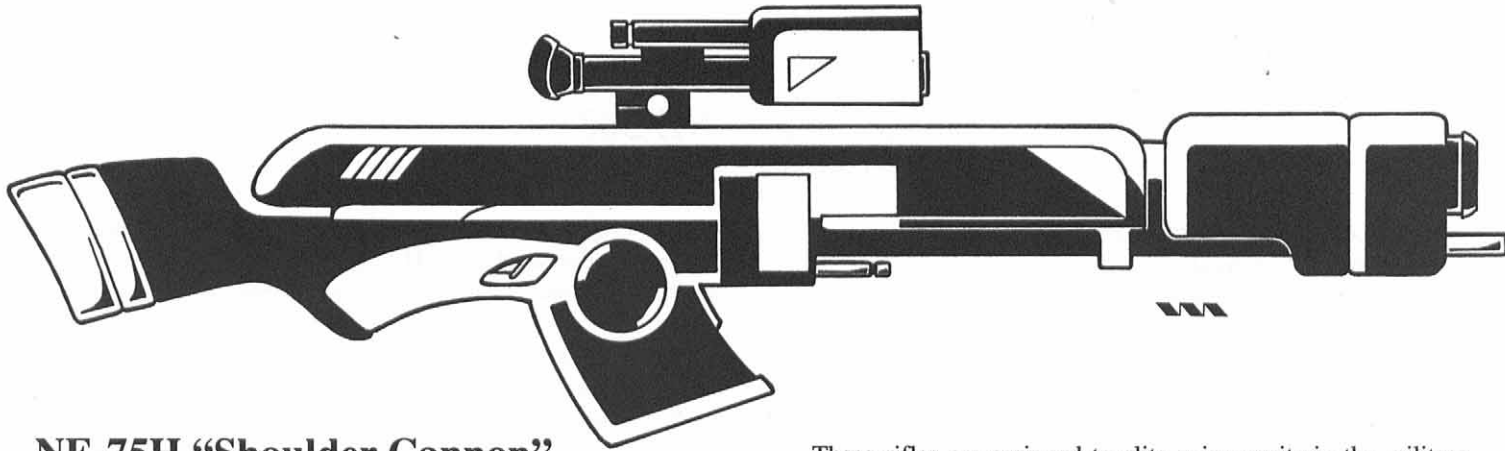

NE-75H “Shoulder Cannon”

The NE-75H is a sniper and anti-armor rifle somewhat similar to 20th Century Earth’s Barretta .50 caliber rifle. Like the Barretta, the NE-75H is a huge weapon, about 6 feet (1.8 m) long from the butt to tip, and much heavier than a standard rifle. Like all Naruni cartridge weapons, its bore is two inches wide. It fires an oversized version of the Naruni plasma cartridge with a much more powerful charge. Its range is an amazing 6000 feet (1830 m). Its sophisticated optic system makes it one of the most accurate weapons on the market. To make it more versatile, the Naruni weaponsmiths also sell a conversion kit that allows the gun to use “standard” plasma cartridges (reduce damage to 1D4×10+10 M.D., and range to 4000 feet/1200 m, but increase payload to 20 rounds). Refitting the gun with the kit takes 1D4 minutes.

These rifles are assigned to elite sniper units in the military and are also popular among assassins and big game hunters. The Free World Council has purchased several hundred to deal with kreeghor officers, especially Royal Kreeghor who are nearly invulnerable to conventional weapons.

Weight: 30 lbs. (13.6 kg).

Mega-Damage: 2D4×10+20 M.D. per shot from heavy bore cartridges. 1D4×10+10 M.D. for light NE-H10 and NE-2L cartridges.

Rate of Fire: Each shot counts as one melee attack.

Maximum Effective Range: 6000 feet (1830 m) or 4000 feet (1200 m) when using the light NE-10 cartridges.

Payload: 8 cartridges in magazine (20 with light cartridges).

Cost: 80,000 credits, plus 5,000 credits for the conversion kit. Each oversized cartridge costs 50 credits.

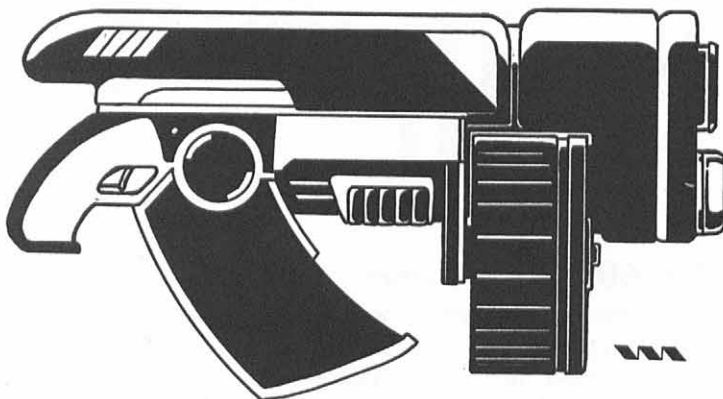

NE-95 “Double Threat”

Assault Rifle

This weapon is an over-and-under, two-barreled rifle. The lower barrel is a semi-automatic grenade launcher with a drum magazine. The upper barrel fires standard Naruni plasma cartridges. The drum magazine is located in the front, while the cartridge magazine is in the back in a “bull-up” configuration. Both weapon systems use the same trigger mechanism; switching from one to the other is a matter of pressing a button on the handle of the rifle. The resulting weapon is heavy and cumbersome for humanoid soldiers, but is a very useful weapon for cyborgs, robots, those with superhuman strength and troopers wearing exoskeletons and power armor. Wolfen and seljuk warriors, who are strong enough to disregard the extra weight, love this devas-

tating assault weapon and its particle beam equivalent, the NE-195 (see below).

Weight: 25 lbs. (11.3 kg)

Mega-Damage: Plasma Cartridge: 1D4×10 M.D. Grenade Launcher: Varies with grenade. Typically fires NE-10G fragmentation (4D6 M.D.) or high explosive (6D6 M.D.) grenades.

Rate of Fire: Standard. The shooter can only operate one weapon system at a time.

Maximum Effective Range: Plasma Cartridge: 1200 feet (365 m). Grenade Launcher: 1000 feet (305 m).

Payload: Plasma Cartridge: 20 round magazine. Grenade Launcher: 12 rounds drum magazine.

Cost: 42,000 credits.

NE-195 Assault Rifle

This weapon is almost identical to the NE-95, but it replaces the plasma cartridge action with a conventional plasma ejector system. The Consortium Armed Forces (CAF) have purchased several thousand of these weapons and distributed them among infantry squads, especially wolfen units.

Weight: 25 lbs. (22 kg)

Mega-Damage: Plasma Ejector: 6D6 M.D. Grenade Launcher: Varies with grenade. Typically fires NE-10G fragmentation (4D6 M.D.) or high explosive (6D6 M.D.) grenades.

Rate of Fire: Standard. The shooter can only operate one weapon system at a time.

Maximum Effective Range: Plasma Ejector: 2000 feet (610 m); Grenade Launcher: 1000 feet (305 m)

Payload: Plasma Ejector: 16 shots; Grenade Launcher: 12 shots.

Cost: 50,000 credits.

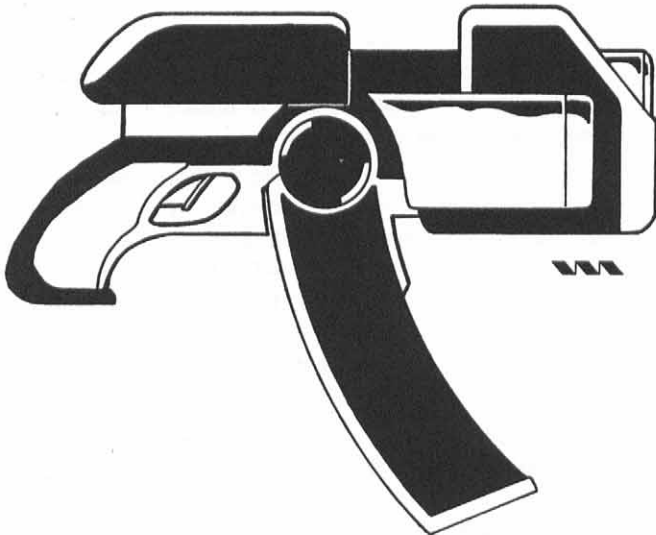

NE-74GL Grenade Launcher

The NE-74GL uses Naruni Enterprises new micro-grenades (see below). The small size of the grenades gives this weapon a greater payload and range than conventional grenades, allowing the wielder to spray a large area with explosives. So far, a number of mercenary armies have adopted this weapon. The weapon has a short “banana” magazine with 24 rounds or a drum magazine with 48 shots.

Weight: 21 lbs. (9.45 kg) with short magazine, or 30 lbs (18.6 kg). with drum magazine.

Mega-Damage: Varies with grenade type. Usually carries fragmentation (3D6 M.D. to a radius of 20 feet/6.1 m). A short burst is 8 rounds and will do the same damage to an area of 50 feet (15.2 m). A long burst (16 rounds) will do an extra 1D6 damage to an 80 foot (24.4 m) area.

Rate of Fire: Standard

Maximum Effective Range: 4000 feet (1220 m)

Payload: 24 or 48 shots.

Cost: 75,000 credits. The grenades cost 350 credits each.

K-HEX Explosives

Naruni Enterprises has released a new explosive substance called K-HEX (Killaryte High Explosive). Killaryte is a strange crystalline substance found only on a few planets in the Three Galaxies. Researchers have determined that Killaryte is created through the same natural process as coal and petroleum — decomposed organic matter subjected to enormous pressures deep underground. Whereas petroleum and coal are flammable, however, Killaryte is extremely explosive; about ten times more explosive than conventional explosives. The crystals are also ten times more unstable than nitroglycerin, so even minor vibrations could detonate it! Somehow, Naruni Enterprises has been able to stabilize Killaryte and manufacture a chemical explosive more powerful than plasma explosives!

K-HEX products include plastique cubes, explosive ammunition, grenades, and an entire line of missiles, among them a new type of *micro-missile*. A number of military organizations in the Three Galaxies have conducted tests with the new explosives, which have exceeded expectations on every front. Naruni Enterprises is just beginning to introduce these weapons to other markets in the Megaverse, including Rifts Earth. The corporation is confident it can corner the explosives market in a matter of years. The only obstacle to this plan is the price of K-HEX; the substance is a lot more expensive than conventional explosives.

The discovery of how to stabilize K-HEX has changed Killaryte from being a dangerous element to a valuable commodity. Worlds that had been shunned due to high concentrations of this unstable substances have been turned into prosperous mining colonies overnight. Not surprisingly, shortly before K-HEX was made public, Naruni Enterprises acquired exclusive mining rights to several of those planets for a ridiculously low price. The corporation also continues to purchase this mineral from private individuals. Several other corporations and military research organizations are working hard at discovering the process that makes Killaryte relatively stable and usable, but so far, without success. Since NE has cornered the market, other sources of Killaryte are scarce and the prices for it are exorbitant; still, many researchers will pay high prices for any amount.

In its natural form, the crystals are extremely dangerous. Even a loud noise has a 20% chance of setting off Killaryte crystals. Any sort of impact (such as dropping a case of the crystals on the floor) has a 60% chance of causing an explosion. The only safe way to transport Killaryte is to surround it in soft cushioning materials and keep it in a contra-gravity chamber, using gravity fields to keep the cases firmly anchored. Natural Killaryte is actually more explosive than K-HEX: each pound of the crystals does 2D4×10 M.D. to a 50 foot (15.2 m) radius when it

explodes! 2,000 lbs. (907 kg) of the crystal could vaporize a star-ship!!

K-HEX Plastique Cubes

K-HEX cubes are sold in units of one pound (0.45 kg). These cubes are as easy to mold as *Silly Putty*, and can only be exploded with a detonator or by triggering an explosion on top of them. They are ideal for breaking through ship bulkheads, hatches, safes, and security doors. The substance is also used to make booby-traps and improvised mines. A demolitions skill roll is necessary to get the most out of the explosion. A failed roll means the explosive does 1/5 of its normal damage.

A one pound cube of K-HEX does 1D6×10 M.D. to a 20 foot (6.1m) area. By molding it around an object, the damage can be focused and doubled. Used as a thrown weapon, the cubes are not very effective; damage is reduced to 5D6 M.D. to a 10 foot (3.0 m) area.

Cost: 1000 credits per cube.

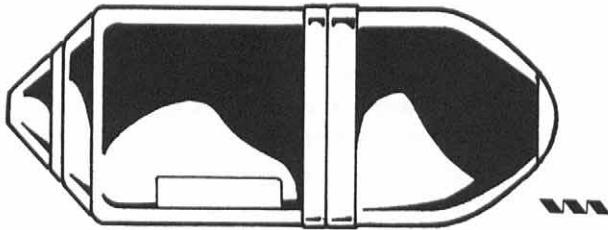

NE-10G Grenades

A new line of Naruni Enterprise grenades use K-HEX. They are the NE-10G grenades and come in fragmentation and high explosive variants. These grenades can be used on any standard grenade launcher weapon system, including Naruni's new "Double Threat" assault rifle. NE-10G grenades can be thrown or fired from a launcher and their hand-set timers can delay detonation for up to one minute, or can be set to go off as quickly as two seconds.

Fragmentation: 4D6 M.D. to a 30 foot (9.1 m) area.

High Explosive: 6D6 M.D. to a 12 foot (3.6 m) area.

Cost: 400 credits for fragmentation and 500 credits for high explosive.

NE-20G Micro-Grenades

The enhanced power of K-HEX grenades has allowed Naruni Enterprises to produce a line of small grenades about half the size of a shotgun shell and which are roughly as powerful as conventional hand grenades! The small size of the NE-20Gs makes them ideal for grenade launchers (see the NE-74GL, above). They are also useful for spies and assassins, because the little explosives can be easily disguised as harmless items like lipstick, marker pens, flashlights, etc.

Fragmentation: 3D6 M.D. to a 20 foot (6.1 m) area

High Explosive: 4D6 M.D. to a 6 foot (1.8 m) area.

Cost: 300 credits for fragmentation or 350 credits for high explosive.

Naruni Guided Missiles

Naruni Enterprises has developed guidance systems for mini-missiles, as well as short and medium-range missiles. These guided missiles work like smart missiles: +5 to strike, +4 to dodge, and have two attacks per melee. Their radar systems have a range equal to the missile's attack range: about one mile (1.6 km) for mini-missiles, 3 to 5 miles (4.8 to 8 km) for short-range missiles, and approximately 50 miles (80 km) for medium range.

Cost: The guidance system costs 15,000 credits in addition to the cost of the missile.



Naruni Micro-Missiles

Micro-Missiles are a triumph of Naruni technology and are rapidly becoming the rage in the Three Galaxies. These weapons combine sophisticated miniaturized guidance and contra-gravity systems with a K-HEX warhead. The resulting rocket explosive is roughly the size of a magic marker, but it has almost the same explosive power as a mini-missile! Plus it can be purchased in a "smart" version that can track down its target!!

Smart missiles can shoot around corners and track down a target through a crowd, making them ideal for snipers. Non-smart versions are cheaper but can only be used as direct-fire weapons. The NE-28R wrist launcher is already a best-seller in the mercenary and outlaw community.

Smart micro-missiles are +4 to strike. If they miss, they will double back and attack again (two attacks per melee round!). Their size makes them very difficult targets to hit (require a called shot to strike and can dodge at +4!). They fly at relatively low speeds (Speed 88, or 60 mph/96 km) to weave around obstacles. If the target is fast-moving or there is a relatively clear path towards it, the missile can attain a flight speed of up to Mach 2! Standard missiles use the shooter's bonuses to strike, and fly in a straight line at about Mach 2.

Damage: Armor-piercing only: 6D6 M.D. to a 3 foot (0.9 m) area.

Range: One mile (1.6 km) for "dumb" missiles; 2 miles (3.2 km) for smart micro-missiles.

Cost: 1600 credits for a standard missile; 8000 for a smart micro-missile. See launch systems, below.

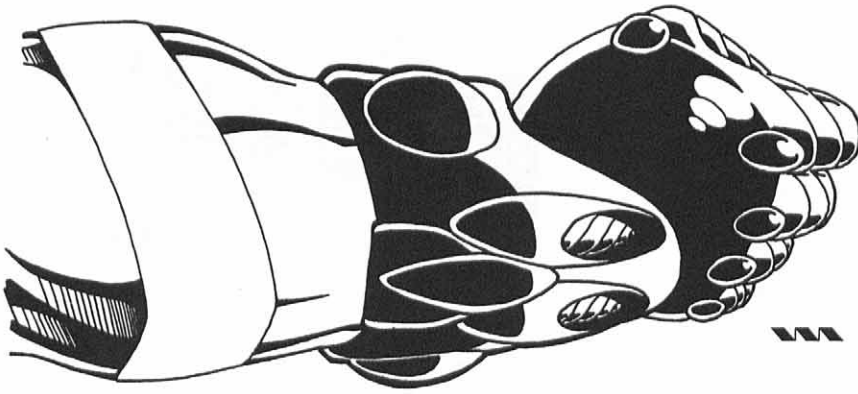

NE-28R Micro-Missile

Wrist Launcher

The NE-28R is mounted on the wrist and forearm, and fires two micro-missiles. The weapon should only be used while wearing body armor, because the heat of the missiles' exhaust will inflict 5D6 S.D.C. to unprotected skin and leaves ugly scars. The launcher makes a handy back-up weapon and is easy to conceal, thus it has become a favorite among spies, mercenaries, pirates, assassins and outlaws. The weapon can also be built into body armor, power armor or bionic arms (add 7,000 credits for installation costs and increase the payload to four; giant-sized robots can have as many as ten micro-missiles in a forearm, shoulder or chest launcher).

The wrist launcher is typically loaded with "dumb" (non-guided) missiles, but it can use either kind.

Weight: 3 lbs. (1.35 kg)

Mega-Damage: 6D6 M.D. to a 3 foot (0.9 m) area.

Rate of Fire: One at a time or volley of two.

Maximum Effective Range: Typically one mile (1.6 km).

Payload: Two micro-missiles. Reloading the launcher takes one melee action per missile. A missile pouch holding 10 micro-missiles weighs 10 lbs. (4.5 kg) and can be carried in a hip-pack, shoulder pack, or backpack.

Cost: 50,000 credits for the wrist launcher; micro-missiles sold separately.

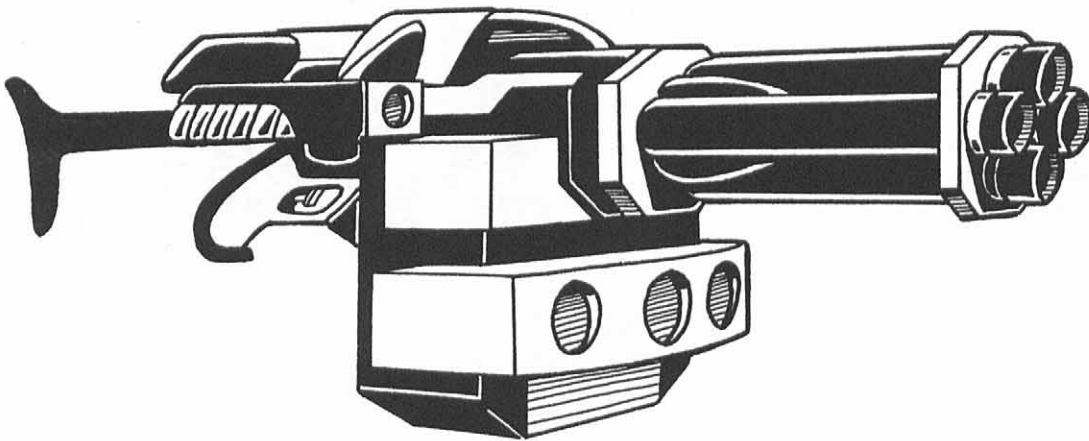

NE-800R

Missile Assault System

Touted by the Naruni publicists as "the ultimate small arm," the NE-800R can be used as an anti-personnel, anti-armor and anti-aircraft weapon system, all in a relatively compact package. The launcher-rifle resembles a shortened four-barreled shotgun with a large box magazine. The magazine can be loaded with "dumb" micro-missiles and used as a devastating assault rifle, or use smart micro-missiles to fire at long distance targets, aircraft, flying power armor, etc. The weapon is somewhat bulky and heavy, but supernaturally strong races like the seljuk and catyr

love it, as do cyborgs and robots. The main drawback of the weapon is its high cost, especially for its ammunition.

Weight: 22 lbs. (10 kg)

Mega-Damage: 6D6 M.D. per missile to a 3 foot (0.9 m) area.

Rate of Fire: One at a time or volleys of two, three or four missiles. Each volley counts as one melee attack.

Maximum Effective Range: One mile (1.6 km).

Payload: 16 missiles in a box magazine. Changing magazines takes up two melee actions.

Cost: 80,000 credits for the rifle; micro-missiles sold separately.

K-HEX Missiles

Besides micro-missiles, a whole line of K-HEX explosive missiles have been released on the market. These missiles do more damage but are considerably more expensive (double normal cost), which has limited their popularity to wealthy mercenaries, armies and governments. Adventurers, space explorers, pirates and mercenaries with the necessary funds are snapping them up in small quantities.

Mini-Missiles: Fragmentation: 1D4×10 M.D.; Armor Piercing: 1D6×10 M.D.; High Explosive: 1D4×10 M.D.; range and blast radius remains unchanged; same as normal mini-missiles.

Short-Range Missiles: High Explosive (medium only): 2D4×10 M.D.; Fragmentation: 1D6×10 M.D.; Armor Piercing: 2D6×10 M.D.; range and blast radius remains unchanged; same as conventional missiles.

Medium-Range Missiles: High Explosive (medium): 2D6×10 M.D.; High-Explosive (heavy): 3D4×10 M.D.; Fragmentation: 2D6×10 M.D.; range and blast radius remains unchanged; same as conventional missiles.

Long-Range Missiles: High Explosive (Medium): 3D4×10 M.D.; High Explosive (Heavy): 4D6×10 M.D.; Fragmentation: 3D6×10 M.D.; Armor Piercing (heavy): 4D6×10 M.D.; range and blast radius remains unchanged; same as conventional missiles.

Cost: Double the cost of conventional missiles.

Other Weapons & Weapons Manufacturers

Naruni Enterprises is not the only weapon manufacturer in the Three Galaxies. The **Kreeghor Foundries**, a government-owned company, produces most of the Transgalactic Empire's weaponry and even sells some of its surplus production at neutral markets, including Phase World. Half a dozen gun makers exist in the CCW, among them **Wolfpack Weapons**, a wolfen controlled corporation, responsible for the *Phalanx Battletank* and the *Packmaster Dreadnought* spaceship, among other vehicles. **Malkovitch Armaments, Inc.**, specializes in gravity weapons. **Bushido Industries**, controlled by the oni race, specializes in energy and advanced weaponry. The **Galactic Armory** is a large government weapons contractor operating in the Three Galaxies, while the United World's major manufacturer is the **Smithy** (both the planet and the guild-owned company have the same name). The Smithy makes both advanced technological weapons, like the Volcano plasma projector, and techno-wizard items.

“Slicer” GR-Gun Malkovitch Armaments

The Slicer is a gravity gun that fires ultra-sharp spinning darts (similar to Japanese shurikens) instead of conventional metal slugs. These 100mm four-bladed darts are not only effective ar-

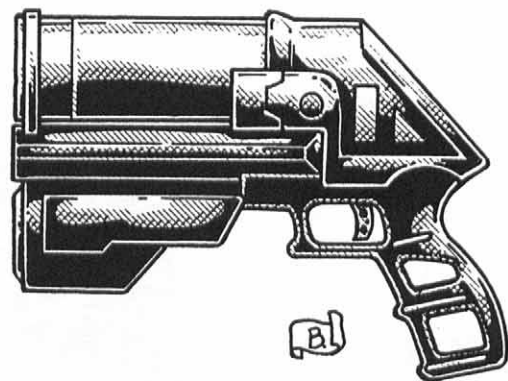

mor piercers, but can be used to sever lines, hoses and cables. The weapon is loaded through a barrel-shaped magazine lying lengthwise over the receiver and barrel; twelve disks are stacked inside. They are intimidating weapons favored by bounty hunters, outlaws and adventurers. Their main drawback is their unique ammunition, which can be hard to find in remote areas of the Three Galaxies.

Weight: 6 lbs. (2.7 kg)

Mega-Damage: 4D6 M.D. per shot.

Rate of Fire: Single shot only; each shot counts as one melee action/attack.

Maximum Effective Range: 800 feet (244 m)

Payload: 12 shots

Cost: 15,000 credits. Each loaded magazine costs 1,500 credits.

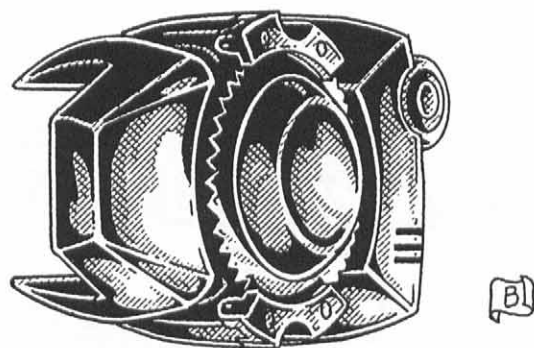

“Death Disk” Weapons System Malkovitch Enterprises

This highly sophisticated weapon combines a miniaturized computer guidance system with a battery-powered contra-gravity system to produce a flying buzz-saw!

The spinning, “buzz-saw” disk is released from a wrist mounting on the arm and flies to attack one target, attacking repeatedly, or to strike at several targets, or even follow one specific target for several yards!!

The weapon system consists of a 5 inch wide (12.7 cm) jagged disk with mono-molecular M.D.C. edges and a wrist mounting that can be built into body armor, power armor, cyborg and robot limbs, or worn as a long metallic glove. At the center of the disk is a smaller, slightly thicker disk which contains both the guidance system and the contra-gravity generator. A laser aiming system is built into the wrist mounting/disk launcher and can be linked to a Heads-Up-Display (HUD) built into a helmet. The weapon user designates a target by “pinging” him with a

low-power laser beam (inflicts no damage). A split-second later, the disk is fired from the wrist mounting and flies towards the target at bullet speed.

Multiple targets can be selected by “illuminating” them with the laser aiming system, one after another — the disk strikes at the first victim and then immediately changes trajectory to strike whatever target is designated next by the laser. Keeping the laser trained on one target will cause the disk to strike that target repeatedly (equal to the operator’s number of attacks per melee round). Each laser designation requires the character using the death disk to point and aim at each desired target, making this primarily a “line of sight” system. Each act of pointing or targeting action counts as one melee attack. The disk will fly from one target to the next and finally dart back towards the shooter and reattach itself to the wrist mounting at the end of the melee round (a 15 second period).

The shooter can also send the disk on a “search and destroy” mission, in which the computer guidance system will follow *one* specific target whose image is temporarily stored in a memory chip on the disk and pursue that target until it strikes. In this mode the disk can dart through crowds and around obstacles to strike the designated target, but only once. If the target, hides behind a barrier and the disk cannot get to him within one melee round, it flies back to the shooter, reattaches itself to the firing mechanism and waits to be fired again (at the same or a different

target). **Note:** In both modes, the disk is self-guided: +4 to strike and +2 to dodge/avoid obstacles. If it hits an obstacle (like somebody leaping in front of it or a force field barricading its way, the disk hits the interfering target and returns to the shooter.

Weight: 7 lbs. (3.2 kg) counting both the disks and the wrist housing/metallic glove.

Mega-Damage: 5D6 M.D. per strike

Rate of Fire: 3 times per melee when in the “search and destroy” mode, or once for every hand to hand attack of the wearer if attacking multiple targets.

Maximum Effective Range: 500 feet (152 m), but it is considered to be most effective at 200 feet (61 m) and closer (less likelihood of interference from obstacles and attackers).

Payload: One disk. The battery on the glove launcher has an 18 hour life even with frequent use, before requiring recharging (takes three hours to recharge). Two spare disks can be carried in a pouch that can be attached to a belt. A spare can only be used when the original disk is destroyed; the aiming and guidance system cannot coordinate the attacks of more than a single disk. It takes two melee rounds (30 seconds) for the launch and targeting system to link with and encode with the new disk. Each disk has an M.D.C. of 8.

Cost: 80,000 credits. Each battery costs 500 credits. The old battery can be removed and a new battery hooked-up in 1D4 minutes.

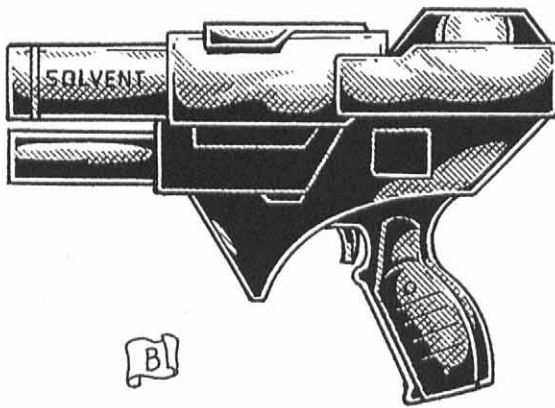
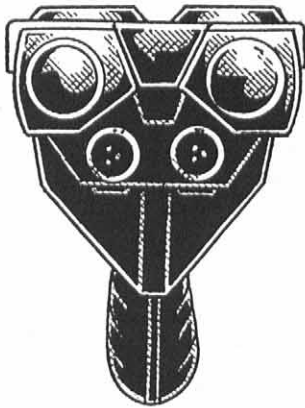

Web Gun

This weapon is used to subdue enemies without harming them. The web gun fires a sticky foam that hardens upon contact. It is similar to a 20th Century Earth prototype used by police and the military, only this foam is much harder, forming an M.D.C. coating around the target. Only cyborgs, robots and characters with supernatural strength or clad in power armor can hope to break free. These characters can inflict the equivalent of their punch damage to the foam coating every melee round they struggle.

The gun has two nozzles. One fires the foam, the other sprays a solvent to remove the foam. Web guns are bulky and heavy, roughly the size of a sub-machinegun. The two canisters (one for the foam, the other for the solvent) are mounted side by side above the twin barrels.

Web guns are commonly found in the police forces of most CAF planets. They are rarely used by the Transgalactic Empire, since taking prisoners is not a high priority there. Pirates, bounty hunters, slavers and kidnappers also use them to capture valuable people.

Weight: 13 lbs. (5.9 kg)

Mega-Damage: None. Each shot fires a stream of foam that will envelop a target 8 feet (2.4 m) tall or smaller. Each shot covers its victim with 4D6 M.D.C. of hardening foam. Additional shots will add M.D.C. to the covering. The second nozzle fires a solvent that will remove 6D6 M.D.C. worth of foam per shot.

Rate of Fire: Standard.

Maximum Effective Range: 400 feet (122 m)

Payload: 20 blasts of foam (and 20 of solvent) per canister.

Cost: 2,000 credits

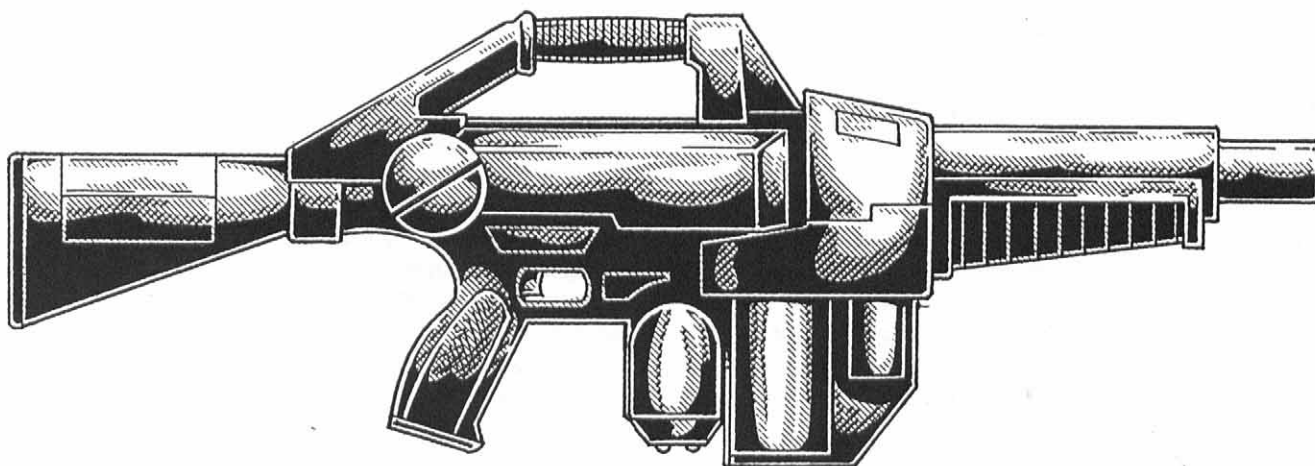

“Colonial” HI-Laser Rifle

Galactic Armory

This HI-Laser rifle is a bulky weapon with a carrying handle on top. The “Colonial” is primarily used by people in remote areas who may not have access to E-clips. The weapon is designed with its own internal battery and can recharge energy in several different ways. Built inside the stock is a solar collector that can be assembled in a few minutes. The solar receptors, once unfolded, cover an area of 10 feet/3.1 m. The gun also has an adapter cord that allows it to tap into the power of any nuclear or anti-matter power plant, which are found in many vehicles. The weapon has a guaranteed life of 20 years before the batteries finally decay. They are a favorite among colonists and guerrilla fighters.

Weight: 21 lbs. (9.5 kg)

Mega-Damage: 4D6 per single shot. Can only fire single shots

normally, but a competent armorer can “convert” it to fire multiple pulse bursts, inflicting 1D6×10+10 M.D. (three simultaneous shots; counts as one melee action).

Rate of Fire: Single shots only, unless converted.

Maximum Effective Range: 2000 feet (610 m)

Payload: 30 shots. One minute of bright sunlight (two minutes of normal sunlight, five minutes if lightly overcast, and nothing if heavily overcast or at night) will recharge one shot via the use of the solar receptors. Typically it will take about one hour of normal sunlight to recharge the entire battery. The entire battery can also be recharged from a nuclear or anti-matter power plant, in five minutes.

Cost: 35,000 credits. For an additional 5,000 credits, the battery can be modular and easily replaceable by another battery (will not accept normal E-clips). Each battery costs 6,000 credits and weighs 5 lbs. (2.25 kgs). A rifle with automatic fire capability is only available on the black market and might cost an additional 10,000 credits.

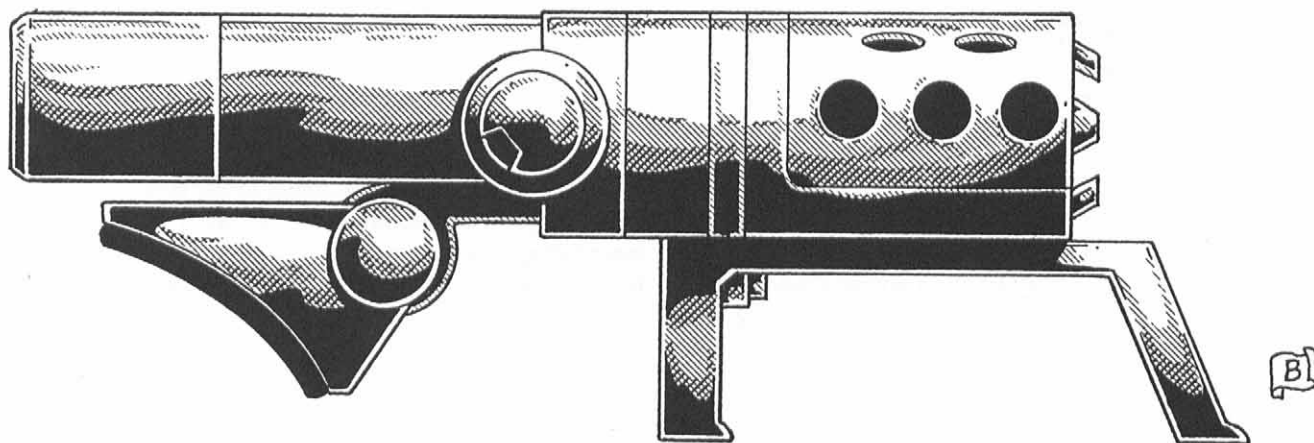

V-81 Volcano Mark-I

Plasma Discharger (UWW)

This heavy energy weapon consists of a squat plasma tube with a shoulder rest and is fired like a bazooka or rocket launcher. It also has large handles that make it suitable for use by giants, over-sized cyborgs and the wearers of power armor. The V-81 Volcano fires intense bursts of plasma. It has two settings:

one concentrates the plasma jet on a small area (used against armored targets); the other one fires a wide blast that can affect several targets, start fires, and melt down walls, starship hulls, and other obstacles. The gun can be used by soldiers in power armor or humanoids with a P.S. of 24 or greater. Assault infantry squads of the United Worlds of Warlock are usually assigned one V-81. This is also the sidearm of the dreaded Warlock Marines.

Weight: 60 lbs. (27.2 kg). A long E-clip adds 5 pounds (2.25 kg) and a canister adds 10 pounds (4.5 kg)

Mega-Damage: Concentrated Blast: 1D6×10 M.D. Wide Blast: 4D6 M.D. to any targets in a 30 foot (9.1 m) area or 2D6×10 M.D. to a 30 foot/9.1 m length of wall or starship hull.

Rate of Fire: Each blast counts as one melee attack. Cannot fire bursts.

Maximum Effective Range: Concentrated Blast: 4000 feet (1200 m). Wide Blast: 2000 feet (610 m)

Payload: 8 shots with standard E-clip, 16 with long E-clip, or 24 with energy canister

Cost: 120,000 credits.

Daisho-10 Multiweapon

Bushido Industries

The Daisho-10 uses nanotechnology (microscopic machinery) to create this exotic multi-purpose weapon. The Daisho-10 is two weapons in one: a laser sub-machinegun and a vibro-sword. The weapon can be configured to either of those shapes with the touch of a button. In a matter of seconds (15 seconds, or one melee round), the gun's barrel compresses into a sword shape, or vice versa, and the handle shifts to provide a proper grip for the weapon. The same E-clip powers both versions (fitted into the pommel/handle).

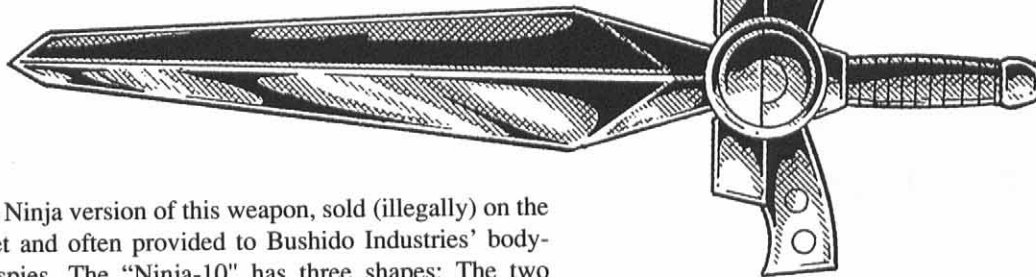

There is a Ninja version of this weapon, sold (illegally) on the Black Market and often provided to Bushido Industries' bodyguards and spies. The "Ninja-10" has three shapes: The two weapons, and a harmless-looking object, typically a video camera or a hand computer (fully operational, by the way). The Ninja-10 can fool conventional weapon detectors (85% chance of getting through undetected while in the non-lethal shape), making it ideal for assassins, spies, and terrorists.

Weight: 6 lbs. (2.7 kg)

Mega-Damage: 4D6 M.D. as a laser, or 3D6 M.D. as a high-powered vibro-blade.

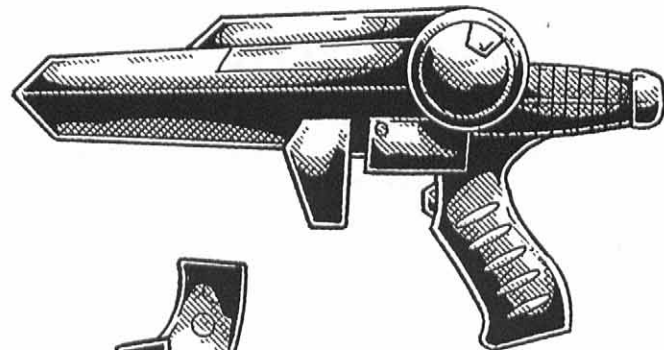

Rate of Fire: Standard.

Maximum Effective Range: 2000 feet (610 m) for the laser version.

Payload: 20 shots or 20 minutes of vibro-blade use; each minute (4 melee rounds) as a vibro-blade use up one "shot."

Cost: 60,000 credits. The Ninja-10 version (with a third shape, usually a camera or hand computer) goes for 100,000+ credits on the Black Market.

PB-60 Blast Pistol (UWW)

These weapons are similar to the kreeghor energy pulse pistol (see **Rifts Phase World**, page 116), but rather than firing bursts, they release steady streams of charged particles. The resulting weapon has a greater rate of fire but less penetration and damage. Blast pistols and rifles are commonly used by the United Worlds of Warlock (about 50% of the Warlock Navy use this weapon; the other 50% are issued HI-lasers, energy pulse weapons and even some plasma cartridge rifles).

Weight: 3 lbs. (1.4 kg)

Mega-Damage: 2D6 M.D.

Rate of Fire: Standard. Can fire short and long bursts (see **Rifts RPG**, page 34).

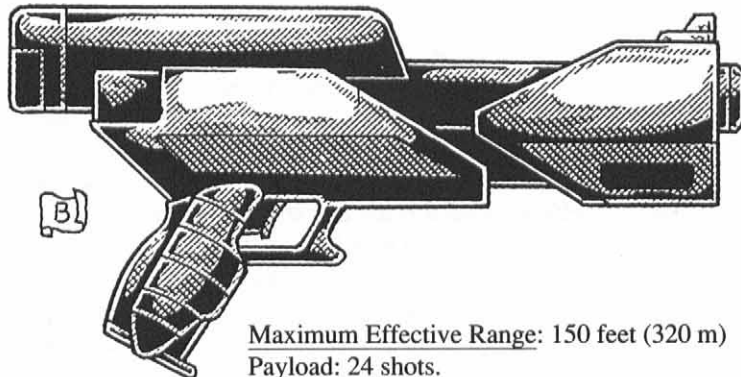

Maximum Effective Range: 150 feet (320 m)

Payload: 24 shots.

Cost: 10,000 credits.

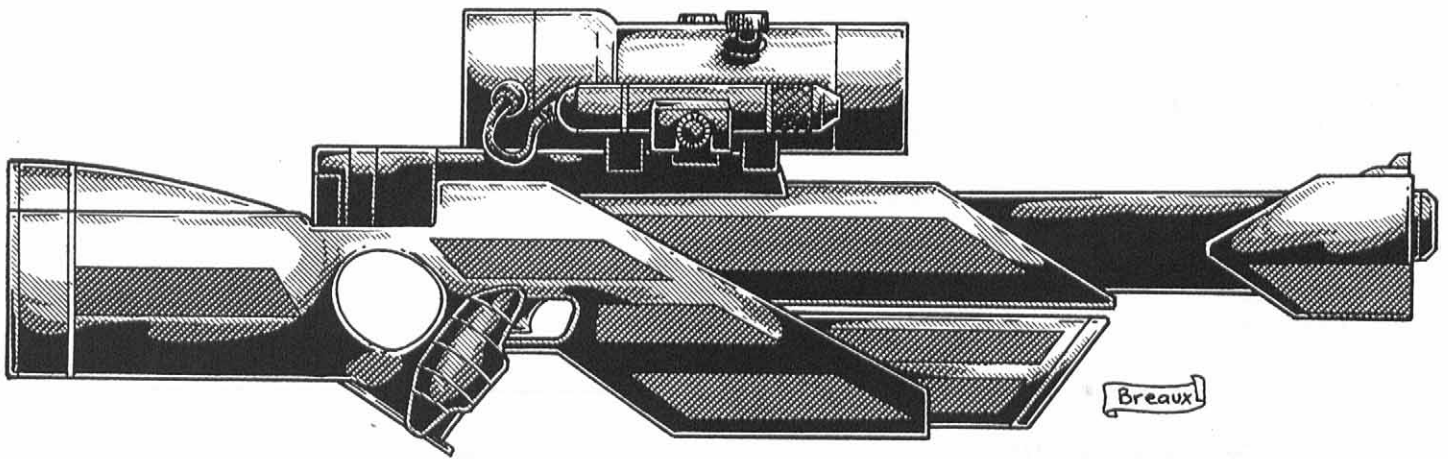

PB-85 Blast Rifle (UWW)

A military rifle that has selective fire capabilities. It normally uses a long E-clip but will accept standard E-clips. Sniper versions come with a high-powered scope and laser targeting devices for an extra cost.

Weight: 7 lbs. (3 kg)

Mega-Damage: 3D6 M.D. single shot or 1D4×10 M.D. multiple pulse burst (three simultaneous shots).

Rate of Fire: Standard.

Maximum Effective Range: 2600 feet (792 m)

Payload: 48 shots long E-Clip or 24 shots short E-Clip.

Bonus: Sniper version with scope is +2 to strike on an aimed shot (single shot only).

Cost: 22,000 credits; 30,000 for the sniper version.

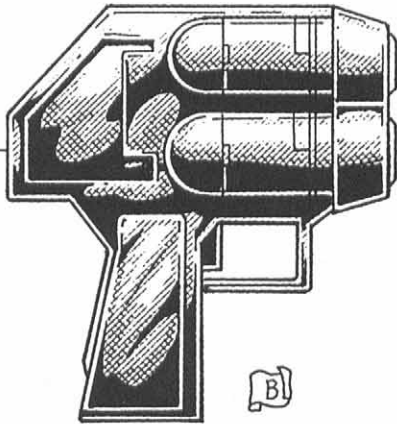

HW-19 Stun Pistol

This short handgun is designed to subdue people without harming them (HW is short for Humane Weapon). The beams from this weapon cause temporary loss of muscle control. Every time a person is hit, the weapon reduces both the *speed* and *physical prowess* attribute by 3D6 each, plus the victim loses one melee attack and is at -3 to all combat actions. Each stun blast has cumulative effect on the victim. When either of the two attributes is reduced to zero, the character collapses, still fully conscious but unable to move. Combat is impossible unless the character has psionic abilities or other special powers (like eye beams). The effects of each beam that struck lasts for 2D6 minutes (half that for characters with a P.E. of 18 or higher and only one-quarter for characters with a P.E. of 28 or higher).

Victims wearing fully sealed body armor can save against the effects of the stun pistol equal to save vs lethal poison (14 or bet-

ter). A successful save means the beam has no effects. M.D.C. non-supernatural creatures can also save (12 or better), and even if they fail their save, they only take half "damage." Supernatural beings like demons and dragons are unaffected.

Stun guns are usually carried by civilians as a defensive weapon. Police organizations, kidnappers and people who need to "bring 'em back alive" also favor both this weapon and the web gun.

Weight: 2 lbs. (0.9 kg)

Mega-Damage: No damage. Instead, P.P. and Spd are reduced by 3D6 each and attacks per melee by one; see the description above.

Rate of Fire: Single shots only.

Maximum Effective Range: 1000 feet (305 m)

Payload: 20 shots.

Cost: 3,200 credits.

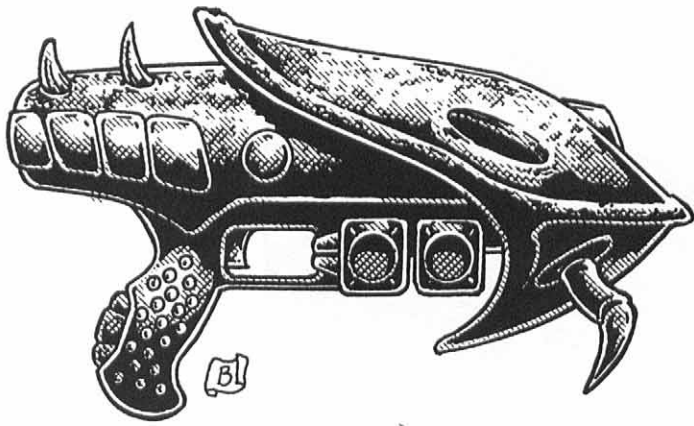

T'Zee Piranha Gun

This highly unusual weapon uses the t'zee race's mastery of nanotechnology (the T'Zee are described in the CCW section) to kill and maim victims. The weapon is a gravity-powered grenade launcher (can also use mini-grenades instead of piranha rounds). It fires hollow spheres filled with nanomachines — microscopic robots programmed to eat both M.D.C. alloys and living flesh! On impact, the target is covered by a liquid (actually, millions of nano-machines floating in a saline solution) which starts “eating” into him like a powerful acid!! The nanomachines “die” off in 1D6 melees, but until then they will devour the armor and the character inside!

Weight: 3 lbs. (1.4 kg)

Mega-Damage: 4D6 M.D. per melee round to armor and M.D.C. creatures, 3D6 to S.D.C. beings. This damage is inflicted for

1D6 melee rounds! Multiple shots at the same target each do damage separately! The only way to get rid of the devouring mecha-virus is to subject oneself to intense fire or vacuum. One melee round of exposure to a vacuum will freeze-dry the nanites. 60 S.D.C. points or any amount of M.D. fire damage will terminate them within half a melee round (7 seconds).

The gun can also fire mini grenades (3D6 M.D. to a 3 foot/0.9 m area) rather than the devouring solution, giving it a deadly versatility that t'zees and evildoers like.

Rate of Fire: Single shots only.

Maximum Effective Range: 400 feet (122 m)

Payload: 6 shots.

Cost: 30,000 credits for the gun; each nanomachine round costs 1,000 credits. Mini-grenades cost only 50 credits each.

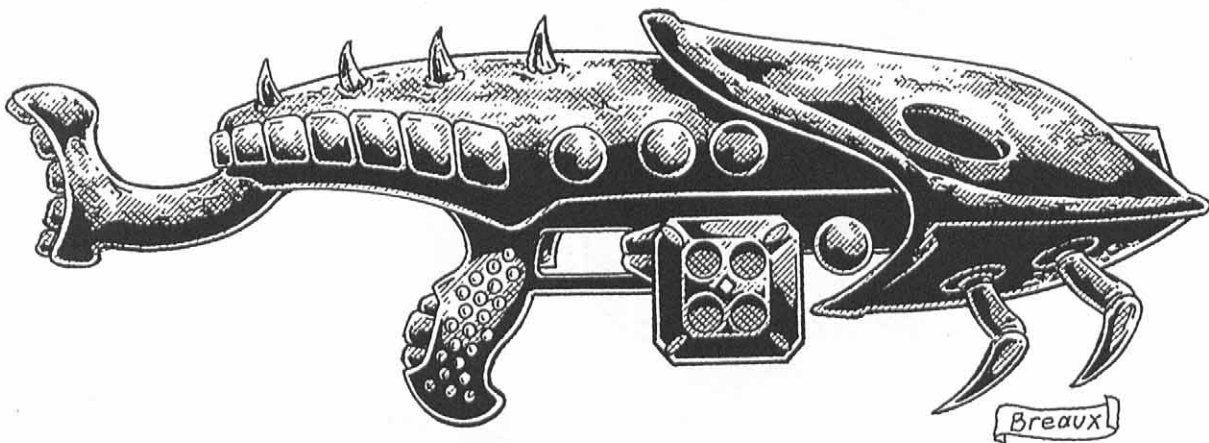

T'Zee Piranha Rifle

Same as the Piranha pistol, above, but with greater range and ammo capability. T'zee security forces are sometimes equipped with these brutal weapons. The CCW has declared the use of Piranha weapons illegal, but the leaders of Malthus' World are fighting this law in the courts. In the meanwhile, t'zee weapons dealers cheerfully sell the weapon to pirates, murderers and anybody who can afford it.

Weight: 7 lbs. (3.2 kg)

Mega-Damage: 4D6 M.D. to armor and M.D.C. creatures, 3D6 to S.D.C. beings, for 1D6 melee rounds! The gun can also fire micro-grenades (3D6 M.D. to a 3 foot/0.9 m area). See the Piranha pistol above, for complete details.

Rate of Fire: Single shots only.

Effective Range: 1000 feet (305 m)

Payload: 12 shots.

Cost: 48,000 credits for the gun; each nano-machine round costs 1,000 credits. Mini-grenades cost only 50 credits each.



Power Armor

Warlock Combat Armor (UWW)

The feared Warlock Marines (see Warlock Marine O.C.C.) use this suit of power armor exclusively. It is unique in that it combines high technology, techno-wizardry and standard magic. A mystical bond is forged between the suit of armor and its wearer, making it in effect, an extension of the marine's body. The reaction time and speed of marines in warlock combat armor are unmatched by "mundane" suits. The only drawback to the magical linking process is that the armor will accept and recognize only its original wearer. If the pilot is killed, the armor needs to be re-linked to a new owner, a complicated and expensive process only slightly cheaper than manufacturing a new suit.

The warlock combat armor is bulky and threatening in appearance, with heavy shoulder and chest plates, thick legs and a helm-shaped headpiece. Due to the mystical link with the wearer, it moves incredibly fast despite its bulk, and is also amazingly strong and agile for power armor of its size; the armor magically instills its wearer with supernatural strength! There is also a lighter version (the W-F1 suit) that is slightly more slender, and which has flying capabilities.

Warlock armor only has a wrist blaster and a shoulder mounted mini-missile launcher in terms of built-in weapons. The standard issue sidearm of the Marines is a Volcano Mark I plasma projector in a rifle configuration. For close combat, a short vibro-sword is employed to augment the already formidable strength of the Marine. Other weapon systems commonly carried by Marines include gravity guns, heavy lasers, and multi-missile launchers (described below).

In addition to its obvious armored protection, the suit is enchanted with the armor of Ithan spell for added protection (the spell can be activated three times per 24 hour period). The sensor system in the suit combines technological IR and UV sights, laser targeting system and radar with magical/psychic senses like see the invisible, sense evil and presence sense. A final magical spell in the armor prevents it from being used against the people and property of the United Worlds of Warlock, unless the intended victim(s) have first been declared criminals or traitors by the authorities. Attempts to go against the spell will cause the armor to self-destruct! Other bonuses the armor grants is resistance to hostile spells (+3 to save versus magic). The other side of this mystical link, however, is that the anti-magic cloud spell has a chance to cause the armor to stop working (see the **Rifts RPG**, page 182, for information about that spell). The armor saves at +3 against that and other anti-magic spells.

Warlock Marines who have finished their tour of duty honorably, can opt to keep their suit of armor. Many do so, either to keep it proudly on display at their homes or places of business (many a bar owned by an ex-Marine has one or more suits in exhibit), or to use it while adventuring or serving as a mercenary (so long as the trooper never goes against his own people).

Model Type: W-1 or W-F1 (the lighter flying version).

Class: Techno-wizard assault armored exoskeleton.

Crew: One.

M.D.C. by Location: (Numbers in parentheses are for the W-F1 suit, which is identical in all other respects).

Shoulder Plates (2) — 120 each (100)

Mini-Missile Launcher (1, on left shoulder) — 90

Arms (2) — 150 each (120)

Legs (2) — 200 each (150)

* Head — 120/50 (80/50)

** Main Body — 400 (320)

*** Armor of Ithan Force Field — 100

* Destroying the head will eliminate all forms of optical enhancement and sensory systems. The pilot is forced to rely on his own human vision and senses. However, the mystical link between armor and wearer is not lost and the wearer can continue to fight, albeit with reduced abilities. The wearer only loses one attack per melee and half the power armor combat bonuses from such damage.

Special: Whenever the head armor is depleted, a mini-armor of Ithan bubble comes on-line, protecting the head from further damage. An additional 50 M.D. must be inflicted to damage the pilot. Hitting the head requires a called shot at -3 to strike.

** Depleting the M.D.C. of the main body will shut the armor down completely, making it useless.

*** The force field can be activated up to three times over a 24 hour period. Each field will last 10 minutes or until its M.D.C. is depleted, whichever comes first.

Speed:

Running: Can run at up to 70 mph (112.6 km) maximum. Note that the act of running *does* tire out the operator, but at only 10% of the normal fatigue rate.

Flying: W-1: not possible. W-F1: Contra-gravity system allows for flight at up to 200 mph/320 kmph in an atmosphere or Mach One (670 mph/1080 kmph) in space.

Range: Limited only by the endurance of the pilot.

Statistical Data:

Height: One foot (0.3 m) taller than the wearer (each suit magically molds itself to the pilot, adapting to his size).

Width: 4 to 6 feet (1.2 to 1.8 m) wide, depending on the size of the pilot (usually 3 feet/0.9 m less than the suit's height).

Length: 3 feet (0.9 m) average.

Weight: 450 lbs. (202.5 kg) to 1,200 lbs. (544 kg).

Physical Strength: Equal to a supernatural P.S. 45!

Cargo: None

Power System: Anti-matter and magic; average energy life of 50 years.

Market Cost: Costs 5 million credits to manufacture. The black market has a limited supply of these suits, which sell at anywhere between 10 and 30 million credits.

Weapon Systems:

1. Volcano Rifle: This is a rifle version of the Volcano Mark I plasma projector. With it, the character can destroy heavy vehicles, robots, power armor, and scatter or mow down infantrymen. The weapon can use E-Clips, or can be connected with a cable to the armor's power supply, giving it an unlimited payload. Other rifles or hand weapons can be substituted (weapon numbers 5, 6 and 7 are the three most common replacements).

Primary Purpose: Anti-armor

Secondary Purpose: Anti-personnel

Mega-Damage: Concentrated Blast: 1D6×10 M.D. Wide Blast: 4D6 M.D. to any targets in a 30 foot (9.1 m) area or 2D6×10 M.D. to a 30 foot/9.1 m stretch of wall/starship hull.

Rate of Fire: Each blast counts as one melee attack. Cannot fire bursts.

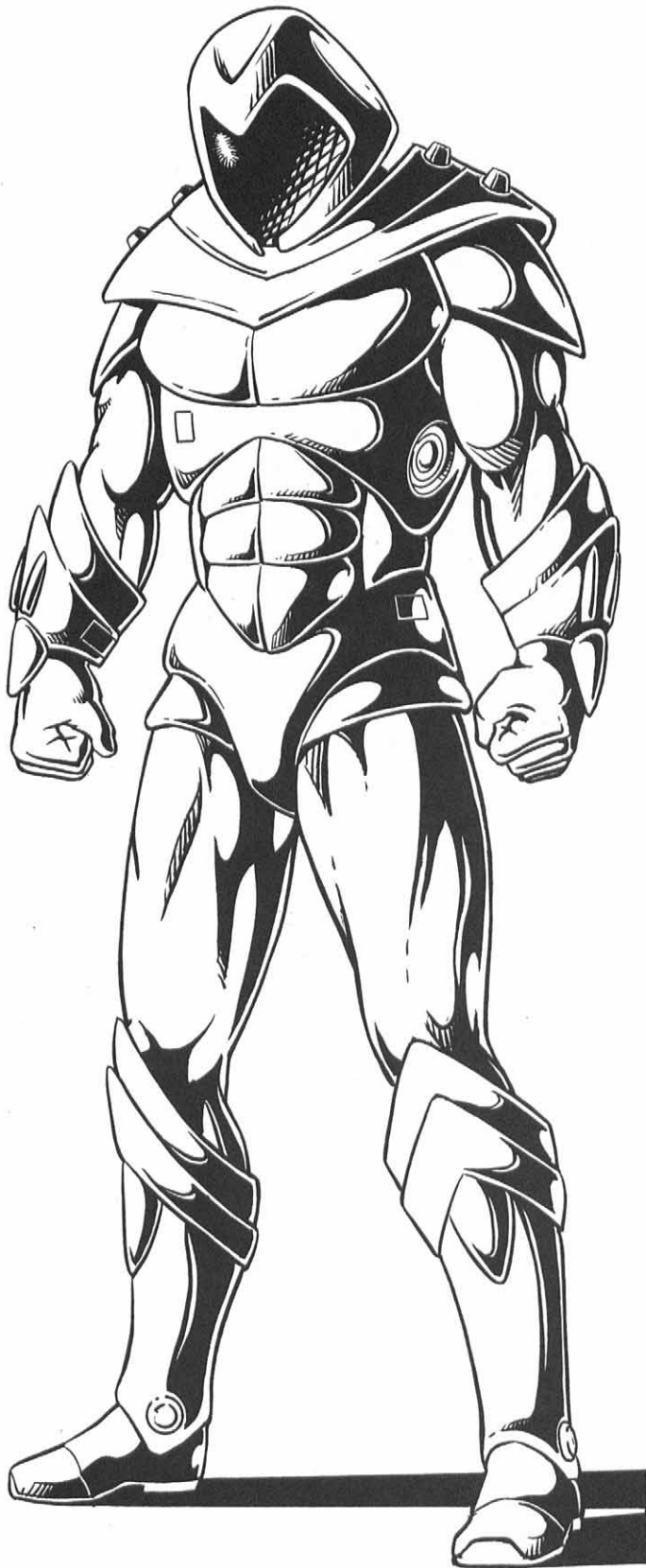

JOHNSON

Maximum Effective Range: Concentrated Blast: 4000 feet (1200 m). Wide Blast: 2000 feet (610 m)

Payload: Effectively unlimited.

2. Wrist Blaster: Mounted on the left wrist is a short-range particle beam weapon used as a back-up weapon. Some cocky

Marines fire their Volcano rifles one-handed while shooting their wrist blaster with the other hand.

Primary Purpose: Anti-personnel

Secondary Purpose: Defense

Mega-Damage: 4D6 M.D. per shot

Rate of Fire: Equal to the combined number of hand to hand attacks of the pilot.

Maximum Effective Range: 500 feet (152 m)

Payload: Effectively unlimited.

3. Missile Launchers (2): Three mini-missiles are mounted in each of the shoulder plates. Many combat operations requires the Marines to use the missiles in massive volleys, with an entire squad, platoon or company firing two to six missiles per trooper (for as many as 500 missiles in a volley — actually more, since one member of each squad carries a multi-missile launcher, described below). Assault missions usually let the individual soldier fire at his discretion.

Primary Purpose: Anti-aircraft and anti-armor.

Secondary Purpose: Defense

Mega-Damage: Varies with missile type.

Rate of Fire: One at a time or volleys of two, three, four or six.

Maximum Effective Range: About one mile (1.6 km).

Payload: Six total, three per launcher.

4. Vibro-Sword: A vibro-sword is carried in a scabbard on the left side (or right for left-handed troopers) of the armor.

Primary Purpose: Close Combat.

Mega-Damage: 2D6 M.D. in addition to P.S. damage.

Effective Range: Close Combat Weapon.

5. HI-800 Assault Laser (optional): A heavy HI-Laser rifle can replace the Volcano weapon system. About 10% of the marines in any one division will use the lasers, which have greater range than their counterparts. Like the volcano, the assault laser can be connected to the power source of the armor for unlimited power.

Primary Purpose: Anti-armor

Secondary Purpose: Sniper

Mega-Damage: 1D4×10+6 M.D. per concentrated blast.

Rate of Fire: Equal to the number of hand to hand attacks of the pilot.

Maximum Effective Range: 6000 feet (1830 m)

Payload: Effectively unlimited.

6. GC-55 G-Cannon: A powerful gravity rifle is used by 10% of the marines instead of the standard plasma projector. The G-Cannon has more stopping power and equivalent range, but has the drawback of requiring a source of ammo. Even with the oversized drum magazine used by the marines, the G-Cannon will run dry very quickly. Up to five additional ammo canisters can be attached to clamps on the sides and back of the armor.

Primary Purpose: Anti-armor

Secondary Purpose: Anti-personnel

Mega-Damage: 2D4×10 M.D. per 10 round burst. Can only fire bursts.

Rate of Fire: Equal to the number of hand to hand attacks of the pilot.

Maximum Effective Range: 4000 feet (1200 m)

Payload: 500 round drum magazine. Up to five reloads can be carried by the marine. Reloading takes two melee attacks/actions.

7. AML-11 Autoloading Missile Launcher: One member of every squad (4-6 marines) carries this autoloading missile launcher as a support weapon. The AML fires missiles from an oversized magazine that carries 8 mini-missiles. Up to five magazines can be carried by the Marine, for a total capacity of 48 mini-missiles!

Primary Purpose: Anti-armor and anti-aircraft.

Secondary Purpose: Defense

Mega-Damage: Varies with missile type.

Rate of Fire: Each missile fired counts as one melee attack. Cannot fire volleys.

Effective Range: About one mile (1.6 km).

Payload: 8 missiles per magazine; up to 48 missiles total can be carried. Changing magazines counts as two melee attacks/actions.

8. Sensor Systems: The Warlock combat armor has all standard sensor systems. Additionally, it has magical sensors that allow the wearer to see the invisible (200 feet/61 m range, lasts 15 minutes per activation), sense evil (90 ft/27.4 m range, lasts 30 minutes per activation), and presence sense (120 ft/36 m range, lasts 30 minutes per activation). Each of these abilities can be activated 4 times per 24 hour period.

9. Hand to Hand Combat: Rather than use a weapon, the wearer of the Warlock Combat Armor can engage in hand to hand combat. The following bonuses are in addition to combat training and attributes:

Bonuses from the armor:

+1 to initiative

+1 to strike, parry and dodge

+1 additional hand to hand attack at levels five and ten

+1 to roll with impact or fall.

+1 to pull punch.

Damage (Supernatural P.S.):

Punch: 6D6 M.D.

Power Punch: 2D4×10 M.D. (counts as two attacks)

Kick: 6D6 M.D.

Body Flip/Throw 1D6 M.D.

Body Block/Tackle 2D4 M.D.

Note: The magical suit *may* be sentient. Over the decades, there are hundreds of reports where Marines insist that their suit fired a built-in weapon and/or engaged sensors, warning or protecting the wearer when he was dazed or otherwise incapacitated. Such occurrences are unexplained, inconsistent and completely unpredictable. More details are offered in the character description for the Warlock Marine.

Enforcer Power Armor

Naruni Enterprises

Naruni Enterprises advertises this suit as an urban combat model, ideal for law-enforcement purposes. The armor's non-lethal weapon systems are indeed useful for police agencies, but the largest purchases have come from pirates, bounty hunters and galactic mercenaries. As usual, NE accepts any customers who can afford the price, with few if any, questions asked.

The Enforcer is also a capable infantry combat suit with limited flying abilities and a decent array of weapons that allows it to deal with riots, fleeing felons (or victims), and even military

power armor. Also, the Enforcer has an advanced thermographic and gravity-wave sensor system, with which the pilot can literally see through walls and detect invisible targets. This sensor system is optional and adds a cool million to the armor's cost. Both cops and criminals love it, the former because they do not need to go blind into a house or building and have a wide range of combat/defensive systems available to them. The latter, because the sensor system allows them to find people hiding from them and the suit offers a good range of versatile combat options.

The helmet of the Enforcer has no eye-holes or facial features, which enhances its intimidation value. One of its unusual features is the extra pair of limbs placed on the lower chest/rib cage area. Each "limb" holds a combination weapon system (an over-and-under, triple-barreled mini-laser and a stunner) that the pilot can aim with a glance. The suit is also equipped with grenade launchers (useful both for riot control and lethal fighting), and two mini-missile launchers. Pirates and mercenaries sometimes have the second pair of weapon limbs modified by mechanical engineers to be replaced by other, more lethal weapons or robot arms and hands.

Model Type: PA E-1000

Class: Law Enforcement/Combat Exoskeleton

Crew: One

M.D.C. by Location:

Mini-Missile Launchers (2, on shoulders) — 80 each

Grenade Launchers (2, upper torso) — 90 each

Arms (2) — 100 each

Foam Dispensers (2, in forearms) — 80 each

Weapon Limbs (2, lower torso) — 85 each

Legs (2) — 150 each

* Head — 110

** Main Body — 300

* Destroying the head/helmet has a 01-70% chance of knocking the pilot unconscious. If conscious, the pilot has two problems: one, no power armor combat bonuses to strike, parry and dodge, and two, the human head is now vulnerable to attack. Note: The head is a small and difficult target to hit. Thus, it can only be hit when a character makes a called shot and even then the attacker is -3 to strike.

** Depleting the M.D.C. of the main body will shut the robot suit down completely, making it useless.

Speed:

Running: 50 mph (80 km) maximum. Note that the act of running does tire out the operator, but at 20% the normal fatigue rate.

Leaping: The armor can leap 15 feet (4.6 m) high or across. Add 10 feet (3.0 m) with a running start.

Flying: Not possible, without the addition of a jet pack (virtually any model can be used). However, the suit does have a number of small maneuvering jets located in the bottom of the feet and in the legs, arms and back. These jets enable the wearer to "fly" in space (20 mph/32 km) or propel himself underwater (5 mph/8 km).

Statistical Data:

Height: 10 feet (3.0 m)

Width: 6 feet (1.8 m)

Length: 4 feet (1.2 m)

Weight: 500 lbs. (225 kg)

Physical Strength: Equal to a P.S. 30

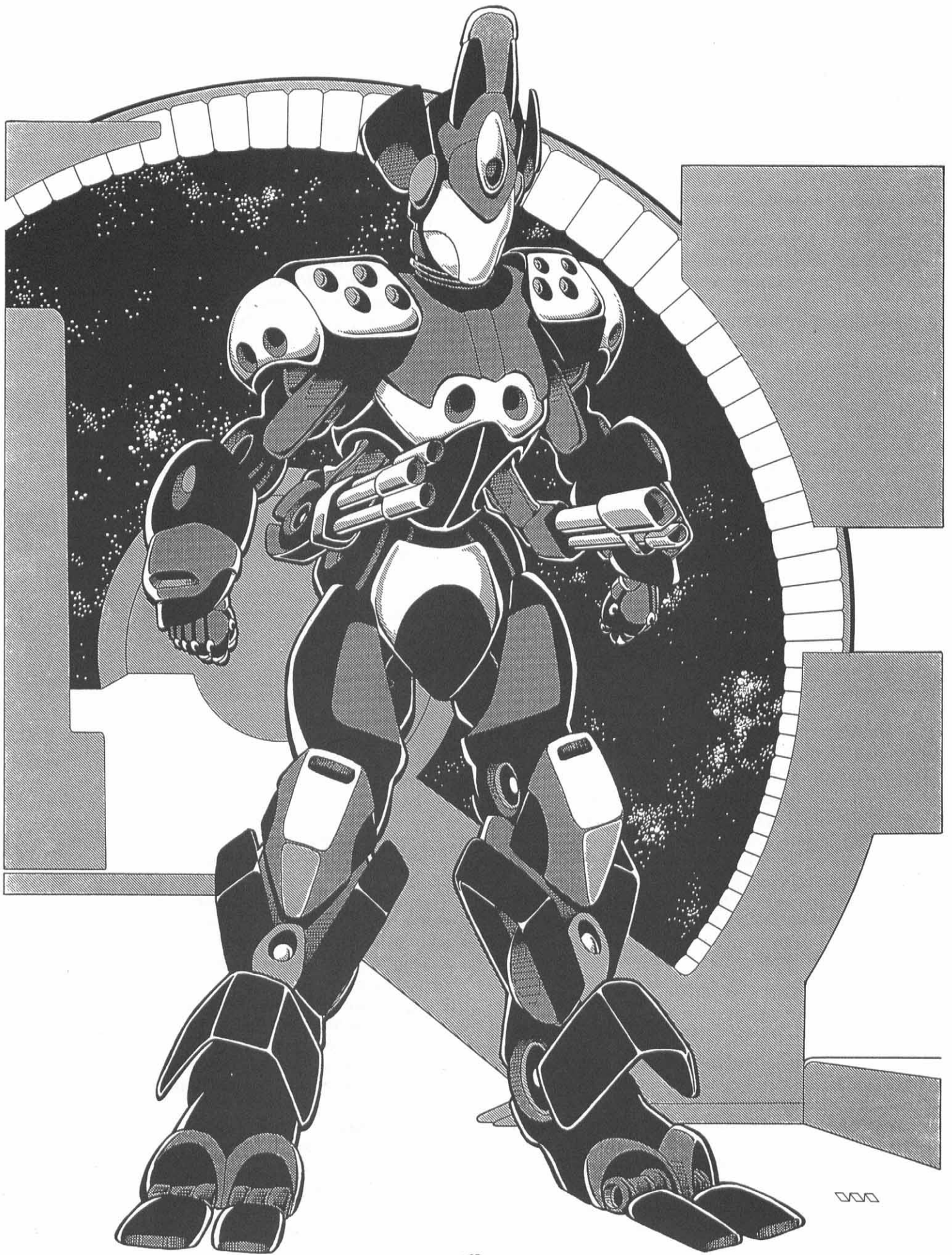

Cargo: None.

Power System: Anti-matter; average energy life of 30 years.

Market Cost: Four million credits without the special optics system (5 million with it); price may vary 1D4×10% depending on the seller, purchaser and availability.

Weapon Systems:

1. Foam Dispensers (2): These short vents mounted on the forearms of the suit, fire quick-drying foam. This foam is sticky and in a matter of seconds, hardens into an M.D.C. cement, completely immobilizing the target. To completely cover a victim, the attacker must roll a 12 or higher (including combat bonuses); on a normal hit, only part of the target is covered, usually the legs or arms, immobilizing them but allowing the target to either run or fight. A target without a robotic or supernatural P.S. of 40 or higher is stuck until released. Stronger beings can break free in 1D6 rounds. An application of foam can withstand up to 60 M.D. before being destroyed; if using normal weapons, any damage above 60 M.D. will affect the trapped character! The suit has a nozzle above each vent that sprays a solvent that will dissolve the foam in 1D4 melees.

These weapons are very useful to capture criminals and also to put a stop to riots. The foam can be substituted with different types of chemical sprays, including tear gas, blinding mace or tranquilizer spray (all are fundamentally the same as the sprays described in the **Rifts RPG**, page 240). Criminals may use toxins or acid, and vampire hunters may fill them with ordinary water (one spray does 5D6 damage to vampires).

Primary Purpose: Capture

Secondary Purpose: Riot control

Mega-Damage: Normally none, immobilizes the target.

Rate of Fire: Two blasts per melee; each counts as one melee attack.

Maximum Effective Range: 200 feet (61 m)

Payload: 80 spray blasts, 40 each arm.

2. Weapon Limbs (2): These mechanical arms have a combined weapon system that includes a tri-barrel laser and a stun gun. The lasers are the main lethal system of the power armor. The stun gun is a more powerful version of the pistol described above.

Primary Purpose: Anti-personnel.

Secondary Purpose: Defense.

Mega-Damage: Laser: Multiple pulse burst does 1D6×10 M.D. Can only fire bursts.

Stunner: Single or simultaneous dual blast. Reduces both the *speed* and *physical prowess* attributes by 3D6 each, plus the victim loses one melee attack and is at -3 to all combat actions. Each stun blast has cumulative effect on the victim. When either of the two attributes is reduced to zero, the character collapses, still fully conscious but unable to move. Combat is impossible unless the character has psionic abilities or other special powers (like eye beams). The effects of each blast last for 2D6 minutes (half that for characters with a P.E. of 18 or higher).

Victims wearing fully sealed body armor can save against the effects of the stun pistol equal to save vs lethal poison (14 or better). A successful save means the blast has no effects. M.D.C. non-supernatural creatures can also save (12 or better), and even

if they fail their save, they only take half "damage." Supernatural beings like demons and dragons are unaffected.

Rate of Fire: Equal to the number of combined hand to hand attacks of the pilot. Only one of the two weapon systems can be fired at a time.

Maximum Effective Range: 2000 feet (610 m) for the laser; 1000 feet (305 m) for the stun gun.

Payload: Effectively unlimited.

3. Grenade Launchers (2): These autoloading launchers can be used for either non-lethal purposes (spreading tear gas, smoke or sleeping gas) or for combat (explosive).

Primary Purpose: Riot control

Secondary Purpose: Anti-personnel

Mega-Damage: Varies with grenade type.

Rate of Fire: Equal to the number of hand to hand attacks of the pilot. Up to two grenades can be launched in one attack.

Maximum Effective Range: 1000 feet (305 m)

Payload: 40 grenades per launcher.

4. Mini-Missile Launchers (2): Eight mini-missiles (four per shoulder) are carried by the Enforcer. The loads can be configured for any number of missions, from crowd control to anti-aircraft.

Primary Purpose: Anti-riot, anti-personnel, or anti-aircraft.

Secondary Purpose: Defense

Mega-Damage: Varies with missile type.

Rate of Fire: One at a time or in volleys of two, four or eight.

Maximum Effective Range: About one mile (1.6 km).

Payload: 8, four per launcher.

5. Hand to Hand Combat: Rather than use a weapon, the pilot can engage in mega-damage hand to hand combat. See Basic and Elite Power Armor Combat Training in the Robot Combat section of the **Rifts RPG**, page 45.

6. Hand-Held Weapons: In addition, the wearer of the armor can carry and use a nightstick/club, vibro-blade, sidearm, rifle, hand grenades, or any variety of hand-held weapons.

7. Sensor System: In addition to the standard power armor accessories, the Enforcer can be outfitted with an advanced system that uses gravity waves as a form of "radar." This system can electronically map even the insides of structures (and any occupants). Combined with an enhanced thermographic sight, the sensor system can detect invisible targets, find people hiding inside buildings or ships, and even detect traps and hidden rooms. The sensor system cannot penetrate force or phase fields, however.

Range: 2000 feet (610 m).

Cost: One million credits.

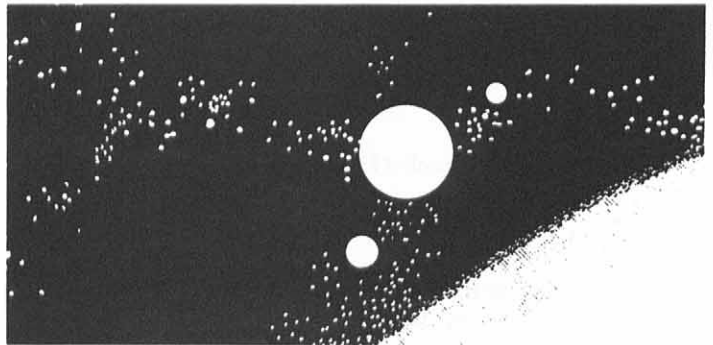

A-1 “Avenger” Power Armor

The Avenger power armor is considered to be the most lethal and effective war machine of its class ever designed. Regrettably, it is no longer in production. Less than two thousand of these suits exist in the Three Galaxies. The creator, Lester M’Kri, was a genius designer who quit Naruni Enterprises to launch his own weapon company, **M’Kri Hardware**. The company quickly acquired a reputation for producing the highest quality weapons around. M’Kri Hardware might have become a major player in the weapons market, but Naruni Enterprises was not about to let a former employee become a successful competitor.

First, a number of lawsuits against the company were filed by Naruni, which claimed ownership of any creation M’Kri had developed. According to their files, M’Kri’s resignation was not valid, which meant that the corporation (allegedly) still had an enforceable contract with the designer. The years of lawsuits that followed drove M’Kri and his company into bankruptcy. The dejected weapon designer committed suicide (many have suggested he was murdered. Most of his designs were appropriated by Naruni. According to the records of M’Kri Hardware, 7,781 A-1 armor suits were sold on the open market. Naruni tried to duplicate the suit, but kept coming up with dangerously flawed or terribly expensive versions; it seems that M’Kri took the suit’s secrets with him to the grave. As a result, the few suits in existence (thousands have been destroyed in combat and scores purchased and then dismantled by Naruni researchers) are the only ones of their kind.

The Avenger is an impressive power armor suit standing as tall as many robots and designed to accommodate human to wolfen sized pilots. Some of its lines remind people of the stylized armor many cosmo-knights favor, which is one of the reasons for the suit’s “Avenger” nickname. The A-1 originally came in silver, gold or metallic red; a few owners have repainted the suits, but not many. Whatever the original color, the suit could generate a camouflage variable field (identical to Naruni’s NE-C20 Camouflage Variable Armor; this was one of the patent infringements Naruni accused M’Kri of committing), a powerful defensive force field, and a sensor-radar jamming signal. Added to this was an array of devastating weaponry, all built-in, allowing the pilot to carry an additional hand weapon if so desired, plus heavy armor and extraordinary speed, both on the ground and in space.

Avenger pilots, like the Glitter Boys of Rifts Earth, are a respected and feared elite. Most are currently owned by mercenaries, heroes, wanderers and adventurers. A few are operated by warriors who have joined the freedom fighters of the Free World Council, where they fight the best the Kreeghor Empire can throw at them.

Model Type: ME-95A1

Class: Multi-Purpose Combat Exoskeleton.

Crew: One

M.D.C. by Location:

Arms (2) — 200 each

GR-Gun (Left Arm) — 100

Hi-Laser (Right Arm) — 100

Mini-Missile Launcher (1, chest) — 100

Head Lasers (2) — 20 each

Legs (2) — 300 each

* Head — 180

** Main Body — 825

Force Field — 200

* Destroying the head/helmet has a 01-60% chance of knocking the pilot unconscious. If conscious, the pilot has two problems: one, no power armor combat bonuses to strike, parry and dodge, and two, the human head is now vulnerable to attack. Note: The head is a small and difficult target to hit. Thus, it can only be hit when a character makes a called shot and even then the attacker is -3 to strike.

** Depleting the M.D.C. of the main body will shut the armor down completely, making it useless.

Speed:

Running: 100 mph (160 km) maximum. Note that the act of running *does* tire out the operator, but at 10% normal fatigue rate.

Flying: Mach 4 in an atmosphere, or Mach 10 in space.

Range: Limited only by the pilot’s endurance. Emergency food and air supply will keep the pilot alive for a week.

Statistical Data:

Height: 11 feet (3.3 m)

Width: 8 feet (2.4 m)

Length: 6 feet (1.8 m)

Weight: 1,000 lb. (453 kg).

Physical Strength: Equal to a P.S. 55

Cargo: None

Power System: Anti-matter; average energy life of 50 years.

Market Cost: Varies widely; no new Avenger suits are available on the open market. The suit can go for as much as 150+ million credits in “mint” conditions

Weapon Systems:

1. GR-Gun: A multi-barreled gravity rail gun is mounted over the armor’s left forearm.

Primary Purpose: Anti-armor and anti-personnel.

Secondary Purpose: Defense

Mega-Damage: A burst is 60 rounds and does 2D4×10 M.D. Can only fire bursts.

Rate of Fire: Equal to the combined number of hand to hand attacks of the pilot.

Maximum Effective Range: 3000 feet (914 m)

Payload: 6000 rounds in back-mounted magazine; that’s 100 bursts.

2. HI-Laser: This arm-mounted, high-intensity laser is the main weapon system of the Avenger.

Primary Purpose: Anti-armor

Secondary Purpose: Defense

Mega-Damage: 2D6×10 M.D. per laser burst!

Rate of Fire: Equal to the combined number of hand to hand attacks of the pilot.

Maximum Effective Range: 4000 feet (1200 m)

Payload: Effectively unlimited.

3. Mini-Missile Launcher: A chest-mounted launcher that stores a total of 16 missiles in the torso of the armor.

Primary Purpose: Anti-aircraft and anti-personnel.

Secondary Purpose: Defense

Mega-Damage: Varies with missile type.

Rate of Fire: One at a time or in volleys of two or four.



W

Maximum Effective Range: About one mile (1.6 km).

Payload: 16 total, 8 per launcher.

4. Helmet Lasers: Two small lasers are mounted on each side of the helmet, where they are used as back-up weapons. One laser will be destroyed if the helmet takes more than 20 M.D. points; both will be gone after an additional 20 M.D. (for a total of 40) are inflicted on the helmet.

Primary Purpose: Anti-personnel

Secondary Purpose: Defense

Mega-Damage: 6D6 M.D. per simultaneous double blast. If one of the lasers is damaged, damage is reduced to 3D6 M.D. Can only fire at one target at a time.

Rate of Fire: Equal to the combined number of hand to hand attacks of the pilot.

Maximum Effective Range: 2000 feet (610 m)

Payload: Effectively unlimited.

5. Camouflage System: The suit's skin is covered by a fiber-optic material that can change colors to match the general environment. Color change takes 1D4 melee rounds (15 to 60 seconds), in which the armor becomes the exact same color as the predominant one in the area. In the woods or in broken terrain, the suit will also create stripes and blotches of lighter and darker color like a camouflage pattern. In all cases, the wearer is difficult to spot: -20% for others to detect ambush and detect concealment, +5% to the wearer's prowl skill, and even characters without prowl have a 40% chance of not being seen if they stay under cover and don't move.

The system also masks infrared and thermal emissions, making the wearer's heat invisible to infrared and thermal optics! There is only a 21% chance of the suit showing up on thermal systems and even then the reading/image will seem unusual. The camouflage system is disabled after the armor's main body takes 200 points of damage.

6. Radar Jammer: Additionally, the pilot can activate a radar/sensor jammer and "spoofer." While the jammer is on, conventional radar, gravity-wave sensors, and missile guidance systems will not be able to function in the area affected (have only a 20% chance of detecting any targets in the area, including the armor). The jammer will affect a one mile (1.6 km) area. Leaving it on all the time will automatically alert the enemy that a jammer-equipped vehicle is in the area, so standard operational procedure is not to activate it until combat is under way, or just before attacking.

7. Hand to Hand Combat: Rather than use a weapon, the pilot can engage in hand to hand attacks.

Restrained Punch: 2D6 M.D.

Full Strength Punch: 6D6 M.D.

Power Punch: 2D6×10 M.D.

Kick: 6D6+6 M.D.

Leap Kick: 2D6×10 +6 M.D.

Body Flip: 2D6 M.D.



War Beast Combat Armor Intruders

The Intruder civilization (described elsewhere) outfits their giant warriors (commonly known as the beasts or war beasts) with these sophisticated suits of power armor. Intruder technology is far superior to what the Three Galaxies can manufacture and the war beast combat armor is a clear example of this. The suit has a crystalline appearance, with diamond-like sharp angles, and is semi-transparent: one can see the beast pilot (wearing body armor) through it! In reality, this "suit" seems to be some sort of hyper-tech force field system, like many Intruder constructs. The solid plates are actually "hardened" energy, which regenerates damage almost as fast as it is inflicted! To the horror of the CAF, Imperial and Warlock soldiers, war beasts often get up after being hit by a volley of missiles and energy beams, its "armor" looking as good as new! "Hit them until you see blood," has become the brutally pragmatic motto of those who fight these deadly war machines.

The solid energy armor has one weakness: it is totally transparent to phase beams, just like normal armor, and the wearer takes full damage. This is yet another reason why Intruders seem so eager to capture phase weapons and equipment.

Recent rumors claim that a few war beasts have fallen into the hands of members of the Free World Council, and that the power armor has been seen fighting Imperial troops. Some of the

rumors say that some Intruders have deserted and joined the Free World Council as mercenaries. Others suggest that a team of rebel scientists was able to capture and adapt these powerful vehicles for use by normal humanoids. It is up to game masters to decide which, if any, rumors are true.

Model Type: I-WB

Class: Solid Energy Assault Suit

Crew: One

M.D.C. by Location:

Arms (2) — 180 each

Legs (2) — 200 each

Head — 150

* Main Body — 300

** Power Generator — 100

* Depleting the M.D.C. of the main body will NOT destroy the armor. See Note.

** Destroying the power generator destroys the armor! However, the generator can only be hit with a “called” shot and is -2 to strike. Inflicting 100 M.D.C. to the generator puts the unit in jeopardy but an additional 100 M.D.C. is required to destroy it and to prevent the overall regeneration process. Thus, a total of 200 M.D. must be inflicted against the generator to destroy the energy suit.

Note: The armor of the suit is actually “solid energy” that feeds off the power generator built into the pilot’s body armor. As long as the power is on, the armor will regenerate damage at the rate of 4D6 M.D.C. per melee round for the main body and 2D6 M.D. for the limbs and head. Even if the armor is reduced to 0 M.D.C., the regeneration will continue! The only way to stop the regeneration process is to destroy the power generator.

Speed:

Running: 100 mph; does not tire out the wearer.

Flying: Up to Mach One (670 mph/1080 kmph) in an atmosphere, or Mach 10 in space.

Leaping: The incredible lightness of the suit/force field allows the wearer to jump up to 60 feet (18.3 m) high or lengthwise. A running leap allows for a jump of 80 feet (24.4 m) high or lengthwise.

Statistical Data:

Height: 12 feet (3.65 m)

Width: 10 feet (3.0 m)

Length: 7 feet (2.1 m)

Weight: 500 lbs. (227 kg)

Physical Strength: Equal to the P.S. of the wearer (supernatural).

Cargo: None

Power System: Unknown. Maybe miniaturized anti-matter or fusion; the suit has an energy life of 50 years.

Market Cost: Not for sale! Any major nation or corporation of the Three Galaxies would pay billions to get their hands on one of these suits. If the Game Master allows players to own one, he should keep in mind that everybody in the Three Galaxies will be trying to buy, cheat, or steal the suit(s) away from them. Intruder weapons are very powerful and potentially overbalancing in the hands of player characters. They are best used by non-player villains in most campaigns.

Weapon Systems:

1. Energy Blasts: The suit projects energy blasts from the arms, face or torso of the suit at the will of the wearer. These beams seem to be extensions of the same force field technology that produces the “solid energy” in the suits.

Primary Purpose: Anti-armor

Secondary Purpose: Defense

Mega-Damage: 1D6×10 M.D. per blast.

Rate of Fire: Equal to the number of hand to hand attacks of the pilot.

Maximum Effective Range: 2000 feet (610 m) in an atmosphere; two miles (3.2 km) in space.

Payload: Effectively unlimited.

2. Hand to Hand Combat: Rather than use a weapon, the pilot can engage in mega-damage hand to hand combat. See Basic and Elite Power Armor combat (**Rifts RPG**, page 45). All abilities are the same except damage, which is +2D6 M.D. from punches and kicks in addition to the supernatural strength of the wearer.

Robot Vehicles

Ovoid Combat Robot Naruni Enterprises

The Ovoid, commonly known as the “death egg” is a curious robot that originates from another dimension. It is unknown whether Naruni Enterprises stole or purchased the blueprints from the Ovoid’s creators, or whether it is an original design. Rumor has it that the Ovoid is actually built to resemble the egg-shaped alien species that created it. In any case, this robot cuts a rather ludicrous figure, resembling an egg with arms and legs more than anything else. Despite its looks, however, the Ovoid is one of the most advanced robot designs in the Three Galaxies, with better armor, mobility and firepower than most other vehicles of the same class.

Ovoids have limited transformation capabilities. They are designed to serve in both space and an atmosphere, and their con-gravity generators allow for fast flight. While flying, the arms and legs of the robot retract into the egg-shaped main body, transforming the robot into a flying sphere that can double as a fighter. Most of its weapon systems are built inside the hull, and do not protrude at all from its surface, which makes it very difficult to target and destroy them. With a combination of rail guns, plasma cartridge machineguns, and two types of missiles, an ovoid can lay down an enormous volume of fire.

These robots are used by a number of independent planets, and even some of the Consortium Independent Defense Forces (IDF). Pirates and mercenaries have also purchased several hundred, as they make ideal assault and boarding vessels.

Model Type: O-AR600

Class: Tactical Assault Robot with Space Fighter Configuration

Crew: Two; a pilot/gunner and one additional gunner. Can carry an additional two passengers. The controls are designed so that the pilot can handle all functions if necessary, but then he is limited to his own combined hand to hand attacks per melee.

M.D.C. by Location:

Arms (2) — 300 each

Legs (2) — 350 each

* Weapon Systems (6)— 250 each

* Missile Launchers (2) — 250 each

** Main Body — 650

Force Field — 320

* The weapon systems are built into the hull and shoot from tiny firing slits. Shooting at the armored firing slits requires a called shot at -4 to strike.

** Depleting the M.D.C. of the main body will shut the robot down completely, making it useless.

Speed:

Running: 70 mph (112 km) maximum. Note that the act of running does NOT tire the robot and speed can be maintained indefinitely. Leaping is not necessary; the contra-gravity system allows for flight.

Flying: The robot's contra-gravity system allows for flight. Speed is limited to Mach One (670 mph/1080 kmph) in an atmosphere, but can reach up to Mach 8 in space.

Range: The robot's life support will keep up to four crew members alive for two weeks.

Statistical Data:

Height: 40 feet (12.2 m) with legs extended. The spherical body, itself, is 20 feet (6.1 m) tall.

Width: 30 feet (9.1 m)

Length: 30 feet (9.1 m)

Weight: 60 tons

Physical Strength: Equal to a P.S. 50

Cargo: Minimal storage space; about 4 feet (1.2 m).

Power System: Nuclear; average energy life is 20 years.

Market Cost: 95 million credits for a new, undamaged, fully powered unit, complete with weapon systems.

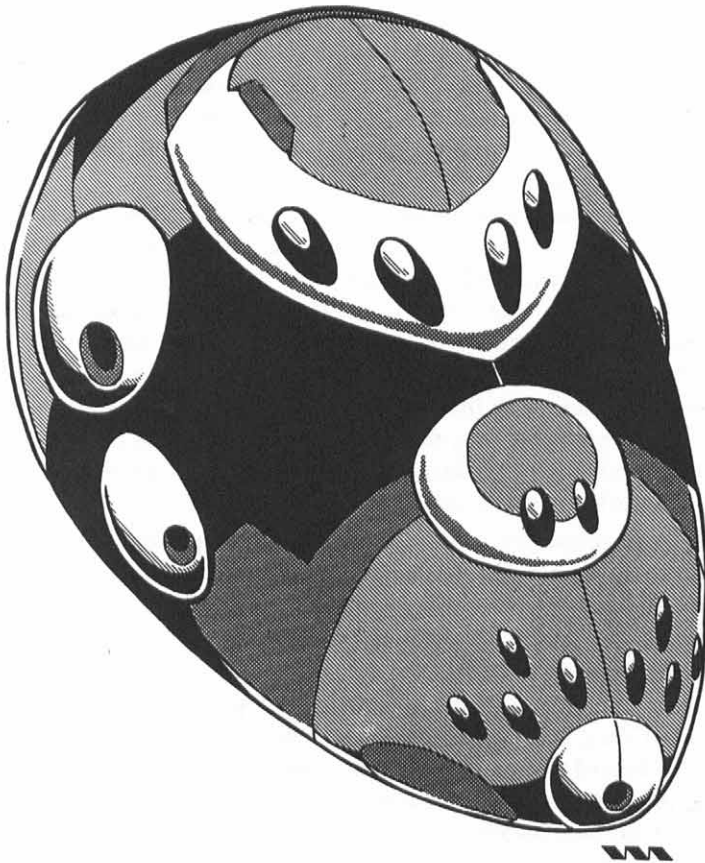

Weapon Systems:

1. Plasma Cartridge Machineguns (2): Two machineguns are mounted on opposite sides of the sphere. Either the pilot or the gunner can operate them. Each gun must engage separate targets.

Primary Purpose: Anti-aircraft and anti-armor.

Secondary Purpose: Defense

Mega-Damage: A burst is 10 shots and inflicts 2D6×10 M.D. Can only fire bursts.

Rate of Fire: Equal to the combined number of hand to hand attacks of the pilot or the gunner.

Maximum Effective Range: 2000 feet (610 m) in an atmosphere; one mile (1.6 km) in space.

Payload: 2000 round drum per gun; that's 200 bursts.

2. Rail guns (2): Two rail guns are mounted in the two sides not covered by the plasma cartridge weapons. The guns can be aimed so that both a plasma cartridge weapon and a rail gun can bear on any target at any given time.

Primary Purpose: Anti-armor and anti-aircraft.

Secondary Purpose: Defense

Mega-Damage: A burst is 80 rounds and inflicts 2D6×10 M.D. Can only fire bursts.

Rate of Fire: Equal to the combined number of hand to hand attacks of the pilot or gunner.

Maximum Effective Range: 6000 feet (1830 m).

Payload: 8000 round drum magazine per gun; that's 100 bursts.

3. Short-Range Missile Launcher: A launcher is built into the top of the "egg." It can "hatch" volleys of up to 8 missiles at a time, ideal for taking out enemy aircraft or intercepting missiles.

Primary Purpose: Anti-aircraft

Secondary Purpose: Defense

Mega-Damage: Varies with missile type.

Rate of Fire: One at a time or in volleys of two, four, six or eight.

Maximum Effective Range: About one mile (1.6 km).

Payload: 32 mini-missiles.

4. Long-Range Missile Launcher: This mid-section launcher fires volleys of long-range missiles, designed to destroy enemy vehicles or to damage starships. Commonly equipped with nuclear or proton torpedoes.

Primary Purpose: Anti-ship and anti-armor.

Secondary Purpose: Anti-aircraft

Mega-Damage: Varies with missile type.

Rate of Fire: One at a time or in volleys of two or four missiles.

Maximum Effective Range: Varies.

Payload: 16 missiles.

5. Laser Guns (2): Two medium-power laser guns act as backups in case the main guns run out of ammo. They are also used to intercept enemy missiles. The lasers are mounted on opposite sides of the robot.

Primary Purpose: Anti-aircraft

Secondary Purpose: Defense

Mega-Damage: 1D4×10 M.D. per blast.

Rate of Fire: Equal to the combined number of hand to hand attacks of the pilot or gunner.

Maximum Effective Range: 4000 feet (1200 m)

Payload: Effectively unlimited.

6. Hand to Hand Combat: Rather than use a weapon, the pilot can engage in hand to hand combat.

Restrained Punch: 1D6 M.D.

Full Strength Punch: 3D6 M.D.

Power Punch: 1D4×10 M.D. (counts as two attacks)

Kick: 4D6 M.D.

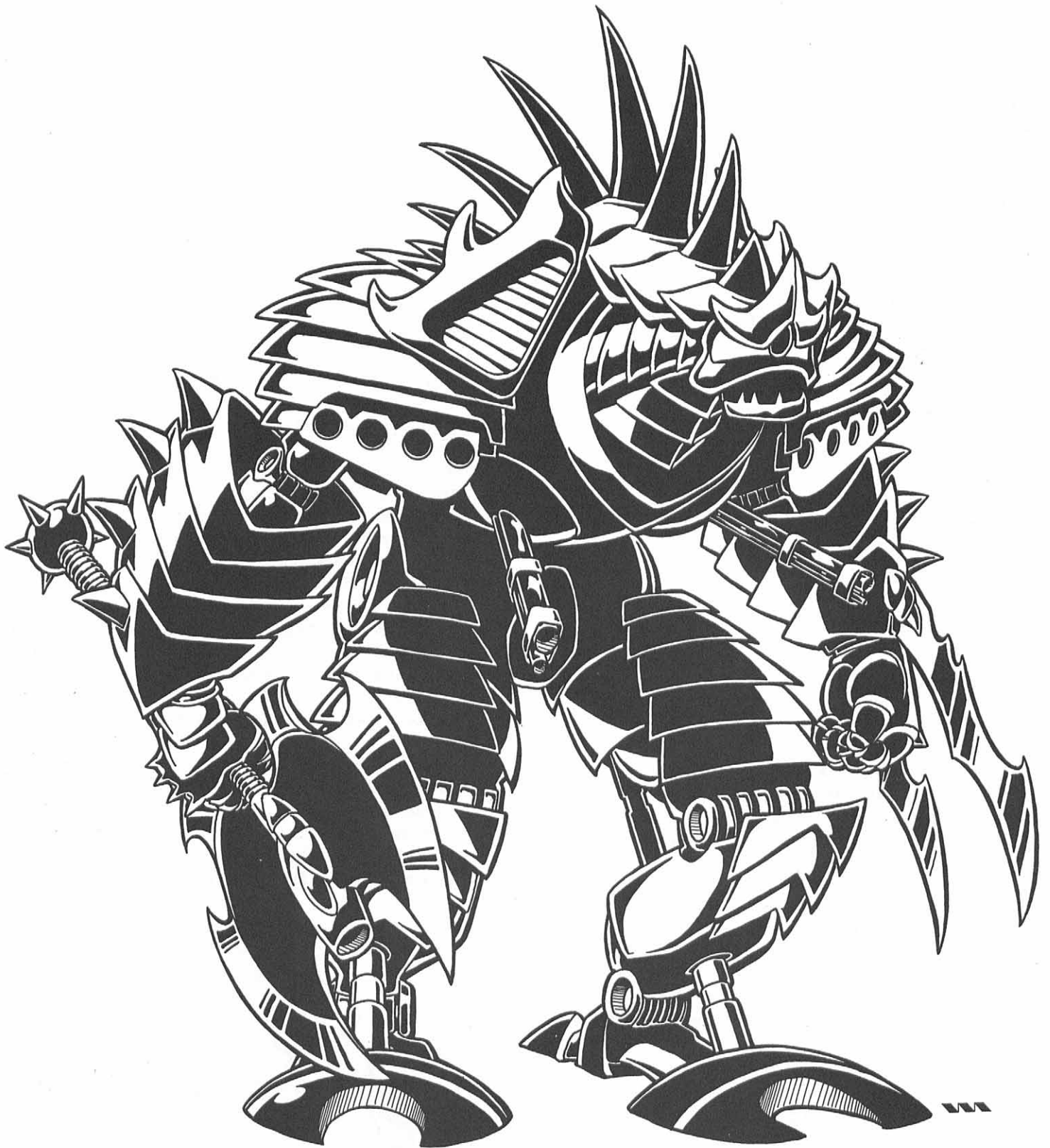

Imperator Assault Robot Transgalactic Empire

The Imperator is the only large robot commonly used by the Transgalactic Empire. The kreeghor prefer versatile power armor suits to (in their opinion) oversized and cumbersome giant robots. Like most imperial designs, the Imperator resembles a giant kreeghor in ornate armor and it bristles with weaponry. To appeal to the kreeghor's romantic warrior image, the Imperator

wields a giant sword or axe, and a "fang," a two-pronged stabbing weapon; both weapons have energy capabilities. To inspire terror in enemies, the Imperator has a loudspeaker system in its mouth that enables it to roar in the fashion of the kreeghor; it can bellow loud enough to shatter glass!

These robots are typically commanded by a kreeghor and piloted and gunned by a crew of other races (typically humans and/or wolfen). The command station amounts to little more than having an extra gunner, and many mutinous crews have discovered they can do just fine without a commander giving them orders.

The Free World Council has captured or rebuilt a few hundred of these vehicles. Most of them are fighting on Axis-5, a planet commonly known as the Battlefield.

Model Type: IAR-500

Class: Infantry Assault Robot

Crew: Four; a commander, a pilot and two gunners.

M.D.C. by Location:

Gravity Auto-cannons (2, on upper torso) — 200 each

Missile Launchers (2, on shoulders) — 240 each

Arms (2) — 300 each

Energy Sword or Axe — 300

Energy "Fang" — 280

Legs (2) — 360 each

Head/Loudspeaker — 200

* Main Body — 655

Reinforced Crew compartments (4) — 100 each

* Depleting the M.D.C. of the main body will shut the robot down completely, making it useless.

Speed:

Running: 90 mph (144 km)

Leaping: 20 feet (6.1 m) high or lengthwise.

Flying: Not possible.

Statistical Data:

Height: 40 feet (12.2 m)

Width: 20 feet (6.1 m)

Length: 20 feet (6.1 m)

Weight: 35 tons

Physical Strength: Equal to a P.S. 60

Cargo: Minimal storage space; about 5 feet (1.5 m)

Power System: Anti-matter; average energy life is 50 years.

Market Cost: 45 million credits. Not for sale outside the Transgalactic Empire.

Weapon Systems:

1. Gravity Auto-cannons (2): These torso-mounted guns are the same model as the main weapon of the Warlord powered armor. The dual guns can engage separate targets or, when controlled by one gunner, blast one target simultaneously. Only a gunner or the commander can use this gun (no controls from the pilot's station).

Primary Purpose: Anti-armor and anti-personnel.

Secondary Purpose: Defense

Mega-Damage: A burst is 40 rounds and inflicts 1D6×10+10 M.D.; can only fire bursts. A simultaneous dual bursts does 2D6×10+20 M.D.

Rate of Fire: Equal to the combined number of hand to hand attacks of the gunner or commander.

Maximum Effective Range: 4000 feet (1200 m)

Payload: 4000 round drum per gun; that's 100 bursts each.

2. Missile Launchers (2): Mounted on the shoulders are two medium-range missile launchers, used primarily against aircraft or for long-range attacks.

Primary Purpose: Anti-aircraft

Secondary Purpose: Anti-armor

Mega-Damage: Varies with missile type.

Rate of Fire: One at a time or volleys of two, four or eight.

Maximum Effective Range: Varies

Payload: 16 total; 8 per launcher.

3. Energy Sword or Axe: A hand weapon with vibro-edges that also doubles as a particle beam cannon. The robot can either fire particle beam blasts or strike with the energized edges. This weapon and the energy fang are under the control of the pilot.

Primary Purpose: Anti-armor

Secondary Purpose: Defense

Mega-Damage: A particle beam blast inflicts 2D4×10 M.D.

An energized sword strike does 2D4×10 M.D., but when not energized, the weapon does 3D6 M.D. in addition to normal hand to hand damage.

Rate of Fire: Equal to the number of hand to hand attacks of the pilot.

Effective Range: 1200 feet (366 m) for the blast; close combat for the strike.

Payload: Effectively unlimited.

4. Energy Fang: A giant, pronged stabbing weapon that has been modified to fire laser beams in addition to serving as a mega-damage hand to hand combat weapon.

Primary Purpose: Anti-Armor

Secondary Purpose: Defense

Mega-Damage: The twin laser beams inflict 2D4×10 M.D. A thrust or swing with the fang does 3D6 M.D. in addition to normal hand to hand damage.

Rate of Fire: Equal to the combined number of hand to hand attacks of the pilot.

Effective Range: 4000 feet (1200 m) for the laser; close combat for the fang.

Payload: Effectively unlimited.

5. Hand to Hand Combat: Rather than use a weapon, the pilot can engage in hand to hand combat.

Restrained Punch: 2D6 M.D.

Full Strength Punch: 6D6 M.D.

Power Punch: 2D6×10 M.D. (counts as two attacks)

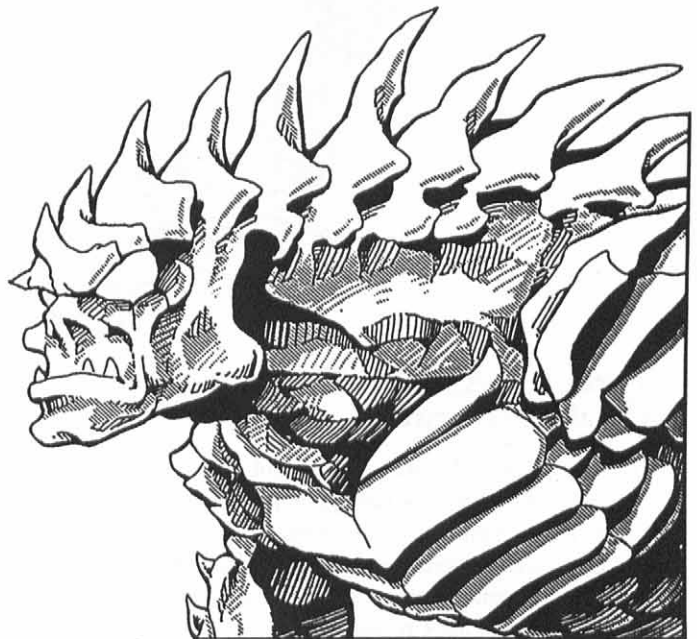

Greataxe IFV Tank (UWW)

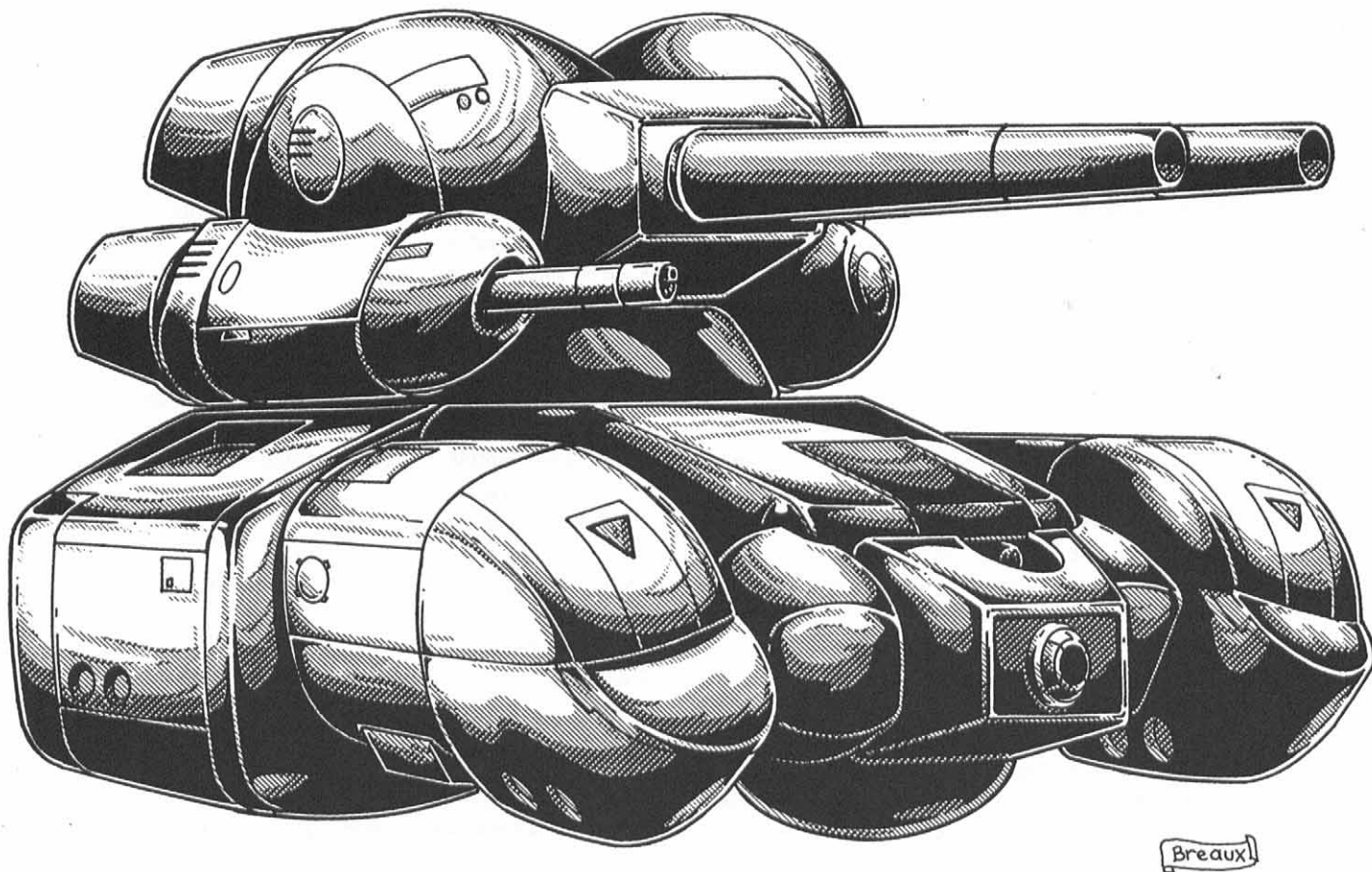

The Greataxe is the fighting and transport vehicle of the Warlock Marines. It is designed to quickly transport power armor soldiers and provide artillery support. This expensive vehicle uses a low-power contra-gravity system to float a short height above the ground and air thrusters for speed and guidance. Its weapon turret has a combination cannon/missile launcher. The double-barreled cannon can fire conventional unguided explosive rounds, or it can fire two missiles out of the same barrel. The ammunition load is a mixture of 200mm explosive rounds and Bottled Demon techno-wizardry missiles. Other weapons include a plasma gun located in the main body of the tank along with a rail gun for anti-personnel purposes.

Model Type: WIFV-99

Class: Infantry Fighting Vehicle

Crew: Four; pilot, co-pilot/communications officer, and two gunners.

Troop Capacity: The Greataxe can carry a complement of 10 soldiers in Warlock Combat armor.

M.D.C. by Location:

* Turret — 200

Cannon/Missile Launcher — 120

Coaxial Rail Gun (in turret) — 80

Plasma Gun (Main body) — 160

Mini-Missile Launchers (2, on sides of the main body) — 50 each

** Main Body — 420

* Destroying the turret prevents the use of all its weapon systems.

** Depleting the M.D.C. of the main body will shut the tank down completely, making it useless.

Speed:

Driving on the ground: 200 mph (320 km) maximum speed. Can travel over ground and water and the contragravity system can lift the vehicle over any obstacle.

Flying: Limited flight capabilities. Has no maximum altitude (can reach orbit, or even land from orbit!) but at altitudes higher than 100 feet (30.5 m), speed decreases to a crawling 80 mph (128 km). Also, the belly plates of the vehicle are vulnerable, so attacks from the ground below inflict double damage!.

Statistical Data:

Height: 20 feet (6.1 m), including the turret

Width: 20 feet (6.1 m)

Length: 40 feet (12.2 m)

Weight: 30 tons

Cargo: Has a weapons locker and personal effects locker (5 feet/1.5 m).

Power System: Nuclear; average energy life of 15 years.

Market Cost: 50 million credits.

Weapon Systems:

1. Dual-Purpose Cannon: This double-barreled, smoothbore cannon can fire both explosive rounds and guided missiles. The missiles are used against aircraft or for long-range bombing purposes. The stats of the missiles are described below.

Primary Purpose: Anti-armor

Secondary Purpose: Anti-personnel

Mega-Damage: The explosive shells inflict 2D4×10 M.D. to a 40 ft (12.2 m) radius. Two shells fired at the same time do double damage (4D4×10 M.D.) to any target they hit directly, and do normal damage to a radius of 60 feet (18.3 m).

Rate of Fire: Equal to the number of hand to hand attacks of the gunner. Reloading counts as one melee attack.

Maximum Effective Range: 6000 feet (1830 m).

Payload: 40 rounds in an internal magazine. The gunner can select tank rounds or missiles, or even one of each.

2. Bottled-Demon Missiles: These missiles are fired from the dual-purpose cannon. Bottled Demon missiles are, literally, demonic beings summoned and bound into a missile shell! The evil creatures are filled with rage and hatred, so when they are fired, they fly after the target relentlessly. If it misses, the demon-missile will turn back and continue pursuing the target until either it is destroyed (inflicting 50 M.D. to the missile will destroy the enchantment and send the demon back to its dimensional realm) or it finds its target.

Bottled Demons are slightly bigger than mini-missiles, and require special launchers (will not fit normal launchers). When fired at short range, use the combat bonuses of the pilot. At long range, or if they miss, treat them like smart missiles: +4 to strike and +5 to dodge, and have three attacks per melee until they hit or are destroyed. The demons will not attack anybody other than the designated target; if that target disappears, runs away or is destroyed, the demon missile vanishes, its purpose fulfilled.

Primary Purpose: Anti-aircraft

Mega-Damage: 3D4×10 M.D. magical energy.

Rate of Fire: One at a time or volleys of two. Each volley counts as one attack; reloading the cannon also counts as one attack/action.

Maximum Effective Range: Once fired, the demon will fly and pursue the designated target until destroyed, at a speed of Mach 3; effectively unlimited.

Payload: 32 in weapon magazine, but only two demon-missiles can be fired per melee round.

3. Coaxial Rail Gun: A rail gun mounted below and to the left of the dual cannon. It can be fired by the gunner as a backup gun, or against infantry.

Primary Purpose: Anti-personnel

Secondary Purpose: Defense

Mega-Damage: A burst of 40 rounds that inflicts 1D6×10 M.D. Can only fire bursts.

Rate of Fire: Equal to the combined number of hand to hand attacks per melee.

Maximum Effective Range: 3000 feet (914 m)

Payload: 8000 rounds; that's 200 bursts.

4. Plasma Gun: This is a more powerful version of the Volcano Rifle issued to the Warlock Marines. Like the Volcano, it can fire a concentrated blast or a dispersed, wide blast designed to mow down infantrymen.

Primary Purpose: Anti-Armor

Secondary Purpose: Anti-Personnel

Mega-Damage: Concentrated Blast: 2D4×10 M.D. Wide Blast: 5D6 M.D. to any targets in a 40 foot (12.2 m) area, or 3D6×10 M.D. to a 30 foot (9.1 m) stretch of wall/starship hull.

Rate of Fire: Each blast counts as one melee attack. Cannot fire bursts.

Maximum Effective Range: Concentrated Blast: 4000 feet (1220 m). Wide Blast: 2000 feet (610 m)

Payload: Effectively unlimited.

5. Mini-Missile Launchers (2): Two boxed launchers are mounted on the sides of the main body, and are used for defensive or anti-aircraft purposes.

Primary Purpose: Anti-aircraft

Secondary Purpose: Defense

Mega-Damage: Varies with missile type.

Rate of Fire: One at time or volleys of 2, 4, or 8.

Effective Range: About one mile (1.6 km).

Payload: 32 total; 16 per launcher.

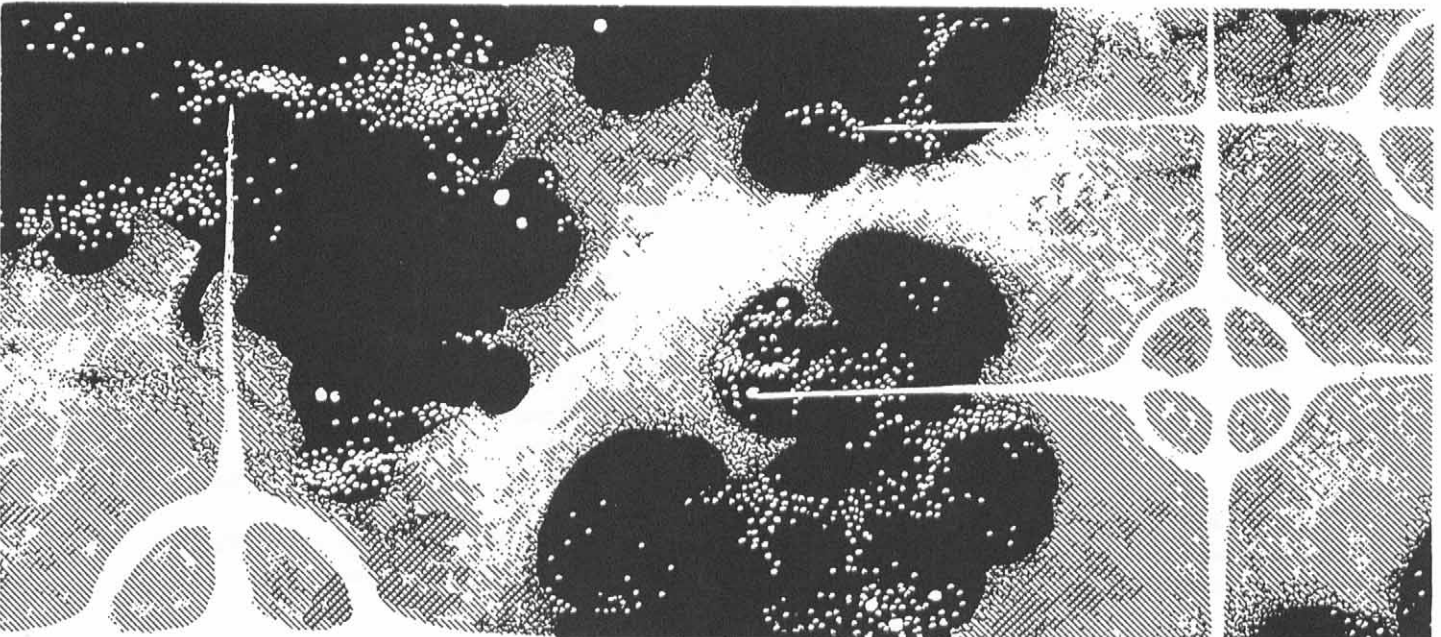

Starships of the Three Galaxies

The following descriptions are more starships active in the Three Galaxies setting. Game Masters may drop them into a campaign with little difficulty, or use them as a model from which to pattern their own designs for ships of the same class and type.

Fighter Ships

Space fighters are typically small vessels roughly the size of Earth jet aircraft. They are designed for close combat with other fighters, power armor troops, robots and similarly small opponents. They are also used to escort and defend larger spacecraft and space stations, as well as attack such vessels. In many instances, the main defense systems of the large vessels are not equipped to repel these small and agile fighters, who can get in close and avoid the “big” anti-spacecraft guns. This leads to comparatively close combat and dogfights with other fighters, bots and armored troops.

Most fighters have a battery of weapons, are maneuverable, and manned by one pilot or a pilot and a gunner. Only a few have crews of three or more, or can accommodate a handful of passengers. Many also have transatmospheric capabilities, which means they can function both in space and in an atmosphere, and in some cases, even underwater. In an atmosphere they are comparable to a fighter jet.

Black Eagle Medium Fighter (CAF)

The Black Eagle is a relatively new (“only” 20 years in service) medium fighter adopted by the Consortium Armed Forces (CAF). It replaced a venerable medium fighter developed by the Human Alliance several centuries back, because the old fighter was no longer able to perform its duties in the face of more advanced ships and weapon systems.

The Black Eagle fighter serves both as a carrier-based fighter or as part of a planetary defense force. It can be configured for a variety of missions, including bomber (outfitted with cruise missiles), interceptor (eliminating enemy fighters), rescue, escort, and long-range missions (one version of the ship is outfitted with an FTL drive).

Black Eagles are D-shaped, with two laser cannons, one on each side and an auto-cannon in the nose. The attack version carries two cruise missiles for use against large targets (frigates or bigger ships). The ship has an aerodynamic profile which allows for atmospheric flight and combat as well. Their atmospheric

performance is so good that some of these ships operate from planetary bases where they can intercept invaders within the planet’s atmosphere or out in orbit. More importantly, it has a variable force field, which gives it a huge advantage over most jet fighters.

So far, the Black Eagle has not been tested in an all-out war, but has performed well in light combat situations against pirates, smugglers and raiders. It has yet to prove itself against comparable military vessels in a sustained conflict. However, these skirmishes and years of service strongly suggest that the fighter would function admirably even under the more extreme and deadly of combat environments.

Currently, Black Eagles are assigned to the Packmaster carrier ship, the Warshield Cruiser, and the Hunter Frigate. The relative newness of the Black Eagle means that very few of these ships can be found outside the CAF’s service, but a few dozen have popped up on Phase World and some Black Markets.

Model Type: SF-101A (attack ship), SF-101AI (attack/interceptor), or 101LR (long-range fighter).

Class: Medium Fighter with three configurations.

Crew: One pilot and can accommodate two passengers.

M.D.C. by Location:

Pilot’s Cockpit/Escape Pod — 120

Laser Cannons (2, built into body) — 100 each

Nose GR Cannon — 40

Mini-Missile Launchers (2, on sides) — 80 each

Cruise Missiles (SF-101A only; 2 in underbelly) — 60 each

Pilot’s Compartment — 120

** Main Body — 800

Variable Force Field — 200 per side (1200 total)

** If the M.D.C. of the main body is depleted, the vehicle is destroyed. The pilot’s only hope is to eject (the reinforced pilot’s compartment becomes an escape pod with 48 hours’ worth of oxygen).

Speed:

Driving on the ground: Not possible

Flying: In space: Mach 16. In an atmosphere, maximum speed is Mach 7. The SF-101A has the same performance in space, but can only fly at Mach 3 in an atmosphere (the missiles add to air drag).

FTL: Only the SF-101LR has a CG-drive that allows FTL travel (2 light years per hour).

Range: Limited only by supplies and air support, it can support three people for up to fourteen days, or the pilot for six weeks.

Statistical Data:

Height: 14 feet (4.3 m)

Width: 32 feet (9.75 m)

Length: 45 feet (13.7 m)

Weight: 12 tons

Cargo: Utility closet (4×4×4 feet/1.2×1.2×1.2 m) for personal effects.



Power System: Anti-matter; average energy life of 40 years.
Market Cost: 45 million credits (75 million for the SF-101LR). Due to this ship's newness, only a few dozen have been found in the hands of the Black Market, at a cost of 35 to 50 million credits, depending on how fully-equipped they are. The cheaper versions will have 30% less M.D.C., and may be missing one or two weapon systems.

Weapon Systems:

1. Laser Cannons (2): These are souped-up HI-laser cannons, more powerful and with a longer range than most conventional lasers (see **Rifts Phase World**, page 154). Each cannon can fire in succession, engaging different targets or shooting simultaneously against the same target

Primary Purpose: Anti-ship and anti-aircraft.

Secondary Purpose: Defense

Mega-Damage: 2D4×10 M.D. per single blast, or 4D4×10 M.D. per double blast.

Rate of Fire: Equal to the number of hand to hand attacks of the pilot.

Effective Range: 5 miles (8 km) in space; 2 miles (3.2 km) in an atmosphere.

Payload: Effectively unlimited.

2. GR-Cannon: A nose-mounted GR-cannon is the secondary weapon, used primarily for dogfights.

Primary Purpose: Anti-aircraft and anti-missile.

Secondary Purpose: Defense

Mega-Damage: A burst is 30 rounds and inflicts 3D6×10 M.D. Can only fire bursts.

Rate of Fire: Equal to the number of hand to hand attacks of the pilot.

Effective Range: 10 miles (16 km) in space; one-third that in an atmosphere.

Payload: 6000 rounds (200 bursts).

3. Cruise Missiles: The SF-101A attack version carries two cruise missiles for bombing missions. Standard attack doctrine calls for firing the missiles at "point-blank" range (one mile/1.6 km or less), at which point the speed of the missiles makes them almost impossible to evade or destroy.

Primary Purpose: Anti-ship

Secondary Purpose: Bombardment

Mega-Damage: 2D6×100 (nuclear) or 4D6×100 (anti-matter)

Rate of Fire: One at a time or a volley of two.

Effective Range: 1,000 miles (1600 km)

Payload: Two cruise missiles.

4. Mini-missile Launchers (2): This multiple mini-missile launch system can be used against ground targets, incoming missiles, enemy fighters, armored troops, for precision strikes, and even against man-sized targets.

Primary Purpose: Bombardment and anti-ship.

Secondary Purpose: Defense

Mega-Damage: Varies with missile type.

Rate of Fire: One at a time or volleys of two, four, eight or 12.

Effective Range: About one mile (1.6 km).

Payload: 24 mini-missiles per launcher; total of 48.

Katana-Class Fighter Ship

CAF/Bushi Federation

This new ship design is the brainchild of the "weaponsmiths" from the Bushi Federation. Using the most advanced metal alloys and force field technology available, the oni's have produced one of the best medium fighters in the Three Galaxies. The Katana is allegedly sold only to responsible governments, but the manufacturer, *Bushido Industries*, shares Naruni Enterprises' lack of concern about who they sell their products to as long as they make a profit. As a result, Katana fighters have found their way into the hands of both law enforcers and criminals.

Despite its name, the Katana does not resemble the traditional Japanese (or Oninese) sword. Instead, the ship resembles a broad arrowhead, built low to the ground, with a small profile that is both highly aerodynamic and hard to detect with radar and sensors. A weapon pod is slung under each side. The pods are currently available in four different modular weapon systems, each allowing for quick replacement of damaged pods or tactical modification in a matter of minutes.

Several different pod weapon systems are offered for sale, making the basic ship quick and easy to modify for a multitude of tasks and combat missions. In addition to the pods, the Katana has a long-range particle-beam cannon built into it, forward section. The fighter also has four missile pylons that can use long-range or cruise missiles. In terms of speed and maneuverability, the vessel is the match of any Three Galaxies fighter.

The CAF has purchased 10,000 of these ships to supplement their new Black Eagle fighters. The Katana warships were purchased to "pick up the slack" when the *Galactic Armory*, the designer and manufacturer responsible for the Black Eagle fighters, could not meet their original delivery projections (they were two years late and short 12,000 fighters!). As a result, a number of concerned Consortium politicians pushed for the purchase of *Katana fighters*. The CCW government contracts with *Bushido Industries* has given the Katana fighter instant and resounding notoriety. Sale of the ship throughout the Three Galaxies has increased by 78% with no sign of fading. This has created a bitter feud between it and the Galactic Armory and Bushido Industries. On top of that, the notoriety gained from the CAF's purchase/endorsement of the Katana has caused *Naruni Enterprises* to lose a number of sales in the independent markets. The Naruni's biggest loser has been their Broadsword fighter; sales are in the gutter, even with the price slashed by 40%. Naruni is not likely to take this situation well and there are already rumors of sabotage and espionage against Bushido Industries from, as of yet, unknown assailants (Naruni Enterprises perhaps? Or maybe the Galactic Armory?).

Model Type: BIF-67

Class: Tactical Space Fighter

Crew: One

M.D.C. by Location:

Weapon Pods (2, on underside) — 300 each

Missiles (4, on the underside) — 60 each

Pilot's Cockpit/Escape Pod — 250

** Main Body — 600



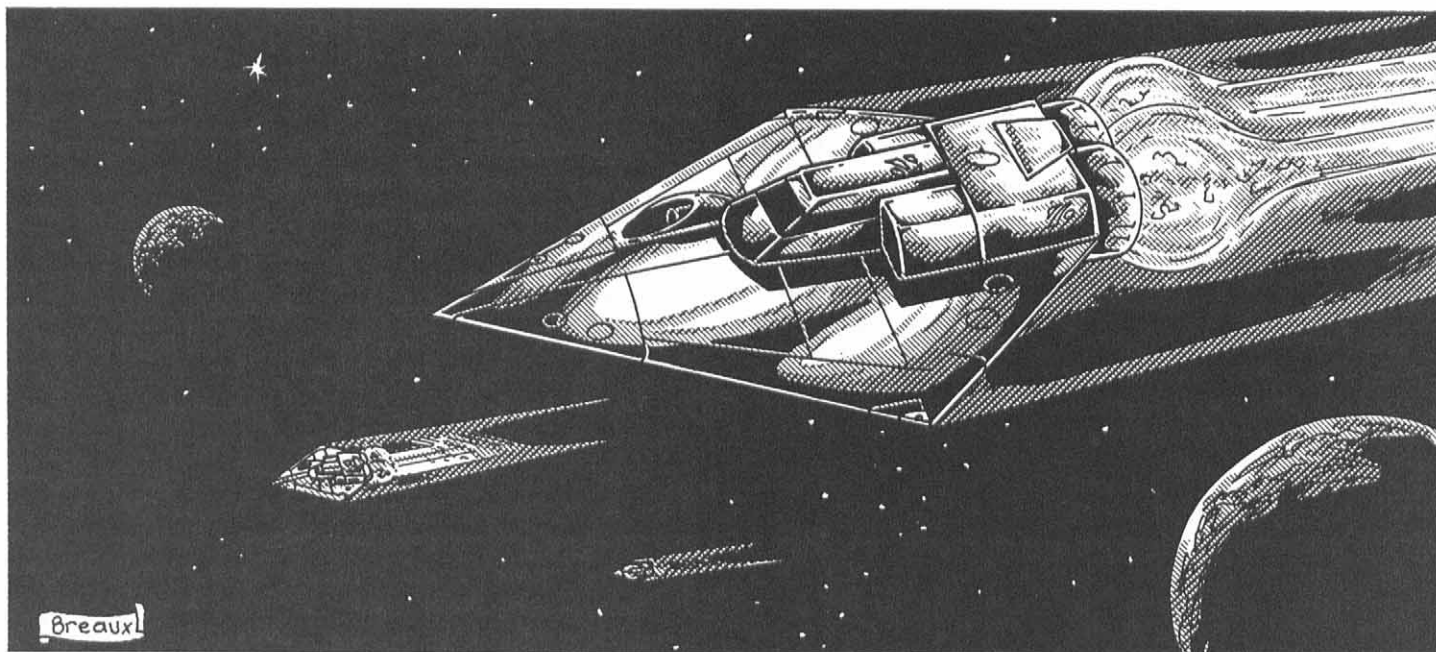

Variable Force Field — 300 per side (1800 total)

** Depleting the M.D.C. of the main body destroys the propulsion system and causes the escape pod to eject.

Speed:

Driving on the ground: Not possible

Flying: Mach 14 in space, or up to Mach 8 in an atmosphere.

Does not have FTL capabilities.

Range: Life support will keep the pilot alive for up to three weeks.

Statistical Data:

Height: 12 feet (3.65 m)

Width: 40 feet (12.2 m) at its widest point.

Length: 50 feet (15.2 m)

Weight: 15 tons.

Cargo: Small utility closet, enough for personal effects and hand weapons.

Power System: Anti-matter; average energy life is 30 years.

Market Cost: 65 million credits when sold to a reputable government or military organization. The price tag includes one weapon pod system; additional pods can be purchased for 5 to 10 million credits each; discounts are given for quantity sales.

Thousands of Katana fighters are sold “under the table” through the Black Market; prices range from 70 to 100 million credits for fully-equipped ships, and 50 million for second-hand or cheap reproductions (reduce M.D.C. by 20%, the power of the force fields to 100 per side, and speed by 30%; furthermore the particle beam cannon is usually missing, although weapon pods can be purchased).

Weapon Systems:

1. Particle Beam Cannon (standard): This weapon is built inside the ship’s hull and is destroyed when the main body is destroyed.

Primary Purpose: Anti-aircraft

Secondary Purpose: Defense

Mega-Damage: 2D6×10 M.D. per blast.

Rate of Fire: Equal to the number of combined hand to hand attacks of the pilot.

Effective Range: 2 miles (3.2 km)

Payload: Effectively unlimited.

2. Missile Pylons (4): These missile racks are located on the underbelly of the fighter and can hold four cruise, medium or long-range missiles.

Primary Purpose: Anti-ship

Secondary Purpose: Defense

Mega-Damage: Varies with missile type.

Rate of Fire: Missiles launched one at a time or in volleys of two, three or four.

Effective Range: Cruise missiles: about 1,000 miles (1600 km), medium-range missiles: 50 miles (100 miles/160 km in space), or long-range missiles: 1200 miles (1920 km; 2400 miles/3840 km in space).

Payload: Four missiles total.

3. Weapons Pods (2): Two identical or different weapon pods can be attached to the undercarriage of the fighter. These modular pods can be changed and interchanged within 10 to 15 minutes by a capable service crew familiar with the vessel. Those not familiar with the Katana may require an additional 2D4 minutes. The following are the current available weapon “pods”:

Anti-Aircraft Weapon Pod: This pod combines a medium-range missile launcher and a gravity gun. It is designed to destroy small vessels, robots and power armor.

Primary Purpose: Anti-aircraft

Secondary Purpose: Defense

Mega-Damage: Gravity gun: 3D6×10 M.D. per 40 round burst. Medium-range missiles: varies with missile type.

Rate of Fire: Each gravity gun burst or missile volley (one, two or four missiles) counts as one melee attack/action.

Effective Range: One mile (1.6 km) for each weapon.

Payload: Gravity Gun: 8000 rounds (200 bursts). Missile payload: 16.

Cruise Missile & Laser Pod: A mounting that can carry two cruise missiles and which includes a laser gun for self-defense.

Primary Purpose: Anti-ship

Secondary Purpose: Defense

Mega-Damage: Varies with missile type. The laser inflicts

6D6 M.D. per blast.

Rate of Fire: Each volley or blast counts as one melee attack/action

Effective Range: Cruise missiles: about 1,000 miles (1600 km). Laser: One mile (1.6 km; half range in an atmosphere).

Payload: Two missiles; effectively unlimited for the laser.

Mini-missile Pod: This is a multiple launch missile system that can be used against infantrymen, ground targets, and against ships.

Primary Purpose: Bombardment and anti-ship.

Secondary Purpose: Defense

Mega-Damage: Varies with missile type.

Rate of Fire: One at a time or volleys of two, four, eight or 12.

Effective Range: About one mile (1.6 km).

Payload: 48 mini-missiles per weapon pod (as many as two pods).

Plasma Ejection Pod: This is a destructive, but very limited and close range weapon designed to destroy enemy

tanks, giant robots and incapacitate large spaceships. The pod can generate a devastating plasma charge, but range is restricted to a mere 600 feet (183 m) and the weapon can only fire twice per melee round! It is most effective in strafing runs against large vessels and stationary targets, like bunker and weapon turrets, or slow moving armored vehicles, tanks and giant robots.

Primary Purpose: Anti-large ships

Secondary Purpose: Anti-armor and bunkers.

Mega-Damage: 1D4×100 M.D. per blast.

Rate of Fire: Twice per melee round (each blast counts as two melee attacks).

Effective Range: 600 feet (183 m)

Payload: Effectively unlimited.

- 4. Special Bonuses:** The vessel is extremely maneuverable: add +5% to the piloting skill, +1 to strike, +2 to dodge laser fire and +3 to dodge missiles, obstacles, flying debris and meteors. It can also avoid ground radar detection by flying low to the ground while traveling at great speeds.

“Fire-Eater” Attack Ship

Naruni Enterprises

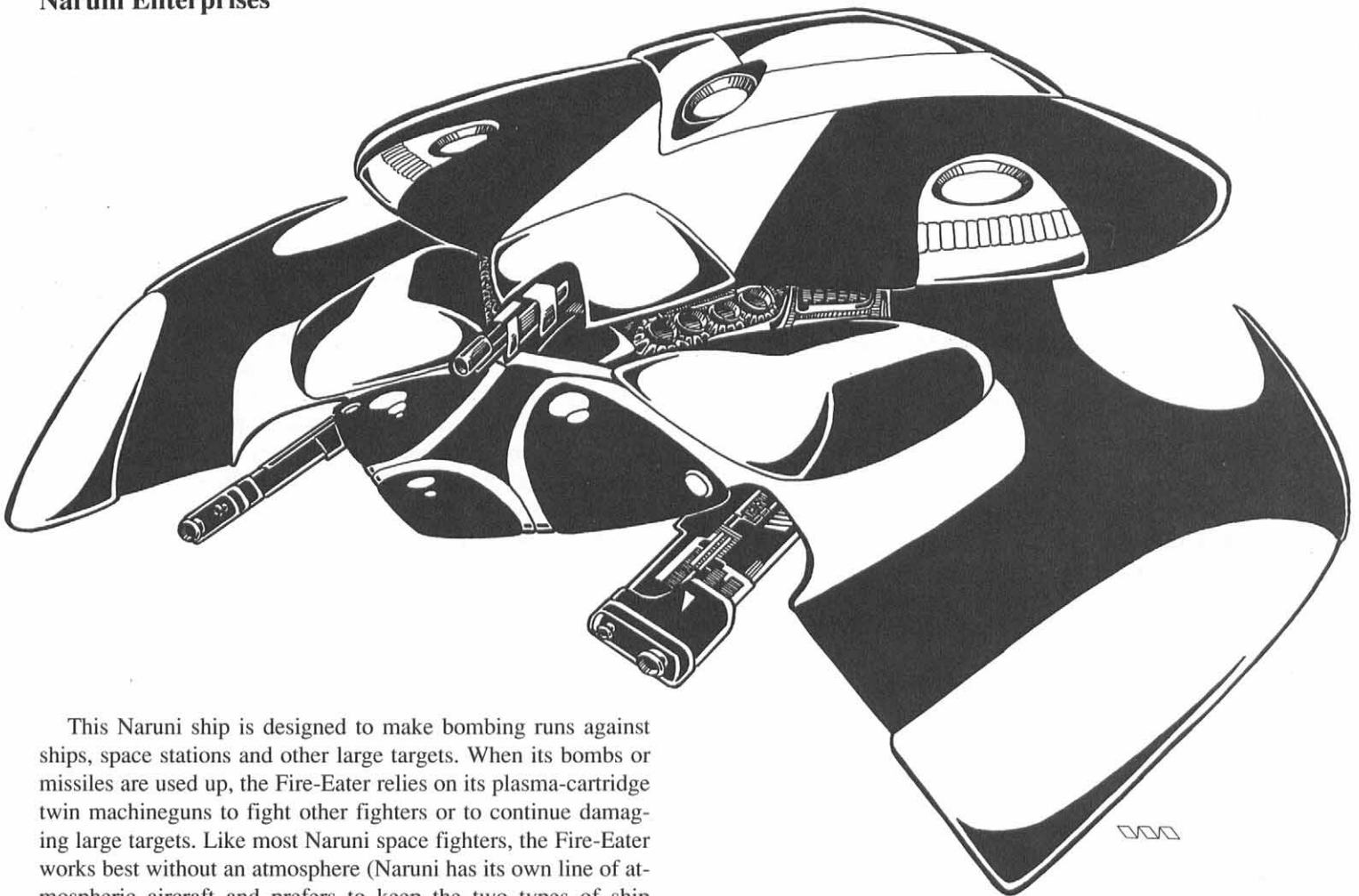

This Naruni ship is designed to make bombing runs against ships, space stations and other large targets. When its bombs or missiles are used up, the Fire-Eater relies on its plasma-cartridge twin machineguns to fight other fighters or to continue damaging large targets. Like most Naruni space fighters, the Fire-Eater works best without an atmosphere (Naruni has its own line of atmospheric aircraft and prefers to keep the two types of ship separate).

The United Worlds of Warlocks has bought over three hundred Fire-Eaters to supplement their own sorcery-powered ships. The fighters are also frequently found among the larger pirate fleets that constantly plague the edges of the Three Galaxies.

Planetary defense forces also use this ship. Often, both sides of a pitched battle turn out have this fighter as part of its fleet!

Model Type: FB-49

Class: Fighter/Bomber

Crew: One, the pilot

M.D.C. by Location:

- Missile Compartment (underbelly) — 150
- Side-mounted Auto-Cannons (2, on sides) — 120 each
- Reinforced Pilot's Compartment — 200
- * Main Body — 550
- Variable Force Field — 200 per side (1200 total)
 - * Depleting the M.D.C. of the main body destroys the propulsion system and causes the escape pod/reinforced pilot's compartment to eject.

Speed:

Driving on the ground: Not possible.

Flying: Mach 10 in space. Maximum atmospheric speed is Mach 2.

Range: Limited only by life support (will keep one person alive for up to two weeks).

Statistical Data:

Height: 12 feet (3.65 m)

Width: 30 feet (9.1 m)

Length: 40 feet (12.2 m)

Weight: 15 tons fully loaded.

Cargo: Bomb bay can be filled with up to two tons (1800 kg.) of cargo or bombs.

Power System: Nuclear; average energy life of 20 years.

Market Cost: 70 million credits.

Weapon Systems:

1. Plasma Auto-cannons (2): These weapons fire long bursts of Naruni plasma cartridge ammunition. The longer barrels extend the range of the cartridges, enabling them to hit targets at great distances. The auto-cannons are set to fire simultaneously at the same target.

Primary Purpose: Anti-aircraft

Secondary Purpose: Defense

Mega-Damage: The two cannon firing together inflict 3D6×10 M.D. per 20 round burst (40 rounds total). If one of the cannons is destroyed, damage drops to 2D4×10 M.D. per burst. Can only fire bursts.

Rate of Fire: Each burst counts as one hand to hand attack per melee.

Effective Range: Two miles (3.2 km) in space, 4000 feet (1220 m) in an atmosphere.

Payload: 2000 rounds per cannon that's 100 bursts.

2. Missile Launcher: The bottom of the ship is a missile and bomb bay that can fire either long-range missiles or self-guided bombs.

Primary Purpose: Anti-ship and bombardment.

Secondary Purpose: Defense

Mega-Damage: Varies with missile and bomb type. Usually 3D6×10 or 4D6×10 M.D. per bomb.

Rate of Fire: Up to four missiles or eight bombs can be released per melee attack/action.

Effective Range: Missiles: varies with missile type. Bombs have a 200 mile (320 km) range.

Payload: 16 long-range missiles or 32 bombs.

3. Light Laser: This weapon is built into the main body of the ship and is used as a secondary weapon against fighters and missiles.

Primary Purpose: Anti-aircraft

Secondary Purpose: Defense

Mega-Damage: 1D4×10 M.D. per blast.

Rate of Fire: Equal to the total number of hand to hand attacks of the pilot.

Effective Range: One mile (1.6 km).

Payload: Effectively unlimited.

Spinnerette Interceptor Intruders

The ship design of the Spinnerette does not resemble any other vessel of its class. As their nickname indicates, these diamond-shaped vessels are constantly spinning. It flashes and

changes colors regularly as well, and has no visible weapons, engines or normal ship components. These fighters are the creation of the transgalactic race known as the Intruders. The little ships are as fast as the swiftest CAF or Imperial vessel and some Spinnerettes have reportedly been clocked at Mach 20! They also have incredible firepower and amazing maneuverability. Their "hulls" are unaffected by air drag and can fly at incredible speeds in an atmosphere and even under water. To the astonishment and terror of the Three Galaxies, the fighters are undetectable by standard sensor systems, until they are within close range (close for space vessels that is). Most victims aren't aware of the tiny ships (or their larger counterparts) until they close within visual range. But the most unsettling power of the Spinnerettes is their power to regenerate damage within minutes.

The tiny ships always seem to survive more damage than they have any right to do. After a while, galactic pilots realized that if the Spinnerettes are given a few minutes to recover, all the apparent damage they had suffered is completely repaired. CAF and Imperial pilots have learned to keep hitting the Spinnerettes until they explode or vaporize; that's the only way to be sure they are destroyed.

Three ships have been captured by the CAF when phase weapons killed the pilots (phase energy passes through the energy hull and strikes the pilots directly); thankfully, the Intruders don't seem to have any defenses against phase technology. To the amazement of scientists and soldiers alike, the "ship" was nothing more than a pilot-sized metal "cage!" The flashing "walls" of the ship are some sort of solid force field!! This "solid energy" technology has so far baffled the best minds in the Three Galaxies. Furthermore, no apparent weapon systems can be found inside the ship's skeleton. It is now believed that the rapid-fire energy bursts the little ships fire are extensions of or generated and emitted from the same "solid energy" field of the ships. This control and manipulation of energy may be the creation of magic or a technology so far ahead of the Three Galaxies that it might as well be magic. Further examination of the ships was impossible, because they self-destructed approximately one hour after their capture and the energy explosion severely damaged the transport vessels carrying them. **Note:** Most civilizations in the Three Galaxies would pay a fortune for an unharmed Spinnerette to study.

Model Type: Unknown

Class: Light fighter vessel

Crew: One, the pilot.

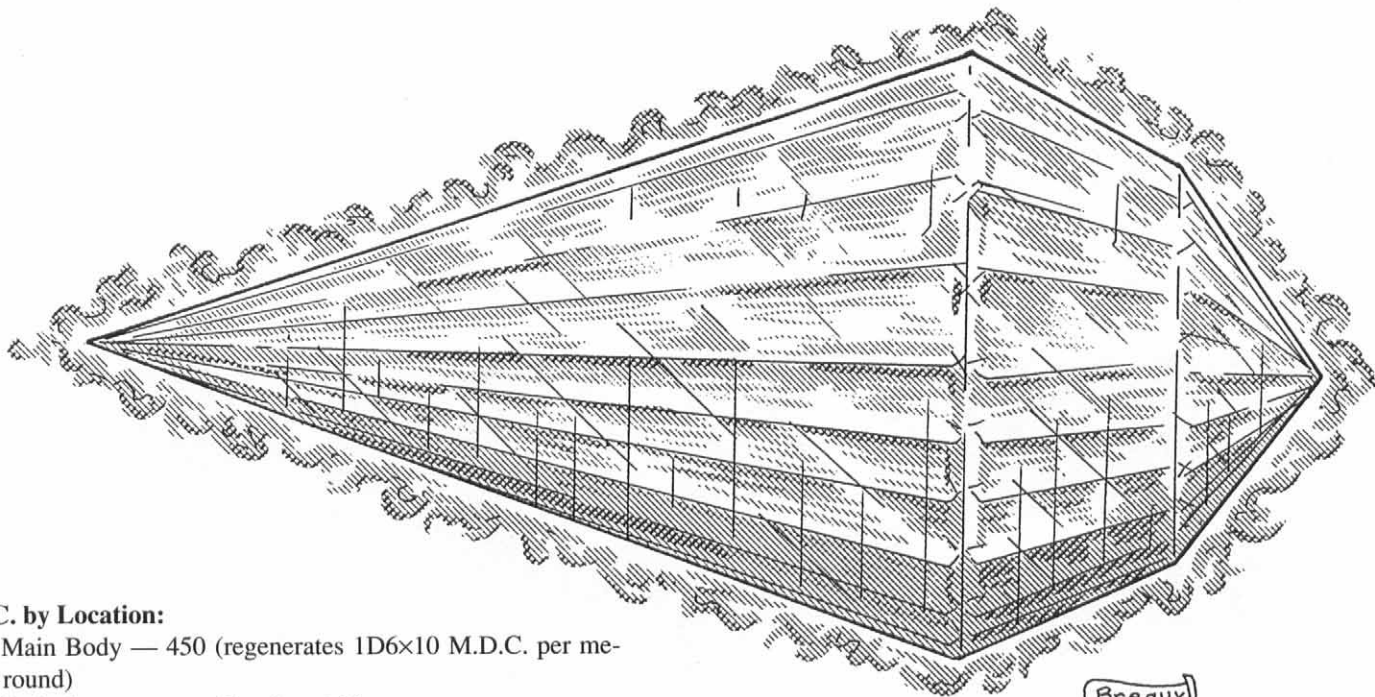

M.D.C. by Location:

** Main Body — 450 (regenerates 1D6×10 M.D.C. per melee round)

* Pilot's Compartment (Cage) — 100

* The pilot's compartment is the only truly solid part of the ship. Unless it is destroyed or the pilot killed, the main body will continue to regenerate.

** The "main body" is made up of solid energy that regenerates damage at the rate of 1D6×10 M.D.C. per melee round! Depleting the M.D.C. of the main body has little effect on the ship, except that the pilot's compartment becomes vulnerable to damage. When the pilot's compartment is reduced to zero, the regeneration process stops and the ship is destroyed. However, to strike the pilot's compartment, the main body of solid energy (450 M.D.C.) must be depleted first.

Speed:

Driving on the ground: Not possible.

Flying: Up to Mach 20 in space and in an atmosphere, Mach 10 underwater! The "solid energy" field seems to render the ship immune to air friction and air and water drag.

Star Drive: The ship (unknown to most scientists in the Three Galaxies) uses a space-fold system that lets it cross 100 light years in one jump! The fold system can perform up to 5 jumps per day (500 light years in a day).

Statistical Data:

Height: 31 feet (9.5 m)

Width: 9 feet (2.7 m)

Length: 10 feet (3.0 m)

Weight: The pilot's compartment weighs one ton/907 kg.; the solid energy "hull" is weightless.

Cargo: Small utility locker in the pilot's compartment.

Power System: Unknown. Presumed to have an energy life of at least 50 years.

Market Cost: Not available! The CAF, Naruni Enterprises, the Splugorth or the Transgalactic Empire would pay 500 million credits or more for a new, undamaged craft that does not self-destruct in an hour.

Weapon Systems:

1. Energy Blaster: Beams of energy can be fired from any side of the ship, although no apparent weapon systems are visible. These energy beams are neither lasers nor particle beams;

Breauxl

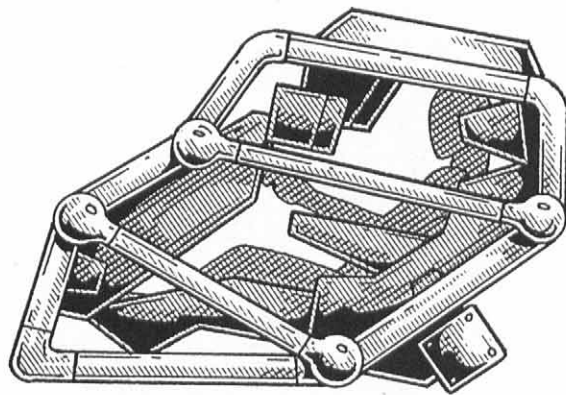

they seem to be the same "energy" as the ships and fire from the body of the vessel rather than the barrel of a gun.

Note: These beams do extra damage to cosmo-knights! Normally, energy damage against a knight is divided by 100, in the case of Intruder vessels, divide normal damage by ten, instead of a hundred. Furthermore, the beams do full damage to ships, robots and characters enchanted with the spell: invulnerable to energy!

Primary Purpose: Anti-ship

Secondary Purpose: Defense

Mega-Damage: 2D4×10 M.D. per blast.

Rate of Fire: Each blast counts as one melee attack.

Effective Range: 5 miles (8 km) in space; 1 mile (1.6 km) in an atmosphere.

Payload: Effectively unlimited.

2. Self-destruct Device: If the pilot is killed or captured, the ship will self-destruct one hour and fifteen minutes later, doing 4D6×10 M.D. to a 80 foot (24.4 m) area. So far, no way to find and disable this system has been found.

3. Stealth System: The Spinnerettes are almost undetectable to standard radar and other sensor systems. The ship can be detected by standard visual sensors, usually when it is 1,000

miles (1600 km) away for most warships, or about 500 miles (800 km) for civilian vessels.

Star Frigates

In addition to the ships described below, refer to the frigates found in **Rifts Phase World**, pages 168-171.



Hunter-Class Destroyer (CAF)

A veteran of the wars between the old Wolfen Empire and the Kreeghor Dominion, the Hunter-class vessels are still in the service of the Consortium. The Hunters are sleek attack ships, sometimes described as “oversized fighters with more guns than they should have.” Armed with an assortment of medium and heavy weapons, the Hunters are a good compromise between the desire for speed and maneuverability, and the need for decent armor protection.

The Hunter has a slimmer profile than comparable Consortium vessels (like the Scimitar described in **Rifts Phase World**, page 169). The ship is flat, with the bridge seeming to form the body of a flat butterfly. Although these smaller dimensions limit the cargo space and supplies of the ship, it manages to be well-armed and heavily armored. Three particle beam cannons and oversized rail guns firing depleted uranium slugs, and several missile systems, comprise its armaments. Most weapons are built into the fuselage of the Hunter, reducing the chances of their being destroyed by sharp-shooting fighters and robots. The

Hunter has a small crew, and only a squad of 4 fighter ships used as a screening force.

Before the Consortium’s formation, the Wolfen Empire relied on these ships to counter the kreeghor’s Berserker class warships (see **Rifts Phase World**, page 170), or to strike blows of their own against the Dominion’s Dreadnoughts. After the Wolfen Empire was divided between the victorious kreeghor and the protective CCW, most Hunters were incorporated into the service of the Consortium’s CAF. The Hunters that were captured by the kreeghor were decommissioned and used as target drones in war-games: the kreeghor prefer to rely on their own vessels and did not trust the wolfen starships. In later conflicts, they have had reason to regret this decision.

The CAF has over 8,000 Hunter class ships on active duty. An additional 2,000+ ships can be found in the hands of independent defense forces (IDFs), especially around wolfen controlled planets. A few thousand more have found service outside the Consortium, purchased or stolen by pirates and mercenaries, or copied by non-aligned planets.

Model Type: HF-75**Class:** Frigate Combat Ship**Crew:** 24, plus 10 marines and 10 fighter pilots for the complement of four fighter ships.**M.D.C. by Location:**

Particle Beam Cannon (front, built into hull) — 800

Particle Beam Cannons (2, built into the sides) — 650 each

Rail Gun Turrets (4) — 400 each

Defense Lasers (4) — 300 each

Cruise Missile Launcher (1, underside) — 1,000

Missile Batteries (2, top and underside) — 450 each

* Bridge — 1,200

** Main Body — 4,500

Variable Force Field — 1,000 on each side (6,000 total)

* Destroying the bridge will eliminate the main computer and controls, but the ship can be controlled from the engineering section, deep inside the ship. The secondary control system is less sensitive and is -2 to strike, parry and dodge. Hits on the bridge may injure crew members even if they do not destroy it; see Ship Combat Rules.

** Depleting the M.D.C. of the main body means the ship is in tatters, with life support and contragravity systems knocked out, and unable to fight or move under its own power (the missile batteries are another matter, however and can still attack). If the ship is reduced to -1,500 M.D.C., it explodes, doing 2D6×1,000 M.D. to all other ship components and any target within 1,000 feet (305 m).

Speed:Driving on the ground: Not possible.Flying: Mach 9.5 in space, or Mach 1 (670 mph/1080 kmph) in an atmosphere.Star Drive: Gravitonic Drive, maximum speed: 4.5 light years per hour.Range: Limited only by supplies. A Hunter has enough supplies for a crew of 50 to last one year. These supplies could be stretched to two years in an emergency. Typical patrol mission lasts six months.**Statistical Data:**Height: 70 feet (21.3 m)Width: 80 feet (24.4 m)Length: 300 feet (91.4 m)Weight: 6,000 tons fully loaded.Cargo: Small cargo hold: 20×40×40 feet (6.1 x 12.2 x 12.2 m). Can carry 500 tons of cargo, not counting the standard complement of supplies and ammunition.Power System: Anti-matter; average energy life is 50 years.Market Cost: 320 million credits, but sold only to respectable independent planets or CCW planetary defense forces. Decommissioned "army surplus" versions which can cost from 90 to 150 million credits may be available, but reduce M.D.C. by 40%, remove all weapon systems, stealth system and advanced sensory systems, plus power armor and fighters are NOT available.**Weapon Systems:**

1. Particle Beam Cannons (3): These powerful artillery pieces are the main guns of the Hunter. These particle beam cannons use extra-powerful projectors that give them more range than typical weapons of their class, at the expense of having a lower rate of fire. One cannon is in the "nose" of the ship, although 90% of its length is built into the ship's hull. The other two are on the sides, also mostly kept inside the hull for

extra protection. Each gun can fire once per melee round. At the captain's discretion, each gun can fire independently at different targets, or all three can engage the same target in a devastating triple blast.

Primary Purpose: Anti-shipSecondary Purpose: DefenseMega-Damage: 2D4×100 per cannon; two cannons firing at the same target would do 4D4×100 M.D., and all three would inflict 6D4×100 M.D.!Rate of Fire: Each cannon can fire once per melee round.Effective Range: 10 miles (16 km) in space, or 4 miles (6.4 km) in an atmosphere.Payload: Effectively unlimited.

2. Rail Gun Turrets (4): These are high-caliber weapons that fire depleted uranium slugs in a magnetic metal jacket. They are useful both in knocking out incoming missile fire and to engage fighters, robots and even frigates that get into range.

Primary Purpose: Anti-aircraftSecondary Purpose: DefenseMega-Damage: A burst is 80 rounds and inflicts 3D6×10 M.D. Can only fire bursts.Rate of Fire: Equal to the total number of hand to hand attacks of the gunner.Effective Range: 8 miles (12.9 km).Payload: 32,000 rounds per turret (400 bursts).

3. Defense Lasers (4): Four small laser cannons on ball-turrets cover the areas the rail guns don't. They are used primarily for anti-fighter and anti-missile fire.

Primary Purpose: Anti-aircraftSecondary Purpose: DefenseMega-Damage: 2D6×10 M.D. per blast.Rate of Fire: Equal to the total number of hand to hand attacks of the gunner.Effective Range: 2 miles (3.2 km)Payload: Effectively unlimited.

4. Cruise Missile Launcher: This launcher is the Hunter's secondary weapon system. This is not very effective, however, because it cannot fire in volleys, which makes its attacks easy to avoid. Missile attacks are usually saved up for "point-blank" (one-mile/1.6 km or less) shots.

Primary Purpose: Anti-ship.Secondary Purpose: Defense.Mega-Damage: 2D6×100 or 4D6×100 M.D.Rate of Fire: One at a time. Each launch counts as one melee attack.Effective Range: About 1,000 miles (1600 km)Payload: 50 missiles.

5. Missile Batteries (2): These batteries fire volleys of medium-range missiles, which can be used for both defensive and offensive purposes.

Primary Purpose: Anti-aircraftSecondary Purpose: DefenseMega-Damage: Varies with missile type.Rate of Fire: One at a time or in volleys of 2, 4 or 8 per launcher.Effective Range: About 80 to 120 miles (129 to 193 km).Payload: 320 total; 160 missiles per launcher.

6. Aircraft and Military Vehicles: In addition to its main weaponry, the Hunter has a wing of four fighters, usually *Scorpions* or the newer *Black Eagles*. A few Hunters have

been issued *Star-Ghost* phase fighters purchased from Phase World. Additionally, the Hunter has a marine complement of 10 soldiers in CAF combat armor, but no power armor or robots.

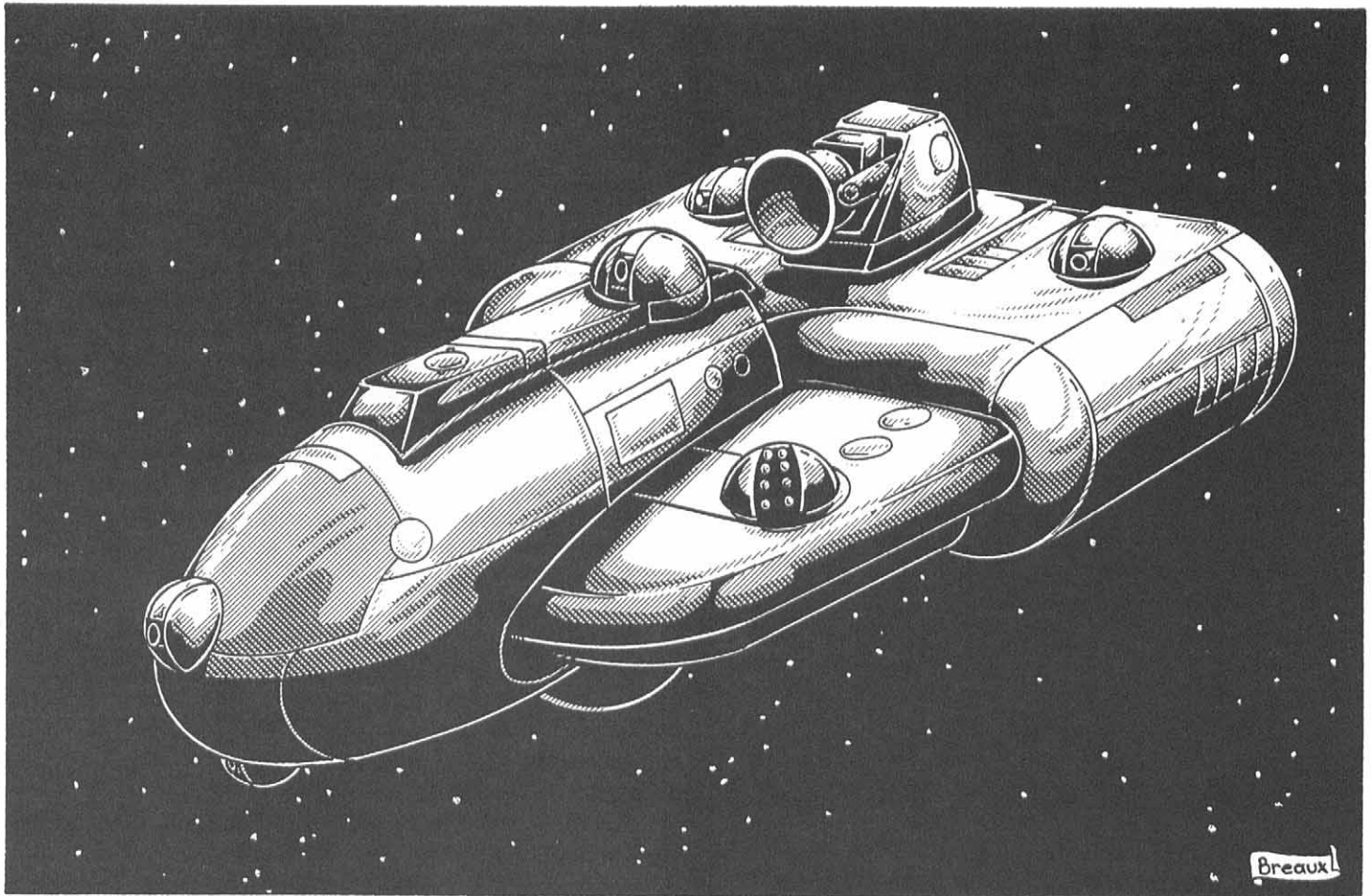

Arcane Mark II Patrol Ship

Warlock Federation

The Arcane frigate combines technology with techno-wizardry. Most of its weapon systems are “mundane,” with one important exception the “death cloud” cannon, a unique weapon found only in the Arcane ships, and the brainchild of the insanely brilliant Dwarven Techno-Wizard, *Inglis the Mad* (see the UWW section for his description). The “death cloud” cannon uses Rift technology and advanced technological sensors to Rift in nothing more than ... water. What the weapon does is place millions of gallons of frozen water, moving at speeds of Mach 2 or greater, in the path of ships traveling at speeds of Mach 6-20. At those speeds, hitting the frozen water is like smashing into a brick wall! In addition to the “death cloud,” Arcane ships have standard lasers and missiles, and a point-defense TW system that fires magical lightning bolts.

In large-scale combat, arcane frigates fight in screening lines around larger ships, firing their “death clouds” to slow down enemy attacks. The Arcane also serves as a patrol vessel, and often uses the death cloud to stop fleeing pirates or smugglers. A few Arcane vessels are found in the hands of independent planets, and even among pirates and mercenaries. Their design does not

make them suitable as cargo ships, however, so they are not popular among runners and traders.

Model Type: ARC-II

Class: Light Patrol Vessel/Escort

Crew: 60, plus Warlock Marine complement of 48 power armor troopers with jet packs.

M.D.C. by Location:

Death Cloud Cannon — 400

Laser Batteries (4) — 300 each

Long-Range Missile Launchers (4) — 250 each

Lightning Rods (8) — 100 each

* Bridge — 800

Hangar Door (1) — 500

** Main Body — 3,500

*** Armor of Ithan Force Field — 2,000 (entire ship)

* Destroying the bridge will eliminate the main computer and controls, but the ship can be controlled from the engineering section, deep inside the ship. These secondary controls are less sensitive and are -2 to strike, parry and dodge. Hits on the bridge may injure crew members even if they do not destroy it; see Ship Combat Rules.

** Depleting the M.D.C. of the main body means the ship is in tatters, with life support and contragravity systems knocked out, and the ship is unable to fight or move under its

own power (the missile batteries are another matter and can continue to launch). If the ship is reduced to -500 M.D.C., it explodes, doing 2D6×1,000 M.D. to all ships and anybody within 1,000 feet (305 m).

*** The TW force field is not a variable field; it can be re-activated up to three times over a 24-hour period.

Speed:

Driving on the ground: Not possible.

Flying: Mach 8

Star Drive: Rift Jump drive; maximum safe jump of 20 light years every 4 hours.

Range: Effectively unlimited (flight); up to 500 jumps (10,000 light years) before needing to renew spells. Has enough life support and supplies for one year of uninterrupted operations.

Statistical Data:

Height: 70 feet (21.3 m)

Width: 80 feet (24.4 m)

Length: 100 feet (30.5 m)

Weight: 10,000 tons fully loaded.

Cargo: Small cargo hold for up to 200 tons of extra equipment.

Power System: Nuclear; average energy life of 20 years, and a P.P.E. generator that produces 500 P.P.E. per hour (activating the Rift-drive costs 2,000 P.P.E.) and can hold up to 2,000 P.P.E. in storage. This P.P.E. can be used to power up magical weapon systems, or can be tapped by magic-adept crew members to fuel their own spells!

Market Cost: 550 million credits.

Weapon Systems:

1. Death Cloud Cannon: The so-called "cannon" is a bell-shaped weapon mounted on the top of the vessel. The cannon opens a Rift that releases enormous amounts of water in the path of incoming vessels or missiles. The cloud of water particles quickly freezes in the vacuum of space (within 3D4 seconds) and acts as a solid obstacle, presenting a hazard for any ship flying toward it, and also confusing sensors and radar.

Primary Purpose: Anti-ship

Secondary Purpose: Defense

Mega-Damage: A ship flying into the cloud/solid chunk/wall of frozen water will take 4D6 M.D. times its Mach Speed (i.e., 4D6 M.D. at Mach one, 4D6×2 at Mach Two, 4D6×3 at Mach Three, and so on). Larger ships take even more damage; multiply the damage by 10 for ships weighing 10,000 to 40,000 tons, by 20 if they weigh 41,000 to 100,000, and by 100 if they weigh more than 100,000 tons! A ship may attempt to dodge the cloud, but is at -6 to do so! Truly gigantic starships and freighters are -8. Missiles flying into the cloud/wall will automatically detonate.

Rate of Fire: Once per melee round.

Effective Range: 10 miles (16 km). The icy cloud/hunk is 500 feet (152 m) high, wide and thick.

Payload: The Rift generator can be activated 10 times per 24 hour period. Further activation requires the expenditure of 500 P.P.E., using either magicians on board or the ship's P.P.E. generators.

2. Laser Batteries (4): These are standard lasers, drawing power from the ship's nuclear power plant. These are largely secondary weapons; if it wasn't for the vaunted "death cloud" cannon, the ship would be outgunned by most frigate class ships.

Primary Purpose: Anti-ship

Secondary Purpose: Defense

Mega-Damage: 4D6×10 M.D. per turret.

Rate of Fire: Equal to the total number of hand to hand attacks of the gunner.

Effective Range: 5 miles (8 km)

Payload: Effectively unlimited.

3. Missile Batteries (4): Four missile batteries are placed at strategic locations around the ship. They are used to swat enemy fighters out of the sky, or in concentrated volleys against larger ships.

Primary Purpose: Anti-ship

Secondary Purpose: Defense

Mega-Damage: Varies with missile type. Usually plasma (4D6×10 M.D.).

Rate of Fire: One at a time or in volleys of 2, 4, or 8 missiles per turret.

Effective Range: About 500 miles (800 km)

Payload: 96 missiles per turret. The ship traditionally carries 400 additional missiles in its cargo hold. Reloading from the cargo hold is done through a robotic feed system that takes 2 minutes per turret.

4. Lightning Rods (8): These TW-lightning guns fire magical blasts of electricity. The weapons are identical to the main gun of the Shadow Bolt fighter. The TW enchantment must be renewed every two months (costs 400 P.P.E. and 20,000 credits), but during that period the weapon can fire unlimited blasts.

Primary Purpose: Defense

Secondary Purpose: Anti-aircraft/fighter

Mega-Damage: 1D6×10 M.D.

Rate of Fire: Equal to the number of combined hand to hand attacks of the gunner.

Effective Range: One mile (1.6 km) in space, half in an atmosphere.

Payload: Unlimited; the spell must be renewed every two months, whether the weapon is used or not.

5. Fighters, Military Vehicles, & Troops: The Arcane Mark II carries a standard complement of 48 Warlock Marines and 4 Shadow Bolt fighters. It may also have 2D6 practitioners of magic on board who can assist against boarding by raiders, close-range attacks, and internal defenses.

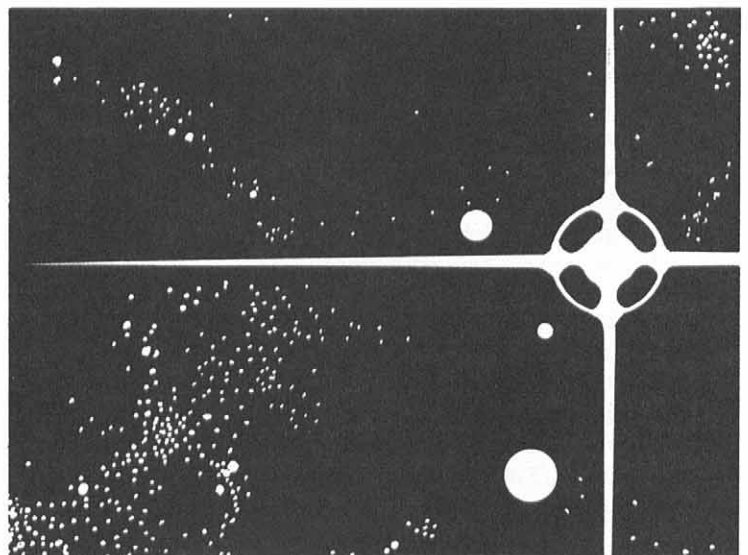

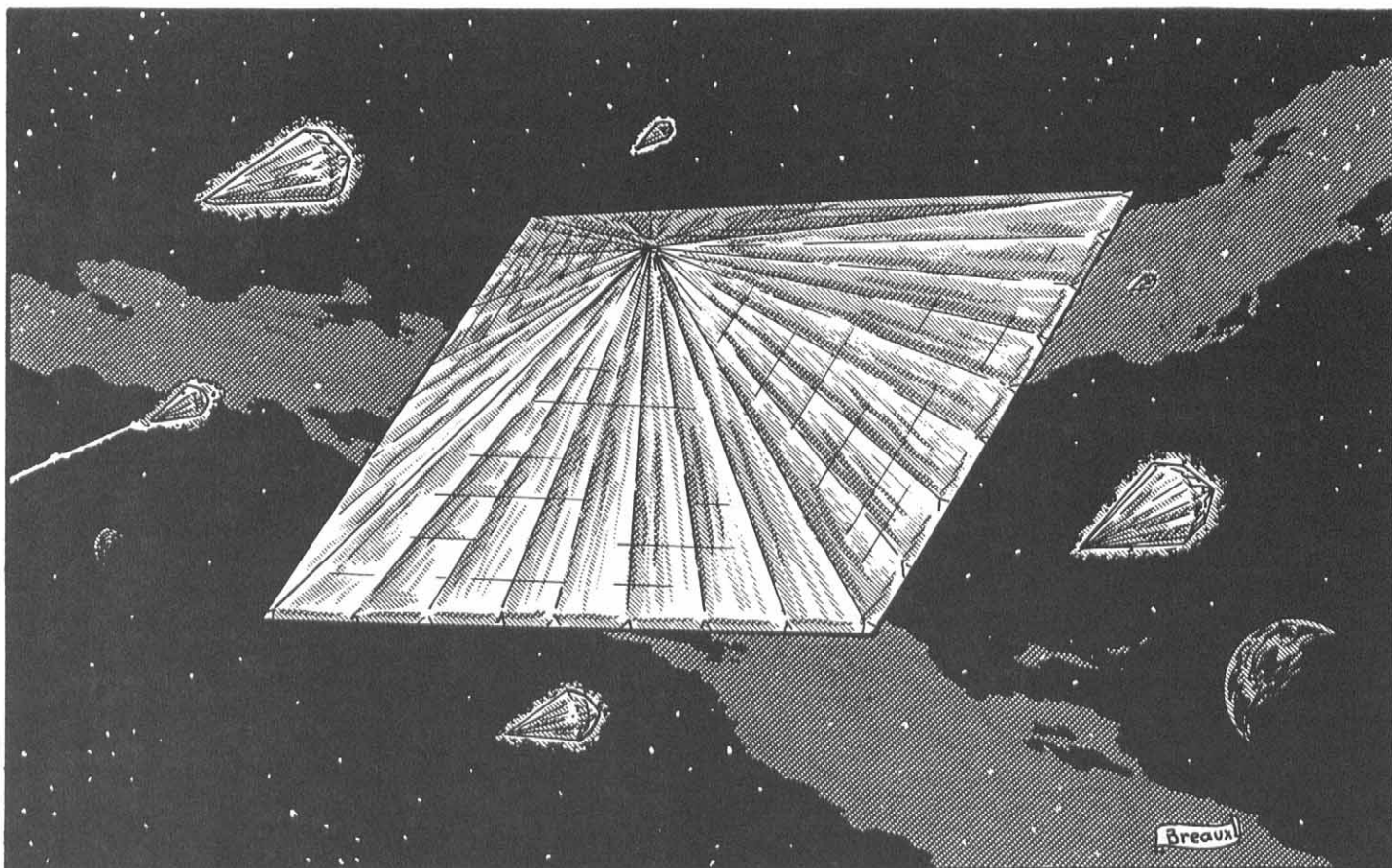

UFO Attack Ship

Intruders

The UFO Attack Ship looks like a larger version of the Spinnerette fighter previously described. It has the same diamond-like surface, but it is a great deal flatter, more closely resembling the “flying saucers” of human legends. None of these larger vessels have been captured; they always self-destruct if capture seems inevitable, so it is not known if it is made completely of “solid energy” with nothing but a latticework of metal, or whether it has material components. Like the Spinnerette, UFO attack ships (the name given to them by the mystified galactic civilizations) are almost impossible to detect beyond visual range.

These vessels seem to be a combination frigate and troop transport. One to six of these ships will sweep in on an unsuspecting planet, space station or large ship, and either utterly destroy the target or land some troops to carry off the occasional slave or loot. The ships carry as many as 60 beast warriors and 10 mind creatures, and are typically escorted by four to nine (1D6+3) Spinnerette fighters. **Note:** See the Intruders section for more information on these mysterious aliens.

Model Type: Intruder Mark II

Class: Frigate

Crew: 10 mind creatures.

Troop Capacity: 60 beast troopers.

M.D.C. by Location:

** Forward 1/3 of the ship — 1,000

** Middle Section — 1,000

** Rear 1/3 of the ship — 1,000

* Ship’s Bridge and hangar section — 800

* The bridge/hangar section is the only truly solid part of the ship. It can only be attacked if one of the solid energy sections (forward, middle, or rear) has been momentarily overwhelmed and depleted of M.D.C. (at least until it can regenerate). Until the bridge is destroyed, the solid energy sections will continue to regenerate!

** The “main body” is made up of solid energy that regenerates damage at the rate of 2D6×10 M.D.C. per melee round! Depleting the M.D.C. of the main body has little effect on the ship, except that the pilot’s compartment becomes vulnerable to damage. Depleting the bridge’s M.D.C. to 0, stops the regeneration process and if the bridge section is destroyed the entire ship is destroyed!

Speed:

Driving on the ground: Not possible.

Flying: Up to Mach 20 in space, atmosphere and underwater! The “solid energy” field seems to render the ship immune to air friction and air and water drag.

Star Drive: The ship (unknown to most scientists in the Three Galaxies) uses a space-fold system that lets it cross 100 light years in one jump! The fold system can perform up to 5 jumps per day (500 light years in a day).

Statistical Data:

Height: 70 feet (21.3 m)

Width: 200 feet (61 m)

Length: 200 feet (61 m)

Weight: 2,000 tons (bridge and hangar; the “hull” is almost weightless).

Cargo: The hangar is large enough to carry six Spinnerette Interceptors and 500 tons of additional cargo.

Power System: Unknown. Presumed to have an energy life of at least 50 years.

Market Cost: Not available! The CAF, Naruni Enterprises, the Splugorth or the Transgalactic Empire would pay a billion credits or more for a new, undamaged UFO craft.

Weapon Systems:

1. Main Energy Blaster: Beams of energy can be fired from any side of the ship, at any angle, although no apparent weapon systems are visible. These energy beams are neither lasers nor particle beams, but seem to be the same “solid energy” the ships are made of.

Note: These beams do extra damage to cosmo-knights! Normally, energy damage against a knight is divided by 100. In the case of intruder vessels, divide normal damage by ten, instead of a hundred. Furthermore, the beams do full damage to ships, robots and characters enchanted with the spell: invulnerable to energy!

Primary Purpose: Anti-ship

Secondary Purpose: Defense

Mega-Damage: 1D6×100 M.D. per blast.

Rate of Fire: Each blast counts as one attack/action per melee. Up to six blasts can be fired during a given round.

Effective Range: 10 miles (16 km) in space; one mile (1.6 km) in an atmosphere.

Payload: Effectively unlimited.

2. Secondary Energy Blasters: Smaller beams of the same type can be fired with greater frequency. They are used against enemy fighters and missiles.

Primary Purpose: Anti-aircraft

Secondary Purpose: Defense.

Mega-Damage: 1D6×10 M.D. per blast.

Rate of Fire: Equal to the combined number of hand to hand attacks of the gunner, typically 3 to 6 blasts. As many as 6 gunners can fire these short-range blasters (18 to 36 blasts per melee round).

Range: 2 miles (3.2 km) in space, 4000 feet (1200 m) in an atmosphere.

Payload: Effectively unlimited.

3. Self-destruct Device: If the entire crew is killed, the ship will self-destruct an hour and fifteen minutes later, doing 4D6×100 M.D. to a 200 foot (61 m) radius. So far, no way has been found to disable the self-destruct system. Actually, the destruct mechanism has never been located.

4. Stealth System: Intruder ships are almost undetectable to standard radar and other sensor systems. The ship can be detected by standard visual sensors, usually when it is 2,000 miles (3200 km) away for most warships, or about 500 miles (800 km) by civilian vessels.

5. Military Vehicles & Troops: In addition to its weaponry, most UFO Attack Ships have a complement of 6 Spinnerette Interceptors, plus 10 mind creatures and 60 beasts.

Space Cruisers

Cruisers are the most common “ships of the line” active in fleets of the Three Galaxies. They have a mass of 20,000 to 200,000 tons and a length of 300 to 800 feet (483 to 1290 m). The M.D.C. value of cruisers is five to ten times greater than that of frigates, so only the heaviest weapons have any chance of destroying them quickly. They are usually the flagships of small fleets (usually made up of fighters and frigates), or the main component of larger fleets led by a battleship or carriership. Cruisers also conduct long-range patrol operations, navigating the borders of their star systems and protecting worlds from pirates, raiders and invaders. Most cruisers have a good-sized fighter and power armor complement used to screen the ship from attacks and to conduct investigations, scouting missions, escort, and bombing and assault runs against hostile ships.

Warshield-Class Cruiser (CAF)

The Warshield is a common sight in most CCW starports. These well-armed, sturdy vessels are often viewed as the symbol of the Consortium Armed Forces (CAF). To enemies of the Consortium, the Warshield represents a threat and a reminder that the CCW’s conciliatory policies are backed up by a powerful military arm. Thousands of these warships patrol the CCW’s space, either alone or at the head of a battle group consisting of 2D4 Scimitar (see **Rifts Phase World**, page 168) or Hunter ships, and/or 2D6 Proctor long-range fighters (see **Rifts Phase World**, page 158) or the Black Eagle fighters (FTL version).

Armed with a combination of lasers and particle beams, as well as several secondary weapons and missile systems, the Warshield can take on a fleet of fighters or several frigates with a good chance of winning. Its main guns are powerful enough to threaten anything smaller than a dreadnought, and its force fields can withstand a direct hit from a cruise missile. It normally carries a 12 fighter and 12 robot squadron, including two of the dreaded Battlerams (see **Rifts Phase World**, page 133).

Warshields are only sold to Independent Defense Forces (IDF) within the Consortium, and are not willingly given to anybody else. A few pirate bands have managed to capture a couple of these ships. These (literally) “pirated” ships have much weaker (or no) force fields, reduced M.D.C. (30%) and are missing many weapon systems (1D4×10%).

Model Type: SC-55

Class: War cruiser

Crew: 260, including officers. All ship systems could be run by 40 to 60 people without problems; the crew is designed to have enough people to handle four work shifts. This also includes a security detail of 40 soldiers equipped with CAF combat armor. In an emergency, the ship can be run entirely by the bridge crew (6 to 10 people), but problems and breakdowns would crop up in 1D6 hours.

Troop Capacity: Typically has a marine force of 40 soldiers and a robots squadron (12), in addition to the security detail (30 soldiers) and 40 pilots.

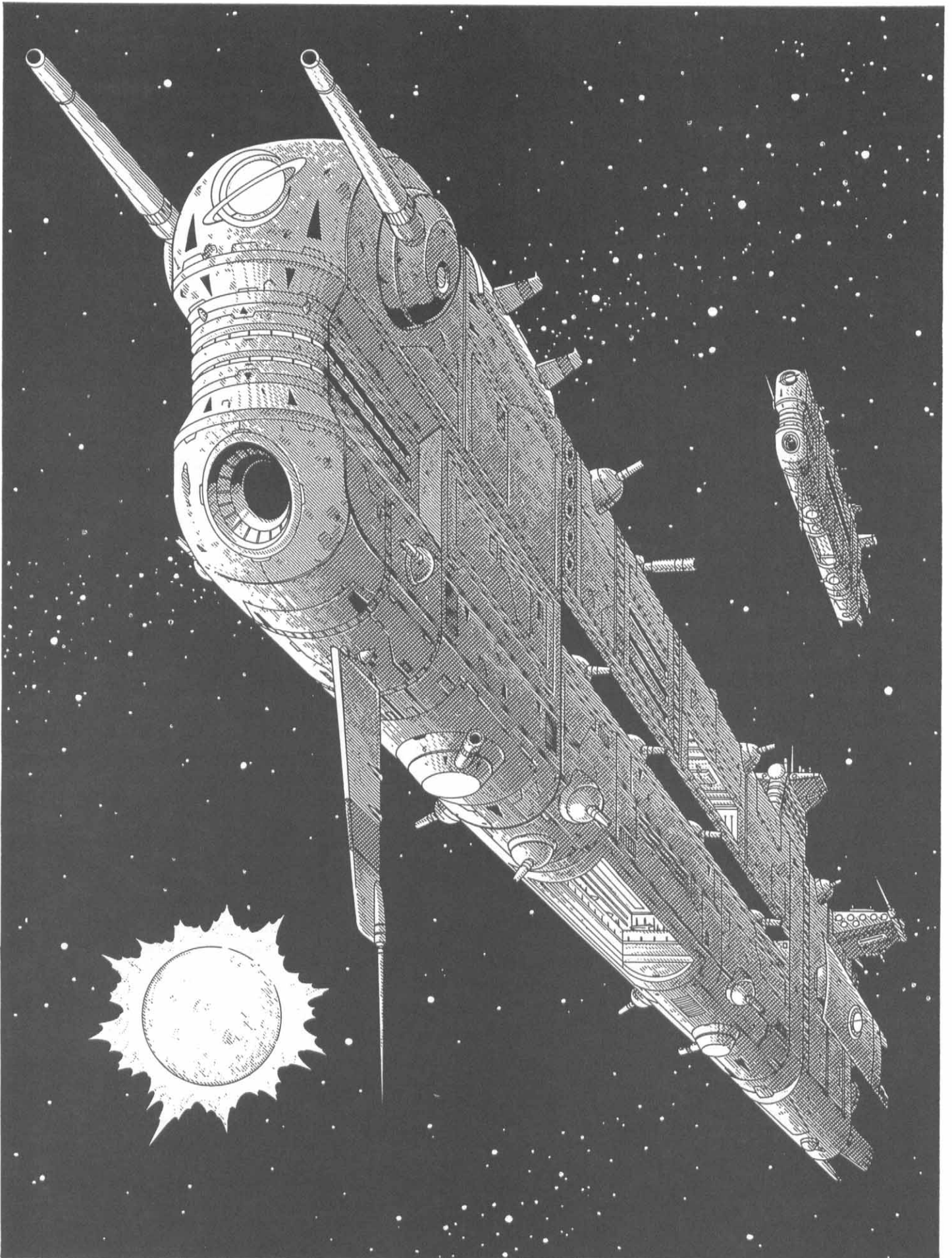

M.D.C. by Location:

Main Laser Cannons (2) — 1,200 each
G-Cannon Turrets (4) — 800 each
Secondary Laser Cannons (4) — 800 each
Cruise Missile Batteries (2) — 1,000 each
Long-Range Missile Batteries (4) — 600 each
Gravity Auto-cannons (8) — 200 each
Particle Beam Cannons (8) — 150 each
Mini-Missile Launchers (8) — 100 each
Outer Hull Section (40 ft/12.2 m area) — 150
Inner Hull Section (40 ft/12.2 m area) — 100
Variable Force Fields — 5,000 on each side (30,000 total)
* Bridge — 10,000
** Main Body — 45,000
Hangar Bay — 12,000
*** Main Engines (2, rear 1/4 of the ship) — 12,000 each

* Destroying the bridge will eliminate the main computer and master controls. The ship can be controlled from the engineering section, deep inside the ship, but those controls are less sensitive and -2 to strike, parry and dodge. Hits on the bridge may injure crew members even if they do not destroy it; see Ship Combat Rules.

** Depleting the M.D.C. of the main body means the ship is in tatters, with life support and contragravity systems knocked out, and unable to fight or move under its own power. The missile batteries are another matter, and can continue to launch. Likewise, the robot squadron and fighters can manually open hatches and launch themselves to engage the enemy. If the ship is reduced to -20,000 M.D.C., it explodes, doing 4D6×1,000 M.D. to anything in a one mile (1.6 km) radius:

*** Destroying the main engines eliminates FTL systems and reduces maximum sublight speed by half.

Speed:

Driving on the ground: Not possible.

Flying: Mach 8.5 in space; cruising speed is Mach 4 or 5. In an atmosphere, it can only fly at 300 mph (480 km) without risking structural damage.

Star Drive: Gravitonic drive, maximum speed: 5 light years per hour.

Range: Carries enough life support and supplies for three years of uninterrupted travel. This could be stretched to five or six in an emergency. Typical patrol mission lasts six months to a year.

Statistical Data:

Height: 120 feet (36.5 m)

Width: 200 feet (61 m)

Length: 600 feet (183 m)

Weight: 100,000 tons fully loaded, plus up to 10,000 tons of additional cargo.

Cargo: Cargo Hold can hold up to 10,000 tons of additional material.

Power System: Anti-matter; average energy life is 50 years.

Market Cost: 2.4 billion credits; this is the cost to the Consortium. The ships are only sold to Consortium member planets at three times their cost.

Weapon Systems:

1. Main Laser Cannons (2): These heavy artillery pieces are used to engage large ships, space stations and other important targets (usually cruiser-sized or larger). These beams will gut

a frigate or smaller ship with a single shot. The cannons can be aimed towards different targets, or used simultaneously against the same target.

Primary Purpose: Anti-starship/cruiser

Secondary Purpose: Anti-city/space station

Mega-Damage: 1D4×1,000 M.D. per single blast or 2D4×1,000 M.D. per double blast! Against a station or planet, the guns will do the listed damage at the point of impact (40 foot radius/12.2 m) and 1D6×10 M.D. of heat damage to a 100 foot (30.5 m) area around it!

Rate of Fire: Two double blasts or two single blasts each; 4 total attacks per melee round (two for each gun).

Effective Range: 100 miles (160 km) in space, 30 miles (48 km) in an atmosphere.

Payload: Effectively unlimited.

2. G-Cannon Turrets (4): Each cannon is in a separate turret, operated by a gunner or a gunner program (+2 to hit, 3 attacks per melee). It is used for anti-ship combat, especially against frigates or cruisers, or against fighters and robots (these small targets are +2 to dodge, however).

Primary Purpose: Anti-ship

Secondary Purpose: Defense

Mega-Damage: 1D4×100 per 80 round burst.

Rate of Fire: Equal to the number of hand to hand attacks of the gunner.

Effective Range: 10 miles (16 km) in space, three miles (4.8 km) in an atmosphere.

Payload: 32,000 rounds per turret (400 bursts).

3. Secondary Laser Cannons (4): The “secondaries” are the main guns used by frigates to engage other frigates, or to strafe heavier vessels. The four cannons are aimed in two separate directions; two cannons can engage the same target, but not all four.

Primary Purpose: Anti-ship

Secondary Purpose: Anti-building

Mega-Damage: 2D6×100 per cannon, or a double blast does 4D6×100 M.D.

Rate of Fire: Each cannon can fire twice per melee round.

Effective Range: 16 miles (25 km) in space, or 7 miles (11 km) in an atmosphere.

Payload: Effectively unlimited.

4. Cruise Missile Batteries (2): Two missile turrets are on the front and middle of the ship. They can volley as many as 32 cruise missiles simultaneously, or up to 64 missiles per melee round!

Primary Purpose: Anti-ship

Secondary Purpose: Bombardment

Mega-Damage: Varies with missile type (2D6×100 to 4D6×100 M.D.)

Rate of Fire: One at a time or volleys of two, eight, sixteen or 32 missiles per launcher!

Effective Range: Over 1,000 miles (1600 km). Optimum launching range is 1 to 3 miles (1.6 to 4.8 km).

Payload: 32 missiles per launcher. Additional missiles are auto-loaded from the cargo hold (takes 2 melee rounds). Standard missile complement is 640 cruise missiles.

5. Long-Range Missile Batteries (4): These weapons are used against fighters and missiles, especially cruise missiles.

Primary Purpose: Anti-aircraft

Secondary Purpose: Defense

Mega-Damage: Varies with missile type.

Rate of Fire: One at a time or volleys of 2, 4, 8, 16 or 32.

Effective Range: Varies with missile type.

Payload: 62 missiles per launcher. Loading from the cargo hold takes 1D6 missiles.

6. Gravity Auto-cannon (8): Light anti-aircraft pieces scattered to cover the entire ship.

Primary Purpose: Anti-aircraft, robots, and anti-power armor.

Secondary Purpose: Defense

Mega-Damage: 2D4×10 M.D. per 20 round burst.

Rate of Fire: Equal to the combined number of hand to hand attacks of the gunner.

Effective Range: 2 miles (3.2 km) in space 4000 feet (1200 m) in an atmosphere.

Payload: 10,000 rounds (500 bursts) per auto-cannon.

7. Particle Beam Cannons (8): These turrets have light particle beam cannons used to engage enemy vessels and knock down enemy fighters and missiles.

Primary Purpose: Anti-aircraft and defense.

Secondary Purpose: Anti-ship.

Mega-Damage: Varies with missile type.

Rate of Fire: Equal to the total number of hand to hand attacks of the gunner.

Effective Range: Six miles (9.6 km) in space, two miles (3.2 km) in an atmosphere.

Payload: 10,000 rounds (500 bursts) per auto-cannon.

8. Mini-Missile Launchers (8): These are missile turrets used for point defense against enemy fighters and missiles. Each turret usually fires volleys of four missiles per target to insure a kill.

Primary Purpose: Anti-aircraft, robots, and power armor.

Secondary Purpose: Defense

Mega-Damage: Varies with missile type.

Rate of Fire: One at a time or volleys of four to eight missiles.

Effective Range: About two miles (3.2 km) in space, one mile (1.6 m) in an atmosphere.

Payload: 128 missiles per launcher turret (1,024 missiles) plus cargo hold carries an additional 3,072 missiles. Reloading a turret from the cargo hold takes 1D6 minutes.

9. Aircraft and Military Vehicles: In addition to its main weaponry, the Warshield typically has a complement of 6 Scorpion Fighters, 6 Black Eagle or Katana Fighters, 10 Silverhawk power armor troops, and 2 Battleram assault robots.

Smasher-Class Cruiser Transgalactic Empire

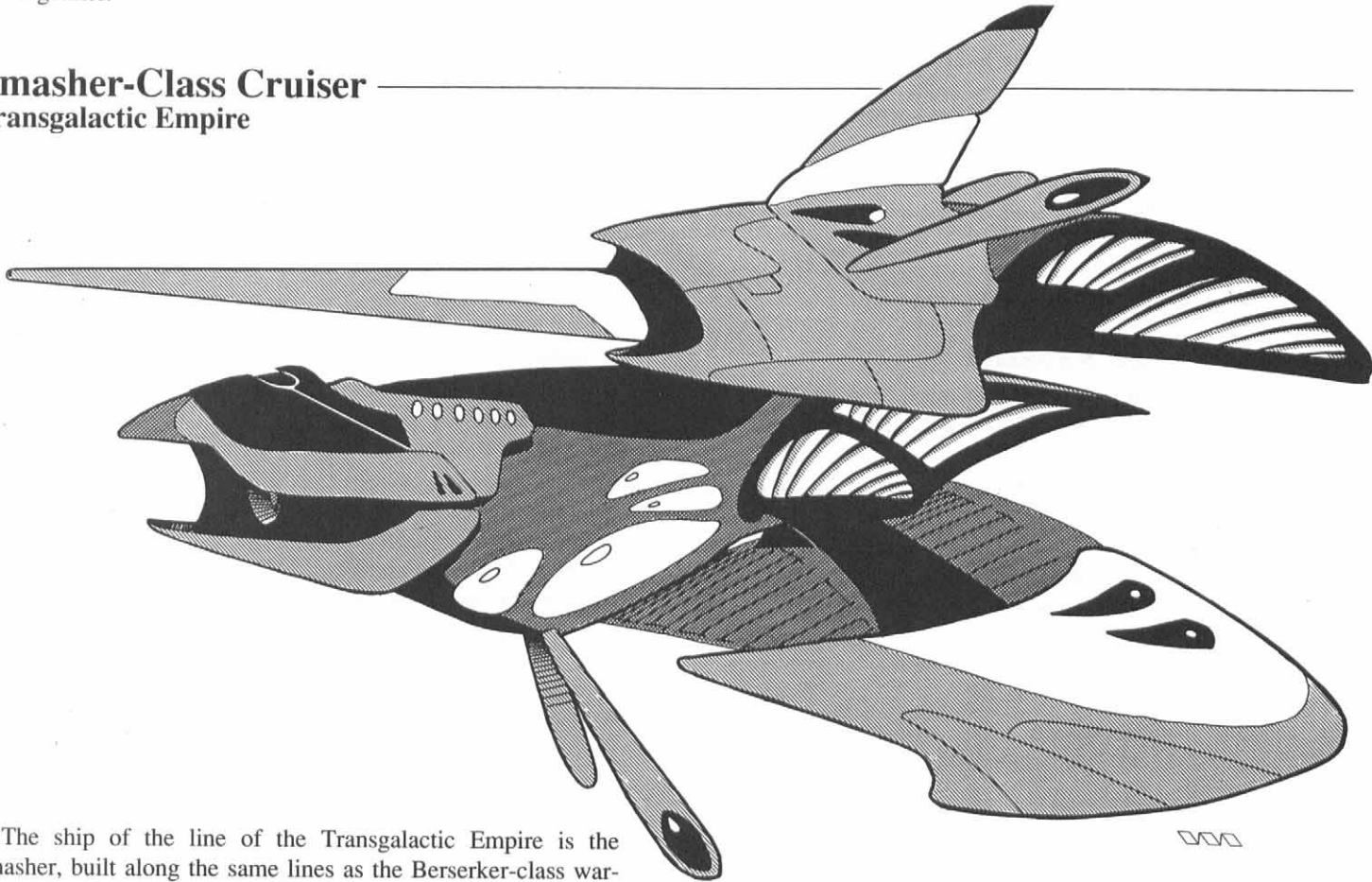

The ship of the line of the Transgalactic Empire is the Smasher, built along the same lines as the Berserker-class warship, but twice as big. An important difference in their outlines is the protruding “energy lance” (a heavy laser cannon) built on the top of the ship. Smashers usually travel in flotillas of three cruisers, escorted by six Berserkers. Although the Smasher is not as heavily armed and armored as the CAF Warshield, it makes up for it with its fighter complement of 36 attack ships.

Smashers are the bane of the Free World Council. The flotillas sweep down on liberated worlds, destroy defense satellites

and local defense fighters, and then scour cities and farming fields with laser fire, setting them ablaze. Since the small fleets don't have enough troops to conquer a planet, they content themselves with ravaging it and condemning the survivors to hardship and/or starvation. However, the kreeghor's “scorched earth policy” has not weakened the resolve of the freedom fighters.

Model Type: TIV-SC

Class: Space Cruiser

Crew: 195, plus 200 combat troops.

M.D.C. by Location:

Main Laser Cannon (top) — 1,200

Secondary Laser Cannons (4, top and underside) — 700 each

Cruise Missile Launchers (2, front) — 1,000 each

* Bridge — 7,000

GR-Gun Turrets (8) — 600 each

Mini-Missile Batteries (8) — 400 each

** Main Body — 18,000

Hangar Bay — 5,000

Variable Force Field — 3,000 per side (maximum 9,000)

* Destroying the bridge will eliminate the main computer and master controls. The ship can be controlled from the engineering section, deep inside the ship, but those controls are less sensitive and -2 to strike, parry and dodge. Hits on the bridge may injure crew members even if they do not destroy it; see Ship Combat Rules.

** Depleting the M.D.C. of the main body means the ship is in tatters, with life support and contragravity systems knocked out, and unable to fight or move under its own power. The missile batteries are another matter, and can continue to launch. Likewise, the robot squadron and fighters can manually open hatches and launch themselves to engage the enemy. If the ship is reduced to -5,000 M.D.C., it explodes, doing 3D6×1,000 damage to anything within one mile (1.6 km) from it.

Speed:

Driving on the ground: Not possible.

Flying: Mach 9 in space; not designed to fly in an atmosphere.

Star Drive: Gravitonic Drive; maximum speed: 4 light years per hour.

Range: Limited only by life support; has enough supplies to keep the crew alive for one year; can be stretched to a year and a half under emergency conditions.

Statistical Data:

Height: 208 feet (63.4 m) from the horn cannons to the top of the ship, or 160 feet (48.8 m), main body only.

Width: 120 feet (36.5 m)

Length: 600 feet (183 m)

Weight: 70,000 tons fully loaded.

Cargo: Can carry an additional 5,000 tons.

Power System: Anti-matter; average energy life of 50 years.

Market Cost: 1.8 billion credits, but never legally sold to anybody outside of the Empire.

Weapon Systems:

1. Energy Lance: This large cannon protrudes menacingly from the main body of the ship. It is a heavy laser cannon, used against large vessels or planetary facilities.

Primary Purpose: Anti-ship.

Secondary Purpose: Anti-building and anti-planet.

Mega-Damage: 1D6×1,000 per blast. When used against a planet, it inflicts the listed damage on the point of impact (40 ft/12.2 m radius) and does an additional 1D6×10 M.D. heat damage to a 100 ft (30.5 m) radius around that. Against flammable targets, a few beams will trigger a massive blaze.

Rate of Fire: Can fire once per melee round.

Effective Range: 100 miles (160 km) in space, about 30 miles (48 km) in an atmosphere.

Payload: Effectively unlimited.

2. Secondary Laser Cannons (4): These top and underside mounted laser cannons fire high-intensity beams meant to melt and burn large ships. They can engage different targets, or perform simultaneous attacks.

Primary Purpose: Anti-ship.

Mega-Damage: 1D6×100+100 per single blast, or 2D6×100+200 double blast. Only two cannons can engage one target at the same time.

Rate of Fire: Two per melee per cannon.

Effective Range: 16 miles (25 km) in space, six miles (9.6 km) in an atmosphere.

Payload: Effectively unlimited.

3. Cruise Missile Launchers (2): These launchers are identical to those found in the Berserker. Some Smasher captains started out as Berserker commanders and they often try to use the same tactics, although their ship is meant to fight at long range.

Primary Purpose: Anti-ship

Secondary Purpose: Assault

Mega-Damage: Each missile does 2D6×100 or 4D6×100 M.D. Countermeasures will work if missiles are launched at a distance greater than three miles (4.8 km). Otherwise, the missiles will reach the target in less than one second! Only a counter volley of 40 missiles or more will stop the barrage (roll 2D6+8 to determine how many cruise missiles were destroyed; the remainder will hit the target).

Rate of Fire: Volleys of 10 per launcher, per melee round, for a total of 20 missiles per round. Launchers are reloaded in the same melee and can fire again on the next.

Effective Range: Over 1,000 miles (1600 km), but optimum range is 1 to 3 miles (1.6 to 4.8 km).

Payload: 100, 50 missiles per launcher.

4. GR-Guns (8): These weapon systems use a heavy gravity gun as an anti-fighter or anti-missile defense.

Primary Purpose: Anti-aircraft and anti-robot.

Secondary Purpose: Defense

Mega-Damage: 4D6×10 M.D. per 40 round burst.

Rate of Fire: Equal to combined hand to hand attacks per melee.

Effective Range: 3 miles (4.8 km) in space, but 1.5 miles (2.2 km) in an atmosphere.

Payload: 8,000 rounds per cannon; that's 200 bursts.

5. Mini-Missile Launchers (8): Missile turrets designed to engage incoming missiles or approaching aircraft.

Primary Purpose: Anti-aircraft.

Secondary Purpose: Defense.

Mega-Damage: Varies with missile type.

Rate of Fire: One at a time or volleys of 2, 4, or 8 missiles.

Effective Range: About 2 miles (3.2 km) in space, or one mile (1.6 km) in an atmosphere.

Payload: 64 missiles per launcher.

6. Aircraft and Military Vehicles: The Smasher has a complement of 36 Flying Fang fighters!

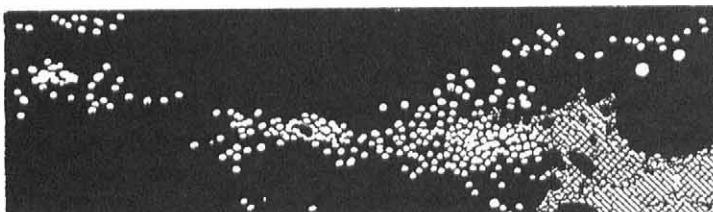

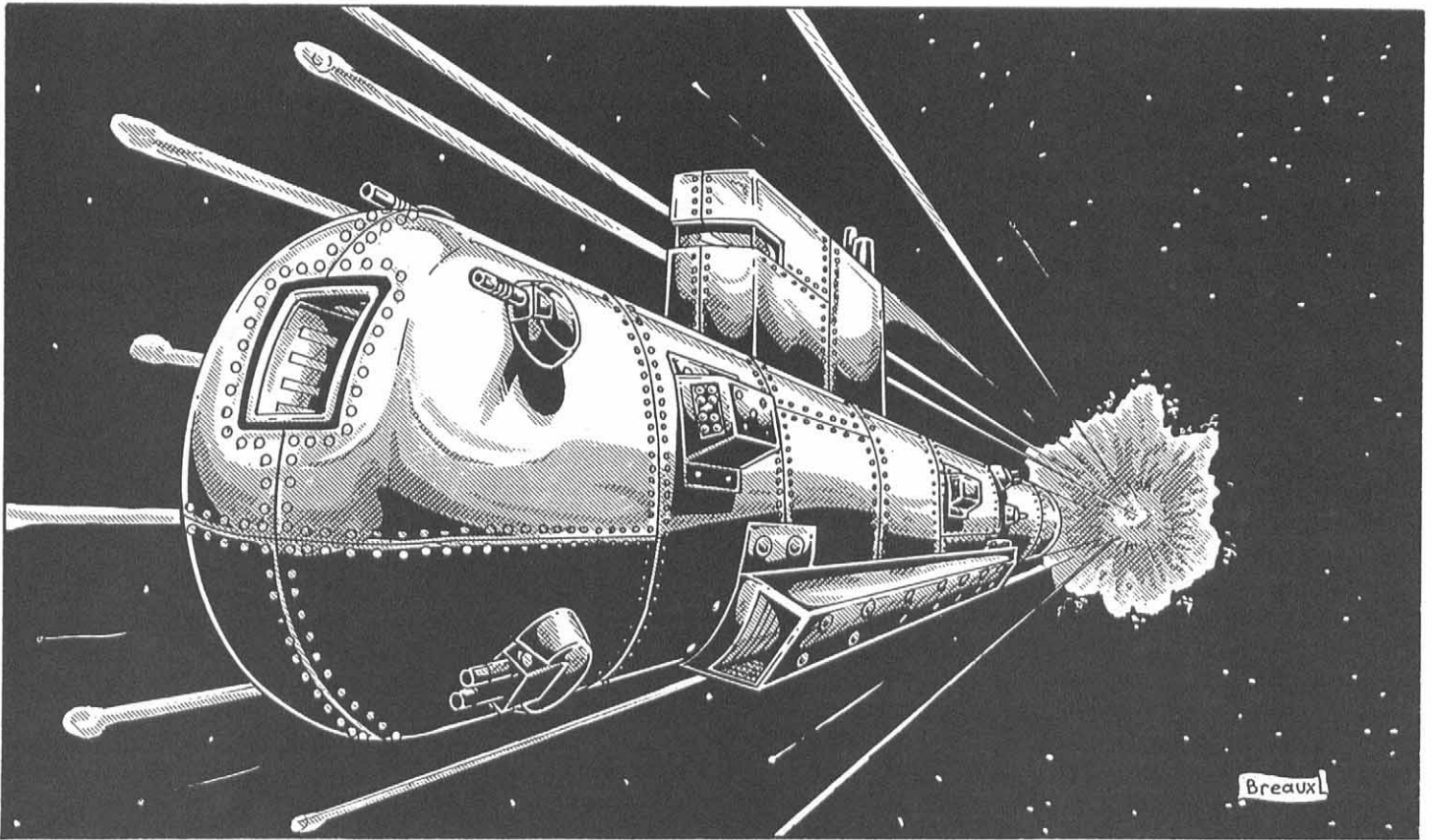

Dwarven Iron Ship (UWW)

These unusual ships look like constructs from an older time. Riveted metal plates cover these long, bullet-shaped vessels, which resemble a 20th Century submarine built by 19th Century engineers. The techno-wizard *Dwarven Guildmasters* built them using mostly enchantments rather than science. The development of this ship was the result of an early encounter with a star-faring race. The idea of building a ship that could travel in cold, empty space inspired the dwarven magicians. Lacking scientific know-how, they used a brute-force approach. The result was a working spaceship of enormous power, albeit unbelievably crude. The riveted metal plates are covered with enchantments, signs and circles of protection that make them as tough as the best M.D.C. alloys. Built-in spells give the ship life support, guidance systems, flying capabilities (although very slow ones), and a workable Rift jump drive (see **Rifts Phase World**, page 152).

After the United Worlds were founded, most Iron Ships were donated to the Warlock Navy. A number of techno-wizards have made improvements on the ship's design, while retaining most of the magical features. No more Iron Ships have been made since the *Great Dwarven Armada* destroyed the Splugorth invaders in the battle that gave birth to the UWW. The reason for this is that each ship cost as much as any dozen normal ships built with technology or more advanced techno-wizardry. The Iron Ships were as complex and difficult to create as a greatest rune weapon or other magical artifact. Only a handful of the most powerful magicians among the guildmasters (including Inglix the Mad; see the UWW section in this book for more about him) were able to cast the spells that kept the ships going.

Four thousand Iron Ships were built before the UWW was founded. Since then, 763 have been destroyed, leaving a little over three thousand (3,137) ships in the service of the Warlock Navy. Equipped with a Rift projector cannon, magical flame cannon, and (more recently) a fighter squadron and an array of technological weapons, the Iron Ships are the match of any cruiser-class vessel in the Three Galaxies. Only an estimated one hundred Iron Ships are owned by private industry, powers like Inglix, and the occasional mercenary or rogue; many of these alleged 100 ships are unaccounted for and may have been lost or destroyed over the years.

Model Type: UW-C15

Class: Space Cruiser (techno-wizard)

Crew: 245, including a magic team of 16 techno-wizards (levels 2-6). Plus an additional 150 combat troops and pilots.

M.D.C. by Location:

Rift Projector Cannon (One, in front) — 1,500

Flame Cannons (2, one on each side) — 900 each

Medium Laser Cannon Turrets (4) — 800 each

Bottled Demon Missile Batteries (4) — 600 each

Particle Beam Cannon Turrets (8) — 100 each

* Bridge (on top and middle of the ship) — 10,000

** Main Body — 30,000

Hangar Bay — 2,000

*** Magical Armor of Ithan Force Field — 10,000

* Destroying the bridge will eliminate the main computer and controls. The ship can be controlled from the engineering section, deep inside the ship, but those controls are less sensitive: -2 to strike, parry and dodge. Hits on the bridge may injure crew members even if they do not destroy it; see Ship Combat Rules.

** Depleting the M.D.C. of the main body means the ship is in tatters, with life support and contragravity systems knocked out, and unable to fight or move under its own power. The missile batteries are another matter, and can continue to launch. Likewise, the robot squadron and fighters can manually open hatches and launch themselves to engage the enemy.

If the ship is reduced to -10,000 M.D.C., it is utterly destroyed, but does not explode; the magical systems instead overload and open a giant (1D6 miles wide) rift, which may bring in monsters, or may suck in nearby vessels, taking them anywhere (or any when).

*** This is not a variable force field, but a magical shield that must be completely depleted. Once it has been knocked down, it will cost 1,000 P.P.E. and one minute (4 melees) of spellcasting to restore the force field.

Speed:

Driving on the ground: Not possible.

Flying: Mach 8 in space (contragravity generators). In an atmosphere, maximum flying speed is 200 mph (320 km).

Star Drive: Rift jump drive; maximum safe jump is 20 light years every four hours (costs 2,000 P.P.E.).

Range: Life support (magical) will keep the crew alive for up to ten years, as long as the P.P.E. generators are kept in working order.

Statistical Data:

Height: 80 feet (24.4 m) main body; 160 feet (48.8 m) from the bottom of the main body to the top of the bridge.

Width: 80 feet (24.4 m)

Length: 800 feet (244 m)

Weight: 120,000 tons

Cargo: Can carry an additional 5,000 tons

Power System: P.P.E. Generators provide up to 6,000 P.P.E. per hour (100 P.P.E. per minute/4 melees; used to fuel Rift jump system, Rift projector, and magical life support. Energy storage units can keep up to 20,000 P.P.E. in reserve. Additionally, the ship has a nuclear power plant to fuel the contragravity system and the ship's technological systems (average energy life is 20 years).

Market Cost: Would cost 22 billion credits to manufacture; no longer in production or for sale.

Weapon Systems:

1. Rift Projector Cannon: Refer to **Rifts Phase World**, page 155, for the effects of this strange weapon.

2. Flame Cannons (2): Another techno-wizardry marvel, flame cannons fire giant fireballs at enormous distances. The guidance systems of the flame cannon will not lock onto any target smaller than a frigate, but it can be used to bomb planets from orbit.

Primary Purpose: Anti-ship

Secondary Purpose: Anti-planet

Mega-Damage: 1D4×1,000 M.D. per blast.

Rate of Fire: Each cannon can fire twice per melee (for a total of 4 blasts).

Effective Range: 20 miles (32 km) in space, but 8 miles (12.8 km) in an atmosphere.

Payload: Needs 1,000 P.P.E. per day to function.

3. Medium Laser Cannons (4): These weapons are in their own turrets on the top, sides and bottom of the ship. They are a modern add-on powered by the nuclear power plant.

Primary Purpose: Anti-ship

Secondary Purpose: Anti-building

Mega-Damage: 1D6×100 M.D.

Rate of Fire: Equal to the total number of hand to hand attacks per melee of the gunner.

Effective Range: 16 miles (25 km) in space, but 7 miles (11 km) in an atmosphere.

Payload: Effectively unlimited.

4. Bottled Demon Missile Batteries (4): Bottled Demon missiles are, literally, demonic beings summoned and bound into a missile shell! The evil creatures are filled with rage and hatred, so when they are fired, they fly after the target relentlessly. If it misses, the demon-missile will turn back and continue pursuing the target until either it strikes the target or the missile is destroyed (inflicting 50 M.D. to the missile will destroy the enchantment and send the demon back to its dimensional realm).

Bottled Demons are slightly bigger than mini-missiles, and require special launchers (will not fit normal launchers). When fired at short range, they have the combat bonuses of the pilot. At long range, or if they miss, treat them like smart missiles: +4 to strike and +5 to dodge, three attacks per melee until they hit or are destroyed. The demons will not attack anybody other than the designated target; if that target disappears, runs away or is destroyed, the demon missile vanishes.

Primary Purpose: Anti-ship

Mega-Damage: 3D4×10 M.D. magical energy.

Rate of Fire: One at a time or volleys of two, four or eight.

Effective Range: Once fired, the missile will fly and pursue the designated target at a speed of Mach 3. Otherwise the range is effectively unlimited.

Bonuses: +4 to strike and +5 to dodge; has 50 M.D.C.

Payload: 32 per turret.

5. Particle Beam Cannon Turrets (8): These light particle beam cannons are primarily anti-missile defense systems, but can also be used against fighters and robots.

Primary Purpose: Defense

Secondary Purpose: Anti-aircraft

Mega-Damage: 1D6×10 M.D. per blast.

Rate of Fire: Equal to the combined number of hand to hand attacks of the gunner.

Effective Range: 2 miles (3.2 km) in space, but only 4000 feet (1200 m) in an atmosphere.

Payload: Effectively unlimited.

6. Aircraft and Military Vessels: The Iron Ships have a complement of 36 Shadow Bolt strike ships and 12 Broadsword or Fire-Eater Naruni fighters.



Battleships, Carriers & Dreadnoughts

The largest military ships are the equivalent to the battleships and aircraft carriers of old, often combining both functions in one vessel. They range in size from a minimum of 1,000 feet (305 m) to over two miles long (3.2 km)! Their weight runs the gamut from 200,000 to 11 million tons. Their M.D.C. values are four to ten times greater than that of a cruiser and no weapon system can destroy them in one shot. One ship of each type is described below. Battleships are the smallest versions of this class; dreadnoughts are the biggest. The CAF favors battleships and carriers over dreadnoughts, while the kreeghor favor dreadnoughts.

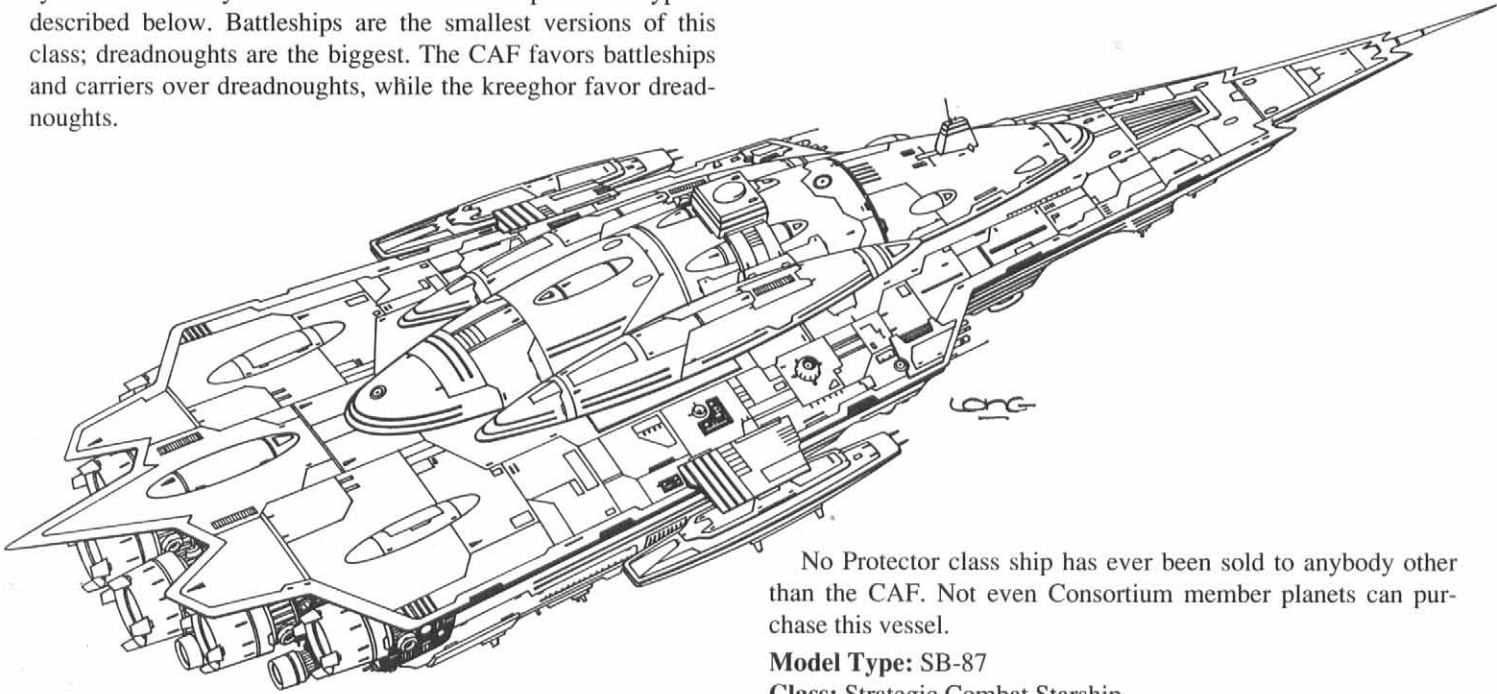

Protector-Class CCW Battleship

The Protector is designed to be the flagship of an entire fleet. The CAF has eight fleets on active duty; two each in the Anvil and Thundercloud Galaxies, and four in the Corkscrew. A typical peacetime CAF fleet has 1 or 2 battleships, 1 to 4 carriers, 6 to 24 cruisers, 24 to 60 frigates and thousands of fighters. In times of war, a fleet might have four or five times as many vessels. Given its armaments, force fields and armor, only another battleship or small fleet can hope to match the Protector in combat. The ship has enough weapon systems to devastate a planet or shatter a small moon. Fortunately, the Protector has never had to do either. Its main function is to act as a deterrent against invasions, and to intercept and fight enemy fleets.

In addition to its weapon systems, the Protector carries a small fleet of fighters, power armor and robot vehicles, including 6 "Star Ghost" Phase Ships (see **Rifts Phase World**, page 162). Only the Packmaster carriership (described later) carries more fighters. Its main weapons are four giant 40 inch laser cannons in two-gun batteries. Each battery can take out a cruiser or a frigate with a direct hit. The "secondaries" are cruiser and frigate main guns, and include several missile batteries, gravity cannons, and assorted means of destruction.

No Protector class ship has ever been sold to anybody other than the CAF. Not even Consortium member planets can purchase this vessel.

Model Type: SB-87

Class: Strategic Combat Starship

Crew: 1,245; also see troop capacity.

Troop Capacity: Carries one reinforced mechanized brigade with 2500 troops, 48 tanks, 60 IFVs, and 240 power armor and robot vehicles.

M.D.C. by Location:

Main Laser Batteries (2) — 5,000 each

Secondary Laser Batteries (2) — 1,200 each

Laser Batteries (8) — 800 each

G-Cannon Turrets (4) — 800 each

Cruise Missile Batteries (4) — 1,000 each

Long-Range Missile Batteries (8) — 600 each

Gravity Auto-cannons (16) — 200 each

Particle Beam Cannons (16) — 150 each

Mini-Missile Launchers (16) — 100 each

Outer Hull Section (40 ft/12.2 m area) — 200

Inner Hull Section (40 ft/12.2 m area) — 120

Variable Force Fields — 15,000 on each side (90,000 total)

* Bridge — 60,000

** Main Body — 250,000

Hangar Bay — 75,000

*** Main Engines (2, top and bottom of the rear 1/3 of the ship): 60,000 each

* Destroying the bridge will eliminate the main computer and master controls. The ship can be controlled from the engineering section, deep inside the ship, but those controls are

less sensitive and -3 to strike, parry and dodge. Hits on the bridge may injure crew members even if they do not destroy it; see Ship Combat Rules.

** Depleting the M.D.C. of the main body means the ship is in tatters, with life support and contragravity systems knocked out, and unable to fight or move under its own power. The missile batteries are another matter, and can continue to launch. Likewise, the robot squadron and fighters can manually open hatches and launch themselves to engage the enemy. If the ship is reduced to -60,000 M.D.C., it explodes, doing 6D6×1,000 M.D. to anything in a one mile (1.6 km) radius.

*** Destroying the main engines eliminates FTL systems and reduces maximum sublight speed by half.

Speed:

Driving on the ground: Not Possible

Flying: Mach 9 in space. Not designed to travel in an atmosphere.

Star Drive: Gravitonic drive; maximum speed: 6 light years per hour.

Range: Carries enough life support and supplies for two years of uninterrupted travel. This could be stretched to four years in an emergency. Typical patrol missions lasts six months to one year.

Statistical Data:

Height: 600 feet (183 m)

Width: 800 feet (244 m)

Length: 4,000 feet (1220 m)

Weight: 15 million tons fully loaded, plus up to 500,000 tons of additional cargo.

Cargo: Cargo Hold can hold up to 500,000 tons of additional material.

Power System: Anti-matter; average energy life is 50 years.

Market Cost: 50 billion credits; this is the production cost to the Consortium. The ships are only available to the Consortium Armed Forces.

Weapon Systems:

1. Main Laser Batteries (2): Two 40 inch laser cannons are in each battery (four guns total). Each battery can fire at two different targets or combine both attacks in a devastating double blast that will take out most ships. By firing combined blasts, they can core a planetoid with a few shots.

Primary Purpose: Anti-ship

Secondary Purpose: Anti-planet

Mega-Damage: 2D6×1,000 for a single blast, or 4D6×1,000 for a double blast (both guns in the turret engaging the same target). Against a station or planet, the guns will do the listed damage at the point of impact (100 foot/30.5 m radius) and 2D4×10 M.D. of heat damage to a 200 foot (61 m) area around it! This gun will consume entire city blocks, start fires, and turn a forest into a charred wasteland.

Effective Range: 100 miles (160 km) in space, 30miles (48 km) in an atmosphere.

Rate of Fire: Each cannon can fire up to two times per melee round.

Payload: Effectively unlimited.

2. Secondary Laser Batteries (2): Slightly smaller cannons used against cruisers and frigates.

Primary Purpose: Anti-ship and space stations.

Secondary Purpose: Anti-city

Mega-Damage: 1D6×1,000 M.D. per single blast or 2D6×1,000 M.D. per double blast. Against a station or planet, the guns will do the listed damage at the point of impact (40 foot/24.4 m radius) and 1D6×10 M.D. of heat damage to a 100 foot (30.5 m) area around it.

Rate of Fire: Two double blasts or two single blasts each (4 total).

Effective Range: 100 miles (160 km) in space or 30 miles (48 km) in an atmosphere.

Payload: Effectively unlimited.

3. Laser Cannons (8): These cannon are used to engage frigates or to strafe large or heavily armored vessels. The eight cannons are aimed in two separate directions; two cannons can engage the same target, but not all eight.

Primary Purpose: Anti-ship

Secondary Purpose: Anti-building

Mega-Damage: 2D6×100 per cannon, or a double blast doing 4D6×100 M.D.

Rate of Fire: Each cannon can fire twice per melee round.

Effective Range: 16 miles (25 km), or 7 miles (11 km) in an atmosphere.

Payload: Effectively unlimited.

4. G-Cannon Turrets (4): Each cannon is in a separate turret, operated by a gunner or a gunner program (+2 to hit, 3 attacks per melee). It is used for anti-ship combat, especially against frigates or cruisers, or against fighters and robots (these small targets are +2 to dodge, however).

Primary Purpose: Anti-ship

Secondary Purpose: Defense

Mega-Damage: 1D4×100 per 80 round burst.

Rate of Fire: Equal to the number of hand to hand attacks of the gunner.

Effective Range: 10 miles (16 km) in space, three miles (4.8 km) in an atmosphere.

Payload: 32,000 rounds per turret (400 bursts).

5. Cruise Missile Batteries (4): These missile turrets are on the front and middle of the ship (two on each). They can volley as many as 32 cruise missiles simultaneously, or up to 128 missiles per melee round!

Primary Purpose: Anti-ship

Secondary Purpose: Bombardment

Mega-Damage: Varies with missile type (2D6×100 to 4D6×100 M.D.)

Rate of Fire: One at a time or volleys of 2, 8, 16 or 32 missiles per launcher.

Effective Range: Over 1,000 miles (1600 km). Optimum launching range is 1 to 3 miles (1.6 to 4.8 km).

Payload: 32 missiles per launcher. Additional missiles are auto-loaded from the cargo hold (takes 2 melee rounds). Standard missile complement is 2560 cruise missiles.

6. Long-Range Missile Batteries (8): These weapons are used against fighters and missiles, especially cruise missiles.

Primary Purpose: Anti-aircraft

Secondary Purpose: Defense

Mega-Damage: Varies with missile type.

Rate of Fire: One at a time or in volleys of 2, 4, 8, 16 or 32.

Effective Range: Varies with missile type

Payload: 62 missiles per launcher. Loading from the cargo hold takes 1D6 minutes.

7. Gravity Auto-cannons (16): Light anti-aircraft pieces scattered to cover the entire ship.

Primary Purpose: Anti-aircraft.

Secondary Purpose: Defense.

Mega-Damage: 2D4×10 M.D. per 20 round burst.

Rate of Fire: Equal to the combined number of hand to hand attacks of the gunner.

Effective Range: 2 miles (3.2 km) in space, but only 4000 feet (1200 m) in an atmosphere.

Payload: 10,000 rounds (500 bursts).

8. Particle Beam Cannons (16): These turrets have light particle beam cannons used to engage enemy vessels and knock down enemy fighters and missiles.

Primary Purpose: Anti-aircraft and defense.

Secondary Purpose: Anti-ship

Mega-Damage: 3D6×10 M.D. per blast.

Rate of Fire: Equal to the total number of hand to hand attacks of the gunner.

Effective Range: 6 miles (9.6 km), or two miles (3.2 km) in an atmosphere.

Payload: Effectively unlimited.

9. Mini-Missile Launchers (16): These are missile turrets used for point defense against enemy fighters and missiles. Each turret usually fires volleys of four missiles per target to insure a kill.

Primary Purpose: Anti-aircraft

Secondary Purpose: Defense

Mega-Damage: Varies with missile type.

Rate of Fire: One at a time or volleys of four to eight missiles.

Effective Range: About two miles (3.2 km) in space, one mile (1.6 km) in an atmosphere.

Payload: 128 missiles per launcher. Reloading a turret from the cargo hold takes 1D6 minutes. The ship's standard load is thousands of missiles (more than enough for an entire battle).

10. Aircraft and Military Vehicles: In addition to its main weaponry, the Protector has a complement of 12 Scorpion Fighters, 12 Black Eagles, 12 Katana Fighters, 6 Star Ghost phase ships, 48 Silverhawk power armor troops, and 6 Battleram assault robots (96 space assault units total). Additionally, it has 4 CAF Assault Shuttles (see **Rifts Phase World**, page 165). It would take five to eight trips for the shuttles to completely off-load the ground troops it carries.

Packmaster Class Carriership

Wolfen/CAF/CCW

This ship is a little bigger than the CAF Protector Battleship. It needs to be, since the Packmaster carries a fleet of 500 fighters, 350 power armor and robot vehicles, and an armored division with full shuttle support! The mile long (1.6 km) Packmaster has a glorious history in the annals of warfare. It first entered service under the Wolfen Empire, where a dozen Packmasters fought and perished in wars against the Kreeghor Dominion. When the wolfen joined the CAF, their carrier design proved far superior to anything human or noro engineers had come up with, so the ship was adopted as the main carrier, and Packmasters have served under the Consortium ever since.

Packmasters have several weapon systems, but they are not meant to engage enemy ships directly. Typically, the carrier is protected by a screen of cruisers and frigates, and sends out most of its fighter ships to engage enemies 1,000 miles (1600 km) or more away. Standard escort forces for this carrier include four frigates and two cruisers. Also, 10 to 20 fighters and robot vehicles are held in reserve to protect their mothership.

All 90 Packmasters in the CAF are attached to major fleets or large bases. Among the Independent Defense Forces, several wolfen planets have one or two of these ships in orbit as a means of defense. There are no known cases of this ship being used, captured or built outside the Consortium of Civilized Worlds (CCW).

Model Type: CS-700

Class: Strategic Carrier Ship.

Crew: 1,500 crew members (including officers).

Troop Capacity: Has 3,000 pilots and co-pilots, and carries 5,000 additional troops, plus 200 Maniple IFVs, 150 Phalanx Main Battle Tanks, and 1,200 ground robots and power armor vehicles. Also see fighters and fighting vehicles described below.

M.D.C. by Location:

Main Laser Batteries (2) — 1,200 each

Secondary Laser Batteries (4) — 800 each

Cruise Missile Launchers (2) — 1,000 each

Gravity Auto-cannons (8) — 200 each

Particle Beam Turrets (12) — 150 each

Mini-Missile Launchers (12) — 100 each

Hangar Section (Lower 1/2 of the Ship) — 60,000 M.D.C.

* Bridge — 15,000 M.D.C.

** Main Body — 80,000 M.D.C.

* Destroying the bridge will eliminate the main computer and master controls. The ship can be controlled from the engineering section, deep inside the ship, but those controls are less sensitive and -3 to strike, parry and dodge. Hits on the bridge may injure crew members even if it is not destroyed by the attack; see Ship Combat Rules.

** Depleting the M.D.C. of the main body means the ship is in tatters, with life support and contragravity systems knocked out, and unable to fight or move under its own power. The missile batteries are another matter, and can continue to launch. Likewise, the robot squadrons and fighters can manually open hatches and launch themselves to engage the enemy. If the ship is reduced to -60,000 M.D.C., it explodes, doing 6D6×1,000 M.D. to anything in a two mile (3.2 km) radius.

Speed:

Driving on the ground: Not possible.

Flying: Mach 7 in space. Not designed to fly in an atmosphere.

Range: Has enough supplies for one year, but can be stretched to two in an emergency.

Statistical Data:

Height: 1,000 feet (305 m)

Width: 1,000 feet (305 m)

Length: Roughly one mile (1600 km)

Weight: 50 million tons fully loaded, plus can carry an additional 5 million tons of cargo.

Cargo: 5 million tons.

Power System: Anti-matter; average energy life of 50 years.

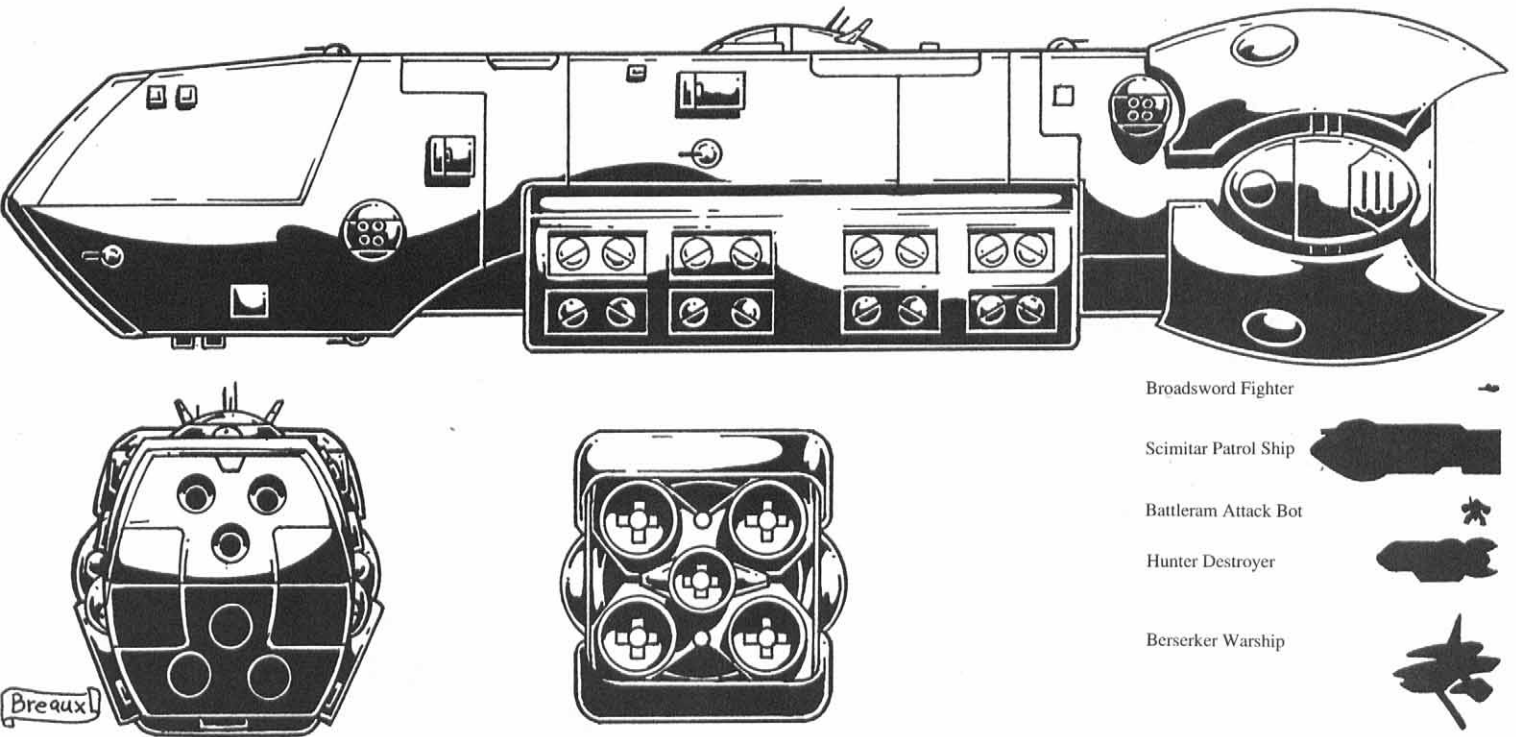

Broadsword Fighter

Scimitar Patrol Ship

Battleram Attack Bot

Hunter Destroyer

Berserker Warship

Market Cost: Production cost of 20 billion credits (not counting other vehicles). Not for sale outside the Consortium.

Weapon Systems:

1. Main Laser Batteries (2): These cannons are used to engage any large ships that come into range, or on the few occasions when the Packmaster joins in on orbital bombardment.

Primary Purpose: Anti-ship and space station.

Secondary Purpose: Anti-city.

Mega-Damage: 1D4×1,000 M.D. per single blast or 2D4×1,000 M.D. per double blast. Against a station or planet, the guns will do the listed damage at the point of impact (60 foot/18.3 m radius) and 1D4×10 M.D. of heat damage to a 100 foot (30.5 m) area around it.

Rate of Fire: Two double blasts or two single blasts each (4 total per battery).

Effective Range: 100 miles (160 km) in space, or 30 miles (48 km) in an atmosphere.

Payload: Effectively unlimited.

2. Secondary Laser Batteries (4): These cannons are used to engage frigates, or to strafe large, heavily armored vessels. The four cannons are aimed in two separate directions; two cannons can engage the same target, but not all four.

Primary Purpose: Anti-ship

Secondary Purpose: Anti-building

Mega-Damage: 2D6×100 per cannon, or a double blast does 4D6×100 M.D.

Rate of Fire: Each cannon can fire twice per melee round.

Effective Range: 16 miles (25 km) in space, but 7 miles (11 km) in an atmosphere.

Payload: Effectively unlimited.

3. Cruise Missile Batteries (2): These missile turrets are on the front and middle of the ship (one on each). They can volley as many as 24 cruise missiles simultaneously, or up to 48 missiles per melee round!

Primary Purpose: Anti-ship

Secondary Purpose: Bombardment

Mega-Damage: Varies with missile type (2D6×100 to 4D6×100 M.D.)

Rate of Fire: One at a time or volleys of 2, 8, 16 or 24 missiles per launcher.

Effective Range: Over 1,000 miles (1600 km). Optimum launching range is 1 to 3 miles (1.6 to 4.8 km).

Payload: 24 missiles per launcher. Additional missiles are auto-loaded from the cargo hold (takes 2 melee rounds). Standard missile complement is 2400 cruise missiles.

4. Gravity Auto-cannons (8): Light anti-aircraft pieces scattered to cover the entire ship.

Primary Purpose: Anti-aircraft

Secondary Purpose: Defense

Mega-Damage: 2D4×10 M.D. per 20 round burst.

Rate of Fire: Equal to the combined number of hand to hand attacks of the gunner.

Effective Range: 2 miles (3.2 km) in space, but only 4000 feet (1200 m) in an atmosphere.

Payload: 10,000 rounds (500 bursts).

5. Particle Beam Cannons (12): These turrets have light particle beam cannons used to engage enemy vessels and knock down enemy fighters and missiles.

Primary Purpose: Anti-aircraft and defense.

Secondary Purpose: Anti-ship

Mega-Damage: 3D6×10 M.D. per blast.

Rate of Fire: Equal to the total number of hand to hand attacks of the gunner.

Effective Range: 6 miles (9.6 km) in space, but two miles (3.2 km) in an atmosphere.

Payload: Effectively unlimited.

6. Mini-Missile Launchers (12): These are missile turrets used for point defense against enemy fighters and missiles. Each

turret usually fires volleys of four missiles per target to insure a kill.

Primary Purpose: Anti-aircraft and anti-missile.

Secondary Purpose: Defense

Mega-Damage: Varies with missile type.

Rate of Fire: One at a time or volleys of four to eight missiles.

Effective Range: About two miles (3.2 km) in space, or one mile (1.6 km) in an atmosphere.

Payload: 128 missiles per launcher. Reloading a turret from the cargo hold takes 1D6 minutes. The ship's standard load is thousands of missiles (more than enough for an entire battle).

7. Aircraft and Military Vehicles: In addition to its main weaponry, the Packmaster has the following ship complement: 200 Scorpion Fighters, 140 Black Eagles, 100 Katana Fighters, 20 Proctor Long-Range Interceptors, 40 Star Ghost Phase Ships, 320 Silverhawk Power Armor suits, 30 Batteram assault robots, 50 CAF Assault Shuttles.

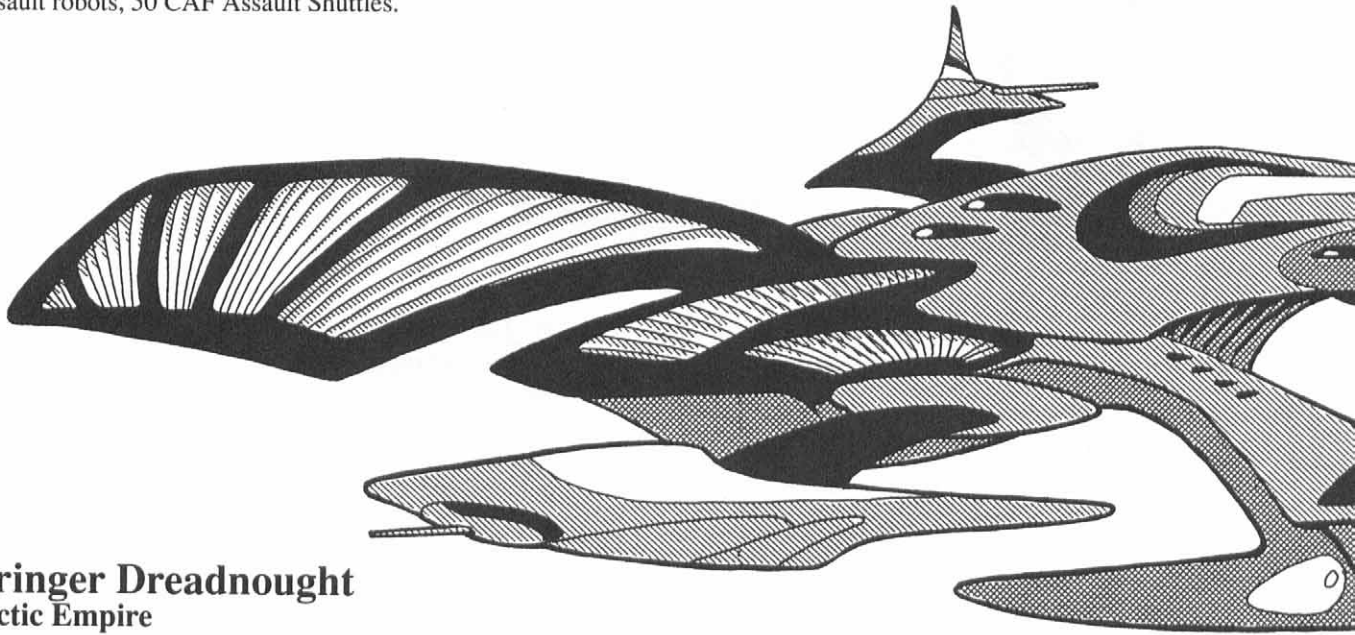

Doombringer Dreadnought Transgalactic Empire

The Doombringer is the largest ship of the Transgalactic Empire, and one of the largest in the Three Galaxies; nearly three miles (4.8 km) long. It packs the firepower of an entire fleet and also doubles as a carrier, with over 800 fighter ships. Whenever these dreadnoughts make their appearance, they elicit fear and apprehension. Seeing the huge pseudo-organic profile floating just on the edge of the atmosphere of a planet has often driven thousands of people into a mindless panic. The fear is justified, the 23 Doombringers in the Imperial Fleet have lived up to their nickname, raining death and destruction down on civilian as well as military fleets. Rebellious cities have been reduced to smoking cinders by a single Doombringer sent as punishment.

Unlike CAF battleships, these dreadnoughts are never attached to a large fleet. The Kreeghor Emperors are too paranoid to put that much power in the hands of a single commander, lest he seek to use it to overthrow his master. Instead, a Doombringer may be sent out on its own or escorted by a flotilla of four cruisers and eight frigates under a separate commander.

Despite their size, weaponry, and the hundreds of fighters they carry, the ships are not invincible. Both in the wars against the Consortium and the current conflict against the Free World Council, many Doombringers have been destroyed by groups of smaller, comparatively weaker ships that combined their fire-

power to first cripple, then obliterate the dreadnought. The very size of the ship makes it a tempting target and the dreadnoughts always get more than their share of missile and laser attacks.

There are 24 known dreadnoughts in the Three Galaxies. The kreeghor control 23 of them. The freedom fighters who rose up against the Empire on the planet of Good Hope were lucky enough to *capture* a dreadnought that had been docked for repairs. Renamed The **Hopebringer**, this vessel is the flagship of the Free World Council and a symbol of hope. Since its capture, the Hopebringer has managed to destroy two of its "sister" ships in brutal combat, although only after suffering heavy damage (has permanently lost 10% of its M.D.C. due to severe structural damage).

Model Type: ID-1

Class: Dreadnought

Crew: 3,200 crew members, including officers. Does not include troops.

Troop Capacity: 8,000 marines (4,000 in power armor) and 1,500 pilots.

M.D.C. by Location:

Horn Cannons (2) — 6,000 each

Laser Batteries (6) — 2,000 each

Particle Beam Cannons (8) — 1,200 each

Cruise Missile Batteries (4) — 900 each
 Laser/Missile Batteries (24) — 350 each
 GR-Gun/Missile Batteries (24) — 400 each
 * Bridge — 100,000
 Hangar Bay — 100,000
 ** Main Body — 350,000
 *** Main Engines (rear 1/3 of the ship) — 200,000
 Variable Force Field — 15,000 per side (90,000 total)

* Destroying the bridge will eliminate the main computer and master controls. The ship can be controlled from the engineering section, deep inside the ship, but those controls are less sensitive and -3 to strike, parry and dodge. Hits on the bridge may injure crew members even if it is not destroyed by the attack; see Ship Combat Rules.

** Depleting the M.D.C. of the main body means the ship is in tatters, with life support and contragravity systems knocked out, and unable to fight or move under its own power. The missile batteries are another matter, and can continue to launch. Likewise, the robot squadrons and fighters

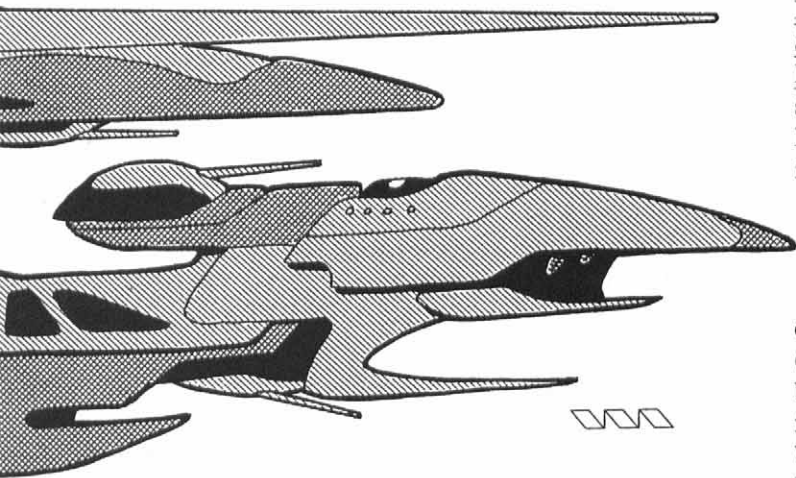

can manually open hatches and launch themselves to engage the enemy. If the ship is reduced to -30,000 M.D.C., it explodes, doing 4D6×1,000 damage to anything within four miles (6.4 km).

*** Destroying the main engines eliminates the ship's FTL capability, and reduces sublight speed by half.

Speed:

Driving on the ground: Not possible.

Flying: Mach 7.5 in space. Can hover into and out of an atmosphere, but maximum safe speed is only 100 mph (160 km). It is almost impossible to find a suitable landing field for a ship this size on most planets.

Range: Limited by supplies. Can keep its crew alive for up to two years, or four years in an emergency.

Statistical Data:

Height: 2000 feet (610 m)

Width: 3000 feet (915 m)

Length: 13,000+ feet (3962+ m)

Weight: 100 million tons fully loaded.

Cargo: 40 million tons.

Power System: Anti-matter; average energy life of 50 years.

Market Cost: 50 billion credits to build; NOT available on the open market!

Weapon Systems:

1. Horn Cannons (2): These massive weapons are built in the Kreeghor tradition, roughly in the shape of animal horns. The cannons do massive amounts of damage and can be fired together at the same target or independently at different targets. Even battleships respect the firepower of these dreadnoughts.

Primary Purpose: Anti-ship

Secondary Purpose: Anti-city or anti-planet.

Mega-Damage: 4D4×1,000 per single blast, or 8D4×1,000 per simultaneous double blast! When used against a planet, it inflicts the listed damage on the point of impact (60 ft/18.3 m radius) and does an additional 2D6×10 heat damage to a 200 ft (61 m) radius around that.

Rate of Fire: Each gun can fire once per melee round.

Effective Range: 120 miles (192 km) in space, 60 miles (64 km) in an atmosphere.

Payload: Effectively unlimited.

2. Laser Cannons (6): These spear-shaped cannons are used against large vessels or planetary facilities. Each of them is large enough to threaten any vessel and can combine their firepower for massive volleys.

Primary Purpose: Anti-ship

Secondary Purpose: Anti-building and anti-planet.

Mega-Damage: 1D4×1,000 per single blast. Up to three of the six cannons can fire at the same target, inflicting 3D4×1,000 M.D. per combined triple blast! When used against a planet, it inflicts the listed damage on the point of impact (40 ft/12.2 m ra-

dus) and does an additional 1D6×10 heat damage to a 100 ft (30.5 m) radius around that. Against flammable targets, a few beams will trigger a massive blaze. Simultaneous blasts add 50 feet (15.2 m) to the radius of destruction per each additional blast (maximum three blasts total).

Rate of Fire: Each cannon can fire once per melee round.

Effective Range: 100 miles (160 km) in space or 30 miles (48 km) in an atmosphere.

Payload: Effectively unlimited.

3. Particle Beam Cannons (8): These medium energy weapons are the "light" guns of this ship, still for use against starships rather than fighters or robot vehicles. The cannons are scattered at key points on the ship.

Primary Purpose: Anti-ship

Secondary Purpose: Defense

Mega-Damage: 2D4×100 per blast.

Rate of Fire: Equal to the total number of hand to hand attacks of the gunner.

Effective Range: 4 miles (6.4 km) in space, but only 1.5 miles (2.4 km) in an atmosphere.

Payload: Effectively unlimited.

4. Cruise Missile Launchers (4): These launchers are identical to those found in the Berserker and Smasher ships.

Primary Purpose: Anti-ship

Secondary Purpose: Assault

Mega-Damage: Each missile does 2D6×100 or 4D6×100 M.D. Countermeasures will work if missiles are launched at a distance greater than three miles (4.8 km). Otherwise, the missiles will reach the target in less than one second! Only a counter volley of

Space Combat

Large Ship Combat

The massive firepower and damage capacity of large ships in the **Phase World** setting require special rules and considerations. Space combat is conducted somewhat differently from normal hand to hand combat in the Palladium system. The system below is not a complex war-game, but intended to simulate the madcap action of movies like Star Wars, Japanimation, and other cinematic settings. Some of the rules and rule variants are optional, depending on how important the combat will be.

A Note to Robotech/Macross II Players: Since the Phase World war machines tend to be smaller, and due to more advanced targeting systems, the bonuses and penalties presented below are different from those of the **Macross II Deck Plan books** and **Robotech's Zentraedi Sourcebook**. If combining the two settings, Game Masters should pick one of the two systems, or perhaps have the system in the Macross Deck Plans apply to Macross and Robotech ships, and use the Phase World system for Three Galaxies' ships.

Weapon Types

Starships, frigate class or larger, carry one or more *main guns*; these are heavy weapons used only against large targets. They also have several *secondary guns*, also used against starship-sized targets, and many *point defense guns*, used against small targets like fighters, robots and missiles. Main and secondary guns are almost useless against small targets such as fighters, power armor and robots. For one thing, these weapons have limited gunner bonuses: typically only +1 from the *weapon systems skill*, plus a +2 from computer aiming systems. For another, these powerful weapons of destruction have incredible range, especially in space, and are easy to notice and easy for small vessels to dodge. After all, these "big" guns were designed to fight "big" starships and space stations.

Volley Attacks

Most ships carry at least 10 weapon systems, and some have hundreds of energy cannons. Rolling to determine strikes and damage for each weapon would probably take hours for a single large ship! To simplify matters, the weapons are fired in volleys (which is both logical and realistic). In standard starship combat, multiple weapon systems can lock onto one single target among even a massive attack force and fire a volley at it.

A volley is the simultaneous firing of several energy cannons/turrets/blasts at the same, specific target. All the blasts in that volley, whether it be 3 or 33, are directed at that one target and can NOT be divided to strike several different ones. If the

40 missiles or more will stop the barrage (roll 2D6+8 to determine how many cruise missiles were destroyed; the remainder will hit the target).

Rate of Fire: Volleys of 10 per launcher, per melee, or up to 40 missiles total, launched every melee! Launchers are reloaded on the same melee and can fire again on the next.

Effective Range: Over 1,000 miles (1600 km), but optimum range is 1-3 miles (1.6 to 4.8 m).

Payload: 200; 50 missiles per launcher. Reloading the launcher from the cargo hold takes 1D4 minutes.

5. Laser/Missile Batteries (24): Similar to the point-defense systems in the Berserker frigate, these light weapon systems are designed to destroy enemy missiles, fighters, and robot vehicles. Instead of a gravity gun, these batteries use lasers.

Primary Purpose: Anti-aircraft and anti-robot.

Secondary Purpose: Defense

Mega-Damage: Laser: 3D4×10 M.D. Mini-missile: Varies with missile type.

Rate of Fire: Laser: Equal to the number of combined hand to hand attacks per melee. Missiles: One at a time or in volleys of two or four missiles.

Effective Range: 2 miles (3.2 km) for both weapons in space, but one mile (1.6 km) in an atmosphere.

Payload: Unlimited for the lasers, 32 missiles per launcher; additional missiles can be loaded from the cargo hold in 1D4 minutes.

6. GR-Gun/Missile Batteries (24): These are identical to the Berserker frigate mini-batteries. They have been installed to deal with enemies that are immune to energy weapons (including some techno-wizard ships and the cosmo-knights).

Primary Purpose: Anti-aircraft and anti-robot

Secondary Purpose: Defense.

Mega-Damage: GR-Gun: 3D6×10 M.D. per 40 round burst.

Mini-missiles: Varies with missile type.

Rate of Fire: GR-Gun: Equal to the number of combined hand to hand attacks per melee. Missiles: One at a time or in volleys of two or four missiles.

Effective Range: 2 miles (3.2 km) for both weapons in space, but the GR-gun has a range of 4000 feet (1200 m) and missiles one mile (1.6 km) in an atmosphere.

Payload: 8,000 rounds/200 bursts for the gun and 32 missiles for the launcher. Additional ammo and missiles can be loaded from the cargo hold in 1D4 minutes.

7. Aircraft and Military Vehicles: In addition to its armor, the Doombringer has a fighter wing of 600 Flying Fang fighters and 300 modified Flying Fangs (all stats remain the same, but have missile mountings for 2 to 4 cruise missiles; used for bombing runs). The ship also holds 6 "Rain of Death" troop transports (see **Rifts Phase World**, page 166).

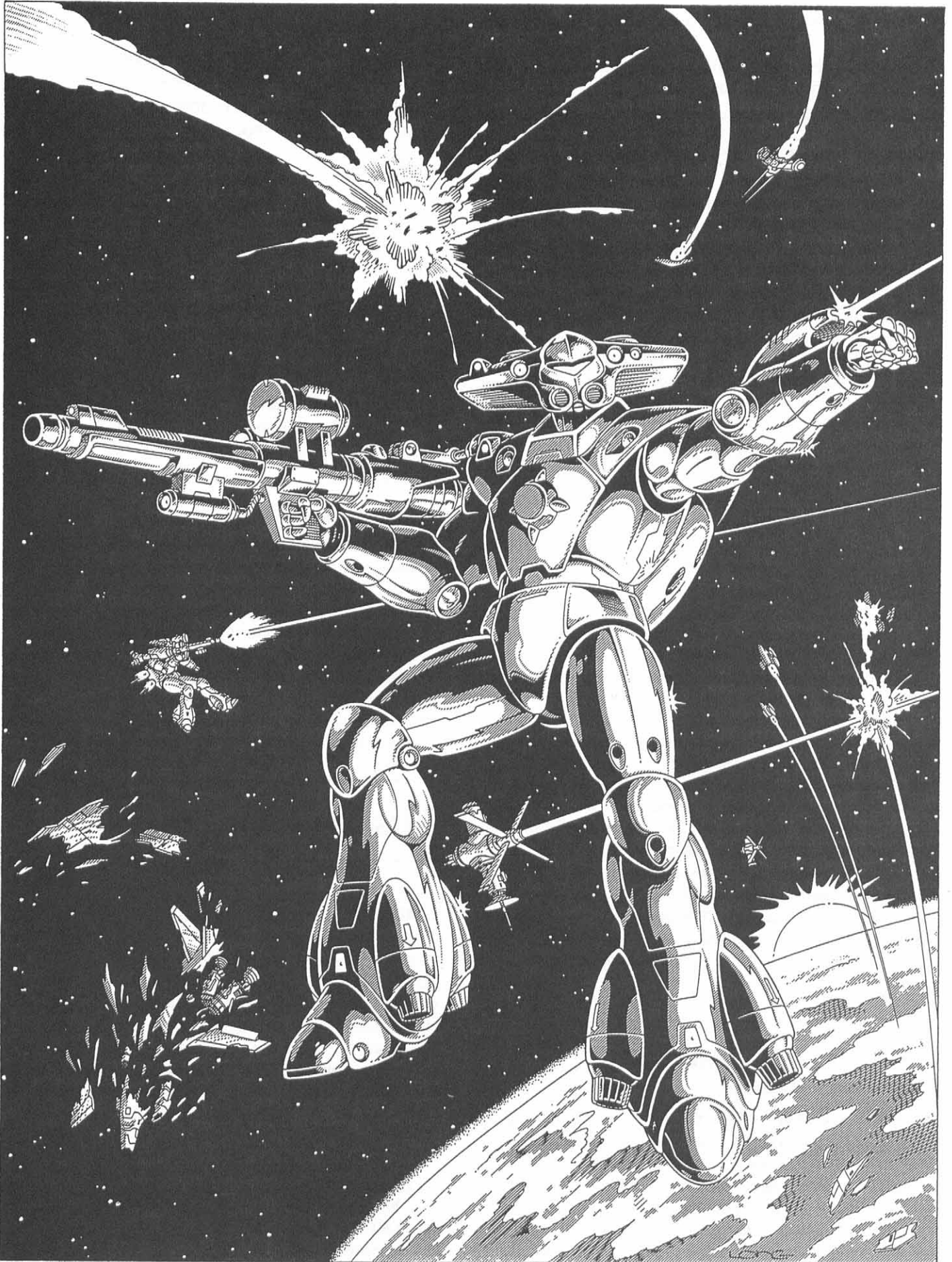

volley hits, the target suffers the damage inflicted by the entire volley. If the volley misses, the target avoids taking any damage whatsoever.

This greatly reduces the number of dice rolls needed to conduct combat and helps to speed up play.

Damage From an Energy Beam Volley

If a target is hit by a volley, the attacker rolls the appropriate damage from total energy blasts in the volley. This can lead to rolling handfuls of dice.

One way to reduce this is to multiply the damage of ONE blast times the total number of blasts or missiles in the volley. Another way is to total the maximum damage possible from the volley and then apply 60% of the total as the damage inflicted.

Example: A Doombringer Dreadnought hits a target with a volley of 21 particle beam weapons. This amounts to 21 blasts doing 1D4×100 M.D. each. The player can roll dice 21 times (boring), or he can roll 1D4×100 once and multiply by 21, or simply roll 1D4×2,100.

Or, take the total damage possible: 8,400 M.D. and apply 60%, 5,040 M.D., automatically.

Of course, if the amount of damage received by a vessel would obviously destroy it, then by all means, declare it destroyed and avoid any rolls. The Game Master should be the one who recognizes and proclaims a vessel's destruction to forgo the need of dice rolls.

Number of Volleys Per Melee

Many heavy starship weapon systems can only fire once per melee or once every other melee. Volleys that include those weapons can only fire at the slowest rate available. When firing in volleys, give all other weapon systems one attack per melee round (in the case of pulse weapons, each attack should be the most damaging burst attack). These attacks can be divided into smaller volleys, as long as the total number of individual blasts does not exceed the total number of weapon systems. The maximum number of volleys per melee per weapon system cannot exceed the total number of weapon systems divided by three.

Example: The *Imperial Doombringer Dreadnought* has 24 medium particle beam cannons. The ship can fire up to 8 volleys of 3 blasts, or one volley of 8, and three volleys of 5 blasts each, or any combination that does not exceed 8 total volleys or 24 blasts.

Bonuses & Penalties to strike from Heavy Energy Weapons

Bonuses to strike apply when the target is especially large — 400 feet (122 m) or bigger. Gunners have a maximum base bonus of +3 to strike with heavy ship armaments.

Penalties to strike apply when the target is small (less than 400 feet/122 m) or very agile. The large weapons of the big ships are not designed to engage tiny targets: their weapon systems are too big and too cumbersome against small attackers.

Bonuses/Penalties

<u>to strike</u>	<u>Target's Approximate Size</u>
+11	20,000 ft (6096 m) or larger
+10	10,000 ft (3048 m) to 19,999 ft (6093 m)
+6	5,000 ft (1524 m) to 9,999 ft (3048 m)
+4	2,000 ft (609 m) to 4999 ft (1523 m)
+2	1,000 ft (304.8 m) to 1999 ft (603 m)
+1	400 ft (122 m) to 999 ft (304 m)
No bonus	
/Penalty	200 ft (61 m) to 399 ft (122 m)
-4	150 ft (45.7 m) to 196 ft (60 m)
-8	70 ft (21.3 m) to 140 feet (42.6 m)
-10	less than 70 ft (21.3 m) to man-sized
-12	Man-sized or smaller (9 ft./2.7m or shorter).

Note: All small spacecraft, power armor, and robot vehicles 150 feet (45.7 m) or smaller get an automatic dodge against large energy blasts/volleys.

Modified Dodge For Large Vessels vs. Energy Weapons

Dodging Energy & Rail Gun Blasts: Large vessels, 1,000 ft (305 m) or bigger, are too massive and slow to dodge or move completely out of the way. They can, however, maneuver so that they receive only a glancing blow instead of the full attack.

The roll to dodge is unchanged. The defender must roll a twenty-sided die (1D20) and match or better his attacker's roll to strike. A failed roll means the ship takes full damage. A successful roll means the ship has completed the maneuver and takes only one-half of the normal damage from a glancing blow.

Missile Combat

Dodging Missile Strikes

These bonuses are somewhat different because we are no longer dealing with streams of projected energy or direct-fire weapons like gravity cannons, but with guided missiles. Each missile can be instantly programmed to seek out and hit a specific target or variety of targets (seek, select, and destroy). The targeting system includes a limited memory for target identification, radar, heat and video. Once a missile or volley of missiles has locked on one target, they will head toward it, strike and detonate.

Large vessels cannot dodge even one missile, let alone a volley of missiles. The only option is to shoot the missiles before they hit. If missiles are launched at point-blank range (one mile/1.6 km or less), their speed is such that they simply cannot be stopped by anything other than a force field (see below).

Bonuses & Penalties to Strike with missiles:

Bonus	Target's Approximate Size
+14	10,000 ft (3048 m) or larger
+10	9,990 ft (3045 m) to 5,000 ft (1524 m)
+6	4,990 ft (1520 m) to 2,000 ft (609 m)
+3	*1,990 ft (607 m) to 200 ft (61 m)
* +5	if a smart bomb

Penalty: 200 ft (61 m) or smaller vessels cannot be hit by a volley of ten or more missiles, unless it is a smart bomb or point-defense systems, including mini-missiles.

Random Missile Assault

A unique missile attack capability is a random bombardment of TEN or more missiles. In this assault, at least ten missiles are launched simultaneously, but they are NOT launched as a volley at any one target. Instead, *each* of the missiles speeds off in search of its own target. Once a target is identified, the missile(s) locks in and strikes.

The randomness of the seek and destroy program means more than one missile is likely to home in on the same target, even if there are many other targets available. The missiles will tend to lock in on the first available and most immediate target. If only one or a few targets are available, several of the missiles may link up and in effect, attack as a volley against that or a handful of targets. Random missile assaults are more likely to single out smaller objects like fighters, power armor and robots. This tactic is also used for orbital or aerial bombardment against troop and vehicle concentrations. **Note:** Only long, medium and short range missiles can be used in random missile assaults.

The formula for determining the number of missiles that will randomly home in on a target is simple.

- 1D4 missiles per 10 to 20 launched will key on one specific target.
- Roll at least once for each available target, beginning with the closest, until most of the missiles are accounted for. There is bound to be some that stray off, so don't worry about numbers under 4.

Example: A squadron of 6 Silverhawks is attacked by a random assault of 40 missiles. 2D4 missiles are rolled for each. The first one has 2 missiles on his tail, the next two have 6 each, the fourth one is unlucky enough to get 8, and the fifth and sixth get 4 and 3 respectively. That accounts for 29 missiles: the remaining 11 are "strays" that wander in search of other targets (or the G.M. can redirect them at a few unfortunate Silverhawks).

Note: If only one target is available, 50% of the missiles will automatically home in on it, the remainder will stray off.

The usual means of dealing with missiles, such as dodges, shooting them, and so on, are applicable. See pages 42 and 43 in the **Rifts RPG** rule book.

Missiles & Force Fields Optional Rules

Force fields have a very important benefit against missiles. On large ships, force fields are extended 20 to 40 feet (6 to 12 m) away from their hulls. The effectiveness of missiles is greatly reduced if they are not in direct contact with the target vessel. This means that the force field, even when destroyed by a missile attack, will keep most of the impact and explosive damage away from the ship's hull. This rule does not apply to small space fighters, robots, power armor or small vehicles 100 feet

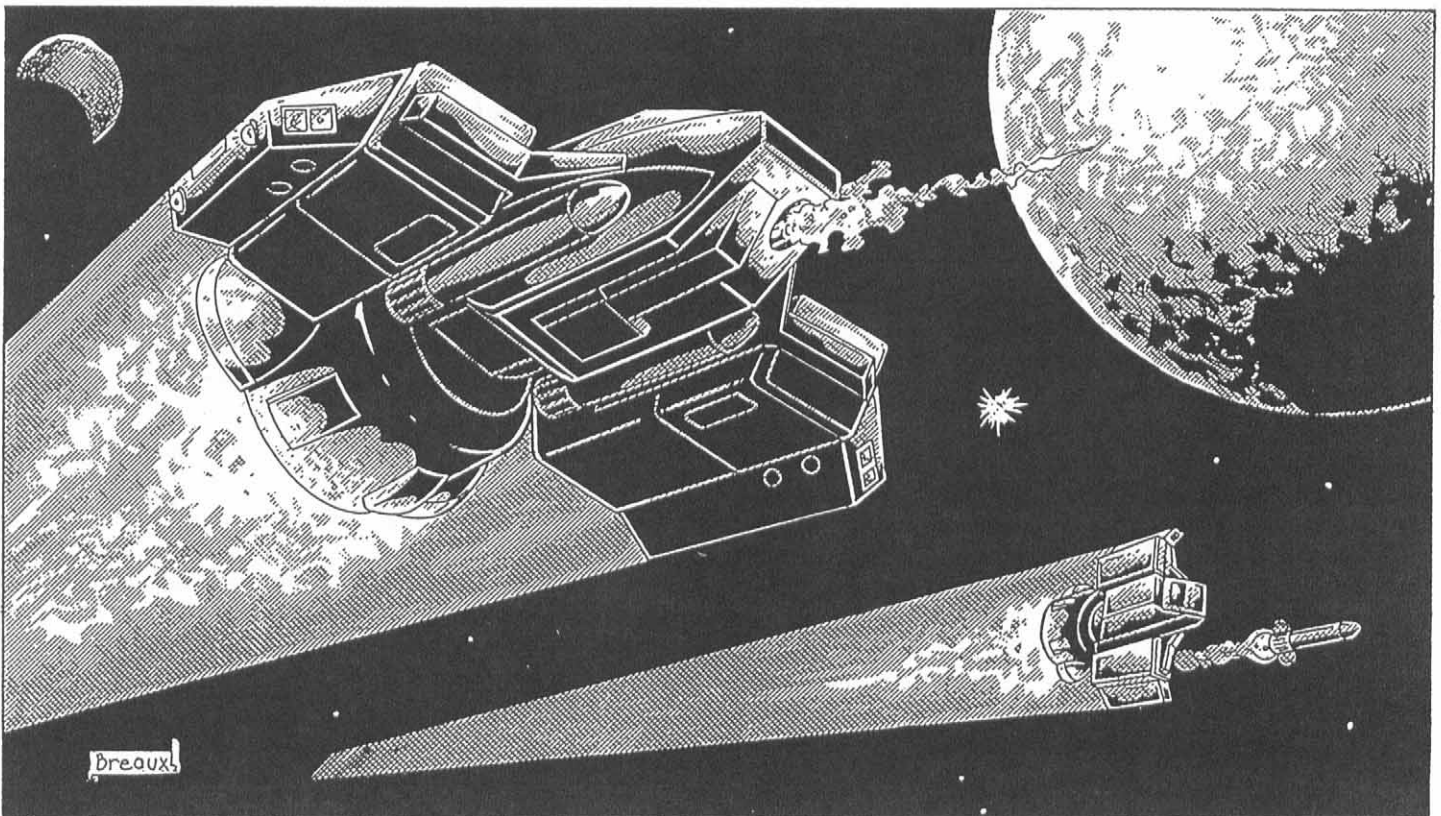

(30.5 m) or smaller, because the force fields are too close to their “skins” to make any difference.

Missiles do normal damage to force fields. If a missile strike penetrates a force field, divide its damage by TEN before applying it to the ship’s hulls and components. This applies even if the force field had only one M.D.C. left before the missile or missile volley impacted! This protection only applies to any missiles that strike before the shield was gone. All subsequent missile (and beam) attacks inflict full damage because the ship is no longer protected by the force field

Example: A Scimitar Patrol ship is struck by a volley of 10 anti-matter cruise missiles (4D6×1,000 total!). The volley hits the ship’s force shields (1,000 M.D.C. per side). The damage roll is 15,000 M.D.C.! 1,000 points eradicate the shield, leaving 14,000 M.D.C. to get through (more than enough to obliterate the ship). However, since the missiles impacted and exploded on the force field, much of their destructive energies were diffused. Thus, the damage is *divided by ten*, for a total damage of 1,400 M.D.C. that actually strikes the patrol ship; severe damage but survivable. If any other missiles or missile volleys hit the ship, however, it will get no special benefits for the rest of the melee round (see Shield Damage Rules, below). If the force field is destroyed or incapacitated for hours, all subsequent attacks do full damage!



Special Damage Rules Regarding Variable Force Field Damage & Repairs

Force fields are a special case in terms of damage taken. *Variable force fields* (see **Rifts Phase World**, page 156) are set to regenerate themselves (eliminating damage), as the power plant of the ship restores the field’s density. A ship functioning normally can restore the damage done to a variable force field at the rate of about 5% (5 M.D.C. per 100 M.D.C. of normal field strength) per side, per melee round. By shifting energy from shield to shield, a damaged side can regenerate as much as 30% per melee round, but none of the other field sides will recover any M.D.C. during that round. This regeneration takes time, so if one side of a variable force field is depleted, it will not recover any power until the next melee round. Any subsequent attacks that melee will damage the ship’s hull.

Example: A Berserker warship has 1,000 M.D.C. per side. At the beginning of a round, it is hit by a laser beam doing 2,000 M.D. on the front. The shield is depleted and the main body takes 1,000 M.D.! The pilot spends one melee action to shift energy from the other fields to the damaged area: 200 M.D.C. from each side is shifted, reducing all other five sides to 800 M.D.C. and restoring the front field to 1,000. During the same round, the ship is hit again by a volley of four long-range missiles that inflict 650 M.D. to the front, reducing the front force field to 350 M.D.C. No more damage is inflicted on that round. At the beginning of the next round, power restores the force field by 5%, or 50 M.D.C. per side. This restores the front to 400 M.D.C., and the other sides to 850 M.D.C. each.

Damage to Crew Members Optional Rules

Even if a ship survives an enemy attack, there is a chance that the attack will injure crew members and damage equipment. This can be caused by many factors. For instance, some heat or radiation from lasers and particle weapons might have “leaked” into the ship, or the bombardment causes pieces of the hull to “spall” and go flying inside the corridors (or the bridge) like shrapnel. The sudden shakedown of a ship may cause people to stumble and fall, objects to fall on top of them, or electrical equipment to overload, explode, or catch fire and burn. The following rule of thumb is suggested to be used only during dramatic situations, especially if the player characters are on board of the ship being attacked.

The power of the attack and the size of the ship affects the possible amount of damage taken by crew members. Small ships (fighters and the like) use the Impact Rule in the **Rifts RPG**, page 12 — every 10 M.D.C. from an explosion does one S.D.C. point to the pilot (and in this case, any passengers). Other attacks have no effect, because fighter and robot pilots are in well-protected compartments.

Crew members in a ship under 1,000 tons have a cumulative 10% chance of taking 1D6 S.D.C. damage for every 100 M.D. inflicted by any damaging attacks that gets through force fields and hits the hull directly. Ships between 1,000 and 10,000 tons are affected by attacks of 500 M.D. or more, and heavier ships may be affected by attacks that inflict 1,000 M.D. or more.

Random Damage & Effects Table (optional)

01-10 An explosion, caused by overloading or something else triggered by the attack, erupts in one room. Everything and every person inside that room suffers from 2D6×10 S.D.C. damage (2D6 M.D. if appropriate); casualties are likely. People and items in adjoining rooms or hallway take 4D6 damage and knocked off their feet (lose initiative and one melee action).

11-15 Objects fall, strike people or player characters and inflict 2D6 S.D.C. damage to each character.

16-20 Internal damage. Doors, shelves, ceiling fixtures, or portions of the wall or ceiling fall, striking people or player characters and inflict 1D6×10 S.D.C. damage to each character in that room/section.

21-30 Small fires spring up at 1D6 locations. They can be easily extinguished with minimal damage but doing so requires two melee actions (not to extinguish the fires means smoke and greater damage).

31-40 Electrical short! 50% of the ship’s internal communication system is knocked out. Repairs will take 1D4 hours.

41-50 Minor fires that go out themselves in less than a melee round but continue to smolder, creating choking smoke. All who remain in smoke filled areas are -30% on all skill performance, take one point of damage every melee round (unless in an environmental suit), and lose two melee actions because vision is impaired and it is a panic situation.

51-60 Electrical short or fire has knocked-out 50% of the computer systems and internal electrical systems are slow to respond (take five seconds longer to respond, open, react). Repairs will take 2D4 hours.

61-65 Unspecified damage has slowed weapon response time! All weapon turrets and systems lose one melee attack! Repairs will take 1D6 hours.

66-70 Unspecified damage has knocked-out long range communications; range is limited to 3D4 miles (2D4 km). Fighters and allies may be cut off from the ship. Repairs will take 1D4 hours.

71-75 Serious electrical problem has knocked-out all internal systems! Emergency power is given to lighting, navigation, force fields, weapons, sensory/radar/targeting and life support systems only. Computers and all other systems are down. Repairs will take 2D4 hours.

76-80 Lights out! Only emergency lights are on in corridors and areas of strategic importance, like the bridge, medical facilities, and engineering. Repairs will take 1D6 hours.

81-85 Unspecified damage reduces speed and maneuverability (bonuses to dodge) by half. Repairs will take 1D6 hours.

86-90 Explosion! A computer, monitor, radio or other electrical item explodes, causing 2D6 damage to anybody within a four foot (1.2 m) area around it. The device is destroyed and must be replaced.

91-00 Unspecified damage reduces the capabilities of FTL, Rift or hyper-space jump/warp systems. Half normal distance/speed. System takes three times longer than normal to respond. Repairs will take 3D4 hours.

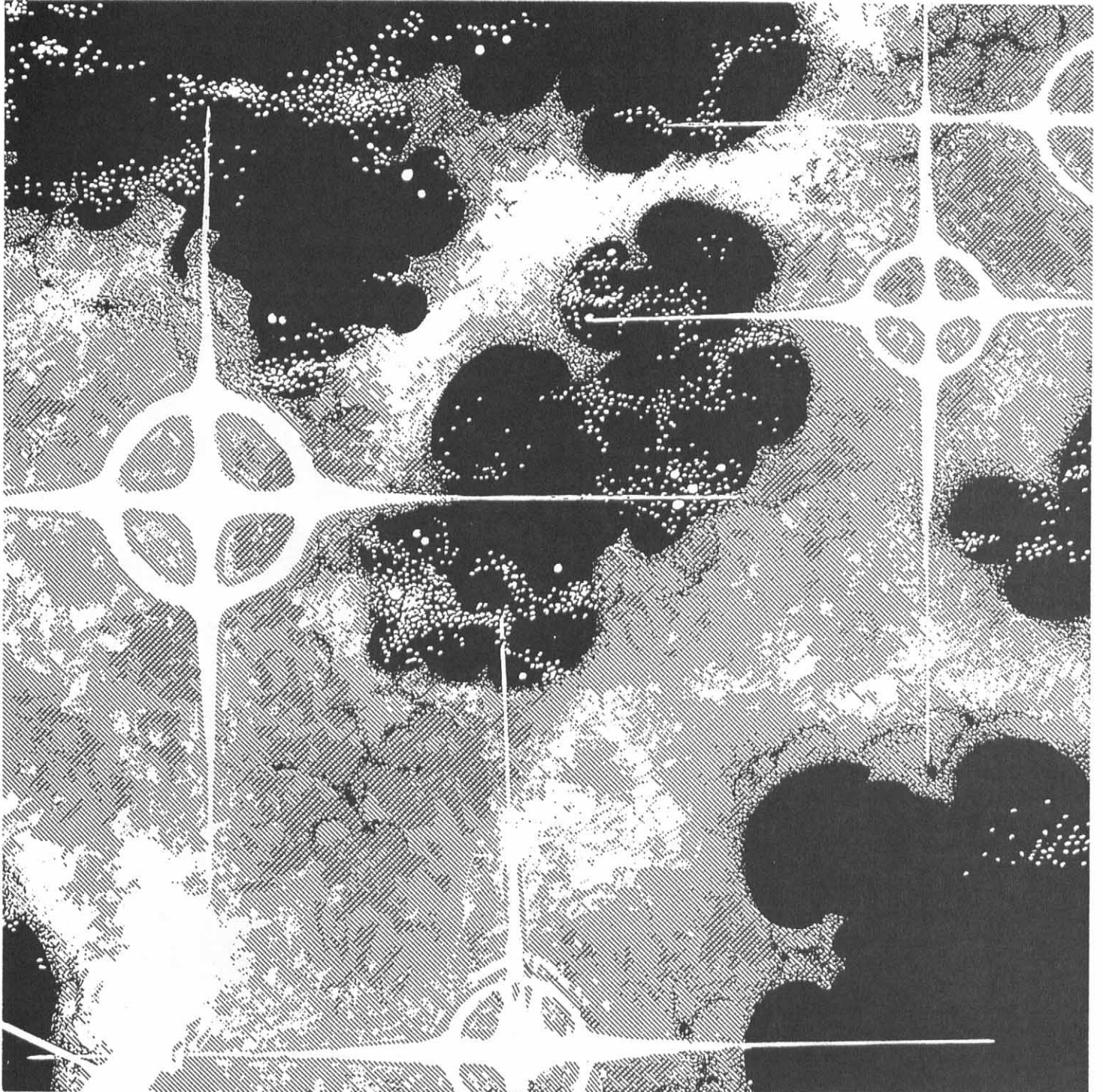

Experience Point Tables

In'Valian "Robo-Jockeys"

1	0,000-2,150
2	2,151-4,250
3	4,251-8,850
4	8,851-17,000
5	17,001-25,000
6	25,001-35,000
7	35,001-50,000
8	50,001-70,000
9	70,001-95,000
10	95,001-130,000
11	130,001-180,000
12	180,001-230,000
13	230,001-280,000
14	280,001-330,000
15	330,001-400,000

Cyberai & Oni Ninja

1	0,000-2,650
2	2,651-5,300
3	5,301-11,000
4	11,001-21,000
5	21,001-32,000
6	32,001-42,000
7	42,001-62,000
8	62,001-90,000
9	90,001-120,000
10	120,001-170,000
11	170,001-220,000
12	220,001-290,000
13	290,001-400,000
14	400,001-500,000
15	500,001-700,000

Gun Brother, Invincible Guard

1	0,000-2,300
2	2,301-4,500
3	4,501-10,000
4	10,001-20,000
5	20,001-30,000
6	30,001-42,000
7	42,001-65,000
8	65,001-85,000
9	85,001-110,000
10	110,001-160,000
11	160,001-210,000
12	210,001-285,000
13	285,001-370,000
14	370,001-450,000
15	450,001-575,000

Warlock Marine & Turbo-Jockey

1	0,000-2,100
2	2,101-4,200
3	4,201-8,400
4	8,401-17,200
5	17,201-25,400
6	25,401-35,800
7	35,801-51,000
8	51,001-71,200
9	71,201-96,400
10	96,401-131,600
11	131,601-181,800
12	181,801-232,000
13	232,001-282,200
14	282,201-342,400
15	342,401-402,600

Warlock Marine

Magic Specialist

1	0,000-2,200
2	2,201-4,400
3	4,401-8,900
4	8,901-18,000
5	18,001-26,000
6	26,001-36,000
7	36,001-52,000
8	52,001-76,000
9	76,001-100,000
10	100,001-150,000
11	150,001-200,000
12	200,001-275,000
13	275,001-350,000
14	350,001-425,000
15	425,001-525,000

"Beast" Intruder

1	0,000-2,600
2	2,601-5,000
3	5,001-10,000
4	10,001-20,000
5	20,001-30,000
6	30,001-39,000
7	39,001-52,000
8	52,001-70,000
9	70,001-100,000
10	100,001-140,000
11	140,001-190,000
12	190,001-240,000
13	240,001-290,000
14	290,001-350,000
15	350,001-520,000

"Mind Creature" Intruder

1	0,000-2,650
2	2,651-5,300
3	5,301-11,000
4	11,001-21,000
5	21,001-32,000
6	32,001-42,000
7	42,001-62,000
8	62,001-90,000
9	90,001-120,000
10	120,001-170,000
11	170,001-220,000
12	220,001-290,000
13	290,001-400,000
14	400,001-500,000
15	500,001-700,000



Note: The **Monro** and **T'Zee R.C.C.** allows the character to pick a specific O.C.C. and corresponding skills. Experience advancement will depend on the O.C.C. selected.

The **Kreeghor Witch** is a villainous Non-Player Character (NPC). If the G.M. would like an experience table for the character use the **Techno-Wizard**, found on page 17 of the **Rifts RPG**.

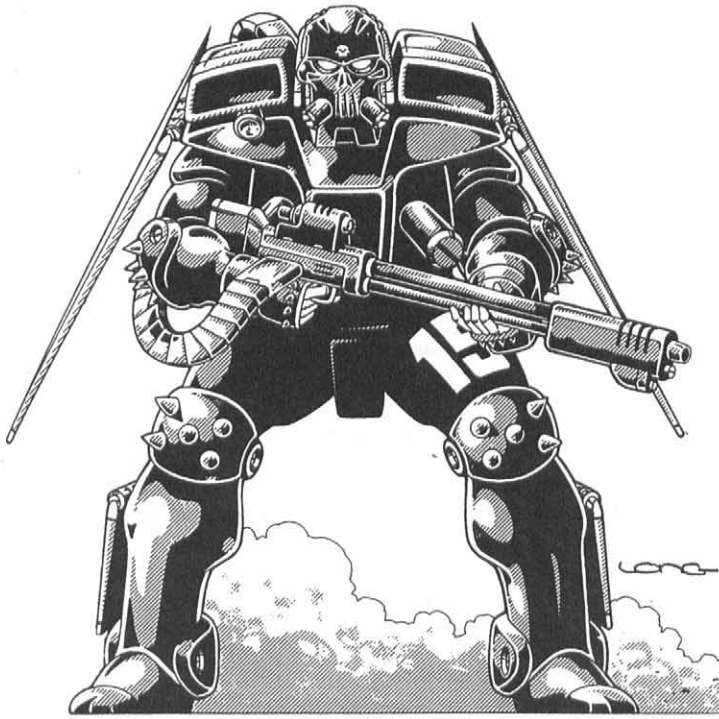

Rifts® RPG Check List

- ___ **Rifts® Role-Playing Game (paperback):** 256 pages, color, and all the basics. \$24.95 plus \$2.00 for postage and handling.
- ___ **Rifts® RPG Hardbound Edition:** Available in August. \$32.95
- ___ **Rifts® Sourcebook One™:** More on the Coalition States, Archie-3, bots and equipment. 112 pages, \$11.95 plus \$1.50 for postage and handling.
- ___ **Rifts® Sourcebook Two: The Mechanoids.** Mechanoid invaders, adventure and more on Archie-3. 112 pages, \$11.95 plus \$1.50 for postage and handling.
- ___ **Rifts Sourcebook Three: Mindwerks™.** Psynetic crazies, psi-blood-hounds, and nearly a dozen new O.C.C.s and R.C.C.s, plus Mindwerks, The Angel of Death, Gene-Splicers, monsters, magic, weapons, vehicles, bots, more about the Brodkil and Gargoyle Empires, and adventure. 112 pages, \$11.95 plus \$1.50 for postage and handling.
- ___ **Rifts® World Book One: The Vampire Kingdoms™.** Vampires like you've never seen 'em. Texas, Mexico and the Yucatan, plus travelling shows and other monsters. 176 pages, \$15.95 plus \$1.50 for postage and handling.
- ___ **Rifts® World Book Two: Atlantis™.** The Splugorth & their minions, True Atlanteans, Sunaj assassins, tattoo magic, rune magic, stone magic, bio-wizardry (symbiotic organisms), new character classes and more! 160 pages, \$15.95 plus \$1.50 for postage and handling.
- ___ **Rifts® World Book Three: England™.** 21 new O.C.C.s & R.C.C.s, including the Chiang-ku dragon, temporal wizard, nexus knights, druids, sectles, and more! Temporal magic, herb magic, New Camelot and adventure. \$15.95 plus \$1.50 for postage and handling.
- ___ **Rifts® World Book Four: Africa™.** A dozen new O.C.C.s & R.C.C.s, including the necromancer, priest, medicine man, pygmy warrior, tree people, and more! Plus the Four Horsemen, Egyptian gods, the Phoenix Empire, and world information. \$15.95 plus \$1.50 for postage and handling.
- ___ **Rifts® World Book Five: Triax & The NGR™.** 224 pages of bots, cybernetics, weapons and adventure in the New German Republic. By Siembieda and Long. \$19.95 plus \$2.00 for postage and handling.
- ___ **Rifts® World Book Six: South America™.** 20 new O.C.C.s, including the anti-monster and biomancer, plus tons of new weapons and equipment, Cibolans, Felinoids, tanks, boats, weapons, power armor, adventure ideas and more. \$15.95 plus \$1.50 for postage and handling.
- ___ **Rifts® World Book Seven: Rifts Undersea™.** The oceans of Rifts Earth are more alien and dangerous than the surface world! Scores of aliens, D-bees, monsters, and player characters, plus underwater bionics, bots, weapons, vehicles, magic and psionics. \$15.95 plus \$1.50 for postage and handling.

___ **Rifts® Dimension Book One: Wormwood™.** An alien world locked in battle against supernatural forces. Strange new magic, symbiotes, slime, a living planet, and many new O.C.C.s & optional R.C.C.s. An original 20 page comic strip and artwork by Truman and Henry. Written by Siembieda. \$15.95 plus \$1.50 for postage and handling.

___ **Rifts® Dimension Book Two: Phase World™.** If you're looking for epic space opera adventure, look no farther. 30 new O.C.C.s, cosmo-knights, phase technology, magic, spaceships, weapons, equipment, the Splugorth and more! \$19.95 plus \$2.00 for postage and handling.

___ **Rifts® Dimension Book Three: Phase World Sourcebook™.** More details about the Three Galaxies, dark secrets, space combat, Naruni Enterprises, and adventure. 112 pages — \$11.95 plus \$1.50 for postage and handling.

___ **Rifts® Conversion Book One™:** Conversion rules, playing tips, culture shock, 40 optional O.C.C.s/R.C.C.s, stats for over 100 specific creatures, the adult dragon, warlock magic, elementals, and more. \$19.95 plus \$2.00 for postage and handling.

___ **Rifts® Conversion Book Two: Pantheons of the Megaverse™:** Mythological gods done Rifts style. Over 150 gods, demigods, and god pretenders, over a dozen optional O.C.C.s/R.C.C.s, including the godling. Tons of adventure ideas and insight into the Palladium Megaverse. 208 pages, \$19.95 plus \$2.00 for postage and handling.

___ **Mutants in Orbit™.** Half of this book is for Rifts. The section on "Rifts Space" includes space stations in Earth's orbit, moon and Mars colonies, A.R.C.H.I.E. 7, the Cyberworks Corporation, space Glitter Boys, bots, power armor, killer satellites, mutants, and more! \$11.95 plus \$1.50 for postage and handling.

___ **Rifts® Mercenaries™:** 9 new O.C.C.s, including the bounty hunter, forger, spy, smuggler and safecracker. Rules for creating mercenary armies, organizations like Crow's Commandoes and Robot Control, Naruni Enterprises, more data about North America and tons of new weapons, power armor, and equipment! 160 pages, \$15.95 plus \$1.50 for postage and handling.

___ **Rifts® T-shirts.** Four different shirts currently available.

___ **Aliens Unlimited™.** A 196 page sourcebook with over 100 different aliens, plus weapons and vehicles. Written for *Heroes Unlimited*, but compatible with Rifts (includes conversion notes). \$19.95 plus \$2.00 for postage and handling.

Coming in 1995 for Rifts®

- Rifts® South America 2:** 160 pages, \$15.95, coming this Summer.
- Rifts® New West™:** 160 pages, \$15.95, coming this Summer or Fall.
- Rifts® Lone Star™:** 160+ pages, \$15.95, coming this Fall.
- Rifts® Game Master Companion™:** Coming this Summer.
- Rifts® Novels and other surprises.**

Other Palladium® Products

- Heroes Unlimited™ RPG**
- Villains Unlimited™ Sourcebook**
- Aliens Unlimited™ Sourcebook (new)**
- Scrapers™ (by Zeleznik & Siembieda; coming soon)**
- Mystic China™**
- The Compendium of Contemporary Weapons™**
- Beyond the Supernatural™**
- Scrapers™ (coming Soon)**
- Original RECON®(coming soon)**
- RECON® Modern Combat (coming later this year)**
- Robotech®**
- Robotech® II: The Sentinels™**
- Nightspawn™ (coming this summer)**
- Macross II™**
- Macross II™ Deck Plan Series**
- Palladium (fantasy) RPG®**

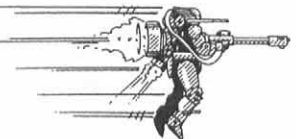

Palladium Books® Catalog

A mere 75 cents gets you our latest 32 page catalog filled with exciting products, like **Robotech®**, **Heroes Unlimited™**, **Beyond the Supernatural™**, **Heroes Unlimited™**, **Ninjas & Superspies™**, **Macross II™**, **RECON®**, **Palladium RPG® (fantasy)**, miniatures and more!

**Palladium Books® 12455 Universal Drive
Dept. D Taylor, Mi. 48180**

Palladium Books®, Megaverse®, Rifts®, RECON® and The Mechanoids® are all registered trademarks owned & licensed by Kevin Siembieda and Palladium Books®. Phase World™, New West™ and other titles are trademarks owned by Kevin Siembieda and Palladium Books®.

PALLADIUM BOOKS® PRESENTS . . .

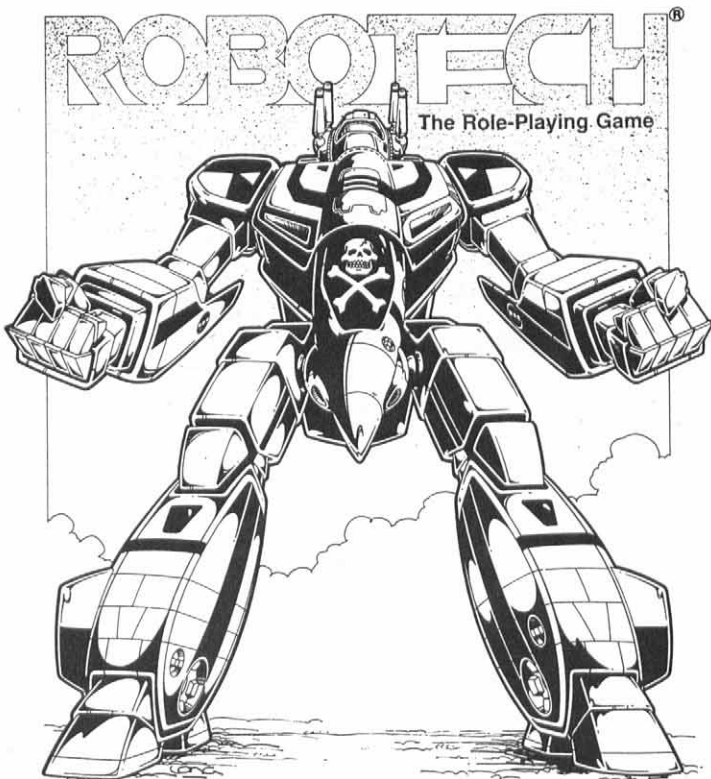

Robotech® mania is back with the release of the toy line by *Playmates®*, the mass market distribution of videocassettes and laser discs of the animated series, TV syndication, new novels, and talk about computer games and more!

Enjoy the action and adventure of **Robotech®** right now, with Palladium's **Robotech®** RPG series!

The **Robotech®** RPG has sold over 120,000 copies and remains one of the most popular role-playing game lines ever published!

Robotech® is an epic saga of war, survival, heroics and fortitude that pits courageous mecha pilots against deadly aliens and overwhelming odds. Play the pilot of the fabulous, transformable Veritech Fighters, Veritech Hover Tank, Cyclone motorcycle, or one of the incredible Destroids (50 feet of mega-damage steel with the fire power of a tank division)! Or any number of other human and alien characters.

The **mega-damage™** system, science fiction setting, and high technology makes **Robotech®** suitable for use with **Rifts®**, **The Mechanoids®** and any of Palladium's **mega-damage** settings.

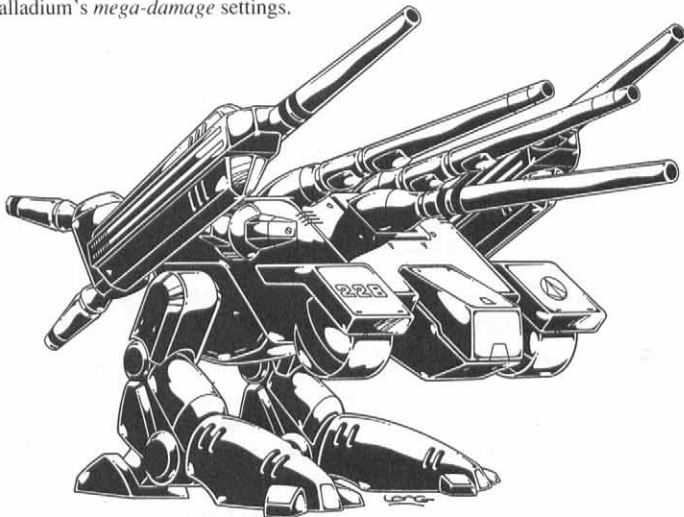

Robotech® RPG Check List!

ROBOTECH® RPG: Book One: Macross. A complete role-playing game that recounts the **Robotech Defense Force's** valiant efforts to protect the Earth from the alien invaders known as the Zentraedi. Includes: Five different transformable Veritech Fighters, the famous RDF Destroids, Zentraedi Mecha, Lancer Space Cannon and Fighter, A.R.M.D. space platform, Macross characters, O.C.C.s., and the SDF-1. 112 pages, written by Kevin Siembieda and illustrated by Kevin Long. Over 120,000 copies sold! **\$11.95 plus \$1.50 for postage and handling.**

ROBOTECH®: Book Two: The RDF™ Manual. A 48 page source book with more data on the RDF and the world. Includes the floor plans of the Dae-dalus and Prometheus, plus additional aircraft, tanks, character sheets, a time-line, random encounters and optional hit location tables. 48 pages, written by Kevin Siembieda, with art by Kevin Long and Peter Simon. **\$7.95 plus \$1.00 for postage and handling.**

ROBOTECH®: Book Three: Zentraedi™. Complete deck plans for the five giant Zentraedi space ships, more Zentraedi mecha and weapons, quick roll Zentraedi characters, characters sheets and space combat rules. 48 pages, written by Kevin Siembieda. **\$7.95 plus \$1.00 for postage and handling.**

ROBOTECH®: Book Four: The Southern Cross™. A 112 page source book with **all** of the mecha and armies of the *Southern Cross*. Including the Veritech Hover Tank, Veritech Helicopter, Logan, giant Battloids, body armor, numerous energy weapons, vehicles, bioroids and the Robotech Masters! Written by Kevin Siembieda, with art by Siembieda, Simon, and Long. **\$11.95 plus \$1.50 for postage and handling.**

ROBOTECH®: Book Five: The Invid Invasion™ A 112 page source book with the famous and fabulous mecha of *Robotech New Generation!* Includes the transformable Veritech motorcycles known as the *Cyclones*, plus Alpha and Beta fighters, the Shadow Fighter, a variety of weapons, the insidious Invid and their mecha, Invid hives, Lancer, Rook and all the other characters. Written by Kevin Siembieda and illustrated Siembieda and Long. **\$11.95 plus \$1.50 for postage and handling.**

ROBOTECH II: The Sentinels™ A complete RPG in itself, that presents the mecha, vehicles, aliens, and characters of the never completed, second Robotech animated series! 5 alien player characters, 8 REF O.C.C.s, new Destroids, Veritechs and war machines, plus the invid *inorganics!* 160 pages, written by Kevin Siembieda and illustrated by Kevin Long. **\$15.95 plus \$1.50 for postage and handling.**

ROBOTECH II: The REF™ Field Guide. A sourcebook that publishes a great variety of artwork directly from the **animation model sheets** created for the *New Generation* and *Sentinels* television series. It pays close attention to details regarding the operation of REF mecha and transformation sequences, as well as stats on REF characters, floor plans for typical REF bases and the Robotech Factory, adventures and more. Written by Siembieda, with art by Kevin Long. **\$15.95 plus \$1.50 for postage and handling.**

RDF Accelerated Training Program™: A 56 page adventure sourcebook for new recruits into the *Robotech Defense Force*. 20 adventures in all! **\$7.95 plus \$1.00 for postage and handling.**

The Newest Robotech® Releases

Zentraedi™ Breakout (New!): A 68 page adventure sourcebook detailing the RDF bases, allies, governments and rebels around the infamous *Zentraedi Control Zone* in the South America Sector. Both RDF and Southern Cross mecha and characters can be played. **\$9.95 plus \$1.00 for postage and handling.**

Robotech® New World Order (New!): A unique 112 page adventure sourcebook that not only details the Zentraedi warlords of the Congo, baronies and would-be-dictators of Africa, but pits RDF Destroids and Veritechs against each other! **\$11.95 plus \$1.50 for postage and handling.**

Robotech® Strike Force (New!): 112 pages of adventures, new RDF mecha, weapons, equipment, characters and adventure ideas. Written by Wayne Breaux and Kevin Siembieda. **\$11.95 plus \$1.50 for postage and handling.**

Send 75 cents for Palladium's complete catalog of other exciting role-playing games, miniatures and T-shirts.

Palladium Books®
Dept. D
12455 Universal Drive
Taylor, MI 48180

Palladium Books® Presents
A Sourcebook for Heroes Unlimited™

Aliens Unlimited™

By Wayne Breaux Jr.

Includes Rifts conversion notes.
Adaptable to Rifts® and Rifts Dimension Books™.



Also from Palladium Books® Aliens Unlimited

This idea packed sourcebook presents over 100 different aliens player characters complete with world background, special powers, rivals and enemies.

Although written specifically for the Heroes Unlimited series, this book was written with Rifts in mind and contains Rifts conversion suggestions and notes.

If you're look for ideas for over a 100 different aliens and their worlds plus more weapons, robots, power armor, spaceships, superheroes, powers and adventure ideas, this is the book to look at.

Highlights Include:

- Over 100 aliens player characters plus villains.
- Random alien creation tables and rules.
- New super powers, bionics and skills.
- Spaceships and creation rules.
- U.F.O. watch groups.
- Secret organizations and spies.
- Enough ideas to create countless adventures.
- Written by Kevin Siembieda and Wayne Breaux Jr.
- Adaptable to Rifts® and the entire Megaverse®.
- 192 pages — \$19.95

Palladium Books® Presents:

Rifts® Dimension Book Three™: Phase World Sourcebook

- Over a dozen new Occupational Characters Classes and R.C.C.s including the Oni Ninja, Cyberai, Turbo-Jockey, Warlock Marines, T'Zee aliens, Kreeghor Witch, the Invisible Guardsmen, Gun Brothers and others.
- Tons of new weapons, including plasma cartridges, micro-missiles, nanomachines, new explosives, power armor, and robots, plus a number of new weapon dealers.
- Space ships, fighters, frigates and cruisers.
- Optional spaceship combat rules.
- The mysterious and deadly Intruders with "solid energy" spaceships and body armor.
- More information about the Three Galaxies, the Kreeghor, Naruni Enterprises, CCW, CAF, Splugorth and others.
- A dynamic sourcebook full of adventure ideas.
- 112 pages.

A supplement for the Rifts® RPG.

Compatible with the entire Palladium Books® Megaverse®!

\$12.95

Cat. No. 817

I.S.B.N. 0916211-79-7

ISBN 0-916211-79-7

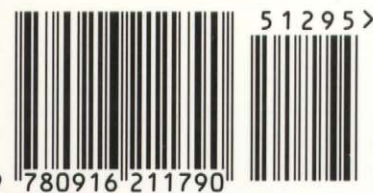

9 780916 211790