

**GERMAN
ACES
OF THE
RUSSIAN
FRONT**

GERMAN ACES OF THE RUSSIAN FRONT

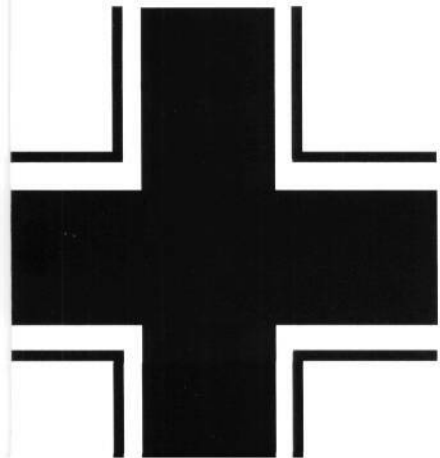
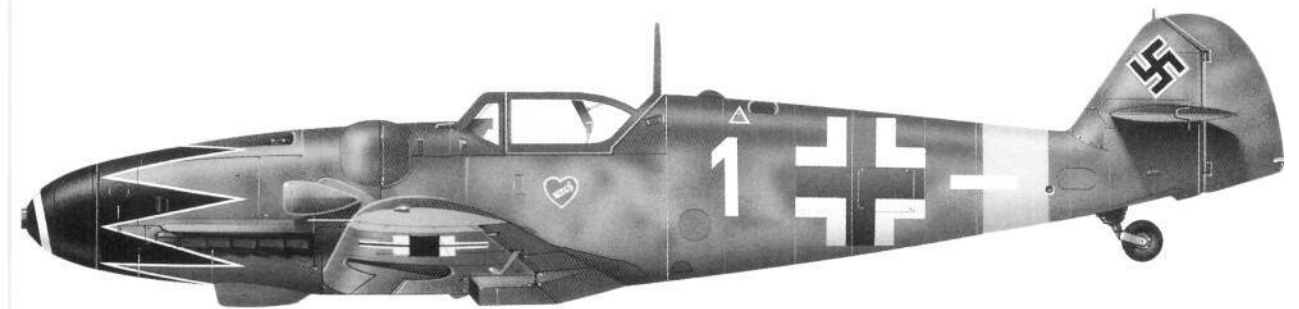
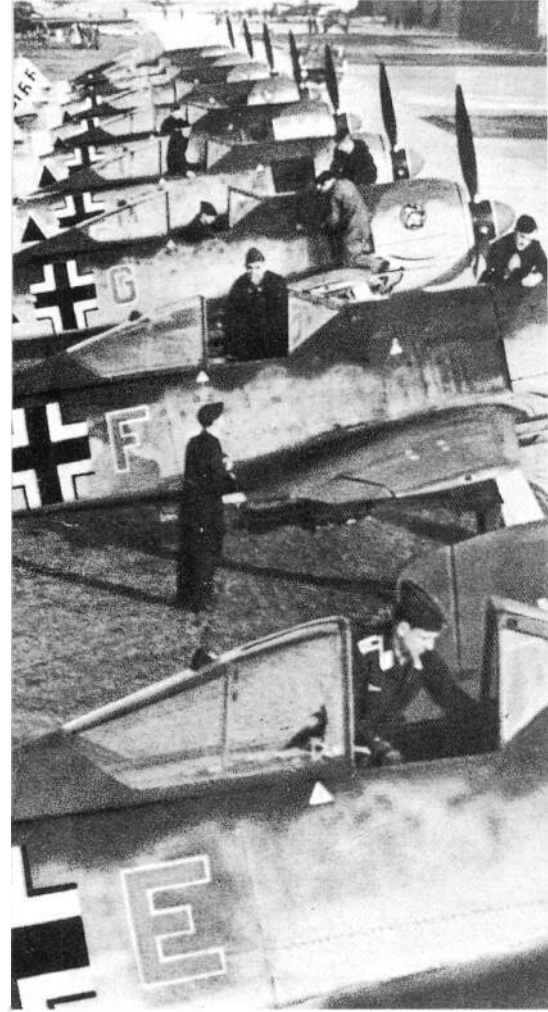

John Weal

First published in Great Britain in 2002 by Osprey Publishing,
Elms Court, Chapel Way, Botley, Oxford OX2 9LP, United Kingdom.
Email: info@ospreypublishing.com

© 2002 Osprey Publishing

All rights reserved. Apart from any fair dealing for the purpose of private study, research, criticism or review, as permitted under the Copyright, Design and Patents Act, 1988, no part of this publication may be reproduced, stored in a retrieval system, or transmitted in any form or by any means, electronic, electrical, chemical, mechanical, optical, photocopying, recording or otherwise, without the prior written permission of the copyright owner. Enquiries should be addressed to the Publishers.

ISBN 1 84176 620 8

Editor: Sally Rawlings
Series editor: Tony Holmes
Aircraft profiles by John Weal
Figure Artwork by Mike Chappell
Scale drawings by Mark Styling
Index by Alan Thatcher
Design by Tony Truscott

Origination by Grasmere Digital Imaging, Leeds, UK
Printed in China through Bookbuilders

02 03 04 05 06 10 9 8 7 6 5 4 3 2 1

For a catalogue of all Osprey Publishing titles please contact us at:

**Osprey Direct UK, PO Box 140,
Wellingborough, Northants NN8 2FA, UK**
E-mail: info@ospreydirect.co.uk

**Osprey Direct USA, c/o MBI Publishing,
729 Prospect Ave, PO Box 1,
Osceola, WI 54020, USA**
E-mail: info@ospreydirectusa.com

Or visit our website: www.ospreypublishing.com

CONTENTS

PART 1

CHAPTER ONE

BACKGROUND AND INTRODUCTION 6

CHAPTER TWO

BARBAROSSA - THE EARLY ADVANCES 15

COLOUR PLATES 33

SCALE DRAWINGS 43

COLOUR PLATES COMMENTARY 45

CHAPTER THREE

THE ROAD TO DISASTER 51

CHAPTER FOUR

STALINGRAD AND ZITADELLE 68

CHAPTER FIVE

FIGHTING RETREAT 78

PART 2

CHAPTER ONE

'EXEUNT OMNES' 92

CHAPTER TWO

FAMILIARISATION 94

CHAPTER THREE

JG 51 IN COMBAT 98

CHAPTER FOUR

JG 54 - ENTER THE 'GREEN HEARTS' 102

CHAPTER FIVE

... AND OTHERS 115

CHAPTER SIX

ZITADELLE 118

CHAPTER SEVEN

SCHLACHTFLIGER 121

COLOUR PLATES 132

SCALE DRAWINGS 150

COLOUR PLATES COMMENTARY 152

CHAPTER EIGHT

JG 51 REVERTS TO TYPE ... 160

CHAPTER NINE

... BUT THE 'GREEN HEARTS' SOLDIER ON 163

CHAPTER TEN

TOO LITTLE, TOO LATE 173

CHAPTER ELEVEN

'FINIS' 177

APPENDICES 182

BIBLIOGRAPHY 188

INDEX 189

BACKGROUND AND INTRODUCTION

The German invasion of the Soviet Union, code-named Operation *Barbarossa*, was a campaign unparalleled in both its scale and ferocity. Within weeks of its launch early on the morning of 22 June 1941, the frontline stretched a staggering 2780 miles (4480 km), linking the Arctic wastes of the Barents Sea in the north to the sub-tropical shores of the Black Sea in the south.

At first glance, the opposing armies appeared to be almost evenly matched. The Germans committed 120 divisions to the initial assault, holding a further 26 in immediate reserve, making a total of 146 divisions - some three million men in all. Facing them, the Soviet army had 149 divisions stationed in its westernmost military districts.

But the German and Russian divisions differed greatly in composition and strengths. Take the all-important tank, for example, which played such a crucial role throughout the campaign in the east. At the outset the Germans deployed 17 armoured divisions (plus a further two in reserve) against the Soviet's 36 - a seeming majority of two-to-one in favour of the Red Army. In reality, a Russian armoured division of 1941 numbered some 400 tanks, whereas its German counterpart varied between 150 and 200 ... a fourfold advantage to the Soviets.

At the start of *Barbarossa* the sole single-engined fighter presence in the far north was provided by the ten Bf 109Es of the *Jagdstaffel Kirkenes*. This E-7 (complete with dust filter!) patrols the barren shores of the Arctic Ocean . .



On paper, the Red Air Force enjoyed a similar numerical superiority. It is a little remarked fact that the Luftwaffe embarked upon *Barbarossa*, the Wehrmacht's most ambitious undertaking, with far fewer frontline aircraft (2598) than it had deployed either at the start of the *Blitzkrieg* in the west in May 1940 (3826) or at the height of the Battle of Britain some three months later (3705).



In terms of single-engined fighters, the *Jagdwaaffe* had exactly 619 serviceable machines (predominantly Bf 109Fs) ranged along the eastern front on the eve of the invasion. This was just over two-thirds (68 per cent) of the fighter arm's total available strength, the remaining third being deployed in the west, the homeland and the Mediterranean.

Yet it was in the east that Luftwaffe fighter pilots (understrength and overstretched as they were) would achieve the highest individual scores in the history of aerial warfare - scores that would be deemed impossible in other theatres and by other air forces.

Osprey's *Aircraft of the Aces* series has been based throughout on the accepted British and American definition of an 'ace' as being any fighter pilot with five or more aerial victories to his credit. Using this figure as a yardstick, a volume of this size dealing with the subject of the Bf 109 pilots on the eastern front would perforce consist of little more than a list of names. There are well over 5000 Luftwaffe fighter pilots in this category!

In fact, *the Jagdwaaffe itself*: did not often use the dogmatic term 'As' (ace) in relation to a specific number of victories. They preferred the more generic '*Experte*', which was taken to mean any pilot of outstanding ability and achievement. The author has spoken to several Luftwaffe fighter pilots credited with 50 or more aerial victories - a far higher total than any western Allied ace - only to be told, in all seriousness, 'I was no great *Experte*. You really ought to talk to ...', and here would follow the name of some stellar individual with three or four times the number of the speaker's own kills.

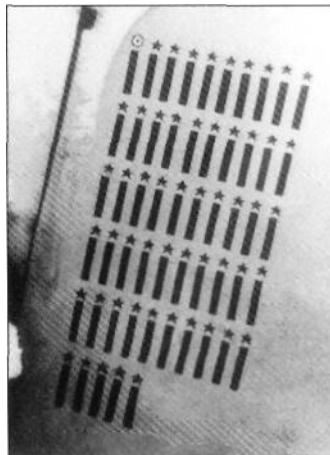

... whilst at the other end of the 2780-mile (4480-km) long front, this *Friedrich* rests between sorties safeguarding the Black Sea coast. Assigned to southernmost *Jagdgruppe*, III./JG 52, the aircraft was the mount of future Knight's Cross winner Obergefreiter Friedrich Wachowiak

Indicative of the imbalance between the eastern and western fronts, the Scoreboard on the rudder of this machine shows that its pilot, Oberfeldwebel Edmund Wagner of 9./JG 51, had claimed just one western victory prior to *Barbarossa*. With the first snows of the winter just starting to fall, Wagner has already added 54 Soviet kills. He would achieve two more before being killed in action against low-flying Pe-2s on 13 November 1941



Another of JG 51's NCO pilots, Oberfeldwebel - later Leutnant - Otto Gaiser is representative of the many hundreds of eastern front flyers who amassed scores in the high double figures, and yet who are practically unknown today. Gaiser had claimed 74 victories by the time he too was killed in a low-level encounter (this time with four Il-2 *Stormoviks*) early in 1944



In the history of aerial warfare, only two fighter pilots have achieved more than 300 victories - Hauptmann Erich Hartmann (left) and Major Gerhard Barkhorn (right), both of JG 52



II./JG 3's Oberfeldwebel Ullmann points to an area on the map where he has just downed an enemy machine. The *Werkmeister* of 6. *Staffel* has reason to look doubtful, for the crash site could not subsequently be located, and the claim remained unconfirmed

The Luftwaffe hierarchy seems to have been taken almost unawares by the success of its own fighter pilots. In the opening months of the war 20 aerial victories would ensure the claimant the award of the Knight's Cross. Towards the close of hostilities some long-serving pilots would have amassed well over 100 kills in the east before they received this coveted decoration.

Nothing better illustrated the yawning chasm between eastern and western front conditions than the prestigious 'century' of kills. Only a select handful of Luftwaffe fighter pilots topped the 100 mark in action solely against the western Allies. By contrast, over 70 pilots achieved this feat in the east. Eight claimed more than 200 victories, and two even surpassed the 300 figure!



Oberleutnant Kurt Sochatzy, *Staffelkapitän* of 7.JG 3, was more fortunate. A witness on the ground took this telephoto shot of one of his victories - a Tupolev twin - as it headed down into the trees with no chance of recovery. Sochatzy claimed 38 Soviet kills (and a single No 603 Sqn Spitfire whilst on the Channel Front) before being rammed during a dogfight with an 1-16 over Kiev on 12 August 1941. He would spend the next eight years in captivity in the USSR

In the light of post-war investigation, it is now conceded that overclaiming occurred in every air force. Mostly this was attributable to the heat and confusion of battle. Sometimes it was a case of genuine error - the trail of smoke emitted by a Bf 109 diving away at full throttle fooled many an Allied fighter pilot or air gunner into believing that his opponent was mortally hit. Only in very rare instances was it a matter of deliberate deceit. And any pilot suspected of falsifying his victory claims was given very short shrift by his peers.

Each of the combatant air forces tried to regulate claims by a strict set of conditions. None more so than the Luftwaffe, which required written confirmation of the kill by one or more aerial witnesses to the action, plus - if possible - back-up confirmation, also in writing, from an observer on the ground. Given the amount of paperwork this engendered back at OKL in Berlin, it is little wonder that it could sometimes take a year or more for a pilot's claim to receive official confirmation.

Despite such bureaucratic safeguards, some of the more astronomical claims by Luftwaffe pilots on the eastern front still remain the subject of discussion, doubt and downright disbelief. So how were they achieved?

There is no simple answer, but rather a unique set of circumstances which was not replicated in any other campaign.

Firstly, it must be borne in mind that Luftwaffe pilots did not fly 'tours', with lengthy breaks in between, as was the practice in Allied air forces. Most remained operational until either killed, incapacitated or elevated to a staff position. Apart from periods of leave, there were many who served in frontline units throughout the entire war, from the first day of hostilities until the last.

Also, for much of the air war in the east, the *Jagdwaaffe* enjoyed undisputed superiority in those three essentials to survival and success - equipment, training and tactics.

The Bf 109 was a far better fighting machine than anything the Soviets possessed during the early years of the air war in the east. In the opinion of some veterans it remained so until the very end - 'unencumbered (i.e. without additional underwing weaponry such as gondolas or rocket tubes), the Bf 109 was superior to the Russian Yak-9'.



Major Gerhard Barkhorn is congratulated upon the completion of his 1000th operational sortie. The ribbons on the garland list the countries over which he has fought since joining II./JG 52 in August 1940 - (from bottom left) Denmark, Belgium, Soviet Union, France, England and Holland. By war's end Barkhorn would have flown no fewer than 1104 missions



Secondly, all *Jagdwaaffe* combat leaders had enjoyed the priceless benefit of thorough training. Ironically, some - such as Lutzow and Trautloft - had even attended the clandestine fighter training school at Lipezk, north of Voronezh, which the *Reichswehr* had operated in conjunction with the Soviets between the years 1925 to 1933. Many had also flown with the *Condor Legion* in Spain, and more recently a great number of fighter pilots had seen action in Poland, the west and the Balkans. This wealth of expertise and experience in turn gave them the flexibility to devise new and effective tactics to counter any situation they might meet in the air.

Much of the above could equally well apply to all the other campaigns in which the *jagdwaaffe* was involved. What made the eastern front different was the second half of the equation - the nature and make-up of the opposition.

The Stalinist purges of the late 1930s had emasculated the Soviet armed forces, cutting huge swathes through their ranks. Many air force officers, including those with recent combat experience (in Spain, the Far East and Finland), were dismissed, imprisoned or worse. This not only robbed the Red Air Force of an invaluable core of experts, it thoroughly cowed those who remained, stifling any initiative they might otherwise have displayed, and ensuring that they followed every official operational edict to the letter irrespective of the consequences.

In an effort to make good the losses brought about by its own actions, the Kremlin then ordered a rapid expansion of Russia's armed forces. But time was not on the Soviets' side. With the emphasis on numbers rather than quality, pilot training was hurried and perfunctory. Consequently their performance was, in general, of a much lower standard than that of the Luftwaaffe during the opening rounds of *Barbarossa*. This inflexibility and inexperience is borne out by the combat reports of German pilots, which are full of accounts of formations of Russian aircraft either 'sticking tidily to their course and altitude as they were chopped down one by one', or 'milling about in the air like a huge, chaotic swarm of bees'.

Inadequate training does not imply lack of courage on the part of the Soviet pilots. Quite the reverse. Unable to bring down their opponents in any other way, many resorted to ramming. Dubbed 'taran' attacks by the Russians, the first recorded instance of this ultimate act of desperation occurred within minutes of the launch of *Barbarossa*.

The barrel-like shape of an abandoned I-16 sitting alongside this Friedrich of II./JG 54 illustrates the yawning chasm in design technology between the Soviet and German fighter arms during the opening phases of *Barbarossa*



Although not a high scorer himself, Hannes Trautloft's wealth of early experience - from the Lipetsk training establishment to service with the *Condor Legion* in Spain - made him the archetypal fighter leader. He commanded JG 54, the famous 'Green Hearts', from 1940 to 1943

they retained a definite edge over the Russian rank and file throughout.

The same totalitarian obsession with numbers governed the Kremlin's dictates to the Soviet aircraft industry. The portly Polikarpovs which had fought for Republican Spain were obsolete or obsolescent by the summer of 1941. Three 'modern' designs had begun to enter service in 1940. But all suffered severe teething problems and were full of faults.

The Yak-1 was unreliable and had poor firepower. Both the LaGG-3 and MiG-3 lacked manoeuvrability, and were particularly unforgiving to novice pilots. Those selected to fly the LaGG joked grimly (but only amongst themselves) that the aircraft's initials stood for 'Lacquered Coffin Guaranteed'. Even pilots with many hours on Polikarpovs found the new monoplanes sluggish and hard to handle.

Despite this, production figures came before performance. Numbers of aircraft at the front were all that mattered to Moscow. As with the pilot training programmes, the situation gradually improved. Both Lavochkin and Yakovlev subsequently developed excellent fighters out of their original designs. But it all took time. Indeed, the world would have to wait until 1950, and the war in Korea, before discovering what the Mikoyan bureau could really do - and even then the revolutionary

At 0415 hrs on 22 June Junior Lieutenant D W Kokoryev of the 124th Fighter Regiment knocked the tail off a reconnaissance Do 215 near Sambruv after the guns of his MiG-3 had jammed. Ten minutes later the 46th Regiment's Senior Lieutenant I T Ivanov despatched a He 111 bomber in similar fashion during a dogfight above Rovno. Unlike the former, Ivanov did not survive his encounter. On 2 August he was posthumously awarded the title of Hero of the Soviet Union.

The early battles took a heavy toll of the Red Air Force. Anxious to replace their losses and get pilots to the front as quickly as possible, training programmes did not rise above the barely adequate for many months. It was not until the latter stages of the campaign that a marked improvement came about. But by that time the Luftwaffe's many *Experten* had themselves gained two or three more years of eastern front experience. And although they took no chances with their Soviet opponents - never knowing when they might come up against one of the Red Air Force's 'naturals' - most are convinced that

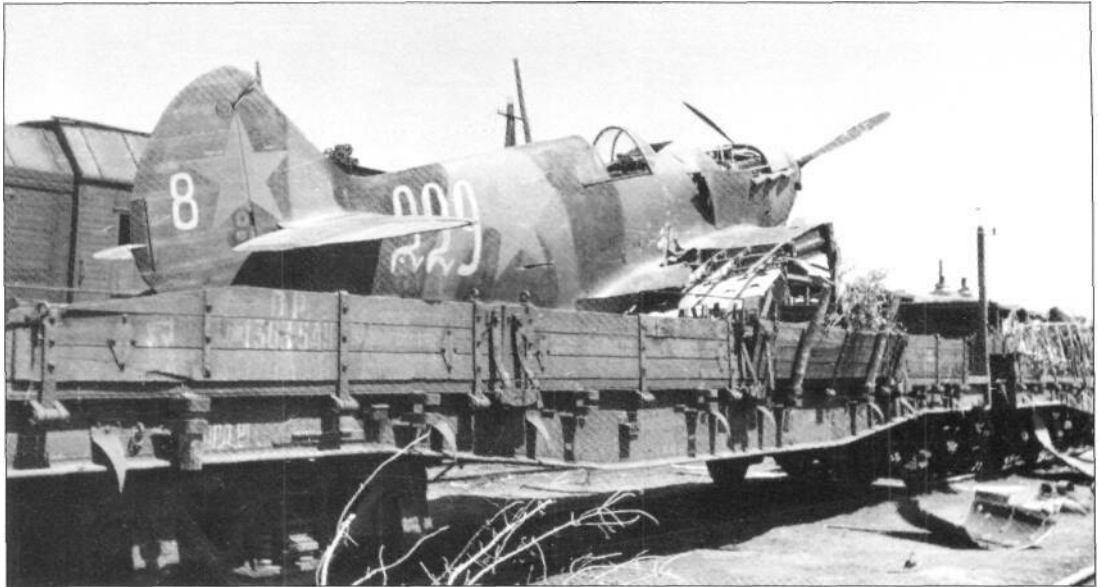

MiG-15 jet fighter relied heavily on captured German research and British engine design.

Much has been made of the Lend-Lease aircraft delivered to the Soviet Union to 'bridge the gap' between the initial shock of *Barbarossa* and Russian industry's gearing up to full production after evacuating its manufacturing plants to safety beyond the Ural mountains. Indeed, between 1941 and 1945 the United States alone despatched close to 10,000 fighters to Russia.

But here, too, quantity ruled over quality, for over 7000 of these machines were mid-engined Bell P-39s and P-63s. The former type was deemed 'specially disappointing' as an interceptor by the USAAF, and rejected by the RAF after just one operational mission. Both Bell fighters were extensively used by the Red Air Force, although mainly for close support and ground-strafting operations. Obsolescent P-40s were also

This LaGG-3 'lacquered coffin', showing signs of combat damage to the starboard wing root, was captured by German troops on a Soviet railway freight wagon before it could be transported to the rear for repair

Not every flyer who was forced to land behind enemy lines was as lucky as the unknown pilot of this II./JG 53 machine. He was picked up by a patrol of the 16. SS Grenadier Division 'Reichsführer SS' and brought back to safety



supplied in great numbers, although less than 200 P-47s were received by the USSR, and not a single P-51 - the only Mustangs to arrive in Russia were ten Allison-engined Mk Is from RAF stocks.

The British also provided over 4000 Hurricanes and Spitfires, and although both types gave a good account of themselves, the latter, in particular, was not ideally suited to the often primitive conditions to be found on Soviet forward landing grounds.

Lastly, to tactics. Despite the vast distances involved, the air war in the east was essentially a non-strategic conflict. Both air forces concentrated primarily on direct, medium to low-level support of ground operations. For reasons which will become clear, Luftwaffe fighter pilots were loath to venture too far behind the Russian lines.

The Soviet High Command, for its part, was as rigid - and almost as profligate - in the control and use of its pilots and aircrew as it was with its foot soldiers. Just as, on the ground, wave after wave of Red infantrymen would be hurled, regardless of losses, against an entrenched German position in a series of frontal assaults until either none of the attackers was left standing or the defences were overwhelmed, so, in the air, wave after wave of Soviet aircraft were despatched to bomb targets along the German frontline.

The defending Luftwaffe fighter pilots, usually based close to the action, often flew as many as five or six - or even more - sorties per day. Patrolling the front, they would dive on the enemy machines, knock down one or two, break up the formation, and then climb back up to altitude to await the next incoming wave.

Although an oversimplification, such was the essence of air combat on the eastern front. Attempting to swamp the enemy by sheer weight of numbers, the Soviets bore the inevitable attrition with stoicism. The Luftwaffe's *Experten* reaped the rewards.

As to the campaign itself, the eastern front was divided into three main sections, or axes of advance - northern, central, and southern (four, if one includes the somewhat isolated far northern Finnish/Arctic region, which was a more static area of operations).

A crowded airfield towards the close of the campaign in the Balkans. On the original print the markings of the Emil seen below the port wing of the Henschel Hs 126 can just be made out. They reveal it to be the machine of the Gruppen-Adjutant of II./JG 54, Leutnant Steindl...





Despite the much greater length of the front, the Luftwaffe embarked upon *Barbarossa* in tried and tested fashion - by mounting a series of pre-emptive strikes that were designed to destroy the enemy air force on the ground. In this they proved remarkably successful. But the seeds of Germany's ultimate defeat had already been sown.

Hitler's intention to invade the Soviet Union had first been spelled out in his *Führer* Directive No 21 of 18 December 1940. He originally planned to launch Operation *Barbarossa* in the late spring of 1941. But the difficulties his Axis partner Mussolini was experiencing in Greece, and a revolt by the people of Yugoslavia against joining the Tripartite Pact (of Germany, Italy and Japan) persuaded him instead first to subjugate the Balkans.

This put *Barbarossa* back by a few vital weeks. The Wehrmacht's initial objective was Moscow. By 15 November 1941 a reconnaissance detachment of *Panzerpionierbataillon 62* was just 12 miles (20 km) short of the Kremlin. But the winter snows brought the German army to a halt. The Russian capital held, and the *Führer* had lost his one chance for a 'speedy conclusion' to the campaign in the east.

The German offensive resumed in the spring of 1942. This time it was aimed not at Moscow, but along the southern sector towards the oilfields of the Caucasus and the city of Stalingrad. The 6. *Armee* reached Stalingrad late in August, only to be encircled and destroyed there during the winter months of 1942-43.

The epic battle of Stalingrad is regarded by many as the turning point of the war in the east. In fact, it was the third annual German offensive, launched on the central sector in the mid-summer of 1943, which really marked the beginning of the end for the Wehrmacht in Russia. Operation *Zitadelle*, better known as the battle of Kursk, was the greatest tank battle in military history. When Hitler ordered his armour to disengage on 13 July, it was more than a tacit admission of a local reversal. It paved the way for the huge Soviet advances of 1944-45, which would end with the Red Army in the centre of Berlin.

This, then, was the broad and sombre canvas against which the most successful fighter pilots the world has ever seen — or is ever likely to see — shone so briefly, and yet so brightly.

... who is pictured here flying the same E-7 on a *Jabo* mission only a matter of days later at the start of *Barbarossa*. In the interim, however, the narrow yellow band aft of the fuselage cross has been dispensed with, and the unit's distinctive 'crazy paving' camouflage pattern is already beginning to show through the thin coat of yellow wash hastily applied to the engine cowling

BARBAROSSA - THE EARLY ADVANCES

The first kill on the eastern front was claimed by the *Staffelkapitän* of I./JG 3, Oberleutnant Robert Olejnik, who described the historic action in the following report;

'Everybody knew that I was an early riser and liked to fly the dawn missions. So, shortly before 0330 hrs, I took off with my wingman to reconnoitre the Russian airfields along our stretch of the border.

'Everything seemed quiet in the semi-darkness below. It was not until we were returning to base, and flying back over the first airfield we had visited some 20 minutes earlier, that I spotted signs of activity.

'Two Russian fighters were preparing to scramble. As we circled 700-800 metres (2300-2600 ft) overhead, I saw the Russians start their engines and begin to taxi out. They took off immediately and climbed towards us, obviously looking for a fight.

'They were still some 300-400 metres (980-1300 ft) below us when we dived to the attack. I caught the leader with a short burst on my first pass and he went down in flames. His wingman disappeared.

'Arriving back over our own airfield I wagged my wings to indicate a victory. My comrades, most of whom had only just woken up, peered sleepily from their tent flaps shaking their heads in disbelief.'

But some confusion surrounds the exact time of Olejnik's kill. The unit diary credited him with the destruction of an I-16 at 0340 hrs - just 25 minutes after the opening artillery salvos of *Barbarossa* had rent the pre-dawn darkness — whereas he himself logged the 'Rata' ('Rat') as going down at 0358 hrs.

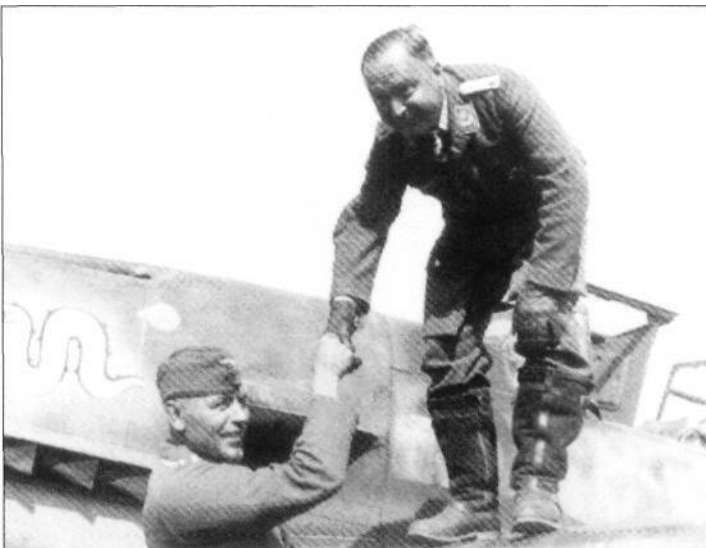

Oberleutnant Robert Olejnik who, by his own account, claimed the first aerial kill of *Barbarossa* is greeted by his chief mechanic, Feldwebel Mackert, upon his return from another successful mission some weeks later. The Knight's Cross, awarded for 32 victories, is just visible around Olejnik's neck. Note also I./JG 3's 'Tatzelwurm' (Dragon) emblem, which would be retained after the *Gruppe's* redesignation as II./JG 1

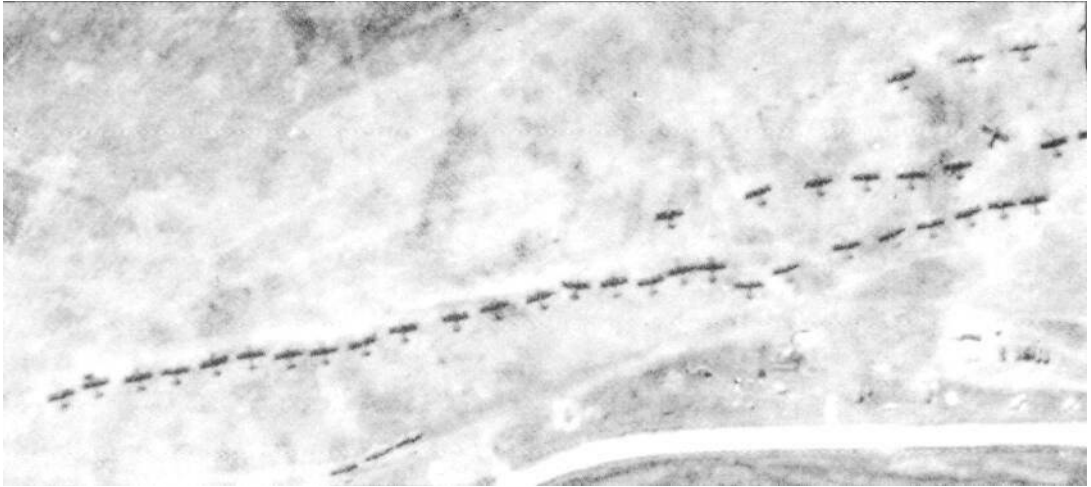

Another strong contender for the distinction of claiming the first aerial kill of the eastern front campaign must therefore be 5./JG 27's Leutnant Hans Witzel, who downed one I-15 at 0354 hrs, followed by another just 60 seconds later.

One fact not in dispute, however, was that the Luftwaffe's pre-emptive strikes had caught the Soviet Air Force completely off guard. All along the front the scene was the same as that described by Robert Olejnik's *Gruppenkommandeur*, veteran Channel front *Experte* Hauptmann Hans von Hahn;

'We could hardly believe our eyes. Every airfield was chock full of reconnaissance aircraft, bombers and fighters, all lined up in long straight rows as if on a parade. The number of landing strips and aircraft the Russians had concentrated along our borders was staggering.'

Staggering, too, was the price the Soviets paid for their unpreparedness. The Luftwaffe fighter pilots had a field day.

In the northern sector Major Hannes Trautloft's JG 54 had claimed 45 Russian aircraft shot down by the close of the first day's fighting, and the attached II./JG 53 had added a dozen more.

A Luftwaffe reconnaissance photo of a Soviet airfield with rows of fighters lined up wingtip to wingtip. The constant chord wings would suggest that the majority of these machines are Polikarpov biplanes. Targets such as this were the first priority of the new *Blitzkrieg* in the east

The result of one early strike. Of the nearly two-dozen aircraft visible here, all but two have been reduced to piles of wreckage. Although seemingly intact, the 1-16 at the top of the picture is resting on its starboard wingtip. Below it a biplane is still upright, but no doubt badly damaged by debris from the machine still burning to its right



Hauptmann Wolf-Dietrich Wilcke, Gruppenkommandeur of III./JG 53, shot down five Soviet fighters on the opening day of *Barbarossa*



Leutnant Jürgen Harder of Wilcke's Gruppenstab returned to Sobolevo on the afternoon of 22 June with his first kill under his belt. Like the Kommandeur's fifth victory of the day, it was identified as an '1-17', and has already been recorded by the single bar seen here at the top of the rudder hinge line of Harder's *Friedrich*



'If an aircraft looks right, it is right.' But not always. The MiG-3's sleek lines belied its sluggish performance in the air, while on the ground the length of that streamlined cowling meant that forward visibility when taxiing was almost nil

confusion surrounding many of the early claims submitted by German fighter pilots.

The 1-17, for example, was a Polikarpov design of the mid-1930s. It was powered by a water-cooled engine in a long streamlined nacelle, but never progressed beyond the prototype stage. Nearly every reference to an '1-17' (or '1-18') shot down during the opening months of the war in the east was almost certainly the result of an encounter with one of the 'new'

JG 53's other two *Gruppen*, deployed in the central sector - the scene of the invasion's main thrust - accounted for no fewer than 62 Soviet aircraft. Hauptmann Wolf-Dietrich Wilcke, Gruppenkommandeur of III./JG 53, was perhaps the eastern front's first ace, for he downed five Soviet fighters in the course of three separate sorties on 22 June. Wilcke's victims comprised a trio of I-15s shortly after 0400 hrs, a single I-16 later in the morning, and an '1-17' in the afternoon.

The actual identity of Wilcke's fifth and final kill of the day remains conjectural. The shortcomings of Germany's intelligence services, combined with an almost paranoid secrecy on the part of the Soviets, meant that the Luftwaffe embarked upon *Barbarossa* without a proper grasp of the Soviets' - admittedly somewhat complicated - system of aircraft designation. This in turn has meant that there is a great deal of



generation of Russian in-line engined fighters - almost certainly the MiG-3, which did bear more than a passing resemblance to published photos of the earlier Polikarpov I-17, and which was in service in far greater numbers at the beginning of *Barbarossa* than either of its Lavochkin or Yakovlev contemporaries.

Many Luftwaffe pilots also retained the habit (prevalent in the days of the *Condor Legion*) of referring to Polikarpov biplanes as 'Curtiss' fighters. Likewise, the Soviets' Tupolev SB-2 twin-engined bombers were commonly known as 'Martins' on account of their similarity to the American Martin B-10.

Future Knight's Cross holder Franz Schiess, who flew with the *Geschwaderstab* of JG 53, quickly developed a healthy respect for the agile Polikarpovs;

'We became involved with a group of about 20 Curtiss fighters, whose pilots clearly knew what they were doing. They let us get on their tails and almost into firing position. Then they suddenly pulled a 180-degree turn and we found ourselves shooting at them from head-on. In such a situation a kill becomes a matter of luck.'

Schiess nevertheless managed to claim his first victory - an I-153 - at 0725 hrs on that 22 June.

Also in the central sector, JG 51 was credited with 69 aerial victories. Four of that number had fallen to the guns of the *Geschwaderkommodore*, Oberstleutnant Werner Mölders. This took his personal score to 72, and won him the immediate award of the Swords to his Knight's Cross with Oak Leaves (just one day after the same honour had been conferred upon his arch rival, Oberstleutnant Adolf Galland, *Kommodore* of JG 26 back in France - see Osprey *Aircraft of the Aces 29 - Bf109F/G/KAces on the Western Front*).

'Vati' ('Daddy') Mölders, arguably the most famous and revered Luftwaffe fighter pilot of them all, had warned his pilots on the eve of *Barbarossa* that the coming campaign against Russia would not only be hard, but could also last a very long time. He would not live to see his predictions come true.

In just three weeks of action against the Soviets he added another 27 kills to his tally. Then, on 15 July, two more victories brought his total to 101. Mölders, who had not only been the *Condor Legion*'s top scorer with 14 kills, but had also been the first Luftwaffe pilot to achieve 20 victories in World War 2, and thus received the *Jagdflieger*'s first Knight's Cross, had now become the first fighter pilot in history to reach the century mark.

This feat earned him the Diamonds to his Swords (in yet another 'first', he was the first of only 27 members of the entire German armed forces — seven of them *Jagdflieger* - to receive this prestigious decoration. But the award of the Diamonds brought

Oberst Werner Mölders, the Luftwaffe's first *General der Jagdflieger*, is seen on a tour of inspection in the early autumn of 1941. He is flanked by Major Günther Lützow, *Kommodore* of JG 3 (right), and Hauptmann Karl-Gottfried Nordmann, *Kommandeur* of IV./JG 51 (left). The latter pair are both already wearing the Oak Leaves to their Knight's Crosses (awarded in July and September for 42 and 59 victories respectively)



with it an immediate ban on all further operational flying. Promoted to the rank of Oberst, Werner Mölders was appointed to the newly-established office of *General der Jagdflieger*.

It was while on a tour of inspection of fighter units on the eastern front in November 1941 that he was informed of the death of World War 1 ace Ernst Udet, and instructed to return forthwith to Berlin to form part of the guard of honour at the late *Generalluftzeugmeister's* (Chief of Aircraft Procurement and Supply's) state funeral.

Mölders took off for the German capital in a Heinkel He 111. The weather was appalling, with the forecasters predicting that even worse was to come. But Mölders overrode the Heinkel pilot's objections and ordered him to continue - he had to get to Berlin on time. After departing Lemberg (Lvov) on the last leg of the flight, however, conditions deteriorated to such an extent that even the *General der Jagdflieger* forced to admit defeat.

He instructed the pilot to head for the nearest airfield. Now reportedly flying on only one engine, the Heinkel crabbed towards Breslau. During the final approach a factory chimney suddenly loomed out of the murk and driving rain. The experienced NCO pilot managed to avoid the obstacle, but could then no longer hold the wallowing transport. It smashed to earth on Martin Quander's poultry farm at exactly 1130 hrs on 22 November.

The whole nation mourned the passing of one of its greatest heroes. A plaque to mark the spot where Mölders had perished was erected on Quander's premises at No 132 *Flughafenstrasse* (Airfield Road) - they had come that close to making it!

But to return to the opening day of *Barbarossa*.

The third *Jagdgeschwader* deployed on the central sector was JG 27 (more accurately, that unit's II. and III. *Gruppen*, plus the attached II./JG 52, the latter taking the place of the absent I./JG 27, which was currently in North Africa). These *Gruppen* achieved far fewer aerial victories in their first pre-emptive strikes against the Red Air Force. II. and III./JG 27, for example, were credited with just eleven and two kills respectively.

The two southern sector *Jagdgeschwader*, JGs 3 and 77, also submitted far fewer claims than the bulk of the units stationed along the central and northern fronts. JG3's kills totalled 25, including one (listed as an 'I-18') for *Geschwaderkommodore* Günther Lützow.

The majority of the victories, 15 in all, had been achieved by Hauptmann Lothar Keller's II./JG 3. The *Gruppenkommandeur* himself claimed four - a brace each of I-16s and I-153s - which took his overall score to 20. Four of Keller's pilots opened their scoreboards on this day too. Among them was Oberleutnant Walther Dahl - a future Oak Leaves recipient, noted *Sturm* leader, and the Luftwaffe's last *Inspekteur der Tagjäger* (Inspector of Day Fighters) - whose first kill was another 'I-18'.

JG 77's III. *Gruppe* were responsible for all 15 of that *Geschwader's* successes, Oberleutnant Kurt Ubben, *Staffelkapitän* of 8./JG 77, downing two of them - an I-16 and an Ilyushin DB-3 bomber. He too would go on to win the Oak Leaves, but unlike Dahl, he would not survive the war. Risen to the command of JG 2, Major Kurt Ubben was killed in action over France in the spring of 1944 (see *Osprey Aviation Elite 1 - Jagdgeschwader 2 'Richthofen'* for further details).

One of the main reasons for the widely diverging levels of claims for aerial victories submitted by the various *Jagdgruppen* on 22 June 1941 was that many of their number were employed primarily on ground-attack missions throughout the opening phases of *Barbarossa*. Although the Luftwaffe threw some 35 *Kampf-* and *Stukagruppen* into the initial strikes against the Soviet Air Force on the ground, so numerous — and so crowded — were Russia's airfields along her western borders that a substantial proportion of the German fighter force had to fly bombing missions too.

The weapon they were to use was the recently introduced SD-2 *Splitterbombe* (fragmentation bomb, also called the 'Butterfly' bomb). Weighing only 2 kg (4.4 lbs), this devilish little device, which could be fused to explode either on or before impact with the ground, had been developed as an anti-personnel weapon. But, if dropped in sufficient numbers, it could also do a lot of damage to rows of parked aircraft. And each Bf 109 could carry 96 *Splitterbombe*^.

Shuttling back and forth between their bases and the target airfields just beyond the frontier, the bomb-laden Bf 109s did indeed wreak considerable havoc. And although of short duration, such missions were not at all popular with the pilots who had to fly them.

Firstly, the four bulky panniers (arranged in two tandem pairs) from which the SD-2 were suspended had a marked effect on the Bf 109's performance and handling characteristics. Secondly, for maximum effect, the bombs had to be salvoed from an altitude of just 40 metres (130 ft), at which height Soviet small-arms fire was at its most vicious.

But, perhaps most alarming of all, the SD-2 had an unfortunate tendency to hang up. At any sort of speed - and, for obvious reasons, pilots did not dawdle when making low-level runs across an enemy airfield - the build-up of air pressure held the SD-2s in place in their racks; particularly the eight bombs of the two front rows.

It was only when the fighter slowed down - on approaching to land back at base, for example - that the last of any remaining bombs fell away. Numerous reports from this time note that incoming Bf 109s could often be distinguished by the trail of small explosions left in their wake. Worst still was the fact that some SD-2s did not release until the fighter was actually taxiing in. A number of casualties were incurred.

It soon became standard practice for returning Bf 109s to make a low (but high-speed!) pass across their home fields to allow observers on the ground to confirm that their bomb racks were indeed empty. Only when they got the all-clear from below did the pilots then come in to land.

It is not known how many Soviet aircraft the Bf 109 fighter-bombers accounted for in such raids, but Russian losses on the ground far exceeded the number of machines shot down on 22 June. By the close of the day's operations it was estimated that the Red Air Force had lost 322 aircraft to fighters and flak, but that some 1500 had been destroyed on the ground.

Such was the magnitude of the enemy's losses that Hermann Goring at first refused to believe the reports of his pilots' successes. He ordered an

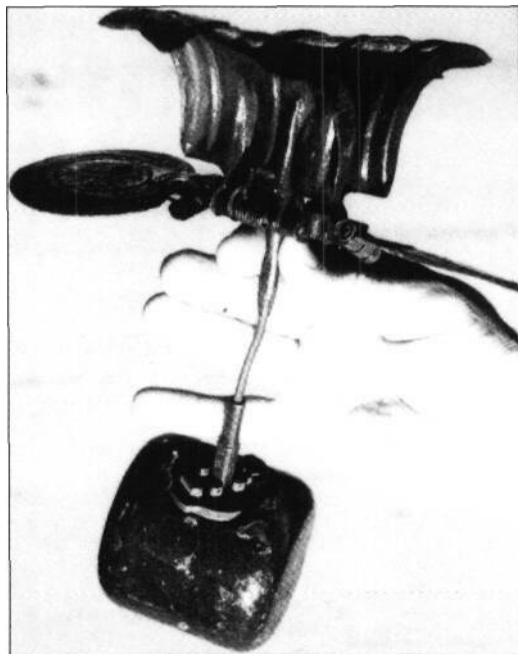

The SD-2 *Splitterbombe* in its fully-armed state. After release, the outer casing's two clamshell halves sprang open to form a kind of parachute to retard the bomb's fall. They in turn freed a pair of circular discs which acted as a wind vane as they rotated about, and moved up, the short steel cable. This action fused the bomb's 7.5-oz (212-gr) charge of TNT

enquiry. Within days the advancing German army had overrun all 31 of the airfields which had been the targets of the Luftwaffe's pre-emptive opening strikes. This allowed examination of the wreckage, and showed that the initial reports submitted to the *Reichsmarschall* had, if anything, erred on the conservative side.

Even the official Soviet history of the Great Patriotic War - not a work noted for its objectivity - conceded that, 'By midday of 22 June our losses totalled approximately 1200 aircraft, including more than 800 machines destroyed on the ground'.

Against this the Luftwaffe recorded the loss of just 35 aircraft of all types. Casualties among the fighter arm were light, but included three unit leaders. Knight's Cross holder Hauptmann Heinz Bretnitz, *Gruppenkommandeur* of II./JG 53, downed a Soviet SB-2 bomber, but was himself wounded. Forced-landing behind enemy lines, Bretnitz was hidden by friendly farmers, who tended his injuries as best they could until the arrival of the first German spearheads on 26 June. Despite an emergency operation to amputate a gangrenous leg, Heinz Bretnitz died in hospital the following day.

Grim as the fate of Pietsch' Bretnitz may have been, that of the other two was infinitely worse. Major Wolfgang Schellmann, *Kommodore* of JG 27, and Oberleutnant Willy Stange, *Staffelkapitän* of 8./JG 3, both came down behind Russian lines. The former was forced to take to his parachute when his *Emil* was damaged by debris from the I-16 he had just destroyed, whilst the latter crash-landed his *Friedrich* after being hit by flak. Both fell into the hands of Soviet troops and were killed.

The barbaric treatment meted out to downed flyers, particularly during the early stages of *Barbarossa*, was yet one more facet of the aerial war in the east which set it apart from all other European air campaigns. The threat of capture was never far from the minds of single-engined fighter pilots whenever they were required to fly deep into Soviet-held territory.

Although the Luftwaffe's initial strikes had inflicted enormous damage, the Red Air Force was by no means neutralised. As early as midday on 22 June penny-packet formations of Soviet medium bombers were beginning to hit back at the German invaders. Throughout the last week of June these attacks grew in strength and frequency, but they were ill-planned and lacked both cohesion and adequate fighter cover. Unlike the longer range bombers, much of the western districts' fighter strength had been deployed - and destroyed - on those frontier airfields targeted at the start of the campaign.

As each rigid formation of bombers approached, it was set upon by Luftwaffe fighters. Individual and unit scores began to escalate rapidly as old hands - '*alte Hasen*' ('old hares') in the vernacular of *the Jagdwaffe* - added to their already considerable numbers of western victories and newcomers, their names as yet unfamiliar, achieved their first kills.

On 23 June it was estimated that over 775 Soviet aircraft had been destroyed (again, many of them on the ground). But by the following day most of the action was aloft, with JG 51 being credited with no fewer than 57 'Martin' bombers shot down. Twenty-four hours later II./JG 27 and III./JG 53 each claimed 25 bombers apiece.

5./JG 27's Leutnant Gustav Langanke, whose sole victory to date had been a Hurricane downed in the London area the previous September,



Major Wolfgang Schellmann, Geschwaderkommodore of JG 27, was forced to take to his parachute over enemy territory on the opening day of *Barbarossa* and was reportedly shot by the NKVD 48 hours later

was alone responsible for the destruction of seven Tupolevs (but he would add nothing further to his total before being killed in action against South African Marylands over Libya some three months later).

At least three of III./JG 53's pilots claimed triple kills. Among Feldwebel Hermann Neuhoffs trio was an Ilyushin 11-2, one of the earliest examples of the Soviet Air Force's heavily-armoured *Stormovik* ground-attack aircraft to be brought down.

On that same 25 June II./JG 51 produced another 'instant ace' when Oberleutnant Hans Kolbow, the *Kapitän* of 5. *Staffel*, shot down five Russian bombers in a row — Kolbow already had 13 western kills to his credit. To this he would add another 14 in the east, including the five on 25 June, before being brought down by Soviet ground fire on 16 July. He was awarded a posthumous Knight's Cross 11 days later.

The most spectacular success of all came about on 30 June when the Red Air Force hurled hundreds of bombers against the central sector. Everything that could fly was sortied, including antiquated Tupolev TB-3 four-engined heavy bombers.

In reply, JG 51's three *Gruppen* put up 157 individual sorties. Sixty pilots returned to base with one or more victories, resulting in the *Geschwader* being credited with 113 kills in total! Among the total was JG 51's 1000th enemy aircraft destroyed since the outbreak of war. It was the first unit within the *Jagdwaaffe* to reach this figure. Three pilots had claimed five kills apiece on this day.

Kommodore Werner Mölders' five took his personal score to 82, thereby surpassing the world record 80 victories set by the immortal 'Red Baron', Rittmeister Manfred Freiherr von Richthofen, in World War 1. The other two claimants were the *Gruppenkommandeur* of I./JG 51, Oak Leaves wearer Hauptmann Hermann-Friedrich Joppien, and a certain Leutnant Heinz 'Pritzl' Bär, who was to become one of *the Jagdwaaffe's* true greats.

Several other members of JG 51, including Hauptleute Josef Fözö and Richard Leppla, the *Kommandeure* of II. and III. *Gruppe* respectively, took their scores to 20 or more during the course of the day's fighting. Hitherto the 'magic 20' had automatically brought with it the award of the Knight's Cross. But with the war in the east little more than a week old, a total of just 20 kills no longer guaranteed this coveted honour. So many Soviet aircraft were being shot down that more stringent requirements were already being applied to the winning of the award in order not to devalue it.

The damage being inflicted upon the Red Air Force was undoubtedly enormous. On 29 June the Luftwaaffe had reported to the OKW (High Command of the Armed Forces) the destruction of 4017 aircraft on the ground and in the air. No longer the sceptic, *Reichsmarschall* Goring thereupon announced that, 'In the first week of the campaign the Luftwaaffe has destroyed 4990 enemy aircraft for the loss of 179 of its own.'

The opening phase of *Barbarossa* was coming to an end. In the air the Luftwaaffe had delivered its knockout blow to the Soviet Air Force. Although not mortal, it had succeeded in securing for the Germans mastery of the skies for the months ahead - long enough, it was confidently assumed by most, for the campaign to reach the 'speedy conclusion' demanded by Hitler.



Bf 109s of JG 51 occupy a Russian airfield as the advance into the Soviet Union gets underway. Note the abandoned I-153s among the trees on the left

One of Werner Mölders' earliest duties as *General der Jagdflieger* was to make a welcome return visit to III./JG 53, the *Gruppe* he had formed and first commanded in October 1939. The occasion was the award of the Knight's Cross to Leutnant Erich Schmidt on 23 July for his 30 victories (17 of them in the west). From left to right are Oberst Mölders, *Gruppenkommandeur* Hauptmann Wilcke and Leutnant Schmidt

missions. At least one *Staffel* continued to operate in the fighter-bomber role against enemy airfields, but pilots no longer had to contend with the temperamental SD-2 *Splitterbomben*, their aircraft being equipped instead to carry four 50-kg bombs.

On 12 July Hauptmann Leppla claimed JG 51's 500th Soviet victim (which also proved to be the *Geschwader's* 1200th aerial victory of the war). But the pressure of the past three weeks' constant campaigning was beginning to tell. Although only six pilots had been killed or reported



missing during that time, the three *Gruppen* had, between them, written off 89 Bf 109s - for which they had received just 49 replacements. The *Geschwader* was operating at less than half its normal establishment. And of those 58 fighters which were serviceable, 22 had engines with more than 50 hours' flying time which needed urgent overhaul.

Just over a month later, on 27 August, and Schmidt (top left) watches the 44th kill bar being applied to the rudder of his *Friedrich*. Four days - and three victories - later still, Erich Schmidt would be reported missing, shot down by Soviet anti-aircraft fire near Dubno, in the Ukraine





Already a seasoned campaigner - his first kill had been a French *Moräne* claimed on 14 March 1940, the famous 'Day of the Fighters' - Oberleutnant Franz 'Altvater' ('Qld Father') Götz of 9./JG 53 knew the value of grabbing 40 winks whenever the chance presented itself. He was another who would remain in frontline service until the very end of the war, by which time he had risen to become *Kommodore* of JG 26 in the west

Looking almost as relaxed as 'Altvater' Götz, 'Fürst' ('Prince') Wilcke enjoys a cigarette in the company of two of his *Gruppe's* leading *Experten*, namely Leutenants Herbert Schramm (left) and Erich Schmidt (right). Wilcke and Schramm were both awarded the Knight's Cross on 6 August



Despite such problems, JG 51 continued to take a toll of the Soviet Air Force. The *Kommodore's* century on 15 July was the cause for great celebration, and four days later Werner Mölders passed command of the *Geschwader* to Major Friedrich Beckh and departed to assume his duties as the Luftwaffe's first *General der Jagdflieger*.

Mölders' new post was no sinecure. It was clear that *the jagdu>affe* was becoming dangerously overstretched. Already committed in western Europe and the Mediterranean, the German fighter arm was now waging war on three fronts. The very size of the new theatre, the huge distances to be covered and the vast areas to be controlled were simply too much for the number of fighters available.

As a consequence, July was to witness not only the first transfer of units from one part of the eastern front to another (such transfers would become increasingly frequent as the campaign wore on), but also the withdrawal of the *fix Jagdgruppe* to meet the more 'pressing' operational demands of another theatre.

The latter was Hauptmann Wolfgang Lippert's II./JG 27. After just four weeks in the east, which had netted a total of 42 victories, II./JG 27 returned to Germany to re-equip with Bf 109Fs, before staging southwards to join I. *Gruppe* in Africa.

To make up for the departed II./JG 27, Hauptmann Wolf^Dietrich Wilcke's III./JG 53 was temporarily subordinated to *Stab* JG 27 (commanded since the disappearance of Wolfgang Schellmann by Major Bernhard Woldenga). Throughout the late summer and early autumn JG 27's three main component *Gruppen* (III./JG 27, II./JG 52 and III./JG 53) also supported the central sector armies' advance on Moscow.

By far the most successful of III./JG 27's pilots at this time was Oberleutnant Erbo Graf von Kageneck, the *Kapitän* of 9. *Staffel*, who added 48 eastern front victories to his previous tally of 17 western kills (and gained the Knight's Cross in the process) before both the *Geschwaderstab* and III./JG 27 withdrew from Russia in mid-October to fight alongside the unit's other two *Gruppen* in North Africa.

During the same period the attached III./JG 53 had claimed some 200 kills. The *Gruppe's* three leading scorers in the east were Oberleutnant Franz Götz, *Staffelkapitän* of 9./JG 53, with 23 victories, 7. *Staffel's* *Obfeldwebel* Hermann Neuhoff with 21, and Hauptmann Wilcke with 20.

Wilcke was awarded the Knight's Cross on 6 August for achieving 25 kills (the first 13 of them in the west), but both Götz and Neuhoff would have to wait until the following year, and the destruction of 40 enemy aircraft each, before they were similarly honoured.

One member of II./JG 52 also received the Knight's Cross at this juncture. Oberleutnant Johannes Steinhoff, *Kapitän* of 4. *Staffel*, had claimed 35 victories by the time of his award on 30 August. Destined to become one of *the Jagdwaffe's* most

A later photograph of Hauptmann Johannes "Mack" Steinhoff after his promotion to the command of II./JG 52 early in 1942. The lettering on the leading edge of the port wing specifies the largest permissible tyre size for this particular machine's mainwheels



respected unit leaders, 'Mäcki' Steinhoff would amass 148 kills on the eastern front. But there was another pilot within the *Gruppe* who would achieve more than double that total.

Leutnant Gerhard Barkhorn had already served with II./JG 52 for over a year by the time he finally shot down his first enemy aircraft on 2 July - this was his 120th mission! This solitary victory was in itself an unremarkable event, except for the fact that Barkhorn would go on to add exactly 300 more to become the second-highest scoring fighter pilot in history.

While existing scores were being added to, and new reputations being launched on the road to Moscow, other *Jagdgruppen* were achieving similar results on either flank of the German advance into the Soviet Union.

The sole *Jagdgeschwader* deployed on the northern sector was Major Hannes Trautloft's JG 54 (initially with 4. and 5. *Staffeln* of JG 53 attached). Its task was to provide aerial support during *Heeresgruppe Nora's* drive through the Baltic states towards the great Soviet naval base of Leningrad, Russia's second largest city and one-time capital.

The *Geschwader's* first major success came on 29 June when large formations of bombers attacked the Dvina bridges in an attempt to halt the Panzers' advance. By the end of the day JG 54 had downed 65 of their number, and on 18 July the *Geschwader* claimed its 500th Russian victim.

Twenty-four hours later another of the eastern front's true 'greats' opened his Scoreboard when 9./JG 54's Leutnant Walter Nowotny destroyed a trio of I-153s over the Baltic island of Ösel. Nowotny's career

JG 54's advance through the Baltic states took them to Schaulen, (Siauliai) in Lithuania, where they found this motley collection of abandoned enemy aircraft. Among the usual assortment of I-16s, MiG-3s and SB-2s, note the ex-Lithuanian Air Force Gloster Gladiator fighters (background left) purchased from Great Britain before the war



almost ended there and then, however, for he was himself shot down during the engagement and only just survived three days and nights in a rubber dinghy.

Kommodore Hannes Trautloft's Knight's Cross, awarded on 27 July for 20 victories, was but the first of a number conferred upon members of JG 54 during the push on Leningrad. On 1 August JG 54 became the third *Jagdgeschwader* to achieve 1000 aerial victories since the outbreak of war — although widely separated and on different sectors of the front, JG 3's component *Gruppen* had achieved their collective 'thousandth' just the day before.

Already wearing the Knight's Cross, Oberleutnant Hans Tips' Philipp, *Staffelkapitän* of 4./JG 54, won the *Geschwader'sf/Kt* Oak Leaves (for 62 victories) on 24 August. Less than a fortnight later the German army was at the gates of Leningrad. Early in September JG 54 took up residence on the Russian airfields at Siverskaya and Krasnogvardeisk, and these would remain their principal bases for much of the epic 900-day siege of Leningrad that was now about to begin.

The city, its naval installations, and the surrounding area were subjected to constant aerial bombardment. One of the first major raids was mounted on 9 September, when JG 54's fighters escorted Ju 87 dive-bombers of StG 2 against units of the Soviet Baltic Fleet. But the day was marred by the loss of Oberleutnant Hubert Mutherich, *Staffelkapitän* of 5./JG 54 and one of the recent Knight's Cross recipients, who was killed when his aircraft somersaulted while attempting a forced-landing. At the time of his death 'Hubs' Mutherich had a total of 43 victories, 33 of them claimed since the beginning of *Barbarossa*.

JG 54 was to lose another Knight's Cross wearer, of longer standing, on 30 September when the *Kommandeteuroflll. Gruppe*, Hauptmann Arnold Lignitz, shed a wing during a dogfight over Leningrad. Before the fighter spun in, Lignitz was able to take to his parachute. He was last seen drifting down over the centre of Leningrad, and reportedly died later in one of the city's gaols. This marked the start of a long war of attrition for JG 54 as the Soviets threw in more and more aerial reinforcements to defend their second city.

In contrast to JG 54's somewhat sedentary existence in the north, the campaign on the southern sector was one of speed and movement as the armoured units of *Panzergruppe* 1 took full advantage of the wide open expanse of the Ukrainian steppe to outmanoeuvre and encircle whole Russian armies. The two main fighter units supporting operations in the south were JGs 3 and 77.

From its jumping-off points south of Warsaw in occupied Poland, JG 3 covered the left-hand flank of the southern front (adjoining the central sector) which was the scene of the main armoured thrust towards the Ukrainian capital Kiev, and thence onwards to the great industrial centre of Kharkov. On their right, JG 77 set out from its fields in Bulgaria and Rumania in support of the ground forces' advances along the shores of the Black Sea towards the Crimea.

The most successful fighter pilot during the early months of the air war over southern Russia was the *Geschwaderkommodore* of JG 3, Major Günther Lütow. He alone was responsible for 83 of the *Stabsschwarm's* 106 victories between June and November 1941, this remarkable string



Oberleutnant Hans Philipp, who won JG 54's first Oak Leaves, would be killed in action in defence of the Reich late in 1943 when *Kommodore* of JG 1

of successes being marked by the award of the Oak Leaves on 20 July (for a total of 42 kills) and the Swords on 11 October (for 92). Exactly a fortnight later a trio of MiG-3s boosted his score to 101.

Günther Lützwitz thus became the second member of the *Jagdwaaffe*, after Mölders, to achieve the century. He too received an immediate ban on all further operational flying, but this did not stop him from adding two more victories to his overall total — during 'involuntary encounters' (!) with Soviet fighters - before he finally relinquished command of JG 3 in August 1942 to join the staff of the *General der Jagdflieger*.

The Russian reaction along the southern front was similar to that on the central sector. After most of its fighter strength had been destroyed on the ground, the Red Air Force sent in waves of unescorted bombers in an effort to prevent a German break-out. They suffered appalling losses. In expressing his appreciation for the support provided by the Luftwaffe, the Chief of the Army High Command spoke of 'entire Russian bomber *Geschwader*, flying without fighter cover' being wiped out.

This is believed to have been a reference to the action of 8 July when JG 3 claimed the destruction of 38 twin-engined bombers. I. *Gruppe* was credited with 20 Ilyushin DB-3s, three of which fell to Oberleutnant Robert Olejnik. This brought the number of Olejnik's Russian victims to 25 since claiming the opening kill of *Barbarossa*. He would achieve half-a-dozen more - and receive the Knight's Cross while so doing - to emerge as I./JG 3's highest scorer before the *Gruppe's Krumm* to the Reich at the end of September 1941, and subsequent redesignation as II./JG 1.

Not too far behind 'Franz' Lützwitz in respect of the number of Soviet aircraft destroyed during this period was Hauptmann Gordon Gollob, *Kommandeur* of II./JG 3. He had assumed command of the *Gruppe* on 27 June after the previous incumbent, Hauptmann Lothar Keller, had been killed in a mid-air collision.

An *ex-Zerstörer* pilot, and with six victories already to his credit, Gollob had added 79 Soviet aircraft to his tally by late October. This earned him both the Knight's Cross and the Oak Leaves. In November 1941 II./JG 3 was also withdrawn from the eastern front, but Major Gordon Gollob would reappear in the Soviet Union the following year as *Kommodore* of JG 77. Thereafter, he would serve in various staff positions before replacing the 'disgraced' Adolf Galland on 31 January 1945 as the third, and final, *General der Jagdflieger*.

Also pictured wearing the Oak Leaves, awarded on 26 October for 85 victories, II./JG 3's Hauptmann Gordon Gollob subsequently commanded JG 77, before ending the war as the Luftwaffe's third and final *General der Jagdflieger*



Yet another high scorer during the opening phase of *Barbarossa* was the *Gruppenkommandeur* of III./JG 3, Hauptmann Walter Oesau. A veteran of the *Condor Legion* who had since claimed 42 World War 2 victories to add to the eight Republican machines he had downed in Spain, he was already wearing the Oak Leaves prior to the invasion of Russia. In just five weeks over southern Russia 'Guile' Oesau was credited with a further 44 enemy aircraft destroyed, his 80th kill of the war - a DB-3 bomber brought down on 15 July - bringing him the Swords to his Knight's Cross. But less than a fortnight later Walter Oesau relinquished command of II./JG 3 to take over as *Kommodore* of JG 2 in the west.

A number of other pilots were also scoring steadily as the ground forces advanced on Kharkov. At least six members of JG 3 were awarded the Knight's Cross during this period, and several of them went on to take their final totals close to the 100 mark.

In any other theatre, and in any other air force, an achievement of this kind would be considered outstanding. But such is the dominance of the 'select few' of eastern front aces within much post-war aviation literature that the names of numerical lesser lights such as Franz Beyer, Eberhard von Boremski and Walter Ohlrogge are now all but forgotten.

Much the same applies to JG 77, which was operating on JG 3's right flank. By the end of 1941 this *Geschwader* had a collective total of over 1000 Soviet aircraft destroyed, and five Knight's Crosses had been won as several later high-ranking and highly decorated *Experten* took their scores into double figures. The two most successful pilots of JG 77 during this period were Oberleutnants Kurt Ubben and Heinrich Setz, with 54 and 52 kills respectively. Both would subsequently be killed in action on the western front, Ubben as *Kommodore* of JG 2 and Setz as *Kommandeur* of I./JG 27.

Like the *Jagdgeschwader* to the north, JG 77 also inflicted grievous damage on unescorted Soviet bomber formations. Many multiple successes were achieved. On 25 June Oberleutnant Walter Hoeckner, *Staffelkapitän* of 6./JG 77, downed eight SB-2s during a *Freie Jagdsweep*. Eighteen of the following day's 47 kills were claimed by just four pilots, with Oberfeldwebel Reinhold Schmelzer, who was credited with five of the 32 SB-2s shot down on this date, then chalking up another five

This oddly-marked Em/ was the mount of Oberleutnant Georg Schirmböck, the *Gruppen-TO* of II./JG 77. The symbol behind the chevron, which appears at first glance to be one half of the runic SS insignia, is in fact the emblem of the 'Jungvolk', a youth organisation to which Schirmböck presumably once belonged. He is reported to have adopted this marking after *Gruppenkommandeur* Hauptmann Anton Mader complained that the *TO*'s standard 'Chevron circle' was too similar to his own 'Double chevron'

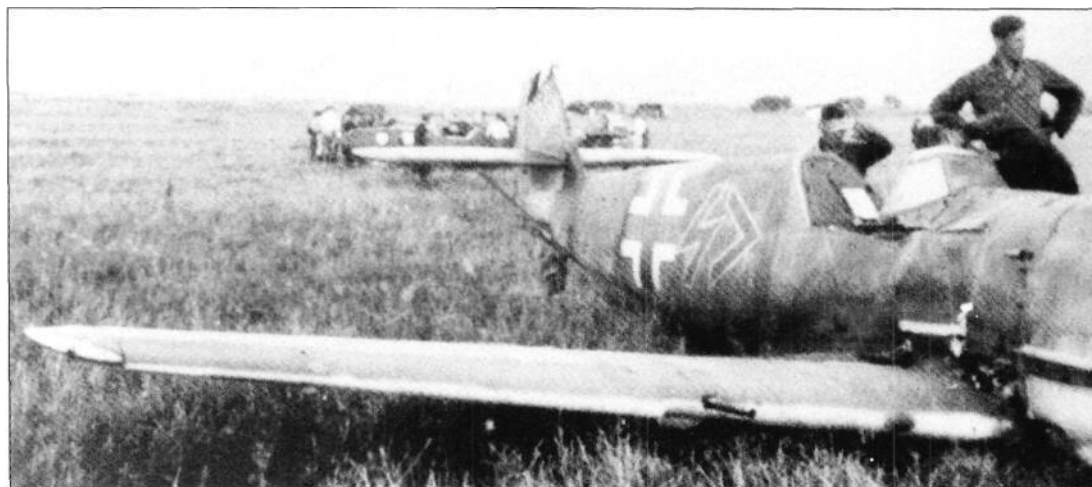

As well as being the *General der Jagdflieger*, Werner Mölders also temporarily held the post of *Nahkampfführer Krim* (Close-support Leader Crimea). And it was no doubt in the latter role that he toured the Stuka units operating over the Crimea in the autumn of 1941. Here, he appears to be making a forceful point to Hauptmann Helmut Bode, *Gruppenkommandeur* of IM./StG 77, while Leutnant Gawlina looks on



victories on 10 July. Half of Oberfeldwebel Eugen Wintergerst's 22 kills were also scored on just two days - four SB-2s on 9 August and seven SB-3s three days later.

These names may be unfamiliar, but there was one very well-known figure who would see brief action with JG 77 early in November, by which time the *Geschwader* was operating over the Crimea. In his dual capacity as *General der Jagdflieger* and temporary *Nahkampfführer Krim* (Close-

support Leader Crimea), Oberst Werner Mölders was visiting JG 77 when he heard an NCO pilot complain of a botched attack on an 11-2.

Ilyushin's heavily armoured ground-attack *Stormovik* was undoubtedly the hardest Soviet aircraft to bring down. Mölders took the Oberfeldwebel up the next day to demonstrate his technique;

'He positioned himself off to one side of - and some distance away from - the last 11-2 in a formation of six. He then turned in quickly and opened fire at the enemy's cockpit from an angle of some 30 degrees. The 11-2 immediately burst into flames and crashed. "Do you see how it's done?" Oberst Mölders voice came over the R/T. "Right, now you take the next one".

'I carried out the same manoeuvre and, sure enough, the next 11-2 went down on fire. "And again!" It was like being on a training flight. Another short burst and the third 11-2 was ablaze. The whole lesson had lasted no more than 12 minutes!'

It was a gesture typical of 'Vati' Mölders. Herbert Kaiser never forgot his 23rd and 24th kills. But because the *General der Jagdflieger* was officially banned from operational flying, the first *Stormovik* was never

But it was as a fighter tactician that Mölders excelled. One lesson he passed on was how to bring down the formidable *Stormovik* which, at this early stage of the war, was a single-seater machine with no rear-gunner. The spot to aim at was the unprotected top of the fuel tank immediately behind the cockpit - which is precisely where this early 11-2 has been hit. A fierce fire has already taken hold as the machine starts to go down





added to Mölders' list of victories - there has been much speculation as to how many other such 'demonstrations' went unrecorded!

Oddly, the one *Jagdgeschwader* perhaps associated more than any other with the eastern front, and certainly ultimately the most successful of all in terms of numbers of Soviet aircraft destroyed, made the least impact at the beginning of *Barbarossa*.

This was due entirely to the nature of JG 52's deployment. I. *Gruppe* was not even part of the invading order of battle, but was retained in the west to guard the North Sea coastline. And while Hauptmann Erich Witke's II. *Gruppe* performed creditably enough on the central sector (claiming no less than 270 victories during its secondment to JG 27), III./JG 52's kill rate was so poor in comparison to all the other *Jagdgruppen* involved in the opening stages of the campaign in the east that Hermann Goring was moved to despatch the following telegram to the *Gruppenkommandeur* on 4 July;

'Your unit continues to distinguish itself by its failure to shoot down the enemy. Just how much longer are the Russians to be allowed into your airspace unhindered?

'Signed-Goring'

This was a perfect example of the *Reichsmarschall's* lack of understanding of the conditions at the front. He now accepted the huge claims of the *other Jagdgruppen* as the norm, and against these III./JG 52's figures were admittedly low. But Major Albert Blumensaat's unit was the southernmost *Gruppe* of the entire front. Its task was to patrol the Black Sea coast. Enemy incursions were few, and such raids as were mounted almost invariably approached undetected from across the sea, struck at some coastal or fringe target, and quickly escaped back over open water again.

Against hit-and-run tactics of this kind, which could be aimed at any point along a stretch of coastline over 200 miles (320 km) long, it is hardly surprising that the *Gruppe's* 35+ serviceable fighters fared badly in the scoring stakes. But when III./JG 52 was re-directed inland, its pilots soon began to make up for their slow start.

This *Friedrich* belongs to III./JG 52, which was the *Gruppe* responsible for guarding the Black Sea coastline during the opening phase of *Barbarossa*. Note the unusual angular '6' and the wavy bar *Gruppe* symbol, both applied in black to denote 8. *Staffel*

III./JG 52's first Knight's Cross was awarded to Feldwebel Gerhard Koppen of 7. *Staffel*. This early 1942 shot shows the 40th kill, which won Koppen the award, marked in black on a rudder now displaying a total of 62 victories - just ten short of the number which would earn him the Oak Leaves on 27 February. Koppen was posted missing after an engagement with Pe-2s over the Sea of Azov on 5 May. His final score stood at 85



During a Stuka-escort mission on 3 August Leutnant Hermann Graf scored the first kill of a career that would transform him into one of the *Jagdwaaffe's* truly outstanding combat leaders. At this time Graf was a member of 9./JG 52. The skies above Kharkov were this *Staffel's* favourite hunting ground, and before its capture, the town's three main military airfields ensured that there was no lack of aerial opposition. By 11 October 9./JG 52's collective total had risen to 59, making it the most successful of the *Gruppe's* three *Staffeln*.

A portent of things to come. The *Gruppen-TO* of II./JG 51 (note the *Gruppe* horizontal bar just visible behind the circle - see colour profile 16) casually brushes the first snow of the winter from the wing of his *Friedrich* at Vyazma in October 1941

The others were not far behind. But on 28 November 8./JG 52 suffered a serious blow when *Staffelkapitän* Oberleutnant Günther Rail was seriously wounded after claiming his 36th kill. Temporarily paralysed, it would be nine months before Rail returned to his *Staffel*. He, too, was destined for great things. Despite being shot down five times, Günther Rail survived the war as the Luftwaaffe's third-highest scoring fighter pilot.





The winter of 1941-42 quickly tightened its grip. This III. *Gruppe* machine, and the sentry alongside his tripod-mounted MG 34 machine gun, are fortunate to be well-muffled against the sub-zero temperatures



Soon the snow was so deep that hardstands had to be shovelled free. But there was no respite for the groundcrews, and here a pair of 'black men' refuel a winter-camouflaged III./JG 53 aircraft from individual drums

Yet it was a relatively unknown NCO, 7./JG 52's Feldwebel Gerhard Koppen, who was awarded the *Gruppe's* first Knight's Cross, for 40 victories, on 18 December.

By then, however, *Barbarossa* was in serious difficulties. The *Führer's* 'speedy victory' was to be denied him by that one implacable and impartial foe of any invader of Russia's vast open spaces - 'General Winter'. By mid-November autumn's mud had finally given way to snow and ice, and bone-chilling temperatures of -40 degrees descended over the frontlines.

Totally unprepared for a winter campaign, and lacking proper clothing and specialised equipment, the Wehrmacht ground to a halt.

Taking full advantage of the Germans' immobility, fresh Soviet divisions that had been hastily brought in from Siberia launched a series of counter-attacks. The leading Panzers were soon pushed back from the approaches to Moscow, and German forces retreated and dug in for the winter. The late Werner Mölders' fears that the campaign in the east could be a long one had become grim reality.

Hangar space was at a premium, and those units lucky enough to be based on ex-Soviet airfields where hangars were still standing made use of every available inch of cover to carry out essential maintenance work

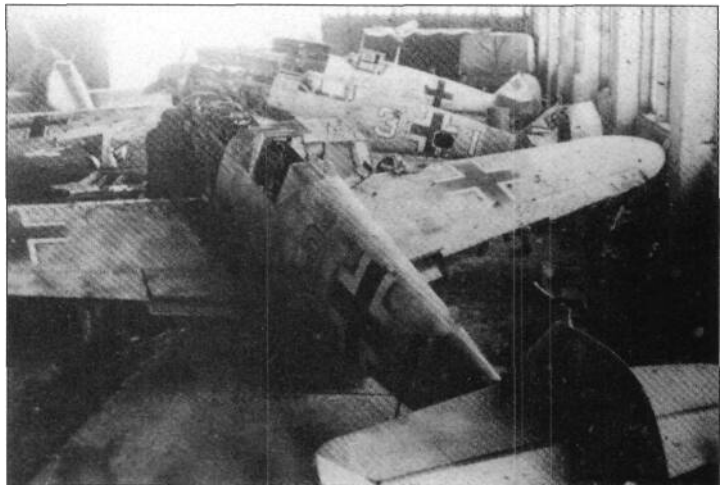

COLOUR PLATES



1

Bf 109F-2 'White Triple Chevron' of Major Günther Lützw, *Geschwaderkommodore* JG 3, Hostynne, June 1941



2

Bf 109G-2 'Black Chevron and Bars' of Major Wolf-Dietrich Wilcke, *Geschwaderkommodore* JG 3 'Udet', Morosovskaya, November 1942

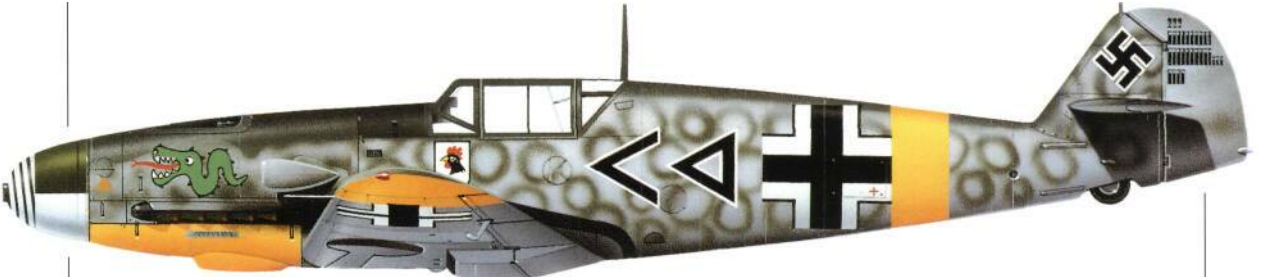

3

Bf 109F-2 'Black Chevron and Triangle' of Hauptmann Hans von Hahn, *Gruppenkommandeur* I./JG 3, Luzk, July 1941



4

Bf 109F-2 'Black Chevron and Circle' of Leutnant Detlev Rohwer, *Gruppen-TO* I./JG 3, Byelaya-Zerkov, August 1941



5

Bf 109F-4 'White Double Chevron' of Hauptmann Kurt Brändle, *Gruppenkommandeur* II./JG 3 'Udet', Tusow, August 1942



6

Bf 109F-4 'Yellow 7' of Oberleutnant Viktor Bauer, *Staffelkapitän* 9./JG 3 'Udet', Szolzy, March 1942



7

Bf 109F-4 'Yellow 4' of Oberfeldwebel Eberhard von Boremski, 9./JG 3 'Udet', Zhuguyev, May 1942



8

34 Bf 109F-4 'White Triple Chevron' of Hauptmann Franz Hahn, *Gruppenkommandeur* I./JG 4, Mizil/Rumania, January 1943



9

Bf 109E-7 'Black Double Chevron' of Hauptmann Günther Scholz, *Gruppenkommandeur* III./JG 5, Petsamo/Finland, September 1942



10

Bf 109G-2 'Yellow 12' of Oberleutnant Heinrich Ehler, *Staffelkapitän* 6./JG 5, Petsamo/Finland, March 1943



11

Bf 109G-2 'White 4' of Oberleutnant Theodor Weissenberger, *Staffelkapitän* 7./JG 5, Petsamo/Finland, July 1943

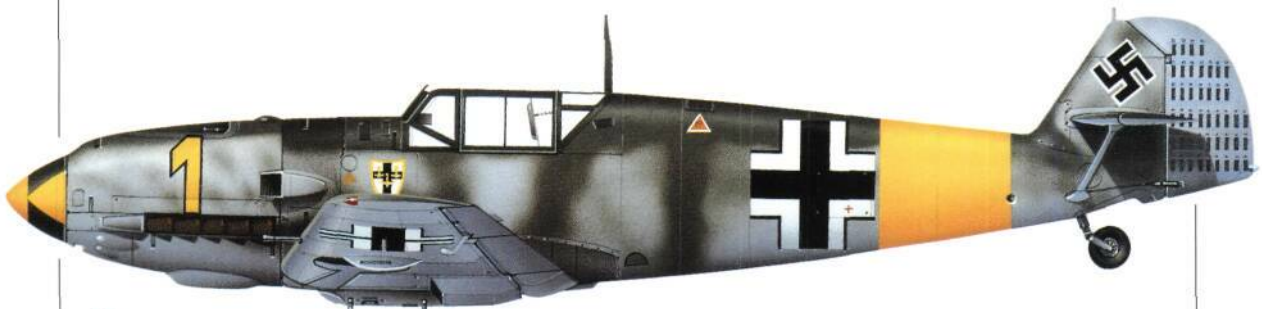

12

Bf 109E-7 'Yellow 1' of Oberleutnant Erbo Graf von Kageneck, *Staffelkapitän* 9./JG 27, Solzy, August 1941



13

Bf 109F-4 'Black Chevron and Bars' of Major Karl-Gottfried Nordmann, *Geschwaderkommodore* JG 51 'Mölders', Shatalovka, Summer 1942



14

Bf 109G-6 'White 9' of Leutnant Günther Josten, 1.JG 51 'Mölders', Bobruisk, Spring 1944



15

Bf 109F 'Yellow 7' of Oberleutnant Heinrich Krafft, *Staffelkapitän* 8./JG 51 'Mölders', Stolzy, March 1942



16

Bf 109F 'Black Double Chevron' of Hauptmann Josef Fözö, *Gruppenkommandeur* of II./JG 51, Stara-Bychov, July 1941



17

Bf 109G-2 'Yellow 5' of Feldwebel Anton Hafner, 6./JG 51 'Mölders', Orel-North, August 1942



18

Bf 109F-4 'Red 12' of Oberfeldwebel Heinz Klöpfer, 11./JG 51 'Mölders', Dugino, September 1942



19

Bf 109G-6 'Black Double Chevron' of Hauptmann Gerhard Barkhorn, *Gruppenkommandeur* 1./JG 52, Kharkov-South, August 1943



20

Bf 109G-6 'Red 4' of Oberfeldwebel Rudolf Trenkel, 2./JG 52, Poltava, July 1943



21

Bf 109G-2 'Black Double Chevron' of Hauptmann Johannes Steinhoff, *Gruppenkommandeur* II./JG 52, Rostov, August 1942



22

Bf 109G-6 'White T' of Hauptmann Erich Hartmann, *Staffelkapitän* 4./JG 52, Budaörs/Hungary, November 1944



23

Bf 109G-4 'Black 12' of Leutnant Peter Düttmann, 5./JG 52, Anapa, May 1943



24

Bf 109G-2 'Yellow 5' of Leutnant Walter Krupinski, 6./JG 52, Armavir, August 1942



25

Bf 109G-4 'Yellow 3' of Unteroffizier Hans Waldmann, 6./JG 52, Anapa, June 1943



26

Bf 109G-6 'Yellow 3' of Leutnant Heinz Ewald, 6./JG 52, Zilistea/Rumania, June 1944



27

Bf 109G-2 'Black 13' of Oberleutnant Günther Rail, *Staffelkapitän* 8./JG 52, Gostanovka, August 1942

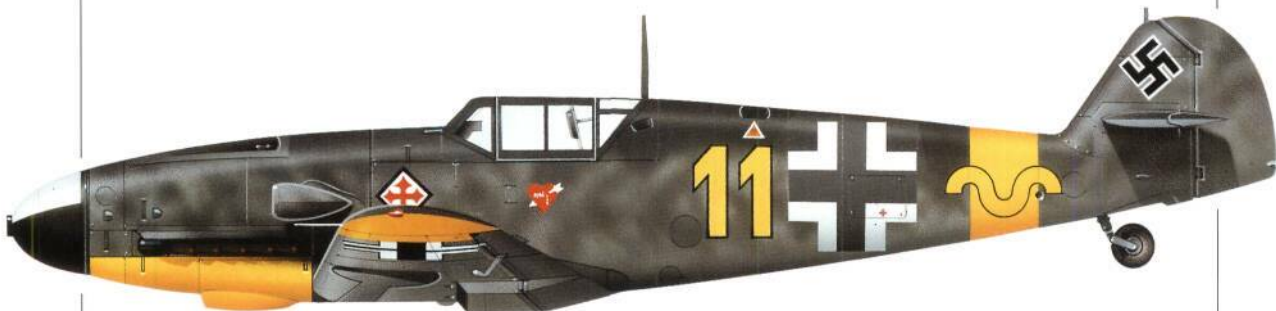

28

Bf 109G-2 'Yellow 11' of Oberleutnant Hermann Graf, *Staffelkapitän* 9./JG 52, Pitomnik, September 1942

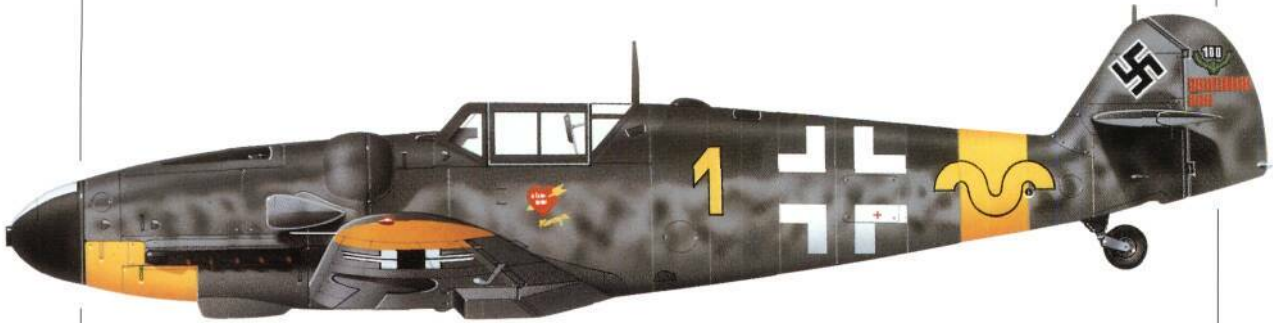

29

Bf 109G-6 'Yellow V of Leutnant Erich Hartmann, *Staffelkapitän* 9./JG 52, Novo-Zaporozhe, October 1943



30

Bf 109F-2 'Black Chevron and Bars' of Major Günther Freiherr von Maltzahn, *Geschwaderkommodore* JG 53, Byelaya-Zerkov, July 1941



31

Bf 109F-2 'Black Chevron and Circle/Bar' of Leutnant Jürgen Harder, *Gruppenstab III./JG 53*, Sobolevo, June 1941



32

40 Bf 109G-2 'White Chevron and Bars' of Major Hannes Trautloft, *Geschwaderkommodore* JG 54, Siverskaya, Summer 1942



33

Bf 109F-2 'Black Chevron and Bars' of Hauptmann Hans Philipp, *Gruppenkommandeur* 1./JG 54, Siverskaya, March 1942



34

Bf 109F 'White 8' of Leutnant Walter Nowotny, 1./JG 54, Ryelbitzi, Summer 1942

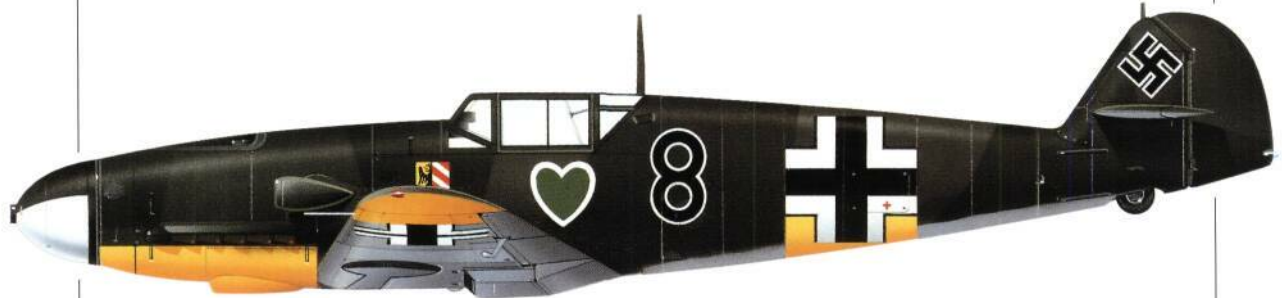

35

Bf 109F 'Black 8' of Feldwebel Otto Kittel, 2./JG 54, Krasnogvardeisk, May 1942

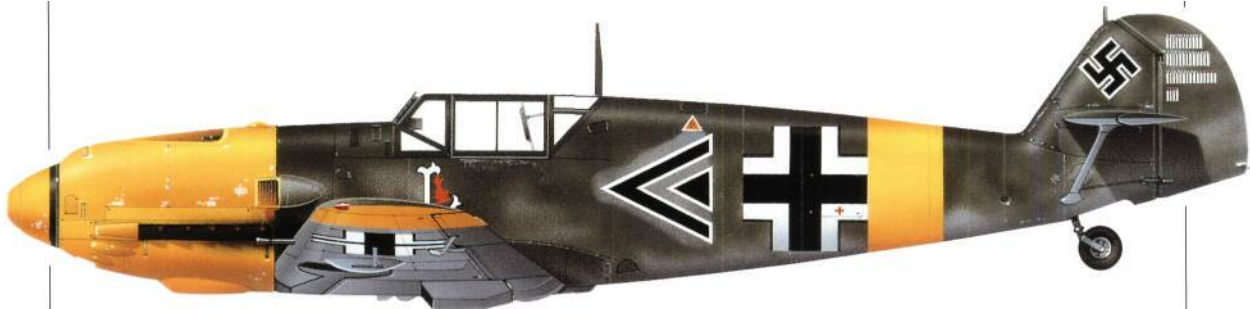

36

Bf 109E 'Black Double Chevron' of Hauptmann Herbert Ihlefeld, *Gruppenkommandeur* 1.(J)/LG 2, Jassy/Rumania, July 1941



37

Bf 109F-4 'Black Double Chevron' of Hauptmann Anton Mader, *Gruppenkommandeur* I./JG 77, Stary Oskol, September 1942



38

Bf 109F-4 'Black 5' of Oberleutnant Anton Hackl, *Staffelkapitän* 5./JG 77, Kastornoje, September 1942

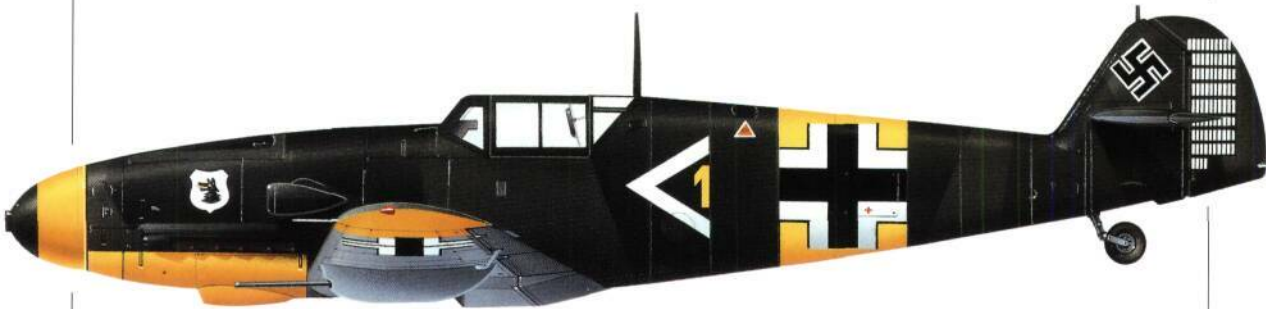

39

Bf 109G-2 'White Chevron/Yellow V' of Hauptmann Kurt Ubben, *Gruppenkommandeur* III./JG 77, Lyuban, September 1942



40

42 Bf 109F 'White V' of Oberleutnant Wolfdieter Huy, *Staffelkapitän* 7./JG 77, Lunga/Rumania, August 1941

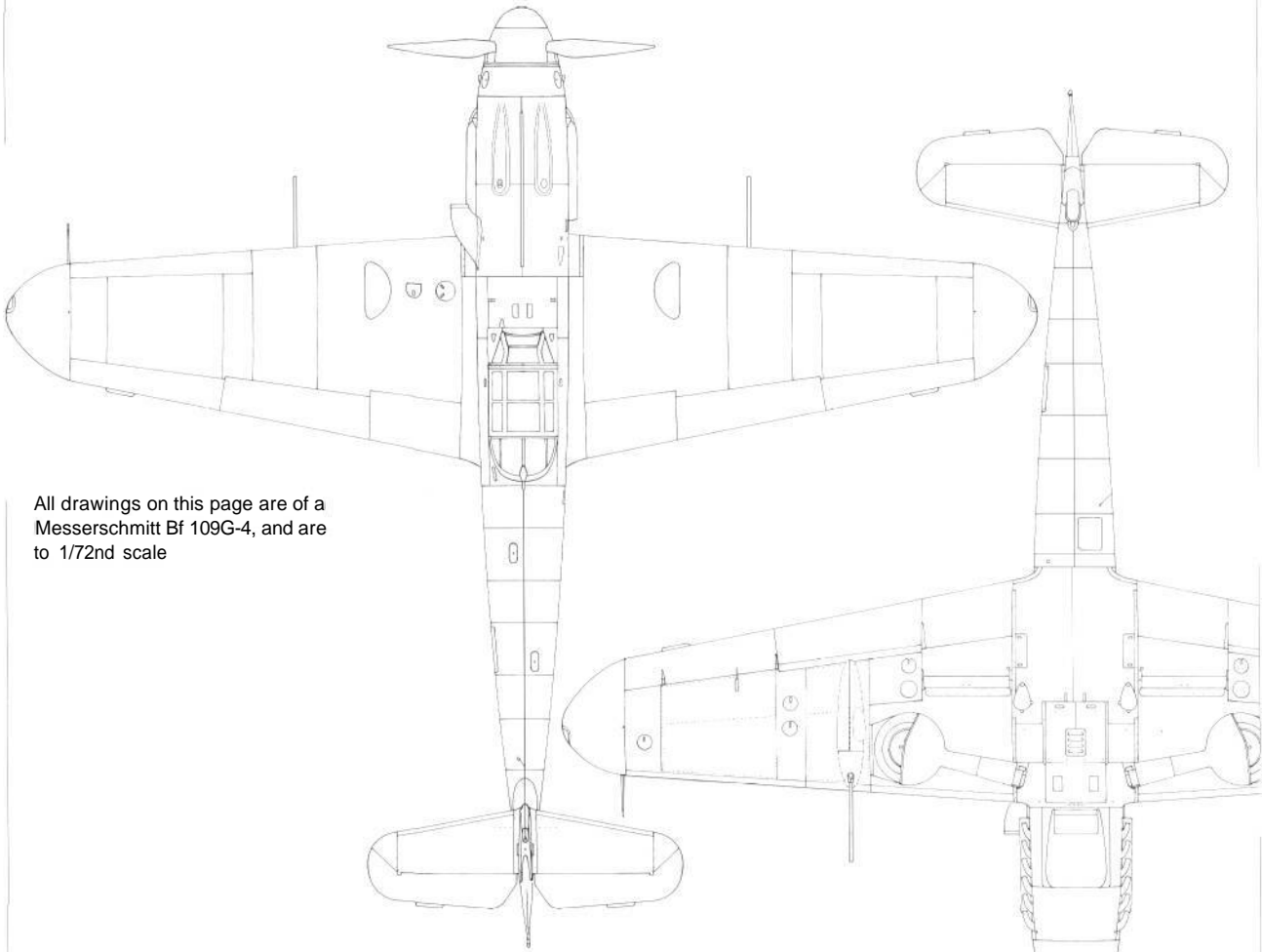
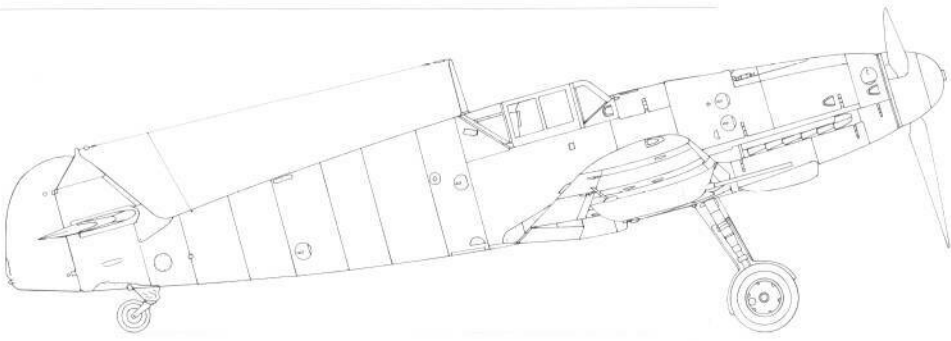

All drawings on this page are of a Messerschmitt Bf 109G-4, and are to 1/72nd scale

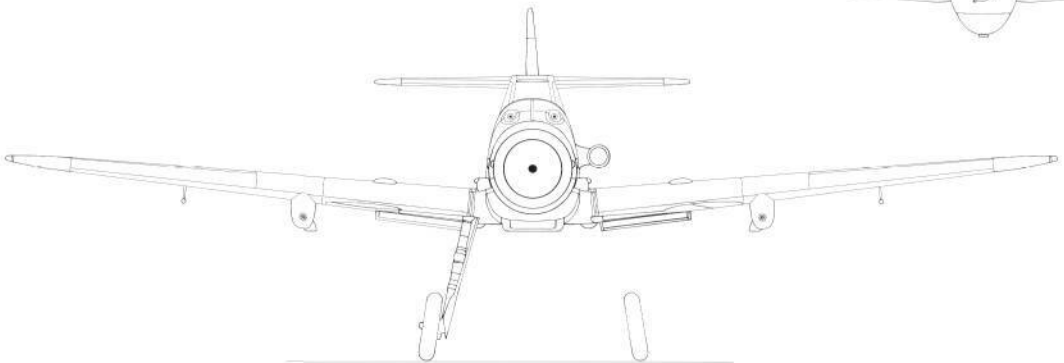

Bf 109E-4/B fitted with SD-2
Splitterbomben panniers

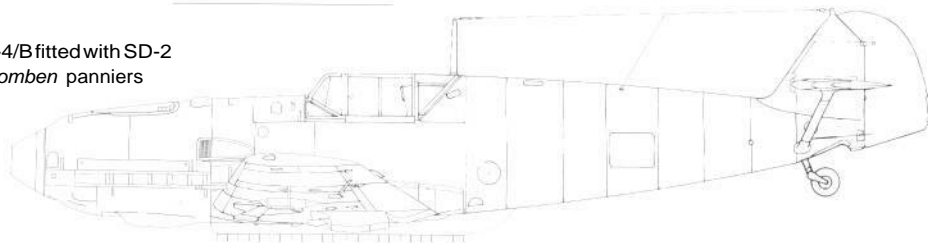

Bf 109F-4

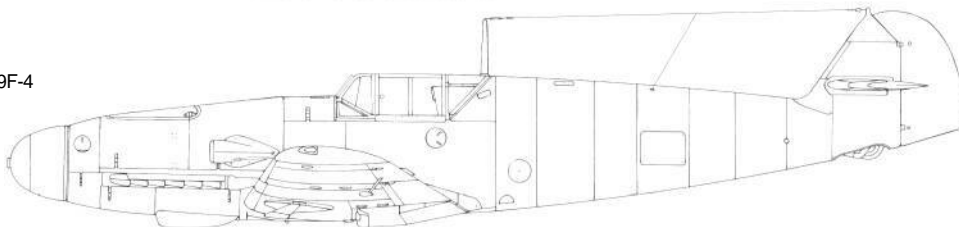

Bf 109G-2

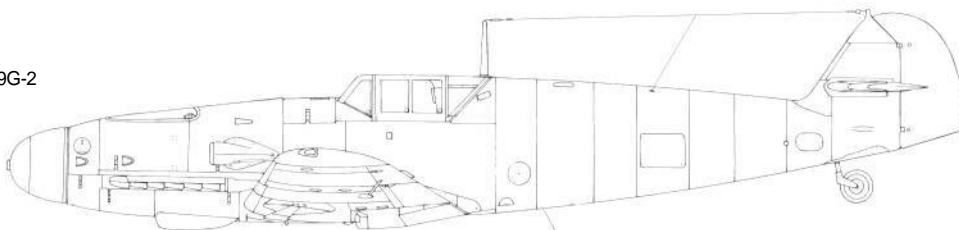

Bf 109G-4

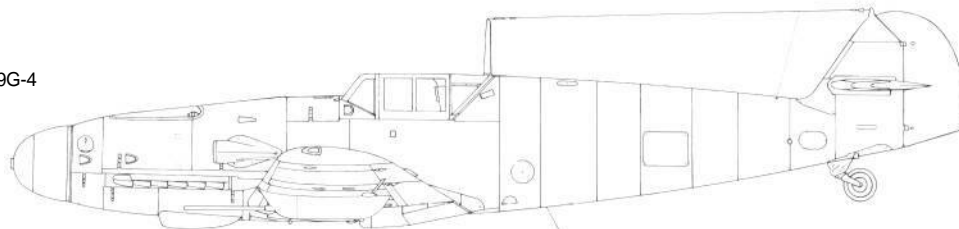

Bf 109G-6 (early-build)

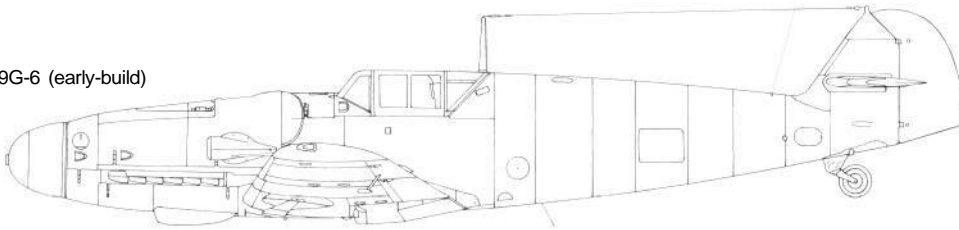

Bf 109G-6 (late-build)

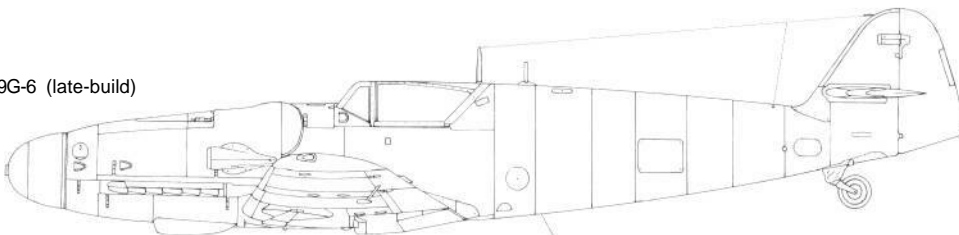

Bf 109G-14

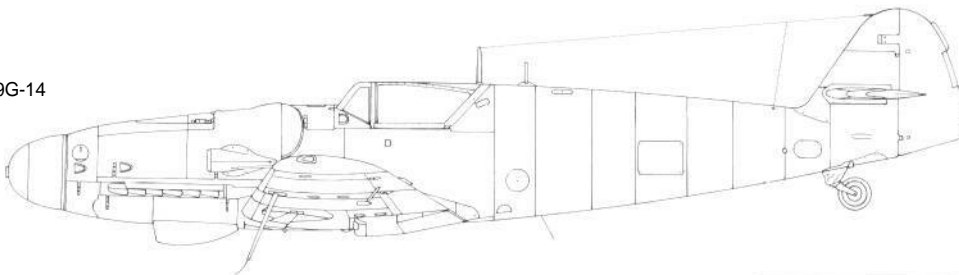

COLOUR PLATES

1

Bf 109F-2 'White Triple Chevron' of Major Günther Lützw, *Geschwaderkommodore* JG 3, Hostynne, June 1941

One of three *Friedrichs* available to Günther Lützw at the start of *Barbarossa*, this machine carries prominent early eastern front yellow theatre markings. It also wears Lützw's preferred style of *Kommodore* insignia - a triple chevron. Although superficially similar to the aircraft he had flown in France immediately prior to JG 3's transfer eastwards (see *Aircraft of the Aces* 29, colour profile 11), this is not the same machine, as it displays several minor differences.

2

Bf 109G-2 'Black Chevron and Bars' of Major Wolf-Dietrich Wilcke, *Geschwaderkommodore* JG 3 'Udet', Morosovskaya, November 1942

Lützw's successor at the head of JG 3 also enjoyed a *Kommodore's* perks, for this is one of at least two Gustavs kept at Major Wilcke's disposal during the winter of 1942-43. They wore the more usual style of markings for a *Geschwaderkommodore*, and featured a much broader aft fuselage yellow theatre band. Note, too, the winged red 'U' unit badge, which was introduced when JG 3 was formally named the *Jagdgeschwader 'Udet'* on 1 December 1941 following the death of Ernst Udet, the Luftwaffe's Chief of Aircraft Procurement and Supply.

3

Bf 109F-2 'Black Chevron and Triangle' of Hauptmann Hans von Hahn, *Gruppenkommandeur* I./JG 3, Luzk, July 1941

A somewhat unusual camouflage scheme and set of *Kommandeur's* insignia adorned Hans von Hahn's F-2 during the opening weeks of *Barbarossa*. In addition to the Gruppe's *'Tatzelwurm'* emblem on the nose, the machine sported von Hahn's personal badge under the windscreen. Like his namesake, Hans 'Assi' Hahn of western front fame, von Hahn chose a rooster's head ('Hahn' meaning cockerel in German). Below the cockpit sill on the starboard side was the coat-of-arms of von Hahn's home town, Frankfurt-am-Main. At this stage the rudder Scoreboard displays fifteen western kills (plus three balloons) and the first nine of his Soviet victories. He would add ten more to the latter before I./JG 3 left the eastern front to become II./JG 1.

4

Bf 109F-2 'Black Chevron and Circle' of Leutnant Detlev Rohwer, *Gruppen-TOL*/JG 3, Byelaya-Zerkov, August 1941

The *Friedrich* of von Hahn's Technical Officer sported an even more distinctive camouflage pattern. Rohwer's machine also retained the yellow nose (with rectangular cut-out for the Gruppe emblem) more associated with the Battle of Britain period. His personal badge was a cartoon rendition of Germany's medieval knight-adventurer Götz von Berlichingen in a decidedly bawdy pose (depicting Götz's invitation to his enemies to 'kiss my a..e!'). Four western victories and all but

one of Rohwer's final tally of 24 Russian kills are carried on the rudder. The half-length bars (also seen on von Hahn's machine above) indicate aircraft destroyed on the ground.

5

Bf 109F-4 'White Double Chevron' of Hauptmann Kurt Brändle, *Gruppenkommandeur* II./JG 3 'Udet', Tusow, August 1942

Kurt Brändle was one of JG 3's highest scorers, with a final overall total of 180 enemy aircraft destroyed (160 in the east). The 95 kill bars on the rudder of his *Friedrich* show that he is already over halfway to achieving that tally, and also offer a clue as to time and place - mid-August 1942 on the road to Stalingrad. Note that in addition to the *Geschwader's* 'Winged U', Brändle's machine is wearing II. Gruppe's heraldic gryphon shield below the windscreen

6

Bf 109F-4 'Yellow 7' of Oberleutnant Viktor Bauer, *Staffelkapitän* 9./JG 3 'Udet', Szolzy, March 1942

With its pilot yet to reach the halfway mark of his final score of 106 (as witness the 42 victory bars on the rudder), Bauer's F-4 displays a somewhat worn overall white finish as the first winter of the war in the east nears its end. Note that the slushy conditions have necessitated the removal of the mainwheel leg covers. As was common with III./JG 3, this machine does not carry the *Geschwader* badge, but wears in its place the Gruppe's own 'Double-headed axe'.

7

Bf 109F-4 'Yellow 4' of Oberfeldwebel Eberhard von Boremski, 9./JG 3 'Udet', Zhuguyev, May 1942

In early spring 1942 III./JG 3 retired briefly to Germany for re-equipment. Its new aircraft had been destined for the Mediterranean - some even retained tropical filters - and wore that theatre's standard tan and light blue camouflage scheme (see *Aircraft of the Aces* 2). This was toned down by large segments of dark green and light grey before the Gruppe returned to the east. In addition, every 9. *Staffel* machine apparently sported the name of its pilot's wife or girl friend below the cockpit. Von Boremski's 'Maxi' (for Maxine?) also displays 43 kills on the rudder. His final eastern front total would reach 84.

8

Bf 109F-4 'White Triple Chevron' of Hauptmann Franz Hahn, *Gruppenkommandeur* I./JG 4, Mizil/Rumania, January 1943

Arguably one of the least known fighter units to see service in the east was JG 4. Its I. Gruppe was initially deployed in defence of the Rumanian oilfields, where the opposition was predominantly American. Although the *Geschwader* produced no outstanding aces, this profile is included not only for the sake of completeness, but also on the strength of its pilot-yet another Hahn! -Franz 'Gockel' ('Rooster') Hahn having already scored some 17+ kills as *Staffelkapitän* of 11./JG 51 (the ex-2./JG 77), prior to assuming command of I./JG 4 in the autumn of 1942. Hahn's choice of command

insignia (the triple chevron more usually associated with a *Geschwaderkommodore* - see profile 1 for example), may perhaps be explained by the fact that I. *Gruppe* was still the only component of JG 4 in existence at this time.

9

Bf 109E-7 'Black Double Chevron' of Hauptmann Günther Scholz, Gruppenkommandeur III./JG 5, Petsamo/Finland, September 1942

Spending much of his time astride and above the Arctic Circle, and thus somewhat isolated from the major ground battles along the main fronts, JG 5 nonetheless produced five 100+ *Experten*. Although Günther Scholz was not one of them - his score climbing little higher than the 30 depicted here - he did end the war as *Kommodore* of the *Geschwader* (while at the same time serving as *Jafü Norwegen*). Note III. *Gruppe*'s badge (a Lapland fur boat on a Finnish cross) and Scholz's personal emblem - a cute young lady baring the same part of her anatomy as Götz von Berlichingen!

10

Bf 109G-2 'Yellow 12' of Oberleutnant Heinrich Ehrler, Staffelfkapitän 6./JG 5, Petsamo/Finland, March 1943

Most successful of the Arctic's 'Big Five' was Heinrich Ehrler. References to his final score vary between 201 and 220. To provide a camouflage scheme more suited to the terrain over which it was operating, Ehrler's early *Gustav* has been given a coat of washable white paint (including the fuselage cross), to which large irregular patches of dark green have been added. Note the 77 Soviet kills that have been carefully recorded on the rudder.

11

Bf 109G-2 'White 4' of Oberleutnant Theodor Weissenberger, Staffelfkapitän 7./JG 5, Petsamo/Finland, July 1943

Like Ehrler, Weissenberger also scored over 200 victories, but 'only' 175 of these were claimed in the east. His G-2 is seen here in the same standard grey finish which is hidden by the temporary winter camouflage of 'Yellow 12' (above). His rudder, too, displays a meticulous Scoreboard - a Knight's Cross garlanded with oak leaves and surmounted by an eagle to denote his century, plus 12 individual kill bars below. The last five of these were a brace of Airacobras and a trio of Pe-2s all claimed on 25 July 1943. They would bring him the Oak Leaves proper eight days later.

12

Bf 109E-7 'Yellow V' of Oberleutnant Erbo Graf von Kageneck, Staffelfkapitän 9./JG 27, Solzy, August 1941

Although JG 27 did not remain in the east long enough for its pilots to rack up huge scores, several of its members enjoyed considerable success in the opening phases of *Barbarossa*. One such was Erbo Graf von Kageneck, who claimed 48 Soviet kills between June and October 1941 - 27 of them are recorded here, along with 18 earlier western victories. Note the lack of a III. *Gruppe* vertical bar, III./JG 27's unique practice of displaying its aircraft's individual numbers on the engine cowling (a custom introduced during its time as the original I./JG 1) presumably being deemed sufficient for purposes of n-Gesc/wader identification.

13

Bf 109F-4 'Black Chevron and Bars' of Major Karl-Gottfried Nordmann, Geschwaderkommodore JG 51 'Mölders', Shatalovka, Summer 1942

Bearing standard finish plus a textbook set of eastern front markings and /Commodore's insignia, this *Friedrich* is otherwise devoid of any form of unit or personal badge. It is, in fact, the mount of Major Karl-Gottfried Nordmann, who commanded JG 51 from April 1942 to March 1944. Nordmann had added 69 Soviet kills to his earlier tally of nine western victories by the time his involvement in a mid-air collision on 17 January 1943 ended his frontline career.

14

Bf 109G-6 'White 9' of Leutnant Günther Josten, 1./JG 51 'Mölders', Bobruisk, Spring 1944

After having re-equipped with Fw 190s towards the end of 1942, JG 51 converted back on to the Bf 109 early in 1944. Despite being seen here with a ventral bomb-rack, this anonymous *Gustav* was flown by one of the *Geschwader*'s foremost *Experten*, For as well as carrying out some 80 fighter-bomber sorties, Günther Josten claimed 178 aerial victories in the east. This total included more than 60 *Stormoviks*, plus one Eighth Air Force B-17 (downed on a supply-dropping mission to Warsaw on 18 September 1944).

15

Bf 109F 'Yellow 7' of Oberleutnant Heinrich Krafft, Staffelfkapitän 8./JG 51 'Mölders', Stolzy, March 1942

This winter-camouflaged *Friedrich* displays on its rudder the 46 victories (all but four scored in the east) which won the Knight's Cross for its pilot on 18 March 1942. 'Gaud'/Krafft would be promoted to *Kommandeur* of I. *Gruppe* on 1 June, and had taken his overall total to 78 before being brought down by Soviet anti-aircraft fire on 14 December 1942.

16

Bf 109F 'Black Double Chevron' of Hauptmann Josef Fözö, Gruppenkommandeur of II./JG 51, Stara-Bychov, July 1941

Austrian-born Fözö had already claimed three 1-16s, during his time with the *Condor Legion*, and 18 western victories before JG 51 was transferred to the east. There, however, two serious injuries - one as *Kommandeur* of II./JG 51, and the second when commanding I. *Gruppe* - severely curtailed his operational career. This *Friedrich* displays two points of interest. The white silhouette on the first kill bar represents a French observation balloon shot down on 13 March 1940. This profile also shows that II./JG 51 had by now discontinued its earlier practice of positioning the *Gruppe* badge on the aft fuselage in lieu of the regulation horizontal bar (see examples in *Aircraft of the Aces 11*, pages 33 and 58). Although the bar is now in evidence, the *Gruppe* - still non-conformist - have wedged it between Fözö's *Kommandeur* chevrons and the fuselage cross.

17

Bf 109G-2 'Yellow 5' of Feldwebel Anton Hafner, 6./JG 51 'Mölders', Orei-North, August 1942

One of II./JG 51 's early *Gustavs* also illustrates the unit's unique custom of wearing its horizontal *Gruppe* bar ahead of

both the fuselage cross and the individual aircraft number. Having already gained his first 62 Soviet victories, the pilot of this machine, Feldwebel - later Oberleutnant - Anton Hafner, would emerge as JG 51 's highest scorer with a final total of 204 kills before his own death in action against a Yak-9 over East Prussia on 17 October 1944 when *Staffelkapitän* of 8./JG 51. It should be borne in mind, however, that part of Hafner's double century had been scored in the Mediterranean, and while flying the Fw 190 upon his return to Russia.

18

Bf 109F-4 'Red 12' of Oberfeldwebel Heinz Klöpfer, 11./JG 51 'Mölders', Dugino, September 1942

Another of JG 51 's highly successful NCO pilots whose aircraft displayed both an unusual *Gruppe* marking and an impressive Scoreboard was 11. *Staffe*'s Heinz Klöpfer. The 65 kill bars on the rudder earned him the Knight's Cross on 4 September 1942. The smaller, simplified cross behind the fuselage *Balkenkreuz* was an uncommon, but not unique, method of identifying a IV. *Gruppe* machine. Klöpfer would claim a total of 86 Soviet kills before his promotion to Oberleutnant and transfer to the west as *Staffelkapitän* of 7./JG 1.

19

Bf 109G-6 'Black Double Chevron' of Hauptmann Gerhard Barkhorn, *Gruppenkommandeur* I./JG 52, Kharkov-South, August 1943

There is little to distinguish this standard, and rather plain, Gustav other than the name below the cockpit. 'Christi' was the wife of Gerhard Barkhorn, the second most successful fighter pilot in the history of aerial warfare. At this stage the *Kommandeur* of I. *Gruppe* was already well on the way to his double century. He would survive the war with a staggering final total of 301 kills, all scored on the eastern front.

20

Bf 109G-6 'Red 4' of Oberfeldwebel Rudolf Trenkel, 2./JG 52, Poltava, July 1943

One of Barkhorn's high-scoring, but relatively little known, NCO pilots was Rudolf Trenkel of 2. *Staffel*. This *Gustav*, which Trenkel was flying at the time of *Zitadelle*, was even more anonymous than the *Kommandeur*'s machine above, and is completely lacking any unit or personal markings. Such caution was not merely a matter of denying intelligence to the enemy. Many pilots were by now wary of disclosing their identities and successes in case they were forced down behind enemy lines. In fact Trenkel would survive unscathed (despite having to bail out five times in one ten-day period), and would end the war as *Kapitän* of 2./JG 52 with a total of 138 victories.

21

Bf 109G-2 'Black Double Chevron' of Hauptmann Johannes Steinhoff, *Gruppenkommandeur* II./JG 52, Rostov, August 1942

Although giving nothing away intelligence-wise, 'Mack!' Steinhoff's G-2 presents a more interesting appearance with its three-colour spinner, densely dappled engine cowling and obvious signs of overpainting on its rear fuselage. Another of JG 52's solid core of 100+ *Experten*, Johannes Steinhoff

amassed 148 victories in the east before transferring to the Mediterranean and thence to the Reich. He was seriously burned on 18 April 1945 when his *Me* 262 crashed on take-off, but survived his injuries to head the post-war German air force.

22

Bf 109G-6 'White V' of Hauptmann Erich Hartmann, *Staffelkapitän* 4./JG 52, Budaörs/Hungary, November 1944

One pilot who positively advertised his presence in the air was the one known to the Russians as the 'Black Devil of the South'. This is the late model G-6 flown by Erich Hartmann after he relinquished his year-long command of 9. *Staffel* to set up a new 4./JG 52 in October 1944. Although the machine retains the distinctive black 'tulip-leaf' which was Hartmann's individual marking, the 'Karaya' *Staffel*'s famous 'pierced heart'¹ emblem below the cockpit is now a plain red heart bearing the name 'Usci/i' (for Ursula, whom Hartmann had married two months previously). Note, however, there is no record of Hartmann's current score, which by this time was well above the 300 mark.

23

Bf 109G-4 'Black 12' of Leutnant Peter Duttmann, 5./JG 52, Anapa, May 1943

Back to 1943 and anonymity for this earlier *Gustav*, which was flown over the Kuban bridgehead by the newly-arrived Leutnant Peter Duttmann. In his two years at the front 'Bonifaz' Duttmann was shot down, or was forced to land, no fewer than 19 times. But he gave as good as he got, however, claiming nine kills in one day alone on 7 May 1944. He ended the war as *Staffelkapitän* of 5./JG 52 with a total of 150 aerial victories (and two tanks destroyed, which were counted as kills in 1945), plus a further 42 unconfirmed

24

Bf 109G-2 'Yellow 5' of Leutnant Walter Krupinski, 6./JG 52, Armavir, August 1942

Still sporting the now seldom seen 'Winged sword' badge of JG 52 beneath the windscreen, 'Yellow 5' was the mount of Walter 'Graf Punski' Krupinski, who was to be a major influence on the early career of one Erich Hartmann. After a year serving as *Staffelkapitän* of 7./JG 52, Krupinski himself was transferred to the west where he commanded, in turn, 1./JG 5, II./JG 11 and III./JG 26, before ending the war flying *Me* 262s with JV 44. His eastern front victories totalled 177.

25

Bf 109G-4 'Yellow 3' of Unteroffizier Hans Waldmann, 6./JG 52, Anapa, June 1943

Another of JG 52's successful young NCOs, 'Dackel' Waldmann had already scored 53 kills in the nine months up to June 1943. By the end of May 1944 his final eastern front total had reached 125. He, too, transferred to the west and later converted on to the *Me* 262, but was killed in a mid-air collision in the closing weeks of the war when serving as *Staffelkapitän* of 3./JG 7. This particular G-4 is apparently a new delivery, hence the areas of fresh paint covering the four-letter code applied at the factory. Note also the small dimensions of the individual aircraft number common to the

Gruppe's aircraft at this period. The personal emblem is a play on the pilot's nickname, 'Waldmann' ('Woodsmen') also being a favourite name for a pet Dackel, or dachshund.

26

Bf 109G-6 'Yellow 3' of Leutnant Heinz Ewald, 6./JG 52, Zilistea/Rumania, June 1944

Reflecting II./JG 52's brief period of service in the specialised anti-bomber role defending the Rumanian oilfields against high-flying US 'heavies', this G-6 *'Kanonboot'*(Gunboat) is equipped with 20 mm underwing cannon gondolas and sports a spiral spinner (widely believed to throw off the aim of the enemy bombers' gunners). It also bears another word-play personal emblem, Heinz Ewald's nickname being 'Esau' CE-sow! Like Waldmann, Ewald also flew many missions as Barkhorn's wingman before he assumed command of 7./JG 52 in February 1945. His score at the war's end stood at 84.

27

Bf 109G-2 'Black 13' of Oberleutnant Günther Rail, Staffelkapitän 8./JG 52, Gostanovka, August 1942

The third of JG 52's triumvirate of top scorers, Oberleutnant Günther Rail flew this 'Black 13' upon his return to the command of 8. *Staffel* on 28 August 1942, exactly nine months to the day after being severely wounded the previous November. At that time he had claimed just 36 kills. He would add 235 more Soviet victories to his score (latterly as *Kommandeur* of III./JG 52) before his transfer to the west in the spring of 1944. Note III. *Gruppe's* 'Barbed cross' badge forward of the windshield, and wavy bar symbol on the aft fuselage.

28

Bf 109G-2 'Yellow 11' of Oberleutnant Hermann Graf, Staffelkapitän 9./JG 52, Pitomnik, September 1942

The same *Gruppe* badge adorns the Gustav of fellow-*Staffelkapitan* Hermann Graf. But this machine also carries 9./JG 52's famous 'Pierced heart' emblem, albeit without the word 'Karaya' - the *Staffel's* equally celebrated radio call-sign - beneath it. As with most of the 'Karaya' *Staffel's* machines, the red heart has a girl's name (E///?) superimposed on it in tiny white letters. Graf reportedly scored his 150th kill in this aircraft on 4 September. After service in the west (where he claimed ten US 'heavies') Graf returned to JG 52 in October 1944, this time as *Kommodore* - a position he held until the end. His final tally of Soviet kills numbered 202.

29

Bf 109G-6 'Yellow 1' of Leutnant Erich Hartmann, Staffelkapitän 9./JG 52, Novo-Zaporozhe, October 1943

The mount of the 'Karaya' *Staffel's* most famous *Kapitän*, Leutnant - later Oberleutnant - Erich Hartmann. The century motif and additional 21 individual victory bars date this as 2 October 1943 (on this day Hartmann claimed four kills - a brace of La-5s, a Pe-2 and an Airacobra). But he was still 27 victories - and 27 days - away from winning the Knight's Cross! Note that the distinctive 'tulip-leaf nose decoration has yet to put in an appearance, as has the name 'Ursel'-tor fiancée Ursula Paetsch - which would grace the pierced heart. For some reason the inscription worn on the *Staffel* emblem at this time reportedly read 'Dicker Max'('Fat Max')!

30

Bf 109F-2 'Black Chevron and Bars' of Major Günther Freiherr von Maltzahn, Geschwaderkommodore JG 53, Byelaya-Zerkov, July 1941

Although not a high scorer himself, 'Henri' von Maltzahn was one of the *Jagdwaaffe's* true leaders (a quality recognised by the award of the Knight's Cross back in December 1940, when his personal score stood at just 13 - a far cry from Hartmann's 148!). Here, the tail of his *Friedrich* displays all 20 of his western victories to date, plus the additional 22 Soviet kills which won him the Oak Leaves on 24 July 1941. He would end his three years as *Kommodore* of JG 53 with a final tally of 68 victories - 35 in the west and 33 in the east.

31

Bf 109F-2 'Black Chevron and Circle/Bar' of Leutnant Jürgen Harder, Gruppenstab III /JG 53, Sobolevo, June 1941

Bearing a single kill bar on the rudder for his first Soviet victim (an '1-17' claimed on the opening day of *Barbarossa*), Harder's F-2 also displays a heavily dappled cowling - the result of heavy-handed overspraying of the earlier Channel front yellow - and an unusual *Gruppenstab* symbol. It has been suggested that the latter denotes the combined duties of an adjutant and TO. One of three fighter-pilot brothers, none of whom would survive the war, the name below the cockpit commemorates the first brother to be killed in action - Hauptmann Harro Harder, *Gruppenkommandeur* of III./JG 53, who was shot down off the Isle of Wight on 12 August 1940. As *Kommodore* of JG 11, Jürgen Harder would lose his life in a crash near Berlin early in 1945. His final score of 64 included 17 eastern front victories.

32

Bf 109G-2 'White Chevron and Bars' of Major Hannes Trautloft, Geschwaderkommodore JG 54, Siverskaya, Summer 1942

Another celebrated fighter leader who put the welfare and success of his *Geschwader* before personal ambition, Hannes Trautloft's eastern front score of 45 was modest by some standards, but his contribution to JG 54 was incalculable. He flew at least three machines similarly (but not identically) marked to the example depicted here. All wore a non-standard segmented camouflage (of two-tone green, or tan and green) which accentuated the white *Kommodore's* insignia. Note, also, that the famous 'Green Heart' *Geschwader* badge features the crests of JG 54's three component *Gruppen* in miniature.

33

Bf 109F-2 'Black Chevron and Bars' of Hauptmann Hans Philipp, Gruppenkommandeur I./JG 54, Siverskaya, March 1942

Despite its *Major beim Stab* insignia, this rather worn winter-camouflaged *Friedrich* is the machine flown by Hans Philipp, *Kommandeur* of I. *Gruppe*, as he neared his century in the early months of 1942. He would be the fourth member of the *Jagdwaaffe* to reach the 100 mark (on 31 March 1942), and the second to achieve the double century (behind Hermann Graf) a little less than a year later on 17 March 1943. He transferred to the west as *Kommodore* of JG 1 shortly thereafter, only to

be killed in action against P-47s in October 1943. All but 29 of his 206 victories had been claimed in Russia.

34

Bf 109F 'White 8' of Leutnant Walter Nowotny, 1./JG 54, Ryelbitzi, Summer 1942

Also sporting the *Geschwader's* 'Green Heart' and the badge of I. *Gruppe*, 'White 8' was flown by 1. *Staffel's* Walter Nowotny. Although more properly associated with the Focke-Wulf Fw 190 (see *Osprey Aircraft of the Aces 6 - Fw 190 Aces of the Russian Front*), Nowotny's first half-century and more were scored on Bf 109s. The rudder of this *Friedrich* shows that he is already well on the way to his Knight's Cross, awarded on 4 September for 56 kills. Altogether, his final eastern front tally would be 255. Note, incidentally, that the green heart emblem has been embellished with Nowotny's personal 'lucky 13'.

35

Bf 109F 'Black 8' of Feldwebel Otto Kittel, 2./JG 54, Krasnogvardeisk, May 1942

Very similar to the aircraft in profile 34 (albeit minus the rudder Scoreboard), and also by chance a number '8', this machine was an early mount of the NCO pilot who was destined to become JG 54's highest scorer. Before his death in action in February 1945, the little-known Otto Kittel would be credited with no fewer than 267 Soviet kills. In fact, he was the fourth most successful eastern front *Experte* after JG 52's 'top three'. Although the vast majority of his claims were made on the Fw 190, Kittel - like Nowotny - cut his operational teeth on Bf 109s. It was, however, a long and laborious process. In the eight months leading up to May 1942 he had achieved just 15 victories.

36

Bf 109E 'Black Double Chevron' of Hauptmann Herbert Ihlefeld, Gruppenkommandeur I.(J)/LG 2, Jassy/Rumania, July 1941

With I./JG 77 operating semi-autonomously in northern Scandinavia (where it later formed the nucleus of I./JG 5), the vacant I. *Gruppe* slot in the parent JG 77 was long filled by I.(J)/LG 2. Here, the *Kommandeur's* Em7 displays both that *Gruppe's* badge - an elaborate 'L' (for Lehr) and a map of Great Britain (now somewhat out of place in Rumania) - plus 36 kill bars representing his western victories to date. To the latter a further ten Soviet kills have already been added. The fifth pilot to achieve the century (on 22 April 1942), Ihlefeld subsequently commanded various *Geschwader* in both east and west. His eastern front total was 67.

37

Bf 109F-4 'Black Double Chevron' of Hauptmann Anton Mader, Gruppenkommandeur II./JG 77, Stary Oskol, September 1942

Another *Kommandeur's* machine, this time of II. *Gruppe*, as witness the badge below the windscreen and horizontal bar aft of the fuselage cross. But no sign on that pristine (and rather unusual) white rudder of Mader's current tally of 62 Soviet kills. Like Ihlefeld, Mader would later command both eastern and western front *Jagdgeschwader*, ending the war with a combined total of 86 victories.

38

Bf 109F-4 'Black 5' of Oberleutnant Anton Hackl, Staffelkapitän 5./JG 77, Kastornoje, September 1942

No hesitation on the part of Anton Hackl, *Kapitän* of Mader's 5. *Staffel*, in proclaiming his score. All but the first four of the 117 kill bars carefully recorded on the rudder of this *Friedrich* are eastern front victories, the last two denoting a brace of I-2s downed on 18 September. 'Tom' Hackl was yet another alumnus of JG 77 who would go on to command various *Jagdgeschwader*. Some 130 out of his final total of 192 had been claimed in the east.

39

Bf 109G-2 'White Chevron/Yellow V' of Hauptmann Kurt Ubben, Gruppenkommandeur III./JG 77, Lyuban, September 1942

A distinctly idiosyncratic set of markings adorn this early *Gustav* 'gunboat' - unusual *Kommandeur's* insignia (presumably indicating Ubben's position as No 1 in the *Stabskette*), a yellow theatre band centred on the fuselage cross (a custom more associated with JG 54) and no *Gruppe* symbol on the aft fuselage (III./JG 77 appear to have discarded their oversized 'wavy bar' at the end of the Balkans campaign). What remains is the *Gruppe's* 'Wolf's head' badge and a careful record of Ubben's 84 kills to date. In all, 'Kuddel' Ubben would claim 90 Soviet kills with JG 77 before assuming command of JG 2 in the west. He was killed in action over France in April 1944,

40

Bf 109F 'White T' of Oberleutnant Wolfdieter Huy, Staffelkapitän 7./JG 77, Lunga/Rumania, August 1941

Another slightly unusual, but not unique, positioning of the yellow theatre band, this time ahead of the fuselage cross. It was first introduced on III./JG 77's Bf 109s during the recent Balkans campaign. Huy's *Friedrich* also carries the *Gruppe* badge, but no aft fuselage symbol. The ship silhouettes on the rudder refer back to his anti-shipping activities off Greece and Crete. Since then he has been credited with a dozen Soviet kills. Huy would claim 37 victories in the east before III./JG 77 transferred back to the Mediterranean area, where he was shot down and captured on 29 October 1942.

THE ROAD TO DISASTER

The counter-attack on the outskirts of Moscow was not the only surprise the Soviets had in store for the ill-prepared German army.

On 9 January 1942 Russian forces launched a second counter-offensive. This thrust was aimed at the boundary between the central and northern sectors. A breach some 60 miles (100 km) wide was soon driven between the two German fronts. This posed a serious threat to the rear of the German units encircling Leningrad to the north, who were now themselves in danger of being surrounded and cut off.

Much of JG 54's activity during 1942 was therefore governed by the twin needs to keep up their own pressure on beleaguered Leningrad while, at the same time, alleviating the Soviet pressure in the Lake Ilmen area at their backs.

In February alone, despite their now being outnumbered, the pilots of JG 54 claimed 201 kills for the loss of 18 of their own. Their successes were recognised by a clutch of awards. On 10 March Oberleutnant Max-Hellmuth Ostermann, *Staffelkapitän* of 7./JG 54, received the Oak Leaves for 62 victories, and two days later Hauptmann Hans Philipp, who had recently assumed command of I. *Gruppe*, became the first member of the *Geschwader* to be awarded the Swords (for 82 victories). On 31 March 'Pips' Philipp scored his century. But it fell to the relatively inexperienced Oberfeldwebel Rudolf Klemm of 8. *Staffel* to claim JG 54's 2000th kill of the war on 4 April.

It would take the *Geschwader* just over five months to add the next 1000 enemy aircraft to its collective Scoreboard, although this figure was not achieved without cost. Among the summer's lengthening casualty lists was the *Kapitän* of 7. *Staffel*, Oberleutnant Max-Hellmuth Ostermann. Having been awarded the Swords on 17 May for reaching his century, he would add just two more to that total before falling victim to nine Soviet fighters over the Lake Ilmen front on 9 August.

Twenty-four hours later Hauptmann Karl Sattig, *Staffelkapitän* of 6./JG 54, was also brought down during a dogfight. Sattig was honoured with a posthumous Knight's Cross the following month. He had claimed 53 victories in the east, two of them by night.

The latter were the direct result of an initiative by the *Geschwaderkommandoreback*. at the beginning of the year. Hannes Trautloft had proposed that selected pilots should take off on bright moonlit nights and circle low over the snowy landscape of the Volkhov front north of Lake Ilmen ready to pounce on unwary Soviet bombers. These first nightfighter sorties of the war in the east soon began to pay dividends.

Between mid-January and the end of July 1942, JG 54 Bf 109s shot down 56 enemy aircraft during the hours of darkness. The most successful of the pilots taking part in Trautloft's 'experiment' was

I laupmann Reinhard 'Seppl' Seiler, *Kommandeur* of III. Gruppe, whose final tally of 96 eastern front victories included 16 night kills during this period. Second came Oberleutnant Günther Fink with nine. But the greatest single achievement was that claimed by Leutnant Erwin Leykauf, for six of his eight nocturnal victories were Russian transports - all downed on the night of 22 June, and all in the space of just one hour!

By day the *Geschwader's* tally of victories had continued to rise steadily despite the approach of autumn. Two recent Knight's Cross recipients, Leutnant Hans Beisswenger, *Staffelkapitän* of 6./JG 54, and Oberfeldwebel Max Stotz, had both gone on to double their scores in little more than four months to reach a century apiece. Each was awarded the Oak Leaves, Beisswenger on 30 September and Stotz exactly a month later.

On the other side of the coin there were those who were finding it more difficult to make their mark. Men such as Horst Ademeit, for example, who had joined JG 54 as an Unteroffizier in 1940, and then taken nearly two years to claim his first 20 kills. Another NCO pilot, Feldwebel Otto Kittel, had even fewer with just 15. Yet both these slow starters were also destined to achieve high scores.

In fact Beisswenger, Stotz, Ademeit and Kittel would all share a remarkably similar fate, joining the ranks of the eastern front's top scorers, each with a total of more than 150 Soviet aircraft destroyed, before they themselves were killed or posted missing. These events were to take place after JG 54 had converted to the Fw 190, however (see *Osprey Aircraft of the Aces 6- Fw 190 Aces of the Russian Front* for further details).

The first *Staffeln* began to re-equip with the radial-engined Focke-Wulfs in February 1943, and almost as if to commemorate the passing of their trusty Bf 109s, Feldwebel Otto Kittel claimed JG 54's 4000th victory of the war on 19 February.

Forty-eight hours later II. Gruppe lost their *Kommandeur*. Major Hans Hahn - nicknamed 'Assi', and not to be confused with I./JG 3's Hans von Hahn — had been a long-time member of JG 2, and one of the Channel front's leading *Experten* with 68 western kills to his credit. He had moved east to take command of II./JG 54 on 1 November 1942 after the previous *Kommandeur*, Major Dieter Hrabak, had assumed the leadership of JG 52.

On 26 January 1943 Hans Hahn claimed his 100th victory (the same day, incidentally, that Max Stotz got his 150th). In just under a month he accounted for eight more Soviet aircraft, but then on 21 February engine failure brought him down behind enemy lines south of Lake Ilmen. A popular figure known throughout the *Jagdwaaffe* for his natural ebullience, 'Assi' Hahn also possessed great inner strength, as he was to demonstrate during seven long years of Soviet captivity.

On the central sector during the early weeks of 1942 JG 51 had likewise to focus its attentions and energies in two different directions - towards the Soviets pushing westwards from Moscow, and against the counter-offensive simultaneously threatening *Heeresgruppe Mitte* Heft flank.

The reappearance in numbers of the Red Air Force afforded JG 51's pilots ample opportunity to add to their growing scores. This in turn led to a number of decorations. Among the first of these was the Swords awarded to Hauptmann Heinz Bär on 16 February for 90 victories. 'Pritzl' Bär was another of the *Jagdwaaffe*'s true characters. He had been

Wearing his recently-awarded Swords, Heinz 'Prfz/Bär' (in peaked cap) poses with three of I./JG 51's then leading *Experten*. They are, from left to right, Leutnant Heinrich Höfemeier (96 victories, killed in action on 7 August 1943), Leutnant Erwin Fleig (66 victories, PoW on 29 May 1942), Bär and Oberleutnant Heinrich Krafft (78 victories, missing in action on 14 December 1942)



Staffelkapitän of 12./JG 51 since July 1941. Subsequently serving as *Kommodore* of both JGs 1 and 3, he ended the war flying the Me 262 jet (see *Osprey Aircraft of the Aces 17 - German Jet Aces of World War 2* for further details). His final total of 220 kills included 96 claimed during his time on the eastern front.

On 18 March Oberleutnant Heinrich Krafft and Leutnant Hans Strelow both received the Knight's Cross, for 46 and 52 victories respectively. Six days (and 14 kills) later, Strelow was awarded the Oak Leaves. Just two days short of his 20th birthday, Hans Strelow was then the youngest wearer of the Oak Leaves in the entire *Wehrmacht*, but before the year was out both Krafft and Strelow had forced-landed behind enemy lines. 'Gaudi' Krafft was beaten to death by Russian soldiers, and Hans Strelow reportedly shot himself rather than suffer the same fate.

On 9 April Oberstleutnant Friedrich Beckh, who had succeeded Werner Mölders as *Kommodore* of JG 51, was promoted to a staff position in the RLM. 'Vati' Mölders would have been a difficult act for any commanding officer to follow, but Beckh was a distant and not particularly popular figure. Indeed, a number of pilots apparently did not even know that he had joined the *Geschwaderstab* back in 1940, believing he had been brought in from outside to take over JG 51!

Beckh's successor, the erstwhile *Kommandeur* of IV. *Gruppe*, was an entirely different type. Already sporting the Oak Leaves, Major Karl-Gottfried Nordmann soon stamped his personality on the *Geschwader*. One of the measures he took was to release 2./JG 51 from its predominantly fighter-bomber role - this *Staffel* had been flying mainly *Jabo* sorties since the beginning of *Barbarossa*.

Relieved of this chore, its pilots' scores rose dramatically, and none more so than that of Oberfeldwebel Joachim Brendel. Having been credited with his first kill in the early days of the campaign in the east, Brendel took a further nine months to claim a second. By war's end Hauptmann Joachim Brendel, *Kommandeur* of I./JG 51, and winner of the Knight's Cross and Oak Leaves, had emerged as the *Geschwader's* highest scorer on the eastern front with 189 Soviet aircraft destroyed - including over 90 heavily-armoured Ilyushin *Stormoviks*.

Despite there being something of a lull over JG 51's areas of operations during April and May, the *Geschwader* still suffered a number of



'Gaudi' (literally 'Fun and games') Krafft - seen in the photograph at the top of this page - had won his Knight's Cross on 18 March 1942. On the same day 5. *Staffel's* Leutnant Hans Strelow (right) had also been presented with the award during a visit to Bryansk by the new *General der Jagdflieger*, Adolf Galland. The latter appears to be taking no chances with the still bitter Russian winter! Strelow and Krafft shared a similar fate. Both would perish - albeit under very different circumstances - after forced-landing behind Soviet lines



Judging by the guilty smile. Major Karl-Gottfried Nordmann, *Kommodore* of JG 51 'Mulders', is seen here carrying out a well-known pre-op ritual. But has he really been caught on camera in the act of watering the tailwheel - or is that small puddle behind the object in question the last vestige of winter's snow?

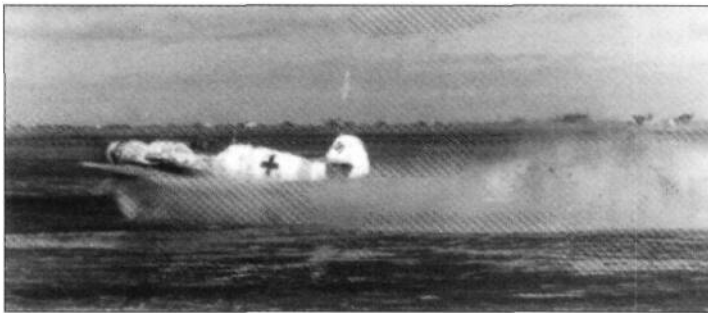

Little doubt here that this is the spring thaw proper as a Bf 109, still in winter camouflage, mashes its way across a waterlogged field



Mother Russia is nothing if not resilient and by the summer of 1942 the Luftwaffe's airfields were once again a riot of colour as the wild flowers bloomed. 7./JG 51's 'White 10' enjoys the lull before the coming storm

casualties. On 29 May - exactly a week after the disappearance of Hans Strelow - Leutnant Erwin Fleig, *Staffelkapitän* of 2./JG 51 and 66-victory *Experte*, bailed out over enemy territory and was taken prisoner.

Forty-eight hours later another Knight's Cross holder was lost when the *Kommandeur* of II. *Gruppe*, Hauptmann Josef Fözö, was badly injured in a take-off accident. Ex-Austrian air force and a *Condor Legion* veteran, Fözö would not return to combat flying. Earlier in May Oberleutnant Bernd Gallowitsch, who had since added 22 more kills to the 42 which had earned him the Knight's Cross on 24 February, had also been seriously injured. Unlike Fözö, he would return to operations, flying the He 162 with JG 1 during the final weeks of the war.

Pictured here as an Unteroffizier at the time of the award of his Knight's Cross (for 42 kills) back in October 1941 - hence the fetching fur headgear - Oberfeldwebel Franz-Josef Beerenbrock was the first member of JG 51 to surpass Mulders' century



In July the skies over the central sector flared into life again as the Soviets prepared for a new offensive. For a brief period the *Geschwader* scoring rate rose to a level approaching that enjoyed in the opening phases of *Barbarossa*.

On 5 July Hauptmann Hartmann Grasser's II./JG 51 claimed 46 victories, the *Kommandeur* himself being credited with eight of them. Two of his pilots, Oberleutnant Karl-Heinz Schnell and Feldwebel Anton Hafner, accounted for seven each. The latter pilot was awarded the Knight's Cross on 23 August, for 60 kills, and would subsequently become JG 51's highest scorer of all with a total of 204 enemy aircraft destroyed before being killed in action in 1944.

Hauptmann Richard Leppla, *Kommandeur* of III./JG 51, was severely wounded in combat on 2 August 1942. Despite losing the vision in one eye, he endeavoured to remain operational, only to collide with a landing Ju 52 five days later. After hospitalisation, Leppla commanded various training units before being appointed *Kommodore* of JG 6 in mid-April 1945



On 2 August Oberfeldwebel Franz-Josef Beerenbrock of IV./JG 51 downed nine Soviet aircraft, taking his score to 102. He thus became the first pilot within the *Geschwader* to surpass Werner Mölders' century, and it earned him the Oak Leaves the following day.

A Ju 87D of StG 2 'Immelmann' enjoys a close escort from one of I./JG 51's *Friedrichs* during the late summer of 1942 shortly before the *Gruppe* began to re-equip with the Fw 190

But losses were continuing to rise too. Among August's 16 casualties were Hauptmann Richard Leppla, *Kommandeur* of III. *Gruppe*, who was seriously wounded (but who would return to frontline service for the last three weeks of the war as *Kommodore* of JG 6), and three *Staffelkapitäne*.





The introduction into service of upgraded versions of the 'new generation' Soviet fighters, and the employment of improved tactics by their pilots, were beginning to erode the *Jagdwaaffe's* hitherto undisputed superiority. But JG 51 was also about to receive new aircraft. Early in September I./JG 51 was withdrawn from the front to begin conversion on to the Fw 190. Other *Gruppen* followed in short order.

In the far north the new JG 5 was also tasked with Stuka escort duties. A solitary Bf 109 waits in the foreground as a *Staffel* of Ju 87s run up their engines preparatory to a massed take-off

The Messerschmitt Bf 109 may have been disappearing from the ranks of JGs 51 and 54 on the central and northern sectors, but elsewhere on the eastern front it was still the mainstay of the German fighter force.

Early in 1942 a completely *new Jagdgeschwader* was formed in the far north. Made up of previously autonomous *Gruppen*, JG 5 was somewhat unusual in that it was deployed to combat both western and eastern opponents. While two of its *Gruppen* were stationed in central and southern Norway to guard against RAF incursions from across the North Sea, II. and III./JG 5 were based in northern Norway and Finland facing the Soviet Air Force.

Operating astride and above the Arctic Circle, the pilots of the two latter *Gruppen* fought an isolated, almost self-contained war. Their tasks included bomber- and Stuka-escort missions against the Russian port of Murmansk and the strategically vital railway line linking it to the south, as well as the defence of the Wehrmacht's own northernmost bases and lines of supply.

Heavily outnumbered from the outset, JG 5 nevertheless produced some of the highest scorers of the eastern front. Foremost amongst them was Leutnant, later Major, Heinrich Ehrler.



JG 5 had their own ideas about suitable camouflage for the Arctic theatre. This *Friedrich of IV. Gruppe* (note the small solid circle behind the fuselage cross) displays a favourite scheme consisting of a light wave-mirror 'scribble' over all upper surfaces

Arctic *Experte* Oberleutnant Walter Schuck of 7./JG 5 returns to Petsamo, zooming in low, wings wagging, to indicate to those watching below that he has just claimed another victory to add to his lengthening list of kills



Third in JG 5's trio of top scorers was *ex-Zerstörer* pilot Oberleutnant Theodor Weissenberger, *Kapitän* of 7. *Staffel*, who is pictured here wearing the Oak Leaves awarded on 2 August 1943 for 112 enemy aircraft destroyed . . .

. . . and a close-up of the rudder of Weissenberger's *Gustav* when his score had risen to 131 (a minor mystery here - a record of Weissenberger's victories lists kill no 131 as the second of a trio of Yak-9s all downed within the space of three minutes south of Luga on the afternoon of 16 February 1944, so why not 132 kill bars?). Compare this machine's camouflage scheme and elaborate rudder decoration with his earlier G-2 depicted in colour profile 11



Initially a member of the flak arm, Ehrler retrained as a fighter pilot in 1940. Rising through the ranks of JG 5, he commanded both the highly successful 6. *Staffel*, and then III. *Gruppe*, before being appointed *Geschwaderkommodore* in May 1944. References quoting his final tally of kills vary between 200 and 220. Despite having been awarded the Oak Leaves - on 2 August 1943 for 112 victories - and being nominated for the Swords, Major Ehrler left JG 5 under something of a cloud after being held officially responsible for the Luftwaffe's failure to protect the battleship *Tirpitz* from the RAF bombing raid which sank her in Norway's Tromsø Fjord on 12 November 1944.

Although sentenced by court-martial to three years' imprisonment (to commence after the 'final victory'), Heinrich Ehrler retrained yet again, this time on to the Me 262 jet fighter. Serving with JG 7, he was killed in action on 6 April 1945 - by deliberately ramming a B-17, according to some reports.

Two other Oak Leaves winners from JG 5 went on to fly the Me 262 with JG 7. Oberleutnant Walter Schuck's eastern front total fell just two short of 200, while Hauptmann Theodor Weissenberger claimed 175

Although not a high scorer himself (his final tally was 56), Oberleutnant - later Major - Horst Carganico was another of the *Jagdwaaffe's* natural leaders. He commanded, in turn, the original *Jagdstaffel* Kirkenes (ex-1./JG 77, later 1./JGrzbV), 6./JG 5 and then II. and I./JG 5. Revealing a closer affinity to the art of Walt Disney, rather than the designs of ancient heraldry, his cowling is here embellished with a miniature Mickey Mouse .. .

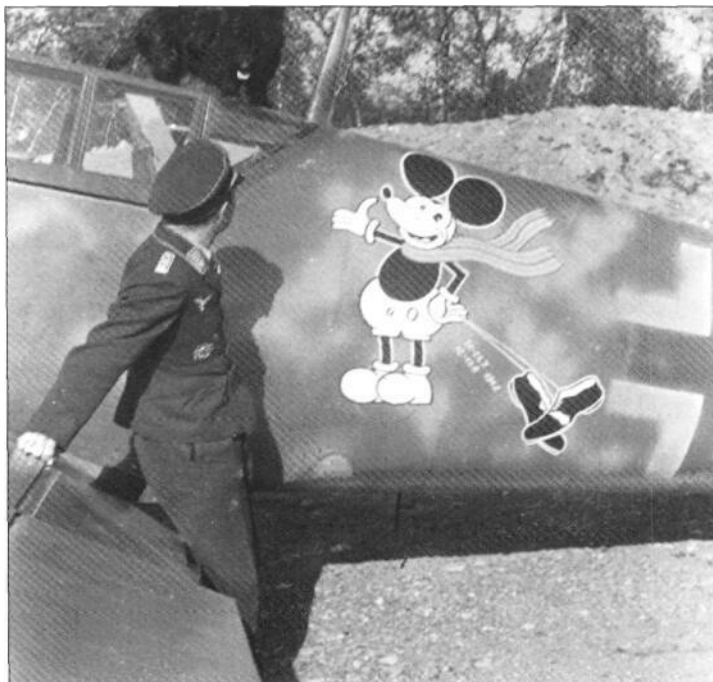

... which was later to grow somewhat in size! The extra pair of shoes, and the dates close alongside (22-23 July and 12-13 August 1942), refer to occasions when Carganico forced-landed and had to return to base on foot. His pet scottie, perched on the cockpit roof, had provided the inspiration for an earlier personal emblem when he was *Kapitän* of 1./JG 77. Major Carganico was killed in France on D-Day+10

Soviet aircraft, latterly as *Kommandeur* of II./JG 5, before assuming command of I. *Gruppe* in the west immediately prior to D-Day. Unlike Ehrler, both Schuck and Weissenberger survived the war. Coincidentally, each was credited with eight jet victories while serving with JG 7.

More than a dozen members of JG 5 received the Knight's Cross. Although not the first to be so honoured, Feldwebel Rudolf 'Rudi' Müller emerged as one of the *Geschwader's* first true 'Experten', downing five Red Air Force Hurricanes over the Kola Inlet on 23 April 1942. Twelve months later, almost to the day, he was himself shot down in the same area - by then his score stood at 94. Forced-landing on a frozen lake close to Murmansk, Rudolf Müller died in post-war Soviet captivity.

Like Müller, Oberfeldwebel Jakob Norz was another high-scoring NCO belonging to 6. *Staffel*. His final total of 117 included 12 Soviet aircraft downed in a single day. Later commissioned, Leutnant 'Jockey' Norz lost his life when he crashed in northern Norway following engine failure.

Spectacular as some of these individual Arctic successes undoubtedly were, the main focus of attention in 1942 was fixed on the

southern sector of the front. This was to be the scene of the Wehrmacht's major summer offensive. *Fall Blau* (*Case Blue*) was launched on 28 June along a front stretching some 500 miles (800 km) from Kursk down to the Sea of Azov. Its initial objectives were quickly reached, and within days Hitler had expanded *Blau* into *Braunschweig* (*Brunswick*).

This new, more ambitious operation had twin aims - the seizure of both Stalingrad, an important industrial and communications centre on the River Volga, and the rich oilfields of the Caucasus. This meant, however, that the two armies involved had to proceed along dangerously diverging lines of advance until, finally, a yawning 185-mile (300-km) gap had opened up between 6. *Armee* in Stalingrad and 17. *Armee* on the Caucasus front. Furthermore, for the first time since the campaign in Poland, the German ground forces were lacking the one essential ingredient to a successful *Blitzkrieg*—overwhelming air support.

Back to the spring of 1942 and the southern sector for these four shots, illustrating the aftermath of a spectacular synchronised somersault. Coming in to land side-by-side at Otozeni, near Kharkov, on 5 May 1942, these two pilots of III./JG 77 failed to spot that part of the field was waterlogged. The result was a simultaneous nose-over, with both machines ending up on their backs



A closer look at one of the hapless *Friedrichs* ('Yellow 5'), wheels in the air and cockpit partially open



It is estimated that the Luftwaffe units deployed on the southern sector at this time amounted to only a quarter of the strength required to properly cover *Braunschweig's* two-pronged offensive. Combined with the growing numbers of Soviet aircraft appearing in the area, it was a recipe for disaster.

Having remained responsible for the southernmost part of the front, including the Black Sea coast and the Crimea, throughout the winter and spring of 1942, JG 77's component *Gruppen* began to be dispersed within days of the launch of the summer offensive. This seemingly inexplicable move, weakening yet further the *Jagdwaffe's* already inadequate presence in southern Russia, serves to illustrate just how overstretched Germany's fighter forces were becoming.

Early in July I./JG 77 was transferred to the Mediterranean. At the same time Hauptmann Anton Mader's II. *Gruppe* moved to the region north of Kharkov to support the left flank of the 6. *Armee* as it set out on its fateful drive on Stalingrad. Having completed its re-equipment with Bf 109G-2s in August, III./JG 77 deployed even

Fortunately both pilots were able to escape unharmed, suffering nothing worse than a ducking





With his boots and socks laid out to dry in the gun troughs of a neighbouring machine, at least one of the pair was able to retrieve his *Jabuko* (fighter pilot's overnight case) from his own overturned aircraft and change into dry underclothes!

further northwards in September adding its weight to the continuing pressure on Leningrad. The following month II. and III. *Gruppen* were withdrawn from Russia altogether to join I./JG 77 in North Africa.

During their final four months on the eastern front II. and III./JG 77 had been credited with some 775 Soviet aircraft destroyed between them. Over a quarter of this total had been claimed by just four pilots, all of whom were members of II. *Gruppe*, and included the three *Staffelkapitäne*.

Hauptmann Heinrich Setz, *Kapitän* of 4./JG 77, was the only one of the four to have been awarded the Knight's Cross prior to the launch of *Braunschweig*. Yet all would be sporting the Oak Leaves before leaving for North Africa, for



In August 1942 III./JG 77 exchanged its Bf 109Fs for early model *Gustavs*. The pilot to the right in front of this G-2 '*Kanonenboot*' (Gunboat), pictured on the Leningrad front in September, is future *Experte* and Knight's Cross winner Oberfeldwebel Johann Pichler. Note III. *Gruppe*'s 'Wolf's head' badge



Hauptmann Heinrich Setz, *Staffelkapitän* of 4./JG 77, was already wearing the Oak Leaves when he downed a brace of Yak-1s on 24 July 1942 to take his total to exactly 100. The newly fledged 'centurion' clammers from the cockpit of his *Friedrich*. This time the badge on prominent display is the 'Sea eagle's head' of II. *Gruppe*

each had added 50 or more kills to his individual score to take it above the century mark.

Setz's 54 victories in these closing weeks had raised his eastern front total to 132. Oberleutnant Erwin Clausen, 6./JG 77's *Staffelkapitän*, scored 63 between July and September, which took his tally of Soviet victories to 114. Both Setz and Clausen would be killed in action in the west the following year while serving as *Gruppenkommandeure* of JG 27 and I./JG 11 respectively.

The *Staffelkapitän* of 5./JG 77, Oberleutnant Anton 'Toni' Hackl, claimed 56 victories during this period and left Russia with 105 eastern front kills. Feldwebel Ernst-Wilhelm Reinert, a member of Setz's 4. *Staffel*, achieved similar results, his 50 victories raising his Soviet total to 103. Subsequently adding a considerable number of western kills to their scoreboards, and winning the Swords in the process, Hackl and Reinert both managed to survive the war - the former as *Kommodore* of JG 11 with a final total of 192, and the latter as *Kommandeur* of IV./JG 27 with 174.

The transfer of JG 77 meant that yet another *Jagdgeschwader* had departed the Russian scene. But one *Jagdgruppe* which had left earlier for the Mediterranean was brought back in the later spring of 1942 to help bolster the *Jagdwaaffe's* support of the coming summer offensive.

Between the end of May and the beginning of October I./JG 53 claimed an amazing 900+ victories as it, too, accompanied 6. *Armee's* advance on Stalingrad. And although many pilots added significantly to their individual totals during the *Gruppe's* temporary recall to the eastern front, once again there were four outstanding performances, which this time accounted for more than a third of all claims made.

Oberleutnant (later Hauptmann) Friedrich-Karl Müller, the *Staffelkapitän* of I./JG 53, had already been awarded the Knight's Cross (for 22 victories) in September 1941, and had since added a trio of Hurricanes over Malta. On the road to Stalingrad he amassed 76 more kills, culminating in a brace of Soviet aircraft downed on 19 September, which took his score to 101, and earned him the Oak Leaves.

Hard on Müller's heels came two others - 3./JG 53's *Staffelkapitän*, Oberleutnant Wolfgang Tonne, and his erstwhile wingman, Feldwebel Wilhelm Crinius, both of whom had claimed their 96th victim on that same 19 September. Each got another kill 24 hours later. Although no longer flying together as a *Rotte* (two-aircraft formation), officer and NCO agreed to try for simultaneous centuries the next day. But luck was not with them. Tonne managed just one victory, while Crinius claimed a double. Success came on 22 September, however, with Crinius getting one more for his hundred and Tonne's three taking his score to 101.

Tonne had originally arrived back in Russia in May with a mere 13 kills to his credit. He had added 41 more to win his Knight's Cross on 6 September, and now, just 18 days later, he received the Oak Leaves. Crinius' feat was all the more remarkable in that his century had been achieved entirely in the Soviet Union over the past 16 weeks (he had opened his Scoreboard on 9 June with a pair of *Stormoviks*). On 22 September his 100 victories won him the Knight's Cross and the Oak Leaves both on the same day! The two pilots' careers continued to run on parallel lines until each came to an end over Tunisia early in 1943 (see



Every century achieved gave rise to celebrations involving congratulatory placards and/or garlands and suitable liquid refreshment. Oberleutnant Friedrich-Karl Totti" Müller, *Kapitän* of I./JG 53, appears to be coping admirably with two out of the three at Tusov, on the Stalingrad front, on 19 September. Like Setz (featured at the bottom of the previous page), Müller would later be killed in action on the western front

Another of I./JG 53's high scorers on the road to Stalingrad was Oberleutnant Wolfgang Tonne, *Kapitän* of 3. *Staffel*. He is pictured here (along with his canine friend) earlier in the campaign while still a lieutenant, and with a victory tally only just into double figures



Osprey Aircraft of the Aces 2 - Bfl 09 Aces of the Mediterranean and North Africa for further details).

The fourth most successful pilot during the *Gruppe's* brief sojourn in Russia would not survive to make the return trip to the Mediterranean in October. 1. *Staffel*'; Leutnant Walter Zellot scored his 70th kill of the present offensive on 9 September. It took his overall total to 85, but would also be his last. The following day the tail of his *Gustav* was shot off — reportedly by 'friendly' flak — over Stalingrad. Having been caught at low-level, there was insufficient height for his parachute to open.

As the above suggests, the Battle of Stalingrad had now been joined. In fact, 6. *Armeehud* reached the outskirts of the city late in August. To the south, German mountain troops had raised their flag on Mount Elbrus, the highest peak in the Caucasus. But this was a gesture more for home newsreel consumption than of strategic significance, for neither of *Braunschweig's* stated objectives had been secured. The defenders of Stalingrad were holding on grimly, and the coveted oilfields remained tantalisingly out of reach on the far side of the Caucasus range.

Following the departure of JG 77 and I./JG 53, there were just two *Jagdgeschwader* left to cover the huge southern sector area as the second winter of the war in the east closed in — JG 3, which had accompanied von



Wearing the Oak Leaves with Swords, awarded on 19 May 1942 for 106 victories, Oberleutnant Hermann Graf (second from right) relaxes in the company of three of his 9./JG 52 Knight's Cross NCO *Experten*. They are, from left to right, Oberfeldwebel Ernst Suss (approximately 60 kills, killed in action on 20 December 1943), Feldwebel Hans Dammers (113 kills, died of wounds on 13 March 1944) and Oberfeldwebel Josef 'Jupp' Zwernemann (approximately 106 kills, killed in action on 8 April 1944)

Hermann Graf's 150th kill was reportedly claimed while flying this 'Yellow IT. .



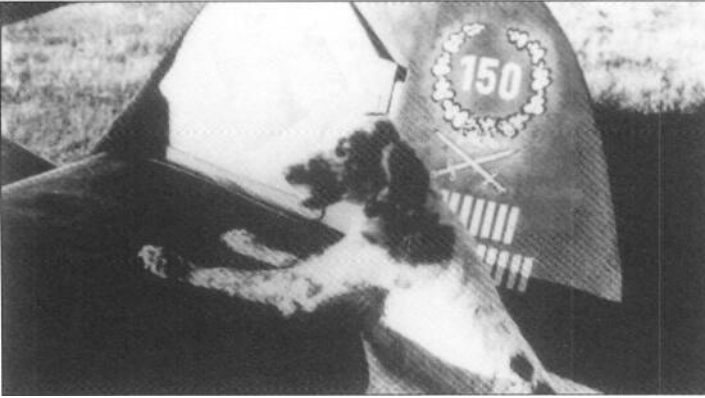

... although the achievement was 'officially' recorded on the rudder of his regular mount, 'Yellow V

A typical *Feldflugplatz* (forward landing ground) as occupied by I/JG 52 in the late summer of 1942. The air of apparent tranquillity is deceptive, however, for each camouflaged pup tent is topped by its owner's steel helmet. A necessary precaution ...



Paulus' 6. *Armee* across the steppe to Stalingrad, and JG 52, which had taken over JG 77's responsibilities for the Black Sea and Caucasus fronts.

1942 was to witness the start of JG 52's steady rise to prominence as the most successful, and highest-scoring, of all eastern front Bf 109 *Jagdgeschwader* - not least because, for much of the time thereafter, it was the only eastern front Bf 109 *Jagdgeschwadei**. But it was also

fortunate in having a considerable number of truly exceptional pilots within its ranks.

Most of 1942 was dominated by the outstanding success of Leutnant Hermann Graf, who was awarded all four of Germany's highest decorations in the space of just eight months. On 24 January he won the Knight's Cross for 42 eastern front kills. Exactly two months later he became *Staffelkapitän* of 9.1/JG 52. Seven victories on 14 May elevated his score to 104, for which he received the Oak Leaves three days later. And just two days and two kills after that, he was honoured with the Swords.

On 4 September Graf became the second pilot to reach 150 (behind Major Gordon Gollob, who had achieved this total on 29 August while serving as caretaker *Kommodore* of JG 52). Now promoted to Oberleutnant, Graf's score continued to mount. 172 victories earned him the highest award of all, the Diamonds, on 16 September. And on 2 October he became the first member of *die Jagdwaffe* to attain the double century.

Although overshadowed by Graf's achievements, many other pilots were also putting in sterling performances. It is a measure of JG 52's growing success that over 20 Knight's Crosses and seven sets of Oak Leaves were awarded to the *Geschwader* during the course of 1942.

. . . for Soviet air raids were becoming increasingly frequent. The result of one such strike by Russian ground-attack aircraft - a Bf 109 totally wrecked by cannon fire (note the dead mechanic by the starboard wing root), with another blazing furiously in the background



But the groundcrews had to carry on with their essential duties despite the danger. Ever resourceful, the 'black men' of II./JG 52 have rolled the main wheels of these F-4s into shallow trenches, and jacked up their tails, to make it easier to work on the engines and adjust the armament



Soviet resistance in the air was also on the increase. This damaged *Friedrich* of II./JG 52 has made it back to friendly territory - a decidedly lush meadow housing the Hs 126s of a tactical reconnaissance *Staffel*. .



. . . but the pilot of this III. *Gruppe* machine has not been so fortunate. A Red Army infantryman peers suspiciously into the radio compartment



The majority of the recipients - the likes of Karl Hammerl, Ernst Suss, Heinz-Wilhelm Ahnert and Karl Steffen, all with scores in the high 50s and 60s - are now little remembered, but some deserve fuller mention. One such pilot is Feldwebel Leopold Steinbatz, who received JG 52's second Knight's Cross of the year on 14 February for 42 kills.

'Bazi' Steinbatz regularly flew as wingman to Hermann Graf. During May he scored 35 kills, and on 2 June won the Oak Leaves when his total reached 83. Less than a fortnight later, on 15 June, three victories took him to one short of his century, but he failed to return from this last mission, having himself fallen victim to AA fire while still over enemy territory. On 23 June Oberfeldwebel Leopold Steinbatz became the first NCO of the entire *Wehrmacht* to be honoured with the Swords, albeit posthumously.

On 3 June a Petlyakov Pe-2 twin-engined bomber despatched by Oberleutnant Helmut Bennenmann, *Staffelkapitän* of 3./JG 52, had provided the *Geschwader* with its 2000th victory of the war. But the rapidly lengthening Scoreboard was not being achieved without cost. Only the day before, on 2 June, JG 52 had lost its first *Kommodore* to enemy action when Major Wilhelm Lessmann was also downed by Soviet flak.

His successor lasted less than three weeks. Returning to frontline service after his short stint at the RLM, the aloof Oberstleutnant

A line-up of II./JG 52's new *Gustavs* in the early autumn of 1942.

Although none display any unit badges, the two nearest machines have the densely mottled engine cowlings associated with this *Gruppe*

Featuring a similar cowling, 'Chevron 2' was often flown by Unteroffizier Hans Waldmann as wingman to II./JG 52's *Gruppenkommandeur* Johannes Steinhoff. The future *Experte* had a narrow escape in September 1942 when a Soviet anti-aircraft shell shredded his rudder (for a later aircraft of Waldmann's see colour profile 25)



Major Helmut Bennemann who, as a Hauptmann and Kommandeur of I./JG 52, claimed his Gruppe's 600th and 800th kills of the war. A month prior to the latter event Bennemann had received the Knight's Cross for a personal score of 50



Friedrich Beckh, who had made such little impression at the head of JG 51, was given scant time to leave his mark on JG 52. He was posted missing after a ground-attack mission east of Kharkov on 21 June. It was following Beckh's unexpectedly quick loss that JG 77's Major Gordon Gollob was brought in as acting Kommodore for eight weeks (during which time he claimed 43 kills, culminating in his 150th).

In mid-July I. and III. Gruppe began re-equipping with Gustavs. By this stage Braunschweig's southern spearheads were biting

deep into the Caucasus. But while II. and III./JG 52 dutifully followed the ground advance, I. Gruppe, commanded now by Hauptmann Helmut Bennemann, was employed as a 'Tire brigade' formation - Luftwaffe parlance for a unit sent at short notice to any area where sudden danger threatened (another telling indication of the paucity of fighter forces on the eastern front).

Shuttling between the southern and central sectors - ranging from the Kerch Peninsula on the Black Sea to the Moscow region and beyond - I./JG 52 was in near constant action. On 23 August another Pe-2 brought down by Bennemann was the Gruppe's 600th victory since hostilities began. Just over a month later, on 29 September, a LaGG-3 claimed by Hauptmann Johannes Wiese, Staffelkapitän of 2./JG 52, took their collective total to 700. The Kommandeur's 62nd, a MiG-3 downed on 2 November, raised the figure to 800. Such pressure could not be sustained indefinitely, however, and 48 hours later I./JG 52 handed over its remaining Gustavs to JG 3 and retired to Rostov to te-equip yet again.

Nor had there been any lack of aerial opposition over the Caucasus front in the interim, as the growing scores and associated awards among



One of Bennemann's then Staffelkapitäne, and his successor at the head of I./JG 52, was Hauptmann Johannes Wiese. His Knight's Cross was awarded on 5 January 1943 for 51 victories

Hauptmann Johannes Steinhoff, Kommandeur of II./JG 52, is seen easing himself into the cockpit of his Gustav- complete with the Geschwader's 'Winged sword' badge - in the Crimea in the late autumn of 1942



II. and III. *Gruppen* amply demonstrated.

Two of the Knight's Crosses won on 23 August had gone to members of Hauptmann Johannes Steinhoffs II./JG 52. Oberleutnant Gerhard Barkhorn, *Kapitän* of 4. *Staffel*, received his for 59 victories. Leutnant Heinz Schmidt had eight fewer kills, yet it was the latter who first reached the century, which earned him the Oak Leaves on 16 September. 'Johnny' Schmidt, who later became *Staffelkapitän* of 6.1/JG 52, might well have emerged as one of the true 'greats' of the eastern front had he not been shot down - in error, it is believed, by a Hungarian fighter - in September 1943 when his score was standing at 173.

In III. *Gruppe* Hermann Graf continued to reign supreme. But one of his fellow *Staffelkapitäne*, Oberleutnant Günther Rail of 8./JG 52, was just resuming the climb which would ultimately take him into the *Jagdwaaffe's* top three. Rail had been seriously wounded back in November 1941. Now, on 3 September 1942, and less than a week after returning to operations, he was awarded the Knight's Cross for 65 kills. The following month, on 26 October, Rail's century would bring with it the Oak Leaves.

During that same October - by which time eastern front scores in triple figures, if not exactly commonplace, were no longer altogether rare - four young lieutenants, 'freshly-baked' from fighter training school, arrived at JG 52's *Stab* HQ at Maikop in the Caucasus.

Geschwaderkommodore Major Dietrich Hrabak's welcoming pep talk was cut short by the crash-landing of a flak-damaged Bf 109 on the field outside. Somewhat chastened by this introduction to the realities of frontline service, the four were flown on 48 hours later to Soldatskaya, the home of Major Hubertus von Benin's III. *Gruppe*. Here, they were paired off between 7. and 9. *Staffeln*, and each was assigned to an experienced NCO pilot whose job it was to show them the ropes.

Oberfeldwebel Edmund Rossmann's charge was eager - perhaps too eager. On their first contact with the enemy he overtook his leader, sprayed bullets in the general direction of 'two dark green aircraft', got lost, and forced-landed out of fuel 32 km (20 miles) away from base. It was not an auspicious beginning.

Three weeks later, on 5 November, he got a second chance. One of a *Schwärm* (formation of four aircraft) attacking a force of 18 Il-2s, escorted by ten LaGG-3 fighters, he succeeded in downing one of the heavily-armoured *Stormoviks*. Although debris from his victim damaged his own machine, and resulted in another forced-landing, Leutnant Erich Hartmann - destined to become the most successful fighter pilot in aviation history - had scored his first kill.

It would take him three months to claim a second - three months which were to seal the fate of the 6. *Armeezt* Stalingrad.



II./JG 52's Leutnant Heinz 'Johnny' Schmidt. The combination of Bf 109F and the state of undress of the mechanic would seem to indicate that this photograph was taken a little earlier than the one featuring his *Kommandeur*, 'Macki' Steinhoff - the floral tribute suggests that this event was perhaps Schmidt's 50th kill, or the announcement of his Knight's Cross shortly thereafter on 23 August

Severely wounded the previous year, and following a long convalescence, Oberleutnant Günther Rail returned to his 8./JG 52 on 28 August. Within two months he was awarded the Knight's Cross and the Oak Leaves, and would end the war as the world's third-highest scoring fighter pilot



STAUNGRAD AND ZITADELLE

The main fighter unit tasked with supporting the ground troops' advance on Stalingrad was Oberstleutnant Günther Lützow's JG 3. This *Geschwader* had been re-assembled on the southern sector in the late spring of 1942, with *Stab and II. Gruppe* returning from the Mediterranean, and III./JG 3 being brought back from a brief stint in the Lake Ilmen area in the north. A new I. *Gruppe* had been activated to make good the original I./JG 3's transfer to the west and re-designation as II./JG1.

As von Paulus' army forged eastwards across the dry, dusty steppe towards the Volga, JG 3 faced increasing opposition in the skies overhead. The determination of the enemy to blunt the German offensive and to defend Stalingrad is indicated by the severity of their losses. By year's end JG 3's pilots would have claimed over 2200 aerial victories.



Wearing JG 3's distinctive 1942 'Mediterranean mix' camouflage scheme (see colour profile 7), an F-4/trop of the new I. *Gruppe* displays the recently introduced 'Winged U' (for 'Udet') *Geschwader* badge on the cowling, and I./JG 3's own 'crossed cutlasses' below the windshield



Groundcrew swarm over the F-4/trop (note mounting holes for the absent dust filter immediately below the gun trough) of Hauptmann Wolfgang Ewald. This photograph was reportedly taken in July 1942, although the reason for the obvious excitement remains unknown - unless perhaps it is the announcement of Ewald's appointment as *Kommandeur* of III./JG 3 (he replaced Major Karl-Heinz Greisert, who was killed in action against I-16s on 22 July)



The markings on this *Friedrich* identify it as the mount of III /JG 3's *TO*, Leutnant Heinrich Graf von Einsiedel, and the five kill bars on the rudder (two surmounted by roundels and three by red stars) definitely date it as July 1942 - von Einsiedel's fifth was a Pe-2 downed on the 4th of that month. Both von Einsiedel and Ewald, seen in the photograph at the base of the previous page, would come down behind enemy lines, near Stalingrad and Kursk respectively, and spend many years in Soviet hands

Wearing the Oak Leaves (awarded on 27 August for achieving his century four days earlier) Hauptmann Kurt Brändle, *Kommandeur* of II./JG 3, displays more than a passing interest in an engine change being carried out on one of his *Gruppe's* fighters



The *Geschwader's* success was broad-based. During this period no fewer than 19 pilots, all with totals ranging between the high 40s and 60s, were awarded the Knight's Cross, but only one actually claimed 100 kills on the road to Stalingrad.

Ever since *Kommodore* Günther Lützow's century the previous October - and its attendant ban on his further combat flying - the *Stabsschwarm* had been without a regular leader in the air. In May 1942 Hauptmann Wolf-Dietrich Wilcke, *ex-Kommandeur* of I./JG 53, was brought in to fulfil this function. Already wearing the Knight's Cross, and with 38 victories to his credit, 'Fürst' Wilcke quickly proved his worth, accounting for 118 of the *Geschwaderstab's* final 191 kills on the eastern front (34 of the remainder went to Adjutant Hauptmann Walther Dahl of later Fw 190 *Sturm* fame).

On 12 August Wolf-Dietrich Wilcke officially assumed command of JG 3. Less than a month later, on 9 September, he was awarded the Oak Leaves for 100 victories. A further 55 kills by the end of December earned him the Swords, and then it was Major Wilcke's turn to face a ban on all further operational flying.

Two of the earlier Knight's Cross winners had also received the Oak Leaves for attaining an overall total of 100 victories by the late summer of 1942. The three victories (a solitary Hurricane and a pair of *Stormoviks*) claimed by Oberleutnant Viktor Bauer, *Staffelkapitän* of 9./JG 3, on 25 July took his score to 102, and resulted in the Oak Leaves the following day.

Almost exactly a month later II. *Gruppe's* *Kommandeur*, Hauptmann Kurt Brändle, was also credited with three victories - including a brace of LaGG-3s - which raised his total to 102. He was presented with the Oak Leaves on 27 August. Unlike Bauer, who was transferred to a training unit shortly after receiving his award, and survived the war, Major

Kurt Brändle was killed in action in the west late in 1943 with a final score standing at 172.

By late August 6. *Armees* was fighting its way into Stalingrad. During the second week of September JG 3 began moving up to Pitomnik, a small airstrip some 12 miles (20 km) to the west of the city. Suitably enlarged and fortified, it would serve as the *Geschwader's* main base for the next two months. It also briefly housed elements of JG 52 and I./JG 53.

But the storm was about to break . . .

Despite a long and bloody struggle, von Paulus' men were unable to prise Stalingrad's defenders from their last desperate toeholds among the ruined buildings lining the west bank of the Volga. Then, on 19 November, as the street-fighting in the city was approaching its climax, the Soviets suddenly counter-attacked.

In a huge pincer movement, strong forces crossed the Volga to the north and south of Stalingrad. Smashing through the Axis flanks, they joined up 43 miles (70 km) to the west of the city three days later. The



Come the Russian autumn, come the Russian mud. A pilot of II./JG 3 wades towards his G-2 'Kanonenboot' as groundcrew struggle to remove its protective tarpaulin ...

. . . having clambered up on to the wing, the pilot tries to lend a hand . .



... before lowering himself down on to the port mainwheel and letting the experts finish the job. Now all he has to do is get 'White 6' out of that flooded dispersal!

As the second winter of the campaign closed in on the eastern front the *Jagdwaife* put into practice the lessons hard-learned from the previous year's unpreparedness. Dispersal pens were strengthened against both the elements and enemy bombing raids ..

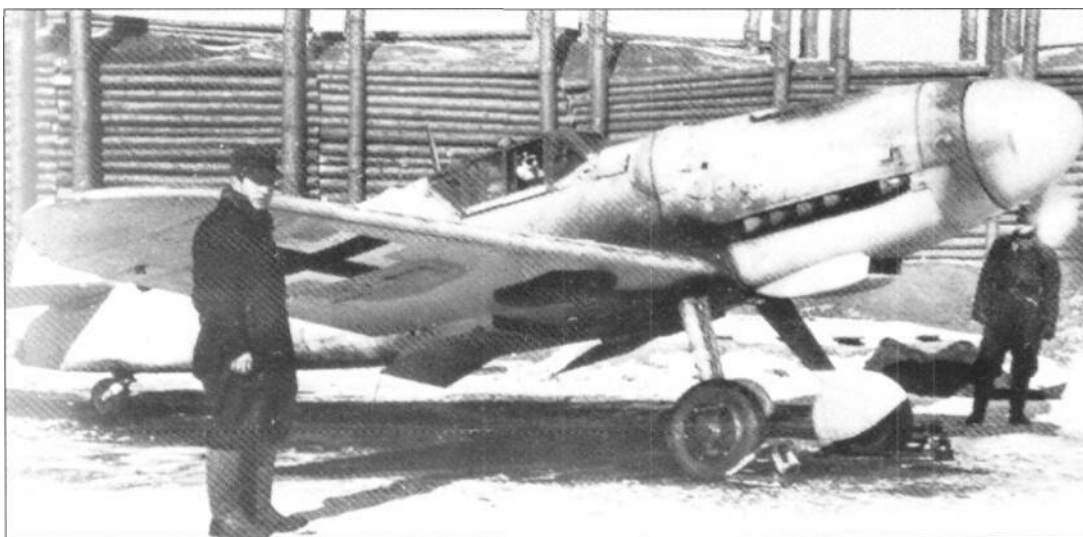

... and its fighters had their wheel and undercarriage leg covers removed to prevent compacted snow building up between them and causing take-off and landing accidents ..

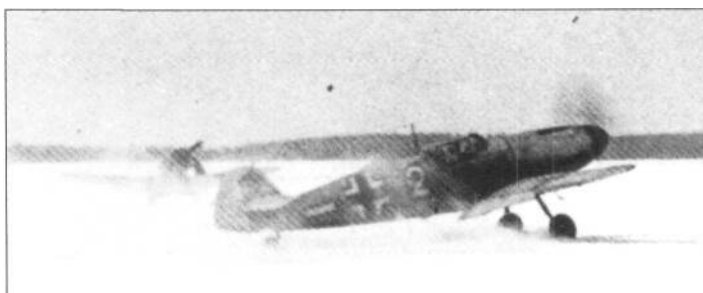

besiegers had become the besieged. Over 20 German and satellite divisions were encircled and cut off, and among the 250,000 men trapped within the Stalingrad perimeter were more than 200 JG 3 groundcrew, mainly from I. *Gruffe*, who had been unable to escape from Pitomnik.

Meanwhile, the bulk of the *Geschwader* retreated to Tazinskaya and Morozovskaya, about 185 miles (300 km) to the south-west of Stalingrad. These two airfields, universally referred to as Tazi and Moro, were the



... and suitably attired groundcrew used rubber hammers and wooden mallets to keep flying surfaces free from snow and ice

There was also an efficient aircraft recovery and repair organisation. But the speed of the surprise Soviet counter-offensive at Stalingrad overran the Chir railhead collecting point before these damaged machines could be transported to the rear. The black triangle on the Bf 109E in the foreground identifies it as a ground-attack aircraft of M./SchIG 1. But note JG 53's 'Ace-of-Spades' and JG 3's 'Winged U' on the noses of the Bf 109s to the left..

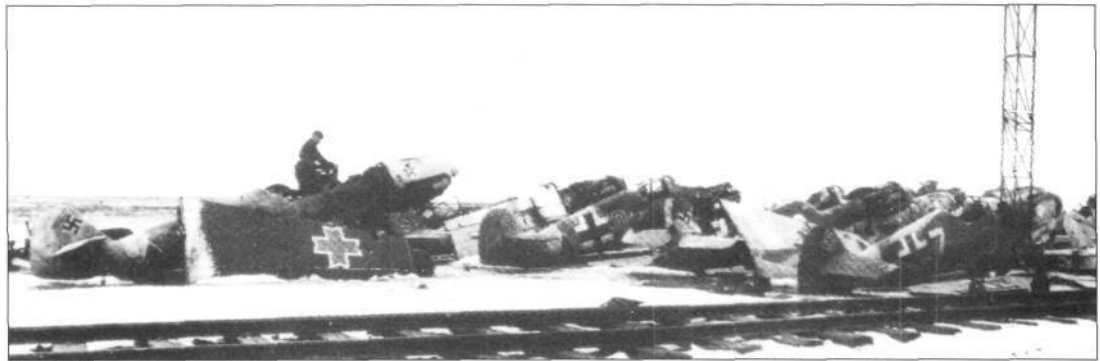

major bases from which was mounted the ill-fated attempt to supply 6. *Armee* by air. And to offer the gallant but near defenceless Ju 52 transports some protection while inside the perimeter, and during turnaround on the ground at Pitomnik, Major Wilcke called for volunteers to form the so-called *Platzschutzstaffel* (Airfield defence squadron) Pitomnik.

Some 22 pilots responded to the appeal. Led by Hauptmann Rudolf Germeroth, *Staffelkapitän* of 3./JG 3, they would remain in Pitomnik-under conditions and amidst scenes which quickly degenerated from the merely appalling to the truly horrific - until mid-January 1943.

During these two months of unimaginable hardship, they nonetheless managed to claim 130 Soviet aircraft destroyed. The *Platzschutzstaffel*'s

... while this shot of another area of the Chir facility (including the wing of a Rumanian Air Force Bf 109) shows at right, below the gantry, 3./JG 3's 'Yellow 7' still wearing the modified Mediterranean camouflage of the previous spring

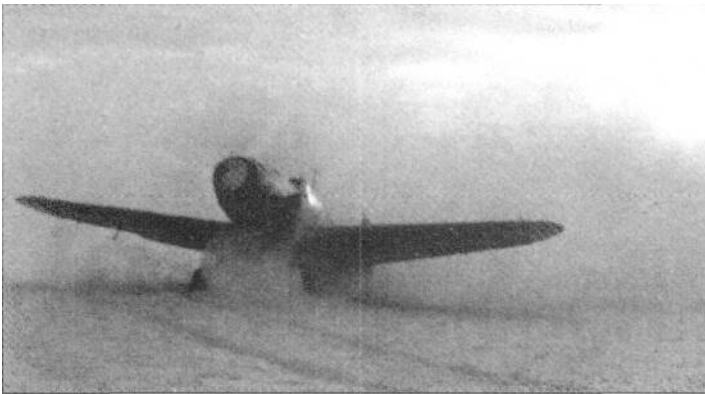

This anonymous *Gustav*, following another's tracks across a snow-covered field in the gloom of a mid-winter's day, typifies the conditions under which the *Platzschutzstaffel* Pitomnik operated. However, it cannot convey the horror that was unfolding around them as 6. *Armee* fought, suffered and died

Knight's Cross wearer Georg 'Peterle' Schentke of the Pitomnik volunteer *Staffel*, who was posted missing after bailing out over enemy territory on Christmas Day 1942. He is pictured here as an Oberfeldwebel serving with 9./JG 3 earlier in the year. Note the Bf 109F-4's segmented 'Mediterranean' camouflage, III. *Gruppe*'s 'Double-headed axe' badge, and Schentke's nickname (which he shared with his pet cat!) below the cockpit



most successful pilot was Feldwebel Kurt Ebener of II. *Gruppe*, whose 35 kills took his total to 52, and won him the Knight's Cross. But, inevitably, there were casualties too. Among those lost was an earlier Knight's Cross recipient, I. *Gruppe*'s Oberleutnant Georg Schentke, who was forced to bail out over Soviet-held territory beyond the perimeter after downing a bomber - his 90th kill of the war - on Christmas Day.

By 15 January 1943 Pitomnik

was in imminent danger of being overrun as the Red Army tightened its noose around Stalingrad. And 48 hours later the remaining *Gustav*s of the *Platzschutzstaffel* were ordered to fly out.

The epic Battle of Stalingrad is rightly regarded as the turning point of the war in the east. But it was the third and final great German summer offensive of the eastern front campaign - code-named *Zitadelle* - which finally dashed any remaining hopes Hitler may have had of defeating his arch enemy Stalin.

Although JG 52 was not directly involved in the closing stages of the fight for Stalingrad, Hauptmann Johannes Steinhoff's II. *Gruppe* had been brought up from the Caucasus front in mid-December 1942 to support the abortive attempt by 4. *Panzer-Armee* to break through to the besieged city from the south-west. It was at the height of this action, on 19 December, that Oberleutnant Gerhard Barkhorn, *Staffelkapitän* of 4./JG 52, was able to attain his century.

Both JGs 3 and 52 would, however, be committed to *Zitadelle*. But first a new danger threatened. 17. *Armee*, the southern arm of the now defunct *Braunschweigoperation*, was still deep in the Caucasus, and at grave risk of being cut off by Red Army advances to its north. To avoid another Stalingrad, these troops would have to be evacuated from the Kuban, across the Kerch Straits, to the Crimea. Throughout the first half of 1943 much of the two *Geschwaders*' activities were consequently centred on these areas of the Black Sea coast.

I./JG 3 had already been withdrawn back to the Reich late in January, before the final surrender at Stalingrad. But two pilots of Major Kurt Brändle's II. *Gruppe* would reach their centuries over the Kuban bridgehead on consecutive days in the spring. On 27 April one of a pair of lend-lease Bostons gave Oberleutnant Joachim Kirschner his 100th victory. Kirschner, the *Kapitän* of 5. *Staffel*, was already wearing the Knight's Cross (awarded on 23 December for 51 victories), and he would duly



Although the featureless expanse of the southern steppe gives nothing away as to the exact location, the two German rifles leaning against the trailing edge of 'White 2's' port wing, and the cavalry patrol just visible in the right background, would seem to suggest that this unknown 4./JG 3 pilot just managed to reach friendly lines before making a successful belly-landing in the spring of 1943



Studying a map with a group of his pilots, 5./JG 3's Oberleutnant Joachim Kirschner (centre, wearing a lifejacket and fur collar) wears the Knight's Cross, awarded at the height of the battle of Stalingrad (for 51 kills), and the Oak Leaves, won in the aftermath of *Zitadelle* (for 170 kills)

become JG 3's top scorer - with 175 kills - before being posted to the command of IV./JG 27 in October.

Twenty-four hours after Kirschner's century, a trio of LaGG-3s took the score of 4. *Staffel's* Leutnant Wolf Ettl to exactly 100. But Ettl would have to wait until 1 June for his Knight's Cross - by which time his total was standing at 120!

Based to the north of the Crimea, only one member of III. *Gruppe* reached treble figures in the months leading up to *Zitadelle*. Another of 1942's Knight's Cross winners, Leutnant Wilhelm Lemke, *Staffelkapitän* of 9./JG 3, had achieved his 100 with the destruction of a La-5 on 16 March.

Meanwhile, JG 52 was evacuating its forward bases down in the Caucasus. These fields, along the line of the River Terek, which flows into the Caspian Sea, were the easternmost airstrips occupied by the Luftwaffe during the war against the Soviet Union. By mid-March 11. and III. *Gruppen* were back guarding the all-important Kerch Straits, which was the most vulnerable bottleneck along 17. *Armee's* main line of retreat.

Although displaying the insignia of Major Wolfgang Ewald, *Kommandeur* of III./JG 3, the *Gustav* in the foreground was being flown by Leutnant Adolf von Gordon of the *Gruppenstab* when it was lost in action against Il-2s on 24 April 1943. Note the Stukas taking off overhead





The original Soviet caption claims this to be 'a Nazi plane shot down by pilots of the air squadron named after Chkalov in action over the Kuban area in May 1943'. Although it is unlikely that the Russian pilots had deliberately targeted this machine, the 15 kill bars on its rudder reveal it to be the regular mount of one Erich Hartmann, wingman to 'Graf Punski' Krupinski of 7./JG 52 (Hartmann's 15th victory was a U-2 biplane downed on 15 May). But 'White 2' was being piloted by Unteroffizier Herbert Meissler when it was forced to land behind enemy lines. It is not known whether the smoke has been caused by combat damage, or by Meissler's deliberately setting fire to the aircraft after landing. Incidentally, the confusion of markings on the rear fuselage was caused by III. Gruppe's white wavy bar being painted across the yellow theatre band, which had itself been applied directly over the last two letters of the fighter's original delivery KJ+GU *Stammkennzeichen*

On 2 March 1943 66-victory *Experte* Oberleutnant Walter Krupinski had assumed command of 7. *Staffel*. It was Krupinski's spectacular crash-landing which had greeted Erich Hartmann's arrival at JG 52 back in October, and now 'Graf Punski' ('Count Punski'), as Krupinski was popularly known, selected the same promising young Leutnant - whose score by this time had risen to four - as his wingman.

In contrast, 4. *Staffel*'s Oberfeldwebel Willi Nemitz was one of the oldest frontline pilots serving in the Luftwaffe. Nicknamed 'Altvater' ('Old Father') on account of his advanced years, the 32(!)-year-old Nemitz was awarded the Knight's Cross, for 54 kills, on 11 March. But exactly one month - and 27 victories - later Oberfeldwebel Nemitz would be killed in action against Soviet fighters above II. *Gruppe*'s Anapa base.

On 20 April Hauptmann Günther Rail, *Staffelkapitän* of 8./JG 52, claimed the *Geschwader*'s 5000th enemy aircraft destroyed. Another 11 weeks would see that total climb to 6000, but success on this scale could not be achieved without loss. Among the many casualties was Hauptmann Rudolf Miethig, long-serving *Kapitän* of 3. *Staffel*. Miethig was one of the *Geschwader*'s 10+ Knight's Cross winners of the previous year, having received the award (for 50 kills) on 29 October - the same day as Walter Krupinski (for 53).

By 10 June 1943 Rudolf Miethig's score had reached the century. But he was himself killed on that date over the Kuban bridgehead when he brought down his 101st victim by ramming.

In the first days of July *Stab*, I. and III./JG 52 moved up from the Black Sea coast into the Ukraine in preparation for Operation *Zitadelle*. This third summer offensive was aimed at eradicating the Soviet salient at

Kursk, which projected westwards into the German front like a huge fist, and threatened to split the central and southern sectors wide open.

Zitadelle was very much a ground battle. In fact, it developed into the largest armoured confrontation in military history, although air power played an important part, too. Fighter cover was to be provided by eight *Jagdgruppen*, divided between the northern and southern flanks of the 'bulge' around Kursk. To the north were four *Gruppen* of Fw 190s, and to the south, four of Bf 109Gs - II. and III./JG 3 and I. and III./JG 52.

Operation *Zitadelle* was launched early on the morning of 5 July. And for a few brief hours those fighter pilots who had participated in *Barbarossa* experienced again the kind of success that had marked the opening rounds of the air war in the east. By the end of the first day of *Zitadelle*», is estimated that the Soviets had lost 432 machines - mainly bombers and ground-attack aircraft attempting to halt the advancing Panzers.

Major Kurt Brändle's II./JG 3 accounted for 77 of them, with a couple of Il-2s downed seven hours apart providing the 150th victories for two members of the *Gruppe*. The first had been claimed by Oberleutnant Joachim Kirschner, *Staffelkapitän* of 5./JG 3, and was one of nine kills credited to him that day. The second was among the *Kommandeur*'own bag of five (four Il-2s and a single Yak-1). Another pilot to bring down five was Oberleutnant Werner Lucas, *Kapitän* of 4. *Staffel*, who thereby took his total to 92.

III. *Gruppe*' top scorer of the day was Oberleutnant Emil Bitsch, *Staffelkapitän* of 8./JG 3, with six - his 75th to 80th victories. Fellow *Kapitän* Oberleutnant Wilhelm Lemke of 9. *Staffel* also claimed six, but three of these were unconfirmed.

The most successful of all were two *Staffelkapitäne* of JG 52. Hauptmann Johannes Wiese of 2./JG 52 shot down no fewer than 12 Soviet machines, which left him five short of his century — a situation he remedied exactly five days later. And 7. *Staffel*'s Walter Krupinski was just one behind with 11 aircraft destroyed. But 'Graf Pinski' was severely wounded claiming the last of these, and for the next six weeks 7./JG 52 would be led by acting *Staffelkapitän* Leutnant Erich Hartmann, whose own four victories on this day had elevated his score to 21.



Hauptmann Walter Krupinski, *Staffelkapitän* of 7./JG 52 from March 1943 to March 1944, is seen here wearing the Oak Leaves awarded to him on 2 March 1944 (for 177 eastern front victories). He was transferred to the west shortly after this photograph was taken, where he in turn served with JGs 5, 11 and 26, before finally joining Me 262-equipped JV 44

Gustavs of I./JG 52 enjoy the sun on a forward landing strip near Bessonovka, east of Byelgorod, at the time of Operation *Zitadelle* in July 1943



After all the pictures of snow and ice, a blazing sun is not something immediately associated with the war in the east - but this Unteroffizier of 4./JG 3 is no doubt grateful for the improvised sunshade as he sits at readiness at Kharkov-Rogan during a break in the *Zitadelle* operations



Forty-eight hours later a kill by one of Wiese's 2. *Staffel* pilots, Oberleutnant Paul-Heinrich Dähne, provided I./JG 52 with its 800th kill of the war - and the *Geschwader* with its 6000th.

Despite these undoubted successes in the air, on the ground *Zitadelle* was already in deep trouble. The Red Army had also been planning a major offensive in the same area, and the two forces were soon locked in a titanic struggle. Although deploying the mighty 55-ton Tiger tank for the first time in any significant numbers, Germany's Panzer divisions were unable to achieve a breakthrough.

After only eight days Hitler conceded that Operation *Zitadelle* had failed in its purpose. Citing the imminent loss of Sicily and the growing threat to southern Europe as the more important of his priorities, he ordered much of the armour to be withdrawn.

On 21 July two of JG 3's recent multiple scorers, Emil Bitsch and Walter Lucas, both attained their century. Before the month was out Brändle and Kirschner, each having reached 150 on the opening day of *Zitadelle*, had raised their totals to 170 a piece. This brought Joachim Kirschner the Oak Leaves on 2 August - Kurt Brändle had received this award exactly one year earlier for just 100 victories!

The *Staffelkapitän* of 5./JG 3, Oberleutnant Joachim Kirschner (in the dark flight blouse), is congratulated by Oberleutnant Förster of the *Geschwaderstab* on his 150th kill (an 11-2 downed in the opening minutes of *Zitadelle* on 5 July 1943). This claim also reportedly represented 5. *Staffel*'s 500th collective victory, and the 2000th of the war for II. *Gruppe*'.



Among JG 3's rank and file at this period was a young NCO pilot with just 32 kills. But Unteroffizier Gerhard Thyben's time was yet to come. After transferring to JG 54 and converting on to the Fw 190, he too would ultimately join the top two dozen eastern front *Experten*. First, however, he would have to see some months' service in the west, for at the beginning of August 1943 II. and III./JG 53 were pulled out of Russia to join the *Geschwaderstab* and I. *Gruppe* in defence of the Reich.

This left JG 52 alone in the east.

FIGHTING RETREAT

The *Fuhrer's* abrupt abandonment of *Zitadelle* set the scene for the closing chapter in the story of the Bf 109 on the eastern front. In the months that followed, the component *Gruppen* of JG 52 would be constantly on the move. As the Red Army grew in strength and gathered momentum in its drive towards Germany, they found themselves being shuttled from one point of danger to the next with increasing frequency and desperation.

Under such conditions - often operating from makeshift landing strips, threatened with being overrun by Soviet tanks on the ground, and facing ever-mounting odds in the air — it is a wonder that they survived. That they produced the most successful fighter pilots the world has ever seen is little short of incredible.

JG 52's nomadic existence commenced within days of the Kursk offensive's being called off, with I. *Gruppe* transferring from Poltava to Kharkov-South, and III. *Gruppe* moving to Orel on the northern flank of the 'bulge'. But after just five days at Orel III./JG 52 returned southwards. It was now that Leutnant Erich Hartmann's extraordinary abilities began to reveal themselves.

The last of four Soviet fighters claimed on 3 August gave Hartmann his half-century. By the middle of the month a succession of multiple daily kills in the Kharkov area had raised that total to more than 80. And when the *Staffelkapitän* of 9./JG 52, 113-victory *Experte* Leutnant Berthold Korts, was reported missing in action on 29 August (the same day, incidentally, that the award of his Knight's Cross was announced), it was Hartmann who was chosen by *Gruppenkommandeur* *M-sjot* Günther Rail to replace him.

With 90 kills already to his credit, Erich Hartmann's year-long leadership of 9./JG 52 would see his personal score rise to an incredible 301. His distinctively-marked aircraft, latterly each with its black

In the month following his promotion to *Staffelkapitän* of 9./JG 52 on 2 September 1943, Leutnant Erich Hartmann regularly flew this Bf 109G-6 (see colour profile 29) in combat



Erich Hartmann, as an Oberleutnant, is seen in the cockpit of a later G-6 (note the clear-vision Erla canopy). 9. Staffers famous 'Pierced heart' emblem and 'Karaya' call-sign are also clearly evident - less so is the name 'Ursel', in white, in the top left segment of the heart. It appears that Hartmann used two familiar names for his girlfriend/fiancee/wife Ursula - 'Ursel' and 'Usch'



'tulip'-patterned nose, reportedly earned him the nickname of 'The Black Devil' among his opponents.

His own pilots, inspired by their *Kapitän's* simple but effective four-part formula for success in the air - 'locate, decide, attack, break away' - keenly followed his example. Many achieved high scores. Soon the entire 'Karaya' *Staffel* (so named after 9./JG 52's radio call-sign) was as famous as its youthful leader. Dismissive of his own achievements, however, Erich Hartmann took far greater pride in the fact that he never lost a wingman in combat.

Meanwhile II./JG 52, which had remained in the Kuban during the abortive *Zitadelle* offensive, was also transferred up into the Kharkov-Poltava region. Hauptmann Gerhard Barkhorn had assumed command of the *Gruppe* on \ September. And six days later fledgling *Experte* Lieutenant Helmut Lipfert took over at the head of 6. *Staffel* *äffet* the previous *Kapitän*, 173-victory Oak Leaves wearer Hauptmann Heinz Schmidt,

Celebrating his 200th kill. Hauptmann Günther Rail (left), *Kommandeur* of III./JG 52, poses at Makeyevka on 29 August 1943 with Walter Krupinski (centre) and an unknown pilot



had been shot down - purportedly in error by that Hungarian fighter.

Back at III. *Gruppe*, September had also seen both the award of the Swords to *Kommandeur* Hauptmann Günther Rail (on the 12th for his double century), and Erich Hartmann reaching his 100th - an Airacobra brought down, along with a trio of La-5s, over the River Dnieper on the 20th.

Just over a month later another Airacobra claimed by Hartmann, on 29 October, raised his total to 148, and resulted in a long overdue Knight's Cross. He was now just behind his good friend, and mentor, Oberleutnant Walter Krupinski, *Staffelkapitän* of 7./JG 52 (whose Knight's Cross had



Over the next three months Rail claimed 50 more Soviet victims, and is here being congratulated by his mechanic for having just despatched the 250th on 28 November

been awarded exactly one year earlier - for 53 victories), who had reached 150 on 1 October.

A welcome spell of home leave meant that Hartmann's own 150th would not be achieved until the last day of the year. JG 52's two high-scoring *Gruppenkommandeure* were still well in the lead, however. Günther Rail's 250th had gone down on 28 November, and Gerhard Barkhorn's 200th just 48 hours later.

But, as so often in the past, such individual successes in the air could do little to influence events unfolding on the ground. On 6 November the Soviets had recaptured Kiev. The whole southern sector was in danger of collapse. I./JG 52, commanded now by Hauptmann Johannes Wiese, was brought up from its Crimean bases to the exotically named Malaja-Wiska (inevitably 'Malaya-Whisky' to the troops) south of the Ukrainian capital. Here they were joined by elements of both II. and III./JG 52.

In the early hours of 14 January 1944 Russian armour attacked the packed airfield. Before the enemy could be repulsed a number of casualties had been suffered by the groundcrews, and eight aircraft had been damaged when their tails were apparently crushed by Soviet tanks driving over them. The remaining *Gustavs* escaped shortly after first light and dispersed on neighbouring strips.

Although the third winter of the war on the southern sector was by no means as severe as the previous two, the all-pervading mud posed huge

Fellow *Gruppenkommandeur* Hauptmann Gerhard Barkhorn of II./JG 52 reached the 250 mark on 13 February 1944. Once again, the chief mechanic is on hand to toast 'his' pilot's success



Here is another of Barkhorn's numerous Bf 109s - probably an earlier G-6 (note the length of the aerial mast and the absence of direction-finding loop mounting) photographed shortly after his appointment as *Kommandeur* of II. *Gruppe*. The photograph reveals obvious differences in the application of both his wife's name below the cockpit and his 'lucky 5' incorporated in the command chevrons. Both were Barkhorn's personal markings throughout the war

problems. At least half-a-dozen pilots were lost in take-off and landing accidents, and sorties had to be broken off prematurely as engines overheated, their radiator intakes clogged with mud thrown up while taxiing. Aviation fuel had to be distributed in 200-litre (45-gal) drums by horse and cart, which was the only wheeled transport that could cope with the boggy conditions on many airfields.

Nevertheless, missions continued to be flown. Operating over the Uman region, III. *Gruppe* claimed 50 victories in 60 days. On 2 March Erich Hartmann's ten kills took his total to 202, this achievement winning him the Oak Leaves. Walter Krupinski and Johannes Wiese were similarly honoured on the same day (for 177 and 125 victories respectively), and all three men were summoned to Hitler's Alpine retreat to receive their awards.

On the penultimate leg of their journey, by rail to Salzburg, they were joined by Gerhard Barkhorn, also en route to Berchtesgaden to be pre-





A long-serving member of the famed 'Karaya' *Staffel*, Oberfeldwebel (later Leutnant) Hans Dammers was most meticulous in recording his achievements. He is seen here wearing his Knight's Cross, which was awarded to him back in August 1942 for 51 kills. These, and his many more aerial victories since, are presumably depicted on the port side of that rudder. On the starboard surface are listed, from top to bottom, 23 unconfirmed kills, 11 aircraft destroyed on the ground, as well as 8 locomotives, 39 horse-drawn wagons, 34 trucks, 3 anti-aircraft guns and 1 command half-track!

Among the decorations awarded to III./JG 52 in March 1944 were the Oak Leaves on the 2nd to Leutnant Erich Hartmann (centre), *Kapitän* of 9. *Staffel*, for 200 victories, and the Knight's Cross on the 23rd to Leutnant Friedrich Obleser (left), *Kapitän* of 8. *Staffel*, for 80. Leutnant Karl 'Charlie' Gratz, on the right, had received his Knight's Cross in July 1942 for 54 victories. All three would add substantially to their respective scores before war's end

sented with the Swords for his 250th. Liquid refreshment flowed a little too freely— courtesy of a friendly train conductor —and, despite the drive in sub-zero temperatures up to the *Führer'seyrie* in an open-topped car (a desperate ploy by a worried aide), they were still far from sober on arrival.

While in an ante-room waiting to be ushered in to the Presence, Erich Hartmann took a fancy to a smart peaked cap which he had spotted hanging on a hat-stand. It was four sizes too large, and came down over his ears. Fortunately, while the other three were convulsed with laughter, the same harassed, but quick-thinking aide snatched the hat off Hartmann's head, thus sparing the *Führer* the ludicrous sight of his own uniform cap half-hiding the face of the young Luftwaffe officer he was about to decorate.

Such moments of light-hearted relaxation were few and far between, and it was soon back to the harsh realities of the front. On 13 March another of JG 52's little-known 'centurions', Leutnant Hans Dammers, was rammed by a crashing Soviet aircraft. A Knight's Cross wearer and 113-victory *Experte*, Dammers, who was a member of Hartmann's own 9. *Staffel*, died of his injuries four days later.

On 18 March Erich Hartmann was promoted to oberleutnant. By now III./JG 52 was the most successful *Gruppe* of the *Geschwader*, scoring its 3500th collective kill of the war on 21 March. But such figures accounted for little in the present crisis. A new Soviet spring offensive was underway, and at the end of the month III. *Gruppe* departed Russian soil, withdrawing to Lemberg (Lvov), in Poland.

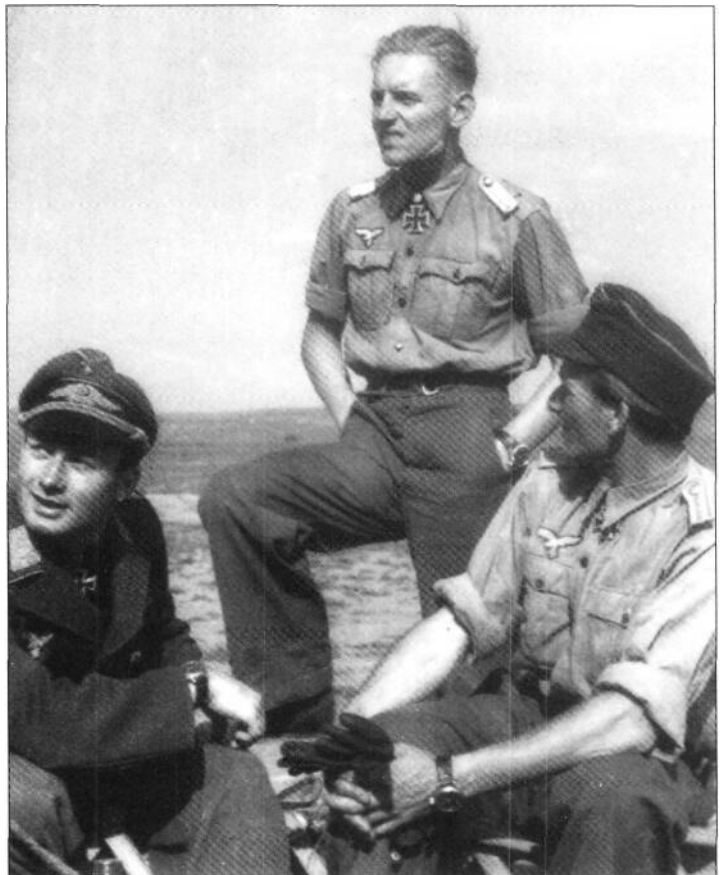

Meanwhile, I. and II./JG 52 had been involved in the final days' fighting in the Crimea. II. *Gruppe's* *Staffelkapitäne* were particularly prominent at this period. Relative newcomer Feldwebel Hans Waldmann, whose 84th kill on 5 February had earned him the Knight's Cross and promotion to lieutenant, took over 4. *Staffel* from fellow Knight's Cross holder and 80+ *Experte* Leutnant Heinrich Sturm on 17 April. After claiming 121 victories in the east, 'Dackel' Waldmann would be transferred to Defence of the Reich duties and lose his life in a mid-air collision between two Me 262s on 18 March 1945.



Another trio of JG 52's leading *Experten*, who achieved a staggering 669 eastern front kills between them. Pictured in the summer of 1944, they are, from left to right, Hauptleute Gerhard Barkhorn and Wilhelm Batz, *Kommandeure* of II. and III. *Gruppen* respectively, and Leutnant Otto Fönnekold, *Kapitän* of 5. *Staffel*

Longer-serving *Experte* Oberleutnant Wilhelm Batz, who had commanded 5. *Staffel* since May 1943, received the Knight's Cross for 75 kills on 26 March. On 19 April he would take over III. *Gruppe* from Major Günther Rall when the latter - his eastern front total having reached 271 - was appointed *Kommandeure* of I./JG 11 in the west. Batz's position at the head of 5. *Staffel* was in turn filled by another Knight's Cross holder, 100+ *Experte* Leutnant Otto Fönnekold.

Lastly, 6. *Staffel** Leutnant Helmut Lipfert was also scoring steadily. His 90th on 5 April had won him the Knight's Cross. Six days later an 'all-white *StormoviK* provided him with his century.

But, here too, individual achievements in the air were having little effect on events on the ground. The last German troops were evacuated from the Crimea on 13 May, and II./JG 52 had been withdrawn a week earlier. Retiring to Kherson, it was joined by III. *Gruppe*, brought back down from Poland in a forlorn attempt to help stem the Red Army's inexorable advance westwards along the Black Sea coast.

At Kherson the two *Gruppen* were subjected to near-constant Soviet bombing raids, and Lipfert's 6./JG 52, in particular, lost a number of aircraft. By 9 May the field was under Russian artillery bombardment, although III. *Gruppe* had prepared for this contingency. Having removed the armour-plating and radio equipment, there was room in each *Gustav*'s rear fuselage for two extra bodies. Every pilot took off for Zarnesti, in Rumania, with two mechanics aboard.

One of the last to taxi out, Lipfert's machine was damaged by Soviet shell-fire, and the *Staffelkapitän* of 6./JG 52 was forced to complete his journey as a rather cramped passenger in the *Gruppen*-Adjutant's fighter.

On 10 May JG 52 claimed its 9000th enemy aircraft of the war. But it was a war now entering its final year, already irretrievably lost. The *Geschwader*'s withdrawal into Rumania did not bring any easing of pressure. Quite the reverse in fact, for now also assigned the additional task of helping to defend the vital Rumanian oilfields, all three *Gruppen* found themselves facing a new enemy - the Americans.



Code-named *Sternflüge* (*Starflights*), the missions undertaken against the US heavy bombers, and their fighter escorts, flying in across the Adriatic from Italy proved both unrewarding and costly. Surviving records indicate that JG 52's six-week defence of Rumania's oil netted just 15 American aircraft, of which only three were four-engined 'heavies'. Two of the latter - both B-24s - were claimed by Oberleutnant Helmut Lipfert and his wingman Unteroffizier Tarnen during the *Starflight* mission of 24 June. II. *Gruppe* had despatched its entire strength - nine *Gustavs*- against the incoming Americans. By the day's end it had two left!

Bad as things were in the east, they were apparently even worse in the Homeland, where much of the Reich's defensive fighter strength had been rushed to the Normandy invasion front. Already stretched to the limit, JG 52's position was further weakened when it was ordered to give up three *Staffeln* (one per *Gruppe*) for service in the west. Although

This 2nd Bomb Group B-17G was a typical '*Starflight*' victim. It is not known with certainty which *Gruppe* was responsible for downing the US 'heavy' near Mährisch-Ostrau in mid-August 1944. The feather-hatted gentlemen guarding the scene appear to be members of the local *Feldgendarmarie*



In the spring of 1944 pilots within JG 51 began reverting from Fw 190s back on to the Bf 109. Focke-Wulf *Experte* Leutnant Günther Josten of 1. *Staffel*- soon to be appointed *Kapitän* of 3./JG 51 - gets to grips with the cockpit layout of his new *Gustav* at Bobruisk in April



The pilots of JG 51 were soon demonstrating their mastery of their new mounts. One of the unit's G-6s carries out a low-level pass for the benefit of the photographer

completely new 2., 4. and 7. *Staffeln* would be activated later in the year, it would by then be far too late to reverse the *Geschwader's* fortunes.

For in June 1944 the Red Army had unleashed its last great summer offensive, which was aimed at smashing open the central sector and paving the way for the drive on Berlin. From now on JG 52 would regularly be facing aerial odds of 40-to-1 or more against.

Late in June III. *Gmppev/ns* transferred northwards to the Minsk area of the central front, where it was to operate under the control of JG 51. This *Geschwader had* converted back on to Bf 109s a few weeks earlier (reportedly because of the demands for the Fw 190 from other fronts), and would remain almost entirely equipped with Messerschmitts until war's end.

Despite the enemy's overwhelming superiority, JG 51 would produce some half-dozen 100+ *Experten* during these final months, although most, if not all, of them had already claimed the majority of their victims while flying the Focke-Wulf. One such was the *Geschwader's* highest scorer, Oberleutnant Anton Hafner, *Staffelkapitän* of JG 51, who had received the Oak Leaves on 11 April for 134 kills. He had added another 70 to that total by the time of his death in action during a low-level dogfight with a Yak-9 on 17 June.

Three more of the *Geschwader's* current *Staffelkapitäne* were also very successful in battling the odds, and all would survive the war with the Oak

But nothing could now halt the advance of the victorious Red Army. This winter-camouflaged *Gustav*, captured by the Soviets towards the close of 1944, is believed to be a machine abandoned by JG 51



Leaves. 1./JG 51's Oberleutnant Joachim Brendel amassed 189 kills in the east, more than 90 of which were *Stormoviks* - universally regarded as the most difficult enemy aircraft to bring down. Leutnant Günther Josten of 3./JG 51 also included more than 60 Il-2s in his overall total of 178. The third, Leutnant Günther Schack of 9./JG 51, who had been awarded the Oak Leaves (for 133 victories) just nine days after Anton Hafner, took his final score to 174.

But none could compete with JG 52's leading *Experten*. On 4 July Erich Hartmann won the Swords for 239 kills. It took him another fortnight to reach his 250th - one of a trio of *Stormoviks* downed on 18 July. He was the fourth *jagdwaaffe* pilot (three of them from JG 52) to attain this figure.

By this time III./JG 52 was back with the rest of the *Geschwader* operating in the Lemberg (Lvov) region of Poland. On 2 July *Gruppenkommandeur* Hauptmann Wilhelm Batz received the Oak Leaves for 175 victories. It was a period of intense activity for JG 52 as the *Gruppenwre* rushed back and forth along the front from Poland up into Lithuania, back to Poland, then south to Rumania.

Nothing could stop Erich Hartmann, however. Another string of successes culminated in eight kills on 23 August, and no fewer than eleven the day thereafter. The last five of these latter, all claimed in the space of twenty minutes, took his total to an amazing 301! He was the first fighter pilot in the world to score a triple century. A telegram from Adolf Hitler arrived 24 hours later, awarding him the Diamonds, and summoning

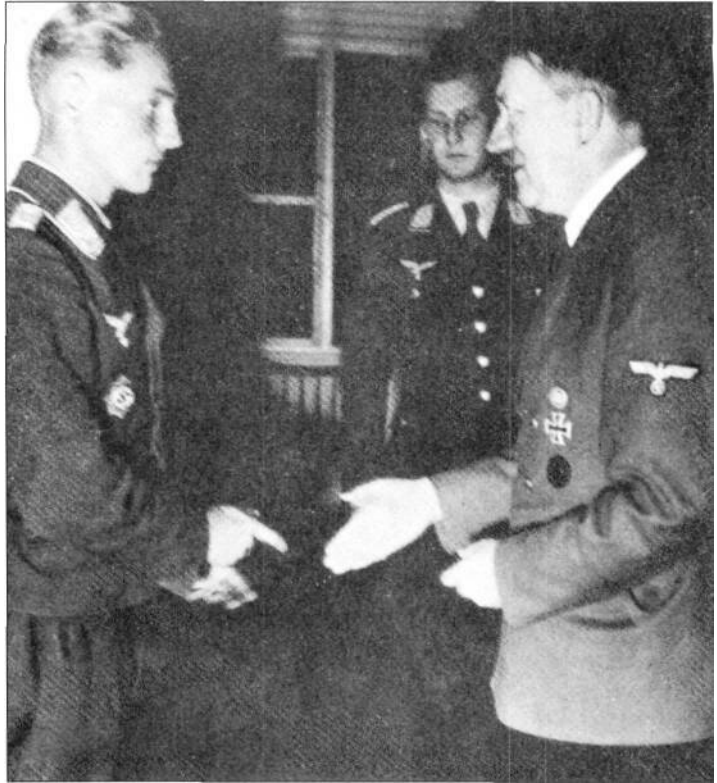

On 26 August 1944 in a cramped wooden hut in his East Prussian HQ, Adolf Hitler awards the now Oberleutnant Erich Hartmann with the Diamonds for his 301 aerial victories - the first fighter-pilot in the world to top the triple century!



Returning to 9./JG 52's base south of Warsaw the following day, Erich Hartmann poses with his devoted friend and indispensable other half of the successful team - his chief mechanic Heinz 'Bimmel' Mertens



136-victory *Experte* Leutnant Otto Fönnekold of 5./JG 52 was killed by a ground- strafing P-51 while landing at Budak, in Hungary, on 31 August 1944

him to the *Führer's* 'Wolfs Lair' forest HQ in East Prussia for the presentation ceremony the following day.

Afterwards over coffee and tea, Hitler, with unusual candour, admitted to his highest-scoring fighter pilot that, 'militarily, the war is lost, Hartmann'. Nevertheless, the young Oberleutnant returned to his *Staffel* and, like the rest of JG 52, continued to fight on as the eastern front collapsed about them.

The end of August brought with it a change of government, and a change of sides, for Rumania. The one-time Axis ally now declared war on Germany, so II./JG 52, which had been operating in Rumania, retired to Budak, in Hungary, on 31 August. The move was taking them dangerously close to the western Allies at their backs, as was demonstrated

Oberstleutnant Dietrich Hrabak commanded JG 52 from 1 November 1942 through to 30 September 1944. He is seen here in the cockpit of his G-6 with Erich Hartmann, *Kapitän* of 9. *Staffel*, who is helping him with his harness straps. 8./JG 52's Friedrich Obleser and Karl Gratz appear amused by Hartmann's solicitude. The presence of the latter pair, and the sticking plaster on Hartmann's cheek, would seem to suggest that this photograph was taken at about the same time as that on page 74



Hrabak's successor at the head of JG 52 was no stranger to the *Geschwader*. Having recovered from wounds suffered during his spell undertaking Defence of the Reich missions, the erstwhile *Kapitän* of 9. *Staffel*, Oberstleutnant Hermann Graf, returned to the eastern front to lead JG 52 for the remaining seven months of the war



on that very same day. 136-victory *Experte* Leutnant Otto Fönnekold, *Staffelkapitän* of 5./JG 52, had just landed at Budak and was taxiing in when he was strafed and fatally injured by a solitary Mustang.

Also involved in the retreat from Rumania was I./JG 53. This *Gruppe* had been transferred up from the Mediterranean to help protect the Ploesti oilfields back in May. Its pilots had seen action mainly against the USAAF in the interim, and they had scored only a handful of successes against the Soviet air force - including a quartet of Yak-9s and a single 11-2 for *Gruppenkommandeur*

Major Jürgen Harder - before they too withdrew into Hungary.

I./JG 53 would remain in the east until the end of the war, vacating Hungary for Austria towards its close. During these final six months the *Gruppe* claimed some 90 kills. The vast majority of these were Russian, but the tally did include a couple of American aircraft - and one Rumanian-flown Bf 109.

The most successful of the *Gruppe's* pilots was Hauptmann Helmut Lipfert, erstwhile *Staffelkapitän* of 6./JG 52, who assumed command of I./JG 53 on 15 February 1945. Lipfert's first kills as *Kommandeur* - two Soviet fighters exactly one week after his arrival - raised his score to 181. His last claim, for a Yak-9 downed on 16 April, took his final tally to 203. It also won him *the Jagdwaffe's* last Oak Leaves of the war 24 hours later.

Meanwhile, JG 52 had been continuing the unequal struggle, responding as best it could to each fresh new danger, scoring victories, suffering casualties.

On 1 September 1944 Erich Hartmann was promoted to hauptmann. The following day Hauptmann Adolf Borchers, who had succeeded

Johannes Wiese as *Kommandeur* of I./JG 52, claimed his 118th kill - and the *Geschwader's* 10,000th since the beginning of the war! This unique accomplishment provided a propaganda highlight in those days of otherwise almost unrelieved gloom for the German people. A special *Geschwader* march was even composed and broadcast on the national radio.

On the last day of the month JG 52 lost its longest-serving *Kommodore* when Oberstleutnant Dietrich Hrabak left to take over JG 54. His successor proved no stranger to JG 52 - Oberstleutnant Hermann



Hauptmann Erich Hartmann is seen here shortly before leaving the famed 'Karaya' *Staffel* to set up the new 4./JG 52. His replacement as *Kapitän* of 9./JG 52 was ...



... Leutnant Hans-Joachim Birkner, who claimed 117 kills during his brief 14-month combat career

Graf, who had won the Diamonds when *Kapitän* of 9. *Staffel* back in September 1942, returned from Defence of the Reich duties to lead the *Geschwader* through its final months, and ultimately into Soviet captivity.

On that same 30 September Hauptmann Erich Hartmann relinquished command of the famous 9. 'Karaya' *Staffel* to activate the newly formed 4./JG 52. His replacement as leader of 9./JG 52 was Leutnant Hans-Joachim Birkner, who had often flown as Hartmann's wingman. A relative newcomer, Birkner had claimed his first kill exactly a year earlier. On 14 October he would achieve his century.

By then III. *Gruppe* had been rushed up into East Prussia, the area where the Red Army had just set foot for the first time on German soil. III./JG 52 were later joined there by I. *Gruppe*. In the meantime, II. *Gruppe* was operating over Hungary where, its pilots reported, the *Stormoviks*' rear-gunners had taken to lobbing hand grenades at them if they got too close to their tails!

Bad weather during the closing weeks of the year restricted operational activity. In December two Knight's Cross *Staffelkapitäne* were killed in take-off accidents - 9./JG 52's Hans-Joachim Birkner suffered engine failure at Cracow, in Poland, on 14th, and Hauptmann Heinrich Sturm of 5./JG 52 somersaulted when his wheels clipped a truck at Csor in

Hungary eight days later.

Sturm was succeeded by another Knight's Cross wearer, Leutnant Peter Duttmann, whose exploits during his two-year operational career with II. *Gruppe* resulted in his crashing or forced-landing no fewer than 19 times - mostly as a result of anti-aircraft fire. Duttmann nevertheless survived the war at the head of 5. *Staffel*. His final number of confirmed victories totalled exactly 150 - plus a brace of Soviet tanks which, in 1945, were being equated with aerial kills!

On 4 January 1945 Major Gerhard Barkhorn became the second, and only other, *Jagdwaaffe* pilot to achieve 300 victories. Less than a fortnight later he left II./JG 52 to take command of JG 6 in Defence of the Reich. II. *Gruppe*'s new commander was to be Hauptmann Wilhelm Batz, who moved across from III./JG 52 on 1 February.

Batz's position was in turn filled by Hauptmann Adolf Borchers, *Kommandeur* of I./JG 52. This left vacant the leadership of I. *Gruppe*, which was assumed by 331-victory Hauptmann Erich Hartmann.

Hauptmann Hartmann climbs from the cockpit of the all-white G-6 depicted in Iain Wyllie's cover painting, reportedly after just claiming his only non-JG 52 victory of the war - a Yak-9 destroyed on 4 February 1945 while serving as temporary acting *Kommandeur* of I./JG 53





This frenetic round of command re-shuffling paled into insignificance against movements on the ground. By now the rapidly advancing Soviet Army was chasing I. and III./JG 52 out of one Silesian airfield after the other on an almost daily basis. In mid-March it retired down into Czechoslovakia. II. *Gruppe*, meanwhile, crossed the Hungarian border into Austria.

At the beginning of March 1945 Hauptmann Erich Hartmann was taken off operational flying and ordered to report to Lechfeld for conversion training on the Me 262 jet. Just what the world's most successful fighter pilot - now with 346 kills - could have achieved in one of these revolutionary machines must remain conjectural. For Hartmann turned down Adolf Galland's subsequent invitation to join his elite JV 44, opting instead to return to I./JG 52 in the east as requested in a telegram from Oberstleutnant Hermann Graf.



There, on 17 April, he claimed his 350th enemy aircraft destroyed. Four days later fellow *Gruppenkommandeur* Hauptmann Wilhelm Batz became the last member of the *Jagdwaaffe* to receive the Swords. By now, however, such individual successes, and such decorations — increasingly irrelevant of late — were totally meaningless. The centre of Berlin was already coming under Soviet artillery fire. On 30 April Adolf Hitler would commit suicide.

Hauptmann Erich Hartmann's 352nd and final kill, an unidentified Yak fighter, went down over Brunn (Brno), in Czechoslovakia, on 8 May 1945 - the last day of the war in Europe.



The fate of I./JG 53 was closely bound up with that of JG 52 during the final weeks' hostilities. Located in Czechoslovakia at the time of the capitulation, members of I. and III./JG 52 suffered long years of post-war Soviet captivity. Only Austrian-based II./JG 52 succeeded in surrendering to the Western Allies. Pictured at Neubiberg in May 1945, the late-model Gustav in the foreground is a machine of II./JG 52. But the diamond-shaped patch of overpainting on the cowling, obliterating the famous 'Ace-of-Spades' insignia, suggests it has been taken over from I./JG 53

Lastly, and dedicated to every pilot - *Experte* or otherwise - who suffered the rigours of the eastern front, one final reminder of the two greatest of them all - Gerhard Barkhorn (20 March 1919 to 8 January 1983). . .

. . . and Erich Hartmann (19 April 1922 to 20 September 1993)

'EXEUNT OMNES'

Tuesday, 8 May 1945. The last day of the war in Europe dawned fine and clear as the sun slowly rose over the central Baltic. There was no sign today of the low-lying, early morning sea and ground mist which had so bedevilled the Luftwaffe's opening strikes against Poland over this very area six long years before.

Flying north in the gathering light along the coastal sea lanes off the Courland Peninsula, the three-man crew of a solitary Soviet maritime-reconnaissance aircraft were confident that they would have little difficulty in locating and reporting the position of most, if not all, of the several large convoys (each composed of anything up to sixty minor naval units and small passenger vessels) which were known to be assembling off Libau and Windau. The presence of these ships in waters so far to the rear of the advancing Russian Army represented a desperate, last-ditch attempt to evacuate as many as possible of the tens of thousands of military personnel and civilian refugees still pouring into the last two peninsula harbour towns remaining in German hands. Once detected, it would be the job of the Red Banner Baltic Fleet's dive- and torpedo-bomber squadrons to ensure that few, if any, of the critically overcrowded vessels - and their human cargoes - should escape westwards to the safety of Kiel Bay and other such sanctuaries along the now British-held coastline of Schleswig-Holstein.

A 'new' Fw 190A-4 of II/JG 54 alongside a Bf 109G at Siverskaya early in 1943. The hinged fuselage fairing has been cranked back to allow the rugged up 'black men' access to the aircraft's twin 7.9 mm WIG 17 machine guns sandwiched between the BMW engine and the cockpit. Despite having been at the frontline only a matter of weeks, the aircraft's whitewash finish is already severely weathered, particularly around the cowling and the exhaust pipes

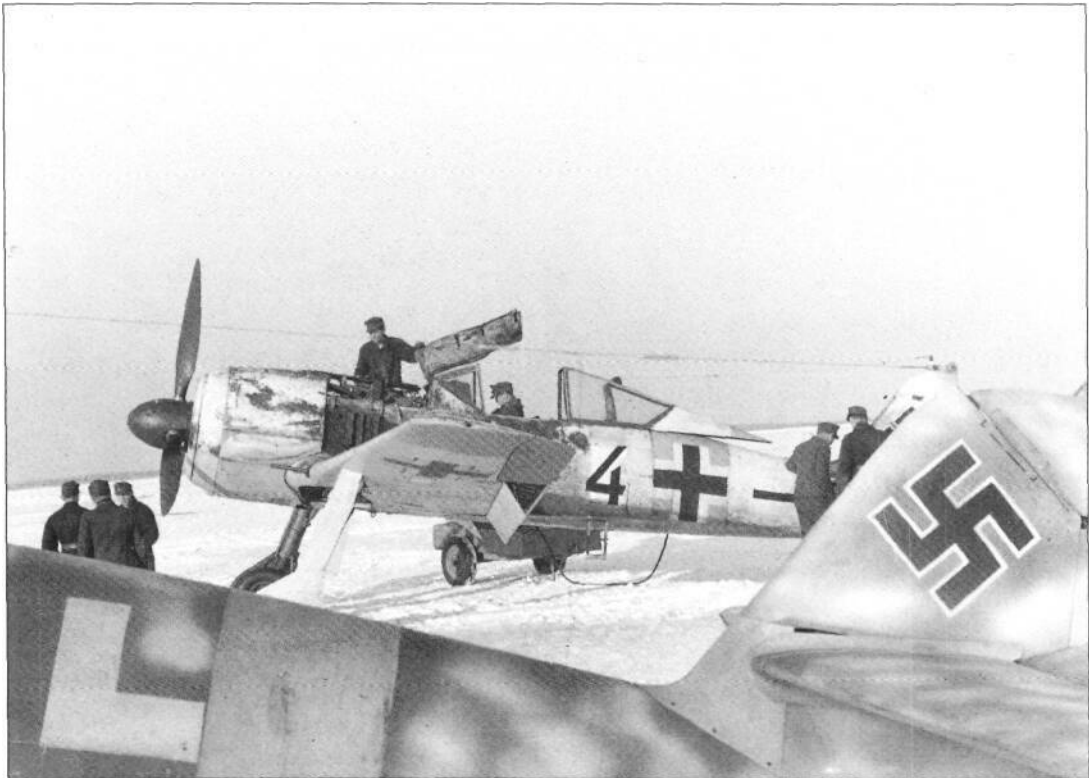

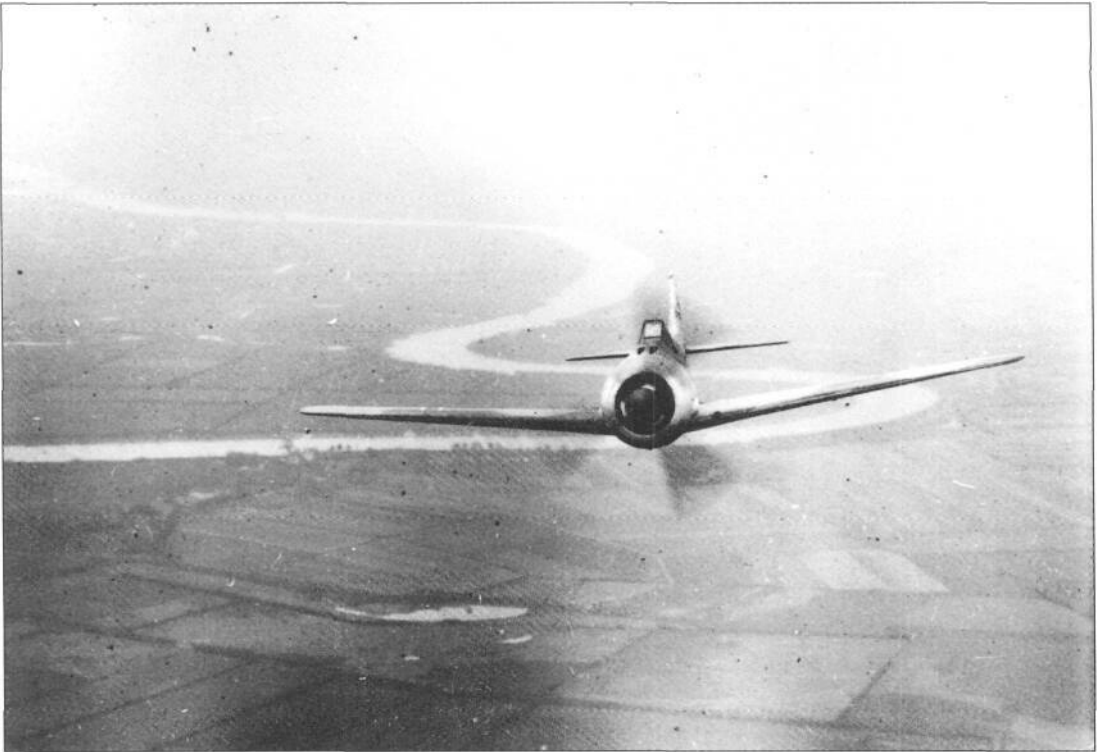

But so intent were the trio of Russians upon scanning the surface of the sea beneath them, that they failed to spot a pair of miniscule black specks off to starboard high in the eye of the rising sun. Within seconds the hunters had become the hunted as the two small dots developed wings and materialised into the unmistakable head-on silhouettes of radial-engined fighters. The leading machine opened fire at maximum range. Rather than diving away, the Russian pilot opted simply to increase speed. It was to prove a fatal error. A second burst of cannon fire buried itself in his right-hand engine. Only then did he seek the now dubious protection of zero-altitude. At little more than six feet above the wave tops, and with the observer and rear gunner hosing up a curtain of heavy machine-gun fire, the dark green Petlyakov crabbed round towards the safety of dry land. But the glitter of the single, sun-mirrored wake thrown up by his one good engine betrayed the Russian's new heading as unerringly as any contrail. One more diving pass by the leading fighter hammered him into the sea. The Pe-2 disappeared in a sparkling flurry of spray, taking with it Major Grigori Davidenko and observer Major Grashchev - 'Heroes of the Soviet Union' both - together with their anonymous gunner.

The two fighters, Fw 190A-8s of II./JG 54, resumed their westward course for Kiel and British captivity. In shooting down the luckless Petlyakov, they had not only both claimed the last of the nearly 9500 victories accredited to their parent *Geschwader*, as well as undoubtedly one of the very last Luftwaffe kills of all of World War 2, they had also written finis to the saga of the Focke-Wulf fighter on the Eastern Front, a saga that had begun just 32 months earlier, almost to the day.

The final view of Mother Russia for many a Soviet aircrewman from late 1942 onwards included this ominous head-on silhouette within it. Fortunately for this photographer he was sitting in a Luftwaffe aircraft when he exposed this remarkable shot in mid-1943

FAMILIARISATION

Originating in the autumn of 1937 with an order from the *Reichsluftfahrtministerium* (German Air Ministry) to Focke-Wulfs Bremen factory for a single-seat fighter to supplement the Messerschmitt Bf 109 then entering service, the Fw 190 was very nearly stillborn. There was a strong lobby within both the RLM and the Luftwaffe Operations Staff who argued that Willi Messerschmitt's superlative and world-beating 109 required no such back-up programme. In the event, and after submitting several alternative concepts utilising the liquid-cooled in-line powerplant then very much the vogue in Europe, it was not until Focke-Wulf's chief designer, Dipl-Ing Kurt Tank, began to argue in favour of a radical configuration built around a powerful 14-cylinder, air-cooled BMW radial engine that the future of the Fw 190 was assured. It is ironical that the only completely successful new fighter introduced on any scale by the Luftwaffe during the war owed its existence not to its own merits - classic though these turned out to be - but rather to fears on the part of the RLM's Technical Department that production and delivery schedules of the Bf 109's engine could be placed in jeopardy if it were also to be selected to power a second fighter!

The first Russian-based unit selected to re-equip with the Fw 190 was I./JG 51, the first wing of the 51st 'Mölders' Group. Blissfully ignorant of the contretemps surrounding the fighter's inception, the unit's pilots simply regarded their withdrawal for conversion onto the Fw 190 as a well-earned respite from the Russian Front, and a welcome opportunity, however brief, to return to the Homeland. Tracing its history back to

Chief mechanic Unteroffizier Rommer inspects 'his' Fw 190 which returned from ops to Siverskaya in mid-1943 with two complete cylinder heads shot away from its BMW engine by Soviet groundfire. Despite chronic damage to the powerplant itself, the pilot returned safely and made a perfectly routine 'three-point landing



I./JG 135 - a *Jagdgruppe* originally activated at Bad Aibling in Bavaria on 1 April 1937- I./JG 51 had since participated in the invasions of France and the Low Countries, and in the Battle of Britain, before moving eastwards at the end of May 1941, along with the bulk of the Luftwaffe's striking power, in preparation for the invasion of the USSR. After two pilots, both of 2. *Staffel*, were posted missing in July, the *Gruppe's* third loss in-theatre had been that of the *Gruppenkommandeur*, Hauptmann Hermann-Friedrich Joppien, a 70- victory ace and holder of the Knight's Cross with Oak Leaves, who was killed on the Central Sector south-west of Moscow on 25 August 1941. Now, 12 months and three *Kommandeure* later, I./JG 51 was still on the Central Sector facing a new counter-offensive supported, for the first time, by the Lavochkin La-5 and the



Yakovlev Yak-7B, both of which were superior in performance to the *Gruppe's* tiring Bf 109Fs. It was at the height of this crisis that I./JG 51, under Hauptmann Heinrich Krafft, was pulled from the frontline and retired to Jesau, near Königsberg, for conversion onto the Fw 190A-3.

The conversion course itself comprised a series of technical lectures on the handling and flight characteristics of their new mount. The most obvious difference from the familiar form of the Bf 109 was the pugnacious size of the powerplant; on the Fw 190A-3 this being the 1700 hp BMW 801D-2. Ideally suited to the Eastern Front, the BMW possessed two important advantages over the Daimler-Benz: its very bulk offered a degree of head-on protection for the pilot, and it could absorb a tremendous amount of damage; qualities which were quickly appreciated in the low-level arena of the Russian Front where ground-fire was a constant hazard. Whereas the Bf 109 could be downed if nicked in the cooling system by a single rifle bullet, tales would soon be told of Fw 190s staggering back to base with one or more complete cylinder heads shot away.

One word of warning was sounded, however. If, for any reason, the Focke-Wulf's engine did stop, the advice was to get out - quickly. Powerless, the Fw 190 had 'the glide characteristics of a brick. As soon as the engine faltered, the nose pointed earthwards, followed by the rest of the airframe in close formation'. Opinions were to vary as to the advisability of trying to land with a dead engine. Some pilots swear they never witnessed a single successful attempt at a deadstick landing. Others claim to have actually done so, with varying degrees of damage to self and aircraft. All are agreed, however, that such action was a course of last resort and not one to be recommended on a regular basis. Belly landings, on the other

'Like a bullfrog on water-skis' - two Fw 190s plough through the slush brought on by the spring thaw in early 1943. Devoid of any distinguishing *Staffel* or *Gruppe* markings, it is difficult to ascertain exactly who these Fw190A-4s belong to - if they are JG 51 machines then the photographs were taken at Orel, but if they hail from JG 54 then this site is probably Krasnogvardeisk. Note the mottled grey/white Fw 190 parked behind 'White 10'

hand, offered the pilot a reasonable chance of walking away from the resultant mayhem. The forward momentum of the BMW, ensconced behind its armoured ring, tended to brush aside all but the most immovable of obstacles. The trick, one pilot discovered, was in setting the prop blades to as fine a pitch as possible immediately prior to impact. As soon as they hit the ground, they bent backwards and doubled as makeshift skis. Some future ground-attack pilots would even profess to being able to make smoother wheels-up landings on their fuselage and wing weapons-racks than they ever did by performing a normal three-pointer!

The width of the undercarriage track also proved a distinct boon to Eastern Front flyers. Where the Bf 109 skittered perilously, the Fw 190 ploughed its way splay-legged and tail-down through the worst surfaces the Soviet winter could throw at it - snow, slush, rain or mud - 'like a bullfrog on water skis.' Taxying and take-off could, however, pose a problem. Despite the near all-round vision from the cockpit (there was a 15-degree blind spot immediately to the rear occasioned by the pilot's head armour), the obtrusive cowling precluded a full forward view until airborne. For unlike the Bf 109, the pilots were told, the Fw 190 had to take-off the same way as it landed: on all three points. Raise the tail too early and there was every danger that the propeller would dig in and flip the aircraft on to its back.

On the subject of flight characteristics, it was tacitly acknowledged that the Fw 190's performance did fall away at altitude. Although this was currently posing a problem on the Channel Front (and was to assume greater proportions in Defence of the Reich operations in the years to come), it played no part in Eastern Front operations where, experience had shown, the Soviets tended to swarm at low-level over the scene of any ground action 'like a plague of gnats at a picnic'. For the Russian Front, therefore, the Fw 190 was to prove the ideal machine, combining ruggedness with manoeuvrability and stability. In short a superb dogfighter - in all but the tightest of horizontal turns - and an excellent gun platform. The contemporary Bf 109 could only match the Fw 190A-3's formidable armament of two 7.9mm machine guns and quartet of 20mm cannon by bolting on two performance-sapping underwing gondolas.

The tactic evolved in the west of fighting the Fw 190 in the 'Vertical plane' — in other words, a quick diving pass and rapid zoom recovery — rather than of mixing it on the horizontal, was also suited to the east where the enemy seldom sought the advantage of height and tended to pay scant regard to his rear. In fact, one of the Luftwaffe's major opponents on the Russian Front, the rugged Ilyushin Il-2 *Stormovik* ground-attack aircraft, was all but impervious to anything but a stern attack. While bullets bounced harmlessly off its thickly protected underside and flanks, a well placed burst of fire into the tail unit could often bring about its demise.

If, however, the pilots of I./JG 51 found themselves embroiled in a twist-and-turn dogfight, they were strongly warned of the Fw 190's one basic, and potentially lethal, flaw. In clean configuration the stall was sudden and vicious. Let the speed fall below 127 mph and, virtually without warning, the port wing would drop so violently that the Fw 190 all but turned on its back. Pull into a G-stall in a tight turn and it 'would flick over into opposite bank and you had an incipient spin on your hands'. But a virtue could be made even of this vice, Krafft's pilots were told. It

was a manoeuvre no pursuer could emulate. 'Be prepared to control the spin, and it is one sure way of shaking Ivan off your tail. Just don't try it at low level, the initial movement eats up too much vertical airspace!' With this caveat ringing in their ears, the next stage of the course was cockpit familiarisation. There was, as yet, no dual-seat trainer variant of the Fw 190 available (a few appeared in 1944, but were used primarily to re-train ex-Ju 87 'drivers' for the ground-attack role), and it was crucial that each pilot be made conversant with his new 'office' before his first flight.

Pressing the button high on the fuselage side which released the retractable stirrup step buried aft of the port wing root, the pilot climbed aboard by means of a further spring-loaded handhold and step. Once in the semi-reclining seat, vertically adjustable over a range of some four inches, it was immediately apparent just how much of a quantum leap the Fw 190 represented over the Bf 109. The basic instrumentation could, of course, be recognised from old, but there was also an impressive array of new electric instruments and indicators, for the Fw 190 was equipped with a revolutionary and ingenious *Kommandogerät*—variously described as an 'early form of computer' or, more basically, a sort of 'brain box'—which relieved the pilot of such mundane tasks as the setting and controlling of the propeller pitch, mixture, boost and rpm. The Fw 190 was also a nest of electrics which, with the punch of a button, allowed the pilot to lower or retract the undercarriage (a separate electric motor for each gear leg), set the flaps and adjust trim. All this and more had to be explained, including the arming of the guns; first the fuselage machine guns and wingroot cannon had to be switched to live, then a three-second wait before arming the outer wing cannon—forget that delay in the heat of the moment, it was said, and you risked overloading the battery.

Finally, all was ready. One last check under the watchful gaze of the mechanic standing on the wing alongside the cockpit—shoulder straps, parachute harness, oxygen supply, run a not-yet-quite-practiced eye over the still unfamiliar banks of switches and buttons. The mechanic jumps down off the wing and takes station off to the left. 'All clear ahead?' 'All clear ahead.' 'Contact.' The BMW 801 is started by an inertia starter which is energised either by an ace trolley or the aircraft's own battery. A stab at the starter, and then the BMW roars into life in a cloud of blue smoke. Twelve degrees of flap at the touch of another button, release the brakes and start to roll. Unstick at 112 mph, punch the undercarriage and flap retraction buttons as, one by one, the pilots of I./JG 51 forsook theory and returned to their natural element. After a few cautious circuits and bumps, they were soon revelling in the superb control harmony of their new mounts, the lightness of the ailerons, the incredibly high rate of roll. Before long, they were practising dummy attacks on one another and staging mock dogfights during which they found themselves pulling aileron turns which would have wrenched the wings off their old Bf 109s.

The conversion course was at an end. It had been brief, but intensive. For Krafft's pilots—the majority of them products of the Luftwaffe's excellent and exhaustive pre- and early-wartime training programmes, and many already veterans of nearly three years of combat flying—there was neither the need, nor the time, to teach them anything more of combat tactics at this late stage. They knew exactly what they were returning to as they pointed their radial noses eastwards to resume the struggle.

JG 51 IN COMBAT

6 September 1942, the day I./JG 51 arrived back on the Russian Front, also marked the eve of the final German push on Stalingrad. Within 24 hours the strategically vital Gumrak airfield had been captured, German forces were probing into the outer suburbs of the city and Soviet Gen Andrei Yeremenko had withdrawn his battle headquarters to the far bank of the River Volga. Over the next four months the life, and ultimately death, struggles of von Paulus' 6th Army as they first attacked, and were then trapped by the resurgent Russians in the ruins of Stalingrad, were to overshadow all other events in the east.

Far from the battle unfolding to the south, I./JG 51 were initially assigned to the Northern Sector of the front, flying Fw 190-acclimatisation *Freie Jdgd* (literally 'free-hunting') sweeps in *Schwärm* and *Rotte* strength out of Lyuban to the southeast of Leningrad. Within days, however, they were redeployed south of Lake Ilmen to provide air cover for the vulnerable bottleneck which supplied the Demyansk 'mushroom'.

In October, with the onset of winter, I./JG 51 moved south again, this time to the Rzhev-Vyazma salient on the Central Sector opposite Moscow. Like the Demyansk 'mushroom' 200 miles to the north, the Rzhev-Vyazma salient had also been created - albeit on a larger scale - by 'boulders of resistance' - bodies of German troops which had stood firm against the Russian counter-offensive the previous spring. It was to be here that the Fw 190's war on the Eastern Front would really begin.

Meanwhile, Hauptmann Grasser's II./JG 51 had retired to Jesau as the second unit to re-equip with the Fw 190. Their conversion was cut short, however, by news of the Allied landings in north-west Africa. As part of the Luftwaffe's response to this threat, 4. and 5./JG 51 immediately abandoned the Fw 190 and transferred to Wiener-Neustadt to collect 20 Bf 109G-2/trops, already resplendent in desert-tan camouflage, prior to staging south to Sicily and thence to the fighting fronts in Tunisia (see *Aircraft of the Aces 2 Bfl 09 Aces of North Africa and the Mediterranean*).

To replace the departed *Staffeln* of II. *Gruppe*, Hauptmann Karl-Heinz Schnell's III./JG 51 were pulled out of the Rzhev-Vyazma salient to join the solitary 6. *Staffel* at Jesau for re-equipment with the Fw 190. This meant that I./JG 51 was the only *Jagdgruppe* defending the salient from within (although supported by the Bf 109s of IV./JG 51 based at nearby Vitebsk) as Soviet pressure mounted. No longer appearing in the huge, haphazard swarms which had so characterised the opening months of the Russian campaign, new Soviet aircraft - predominantly Petlyakov Pe-2 dive-bombers and the ubiquitous Il-2 *Stormoviks* - while attacking in equal, if not even greater numbers than before, were now operating in smaller, more disciplined formations. In the face of almost non-stop raids on the five major airfields within the salient - particularly the sprawling central complex at Dugino with its concrete runway nearly a mile in length, its hangars, barracks, supply and equipment depots - the pilots of I./JG 51 in their new Fw 190s were soon adding to the scores they had amassed while flying the Bf 109 (the *Geschwaderhund* achieved its 4000th



Dispersal on a frozen surface of Lake Ivan, west of Moscow, during the winter of 1942-43 for a detachment of Fw 190A-3s from I./JG 51. Note that the aircraft furthest from the camera is having its BMW engine changed background left. The *Gruppenstab* machines on the right clearly wear their distinctive chevron markings, as well as yellow theatre bands beneath the fuselage crosses. These aircraft were heavily involved at the time protecting Ju 87s 'dive bombing' supplies to the besieged defenders of Velikiye Luki

victory on 1 November). A newcomer to the *Gruppe* at this period, although not to the Eastern Front, was Hauptmann Heinz Lange. In fact, Lange had scored his first kill as long ago as October 1939 when an RAF Blenheim on a recce mission over Germany fell to the guns of his Bf 109E. For the past year *Staffelkapitän* of I./JG 54 on the Leningrad front, Lange had been appointed to the command of 3./JG 51 on 26 October:

'I first flew the Fw 190 on 8 November 1942 at Vyazma in the Soviet Union. I was absolutely thrilled. I flew every fighter version of it employed on the Eastern Front. Because of its smaller fuselage, visibility was somewhat better out of the Bf 109. I believe the Focke-Wulf was more manoeuvrable than the Messerschmitt - although the latter could make a tighter horizontal turn, if you mastered the Fw 190 you could pull a lot of Gs and do just about as well. In terms of control force and feel, the 109 was heavier on the stick. In the Fw 190 aerobatics were a pleasure!

'Structurally, it was distinctly superior to the Messerschmitt, especially in dives. The radial engine of the Fw 190A was also more resistant to enemy fire. Firepower, which varied with the particular series, was fairly even in all German fighters. The central cannon of the Messerschmitt was naturally more accurate, but that was really a meaningful advantage only in fighter-to-fighter combat. The 109's 30 mm cannon frequently jammed, especially in hard turns - I lost at least six kills this way.

'In the development of our fighter operations, the most significant step was our transition from the closed *Kette* of three planes to the four-plane "finger-fours" *Schwärm*. This innovation was developed during the Spanish Civil War with considerable help by Werner Mölders. I attribute to this tactic the high number of kills attained by German fighter pilots.'

Lange eventually became the sixth, and final, *Kommodore* of JG 51, ending the war with 70 kills, all but one of which he scored in the east.

On 24 November 1942, with winter really beginning to bite, the Rus-

sians pre-empted any plans for a renewed German attack on Moscow by hurling seven Armies, supported by a host of Frontal Aviation Regiments, against the northern flank of the Rzhev-Vyazma salient. The German central front was broken at Rzhev itself, at Byeli and at Velikiye Luki. The latter breach was the most dangerous. Velikiye Luki, a vital rail junction, had originally been captured by the Germans in August 1941 and since built up into the strongest hedgehog defence base on the Central Sector. It was now surrounded. As the only fighter presence in the area, JG 51's two *Gruppen* were hard pressed to answer all the calls now suddenly being made upon them - calls not only to drive off the Soviet air attacks being mounted with increasing ferocity all along the sector, but also to protect their own bombers attempting to drop supplies to the besieged defenders of Velikiye Luki. Thinly stretched though he was, Hauptmann Krafft was obliged to detach part of his *I. Gruppe* to operate from the frozen surface of Lake Ivan near to Velikiye Luki. From here they escorted Ju 87s 'dive-bombing' supply containers to the troops trapped in the hedgehog below. In December they were joined by III./JG 51 and by *6. Staffel*, both newly arrived from Jesau and now flying the Fw 190A-4. But the Luftwaffe efforts were to no avail. On 1 January, 1943 Velikiye Luki was stormed.

Meanwhile, along the northern flank of the Rzhev-Vyazma salient the main body of I./JG 51 had been suffering its first combat losses on the Fw 190. On 10 December Hauptmann Horst Riemann, who also served as the *Geschwader* *Signais* Officer, was killed in action. Then, four days later, Hauptmann Krafft and Unteroffizier Ritterbusch were both downed by *Flak*. Knight's Cross holder Heinrich 'Gaudi' Krafft, who had commanded I. *Gruppe* since May, and whose score stood at 78 kills, survived the crash, only to be beaten to death by Russian soldiers.

Unlike I./JG 51's earlier *Freie Jagd sweeps*, the pilots of III. *Gruppewete* allowed no time for 'breaking-in' their new mounts. Returning from Jesau, where the conversion had already cost them one casualty killed in a mid-air collision, they found themselves in the thick of the fray.

The pilots of JG 51 were hard put to counter the growing Soviet pressure which was being felt along the entire length of the Central Sector. There now began a period of 'Tire brigade' actions as separate *Gruppen*, *Staffeln* - sometimes even individual *Schwärme* — were despatched back and forth along the front from one new area of danger to the next. By the end of the year I./JG 51 found themselves being rotated between Lake Ivan, Vyazma and Orel. Not unnaturally casualties began to climb, none more tragic than that of Hauptmann Rudolf Busch, who had taken over acting command of *I. Gruppe* after the loss of 'Gaudi' Krafft. On 17 January Busch took off from the frozen surface of Lake Ivan as wingman to *Geschwaderkommodore* Oberstleutnant Karl-Gottfried Nordmann. Still in a steep, climbing turn Nordmann must have let his speed drop away, for suddenly, without warning, his Fw 190 whipped over onto its opposite wing and smashed into Busch, who went down in flames behind enemy lines. The wounded Nordmann managed to parachute to safety, but the incident had so shattered him that, although he returned after recovery from his injuries to resume command of the *Geschwader*, never again did he fly operationally. During Nordmann's absence the *Geschwader* WAS, led by Hauptmann Schnell, *Kommandeur* of III. *Gruppe*.

Early in 1943 III. *Gruppe* had been transferred to Orel. Here, on 29 Jan-

uary, Oberleutnant Günther Schack of 9./JG 51 had a field day. After escorting a formation of Ju 87s to their target, Schack's *Schivarmwerve* on their way back to base when they were informed by ground control that eight *Möbelwagen* ('furniture vans', the code for enemy bombers) had been reported crossing the German lines at Novosil. Closing up, the Fw 190s soon found eight Pe-2s flying in line astern. What followed was, in Schack's own words, a real 'turkey shoot'. Within five minutes all eight Pe-2s were burning on the ground, five of them claimed by Schack.

In the ten days following the destruction of the eight Pe-2s, III./JG 51 were in action every day. And by 11 February Schack's score had risen to 30. His particular forte was to attack and fire while turning, a manoeuvre that required considerable skill, and one which he demonstrated no better than on 23 February. By the end of that day I. and III./*Gruppen* between them had brought down a total of 46 aircraft. Five had fallen to Schack, three of them being LaGG-3s which he had shot out of a tight defensive circle of four in the space of less than a minute by once again using his favourite steep turn tactic - a manoeuvre, incidentally, which the legendary Werner Mölders had declared 'impossible' two years earlier. By war's end Günther Schack would himself be a *Gruppenkommandeur* with 174 kills to his credit, all scored on the Eastern Front.

As February gave way to March, the crisis on the Central Sector was coming to a head. To the north the Demyansk 'mushroom' was slowly being cleared. To help cover the final stages of the withdrawal, III./JG 51 were deployed to Krasnogvardeisk for temporary assignment to JG 54.

In March, too, all hope of using the shrinking Rzhev-Vyazma salient as a launching pad for an attack on Moscow had to be finally abandoned. I. and IV./JG 51 supported the ground forces' withdrawal to the best of their limited ability, the former now being down to just eight serviceable Fw 190s, and IV. *Gruppe* little better off in terms of Bf 109s. After the salient had been collapsed and the frontline straightened, *W.Gruffe* retired to convert to the Fw 190. In the meantime, I. *Gruffe*, now commanded by Major Erich Leie, were transferred southwards to Bryansk, where a new threat was developing. At Bryansk I./JG 51 again had the chance briefly to fly that one type of sortie most dear to the fighter pilot's heart - the *Freie Jagd*. And two new names began to emerge from the ranks of I. *Gruppe* - Joachim 'Achim' Brendel and Josef 'Pepi' Jennewein. Like *9.Stoffels* Günther Schack, both were long-serving members of JG 51, but neither had particularly shone in the scoring stakes during their time on the Bf 109. Brendel's rise to fame was to begin in the spring of 1943. During the course of the next two years he would amass a total of 189 kills - all in the east - including 25 Yak-9s and, incredibly, 88 *Stormoviki* Austrian 'Pepi' Jennewein, the 1940 world ski champion, had become an ace during the Battle of Britain. But it was not until he got the Fw 190 that he, too, began to show his talent, scoring as many as seven victories in a single day and, on one notable occasion, five bombers in just six minutes - instant 'acedom' doesn't come much quicker than that!

By the end of March 1943, however, both sides had flown and fought themselves to a near standstill. The onset of the spring thaw came as a welcome relief. Offensive activity was reduced to a minimum on the Central Sector as Germans and Russians alike sought to rebuild their strength for what was to be the next great test - the battle of Kursk.

JG 54 - ENTER THE 'GREEN HEARTS'

Back at the turn of the year, when JG 51 had been busy trying to bring succour to the defenders of Velikiye Luki while, at the same time, attempting to shore up the rest of the Central Sector, the second, and last, *Jagdgeschwader* on the Eastern Front to be re-equipped with the Fw 190 began conversion. The unit in question, JG 54 *Grünherz*- the famous 'Green Hearts' *Geschwader*- had not even been in existence as such at the beginning of the war having been formed from three hitherto disparate *Gruppen* only immediately prior to the Battle of Britain.

At the beginning of Operation *Barbarossa*, JG 54's three *Gruppen* of Bf 109Fs constituted the sole fighter strength of *Luftflotte 1* on the Northern Sector of the front. Keeping pace with *Feldmarschall* Ritter von Leeb's *Heeresgruppe Nord*, the *Geschwader* marched swiftly through the Baltic States in the high summer of 1941, arriving at the gates of Leningrad by early September. On 5 September they occupied the airfield at Siverskaya, and that at Krasnogvardeisk (also known as Gatschina) a few days later. For the next year concentrated primarily around Leningrad, JG 54 was to lead, by Eastern Front standards, a relatively sedentary existence. Their zone of operations stretched from the Demyansk 'mushroom' in the south (where it co-joined with JG 51's left flank on the Central Sector) northwards to the shores of the Gulf of Finland and, sometimes, beyond into southern Finland itself- a front some 300 miles long.

In December 1942 the first members of Hauptmann Hans Philipp's I./JG 54 departed Krasnogvardeisk for East Prussia and re-equipment with the Fw 190A-4. This time, however, the destination was not Jesau, but Heiligenbeil, an ex-bomber station now serving as a major supply and repair base, on the main road and rail link some 30 miles to the south-west of Königsberg. Among their number were a duo who would rise to become the Eastern Front's most successful Fw 190 pilots - in fact, the fourth- and fifth-highest ranking aces of all times.

The first, an NCO pilot small in stature and quiet in demeanour, had yet to properly make his mark. Few would then have guessed that the hesitant, slow-spoken Sudeten-born Otto Kittel would ultimately be the *Grünherz-Geschwader*'s top scorer. During the early phases of *Barbarossa*, the 'happy time' for Bf 109 kills, it had taken Kittel some eight months to achieve just 15 victories. As with others before him, it seemed that conversion to the Fw 190 was to provide the spark. Where once the shooting-down of enemy aircraft had seemed to pose an insuperable problem, soon for Kittel there was to be no looking back.

The second future *Experte*, by contrast, already had more than 50 victories to his credit. *Staffelkapitän* of I./JG 54 since 25 October, the career of 22-year-old Austrian Leutnant Walter Nowotny was almost over before it had begun. He had scored his first three kills on 19 July 1941 at

the height of the *Geschwaders*, dash across the Baltic States, by despatching three Polikarpov 1-153 biplanes over Ösel, the large island at the mouth of the Gulf of Riga. Hit by return fire from his third and final victim, Nowotny's options were stark: force-land behind enemy lines, or ditch in the sea. He chose the latter, setting the Bf 109 down off the southernmost tip of Ösel. Despite his care, he was thrown from the cockpit into the heavy swell. Inflating his life-jacket underwater, he was almost throttled by his parachute harness, which he had forgotten to release. Disentangling himself, he managed to climb into his dinghy. At last he could take breath, regretting only that his cigarettes had dissolved into a soggy mass and were unsmokable!

'Later I came to realise that it was a good thing I threw that packet of cigarettes away. I had nothing to eat or drink with me, and to smoke in the conditions I was about to face could have been my undoing. Luckily I had no idea of what lay before me. I would soon be found and fished out of the drink, I hoped, throwing my wet matches overboard one after the other to establish the strength and direction of the current and to set my course accordingly. So there I was, a little yellow dot on the surface as the sun sank slowly deeper and with no sign of rescue. I noticed that the current was carrying me south-westwards, away from Ösel. They'll find me, I thought, if not today then tomorrow. But just to be on the safe side, I wanted to get as close as possible to the mainland which, by my reckoning, lay 40 miles away due south.

'So I began to paddle with my hands, noting with satisfaction that the distance between myself and the lighthouse still visible on the southern tip of Ösel was slowly increasing. Strangely, no notice had been taken of me by the keepers of the lighthouse; perhaps they thought I'd drown anyway. And then it got dark. It was a starry sky and I continued paddling southwards, the Pole Star at my back. Despite only having on a sports shirt, breeches and socks - I had kicked off my fur-lined flying boots while still in the water - I did not feel the cold because of my exertions.

'On the next day the lighthouse tower was only half its previous size. During the morning a number of Bf 109s flew past, but all attempts to attract their attention failed. Once, as two Bf 109s passed by quite close to my position, I let off a couple of rounds from my Mauser pistol. I also took off my shirt and waved it. But as it was dark blue, it didn't stand out very much. They didn't even spot the bright yellow dinghy!

'So I had to attempt the seemingly impossible on my own. This was a bitter realisation which didn't make that first day any easier. Later, it also became very hot and I couldn't quench my thirst. From time to time I held my shirt over my head to protect myself from the sun. But I needed my hands to paddle. By now the paddling motion over the sides of the dinghy had chafed the insides of my arms raw and they burned like fire, so I tried another method, throwing the small sheet anchor ahead of the dinghy and pulling myself towards it. At the same time I was having problems coping with the waves breaking over the sides.

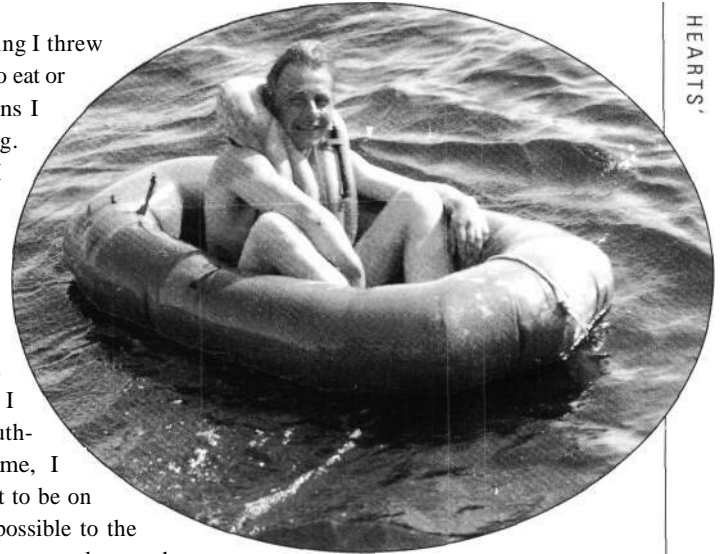

Although this jolly looking fellow is not Walter Nowotny, the photograph does give some idea of the size of the one-man dinghy in which he spent nearly four days. This vital piece of equipment was stowed as part of the parachute pack, in place of a seat or back cushion, in much the same way as the RAF Fighter Command K Type dinghy of post-1942 fitted into a Spitfire or Typhoon



'There was nothing to be seen of Ösel anymore. I used my pilot's watch to set direction and course. The peace and quiet which I had found so restful after the ditching yesterday was beginning to have its effect on me; that and the water which was making me sore all over and threatening to fill the dinghy.

'The stillness of the second night was suddenly shattered around midnight as two black shadows approached me and, at the same time, fountains of water erupted a hair's breadth away. If they were Soviet warships shooting at me, I ought to have been able to see their muzzle flashes. From close up I recognised them as Soviet destroyers, steaming eastwards at full speed and coming under fire from the south. Frightened of being spotted, I draped everything I could find over the edges of the dinghy to hide its bright yellow colour. I remained undetected . . .

'Although exhausted by this encounter, it also gave me new heart. The fire could only have come from German coastal artillery. So the distance to the mainland could only be eight kilometres at the most.

'As the second day dawned I again saw nothing but water. The real battle with myself began; thirst, cramps and - above all - the pain from the raw wounds all over my body. "It's no good, you're a goner", I thought. Better finish it quickly. With my silver propelling pencil I began to write 'Dear Parents' on the edge of the dinghy. Perhaps the dinghy at least would be found.

'But as soon as I wrote the word "Dear", I threw the pencil into the bottom of the dinghy and tried to start paddling again. Twice I took out my pistol and released the safety, and then finally put it away.

A factory-fresh I./JG 54 Fw 190A-4 has its engine run up by its pilot prior to the first sortie of the day being flown from Krasnogvardeisk in early 1943. The gentle mottling of the winter white camouflage is clearly visible from this angle, as is the fact that the groundcrew have painted out the yellow theatre band that once surrounded the fuselage cross. Note also the carbon deposits from the starboard MG 151 20 mm cannon, which denote that this aircraft has very recently seen action

Lower engine inspection panels were often painted yellow for identification purposes early on in the Fw 190's war in Russia - all three I./JG 54 A-4s in this shot exhibit such markings



I awoke slowly on the third morning with a feeling of unease. A constant, cool damp breeze rippled over me. At first I could find no explanation. I drifted through a sort of cloud and, through the haze, saw a dark indistinct strip of coastline with spray being thrown up by the breakers crashing ashore. I paddled towards it, felt a gentle bump, was thrown sideways out of the dinghy and found myself on all fours on coarse sand. I pulled myself one or two metres up the beach - and then lost consciousness. Coming to, I crawled through a belt of barbed wire defences on the shoreline until I saw a farmhouse, and there must have fainted again.



Mission accomplished, a I/JG 54 A-4 approaches Krasnogvardeisk with its gear firmly locked down and flaps deployed. 'White 7' exhibits a full set of Eastern Front theatre markings typical of a newly-arrived JG 54 Fw 190 in the first weeks of 1943, including yellow wingtip flashes, fuselage band and cowling decoration - both yellow inspection panels and a *Gruppe* crest

'When I awoke, I was between sheets. My things were on a stool beside the bed, my pistol on top of them. To my horror I saw two soldiers in Russian uniform and lunged for the pistol. Just in time, I noticed their armbands. They were Latvian auxiliaries - the place was called Mikelbaka, a name I'll never forget.

The coastal artillery men who looked after me were the ones who had fired at the destroyers during the night. They admitted to having seen something yellow in the far distance, but thought it was a buoy.

'Back at the *Staffel* (9./JG 54) they had already packed my belongings and were about to inform my parents. A week later, when I was back in the air, I got an unpleasant and oppressive feeling whenever I had to fly over the sea. It was not until a fortnight afterwards, when I sent a Russian bomber down over the very same spot near the lighthouse on the southern tip of Ösel, that I finally got over it.'

Although all this happened at the very beginning of his operational career, the events off Ösel played an integral part in Walter Nowotny's subsequent meteoric rise in JG 54. From that day on he never flew a mission without first climbing into his salt-stained, ripped and torn breeches. Nowotny's lucky '*Abschusshosen*'—his Victory trousers' - became a watchword throughout the *Geschwaderfi*

Gradually the pilots of I. and II./JG 54 underwent a similar type of conversion course as had JG 51 before them. And, like JG 51, they too suffered at least one fatality; Leutnant Walter Beims of 3. *Staffel* losing his life when his Fw 190A-4 crashed at Heiligenbeil on 28 December. Nor were all members of the course as equally enamoured of their new mounts, one future *Experte* declaring disgustingly that the Focke-Wulf 'landed like a wet sack' and thereafter referring to it disparagingly as a 'wardrobe'.

Strangely, too, the instructional



Weak morning light in the depths of a Russian winter does little to warm this bleak view of a snow-covered flightline in January 1943. Every day the fresh snowfall was rolled flat by the diligent groundcrewmembers prior to the first sorties being flown, with the excess being banked up as wind-breaks around the edges of the small dispersals



Seemingly oblivious to the roar of the BMW 801D-2 ticking over just feet away from them, two suitably insulated 'black men' turn their thoughts to Bavaria in July. The pilot, meanwhile, has gone 'head down' in the cockpit in order to check that the engine oil temperature is rising correctly. Once his dials indicate that the radial powerplant has 'warmed to the occasion', he will wave away both the trolley ace, parked behind the fighter, and the wheel chocks

The Russians had become more proficient at staging surprise hit and run raids on the Luftwaffe's airfields by early 1943, and take offs and landings became times of great peril for Fw 190 pilots. Amongst the first things taught to new arrivals in the east was how to take-off from any position on the field, either from a standing start or taxiing, and how to land quickly and safely from a low-level formation. Here, a pilot from I/JG 54 does just that, skimming in low over a huge snow bank



staff at Heiligenbeil appear not to have mentioned the Fw 190's propensity to flick over into a spin if turned too tightly. Certainly, the pilots can recall no such warning. Suggestions that this inherent vice of the A-3 had been cured by the introduction of the A-4 seem unlikely, as similar incidents were still being reported on even later variants during the final months of the war. The one feature of their new mount which seems to have

impressed the young bloods of JG 54 most of all was its ruggedness of construction, particularly the strength of the one-piece, through wing structure. This eventually led to an unofficial 'experiment' to find out just how much punishment the airframe could really take. Pushing his wallowing Focke-Wulf to its maximum ceiling, one of their number - who was, in fact, a veteran Lufthansa pilot old enough to know better! - then proceeded deliberately to point the nose straight down. The speed built up alarmingly. And although the sound barrier may have remained inviolate that day, such was the rate of descent that the propeller arc itself began to act as a brake. The pilot was no seven-stone weakling either, but it took all his strength to pull the complaining fighter out of its near terminal power dive and bring it safely down. The others crowded round to count the missing rivets, only to find every single one obstinately unpopped! As a confidence booster in a new aircraft, Kurt Tank himself could have staged no better demonstration.

Early in January, 1943, it had been decreed at a meeting of fighter commanders in Berlin that JG 26 *Schlageter* in the west should change places with JG 54 in the east. Fearing that a simultaneous transfer of both *Geschwader* would denude their respective fronts for too long a period, it was decided that the transition would be carried out piecemeal, one *Gruppe* at a time. In the event, only one *Gruppe* - plus one additional *Staffel* - of each *Geschwader* actually made the switch. This resulted in I/JG 26's temporarily operating for some four months on the Russian

Front - of which more later - before returning to the west in June 1943. For JG 54, however, it meant a complete parting of the ways with their *III. Gruppe*, which decamped westwards in February never to return.

Meanwhile, I. and II./JG 54's conversion was likewise progressing piecemeal. From January to March individual *Staffeln* gradually began returning to the snow-covered runways at Siverskaya and Krasnogvardeisk, where brand-new winter camouflaged Fw 190A-4s then shared hangar space and dispersals



Taxying in the Fw 190 was never straightforward, literally, as Hauptmann Heinz Lange of 3./JG 51 relates:

'When taxying, visibility forward was worse out of the Fw 190 than the Bf 109, but that was easily solved by S-turning. Visibility was also worse out of the Fw 190 during take-off and landing because these were performed in a tail-low attitude, unlike the Bf 109 which was fairly level at these times.' The pilot of this I./JG 54 A-4 has just opened the throttle to commence his take-off run down the freshly carved-out snow runway at Krasnogvaedeisk

The engine runs on the A-4 featured at the top of page 20 have obviously thrown up a snag as the pilot has now shut the BMW down and is consulting his 'black man'

with the less pristine Bf 109s (II. Gruppe would not relinquish its last Messerschmitt until August). Having been resident at these two large ex-Soviet bases for so long, the pilots had settled in to almost all the comforts of home. At Siverskaya, where the *Geschwader* HQ was fronted by two stuffed bears and large cut-out figures of Stalin, Roosevelt and Churchill stood outside the ops room, they enjoyed the pleasures of a cinema and sauna. Quar-

ters at Krasnogvardeisk were even more luxurious, for tucked away in the woods alongside the broad runway was the one-time summer palace of the Czars, complete with ornamental lake.

Arguably of even greater importance, the groundcrews, or *Schwarze Männer* ('black men', so called because of the colour of their one-piece overalls), to whom every pilot owed an incalculable debt, were equally well catered for, with both bases having extensive hangarage and covered working areas. The only drawback was their proximity to the frontline, but the attentions of Soviet bombers and long-range artillery had come to be accepted as part of the daily routine.

Not all Russians were so overtly hostile, however. For the occupants of Siverskaya, which did not boast a paved runway, the advice of an obliging Soviet deserter on how to keep the base operational all year round was most welcome. After the first snow had fallen, he explained, half the field's area had to be rolled or stamped flat. This provided a firm, compressed surface for take-off and landing during the winter months. Meanwhile, the other half of the field was strictly off-limits. Come the spring, this untrodden snow quickly thawed and the grassy surface beneath was sufficiently dried out to permit operations from that half of the field long





Whilst the pilot secures the chin strap on his fur-lined helmet, his ever-faithful 'black man' frees his seat straps from behind his back - the ambient temperature can be gauged by the groundcrewman's ear muffs, which also serve the dual purpose of cutting down the engine noise once the pilot starts up the Fw ISO's engine. The famous *Grünherz* emblem of JG 54 sits proudly below the cockpit

Rugged up against the bitter cold, a suitably attired member of I./JG 54 poses for the camera in front of an aircraft adorned with the *Gruppe's* distinctive Nuremberg coat of arms crest in January 1943. Quite who those booted legs laying over the wing belong to remains a mystery!



before the expanse of compacted snow used throughout the winter finally melted.

It was tricks such as this, and of keeping small fires going beneath the engines of aircraft standing in open dispersal pens to ease maintenance and starting, which made the harsh Russian winter almost bearable. During the worst of the weather most of the personnel at Siverskaya retired into the nearby village. Here they shared quarters

with the local inhabitants, basking in the snug warmth of wood-burning stoves while the temperatures outside dropped to 40 degrees below, and only returning to their unheated barracks with the first signs of spring.

This cosy existence was soon to change, however, for coincident with their conversion to the Fw 190, JG 54 had reached a watershed in their history. The previous two-and-a-half years of hard campaigning, which had seen success in the air allied to huge advances on the ground, were over. The coming two and a half years, although they were to witness some local ground victories, and individual and unit scores' rising to unprecedented heights, would paint a very different picture. For despite numerous 'fire-brigade' actions from one end of the Eastern Front to the other, the underlying and irreversible movement would henceforth be one of retirement back towards the borders of the Reich.

The events of the early weeks of 1943 neatly encapsulated this reversal of fortune. On 13 January Russian fighters jumped a *Rotte* of 2./JG 54 east of Leningrad. One Fw 190 was shot down, but the other, piloted by Unteroffizier Helmut Brandt, force-landed on the ice along the edge of Lake Ladoga. Although Brandt managed to evade capture, his Fw 190 - black '2'— became the first to fall virtually intact into Soviet hands. On 26 January Oberleutnant Max Stotz, who had joined the Austrian air arm in 1935, scored his 150th kill with JG 54. On that same day the effervescent Major Hans 'Assi' Hahn, one of the *jagdwaaffe's* 'characters', who had already achieved 68 victories in the west with JG 2 *Richthofen* before assuming command of II./JG 54 in November 1942, claimed his 100th victim. Then, on 19 February, JG 54 scored their 4000th kill of the war, as reported by war correspondent Scheuermann:

'In the course of the recent heavy air fighting -A. *Jagdgeschwader* on the Northern Sector of the Eastern Front under the command of Oberstleutnant Trautloft has achieved its 4000th aerial victory.

Those taking part in the day's activity, which resulted in the destruction of 33 Bolshevik aircraft, included holder of the Knight's Cross with Oak Leaves and Swords Hauptmann Hans Philipp with his 168th and 169th victories, together with Oak Leaves holder Leutnant Stotz with his 158th and 159th, Oberleutnant Beisswenger with his 137th and Major Hahn with his 107th.'

Within days of this announcement, however, both 'Assi' Hahn and 'Beisser' Beisswenger were gone. A forced-landing due to engine failure behind enemy lines near Demyansk on 21 February was to cost the for-

mer seven years of Soviet captivity; - his final score stood at 108, plus another 36 unconfirmed. The latter, victor over 152 Soviet opponents was last seen going down over Lake Ilmen, propeller slowly windmilling, after being bounced by ten enemy fighters on 6 March. His fate remains unknown. Nor were the other two pilots mentioned by name in the above report to survive the year. On 17 March Hauptmann Hans Philipp became only the second Luftwaffe fighter pilot to reach the 200 victory mark. Promoted at the end of the month, he relinquished command of I./JG 54 to become *Geschwaderkommodore* of JG 1 in the west, where he was shot down by American P-47s in October. The fourth man, Max Stotz, would number among the high proportion of JG 54 formation leaders to fall victim to the blood-letting of the coming late summer.

There were other, unseen, enemies too, as one young Fährnich found out to his cost. Norbert Hannig recalls the following incident:

'Early May 1943. I had some 20 missions under my belt as *Katschmarek* to an experienced old Oberfeldwebel (Warrant Officer), one Xaver Müller. On the ground he was a typically dour Swabian. But in the air, although cautious, he had lightning fast reflexes and always looked after his wingman. He already had over 40 victories to his credit, for which he had been awarded the German Cross in Gold (a decoration more commonly known among flyers as the "Fried Egg" because of its shape and size). I had been able to confirm a number of his kills and a mutual understanding had developed between us. I stuck to him like a leech, kept the enemy off his back and followed his every manoeuvre.

"That day the 5. *Staffel*, to which I was assigned, was at readiness at Siverskaya; the pilots dozing in the sun in deck-chairs, reading or playing endless hands of cards. Xaver was fast asleep next to me when the ops



At last, after an interminably long Russian winter, the first signs of spring thaw arrived at Orel (JG 51) and Krasnogvardeisk in late March 1943, and the whitewash was finally removed, almost - 'White 3' still shows large patches of winter finish, which contrast with the temperate green used elsewhere on the fuselage and wing surfaces. This odd mix proved ideal for blending a low flying Fw 190 in with the partially snow-covered terrain on the Eastern Front during the long spring thaw. Notice that the runway is still essentially compacted snow, which means that the temperature is still probably around freezing point. The cause of the smoke rising ominously in the background is unknown

This view of the same scene shown above reveals a fourth A-4 parked in the background receiving attention to its MG 17 guns



room clerk woke him with orders: "Herr Oberfeld (Chief), a mission for you. One *Rotte* to act as escort for a Bf 110 artillery observer spotting fall ofshot for the railway guns at Mga. Target is the railway bridge at Schlüsselburg. The Bf 110 will be overhead at 10.30 hours and will fire a green flare to signal your start. You're flying black "2", Fähnrich Hannig black "12". The aircraft are ready. Your call signs are *Edelweiss* 1 and 2."

Xaver nodded, blinked up into the sun, looked at his watch and said to me: "All clear? Another half an hour", and went back to sleep. It was ten o'clock.

Fifteen minutes later we went to our aircraft. The mechanics helped us aboard and we strapped ourselves in. I looked across at Xaver and he gave me the signal to start up. A quick check of the controls before reaching for the starter. The engine coughed a couple of times and then burst into life. The groundcrew disconnected the ace trolley and gave the signal to taxi. I set the flaps to the take-off position and followed Xaver to the end of the grass runway. 10.27 hours. Another brief glance at the instruments — everything in order. I signalled this fact to Xaver and he nodded. We closed our canopies and searched the sky for the recce 110. I saw a small dot behind us and reported over the R/T:

"*Edelweiss* one from two, nightwatchman at 6 o'clock, *Hanni* (height) 1000, Wtor(roger)?"

"*Edelweiss* two from one, *Viktor, Viktor.*" Xaver confirmed.

We got the green flare and took off as the 110 flew overhead. Formating ahead of it, Xaver wagged his wings to indicate we were assuming escort responsibility. We had no direct R/T contact with the recce machine. The weather was perfect. A clear blue sky, visibility more than 50km. The front-line lay along the River Neva which flowed south out of Lake Ladoga before turning west and emptying in the Baltic at Leningrad. The only rail link from the Russian hinterland to Leningrad at this time was across the Neva. But every time the vital supply bridges were knocked out, the Russians immediately repaired them again. Now heavy 40 cm railway guns had been brought up to Mga, a village south of the Neva, to destroy the bridges at Schlüsselburg once and for all.

The 110's job was to observe where the shells landed and correct the fire accordingly. To prevent the Russians from using their sound-locating equipment to pinpoint the position of our railway guns, a number of other heavy batteries in the area fired at the same time. From above the effect was like a giant firework display. A more active defence of the bridges was provided by the two Russian fighter fields at Schlüsselburg and Schum.

We crossed the Neva at about 5000 metres. No sign of Flak. Below us was the railway bridge with the single track disappearing into the woods to the east. We could also clearly see the two airstrips.

"From *Anton* 1 to all cyclists: fighters at Schlüsselburg have been ordered to scramble, fighters at Schlüsselburg have been ordered to scramble." *Anton* 1 was the code-name of our wireless intercept station.

"From *Edelweiss* 1 to *Anton* 1, *Viktor, Viktor.*" Xaver calmly replied. Everything was going as expected.

By now the first artillery shells were throwing up huge fountains of earth south of the bridge. Too short. Suddenly we spotted clouds of dust



Fährnich Norbert Hannig poses for the camera in the cockpit of his A-4, 'Black 12', at Siverskaya in the early spring of 1943. Note his fur-collared sheepskin flying jacket, known as a 'Bulgarian' jacket because it was derived from sheepskin that originated in that country. Hannig finished the war flying Me 262s, with his score in the east standing at 34 kills

on one of the fields below - always two at a time, side by side. They were taking off in pairs, just like us. We counted up to 16. Four *Schwärme*, or 16 against 2.

"*Edelweiss* 1 from 2, 16 *Indianer* scrambled from Schlüsselburg."

"*Viktor*, close up - stick close."

I positioned myself 50 metres behind Xaver's tail and continued to watch. The Russians were clearly visible as small dots against the bright northern horizon as they climbed in a swirling bunch towards us. By now the artillery had fired their third salvo. Detonations exploded around the bridge. The 110 dived away, its job done. The recce pilot wagged his wings to signal our services were no longer required. Now it was just us against the Russians. The dogfight could begin. "*Horrido!*"

Xaver flew a wide turn to starboard above the group of enemy fighters. I followed tucked in on his right. We watched the milling mass of Ivans below us. One of their number started to loop. He loosed off a harmless string of pearls straight up into the air - no danger there. Another tried a clumsy sort of Immelmann which brought him up almost level with us 100 metres in front of our noses. A desperate break to port and he presented himself to Xaver as if on a plate. A short burst of fire tore the LaGG-3 apart.

I confirmed Xaver's success, "*Abschuss!*"

"Your turn, I'll cover you", he replied.

I pulled ahead just as another Russian climbed up towards us. He fired and then attempted to dive back into the protective pack below. I looked through the Revi (gunsight). Range: 150 metres. My guns hammered. I could smell the cordite even through my oxygen mask. Streaming a long banner of black smoke Ivan dived away towards his base.

"He's still flying. Have another go", this from Xaver.

I checked my tail. Xaver to the right, all clear to the left. Ahead and below me the Russian's smoke trail. I opened the throttle and followed him down, watching the range close through my Revi, 150, 100,75 metres . . . now! I thumbed the gun button. My tracers buried themselves in their target. Large chunks flew off.

"*Abschuss!!!*"

I was about to pull up when I was suddenly engulfed in a fireball. I was thrown against the right-hand side of the cockpit as the 190 went into an involuntary roll. Black oil covered the canopy - what the hell had gone wrong? I somehow managed to correct the roll and could just make out the horizon through the oil-smearing canopy. I levelled out, but then:

"Bale out!! You're on fire", Xaver yelled.

My first thought: 15 kilometres behind enemy lines - that means Russian captivity. Immediate reaction: don't bale out until you have to. A quick check: no flames, so no fire in the cockpit. I tried the tap which sprayed fuel on to the windscreen to clear some of the oil. A distinct improvement. I was down to about 3000 metres. And now I could see the damage: my starboard wingroot cannon was split open back to the breach. There was a gaping hole a metre square in the wing. The right undercarriage leg was hanging down in the slipstream. The U-shaped oil cooler had been punctured and oil was streaming back along the fuselage. My oil pressure was dropping and the temperature climbing towards the red. But there was still a little time.

Below and bottom 'You can't teach a young dog new tricks either!' Hannig's dachshund 'Fuchsie' ('Little foxy') flew no less than 20 combat missions sitting on his master's back parachute between him and the head armour. All attempts to teach 'Fuchsie' to bark when he spotted 'Indianer' on their tail sadly came to nothing!



"Xaver, get me back over our frontlines. I can still hold her", I said in clear, all thoughts of correct radio procedure forgotten.

"A bit more to your left and you'll hit Mga", was his reply.

The Mga emergency strip was a small area in the middle of the forest, half meadow, half swamp, directly behind our forwardmost positions. Just three days ago Walter Heck, one of the 'old hares' of the *Gruppewhh* more than 30 victories to his credit, had overturned trying to land at Mga. The armoured headrest had broken away and crushed his verterbra. He was completely paralysed and had died only yesterday. So, forced landing or bale out? First get back over our own lines. I turned towards Mga. Xaver was behind me.

"Watch out, Ivan's coming back again!"

I looked up and saw a pair of LaGG-3s above me to port. They were positioning themselves for a copybook bounce. This could be it, I thought, as I turned into them and fired with everything I had. They broke away beneath me. Their canopies were open and I could clearly see their light blue overalls, tan flying helmets and the large, black-framed goggles through which they both stared straight at me as they dived past.

I had lost even more height and was now down to 1500 metres as I again turned back toward the safety of our own front lines. I looked around for Xaver and spotted another machine closing in on my tail. I wrenched my willing black "12" into yet another 180-degree turn and opened fire.

"Don't shoot! It's me," Xaver's voice remained calm as he easily evaded my wild fusilade, thank God!

"Turn left, keep going."

'And there, only 500 metres in front of me, was the marshy patch of ground between tall banks of conifers. The landing gear was useless, and the flaps didn't respond. I lost height. The oil temperature was well into the red by now, the engine could seize at any moment. Ease off the throt-

Not quite an evening 'sing-song' around the camp fire - pilots from 5./JG 54 sit at a relaxed state of readiness between sorties amongst the trees at Siverskaya in May 1943. Amongst the group is ranking ace (173 kills) Leutnant Emil Lang (third from left). Due to an increasing number of surprise attacks by Russian Air Regiments all along the front, pilots rarely had time to rest during daylight hours by this stage in the conflict. Always on alert, 'Readiness plus 15 minutes' allowed the pilots out of their cockpits, but kept them at dispersal - as seen here - their aircraft allocated and ready. 'Readiness plus one hour' equalled aircraft and pilots on stand-by awaiting orders; 'Readiness plus two hours', groundcrews at aircraft, and pilots with free time on base; and 'Stand down until x hours', no readiness until the time indicated. The *Alarmrotten* were relieved every two hours in summer, and every hour or 30 minutes in winter. As soon as one pair was given the order to scramble, they were immediately replaced by the next two pilots on the duty roster



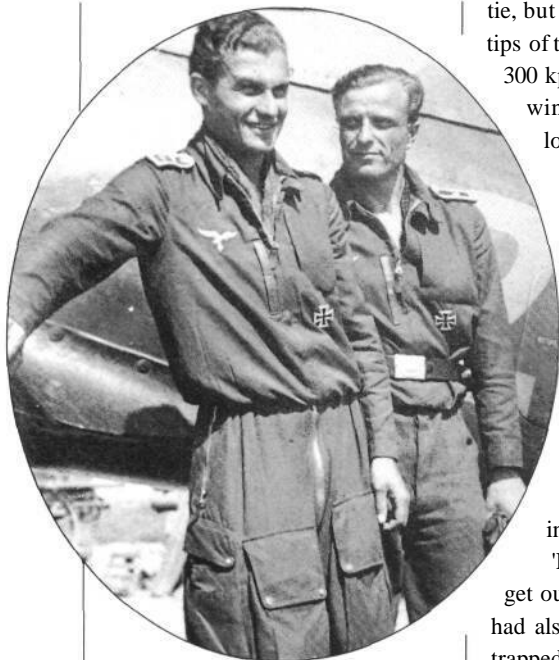

Two inseparable friends from II/JG 54, Feldwebel 'Bazi' ('Rascal') Sterr (left), who scored an estimated 127 kills, and Feldwebel Albin Wolf, who finished with 144 kills, seen on the Leningrad Front in May 1943. Both were later awarded the Knight's Cross before being killed in 1944 - Wolf in the east on 2 April and Sterr in the west on 26 November. The latter was flying with IV/JG 54 in Defence of the Reich duties when he was shot down by a P-51

tie, but the linkage had been damaged. Too much speed! Ignition off. The tips of the conifers were whipping past just below me at something like 300 kph. Landing speed was 150 kph! I tightened my straps. The prop windmilled. I couldn't get her down! The trees at the end of the strip loomed up at a frightening rate... I had to go round again ... ignition on, she wouldn't catch ... hit the primer pump ... the engine howled and pulled me up just in time. Fortunately, I still had sufficient speed to risk one last, highly dangerous 180.

A second approach from the opposite direction, a sudden bang, and the propeller came to a standstill. The engine had finally given up the ghost. I quickly dropped the starboard wing and applied full left rudder, hoping the resulting slip would help to push the dangling right mainwheel at least part way back up into the wing before I belly landed. It worked. Planing across the watery surface, I eased the nose up. A few more bangs and crashes and I was safely down, skidding to a stop without nosing over.

'Everything was quiet - completely still. Unbuckle the harness and get out. But, like the throttle controls, the canopy release mechanism had also been damaged by flying splinters. It was stuck fast and I was trapped in the cockpit.

'Suddenly a hissing sound like a locomotive getting up steam. My first thought: "the fuel tank's going to go up". The second: "canopy emergency jettison!" That was jammed too, but I was able to get a foot behind the handle and force it downwards. In doing so I caught a hefty blow from the canopy side-frame as the release cartridge blew it off. But at least I was out, even if I was in the middle of a marsh. I saw steam rising from the hot engine as it lay in the water - that explained the hissing noise.

I climbed on to the forward fuselage and waved up at Xaver who had continued to circle above me. He saw that I was safe and sound, waggled his wings and flew off in the direction of Siverskaya. Looking about me, I realised I was standing on the engine which was still attached to the cockpit section. Behind me the wings were sticking up out of the swamp grass with the undercarriage still attached. Further away still, right at the beginning of the long scar I had gouged in the boggy ground, lay the rest of the fuselage and the tail unit. All in all a good landing. The aircraft may have been reduced to wreckage, but at least I was able to walk away from it... once the airstrip's fire crew had rescued me from the swamp with ladders, that is.

'It turned out that the cause of the damage was sabotage. Somebody in the munitions factory - we never found out who, of course - had tampered with a centrifugally-fused explosive shell, which had resulted in its exploding in the barrel of my starboard wingroot cannon. The next round - an armour-piercing shell - then got stuck in the feed and was detonated by the following semi-AP round. It was pure luck that I was not injured. The cockpit, like the engine, had been sieved by splinters.

'While I was sitting in the sun trying to smoke a cigarette, a half-track motor-cycle combination pulled up. Two army sergeant-majors, old sweats, each with a chestful of decorations, clambered off and smilingly saluted me, one asking, "Excuse me, perhaps you can help us. About 15 minutes ago a Focke must have come down somewhere near here. It was

trailing a thick cloud of smoke. Up at the front we were blazing away like mad trying to keep the Ivans off its tail. Can you tell us whether the pilot survived?"

"Why do you want to know?" I countered.

The other answered in a broad Bavarian dialect, "We've had a small wager. I say he made it. He", pointing to his companion, "bets me he didn't. There's a bottle of cognac riding on it."

"Congratulations", I said, "you've won. I'm the pilot and I've just about survived. That pile of junk over there in the swamp is all that's left of my Focke though." I was promptly invited back up to the forward trenches to help dispose of the winnings, but sadly I had to decline as I was expecting to be picked up by someone from Siverskaya.

'About an hour later a Klemm K1-35, the *Geschwaders* runabout, came in to land. It taxied up to the barracks where I was still sitting and Xaver climbed out. He held out his hand, "Congratulations! Well done, all of it. Wounded? Come on, the chief and all the others are waiting back at base."

The following day I flew my next mission with Xaver. This time it was to escort a formation of Stukas —just routine.'

Norbert Hannig's luck was to hold. He survived the war, having achieved 34 victories with II./JG 54 in the east before converting on to Me 262s during the closing weeks. But Oberfeldwebel Xaver Müller, the quiet Swabian, was not so fortunate. He would be killed in action three months later, on 27 August 1943, his final score standing at 47 enemy aircraft destroyed.

Thus the spring ended with JG 54's two *Gruppen*, having lost some dozen pilots since the beginning of the year, stretched thinly along the length of their own front and beyond, southwards to the Rzhev-Vyazma salient and Orel, as they too awaited the Kursk offensive.



A bomb-carrying Fw 190 seen in the spring of 1943. The weapon mounted to the centreline ventral stores rack is an SB 500 kg High Explosive (HE) bomb. This type of weapon was the favoured ordnance for the *Gruppe* on the Russian Front, although a single SB 1000 kg bomb could also be carried, as well as smaller 250 and multiple 50 kg devices

This bombed-up Fw 190A-4 is a bit of a mystery machine as it wears both JG 54-type summer camouflage and a yellow theatre band behind the fuselage cross, but it has an individual letter instead of a number forward of the national insignia. This perhaps indicates that the aircraft belongs to the *Grunheiz's* semi-autonomous *Jabostaffel*. Note the *Rotte* of Bf 109Gs taking off behind the parked Fw190



—AND OTHERS

While the four *Gruppen* of JGs 51 and 54 had provided the main Fw 190 presence on the Eastern Front during the early months of 1943, there had been two other *Jagdgeschwader* operating the Focke-Wulf against the Russians.

The first of these, as already mentioned, was JG 26 *Schlageter*, whose I. *Gruppe* had been ordered to exchange places with III./JG 54. In reality, only the pilots and certain key members of the *Gruppenstab* and ground-crews were to make the move from northern France, and that by rail; the majority of the mechanics and equipment were left behind to await the arrival of III./JG 54. The party, under *Gruppenkommandeur* Johannes Seifert, entrained for Heiligenbeil late in January 1943.

There they collected their factory-fresh Fw 190A-5s before staging via Riga to their destination Ryelbitzi. Situated west of Lake Ilmen, this was another of JG 54's bases of long standing, having also first been occupied back in September 1941. A typical *Feldflugplatz* (frontline airstrip), Ryelbitzi did not boast all the facilities of a Krasnogvardeisk or Siverskaya, but accommodation in the thatched huts of the local village - if not exactly up to chateau standards — provided adequate protection against the elements. While the *Schwarze Manner* left at Ryelbitzi by the departed, Bf 109-equipped III./JG 54 familiarised themselves with the Fw 190, the pilots of I./JG 26 were briefed on their new area of operations. Eastern Front missions were perforce very different from those they were accustomed to in the west: low-level, small formations were the watchwords, keep a sharp eye open for Soviet Flak and, above all, try to maintain a sense of location and direction in relation to the German lines, however difficult this might at first appear when flying over a vast, unfamiliar and near featureless snowscape. Few who forced-landed behind the enemy's lines returned to tell the tale. Experienced pilots' preferred, whenever possible, to remain within safe gliding distance of friendly territory.

I./JG 26's first action in the east took place on 16 February when they downed 11 Il-2 *Stormoviks* without loss to themselves while helping to cover the ground forces' withdrawal from the Demyansk 'mushroom'. But this auspicious start was somewhat marred 24 hours later by their first casualties, when two NCO pilots apparently fell victim to their new surroundings. One was brought down by Flak, the other hit the ground while attempting to attack a formation of low-flying Il-2s. A third was fortunate to survive a crash-landing after being set upon by fighters.

The Demyansk 'mushroom' operations continued for the next month, by the end of which time the *Gruppelhad* claimed 75 kills; 14 of them on 5 March alone, and with Hauptmann Walter Hoeckner, *Staffelkapitän* of I./JG 26, downing four *Stormoviks* and two lend-lease Tomahawks in a single day.

With the staged collapse of the Demyansk 'mushroom' successfully completed, the *Gruppe* was transferred southwards in mid-March, via Dno, to Shatalovka near Smolensk. From here they operated in support

of the final stages of the withdrawal from the larger Rzhev-Vyazma salient. Aerial activity was winding down, however, so much so that Hauptmann Rolf Hermichen's 3.Staffel was temporarily detached to Ossinovka during May for anti-partisan duties.

By now it was becoming clear to Generalmajor Adolf Galland, *Inspekteur der Jagdflieger* and leading light behind the whole exchange scheme, that the experiment was not proving a success. The folly of employing experienced Channel Front fighter-pilots - the first line of defence against the ever-increasing tenor of the RAF and USAF's incursions into western Europe - simply to chase partisans through the Russian boon-docks was all too obvious. And early in June I./JG 26 vacated Orel-West to return to northern France. During their four-month sojourn on the Russian Front they had claimed 126 Soviet aircraft destroyed, of which 17 were, in fact, lend-lease American machines, including one oddity - a Curtiss O-52 Owl shot down while purportedly carrying out a Lysander-like partisan supply operation. Against this they had suffered the loss of nine of their own pilots. Among the returnees were a number of newly fledged *Fw 190 Aces of the Russian Front*, such as the aforementioned Walter Hoeckner, *Gruppenkommandeur Johannes Seifert* with 11 victories to his credit and 2.Staffels Feldwebel Karl 'Charlie' Willius with 9.

The departure of I. Gruppe was not quite the end of JG 26's Eastern Front foray. A single *Staffel* of each *Geschwader* also exchanged places - 7./JG 26 with 4./JG 54. Hauptmann Klaus Mietusch's 7.Staffel arrived at Krasnogvardeisk late in February, where it was subordinated to I./JG 54. Remaining on the Leningrad Front throughout its entire stay in the east, 7./JG 26 had achieved some 63 victories before retiring back to France in July. The lion's share of the kills had gone to just three pilots: *Staffelkapitän* Mietusch, Oberfeldwebel Heinz Kemethmueller and Feldwebel Erich Jauer.

The fourth *Jagdgeschwader* to field the Focke-Wulf against the Soviets did so only in single *Staffel* strength, and then only along the very northernmost periphery of the front. After a lengthy and complicated period of gestation JG 5 - the *Eismeer*, or 'Arctic Ocean' *Geschwader* - had evolved into a microcosm of the Luftwaffe itself. Split down the middle, it was facing and fighting in two directions at once: against the Allies to the west, and the Russians in the east.

By 1943 I. and IV./JG 5, flying the Fw 190, were based along the Norwegian seaboard where they formed the right-hand flank of the continuous, if thinly stretched, arc of Luftwaffe fighter defences guarding the English Channel and North Sea coastlines from Ushant to Narvik. In the east the two Bf 109-equipped *Gruppen*, II. and III./JG 5, pitted themselves against the Soviets along the 850 mile length of the Finnish Front, from the Gulf of Finland in the south to Murmansk in the north. Apart from a brief deployment by IV./JG 5 to reinforce I. Gruppe in the early autumn of 1944 during the German withdrawal from Finland and northern Norway, JG 5's Fw 190s thus saw no service against the Soviet enemy.

In mid-February 1943, however, the *Geschwader* established a semi-autonomous fighter-bomber *Staffel*. Activated at Petsamo under Hauptmann Friedrich-Wilhelm Strakeljahn, the Fw 190A-2s and A-3s of 4.(Jabo)JG 5 were tasked primarily with combating the Soviet coastal traffic plying along the Arctic Ocean seaboard. This they proceeded to do

with great success; the tonnage sunk, both of merchantmen and Soviet naval units, rising steadily in the coming months. One particular three-day period early in May, during which they claimed two 'M'-class submarines destroyed (by Feldwebel Froscheck and Unteroffizier Fohl) and a 2000-ton auxiliary and 3000-ton freighter (both by Strakeljahn), brought well-merited, teletyped recognition from on high. From the C-m-C *Lufiflotte 5*:

To: *14.(Jabo)/JG 5* Petsamo 11.5.1943

For the excellent successes of the past days my very special appreciation.
Generaloberst Stumpff.'

Fw 190A-3 'Black 5' of 14.(Jabo)/JG 5, based at Petsamo, Finland, on the Arctic Front in early spring 1943. Led by Hauptmann Friedrich-Wilhelm Strakeljahn, this small *Staffel* wreaked havoc on the previously unmolested Soviet coastal traffic in the area - so much so that the outfit was personally congratulated by the Führer himself in May 1943. 'Straks' Strakeljahn himself also became an ace during this period, destroying nine Russian aircraft. This aircraft is painted up in standard early Fw 190 colours, and lacks the yellow theatre flashes. It does, however, boast the Staffers unique 'bow and bomb' badge on its engine cowl. Also, note the SC 250 (foreground) and 500 kg bombs sitting behind the clutch of 'black men'

. . . and five days later:

From *Fliegerführer Nord (Ost)* 16.5.1943

To: *14.(Jabo)/JG 5* Petsamo

Following teletype for attention of all personnel:

'The Führer has expressed his recognition of the attacks on shipping carried out by the *Jabos* of *Flg.Fu.Nord(Ost)*, and further conveys his wishes that these operations be continued with all available means.'

Although principally an anti-shipping unit (by the year's end tonnage sent to the bottom totalled some 39,000 BRT), *14.(Jabo)/JG 5* inevitably came into contact with defending Russian fighters, of which they also managed to take their toll. When awarded his Knight's Cross on 19 August for outstanding leadership, for example, 'Straks' Strakeljahn already had nine kills to his credit. In April 1944 the unit was transferred from the Arctic to the sunnier climes of the Italian theatre, where it was redesignated and incorporated into the ground-attack arm as 4./SG 4.



ZITADELLE

On the major fighting fronts of the Northern, Central and, to a much lesser extent, Southern Sectors the full weight of the Fw 190 fighter presence in the Soviet Union continued to be felt (if 'full weight' be the proper term to describe a force whose numbers never once topped the 200 mark, and this along a front currently some 1200 miles in length!). In fact, the weeks prior to the Kursk offensive were to see Fw 190 serviceability totals in Russia reach their all-time peak - 189 in May and 196 in June 1943. It should be pointed out, moreover, that these figures also include the residual Bf 109s still on the strength of II./JG 54.

If numbers were increasing, so too was Soviet air activity, and with it the opportunity for the *Jagdwaaffe* to add to its score. It was in June that Walter Nowotny's star began to ascend, for in that month he achieved 41 kills — his 100th on 15 June, plus 10 in one day on 24 June. Overall, the involvement of JG 54, *of Jagdgeschwader^fa\it\oft*, at this time was pivotal. The latter sobriquet was the name by which the unit had become famous on the Northern Front; the name of the man who had been at their head for nearly three years. The then Major Hannes Trautloft had first taken command of the three previously separate *Gruppen* which made up JG 54 during the Battle of Britain. He had welded them into a single whole, had given them an identity by introducing the famous *Grünherz* badge, in honour of his Thuringian homeland - the Green Heart of Germany - and had been their *Kommodore* ever since.

On 5 July Oberstleutnant Trautloft relinquished command of JG 54 to Major Hubertus von Bonin. Promoted to the position of *Inspizient Ost* (Inspector of Fighters, Eastern Front) on the staff of *General der Jagdflieger* Adolf Galland, Trautloft would continue to keep a paternal eye on the *Jagdgeschwader* with which his name will always be associated.

The same day Trautloft left JG 54, the long-awaited Operation *Zitadelle*, Hitler's last huge gamble to break the deadlock and turn the tide in the east once and for all, finally commenced. All but one of the five Fw 190 *Jagdgruppen* in the east were directly involved in *Zitadelle*. Leaving just Hauptmann Heinrich Jung's II./JG 54 with its mixed bag of 50 Fw 190s and Bf 109s (38 serviceable) under *Luftflotte* 1 to guard the sectors further to the north, I./JG 54, together with I., III. and IV./JG 51 (140 Fw 190s in all, 88 serviceable) gathered along the northern flank of the salient as the fighter component of *Luftflotte* 6, the Air Fleet tasked with supporting Generaloberst Walter Model's 9th Army.

The first morning of the offensive was occupied in providing bomber and Ju 87 escort, and it was not until the afternoon that the first serious clashes with Soviet fighters took place. Having exchanged their Fw 190A-3s for newer A-4s and -5s just prior to *Zitadelle*, the pilots of JG 51 managed to wrest local air superiority from the Russians for the first few days of the assault. During this period the acknowledged *Experten* all added to their scores. But it was a hitherto unfamiliar name which flared suddenly, and all too briefly, into brilliance over the battlefields of Kursk. 8. *Staffel's* Oberfeldwebel Hubert Strassl, a 24-year-old Austrian, had been with the

Geschwader since late 1941, in which time he had achieved 37 kills. In four separate sorties during the first afternoon and evening of *Zitadelle*, he claimed an amazing 15 more! On the next day he added a further 10. On 7 July it was just two, but on the fourth day the exhausted Strassl's luck finally deserted him. After despatching three more victims, he was himself bounced by four LaGG-3s south of Ponyri. Unable to get out from under his attackers, Strassl found himself being forced ever lower. Then a burst from one of the Russians shredded his wing. Desperately he baled out at less than 1000 ft, but failed to open his parachute in time.

JG 51 were to lose four more pilots during the first five days of *Zitadelle*, but on 10 July events took a more ominous and alarming turn. Aerial opposition was hardening; Russian bomber attacks were on the increase, and their fighters began, for the first time, to mount their own version of the '*Freie Jagd*' sweep over German-held territory. On the ground, the Soviet counter-offensive was launched north of Orel, smashing into 9th Army's rear. The strength of resistance was being reflected in JG 51's losses. By 17 July, when the German assault was broken off, ten more pilots had gone down, including two 30-plus aces: Leutnant Albert Walter and Oberfeldwebel Hans Pfahler of III. and IV. *Gmpfe* respectively. On 11 July IV./JG 51 had also lost their *Gruppenkommandeur*, Major Rudolf Resch (94 kills), to fighters south of Ponyri.

Present in only single *Gruppe* strength, JG 54's Kursk casualties were commensurately lighter. But on the second day of the action I./JG 54 also suffered the loss of their *Gruppenkommandeur* when Major Reinhard 'Seppel' Seiler, who had replaced the departed Major Philipp in April, was severely wounded minutes after achieving his 100th victory. At least five more pilots were lost at Kursk, including newcomer, Leutnant Günther Scheel. Having joined 3. *Staffel* in the spring, Scheel had rarely returned from a mission without scoring; amassing 71 kills in about as many sorties. On 17 July Scheel rammed a Yak-9 near Orel and crashed from 700 ft, his Fw 190 exploding on impact. Twenty-four hours later Feldwebel Helmut Missner was able to record the *Geschwader*'s*, 5000th victory.

But it was in the immediate aftermath of *Zitadelle* that the most grievous losses of all were sustained, among them a quartet of long-serving, highly experienced, formation leaders. Hauptmann Heinrich Jung, who had been promoted from *Staffelkapitän* of 4./JG 54 to take command of II. *Gruppe* after the loss of 'Assi' Hahn, had scored 68 kills before succumbing to Soviet fighters near Mga, southeast of Leningrad, on 30 July. Four days later Major Gerhard Homuth, an ex-Mediterranean Bf 109 ace with 63 victories who had been posted to I./JG 54 on 1 August to fill the vacancy left by 'Seppel' Seller's recent wounding, failed to return from the Orel area on only his second mission at the head of the *Gruppe*. Stepping into the breach, acting *Gruppenkommandeur* Hans Götz (82 victory *Experte* and *Staffelkapitän* of 2./JG 54) was lost on the very next day - he was last seen going down inverted into woodlands near Karachev after attacking a formation of marauding Il-2s. Finally, Austrian veteran 31-year-old Hauptmann Max Stotz, *Staffelkapitän* of 5./JG 54, also disappeared without trace after baling out over Soviet territory east of Vitebsk on 19 August. With a final total of 189 enemy aircraft destroyed, Stotz is numbered among the top 20 highest scoring Luftwaffe aces of the war.

Still concentrated along the northern flank of the dwindling salient, JG

Despite leading a seemingly endless succession of sorties over the huge battle front at Kursk Hauptmann Erich Rudorffer, *Gruppenkommandeur* of II./JG 54, still manages to raise a smile as he enjoys a quick cigarette between ops at Orel on 28 August 1943. Rudorffer ended the war with a staggering total of 222 kills, 136 of which were claimed on the Russian Front. His final dozen kills were achieved with the Me 262 whilst serving as *Gruppenkommandeur* of I./JG 7



51's three *Gruppen* also continued to suffer attrition in the days and weeks which followed the abandonment of the Kursk offensive. Lying in the very path of the Soviet counter-attack, their losses were not just restricted to pilots; an increasing number of groundcrew were being killed by Russian bomber and *Stormovik* raids on the airfields at and around Orel. Austrian skier Leutnant Josef Tepi Jennewein, to whom real success had only come after I. *Gruppe*'s conversion to the Fw 190, and whose tally now stood at 86, was lost at this time. He finally met his match east of Orel on 26 July. Twelve days later Hauptmann Heinrich Höfemeier of 3./JG 51, who was just four kills short of his 100, was lost to flak near Krachev.

But for *die Jagdwaffe* the real repercussions of the failure at Kursk were far wider reaching than individual unit losses, as swingeing as these had been. Although the initial Soviet counter-thrust had been halted at great cost just short of Orel, the respite was short-lived. Sixty-one Soviet armies lay coiled behind their frontline, and in August Stalin unleashed them in a series of smashing blows. To the north of Kursk the offensive was renewed not just against Orel, but now also against Yelnya, Smolensk and Velizh as well. To the south Kharkov and Poltava were threatened; further south still, Stalino and the entire Ukraine. Only the 12 armies opposite the Northern Sector still remained relatively dormant. And this time the Soviet offensives would not be halted; not by the Germans, not by the weather. Maintaining their pressure throughout the winter, they would continue until the spring of 1944.

This entire eight-month period was one of unparalleled movement for the Fw 190 *Gruppen* of JG 51 and JG 54 as an increasingly hard pressed General Staff shuffled them around on their headquarters operations maps like so many chessmen from one new breach along the endangered 700 mile front to the next. For not only were the Russians growing stronger by the day, the *Jagdwaffe*'s Eastern Front strength was continually being eroded.

The seven *Jagdgeschwader* which had accompanied the launching of *Barbarossa* two summers ago had since been reduced to four by the demands of the Mediterranean fronts. Now it was the defence of the *Reich* which needed shoring up. And the result? The departure of another *Jagdgeschwader*, leaving just three — in theory, one neatly allocated to each of the sectors, North, Central and South - to stand in the way of the greatest advance in military history.

Nor was it simply in numbers that home-defence took precedence. The reality of US heavy bombers actually parading their might deeper into *Reich* airspace had focussed the collective Berlin mind wonderfully. And the supply of new Fw 190s to the far flung, low priority, reaches of Russia - never good at the best of times - became positively precarious. The first *Jagdgruppe* to suffer, Major Hans-Ekkehard Bob's IV./JG 51, had already perforce reverted to the Bf 109G-6. Others would follow. But before tracing the fortunes of the remaining Fw 190-equipped *Gruppen* as they embarked upon their long retreat, it is necessary to go back to the start of *Zitadelle*... this time to the southern flank.

SCHLACHTFLIEGER

While JGs 51 and 54 had been engaged along the northern flank of the Kursk salient, the southern extremities had been similarly covered by their Bf 109-equipped counterparts, JGs 3 and 52 (the former being the unit soon to be recalled to Defence of the Reich duties). There *wasn't* Fw 190 presence in the south as well, however, in the form of two *Gruppen* - some 40 plus aircraft in all - currently being employed as bombers!

The evolution of the Luftwaffe's ground-attack arm was a protracted and complicated process. It began simply enough on the outbreak of war with a single *Gruppe* of ageing Hs 123 biplanes operating under the not-so-simple designation of II.(5cA./)LG 2 [2nd (Ground-attack) Wing of the 2nd Instructional and Development Group]. Having wrought surprising havoc in the close-support role across Poland and through France, this *Gruppe* then came to an abrupt halt. Its biplanes too vulnerable to be exposed to direct cross-Channel confrontation with the Hurricanes and Spitfires of RAF Fighter Command, it retired instead to the homeland for re-equipment with the Bf 109. The onus of carrying the *Blitzkrieg* into England would be shouldered by the hitherto invincible Ju 87 alone. But the latter was soon found sadly wanting in the historic air battle that followed; a truth tacitly admitted by Reichsmarschall Hermann Goring when he ordered that a third of all his single-engined fighter strength in the Pas de Calais be converted to carry bombs in place of the Stukas.

Having set a precedent, these early bomb-carrying Bf 109s were subsequently formed into specialised *Jabostaffeln* (fighter-bomber squadrons); in turn to be reorganised, together with Bf 110s, into *Schnellkampfgeschwader* (fast bomber groups). And the successful conclusion of yet another land *Blitzkrieg*, this time against Yugoslavia, had also restored confidence in both the Stuka and in the ground-attack, or *Schlacht*, Hs 123, with which I.(Schl.)LG 2 was again partially equipped.

This then was the somewhat confusing triumvirate of *Luftwaffe* tactical air support — *Schnellkampf*, *Stuka* and *Schlacht*— which accompanied the initial ground advances into Russia. By 1942 the single *Schlachtgruppe* of 1939 had expanded into two full *Schlachtgeschwader*, operating a mix of predominantly Bf 109Es with a leavening of Hs 123s and twin-engined Hs 129s. Towards the end of that year, however, the increasing rigours of the Eastern Front were proving that the Bf 109's weaknesses made it even less suitable as a *Schlacht* aircraft than it was as a fighter in the often primitive conditions encountered in the Soviet Union. And when a replacement was sought - a machine that was

II./Schl.G 1 converted to Fw 190F-2s at Deblin-Irena, Poland, in March 1943. This aircraft carries the unit's famous Mickey Mouse badge on its cowling, with its background colour in red to denote its assignment to 5.Staffel- the prop boss and fuselage code letter were also sprayed red. All of these would be leached of their colour and left in black prior to the *Staffel*s return to the front





An impressive line up of pristine II./Schl.G 1 Fw 190Fs

Hauptmann Hans Stollnberger, *Staffelkapitän* of 6./Schl.G 1 at Kursk. He spent four days in Russia behind enemy lines during the battle following a forced landing, and only escaped by swimming the River Don under the cover of darkness. Stollnberger ended the war as *Kapitän* of 8./SG 10 with 45 victories



robust, reliable, handled well at low altitudes and could absorb punishment - the choice was obvious. The first ground-attack unit in the East to be re-equipped with the Fw 190 was Major Hubertus Hitschhold's *Schlachtgeschwader* 1 (Schi.G.I), whose two component *Gruppen* of Bf 109Es began withdrawing one *Staffel* a time from the River Chir sector of the Stalingrad front in the late autumn of 1942.

The comments of the pilots upon their introduction to the Focke-Wulf were remarkably similar to those of their fighter brethren. Lieutenant Fritz Seyffardt of II./Schl.G.I, one of the first to fly the Fw 190 operationally on the Eastern Front and who would end the war with 30 aerial victories:

'In 1942, I saw and flew my first Fw 190; I was thrilled with this machine. During the war I flew the Fw 190A, F and G models, and also the Messerschmitt Bf 109. The difference between the Fw 190 and the Bf 109 was that there was more

room in the Focke-Wulf's cockpit and the controls were simpler - for example, landing flaps and trim were electric. Another pronounced difference was the stability of the Fw 190. Thanks to its through-wing spars and wide landing gear the machine was substantially more stable in flight, and especially in landing on rough fields. At great height, engine performance was inadequate. Normal range of the later F models was approximately 375 - 425 miles. The average mission on the Russian Front lasted 45 - 60 minutes. Firepower was very good. As a rule we had two 20 mm cannon and two machine guns. There was also provision for two additional 20 mm cannon in the outer wing panels. As a flying tactic, we had the greatest success when we flew in open formation, in other words with approximately 80 to 100 metres separation between aircraft. In the target area we split into two-plane *Rotte* elements for the attack, only re-assembling into larger formations on the return flight. In altogether about 500 frontline missions, I had to make several belly landings on differing terrains, something that could be done without undue difficulty.'

A similar view, albeit with some reservations, was expressed by Feldwebel Peter Taubel, who first flew the Fw 190 with II./Schl.G.2 in the Mediterranean, before transferring to the Eastern Front:

'The Fw 190 as an aircraft was very advanced. The wide landing gear gave better tracking stability than with the Bf 109. The pilot's seat was comfortable, and armour protection was adequate. Instruments were easily scanned, a fact which pleased me on my first flight in the 190.1 found

myself very quickly at home. During combat we feared the great risk of fire from being hit. I remember that a fellow pilot burned in his cockpit when he was hit in the fuel system. The inside of his plane instantly burst into flames. Our heavy loading was also a problem. The Fw 190 was very cumbersome at full gross weight.'

Unteroffizier Fritz Kreitl, another later transferee from the Mediterranean theatre, was even less enthusiastic:

'Although the Fw 190 was a fine aircraft, it was not built for fighter-bombing. With 1000 lb of bombs or wing rockets, it performed sluggishly. Thus, take-off and landing with heavy loads forced us to re-write the manual. Landing speeds were increased by nearly 15 mph and when we were posted to the north Russian Front we were confronted with other hazards. The howling albino hell of the Russian winter made flying and maintenance a nightmare. In order to keep our engines from freezing up, fires were often built beneath them. Starts were accomplished in 20 degrees below zero weather by filling the sump with $\frac{3}{4}$ gasoline and $\frac{1}{4}$ oil. When you ignited this mixture, the gasoline would burn off immediately, heating the oil; one check of the mags, and a quick rev of the engine and you were up and flying. The cockpit of the Fw 190 was roomy, but forward vision on landing and take-off was nil, and the pilot could not see the ground either when lifting off or prior to touchdown. The aircraft's climb was outstanding and one of the best ways to leave an attacker was to haul back on the stick and point straight up. Although it turned well, the Focke-Wulf had the same tendency to skid in a turn as did the Bf 109. In a turn, the Fw 190 had an alarming, almost frightening penchant when the stick was sucked all the way back. In a tight right-hand turn, the aircraft would flip on its back and go down. Right rudder would escalate this and if you were being pursued, this disengaging manoeuvre was certain to

One of the Luftwaffe's most experienced *Schlachtflieger* was Major Alfred Druschel, *Geschwaderkommodore* of Schl.G 1. Note his Oak Leaves and Swords, awarded on 19 February 1943 for completing 700 missions. He was killed over the Ardennes during Operation *Bodenplatte* on New Year's Day 1945



A 'black man' catches 40 winks alongside a *Stab* machine of the *Gefechtsverband* Druschel (Schl.G 1) during the hot summer of 1943. Note the mechanic's standard issue toolbox to his left





The *Schlachtflieger*s' principal targets at Kursk were tanks, and the Russians certainly provided them with plenty of targets. Near Rzhev no less than 45 T-34s were destroyed from the air by II./Schl.G 1, their charred remains serving as testament to the firepower of the ground-attack configured Fw 190

If T-34s proved vulnerable to the prowling Fw 190s, then soft-skinned vehicles stood no chance at all. This is all that remains of just one of 46 trucks blown apart by II./Schl.G 1 again at Rzhev

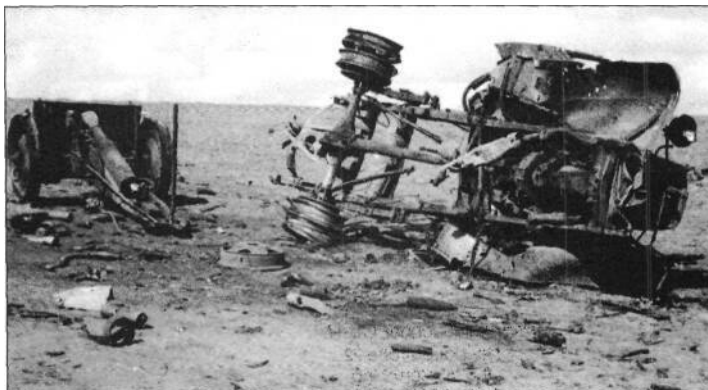

throw your enemy off. However, it was not recommended under 3000 ft. You needed that much altitude to recover, and at high speeds the G-forces were immense, often causing the blood vessels in the eye to burst.'

Although the first *Staffeln* of Schl.G. 1 had returned to the Southern Sector of the front early in 1943, where they helped to cover the first stages of the withdrawal from the Caucasus, the *Geschwader* did not complete re-equipment with the Fw 190 until May; just in time for the build-up to *Zitadelle*. The part played by Schl.G. 1's two *Gruppen* of Fw 190s in the Battle of Kursk has always been overshadowed by the specialised tank-buster units equipped with cannon-armed versions of the Ju 87 and Hs 129. For while the latter targeted the Soviet armour, the Fw 190s' primary job was to attack its supporting infantry and

the Russian artillery positions with SD-1 and -2 anti-personnel cluster bombs. These were containers which scattered either 180 or 360 small fragmentation bombs over a wide area with devastating effect. But for the pilots of Schl.G. 1, commanded now by Major Alfred Druschel and based for the Kursk assault at Varvarovka, the Red Army's response to their attacks was an eye-opener. In contrast to the German habit of promptly hitting the dirt and relying upon their accompanying flak to deal with low-flying aircraft, it was observed that, 'with the Russians, everyone and everything shoots back!' One famous contemporary comment describes the hail of fire encountered over Kursk even more graphically: 'They just blazed away with everything they'd got; machine guns, rifles, even pistols. The amount of iron in the air was indescribable. I swear, they would have thrown horseshoes at us, if they could have got them off the horses in time.' It did not augur well for future *Schlacht* operations.

After the German attack was called off in mid-July, the Fw 190s of I. and II./Schl.G 1 began to concentrate more and more on the Russian lines of supply which were bringing up the men and equipment needed to sustain the massive Soviet counter offensive. They enjoyed considerable success against these soft-skinned targets, as typified by the following report:

'On 11 July I was leading my *Schwärm* towards Kursk. We were

flying at about 1500 metres, well spread out in battle formation. A beautiful summer's day, not an enemy fighter in the sky, and below us a supply road - at first without any traffic on it. But look there, a column of trucks heading south, huge clouds of tell-tale dust, they were certainly in a hurry. About a dozen trucks in all, each heavily laden with fuel drums. I split my

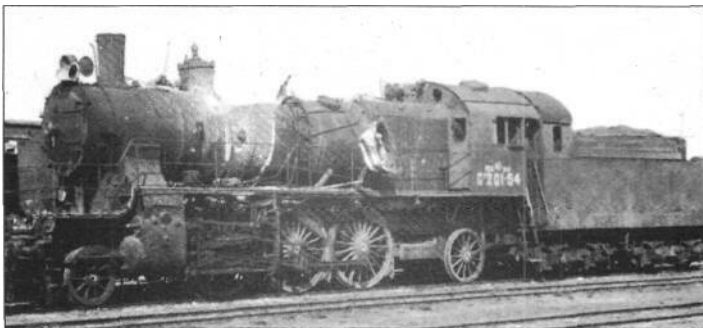

Schwärm into two *Rotten* and gave the order for a low-level attack. My *Rotte* took the head of the convoy, attacking from the flank; the other began from the tail end. After the first pass one or two trucks were already well alight. We were in luck. We'd caught a fuel convoy and could destroy it at our leisure - no fighters around and the ground defences were minimal. After 15 minutes nothing remained but a dozen blazing wrecks, and smoke climbed some 500-700 metres into the air. There were targets galore for us ground-attack units. We certainly couldn't complain.'

However, such individual attacks were pin-pricks against the flood-tide of advancing Soviets. A month after Kursk II./Schl.G 1 had retired to the area of Kharkov. The above report continues:

'Despite every effort, our ground forces were unable to stop the Red Army's onslaught. The road to Kharkov ran alongside our new base at Kharkov-Rogan. It was full of our infantry heading westwards. Our groundcrews asked the soldiers what their orders were, where they were heading for, only to be told that they were the division's rearguard and that the next lot of troops coming down the road would be Russian! We pilots were none too pleased at this news. We told our chief, who in turn informed the *Gruppenkommandeur* of the situation. All hell broke loose. Within the hour we had transferred lock, stock and barrel to Bol-Rudka, a field north of Poltava. Nobody had thought to let our *Gruppe* know what was happening. That same day Rogan was overrun by the Russians. But we had managed to save our machines, equipment and ground staff without loss. The Ju 52 crews, as so often during this period, were right on the spot. Without the help of the transport *Staffelnde* Eastern Front flyers could have simply disappeared without trace on many an occasion.

'Bol-Rudka was just a field which had been turned into a landing strip. We arrived like a travelling circus and set up shop. Everybody knew what he had to do, and soon we were flying missions to the north and north-east. The exact location of our front lines was unknown. Our first job was to pin-point the positions of our forward troops. Many had been cut off behind the advancing Russians. Enemy spearheads were pushing deep to the south and south-west. One thing was certain, they had broken through our front in many places and were pouring into our rear.

'Our groundcrews were magnificent. We were flying from first light until late evening. Our main task was to attack Ivan's armour and his supply lines. Our local successes were colossal, but we couldn't stop the overall momentum of the advance. It was also becoming obvious that the *Stukageschwadervfhw* their Ju 87s were no longer up to the conditions we were having to face by the autumn of 1943.'

Locomotives also proved highly desirable targets for marauding *Schlachtflieger*, as this engine found out to its cost. An impressive tally of 47 locos was claimed destroyed by II./Schl.G 1 at the time of the Kursk offensive

A suitably chuffed Oberfeldwebel Hermann Buchner receives the accolades of his groundcrew following the successful completion of his 300th operational sortie at Bol-Rudka on 27 August 1943





Living quarters in the south didn't run to Czars' palaces, as enjoyed by the *Jagdflieger* on the Leningrad Front. II./Schl.G 1 had to make do with tents, or even holes in the ground. Steel helmet perched on the lip of his fox hole, a young *Schlachtflieger* practices his accordion in between sorties. The exposed nature of this accommodation on the Crimean plain can be easily seen from this snapshot

When II./Schl.G 1's 'lavish' complex of holes in the ground at Tusow was overrun by sand vipers in late summer 1943, only Unteroffizier Lebsantf, seen here, saved the day as he proved to be extremely adept at catching these poisonous reptiles. He was duly crowned the *Gruppe's* champion viper catcher!



In fact, one result of the failure at Kursk was the long-overdue restructuring of the Luftwaffe's ground-attack and close-support formations. Until this time all *Stukagruppen* had been part of the bomber arm and were controlled by the *General der Kampfflieger*, whereas the *Schlacht-* and *Schnelkampflgruppen*, although not 'fighters' in the strict sense of the meaning, had nonetheless found themselves operating under the aegis of the *General der Jagdflieger*. With effect from 18 October 1943, all three branches were combined

into a new and separate ground-attack arm of the Luftwaffe under the command of a *General der Schlachtflieger*. As of this date all existing *Stukageschwader* (St.Gs 1, 2, 3, 5 and 77), with the exception of two *Gruppen*, were officially redesignated *Schlachtgeschwader* (henceforth to be abbreviated to the simpler SG).

Of the original pair of *Schlachtgeschwader*, Schl.G.1's two component *Gruppen* were used to fill the gaps in the newly created SGs left by the two *Gruppen* referred to above (II./St.G 2 and I./St.G 77) which initially retained their *Stuka* designations and continued to operate semi-autonomously as dive-bomber units. Thus I. and II./Schl.G.1 joined the ranks of the SGs as I./SG 77 and II./SG 2 respectively. Meanwhile the *Gruppen* of Schl.G.2, together with those of SKG 10, were amalgamated, via a convoluted series of redesignations, into two new *Schlachtgeschwader*, emerging as SGs 4 and 10.

Despite the new nomenclature, the bulk of the *ex-Stuka*, now *Schlachtgeschwader* continued to fly their Ju 87s. The pressing and ever-growing need for Fw 190s in the Homeland and the West meant that the SGs on the Russian Front - still very much the poor relation in terms of aircraft allocation - would not begin converting on to the Focke-Wulf until the spring of 1944. It also meant that the conversion programme itself would be a long drawn out affair. Conducted on a *Gruppe* by *Gruppe* basis, it would eventually degenerate from a 6-8 week course somewhere in a rear area for those fortunate enough to undergo 'early' transition and re-equipment, into a few circuits and bumps, plus some 15-20 sorties flying as wingman to a more experienced pilot while remaining on operations, which is all that the final few to forsake the Ju 87 for the Fw 190 would enjoy, before the whole programme ground to a halt in January 1945.

And so, with the Fw 190-equipped SGs 10 and 4 not transferring in from the Mediterranean to Russia until the end of 1943 and mid-1944 respectively, it fell to the two original *Schlachtgruppen* from the Battle of Kursk - now operating as I./SG 77 and II./SG 2 - to remain as the Eastern Front's only Fw 190 ground-attack presence for the rest of the year. Fielding a combined total of something less than 40 serviceable machines between them for most of that time, there was little they could do to halt the advance of 13 Soviet armies south-westwards towards the Black Sea.



Here's one for the experts. According to the original Russian caption, this somewhat battered Fw 190 conveniently providing a perch for a couple of young goatherds came down near Glukhov, in the Ukraine, in September 1943. The vertical bar aft of the cross denotes a III. Gruppe machine, but the 'White O' in old-fashioned German script is not exactly regulation! Did III./JG 51 perhaps have an individualist among its numbers?

By the beginning of January 1944 the *Gruppe* which had had to vacate Kharkov-Rogan for Bol-Rudka in such a hurry the previous August had been pushed back even further. They now found themselves on Malaya-Whisky, the oddly named forward landing strip located to the west of Kirovograd, which they shared with the Bf 109Gs of II./JG 52. Here, in their new guise as II./SG 2, they had an even closer shave. *Oberfeldwebel* Hermann Buchner takes up the story from where he left off in the autumn:

'By now it was deep winter and weather conditions were not exactly good. Visibility was a few kilometres at best, overcast with light snow showers. Our position wasn't exactly rosy either. Ivan's tanks had broken through at Kirovograd. The road leading south-westwards was packed with his armour and supply columns in division strength. We had our hands full. Continual low-level attacks, supported by a *Stukagruppe* and covered by the Bf 109s of II./JG 52. We were flying from morning till night and were very unpopular with Ivan. The consequences weren't long in coming. On the night of 13 January a force of enemy tanks managed to break through to our field.

'About midnight the alarm sounded and the adjutant woke the pilots. We were housed in the village school and were ordered to

Below and bottom The first snowfall of the impending winter catches two II./SG 2 machines (below) bombed up and ready for their next sortie from the flat expanse of the steppes. Note the tropical filter on the *Gruppen-Adjutant's* machine in the left foreground - this won't be needed for much longer as the summer's dust gives way to snow. The temporary nature of facilities in this region is graphically brought home by a close examination of the bottom photograph





Yet to receive their winter coats, a scattered group of *Schlact* Fw 190Fs sit quietly nestling their bombs, awaiting the appearance of pilots from tents or foxholes in late 1943

were engaging the Russian infantry. We pilots and groundcrew alike found ourselves on the western perimeter of the field. We were ordered to prepare our 190s and technical equipment for demolition should Ivan manage to overrun our area too. The signal would be a green flare from the *Gruppe* main ops room. After that we were to make our way westwards on foot. It was a pitch-black night and freezing cold. At about 3 in the morning a dim figure approached. It was the acting *Kommandeur* of the 109 *Gruppe*, Hauptmann Sepp Haiböck, who informed us that most of his aircraft had been flattened by the enemy's tanks.

'Our own 20 mm flak vehicles drove off into the darkness to join the fight on the eastern edge of the field. The base's heavier 88 mm flak guns began to engage the T-34s with some success. We just stood around, frozen stiff and waiting for orders. Towards dawn the sounds of battle from across the field began to diminish. At first light a trio of He IIIIs roared in at low-level with the obvious intention of bombing us - they must have thought the field had been captured. We were able to stop them at the last minute by shooting off recognition flares. Then came the Stukas, looking for

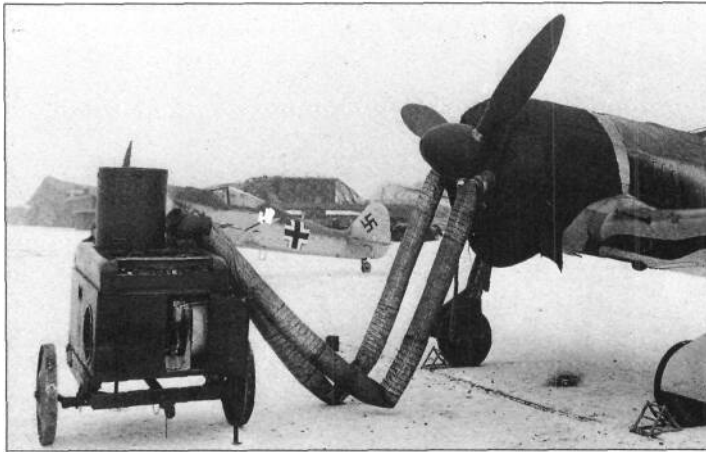

Above and right What the well-dressed Fw 190F wore in the depths of winter. Heating trollies and tents were available only for the lucky few! The latter were often reserved for aircraft undergoing in-the-field maintenance, as conditions often proved too bitter in the depths of winter for 'black men' to work outdoors for any period of time. Note that 'White N' has had a toned down cross applied to its fuselage, although its overall effect is spoiled somewhat by the full-colour *Staffel* markings

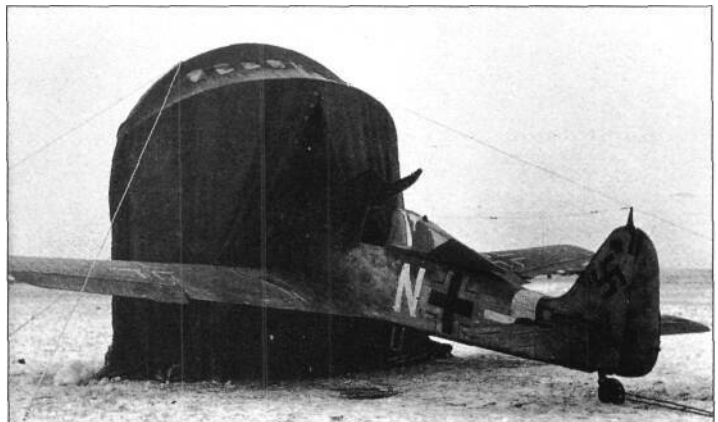

targets around the eastern perimeter. We had a ringside view as one of them was shot down by a Russian anti-aircraft tank. But fortunately the crew managed to parachute to safety.

'It had been a hectic night. And it wasn't over yet. At about 10.00 hours our flak, supported by some mounted infantry from the village, managed to seal the breach. All the enemy tanks were destroyed, and his infantry either killed or taken prisoner. We could breathe again. Our 190s were undamaged. But JG 52's 109s had all been lost, and one unfortunate HQ clerk had been crushed by the T-34 falling into the ops dugout.

'By mid-day it was business as usual. The *Kommandeur* issued new orders. For me this meant taking a group of pilots to collect four new 190s from the depot at Uman.'

Shortly after this II./SG 2 retired to the Crimea, based first at Karankut and then sharing Cherson-South with the Bf 109s of II./JG 52 again. The severity of the recent fighting had reduced the *Jagdgruppe*'s serviceable strength to single figures. And so, in addition to their continuing ground-attack missions, the Fw 190A-5/U1s of II./SG 2 found themselves becoming embroiled in the battle for air supremacy over the beleaguered Crimean bridgehead. 6. *Staffeis* Oberfeldwebel Hermann Buchner here recalls a typical operation of this period, ordered to be flown by a mixed *Schwarm* of two Fw 190s and two Bf 109s:

'Shortly before 11.00 hours we taxied out for take-off. Unfortunately, my wingman did not spot a fresh bomb crater and completed his mission there and then standing on his nose. I reached the take-off point somewhat late myself, to find only a single Bf 109 waiting for me. Obviously his wingman had had some difficulties too!

'The Bf 109 had two black chevrons on his fuselage (presumably indicating the aircraft, if not the actual presence, of II./JG 52's *Gruppenkommandeur*, Hauptmann Gerhard Barkhorn, who, with a final total of 301 victories, was to become the world's number two ranking ace of all time, second only to the legendary Erich Hartmann). The pilot signalled that he would fly as leader. We took off westwards, and I soon discovered that my Fw 190 could more than hold its own against the Bf 109.

'We were some 1000 metres above the Black Sea when the first message came through from ground control: "*Indianer* in harbour area SEWA; *Hanni* 3-4." ("Bandits over Sevastopol harbour, height 3000 - 4000 metres").

'My *Schwarmfuehrer* continued to climb while I covered his tail and kept a careful watch for bandits. We were soon flying at 4000 metres approaching Sevastopol from the west. Then we spotted them, somewhat lower: enemy fighters. The *Schwarmfuehrer*'s voice crackled over my headphones: "*Pauke, Pauke*" ("Tally-Ho!").

'He dived into the attack, scattering the enemy fighters. They were Yaks and we twisted and turned among them for about ten minutes without scoring a single kill. Then they broke away. Ground control quickly came back on air: "Fly to Balaclava area, large formation of II-2s and *Indianer*."

'The Bf 109 reduced speed and its pilot indicated that I should take over the lead. Now I was in front with the Messerschmitt protecting my tail. We were soon approaching Balaclava and could see the smoke-bursts of our own flak. Another wild dogfight with Yak-9s began, and this time



Karankut, in the Crimea. A combat-weary Hermann Buchner celebrates his 500th mission in March 1944

II./SG 2's *Gruppe* ops bunker at Cherson in April 1944 is the meeting place for Oberleutnant Ernst Beutelspacher (right), *Staffelkapitän* of 6./SG 2, and an anonymous pilot from his *Staffel*. The former would be awarded the Knight's Cross the following month, only to be killed in action against US fighters over Rumania in July





The most successful *Schlachtflieger* in terms of aerial kills was 5./SG 2's Leutnant August Lambert, pictured here in the Crimea in May 1944. By the time he was killed in April 1945, Lambert had downed 116 aircraft

Hermann Buchner's 600th op is celebrated barely two months after his 500th at Bacau, in Rumania, in early June 1944. He is flanked in front of his Fw 190F-8 'Green Y' by his chief mechanic (at the back on the right) and his 'Katschmarek' (left), a fresh-faced youngster named Wolfgang von Richthofen, son of the famous General Wolfram von Richthofen of the early Stuka days. Gefreiter von Richthofen was reported missing in action in Fw 190 'Green G' over Jasy, Rumania, on 5 June 1944



Oberfeldwebel Buchner pictured after the award of the Knight's Cross on 20 July 1944. Although not visible in this view, Buchner also wore the *Deutsches Kreuz* (German Cross) on the right breast pocket, and a ground-attack clasp and pennant, pilot's badge, wound badge and the Crimea shield on his left sleeve

I was able to bring one down. It crashed to the ground in flames. The rest of the *Indianer* broke for the east. Far below us the Il-2s were attacking our ground positions north of Balaclava. Quickly losing height, we dived on the enemy *Stormoviks* from astern. After a few bursts I managed to get an Il-2. His port wing erupted in flames. He tipped over and smashed into the ground.'

The above victories were but two of Hermann Buchner's final tally of 58 enemy aircraft destroyed. Having first joined II./Schl.G. 1 in February 1942, his subsequent career was nothing if not spectacular. Shot down five times, he twice baled out and was twice wounded. On the Eastern Front he claimed 46 kills, plus the same number of tanks and one armoured train destroyed. Awarded the Knight's Cross and commissioned, Leutnant Buchner ended the war flying the Me 262 in Defence of the Reich duties, shooting down 12 four-engined bombers, and being nominated for the Oak Leaves in the process.

But during the closing stages of the Crimean campaign there was one member of II./SG 2 whose exploits eclipsed all others. It is claimed that some 604 Soviet aircraft were brought down during the six months' fighting leading up to the final German evacuation of the Crimea. Of that total an astounding 247 had fallen to the Fw 190s of U./SG 2. More amazing still, one man alone accounted for over a third of the *Schlachtgruppe's* victories. 5.*Staffels* Leutnant August Lambert amassed over 70 kills in just three weeks, scoring as many as 12, Hand 17 in a single day! He was awarded the Knight's Cross in May 1944 when he had 90 victories to his credit. After the fall of the Crimea Lambert went back to instructing, a job he had been doing prior to his posting to II./Schl.G 1 in April 1943. He was to return to the front in the final weeks of the war, only to fall victim to American Mustangs. His final total stood at 116 enemy aircraft destroyed - all gained on the Eastern Front - making him the highest scoring *Schlachtflieger* of them all.

Having been bottled up on the Crimea for over four months, II./SG 2 retired westwards across the Black Sea to Rumania early in May 1944. They were initially based at Bacau, a field they shared with I./SG 10. For, at long last, the ex-Stuka re-equipment programme was finally beginning

Buchner shares a joke with two members of his *Schwärm* after surviving yet another sortie over Rumania in mid-1944. Note the extreme variation in clothing



Buchner's chief mechanic Unteroffizier Wiezorek, poses in the spring slush in front of 'his' Fw 190F-8



The losses - Oberleutnant Beutelspacher (left) and Leutnant Lambert (right), were both *Schlachtflieger* Knight's Cross holders and were both killed by US fighters. They are seen here in their respective finery in Rumania in 1944

Pilots of II./SG 2 shot down by marauding USAAF P-38 Lightnings over Czechoslovakia are buried at Prossnitz in 1944. By this stage in the war the military cemeteries were rapidly filling up with downed *Schlachtflieger*

to make itself felt. There were seven Fw 190-equipped *Schlachtgruppen* deployed on the Southern and Central Sectors of the Eastern Front. The ex-Mediterranean SG 10 was present in no less than full three *Gruppe* strength. I. and II./SG 10 were both in Rumania with II./SG2. In southern Poland III./SG 10 was grouped alongside I./SG 77 (the original I./Schl.G 1) and the newly converted II./SG 77. On the Central Sector there was as yet just the one *Gruppe* fully re-equipped with the Fw 190 - III./SG 1.

This 'build-up' (between them the seven *Gruppen* fielded 197 serviceable Fw 190s in May; a more than three-fold increase on the previous month's figure) was timely. The series of Soviet counter-offensives which had followed on from the German retreat at Kursk had finally halted. But the respite was to be only temporary. In June Stalin would launch his massive Belorussian offensive which would take the Red Army to the eastern borders of Germany itself.

The burgeoning strength of the *Schlacht arm* may have been cause for cautious optimism, even at this late stage of the war in the east. But what of the Fw 190 fighter presence on the main Soviet fronts post-Kursk? By that same June 1944, when it was estimated that Soviet air power stood at nearly 13,500 aircraft, the number of serviceable Focke-Wulfs would have sunk to an incredible all-time low of just 31!



COLOUR PLATES

This 18-page section profiles many of the aircraft flown by Lufwaffe Fw 190 aces of the Russian Front. The majority of these aircraft have never been seen in colour before, and the sheer breadth of variation in camouflage schemes is quite fascinating, as is the general lack of unit markings or rudder scoreboards.

As is always the case in this ever-growing series, the artworks have all been specially commissioned for this volume, and author/artist John Weal, plus figure artist Mike Chappell, has gone to great pains to illustrate the aircraft, and their pilots, as accurately as possible following much original in-depth research.



1

Fw 190A-8 'Black Double Chevron', flown by Hauptmann Paul-Heinrich Dähne, Gruppenkommandeur II./JG 1, Mecklenburg, circa February 1945



2

Fw 190A-8 'Yellow T', flown by Major Bernd Gallowitsch, Staffelkapitän 7./JG 1, Garz/Usedom, March 1945



3

Fw 190D-9 'Black Double Chevron', flown by Oberleutnant Oskar Romm, Gruppenkommandeur IV./JG 3, Prenzlau, March 1945



4
 Fw 190D-9 'Black Chevron and Bars', flown by Oberstleutnant Gerhard Michalski, Geschwaderkommodore JG 4, Oder Front, circa January 1945



5
 Fw 190A-3 'Black 1', flown by Hauptmann Friedrich-Wilhelm Strakeljahn. Staffelkapitän 14. (Jabo)/JG 5, Petsamo/northern Finland, circa June 1943



6
 Fw 190D-9 'Black Chevron and Bars', flown by Major Gerhard Barkhorn, Geschwaderkommodore JG 6, Lower Silesia, circa January 1945



7
 Fw 190A-8 'Black Double Chevron', flown by Hauptmann Herbert Kutscha, Gruppenkommandeur III./JG 11, Brandenburg, circa February 1945

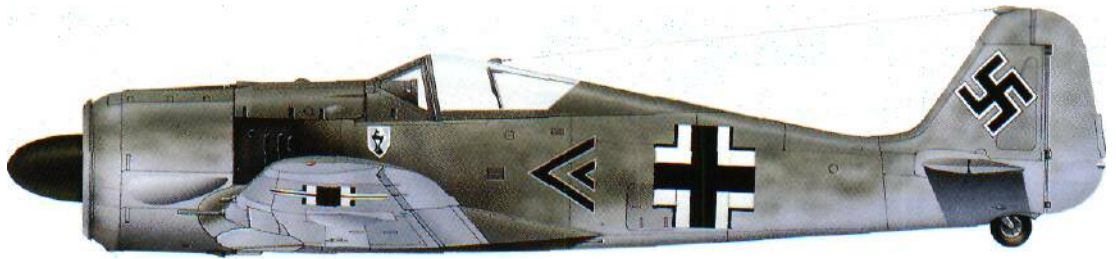

8

Fw 190A-3 'Black Double Chevron', flown by Hauptmann Heinrich Krafft Gruppenkommandeur I./JG 51, Jesau/East Prussia, August 1942

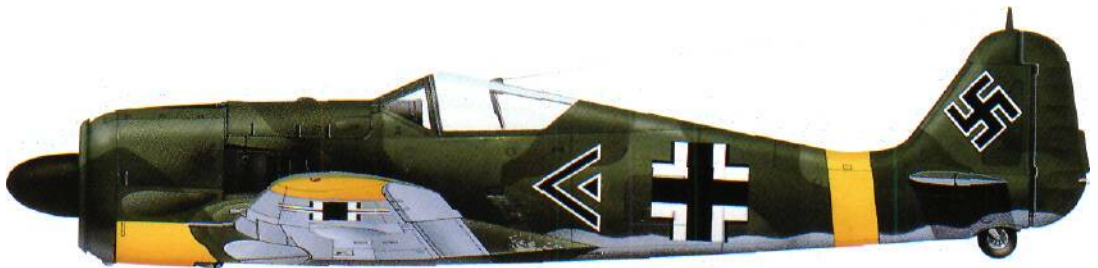

Fw 190A-5 'Black Double Chevron', flown by Major Erich Leie, Gruppenkommandeur I./JG 51, Orel, Circa May 1943



10

Fw 190A-3 'Black Double Chevron', flown by Hauptmann Rudolf Busch, Gruppenkommandeur I./JG 51, Lake Ivan/Russia, January 1943



11

Fw 190A-3 'Yellow 9', flown by Hauptmann Heinz Lange, Staffelkapitän 3-/JG 51, Vyazma, December 1942

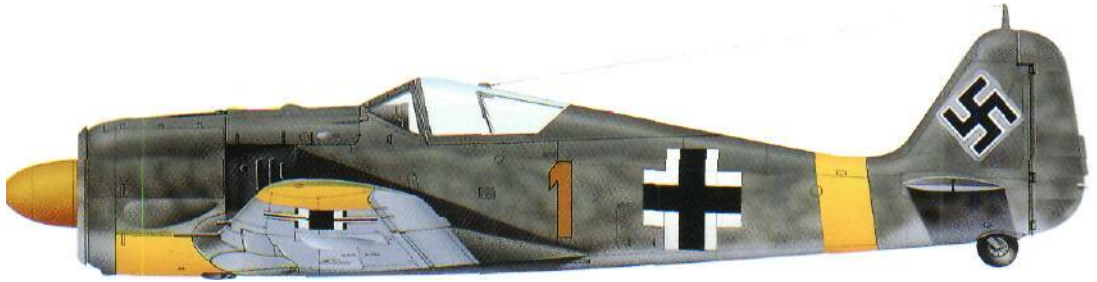

12

Fw 190A-4 'Yellow 1', flown by Oberfeldwebel Herbert Bareuther, 3./JG 51,
Orel. June 1943



13

Fw 190A-4 'Yellow 5', flown by Leutnant Josef Jennewein, 3./JG 51,
Orel, June 1943



14

Fw 190A-5 'Black Double Chevron', flown by Hauptmann Fritz Losigkeit, Gruppenkommandeur III./JG 51,
Kursk. July 1943



15

Fw 190A-3 'White IV', flown by Hauptmann Herbert Wehnelt, Staffelkapitän 7./JG 51,
Orel, circa January 1943

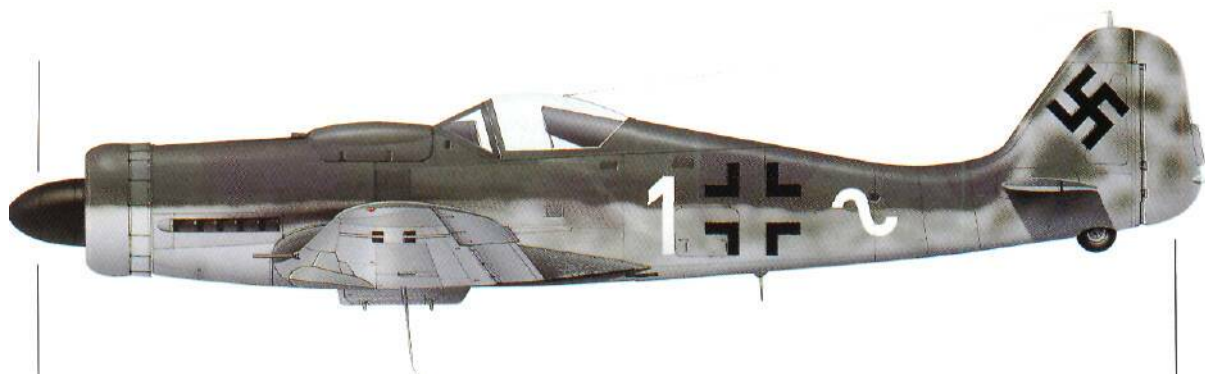

16
 Fw 190D-9 'White T', flown by Leutnant Kurt Tanzer, Staffelkapitän 13./JG 51,
 Schmoldow/Pomerania, April 1945



17
 Fw 190A-8 'Black 3 and Bars', flown by Unteroffizier Helmut Johne, Stabsstaffel JG 51,
 Memel, November 1944



18
 Fw 190A-8 'Black 6 and Bars', flown by Oberfeldwebel Fritz Lüddecke, Stabsstaffel JG 51,
 Orscha, circa July 1944



19
 Fw 190A-8 'Black 11 and Bars', flown by Leutnant Günther Heym, Stabsstaffel JG 51,
 Zichenau, circa September 1944



20

Fw 190A-8 'Black 12 and Bars', flown by Feldwebel Johann Merbeler, Stabsstaffel JG 51, Neukuhren/East Prussia, November 1944

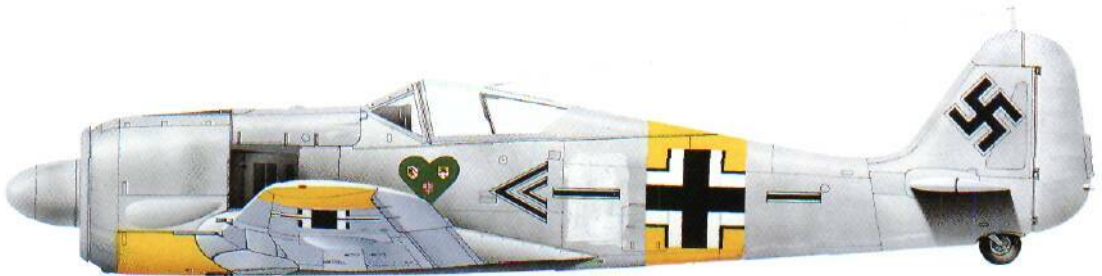

21

Fw 190A-4 'Black Double Chevron and Bars', flown by Oberstleutnant Hannes Trautloft, Geschwaderkommodore JG 54, Krasnogvardeisk, circa December 1942

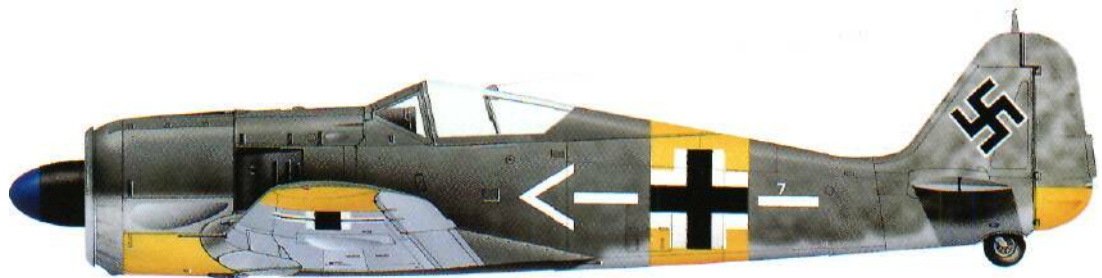

22

Fw 190A-4 'White Chevron and Bars', flown by Major Hubertus von Bonin, Geschwaderkommodore JG 54, Krasnogvardeisk, circa August 1943



23

Fw 190A-5 'White Chevron and Bars', flown by Major Hubertus von Bonin, Geschwaderkommodore JG 54, Central Sector, circa November 1943



24

I-w 190A-6 'White Chevron and Bars', flown by Oberstleutnant Anton Mader, Geschwaderkommodore JG 54, Dorpat/Estonia, July 1944



25

Fw 190A-4 'Black Double Chevron', flown by Hauptmann Hans Philipp, Gruppenkommandeur I./JG 54, Krasnogvardeisk, circa January 1943



26

Fw 190A-6 'Black Double Chevron', flown by Hauptmann Walter Nowotny, Gruppenkommandeur I./JG 54, Vitebsk, November 1943



27

Fw 190A-8 'Black Double Chevron', flown by Hauptmann Franz Eisenach, Gruppenkommandeur I./JG 54, Schruden/Courland, circa November 1944

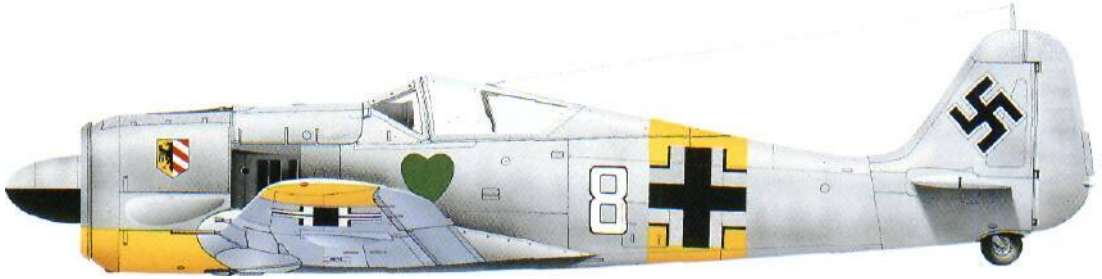

28

Fw 190A-4 'White 8', flown by Leutnant Walter Nowotny, Staffelkapitän 1./JG 54, Krasnogvardeisk, November 1942



29

Fw 190A-4 'White 10', flown by Leutnant Walter Nowotny, Staffelkapitän 1./JG54, Krasnogvardeisk, Spring 1943



30

Fw 190A-5 'White 5', flown by Oberleutnant Walter Nowotny, Staffelkapitän 1./JG 54, Krasnogvardeisk, circa June 1943



31

Fw 190A-6 'White 12', flown by Leutnant Helmut Wettstein, Staffelkapitän 1./JG 54, Central Sector, circa 1943



32

Fw 190A-8 'White T', flown by Leutnant Heinz Wernicke, Staffelkapitän 1./JG 54, Riga-Skulte/Latvia, circa September 1944



33

Fw 190A-8 'White 12', flown by Oberleutnant Josef Heinzeller, Staffelkapitän 1./JG 54, Schrudnen/Courland, November 1944



34

Fw 190A-4 'White 9', flown by Feldwebel Karl Schnorrer, 1./JG 54, Krasnogvardeisk, circa January 1943



35

Fw 190A-4 'White 2', flown by Oberfeldwebel Anton Döbele, 1./JG 54, Krasnogvardeisk. Spring 1943



36
Fw 190A-4 'White 3', flown by Feldwebel Peter Bremer. 1./JG 54,
Orel, July 1943



37
Fw 190A-4 'Black 5', flown by Hauptmann Hans Götz. Staffelkapitän 2./JG 54,
circa July 1943



38
Fw 190A-4 'Black 11', flown by Feldwebel Hans-Joachim Kroschinski, 2./JG 54,
Krasnogvardeisk, February 1943



39
Fw 190A-6 'Yellow 5', flown by Oberleutnant Otto Kittel, 3./JG 54,
Riga-Skulte. circa August 1944



40
 Fw 190A-5 'Yellow 8', flown by Leutnant Robert Weiss, 3./JG 54,
 Orel, circa June 1943



41
 Fw 190A-6 'Black Double Chevron', flown by Major Erich Rudorffer, Gruppenkommandeur II./JG 54,
 Immola/Finland, June 1944



42
 Fw 190A-6 'Black 5', flown by Oberleutnant Max Stotz, 5./JG 54,
 Siverskaya, late Spring 1943



43
 Fw 190A-6 'Black 7', flown by Leutnant Emil Lang, 5./JG 54,
 Northern Sector, Summer 1943



44
Fw 190A-4 'Black 12', flown by Fähnrich Norbert Hannig, 5/JG 54,
Siverskaya, circa May 1943

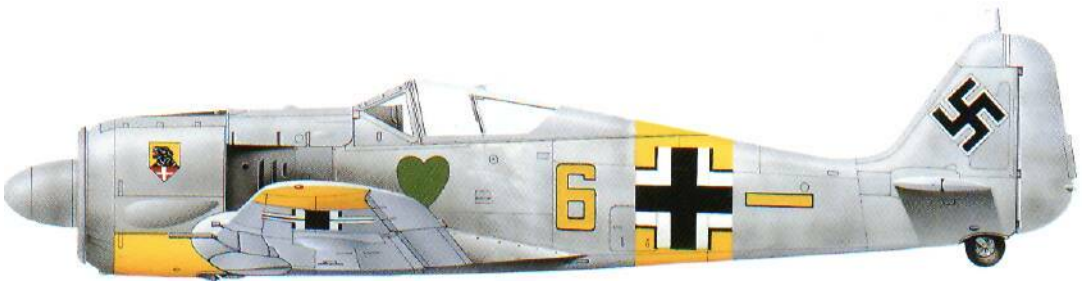

45
Fw 190A-4 'Yellow 6', flown by Oberleutnant Hans Beisswenger. Staffelkapitän 6./JG 54,
Ryelbitzi, February 1943



46
Fw 190A-9 'Yellow T', flown by Hauptmann Helmut Wettstein, Staffelkapitän 6./JG 54,
Libau-Grobin/Courland, February 1945



47
Fw 190A-8 'Yellow T', flown by Leutnant Gerd Thyben. Staffelkapitän 7./JG 54,
Libau-Grobin/Courland, circa January 1945





49

Fw 190A-8 'White 3', flown by Oberleutnant Karl Brill, Staffelkapitän 10./JG 54.
Lemberg (Lwow)/Poland, summer 1944

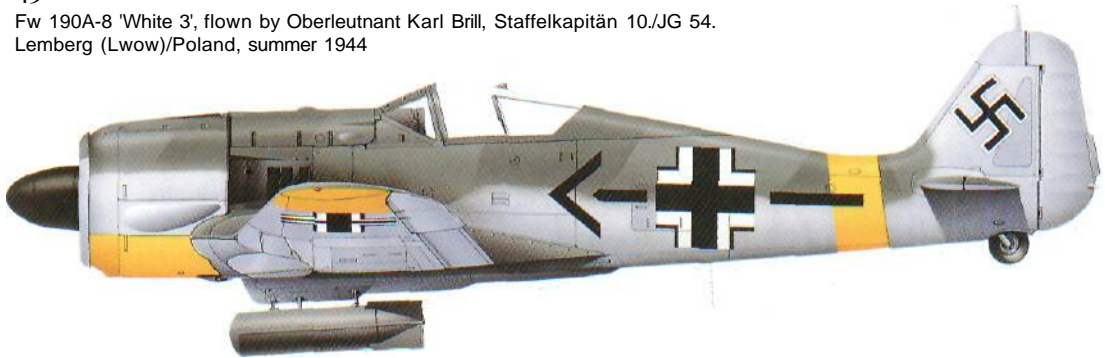

50

Fw 190F-2 'Black Chevron and Bars', flown by Major Alfred Druschel, Geschwaderkommodore, Schl.G 1,
Varvarovka, Summer 1943



51

Fw 190F-2 'Black Double Chevron', flown by Hauptmann Georg Dörffel, Gruppenkommandeur I/Schl.G 1.
Kharkov, circa February 1943



52

Fw 190F-2 'Black Chevron', flown by Oberleutnant Karl Kennel, Staffelkapitän 5./Schl.G 1,
Varvarovka, July 1943

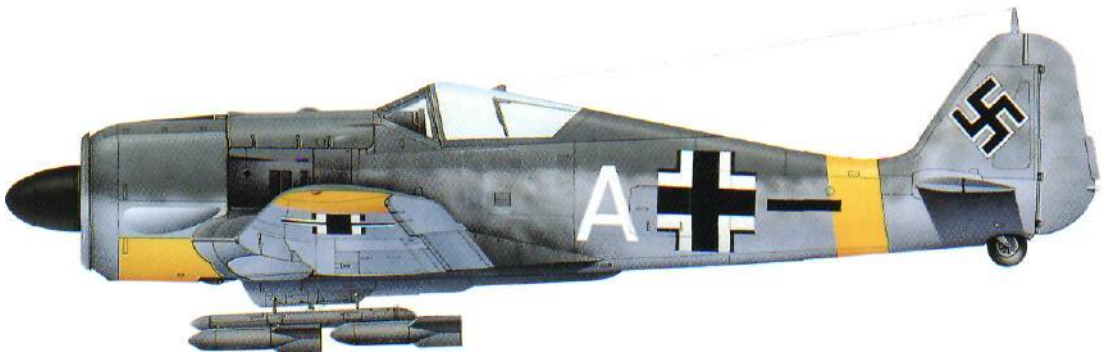

53

Fw 190F-2 'White A', flown by Leutnant Fritz Seyffardt, 6./Schl.G 1,
Ukraine, circa May 1943



54

Fw 190F-2 'Black T', flown by Oberfeldwebel Otto Dommeratzky, S./Schl.G 1,
Southern Sector, September 1943

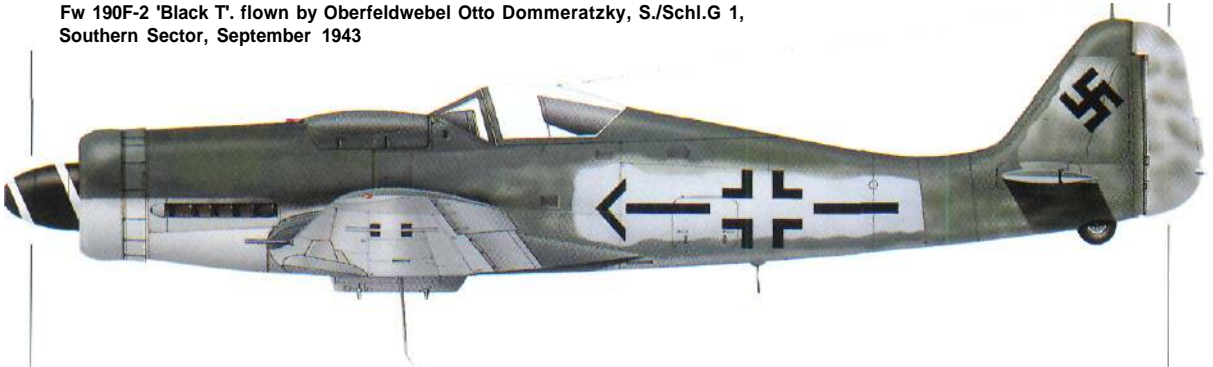

55

Fw 190D-9 'Black Chevron and Bars', flown by Oberst Hans-Ulrich Rudel, Gesch
waderkommodore SG2, Grossenhain, April 1945



56

Fw 190F-2 'Black Double Chevron', flown by Major Heinz Frank, Gruppenkommandeur II./SG 2,
Karankut/Crimea, April 1944

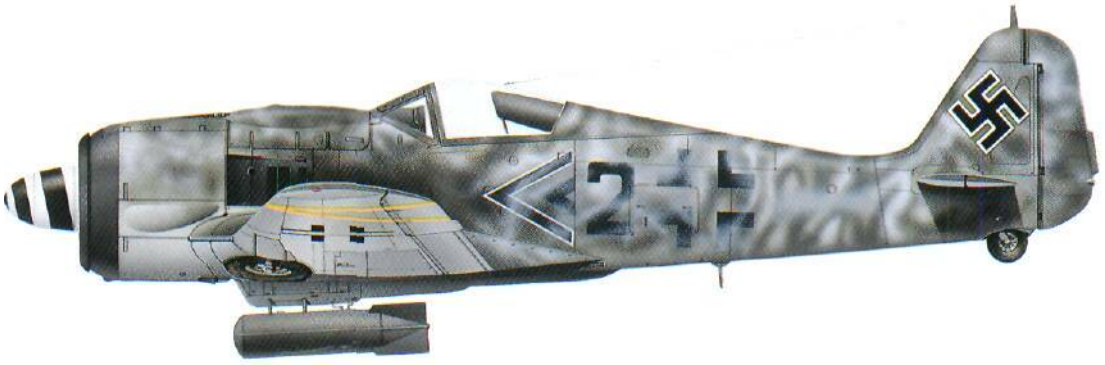

57

Fw 190F-9 'Black Double Chevron/2', flown by Major Karl Kennel, Gruppenkommandeur II./SG 2, Börgönd/Hungary, circa December 1944



58

Fw 190F-8 'Black Chevron', flown by Leutnant Hermann Buchner, Staffelkapitän 4./SG 2, Zilistea/Rumania, June 1944



59

Fw 190A-5 'Black G', flown by Oberfeldwebel August Lambert, 5./SG 2, Southern Sector, late 1943



60

Fw 190F-8 'Black Chevron/Green H' flown by Hauptmann Günther Bleckmann, Staffelkapitän 6./SG 2, Bacau/Rumania, May 1944



1
3./JG 54's Oberfeldwebel Otto Kittel,
the top scoring Fw 190 pilot on the
Eastern Front, in early 1944

2
The highest scoring *Schlachtfieger*
of them all, Leutnant August
Lambert of 5./SG 2 in early 1944

3
Long-time *Kommodore* of JG 54,
Oberstleutnant Hannes Trautloft as
he appeared in autumn 1943



4
Oberfeldwebel Hermann Buchner of 4./SG 2 is seen in his lightweight summer kit in spring 1944

5
The most famous Fw 190 pilot of them all, Walter Nowotny runs for his Fw 190 in October 1943

6
Oberleutnant Joachim Brendel, a 189-victory ace with JG 51, is seen between sorties in the spring of 1944

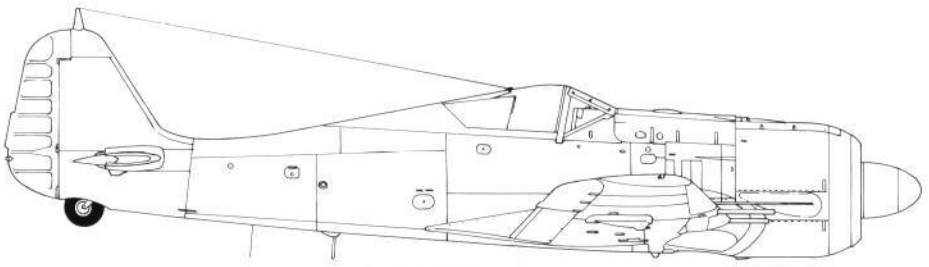

**Focke-Wulf Fw 190A-6
(planform and side-view)**

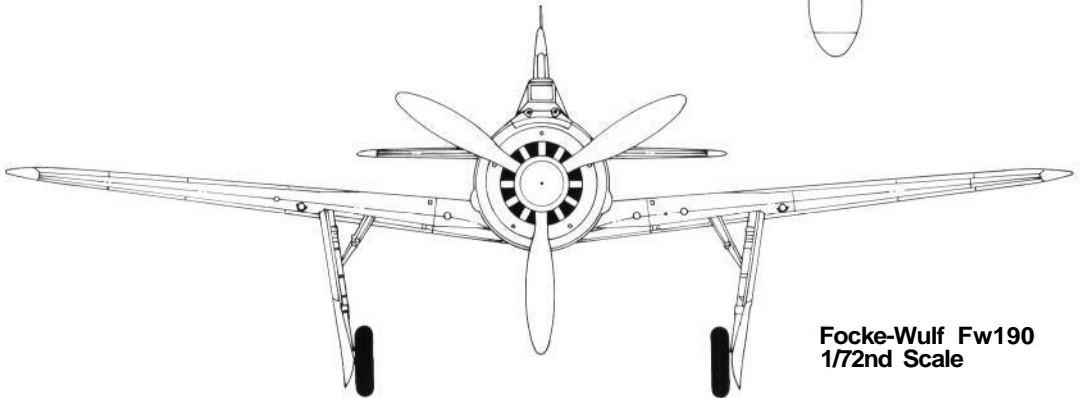
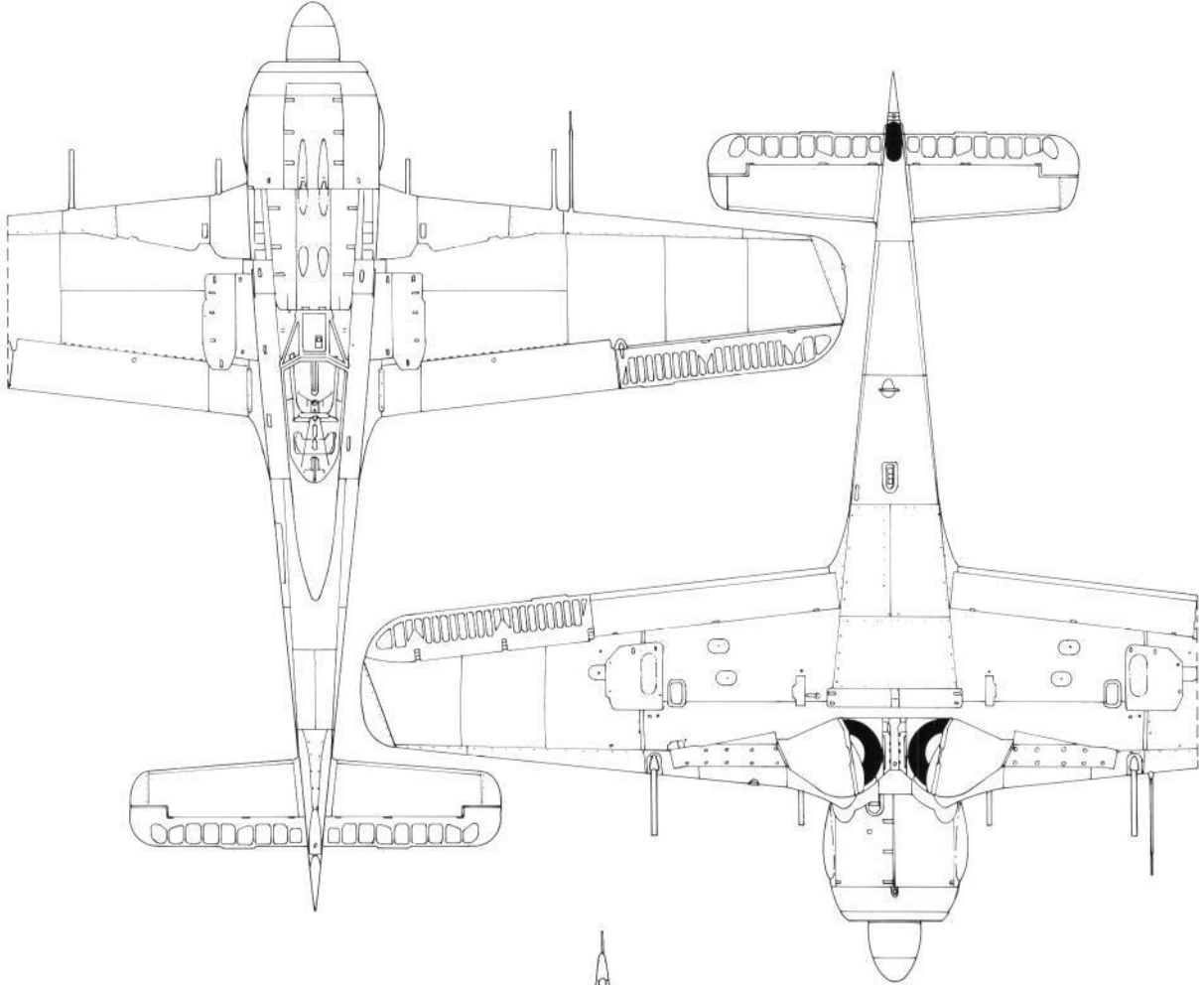

**Focke-Wulf Fw190
1/72nd Scale**

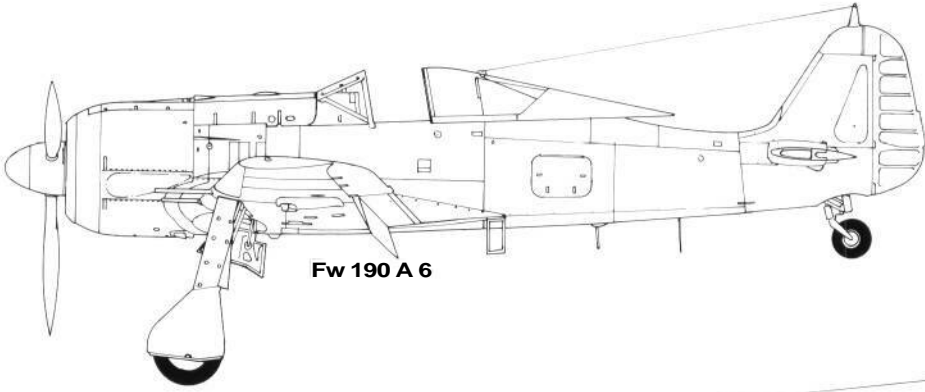

Fw 190 A 6

Fw 190A-3

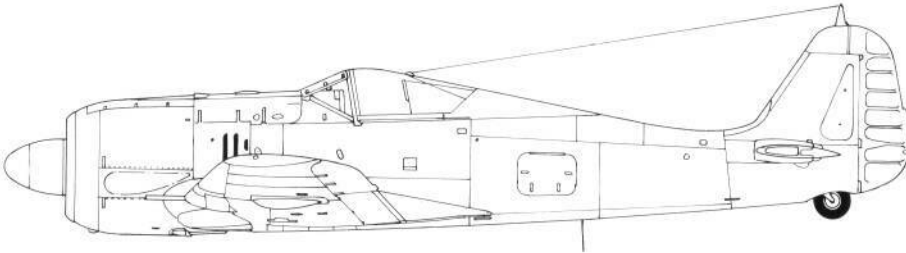
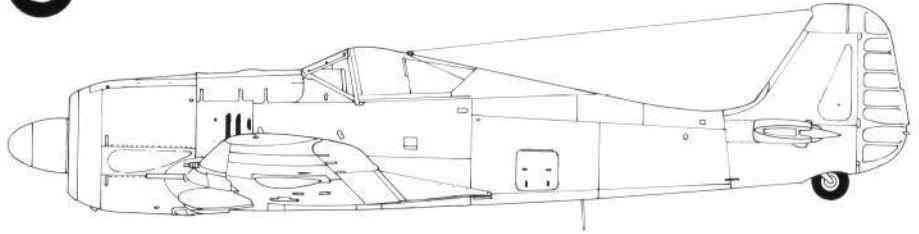

Fw 190A-4

Fw 190A-8

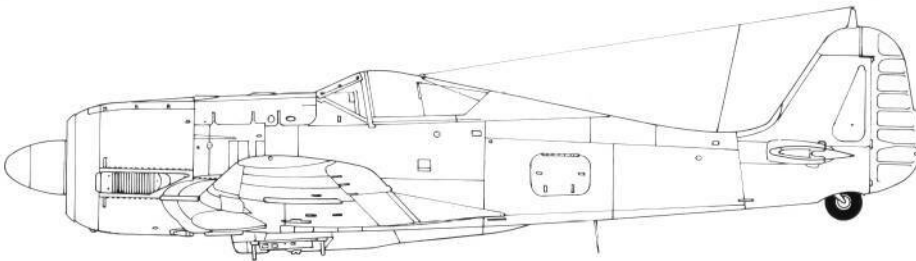
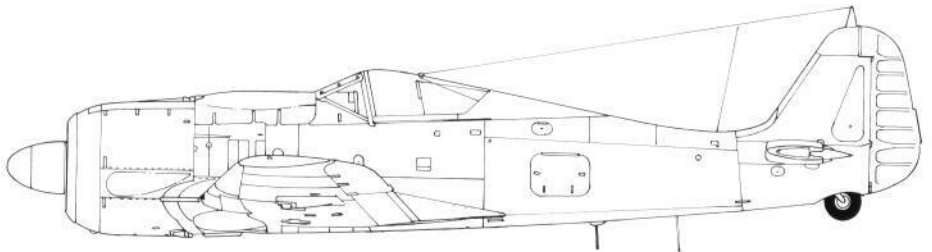

Fw 190F-2

Fw 190F-8

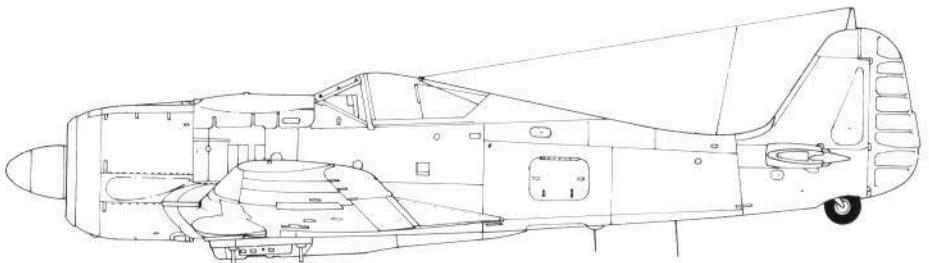

COLOUR PLATES

1

Fw 190A-8 'Black Double Chevron' of Hauptmann Paul-Heinrich Dähne, *Gruppenkommandeur* II./JG 1, Mecklenburg, circa February 1945

Representative of the influx of Fw 190s to the Eastern Front in 1945, Dähne's machine displays one of the typical styles of late-war camouflage and national insignia. The retention of JG 1's Defence of the Reich red aft fuselage band indicates that it was probably among the earliest batch of transferees in mid-January and Dähne may well have inherited it from the previous *Gruppenkommandeur* at the time of the move, Major Hermann Staiger. Dähne himself scored 100+ victories, some 80 of them in the east (he had served with JG 52 in 1942/43) but, in the absence of log books or unit diaries, it is impossible to establish exactly how many were gained on Fw 190s in 1945. He was killed on 24 April 1945 flying the Heinkel He 162 *Volksjäger*.

2

Fw 190A-8 'Yellow 1' of Major Bernd Gallowitsch, *Staffelkapitän* 7./JG 1, Garz/Usedom, March 1945

Unlike Dähne's aircraft, Gallowitsch's 'Anton-8' wears no Defence of the Reich band. Probably a replacement delivered after the *Gruppe*'s arrival in the east, note too the completely different, closely dappled camouflage finish and national insignia presentation. After a varied career, including service with JG 51 in Russia, Gallowitsch ended the war with 64 kills, all but 5 of which he claimed in the east. Again, it is unknown just how many he scored on the Fw 190 during the closing months.

3

Fw 190D-9 'Black Double Chevron' of Oberleutnant Oskar Romm, *Gruppenkommandeur* IV./JG 3, Prenzlau, March 1945

Romm's aircraft displays standard, almost pristine camouflage and markings of the period, including a carefully outlined *Kommandeur*'s double chevron. This was in contrast with many of *Stab* IV./JG 3's 'Dora-9's which showed heavy wear and evidence of much repainting to cover traces of previous ownership. None, however, appears to have been given any form of IV.*Gruppe* identity marking aft of the fuselage cross. Romm's wartime career also ended in a crash on 24 April 1945 (see Dähne above) in which he was severely injured; his score at the time standing at 92.

4

Fw 190D-9 'Black Chevron and Bars' of Oberstleutnant Gerhard Michalski, *Geschwaderkommodore* JG 4, Oder Front, circa January 1945

Wearing a slightly unusual dapple scheme, this was one of several similarly marked 'D-9s' flown by Michalski during the winter of 1944/45. The */Kommodore*'s insignia, consisting of a single chevron with a bar each side of the fuselage cross, dates back to pre-war biplane days. Note the overpainting of JG 54's black-white-black Defence

of the Reich bands, evidence of recent transfer from the Rhine to the Oder Front. A long-time member of II./JG 53, and a Bf 109 Mediterranean ace, Michalski ended the war with 14 Eastern Front kills, only to lose his life in a road accident nine months later.

5

Fw 190A-3 'Black 1' of Hauptmann Friedrich-Wilhelm Strakeljahn, *Staffelkapitän* 14. (Jabo)/JG 5, Petsamo/northern Finland, circa June 1943

Early standard finish Fw 190 with no (or prior to application of) yellow Eastern Front theatre markings, but note the 'bow and bomb' *Staffel* badge on the cowling; very much the exception rather than the rule on eastern-based Fw 190s after the spring of 1943. Strakeljahn took his *Staffel* to Italy in the spring of 1944, but returned to the Russian Front that same summer as *Gruppenkommandeur* of II./SG 4. He was killed in action on 6 July 1944. Although primarily a fighter-bomber exponent throughout, he nevertheless managed also to score at least 9 aerial victories.

6

Fw 190D-9 'Black Chevron and Bars of Major Gerhard Barkhorn, *Geschwaderkommodore* JG 6, Lower Silesia, circa January 1945

Wearing similar insignia to Michalski's, Barkhorn's 'Dora-9' is included by default, for although he was the Luftwaffe's second-ranking ace with 301 Eastern Front kills to his credit, he didn't score a single one on the Fw 190. His aircraft does, however, show JG 6's finish and markings of the period including, it is claimed, the red-white-red bands indicating the unit's Defence of the Reich duties immediately prior to its transfer eastwards. It also displays his wife's name, *Christi*, below the cockpit sill and a tiny 'white 5' in the angle of the chevron, both dating back to the Bf 109F he flew at the start of the campaign.

7

Fw 190A-8 'Black Double Chevron' of Hauptmann Herbert Kutscha, *Gruppenkommandeur* III./JG 11, Brandenburg, circa February 1945

Another late war finish incorporating simplified national insignia is illustrated by Kutscha's A-8. It also features the unit's previous Defence of the Reich aft fuselage band. Being yellow - the colour of the official Eastern Front theatre markings - little attempt was made to obliterate these bands on being transferred eastwards during the latter part of January 1945. Having scored his first kill as early as 14 December 1939 (a Wellington over the German Bight), Kutscha subsequently saw service as a *Zerstörer* close-support pilot. He ended the war with 47 victories, 14 of them against the Soviets, plus many ground targets destroyed.

8

Fw 190A-3 'Black Double Chevron' of Hauptmann Heinrich Krafft *Gruppenkommandeur* I./JG 51,

Jesau/East Prussia, August 1942

The A-3s assigned to I./JG 51 during their conversion on to the type at Jesau wore standard camouflage and markings of the period but, as yet, no Eastern Front yellow theatre bands. Many did, however, display the *Gruppe* badge as shown here, a stylised chamois on a mountain peak. This badge did not long survive the transfer to Russia, where such identifiable emblems would soon be forbidden. 'Gaudi' Krafft did not himself survive long either, being downed by flak on 14 December with his score standing at 78.

9

Fw 190-A-5 'Black Double Chevron' of Major Erich Leie, *Gruppenkommandeur* I./JG 51, Orel, Circa May 1943

I. Gruppe's third Fw 190 *Kommandeur*, Erich Leie, was more fortunate than his predecessors, remaining at the helm for almost two years. His A-5, pictured here prior to the Kursk offensive, has abandoned winter white for the two-tone splinter green of early summer. Note too that the yellow theatre marking, previously centred behind the fuselage cross, has now moved to the aft position immediately forward of the tail unit. Promoted *Geschwaderkommodore* of JG 77 at the end of 1944, Leie was killed over Czechoslovakia on 7 March 1945 when he collided with a crashing Yak-9 and failed to survive a low-level bale out. He had scored 75 Eastern Front kills, plus 43 in the west.

10

Fw 190A-3 'Black Double Chevron' of Hauptmann Rudolf Busch, *Gruppenkommandeur* I./JG 51, Lake Ivan/Russia, January 1943

The 'Anton-3' of Krafft's successor. Hauptmann Rudolf Busch, demonstrates what just a few weeks hard campaigning can do. The recently applied white winter finish is already stained and weathered from operations and dispersal in the open on the frozen surface of Lake Ivan. Yellow theatre markings have been added, but note that the *Gruppe* badge has now disappeared. After little more than a month in command of I. Gruppe, Busch was killed in a collision during take-off from Lake Ivan on 17 January 1943. He had achieved some 40 victories, all but 5 of them in the east.

11

Fw 190A-3 'Yellow 9' of Hauptmann Heinz Lange, *Staffelkapitän* 3./JG 51, Vyazma, December 1942

Back to the depths of winter for Lange's A-3, which has been given a temporary coat of patchy winter white overall. From *Kapitän* of 3./JG 51 Heinz Lange rose, via *Kommandeur* of IV. Gruppe, to become JG 51's sixth and final *Kommodore* less than four weeks before the end of the war. He had begun his career with I./JG 51, shooting down an RAF Blenheim near the German-Dutch border on 30 October 1939. To this single western kill he subsequently added 69 more during nearly four years' service on the Eastern Front.

12

Fw 190A-4 'Yellow 1 of Oberfeldwebel Herbert Bareuther, 3./JG 51, Orel, June 1943

Another I. Gruppe machine pictured about the time of *Zitadelle*, Bareuther's 'Yellow 1' shows marked differences in finish from Leie's A-5 above. Note that 3. *Staffel*'s individual aircraft numerals were of a very dark yellow shade, often described as 'brown'. Bareuther subsequently joined Oskar Romm's IV./JG 3, and was killed on 30 April 1945 leading that unit's 14. *Staffel* in a low-level attack on Soviet forces north of Prenzlau. His final score stood at 55, all gained in the east.

13

Fw 190A-4 'Yellow 5' of Leutnant Josef Jennewein, 3./JG 51, Orel, June 1943

Displaying yet another variety of finish, Jennewein's A-4 wears a segment camouflage scheme variously described as brown, or tan, and green. Again note the deep yellow of the numeral in comparison to the aft fuselage band. '5' was Jennewein's lucky number. It was the numeral he was wearing when he won the 1940 combined slalom, downhill and alpine World Ski Championship.

14

Fw 190A-5 'Black Double Chevron' of Hauptmann Fritz Losigkeit, *Gruppenkommandeur* III./JG 51, Kursk, July 1943

One of the earliest machines flown by Losigkeit during his ten months at the head of III./JG 51, this slightly lighter than usual A-5 wears standard markings and insignia of the period, including the vertical III. Gruppe bar immediately forward of the aft fuselage yellow theatre band. Promoted to *Kommodore* in April 1944, he remained in that post for a further year before assuming command of JG 77 in the final weeks of the war. All but about a dozen of his 68 victories were achieved during his service in the east with JG 51.

15

Fw 190A-3 'White 11' of Hauptmann Herbert Wehnelt, *Staffelkapitän* 7./JG 51, Orel, circa January 1943

Its coat of winter white already showing distinct signs of wear and tear, Wehnelt's 'White 11' has also had the upper part of its aft fuselage yellow theatre band painted over to reduce visibility from above; a pointer that air attacks on JG 51's bases were beginning to make themselves felt. Wehnelt scored all 36 of his kills with JG 51 (including 2 in the west) before being promoted to the command of *Erganzungsgruppe West* in August 1943.

16

Fw 190D-9 'White V of Leutnant Kurt Tanzer, *Staffelkapitän* 13./JG 51, Schmoldow/Pomerania, April 1945

After a long period on Bf 109s, IV./JG 51 reverted to Focke-Wulfs in the closing weeks of the war. Both A-8s and D-9s wore the standard finishes of the period, and all carried the wavy bar *Gruppe* marking aft of the cross as depicted here, but they no longer displayed any yellow theatre colouring. Tanzer himself scored 126 of his 143 victories in the east. He rejoined the post-war *Bundesluftwaffe*, only to be killed in a T-33 trainer in 1960.

17

Fw 190A-8 'Black 3 and Bars' of Unteroffizier Helmut Johne, *Stabsstaffel* JG 51, Memel, November 1944

While the three Eastern Front *Gruppen* of JG 51 converted from their early Focke-Wulfs back to the Bf 109 in 1943-4, the *Stabsstaffel* remained on Fw 190s during the whole of their time in the east. Their *Staffel* markings also remained constant throughout, consisting, in effect, of a *Geschwaderkommodore's* insignia of a bar either side of the fuselage cross (the forward one pointed), but with the latter's chevron replaced by a black individual number. The significance of the yellow spinner and nose ring is unknown, unless perhaps they served as a recognition aid for German flak and ground troops who were becoming notoriously quick on the trigger by this stage of the war, so unused were they to seeing 'friendlies' overhead: 'If it's uncamouflaged it's American, if it's camouflaged it's Russian, if it's invisible it's German!' Johne's score stood at eight Soviet aircraft destroyed before he was himself shot down (by the enemy!) on 9 February 1945.

18

Fw 190A-8 'Black 6 and Bars' of Oberfeldwebel Fritz Lüddecke, *Stabsstaffel* JG 51, Orscha, circa July 1944

For a brief period earlier in 1944 the *Stabsstaffel* had also taken to decorating their A-8s with personal names (presumably of wives or girlfriends), a highly unusual practice for Eastern Front 190s. Note that unlike the other three *Stabsstaffel* machines illustrated, 'Hanni' does not have her markings outlined in white. A 50-victory 'Experte' also renowned for numerous close-support and fighter bomber missions, 'Paule' Lüddecke succumbed to flak over the Lithuanian/-East Prussian border on 10 August 1944.

19

Fw 190A-8 'Black 11 and Bars' of Leutnant Günther Heym, *Stabsstaffel* JG 51, Zichenau, circa September 1944

Günther Heym's *Tanja* (*Tania*) has a distinctly oriental flavour about her. She certainly brought him luck as of the four *Stabsstaffel* pilots depicted here, Heym - with over 20 kills to his credit - was the only one to survive the final stages of the war.

20

Fw 190A-8 'Black 12 and Bars' of Feldwebel Johann Merbeler, *Stabsstaffel* JG 51, Neukuhren/East Prussia, November 1944

Last of the quartet, Merbeler's A-8 had reverted to nameless anonymity by the late autumn of 1944. Having downed a dozen enemy aircraft as a member of the *Stabsstaffel*, Merbeler was reported missing early in January 1945.

21

Fw 190A-4 'Black Double Chevron and Bars' of Oberstleutnant Hannes Trautloft, *Geschwaderkommodore* JG 54, Krasnogvardeisk, circa December 1942

Already showing signs of weathering, the white

winter camouflage of the *Kommodore's* A-4 is further compromised by the colourful yellow theatre markings and elaborate emblem. This latter consists of the 'Green Heart', introduced by Trautloft himself, with the coats-of-arms of the home bases of JG 54's three component *Gruppen* superimposed: top left, Nuremberg (I.); top right, Vienna-Aspern (II.) and bottom - with three Bf 109 silhouettes added - Jesau (III.). These badges would soon disappear, an official edict early in 1943 prohibiting all such identifying markings on Eastern Front aircraft. Although seemingly ignored by a number of Bf 109 units, this order - together with another discouraging personal scores from being displayed - was apparently strictly adhered to by JG 54. It is not known why Trautloft opted for the command insignia shown here, an unusual combination of a *Gruppenkommandeur's* double chevron with a *Kommodore's* horizontal bars. At the head of JG 54 for almost three years, Trautloft scored 45 Eastern Front victories before promotion to a General Staff position.

22

Fw 190A-4 'White Chevron and Bars' of Major Hubertus von Bonin, *Geschwaderkommodore* JG 54, Krasnogvardeisk, circa August 1943

In contrast to the above 'Anton-4', von Bonin's machine bears standard early style *Kommodore's* insignia, but note the small 'white 7' above the aft bar. It wears a solid dapple camouflage and full Eastern Front theatre markings, but is now minus the 'Green Heart'. Henceforth, the only clue to unit identity would be provided by JG 54's unique positioning of the yellow fuselage band directly behind the fuselage cross - JG 51 appear to have dropped their earlier practice of doing likewise in favour of the more usual aft fuselage position.

23

Fw 190A-5 'White Chevron and Bars' of Major Hubertus von Bonin, *Geschwaderkommodore* JG 54, Central Sector, circa November 1943

A later machine of von Bonin's displays a similar camouflage scheme with minor variations in the markings. Note that the small 'white 7' above the aft bar has now given way to a 'black 4'. Their significance is not known. It seems unlikely that they are 'lucky' talismans, and the sequence would seem to rule out their referring to the number of machines von Bonin got through during his tenure of office! One explanation could be that during this period all *Stabsschwarm* aircraft carried *Kommodore* insignia (plus a small numeral to differentiate between them) in order to confuse the enemy in the air, and that von Bonin simply used whichever happened to be serviceable. Von Bonin was the only *Kommodore* JG 54 lost to enemy action. He was killed near Vitebsk on 15 December 1943 after achieving 64 Eastern Front victories.

24

Fw 190A-6 'White Chevron and Bars' of Oberstleutnant Anton Mader, *Geschwaderkommodore* JG 54, Dorpat/Estonia, July 1944

Von Bonin's successor, Anton Mader, has retained the white command chevron and bars. But his

machine wears a completely different camouflage scheme of faded brown and green, a combination particularly suited to the northern sector and also to be found on many of *Luftflotte 1*'s reconnaissance aircraft. Altogether Mader claimed a total of 86 kills, about 25 of them during prior service in the western and Mediterranean theatres.

25

Fw 190A-4 'Black Double Chevron' of Hauptmann Hans Philipp, *Gruppenkommandeur* I./JG 54, Krasnogvardeisk, circa January 1943

Freshly painted in winter white, Philipp's A-4 wears full fig theatre markings, command insignia and unit badges. I.Gruppe's machines did not remain this pristine for long. Having scored his first kill over Poland in 1939 with JG 76, Tips' Philipp went on to become the second pilot to reach the 200-victory mark (on 17 March 1943). He left JG 54 a fortnight later to assume command of JG 1 in the west and was shot down by US P-47s on 8 October 1943 when his total was standing at 206, all but 29 scored on the Russian Front.

26

Fw 190A-6 'Black Double Chevron' of Hauptmann Walter Nowotny, *Gruppenkommandeur* I./JG 54, Vitebsk, November 1943

The machine in which Nowotny scored his 250th victory (on 14 October 1943) making him the Luftwaffe's leading ace of the time, Werk-Nr. 410004 has had its standard grey camouflage finish heavily overpainted in two shades of green. Note the small 'white 8' in the angle of the command chevrons (believed to be a reference to an earlier favourite aircraft) and Nowotny's additional 'lucky 13' below the cockpit sill. Walter Nowotny relinquished command of I./JG 54 in February 1944, first to take over a training unit and then to head the experimental Me 262 jet fighter unit which bore his name. He died in a crash at Achmer on 8 November 1944 after an engagement with US heavy bombers and their fighter escort. 255 of his 258 confirmed victories were scored in the east; a further 22 remain unconfirmed.

27

Fw 190A-8 'Black Double Chevron' of Hauptmann Franz Eisenach, *Gruppenkommandeur* I./JG 54, Schruden/Courland, circa November 1944

I.Gruppe's last *Kommandeur* of the war, Eisenach flew this remarkably well-preserved (or newly delivered?) 'Anton-8' during the height of the Courland battles. It wears a standard finish of the time and features a simplified fuselage cross and spiral spinner. Originally a *Zerstörer* pilot, all 129 of Eisenach's kills were achieved in the east.

28

Fw 190A-4 'White 8' of Leutnant Walter Nowotny, *Staffelkapitän* 1./JG 54, Krasnogvardeisk, November 1942

Another well-documented machine, in stark contrast to the majority of the anonymous and unidentifiable 190s flown on the Eastern Front by all and sundry - or at least by whoever's name happened to be next on the ops board) - this is the

aircraft in which Nowotny scored his Staffers 300th victory of the war. The toned-down (or simply dirty?) white of the fuselage cross seems an unnecessary precaution on an otherwise standard white winter camouflaged A-4.

29

Fw 190A-4 'White 10' of Leutnant Walter Nowotny, *Staffelkapitän* 1./JG 54, Krasnogvardeisk, Spring 1943

The spring thaw of 1943 is reflected in the finish of this A-4, also flown on occasion by Nowotny. The white winter camouflage has been partially removed leaving a green-white segment finish ideally suited to blend in with the terrain below. Note I.Gruppe's badge and the 'Green Heart' are still being worn, but not for much longer.

30

Fw 190A-5 'White 5' of Oberleutnant Walter Nowotny, *Staffelkapitän* 1./JG 54, Krasnogvardeisk, circa June 1943

By June, the month in which Nowotny scored his 100th over Nowa-Ladoga, both *Gruppe* badge and *Geschwader* emblem were gone. This heavily mottled A-5 flown by Nowotny graphically illustrates the anonymity which cloaked JG 54's machines from mid-1943 onwards

31

Fw 190A-6 'White 12' of Leutnant Helmut Wettstein, *Staffelkapitän* 1./JG 54, Central Sector, 1943

Devoid of all unit markings, the A-6 flown by Nowotny's successor at the head of 1.*Staffel* wears the two-tone green splinter camouflage finish which typified I./JG 54's aircraft in the high summer of 1943. Wettstein subsequently transferred back to II.Gruppe, where he served as *Staffelkapitän* of 6./JG 54 until the war's end.

32

Fw 190A-8 'White V of Leutnant Heinz Wernicke, *Staffelkapitän* 1./JG 54, Riga-Skulte/Latvia, circa September 1944

Wearing a typical late wartime finish with simplified fuselage cross and tail swastika, Wernicke's 'Anton-8' is distinguished only by its surprisingly clean individual number, the latter apparently having been applied over a previous two-digit identity. Having started his career with I./JG 54 in the spring of 1942, all 117 of 'Piepl' Wernicke's victories were achieved while with this unit. He was killed in a mid-air collision with his wingman over Courland on 27 December 1944.

33

Fw 190A-8 'White 12' of Oberleutnant Josef Heinzeller, *Staffelkapitän* 1./JG 54, Schruden/Courland, November 1944

Another drab, late war A-8, this Fw 190 wears a different style of cross to the above, but it too displays 1. *Staffel*'s white spinner spiral of the period. Heinzeller ended the war with 35 kills.

34

Fw 190A-4 'White 9' of Feldwebel Karl Schnorrer, 1./JG 54, Krasnogvardeisk, circa January 1943

Nowotny's long-time wing man, 'Quax' Schnorrer often flew the winter camouflaged 'White 9' during the early months of 1943. Here it wears a near textbook set of national, theatre and unit markings; all that is lacking is the yellow segment sometimes applied to the lower rudder. Severely injured on 12 November 1943 with his Eastern Front score standing at 35, Schnorrer subsequently returned to operations on the Me 262 jet fighter. He added nine four-engined bombers to his total while with JG 7, but was again seriously wounded when shot down over Hamburg on 30 March 1945.

35

Fw 190A-4 'White 2' of Oberfeldwebel Anton Döbele, 1./JG 54, Krasnogvardeisk, Spring 1943

Another member of the famous 'Nowotny Schwärm', Anton Döbele flew this 'White 2' with the winter camouflage partially removed to suit the season of melting snow. Although the 'Green Heart' has been retained, the *Gruppe* badge on the engine cowling has already been overpainted. Döbele's death on 11 November 1943, when he was accidentally rammed by another German fighter near Vitebsk, signalled the end of the *Schwarm's* run of 524 victories (Schnorrer was wounded the following day). Toni' Döbele had himself scored a total of 94 Eastern Front kills.

36

Fw 190A-4 'White 3' of Feldwebel Peter Bremer, 1./JG54, Orel, July 1943

Another example of I.*Gruppe's* two-tone green summer camouflage, Bremer's 'Anton-4' crash-landed behind enemy lines at the height of the Battle of Kursk on 13 July 1943. At the time of his capture Bremer had scored 40 kills in the east.

37

Fw 190A-4 'Black 5' of Hauptmann Hans Götz, Staffelkapitän 2./JG 54, circa July 1943

Götz's A-4 illustrates a variation on the summer camouflage theme with a slightly less well defined combination of the two greens. Note that the second *Staffel* of both JG 54's two Eastern Front Fw 190 *Gruppen* (i.e. 2./JG 54 and 5./JG 54) carried *black* and not red individual numerals as was previously the norm. The use of red had been banned (in a move similar to that taken by the Allied air forces in the Pacific theatre) to avoid any possible confusion with the markings worn by the enemy. Having joined 2./JG 54 back in January 1940, Götz's success did not begin until after his arrival in Russia, where he scored all of his 82 kills before being lost in action on 4 August 1943.

38

Fw 190A-4 'Black 11' of Feldwebel Hans-Joachim Kroschinski, 2./JG 54, Krasnogvardeisk, February 1943

Back to winter-camouflaged A-4s, this example showing distinct signs of use and weathering. A long-serving member of I.*Gruppe*, Kroschinski had claimed 75 Soviet aircraft destroyed - plus one US heavy bomber downed while serving as an instructor in the west - before being wounded over Courland on 24 December 1944.

39

Fw 190A-6 'Yellow 5' of Oberleutnant Otto Kittel, 3./JG 54, Riga-Skulte, circa August 1944

In keeping with Eastern Front anonymity, there is nothing to distinguish this perfectly standard A-6 as being the mount of JG 54's most successful pilot. The self-effacing Otto Kittel spent his entire 3V2-year frontline career in the east with the 'Green Hearts'. Having achieved less than 40 kills during his early months on the Bf 109, the vast bulk of his final total of 267 confirmed victories were scored with the Focke-Wulf, making him arguably the greatest *Fw 190 Ace of the Russian Front* of them all! Kittel was killed over Courland on 14 February 1945 in action against that nemesis of so many Fw 190 pilots, the *Stormovik*.

40

Fw 190A-5 'Yellow 8' of Leutnant Robert Weiss, 3./JG 54, Orel, circa June 1943

Previously a member of JG 26 in the west, 'Bazi' Weiss then spent some two years in Russia before returning to the Reich to assume command of the 'Green Hearts' western-based *Gruppe*, III./JG 54, at whose head he was killed in action against Spitfires near the German-Dutch border on 29 December 1944. It is believed that some 90 out of his final total of 121 victories were scored on the Eastern Front, the majority on Fw 190s such as the two-tone green example depicted here.

41

Fw 190A-6 'Black Double Chevron' of Major Erich Rudorffer, Gruppenkommandeur II.JG 54, Immola/Finland, June 1944

Depicted at the time of his *Gruppe's* brief deployment to Finland, Rudorffer's closely dappled A-6 wears narrow-bordered *Kommandeur* chevrons, enclosing a small 'black 1', and matching II. *Gruppe* bar aft of the cross. Note the spiral spinner and light tail surfaces. The 'Green Heart's' overall third-ranking ace (after Kittel and Nowotny), 136 out of Rudorffer's tally of 222 kills were claimed on Fw 190s in the east. Belying his quiet nature, Rudorffer's was an incident-packed war which he ended with 12 kills on the Me 262.

42

Fw 190A-6 'Black 5' of Oberleutnant Max Stotz, 5./JG 54, Siverskaya, late Spring 1943

Recently freed of their winter white, many II. *Gruppe* aircraft were given a distinctive new camouflage scheme combining what has been described as tan, or brown, with two shades of green. Note that both *Geschwader* and *Gruppe* badges are still being worn, and also the black *Staffel* number. Stotz was promoted to *Kapitän* of 5./JG 54 later that same summer, only to be reported missing in action near Vitebsk on 19 August 1943. All but 16 of his 189 kills were gained with 11. *Gruppe*.

43

Fw 190A-6 'Black 7' of Leutnant Emil Lang, 5./JG 54, Northern Sector, Summer 1943

Whether the paint II./JG 54 was using actually was official desert tan has not been established, but

Lang's machine graphically demonstrates that it too quickly faded. Compared with 'Black 5' above, it presents a much lighter overall appearance. Note also that all identifying badges have now been overpainted. 'Bully' Lang scored 173 kills, including 25 gained in the west after his promotion to command II./JG 26. He was killed in a dogfight with P-47s over Belgium on 3 September 1944.

44

Fw 190A-4 'Black 12' of Fähnrich Norbert Hannig, 5/JG 54, Siverskaya, circa May 1943

Another example of II. Gruppe's summer uniform of light brown and greens is illustrated by 5. Staffel's 'Black 12'. Presumably a more recent replacement machine, it never wore the unit badges of the earlier months.

45

Fw 190A-4 'Yellow 6' of Oberleutnant Hans Beisswenger, Staffelkapitän 6./JG 54, Ryelbitzi, February 1943

One last look at a typical winter finish already becoming stained and worn from hard use. A member of II. Gruppe since the autumn of 1940 (and Staffelkapitän of 6./JG 54 since 10 August 1942), a greater part of Beisswenger's 152 victories were achieved on the Bf 109. He flew the 190 for only a matter of weeks before being reported missing over Lake Ilmen on 6 March 1943.

46

Fw 190A-9 'Yellow V of Hauptmann Helmut Wettstein, Staffelkapitän 6./JG 54, Libau-Grobin/Courland, February 1945

After earlier serving as Staffelkapitän of 1./JG 54 (see profile 31), Wettstein ended the war in Courland at the head of 6. Staffel. His closely-dappled 'Anton-9' shown here is typical of the period with simplified national insignia. Helmut Wettstein had scored the 'Green Heart's' 8000th victory of the war over Courland on 15 October 1944. He ended the war with 43 kills.

47

Fw 190A-8 'Yellow 1' of Leutnant Gerd Thyben, Staffelkapitän 7./JG 54, Libau-Grobin/Courland, circa January 1945

Another drab late war finish with simplified insignia, but enlivened in this instance by a tightly spiralled spinner. Thyben had come to II./JG 54 in April 1944 after first serving with JG 3 in Southern Russia. Heading 7. Staffel by the war's end, he had scored 152 Eastern Front victories (plus 5 in the west). His final victim on 8 May 1945 was also the very last of the nearly 9500 enemy aircraft claimed destroyed by the 'Green Hearts' in World War 2.

48

Fw 190A-4 'Yellow 2' of Oberfeldwebel Heinrich Sterr, 6./JG 54, circa March 1943

Indicative of the spring thaw period, II. Gruppe also removed large areas of winter white to reveal the two-tone green beneath. They sometimes added an extra refinement, however, by applying patches

of black to break up the aircraft's outline even further. Sterr who, like Robert Weiss, rejoiced in the nickname 'Bazi' (a Bavarian and Austrian colloquialism for 'Rascal'), had joined II./JG 54 in 1942. He scored 127 kills in the east - most of them on Fw 190s - before transferring to IV. Gruppe and Defence of the Reich duties in late 1944. He was downed by a P-51 on 26 November 1944 while attempting to land at Vorden.

49

Fw 190A-8 'White 3' of Oberleutnant Karl Brill, Staffelkapitän 10./JG 54, Lemberg (Lwow)-Poland, summer 1944

Newly equipped with A-8s in preparation for Defence of the Reich, IV./JG 54 suddenly found itself sent eastwards in the summer of 1944. 'White 3' is representative of the Gruppe's aircraft at that time. Mindful of JG 54's tradition, the Gruppe badge on the cowling is a stylised version of the Königsberg coat-of-arms on a 'Green Heart' background. The Navajo Indian's head beneath the cockpit is the badge of IO.Staffe/(subsequently redesignated 13./JG 54). Brill is credited with 35 kills, but it is unknown how many of these were gained in the east.

50

Fw 190F-2 'Black Chevron and Bars' of Major Alfred Druschel, Geschwaderkommodore, Schi.G 1, Varvarovka, Summer 1943

Kommodore of the first Fw 190-equipped Schlachtgeschwader, Druschel opted for pre-war fighter style command markings, rather than the more usual triple-chevron of a Schlacht-Kommodore on this remarkably clean-looking F-2. His operational career of some 800 combat missions encompassed Stalingrad, Kursk and the Crimea, but the exact number of his victories - certainly enough to qualify him for Eastern Front acedom - has never been established. After over a year in staff positions, he returned to operations in December 1944 as Kommodore of SG 4 in the west, only to disappear somewhere over the Ardennes on New Year's Day 1945, en route to attack Allied airfields as part of Operation Bodenplatte. He remains missing to this day.

51

Fw 190F-2 'Black Double Chevron' of Hauptmann Georg Dörrfel, Gruppenkommandeur I/Schl.G 1, Kharkov, circa February 1943

Displaying a textbook set of early markings for the first-generation Fw 190 Schlachtgeschwader, Dörrfel's F-2 combines the double chevron of a Gruppenkommandeur with the solid black triangle of the ground-attack arm. This latter dates back to the Hs 123 Gruppen of the late 1930s. Schl.G 1 initially used it to differentiate between Gruppen: I Gruppe machines carried the triangle forward of the fuselage cross on both sides of the fuselage (hence Dörrfel's chevrons - and all individual letters - had to be displayed in the aft station); II. Gruppe positioned the triangle behind the cross on both sides. 'Orge' Dörrfel scored 30 kills in the east. Later heading SG 4 in Italy, he was killed in action northwest of Rome on 26 May 1944.

52

Fw 190F-2 'Black Chevron' of Oberleutnant Karl Kennel, *Staffelkapitän* 5./Schi.G 1, Varvarovka, July 1943

Kennel's machine shows that SchI.G 1 had abandoned the solid black triangle prior to *Zitadelle* in favour of an amended fighter-style system: I.Gruppe devoid of markings behind the fuselage cross, II.Gruppe carrying a horizontal bar. Here the similarity ended, for each *Staffelkapitän* displayed a single black chevron, and *Staffel* members were identified by letter - and not by number - in the respective *Staffel* colours of white, black and green (note that, as with the fighters, all previous red markings had now been deleted to avoid confusion with the enemy's insignia). Kennel himself would survive the war with 34 victories, all but three scored on the Eastern Front.

53

Fw 190F-2 'White A' of Leutnant Fritz Seyffardt, 6./Schi.G 1, Ukraine, circa May 1943

Seyffardt's F-2 illustrates the white individual coding initially adopted by 6./Schi.G 1 upon their return to the Eastern Front after conversion from the Bf 109 to Fw 190, and prior to their being allocated green as their definitive *Staffel* colour. Subsequently serving with 5./SG 2, Seyffardt ended the war as *Staffelkapitän* of 12./SG 151 still flying ground-attack sorties against Soviet forces in Germany. His aerial victories totalled 30, many of them *Stormoviks*.

54

Fw 190F-2 'Black T' of Oberfeldwebel Otto Dommeratzky, 8./Schi.G 1, Southern Sector, September 1943

As a member of the semi-autonomous Fw 190 and Hs 129-equipped 8./Schi.G 1, Dommeratzky flew this heavily mottled and somewhat worse for wear F-2 in the Kiev area in the autumn of 1943. Later transferring to 6./SG 2, he had claimed some 38 aerial kills before himself being shot down by marauding US fighters over Czechoslovakia on 13 October 1944.

55

Fw 190D-9 'Black Chevron and Bars' of Oberst Hans-Ulrich Rudel, *Geschwaderkommodore* SG 2, Grossenhain, April 1945

The most highly decorated member of the entire *Wehrmacht* (and the sole recipient of the Golden Oak Leaves), Rudel's career flying the Ju 87 in Russia is legendary. His unit continued to employ anti-tank Ju 87s long after all other SGs had converted to the Fw 190. But in the closing weeks of the war he too was persuaded to fly the single-seater. Among several issued to *Stab* SG 2, the /Commodore's own D-9, seen here, shows evidence of overpainting before application of the command insignia which had previously adorned his Ju 87G. Having sunk a battleship, a cruiser, a destroyer and over 70 landing craft, and destroyed over 500 enemy tanks, 800 soft-skinned vehicles, 150 artillery positions, four armoured trains, and bridges too numerous to mention, Rudel's tally of nine aerial kills almost pales into insignificance!

56

Fw 190F-2 'Black Double Chevron' of Major Heinz Frank, *Gruppenkommandeur* I./SG 2, Karankut/Crimea, April 1944

A standard *Kommandeurs* double chevron forward of the fuselage cross and the horizontal bar aft identify this clean-looking F-2 as the mount of Heinz 'Allan' Frank, a long-time *Schlacht* pilot who had flown his first missions over Poland and France on the Hs 123. He died in hospital on 7 October 1944 after the accidental discharge of a pistol left a bullet in his hip. His score of aerial kills stood at eight.

57

Fw 190F-9 'Black Double Chevron/2' of Major Karl Kennel, *Gruppenkommandeur* II./SG 2, Börgönd/Hungary, circa December 1944

Having risen from *Staffelkapitän* of 5./Schi.G 1 to become *Kommandeur* of II./SG 2 for the final nine months of the war, Kennel's F-9 graphically illustrates the importance played by camouflage in the winter of 1944-45. The *Schlachtflieger* were now equally, if not more, at risk of being caught by marauding Allied fighters on the ground than they were when in the air. The significance of the darker nose ring is not known (it may simply have been a replacement), but the yellow wraparound chevron on both upper and lower surfaces of the port wing was the standard in-theatre recognition marking of all Hungarian-based low-flying attack aircraft, Fw 190 and Ju 87 alike.

58

Fw 190F-8 'Black Chevron' of Leutnant Hermann Buchner, *Staffelkapitän* 4./SG 2, Ziiistea/Rumania, June 1944

Another well-used F-8, Buchner's 'White L' wears an Indian's head badge superficially similar to that of 10./JG 54 (see profile 49), but was, in fact, purely a personal insignia applied to the aircraft during his time as *Kapitän* of 4./SG 2 in the summer of 1944. Previously a member of Bleckmann's highly successful 6. *Staffel*, Buchner had flown many escort missions for SG 2's *Stukas* and had scored 46 victories before transition to the Me 262 in the autumn of 1944. With III./JG 7 in Defence of the Reich he subsequently added 12 US heavy bombers to his tally.

59

Fw 190A-5 'Black G' of Oberfeldwebel August Lambert, 5./SG 2, Southern Sector, late 1943

A somewhat weathered and undistinguished aircraft for the most successful of them all. During the Crimean campaign of 1944 Lambert's score rocketed; in the three week battle of Sevastopol alone it went from 20 to 90! After a spell as an instructor, Lambert returned to operations in the closing weeks of the war as *Staffelkapitän* of 8./SG 77. His 'Black 9' was downed by P-51s near Dresden on 17 April 1945, his total standing at 116 - by far the highest of any *Schlachtflieger*.

60

Fw 190F-8 'Black Chevron/Green H' of

**Hauptmann Günther Bleckmann, *Staffelkapitän*
6./SG 2, Bacau/Rumania, May 1944**

Bleckmann's F-8 carries his /Cap/fan's chevron applied ahead of the individual aircraft letter as per the book. Heading 6./SG 2 for over a year. Bleckmann also served at times as acting *Kommandeur* of II.Gruppe. Having flown numerous escort sorties for SG 2's remaining Ju 87s, Bleckmann's score had reached 27 when he was killed on 4 June 1944 in a crash south of Jasy, Rumania, after his aircraft caught fire in the air while returning from another such mission.

FIGURE PLATES

1

3./JG 54's Oberfeldwebel Otto Kittel, the top scoring Fw 190 pilot on the Eastern Front, is seen wearing his one-piece winter overalls, equipped with a fur collar, in the northern secto in early 1944. He is also wearing a standard issue fur cap. Note the diagonal line of the upper body zip on the suit.

2

The highest scoring *Schlachtflieger* of them all, Leutnant August Lambert of 5./SG 2 is wearing a two-piece black leather flying suit - a popular choice amongst many single-seat fighter and attack pilots throughout the war. He has his trousers tucked into standard issue flying boots, and a Walther PP pistol and compass adorn his waist belt. Note that Lambert has a simple silk scarf draped around his neck - this was replaced in the summer of 1944 by the Knight's Cross.

3

The long-time *Kommodore* of JG 54, Oberstleutnant Hannes Trautloft stood head and shoulders above most other pilots in the *Geschwader* due to his loft frame (6 ft 4 in) and bear-like build, he is seen here in the autumn of 1943 wearing his favourite leather jacket, with fur collar, officers' breeches and knee-length flying boots. Trautloft's Knight's Cross and rank tabs are just visible beneath his jacket.

4

Compared to the stylish leather suits and jackets worn in the winter months on the Russian Front, Oberfeldwebel Hermann Buchner of 4./SG 2 models the simple lightweight summer tunic and breeches so favoured by the lower flying ranks in the warm summer months. On his sleeve are Oberfeldwebel's 'moustaches' - flying overall rank badges - and he is wearing a 1943 pattern cap. Buchner flew over 600 missions in the east, and finished the war an ace.

5

Without a doubt the most famous Fw 190 pilot of them all, Walter Nowotny (here, an Oberleutnant) was a fighting legend within the Luftwaffe. The first man past the magical 250 kills mark, he is seen here at around the time this milestone was passed in October 1943. He is wearing a

lightweight summer shirt with the sleeves rolled down, a full Fallschirm30/1 parachute and harness and his famous 'victory trousers', patched up with leather at the knees. These were worn on every mission following Nowotny's dunking in the Baltic in July 1941. Salt-stained and torn by barbed wire, the breeches are tucked into far newer flying boots. On his head he wears a Netzkopphaube lightweight flying helmet, and above his Knight's Cross with Oak Leaves and Swords is a standard issue throat mike, popular amongst Fw 190 pilots in-theatre. Trailing over his back is the lead for the mike.

6

Oberleutnant Joachim Brendel, a 189-victory ace with JG 51, wears similar rig to Nowotny, although his breeches are genuine 'baggy' flight trousers with deep knee pockets. Again he is also wearing a 1943 issue soft cap. Unlike the other five pilots featured in these plates, Brendel is wearing lace up shoes, as well as a black tie behind his Knight's cross. This was how he appeared in the spring of 1944.

JG 51 REVERTS TO TYPE_____

For JG 51 the writing was plainly on the wall with the conversion of its IV. *Gruppe* back on to the Bf 109 in the immediate aftermath of Kursk. And the events which were to follow did little to ease the supply situation regarding replacement aircraft for the *Geschwaders* two remaining Fw 190 *Gruppen*. Forced to vacate Orel post-haste in the face of the advancing Soviets, I. and III./JG 51 retired first to the even greater confusion and gross overcrowding of Bryansk. They did not stay there long, however. Major Erich Leie's *Gruppe* was soon despatched southwards, to the Poltava area, to help stem the developing Russian threat against Kharkov. III./JG 51, under Hauptmann Fritz Losigkeit, were initially sent north-westwards to bar Smolensk to the enemy. But when the Red Army opened another offensive, this time aimed at Kiev, III. *Gruppe* also suddenly found themselves en route to the Ukraine.

This war of movement, and of subsequent continual retreat, set the pattern for the remainder of 1943. It was to prove costly in aircraft as the accident rate climbed and machines under repair had to be either abandoned or blown up before each hasty retirement. By the end of August the two *Gruppen* were each down to half strength or less. They would rarely be able to improve upon this state of affairs in the months ahead.

But despite all the difficulties, scores continued to mount. Collectively, JG 51 had claimed its 5000th kill on 2 June. By 15 September this figure had risen to 7000. Another 1000 would be added by the end of April 1944. Individually, a number of *Experten* topped the 100 mark during this period. *Gruppenkommandeur* Major Erich Leie - 'Tiger-Leie' - got his hundredth on 11 November. Oberleutnant Joachim 'Achim' Brendel, a long-serving member of Leie's *Gruppe*, followed suit just 11 days later. In III./JG 51 two future *Staffelkapitäne* were particularly successful. Oberleutnant Karl-Heinz Weber had achieved his century on 13 August. In the course of that same month Leutnant Günther Schack had added 40 kills to his score before reaching his hundredth on 3 September.

Extracts from Günther Schack's reports of the time offer an insight into the chaotic nature of that late summer and early autumn:

'7 August: We transfer to a little field east of Smolensk.

'8 August: The balloon goes up at 16.00 hours. We escort bombers to Yelnya. In the late afternoon the entire *Gruppe* scrambles (each *Staffel* no more than four machines). Low-flying Russian aircraft are reported at Yarzevo. I am the first to reach them. Sitting ducks, so I am able to waggle my wings twice as I land back at base. My *Rotte* is ordered to take off again immediately without waiting to refuel or rearm. We are to escort another bomber unit. At 16,000 ft over the target two enemy fighters attack. One soon goes down in flames near the bombers; the other quickly makes off. On the third sortie we meet 25 *Zementers* escorted by 40

fighters. As there are only the two of us I climb up to the highest ones and manage to shoot two down. Every day we have to fight against an enemy who enjoys a numerical superiority such as we have never experienced in Russia before; large squadrons of bombers escorted by many fighters."

The following day Schack scored his 70th kill, his Fw190 being damaged in return by two cannon and two machine-gun hits. Four days after that he completed his 500th sortie, scored four kills in the course of it, and brought his total to 75. On 15 August Schack had a close call when, together with two young pilots of 9.Staffel, he was escorting Ju 87s. Due to a faulty gunsight he took longer than usual to despatch a Soviet fighter. As his two companions were no longer in view, he had no witnesses to his victory. Spotting a flak battery near the crash site, he dived down rocking his wings and inviting the gun crews to confirm his kill. Their reply was a fusillade of shells. The latest intelligence reports were already out of date; the area was in Russian hands!

With a hole of about 20 inches diameter in his port wing, Schack had difficulty in controlling his aircraft. But by pressing his knee against the control column he was able to maintain level flight, slowly climb from the 300 ft altitude at which he had been hit, and safely make it back to base.

For the next three days the *Staffel* was unable to fly any missions at all as it did not have a single aircraft serviceable. Shortly afterwards they moved the short distance to Bryansk, where they joined forces with II./JG 54 down from the north, before both were transferred to the Ukraine.

On 27 August, again accompanied by two other pilots, Schack engaged a large bomber formation escorted by about 30 fighters. He managed to bring down one bomber (his 90th kill), but then the three Fw 190s were set upon by the escorts, and had great difficulty in extricating themselves.

Another sortie later that same day was again very nearly his last. While attacking a Soviet fighter, Schack was accidentally rammed by Oberfeldwebel Lothar Mai, an *Experte* with 45 kills, who was apparently so intent upon attacking the same fighter that he did not see Schack. Mai's 190 went straight in from about 12,000 ft, crashing alongside the Russian. There was no sign of a parachute from either machine. Luckily, Schack managed to pull his damaged Fw 190 out of its spin and limp home.

Two days later, the *Staffel* moved to Konotop. On 1 September the *Gruppe* scored a total of 40 victories, but Schack was forced to belly-land after each of the four missions he flew that day. Forty-eight hours later he achieved his 100th kill. *Gruppenkommandeur* Hauptmann Fritz Losigkeit was also in the air at the time:

'Günther from *Hannibal*, congratulations on the 100th!'

Shortly afterwards III./JG 51 was ordered back to the Bryansk area. On 12 September another move took them to Rosslavl. Three days later - the day the *Geschwader* recorded its 7000th victory - their destination was Smolensk. On 19 September they transferred to Mogilev. By 10 October they were at Vitebsk. And so it went on. From one field to the next. But all the time being pushed slowly backwards. Under conditions such as these, it is little wonder that they were suffering a lengthening list of casualties, which was now beginning to include a growing toll of young replacement pilots who were falling victim to the Soviet's overwhelming superiority in numbers before they themselves had been able to achieve a single kill.

But, in the end, it was the availability, or, rather, the non-availability, of Fw 190s which dictated the future for JG 51. Focke-Wulf's production line simply could not keep pace with demand; demand not only from the Home and Western Fronts, but now also for specialized ground-attack variants. Early in 1944 I./JG 51 began withdrawing to Deblin-Irena for re-equipment with the Bf 109G. When they returned to Bobruisk on the Central Sector in March, it was the turn of III. Gruppe to retire to Deblin for similar conversion. Thus, by the beginning of May, all three Eastern Front Gruppen of JG 51 were mounted on the Bf 109G. They would fly the 'Gustav' for the final 12 months of the war.

There was, however, one small link in the chain between JG 51 and the Fw 190 which remained unbroken throughout. When II./JG 51 had been forced to abandon its conversion programme on to the Fw 190 after news of the Anglo-American landings in north-west Africa late in 1942, only two of its component Staffeln, 4. and 5./JG 51, had been sent to the Mediterranean. Oberleutnant Diethelm von Eichel-Streiber's 6./JG 51 had stayed on at Jesau to complete re-equipment with the Fw 190 before returning to the Eastern Front in the company of III. Gruppe. Shortly after their arrival back in Russia, 6./JG 51 had been redesignated as the *Stabsstaffel* (RQsquadron), being used thereafter on a semi-autonomous basis either to bolster the strength of the regular four-aircraft *Stabschwarm*, or to be otherwise deployed under the direct control of the *Geschwaderkommandore*. Its average strength numbering about a dozen aircraft during the whole of its two-and-a-half-year history, the *Stabsstaffel* flew the Fw 190 from beginning to end, although sometimes operating a handful of Bf 109s as well. Hauptmann von Eichel-Streiber remained at its head until the close of April 1944, when he replaced Fritz Losigkeit as *Kommandeur* of III./JG 51 (the latter having been promoted to *Geschwaderkommandore*). During his tenure of command of the *Stabsstaffel* von Eichel-Streiber had added some 70 kills to the 5 he had scored while serving with previous units. He ended the war as a member of JV 44 flying the Me 262 and with a final total of 96 victories, all but two of which had been achieved on the Eastern Front.

Von Eichel-Streiber's immediate successors were neither as long-serving, nor as fortunate. *Staffelkapitän* Hauptmann Edwin Thiel succumbed to Soviet flak over Kobryn in Poland on 14 July 1944 with his score standing at 76. The *Stabsstaffel* lost four pilots the following month, including Oberfeldwebel Fritz Lüddecke, a 50-victory *Experte* who also fell victim to enemy anti-aircraft fire, this time near Wilkowschken (Vilkaviskis) on the Lithuanian border close to East Prussia on 10 August, and Oberleutnant Heinz Busse, the *Stabsstaffel's* third *Kapitän*, who had a total of 22 kills to his credit when he was shot down in a dogfight over the same area 15 days later.

The mention above of East Prussia indicates just how far JG 51 had been forced to retreat during 1944. From Bobruisk on the River Beresina in the spring, the *Stabsstaffel* was withdrawn, via Terespol, to Memel on the Baltic coast by September, and thence back across the borders of the Reich itself from Insterburg in central East Prussia to Neukuhren, once more on the shores of the Baltic, by the year's end. Here, five months later, the *Mulders Geschwader*, including the *Stabsstaffel*, would make its last stand.

——BUT THE 'GREEN HEARTS' SOLDIER ON

The series of powerful Soviet counter-strokes which followed on from Kursk were all targeted across the Central and Southern Sectors. Throughout 1943 the Northern Sector, locked solid around the continuing siege of Leningrad, remained relatively stable (there were 12 Russian armies deployed along the front north of Velikiye Luki compared with 49 to the south) and curiously detached from the maelstrom that had been unleashed below.

But for JG 54's two Fw 190 *Gruppen* the settled, almost comfortable, lifestyle enjoyed at Krasnogvardeisk and Siverskaya would soon become but a dim memory. I./JG 54 had already had a foretaste of what was to come. Their transfer south to back up JG 51 in the opening rounds of *Zitadelle* early in July had cost them three leaders - Seiler, Homuth and Götz - in very short order. In August I. *Gruppe*, under the caretaker command of Oberleutnant Otto Vincent, was joined on the Central Sector by detachments from both II./JG 54 and the newly activated, Bf 109-equipped IV. *Gruppe*. They too now became part of the hopelessly outnumbered 'fire brigade', shuttling between *Luftflotte*^ and *Luftflotte*^, as the Red Army bore down on the defenders of the central front and threatened to engulf the Ukraine. It was during the turmoil of the closing months of 1943 that one man was to soar to prominence; arguably to become the most famous Eastern Front Fw 190 *Experte* of them all.

In August Oberleutnant Walter Nowotny added 49 kills to his score (a total, coincidentally, matched exactly by JG 52's rising star Erich Hartmann to the south — Hartmann would claim his century on 20 September, Nowotny's hundredth had gone down on 15 June). On 21 August Walter Nowotny was promoted from *Staffelkapitän* of I./JG 54 to the command of I. *Gruppe*. His reaction in a letter home was typical:

'Got my 161st yesterday, in other words 37 in 10 days. Also informed I was to be the new *Kommandeur*. Two happy events that we celebrated accordingly! It's not every day that a 22V2-year-old Oberleutnant gets made up to *Kommandeur*, that's normally a Major's post, which means that sooner or later I'll get to be a Hauptmann or perhaps even a Major. Something I'd never dreamed of. Still no sign of the Oak Leaves though.'

Nowotny was obviously displaying early symptoms of 'throat-ache', Luftwaffe slang for those who were eager to receive some new decoration to hang around their necks. His mystification was understandable. The Oak Leaves to his Knight's Cross were certainly long overdue. In the first year of the war about 40 victories would have assured a fighter pilot of the coveted Oak Leaves. By 1941-42 this figure had risen to nearer the 100 mark. Now, in 1943, some 120 kills were required before the 'Cauli-

flower', as the award was known by the more irreverent, could be anticipated. And Nowotny had gained his 120th back on 24 June; one often Russian aircraft he had shot down that day.

Despite the apparent lack of official appreciation, Nowotny went from strength to strength. He had around him three inseparable companions: his *Katschmarek*, Karl 'Quax' Schnorrer (whose unusual nickname derived from a popular film of the period chronicling the misadventures of an accident-prone pilot), Anton 'Toni' Döbele and Rudolf Rademacher. This team, the *Nowotny-Schwarm*, became justly famous - between them they accounted for 524 enemy aircraft destroyed!

On 1 September Nowotny claimed another ten kills; seven in the space of 17 minutes during a morning sortie and three within nine minutes after lunch. Part of his description of the day's events reads:

'At 06.00 hours we were escorting bombers at high altitude when we were approached by six Soviet fighters. I managed to bring down four of them. Then I saw another five circling below us. I got two of these and was after the third when my cannon jammed. " *Teufel!* I thought to myself, "this would have to happen 180 kilometres behind the enemy lines. (Nowotny was obviously no proponent of remaining within safe gliding distance of friendly territory!). But I was determined to get that seventh one, and so I gave chase, closing right up on him to let him have it with my machine-guns. By the time he'd finally bought it, we were right over a large town, bang in the middle of a barrage of 20 mm flak. Nothing for it but to dive down to street level. At a height of five metres I followed the roads out, hopping over flak emplacements and houses, before escaping by climbing over a patch of open, swampy ground on the edge of town.

'In the afternoon we bumped into just five Soviet fighters. When things got too hot for them, they began playing hide-and-seek in the cumulus clouds. But I waited around until one or the other poked his nose out. This happened three times, and made it a total of ten for the day."

It was at this time, shortly before his 190th victory, that Nowotny's brother wrote him a letter. In it he pointed out that people such as Mölders, Galland and Marseille had achieved nothing like the same number of kills as he had, and yet they had all received the Diamonds to their Knight's Cross. Had Walter said or done something to upset the powers-that-be? Nowotny's reply, scribbled on a postcard from the front, was brief and to the point:

In answer to your last letter:

1. None of your business.
2. Why are you worrying your head about my problems?
3. If they don't want to give me the Oak Leaves, I'll get myself the Diamonds.

Yours, Walter.'

And he proceeded to do just that!

On 4 September 1943 Oberleutnant Walter Nowotny finally became the 293rd member of the Wehrmacht (German Armed Forces) to be awarded the Oak Leaves to the Knight's Cross. There had been nothing sinister about the delay; the stakes had simply been upped another 70 or so since the 120 kills needed earlier in the year, and Nowotny just happened to be the first recipient to have to meet the new criteria! But someone in authority must have taken note of the apparent injustice. For

when, less than three weeks later, he was summoned to Hitler's HQ to be presented with his Oak Leaves, he had already been awarded the next highest order, the Swords, as well. On 22 September, looking suitably dignified, Nowotny lined up with other fighter and night-fighter aces to receive his decorations from the hands of the *Führer* himself. Back at *Gruppe* the mood was less formal. Toasts were drunk to the 'Old Man's' getting the double: The 'Cauliflower' and the 'Knife and Fork'!

In those intervening 17 days Nowotny's total had risen by another 29. It made him the Luftwaffe's top scorer of the time. A war correspondent was on hand to record the events:

'For two days nothing had happened. With 203 enemy aircraft destroyed the *Kommandeur* was among the leading ranks of successful fighter pilots. But could he get just those few extra to put him ahead of all the others? It was cool, clear weather with perfect visibility; but not a Bolshevik to be seen in the sky. Then, about midday on 14 September the sound of flak. A large formation of enemy bombers, strongly escorted by fighters, was approaching the base.

'Our fighters scrambled — but without their *Kommandeur*. He was away on a Stuka-escort mission. On his return he immediately led his *Schwärm* off on a *Freie Jagd* sweep. Soon, the one word everybody in the ops room had been waiting to hear. "Aufpassen" ("Watch out"); the *Kommandeurs* voice over the loudspeaker. It was the word he used every time

he scored a kill, requesting his *Katschmarekto* observe and confirm the victory. Oberleutnant Nowotny had his 204th. Soon after he added the 205th, 206th, 207th ...

'Oberleutnant Walter Nowotny had just become the Luftwaffe's most successful fighter pilot. But when he lands there is no time for congratulations. The Bolsheviks seem to be softening the ground for a new breakthrough with massive air attacks. The *Kommandeur* changes machines and takes to the air again.'



Major von Bonin, Geschwaderkommodore of JG 54, on the left, discusses the Berlin awards ceremony with Hauptmann Walter Nowotny shortly after the latter's return with both the Oak Leaves and Swords

Within days of returning from the *Führer* HQ, Nowotny, now promoted to Hauptmann, had taken his score to 235. Oberleutnant Hübner, the war correspondent again:

'Yesterday evening the *Kommandeur* suddenly arrived back. Nobody was expecting him. After the awards ceremony he had been due a long spell of home leave. But, he said, he'd spent two enjoyable days in Vienna and that was enough.

'After many miserable and overcast days, this morning it is perfect autumnal weather, clear and fresh. The best uniform is packed away and the old Russian front flying gear is put back on, including the famous "victory trousers". These show several large repairs, and are turning grey from age and constant use. But the *Kommandeur* won't be parted from them, even if they are just about ready for the museum.'

The skies south of Velikiye Luki were alive with enemy air activity. That afternoon Nowotny shot down three out of a gaggle of 14 Airco-

bras which he had spotted some 1000 metres below on an opposing course. The first went down in steep spirals, leaving a corkscrew trail of smoke which hung for some minutes in the still air to mark the spot. The second exploded, followed by the third only moments later. 'Quax' Schnorrer claimed a fourth.

The next day was a replay of the last. The six Airacobras they encountered may even have been survivors from the previous afternoon, for no sooner had they sighted the Focke-Wulfs than they turned tail and fled back eastwards. Only two made it. The following day was a write-off. Nowotny's guns jammed in the middle of a dogfight. And when he got back to base his only other machine was unserviceable.

Twenty-four hours later he had more success. Four enemy machines downed in the space of nine minutes: a Curtiss P-40, an Airacobra, a LaGG-3 and another P-40. The latter was number 235.

It took almost a month to rack up the next 15. On 9 October Nowotny himself scored JG 54's 6000th victory of the war. Then, four days later, as Oberleutnant Hübner recounts:

'Just as our Ju 87s went into the attack they were set upon by enemy fighters. Nowotny managed to shoot a P-40 off the tail of a diving Stuka. The Russian hit the ground and was engulfed in the explosions of the Junker's bombs. Climbing to engage another Bolshevik, Nowotny was unaware that a P-40 was on his own tail until a warning shout from his *Katschmarek*. The odds were with the attacker, but Nowotny managed to out-turn him and bring him down.

The Stukas had departed by now, but the Hauptmann hung back and was rewarded by the sight of several more enemy fighters flitting low over the frontlines. One diving pass gained him his 246th.

The next day several Bolshevik fighters tried to prevent one of our reconnaissance machines from carrying out its task. Nowotny disposed of three of them and suddenly the others were nowhere to be seen. The reconnaissance aircraft had a clear run.

'Finally, combing the frontline area one last time, he discovered a single enemy fighter, a P-40. It proved to be a worthy opponent. The dogfight lasted some ten minutes before the Curtiss finally crashed to the ground. Number 250!

'Wild celebrations back at base. The commander of the field's flak defences sent up a victory salute and there was a veritable firework display of flares to greet the returning flyer, the first fighter pilot in the world to score 250 kills.'

There was a postscript, too. After receiving a telephone call from General Ritter von Greim, C-in-C *Luftflotte 6*, who was the first to offer official congratulations, Nowotny took Schnorrer to one side:

"'Quax", I promised myself that if I ever got my 250th I'd really celebrate. I'm going to take the courier aircraft to Vilna and really tie one on. Why don't you come with me?'

Schnorrer regretfully declined. Somebody had to stay behind and mind the shop. So Nowotny took the *Gruppe s* MO with him in the Bf 108 to Vilna, leaving Schnorrer to organise the base festivities. As these included emptying the mess of its entire stock of wines and spirits - at Nowotny's express invitation and expense - it was not long before everybody was more than a little merry.

And it was at this point in the proceedings that another call from 'Papa' Greim came through. Nowotny was wanted on the phone again. 'Quax' Schnorrer:

'Everybody looked in my direction. I shook myself and tried to stand up, hot and cold at the same time. I knew where Nowotny was to be found. But how could I explain this to the General?

I slumped against the phone and tried to clear my throat. All I could get out was a hoarse "*Herr General!*" Hardly had I spoken when the General cut in, "You old *Wildsau*. You're drunk, aren't you?"

"There was no point denying it, "*Jawohfr*"

"Papa" Greim was an old World War 1 flyer and understood the situation perfectly. "For God's sake, 'Quax'", he bellowed, "pull yourself together and tell me where Nowotny's hiding himself. The *Führer* wants to congratulate him and give him the Diamonds."

I was sober in an instant, "*Herr General*, Nowotny's in the Ria-Bar in Vilna. He's having a party."

"So that's it. Well, the signals people are really going to have to show us what they can do. You be ready at 08.00 hours too, you're accompanying 'Nowy' to the *Führer*."

I put the phone down and hurried back into the mess. Despite my "acting *Kommandeurship*", I had a hard time calling for peace and quiet amidst the general uproar. When I repeated my phone conversation with "Papa" Greim the noise and jubilation, if anything, grew even louder. But a few older and wiser heads began to worry about the outcome. The signals staff would never manage to connect Hitler with the Ria-Bar, they prophesied. And what then?

But in the event they did. "Nowy" described to me later how he was called to the phone. He heard the voice of an adjutant, "I'm connecting you to the *Führer*." "Nowy" nearly fell through the floor. There he was, propped up on a bar stool in Lithuania, surrounded by a bevy of young ladies, listening, between the hubbub, to the voice of the Commander-in-Chief of the German Armed Forces calling in person from his headquarters in East Prussia to inform him that he had just been awarded the Reich's highest military decoration!

"Had Adolf known where I really was, I reckon he would have had second thoughts about the Diamonds", 'Nowy' confessed.

Next morning General von Greim's He 111 arrived at Vitebsk to collect me. We flew to Vilna to pick "Nowy" up and we both had a quick bath and changed into our best uniforms before the flight to East Prussia. There we were met by a huge Mercedes and driven to the *Führer's* HQ through three sets of checkpoints. We were offered coffee and sandwiches, but our heads were still spinning from the night before. My face was as white as cheese, and I felt as if I would rather die than stand to attention in front of Hitler. So it was agreed that I would wait outside with the adjutant while "Nowy" went into the inner sanctum alone.

He came out about an hour later with a broad smile on his face. The



Fw 190A-6 Werk-Nr 410004 was the aircraft with which Hauptmann Nowotny scored his 250th kill. This event took place on 14 October 1943, and his victim was a skillfully flown lend-lease P-40 -the dogfight involving the two protagonists lasted a full 10 minutes! Part of I./JG 54, this aircraft is seen being taxied out from its dispersal at Vitebsk in November 1943

This official portrait was taken soon after Nowotny had been awarded the Diamonds by the *Führer* in Berlin. The award is clearly visible, along with the Knight's Cross, Oak Leaves and Swords at his throat



Oberkommando der Luftwaffe
 Chef f. Ausz. u. Diszpl. (V)
 Az. 29 Nr. 1179 /4 4

Berlin, den 5.12.44

An 5./J.G. 54

Der 5./J.G. 54

wird der Abschuß eines sowjetischen Jagdflugzeuges vom Typ
 "LAGG - 3" am 4.10.43, 16.10 Uhr
 durch Lt. Norbert Hannig
 als siebenhundertsechundachtzigster (786.) Luftsieg anerkannt.

I. A.

10000 3144 1.95-1791

A LaGG-3 downed by Leutnant Norbert Hannig on 4 October 1943 gave 5 Staffel IIs 786th kill of the war, but just look at how long it has taken official confirmation to come through from the OKL - the date on the document, top right, reads 5.12.1944!

'Bully' Lang's 18 kills in one day got him on the cover of the 13 January 1944 issue of Berlin's fortnightly *Illustrierte* magazine. The headline at the foot of the cover reads 'Eighteen in one day: the victor returns'. Lang, of II/JG 54, scored this world record tally in late October 1943 near Kiev



Diamonds sparkled at his neck. As we left, Hiker was standing outside his bunker, lost in thought and holding "Blondi" his German shepherd on her lead. In passing, Nowotny could not resist the temptation of formally introducing me to the *Führtet*

Meanwhile, the daily life-or-death struggles along the front continued unabated. Successes such as Nowotny's, and one or two other stellar individuals' - like Leutnant Emil 'Bully' Lang, II. *Gruppen*'s one-time unsuccessful popper of rivets, who achieved the world's all-time record of 18 kills in one day over the

Kiev region late in October - had to be measured against a growing rate of attrition. Shuttling between three *Luftflotten*, from Leningrad to the Ukraine, JG 54 lost some 30 pilots during the final months of 1943. And although many of the casualties were untried youngsters, the ranks of the experienced *'Alte Hasen'* were inevitably thinning too.

On 11 October the famous *'Nowotny Schwärm'* was finally broken up by the loss of Leutnant Anton Döbele, who was killed in a mid-air collision with another German fighter over the Smolensk-Vitebsk supply highway. 'Toni' Döbele's score stood just four short of the 100. His death marked the end of an era. The following day 'Quax' Schnorrer was seriously injured. He and Nowotny had scrambled in pouring rain to answer calls for help from infantry under attack by *Stormoviks* near Nevel. Despite the appalling visibility they had each managed to down one of the Russians before Nowotny suddenly shouted:

'Quax, break left, you're burning!'

The fire spread rapidly. 'Bale out, you'll never land in those trees!' Nowotny watched as his *Katschmarek* tried to extricate himself from the flames licking around the cockpit. Just below cloud level, only some 50-70 metres from the ground, he finally succeeded. His auxiliary chute had only just begun to deploy the main canopy when 'Quax' disappeared into the muck below. Despite concussion and two broken legs, Schnorrer was rescued from the woods by the infantrymen and collected by Nowotny in a *Fieseier Storch*. He recovered after a long stay in hospital and returned to operations on Me 262s towards the end of the war. During his service with JG 54 Leutnant Karl Schnorrer, primary guardian of Nowotny's tail, had himself claimed 35 kills.

It was on 15 November 1943 that Nowotny scored his own 255th and last Eastern Front victory. He was later posted as *Kommodore* to a training *Geschwader* before assuming command of the Me 262 test unit which bore his name. The exact sequence of events surrounding the air battle and subsequent crash which led to his death at Achmer on 8 November 1944 has never been fully ascertained.

The 'Green Hearts' lost only one of their *Kommodore* in action. This was on 15 December when Oberstleutnant Hubertus von Bonin was shot

down near Vitebsk. Von Bonin, who had taken over from Oberst Trautloft in July, had achieved 77 victories, including four while serving with the 'Condor Legion' in Spain. His replacement at the head of JG 54 was Major Mader, previously *Kommodore* of JG 11 in the west.

In mid-January 1944 the North Sector of the front, so long dormant, suddenly exploded into life with the launching of a major Red Army offensive. The capture of Mga on 21 January heralded the lifting of the almost 900-day siege of Leningrad. I. and II./JG 54 were hurriedly recalled from the Central and Southern Sectors respectively. Returning to their old stamping grounds, it quickly became clear that this new northern tide of the Russian advance would prove as impossible to stem as that currently surging across the Ukraine far to the south. In fact, JG 54 soon found themselves retracing their steps back through the Baltic States almost as rapidly as their predecessors had advanced across them during that balmy summer of 1941.

By February I. *Gruppe*, commanded since Nowotny's departure by Hauptmann Horst Ademeit, had taken up residence at Wesenberg in Estonia. They were joined the following month by II./JG 54, who occupied Dorpat and Petschur (Petseri) west of Lakes Peipus and Pleskau. Fortunately it was a time of minimal losses for the two Fw 190 *Gruppen*. Successes continued to mount, however, and on 23 March, with his 135th kill, Leutnant Albin Wolf scored the *Geschwaders* 7000th victory. *Staffelkapitän* of 6./JG 54 since Ademeit's promotion, Wolf was killed by a direct flak hit over Pleskau ten days later. In those ten days he had downed another nine enemy aircraft, bringing his final total to 144; no mean feat for a pilot who had once described the Fw 190 as 'landing like a wet sack!'

In June 1944 the Soviets unleashed their massive Central Front summer offensive which would cut off the coastal regions of the Baltic States to the north from the main bodies of the German armies being pushed back towards the borders of the Reich. At the same time the Russians attacked the Finnish forces still occupying the Karelian Isthmus north of Leningrad. In the face of the former threat, I./JG 54 vacated Estonia for neighbouring Latvia, first detaching 1. *Staffel* briefly to Turku in Finland to protect German naval units in the northern Baltic. In response to the latter, Major Erich Rudorffer's II. *Gruppe* also went to Finland as the fighter component of *Gefechtsverband* (Battle Group) Kuhlmei, a mixed-bag formation of Stukas and ground-attack Fw 190s sent to aid the hard-pressed Finns. During their month's sojourn at Immola in northern Karelia II./JG 54 claimed 66 Soviet aircraft destroyed.

A surprise arrival on the Russian Front that same June was a rejuvenated and reinforced IV./JG 54. After earlier retiring through Rumania, this Bf 109 *Gruppe* had withdrawn to Germany to re-equip with Fw 190A-8s and be brought up to full current Defence of the Reich

Geschwaderkommodore Hubertus von Bonin (left) was shot down and killed near JG 54's base at Vitebsk on 15 December 1943. He scored 77 kills, including four in Spain as part of the 'Condor Legion'



144-victory ace Oberfeldwebel Albin Wolf gets JG 54's 7000th victory of the war on 23 March 1944. A motley looking group of 'black men' look on with weary approval





The *Geschwaderkommodore's* machine undergoes gun calibration following routine servicing away from the frontline at Dorpat, in Estonia, on 18 July 1944. Major Anton Mader's Fw 190A-6 wears a white command chevron and bars, as per regulations. The scheme worn by the A-6 is typical of that adopted by the *recces* assets of *Luftflotte I* in the northern sector of the front, and consisted of an upper surface camouflage pattern of green and brown

Rushed to the Finnish front in June 1944 to protect German naval units in the northern Baltic, 'White 4' of 4 *Staffel* *WJG 54* is seen at *Immola* during a lull between sorties. It has its upper engine inspection panel hinged open, which may mean that the machine has been temporarily grounded with a technical write up. Also suffering engine problems in the background is a Finnish Air Force Brewster Buffalo



establishment of four *Stoffeln* each of 16 aircraft. In one of the first instances of precedence being given to the Eastern Front over home defence requirements, *IV./JG 54* was suddenly despatched to the Soviet-Polish border region on 30 June to provide air cover for the retreating ground troops. Commanded by Major Wolfgang Späte - later to achieve fame as the *Kommodore* of *JG 400*, the rocket-powered *Me 163 Komet* unit - *IV./JG 54* suffered grievously in the ensuing two months before retiring back to the Reich early in September.

By that time the two long-serving *Fw 190 Gruppen*, I. and II./*JG 54*, had retired deeper into isolated Latvia, occupying bases on the Courland peninsula at *Schrunden* (Cirava) and *Libau-Grobin* respectively. It was during this period, too, that a final round of personnel and organisational changes took place. On 8 August Major Horst Ademeit had been reported missing in action. A rare occurrence, his *Fw 190* had succumbed to infantry fire over *Dünaburg* in southernmost Latvia and was last seen going down behind enemy lines. A member of *JG 54* since the days of the *Battle of Britain*, Ademeit's score was standing at 166 at the time of his disappearance. His place at the head of I. *Gruppe* was filled by Major Franz Eisenach, who had served as *Staffelkapitän* of 3./*JG 54* before being severely wounded back in May 1943.

And at the end of September Oberstleutnant Mader relinquished command of the *Geschwader* to Oberst Dietrich Hrabak. A highly experienced *Kommodore*, late of *JG 52*, Hrabak's career had begun as far back as February 1938. He too had flown with the 'Green Hearts' in the *Battle of Britain* and had been *Kommandeur* of II./*JG 54* during the latter half of that conflict. The *Geschwader* could want for no better leader in the difficult days that lay ahead.

With all but the *Stabsstaffel* of *JG 51* having converted back on to the *Bf 109* in May, *JG 54's* two *Gruppen* were now effectively the sole *Fw 190* fighter presence on the Eastern Front- albeit already bottled up in Cour-

land. They also now underwent Defence of the Reich style reorganization, a fourth *Staffel* being added to each *Gruppe*. In theory, this translated into an official total establishment of well over 130 aircraft. The reality - as of mid-October - was that they could muster just 56 serviceable aircraft between them. And a new spectre was also beginning to make itself felt: the increasing scarcity of aviation fuel. With everything having to be ferried in to

Courland by either air or sea, the fuel situation would soon reach crisis proportions. Before the end teams of oxen would be employed to move aircraft to and from dispersals to prevent unnecessary taxiing!

There was, however, one shortage they were not suffering from: pilots. The earlier wartime system whereby a pilot, upon the successful completion of his formal training programme, would be posted to the

subordinate *Ergänzungsgruppe* (replacement wing) of the particular frontline unit he was scheduled to join, had been abandoned in 1942. Instead of each *Jagdgeschwaders* operating what was, in effect, its own personal OTU to prepare its newly assigned pilots for frontline combat, henceforth this task would be taken over by the official *Ergänzungs-jagdgeschwader* (replacement fighter group), a unit intended to supply the entire fighter arm with combat-ready pilots.

This new EJG was divided into two *Gruppen*, 'Ost' and 'West', these in turn composed of a number of *Staffeln*, each of which was responsible for supplying the requirements of a particular *Jagdgeschwader*. Frontline pilots from these *Jagdgeschwader* were rotated back to their specific *Ergänzungsstaffel* to help prepare the trainees for the conditions they would face when posted forward to their operational unit.

JG 54's *Ergänzungsstaffel* had initially been based in southwestern France, at Bergerac, Biarritz and Toulouse, before retiring to the then greater safety of the Reich's eastern provinces, where they occupied Liegnitz, Rogau-Rosenau and Sagan. As with all training establishments, there were plenty of incidents. Some were tragic, like the pupil who tried a loop on his first flight and augered straight in from 2000 metres. Others less so. One hopeful, equipped with a belly tank, came in for a perfect three-pointer straight down the centre of the concrete runway, neglecting only to punch the button which lowered the undercarriage. As the first sparks began to fly, the onlookers closed their eyes and covered their ears . . . and nothing happened!

Another near textbook belly-landing was made by an instructor returning from an operational sortie - experienced *Ergänzungsstaffel* pilots often being called upon to participate in local air actions - when he realised that the starboard mainwheel indicator was not showing (this was a small metal rod which rose up out of the wing's top surface as the undercarriage



Above and below Problem rectified, 'White 4's' BMW awaits cranking up a session of post-rectification checks, prior to be leared for a return to the operations. Another Finnish Air Force stalwart fighter in the form of a Fiat G.50 is also out on the ramp at Immola undergoing power checks. II/JG 54 claimed 66 kills in just a month of operations from this northern Karelian base





leg was lowered). In the cockpit both green indicator lamps were on; but so were the reds. Better safe than sorry, he decided, and approached for a perfect wheels-up landing... with both legs locked securely down. Everybody in the *Staffel*, except him, had known that the right-hand indicator rod on this particular machine had been broken for days.

Although the basic training programmes were gradually curtailed as the war progressed (a result of the growing demand for quick replacements allied to declining fuel stocks), the *Ergänzung!* system continued. The frontline pilots did what they could with the ever more youthful and sketchily trained material passing through their hands. But the outcome was predictable. In the face of overwhelming enemy strength, many young pilots, however eager and willing, failed to return from their first mission.

Despite the official increase in complement, it also meant that there were more pilots available than there were machines to fly. This problem had plagued the Fw 190 *Gruppen* throughout their time on the Eastern Front, which is why few pilots, other than the higher ranking formation leaders, had individual aircraft permanently assigned to them. They were simply allocated a machine prior to a mission, the ground-crew ad-justed the rudder pedals and seat height accordingly, and off they went.

On 16 October 1944 the Soviets launched their first attempt to destroy the Courland army. By March 1945 they would have mounted six separate offensives against the peninsula pocket. But the defenders resisted stubbornly. Hitler had expressly forbidden their evacuation. The *Führer* had a grandiose scheme of his own to use Courland as a springboard for a counterthrust southwards into the right flank of the main body of by-passing Russian armies. However, like many of his brainstorms in the last year of the war, this plan would come to nothing due to both a lack of men and machinery.

Unable to influence events elsewhere, the men of the Courland army simply clung on, fighting grimly for every inch of ground. And for the remaining six months of the war the task for each of I. and II./JG 54's 50-odd Fw 190s, whether flown by *Experte* or tyro, would be simply to protect them, and their vital sea and air supply routes, from the burgeoning 3600-plus fleet of aircraft on the combined Soviet Baltic and northern Belorussian fronts!

II./JG 54's young, yet seasoned, instructors take a break from the strenuous flying routine maintained seven days a week at Liegnitz, in Germany's eastern provinces, in the summer of 1944. Behind them are one of the many tented workshops quickly erected at the site following their recent move from more permanent locations in France. Many of these *Ergänzungsstaffel* pilots were called upon to fly hazardous local Defence of the Reich sorties when US bombers flew raids in their area



Enjoying a brief respite from the Russian Front, Leutnant Norbert Hannig is seen during his time as an instructor with *Ergänzungsguppe Ost*, at Liegnitz, in June 1944

TOO LITTLE, TOO LATE

JG 54's enforced retirement into Baltic isolation meant that the *only* Fw 190s on the main Eastern fighting fronts during the latter half of 1944 were ground-attack machines. Despite a significant increase in numbers (the seven *Schlachtgruppen* of mid-1944 had grown to 12, plus several independent *Staffeln*, by the year's end), it was still a pitifully small force, some 300 serviceable aircraft in all, to place in the path of the greatest concentration of armour in military history as it erupted through the Vitebsk-Dnieper gap, the traditional 'gateway' for invading armies in, and out, of Russia.

Although their principal targets were the advancing Soviet ground forces, some *Schlacht* pilots still managed to add to their list of aerial kills. The heady days of the Crimea were long past, but II./SG 2, for example, tasked with flying escort for the Ju 87-equipped components of their parent *Geschwader* during the long retreat back across Rumania and Hungary, continued to take a steady toll of Russian fighters. Their success was not achieved without cost, however, one of the earliest victims of this final stage of the war having been Hauptmann Günther Bleckmann, *Staffelkapitän* of 6./SG 2, who had scored 27 kills before his death over Rumania on 4 June.

The following month Hauptmann Friedrich-Wilhelm Strakeljahn, who had led the ship-busting 14.(Jabo)/JG 5 to such effect over Arctic waters in 1943, and who had since returned to the Eastern Front as *Kommandeur* of II./SG 4, was downed by a direct flak hit near Macuty on the Northern Sector on 6 July.

In October Leutnant Otto Dommeratzky, also of 6./SG 2 and with close on 40 kills to his credit, lost his life in tragic circumstances when bounced by US fighters during an unarmed ferry flight over Czechoslovakia. With his crew chief - minus parachute - stowed uncom-



Seen in Rumania in July 1944, a I.Gruppe *Schlacht* Fw 190 sits quietly in the high grass as an impressive formation of five Bf 110s cruises past at low level. Note the tropical filter fitted to the F-8, which helped keep the sand and dust of the dry plains out of the BMW during taxiing and take-off

A *Rotte* of II.Gruppe machines. Like the aircraft featured above, the wheel covers have been removed from these Fw 190F-8s - perhaps this signifies recent spring mud?





The greatest Stuka ace of them all. Major Hans-Ulrich Rudel's Ju 87s were often escorted by the Fw 190s of II./SG 2

A summer-uniformed Major Rudel being entertained in a unit mess. It is uncertain what's in the glass, as Rudel was a well-known teetotaler and keep-fit fanatic - a piece of Luftwaffe doggerel ran 'Major Rudel trinkt nur Sprudel' (Major Rudel drinks only mineral water)



fortably in the fuselage behind him, Dommeratzky himself refused to bale out, electing instead to risk a crash-landing. Unfortunately he was unsuccessful and both were killed on impact.

The danger from American fighters was not new. P-51 Mustangs had first been encountered by II./SG 2 following their retreat from the Crimea into Rumania in June. A number of pilots, including two *Staffelkapitäne*, had already been lost to the Italian-based Americans. But as 1944 gave way to 1945 and the Germans were pushed steadily back - and the distance between their Eastern and Western Fronts diminished - so that danger grew. Marauding Allied fighters, rather than posing the occasional threat, became a constant menace. Nobody was safe. And on 17 April 1945 they claimed their greatest prize. Crimean ace Oberleutnant August Lambert, with 116 Russian aircraft destroyed, the highest scoring *Schlachtflieger* of them all and now *Staffelkapitän* of 8./SG 77, was taking off with his unit from Kamenz, northeast of Dresden, to attack the advancing Russians when he was jumped by 60 to 80 Mustangs. After a short but hopeless struggle he was brought down over Hoyerswerda some 12 miles away. Six other members of his *Staffel* died in the same sprawling, desperate dogfight.

To the north the RAF were proving equally predatory. On 30 April a group of Spitfires caught a formation of Fw 190s of I.(Pz)/SG 9, a specialised rocket-armed anti-tank *Gruffe*, landing at Suite near Schwerin. *Gruppenkommandeur* Hauptmann Andreas Kuffner and Oberleutnant Rainer Nossek, *Staffelkapitän* of 3. (Pz)/SG 9, were both killed. Oberleutnant Wilhelm Bromen managed to bring down one of the attackers before he was himself shot down and seriously wounded. Bromen's victim, his sixth kill on the Fw 190, was one of the last to fall to the guns of a *Schlacht* pilot, for eight days later the war was over.

Some weeks prior to the final cessation of hostilities, however, the Eastern Front had at long last witnessed an influx of Fw 190 fighter reinforcements. Less than a month after Operation *Bodenplatte* (Baseplate), the ill-advised and costly New Year's day attack by the *Jagd* on Allied-occupied air bases in north-west Europe, elements of some ten *Jagdgeschwader*, including 11 Fw 190-equipped *Gruppen*, began transferring eastwards. There had, in fact, already been a couple of brief appearances by Fw 190s on *Luftflotte G*s orders of battle on two previous occasions. III./JG 11 had accompanied the re-equipped IV./JG 54 into Poland at the end of June 1944. An even more intriguing entry a year earlier revealed one(!) Fw 190 night-fighter being operated by 8./NJG 200 alongside its handful of He 111s and Ju 88s in August 1943.

But it was not until mid-January

1945, with Russian armour already encroaching on German soil and Berlin soon to be directly threatened, that any meaningful transfer began. By then it was too late. With the Eastern and Western powers drawing ever closer together, and the Reich within weeks of being cut in two by American and Russian forces linking up on the River Elbe, it is arguable whether these latecomers can be classed as true 'Eastern Front' units. For although committed against the Soviets on paper, the majority had also to contend with the marauding Western Allies at their backs.

Ordered to East Prussia on 14 January, for example, I./JG 1 lost some dozen pilots killed or wounded to British fighters, arriving at Jürgenfelde only ten strong. Although claiming several Soviet aircraft destroyed, including a Yak-9 downed by *Gruppenkommandeur* Oberleutnant Emil Demuth on 30 January, they suffered five more casualties before their withdrawal in early February to retrain on the He 162 *Volksjäger*. II. Gruppe's introduction to Eastern Front conditions was little better. Losing two pilots killed in a clash with Yaks on the day of their arrival, they were then forced to blow up ten of their own aircraft in hasty retreats before the week was out.

Equipped with heavily armed and armoured Fw 190A-8/R8s, IV./JG 3 'Udet' was a Defence of the Reich *Sturmgruppe*, a dedicated anti-bomber unit. But it too was rushed eastwards and pressed into service bombing and strafing Soviet forces advancing along the Oder front towards Stettin and Berlin. Although even more impervious to ground fire than the normal A-8, the '*Sturmbock*' was no match for Russian fighters. But IV./JG 3's newly-appointed *Gruppenkommandeur*, Oberleutnant Oskar Romm — the same 'Ossi' Romm who had scored his first kills with I./JG 54 over Vyazma in December 1942 - was nothing if not resourceful.

He had first seen the penultimate model of the Focke-Wulf line, the long-nosed D-9 powered by a liquid-cooled Junkers Jumo engine, a few weeks earlier. And he now set about organising himself some of these new fighters; even to the extent of rescuing abandoned examples from bases about to be overrun by the enemy. He soon had enough to equip not just his *Stabsschwarm*, but an entire *Staffel* as well:

'As an air-superiority and interceptor fighter the Fw 190D-9 handled better than the Fw 190A. It was faster and had a superior rate of climb. In the dive it could leave the Russian Yak-3 and Yak-9 fighters standing.'

Romm's career on the 'Dora-9' was cut short on 24 April. Attacking a group of *Stormoviks* south of Stettin, he had sliced through their fighter escort without difficulty when his engine began to overheat. Diving steeply away, he outdistanced with ease the Russian fighters attempting to follow him, only



Otto Dommeratzky of 6./SG 2 is pictured here as an Oberfeldwebel in 1943. His Knight's Cross was awarded on 5 January 1943, and he was tragically killed on 13 October 1944. The Oak Leaves were awarded to Dommeratzky posthumously on 25 November 1944. He had scored close to 40 victories by the time of his death

The middle machine in this trio of Fw 190D-9s of IV./JG 3 seen at Prenzlau in March 1945 shows distinct signs of previous ownership - its rear fuselage band has been overpainted at some point in its recent past

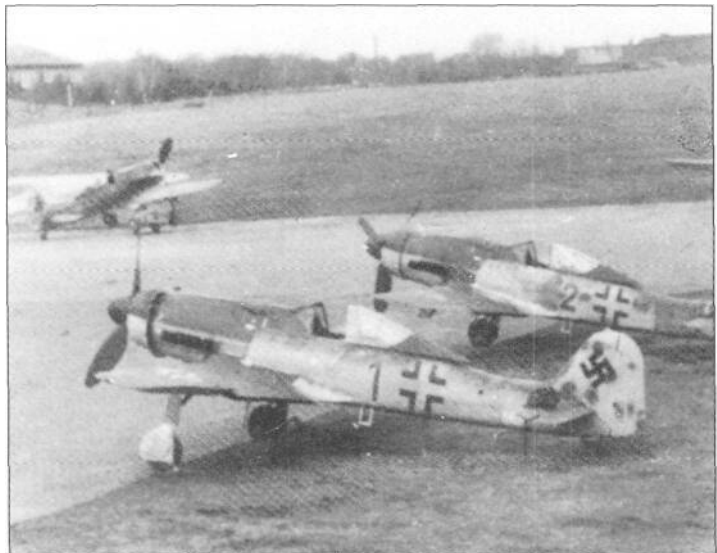



'Ossi' Romm's personally scrounged 'Dora-9' (note *Gruppenkommandeur's* double chevron just visible behind wing) outside a Prenzlau hangar in early 1945

Romm's reserve aircraft wore the single chevron of the *Gruppen-Adjutant*-the latter was not qualified as a fighter pilot, and so never flew it himself whilst with IV./JG 3



to be seriously injured in a crash-landing back over his own lines.

Hauptmann Herbert Kutscha's III./JG 11 also returned to the east towards the end of January 1945, this time accompanied by the *Geschwaderstab* and I. *Gruppe* as well. Together they operated primarily along the Oder front and beyond, towards Posen (Poznan). But it was over Straussberg, near Berlin, on 17 February that they lost their *Geschwaderkommodore* when Major Jürgen Harder - formerly a Mediterranean Bf 109 ace - was

killed in a crash caused, it is believed, by oxygen failure.

II./JG 300 was another A-8/R8 *Sturmgruppe* sent to the Eastern Front. Together with elements of JG 301 (a *Geschwader* which also possessed a number of D-9s, plus the only examples of the Ta 152H, the final development of the entire wartime Focke-Wulf fighter family, known to have entered operational service), it was ordered to the scene of the Russian breakthrough along the Oder on 1 February.

But the danger of having to wage war on two fronts was graphically demonstrated eight days later when the combined *Gruppenvere* recalled to combat US bombers over western Germany and lost 11 of their number in the process. By April III./JG 301 were attacking American ground forces along the River Elbe, only to be ordered to about-turn once again. They ended their war in the defence of Berlin where, many witnesses report, they encountered captured, Russian-flown 'Dora-9s' -'Ossi' Romm apparently didn't get them all!

While the majority of these 'new' Fw 190 *Gruppen* fought over the northern and eastern approaches of Berlin, others were being despatched to the southern sectors. JG 6's destination was lower Silesia. At Görlitz, as part of the *GefechtsverbandRude*), their II. *Gruppe* took on the unenviable task formerly performed by II./SG 2 - protecting the handful of obsolete anti-tank Ju 87s of SG 2 that were somehow still flying on a daily basis. *Stab* and I./JG 6 shared their Reichenberg base with a small tactical reconnaissance unit.

Until the end of March JG 6's *Geschwaderkommodore* was Major Gerhard Barkhorn, the Luftwaffe's second-highest scorer. All 301 of Barkhorn's victories were achieved on the Eastern Front (with JG 52). It is perhaps indicative of the difficulties of those final days that the last of them had gone down on 5 January, 11 days before he assumed command of JG 6, and that he did not add a single one during the ten weeks he led the unit.

'FINIS'

While the newcomers from the west were learning the harsh realities of Eastern Front air warfare, the campaign veterans, JGs 51 and 54, were now both cut off with their backs to the Baltic Sea. By mid-March German forces in East Prussia had been pushed back into two pockets either side of Danzig Bay, one around the state capital Königsberg and the other around Danzig itself. They also held the 'Frische Nehrung', the long spit of land between the two. In mid-March JG 51's *Stabsstaffel* viZK based at Neutief out along this narrow spit. From here on 25 March they had downed seven Soviet bombers. Three days later the field came under heavy Russian artillery fire, directed from a tethered balloon on the mainland. Volunteers among the groundcrews struggled to keep the remaining Fw 190s serviced between the incoming salvos. On 7 April the *Kapitän*, Leutnant Wilhelm Hübner, was killed by a direct flak hit over Neukuhren; he had scored 62 victories while with the *Staffel*. As Neutief was becoming completely untenable, the *Staffel* moved east into the shrinking Königsberg pocket. But their new base, Littausdorf, was soon under constant air attack from *Stormoviks*, Pe-2s and ground-strafting Airacobras. At the height of one such raid, on 15 April, a solitary Fw 190 managed to sneak in, miraculously surviving the exploding bombs and cannon fire. It was piloted by Major Heinz Lange, who had just flown alone over 250 miles of enemy held territory to take over from Major Fritz Losigkeit as the sixth and final *Kommodore* of JG 51. But Lange's sad duty was to do little more than oversee the dissolution of the *Geschwader*. On 28 April the *Stabsstaffel* was disbanded. Several pilots flew their aircraft out to the west; one enterprising young *Unteroffizier* even managed to take his girlfriend with him!

The disappearance of the *Geschwaderstab* allowed Lange to return whence he came: to the command of IV./JG 51. This *Gruppe* had just re-equipped with brand-new Fw 190A-8s, and even a few D-9s, at Garz, further west along the coast. Compared to the painstaking transition from Bf 109 to Fw 190 back in the winter of 1942-43, their recent 'conversion' could best be termed rudimentary. A civilian employee from the Focke-Wulf factory explained the cockpit layout to them, described the 190's handling characteristics, warned them *never* to lift the tail on take-off . . . and that was it! After a few practice flights they were transferred south to the Berlin area. It says something about the men, or the machines - or both - that in three weeks they claimed 115 kills for the loss of 5 of their own.

On 29 April Major Heinz Lange was involved in his last dogfight,



Major Erich Rudorffer, *Gruppenkommandeur* of II./JG 54 for almost two years, is pictured here in August 1943, prior to being awarded the Oak Leaves and Swords. He survived the war to finish with an incredible 222 kills, 136 of which he claimed in the east with JG 54

Father Christmas (aka Feldwebel Fritz Hangebrauk, Gerd Thyben's wing man) is welcomed by 7./JG 54 'black men' at Libau, in Courland, on Christmas Day 1944





Hauptmann Herbert Findeisen, replaced Rudorffer as *Gruppenkommandeur* of II./JG 54 in Courland 1945



Two newly decorated Knight's Cross wearers - (left) Leutnant Hermann Schleinhege (awarded on 19 February 1945), and (right) Leutnant Hugo Broch (awarded 12 March 1945). Both were from II./JG 54 at Schründen (Ciraval/Courland, in March 1945

Seen at Libau-Nord, Leutnant Schulz gets the newly established *G.Staffel's* 100th kill in March 1945

with four La-7s over Neubrandenburg; but it fell to Oberfeldwebel Alfred Rauch to claim JG 51's final Fw 190 victory of the war on that same date. And on 1 May they suffered their last Fw 190 casualty when Oberfeldwebel Heinz Marquardt had to take to his parachute after an encounter with Spitfires north of the German capital. The following day they retired to Flensburg and British captivity. For the Fw 190s of JG 51 the war was over.

Which left just *Jagdgeschwader* 54.

And they had their own private war raging on their doorstep. But despite - or perhaps because of - their sense of isolation, I. and II./JG 54's scores continued to mount during their final months trapped up on the Courland peninsula. On 15 October 1944, the eve of the first Russian attempt to overrun the pocket, Oberleutnant Helmut Wettstein, *Staffelkapitän* of 6./JG 54, had achieved the *Geschwaders* 8000th victory. In all the Soviets would hurl six separate offensives against the defenders of Courland. By the close of the second, on 28 November, JG 54 had claimed another 239 kills. On just two days during the course of the third, which lasted from 21 to 31 December, they achieved 100 victories at the cost of 11 to themselves. But every casualty was deeply felt. A sad blow on the opening day of third Courland was the loss of *Staffels* Leutnant Hans-Joachim Kroschinski. A member of I./JG 54 since the summer of 1942, 'Kroschi' was on the point of downing the last of five Pe-2s — bringing his total to 76 - when its rear gunner bracketed his Fw 190. The forward fuel tank immediately burst into flames and an explosive shell shattered Kroschinski's ankle.

Despite his wound, and the flames searing into the cockpit, he somehow managed to bale out. He was unconscious when he hit the ground. He survived, but only at the cost of his sight and the loss of a leg. Six days later an even longer serving pilot was lost when Leutnant Heinz 'Piepl' Wernicke, a 112-victory *Experte* leading *I.Staffel*, was accidentally rammed by his *Katschmarek* during a dogfight southwest of Riga.

The comparative lull in the ground fighting between each Soviet offensive offered some semblance of a respite for the weary Courland army. But for JG 54's two *Gruppen* there were no such let-ups. The Russian air force attacked the peninsula's supply and evacuation ports without pause. The



main harbour in particular, Libau, suffered raid after heavy raid. II./JG 54 based at nearby Libau-Grobin, and I. *Gruppe* some 40 miles inland at Schruden, took a steady toll of the attackers. On two consecutive days during one such 'lull' in mid-December, they claimed 44 and 56 enemy aircraft destroyed during massed raids on Libau's town and dock areas. When not defending the supply ports, they were protecting the ships themselves as they ran the gauntlet of Soviet air and sea attack. They also provided fighter escort for Courland's few *'Mausis'* - lumbering Ju 52s, each with a large dural hoop beneath fuselage and wings - as they swept the sea approaches to the peninsula for enemy mines.



The fi.Staffel *Schwärm* which sank two Soviet MTBs off Bad Polangen, in the Courland Peninsula, in March 1945. Left to right, Feldwebel Meschkat, Unteroffizier Licht, Leutnant Hannig and Unteroffizier Kohler

The pressure never eased. On 24 January 1945 the Russians launched their fourth offensive; on 20 February their fifth. It was during February that JG 54 lost two leading personalities. The first came about with the transfer of Major Erich Rudorffer to the command of II./JG 7. Rudorffer had been *Gruppenkommandeur* of II./JG 54 ever since, the death of Hauptmann Jung over Mga back in July 1943. Previously a member of JG 2 in the west and the Mediterranean, he quickly began adding to his already considerable number of victories after arrival in Russia.



Feldwebel Meschkat climbs out of his Fw 190A-8 after the above-mentioned MTB mission

An expert marksman, the quiet, retiring Rudorffer may be ranked alongside the likes of the more extrovert Nowotny, Hartmann and Marseille. But he outshone them all in terms of multiple daily kills. His most outstanding feat of gunnery occurred on 6 November 1943 when he shot down 13 Soviet aircraft in the course of one 17-minute engagement! Rudorffer survived the war with his final score standing at 222. But this figure had not been achieved without incident. He was himself shot down on 16 occasions and had to bale out nine times; the latter feat alone more than enough to earn him his paratrooper's wings! For the final three months of the war Rudorffer's place at the head of II./JG 54 was taken by Hauptmann Herbert 'Mungo' Findeisen, who added 25 kills during that time to the 47 he had earlier scored over Russia as a reconnaissance pilot.

The *Geschwaders* second major loss of February 1945 hit the 'Green Hearts' hard. It was the death of the highest scoring of them all. Another quiet and serious type, the slow-spoken Otto Kittel had joined 2./JG 54 as an NCO pilot in the autumn of 1941. His early days on the Bf 109 gave no indication of the success that was to come. It took him some eight months to achieve his first 15 kills, and another nine to



A Soviet G-class MTB comes under air attack in the Baltic



The commanders meet - left to right, Oberst Dieter Hrabak (*Geschwaderkommodore* JG 54), Hauptmann Helmut Wettstein (*Staffelkapitän* 6JG 54), Major Herbert Findeisen (*Gruppenkommandeur* II./JG 54) and Generaloberst Kurt Pflugbeil, AOC *Luftflotte* 1, are seen at Libau-Nord in February 1945

Although not an escapee from Courland, the NCO just visible in the aft fuselage radio compartment nevertheless gives some idea of the cramped conditions experienced by the occupant, even without the hatch screwed back on!



add two dozen more. But number 59 in February 1943 marked not just the 4000th for the *Geschwader*, it also heralded Feldwebel Otto Kittel's rise to fame. Recently converted to the Fw 190, thereafter he never looked back. In just over a year his score stood at 150. And despite being shot down twice — and suffering two weeks of Soviet captivity, from which he managed to escape - it had continued to rise ever since.

On 14 February Oberleutnant Otto Kittel scrambled to intercept a formation of incoming *Stormoviks*. But on this, his 583rd combat mission, luck finally deserted him. He was killed by return fire from one of the Ilyushins' rear-gunners. With a total score of 267 confirmed victories, Otto Kittel was the Luftwaffe's fourth highest ranking ace. Over Courland his name was known in the forwardmost trenches. As a

member of his *Staffels* said, 'When Otto Kittel was killed, for us darkness fell in the Courland pocket.'

And he was right. The following month, on 18 March, the sixth and final Soviet onslaught began. Once more it was blunted and stopped. But when Adolf Hitler - the one man at whose insistence the Courland peninsula had been held for all these months - committed suicide in Berlin on 30 April, there died with him all thoughts of using the 'fortress' of Courland as the jumping-off point for a last-minute counter-attack.

The capitulation of Germany, and the surrender of all her armed forces, was only days away. For the Luftwaffe units in Courland this meant one thing: escape to the west, taking as many of their comrades with them as they could. The *'Mausis'* repaid JG 54's previous services by loading their departing Ju 52s with fighter groundcrew in addition to their own. The C-in-C of *Luftflotte* 1, Generaloberst Kurt Pflugbeil — 'Papi' Pflugbeil to his men - placed his own Ju 52 at their disposal, preferring to see it used to evacuate more ground personnel while he, together with his staff, elected to stay behind and endure many years of Soviet captivity.

The Fw 190 pilots also helped their own. Some 50 aircraft left Courland, stripped of equipment but packed with two, three or even four occupants. The faces of those who watched one Fw 190 land safely

The end in the north saw dozens of Fw 190As and Ds (plus a solitary Bf 109), mostly minus propellers, parked at Flensburg, and photographed from the elevated vantage point of a dumped Ju 52 'Mausi'

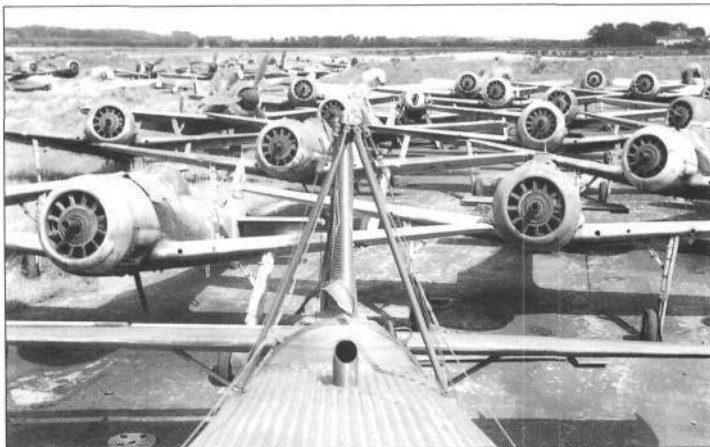

An upturned 'Mausi' of 2./Minensuchgruppe der Luftwaffe (3K+CK) rests on 'Yellow C', a Schlacht Fw 190 almost certainly of III /SG 3, a Gruppe which shared the last days in Courland with JG 54

in the west and saw five people emerge - two squashed behind the pilot, one from the rear fuselage radio compartment and one from each wing ammunition bay - were, by all accounts, something to behold!

A few 'Green Hearts' made for their home towns. One or two opted for neutral Sweden less than 200 miles away across the Baltic. But the majority followed orders directing them to fly to British-held Flensburg or Kiel in Schleswig-Holstein. Among the latter, one of the last to leave was the *Staffelkapitän* oⁿ.1 JG 54, Oberleutnant Gerhard Thyben. Prior to joining the *Geschwaders*, little over a year earlier, Thyben had served with JG 3. He had scored his 100th victory on 30 September 1944, and had since added another 56.

Early on the morning of 8 May Thyben took off, his chief mechanic Albert Mayers crammed into the radio compartment behind him trying hard not to disturb the tail control rods and cables running the length of the fuselage. With his *Katschmarek*, Feldwebel Fritz Hangebrauk, tucked alongside, the two Fw 190s set course westwards. As they headed out over open water, the smoke and ruins of Libau began to slip away behind them. Suddenly, ahead and below, Gerd Thyben spotted a dark green Petlyakov...



The end on the central front - Fw 190 carcasses litter the apron of Berlin's huge Tempelhof airport, which was used throughout the war as a storage and repair facility for all manner of Luftwaffe aircraft

APPENDICES

Pilots with 100+Eastern Front Victories

	<i>Eastern Front Victories (1)</i>	<i>Others (2)</i>	<i>Knight's Cross (3)</i>	<i>Oak Leaves</i>	<i>Swords</i>	<i>Diamonds</i>	<i>Eastern Front JG/Is</i>
Hptm Erich Hartmann	352		148	200	239	301	52
Maj Gerhard Barkhorn	301		59	120	250		52
Maj Günther Rail	271	4	65	100	200		52
Obit Otto Kittel (+)	267	-	123	152	230		54*
Maj Walter Nowotny (+)	255	3	56	189	218	250	54"
Maj Wilhelm Batz	232	5	75	175	?		52
Hptm Helmut Lipfert	203	-	90	203			52,53
Oberst Hermann Graf	202	10	42	104	106	172	52
Maj Heinrich Ehrler (+)	200+	-	41	112			5
Obit Walter Schuck	198	8	84	171			5
Hptm Joachim Brendel	189		95	156			51"
Obit Anton Hafner (+)	184	20	60	134			51*
Obit Günther Josten	178		84	161			51"
Obstlt Hans Philipp (+)	177	29	(20)	62	82		54
Maj Walter Krupinski	177	20	53	177			52
Maj Theodor Weissenberger	175	33	38	112			77,5
Hptm Günther Schack	174		116	133			51*
Hptm Heinz Schmidt (+)	173		51	102			52
Hptm Max Stotz (+)	173	16	53	100			54*
Hptm Joachim Kirschner (+)	167	21	51	170			3
Maj Horst Ademeit (+)	165	1	53	c120			54*
Maj Kurt Brandle (+)	160	20	49	100			53,3
Hptm Heinrich Sturm (+)	c157		82				52
Obit Gerhard Thyben	152	5	116	?			3,54*
Obit Hans Beisswenger (+)	151	1	47	100			54*
Lt Peter Düttmann	150		91				52
Oberst Johannes Steinhoff	148	28	36	101	(167)		52
Hptm Emil Lang (+)	148	25	119	144			54"
Lt Fritz Tegtmeier	146		99				54"
Oberst Gordon Gollob	144	6	42	85	107	150	3,77
Obit Albin Wolf (+)	144		117	144			54"
Hptm Rudolf Trenkel	138		75				77,52
Oberst Wolf-Dietrich Wilcke (+)	137	25	25	100	155		53,3
Obit Walter Wolfrum	137		126				52
Maj Erich Rudorffer	136	86	(19)	130	210		54*
Hptm Karl-Heinz Weber (+)	136	-	100	136			51*
Obit Otto Fö'nnkold (+)	136		100+				52
Maj Johannes Wiese	133		51	125			52
Maj Heinrich Setz (+)	132	6	c50	76			77
Maj Anton Hackl	c130	c62	48	104	(150)		77
Maj Franz Eisenach	129	-	107				54*
Maj Adolf Borchers	127	5	78				51,52*

	<i>Eastern Front Victories (1)</i>	<i>Others (21</i>	<i>Knight's Cross 13)</i>	<i>Oak Leaves</i>	<i>Swords</i>	<i>Diamonds</i>	<i>Eastern Front JGjsi</i>
Obit Heinrich Sterr(+)	127	3	86				54*
Lt Kurt Tanzer	126	17	35				51*
Lt Gerhard Hoffmann (+)	125+		125				57
Obit Hans Waldmann (+)	125	9	84	(?)			57
Hptm Wilhelm Lemke (+)	125	6	50	(c125)			3
Hptm Franz Schall (+)	c123	c14	117				57
Hptm Franz Dörr	122	6	95				5
LtKarlGratz	121	17	54				57
Obit Wolf Ettel (+)	120	4	120	(124)			3
Oflw Heinz Marquardt	120	1	89				51'
Obit Friedrich Obleser	120		80				57
Lt Franz-Josef Beerenbrock	117		42	102			51
Lt Hans-Joachim Birkner(+)	117		98				57
Lt Jakob Norz(+)	117		70				5
Lt Heinz Wermcke(+)	117		112				54*
Oberst Adolf Dickfeld	115	21	47	101			57
Maj Erwin Clausen (+)	114	18	52	101			77
Lt Hans Dammers (+)	113		51				52
Lt Berthold Korts (+)	113		113				52
Hptm Alfred Gnslawski	109	24	40	(114)			52
Oberst Dietrich Hrabak	109	16	(16)	118			54, 52*
Obit Bernhard Vechtel	108		93				51*
Obit Franz Woidich	108	2	80				52
Obit Josef Zwernemann (+)	c106	c20	57	101			52
Hptm Werner Lucas (+)	105	1	52				3
HptmEmilBitsch(+)	104	4	105				3
Obit Ernst-Wilhelm Reinert	103	71	53	103	(?)		77
Lt Heinz Sachsenberg	103	1	101				57
Oberst Viktor Bauer	102	4	34	102			3
Hptm Rudolf Miethig (+)	101		50				52
Lt Ulrich Wernitz	101		82				54*
Obstlt Friedrich-Karl Müller (+)	100	40	c30	100			53,3
Lt Wilhelm Crinius	100	14	100	100			53

Key

(1) = includes US aircraft claimed over Rumania and Hungary

(2) = kills claimed in West, Mediterranean, Balkans and Reich

(3) = figures in awards columns indicate number of victories at the time of award
(figures in brackets for award won in another theatre)

(*) = after JG indicates pilot's score includes kills on Fw 190

(+) = after name indicates killed or missing

(c)=*circa*

Bf 109s on the Eastern Front- Representative Orders of Battle

21 June 1941 - Operation *Barbarossa*

			Variant	Est/Serv
<i>Lufflotte 1</i> (Northern Sector)				
SY3ÖJG54	Maj Hannes Trautloft	Lindental	F	4-3
I./JG 54	Hptm Hubertus von Bonin	Rautenberg	F	40-34
II./JG 54	Hptm Dieter Hrabak	Trakehnen	E/F	40-33
III./JG54	Hptm Arnold Lignitz	Blumenfeld	F	40-35
II./JG 53	Hptm Heinz Bretnitz	Neusiedel	F	35-33
<i>Lufflotte 2</i> (Central Sector)				
<i>Stab</i> JG 27	Maj Wolfgang Schellmann	Sobolevo	E	4-4
II./JG 27	Hptm Wolfgang Lippert	Berzniki	E	40-31
III./JG27	Hptm Max Dobislav	Sobolevo	E	40-14
II./JG 52	Hptm Erich Woitke	Sobolevo	F	39-37
<i>Stfa</i> ?JG51	Obstlt Werner Molders	Siedlce	F	4-4
I./JG 51	Hptm H-F Joppien	Staravis	F	40-38
II./JG 51	Hptm Josef Fözö	Siedlce	F	40-23
III./JG51	Hptm Richard Leppla	Halaszi	F	38-30
IV./JG 51	Maj Friedrich Beckh	Crzevica	F	38-26
SY3ÖJG53	Maj Frh G von Maltzahn	Crzevica	F	6-6
I./JG 53	Obit Wilfried ßalfanz	Crzevica	F	35-29
III./JG53	Hptm Wolf-Dietrich Wilcke	Sobolevo	F	38-36
<i>Lufflotte 4</i> (Southern Sector)				
SfsoJGS	Maj Günther Lützwow	Hostynne	F	4-4
I./JG 3	Hptm Hans von Hahn	Dub	F	35-28
II./JG 3	Hptm Lothar Keller	Hostynne	F	35-32
III./JG3	Hptm Walter Oesau	Modorovka	F	35-34
<i>5fa</i> ?JG52	Maj Hans Trübenbach	Bucharest/Mizil	<i>f</i>	4-3
III./JG2	Maj Gotthard Handrick	Mizil/Pipera	<i>f</i>	43-41
<i>Stab</i> JG 77	Maj Bernhard Woldenga	Bacau	<i>E</i>	2-2
II./JG 77	Hptm Anton Mader	Roman	E	39-19
III./JG 77	Hptm Alexander von Winterfeld	Bacau	E/F	35-20
I.(J)/LG 2	Hptm Herbert Ihlefeld	Janca	E	40-20

Totals: 793-619

July 1942 - circa Operation Braunschweig

Luftflotte 1 (Northern Sector)

Stab JG 54	Obstlt Hannes Trautloft	Siverskaya	F	2-1
I./JG 54	Hptm Hans Philipp	Krasnogvardeisk	F/G	40-25
II./JG 54	Maj Dietrich Hrabak	Ryelbitzi	F	40-28
III./JG 54	Hptm Reinhard Seiler	Siverskaya	F	22-18

Lw.KdoOst (Central Sector)

SfaoJGS1	Obstlt Karl-Gottfried Nordmann	Orel	F	2-1
I./JG 51	Hptm Heinrich Krafft	Vyasma	F	31-15
II./JG 51	Hptm Hartmann Grasser	Orel	F	34-30
III./JG 51	Hptm Richard Lappla	Vyasma	F	37-22
IV./JG 51	Hptm Hans Knauth	Sechinskaya	F	36-29

Luftflotte 4 (Southern Sector)

StabJG3	Obstlt Günther Lützwow	Millerovo-North	F	3-2
I./JG 3	Hptm Georg Michalek	Morosovskaya	F	24-9
II./JG 3	Maj Kurt Brändle	Millerovo	F	22-10
III./JG 3	Maj Karl-Heinz Greisert	Millerovo	F	25-12
SfaoJG52	Maj Herbert Ihlefeld	Taganrog	F	4-4
II./JG 52	Hptm Johannes Steinhoff	Taganrog	F	40-24
III./JG 52	Maj Hubertus von Bonin	Kharkov	F/G	35-20
I./JG 53	Maj Herbert Kaminski	Kharkov	F/G	40-8
Sfa6JG77	Maj Gordon Gollob	Kastornoye	F	4-4
II./JG 77	Hptm Anton Mader	Kastornoye	F	23-16
III./JG 77	Hptm Kurt Ubben	Kerch-IV	F	27-21

Luftflotte 5 (Arctic)

II./JG 5	Hptm Horst Carganico	Petsamo	E/F	35-25
III./JG 5	Hptm Günther Scholz	Petsamo	E/F	23-17

Totals: 549-341

July 1943 - circa Operation Zitadelle

Luftflotte 4 (Southern Sector)

II./JG 3	Maj Kurt Brändle	Kharkov-Rogan	G	46-30
III./JG 3	Maj Walther Dahl	Bessonovka	G	36-25
SYa6JG52	Obstlt Dietrich Hrabak	Krivotorovka	G	4-2
I./JG 52	Hptm Helmut Bennemann	Poltava	G	36-27
II./JG 52	Hptm Helmut Kühle	Anapa	G	42-27
III./JG 52	Maj Günther Rail	Orel	G	31-14

iofir/7ofte5(Finland/Arctic)

II./JG 5	Obstlt Kurt Kettner	Alarkurtti	E/F/G	23-18
III./JG 5	Maj Heinrich Ehrler	Petsamo	E/F/G	26-24

Totals: 244-167

26 June 1944 - Soviet Summer Offensive

Luftflotte 6 (Central Sector)

I./JG 51	Maj Erich Leie	Orscha	G	35-20
III./JG 51	Hptm D von Eichel-Streiber	Bobruisk	G	31-14

Luftflotte 4 (Southern Sector)

Sfa6JG52	Obstlt Dietrich Hrabak	Manzar	G	1-1
I./JG 52	Hptm Adolf Borchers	Leipzig (Rum)	G	23-20
II./JG 52	Hptm Gerhard Barkhorn	Manzar	G	11-7
III./JG 52	Hptm Wilhelm Batz	Roman	G	19-15
I./JG 53	Maj Jürgen Harder	Targsorul-Nou	G	28-24

Luftflotte 5 (fucl/c)

III./JG 5	Hptm Franz Dörr	Petsamo	G	24-21
-----------	-----------------	---------	---	-------

Totais: 172-122

April 1945

Lw.Kdo. Ostpreussen (Northern Sector)

I./JG 51	Hptm Günther Schack	Littausdorf	G	10-8
III./JG 51	Hptm Joachim Brendel	Junkertroylhof	G/K	23-7

Luftflotte 6 (Central Sector)

5faöJG52	Obstlt Hermann Graf	Deutsch-Brod	G	8-7
I./JG 52	Hptm Erich Hartmann	Chrudim	G	37-34
III./JG 52	Maj Adolf Borchers	Deutsch-Brod	G/K	40-33

Luftflotte 4 (Southern Sector)

II./JG 51	Oblt Otto Schulz	Fels am Wagram	G	7-5
II./JG 52	Hptm Wilhelm Batz	Hörsching	G/K	55-36
I./JG 53	Hptm Helmut Lipfert	Hörsching	G	27-25

Totais: 207-1 55

Fw 190 Eastern Front Orders of Battle 1943-45

(A) 10 July 1943 (Battle of Kursk)

Luftflotte 1 (Leningrad area)

	<i>Strength</i>	<i>Serviceable</i>
Stab JG 54	5	5
II./JG54(Fw190/Bf 109)	50	28
12./JG54	11	8

Luftflotte 6 (Kursk Northern Flank)

Stab JG 51	15	10
I./JG 51	28	15
III./JG 51	35	19
IV./JG 51	30	25
[15.(span.)/JG51	22	16]
I./JG 54	32	19

Luftflotte 4 (Kursk Southern Flank)

Stab Schl.G 1	2	1
I./Schl.G1 (Fw190/Hs129)	51	36
II./Schl.G! (Fw190/Hs129)	54	38

TOTALS:	335	220
----------------	------------	------------

(B) 26 June 1944 (Soviet Summer Offensive)

Luftflotte 1 (Northern Sector)

<i>Gefechtsverband Kuhlmei</i> (Finland)			
II./JG 54	Immola	28	19
1./JG54	Turku	12	9
1./SG5	Immola	12	5

Jagdabschnittsführer Ostland (Estonia)

Stab JG 54	Dorpat	12	7
I./JG 54 [minus!.]			
	Reval-Laksberg	22	13

Luftflotte 6 (Central Sector)

1. Fliegerdivision			
Stab SG1	Pastovichi	5	4
III./SG 1	Pastovichi	38	20
I./SG10	Bobruisk	36	22

4. Fliegerdivision

III./SG 10	Dokudovo	39	30
------------	----------	----	----

Jagdabschnittsführer 6

Stabsstaffel JG 51			
(Fw190/Bf109)	Orscha	12	11

Luftflotte 4 (Southern Sector)

I. Fliegerkorps (Rumania)			
II./SG2	Zilistea	27	20
II./SG10	Culm	29	18

VIII. Fliegerkorps (Poland)

II./SG77	Lemberg (Lvov)	33	24
----------	----------------	----	----

TOTALS:	305	202
----------------	------------	------------

(C) 1 April 1945 (*Post-Bodenplatte* build-up)

Luftflotte 1 (North)

<i>Luftwaffenkommando Courland</i>		
Stab JG 54	5	4
I./JG 54	38	33
II./JG 54	40	37
III./SG 3	43	42

Luftwaffenkommando Ostpreussen

Stab(Staffel)JG51	22	21
I./SG3	45	31

Luftflotte 6 (Centre)

Stab JG 1	4	4
II./JG 1	68	67
Stab JG 3	5	5
[II./JG 3]		
IV./JG 3	58	47
II./JG 4	57	57
StabJG6(Fw190/Bf109)	4	4
I./JG 6	72	55
II./JG 6	47	45
StabJG 11	4	4
I./JG 11	45	45
III./JG 11	45	44
III./JG 54	42	42
[II./JG 300]		
[II./JG 301]		
[III./JG 301]		

Stab SG 1	3	3
I./SG1	42	38
II./SG 1	44	39
III./SG 1 (minus 8.)	41	20
Stab SG 2	8	6
II./SG 2	49	49
Stab SG 3	8	7
II./SG 3	43	40
Stab SG4	1	1
I./SG4	29	19
II./SG 4	39	32
III./SG 4	21	9
1.(Pz)/SG9	16	15
Stab SG 77	8	7
I./SG77	34	33
II./SG 77	35	29
III./SG 77	45	41
13./SG151	18	18

Luftflotte 4 (South)

I./SG 2	28	19
Stab SG 10	6	4
I./SG10	19	9
II./SG 10	4	0
III./SG 10	33	17
ung.Schl.Gr. (Hungarian)	23	12

TOTALS:	1239	1054
----------------	-------------	-------------

SELECTED BIBLIOGRAPHY

- ADERS, GEBHARD and HELD, WERNER**, *Jagdgeschwader 51 'Mölders'*. Motorbuch Verlag, Stuttgart, 1985
- BARBAS, BERND**, *Planes of the Luftwaffe Fighter Aces*, Vols. 1 & 2. Kookaburra, Melbourne, 1985
- CONSTABLE, TREVOR J and TOLIVER, COL RAYMOND F**, *Horrido! Fighter Aces of the Luftwaffe*. Macmillan, New York, 1968
- CONSTABLE, TREVOR J and TOLIVER, COL RAYMOND F**, *The Blond Knight of Germany: A Biography of Erich Hartmann*. Doubleday & Co., New York, 1970
- DIERICH, WOLFGANG**, *Die Verbände der Luftwaffe 1935-1945*. Motorbuch Verlag, Stuttgart, 1976
- EWALD, HEINZ**, *Esau: Als Jagdflieger im erfolgreichsten Jagdgeschwader 1943-1945*. Privately printed, Coburg, 1975
- FRASCHKA, GÜNTER**,. . . mit *Schwertern und Brillanten*. Erich Fabel Verlag, Rastatt, 1958
- GIRBIG, WERNER**, *Jagdgeschwader 5 'Eismeerjäger'*. Motorbuch Verlag, Stuttgart, 1976
- GROEHLER, OLAF**, *Kampf um die Luftherrschaft*. Militärverlag der DDR, Berlin, 1988
- HARDESTY, VON**, *Hed Phoenix, The Rise of Soviet Air Power, 1941-1945*. Arms and Armour Press, London, 1982
- HAYWARD, JOEL S A**, *Stopped at Stalingrad*. University Press of Kansas, Lawrence, 1998
- HELD, WERNER**, *Die Deutschen Jagdgeschwader im Russlandfeldzug*. Podzun-Pallas-Verlag, Friedberg, 1986
- HELD, WERNER/TRAULOF, HANNES/BOB, EKKEHARD**, *Die Grünherzjäger, Bildchronik des Jagdgeschwaders 54*. Podzun-Pallas-Verlag, Friedberg, 1985
- KUROWSKI, FRANZ**, *Balkenkreuz und Hoter Stern, Der Luftkrieg über Russland 1941-1944*. Podzun-Pallas-Verlag, Friedberg, 1984
- LIPFERT, HELMUT**, *Das Tagebuch des Hauptmann Lipfert*. Motorbuch Verlag, Stuttgart, 1973
- MEILLER-HAFNER, ALFONS**, *Flieger Feinde Kameraden*. Erich Pabel Verlag, Rastatt, 1962
- MÖLLER-WITTEN, HANNES**, *Mit dem Eichenlaub zum Ritterkreuz*. Erich Pabel Verlag, Rastatt, 1962
- MOMBEEK, ERIC**, *Sturmjäger; Zur Geschichte des Jagdgeschwaders 4 (2 vols)*. Verlag ASBL, Linkebeek/Belgium, 1997-99
- NOWARRA, HEINZ J**, *Luftwaffen-Einsatz Barbarossa 1941*. Podzun-Pallas-Verlag, Friedberg,
- OBERMAIER, ERNST**, *Die Ritterkreuzträger der Luftwaffe 1939-1945; Band I, Jagdflieger*. Verlag Dieter Hoffmann, Mainz, 1966
- PLOCHER, GENERALLEUTNANT HERMANN**, *The German Air Force versus Russia, 1942*. Arno Press, New York, 1966
- PLOCHER, GENERALLEUTNANT HERMANN**, *The German Air Force versus Russia, 1943*. Arno Press, New York, 1967
- PRIEN, JOCHEN**, *Geschichte des Jagdgeschwaders 53 3volst. Flugzeug (vol 1)* 1989/Struwe Druck, Eutin, 1990
- PRIEN, JOCHEN**, *Geschichte des Jagdgeschwaders 77 14 vols*). Struwe Druck, Eutin, 1992
- PRIEN, JOCHEN and STEMME, GERHARD**, *Jagdgeschwader 3* (4 vols of individual *Gruppe* histories). Struwe Druck, Eutin
- PRIEN, JOCHEN/RODEIKE, PETER/STEMME, GERHARD**, *Jagdgeschwader 27* (3 vols of individual *Gruppe* histories). Struwe Druck, Eutin
- RING, HANS and GIRBIG, WERNER**, *Jagdgeschwader 27*. Motorbuch Verlag, Stuttgart, 1971
- ROBA, JEAN-LOUIS et MOMBEEK, ERIC**, *La Chasse de Jour Allemande en Roumanie*. Editions Modelism Int., Bucharest, 1994
- ROHDEN, HANS-DETLEF HERHUDT VON**, *Die Luftwaffe ringt um Stalingrad*. Limes Verlag, Wiesbaden, 1950
- SCHREIER, HANS**, *JG 52, Das Erfolgreichste Jagdgeschwader des II. Weltkrieges*. Kurt Vowinckel Verlag, Berg am See, 1990
- SCUTTS, JERRY**, *JG 54 Aces of the Eastern Front*. Airlife Publishing Ltd, Shrewsbury, 1992
- SHORES, CHRISTOPHER**, *Air Aces*. Bison Books, Greenwich, 1983
- STIPDONK, PAUL and MEYER, MICHAEL**, *Das JG 51: Eine Bilddokuination über die Jahre 1938-194b*. Heinz Nickel, Zweibrücken, 1996

INDEX

References to illustrations are shown in bold. Colour Plates are prefixed 'pH.' or 'pI2.' and Figure Plates 'fig.pM.' or 'fig.pI2.', with page numbers and caption locators in brackets.

6. *Armee* 58, 59, 62-63,70
M.Armee 73,74

Ademeit, Unteroffizier Horst 52,170

Bär, Leutnant (later Hauptmann) Heinz Pritzl' 22, 52-53, 53

Bareuther, Oberfeldwebel Herbert pI2.12(135,153)

Barkhorn, Leutnant (later Hauptmann) Gerhard 8,9, 25, pH.19(37, 47), 67, 81, 81-82, 83, 89, 90,129, pI2.6(133,152), 176

Batz, Oberleutnant (later Hauptmann) Wilhelm 83, 83, 86, 89, 90

Bauer, Oberleutnant Viktor pH.6(34,45), 69

Beckh, Oberstleutnant Friedrich 53, 65-66

Beerenbrock, Oberfeldwebel Franz-Josef 55, 55

Beims, Leutnant Walter 105

Beisswenger, Leutnant (later Oberleutnant) Hans 'Beisser' 52,108,109, pI2.45(143,157)

BellP-39Airacobra 12

Bennenmann, Oberleutnant Helmut 65, 66, 66

Berlin, Tempelhof airport 181

Beutelspacher, Oberleutnant Ernst 129,131

Birkner, Leutnant Hans-Joachim 88,89

Bitsch, Oberleutnant Emu 76, 77

Bleckmann, Hauptmann Günther pI2.60(147,158-159), 173

Bode, Hauptmann Helmut 29

Boeing B-17G 84

bombs, SB 500 kg High Explosive (HE) 114

bombs, SD-1 and SD-2 anti-personnel cluster *Splitterbomben* 20, 20, 44,124

Bonin, Major (later Oberstleutnant) Hubertus von pI2.22,23(137,154), 165, 168-169,169

Borchers, Hauptmann Adolf 88,89

Boremski, Oberfeldwebel Eberhard von pH.7(34, 45)

Brändle, Hauptmann Kurt pH.5(34,45), 69, 69-70, 76, 77

Brandt, Unteroffizier Helmut 108

Bremer, Feldwebel Peter pI236(141,156)

Brendel, Oberfeldwebel (later Hauptmann) Joachim'Achim' 53,86,101, fig.pI.6(149,159)

Bretnütz, Hauptmann Heinz 'Pietsch' 21

Brewster Buffalo 170

Brill, Oberleutnant Karl pI2.49(145,157)

Brach, Leutnant Hugo 178

Bromen, Oberleutnant Wilhelm 174

Buchner, Oberfeldwebel (later Leutnant) Hermann 124-125,125,127-130, 129,130,131, pI2.58(147,158), fig.pI.4(149,159)

Busch, Hauptmann Rudolf 100, pI2.10(134,153)

Busse, Oberleutnant Heinz 162

Carganico, Oberleutnant (later Major) Horst 58

Chir railhead 72

Clausen, Oberleutnant Erwin 61

Courland army 172

Courland peninsula 172,178-179,180-181

Crinius, Feldwebel Wilhelm 61-62

Dahl, Oberleutnant Walther 19

Dähne, Hauptmann Paul-Heinrich pI2.1(132,152)

Dammers, Feldwebel (later Leutnant) Hans 62,82,82

Danzig 176

Davidenko, Major Grigori 93

Demuth, Oberleutnant Emil 175

Demyansk'mushroom' 98,101,115

dispersal pens 71

Döbele, Oberfeldwebel Anton Toni' pI2.35(140,156), 164,168

Dommeratzky, Oberfeldwebel (later Leutnant) Otto pI2.54(146,158), 173-174,175

Dörrfel, Hauptmann Georg pI2.51(145,157)

Dorpat airfield, Estonia 170

Druschel, Major Alfred 123, pI2.50(145,157)

Dugino airfield 98

Düttmann, Leutnant Peter 'Bonifaz' pH.23(38,47), 89

Ebener, Feldwebel Kurt 72-73

Ehrler, Leutnant (later Major) Heinrich pH.10(35,46), 56-57

Eichel-Streiber, Hauptmann von 161

Einsiedel, Leutnant Heinrich Graf von 69

Eisenach, Hauptmann Franz pI2.27(138,155)

Ettel, Leutnant Wolf 74

Ewald, Leutnant Heinz 'Esau' pH.26(39,48)

Ewald, Hauptmann Wolfgang 68, 69

'fxperte'status 7

Fiat 6.50:171

Findheisen, Hauptmann Herbert 'Mungo' 178,179,180

Fleig, Leutnant Erwin 53, 54

Focke-Wulf

Fw 190: 93, 94, 95-97,122-124,150,170,171

Fw 190A-3: 95, 99, 99,105-106,117, pI2.5(133,152), pI2.8,10, 11(134,152-153), pI2.15(135,153), 151,181

Fw190A-4:95, 105-106,109,114,151

(I./JG 54) 104,106,107

(II./JG 54) 92

'BlackS' pI2.37(141,156)

'Black 11' pI2.38(141,156)

'Black 12' pI2.44(143,157)

'Black Double Chevron' pI2.25(138,155)

'Black Double Chevron and Bars' pI2.21(137,154)

'White 2' pI2.35(140,156)

'White3' pI2.36(141,156)

'White?' 105

'WhiteS' pI2.28(139,155)

'WhiteB' pI2.34(140,155-156)

'White 10' pI2.29(139,155)

'White Chevron and Bars' pI2.22(137,154)

'Yellow 1' pI2.12(135,153)

'Yellow 2' pI2.48(144,157)

'YellowS' pI2.13(135,153)

'Yellow 6' pI2.45(143,157)

Fw 190A-5 pI2.9(134,153), pI2.14(135,153), pI2.23(137,154), pI2.30(139,155), pI2.40(142,156), pI2.59(147,158)

Fw190A-6:150,151

'Black 5' pI2.42(142,156)

'Black?' pI2.43(142,156-157)

'Black Double Chevron' pI2.26(138,155), pI2.41(142,156)

Werk-Nr 410004 'Black Double Chevron' pI2.26(138,155), 167

'White 12' pI2.31(139,155)

'White Chevron and Bars' pI2.24(138,154-155), 170

'YellowS' pI2.39(141,156)

Fw190A-8:151

'Black 3 and Bars' pI2.17(136,154)

'Black 6 and Bars' pI2.18(136,154)

'Black 11 and Bars' pI2.19(136,154)

'Black 12 and Bars' pI2.20(137,154)

'Black Double Chevron' pI2.1(132,152), pI2.7(133,152), pI2.27(138,155)

'White!' pI2.32(140,155)

'WhiteS' pI2.49(145, 157)

'White 12' pI2.33(140,155)

'Yellow 1' pI2.2(132,152), pI2.47(143,157)

Fw190A-9 pI2.46(143,157)

Fw190D 181

Fw190D-9 pI2.3(132,152), pI2.4, 6(133,152), pI2.16(136, 153),

pI2.55(146, 158), 175, 175,176

Fw 190F 122,128
Fw 190F-2:121, pl2.50, 51(145,157), pl2.52-54, 56(145-146,158), 151
Fw 190F-9 pl2.57,58(147,158), pl2.60(147,158-159), 151,173
Fönnekold, Leutnant Otto 83, 83,87, 88
Fözö, Hauptmann Josef 22, 31, pH.16(36, 46), 54
Frank, Major Heinz 'Allan' pl2.56(146,158)

Gaiser, Oberfeldwebel (later Leutnant) Otto 7
Galland, *General der Jagdflieger* Adolf 53,116
Gallowsch, Oberleutnant (later Major) Bernd 54, pl2.2(132,152)
Gawlina, Leutnant 29
Gloster Gladiator 25
Gollob, Major (later Hauptmann) Gordon 27,27,63,66
Goring, *Heichsmarschall*Hermann 20-21, 22, 30,121
Götz, Oberleutnant Franz 'Alivater' 24, 24
Götz, Hauptmann Hans 119, pl2.37(141,156)
Graf, Leutnant (later Oberstleutnant) Hermann 31, pH.28(39, 48), 62,63,
63,88,88-89
Grashev, Major 93
Gratz, Leutnant Karl 'Charlie' 82,87
Greim, General Ritter/Papa'von 166,167
ground crew ('black men') 68, 70, 72,106,107,107,108,123,169,177

Hackl, Oberleutnant Anton Toni' pH .38(42,49), 61
Hafner, Feldwebel (later Oberleutnant) Anton pH.17(37, 46-47), 55, 85
Hahn, Hauptmann Franz pl1.8(34,45-46)
Hahn, Major Hans 'Assi' 45, 52,108-109
Hahn, Hauptmann Hans von 16, pH .3(33,45)
Haiböck, Hauptmann Sepp 128
Hangebrauk, Feldwebel Fritz 177
Hannig, Fähnrich (later Leutnant) Norbert 109-114,110, 111,
pl2.44(143,157), 168,172,179
Harder, Hauptmann Harro 48
Harder, Leutnant (later Major) Jürgen 17, pH .31(40, 48), 88,176
Hartmann, Leutnant (later Hauptmann) Erich 'Bubi' 8, pH .22(38,47),
pH .29(40, 48), 67, 78, 78-79, 79, 81-82, 82, 86, 86-87, 87, 88, 89, 90, 90
Hawker Hurricane 13
Heck, Walter 112
Heinzeller, Oberleutnant Josef pl2.33(140,155)
HenschelHs123:121
HenschelHs126:13,64
Heym, Leutnant Günther pl2.19(136,154)
Hitler, Adolf 14, 77,86, 87, 90,167,168,172,180
Hoekner, Hauptmann Walter 115
Höfemeier, Leutnant Heinrich 53,120
Homuth, Major Gerhard 119
Hrabak, Major (later Oberst) Dietrich 67,87, 88,170,180
Hübner, Leutnant (later Oberleutnant) Wilhelm 165,166,176
Huy, Oberleutnant Wolfdieter pH.40(42, 49)

Ihlefeld, Hauptmann Herbert pH.36(41, 49)
Illustrierte 168
Ilyushin Il-2 *Stormovik* 29, 29-30, 86, 96
Immola airfield 170,171
Ivanov, Senior Lieutenant IT 11

Jauer, Feldwebel Erich 116
Jennwein, Leutnant Josef 'Pepi' 101,120, pl2.13(135,153)
Johne, Unteroffizier Helmut pl2.17(136,154)
Joppien, Hauptmann Hermann Friedrich 95
Josten, Leutnant Günther pH.14(36,46), 84, 86
Jung, Hauptmann Heinrich 119
Junkers
Ju52:181
Ju87:56,121
Ju 87D 55

Kageneck, Oberleutnant Erbo Graf von 24, pH.12(35, 46)
Kaiser, Oberfeldwebel Herbert 29

Keller, Hauptmann Lothar 19,27
Kemethmueller, Oberfeldwebel Heinz 116
Kennel, Oberleutnant (later Major) Karl pl2.52(145,158), pl2.57(H7,158)
Kirschner, Oberleutnant Joachim 73-74,74,76,77,77
Kittel, Feldwebel (later Oberleutnant) Otto pH.35(41,49), 52,102,
pl2.39(141,156),fig.pl.1(148,159), 179-180
Kröpfer, Oberfeldwebel (later Oberleutnant) Heinz pH 18(37, 47)
Kohler, Unteroffizier 179
Kolbow, Oberleutnant Hans 22
Koppen, Feldwebel Gerhard 31, 32
Krafft, Oberleutnant (later Hauptmann) Heinrich 'Gaudi' pH .15(36,46), 53,
53,100, pl2.8(134, 152-153)
Krasnogvardeisk airfield 106-107
Kreitl, Unteroffizier Fritz 123
Kroschinski, Feldwebel (later Leutnant) Hans-Joachim 'Kroschi'
pl2.38(141,156), 178
Krupinski, Leutnant (later Oberleutnant) Walter 'Graf Punski' pH .24(38, 47),
67,75,76,76,79,79-80,81-82
Kuffner, Hauptmann Andres 174
Kursk, Battle of 124-125
Kutscha, Hauptmann Herbert pl2.7(133,152)

Lake Ivan 99
Lambert, Oberfeldwebel (later Oberleutnant) August 130,130,
pl2.59(147, 158),fig.pl.2(148,159), 174
Lang, Leutnant Emil 'Bully' 112, pl2.43(142,156-157), 168,168
Langanke, Leutnant Gustav 21-22
Lange, Hauptmann (later Major) Heinz 99,107, pl2.11(134,153), 177-178
Lavochkin La-5: 95
LavochkinLaGG-3:11,12
Lebsanft, Unteroffizier 126
Leie, Major Erich 'Tiger-Leie' pl2.9(134,153), 160
Lemke, Leutnant Wilhelm 74, 76
Lend-Lease aircraft 12-13
Leningrad 25, 26
Leppla, Hauptmann Richard 22, 23, 55, 55
Leykauf, Leutnant Erwin 52
Licht, Unteroffizier 179
Lignitz, Hauptmann Arnold 26
Lipfert, Leutnant (later Hauptmann) Helmut 79,83,84, 88
locomotives 125
Losigkeit, Hauptmann Fritz pl2.14(135,153), 160
Lucas, Oberleutnant Werner 76,77
Lüddecke, Oberfeldwebel Fritz 'Pauli' pl2.18(136,154), 162
Luftwaffe *Ergänzungsjagdgeschwader* 171
Luftwaffe *Gruppe Schlacht*, I and II 173
Luftwaffe *Jagdgeschwader*(JGI
JG 1

I. *Gruppe* 175
II. *Gruppe* pl2.1(132,152), 175
7. *Staffel* pl2.2(132,152)
JG 3 'Udel' 19, 26, 27, pH.1,2(33, 45), 62-63, 68, 68-69, 70, 71, 73
I. *Gruppe* pH.3,4(33,45),68
II. *Gruppe* 19, pH .5(34, 45)
III. *Gruppe* 73
IV. *Gruppe* pl2.3(132,152), 175,175,176
4. *Staffel* 74, 77
9. *Söffe*/pH.6,7(34,45)
JG 4 pl2.4(133,152)
I.*Gruppe* pH.8(34, 45-46)
JG 5: 56-58,116
II. *Gruppe* 56
III. *Gruppe* pH.9(35, 46), 56
6. *Staffel* pH.10(35, 46)
7. *Staffel* pH. 11(35,46)
U.Uaboj *Staffel* 116-117,117, pl2.5(133,152)
JG 6 pl2.6(133,152), 176
JG 11 I.*Gruppe* 176
JG 11 III.*Gruppe* pl2.7(133,152), 176

JG 26 *Schlageteri Gruppe* 106,115-116

JG 26 7. *Staffel* 116

JG27:24

II. Gruppe 19,24

III. Gruppe 19

9. *Söffe*/pH.12(35,46)

JG 51 'Mulders' 22, 23, 23-24, pH.13(36, 46), 52-54, 55, 56, 85-86, 98-101,118-120,160-162

I. Gruppe 94-95, 97, 98-99, 99,100,101, pI2.8-10(134,152-153)

II. Gruppe pH.16(36,46),98

III. Gruppe 98,100,101,127, pI2.14(135,153)

N.Gruppe 56, 101, 120,177-178

1. *Staffel* pH.14(36, 46)

3. *Staffel* pI2.11-13(134-135,153)

4. *Staffel* 98

5. *Staffel* 98

S. *Staffel* pH.17(37,46-47)

7. *Söffe*/54, pI2.15(135,153)

8. *Staffel* pH.15(36,46)

W.*Staffel* pH.18(37,47)

n. *Staffel* pI2.16(136,153)

Stabstaffel pI2.17-20(136-137,154), 162,177

JG 52: 30, 62-63, 65, 73, 74, 78, 83-85, 86, 88

I. Gruppe pH.19(37, 47), **63, 64, 66, 75, 78, 80, 90**

I I. Gruppe pH.21(38, 47), **64, 65, 66, 73, 79, 83, 84, 87-88, 89**

I I I. Gruppe 66, 74, 75, 78, 81, 82, 85, 86, 89, 90

2. *Staffel* pH.20(37, 47)

4. *Staffel* pH.22(38, 47)

5. *Staffel* pH.23(38,47)

6. *Staffel* pH.24-26(38-39, 47-48), 83

8. *Staffel* pI 1.27(39,48)

9 'Karaya' *Staffel* 31, pH.28-29(39-40, 48), 78-79, 79

Stabstaffel 75

JG53 pH.30(40, 48)

I. Gruppe 61,88

II. Gruppe 77

III. Gruppe 24,32, pH.31(40,48),77

JG 54 'Grünherz' ('Green Hearts') 25, 26, pH.32(40,48), 51-52,102-114,

108,114,118, pI2.21-24(137-138,154-155), 163-172

I. Gruppe pH.33(41, 48-49), 102,104,105,106,107,108, pI2.25-27(138, 155,167,178,179

II. Gruppe 92, 94, pI2.41(142,156), 172,178,179

III. Gruppe 106

IV. Gruppe 169-170

1. *Staffel* pH .34(41, 49), pI2.28-36(138-141,155-156)

2. *Staffel* pH .35(41, 49), pI2.37,38(141,156)

3. *Staffel* pI2.39-40(141-142,156)

4. *Staffel* 170

5. *Staffel* 112, pI2 42-44(142-143, 156-157)

6. *Staffel* pI2.45,46(143,157)

7. *Staffel* pI2.47(143,157), 177

10. *Staffel* pI2.49(145,157)

Ergänzungsstaffel 171-172,172

JG 74 6. *Staffel* pI2.48(144,157)

JG 77: 26, 28, 59-61

II. Gruppe pH.37(42,49), 59,60,60

III. Gruppe 19, pH.39(42, 49), 59-60,60

5. *Staffel* pI 1.38(42,49)

7. *Staffel* pH.40(42,49)

JG300II. Gruppe 176

JG301:176

Luftwaffe *Jagdwafl*e 7, 24

Luftwaffe *Lehr*geschwader(LG) 1

I. Gruppe (J) pH .36(41,49)

II.(Sc<) Gruppe 121

Luftwaffe ScWac/?fgesc/?waa'er(Schl.G or SG)

Schl.G 1:121,122-126,123, pI2.50(145,157)

I.Gruppe pI2.51(145,157)

II. Gruppe 122,125,126

5. *Söffe*/pI2.52(14b, 1b8)

6. *Staffel* pI2.53(146,158)

8. *Staffel* pI2.54(146,158)

Stabstaffel 123

SG 2 pI2.55(146, 158)

II. Gruppe 126,127,127-131, pI2.56-57(146-147,158), 173

4. *Staffel* pI2.58(147,158)

5. *Steffis*/p8.59(147,158)

6. *Staffe*/pI2.60(147,158-159)

SG 3 III. Gruppe 181

SG10:131

SG77I. Gruppe 126

Lützow, Major Günther Tranzl' 18, 26-27, pH.1(33, 45)

MTB, Soviet G-class 179

machine gun, MG 34:32

Mackert, Feldwebel 15

Mader, Hauptmann (later Oberst) Anton pH .37(42,49), pI2.24(138, 154-155,170,170

Mai, Oberfeldwebel Lothar 160

Malaja-Wiska ('Malaya-Whisky') landing strip 80,127-129

Maltzahn, Major Günther 'Henri' Freiherr von pH.30(40,48)

Marquardt, Oberfeldwebel Heinz 178

Mayers, Albert 181

Meissler, Unteroffizier Herbert 75

Merbeler, Feldwebel Johann pI2.20(137,154)

Mertens, Heinz 'Bimmel' 86

Meschkat, Feldwebel 179

Messerchmitt

8(109:9,94,95,96,99

Bf109E'Emil' pH.36(41, 49), 72

Bf109E-4/B 44

Bf109E-7:6,13,14,28, pH .9.12(35, 46)

Bf 109F 'Friedrich' 7,10,17,30, pI1.15,16(36,46), pI1.34,35(41,49),

pI 1.40(42, 49), 56, 59, 64, 69

Bf 109F-2 pI 1.1,3,4(33, 45), pI 1.30,31(40, 48), pH.33(41, 48-49)

Bf 109F-4 pH.5-8(34, 45), pH.13(36, 46), pH.18(37, 47), pH.37,38(42, 49), 44,73

Bf109F-4/trop 68

Bf 109G 'Gustav' 57, 65, 74, 76, 85, 90, 92,114

Bl 109G-2 pH .2(33, 45), pH .10.11(35, 46), pH .17(37, 46-47), pH 21, 24(38, 47), pH.27.28(39, 48), pH.32(40, 48), pH.39(42, 49), 44

Bf 109G-2 Tfanonenboot(gunboat) 60, 70, 71

Bf109G-2/trop 98

Bf 109G-4 pH .23(38, 47), pH .25(39, 47-48), 43, 44

Bf 109G-6 pH.14(36, 46), pH.19,20(37, 47), pH.22(38, 47), pH.29(40, 48), 44,78,79,81,85,87

Bf109G-6 'Kanonenboot'(gunboat) pI1.26(39, 48)

Bf 1096-14:44

Bf 110:173

Michalski, Oberstleutnant Gerhard pI2.4(133,152)

Miethig, Hauptmann Budolf 75

Mietusch, Staffelpatän 116

Mikoyan MiG-3:17,18,25

Missner, Feldwebel Helmut 119

Mölders, Oberstleutnant Werner 'Vati' 18,18-19,22,23, 24,29,29

Morozovskaya ('Mora') airfield 71-76

Müller, Oberleutnant (later Hauptmann) Friedrich-Karl 'Tutti' 61,61

Müller, Feldwebel Budolf 'Rudi' 58

Muller, Oberfeldwebel Xaver 109-112,113,114

Mutherich, Oberleutnant Hubert 'Hubs' 26

Nemitz, Oberfeldwebel Willi 'Altwater' 75

Neuhoff, Feldwebel (later Oberfeldwebel) Hermann 22,24

nightfighter sorties 51-52

Nordmann, Major (later Oberstleutnant) Karl-Gottfried 18, pH .13(36,46), 53,54,100

North American Mustang Mk I 13

Norz, Oberfeldwebel Jakob 'Jockei' 58

Nossek, Oberleutnant Rainer 174
 Nowotny, Leutnant Walter (later Hauptmann) 25-26, pH.34(41, 49),
 102-105,103,118,119, p!2.26.28-30(138,139,155), fig.pl.5(149,159),
 163-168,165,167

Obleser, Leutnant Friedrich 82,87
 Oesau, Hauptmann Walter 28
 Olejnik, Oberleutnant Robert 15,15, 27
 operations
Barbarossa 6-7,15-32,102
Braunschweig (Brunswick) 58-59, 62, 66
Fall Blau (Case Blue) 58
Zitadelle 14, 73, 75-76, 77,118-120
 orders of battle 184-187
 Ostermann, Oberleutnant Max-Hellmuth 51

Pflugbeil, Generaloberst Kurt 'Papi' 180,180
 Philipp, Oberleutnant (later Hauptmann) Hans Tips' 26, 26, pH .33(41,
 48-491, 51,108,109, p!2.25(138,155)
 Pichler, Oberfeldwebel Johann 60
 pilots with 100+ Eastern Front victories 182-183
 Pitomnik, *Plaüschutisüffel* (Airfield defence squadron) 72-73
 Pitomnik airstrip 70,71,73
 Polikarpov
 1-16:10,25
 1-17:17-18
 1-153:23
 Prossnitz 131

Fiademacher, Rudolf 164
 Rail, Oberleutnant (later Hauptmann) Günther 31, pH .27(39, 48), 67, 67,75,
 79, 79, 80, 80, 83
 ramming ('taran') attacks 10-11
 Rauch, Oberfeldwebel Alfred 178
 Red Banner Baltic Fleet 92
 Reinert, Feldwebel Ernst-Wilhelm 61
 Resch, Major Rudolf 119
 Richthofen, Gefreiter Wolfgang von 130
 Riemann, Hauptmann Horst 100
 Rohwer, Leutnant Detlev pH.4(33,45)
 Romm, Oberleutnant Oskar 'Ossi' p!2.3(132,152), 175-176,176
 Rommer, Unteroffizier 94
 Rudel, Major (later Oberst) Hans-Ulrich p!2.55(146,158), 174
 Rudorffer, Hauptmann (later Major) Erich 120, p!2.41(142,156), 177,179
 Rumania 87
 Ryelbitzi airfield 115
 Rzhew-Vyazma salient 98,100,124

Sattig, Hauptmann Karl 51
 Schack, Leutnant (later Oberleutnant) Günther 86,100-101,160-161
 Schaulen(Siauliai), Lithuania 25
 Scheel, Leutnant Günther 119
 Schellmann, Major Wolfgang 21,21
 Schentke, Oberfeldwebel (later Oberleutnant) Georg 'Peterle' 73,73
 Scheuermann (war correspondent) 108
 Schiess, Franz 18
 Schirmböck, Oberleutnant Georg 28
 Schieinhege, Leutnant Hermann 178
 Schmelzer, Oberfeldwebel Reinhold 28-29
 Schmidt, Leutnant Erich 23,24
 Schmidt, Leutnant (later Hauptmann) Heinz 'Johnny' 67,67,79
 Schnorrer, Feldwebel Karl 'Quax' p!2.34(140,155-156), 164,166,167-168
 Scholz, Hauptmann Günther pH.9(35,46)
 Schramm, Leutnant Herbert 24
 Schuck, Oberleutnant Walter 57, 57, 58
 Schulz, Leutnant 178
 Seifert, *Gruppenkommandeur* Johannes 116
 Seiler, Hauptmann (later Major) Reinhard 'Seppl' 51-52,119

Setz, Oberleutnant (later Hauptmann) Heinrich 28, 60, 60-61
 Seyffardt, Leutnant Fritz 122, p!2.53(146,158)
 Siverskaya airfield 106-108
 snow removal 72
 Sochatzy, Oberleutnant Kurt 8
 Soviet airfields 16
 Stalingrad 14,62,70-71,73,98
 Stange, Oberleutnant Willy 21
 Steinbatz, Feldwebel (later Oberfeldwebel) Leopold 'Bazi' 65
 Steindl, Leutnant 13,14
 Steinhoff, Oberleutnant (later Hauptmann) Johannes 'Mäcki' 24-25,25,
 pl.21(38, 47), 66
 Stemflüg(Starflight) missions 84
 Sterr, Feldwebel (later Oberfeldwebel) Heinrich 'Bazi' ('Rascal') 113,
 p!2.48(144,157)
 Stollberger, Hauptmann Hans 122
 Stolz, Oberfeldwebel (later Oberleutnant) Max 52,108,109,119,
 p!2.42(142,156)
 Strakeljahn, Hauptmann Friedrich-Wilhelm 'Straks' 116,117,
 p!2.5(133,152), 173
 Strassl, Oberfeldwebel Hubert 118-119
 Strelow, Leutnant Hans 53, 53
 Sturm, Hauptmann Heinrich 89
 Süß, Oberfeldwebel Ernst 62

Tank, Dipl-Ing Kurt 94
 tanks, 1-34:124,128
 Tanzer, Leutnant Kurt p!2.16(136,153)
 Taubel, Feldwebel Peter 122-123
 Tazinskaya ('Tazi') airfield 71-72
 Thiel, Hauptmann Edwin 162
 Thyben, Unteroffizier (later Oberleutnant) Gerhard 77,
 p!2.47(143, 157), 181
 Tonne, Oberleutnant Wolfgang 61, 61-62
 Trautloft, Major (later Oberleutnant) Hannes 11, 26, pH.32(40,48), 51,
 118,p!2.21(137,154),fig.pl.3(148,159)
 Trenkel, Oberfeldwebel Rudolf pl.20(37, 47)
 TupolevSB-2:18,25

Ubben, Oberleutnant (later Hauptmann) Kurt 'Kuddel' 19, 28, pH .39(42,49)
 Udet, *Generalluftzeugmeister* Ernst 19, 45
 Ullmann, Oberleutnant 8

VelikiyeLuki 100,101

Wagner, Oberfeldwebel Edmund 7
 Waldmann, Feldwebel (later Leutnant) Hans 'Dackel' pH .25(39,47-48),
 65,83
 Weber, Oberleutnant Karl-Heinz 160
 Wehnelt, Hauptmann Herbert p!2.15(135,153)
 Weiss, Leutnant Robert 'Bazi' p!2.40(142,156)
 Weissenberger, Oberleutnant (later Hauptmann) Theodor pH .11(35,46), 57,
 57-58
 Wemicke, Leutnant Heinz 'Piepl' p!2.32(140,155), 178
 Wettstein, Leutnant (later Hauptmann) Helmut p!2.31(139,155),
 p!2.46(143,157),178,180
 Wiese, Hauptmann Johannes 66, 66,76, 81-82
 Wiezorek, Unteroffizier 131
 Wilcke, Hauptmann (later Major) Wolf-Dietrich 'Fürst' 17,17,23,24, 24,
 pH.2(33, 45),69
 Willius, Feldwebel Karl 'Charlie' 116
 Witzel, Leutnant Hans 16
 Wolf, Feldwebel (later Oberfeldwebel) Albin 113,169,169

Yakovlev Yak-7B 95

Zellot, Leutnant Walter 54
 Zwernemann, Oberfeldwebel Josef 'Jupp' 62