

OSPREY · MEN-AT-ARMS SERIES

The Stonewall Brigade

Text by JOHN SELBY

Colour plates by MICHAEL ROFFE



MEN-AT-ARMS SERIES

EDITOR: PHILIP WARNER

The Stonewall Brigade

Text by JOHN SELBY

Colour plates by MICHAEL ROFFE



OSPREY PUBLICATIONS LIMITED

Published in England by
Osprey Publications Ltd, P.O. Box 25,
707 Oxford Road, Reading, Berkshire
© Copyright 1971 Osprey Publications Ltd

This book is copyrighted under the Berne Convention. All rights reserved. Apart from any fair dealing for the purpose of private study, research, criticism or review, as permitted under the Copyright Act, 1956, no part of this publication may be reproduced, stored in a retrieval system, or transmitted in any form or by any means, electronic, electrical, chemical, mechanical, optical, photocopying, recording or otherwise, without the prior permission of the copyright owner. Enquiries should be addressed to the Publishers.

The author and publishers would like to thank the Confederate Historical Society and the editor of their journal for their kind assistance with the illustrations.

SBN 85045 052 7

T. J. Jackson



The Stonewall Brigade was the creation of Thomas Jonathan Jackson. Jackson was born at Clarksburg, Harrison County, Virginia on 21 January 1824. Both his parents died young, and after staying with his grandmother until her death, and then with various relatives, he lived from the age of seven with his well-to-do bachelor uncle Cummings Jackson at his farm and mill in Lewis County, Virginia. Uncle Cummings was a good guardian. He treated his nephew as he would his own son and brought him up to be trustworthy and reliable. On the farm he was able to follow country pursuits and became among other things a good horseman. But that was not all. His uncle also obtained for him the best education open to the youth of America. When a vacancy occurred in 1842 at the Military Academy at West Point, through the agency of his uncle's friend Samuel Hayes who was a Member of Congress Jackson was appointed to fill it. Although he lacked formal schooling, and found the work very difficult, West Point suited Jackson. He firmly believed in system and method, and the combination of academic studies with military training and severe discipline fitted his philosophy of life. Surrounded

by cadets who had much more education, and hampered by being slow to learn, he got through his first year at West Point by sheer force of will. Thereafter, by continued rigid application he rose higher and higher in his class. His fellow cadets said that if the course had been a year longer he would have come out first. In any case his high final standing allowed him to choose his arm of the service, and he requested assignment to the artillery – an honoured and active corps which had also been Napoleon's selection.

After West Point Jackson saw service in the Mexican War. Gen. Zachary Taylor had advanced from the north over the Rio Grande; but progress was slow, and instead of continuing the drive there in more strength, an amphibious

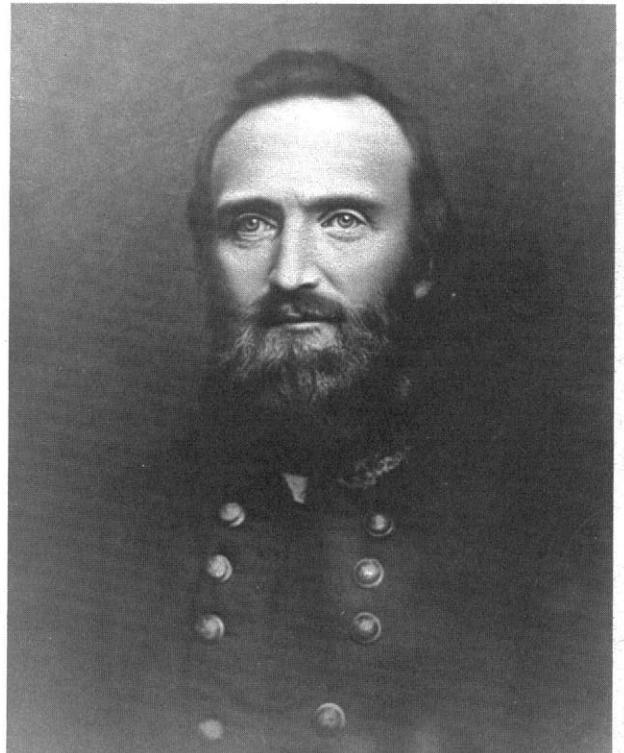

Thomas Jonathan (Stonewall) Jackson, pictured in the early 1860s.

Confederate officers' rank insignia on 'kepi', collar and sleeve. Top row: general, colonel, lieutenant-colonel; bottom row: major, captain, 1st lieutenant, 2nd lieutenant.

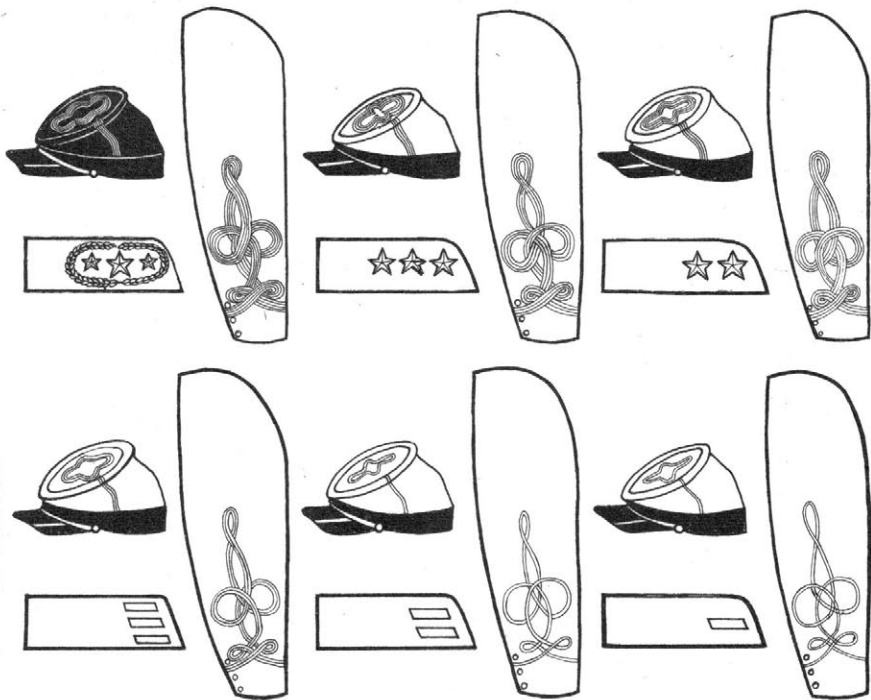

expedition under Gen. Winfield Scott was planned to land near Veracruz on the east coast of Mexico, and march up the National Road on the capital, Mexico City. Jackson, posted to the First Artillery, joined this expedition; and with the First Artillery acting as infantry, took part in the storming of Veracruz. The American forces marching inland were then forced to fight a series of actions against Mexicans in defence positions on mountain barriers across the National Road. At one of these, the Cerro Gordo, Gen. Scott carried out a model operation to clear the way. First, Capt. Robert Lee (later Commander-in-Chief of the Confederate Forces) scouted round the Mexican left flank and discovered a route by which the Mexican position could be turned. Then a flanking column swung round by it and cut the National Road, while a frontal attack kept the Mexican defenders occupied. Although Jackson did not take an active part in the battle, he learnt several lessons from watching its progress. Gen. Scott made full use of his engineers to find out all they could about the Mexican position and plot the flanking route

round it. Next, Scott carried through a successful surprise flank attack – the Mexican Gen. Santa Anna is reported as saying that he had not believed a goat could approach his lines that way. Finally, although hampered by a shortage of cavalry, he followed up with a quick and vigorous pursuit. Scout, flank, pursue – here was a formula to become familiar as Jackson's own trade-mark in the future. He also learnt the limitations of volunteers. The United States Army was a very small one. Even in this restricted operation in Mexico, Gen. Scott had to rely on a proportion of volunteers. Some of these were enlisted for three months only, and had to be sent home in the middle of the campaign – a feature to be repeated in the early days of the American Civil War. Also, they did not show up well in action. At Cerro Gordo, for example, the volunteers were badly disciplined and soon got into complete confusion. The First Tennessee Regiment had seen service at Monterey and was fairly well disciplined; but the other troops of the brigade were eminently raw, and the check which had been received shook the

nerves of many so that a large number fled from the colours.

Maj. Magruder of the First Artillery captured four guns at Cerro Gordo, and Gen. Scott presented them to him in recognition of his gallantry. Jackson, eager to return to his own arm, volunteered to serve with Magruder when he reverted to artillery. This turned out to be a fortunate move. Approaching Mexico City from the south-west, having skirted the great lakes of Chalco and Yochisilco, the Americans were held up at the fortress of Chapultepec on the outskirts of the capital. In the storming of the fortress on its high hill, Jackson played a distinguished part. In a force on the left under Col. William Trousdale he was in independent command of two of Magruder's guns. The position to which Trousdale advanced was exposed to fire from the castle, causing serious annoyance. Believing he saw reinforcements entering the castle, he determined to advance. Lieut. Jackson was ordered to move forward with the guns, and a part of the 14th Regiment to follow in support. Before the pieces were unlimbered, a heavy fire of cannon and musketry was opened from the barricades, besides that from the castle above. Under it, the horses of the pieces were nearly all killed and disabled, the drivers and cannoneers much cut up, and the supporting force instantly checked. The soldiers found some shelter and held their ground (other authorities say that except for a doughty sergeant they ran away); with great exertion Jackson got one of his pieces out of the direct fire, and opened in reply to the enemy. The point was then held until the castle was carried and the Mexicans around the barricades commenced the retreat.

Jackson's share in the glory of the victories in the Mexican War was considerable. Highly praised by Magruder and Gen. Scott, within eighteen months from joining his regiment he was breveted major. Such promotion was phenomenal even in the Mexican War, and none of his West Point comrades made so great a stride in rank.

After Mexico Jackson served at Fort Hamilton on Long Island, New York, and then in Florida, where he was attached to a force which had the task of subduing a number of Seminole Indians who were eluding deportation to Indian Territory and making the lives of the Florida settlers

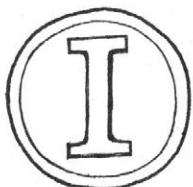
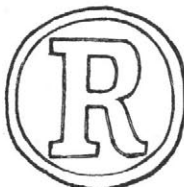

Coat buttons:
general; artillery;
rifleman; infantry

**The uniform jacket
and belt with the
Confederate buckle**

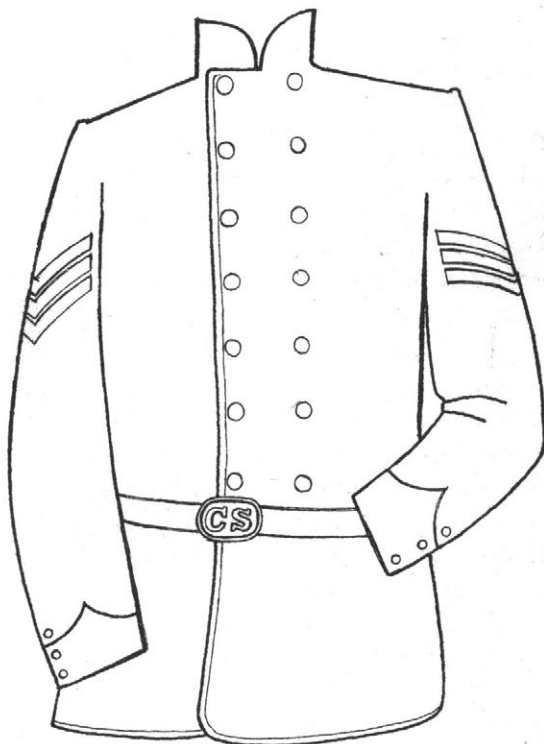

hazardous. Next, in 1851 he became Professor of Philosophy and Artillery Tactics at the Virginian Military Institute at Lexington. The cadets of the V.M.I., although they wore uniform, were taught by officers from the Regular Army, were disciplined as soldiers and spent some of their time in camp, were not all destined for a military career. Still, in all essential respects, the V.M.I. was little behind West Point. The discipline was strict and the drill precise. The cadets had their own officers and sergeants, and the whole establishment was administered on a military footing. Therefore, although he had left the army, Jackson had not escaped the military way of life. He was destined to spend several years at Lexington, to marry and lose his first wife, and then to marry for the second time. His time there, however, ended with the beginning of the Civil War in 1861.

When Abraham Lincoln was elected President of the United States in 1860, civil war became inevitable, for Lincoln believed that the fathers of the republic desired the abolition of slavery. There

had long been friction between the states following an industrial economy in the North and those with a plantation economy in the South. They had different views about free trade and protection; and the South wished to retain slavery which the North wanted to abolish. The South not only believed that slavery was an economic necessity for their plantations, but that they had the right to decide such matters for themselves. This involved the doctrine of States' Rights. The South interpreted the Constitution in a different way from the North. They considered they could decide most matters in their state assemblies, and even break away from the Union if they wished. The North thought the Union indissoluble and the Federal Government supreme. Unwilling to submit to the dictates of the Union Government, some of the Southern States did break away, including Jackson's Virginia, and the war was fought to bring them back into the Union.

When war was declared, Jackson was sent from Lexington on a mission to Richmond. The most important Confederate military training camp

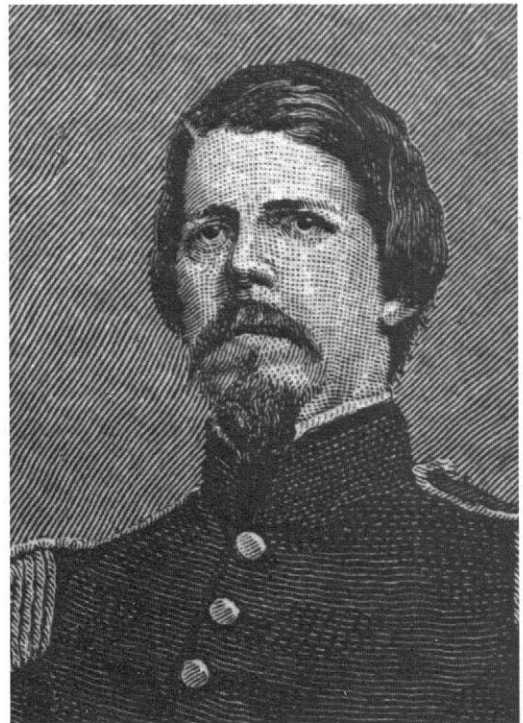
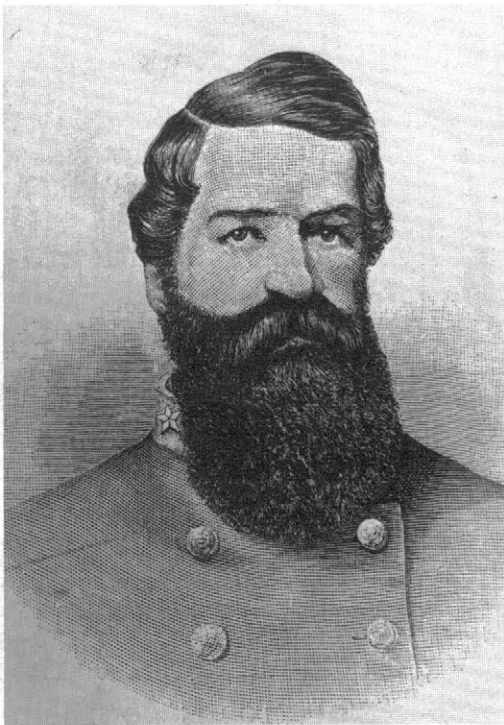

had been set up in its western suburbs. The Southern Government thought that the senior cadets of the V.M.I. would make suitable drill sergeants for the rush of volunteers assembling in the capital; and Jackson was given the task of conducting them there by rail. During Jackson's stay in Richmond he tried to get an appointment for himself, and was offered one in the engineer department. Fortunately he had friends in the capital who realised that he was far more suitable for a post in the field. These persuaded the authorities to offer him instead an active command at Harper's Ferry.

Harper's Ferry lies on a triangle of land at the junction of the Shenandoah River with the Potomac and is surrounded by hills. It was a focal point of rivers, canals, roads and railways; and the Confederate Government considered it a valuable place to occupy as an advanced post, as well as for the supply of arms that might be had from the factories and stores which had been established there earlier by the Federal Government. The Virginia Militia were assembled to

capture the place. Unfortunately for them they arrived almost too late, for when they entered the village the storehouses containing the arms were wrapped in flames. Most of the muskets, however, had already been taken and hidden by the inhabitants and many were discovered and gathered in. The machinery for making arms in several of the factories was also unharmed.

A large number of volunteers from the locality were now assembled at Harper's Ferry to be prepared for the coming battles and Jackson set about most capably drilling and organising them. With the help of two colleagues from the V.M.I. he is said to have 'speedily reduced the crude rabble to order and consistency'.

On 23 May 1861, however, Maj.-Gen. J. F. Johnston was appointed to command in the Shenandoah Valley area, and Jackson's first short period of command ended. Johnston now made Jackson commander of the Virginian regiments at Harper's Ferry and this was how the famous brigade which is the subject of this book came into being.

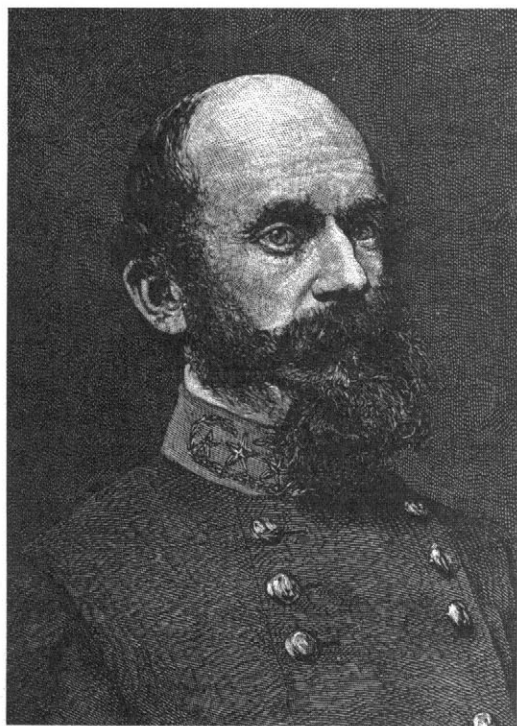

Left to Right
Brig.-Gen. Turner Ashby
Gen. Bee
Gen. Richard S. Ewell
Brig.-Gen. Charles S. Winder

The First Virginia Brigade consisted of the 2nd and 33rd Virginia who came from Winchester and the northern end of the Shenandoah Valley, the 4th Virginia who came from the southern end of the valley from around Pulaski and Wytheville, and the 5th and 27th Virginia from the Staunton and Lexington areas in the middle. There was also a battery of artillery raised in Rockbridge County in the Shenandoah Valley. The brigade was composed of recruits of all ages, from boys to old men. A survey of the muster rolls reveals that 54 per cent were farmers, 13 per cent blacksmiths, masons and machinists, 11 per cent clerks and merchants, and 9 per cent college students. The remainder were carriage-makers, teachers, lawyers, carpenters, cabinet-makers and distillers, while four called themselves simply 'Gentlemen'. The brigade had a number of non-English, foreign-born men. One company of the 5th Va. consisted almost entirely of Americanised German boys. Out of its 87 original members, 84, including a captain, were 18 years old or under. The 33rd Va. had an Irish Company known as the 'Emerald Guards', and because of its fondness for liquor and fighting among themselves it was to become the problem child of the brigade. There were other unusual units. For example, a company in the 4th Va. was known as the 'Liberty Hall Volunteers'. Of this company's original 69 members, 57 were students of Washington College, Lexington, and their professor of Greek became the first company commander. The Rev. Dr W. N. Pendleton, rector of Grace Episcopal Church, Lexington, and a West Point graduate, was the first commander of the Rockbridge Artillery. It was so popular that Jackson had to restrict its membership. It was recruited largely from college graduates and theological students, and its four guns were at once christened Matthew, Mark, Luke and John. Many members of the same family served together in the Brigade. In C Company of the 5th Va. were eighteen members of the Bell family, and all six sons of David Barton of Winchester served with the 33rd Va.

First Bull Run



When the war began the people of the North clamoured for a quick march on Richmond, and this popular pressure forced Gen. McDowell to launch a drive south prematurely. Believing the direct route too difficult, crossed as it was by creeks and rivers, he followed instead the railway, advancing south-west from Washington towards Manassas Junction where Gen. Beauregard had drawn up 22,000 Confederates along Bull Run River to block his path. Meanwhile, Gen. Patterson with a smaller force of 18,000 advanced up the Shenandoah Valley with the object of preventing the 12,000 men under Gen. Johnston from reinforcing Beauregard.

When Gen. Patterson approached Harper's Ferry Johnston decided that the village was too difficult to defend, and a better defensive position would have to be found further south around Winchester. With this in mind, he evacuated Harper's Ferry and withdrew towards Winchester; but he ordered Jackson's brigade to move against the enemy to try and delay their advance. Jackson was delighted to move forward instead of retreating, and equally disappointed when a counter-order brought him back to Winchester without firing a shot. About this time Col. A. P. Hill, who was to become a familiar figure in operations with Jackson, appeared on the scene, and was sent off with a detachment of troops to destroy bridges and hold back the enemy. In conjunction with Hill's

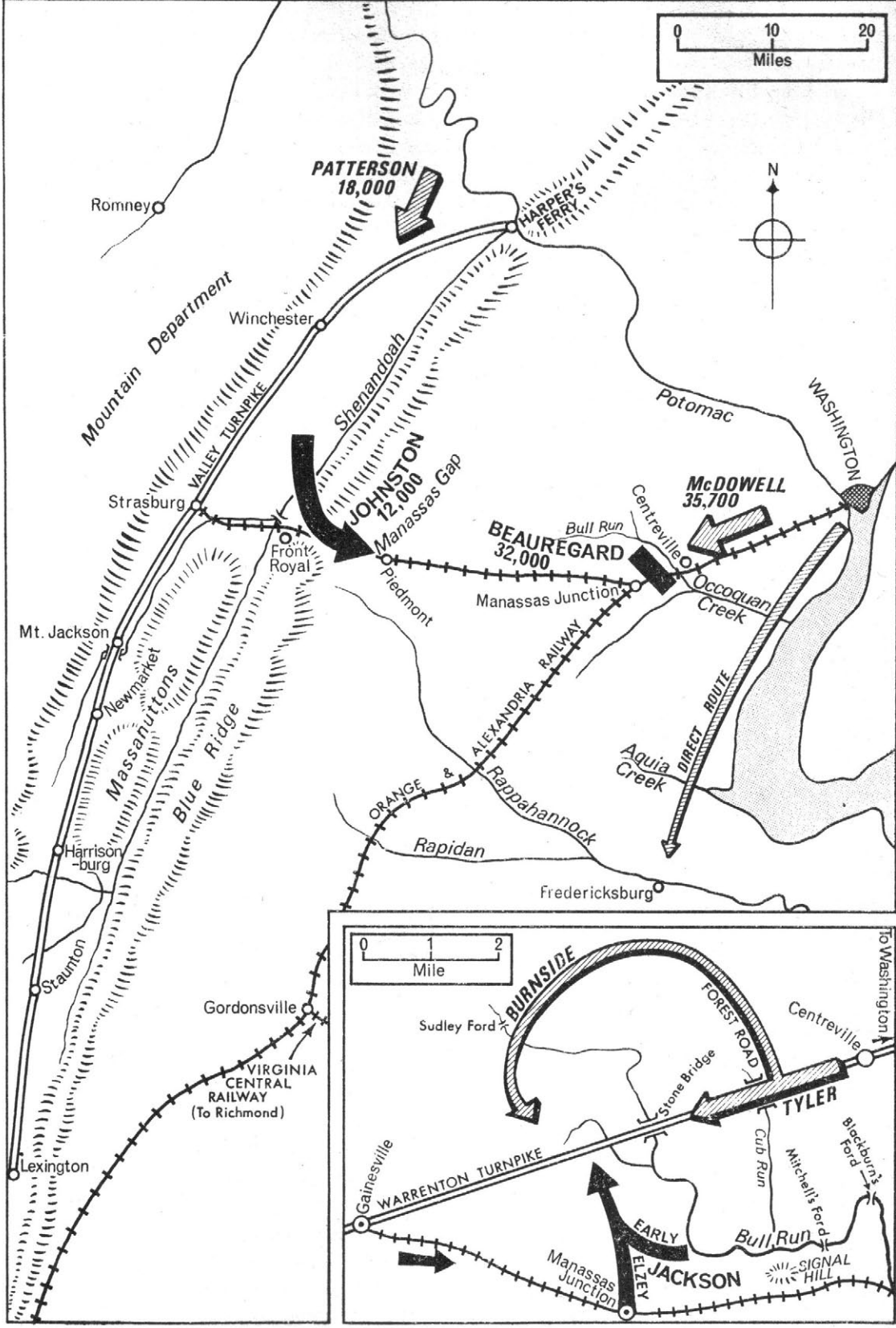

Troop movements before the Battle of First Bull Run or First Manassas

expedition Jackson was ordered forward again to destroy a number of Federal locomotives and wagons in the railway yards near the Potomac, and having done this successfully, he fell back again, and with the cavalry under the later famous Col. 'Jeb' Stuart out to his front, waited the arrival of the enemy.

Jackson's first contact with them came on 2 July 1861. He had been told to observe the Federals, and if they advanced in full force, to retire on the main body behind him. Near Falling Waters Church his 5th Va., a few cavalry and Pendleton's battery brushed with them. Jackson's men got the better of this first engagement and of a second one which immediately followed. Then the Federals developed a double turning movement against Jackson's force which was posted in the buildings and barns of Haine's Farm. Here, with 380 men and one gun, he repulsed attacks by nearly ten times as many Federals and held his position for three hours. During this engagement, in which Jackson's force inflicted fairly heavy casualties, Stuart's cavalry captured 45 prisoners. Jackson's loss was only 2 men killed and 10 wounded. He was probably the only man among the infantry who had ever been under fire; but he declared that 'officers and men behaved beautifully'. His brigade had made a good start.

Meanwhile, back at Manassas, Beauregard did not feel confident of holding McDowell's superior force and called for help from the valley. Beauregard had drawn up and partially entrenched his forces along the Bull Run River which ran like the ditch of a fortress across his front. The first action was when a part of McDowell's army attacked at a ford down-river from Stone Bridge and was smartly repulsed. There followed two days of delay while McDowell brought up supplies, and the Confederates made good use of the respite to build road blocks of felled trees on the road near Stone Bridge, and in general to strengthen their defences. It also gave time for reinforcements from the valley to support Beauregard's Army of the Potomac, the first to arrive being Gen. Bee's 3rd Brigade, followed by the 2nd Brigade, and then Jackson's 1st Brigade. Beauregard had planned an attack on the south flank of McDowell's force as it advanced along the road to Stone Bridge. In the event, owing to a miscarriage of orders, this was so

much delayed that McDowell's second attack came in beforehand. McDowell's plan was well thought out, with the main force led by Hunter's Division and Burnside's Brigade in the van turning the Confederate left flank by sweeping round to the north and approaching via Sudley Ford, while a subsidiary attack was made by Gen. Tyler's Division along the main road towards Stone Bridge.

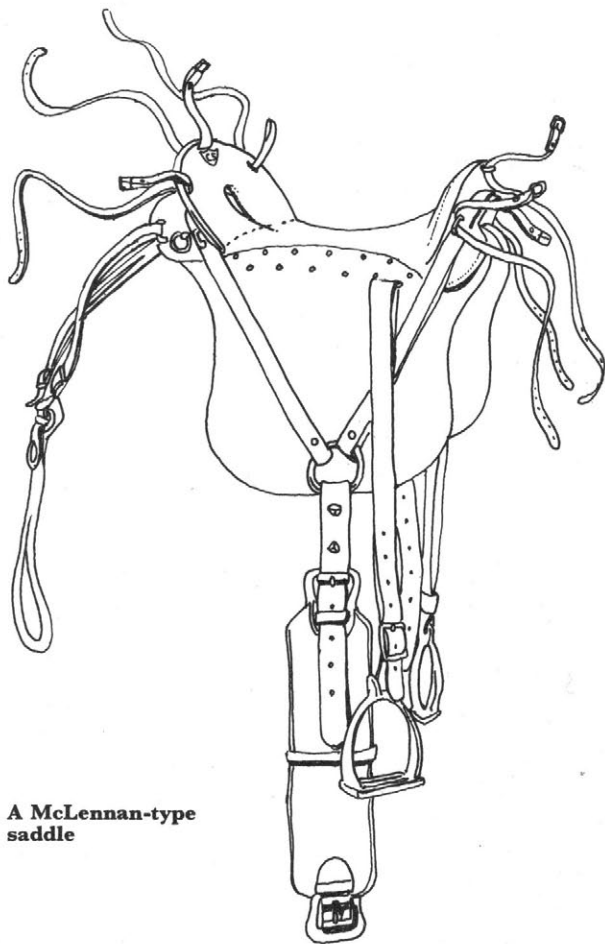

A McLennan-type saddle

The battle began with the arrival of shells from a Federal 30-pounder Parrott gun, one of which passed through the tent of Beauregard's signal officer. Next, while the signal officer was viewing the countryside through his telescope, he saw the glint of the morning sun on bayonets and musket barrels in the Sudley Ford area. Quickly he signalled to the forces guarding Stone Bridge. 'Look out for your left. It is being turned!' Warned in time, a Confederate force which included Bee's

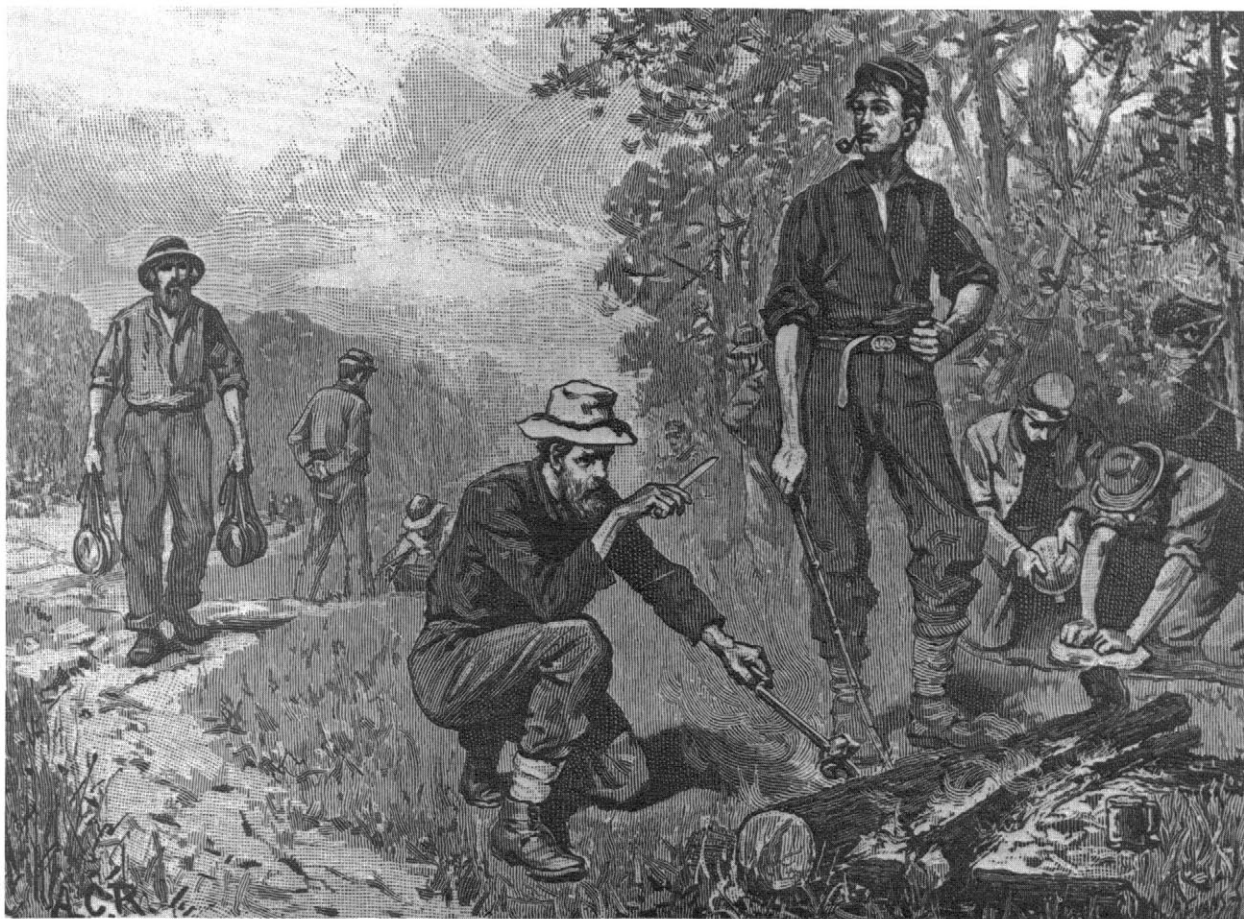

Confederate soldiers preparing supper after the hard march to Manassas, July 1861

3rd Brigade from the valley, moved up to guard the threatened northern flank. Crossing Young's Branch this took up a defensive position to the south of Matthews Hill (see map).

These forces, however, were soon pushed back from their advanced position on the north of the battlefield. They fell back in disorder towards Henry House Hill. It was at this stage that Jackson's First Virginian Brigade entered the fight.

Jackson had arrived from the valley on 19th July having covered approximately 55 miles in 25 hours, his infantry using the railway for the section Piedmont to Manassas Junction, his cavalry, artillery and wagons coming all the way by road. He went first towards the Bull Run defence line south of Stone Bridge, but hearing the sounds of battle to the north where Bee's men were

already engaged he immediately marched to the sound of the guns.

When Jackson arrived on the top of Henry House Hill Bee's men were coming back in disorderly retreat. Down by Robinson House Hampton's Legion, who had attempted to cover Gen. Bee's men, were themselves beginning to retire, and a battery which had been on the forward slopes of Henry House Hill galloped up complaining that Gen. Bee had left them unsupported. Jackson replied, 'I'll support your battery. Unlimber right here.' Then he formed up some of his own men alongside the guns. At that moment Gen. Bee appeared, approaching at full gallop, and he met his fellow brigadier face to face; Jackson cool and composed, Bee covered with dust and sweat, his sword in his hand and his horse foaming. 'General,' he said, 'they are beating us

back?' 'Then, sir, we will give them the bayonet,' Jackson replied; and he formed up the rest of the First Brigade in line on the top of Henry House Hill to carry this out. Jackson's determined bearing inspired Bee with renewed confidence. He turned and galloped back towards Robinson House where the officers of his 3rd Brigade from Mississippi and Alabama were attempting to reform their broken companies. Riding into the confused throng while the fate of the battle seemed hung in the balance, there occurred one of the dramatic moments of the war. Bee, desperately attempting to rally his men, glanced towards the top of Henry House Hill where he saw Jackson and his men standing bold and resolute. Catching the inspiration of the moment he leaned forward in his stirrups. 'Look!' he shouted, pointing with his sword. 'There is Jackson standing like a stone wall! Rally behind the Virginians!' Bee's men echoed the shout and formed on their colours, and the tide of battle turned at the moment Jackson and his First Brigade were given their immortal name.

The next phase showed Jackson establishing a line of defence across the summit of the hill. More batteries were brought up until twenty-six guns faced the advancing Federals. New regiments came up, some from the Bull Run line, and other late arrivals from the Valley. After this a series of charges on the top of the hill were to decide the issue. Two Federal batteries supported by Zouaves (several regiments were dressed like French Zouaves) moved up to a position south of Henry House only a few hundred yards from Jackson's line. Seeing an opportunity Col. Stuart's cavalry charged them. The cavalry charge was followed by another by the 33rd Va. who had been concealed on a copse on the left of the line. Mistaking the 33rd Va. for one of their own regiments the officers of the battery held their fire. The 33rd Va. fired a volley and shot down most of the officers and men of the battery. Meanwhile, the already shaken Zouaves had taken to their heels.

There followed a general advance of the whole Confederate line under the command of Gen. Beauregard. This swept the plateau clear of



Rallying the troops on Henry House Hill at the Battle of First Bull Run. It was during this battle that Gen. Bee is reported to have shouted the words which won for

Jackson his nickname: 'Look! There is Jackson standing like a stone wall. Rally behind the Virginians!'



The contest for Henry House Hill

Federals for a time; but they rallied and fought back, coming forward beyond Henry House Hill and Robinson House again, and reaching their unmanned guns. Jackson at this stage addressed his men as follows: 'Reserve your fire till they are within 50 yards! Then fire a volley and charge! When you charge, yell like Furies!' This proved too much for the Federals. They were now swept from the hill never to return. A brief rally north of Young's Branch was broken by artillery fire. The Federals had had enough. They made for home as

best they could, covered by Sykes's Regulars and Palmer's cavalry. A lucky shot from Kemper's battery hit the bridge over Cub Run, upsetting a wagon which had just driven upon it. This blocked the bridge and caused panic and confusion which was increased by the throngs of sightseers also making their way back to Washington along the crowded narrow roads. All through the night and the rain of the next day the soldiers and civilians streamed into Washington. Attempts by McDowell to rally the soldiers were in vain.

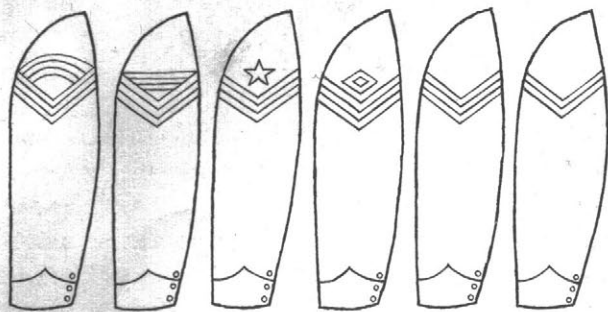

Confederate N.C.O.s' sleeve rank insignia. Left to right: sergeant-major, quartermaster-sergeant, ordnance sergeant, 1st sergeant; sergeant, corporal

Gen. Jackson and his brigade won great renown at Bull Run. Gen. Beauregard wrote: 'The conduct of General Jackson requires mention as eminently that of an able, fearless soldier and sagacious commander, one fit to lead his efficient brigade. His prompt, timely arrival on the plateau of the Henry House, and his judicious disposition of his troops, contributed much to the success of the day.'

Because of what he and his brigade achieved at Bull Run, Jackson was promoted major-general on 4 November 1861, and given command of all the

forces in the Shenandoah Valley. Thus he no longer continued to command the First Brigade directly. However, as will be seen, the brigade remained under him as divisional or corps commander until his death after Chancellorsville in 1863, and he always showed a proprietary interest in its operations. This was just what he said he would do in a striking farewell to his brigade in 1861, a description of which is given in the *Confederate Scrap Book* as follows:

““Officers and Soldiers of the First Brigade! I am not here to make a speech, but simply to say farewell. I first met you at Harper’s Ferry, in the commencement of this war, and I cannot take leave of you without giving expression to my admiration of your conduct from that day to this, whether on the march, the bivouac, the tented field, or on the bloody plains of Manassas, where you gained the well-deserved reputation of having decided the fate of the battle. Throughout the broad extent of the country over which you have marched, by your respect for the rights and property of citizens, you have shown that you were soldiers, not only to defend, but able and willing both to defend and protect. You have already gained a brilliant and deservedly high reputation throughout the army of the whole Confederacy, and I trust, in the future, by your

deeds on the field, and by the assistance of the same kind of Providence who has heretofore favoured our cause, you will gain more victories and add additional lustre to the reputation you enjoy. You have already gained a proud position. I shall look with great anxiety to your future movements; and I trust, whenever I shall hear of the First Brigade on the field of battle, it will be of still nobler deeds achieved and higher reputation won. In the army of the Shenandoah, you were the First Brigade! In the army of the Potomac, you were the First Brigade! In the second corps of the army, you were the First Brigade! You are the First Brigade in the affections of your general; and I hope by your future deeds and bearing you will be handed down as the First Brigade in this our second war of independence. Farewell!”

‘For a moment there was a pause, and then there arose cheer after cheer, so wild and thrilling that the very heavens rang with them. Unable to bear calmly such affecting evidence of attachment, Gen. Jackson hastily waved farewell to his men, and gathering his reins rode rapidly away.’

The Valley

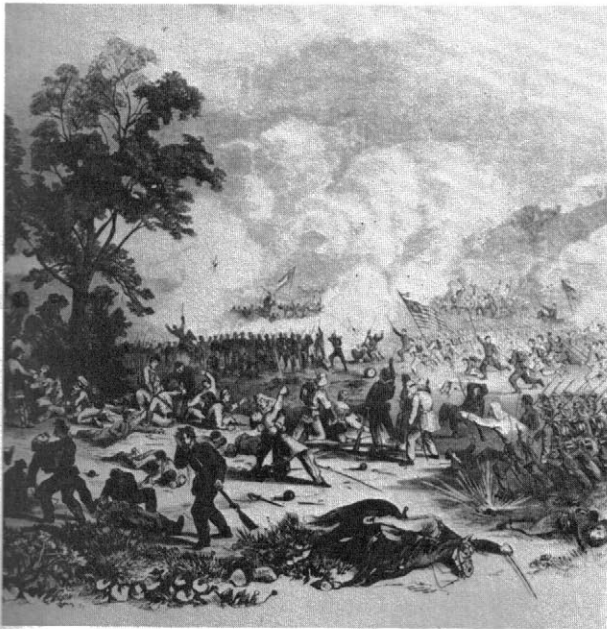

A dramatic painting of the Battle of First Bull Run, 21 July 1861



The great reputation which the First Brigade won at First Bull Run was enhanced in Jackson’s Shenandoah Valley Campaign. They were under Jackson from the start. They took part in his canal-breaking activities in the north-west before Christmas 1861; and in the operations from Romney to reclaim West Virginia after Christmas. During the latter Jackson had on one occasion to

rebuke Brig.-Gen. R. B. Garnett, the brigade's new commander. Jackson was pressing his troops forward in very wintry conditions and their spirits were noticeably sinking. On the third day out Garnett took it upon himself to give his wearied men a rest, and riding along the column, Jackson found them stationary and asked the reason.

'I have halted to let the men cook their rations,' explained Garnett.

'There is no time for that,' said Jackson.

'But it is impossible to march further without them.'

'I never found anything impossible with this brigade,' replied Jackson and rode on.

In February 1862, on orders from President Lincoln, Gen. Banks threw a pontoon across the Potomac at Harper's Ferry and entered the valley. Jackson, who had only 4,500 men, had been told to defend the valley as best he could and occupy the attention of the invaders without risking defeat. When menaced by Banks's large force, therefore, he fell back 30 miles from Winchester leaving behind Col. Turner Ashby's cavalry as a rearguard screen. Jackson's cavalry leader, Ashby, was 'the *beau-idéal* of a captain of light horse. His reckless daring, both across country and under fire, made him the idol of the army.' Jackson's cavalry, comprising horse-loving Virginians of good standing, were better than the Federal cavalry; and Jackson demanded more of them. It was not sufficient for him just to receive a warning

that the enemy was advancing. He expected to be given an estimate of its strength and details of its every movement. To penetrate the enemy's lines, to approach his camps, and observe his columns – these were the tasks of Ashby's riders, and in them they were unrivalled. They were acquainted with every country lane and woodland track. They had friends in every village, and their names were known to every farmer. 'We thought no more of riding through the enemy bivouacs than of riding round our fathers' farms', was how they put it.

When he heard that Jackson had pulled back, Banks felt confident that the valley could be controlled by only a token force, and began to move some of his troops over Blue Ridge to help the main Federal attack on Richmond which had now begun. Ashby, overestimating the extent of the withdrawal, reported that almost the whole of Banks's force seemed to be leaving the valley. In accordance with his instructions to hold the enemy in the valley, Jackson pushed northwards again, and receiving confirmation of Ashby's report from the local inhabitants, decided to attack forthwith what he supposed was the enemy rearguard south of Winchester.

In the encounter that followed in the neighbourhood of Kernstown the First Brigade played an important part. The enemy were athwart the turnpike south of Winchester in the neighbourhood of Pritchard's Hill on which they had some guns. Jackson decided not to attack frontally, but

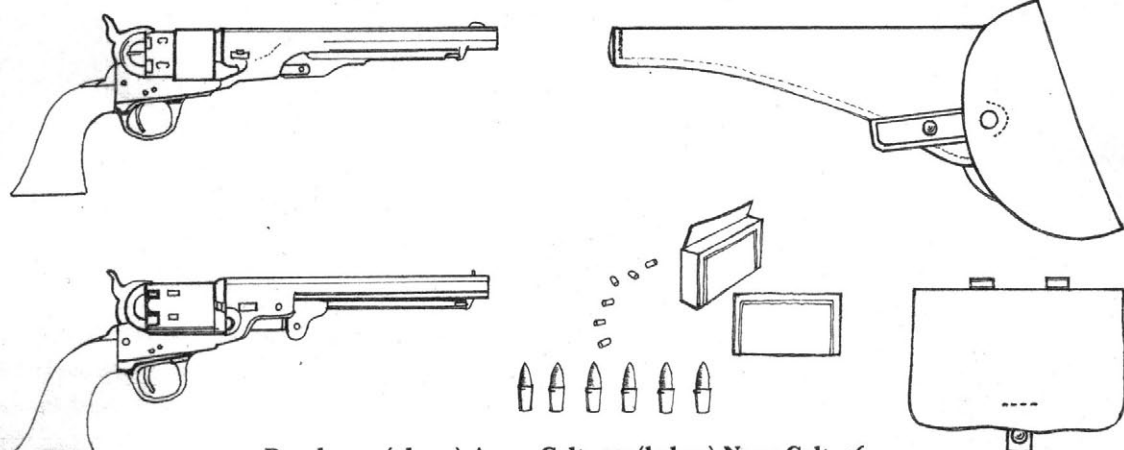

Revolvers: (above) Army Colt .44; (below) Navy Colt .36. Holster; cartridge box and packets; .44 cartridges and percussion caps

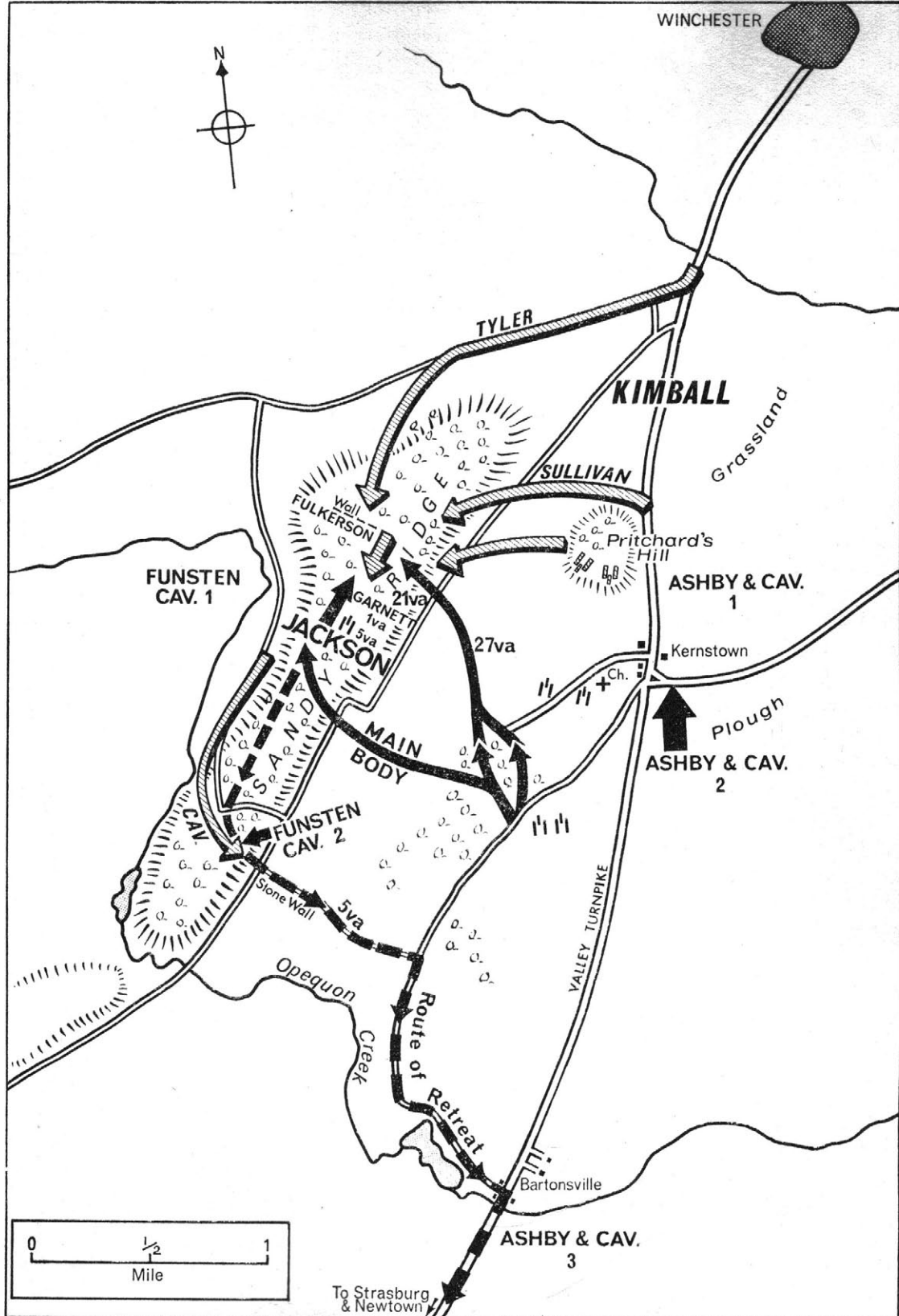

Battle of Kernstown, 23 March 1862

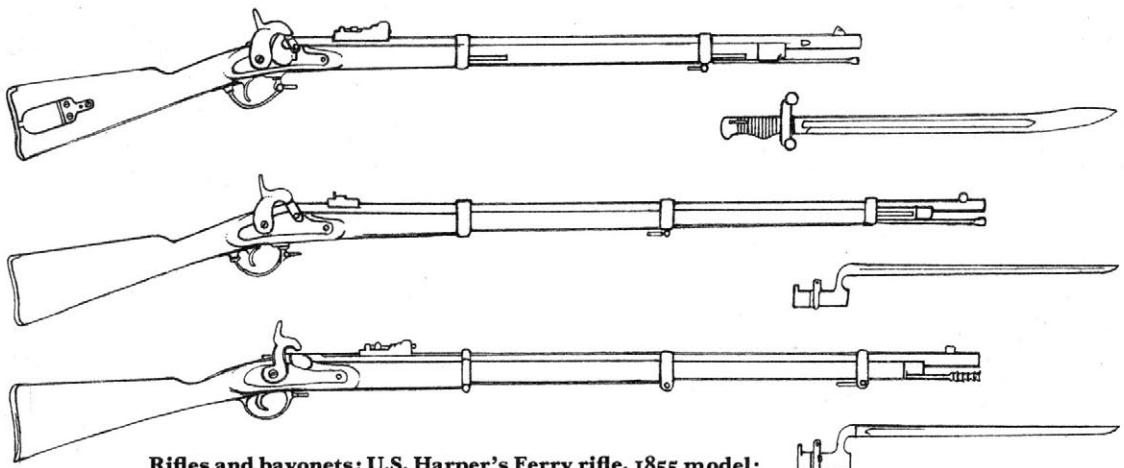

Rifles and bayonets: U.S. Harper's Ferry rifle, 1855 model; U.S. Springfield rifle-musket, 1861 model; Enfield rifle-musket

hold the enemy with Ashby's cavalry while he moved his main body westwards up on to a wooded ridge beside a secondary road into Winchester, thereby both outflanking the enemy and approaching them by a concealed route.

The cross-march westwards was led by the 27th Va. Regiment from the brigade with guides recruited from Winchester who were familiar with the locality. When the 27th Va. had climbed the ridge they took up a position on the east side while other Confederate units went over and manned a wall on the west side. Meanwhile the 5th Va. from the brigade at first remained at the foot of the ridge on the line of march, and then mounted the ridge and took up a position behind the 27th Va. The rest of the brigade joined the second line further back on the ridge from the enemy.

There now followed a spirited engagement on the top of the ridge which did not go in accordance with Jackson's plan. Instead of a small rearguard, a force of 7,000 opposed him, and Kimball, its temporary commander, acted with great vigour and soon had the bulk of his forces opposing Jackson on the ridge.

Jackson had left the conduct of operations to his brigadiers, and watching the progress of the action saw that those on the left were holding off the enemy attacks successfully. He was amazed and angered, however, to see on the right his old brigade faltering and falling back. To this rearward movement the Confederate force by the wall

on the left also had to conform. One of the 27th Va. described it in this way.

'All our ammunition being gone we gradually retired, passing through the 5th Va. that had formed in the rear. Our artillery had taken position and were firing on the enemy, but when we retreated they were compelled to do so. In going through a gap in a stone wall one of the guns became entangled and disabled and was lost. One of our company in going to the rear encountered General Jackson who inquired where he was going. He answered that he had shot all his ammunition away, and did not know where to get more. Old Stonewall rose in his stirrups, and gave the command, "Then go back and give them the bayonet", and rode off to the front. He galloped up to Garnett and ordered him to hold his ground and then turned to try and restore the fight himself. Seizing a drummer by the shoulder, he dragged him to a rise of ground in full view of the troops, and bade him in curt terms to "Beat the rally!" The drum rolled at his order, and with his hand on the frightened boy's shoulder, amidst a storm of balls, he tried to check the flight of his defeated troops. His efforts proved useless. It was impossible to stop the rout. The 5th Va. had been halted by Garnett in a position well behind so that a new front could be established for the shattered troops, and to this arrangement Jackson had unwillingly to agree.'

There followed more severe fighting on the new line. In front of the 5th Va. one of the colours of the 5th Ohio changed hands no less than six times and was pierced by eighty-four bullets. But although most of the Confederates got away from the ridge, even this new line could not long be held. As night began to fall the 5th Va., retiring steadily towards the turnpike, filed into a narrow lane fenced by a stone wall nearly a mile from their last position, and took post for a final stand. Up from the valley beyond the ridge now came the Federal cavalry; but it was too dark for them to attack the gallant 5th Va. Nor could the Federal infantry dislodge them from their stone-wall rampart, as the enemy only emerged in 'dribs and drabs', many being lost in the darkened pathless woods. Thus the 5th Va. were able to protect the rear of the retreating Confederate force, and eventually to retire themselves unmolested.

It was now night, and the Federals had full possession of the field of battle so that the attack by Jackson at Kernstown, in which like the Federals he suffered 600 casualties, must be classed a failure. Nevertheless, in spite of this, the battle was to have important results. It led to the return to the valley of the Federal troops which had previously set off to reinforce the main attack on

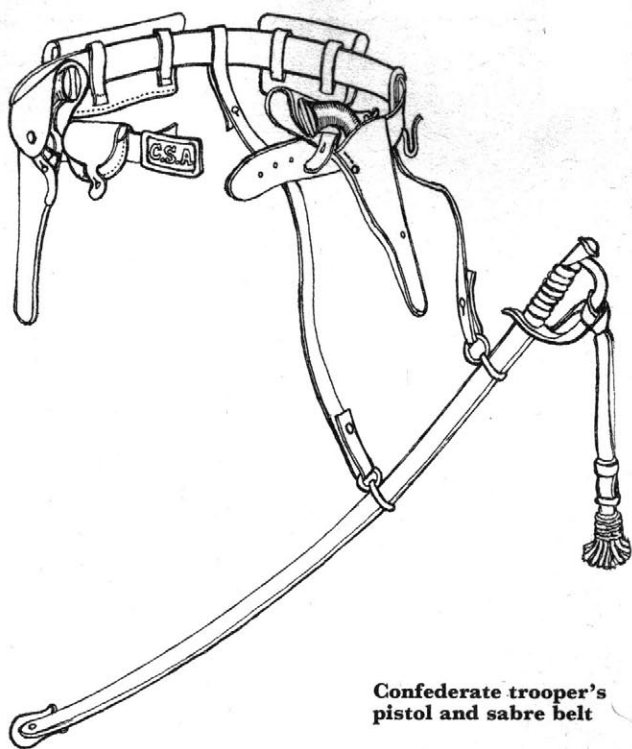

**Confederate trooper's
pistol and sabre belt**

Richmond. The Federals could not believe that Jackson would have attacked at such a distance from his main body unless he had been expecting reinforcements. Although a tactical defeat, Kernstown therefore became a strategic victory.

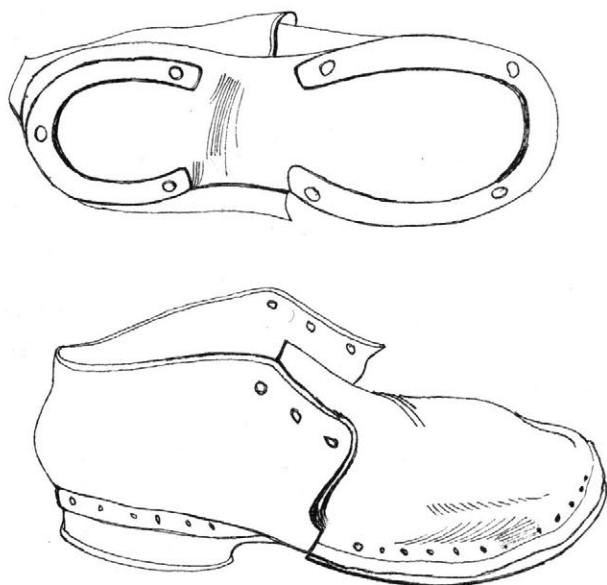

The 'shoe-boot' - horse-shoes nailed to a wooden sole - used by many Confederate troopers in the later years. Shortage of boots and shoes was a severe problem throughout the South

After the Battle of Kernstown Jackson first fell back down the turnpike to Harrisonburg followed by Banks's troops, and then moved eastwards across the south branch of the Shenandoah River to Elk Run where he was reinforced with 8,000 men under Gen. R. S. Ewell.

Banks was now at Harrisonburg, and another considerable Federal force, very spread out, with Milroy in the van, was moving from the Mountain Department in the west towards Staunton where 3,000 Confederates under Brig.-Gen. Edward Johnson were positioned.

Jackson who now had 6,000 men, not counting Ewell's, came to the conclusion that he should attack either Banks or Milroy before they could join up. Choosing Milroy, he left Ewell's force at Elk Run to watch Banks, and first marched along the east bank of the Shenandoah, and then crossed over Blue Ridge at Brown's Gap as if he were going off to reinforce the troops defending Richmond. Next, when he came to Meechum's River

Station, he turned back and partly by rail, partly by road, joined Johnson at Staunton. Having surprised both the enemy and his own people, Jackson was able to move west and defeat Milroy's brigade at McDowell long before the following brigades could catch up and support him. After this Jackson moved north against Banks, who, however, fell back and fortified Strasburg at the head of the west side of the valley with an outpost at Front Royal on the east side.

The next phase in the Valley Campaign is also complicated. Banks was convinced that Jackson was about to advance on him up the turnpike, and Jackson for his part did everything in his power to confirm Banks's view. He fetched over some of Ewell's men from Elk Run, and then advanced up the turnpike as far as Newmarket. Here was a pass through the Massanuttons which divide the valley, and Jackson led his force over it to the east valley, and combining with the rest of Ewell's force, attacked the weakly defended Federal post at Front Royal.

The whole manœuvre was completely successful. Once again Jackson surprised the enemy. The Front Royal garrison was dispersed. Banks, fearing his line of communication back to Winchester would be cut, retreated speedily, partly northwards, and partly along the turnpike towards Winchester. The northern-bound column escaped, but the rearguard and wagons of the Winchester column were caught. Jackson was not satisfied. He pressed on through the night after the main body on the Winchester road. Catching up with them next day, he immediately attacked the brigade under Col. Gordon defending the southern outskirts of Winchester.

The battle began with the advance of the First or Stonewall Brigade under Brig.-Gen. C. S. Winder against Gordon's pickets, and these were quickly driven back. There followed an artillery duel in which the Confederate gunners suffered heavily, but finally silenced the Federal guns opposite the Stonewall Brigade. Meanwhile Ewell had come into action, employing a small turning movement of his own to take the enemy in the flank. This was the sign for Jackson to bring forward his brigades from the reserve to start their major turning movement on Gordon's right flank. Taylor's Louisianians played a large part in this.

To speed the movement of Taylor's Brigade, which was already moving forward from its reserve position, Jackson rode in the direction of Taylor's advance past the Virginians of the Stonewall Brigade. Inquiringly they looked at him. As they had been told not to cheer, they did not greet him in the usual manner but took off their hats in silent salute.

Jackson waited a few minutes until the columns arrived, and then rode on with Taylor. They were under fire from the Federals and as some men fell, the Louisianians began to duck. Taylor writes:

'This annoyed me no little, as it was child's play to the work immediately in hand. Forgetting Jackson's presence, I ripped out, "What the hell are you dodging for? If there is any more of this you will be halted under fire for an hour." The sharp tones of a familiar voice produced the desired effect, and the men looked as if they had swallowed ramrods; but I shall never forget the reproachful surprise expressed in Jackson's face.'

Looking over the brow of the hill, Jackson waited while the Louisianians slipped round to a point opposite the end of a shattered and abandoned stone wall from which the Federals had earlier been enfilading the Confederate gunners. Then, about 7.30 p.m. when Taylor emerged, there was staged such a spectacle as the Army of the Valley never witnessed before. The enemy poured grape and musketry into Taylor's line as soon as it came in sight. Gen. Taylor rode in front of his brigade, drawn sword in hand, occasionally turning his horse, at other times merely turning in his saddle to see that his line was up. They marched up the hill in perfect order, not firing a shot! About half-way to the Yankees he gave in a loud and commanding voice the order to charge; and over the stone wall they went!

Soon the other brigades could be seen advancing. Much of the Confederate Army was now pouring over the ridges. Jackson watching it all could restrain himself no longer. Turning to his staff officers he said: 'Order forward the whole line, the battle's won.' Winder's men now came sweeping past, and as they did so Jackson cried out, 'Very good! Now let's holler!' He raised his old grey cap, his staff took up the cheer, and soon from the advancing line rose and swelled a deafen-

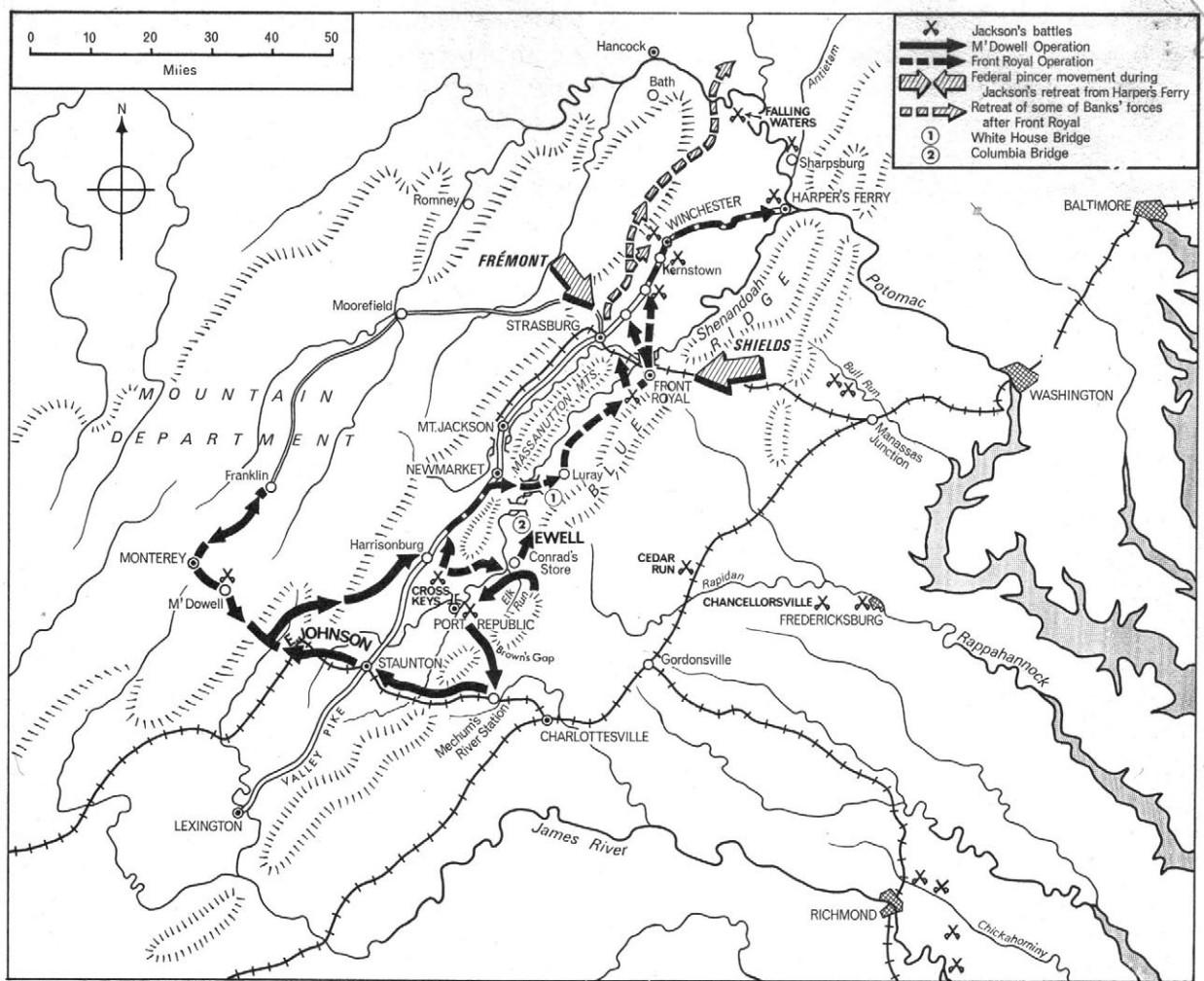

The Valley Campaign, 1 January–9 June, 1862. In Jackson's Shenandoah Valley Campaign he had only 4,500 men with which to defend the valley against the invading Federal forces under Gen. Banks. In May and June Jackson's

First Virginia Brigade fought five battles, defeated four separate armies, and survived with total losses of under 1,000 killed, wounded and missing

ing roar. Then a panic seized the Federals and the retreat became a rout through the streets of Winchester.

After the battle the Stonewall Brigade led the pursuit up to Harper's Ferry, a pursuit which nevertheless did not achieve very much. The cavalry were too busy plundering to participate, and the infantry on their own were not fast enough to catch the fleeing Federals. Nevertheless Banks was driven across the Potomac, and 1,500 Federal soldiers were killed or wounded for a total loss of 400 Confederates. Also 3,000 prisoners, 10,000 stands of much-needed small arms and a vast quantity of stores were now in Jackson's hands.

A feature of the Valley Campaign was the sudden change of fortune of each side. The Federal higher command reacted very quickly to Banks's discomfiture. He had scarcely been driven across the Potomac before Frémont was ordered to strike at Jackson's flank, from the Mountain Department, and Shields, on the other flank, was sent across the Blue Ridge by McDowell. Jackson soon faced being cut off by a skilful Federal pincer movement of serious dimensions. He was forced to withdraw, and all the strategic gains of the Front Royal operations appeared lost. Quickly Jackson withdrew his forces, first back to Strasburg, and then down the turnpike again. The cavalry and rear-guard turned against Frémont's force which was

fast approaching Strasburg from the Mountain Department. They fought some sharp actions and held Frémont's vanguard back until the Stonewall

Trooper's 'képi'

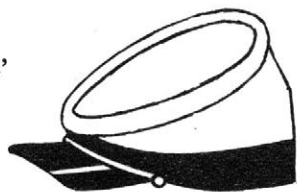

Brigade, the last to arrive, had passed through Strasburg and were able to join the retreating columns down the turnpike. Frémont's force was the dangerous one. Shields's force coming from the east never got so close. On reaching Front Royal it started to move down the east side of the

Shenandoah Valley. To prevent Shields from joining Frémont across the Massanutts through the Newmarket gap, Jackson sent troopers to burn the bridges over the South Fork of the Shenandoah River. The fords were impassable owing to the swollen state of the river, so the destruction of the bridges removed Shields's only access to the Newmarket gap.

Meanwhile, west of the Massanutts, the rivers were also used to impede Frémont's pursuit, now developing with unusual vigour. South of Mount Jackson the North Fork of the Shenandoah is a deep and turbulent river; and on 4th June the bridge which took the turnpike over it was destroyed by Ashby's cavalry. 'Under a deluge of rain the Federals attempted to launch their pon-

The Seven Days' Battles, 26 June–2 July 1862. The brigade under Gen. Winder took part in these battles and suffered 179 casualties including 30 killed

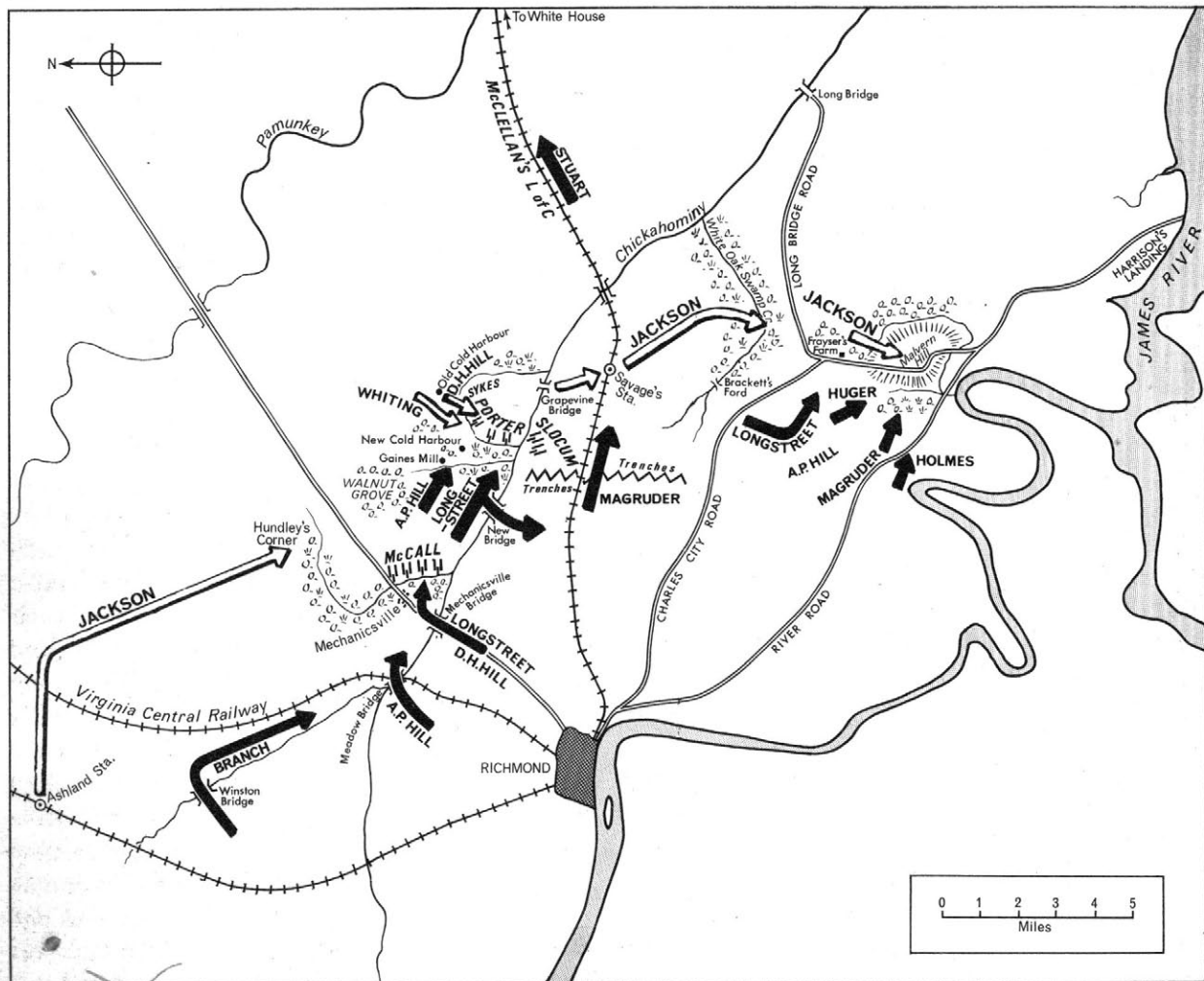

toons; but the boats were swept away by the rising flood, and it was not till the morning that the bridge was made. The Confederates had thus gained twenty-four hours respite.'

By spirited encounters with Frémont's vanguard, Ashby and his cavalry played a large part in slowing up the Federal advance; but near Harrisonburg, rallying his supporting infantry on foot when his horse had been killed under him, he was shot through the heart and fell dead, a severe loss to the Confederate cause. Jackson was making for Port Republic in the south of the valley. Here athwart the South Fork of the Shenandoah River he proposed to fight and defeat Frémont, who was coming down the turnpike on the west side of the river, and then turn against Shields on the east side. Everything went according to plan. Ewell defeated Frémont decisively at Cross Keys on 8 June 1862, and on the next day Jackson came out of Port Republic and fought Shields, the Stonewall Brigade playing an important part in the battle.

Shields's army approached to within two miles of Port Republic, and then drew up along a hollow road which provided excellent cover for the Federal riflemen. Here they were attacked in a spirited manner by the Stonewall Brigade under Winder; but being enfiladed by a battery on a hill by a ravine in the south, the brigade was forced back. Isolated by the ravine in front, the battery was difficult to approach; but to Jackson it appeared the key to the position and it had to be silenced. First he gave the task to one of his own batteries accompanied by two regiments from the Stonewall Brigade, and when these failed, further attempts were made by Ewell's men. Meanwhile the battle to the north of the battery was continuing. Further attacks by Winder met with no more success than the earlier ones; but when the Federals in the centre moved forward from their hollow road protection, Ewell who had hidden some troops in the woods to the south, struck at the Federals' flank and took the pressure off the Stonewall Brigade. This, and the final capture of the battery near the ravine by Taylor's Louisianians proved decisive, and the Federals began to withdraw. The Federal flight never became a rout, but prisoners were taken. For example, in one instance nearly half a Federal regiment were separated from their comrades and surrendered in a body.

The pursuit was then continued eight miles further by the cavalry who gathered, as spoils of war, small arms, vehicles and many more prisoners.

The battle at Port Republic saw the end of Jackson's splendid Valley Campaign. In 30 days his army had marched nearly 500 miles, skirmishing almost daily, fought five battles, defeated four armies, two of which were completely routed, captured about 20 pieces of artillery, some 4,000 prisoners, an immense quantity of stores of all kinds, and had done all this with a loss of less than

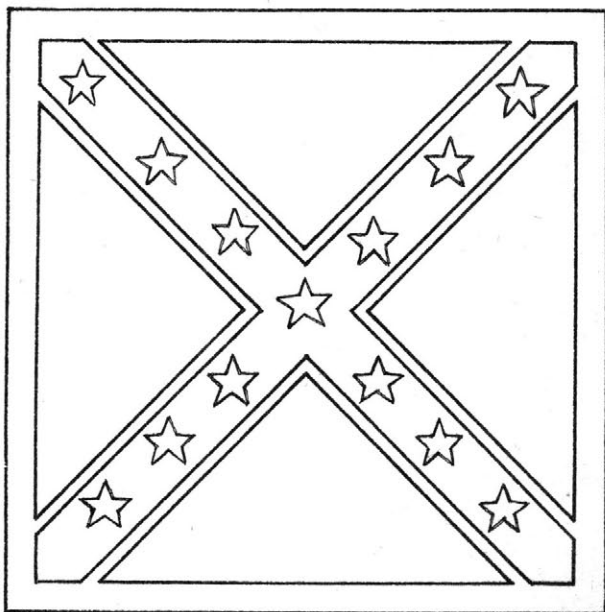

The Confederate flag

1,000 killed, wounded and missing. The Stonewall Brigade were present throughout and played a part in almost every encounter. Because of their advance and retirement to Harper's Ferry and back, they marched an even greater distance than the rest. As the march table in the Appendix indicates – and this includes the long march of 150 miles or so over to Richmond after the Battle of Port Republic – they are reckoned to have marched 676 miles in 48 marching days averaging 14 miles a day. Their casualties were also among the highest, reaching 361 at Kernstown, and 236 in the operations about Front Royal at Port Republic.

The Seven Days' Battles



After the Valley Campaign Jackson's force marched eastwards and joined in the defence of Richmond, which was being attacked by a large force under Gen. McClellan from the Yorktown Peninsula. Believing the best way to defend the capital was to attack McClellan's forces, Lee, the Confederate commander, sent a strong Con-

federate army joined by Jackson's men to assault the Federals north of the Chickahominy River, which flowing from west to east divides the Peninsula. There followed the Seven Days' Battles in all of which the Confederates had the advantage. They drove McClellan's men over the river, and then on down to Malvern Hill in the south, after which the Federals took ship and returned to Washington.

The Stonewall Brigade commanded by Brig.-Gen. C. S. Winder took part in these battles and suffered in them 179 casualties of which 30 were killed including Col. J. W. Allen commanding the 2nd Va. The brigade distinguished themselves particularly at Gaines Mill. Here the Federals had taken up a strong position with their backs to the Chickahominy, and the Stonewall Brigade attacking from the north-east drove back the Regulars of Brig.-Gen. Sykes's Division. After the battle the Federals crossed to the south bank of the river, passed over White Oak Swamp Creek and defended Malvern Hill, and it was in these locations that the two last battles of the Seven Days' were fought.

Although the threat on Richmond from the east had been obviated, the Confederates soon had to



The Stonewall Brigade on the march



1 Infantryman, 1861
2 Infantryman, 1862
3 Infantryman, 1863

MICHAEL ROFFE

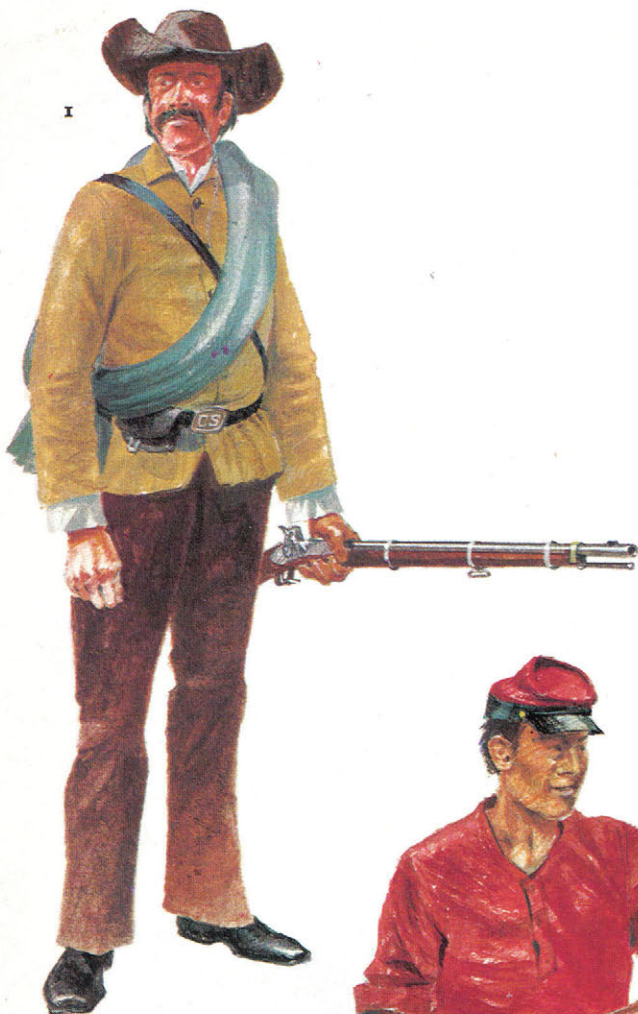

1 Infantryman, 1862
2 Horse artilleryman, 1863
3 Artilleryman (cannoneer), 1862

- 1 Infantry officer, 1862
- 2 Horse artillery officer, 1863
- 3 Cavalry officer, 1862





1 Cavalry colonel, 1861-5
2 General, 1863
3 Cavalry officer, 1864



General, 1862

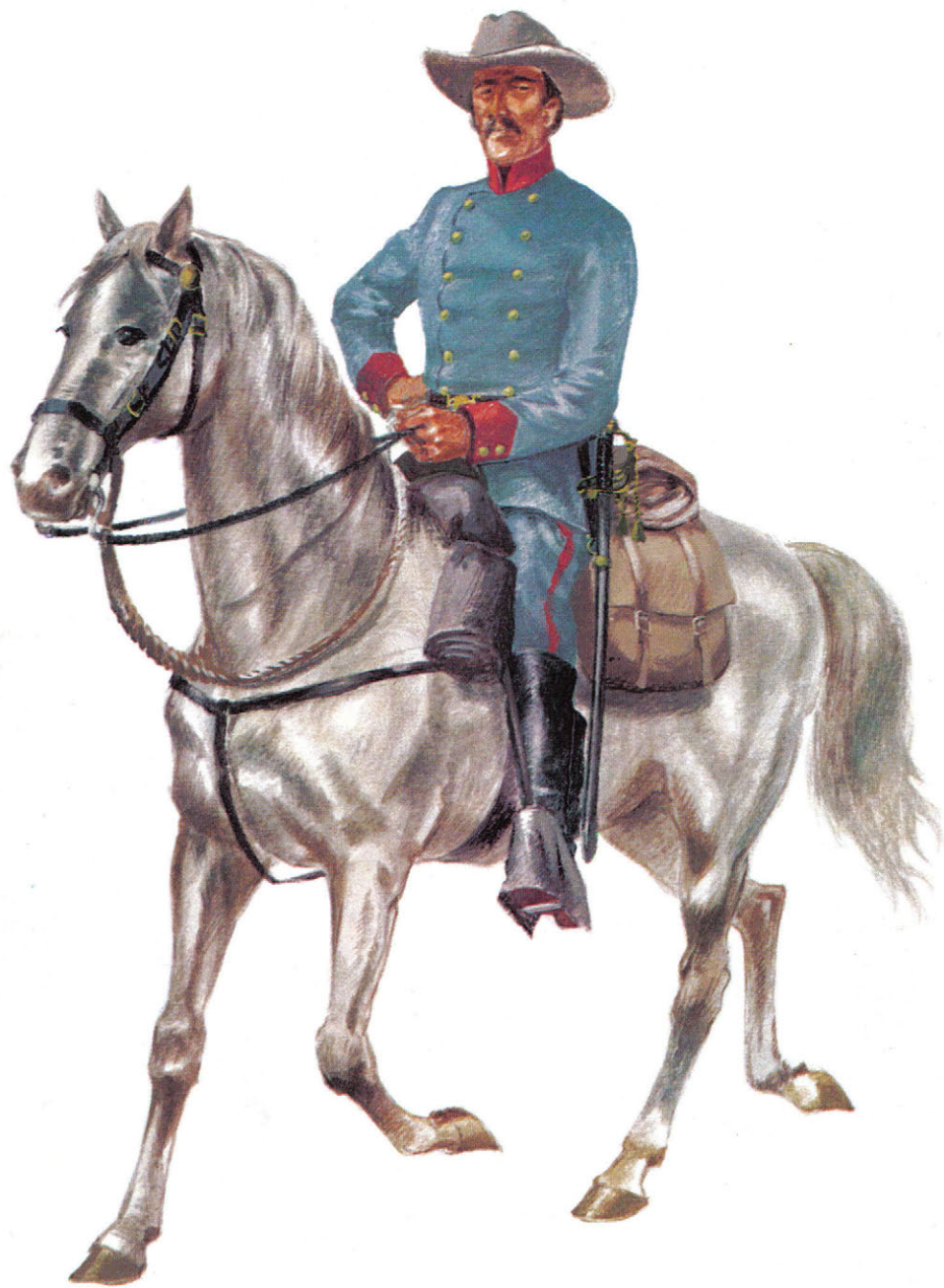

Senior artillery officer, 1863



Cavalry sergeant, 1862



Mounted trooper, 1862

face an even more formidable one from a new army assembled under General Pope, which McClellan's routed forces were later to join. Pope's army approached from the north, and Lee quickly sent across forces to hold back its advanced elements, choosing Jackson's corps of 20,000 men. Brig.-Gen. C. S. Winder had now been appointed to command the 1st Division and the Stonewall Brigade was led by Col. C. A. Ronald. Jackson moved north-westwards from Richmond to a camp at Gordonsville. Then, hearing that Pope's corps were advancing in separate columns, he decided to move north to defeat them in detail before they could concentrate. In this way he met at an advantage the advanced division of Banks's II Army Corps at Cedar Run on 9 August 1862. Jackson was by no means displeased when he learned who was in command of the Federal advance. 'Banks is in front of me,' he said to Dr Hunter McGuire, his medical director. 'He is always ready for a fight,' and then laughing, he added as if to himself, 'and he generally gets whipped.'

Shortly before noon, Jackson's advanced troops came upon enemy cavalry and guns on a low ridge beyond Cedar Run where it crosses the Culpeper road. Jackson, having summed up the situation, sent Ewell's division to outflank the Federal position in the east, placed some batteries on Slaughter Mountain which dominated the whole position, and ordered Winder's division, which included the Stonewall Brigade, to attack in the west.

Before this attack developed, however, the Federals struck first on Winder's front. In the van here was a battalion under Maj. Seddon lining the edge of a wheat-field, with the rest of the 2nd Brigade and the Stonewall Brigade behind; 1,500 Federals had formed up in the wood on the other side of the wheat-field. First came the skirmishers, making good use for cover of the shocks of wheat. Then emerged the main body with fixed bayonets and colours flying. Their long lines overlapped Seddon's men, who, resisting staunchly, were hurled back in confusion, as were the rest of the Brigade trying to support them. Chaos reigned on the Confederate left for a time, and it was no help that early in the battle Gen. Winder was mortally wounded by a shell near the Culpeper road.

Jackson now went forward to take charge. By his order the batteries were withdrawn and not one gun lost. The infantry did not escape so lightly. Every commander of the 2nd Brigade was either killed or wounded, and most of the regiments were driven back and broken. Some attempted to change front, others retreated in disorder. Men were captured and recaptured, and blue and grey mingled in close conflict amid the smoke. Then while the Federals were unsupported, the Stonewall Brigade entered the fray. Breaking into the mêlée on the left of the Culpeper road, the five staunch regiments, undismayed by the disaster, opened a heavy fire. The Federals stopped and

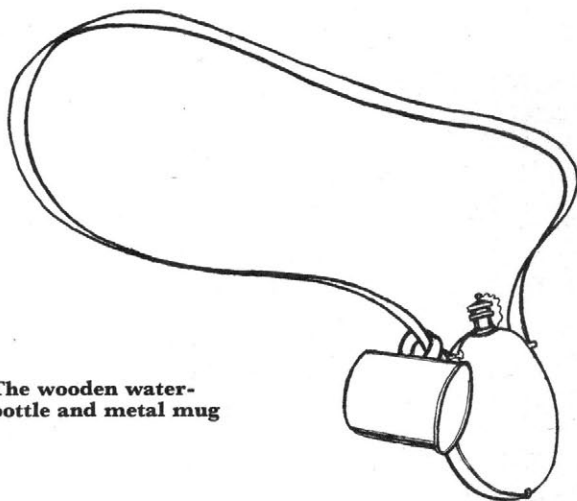

The wooden water-bottle and metal mug

drew together to meet the Virginians, and just at that moment Jackson rode up and turned the tide of battle in the favour of the Confederates. He sent off orders to Gen. Ewell to speed up his attack with the 3rd Division on the right, and to Gen. Hill to enter his reserves into the battle. Then he galloped forward unattended into the midst of his men of the valley. Drawing his sword for the first time in the war, his voice pealed high above the din, 'Rally men! Follow me!' The troops hearing his familiar resolute tones reacted as to a spell. Gathering round their colours, they surged forward and drove the Federals from the field.

By this time the two brigades from the reserve division were making a wide turning on the left, and Ewell's men were doing the same on the right.

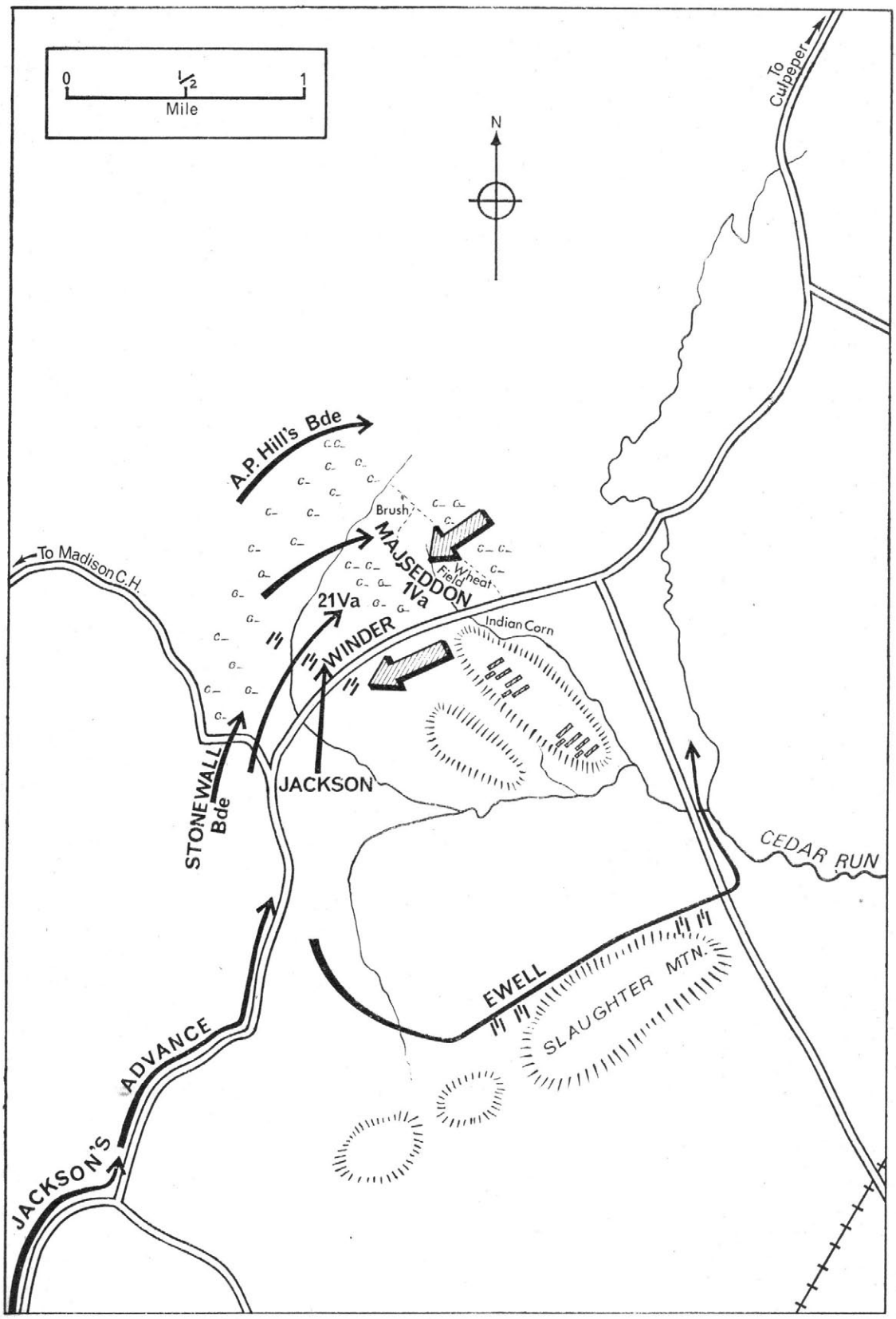

Battle of Cedar Run, 9 August 1862

Realising they were outflanked, the Federals began a general retreat, the cavalry making charges to ease the pressure on their infantry. As darkness fell the Confederates crossed Cedar Run and swept up the slope beyond. They pushed on through the night under a full moon, but they never managed to close with the enemy. Next day Jackson withdrew to his old position at Cedar Run. Then, having learnt that opposite him was not just one of Banks's divisions but the bulk of Pope's army, he withdrew regretfully to his camp at Gordonsville. Jackson was to say that this battle was the most successful he fought, but in his report to Lee he offered the usual, modest 'God blessed our arms with another victory'. Certainly the Stonewall Brigade played a valuable part in his success.

Chancellorsville



After Cedar Run the Confederates around Gordonsville were reinforced. At first Pope set up his camp at Culpeper, but later he fell back beyond the Rappahannock River, which formed a barrier between the two sides for a time.

The Confederates next carried out two spirited attacks on the Federal lines of communication. The first was a raid by Stuart's cavalry on Cattlett's Station which resulted in 300 prisoners and some new mounts for the troopers; the second by Jackson was more ambitious, and was followed by the Battle of Second Bull Run.

Jackson set out north along the west bank of the Rappahannock to Salem and then turned east through Thoroughfare Gap (see map). At one

stage he stopped to see his army pass. The men of Ewell's division noticed the General and were about to give a cheer; but Jackson raised his hand to stop them, and the word went down the column, 'Don't shout, boys, the Yankees will hear!' Then, when his own Stonewall regiments passed, he could not restrain them, and was heralded by a particularly wild rebel yell. 'It is no use,' said Jackson turning to his staff, 'you see I can't stop them.' And then, with pride, half to himself, 'Who could fail to win battles with such men as these?'

After passing through Thoroughfare Gap they brushed with the enemy, and then passed on to Bristoe Station, and from there to Manassas Junction, Pope's main commissary depot. Coming to the conclusion that it was impossible to take away a tithe of the stores, the regiments were let loose on the magazines with orders to load up with four days' rations per man. Then they withdrew and formed up on Groveton Ridge to await the expected attack from Pope's forces. This was north of Groveton and south-west of Sudley Ford, just west of the battlefield of First Bull Run.

Soon some of Pope's divisions came rushing back to deal with the intruders behind their lines; but by the time they were able to stage a full attack on Jackson's position on Groveton Ridge, he had been reinforced via Thoroughfare Gap, and the main battle was conducted on the Confederate side by Lee himself. In it, the Stonewall Brigade under Col. W. S. H. Baylor defended the unfinished railroad near Deep Cut.

On the second day of the battle an officer rode up and reported that Col. Baylor had been killed and that his successor in command wanted help.

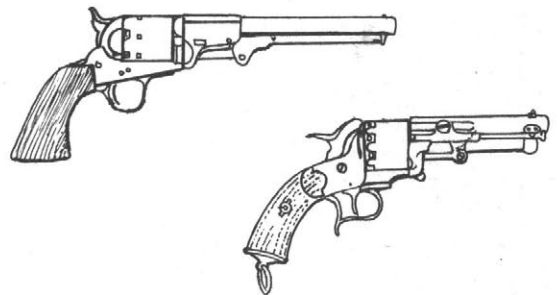

Above; Leech & Rigdon revolver made at Greensboro; below; Limat revolver imported from France

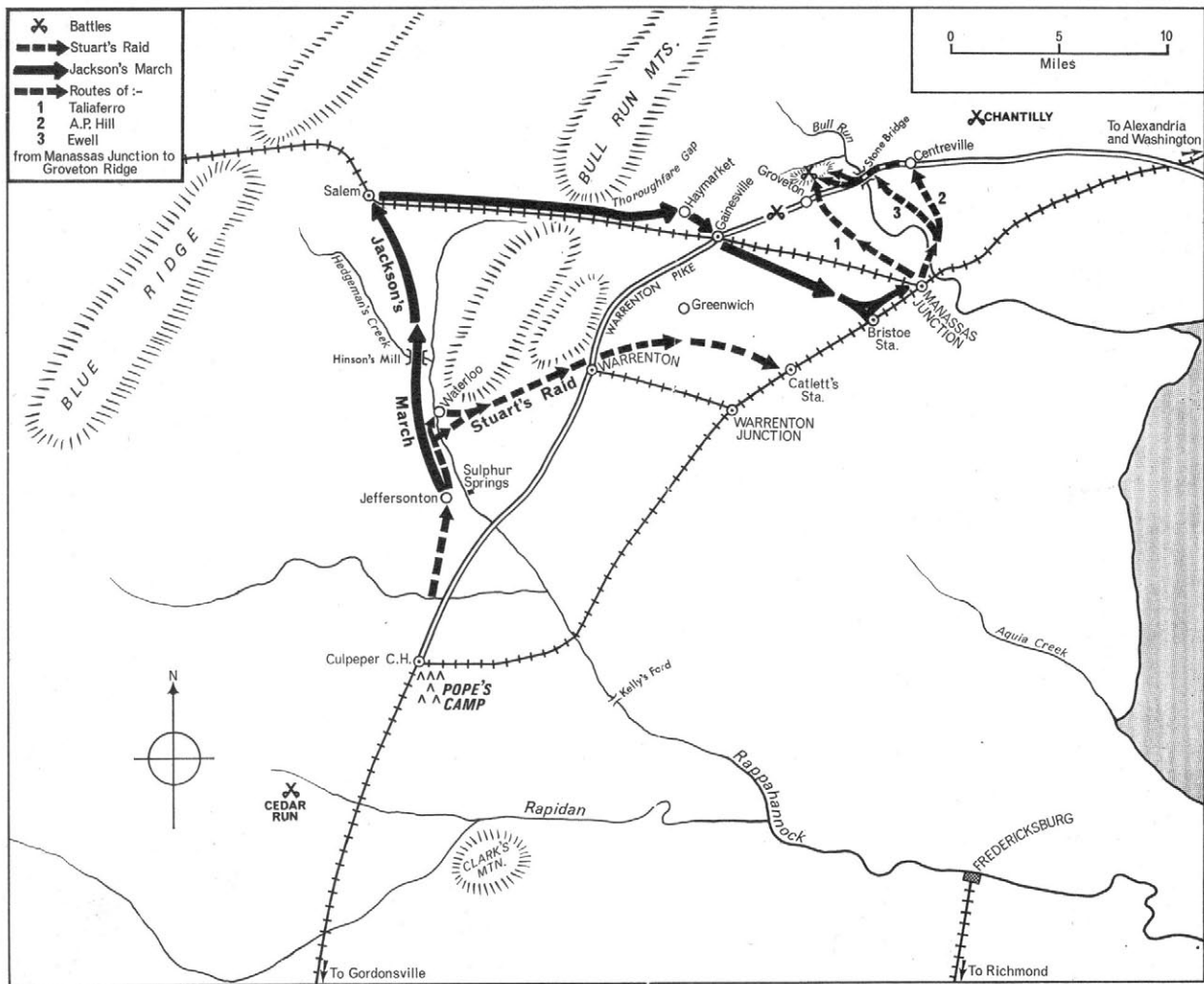

The Confederate advance before the Battle of Second Bull Run or Second Manassas, showing the route taken during the raid on Manassas Junction

Jackson did not catch the names. 'What brigade?' he asked.

'The Stonewall Brigade.'

Promising quick reinforcement Jackson added, 'Go back, give my compliments to them, and tell the Stonewall Brigade to maintain its reputation.' This it did. It fought most gallantly throughout the action.

On Lee's orders, Longstreet's corps now swung forward, and wheeling, struck the flank of the Federals who were attacking Jackson's position. This move proved decisive. The Federals were swept in disorder eastwards in the way they had been at First Bull Run, and along the same road over Stone Bridge.

Riding back after the battle, Jackson noticed a disabled soldier trying to climb up the railroad embankment where the fight had been so hot. He rode up to the soldier and asked him if he were wounded. 'Yes, General. But have we whipped them?' Jackson replied in the affirmative and dismounting approached the soldier and asked him his brigade. 'I belong to the 4th Virginia, your old brigade, General,' the man said. 'I have been wounded four times but never as bad as this. I hope I will soon be able to follow you again.' 'You are worthy of the old brigade,' replied Jackson in a low and husky voice, placing his hand on the man's head. 'I hope with God's blessing, you will soon be well enough to return to it.'

The Brigade's loss was heavy at Second Bull Run. Casualties of 4111 made it second only to First Bull Run. This is some measure of the gallant way they fought.

After the Confederate victory at Second Bull Run, Lee crossed the Potomac and entered Maryland. Parts of Maryland were sympathetic, and it was thought that the presence of a Southern army might induce Maryland to ally herself with the South. Lee hoped to recruit men for his armies, and obtain supplies of food and clothing. He also believed by moving north to lure the Federals away from Richmond.

The Maryland Campaign, however, was not very successful. Lee fought and won the battle of Antietam on 17 September 1862, where the Stonewall Brigade under Lieut.-Col. A. J. Grigsby defended his left around West Woods. In the

encounter Grigsby died of wounds and ten others of the brigade were killed. But the battle was not won decisively enough for the Confederates to remain north of the Potomac, and they withdrew back to defend Richmond again along the line of the Rappahannock. The Federals attacked at Fredericksburg where the Stonewall Brigade under Lieut.-Col. E. F. Paxton helped to hold the right of the Confederate line. The Federals were repulsed decisively at Fredericksburg on 13 December 1862; but in the New Year, and under a new commander, Gen. 'Fighting Joe' Hooker, they attacked again in the same neighbourhood, and the Battle of Chancellorsville was fought early in May 1863.

This time the Federals did not make just a frontal attack as they had at Fredericksburg, but staged a wide double envelopment, one arm against Fredericksburg and a stronger one striking

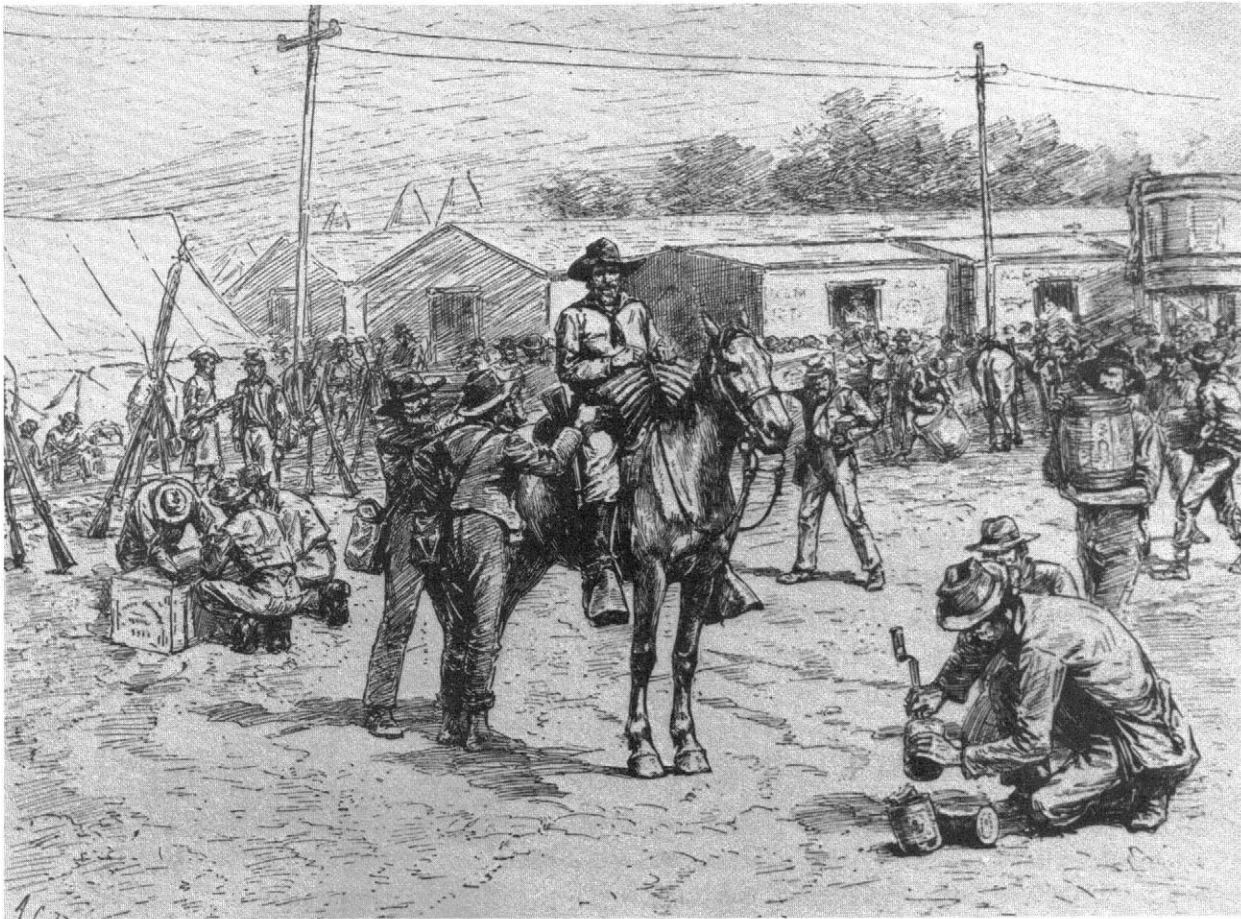

The Stonewall Brigade stocking up during the raid on Manassas Junction

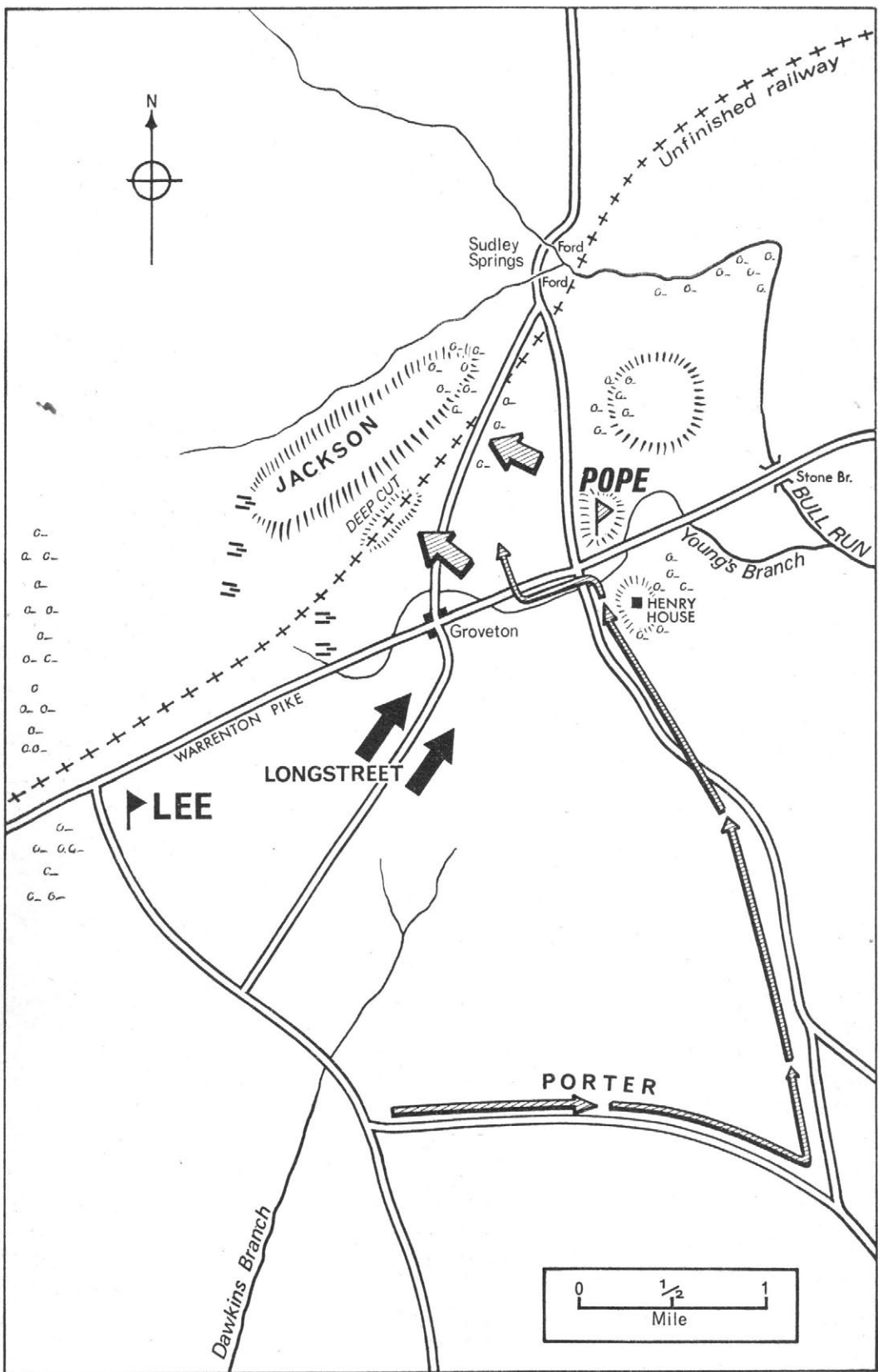

Battle of Second Bull Run or Second Manassas, 30 August 1862

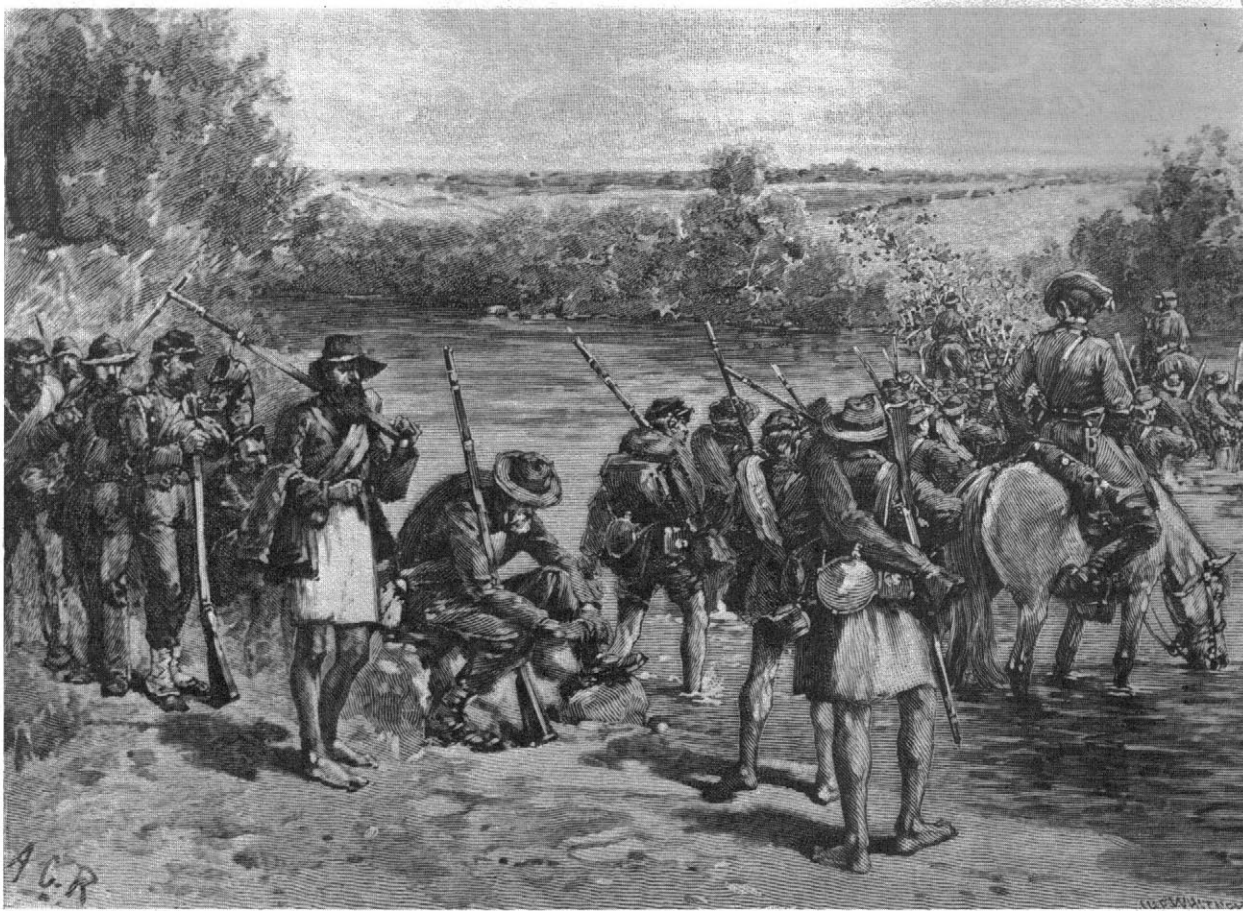

The Stonewall Brigade fording the Potomac at the start of the Maryland campaign

from the north 15 miles to the west. Passing through the Wilderness forest, the western attack threatened the rear of Lee's force at Fredericksburg. Lee, however, was not greatly perturbed. Leaving a small force to hold Fredericksburg, he turned with his main body to face Hooker's forces emerging from the Wilderness, and struck at them so boldly that they wavered and moved back into the fringes of the forest and dug in.

Among the pines near the cross-roads a mile from Chancellor House or Chancellorsville, Lee and Jackson sat together on a fallen log and considered what their next action was to be. Reports from patrols said the Federals were massed in front, and a turning movement on the right would be difficult owing to the thickness of the forest; but one cavalry report declared that the other Federal flank was 'in the air'. Lee turned to Jackson and

said, 'How do we get at these people?' Jackson replied that Lee must make the decision. He quickly did so. Accepting the cavalry report, he ordered Jackson to take a force round Hooker's exposed flank and attack the Federals in the rear. He drew with his cane a rough map of the projected envelopment in the sandy patch at their feet, but he left the details as to the route and composition of the force to Jackson. Jackson rose quickly from the log and saluted. 'My troops will move early tomorrow,' he said.

Jackson's column started at 8.00 a.m. on the morning of 2 May 1863. Following the van was Jackson himself, and the Stonewall Brigade came in the middle. At the cross-roads he found Gen. Lee waiting to wish him God-speed, and Jackson pulled up his favourite mount Little Sorrel for a moment to say a few words to his commander. The first danger was just short of Catharine Furnace



Lee and Jackson conferring before Jackson's flank march on Chancellorsville

where the road crossed an exposed ridge. Here the column came under fire from Federal batteries on elevated cleared ground south of the main road to Chancellor House. As the fire continued, Jackson gave orders that this part of the road should be crossed at the double-quick, and he diverted the wagons in the rear. Next, spotters in Federal observation balloons reported the dust clouds being thrown up by Jackson's column, and a rumour reached Federal headquarters to say that

Lee was in full retreat. On this an attempt was made to capture the Confederate artillery which it was believed would be the last to leave. However, the two rear brigades of Jackson's column turned back and foiled the Federal manoeuvre.

Meanwhile, Jackson and the main body were well on the way. Following a track parallel to Brock Road they were approaching Plank Road when one of Stuart's cavalry brigadiers came trotting down the road to meet them. 'General,'

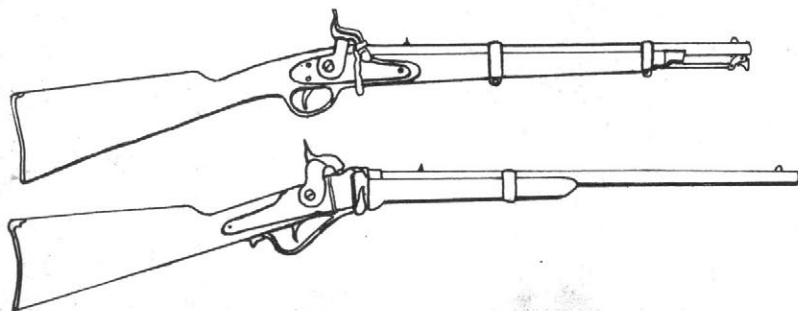

Above: Cooke & Brother carbine; below: Richmond copy of Sharp's carbine

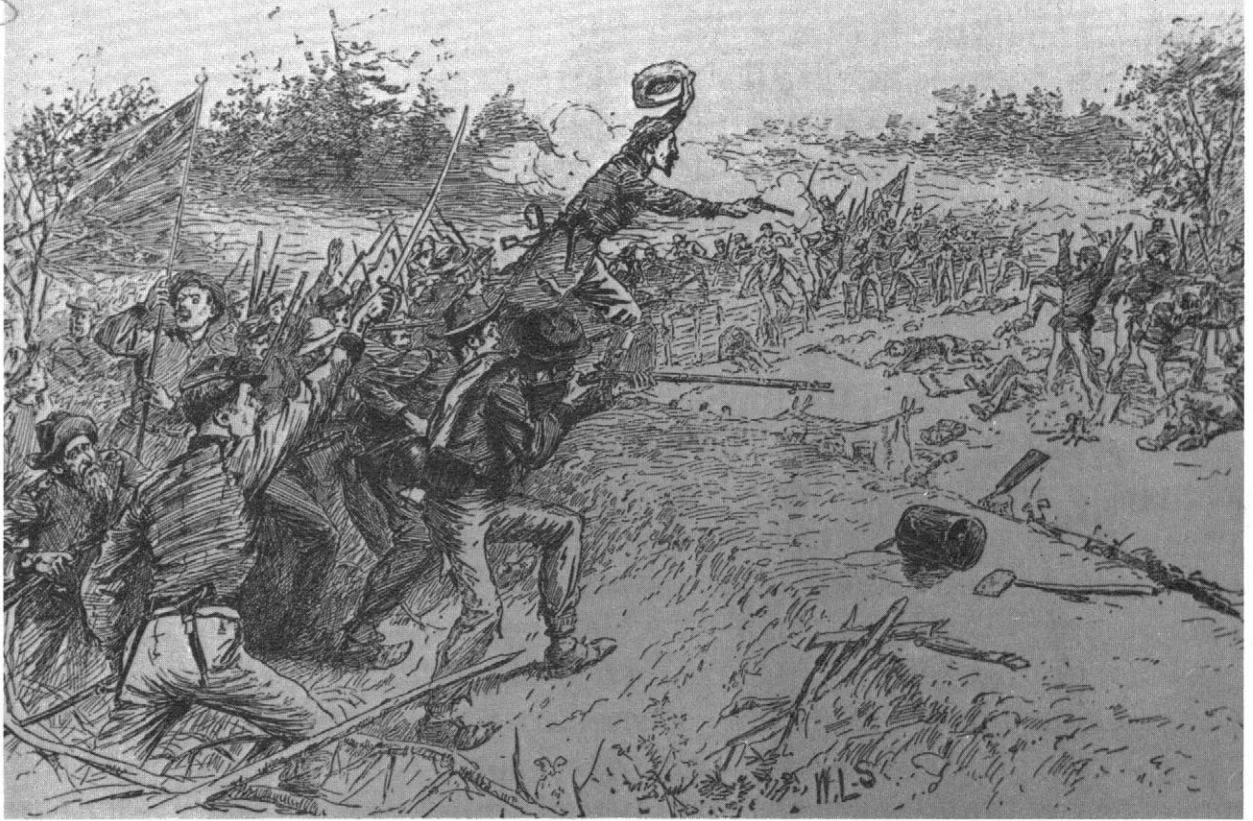

Jackson's soldiers charging at Chancellorsville, 2 May 1863, to the utter surprise of the Federals



A straggler passing the Stonewall Brigade

'Yes, sir,' said Rodes sitting his horse beside him, and impatient to start.

'You can go forward then.'

A bugle sounded, and back came the sound of other bugles on right and left. The attack had begun.

Strangely heralded by a sudden rush of wild life, deer and rabbits fleeing before the Confederate advance, the Confederates burst through the woods on the unsuspecting Federal troops and drove them back in confusion four miles until they rallied near Chancellor House.

It was now beginning to get dark and the tired troops stopped in their tracks to form a rough line round their defeated opponents. In the dusk Jackson rode forward to reconnoitre and plan the next move. Mistaken for an enemy patrol his cavalcade was fired on by his own troops, and Jackson, badly wounded, had to be borne away

from the battlefield. He died a week later. Next morning Maj.-Gen. J. E. B. Stuart took over command. As he passed the Stonewall Brigade, he called out, 'Remember Jackson!' and the exhausted troops responded with vigour. To-

gether with their comrades in other units, they hastened the Federals' retirement northwards; over U.S. Ford, and out of the battle.

Not only did the Stonewall Brigade lose their famous leader at Chancellorsville; Brig.-Gen.



The house at Guiney Station, south of Fredericksburg, where General Jackson died on 10 May 1863



Confederate infantry waiting for the end of the artillery duel at Gettysburg

Paxton was also killed there. A measure of their gallantry is written once again in their list of casualties which numbered 493, and so exceeded those of Second Bull Run. Following Jackson's death, after a resolution submitted to the War Department from its officers and men, the Stonewall Brigade was at last given official recognition when Special Orders 129, XI, of 30 May 1863 announced: 'The Department cheerfully acquiesces in the wish expressed and directs that the brigade referred to be henceforth designated the "Stonewall Brigade".'

The Stonewall Brigade continued to fight gallantly throughout the rest of the war. In the Gettysburg campaign it arrived with Ewell's corps at the end of the first day's fighting. During the next two days it took part in the hard but unsuccessful frontal assaults on Culp's Hill. It fought in the Wilderness for two bloody days, and a week

later, at Spotsylvania, it was on the left of the critical salient remembered as the Bloody Angle. Here 200 were killed or captured. This ended the existence of the brigade as a unit, for its surviving members were then consolidated into one regiment.

The Stonewall Brigade was a fine fighting unit proud to call themselves Jackson's 'Foot Cavalry', but prouder still of the title Stonewall which they shared with their leader, a title which was borne unofficially after Bull Run and officially, as has been seen, following Chancellorsville. They proved themselves in the Valley Campaign to be among the greatest marchers of all time. They were the stoutest of fighters as their casualty lists substantiate. It may truly be said that the Stonewall Brigade, like the Tenth Legion of Caesar and the Old Guard of Napoleon, has made its name for ever famous.

The Marches in the Valley Campaign

March 22 - June 25 1862

March 22	Mount Jackson-Strasburg	22 miles	
23	Strasburg-Kernstown-Newtown	18	Battle of Kernstown
24-26	Newtown-Mount Jackson	35	
April 17-19	Mount Jackson-Elk Run Valley	50	
30-May 3	Elk Run Valley-Mechum's River Stn.	60	
May 7-8	Staunton-Shenandoah Mount	32	Battle of M'Dowell
9-11	Bull Pasture Mount-Franklin	30	Skirmishes
12-15	Franklin-Lebanon Springs	40	
17	Lebanon Springs-Bridgewater	18	
19-20	Bridgewater-Newmarket	24	
21	Newmarket-Luray	12	
22	Luray-Milford	12	
23	Milford-Front Royal-Cedarville	22	Action at Front Royal
24	Cedarville-Abraham's Creek	22	Action at Mindletown and Newtown
25	Abraham's Creek-Stevenson's	7	Battle of Winchester
28	Stevenson's-Charlestown	15	Skirmish
29	Charlestown-Halltown	5	Skirmish
30	Halltown-Winchester	25	
31	Winchester-Strasburg	18	
June 1	Strasburg-Woodstock	12	Skirmish
2	Woodstock-Mount Jackson	12	
3	Mount Jackson-Newmarket	7	
4-5	Newmarket-Port Republic	30	
8	Port Republic-Cross Keys	5	Battle of Cross Keys
9	Cross Keys-Brown's Gap	16	Battle of Port Republic
12	Brown's Gap-Mount Meridian	10	
17-25	Mount Meridian-Ashland Station (one rest day)	120	

48 marching days

The Plates



The men of the Stonewall Brigade were by no means soldierly in appearance. There were no definite orders about the clothing to be worn, though the cavalry and artillery who worked with them, and their own officers, made some attempt to conform with the Confederate Army Dress Regulations issued before hostilities began. At first it was forbidden to wear Federal uniform, but even this was relaxed as time went on and the Southern States ran desperately short of clothing. Clothes were all shades of grey from light blue to butternut, and soft hats soon replaced *képis*. Long boots also disappeared and were replaced by strong brogues which were found to be more comfortable; but a shortage of footwear in the Confederate Army was a feature of the whole war and men were generally only too pleased to wear anything that came to hand. Greatcoats and knapsacks were soon abandoned as too cumbersome for the long marches the brigade had to undertake. All that was kept was a blanket and waterproof sheet slung over one shoulder and knotted on the other side of the waist. Spare kit was carried in a small haversack. It was said that Jackson considered 'a gum cloth, a blanket, a toothbrush and forty rounds of ammunition' as the full equipment for one of his soldiers.

A1 Infantryman, 1861

It is early in the war, so this man is dressed almost in accordance with the Confederate Dress Regulations. He wears the correct blue *képi* for infantry, and carries a knapsack on his back, a fashion soon

discarded. He holds rather casually a Springfield rifle musket of 1861 (another model was issued two years later). The Springfield Armoury manufactured about 800,000 of these muskets, and other sources furnished almost 900,000 more; the Confederates obtained some from their own arsenals and captured approximately 150,000 more.

A2 Infantryman, 1862

This soldier is still wearing boots and improvised gaiters and carries the knapsack on his back. But his greatcoat has been abandoned, and a blanket is rolled and carried over his shoulder so the knap-

Top right, Jennifer saddle. Centre, Confederate adaptation of 1842 model Grimsley saddle. Below, a U.S. dragoon bit on the left compared to bits imported and made by the South

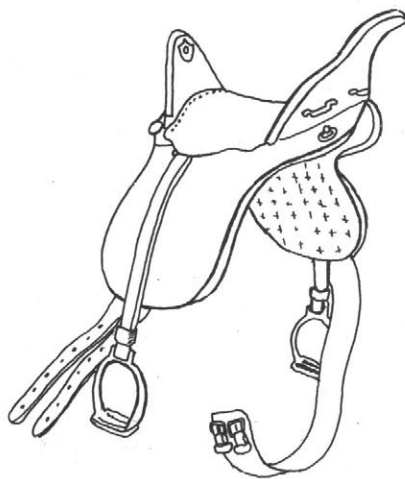
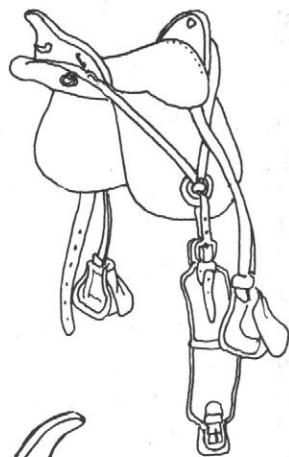

sack will also soon disappear, its essential contents being transferred to the rolled blanket. In his knapsack or blanket will be a waterproof sheet.

A3 Infantryman, 1863

This is what a typical soldier of the Stonewall Brigade looked like after two years of war. He still has his butternut tunic, but will soon discard it. The essential water-bottle and mug are well in evidence, and he has discarded his boots in favour of strong brogues. On page 19 is illustrated the shoe-boot he could well be wearing in another few months.

B1 Infantryman, 1864

His butternut tunic and belt-buckle bearing the 'CS' are the only remaining vestiges of official uniform. It is surprising that he has kept his tunic for so long, and the CS could well have been US by now, for the Confederates purloined a great deal of equipment from the Federals, most of which was superior to their own.

B2 Horse Artilleryman, 1863

Here is an artilleryman wearing the correct red *képi* and light blue trousers of his arm. The jack-boots show that he is a horse artilleryman. He is wielding the ramrod used for ramming home the charge, and for cleaning the barrel of the cannon.

B3 Artilleryman (Cannoneer), 1862

The artillerymen who fought with the Stonewall Brigade – in contrast to the infantry – wore relatively neat uniforms. This one has a tunic with official buttons and a proper 'CS' belt. He is carrying a bucket of water to swab out the gun.

C1 Infantry Officer, 1862

This officer wears the blue *képi* of the infantry and a butternut frock-coat. The gaiters are the most obvious indication that it is early in the war, for these articles were soon discarded.

C2 Horse Artillery Officer, 1863

A correctly dressed officer of the artillery wearing the short jacket with red trimmings and holding his red artillery *képi*. The hilt of his sword is similar to those carried by cavalry officers, and identical with officers of the British artillery. His decorated sleeves and coloured sash give him an ornate appearance.

C3 Cavalry Officer, 1862

The cavalry officers were often quite dandies, wearing feathers in their western-type hats, or attaching tassels to them, and sporting ornate braided jackets. This one also fancies himself as a two-gun man, with holsters on either hip. The Colt revolver he is flourishing lasted with minor modifications for many years and still resembles those of recent times.

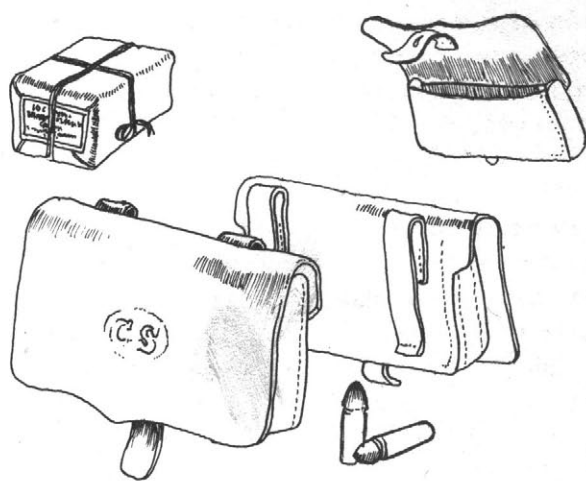
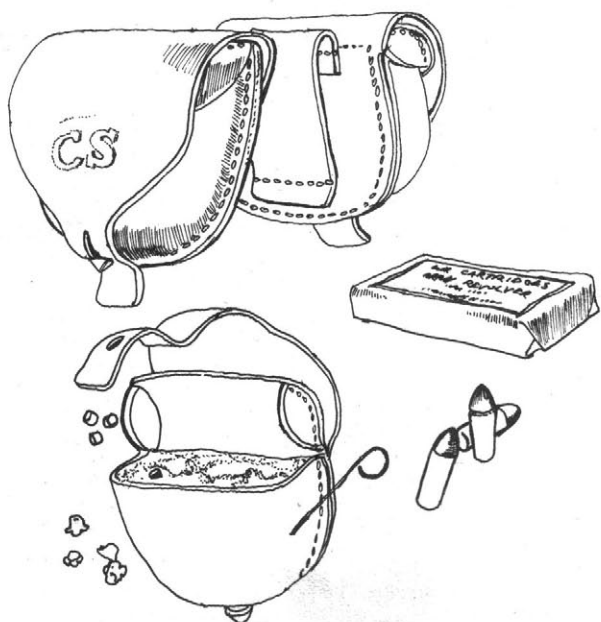

A selection of Confederate caps, cartridges and pouches. At extreme left are pistol caps, with musket caps below; on the right-hand side of the open powder pouch are carbine cartridges

D1 Cavalry Colonel, 1861-5

This officer is not so ornately turned out as the cavalry officer in Plate C3. He wears the official double-breasted jacket, and the pattern of the hilt of the cavalry sword is well shown.

D2 General, 1863

The dark colour of this general's frock-coat indicates that he is still wearing his old regular or militia uniform. Jackson might have dressed like this when he was a lieutenant-general and the Stonewall Brigade was serving under him in his corps.

D3 Cavalry Officer, 1864

Here is a cavalry officer dressed more or less correctly except for his western hat, though by now it can hardly be regarded as improper. Note the cutaway pattern of the jackboots to facilitate the bending of the knee when in the saddle.

E General, 1862

This general is correctly dressed in every respect, wearing a light-coloured *képi* and uniform suitable for a Confederate. Gen. Joseph E. Johnston would have been dressed like this when he was Jackson's superior during the Valley Campaign.

F Senior Artillery Officer, 1863

As usual with the artillery, this officer is correctly and smartly dressed with red trimmings to his light uniform, but he is wearing the western hat which senior officers on both sides favoured. The bucket-type stirrup is well illustrated. The head-rope could be undone and used to tie up the horse.

G Cavalry Sergeant, 1862

The yellow *képi* and yellow trimmings to the uniform are correct dress. He carries a sword tucked under the flap of the saddle and grasps a Sharps carbine probably captured from the Federals. This carbine was one of the first successful breech-loaders; it was of .52 calibre, had a rate of fire of up to ten rounds per minute, and was accurate to 600 yards.

H Mounted Trooper, 1862

The trooper wears a western hat instead of a *képi* but is otherwise correctly dressed, which would have been a very acceptable standard at this stage of the war. He has bucket stirrups like the artillery officer in F. The carbine in his left hand has been drawn from its bucket unseen on the right of the saddle. He carries the regulation sabre, though they had been discarded by most Confederates by 1863.

Men-at-Arms Series

Each title in this series gives a brief history of a famous fighting unit, with a full description of its dress and accoutrements, illustrated with eight colour plates and many drawings and photographs. Collectors of militaria, war-gamers, and historians will find no other series of books which describe the dress of each unit so comprehensively. The series will range widely in time and terrain, with a special effort to include some of the lesser-known armies from other lands. About twelve titles will be published each year.

TITLES ALREADY PUBLISHED

- THE STONEWALL BRIGADE *John Selby*
THE BLACK WATCH *Charles Grant*
FRENCH FOREIGN LEGION *Martin Windrow*
FOOT GRENADIERS OF THE IMPERIAL GUARD *Charles Grant*

FUTURE TITLES INCLUDE

- CHASSEURS OF THE GUARD *Peter Young*
THE IRON BRIGADE *John Selby*
ARGYLL & SUTHERLAND HIGHLANDERS *W. McElwee*
COLDSTREAM GUARDS *Charles Grant*
U.S. CAVALRY *John Selby*
30TH PUNJABIS *James Lawford*
ARAB LEGION *Peter Young*
CONNAUGHT RANGERS *Alan Shepperd*
SOVIET ARMY, 1917-42 *Albert Seaton*

JOHN SELBY was educated at Haileybury, The Royal Military Academy, Woolwich, and Christ's College, Cambridge. He is a military historian and Senior Lecturer at the Royal Military Academy, Sandhurst. His previous books include *The Second World War*, *Stories of Famous Sieges*, *The Recollections of Sergeant Morris* (editor), *The Paper Dragon*, *The Boer War*, *The Thin Red Line*, and a biography of Stonewall Jackson. He is the author of three other books to be published in the Men-at-Arms series.

£1.25 net (in UK only)