

# AMERICAN CIVIL WAR FORTIFICATIONS (2)

Land and Field Fortifications

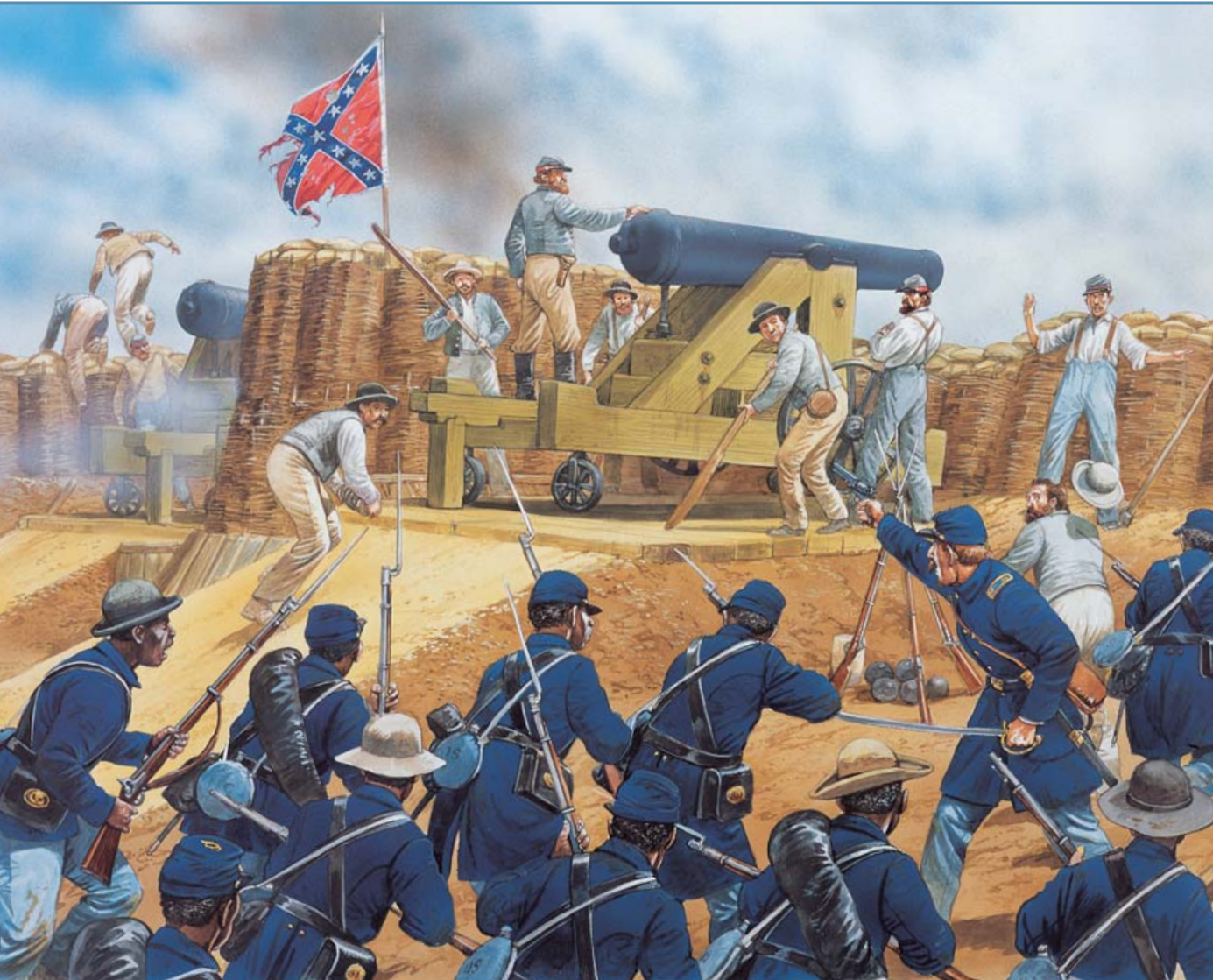

**RON FIELD**

ILLUSTRATED BY PETER DENNIS

FORTRESS • 38

---

# AMERICAN CIVIL WAR FORTIFICATIONS (2)

Land and Field Fortifications



**RON FIELD**

ILLUSTRATED BY PETER DENNIS

*Series editors* Marcus Cowper and Nikolai Bogdanovic

# Contents

Introduction	4
Chronology	
The antebellum experience, 1830–61	6
The key elements of field fortification	8
Semi-permanent field fortifications • Outer field fortifications	
The war in the East, 1861–64	26
Defenses of Washington, May–July 1861 • Big Bethel, 1861 • Manassas, 1861–62 Extension of the Washington defenses, 1861–64 • The Peninsula Campaign, 1862 • Battle of Williamsburg, 1862	
The Richmond defenses, 1861–65	35
Siege of Suffolk, April 11–May 4, 1863	
The western campaign, 1862–64	38
Siege of Chattanooga, 1863 • Siege of Knoxville, 1863 • Struggle for Atlanta, 1864 • Siege of Savannah, 1864	
War in the East, 1864–65	43
The Confederate attack on Washington, July 11–12, 1864 • The Wilderness, 1864 • Spotsylvania, 1864 Bloody Angle, 1864 • Cold Harbor, 1864	
The fortifications of Petersburg, 1864–65	48
Life in the Petersburg fortifications	
The fate of the fortifications	58
Visiting the sites today	61
Further reading and research	63
Index	64

# Introduction

The American Civil War saw a massive development in the use of field fortifications. Often considered the first modern war, scenes during many of the campaigns and battles of the conflict foreshadowed the shape of things to come in the trenches of the First World War of 1914–18. Early in the Civil War during actions such as Big Bethel, First Manassas (Bull Run), and the Seven Days' Battles, soldiers were required to dig simple defensive rifle trenches or pits in order to hold their ground. However, as a result of the increased practical application of lessons learned at the US Military Academy in the antebellum years, and the deadly impact of rifled infantry weapons and artillery, both Northern and Southern armies began to adopt and develop a far more sophisticated system of field fortifications as the Civil War unfolded. The unsuccessful Union assault on the Confederate field positions on Marye's Heights at Fredericksburg in December 1862 was early evidence of the employment and impact of semi-fortified lines. Union General Joseph Hooker's withdrawal from Fredericksburg towards the Rappahannock was subsequently covered by entrenched positions. In a concentrated position fronting the river, the pioneer brigade of the Army of the Potomac, commanded by General Gouverneur K. Warren, threw up five miles of formidable entrenchments in less than 48 hours. Accordingly, Confederate artillery commander E. P. Alexander commented, "Our engineers were amazed at the strength and completeness of the enemy's entrenchments. Impenetrable abatis covered the entire front, and the crest everywhere carried head-logs under which the men could fire as through loopholes. In the rear, separate structures were provided for officers, with protected out-looks, where they could see and direct without exposure."

At Chancellorsville in May 1863, Hooker further entrenched much of his army behind parapets and log breastworks supported by abatis. At some points his troops threw up a triple line of entrenchments. Gettysburg saw the construction of makeshift fieldworks from rocks or split rail fence, plus rifle trenches, as appropriate to the terrain, along nearly the entire length of each opposing line of battle. Those of the Union army were particularly effective on Culp's Hill, Cemetery Hill, the Angle, and the Round Tops, when the Confederates made their valiant attacks on the second and third days of the battle.



Soldiers standing at the gate of Fort Slemmer, one of the enclosed forts constructed to the north of Washington, DC. Note the wide wooden ramp that gave access across a deep ditch. The siege gun in the rear stands on a wooden barbette carriage. (Library of Congress B811-2318)

By 1864, the trend towards a more elaborate system of fortification had evolved into the more sophisticated fieldworks used at Spotsylvania Court House and Cold Harbor, in Virginia. Similarly, the larger field works and fortifications surrounding Washington, DC and Richmond, Virginia were redesigned and rebuilt several times. By 1865 they approached a standard of physical adaptation little short of permanent fortifications. Indeed, in a report dated October 20, 1864 Major Nathaniel Michler, Corps of Engineers, US Army, summed up the changing face of warfare: “The new era in field-works has so changed their character as in fact to render them almost as strong as permanent ones, and the facility with which new and successive lines of works can be constructed (so well proven throughout the whole campaign just terminated) renders it almost useless to attempt a regular siege. The open assault of works is attended with immense loss of life, but at the same time during the slow operations of the siege the sharpshooter so effectually does his work as to produce a large bill of mortality.”

The nine-month siege of Petersburg, which is the longest siege in the history of American warfare and involved nearly 150,000 soldiers in both Union and Confederate armies, saw some of the most sustained fighting and extensive building of fortifications of the Civil War. The Petersburg lines witnessed the further development of redoubts, lunettes, and redans, as well as bomb-proof shelters and powder magazines, covered ways, rifle trenches, and rifle pits. Mining was attempted by both armies, and resulted in the debacle of the Battle of the Crater on July 30, 1864. With the final collapse of the sparsely manned Petersburg lines on April 2, 1865, the Confederates evacuated their capital, and one week later the remains of the Army of Northern Virginia surrendered at Appomattox Court House. The Civil War was over, and the face of warfare had changed forever.

The subject of this volume is the role of land and field fortifications in the eastern and western campaigns of the Civil War between 1861 and 1865. The part they played in the Mississippi and Tennessee river valleys, and along the Atlantic coast and in the Gulf of Mexico, will be dealt with in future proposed volumes in the Fortress series.

## Chronology

1824	Dennis Hart Mahan graduates from West Point.
1830	Mahan begins to teach military science and engineering at West Point.
1846–48	Mexican-American War.
1854–56	Crimean War.
1861	April: Civil War begins. May: Washington DC defenses begun. May: Richmond defenses begun. June: Big Bethel. July: First Manassas (Bull Run).
1862	March–July: Peninsula Campaign, including the siege of Yorktown and Williamsburg. August: construction of “Dimmock Line” begun at Petersburg.
1863	April–May: siege of Suffolk. July: Gettysburg. September–November: siege of Chattanooga. November–December: siege of Knoxville.
1864	May: Wilderness and Spotsylvania Court House. June: Cold Harbor. Siege of Petersburg begun. July: Battle of the Crater. Confederate attack on Washington DC defenses. July–September: Atlanta campaign. December: siege of Savannah.
1865	March: Confederates attack Fort Stedman. April: Federal breakthrough at Petersburg. Fall of Richmond. Confederate surrender at Appomattox Court House.

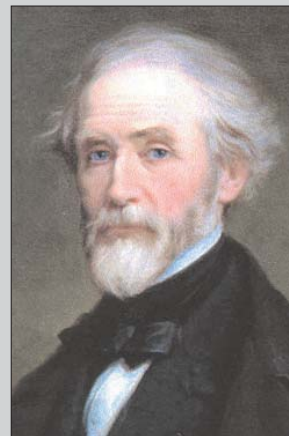

**Dennis Hart Mahan  
(1802–71)**

Following graduation from the US Military Academy in 1824, Mahan was assigned to the Corps of Engineers and also appointed to the faculty of the Academy. Before assuming his teaching responsibilities, he spent four years in France as a student and observer. This included one year at the prestigious School of Engineering and Artillery at Metz. Returning to West Point in 1830, he taught military science and engineering for the next 41 years. In 1832, he introduced field fortification into the curriculum at senior level in his course on military and civil engineering and the science of war. Mahan also influenced tactical doctrine by writing treatises that were adopted as official textbooks. His most important works were *A Complete Treatise on Field Fortification* (1836) and *An Elementary Treatise on Advanced-Guard, Out-Post, and Detachment Service of Troops* (1847). The former work contained his modification of the French-derived tactical system and replaced François Gay de Vernon's *A Treatise on the Science of War and Fortification*, which had been a West Point text since 1817.



**Charles H. Dimmock  
(1800–63)**

Dimmock graduated from West Point fifth in the class of 1820, and served with the rank of lieutenant in the US Army until 1837, when he resigned to become a civil engineer. He was appointed by the War Department during the same year to survey the middle section of the “Military Road” on the “Permanent Indian Frontier,” from Fort Coffee to Fort Leavenworth. He was elected captain of the Richmond Grays upon their organization at Richmond, Virginia, on January 29, 1844. In 1861 he was appointed colonel of ordnance, and in August was assigned to command the Virginia troops “in and near” Richmond. In February 1862 he produced a report recommending that the Richmond defenses be strengthened. During 1862–63 he supervised the construction of the Petersburg defenses, known as the “Dimmock Line.” The same year, and with the assistance of Henry de Feuvre, he began supervision of the construction of Fort Clifton, near the junction of the Appomattox River and Swift Creek. Completed in 1864, this formidable fort controlled navigation on the river north of Petersburg and was not taken by Union forces until the fall of Petersburg. He died suddenly on October 27, 1863, and was buried with full military honors two days later.

# The antebellum experience, 1830–61

During the 1830s, a new generation of American military theorists began to elevate the role of entrenchment, as opposed to open frontal assault, to a more prominent place in military tactics. As the only official military academy in the US, West Point was a college of engineering modeled on the *École Polytechnique* established in France in 1794. The graduates of West Point might not have been particularly well versed in the art of commanding infantry or cavalry, but they had a solid grounding in mathematics and military engineering. Professor of Military and Civil Engineering, and of the Science of War, since 1832, Dennis Hart Mahan believed in the pre-eminence of the spade in combat, and drew inspiration from the 17th-century French military engineer Sebastien Le Prestre, Seigneur de Vauban (1633–1707). Best remembered as *Le Maréchal de Vauban*, he improved existing French fortresses and designed a new system of fortifications that stabilized and strengthened the borders of France. Another major influence on Mahan was the 19th-century Swiss military theorist General Baron Antoine Henri de Jomini (1779–1869). Based on experience in Napoleon’s *Grand Armée* and as a military adviser to the Tsar of Imperial Russia during the Crimean War of 1854–56, Jomini wrote numerous treatises including the *Art of War* (1838), which explained the Napoleonic method of warfare and became the premier military textbook of the 19th century.

After graduation from West Point, a variety of US Regular Army officers and men, and some volunteers, fought in wars during the 1830s and 1840s, and were involved in the construction of fortifications in the field. Joseph G. Totten served as US Chief of Engineers during the Mexican War. Ulysses S. Grant, Robert E. Lee, and Thomas J. Jackson witnessed a classic siege at Vera Cruz in 1847. As army engineers, both Lee and George McClellan had laboured side-by-side overseeing the building of batteries during the remainder of the campaign in central Mexico. Numerous other US Army officers, including McClellan, John G. Barnard, Joseph G. Totten, and Philip St. George Cooke, observed methods of fortification abroad between 1815 and 1861, and some even witnessed fighting. An official observer with the British Army, McClellan saw firsthand the Crimean War siege operations at Sebastopol in 1854–55; this experience would later influence his decisions during the 1862 Peninsula Campaign in Virginia.





Both North and South used Mahan's military manuals extensively in the Civil War. This advertisement appeared in the *Charleston Daily Courier* on January 23, 1862 and announced the publication of an edition of *Treatise on Field Fortification* by West & Johnston of 145 Main Street, Richmond, Virginia. (Author's collection)

LEFT Many young army officers, such as Ulysses S. Grant, Robert E. Lee, and Thomas J. Jackson, gained practical experience with field fortifications during the Mexican War. In this painting of the siege of Vera Cruz, 1847, English-born artist James Walker depicts the US artillery protected by battery traverses behind embrasures. (Dept. of Defense Still Media Records Center)

Despite this, many of the officers and most of the enlisted men who served in the Civil War had no experience of fortifications whatsoever. To help these, a variety of manuals and other technical literature was available. Numerous pertinent British texts, such as J. S. Macauley's *Treatise on Field Fortification, and Other Duties of the Field Engineer* (1847) and Hector Straith's *Introductory Essay to the Study of Fortification for Young Officers of the Army* (1858) were extant and some officers used them. When the war began in 1861, available fortification manuals published in the US included Louis von Buckholtz, *On Infantry, Camp Duty, Field Fortification, and Coast Defence* (1860); and Dennis Hart Mahan, *A Complete Treatise on Field Fortification, with the General Outlines of the Principles Regulating the Arrangement, the Attack, and the Defense of Permanent Works*. A first edition of the *Treatise on Field Fortification* was published in 1836; it was reprinted in New York in 1861 and 1863; and in the Confederacy in 1862. This volume became the standard manual on the subject, and contained complete and detailed instructions for

planning, siting, constructing, defending, and attacking field fortifications and entrenchments, including information on permanent works.

As the war progressed, new books became available. James C. Duane's *Manual for Engineer Troops* (1862) included chapters entitled "Rules for Conducting a Siege," "School of the Sap," "Military Mining," and the "Construction of Batteries." Assigned by McClellan to design bridge-building equipment in 1861, Duane had become Chief Engineer in the Army of the Potomac by 1864. William P. Craighil's *The Army Officer's Pocket Companion* (1863) included Article 98 – "Field Works." Even the Confederates, despite poor supplies of paper, published field fortification manuals such as Egbert L. Viele's *Hand-Book of Field Fortifications and Artillery* (1861), while an edition of Mahan's *Treatise on Field Fortification* was published by West & Johnston, 145 Main Street, Richmond, on March 7, 1862.

Generally, both armies considered Mahan's manuals as state of the art. Indeed, Major General Henry W. Halleck, an Army engineer for many years who became commander-in-chief of Union forces in July 1862, wrote in both the 1846 and 1859 editions of his *Elements of Military Science* that Mahan's *Treatise on Field Fortification* was "undoubtedly the very best work that has been written on field fortification, and every officer going into the field should supply himself with a copy."

### James Chatham Duane

James Chatham Duane graduated from West Point Military Academy in 1848 and served two tours teaching engineering. He also supervised river and harbor construction and was involved in the Utah Expedition of 1857–58. Promoted captain in August 1861, he was assigned by McClellan to organize engineer and bridge-building equipage for the Peninsula Campaign. Subsequently assigned as Chief Engineer, Army of the Potomac, he held this position from Antietam until McClellan was dismissed in November 1862, following which he was



appointed to the same post in the Department of the South. Promoted to major, he was recalled to Chief Engineer, Army of the Potomac, in July 1863, and a year later laid out the formidable siege lines to the east of Petersburg. He retired in 1888 as Brigadier General, Chief of Engineers, a position he had held since 1886. Sketched by Alfred Waud in September 1864, Duane is shown discussing

the construction of fortifications with General Henry J. Hunt, who commanded the siege operations outside Petersburg. (Photo: Library of Congress USZ62-14656)

# The key elements of field fortification

Field fortifications during the American Civil War consisted of temporary works constructed of earth and wood that were designed to increase the defensive capabilities of a body of troops holding a position. The two basic components of most field works consisted of the parapet and the ditch. The parapet was an earthen embankment raised high enough to provide cover from enemy fire, while the ditch supplied soil to construct the parapet and served as an obstacle to impede an assault on the field work.

Most field works were designed according to a standard set of proportions that regulated the height and width of their various elements. They could also be given any outline necessary to adequately fortify a position. This mostly consisted of straight lengths of parapet arranged to provide for a mutual defense of the various faces and flanks of the work. The length of parapet in an outline depended on several factors, such as the number of troops and pieces of artillery necessary to hold the position; the circumstances of the site of the work and its relationship to the ground around it; and whether it was an isolated post or an element within a line of works.

Competent Civil War military engineers such as John G. Barnard and Charles Dimmock had an extensive repertoire of standardized figures such as lunettes, redans, square and polygonal redoubts, bastioned lines of defense, and cremaillère lines that they used to design field works. Certain outlines incorporated particular strengths and weaknesses; for example, a square redoubt would have four salient angles, producing large sectors without fire at the corners of the square. However, such a work was closed at the gorge and made a good shelter for troops holding an isolated position that could be attacked from more than one direction. Military engineers were by no means limited by the standardized figures outlined in various manuals and textbooks at their disposal. Indeed, during the Civil War they produced an extremely wide variety of outlines, each one designed to meet the particular needs and conditions present at a specific site. Furthermore, almost all of the various types of field works could be combined to form lines of defenses to cover the front of an army, or to protect a strategic point.

## Semi-permanent field fortifications

### Redoubts

Within permanent fortifications, a redoubt, or reduit, was placed inside a larger outwork, and was designed to prolong the defense of the work after its scarp had been breached. It also provided an interior shelter for the collection of troops and materials necessary for the defense of the outwork. In the context of field fortifications, redoubts could be laid out as any regular or irregular convex polygon, as necessary to adequately fortify a particular site. The most common forms were four- and five-sided figures. This type of field work could be adapted to fortify

This large star fort called Fort Phelps formed part of the Federal defenses built by 1865 to protect Chattanooga in Tennessee. Note the cross-shaped blockhouse in its upper terre-plein. (*Official Military Atlas of the Civil War*)

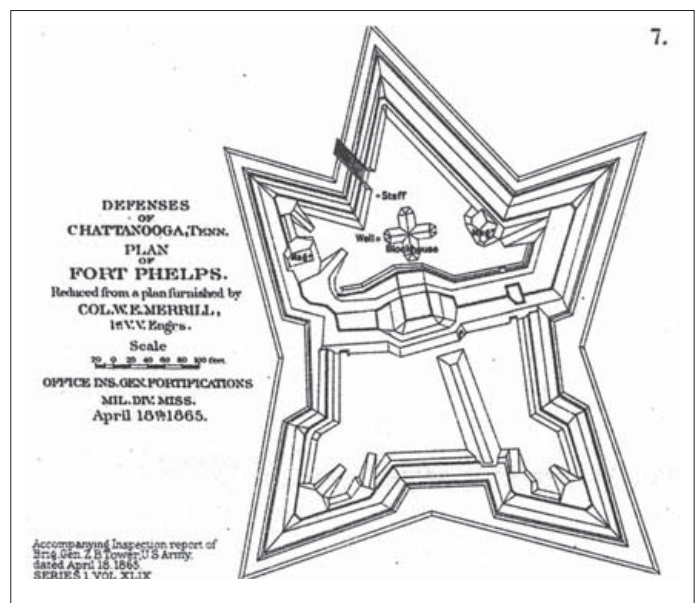



almost any position, but was generally applied to situations in which a garrison might be compelled to defend itself against attacks from any direction. This included isolated garrison posts along lines of communication and continuous lines of works where it might be necessary for the garrison of a work to maintain its position after another section of the line had been breached. Several redoubts could be placed in defensive support of each other to form lines with intervals in which fire crossed.

### Star forts

A star fort, or tenaille fort, was surrounded on the exterior with projecting angles or salients, and was categorized by the number of salients included in its traces, e.g. a fort with six salient angles was referred to as a hexagonal fort. Although they were used quite extensively in earlier wars, star forts fell from favor following disappointing service in the Napoleonic Wars. Most 19th-century engineering manuals had more to say about their disadvantages than their advantages. Flank defense of the ditch was ineffective, and salients could only be defended by oblique fire. Also, the development of the parapet required a garrison too large for the area enclosed by the fortification. Furthermore, salients were vulnerable to enfilade fire and difficult to protect with traverses without severely restricting the number of troops able to defend each face of the fort. Bastion fortifications, particularly those with five bastions, were sometimes referred to as star forts.

A cremaillère line was an indented or serrated continuous line consisting of a series of alternating faces and flanks traced perpendicular to each other. These often linked redans and redoubts together.

### Redans

A redan was a simple field work consisting of two faces joined to form a salient, or outward projecting angle, in a line of defense works. Redans were used in conjunction with larger works as advanced posts to protect ground that could not otherwise be seen. In many cases, two or more redans were joined together to form double or triple redans, as in the Confederate lines at Fort Blakeley in Alabama. Fifty-five redans had been built into the Petersburg defenses by 1864. This type of field work could also be used to cover small posts guarding roads or bridges, provided the avenues of approach were restricted and the direction of enemy approach could be adequately predicted.

### Lunettes

In field fortification, a lunette was a detached field work consisting of two faces, forming a salient angle, and two parallel flanks. Similar to redans, lunettes were employed as advanced works in front of a line with gaps. Lunettes were placed in the defenses of Washington DC in 1861. They were also used in the design of Fortress Rosecrans, an earthen fort constructed near Murfreesboro, Tennessee, after the Battle of Stones River, fought between December 31, 1862 and January 2, 1863. Large irregular lunettes were used to fortify the perimeter of the entrenched camp.

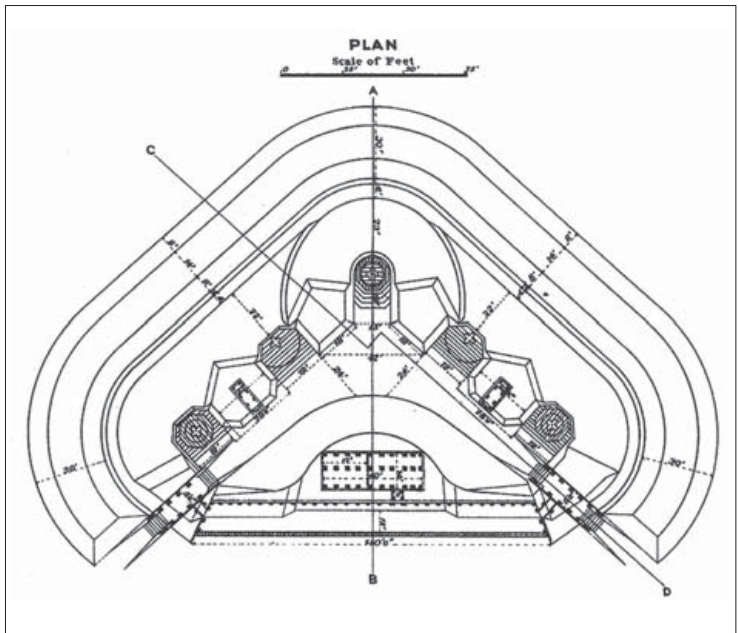

Plan of Lunette D in the Mobile defenses supervised by Lieutenant Colonel Victor Von Sheliha, of the Confederate Corps of Engineers, in 1864. This battery stood on the westernmost of the city defenses during the siege begun on March 12, 1865. (*Official Military Atlas of the Civil War*)

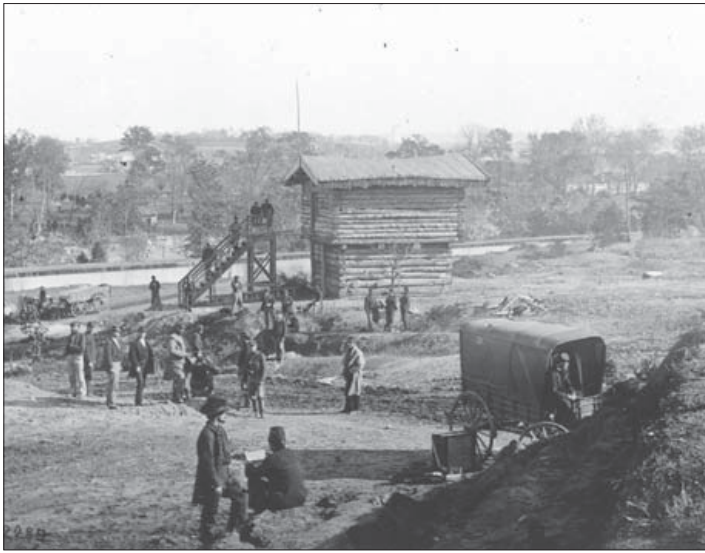

This blockhouse near the Aqueduct Bridge at Arlington Heights, Virginia, has an overhanging upper story, and an entrance reached by a freestanding staircase. (Library of Congress B8171-2282)

single-level squares to large, two-storied, cross- or hexagon-shaped works capable of housing artillery. Logs at least 12 inches thick when squared on either two or four sides were considered the minimum material necessary for both walls and roofs to prevent penetration with common musket balls. Blockhouse walls were formed either by placing the logs upright and side by side, as in palisades, or they could be laid horizontally on top of each other and joined with notches in the manner of a common log cabin. The logs composing a vertical wall had to be buried at least three feet into the ground or set into a ground-sill, and their tops had to be mortised into a cap-sill, or head piece, to keep them from spreading and separating. Blockhouse walls were often banked up with earth to the loopholes, or surrounded by earthworks, which provided a partial mask from artillery fire.

To enable troops forming the garrison to work their ramrods without excess interference, nine feet was considered the minimum height necessary for a Civil War blockhouse wall. The minimum length was 12 feet, since a shorter wall would not provide space for enough loopholes to allow an adequate defense.

### Fortress Rosecrans

Fortress Rosecrans was the largest field fortification built during the Civil War. It was designed by General James St. C. Morton, who had taught engineering at West Point, and named for General William S. Rosecrans. It consisted of a line of detached lunettes and connecting works with intervals that would have allowed the defending force to counter-attack out of the camp. Constructed southeast of Nashville, Tennessee in early 1863 by Union troops occupying Murfreesboro following the Battle of Stones River, this massive earthen fortification served as a 200-acre base of occupation, and as a depot to supply troops as they marched to Atlanta. Its four redoubts, plus lunettes Thomas and McCook, contained cross-shaped blockhouses. With the exception of outworks Lunette Davis and Redan Van Cleve, all 14,000 feet of earthworks were linked together by either abatis or natural features such as the river. Much of this fortress was built by a Pioneer Corps of specially selected, skilled men.

### Bastions

Designed to project outward from the main enclosure of a fortification, bastions consisted of two faces and two flanks, and were so constructed that it was possible to defend by a flanking fire the adjacent curtain, or wall, which extended from one bastion to another. Two adjacent bastions were connected by a curtain wall, which joined the flank of one with the adjacent flank of the other.

### Blockhouses

Large field works often contained blockhouses, which were enclosed wooden fortifications that served as interior keeps. They also allowed small garrisons posted at isolated locations to protect themselves from attack by superior enemy forces.

Blockhouse designs varied from simple

A reconstruction of the cross-shaped blockhouse in Redoubt Johnson is shown on the right. According to Mahan's principles of fortification, the ceiling height was to be not less than nine feet from ground level, to allow "ample room for loading the musket." The internal "camp beds of boards" on each side of the interior also served as raised firing platforms. Loopholes were placed at intervals of three feet along the walls, and vents were placed above each loophole to prevent the build up of powder smoke. The wooden doors, also containing loopholes, were protected by galleries. The whole structure was protected by a 12-foot-deep ditch, with a palisade standing at the foot of the outer slope, inside which was an infantry parapet. A removable bridge-way provided access across the ditch. The interior of the blockhouse is shown empty here, but would have been filled with knapsacks, cartridge boxes, gun racks, provisions, and other accoutrements of daily life, stacked up on shelves.

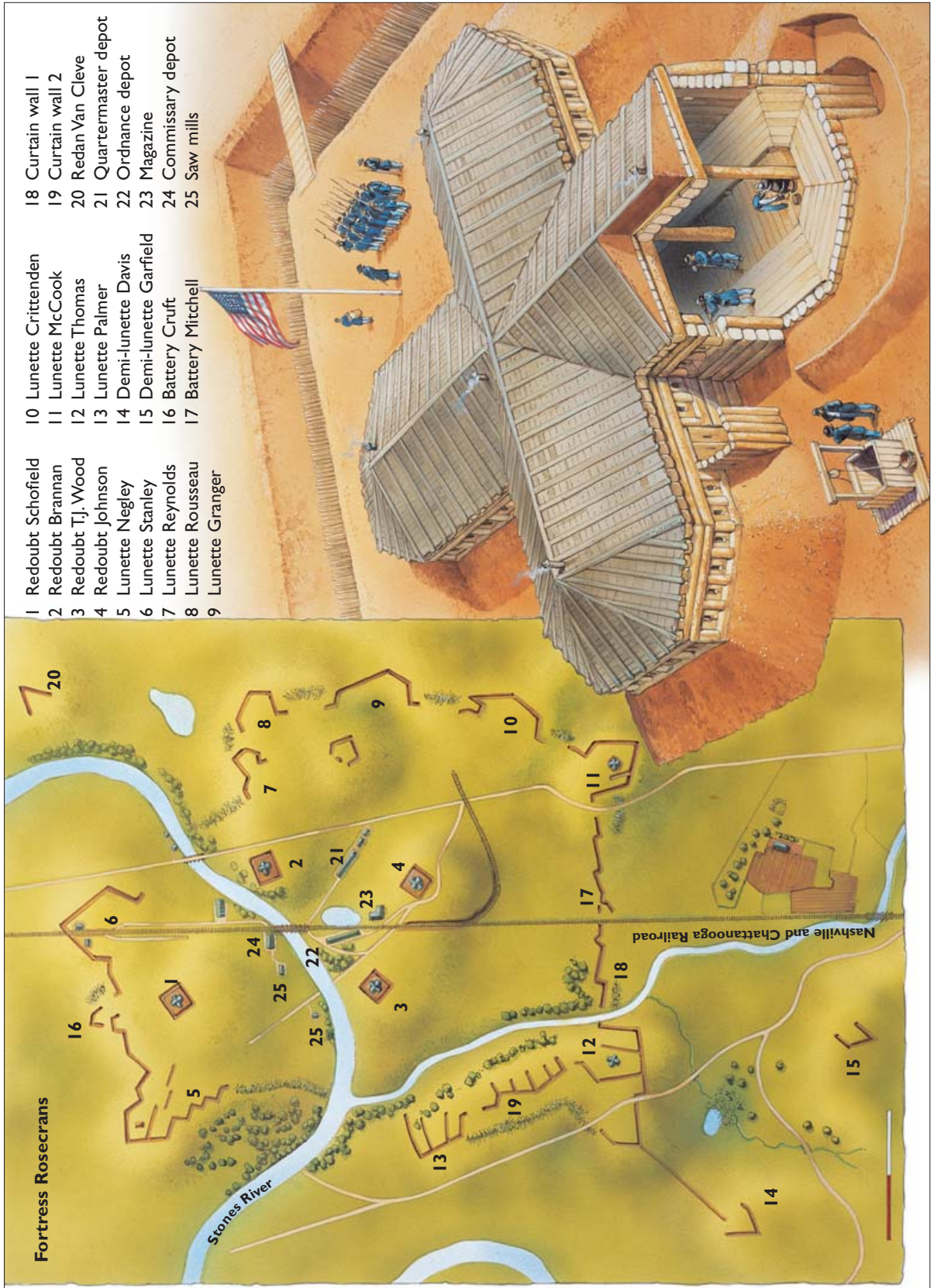

- |                     |                          |                        |
|---------------------|--------------------------|------------------------|
| 1 Redoubt Schofield | 10 Lunette Crittenden    | 18 Curtain wall 1      |
| 2 Redoubt Brannan   | 11 Lunette McCook        | 19 Curtain wall 2      |
| 3 Redoubt T.J. Wood | 12 Lunette Thomas        | 20 Redan Van Cleve     |
| 4 Redoubt Johnson   | 13 Lunette Palmer        | 21 Quartermaster depot |
| 5 Lunette Negley    | 14 Demi-lunette Davis    | 22 Ordnance depot      |
| 6 Lunette Stanley   | 15 Demi-lunette Garfield | 23 Magazine            |
| 7 Lunette Reynolds  | 16 Battery Cruft         | 24 Commissary depot    |
| 8 Lunette Rousseau  | 17 Battery Mitchell      | 25 Saw mills           |
| 9 Lunette Granger   |                          |                        |

**Fortress Rosecrans**

Stones River

Nashville and Chattanooga Railroad



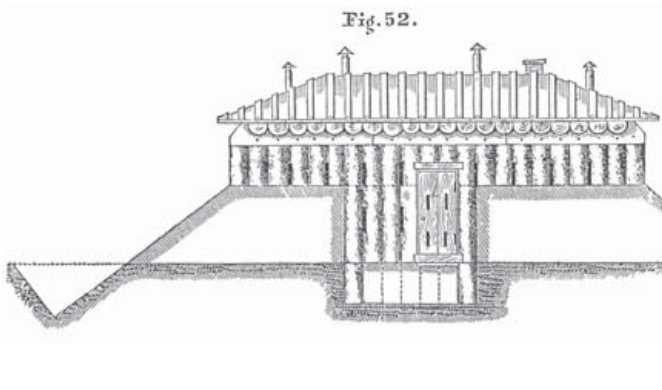
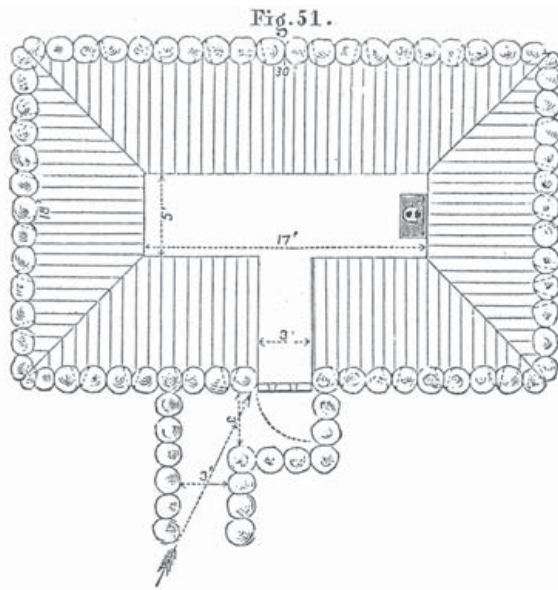

This plan and elevation of a blockhouse of single thickness, and showing the entrance protected by a gallery, was published in Mahan's *An Elementary Course of Military Engineering* in 1865. (Author's collection)

water. Those built to the "American" system had pitched roofs filled with earth, three feet thick at the ridge and sloping towards the eaves to about six or nine inches, where it was confined by a pole plate. The earth was protected from the weather by board roofing. Tin or sheet-iron ventilators were inserted through the roof and ceiling, and a brick flue was built to receive the pipe of the stove used in cold weather.

Two-story blockhouses usually only had a light framework forming the ceiling of the lower level, while a resistant roof covered the upper level. The upper level could be constructed to project beyond all four walls of the lower section, or could be built at an angle to the lower level with just the four corners projecting. Those sections of the upper-level floor projecting beyond the lower level would be reinforced, and would contain loopholes and/or machicolations in the floor to allow troops to fire down on the heads of an enemy attempting to shelter along the lower-level walls.

The doorway was the weakest point on the blockhouse, and special precautions were taken to prevent the enemy from gaining direct and unimpeded access to the door. Two-level blockhouses usually had the door on the upper floor, reached by a freestanding staircase about six feet from the exterior wall, which had loose planks laid across to the doorway. If the enemy captured the staircase, the planks could be quickly pulled inside the

Any walls longer than 16 feet required girder and shore support framing to carry the weight of the roof. The maximum length was 24 feet, beyond which the wall would not support the weight of the roof, which had to be as thick as the walls.

Loopholes were cut at three-foot intervals along each wall and at least six feet above ground level to prevent an enemy from using them to fire into the blockhouse. These loopholes were wider on the interior side of the wall to allow muskets to be pointed in all directions, and narrow on the exterior side to offer as much protection as possible.

Blockhouses built to guard railroads and bridges were usually constructed with roofs and walls of double thickness in an effort to withstand artillery fire, using logs 18 inches in diameter and hewn to a face of eight inches where they made contact. Known as "American" or double-cased blockhouses, the inner logs were usually placed upright, while the outer ones were horizontal. A space was left in the outer casing sufficient for the garrison to fire from the loopholes made through the inner wall. The horizontal logs above the loopholes were supported by short uprights, mortised into them and into those just below.

The roof of most blockhouses was made to sustain the same external impact as the walls. This could consist of 12-inch square logs covered by a simple pitched roof to help the building shed

blockhouse. This method had the great disadvantage of trapping the garrison inside the work, which was an unpleasant situation if the enemy succeeded in setting the blockhouse on fire! A better method of protecting the doorway was to construct a narrow gallery that opened on one end of the wall and turned to the right or left before it reached the doorway. This prevented enemy fire from reaching the door, while the attackers could only rush the door in single file under fire from the loopholes.

### Parapets

With regard to the defense of the parapet, the defending troops used the slope of the banquette as a ramp to mount the tread of the banquette, where they stood or leaned against the interior

slope to fire across the superior slope. As the exterior slope absorbed most of the enemy fire, it was supported by the berme that prevented it from collapsing into the ditch. The scarp was the wall of the ditch closest to the parapet, so it had to be given a slope that would support the weight of the parapet. The bottom of the ditch was usually flat and often contained obstacles such as palisades and stockades. The counterscarp was the outer wall of the ditch. This was given a sharper grade than the scarp since it only had to support the weight of the glacis, which was a cleared ramp that forced attacking troops to run uphill and into fire delivered from the parapet.

### Artillery emplacements

Provided it was well placed, and its interior arrangements were properly constructed, artillery was a powerful accessory to the defense of a field work. Cannon could be mounted in a field work either on a barbette carriage, to fire over the parapet, or behind embrasures to fire through openings in the parapet. Barbette mountings allowed a wider field of fire, but exposed both gun and crew to enemy fire. Although embrasures allowed guns to be served from behind the protection of the parapet, they restricted fields of fire. There were also weak points in the parapet where attacking troops could enter a work under cover of the cheeks of the embrasures.

Artillery could be placed at any point along a parapet of a field work, where its fire could reach across the crest of the counterscarp. However, it was best placed at salient angles, which jutted out from the main line, in order to reduce the number and extent of sectors without fire in front of the work. It was also best placed on flanking faces where its fire could be extended parallel to another face to catch attacking troops in a cross fire. Since



Gunners of the 4th New York Heavy Artillery loading a 24-pounder siege gun mounted on a wooden barbette carriage at Fort Corcoran, Virginia, in 1862. (Library of Congress B811- 2341)

Soil compacted over a stout wooden frame has been supplemented with gabions and sandbags in this bomb-proof at Fort Sedgwick in the Federal lines during the siege of Petersburg, 1864-65. (Library of Congress B8171-3199)

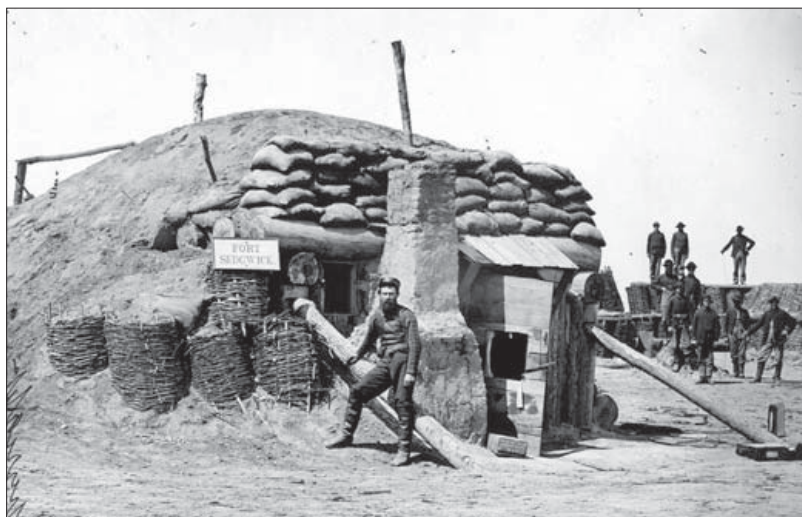



This drawing by Alfred R. Waud shows a Confederate battery behind an earthwork with embrasures near Munson's Hill, Virginia, in September 1861. (Library of Congress USZ62-83034)

cannon mounted in field works would be required to fire repeatedly from the same spot, their weight had to be supported by a platform that would prevent them from sinking into soft soil and creating ruts when they recoiled.

Platforms for light field pieces could be as simple as three planks laid on the ground to support the wheels and trail. Mortars and heavy artillery mounted on siege carriages required more substantial platforms consisting of 12 sleepers laid in two rows, the second overlapping and at an angle to the first row. Thirty-six planks measuring 5 by 3½ inches were laid on the sleepers and fastened with dowels. A headpiece, called a "hurter," was placed at the front of the platform to prevent the wheels of the artillery carriage from striking the revetment of the interior slope. The hurter also permitted the piece to be run up to the embrasure and fired in the proper direction at night.

### Bomb-proofs

Fortifications exposed to enemy shellfire often included bomb-proofs and shelters where troops occupying a work could retire when under enemy bombardment. Bomb-proofing in field fortifications generally required a heavy post and beam framework sunken below the natural level of the ground with a roof covering consisting of one or more courses of large-diameter timbers covered by four to six feet of tamped soil. Sometimes the dirt covering of a bomb-proof was pierced with loopholes from which rifleman could fire. Powder magazines were also made bomb-proof, and were sometimes included in parapet traverses. Covered ways often linked bomb-proofs to the parapets to protect men on duty from enemy mortar shells, artillery fire, and sharpshooters.

### Fort Negley (Harker)

A complex structure designed by General James St. Clair Morton, Fort Negley (later renamed Fort Harker) was 600 feet long, 300 feet wide, and covered four acres. The east (1) and west (2) parapets were partially star-shaped. Placed at the southern end of the fort, where attack was most likely, were two massive bomb-proof bastions (3 and 4) equipped with guns that could be aimed in several directions. Each bastion had tunnels that protected men moving through the works. The stone foundation of the fort was covered with dirt, which was designed to absorb the concussion of incoming artillery rounds and prevent the stonework from shattering. Grass was grown on the earthworks to prevent erosion. At the center of the fort was a 12-foot-high stockade (5) built of cedar posts, with a sentry box, or guerie, above each corner. Underground

water cisterns were placed inside the stockade, which was designed as the last defensive position in case the fort was overrun. Two tall trees left standing inside the fort near the stockade were intended for use as observation platforms and signal stations. Two ravelins (6 and 7) flanked the stockade. A gun emplacement fortified with railroad iron, called casement No. 1, and containing a 30-pound Parrot rifle capable of hurling a 29-pound shell two and a half miles, was placed to the west of the stockade (8). Two more 24-pounders (9 and 10) were placed in casemates of timber in the South Main Work, "covered on the slope toward the enemy with railroad iron and made bomb-proof with earth." The other four guns in the fort were placed en barbette on wooden artillery platforms situated behind the east and west parapets (11–14). Fort Negley was completed on December 7, 1862; it was never attacked.

Fort Negley (Harker)

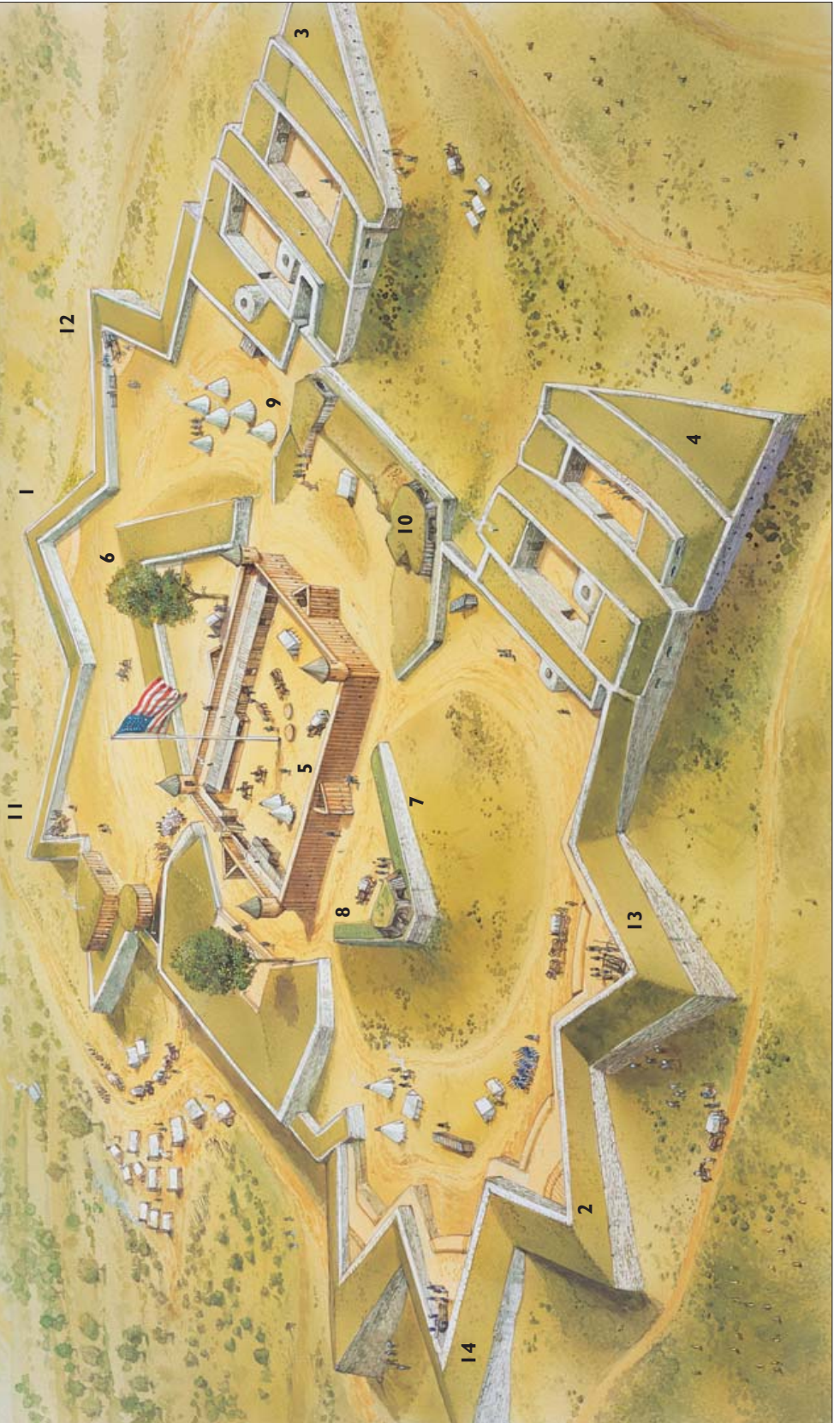

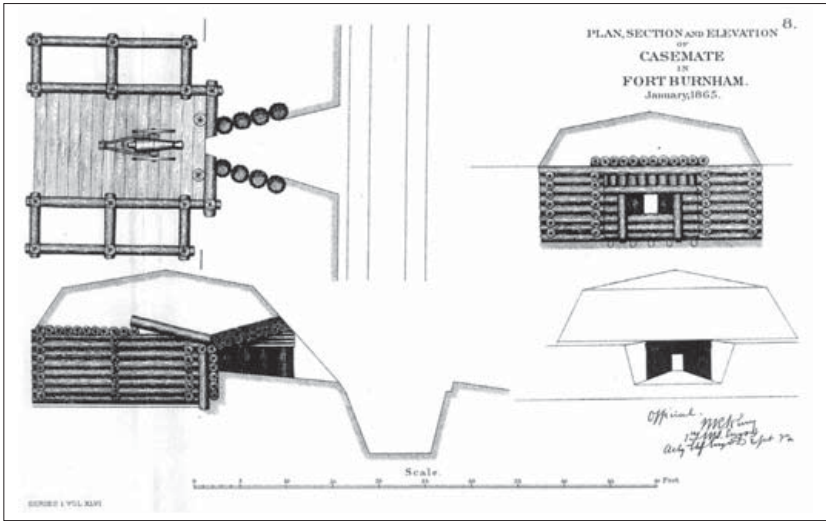

Captured from the Confederates in September 1864, Battery or Fort Harrison, at Chaffin's Farm, in the Richmond defenses, was re-named Fort Burnham in honor of Federal General Hiram Burnham who was killed during this action. Heavy enemy mortar fire drove the gunners into their bomb-proofs, and so casemates designed by Lieutenant William R. King, Corps of Engineers, US Army, Acting Chief Engineer, were added to this fort by February 1865. (*Official Military Atlas of the Civil War*)

### Casemates

A field-fortification casemate was a stoutly constructed bomb-proof enclosure attached to the interior of a parapet for the purpose of protecting an embrasured gun position. By 1865, two of the guns in Fort Negley, in the Federal defenses at Nashville, Tennessee, had "casemates of timber, covered on the slope toward the enemy with railroad iron and made bomb-proof with earth." A Confederate six-gun battery defending Atlanta, in front of the Federal 17th Corps, was reported to have "part of the embrasures casemated" in August 1864. Casemates in more permanent fortifications consisted of vaulted masonry chambers within a rampart or wall. These were used for a variety of purposes, including both embrasured and loopholed gun positions on the flanks of bastions, curtain walls, and in caponiers. Mortar casemates open for vertical fire were also used in many polygonal system fortifications.

### Merlons

In a permanent or semi-permanent fort, a battlement or a crenellation consisted of a parapet with open spaces for shooting. The raised portions of a battlement were called merlons, and the openings were known as embrasures. Merlons were constructed from various materials, including sandbags, gabions, or barrels filled with soil, sods of earth, and cotton bales. The merlons in the redoubt at Lee's Farm, in the Warwick-Yorktown line on the Peninsula, in 1862 were described as "extending at least five or six yards on each side," and also had heavy logs laid over the embrasures that were covered with a six-foot thickness of earth.

### Guerites

A sentry box, known as a guerite, was incorporated into several semi-permanent Federal field fortifications such as Fort Lincoln in the Washington defenses, and Fort Negley at Nashville, Tennessee. These were square or octagonal with conical roofs and were usually placed on the superior slopes of parapets to provide sentinels with protection from the elements and a good view of the near approaches to a fortification.

A detachment of Co. K, 3rd Massachusetts Heavy Artillery manning guns either side of a gabionade defilade traverse at Fort Stevens, Washington, DC in 1865. President Abraham Lincoln came under fire at this fort during Early's attack on the Federal capital in July 1864. (Library of Congress B817-7692)





## Traverses

Traverses were raised mounds of earth designed to defilade, or obscure from the view of the enemy, the interior spaces of field works. They also limited the area affected by explosions that might occur within gun positions. Most traverses were given a rectangular outline with sides that sloped inwards from the base. Defilade traverses were usually connected at right angles to the parapet. Those made to intercept the fire of heavy siege and garrison guns could be 12- to 18-feet thick, while those designed to withstand prolonged bombardments were 24- to 40-feet thick. Traverses in rifle trenches, such as those in the "Bloody Angle" at Spotsylvania Court House in 1864, would only need to be two- to three-feet thick to intercept small-arms fire.

Parados traverses were positioned independently of the parapet and across the terre-parade of field works in order to intercept ricochet fire. When extended the full width of the terre-parade, a parados traverse could be pierced with access galleries that allowed movement from one side to the other. A parados traverse could also serve as a bomb- or splinter-proof shelter. Sally port traverses were placed on the terre-parade immediately behind a sally port entrance in order to intercept enemy fire that might otherwise pass through. They also provided the garrison with a short parapet to deliver fire into the sally port and to defend the sally port barrier.

Battery traverses were placed in batteries between guns to limit the damage caused by enemy shells exploding within the battery. They could also restrict the damage caused by accidental explosions or the premature explosion of fired shells. Not usually intended to intercept enemy fire, this type of traverse was given a splinter-proof thickness of six to eight feet, which was only capable of absorbing shell fragments. The length of a battery traverse was determined by the weight of guns forming the armament of the battery. Field guns required traverses from 15 to 18 feet long, while siege guns required traverses 18 to 24 feet long.

The defenses surrounding Washington DC originally included bomb-proof defilade traverses called gabionades. These were approximately 12 feet wide and 24 feet long at the base. Constructed with two courses of gabions interlocked by an intermediate course of fascines, they were replaced by unrevetted mounds planted over with grass to make them more durable by the end of the war.

## Gabions

A gabion was a rough cylindrical wicker basket open at both ends that was used as revetment material to retain the soil of earthwork slopes. Gabion revetments were constructed by placing a number of gabions side by side. These were filled with soil, and topped with a layer of long fascines. When greater height was required a second tier of gabions could be added on top of the fascines. Gabions were often made by engineer troops at depots near the place where they would be used. Three men could make a common gabion two feet in diameter and three feet tall in about two hours. During the siege of Yorktown, Colonel Henry J. Hunt, commanding the Federal Artillery Reserve, reported that "cannoneers of

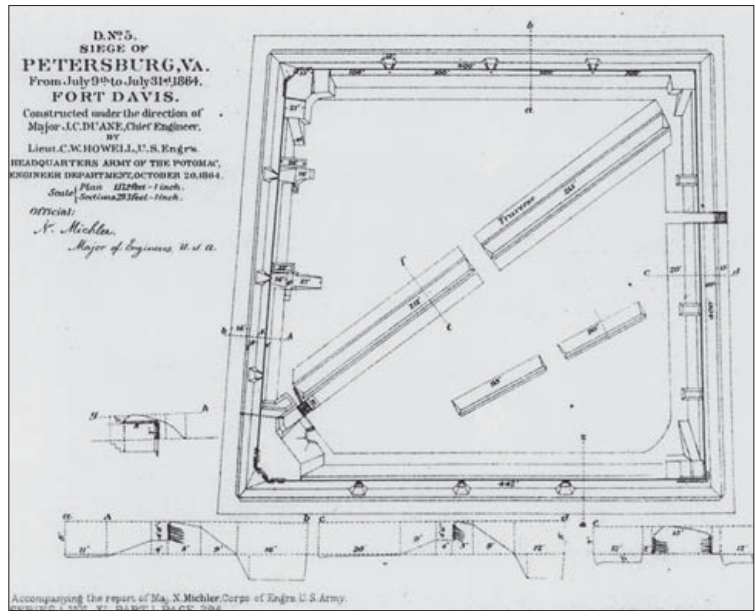

Constructed under the supervision of General Gouverneur K. Warren in July 1864, Federal Redoubt H, also called Fort Davis, had a parados traverse running diagonally across its terre-parade. (*Official Military Atlas of the Civil War*)

two batteries at a time were detailed daily for making gabions and fascines, under direction of General [Daniel Phineas] Woodbury," who commanded the engineer brigade responsible for constructing the Yorktown siege works.

### Fascines

Used as revetment material to retain soil composing the interior slopes of parapets, and in chamber walls of field powder magazines, fascines were tightly bound bundles of brushwood and small straight branches. They were also used as foundation and topping material within gabion revetments. A fascine could also be used in gun platforms to arrest the wheels of a gun carriage and prevent the wheels from striking and damaging the interior slope. Simple field magazines could also be constructed with interior roofs composed of crossing layers of fascines. Fascines were also used to construct blindages in front, or to the rear, of batteries, and to cover the tops of saps or galleries when these works were exposed to fire from above.

### Blindage

Bomb- and splinter-proof shields constructed in permanent fortifications such as forts Sumter and Pulaski were known as blindage. This form of screening was also used in field fortification to prevent an enemy from seeing into a trench or bringing accurate fire against a field work under construction. During siege operations, blindage was particularly useful for covering saps exposed to defensive fire. Blindage covering the tops of saps could simply consist of sandbags, or a layer of fascines laid over the crest of the parapet. More complex examples could consist of constructions using scantling, or thin wooden frames anchored into forward and reverse slopes of a sap and covered by layers of fascines and earth to make them bulletproof. Blindages in front of batteries under construction were usually placed along the exterior crest of the ditch in front of the battery parapet and were made by laying several rows of gabions outside the ditch and filling them with vertically placed fascines. Although this type of blindage had sufficient height and thickness to cover working parties from enemy musket fire, it could be destroyed by artillery. As batteries were usually constructed under cover of darkness, a blindage would allow working parties to continue working during the daylight hours. However, this also made it easier for the enemy to locate battery positions and harass the work with counter-battery fire.

### Counterscarp galleries

In both temporary and permanent fortifications, a counterscarp gallery was a loopholed enclosure set into the counterscarp wall of a ditch. This provided cover for troops defending the ditch. A heavy door pierced with a loophole provided



These casemates were found covered by heavy timber blindage after the capture of Fort Pulaski by Federal forces in April 1862. (Library of Congress B8171-0194)

These impressive gabionade traverses along the interior slope of the parapet forming the right face of the right redan of Fort Sedgwick (nicknamed "Fort Hell") were photographed on April 3, 1865. Fascines are placed between the two layers of gabion. Note the empty gabion lying by the bomb-proof shelter. (Library of Congress B8171-7693)



access to the gallery from the bottom of the ditch. Counterscarp galleries could also be prepared for an artillery armament consisting of light casemate howitzers or carronades.

### Glacis

More common to permanent fortifications than field fortifications, a glacis was a wide and gently sloped parapet that provided the defenders with a clear and unencumbered field of fire immediately surrounding the fortification. In field fortifications a glacis could be added along the crest of the counterscarp of the ditch to ensure that attacking troops could not avoid fire from the parapet by crawling or crouching through the last few yards immediately in front of the ditch.

### Gorges

In unenclosed field fortifications consisting of continuous lines of works containing lunettes and redans, the gorge was considered to be the rear of the fortification or a fortification front not shielded by a continuous parapet. In permanent fortifications and enclosed field works such as star forts, bastion forts, and redoubts, the gorge was the main entrance or sally port, or the rear of an outwork.

### Têtes-de-pont

Forts that offered protection to a bridge or river crossing point were called têtes-de-pont, and were used extensively by both Union and Confederate armies. The Federals used a tête-de-pont, consisting of forts Marcy and Ethan Allen, to protect the Chain Bridge in the Washington defenses in 1864. On the Alexandria side of the Potomac River, Fort Runyon was a large tête-de-pont guarding the approaches along the Columbia Turnpike.

## Outer field fortifications

A wide variety of hastily prepared defensive works and obstacles were used during the course of a Civil War battle. Rifle trenches connected larger works, while rifle pits were placed in advance of them. Once the ground had been cleared of all natural and man-made obstructions in front of more permanent field works, these could be employed with even greater effect to impede the advance of an attacking body of troops. Different types of obstacles could be placed either just beyond the crest of the counterscarp of a parapet, where the enemy could be hit with close-range musket fire, or within the ditch itself to prevent the enemy from passing through and scaling the scarp. Further obstacles could be placed in the actual trenches to prevent the enemy from taking advantage once a section of trench had been captured. An illustration of a rifle trench is shown on page 22.

### Rifle pits

Rifle pits were small trenches for one or two men with a slight parapet or other cover in front. They were generally established well in advance of the outworks of a fortification or main line of field works, or on the flanks of a besieging army. With brush and branches placed in front of them to hide the occupant, they were commonly known as “gopher holes.” During the siege of Atlanta, Captain O. M. Poe, Chief Engineer under Sherman, described how the Army of the Tennessee

Photographed by Timothy O'Sullivan in May 1864, these Federal troops occupy a rifle trench on the north bank of the North Anna River, Virginia. The men have draped their shelter-half tents over scantling, or wooden poles, to provide some protection from the elements. (Library of Congress B8171-0756A)



employed rifle pits and linked them together to form rifle trenches. Each man got "such cover as he could, generally by scooping out a rifle-pit at the foot of a tree, behind a log or stone, in which they could find shelter. As soon as night made it possible, working parties were thrown out to the skirmish line and connected by the ordinary rifle trenches the entire chain of rifle-pits. These lines were continually being strengthened until it was desired to make another advance, when the operation was repeated. In this way our lines were pushed at any point we wished to within 200 yards of the enemy's and with slight loss."



### Breastworks

The term breastwork more commonly refers to any protective embankment that could be raised rapidly, using logs, rails, or rocks, in order to provide infantry with cover to the level of the chest, or breast. According to the report of Colonel Thomas Pattison, 18th Indiana Infantry, it took his men about five hours to build "quite a respectable breastwork" during the Battle of Pea Ridge, or Elk Horn Tavern, Arkansas, on March 6, 1862. "Slight" breastworks referred to those defenses behind which infantry might crouch. Masked breastworks, such as those used at Big Bethel in 1861, were used to surprise and repulse an advancing enemy force. Breastworks were particularly useful on wet ground with a high water table that prevented the excavation of a deep ditch or trench. Soil for construction could be taken from shallow trenches both in front and to the rear of the parapet. This also applied to ground where a thin layer of topsoil covered a solid rock bed. Breastworks were also useful when positioned along the crest of a ridge, where enemy troops approaching the work, or standing near the foot of the exterior slope, could not see over the parapet.

### Barricades

An obstruction placed on a battlefield to block the passage of the enemy, barricades were formed using whatever materials were close at hand, such as felled trees, cotton bales, tipped-over wagons, and fence rails. They could also be constructed using regular obstacles such as chevaux-de-frise or palisades. Sometimes they were arranged to include a makeshift banquette to enable the defenders to fire over the barricade. They might also have loopholes to facilitate fire through the material composing the obstacle. Both armies used barricades to afford makeshift defensive positions during many of the major battles of the war. The construction of barricades in some regiments was the job of pioneers equipped with axes.

When the Union army marched out from the Washington defenses in July 1861, the Confederates placed barricades across the roads leading to Manassas. After Malvern Hill in 1862, Colonel Charles W. Roberts, 2nd Maine Infantry, reported: "Having the advantage of a rail fence, I ordered my boys to make with their knapsacks a barricade, which they did in a very short time. In this position we remained nearly two hours, waiting for the enemy."

During the Yazoo River expedition in Mississippi during January 1863, Lieutenant Colonel James H. Wilson, Chief of Topographical Engineers, Union Army of the Tennessee, encountered deserted barricades erected by the Confederates that were about two miles in length. "They were formed by

Despite Grant's insistence that entrenching tools be carried by each of his columns, artist Alfred Waud was able to sketch elements of Hancock's 2nd Army Corps frantically throwing up breastworks using bayonets, tin pans, old canteens, and even their hands, at Cold Harbor on June 3, 1864. (*Battles & Leaders*)



felling trees into and across the stream," he reported. "The forest being very dense, and the growth luxuriant, the trees were of the largest and heaviest kinds, cottonwood, sycamore, oak, elm, and pecan prevailing, and all, except cottonwood, having a greater specific gravity than water. These, mixed with drift-wood, rendered the barricade of no trifling nature."

### Cavaliers

A cavalier in a permanent fort was a raised work that commanded fire over outer works or surrounding ground. Reported in the Confederate defenses of both Richmond and Petersburg, cavaliers were trenches with their parapets raised high enough to see over the crest of the glacis. Constructed on top of a raised mound or small rampart, a cavalier battery was constructed in Fort McPherson at Louisville, Kentucky, in October 1864, while a cavalier was built over a magazine in the defenses of Mobile, Alabama, during the same period.

### Covered ways

Sunken roads known as covered ways, wide enough to accommodate the free circulation of troops and the passage of wagons and artillery, connected two or more field works through ground exposed to enemy fire. A parapet protected the side of the road facing the enemy. In permanent fortifications covered ways were outworks that ran parallel to the crest of the counterscarp. This allowed the garrison to guard and defend the glacis.

This drawing by Edwin Forbes shows members of the Pennsylvania Reserves behind a barricade made from fence rails, resisting a Confederate attack near the Bethesda Church during the battle at Cold Harbor. (*Battles & Leaders*)

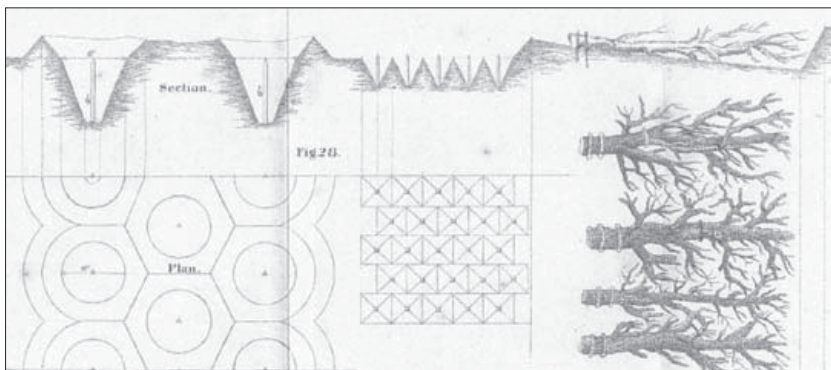

Detail from a plate in Mahan's *Treatise on Field Fortification* showing a plan and cross section of an arrangement of conical trous-de-loup, small pyramidal pits with pickets, and an advanced glacis and abatis. (Author's collection)

Basic field fortifications

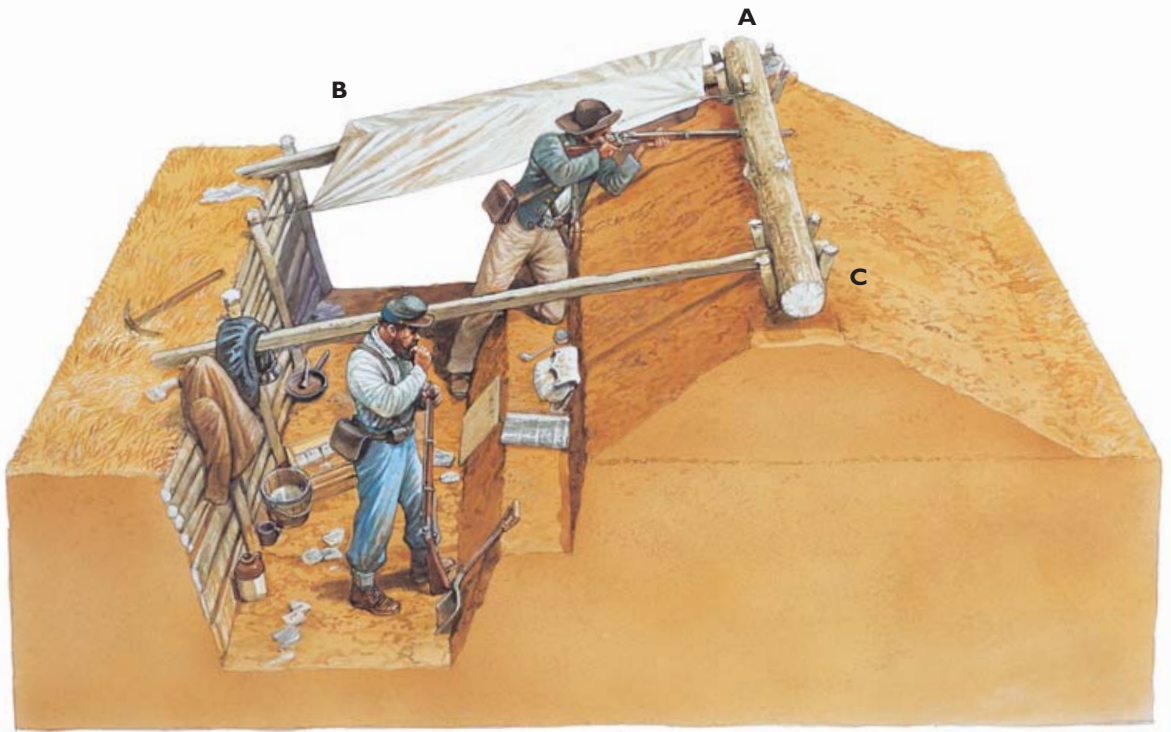
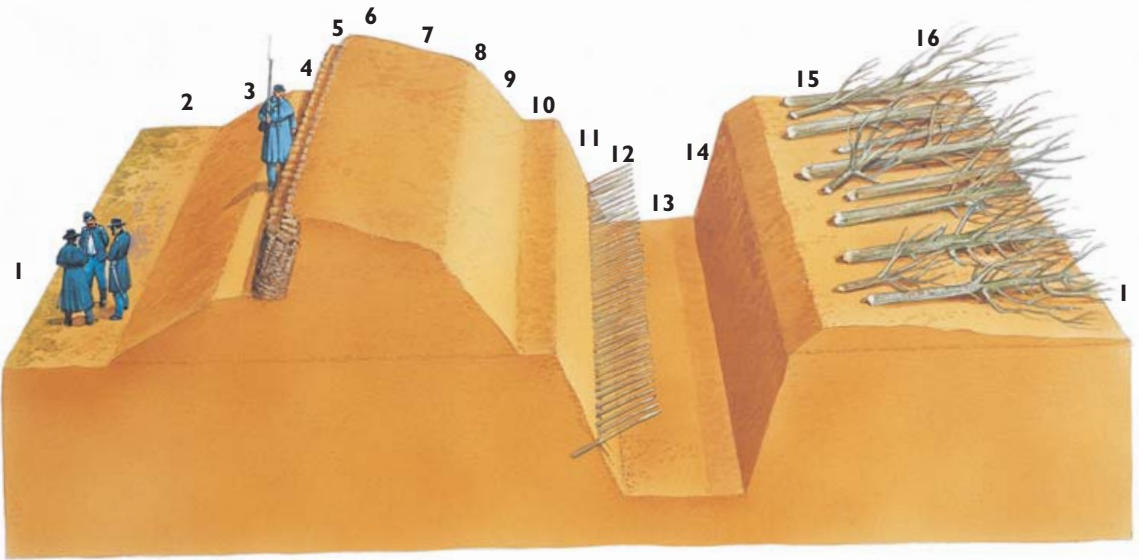

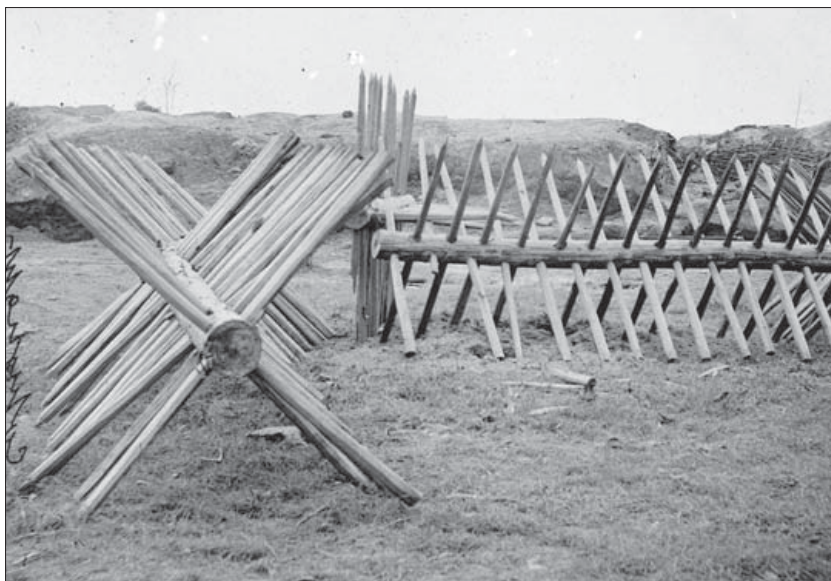

These sections of chevaux-de-frise were found in place before the Confederate field works at Petersburg in 1865. (Library of Congress B811-3206A)

### Parallels

Used to provide defensive positions that allowed a besieging army to hold the ground gained in its approaches to a fortified position, parallels were laid out either parallel to the point of attack or on a concentric line that enveloped it. As the besieging army drew closer to its objective, parallels were also used as forward supply depots. If threatened by enemy sorties, the fronts of the parallels could be protected by obstacles such as abatis or palisading, though the extra labor involved in constructing extensive obstacles was usually too expensive in time and material for most attacking armies.

### Boyaux

Communication trenches that provided covered passage to and from parallels and batteries were known as boyaux. For infantry these were usually about four to five feet wide, which was sufficient for the passage of two men. Dimensions had to be increased when it was necessary to pass artillery through the trenches rather than move guns and howitzers into position over open ground under

### Basic field fortifications

The upper illustration shows the main features of a parapet and ditch. Ground level (1) was referred to as the "plane of the site." The area enclosed within the parapet was known as the terre-plein (2). The ground sloping up from this was the banquette slope (3). The raised earthen platform on which the garrison stood to defend the work was the banquette tread (4). The inner face of the parapet was called the interior slope (5), supported by a gabion revetment with a fascine base; at the top of the slope was the interior crest (6). The top surface of the parapet was known as the superior slope (7), which terminated at the exterior crest (8). The outer face of the parapet was the exterior slope (9), at the bottom of which was the berme (10). The side of the ditch facing the enemy was the scarp (11), and was often pierced with a fraise (12); the bottom of the ditch (13) could also have sharpened palisading. The opposite facing edge of the ditch is the counterscarp (14),

and the ground sloping gently away from this was the glacis (15) containing abatis (16).

The lower illustration shows a rifle trench, the single most common form of field fortification employed during the Civil War; these were often used to defend the intervals in between large works. Notched or loopholed timbers placed along the crest of the parapet enabled men to fire on the enemy without being seen. Alternatively, a headlog (A) was placed along the top of the parapet, resting on top of blocks, or skids (B), c. one foot from the interior crest of the parapet; the skids' purpose was to catch the log if it happened to be struck by artillery and send it rolling over the heads of the men in the trench. Headlogs were usually pinned in place using small pickets (C). Alternatively, sandbag loopholes were formed by placing two sandbags a few inches apart on the parapet. Crossbeams were also sometimes inserted across the top of a trench to provide shelter against the elements or the collapse of soil.

cover of darkness. On August 5, 1864, Captain G. H. Mendell, commanding the US Engineer Battalion during the siege of Petersburg, reported that 17,200 feet of boyaux, averaging nine feet in width and three and a half feet in depth, had been constructed in the Federal trenches.

### Carnot walls

Incorporated into the Richmond defenses by 1863, Carnot walls were named after the French general Lazare Nicholas Marguerite Carnot (1753–1823), and were part of a system of “active defense.” To facilitate sorties in great force, Carnot did away with a counterscarp wall, and provided instead a long gentle slope from the bottom of the ditch to the crest of the glacis. This, he believed, would compel an assailant to maintain large forces in the advanced trenches, which he proposed to attack by vertical fire from mortars. Along the front of his fortress was built a heavy detached wall that was loopholed for fire, and high enough to be a most formidable obstacle. The Carnot wall, and, in general, Carnot’s principle of active defense, played a great part in the rise of modern fortification.

### Abatis

Referred to as “an obstructing jungle” by Confederate Major J. F. Gilmer, Chief Engineer of the Western Department, in November 1861, abatis consisted of felled trees stripped of their leaves and smaller off-shoots, with remaining branches sharpened into points. These were placed side-by-side and staked down with the sharpened branches pointing towards the enemy. Their purpose, like other obstacles exterior to the ditch, was to break the momentum of an assaulting body of troops and hold them up under close musket fire delivered from the defensive position.

As early as February 1861, Lieutenant A. J. Slemmer, 1st US Artillery, reported that “an abatis of brush” had been placed about the exposed points of attack at Fort Pickens, in Florida. According to Brigadier General Charles F. Smith, commanding Union forces at Paducah, in Kentucky, during the fall of 1861, “a very sufficient abatis, several hundred yards in width” formed part of the defense of that place. Artificial, or incompletely made, abatis were used in the defenses around Washington, DC to confuse the enemy.

Not all combatants respected the field works there to protect them. Later in the war, Major James C. Duane, US Engineers, reported that portions of the Federal abatis between batteries 11 and 12 outside Petersburg had been “taken away by the pickets for fire-wood.”

### Chevaux-de-frise

An obstacle called a cheval-de-frise (pl. chevaux-de-frise), or “horse of Friesland,” was possibly invented by the Dutch during the siege of Groningen in 1594, and usually consisted of a nine- to ten-foot long horizontal beam pierced by two diagonal rows of ten-foot-long, sharpened lances. Hooks and chains were attached to the ends of the beams to allow several chevaux-de-frise to be bound together. This type of obstacle was free-standing and hence ideal for covering the front of field works when the danger of exposure to hostile fire, even at night, was too great to permit working parties to construct more solidly fixed obstacles. It also did effective service in the

These roughly hewn Confederate chevaux-de-frise was photographed on Marietta Street in the Atlanta defenses in 1864. (Library of Congress B811-2724A)





bottom of ditches and in the entrance to field works.

A second type of cheval-de-frise, often referred to as "palisading," was constructed using a stout, sharpened timber stake to which one or more legs were attached to secure it in an inclined position pointing in the direction of an expected enemy attack. When a number of chevaux-de-frise were positioned close together it created an inclined palisading.

### Fraises

A fraise was an obstacle consisting of palisades projecting horizontally from the scarp or counterscarp of the ditch of a temporary fortification. In the former, a fraise was designed to inhibit attacking troops who had already entered the ditch from scaling the scarp to reach the parapet. When positioned just below the crest of the counterscarp, a fraise was designed to prevent attacking troops from entering the ditch or escaping from it if their attack failed. An interval of 12 feet had to be left between the extremities of the palisades and the opposite side of the ditch to prevent attacking troops from using ladders or planks to bridge the gap and cross the ditch.

### Trous-de-loup

Also called "military pits," these obstacles were usually sited beyond the crest of the counterscarp and consisted of an arranged pattern of pits about six feet in diameter and six feet deep with a sharpened picket, or post, planted at the bottom. The pits were often concealed with a light layer of brushwood and soil. Trous-de-loup were used near Charleston, South Carolina, at Secessionville in 1862, and in front of Battery Wagner, in 1863. At the latter location they were combined with "boards with sharp nails or spikes in the bottom of the ditches." They were later placed in front of the Union lines around Petersburg, Virginia, during March 1865.

### Wire entanglements

Although James F. Glidden did not invent true barbed wire for use on the Western plains until 1873, smooth telegraph wire was readily available by 1863. During the Union retreat from Winchester towards Harper's Ferry, Virginia, in May of that year, Major Alonzo W. Adams, 1st New York Cavalry, reported that the Confederates had created "a perfect barricade of telegraph wire wound together and stretched from tree to tree across roads and through woods and fields, so as to completely obstruct the farther progress of cavalry."

Wire entanglement appears to have been used quite extensively by the Federal army during the siege of Knoxville in November 1863. Stretched from one tree stump to another, it delayed the attack on Fort Sanders and contributed to a Federal victory.

On November 16, 1864, wire was also placed in front of the siege works to the right of Fort Fisher on the Petersburg lines. Completed in two days, this ran west and terminated about 200 yards to the left of Fort Welch, in the lines to the southwest of the city. On this occasion, it was employed "to take the place of slashings [abatis] removed by the troops." More wire entanglement was placed around Fort Fisher during February 1865.



Taken from Fort Sedgwick outside the Petersburg lines on April 3, 1865, this photograph shows a fraise and deep ditch in front of the breastworks. (Library of Congress B811-3209A)

# The war in the East, 1861–64

## Defenses of Washington, May–July 1861

The Federal capital was considered vulnerable at the outset of the Civil War, and a number of forts, blockhouses, and infantry parapets were hastily constructed to protect the northern approaches from Maryland and the bridges across the Potomac River. Most of these works, and many of those that followed after, were built under the guidance of Major, later Brigadier General, John G. Barnard. The Superintendent at West Point when war broke out, Barnard used Mahan's *Treatise on Field Fortification* as his principal reference manual.

When the Federal army moved into Northern Virginia on May 24, 1861, Barnard oversaw the erection of the first fortifications there. Fort Corcoran and associated defenses were built in May 1861 to command the approaches to the Aqueduct Bridge. A bastioned earthwork, this fort was garrisoned by the 13th New York Infantry, and had a perimeter of 576 yards plus emplacements for 10 guns, which were initially manned by Co. K, 2nd Wisconsin Infantry. Linked with this were the outworks called forts Bennett and Haggerty. The former fort had a perimeter of 146 yards and emplacements for five guns, and was designed to bring under fire the slope northwest of Fort Corcoran. The latter possessed a perimeter of 128 yards with emplacements for four guns, and was built to protect the slope south of Fort Corcoran. Two more large bastioned earthworks were thrown up to guard the approaches to the Long Bridge. With a perimeter of 1,484 yards, Fort Runyon was established at the northern end of the

Chesapeake and Ohio Canal, while the much smaller Fort Albany, with a perimeter of 429 yards and emplacements for 12 guns, was placed about a mile farther down the Columbia Turnpike.

## Big Bethel, 1861

Field fortifications and entrenchments featured at Big Bethel, the first land battle of the Civil War, fought on June 10, 1861. Despite being surrounded by Virginia state troops, plus those of the Provisional Confederate Army, Federal forces had garrisoned Fortress Monroe on the Peninsula, in Virginia, since the beginning of the conflict. On the night of June 9, Major General Benjamin F. Butler, commanding the District of Annapolis, ordered units under Brigadier General Ebenezer W. Pierce to attack a small Confederate force led by Colonel John Bankhead Magruder (nick-named "Prince John"), dug in at a small hamlet called Big Bethel, about eight miles inland.

The position held by the Confederate troops at Bethel Church was described as "a natural strongpoint" which Colonel Daniel Harvey Hill, commanding the 1st North Carolina, decided to fortify. Despite initially having at his disposal only "twenty-five spades, six axes, and three picks," Colonel Hill ordered his troops to throw up a redoubt consisting of breastworks on four sides forming a rough rectangle. A "masked" or

Major John Gross Barnard was appointed Chief Engineer of Washington, DC in 1861, and was responsible for planning the fortifications that surrounded the capital. Promoted to brigadier general, he directed the siege works at Yorktown in 1862, and by 1864 was Chief Engineer of the armies in the field under Grant. (National Archives 530217)

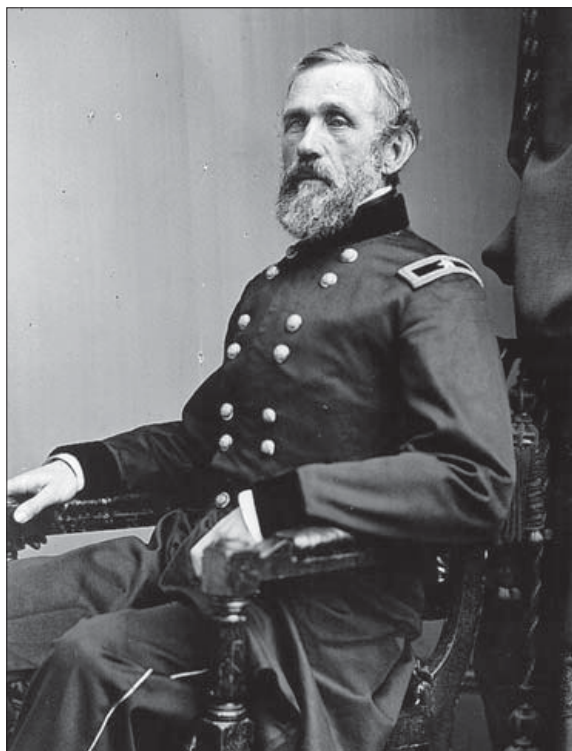

concealed battery was also established in a small salient on the opposite bank of the river, in order to protect the approaches to the County Bridge, which carried the Sawyer Swamp road.

The Federals advanced towards the redoubt where the Confederates knelt waiting in their concealed trenches. As they proceeded towards a very harmless-looking fence, house, cowshed, and barn, a member of Duryée's Zouaves remembered how "the curtain fell." The masked battery was suddenly exposed to full view, and did not lose any time in opening fire.

Meanwhile, the Confederate infantry in the advanced positions, consisting of the Virginia Life Guard, 15th Virginia, were ordered to kneel in their trenches to avoid being seen until the enemy was in "the middle of the open field" at their front. According to their commander, First Lieutenant Charles P. Rady, "the men of the first platoon rose, and taking deliberate aim, fired; the shots had good effect, seven of the Zouaves falling, two killed and the remainder wounded ... We immediately drew upon us the fire of the Zouaves and one piece of cannon, but our men were undaunted, and between every fire of the dastardly crew they rose by file and fired. Nearly every time a man was felled." Although the Confederates were required to temporarily evacuate their salient later in the short battle, the Federals were shaken by such an effective use of field fortifications, and withdrew in great chaos and disorder back to Fortress Monroe.

## Manassas, 1861–62

When the Federal army under Brigadier General Irwin McDowell advanced south towards Manassas Junction on July 17, 1861, Major Barnard and seven other engineer officers accompanied it and supervised the construction of a number of field works. Issued the day before, McDowell's general order to his army stated: "Each column is provided with entrenching tools and axes, and if the country affords facilities for obstructing our march, it also gives equal facilities for sustaining ourselves in any position we obtain. Troops will march without tents, and wagons will only be taken with them for ammunition, the medical department, and for entrenching tools."

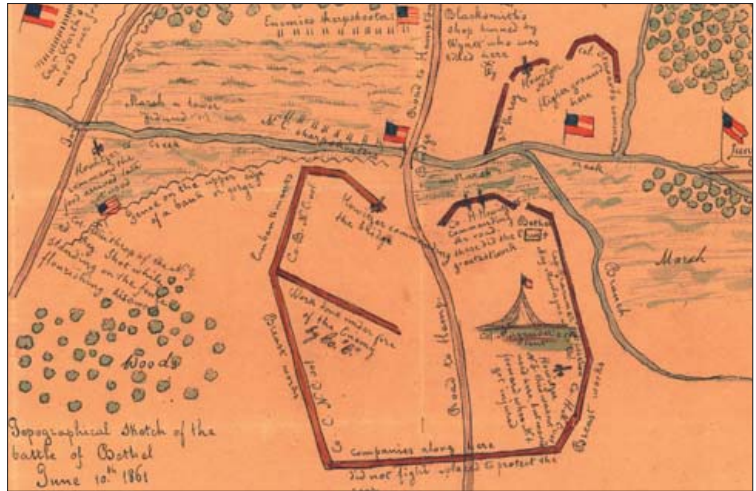

Drawn by Corporal William B. Taylor of the Charlotte Grays, Co. B, 1st North Carolina Infantry, this detail from a plan of the Battle of Big Bethel fought on June 10, 1861 shows the Confederate fortifications. It is oriented with the north at the bottom. (Library of Congress)



Photographed after capture in 1862, these Confederate field fortifications at Manassas, Virginia consisted of a hurdle revetment behind an earthen parapet with an embrasure. Note the artillery platform in the foreground. (Library of Congress B817-7171)



Captured Confederate fortifications at Manassas, Virginia in 1862. The remains of a gabion revetment can be seen in the middle ground. A vertical post revetment protects the battery in the background. (Library of Congress B817-7936)

Meanwhile, the Confederate army concentrated at First Manassas established extensive rifle pits and entrenchments along the southwest bank of Bull Run during June/July 1861. The brigade forming “the advance forces of the [Confederate] Army of the Potomac,” under Brigadier General M. L. Bonham, was ordered to fall back to prepared trenches in the face of the Federal advance from Washington. Two days later, Lieutenant Colonel George W. H. Legg, 5th South Carolina Infantry, wrote a letter to his local newspaper *The Carolina Spartan* stating, “We will have it today. We have been entrenching ourselves all night. We are well fortified at McLane’s [sic] Ford.” Several days before the commencement of fighting, Confederate General P. G. T. Beauregard ordered a “heavy” abatis about 200 yards in depth to be constructed on the western side of the Stone Bridge across the Run. As General McDowell reported on August 4, this discouraged his forces from advancing at that point and he decided to “turn the extreme left” of the Confederate position at Sudley’s Ford.

On the day of the main battle, Major Barnard supervised Federal engineer and pioneer troops as they entrenched on the northern banks at Blackburn’s Ford as part of a holding-flanking movement. Entrenchments and a battery were dug either side of the approach to the Ford, and an abatis was constructed across the road. Barnard described the battery as having “a log revetment for the interior slope, and some ten or twelve feet of dirt in front.” This battery was occupied by Co. D, 2nd US Artillery, commanded by Lieutenant O. D. Greene, and consisted of four guns placed with two either side of the road. Farther back along the same road, Lieutenant Frederick E. Prime, US Engineers, oversaw the pioneers of the Garibaldi Guard, or 49th New York Infantry, as they constructed a redoubt with two embrasures. According to Prime, this work would “sweep the old Braddock road, and resist any attempt to outflank us from the left, by Union Mills road or road from Gaines’ Ford.”

After the battle got underway on July 21, the pioneers under Captain B. S. Alexander, US Engineers, crossed over the Stone Bridge one by one, and set about cutting away the Confederate abatis, in order to clear the way for General Robert C. Schenck’s brigade to fall on the enemy right flank. Unfortunately, the Federal forces collapsed moments before Schenck’s brigade could be marshaled across the bridge, and the whole Northern army fell into a full-scale retreat.

Following their victory at First Manassas, the Confederates continued to fortify and entrench their positions around Centreville and Manassas Junction

during the remainder of 1861. After General J. E. Johnston evacuated the last of his army from that location on March 9, 1862, in response to McClellan's move to the Virginia Peninsula, Union reconnaissance parties reported them in detail. Those at Centreville consisted of "two lines, one facing east and the other north. The former consisted of seven works, viz: one bastion fort, two redoubts, two lunettes, and two batteries, all containing embrasures for 40 guns, and connected by infantry parapets and double caponiers. It extended along the crest of the ridge a mile and three-quarters from its junction with the northern front to ground thickly wooded and impassable to an attacking column. The northern front extended about one and a quarter miles to Great Rocky Run, and thence three-quarters of a mile farther to thickly wooded, impassable ground in the valley of Cub Run. It consisted of six lunettes and batteries, with embrasures for 31 guns, connected by an infantry parapet in the form of a cremaillere line with redans. At the town of Centreville, on a high hill commanding the rear of all the works within range, was a large hexagonal redoubt with ten embrasures." Meanwhile, the defenses at Manassas consisted of "a system of detached works, with platforms for heavy guns arranged for marine carriages, and often connected by infantry parapets. This system was rendered complete by a very large work, with 16 embrasures, which commanded the highest of the other works by about 50 feet." Following the Confederate withdrawal from Manassas in March 1862, McClellan ordered the re-fortification of that place, plus the re-opening of the Manassas Gap Railroad, with blockhouses built to protect its bridges.

## Extension of the Washington defenses, 1861-64

Following the debacle at Bull Run in July 1861, it became a priority to surround Washington with a chain of fortifications. A resolution from the House of Representatives, dated July 8, requested that Secretary of War Simon Cameron should provide "plans and estimates" for the completion of defensive works around the city. Major Barnard, Chief Engineer attached to the headquarters of McDowell, was soon engaged in the task.

In developing the system of fortifications around Washington, DC Barnard looked to historical examples, especially the Lines of Torres Vedras, which were planned and supervised by Colonel Richard Fletcher, Royal Engineers, to protect Lisbon from Napoleon's invasion of Portugal in 1810-11. In January 1863, Barnard wrote: "The theory of these defences is ... to occupy the commanding points within cannon range of each other by field-forts, the fire of which shall sweep all the approaches. These forts furnish the secure emplacement of artillery. They also afford cover to bodies of infantry. The works may be connected by lines of light parapets, or ground (where practicable) may be obstructed that the enemy's troops cannot penetrate the interval without being exposed, for considerable time, to the effects of artillery or musketry fire of the forts."

Barnard's first priority was the building of a chain of lunettes, called forts De Kalb, Woodbury, Cass, Tillinghast, and Craig. Earthworks connected the former two forts, as this was believed by him to be "one of the most

Construction of Fort Totten began in August 1861 and was finally completed during 1863. Named for Brigadier General Joseph G. Totten, Chief of Engineers, it occupied a high point north of Washington, DC and mounted 20 guns and mortars, including eight 32-pounders. The 100-pounder Parrott rifle in this fort provided long-range support when Confederate General Jubal A. Early's forces attacked nearby Fort Stevens on July 11 and 12, 1864. This view of the interior shows three of the guns on barbette carriages, and the banquette tread and slope behind the parapet. Also note the bomb-proof on the right. (Library of Congress B811-2313B)



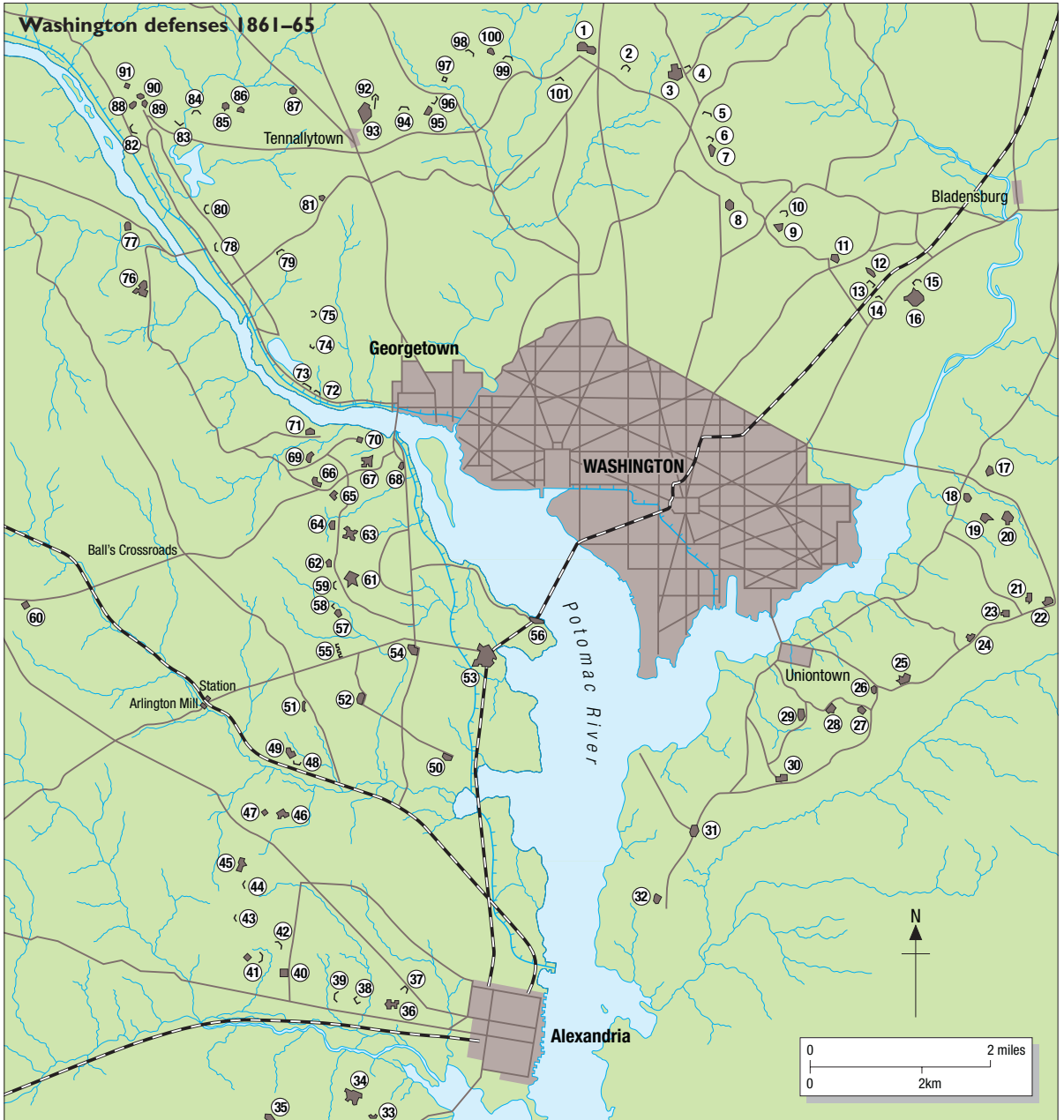

- |                   |                 |                   |                   |                     |                          |                       |
|-------------------|-----------------|-------------------|-------------------|---------------------|--------------------------|-----------------------|
| 1. Ft Stevens     | 16. Ft Lincoln  | 31. Ft Carroll    | 46. Ft Reynolds   | 61. Ft McPherson    | 76. Ft Ethan Allen       | 91. Ft Sumner         |
| 2. Battery        | 17. Ft Mahan    | 32. Ft Greble     | 47. Battery       | 62. Ft Tillinghast  | 77. Ft Marcy             | 92. Battery Reno      |
| 3. Ft Slocum      | 18. Ft ?        | 33. Ft Farnsworth | 48. Battery       | 63. Ft Whipple      | 78. Battery Martin Scott | 93. Ft Reno           |
| 4. Battery        | 19. Ft ?        | 34. Ft Lyon       | 49. Ft Barnard    | 64. Ft Cass         | 79. Battery Kemble       | 94. Battery Russell   |
| 5. Battery        | 20. Ft Chaplin  | 35. Ft ?          | 50. Ft Scott      | 65. Ft Woodbury     | 80. Battery Vermont      | 95. Ft Kearney        |
| 6. Battery        | 21. Ft Meigs    | 36. Ft Ellsworth  | 51. Ft Berry      | 66. Ft Morton       | 81. Ft Gaines            | 96. Battery Terrill   |
| 7. Ft Totten      | 22. Ft ?        | 37. Battery       | 52. Ft Richardson | 67. Ft Corcoran     | 82. Battery Alexander    | 97. Battery           |
| 8. Ft Slemmer     | 23. Ft DuPont   | 38. Battery       | 53. Ft Runyon     | 68. Ft Haggerty     | 83. Battery Benson       | 98. Battery Smead     |
| 9. Ft Bunker Hill | 24. Ft Davis    | 39. Battery       | 54. Ft Albany     | 69. Ft Strong       | 84. Battery Bailey       | 99. Battery Kingsbury |
| 10. Battery       | 25. Ft Baker    | 40. Ft Williams   | 55. Battery       | 70. Ft Bennett      | 85. Ft Mansfield         | 100. Ft De Russy      |
| 11. Ft Saratoga   | 26. Ft Wagner   | 41. Ft Worth      | 56. Ft Jackson    | 71. Ft C.F. Smith   | 86. Ft Simmons           | 101. Battery Sill     |
| 12. Ft Thayer     | 27. Ft Ricketts | 42. Battery       | 57. Ft Craig      | 72. Battery         | 87. Ft Bayard            |                       |
| 13. Battery       | 28. Ft Stanton  | 43. Battery       | 58. Battery       | 73. Battery         | 88. Ft Davis             |                       |
| 14. Battery       | 29. Ft ?        | 44. Battery       | 59. Battery       | 74. Battery Cameron | 89. Ft Cross             |                       |
| 15. Battery       | 30. Ft Snyder   | 45. Ft Ward       | 60. Ft Ramsay     | 75. Battery Parrott | 90. Ft Kirby             |                       |

The Washington defenses were built between 1861 and 1865 and consisted of 68 forts, over 90 batteries and 20 miles of rifle trenches. These were garrisoned at any one time by approximately

23,000 troops who manned about 450 artillery pieces consisting of 24- and 32-pounder cannon on seacoast carriages; 24-pounder siege guns; rifled Parrott guns; and guns on field carriages of lighter caliber.



practicable and probable routes of approach for the enemy." All these forts established a screen of outposts known as the Arlington Line, which faced southwest and connected forts Corcoran and Albany. A large lunette named Fort Scott, after General Winfield Scott, then General-in-Chief of the Army, was placed on a ridge overlooking the Long Bridge over the Potomac River. Originally called Fort Alexandria, but renamed Fort Ellsworth after the death of Elmer Ellsworth, colonel of the 11th New York Infantry, or 1st Fire Zouaves, another earthwork protected the immediate approaches to the city of Alexandria. An outer line of works consisting of forts Ward, Worth, Blenker, and Richardson, was established to secure the same city during September 1861. Fort Lyon guarded the route from the south.

A bulletproof barricade, capable of being thrown down "at will," was erected across the Chain Bridge over the Potomac at "the first pier from the Virginia side," with a movable staircase to the flats below, by which defenders could retreat. A stonewall was erected as a temporary measure at the Washington end of the bridge, behind which two antiquated 12-pounder howitzers were placed. Battery Martin Scott, consisting of one eight-inch seacoast howitzer and two 32-pounders, was placed on the bluffs at the Maryland end of the bridge. Battery Vermont provided additional protection from a higher point to the northwest. The occupation of the Virginia shore was secured by the

The official plan of the Confederate fortifications at Yorktown for the period April 5 to May 3, 1862, prepared under the direction of Brigadier General J. G. Barnard. This plan shows about half the line, including the point of attack. A note accompanying this map stated: "The Rebel works are laid down from reconnaissances [sic] made immediately after the evacuation, and are correctly, but very incompletely represented, owing to want of time for sketching minor details." (Library of Congress)



Based on an "on-the-spot" drawing by Sergeant Charles Worret, 20th New York Infantry, this rather idealistic lithograph depicts the siege of Yorktown of April 1862. (Library of Congress)

construction of forts Marcy and Ethan Allen. These works were subsequently connected and supported by covered-way rifle pits, and batteries for field guns. Further west in Virginia, Fort Ramsay was established as an advanced post on Upton's Hill.

To protect the northern approaches to the capital, a series of earthworks known as forts Pennsylvania (changed in January 1863 to Fort Reno, in memory of General Jesse Lee Reno, killed at South Mountain); Massachusetts (changed to Fort Stevens); Slocum; Totten; Bunker Hill; Saratoga; and Lincoln, were begun during August, and completed during the winter of 1861. Forts Gaines, De Russy, and Thayer were started shortly afterwards. A further set of strongpoints consisting of forts Greble, Meigs, Carroll, and Mahan protected the southeastern approaches to the Navy Yard Bridge, and gaps were subsequently filled by six more forts and a battery.

Eventually, a total of 68 forts, 93 batteries, and 20 miles of rifle trenches, manned at one time by approximately 23,000 troops, surrounded Washington, DC. Amounting to about 450 pieces, the armaments in these forts were made up of 24- and 32-pounder cannon on seacoast carriages, with a limited number of 24-pounder siege guns, rifled Parrott guns, and guns on field carriages of lighter caliber. This required about 7,200 men to furnish three relief crews of gunners. The underground shelters, or bomb-proofs, placed in nearly all of these works were capable of accommodating about one third of the garrison. Some forts also had blockhouses and/or log barracks. Infantry trenches were placed in advance of many forts in order to cover ground not seen from the larger earthworks.



Elements of the 1st Connecticut Artillery drilling with their guns at Fort Richardson, near Fair Oaks Station, Virginia. (Library of Congress B8171-2311)

## The Peninsula Campaign, 1862

With the Federal defeat at First Manassas in 1861, George Brinton McClellan was made Commander-in-Chief of the Union armies. Following the withdrawal of the Confederate Army of the Potomac, under General Joseph E. Johnston, to the line of the Rappahannock, McClellan was able to execute his plan of advancing on Richmond by water. Transporting his army by sea to the Peninsula during March 1862, he sallied forth from Fortress Monroe, only to find the way to the Confederate capital blocked at Yorktown by the most formidable of fortifications, many of which were begun during the previous year. In keeping with his proclivity for entrenchment, the Union general ordered his forces to also dig in, and Hampton Roads and the Peninsula became the most fortified area in North America. As a result, the Confederate and Union positions contained every example of fortification design.

Built by slave labor under the orders of General Magruder, the Confederate defenses consisted of two main lines across the Peninsula, the most formidable being the Warwick–Yorktown line. This stretched from Mulberry Island on the James River, and followed the Warwick River to within 1½ miles of Yorktown. The defenses at Yorktown consisted of a series of redoubts, the largest two being known as the “red” and “white” forts or redoubts, some of which were built atop British works remaining from the Revolutionary War siege of 1781. The



Confederates also constructed dams to make the sluggish Warwick River into a defensive barrier. Dam No. 1 was the midpoint between two pre-war tide mills at Lee's Mill and Wynne's Mill. Companion works were constructed across the York River at Gloucester Point.

A third defensive line was constructed further north outside Williamsburg. This consisted of a series of 14 redoubts, complete with supporting redans and rifle pits, with its centre anchored by Fort Magruder, also known as Redoubt No. 6, which sat astride the Williamsburg Road. In his report on the Peninsula Campaign, McClellan described this fort as including a parapet "about 6 feet high and 9 feet thick, the ditch 9 feet wide and 9 feet deep, filled with water. The length of the interior crest is about 600 yards. The redoubts have strong profiles, but are of small dimensions, having faces of about 40 yards. The woods in front of the position were felled and the open ground in front of the works was dotted with numerous rifle pits."

In his report dated May 6, 1862, Federal General Barnard, US Engineer Corps, described the Williamsburg defenses as follows: "In Fort Magruder [the first exterior work] there were found one 8-inch columbiad, one 42-pounder, and one 8-inch siege howitzer, the two former en barbette ... guns on field or siege carriages, making, I think, with the foregoing, twenty-two. Two of these were placed behind traverses, with embrasures covered by blindages. The two external redoubts with the connecting parapets formed a re-entrant with the fronts of attack, and all the guns bore on our approaches. It will be seen, therefore, that our approaches were swept by the fire of at least forty-nine guns, nearly all of which were heavy, and many of them the most formidable guns known."

McClellan commenced his siege operations on Yorktown on April 5, 1862. With Brigadier General Fitz John Porter as the Director of siege operations, and Captain James C. Duane, US Engineer Corps, superintending the siege works, he ordered the construction of bridges, and the building and improving of roads for the rapid transit of supplies to aid his advance. The first parallel was opened about a mile from the Confederate fortifications, extending along the entire front of their works. Along this were planted 14 batteries and three redoubts, each of which was heavily armed with ordnance. Sergeant Warren Lee Goss, Co. H, 2nd Massachusetts Heavy Artillery, recalled, "We had at last corduroyed every road and bridged every creek; our guns and mortars were in position; Battery No. 1 had actually opened on the enemy's works, Saturday, May 3d, 1862, and it was expected that our whole line would open on them in the morning. About 2 o'clock of Saturday, or rather Sunday morning, while on guard duty, I observed a bright illumination, as if a fire had broken out within the enemy's lines. Several guns were fired from their works during the early morning hours, but soon after daylight ... it was reported that they had abandoned their works in our front, and we very quickly found the report to be true. As soon as I was relieved from guard duty, I went over on 'French leave' to view our enemy's fortifications. They were prodigiously strong. A few

Sandbags provided the traverses for this Confederate redoubt captured at Yorktown in April 1862. A 32-pounder seacoast gun stands nearest the camera, while a 24-pounder siege piece on a wooden barbette carriage is seen nearby. (Library of Congress B811-2366A)



An engraving based on this drawing by Alfred Waud showing Federal troops occupying the "Red Redoubt" at Yorktown was published in *Harper's Weekly* on May 24, 1862. (Library of Congress)

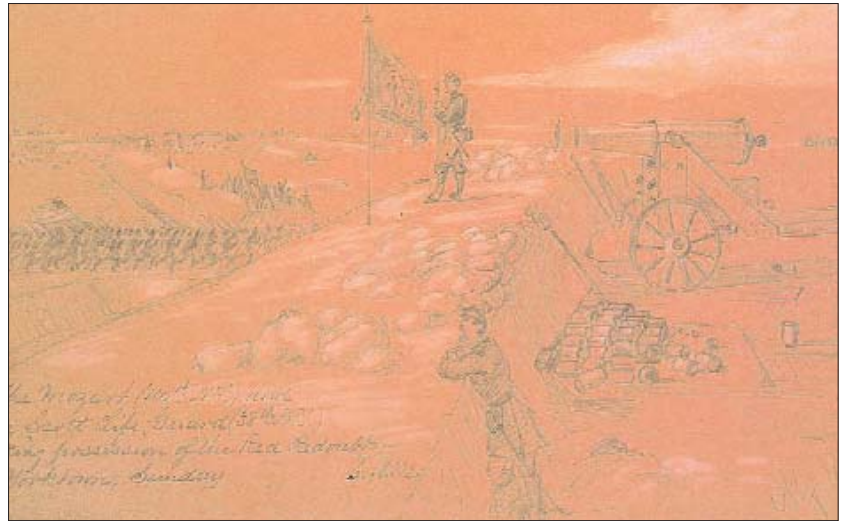

tumble-down tents and houses and seventy pieces of heavy ordnance had been abandoned as the price of the enemy's safe retreat."

## Battle of Williamsburg, 1862

When General Joseph E. Johnston withdrew from Yorktown, his forces fell back to the Williamsburg line. Major General James Longstreet's division took up rearguard positions in Fort Magruder and the 13 other redoubts during the evening of May 4, 1862. The next morning Federal troops commanded by Major General Joseph Hooker attacked these positions. An unidentified member of this force remembered: "The main fort [Magruder] was a strong earth-work with a bastioned front and a wide ditch. In front of this muddy-looking heap of dirt was a level plain, sprinkled plentifully with smaller earth-works; while between us and the level plain the dense forest, for a distance of a quarter of a mile, had been felled, thus forming a labyrinth of tangled abatis difficult to penetrate. A mile away lay the village of Williamsburg." Advancing into this exposed area, Hooker's division fought the first pitched battle of the Peninsula campaign but was repulsed and driven back by a strong Confederate counter-attack, until Brigadier General Philip Kearny's division arrived to stabilize the Federal position.

Meanwhile, Brigadier General Winfield Scott Hancock's brigade marched around the Confederate left flank and occupied two abandoned enemy redoubts, numbered 12 and 13, along Cub Creek. Hancock's men then began shelling the Confederate flank and rear. Longstreet ordered elements of Major General D. H. Hill's division to dislodge the Federals, but Hill's efforts were misdirected and disjointed, resulting in a bloody repulse for the Confederates. Confederate casualties for the battle were 1,600, while Union losses were 2,300. Nonetheless, this action delayed the Federal advance, while the Confederates abandoned the Williamsburg redoubts and continued their withdrawal toward Richmond.

A sketch of the Confederate fortifications in front of Williamsburg, Virginia, drawn by Lieutenant Miles Daniel McAlester, Chief Engineer, 3rd Corps, Army of the Potomac, on May 5, 1862. (Library of Congress)

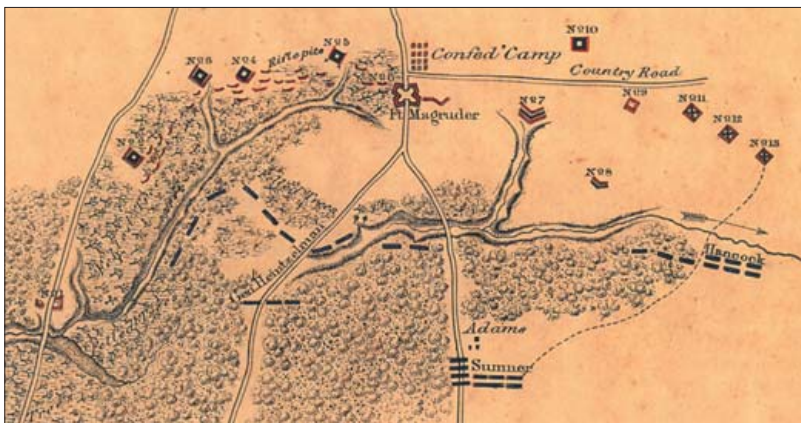

# The Richmond defenses, 1861–65

Following his acceptance as Major General of Virginia Forces on April 23, 1861, Robert E. Lee appointed Colonel Andrew Talcott, Engineer of Virginia Forces, to the job of setting up a system of defensive fortifications around the Confederate capital. On May 9, a “Committee on Defense” was selected amongst the City Council to assist in providing a work force and materials. Councillor Richard Reins had been appointed as Superintendent of City Defenses by the beginning of July.

Problems arose in construction due to tardiness in selecting a sufficient number of experienced military engineers within the Provisional Confederate Army to supervise the works. Despite various efforts to throw up redoubts and entrenchments using both slave and free-colored labor during the summer of 1861, satisfactory defenses were incomplete by the end of the year. On December 9, Colonel Charles Dimmock, colonel of the Ordnance Department of Virginia, appealed to the City Council to consolidate the work. Although “embankments” and “batteries” had been erected by that time, cannon had still to be mounted, and Dimmock argued that if “any smash up should occur to General Magruder’s or Johnston’s army, the approach to Richmond by the



A detail from Plate 92 of *The Official Military Atlas of the Civil War*; this map shows the inner and intermediate defenses of Richmond, Virginia. Based on surveys made by Captain A. H. Campbell, Provisional Engineers, CSA, which were approved on April 26, 1864, it shows the 17 inner batteries constructed by February 1862, and the intermediate line built between 1862 and 1864. (Author's collection)

enemy would follow quickly." He added he was concerned that the Council should not wait for the Confederate authorities to take action, but should immediately take the matter in hand.

On February 28, 1862 a report produced by Captain Dimmock stated that the fortifications and defenses of Richmond ran from "the north side of James River, commencing on the river below the city and training around to the river above the city [the Chickahominy and its tributaries]," along which there were 17 separate batteries and two more under construction. On the south side of the river, enclosing the town of Manchester, commencing on the river below and running around to the river above that town, there were four separate batteries, besides two more "about to be thrown up." Dimmock stated that the length of line of works on the north side of the river was 7½ miles and on the south side 4½ miles—in all about 12 miles.

In a medical inspection report dated November 20, 1862, William A. Carrington, Surgeon and Inspector of Hospitals, revealed how undermanned the Richmond fortifications were at this stage in the war. "The defenses consist of an immense line of embankments & heavy artillery in a circle of about 2 miles from the city being numbered from Battery 1 on the north side of the James River to No. 17 on the south side – Batteries no. 1 to 10 are on the north side ... Batteries no. 11 to 17 are on the South side [batteries 11 and 12 were actually on the north side], of these no. 15 only has one Co. of light artillery in 4 houses used as Barracks ... The other batteries have each one sentinel who guards them. The outer line consists of 7 Cos. of light artillery all static and in and about the Charles City road ... The whole command numbers 2,509 and 192 are sick & off duty."

Built between 1862 and 1864, the intermediate line of Richmond defenses consisted of 25 inner forts and batteries, including forts Johnson, Gregg, and Gilmer. By 1864, the Confederates had created an exterior system of fortifications anchored south of the capital on the James River at Chaffin's Bluff. Fortifications at this end of the line included Fort Harrison, named for Confederate engineer Lieutenant William Harrison; and Fort Hoke, named for Major General Robert F. Hoke of North Carolina. Battery Alexander was built on an extension of this line begun in 1864, and was named for General E. Porter Alexander, who designed it and supervised its construction. At a point farther north where the exterior line dissected the Charles City Road stood Fort Lee, named after General Robert E. Lee. Fort Drewry, a three-bastioned fort, dominated Drewry's Bluff protecting the approaches along the James River. Fort Stevens also formed part of the earthworks around Drewry's Bluff. Also south of the James was Parker's Battery and Battery Dantzler. Forming part of the Howlett Line, these fortifications bottled up the forces of Union General Benjamin Butler at Bermuda Hundred. Fort Wead was part of the secondary Union line built opposite the Howlett Line.

The strength of the Confederate defenses remained largely untested until September 1864 when Grant tried to capture Richmond or Petersburg by attacking simultaneously north and south of the James. The attack north of the river occurred on September 29. General Butler commanded an assault force of 2,500 that captured the strategically important New Market Heights in the early morning. Other elements of Butler's forces, including African-American troops, then overwhelmed the Confederate defenders inside Fort Harrison, which was renamed Fort Burnham. 14 colored soldiers were subsequently awarded the Medal of Honor for bravery during the capture of this fort. However, uncoordinated attacks against Forts Johnson, Gregg, and Gilmer all encountered dismal failure, leaving Butler and Grant with only partial success. A Confederate counter-attack on Fort Harrison on September 30 proved equally futile, and the two armies settled into trench warfare that continued until the end of the war. During this phase, the Federals established extensive siege lines, including Fort Brady, which anchored their lines on the James River.

## **Siege of Suffolk, April 11–May 4, 1863**

During the winter and early spring of 1863, Lieutenant General James Longstreet, commander of the Confederate Department of North Carolina and Southern Virginia, began siege operations against Union forces under Major General John J. Peck in the city of Suffolk, Virginia. Although considered a minor campaign because Suffolk was of little strategic significance, this action was important to Lee's army, which was still stationed in devastated central Virginia. While conducting the siege of Suffolk, Confederate forces under Longstreet were able to collect huge amounts of food that had been under Union control, and send it to Lee's hungry soldiers. Nonetheless, this operation failed to capture Suffolk, and resulted in Longstreet and 15,000 men of his Corps being absent from the Battle of Chancellorsville fought in May of that year.

The main Federal defenses around Suffolk consisted of forts Seward, McClellan, Nansemond, Union, Connecticut, Dix, and Halleck. Among the smaller works were batteries Mansfield, Monday, Stevens, Onondaga, Montgomery, and the Draw-Bridge Battery. Longstreet advanced upon Suffolk on April 11, 1863, and probed the defenses for several weeks, after which he settled down to a prolonged siege. According to General Peck, the Confederates "commenced an investment according to the most improved principles of military science." Longstreet reported that Suffolk could have been captured in a few days, but concluded that he could not "afford to spend the powder and ball." He finally ended siege operations on May 4, 1863.

A principal engagement during this siege was the Federal surprise and capture of Battery Huger, a Confederate strongpoint at Hill's Point on the Nansemond River, by combined army and navy forces on April 19, 1863. Masterminded by Navy Lieutenant Roswell H. Lamson, commanding the Flotilla off Suffolk, and conducted by elements of the 89th New York and 8th Connecticut, the Federal force landed upstream from the battery, and approached it through dense woodland. Unable to defend themselves from the landward side, the Confederate garrison consisting of the Fauquier Artillery, commanded by Captain Robert M. Stribling, and the 44th Alabama, under Lieutenant Colonel John A. Jones, was captured without firing a shot.

# The western campaign, 1862–64

Field fortifications also played an important role in Tennessee. Once Nashville fell after the capture of forts Henry and Donelson in February 1862, the Federal army wasted no time in fortifying that city. Included in these works were forts Morton, Casino, Gillem, and Negley (later renamed Fort Harker). Although never finished, the latter was the largest single fort west of the Washington defenses. Named for General James S. Negley, provost marshal and commander of Federal forces in Nashville, Fort Negley was built on St. Cloud Hill, and became the center of military operations in the Western theatre of the war.

## Siege of Chattanooga, 1863

Following the disastrous Federal defeat at Chickamauga, the demoralized Rosecrans withdrew his army to the vital railroad center of Chattanooga, Tennessee, and threw up defensive works in preparation for a siege. Bragg arrived outside that city on September 23 and established a line of field fortifications that mainly extended along the western base of Missionary Ridge, and across the valley between Missionary Ridge and Lookout Mountain. From their lofty positions, the Confederates attempted to shell the city, but gave up after a couple of days because the range was too great to be effective and their fuzes were so poor.

Under the supervision of engineering specialist General Morton, the Federals worked constantly to strengthen their fortifications around Chattanooga before and during the siege. These works included forts Wood and Negley, which were linked together by infantry parapet. Outer works consisted of a line of rifle pits and a picket line. Following Grant's relief of Chattanooga on November 25, 1863, and while they were making the city the forward base of Sherman's drive on Atlanta, the Federals significantly altered these works. Inner strongpoints closer to the river to the east of the city included forts Sherman and Lytle; batteries

Sketch map of the fortifications, rifle pits, plus Union and Confederate picket lines, outside Chattanooga, Tennessee, drawn by G.H. Blakeslee, US Topographical Engineers, in 1863. (Library of Congress)

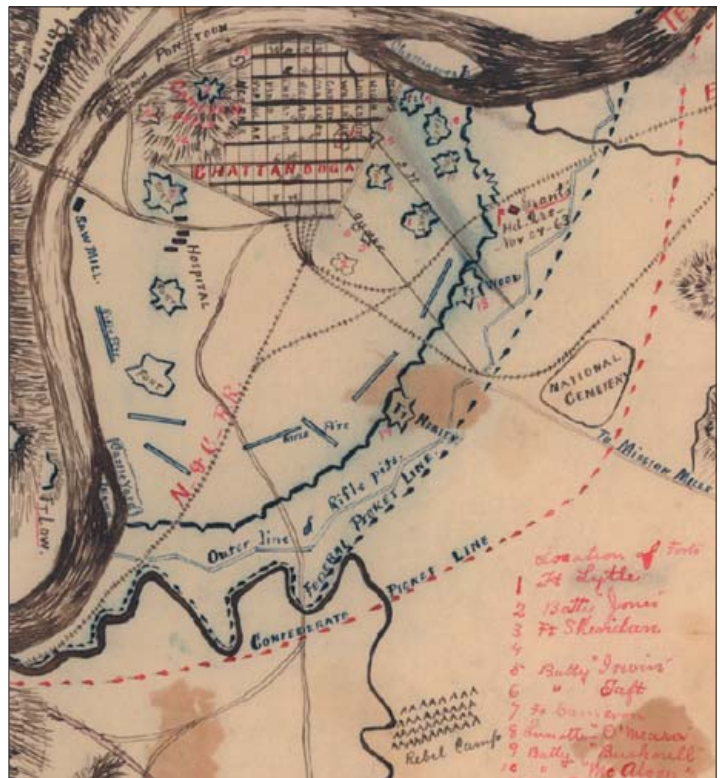

### Fort Mouton (Redoubt B), Mobile, Alabama

By 1864, the city of Mobile, Alabama, was protected by 58 forts and redoubts with connecting breastworks. Construction of the middle line of defenses was supervised by Chief Engineer Lieutenant Colonel Victor Von Sheliha, of the Confederate Engineer Corps, and included Fort Mouton (Redoubt B), an isolated post situated on high ground behind Eight Mile Creek. Fort Mouton was a square redoubt with two bastions facing

towards the outer defense lines. The inner works contained eight 8-inch columbiads, plus an unspecified number of 42-, 32-, and 24-pounder siege guns. The parapets of this fort were from 15–25 feet thick, and ditches through which tidewater flowed were about 20 feet deep and 30 feet wide. The garrison of Confederate troops also contained a large number of African-American laborers who were subject to the command of the engineers.

**Fort Mouton (Redoubt B), Mobile, Alabama**



Bushnell, McAloon, Irwin, Taft, and Jones; plus Lunette O'Meara and Redoubt Putnam. Inner works to the west of the city included Fort Sheridan, on Cameron Hill, and forts Mihalotzy and Cameron, plus Battery Cooledge. Many of these works had blockhouse keeps, deep ditches, and steep scarps.

## Siege of Knoxville, 1863

In early November 1863, Longstreet undertook his Knoxville expedition to divert Union troops from Chattanooga, and also to get away from Bragg, with whom he was engaged in a bitter feud. By mid-November, the city of Knoxville, held by forces under General Ambrose Burnside, fell under siege. On the 29th of that month a bastioned earthwork on a hill forming a sharp salient in the northeast corner of the entrenchments at Knoxville was assaulted. Named by the Federals as Fort Sanders, after cavalry General William P. Sanders who had been killed nearby 13 days earlier, the garrison of 250 men under Lieutenant S.L. Benbow was alerted as the Confederates attempted to assemble in the darkness to launch a surprise attack just before dawn. After some difficulty scrambling through wire entanglements, the assault force reached the ten-foot deep ditches on the north, west, and south faces of the fort with heavy loss. Without scaling ladders, few Confederates emerged on the scarp side, and only a small number entered the fort to be wounded, killed, or captured. Following their failure to take Knoxville, the Confederates withdrew and much of eastern Tennessee fell into Federal hands.

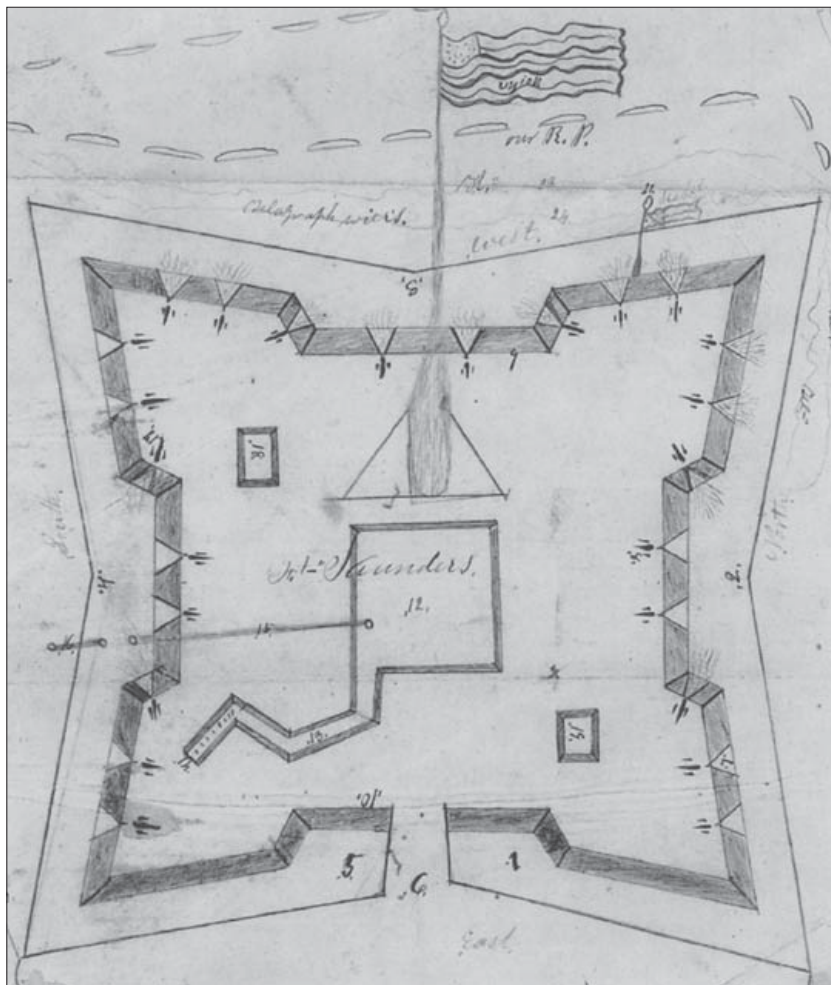

Drawn by John G. Orth, this map of Fort Sanders, Knoxville, Tennessee, illustrates the Confederate assault of November 29, 1863. Note the cannon firing, which shows the extent of the attack. The small "Rebel" flag flying on the northwest angle indicates the point at which the Confederates temporarily raised their banner on the Federal parapet with great loss of life. (Library of Congress)



## Struggle for Atlanta, 1864

The Atlanta campaign lasted from July 1 to September 2, 1864. Following the Chattanooga campaign, Bragg retreated 25 miles south to Dalton, Georgia, and entrenched. However, Grant did not pursue him but instead went to Burnside's aid at Knoxville. As a result of public clamor, Bragg replaced Joseph E. Johnston in command during December 1864. Meanwhile, Grant was appointed General-in-Chief of the Armies of the US, and he proceeded east to Virginia, while General William Tecumseh Sherman was ordered to smash Johnston's army and "get into the interior of the enemy's country." In a series of thrusts, Sherman forced Johnston south towards Atlanta, a very important rail hub and industrial center for the Confederacy, and, after a victory at Kennesaw Mountain on June 27, 1864, closed in around that city.

According to the report of Captain Orlando M. Poe, Chief of Engineers under Sherman, the Confederate defenses at Atlanta "completely encircled the city at a distance of about one and a half miles from the center and consisted of a system of batteries open to the rear and connected by infantry parapet, with complete abatis, in some places in three and four rows, with rows of pointed stakes, and long lines of chevaux-de-frise. In many places rows of palisading were planted along the foot of the exterior slope of the infantry parapet with sufficient opening between the timbers to permit the infantry fire, if carefully delivered, to pass freely through, but not sufficient to permit a person to pass through, and having a height of twelve to fourteen feet. The ground in front of these palisades or stockades was always completely swept by the fire from the adjacent batteries, which enabled a very small force to hold them."

Rather than begin full-scale siege operations with saps and parallels, Sherman adopted the offensive tactic of creeping forward just before daylight each day, with each man hastily digging rifle pits that were subsequently linked together to form rifle trenches. These could be pushed forward to within 200 yards of any point on the Confederate lines with minimal loss of life. Towards the end of August, the Federal lines had been strengthened with batteries of 4½-inch guns, which maintained a steady fire upon the enemy's lines and upon the city of Atlanta. Thus, Sherman believed he could encourage the Confederate army, under command of General John Bell Hood since July 17, 1864, to either sally out and become involved in a general engagement, or evacuate the city. He eventually achieved both, and on September 1, following the failure of several sorties, the Confederate army burned and evacuated the city.

## Siege of Savannah, 1864

Sherman's infamous "march to the sea" culminated in the siege of Savannah, which began on December 10, 1864. According to Lieutenant Colonel Charles Colcock Jones, Jr., chief of artillery for the military district of Georgia, the Confederate inner defenses at Savannah consisted of "detached works, located at prominent points, commanding the established avenues of approach to the city, crowning causeways and private crossings over these lowlands, and offering resistance wherever the swamps were practicable." Furthermore, canal banks were breached and river dams were cut, which contributed to the naturally flooded landward approaches to the city.



**The 17th Iowa Infantry at Tilton, Georgia, October 1864**

The 17th Iowa Infantry was guarding the railroad at Tilton, Georgia, in October 1864, when it was attacked by a Confederate force commanded by General Alexander P. Stewart. Lieutenant Colonel Samuel M. Archer, commanding the 17th Iowa, reported: "At 7 o'clock on the morning of the 13th my pickets on the railroad between Resaca and this place were fired upon ... they fell back to the blockhouse into which I at once placed as many men as could conveniently man the loopholes, and disposed of the rest in the pits on either side ... very soon we were surrounded by a very heavy force of skirmishers ... A brisk fire was maintained on both sides for four hours, during which time the rebels gained no ground, and were punished considerably ... They introduced three 24-pounder Napoleons, and opened a terrific fire upon us ... The roof was soon demolished and its timbers so much strained that the dirt covering rained down on us in torrents. The last and forty-seventh shot fired ... entered a loophole and exploded in the center of the room ... I surrendered the garrison, satisfied with having detained the rebels seven and a half hours." (*Official Records*, Vol. 39, Part 1, pp 759–60. Photo: Library of Congress B811-2669)



A view of the interior of Fort McAllister, Savannah, taken after its capture by Federal forces on December 13, 1864. The large parapets traverse standing in the foreground was designed to limit the area affected by explosions that might occur within gun positions during heavy and prolonged bombardment. The entrance work at bottom left also indicates that it probably served as a bomb-proof shelter or powder magazine. (Library of Congress B81 I-4004)

#### Fort Hardeman, Savannah

Fort Hardeman was situated in front of the extreme right of the Confederate line at Savannah. Planned and constructed under the immediate supervision of Lieutenant Colonel Bushrod W. Fobel, CS Engineers, this work enfiladed that part of the defenses, and consisted of a redan with an open gorge that rested on the Savannah River. Colonel Jones recorded that the "lunette, which constituted its prominent feature was approached by a covered way, and in it was located an ample bomb-proof made by cutting a deep ditch from the salient to the bastion line. This ditch was crossed at right angles by another of similar dimensions, commencing and terminating at the flank angles respectively. These ditches were then roofed with timber and covered with the earth removed in making the excavations. Thus was constructed not only a commodious bomb-proof, but also an excellent magazine. Semi-lunar in outline, the enclosed lunette constituted its center, with a redan on the left and a semicircular work on the right. The infantry line and curtains connecting these were substantial in character and showed a double front. The interior front commanded the terre-plein in case the enemy should attack from Hutchinson's island. Sand bags were used instead of headlogs, and they were so arranged as to permit the garrison, while firing, to be entirely under cover. The exterior front was protected by a double frieze of stakes and fence-rails planted firmly in the ground and interlaced with iron wire."

Designed by Captain John McCrady, Chief Engineer of the state of Georgia, the landward defenses consisted of forts Hardeman, Thunderbolt, Wimberly, Brown, Mercer, Boggs, Lee, Tattnall, and McAllister. The main batteries were named McBeth (railroad battery), Acee, Barnes, Pine-Point, Jones, Tucker's Point, Burnside, Green Island, Daniels, Harrison, Wilmington, Turner's Rock, Bonaventure, Hutchinson Island, and Causten's Bluff.

The most elaborate fortification in the Savannah defenses was Fort Hardeman, situated in front of the extreme right of the Confederate line (see box below). On December 9 and 10, the Federals attempted to capture this work, but the assaults were feeble and easily repulsed. It was a different story with Fort McAllister, a strong enclosed redoubt on the Ogeechee River to the south of Savannah. Defended by only a small garrison of 150 men, the big guns of this

work were trained on the river, and not inland, and had already beaten off seven Federal naval attacks. Meanwhile, Hazen's division of the 15th Union Corps consisted of approximately 4,000 troops, which simply overran the defenses on December 13 and fought the Confederates hand-to-hand. Major George W. Anderson, Jr., commanding Fort McAllister, reported: "The fort was never surrendered, it was captured by overwhelming numbers." When artillery officer Captain Nicholas B. Clinch was called on to surrender during the assault, he responded with a thrust of his sword, and hand-to-hand combat continued, with Clinch going down only after having sustained three saber, six bayonet and two gunshot wounds. The capture of this fort sealed the fate of the city of Savannah, which was evacuated December 19–20, 1864.

# War in the East, 1864–65

## **The Confederate attack on Washington, July 11–12, 1864**

The only Confederate assault on the Washington defenses occurred in the summer of 1864. Learning from spies that the capital was poorly defended due to Grant's insistence that troops be moved south to reinforce his army besieging Petersburg, Lee sent General Jubal A. Early to attack Washington from the north. During the morning of July 11, 1864, lookouts in the signal tower at Fort Reno spied clouds of dust in the distance, and then saw Confederate forces advancing towards the capital from the direction of Rockville, Maryland. Early's forces, consisting of the divisions of Rodes, Gordon, and Ramseur, reached the outskirts of Washington, DC near Silver Spring, and skirmishers advanced to "feel" the fortifications, which at the time were manned by only small garrisons in each fort, plus support troops consisting of the 2nd Regiment of District Volunteers, the 9th Regiment Veteran Reserve Corps, and several troops of cavalry and batteries of field artillery. During the night, veteran units from the Union Sixth Army Corps disembarked from troop transports and marched north through the streets of Washington to bolster the defenses. Joined by about 1,500 well-armed and equipped US Quartermaster Department employees, they took up position in the rifle pits. The Confederate skirmishers approached to within a distance of 150 yards until Federal fire drove them back. The Union forces in the forts and rifle pits spent the night lying on their arms.

The next day, Early was finally in position to make a strong demonstration, which was repulsed by the veteran Union troops. In the afternoon, Sixth Corps units sortied against the Confederate skirmishers, driving them back from their advanced positions in front of forts Stevens and DeRussy, at a loss of about 280 killed and wounded.

As President Lincoln watched the action from Fort Stevens, he came under fire from Confederate sharpshooters. Recognizing that the Union Capitol was defended by veteran troops, Early abandoned any thought of taking the city. Withdrawing during the night, he marched toward White's Ford on the Potomac, ending his invasion of Maryland. "We didn't take Washington," Early told his staff officers, "but we scared Abe Lincoln like Hell."

## **The Wilderness, 1864**

Meanwhile, Grant began his campaign to capture Richmond, Virginia. From the Wilderness Campaign to the siege of Petersburg in 1864, the use of field fortifications grew more intense and sophisticated. The densely wooded countryside of northern Virginia contributed to this by making offensive maneuver and coordination very difficult. The importance that Grant gave to entrenching equipment in the Union supply trains illustrates his increased respect for hasty entrenchment. In preparation for the 1864 campaign, he ordered half the wagons carrying entrenching tools to be placed at the head of the supply column attached to the leading division of each army corps. Until Cold Harbor, engineer troops in the eastern theater of the war were generally responsible for laying out fortifications. Thereafter, non-specialist troops often chose where to dig in, and were more involved in the digging.

From the first clash of arms in the Wilderness on May 5, 1864, offensive entrenchments were used to launch frontal assaults from positions as close to the enemy as possible. They were also needed in order to hold captured

ground. Indeed, the length of the Union line was entrenched before the Federal assault, while the Confederates hesitated to build trenches until they had engaged with the enemy.

General Winfield Scott Hancock entrenched his 2nd Army Corps behind a triple line of log and earth breastworks immediately upon taking up positions facing southwest below Wilderness Tavern. Commanding the Confederate 2nd Army Corps, General Richard S. Ewell ordered his men to throw up only slight earthworks during the first day of battle. During the night of May 5/6, Ewell had a strongly entrenched second line created about 300 yards behind his first position. The failure of General Ambrose P. Hill to entrench his 3rd Army Corps almost led to a Confederate disaster during the Union assault on May 6. His routed troops were saved only by the belated arrival of Longstreet's 1st Corps just before dawn on the second day of battle. Both armies entrenched thoroughly during the remainder of the Wilderness battle. By 10 am on May 6, and after a series of Federal assaults and Confederate counter-attacks, stalemate set in on a temporarily stabilized front.

## **Spotsylvania, 1864**

Despite heavy losses at the Wilderness, Grant continued to press the Confederates toward Richmond. On May 7, the Army of the Potomac began moving southeast in the direction of Spotsylvania Court House. After further heavy fighting on May 8, both armies spent that night, and the next day, digging in once more. On the Union lines, Hancock led the way by again throwing up three successive entrenched lines. Meanwhile, the ill-fated General John Sedgwick, commanding the 5th Army Corps, ordered working parties from each brigade to fortify his position.

Anticipating that Grant intended to fight it out on the Richmond line, the Confederates were equally as busy. Taking into account his limited human and material resources, plus the absence of a viable offensive opportunity, Lee decided to adopt a defensive posture, and ordered General Richard H. Anderson, commanding the wounded Longstreet's 1st Corps, to develop fortifications on the left of the Confederate line, while Ewell followed suit in the centre. Expecting its arrival on the right of the line on May 9, Lee personally laid out a strong defensive line for A. P. Hill's 3rd Army Corps. Following these developments, the prospect of a drawn-out war of entrenched stalemate seemed increasingly more likely.

Lee's army rapidly occupied a semicircular line about three miles in length along a ridge resting between the Po and the Nye rivers. Weaknesses included a salient near the centre about half a mile wide and a mile deep. Furthermore, if the Federals captured the high ground on the line, their guns could command the remaining Confederate positions. General Henry Upton, who commanded the second brigade of the Union 1st Division, 6th Army Corps, reported that the Confederate entrenchments at Spotsylvania were of "a formidable character with abatis in front and surmounted by heavy logs, underneath which were loopholes for musketry. In the re-entrant to the right of the house was a battery with traverses between the guns. There were also traverses at intervals along the entire work. About 100 yards to the rear was another line of works, partly completed and occupied by a second line of battle." Lee also wished to have constructed a line of retrenchment across the angle at the base of the salient, but this appears not to have been commenced when the Union attack began, but quickly petered out.

## **Bloody Angle, 1864**

The next two days were relatively quiet, with intermittent sharpshooting preventing all but the foolhardy exposing any part of their anatomy from behind the entrenchments. This lull in proceedings ended abruptly on May 12, when one of the most gruesome trench battles of the Civil War occurred in



what became known as the “Bloody Angle.” Initially, a rain-soaked Federal assault on the salient at about 6 am involving Hancock’s Corps went well. An intelligence error had led Lee to believe that Grant was retreating and consequently the 22 cannon in that section of the Confederate line had been withdrawn. General Edward Johnson, commanding the 2nd Division of Ewell’s Corps, ordered them back again but they were still being returned when the attack occurred, and nearly all were captured without firing a shot. Three generals and a full division of men were also taken in the initial rush. However, a Confederate counter-attack by the Georgia brigade of General John B. Gordon slammed into the packed mass of men with devastating effect and drove the Federals back, but not away from the salient. The Federal infantry halted on the outer side of the Confederate works and threw a murderous fire into Gordon’s men, who were now stranded, it being difficult to withdraw safely to the gorge to consolidate at a second line. Meanwhile, prevented by Federal entrenchments from launching a flanking attack, Lee ordered the Georgians in the salient to maintain their position at the parapet, and for about 24 hours the opposing forces fired at nearly point-blank range through every loophole and opening in the Confederate breastworks. At one point Federal troops managed to enfilade the Confederates, but traverses enabled the defenders to hold their positions. Federal artillery and mortars also took their toll, while trees with 22-inch-diameter trunks were felled by the intensity of the musket fire.

The heavily outnumbered Confederates managed to hold on, at a total cost to both sides of about 12,820 killed, wounded, or captured. By midnight, the line at the gorge was completed. Consequently, Lee ordered a gradual withdrawal, and just before dawn, the last of the defenders slipped through the new line, bringing to a close one of the toughest trench warfare encounters of the conflict.

A drawing by W.T.Trego entitled “Struggling for the works at the ‘Bloody Angle’” depicts the vicious fighting that took place in the trenches near Spotsylvania Court House, Virginia, on May 12, 1864. (*Battles & Leaders*)

The Confederate attack on Fort Stevens, Washington, DC on July 11, 1864

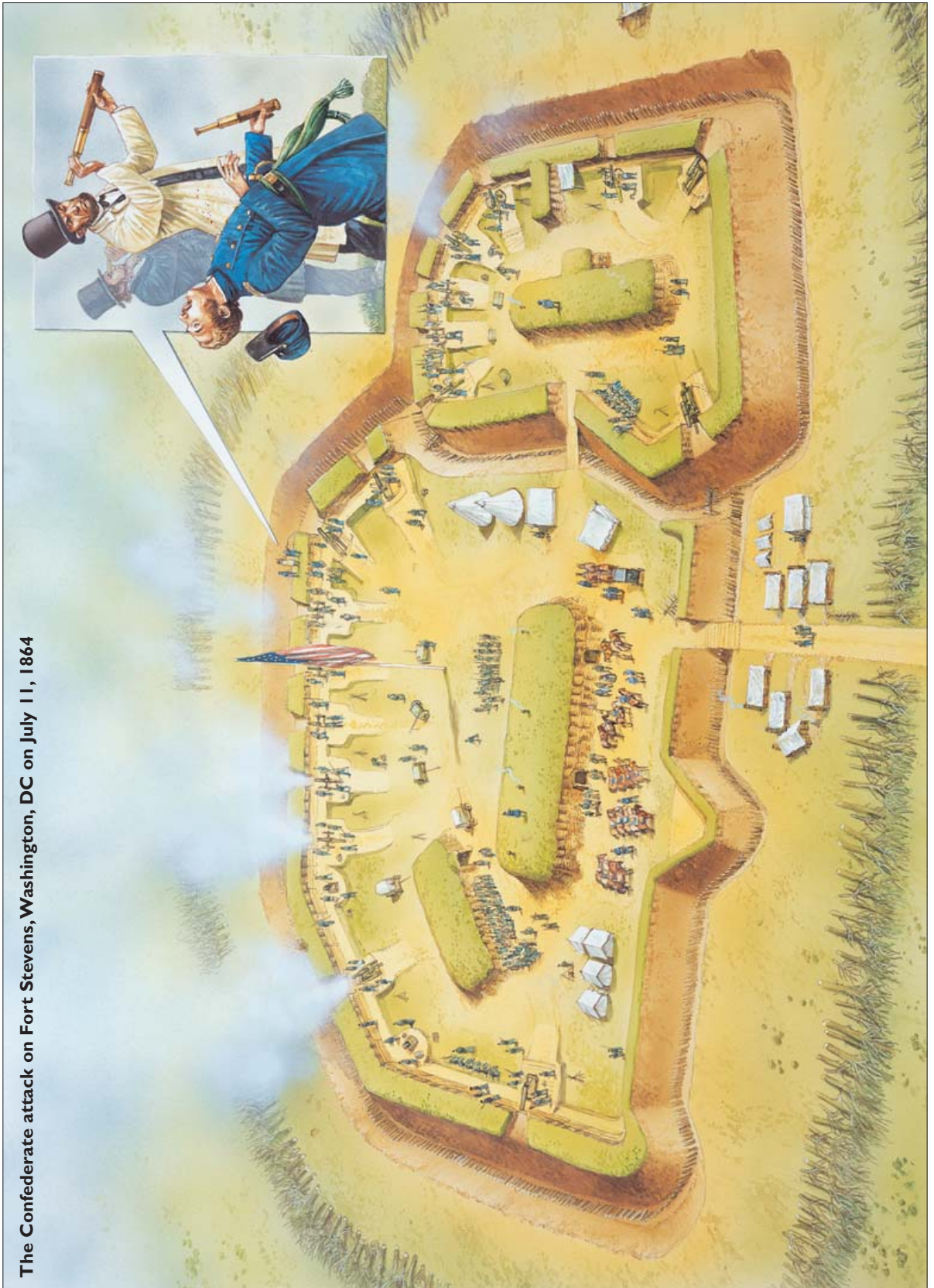

## Cold Harbor, 1864

Still determined to push on towards Richmond, Grant once again moved the Army of the Potomac in an attempt to outflank Lee's forces. Following several days of inconclusive maneuvering for control of the vital crossroads of Cold Harbor, Grant decided, on June 3, 1864, to launch an all-out assault on Lee's entrenchments, which consisted of the 2nd, 6th, and 18th Corps, totalling 50,000 men, along the Bethesda Church–Cold Harbor line. Although the Confederates were greatly outnumbered by a better-armed and physically fitter army, the combination of strong field fortifications, rifled infantry weapons, and well-placed artillery presented Lee with one of his most decisive triumphs of the 1864 campaign. Reaching within 50 yards of the Confederate breastworks, the advanced Federal units were forced to the ground by heavy enemy fire. During furious fighting on the extreme left of the Federal line, Barlow's division overran the lines defended by Breckinridge and captured an advanced position, but was thrown back trying to take Hill's main breastworks. Grant's main attack was crushed within eight minutes of its commencement. Meeting with withering artillery and rifle fire from Lee's lines, further Federal assaults were unable to make any further progress towards the Confederate lines. Grant gave up the offensive about 1 pm, some eight hours after the first attacks. Lee had lost only about 1,500 along his entire six-mile front. Grant's casualties totaled about 12,000 dead and wounded. In his memoirs, he later commented that this was the only attack he wished he had never ordered.

The armies confronted each other on these lines until the night of June 12, when Grant again advanced by his left flank, marching towards the James River. On June 14, the Federal II Corps was ferried across the river at Wilcox's Landing. On June 15, the rest of the army began crossing on a 2,200-foot-long pontoon bridge at Weyanoke. Abandoning all attempts to penetrate the well-defended approaches to Richmond, Grant sought to shift his army quickly south of the river to threaten Petersburg.

### **The Confederate attack on Fort Stevens, Washington, DC on July 11, 1864**

The small polygonal redoubt called Fort Massachusetts was built in 1861 to guard the Seventh Street Road, or Turnpike, leading directly into Washington from Silver Spring. Expanded westward by the 2nd Pennsylvania Heavy Artillery in February 1862, it was renamed Fort Stevens in January 1863 for Brigadier General Isaac Ingalls Stevens, killed at the Battle of Chantilly, Virginia, September 1, 1862. The original fort contained a five-gun battery, and a magazine that served as a small parapet traverse. It was surrounded by a strong parapet and ditch. The extended fort included a larger magazine and a bomb-proof, both of which also doubled as parapet traverses. Abatis also surrounded these works, although the gorge was only protected by a modest infantry parapet. By the summer of

1864, the garrison at Fort Stevens consisted of Companies C and G, 151st Ohio National Guard, commanded by Major J. L. Williams; Company A, 1st Wisconsin Heavy Artillery, under Captain Wallace M. Spear; and one-half Company L, 9th New York Heavy Artillery, under Lieutenant S. A. Howe. Armament consisted of four 24-pounders on barbette carriages, six 24-pounder siege guns, two 8-inch siege howitzers, one Coehorn mortar, one 10-inch mortar, and five 30-pounder Parrotts. The enlarged fort played a significant role in repulsing the attempted Confederate assault on Washington, DC on July 11, 1864. President Lincoln observed this attack standing on the parapet of Fort Stevens, and came under fire from enemy sharpshooters. Surgeon Crawford, an army medical officer standing beside Lincoln, was hit by a Confederate round.

# The fortifications of Petersburg, 1864–65

In June 1864, the outer line of Confederate fortifications built around Petersburg stretched for ten miles, and began and ended on the Appomattox River, protecting all but the northern approaches to the city. The 55 partially enclosed artillery batteries were consecutively numbered from east to west, and were linked together with rifle trenches. The building of these works was ordered on August 4, 1862, and was initially undertaken by 4,000 troops from three Confederate brigades, who were eventually replaced by about 1,000 slaves, plus numerous freedmen, from Virginia and North Carolina. As late as March 1863, Dimmock was still conscripting slaves and free-colored to work on the line.

Known unofficially as the “Dimmock Line,” for Captain Charles Dimmock who had supervised the construction of the Richmond defenses, the finished works around Petersburg were placed on high ground. They also had batteries and salients, such as Battery 5 to the east of the city, projecting out in front of the main defenses so they could deliver enfilade fire up and down the lines.

Unfortunately, the “Dimmock Line” had some important defects. Between batteries 7 and 8 lay a deep ravine that could provide a means of penetration by an attacking infantry force. There was a significant gap created by another ravine, along which flowed Taylor’s Branch, between Battery 24 and Battery 25, near the Jerusalem Plank Road, one of several important southern routes into Petersburg. Furthermore, too many artillery pieces along the line were exposed en barbette above the parapets, and insufficient fields of fire had been cleared in front of them. Also, none of the Confederate batteries were completely enclosed. Although this permitted the evacuation of artillery pieces should there be a need to fall back quickly, it left these forts vulnerable to attack from the rear if their lines were penetrated at any point. However, according to General P. G. T. Beauregard, if properly manned, the “Dimmock Line” should have been almost impregnable. Unfortunately the Confederates were outnumbered seven-to-one on June 15, 1864, and the line was broken.

After the Confederate collapse and withdrawal to an inner line of works on June 18, 1864, Grant ordered the commencement of siege operations and the

## The fighting at Petersburg, June 1864–April 1865

In June 1864, Confederate forces at Petersburg were under the command of General Beauregard. General W. F. “Baldy” Smith’s Union XVIII Corps arrived at the Dimmock Line around noon on June 15, and began their attack. By June 18, the Confederates were forced to withdraw to new positions closer to Petersburg. Shortly after, Lee arrived to direct operations in person. The Federal drive to capture Petersburg faltered though, and both armies settled down for a long siege. Shortly after, Lieutenant Colonel Henry Pleasants began digging a mine underneath the Confederate trenches. The Federals tunneled over 500 feet to the Confederate lines, and at 4.40 am on July 30, the mine was exploded, killing and wounding 278 men and creating a crater 170 feet wide, 60 feet across, and 30 feet deep. By March 1865, the Confederate supply situation was worse than ever, and Lee ordered a last-ditch assault on the Union lines at Fort Stedman. The attack was a disaster for Lee that cost 4,000 men. On April 1, 1865, Grant finally managed to sever the last rail line leading into Petersburg, and a 14,000-man Federal assault began, crashing through the Confederate lines. The small Confederate garrison at Fort Gregg made a gallant stand, which bought time for Lee’s army to withdraw. The respite was only temporary, though; on April 9, 1865, Lee surrendered to Grant at Appomattox Courthouse, Virginia.

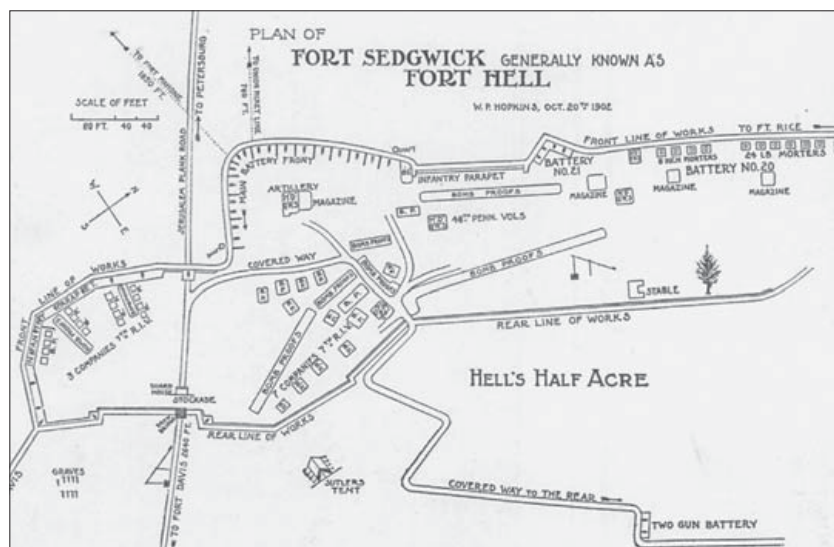

Nicknamed “Fort Hell” because it was in a “hot place” opposite the Confederate lines, Fort Sedgwick was an enclosed earthwork with infantry parapets either side of the main battery and numerous bomb-proofs. (Library of Congress)





Federal army built a formidable system of forts and breastworks protected by miles of chevaux-de-frise, gabions, and abatis. A short distance behind the Federal front line was a "reverse line" that faced in the opposite direction to afford protection in the rear.

The mastermind behind the Federal siege lines to the east of Petersburg was Colonel James C. Duane, Chief Engineer of the Army of the Potomac. Assisted by Captain Benyaud, US Engineers, he designed a system of fortifications consisting of a series of small field works, capable of containing a battery of artillery and an all infantry garrison of about 200 men each. Most of these works were enclosed at the gorge, or rear, and were well protected with abatis or palisading from front and behind. Strong and continuous infantry parapets, with obstacles in front, connected the whole line. Bomb-proofs were constructed about every 20 yards, with both forts and batteries in close proximity to one another. The other lines around Petersburg were also based on these principles. Major F. Harwood, commanding the battalion of US Engineers, had charge of consolidating the outer line between forts Bross and Dushane. Captain Howell was responsible for the construction of Fort Fisher.

The eastern line of Federal works eventually consisted of Fort McGilvery (Redoubt A), Fort Stedman (Redoubt B), Fort Haskell (Redoubt C), Fort Morton (Redoubt D), Fort Meikle (Redoubt E), Fort Rice (Redoubt F), Fort Sedgwick (Redoubt G), and Fort Davis (Redoubt H). Those on the inner southern line were Fort Prescott (Redoubt I), Fort Alexander Hays (Redoubt K), Fort Howard (Redoubt L), and Fort Wadsworth (Bastion Fort M), plus forts Keene, Tracy and Urmston. Forts Wheaton, [Union Fort] Gregg, Welch, Fisher, and Conahey surrounded the signal tower along the "Fish Hook" line to the southwest. The reverse southern line consisted of Fort Dushane (Bastion Fort N), Fort Davison (Redoubt O), Fort McMahon (Redoubt P), Fort Stevenson (probably Redoubt Q), Fort Blaisdell (probably Redoubt R), Fort Patrick Kelly (Redoubt S) and Fort Bross (Redoubt T), plus forts Clarke, Siebert, Emory, Cummings, and

ABOVE LEFT This cracked wet-glass plate shows the rifle trenches and parapets that linked the forts and redoubts together along the Petersburg lines. (Library of Congress DIG-cwpb-01323)

ABOVE RIGHT The men who helped build the Federal siege lines at Petersburg, Co. D, US Engineer Battalion, were photographed in camp during August 1864. Three of the men wear the "Engineer's castle" insignia on their caps. (Library of Congress B8171-7387)

Battery No. 5 projected out as a salient from the Confederate lines east of Petersburg. Containing four guns, it was captured during the Federal assault on June 15, 1864. (Library of Congress)

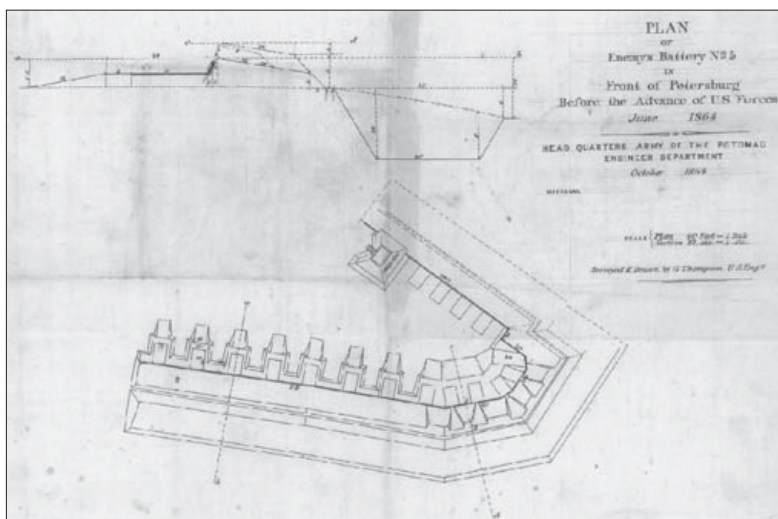

### The Confederate attack on Fort Stedman, March 25, 1865

Fort Stedman was a seven-sided redoubt with accommodation for 10 guns behind an earthen parapet. However, only four light 12-pounder guns were in place at the time, manned by the 19th New York Battery. The fort was garrisoned by 300 men of the 29th Massachusetts Infantry. A large bomb-proof was constructed in the parade of the fort, which was protected by a reinforced earthen parapet. The ground to the front of the fort was protected by picket trenches, and two distinct lines of entangling obstacles, including chest-high fraises. The inset illustration shows a cross section of a bomb-proof dugout. This was dug deep into the ground, heavily reinforced with sandbags, gabions, railroad iron, and huge wooden beams, and covered over with a deep layer of earth.

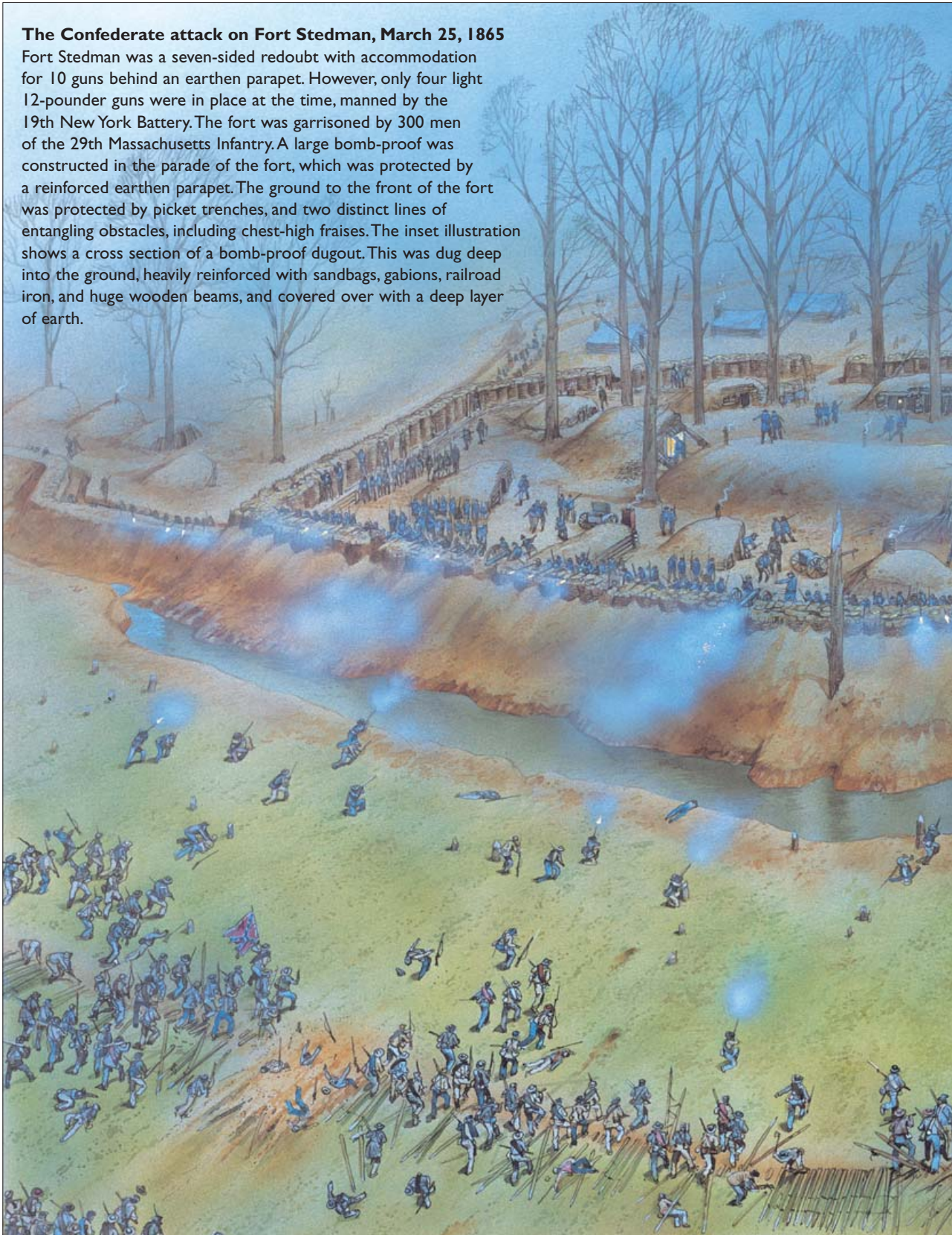

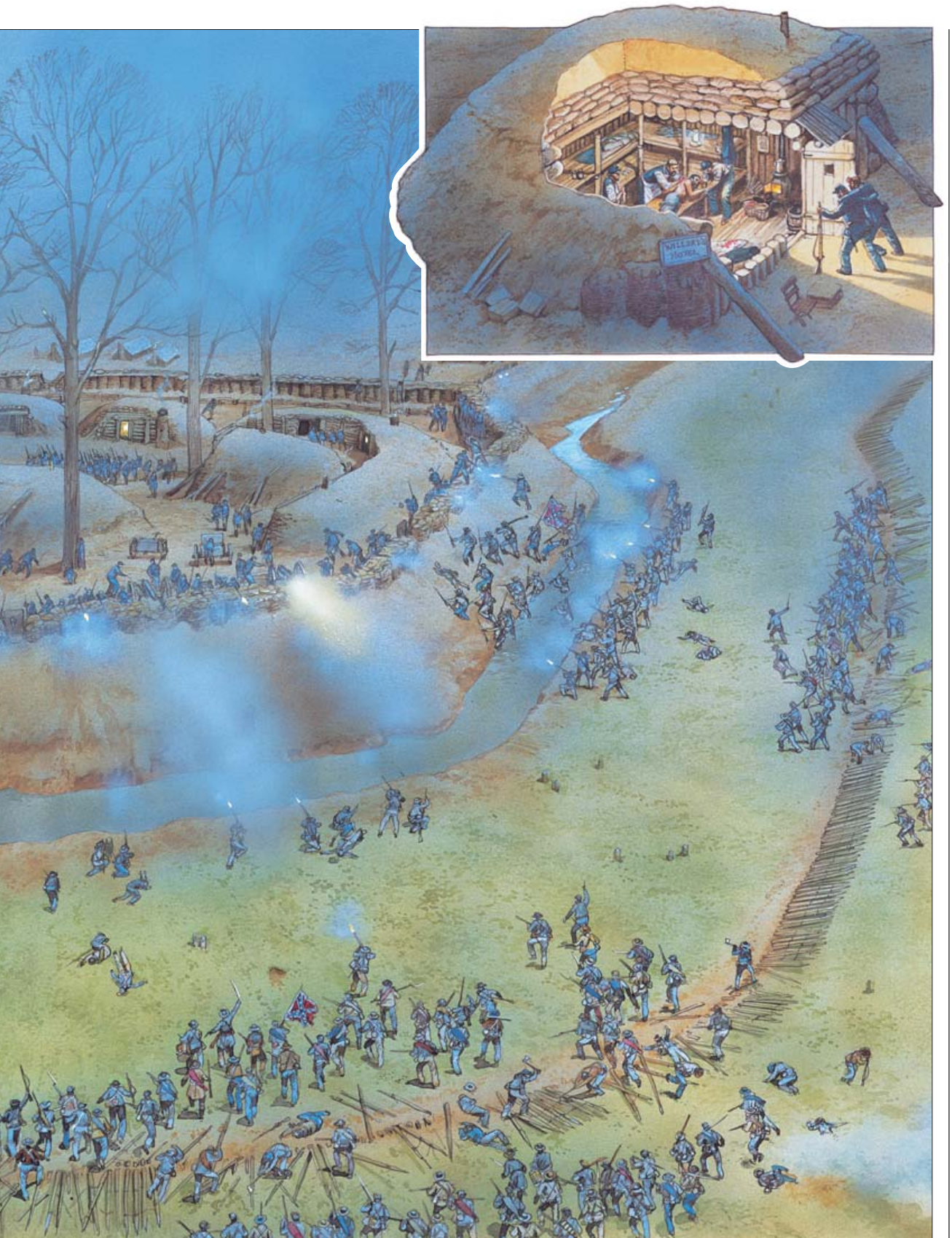

Sampson. The western lines were linked together by forts Baldwin and Gregg (No. 2).

Of the 31 Union forts built along the Petersburg line, no two looked alike. Finished in March 1865, Fort Fisher was the largest, covering five acres. One of the most unusual was Fort Stevenson, which was built on the reverse line in a distinctive inverted "W" shape. Located where the front siege line met Jerusalem Plank Road, Fort Sedgwick was the one perhaps best remembered by the Union veterans. Its close proximity to the Confederate lines made it a prominent and continual target for enemy mortar fire and sharpshooters. According to a New York soldier, this post became known as "Fort Hell" because it was nearer the Confederate lines and therefore subjected to "the hottest fire."

Meanwhile, the Confederates transformed their new lines into a formidable system of earthworks on well-chosen high ground highly favorable to retrenchment, palisades, and abatis. Colquitt's Salient, Gracie's Salient, Elliott's Salient and Rives Salient made up the strongpoints on their eastern lines. Forts Mahone ("Fort Damnation") and Walker, plus Battery Pegram and Miller's Salient, strengthened the southern line. Forts Lee and New Orleans bolstered the western line. At the peak of the siege, some 51,000 men defended Petersburg against approximately 113,000 besiegers. Furthermore, the defenses of Richmond were stretched to a distance of 26 miles from White Oak Swamp, east of that city, to the Jerusalem Plank Road, south of Petersburg. By the end of the siege, the lines were 37 miles in length.

## Life in the Petersburg fortifications

### In the forts and batteries

Inside and around the forts and batteries of both the Union and Confederate lines at Petersburg, troops led a troglodyte existence in bomb-proofs dug deep into the ground and heavily reinforced and protected by earth, sandbags, gabions, railroad iron, and huge wooden beams. These were often linked together, and to covered ways and boyaux leading towards the parapet, and were continually being repaired or extended by their occupants. According to one soldier: "The lines in some places became involved labyrinths, nearly impassable at night to one not familiar with the locality."

The men of both armies also spent much of their time building and repairing the main defenses of the forts and batteries they manned. The US Engineer Battalion, plus the 1st and 50th New York Volunteer Engineers, supervised much of the construction and consolidation of the Union lines. However, the manual work was performed by non-specialist troops who put together gabions and fascines, both



Based on a drawing by artist Andrew McCallum, this engraving was published in *Harper's Weekly* on April 15, 1865, and shows Confederate pioneers and axemen removing Federal abatis during the attack on Fort Stedman outside Petersburg on March 25. (Author's collection)

The interior of Fort Sedgwick, and most of the other forts on the Petersburg line, was filled with a rabbit warren of bomb-proofs containing soldiers' quarters. (Library of Congress B8171-7534)

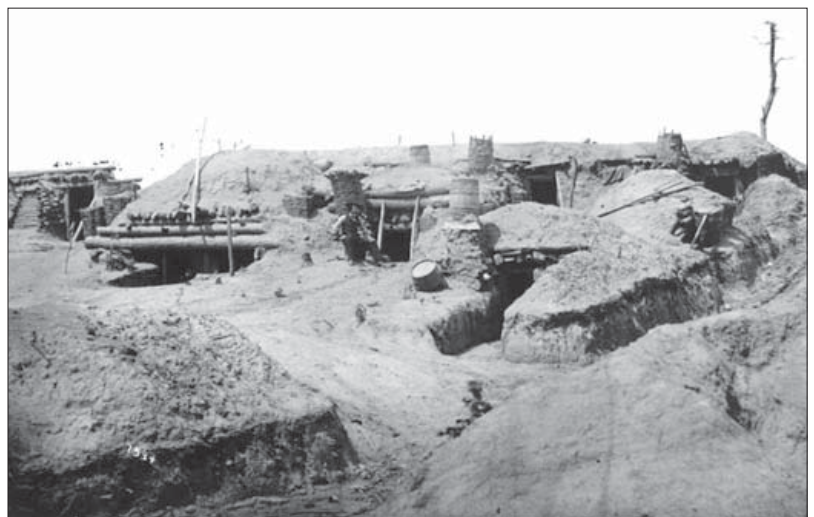

important materials in supporting the interior structures of large field fortifications. They also began clearing roads, building bridges, and making "covered ways" so that troops and equipment could be moved without presenting a target to the enemy. A company of the US Engineer Battalion under Captain Van Brocklin built Fort Stevenson, south of Petersburg, during September 1864 with the help of "1,400 infantry each day and 500 each night." Nearby Fort Patrick Kelly was thrown up by the same unit with the help of "a daily detail of about 600 men" during the same period.



Situated at the eastern end of the siege lines at Petersburg, and overlooking the Appomattox River, Federal Battery 5 contained Parrott rifles behind sandbagged embrasures. Note the battery flag fluttering from the parapet. (Library of Congress)

Productivity digging ditches and trenches dropped sharply in rocky soil or close to enemy lines, where the work was always done at night. In one deep ditch in the Union lines, it took eight men to get one shovelful of earth to the top of the works, with one digging and the others perched in niches cut into the counterscarp and passing the soil upward. However, as one officer explained, "Nothing in the world finds more willing workers than throwing up breastworks under the spur of hostile fire."

The Union army had ample manpower with which to build and garrison its forts on the Petersburg line, and orders were frequently given to fill them with "as many troops as they will profitably hold." In general terms, Northern forts were garrisoned with 300 men, while batteries were occupied by anything between 20 and 150 men, depending on the size of the work and the number of guns being manned.

Some Federal units served for almost a month in the Petersburg lines. For example, elements of the 3rd Brigade, Second Division, 2nd Army Corps, moved into the main line on November 1, 1864, where a portion of them garrisoned Fort McGilvery and Battery No. 5 on the extreme right, resting on the Appomattox River. The command remained in this position until the night of the 29th, when it was relieved by the 9th Corps and transferred to the left of the line, near the Vaughan road, where it went into camp.

The gun crews in the forts were often required to serve their guns en barbette, or over the top of the parapet, which meant they were exposed to enemy fire. Barbette platforms were generally placed wherever a wide field of fire was desirable, especially at salient angles to cover the sectors of the work without batteries. Commanding the 1st Brigade, Third Division, 2nd Corps, Army of the Potomac, in September 1864, Brigadier General R. De Trobriand reported that the position of two of the six guns in Fort Rice, served by the 3rd Battery, Maine Light Artillery, commanded by Captain Ezekiel R. Mayo, were "extremely perilous. Being now on high platforms in barbette, the men are fully exposed to the firing of the enemy's sharpshooters at a place where no one can show his head with impunity for five minutes." A Union gunner who served in Fort Sedgwick wrote, "I expend about 100 rounds of ammunition every day, and the picket and sharpshooters pour in such a continuous storm of bullets that the said fort is anything but an agreeable place."

The weather played havoc with the earthen field works in the Petersburg lines. Heavy rainstorms lashed northern Virginia towards the end of November 1864. On the 24th of that month, Brigadier General Byron R. Pierce, 2nd Brigade, Third Division, 2nd Army Corps, reported, "I found that two or three posts in front of

**Confederate Battery No. 9; part of the “Dimmock Line,” Petersburg, Virginia**  
Confederate Battery No. 9 (renamed “Fort Friend” after capture and reconstruction by the Federals) formed part of the “Dimmock Line” built outside Petersburg, Virginia, between August 1862 and March 1863. Built in the shape of a triple redan and without a gorge, it contained eight emplacements for 24-pounder siege guns mounted on barbette carriages. It was one of nine Confederate batteries captured on June 15, 1864 during the Battle of Petersburg. Having burst through a ravine between batteries 7 and 8, US Colored Troops attacked the Dimmock Line from the rear.



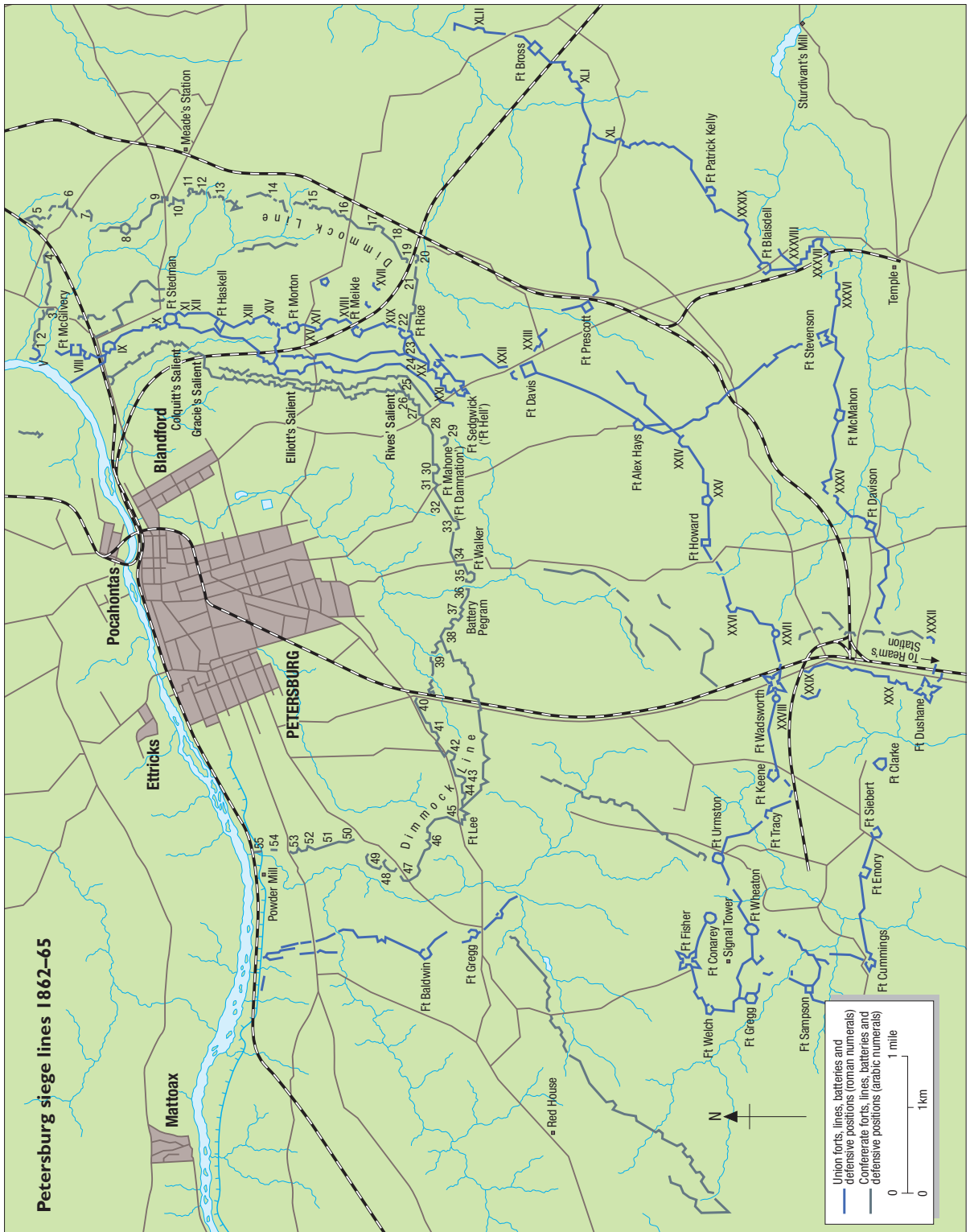

The original Confederate fortifications built around Petersburg between 1862 and 1864 were known as the "Dimmock Line", after engineer Charles H. Dimmock, and stretched for ten miles around the southern approaches to the city. The 55 artillery batteries were consecutively numbered from east to west, and

were linked together with rifle trenches. Following the Federal assaults of June 18-20, 1864 the Confederates withdrew to inner lines and Grant ordered siege lines to be established around the city. The inner Confederate defenses were held until the final Federal breakthrough on April 2, 1865.

Fort Stedman had been abandoned on account of the storm washing away the parapets. I instructed the officer of the day of the Second Division to have the work repaired last evening. I would also recommend that plank be furnished for platforms for the guns in Fort Stedman. It was almost impossible to work the guns during the last storm." Four days later, Major General Andrew A. Humphreys, commanding the 2nd Army Corps, reported that "a portion of the gallery on the right of Fort Stedman has caved in, making it impossible to post a sentinel therein as has been the custom. Should it cave in any more, a portion of the parapet on the right of the fort may come down." He requested assistance from the Engineer Corps to repair this work.

Cold weather also hindered work and repairs. In January 1865, Brevet Colonel I. Spaulding, commanding detachment 50th New York Volunteer Engineers, reported: "The severity of the weather during the past week, and the depth to which the ground was frozen, has prevented any considerable progress being made where the digging and dressing of the banks have been principally near the surface."

### On the picket lines

Federal troops usually spent one day at a time in the picket lines, or vidette pits, outside Petersburg, where they observed the enemy and engaged in skirmishing. According to Connecticut army chaplain H. Clay Trumbull: "It was toilsome living or dying in that terrible siege. At points the advanced vidette-pits of the two sides were within a stone's throw of each other, and within short rifle range of the main works ... one must keep under close cover while there. Men on duty there could be relieved only by night, and then as quietly as possible. If a soldier raised head or hand above the low earth bank by day, 'chew' came a bullet past him, or 'chug' came a bullet into him ... Twenty-four hours of unrelieved round of duty in such a place was a long time for any man."

As enemy raids and larger attacks usually took place just before dawn, pickets always manned the rifle loopholes at 4 o'clock in the morning until after daylight. Known as "picket firing," sharpshooters on both sides also concentrated on picking off any troops seen in the enemy lines. Regarding the Union lines from Fort Stedman to Battery No. 11 for the period September 17–November 14, 1864, Major N. Michler, US Engineer Corps, reported that the "present system of sharpshooting along that front" prevented any repair work being done during the day. By the beginning of 1865, the 2nd and 5th Army Corps in the Army of the Potomac had 128 target rifles with telescopic sights in field service. According to Northern artist Alfred Waud, picket firing was discontinued on some portions of the lines. "Genl. [Gouverneur Kemble] Warren considered it unnecessary to the safty [sic] of the 5th Corps front," he stated, "and put a stop to it. The enemy did likewise. But where the practice was in vogue it was very dangerous to be exposed." The type of wounds inflicted in the trenches before Petersburg is illustrated in letters home that reported the high number of head, neck, wrist, and upper torso wounds received.

### In the trenches

When not assembled in full line of battle, troops in the main Union trenches outside Petersburg were usually deployed "one man to the yard." With a growing shortage of manpower towards the end of 1864, the Confederate trenches were much more thinly populated and stood 10 to 21 feet apart.

RIGHT This watercolor by William Sheppard, who originally enlisted in the Richmond Howitzers and reached the rank of engineering officer, is entitled "Newspapers in the Trenches" and depicts a group of Confederate defenders gathered outside a bomb-proof signposted "Spottswood Hotel" in the Petersburg trenches. The actual Spottswood Hotel was one of Richmond's finest hosteleries. (The Museum of the Confederacy, Richmond, Virginia)

Published in *Harper's Weekly* on September 24, 1864, this engraving shows Federal troops manning the trenches during the siege of Petersburg. Two men are shown firing through sandbag loopholes, while others are either playing cards or showing their hats and caps above the parapet to draw enemy fire. (Author's collection)







This sketch by Alfred Waud shows sharpshooters of the 18th Corps engaged in "picket firing." According to the artist, "A common plan of protection was that shown in the sketch, by a wooden tube widening outwards like a miniature embrasure buried in the crest of the rifle pit and protected by sandbags." (Library of Congress USZ62-7053)



Regarding life in the trenches, an Alabama Confederate recalled that the "heat was excessive [sic], there was no protection from the rays of the sun; the trench was so narrow that two men could scarcely pass abreast, and the fire of the enemy was without intermission." To make matters worse, the men were tormented by swarms of flies, lice, ticks, and chiggers, and suffered from the lack of good water near the front. Death sought them out in innumerable ways: from sickness, accident, a sniper's bullet, or the burst of a mortar shell. "This life in the trenches was awful, beyond description," a Confederate officer declared.

The men in the trenches were not only exposed to shot and shell, but had scant protection from the elements. They stretched their shelter tents across the rifle pit, formed by the outer parapet and a second embankment in the rear; or they built "bough houses" made from leafy tree branches stretched over the space. There they cooked and ate, and slept and fought.

The close proximity of the trenches encouraged some men to fraternize with the enemy during lulls in the fighting. Sometimes they would enter the trenches occupied by enemy troops, and exchange news and goods. On February 18, 1865, Private Charles McDowell, 9th New York Heavy Artillery, wrote to his wife Nancy, "We have got pretty well settled down again. I don't know how long we will stay here but I hope till the war is over. I don't think

that will be long. They are getting pretty well cornered up and they begin to find it out. Ten come in our lines in front of us last night. We are so close together on picket we can talk with one another. They left to be pretty sharp about getting away for they are watched pretty well by their picket men ... We are putting up some big forts here. Eighteen hundred men reports to one fort every morning for work."

On Christmas Day, 1864, both sides enjoyed an impromptu and unauthorized truce in the trenches. According to a Georgian, "The men had suspended their work without being so ordered and in a few minutes they were passing in full sight of each other, shouting the compliments of the season, giving invitations to cross over and take a drink, to come to dinner, to come

back into the Union ... and other amenities, which were a singular contrast to the asperities of war." Many of the Federal troops enjoyed what a New Hampshire soldier noted in his diary as a "fine Christmas dinner for all." On the Confederate side there was a concerted effort to see that the men at the front got something special this day. A Virginian recorded, "The newspapers urged the movement forward, committees were appointed to collect and forward the goods to the soldiers." In one company the men eagerly waited for the Christmas bounty to arrive. When it did finally show up two weeks late, it consisted of "one drumstick of a turkey, one rib of mutton, one slice of roast beef, two biscuits, and a slice of highbred." It was the thought that mattered and, recalled a young Confederate, "we thanked our benefactors and took courage."

# The fate of the fortifications

The American people temporarily forgot about the field fortifications and earthworks outside cities such as Petersburg, Richmond, and Washington, as they healed their wounds during the several decades following the Civil War. Farmers dismantled earthworks, plowed and planted the battlefields, and rebuilt their farmhouses and barns on numerous sites of intense combat and human loss. However, the National Park Service was established, if in name only, in 1872, and by 1890 the Chickamauga-Chattanooga National Military Park was established as the first Federal area of its type under the administration of the War Department. Congress passed an “Act for the Preservation of American Antiquities” in April 1906 that provided for “the examination of ruins, the excavation of archaeological sites, and the gathering of objects of antiquity.” On August 25, 1916 President Woodrow Wilson signed a bill creating the National Park Service as a separate bureau of the Department of the Interior, and the Service came into its own in 1917. A number of national military parks and sites in the east, including Rock Creek Park in Washington, DC, were transferred from various Federal agencies to the National Park Service via the New Deal in 1933. Established in 1935 as a result of the Historic Sites Act, the Branch of Historic Sites became responsible for the preservation of the various Civil War locations that remained. The Civilian Conservation Corps, established as one of the “Alphabet” agencies by Roosevelt in April 1933, provided the work force to clean up and landscape a number of these military sites, including the remains of fortifications. A further “Act to Provide for the Preservation of Historic Sites, Buildings, Objects, and Antiquities of National Significance” passed in 1955 consolidated much of the preservation work in progress.

Regarding the forts defending the Federal capital, most were slowly dismantled following the end of hostilities, and the land on which they had



Originally forming part of the exterior line of Confederate defenses surrounding Richmond, Virginia, the substantial earthwork remains of Fort Harrison are today part of the Richmond National Battlefield Park. (Courtesy of Richmond National Battlefield Park)



Cast at the Bellona Arsenal outside Richmond, this 8-inch Columbiad cannon still stands within the remains of Fort Drewry, overlooking the James River on Drewry's Bluff. The wooden carriage is reproduction and the sandbags in the embrasure are modern. (Courtesy of Richmond National Battlefield Park)

been built was returned to its original owners. In 1890, after much campaigning and lobbying by military engineer Nathaniel Michler and prominent Washington banker Charles Carroll Glover, Rock Creek Park was established. Under the supervision of the National Park Service from 1933, the Civil War fortifications within its boundaries were restored. As a result, the site of Fort Whipple survives today, having become a permanent post in 1872, and being renamed Fort Myer in 1881. The first military test flight of an aircraft by Orville Wright was made from the Fort Myer parade ground on September 9, 1908. This fort has been the home of Army chiefs of staff, such as Generals George C. Marshall, Omar N. Bradley, Douglas MacArthur, and Dwight D. Eisenhower, for a century, and today is home for service members working throughout the Military District of Washington and the National Capital Region. To commemorate the Civil War Centennial in 1961, the City of Alexandria, Virginia, undertook the partial restoration and preservation of Fort Ward.

Meanwhile, the work of privately funded organizations was also underway. In 1925, the Battlefield Markers Association, a group of historians committed

Federal Fort Stedman today, part of the extensive earthwork remains at the Petersburg National Battlefield. (Courtesy of Petersburg National Battlefield)



Marker 49 on the Richmond National Battlefield Park indicates the location of Fort Gilmer, on the exterior line of defenses. This and 58 others like it are known as "Freeman" markers, named for Dr. Douglas Southall Freeman, who helped establish the Park in 1936. (Courtesy of Bernard Fisher, Richmond Civil War Round Table)

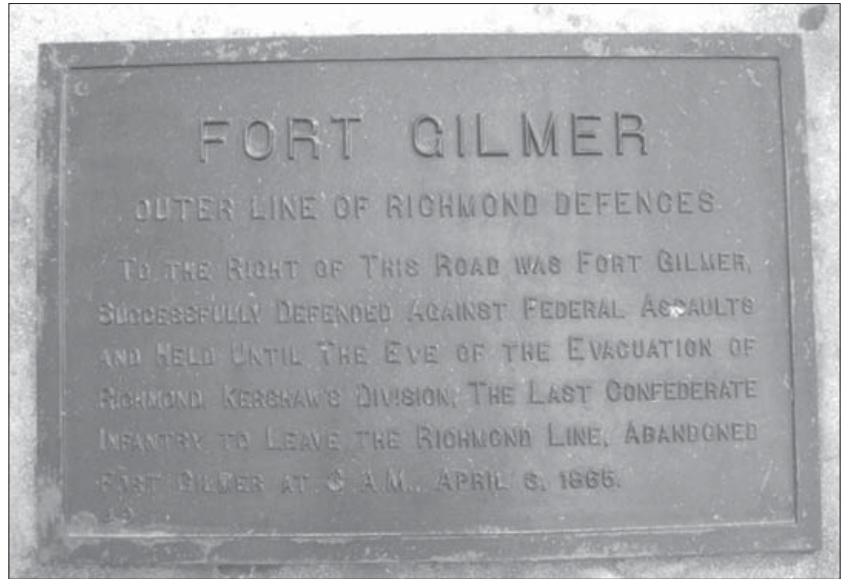

to commemorating the Richmond battlefields, began to erect markers to commemorate the battlefields and earthworks around Richmond, Virginia. Most prominent among the members of this association were James Ambler Johnston and Dr. Douglas Southall Freeman, the eminent biographer of George Washington and Robert E. Lee. The work of Dr. Freeman and the Association ultimately led to the foundation of the Battlefield Parks Corporation in 1930, the purchase of battlefield lands, including that containing forts Harrison, Gilmer, and Alexander, and the establishment of Richmond National Battlefield Park in 1936.

Across the James River, the Petersburg National Battlefield Association was organized in 1898 with Stith Bolling, a Confederate veteran, as its president. In 1926 the Petersburg National Military Park was finally established, and in 1962 it was transformed into the Petersburg National Battlefield. Preservation work has continued at this site in recent years. In April 1998, Cultural Resources GIS conducted a systematic Global Positioning Systems survey of the principal artillery earthworks on the Fish Hook line, including forts Urmston, Conahey, Fisher, Welch, Gregg, Wheaton, and the Siege Battery. Assessment of these sites continues today.

Farther west, the remains of Fort Rosecrans were included in the Stones River National Military Park established on March 3, 1927. This site became the Stones River National Battlefield on April 22, 1960. In Nashville, Tennessee, the Union army abandoned Fort Negley soon after 1867. During the early 1900s, Nashville's black Republican Party leaders unsuccessfully petitioned Republican presidents to restore the fort. In 1937, the Federal Works Progress Administration restored Fort Negley. However, the fort was allowed to fall into ruins again until interest to restore it began anew with the 1964 Civil War Centennial Celebration. In 1975, Fort Negley was listed in the National Register of Historic Places. In 1980, the Metro Historical Commission placed a historical plaque to note the black involvement in the Civil War and construction of Fort Negley. Local community activist "Ghetto" Joe Kelso pushed for the restoration of the fort until his death. Based on the recommendations made by the Mayor's Advisory Committee in 1994, the Nashville City Council approved \$500,000 to begin the restoration of Fort Negley as a historical community and tourist resource. In December 2004, the site was re-opened to the public for the first time in 60 years, complete with walkways and interpretive signage. It is again under restoration, based on plans located in Washington, DC.

# Visiting the sites today

The following selection is not exhaustive, but includes the main historical sites containing Civil War field fortifications of the eastern and western campaigns owned by the National Park Service, government agencies, the local community, plus those in private hands. At the time of writing, all of these sites are open to the public unless otherwise noted.

**Richmond National Battlefield Park** contains the earthwork remains of Fort Harrison/Burnham, plus those at forts Brady, Hoke, Johnson, Gregg, Gilmer, and Battery Alexander. Also encompassed are surviving earthworks at Fort Drewry/Darling, on Drewry's Bluff, and Parker's Battery on the Howlett Line, south of the James River. Extensive entrenchments survive at the Cold Harbor battlefield.

Location: Richmond, Virginia  
Owner: National Park Service  
Website: [www.nps.gov/rich](http://www.nps.gov/rich)

**Fort Stevens Historical Park** consists of a two-acre site containing the remains of Fort Stevens, part of the Richmond defenses south of the James River. It has a trail along the earthworks.

Location: Chesterfield County, Virginia.  
Owner: Chesterfield County

**Fort Pocahontas** (also known as Wilson's Wharf) was a redoubt that enabled Union forces to menace that part of Virginia and supply themselves there if needed. It is a privately owned site and open by appointment only, and during the annual Civil War weekend in May (always the weekend before Memorial Day).

Location: Near Charles City, Virginia  
Website: [www.fortpocahontas.org](http://www.fortpocahontas.org)

**Manassas Forts.** The Federal Cannon Branch Fort is preserved along the railroad on the western side of Manassas (on a knoll above Cannon Branch near the airport). The Confederate Mayfield Fort has been reconstructed along the railroad on the eastern side of town. This is the last remaining of 11 Confederate forts that protected this important railroad junction.

**Petersburg National Battlefield.** Both armies built a total of about 42 forts and 136 batteries during the siege of Petersburg. The main park includes the following Federal forts: Fort Friend (originally Confederate Battery 8); Fort Stedman; Fort Haskell, the site of Fort Morton (2). It includes the following Confederate fortifications: Battery 5 (site of the Union Dictator mortar battery); Battery 9; Gracie's Salient; Colquitt's Salient; and "The Crater" which is the remains of a small Confederate fort that was part of Elliott's Salient.

Owner: National Park Service  
Website: [www.nps.gov/pete](http://www.nps.gov/pete)

**Colonial National Historic Park** contains remains of earthworks created during the Revolutionary War siege of 1781, much of which was re-used by the Confederates in 1862. Also within the boundaries of the park are the remains of the Williamsburg battlefield, including Fort Magruder, the

Kingsmill Wharf Batteries (aka Burwell's Landing), plus 13 other redoubts.

Location: Colonial Parkway on the Virginia Peninsula

Owner: National Park Service

Website: [www.nps.gov/colo/Ythanout/ytbriefs.html](http://www.nps.gov/colo/Ythanout/ytbriefs.html)

**Fredericksburg-Spotsylvania National Military Park** contains extensive Confederate and Union earthwork trench lines and rifle pits at various locations, including Chancellorsville, Wilderness, and Spotsylvania Court House. All the earthworks on Marye's Heights in Fredericksburg survived the war, but were plowed under during the 1880s.

Owner: National Park Service

Website: [www.nps.gov/frsp/index.htm](http://www.nps.gov/frsp/index.htm)

**Rock Creek Park** contains the remains of some of the Washington defenses. Fort DeRussy is in a good state of preservation (follow a foot trail from the intersection of Military Road and Oregon Avenue, NW). The parapet and the deep ditch remain in clear and distinct outline. Evidence of well-defined rifle trenches is to be found outside the fort. Also surviving are the partially restored remains of Fort Stevens (off Georgia Avenue); the badly eroded remains of the field gun battery and rifle pits of Fort Slocum (in Fort Slocum Park); remains of parapets, embrasures, and the powder magazine of Fort Totten (located on Fort Totten Drive, just south of Riggs Road); and the parapet and gun positions of Battery Kemble (in Battery Kemble Park).

Location: Washington, DC and Arlington, VA

Owner: National Park Service

Website: [www.nps.gov/rocr/ftcircle/index.html](http://www.nps.gov/rocr/ftcircle/index.html)

**Fort Ward Museum & Historic Site** holds the best-preserved of the system of Union forts and batteries built to protect Washington, DC. The site remains approximately 90–95 percent intact, with the Northwest Bastion restored to illustrate the appearance of the entire fortification c.1864.

Location: Alexandria, Virginia

Owner: Friends of Fort Ward

Website: <http://oha.ci.alexandria.va.us/fortward/>

**Fort Lincoln** was built by Confederate prisoners-of-war when Washington was threatened by Early's raid and a prison break was feared. It is the only surviving fortification of three that guarded Camp Hoffman, the stockade POW camp established in 1863. This fort is a small, four-sided, earthen fort with four reconstructed buildings, and the remains of a powder magazine.

Location: Point Lookout State Park, near Scotland, Maryland

Owner: State Forest and Park Service

**Fort Whipple** was a bastioned earthwork that has evolved today into Fort Myer. The old part of the fort rests under the Fort Myer stables. Of interest here is the Old Guard Museum.

Website: [www.fmmc.army.mil/fhistory.htm](http://www.fmmc.army.mil/fhistory.htm)

**Fort Marcy** is a relatively undisturbed site with trenches still in a very good state of preservation.

Location: Fort Marcy Park, Virginia

Owner: National Park Service

Website: [www.nps.gov/gwmp/vapa/FtMarcy.htm](http://www.nps.gov/gwmp/vapa/FtMarcy.htm)

**Fort Negley** was a complex earthen, dry stone, and wooden fort with a turreted stockade at center, a ravelin either side, and quadruple redans at either end. Designed for six guns, its outer works consisted of two bomb-proof bastions.

Location: On St. Cloud Hill south of downtown Nashville at the confluence of Interstates 65 and 40, and adjacent to the Cumberland Science Museum and Greer Stadium.  
Owner: The Battle of Nashville Preservation Society, & Civil War Round Table, Inc.  
Website: [www.bonps.org/neg.htm](http://www.bonps.org/neg.htm)

**Fortress Rosecrans** served as a Union supply base in Tennessee, and consisted of a complex earthen system of four redoubts, ten lunettes, two curtains, one redan, and two batteries. Lunettes Palmer and Thomas, Curtain Wall No. 2 and Redoubt Brannan are preserved today.

Location: Old Fort Park, Murfreesboro, Tennessee  
Owner: National Park Service  
Website: [www.nps.gov/stri/battle\\_aftermath.htm](http://www.nps.gov/stri/battle_aftermath.htm)

## Further reading and research

- Cooling, B. Franklin, and Walton, H. Owen, *Mr. Lincoln's Forts: a Guide to the Civil War Defenses of Washington* (Shippensburg, PA, 1988)  
Davis, Major George B. et al, *Atlas to Accompany the Official Records of the Union & Confederate Armies* (Washington, DC, 1891–1895)  
Davis, William C., and the Editors of Time-Life Books, *The Civil War: Death in the Trenches* (Alexandria, VA, 1986)  
Griffith, Paddy, *Rally Once Again: Battle Tactics of the American Civil War* (Marlborough, Wiltshire, 1987)  
Hagerman, Edward, *The American Civil War and the Origins of Modern Warfare: Ideas, Organization, and Field Command* (Bloomington & Indianapolis, 1992)  
Henderson, William D., *Petersburg in the War: War at the Door* (Lynchburg, 1998)  
Hess, Earl J. *Field Armies and Fortifications in the Civil War: The Eastern Campaigns, 1861–1864* (Chapel Hill, NC, 2005)  
McMurray, John, *Recollections of a Colored Troop* (Brookville, PA, 1995)  
Scott, Robert N. (compiler), *The War of the Rebellion: A Compilation of the Official Records of the Union and Confederate Armies* (Washington, DC, 1880–1901)  
Trumbull, H. Clay, *War Memories of an Army Chaplain* (New York, 1898)

The following website is also invaluable to the student of ACW field and permanent fortifications:

Civil War Field Fortifications: [www.civilwarfortifications.com](http://www.civilwarfortifications.com)

# Index

Figures in **bold** refer to illustrations

abatis **21, 22, 23, 24, 52**

artillery

24-pounders **13, 33**

32-pounders **33**

barbette carriages **4, 13, 29, 33, 53**

emplacements **13–14, 14, 15, 27, 53, 54**

Parrott rifles **53**

Atlanta **19–20, 24, 41**

Barnard, Brig. Gen. John G. **6, 26, 26, 27–8, 29, 33**

barricades **20–1, 21, 31**

bastions **10, 14, 15**

Battery Wagner **25**

Beauregard, Gen. P. G. T. **28, 48**

Big Bethel, Battle of (1861) **20, 26–7, 27**

blindage **18, 18**

blockhouses **10–13, 10, 11, 12**

Bloody Angle, Battle of (1864) **44–5, 45**

bomb-proofs **13, 14, 29, 51, 52, 57**

boyaux **23–4**

Bragg, Gen. Braxton **40, 41**

breastworks **20, 20, 25**

Butler, Maj. Gen. Benjamin F. **26**

Carnot walls **24**

casemates **14, 16, 18**

cavaliers **21**

Chancellorsville, Battle of (1863) **4**

Chattanooga, siege of (1863) **38–40, 38**

chevaux-de-frise **23, 24–5, 24**

Cold Harbor **5, 21, 47, 61**

Colonial National Historic Park **61–2**

counterscarp galleries **18–19**

counterscarps **13, 22, 23**

covered ways **21**

Crater, Battle of the (1864) **5, 48**

cremaillère lines **9**

Dimmock, Col. Charles H. **6, 6, 35–6, 48**

ditches **8, 22, 23, 25**

Duane, James Chatham **7, 7, 24, 33, 49**

Early, Gen. Jubal A. **43**

Elk Horn Tavern (Pea Ridge), Battle of (1862) **20**

Ewell, Gen. Richard S. **44**

fascines **18, 18, 22, 23**

Fort

Albany **26**

Bennett **26**

Blakeley **9**

Clifton **6**

Corcoran **13, 26**

Davis **17**

Haggerty **26**

Hardeman **42**

Harrison (Burnham) **16, 36, 58**

Lincoln **16, 62**

McAllister **42, 42**

McPherson **21**

Magruder **33, 34, 62**

Marcy **62**

Mouton **38, 39**

Negley (Harker) **14, 15, 16, 38, 60, 62–3**

Phelps **8**

Pickens **24**

Pocahontas **61**

Pulaski **18**

Richardson **32**

Runyon **19, 26**

Sanders **40, 40**

Sedgwick **13, 18, 25, 48, 52, 52**

Slemmer **4**

Stedman **50–1, 52, 56, 59**

Stevens (Richmond) **61**

Stevens (Washington, DC) **16, 29, 46, 47, 62**

Totten **29, 62**

Ward Museum & Historic Site **62**

Whipple **59, 62**

Fortress Rosecrans **9, 10, 11, 63**

fraises **22, 23, 25, 25**

Fredericksburg, Battle of (1862) **4**

Fredericksburg-Spotsylvania National Military Park **62**

gabionades **17, 18**

gabions **17–18, 18, 22, 23, 28**

Gettysburg, Battle of (1863) **4**

glacis **19, 21, 22, 23**

gorges **19**

Grant, Gen. Ulysses S.

in the field **36, 38, 41, 43, 44–5, 47, 48**

and fortifications **6, 20**

guerites **16**

Halleck, Maj. Gen. Henry W. **7**

Hancock, Brig. Gen. Winfield Scott **34, 44, 45**

Hill, Gen. A. P. **44**

Hill, Maj. Gen. D. H. **34**

Hooker, Maj. Gen. Joseph **4, 34**

Hunt, Gen. Henry J. **7, 17–18**

Jackson, Gen. Thomas J. **6**

Johnston, Gen. Joseph E. **29, 32, 34**

Jomini, Antoine Henri de **6**

King, Lt. William R. **16**

Knoxville **25, 40, 40**

Lee, Gen. Robert E. **6, 35, 36, 45, 47, 48**

Lincoln, Abraham **43**

Longstreet, Lt. Gen. James **34, 37, 40, 44**

lunettes **9, 9**

McClellan, Gen. George **6, 7, 29, 32, 33**

McCrary, Capt. John **42**

McDowell, Brig. Gen. Irwin **27, 28, 29**

Mahan, Dennis Hart **5, 5, 6**

manuals by **7, 7, 12, 21**

Manassas **27–9, 27, 28, 61**

manuals **7, 7, 12, 21**

merlons **16**

Michler, Maj. Nathaniel **5, 56, 59**

Mobile **9, 21, 38, 39**

Morton, Gen. St. James C. **10, 14, 38**

Nashville **38**

National Park Service **58**

Paducah **24**

parallels **23**

parapets **8, 13, 14, 15, 22, 23**

Pea Ridge (Elk Horn Tavern), Battle of (1862) **20**

Peck, Maj. Gen. John J. **37**

Peninsula Campaign (1862) **17–18, 31, 32–4, 33, 34**

Petersburg

batteries **53, 54**

Fort Sedgwick **13, 18, 25, 48, 52, 52**

fortifications **6, 21, 23, 24, 25, 25, 48–52, 48–57**

life in fortifications **52–7**

siege of (1864–65) **5, 48**

Petersburg National Battlefield **59, 60, 61**

“picket firing” **56, 57**

Poe, Capt. O. M. **19–20, 41**

redans **9**

redoubts **8–9, 33, 38, 39**

Richmond **5, 16, 21, 24, 35–6, 35**

Richmond National Battlefield Park **58–60, 59–60, 61**

rifle trenches and pits **19–20, 19, 22, 23**

Rock Creek Park **59, 62**

Savannah **41–2, 42**

scarps **13, 22, 23**

Sherman, Gen. William Tecumseh **38, 41–2**

Spotsylvania Court House **5, 17, 44–5, 62**

star (tenaille) forts **8, 9**

stockades **14, 15**

Stones River National Battlefield **60**

Suffolk, siege of (1863) **37**

Talcott, Col. Andrew **35**

tenaille forts see star forts

têtes-de-pont **19**

Tilton, action at (1864) **41**

Torres Vedras, Lines of **29**

Totten, Joseph G. **6**

traverses **16, 17, 17, 18, 33, 42**

trous-de-loup **21, 25**

Vauban, Sebastien Le Prestre, Seigneur de **6**

Vera Cruz, siege of (1847) **6, 6**

Washington, DC

attack on (1864) **43**

fortifications **5, 9, 17, 24, 26, 29–32**

fortifications nowadays **58–9, 62**

Waud, Alfred **56**

drawings by **14, 28, 57**

West Point **6**

Wilderness Campaign (1864) **43–4, 62**

Williamsburg

Battle of (1862) **34**

fortifications **33, 34, 61–2**

wire entanglements **25**

Yorktown **17–18, 31, 32, 33–4, 33, 34**



## Related Titles - Fortress Series

---

<b>epub ISBN</b>	<b>PDF ISBN</b>	<b>No.</b>	<b>TITLE</b>
9781782004639	9781849080002	1	Japanese Pacific Island Defenses 1941–45
9781782004356	9781849080033	4	American Defenses of Corregidor and Manila Bay 1898–1945
9781472800688	9781849080057	6	American Civil War Fortifications (1)
9781472800626	9781849080071	8	Defenses of Pearl Harbor and Oahu 1907–50
9781782005513	9781849080132	14	Fortifications in Wessex c. 800–1066
9781782001454	9781849080156	16	The Fortifications of Malta 1530–1945
9781782004646	9781849080224	23	German Field Fortifications 1939–45
9781782002246	9781782002505	25	The Walls of Constantinople AD 324–1453
9781782006923	9781849080293	30	Fort Eben Emael
9781782004363	9781849080354	36	US Strategic and Defensive Missile Systems 1950–2004
9781472800237	9781849080415	42	The Vauban Fortifications of France
9781782005162	9781849080569	57	The Great Wall of China 221 BC–AD 1644
9781782002222	9781782002482	58	Vietnam Firebases 1965–73
9781782008675	9781849080613	62	Soviet Field Fortifications 1941–45
9781782005209	9781849080637	64	The Castles of Edward I in Wales 1277–1307
9781472800244	9781849080644	65	The Forts of Judaea 168 BC–AD 73
9781782005155	9781849080668	67	Japanese Castles in Korea 1592–98
9781782005087	9781849080682	69	The Berlin Wall and the Intra-German Border 1961–89
9781782005179	9781849080736	74	Japanese Castles AD 250–1540
9781782007111	9781846038563	76	Saracen Strongholds AD 630–1050
9781472800251	9781846037771	78	The German Fortress of Metz 1870–1944
9781782007050	9781846038723	82	Scottish Baronial Castles 1250–1450
9781782005056	9781846038921	84	Chinese Walled Cities 221 BC– AD 1644
9781472801500	9781849080828	85	Scapa Flow
9781782005216	9781849082563	91	The Fortifications of Ancient Israel and Judah 1200–586 BC
9781472801661	9781849082570	92	Strongholds of the Picts
9781782003038	9781849085946	107	Defense of the Third Reich 1941–45

---

**OSPREY**  
PUBLISHING

First published in Great Britain in 2005 by Osprey Publishing,  
Midland House, West Way, Botley, Oxford OX2 0PH, UK  
44-02 23rd St, Suite 219, Long Island City, NY 11101, USA  
E-mail: info@ospreypublishing.com

© 2005 Osprey Publishing Ltd.

All rights reserved. Apart from any fair dealing for the purpose of private study, research, criticism or review, as permitted under the Copyright, Designs and Patents Act, 1988, no part of this publication may be reproduced, stored in a retrieval system, or transmitted in any form or by any means, electronic, electrical, chemical, mechanical, optical, photocopying, recording or otherwise, without the prior written permission of the copyright owner. Enquiries should be addressed to the Publishers.

A CIP catalog record for this book is available from the British Library

Print ISBN: 978 1 84176 883 0  
PDF e-book ISBN: 978 1 84908 037 8  
ePub e-book ISBN: 978 1 4728 0531 7

Design by Ken Vail Graphic Design, Cambridge, UK (www.kvkd.com)  
Index by Alison Worthington  
Cartography by the Map Studio, Romsey, UK  
Origination by PPS Grasmere, Leeds, UK

#### **Acknowledgements**

The author wishes to thank the following for their generous assistance: the staff at the Petersburg National Battlefield (including Chris Calkins, Park Historian; James H. Blankenship, Jr., Historian/Curator; Christopher T. Ziegler, Archaeological Technician; and Nathaniel Irwin. Thanks are also due to Robert E. L. Crick, Historian, Richmond National Battlefield Park; Bernard J. Fisher, Richmond Civil War Round Table; James H. Ogden III, Park Historian, Chickamauga & Chattanooga National Military Park; David M. Reel, Curator of Fine Art & Decorative Art, West Point Museum, US Military Academy; Richard Hatcher III, Park Historian, Fort Sumter National Monument; Mark R. Terry; and Bobby L. Lovett.

#### **Artist's Note**

Readers may care to note that the original paintings from which the color plates in this book were prepared are available for private sale. All reproduction copyright whatsoever is retained by the Publishers. All enquiries should be addressed to: Peter Dennis, Fieldhead, The Park, Mansfield, Nottinghamshire, NG18 2AT, UK  
The Publishers regret that they can enter into no correspondence upon this matter.

#### **Measurements**

Distances, ranges, and dimensions are given in Imperial measures. To convert these figures to metric, the following conversion formulae are provided:

1 inch	2.54cm
1 foot	0.3048m
1 yard	0.9144m
1 mile	1.609km
1 pound	0.4536kg

#### **The Fortress Study Group (FSG)**

The object of the FSG is to advance the education of the public in the study of all aspects of fortifications and their armaments, especially works constructed to mount or resist artillery. The FSG holds an annual conference in September over a long weekend with visits and evening lectures, an annual tour abroad lasting about eight days, and an annual Member's Day.

The FSG journal *FORT* is published annually, and its newsletter *Casemate* is published three times a year. Membership is international. For further details, please contact: The Secretary, c/o 6 Lanark Place, London, W9 1BS, UK

#### **The Coast Defense Study Group (CDSG)**

The Coast Defense Study Group (CDSG) is a non-profit corporation formed to promote the study of coast defenses and fortifications, primarily but not exclusively those of the United States of America; their history, architecture, technology, and strategic and technical employment. Membership in the CDSG includes four issues of the organization's two quarterly publications, the *Coast Defense Journal* and the *CDSG Newsletter*. For more information about the CDSG please visit [www.cdsg.org](http://www.cdsg.org) or to join the CDSG, write to:

The Coast Defense Study Group, Inc., 634 Silver Dawn Court,  
Zionsville, IN 46077-9088, USA (Attn: Glen Williford)

© Osprey Publishing. Access to this book is not digitally restricted. In return, we ask you that you use it for personal, non-commercial purposes only. Please don't upload this ebook to a peer-to-peer site, email it to everyone you know, or resell it. Osprey Publishing reserves all rights to its digital content and no part of these products may be copied, stored in a retrieval system or transmitted in any form by any means, electronic, mechanical, recording or otherwise (except as permitted here), without the written permission of the publisher. Please support our continuing book publishing programme by using this e-book responsibly.

***Every effort has been made by the Publisher to secure permissions to use the images in this publication. If there has been any oversight we would be happy to rectify the situation and written submission should be made to Osprey Publishing.***