

MOTHERSHIP

SCI-FI HORROR RPG



*Tuesday
Knight
games*

PLAYER'S SURVIVAL GUIDE

WEAPONS

WEAPON	COST	DMG	CRIT	S	M	L	AMMUNITION	SHOTS	SPECIAL
Ammo	50*						*Cost per magazine or box of ammunition (equal to weapon's full shots)		
Combat Shotgun	1,400	2d10	Knock-down.	10m	20m	30m	Knockback. 1/2 DMG at medium range. 1/4 DMG at long range.	4	Audio Rangefinder: beeps when non-friendlies approach within 10m.
Crowbar	50	1d10			CQC Only.		N/A	N/A	+5 Mechanical Repair.
Flame Thrower	2,000	2d10		2m	10m	20m		8	Body Save or get set on fire and take 1d10 DMG per turn.
Flare Gun	85	1d10		5m	10m	20m	High Intensity Flare: Visible from 25km away.	2	
Foam Gun	275	N/A	No Save.	<1m	5m	10m	Quick Hardening Foam: Body/Instinct Save to avoid or become stuck. Foam covers 5sqm.	10	Fire retardant.
Frag Grenade	70	1d10		20m	30m	40m	Deals DMG to all within 15m radius.	1	Can deal 1 MDMG to ships (or more if internal).
Hand Welder	250	1d10			CQC Only.			∞	Ultra heat emitter: Cuts through airlocks/heavy doors. -10 vs. Armor Save.
Laser Cutter	1,200	1d% or 1MDMG		25m	250m	700m	Takes 1 round to recharge between shots.	6	Takes 1 hour to recharge from a power source or 6 hours in sunlight.
Nail Gun	150	2d10	Double DMG.	<1m	5m	10m	Heavy Duty Nails: -10 vs. Armor Save	32	
Pulse Rifle	1,600	5d10	Double DMG.	15m	125m	300m	Phosphorus Rounds. Fully automatic.	1(3)	Smart-link system: +5 Combat if wearing HUD. Pump-Action Grenade Launcher: Holds 6 frag grenades.
Revolver	750	3d10	Knock-down.	2m	30m	125m	Kineti-slugs: -5 vs. Armor Save.	8	
Rigging Gun	350	2d10	Impale. Triple DMG.	10m	30m	100m	Micro-filament: 500m. Hard to cut.	1	Retractable Harpoon: Body/Instinct Save or become entangled. Does an extra +1d10 DMG when grapnel is pulled out of target.
Scalpel	50	1d10	+1d10 DMG and bleeding.		CQC Only.		N/A	N/A	+10 Surgery.
Smart Rifle	12,000	1d10	x3 DMG.	25m	200m	500m	Armor Piercing: -10 vs. Armor Save.	12	Smart-link system: +10 Combat if wearing HUD. Spectroscope: Night/Thermal Vision.
SMG	1,200	4d10		10m	75m	150m	Fully automatic.	1(5)	
Stun Baton	115	1d10	No Save.		CQC Only.		N/A.	N/A	Body Save or stunned for 1 round.
Trang Pistol	850	N/A	No Save.	2m	10m	20m	Tranquilizer Darts.	6	Body [+1] Save or fall unconscious for 1d10 rounds.
Vibechete	75	2d10	Hacks off limb.		CQC Only.				Can hack through limbs or dense forestry but not metal doors, airlocks, etc.

MOTHERSHIP

PLAYER'S SURVIVAL GUIDE

CONTENTS

CHARACTER CREATION	1	HIRING MERCENARIES	21
BASIC RULES	3	Mercenary Stats	21.1
Rolling the Dice	3.1	How much do Mercenaries cost?	21.2
Stats and Stat Checks.....	3.2	Can Mercenaries level up?	21.3
Advantage & Disadvantage	3.3	Mercenaries in Combat.....	21.4
Critical Hits & Failures	4.1	Mercenary Cost Table	22
Opposed Checks.....	4.2	Mercenary Scum Table	23
SKILLS	5	Mercenary Motivation Table	24
SAVES	7	STRESS	25
SURVIVAL	8	How do I gain Stress?	25.1
Crisis Checks	8.1	How do I relieve Stress?	25.2
Food & Water	8.2	PANIC & RESOLVE	26
Oxygen.....	8.3	What is a Panic Check?	26.1
Earning Credits	8.4	When should I roll a Panic Check?	26.2
COMBAT	9	Resolve.....	26.3
Surprise.....	9.1	SPACE TRAVEL, HYPERSPACE	27
Who goes first?	9.2	How long does it take?.....	27.1
How long is a turn?	9.3	Jump Drives & Hyperspace	27.2
What can I do on my turn?	9.4	Can I captain my own ship?	27.3
How do I attack?	9.5	Basic Ship Classes	27.4
Do I get a bonus from cover?	9.6	Buying a Ship	27.5
How far can I move?.....	9.7	Refueling	27.6
Hit Location	10.1	Upgrades & Repairs.....	28.1
Damage	10.2	BASIC SHIP CLASSES TABLE	28
How do I heal?	10.3	SHIP DESIGN	30
Unconsciousness & Death	10.4	Ship Weapons	30.3
WEAPONS	11	SHIP-TO-SHIP COMBAT	33
Weapons.....	11.1	What's the same?	33.1
Ammunition	11.2	What's different?	33.2
Range	12.1	What can I do on my turn?	33.3
Aiming	12.2	Ship Critical Hits	34.1
Reloading.....	12.3	EXPERIENCE POINTS	35
Automatic Weapons.....	12.4	LEVELING UP	36
Special Weapon Abilities	12.5		
WEAPON CHART	13		
ARMOR TABLE	15		
EQUIPMENT TABLE	17		
Starting Loadouts & Credits	18.1		
Addiction	18.2		
D100 TRINKETS	19		
D100 PATCHES	20		

Written & Illustrated by Sean McCoy.

Developed by Donn Stroud, Nick Reed, Tyler Kimball, Fiona Maeve Geist | Editing by Jarrett Crader.

Special thanks to Lindsay Campbell, Alan Gerding, Donald Shults.

Copyright © 2018 Tuesday Knight Games | Alpha Zine Edition, Fifth Printing 2018.

Alternate character sheets, Warden resources, and more at mothershippg.com.



1 CHARACTER CREATION

Welcome to **Mothership**, a sci-fi horror RPG where you and your crew try to survive in the most inhospitable environment in the universe: outer space! You'll excavate dangerous derelict spacecraft, explore strange unknown worlds, exterminate hostile alien life and examine the horrors that encroach upon your every move. Let's get started!

You can actually design your character right from the **character sheet** at the back of this book. All the steps are printed on the sheet. You can see an example of a completed sheet on the next page. If you need a little bit more information, or find the character sheet confusing, here's what you do:

1.1 ROLL 6D10 FOR EACH OF YOUR STATS

Mothership uses d10s for everything, so grab a handful and get rolling! You'll roll 6d10 for each Stat and record the results in order starting with **Strength**, then **Speed**, **Intellect** and finally **Combat**. A Stat of 30 is about average, but don't get too hung up on your numbers right now.

>> Read more about Stats on page 3.2.

1.2 PICK A CLASS & NOTE THEIR STARTING SAVES

These are the four basic classes in **Mothership**:

- » **Teamsters** are the rough and tumble crew and workers out in space. If Ripley from *Aliens* is your hero you'll want to play a Teamster.
- » **Scientists** are doctors, researchers and anyone who wants to slice open aliens (or infected crew members) with a scalpel.
- » **Androids** are a terrifying and exciting addition to any crew. They tend to unnerve other crew with their cold inhumanity.
- » **Marines** are here to shoot bugs and chew bubblegum. They're handy in a fight and good when grouped together, but whenever a Marine Panics it may cause problems for the rest of the crew.

Put a √ in the circle above the class you picked. Each class has their own starting **Save** values which represent how resistant they are to different kinds of trauma, danger or damage. You have four different Saves: **Sanity**, **Fear**, **Body** and **Armor**. The starting Saves are already filled in for you in light grey in the appropriate boxes.

>> Read more about Saves on page 7.

If you follow the arrows at the bottom of each class column you'll see that each class alters your starting Stats a little bit. (*Example: the Teamster class provides +5 to both Strength and Speed*). Go ahead and change your starting Stats.

1.3 MARK YOUR STARTING SKILLS & SPEND YOUR STARTING SKILL POINTS

Each class comes preloaded with some relevant Skills which will help them perform better at different challenges. Additionally, each class has a number of points to spend on Skills during character creation. Spend all of your Skill points now, keeping in mind:

- » **Trained Skills** cost 1 point.
- » **Expert Skills** cost 2 points.
- » **Master Skills** cost 3 points.
- » To take an Expert or Master Skill you must first take one of its prerequisite Skills.

>> Read more about Skills on page 5.

1.4 TAKE NOTE OF HOW YOUR CLASS DEALS WITH STRESS & PANIC

Each class deals with **Stress** and **Panic** differently, which will come into play later in the game. Go ahead and mark your class' special rules with a √ for future reference.

>> Read more about Stress & Panic on pages 25-26.

1.5 PICK A STARTING LOADOUT AND ROLL A RANDOM TRINKET & PATCH

There are four different starting equipment packages to choose from. These are here for convenience so that you don't have to spend a lot of time shopping before the game begins. Also roll for a random Trinket and Patch from pages 19-20. Your Trinket and Patch don't have any mechanical significance but might give you insight into what your character is like. Your Armor will also improve your Armor Save, which you should update now.

>> Read more about Armor on pages 15-16.

1.6 FINISHING TOUCHES

Fill out your **Stress** (starts at 2), **Resolve** (starts at 0), **Max Health** (x2 **Strength**), starting **Credits** (5d10x10) and give yourself a name (and rank if you have one). You're now ready to play your first session of **Mothership**!

MOTHERSHIP

NAME: LILITH
LEVEL: 0 RANK: TITLE: NAVIGATOR

STRESS RESOLVE HEALTH

2 0 78 78

STARTS AT 2 STARTS AT 0

2. PICK A CLASS AND NOTE THEIR STARTING SAVES

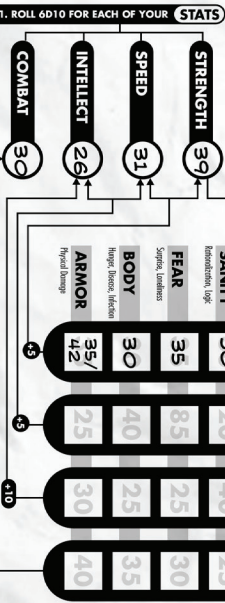

4/5.3 WHENEVER A FRIENDLY PLAYER IS TAKEN

4. TAKE NOTE OF HOW YOUR CLASS DEALS WITH STRESS & PANIC

- TEAMSTER** Once per session, a Teamsster may reveal a roll on the Panic Effect table.
- SCIENTIST** Whenever a Scientist fails a Sanity Save, every friendly player nearby gains 1 Stress.
- ANDROID** Fear Saves made in the presence of Androids have Disadvantage.
- MARINE** Whenever a Marine Panics, every friendly player nearby must make a Fear Save.



5. PICK A STARTING LOADOUT AND ROLL A RANDOM TRINKET & PATCH

EXPLANATION	EXPLANATION	EXTRINATION	EXAMINATION
COMBAT Hand Welder, Laser Historical (Coyote), Locked Set, Accusuit (Coyote), Tank, Magsuit, Storageage (Cannal)	EXPLOSION Vindicator, Rigging Gun, Home Defense (Coyote), Storageage (Longrange Comms, Coyote), Tank, Saver/Kit, Welder Filter, Cammie, Simpack x6, Electronic Resilient, Coyote, Crew, Welder, Z	SAVING SKILLS Frag Grenade x6, Storageage (Coyote), Storageage (Longrange Comms, Coyote), Disposable Body Cam, Storageage Disposable x6, Electronic Resilient, Coyote, Crew, Welder, Z	SCOUT Hand Patch, Skin Boon, Storageage (Coyote), Storageage (Longrange Comms, Coyote), Disposable Body Cam, Storageage Disposable x6, Electronic Resilient, Coyote, Crew, Welder, Z

EQUIPMENT

CIGARETTES (GRINNING SKULL)
LASER CUTTER 1D6 DAMAGE (1 ARMd)
 6 SHOTS - TAKES 1 ROUND TO RECHARGE
 RANGE: 700M

HAND WELDER 1D10 DAMAGE -1C VS ARMOR SAVE
CRWBAR (+ 5 MECHANICAL REPAIR) 1D10 DAMAGE

PATCH: ALLERGIC TO BULLSHIT

Credits 260

3. MARK YOUR STARTING SKILLS AND START SKILL POINTS

- TEAMSTER** Zero-G, Mechanical Repair, First Aid, Heavy Machinery, or Training, +4 PTS
- SCIENTIST** Add Two Biology, Hydroponics, Mathematics, Chemistry, +3 PTS
- ANDROID** Linguistic, Computing, Mathematics, +2 PTS
- MARINE** Military Training, +3 PTS

TRAINED SKILLS cost 1 point
EXPERT SKILLS cost 2 points
 • You can add Expert or Master skills you must first take one of its prerequisite skills.

NOTES
 CAPTAIN, CARVER
 CO-PILOT, ABEL
 SHIP, FALSTAFF

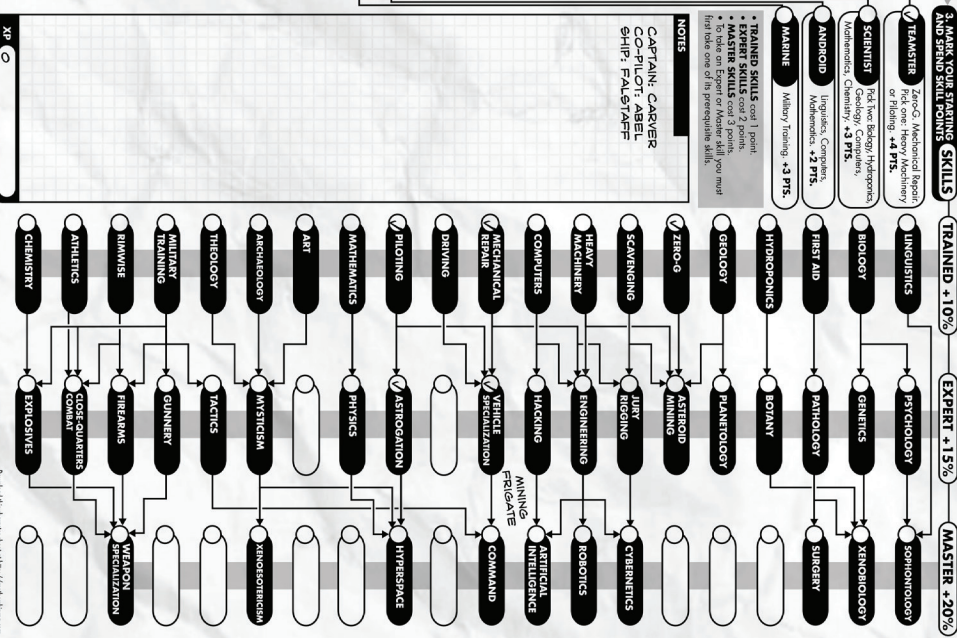

Example: Lilith showed up late and her Warden was busy ordering pizza, so he handed her a character sheet and told her to ask him any questions if they came up.

First, she rolls 6d10 for each Stat: Strength, Speed, Intellect, and Combat and writes them down in the circles.

Next she picks a class. She always loved Kaylee from Firefly, so she decides to pick Teamsster, putting a checkmark in the bubble. She fills in her starting Saves (which are written in grey on the sheet already) and then adjusts her Strength and Speed by 5 each (a bonus from being a Teamsster).

Next, she picks some skills. As a Teamsster, Lilith already gets Zero-G and Mechanical Repair. She wants to know everything about her ship, which another player tells her is called the Falstaff, so she picks Astroagtion (so she can Navigate if she needs) and Vehicle Specialization (she writes in Mining Figtale because that's what the Falstaff is).

Then, she picks her starting loadout. Lilith imagines excavating derelict spacecraft and scavenging them for parts, so she picks the Excavation loadout, then rolls for a random Trinket and Patch. Her Vaccusil gives her +7% Armor Save (for 42 total), so she notes that too.

Finally, she fills in her Max Health, Stress, and Resolve and rolls 5d10*10 for her starting credits. She's ready to play and the Warden's just got the pizza ordered.

Powered by the internet, here's how: <http://www.roleplaying.com>

DICE, STAT CHECKS, ADVANTAGE & DISADVANTAGE

Mothership plays like many other RPGs. You and your friends get together and one of you, the **Warden**, creates or has prepared a scenario for the rest of you to explore and interact with. The rules below will help outline some procedures for dealing with the most common situations that come up during the game. For everything else: the Warden will have to make a judgment call.

3.1 ROLLING THE DICE

Mothership uses standard **d10s** for all of its rolls, though it uses them in 3 different ways:

- » **xd10**: Roll a certain number of **d10s** and add them together. 2d10 would give you a number between 2-20.
- » **xd10**: Note the **underline**. This means to roll a certain number of d10s and add them together and multiply the result by ten. **2d10** would give you a number between 20-200. If you have a set of d10s with just the tens digits on them, they're perfect for rolls like this.
- » **d%**: Roll **1d10** and **1d10** and add them together (reading the result as a percentile). This gives you a number between 0-99. You'll need two sets of d% dice that you can tell apart easily.



3.2 STATS AND STAT CHECKS

Whenever you want to do something and the price for failure is high, you must roll under the appropriate Stat on **d%**; otherwise you fail. This is called a **Stat Check**. Your four Stats are:

- » **Strength**: How able-bodied you are. Lifting, pushing, hitting things hard, etc.
- » **Speed**: How quickly you can act and react under pressure.
- » **Intellect**: How knowledgeable and experienced you are.
- » **Combat**: How good you are at fighting.

There are a few things that commonly modify Stat Checks, namely: situational **Advantages & Disadvantages**, **Critical Successes & Critical Failures** and your **Skills**.

3.3 SITUATIONAL ADVANTAGES & DISADVANTAGES

Whenever you make a Stat Check and you have a situational **Advantage**, roll **d%** twice and use the better result. Some examples of Advantage are:

- » Assistance from another player.
- » Taking certain drugs.
- » Attacking from surprise.
- » Using a particularly good tool for the job at hand.
- » Being in cover.

The Warden will decide on a case-by-case basis whether certain in game actions or effects will confer Advantage on a Check.

Example: Abel is trying to open a rusted-shut airlock on a derelict spacecraft. He's using a crowbar and his crew mate, Lilith, is assisting him. The Warden decides this is a Strength Check with Advantage due to Lilith's assistance, so Abel tries to roll under his Strength score of 36. He rolls d% (with Advantage) and rolls 23 and 45. Abel takes the best of the two rolls, the 23 - success!

Disadvantage works much the same way as Advantage. You roll **d%** twice and use the worse result. Some examples of situational Disadvantages are:

- » Attempting to work in poor terrain, bad weather conditions
- » Suffering from withdrawal
- » or the vacuum of space
- » Trying to perform extremely difficult tasks
- » Being injured
- » You're drunk, concussed or mentally impaired
- » Not having a required Skill

Having Advantage and Disadvantage at the same time cancels each other out. Having more Disadvantages than Advantages, however, leads to Disadvantage, and vice versa.

Example: Lilith is trying to run to an airlock before it closes while the ship is spinning out of control. The Warden rules her Speed Check has Disadvantage. Lilith rolls d% (with Disadvantage) against her Speed 42. She rolls 55 and 62. Both are failures but taking the highest roll here isn't the worst roll - taking the 55 (a Critical Failure) is! Lilith won't make it to the airlock, and, worse, it sounds like she's about to get hit by debris!

A FEW NOTES ON ADVANTAGE & DISADVANTAGE

Advantage and Disadvantage don't have to be used on just Stat Checks - they can be used on any kind of roll: Saves, Damage, Stress, or anything else. This is why we say Disadvantage means picking the "worse" result and Advantage means picking the "best" result. Damage rolls with Disadvantage, for example, would take the lower number rolled (as opposed to the higher number rolled for Saves and Stat Checks).

For simplicity you can notate rolls with Advantage with the [+] sign and rolls with Disadvantage with the [-] sign. For example:

- » **2d10[+] damage** would mean to roll 2d10 twice and pick the best roll.
- » **1d10[-] Stress** would mean to roll 1d10 twice and pick the worst roll.
- » **Body[+] Save** would mean to roll d% twice and pick the better (usually lower) roll.

4.1 CRITICAL HITS & FAILURES

In that last example we showed you what a **Critical Failure** was before explaining it in order to illustrate how sometimes the highest number on a Disadvantaged roll isn't always the worst result. So, let's back up and explain:

Anytime you roll **doubles on a d% roll** (e.g. 55, 22, 99) that roll is what we call a **Critical**. If the roll was a success we call that a **Critical Success**: you have succeeded admirably at the task at hand. However, if the result was a failure, it's called a **Critical Failure**, a catastrophe where not only do you fail at the task but you may incur some other penalty, complication or even Damage as a result.

A roll of 00 is always a Critical Hit and a roll of 99 is always a Critical Failure.

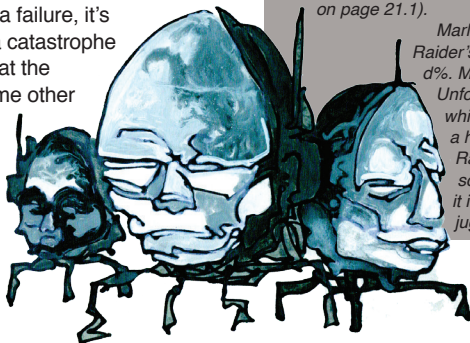

4.2 OPPOSED CHECKS

When you are in direct competition with another character (be that an enemy or a friendly crew mate) you roll what's called an **Opposed Check**. To make an Opposed Check you and your opponent both roll a Stat Check as usual, **however rolls higher than the other person without going over their own Stat wins**. A few notes:

- » **Critical Hits beat regular successes** (even if the Critical Hit is a lower roll).
- » **If you Critically Fail your roll your opponent wins** the Opposed Check automatically (even if they failed their roll).
- » **If you both succeed and tie, re-roll.**
- » **If you both fail, the situation gets worse** and more complicated, somehow, for the both of you.

Opposed Checks do not have to involve the same Stat: they can involve Saves as well. A basic case would be a race to see who gets to an airlock first: both parties make an Opposed Speed Check. You could also try to trick something into attacking in the wrong direction by making an Opposed Intellect vs. Combat Check.

>> Read more about Saves on page 7.

Example: Marlowe, an astrogation android, is facing off against a deranged Void Raider. Both are Unarmed but between them lies a pulse rifle. Marlowe's Speed isn't that high but his Intellect is. He decides that racing the Raider for the weapon isn't his best option. Rather, he wants to trick the Raider into thinking he'll go after the weapon and instead he wants to go for the emergency release valve on the airlock, which will depressurize the cabin and suck the Raider into the Void they so crave. The Warden thinks this is a pretty interesting solution and so rules that this will be an Opposed Check, pitting Marlowe's Intellect against the Raider's Instinct (Instinct is a catch-all Stat that only Non-Player Characters and Enemies use, read more about it on page 21.1).

Marlowe's Intellect is 52, while the Raider's Instinct is 30. They both roll d%. Marlowe rolls a 9, a success! Unfortunately, the Raider rolls a 20, which is also a success, but also a higher roll than Marlowe's. The Raider catches on to Marlowe's scheme and leaves the gun where it is, lunging instead for Marlowe's jugular!

Skills represent the accumulated knowledge, craft, techniques and training you possess. Whenever you make a Stat Check and you have a relevant Skill you add your Skill Bonus to your Stat, giving you a higher number to roll under. Every class starts with a few **Skills** and gains more by leveling up.

>> Read more about Leveling Up on page 35-36.

There are four different Skill ranks which determine how much you know about a given subject:

- » **Untrained (Skill Bonus: +0%):** You have little to no experience in this field and you get no bonus. Depending on how complex the task is you might roll with Disadvantage.
- » **Trained (Skill Bonus: +10%):** You've received standard training in this area equivalent to a bachelor's degree or on-the-job training for a couple years.
- » **Expert (Skill Bonus: +15%):** you have the equivalent of a doctorate or many years of experience.
- » **Master (Skill Bonus: +20%):** You are one of the luminaries of this field and are aware of cutting edge techniques or highly specialized and niche information.

All Skills start out as Untrained: you don't have the Skill. By taking a Trained Skill you unlock Expert and Master Skills. Below is a non-comprehensive list of Skills. Work with your Warden to come up with new and interesting Skills through play and development of your own dark corner of the galaxy. You can easily add new Skills to your Character Sheet in the provided empty white boxes.

TRAINED SKILLS

- » **Archaeology:** Ancient cultures and their artifacts.
- » **Art:** The expression or application of a species' creative ability and imagination.
- » **Athletics:** Physical sports and games.
- » **Biology:** Study of life.
- » **Chemistry:** The identification of the substances of which matter is composed.
- » **Computers:** Fluent use of computers and networks.
- » **Driving:** Operation and control of motor vehicles.
- » **First Aid:** Emergency medical care and treatment.
- » **Geology:** The solid features of any terrestrial planet or natural satellite.
- » **Heavy Machinery:** Operation and use of large pieces of equipment (cranes, exosuits, forklifts, etc.).
- » **Hydroponics:** Growing plants in nutrient solutions without soil (farming in space).
- » **Linguistics:** Study of language.
- » **Mathematics:** The science of numbers, quantity, and space.
- » **Mechanical Repair:** Fixing broken machines.

- » **Military Training:** Standard basic training given to all military personnel.
- » **Piloting:** Operation and control of air and spacecraft.
- » **Rimwise:** Outer rim colonies and seedy parts of the galaxy.
- » **Scavenging:** Searching discarded waste for useful items.
- » **Theology:** Study of religion.
- » **Zero-G:** Working in a vaccuum, vaccsuits, etc.

EXPERT SKILLS

- » **Asteroid Mining:** Training in the tools and procedures used in mining asteroids.
- » **Astrogration:** Navigation in outer space.
- » **Botany:** The study of plant life.
- » **Close-Quarters Combat:** Hand-to-hand, melee fighting.
- » **Engineering:** design, building, and use of engines, machines, and structures.
- » **Explosives:** Bombs and incendiary devices.
- » **Firearms:** Guns and their use.
- » **Genetics:** Heredity and the variation of inherited characteristics.
- » **Gunnery:** Starship weaponry.
- » **Hacking:** Unauthorized access to computer systems.

- » **Jury-Rigging:** Makeshift repairs.
- » **Mysticism:** Spiritual apprehension of hidden knowledge.
- » **Pathology:** Study of the cause and effect of disease.
- » **Physics:** Study of nature and properties of matter and energy.
- » **Planetology:** Study of planets and other celestial bodies.
- » **Psychology:** The study of behavior and the human mind.
- » **Tactics:** Manuevering military forces in battle.
- » **Vehicle Specialization:** Specific vehicle class.

MASTER SKILLS

- » **Artificial Intelligence:** Knowledge of simulacrum of human consciousness.
- » **Command:** Leadership and authority.
- » **Cybernetics:** Interface between man and machine.
- » **Hyperspace:** FTL travel.
- » **Robotics:** Design and operation of robots, drones, and androids.
- » **Sophontology:** Alien psychology.
- » **Surgery:** Medical speciality involving manual operation.
- » **Weapon Specialization:** Proficiency with a specific weapon.
- » **Xenobiology:** Alien biology.
- » **Xenoosotericism:** Obscure alien mysticism, religion, and belief.

TRAINED +10%

EXPERT +15%

MASTER +20%

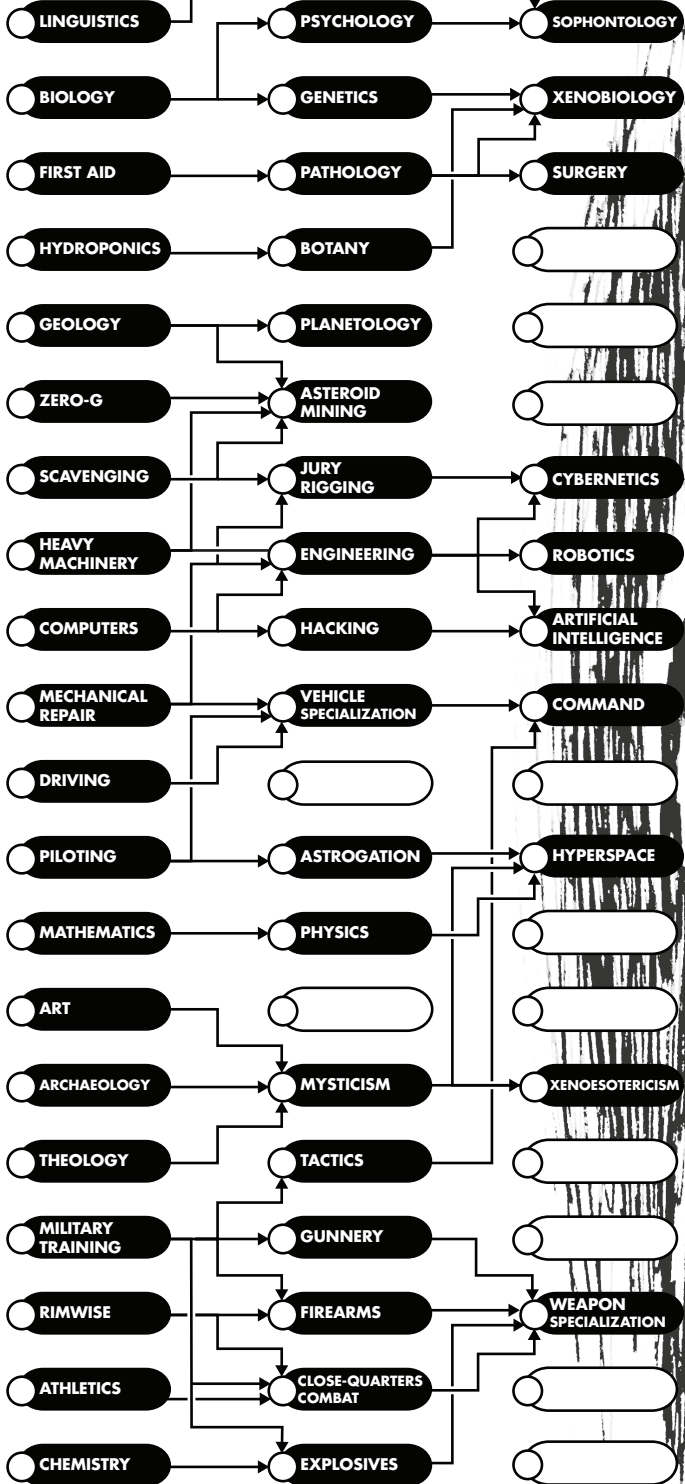

Oftentimes in **Mothership** you won't have control over what happens to you. Strange organisms will attack or invade your body. Terrifying horrors will surprise you from the void. You'll find or become aware of some ancient knowledge that is beyond your comprehension. Whenever these kinds of things happen you make a **Save**. These Saves represent how resistant you are to different kinds of danger and Damage.

7.1 SAVES

You have four **Saves: Sanity, Fear, Body and Armor**.

- » **Sanity** is your ability to explain away logical inconsistencies in the universe, rationalize and make sense out of chaos, detect illusions and mimicry and think quickly under pressure.
- » **Fear** is how well you can cope with emotional trauma, and covers not only fear, but also loneliness, depression or any other emotional surge.
- » **Body** is your reflexes, and how well you can resist hunger, disease or any other organism that might attempt to invade your insides.
- » **Armor** is how resistant you are to damage sustained during combat, whether that be through bullets, claws, teeth, etc.

Saves are not rolls you make willingly (like when you use your Strength to open a jammed airlock). You make Saves when something bad might happen to you and you need to find out whether you resist it.

To make a Save, roll d% equal to or under your Save value (just like with a Stat Check). If you fail your Save you'll gain 1 (or more) **Stress**. Additionally, you may suffer some other consequence like taking Damage (in the case of a failed Armor Save) or contracting a deadly virus (in the case of a failed Body Save).

If you Critically Fail a Save, you'll have to make a **Panic Check**. Rolling a Critical Success could mean a wide variety of things depending on the context. A Critical Success on a Sanity Save may grant some further insight into the strange horrific artifact you've encountered or in the case of an Armor Save give you a chance to counter attack. All of these cases are ultimately up to the Warden.

>> Read more about Stress and Panic on pages 25-26.

Example: While investigating the cause of a recently abandoned mining colony Lilith and Abel encounter a massive artifact. The artifact casts no shadow and after touching it Lilith and Abel are surprised by two strangers in vacsuits. The strangers are also surprised by Lilith and Abel and after taking off their helmets it's apparent why - they ARE Lilith and Abel. The Warden calls for Sanity Saves from both Lilith (Sanity 30) and Abel (Sanity 25). Lilith rolls 76, a Failure. The Warden rules that she'll gain 1d10 Stress from the shock. Abel, however, doesn't get off that easily. He rolls a 33, a Critical Failure. He'll gain 1d10 Stress and have to make a Panic Check. What's worse, Abel is a Marine so if he fails his Panic Check Lilith will have to make a Fear Save. Things can spiral out of control quickly when someone fails a Save, so be careful.



Survival is hard in Mothership: you'll have to scrimp, save and scavenge to make it from one rock to the next. And all of this is before defending yourself from the vile monstrosities out there in the forbidding galaxy.

8.1 CRISIS CHECKS

When a single Check seems too simple you can use a **Crisis Check**. Crisis Checks represent longer, more arduous tasks, like performing surgery or mining an asteroid.

To make a Crisis Check the Warden first sets the **Crisis Difficulty** between 1 and 3. This is the number of Stat Checks in a row you'll need to succeed in order to overcome the current Crisis. If you fail a Check you gain Stress equal to the Crisis Difficulty and Fail the Crisis. However, you can reroll a Failed Crisis Check by immediately taking 1d10 Stress. No matter what, the third time you fail a Crisis Check, the Crisis ends and you take your final Stress as well as whatever else Failure entails (the repairs don't work, the patient dies, etc.).

8.2 FOOD & WATER

Humans can survive roughly 3 weeks without food. **After 24 hours without food you're at Disadvantage to all rolls.**

The bare minimum to survive: you'll need **1 liter of water a day**. However, at this level any strenuous activity (like running, Combat, or making mechanical repairs) will force you to make a Body Save or pass out. When water is scarce and you're tracking it this closely you're at Disadvantage to all Checks.

8.3 OXYGEN

In space you can last 15 seconds without oxygen before you fall unconscious. After passing out you can survive for 3-5 minutes before dying.

If all of a ship's **Life Support Modules** are destroyed take the ship's current **Hull**, subtract 1d10, and then divide by the number of living humans onboard (Androids don't need oxygen to breathe). This is how many days of breathable oxygen remain per person.

>> Read more about Ship Design on pages 28-32.

Take the allotment of oxygen and assign it to every human aboard the ship. If a crew member dies divide their remaining days amongst the rest of the crew. If a crew member engages in strenuous activity like running, Combat, mechanical repairs, etc., subtract a day from them and randomly from one other crew.

Once per day (when dealing with **Rest**) take a look at the total remaining oxygen amongst the crew:

- » If less than half of the original oxygen remains every roll is made at Disadvantage. All crew suffer headaches, fatigue, anxiety and general clumsiness.
- » If less than a quarter of the original oxygen amount remains players must make a Body Save once per day (and after every strenuous activity) or fall unconscious. All crew suffer panting, dizziness, severe headaches and impaired vision and tinnitus.
- » If a player runs out of oxygen they must make a Body Save. Failure means they die. Success means they fall unconscious and leach oxygen from a random player every day.

Crew members in cryosleep or doing nothing but resting take up 1/4 of an oxygen unit per day.

>> Read more about Rest on 10.3.

8.4 EARNING CREDITS

Everything in Mothership from fuel to food to weapons and ammunition costs Credits. Owning a starship is an expensive proposition. Here are a few things you can do to earn credits:

ROLL	JOB
1	Mine asteroids (ore, unrefined fuel, precious metal).
2	Ship cargo (trade goods, ore, supplies).
3	Courier important messages.
4	Escort passengers.
5	Scrap derelict spacecraft.
6	Smuggle goods (contraband, drugs).
7	Raid corporate vessels.
8	Map sectors of uncharted space.
9	Hunt dangerous criminals for bounty.
10	Collect data on unknown species.

Combat in **Mothership** is incredibly deadly and usually best avoided altogether in favor of running and hiding. In those dire situations when you must fight for your life here's what you do:

9.1 CHECK FOR SURPRISE

Sometimes the various creatures, horrors and denizens of long forgotten spacecraft will sneak up on you before making themselves known - when this happens you make a **Fear Save**; failure means you become so **Surprised** that you are unable to act for one round.

9.2 WHO GOES FIRST?

After checking for Surprise you can determine the turn order. **First: you and your crew mates each make a Speed Check; those who pass can act before the enemies. Those who Fail act after.** Critical Successes give you an extra action while Critical Failures reduce you to one action. This repeats every round.

Characters with the Tactics Skill can add their Skill bonus to their Speed Stat (and can also give their bonus to one other player). Characters with the Command Skill give all nearby crew members their Skill bonus on these Checks.

9.3 HOW LONG IS A TURN?

Combat takes place in both **rounds** and **turns**. A **turn** is focused on one individual player, non-player-character or group of enemies. A **round** is the time it takes for everyone to take a **turn**.

Each round is equal to roughly ten seconds of real time, with every character's turn happening roughly within that time but in turn order (as opposed to all at once). Therefore, someone who is killed before their turn does not get to act on their turn.

9.4 WHAT CAN I DO ON MY TURN?

When it's your turn tell the Warden what you'd like to do. The Warden will tell you if you can get all of that done in one turn or if it would take multiple turns to accomplish all of what you want.

Generally you can take **two significant actions** on your turn. Examples of significant actions are (but not limited to):

- » Attacking
- » Bandaging a wound
- » Checking someone's vital signs
- » Firing a vehicle's weapons
- » Maneuvering a vehicle
- » Opening an airlock
- » Operating a machine
- » Reloading a weapon
- » Running/walking
- » Throwing something
- » Using a computer terminal (search a directory, engage airlocks, send a distress signal, cycle through CCTV cameras, disable Life Support, etc.)

Insignificant actions are things like talking, taking cover (as part of a move action), looking around, etc. The Warden will ultimately decide what counts as a significant or insignificant action given the context of each specific situation.

9.5 HOW DO I ATTACK?

Attacking is a specific kind of significant action performed by rolling an **Opposed Check**. In ranged combat the attacker makes a **Combat Check** against the defender's **Armor Save**. If the attacker succeeds they roll their weapon's Damage dice.

>> Read more about Weapons on pages 11-14.

In Close-Quarters Combat the attacker makes a Combat Check as usual but the defender can decide whether they want to oppose that roll with their Armor Save (to defend against the damage), another Combat Check (to counter-attack) or a Body Save (to try and get out of CQC and run away). If two characters are wrestling or grappling that would be an opposed Strength Check.

>> Read more about Opposed Checks on page 4.2.

9.6 DO I GET A BONUS FROM COVER?

If you hide behind cover that conceals at least half of your body you gain Advantage on your Armor Saves against ranged attacks.

9.7 HOW FAR CAN I MOVE?

You can move half your Speed in meters in one movement action or your full Speed in meters for both actions. If you're wearing heavy armor, like a Vaccsuit or Advanced Battle Dress you'll need to make a Strength Check to move your full allotment. Failure means you move half.

HIT LOCATION, DAMAGE, HEALING, DEATH

10.1 HIT LOCATION

It's not usually necessary, but if it becomes important, you can use the diagram below to see where a character was hit. Rolling "evens" means that their left side was hit while rolling "odds" means the right side was hit.

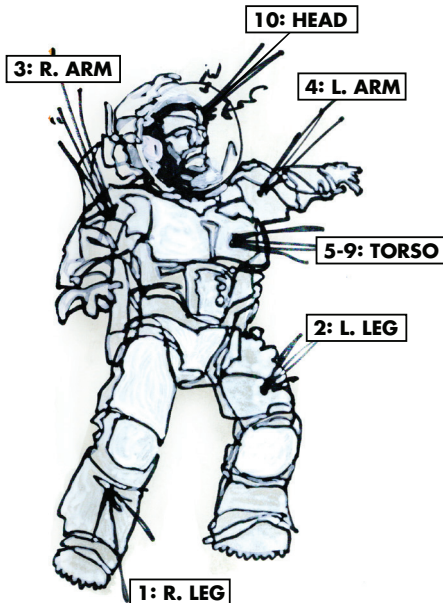

10.2 DAMAGE

Whenever you lose an opposed Combat Check you take Damage, which is subtracted from your Health. If the hit was a Critical Success or if you take more Damage than half your Max Health in one hit you'll need to make a **Panic Check**.

>> Read more about Stress and Panic on pages 25-26.

10.3 HOW DO I HEAL?

Whenever you have a chance to rest for at least six hours your body will attempt to heal your wounds naturally. To represent this, when resting, you should make a **Body Save**. If successful you heal Health equal to the amount you succeeded by. On a failure you are unable to heal your wounds naturally. On a Critical Failure your wounds actually worsen and you lose 1d10 Health. A Critical Success doubles the amount of healing. Various drugs can also heal you, and some ships are equipped with Medbays that can

grant Advantage to your Body Save while resting. The Warden, however, can rule that trying to rest under adverse circumstances (like hiding from predators) confers Disadvantage on the healing roll. **You can only heal from rest once per day.**

Example: After a grisly encounter with some ancient malfunctioning androids, Lilith's current Health is 42. She isn't able to make it back to her ship and has to hole up in an abandoned airlock. After jamming the airlock shut with a crowbar, she spends the night trying to rest (in spite of the insane gibbering androids outside her door).

The Warden rules that under these circumstances she has Disadvantage on her Body Save to heal for the night. Lilith's Body is only 30, so it'll be a tough roll. Luckily, Lilith rolls a 22 and a 12, both successful rolls. This is a tricky one, though, because which of the rolls is worse?

The Critical Success of 22 would heal her 16 (30-22=8, 8x2=16), whereas the regular 12 would heal her 18 (30-12=18). So technically "Rules as Written" the 22 is the worse roll. That's a whole lot of math to deal with one night's sleep for one player, and you'll often have multiple players rolling for rest each night, so it's best just to pick a lane (like "Crits always count as better rolls") and stick with it.

10.4 UNCONSCIOUSNESS & DEATH

Whenever you reach 0 Health, make a **Body Save: Failure means you die**. Success means you fall unconscious and the Warden will make a secret roll on the table below to find out when you regain consciousness. Usually a crew member with a medscanner can determine your condition. Additionally, scientists and androids who pass an **Intellect Check** can usually tell, as can anyone else with a relevant Skill, like First Aid or Biology.

ROLL YOU REGAIN CONSCIOUSNESS...

1	You are comatose and brain-dead. Only extraordinary measures will return you to the waking world.
2-3	In 1d10 days, with 1 Health. -5 Strength, -5 Speed, -5 Intellect (permanent loss). Disadvantage on all rolls for 1d10 days. +1d10 Stress.
4-6	In 1d10 hours. 1 Health. -5 Strength, and -5 Speed (permanent loss). Disadvantage on all rolls for 1d10 hours. +3 Stress.
7-9	In 1d10 minutes. 1 Health. -5 Strength (permanent loss). Disadvantage on all rolls for 3d10 minutes. +2 Stress.
10	Immediately. 1 Health. Disadvantage on all rolls for 1d10 minutes. +1 Stress.

In **Mothership** the weapons you use and how you choose to use them are very important. Ammunition is often in short supply, and a powerful weapon, in the hands of an untrained, panicked character, can quickly turn a bad situation into a disaster.

11.1 WEAPONS

In **Mothership** you use your Combat Stat when fighting. Having a relevant Skill, like Firearms or Close-Quarters Combat, will often increase your Combat Stat temporarily, giving you a higher number to roll under. Additionally, weapons often have special abilities of their own which can further increase your chances of survival.

11.2 AMMUNITION

Each weapon holds a certain amount of shots which represents how many times you can fire the weapon before you must reload. Whenever you fire your weapon mark down how many shots you have left before you reload. Whenever you take a reload action take the time to mark down how many shells, bullets or magazines you have left as well.

Note on Bookkeeping: Most people hate tracking ammunition. Ultimately it's up to the Warden whether you track ammo or not, but for survival-oriented games we recommend it. It's not so much about being "realistic" as it is that running out of ammo leads to all sorts of interesting play, where players have to seek out new weapons and ammo, improvise weapons from found objects, or even tinker with their weapons to use the ammo they do find. Using "bullet" tokens or poker chips to represent 1, 5 and 10 shots can make this bookkeeping really easy at the table since players only have to write down how much ammo they start or end a session with. You can also use a polyhedral die and wind it down as you fire each shot.

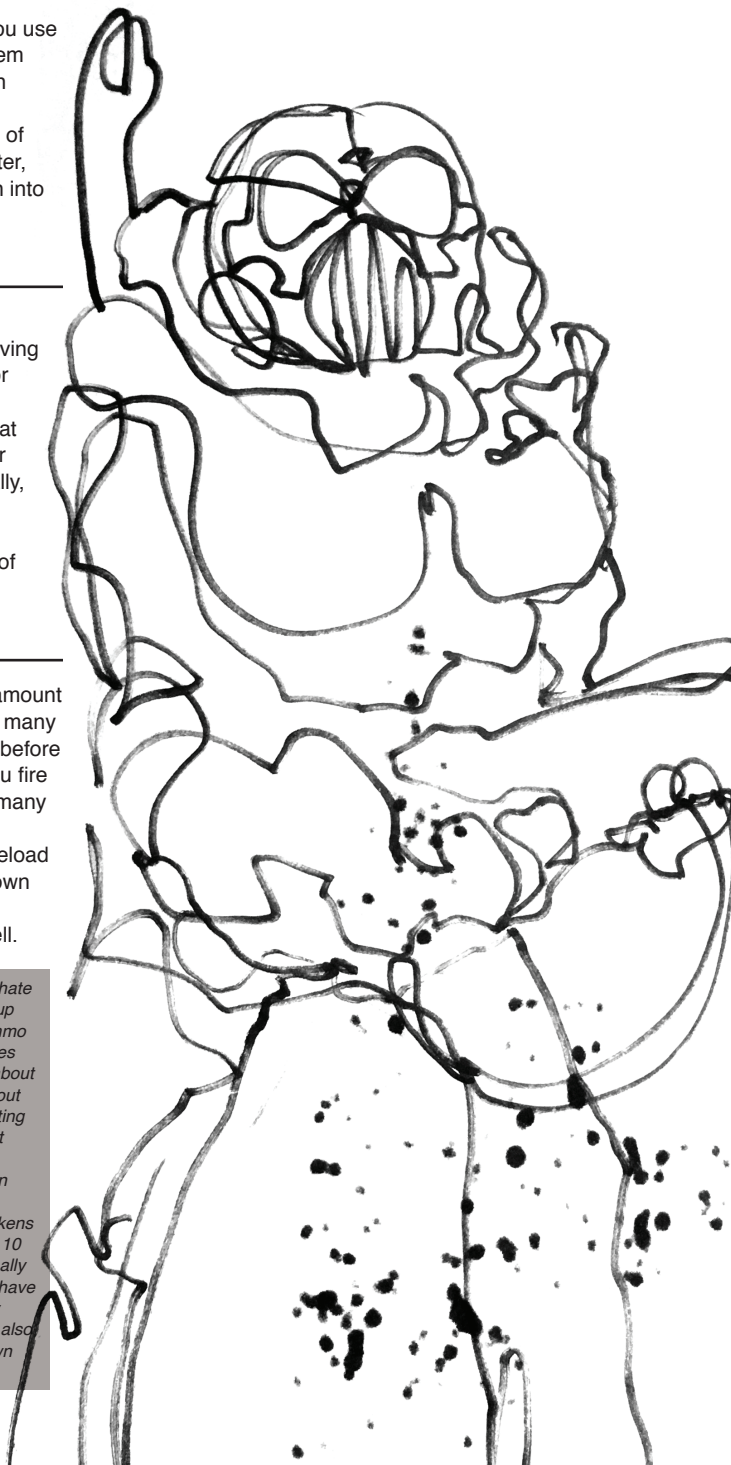

WEAPONS: RANGE, RELOADING, AUTOMATIC FIRE

12.1 RANGE

Each ranged weapon has a Short, Medium and Long Range associated with it.

- » **Short Range:** Weapons firing within this range (or lower) suffer no penalty to the shooter's Combat Stat.
- » **Medium Range:** Weapons firing at this range confer a -10% penalty to the shooter's Combat Stat.
- » **Long Range:** This is the maximum distance the weapon can effectively target. In the vacuum of space a bullet fired may travel an indefinite distance, but for the sake of firing on a ship or a planet this is the maximum range of the weapon. Firing at this range confers Disadvantage to the Shooter's Combat Check.

Example: Abel is taking aim with his Smart Rifle at a rogue mercenary 450m away, tucked back in the crater of an asteroid. Abel is perched atop a high ridge and has a good vantage point on the mercenary. Abel's Combat is 34, but he also has a HUD hooked up to his Smart Rifle, which gives him +10 to his Combat. Additionally, another marine is with Abel and the Warden rules that since the other marine is using his binoculars to act as a spotter Abel can get the added +5% proximity bonus from having a nearby marine. Additionally, Abel has Firearms which grants another +15%, bringing his total Combat to 64%. He's at Long range so he rolls with Disadvantage, getting a 15 and a 53. It's an Opposed Check so the 15 is the worse roll (though still successful). Meanwhile, the mercenary, because of their cover, gets to roll their Armor Save with Advantage. The mercenary has an Armor Save of 30 and rolls a 2 and a 33. The 33 is a Critical Failure, so the mercenary takes the 2. Abel's 15 is higher than the mercenary's 2, so Abel hits and rolls Damage.



bullets or shells are easily accessible. No amount of training can prepare you for rooting around in a loaded pack looking for ammunition while being attacked by a band of grotesque beasts on a dark and distant rock.

12.4 AUTOMATIC WEAPONS

Some weapons (like the **Pulse Rifle** and **Submachine Gun**) are fully-automatic weapons, meaning that as long as you hold down the trigger the weapon will continue to fire at an incredible rate. This means that after every time you fire a fully automatic weapon you have to reload unless you have the Military Training or Firearms Skills, in which case you can fire it three times before reloading. This is due to the intense "trigger discipline" required to fire these weapons in bursts without emptying the entire magazine. The Weapons Chart on the inside front cover shows these weapons as having "**Shots: 1(3)**" to represent this.



12.2 AIMING

If you spend a full turn (both actions) aiming and don't take any Damage that turn you gain Advantage on your next shot with a ranged weapon. You can hold an aim for any number of rounds (waiting to take your shot) as long as you don't take Damage, get grappled, shoved or moved, etc.

12.3 RELOADING

Reloading a weapon takes a significant action. However, if you have the Military Training or Firearms Skills then you can reload as a free action. This is assuming that your magazines,

12.5 SPECIAL WEAPON ABILITIES

Some weapons come equipped with powerful targeting sensors or gyroscope stabilization that make them easier to use. This means that while you are using the weapon you can add certain bonuses to your rolls. For instance:

- » **If the weapon says +10 (Combat):** When using the weapon you can add 10 to your Combat Stat.
- » **If the weapon says +10 (Firearms):** When using the weapon you can add +10 to your Combat Stat if you have the Firearms Skill.
- » **If the weapon says -10 (vs. Armor Save):** Your opponent must subtract 10 from their Armor Save when rolling against this weapon.

WEAPONS: COMBAT GUNS

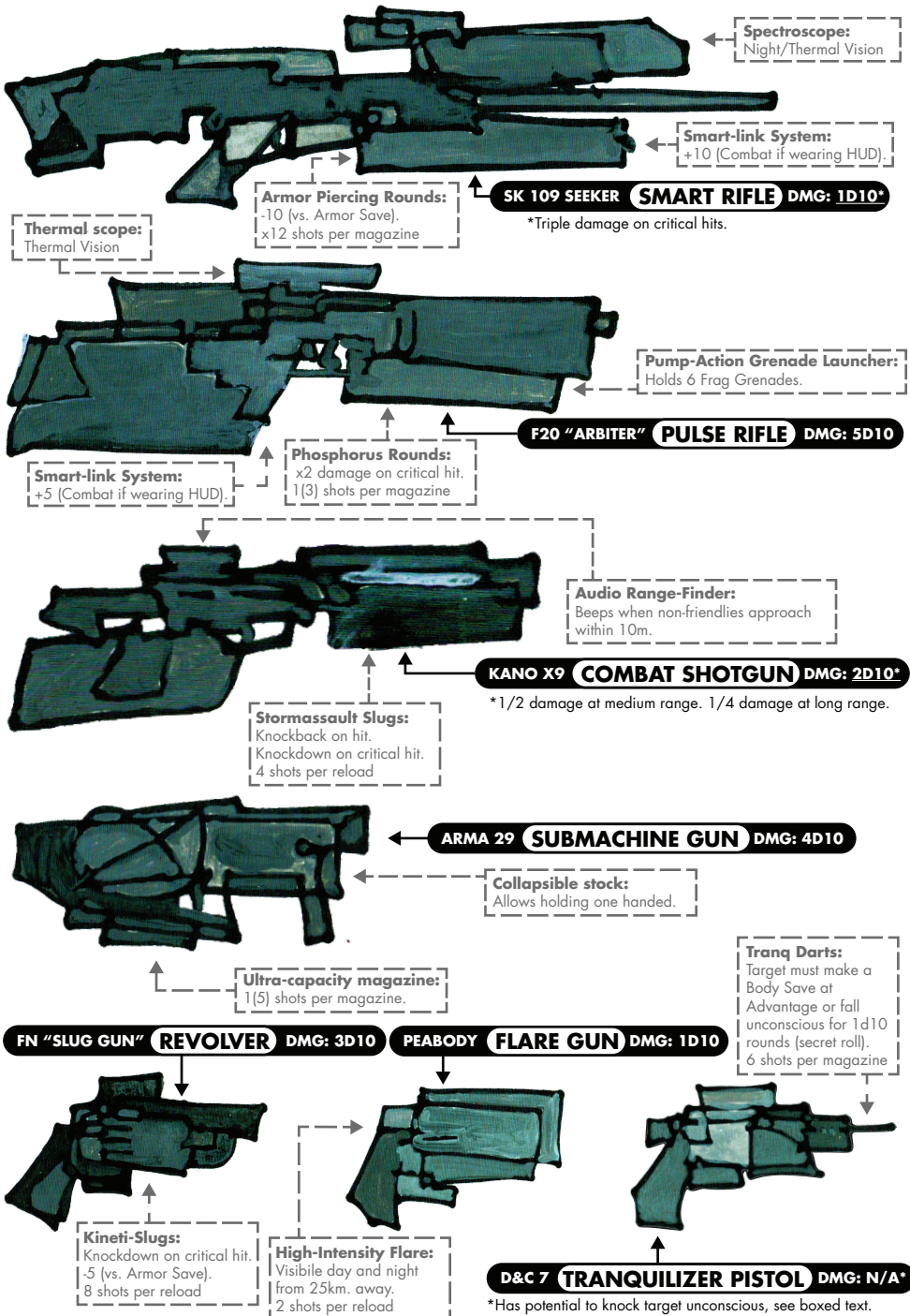

WEAPONS: SPECIALTY GUNS

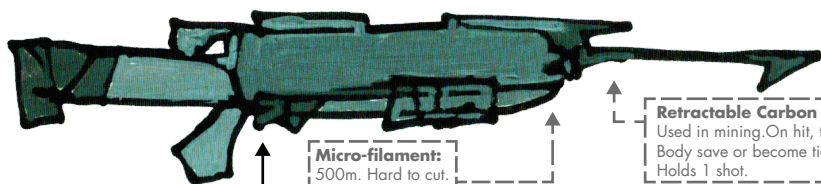

Micro-filament:
500m. Hard to cut.

Retractable Carbon Harpoon:
Used in mining. On hit, target must
Body save or become tied.
Holds 1 shot.

HAN-290 RIGGING GUN DMG: 2D10*

*1d10 dmg if harpoon is pulled out of target

Wide Beam Laser:
Built to scrap ships. 700m range.
Takes 1 round to recharge every
shot. -15 (vs. Armor Save).

Mega-DX Solar Battery:
Holds 6 Laser shots. Takes 1 hour
to re-charge via ship's generator,
or 6 hours via solar power.

MNC MODEL A LASER CUTTER DMG: D%*

*or 1 MDMG if firing against a vehicle or ship



Strap

Igniter

Flammable Fuel Tank:
Fires liquid flame up to 20m. Fire
stays where it lands. Holds 8 shots.

RAMHORN 1 FLAME THROWER DMG: 2D10*

*Body Save or be set on fire. 1d10 dmg/turn.

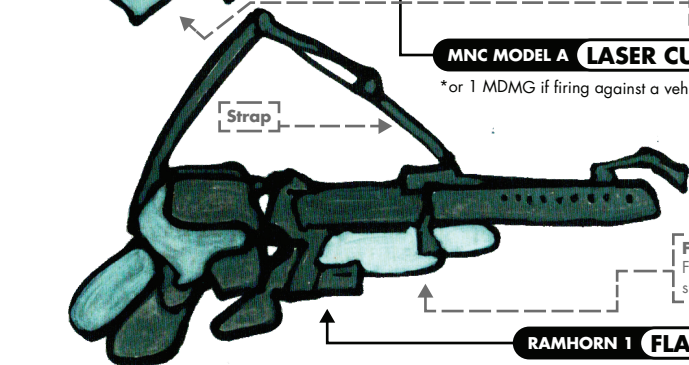

ROSCO 556 NAIL GUN DMG: 2D10

Heavy Duty Nail Slugs:
Built for spacecraft repair.
-10 (vs. Armor Save).

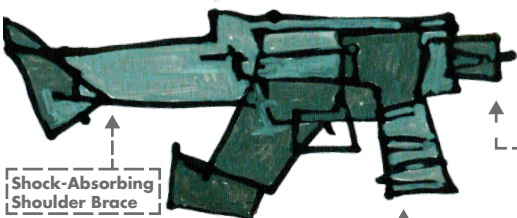

Shock-Absorbing
Shoulder Brace

Auto-loader Nail Magazine:
32 shots per magazine

Quick-Hardening Foam:
On hit, Body/Instinct Save
to avoid. Foam covers 1m².
Requires Strength[] Check
to escape.

Strap

Compressed Tank:
Explosive if punctured.
Holds 6 charges.

Ultra Heat Emitter:
Cuts through airlocks/heavy doors.
-5 (vs. Armor Save).

EVA MK II HAND WELDER DMG: 1D10

HALLS B SERIES FOAM GUN DMG: N/A*

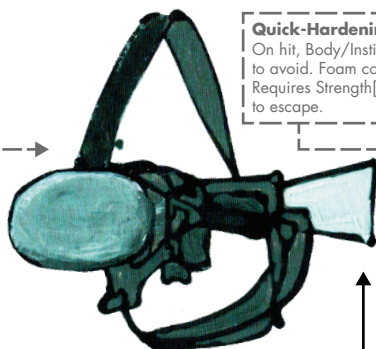
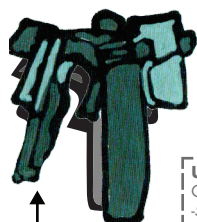

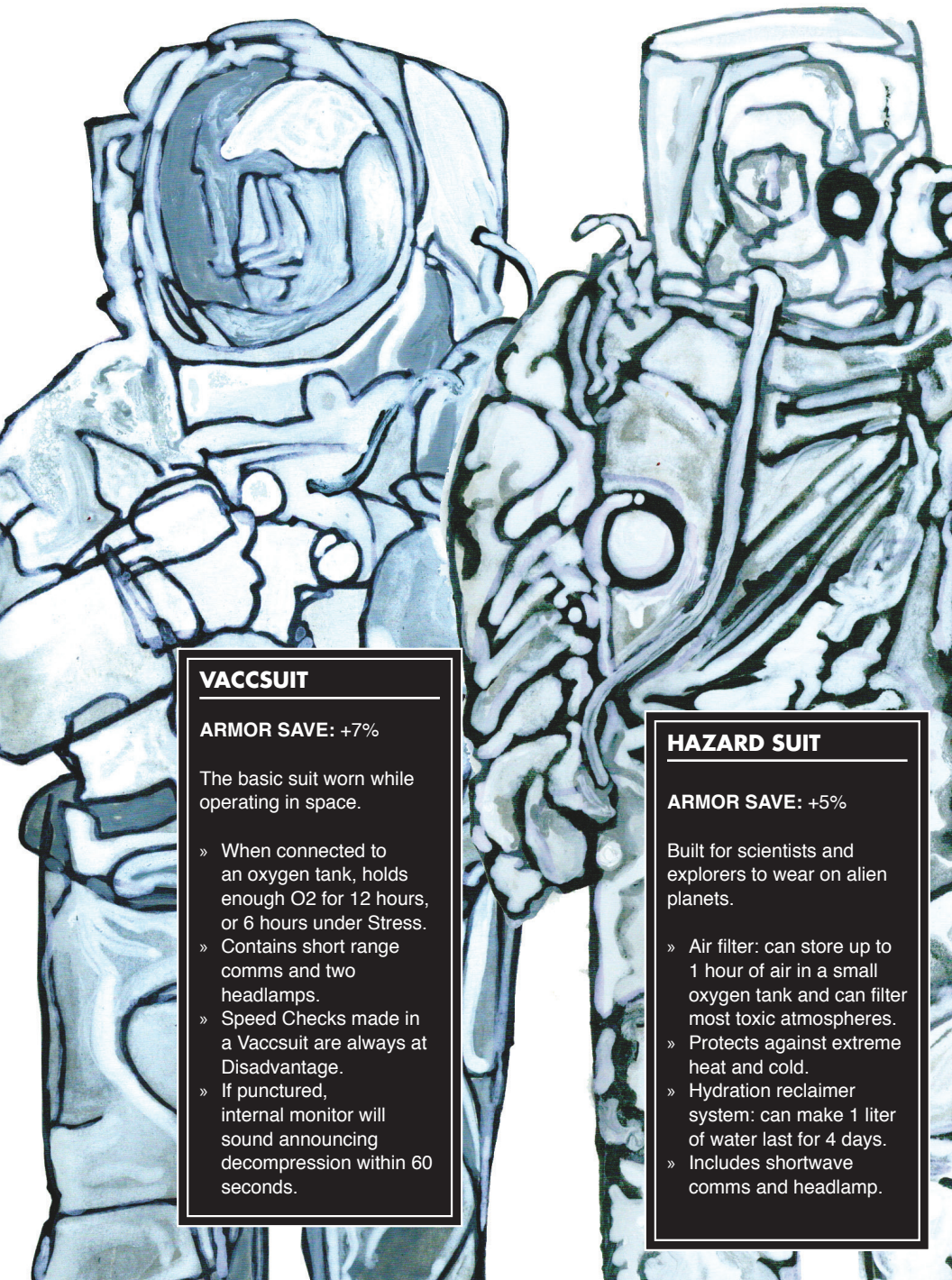

VACCSUIT

ARMOR SAVE: +7%

The basic suit worn while operating in space.

- » When connected to an oxygen tank, holds enough O2 for 12 hours, or 6 hours under Stress.
- » Contains short range comms and two headlamps.
- » Speed Checks made in a Vaccsuit are always at Disadvantage.
- » If punctured, internal monitor will sound announcing decompression within 60 seconds.

HAZARD SUIT

ARMOR SAVE: +5%

Built for scientists and explorers to wear on alien planets.

- » Air filter: can store up to 1 hour of air in a small oxygen tank and can filter most toxic atmospheres.
- » Protects against extreme heat and cold.
- » Hydration reclaimer system: can make 1 liter of water last for 4 days.
- » Includes shortwave comms and headlamp.

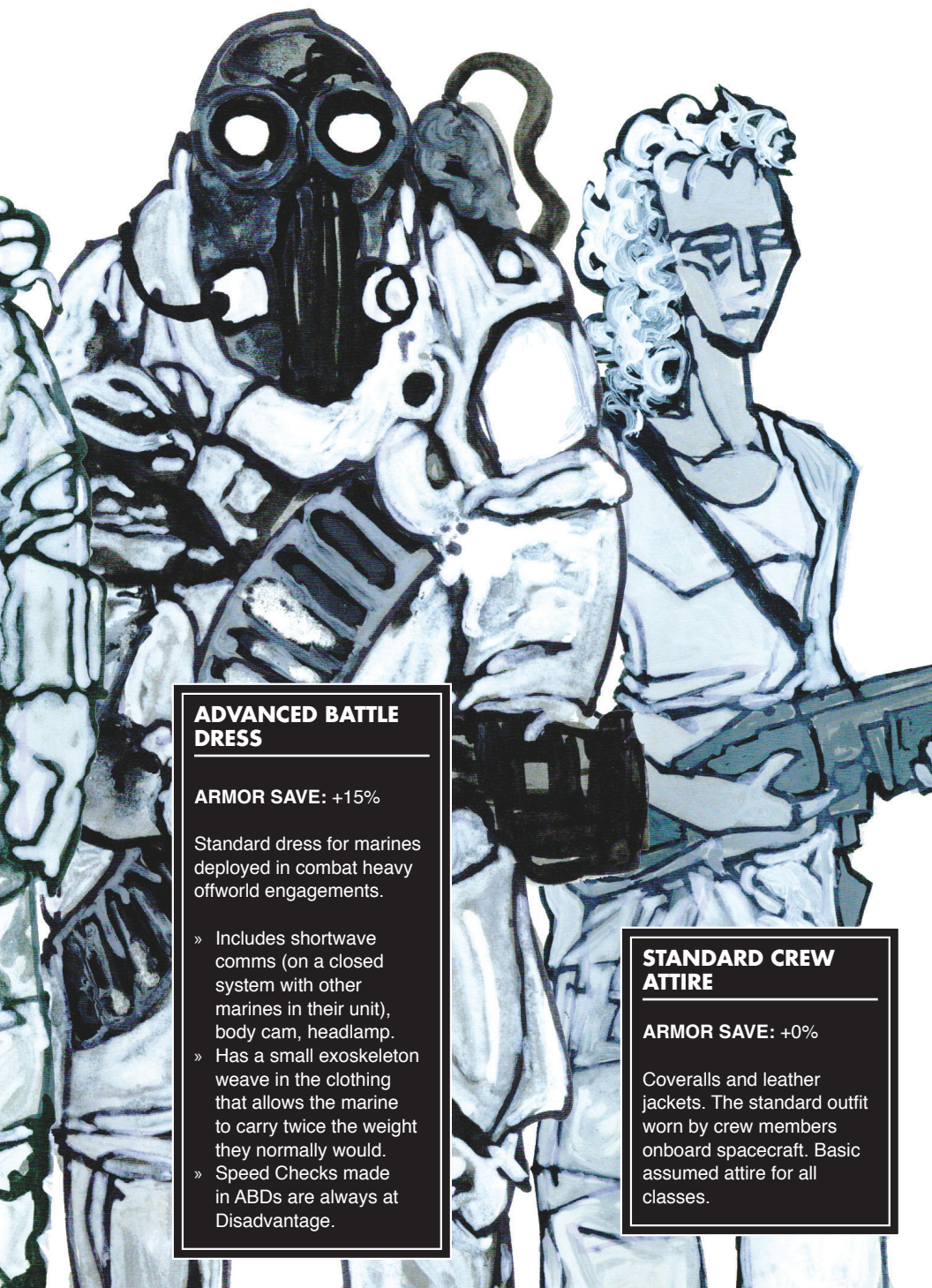

ADVANCED BATTLE DRESS

ARMOR SAVE: +15%

Standard dress for marines deployed in combat heavy offworld engagements.

- » Includes shortwave comms (on a closed system with other marines in their unit), body cam, headlamp.
- » Has a small exoskeleton weave in the clothing that allows the marine to carry twice the weight they normally would.
- » Speed Checks made in ABDs are always at Disadvantage.

STANDARD CREW ATTIRE

ARMOR SAVE: +0%

Coveralls and leather jackets. The standard outfit worn by crew members onboard spacecraft. Basic assumed attire for all classes.

ITEM	COST	DESCRIPTION
Advanced Battle Dress	1500	Heavy combat outfit worn by marines in battlefront offworld engagements. Confers a +15% bonus to the wearer's Armor Save. Has a small exo-skeleton that allows the wearer to carry twice what they normally could.
Automed (x6)	300	Nanotech pills that assist your body in repairing damage. They give +10% to Body Saves meant to repel disease or poison, as well as attempts to heal, and +10% to Fear Saves made to reduce Stress.
Binoculars	35	20x magnification. Often come with thermal and night vision options.
Bioscanner	150	Allows the user to scan the immediate area for signs of life. Generally can scan for 100m in all directions without being blocked by most known metals. Can tell the location of signs of life but not what that life is.
Body Cam	50	A camera worn on your clothing that can stream video back to a control center so that your other crew members can view what you're seeing.
Camping Gear	250	Tent, canteen, stove, backpack, sleeping bag.
Crowbar	25	Confers Advantage on Strength Checks to open jammed airlocks or lift heavy objects. Can also be used as a weapon.
Cybernetic Diagnostic Scanner	500	Allows the user to scan androids and other cybernetic organisms in order to diagnose any physical or mental issues they may be having. Often distrusted by androids. Can be used as a locating device for synthetic organisms.
Electronic Tool Set	650	A full set of tools for detailed repair or construction work on electronics. Confers +10% to Checks seeking to repair electronics.
Emergency Beacon	30	A small device that sends up a flare and then emits a loud beep every few seconds. Additionally, sends out a call on all radio channels to ships or vehicles in the area. Can be configured to be silent or to only make calls on known channels.
Field Recorder	50	Used to research alien flora and fauna in the field. Can take vital signs, collect DNA samples and perform basic genetic and material analysis on foreign objects.
First Aid Kit	75	Adds +10% to rolls made to bandage wounds and stop bleeding.
Flashlight	10	Handheld or shoulder mounted, illuminates 20m ahead of the user.
Frag Grenade (x6)	400	Often come loaded in pulse rifles, frag grenades deal 1d10 damage to everyone within a 20m radius when they explode. Can often do 1MDMG to a ship if placed in their engine room or bridge.
Hazard Suit	750	A standard suit for scientists to wear on alien planets. Not built for outerspace travel like the vacsuit but does provide air filtration and a small supply of air as well as +5% Armor Save.
Heads-Up Display	75	Often worn by marines, the HUD allows the wearer to see through the body cams of others in their unit and tap into their guns' smart-link capabilities.
Infrared Goggles	100	Allows the wearer to see heat signatures, sometimes several hours old.
Locator	45	Allows crew members at a control center (or on the bridge of a ship) to track the location of the wearer.
Lockpick Set	40	A highly advanced set of tools meant for hacking basic airlock and electronic door systems. Confers +10% on Checks made to open these doors.
Long-range Comms	65	For use in ship-to-surface communication.
Mag-Boots	55	Grants a magnetic grip to the wearer, allowing them to easily to walk on the surface of a ship (in space, while docked or free-floating), or metal based asteroids.
Medscanner	150	Allows the user to scan a living or dead body and to analyze it for disease or abnormalities without having to do a biopsy (or autopsy).
MRE (x7)	70	"Meal, Ready-to-Eat." Self-contained, individual field rations in lightweight packaging. Each one has sufficient sustenance for a single person for one day (does not include water).
Oxygen Tank	50	When attached to a vacsuit allows up to 12 hours of oxygen under normal circumstances. 4 hours under stressful circumstances. Explosive.

ITEM	COST	DESCRIPTION
Pain Pills (x6)	450	When ingested immediately heals 1d10 points of damage and lowers Stress by 1. There is a danger of addiction and/or overdose if used frequently.
Radio Jammer	175	Renders incomprehensible the radio signals of all within 100km.
Rebreather	45	Filters air and allows for underwater breathing for up to twenty minutes at a time without resurfacing.
Scalpel	50	Grants +10% to anyone making Surgery Checks. Can be used as a weapon.
Short-range Comms	30	Allows communication from ship-to-ship within a reasonable distance as well as surface-to-surface within 12 kilometers.
Standard Battle Dress	750	This light plated armor is the standard dress for marines going into combat and confers a +10% bonus to the wearer's Armor Save.
Standard Crew Attire	20	Coveralls, leather jackets, sneakers, tank top or ragged tee. The standard outfit worn by crew members aboard spacecraft. Standard assumed attire for all classes.
Stimpak (x6)	600	Grants an immediate 2d10 to Health and temporarily increases Strength and Combat by 2d10 each for 1d10 hours. There is a danger of addiction and/or overdose if used frequently.
Survey Kit	200	When used on the surface of a planet allows for quick mapping of a nearby few kilometers as well as data on air breathability, gravity and other important notable features of the surrounding landscape.
Vacsuit	1000	Allows for movement in space without suffering penalties from radiation or lack of oxygen. Requires an oxygen tank to breathe. Often used with Mag-boots and a rigging gun. Confers +7% to Armor Saves.
Vibechete	75	Machete that vibrates at ultra-high speeds in order to cut cleanly through dense foliage. Can be used as a weapon.
Water Filter	15	Can pump 50 liters of filtered water an hour from even the most brackish swamps.

Oftentimes the difference between life and death in **Mothership** is having the right tools for the job at hand. Above is a non-comprehensive list of the kinds of gear you'll find in **Mothership**.

18.1 STARTING LOADOUTS & CREDITS

In character creation you have four different starting **Loadouts** to choose from. The Loadouts are there to make re-rolling a character fairly painless. If you pick one of the starting Loadouts then you get **5d10 Credits** to start with. If, however, you choose to forgo the starting Loadouts and buy your equipment piecemeal, then you roll **5d10+10** for your starting credits.

18.2 ADDICTION

Excessive use of Pain Pills or Stimpaks requires a **Body Save to prevent addiction**. Once addicted, make a daily Body Save or gain 1d10 Stress every day you go without. If used once per day for a week you'll need to take twice the amount of pills to gain the same effect.

Whenever you take more than one pill at a time roll 1d10. If you roll equal to or under the

number taken make a Body Save. Failure means you fall unconscious and the Warden rolls on the table on page 10.4. You can cure an addiction through in-game treatment or leveling up.

>> Read more about Stress and Panic on pages 25-26.

>> Read more about Leveling Up on pages 35-36.

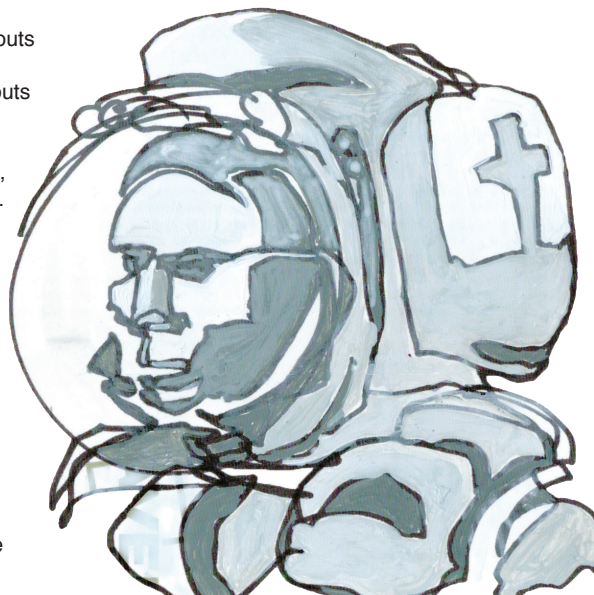

D100 TRINKETS

Roll on this table during character creation to find a random **trinket**. It can also be used anytime you search someone's pockets, body, bunk or backpack to find a random item of note.

D100	TRINKET
0	Preserved Insectile Aberration
1	Faded Green Poker Chip
2	Antique Company Script (Asteroid Mine)
3	Dessicated Husk Doll
4	Alien Pressed Flower (common)
5	Necklace of Shell Casings
6	Corroded Android Logic Core
7	Pamphlet: <i>Signs of Parasitical Infection</i>
8	Manual: <i>Treat Your Rifle Like A Lady</i>
9	Bone Knife
10	Calendar: <i>Alien Pin-Up Art</i>
11	Dog Tags (Heirloom)
12	Holographic Serpentine Dancer
13	Snake Whiskey
14	Medical Container, Purple Powder
15	Pills: Male Enhancement, Shoddy
16	Casino Playing Cards
17	Lagomorph Foot
18	Moonstone Ring
19	Manual: <i>Mining Safety and You</i>
20	Pamphlet: <i>Against Human Simulacrum</i>
21	Animal Skull, 3 Eyes, Curled Horns
22	Bartender's Certification (Expired)
23	Bent Wrench
24	Prospecting Mug, Dented
25	Eerie Mask
26	Vantablack Marble
27	Ivory Dice
28	Tarot Cards, Worn, Pyrite Gilded edges
29	Bag of Assorted Teeth
30	Ashes (A Relative)
31	DNR Beacon Necklace
32	Cigarettes (Grinning Skull)
33	Pills: Areca Nut

D100	TRINKET
34	Rejected Application (Colony Ship)
35	Pamphlet: <i>Android Overlords</i>
36	Smut (Seditious): <i>The Captain, Ordered</i>
37	Key (Childhood Home)
38	Manual: <i>Panic: Harbinger of Catastrophe</i>
39	Token: <i>"Is Your Morale Improving?"</i>
40	Phosphorescent Sticks, Neon
41	Pamphlet: <i>The Indifferent Stars</i>
42	Calendar: <i>Military Battles</i>
43	Manual: <i>Rich Captain, Poor Captain</i>
44	Campaign Poster (Home Planet)
45	Pendant: Shell Fragments Suspended in Plastic
46	Titanium Toothpick
47	Gloves, Leather (Xenomorph Hide)
48	Pamphlet: <i>Zen and the Art of Cargo Arrangement</i>
49	Pictorial Pornography, Dogeared, Well Thumbed
50	Brass Knuckles
51	Fuzzy Handcuffs
52	Journal of Grudges
53	Stylized Cigarette Case
54	Ball of Assorted Gauge Wire
55	Spanner
56	Switchblade, Ornamental
57	Powdered Xenomorph Horn
58	Bonsai Tree
59	Golf Club (Putter)
60	Trilobite Fossil
61	Pamphlet: <i>A Girl In Every Port</i>
62	Patched Overalls, Personalized
63	Fleshy Thing Sealed in a Murky Jar
64	Spiked Bracelet
65	Harmonica
66	Manual: <i>Spacefarer's Almanac</i> (out of date)

D100	TRINKET
67	Faded Photograph, A Windswept Heath
68	Stress Ball reads: <i>Zero Stress in Zero G</i>
69	Manual: <i>Moonshining With Gun Oil & Fuel</i>
70	Gyroscope, Bent, Tin
71	Coffee Cup, Chipped, HAPPINESS IS MANDATORY
72	Darts, Magnetic
73	Spray Paint
74	Wanted Poster, Weathered
75	Locket, Hair Braid
76	Pick, Miniature
77	Blanket, Fire Retardant
78	Hooded Parka, Fleece-Lined
79	BB Gun
80	Flint Hatchet
81	Pendant: Two Astronauts form a Skull
82	Rubik's Cube
83	Manual: <i>Survival: Eat Soup With a Knife</i>
84	Sputnik Pin
85	Ushanka
86	Trucker Cap, Mesh, Grey Alien Logo
87	Menthol Balm
88	Pith Helmet
89	10x10 Tarp
90	<i>I Ching</i> , Missing Sticks
91	Kukri
92	Trench Shovel
93	Shiv, Sharpened Butter Knife
94	Taxidermied Cat
95	Pamphlet: <i>Interpreting Sheep Dreams</i>
96	Pair of Shot Glasses, Spent Shotgun Shells
97	Opera Glasses
98	Pamphlet: <i>The Relic of Flesh</i>
99	Miniature Chess Set, Bone, Pieces Missing

Roll on this table during character creation to find a random **patch** that you have sewn on your clothing or gear. Patches don't have any mechanical significance but give you insight into your character.

D100	PATCH
0	"#1 Worker"
1	Security Guard patch
2	Blood Type (Reference Patch)
3	Red Shirt Logo
4	"Don't Run You'll Only Die Tired" Backpatch
5	Poker Hand: Dead Man's Hand*
6	Biohazard Symbol
7	Mr. Yuck
8	Nuclear Symbol
9	"Eat The Rich"
10	"Be Sure: Doubletap"
11	Flame Emoji
12	Smiley Face (Glow in the Dark)
13	"Smile: Big Brother is Watching"
14	Jolly Roger
15	Viking Skull
16	"APEX PREDATOR" (Sabertooth Skull)
17	Pin-Up (Ace of Spades)
18	Queen of Hearts
19	Pin-Up (Mechanic)
20	BOHICA**
21	Front Towards Enemy (Claymore Mine)
22	Pin-Up (Riding Missile)
23	FUBAR
24	"I'm A (Love) Machine"
25	Medic Patch (Skull and Crossbones on Logo)
26	HELLO MY NAME IS:
27	"Powered By Coffee"
28	"Take Me To Your Leader" (UFO)
29	"DO YOUR JOB"
30	"Take My Life (Please)"
31	"All Out of Fucks To Give" (Astronaut with Turned Out Pockets)
32	Allergic To Bullshit (Medical Style Patch)

D100	PATCH
33	"Fix Me First" (Caduceus)
34	"Upstanding Citizen"
35	NASA Logo
36	"Cowboy Up" (Crossed Revolvers)
37	Dove in Crosshairs
38	Chibi Cthulhu
39	"Welcome to the DANGER ZONE"
40	Skull and Crossed Wrenches
41	Pin-Up (Succubus)
42	"DILLIGAF?"
43	"DRINK / FIGHT / FUCK"
44	"Work Hard / Party Harder"
45	Mudflap Girl
46	Fun Meter (reading: Bad Time)
47	"GAME OVER" (Bride & Groom)
48	Heart
49	"IMPROVE / ADAPT / OVERCOME"
50	"SUCK IT UP"
51	HMFIC***
52	"Troubleshooter"
53	"IF I'M RUNNING KEEP UP" Backpatch
54	Crossed Hammers with Wings
55	"Keep Well Lubricated"
56	Soviet Hammer & Sickle
57	"Plays Well With Others"
58	"Live Free and Die"
59	Pin-Up (Nurse): "The Louder You Scream the Faster I Come"
60	"Meat Bag"
61	"I Am Not A Robot"
62	Red Gear
63	"I Can't Fix Stupid"
64	"Space IS My Home" (Sad Astronaut)
65	All Seeing Eye
66	"Do I LOOK Like An Expert?"

D100	PATCH
67	"NOMAD"
68	"I'm Not A Rocket Scientist / But You're An Idiot"
69	"LONER"
70	"I Am My Brother's Keeper"
71	"Mama Tried"
72	Black Widow Spider
73	"My Other Ride Married You"
74	"One Size Fits All" (Grenade)
75	Grim Reaper Backpatch
76	ОТЪБИСЬ (Get Fucked, Russian)
77	"Smooth Operator"
78	Atom Symbol
79	"For Science!"
80	"Actually, I AM A Rocket Scientist"
81	"Help Wanted"
82	Princess
83	"I Like My Tools Clean / And My Lovers Dirty"
84	"GOOD BOY"
85	Dice (Snake Eyes)
86	"Travel To Distant Exotic Places / Meet Unusual Things / Get Eaten"
87	"Good" (Brain)
88	"Bad Bitch"
89	"Too Pretty To Die"
90	"Fuck Forever" (Roses)
91	Icarus
92	"Girl's Best Friend" (Diamond)
93	Risk of Electrocutation Symbol
94	Inverted Cross
95	"Do You Sign My Paychecks?" Backpatch
96	"I ♥ Myself"
97	Double Cherry
98	"Volunteer"
99	"Solve Et Coagula" (Baphomet)

*Aces full of 8s

** Bend Over Here It Comes Again

*** Head Mother Fucker in Charge

HIRING MERCENARIES: STATS

At many starports throughout the galaxy you'll find busy and hungry mercenaries, freelancers, pioneers, and hitchhikers, all looking for work or a ride to the next system. If you find your crew light and need extra hands to fulfill your mission or staff your ship you may want to hire some mercenaries. But you should be careful: many mercenaries can be cutthroat and disloyal, leaving you to die when you need them the most.

21.1 MERCENARIES' STATS

Mercenaries are much simpler characters than the one you'll play and so only have four Stats:

- » **Combat:** This works exactly like your Combat Stat though it also serves as a mercenary's Armor Save.
- » **Instinct:** This is a catchall for Fear, Sanity, Body, Speed, Intellect and everything else.
- » **Hits:** As opposed to tracking their Health, most mercenaries die in one or two hits.
- » **Loyalty:** Rolled on hire. Loyalty is a Save that should be rolled whenever the mercenary needs to make a choice between what's best for them and what's best for you.

These simplified Stats make mercenaries easier to track and a sheet is included on the next page to track the mercenaries you've hired.

Mercenaries are generally weaker than you are, and don't last long in Mothership, so be sure to protect them.

21.2 HOW MUCH DO MERCENARIES COST?

Mercenaries are paid an advance when hired and then paid a monthly salary going forward. This advance and salary are negotiated up front along with any potential share of earnings that might be incurred on the particular mission.

MOTHERSHIP		MERCENARIES					EXP
NAME	JOB	HITS	COMBAT	INSTINCT	LOYALTY	NOTES	
AMBROSE	PILOT	1	25	25	35	2XP	
DR. HAGAR	RESEARCHER (GENETICIST)	1	15	10	26	1XP	
PFC. JACOB CARVER	MARINE GRUNT	1	25	25	36	FLAME THROWER SPECIALTY	
LT. EVE ATKINSON	MARINE LT.	3	30	35	15	MILITARY TRAINING, COMMAND	

Mercenaries may negotiate a higher price (up to twice as much on their advance and/or salary) depending on the danger and length of the job and the reputation of the crew. However, they often give discounted prices for hiring in bulk (say hiring a team of Marines with an officer, or a crew of Teamsters including a Captain, Co-Pilot and Engineer who are used to working together). To hire a mercenary, make an Intellect Check modified by the chart below. Success means they accept the job, failure means they won't (without further remuneration).

INTELLECT	MERCENARY NEGOTIATION
-20	Not given a share of earnings.
-5	Won't have their own quarters on ship.
-10	Job is known to be dangerous.
-5	Advance is less than standard.
+5	Hiring for at least a month.
+10	Hiring 4 or more from the same crew.

Additionally, mercenaries always indicate a next-of-kin who will receive any earnings owed to them in the event of their death. Non-payment of these earnings is often enough justification to warrant a low bounty (usually for half the amount owed) and opportunistic warrant officers may take up the case the next time you dock.

21.3 CAN MERCENARIES LEVEL UP?

Mercenaries gain XP just like you do, with one important caveat: they do not get the normal "survival bonus" of having survived the night of gameplay; instead they get 1 XP for surviving.

All mercenaries start as 0 level characters. If your character dies, becomes insane, or is otherwise unplayable you can play one of the mercenaries you've hired and roll up a full character for them (starting at the level they currently are).

21.4 MERCENARIES IN COMBAT

In combat Mercenaries can be played by the person who hired them or by whoever is closest (or by the Warden if no player accompanies them). Generally, mercenaries only take orders from the person who hired them (or from their own internal officers, if they have any). They always go last in turn order.

HIRING MERCENARIES: COST

MERCENARY	HITS	COMBAT	INSTINCT	LOYALTY	ADVANCE	SALARY	LOADOUT	SKILLS
Archaeologist	1	20	15	5d10	500	750	Excavation	Archeology
Asteroid Miner	2	25	25	4d10	125	500	Excavation	Rimsmart, Asteroid Mining
Android	2	25	35	5d10	1000	5000	Any package	Pick one Trained and one Expert
Captain	3	30	40	5d10	2000	8000	Exploration	Piloting, Vehicle Specialization, Command
Courier	2	20	30	6d10	75	250	Exploration	Zero-G, Rimsmart
Doctor	1	15	25	6d10	2000	6000	Examination	First Aid, Pathology
Engineer	2	25	25	6d10	750	4000	Exploration	Mechanical Repair, Engineering
Gunner	2	30	25	5d10	500	1500	Exploration	Gunnery
Marine Grunt	2	25	25	4d10	150	600	Extermination	Military Training
Marine Officer	2	30	35	6d10	500	2000	Any package	Military Training, Command
Marine Specialist	3	35	30	5d10	275	1500	Extermination	Military Training, Weapon Specialization (Pick Weapon)
Navigator	1	15	20	5d10	400	2000	Exploration	Astragation
Pilot	1	15	25	5d10	500	3000	Exploration	Piloting
Priest	1	15	20	4d10	60	200	None	Theology or Mysticism
Psychologist	1	15	15	5d10	250	1000	Examination	Psychology
Researcher	1	15	10	5d10	400	1500	Examination	Pick One: Biology, Geology, Computers, Mathematics, Art, Chemistry, Genetics, Planetology, Physics
Sophontologist	1	15	10	6d10	500	1750	Examination	Sophontology
Surgeon	1	15	20	6d10	2000	7000	Examination	First Aid, Pathology, Surgery
Void Urchin	2	25	40	3d10	40	100	None	Rimsmart, Mysticism

MOTHERSHIP

MERCENARIES

PLAYER

NAME

JOB

HITS

COMBAT

INSTINCT

LOYALTY

NOTES

HIRING MERCENARIES: SCUM

Sometimes there is no one to hire but the people no one is desperate enough to hire. If you cannot find a mercenary who will work for you you can roll once on the table below and take what you get.

The **scum** below are archetypes, not individuals. They cost 100 credits in advance and have a salary of 200. They have lower than average Stats (15 Combat, 15 Instinct, and 3d10 Loyalty) as well as tactical and personal issues conjoined with a lack of redeeming knowledge skills.

ROLL	SCUM	DESCRIPTION	NOTES
1	Whiskey Tango Ronin	Domestic Violence, outstanding warrants, Fealty To One's Lord, Honorable Combat, only obeys master, refuses stealthy solutions.	Loadout: Katana, Hagakure. Demand for One Year's Pay from Their New Master (non-negotiable, paid in spring).
2	The Witness	Exceedingly polite, courteous and dressed in crisp and clean clothing. Will explain their religion and witness to you at any point you may be susceptible to conversion—we all know there are no atheists in foxholes—will happily torture and/or murder those who disparage their god.	Loadout: Religious Text, Immaculate Clothes, Pamphlets about Their Religion, Missionary Zeal.
3	The Sex Bot (Android)	Some genius thought the logic chip on an Android attuned to game theory and human sexuality would be an unbeatable prostitute—their rote behavior and uncanny valley state were a turn off. Because of this they are hypersexual at all times, inappropriately frank about your appearance, lack any scientific knowledge and cannot handle weapons.	Loadout: Lube, amyl nitrates, many sex manuals, tear away clothes, shady sunglasses.
4	The Wretch	Self-pitying, ratfucked, miserable and talkative; they lack any awareness of how depressing they are and how much they stress everyone out.	Mechanical: Stress gains are doubled when the Wretch is around (they blurt out the worst possible outcome and denigrate all solutions).
5	The Preening Pseudo-Intellectual	You have met their kind on every habitable planet, you will most likely encounter them in hell. This ignoramus seamlessly integrates a complete lack of self awareness and tact with a total paucity of knowledge. This results in tantrums, evasions, compulsive lying and attempts to micromanage others.	Mechanical: Intellect Saves have Disadvantage when the Preening Pseudo-Intellectual is around (they argue in bad faith, making it difficult to accomplish anything).
6	The Dude	Lackadaisical, lax, indifferent, just wants to minimize work and half asses any task.	Loadout: Tattered bathrobe, poorly maintained gear, drugs to cope with working.
7	The Rich Kid	Feels stifled by the upper echelons of society and wishes for the authentic experiences of the poor. Is in a contest to be the "most poor," performing as an isolated rich child would assume; wishes for the crew to go without luxuries or reserves; prides himself on using only scavenged, poorly maintained gear.	Mechanical: Their family will not financially help vagabonds; they will put out a bounty on every member of the crew should their unwanted child die, simply to keep up appearances.
8	The Hitchhiker	Only in it for the free ride, the Hitchhiker will abandon your crew as soon as it is most convenient for them, possibly making off with whatever isn't tied down.	Loadout: Towel, eReader, electronic toolkit.
9	The Moon Child	Blessedly ignorant, into crystal healing, against medicine, wants to vibe with you, does not comprehend hygiene. Will replace your gear with "natural" solutions.	Loadout: Interesting twigs and rocks, some sort of fruit jerky, a book on non-violent communication to be angrily foisted on your crew.
10	The Sole Survivor	Grizzled, seemingly immortal, a crew member of ill omen. They are the last to survive because they will cut down, abandon or sell out their companions to take the full share of the loot and minimize risk. Tells gruesome, stressful stories about the passing of previous compatriots distorted to minimize their responsibility.	Mechanical: During combat, when determining turn order, randomly give one member of the crew Disadvantage on their Speed Checks for the entire Combat. The Sole Survivor, however, always acts with those who succeeded.

HIRING MERCENARIES: MOTIVATIONS



Regardless of who you end up hiring, it may at some point become important to know why they decided to ship out with you. The Warden can roll on the table below to find out what exactly makes your new-found hires tick and when and where that may become a problem for you.

D100	D10	MOTIVATION
0 - 49	1	Need to pay off a Crime Syndicate
	2	Need to pay off a Repossession agent
	3	Need to pay off advance from another Captain*
	4	Need to pay off a Separatist Militia
	5	Need to pay off their Unpaid Taxes
	6	Need to pay off jumped Bail/Court fine
	7	Need to pay off a Pawn Shop**
	8	Need to pay off a Brothel
	9	Need to pay off a Loan Shark / Payday Loan
	10	Need to pay off losing everything to a Ponzi Scheme***
50 - 80	1	They are hunting down a former partner
	2	They are hunting down a bounty hunter
	3	They are hunting down a petty official
	4	They are hunting down a mining magnate
	5	They are hunting down a military commander
	6	They are hunting down a parent
	7	They are hunting down a loan shark
	8	They are hunting down a snitch
	9	They are hunting down their sibling
	10	They are hunting down an opulently wealthy Scion
81 - 99	1	They are secretly part of a cult (Aberrant, Secretive)
	2	They are secretly a spy (Corporate, Rival Crew, Government)
	3	They are secretly a Smuggler (Extremely Illegal Goods)
	4	They are secretly a Saboteur/Wrecker (Opportunistic)
	5	They are undercover Secret Police (Investigating Party)
	6	They are secretly Infected (Seeks to Spread)
	7	They are secretly a Recruiter (Evaluating Ship on Behalf of Criminal Syndicate, Corporate Concern, Cult, etc.)
	8	They are secretly a Con Artist
	9	They are secretly a Serial Killer hiding from the law
	10	They are secretly a Bounty Hunter looking for you

*This is more "took the money and ran"

**They Need Your Advance to Recover their Gear

***They have only the Clothes on their Back



Whether it's the unknown horrors in the cosmos or the vast emptiness of space, encounters in **Mothership** take their toll on a person. **Stress** is a measure of that toll and how it subtly affects you, bringing you closer to the brink of **Panic**. While Stress by itself doesn't do anything, **the higher your Stress is, the more likely you are to Panic** when the time comes and the more likely the results will be devastating.

25.1 HOW DO I GAIN STRESS?

The primary way you gain Stress is by failing a Sanity, Fear, Body or Armor Save. When this happens, you **gain 1 (or more) Stress**.

There are a number of other ways to gain Stress as well, and the Warden is encouraged to come up with their own. Here are a few examples:

- » Any time the ship you're in takes a hit
- » Certain creatures, haunts and locations can give you Stress just by interacting with or seeing them
- » Getting knocked unconscious (see 10.4)
- » Going 24 hours without rest
- » Going without food or water
- » Near misses with asteroids and other massive objects
- » Whenever a scientist fails a Sanity Save, not only do they gain a Stress point, so does everyone nearby

25.2 HOW DO I RELIEVE STRESS?

Getting rid of Stress is a lot like healing from rest. Whenever you rest for at least 6 hours you can attempt a **Fear Save** to relieve your Stress. If you're successful then you can relieve 1 Stress point for every 10 points your Save succeed by (rounded down). Critical Successes double the amount of Stress reduced.

Example: Abel has 6 Stress and is really worried about making it through the next few days without panicking. The next time the crew takes a rest he decides to try and relieve some of his Stress. His Fear Save is 35, and luckily one of the scientists on the crew has Psychology as a Skill, and successfully makes an Intellect Check (Psychology), giving Abel Advantage on his Save. Unfortunately, Marlowe, the resident android, is going to keep watch while the rest of the crew sleeps, and Fear Saves made in the presence of androids are at Disadvantage. You can't have Disadvantage and Advantage at the same time, so they cancel out. Abel really want his Stress to come down, so he takes an automed which temporarily raises his Fear Save by 10% (for a total of 45). He rolls his Fear Save, a 44! Unfortunately, this isn't more than 10 points lower than his Save, so Abel would normally be awarded no respite. The Warden rules that since this was a Critical Success he should get something and so allows Abel to remove 1 point of Stress.

Resting isn't the only way to recover Stress — in our example above, another crew member spent time to give therapy to the character, which gave them Advantage on their Fear Save before resting, and pills also came into play. Here are a few other ways you might reduce your stress (by how much is up to the Warden):

- » Docking at a safe, civilized starport
- » Escaping from deadly peril
- » Sex, drugs, alcohol and carousing in general
- » Defeating a particularly difficult horror
- » Going a week without having to roll a Save

Taking a rest in cryosleep generally won't allow you to relieve Stress. And, of course, just like healing, attempting to rest in an unsettling or dangerous environment will mean Disadvantage on any Fear Saves (if the Warden even allows one).

If you have a Skill like Psychology or Theology, which allows you to assist other characters in relieving their Stress, you can only use it once per day (and you can't try to relieve your Stress that day either).

Eventually, Stress, Damage and emotional wear and tear will bring you to your breaking point. When that happens there's a chance that you'll lose control and Panic. You determine this by making a **Panic Check**.

26.1 WHAT IS A PANIC CHECK?

A Panic Check determines whether you are able to keep your cool under extreme pressure. There are two steps:

1. **Make a Stress Check (2d10):** If you roll over your current Stress you don't Panic and you relieve 1 Stress. If you roll equal to or lower than you current Stress you Panic and move on to step two.
2. **Roll for Panic Effect (2d10):** Roll another 2d10 on the Panic Effect Table to the right and add your current Stress.

While the results on **Panic Effect Table** are primarily negative there is the possibility of grace under fire.

26.2 WHEN SHOULD I ROLL PANIC?

The Warden has a lot of sway here in determining when is a good time to call for Panic rolls, but here are a few places where it would definitely be appropriate:

- » After seeing more than one crew member Panic at the same time
- » Encountering a strange and horrifying alien for the first time
- » Getting hit with a Critical Success
- » Losing more than half your Max Health in one hit
- » Rolling a Critical Failure on any kind of Save
- » Seeing another crew member die
- » When all hope seems lost and death seems certain
- » Whenever your ship takes Damage from a Critical Success

26.3 RESOLVE

Resolve is your ability to ignore or cope with your accumulated Stress. Every point of Resolve you have provides -1 to all rolls on the **Panic Effect Table**. If Resolve brings your Panic Effect total to 1 or less then there is no effect and you did not Panic. You start with 0 Resolve and can gain more (up to a maximum of five) by leveling up.

>> Read more about Leveling up on page 35-36.

ROLL	PANIC EFFECT
2-3	Laser Focus. Advantage on all rolls for the next 1d10 hours.
4-5	Major Adrenaline Rush. Advantage on all rolls for the next 3d10 minutes.
6-7	Minor Adrenaline Rush. Advantage on all rolls for the next 1d10 minutes.
8-9	Anxious. Gain 1 Stress.
10-11	Nervous Twitch. Gain 2 Stress. The nearest crew member also gains 1 Stress.
12-13	Cowardice. Gain 1 Stress. For the next 1d10 hours you must make a Fear Save to engage in combat or else flee.
14-15	Hallucinations. For the next 2d10 hours (determined secretly) you have trouble distinguishing between reality and fantasy.
16-17	Crippling Fear. Gain a new permanent phobia. Whenever you encounter this phobia make a Fear Save at Disadvantage or gain 1d10 Stress.
18-19	Overwhelmed. Gain 1d10 Stress.
20-21	Rattled. Let out a blood-curdling scream. Disadvantage on all rolls for 2d10 minutes.
22	Paranoid. For the next 1d10 days, whenever a character joins your group (even if they only left for a short period of time), make a Fear Save or gain 1 Stress.
23	Death Drive. For the next Xd10 days (where X=Stress) whenever you encounter a stranger or known enemy you must make a Sanity Save or else immediately attack them.
24	Catatonic. Become unresponsive and unmoving for Xd10 minutes (where X=Stress).
25	Broken. For the next Xd10 days (where X=Stress) make a Panic Check whenever a nearby crew member fails a Save.
26	Psychotic. Immediately attack the closest crew member until you do at least 2d10 Damage. If there is no crew member nearby you attack the environment.
27	Compounding Problems. Roll twice on this table.
28	Descent into Madness. Gain 2 new phobias. Your Stress cannot be relieved below 5.
29	Psychological Collapse. You become permanently, irreparably insane. Your character is now played by the Warden.
30+	Heart Attack. Instant death.

The majority of your time in **Mothership** will be spent aboard spacecraft, either traveling, in cryosleep, during downtime, excavating or scavenging from the ruins of one or trying to survive against some horrific force in one.

>> Read more about Ship Design on pages 29-32.

27.1 HOW LONG DOES IT TAKE?

There are two possible ways for a ship to travel: via Jump Drive or via Thrusters. Jump Drives are powerful engines designed to allow a ship to move faster than the speed of light and travel great distances by “jumping” into hyperspace. Many ships don’t need them and rely strictly on their Thrusters, powerful jets that propel ships between planets and occasionally solar systems (albeit at a much slower speed than jump drives). All ships must have Thrusters for maneuvering in and out of spaceports and from planet to planet, but not all ships need a Jump Drive.

Each ship has a Speed Stat (determined by its thrusters). As a general rule you can determine how long it’ll take to get places, using Thrusters alone, based on the table below.

SPEED	INTERPLANETARY	INTERSTELLAR	INTERGALACTIC
10-30	Weeks	Years	Millenia
31-50	Days	Months	Decades
51-80	Hours	Weeks	Years

27.2 JUMP DRIVES & HYPERSPACE

Jump Drives are rated from 1-9, with the rating showing how large of a jump they can make at a time as determined by the Warden. Most crews spend their time in hyperspace in cryosleep with an android manning the astrogation computer during the jump. Those who stay awake during hypersleep have reported strange and conflicting stories about the experience, and often androids’ memories of the experience are at best described as unsettling.

Time dilation due to the effects of relativity on Faster-Than-Light travel are uncertain and sometimes seemingly random. A crew will return from a standard Jump-3 voyage to find that they have been gone for several years. Others return to find it has only been a month. Standardized trade routes seem to wear down the chaotic

effects, but those who make long jumps, like the legendary Jump-9 colony ships, are never expected to return, their settlers leaving their previous lives behind. Part of it is the expense of building the colony ship but the other part is that no one is certain what the effects of multiple Jump-9s would be. And perhaps they have returned, just millenia into our future, or else somewhere in our past.

27.3 CAN I CAPTAIN MY OWN SHIP?

In general, most ships can be piloted by one person and a working Computer. To be considered a Captain, however, (generally a requirement for purchasing or owning a ship), you’ll need to have the **Vehicle Specialization** skill in the class of ship you’ll Captain as well as the **Command Skill**.

27.4 BASIC SHIP CLASSES

The table on page 28 includes a few basic ship classes to start out. This is certainly not a comprehensive list. If you took Vehicle Specialization as a Skill any of these classes would make for a suitable Specialization. Included below are the minimum and maximum hull sizes for the various classes as well as any modules (or quantity of modules) that the ship requires. Beyond the required modules the ships can be outfitted however you want.

27.5 BUYING A SHIP

Ships are incredibly expensive, with each point of hull costing roughly 10 million credits (more or less depending on the port and condition of the ship). If your Warden allows you to start your campaign with a ship we recommend starting with a ship of the minimum hull size allowed for the ship’s class and the assumption that 6d10 percent of the ship’s cost has been paid off before the campaign began. For simplicity’s sake, 10% of all credits earned in play go directly to paying down the debt.

27.6 REFUELING

It costs 1 unit of fuel per day to run the Thrusters. Jumps require fuel equal to the jump (so a Jump-2 requires 2 units of fuel). While in orbit, the ship only consumes 1 unit of fuel per week. To launch from the surface of an average gravity

planet consumes 3 fuel. Complicated ship-to-ship combat with lots of maneuvering may also consume a unit of fuel depending on the Warden's ruling. All of these units are in refined fuel, which is what most star ports use. Unrefined fuel can be found in some asteroids as well as in some distant star ports. It costs twice as much unrefined fuel as refined fuel to do the same job. Refined fuel costs vary by system but start at 10,000 credits per unit.

28.1 UPGRADES & REPAIRS

Every player on board a ship with Mechanical Repair, Engineering or any similar Skills can attempt an Intellect Check to repair damage to the ship. **For every five points you succeed the Check by you can repair 1 Hull.** A ship which has taken 25%, 50%, or 75% damage, however, cannot be repaired beyond that point without returning to a starport. Players may **only attempt to repair once** before

they need to return to a starport, dock with another ship, buy more parts, etc.

At a well-equipped star port upgrades to a ship take 1 week per 10 Hull added (or changed). Repairs take 1 day per 10 Hull repaired. Poorly equipped or remote star ports can double or triple the time taken to repair or upgrade ships. Repairs cost 100,000 credits per Hull while upgrades cost the standard 10 million credits per Hull. If the crew can't pay the full cost of the repair or upgrades most ports will let them take out a loan as long as they can pay 30-50% of the cost upfront and pay off the remainder over the coming months. If the crew can't pay the upfront charge then the ship is held until the crew can come up with the money. There are often patrons looking to hire mercenaries for dangerous jobs at these ports and you can often find work with them in hopes of paying off your ship's repairs.

CLASS	MIN. HULL	MAX. HULL	REQUIRED MODULES	NOTES
Escape Pod	20	35	Only minimum requirements.	Capable of drop-landing on planet surface.
Utility Pod	22	45	Weapon Mount 1, Cargo Hold 1	Used for outerspace maintenance and repair.
Fighter	34	68	Armor 3, Weapon Mount 1, Thruster 3	Weapons can be fired by the pilot from the command module.
Shuttle	25	50	Galley 1, Living Quarters 1, Cargo Hold 1	Often hangared within a larger ship.
Courier	30	60	Jump Drive 1, Computer 1, Galley 1, Cryo 1, Living Quarters 1, Cargo 1, Thruster 3	Extremely fast ships used for quick transportation and communication.
Research Vessel	35	90	Computer 1, Galley 1, Living Quarters 1, Barracks 1, Cargo Hold 1, Science Lab 1	Dispatched to observe strange new planets or phenomena.
Cutter	50	125	Armor 3, Galley 1, Weapon Mount 3, Medical Bay 1, Living Quarters 2, Barracks 1, Cargo Hold 1, Thrusters 3	Used by police forces and planetary patrols. Often escorts for larger ships.
Hunter	55	140	Life Support 2, Armor 4, Jump Drive 1, Computer 1, Galley 1, Weapon Mount 3, Cryochamber 1, Living Quarters 1, Cargo Hold 1, Thrusters 4	Bounty Hunter's preferred vehicle. Fast, well armed, and armoured. Prisoners are kept in cryosleep.
Mining Frigate	55	165	Jump Drive 1, Computer 1, Galley 1, Weapon Mount 1, Medical Bay 1, Cryochamber 1, Living Quarters 1, Barracks 1, Cargo Hold 1, Science Lab 1	Standard vessel for mining operations. Often carry Utility Pods for use in asteroid mining.
Blockade Runner	60	120	Armor 3, Jump Drive 1, Computer 1, Galley 1, Weapon Mount 2, Medical Bay 1, Cryochamber 2, Living Quarters 1, Barracks 1, Cargo Hold 1, Thrusters 4	Smuggler's choice. Equipped to evade patrols and often disguised to look like a freighter or mining frigate.
Freighter	65	230	Galley 1, Medical Bay 1, Living Quarters 1, Barracks 1, Cargo Hold 30	Primarily used for shipping, a common choice for smugglers and pirates.
Troopship	130	325	Life Support 10, Armor 5, Galley 5, Weapon Mount 2, Medical Bay 1, Cryochamber 25, Living Quarters 4, Barracks 8, Cargo Hold 10	Marine vehicle meant to transport troops and vehicles into combat. Occasionally carries a couple fighters.
Colony Ship	210	???	Life Support 16, Command 3, Jump Drive 4, Computer 4, Galley 8, Medical Bay 2, Cryochamber 40, Living Quarters 20, Barracks 7, Cargo Hold 30, Science Lab 3	Long distance transport meant for establishing colonies in distant systems. Poorly armored but well stocked.

MOTHERSHIP

SHIP NAME **FALSTAFF**

TYPE **ASTEROID** CLASS **MINING FRIGATE**

1. SELECT PRIMARY MODULES *REQUIRED MODULES

LIFE SUPPORT* Life support keeps the human crew alive. Each point of life support can support up to 10 humans. For every point below the required minimum, anyone not wearing a vacsuit must make a Body Save every hour or take 1d10 damage. This includes those in cryochambers as well, but does not include androids. Many ships include 2-3 times the required amount of life support in case of extra passengers or damage to the system.

COMMAND* The command module is the cockpit, command center, or bridge of a ship. For every 4 officer positions, one command module is required. Officers can be captains, first mates, navigation officers, communications officers, and is largely up to the Warden and the players to decide.

ARMOR* Armor plating protects the ship from small meteorites, space dust and debris, as well as, if need be, attacks from other vessels. Every point of armor costs 3 hull, and grants the ship +10% Armor Save (Max 80).

2. SELECT SECONDARY MODULES

JUMP DRIVES Jump drives enable the ship to travel through hyperspace. Every point of Jump Drive increases the ship's jump capability by 1 (Max 9). The first drive costs 1 hull, the second costs 2, the third costs 3, etc.

COMPUTER The ship's computer is a powerful artificial intelligence that helps with astrogation, combat, and a number of other autonomous tasks. A ship's Intellect is equal to the number of computer modules $\times 10 + 30\%$. It's Combat is equal to the number of computer modules $\times 10 + 10\%$. A computer module is required for each jump drive. Additionally, each computer module equipped allows the computer to take more actions during combat.

GALLEY Galleys contain a kitchen, restrooms, and a common area on a ship. Any ships making trips longer than 1 day must have 1 galley for every 2 life support modules or else the crew must take Body Saves once/day. Failure means 2d10 damage and 1d10 Stress. Galleys must be re-stocked once a month and extra stores take up 1 Cargo.

WEAPON MOUNT For every weapon your ship has you must have 1 mount for it. You can find the list of ship weapons in the Player's Survival Guide on page 30.

MEDICAL BAY Medical bays allow scientists, doctors, and other researchers to heal crew members and perform various procedures (biopsies, autopsies, surgery). Each connected medbay on the ship grants +5% to the Intellect of the Scientists or Androids using them. Medical bays also grant advantage on Body Saves made for healing.

CRYOCHAMBER Cryochambers allow humans to sleep during long trips, particularly through hyperspace. Androids do not require them. Each point of hull spent on cryochambers accommodates up to 4 cryosleep pods. Individuals who don't go into cryosleep during hyperspace jumps often have strange and terrifying experiences.

LIVING QUARTERS Generally, if a ship is to travel through normal space for at least a week, then living quarters or "staterooms" are provided for each of the ship's officers, or other important crew members.

BARRACKS The same as living quarters, except they are non-private and house up to twelve crew members. Like living quarters, they are non-essential rooms, but ships that need them, but don't have them, give their crew +1 Stress per journey or month of travel.

CARGO HOLD Cargo holds are essentially 20x20m rooms used for storage. Each cargo hold can hold up to 10 cargo units (each cargo is roughly the size of a large pallet). Cargo holds can also be used for any other basic room not provided for on this list (brig, secret compartments, mining equipment, training facilities, hangars, armories, etc.).

SCIENCE LAB Similar to the medical bay, the science lab allows for detailed research. Each connected science lab grants +5% Intellect to Scientists and Androids using them to conduct research or experiments. Additionally, they can be designated as repair shops and used by Teamsters to repair electronics, machines, or even Androids.

3. CALCULATE BASE HULL BY ADDING UP THE TOTAL HULL FROM THE LIST ABOVE.

4. CALCULATE TOTAL HULL BY ADDING UP THE REQUIRED MODULES BELOW.

THRUSTERS* Without thrusters, the ship cannot move. Every thruster module equipped increases the speed of the ship by +10% (to a maximum of 80). Additionally, thrusters cost an extra 1 hull for every 10 base hull.

ENGINE* Without the engine, the entire ship ceases to operate and becomes a ruin. You must have 1 engine module for every jump drive, plus 1 for every 4 thrusters, plus 1 for every 20 points of base hull.

FUEL* The engine needs fuel to run on. Every jump requires double the fuel of the jump (Jump 2 = 4 fuel) and thrusters burn 1 unit of fuel per day. The engine requires at least 3 fuel for every point of engine plus any extra fuel capacity you want to add. More fuel can be stored in Cargo Holds at 1 Fuel per 10 Cargo.

FRAME* Frame covers the miscellaneous parts of a ship, docking gear, airlocks, ventilation, corridors, comms relays, everything else a ship generally uses. Frame is 1 point per 10 points of base hull.

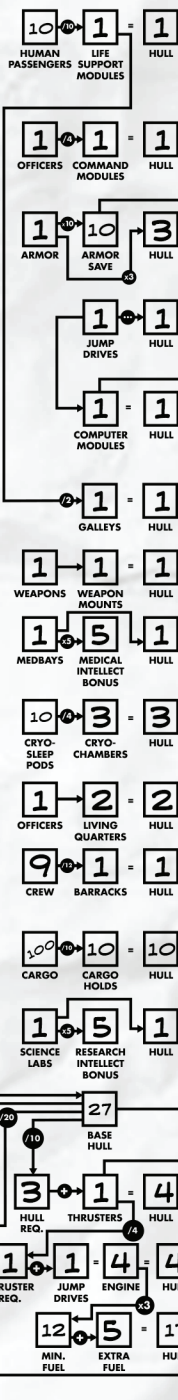

Like building a character, all the rules you need to know to design a ship are included on the sheet at the back of this book. You can also take the ship example (*The Falstaff*) we've included and use it in your starting campaign as is. However, here's a little more detail if the sheet doesn't make sense at first glance.

30.1 SELECT PRIMARY MODULES

Ships are made up of **modules**, which are like rooms or parts of a machine. Each module does something special to help keep the ship running or provide for its crew members. Some of them, like Life Support and Fuel, are required. Other modules, like Weapon Mounts, are optional.

The basic building blocks of ship design are **Hull Points**. Each module costs a certain amount of Hull to make, oftentimes depending on other variables like how big your crew is, or how fast you want your ship to go. Each Hull Point costs roughly 10 million credits (ships are incredibly expensive). For now, starting at the top, fill in the data that you know in the boxes provided, starting with how many human passengers you think will be on the ship on average. Leave a little extra room in case you pick up some passengers along the way.

30.2 SELECT SECONDARY MODULES

All of these modules are non-essential to build a working ship. However, almost all ships will need at least some of these modules - for example, any ship wanting to make the leap into hyperspace will need Jump Drives, and if you have Jump Drives, you'll need a Computer as well as a Cryochamber. Many ships will have large Cargo Holds in order to fund their operations or to store other vehicles (or even smaller ships) for planetary exploration. This list of modules is not comprehensive and you are encouraged to work with your Warden to come up with new modules or upgrades for previously existing modules.

30.3 SHIP'S WEAPONS

Not every ship has weapons but many have at least a Laser Cutter to deal with incoming asteroids or meteorites. Most ship's weapons deal MDMG, or Megadamage, which is equivalent to about 100 regular damage. Here's a list of

some of the more common weapons you'll find ships equipped with. Each one must be manned by a crew member, or else be attached to an automated system, and thus, the Computer:

- » **Laser Cutter:** 1d10 MDMG. Shots before reloading: 12. The Laser Cutter takes one round to charge between firing. After firing 12 shots it must recharge for one day.
- » **Autocannon:** 2d10 MDMG. Shots before reloading: 24. Often automated by the Computer and a standard weapon for vehicles travelling in the far reaches of space.
- » **Railgun:** 1d10+10 MDMG. Shots before reloading: 12. A massive weapon used almost exclusively in military vehicles. Uses up two weapon slots and cannot be computer automated.
- » **Mounted Machine Gun Turrets:** 5d10 DMG. Shots before reloading: 36. These are anti-personnel turrets, used in protecting the ship while inside a planet's atmosphere. They're often mounted on ground vehicles as well. Often computer automated.
- » **Torpedoes:** 3d10 MDMG. Shots before reloading: 2. Incredibly powerful weapons that roll on the Critical Hit Effect Table (pg. 34) anytime they hit. The enemy, however, gets Advantage when making Armor Saves.
- » **Rigging Gun:** 1MDMG. Shots before reloading: 3. Deals little Damage but on a successful hit the two ships become attached and it takes requires a Speed Check to break free, often at the cost of rolling on the Critical Hit Effect Table (pg. 34). Rigging guns are often employed as the first step towards boarding another ship.

Each weapon can hold its amount of "shots before reloading" within its own mechanism while the rest of the ammunition must be retained in cargo. Some ships will designate cargo space adjacent to their weapons to ensure automated reloading.

30.4 CALCULATE TOTAL HULL

After adding up all the Hull Points from the modules you've installed, you'll have your **Base Hull**. This number is used to help calculate how much Hull is allocated to your Thrusters (for moving a big ship), as well as how big an Engine you'll need, which determines how much Fuel you'll need, as well as how big a Frame (the miscellaneous parts of the ship) the ship requires.

31.1 FILL IN YOUR SHIP STATS

Based on the modules you've purchased you'll now be able to fill in your ship's Stats. Pay careful attention to the arrows leading to your Stats.

Example: Your ship's Combat score is based on the number of Computer modules you have, multiplied by ten, and then adding ten to that number. In the case of The Falstaff we have 1 Computer module (see page 29) which multiplied by 10 gives us 10, plus the additional 10 gives us 20, our final Combat Stat.

Your **Armor**, while listed as a Stat, is really just like your Armor Save; it's what the ship must roll under to avoid taking Damage. Generally the captain or acting captain of the ship rolls the Armor Save. The ship's **Combat** Stat is used during Combat Checks, just like yours is (however in this case you can use whichever is higher, your own Combat Stat or the ship's). The ship's **Intellect** is both a Stat as well as it's Sanity Save, should the need arise. Sometimes the ship's AI gets corrupted and this becomes incredibly important. The ship's **Speed** is just like your Stat and is often used to see if the ship can dodge asteroids or escape explosions from collapsing stars.

Your ship's **Max Hull** is basically like your Health, and it's important to note what 25%, 50% and 75% of the Max Hull is because any time your ship takes Damage beyond those points it'll have to roll on the Critical Hit Effect Table (pg. 34). It's important to note that while each module is used to determine a ship's hull, just taking Hull Damage does not randomly destroy modules: usually only Critical Hits do that.

>> Read more about Ship Critical Hits on page 34.1.

Now is a good time to also list your **Max Fuel** and **Galley Stock**. Your Maximum Fuel is the same as your Fuel modules that you filled in previously. While you can store more fuel in the Cargo Hold if you need, this is the size of your fuel tank and the amount of fuel you have remaining until you'll need to refuel (either from your Cargo Hold, from a star port or a Tanker vessel). Additionally, your Galleys each store a month's worth of food before needing to be restocked.

31.2 LIST YOUR WEAPONS

Here you'll list your weapons and the Damage they do as well as any other notes you may have about them.

31.3 LIST YOUR OFFICERS

It can be useful to have all the ship's officers' names in one place for reference. What's more important, however, is the **Total Crew** number and the **Max Cap.** (Maximum Capacity) number, since these will determine whether your crew suffers any damage if and when the life support systems are harmed.

31.4 LIST YOUR CARGO MANIFEST

Here is where you list what major cargo your ship is carrying, up to the maximum cargo you're allowed based on your Cargo Hold modules. Each piece of cargo is roughly pallet sized.

31.5 DRAW YOUR SHIP'S LAYOUT

This part is a lot of fun. The ship design system is built such that 1 Hull = 1 square of graph paper, so it's easy to draw a ship with the information you have. Each square is roughly 20x20m. Any partial square counts as half a Hull, even if it's really a fourth of a square, or three-fourths. This just makes counting easier. The easiest way to draw the ship is to block off the entire outline first with your Max Hull and then add in modules as you see fit. Generally, you can avoid the Frame, Armor, and Fuel as these can just be assumed in the dark grey space between the other rooms. Feel free to draw as many connecting corridors, ventilation shafts and airlocks as you think are necessary to round out design. Once you've completed the layout, your ship is good to go!

Example: The Falstaff is built using the specs for the Mining Frigate on page 28. After filling in the required modules for the Mining Frigate specified we went through and made sure the Falstaff had everything else required for a standard ship (like a Command Module, Fuel, an Engine, etc.). After filling out all the modules and Stats, we drew the layout. We decided to give The Falstaff three different decks separated by function: the Command Deck, where our officers could control and pilot the ship, the Habitat Deck where the crew lives, and the Cargo Deck, where the majority of the work gets done when mining an asteroid. We kept the Engine close to the Thrusters and Jump Drive so that our engineers wouldn't have to run all over the ship fixing things in an emergency. We also added a large cargo bay door to the Cargo Hold as well as a docking port on the Cargo Deck between the Life Support and Computer modules. We added some connections between the decks and plenty of corridors, ensuring our crew could move about quickly. Finally, we added lots of airlocks and doors to make sure the crew could quarantine certain areas of the ship in a disaster.

5. FILL IN YOUR **SHIP STATS**

6. LIST YOUR **WEAPONS**

7. LIST YOUR **OFFICERS**

ARMOR 10

COMBAT 20

INTELLECT 40

SPEED 10

WEAPON	DAMAGE	NAME	RANK
LASER CUTTER	1D10MDMG	CARVER	CAPTAIN

8. LIST YOUR **CARGO MANIFEST**

TOTAL CREW 10 MAX CAP. 10

MINING EQUIPMENT X20
ORE X60

MAX HULL 55 55
CURRENT HULL

42
25%

28
50%

14
75%

550MIL 390.5MIL
COST OWED

MAX FUEL 17 17
CURRENT FUEL

GALLEY STOCK 30 30
CURRENT STOCK

9. DRAW YOUR **SHIP'S LAYOUT**

THE FALSTAFF

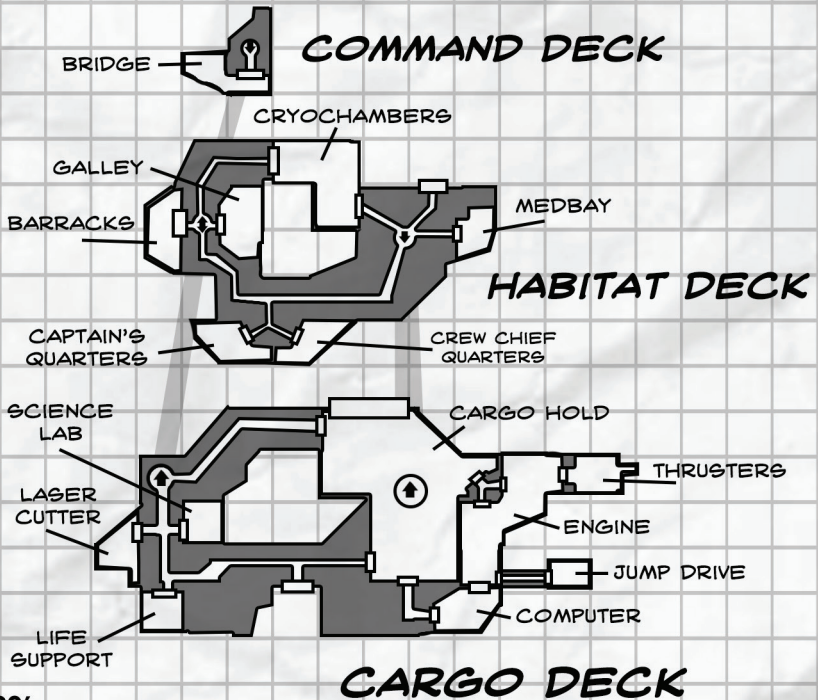

SHIP-TO-SHIP COMBAT: TURN ORDER, ACTIONS

Ship-to-ship combat works much the same as regular combat with a few notable differences.

33.1 WHAT'S THE SAME?

Surprise and turn order are still handled the same, using your Speed Stat to determine how often and in what order you go. You can also take two significant actions on your turn and generally do whatever you want as if this were a normal combat and you just happen to be aboard a ship.

33.2 WHAT'S DIFFERENT?

The big thing is that each ship has its own Stats and character sheet (completely separate from your own) which are used to determine a few different things.

- » It has a **Speed Stat** which is used to determine relative speed between ships in a fight as well as determining the success of complex piloting maneuvers (it's also used to determine travelling speed. See page 27.1.)
- » Most ships' weapons must be manned in order to be fired. Attacks are resolved with either the ship or operator's Combat (whichever is better). Gunnery improves Checks.
- » Instead of dealing regular Damage ships deal what's called **Megadamage**, or **MDMG**. Each point of MDMG is equal to roughly 100 points of regular Damage (so taking a direct hit from an ship's autocanon is likely to completely destroy you).
- » Ships have their own **Armor Save** which they use to absorb or deflect Damage done to their **Hull**.
- » Instead of a Health Stat like you have, ships have a **Hull Stat**, which if reduced to zero means the ship has been completely destroyed (It's also used extensively in ship design). Most combats end before ships are completely destroyed, as destroying a ship entirely often robs the attacker of some resource they presumably desire to take. However, this is sometimes not the case.

>> Read more about Ship's Stats on page 31.1

33.3 WHAT CAN I DO ON MY TURN?

You have a few more options in ship-to-ship combat than you do in a regular combat. However, the key differences to remember about ship-to-ship combat when it comes to your actions are:

- » You can engage in regular combat during a ship-to-ship fight, whether your ship is being boarded by intruders or dealing with some other internal threat. This can all be embedded within the same combat and all takes place in the same timeframe.
- » A ship's Computer can take a certain number of actions a turn on its own. It can take as many actions as there are Computer modules. Generally these actions include firing the ship's weapons, closing airlocks, etc.
- » You can hail the attacking ship or attempt to open a line of communication with them.
- » When the ship takes Damage it tends to affect everyone on board, or at least more than one person.
- » You can pilot fighter craft or sometimes powerful exo-suits and join in the ship-to-ship combat.
- » Ships are big, and it takes awhile to move around in them, so station people in places where they can be useful.
- » You can attempt to **repair Hull Damage** on your turn with an Intellect Check.

>> Read more about Repairing Ships on page 28.1



SHIP-TO-SHIP COMBAT: CRITICAL HITS

34.1 SHIP CRITICAL HITS

While reducing a ship's Hull Points to zero is a surefire way to destroy it, this is generally not how most ships are beaten in combat. Rather, Critical Hits have the ability to destroy important systems within the ship itself, thus disabling the ship or forcing the crew to surrender. Ships must roll on the **Critical Hit Effect Table** to the right every time the ship:

- » Takes a Critical Hit
- » Critically fails an Armor Save
- » The first time the ship takes Damage
- » Whenever the ship loses 25%, 50% and 75% of its Hull Points
- » Any time the ship takes Damage at 20 or less Hull Points

If a Critical Hit Effect cannot be accomplished (for example: if all the weapons are already destroyed) then use the next entry above on the table. Additionally, a roll of doubles on the Critical Hit Effect Table means the Critical Hit has affected more than one system and the player must roll again for an additional effect. This continues as long as the player continues to roll doubles, meaning that even one Critical Hit could mean total doom for a ship.

In general, anyone in the affected room hit must make a Body Save or take 1d10 damage from the shock. Additionally, anyone in a room that's destroyed must make a Body Save or also be destroyed. Final call, as usual, is left up to the Warden.



ROLL	CRITICAL HIT EFFECT TABLE
00-09	Cargo Destroyed. 1d10 units of cargo are destroyed.
10-14	Life Support System. Reduce Life Support modules by 1.
15-19	Massive Hull Damage. Ship takes x2 Hull Damage. Crew makes Body Saves or takes 1d10 Damage.
20-24	Armor Breach. Ship receives Disadvantage on Armor Saves until repaired.
25-29	Data Storage Wiped. All navigation and research data contained on the ship has been destroyed. The crew no longer knows where they are in space.
30-34	Thrusters. Reduce Thrusters by 1.
35-39	Random Stateroom or other non-essential room destroyed. Body Saves for those in the room to escape or be destroyed.
40-44	Random Weapon Disabled. Weapon cannot fire or function until repaired.
45-49	Jump Drive. Reduce Jump Drive by 1.
50-54	Engines. Reduce Engine by 1.
55-59	System Overload. Computer and Jump Drives cease to work for d10 rounds unless repaired. -10% to Combat.
60-64	Artificial Gravity. The artificial gravity in the ship ceases to work and everyone/ everything starts floating. Body Saves or take 1d10 damage from the jolt.
65-69	EMP. All systems shut down for 1 round. Androids shut off and must be rebooted.
70-74	1d10 Cryosleep Chambers Destroyed.
75-79	Hull Breach. Ship begins to depressurize (starting in random room) unless airlocks can be secured. Vacuum suits required for all affected areas and Body Save at Disadvantage to avoid being sucked out of the ship if you are in the vicinity of the breach.
80-84	Navigation Controls. Ship cannot change direction without Repair Check.
85-89	Internal Fire. Starts in random room, spreads one room per turn. Destroys room in 1d10 turns.
90-94	System Reboot. Entire ship ceases to function for 1d10 turns.
95-98	Cockpit or Bridge Destroyed. Body Saves to escape the room before it's destroyed.
99	Fuel Line. Ship destroyed in 1d10 turns.

Surviving in **Mothership** is tough, but those who survive come out even tougher. Every session you will gain some experience points (XP), and when you have enough you'll **level up** and be able to increase your abilities, making you more able to face the challenges ahead.

35.1 HOW DO I GAIN EXPERIENCE?

Surviving a session is worth 10 XP — if you survive the first night, you'll immediately level up. You'll reach level 2 after two more sessions.

Additional XP is awarded by the Warden for accomplishing goals. The triggers for XP rewards may vary considerably; however, they should be public knowledge. Some examples include:

- » Save another crewmember's life (3XP)
- » Investigate a distress signal (3XP)
- » Retrieve an ancient alien artifact (2XP)
- » Learn how to use an alien artifact (1XP)
- » Kill a creature with 70+ Instinct (2XP)
- » Map an unknown sector of space (5XP)
- » Unlock a great mystery (2XP)
- » Interface with strange beings far beyond your scope and abilities (1XP)
- » Be first to set foot on Exoplanet 47F2 (1XP)
- » Collect a genetic sample from the Zetalons on Exodus-4 (2XP)

35.2 XP BASED ON CLASS (OPTIONAL)

Additionally, you can easily tack on class-based XP awards to the current XP system. For example:

- » **Marines** gain 1XP whenever they kill an enemy.
- » **Scientists** gain 1XP whenever they bring a piece of alien technology or living organism aboard their ship for study.
- » **Androids** gain 1XP whenever they interface with a piece of alien technology or with a higher intelligence.
- » **Teamsters** gain 1XP whenever they first step foot on an undiscovered planet.

Note: These are just suggestions - but the idea is not necessarily to award XP for acting "in character" as much as it is to award XP for things that will put you and your crew in harm's way. The Marine wants to shoot the alien creature that's been attacking their troops while the Scientist wants to preserve at least one specimen and bring it aboard the shuttle for further study. While this is going on the Android has connected itself to an alien hive mind computer in order to better understand their fifth dimensional way of thinking and the Teamster is just trying to get off this rock and on to the next one. The crew will form internal alliances and factions when it comes to deciding the direction they should go, or how they should handle problems, which makes the game more fun.

35.3 HOW MUCH XP DO I NEED TO LEVEL UP?

You start off at level zero. If you survive your first session you'll level up and become a first level character. After that, use the table below to see how much XP you need to level up.

LEVEL	TOTAL XP NEEDED
0	0
1	10
2	25
3	50
4	75
5	125
6	175
7	225
8	300
9	375
10	500



36.1 WHAT CAN I DO WHEN I LEVEL UP?

You can level up whenever you are in a place safe enough to rest. Largely this is up to the Warden as to what constitutes a “safe” place, but, generally, even if a place would incur Disadvantage when resting for healing or recovering from Stress purposes, that’s safe enough to level up in.

1. PICK ONE MAJOR IMPROVEMENT

- (A) IMPROVE 1 **(STAT)** BY 5 AND ANOTHER BY 3 - MAX 85
- (B) IMPROVE 2 **(SAVES)** BY 4 EACH - MAX 85

2. PICK ONE MINOR IMPROVEMENT

- (A) GAIN 1 **(RESOLVE)** - MAX 5
- (B) REMOVE 1 **(PHOBIA OR ADDICTION)**
- (C) HEAL ALL **(STRESS)**

3. GAIN 2 **(SKILL POINTS)**

- » **Trained Skills** cost 1 point to learn.
- » **Expert Skills** cost 2 points to learn.
- » **Master Skills** cost 3 points to learn.
- » To take an Expert or Master Skill you must first take one of its prerequisite Skills.
- » You can “bank” Skill points and save them for future use.

Example: Lilith just barely survived her first session of play. After a hearty congratulations from the Warden, Lilith and the other players decide to level up and schedule their next session. Lilith looks over her sheet and thinks about where she can shore up some of her weak spots. She failed two Sanity Saves during play, but she also took a lot of Damage, so she decides to leave her Saves as they are and go with option A and improve 1 Stat by 5 and another by 3. She improves her Combat by 5, taking it to 35, and then increases her Strength by 3, taking it to 42 (and subsequently increasing her Max Health to 84).

Moving on to Step 2, Lilith didn’t gain any phobias (which was unlikely her first session anyway), and her Stress, which is now 5 (2 from failing her two Sanity Saves and one from taking a Critical Hit in combat), isn’t too high for her to worry about (she thinks), so she picks option A and gains 1 Resolve, taking her total Resolve to 2.

Finally, she has 2 Skill points to spend. She has enough points for a single Expert Skill or two Trained Skills. She’s got the prerequisites for Command and Hyperspace but not enough points. With an eye on survival, she decides to spend 1 point on First Aid and save her other point for level 2, where she’ll hopefully spend it on Command.



36.2 CHARACTER DEATH

Characters die quickly in **Mothership** but the leveling system is built to get you back up and running quickly. So: think carefully and play hard.

MOTHERSHIP

SHIP NAME

TYPE

CLASS

1. SELECT PRIMARY MODULES *REQUIRED MODULES

LIFE SUPPORT* Life support keeps the human crew alive. Each point of life support can support up to 10 humans. For every point below the required minimum, anyone not wearing a vacsuit must make a Body Save every hour or take 1d10 damage. This includes those in cryochambers as well, but does not include androids. Many ships include 2-3 times the required amount of life support in case of extra passengers or damage to the system.

COMMAND* The command module is the cockpit, command center, or bridge of a ship. For every 4 officer positions, one command module is required. Officers can be captains, first mates, navigation officers, communications officers, and is largely up to the Warden and the players to decide.

ARMOR* Armor plating protects the ship from small meteorites, space dust and debris, as well as, if need be, attacks from other vessels. Every point of armor costs 3 hull, and grants the ship +10% Armor Save (Max 80).

2. SELECT SECONDARY MODULES

JUMP DRIVES Jump drives enable the ship to travel through hyperspace. Every point of Jump Drive increases the ship's jump capability by 1 (Max 9). The first drive costs 1 hull, the second costs 2, the third costs 3, etc.

COMPUTER The ship's computer is a powerful artificial intelligence that helps with astrogation, combat, and a number of other autonomous tasks. A ship's Intellect is equal to the number of computer modules $\times 10 + 30\%$. It's Combat is equal to the number of computer modules $\times 10 + 10\%$. A computer module is required for each jump drive. Additionally, each computer module equipped allows the computer to take more actions during combat.

GALLEY Galleys contain a kitchen, restrooms, and a common area on a ship. Any ships making trips longer than 1 day must have 1 galley for every 2 life support modules or else the crew must take Body Saves once/day. Failure means 2d10 damage and 1d10 Stress. Galleys must be re-stocked once a month and extra stores take up 1 Cargo.

WEAPON MOUNT For every weapon your ship has you must have 1 mount for it. You can find the list of ship weapons in the Player's Survival Guide on page 30.

MEDICAL BAY Medical bays allow scientists, doctors, and other researchers to heal crew members and perform various procedures (biopsies, autopsies, surgery). Each connected medbay on the ship grants +5% to the Intellect of the Scientists or Androids using them. Medical bays also grant advantage on Body Saves made for healing.

CRYOCHAMBER Cryochambers allow humans to sleep during long trips, particularly through hyperspace. Androids do not require them. Each point of hull spent on cryochambers accommodates up to 4 cryosleep pods. Individuals who don't go into cryosleep during hyperspace jumps often have strange and terrifying experiences.

LIVING QUARTERS Generally, if a ship is to travel through normal space for at least a week, then living quarters or "staterooms" are provided for each of the ship's officers, or other important crew members.

BARRACKS The same as living quarters, except they are non-private and house up to twelve crew members. Like living quarters, they are non-essential rooms, but ships that need them, but don't have them, give their crew +1 Stress per journey or month of travel.

CARGO HOLD Cargo holds are essentially 20x20m rooms used for storage. Each cargo hold can hold up to 10 cargo units (each cargo is roughly the size of a large pallet). Cargo holds can also be used for any other basic room not provided for on this list (brigs, secret compartments, mining equipment, training facilities, hangars, armories, etc.).

SCIENCE LAB Similar to the medical bay, the science lab allows for detailed research. Each connected science lab grants +5% Intellect to Scientists and Androids using them to conduct research or experiments. Additionally, they can be designated as repair shops and used by Teamsters to repair electronics, machines, or even Androids.

3. CALCULATE BASE HULL BY ADDING UP THE TOTAL HULL FROM THE LIST ABOVE.

4. CALCULATE TOTAL HULL BY ADDING UP THE REQUIRED MODULES BELOW.

THRUSTERS* Without thrusters, the ship cannot move. Every thruster module equipped increases the speed of the ship by +10% (to a maximum of 80). Additionally, thrusters cost an extra 1 hull for every 10 base hull.

ENGINE* Without the engine, the entire ship ceases to operate and becomes a ruin. You must have 1 engine module for every jump drive, plus 1 for every 4 thrusters, plus 1 for every 20 points of base hull.

FUEL* The engine needs fuel to run on. Every jump requires double the fuel of the jump (Jump 2 = 4 fuel) and thrusters burn 1 unit of fuel per day. The engine requires at least 3 fuel for every point of engine plus any extra fuel capacity you want to add. More fuel can be stored in Cargo Holds at 1 Fuel per 10 Cargo.

FRAME* Frame covers the miscellaneous parts of a ship, docking gear, airlocks, ventilation, corridors, comms relays, everything else a ship generally uses. Frame is 1 point per 10 points of base hull.

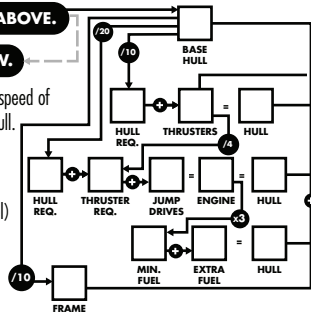
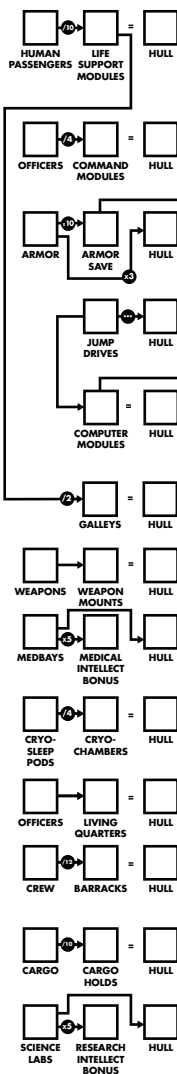

5. FILL IN YOUR **SHIP STATS**

6. LIST YOUR **WEAPONS**

7. LIST YOUR **OFFICERS**

ARMOR

COMBAT

INTELLECT

SPEED

MAX HULL **CURRENT HULL**

COST **OWED**

MAX FUEL **CURRENT FUEL**

GALLEY STOCK **CURRENT STOCK**

WEAPON

DAMAGE

NAME

RANK

8. LIST YOUR **CARGO MANIFEST**

TOTAL CREW

MAX CAP.

9. DRAW YOUR **SHIP'S LAYOUT**

= 20'

= 1 HULL

= 1/2 HULL

= 1/2 HULL

= 1/2 HULL

MOTHERSHIP

NAME

LEVEL RANK / TITLE

STRESS

2

STARTS AT 2

RESOLVE

0

STARTS AT 0

MAX HEALTH

CURRENT HEALTH

x2

1. ROLL 6D10 FOR EACH OF YOUR STATS

STRENGTH

SPEED

INTELLECT

COMBAT

2. PICK A CLASS AND NOTE THEIR STARTING SAVES

SANITY

Rationalization, Logic

FEAR

Surprise, Loneliness

BODY

Hunger, Disease, Infection

ARMOR

Physical Damage

TEAMSTER
30

ANDROID
20

SCIENTIST
40

MARINE
25

35

85

25

30

30

40

25

35

35

25

30

40

+5

+5

+10

+5/+5 WHENEVER A FRIENDLY MARINE IS NEARBY

4. TAKE NOTE OF HOW YOUR CLASS DEALS WITH STRESS & PANIC

TEAMSTER

Once per session, a Teamster may re-roll a roll on the Panic Effect Table.

SCIENTIST

Whenever a Scientist fails a Sanity Save, every friendly player nearby gains 1 Stress.

ANDROID

Fear Saves made in the presence of Androids have Disadvantage.

MARINE

Whenever a Marine Panics, every friendly player nearby must make a Fear Save.

5. PICK A STARTING LOADOUT AND ROLL A RANDOM TRINKET & PATCH

EXCAVATION

Crowbar, Hand Welder, Laser Cutter, Body Cam, Bioscanner, Infrared Goggles, Lockpick Set, Vaccsuit (Oxygen Tank, Mag-Boots, Short-range Comms)

EXPLORATION

Vibechete, Rigging Gun, Flame Gun, First Aid Kit, Vaccsuit (Long-range Comms, Oxygen Tank), Survey Kit, Water Filter, Locator, Rebreather, Binoculars, Flashlight, Camping Gear, MREs x7

EXTERMINATION

SMG, Frag Grenade x6, Standard Battle Dress (Heads-up Display, Body Cam, Short-range Comms), Stimpak x6, Electronic Tool Kit

EXAMINATION

Scalpel, Tranq Pistol, Stun Baton, Hazard Suit, Medscanner, Automed x6, Pain Pills x6, Stimpak x6, Cybernetic Diagnostic Scanner

EQUIPMENT

Equipment list (pg. 17-18), Random Trinket (pg. 19), Random Patch (pg. 20)





Starting Credits 5d10*10

CREDITS

MOTHERSHIP

PLAYER'S CHEAT SHEET

BASIC MECHANICS

- ▶ **STAT CHECKS:** Roll equal to or under your Strength, Intellect, Speed, or Combat on  or fail.
- ▶ **SAVES:** Roll equal to or under your Sanity, Fear, Body, or Armor on  or fail.
- ▶ **CRITICAL HITS/FAILURES:** Rolling doubles on a Stat Check or Save means that you have critically hit or failed.
- ▶ **ADVANTAGE/DISADVANTAGE:** Whenever you have a situational Advantage, roll 2 sets of  and take the best result. Whenever you have Disadvantage, roll 2 sets of  and take the worse result.
- ▶ **SKILLS:** If you have a relevant Skill it may add 10%, 15%, or 20% to a Stat Check (giving you a higher number to roll under).
- ▶ **OPPOSED CHECKS:** Roll equal to or under the relevant Stat or Save on  while your opponent rolls under their relevant Stat or Save. Whoever rolls higher, while still rolling under their relevant Stat/Save, wins the Opposed Check.

STRESS & PANIC

Gain Stress whenever you:

- ▶ Any time the ship you're in gets hit
- ▶ Are near a Scientist and they fail a Sanity Save
- ▶ Fail a Save
- ▶ Get knocked unconscious
- ▶ Go 24 hours without rest
- ▶ Go without food or water

Roll for Panic whenever you:

- ▶ Encounter a horrific creature for the first time
- ▶ Lose more than 1/2 your Max Health in one hit
- ▶ Get hit by a Critical Hit
- ▶ Critically Fail a Save
- ▶ See a crewmember die
- ▶ See more than one crewmember Panic
- ▶ Your ship loses more than 1/2 its Hull

WEAPON RANGE

- ▶ **Short Range:** Weapons firing within this range (or lower) suffer no penalty to the shooter's Combat stat.
- ▶ **Medium Range:** Weapons firing at this range confer a -10% penalty to the shooter's Combat stat.
- ▶ **Long Range:** The maximum distance the weapon can effectively target. Firing at this range confers Disadvantage to the Shooter's Combat Check.

COMBAT BEGINS

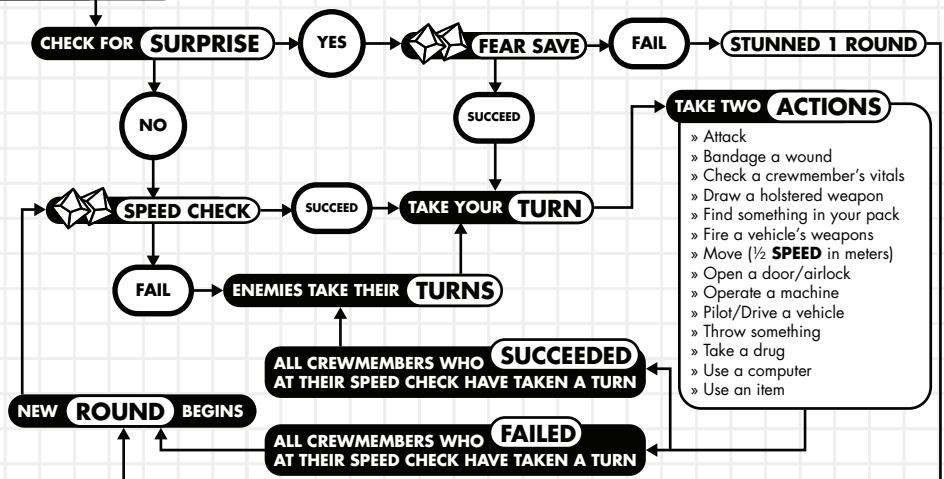

ATTACKING

MAKE AN **OPPOSED CHECK** COMBAT VS. ARMOR  → **SUCCEEDED** → **ROLL DAMAGE** → **MISS OR FAIL TO INFLECT DAMAGE**

DEFENDING

USE **COVER** TO GAIN ADVANTAGE ON ARMOR SAVES

DAMAGE

AT **0 HEALTH** MAKE A  **BODY SAVE** OR DIE

MOVEMENT NORMAL ARMOR:

You can move 1/2 your Speed (in meters) per action.

HEAVY ARMOR:

Make a Strength Check  Failure means you can only move 1/4 your Speed.