

# THE MORROW PROJECT

## OPERATION LUCIFER

A Complete Game Scenario  
By D. PATRICK BECKFIELD and H.N. VOSS



PRIOR POSSESSION OF THE MORROW PROJECT TM1-1  
IS NECESSARY TO THE USE OF THIS MODULE.

PROJECT FILE  
R-003

# THE MORROW PROJECT

PROJECT FILE 003

## OPERATION LUCIFER

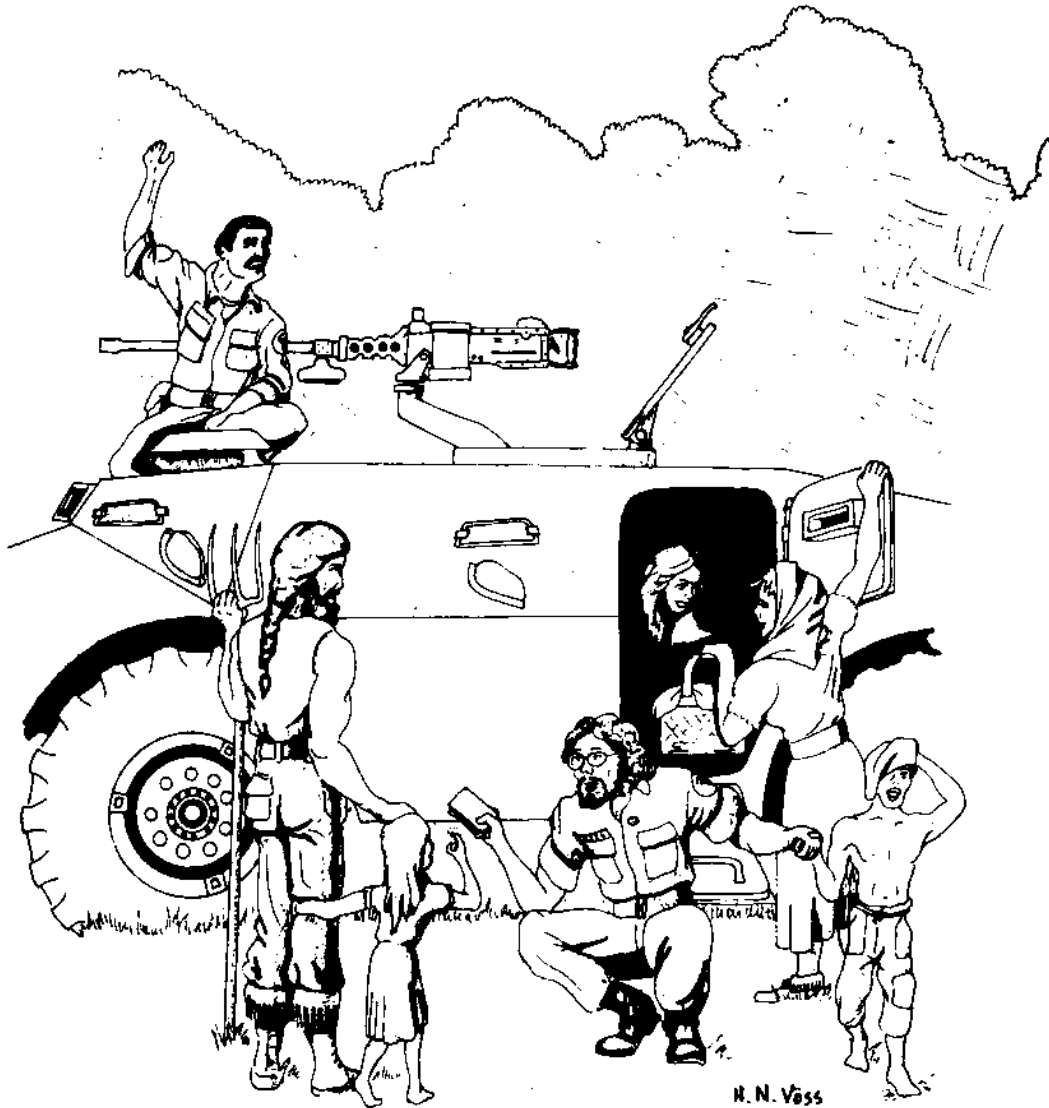

By **D. PATRICK BECKFIELD** and **H.N. VOSS**  
(From an original manuscript by D.P. Beckfield)

## INTRODUCTION

Lucifer is an adventure looking for a recon team. With over 20,000 square miles of terrain to search for a nuclear time bomb, Recon Team G-5 must use all the skill, luck and wits that they can find. They must talk to people that are living in a world that remembers our time as a legend and a dream; search an almost trackless forest that was once the farmland of Wisconsin; and fight off the advance of the evil Krell warriors.

To do this they must think, sweat, try and try again before time runs out. At stake is the fragile world that the survivors have built among the ruins.

BILL WORZEL

### I. SITUATION: PRE-WAR

Western Wisconsin was an area typified by farms and small industry. Agriculturally very prosperous and fertile, a wealth of small communities provided markets for goods and a basis from which light industry could meet the needs of the farms. The entire region was largely self-sufficient. Most "imports" were luxury items like television sets or working machinery. The only things not local to the area, but vital to its economy, were heavy machinery (automobiles, farm equipment, etc.) and fossil fuels.

There were several small cities in the area, notably Eau Claire and LaCrosse. While they had some heavy industry, these towns served more as administrative and consumer centers. Such industry as did exist, was primarily supportive of the regional economy and had to do with farming, dairy products, etc.

### II. SITUATION: THE WAR

Wisconsin was hard hit by the war. Eau Claire, Madison, Milwaukee and Green Bay received direct hits from Soviet missiles. The extreme Southeast corner of the state got one or two more for good measure; missiles originally targeted for the Chicago area.

Further, a "bracketing" effect took place as targets outside of the state were hit. Most of Northern Illinois, Duluth and St. Paul in Minnesota were hit at the same time.

This "bracketing" effectively prevented survivors from leaving the area. But survivors from nearer the points of impact headed for Central Wisconsin. After all, the area was known to be an agricultural paradise, full of food and having no targets worth bombing.

### III. SITUATION: POST-WAR

Wisconsin might have made it but for three things:

1. While Wisconsin was self-sufficient in many ways, it did not exist in an economic vacuum. The war either destroyed or neutralized government, transport, and long-distance communications. The notion of a 'state' ceased to have meaning overnight.
2. The refugees from target areas were too numerous for quick assimilation. They had to be fed, clothed, and housed, all at once, at the onset of winter. In the absence of governmental organization and ready transportation, it could not be done. Many perished. Many turned to robbery and looting. Groups of desperate refugees often dispossessed whole communities, thus adding to the problem.
3. Disease and famine followed. Some refugees carried artificial plagues, spreading these among other refugees and locals alike. But after the first winter, natural diseases became a threat as the medical apparatus to handle them dissolved. There were no medicines. Simple tetanus, in the absence of vaccinations, was again a killer, as were rabies and other diseases previously thought "treatable."

Sometimes due to loss of population, sometimes because armed desperados in the area made it unsafe to farm too far from home, large areas of land went uncultivated.

Some areas were so hopelessly crowded that it was impossible to produce enough to feed them all. Stores dwindled rapidly.

Areas far from targets grew a surplus of food, but it could not be moved in sufficient quantities to make a difference, nor could they be moved quickly enough. Quietly and slowly, a new dark age spread over Wisconsin.

## RECON TEAM G-5

### I. GENERAL

Recon Team G-5 was frozen on 04 July, 1984. Team members know that they were not the only Recon Team frozen in Wisconsin, and that at least one heavy Science Team was frozen in the Wisconsin/Minnesota/Michigan area. The members of G-5 know nothing concerning the location of these other teams.

Given the location of the Bolt Hole, team members might reasonably expect to be assigned to recon Eau Claire and LaCrosse and perhaps St. Paul or Madison as well.

Since there is no contact with Prime Base, the MP General Orders apply: To help the people in any and all capacities, to establish communications with other teams and with Prime Base, and to survive. The team will also receive a message from Damocles on wake-up.

The team had no contact with the local populace before freezing. They are familiar with the terrain only by virtue of the maps contained in the Auto Nav. These maps are, of course, 150 years out of date. Remember that the Auto Nav contains maps of the entire North American continent. For full details of the Auto Nav system, see PF-001 *Liberation at Riverton*.

### II. TEAM PERSONNEL

The members of the team are familiar with one another, having gone through Morrow Project training as a team. The team is completely familiar with all issue equipment and its operation.

Recommended loads for this module are: 01, 07, 08, 09, 10, 11, 17, 19. Team members can always operate the issued equipment of other team members. How well they can operate this equipment may vary.

### III. TEAM EQUIPMENT

The team's personal gear is in perfect condition. The team's vehicle is also in perfect shape, along with its internal stores.

**PD NOTE: If you are using pre-existing characters, it is advisable to equip them just as they were at the end of their last action. In addition to the above consideration, keep in mind that they would not be aware of any of the caches in the area; indeed, the caches might not exist. If you choose to leave the caches in place, remember that the team does not know how to locate them and will find them only by accident.**

### THE BOLT HOLE

This is the standard storage and freezing facility of the Morrow Project, often mentioned in the Game Book. These are the same throughout the project and differ only in size. The size depends upon the number of personnel and the size of the vehicles, if any.

Briefly, the "hole" consists of a buried room constructed of steel and reinforced concrete. It is designed to be air tight and reasonably blast proof. It is also shielded from lethal radiation.

While the occupants are in stasis the hole is filled with an inert gas at slight overpressure. This has the dual function of keeping foreign gasses out and preserving the equipment inside the hole from the normal wear and tear of time; things do not rust in a project bolt hole. Part of the hole's integral equipment is an "idiot box" computer. This computer is responsible for maintaining the gas pressure, monitoring the hibernating team, and awakening them, either upon receipt of the recall signal or in the event of an emergency. For the most part, the idiot box just sits and waits.

When the "activate" signal is received, the computer evacuates the inert gas and fills the chamber with a pre-bottled atmosphere mixture. It then activates the "awake procedure" in the freeze tubes. When this procedure is complete the computer shuts down and cannot be reactivated. All team personnel are aware of these facts.

The hole itself contains the team's freeze tubes, a vehicle (if any) and a large table. It also includes the periscope package which consists of a periscope designed to view the immediate area above the hole, equipment to monitor the levels of radiation in the area and the presence of chemical or biological hazards. A radio antenna com-

pletes the periscope package. This equipment cannot be moved from the hole and the team knows it.

The hole has three exits; two for emergency use by the team and the primary exit for the team and vehicle. All are designed to be blast proof and difficult to detect by casual outside observation. The two emergency exits are cofferdammed with sand which must be removed before the exits can be used. One of the cabinets in the hole contains the tools necessary to do this. The primary exit is equipped with hydraulic rams to open the large door.

It should be noted that the bolt hole is not designed for habitation. There are no beds, no food other than the emergency supplies, no water source and no latrine arrangements. It is **designed** to be abandoned.

#### TEAM VEHICLES

The MPV for this module is the Commando V-150 APC. This vehicle will accommodate 12 in a pinch. The MPV is in perfect working order with all stores intact.

**PD NOTE: Play testing has shown that more than 6 personnel in this MPV can lead to a boring game: there are not enough things for everyone to do. We recommend the inclusion of ONE Commando Scout, or some XR-311's, if more than 6 players are present.**

#### MORROW PROJECT "CONTACT PACK"

Realizing that the local populace, even after only 2 or 3 years, might be mildly surprised by the sudden arrival of a well armed, uniformed group of people out of nowhere, the planning personnel of TMP included a contact pack in each bolt hole. This pack can equip only *one* member of the team, such team member usually having been identified prior to freezing. At no time was this gear intended for use by the leader of the team.

This pack was intended for use among people only 2 or 3 years after the war, and is, therefore, not ideally suited to use 150 years later. Still, the pack is not without points of interest to a team with no other resources.

The items in this pack are NOT brand new. All contents have been carefully treated to show signs of wear—clothes are marked and faded, boots scuffed and worn, bluing absent from some parts of weapons. All items are quite serviceable; the "wear" is purely cosmetic.

- 1 Floppy, white felt, "crusher" hat
- 1 Red bandana, neckerchief
- 1 "Levis" denim jacket
- 1 Pair "Levis" jeans
- 2 Cotton flannel, plaid, work shirts
- 1 Pair "Kastinger" hiking boots
- 1 Leather belt
- 4 Pairs wool socks
- 1 Nylon pack containing candles, twine, 3 days canned food, underwear, other assorted pack and personal items
- 1 Hip flask of 162 year old Scotch (12 oz.)
- 1 M-29 6.5 in. SW .44 mag revolver (pg. 13, MPGB) (w 50 rounds and leather holster)

Either:

- 1 Marlin 1894 lever action carbine in .44 mag

OR

- 1 Remington 870 12 gauge pump shotgun

Each with 30 rounds. Full specs of these weapons are included in the equipment section near the end of the module.

An army issue web belt with ammo pouch is provided to transport the ammo for these weapons. The printed guide published by Morrow Industries recommends that these weapons not be used by persons wishing to make a "clean" contact with the locals.

#### TEAM CACHES

Recon Team G-9 has six supply caches. These are typical Morrow re-supply facilities and are located through the use of the Auto Nav aboard the MPV. Since the cache locations exist on the map displayed by the auto nav, the MPV can simply be driven to the point on the map and search for the cache begun.

**PD NOTE: If the team loses the auto nav they cannot locate their caches. This is not the case if the team had the good sense to make a copy of the map on a piece of paper.**

In this module all caches are buried underground. The usual Morrow Project practice for locating caches is to place them beneath a real or a facsimile USGS Benchmark. In terms of the game, a benchmark is a concrete post driven into the ground with a metal data plate attached to the top of the post. As a rule, only an inch or two of the post will show above ground. Benchmarks are designed so as to make them exceedingly difficult to move, but those made or used by the Morrow Project are sunk only about three feet into the ground.

Having located a benchmark the team will still be unaware of the location of the cache; teams were not told how to identify their supplies other than location through the auto nav. But if the team is medium bright it will begin to dig up the benchmark as these will likely be the only thing in the area that catches their attention.

About a foot below the level of the ground there will be stainless steel data plate attached to the post. This will give the team's number and the exact location of the caches; usually just beneath the bottom of the benchmark post.

Entrance to the cache is gained by way of a stainless steel hatch assembly on top of the cache. Next to the hatch there is a card slot. Insertion of MPID will allow the hatch to be operated. If this is not done, or if the team has somehow managed to lose all of their cards, they will have to blast the door open.

The cache itself is a cube, 2 meters in all dimensions. It is constructed of reinforced concrete and steel. It has no windows, no power source, no lights; it is just a hole in the ground for storage.

Observing frequent requests for a specific guide to cache contents, the following caches are included in this module. PD's should, as ever, feel free to modify the contents of each to suit the needs of the PD's game.

	CACHE					
AMMUNITION	1	2	3	4	5	6
9 x 19 ball	4	4	4	4	4	4
.44 mag	1	-	1	1	1	1
5.56 x 45	1	1	1	1	1	1
7.62 x 51	1	1	1	-	1	-
12 ga.	2	2	2	2	2	2
5.56 x 45 L.	1	1	1	1	1	1
40 mm						
M381 HE	1	1	1	-	-	1
M433 HEDP	1	1	1	1	1	-
M651 CS	1	1	1	-	-	-
M576E2	-	-	1	1	1	1
M573	1	1	1	-	-	-
M585	-	-	-	1	1	1
M663	1	-	-	-	1	-
M664	1	1	1	1	1	1
EQUIPMENT						
AN/PRC-68	2	2	2	2	2	2
AN/PRC-70	1	-	-	1	-	-
AN/PAS-7	1	1	-	-	1	-
Mag. sens.	1	-	-	-	-	1
CP-7	1	-	-	-	1	1
AN/PPS-12	-	-	-	1	-	-
Medkit (per)	3	3	3	3	3	3
Medkit (lg)	1	1	1	1	1	1
reload (medkit)	9	9	9	9	9	9

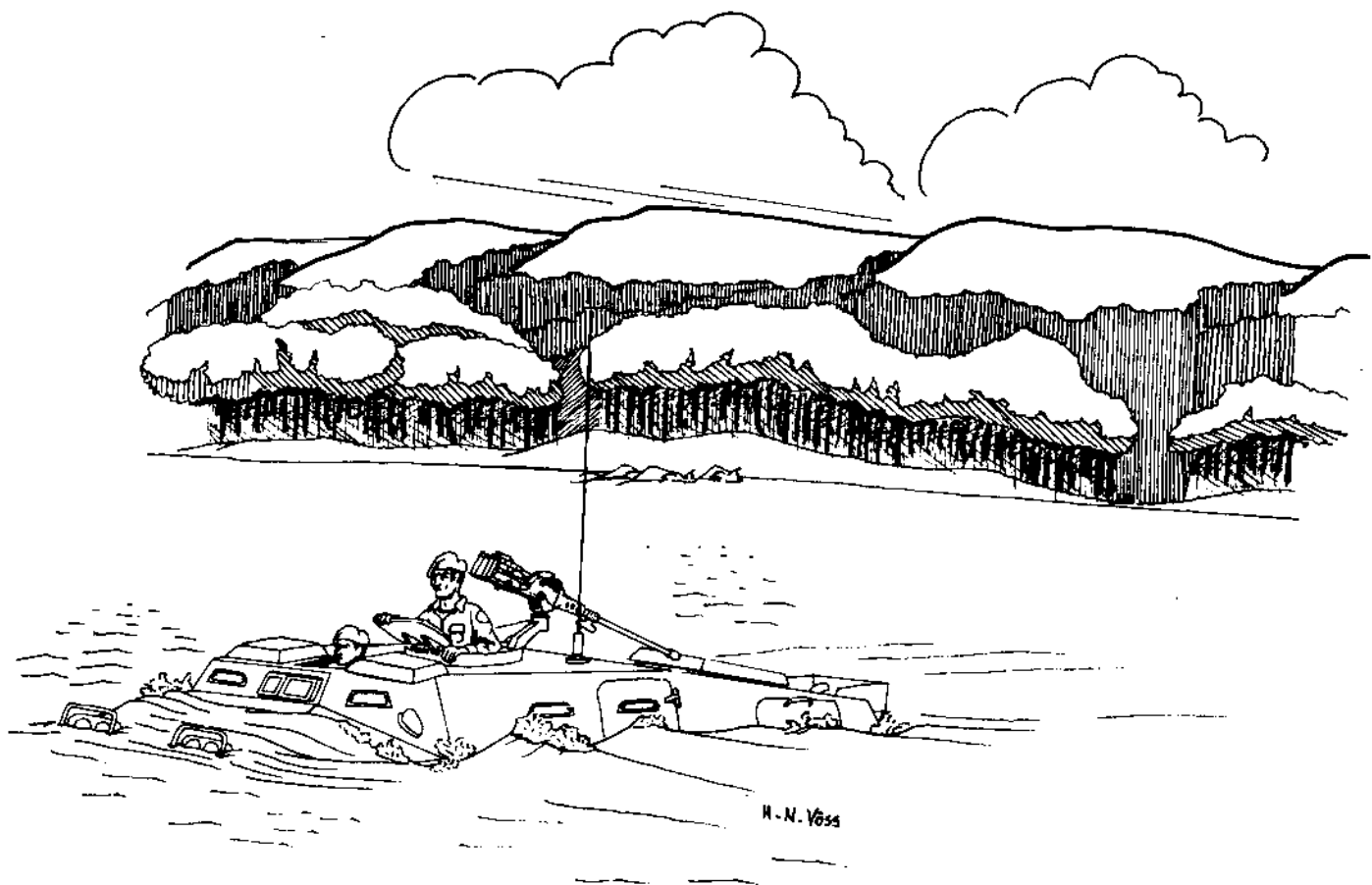

### WEAPONS

	1	2	3	4	5	6	
MAG 58	-	-	-	1	-	-	w/1000 rds.
S&W M29	-	1	-	1	-	-	w/24 rds./wpn.
Atchis.	1	-	-	-	-	1	4 drums
Armburst	3	-	3	-	3	3	
M202A1	-	1	1	-	-	-	
M47	1	-	-	1	-	-	3 missiles
Stinger	1	1	-	-	1	1	

### EXPLOSIVES (cases)

M26A1	1	1	1	1	1	1
M34 WP	1	-	1	-	-	1
M6	1	-	1	1	1	-
M183	1	1	1	-	1	1
Primer.	1	1	1	1	1	1
M700	1	1	1	1	1	1
M7	1	1	1	1	1	1
M60	1	1	1	1	1	1
M18A1	1	1	1	1	1	1
M19A1	1	1	-	-	1	-

### EQUIPMENT

	1	2	3	4	5	6	
pack, std.	8	8	8	8	8	10	w/cold kit
pack trade	2	2	2	2	2	2	
pack ration	4	4	4	6	4	4	
coveralls (MP)	3	3	3	3	3	3	
underwear	3	3	4	4	3	3	
boots	4	4	4	3	6	3	
KCB-70	4	4	4	4	4	4	
M17-A1	2	2	2	2	2	2	
M1-CBR	2	2	2	2	2	2	

### ADDITIONAL EQUIPMENT (by CACHE)

#### CACHE 1

shovels (2), large ax (1), scratch plow 1, (disassembled), carpentry tools

#### CACHE 2

seed corn (200 kg.), nails, 4 1/2" (40 kg.), assorted books on farming (10 kg.)

#### CACHE 3

assorted textbooks (college, 10 kg.), electronics tools

#### CACHE 4

seed corn (200 kg.), textbooks (college, 10 kg.), carpentry tools, nails, 4 1/2" (40 kg.)

#### CACHE 5

scratch plow (1, disassembled), M9823 Starlight scope (1), vehicle tool kit (1), tires, V-150 (4)

#### CACHE 6

tires, V-150 (4), seed corn (200 kg.), general tool kit, assorted nuts & bolts (25 kg.)

### CACHE LOCATIONS:

- Cache: 1. 5 Km NW of SHERIDAN, WI
- 2. 10 Km. S of UNITY, WI
- 3. 5 Km. W of WAUPUN, WI
- 4. 3 Km. NW of NORWAY, MI
- 5. 5 Km. N of DAVIS, IL
- 6. 5 Km. N of CALEDONIA, MN

## THE AREA: TERRAIN AND ENVIRONMENT

Lucifer is intended to be played over a large area. Much of Wisconsin, and some of Minnesota, may be traversed by the team. The sections which follow are written with this in mind.

The module takes place in early Spring, around late April. Planting is either complete or in its final stages. Cultivated plants are not tall enough to provide concealment even to a crawling man.

Before the farmers came to Wisconsin the land was covered by forest. 150 years after the War, the forest has returned. Clear areas only exist where man keeps the forest at bay, in the blasted areas where warheads detonated, or in those areas where trees do not naturally grow.

### I. WEST WISCONSIN/THE BOLT HOLE AND MONDOVI

This is a hilly area punctuated by narrow valleys. Among the steep hills, small streams and rivers cut a path west to the Mississippi. Fords over these rivers exist, and the paths and trails in the area rely on the fords for crossings, since few bridges remain.

Farming is difficult, but not impossible to a hardworking man or family. The people in the area are fairly receptive to strangers. The "pickings" of the area are so slim that "bandit" groups are a real rarity. As one nears the Mississippi, the hills turn to bluffs and ridges. Throughout the area it is impossible to move in a straight line. Visibility is never more than 20m among the trees, and even from hill tops rarely exceeds a mile or two.

### II. THE MISSISSIPPI

Known to the locals as THE River or The Big River, the Mississippi forms a barrier to the west. The river runs across flat land of varying width, sometimes a few miles to either side, sometimes a few hundred meters. On both sides of the river bluffs channel its flow. The soil of the flats is very fertile, but subject to flooding in the spring.

The river averages at least 300m in width, but during the spring, 500m is more common. There are neither fords nor ferries. Bridges exist only at LaCrosse and north of St. Paul.

**PD NOTE: While the V-150 can swim, it must have a beach-like area to enter and to leave the water. The current will carry the V-150 downstream at a rate of 3m for every 1m forward. It is not possible to head "straight across" for what might look like a good landing point on the far side. Commando Scouts and XR-311's cannot "swim."**

### III. CENTRAL WISCONSIN

This is an area which we arbitrarily define as follows: Oshkosh in the East, Eau Claire in the West, Wisconsin Dells in the South and Rhinelander in the North. Draw an imaginary line to connect each of these points and the rough diamond shape formed is "Central Wisconsin."

Typically thought of as a plain, this part of Wisconsin is more truly a series of gently rolling hills. In some areas the roll is not gentle. The land south of Wausau is fairly rugged in that it is frequently cut by small rivers. These rivers have cut gorges in the land, making the rivers very difficult to cross. The "river canyons" are narrow and heavily wooded. This type of terrain is the norm up to 150 miles South of Wausau. By the time one reaches I-94, the plains are again dominant.

### IV. SOUTHERN WISCONSIN

Again, rolling gentle hills, by now almost plains. This is some of the most fertile ground to be found anywhere in the country, but like the rest of the state, it is now mostly forest.

### V. EASTERN WISCONSIN

This is plains country giving way to low hills near Lake Michigan. The presence of Milwaukee and Green Bay in this region prevent a "clear trip" along the coast due to the radiation found near them.

### VI. NORTHERN WISCONSIN

Not unlike the Upper Peninsula of Michigan. PD's who own a copy of "Damocles" might want to use the data there for this part of the

state. The ground here is not as well suited to farming as other areas of the state. Plains and hills are normal, with some steeper hills as one nears Lake Superior. Forests up here are more frequently pine/evergreen as opposed to the hardwoods further south.

## THE PEOPLE OF THE LAND

Within 10 years of the end of the war, the population of Wisconsin had fallen to the point where it was an even money bet whether or not there would be anyone living there in the *next* 10 years. But people faced with extinction often ignore odds and do the impossible. 150 years after the war, the population of Wisconsin is about 100,000 souls. No one has taken a census in some time, so accurate figures are not available.

Most of these people live in the south, near the Mississippi or near Lake Michigan. Many people do live in "the interior," but not in the same density.

People living near the waters, east or west, tend to be more "civilized." They have more contact with people from outside their communities. A fair amount of trade goes on in these parts, often water borne. The medium of trade is still barter. Along the Big River, tobacco is available, as well as cotton and other items traditionally associated with the South. Trade on the water is sometimes conducted on a group basis with many people travelling together as traders, almost like a sea-going caravan.

The people of these areas are more likely to accept the presence of the team, since they are more used to "foreigners." It is *only* as foreigners that the team will be accepted.

News travels fast along the water, especially if traders take up a story. Some items have been known to travel up to 50 miles in a single day. Moving into the interior, a complete change will be noticed when moving among people of the Southern plains. It was here that the worst refugee and plague problems took place following the war. While these times are over a century in the past, memories here are long and traditions firm. Strangers are not welcome unless they are obviously traders, mailmen, or other "normal" types of folks.

Strangers will *not* be attacked out of hand. Locals are merely unfriendly and vocal in their requests for the "foreigners" to go away. This is related, in part, to the fact that small groups of armed bandits still roam the land. The people of Central and Northern Wisconsin are easier to get along with. They are rarely outgoing, but they're usually willing to listen. They are not unfriendly, but they have no time for nonsense. They are deeply rooted in the land and are occupied with extracting a living from the land. Pursuits which do not aid in this struggle are of small interest.

Wanderers are looked forward to for the news that they bring and the diversion which they provide. A hot meal and a place to sleep are common, but only if the strangers have the decency *not* to force their presence until after the day's work is done.

The folks in these parts have a fair amount of trouble with varmints, natural and mutant. People do not travel after dark unless absolutely necessary. Adults are usually armed, children (males under 16, females under 14) stay with adults whenever away from home. Trouble with two legged varmints (humans) is rare, but not unknown. Almost everyone is given the benefit of a doubt, that is: innocent until proven otherwise.

Traders move in this area too, but only singly or in pairs. Some have carts or wagons, most move on foot with a single pack animal. Barter is the norm, but as in areas nearer the water, silver and gold are known. Gold is very rare.

In no area is there a fixation with silver or gold. The people see it as a tool. It may be pretty, but it cannot be eaten, drunk or slept upon or under. It cannot keep you warm. A wolf or bear is not in the least impressed by it, unless it is cast into bullets. There are not many places to spend it. It is certainly nothing to kill for. (Some of the traders on the waters might disagree.)

## TOWNS AND VILLAGES

No new towns or villages have been built since the war. Most towns have been uninhabited ruins since shortly after the war. These are usually rubble mounds or ghost towns now and are overgrown with trees. Some have been stripped of portable useful items, others

have not. Some have served, or do serve, as "bases" for bandit gangs. These are almost always in the south. Old metal road signs are frequently the only means of identifying the ruins.

Those towns which are still inhabited have several things in common. With the radical drop in population brought on by the war, no town is as "full" as it once was. The towns are only inhabited in their interiors. Outskirts have fallen into disuse and often into rubble. These ruined areas form a defensive perimeter around the towns, and are manned on a rotating basis by the residents. This means there will be a few lookouts or sentries during the day. At night the guard doubles, with all men on call in case of trouble. In some places, the ruins of buildings have been joined to form walls, but this is common only in the south.

These towns are surrounded by fields and pastures. These are worked during the day with the owners returning to the shelter of the towns at night.

The largest towns are in the south, or along the Big River. In the south, all of the people live in the towns for mutual protection. In other areas, many isolated farms and homes were never abandoned. With the population rising again, there is a movement (very small as yet) to spread out, clear land, and begin "new" farms.

Hunters and trappers operate "in the bush" and visit population centers only to trade.

### ROADS

As there was no maintenance, the old road network has decayed and is useless. It is more difficult, and more dangerous, to travel on the roads than it is to travel off of them.

But paralleling many of the old roads are trails. These vary in size. A wagon/cart trail follows the line of what used to be I-94, with occasional "fords" over the remains of I-94. Other cart trails are rare, but foot paths, at least, follow the route of the other major roads. Here and there bridges have been maintained by towns situated nearby. These are usually based on the steel I-beams of old bridges, now re-surfaced with rough hewn logs. These bridges will support the weight of a V-150.

### GOVERNMENT

The best way to describe the political situation is to begin by pointing out that there is no political situation. Such government as exists is limited to towns and their immediate surroundings. The most common arrangement is a mayor, usually elected for a one-year term, and a council of residents. This is a very primitive form of Greek City-State democracy. Given the low population and minimal commercial activities, there are no wars but two or more towns sometimes band together to drive bandits from an area.

This lack of government is both good and bad. Taxes are low to non-existent. There is no red tape and no law, other than "Golden Rule." But there are no roads, no police or fire department, and no schools.

Education is handled in the home. Children learn what their parents can teach them. Few people can read. Books are in demand only by traders from other areas. History is verbal; an oral tradition handed down by generations. Memories are pretty good.

The people are rarely stupid, though some are "slow." Common sense and "the school of life" see most people through all of their needs. Friends, and enemies, are always remembered.

### LEGENDS/THE WAR

People here do not understand "war." The War is a thing that happened some time in the past. It was very bad, it killed a lot of people. It ranks with The Flood, and any number of the famines which have hit since the time of the War. Fire came from the sky (?). People died, some from the fire, some later. There is a prevalent attitude of "whatever it was, it can't happen now." The idea of lots of people getting together to kill one another makes no sense. Maybe it happened then, but it can't happen now. People are too smart. There's too many other things to do; like live.

There are no legends of the Morrow Project or anything like it. No one has heard of Krell, etc. The United States is a thing that some people "what are edjicated" talk about, it has no meaning now.

"Wisconsin" is where folks live. Maybe it was once a State, (whatever that is), now it's just home. It is a word which embodies the difference between here and there.

Most people live in one area for the whole of their lives. They rarely travel more than 10 miles in any one direction. Other places are nearly a matter of legend: "I heard tell of a place out east where there's town full o' people what don't like strangers," etc.

Areas hit by bombs are known only to people who live near them. These people can tell a team exactly (more or less) where they are. Other people know of these places only by reputation. Some of them glow at night, or nothing lives near them. They come from the war and are *bad* places. People who go too close get sick and die, but nobody seems to know just what "too close" is. These places have no names, other than "bad places." There seems to be no knowledge among most people that there used to be cities there. Names of these places usually have no meaning.

Most names have been shortened or abbreviated anyway. LaCrosse is now simply "Cross." Chippewa Falls: "Falls." Black River: "River." Bankcroft: "Croft."

**PD NOTE: This can be maddening to a team. Try not to overdo it; keep names roughly similar to map names. But beyond this, give the team no help.**

The only people likely to know old names, or the names of the "bad places" are mailmen (described later in the module). By virtue of their profession these persons can read and are curious. They tend to know the warning signs of "bad places," and often read the old road signs leading to them.

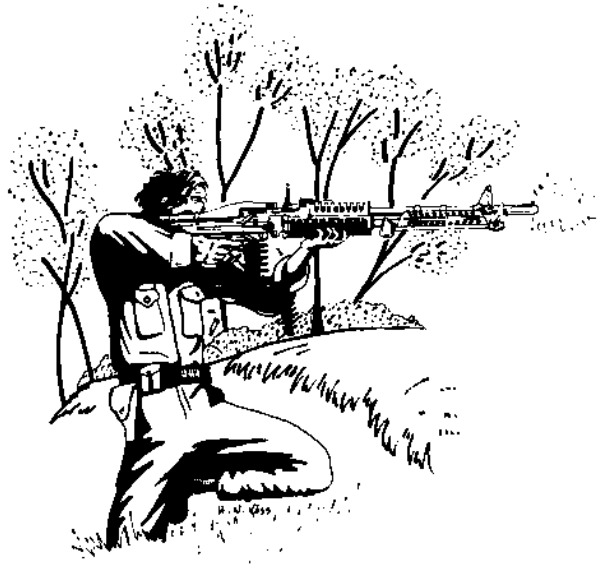

### THE MISSION

Unlike other MP modules, Operation Lucifer outlines a specific mission for Team G-5 to accomplish. This would ordinarily be given in the Play of the Game Section near the end of the module, but since much of the information in the following pages will make little sense if the reader does not know what it applies to, some mission data is included here.

## DAMOCLES

The second module printed as companion to the MP Game System was Damocles. In this module, Recon Team G-9, deployed in Michigan's Upper Peninsula, located and captured a computer complex built by the U.S. Government before the war. This complex had been a secret test site for an extremely sophisticated computer system. The computer, Damocles, was intended to take over control of the strategic nuclear forces of the United States in the event that normal control was destroyed in a war. Damocles, fully connected with the U.S. early warning and communications systems, was still being tested when the War began. Damocles played no part in the War; he merely observed and recorded.

Completely automated, self-programming and with his own fusion power source, Damocles waited out the next 150 years in his subterranean complex.

Recon Team G-9 captured Damocles intact. Unfortunately, Team G-9 was not well equipped to understand or to use Damocles. Through a variety of means, involving Team G-9 in many adventures, a Morrow Project Science Team was finally brought to Damocles.

The members of the Science Team are still learning about Damocles, a process which is likely to continue for years. Damocles is still very much his "own machine." He cooperates with the Morrow personnel, but for reasons of his own. In the meantime, the members of both teams are using the Damocles complex as a base. They are trying to aid the civilization of the area, and to locate and aid other Morrow Teams.

Several members of the Science Team have been working very closely with Damocles. Full rapport with Damocles has not yet been established, but enough communication is possible to be of benefit to both parties. Quite recently, a member of the Science staff realized that Damocles might hold a wealth of data relative to the war, specifically, exactly what areas in the U.S. had been hit during the war.

This was, of course, quite true. Damocles had been fully integrated with the NORAD radar net. Damocles was well aware of what-*ad-come-down-where*. The Science Team looked on happily as Damocles displayed his information.

And the Science Team got a shock, too.

Here and there, Damocles had duly noted things that had come-down-and-had-not-gone-off, usually a stray war head from a Soviet MIRV (Multiple Independent Re-entry Vehicle). One of these was fairly close by, in Central Wisconsin.

The Science Team Leader had some information relative to where other teams were located. One Recon Team, G-5, was considerably closer to the area than was the Damocles complex. Turning the location of the team over to Damocles, the Team Leader requested that Damocles set up a "random number generator program" to activate the recon team and to inform them of the danger. The Science personnel could not do this for themselves as they lacked the computer potential and their radios lacked the range. Damocles agreed to cooperate and has done so; but in his own inimicable fashion.

So it is that Recon Team G-5 is the first Morrow team to be raised intentionally since the war. Raised by Damocles, when the team turns on their radios for the first time, they will receive the following message:

Morrow Project Team G-5

Undetonated impact recorded 19 Nov 1989

Location

44 degrees, 20 minutes, North/

89 degrees, 35 minutes West

Imperative

Locate/Remove/Destroy

Suspect SS-17 MIRV

Imperative

Locate/Remove/Destroy

Damocles

This message repeats itself at 10 second intervals. Once the team tries to contact Damocles themselves, the message will cease.

**PD NOTE:** The team will be ignorant as to the identity of this "Damocles." The only information they should receive is the radio trans printed above.

Damocles, having fulfilled his part of the agreement with the Science Team, will stop attempting to contact/raise G-5 as soon as he is certain that they have received the message. Damocles will know this has happened when the team tries to respond.

Damocles does not use the Morrow Project land coordinate system (based on the Auto Nav. described in PF-01). He has therefore sent an approximate location to the team using the standard latitude/longitude system. The recon team has no maps to make sense of this. Typical SNAFU.

The mission of Team G-5 is therefore to locate, remove and/or destroy the old Soviet warhead. The rest of this module is provided as the setting of this mission.

## PEOPLE AND PLACES

In order for the Team to locate the warhead they will have to move around, ranging over large areas, and talking to the locals. The Team is looking for people who know about the "bomb" and where it is, or for a map to pinpoint the location given by Damocles.

Of course, few people know what a "bomb" is, much less a "warhead." For reasons which will become clear later, the actual location of the bomb is not advertised, and people will not know where it is at.

For purposes of this module, the bomb/warhead is located in the town of Bancroft. This is a place of convenience for writing. The PD may place the warhead wherever he likes, but we recommend that the PD use the name of an actual town, so that the players can find it on a road map. Central Wisconsin is recommended for a location for two reasons: the terrain is difficult and the team will have to move about to get there. If the "full plot" of the module is to be used, then a central location is a must.





## MONDOVI

Mondovi is located about 8 km Northwest of the Bolt Hole. Players often head for this town first thing, as according to their maps, it is the nearest population center.

Mondovi can be reached by travelling cross country, or by heading for route 88. 88 is in ruins, but there is a foot trail which follows its course north to Mondovi.

The town fits the general description of towns given earlier. Mondovi is surrounded by roughly 500m of open, cultivated land. The outskirts of the town are ruins and uninhabited, but are used as a rag-tag sentry area. There is no "town wall."

Both "88" running north-south, and "10" running east-west, meet in Mondovi. These roads have no names for the locals and are no merely trails. The points where these trails cross the fields and enter the "town" are always manned by two "watchers" each. One of these stays in plain view on a makeshift, moveable road block, the other watcher stays hidden to cover the man on the "road."

Mondovi has no more than 200 residents who make their living farming, hunting, smithing, etc. The community is largely self-sufficient. Being reasonably close to the The River, Mondovi has a fair number of traders passing through. This means that the people are somewhat used to strangers just "breezing in." It also means that the people have limited amounts of "foreign" items like tobacco and modern fire arms ammo.

Most weapons are black powder types, but some others exist; shotguns being a particular favorite. There are no heavier weapons in Mondovi.

Watchers will not admit groups of strangers into the town, but single travellers are no problem. Watchers at the "gate" will question all would-be entrants; this is their job. They will not answer questions of strangers and will refer all such to the current "mayor"; Zeke Barsto.

In the event that a group of people show up at a "gate," the watcher will send for Zeke to talk with them. Watchers will not fire on people nor raise the alarm unless the people behave in an obviously hostile manner: brandishing weapons, making threats, etc.

## THE MAYOR

Mayors are elected for one-year terms. They do not "govern" so much as they litigate disputes, run trading, keep and command the watch, etc. The position is unpaid, so mayors tend to be "on duty" only part-time. It is an honor to be mayor, but few people like the honor so much as to want it to last more than a year at a time. It is also a heavy responsibility.

Zeke Barsto is serving his third term as Mayor. He's been mayor two other times in the last 10 years. When he is not being a mayor he is a farmer with a family of six.

Zeke is a "salt-of-the-Earth" type who doesn't like to waste words on nonsense. He is not impressed or inflated by his position (which may be why he's held it so often), he sees it as an extra job which must be done right. He is not an unfriendly man, just short of time.

In his 48 years of life he has learned that, when dealing with strangers and traders (the latter especially), it is best to appear "slow." Zeke is not slow or stupid, but looking that way "gen'erly gits the other fella' talkin' so's you can find out quicker what's really on his 'mind.'"

Zeke will answer questions as honestly as he can, but will not endanger his town. If the strangers seem like reasonable people, he will let the lot of them in, armed, with the MPV. Not being a Southerner (that is, from Southern Wisconsin), he is not suspicious by nature. "Bad" folks shoot first and don't talk at all. If he feels that he must turn strangers away, he will try to do so politely. Zeke, like most people in these parts, is uneducated. He can read, but only outloud and slowly. He has never been more than 20 miles from Mondovi and does not know what other areas are like.

Zeke does know that:

1. There are more folks nearer the River, and that there are two towns: "Cross" in the South. "Paul" (St. Paul), further North. Both are a long way away though he doesn't know how far.
2. There's a bad place (Eau Claire) to the North, but nobody goes there.

3. Things ain't good in the South (S. Wisconsin).

4. The best folks for news are Mailmen and Traders.

Zeke has heard many other things, but since he has not seen them himself, he will not relate them. "Tales" often are not true.

**PD NOTE: The NPC specifications are grouped, for PD convenience, near the end of the module.**

What Zeke knows and does not know is typical of all of the people of Mondovi. The PD might want to include, inside of Mondovi, one of the "wanderers" described later on. A mailman or a trader works best.

Mondovi and its "political system" is the commonest pattern. Other towns may simply be described as "The Mondovi Pattern."

## EAU CLAIRE

This city was destroyed during the war. Situated in a valley, the outlying areas were not much affected by blast or fire. The radiation has tapered off, but is still high in the valley itself. The Team will be unaware of this peril unless they crest the ridges surrounding the valley. Radiation is not dangerous at this point, unless people decide to hang around for several days. Nothing human lives in or near Eau Claire, and its name has fallen from common use.

## WAUSAU

This is a town on the Mondovi pattern, though there are some differences. Wausau's population is larger; in all, nearly a thousand people live in or near Wausau. These people hunt and farm. All 1,000 people do not live in Wausau, which houses no more than 400. The remainder live up to 20 miles away, mostly in the West, North and East. Fewer live to the south for two reasons: the terrain soon gets rough, and there are odd folks living further south.

The people in the Wausau area do not know exactly what is wrong with folks "away south," only that they are unsociable and very unfriendly to strangers. Occasional killings, and darker things, are rumored.

Years ago an attempt was made to form a University/school in Wausau. The idea died from equal parts of apathy, and the opposition of a vociferously anti-intellectual minority.

Wausau is now known as "Saw."

## MADISON

Being the former capital, Madison was a target in the war. Situated on a low ground, the area is radioactive marsh and rubble. Otherwise, the comments on Eau Claire apply.

## MILWAUKEE AND GREEN BAY

Both of these cities have been destroyed and their sites are still somewhat dangerous. Comments for these places are the same as that for Eau Claire.

## ASHLAND

A Mondovi pattern town, Ashland is the port of the North and has been since the destruction of Duluth/Superior. Its population peaks at 400 when the trappers leave the forests in the spring.

## BLACK RIVER

While the town is in ruins, Black River is a point of interest in that it is one of the places at which a "wheel ford" exists over I-94, as well as a bridge for crossing the Black River.

While the town is no more, there is a small, two-story "public house" situated by the ford. This "Inn" serves the cart track paralleling '94 and is the only permanent human habitation along the trail between Menominee and Tomah. This house is known simply by the name "Rivers."

The house is run by a former trader of the '94 route (known as the "West Road"). The Ostler brews beer, hunts and maintains small fields. Most of what the "Inn" "sells," the proprietor fashions himself. Barter is the norm here, though metals are accepted. The beer is rich, the food solid, and the stay of a night a welcome novelty from the open camps more usual along the road. "Rivers" is the best place for news in all of Western or Central Wisconsin.

## BURLE AMES

Burle is the owner, cook, barkeep, gossip and proprietor on Rivers. He "inherited" it, passing through some seven years before on the night that the previous "owner" died (of natural causes: a fever in winter). Burke decided to settle down. Ames is now 56 years old. As a trader he ranged an area encompassing Wisconsin, Minnesota, Michigan's U.P., and Northern Illinois and Iowa. His information of this far flung area is, of course, decades out of date. But the "doings" of central Wisconsin he knows fairly well, as fresh information comes in regularly.

Burle is a garrulous, rotund, balding man. His chief joy in life is to swap gossip with travellers, as well as the occasional tall tale. He is always hospitable, for this is his trade. But he is no man to trifle with. Above his bar, hanging on a string, are seven spent 12 gauge shotgun cartridges: one for each of the "guests" he has had to "allow to stay indefinitely." Ames is not proud of this, but recognizes that such measures are sometimes necessary. His "Rivers" has gained a reputation as an honest house, where the guest had best be honest, too. He's had no trouble for the past two years, but he keeps a sawed off, single barrel 12 gauge under the bar; just in case.

Burle, once he is reasonably sure that guests are "honest folks," will make himself very friendly and available. The usual stay at Rivers is two nights, as Burle usually keeps his guests up all of the first night talking. This is not too bad, as his rates are very reasonable. The "Rivers" does not show a profit, but it does provide Ames with a comfortable living.

Burle knows a fair amount about local conditions. He knows, among other things, that the folk up in Croft are queer and to be avoided by all right thinking folks. He has never been there (always having had better sense), but he's seen some of their people out trading themselves, since traders are never allowed in Croft. These groups are very close-mouthed, (which ain't natural itself), and always with a man all dressed in a black dress, like a woman. "That fellow doesn't talk at all, 'cept to his own folks." They're seen only now and then, fairly rarely, and never as far away as "Rivers."

Burle is just as lucid about things he knows nothing about. He does have a map: a page of an old Rand McNally road atlas showing Wisconsin, with "Rivers" marked proud and bold in homemade ink. He also knows about where Croft is plus or minus 10 miles.

**PD NOTE: Burle will give information about "Croft" only if he knows that the Team plans to use the "ford" and head East. His presentation of the information will take the form of a warning about the "odd" folks who ought to be avoided. He knows nothing of bombs or wars, so such conversation cannot make him think of "Croft." He will "dig out" his map only if specific questions are asked about some location. The map has no particular marking for the "Croft" area.**

**One more thing: Burle cannot read. He was given the map a few years ago by a wanderer calling himself Warrior, Warlock, Wormy, or something, who marked Rivers on the map for him. Burle will not part with the map now for love or money (because it has Rivers marked on it). The map, other than for the handling that Burle has given it, looks almost new.**

I-94/The Road is by no means a turnpike. Travelers are few. Burle has guests only about once a week.

## LACROSSE

Or "Cross," as the people who know it call it. It too is a Mondovi pattern town, but in its way quite different from the norm.

Cross is larger than any of the other communities previously mentioned. In-town residents number in excess of 500, with many more in the outlying areas. The town lies on the flats along the Mississippi, which at this point is not more than half a mile wide. The flats, on the eastern banks of the river, are roughly a mile wide. Low hills then begin to eventually form a ridge bounding the Mississippi flats of this region.

LaCrosse has also suffered heavy population decreases. Its outlying areas are a comparative wilderness or ruined buildings. The farmed areas of the flats are quite extensive, stretching about 2.5 kms north and south of the town.

The town is not walled for the ruins are too extensive to make the manning of so long a wall practical. The inhabited portion of the town is semicircular, with the flattened portion of the circle caused by the river.

LaCrosse is the center of trade for all of lower Wisconsin and Minnesota. Boats plying the river North and South stop here to trade, often trading for items from the interior. Annual trade fairs have taken place each July for the last 30 years.

In ordinary times, the citizens of Cross do not trouble themselves with the defense of their town. It is not necessary that they do so as Cross has a small standing army, but this "army" does not belong to Cross.

A Contingent of Maxwell's Militia is based in LaCrosse. They number roughly 20 men (some of whom have families in the town), and are equipped in a haphazard fashion.

This unit of Maxwell's Militia has been "based" in LaCrosse since shortly after the war. Originally these men were sent to hold the town and to maintain the bridge over the Mississippi. Theoretically, their troops owe faith to the "Overlord of Kalkasa." As it has been over a hundred years since any contact with this "overlord," this connection is very questionable.

But the men of the militia do not take orders from the civil authorities of Cross. They have their own leader, as they always have had. The first leader of the LaCrosse patrol was a sergeant. Every leader since that time has also been a "sergeant."

The sergeant cooperates closely with the mayor of Cross, for he relies on this man for the pay and keep of his troops and their families. For their part, the civilians of LaCrosse rely on the "troops" to defend the town, deal with armed strangers, maintain control of the bridge and see to its upkeep, and to collect a toll from each of those persons who cross the bridge. This arrangement has worked well now for over 100 years, with no serious trouble between the troops and the town. New recruits usually come from the town and often continue to live with their families. It is such common knowledge that LaCrosse has its own "army" that no one much mentions it.

The troops are armed with old M1 rifles (see the equipment section in the rear of this module), for which they have an ample supply of ammunition. They wear a "uniform" which consists of a green wool shirt. The sergeant also wears green trousers and has a set of old army sergeant's stripes sewn to a shirt pocket.

Of interest is the fact that the militia has an M60-A1 Tank. This tank is no longer capable of movement, although the turret will still traverse. It is parked hard by an old building on the edge of the town nearest the river. It is positioned such that it blocks fully half of the road leading to the bridge, and the tank is only 10m from the beginning of the bridge. The front of the tank faces the bridge, the rear is in the town. From this position the tank can cover all of the bridge, much of the far side of the river, and all of the street behind the vehicle. The tank cannot be seen from outside of the town, nor from any point on the East side of the river.

The M60-A1's armament is fully functional, though only HE rounds are available for the main gun. Full data for the M60-A1 can be found in PF01 (Riverton).

**PD NOTE: The men of the militia are all reasonable people who are doing a job for which the need is obvious. They are responsible and intelligent, if untrained and not very professional. They are brave and will fight for their people. They are not butchers or slave masters. They do not govern, they protect.**

**Since the team falls under the heading of "armed strangers" they will first have to satisfy the militia to enter LaCrosse or use the bridge. Once contact has been made, the guards will request that the team wait while their sergeant is called for. All negotiations will be conducted by this person.**

### SGT. "MAX" GREEN

The current leader of the militia, Max, is no relation to Maxwell; founder of the organization. "Max," as he is wont to say "is what my folks named me." He is 36 and has been the sergeant for the last five years. He's thinking of retiring in not too long, maybe another year or two, and doing something "civy."

Max has been in the militia 20 years, quite a piece of time and fairly unusual. He has no sense of strategy, but his tactics are very good. He can use his 20 men to good effect. He sees his force as a large family, himself as the father. He is brave to a fault, but in no way foolhardy.

Max knows the tank inside and out, but he cannot get it to run (no oil) and he cannot fix the radios. He has made it a point to teach all of the troops to use the weapons in it. He has also piled a 10 foot thick wall in front of, and behind the chassis so that only the turret is exposed. As he says: "If the sucker can't move, I'll use the damn thing as a fort."

He is an easy man to talk to and quite intelligent. A very charismatic leader, his troops will obey his orders instantly. They know that he will never risk their lives needlessly, and never without sharing the risk.

Sgt. Green is a good man without a dishonest bone in his body. As such, he is very hard to deceive, many a crooked trader has tried, and regretted the attempt. Max has a reputation as a fair and honest man whom you do not want to aggravate.

### THE KRELL

The Warriors of Krell (see page 53 of the MPGB) are advancing along the Western Banks of the Mississippi. Krell has made one of his rare appearances and exhorted his hordes northward.

Starting from Southern Iowa, the forces of Krell have been marching north for about a month now, burning and looting as they come. The exact strength of the force is not known, but refugees state that the advance force is about 2,000 strong and is covering an area 100 miles wide, west from the river. These forward units are fast, using either horses or light vehicles. So far, only small arms have been encountered. Heavier stuff may be following.

What is known of them comes mostly from the Amerind Nation beyond the river. Their people, taken totally by surprise, have been retreating Northward fighting a fast rear guard action. The other nations may be massing for a counter blow, but this is not known. If such does come about, it will come from the region of the Dakotas. Word of this will be weeks in coming, if it comes at all.

Few refugees have come at all, for the Krell are slaughtering all as they advance in an orgy of conquest. The Indians have suffered grievous losses, as have the white settlements. But the Amerinds have taken a few prisoners of their own. None of these are available for questioning anymore, but some things were learned from them during their demise.

The Krell are looking for a way across the river, they are hunting "Morrow Project" and "Darcloles." They know that these things lie to the North. Somewhere. The Krell have made common cause with some other groups, a marriage of convenience. In the Krell ranks can be found groups of Badges, Inquisitors, Razers, and Slavers. It is further rumored that Cannibals are scouting for the van. In any event, the fight is on, and it is extremely savage. Whether or not Krell himself is with the expedition is not known.

**PD NOTE:** This information is available only near (within 5 miles) the river. Sgt. Green has all of the data listed above. Other people probably would not.

An interesting variation can be had by allowing the far side of the river, from Cross, to be under the control of elements of the van of the Krell forces. The town would then be in a de facto state of war with the Krell. This means that the militia, and Sgt. Green, are the effective power at the moment, with most of the citizens in arms and the streets aswam with refugees from across the river. Very grim. The project personnel would have a marginally harder time making contact, as they might, on the basis of their actions, be mistaken for Krell.



Should the Team reveal that they are Morrow Project, they will not be fired on. Neither will they be loved. They, whether they are aware of it or not, seem to be the cause of this free-for-all.

Given time, the town of Cross will fail. Unless it gets help. Lots of it.

So far, the tank, and perhaps an occasional raid across the river by Sgt. Green and some of his "boys," are keeping the Krell at bay and licking their wounds. This will change as more Krell arrive, or if heavier weapons are brought up.

If LaCrosse falls, the Krell will be on the heels of Team G-5 in short order.

## LUCIFER

**PD NOTE:** The actual location of Lucifer is up to the PD. We recommend central Wisconsin for reasons previously mentioned. We are using Bancroft for a location, but the town we include is completely fictitious in its people, layout and history. Assign it any name you like, but remember to see that it appears on a map that your players possess.

## THE TOWN: HISTORY

Plainfield was destroyed in the war, an accident, as nothing meriting a nuclear warhead existed in Plainfield. And Plainfield was destroyed by a MIRV. Not all of the MIRV's hit in or near Plainfield: one came down a stone's throw from Bancroft . . . and failed to detonate.

Humans are not utter fools. They may fail to prepare for a nuclear war. They may fail to prevent such a war. They may fail to run when the sirens wail. Most, however, will not choose to hang around when a bomb comes down in their backyard. Most of the inhabitants of Bancroft ran when the sky opened and left them a gift.

Some of them also returned. Central Wisconsin was "boxed" by detonations, there were few places to run. Further, the farther one "ran" the more one was forced to "fight the current" of other refugees; and to fall prey to those desperate men. Having nowhere else to go, many returned "home."

Home had changed. Some had stayed, for whatever reason. These people had come to terms, of a sort, with their visitor. Men had been detailed to "keep an eye on it," which meant hoping to God that it did not go off. They kept children and domestic animals away.

And the winter was hard. Cruel. Eventually cannibalism began. No one was killed for food, but those who died gave up their remains to sustain the lives of those "more fortunate." The people lived in shame, and the ever present fear of their "neighbor" in its shallow crater. No one visited Bancroft from the 'outside,' for those fleeing the area had made the reason for their flight known.

Until the Spring. Then there came a man, robed in black, with a ragged group of hungry male followers. His sparse grey hair framed the skin stretched across a thin skull and a pair of fevered eyes. He had no name, but those who followed him called him simply "Father"; but whether or not he took holy orders of any kind is a matter of some great doubt.

The "Father" called to the people of the town, and they came to him, in mingled curiosity and fear. They listened to him with dread and hope, as he told them that he had been made known of their plight, and that he had come to share their burden.

He spoke and they listened; he told them that they were the chosen of God, to have present among them the very manifestation of the sins of their fathers. That God had sent unto them Lucifer himself, in the guise of a nuclear warhead, to be held, from all of mankind, by them. To let no man know of their trust, but to be steadfast in their defense, to their own peril. Only thus their salvation, and that of their children, was assured. To enter the kingdom of heaven for this earthly service.

The Father, and his followers, had come to guide and to aid these folk in the bearing of their holy burden. He and his followers would take upon themselves the task of safe keeping and guarding the sleeping Lucifer. The people would have only to provide for the

earthly needs of the Holy Guards and to partake from time to time, in "ritual," so that they would not forget their charge, or its infernal nature. Once a year one of their number would be chosen by lot, to be slain by stoning, so that all of the members of the community should participate. This person, this lamb, their anointed, would then be consumed by those who remained behind. This as a reminder that they all held in common the trust to defend, to protect, and to keep secret their sacred trust. The Father would aid them. To this the people agreed, and a semblance of normality returned to the town.

The Father survived another 19 years. Under his guidance and rule, a sanctuary was constructed to shelter Lucifer, perhaps to shield it from the eyes of the occasional innocent who might wander into the area, all unknowing. Such persons, while the Father lived, were always steered away gently, but firmly. Strangers were not welcome.

A schedule of tithes was established to provide for the needs of the Holy Ones, and if they received much for little labor, who was to complain? Did they not bear a heavy burden? But some grumbling was heard, particularly among the young. And some of those who complained in such a way that they might be heard, these might be found dead. And the yearly rituals continued, most often taking young children, even though the drawings were by lot. In his last days the Father explained that this was likely due to the fact that they were innocent and thus, least touched by the sins of their fathers. They must go, most directly, to their True Father.

Once the Father died, things began to change. Some protest was known, and the new Father, chosen by the Holy Men from among their own number, explained as best he could. When this was not good enough villagers were found dead. The New Father then shook his head and piously offered the opinion that the Hand of the Father; or perhaps of Lucifer, had moved among them and had punished, or had taken, his own.

It was not long before the Holy Men acquired a store of arms, none knew from where, to more readily have their temporal authority observed. An armory was added to the sanctuary, as well as other rooms. Houses were built for each of the Holy Men, places for them to sleep, to contemplate, and in which their other earthly needs might be met. Some fathered children. The male children were always raised in the "priesthood." Yearly "ritual" continued to be observed, although now and then the people had to be forced to it at gun point. Lucifer "slept" in his sanctuary, well guarded.

## TODAY

Bancroft is much as it was, with a population of about 150. These people are the virtual slaves of the 15 "Fathers" or "Priests" who minister to Lucifer. All of the former "Holy Men" are now Priests or Fathers, although there is one paramount Father at any given time.

The people live dull lives without hope. It is doubtful whether or not any believe the pseudo-religious yammerings of the Priests, but all fear their power, and the sleeping menace of Lucifer. Some might well die to be free of this curse, others might fall back upon the security of the Fathers, who, if nothing else, do keep the outside world at bay.

Now and then groups of "Crofters" do venture into the world, in order to trade for those things which "Croft" cannot produce. Such items most often go to the Fathers, whose greed exceeds the comprehension of most men. Such groups of traders are always accompanied by a priest. The priest prevents free intercourse with "the ungodly."

Strangers are always driven from "Croft," most often by night. Some have been killed.

It could be that the priests are overzealous in their attempts to maintain the secrecy of Lucifer. The people whom they "guard" know only Lucifer. "Bomb" and "Warhead" are only different words which mean Lucifer.

Who can say what the Priests believe? Some are surely cynical men who believe none of the "Word." There are certainly a few who are the opposite, who believe that Lucifer rests among them and that they are appointed to see that Lucifer does not wake. Some of them may know that Lucifer is really, and merely, a very old bomb. There is, however, one thing upon which all of the Priests can agree: Lucifer must NOT be tampered with or moved.

It matters not whether the reason for this is to prevent Lucifer's waking, or to prevent the source of power over the people from being removed. Any, or all of the Priests will fight to the death to keep Lucifer intact, undisturbed and in the Sanctuary. Nor will it matter to them who wants possession, Krell, Morrow Project or some third party. No one tampers with Lucifer. There are no conditions. These men *cannot* be reasoned with.

### THE VILLAGE OF CROFT

It used to be a town. Croft has deteriorated to the point where only a handful of people remain.

The village consists of about 50 houses of varying sizes, some built before the war, some having been built later on. These buildings follow no set pattern and are a ramshackle lot. All are situated in a haphazard fashion on the filthy dirt/mud "streets" of Croft. All buildings are in a poor state of repair and are crammed close to one another. Most buildings are single story, some are two story, none are three or more stories in height. There is little glass, people rely on shutters and cloth to cover their windows.

Nearby all of the houses are barns, stubby silos and the other structures common to primitive farming folk. There is no "sanitation system." Some refuse is used for fertilizer, other piles of refuse lie strewn about, much is thrown into "the creek." Of course, the only source of water available to the inhabitants is also "the creek." Trees and weeds grow where they will. The "streets" are, depending on the weather, either areas of choking dust, or quagmires of mud and filth with pools of standing water.

The impression a casual traveler might get of Croft is one of unrelenting squalor. This impression is accurate. On a warm day, with the wind from the right quarter, one can smell Croft before one sees it.

The people of Croft complete this dismal picture. They are dull and bowed, slaves in all but name. Their lives are an unremitting purgatory of fear; of the Priests, of the Ritual, of Outsiders, and of Lucifer.

Their days are spent toiling in the fields which surround Croft, or in their households. No one lives "outside" of Croft, there are no "outlying farms." All of the people live in the town, where an eye can be kept upon them. This is part of the reason for the crowded, squalid conditions of Croft: since the Priests forced this move years ago.

The only interruption in this deadly routine is the weekly, mandatory attendance at the Sanctuary. This occurs one morning per week, begins before dawn, and lasts until noon. The people are herded into the Sanctuary and are there made to sit, facing the "eternal flame," and are then subjected to pseudo-religious "sermons" punctuated by periods of utter silence, permitted for "meditation" upon the sins of man in general, and the Crofters in particular. The people then leave the Sanctuary and are committed to "contemplation and reflection" for the remainder of the day. This is very hard on the children. Their elders generally employ this time most gainfully in deep slumber.

Whether or not these people believe in this "theology" is unimportant. They fear the Priests. They fear Lucifer. Fear is the single, most constant facet of their lives. Hopelessness comes in a poor second. They may not believe in the Priests, but they do believe in Lucifer. Most of these people would aid in any attempt to be rid of Lucifer, if they could do so in such a way as not to be noticed by the Priests. None of these love the Priests, none are their secret spies. And yet, faced with an upheaval in their lives, they might rally to the Priests. None of these people can imagine life without the Priests or Lucifer. None will undertake action on their own.

There is here the possibility of a very ugly mob scene. These people might tear the Priests limb from limb, or they might go for the Team. The most likely event is that, faced with a choice, they will hole up in their homes in terror. There are no leaders in this community. All of the people, with the exception of the Old Man, who does not count, may be treated as sheep, cringing in abject terror. But do not overlook the potential for spontaneous mob violence.

### THE PRIESTS

At the moment there are 15 priests in Croft. These men do not work, nor do they perform any useful service. They keep a careful eye on the inhabitants of Croft, "guarding" them.

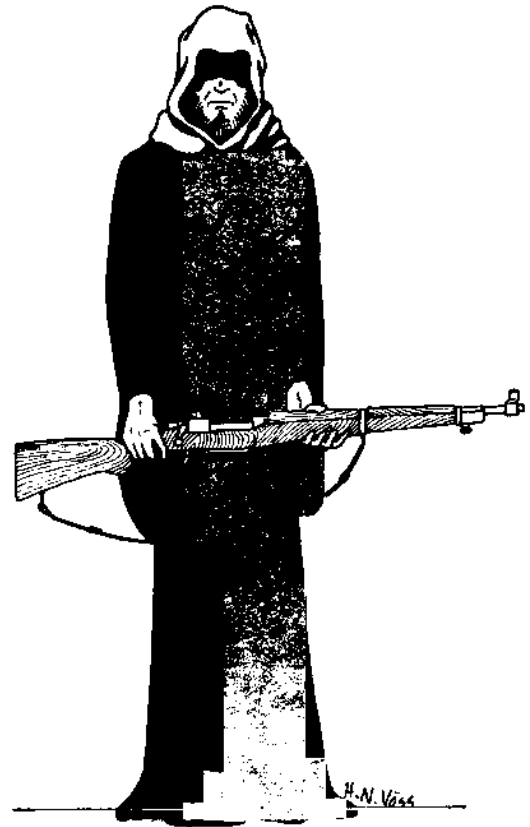

The Priests guard the villagers constantly; in the fields, in their homes, during the hours of daylight and in the darkness. On those occasions when it is necessary for the people to trade with outsiders, small parties leave Croft "accompanied" by one or more priests. Such parties are always made up of mature men with families, and while it is never said, this is because such men are leaving hostages behind them to ensure their return.

And while some priests are always visible to the people, others are very carefully *not*. During the hours of daylight, some Priests are somewhere off in the woods surrounding Croft, either on wooded hill tops which afford a view of the village and its fields, or within sight of the trails that lead into, but more importantly, those that lead out of, Croft. These men are "keeping vigil" to "protect" Croft from outsiders. It is an open secret, though one never mentioned, that the rifles of these vigilant priests most often face Croft.

Curfew begins as soon as night has fallen and the people must remain in their houses. Priests return from their vigils, others begin to move about the streets of Croft in the darkness. The black robes and cowls make a stationary priest next to invisible.

A priest who chances upon a Crofter in the dark, might, depending on his mood, warn the Crofter, chide him for impiety, and see him to his door. It is also possible that the folk huddled around their fires might hear a single rifle shot in the night. Such sounds are never investigated, and bodies are never found.

No more than half of the priests are ever keeping vigil at any time. Usually only 3 or 4 are out in the woods or in the dark. The remainder watch over the people during the day, and return to the Sanctuary environs after dark. After sundown, laughter and bright lights often characterize the low hill on which the Sanctuary rests. Sometimes there are also screams.

The priests refer to one another as "Brothers" but to the locals they are always "Father." Crofters must bow their heads in the presence of a father and speak with the *utmost* humility. To not observe these simple precautions is to court being struck in the face with the butt of a rifle, or worse. Torture, under the term "purification," is not unknown. The priests avoid wanton killing, not for love of their charges, but to prevent an unacceptable reduction in the labor force. They will kill without hesitation if they think that their authority is being threatened or challenged.

To the best of anyone's knowledge, the priests do not quarrel among themselves. They seem to live in an enforced harmony necessitated by providing a united front for the eyes of the village. They raise their voices only in those moments when a holy zeal might fall upon them, while preaching "The Word." At all other times they exhibit an unearthly calm. (At least to the villagers.)

They habitually speak a corruption of "biblical" English, heavily laden with "thee's," "thou's," "thy's," etc. They speak ponderously and at length. To most, they become very boring, very quickly.

This is their natural language. 150 years of speaking in this manner, combined with the young hearing nothing else, has made it their only speech. It is not an affectation (anymore), and they cannot speak "normally." Whether they believe in their "theology" or not, they all speak as if they do.

They do not, usually, live alone. Some have families, most have concubines. Priests do not take wives. These dependents form a small community living in the vicinity of the Sanctuary. The two communities, that of Croft and the Sanctuary, do not mix.

More children are born in the Sanctuary than ever reach adulthood. Infant mortality is higher on the hill (perhaps because of the proximity to Lucifer). It is true that Priests and Concubines do not usually live long lives, and that some priests have been seen suffer-

ing horribly, usually just before death. There are rumors in the village of monsters being born to priests, of priests who are impotent or concubines who cannot conceive. There are also tales of infant cannibalism and of semi-regular cannibalism among the priests.

#### **THE "HIGH PRIEST"**

One Priest, often the eldest, is High Priest. It would appear that his only duties are connected with the weekly gatherings and the annual ritual. It can be surmised that his duties also extend to the administration of the Sanctuary and its people, the assignment of vigils, the day-to-day running of affairs in both communities. It can also be assumed that the High Priest would command the other Priests in emergency situations. Nothing more of this position is known.

Priests tend to have biblical names like Elijah, Josephus, Joshua, etc. All are drawn from the Old Testament.

The Priests, while familiar with their weapons, have little or no tactical sense. They are smart enough to hide behind rocks and trees, but true fire and maneuver is unknown to them. Whenever possible they prefer to operate at night. It is at this time that their greatest ally, terror, can most effectively be used. These men are not afraid of the dark and are intimately familiar with the terrain. They have the instincts of rats, in life, in a fight, when threatened, and when cornered.

## THE MAPS

A. The village of Croft is made up only of farm houses and their related buildings. There are no inns, taverns, bars, stores, smithys, *nothing* else. This is effectively a slave community with no amenities. This village is marked "A."

B. This is an area of ruins on the North side of Croft. These ruins are fairly recent, being only about fifty years old. A casual inspection of the area will reveal that this devastation was caused by fire.

Few people in the village remember this calamity. There is a tradition that this was an area which sheltered impious people, and it was stricken one night by the Fire of the Lord.

The Old Man tells it differently. It is his memory, for he lived nearby, that the High Priest of the time set the blaze with his own hand. Other Priests waited nearby. The few terrified souls who escaped the blaze fell to the rifles of these priests, who found it difficult to miss targets backlit by the fire.

No one lives there now, and the area is shunned by all. The ruins are overgrown, and are dotted with bits of bone.

### C. The Creek

This water course flows mostly North to South, with many windings. Throughout its course it is surrounded by trees and brush. It flows between loose, steep banks, anywhere between 1 to 3 meters tall.

During most of the year it is little more than a meter deep and flows slowly. In the Spring the creek may reach 2 meters in depth, though this is rare. It also flows more quickly. A man on foot can cross it almost anywhere, but the MPV must find an area with smooth, firm banks on either side to attempt a crossing. There is no traffic on this water course, and there could not be, as trees and brush interrupt its course at many points, and there are a wealth of sunken logs, and other, nameless sins of the past to block its flow.

The creek can be up to 10 meters wide. In most places, however, it is only about 3m across.

There is a low stone bridge across the creek in the town of Croft. It has no railing, but is just wide enough to allow the V-150 to pass. This should not be attempted at speed.

### D. The Fields

These surround Croft but roughly follow the line of the creek, so most lie north and south of Croft. These are divided only on the basis of the sort of crop grown, for in these later days of Croft, no man owns his own land. All persons are forced to work where the Priests dictate.

The fields are bounded by rough hewn, split rail fences. Those furthest from Croft are poorly maintained: in many places the fences have fallen entirely. In all places, the forest grows right up to the fences.

### E. The Sanctuary and Its Environs

The Sanctuary "complex" lies on a low hill to the Northwest of Croft, roughly 1 km away from Croft. It stands in this place because it is here that the bomb fell. The Sanctuary was built around Lucifer.

The fields stop at the foot of the hill, and the slopes of the hill are kept bare. On top of the hill are a variety of buildings.

1. **HOUSES:** On the south side of the hill are 15 houses. These are small, two or three room buildings, all one-story tall. They are the homes of the Priests, housing them and their "families" (if any). On the East side, nearest the Sanctuary, is a larger house. These are the quarters of the High Priest.

All of these buildings are made of wood set upon stone foundations. They have no basements, but they usually have two doors, facing East and West.

2. **STOREHOUSES:** Covering the top of the hill to the East, North and West sides of the Sanctuary are five long, low buildings built of stone and wood. These are the storehouses used to hold the tithes "collected" from the Crofters, and other items acquired from trading with outsiders.

Each has but one door, located in the center of each building facing inward toward the Sanctuary. The doors are kept locked

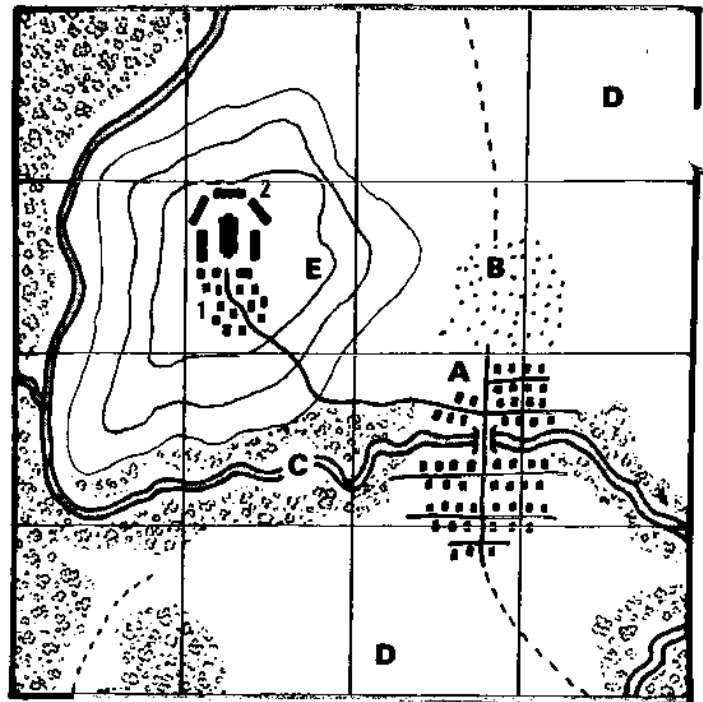

**Croft and the Sanctuary Complex**  
one square equals one kilometer

unless the building is in immediate use. There are no windows and no firing slits. They are built to be "burglar" proof, and while solid, they would make poor points of defense.

The storehouses and the Priests' houses form what is effectively a wall around the Sanctuary. It is impossible to see the Sanctuary from beyond these buildings, much less to get a clear line of fire to it. There are no nearby hills of sufficient height to offer an overview of this complex.

### F. The Sanctuary

This is a roughly square building, constructed over a period of several seasons 150 years ago. It is made entirely of stone and is very solid. The interior walls, unless otherwise noted, are all made of wood. This building is only one-story high.

1. **THE FOYER:** This is the anteroom of the Sanctuary and serves no purpose other than that of effect. It is 3 meters wide and six long. On its southern side is a 2m wide pair of heavy wooden doors. These are duplicated on the north wall. The doors are from floor to ceiling; about seven feet tall. They can be barred from the inside, but there are no other provisions for "locking" them.

The walls and ceiling of this room were painted by a long dead artist. They depict highly graphic scenes of a nuclear war. The representation of death and destruction are very lurid, graphic, and in very poor taste. These paintings are now explained as representing Hell, the vengeance of the Lord, and the wrath of Lucifer, all in the same breath.

2. **THE PEOPLE'S COURT:** This is the main room of the Sanctuary. It is 14m wide and 10m deep. In the center of the floor is a 2m square fire pit, with a hole in the ceiling to exit smoke and allow air in. The fire is kept burning at all times, an "eternal flame" to serve as a reminder of the power and terror of Lucifer. This fire, and the hole in the ceiling, are the only sources of light, as the room has no windows.

Situated in a semi-circle around the fire pit are a collection of hand-hewn benches. They can, with some crowding, accommodate most of the people of Croft. It is in this room that they congregate for the weekly gatherings.

The north end of the semi-circle is bare and faces the north wall of the room. This is a wooden wall with a four-meter gap in its center. This gap is closed from the room by a floor to ceiling black curtain. This opening leads to the "true" sanctuary: Lucifer's court.

3. **LUCIFER'S COURT:** In this room lies Lucifer in a shallow pit in the floor. The rest of the building has a floor of flat stones, but in this room, the pit in which Lucifer lies is bare earth. Nothing grows in it, no insects burrow there.

This pit is four meters long and three wide and it is one meter deep. It is almost completely filled by the three ton bulk of Lucifer, lying on an angle in the crater.

The pit is surrounded by a floor to ceiling purple curtain. Both this curtain, and the black curtain which separates this room from the People's Court, have arrangements for drawing the curtains aside. This is habitually done with the black curtain. The purple curtain is moved only on very special occasions.

Lucifer's pit lies in the center of this room, which is 14m long and 9 deep. Halfway between the pit and the black curtain, centered on the 4m gap in the wall, is a pulpit. It is from this point that the Priests speak to the Crofters. It is said that, when the purple curtain is drawn aside as well as the black curtain, some people can see the Priest at the pulpit bathed in the glow of a holy, or infernal, fire.

In the rear of the room, centered in the north wall, is a one meter wide, heavy wooden door. This door is not visible unless the purple curtains are drawn back. There are also two gaps in the wall, one on either side of the door. These begin one meter from the floor, are only four inches wide, and are about a half meter tall. They are, as they appear, firing slits.

Lucifer's court has no roof hole, and no internal lighting.

4. **THE ARSENAL:** This room has the same interior dimensions as the foyer, but all of the walls are one meter thick stone. There are 4 external firing slits in this room; two in the north wall, one each in the east and west wall. Of course, these last two are the two interior firing slits previously mentioned.

The Arsenal holds all of the firearms of the Priests. Only the Priests on vigil or guard keep weapons with them, the other rifles are kept here. At any given time, there are 8-10 rifles here. The ammo for the rifles is also kept here, about 250 rounds of .30-06. Also in this room are two Smith & Wesson M27's (page 13 MPGB) with 12 rounds of .357 magnum for each revolver.

Finally, the room contains 13 kegs (about 4 kg each) of black powder. These have been hoarded by the Priests and placed against the walls, below the level of the firing slits. (The Crofters know nothing of the powder or the handguns.)

One Priest is supposed to be in this room at all times, to safeguard the items stored here. The door can be barred from the inside. There are no other doors and the firing slits are much too narrow for a human.

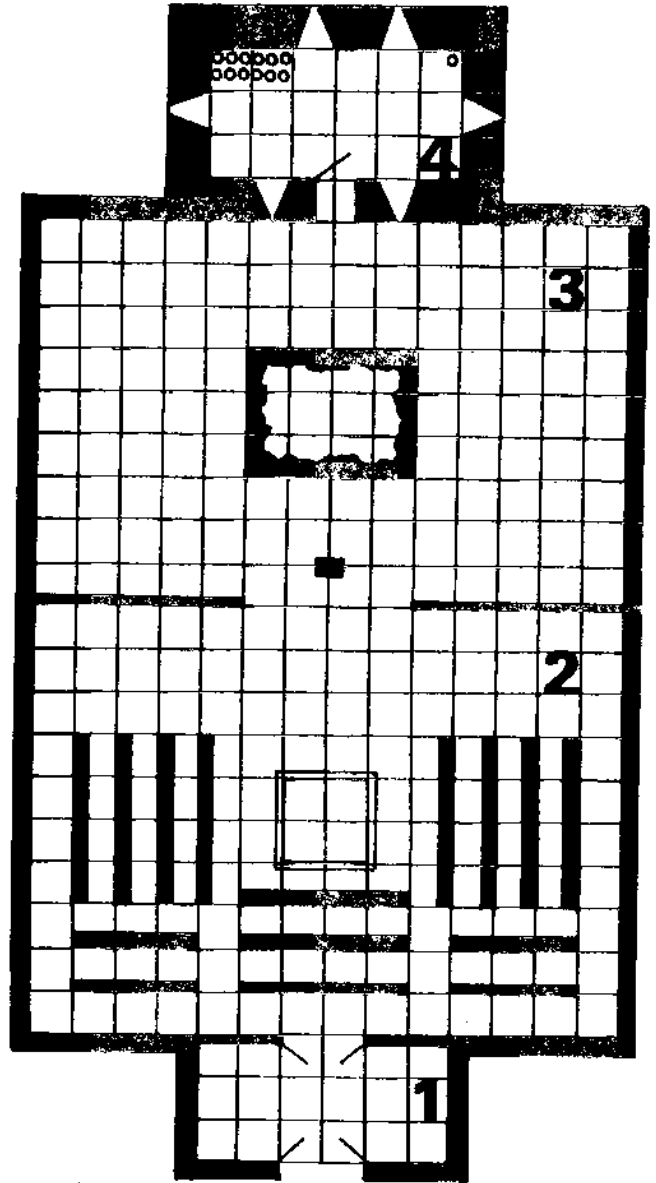

## THE SANCTUARY

one square equals one meter



## ENCOUNTERS

### GENERAL

Since Operation Lucifer covers so much ground, and because the players have so few clues to use in locating Lucifer, a variety of random encounters are provided. Not all of these encounters are sources of information to the Team and some are definite sources of disinformation!

Some of these encounters have limitations upon them as to location, or information available. Keep these in mind, along with the knowledge that these people are not technically oriented. They give directions and distances in vague terms unless they are very familiar with an area. Their knowledge is rarely up-to-date. Hint: Does "One day's travel" mean walking, riding, by wagon, by MPV, or other?

#### 1. Jan Strunk; Horsetrader

Jan is 60'ish and grizzled. He dresses in near rags and smells horrible. This may be because he is *always* in the company of his herd of trade stock: horses. The size of the herd varies, roll 5D10 at any given time. Jan is so dirty that, when visiting Rivers, Burle Ames won't let him inside until he has bathed completely, *outside* of Rivers.

Jan is a Horse Trader. He wheels and deals, moans and groans, is out for the best of it and is a very sharp operator. He will endeavor to trade horses with the Team, for whatever they have of value. He will begin by asking outrageous sums (claiming bargain prices and selling at a loss) for the most decrepit and sickly horses ("the best and finest of the breed, sound all through!"). Mr. Strunk does have some good horse flesh (20% of his herd), and a larger number of "fair" beasts. He *likes* to dicker and bargain, and, in a good session, will throw in hair rending, foot stomping, arm waving, shouting and tears, all absolutely free!

Jan is also a friendly man and likes talking. He travels the remains of old '94 (the Big Road), making stops and side trips all along the way. He's been as far west as the "Plains across the River" (Eastern Dakotas), east to the "Big Water" (Lake Michigan) and as far south as "Where the Rivers Meet" (Ohio and Mississippi). He gives information freely, if asked. (He rarely gets to talk to anyone at any length.)

Questioned about the Bancroft area, or "away east of here, etc." Jan will reply:

"Don't know, never been there m'self; heard bad things about it. Why, there's nothing over that way but the waste, and nobody goes into that and then comes back an' talks about it! There's supposed to be a witch living up there, but 'tween monsters and what I've heard 'bout those jokers in Croft, I don't see how a body could survive."

Jan also has some misinformation, this is about Amerinds, or "Injuns," as Jan calls them. Strunk will claim that they're Dangerous, Treacherous, all Dishonest and None-of-Them's-to-be-Trusted. A cursory inspection of his *herd* might give one insight into Jan's reasons. Some of his horses are not where they belong . . .

Finally, Jan is non-violent and not brave enough to steal (when there's a reasonable chance of getting caught). He will defend his herd if necessary, but prefers to run whenever possible.

#### 2. Herb Deer; Tinker

An itinerant pot mender and jack-of-all-trades, Herb can be found wandering any trail in the area, going from town to town, farm to farm, earning his keep by plying his trade. He is dressed poorly and leads a horse. He does not ride; the horse carries a White Knight's assortment of pots, tools, traps, solder, and you-name-it. The proverbial mousetrap is there. Herb does not talk much by day, but if found in camp, he enjoys sharing tales over the embers of a fire. If asked about the Bancroft area he can reply, for he was in Croft himself once, and fixed some things for an Old Man there, before he was discovered and run out of town. His story:

"The Old Man of Croft tells a story, says his daddy first told it to him, years ago. It's about Plainfield. It seems that on a night long ago, a demon came and claimed the town as his prize. This demon fella came down out of the sky and burned the whole town with a magical fire, plumb melted the stones."

"Now, his daddy also told him that the demon wanted Croft, too, but the Priests kept him away. Can't say I believe that, but the Priests

do try and keep everyone away, guess a demon 'ud be just another stranger."

Herb is in his late 20's, small but with no extra weight on him. He carries an *old* bayonet and a black powder rifle, as he often "sleeps out" between jobs. He never camps near a place which was once inhabited, as he is aware of the dangers: Things that kill in the night. He is non-violent unless threatened, and very fond of "sipping whiskey."

#### 3. George Haydik; Mailman

George is a drifter, first, last, and always. He is dressed in reasonably clean homespuns (if you don't want much), that have obviously known former owners. He has long brown hair, a bushy, matted, tangled brown beard, and wild, fanatical, brown eyes. He is not more than 5 feet 6 inches tall, but is powerfully built.

And he has found his calling in life. He carries messages (which he calls letters), from place to place. Some few of these are written on paper, painted on bark, or what have you. These he carries in a canvas sack slung over his shoulder. Most of the "mail" he carries is oral, person-to-person. At no time will he divulge any of this information. People trust him and that's important. He does all of this free of charge.

Haydik rarely spends a night in the open. People, even in the South, shelter and feed him. This is because of another commodity he carries; news (and gossip). This is greatly sought after and the person of a mailman is held sacred.

George is a veritable gold mine of information, all of it reasonably accurate, though some of it is dated. He can read. He has a phenomenal memory. He is intimately acquainted with the terrain of Wisconsin and Minnesota.

Some of the things he knows, and will tell the Team:

1. The only way across the Big River is at Cross, where there's a bridge. (If the PD is using a Krell assault on the town, then Haydik will also know: "There are bad things going on across The River. The troops in Cross might be a touch trigger happy at the moment." (Haydik has seen the tank but will not talk about it unless questioned in detail: He does not know about "tanks," but does know about fighting machines with big guns.)
2. George knows how far it is to Croft, in day's travel on foot, from anywhere in Wisconsin. He knows this for most places.
3. George has been to Croft:  
"There's nobody in Plainfield now. Fact is, if it weren't for the old signs, nobyd 'yd even know there was a Plainfield. I passed by there, once, and the folks in Croft drove me out! Me! A mailman! I tell you, I won't go back up there! They can keep their guns and their black robes!"
4. About Indians:  
"There's two kinds: A whole lot of 'em with Women and kids, and the kind where there's just a bunch of young guys on horses. Now, the folks all together like, you don't have to worry about them, they're just folks. But now the Bucks! They might just come a ridin' at you, whoopin' an' hollerin' fit to scare you to death!"

"I just get down on the ground in a ball, you know? I let 'em all ride by me. They *whack* you with *sticks*. Then they all keep on going. I can't make no sense of it, but it don't hurt to speak of. I hear if you try and stop 'em from doing it, they can get nasty. Do more than whack you. It don't bother me no more, but the first time it happened it nearly scared me to death!"

George is not afraid of people, since everyone knows that mailmen are O.K. He will hide if he thinks strangers are dangerous, and he will avoid a fight if at all possible. George will also accept a ride from the Team if one is offered, and if they are heading in his direction. George is unarmed. His presence with the Team is a virtual safe conduct among all people, unless the people are crazies, Krells, or Priests of Croft. Or if the Team antagonizes the people themselves.

George can be found along any trail in the area.

#### 4. John Wilu; Fisherman

**PD NOTE: Wilu can be found only at, or near Stevens Point.**

John is a fisherman/trader and a local village leader. He has this to say about the Croft area: "I've never been there, but I once spoke to a man who had. Seems there's a big waste about where nothing natural grows. The folks died a long while back, and there's spirits or something that the Crofters are afraid of. There's talk of some kind of ritual. I can't say as I'd like to go there. Word is that their Priests won't let 'em talk to outsiders; watch 'em like a hawk watches fish."

Nothing else that the man has to say deals with the area.

#### 5. From any Farmer within 20 miles of the Croft/Plainfield area.

These people will *not* talk about Croft; they've heard too many bad things about it. They've seen the forlorn groups of "traders" go by, under guard. They will say that on the north edge of Plainfield an old woman lives who is a witch. That is all they'll say.

#### 6. The Old Woman of Plainfield

**PD NOTE: The Team will have to travel to the Plainfield area to get this information.**

The North side of Plainfield, shielded by a few low hills, missed most of the radiation and is not dangerous anymore. It is a mass of ruined buildings, dotted with stunted trees and visited by no wildlife. At night the sky glows to the South. It is a very eerie landscape.

If a quick search of the area is made, the Team will find an old woman, cooking over a small fire outside of a lean-to shelter. Along the low wall are earthen jars and rude leather sacks.

The Old Woman will at first ignore the Team, but if they persist, she will talk to them:

"Soon, it will be time for the Crofters to come hunting the souls of their children. They'll come during the honeymoon. To prove they're still men; that's why they'll come."

"I know you're not from Croft, my charms protect me from them. The King of the Fires. He gave me my charms. And the charms tell me that you're from a long time ago, a very long time ago."

Is she insane? A touch psionic? Both? The Old Woman/Witch is included for the convenience of the PD. She can be used to provide any information the PD likes. Of course, the Team will have to hang around to get this information.

#### 7. Amerinds

No less than three tribes existed in Wisconsin before the war. Left to their own devices upon reservations far from nuclear targets, a majority of these people survived.

With the resurgence of the plains Amerinds on the far side of the Mississippi, many of the "woodland" Amerinds to the East prospered. Never far removed from the culture of the Plains, the Amerinds of Wisconsin adopted a plains culture of their own.

The Wisconsin Amerinds are now migratory, spending their Winters in the North in, or near, the former reservation lands. With the spring they move south or southwest, toward Illinois and the Mississippi.

The tribes do not number more than 10,000 souls in all. Most groups are made up of a half dozen or fewer family units, or clans. These are the type of groups most likely to be encountered by the Team. They move only about 10 miles a day, camp for the night, pack up and move on in the morning. These people are rarely found near farms as they avoid cleared lands. There is a state of open friendship, with small contact, among the folk of the lands which the migration passes through.

Family groups encountered by the Team will be friendly, if cautious. No violence is likely. There is a good chance here for some fast and loose role playing for the PD. All of these people speak English, as well as their own language, but they are used to "yokels" who do not know this. If the Team goes into a "Great White Father" routine, the Amerinds will counter with a gruff, Red Man, "Tonto"

routine of their own, for as long as they can keep a straight face.

These people know nothing of Croft. It is too near a Nuke Strike. The Amerinds avoid all such places.

#### 8. Amerind "War Parties"

The wild nature of youth being what it is, the elders leading the migration do not attempt to hold their young to the pace of the slower family groups. So it is that the young men, "braves" if you will, range away from the main body, scouting, noting the lay of the land, hunting, and occasionally raising a bit of harmless hell.

These young men are organized into "war parties." There is no war, which may be just as well for them as these kids are not up for it. They are not like their brethren from across the river, who sometimes have to practice this art. Though it is true that, if given time, they would probably be able to rise to the challenge.

The War Parties consist of unmarried youths ages 14 to about 20. There is usually at least one older, more experienced, "war leader" among them. He is there primarily to ensure that the kids do not hurt themselves nor cause any real trouble. Unfortunately, the "braves" often manage to "lose" him for awhile and take off on their own.

The "Braves" are never armed with anything heavier than bows and lances, though the "war leader" always carries a rifle. They are all, despite their years, superb horsemen.

They also tend to carry an item called a "coup stick." This is most commonly a simple rod of wood, no longer than a man's arm. A "weapon of honor," the coup stick is employed by *touching* an enemy: the idea being to show that had it been a real weapon, you could have gotten your enemy, but being a real warrior, and your enemy being both inferior and inept, you do not *need* a real weapon either to "nail" him or to show him up.

This "weapon" is intended for use primarily against other youths of other clans or tribes. True warriors carry them, as well, and use them in deadly earnest against armed opponents. The youths, however, tend to engage "targets of opportunity." The Team, or members thereof, might become such targets. The braves will not "attack" in this fashion if their "war leader" is present. All of this is well known to the peoples living in the area.

It takes a lot to anger these peaceful people, but shooting up a group of their young men would do it. A Team does *not want* to have *these* people stalking them. PD's who run Teams who "shoot first and ask questions later" take note.

#### 9. Amerind Warrior

**PD NOTE: This man is found only within 8 km's of the Mississippi, and only if the PD is using the Krell advance on the Western side.**

This is a lone, mounted warrior from the tribes west of The River. He has been fighting the Krell for the past month and is, as a result, very grim. He has crossed the river only because he is out of ammo for his rifle. As soon as he can find more, he will return to the fight. He no longer particularly cares if he lives or dies, he has seen too much, lost too much. He cares greatly about how he dies: fighting Krell.

His rifle is a Model 1894 Marlin carbine which uses .44 mag. ammo. (See equipment section.) If he can get at least 20 rounds, he will *swim* his horse *back* across The River. To continue the fight.

He has all of the information, pertinent to the Krell, that Max Green has. He will give this to the Team, once he is sure that they are not Krell. A very violent man who can, none-the-less, be reasoned with. He knows nothing of Croft.

#### 10. The Old Man of Croft

An Old Man lives on the outskirts of Croft. Being too old to farm or hunt, he is generally ignored by the Priests. This man, in his 80's, at *least*, remembers many of the stories told him by his father and grandfather about life before the war, the coming of Lucifer, and about The Father. He tells these stories to anyone who will listen, but lately that has meant only a few children, now and then.

He is an *old* man and nods off to sleep as often as not. He also has

nothing to lose and believes nothing that the Priests say. He is held in some respect by the people of Croft, because of his age. More than any other citizen of Croft, he is disposed to help the Team in their mission, but, due to his age and frailty, he can provide no physical support.

**PD NOTE: This man, like the Old Woman, is a vehicle for information. Among other things, he can inform the Team about such things as the interior layout of the Sanctuary. Use your own discretion.**

As if the previous encounters did not provide enough role playing and voice changes for the PD, we also enclose the following NPC's. These are all members of that group whom we refer to as Napoleon's Own (Page 52 of the MPGB).

Not a one of these folks is "tightly wrapped," they are all wandering "America's Dairyland" at random. But do beware; they are all firmly enmeshed in their *persona*; they will role-play to the hilt and cannot be bothered with other people's opinions of their sanity. They believe in themselves.

They are also a marvelous opportunity for the PD to throw some "random numbers" into the game. To say nothing of hilarity into which might otherwise be a very grim game.

None of these people know anything about Croft or Lucifer. None have ever been near the area (God protects . . .). They are only encountered "in the bush" and never in communities. Other locals may know of "the queer folk" in the woods, but are unlikely to know any individuals.

None of these people feel it necessary to introduce themselves! Players should have to ask for names!



#### 11. Davey Crockett

Davey is dressed all in buckskins, sports a beard, a 'coon skin cap, and a long rifle (black powder, flint lock). He looks just like a local.

He is also convinced that it is 1836 and that he MUST get to "The Republic of Texas." After all, there's a war on and Santa Ana is marching. Houston needs some good "scrappers" to help him out!

None of this information should come out all at once! Let the Team get it a piece at a time!

Davey has at his side an 18 inch knife, given to him by Col. Bowie (who couldn't make it, or something). In dire emergencies, Davey can employ a latent "Psi" ability nowhere listed in the MPGB: Grinning. If he has 15 seconds or more, he can grin down a would-be opponent from doing something "unnatural" to him; like shooting him. (PC's must roll 1/2 their luck or less or be "grinned down").

Crockett also trades in tall tales, and will consider "sleeping for 150 years" on a par with "riding a twister."

#### 12. Lady Godiva

A very attractive woman with very long hair, riding a horse. She is also naked. Her protection is psionic level 5 Empathy; when she senses arousal or violent intent she projects a total lack of interest on everyone within 100m.

She is also a mine of information, none of it any good. She hails from York, formerly Eboracum, which lies south of the Wall (Hadrian's), and between the two waters, etc. Lots for the PD to do here. Remember, that there is a King, in London, on the Thames, probably an early Edward, Mark I or II, whichever you like!

Of course, the players should have to ask for all of their information, getting it a bit at a time. Properly done, they may be looking for a King, in the South, days later.

#### 13. Robin Hood

Robin of Locksly is a tall, good-looking man in his late 20's or early 30's. He is dressed in green clothes and sports a feathered cap. He is armed with a bow and carries a quiver of arrows. It could be that this man resembles Errol Flynn.

He, and his band of 10 or so "Merry Men," always strike from ambush along a trail, perhaps dropping a tree in front of the unwary travelers. In true heroic fashion, Robin and his men will never start shooting. Robin will always present himself for parley, trusting that the travellers will know that they are "covered."

Robin Hood robs from the rich and gives to the poor. There are isolated people in the area who look forward to his arrival. He usually takes from the better stocked traders, but moves around "Sherwood" (Wisconsin) so much that no one knows where he and his band will be at any given time.

And he will have a hard time judging the Team. On the one hand, the Team is armored (by virtue of the MPV), much as the (fictional) Sheriff's men might be. On the other hand, the Team is dressed all in green, like the Merry Men themselves. So Robin will find himself disposed equally between either robbing the Team at arrow point, or trying to persuade cooperation of the two "bands" against the "common enemy": the evil Sheriff. His choice will be based on his impression of the Team, and that based on the Team's interaction with him.

The Merry Men? Well, they are not crazy. They also know nothing of the real Robin Hood. As far as they are concerned, this Robin Hood is the genuine item, the one and only. They have seen him take, and give. They believe in him and follow him, willingly. It is true to say that they are the real "Merry Men," and will react to all things accordingly. They are armed with bows, clubs and knives. There is even a "Little John," but no Friar Tuck or Maid Marion. Of course, these people may show up in the years to come . . .

#### 14. Zorro

Identical in appearance, and attitude, to the Zorro of television notoriety. This man is likely to be recognized instantly by all of the members of the Team; years of Sunday morning re-runs having left their cultural residue.

Zorro will not care. He is sure that he is real, the one and only. Initially at least, he will also be sure that he knows exactly what the Team is as well: The minions of the evil Alcalde.

And he has no doubt about what he is to do. It is his job to take back from these "troops" the money which they have stolen (in the form of taxes, ordered by the Alcalde). He will also humiliate these "troops," pointing out how they rob church poor boxes, steal the food from the mouths of widows and orphans, etc., etc.

He has nothing against the "troops" for he knows that they are only tools and not fully responsible. Zorro's ire is reserved for the Officers of the Alcalde (i.e., the Team Leader), who are educated men, like himself, who ought to know better, but do what they do knowing that it is wrong and evil.

It is possible for the Team to convince Zorro that he is wrong about them, but only through the action of the Team Leader. This is not easy, and to some Teams, it is not overly obvious how to do this.

The Team, and more importantly, the Team Leader, must behave in a manner totally at odds with the "traditional" behavior of troops of the Alcalde or his Officers. Something on the order of the Team Leader offering his own life in exchange for the lives of one or more of his men might convince him. (But one for one is better.)

Zorro is armed with a flint lock pistol and a rapier. Well, he calls it a rapier, but such blades are hard to come by in post-war Wisconsin. This "sword" was probably beaten out of the leaf spring of an old Ford pick-up truck. It is sharp (more or less), and Zorro does know how to use it. He is dressed in the black clothes, hat, cloak and mask which are his trademark. He rides a black horse.

And, like his fictional predecessor, he will only kill in self-defense. He strikes with speed and stealth, vanishing quickly. He knows that he lives in the Viceroyalty of New Spain and has never heard of California. Zorro is very careful of his true identity and calling him Don Diego is not wise. A very dashing figure.

#### 15. Thomas Edison

This old man is harmless and potentially beneficial to the Team. He is always encountered in or near his shack, which he calls Menlo Park. He has managed to build a dynamo, powered by a wood burning steam engine, and has electrical power.

Within Menlo Park Mr. Edison maintains a small forge, the tools necessary for drawing wire, making light bulbs, and similar items. He trades vegetables and some items of his handiwork, to travellers and Amerinds, for copper, other conductives and the many other items which he needs.

#### 16. Long John Silver

**PD NOTE: This gentleman is found only near Lake Superior or Lake Michigan.**

The archetypal pirate. Long John has a pegleg beginning at his left knee, and squints his right eye. There is a chance (30%), that he is accompanied by a boy whom he refers to as "Young Jim" (Jim Hawkins). His gravelly voice conceals a powerful ability to persuade, and his gruff appearance conceals a soft heart. Long John Silver is armed with a pistol and a knife, both thrust into the sash he wears by way of a belt.

#### 17. Sir John Falstaff

**PD NOTE: One of the best of the characters to come to life through the pen of the Bard, Sir John Falstaff is best run by those PD's who are familiar with the works of Bill Shakespeare. This is not an NPC to run in a half-hearted fashion!**

A plump, balding man dressed in a local approximation of doublet and hose. Noble Sir John is a drunkard, a womanizer and a liar. He would be a highwayman if he had the guts for it, but he is, regrettably, a coward of the first water. He does, never the less, carry a "sword."

One would not know these things to simply talk to him! Sir John speaks of himself in the most glowing and heroic terms: his exploits are legend! And this is true, but it is a matter of fact, which Falstaff will not mention of his own choice, that these legendary exploits

were the acts of other people. His largest claims to fame are based on the heroism of others.

He is not a "cringer." Coward or no, he will try to bluster and bluff, threaten and worm his way out of a tight spot. But if put to the ultimate test, he will turn tail and run. Of course, as he runs, he will curse his pursuers, vow his return, his just revenge, and his innocence, all simultaneously and in impeccable verse.

Sir John Falstaff is a complete rogue, but an engaging and likeable man. Do not have small change where he can find it, for both it, and he, will be absent in the morning.

#### 18. Calamity Jane

Dressed in buckskin and homespun, this woman, like Davey Crockett, is likely to be taken for a local. She is very good looking in spite of, or perhaps because of, a distinct "tomboy" air. She certainly employs the mannerisms and behavioral pattern of a mature man. Her entire attitude proclaims that she is inferior to no man and will not be "talked down to" or "gentled away."

And this attitude is justified. She can outshoot, outdrink, outride and outgamble practically all of the men she has ever met. This woman is tough as nails.

For all of that she is a friendly person and non-belligerent; if treated with respect. This is not the person to intimidate or corner! Of course, she rarely shoots to kill unless she has to.

Some final comments on the Napoleon's Own:

Do not worry over much about rationales for their presence. These people are here to be used, but using them all may be too much of a good thing.

None of these people know one another, nor have they heard of one another. There is *no* underground network "of Wisconsin crazies." These people have little or no useful information. Some may not even know where the nearest human habitation is to be found. They will not, as a rule, "come along with" the Team. The only exception to this is Crockett, who is desperate to move South fast. Most will not fight with, or for, the Team.

There are exceptions to every rule, and the making of these exceptions is up to the PD. We advise extreme caution and forethought.

#### TO USE THE ENCOUNTERS

The PD in the course of the game, should roll for encounters as outlined in the MPGB, using the encounters listed above for human encounters. Feel free to substitute any of the above at any time that you see fit. "Fudge" as necessary.

When rolling at random, use a D20 and ignore a 19 or 20 result. (Unless you happen to have an 18 sided or a couple of 9 sided dice; then use those.)

Remember, the same people, particularly Napoleon's Own, will rarely be encountered twice, and even more rarely if the Team has moved some distance from the original encounter site. Full specifications for these people are included later on, with additional comments in the Play of the Game section and in the Designers Notes.

#### PLAY OF THE GAME

Operation Lucifer, like most MP modules, begins with the Team waking in their bolt hole. Instrument reconnaissance of the outside world will reveal that radiation levels are normal and that there are no chemical or biological agents present in the area.

Unlike other MP modules, there is radio contact. This is the message from Damocles to the Team. The Team will only receive this message if a Team member turns a radio on. Remember that Damocles will stop sending as soon as the Team tries to contact him.

Few Teams think to try to get an RDF fix on the source of this signal. RDF will not work inside of the Bolt Hole. To get an RDF fix requires not one, but two or more RDF "listeners" at different locations. The more widely separated the locations, the better. The RDF will have something to pick up only if Damocles is still sending. During play testing, all of the Teams tried to talk to Damocles before getting a second RDF fix. As this causes Damocles to stop sending, getting the second fix is impossible.

Some PD's may be starting a Team from the area of Damocles. These Teams should be provided with the same "Mission Data" as a "fresh" Team and sent on their way. These Teams would have further to travel but might, at the PD's discretion, have a *slightly* better notion of the location of the bomb. Such a Team would have to operate under radio silence with Damocles (so as not to endanger Damocles's survival). They also would have no caches in the area they are heading for.

Once out of the Bolt Hole, the Team must begin moving about to try and locate the bomb. The players map on the Auto Nav handout depicts the area around Croft (Bancroft). This map should not be given to the players until they know where the bomb is. Once they do know where the bomb is at, whether they are in the Croft area or not, they can be given the map. Remember that the Auto Nav is also a map "library"; if the Team knows where they are going, they can "punch up" the pertinent map on the Auto Nav.

Like all of the other maps in the Auto Nav the map of Croft is 150 years out of date. The PD's map is accurate.

All of the other map work in this module will have to be performed with a road atlas or equivalent. Due to the extensive movement requirements of this module, no other choice is possible. The PD is advised to perform a careful map study of the area before beginning the game. It is a good idea to locate the approximate positions of the Team's caches, and have this information available to them. The Team, after all, has this information on the Auto Nav.

Remember that most of the towns on the map are ruins, that the roads are not there, the bridges are down, etc. It will take the Team time to travel these great distances. Maps are necessary to the players and the PD to ensure smooth flow of the game.

Most Teams try to locate a road and find a town or village. This is crucial to the play of Lucifer, since the Team must talk to the locals to get information.

With this in mind, most Teams head for Mondovi. There is a great deal of information to be had in Mondovi concerning the "state of the world," most of it non-verbal: Friendly people who must post guards. An inhabited town which is half in ruin. Not far (by Team standards) from the Mississippi, and yet the people do not go there. The very word "Mississippi" seems unknown. Much has changed in the world.

The PD may want to include one of the random encounters in Mondovi, in order to provide the Team with more information. Jan Strunk or George Haydik are good for this. George might even be willing to accept a "lift" from the Team.

The PD should provide the players with a rough idea of where the bomb is. ("On the basis of his former military service, one of your Team has some familiarity, long disused, with the coordinate system used in the message from Damocles. He thinks that the area you are looking for is somewhere near the center of Wisconsin.") Armed with this information, the Team has a rough target and often begins heading in the indicated direction: East from Mondovi, or southwest from Damocles.

The process of locating the bomb should follow the pattern of a detective story. The Team wanders about, picking up clues. These have nothing to do with a bomb. Most deal with curious goings on in, or near a place called Croft; and there is no Croft on the maps. As the pile of clues grows, the Team should perform a little deduction and begin to wonder whether or not anything of such importance can be completely coincidental. Most Teams eventually head for Croft.

Don't let them get these too quickly. Remember that the encounters provided with this module are not the only ones. Other people can be met, along with wildlife and mutants. Maggots attacking in the night when the Team is camped near ruins will do a lot toward disrupting a chain of thought.

A lot of role playing can take place in the LaCrosse area. Sometimes it is difficult to "steer" the Team in that direction.

#### VARIATION:

On the first or second day out, the Team picks up a radio signal. This turns out to be from a George Watkins, member of a Morrow Science Team. His Team received a message from someone or

something called Damocles. The message mentioned an SS-17, some map coordinates, and Recon Team G-5.

Watkins was dropped off with an AN/PRC-70 radio. His Team leader told him to try and reach Team G-5. George was given this job because he is a physicist and might have a good chance at disarming the bomb. He is currently on the far side of the Mississippi, not far from Houston, Minnesota.

If the Krell are being used:

George's Team left him while they went to try and create a diversion elsewhere. They are in the path of a general military advance by some outfit called Krell. Watkins is holed-up in the ruins of the town of Houston, in the remains of a stone church on the top of a hill. He will try to hold out until the Team arrives. George does not want to use the radio much, as he fears the Krell have scramblers too. He will not move from his position. Help!

George Watkins:

Age: 53 Sex: M Ht: 5'11" Wt: 148 Hr: Gy Eyes: Bl  
Int: 16 Cha: 12 Luck: 17 SP/BP: 178

Physics: 70 Special Weapons: 45 Hand Gun: 35

In all other respects, George Watkins is a standard Morrow NPC. He is armed with an M-79 (16 rounds of HE, 1 round Green Star Cluster) and a HP-35 (20 rounds). He also has his pack.

Since George is on the far side of the river, the Team will have to cross it to get to him. This probably means the bridge at Cross will have to be used. It is up to the PD to decide whether or not to provide the Team with the knowledge that Cross is the site of the only bridge for many miles.

This is a good time to point out, again, that the encounters provided are here to be used by the PD.

#### VARIATION:

On the way *back* through Cross, the Team might, at the PD's discretion, be shown an old military map by Sergeant Green. This map uses the coordinates mentioned by Damocles. They place the impact not far from Plainfield, in the vicinity of Bancroft.

If the Krell are to be used, be careful. There are 2000 in the "advance guard," but these are not all together. Most of these people are in small units of from 5 to 20 men. Some are mounted on horses. A large unit might be on the heights facing Cross. This unit ought to be large enough to defeat the Team in a "stand up" fight, but not so large as to prevent the Team from "charging" through them.

These are advance units; scouts and path finders. They should be lightly, and indifferently, armed. Shot guns, rifles, the occasional satchel charge of dynamite. Perhaps a Gatling gun, now and then.

The "heavies" are coming, but are not in the area yet. The Team cannot fight a pitched battle with them and win; this is an army.

The Team can play "jingle-jangle" with the scouts, but only if they keep moving. If the Team stays in one place long enough (3 or 4 days), enough of the advance guard can congregate so as to make their superior numbers tell. Even 8 to 12 hours in the same place may allow as many as 100 to 200 Krell to arrive. Nor does the Team want to follow the same route out as they took going in. If they do so, they may run right into a band of pursuers.

The Team's object is to cross the river, pick up Watkins and leave as fast as they can.

The Krell leadership does have some Morrow equipment, including radios. The advance units do not. Once scouts warn the main body (2 or 3 days away) of an active Morrow presence, these radios will be used to monitor the Teams' Commo. (This will not pick up the Team's "68" personal radios at any great distance, but the larger radios may prove a security leak which the Team may be unaware of.)

Finally, the Krell do not like Morrow personnel. They will try to kill or capture the Team. It is best not to be captured. These are *bad* guys.

The Krell are best used as a threat, the impetus of which will keep the Team racing to find the bomb. Combat contact with Krell units ought to be kept brief and light. It is more effective to have Krell scouting units seen in the distance, paralleling the path of the Team, dogging their movements.

Now and then the Team may come near a "hot spot" left over from the war. These will register on the Team's CBR gear soon enough to

prevent the Team suffering any real harm. If the Team, for whatever reason, chooses to enter or drive through such an area, then there may be problems.

Still, even the "hottest" of these areas is emitting no more than 1000 rads per hour at ground zero. The Team could drive through, quickly, and not be much the worse for it. Foot travel or long stays is something else again.

Eventually the Team will reach Croft.

The appearance, the squalor of Croft, is unlike anything else the Team will have seen in Wisconsin. The Team will likely reach the village without incident, for even if they are spotted by a Priest on vigil, he would hesitate to fire on an unknown quantity like the MPV.

This is less true if a single individual is involved. An attempt would be made to turn the outsider away with words or threats, but if this did not work, the Priest might shoot. He might also wait, in order to form a group to "drive" the stranger from the village later. This sort of example is felt to be necessary now and then. No Priest keeping vigil would be so rash as to attempt speech with the Team in the V-150. Rather, he would try to flee and warn his fellows, without being seen.

The Team's reception in the village will be, at best, cool. People will ignore them, they will not willingly speak to them. A Team member might have to grab a passerby and shake him to get somebody to talk. Even then, the most likely thing the Team will get is a terrified request for the Team to go away.

An exception to this is the Old Man. Having nothing to lose and being too old to care, he will talk to the Team and invite them to his shack on the North side of the village, not far from the ruins. The Old Man will answer questions freely; to the best of his knowledge.

The Priests will not move until after nightfall. If the Team is still in the village, and if they've made no attempt on the bomb, the Priests will organize a driving out. This is a mob, led by Priests, throwing stones, waving clubs and farm tools, screaming loudly. They will do violence only on those who are slow to leave and offer no resistance. This mob will be thrown into confusion by gunfire from the Team, whether it is aimed at them or not. The Priests will return fire and begin a retreat to the Sanctuary. They will use villagers for cover wherever possible.

Should the Team leave the area overnight, when they return they will find that the Old Man has been murdered. Presumably for talking with/helping the Team.

The Priests never carry more than the five rounds which their rifles will hold when leaving the Sanctuary. If they are preparing to defend the Sanctuary from attack this rule does not apply.

Eventually the Team will have to force the Sanctuary. This is best done as soon after arrival as possible, before the Priests can organize to stop them. Done quickly, the Team can be among the Sanctuary buildings before the shooting starts, with some Priests still on vigil or in the fields. This is only true if the Team attacks on the day that they arrive.

The non-Priest inhabitants of the Sanctuary are non-combatants and will not interfere with the Team. The Priests are likely to use these people, even their own families, as living cover or hostages.

The whole area of the Sanctuary hill is mildly radioactive. Continuous occupation, over a period of years, would be fatal. The interior of the Sanctuary is worse; constant habitation there would kill in two or three years.

If the Team delays their attack, the Priests will all be waiting on the hill. In either case, the Priests will fight as long as they can, eventually falling back on and trying to hold the Sanctuary itself, and the arsenal.

The stone walls of the Sanctuary are proof against most of the Team's weapons. The .50 cal could, given time, chew through. The walls, and the doors, are vulnerable to C-4 and anti-tank weapons. The arsenal is also vulnerable to these but is a much harder nut to crack. All of the Priests will have to be killed; survivors will keep trying to stop the Team.

## THE BOMB

This 3-ton Soviet warhead is in bad shape. It fell out of the sky and has been lying in a hole in the ground for 150 years. It is rusted and is

no longer radiation tight. It is in the process of its own, quiet, melt-down.

There is next to no chance of this device detonating, but the Team is not likely to know this. Only on a percentile roll of 100, during the disarming attempt, will detonate it.

If George Watkins is present, he has a 90% chance of disarming the device. This will take him half an hour of uninterrupted work.

Should the Team attempt to contact Damocles now, he can give instructions for disarming. This will take one-and-a-half hours, with a 60% chance of success.

If the Team is successful in disarming the device, it can be rendered completely useless by smashing the contact face of the fissionable material (Uranium in this case) with a hammer or similar object. Please note the inherent dangers of radiation exposure in employing this procedure.

Should the Team wish to move the device, they will have to remove most of a wall of the Sanctuary. Using the winch on the V-150, the warhead can be dragged outside. A farm wagon might be acquired from the locals, and some means contrived to load the device onto it.

The locals will not interfere with the removal of Lucifer, if the Priests are not available to lead them. The V-150 will not exceed 20 mph while hauling such a wagon, as the wagon and its load could not take the stress. The V-150 certainly cannot swim while pulling a "trailer."

Where the Team moves the bomb is up to them. One thing is sure: Damocles, and the Science Team with him, do not want it.

Prior to disarming, the Team, if in dire need, has a 50% chance of detonating the device on purpose. No delay can be arranged, somebody must physically "pull the trigger."



## DESIGNERS NOTES

I. Lucifer is the first of its kind among the modules designed to accompany the Morrow Project in that it is not a totally in-house effort. The manuscript for Lucifer comes from a writer who is not on the Timeline staff: Mr. D.P. Beckfield. We have elaborated upon Mr. Beckfield's plot, fleshed out some ideas and added some few of our own. We feel that Lucifer is a good effort, both on Mr. Beckfield's part and on our own. We hope that you enjoy this module as much as we have enjoyed play testing it.

II. The first duty of a game master, a project director in MP parlance, is to invoke a sense of wonder in the gamer. This we cannot provide, it comes from the PD and his rapport with the players. But the second duty of the PD is to impact the power and terror of this situation into which he transports his players. This is something with which we can be of service, and the Lucifer game module is well suited to aid in this task.

III. So far, all of the modules which TimeLine has produced have taken place in the Northern Midwest of the United States. Lucifer is no exception, though other locales will appear in time. The following comments apply to this region, and sometimes, to others as well.

Too many people look at a map and perceive the borders drawn thereon, borders placed arbitrarily, on a man made map, by men.

A *map* is a two dimensional representation of a portion of the Earth's surface. It, the map, has nothing to do with the actual land. The land is never wrong. It is simply there. There are no borders on the ground.

And yet, because borders are represented on maps, some people persist in believing that these borders have some real existence of their own, as if they had some real existence other than in the minds of men. People believe that Canada is somehow different than the U.S. in terms of terrain, or that Wisconsin and Illinois and Michigan are necessarily separate, somehow, naturally.

This is, of course, absurd. There is simply the land. There are no bright red lines on it, and, in the absence of man to enforce his artificial demarcations, things tend to revert to their natural homogeneity. In the case of the Morrow Project, this means the North American continent. It is all one. It is vast. Forget abstractions like "states." Save for in the minds of a few scattered individuals, they no longer exist. There is only the land, and, here and there, groups of humans struggling to survive.

Before the European expansion, practically all of North America east of the Mississippi was one large forest. In the north this forest extended to, and beyond, the Rocky Mountains. Try to imagine it.

The only thing which removed the primal North American forest was the sweat of the European farmer, who cleared as much of the land as could be used. Three hundred years of this and there are still large tracts of forest.

Now—a nuclear war. Stipulate for the moment that only one person out of one hundred survives the war by five years. Ignore questions of transportation, communication, food distribution, energy supply, medicine, etc., etc., etc. These are human problems.

Think of the land; what happens to the land?

On much of the North American continent the forest has returned. It is everywhere, unbroken, there is no escaping it. Only in those areas where there are permanent human habitations is there any break in the forest's superiority. One hundred and fifty years, without human interference. Not only the forests, but the wildlife. Think of it. Use it.

Also use the remains of the former human civilization. Ruins in the midst of the trees, bits of crockery, shards of glass, the rusted, fallen, skeleton of a high tension power line tower. The broken roads, the remains of a McDonald's, an overgrown cemetery in the middle of nowhere. The absence of people. Remember, that the Team has knowledge of these things as though they were yesterday. Now there is nothing; it is all gone. You cannot send out for a pizza. You cannot even make a pizza. Properly handled, you can have the Team crying over finding a rusted beer can on a lonely hill top.

For the Team, the world has ended. Think about it. Use it.

Emphasize the *small things*. No plumbing, no smooth soap, no

easy laundry. No penicillin, no ice cubes, no coffee. No radio or television. You can make them want to build civilization again, and not for themselves, but for others. To prove that men who are long dead did not live in vain.

IV. The center of this module is the Team's locating and neutralizing "Lucifer." It is likely to take the Team days or weeks to simply find this item. Thus an opportunity is provided for the PD to "allow" the Team to wander the land/forest, searching for people.

And while there is next to no likelihood of the warhead detonating, remember that the Team is unlikely to know this. For them, the elimination of this menace should amount to a religious crusade. This will be especially true if the PD has done a good job of presenting the emptiness of the land and the vulnerability of its inhabitants. It becomes a matter of ensuring that the sins of the fathers shall not be visited upon the sons.

The Krell advance can lend to this greatly. Lucifer must not fall into their hands. The Team must know this. The Krell become THE ENEMY closing in on the ONE RING. The ring would have to be unmade anyway, but the enemy's potential use of it makes its destruction a holy quest.

A Team which dies to the last man, to buy the time for one of their number to render the device inoperative, has died well. In any event, the use of the Krell to hound the Team every inch of the way to the bomb, should not be overlooked.

V. The Napoleon's Own, as previously mentioned, are included to lend some levity to what might otherwise be a very grim game. Feel free to have some fun with these people, try to ensure that the Team has fun with them as well, even if it is at the expense of their having to laugh at themselves.

These crazies were *not* included to allow the PD to be "cute." We are not trying to be funny. We are trying to allow the Team some humor, perhaps at their own expense. A chance to smile at the crazies, and to perhaps realize that it is also for the crazies that the Morrow Project exists.

Do not employ these people so as to have fun yourself at the Team's expense. Use them to have fun with the Team. They are a tool.

VI. If the Team survives and accomplishes their mission (and we hope that they do), what do they do next? One option open to the Team, particularly if they are being pursued by the Krell, is to have the Team head for Damocles. But whether they are being pursued by the Krell or not, *do not* "magically transport" the Team either to Damocles or into their next mission/adventure. They should have to move all of the way, naturally, role playing all the way, as they would in real life. Adventures end only with death. If the players do not die, then an adventure should "taper off," and eventually lead to another. This is the best way to maintain continuity and character reality.

Allow the Team contact with Damocles only after Lucifer has been "taken care of," if George Watkins is being used. If Watkins is not there when the Team reaches, and is attempting to disarm Lucifer, the PD might want to allow the Team contact with Damocles so that Damocles can give instructions on how to disarm the bomb.

For effect, this should not be a "note taking" exercise. Rather, it should be a matter of a radio next to a sweating Team member, with instructions being given step-by-step as the bomb is being worked on. Perhaps with a fire fight in the background as the rest of the Team tries to defend the Sanctuary from fanatical attack by the Priests, or the Krell.

VII. Of course, the Team does not have to head for Damocles. This is desirable only if the Krell are pursuing, or if, in the PD's judgement, the Team needs some R & R time.

Other objectives might be to have the Team begin the emancipation of Croft. They could make a trip to Cross to see if the bridge is still there, or to secure it. Maybe a scouting mission across the river to verify rumors of a suspected Krell presence. Many possibilities. Or, if the Team knows about the Krell and their advance, it might be an opportune time for a daring commando raid behind the Krell advance to locate and destroy bases, perhaps Krell himself . . .

Perhaps the best use of Damocles is a spiritual one. To let the Team know that somewhere there is a base, that they are not alone in the world. This can give them the moral strength to continue. Now, this use means that the PD should do all that he can to keep the Team away from Damocles for as long as possible. "Re-call" to Damocles might be a goal; a reward for extraordinary service. Better still, an emergency recall to all Teams for the defense of "Damocles base" against an attack. (This should be done up as an Armageddon type affair.) Good luck!

## PEOPLE

The following is a listing of the characteristics of the NPC's mentioned previously in this module. If no percentage is given for a skill or ability, then assume a base 10% chance, or no chance at all. PD's should feel free to modify NPC's to meet their own needs.

### 1. Zeke Barsto

Age: 48 Sex: M Height: 6' Wt: 200 HR: Br Eyes: Br  
Int: 15 CHA: 10 Luck: 7 SP/BP: 243  
Agriculture: 20 Shotgun: 20 Rifle: 20  
First Aid: 20 Oratory: 30

### 2. Burle Ames

Age: 56 Sex: M Height: 5'6" Wt: 210 HR: Gy Eyes: Gr  
Int: 10 CHA: 12 Luck: 10 SP/BP: 210  
Shotgun: 50 First Aid: 50 Treat Disease: 30  
Treat Poison: 30 Oratory: 20

### 3. Sergeant Max Green

Age: 36 Sex: M Height: 6'2" Wt: 190 HR: Br Eyes: Bl  
Int: 14 CHA: 12 Luck: 12 SP/BP: 270  
Rifle: 50 Special Wpns (105mm): 40 Knife: 60  
First Aid: 30 Camouflage: 50 Hide: 50 Listen: 50  
Move Silently: 50 Swim: 70

### 4. Sample Cross Militiaman

Age: 21 Sex: M Height: 5'9" Wt: 150 HR: Br Eyes: Br  
Int: 08 CHA: 08 Luck: 05 SP/BP: 200  
Rifle: 20 Knife: 20 105mm: 15 Hide: 20  
Listen: 30 Move Silently: 30 Swim: 35

### 5. Sample Kreil "Soldier"

Age: 18 Sex: M Ht: 5'9" Wt: 130 HR: Br Eyes: Br  
Int: 07 CHA: 05 Luck: 05 SP/BP: 180  
Rifle: 15 Shotgun: 20 Knife: 10 Hide: 10

### 6. Jan Strunk

Age: 62 Sex: M Ht: 5'4" Wt: 130 HR: Bl Eyes: Br  
Int: 11 CHA: 07 Luck: 11 SP/BP: 205  
Veterinary Medicine: 30 Rifle: 15 Knife: 20  
First Aid: 30 Oratory: 30 Hide: 20 Listen: 35

### 7. Herb Deer

Age: 28 Sex: M Ht: 5'8" Wt: 140 HR: Br Eyes: Br  
Int: 09 CHA: 08 Luck: 06 SP/BP: 196  
Rifle: 25 Knife: 15 Repair Mechanical: 45  
First Aid: 25 Oratory: 25 Hide: 40 Move Silently: 40

### 8. George Haydik

Age: 29 Sex: M Ht: 5'6" Wt: 190 HR: Br Eyes: Br  
Int: 12 CHA: 17 Luck: 14 SP/BP: 416  
Linguistics: 40 Knife: 15 First Aid: 50  
Hide: 70 Move Silently: 50

### 9. John Wilu

Age: 43 Sex: M Ht: 5'2" Wt: 120 HR: Bd Eyes: Gr  
Int: 08 CHA: 06 Luck: 13 SP/BP: 184  
Knife: 30 Treat Poison: 30 Swim: 90

### 10. The Old Woman of Plainfield

Age: 81 Sex: F Ht: 4'5" Wt: 60 HR: Gy Eyes: Gy  
Int: 18 CHA: 12 Luck: 20 SP/BP: 85  
Chemistry: 20 Dentistry: 20 Linguistics: 50  
Pharmacy: 60 Nursing: 60 Medicine: 35  
Knife: 50 First Aid: 70 Treat Disease: 70  
Treat Poison: 80 Oratory: 50 Hide: 80  
Listen: 70

### 11. Sample Amerind "War Party" Member

Age: 16 Sex: M Ht: 5'4" Wt: 130 HR: Bl Eyes: Br  
Int: 10 CHA: 14 Luck: 07 SP/BP: 150  
Veterinary Medicine: 20 Bow: 20 Knife: 15  
Ride Horse: 35 Hide: 20 Move Silently, Climb, Jump: 30

### 12. Amerind Warrior

Age: 28 Sex: M Ht: 5'8" Wt: 150 HR: Bk Eyes: Br  
Int: 14 CHA: 10 Luck: 15 SP/BP: 310  
Veterinary Medicine: 40 Rifle: 35 Knife: 50 Bow: 60  
First Aid: 30 Tracking: 75 Hide: 70 Listen: 90  
Move Silently, Climb, Jump, Swim: 60

### 13. The Old Man of Croft

Age: 97 Sex: M Ht: 5'1" Wt: 110 HR: Gy Eyes: Bl  
Int: 08 CHA: 12 Luck: 05 SP/BP: 103

### 14. Davy Crockett

Age: 34 Sex: M Ht: 6'0" Wt: 180 HR: Br Eyes: Bl  
Int: 15 CHA: 18 Luck: 18 SP/BP: 324  
Rifle: 70 Knife: 45 First Aid: 40 Tracking: 70  
Oratory: 50 Hide, Listen: 65  
Move Silently, Climb, Jump, Swim: 75

### 15. Lady Godiva

Age: 22 Sex: F Ht: 5'10" Wt: 120 HR: Bd Eyes: Gr  
Int: 08 CHA: 20 Luck: 14 SP/BP: 156

### 16. Robin Hood

Age: 30 Sex: M Ht: 6'0" Wt: 170 HR: Br Eyes: Bl  
Int: 10 CHA: 17 Luck: 12 SP/BP: 345  
Bow: 75 Knife: 40 First Aid: 45 Tracking: 85  
Oratory: 60 Camouflage: 50 Hide: 90 Listen: 65  
Move Silently: 85 Climb: 95 Jump: 50

### 17. Sample "Merry Man"

Age: 24 Sex: M Ht: 5'8" Wt: 150 HR: Br Eyes: Br  
Int: 08 CHA: 12 Luck: 08 SP/BP: 210  
Bow: 30 Knife: 20 Club: 25 Hide, Listen: 35  
Move Silently, Climb, Jump: 45

### 18. Zorro

Age: 28 Sex: M Ht: 5'9" Wt: 160 HR: Bk Eyes: Br  
Int: 15 CHA: 19 Luck: 18 SP/BP: 368  
Hand Gun: 35 "Sword": 70 First Aid: 30  
Oratory: 65 Hide, Listen: 70 Move Silently, Jump: 65  
Ride Horse: 60

### 19. Thomas Edison

Age: 69 Sex: M Ht: 5'6" Wt: 100 HR: Gy Eyes: Br  
Int: 20 CHA: 14 Luck: 07 SP/BP: 122  
Physics (Pre-atomic): 70 Repair, Electrical, Mechanical: 60

### 20. Long John Silver

Age: 57 Sex: M Ht: 5'9" Wt: 143 HR: Bk Eyes: Gy  
Int: 14 CHA: 16 Luck: 16 SP/BP: 173  
Handgun: 35 Knife: 50 Map Making: 70  
Oratory: 65

### 21. Sir John Falstaff

Age: 55 Sex: M Ht: 5'8" Wt: 180 HR: Br Eyes: Bl  
Int: 10 CHA: 17 Luck: 07 SP/BP: 190  
Philosophy: 45 "Sword": 10 Oratory: 50



## 22. Calamity Jane

Age: 19 Sex: F Ht: 5'11" Wt: 130 HR: R Eyes: Gr  
Int: 15 CHA: 19 Luck: 10 SP/BP: 208  
Veterinary Medicine: 25 Hand Gun: 50 Rifle: 60  
First Aid: 45 Tracking: 50 Hide: 40  
Move Silently, Climb, Jump, Swim: 60

## 23. Sample "Priest"

Age: 26 Sex: M Ht: 5'10" Wt: 155 HR: Br Eyes: Br  
Int: 10 CHA: 07 Luck: 08 SP/BP: 224  
Hand Gun: 10 Rifle: 25 Hide (in or near Croft): 50  
In the Dark: 75 Move Silently: 35

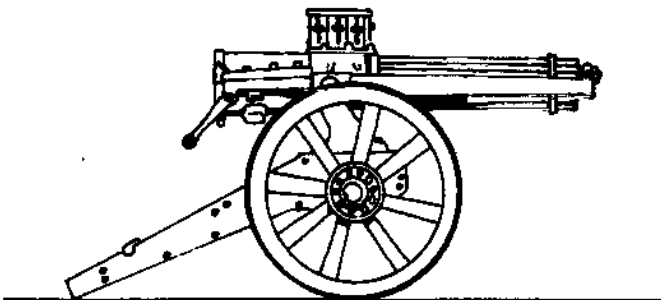

## NEW EQUIPMENT

NAME:	Gatling Gun
Caliber:	.50 caliber
E-Factor:	13
Weight:	130 Kg
Effective Range:	1000m
Max. Range:	2100m
Type of Fire:	Manual Auto Fire
Rate of Fire:	1000 rpm
Feed Device:	240 rd drum
Feed Device Weight:	9.2 Kg
Basic Load:	N/A
Load Weight:	N/A
Total Weight:	139.2 Kg

### Additional comments:

Few machine guns are as well known as the Gatling and few are as misunderstood. First produced by Dr. Gatling in the 1860's, this design is well over 100 years old.

"Gatlings" have been produced in many forms, with different numbers of barrels and wide variations in calibre and mounts. The gun specs above are those of a "generic" Gatling based on the "Gatling-Gardner."

This weapon has ten barrels and fires a .50 cal. bullet pushed by a low power propellant. (This is part of the reason for the low E-Factor.) The weapon is very heavy and cannot be used without its wheeled carriage. The weight listed above is *only* for the gun; the carriage is another matter. It is usually pulled by a team of horses.

The weapon is operated by *pointing* the barrels in the general direction that the bullets are desired to go, and then turning the crank located on the right-rear of the gun. The crank operates the mechanism which fires the rounds, rotates the barrels, etc. There is no trigger. The gun will fire as fast as the crank is turned. Great clouds of smoke are generated by the firing gun.



NAME:	M1903 ('03 Springfield)
Caliber:	7.62 x 63mm (30-06 cal.)
E-Factor:	18
Weight:	4 Kg
Effective Range:	800m
Max. Range:	3155m
Type of Fire:	Single Shot, Bolt Action
Rate of Fire:	15 rpm
Feed Device:	5 rd internal magazine
Feed Device Weight:	N/A
Basic Load:	N/A
Load Weight:	N/A
Total Weight:	4.1 Kg

### Additional comments:

The "Springfield" was issued to U.S. forces from the first World War until the adoption of the M1 Garand; over two million were produced. During WWII the Springfield continued to see action; often as a sniper rifle. It is amazingly accurate.



NAME:	Garand M1 Rifle
Caliber:	7.62 x 63mm (30-06 cal.)
E-Factor:	18
Weight:	4.3 Kg
Effective Range:	600m
Max. Range:	3155m
Type of Fire:	Semi Auto; No Auto Fire
Rate of Fire:	30 rpm
Feed Device:	8 rd internal magazine
Feed Device Weight:	N/A
Basic Load:	N/A
Load Weight:	N/A
Total Weight:	4.4 Kg

### Additional comments:

The M1 Garand was the legendary weapon of the majority of U.S. forces in WWII. It was the standard weapon of both the Army and the Marines until the adoption of the M14. This rifle is both rugged and accurate. It has an internal, spring operated "belly" magazine which will hold up to 8 rounds. The magazine is fed from the top of the receiver, the rounds passing through the open action of the weapon. Large numbers of these weapons were produced.



NAME: Marlin 1894c  
Caliber: .44 magnum  
E-Factor: 14  
Weight: 2.7 Kg  
Effective Range: 250m  
Max. Range: 3000m  
Type of Fire: Single Shot, Lever Action  
Rate of Fire: 20 rpm  
Feed Device: 10 rd internal magazine  
Feed Device Weight: N/A  
Basic Load: N/A  
Load Weight: N/A  
Total Weight: 2.9 Kg

**Additional comments:**

This rifle resembles the classic "Winchester" of cowboy movie fame. It is accurate and hard hitting at close to moderate ranges. It has a tubular, 10 round magazine below the barrel. This magazine is loaded one round at a time through a port in the right side of the receiver of the weapon. Another version of this rifle, the M1895, was produced in .357 mag.



NAME: Remington M870  
Caliber: 12 gauge  
E-Factor: 8  
Weight: 3.2 Kg  
Effective Range: 90m  
Max. Range: 510m  
Type of Fire: Single Shot, Pump Action  
Rate of Fire: 24 rpm  
Feed Device: 8 rd internal magazine  
Feed Device Weight: N/A  
Basic Load: N/A  
Load Weight: N/A  
Total Weight: 3.5 Kg

**Additional comments:**

This weapon was produced and purchased in large quantities throughout the 1970's and 80's. Advertised as both a "riot" and a sporting arm, the "survivalist" market forced the price of these weapons far beyond their relative worth. It is, nevertheless, a fine weapon. The 8 round tubular magazine is located below the barrel.

TABLE B2

AREA HIT	STRUCK BY		EFFECT
	AP	HE	
Wheels & Axles	75%	90%	Vehicle immobilized
Right Bow	10	15	Vehicle immobilized, drive train damaged
	—	5	Detonate ammo stores
	15	25	Computer damaged; will not function
	10	20	Auto Nav damaged; will not track
	10	15	Radio damaged; will not operate
	60	80	Kill/wound radio operator
	30	40	Kill/wound gunner
	5	10	Kill/wound driver
	5	10	Kill/wound passengers
Left Bow	15	20	Vehicle immobilized, drive train damaged
	5	10	Detonate ammo stores
	15	25	Driving controls damaged
	10	20	Radio damaged; will not operate
	5	10	M21 damaged; will not function
	60	80	Kill/wound driver
	30	40	Kill/wound gunner
	5	10	Kill/wound radio operator
	5	10	Kill/wound passengers
	5	20	Destroy AN/TVS-5 binoculars
Winch	80	90	Winch destroyed. Other effects are the same as for Right Bow.
Upper Hull, Right	—	5	Detonate ammo stores
	5	10	Computer damaged; will not function
	10	15	Auto Nav damaged; will not track
	5	10	Radio damaged; will not operate
	5	20	Laser rangefinder destroyed
	70	90	Kill/wound radio operator
	40	50	Kill/wound gunner
	10	20	Kill/wound driver
	5	10	Kill/wound passengers
Upper Hull, Center	—	5	Detonate ammo stores
	10	15	Auto Nav damaged; will not track
	10	15	RDF damaged; will not function
	10	15	Radio damaged; will not operate
	10	15	Driving controls damaged
	40	60	Kill/wound radio operator
	40	60	Kill/wound driver
	10	20	Kill/wound gunner
	5	10	Kill/wound passengers
Upper Hull, Left	—	5	Detonate ammo stores
	10	15	Auto Nav damaged; will not track
	5	10	Radio damaged; will not operate
	10	20	Driving controls damaged
	5	20	AN/TVS-5 binoculars destroyed
	70	90	Kill/wound driver
	10	20	Kill/wound radio operator
	10	20	Kill/wound gunner
5	10	Kill/wound passengers	
Right Side, Front	30	40	Vehicle immobilized; drive train damaged
	20	30	Computer damaged; will not function
	10	20	Auto Nav damaged; will not track
	10	20	Radio damaged; will not operate
	50	70	Kill/wound radio operator
	5	10	Kill/wound driver
Right Side, Center	60	80	Detonate ammo stores
	40	50	Jam cupola; will not rotate
	50	60	Kill/wound gunner
	20	30	Kill/wound radio operator
	20	30	Kill/wound passengers
	10	40	Laser rangefinder destroyed

Right Side, Rear	50	70	Detonate Armbursts/Claymores
	20	30	Vehicle immobilized
	40	60	Supply packs damaged; 50% destroyed
	20	60	AN/PRC-70 radio destroyed
	5	10	Kill/wound passengers
Left Side, Front	30	40	Vehicle immobilized; drive train damaged
	20	30	Driving controls damaged
	10	20	Radio damaged; will not operate
	10	20	M21 damaged; will not function
	10	30	AN/TVS-5 binoculars destroyed
	50	70	Kill/wound driver
Left Side, Center	5	10	Kill/wound radio operator
	70	90	Detonate ammo stores
	40	50	Jam cupola; will not rotate
	50	60	Kill/wound gunner
	20	30	Kill/wound driver
Left Side, Rear	20	30	Kill/wound passengers
	40	60	Detonate ammo stores
	80	90	Vehicle immobilized; drive train damaged
	5	10	Kill/wound passengers
Side Doors	85	90	Door damaged; will not open/close. Other effects as for appropriate Side/Center hit.
Right Rear & Rear Door	40	60	Detonate Armbursts/Claymores
	80	90	Door damaged; will not open/close
	40	60	Supply packs damaged; 50% destroyed
	5	10	Kill/wound passengers
Left Rear	80	90	Vehicle immobilized

#### NOTES ON THE V-150 APC:

APC is an anagram for Armored Personnel Carrier; it does not stand for "tank." This V-150 is designed to transport personnel in reasonable safety, while allowing them to fight from the vehicle if this is absolutely necessary.

The V-150 APC is armed with an M2HB .50 cal. machine gun. This weapon is mounted on a rotating "cupola," allowing the weapon a full 360 degree traverse. The cupola is rotated by the man who is operating the weapon; by shifting body weight against the cupola and the weapon, he rotates the cupola by main force. It is easier to do than it sounds.

The weapon *cannot* be fired from inside of the vehicle; someone must expose himself to operate the weapon. No provision is made for firing this weapon from under cover. Given time and materials, the team could doubtless modify the cupola so as to include some protection for the gunner. An example of this would be the arrangements made on "cavalry" M113 APC's of the U.S. Army during the Vietnam era.

The M2HB is described on pages 15 and 16 of the MPGB. The PD might want to pay particular attention to the Additional Comments regarding this weapon.

With the exception of the two "windows" at the very front of the vehicle, all of the vision blocks are provided with firing ports to allow passengers to fire from inside of the vehicle. These ports are of such a size that they prevent anything other than small arms from being used in the ports. Only pistols, SMG's, shotguns, rifles and LMG's can be used. 40mm's, armbursts, etc., cannot be fired from the ports. The position of the vision blocks relative to the firing ports prevents effective aiming: the sights of a weapon *cannot* be used. Firers are simply trying to "hose down" targets. Reduce the firer's chance to hit by one third.

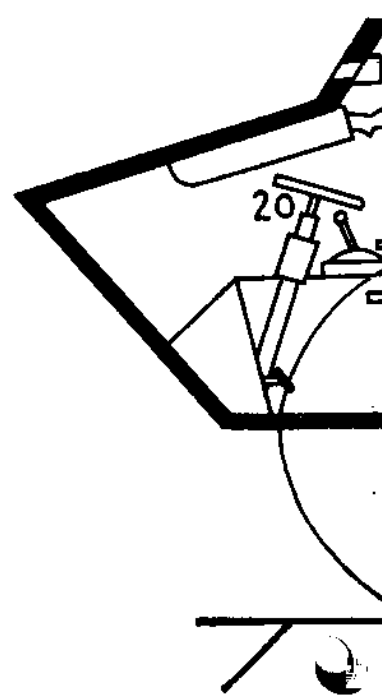
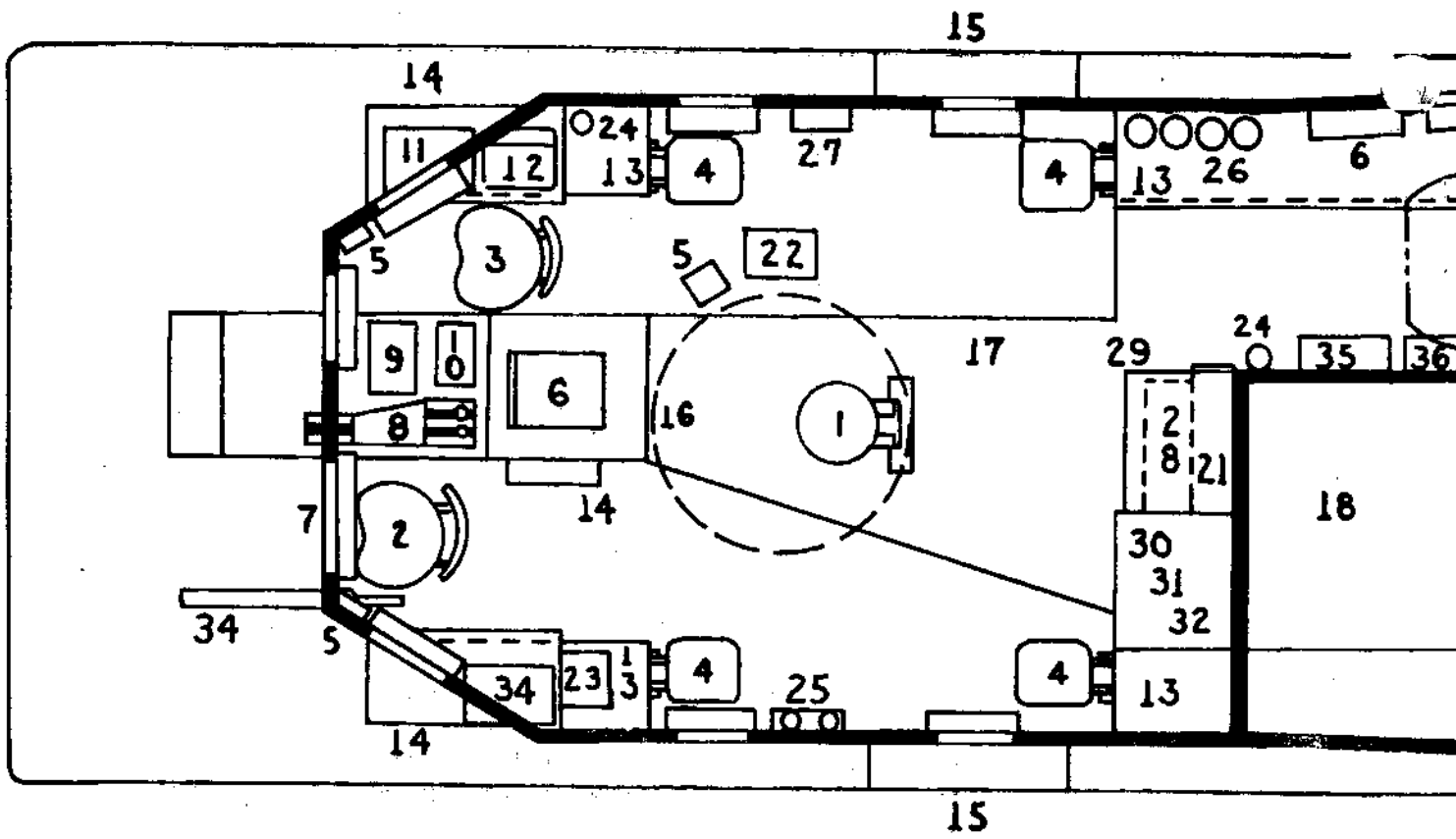

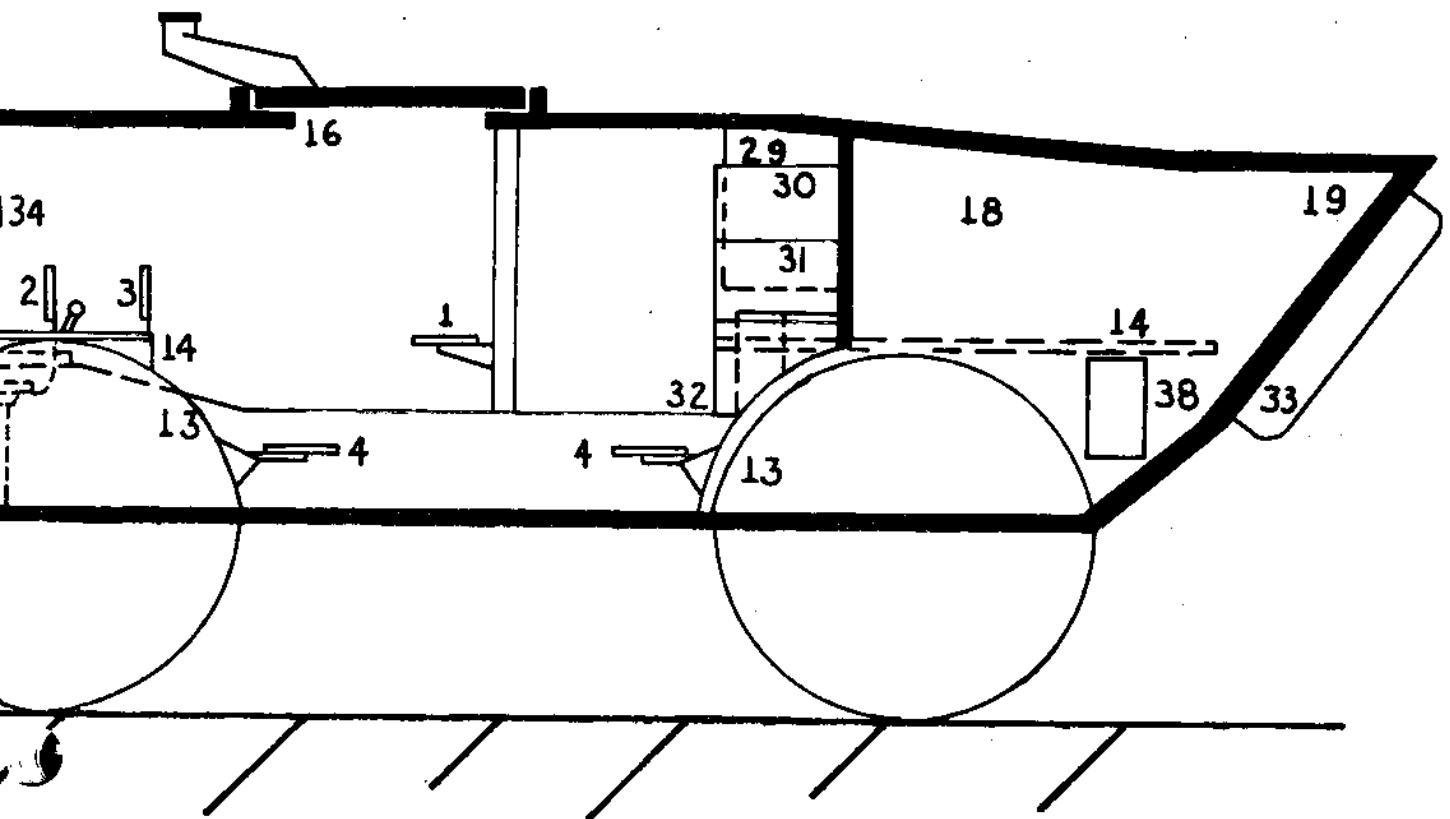
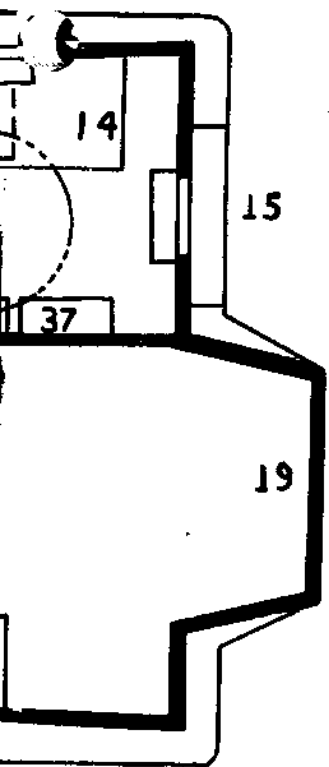

INTERIOR KEY: V-150 APC

NO.	QTY.	DESCRIPTION
1	1	COMMANDERS/GUNNERS SEAT (FOLDING)
2	1	DRIVERS SEAT
3	1	RADIO OPERATORS SEAT
4	4	PASSENGERS SEATS (FOLDING)
5	3	INTERCOM
6	2	AN/PRC 70 RADIO
7	10	WINDOW/VISION BLOCK
8	1	DRIVERS CONTROLS
9	1	AUTO NAV NAVIGATION SYSTEM
10	1	"RDF" RADIO DIRECTION FINDER (VEHICLE MOUNTED)
11	1	COMPUTER
12	1	CRT AND KEYBOARD FOR ITEM 11
13	4	WHEEL WELL
14	3	MOUNTING PLATE (MOUNTED ON WHEEL WELL)
15	3	DOOR
16	1	CUPOLA RING
17	1	HULL RAISED IN THIS AREA TO CLEAR DRIVE TRAIN
18	1	ENGINE COMPARTMENT (CONTAINS DRIVE TRAIN & FUSION REACTOR)
19	1	VENTILATION FOR ENGINE COMPARTMENT
20	1	STEERING WHEEL
21	20	.50 cal. AMMO BOXES (105 ROUNDS EACH)
22	1	LASER RANGE FINDER (MOUNTED UNDER ROOF)
23	1	AN/TVS-5 BINOCULARS
24	3	FIRE EXTINGUISHER
25	1	1 CASE EACH: 12 GAUGE MAGNUM OO BUCKSHOT, 5.56mm BALL, 7.62mm BALL, 9mm BALL
26	4	ARMBRUST 300
27	1	LARGE MEDKIT
28	1	TOOL KIT
29	1	EXPLOSIVES LOCKER
30	1	CASE, M7A3 CS GAS GRENADES
31	1	CASE, M34 WHITE PHOSPHOROUS GRENADES
32	1	CASE, M26A1 FRAGMENTATION GRENADES
33	1	1 EACH: AX, SLEDGE HAMMER, MACHETE, SHOVEL, TRIPOD
34	1	M21 RIFLE, 12 MAGAZINES
35	1	MOUNTAIN KIT
36	1	TRADE PACK
37	2	RATION PACK
38	1	CASE: M18A1 CLAYMORE MINES



BASIC LOAD (VEHICULAR) COMMANDO V-150 w/20mm

1 Rh202 20mm Cannon, 100rd belt, Selective-fire, E=63 (Armor Piercing Incendiary ammunition), E=57, Dpw=40 (High Explosive Incendiary ammunition), 4 belts (2 HEI, 2 API), Short burst= 10rds. Medium burst=20rds, Long burst=30rds.

HEI (2 belts) \*\*\*\*\*\_\*\*\*\*\*---

API (2 belts) \*\*\*\*\*\_\*\*\*\*\*---

2 MAG-58 Machineguns, 100rd belt, Full-auto, E=17, 30 belts, Short burst=6rds, Medium burst=12rds, Long burst=18rds.

Co-Axial Gun (mounted next to 20mm)

\*\*\*\*\*\_\*\*\*\*\*\_\*\*\*\*\*\_  
\*\*\*\*\*\_\*\*\*\*\*\_\*\*\*\*\*\_  
\*\*\*\*\*\_\*\*\*\*\*\_\*\*\*\*\*\_  
\*\*\*\*\*\_\*\*\*\*\*\_\*\*\*\*\*\_  
\*\*\*\*\*\_\*\*\*\*\*\_\*\*\*\*\*\_---

Turret Gun (mounted on top of the turret)

\*\*\*\*\*\_\*\*\*\*\*\_\*\*\*\*\*\_  
\*\*\*\*\*\_\*\*\*\*\*\_\*\*\*\*\*\_  
\*\*\*\*\*\_\*\*\*\*\*\_\*\*\*\*\*\_  
\*\*\*\*\*\_\*\*\*\*\*\_\*\*\*\*\*\_  
\*\*\*\*\*\_\*\*\*\*\*\_\*\*\*\*\*\_---

\* = Short burst

- = Reload

--- = Out of ammunition





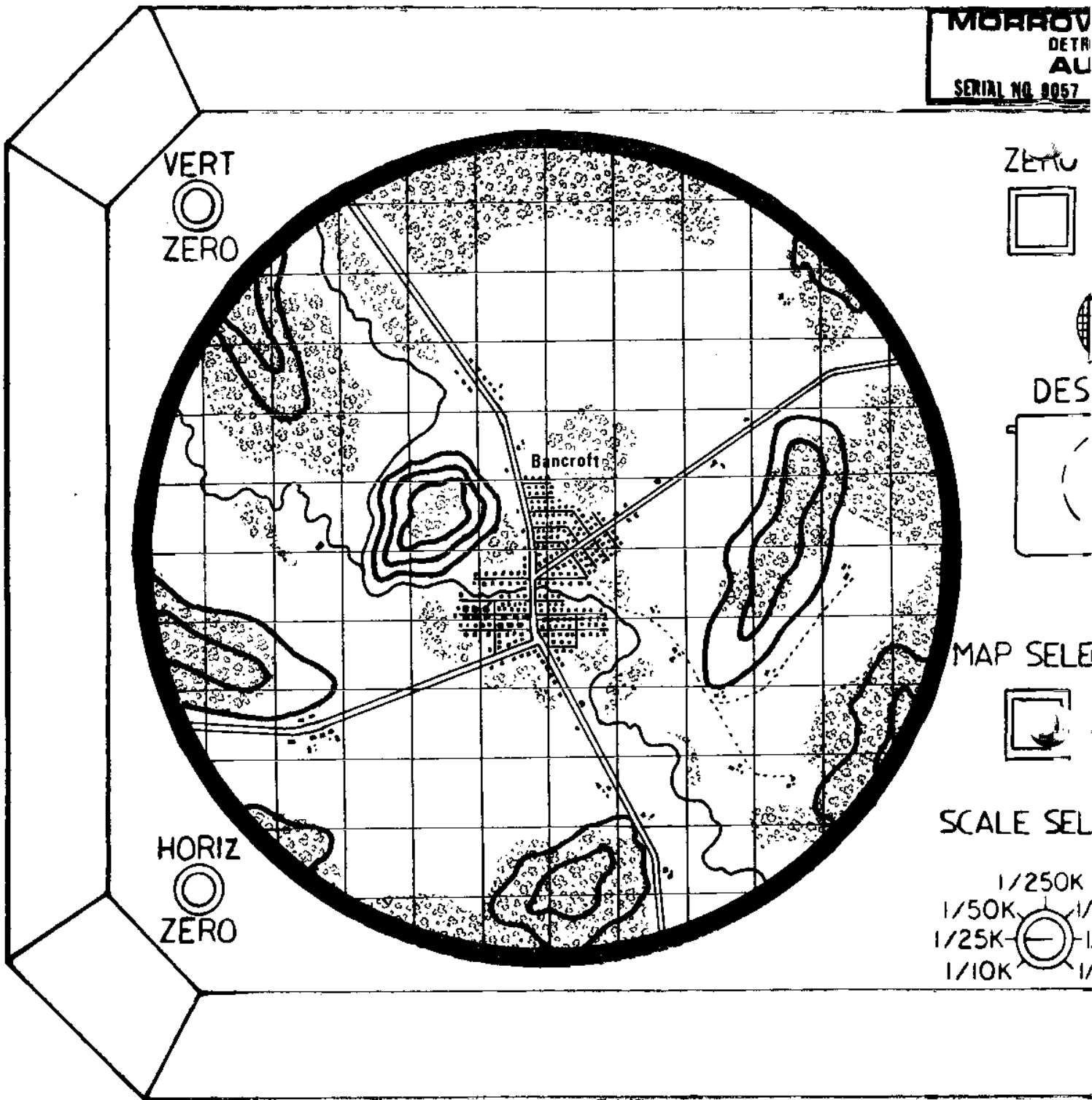

**VERT ZERO;** Allows adjustment of the displayed map to the unit in the vertical plan.

**HORIZ ZERO;** Allows adjustment of the displayed map to the unit in the horizontal plane.

**ZERO;** Allows the use of the Vert and Horiz adjustment dials.

**DESTRUCT ARM;** (covered toggle switch) Arms the destruct system causing a beeping sound once per second until fired or disarmed.

**DESTRUCT;** (covered push button) With the seal wire broken, cover lifted, and button depressed the system fires an internal thermite charge in five seconds. The charge destroys the interior of the AutoNav.

**MAP SELECT;** Initiates system allowing the use of the keyboard to select a specific map.

**SCALE SELECT;** Determines scale of map displayed.

**KEYBOARD;** Used to input information into system.

**SENSOR SYSTEM SELECT**

**RDF;** Allows radio direction finder (if available) screen.

**MAG;** Allows magnetic sensor (if available) targets on display screen.

**RADAR;** Allows radar set (if available to AutoNav) screen.

**CACHE LOCATION;** Shows all assigned cache locations.

**LIBRARY;** Reads out all available maps on display.

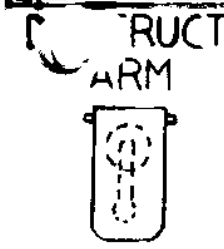

**KEY BOARD**

1	ABC	DEF
2	3	
GHI	JKL	MNO
4	5	6
PQR	STU	VWX
7	8	9
YZ	.	CLR
0		
ENTER		
A	B	C

**GUN SYSTEM SELECT**

MI59C	AGM-65D	M85C	MI74E3
<input type="checkbox"/>	<input type="checkbox"/>	<input type="checkbox"/>	<input type="checkbox"/>
AIM-9D	M29A1	RH202	

**AMMO SELECT**

HE	API	ILLUM
<input type="checkbox"/>	<input type="checkbox"/>	<input type="checkbox"/>
WP	HEI	BALL



**CACHE LOCATION**      **LIBRARY**      **TARGET DATA**

**RANGE**      **AZIMUTH**

<input type="checkbox"/>	<input type="checkbox"/>	<input type="checkbox"/>	<input type="checkbox"/>
--------------------------	--------------------------	--------------------------	--------------------------

**SENSOR SYSTEM SELECT**      **GUN LAY**

MAG      RADAR      MAN      AUTO

RDF                       

**DISPLAY**

TGT

LOC

to AutoNav) to indicate direction on display  
 to AutoNav) to indicate location of detected  
 to AutoNav) to indicate detected targets on display

**GUN LAY**  
**MAN;** Disengages Gun Lay system to allow manual laying (aiming) of gun system.  
**AUTO;** Engages Gun Lay system to aim weapon system according to data in AutoNav.  
**GUN SYSTEM SELECT;** Allows AutoNav to aim indicated weapon system, if vehicle is so equipped, using Gun Lay system.

**AMMO SELECT;** Indicates ammunition fired in selected Gun System.

**TARGET DATA**  
**RANGE;** Allows input of data for Gun Lay system.  
**AZIMUTH;** Allows input of data for Gun Lay system.

**DISPLAY;** Indicates data, either Target or Location, shown on display screen or keyed into system from keyboard.

**CARD SLOT;** Allows insertion of Morrow I.D. card to activate AutoNav displays. AutoNav will function (track its movement) without card but will not display any information or allow any other functions.

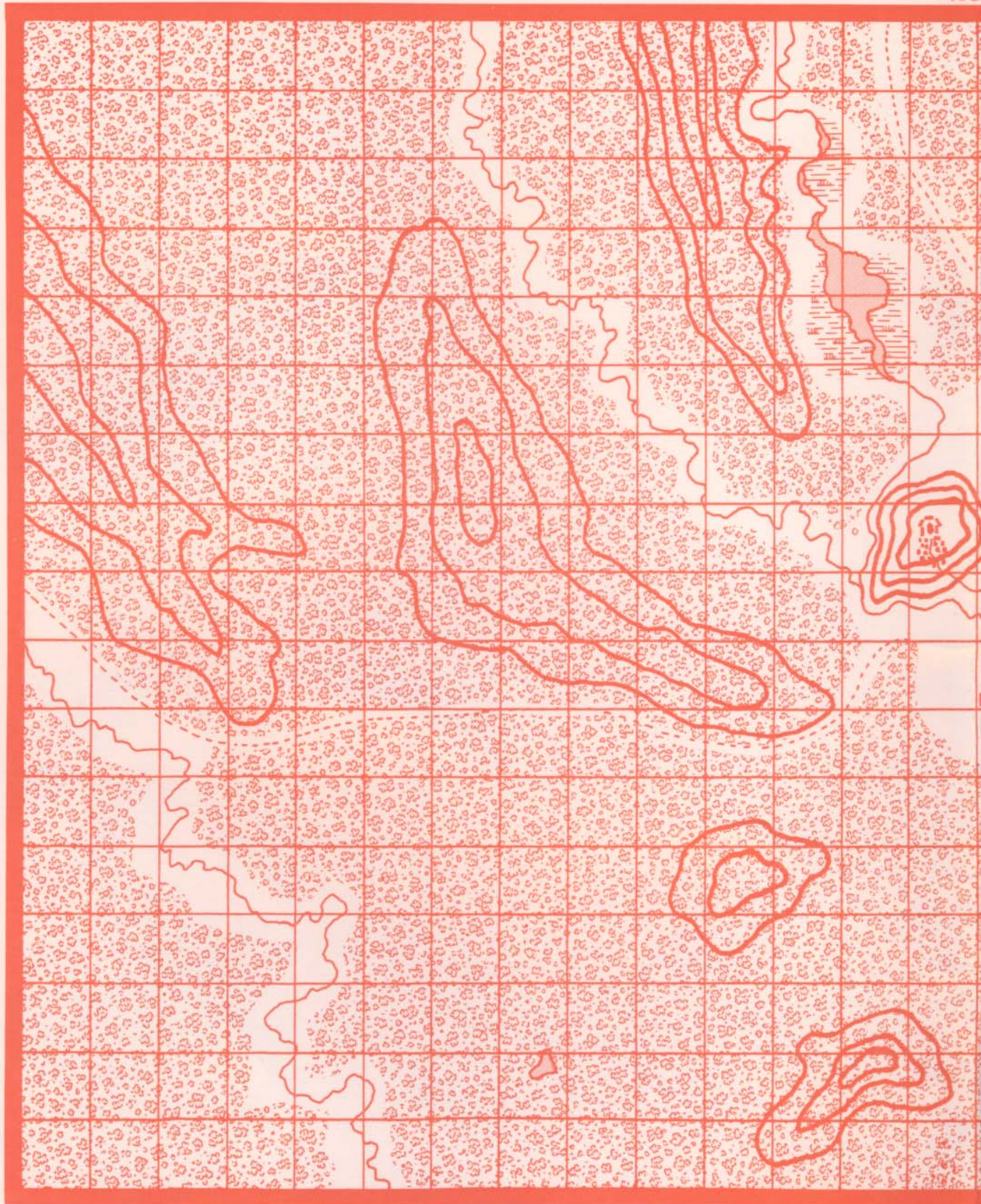

Forest



Swamp



Water

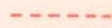

Trail

Contour Inter

th

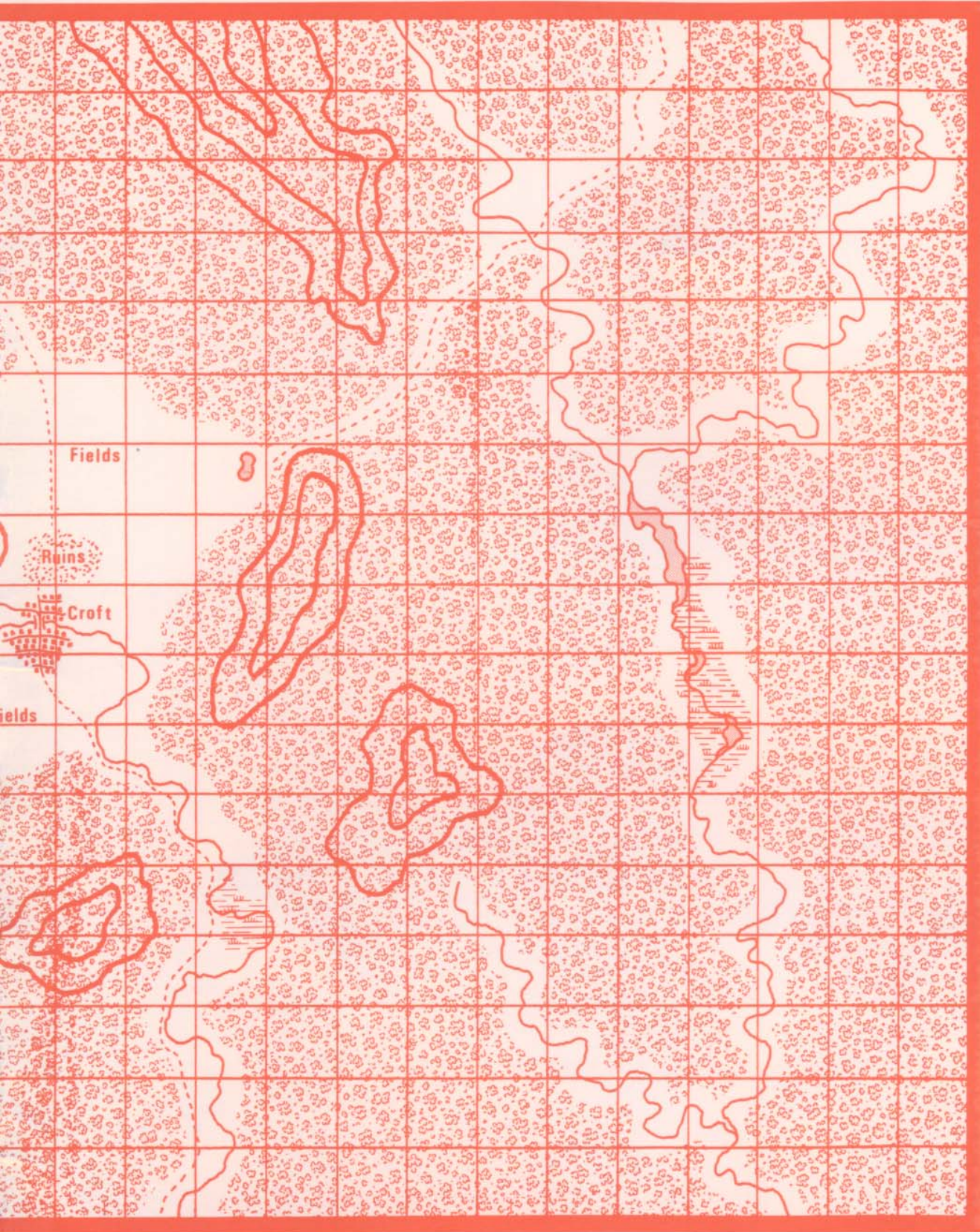

Interval: 10 Meters

Scale: one square equals one Km.

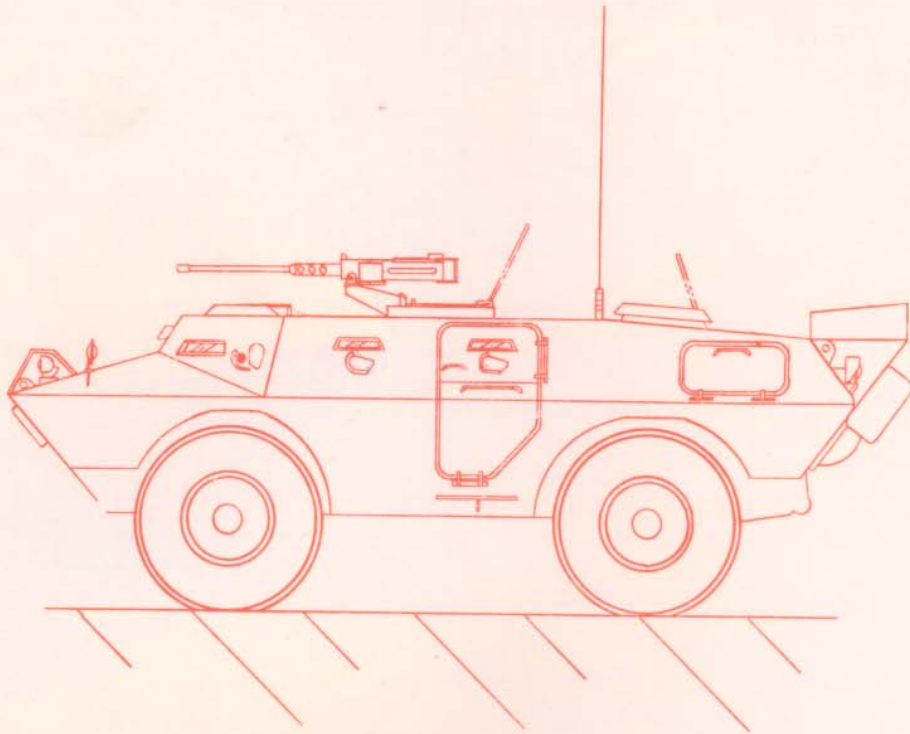

In an area of over 20,000 square miles, Recon Team G-5 is racing against time to locate an undetonated Soviet nuclear warhead. The warhead must be located before it goes off; or before it is captured by the lead units of a Krell advance. But Recon Team G-5 doesn't know where it is . . .

This game package contains all of the information, maps and systems necessary for the Project Director to run this scenario. The package also includes information concerning new weapons, the interior of the Commando V-150 APC, the Morrow Project Contact Pack, detailed cache contents and more.

**POSSESSION OF THE MORROW PROJECT GAME BOOK IS NECESSARY TO THE USE OF THIS GAME PACKAGE.**